

DISCONTINUED

Test&Measurement

YOKOGAWA 

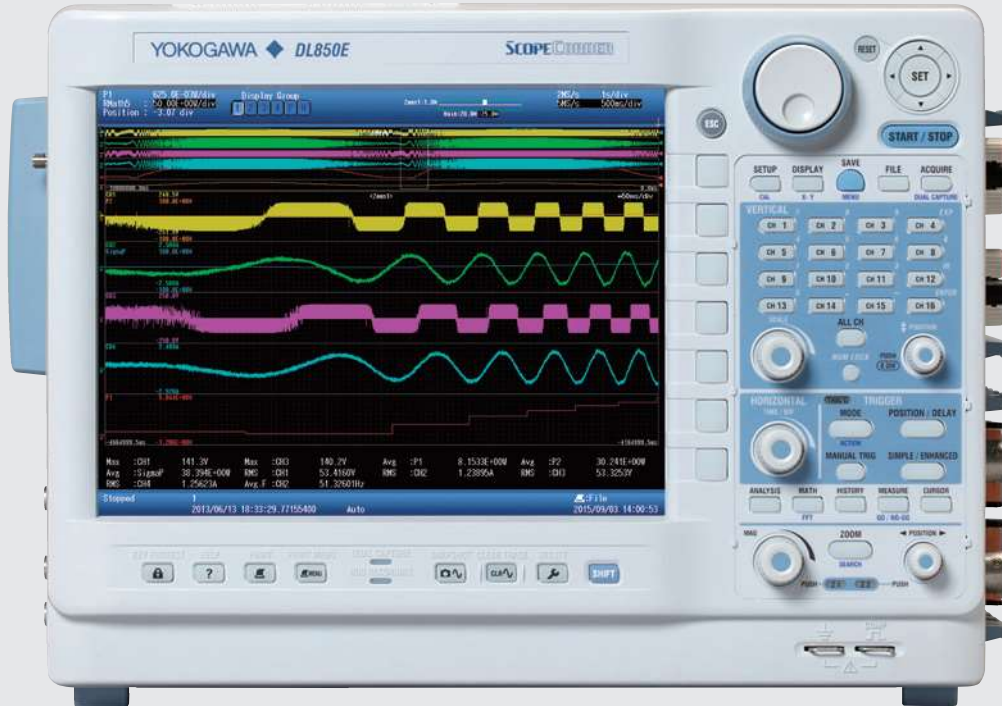

SCOPECORDER 

# Precise data acquisition

DL850E/DL850EV  
ScopeCorder



**Increasing complexities in electronic systems have resulted in the need of instruments capable of measuring a wide range of input signals at fast sampling speeds over longer periods of time.**

**Perfected over years of continuous innovations, ScopeCorder is YOKOGAWA's unique solution to meeting the most stringent measurement requirements.**

**Built to endure the harshest measuring environments, ScopeCorder offers the superior performance and high reliability expected of a waveform measuring instrument.**

#### **The DL850E/DL850EV delivers:**

**Flexibility** – Choose and combine up to 20 types of plug-in module to fit a variety of measuring applications. Simultaneously capture and display data from electrical and physical sensor signals.

**Reliability** – Precisely measure signals at high resolution and secure data in the harshest environments with superior isolation technology.

**Functionality** – Combining the signal fidelity of an oscilloscope and data recording of a recorder, data can be thoroughly analyzed in fine detail or viewed as a trend over long durations.

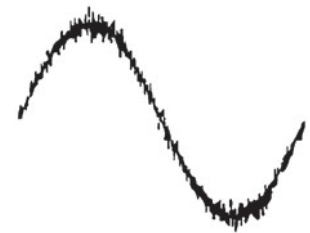

**isoPRO**

**Flexible inputs and built-in signal conditioning**

Choose from 20 types of input module to configure a ScopeCorder with up to 128 channels. Gain thorough insight into any application by synchronizing the measurement of different types of electrical and physical signals.

- Voltage and Current
- Sensor Outputs
- Temperature, Vibration/ Acceleration, Strain, Frequency
- Logic Signals & CAN/CAN FD/LIN and SENT

**Precise measurement of fast switching signals even in the harshest environments**

Individually isolated and shielded input channels provide high-resolution and high sample rates.

**A trustworthy measurement platform for durability testing**

Measurement recording up to 200 days to the large acquisition memory, the internal hard disk and/ or PC hard disk.

**Reduce time spent on fault finding**

Capture transient signals even during long term measurements using powerful triggers and unique features such as dual capture & history memory.

**Real-time evaluation of dynamic behavior within power applications**

Trend calculations such as active power, power factor, integrated power, harmonics and more using the new power math option.



# Superior functionality

A ScopeCorder provides a wide variety of unique acquisition features to handle small or large amounts of data. Therefore it can perform multi-channel measurements for longer measurement periods while still being able to precisely capture transient events with the highest detail.

## Fast and large acquisition memory

A ScopeCorder is equipped with a large acquisition memory of up to 2 G points to allow high sample rates of up to 100 MS/s on multiple channels simultaneously.

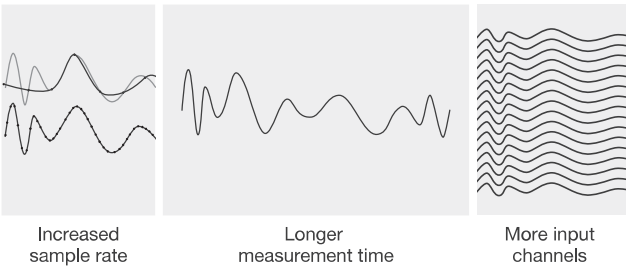

- Standard memory 250 M Points
- Expanded memory 1 G Points (/M1 Option)
- Expanded memory 2 G Points (/M2 Option)

### Measurement examples to 2 G Point acquisition memory

Sample Rate	For 1 ch	For 16 ch	For 32 ch <sup>2</sup>
100 MS/s	20 Sec.	1 Sec.	–
10 MS/s	3 Min. 20 Sec.	10 Sec.	–
1 MS/s	30 Min.	1 Min. 40 Sec.	50 Sec.
100 kS/s	5 Hours	10 Min.	5 Min.
10 kS/s	50 Hours	2 Hours 30 Min.	1 Hour 20 Min.
1 kS/s	20 Days	20 Hours	10 Hours
100 S/s	200 Days <sup>1</sup>	10 Days	5 Days

<sup>1</sup>: 200 days is the maximum.  
<sup>2</sup>: When using the 720254 module

## Real-time hard disk recording

Use a ScopeCorder as a measurement platform for simple durability testing up to 200 days. Real-time hard disk recording enables measurement data to be streamed directly to either the internal HDD drive (/HD1

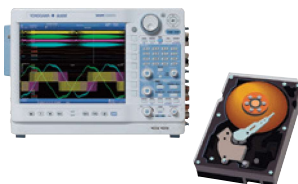

option) or via the eSATA interface (/HD0 option) to an external hard drive.

### Measurement examples to internal or external Hard Disk<sup>3</sup>

Sample Rate	For 1 ch	For 16 ch	For 32 ch <sup>2</sup>
1 MS/s	10 Hours	–	–
200 kS/s	2.5 Days	–	–
100 kS/s	5 Days	10 Hours	–
50 kS/s	10 Days	20 Hours	10 Hours
10 kS/s	50 Days	5 Days	2.5 Days
1 kS/s	200 Days <sup>1</sup>	50 Days	20 Days

<sup>1</sup>: Real-time hard disk recording can be performed for a maximum of 200 days.  
<sup>2</sup>: When using the 720254 module.  
<sup>3</sup>: With the /M2 option, the maximum duration depends on the memory length.

## Capture high speed transients during long term recording – Dual capture –

To visualize long term trends for durability testing, data is typically acquired at lower sample rate speeds. On the other hand, suddenly occurring transitional phenomena have to be captured at high speed sample rates and detail to be able to investigate the event. The “Dual capture” function uniquely resolves these conflicting requirements by simultaneously recording at two different sampling rates. Set waveform triggers and capture 5000 high speed transient events at sample rates up to 100 MS/s, while at the same time continuously record trend measurements at up to 100 kS/s.

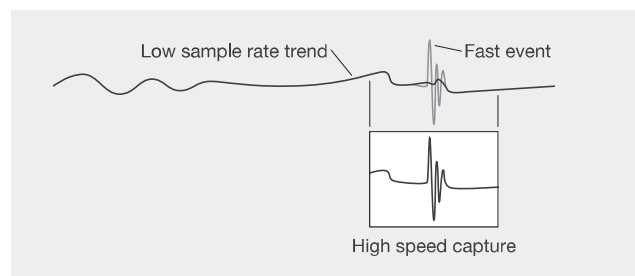



## 5 Continuous PC based data acquisition

Equipped for long duration or surveillance testing, the ScopeCorder comes with an easy setup software for continuous data acquisition.

The software enables continuous data recording to a PC hard drive. When using the software in free run mode there are virtually no restrictions in recording time and/or file size. Just click the start button to immediately start measurements!

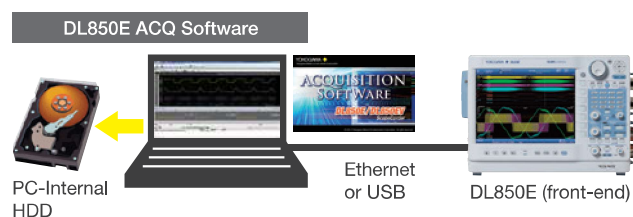

Guided by four screens, the Setup Wizard easily guides you through the necessary settings for configuring the acquisition system such as measurement settings, data save and display options.

Instrument settings can be saved or recalled at any time.

### The maximum sample rate and number of measuring channels.

No. of Measuring Channels*	Maximum Sample Rate
1	1 MS/s
2 or 3	500 kS/s
4 to 8	200 kS/s
9 to 16	100 kS/s

\*Measuring channels do not include sub channels.

## Reduce time spent on fault finding or transient analysis

### — Simple & enhanced triggers —

Having the possibility to set individual triggers on multiple channels provides the power to investigate what causes a particular transient event. Moreover the availability of large acquisition memory, and thus longer measurement time, supports the determination of event cause and effect on other parts of the application.

### Wave window trigger

The ideal trigger for AC power line monitoring. Easily capture voltage sags, interfering impulses, phase shifts or drop outs.

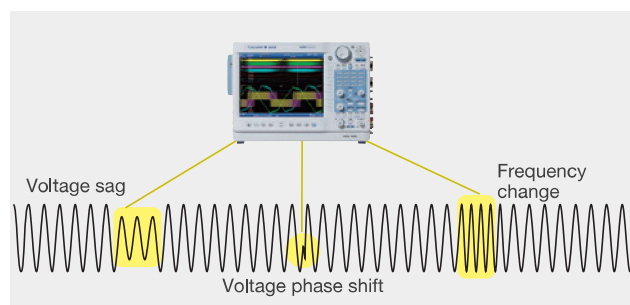

### Action-on trigger

Leave a ScopeCorder unattended and automatically save the waveform to a file or send an email for notification in case of a triggered event.

## Recall waveform events

### — History memory —

When an abnormal phenomenon is spotted during a repetitive high speed measurement, the anomaly has often already disappeared from the screen by the time the measurement is stopped. With a ScopeCorder, the “History” function is always active and automatically divides the available acquisition memory into 5000 “history waveforms”.



These history records are easily accessible and can be displayed simultaneously after measurement is stopped. Using condition-based searches inside the history memory, users can quickly isolate individual waveform records. Once the required waveforms have been identified they can be used for further analysis.

# Powerful real-time calculations and analysis functions

As a standard feature, the ScopeCorder is equipped with a set of basic arithmetic functions such as addition, subtraction, division, multiplication, Fast Fourier transformation and more. In addition to standard math, several advanced real-time analysis functions are available.

## Real-time measurement of electrical power (/G5 option)

Trend calculations such as active power, power factor, integrated power and harmonics, using a dedicated Digital Signal Processor (DSP) that is able to calculate and display up to 126-type of electrical power related parameters in real-time. This enables the user to display raw waveform signals such as voltages and currents along with power calculated parameters and even the capability to trigger on all of them. Data updating rate up to 100 kS/s. Trend waveforms of each order of harmonics, bar-graphs and vector displays can be displayed. Both RMS and Power analysis modes are available. Besides the powerful power calculations, the /G5 option also contains all the functionality of the /G3 option.

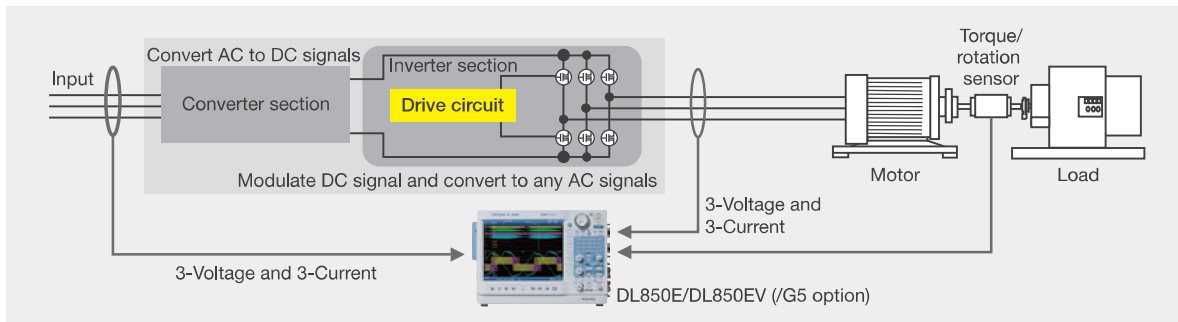

Application example | Inverter/Motor testing

### Automatic waveform parameter measurement

The parameter measure function is the most precise method for automatically calculating any or all of the 29 different waveform parameters such as amplitude, peak to peak values, RMS, rise time, frequency and more.

Items	P-P, Amp, Max, Min, High, Low, Avg, Mid, Rms, Sdev, +OvrShoot, -OvrShoot, Rise, Fall, Freq, Period, +Width, -Width, Duty, Pulse, Burst1, Burst2, AvgFreq, AvgPeriod, Int1TY, Int2TY, Int1XY, Int2XY, Delay (between channels)
-------	---

### Cycle statistics

With this powerful analysis function, the ScopeCorder measures selected parameters individually for each waveform cycle and provides statistical information which can easily be saved to a file. By selecting maximum or minimum values from the results, the instrument can automatically zoom into the selected waveform cycle for further analysis, potentially saving additional data analysis time.

Statistics	Max, Min, Avg, Sdv, Cnt
------------	-------------------------

### Cursor measurement

Using cursors is a quick and easy method to measure waveform parameters on the screen. Available cursors are horizontal, vertical, marker, degree or combined horizontal & vertical.

Cursor types	Horizontal, Vertical, Marker, Degree (for T-Y waveform display only), H&V
--------------	---

## 7 User-defined computations (/G2 option)

With user-defined computations it is possible to create equations using a combination of differentials and integrals, digital filters, and a wealth of other functions. Moreover it is possible to perform various types of FFT analysis using two FFT windows. In applications such as vibration and shock tests, you can easily evaluate abnormal vibrations while simultaneously measuring other signals.

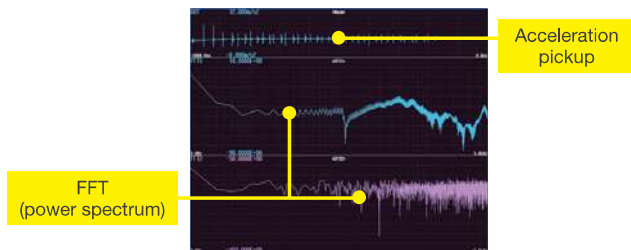

### GiGAZoom ENGINE 2

Zoom into 2 Billion samples in just a blink of the eye. Each ScopeCorder is equipped with the revolutionary GiGAZoom ENGINE 2, a powerful processor designed for optimizing access to data seamlessly. Activate 2 separate zoom windows while simultaneously displaying the entire original signal.

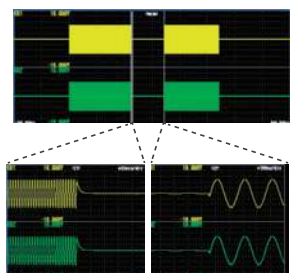

**GiGAZoom**  
ENGINE 2

For instance, instantly zoom 1 second (100 ms/div) even when the main screen is displaying 20 days of recording (2 days/div)

### Real-time mathematical computations and digital filtering (/G3 option)

Armed with a dedicated digital signal processor the ScopeCorder can perform mathematical calculations such as arithmetic operators with coefficients, integrals

and differentials, and higher order equations on acquired measurement data. The results of these calculations are displayed during waveform capture in realtime. In addition to mathematical operators, steep digital filters can also be selected to isolate or trigger on the amplitude of certain frequency components.

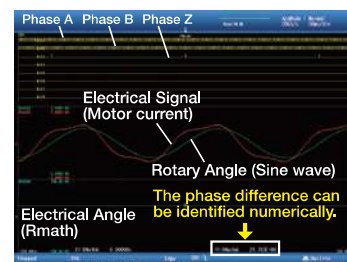

Example of measuring electrical angle

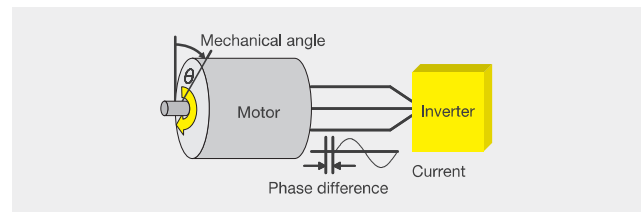

Measuring the electrical angle corresponding to the mechanical angle is important for understanding motor characteristics. The Electrical Angle operation enables the extraction of the fundamental component of current by Discrete Fourier Transform, then the calculation of the phase difference between it and the rotary angle in real time. A trend of the phase difference can also be displayed in real time.

The results of filtering and math operations are acquired in acquisition memory—the same place that input channel waveforms are acquired.

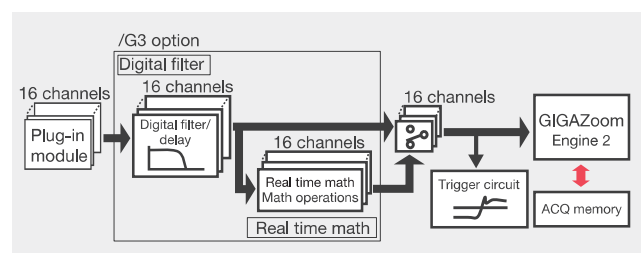

# DL850EV

## ScopeCorder Vehicle Edition

The ScopeCorder Vehicle Edition is designed for engineers working in the automotive and railway industry. A common measurement challenge is to combine measurements of electrical signals, physical performance parameters indicated by sensors, together with CAN/CAN FD bus, LIN bus or SENT data transmitted by the powertrain management system. A ScopeCorder Vehicle Edition addresses this challenge by combining the measurement of all signals to provide thorough insight into the dynamic behavior of the electromechanical system. The result is a considerable time saving compared to other approaches such as analysis on PC or other software.

8



### Battery powered operation (/DC option)

In addition to AC power, it is also possible to take the ScopeCorder Vehicle Edition in a vehicle and power the unit from the vehicle's DC battery. The DC power option allows AC and DC power supplies to be used together to ensure a highly reliable power source.

If the AC power goes down, the DL850EV instantly switches to the DC supply without interrupting the measurement.

■ Low power consumption of 60 – 120 VA (typ.)

■ Low noise compared to using an external inverter

- Can be driven by AC power.  
100 V AC (100 – 120 V)  
200 V AC (200 – 240 V)



- Can be driven by external DC power such as the vehicle's battery  
12 V DC (10 – 18 V)

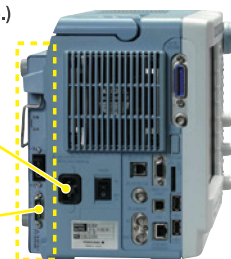



## 9 CAN/CAN FD, LIN Bus and SENT monitoring

Use a ScopeCorder to decode the CAN/CAN FD, LIN-Bus or SENT signals and display information on physical data, like engine temperature, vehicle speed and brake-pedal position, as analog waveforms and compare this with the data coming from real sensors.

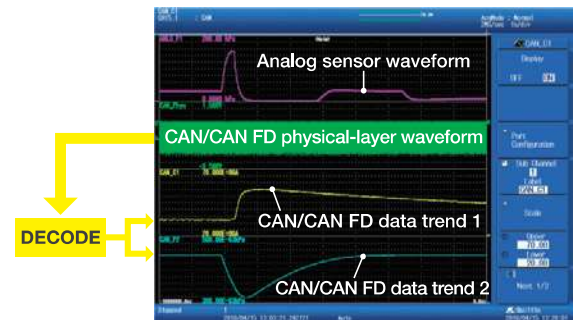

### Example of comparison and verification of a measured signal and CAN/CAN FD bus signal

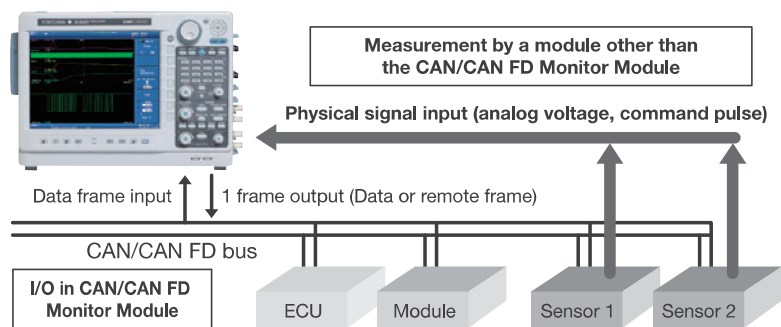

### Symbol Editor for CAN DBC, LIN LDF

The symbol editor is a software tool which makes it possible to define which physical values from the CAN/CAN FD or LIN bus data frame have to be trended as waveform data on the display of the ScopeCorder. The Symbol Editor can accept vehicle-installed network definition files (CAN DBC, LIN LDF).

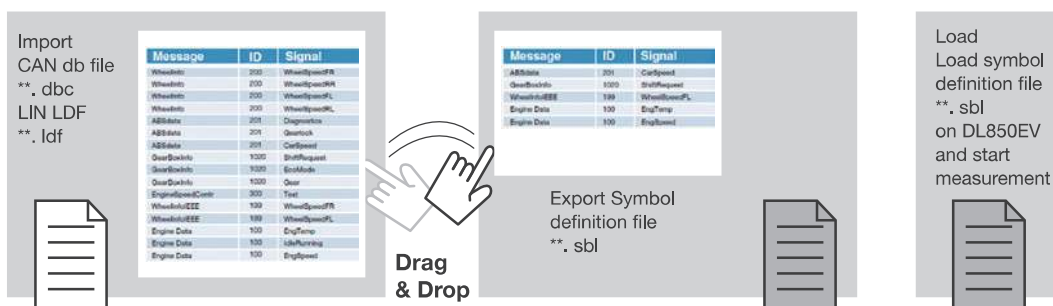

Label, scale and unit are appeared without manual input.



# Flexible operation

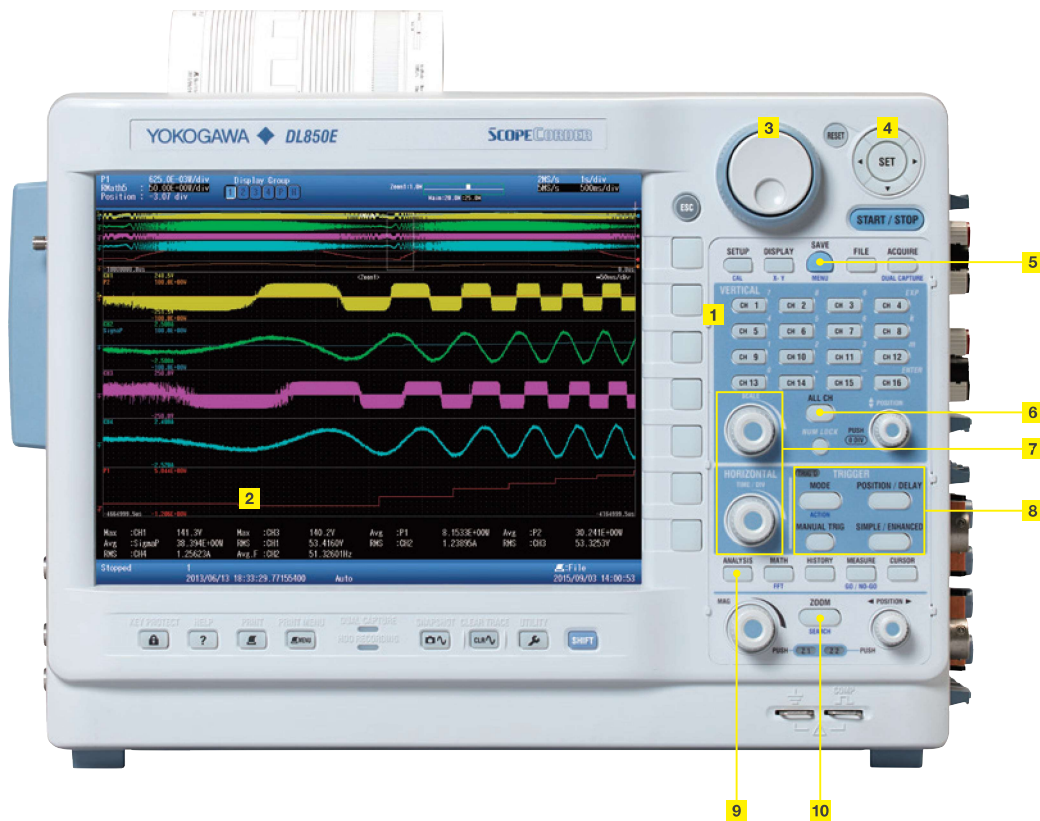

10

## 1 Local language support

Operate the ScopeCorder in the language of your choice by selecting any of the 8 languages for the instrument's software menu and front panel. Choose from English, German, French, Italian, Spanish, Chinese, Korean or Japanese.

## 2 High resolution display

A large 10.4-inch XGA LCD, displays multiple channels in precise detail.

## 3 Jog shuttle

## 4 Cursor keys

For scrolling through setting menus. To enable a setting press the center [SET] key.

## 5 Single button save

A pre-programmable button that saves data to hard drive, SD card, USB stick or a remote network storage location.

## 6 All channel setup

For quick and easy setup, displays an overview of the settings of multiple input channels simultaneously.

## 7 Vertical scale & horizontal time/div

Use these rotary knobs to set the vertical scale (voltage/div) of the selected input channel or to set the required measurement time (time/div).

## 8 Trigger keys

## 9 Analysis key

Display power calculations, such as active power, power factor, integrated power and harmonics in real-time.

## 10 Zoom keys

With 2 zoom windows the Gigazoom Engine II zooms into 2 Billion samples in just a blink of the eye.

# Communications & Connection interfaces

11

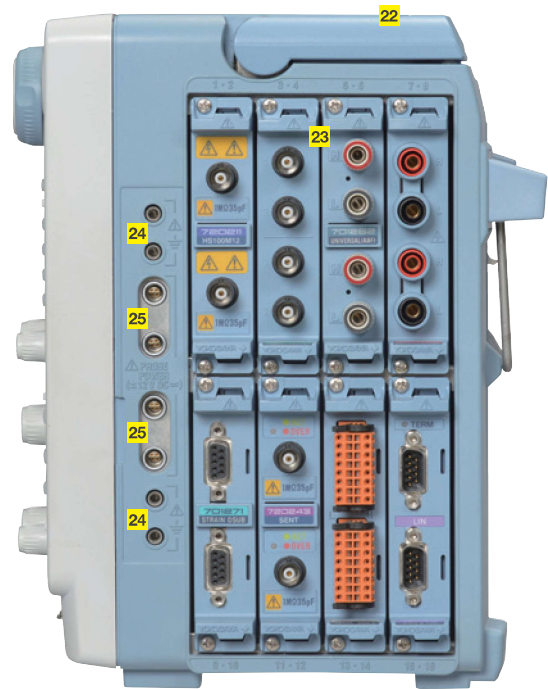
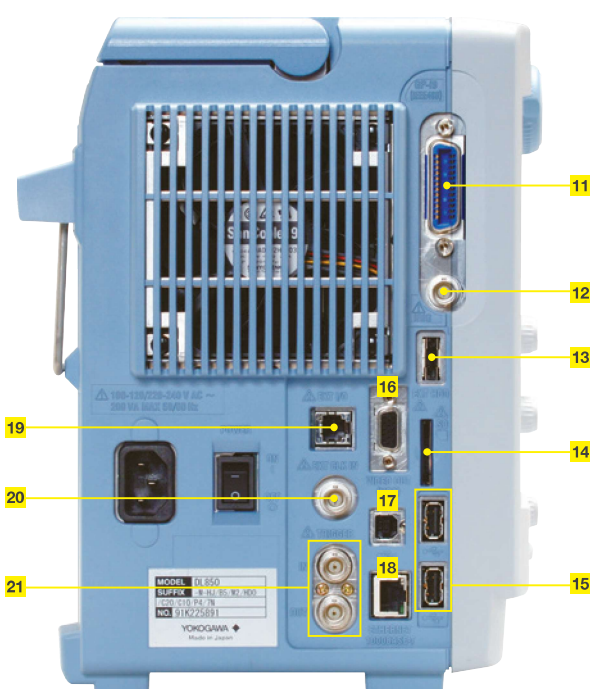

- 11 GP-IB (/C1 or /C20 option)**
- 12 IRIG interface (/C20 option) or GPS interface (/C30 option)**  
Inputting an external time signal (IRIG or GPS) lets you synchronize multiple.
- 13 External eSATA hard drive interface (/HD0 option)**  
Save measurement data to external eSATA hard drive.
- 14 SD card slot**
- 15 USB Type A**  
Two USB ports support USB storage, keyboard input and mouse operation.
- 16 Video output**
- 17 USB type B**
- 18 Ethernet 1000BASE-T**

- 19 EXT I/O**  
Multifunctional port used for indicating the results of repeated automatic GO/NO-GO measurements or for external start/stop of the measurement.
- 20 External clock in**  
Synchronize the sampling clock to an external clock signal, for example when working with rotary devices for position related sampling.
- 21 External trigger input / output**
- 22 Carrying handle**
- 23 Input module slots**
- 24 Ground terminal**
- 25 Probe power supply (/P4 option)**

# Applications in power & transportation

With today's increased incorporation of power electronics and switching devices in power and transportation related applications, measuring the power consumption and performance of the individual components alone is often not sufficient to understand the overall performance and behavior of a system.

12

A ScopeCorder satisfies this new measurement requirement by not only capturing voltage and current waveforms, but it combines these with real-time calculations of power and other electrical and physical parameters into a single measurement overview.

## Motors and electric drives

The majority of industrial applications incorporate a variable speed drive in combination with a three phase induction motor. Where an Oscilloscope often has a limited channel count and non-isolated input channels, the DL850E can be equipped with 16 or more channels and has a diverse range of input modules, where each channel is individually isolated.

The instrument offers direct input of voltages up to 1000 V, with no need for active probing, and samples data at rates up to 100 MS/s with 12 or 16 Bit vertical resolution. These features are ideal for capturing inverter switching signals with high precision.

Being able to connect the outputs from additional torque sensors, rotary encoders or thermocouples also makes the DL850E ScopeCorder an ideal measuring instrument to enable engineers to improve the design of motor and electric drives, reduce size and costs, and increase efficiency levels. This in turn helps to reduce global industrial power consumption.

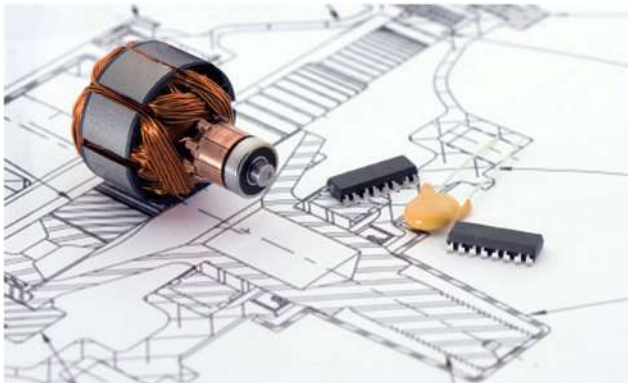

## Simultaneously measure and analyze 3 phase inputs and 3 phase outputs



The ScopeCorder's multichannel platform with large memory enables the power of 6 inputs (3x voltage and 3x current) and 6 outputs to be analyzed simultaneously.

## Real-time evaluation of dynamic behavior within power applications



Active power, power factor, integrated power, harmonics and more can be calculated and shown as trends using the new /G5 power math option.

## Precise measurement of fast switching signals even in the harshest environments



Individually isolated and shielded input channels provide high resolution and high noise immunity.



### 13 Sustainable operation of urban mobility

Perform service and maintenance in the field by taking a ScopeCorder on-board a vehicle. The DL850EV can be driven by DC power, such as the vehicle's battery, in addition to AC power.



### Vehicle testing

The increasing demand for clean and energy efficient ways of transportation drives the development of efficient railway electrification systems incorporating new greener propulsion and control technologies. In the automotive market, the electrification of the powertrain is shaping the future of vehicle technology development. The DL850EV ScopeCorder Vehicle edition is designed to provide engineers with knowledge about the dynamic behavior of their specific application and its efficiency.



Rotary encoder position	Consumed energy
Sensor linearization	RMS
Real power	Harmonics
Frequency	AC waveform trigger

### Analyze the dynamics of electric drive trains

Combine electrical signals and physical sensor parameters, related to mechanical performance, with data from the control system such as a CAN/CAN FD, LIN buses or SENT. This enables R&D engineers to identify the correlation between communication data transmitted over the vehicle bus and analog data such as voltage, temperature and sensor signals, or the ECU's control logic signals.

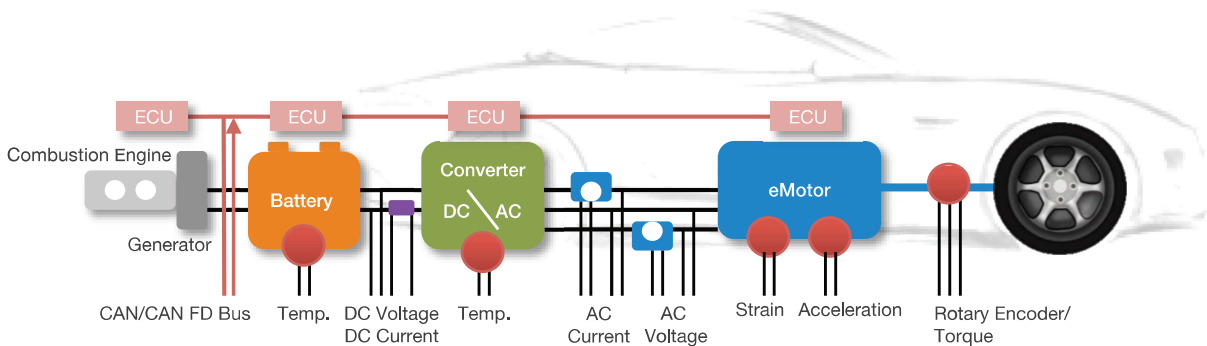

# Flexible and modular inputs with built-in signal conditioning

Choose from 20 types of input modules and install up to 8 in a ScopeCorder at a time. For the detailed DL850E/DL850EV plug-in module specifications, see the “Bulletin DL850E-01EN”.

IF CLASS 1 LASER PRODUCT MODULE IS AVAILABLE  
 クラス1レーザーモジュール実装時  
 安裝Class 1 激光模块时



Complies with 21 CFR 1040.10 and 1040.11 except for deviations pursuant to Laser Notice No.50, dated June 24, 2007  
 2-9-32 Nakacho, Musashino-shi, Tokyo 180-8750, Japan

## Input modules available for high-speed, isolation and multi-channel measurements.



A stand-alone measurement system equipped with multiple 4 channels, 1 MS/s, 16-bit isolation modules, equals a total of 32-channels.\*

\* The sample rate, including when an external clock signal is applied, will be always half or less of the 2-CH voltage input module (such as 720250) under the same recording length.

720254



IsoPRO technology enables High speed (100 MS/s), High resolution (12-bit), 1 kV isolated measurements.\*

\* With the combination of the 720211 high-speed isolation module and a 700929, 702902 or 701947 probe.

720211

## Input modules for DL850EV



CAN/CAN FD  
720242

CAN, LIN  
720241

SENT  
720243



## CAN/CAN FD Monitor Module 720242 (for DL850EV)



### Monitor and decode CAN FD (CAN with Flexible Data Rate)

The 720242 module is capable of extracting specified data from CAN FD serial signals as well as Classical CAN, converting them into analog values, and record their trends. It therefore strongly supports the development and evaluation

of next-generation vehicles. The 720242 module allows a network intermingled with CAN and CAN FD to be monitored by automatically discriminating between these two formats.

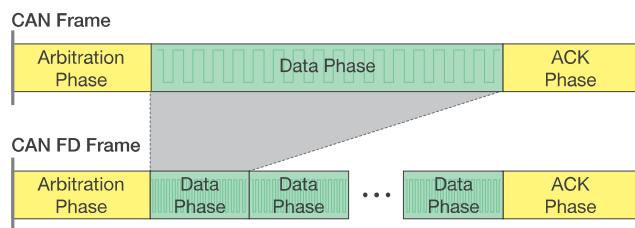

### CAN FD (CAN with Flexible Data-rate) versus Classical CAN

CAN FD is a format in which the transfer rate and data length of the data field has been increased while still following a protocol common to CAN. It therefore enables data rates higher than 1 Mbit/sec to be transmitted on a CAN bus and thus deliver the higher bandwidths now required by the automotive industry for in-vehicle networks.

## 15 All input modules lineup for DL850E and DL850EV.



Update of the firmware may be required depending on the input module used.

### Plug-in Module Selection Guide\*1

Input	Model No.	Sample rate	Resolution	Bandwidth	Number of channels	Isolation	Maximum measurement voltage <sup>10</sup> (DC+ACpeak)	DC accuracy	Note
Analog Voltage	720211*8	100 MS/s	12 bit	20 MHz	2	Isolated	1000 V <sup>2</sup> , 200 V <sup>3</sup>	±0.5%	High speed · High voltage · Isolated
	720250	10 MS/s	12 bit	3 MHz	2	Isolated	800 V <sup>2</sup> , 200 V <sup>3</sup>	±0.5%	high noise immunity
	701251	1 MS/s	16 bit	300 kHz	2	Isolated	600 V <sup>2</sup> , 140 V <sup>3</sup>	±0.25%	High sensitivity range (1 mV/div), low noise (±100 µV/typ.), and high noise immunity
	720254	1 MS/s	16 bit	300 kHz	4	Isolated	600 V <sup>2</sup> , 200 V <sup>3</sup>	±0.25%	4 CH BNC input/low noise, high noise immunity
	701255	10 MS/s	12 bit	3 MHz	2	Non-Isolated	600 V <sup>2</sup> , 200 V <sup>3</sup>	±0.5%	High speed · Non isolated
	720268	1 MS/s	16 bit	300 kHz	2	Isolated	1000 V <sup>11</sup>	±0.25%	With AAF, RMS, and high noise immunity
Analog Voltage & Temperature	720220	200 kS/s	16 bit	5 kHz	16	Isolated (GND-terminal) Non-Isolated (CH-CH)	20 V <sup>3</sup>	±0.3%	16 CH voltage measurement (Scan-type)
	701261	100 kS/s (Voltage), 500 S/s (Temperature)	16 bit (Voltage), 0.1°C (Temperature)	40 kHz (Voltage), 100 Hz (Temperature)	2	Isolated	42 V	±0.25% (Voltage)	Thermocouple (K, E, J, T, L, U, N, R, S, B, W, iron-doped gold/chromel)
	701262	100 kS/s (Voltage), 500 S/s (Temperature)	16 bit (Voltage), 0.1°C (Temperature)	40 kHz (Voltage), 100 Hz (Temperature)	2	Isolated	42 V	±0.25% (Voltage)	Thermocouple (K, E, J, T, L, U, N, R, S, B, W, iron-doped gold/chromel), with AAF
	701265	500 S/s (Voltage), 500 S/s (Temperature)	16 bit (Voltage), 0.1°C (Temperature)	100 Hz	2	Isolated	42 V	±0.08 (Voltage)	Thermocouple (K, E, J, T, L, U, N, R, S, B, W, iron-doped gold/chromel), high sensitivity range (0.1 mV/div)
	720266	125 S/s (Voltage), 125 S/s (Temperature)	16 bit (Voltage), 0.1°C (Temperature)	15 Hz	2	Isolated	42 V	±0.08 (Voltage)	Thermocouple (K, E, J, T, L, U, N, R, S, B, W, iron-doped gold/chromel), high sensitivity range (0.1 mV/div), Low noise
Strain	720221*7	10 S/s	16 bit	600 Hz	16	Isolated	20 V	±0.15% (Voltage)	16 CH voltage or temperature measurement (scan method) Thermocouple (K, E, J, T, L, U, N, R, S, B, W, Au-Fe-chromel)
	701270	100 kS/s	16 bit	20 kHz	2	Isolated	10 V	±0.5% (Strain)	Supports strain NDIS, 2, 5, 10 V built-in bridge power supply
Analog Voltage, Acceleration	701271	100 kS/s	16 bit	20 kHz	2	Isolated	10 V	±0.5% (Strain)	Supports strain DSUB, 2, 5, 10 V built-in bridge power supply, and shunt CAL
	701275	100 kS/s	16 bit	40 kHz	2	Isolated	42 V	±0.25% (Voltage) ±0.5% (Acceleration)	Built-in anti-aliasing filter, Supports built-in amp type acceleration sensors (4 mA/22 V)
Frequency	720281	1 MS/s	16 bit	resolution 625 ps	2	Isolated	420 V <sup>2</sup> , 42 V <sup>3</sup>	±0.1% (Frequency)	Measurement frequency of 0.01 Hz to 500 kHz, Measured parameters (frequency, RPMs, RPSs, period, duty cycle, power supply frequency, pulse width, pulse integration, and velocity)
Logic	720230	10 MS/s	—	—	8 bit × 2 ports	Non-Isolated	depend on logic probe used.	—	(8 bit/port) × 2, compatible with four-type of logic probe (sold separately)
CAN, LIN	720241	100 kS/s <sup>12</sup>	—	—	(60 signals × 2) port	Isolated	10 V (CAN port) 18 V (LIN port)	—	CAN port × 1, LIN port × 1 <sup>5, 6</sup>
CAN, CAN FD	720242	100 kS/s <sup>12</sup>	—	—	(60 signals × 2) port	Isolated	10 V	—	CAN/CAN FD Data of maximum 32 bit allowable <sup>5, 6</sup>
SENT	720243	100 kS/s <sup>12</sup>	—	—	11 data × 2 ports	Isolated	42 V	—	Supported protocol: SAE J2716, <sup>5, 6</sup>

\*1: Probes are not included with any modules. \*2: In combination with 700929, 702902 or 701947 probe. \*3: Direct input \*4: In combination with 10:1 probe model 701940 \*5: Any other modules can be installed in the remaining slots. \*6: When using these modules with DL850EV, up to four CAN/CAN FD Monitor Modules (720242), CAN & LIN Bus Monitor Modules (720241) or SENT Monitor Module (720243) in total can be used on a single main unit. For the CAN/CAN FD Monitor Module (720242) and CAN & LIN Bus Monitor Module (720241), up to two in total can be used on a single main unit. \*7: The 16 CH Scanner Box (701953) is required for measurement. \*8: Class 1 Laser Product, IEC / EN60825-1:2007, GB7247-1-2012 \*9: In combination with 758933 and 701954. \*10: See the main specifications for voltage-axis sensitivity setting and measurement range. \*11: 1000 Vrms (1000 VDC or 1414 Vpeak maximum) when using with DL350, 850V (DC + ACpeak) when using with DL850/DL850V/DL850E/DL850EV or SL1000 \*12: Maximum data update rate

# Accessories and software

Different applications, different types of signals, different measurement needs and different accessories. Analyze measurement data using the ScopeCorder itself or in the PC using Xviewer software.

16

## Xviewer

Xviewer can display acquired waveforms, transfer files and control instruments remotely. In addition to simply displaying the waveform data, Xviewer features many of the same functions that the ScopeCorder offers: zoom display, cursor measurements, calculation of waveform parameters, and complex waveform math. Binary waveform data can be easily converted to CSV, Excel or Floating Point Decimal format.



## Free Xviewer trial

Get the free 30 day trial version of Xviewer at [tmi.yokogawa.com](http://tmi.yokogawa.com).

## Powerful linkage with PC analysis software

### Driver and DataPlugin

A driver and data plugin for such as DIAdem, LabVIEW, FAMOS and DADiSP software are available and can be downloaded on each web site.

### MATLAB\* file saving

Measurement data can be directly saved into a MATLAB .MAT format file. .MAT files can be loaded into MATLAB. Measurement data can be conveniently imported into MATLAB quickly with a smaller file size.

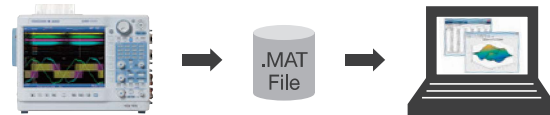

\*MATLAB is a multi-paradigm numerical computing environment and fourth-generation programming language. Developed by MathWorks.

## DL850 Advanced Utility (option)

The Xviewer advanced utility option enables waveform data to be pre-analyzed while the acquisition on the instrument is still in progress. It also adds the possibility to merge and synchronize measurement files taken by multiple DL850E/DL850EV as well as file splitting and file format conversion.

## Related products

### High Speed PC based DAQ SL1000

- Up to 100 MS/s on all channels
- Up to four simultaneously independent sample rates
- Supports parallel testing (Max. 8-unit)

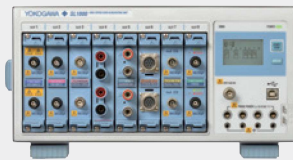

### Precision Power Scope PX8000

- Simultaneous power calculation
- Cycle-by-cycle power trend measurement
- Specific time-period measurement



### ScopeCorder DL350

- Max. 8-CH high-speed isolated recording
- Battery-operated compact chassis
- Ease of use in the field















### Arbitrary/Function Generator FG400 Series

- 0.01  $\mu$ Hz to 30 MHz, 20 Vp-p, 1 or 2 channels
- A variety of sweeps and modulations





	10:1 Probe (for Isolated BNC input) <b>702902</b> (Wide operating temperature range)		Pinchers tip (hook type) <b>B9852MM/B9852MN</b>		Fork terminal adaptor set <b>758921</b>		Bridge head (DSUB) 120 Ω: <b>701957</b> 350 Ω: <b>701958</b>
	100:1 Probe (for isolated BNC input) <b>701947</b>		Alligator clip adaptor set <b>758922</b>		Scanner box <b>701953</b>		High-speed logic probe <b>700986</b>
	1:1 Safety BNC adapter lead <b>701901</b>		Alligator clip adaptor set <b>758929</b>		Current probe 500 Arms DC to 2 MHz <b>701931</b>		Isolation logic probe <b>700987</b>
	1:1 Safety adapter lead <b>701904</b>		7000 Vpk, 50 MHz differential probe <b>701926</b>		Current probe 30 Arms DC to 100 MHz <b>701932</b>		Logic probe (TTL level contact input) 1 m: <b>702911</b> 3 m: <b>702912</b>
	Measurement lead set <b>758933</b>		±1400 V, 100 MHz differential probe <b>700924</b>		Current probe 30 Arms DC to 50 MHz <b>701933</b>		Current probe 5 Arms DC to 50 MHz <b>701917</b>
	Plug-on clip <b>701948</b>		BNC cable <b>366924/366925</b>		Current probe 150 Arms DC to 10 MHz <b>701930</b>		Current probe 5 Arms DC to 120 MHz <b>701918</b>
	Safety BNC cable 1 m: <b>701902</b> 2 m: <b>701903</b>		1:1 BNC-alligator cable <b>366926</b>		Probe power supply 4-output <b>701934</b>		Clamp-on Probe AC 50 Arms 40 Hz to 3.5 kHz <b>720930</b>
	Large alligator-clip (Dolphin type) <b>701954</b>		1:1 Banana-alligator cable <b>366961</b>		Bridge head (NDIS) 120 Ω: <b>701955</b> 350 Ω: <b>701956</b>		Clamp-on Probe AC 200 Arms 40 Hz to 3.5 kHz <b>720931</b>

**Software Control** <http://tmi.yokogawa.com/ea/products/oscilloscopes/oscilloscopes-application-software/>

	Free Software	Advanced Software <span style="background-color: yellow; border: 1px solid black; padding: 2px;">Trial version available</span>	
Off-line waveform display and analysis	<b>XviewerLITE</b> —Basic check— Zoom, V-cursor, conversion to CSV format <b>DIAdem DataPlugin</b> *1	<b>Xviewer—Advanced Analysis</b> — Advanced and useful functions are supported. Good for precise, off-line waveform analysis. <ul style="list-style-type: none"> <li>• Waveform observation and analysis</li> <li>• Cursor, Parametric Measure</li> <li>• Statistical Analysis</li> <li>• Multiple file display</li> <li>• Advanced waveform operations</li> <li>• Comment, marking, printing and making report</li> <li>• Optional Math computation feature</li> <li>• Remote monitor</li> <li>• Instruments communication function</li> <li>• Transferring waveform &amp; image files</li> </ul> <b>DL850 Advanced Utility (option)</b> <ul style="list-style-type: none"> <li>• The advanced utility option allows ScopeCorder to pre-analyze waveform data during acquisition.</li> </ul>	
Waveform monitoring on a PC	<b>XWirepuller</b> Remote monitor and operation Transferring image files.		<b>DL850E ACQ Software</b> Continuous data recording into a PC's HDD.
Data transfer to a PC			
Command control Custom software development	<b>Control library "TMCTL"</b> For Visual Studio <b>WDF File Access Library</b> <b>MATLAB</b> *2 WDF Access Toolbox Transfer data file to MATLAB <b>LabVIEW</b> *3 instrument driver		

\*1: The DataPlugin software can be downloaded from the National Instruments (NI) web site.  
 \*2: MathWorks's product.  
 \*3: Program development environment provided by National Instruments (NI)

# Specifications (Main unit)

\*For the plug-in modules specifications, see the "Bulletin DL850E-01EN".

Main Specifications (Main Unit)	
<b>Input Section</b>	Plug-in module
<b>Number of slots</b>	8 *Up to four 720240, 720241, 720242 or 720243 modules in total can be used on a single main unit. For 720240, 720241 and 720242 modules, up to two in total can be used on a single main unit. These modules are available for the DL850EV only.
<b>Number of input channels</b>	DL850E: 16 CH/Slot, 128 CH/Unit DL850EV: 120 CH/Slot, 336 CH/Unit (Maximum simultaneous display waveform is 64 waveforms x 4 screen selectable)
<b>Max recording length</b>	Max recording length depends on kinds of modules and number of channels Standard: 250 Mpts (1 CH), 10 Mpts/CH (16 CH*) /M1 option: 1 Gpts (1 CH), 50 Mpts/CH (16 CH*) /M2 option: 2 Gpts (1 CH), 100 Mpts/CH (16 CH*) 1 pts (point) = 1 W (word)
<b>Max Time axis setting range</b>	100 ns/div to 1 s/div (1-2.5 step) 2 s/div, 3 s/div, 4 s/div, 5 s/div, 6 s/div, 8 s/div, 10 s/div, 20 s/div, 30 s/div, 1 min/div to 10 min/div (1 min step), 12 min/div, 15 min/div, 30 min/div, 1 h/div to 10 h/div (1 h step), 12 h/div, 1 day/div, 2 day/div, 3 day/div, 4 day/div, 5 day/div, 6 day/div, 8 day/div, 10 day/div, 20 day/div
<b>Time axis accuracy?</b>	±0.005%
Trigger Section	
<b>Trigger mode</b>	auto, auto level, normal, single, single (N), ON start
<b>Trigger level setting range</b>	0 centered ±10 div
<b>Simple trigger</b>	Trigger source CHn (n: any input channel), Time, External, Line Trigger slope Rising, falling, or rising/falling Time trigger Date (year/month/day), time (hour/minute), time interval (10 seconds to 24 hours)
<b>Enhanced trigger</b>	Trigger source CHn (n: any input channel) Trigger type A→B (N), A Delay B, Edge on A, OR, AND, Period, Pulse Width, Wave Window
Display	
<b>Display</b>	10.4-inch TFT color LCD monitor, 1024 x 768 (XGA)
<b>Display resolution of waveform display</b>	selectable either 801 x 656 (normal waveform display) or 1001 x 656 (wide waveform display)
<b>Display format</b>	Max, 3 simultaneous displays available In addition to main, 2 more waveforms available among zoom 1, zoom 2, XY1, XY2, FFT1, FFT2 (/G2 option), Vector (/G5 option), Bar graph (/G5 option)
Function	
<b>Acquisition and display</b>	Acquisition mode Normal Normal waveform acquisition Envelope Maximum sample rate regardless of record time, holds peak value Averaging Average count 2 to 65536 (2 <sup>16</sup> steps) Box average Increase A/D resolution up to 4 bits (max. 16 bits)
<b>Roll mode</b>	It is effective when the trigger mode is set to auto/auto level/single/ON start, and time axis is greater than 100 ms/div.
<b>Dual capture</b>	Performs data acquisition on the same waveform at 2 different sample rates. Main waveform (low speed) Maximum sample rate: 100 kS/s (roll mode region) Maximum record length: 1 G point (/M2, 1 CH) Capture waveform (high speed) Maximum sample rate: 100 MS/s Maximum record length: 500 k point
<b>Realtime hard disk recording (/HD0, /HD1 option)</b>	Maximum sample rate Maximum 1 MS/s (1 CH used), 100 kS/s (16 CH used) depends on channel used Capacity Depends on HDD vacant capacity Action When waveform acquisition occurs according to the specified trigger mode, the DL850E/DL850EV stores the data to an internal hard disk or an external hard disk that supports eSATA.
<b>History memory</b>	Maximum: 5000 waveforms
Display	
<b>Display format</b>	TY display for 1, 2, 3, 4, 5, 6, 8, 12, 16 division display
<b>Maximum number of display traces</b>	64 trace per 1 display group, selectable in every 4 displays
<b>X-Y display</b>	Selectable X axis/Y axis in CHn, MATHn (max. 4 trace x 2 window)
<b>Accumulation</b>	Accumulates waveforms on the display (persistence mode)
<b>Snapshot</b>	Retains the current displayed waveform on the screen. Snapshot waveforms can be saved/loaded.
<b>ALL CH menu</b>	Set all channels while displaying waveforms. Operation using USB keyboard and USB mouse are available.
<b>Expansion/reduction of vertical axis direction</b>	x 0.1 to x 100 (varies depending on the module), DIV/SPAN set selectable
<b>Vertical position setting</b>	±5 div waveform move is available from the center of waveform screen frame.
<b>Linear scaling</b>	Set AX+B mode or P1-P2 mode independently for CHn
Analysis, computation	
<b>Cursor measurement</b>	Horizontal, Vertical I, Marker, Degree (for T-Y waveform display only), H&V
<b>Zoom</b>	Expand the displayed waveform along time axis (up to 2 locations using separate zoom rates) Expanded display: 100 ns/div to 1/2 of Main waveform Auto scroll: Automatically scrolls the zoom position.
<b>Search and zoom</b>	Search for, then expand and display a portion of the displayed waveform. Search conditions: Edge count, logic pattern, event, time
<b>History search function</b>	Search for and display waveforms from the history memory that satisfies specified conditions. Zone search/parameter search

## DL850E/DL850EV

<b>Waveform parameters</b>	Up to 32 items can be displayed
<b>items</b>	P-P, Amp, Max, Min, High, Low, Avg, Mid, Rms, Sdev, +OvrShoot, -OvrShoot, Rise, Fall, Freq, Period, +Width, -Width, Duty, Pulse, Burst1, Burst2, AvgFreq, AvgPeriod, Int1TY, Int2TY, Int1XY, Int2XY, Delay (between channels)
<b>Statistical processing</b>	Automated measured values of waveform parameters
<b>Statistics</b>	Max, Min, Avg, Sdv, Cnt
<b>Mode</b>	All waveforms/cycle statistics/history statistics
<b>Maximum number of cycles</b>	64000 cycles (when the number of parameters is 1)
<b>Maximum number of parameters</b>	64000
<b>Maximum measurement range</b>	No limit. (100 M points for Real-time hard disk recorded data.)
<b>Computation (MATH)</b>	Definable MATH waveforms Max. 8
<b>Calculable record length</b>	Max. 1 M point (1ch)
<b>Operators</b>	+, -, x, /, binary computation, phase shift, and power spectrum
<b>User-defined computation (/G2 option)</b>	Computation setting is available by combining any following operators and parameter measurement items. ABS, SQRT, LOG, EXP, NEG, SIN, COS, TAN, ATAN, PH, DIF, DDIF, INTG, IINTG, BIN, P2, P3, F1, F2, FV, PW/H, PW/L, PWLL, PWXX, DUTYH, DUTYL, FLT1, FLT2, HLBT, MEAN, LS-, PS-, PSD-, CS-, TF-, CH-, MAG, LOGMAG, PHASE, REAL, IMAG
<b>FFT</b>	Subject to be computed CHn, MATHn Number of channels 1 (/G2 no option), 2 (/G2 option) Computation points 1 k/2 k/5 k/10 k/20 k/50 k/100 k Time window Rect/Hanning/Hamming/FlatTop, Exponential (/G2 option) Average function Yes (/G2 option)
<b>Real time MATH (/G3 option)</b>	Number of computation waveforms Maximum 16 (Selectable with any input channel <sup>3</sup> )
<b>Digital filter</b>	Gauss (LPF), SHARP (LPF/HPF/BPF), IIR (LPF/HPF/BPF), MEAN (LPF)
<b>Delay</b>	100 ns to 10.00 ms (The data will be decimated when the delay time is relatively long.)
<b>Types of computation</b>	+, -, x, /, four fundamental arithmetic operations with coefficients, differential, integral, angle, D-A conversion, quartic polynomial equation, rms value, active power value, Reactive power value, integrated power value, logarithm, square root, sin, cos, atan, electrical angle, polynomial addition & subtraction, frequency, period, edge count, resolver, IIR filter, PWM, knock filter (DL850EV only), and CAN ID (DL850EV only), Torque, S1-S2 (Angle)
<b>Power MATH (/G5 option<sup>4</sup>)</b>	Power Analysis Max. number of analyzable system 2-system (3-phase) Max. number of measurement parameters 126 (1-system), 54 (2-system)
<b>Wiring System</b>	single-phase, two-wire; single-phase, three-wire; three-phase, three-wire; three-phase, four-wire; and three-phase, three-wire with three-voltage, three-current method
<b>Delta Computation</b>	3P3W: Difference, 3P3W > 3V3A 3P4W: Star > Delta 3P3W (3V3A): Delta > Star
<b>Measurement Items</b>	RMS voltage/current of each phase, Simple voltage and current average (DC) of each phase, AC voltage/current component of each phase (AC), Active power, Apparent power, Reactive power, Power factor, Current phase difference, Voltage/Current frequency, Maximum voltage/current, Minimum voltage/current, Maximum/Minimum power, Integrated Power (positive and negative), Volt-ampere hours, Var hours, Impedance of the load circuit, Series resistance of the load circuit, Series reactance of the load circuit, Parallel resistance of the load circuit, Parallel reactance of the load circuit, Unbalance rate of three-phase voltage, Unbalance rate of three-phase current, Motor output, Efficiency, Integration time
<b>Harmonic Analysis</b>	Max. number of analyzable system 1-system Max. analyzable frequency 1 kHz (fundamental signal) Number of FFT points 512
<b>Wiring System</b>	single-phase, two-wire; single-phase, three-wire; three-phase, three-wire; three-phase, four-wire; and three-phase, three-wire with three-voltage, three-current method
<b>Delta Computation</b>	3P3W: Difference, 3P3W > 3V3A 3P4W: Star > Delta 3P3W (3V3A): Delta > Star
<b>Measurement Mode</b>	RMS Measurement mode, Power Measurement mode
<b>Measurement Items</b>	RMS Measurement mode: 1 to 40 order RMS, 1 to 40 order RMS distortion factor, 1 to 40 order phase difference, Total RMS, Distortion Factor (IEC), Distortion Factor (CSA) Power Measurement mode: 1 to 35 order active power, 1 to 35 order active power distortion factor, 1 to 35 order phase difference, Total active power, Total Apparent power, Total Reactive power, Power factor, 1st order RMS voltage, 1st order RMS current, 1st order voltage phase difference, 1st order voltage phase difference
<b>GO/NO-GO determination</b>	Operate selected actions based on the determination criteria to the captured waveform.
<b>Zone</b>	Determination using combination of up to 6 waveform zones (AND/OR).
<b>Parameters</b>	Determination using combinations of 16 waveform parameters
<b>Actions</b>	Screen image data output, waveform data storage, buzzer notification, and e-mail transmission
<b>Action-on trigger</b>	Operates the selected actions each time trigger occurs. Actions once triggered Screen image data output, waveform data storage, buzzer notification, mail transmission

<b>Screen image data output</b>	
Built-in printer (/B5 option)	Prints hard copy of screen.
External printer	Outputs the screen image to an external printer via Ethernet or USB
File output data format	PNG, JPEG, BMP
<b>Waveform printing on long roll paper</b>	
Function	high-resolution printing on a A4-size long paper
Compatible printer	Model PJ763/PJ723/PJ663/PJ623 Supplier: Brother Industries, Ltd.
<b>Other functions</b>	
Mail transmission function	Transmission function by SMTP
PROTECT key	Key protection is available to prevent from careless or unexpected operation.
NUM key	Direct input of numerical numbers is available.
Sure Delete	Complete data deletion for security

<b>Built-in printer (/B5 option)</b>	
Printing system	Thermal line dot system
Paper width	112 mm
Effective printing width	104 mm (832 dot)
Feeding direction resolution	8 dot/mm
Function	Display hard copy

<b>Storage</b>	
SD card slot	Memory cards conforms to SD, SDHC
USB memory	Mass storage device which conforms to USB Mass Storage Class Ver. 1.1
External HDD (/HD0 option)	Hard disc conforms to eSATA, FAT32
Built-in HDD (/HD1 option)	2.5 inch, 500 GB, FAT32

<b>USB peripheral interface</b>	
Connector type	USB type A connector (receptacle) x 2
<b>Electrical, mechanical specifications</b>	
Conforms to USB Rev. 2.0*	
<b>Supported transmission standards</b>	
HS (High Speed) mode, FS (Full Speed) mode, LS (Low Speed) mode	
<b>Supported device</b>	
Mass storage device which conforms to USB Mass Storage Class Ver. 1.1 109 keyboard, 104 keyboard, mouse which conform to USB HID Class Ver. 1.1 HP (PCL) inkjet printer which conforms to USB Printer Class Ver. 1.0	
Power supply	5 V, 500 mA (in each port)

\*Connect USB device directly. Composite device is not supported.

<b>USB-PC connection</b>	
Connector type	USB type B connector (receptacle) x 1
<b>Electrical, mechanical specifications</b>	
Conforms to USB Rev. 2.0	
<b>Supported transmission standards</b>	
HS (High Speed) mode (480 Mbps), FS (Full Speed) mode (12 Mbps)	
<b>Supported protocol</b>	
USBTMC-USB488 (USB Test and Measurement Class Ver. 1.0)	

<b>Ethernet</b>	
Connector type	RJ-45 modular jack x 1
<b>Electrical, mechanical specifications</b>	
Conforms to IEEE802.3	
Transmission system	Ethernet (1000BASE-T/100BASE-TX/10BASE-T)
Communication protocol	TCP/IP
<b>Supported services</b>	
Server: FTP, Web, VXI-11 Client: SMTP, SNMP, LPR, DHCP, DNS, FTP	

<b>GP-IB (/C1, /C20 option)</b>	
<b>Electrical specifications</b>	
Conforms to IEEE St'd 488-1978 (JIS C 1901-1987)	
<b>Functional specifications</b>	
SH1, AH1, T6, L4, SR1, RL1, PPO, DC1, DT0, C0	
<b>Protocol</b>	
Conforms to IEEE St'd 488.2-1992	

<b>IRIG input (/C20 option)</b>	
Connector type	BNC connector x 1
Supported IRIG signals	A002, B002, A132, B122
Input impedance	50 Ω/5 kΩ selectable
Maximum input voltage	±8 V
Function	Main unit time synchronization, sample block synchronization
Clock synchronization range	±80 ppm
Accuracy after synchronization	No drift against input signal

<b>GPS input (/C30 option)</b>	
Connector type	SMA 1
Receiver type	GPS L1 C/A code, SBAS: WAAS EGNOS MSAS
Function	Main unit time synchronization, Sample clock synchronization
Accuracy after synchronization	±200 ns (when GPS signal is locked.)
Time for synchronization	Less than 5 minutes after booting
Antenna	Active antenna 3.3 V power A1058ER (standard accessory)

<b>Auxiliary I/O section</b>	
EXT CLK IN	BNC connector, TTL level, minimum pulse width 50 ns, 9.5 MHz or less
EXT TRIG IN	BNC connector, TTL level, rising/falling
EXT TRG OUT	BNC connector, 5 V CMOS level, fallen when triggered, and rising when acquisition completed.

<b>EXT I/O</b>	Connector type: RJ-11 modular jack	
	GO/NO-GO determination I/O	Input level: TTL or contact input Output level: 5 V CMOS
	External start/stop input	Input level: TTL or contact input
	Manual event	Input level: TTL or contact input

<b>Video signal output</b>	D-Sub 15 pin receptacle
	Analog RGB, quasi XGA output 102 x 4768 dot, approx. 60 Hz Vsync

<b>COMP output (probe compensation signal output terminal)</b>	
1 kHz±1%, 1 Vp-p±10%	

<b>Probe power output (/P4 option)</b>	
Number of terminals: 4, output voltage ±12 V	

<b>General specifications</b>	
Rated power supply voltage	100 to 120 VAC/220 to 240 VAC (automatic switching)
Rated power supply frequency	50/60 Hz
Maximum power consumption	200 VA
Withstand voltage	1500 V AC between power supply and earth for 1 minute
Insulation resistance	10 MΩ or higher at 500 V DC between power supply and earth
External dimensions	Approx. 355 mm (W) x 259 mm (H) x 180 mm (D), excluding handle and other projections
Weight	Approx. 6.5 kg (for main unit only, include /B5/M2/HD1/C1/P4 options, exclude chart paper)
Operating temperature range	5 to 40°C

<b>12 V DC power (/DC option, for DL850EV only)</b>	
<b>Supply method</b>	
Automatic DC/AC switching (with priority on AC), isolated between DC power input terminal and main unit	
<b>Rated supply voltage</b>	
12 V DC	
<b>Allowable supply voltage</b>	
10 to 18 V DC	
<b>Power consumption</b>	
Approx. 150 VA maximum	
<b>Voltage input protection circuit</b>	
Overcurrent detection: Breaker (15 A) Inverse connection protection: Breaker shutdown Undervoltage detection: Interruption at approx. 9.5 V or lower Overvoltage detection: Interruption at approx. 18 V or more	
<b>Withstand voltage</b>	
30 V AC between DC power terminal and ground for 1 min	
<b>Insulation resistance</b>	
10 MΩ or more at 500 V DC between DC power terminal and ground	
<b>External dimensions including the main unit</b>	
Approx. 355 mm (W) x 259 mm (H) x 202 mm (D), excluding the grip and projections	
<b>Weight of DC power box</b>	
Approx. 800 g	

<b>Acquisition Software</b>	
Number of connectable units	1 unit per 1 PC
Interface	USB, Ethernet
Functions	Recording Start/Stop, Monitoring, Setup control, Data filing on a PC
Measurement mode	Free-run
Max. transmission rate	100 KS/s (16 CH)
Max. number of channels	336 CH
<b>Operation Conditions</b>	
OS: Windows 7 (32 bit/64 bit), Windows 8 (32 bit/64 bit) Windows 8.1 (32 bit/64 bit), Windows 10 (32 bit/64 bit) CPU: Intel Core 2 Duo (2 GHz) or higher, Memory: 1 GB or more	

<b>Standard operation conditions</b>	
Ambient temperature: 23 ±5°C, Ambient humidity: 20 to 80%RH	
Errors in power supply voltage/frequency: Within ±1% of rated voltage, within ±1% of rated frequency warm-up of 30 min. or more, after calibration.	

- \*1 Example when using the 2-CH Voltage Input Module (such as 720250)
- \*2 Under the standard operating conditions
- \*3 It is not possible to switch a channel associated with the 16-CH Voltage Input Module (720220), 16-CH Temp./Voltage Input Module (720221), CAN Bus Monitor Module (720240), CAN & LIN Bus Monitor Module (720241), CAN/CAN FD Monitor Modules (720242) and SENT Monitor Module (720243) to real-time computation (/G3).
- \*4 The slot 7 and/or 8 cannot be used for signal measurement when the Power Analysis and/or Harmonic Analysis is activated.
- \*5 The LCD may include a few defective pixels (within 5 ppm over the total number of pixels including RGB).

**Measurement Range and Display Range**

The measurement range of the ScopeCorder is ±10 divisions (20 divisions of absolute width (span)) around 0 V. The display range of the screen is ±5 divisions (10 divisions of span). The following functions can be used to move the displayed waveform and display the waveform outside the display range by expanding/reducing the displayed waveform.

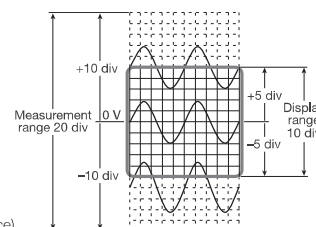

- Move the vertical position.
- Set the offset voltage.
- Zoom in or out of the vertical axis (expand/reduce).

**Outline drawing**

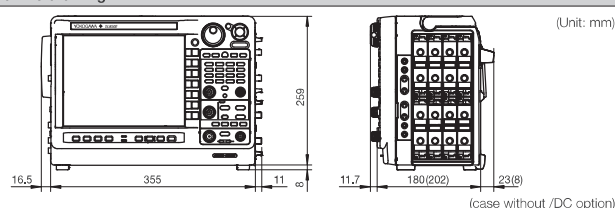



## Model and suffix code

Model	Suffix codes	Description
DL850E		ScopeCorder, 250 M Points (W) memory <sup>1</sup>
DL850EV		ScopeCorder Vehicle Edition, 250 M Points (W) memory <sup>1</sup>
Power	-D	UL and CSA standard
Cord	-F	VDE standard
	-R	AS standard
	-Q	BS standard
	-H	GB standard
	-N	NBR standard
Languages	-HE	English menu and panel
	-HC	Chinese menu and panel
	-HK	Korean menu and panel
	-HG	German menu and panel
	-HF	French menu and panel
	-HL	Italian menu and panel
	-HS	Spanish menu and panel
Options	/B5	Built-in printer (112 mm) <sup>5</sup>
	/DC	DC12 V power (10-18 V DC) (can be specified for DL850EV only) <sup>5</sup>
	/M1	Memory expansion to 1 G Points (W) <sup>2</sup>
	/M2	Memory expansion to 2 G Points (W) <sup>2</sup>
	/HD0	External HDD interface <sup>3</sup>
	/HD1	Internal HDD (500 GB) <sup>3</sup>
	/C1	GP-IB interface <sup>4</sup>
	/C20	IRIG and GP-IB interface <sup>4</sup>
	/C30	GPS interface <sup>4, 7</sup>
	/G2	User-defined math function
	/G3	Real time math function <sup>6</sup>
	/G5	Power math function (with including Real time math function) <sup>6</sup>
	/P4	Four probe power outputs

<sup>1</sup>: The main unit requires plug-in module (s). <sup>2</sup> to <sup>6</sup>: Only one from the each note can be selected.  
<sup>7</sup>: The /C30 option can be provided only for a nation that is not prohibited by the Radio Law.

## Plug-in module model numbers

Model	Description
720211	High-speed 100 MS/s 12 Bit Isolation Module
720250	High-speed 10 MS/s 12 Bit Isolation Module
701251	High-speed 1 MS/s 16 Bit Isolation Module
720254	4 CH 1 MS/s 16 Bit Isolation Module
701255	High-speed 10 MS/s 12 Bit non-Isolation Module
720268	High-Voltage 1 MS/s, 16 Bit Isolation Module (with AAF, RMS)
720220	Voltage Input Module (16 CH)
701261	Universal Module
701262	Universal Module (with Anti-Aliasing Filter)
701265	Temperature/High-Precision Voltage Module
720266	Temperature/High-Precision Voltage Isolation Module (Low Noise)
720221	16 CH Temperature/Voltage Input Module
701953-L1	16 CH Scanner Box (provided with 1 m cable)
701953-L3	16 CH Scanner Box (provided with 3 m cable)
701270	Strain Module (NDIS)
701271	Strain Module (DSUB, Shunt-CAL)
701275	Acceleration/Voltage Module (with Anti-Aliasing Filter)
720281	Frequency Module
720230	Logic Input Module
720242	CAN/CAN FD Monitor Module
720241	CAN & LIN Bus Monitor Module
720243	SENT Monitor Module

\* Probes are not included with any modules.  
<sup>1</sup> The use of a 720221 module always requires the External Scanner Box (model 701953).  
<sup>2</sup> 720240, 720241, 720242 and 720243 modules are available with DL850EV only. Refer to the module selection chart on page 15.

### Yokogawa's Approach to Preserving the Global Environment

- Yokogawa's electrical products are developed and produced in facilities that have received ISO14001 approval.
- In order to protect the global environment, Yokogawa's electrical products are designed in accordance with Yokogawa's Environmentally Friendly Product Design Guidelines and Product Design Assessment Criteria.

## Xviewer model numbers and suffix codes

Model	Suffix Codes	Description
701992	-SP01	Xviewer Standard Edition (1 license)
	-GP01	Xviewer Math Edition (1 license)
Option	/JS01	DL850 Advanced Utility (1 license)

\*Some volume license packs are available. Please contact our sales representative.

## Probes, cables and converters\*<sup>8</sup>

Model	Product	Description <sup>1</sup>
701947	100:1 Probe	1000 V (DC+ACpeak) CAT II, 1.5 m
702902	10:1 Probe	operating temp. range: -40 to 85°C, 2.5 m
700929	10:1 Probe	1000 V (DC+ACpeak) CAT II, 1.5 m
701901	1:1 Safety BNC adapter lead	1000 Vrms CAT II
701904	1:1 Safety Adapter Lead	1000 Vrms CAT II, 600 Vrms CAT III
(in combination with followings)		
	B9852MM Pinchers tip (Hook type)	1000 Vrms CAT III black
	B9852MN Pinchers tip (Hook type)	1000 Vrms CAT III red
701954	Large alligator-clip (Dolphin type)	1000 Vrms CAT III, 1 set each of red and black
758929	Alligator clip adaptor set	1000 Vrms CAT II, 1 set each of red and black
758922	Alligator clip adaptor set	300 Vrms CAT II, 1 set each of red and black
758921	Fork terminal adapter set	1000 Vrms CAT II, 1 set each of red and black
701940	Passive probe <sup>2</sup>	Non-isolated 600 Vpk (701255) (10:1)
366926	1:1 BNC-alligator cable	Non-isolated 42 V or less, 1 m
366961	1:1 Banana-alligator cable	Non-isolated 42 V or less, 1.2 m
701917	Current probe <sup>3,4</sup>	5 Arms, DC to 50 MHz
701918	Current probe <sup>3,4</sup>	5 Arms, DC to 120 MHz
701932	Current probe <sup>3,4</sup>	30 Arms, DC to 100 MHz
701933	Current probe <sup>3,4</sup>	30 Arms, DC to 50 MHz
701930	Current probe <sup>3,4</sup>	150 Arms, DC to 10 MHz
701931	Current probe <sup>3,4</sup>	500 Arms, DC to 2 MHz
720930	Clamp-on probe	AC 50 Arms, 40 Hz to 3.5 kHz
720931	Clamp-on probe	AC 200 Arms, 40 Hz to 3.5 kHz
701934	Probe power supply	External probe power supply (4 outputs)
700924	Differential probe	1400 Vpk, 1000 Vrms CAT II
701926	Differential probe	7000 Vpk, 5000 Vrms
701955	Bridge head (NDIS, 120 Ω)	With 5 m cable
701956	Bridge head (NDIS, 350 Ω)	With 5 m cable
701957	Bridge head (DSUB, 120 Ω)	shunt-CAL with 5 m cable
701958	Bridge head (DSUB, 350 Ω)	shunt-CAL with 5 m cable
758924	Safety BNC-banana adapter	500 Vrms CAT II
B9888AE	Printer roll paper	One lot: 10 rolls, 10m each, for DL850E/EV
702911	Logic probe <sup>5</sup>	8 bit, 1 m, non-Isolated, TTL level/Contact Input
702912	Logic probe <sup>5</sup>	8 bit, 3 m, non-Isolated, TTL level/Contact Input
700986	High-speed logic probe <sup>5</sup>	8 bit, non-Isolated, response speed: 1 μs (typ.)
700987	Isolation logic probe <sup>6</sup>	8 bit, each channel isolated
758917	Measurement lead set	0.75 m, Stackable type (2 per set) Alligator-Clip is required separately.
758933	Measurement lead set	1000 V/19 A/1 m length Alligator-Clip is required separately.
701902	Safety BNC-BNC cable (1 m)	1000 Vrms CAT II (BNC-BNC)
701903	Safety BNC-BNC cable (2 m)	1000 Vrms CAT II (BNC-BNC)
720911	External I/O cable	For DL850E/EV external I/O connection
701948	Plug-on clip	For 700929 and 701947
701906	Long test clip	For 700924, 701901 and 701926
701963	Soft carrying case	For DL850E/DL850EV
701971	DC power supply cable	For DL850EV/DC (Alligator clip type)
701970	DC power supply cable	For DL850EV/DC (Cigarette lighter plug type)

<sup>1</sup>: Actual allowable voltage is the lower of the voltages specified for the main unit and cable.  
<sup>2</sup>: 30 Vrms is safe when using the 701940 with an isolated type BNC input.  
<sup>3</sup>: The number of current probes that can be powered from the main unit's power supply is limited.  
<sup>4</sup>: Either the probe power option of the main unit or the probe power supply (701934) is required.  
<sup>5</sup>: Includes one each of the B9879PX and B9879KX connection leads.  
<sup>6</sup>: Additionally, 758917 and either the 758922 or 758929 are required for measurement.  
<sup>7</sup>: Alligator clip is required.  
<sup>8</sup>: Refer to the bulletin, user's manual of each products to confirm compatibility of each accessory and main unit.

This is a Class A instrument based on Emission standards EN61326-1 and EN55011, and is designed for an industrial environment.  
 Operation of this equipment in a residential area may cause radio interference, in which case users will be responsible for any interference which they cause.

ScopeCorder, **GIGACOM** are registered trademarks of Yokogawa Electric Corporation.  
 \*Any company's names and product names mentioned in this document are trade names, trademarks or registered trademarks of their respective companies.  
 The User's Manuals of this product are provided by CD-ROM.

### NOTICE

- Before operating the product, read the user's manual thoroughly for proper and safe operation.



### YOKOGAWA TEST & MEASUREMENT CORPORATION

Global Sales Dept. /Phone: +81-422-52-6237 E-mail: tm@cs.jp.yokogawa.com  
 Facsimile: +81-422-52-6462

### YOKOGAWA CORPORATION OF AMERICA

#### YOKOGAWA EUROPE B.V.

#### YOKOGAWA TEST & MEASUREMENT (SHANGHAI) CO., LTD.

#### YOKOGAWA ELECTRIC KOREA CO., LTD.

#### YOKOGAWA ENGINEERING ASIA PTE. LTD.

#### YOKOGAWA INDIA LTD.

#### YOKOGAWA ELECTRIC CIS LTD.

#### YOKOGAWA AMERICA DO SUL LTDA.

#### YOKOGAWA MIDDLE EAST & AFRICA B.S.C(c)

Phone: +1-800-888-6400

Phone: +31-88-4641429

Phone: +86-21-6239-6363

Phone: +82-2-2628-3810

Phone: +65-6241-9933

Phone: +91-80-4158-6396

Phone: +7-495-737-78-68

Phone: +55-11-3513-1300

Phone: +973-17-358100

E-mail: tmi@us.yokogawa.com

E-mail: tmi@nl.yokogawa.com

E-mail: tmi@cs.cn.yokogawa.com

E-mail: TMI@kr.yokogawa.com

E-mail: TMI@sg.yokogawa.com

E-mail: tmi@in.yokogawa.com

E-mail: info@ru.yokogawa.com

E-mail: tm@br.yokogawa.com

E-mail: help.ymatmi@bh.yokogawa.com

YMI-KS-MI-SE07

<https://tmi.yokogawa.com/>

The contents in this catalog is as of April 2019. Subject to change without notice.

Copyright © 2012, Yokogawa Test & Measurement Corporation

[Ed: 07/b]

Printed in Japan, 904(KP)

Facsimile: +86-21-6880-4987

Facsimile: +82-2-2628-3899

Facsimile: +65-6241-9919

Facsimile: +91-80-2852-1442

Facsimile: +7-495-737-78-69

Facsimile: +973-17-336100