

**MODEL 562
SCALAR NETWORK ANALYZER
OPERATION MANUAL**

For "Model 562 Version 3.2 Software"

(Software version number appears
on the CRT display when the 562
undergoes a self test.)



WILTRON

490 JARVIS DRIVE • MORGAN HILL, CA 95037-2609
TEL. (408) 778-2000 • TELEX 285227 WILTRON MH • FAX 408-778-0239

WARRANTY

All WILTRON products are warranted against defects in materials and workmanship for one year from the date of shipment, except for YIG-tuned oscillators, which are warranted for two years. WILTRON's obligation covers repairing or replacing products which prove to be defective during the warranty period. Buyers shall prepay transportation charges for equipment returned to WILTRON for warranty repairs. Obligation is limited to the original purchaser. WILTRON is not liable for consequential damages.

LIMITATION OF WARRANTY

The foregoing warranty does not apply to WILTRON connectors that have failed due to normal wear. Also, the warranty does not apply to defects resulting from improper or inadequate maintenance by the Buyer, unauthorized modification or misuse, or operation outside of the environmental specifications of the product. No other warranty is expressed or implied, and the remedies provided herein are the Buyer's sole and exclusive remedies.

CONTENTS

Paragraph	Title	Page
SECTION I — GENERAL INFORMATION		
1-1	SCOPE OF THE MANUAL	1-3
1-2	INTRODUCTION	1-3
1-3	IDENTIFICATION NUMBER	1-3
1-4	DESCRIPTION OF 562 SYSTEM	1-3
1-5	EQUIPMENT REQUIRED	1-4
1-6	OPTIONS	1-4
1-7	ACCESSORIES	1-4
1-8	SPECIFICATIONS	1-4
1-9	PRECAUTIONS FOR USE OF SWR AUTOTESTER AND RF DETECTORS	1-4
1-10	SYSTEM ELEMENTS	1-9
1-11	RECOMMENDED TEST EQUIPMENT	1-10
SECTION II — INSTALLATION		
2-1	INTRODUCTION	2-3
2-2	INITIAL INSPECTION	2-3
2-3	PREPARATION FOR USE	2-3
2-4	GPIB SETUP AND INTERCONNECTION	2-3
2-4.1	Interface Connector	2-3
2-4.2	Cable Length Restrictions	2-3
2-4.3	GPIB Interconnection	2-3
2-4.4	GPIB Address	2-5
2-4.5	Data Delimiting	2-5
2-5	SWEEP GENERATOR INTERCONNECTION	2-5
2-5.1	WILTRON 6600B Sweep Generator	2-5
2-5.2	Other Sweep Generators	2-5
2-6	PREPARATION FOR STORAGE AND/OR SHIPMENT	2-5
2-6.1	Preparation for Storage	2-5
2-6.2	Preparation for Shipment	2-5
SECTION III — FRONT PANEL OPERATION		
3-1	INTRODUCTION	3-3
3-2	CRT DISPLAY	3-3
3-3	SYSTEM FUNCTION KEYS AND MENUS	3-4
3-3.1	SAVE/RECALL Key And Menus	3-4
3-3.2	SELF TEST Key	3-5
3-3.3	SYSTEM MENU Key and Menu	3-5
3-4	DISPLAY KEYS, INDICATORS, AND MENUS	3-9

CONTENTS (Continued)

Paragraph	Title	Page
3-4.1	CHANNEL ON/OFF Key and Indicator	3-9
3-4.2	OFFSET/RESOLUTION Key and Menus	3-9
3-4.3	AUTOSCALE Key	3-9
3-4.4	LIMITS Keys and Menus	3-9
3-4.5	MENU Key and Menus	3-9
3-4.6	CALIBRATION Key and Menus	3-12
3-4.7	UNCAL Indicator	3-12
3-4.8	BEGIN Indicator	3-12
3-5	DATA ENTRY/CURSOR KEYS AND KNOB	3-12
3-5.1	Knob	3-12
3-5.2	Keypad	3-14
3-5.3	ENTER Key	3-14
3-5.4	CLEAR Key	3-14
3-6	HARD COPY KEYS AND MENUS	3-14
3-6.1	MENU Key and Menus	3-14
3-6.2	START PRINT Key	3-14
3-6.3	STOP PRINT Key	3-17
3-7	CURSOR FUNCTION KEYS, INDICATORS, AND MENUS	3-17
3-7.1	CURSOR ON/OFF Key	3-17
3-7.2	RELATIVE CURSOR ON/OFF Key	3-17
3-7.3	CURSOR MEASUREMENTS Keys and Menus	3-17
3-8	ENHANCEMENT KEYS, INDICATORS, AND MENUS	3-17
3-8.1	SMOOTHING Key and Indicators	3-19
3-8.2	AVERAGING Key, Indicator, and Menu	3-19
3-9	GPIB INDICATOR, KEY, AND STATUS DISPLAY	3-19
3-9.1	REMOTE Indicator	3-19
3-9.2	RETURN TO LOCAL Key	3-20
3-10	REAR PANEL CONNECTORS	3-20
3-11	MEASUREMENTS WITH THE 562 SCALAR NETWORK ANALYZER	3-20
3-11.1	Transmission and Return Loss Measurements	3-20
3-11.2	Absolute Power Measurement	3-20
3-11.3	Alternate Setup Measurements	3-20
3-11.4	Operational Checkout	3-20
3-11.5	Ratio-Mode Measurements	3-20
3-12	ERROR MESSAGES	3-20
3-13	562 ANALYZER CONNECTIONS TO WILTRON SWEEP GENERATORS	3-20
SECTION IV — REMOTE (GPIB) OPERATION		
4-1	INTRODUCTION	4-3
4-2	DESCRIPTION OF THE IEEE-488 INTERFACE BUS	4-3
4-2.1	Data Bus Description	4-3
4-2.2	Management Bus Description	4-3

CONTENTS (Continued)

Paragraph	Title	Page
4-2.3	Data Byte Transfer Control (Handshake) Bus Description . . .	4-4
4-3	GPIB OPERATION	4-4
4-4	COMMAND CODES, DESCRIPTIONS	4-4
4-4.1	Inputting Restrictions and Notes	4-4
4-4.2	Reserved Mnemonics	4-5
4-5	BUS MESSAGES, ANALYZER RESPONSE TO	4-5
4-6	ALPHABETICAL INDEX TO ANALYZER COMMAND CODES	4-5

List of Figures

Illustrations	Title	Page
Figure 1-1.	Models 562 Scalar Network Analyzer and 2225C Series Inkjet Printer	1-3
Figure 1-2.	Reading N Connector Pin Depth	1-5
Figure 1-3.	Pin Depth Gauge	1-5
Figure 2-1.	Changing the Analyzer LINE SELECT Switch	2-4
Figure 2-2.	Pinout for Rear Panel GPIB Connector	2-4
Figure 3-1.	Model 562 Scalar Network Analyzer Front Panel Controls	3-2
Figure 3-2.	Typical Model 562 CRT Display	3-3
Figure 3-3.	SAVE/RECALL Key Menus	3-4
Figure 3-4.	SYSTEM FUNCTION Keys	3-4
Figure 3-5.	SYSTEM MENU and Factory-Selected Settings	3-6
Figure 3-6.	APPLICATIONS MENU	3-7
Figure 3-7.	DISPLAY Keys and Indicators	3-9
Figure 3-8.	OFFSET/RESOLUTION Key Menu	3-10
Figure 3-9.	LIMITS Key Menu	3-10
Figure 3-10.	DISPLAY MENU Key Menu	3-11
Figure 3-11.	DATA ENTRY Keys and Knob	3-12
Figure 3-12.	CALIBRATION Key Menu Sequence	3-13
Figure 3-13.	HARD COPY Keys	3-14
Figure 3-14.	HARD COPY Menu	3-15
Figure 3-15.	Hard Copy Examples	3-16
Figure 3-16.	CURSOR Keys and Indicators	3-17
Figure 3-17.	CURSOR MEASUREMENTS Menus (With RELATIVE CURSOR Off)	3-18
Figure 3-18.	CURSOR MEASUREMENTS Menus (With RELATIVE CURSOR On)	3-18
Figure 3-19.	dB Search Mode Cursor, Bandwidth	3-19
Figure 3-20.	ENHANCEMENT Keys and Indicators	3-19

List of Figures (Continued)

Illustrations	Title	Page
Figure 3-21.	AVERAGING Menu	3-19
Figure 3-22.	GPIB Indicator and Key	3-19
Figure 3-23.	GPIB Status Display	3-19
Figure 3-24.	Location of Rear Panel Connectors	3-21
Figure 3-25.	Measurement Test Setup	3-16
Figure 3-26.	Test Setup for Ratio Mode Measurements	3-23
Figure 4-1.	Interface Connections and Bus Structure	4-2
Figure 4-2.	Typical Handshake Operation	4-4
Figure 4-3.	Programming Example: Complex Limits	4-8
Figure 4-4.	Programming Example: Service Request	4-12
Figure 4-5.	Redirected Status Byte	4-13
Figure 4-6.	Programming Example: SCP (mask)	4-15
Figure 4-7.	Available Parameters, OPM(X)	4-17
Figure 4-8.	Sample Program: RDR Command	4-20

List of Tables

Illustrations	Title	Page
Table 1-1	RF Component Pin Depth Tolerance	1-5
Table 1-2	Specifications	1-6
Table 1-3	SWR Autotesters	1-9
Table 1-4	560 Series Detector Parameters	1-10
Table 1-5	Recommended Test Equipment	1-11/1-12
Table 2-1	WILTRON International Sales Representatives	2-7/2-8
Table 3-1	Transmission and Return Loss Measurements	3-23
Table 3-2	Absolute Power Measurements	3-19
Table 3-3	Alternate Setup Measurements	3-26
Table 3-4	Operational Checkout Procedure	3-28
Table 3-5	Ratio Mode Measurements	3-29
Table 3-6	Control Panel LED Error Codes	3-31
Table 3-7	Interconnections, 562 to WILTRON and Other Sweep Generators	3-32
Table 4-1.	562 IEEE-488 Bus Subset Capability	4-5
Table 4-2	Command Codes: Display Channel Control	4-6
Table 4-3	Command Codes: Calibration, Graticle Display, System Functions, Diagnostic Facilities, Averaging, Smoothing	4-10
Table 4-4	Command Codes: Service Request	4-11
Table 4-5	Command Codes: Cursor Control and Search Facility	4-13

List of Tables (Continued)

Illustrations	Title	Page
Table 4-6	Command Codes: Hard Copy	4-14
Table 4-7	Command Codes: Output Functions	4-16
Table 4-8	Command Codes: Data Strings	4-18
Table 4-9	Command Codes: Pass Through Codes	4-19
Table 4-10	Command Codes: General Functions	4-21
Table 4-11	Command Codes: Special Functions (APPLICATIONS Menu)	4-21
Table 4-12	Bus Messages Recognized By the 562	4-24
Table 4-13	Methods of Generating Bus Commands	4-25
Table 4-14	Alphabetical Index to the Command Codes	4-26

SECTION I GENERAL INFORMATION

CONTENTS

Paragraph	Title	Page
1-1	SCOPE OF THE MANUAL	1-3
1-2	INTRODUCTION	1-3
1-3	IDENTIFICATION NUMBER	1-3
1-4	DESCRIPTION OF 562 SYSTEM	1-3
1-5	EQUIPMENT REQUIRED	1-4
1-6	OPTIONS	1-4
1-7	ACCESSORIES	1-4
1-8	SPECIFICATIONS	1-4
1-9	PRECAUTIONS FOR USE OF SWR AUTOTESTERS AND RF DETECTORS	1-4
1-10	SYSTEM ELEMENTS	1-9
1-11	RECOMMENDED TEST EQUIPMENT	1-10

SECTION I GENERAL INFORMATION

1-1 SCOPE OF THE MANUAL

This manual provides general, installation, and operation information for the Model 562 Scalar Network Analyzer (Figure 1-1).

1-2 INTRODUCTION

Section I provides information about the equipment identification number, performance specifications, and options.

1-3 IDENTIFICATION NUMBER

All WILTRON instruments are assigned a six-digit ID number, such as "505001." This number appears on a decal affixed to the rear panel. Please use this

identification number in any future correspondence with WILTRON Customer Service about this instrument.

1-4 DESCRIPTION OF 562 SYSTEM

The Model 562 Scalar Network Analyzer is a microprocessor-based analyzer used to make scalar (magnitude) reflection and transmission measurements and absolute power measurements over a frequency range determined by the source sweeper and the external detectors used. The 562 is programmable over the IEEE-488 interface bus (GPIB). Also, because of the extensive use of internal microprocessors, the 562 can make the majority of measurements without an external controller.

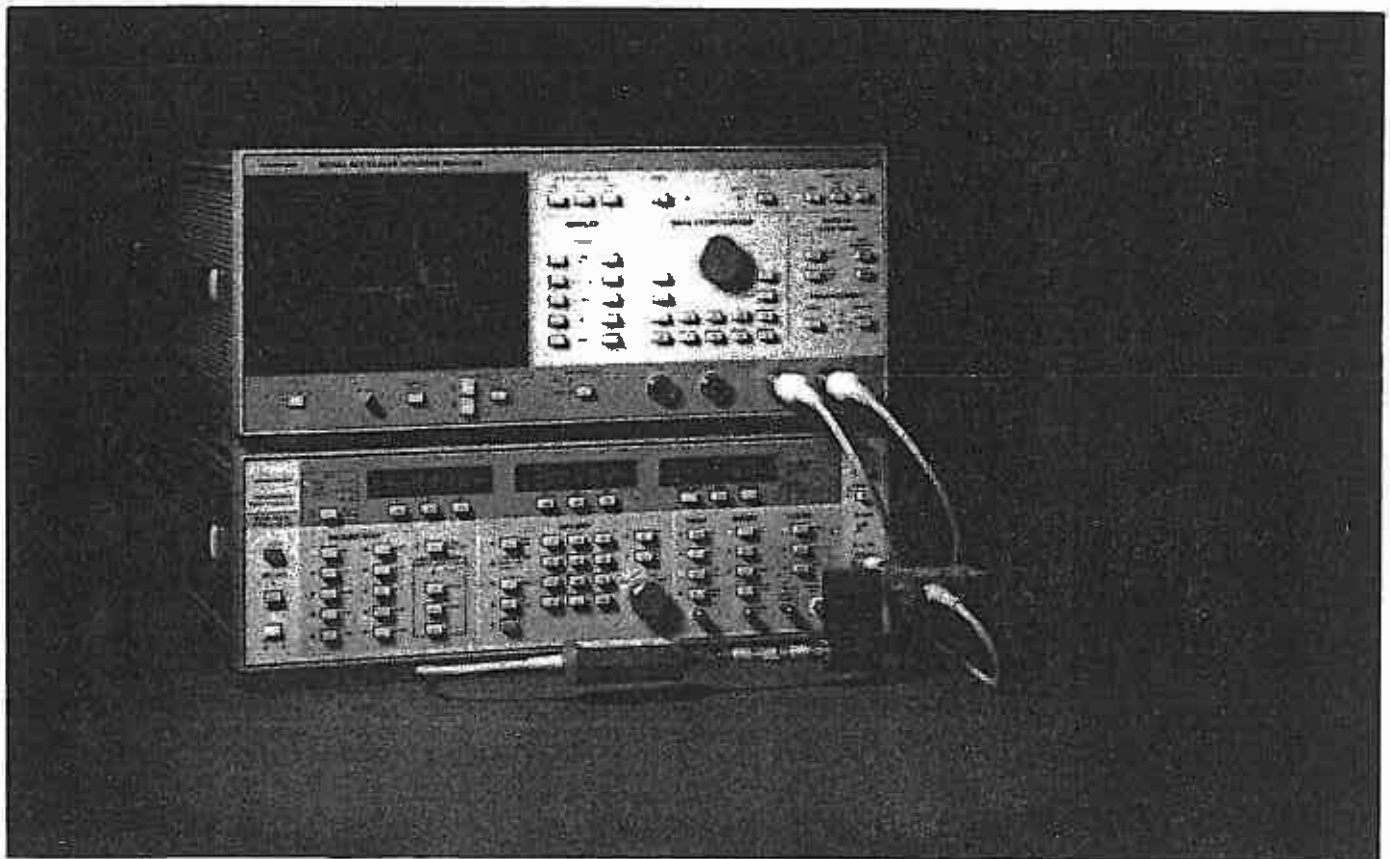

Figure 1-1. Model 562 Scalar Network Analyzer Shown With a WILTRON 6669B 40 GHz Sweep Generator

1-5 EQUIPMENT REQUIRED

The Model 562 Scalar Network Analyzer system requires interconnection with a sweep generator to provide the necessary horizontal, dwell and blanking voltages. The 562 is designed for use with the WILTRON 6600B Series Programmable Sweep Generators and WILTRON 6700A Series Swept Frequency Synthesizers. It is supplied with a dedicated system bus cable (P/N 2100-1) and auxiliary I/O cable (P/N 806-7). It is also compatible with other sweep generators that meet the SIGNAL SOURCE Compatibility requirements listed in Table 1-2.

1-6 OPTIONS

The following options are available:

Option 1, Rack Mount. A kit is available containing mounting brackets and chassis track slides. The track slides have a 90-degree tilt capability.

Option 5, Protective Cover. The 562 Scalar Network Analyzer is available with a protective cover, WILTRON P/N: SPEC-D-31359-3, for the control (front) panel.

1-7 ACCESSORIES

The following accessories are available:

Extender Cables. Extender cables can be installed between the SWR Autotester or detectors and the 562, permitting measurements from up to 200 feet. Cable part numbers and lengths are shown below.

Model	Cable Length
800-109	7.6m (25 ft)
800-110	15.2m (50 ft)
800-111	30.5m (100 ft)
800-112	61m (200 ft)

GPIB Cables. GPIB cables interconnect instruments on the GPIB. GPIB cable model numbers and lengths are shown below.

Model	Cable Length
2100-1	1m (3.3 ft)
2100-2	2m (6.6 ft)
2100-4	4m (13.2 ft)
2100-5	0.5m (1.65 ft)

Adapter Cables. Adapter cables allow the 562 to be used with (1) a waveguide or other detectors having a BNC or SMA female output connector or (2)

for "volt mode" operation. The cable length is 1.2 m (4 ft). Model numbers and connector types are shown below.

Model	Connector
562-15BX	Volt Mode (BNC Male)
560-10BX	BNC Male
560-10BX-1	SMA Male
	(for use with Hughes detectors)

Open/Shorts. An Open/Short is used to establish a 0 dB return loss reference during the calibration procedure. Model part numbers and connector types are shown below.

Model	Connector
22A50	GPC-7
22K50	K Male
22KF50	K Female
22N50	N Male
22NF50	N Female
22S50	WSMA Male
22SF50	WSMA Female

1-8 SPECIFICATIONS

Specifications for the Model 562 Scalar Network Analyzer and the 560 Series SWR Autotesters and RF Detectors are provided in Tables 1-3 and 1-4.

1-9 PRECAUTIONS FOR USE OF SWR AUTOTESTERS AND RF DETECTORS

The 560 Series SWR Autotesters and RF Detectors are high-quality, precision laboratory instruments and should receive the same care and respect afforded other such instruments. Complying with the following precautionary notes will guarantee longer component life and less equipment downtime due to connector failure. Also, such compliance will ensure that RF component failures are not due to misuse or abuse—two failure causes not covered under the WILTRON warranty.

a. Beware of destructive Pin Depth on Mating Connectors

Measure the pin depth (Figure 1-2) of the connector that mates with the RF component, before mating, using a WILTRON Pin Depth Gauge (Figure 1-3) or equivalent. Based on RF components returned for repair, destructive pin depth on mating connectors is the major cause of failure in the field. When an RF component connector is mated with a connector having a destructive pin depth, damage will likely occur

to the RF component connector. (A destructive pin depth has a center pin that is too long in respect to the connector's reference plane.)

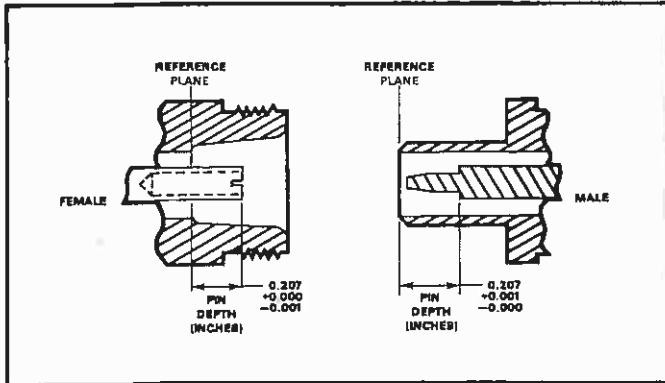

Figure 1-2. Reading N Connector Pin Depth



Figure 1-3. Pin Depth Gauge

The center pin on an RF component connector has a precision tolerance measured in mils (1/1000 inch), whereas connectors on test devices that mate with RF components may not be precision types, and their pins may not have the proper depth. Consequently, they must be measured before mating to ensure suitability. When gauging pin depth, if the test device connector measures out of tolerance (Table 1-1) in the "+" region, the center pin is too long. Mating under this condition will likely damage the RF component connector. On the other hand, if the test device connector measures out of tolerance in the "-" region, the center pin is too short. While this will not cause any damage, it will result in a poor connection and a consequent degradation in performance.

Table 1-1. RF Component Pin Depth Tolerance

Test Port Connector Type	Pin Depth (Mils)	Wiltron Gauge Reading
N-Male	207 -0.000 +0.003	210 -0.000 +0.003
N-Female	207 +0.000 -0.003	same as pin depth

b. Avoid Over-Torquing Connectors

Over-torquing connectors is destructive; it may damage the connector center pin. Finger-tight is usually sufficient, especially on Type N connectors. *Never* use pliers to tighten connectors.

c. Do Not Disturb Teflon Tuning Washers On Connector Center Pins

The center conductor on many RF component connectors contains a small teflon tuning washer located near the point of mating (interface). This washer compensates for minor impedance discontinuities at the interface. The washer's location is critical to the RF component's performance. *Do not disturb it.*

d. Avoid Mechanical Shock

RF components are designed to withstand years of normal bench handling. However, do not drop or otherwise treat them roughly. They are laboratory-quality devices, and like other such devices, they require careful handling.

e. Keep Connectors Clean

The precise geometry that makes possible the RF component's high performance can be easily disturbed by dirt and other contamination adhering to connector interfaces. When not in use, keep the connectors covered.

Table 1-2. Specifications (1 of 3)

MEASUREMENTS

Measurement Modes: Transmission, Power, Return Loss, SWR, Voltage.

Frequency Range: 10 MHz to 40 GHz in coax using WILTRON 560 Series Detectors and SWR Autotesters. Measurements can be made at higher frequencies with waveguide detectors and WILTRON 560-10BX or 560-10BX-1 Adapter Cables.

Inputs: Four Inputs, A, B, R1, and R2 accept detected outputs from WILTRON 560 Series Detectors and SWR Autotesters.

Dynamic Range: 76 dB (-60 dBm to +16 dBm) on all channels, usable to -65 dBm.

Data Correction: System residuals, including the average of open and short reflections, are stored during calibration for automatic subtraction from test data.

Calibration: During the calibration sequence, the number of data points used for each trace are stored with 0.002 dB resolution over any user-selected frequency range. Calibration data are automatically interpolated for ranges less than the original normalized range.

Trace Memory: For both channels, any trace, measurement, or complex limit line may be subtracted from any subsequent measurement.

Save/Recall: Nine sets of front-panel settings (four sets include calibration data and trace memories) can be stored for later recall. All stored data can be previewed on the CRT or printer output prior to selection.

DISPLAY

Channels: Two channels are used to select and simultaneously display any two inputs from A, B, R1, or R2. The same inputs can be displayed as ratios of A/R1, A/R2, B/R1, or B/R2.

Alternate Sweep: Displays alternate sweeps between the current front-panel setup and any of nine stored setups when used in conjunction with any of the sweepers using dedicated GPIB, as indicated in Table 3-7.

Graticule: Ten vertical divisions. Horizontal divisions are set automatically in frequency increments of a 1, 2, 5 sequence. The graticule On/Off control turns all

graticule lines off. Tick marks remain on each axis to indicate graticule position.

Display Resolution:

Horizontal: 101, 201, or 401 points per trace over the selected frequency range.

Vertical: 0.005 dB

Limit Lines: Two lines, either straight or complex, for each trace. Complex lines may be made from up to 10 segments. Measurement data can be compared with limit lines for Pass/Fail testing.

SCALING

Resolution: 0.1 dB to 10 dB per division in 0.1 dB steps with independent control for each channel.

Offset Range: -99.9 dB to +99.9 dB in 0.1 dB steps.

Autoscale: Automatically selects offset and resolution to provide optimum display of test data.

Trace Update Time: Typically less than 100 ms, varying with frequency range, averaging and smoothing settings, and number of data points selected.

Smoothing: Off, Minimum, and Maximum selections use analog techniques to reduce noise on low-level traces. Trace update time is automatically adjusted for any combination of averaging and smoothing.

Averaging: 4, 8, 16, 32, 64, 128, or 256 successive traces can be averaged to smooth the trace display.

CRT Intensity: Variably adjustable from off to bright.

MARKERS AND CURSORS

Markers: Up to eight numerically identified markers generated by the 6600B Sweep Generator and nine with the 6700A Synthesizer may be displayed on the 562. Marker frequency and type are selected on the sweeper. A marker is designated as "Active" if it is open to DATA ENTRY.

Cursor: Position is selectable via tuning knob. Amplitude at the cursor frequency is displayed for both traces.

Cursor Delta: Displays the frequency and amplitude difference between the main Cursor and Relative Cursor for both traces. A menu selection reverses the position of the two cursors.

Cursor Min/Max: Moves the cursor to the minimum or maximum point on the trace as selected.

Table 1-2. Specifications (2 of 3)

Cursor "X" dB: Moves cursor to "X" value on either trace.

Cursor Delta "X" dB: Moves the main Cursor to "X" value relative to Reference Cursor.

Cursor "X" dB Bandwidth: Moves both main Cursor and Reference Cursors to the first "X" dB value to the left and to the right of the initial reference position.

SIGNAL SOURCE

Recommended Signal Sources: The WILTRON 6600B Sweep Generators and 6700A synthesizers are directly compatible with the 562. A dedicated GPIB system interface supplies frequency annotation on the 562 display to form an intelligent link.

Compatibility: The 562 is compatible with any signal source that meets the following minimum requirements:

- **Horizontal Ramp:** Provides a 0V to +10V nominal ramp signal, +12 V maximum.
- **Blanking Signal:** Provides +5V during retrace and bandswitching.
- **Dwell Signal:** Outputs TTL-Low signal to dwell sweep ramp.

ACCURACY

Transmission Loss or Gain Accuracy: Uncertainties from frequency response of components are automatically subtracted from test data during the calibration procedure.

Overall accuracy is then:

Channel Accuracy (25°C)

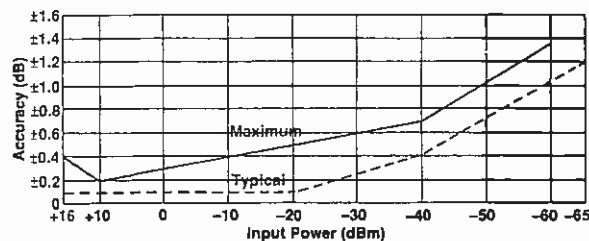

$$\text{Transmission Loss or Gain Accuracy} = \text{Channel Accuracy} + \text{Mismatch Uncertainty}^*$$

**Effects of sweep generator, test device, SWR Autotester and detector mismatch can be significant. This mismatch uncertainty is minimized by Wiltron's exceptionally low reflection characteristics of the detector, sweep generator and SWR Autotester.*

Overall Coaxial Return Loss Measurement Accuracy: Uncertainties resulting from SWR Autotester and sweep generator frequency response and from system open and short characteristics are automatically subtracted from test data. Overall accuracy is then:

Overall Waveguide Return-Loss Measurement Accuracy:

$$\text{Return Loss Accuracy} = \text{Channel Accuracy} + \text{SWR Autotester Accuracy}$$

Mismatch Uncertainty (Typical)*

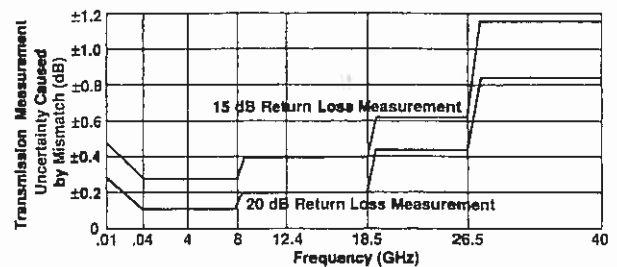

**Varies with the return loss of the detector, SWR Autotester, connecting cables, the source impedance of the sweep generator, and the value of the measured reflection.*

SWR Autotester Accuracy:

Model	Accuracy of Measured Reflection Coefficient (p)**			
	10 MHz-8 GHz	8-18 GHz	18-26.5 GHz	26.5-40 GHz
560-97A50	0.016±0.06p ²	0.016±0.1p ²	N/A	N/A
560-97A50-1	0.010±0.06p ²	0.010±0.1p ²	N/A	N/A
560-97N50	0.018±0.08p ²	0.018±0.12p ²	N/A	N/A
560-97N50-1	0.013±0.08p ²	0.013±0.12p ²	N/A	N/A
560-97NF50	0.018±0.08p ²	0.018±0.12p ²	N/A	N/A
560-97NF50-1	0.013±0.08p ²	0.013±0.12p ²	N/A	N/A
560-98K50	0.018±0.15p ²	0.018±0.15p ²	0.025±0.15p ²	0.032±0.16p ²
560-98KF50				
560-98S50	0.018±0.1p ²	0.018±0.1p ²	0.025±0.12p ²	N/A
560-98S50-1	0.013±0.1p ²	0.013±0.1p ²	0.018±0.12p ²	N/A
560-98SF50	0.018±0.1p ²	0.018±0.1p ²	0.025±0.12p ²	N/A
560-98SF50-1	0.013±0.1p ²	0.013±0.1p ²	0.018±0.12p ²	N/A

***Accuracy includes the effects of directivity and test port reflection over the frequency range.*

Table 1-2. Specifications (3 of 3)

In addition, mismatch uncertainties introduced by the detectors used in a waveguide reflectometer setup can be significant.

$$\text{Return Loss Accuracy} = \text{Channel Accuracy} + \text{User-Selected Coupler Accuracy}$$

Power Measurement Accuracy:
GIPIB

Interface: IEEE-488 interface is standard on all in-

$$\text{Absolute Power Accuracy} = \text{Channel Accuracy} + \text{Detector Frequency Response}$$

Detector Frequency Response:

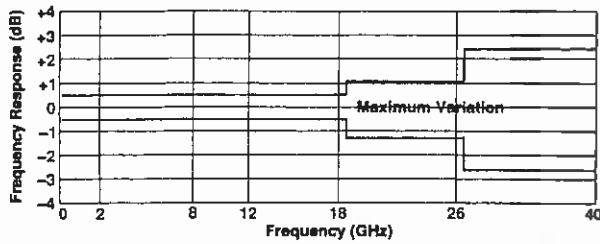

struments. All front panel controls are GPIB controllable except power on/off and CRT intensity. A dedicated GPIB connects to a WILTRON 6600A, 6600B, and HP 8350B Sweep Generators or 6700A Series Swept Frequency Synthesizers and HP 8340/8341 Synthesizers. Pass-through commands allow control of the signal source through the 562 dedicated GPIB port.

Data Transfer: The 562 does not require an external controller for most measurements; nevertheless, it is capable of providing high speed transfer of test data and normalization data to and from an external GPIB controller.

PRINTER/PLOTTER

Printer: The parallel printer interface is compatible with most dot-matrix printers, including Epson FX and HP Thinkjet. Hard copy output in graphical or tabular format can be selected. Selections include graphics with measurement parameters, test data tabulated for 26, 51, 101, 201, or 401 points, marker parameters only, or stored setup parameters. Complex limit lines may also be printed.

Plotter: The dedicated system GPIB interface is compatible with HP Models 7440A, 7470A, and 7475A Plotters. Display traces, markers, cursor, and graticule information are copied. When overlay traces are desired, data traces only can be plotted.

Internal Print Buffer: After approximately 20 seconds of print formatting, a new test can be conducted while previously taken test data are being printed out from an internal printer buffer.

INPUT/OUTPUT CONNECTIONS

Horizontal Sweep Ramp Input: 0 to +10V nominal, +12V maximum. Rear panel BNC connector, 100 kΩ impedance.

Sequential Sync Input: +3.5V to +10V blanks trace during retrace or bandswitching. -3.5V to -10V defines a marker which when in the range of -8V to -10V is an active marker. Rear panel BNC connector, 10 kΩ impedance.

Sweep Dwell Output: TTL-low signal stops sweep. Sweep continues when signal is removed. Rear panel BNC connector.

Bandswitch Blanking Input: Accepts ±5V signal coincident with bandswitching points. Rear panel BNC connector.

Retrace Blanking Input: ±5V blanks traces during retrace. Rear panel BNC connector.

Video Marker Input: ± 2V to ±10V peak input. Rear panel BNC connector.

GPIB IEEE 488: Connects 562 to GPIB controller. Rear panel GPIB connector.

Dedicated GPIB: Connects 562 to WILTRON or HP signal source and plotter. Rear panel GPIB connector.

Parallel Printer (Centronics): Connects 562 to printer. Rear panel.

AUX I/O: Connects 562 to WILTRON 6600B and HP8350B Sweep Generators and to WILTRON 6700A and HP8340/8341 Synthesizers. Rear panel.

GENERAL

Temperature Range:

Operating: 0°C to +50°C

Storage: -40°C to +70°C

Power: 100V/110V/220V/240V ±10%, 48-66 Hz, 130 VA maximum

Dimensions:

177H x 432W x 476D mm + 10mm for feet.

(7H x 17W x 18-3/4D in. + 3/8 in. for feet)

Weight: 16 kg (35 lb)

1-10 SYSTEM ELEMENTS

a. Network Analyzer

The 562 Scalar Network Analyzer provides a simultaneous display of transmission loss/gain and return loss or power, SWR, volts, and custom measurements. A complete measurement system includes a signal source, a 560 Series SWR Autotester and Detector (6400 Series Autotesters and Detectors may also be used). Interface with waveguide detectors is provided by the 560-10BX or 560-10BX-1 Adapter Cables. The system makes direct connection to a printer or plotter and does not require an external controller. An interface cable to measure volts is also available (P/N 562-15BX).

b. Signal Source

The 562 is compatible with the WILTRON 6600A, 6600B, and HP 8350B Sweep Generators and WILTRON 6700, HP 8340A, and HP 8341A Synthesizers or other signal sources that meet the interface requirements listed under SIGNAL SOURCE Compatibility in Table 1-2.

c. SWR Autotester

The 560 Series SWR Autotesters (Table 1-3) integrate in one small package a broadband, high directivity bridge, a detector, a low reflection test port, a reference termination, and a connecting cable. The output of the SWR Autotester is a detected signal, varying in proportion to reflections from the test device connected to the test port. Optional extender cables can be used without degradation in performance.

Accuracy: See accuracy chart on page 1-7.

Maximum Input Power: 500 mW

Cable Length: 122 cm (4 ft)

Insertion Loss: 6.5 dB nominal from input port to test port.

Dimensions and Weight:

Model	Dimensions*	Weight
560-97A50, -1	7.6 x 5 x 2.8 cm	340 g
560-97N50, -97NF50, -1	(3 x 2 x 1-1/8 in.)	425g
560-98K50, -98KF50	5.3 x 3.8 x 1.9 cm	198 g
560-98S50, -98SF50, -1	(2-1/8 x 1-1/2 x 3/4 in.)	

*Plus Connectors and cable.

Table 1-3.SWR Autotesters

Model	Frequency Range (GHz)	Directivity (dB)	Frequency Sensitivity (dB)	Test Port Connector	Input Connector
560-97A50 560-97A50-1	0.01-18	36 40	±1.2	GPC-7	N Female
560-97N50 560-97N50-1	0.01-18	35 38	±1.5	N Male	N Female
560-97NF50 560-97NF50-1	0.01-18	35 38	±1.5	N Female	N Female
560-98S50 560-98S50-1	0.01-26.5	32 35	±2	WSMA Male	Ruggedized WSMA Female
560-98SF50 560-98SF50-1	0.01-26.5	32 35	±2	WSMA Female	Ruggedized WSMA Female
560-98K50 560-98KF50	0.01- 40	30 30	±3	K Male K Female	Ruggedized K Female

d. Detector

The 560 Series Detectors (Table 1-4) are used for coaxial transmission loss or gain, power measurements, and with coaxial adapters for waveguide reflectometer measurements. Zero-biased, replaceable Schottky diodes provide -60 dBm sensitivity. Optional extender cables can be used without degradation in performance. Field replacement of the detector diode is possible with most of the 560-7 Series RF Detectors.

- Maximum Input Power:** 100 mW
- Cable Length:** 122 cm (4 ft)
- Dimensions:** 7.6 x 2.9 x 2.2 cm (3 x 1-1/8 x 7/8 in.)
- Weight:** 170g (6 oz)

Detector Return Loss:

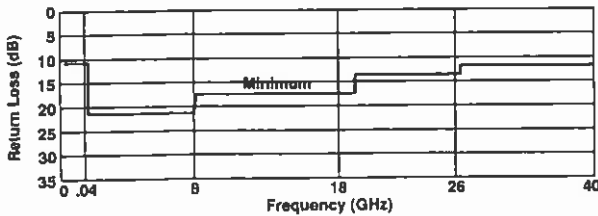

1-11 RECOMMENDED TEST EQUIPMENT

Table 1-5 provides a list of recommended test equipment needed to check, calibrate, service, and troubleshoot the Model 562 Scalar Network Analyzer. The entries are coded to show for which types of testing the equipment is used. These codes are described below.

<i>Code</i>	<i>Type of Testing</i>
C	Calibration
O	Operational Checkout
P	Performance Verification
T	Troubleshooting

Table 1-4. 560 Series Detector Parameters

Model	Frequency Range	Input Connector	Diode Module Model
560-7A50	10 MHz to 18 GHz	GPC-7	560-A-7219-A
560-7K50	10 MHz to 40 GHz	K Male	ND19393 (Wiltron)
560-7N50	10 MHz to 18.5 GHz	N Male	560-A-7219-A
560-7S50	10 MHz to 18.5 GHz	WSMA Male	560-A-7219-A
560-7S50-2	10 MHz to 26.5 GHz	WSMA Male	560-A7219-B

Table 1-5. Recommended Test Equipment

INSTRUMENT	CRITICAL SPECIFICATION	RECOMMENDED MANUFACTURER	USE *
Power Meter	<i>Power Range: -30 to +20 dBm</i> <i>Other: GPIB Controllable</i>	Hewlett-Packard, Model 436A, with Opt 022 (HPIB)	O, P, C
Power Sensor	<i>Frequency Range: 0.01 to 18 GHz</i> <i>Power Range: +16 to -20 dBm</i>	Hewlett-Packard, Model 8481A	O, P, C
Power Sensor	<i>Power Range: -20 to -60 dBm</i>	Hewlett-Packard, Model 8484A	O, P, C
Digital Multimeter	<i>Resolution: 4-1/2 digits (to 20V)</i> <i>DC Accuracy: 0.002% + 2 counts</i> <i>DC Input Impedance: 10 MΩ</i> <i>AC Accuracy: 0.07% + 100 counts</i> <i>(to 20 kHz)</i> <i>AC Input Impedance: 1 MΩ</i>	John Fluke, Inc., Model 8840A, with Option 8840A-09 True RMS AC	T
Oscilloscope	<i>Bandwidth: DC to 150 MHz</i> <i>Sensitivity: 2 mV</i> <i>Horiz. Sensitivity: 50 ns/division</i>	Tektronix, Inc. Model 2445	O, P, C, T
Sweep Generator	<i>Horizontal Output: 0 to 10V</i> <i>Sweep Dwell, Seq Sync lines as</i> <i>defined in Table 1-2,</i> <i>50 MHz, +10 dBm</i>	WILTRON 6647B	O, P, C
Step Attenuator	60 dB range	WILTRON HP 355D	P, C

*C-Calibration, O-Operational, P-Performance, T-Troubleshooting

SECTION II INSTALLATION

CONTENTS

Paragraph	Title	Page
2-1	INTRODUCTION	2-3
2-2	INITIAL INSPECTION	2-3
2-3	PREPARATION FOR USE	2-3
2-4	GPIB SETUP AND INTERCONNECTION	2-3
2-4.1	Interface Connector	2-3
2-4.2	Cable Length Restrictions	2-3
2-4.3	GPIB Interconnection	2-3
2-4.4	GPIB Address	2-5
2-4.5	Data Delimiting	2-5
2-5	SWEEP GENERATOR INTERCONNECTION	2-5
2-5.1	WILTRON 6600B Sweep Generator	2-5
2-5.2	Other Sweep Generators	2-5
2-6	PREPARATION FOR STORAGE AND/OR SHIPMENT	2-5
2-6.1	Preparation for Storage	2-5
2-6.2	Preparation for Shipment	2-5

SECTION II INSTALLATION

2-1 INTRODUCTION

This section provides information on initial inspection, preparation for use, General Purpose Interface Bus (GPIB) interconnections and sweep generator interconnections. It also includes reshipment and storage information.

2-2 INITIAL INSPECTION

Inspect the shipping container for damage. If the container or cushioning material is damaged, retain until the contents of the shipment have been checked against the packing list and the instrument has been checked for mechanical and electrical operation.

If the analyzer is damaged mechanically, notify your local sales representative or WILTRON Customer Service. If either the shipping container is damaged or the cushioning material shows signs of stress, notify the carrier as well as WILTRON. Keep the shipping materials for the carrier's inspection.

2-3 PREPARATION FOR USE

Preparation for use consists of checking for the correct line voltage. The line voltage selector on the rear panel enables the analyzer to be used with either 100, 120, 220, or 240Vac. Before leaving the factory, each analyzer is preset and tagged for the line voltage present in the customer's area. If the actual line voltage is different from that stated on the tag, change the LINE SELECT switch (Figure 2-1) to the correct setting and the line fuses to the correct value.

2-4 GPIB SETUP AND INTERCONNECTION

The analyzer provides automated microwave measurements via the GPIB. The following paragraphs provide information about interface connections, cable requirements, and the addressing of the analyzer.

2-4.1 Interface Connector

Interface between the analyzer and other devices on the GPIB is via a 24-wire interface cable. This cable uses connector shells having two connector faces. These double-faced connectors allow for the parallel connection of two or more cables to a single device. Figure 2-2 shows the pin assignments for the Type 57 GPIB connector installed on the rear panel.

2-4.2 Cable Length Restrictions

The GPIB system can accommodate up to 15 instruments at any one time. To achieve design performance on the bus, proper timing and voltage level relationships must be maintained. If either the cable length between separate instruments or the accumulated cable length between all instruments is too long, the data and control lines cannot be driven properly and the system may fail to perform. Cable length restrictions are as follows:

- No more than 15 instruments may be installed on the bus.
- Total accumulative cable length in meters may not exceed two times the number of bus instruments or 20 meters—whichever is less.

NOTE

For low EMI applications, the GPIB cable should be a fully shielded type, with well-grounded metal-shell connectors.

2-4.3 GPIB Interconnection

The only interconnection required for GPIB operation is between the analyzer and the controller. This interconnection is via a GPIB cable. The WILTRON Part number for such a cable is 2000-1, 2000-2, or 2000-4 (1, 2, or 4 meters in length).

To change the line voltage from that shown on the Line Voltage Selector Module, proceed as follows:

- (a) Remove the power cord from the line voltage module.
- (b) Insert the blade of a small screwdriver into the slot at the top-center of the module, and pry open the cover.
- (c) Remove the voltage selector drum by pulling straight out.
- (d) Rotate the drum so that the desired line voltage marking faces out, then reinstall the drum.
- (e) Remove the fuse cartridge from the right-hand fuseholder. The fuse cartridge is identified with a white arrow and is located beneath the voltage selector drum.
- (f) Check that the proper fuse is installed (see table).
- (g) Change to the correct fuse, if necessary, and replace the fuse cartridge.
- (h) Close the cover, and ensure that the desired line voltage value is displayed through the opening in the cover.
- (i) Reinstall the line cord.

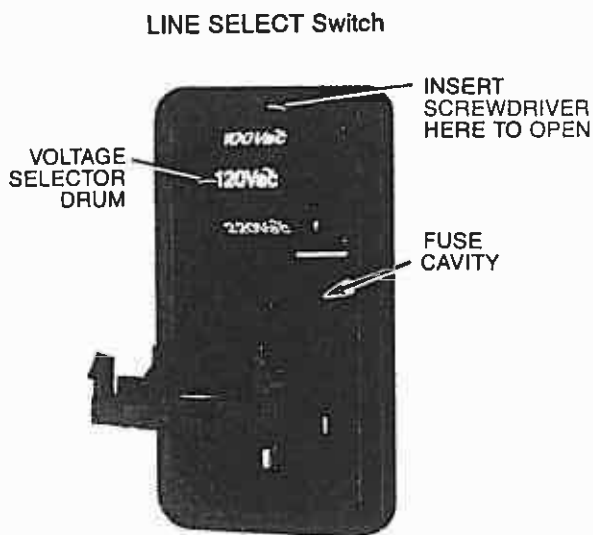

Fuse Sizes, Ratings, and Part Numbers

Line Voltage	Area	Fuse Rating	Fuse Size	Wiltron P/N-Fuse	Wiltron P/N-Fuse Holder
100 Vac	Japan	2A, antisurge	3 AG	631-4	533-221
120 Vac	USA	2A, antisurge	3 AG		
220 Vac	Europe	1A, antisurge	5 x 20 mm	631-49	553-240
240 Vac	UK	1A, antisurge	5 x 20 mm		

Figure 2-1. Changing the Analyzer LINE SELECT Switch

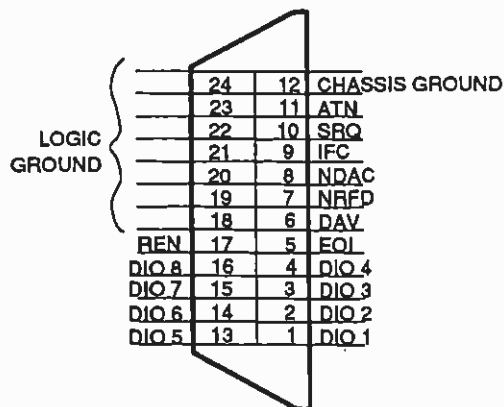

TYPE 57 MICRORIBBON CONNECTOR

Figure 2-2. Pinout for Rear Panel GPIB Connectors

2-4.4 GPIB Address

The analyzer leaves the factory preset to address 6. If a different address is desired, it can be set by entering a new address from the front panel GPIB key.

2-4.5 Data Delimiting

Data used for the input and output functions of the 562 are terminated as follows:

a. Output Functions of the 562:

- Ends of all output binary data strings are terminated with EOI (End or Identify) true.
- Ends of all output ASCII data strings are terminated with CR LF and EOI. The EOI provides complete data termination and is sent with the LF character.

b. Input Functions of the 562:

- All binary data strings received by the 562 must be terminated with EOI true with the last data byte.
- All ASCII data strings received by the 562 must be terminated with either EOI, LF and EOI, CR LF, or CR LF and EOI.

2-5 SWEEP GENERATOR INTERCONNECTION

Paragraphs 2-5.1 and 2-5.2 give instructions for connecting the 562 Network Analyzer to various sweep generators.

2-5.1 WILTRON 6600B Sweep Generator

The 562 Analyzer is supplied with a dedicated system bus cable (PN 2100-1) and auxiliary I/O cable (PN 806-7) for use with a 6600B Sweep Generator. After turning power off for both the 562 and 6600B, install the I/O cable between the AUX I/O connectors of both devices. Next connect the system bus cable between the Dedicated System GPIB connector of the analyzer and the IEEE-488 Interface connector of the sweep generator. The system is now ready for operation.

2-5.2 Other Sweep Generators

The 562 Analyzer requires interconnection with a sweep generator capable of supplying the necessary horizontal, blanking, and dwell signals specified in Table 1-2 Signal Source Compatibility (see Section III, Table 3-7 for instructions on interconnecting the 562 to other sweep generators and frequency synthesizers using male BNC to male BNC cables).

2-6 PREPARATION FOR STORAGE AND/OR SHIPMENT

Paragraphs 2-6.1 and 2-6.2 give instructions for preparing the analyzer for storage or shipment.

2-6.1 Preparation for Storage

Preparing the analyzer for storage consists of cleaning the unit, packing the inside with moisture-absorbing desiccant crystals, and storing the unit in a temperature environment that is maintained between -40 and +70 degrees centigrade.

2-6.2 Preparation for Shipment

To provide maximum protection against damage in transit, the analyzer should be repackaged in the original shipping container. If this container is no longer available and the analyzer is being returned to WILTRON for repair, advise WILTRON Customer Service; they will send a new shipping container free of charge. In the event neither of these two options is possible, instructions for packaging and shipment are given below.

a. Use a Suitable Container

Obtain a corrugated cardboard carton with a 275-pound test strength. This carton should have inside dimensions of no less than six inches larger than the instrument dimensions to allow for cushioning.

b. Protect the Instrument

Surround the instrument with polyethylene sheeting to protect the finish.

c. Cushion the Instrument

Cushion the instrument on all sides by tightly packing dunnage or urethane foam between the carton and the instrument. Provide at least three inches of dunnage on all sides.

d. Seal the Container.

Seal the carton by using either shipping tape or an industrial stapler.

e. Address the Container.

If the instrument is being returned to WILTRON for service, mark the WILTRON address and your return address on the carton in one or more prominent locations. For international customers, use the address of your

local representative (Table 2-1). For U.S.A. customers, use the WILTRON address shown below:

WILTRON Company
ATTN: Customer Service
490 Jarvis Drive
Morgan Hill, CA 95037-2809.

Table 2-1. WILTRON International Sales Representatives

ARGENTINA
I.A. ELECTRONICA S.R.L.
T.C. de Allende 430
5000 Cordoba
Telephone: (051) 32160/34815
Telex: 390 51894 ENTOP AR

AUSTRALIA
Wiltron Pty. Ltd.
Sydney
Telephone: (408) 778-2000
Telex: 285227
Fax: (408) 778-0239

AUSTRIA
WILTRON GmbH
Rudolf Diesel Str 17
8031 Gilching, West Germany
Telephone: (49) 8105-8535/8055/8056
Telex: 841-528523
Fax: (49) 8105-1700

BELGIUM
HEYNEN N.V.
Bedrijfsstraat 2
B-3500 Hasselt
Telephone: 32-11-210008
Telex: 846-39047
Fax: 11211812

BRAZIL
TECELINCO TECNOLOGIA
ELETRONICA LTDA.
Rua Major Sertorio, 483 - 4
Andar
01222 Sao Paulo
Telephone: 55-11-2673645/2584288
Telex: 391-01126588 PYRO BR

CANADA
WILTRON INSTRUMENTS LTD.
215 Stafford Road, Unit 102
Nepean, Ontario K2H 9C1
Telephone: (613) 726-8800/8801/8802
Fax: (613) 820-9525

CHINA
CHINA NATIONAL INSTRUMENTS
IMPORT & EXPORT CORPORATION
P.O. Box 2811
Xi Jiao, Er-Li Kou Beijing
Telephone: 890931
Telex: 718-22304 CMIEC CN

CHINA ELECTRONICS IMPORT & EXPORT CORPORATION
49 Fuxing Road, Beijing
Telephone: 81-28873972
Telex: 718-22475 CEIEC CN

COSTA RICA
ELECTRO-IMPEX, S.A.
Apartado 820, San Jose
Telephone: 216854
Telex: 303-2845 ELEPEX

DENMARK
S C METRIC A/S
Skodsborgvej 305
DK-2850 Naerum
Telephone: (2) 804200
Telex: 855-37163

EGYPT
ALKAN ESTABLISHMENT
2 El Mesaha Square, Dokki,
A.R.E.
P.O. Box 1813, Cairo 11511
Telephone: (2) 987114
Telex: 927-93644 ALKAN UN & 92098 EKA UN

FINLAND
INSTRUMENTARIUM
ELEKTRONIKKA
P.O. Box 64, Viikinka 1
SF-02831 ESPOO
Telephone: 358 (0) 5281
Telex: 857-124426 HAVUL or
857-8100155 INSTRUE
Teletex: 100155
Fax: (0) 524988

FRANCE
WILTRON S.A.
9 Avenue du Quebec
Zone de Courtaboeuf
91851 Les Ulis Cedex
Telephone: (1) 84-46-85-48
Fax: (1) 64-10-48-85

WEST GERMANY
WILTRON GmbH
Rudolf Diesel Str 17,
8031 Gilching
Tel: (8105) 8055/8535/8056
Telex: 841-528523
Fax: (8105) 1700

HONG KONG
SCHMIDT & CO (H.K.) LTD.
18th Floor, Great Eagle Centre
23 Harbour Road, Wanchai
Telephone: (5) 8330222
Telex: 780-74768
Fax: (5) 8918764

INDIA
HINDITRON SERV. PVT. LTD.
Eros Bldg., 5th Floor
Maharshi Karve Road,
Churhgate
Bombay 400 020
Tel: (22) 8125344/8121316/
8121615/8221529
Telex: 853-1175328/1173448

HINDITRON SERV. PVT. LTD.
Field Service Centre
15 Community Centre
Panchshilla Park
New Delhi 110 017
Telephone: 853387
Telex: 0314890

HINDITRON SERVICES PVT. LTD.
Srinath Complex, 5th Floor
1-1-58/1 to 1-1-58/11
Sarajini Devi Road
Secunderabad 500 003
Telephone: (city code) 821117
Telex: 0155675 NIMA IN

HINDITRON SERVICES PVT. LTD.
Office No. 8
Shanlinketan, 8th Floor
8 Cumas Street, Calcutta
Telephone: (33) 434032/477541
Telex: 021-4153 HCPL IN
Cable: FLUKHIND-Calcutta

HINDITRON SERV. PVT. LTD.
33/44A Rajmahal Villas Extn.
Bangalore 560 008
Telephone: (city code) 33139
Telex: 845-741

INDONESIA
PT CENTRONIX
36, Jalan Mairaman Raya
Jakarta Timur
Telephone: (21) 884087
Telex: 796-48216

IRELAND (Southern)
ATRON ELECTRONICS LTD.
(Avelec Group)
Lynwood House, Ballinteer Road,
Dublin 18
Telephone: 353-1-888433/988798
Telex: 852-90862 ATRN EI

ISRAEL
RACOM ELECTRONICS, LTD.
P.O. Box 21120
Tel Aviv 61210
7 Kehilat Salonik St, Tel Aviv
68513
Telephone: (3) 491922
Telex: 922-33808
Fax: (3) 491578

ITALY
WILTRON Sp.A.
Via E. Vittorini 129
00144 Roma EUR
Telephone: (06) 5005171
Fax: (06) 5005273

WILTRON Sp.A.
Centro Direzionale Colleoni
Palazzo Andromeda 2
20041 Agrate Brianza, Milano
Telephone: (02) 651871
Fax: (02) 6056589

JAPAN
WILTRON K.K.
5 Chome, 29-20, Shiba,
Mita Bldg. 6F, Minato-ku Tokyo
108 Tel: (03) 7950411
Fax: (03) 788-0419
WILTRON K.K.
Telephone: (045) 318-0381 R Fax:
(045) 316-0380, Yokohama

KOREA
WILTRON Co.
Seoul
Telephone: (408) 778-2000
Telex: 285227
Fax: (408) 778-0239 KUWAIT

KUWAIT
TAREQ COMPANY
P.O. Box Sajal 20508, 13068
SAFAT
Telephone: 438100/438045
Telex: 958-22315 KT
Fax: 956-2436100, 2436045

LUXEMBOURG
HEYNEN N.V.
Bedrijfsstraat 2
B-3500 Hasselt, Belgium
Telephone: 8851-96111
Fax: 846-39047
Fax: 11211812

MALAYSIA
MECOMB MALAYSIA SDN BHD
Lot 20, Jalan 225
48100 Petaling Jaya, Selangor
Telephone: (03) 743422
Telex: 784-37764
Fax: (03) 7743414

MEXICO
MEXITEK, S.A.
Eugenia 408 Deptos. 2 y 3
Cof. Del Valle, Deleg. B. Juarez
Apdo. Postal 12-1012 03100
Mexico, D.F.
Telephone: (5) 380910
Telex: 383-1773239 MEXIME

NETHERLANDS
Heynen B.V.
P.O. Box 10, 6590 AA Gennep
Telephone: (8851) 96111
Telex: 844-37282

NEW ZEALAND
Wiltron Pty. Ltd.
Sydney
Telephone: (408) 778-2000
Telex: 285227
Fax: (408) 778-0239

NORWAY
HUGO RISO A/S TEKNISK
IMPORT
P.O. Box 33 Voksenskogen
N-0708 Oslo 7
Telephone: (2) 142835
Telex: 856-78216

PAKISTAN
SUPERIOR ELECTRONICS AS-
SOCIATED
B-98 Block H
North Nasimabad, Karachi 33
Telephone: (21) 813865
Cable: SEACONSULT Karachi

PERU
IMPORTACIONES &
REPRESENTACIONES
ELECTRONICAS S.A.
Avda. Franklin D. Roosevelt 105
(Edificio Rimac) Lima 1
Telephone: (14) 272078
Telex: 394-25663
Cable: IREING

PHILIPPINES
PHILIPPINE ELECTRONIC IN-
DUSTRIES, INC.
P.O. Box 498
Makati Commercial Center
Makati, Metro Manila
Telephone: (2) 879926
Telex: 742-22038

PORTUGAL
DECADA ESPECTRAL-EQUIP-
AMENTOS DE ELECTRONICA
E CIENTIFICOS, SARL
Av. Bombeiros Voluntarios, Lote
102B
Miraflores/Alges, 1495 Lisboa
Tel: (01) 410-3420/6073/6098
Telex: 832-15515
Fax: 35114101844

QATAR
TRADING AND AGENCY SERV.
P.O. Box 1884, Doha
Tel: 957-4325 TRAGS DH
Fax: 974-422255

SAUDI ARABIA
ELECTRONIC EQUIPMENT
MARKETING CO.
P.O. Box 3760, Riyadh, 11481
Telephone: (1) 4771650
Telex: 928-20120
Fax: 98614785140, 4783682

SINGAPORE
SINGAPORE ELECTRONIC &
ENGINEERING (PRIVATE), LTD.
24 Ang Mo Kio Street 85
Industrial Park 3
Singapore 2056
Telephone: 4593555
Telex: 788-21901
Fax: 4553813

SOUTH AFRICA
PNI ELECTRONICS
P.O. Box 39127, Bramley 2018
Tel: (11) 7863170/7863171-
7863172 Telex: 4-24409 SA
Fax: (11) 786-1807

SPAIN
UNITRONICS, S.A. Plaza
Espana, 18 Torre de Madrid
PL 12, Ofc. 9, Madrid
Telephone: (01) 2425204
Telex: 831-48788
Fax: (01) 2484228 (Madrid) (03)
3226800 (Barcelona)

SWEDEN
WILTRON AB
Box 247
Jagerhorns vag 19
S-127 45 Starholmen
Telephone: (08) 7405840
Telex: 854-8135089
Fax: (8) 7109960

SWITZERLAND
AMOTEC ELECTRONIC AG
Buehler, 1 / P.O. Box 46
CH-8125 Zollikerberg
Telephone: (1) 3915901
Telex: 845-816906
Fax: (1) 391-56-33

TAIWAN
Wiltron Co. Ltd.
6F-5, No. 188, Sec. 2 Roosevelt Rd.
Taipei

THAILAND
DYNAMIC SUPPLY ENGINEER-
ING F.O.P.
12 Soi Pasana, Ekamai
Sukhumvit 63, BKK 10110
Telephone: (1) 814434
Telex: 788-82455
Fax: (2) 3811467

TURKEY
TEST MUHENDISLIK VE
MUSAVIRLIK TICARET LIMITED
SIRKETI Behr Adem Yavuz
Sokak No. 6/17 Kizilay, Ankara
Telephone: (41) 18-05-98
Telex: 621-48147

UNITED ARAB EMIRATES
SALEM HILAL TRABISH AL
MANSOURI ENTERPRISES
P.O. Box 8888, Abu Dhabi
Telephone: (2) 331200
Telex: 949-23849

UNITED KINGDOM
WILTRON LTD.
Wiltron House, Pinehill Road
Crowthome, Berkshire RG11 7JD
England
Telephone: (344) 777778
Telex: 851-847913
Fax: (0344) 761783

YUGOSLAVIA
SCOUR INDUSTRIAIMPORT
Blatine 12-14, 58000 Split
Telephone: (58) 510888
Telex: 862-26335

SECTION III FRONT PANEL OPERATION

Paragraph	Description	Page
CONTENTS		
3-1	INTRODUCTION	3-3
3-2	CRT DISPLAY	3-3
3-3	SYSTEM FUNCTION KEYS AND MENUS	3-4
	3-3.1 SAVE/RECALL Key And Menus	3-4
	3-3.2 SELF TEST Key	3-5
	3-3.3 SYSTEM MENU Key and Menus	3-5
3-4	DISPLAY KEYS, INDICATORS, AND MENUS	3-9
	3-4.1 CHANNEL ON/OFF Key and indicator	3-9
	3-4.2 OFFSET/RESOLUTION Key and Menus	3-9
	3-4.3 AUTOSCALE Key	3-9
	3-4.4 LIMITS Keys	3-9
	3-4.5 MENU Key and Menus	3-9
	3-4.6 CALIBRATION Key and Menus	3-12
	3-4.7 UNCAL Indicator	3-12
	3-4.8 BEGIN Indicator	3-12
3-5	DATA ENTRY/CURSOR KEYS AND KNOB	3-12
	3-5.1 Knob	3-14
	3-5.2 Keypad	3-14
	3-5.3 ENTER Key	3-14
	3-5.4 CLEAR Key	3-14
3-6	HARD COPY KEYS	3-14
	3-6.1 MENU Key	3-14
	3-6.2 START PRINT Key	3-17
	3-6.3 STOP PRINT Key	3-17
3-7	CURSOR FUNCTION KEYS, INDICATORS AND MENUS	3-17
	3-7.1 CURSOR ON/OFF Key	3-17
	3-7.2 RELATIVE CURSOR ON/OFF Key	3-17
	3-7.3 CURSOR MEASUREMENTS Keys and Menus	3-17
3-8	ENHANCEMENT KEYS, INDICATORS, AND MENUS	3-17
	3-8.1 SMOOTHING Key and Indicators	3-19
	3-8.2 AVERAGING Key, Indicator and Menu	3-19
3-9	GPIB INDICATOR, KEY AND STATUS DISPLAY	3-19
	3-9.1 REMOTE Indicator	3-19
	3-9.2 RETURN TO LOCAL Key	3-20
3-10	REAR PANEL CONNECTORS	3-20
3-11	MEASUREMENTS WITH THE 562 SCALAR NETWORK ANALYZERS	3-20
	3-11.1 Transmission And Return Loss Measurements	3-20
	3-11.2 Absolute Power Measurement	3-20
	3-11.3 Alternate Setup Measurements	3-20
	3-11.4 Operational Checkout	3-20
	3-11.5 Ratio-Mode Measurements	3-20
3-12	ERROR MESSAGES	3-20
3-13	562 ANALYZER CONNECTIONS TO WILTRON SWEEP GENERATORS	3-20

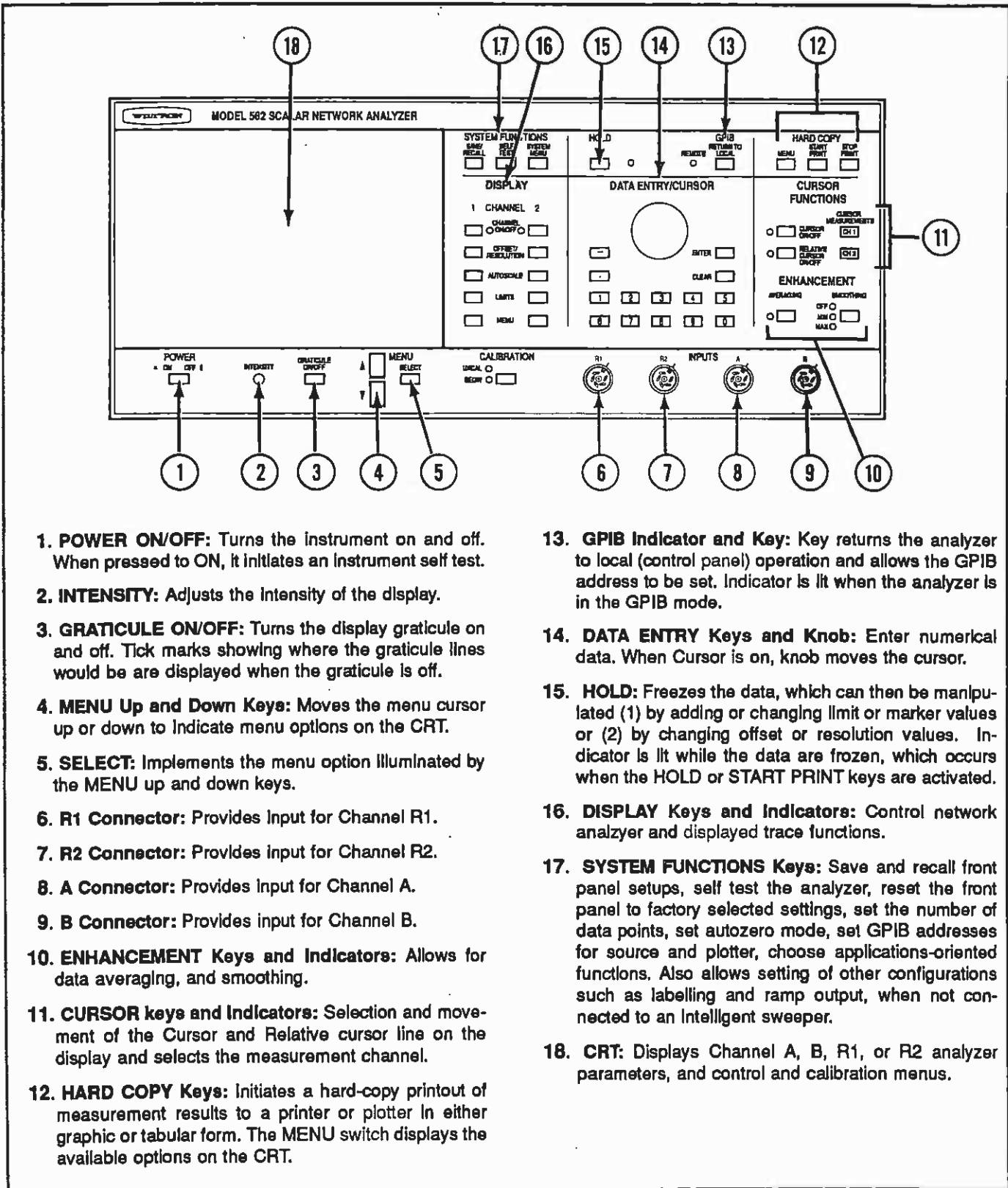

Figure 3-1. Model 562 Scalar Network Analyzer Front Panel Controls

1. **POWER ON/OFF:** Turns the instrument on and off. When pressed to ON, it initiates an instrument self test.
2. **INTENSITY:** Adjusts the intensity of the display.
3. **GRATICULE ON/OFF:** Turns the display graticule on and off. Tick marks showing where the graticule lines would be are displayed when the graticule is off.
4. **MENU Up and Down Keys:** Moves the menu cursor up or down to indicate menu options on the CRT.
5. **SELECT:** Implements the menu option illuminated by the MENU up and down keys.
6. **R1 Connector:** Provides input for Channel R1.
7. **R2 Connector:** Provides input for Channel R2.
8. **A Connector:** Provides input for Channel A.
9. **B Connector:** Provides input for Channel B.
10. **ENHANCEMENT Keys and Indicators:** Allows for data averaging, and smoothing.
11. **CURSOR keys and Indicators:** Selection and movement of the Cursor and Relative cursor line on the display and selects the measurement channel.
12. **HARD COPY Keys:** Initiates a hard-copy printout of measurement results to a printer or plotter in either graphic or tabular form. The MENU switch displays the available options on the CRT.
13. **GPIB Indicator and Key:** Key returns the analyzer to local (control panel) operation and allows the GPIB address to be set. Indicator is lit when the analyzer is in the GPIB mode.
14. **DATA ENTRY Keys and Knob:** Enter numerical data. When Cursor is on, knob moves the cursor.
15. **HOLD:** Freezes the data, which can then be manipulated (1) by adding or changing limit or marker values or (2) by changing offset or resolution values. Indicator is lit while the data are frozen, which occurs when the HOLD or START PRINT keys are activated.
16. **DISPLAY Keys and Indicators:** Control network analyzer and displayed trace functions.
17. **SYSTEM FUNCTIONS Keys:** Save and recall front panel setups, self test the analyzer, reset the front panel to factory selected settings, set the number of data points, set autozero mode, set GPIB addresses for source and plotter, choose applications-oriented functions. Also allows setting of other configurations such as labelling and ramp output, when not connected to an Intelligent sweeper.
18. **CRT:** Displays Channel A, B, R1, or R2 analyzer parameters, and control and calibration menus.

SECTION III FRONT PANEL OPERATION

3-1 INTRODUCTION

This section describes:

- The operation of the 562 Scalar Network Analyzer using the control panel controls.
- The controls and rear panel connectors.
- How to make transmission, return loss, power, and alternating setup measurements.
- How to check that the instrument is operating properly.

3-2 CRT DISPLAY

The CRT Display (Figure 3-2) displays the measurement traces, the present settings for the 562, cursors, markers, limit lines, menu options, and the frequency source parameters.

- **CRT Screen** — Displays Channels 1 and 2 traces as set up in the display channel menu.

If the source is alternating settings or frequencies, then trace 1 displays the main setting and trace 2 displays the alternative settings.

- **Network Analyzer Settings** — The two lines labeled "1" and "2" across the top of the screen display the type of measurement selected and the offset and vertical resolution values set for traces 1, 2, or both.
- **Source Information** — The box in the top right side of the screen displays source information. This box displays the source model number, or "ALTERNATE SETUP" when an alternating setup has been selected, or "HOLD" when the instrument is in the HOLD mode.
- **Source Frequency And Power And Horizontal Resolution (graticule) Settings** — The three lines along the bottom of the screen display

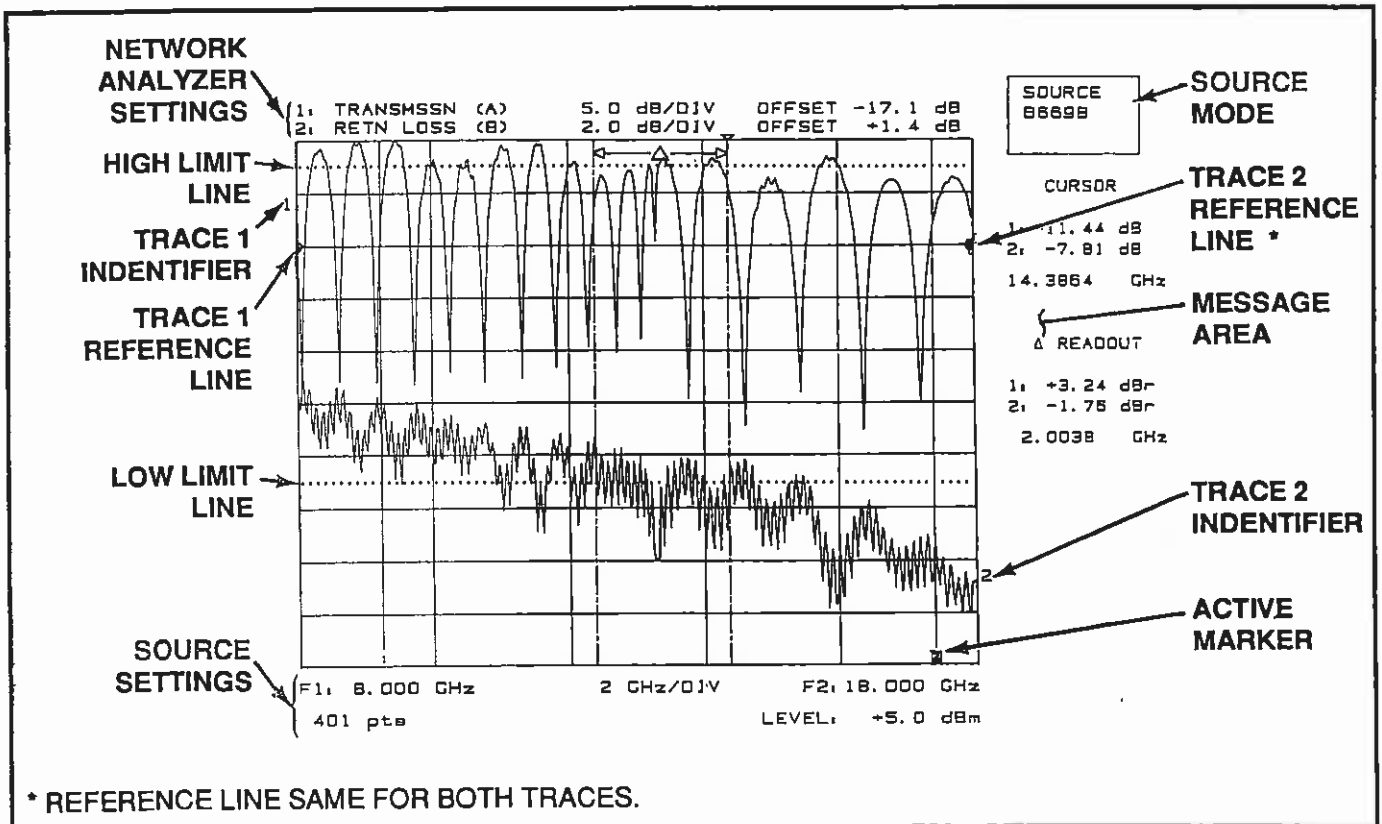

Figure 3-2. Typical Model 562 CRT Display

(1) the source start/stop frequencies; (2) the alternate setup start/stop frequencies (see Table 3-3) or power sweep values if power sweep is selected; (3) the RF power setting and horizontal resolution (Graticule) of the displayed traces.

In the normal-sweep mode, the 562 chooses horizontal resolution and intelligent-graticule divisions for optimum display of the selected frequency-sweep width. In the alternate-setup mode, the graticule is fixed at ten vertical and ten horizontal divisions.

3-3 SYSTEM FUNCTION KEYS AND MENUS

The SYSTEM FUNCTION keys are shown in Figure 3-3. The keys and associated menus are described in paragraphs 3-3.1 thru 3-1.3.

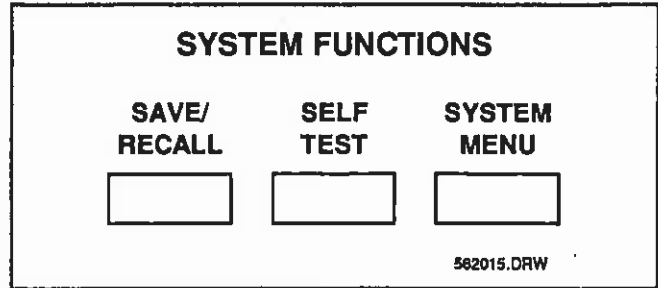

Figure 3-3. SYSTEM FUNCTION Keys

3-3.1 SAVE/RECALL Key And Menus

Pressing this key initiates a series of menus (Figure 3-4) that let you do various save and recall functions. Use the MENU UP/DOWN switches (Figure 3-1) with the MENU SELECT switch to make the selection. If you press this key and then decide it is not the key you wanted, use the DATA ENTRY CLEAR (Figure 3-11) key to cancel the key action. Menu options are described below.

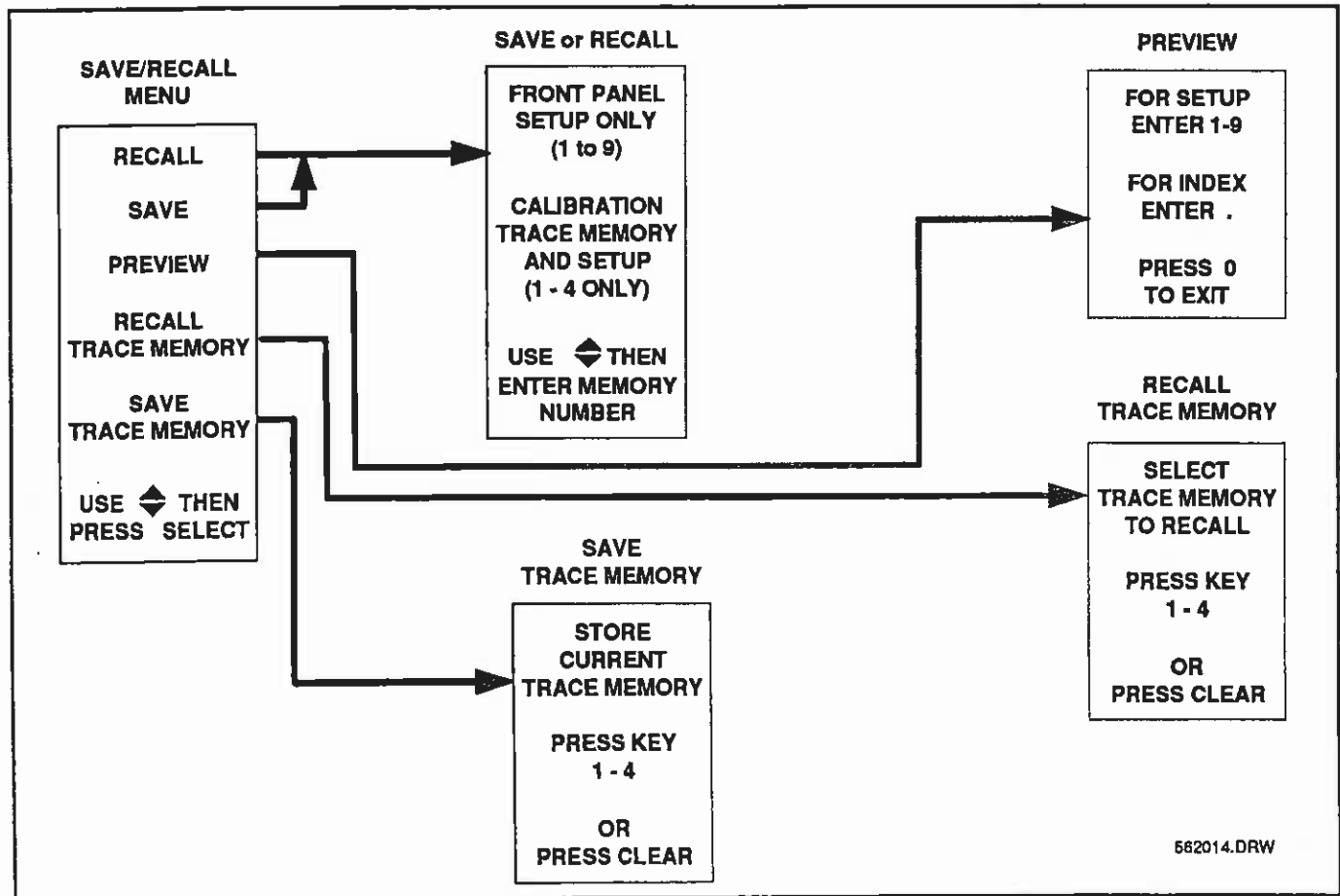

Figure 3-4. SAVE/RECALL Key Menus

- a. Recall or Save.** Either menu option calls up a second menu providing two options.
1. **FRONT PANEL SETUP ONLY (1 to 9).** Recalls a previously stored control panel setting from memory locations 1 thru 9. Or, this option lets you save the current front panel setup into a memory location.
 2. **CALIBRATION TRACE MEMORY AND SETUP (1 - 4 ONLY).** Recalls a previously saved calibration, trace, and setup from memory locations 1-4. Or, the option lets you save the current calibration, trace, and front panel setup into a memory location.
- b. Preview.** Previews the setups stored in memory locations 1 thru 9.
- c. Recall Trace Memory.** Recalls a trace stored using the SAVE TRACE MEMORY option.
- d. Save Trace Memory.** Saves a trace—such as, Power, Transmission, Return Loss, SWR, or Complex Limits—into a storage array. The storage area used here is separate from that used for the CALIBRATION TRACE MEMORY AND SETUP option discussed above.

3-3.2 SELF TEST Key

This key initiates a self test of the analyzer and the source, if the latter is connected to the GPIB. If the analyzer functions properly, the screen displays "ALL TESTS PASSED." If the self test reveals a problem, the screen displays a failure message.

3-3.3 SYSTEM MENU Key and Menus

This key initiates a series of menus (Figure 3-5 and 3-6) that provides various options, as described below.

- a. System Interface.** Displays a menu providing three options.
1. **ON.** Turns the dedicated system interface on.
 2. **OFF.** Turns the dedicated system interface off.
 3. **ADDRESSES.** Displays the current address of the source and plotter or lets you change the address of either.
- b. Configure.** When not connected to the dedicated (intelligent) system bus, this option lets you control the CRT display to be consistent with frequency source settings.

1. **RF ON DURING RETRACE.** Tells the 562 that the RF is on or off during sweep retrace.
 - (a) **YES.** Tells the 562 that the RF is on and displays "RT1" at the bottom of the CRT.
 - (b) **NO.** Tells the 562 that the RF is off and displays "RT0" at the bottom of the CRT.
2. **SWEEP MODE.** Sets the display for the sweep mode of the frequency source. The source sweep mode (AUTO, CW, MANUAL) has to be selected using the source front panel controls.

NOTE

The setting chosen here should be the same as that chosen for the source; otherwise, the display will not function correctly.

- (a) **NORMAL.** Sets display for the normal (AUTO) sweep mode.
 - (b) **CW.** Sets display for the non-sweeping CW mode. The displayed trace(s) is updated with no synchronization sent to the source.
 - (c) **MANUAL.** Sets the display for the source MANUAL SWEEP mode. The displayed trace(s) is a frequency sweep on which a cursor moves horizontally coincident with source power level changes.
 - (d) **562 RAMP OUTPUT.** Turns on the 562 HORIZONTAL (SWEEP RAMP) OUTPUT signal (Index 9, Figure 3-24) and allows control and end-point labeling using the "RAMP OUTPUT CONTROL" option in the "APPLICATIONS" menu (Figure 3-6).
3. **MANUAL LABELING.** Displays a menu that lets you apply labels to the display.
- (a) **START.** Enter the sweep-start frequency.
 - (b) **STOP.** Enter the sweep-stop frequency.
 - (c) **LEVEL.** Enter the power level.
 - (d) **OFF.** Turns off sweep-ramp labeling.
- c. Data Points.** Displays a menu that lets you select the number of points over which trace data is to be plotted.

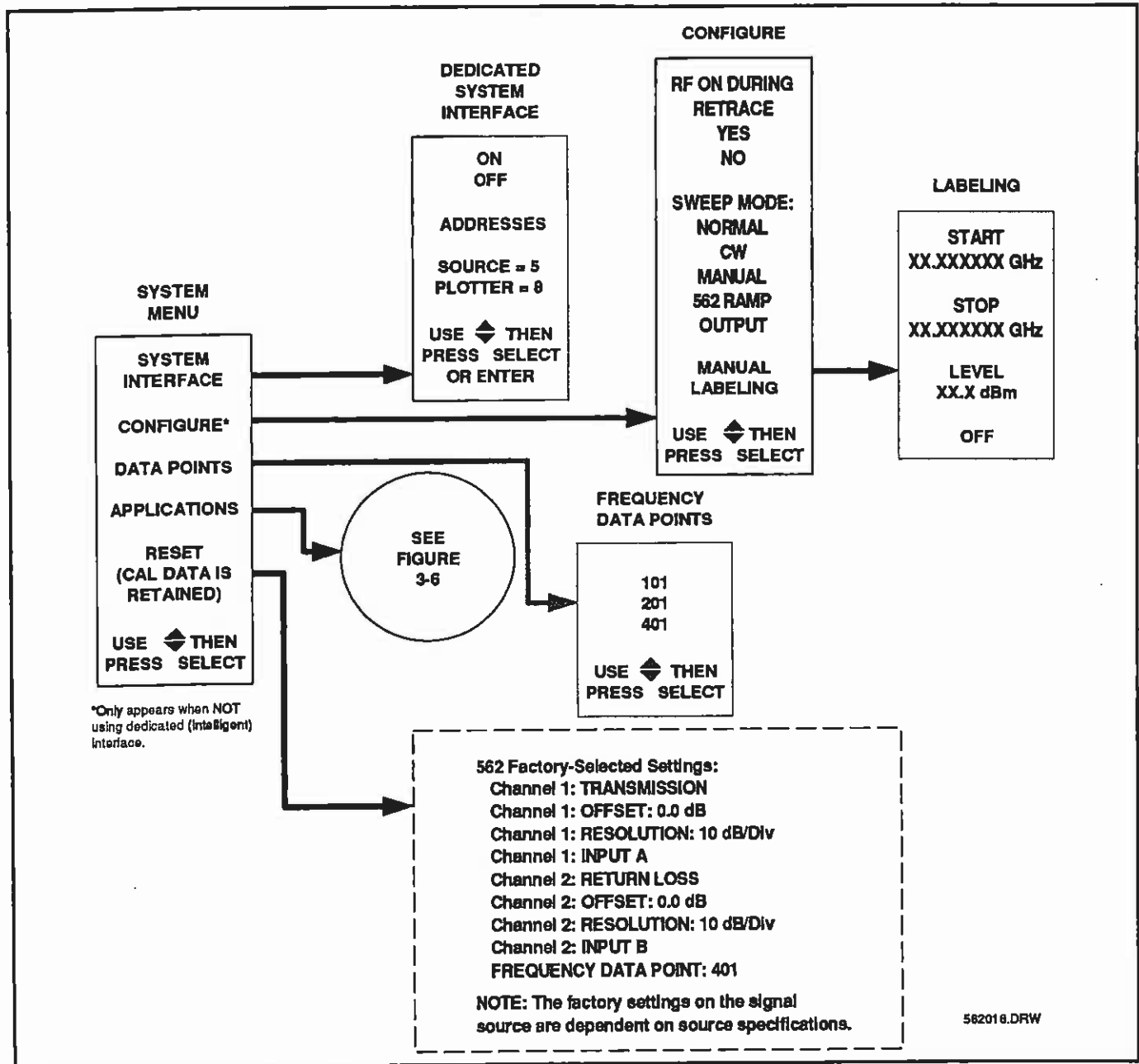

Figure 3-5. SYSTEM MENU and Factory-Select Settings

d. **Applications.** Initiates a series of menus (Figure 3-6) that provides various applications-oriented functions.

1. **TRACE.** Displays a menu that provides the following trace-control options.

(a) 1: OR 2: MAX HOLD. Capture the peak values of trace 1 or 2, and causes "H" to appear at the bottom of the CRT.

(b) 1: OR 2: MIN HOLD. Capture the minimum values of trace 1 or 2, and causes "H" to appear at the bottom of the CRT.

(c) 1: OR 2: PK-PK HOLD. Capture the trace 1 or 2 minimum and maximum values from successive sweeps, and causes "H" to appear at the bottom of the CRT.

NOTE

This mode can be used only with a setting of 401 points.

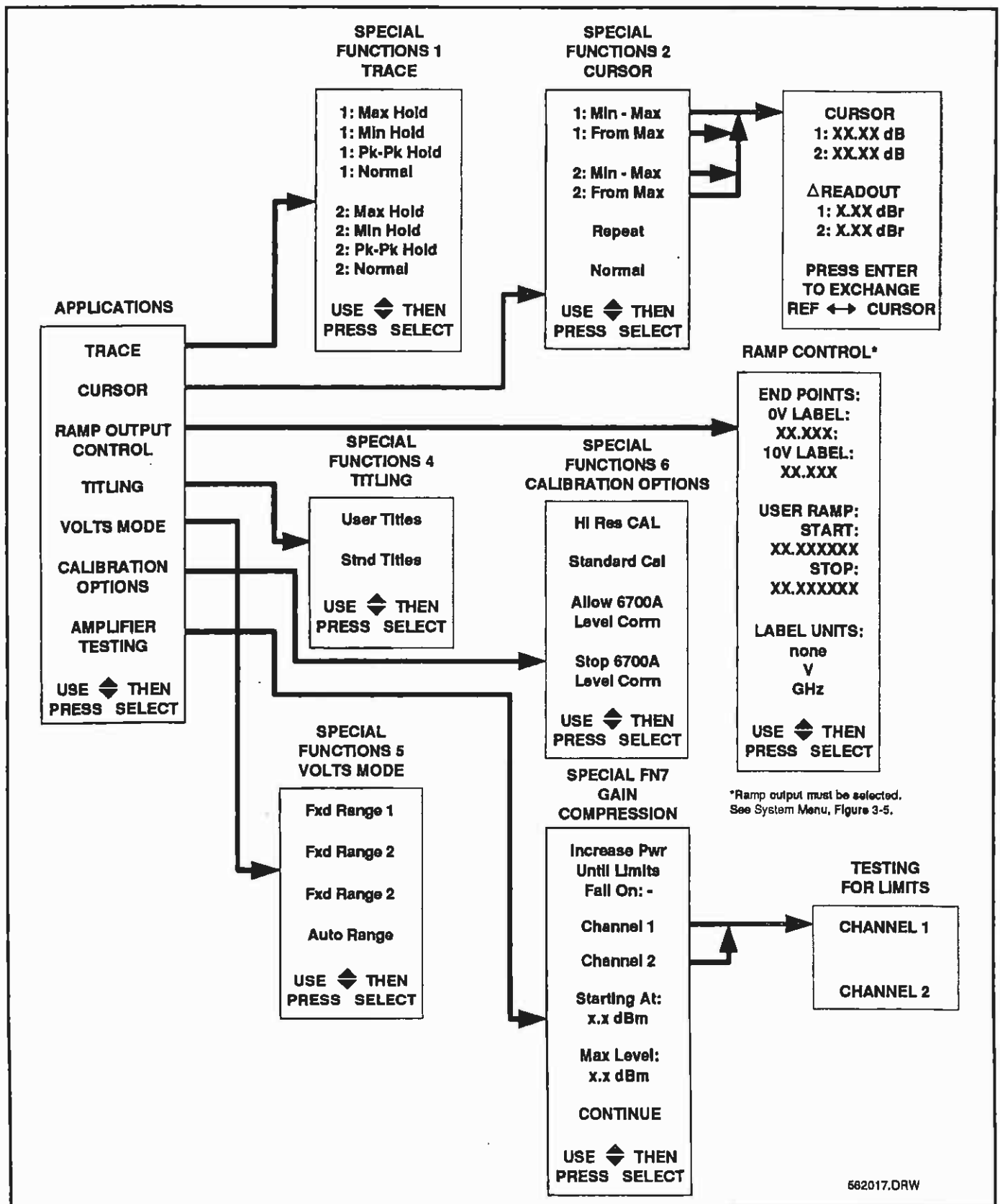

Figure 3-6. APPLICATION Menu-Option Menus

- (d) 1: OR 2: NORMAL. Turns off the capture modes on trace 1 or 2.
2. CURSOR. Displays a menu that provides cursor-control options.
- (a) 1: OR 2: MIN.-MAX. Cause the cursor on trace 1 or 2 to search for the maximum trace value, and the Relative Cursor on trace 1 or 2 to search for the minimum value.
- (b) 1: OR 2: FROM MAX. Cause the selected search to be made from the maximum value of trace 1 or 2 (for example bandwidth relative to peak).
- (c) REPEAT. Repeats the search.
- (d) NORMAL. Returns 562 to the single-search mode.
3. RAMP OUTPUT CONTROL. Displays a menu that lets you control the 562 sweep ramp signal (Index 9, Figure 3-24).
- (a) END POINTS. Lets you label the display with end-point values (V, GHz, or none, as selected in the LABEL UNITS options).
- NOTE**
- Ramp output mode (Figure 3-5) must be active for this function to work.
- (1) 0V LABEL. Assigns a label to the left side of the display.
- (2) 10V LABEL. Assigns a label to the right side of the display.
- (b) USER RAMP. Lets you control the voltage output of the 562 sweep ramp. The full range is from 0V to 10V. The settings chosen here interact with those chosen using the END POINTS options above. The end points define the labels for the 0V and 10V ends of the user ramp. The user ramp is a portion of this ramp up to and including a full 0V to 10V sweep. For example, with end points of from 2 to 12 and a user ramp of from 2 to 7, the 562 sweep ramp goes from 0V to 5V. Units can be none, V, or GHz, as selected using the LABEL UNITS options.
- (1) START. Sets the starting voltage of the 562 sweep ramp (between 0V and 10V).
- (2) STOP. Sets the stopping voltage of the 562 sweep ramp (between 0V and 10V, but must be higher than the start voltage).
- (c) LABEL UNITS. Assigns unit-labels to both END POINTS and USER RAMP options, above.
- (1) NONE. Assigns no unit-labels.
- (2) V. Assigns V (voltage) as unit-labels.
- (3) GHz. Assigns GHz (frequency) as unit-labels.
4. TITLING. Displays a menu that lets you choose titles for displayed traces.
- (a) USER TITLES. Changes the measurement name (type) as required by the user. For example, the titles could read "amp. gain," or "bias volt." The titles "IDENTIFY" and "TEST DEVICE" apply to Channels 1 and 2 respectively.
- (b) STND TITLES. Cause trace to revert to standard title names (Transmission, Return Loss, Power, etc).
5. VOLTS MODE. Displays a menu that lets you define an approximate measurement range.
- (a) FXD RANGE 1. Selects the 0 - 10 volt range.
- (b) FXD RANGE 2. Selects the 0 - 1 volt range.
- (c) FXD RANGE 3. Selects the 0 - 100 mV range.
- (d) AUTO RANGE. Selects the normal autorange operation.
6. CALIBRATION OPTIONS. Displays a menu that provides special functions that will be of use to the programmable system user.
- (a) HI RES CAL. Enables a facility that provides up to 2000 points of calibration memory.
- (b) STANDARD CAL. Selects the standard calibration mode.
- (c) ALLOW 6700A LEVEL CORR. Enables 67XXA/B level correction.

(d) STOP 6700A LEVEL CORR. Disables digital Level Correction on 67XXA/B.

7. AMPLIFIER TESTING. Displays a menu providing several options useful in amplifier testing.

(a) INCREASE POWER UNTIL LIMITS FAIL ON CHANNEL 1. Uses Channel 1 as reference power until limits fail.

(b) INCREASE POWER UNTIL LIMITS FAIL ON CHANNEL 2. Uses Channel 2 as reference power until limits fail.

(c) STARTING At. Enter the power level from which the test will start. Usually this is just below the expected compression point. The test restarts at this point each time that the function is used.

(d) MAX LEVEL. Sets the 562 to the maximum allowable power level.

(e) CONTINUE. Overrides limit-failure and sets the power level to the "Max Level" point, as described above.

e. **Reset (Cal Data Is Retained).** Restores the factory-selected control panel settings (Figure 3-5). If the 562 is connected to the source via the dedicated system bus, selecting this option resets the source control settings also. If a 66XXB is on the dedicated bus, then the 562 is automatically configured to the 66XXB RF retrace setting to provide correct 562 autozeroing. (This function is not presented as a menu option.)

3-4 DISPLAY KEYS, INDICATORS, AND MENUS

The DISPLAY keys and indicator (Figure 3-7) described below are the same for both channels. Generally, with the exception of DISPLAY ON/OFF and AUTOSCALE, should one of these keys be pressed and then not wanted, the CLEAR (Figure 3-11) key can be used to cancel the key action.

3-4.1 CHANNEL ON/OFF Key and indicator

Key turns its associated trace and reference line indicator on or off (Figure 3-2). The associated indicator is lit when the trace is on.

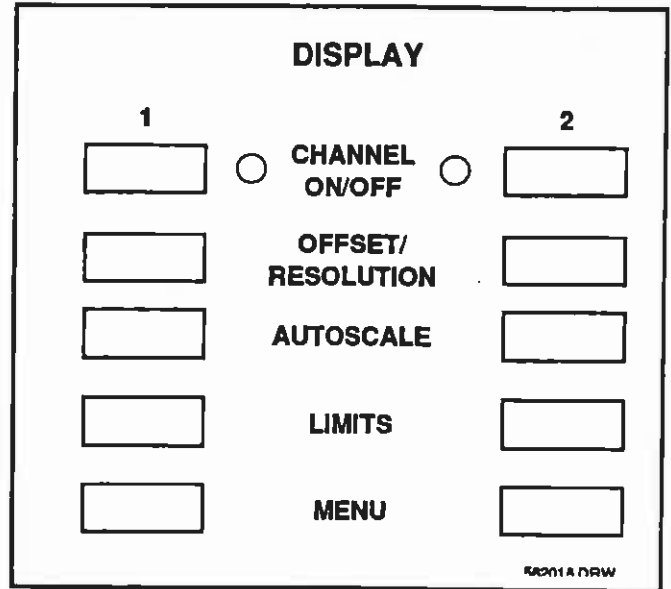

Figure 3-7. DISPLAY Keys and Indicators

3-4.2 OFFSET/RESOLUTION Key and Menus

Displays a menu (Figure 3-8) that lets you select - OFFSET or RESOLUTION.

3-4.3 AUTOSCALE Key

Sets the associated trace at optimum offset and resolution values for viewing the measured data.

3-4.4 LIMITS Keys

Access limit lines that may be used to establish go/no-go data limits (Figure 3-9). Limit lines may be either single lines or complex. Complex limits allow for setting up to ten different values for both the upper and lower limit lines.

3-4.5 MENU Key and Menu

Initiates a series of menus (Figure 3-10) providing various trace display and input options, which are described below.

a. **Transmission.** Configures the trace for a transmission measurement.

b. **Return Loss.** Configures the trace for a return loss measurement.

c. **Power.** Configures the trace for a power measurement.

d. **SWR.** Configures the trace for an SWR (standing-wave ratio) measurement.

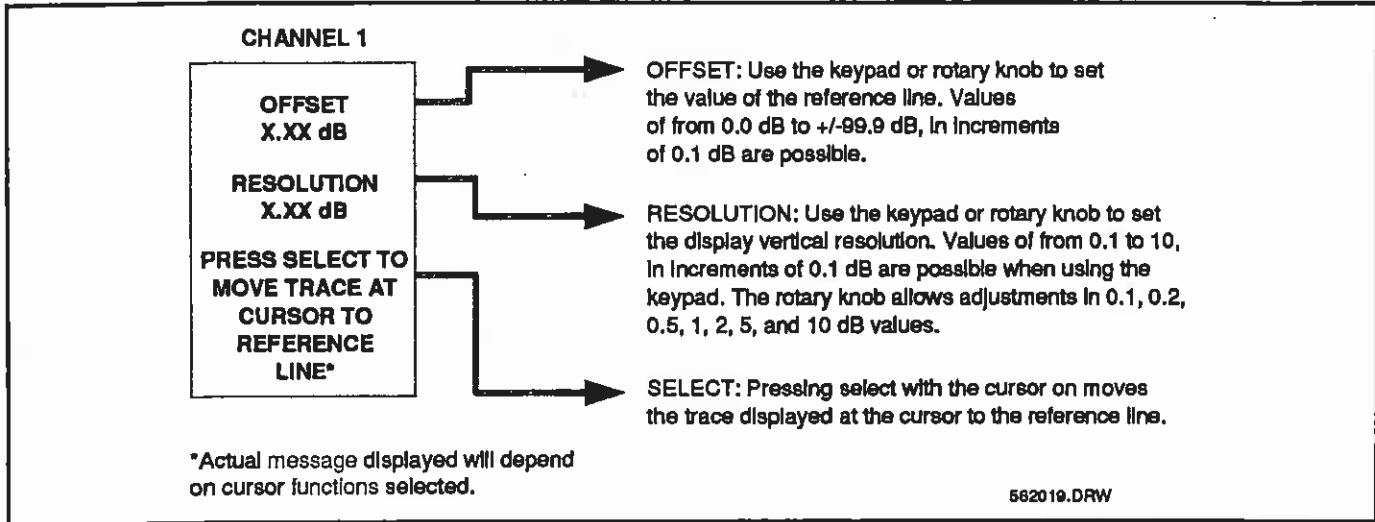

Figure 3-8. OFFSET/RESOLUTION Key Menu

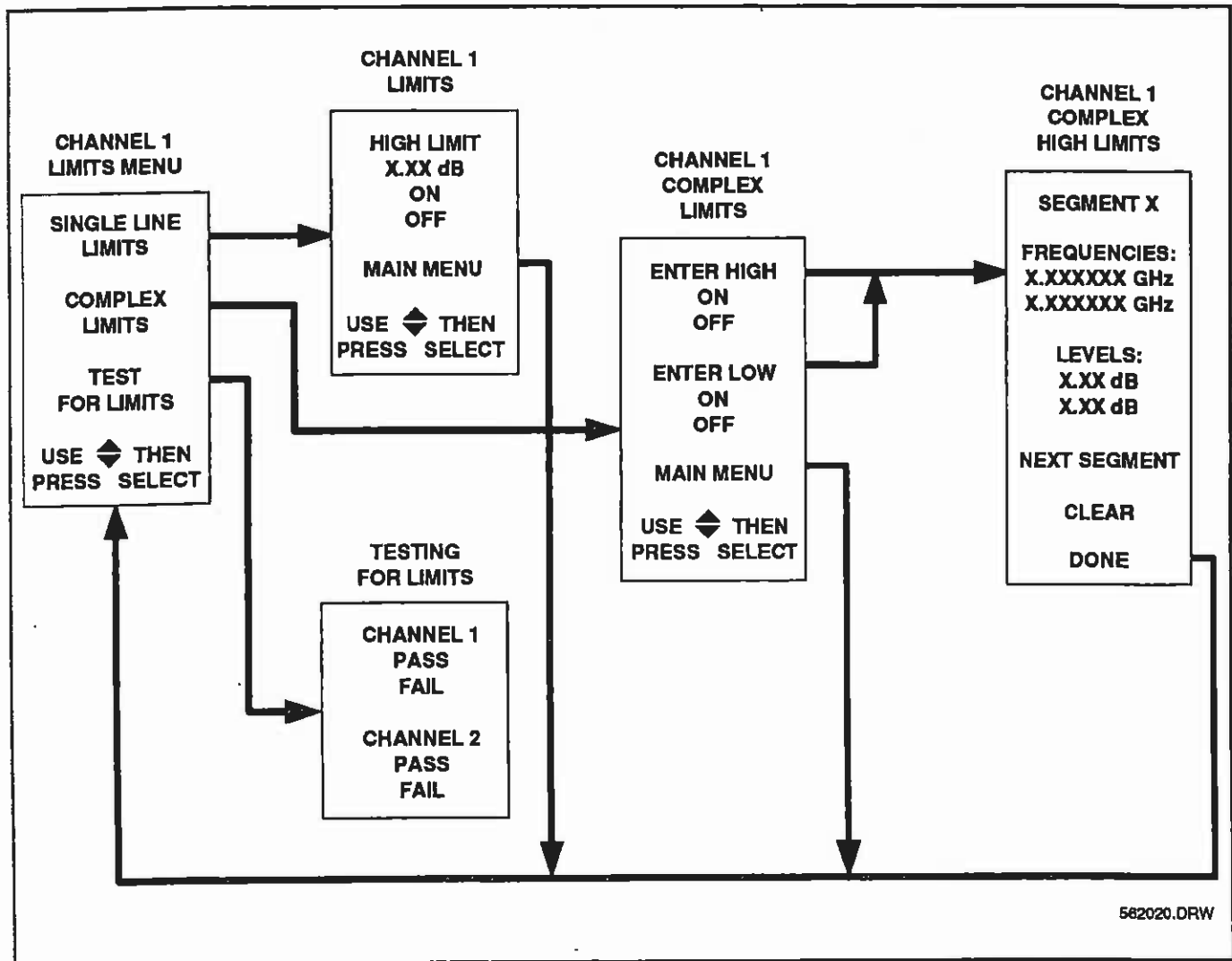

Figure 3-9. LIMITS Menus

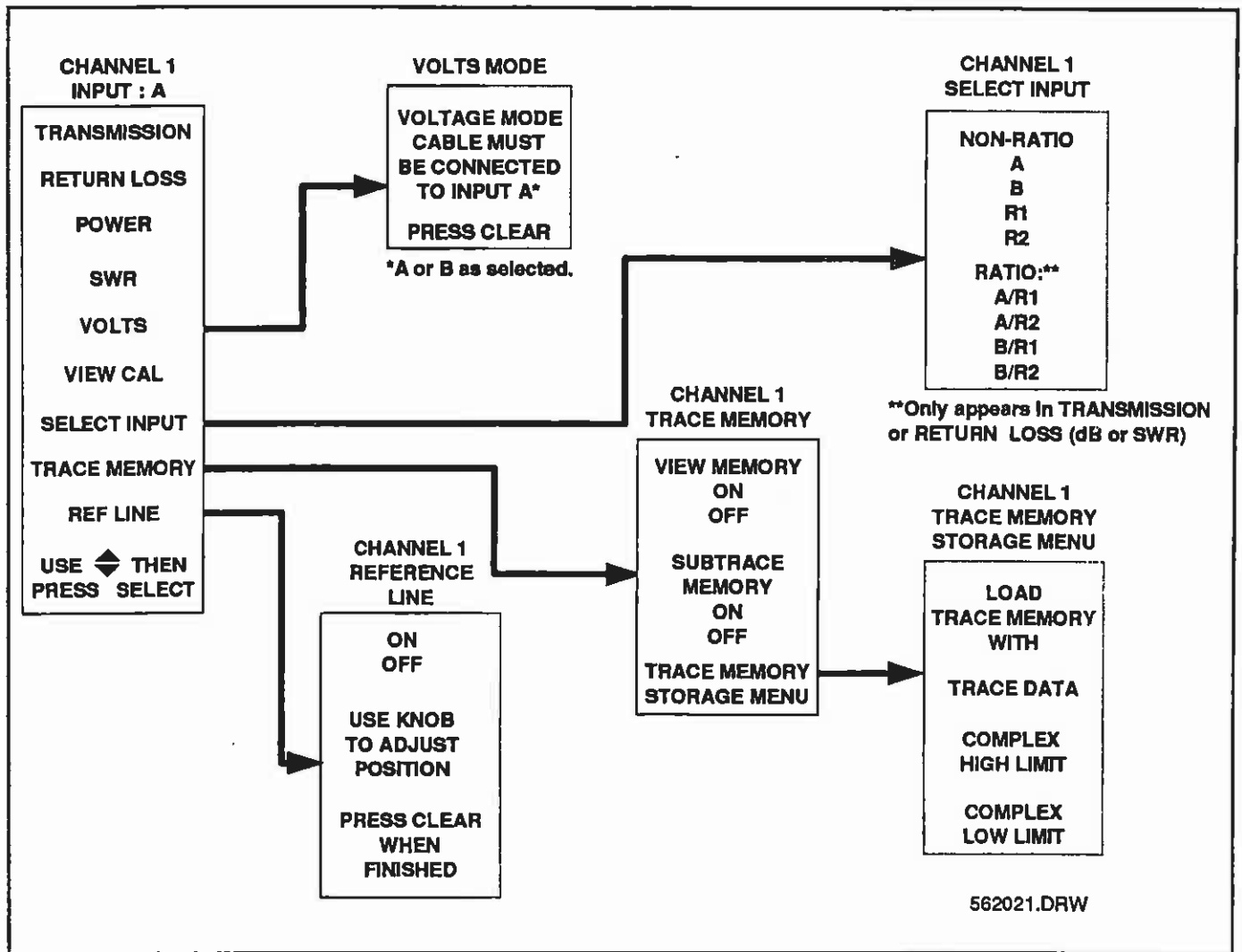

Figure 3-10. DISPLAY MENU Key Menu

- e. **Volts.** Configures the trace for a voltage measurement. In this measurement, the input RF Detector is replaced with a length of BNC-BNC cable.
- f. **View Cal.** View stored calibration data.
- g. **Select Input.** Displays a menu providing the following input selection.
 1. NON RATIO A. Connects the output of the input A amplifier to Channel 1 or 2.
 2. NON RATIO B. Connects the output of the input B amplifier to Channel 1 or 2.
 3. NON RATIO R1. Connects the output of the input R1 amplifier to Channel 1 or 2.
 4. NON RATIO R2. Connects the output of the input R2 amplifier to Channel 1 or 2.
 5. RATIO A/R1. Connects the ratio of input A subtracted by input R1 to Channel 1 or 2. This ratio is the difference signal that results from the logarithm of the signal on input A being subtracted by the logarithm of the signal on input R1.
 6. RATIO A/R2. Same as described for RATIO A/R1, except substitute input R2 for input R1.
 7. RATIO B/R1. Same as described for RATIO A/R1, except substitute input B for input A.
 8. RATIO B/R2. Same as described for RATIO A/R1, except substitute inputs B and R2 for A and R1.
- h. **Trace Memory.** Displays a menu providing options for controlling trace memory.

1. **VIEW MEMORY ON/OFF.** View stored data for this trace.

NOTE

The data accessed here is from a different storage location than those trace memories accessed using **SAVE/RECALL** key menus (Figure 3-4).

2. **SUBTRACT MEMORY ON/OFF.** Subtracts the trace stored in this memory from the displayed trace.
3. **TRACE MEMORY STORAGE MENU.** Displays a menu providing storage options.
 - (a) **LOAD TRACE MEMORY WITH TRACE DATA.** Loads this memory with data from the displayed trace.
 - (b) **LOAD TRACE MEMORY WITH COMPLEX HIGH LIMIT.** Loads this memory with complex-high-limit data.
 - (c) **LOAD TRACE MEMORY WITH COMPLEX LOW LIMIT.** Loads this memory with complex-low-limit data.

- i. **Ref Line.** Displays options for controlling the reference line.

NOTE

Use the **DATA ENTRY/CURSOR** rotary knob to reset the **REFERENCE LINE** to another graticule line. The reference line is the point about which the trace expands vertically with different resolution values; it can be set to any graticule line. Press **DATA ENTRY CLEAR** to return to the measurement mode.

1. **ON.** Turns the reference line on.
2. **OFF.** Turns the reference line off.
3. **ADJUST POSITION.** Lets you position the reference line using the **DISPLAY ENTRY/CURSOR** knob.

3-4.6 CALIBRATION Key and Menus

Displays a series of instructions (Figure 3-12) that guide you through the calibration cycle. The calibration sequence is determined by the measurements chosen. This key also allows low level trim to be

performed (when required), and allows entry of detector offsets. Low level trim optimizes the 562 for measurements of -45 dBm and below. It's use is required when retrace RF is ON or VOLTS mode is selected.

Detector offsets allow a dB offset to be set for any of the A, B, R1, or R2 detectors. These values remain in memory, even after the 562 is reset and powered down. The offsets are only cleared by entering "0 dB". If any detector offset is active, a status message displays at the bottom of the screen.

3-4.7 UNCAL Indicator

Lights when either measurement trace is uncalibrated.

3-4.8 BEGIN Indicator

Lights at the beginning of the calibration cycle and remains lit until the cycle is completed.

3-5 DATA ENTRY/CURSOR KEYS AND KNOB

The **DATA ENTRY** keys and knob (Figure 3-11) are described below.

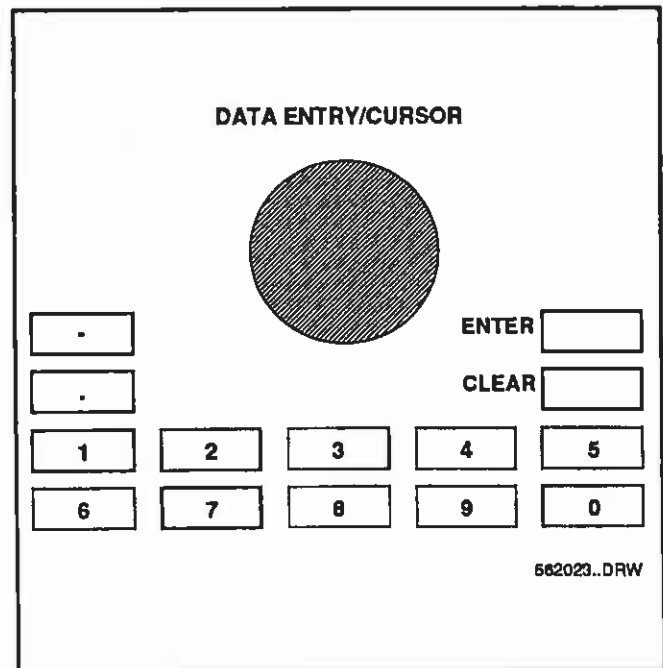

Figure 3-11. DATA ENTRY Keys and

CALIBRATION is the process whereby losses inherent in a transmission or return loss measurement system are measured, stored in internal memory, and later subtracted so that the results displayed are those of the test device, minus residual losses. Pressing the CALIBRATION key initiates the following sequence of menus when the Channel 1 trace has been selected to display transmission loss or gain from Input A and the Channel 2 trace return loss from input B.

Important: Set output power for the desired level before beginning the calibration sequence. Refer to Figure 3-25 for a pictorial of the following test setup.

- Connect the RF Input port on the SWR Autotester to the RF OUTPUT port on the sweep generator. An adapter may be needed.
- Connect the RF detector between input A of the Network Analyzer and the Test Port on the SWR Autotester.

When only transmission loss is being measured and the SWR Autotester is not being used, the test port called out in the menu is the port to which the test device connects. In most cases, it will be the RF OUTPUT port on the sweep generator.

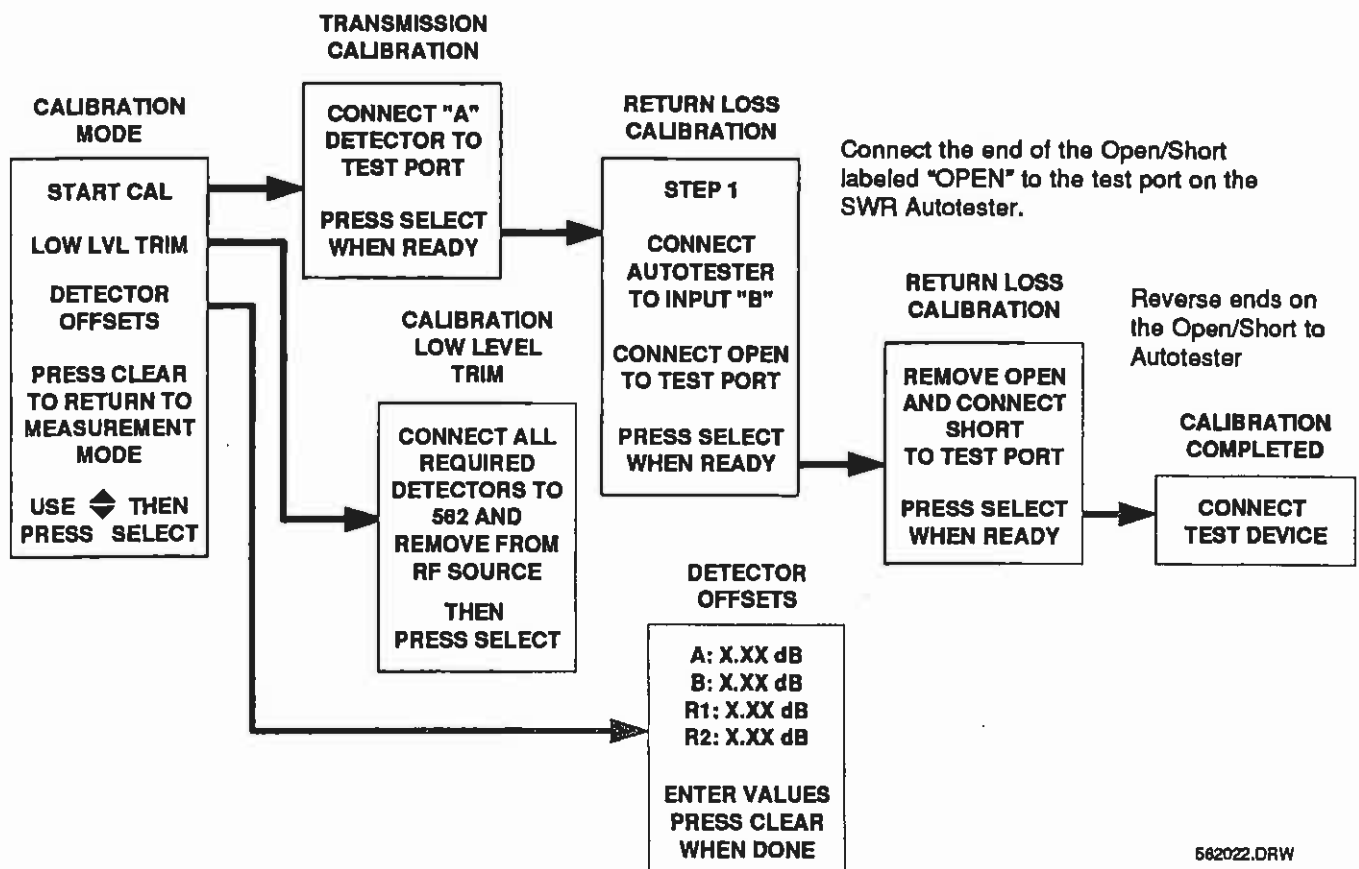

When the calibration cycle is complete, the losses inherent in the SWR Autotester, Adapter, and RF detector have been measured and stored. In all future measurements (in this configuration) of test devices *at this level of* output power, these losses will be subtracted from measured losses; consequently, the results displayed will be those of the test device minus residuals.

Figure 3-12. CALIBRATION Key Menu Sequence

3-5.1 Knob

Enters variably adjusted measurement values (cursor position, offset, resolution, etc.).

3-5.2 Keypad

Enters discrete measurement values.

3-5.3 ENTER Key

Terminates data entries made from the keypad.

3-5.4 CLEAR Key

Clears entered value, if pressed before the ENTRY key. Also clears a displayed menu, entry errors, complex limit segment identifiers, and cursor NOT FOUND message.

3-6 HARD COPY KEYS

The HARD COPY keys (Figure 3-13) are described below.

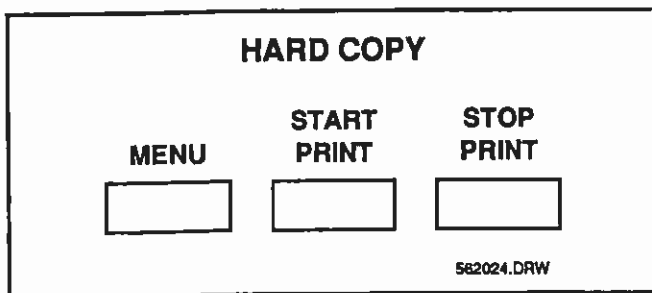

Figure 3-13. HARD COPY Keys

3-6.1 MENU Key

Displays a menu (Figure 3-14) providing print options for any of the following:

- The graphic display.
- A tabulation of the measured values to a printer.
- The graphic values to a plotter.
- Complex limit values in tabulated form.

Figure 3-15 provides examples of hard copy print outs. The MENU key menu selections are shown below.

a. *Print Graph.* Prints the on-screen graphic.

b. *Enter Titles.* Displays a menu providing options for entitling the test.

1. IDENTIFY. Selects an up-to-four character identification for the type of test (such as, TNSM for transmission, RL for return loss, PWR for power). Selecting this entry brings-up the "TITLE ENTRY" menu. To operate this menu, use the DISPLAY ENTRY/CURSOR knob highlight the desired alpha or numeric character. Then, press the ENTER key to select the highlighted entry. When your entry is complete, highlight DONE and press the ENTER key.

2. DATE. Enter the date in the format shown. Date can be entered as dd-mm-yy or mm-dd-yy, where m is the month, d is the day, and y is the year. Selecting this entry also brings up the "TITLE ENTRY" menu that was described above.

3. TEST DEVICE. Lets you enter an up-to-four character name for your test device. Selecting this entry also brings up the "TITLE ENTRY" menu that was described above.

c. *Tabular.* Selects the print resolution in data points—25, 51, 101, 201, or 401.

d. *Markers Only.* Displays data only at the frequency-marker points.

e. *Print Limits.* Prints limit data.

f. *Plotter.* Displays a menu providing plotter options.

1. PLOT ALL. Plots all displayed data.

2. ENTER TITLES. Displays the "SELECT TITLE TO ENTER" menu described above.

3. PLOT ONLY GRATICULES. Plots only the graticule data.

4. PLOT ONLY TRACES. Plots only the trace 1 or 2 data.

5. PLOT ONLY TITLING. Plots only the titling data.

6. PLOT ONLY CURSOR INFO. Plots only the cursor data.

7. PRINTER. Returns you to the "HARD-COPY MENU," which provides you with printer options.

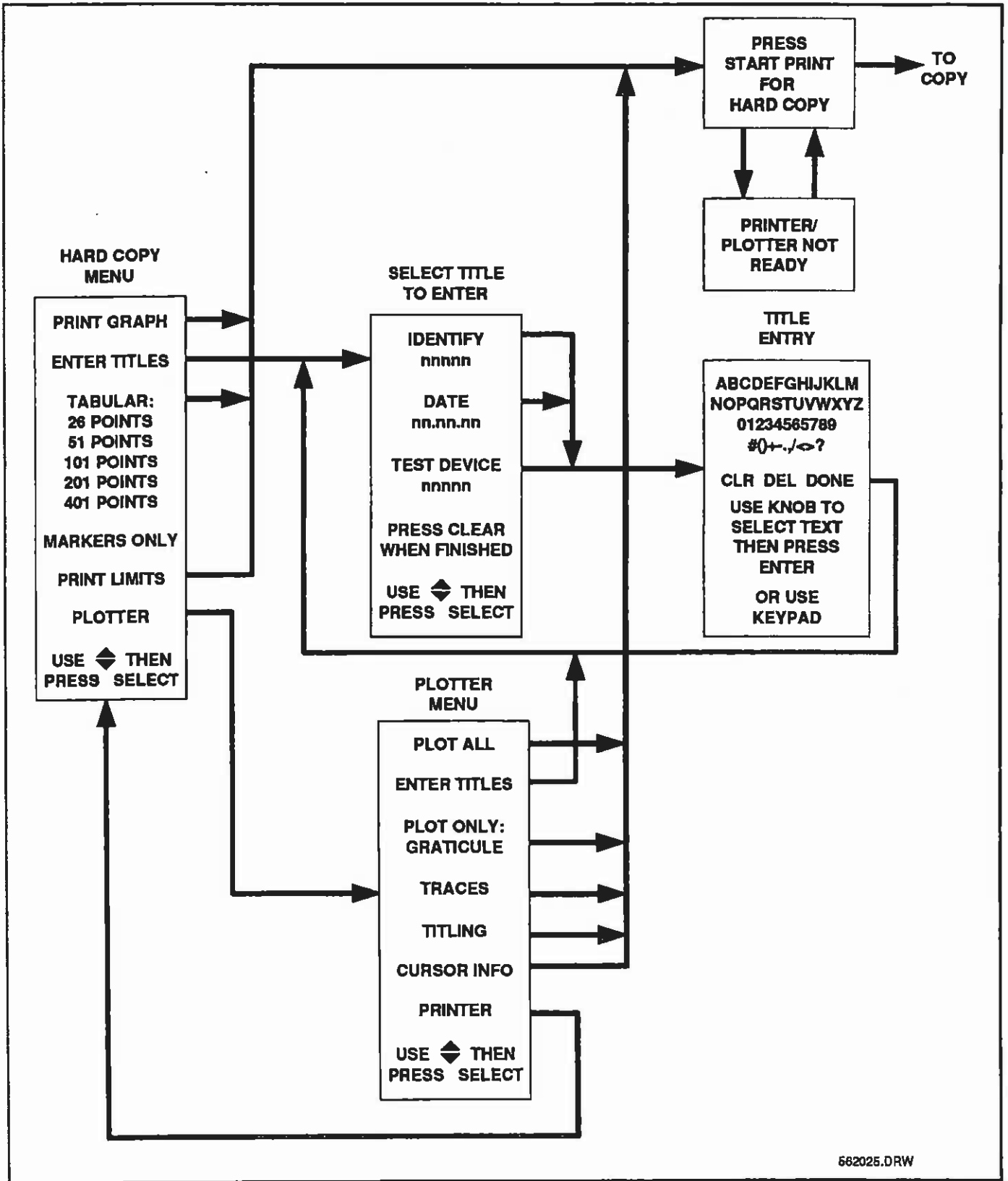

Figure 3-14. HARD COPY Menu

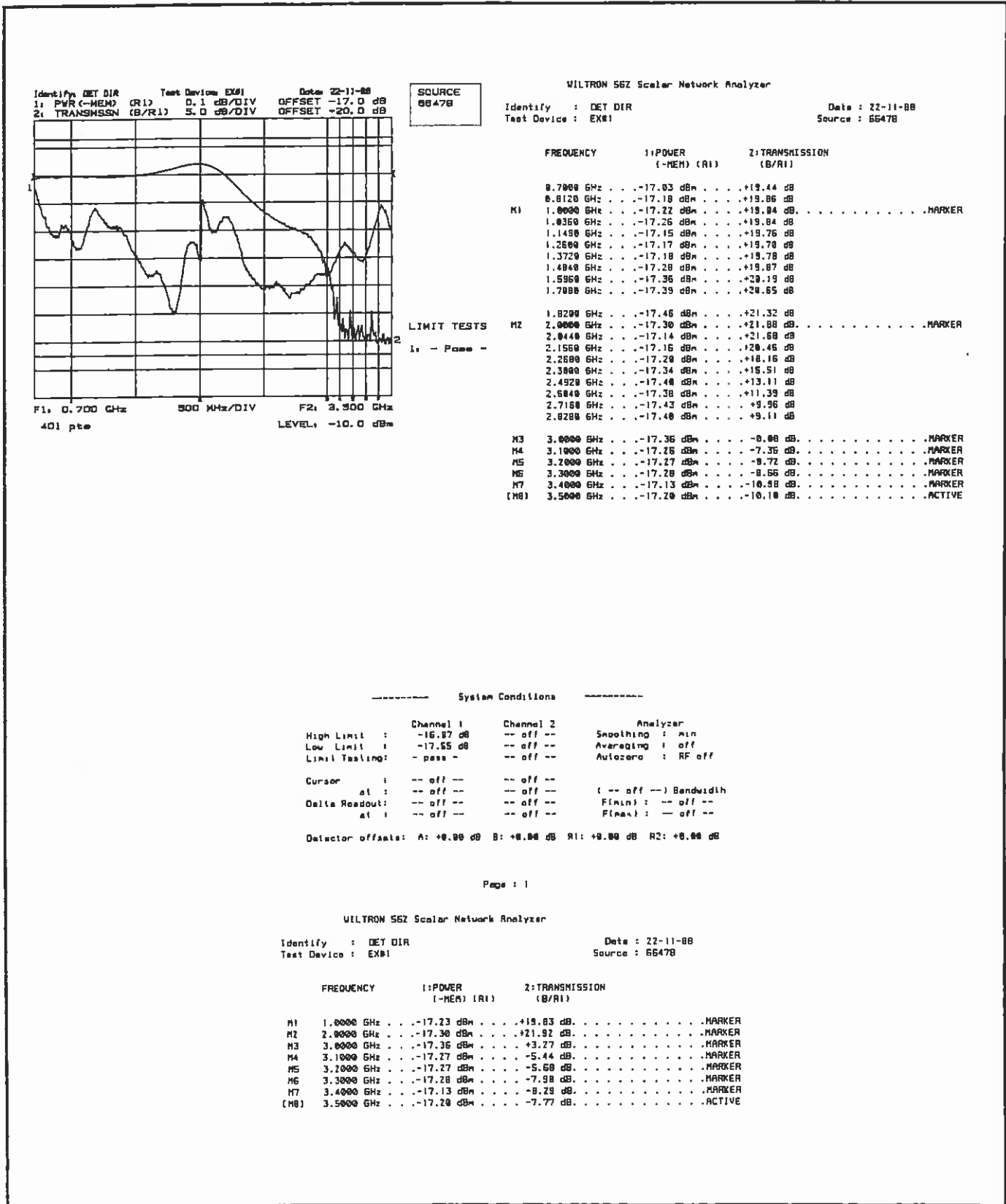

Figure 3-15. Hard Copy Examples

3-6.2 START PRINT Key

Freezes the displayed data and starts printing it. The type of printout then obtained, graphic or tabulated, is based on the last DISPLAY MENU key item selected.

3-6.3 STOP PRINT Key

Stops printing the data immediately. In the case of plotting, the end of a data string is finished and the plotter left in a reset state.

3-7 CURSOR FUNCTION KEYS, INDICATORS AND MENUS

The CURSOR keys and indicators (Figure 3-16) are shown in the figure below. Keys and menus are described in paragraphs 3-7.1 thru 3-7.3.

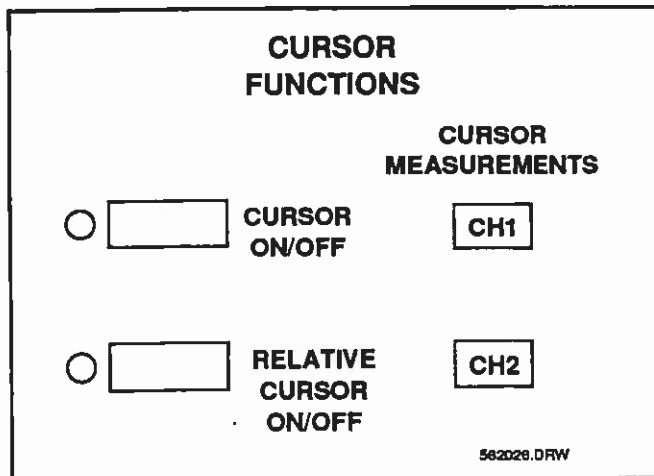

Figure 3-16. CURSOR Keys and Indicators

3-7.1 CURSOR ON/OFF Key

Positions the main cursor to the frequency point it was at when the function was last used. Thereafter, it is continuously variable with the tuning knob, or it may be positioned at the next marker by pressing the SELECT key if this option was last selected from a CURSOR MEASUREMENT menu. The frequency and amplitude of the test data at the cursor on both traces are digitally displayed.

3-7.2 RELATIVE CURSOR ON/OFF Key

Positions a relative cursor on the screen. The main cursor will then move as the tuning knob is varied, or it will advance to the next marker if the SELECT key is pressed. To establish a new reference, the main and reference positions may be reversed by

pressing the ENTER key. The difference in amplitude and frequency between the reference cursor and the main cursor positions on the test data are displayed for both traces.

3-7.3 CURSOR MEASUREMENTS Keys and Menus

Display menus (Figures 3-17 and 3-18) that let you quickly move the CH1 or CH2 cursor to any one of the points indicated.

- a. **Move Cursor To Maximum.** Moves the cursor to the maximum value of the test data and displays the amplitude and frequency.
- b. **Move Cursor To Minimum.** Same as described above, except for the minimum trace value.
- c. **Next Marker.** Moves the cursor to the next frequency marker and displays the amplitude and frequency.
- d. **Active Marker.** Moves the cursor to the active frequency marker and displays the amplitude and frequency.
- e. **dB Search.** Moves the cursor in accordance with instructions set in the "SET SEARCH PARAMETERS" menu described below.
- f. **Set Search Parameters.** Displays a menu providing control options for the "dB SEARCH" mode cursor.

1. **SEARCH VALUE.** Enter the amplitude value that you want to search for.
2. **SEARCH TYPE LEFT.** Directs the "dB SEARCH" mode cursor to search to the left of its current position for the value set using the "SEARCH VALUE" option.
3. **SEARCH TYPE RIGHT.** Same as above, except the search is to the right.
4. **SEARCH TYPE BANDWIDTH.** If the cursor is positioned within the +/- search range of the "SEARCH VALUE" entry, two cursors will diverge to indicate bandwidth (Figure 3-19).

3-8 ENHANCEMENT KEYS, INDICATORS, AND MENUS

The ENHANCEMENT keys and indicators (Figure 3-20) are described below. Keys and menus are described in paragraphs 3-8.1 and 3-8.2.

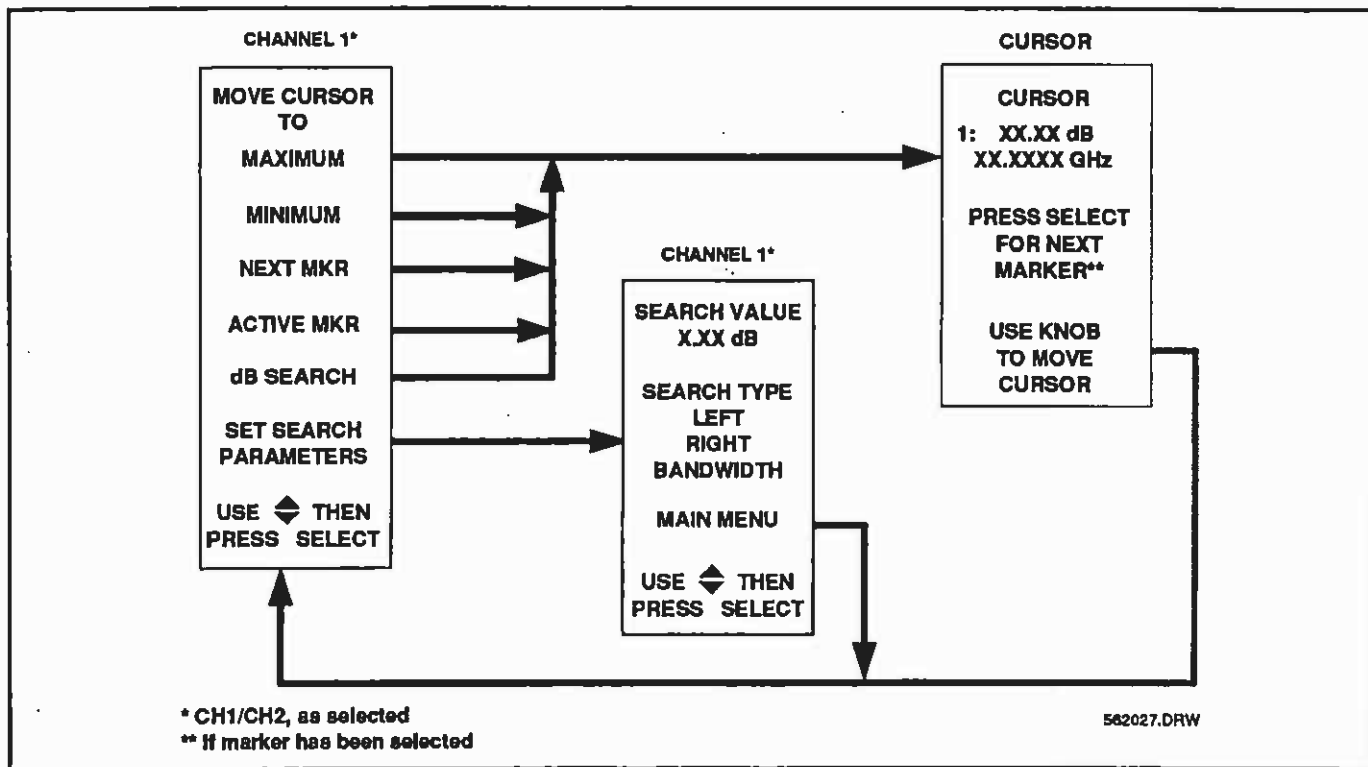

Figure 3-17. CURSOR MEASUREMENTS Menu (With RELATIVE CURSOR Off)

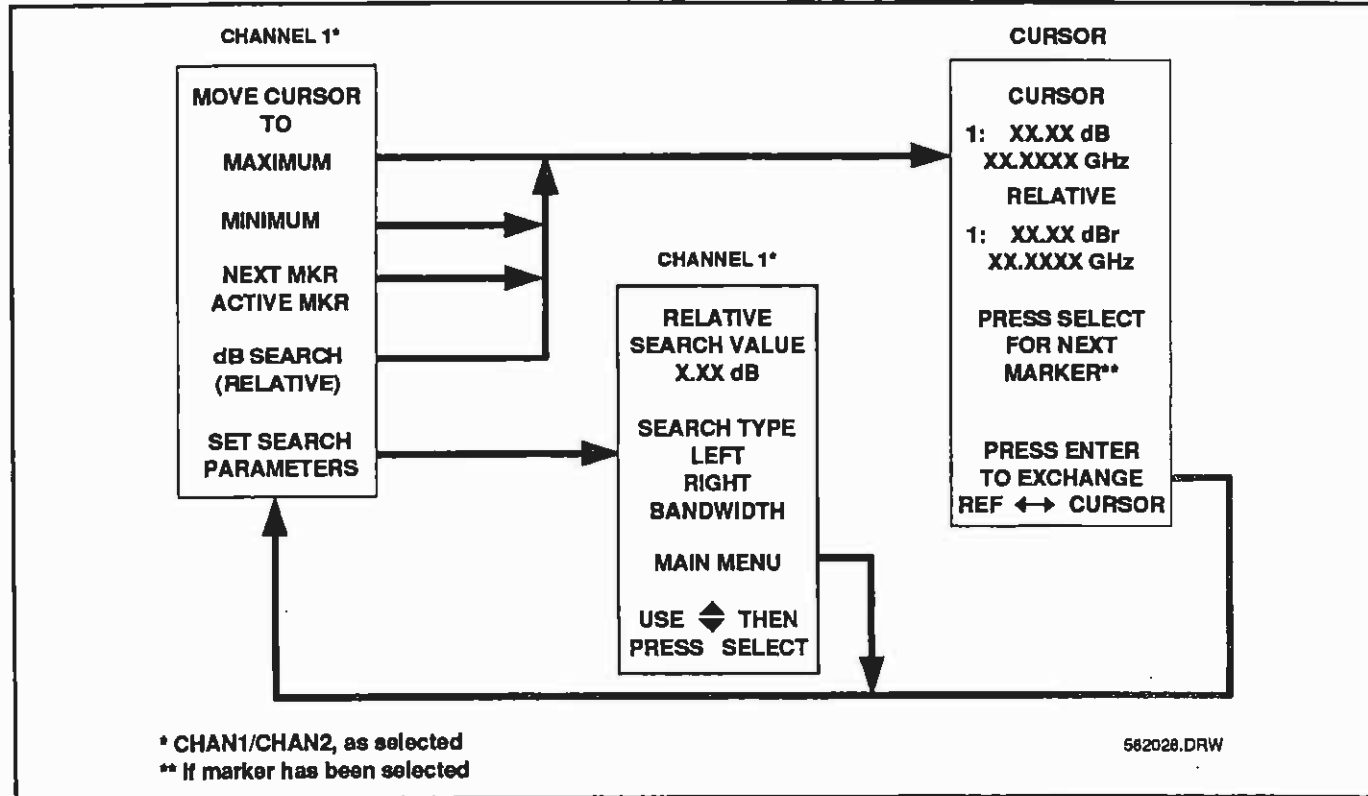

Figure 3-18. CURSOR MEASUREMENTS Menu (With RELATIVE CURSOR On)

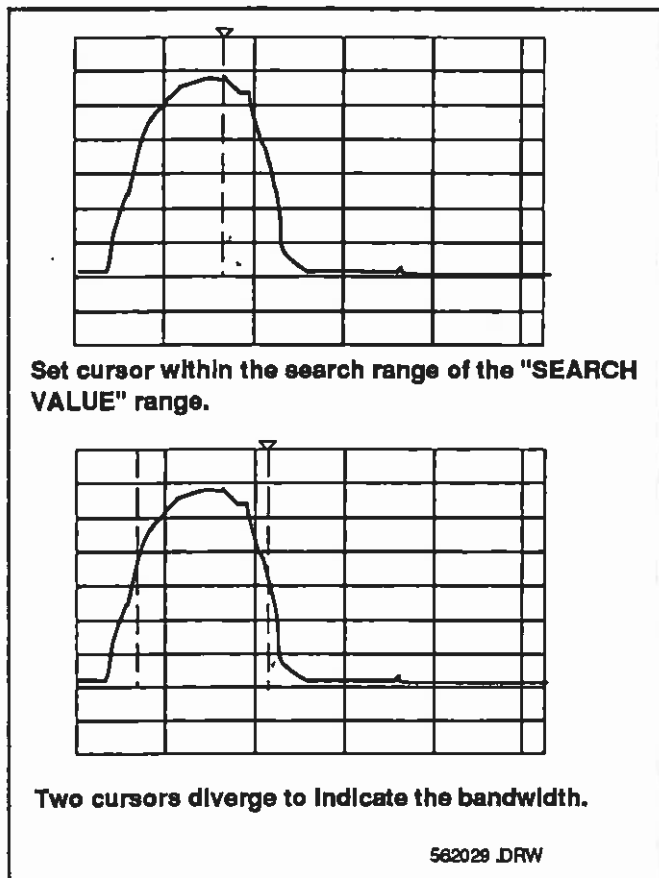

Figure 3-19. dB Search Mode Cursor, Bandwidth

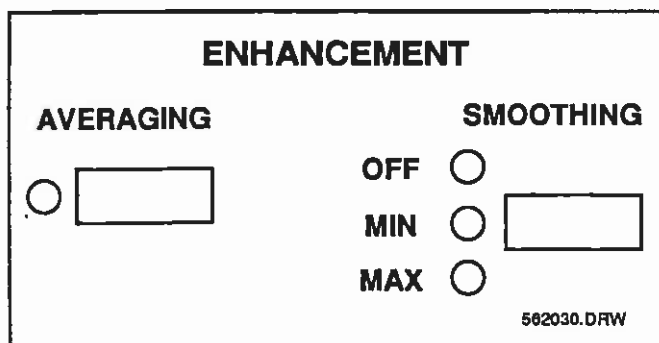

Figure 3-20. ENHANCEMENT Keys and Indicator

3-8.1 SMOOTHING Key and Indicators

Key provides two levels of filtering, MIN and MAX, that improve the display at low-signal levels. The OFF indicator lights when no smoothing (low-level filtering) is supplied.

3-8.2 AVERAGING Key, Indicator and Menu

When you select averaging, 4 to 256 successive sweeps can be averaged to smooth the trace display. The AVERAGING Menu is shown in Figure 3-21).

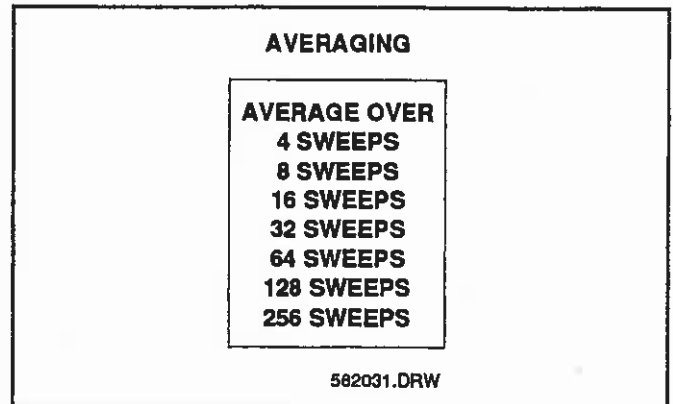

Figure 3-21. AVERAGING Menu

3-9 GPIB INDICATOR, KEY AND STATUS DISPLAY

The GPIB indicator and key (Figure 3-22) are described described in paragraphs 3-9.1 and 3-9.2.

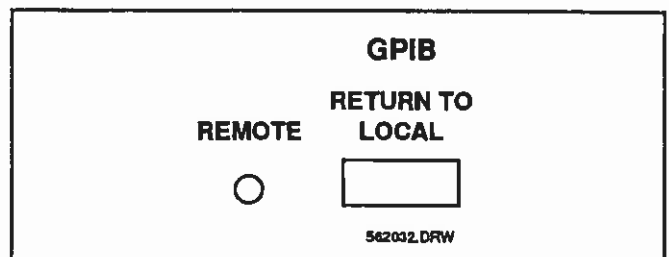

Figure 3-22. GPIB Indicator and Key

3-9.1 REMOTE Indicator

Lights when in the remote (GPIB) mode (Figure 3-23). When lit, a menu providing GPIB status appears at the bottom right side of the screen.

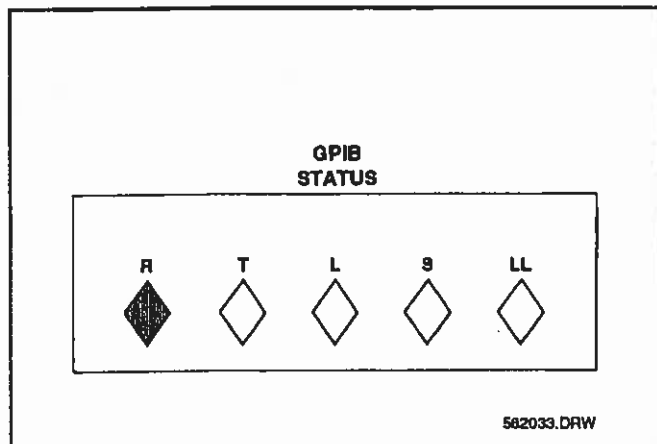

Figure 3-23. GPIB Status Display

3-9.2 RETURN TO LOCAL Key

If pressed while in the GPIB mode, the analyzer returns to the local mode. This occurs unless the local lockout (LLO) message has been programmed, in which case the key causes no action. If pressed while in the local mode, the analyzer's GPIB address displays in the MENU area of the screen. It can be altered by entering a new value from the numeric keypad and pressing ENTER. The new address is saved on power down and RESET.

3-10 REAR PANEL CONNECTORS

The rear panel contains multipin GPIB and printer connectors, the line voltage module, and additional input/output connections. The line voltage module and GPIB connector are described in Section II; the printer interface and the additional input/output connections are described in Figure 3-24.

3-11 MEASUREMENTS WITH THE 562 SCALAR NETWORK ANALYZER

The 562 Scalar Network Analyzer can be used to make transmission loss or gain, return loss, absolute power, SWR, volts, alternating setup measurements, or special custom measurements using TRACE MEMORY.

3-11.1 Transmission And Return Loss Measurements

How to make a transmission and return loss measurement is described in Table 3-1; a test setup is shown in Figure 3-25.

3-11.2 Absolute Power Measurement

How to make an absolute power measurement is described in Table 3-2.

3-11.3 Alternate Setup Measurements

How to make an alternate setup measurement is described in Table 3-3. The alternate setup mode is controlled thru the frequency source control panel.

3-11.4 Operational Checkout

The 562 Scalar Network Analyzer undergoes a comprehensive self test when turned on or when SELF TEST is selected. If the CRT displays "ALL TESTS PASSED," the internal circuits are operating properly. How to perform an operational check is described in Table 3-4.

3-11.5 Ratio-Mode Measurements

Ratio-mode measurements in which the A or B input is subtracted by the R1 or R2 input are described in Table 3-5. A test setup is shown in Figure 3-27. Ratio mode is beneficial in compensating for the effects of a long length of transmission, when making measurement where the device-under-test is located some distance away from the 562.

3-12 ERROR MESSAGES

Upon turning on the equipment or selecting SELF TEST or RESET, the analyzer undergoes a comprehensive self test. If the self test passes, the message "ALL TESTS PASSED" displays; however, if any part of the self test fails, an error message displays. Additionally, a control panel LED flashes. A different LED flashes for each fault. The LED coding for fault detection is shown in Table 3-6. This coding makes it possible to locate a fault even if the CRT has failed or is switched off.

If an intelligent source is used, the 562 directs it to perform a self test as well.

3-13 562 ANALYZER CONNECTIONS TO WILTRON SWEEP GENERATORS

The 562 Scalar Network Analyzer may be used with various WILTRON and other sweep generators. Table 3-7 lists many of the models that may be used with the 562 and the interconnections required.

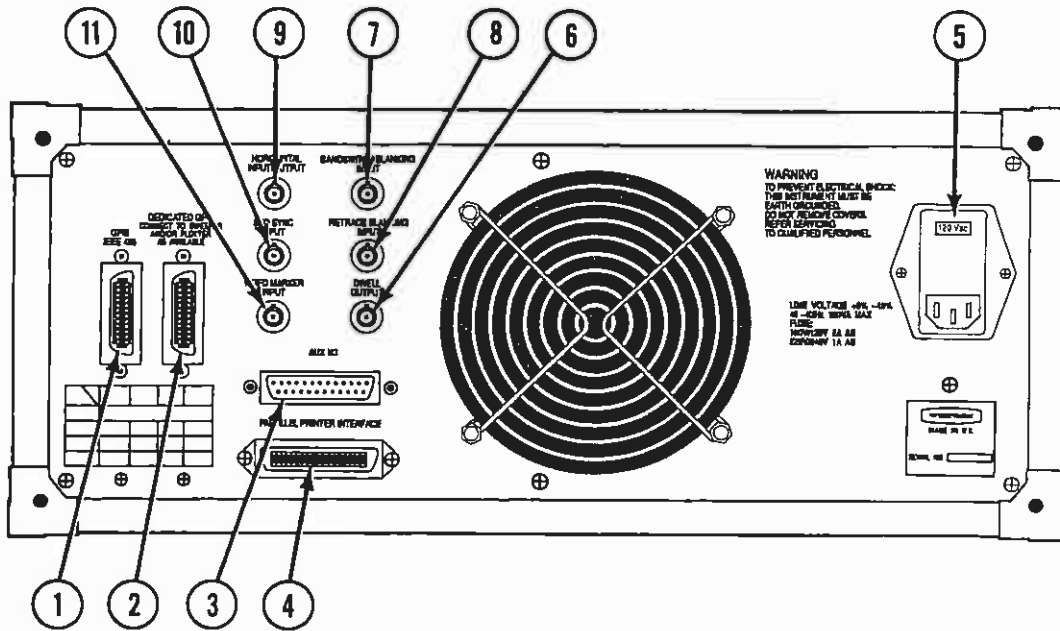

1. **GPIB CONNECTOR:** See Figure 2-2, page 2-4
2. **DEDICATED GPIB:** Connects 562 to signal source and plotter.
3. **AUX I/O:** Connects 562 to WILTRON 66XXA/B Sweep Generator, 67XXA/B Swept Frequency Synthesizer, HP 8350B Sweeper, and HP 8340A/8341A Synthesizers.
4. **PARALLEL PRINTER INTERFACE:** Provides standard Centronics parallel interface with a printer.
5. **LINE VOLTAGE MODULE:** See Figure 2-1, page 2-4.
6. **SWEEP DWELL OUTPUT:** TTL-Low signal stops sweep. Sweep continues when signal is removed. BNC connector.
7. **BANDSWITCH BLANKING INPUT:** Accepts $\pm 5V$ signal coincident with bandswitching points. BNC connector.
8. **RETRACE BLANKING INPUT:** $\pm 5V$ causes retrace to occur. BNC connector.
9. **HORIZONTAL (SWEEP RAMP) INPUT/OUTPUT:** 0 to +10V nominal, +12V maximum input. BNC connector, 100 k Ω impedance. When selected, can also provide a 0-10 V output.
10. **SEQUENTIAL SYNC INPUT:** +3.5V to +10V blanks trace during retrace or bandswitching. -3.5V to -10V defines a marker which, when in the range of -8V to -10V, is an active marker. BNC connector, 10 k Ω impedance.
11. **VIDEO MARKER INPUT:** +2V to +10V peak input. BNC connector.

Figure 3-24. Location of Rear Panel Connectors

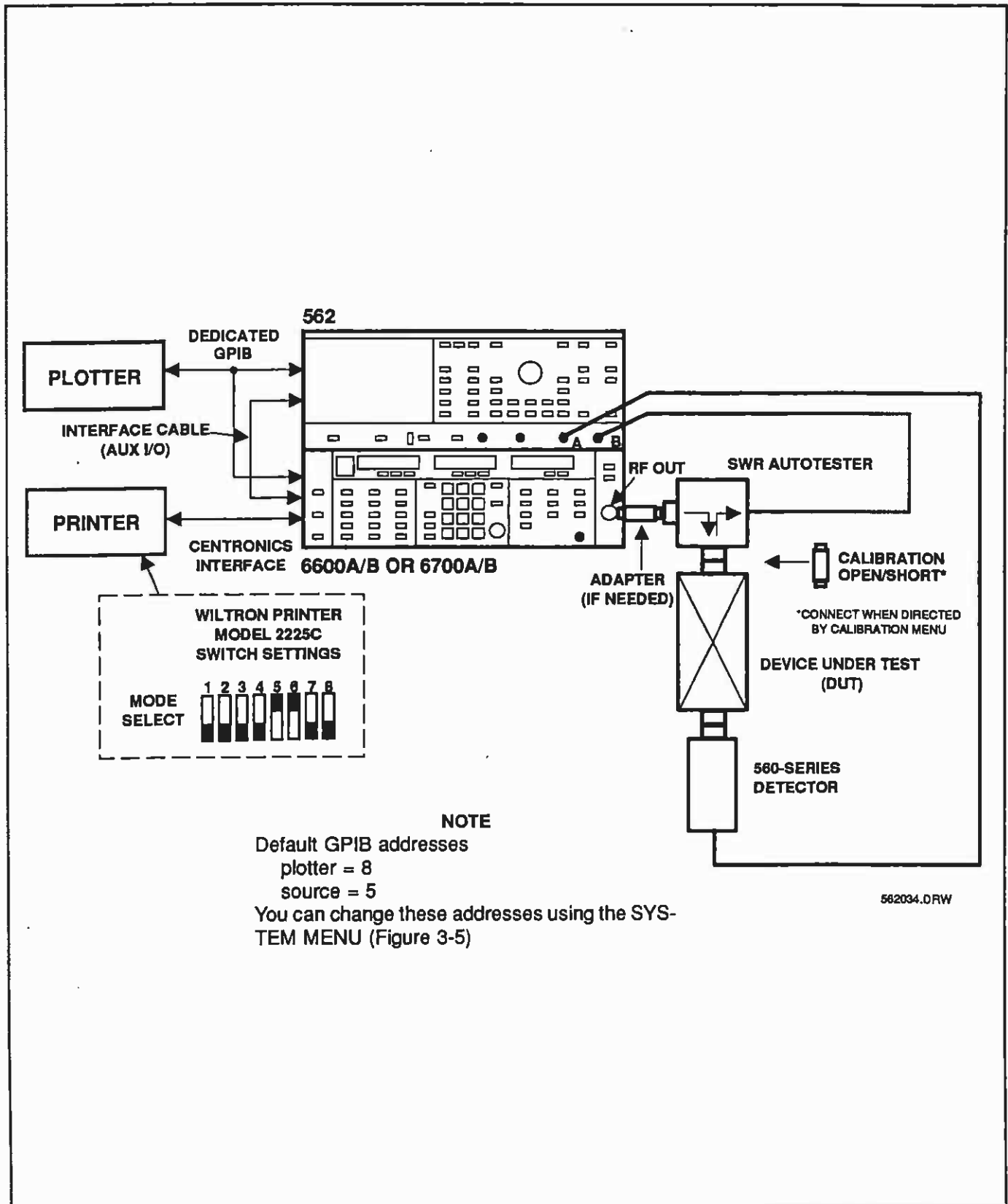
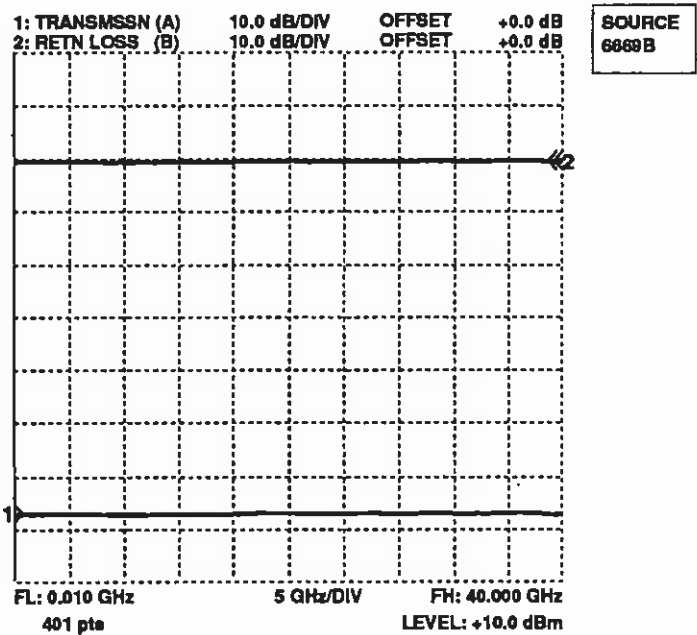

Figure 3-25. Measurements Test Setup

Table 3-1. Transmission and Return Loss Measurements

1. Connect test equipment per Figure 3-25, except do not connect the test device. Turn the printer on.
2. Turn on the 6600B sweep generator, then press POWER on the 562 to ON. At the conclusion of the built-in self test, the screen displays "ALL TESTS PASSED," and the CRT resembles that shown below. Control settings may be different from those shown, which are the RESET control settings*. The Instrument comes on line with the same control settings it had when last turned off. Ensure that both channels are ON and that Channel 1 is set for TRANSMISSION and Channel 2 for RETURN LOSS.
3. Press the CALIBRATION key and follow the directions given in the calibration-cycle sequence of menus. If necessary, refer to Figure 3-11 for an explanation of the menus. After finishing the calibration, connect the test device and RF detector as shown in Figure 3-25.



Transmission Loss Measurement

4. Measure the transmission loss as follows:
 - a. Press the Channel 2 DISPLAY ON/OFF key to off.
 - b. Press the Channel 1 AUTOSCALE key. This gives an optimum vertical display of the test data.
5. Read the transmission loss by interpolating the displayed graphic, or read it directly using the main and/or relative cursors with the readout function as described in step 6. The transmission loss is approximately 0 dB in the pass band and 66 dB at the bottom of the skirt for the 2 GHz LPF shown on the following page.
6. To use the main cursor and delta cursor to read the results of the above measurement directly, proceed as follows:
 - a. For an absolute measurement press the Cursor ON/OFF to on, then position the cursor using the rotary knob or the CURSOR MEASUREMENTS—CH1 key in conjunction with the MENU SELECT key to the required measurement point.
 - b. If a relative measurement is required, first turn on the relative cursor, then once the cursor has been positioned, press the CURSOR MEASUREMENTS—CH1 key, then select the desired parameter from the menu.

* Reset conditions depend upon the sweep generator.

Table 3-1. Transmission and Return Loss Measurements (Continued)

- c. Read the resultant cursor delta position data from the menu screen.
7. Make a hard copy printout of the transmission loss as follows:
 - a. Press the HARD COPY MENU key.
 - b. If device identify, date, and test device information is required, then select "ENTER TITLES" (paragraph 3-2.5).
 - c. Select PRINT GRAPH to print the displayed graphic, or select 26, 51, 101, 201, or 401 to print a tabulation at the selected number of frequency points. You could also choose to print out a tabulation at only the marker frequencies, if any markers were on.
 - d. When using the Wiltron Model 2225C printer, verify that the rear switch settings are as shown in Figure 3-25. Also verify that the power indicator is on and that the reset indicator is not flashing. If it is, press the RESET switch.
 - e. Press START PRINT to print out the data.
 - f. The printout should resemble the one shown below. (Note: both transmission and return loss measurements are shown.)
8. If a plotter is connected, by selecting the hardcopy menu you could choose to plot either graticules, traces, titling, cursor information or all of these items if the "PLOT ALL" function is selected (see paragraph 3-2.5).

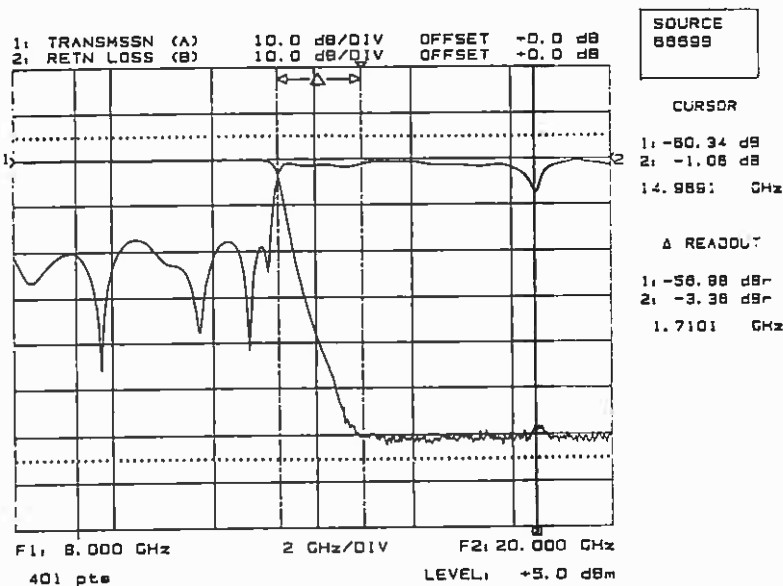

Return Loss Measurement

9. Measure the return loss of the device under test as follows:
 - a. Press Channel 1 DISPLAY ON/OFF key to off.
 - b. Press Channel 2 DISPLAY ON/OFF key to on.
 - c. Press Channel 2 AUTOSCALE key.
10. To use the cursor function to read the results of the return loss measurement directly, repeat step 6 above.
11. Print out the return loss as described in step 7 above.

Table 3-2. Absolute Power Measurement

1. Connect the RF detector between Connector A and the RF output connector as shown below.
2. Press POWER, on the analyzer, to ON. At the conclusion of the built-in self test the screen displays "ALL TESTS PASSED." Control settings may be different from those shown, which are the factory RESET control settings. The Instrument comes on line with the same control setting it had when last turned off.

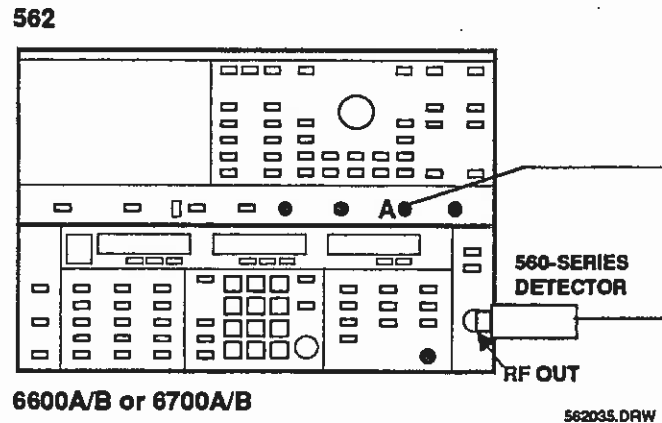

3. Press SYSTEM MENU key. Select RESET option, when menu appears.
4. Press the channel 2 DISPLAY ON/OFF key to off.
5. Press the channel 1 MENU key.
6. When the menu appears, select the POWER option using the MENU and SELECT keys.
7. Press the Channel 1 AUTOSCALE key. This gives an optimum vertical display of the test data.
8. Press the CURSOR ON/OFF key to on.
9. Using the DATA ENTRY rotary knob and/or the CURSOR MEASUREMENTS-CH1 key in conjunction with the MENU SELECT switch, move the cursor from the low to the high ends of the trace and read the source output power, in dBm, at the frequencies of interest.

Table 3-3. Alternate Setup Measurements

1. Connect test equipment per Figure 3-25, except do not connect the test device. Turn the printer on.
2. Turn on the frequency source and 562. At the conclusion of the built-in self test, the screen displays "ALL TESTS PASSED." Control settings may be different from those shown, which are the RESET control setting. The Instrument comes on line with the same control settings it had when last turned off.
3. Set Channels 1 and 2 to display transmission using input A, as follows:
 - a. Press the CH1 MENU key.
 - b. Move the cursor to highlight TRANSMISSION and press the SELECT key.
 - c. Move the cursor to highlight SELECT INPUT and press the SELECT key.
 - d. Move the cursor to highlight A and press the SELECT key.
 - e. Repeat steps a thru d for channel 2.
4. For the 66XXB, select an alternating setup as follows:
 - a. Press the FULL key.
 - b. Press the SHIFT key.
 - c. Press the SAVE key.
 - d. Select "5" on the keypad.
 - e. Press the Δ F CF key.
 - f. Press the ALT SETUP and "5" keys.
4. For the 67XXA/B, select an alternating setup as follows:
 - a. Press the F1-F2 key.
 - b. Press the SHIFT key.
 - c. Press the F3-F4 key.
5. On the 562, press the CALIBRATION key and follow the directions given in the calibration-cycle sequence of menus. If necessary, refer to Figure 3-12 for an explanation of the menus. After finishing the calibration:
 - a. Press SAVE/RECALL key,
 - b. Select menu option SAVE, then highlight CALIBRATION TRACE MEMORY AND SETUP (1-4 ONLY) option on SAVE menu.
 - c. Use keypad to select storage location 1 thru 4.
6. Connect the test device and RF detector as shown in Figure 3-25.
7. On the 562, measure the transmission loss in the Alternating Sweep mode as follows:
 - a. Press Channel 1 AUTOSCALE key. This gives an optimum vertical display of the test data.
 - b. Read transmission loss by interpolating the displayed graphic, or read it directly using main and delta cursors and the readout function per step 7 below. This is the transmission loss for the normal source input.
 - c. Repeat steps a and b for channel 2. This is the transmission loss for the alternate source input. If different alternative measurements are needed, then new calibration may be required (see paragraph 3-2.2a).

Table 3-3. Alternate Setup Measurements (Continued)

8. Make a hard copy printout of the transmission loss as follows:
 - a. Press the HARD COPY Menu key.
 - b. If device identify, date, and test device information are required to be annotated on hard copy, these can be entered by selecting TITLES (paragraph 3-2.5).
 - c. Select PRINT GRAPH to print the displayed graphic, or select 26, 51,101, 201, or 401 to print a tabulation at the selected number of frequency points. You could also choose to print out a tabulation at only the marker frequencies, if any markers were on.
 - d. When using the Wiltron Model 2225C printer, verify that its rear switch settings are as shown in Figure 3-26. Also verify that the power indicator is on and that its reset indicator is not flashing. If it is, press the reset switch.
 - e. Press START PRINT to print out the data.
 - f. The printout should resemble the one shown in Figure 3-14.
9. Measure the return loss of the device under test as follows:
 - a. Repeat steps 3 a thru d, except choose RETURN LOSS instead of TRANSMISSION.
 - b. Repeat step 6 for a return loss measurement.
10. Print out the return loss as directed in step 7 above.

Table 3-4. Operational Checkout Procedure

1. Connect the RF detector between Channel A of the analyzer and the RF output of the source as shown below.

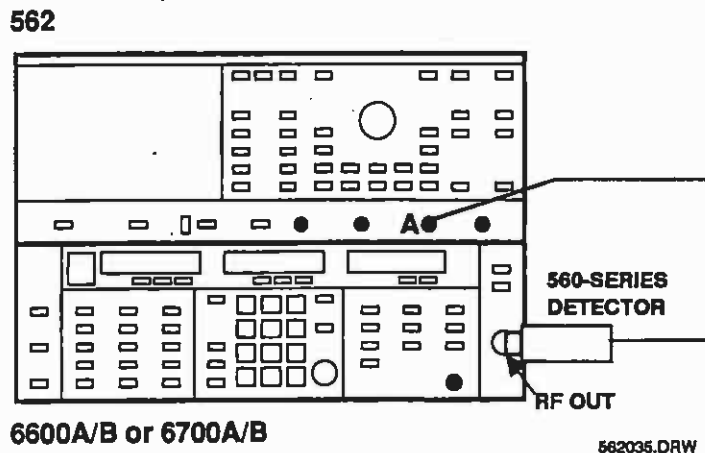

2. Press POWER on the analyzer to on. At the conclusion of the built-in self test, the screen displays "ALL TESTS PASSED." Press the SYSTEM MENU key and select the RESET option with the MENU SELECT switch (returns the system to the factory settings). Observe that the 562 screen is properly annotated for frequency and level.
3. Press the Graticule ON/OFF key.
4. Press the Channel 2 DISPLAY ON/OFF key to off.
5. Press the Channel 1 MENU key.
6. When the menu appears, select the POWER option using the MENU Up/Down switch and SELECT key.
7. Press the Channel 1 OFFSET/RESOLUTION key.
8. When the menu appears, select the OFFSET option and enter 10 dB via the DATA ENTRY keypad and the ENTER switch.
9. Observe that the trace deflects downward by 1 division.
10. Select the RESOLUTION option and enter 2 dB using the DATA ENTRY keypad or rotary knob.
11. On the power source, select a level of 2 dBm.
12. Observe that the trace deflects downward by 4 divisions.

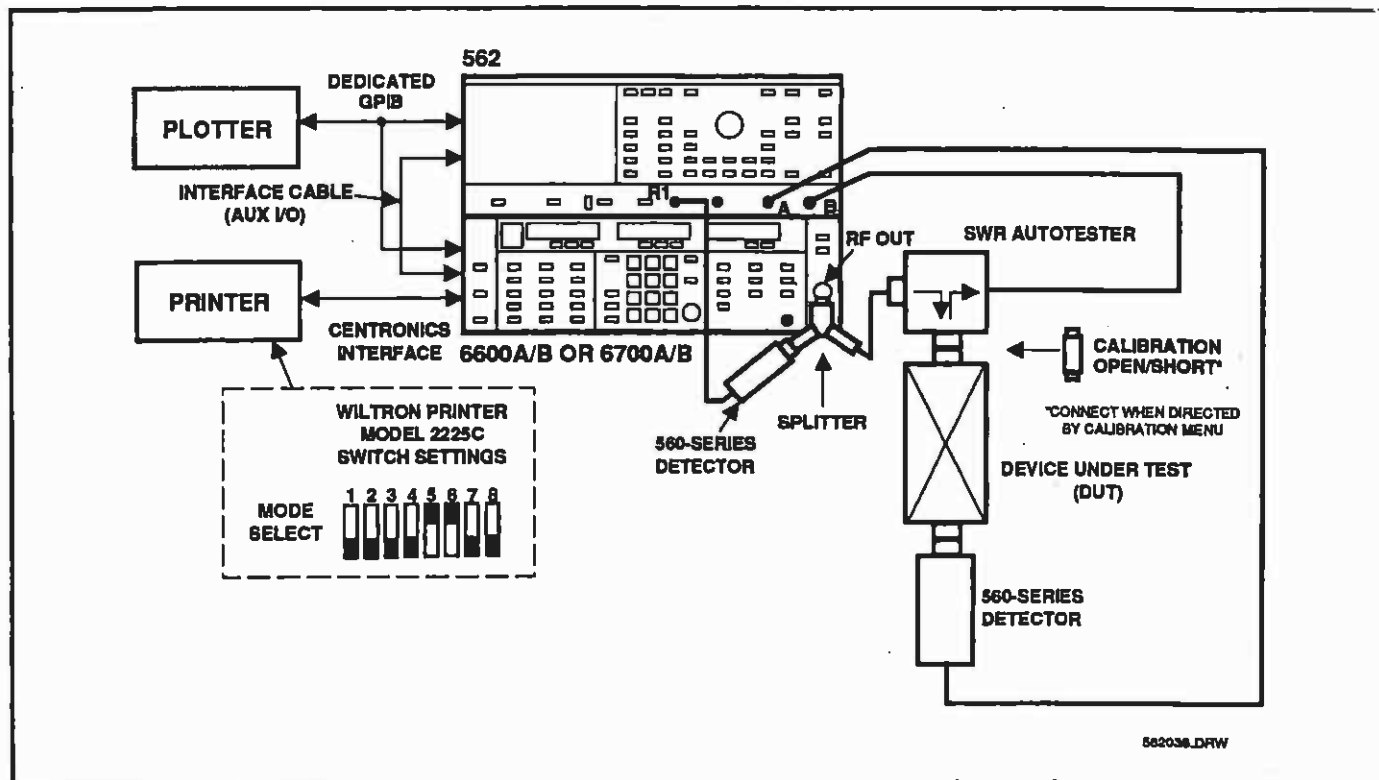

Figure 3-26. Test Setup for Ratio Mode Setup

Table 3-5. Ratio Mode Measurements

1. Connect test equipment per Figure 3-26, except do not connect the test device. Turn the printer (or plotter) on.
2. Turn on the frequency source and 562. At the conclusion of self test, the screen displays "ALL TESTS PASSED."
3. Select transmission mode and ratio input A/R1 for channel 1, and return loss and ratio Input B/R1 for channel 2 (section 3-2.3b).
4. On the 562, press the CALIBRATION key and follow the directions given in the calibration-cycle sequence of menus. If necessary, refer to Figure 3-11 for an explanation of the menus. After finishing the calibration, connect the test device and RF detector as shown in Figure 3-26.
5. On the 562, measure the transmission loss in the ratio mode as follows:
 - a. Press the channel 1 AUTOSCALE key. This gives an optimum vertical display of the test data.
 - b. Read the transmission loss. This is the transmission loss for the A/R1 ratio mode input.
6. To use the main cursor and relative cursor to read the results of the above measurement directly, proceed as follows:
 - a. Press the cursor ON/OFF to ON; then position the cursor using the rotary knob or the CURSOR MEASUREMENTS—CH1 key in conjunction with the MENU SELECT switch.
 - b. Turn the relative cursor on and the CURSOR MEASUREMENTS—CH1 key to ON, then select the desired parameter from the menu.

Table 3-5. Ratio Mode Measurements (Continued)

- c. Read the resultant cursor position data from the menu screen.
7. Make a hard copy printout of the transmission loss as follows:
 - a. Press the HARD COPY Menu key.
 - b. Select PRINT GRAPH to print the displayed graphic, or select 26,51,101, 201, or 401 to print out a tabulation at the selected number of frequency points. You could also choose to print out a tabulation at only the marker frequencies, if any markers were on.
 - c. When using the WILTRON Model 2225C printer, verify that the rear switch settings are as shown in Figure 3-26. Also verify that the power indicator is on and that the reset indicator is not flashing. If it is, press the reset switch.
 - d. Press START PRINT to print out the data.
 - e. The printout should resemble the one of those shown in Figure 3-15.
8. On the 562, measure the return loss in the ratio mode as follows:
 - a. Press the channel 2 AUTOSCALE key. This gives an optimum vertical display of the test data.
 - b. Read the return loss by interpolating the displayed graphic, or read it directly by using main and relative cursors and the readout function per step 6 above. This is the return loss for the B/R1 ratio mode input.
9. Print out the return loss as directed in step 7 above.

Table 3-6. Control Panel LED Error Codes

FLASHING LED*	FAULT	FAULT LOCATION
HOLD (Initial Turn On)	No Communication With 2nd CPU	A6
CHANNEL 1 (Initial Turn On)	Unable To Send Self Test To Sweeper	
CURSOR ON/OFF (Initial Turn On)	Fatal Error While Attempting To Calibrate Ramp	A4
CHANNEL 2	Ramp Not Calibrated	A4, or Sweep Ramp Too Slow
CHANNEL 1	CPU EPROM Checksum	A5 (Observe Initial Test To Identify)
AVERAGING	U22 RAM or U23 RAM	A5
SMOOTHING MINIMUM	Front Panel Key Error	A13
SMOOTHING OFF	U24 RAM or U30 RAM	A5
SMOOTHING MAXIMUM	System GPIB	A8
CAL BEGIN	Dedicated GPIB	A10
UNCAL	ADC Converter	A3
CURSOR	Test Reading Failed	A3 (A1/A2)
RELATIVE CURSOR	Channel A/B Null/Zero Failure/PCB Not Detected	A2 (A3)
REMOTE	Channel R1/R2 Null/Zero Failure/PCB Not Detected	A1 (A3)
HOLD	Tick/Time Scheduling Failure	A9/A5

* After a period of flashing, the option is given, at the users discretion, to continue to attempt operation by pressing SELECT.

Table 3-7. Interconnections, 562 to WILTRON and Other Sweep Generators

562 to WILTRON 6600A*/B		562 to HP8340/8341A	
562 CONNECTOR	6600A/B CONNECTOR	562 CONNECTOR	HP 8340/8341a CONNECTOR
AUX I/O Dedicated GPIB	AUX I/O GPIB	HORIZ IN/OUT SEQ SYNC VIDEO MARKER RETRACE BLANKING BANDSWITCH BLANKING DWELL OUTPUT Dedicated GPIB	SWEEP OUTPUT Z-AXIS/BLANK/MKRS NO CONNECTION NO CONNECTION NO CONNECTION STOP SWEEP GPIB
* 66XXA with retrofit kit installed for operation with the 562.		* Use WILTRON cable P/N 806-13 (only necessary for Alternate Sweep Mode).	
562 to WILTRON 6600A*/B—Using Discrete Cables		562 to WILTRON 610D	
562 CONNECTOR	6600A/B CONNECTOR	562 CONNECTOR	610D* CONNECTOR
HORIZ IN/OUT SEQ SYNC VIDEO MARKER RETRACE BLANKING BANDSWITCH BLANKING DWELL OUTPUT Dedicated GPIB	HORIZ OUT SEQ SYNC MARKERS OUTPUT NO CONNECTION NO CONNECTION SWEEP DWELL INPUT GPIB	HORIZ IN/OUT SEQ SYNC VIDEO MARKER RETRACE BLANKING BANDSWITCH BLANKING	HORIZ OUT SEQ SYNC VARIABLE MARKER OUTPUT +6V DURING RETRACE +10V DURING BANDSWITCH
* 66XXA with retrofit kit installed for operation with the 562.		* 610D requires Option B.	
562 to WILTRON 6600		562 to HP 8350B	
562 CONNECTOR	6600 CONNECTOR	562 CONNECTOR	8350B CONNECTOR
HORIZ IN/OUT SEQ SYNC VIDEO MARKER RETRACE BLANKING BANDSWITCH BLANKING DWELL OUTPUT	HORIZ OUT SEQ SYNC MARKERS OUTPUT RETRACE BLANKING OUTPUT (+) NO CONNECTION SWEEP DWELL INPUT	HORIZ IN SEQ SYNC VIDEO MARKER RETRACE BLANKING BANDSWITCH BLANKING DWELL OUTPUT Dedicated GPIB * AUX I/O	SWEEP OUTPUT POSZ BLANK NO CONNECTION NO CONNECTION NO CONNECTION STOP SWEEP GPIB 8410 PROGRAMMING CONNECTOR
562 to WILTRON 6700A		562 to HP 8620C	
562 CONNECTOR	6700A CONNECTOR	562 CONNECTOR	8620C CONNECTOR
AUX I/O Dedicated GPIB	AUX I/O GPIB	HORIZ IN/OUT SEQ SYNC VIDEO MARKER RETRACE BLANKING BANDSWITCH BLANKING DWELL OUTPUT Dedicated GPIB	SWEEP OUTPUT POSZ BLANK NO CONNECTION NO CONNECTION NO CONNECTION STOP SWEEP (Pin 34 of the 50-pin connector)
562 to WILTRON 6700A—Using Discrete Cables		* Use WILTRON cable P/N 806-14.	
562 CONNECTOR	6700A CONNECTOR		
HORIZ IN/OUT SEQ SYNC VIDEO MARKER RETRACE BLANKING BANDSWITCH BLANKING DWELL OUTPUT Dedicated GPIB	HORIZ OUT SEQ SYNC MARKERS OUTPUT NO CONNECTION NO CONNECTION SWEEP DWELL INPUT GPIB		

SECTION IV REMOTE (GPIB) OPERATION

CONTENTS

Paragraph	Title	Page
4-1	INTRODUCTION	4-3
4-2	DESCRIPTION OF THE IEEE-488 INTERFACE BUS	4-3
	4-2.1 Data Bus Description	4-3
	4-2.2 Management Bus Description	4-3
	4-2.3 Data Byte Transfer Control (Handshake) Bus Description	4-4
4-3	GPIB OPERATION	4-4
4-4	COMMAND CODES, DESCRIPTIONS	4-4
	4-4.1 Inputting Restrictions and Notes	4-4
	4-4.2 Reserved Mnemonics	4-5
4-5	BUS MESSAGES, ANALYZER RESPONSE TO	4-5
4-6	ALPHABETICAL INDEX TO ANALYZER COMMAND CODES	4-5

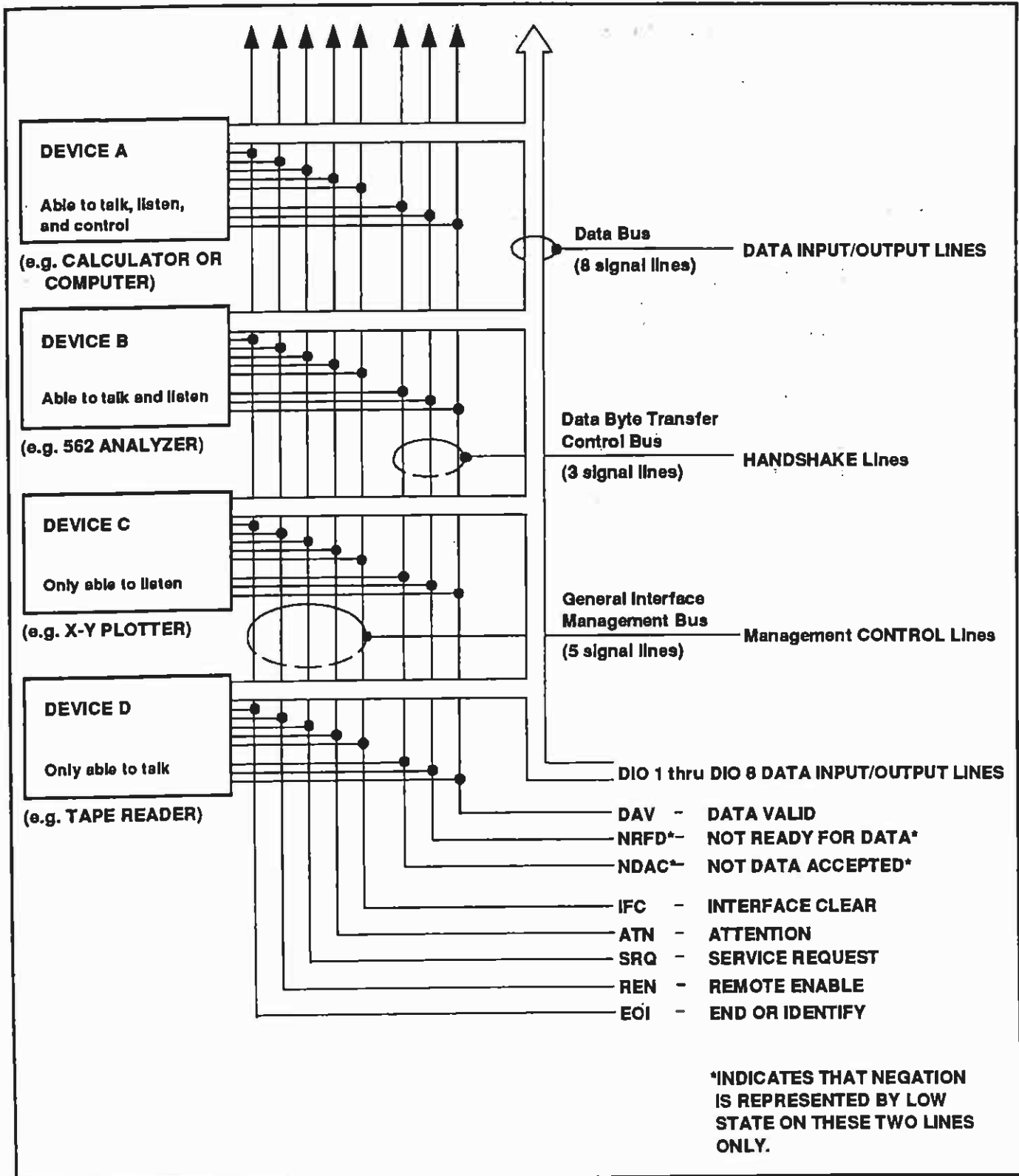

Figure 4-1. Interface Connections and Bus Structure

SECTION IV

REMOTE (GPIB) OPERATION

4-1 INTRODUCTION

This section provides a description of the GPIB and the analyzer command codes. It also provides several examples of bus programming.

4-2 DESCRIPTION OF THE IEEE-488 INTERFACE BUS

The IEEE-488 bus (General Purpose Interface Bus, or GPIB) is an instrumentation interface for integrating instruments, calculators, and computers into systems. The bus uses 16 signal lines to effect transfer of data and commands to as many as 15 instruments.

The instruments on the bus are connected in parallel, as shown in Figure 4-1 on the facing page. Eight of the signal lines (DIO 1 thru DIO 8) are used for the transfer of data and other messages in a byte-serial, bit-parallel form. The remaining eight lines are used for communications timing (handshake), control, and status information. Data is transmitted as eight-bit characters, referred to as bytes. Normally, a seven-bit ASCII (American Standard Code for Information Interchange) code is used. The eighth (parity) bit is not used. Data is transferred using an interlocked handshake technique.

This technique permits asynchronous communications over a wide range of data rates. The following paragraphs provide an overview of the data, management, and handshake buses, and describe how these buses interface with the analyzer.

4-2.1 Data Bus Description

The data bus is the conduit for transmitting control information and data between the controller and the analyzer. It contains eight bi-directional, active-low signal lines—DIO 1 thru DIO 8. One byte of information (eight bits) is transferred over the bus at a

time. DIO 1 represents the least-significant bit (LSB) in this byte and DIO 8 represents the most-significant bit (MSB). Each byte represents a peripheral address (either primary or secondary), a control word, or a data byte. Data bytes are usually formatted in ASCII code, without parity.

4-2.2 Management Bus Description

The management bus is a group of five signal lines used to control the operation of the bus system. Functional information regarding the individual control lines is provided below.

a. *ATN (Attention)*

When TRUE, the analyzer responds to appropriate interface messages—such as, device clear and serial poll—and to its own listen/talk address.

b. *EOI (End Or Identify)*

When TRUE, the last byte of a multibyte message has been placed on the line. Also used in conjunction with ATN to indicate a parallel poll.

c. *IFC (Interface Clear)*

When TRUE, the analyzer interface functions are placed in a known state—such as, unaddressed to talk, unaddressed to listen, and service request idle.

d. *REN (Remote Enable)*

When TRUE, the analyzer is enabled—upon receipt of its listen address—for entry into the remote state. The mode is exited either when the REN line goes FALSE (high) or when the analyzer receives a go-to-local (GTL) message.

e. *SRQ (Service Request)*

This line is pulled LOW (true) by the analyzer to indicate that certain preprogrammed conditions exist.

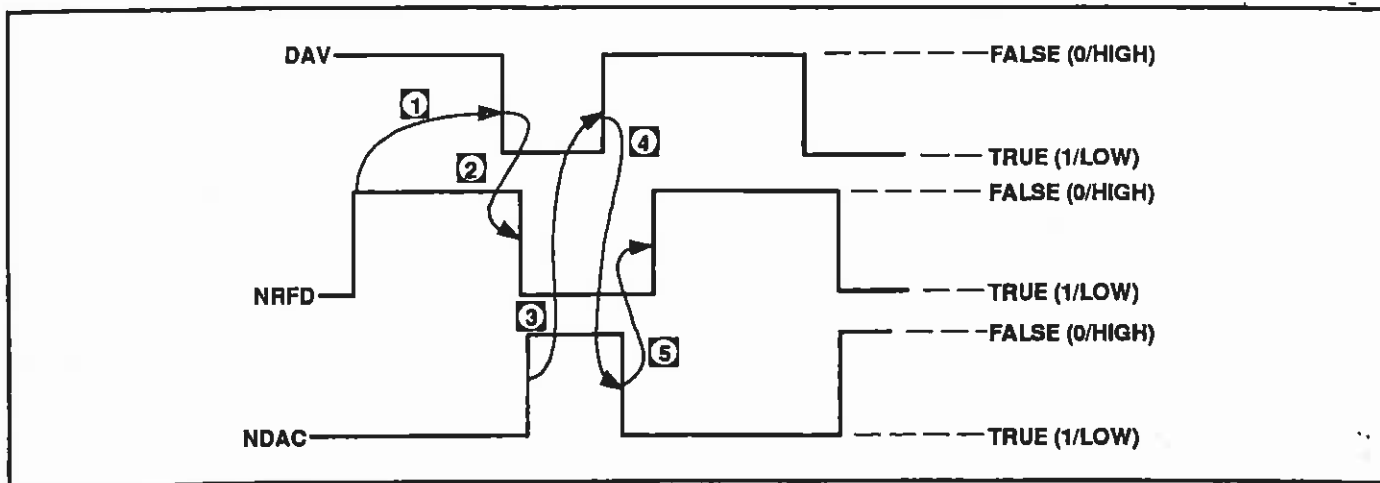

Figure 4-2. Typical Handshake Operation

4-2.3 Data Byte Transfer Control (Handshake) Bus Description

Information is transferred on the data lines by a technique called the three-wire handshake. The three handshake-bus signal lines (Figure 4-2) are described below.

a. DAV (Data Valid)

Goes TRUE (arrow 1) when the talker has sensed that NRFD is FALSE, (2) placed a byte of data on the bus, and (3) waited an appropriate length of time for the data to settle.

b. NRFD (Not Ready For Data)

Goes TRUE (arrow 2) when a listener indicates that valid data has not yet been accepted. The time between the events shown by arrows 1 and 2 is variable and depends upon the speed with which a listener can accept the information.

c. NDAC (Not Data Accepted)

Goes FALSE to indicate that a listener has accepted the current data byte for internal processing. When the data byte has been accepted, the listener releases its hold on NDAC and allows the line to go FALSE. However, since the GPIB is constructed in a wired-OR configuration, NDAC will not go FALSE until all listeners participating in the interchange have also released the line. As shown by arrow 3, when NDAC goes FALSE, DAV follows suit a short time later. The FALSE state of DAV indicates that valid data has been removed; consequently, NDAC goes LOW in preparation for the next data interchange (arrow 4).

Arrow 5 shows the next action in time: NRFD going FALSE after NDAC has returned TRUE. The FALSE state of NRFD indicates that all listeners are ready for the next information interchange. The time between these last two events is variable and depends on how long it takes a listener to process the data byte. In summation, the wired-OR construction forces a talker to wait for the slowest instrument to accept the current data byte before placing a new data byte on the bus.

4-3 GPIB OPERATION

All front panel keys are bus controllable. When used on the GPIB, the analyzer functions as both a listener and a talker. Table 4-1 provides a listing of the GPIB subset functions.

4-4 COMMAND CODES, DESCRIPTIONS

The command codes recognized by the 562 are listed in Tables 4-2 thru 4-11.

4-4.1 Inputting Restrictions and Notes

To initiate a GPIB command mnemonic, enter the command together with any required parameters. You may use a space to separate the command and parameter(s), but you do not have to. Also, you may enter several commands on the line; however, each must be separated by a valid delimiter. We recommend using a comma as the delimiter. Other valid delimiters are the colon (:), hyphen (-), asterisk (*), dollar sign (\$), virgule (/), reverse virgule (\), space (), and semicolon (;). The following is an example of a valid command structure.

Table 4-1. 562 IEEE-488 Bus Subset Capability

GPIB SUBSET	FUNCTION	DESCRIPTION
AH1	Acceptor Handshake	Complete Capability
SH1	Source Handshake	Complete Capability
T6	Talker	No Talk Only (TON)
TE0	Talker With Address Extension	No Capability
L4	Listener	No Listen Only (LON)
LE0	Listener With Address Extension	No Capability
SR1	Service Request	Complete Capability
RL1	Remote/Local	Complete Capability
PP1	Parallel Poll	Complete Capability
DC1	Device Clear	Complete Capability
DT1	Device Trigger	No Capability
C1, C2, C3, C28	Controller	No Capability

SI1 A, SM1 R, OFF 1 20 dB, GON, CRF 1 20GHz, OCF 1

The above command string would do the following:

1. Set the channel 1 signal trace to be from input A
2. Set the measurement type to be displayed on channel 1 and to be the return loss of the test device.
3. Set the channel 1 offset to be 20 dB.
4. Turn on the graticule grid display.
5. Move the cursor to 20 GHz on the channel 1 trace.
6. Return to the controller the cursor frequency for channel 1.

4-4.2 Reserved Mnemonics

In writing command strings, the following mnemonics may be used for clarity, or they may be omitted for brevity: dB, dBm, GHz, MHz. If the units of frequency (MHz, GHz) are not specified, GHz is assumed.

4-5 BUS MESSAGES, ANALYZER RESPONSE TO

Table 4-12 (page 4-24) lists the bus messages responded to by the analyzer. Table 4-13 (page 4-24) lists programming statements showing how the WILTRON 85 and HP Series 200 bus controllers implement the recognized bus messages.

4-6 ALPHABETICAL INDEX TO ANALYZER COMMAND CODES

Table 4-14 (pages 4-26 thru 4-28) provides an alphabetical index to the analyzer command codes.

Table 4-2. Command Codes: Display Channel Control

The following is a list of Mnemonic parameters as indicated within parenthesis: N = 1 or 2 for channel selection n = a number within range +/-99.99 F = a frequency within range +/-0 to 999.9999 GHz S = 0 or 1 for ON/OFF Indication (1 = ON, 0 = OFF) M = 1 to 9, Marker numbers, used for SAVE, RECALL, STORE Marker#, etc. P = 0 to 400, to select pixel position X = a variable that will be defined next to the Instruction or Mnemonic		
MNEMONIC CODE	FUNCTION	DESCRIPTION
SI1(X) SI2(X)	Set Input For Channel 1 Set Input For Channel 2	Selects input to be displayed on selected channel, where X is the input combination: that is A, B, R1, R2, A/R1, B/R1, A/R2, or B/R2. For example, bus command "SI2 B/R2" sets the signal ratio of Input B/Input R2. This input is displayed as the Channel 2 trace signal.
SIF(S)	User Interface ON/OFF	Used to Disable (S=0), or Enable (S=1) the dedicated GPIB interface. Note: After a system reset, the 562 defaults to the last user User Interface status selected.
SM1(X) SM2(X)	Set Channel 1 Display Set Channel 2 Display	Sets measurement type to be displayed on selected channel. In this case X equals P (power), R (return loss), T (transmission), C(calibration data), V(volts), M(trace memory), or S(SWR). For example, bus command "SM2R" sets channel 2 to measure the return loss of the device under test. Bus command "SI1 A, SM1 P" then sets channel 1 to display Input A, and sets the displayed signal to be a measure of absolute power in dBm.
TSS "title"	Title Stored Setups	Used to title the Preview Index for the Stored Setups. The title can be a maximum of 12 characters.
CH1(S) CH2(S)	Set Channel 1 On/Off Set Channel 2 On/Off	Turns the selected channel on or off. For example, bus command "CH1 1" turns channel 1 ON and allows it to display a signal trace.
RON(N) ROF(N)	Reference Display On Reference Display Off	Turns On/Off the reference line. The position is displayed by a chevron "<" ">" and a line drawn across the screen display. The default display is ROF which displays the reference line position using the chevron "<" or ">".
REF(N)(X)	Position	Sets reference line to position "X" on selected channel, where X= 0 to 10. In this case, the top of the screen equals 0, and the bottom of the screen equals 10. For example, bus command "REF 15" places the reference line for trace 1 at the fifth line from the top.
OFF(N)(n)	Offset (dB)	Sets the Offset on the selected channel. For example, bus command "OFF 2 10 dB" sets the trace offset on channel 2 to 10 dB.
SCL(N)(X)	Resolution (dB/div.)	Sets the Resolution of the selected channel to X dB / division, where X = 0.1 to 10 dB/div in any 0.1 dB increment.

Table 4-2. Command Codes: Display Channel Control (Continued)

MNEMONIC CODE	FUNCTION	DESCRIPTION
TCR(N)	Trace At Cursor to Reference Line	Automatically adjusts the offset such that the trace at the cursor is placed on the reference line for channel N.
LHI(N)(n) LHF(N) LLO(N)(n) LLF(N)	High Limit On High Limit Off Low Limit On Low Limit Off	Sets the straight line limits to n dB on the selected channel or turns off the limits. The limits can be used as a guide to test signal trace response. Setting these limits cancel any complex limits previously sent for that channel.
CLH(N)(limits) CLL(N)(limits) CHI (N) (S) CLO (N) (S)	Enter Complex Limits High Enter Complex Limits Low Complex High Limit ON/OFF Complex LowLimit ON/OFF	Sets the complex limits on the selected channel. See Appendix for format of data. See Figure 4-3 for a programming example. Displays or turns off the High Complex Limits for channel N. Displays or turns off the Low Complex Limits for channel N.
LTM (N)	Learn Trace Memory	562 Receives Trace Memory data sent from the controller for channel N
OCH (N) OCL (N)	Output Complex Limits High Output Complex Limits Low	Complex limits previously setup on the 562 may be returned to the controller. The data is returned in ASCII format.
DSI (S)	Display Segment Identifiers	If enabled, a numeric identifier is displayed to identify each segment of complex limit lines.
OLT(N)	Output Limits Test Result	Returns a pass/fail message to the controller. If the test fails, the failed frequency in GHz is returned with the fail message.
DLT	Display Limits Test	Displays a menu that performs pass/fail testing on every sweep for pre-entered limits.
ASC(N)	Autoscale	Automatically adjusts the resolution and offset to fit the signal trace for channel N on the screen.
GSN GSF	GPIB Status Indication On GPIB Status Indication Off	Turns the GPIB status indication display on. Turns the GPIB status indication display off
TM1(S) TM2(S)	Apply trace memory to Channel 1 Apply trace memory to Channel 2	Used to subtract Trace Memory from Signal Trace on the selected channel
TMD (N)	Load Trace Memory with signal trace data	Stores signal trace data for channel N to trace memory
TMH (N)	Load Trace Memory with complex high limits	Stores Complex High Limits for channel N to Trace Memory
TML (N)	Load Trace Memory with complex low limits	Stores Complex Low Limits for channel N to Trace Memory

```
Bus Command: CLH 1 1 900MHz 4GHz -3DB 7 DB  
                2 4GHz 6GHz 7DB -20.03DB  
(Mnemonics may be in either upper or lower case, or mixed.)
```

The above command sets the high values of complex limits for channel 1. The order in which data is entered is as follows:

- Segment Number
- Start Frequency
- Stop Frequency
- Limit Value at Start Frequency
- Limit Value at Stop Frequency

The above command illustrates setting the complex limits for segments 1 and 2. For the frequency parameter, if "GHz" or "MHz" is not entered, then the frequency defaults to GHz.

The "dB" mnemonic as used in the string is optional and may be used to improve readability.

There are ten valid segments (1 – 10), a complete set of segment values may be entered using a single command, or each segment may be entered individually.

The data is entered in an ASCII format.

Figure 4-3. Programming Example: Complex Limits

Table 4-3. Command Codes: Calibration, Graticule Display, System Functions, Diagnostic Facilities,

The following is a list of Mnemonic parameters as indicated within parenthesis: N = 1 or 2 for channel selection n = a number within range +/-99.99 F = a frequency within range +/-0 to 999.9999 GHz S = 0 or 1 for ON/OFF Indication (1 = ON, 0 = OFF) M = 1 to 9, Marker numbers, used for SAVE, RECALL, STORE Marker#, etc. P = 0 to 400, to select pixel position X = a variable that will be defined next to the instruction or Mnemonic		
MNEMONIC CODE	FUNCTION	DESCRIPTION
CALIBRATION		
CAL (X)	Perform 562 calibration	Initiates the calibration sequence on the 562. If (X) is "N" or omitted, calibration data at the number of data points selected is stored. If (X) is "H", up to 2000 points are stored for a high resolution calibration.
CTN	Continue Calibration	Continues a paused calibration routine
NUL	Low Level Null	Low level null is only used in Autozero RF Mode ON
DOA (N)	Detector Offset A	Establishes an equality between dummy loads and RF OFF conditions (only used when no RF is present).
DOB (N)	Detector Offset B	Offsets the measurement for the selected input without affecting the calibration data
DO1 (N)	Detector Offset R1	
DO2 (N)	Detector Offset R2	
GRATICULE DISPLAY		
GON	Turn Graticule On	Turns the graticule grid display on.
GOF	Turn Graticule Off	Turns the graticule grid display off leaving small tick marks.
SYSTEM FUNCTIONS		
SVS(M)	Save Front Panel Setup	Saves the current control panel setup to memory M.
SVC(X)	Save Setup with Calibration Data	Saves the current control panel setup together with all relevant calibration data to memory X, where X = 1 to 4.
RCS(M)	Recall Setup	Recalls the control panel setup from memory M.
RCC(X)	Recall with Calibration Data	Recalls the control panel setup from memory X (X = 1 to 4), together with calibration data.
PRV(X)	Preview	Looks at control panel setup X (X=1 to 9) from memory without recall. If an Intelligent sweeper is connected, it's setup is also displayed. When Preview mode is selected, only the following functions are allowed: other Preview setups, stop print function, and print graph function. Mnemonic command "PRV 0 "deselects the Preview mode.
CN	Configure Normal	Resets the hardware link between 562 and source for normal operation
CNR	CW No Ramp	Only available with non-Intelligent sweepers.
CRO	Configure Ramp Output	Provides 0-10v ramp output from 562 via the RAMP INPUT/OUTPUT BNC connector
CML (data)	Configure Manual Labelling	Allows monitor display to be annotated when using a non-intelligent source, e.g. "2 GHz 8 GHz 10 dBm".

Table 4-3. Command Codes: Calibration, Graticule Display, System Functions, Diagnostic Facilities, Averaging, Smoothing. (Continued)

MNEMONIC CODE	FUNCTION	DESCRIPTION
ASW MSW NSW	Auto Sweep Manual Sweep Normal Sweep	Only available on non-intelligent sweepers. Only available on non-intelligent sweepers. Set sweep to normal. Only available on non-intelligent sweepers.
TMO RCT(X)	Turn Off Manual Labelling Recall Trace Memory	Turn off all label information set using the CML mnemonic. The argument (X) is a number from 1 to 4, based on the trace memory location from which data is to be recalled.
SML(X)	Set Maximum Power Level	The argument (X) is a number from -120 to +30 dBm, based on the desired power level.
SSL(X)	Set Start Power Level	The argument (X) is a number from -120 to +30 dBm, based on the desired power level.
SVT(X)	Save Trace Memory	The argument (X) is a number from 1 to 4, based on the trace memory location to which data is to be saved.
DIAGNOSTIC FACILITIES		
TST	Test	Runs the instrument self test routine. The result of the test is available in the extended status byte.
RST	Reset	Resets the instrument to factory default settings. If an intelligent sweeper is connected to the 562, this too will be reset.
CTN	Continue	Continue after Self Test failed.
FREQUENCY DATA POINTS		
DP1	Set Resolution to 101 Data Points	Sets the screen display resolution to 101, 201, or 401 data points. 101 and 201 are only valid when smoothing is off, else the DP instruction will only take effect when returning to smoothing off.
DP2	Set Resolution to 201 Data Points	
DP4	Set Resolution to 401 Data Points	
AVERAGING		
AVG(X)	Averaging On	Turns the averaging function on or off. The number of sweeps averaged is equal to 2 raised to the power X, where X = 2 to 8.
AOF	Averaging Off	Turn off signal averaging.
AVE (X)	Set Averaging	Sets the number of averaging sweeps (X) valid values for X are 4, 8, 16, 32, 64, 128, and 256.

Table 4-3. Command Codes: Calibration, Graticule Display, System Functions, Diagnostic Facilities, Averaging, Smoothing. (Continued)

MNEMONIC CODE	FUNCTION	DESCRIPTION
SMOOTHING		
SON(X)	Smoothing On	Controls the on/off and minimum/maximum states of the signal trace smoothing function where X = 0, 1, or 2. When X is 0, smoothing is off; X = 1, minimum smoothing; X = 2, maximum smoothing.
SOF	Smoothing Off	Turns smoothing off.
SMO (X)	Set Smoothing	Sets smoothing to minimum, maximum, or off depending on the value of X. When X is 0, smoothing is off; X = 1, minimum smoothing; X = 2, maximum smoothing.
NOTE: SMO (X) is an alternate mnemonic for SON (X).		

Table 4-4. Command Codes: Service Request

MNEMONIC CODE	FUNCTION	DESCRIPTION
SQ1 SQ0	Enable SRQ Disables SRQ	The 562 defaults to SQ0, SRQ being disabled.
SQS(X)	Program Number of Sweeps	After X number of sweeps, an SRQ will be generated.
IPM(X)	Input Primary Mask	Provides an 8-bit mask (X) for the primary status byte. The mask argument (X) can be a number from 0 to 255. The default value is zero. See Figure 4-4 for an example of the status bytes and how they are used.
IEM(X)	Input Extended Mask	Provides an 8-bit mask (X) for the extended status byte. The mask argument (X) can be a number from 0 to 255. The default value is zero.
CSB	Clear Primary Status Byte	Clears the primary status byte.

Bus Command: IPM 135

The argument 135 sets the primary status mask to enable bits 0, 1, 2, and 7 in the primary status byte (see below).

NOTE

The Service Request bit (6) in the primary status byte is not maskable. Separate mnemonics exist for enabling and disabling the SRQs.

STATUS BYTE
Binary Byte Decoding

7	6	5	4	3	2	1	0
128	64	32	16	8	4	2	1

Primary Status Byte

7	6	5	4	3	2	1	0
---	---	---	---	---	---	---	---

All bits except 6 will generate an SRQ when set to a 1 (high).

Bit	Function
0	Provides an SRQ after a programmed number of sweeps have been completed.
1	Syntax error.
2	Calibration sweep finished.
3	Not used.
4	Redirection mode failure. Sets for any error associated with attempting to program an instrument on the dedicated GPIB.
5	Extended status byte contains valid information.
6	Service request bit.
7	Redirected SRQ. Set when any instrument on the dedicated GPIB has requested service. See Figure 4-5 for an explanation.

Extended Status Byte

7	6	5	4	3	2	1	0
---	---	---	---	---	---	---	---

Bits 0, 1, and 2 will contain status information and will also generate a service request. The remaining bits are status bits only.

Bit	Function
0	Print finished = 0 (will generate an SRQ.) Print failed = 1
1	Plot finished = 0 (will generate an SRQ.) Plot failed = 1
2	Last print request failed (will generate an SRQ).
3	562 is uncalibrated.
4	562 is in calibration mode.
5	562 is in secret mode.
6	562 self test failed.
7	Preview mode currently selected.

Figure 4-4. Programming Example: Service Request

When an instrument on the dedicated GPIB requests service, bit 7 in the primary status byte is set. This generates an SRQ. Two data bytes are available to be read. They will indicate which instrument on the dedicated GPIB has requested service and its status. The first byte contains the status information. The second byte contains the address of the instrument requesting service, see below.

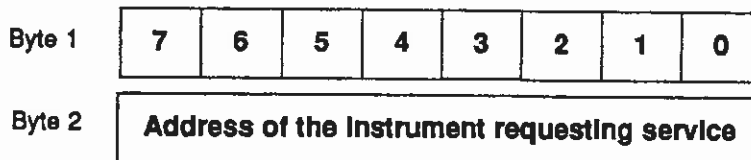

Figure 4-5. Redirected Status Byte

Table 4-5. Command Codes: Cursor Control and Search Facility

The following is a list of Mnemonic parameters as indicated within parenthesis:
 N = 1 or 2 for channel selection
 n = a number within range +/-99.99
 F = a frequency within range +/-0 to 999.9999 GHz
 S = 0 or 1 for ON/OFF indication (1 = ON, 0 = OFF)
 M = 1 to 9, Marker numbers, used for SAVE, RECALL, STORE Marker#, etc.
 P = 0 to 400, to select pixel position
 X = a variable that will be defined next to the Instruction or Mnemonic

MNEMONIC CODE	FUNCTION	DESCRIPTION
CURSOR CONTROL		
COF	Cursor Off	Controls the movement of the main or reference cursor, either by specifying position or frequency, and also the on/off states of the cursors. EXAMPLE: Bus command RCF 1 20 GHz will move the reference cursor to a frequency of 20 GHz on the channel 1 trace. This is the relative cursor operation. This is a Relative Cursor function and requires the Relative Mode to be selected.
CON	Cursor On	
CRP(P)	Move Cursor to Position P	
CRF(N)(F)	Move Cursor to Frequency F	
DON	Relative Mode On	
DOF	Relative Mode Off	
RCF(N)(F)	Move Reference Cursor to Frequency F	
RCP(P)	Move Reference Cursor to Position P	
SEARCH FACILITY		
CMX(N)	Move Cursor to Max	General cursor search on channel N. The cursor will be moved to either the maximum or minimum trace position, a specific marker, or the active marker.
CMN(N)	Move Cursor to Min	
CMK(M)	Move Cursor to Marker M	
CAM	Move Cursor to Active Marker	
CLT(N)(n)	Move Cursor Left to n dB	If the relative cursor is off, then the search will be for an absolute value left or right of the cursor. If the relative cursor is on, the search will be for a value relative to the current reference cursor value.
CRT(N)(n)	Move Cursor Right to n dB	
CBW(N)(n)	Bandwidth	Displays the bandwidth of value n dB on channel N. The reference cursor is left at the lower frequency and the main cursor at the higher.

Table 4-6. Command Codes: Hard Copy

The following is a list of Mnemonic parameters as indicated within parenthesis: N = 1 or 2 for channel selection n = a number within range +/-99.99 F = a frequency within range +/-0 to 999.9999 GHz S = 0 or 1 for ON/OFF indication (1 = ON, 0 = OFF) M = 1 to 9, Marker numbers, used for SAVE, RECALL, STORE Marker#, etc. P = 0 to 400, to select pixel position X = a variable that will be defined next to the instruction or Mnemonic		
MNEMONIC CODE	FUNCTION	DESCRIPTION
PST	Stop Plot/Print	Stops the plotting/printing of hard copy.
PGR	Print Graph	Dumps the current graph displayed on the screen to the Centronics printer.
PT(X)	Print Tabular Data	Where X = 0 - 5. When X = 5 tab data prints only at the markers X = 0 Screen dumps 401 data points. X = 1 Screen dumps 201 data points. X = 2 Screen dumps 101 data points. X = 3 Screen dumps 51 data points. X = 4 Screen dumps 26 data points.
PLA	Plot All	Provides a screen plot containing trace, graticule, cursor, and titles.
PLR	Plot Trace	Provides a screen plot of the signal trace(s).
PLG	Plot Graticule	Provides a screen plot of the graticule and reference lines.
PLC	Plot Cursor	Provides a plot of the current cursor position.
PLT	Plot Titles	Provides a plot of the current titles displayed to indicate the measurement and test being performed.
PC	Output Custom Plot	Always plots the user specified plot. If PC is used and not defined, the 562 defaults to "Plot All."
SCP "bit mask"	Specify Custom Plot	The bit mask (Figure 4-6) is a string of ASCII 0's and 1's that indicate the user's requirements for a plot (e.g., title strings, markers, traces, graticules, etc).
LID 'Ident' LDE 'Device' LDA 'Date'	Set Identification Set Test Device Label Set Date	The name of the operator or test device serial number, the test device used, and the date will be printed for all Centronics prints containing header or title information. EXAMPLE: LID 'A. WILKINS', causes the operator's name, to be printed on any printer using a Centronics interface.
PTL	Print Complex Limits	Provides a hardcopy printout of Complex Limits data.

Bus Command: SCP (mask)

The "mask" is a 16-bit ASCII string of 1's and 0's, where the first four characters are zeros. It must be set to select the desired plot function. Mask selections for plot functions are as follows:

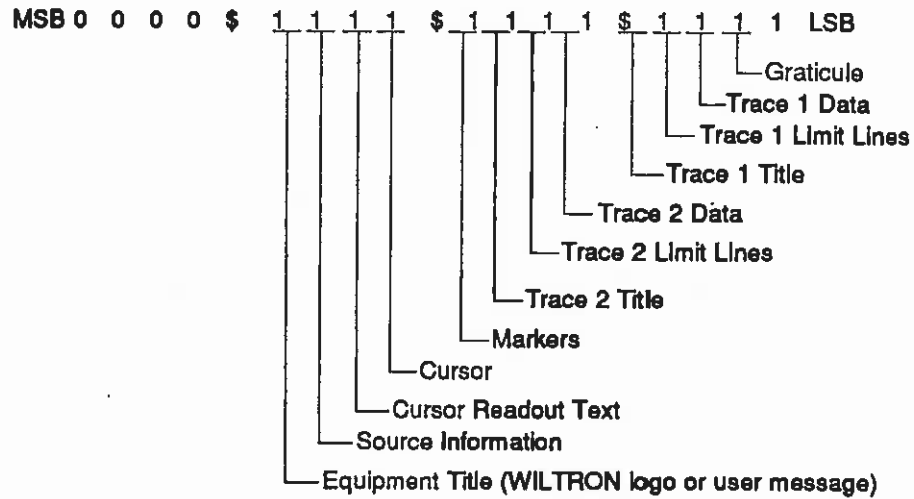

Figure 4-6. Programming Example: SCP (mask)

Table 4-7. Command Codes: Output Functions

The following is a list of Mnemonic parameters as indicated within parenthesis: N = 1 or 2 for channel selection n = a number within range +/-99.99 F = a frequency within range +/-0 to 999.9999 GHz S = 0 or 1 for ON/OFF indication (1 = ON, 0 = OFF) M = 1 to 9, Marker numbers, used for SAVE, RECALL, STORE Marker#, etc. P = 0 to 400, to select pixel position X = a variable that will be defined next to the instruction or Mnemonic		
MNEMONIC CODE	FUNCTION	DESCRIPTION
OCF(N)	Output Cursor Frequency	Returns the cursor frequency from channel N.
OCR(N)	Output Cursor Readout	Returns the cursor value for the current cursor trace position.
OCP	Output Cursor Position	Returns the current cursor position.
ODF(N)	Output Relative Cursor Frequency	Returns the frequency difference between the reference cursor and the main cursor for channel N.
ODR(N)	Output Relative Cursor Readout	Returns the readout difference between the reference cursor value and the main cursor value for channel N.
OEB	Output Extended Status Byte	Returns an ASCII representation of the extended status byte to the controller.
OPM(X)	Output Parameter X	Returns parameter X to the controller. Parameter X is defined in Figure 4-7.
OID	Output Identify	Returns the 562's identity string.
OPB	Output Primary Status Byte	Returns the primary status byte to the controller.
ORB	Output Redirected Status Bytes	Returns an SRQ generated on the dedicated GPIB (sweeper, plotter, etc.) along with the address of the instrument that caused it, when next addressed to talk.
ORD	Output Redirected Data	Returns the last data that was requested from an instrument on the dedicated bus by an RDR command.
ORF(N)	Output Reference Cursor Frequency	Returns reference cursor frequency for channel N
ORP	Output Reference Cursor Position	Causes the 562 to output the reference cursor position when next addressed to talk.
ORR(N)	Output Reference Cursor Readout	Returns the cursor value for the current reference cursor position. (The returned value will be in dB's, mV, or SWR depending on the measurement mode currently selected.)

1	Offset Channel 1 (dB)
2	Offset Channel 2 (dB)
3	Resolution Channel 1 (dB/Div)
4	Resolution Channel 2 (dB/Div)
5	High Limit Channel 1 (dB)
6	Low Limit Channel 1 (dB)
7	High Limit Channel 2 (dB)
8	Low Limit Channel 2 (dB)
9	Sweeper Start Frequency (GHz)
10	Sweeper Stop Frequency (GHz)
11	562 GPIB Address
12	Sweeper GPIB Address
13	Reserved
14	Marker M1 Frequency (GHz)
15	Marker M2 Frequency (GHz)
16	Marker M3 Frequency (GHz)
17	Marker M4 Frequency (GHz)
18	Marker M5 Frequency (GHz)
19	Marker M6 Frequency (GHz)
20	Marker M7 Frequency (GHz)
21	Marker M8 Frequency (GHz)
22	Marker M9 Frequency (GHz)
23	Power Level From Sweeper (dBm)
24	Reserved
25	Reserved
26	dB/Sweep Value (dB)
27	Cursor Position
28	Reference Cursor Position
29	Plotter Address Parameter
30	Reserved
31	Graticule Spacing (GHz/Div)
32	Reserved
33	Reading At Cursor for Channel 1
34	Reading At Cursor for Channel 2
35	Alternate Start Frequency (GHz)
36	Alternate Stop Frequency (GHz)
37	Alternate Power Sweep Level (dB)
38	Alternate Power Level (dBm)
39	Reserved

Figure 4-7. Available Parameters, OPM(X)

Table 4-8. Command Codes: Data Strings

The following is a list of Mnemonic parameters as indicated within parentheses: N = 1 or 2 for channel selection n = a number within range +/-99.99 F = a frequency within range +/-0 to 999.9999 GHz S = 0 or 1 for ON/OFF Indication (1 = ON, 0 = OFF) M = 1 to 9, Marker numbers, used for SAVE, RECALL, STORE Marker#, etc. P = 0 to 400, to select pixel position X = a variable that will be defined next to the instruction or Mnemonic		
MNEMONIC CODE	FUNCTION	DESCRIPTION
OAT(N)	Output ASCII Trace	Returns an ASCII representation of the signal trace data for channel N.
OBT(N)	Output Binary Trace	Returns a binary representation of signal trace data for channel N.
OCD(N)	Output Calibration Data	Returns calibration data for the selected channel to the controller for channel N.
OSB	Output Status Byte Indication	Returns an Ascii representation of the Status Byte to the controller. The returned data will be a numeric string, 0 to 255.
OSS(M)	Output Stored Setup	Returns stored setup M to the controller.
LAT(N)	Learn ASCII Trace	The 562 receives ASCII signal trace data sent from the controller for channel N.
LBT(N)	Learn Binary Trace	The 562 receives binary signal trace data sent from the controller for channel N.
LCD(N)	Learn Calibration Data	The 562 receives calibration data sent from the controller for channel N.
LSS(M)	Learn Stored Setup	The 562 receives stored setup M sent from the controller.
OTM (N)	Output Trace Memory	Returns contents of Trace Memory for selected channel (N) to the controller. This data is in binary format.

Table 4-9. Command Codes: Pass Through Codes

The following is a list of Mnemonic parameters as indicated within parenthesis: N = 1 or 2 for channel selection n = a number within range +/-99.99 F = a frequency within range +/-0 to 999.9999 GHz S = 0 or 1 for ON/OFF indication (1 = ON, 0 = OFF) M = 1 to 9, Marker numbers, used for SAVE, RECALL, STORE Marker#, etc. P = 0 to 400, to select pixel position X = a variable that will be defined next to the instruction or Mnemonic		
MNEMONIC CODE	FUNCTION	DESCRIPTION
RDB (X)	Pass Through Command for Binary Data	Redirects binary data to an instrument on the dedicated bus.
RDR(X)	Pass Through Command for ASCII Data	Addresses and programs instruments connected to the dedicated GPIB interface, where X is the address of the instrument receiving the data. For example, RDR 5 COMMAND STRING would pass the command string data to any instrument on the dedicated GPIB having address 5. "CR LF" at the end of the pass through command string terminates the data transmission. See Figure 4-8 for a sample program using this command.
SDP(X) SDS(X) SDX(X)	Set Plotter Address Set Sweeper Address Set 562 Address	Sets the plotter, sweeper, or 562 address where X= the new address of the instrument. Valid instrument addresses for X are 0 to 30.
FRD (X) (data)	Fast Redirection	High speed data communications with device at address X. This command is used in place of the RDR command when high speed data transfer is required.
FRE	Fast Redirection Ends	This command terminates the Fast Redirection (FRD) command.

```

100 DISP @DISP @DISP @DISP
110 DISP "Version 1: 10-SEP-87"
120 WAIT 12000
130 OUTPUT A ; "RST"
140 OUTPUT A ; "CH1 0, CH2 0, GOF"
150 OUTPUT A ; "RDR 5, CSI, FL1, F050MH, SWP50MS, CF0"
160 OUTPUT R ; "RDR 5, MK0, LVL2DM, RT1"
170 CLEAR @DISP
180 DISP TAB(7) ; "TEST SEQUENCE MENU" @DISP
190 DISP TAB(3) ; "0 = EXIT PROGRAM"
200 DISP TAB(3) ; "1 = P/M DATA"
210 DISP TAB(3) ; "2 = SIG CHAN, RF ON"
220 DISP TAB(3) ; "3 = SIG CHAN, RF OFF"
230 DISP TAB(3) ; "4 = SIG CHAN, RF ON & OFF"
240 DISP TAB(3) ; "5 = ALL"
250 DISP @ DISP TAB(2) ; "SELECT OPTION BY NUMBER";
260 BEEP 100, 30
260 INPUT N
270 IF N OR N5 THEN GOTO 290
280 IF N1 THEN GOTO 420 ELSE GO TO 450
290 CLEAR DISP @DISP @DISP @DISP

```

RDR 5 redirects the following command sequence to the sweep generator, which is at GPIB address 5. The coding in line 150 commands the sweeper to do the following:

- Turn the horizontal sweep on during CW operation.
- Turn the CW filter on.
- Set F0 to 50 MHz.
- Set a sweep time of 50 ms.
- Set F0 for CW operation.

In Line 160, RDR does the following:

- Turns off the markers.
- Sets internal leveling for 2 dBm.
- Turns the RF on during retrace.

Figure 4-8. Sample Program: RDR Command

Table 4-10. Command Codes: General Functions

MNEMONIC CODE	FUNCTION	DESCRIPTION
ARF(S)	Autozero RF Mode On/Off	Autozero occurs every retrace. This establishes if the 562 is to expect the RF to still be on (in which case zeroing is performed using dummy loads) or off (zeroing is performed at the detectors).
BC(S)	Blank CRT	Either blanks (BUS COMMAND = BC1), or unblanks (BUS COMMAND = BC0) the CRT display.
CTN	Continue	Continues to next calibration step, or continues after self test failed.
HON HOF	Hold Enable Release Hold	Holds the current data being displayed on the screen. Continue displaying measurement data.
NUL	Low Level Null	Used in conjunction with autozero RF mode on to establish an equality between dummy loads and actual RF off conditions (when no RF present). Used to calibrate the dummy load.
RTL	Return To Local	Returns the analyzer from the GPIB mode to the local mode.

Table 4-11. Command Codes: Special Functions

MNEMONIC CODE	FUNCTION	DESCRIPTION
SPECIAL FUNCTIONS 1, TRACE		
SF10	1: Max Hold.	Capture the peak values of trace 1.
SF11	1: Min Hold.	Capture the minimum values of trace 1.
SF12	1: Pk-Pk Hold.	Capture the trace 1 minimum and maximum values from successive sweeps.
<p>NOTE This mode can be used only with a setting of 401 points.</p>		
SF13	1: Normal.	Turns off the capture modes on trace 1.
SF14	2: Max Hold.	Capture the peak values of trace 2.
SF15	2: Min Hold.	Capture the minimum values of trace 2.
SF16	2: Pk-Pk Hold.	Capture the trace 2 minimum and maximum values from successive sweeps.
<p>NOTE This mode can be used only with a setting of 401 points.</p>		
SF17	2: Normal.	Turns off the capture modes on trace 2.

Table 4-11. Command Codes: Special Functions

MNEMONIC CODE	FUNCTION	DESCRIPTION
SPECIAL FUNCTIONS 2, CURSOR		
SF20	1: Min.-Max.	Cause the cursor on trace 1 to search for the maximum trace value, and the Relative Cursor on trace 1 or 2 to search for the minimum value.
SF21	1: From Max.	Cause the selected search to be made from the maximum value of trace 1 (for example bandwidth relative to peak).
SF22	2: Min.-Max.	Cause the cursor on trace 2 to search for the maximum trace value, and the Relative Cursor on trace 2 to search for the minimum value.
SF23	2: From Max.	Cause the selected search to be made from the maximum value of trace 1 or 2 (for example bandwidth relative to peak).
SF24	Repeat.	Repeats the search.
SF25	Normal.	Returns 562 to the single-search mode.
SPECIAL FUNCTIONS 4, TITLING		
SF40	User Titles.	Changes the measurement name (type) as required by the user. For example, the titles could read "amp. gain," or "bias volt." The titles "IDENTIFY" and "TEST DEVICE" apply to channel 1 and 2 respectively.
SF41	Std Titles.	Cause trace to revert to standard title names (Transmission, Return Loss, Power, etc).
SPECIAL FUNCTIONS 5, VOLTS MODE		
SF50	Fxd Range 1.	Selects the 0 - 10 volt range.
SF51	Fxd Range 2.	Selects the 0 - 1 volt range.
SF52	Fxd Range 3.	Selects the 0 - 100 mV range.
SF53	Auto Range.	Selects the normal autorange operation.
SPECIAL FUNCTIONS 6, CALIBRATION OPTIONS		
SF60	Hi Res CAL.	Enables a feature that provides up to 2000 points of calibration memory (typically used in special applications, like Distance-to-Fault, Option P2).
SF61	Standard Cal.	Selects the standard calibration mode.
SF62	Allow 6700A Level Corr.	Enables 67XXA level correction.
SF63	Stop 6700A Level Corr.	Disables digital Level Correction on 67XXA. (This may be needed in some system applications).

Table 4-11. Command Codes: Special Functions

MNEMONIC CODE	FUNCTION	DESCRIPTION
SPECIAL FUNCTIONS 7, GAIN COMPRESSION		
SF70	Channel 1.	Increment power on Channel 1 until limits fail.
SF71	Channel 2.	Increment power on Channel 2 until limits fail.
SSL(X)	Starting At.	Enter the power level from which the test will start. Usually this is just below the expected compression point. The test restarts at this point each time that the function is used. Enter the level value the same as for complex limits. The argument (X) is a number from -120 to +30 dBm, based on the desired power level.
SML(X)	Max Level.	Tells the 562 the maximum power level value that should be sent to the source. The argument (X) is a number from -120 to +30 dBm, based on the desired power level.
SF74	Continue.	Overrides limit-failure and sets the power level to the "Max Level" point, as described above.

Table 4-12. Bus Messages Recognized by the 562 Network Analyzer

BUS MESSAGES	HOW MESSAGE IS USED BY THE RF ANALYZER
Device Clear	Resets the network analyzer to its default state. Sending this message is equivalent to sending the RST command.
Go to Local	Returns the network analyzer to local (control panel) control.
Group Execute	No action.
Interface Clear	Stops the network analyzer GPIB interface from listening or talking. The front panel controls are not cleared, however.
Local Lockout	Prevents the front panel RETURN TO LOCAL key from returning the network analyzer to local (control panel) control.
Remote Enable	<p>Places the network analyzer under remote (GPIB) control if the REM line is TRUE and the network analyzer has been addressed to listen.</p> <p style="text-align: center;">NOTE</p> <p>If the network analyzer is placed in remote and not supplied with program data, its operation is determined by the positions in which the front panel controls were set immediately prior to going remote.</p>
Service Request Messages Serial-Poll (SPE) Serial-Poll Disable (SPD)	<p>The network analyzer has been equipped with an SRQ capability. It will respond to both serial- and parallel-poll messages. Responses to these messages are described below.</p> <p>The SPE message causes the network analyzer to respond with a Enable (SPE) decimal-coded status byte.</p> <p>The SPD message, which the controller sends, terminates a serial poll operation.</p>
Parallel Poll Operation Parallel-Poll Configure (PPC) Parallel-Poll ENABLE (PPE) Parallel-Poll Unconfigure (PPU), Disable (PPD)	<p>When queried by a parallel-poll message (PPOLL, Table 4-4), the network analyzer (if configured for parallel-poll operation) responds by setting its assigned data bus line to the logical state (1, 0) that indicates its correct SRQ status. To configure a bus device that is (1) built for parallel-poll operation and (2) designed to be remotely configured via the bus, the controller sends a two-byte parallel-poll configure and enable (PPC and PPE) message.</p> <p>The PPC byte configures the device to respond to a parallel-poll message, such as PPOLL.</p> <p>The PPE byte assigns the logical sense (1, 0) that the parallel- Enable (PPE) poll response will take.</p> <p>When the network analyzer receives the PPC/PPE message, it configures itself to properly respond to the parallel-poll message. The PPU or PPD message is sent by the controller when a parallel-poll response is no longer needed. This message disable causes the network analyzer to become unconfigured for a parallel-poll response.</p>

Table 4-13. Methods of Generating Bus Commands

FUNCTION	METHOD OF EXECUTION	
	WILTRON 85	HP SERIES 200
Go to Local (GTL)	LOCAL 6 * LOCAL 706	LOCAL 6 LOCAL 706
Group Execute Trigger	TRIGGER 6 TRIGGER 706	TRIGGER 6 (GET) TRIGGER 706
Interface Clear (IFC)	ABORTIO 6	ABORT 6
Device Clear (DC) (SDC)	CLEAR 6 CLEAR 706	CLEAR 6 CLEAR 706
Local Lockout (LLO)	LOCAL LOCKOUT 6	LOCAL LOCKOUT 6
Remote Enable (REN)	REMOTE 6 REMOTE 706	REMOTE 6 REMOTE 706
Serial Poll	A-SPOLL (706)	A-SPOLL (706)
Parallel Poll Configure (PPC)	SEND 6; UNL LISTEN 6 CMD 3 SCG 6	PPOLL CONFIGURE 706;6
Parallel Poll	A-PPOLL (6)	A-PPOLL (6)
Parallel Poll Unconfigure (PPU)	SEND 6; CMD 21 SEND 6; UNL LISTEN 6 CMD 21	PPOL UNCONFIGURE 6 PPOL UNCONFIGURE 706

* Assumes GPIB address set to 6.

Table 4-14. Alphabetical Index to the Command Codes

The following is a list of mnemonic parameters as indicated within parentheses:

- N = 1 or 2 for channel selection
- n = a number within range +/-99.99
- F = a frequency within range +/-0 to 999.9999 GHz
- S = 0 or 1 for ON/OFF Indication (1 = ON, 0 = OFF)
- M= 1 to 9, Marker numbers, used for SAVE, RECALL, STORE Marker #, etc.
- P = 0 to 400, to select pixel position
- X = a variable that will be defined next to the Instruction or Mnemonic
- L = Limit Values

MNEMONIC CODE	NAME	PAGE NUMBER	MNEMONIC CODE	NAME	PAGE NUMBER
AOF	Averaging Off	4-10	DON	Relative Mode On	4-13
ARF(S)	Autozero RF On/Off	4-21	DP1	Set Resolution To 101 Data Points	4-10
ASC(N)	Autoscale	4-7	DP2	Set Resolution To 201 Data Points	4-10
ASW	Autosweep	4-10	DP4	Set Resolution To 401 Data Points	4-10
AVE (X)	Set Averaging	4-10	DSI (S)	Display Segment Identifiers	4-7
AVG(X)	Averaging On	4-10	FRD	Fast Redirection	4-19
BC(S)	Blank CRT	4-21	FRE	Fast Redirection Ends	4-19
CAL (X)	Calibrate the 562	4-9	GHZ	Reserved Mnemonic	4-5
CAM	Move Cursor To Active Marker	4-13	GOF	Turn Off Graticule Display	4-9
CBW(N)(n)	Move Cursor To Show Bandwidth	4-13	GON	Display Graticule	4-9
CH1(S)	Set Channel 1 On/Off	4-6	GSF	GPIB Status Indication Off	4-7
CH2(S)	Set Channel 2 On/Off	4-6	GSN	GPIB Status Indication On	4-7
CHI (N) (S)	Complex High Limit On/Off	4-7	HOF	Hold Off	4-21
CLH(N) (L)	Enter High Complex Limits	4-7	HON	Hold On	4-21
CLL(N) (L)	Enter Low Complex Limits	4-7	IEM(X)	Input Extended Mask	4-11
CLO (N) (S)	Complex Low Limit On/Off	4-7	IPM(X)	Input Primary Mask	4-11
CLT(N)(n)	Move Cursor Left To n dB	4-13	LAT(N)	Learn ASCII Trace	4-18
CMK(M)	Move Cursor To Marker M	4-13	LBT(N)	Learn Binary Trace	4-18
CML (data)	Configure Manual Labelling	4-9	LCD(N)	Learn Calibration Data	4-18
CMN(N)	Move Cursor To Min	4-13	LDA "date"	Label For Date	4-14
CMX(N)	Move Cursor To Max	4-13	LDE "device"	Label For Test Device	4-14
CN	Configure Normal	4-9	LHF(N)	High Limit (Off)	4-7
CNR	CW No Ramp	4-9	LHI(N)(n)	High Limit (On)	4-7
COF	Cursor Off	4-13	LLF(N)	Low Limit (Off)	4-7
CON	Cursor On	4-13	LLO(N)(n)	Low Limit (On)	4-7
CRF(N)(F)	Move Cursor To Frequency F On Channel N	4-13	LID "ident"	Label For Identification	4-14
CRO	Configure 0-10v Ramp Output	4-9	LSS	Learn Stored Setup	4-18
CRP(P)	Move Cursor To Position P	4-11	LTM (N)	Learn Trace Memory	4-7
CRT(N)(n)	Move Cursor Right To n dB	4-13	MHZ	Reserved Mnemonic	4-12
CSB	Clear Primary Status Byte	4-11	MSW	Manual Sweep	4-10
CTN	Continue to Next Calibration Step, or Continue after Self Test Failed	4-9	NSW	Normal Sweep	4-10
dB	Reserved Mnemonic	4-5	NUL	Low Level Null	4-9
dBm	Reserved Mnemonic	4-5	OAT(N)	Output ASCII Trace Data	4-18
DLT	Display Limits Test	4-7	OBT(N)	Output Binary Trace Data	4-18
DO1 (X)	Detector Offset R1	4-9	OCD(N)	Output Calibration Data	4-18
DO2 (X)	Detector Offset R2	4-9	OCF(N)	Output Cursor Frequency	4-16
DOA (X)	Detector Offset A	4-9	OCH (N)	Output Complex Limits High	4-7
DOB (X)	Detector Offset B	4-9	OCL (N)	Output Complex Limits Low	4-7
DOF	Relative Mode Off	4-13	OCP	Output Cursor Position	4-16
			OCR(N)	Output Cursor Readout	4-16
			ODF(N)	Output Relative Cursor	4-16

Table 4-14. Alphabetical Index to the Command Codes (Continued)

MNEMONIC CODE	NAME	PAGE NUMBER	MNEMONIC CODE	NAME	PAGE NUMBER
	Frequency		SDX(X)	Set 562 Address	4-19
ODR(N)	Output Relative Cursor Readout	4-16	SF10	1: Max Hold	4-21
OEB	Output Extended Status Byte	4-16	SF11	1: Min Hold	4-21
OFF(N)(n)	Set Channel Offset (dB)	4-6	SF12	1: Pk-Pk Hold	4-21
OID	Output Identify	4-16	SF13	1: Normal	4-21
OLT(N)	Output Limits Test Result	4-7	SF14	2: Max Hold	4-21
OPM(X)	Output Parameter X	4-16	SF15	2: Min Hold	4-21
OPB	Output Primary Status Byte	4-16	SF16	2: Pk-Pk Hold	4-21
ORB	Output Redirected Status Bytes	4-16	SF17	2: Normal	4-21
ORD	Output Redirected Data	4-16	SF20	1: Min-Max	4-22
ORF(N)	Ref. Cursor Readout	4-16	SF21	1: From Max	4-22
ORP	Output Reference Cursor Position	4-16	SF22	2: Min-Max	4-22
ORR(N)	Ref. Cursor Readout	4-16	SF23	2: From Max	4-22
OSB	Output Status Byte	4-18	SF24	Repeat	4-22
OSS	Output Stored Setup	4-18	SF25	Normal	4-22
OTM (N)	Output Trace Memory	4-18	SF40	User Titles	4-22
PC	Output Custom Plot	4-14	SF41	Std Titles	4-22
PGR	Print Graph	4-14	SF50	Fxd Range 1	4-22
PLA	Plot All	4-14	SF51	Fxd Range 2	4-22
PLC	Plot Cursor	4-14	SF52	Fxd Range 3	4-22
PLG	Plot Graticule	4-14	SF53	Auto Range	4-22
PLR	Plot Trace	4-14	SF60	Hi Res Cal	4-22
PLT	Plot Titles	4-14	SF61	Standard Cal	4-22
PRV(X)	Preview	4-9	SF62	Allow 6700A Corr.	4-22
PST	Stop Print	4-14	SF63	Stop 6700A Corr.	4-22
PT(X)	Print Tab Data	4-14	SF70	Channel 1	4-23
PTL	Print Complex Limits	4-14	SF71	Channel 2	4-23
RCC(X)	Recall With Calibration Data	4-9	SF74	Continue	4-23
RCF(N)(F)	Move Reference Cursor To Frequency	4-13	SI1 (X)	Set Input For Channel 1	4-6
RDB(X)	Pass Through Command For Binary Data	4-19	SI2 (X)	Set Input For Channel 2	4-6
RDR(X)	Pass Through Command For ASCII Data	4-19	SIF(S)	User Interface ON/OFF	4-6
RCP(P)	Move Reference Cursor To Position P	4-13	SM1(X)	Set Channel 1 Measurement Display	4-6
RCS(M)	Recall Front Panel Setup	4-9	SM2(X)	Set Channel 2 Measurement Display	4-6
RCT(X)	Recall trace memory; X=1 to 4	4-10	SML(X)	Set maximum Power Level; X= -120 to +30 dBm	4-10
REF(N)(X)	Set Reference Line Position	4-6	SMO (X)	Set Smoothing	4-11
ROF(N)	Reference Line Display Off	4-6	SOF	Smoothing Off	4-11
RON(N)	Reference Line Display On	4-6	SON(X)	Smoothing On	4-11
RST	Reset Instrument	4-10	SQ0	Disable SRQs	4-11
RTL	Return To Local	4-21	SQ1	Enable SRQs	4-11
SCL(N)(X)	Set Resolution (dB/Div.)	4-6	SQS(X)	Program Number of Sweeps	4-11
SCP(bit mask)	Specify Custom Plot	4-14	SSL(X)	Set Start Power Level; X= -120 to +30 dBm	4-10
SDP(X)	Set Plotter Address (Dedicated GPIB)	4-19	SVC(X)	Save Setup With Calibration Data	4-9
SDS(X)	Set Sweeper Address (Dedicated GPIB)	4-19	SVS(M)	Save Front Panel Setup	4-9
			SVT(X)	Save Trace Memory; X=1 to 4	4-10
			TCR(N)	Adjust Offset so that Trace at Cursor Moves To Ref. Line	4-7

Table 4-14. Alphabetical Index to the Command Codes (Continued)

MNEMONIC CODE	NAME	PAGE NUMBER	MNEMONIC CODE	NAME	PAGE NUMBER
TM1 (S)	Apply Trace Memory to Channel 1	4-7	TML (N)	Load Trace Memory With Complex Low Limits	4-7
TM2 (S)	Apply Trace Memory to Channel 2	4-7	TMO	Turn Off Manual Labelling	4-10
TMD (N)	Load Trace Memory With Signal Trace Data	4-7	TSS "title"	Title Stored Setups	4-6
TMH (N)	Load Trace Memory With Complex High Limits	4-7	TST	Run Instrument Test Routine	4-10
			XCG	Exchange Cursor and Reference Cursor	4-13