

NR10

Product no.: T0058736870N

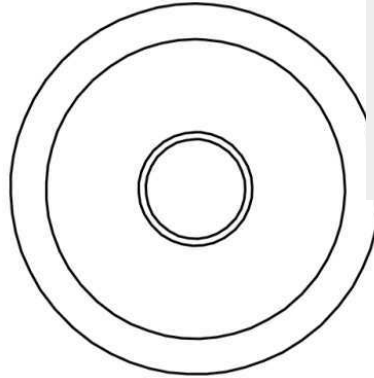
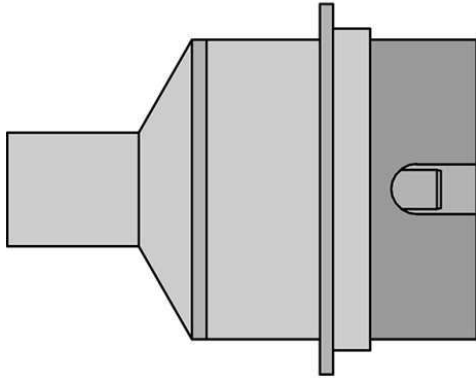

Benefits

- › The ND and NQ nozzles have an integrated pre-heating plate for pre-heating components by means of contact heat. Air outlet slots are located around the plate with a width of approx. 1 mm for the hot air.



Technical Data

Tip shape	Round nozzle, without vacuum
Length mm	---
Length inches	---
Width in mm	---
Width in inches	---
Outer diameter in mm	---
Outer diameter in inches	---
Inner diameter mm	---
Inner diameter inches	---
Nozzle length in mm	---
Nozzle length in inches	---
Packaging unit	1