

Instruction Manual



**TSG 120
YC / NTSC Signal Generator
S/N B020765 and Above**

070-8003-02

Copyright © Tektronix, Inc. All rights reserved.

Tektronix products are covered by U.S. and foreign patents, issued and pending. Information in this publication supercedes that in all previously published material. Specifications and price change privileges reserved.

Printed in the U.S.A.

Tektronix, Inc., P.O. Box 1000, Wilsonville, OR 97070-1000

TEKTRONIX and TEK are registered trademarks of Tektronix, Inc.

WARRANTY

Tektronix warrants that the products that it manufactures and sells will be free from defects in materials and workmanship for a period of one (1) year from the date of shipment. If a product proves defective during this warranty period, Tektronix, at its option, either will repair the defective product without charge for parts and labor, or will provide a replacement in exchange for the defective product.

In order to obtain service under this warranty, Customer must notify Tektronix of the defect before the expiration of the warranty period and make suitable arrangements for the performance of service. Customer shall be responsible for packaging and shipping the defective product to the service center designated by Tektronix, with shipping charges prepaid. Tektronix shall pay for the return of the product to Customer if the shipment is to a location within the country in which the Tektronix service center is located. Customer shall be responsible for paying all shipping charges, duties, taxes, and any other charges for products returned to any other locations.

This warranty shall not apply to any defect, failure or damage caused by improper use or improper or inadequate maintenance and care. Tektronix shall not be obligated to furnish service under this warranty a) to repair damage resulting from attempts by personnel other than Tektronix representatives to install, repair or service the product; b) to repair damage resulting from improper use or connection to incompatible equipment; c) to repair any damage or malfunction caused by the use of non-Tektronix supplies; or d) to service a product that has been modified or integrated with other products when the effect of such modification or integration increases the time or difficulty of servicing the product.

THIS WARRANTY IS GIVEN BY TEKTRONIX IN LIEU OF ANY OTHER WARRANTIES, EXPRESS OR IMPLIED. TEKTRONIX AND ITS VENDORS DISCLAIM ANY IMPLIED WARRANTIES OF MERCHANTABILITY OR FITNESS FOR A PARTICULAR PURPOSE. TEKTRONIX' RESPONSIBILITY TO REPAIR OR REPLACE DEFECTIVE PRODUCTS IS THE SOLE AND EXCLUSIVE REMEDY PROVIDED TO THE CUSTOMER FOR BREACH OF THIS WARRANTY. TEKTRONIX AND ITS VENDORS WILL NOT BE LIABLE FOR ANY INDIRECT, SPECIAL, INCIDENTAL, OR CONSEQUENTIAL DAMAGES IRRESPECTIVE OF WHETHER TEKTRONIX OR THE VENDOR HAS ADVANCE NOTICE OF THE POSSIBILITY OF SUCH DAMAGES.

Contacting Tektronix

Product Support	<p>For application-oriented questions about a Tektronix measurement product, call toll free in North America: 1-800-TEK-WIDE (1-800-835-9433 ext. 2400) 6:00 a.m. – 5:00 p.m. Pacific time</p> <p>Or contact us by e-mail: tm_app_supp@tek.com</p> <p>For product support outside of North America, contact your local Tektronix distributor or sales office.</p>
Service Support	<p>Contact your local Tektronix distributor or sales office. Or visit our web site for a listing of worldwide service locations.</p> <p>http://www.tek.com</p>
For other information	<p>In North America: 1-800-TEK-WIDE (1-800-835-9433) An operator will direct your call.</p>
To write us	<p>Tektronix, Inc. P.O. Box 1000 Wilsonville, OR 97070-1000</p>

Service Assurance

If you have not already purchased Service Assurance for this product, you may do so at any time during the product's warranty period. Service Assurance provides Repair Protection and Calibration Services to meet your needs.

Repair Protection extends priority repair services beyond the product's warranty period; you may purchase up to three years of Repair Protection.

Calibration Services provide annual calibration of your product, standards compliance and required audit documentation, recall assurance, and reminder notification of scheduled calibration. Coverage begins upon registration; you may purchase up to five years of Calibration Services.

Service Assurance Advantages

- Priced well below the cost of a single repair or calibration
- Avoid delays for service by eliminating the need for separate purchase authorizations from your company
- Eliminates unexpected service expenses

For Information and Ordering

For more information or to order Service Assurance, contact your Tektronix representative and provide the information below. Service Assurance may not be available in locations outside the United States of America.

Name	VISA or Master Card number and expiration
Company	date or purchase order number
Address	Repair Protection (1,2, or 3 years)
City, State, Postal code	Calibration Services (1,2,3,4, or 5 years)
Country	Instrument model and serial number
Phone	Instrument purchase date

Table of Contents

	General Safety Summary	v
Getting Started		
	Option 01	1-1
	Option 02	1-1
	Audio Tone ID	1-2
	Physical Description	1-2
	Controls, Connections, and Jumpers	1-3
	Front Panel Controls	1-3
	Rear Panel Connections	1-4
	Jumpers	1-5
Specifications		
	Specifications	2-1
	Option 02 Signals	2-23
Performance Verification		
	Performance Verification Checklist	3-2
	Performance Verification Procedures	3-4
Adjustment Procedure		
	Adjustment Check List	4-2
	Adjustment Procedures	4-4
Maintenance		
	Configuring the Power Supply	5-1
	Selecting the Power Supply Mains Voltage	5-1
	TSG 120 Block Diagram	5-2
Replaceable Electrical Parts		
Diagrams		
Replaceable Mechanical Parts		

List of Figures

Figure 1–1: Standard front panel and controls	1–3
Figure 1–2: Option 02 front panel and controls	1–3
Figure 1–3: Rear panel and connections	1–4
Figure 2–1: Color bars component of SMPTE bars	2–6
Figure 2–2: Reverse blue bars component of SMPTE bars	2–7
Figure 2–3: IYQB component of SMPTE bars	2–8
Figure 2–4: Red field	2–9
Figure 2–5: Green field	2–10
Figure 2–6: Blue field	2–11
Figure 2–7: 50% flat field	2–12
Figure 2–8: 100% flat field	2–13
Figure 2–9: 0% flat field	2–14
Figure 2–10: Chroma noise	2–15
Figure 2–11: Chroma response and markers	2–16
Figure 2–12: Convergence	2–17
Figure 2–13: 5 Step	2–18
Figure 2–14: Mod ramp	2–19
Figure 2–15: Pulse and bar	2–20
Figure 2–16: Multiburst	2–21
Figure 2–17: Matrix	2–22
Figure 2–18: Y channel 75% color bars	2–23
Figure 2–19: C channel 75% color bars	2–23
Figure 2–20: Y channel cable multiburst signal	2–24
Figure 2–21: C channel for the following signals: cable multiburst, cable sweep, Sin(x)/x, and ghost canceling	2–24
Figure 2–22: Y channel cable sweep markers	2–25
Figure 2–23: Y channel cable sweep signal	2–25
Figure 2–24: Y channel FCC test signal	2–26
Figure 2–25: C channel FCC test signal	2–26
Figure 2–26: Y channel of the Sin(x)/x test signal	2–27
Figure 2–27: Y channel for ghost canceling	2–27
Figure 2–28: Y channel NTC7 test signal	2–28
Figure 2–29: C channel NTC7 test signal	2–28
Figure 2–30: Y channel NTC7 combination signal	2–29
Figure 2–31: C channel NTC7 combination signal	2–29

Figure 3-1: Blanking level verification test setup (video measurement set)	3-4
Figure 3-2: Blanking level verification test setup (oscilloscope)	3-5
Figure 3-3: Sync amplitude verification test setup	3-6
Figure 3-4: Differential Gain test setup	3-10
Figure 3-5: Blanking level or amplitude test setup (video measurement set)	3-11
Figure 3-6: Blanking level or amplitude test setup (oscilloscope)	3-11
Figure 3-7: Luminance amplitude test setup	3-12
Figure 3-8: Chrominance blanking level test setup	3-15
Figure 3-9: Chrominance response test setup	3-16
Figure 3-10: Chrominance-luminance delay test setup	3-17
Figure 3-11: Total harmonic distortion test setup	3-18
Figure 3-12: Free-running frequency test setup	3-19
Figure 4-1: Audio tone level test setup	4-4
Figure 4-2: ID click frequency test setup	4-5
Figure 4-3: Oscillator frequency test setup	4-6
Figure 4-4: NTSC sync amplitude test setup (video measurement set)	4-7
Figure 4-5: NTSC sync amplitude test setup (vac and waveform monitor)	4-7
Figure 4-6: NTSC signal blanking level test setup	4-9
Figure 5-1: TSG 120 block diagram	5-2

List of Tables

Table 1–1: Standard instrument test signal summary	1–1
Table 1–2: Option 02 test signal summary	1–2
Table 1–3: Jumper position and function summary.	1–5
Table 2–1: General NTSC/YC test signal characteristics	2–1
Table 2–2: NTSC/YC test signals	2–2
Table 2–3: NTSC/YC test signals Option 02	2–4
Table 2–4: Audio tone characteristics	2–30
Table 2–5: Power supply specifications	2–30
Table 2–6: Physical characteristics	2–31
Table 2–7: Environmental characteristics	2–31
Table 2–8: Certifications and compliances	2–32
Table 3–1: NTSC test signal output	3–2
Table 3–2: Y and C test signal output	3–3
Table 3–3: Audio output and subcarrier frequency	3–3
Table 4–1: List of adjustment procedures	4–2

General Safety Summary

Review the following safety precautions to avoid injury and prevent damage to this product or any products connected to it. To avoid potential hazards, use this product only as specified.

Only qualified personnel should perform service procedures.

To Avoid Fire or Personal Injury

Use Proper Power Cord. Use only the power cord specified for this product and certified for the country of use.

Use Proper Voltage Setting. Before applying power, ensure that the line selector is in the proper position for the power source being used.

Connect and Disconnect Properly. Do not connect or disconnect probes or test leads while they are connected to a voltage source.

Ground the Product. This product is grounded through the grounding conductor of the power cord. To avoid electric shock, the grounding conductor must be connected to earth ground. Before making connections to the input or output terminals of the product, ensure that the product is properly grounded.

Observe All Terminal Ratings. To avoid fire or shock hazard, observe all ratings and markings on the product. Consult the product manual for further ratings information before making connections to the product.

Do not apply a potential to any terminal, including the common terminal, that exceeds the maximum rating of that terminal.

Do Not Operate Without Covers. Do not operate this product with covers or panels removed.

Use Proper Fuse. Use only the fuse type and rating specified for this product.

Avoid Exposed Circuitry. Do not touch exposed connections and components when power is present.

Wear Eye Protection. Wear eye protection if exposure to high-intensity rays or laser radiation exists.

Do Not Operate With Suspected Failures. If you suspect there is damage to this product, have it inspected by qualified service personnel.

Do Not Operate in Wet/Damp Conditions.

Do Not Operate in an Explosive Atmosphere.

Keep Product Surfaces Clean and Dry.

Provide Proper Ventilation. Refer to the manual's installation instructions for details on installing the product so it has proper ventilation.

Symbols and Terms

Terms in this Manual. These terms may appear in this manual:



WARNING. *Warning statements identify conditions or practices that could result in injury or loss of life.*



CAUTION. *Caution statements identify conditions or practices that could result in damage to this product or other property.*

Terms on the Product. These terms may appear on the product:

DANGER indicates an injury hazard immediately accessible as you read the marking.

WARNING indicates an injury hazard not immediately accessible as you read the marking.

CAUTION indicates a hazard to property including the product.

Symbols on the Product. The following symbols may appear on the product:



WARNING
High Voltage



Protective Ground
(Earth) Terminal



CAUTION
Refer to Manual



Double
Insulated



Getting Started

Getting Started

The TSG 120 YC/NTSC Signal Generator is a simple, cost-effective test signal generator designed for the service environment. The TSG 120 digitally generates NTSC and YC test signals simultaneously.

Table 1–1 lists the test signals supplied by the standard generator.

Table 1–1: Standard instrument test signal summary

Format	Standard Test Signals		
YC/NTSC	SMPTE Bars	Red Field	50% Flat Field
	Convergence	Green Field	100% Flat Field
	Chrominance Noise	Blue Field	0% Flat Field
	Chrominance Re- sponse	5 Step	Pulse & Bar
	Matrix	Multiburst	Mod Ramp
			Bounce

Besides a complement of video signals, this test signal generator supplies two channels of a balanced 1 kHz XLR-audio tone with jumper-selectable ID click in Channel 1. The frequency of the ID click is adjustable.

Option 01

Option 01 adds a dedicated black burst output, utilizing the OPTION connector on the rear panel. After S/N B010287, this output includes a Field Reference pulse on field 1 line 10.

Option 02

Option 02 adds a special signal for the cable TV industry.

Table 1–2 lists the test signals supplied by the TSG 120 Option 02.

Table 1–2: Option 02 test signal summary

Format	Opt 02 Test Signals	
YC/NTSC	SMPTE Bars	75% Bars
	Cable Sweep	Cable Multiburst
	(Sin x)/x 3 dB = 4.75 MHz	0% Field
	50% Field	100% Field
	Cable Matrix	Transmission Matrix
	NTC7 Matrix	5-Step
	FCC Composite	Multiburst
	Field Square	Bounce

Audio Tone ID

The generators audio tone output is a balanced 1 kHz XLR audio tone. Audio output gain is adjustable via R123 (Channel 1) and R122 (Channel 2).

A channel ID click is provided on Channel 1. The frequency of the ID click may be changed, or the click may be disabled. To change the frequency of the ID click, adjust R126. To disable the ID click, move jumper J12 from position 1-2 to position 2-3.

Physical Description

The TSG 120 YC/NTSC Signal Generator consists of four circuit boards and three cables in a rectangular sheet-aluminum chassis with a removeable top cover. The major internal components are:

- A main board that performs most of the generators functions.
- A front panel board that decodes front-panel button selections.
- A ribbon cable that feeds decoded front-panel information to the main board.
- Two BNC connector mounting boards: the top board contains one SVHS and three BNC connectors; the bottom board contains two BNC connectors.
- A ribbon cable that supplies signals from the main board to the top BNC connector mounting board.
- A ribbon cable that supplies signals from the main board to the bottom BNC connector mounting board.

Controls, Connections, and Jumpers

This section describes the front and rear panel controls.



CAUTION. This instrument is shipped from the factory configured for 115 VAC, 60 Hz operation. Attempting to operate the instrument at any other voltage without reconfiguring the power supply may cause damage. Refer to the Section 5, Maintenance for information on configuring the power supply.

Front Panel Controls

The front panel contains eight test-signal selection buttons. Above the buttons are two rows of test signal selections. On the left side are two LEDs, one for each row. These LEDs indicate the test signal row selected.

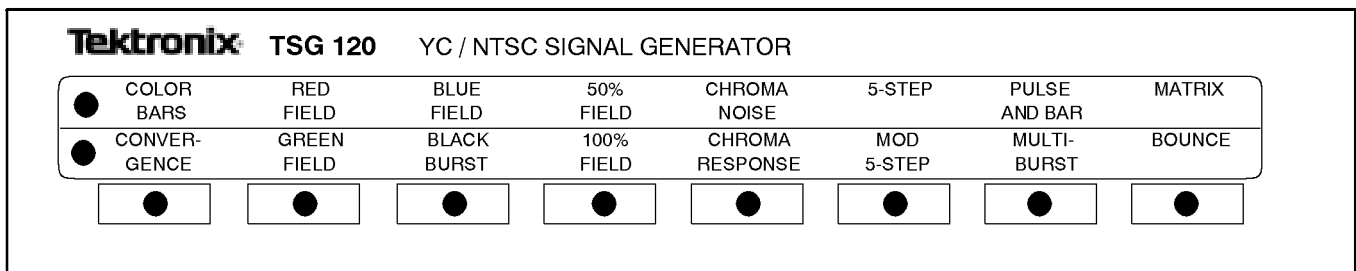

Figure 1-1: Standard Front Panel and Controls

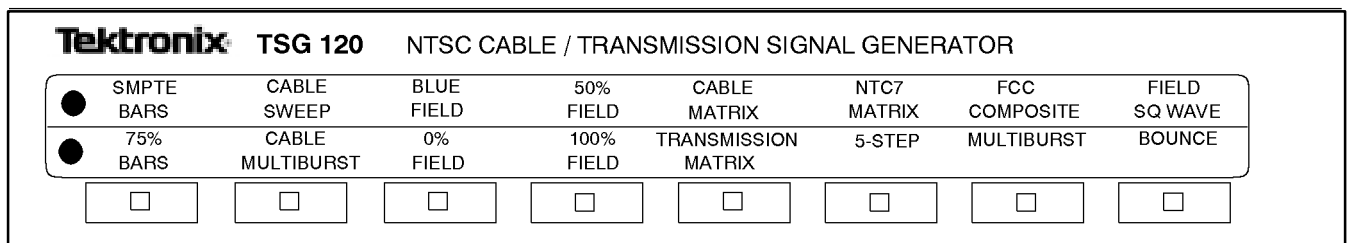

Figure 1-2: Option 02 Front Panel and Controls

Pressing a test-signal button lights the top-row LED and the LED in the button. Successive presses of the same button toggles between the selections above that button (for example, between Color Bars and Convergence).

Rear Panel Connections

The Rear Panel connections, shown in Figure 1–3, are described below.

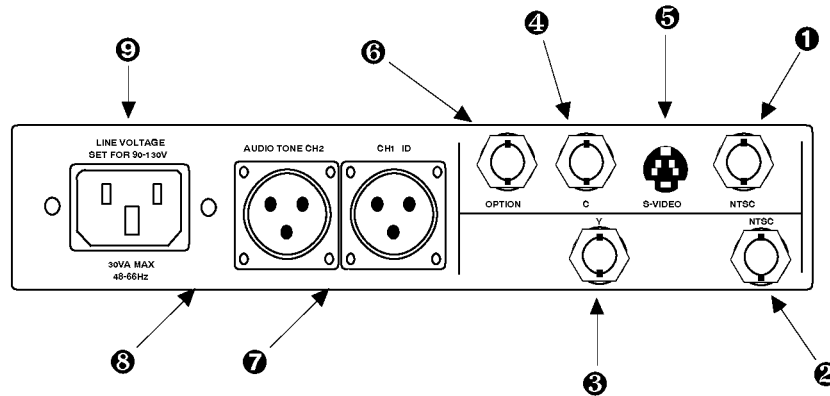

Figure 1–3: Rear Panel and Connections

1. NTSC test signal output.
2. NTSC test signal output.
3. Luminance output. (Y)
4. Chrominance output. (C)
5. Y/C output.



CAUTION. Do not use the S-Video output simultaneously with the Y and C BNC outputs. Using the S-Video output while also using the Y and C BNC outputs will degrade output accuracy.

6. Option 01 (Black Burst output).
7. 1 kHz audio tone output with jumper-selectable ID click (see jumper table and calibration procedure).
8. 1 kHz audio tone output in phase with Channel 1.
9. Electrical mains input, factory set for 115 VAC (to change the power supply operating voltage, see Configuring the Power Supply in Section 5).

Jumpers Table 1–3 describes the jumper settings and their functions.

Table 1–3: Jumper position and function summary.

Jumper	Position	Function
J2	1–2	Service jumper, factory setting
	2–3	Diagnostic test signals enabled
J3	TBD	For future use
J6	1–2	C/B–Y channel test signal enabled (factory setting)
	2–3	C/B–Y channel test signal disabled
J7	1–2	Y channel test signal enabled (factory setting)
	2–3	Y channel test signal disabled
J8	1–2	CTDM/R–Y channel test signal enabled (Option 01 only)
	2–3	CTDM/R–Y channel test signal disabled
J12	1–2	Test jumper. ID click enabled (factory setting)
	2–3	ID click disabled (factory setting)
J30	1–2	Test jumper. Power supply circuit testing (removing this jumper disables the –5 V supply)
J31	1–2	Test jumper. Power supply circuit testing (removing this jumper disables the +5 V supply)
J108 (Option 01 only)	1–2	Field 1 Line 10 pulse enabled (black burst output)
	2–3	Field 1 Line 10 pulse disabled



Specifications

Specifications

The material in this section is organized into two main groupings: the specification tables and the supporting figures. The specification tables include:

- NTSC/YC general and test signal specifications
- Signal level specifications
- Power supply, physical, and environmental specifications

The supporting figures (waveform diagrams and related data) follow the specification tables.

The performance requirements listed in this section apply over an ambient temperature range of +5 to +35°C after a 20-minute warmup. The rated accuracies are valid when this instrument is calibrated at +20 to +30°C.

Table 2-1: General NTSC/YC test signal characteristics

Characteristics	Performance requirements	Supplemental information
Luminance Amplitude Accuracy	±1%	Measured at 100 IRE
Chrominance-to-Luminance Gain	±1%	
Chrominance Accuracy on C Output	±1%	Measured with Chroma Noise signal
Blanking Level	0 VDC ±50 mV	
Luminance Rise Time	250 ns ±25 ns	Except as otherwise specified
Chrominance Rise Time	400 ns ±40 ns	
Burst Amplitude	285.7 mV (40 IRE) ±2%	
Burst Rise Time	400 ns ±40 ns	
Sync Amplitude	285.7 mV ±2%	
Sync Rise Time	140 ns ±20 ns	
Line Timing	See Figures 2-1 to 2-12	
Front Porch Duration	1.5 µs ±0.1 µs	
Line Blanking Interval	10.9 µs ±0.2 µs	Measured at 20 IRE points of active video
Breezeway Duration	600 ns ±100 ns	
Line Sync Duration	4.7 µs ± 0.1 µs	50% amplitude point
Vertical Serration Duration	4.7 µs ± 0.1 µs	50% amplitude point
Equalizing Pulse Duration	2.3 µs ± 0.1 µs	50% amplitude point

Table 2–1: General NTSC/YC test signal characteristics (Cont.)

Characteristics	Performance requirements	Supplemental information
Burst Delay from Sync Burst Duration	5.308 $\mu\text{s} \pm 0.35 \mu\text{s}$ 2.51 $\mu\text{s} \pm 0.1 \mu\text{s}$	19 cycles of subcarrier 9 cycles of subcarrier
Output Impedance		75 Ω
Return Loss		≥ 36 dB to 4.2 MHz
Crosstalk	≥ 60 dB down	
SNR to 5 MHz	≥ 60 dB	
Oscillator Frequency Stability	14.31818 MHz ± 28 Hz	5 – 35° C temperature range. Oscillator to be adjusted annually (divide by 4 to obtain subcarrier specification)
SCH Accuracy	0° $\pm 5^\circ$	
Chrominance-to-Luminance Delay	≤ 12 ns	
Frequency Response NTSC (Multiburst)	Flat to 4.2 MHz $\pm 2\%$	

Table 2–2: NTSC/YC test signals

Characteristics	Performance requirements	Supplemental information
Color Bars	SMPTE Bars	See Figures 2–1, 2–2, 2–3
Convergence Amplitude Pattern Pulse HAD	549.1 mV (76.9 IRE) 225 ns ± 25 ns	See Figure 2–12 Crosshatch-14 horizontal and 17 vertical lines per field
Red Field Luminance Pedestal Chrominance Amplitude Chrominance Phase	201.74 mV 626.66 mV p-p 103.5°	See Figure 2–4
Green Field Luminance Pedestal Chrominance Amplitude Chrominance Phase	344.45 mV 585.28 mV p-p 240.7°	See Figure 2–5
Blue Field Luminance Pedestal Chrominance Amplitude Chrominance Phase	110.06 mV 443.76 mV p-p 347.1°	See Figure 2–6

Table 2-2: NTSC/YC test signals (Cont.)

Characteristics	Performance requirements	Supplemental information
Flat Fields 50% 100% 0%	Amplitudes: 357.14 mV (50 IRE) 714.29 mV (100 IRE) 0.0 mV (0 IRE)	See Figure 2-7 See Figure 2-8 See Figure 2-9
Chrominance Noise Luminance Pedestal Chrominance Amplitude Chrominance Phase	357.14 mV 714.29 mV p-p 103.5°	See Figure 2-10
Chrominance Response C-channel output	Flat from 2.58 MHz to 4.58 MHz \pm 1%	See Figure 2-11
5-Step (Gray Scale) Amplitude Linearity Error	714.3 mV (100 IRE) \leq 1%	See Figure 2-13 Relative step matching
Modulated Ramp Luminance Amplitude Chrominance Amplitude Differential Gain Differential Phase	714.3 mV (100 IRE) 285.7 mV (40 IRE) 0.3% maximum 0.3° maximum	See Figure 2-14 <0.1% Typical <0.1° Typical
Pulse & Bar with Window 2T Pulse HAD White Bar Amplitude Field Tilt Line Tilt Field Timing Pulse-to-Bar Ratio Ringing	250 ns \pm 25 ns 100 IRE \leq 0.5% \leq 0.5% Lines 72 - 202 1:1 \pm 1% \leq 1% peak	See Figure 2-15
Multiburst White Reference Bar Amplitude Packet Amplitudes Pedestal Burst Frequencies Packet Rise Time 500 kHz Other Packets	500 mV (70 IRE) 428.6 mV (60 IRE) p-p 258.7 mV (40 IRE) 500 kHz, 1.0 MHz, 2.0 MHz, 3.0 MHz, 3.58 MHz, 4.2 MHz 	See Figure 2-16 140 ns typical (sine-squared shaped packets) 400 ns typical (sine-squared shaped packets)
Matrix	Convergence, Color Bars, Reverse Bars, Convergence, IWQB, and convergence	See Figure 2-17

Table 2–3: NTSC/YC test signals Option 02

Characteristics	Performance requirements	Supplemental information														
Cable Sweep	0.1 – 4.2 MHz Markers at 1, 2, 3, 3.75 and 4.0 MHz Sweep on Lines 22–221 Markers on Lines 222–262	See Figures 2–23, 2–22, & 2–21														
(Sin x)/x Peak Pedestal Reference flag Frequency	351.1 mV 219.3 & 495.0 mV 428.6 mVp-p 4.75 MHz	3 dB = 4.75 MHz See Figures 2–21 & 2–26														
FCC Composite	Modulated Staircase, 2T Pulse, Modulated Pulse, and 100 IRE Bar.	See Figures 2–24 & 2–25														
Field Square Wave	<table border="0"> <tr> <td><i>Line</i></td> <td><i>Signal</i></td> </tr> <tr> <td>72–202</td> <td>Black lines</td> </tr> <tr> <td>21–71 & 203–262</td> <td>White Lines</td> </tr> </table>	<i>Line</i>	<i>Signal</i>	72–202	Black lines	21–71 & 203–262	White Lines									
<i>Line</i>	<i>Signal</i>															
72–202	Black lines															
21–71 & 203–262	White Lines															
75% Color Bars	75% Color Bars with 100% Flag and 7.5% Setup.	See Figures 2–18 & 2–19														
Cable Multiburst	60 IRE White Reference Pulse with 428.6 mV (60 IRE Packet Amplitudes of 0.75, 1.25, 2.0, 3.0, 3.75, and 4.0 MHz equal energy packets)	See Figures 2–20 & 2–21														
Ghost Canceling Check Pulse	2T Pulse at start and end of horizontal blanking	See Figures 2–21 & 2–27														
NTC7 Composite	100 IRE bar (with 125 ns rise time), 2T and 12.5T mod pulse, 90 IRE 5-Step staircase with 40 IRE subcarrier.	See Figures 2–28 & 2–29														
NTC7 Combination	Multiburst (0.5, 1.0, 2.0, 3.0, 3.57954, and 4.2 MHz) and VIRS.	See Figures 2–30 & 2–31														
Transmission Matrix	<table border="0"> <tr> <td><i>Line</i></td> <td><i>Signal</i></td> </tr> <tr> <td>21–61</td> <td>NTC7 Composite</td> </tr> <tr> <td>62–101</td> <td>NTC7 Combination</td> </tr> <tr> <td>102–141</td> <td>75% Color Bars</td> </tr> <tr> <td>142–181</td> <td>(Sin x)/x</td> </tr> <tr> <td>182–221</td> <td>50% Gray</td> </tr> <tr> <td>222–262</td> <td>Ghost Canceling Check Pulse & Horizontal Blanking Check Signal</td> </tr> </table>	<i>Line</i>	<i>Signal</i>	21–61	NTC7 Composite	62–101	NTC7 Combination	102–141	75% Color Bars	142–181	(Sin x)/x	182–221	50% Gray	222–262	Ghost Canceling Check Pulse & Horizontal Blanking Check Signal	
<i>Line</i>	<i>Signal</i>															
21–61	NTC7 Composite															
62–101	NTC7 Combination															
102–141	75% Color Bars															
142–181	(Sin x)/x															
182–221	50% Gray															
222–262	Ghost Canceling Check Pulse & Horizontal Blanking Check Signal															
Cable Matrix	<table border="0"> <tr> <td><i>Line</i></td> <td><i>Signal</i></td> </tr> <tr> <td>21–61</td> <td>Cable Multiburst</td> </tr> <tr> <td>62–101</td> <td>Cable Sweep</td> </tr> <tr> <td>102–141</td> <td>Cable Markers</td> </tr> <tr> <td>142–181</td> <td>(Sin x)/x</td> </tr> <tr> <td>182–221</td> <td>FCC Composite</td> </tr> <tr> <td>222–262</td> <td>5-Step</td> </tr> </table>	<i>Line</i>	<i>Signal</i>	21–61	Cable Multiburst	62–101	Cable Sweep	102–141	Cable Markers	142–181	(Sin x)/x	182–221	FCC Composite	222–262	5-Step	
<i>Line</i>	<i>Signal</i>															
21–61	Cable Multiburst															
62–101	Cable Sweep															
102–141	Cable Markers															
142–181	(Sin x)/x															
182–221	FCC Composite															
222–262	5-Step															

Table 2-3: NTSC/YC test signals Option 02 (Cont.)

Characteristics	Performance requirements	Supplemental information						
NTC7 Matrix	<table border="1"> <thead> <tr> <th><i>Line</i></th> <th><i>Signal</i></th> </tr> </thead> <tbody> <tr> <td>21-141</td> <td>NTC7 Composite</td> </tr> <tr> <td>143-262</td> <td>NTC7 Combination</td> </tr> </tbody> </table>	<i>Line</i>	<i>Signal</i>	21-141	NTC7 Composite	143-262	NTC7 Combination	
<i>Line</i>	<i>Signal</i>							
21-141	NTC7 Composite							
143-262	NTC7 Combination							
Flat Fields 50% 100% 0%	Amplitudes: 357.14 mV (50 IRE) 714.29 mV (100 IRE) 0.0 mV (0 IRE)	See Figure 2-7 See Figure 2-8 See Figure 2-9						
Bounce Amplitude Rate	0 or 100 IRE flat field 1 second high, 1 second low							
5-Step (Gray Scale) Amplitude Linearity Error	714.3 mV (100 IRE) 31%	See Figure 2-13 Relative step matching						
Multiburst White Reference Bar Amplitude Packet Amplitudes Pedestal Burst Frequencies Packet Rise Time 500 kHz Other Packets	500 mV (70 IRE) 428.6 mV (60 IRE) p-p 258.7 mV (40 IRE) 500 kHz, 1.0 MHz, 2.0 MHz, 3.0 MHz, 3.58 MHz, 4.2 MHz	See Figure 2-16 140 ns typical (sine-squared shaped packets) 400 ns typical (sine-squared shaped packets)						

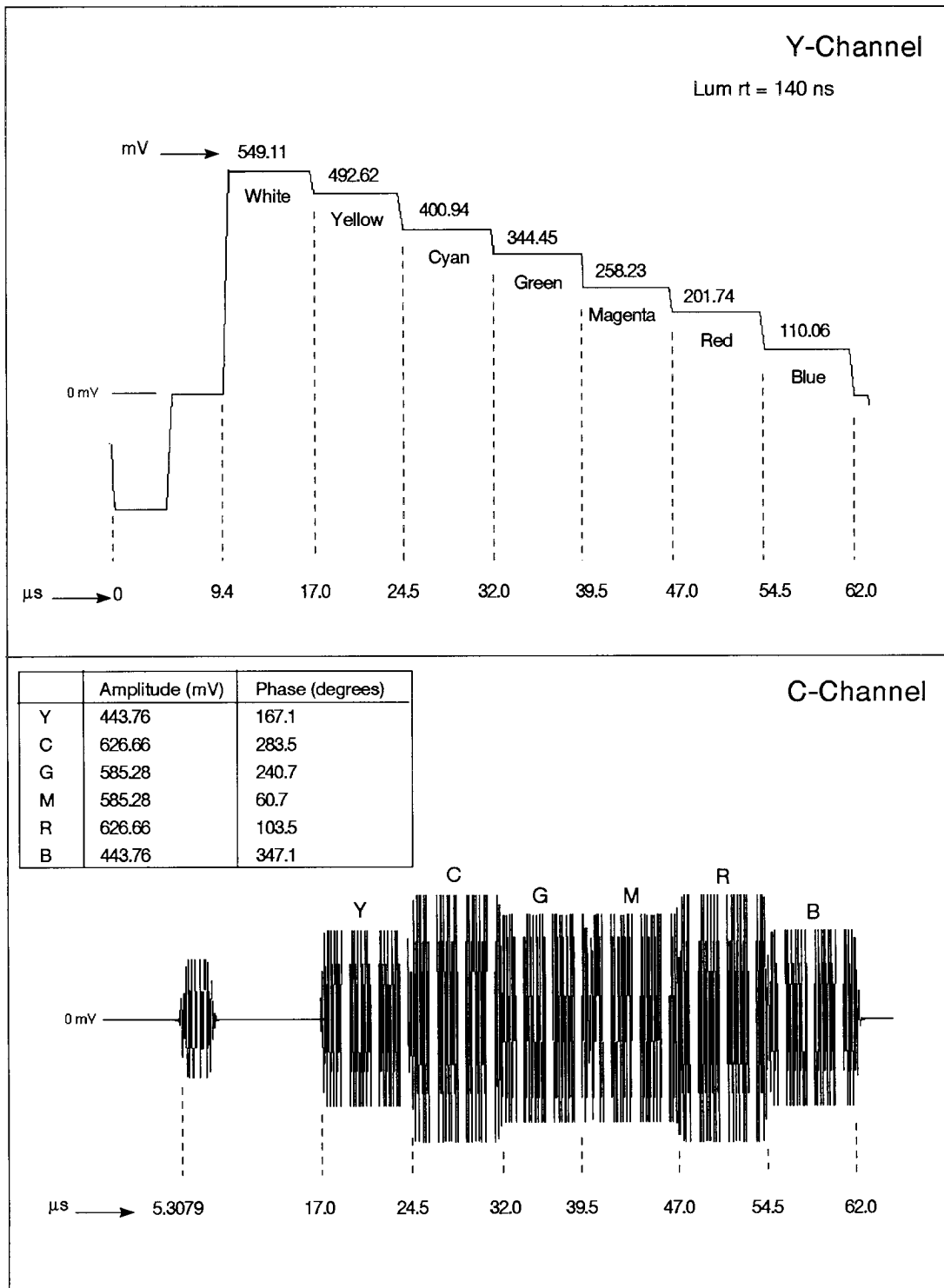

Figure 2-1: Color bars component of SMPTE bars

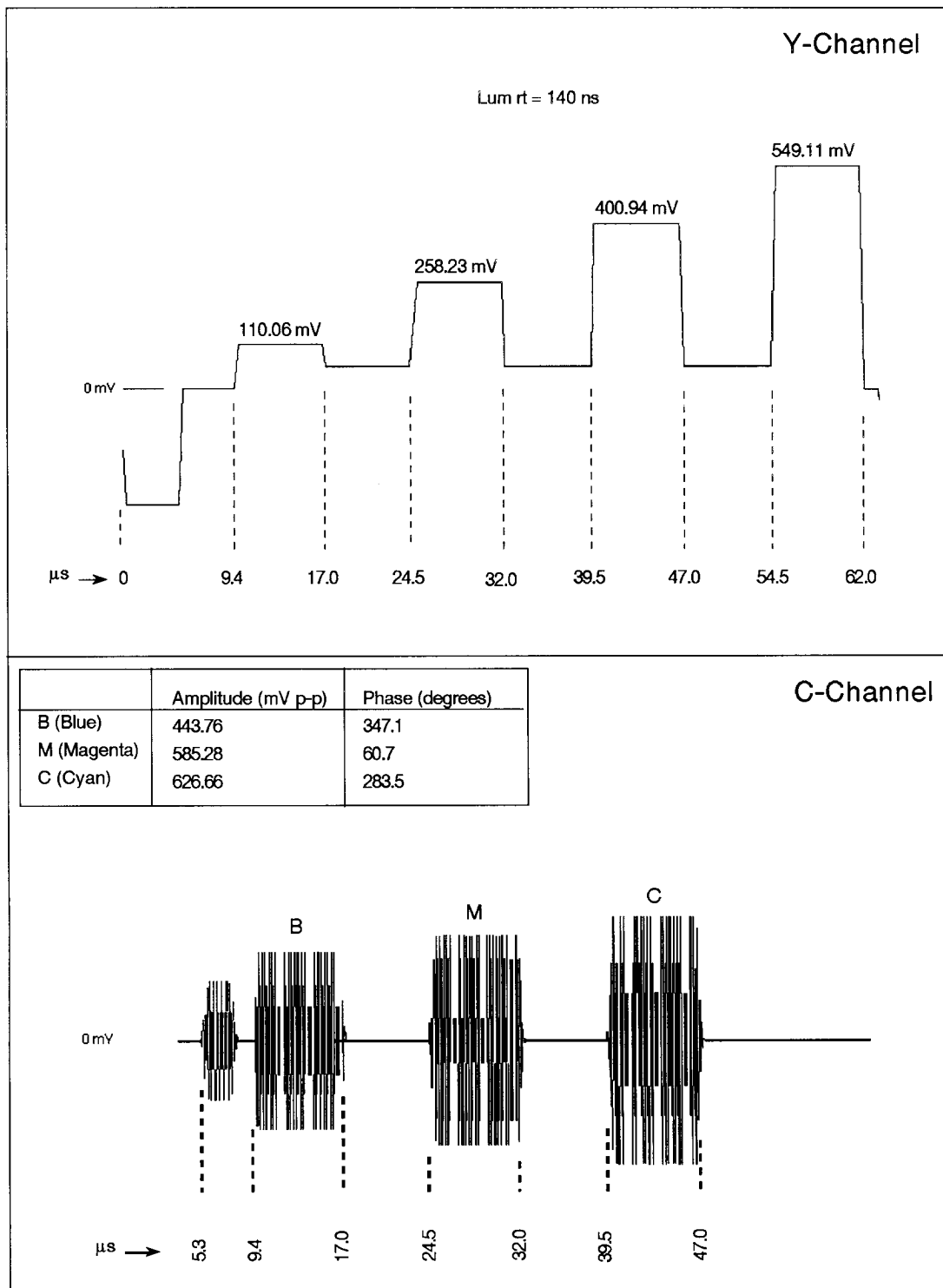

Figure 2-2: Reverse blue bars component of SMPTE bars

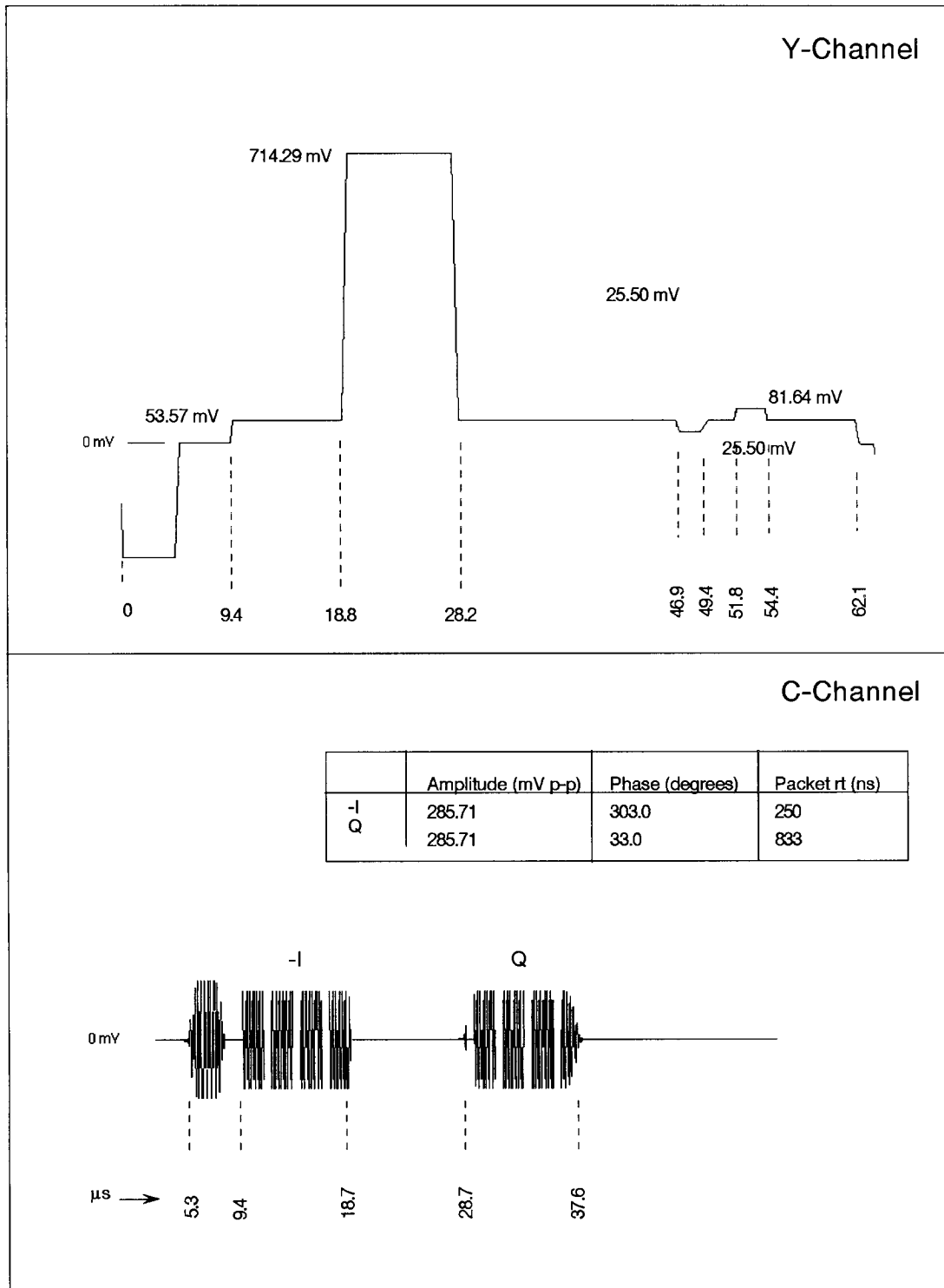

Figure 2-3: IYQB component of SMPTE bars

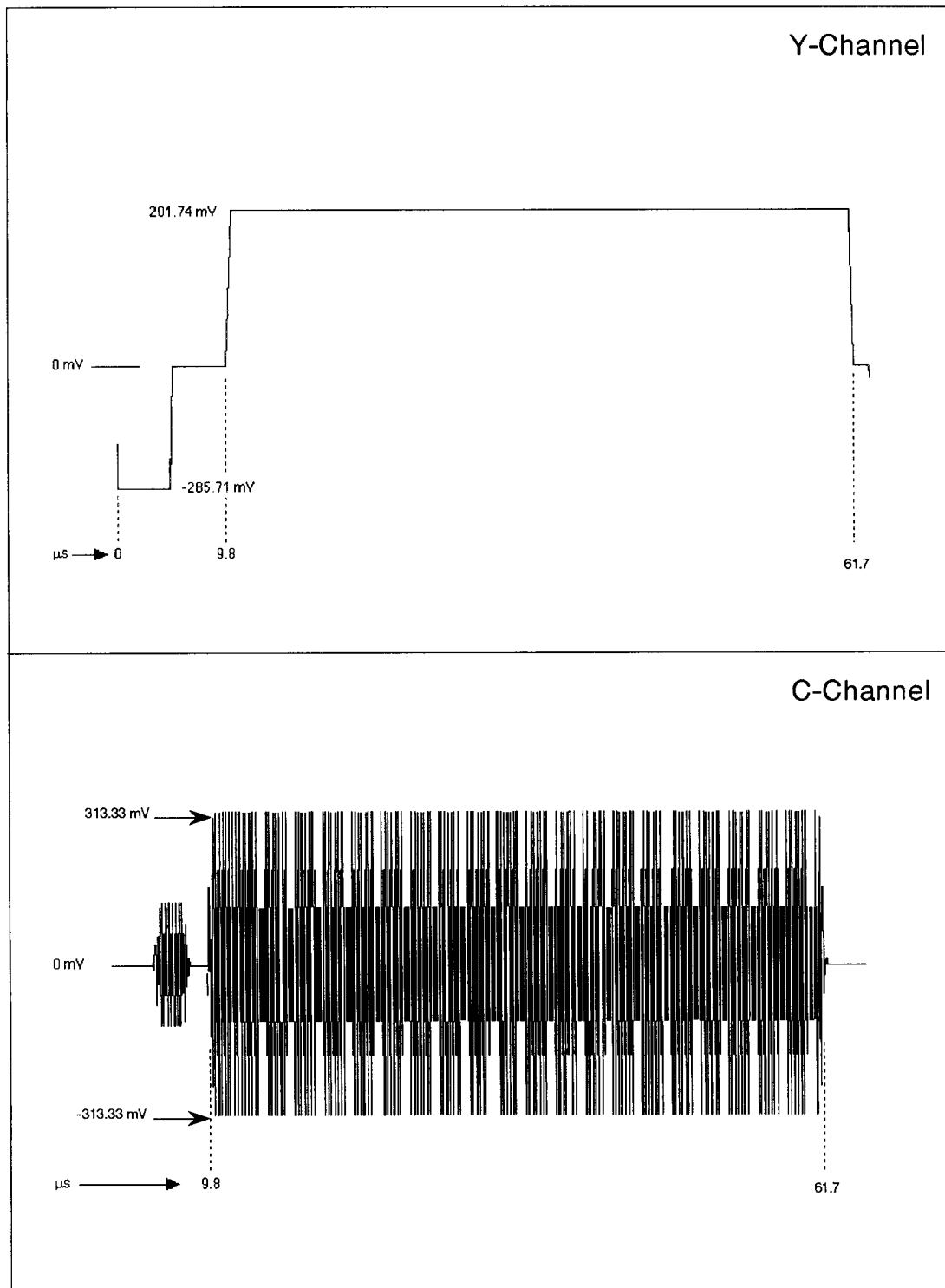

Figure 2-4: Red field

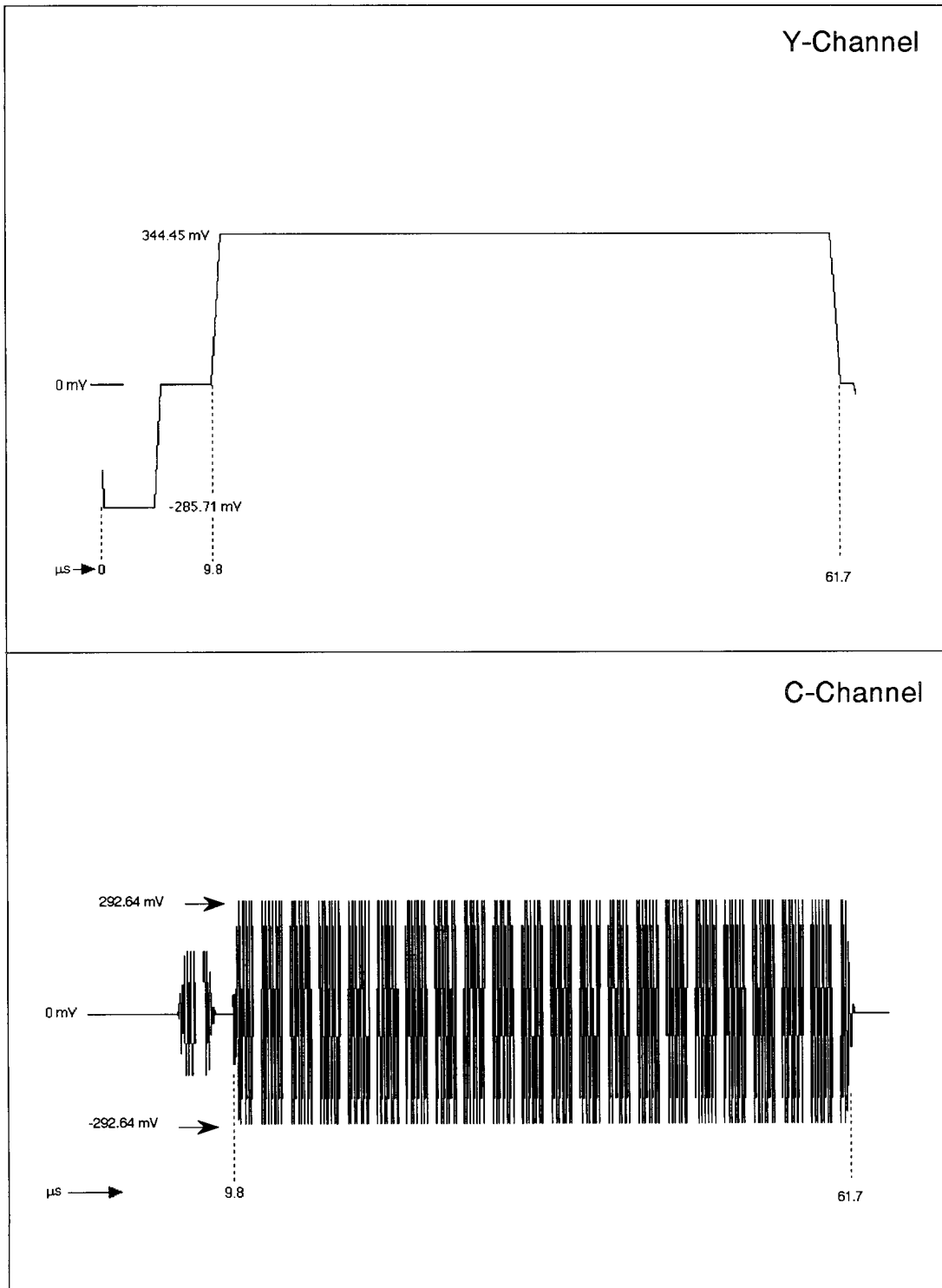

Figure 2-5: Green field

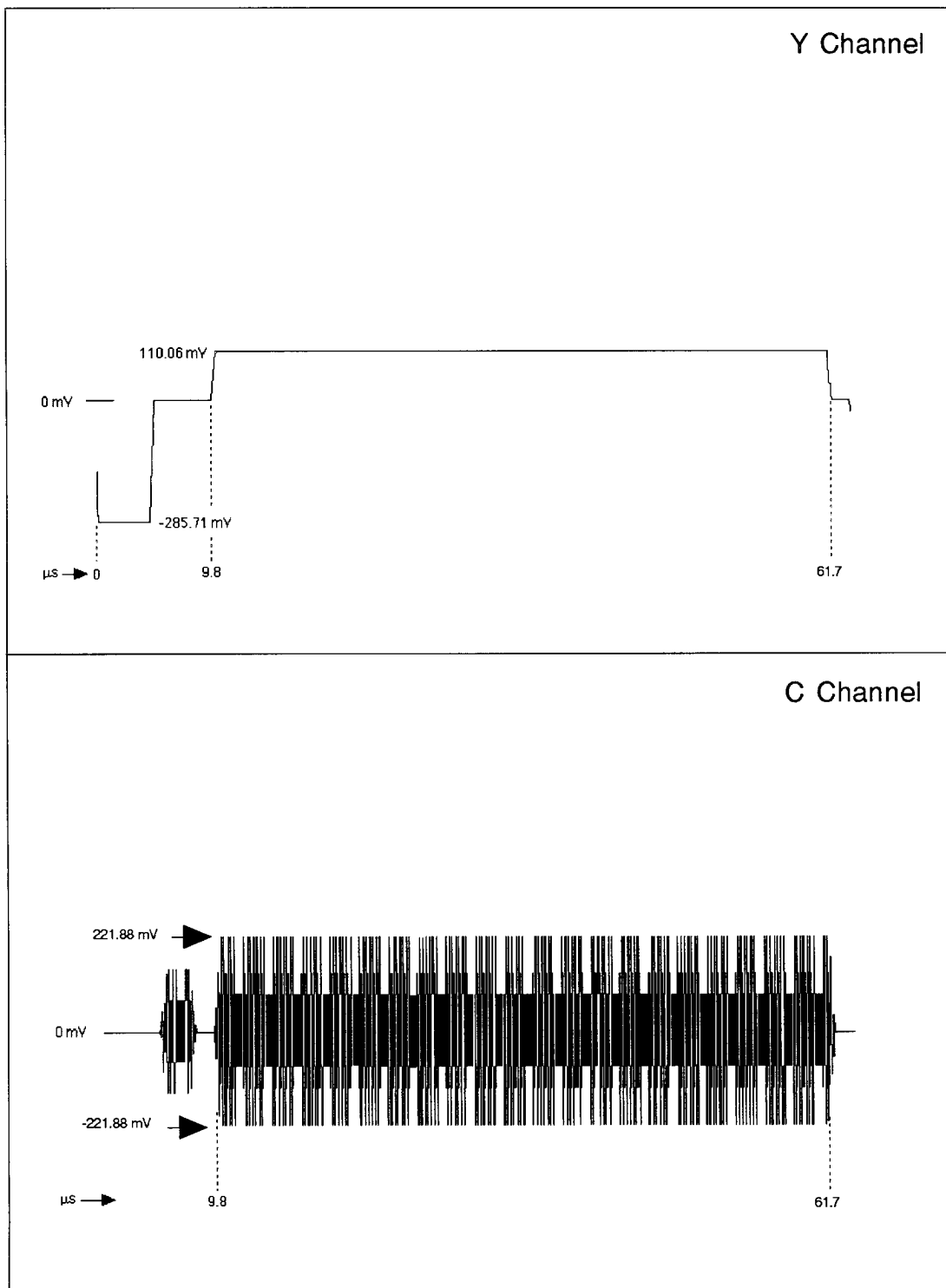

Figure 2-6: Blue field

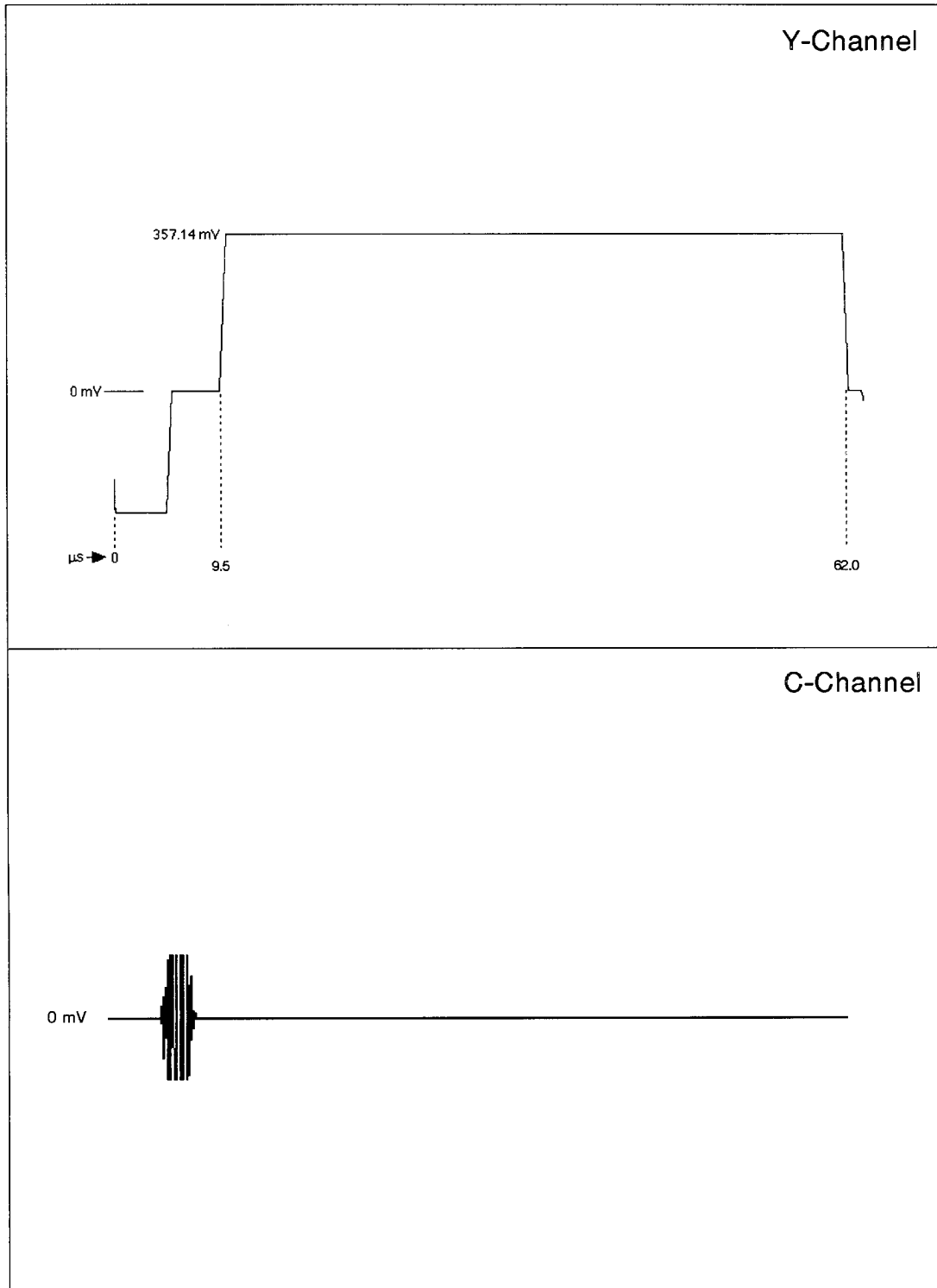

Figure 2-7: 50% flat field

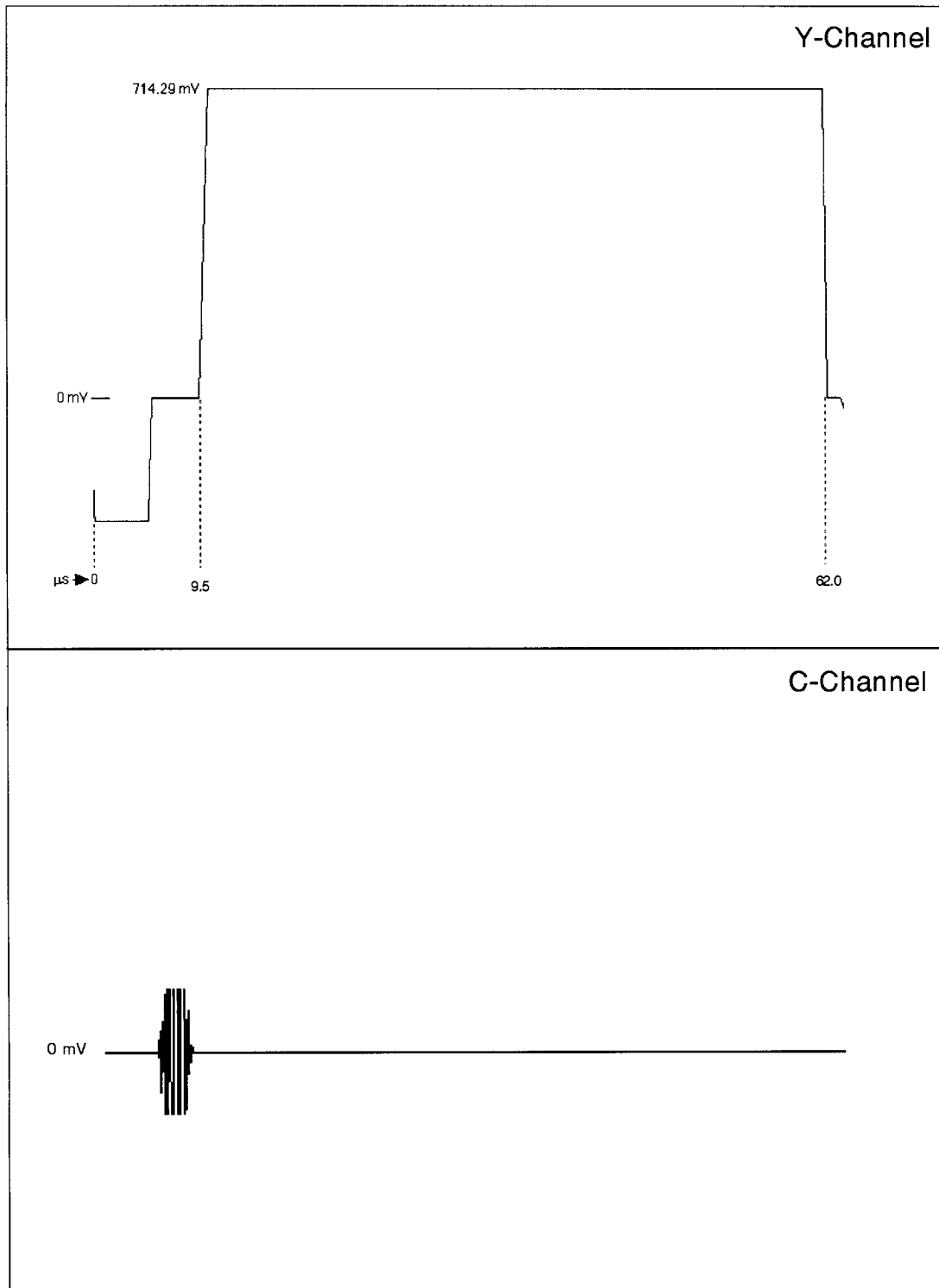

Figure 2-8: 100% flat field

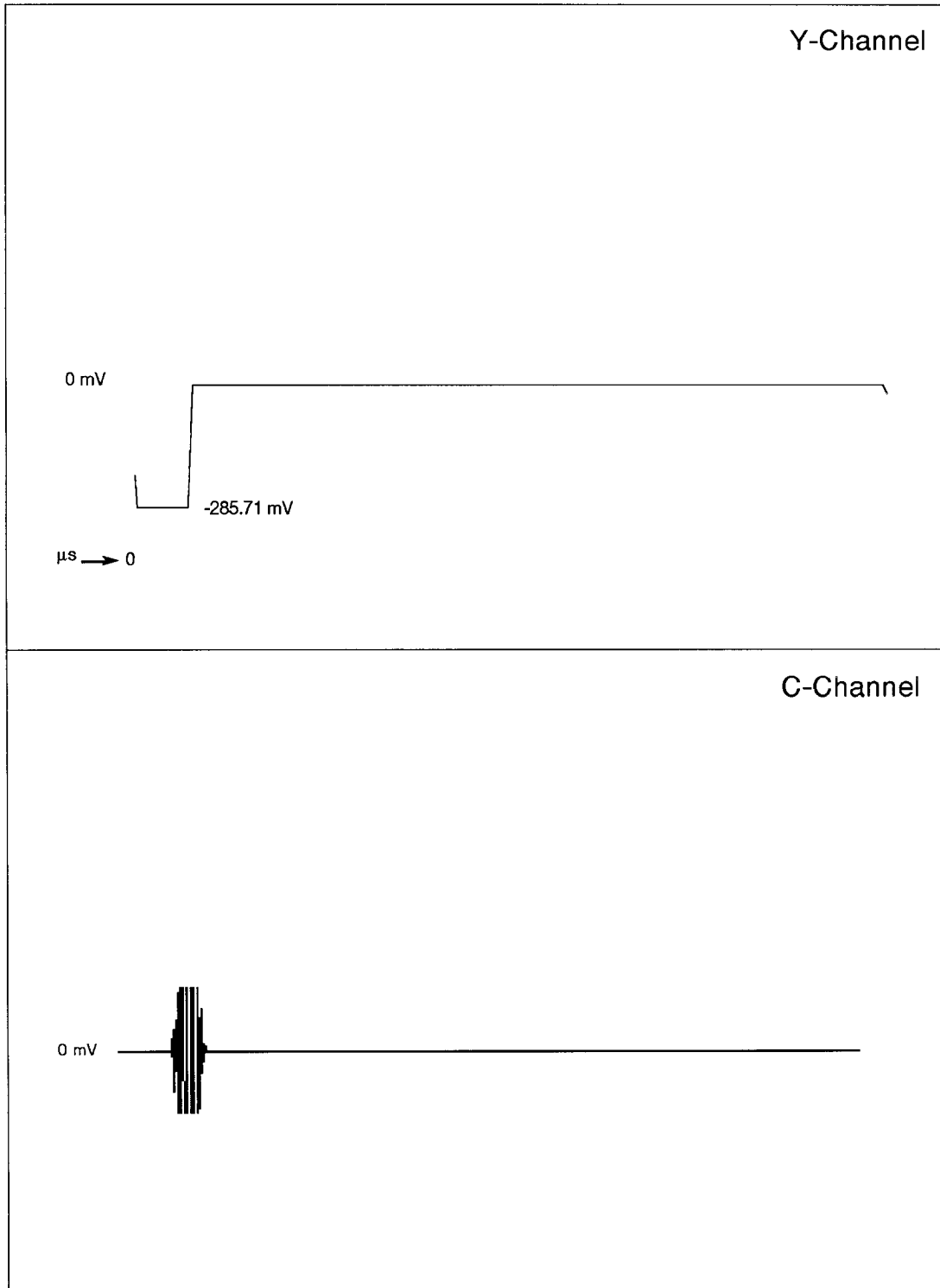

Figure 2-9: 0% flat field

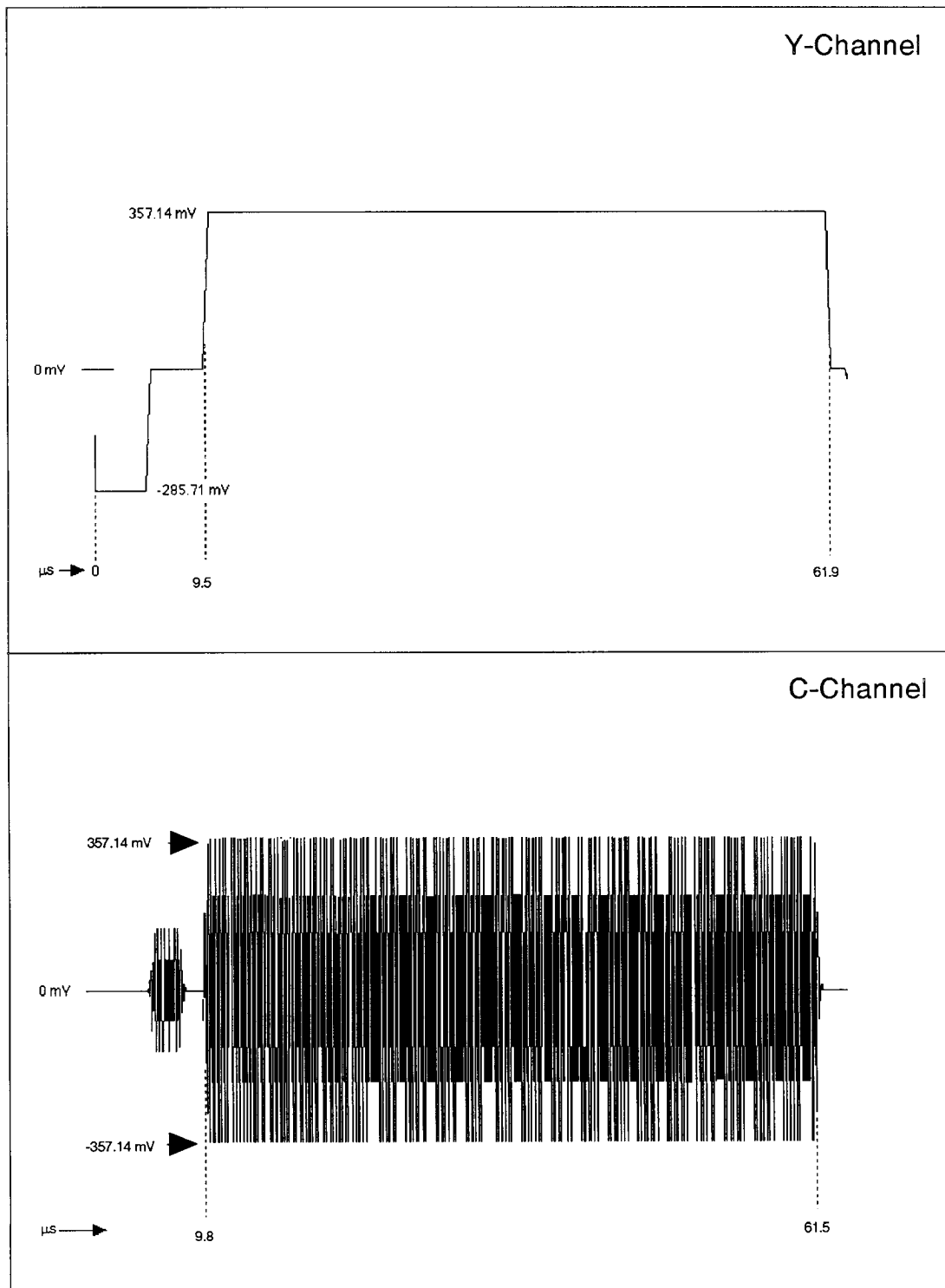

Figure 2-10: Chroma noise

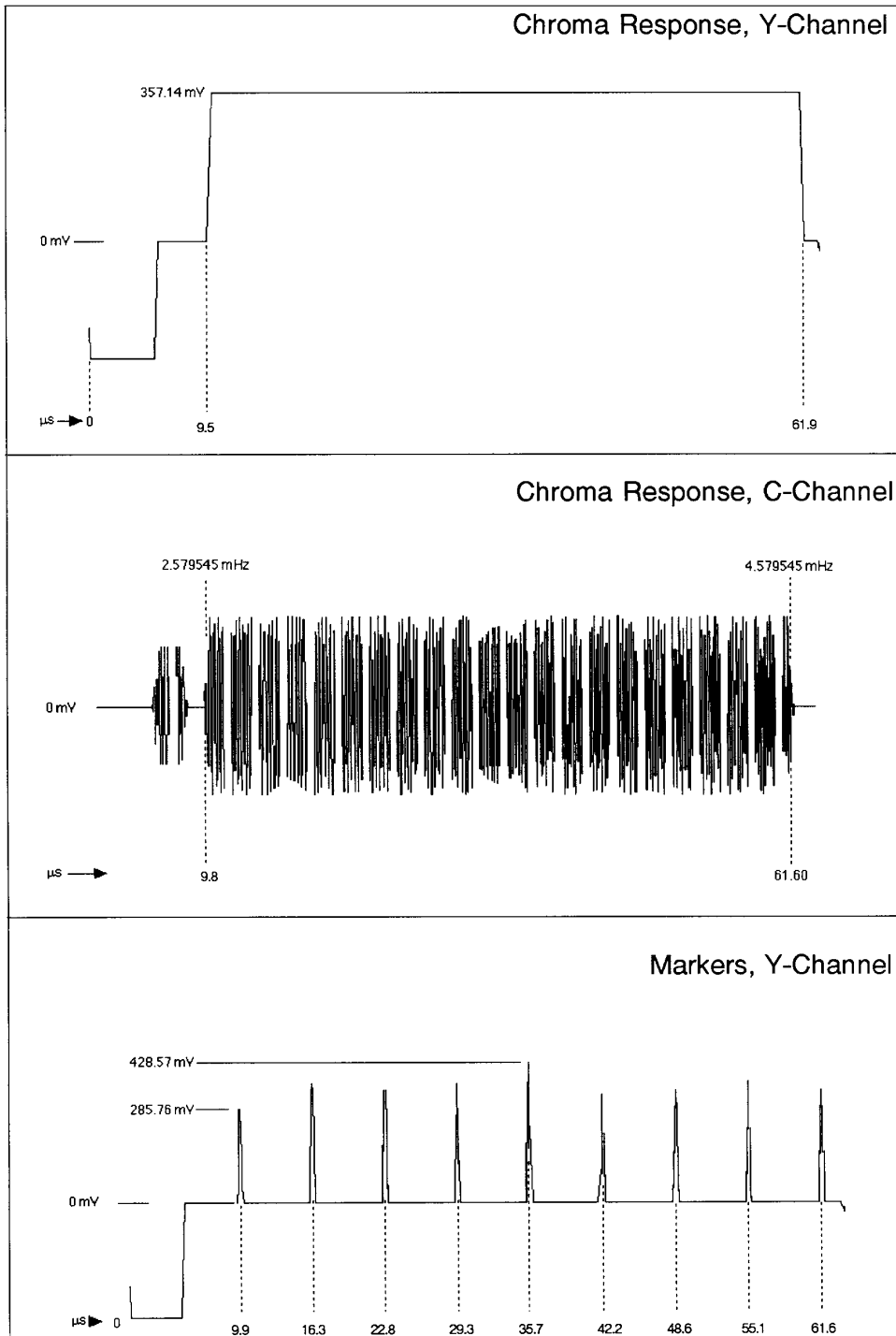

Figure 2-11: Chroma response and markers

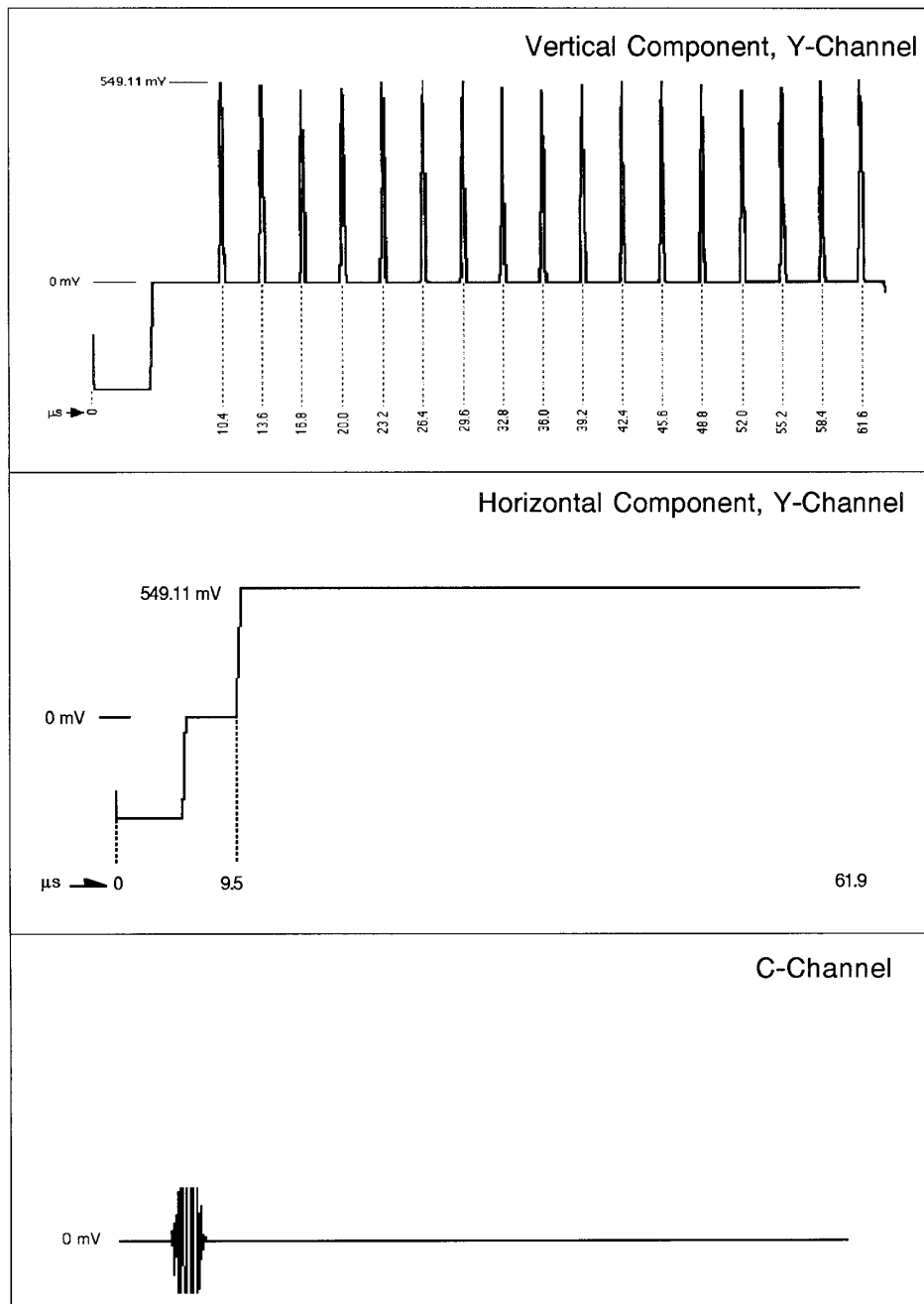

Figure 2-12: Convergence

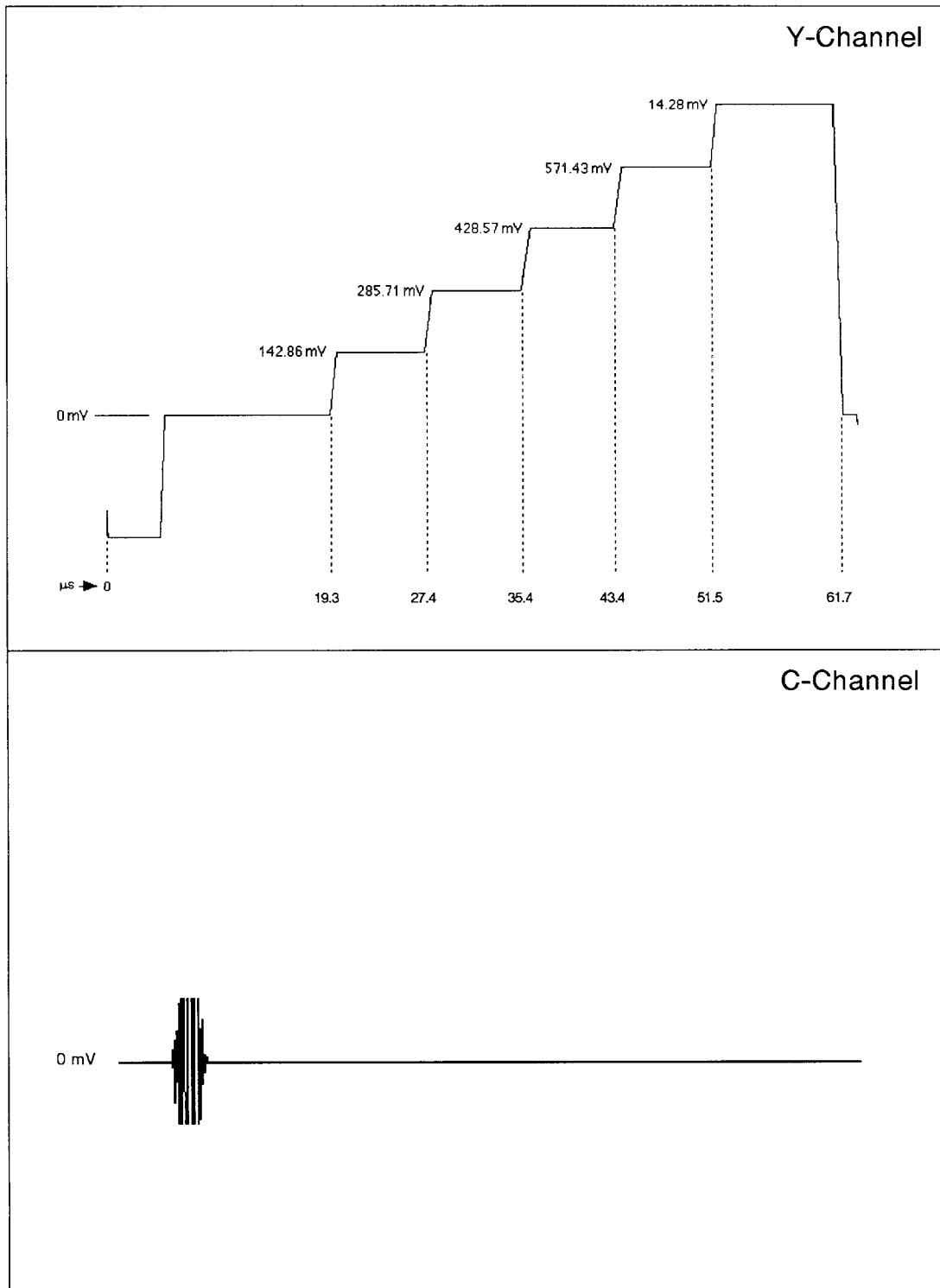

Figure 2-13: 5 step

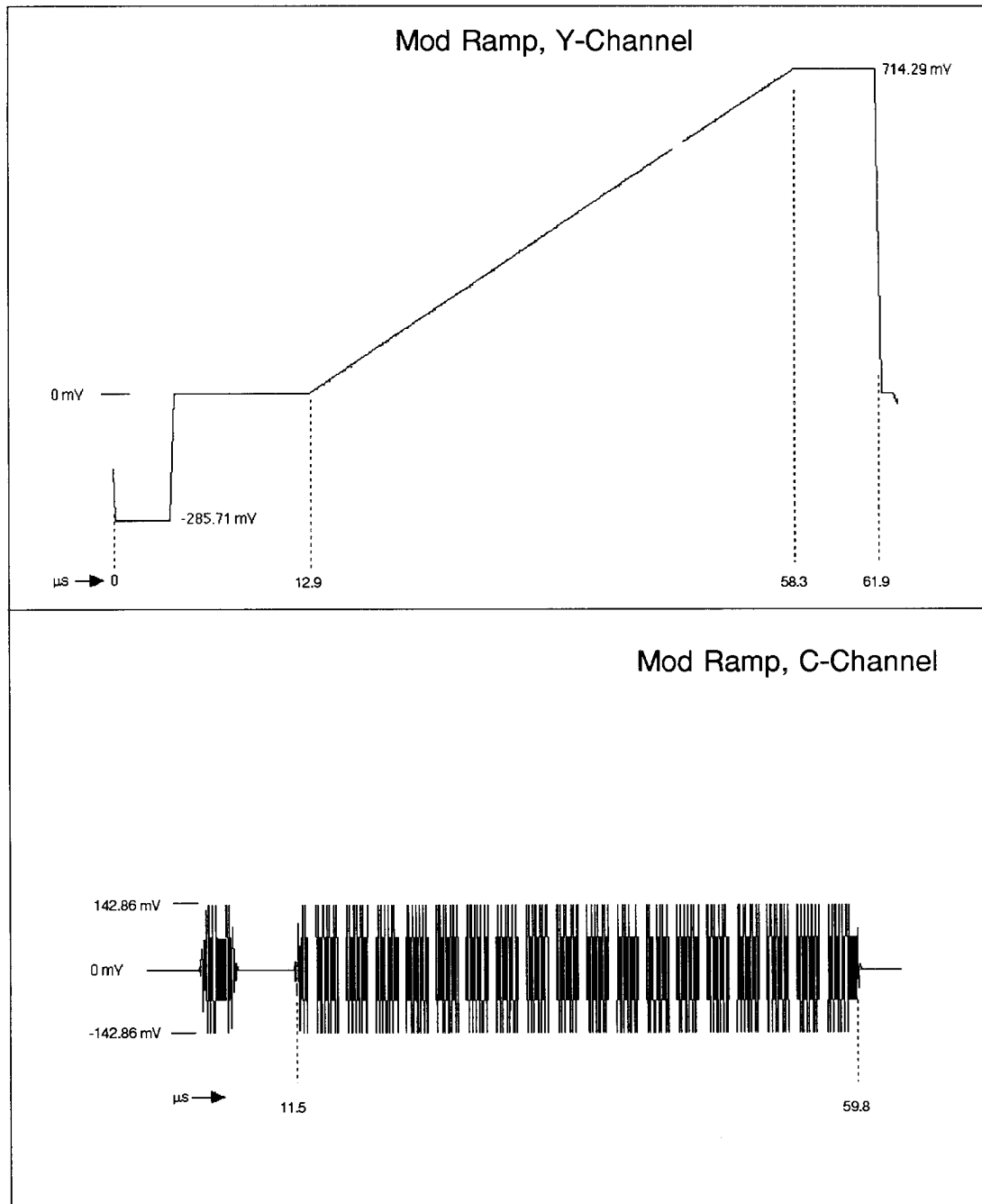

Figure 2-14: Mod ramp

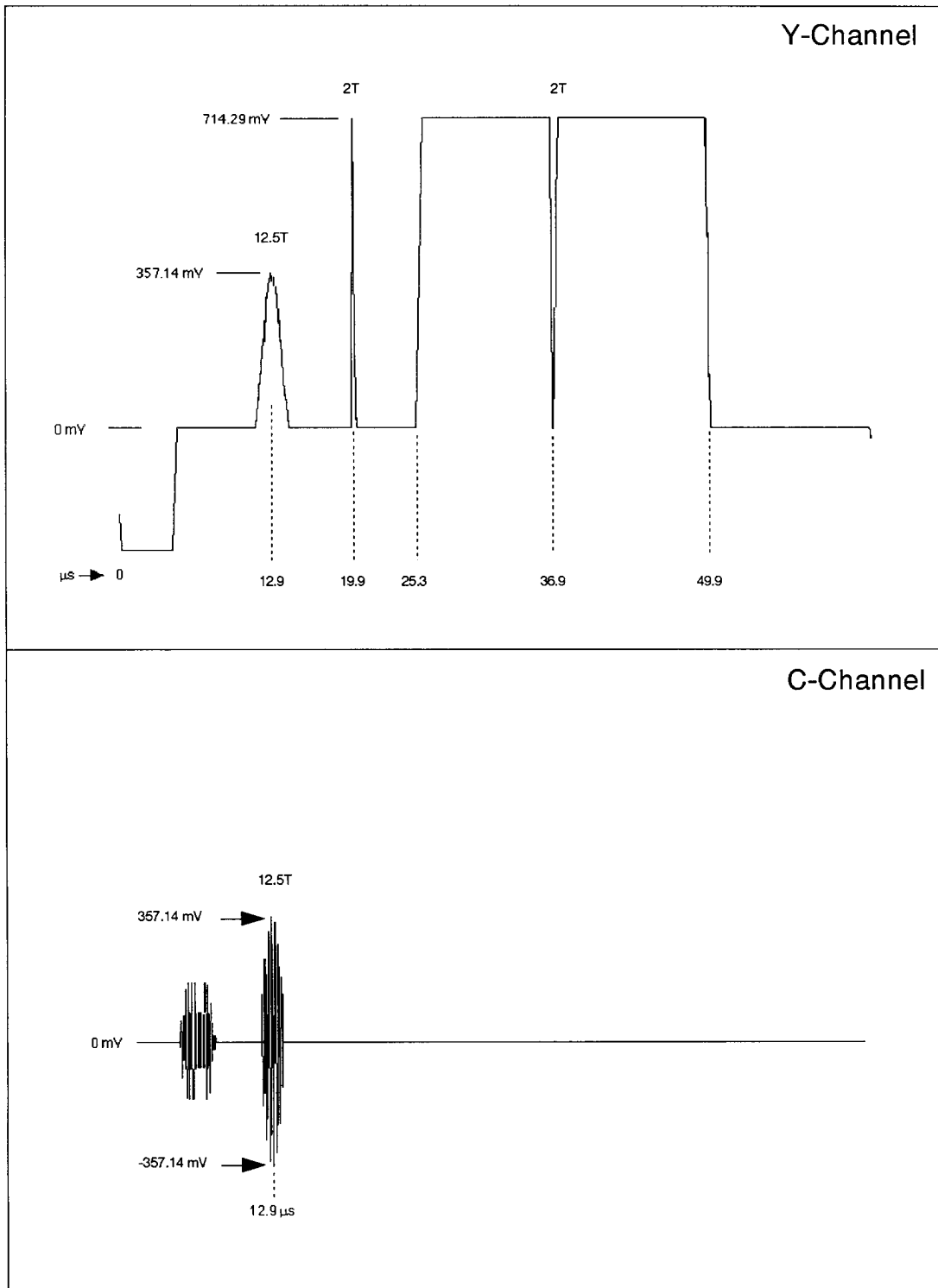

Figure 2-15: Pulse and bar

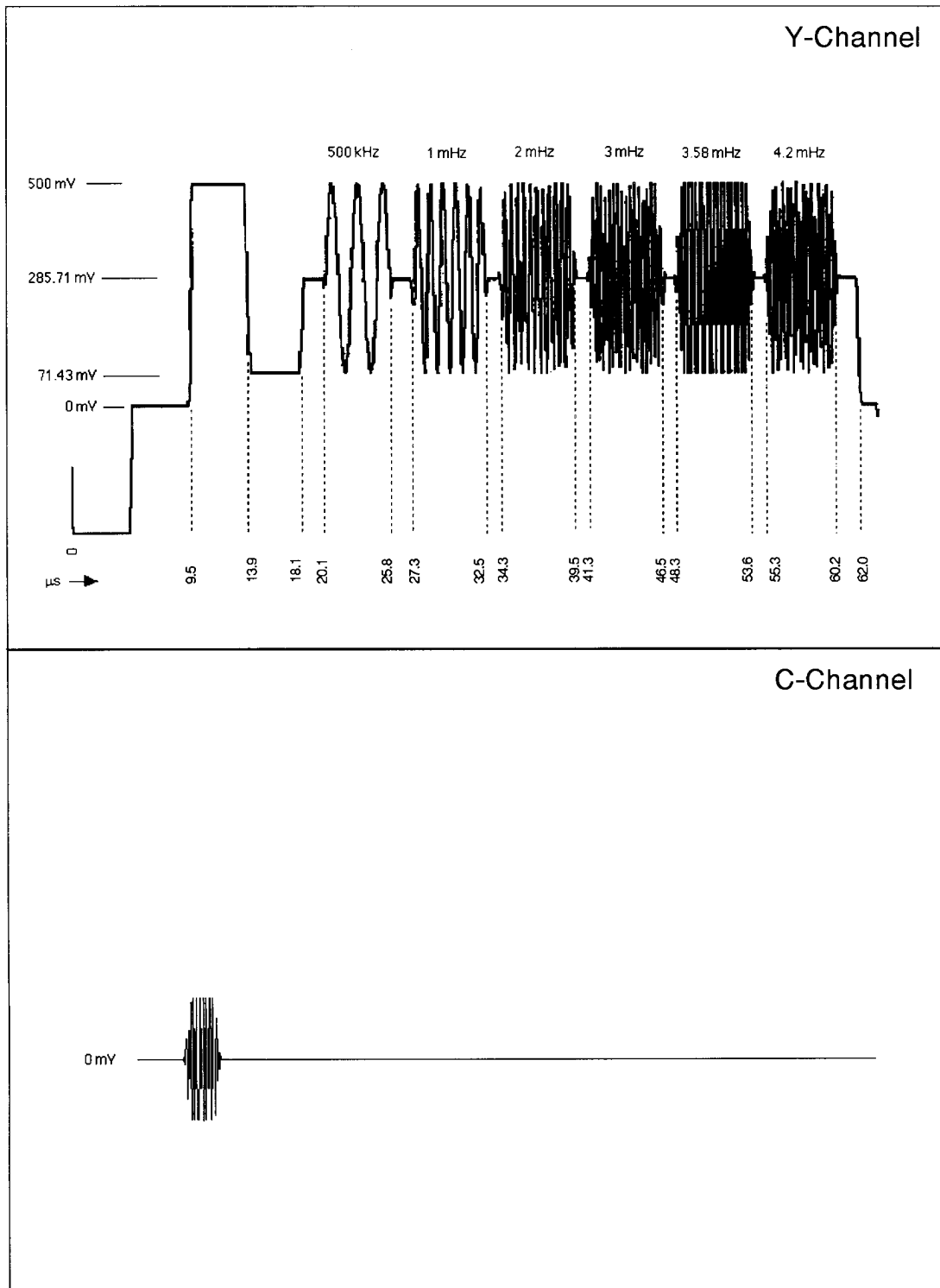

Figure 2-16: Multiburst

Line	
21	Muliburst
62	Chroma Sweep
102	50 IRE Flat Field
142	Chroma Noise
182	75% Color Bar
222	NTC7 Composite
262	

Figure 2-17: Matrix

Option 02 Signals

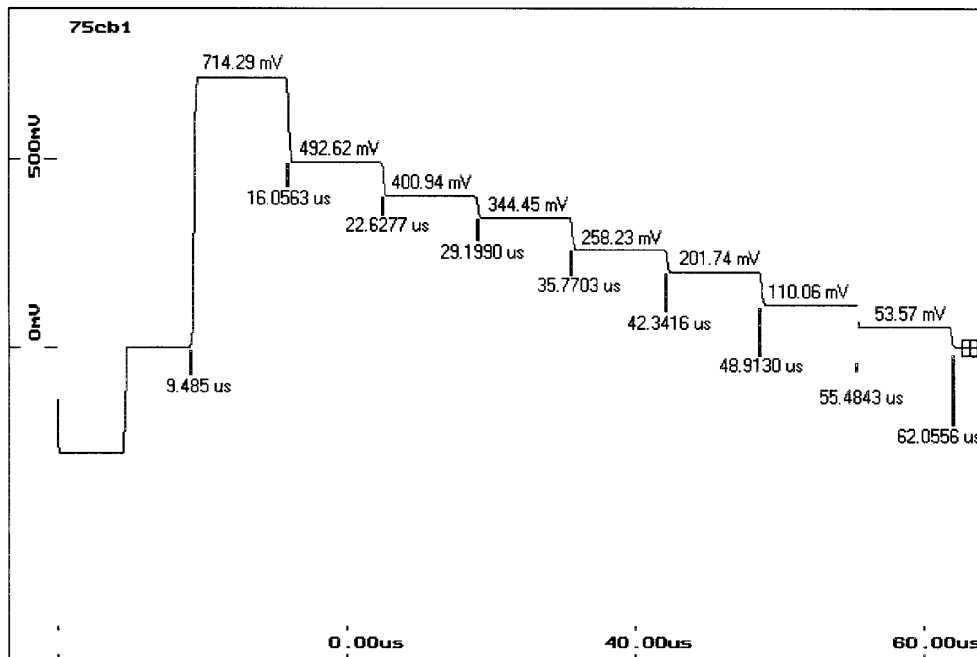

Figure 2-18: Y channel 75% color bars

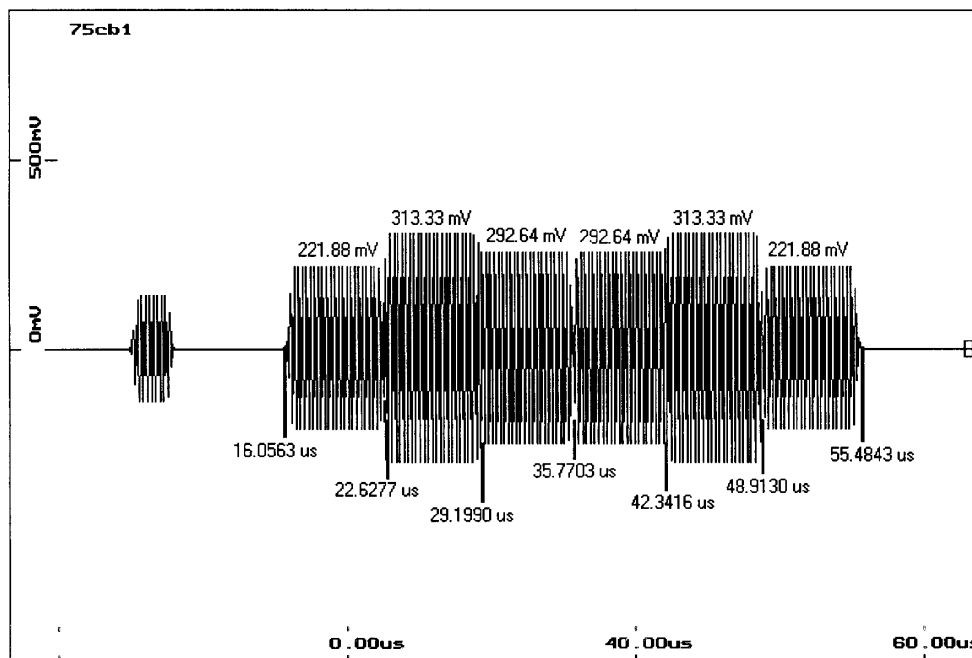

Figure 2-19: C channel 75% color bars

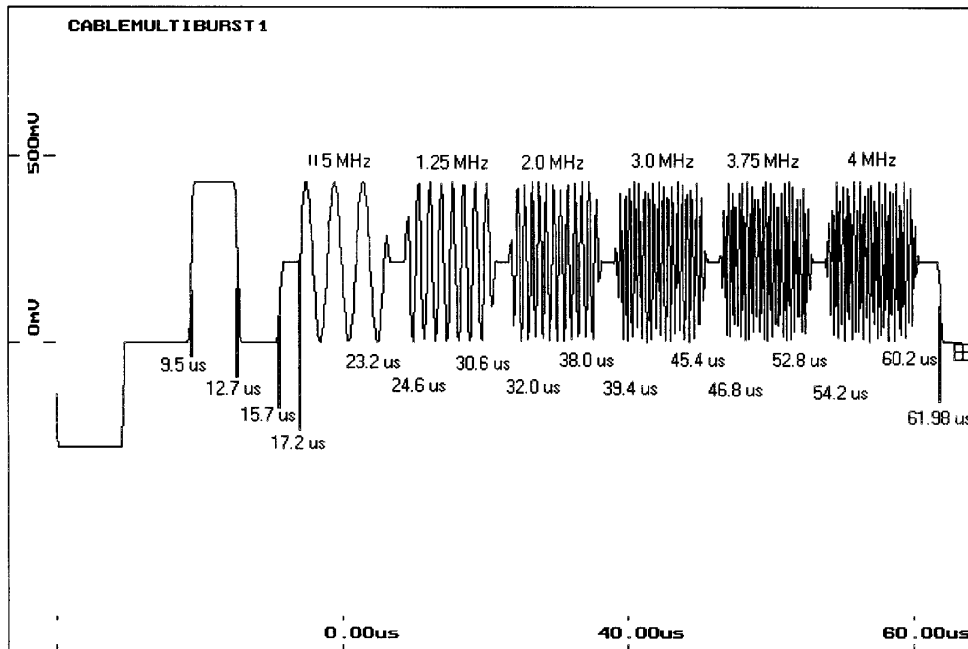

Figure 2-20: Y channel cable multiburst signal

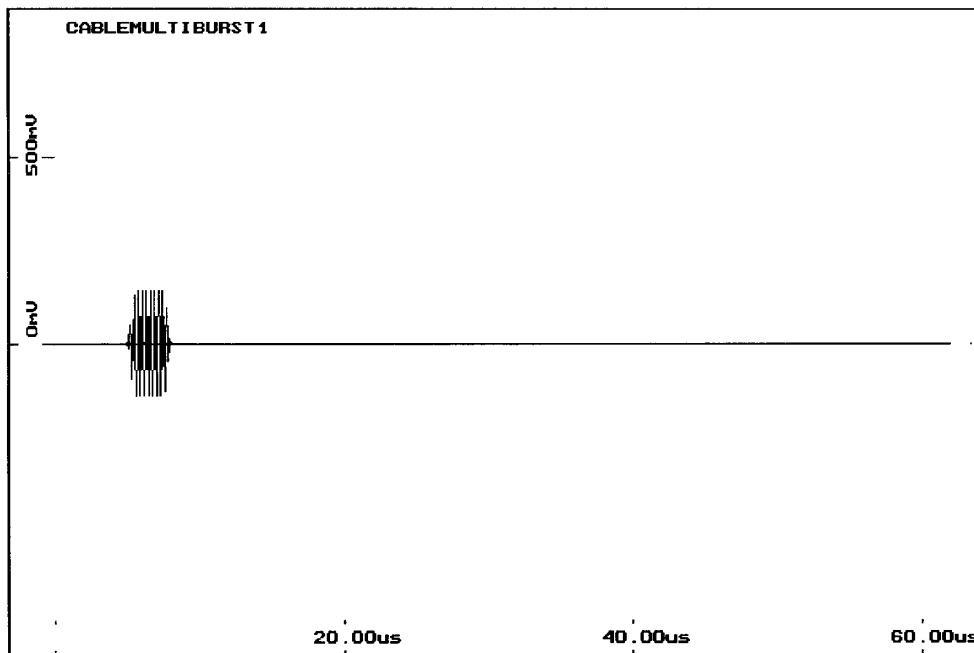

Figure 2-21: C channel for the following signals: cable multiburst, cable sweep, (Sin x)/x, and ghost canceling

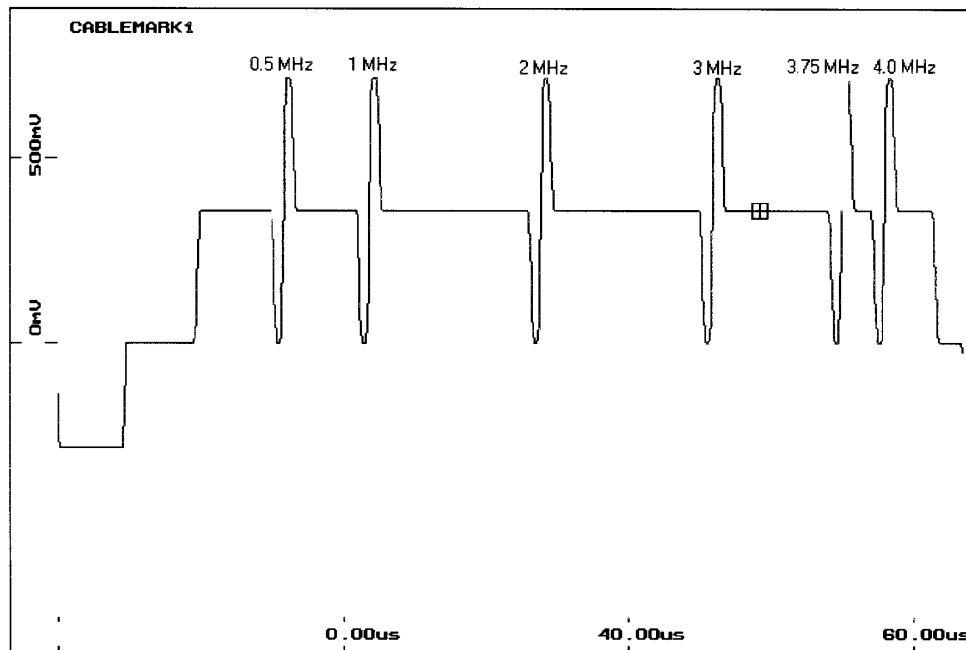

Figure 2-22: Y channel cable sweep markers

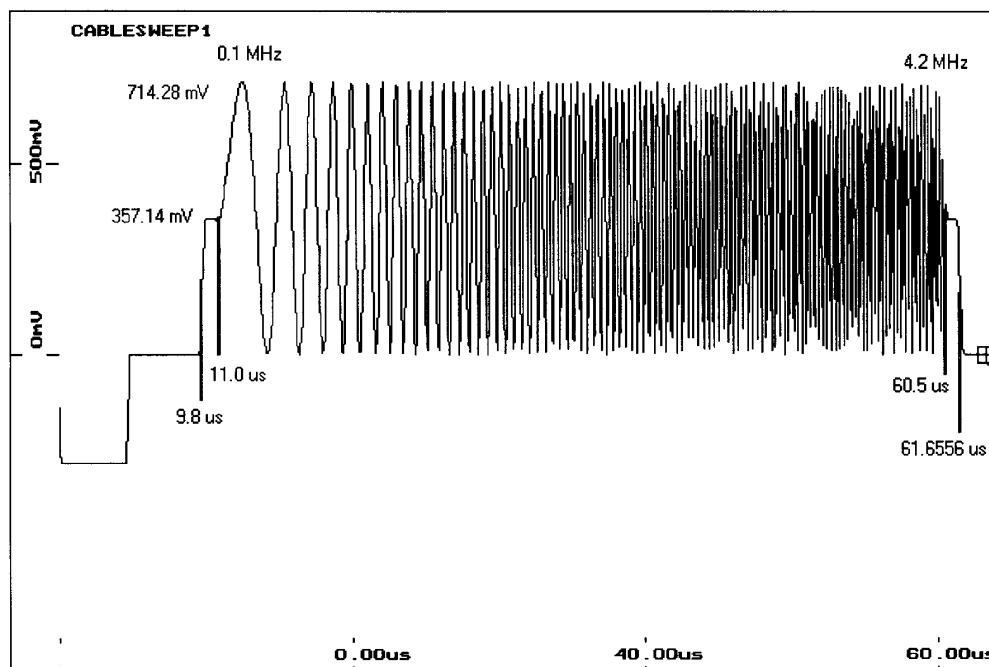

Figure 2-23: Y channel cable sweep signal

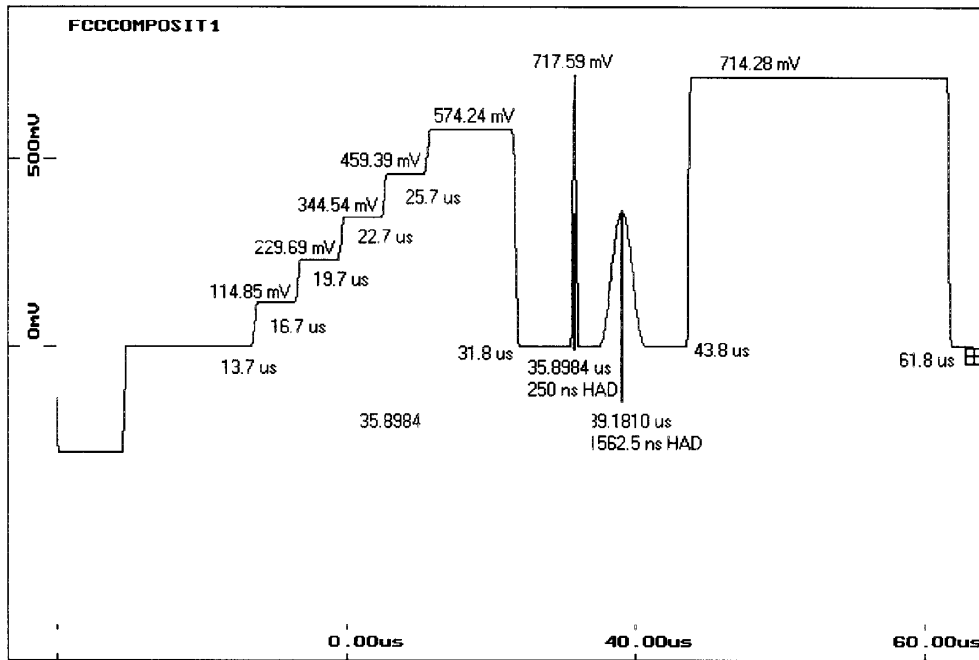

Figure 2-24: Y channel FCC test signal

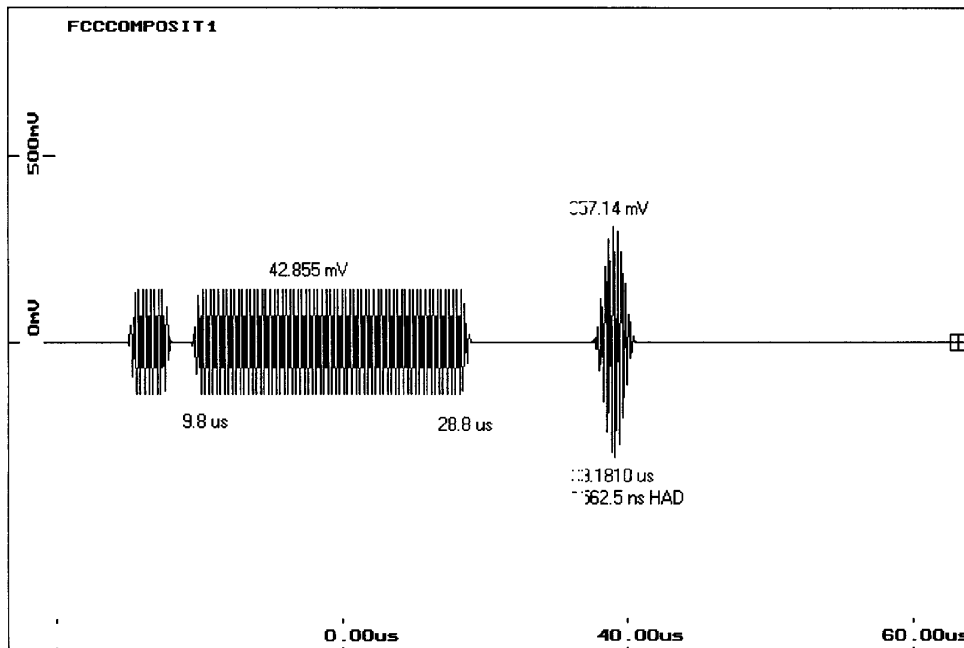

Figure 2-25: C channel FCC test signal

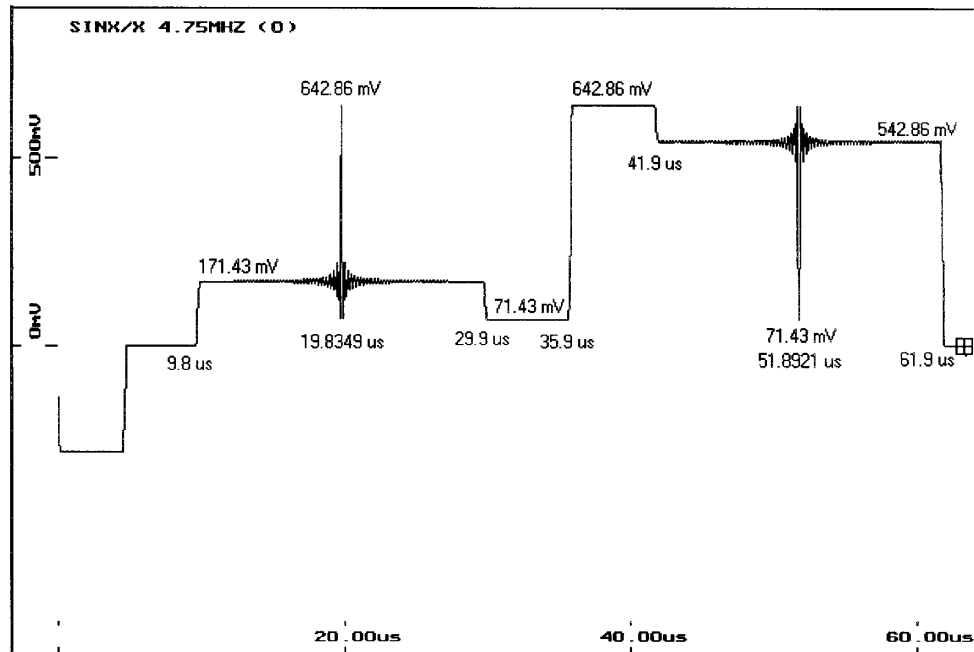

Figure 2-26: Y channel of the (Sin x)/x test signal

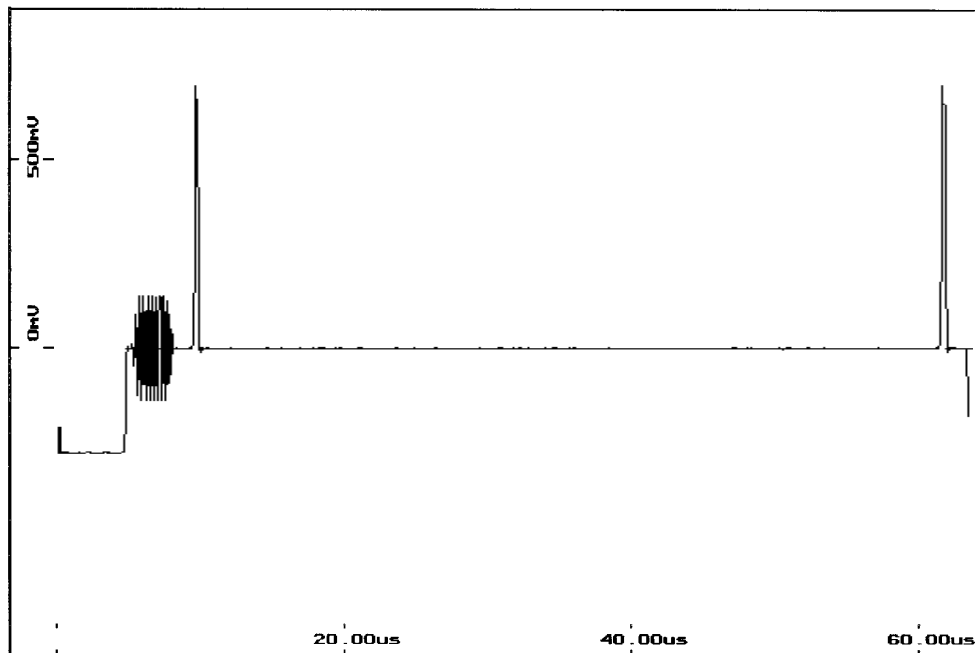

Figure 2-27: Y channel for ghost canceling

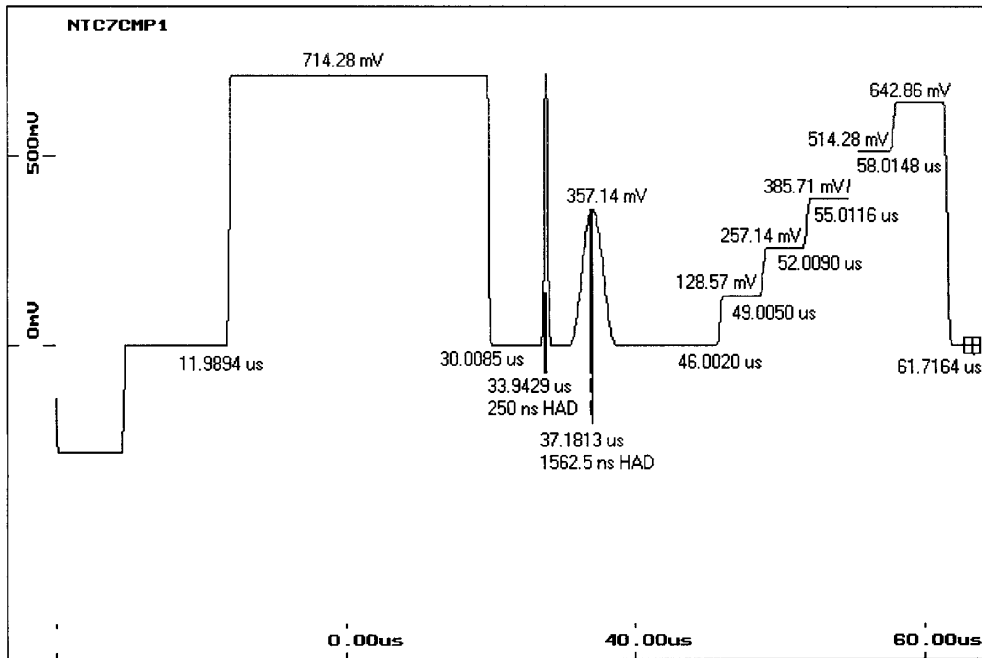

Figure 2-28: Y channel NTC7 test signal

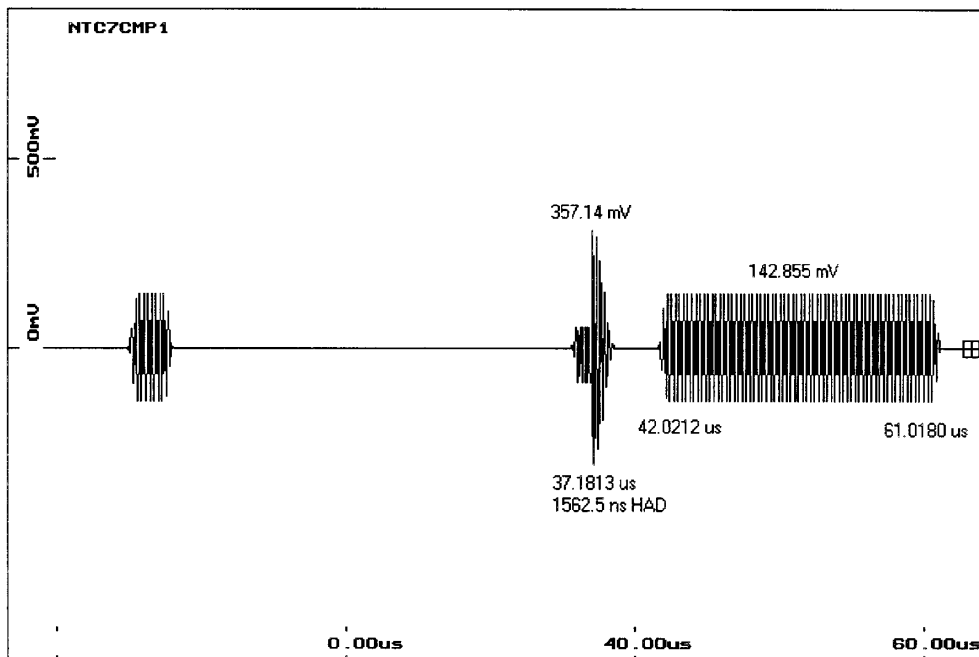

Figure 2-29: C channel NTC7 test signal

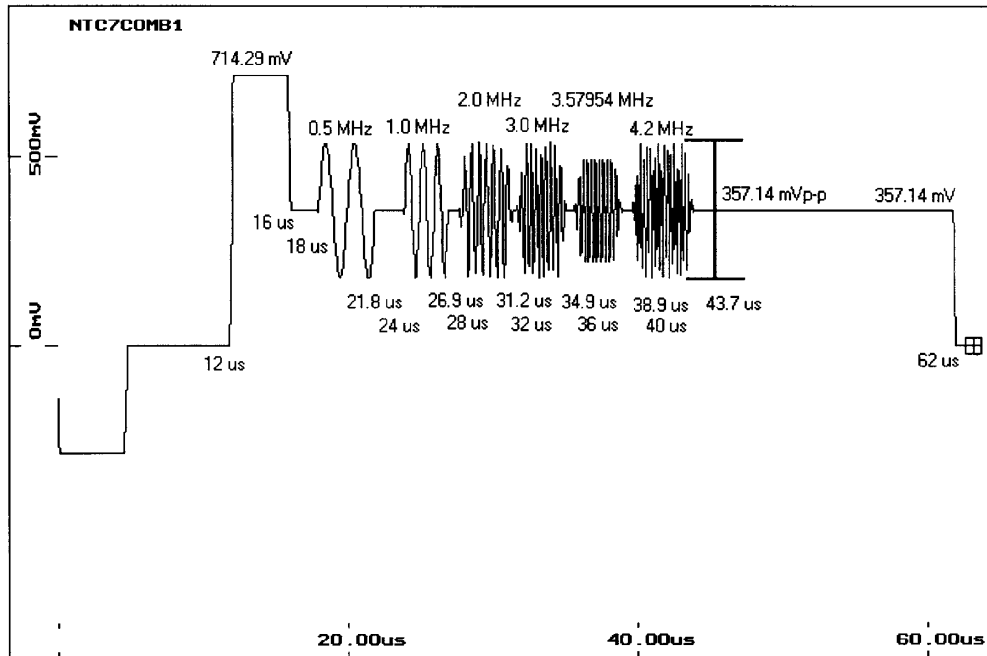

Figure 2-30: Y channel NTC7 Combination signal

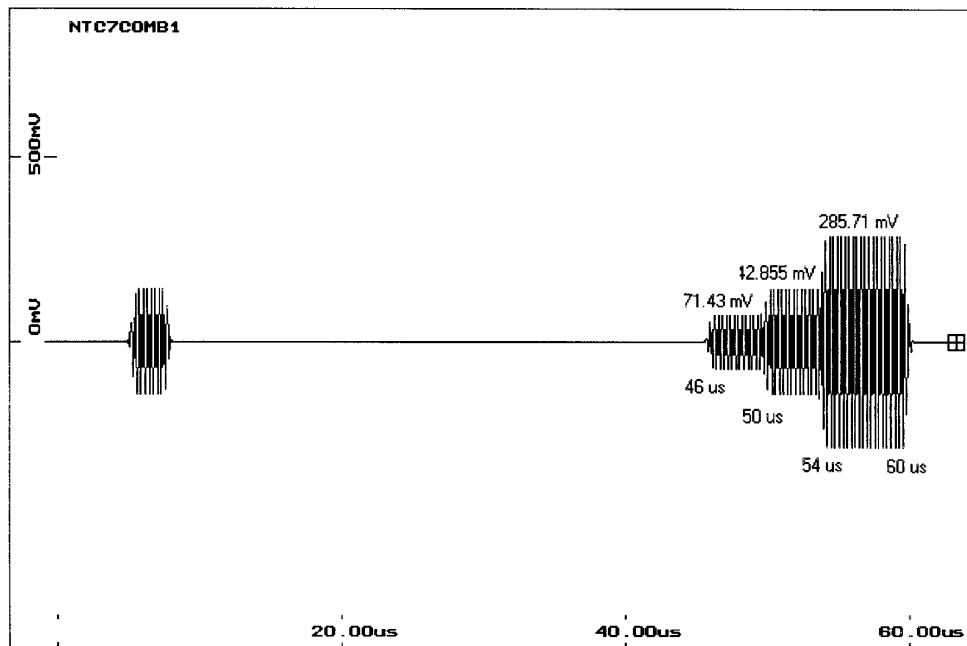

Figure 2-31: C channel NTC7 Combination signal

Table 2–4: Audio tone characteristics

Characteristics	Performance requirements	Supplemental information
Audio Tone Amplitude	0 to +8 dBu adjustable	50 Ω output balanced XLR impedance to drive 600 Ω or high-impedance load.
Frequency Distortion (THD) Audio ID "click" frequency range (channel one only)	1 kHz $\leq 0.5\%$ 5 – 0.2 Hz.	

Table 2–5: Power supply specifications

Characteristics	Performance requirements	Supplemental information
Supply Accuracy +5 V –5.1 V –10 V		5 V ± 250 mV –5.2 V +300 mV –500 mV –10 V ± 600 mV
Power Limit		18 Watts
Hum +12 V +5 V –5.2 V –12 V		Typical 10 mV 10 mV 20 mV 10 mV
Noise +5 V –5.2 V –10 V		≤ 50 mV (5 MHz bandwidth) ≤ 50 mV (5 MHz bandwidth) ≤ 50 mV (5 MHz bandwidth)
Line Voltage Range 115 VAC 240 VAC	90 – 130 VAC 180 – 250 VAC	
Fuse Data 115 V Setting 230 V Setting		.5 A Med Blow .25 A Med Blow
Power Consumption, Typical		15 Watts
Line Frequency		48 – 62 Hz

Table 2–6: Physical characteristics

Characteristics	Supplemental information
Dimensions	
Height	1.71 in. (4.34 cm)
Width	8.1 in. (20.6 cm)
Length	15.0 in (38.1 cm)
Net Weight	4 lbs., 6 oz. (1.98 kg)
Shipping Weight	7 lbs., 1 oz.

Table 2–7: Environmental characteristics

Characteristics	Supplemental information
Temperature	
Non-Operating	–40 to +65° C (–40 to +149° F)
Operating	5 to +35° C (+41 to +104° F)
Altitude	
Non-Operating	To 50,000 feet
Operating	To 2000 feet
Vibration (Operating)	15 minutes each axis at 0.025 inch, with frequency varied from 10-55-10 cycles per second in 4-minute cycles with instrument secured to vibration platform. Ten minutes each axis at any resonant point or at 55 cycles per second.
Shock	50 g, 1/2 sine, 11 ms duration, 3 guillotine-type shocks per side.
Transportation	Qualified under NTSB Test Procedure 1A, Category II (24-inch drop)
Relative Humidity (maximum operating)	80% for temperatures up to 31° C, decreasing linearly to 50% at 40° C
Equipment Type	Test and Measuring
Safety Class	Class I (as defined in IEC 1010–1, Annex H) – grounded product
Overvoltage Category	Overvoltage Category II (as defined in IEC 1010–1, Annex J).
Pollution Degree	Pollution Degree 2 (as defined in IEC 1010–1). Note – Rated for indoor use only.

Table 2–8: Certifications and compliances

Category	Standards or description
FCC Compliance	Emissions comply with FCC Code of Federal Regulations 47, Part 15, Subpart B, Class A Limits
Installation (Overvoltage) Category	<p>Terminals on this product may have different installation (overvoltage) category designations. The installation categories are:</p> <p>CAT III Distribution-level mains (usually permanently connected). Equipment at this level is typically in a fixed industrial location.</p> <p>CAT II Local-level mains (wall sockets). Equipment at this level includes appliances, portable tools, and similar products. Equipment is usually cord-connected.</p> <p>CAT I Secondary (signal level) or battery operated circuits of electronic equipment.</p>
Pollution Degree	<p>A measure of the contaminates that could occur in the environment around and within a product. Typically the internal environment inside a product is considered to be the same as the external. Products should be used only in the environment for which they are rated.</p> <p>Pollution Degree 2 Normally only dry, nonconductive pollution occurs. Occasionally a temporary conductivity that is caused by condensation must be expected. This location is a typical office/home environment. Temporary condensation occurs only when the product is out of service.</p>
Safety Standards	
U.S. Nationally Recognized Testing Laboratory Listing	UL1244 Standard for electrical and electronic measuring and test equipment.
Canadian Certification	CAN/CSA C22.2 No. 231 CSA safety requirements for electrical and electronic measuring and test equipment.
European Union Compliance	Low Voltage Directive 73/23/EEC, amended by 93/69/EEC
	EN 61010-1 Safety requirements for electrical equipment for measurement, control, and laboratory use.
Additional Compliance	IEC61010-1 Safety requirements for electrical equipment for measurement, control, and laboratory use.
Safety Certification Compliance	
Temperature, operating	+5 to +40° C
Altitude (maximum operating)	2000 meters
Equipment Type	Test and measuring
Safety Class	Class 1 (as defined in IEC 1010-1, Annex H) – grounded product
Overvoltage Category	Overvoltage Category II (as defined in IEC 1010-1, Annex J)
Pollution Degree	Pollution Degree 2 (as defined in IEC 1010-1). Note: Rated for indoor use only.

WARNING

The following servicing instructions are for use only by qualified personnel. To avoid injury, do not perform any servicing other than that stated in the operating instructions unless you are qualified to do so. Refer to all safety summaries before performing any service.



Performance Verification

Performance Verification

This section consists of checklists and detailed procedures to use in verifying the instruments performance parameters.

This procedure is intended to be done in sequence. If only selected parameters are to be checked or adjusted, always begin at a step with a setup illustration.

The following is a list of equipment required for performance verification and calibration. If alternate equipment is used, make sure that it meets the minimum requirements given. Use of inadequate equipment may result in inaccurate measurements or calibration.

1. NTSC Video Measurement Set. For measuring and displaying field-rate and line-rate waveforms, differential phase and gain, and SCH phase. Example: Tektronix 1780R NTSC Video Measurement Set.
2. Instead of the Video Measurement Set, you may substitute the following test equipment:
 - a. NTSC Waveform Monitor. For displaying and measuring field-rate and line-rate waveforms. Example: Tektronix 1480 Mod W5F.
 - b. NTSC Vectorscope. With specific modes for measuring differential phase and gain. Example: Tektronix 520A.
 - c. Video Amplitude Calibration Fixture (VAC). Provides a chopped voltage reference accurate to $\pm 0.05\%$ from 0 to 1 V in 0.1 mV increments. This fixture is used with the waveform monitor. Example: Tektronix part number 067-0916-00 (plugs into Tektronix TM 503 Power Mainframe).
 - d. Test Oscilloscope. With the following vertical amplifiers:
 1. 50 MHz bandwidth, 1 mV sensitivity, 5 MHz switchable bandwidth, DC offset.
 2. Dual trace with minimum deflection factor of 50 mV/div with 10x probe.
 3. Time Base: 5 ns/div to 5 μ s/div sweep speeds, triggering to 5 MHz, and capable of accepting both direct and delayed external triggers. Example: Tektronix 7603 Oscilloscope with a 7A13 Differential Comparator, 7A26 Dual Trace Amplifier, and 7B53A Dual Time Base. Use with P6106 10x probes (part number 010-610-03).
4. Frequency Counter. Must be accurate to within 2.5 Hz out of 5 MHz. Example: Tektronix DC 501, Option 01: plugs into a TM 503 Power Mainframe.

5. Distortion Analyzer. Must test power output over range of 0 – 8 dBm and be capable detecting THD of 0.01% or less. Example: Tektronix AA501.
6. Audio Amplifier. 600 Ω impedance.
7. BNC Coax Cables. 75 Ω impedance. Example: Tektronix part number 012-0074-00.
8. End-Line Termination. 75 Ω termination equipped with a BNC connector. Example: Tektronix part number 011-0102-00.
9. Feed-Through Termination. 75 Ω termination equipped with BNC connectors. Example: Tektronix part number 011-0103-00.
10. Audio Connector-to-Triple Banana Cable. Must be configured to match the generators audio output. Pin 1, shield; pin 2, +; pin 3, -. Example: ITT Pamona Electronics, Model 4953-J-36.

Performance Verification Checklist

Table 3–1: NTSC test signal output

No.	Procedure	Limits
1	Blanking Level	0 V \pm 50 mV
2	Sync Amplitude	40 IRE \pm 0.8 IRE/285.7 mV \pm 5.7 mV
3	Burst Amplitude	40 IRE \pm 0.8 IRE/285.7 mV \pm 5.7 mV
4	5-Step Staircase Linearity	Within 1%
5	Luminance Amplitude	100 IRE \pm 1.0 IRE/714.3 mV \pm 7.14 mV
6	Chrominance Amplitude	100 IRE \pm 1.0 IRE/714.3 mV \pm 7.14 mV
7	Chrominance-to-Luminance Gain	\pm 1%
8	Line Tilt	< 0.5%/0.5 IRE/3.6 mV
9	Field Tilt	< 0.5%/0.5 IRE/3.6 mV
10	Chrominance-Luminance Delay	< 10 ns
11	Ringing	< 1.5 IRE/10.7 mV
12	Pulse-to-Bar Ratio	1:1 \pm 1%
13	Sync Rise and Fall Times	140 ns \pm 20 ns
14	Sync Timing H Sync and Vertical Serrations	4.7 μ s \pm 0.1 μ s
	Equalizing Pulses	2.3 μ s \pm 0.1 μ s
15	Horizontal Blanking Interval	10.9 μ s \pm 0.1 μ s
16	Multiburst Frequency Response	\pm 2%/1.2 IRE/8.6 mV

Table 3–1: NTSC test signal output (Cont.)

No.	Procedure	Limits
17	Differential Phase and Gain	< 3° and < 0.3%
18	SCH Accuracy	0° ±5°

Table 3–2: Y and C test signal output

No.	Procedure	Limits
19	Luminance Blanking Level	0 V ± 50 mV)
20	Luminance Amplitude	100 IRE ± 1.0 IRE/714.3 mV ± 7.14 mV
21	Sync Amplitude	40 IRE ± 0.8 IRE/285.7 mV ± 5.7 mV
22	5-Step Staircase Linearity	within 1%
23	Line Tilt	< 0.5%/0.5 IRE/3.6 mV
24	Field Tilt	< 0.5%/0.5 IRE/3.6 mV
25	Ringing	< 1.5 IRE/10.7 mV
26	Pulse-to-Bar Ratio	1:1 ± 1%
27	Multiburst Frequency Response	± 2%
28	Chrominance Blanking Level	0 V ± 50 mV
29	Chrominance Response	±1% to 5MHz
30	Burst Amplitude	40 IRE ± 0.8 IRE/285.7 mV ± 5.7 mV
31	Chrominance Amplitude	100 IRE ± 1.0 IRE/714.3 mV ± 7.14 mV
32	Chrominance-to-Luminance Gain	± 1%
33	Chrominance-Luminance Delay	< 12 ns

Table 3–3: Audio output and subcarrier frequency

No.	Procedure	Limits
34	Total Harmonic Distortion	< 0.5%
35	Subcarrier Oscillator Frequency	14.31818 MHz ± 28 Hz, 5 to 35° C. Typical is 14.31818 MHz ±15 Hz at room temperature.

Performance Verification Procedures

NTSC Test Signal Output Test Procedures

1. Blanking Level
 - a. Connect the equipment as shown in Figure 3-1 or 3-2.
 - b. Select the 5-Step signal.
 - c. Confirm that any DC-Restorer feature of the monitor or oscilloscope is OFF.
 - d. Toggle the display between DC coupled and ground reference.
 - e. Check that the blanking level is $0\text{ V} \pm 50\text{ mV}$.

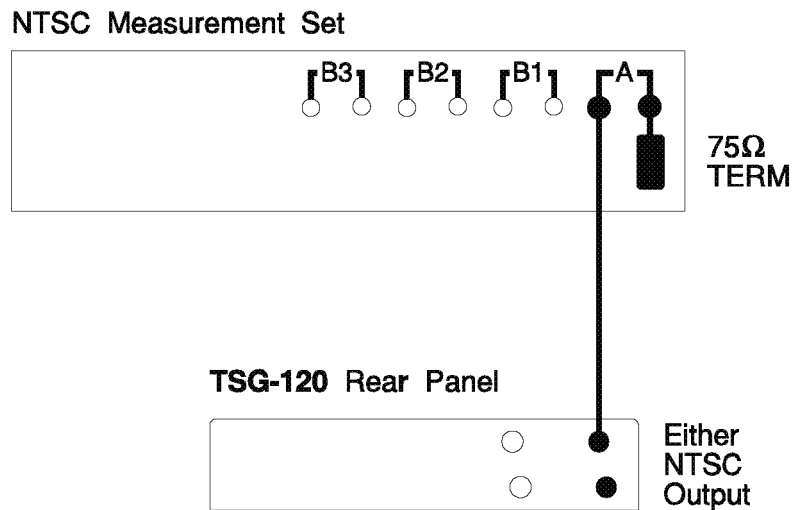

Figure 3-1: Blanking level verification test setup (video measurement set)

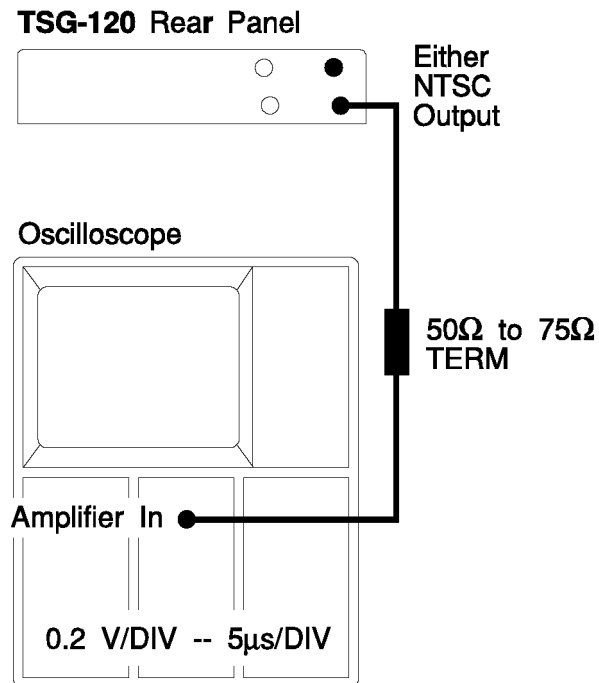

Figure 3–2: Blanking level verification test setup (oscilloscope)

2. Sync Amplitude

- a. Connect the test equipment as shown in Figure 3–1 or 3–3.
- b. Select 5-Step signal.
- c. With the Waveform + CAL function of the measurement set, or with the VAC, match the blanking level of the lower waveform to the sync tip of the upper waveform.
- d. Check that the sync amplitude is $40 \text{ IRE} \pm 0.8 \text{ IRE}/285.7 \text{ mV} \pm 5.7 \text{ mV}$.

3. Burst Amplitude

- a. If necessary, adjust the measurement set or VAC to match the top of the lower burst to the bottom of the upper burst.
- b. Check for a burst amplitude of $40 \text{ IRE} \pm 0.8 \text{ IRE}/285.7 \text{ mV} \pm 5.7 \text{ mV}$.

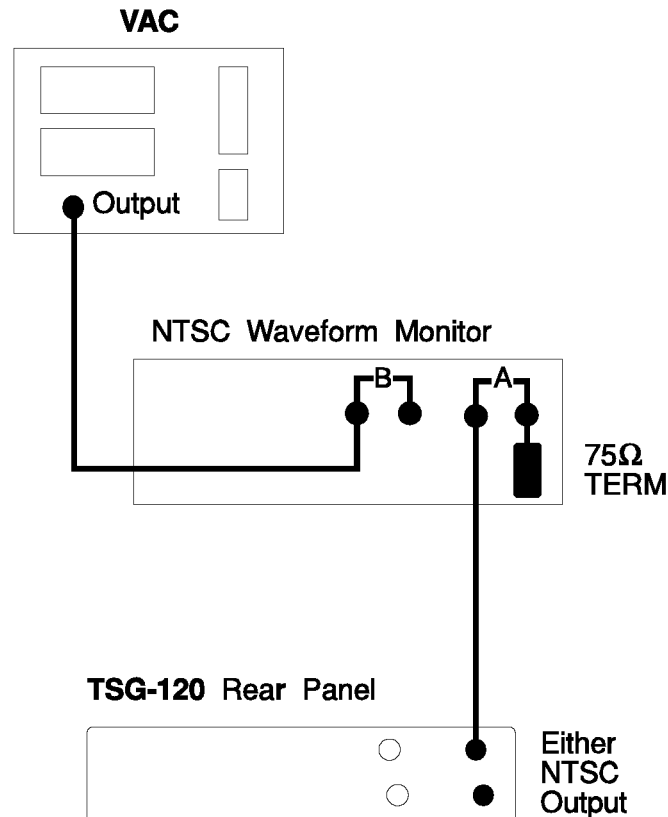

Figure 3-3: Sync amplitude verification test setup

4. 5-Step Staircase Linearity

- a. With the 5-Step signal still selected, set the test equipment to view the signal through a Differentiated Step filter.
- b. Check that the difference between the highest and lowest spikes (differentiated steps) is no greater than 1%.

(Or, use a VAC to measure the amplitude of each signal step. Check that the variation between the largest and smallest steps is no greater than 0.2 IRE/0.14 mV.)

5. Luminance Amplitude

- a. Set the test equipment to match the top of the lower 5-Step waveform with the blanking level of the upper waveform.
- b. Check that the 5-Step amplitude is $100 \text{ IRE} \pm 1.0 \text{ IRE}/714.3 \text{ mV} \pm 7.14 \text{ mV}$.

6. Chrominance Amplitude

- a. Select the Chroma Noise signal.

Option 02. Select the NTC7 Combination (in NTC7 Matrix) signal.

- b. If necessary, adjust the test equipment to match the top of the lower waveform with the blanking level of the upper.
- c. Check that the chrominance amplitude is $100 \text{ IRE} \pm 1.0 \text{ IRE}/714.3 \text{ mV} \pm 7.14 \text{ mV}$.

7. Chrominance-to-Luminance Gain

Check that the measured values for Luminance and Chrominance amplitude are equal within $1.0 \text{ IRE}/7.14 \text{ mV}$.

8. Line Time Distortion (Line Tilt)

- a. Select the Matrix signal.

Option 02. Select the Field Square Wave.

- b. Set the test equipment to view the signal through a luminance filter.
- c. If necessary, normalize the signal gain so that blanking level of the waveform is on the baseline and the top of the $18 \mu\text{s}$ line bar (or the pulse and bar part of the signal) passes through 100 IRE at its midpoint.
- d. Center the bar horizontally over the L.D. graticule, if the monitor has one.
- e. Check that the line bar tilts no more than $0.5\%/0.5 \text{ IRE}/3.6 \text{ mV}$ over its length. Ignore the first microsecond and last microsecond of the bar.

9. Field Time Distortion (Field Tilt)

- a. Select the 100% Field signal.
- b. Set the test equipment to view one field of the signal.
- c. Check that the field bar tilts no more than $0.5\%/0.5 \text{ IRE}/3.6 \text{ mV}$ over its length. Ignore the first and last 0.2 milliseconds (about 3 lines) of the bar.

10. Chrominance-Luminance Delay

- a. Select the Pulse and Bar signal.

Option 02. Select the NTC7 Combination (in NTC7 Matrix) signal.

- b. Set the waveform monitor to view the bottom of the 12.5T modulated pulse.

- c. Check (with the voltage cursors of the measurement set, or with a VAC) that the envelope at the base of the modulated pulse is no more than 1.2 IRE p-p/8.6 mV p-p, equivalent to 12 ns delay.

(Or, use the Chroma/Luma measurement mode of the Tek 1780 to get an estimate of both C/Y delay and gain. Check that delay is no greater than 12 ns.)

11. Ringing

- a. With the Pulse and Bar still selected, set the waveform monitor to display the bottom of the 2T pulse.

Option 02. With the NTC7 Combination (in NTC7 Matrix) still selected, set the waveform monitor to display the bottom of the 2T pulse.

- b. Check (with voltage cursors or graticule) that after-pulse ringing is no greater than 1%/1.0 IRE/7.14 mV peak.

12. Pulse-to-Bar Ratio

- a. Set the waveform monitor to display the tip of the inverted pulse of the Pulse and Bar signal.

Option 02. Set the waveform monitor to display the tip of the inverted pulse of the NTC7 Combination (in NTC7 Matrix) signal.

- b. Check with voltage cursors or graticule - that the inverted pulse tip is within 1%/1.0 IRE/7.14 mV of blanking level.

(Or, use a VAC and match the tip of the inverted pulse of one waveform to the blanking level of the other. Check that the inverted pulse is within 7.14 mV of the bar amplitude.)

13. Sync Rise and Fall Times

- a. Set the Waveform Monitor to display the sync on any test signal from the generator.
- b. Identify the 10% and 90% points of the sync transitions. This can be done with voltage cursors or graticule, and may be aided by using variable gain to normalize the sync to 100 IRE.
- c. Check with time cursors or graticule - that rise and fall times between 10% and 90% are 140 ns \pm 20 ns.

14. Sync Timing

- a. Check that horizontal sync duration between 50% points is $4.7 \mu\text{s} \pm 0.1 \mu\text{s}$.
- b. Set the waveform monitor to display the serrations and equalizing pulses in the vertical interval.
- c. Check that the half-amplitude duration of the vertical serrations is $4.7 \mu\text{s} \pm 0.1 \mu\text{s}$.
- d. Check that the half-amplitude duration of the equalizing pulses is $2.3 \mu\text{s} \pm 0.1 \mu\text{s}$.

15. Horizontal Blanking Interval

- a. Select the 100% Field signal.
- b. Set the waveform monitor to display horizontal blanking.
- c. Check that the horizontal blanking interval is $10.9 \mu\text{s} \pm 0.2 \mu\text{s}$ between 20 IRE signal levels.

16. Multiburst Frequency Response

- a. Select the Multiburst signal.
- b. Check with the Waveform + CAL function of the measurement set, or with a VAC -- that the white flag and burst packets are equal in amplitude within $\pm 2\%/1.2 \text{ IRE}/8.6 \text{ mV}$ peak-to-peak.

17. Differential Phase and Gain

- a. Connect the test equipment as shown in Figure 3–1 or 3–4.
- b. Select the Modulated Ramp signal.
Option 02. Select the NTC7 Combination (in NTC7 Matrix) signal.
- c. Set the measurement set or vectorscope to measure differential phase using the double trace method, if available.
- d. Check for differential phase of no greater than 0.3° .

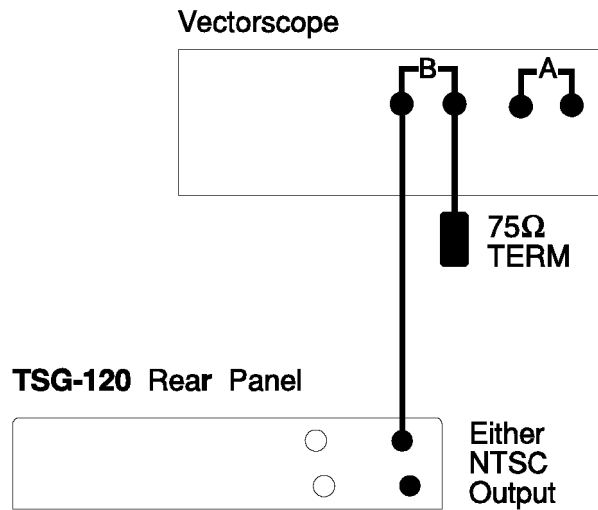

Figure 3–4: Differential Gain test setup

- e. Set the test equipment to measure differential gain. Use a double trace if possible.
- f. Check that the differential gain of the Modulated Ramp is $< 0.3\%$ from 0 IRE to 100 IRE.

Option 02. Check that the differential gain of the NTC7 Combination (in NTC7 Matrix) is $< 0.3\%$ from 0 IRE to 100 IRE.

18. SCH Phase

NOTE. *Accurate Subcarrier-to-Horizontal Phase measurements may be difficult without test equipment having modes intended for that purpose. The SCH phase error in the test signals is typically less than one degree.*

- a. Select any test signal from the instrument.
- b. Confirm that the measurement set is internally referenced and set it to display the SCH phase of the signal.
- c. Check that the SCH phase error is no greater than 5° .

Y and C Test Signal Output Test Procedures

19. Luminance Blanking Level

- a. Connect the equipment as shown in Figure 3–5 (and select channel B1 at the front panel of the measurement set) or Figure 3–6.
- b. Select the 5-Step signal.

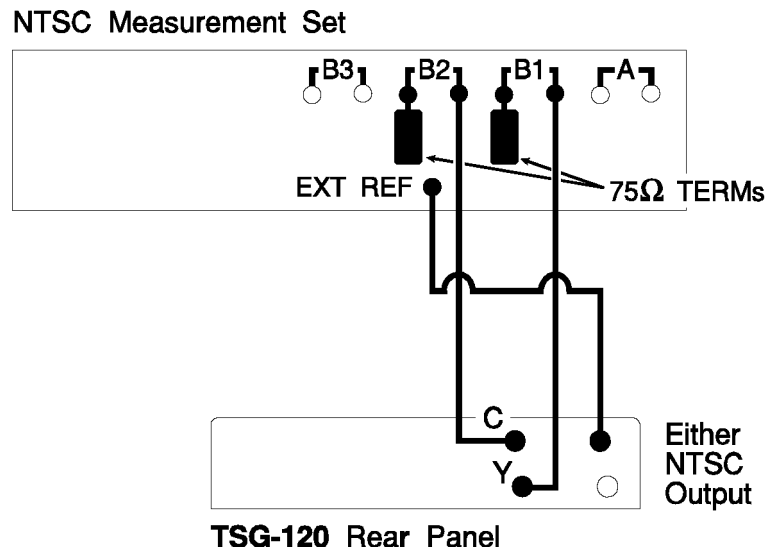

Figure 3–5: Blanking level or amplitude test setup (video measurement set)

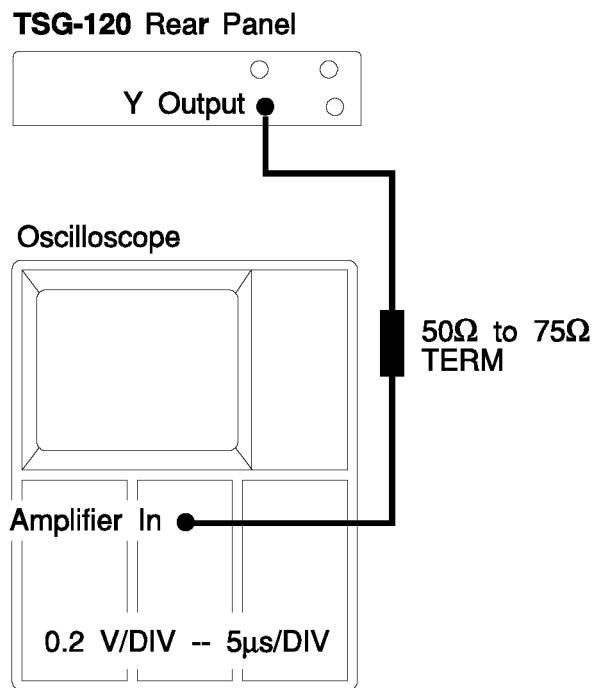

Figure 3–6: Blanking level or amplitude test setup (oscilloscope)

- c. Confirm that any DC-Restorer feature of the monitor or oscilloscope is OFF.

- d. Toggle the display between DC coupled and ground reference.
- e. Check that the blanking level is $0\text{ V} \pm 50\text{ mV}$.

20. Luminance Amplitude

- a. Connect the test equipment as shown in Figure 3–5 (channel B1 selected at the front panel of the measurement set) or Figure 3–7.

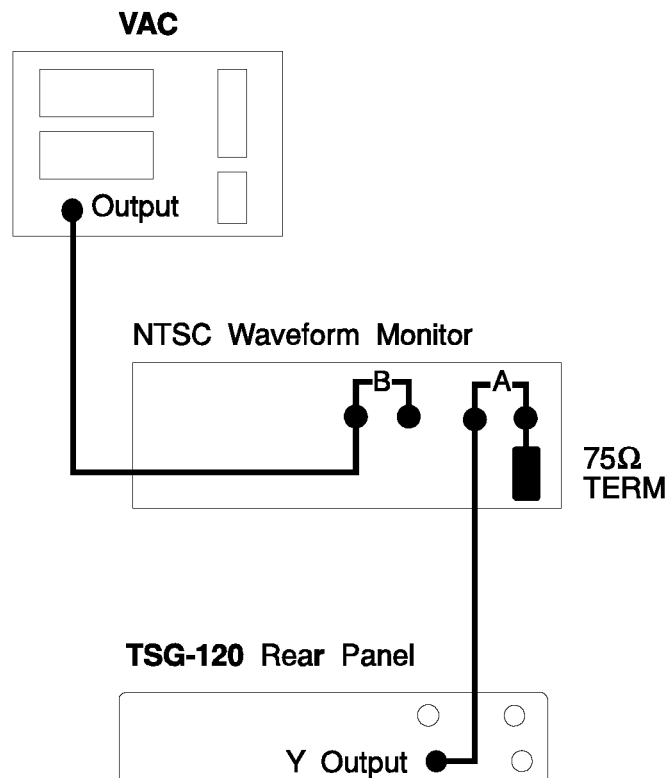

Figure 3–7: Luminance amplitude test setup

- b. Select the 5-Step signal.
- c. With the Waveform + CAL function of the measurement set, or with the VAC, match the top of the lower 5-Step waveform with the blanking level of the upper waveform.
- d. Check that the 5-Step amplitude is $100\text{ IRE} \pm 1.0\text{ IRE}/714.3\text{ mV} \pm 7.14\text{ mV}$.
- e. Note the luminance amplitude for use in step 32 of this procedure.

21. Sync Amplitude

- a. Match the blanking level of the lower waveform to the sync tip of the upper waveform.
- b. Check that the sync amplitude is $40 \text{ IRE} \pm 0.8 \text{ IRE}/285.7 \text{ mV} \pm 2.9 \text{ mV}$.

22. 5-Step Staircase Linearity

- a. With the 5-Step signal still selected, set the test equipment to view the Y output through a Differentiated Step filter.
- b. Check that the difference between the highest and lowest spikes (steps) is no greater than 1%.

(Or, use a VAC to measure the amplitude of each signal step. Check that the variation between the largest and smallest steps is no greater than $0.2 \text{ IRE}/0.14 \text{ mV}$.)

23. Line Time Distortion (Line Tilt)

- a. Select the Matrix signal.
- b. If necessary, normalize the signal gain so that blanking level of the waveform is on the baseline and the top of the $18 \mu\text{s}$ line bar (of the pulse and bar part of the signal) passes through 100 IRE at its midpoint.
- c. Center the bar horizontally over the L.D. graticule, if the monitor has one.
- d. Check that the line bar tilts no more than $0.5\%/0.5 \text{ IRE}/3.6 \text{ mV}$ over its length. Ignore the first microsecond and last microsecond of the bar.

24. Field Time Distortion (Field Tilt)

- a. Select the 100% Field signal.
- b. Set the test equipment to view one field of the signal.
- c. Check that the field bar tilts no more than $0.5\%/0.5 \text{ IRE}/3.6 \text{ mV}$ over its length. Ignore the first and last 0.2 milliseconds (about 3 lines) of the bar.

25. Ringing

- a. Select the Pulse and Bar signal.
Option 02. Select the NTC7 Combination (in NTC7 Matrix) signal.
- b. Set the equipment to display the bottom of the 2T pulse at line rate.
- c. Check with voltage cursors or graticule - that after-pulse ringing is no greater than $1\%/1.0 \text{ IRE}/7.14 \text{ mV}$ peak.

26. Pulse-to-Bar Ratio

- a. Set the waveform monitor to display the tip of the inverted pulse of the Pulse and Bar signal.

Option 02. Set the waveform monitor to display the tip of the inverted pulse of the NTC7 Combination (in NTC7 Matrix) signal.

- b. Check with voltage cursors or graticule - that the inverted pulse tip is within 1%/1.0 IRE/7.14 mV of blanking level.

(Or, use the VAC and match the tip of the inverted pulse of the lower waveform to the blanking level of the upper waveform. Check that the inverted pulse is within 7.14 mV of the bar amplitude.)

27. Multiburst Frequency Response

- a. Select the Multiburst signal.
- b. Check with the Waveform + CAL function of the measurement set, or with a VAC - that the white flag and burst packets are equal in amplitude within $\pm 2\%/1.2$ IRE/8.6 mV peak-to-peak.

28. Chrominance Blanking Level

- a. Connect the equipment as shown in Figure 3–5 (and select channel B2 at the front panel of the measurement set) or Figure 3–8.
- b. Select external reference or sync at the monitor or oscilloscope and confirm that any DC-Restorer feature is OFF.
- c. Select the Chroma Response signal.
Option 02. Select the NTC7 Combination (in NTC7 Matrix) signal.
- d. Switch the display between DC coupled and ground reference.
- e. Check that the blanking level is $0\text{ V} \pm 50\text{ mV}$.

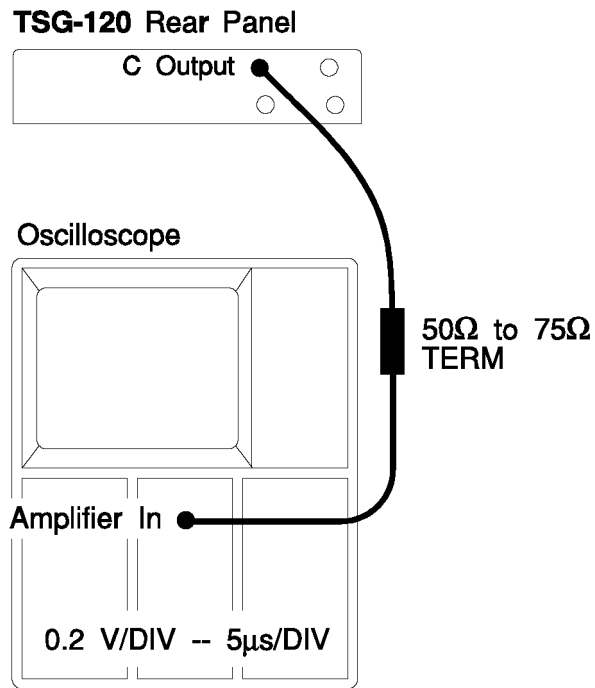

Figure 3–8: Chrominance blanking level test setup

29. Chrominance Response

- a. Connect the equipment as shown in Figure 3–5 (with channel B2 selected at the front panel of the measurement set) or Figure 3–9.
- b. Set the test equipment to external reference or sync.
- c. Select the Chroma Response signal.

Option 02. Select the NTC7 Combination (in NTC7 Matrix) signal.

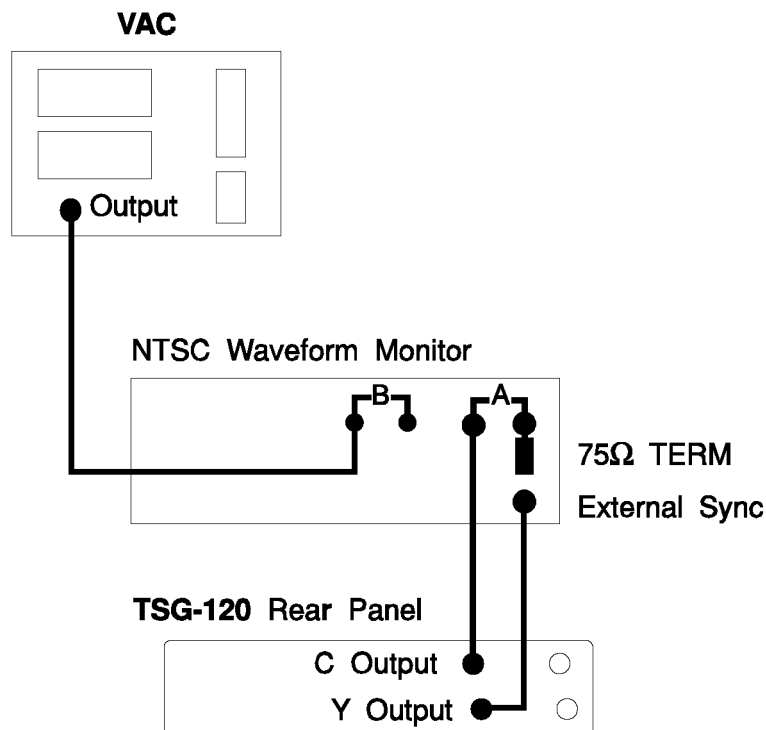

Figure 3-9: Chrominance response test setup

- d. Check with voltage cursors, graticule, or a VAC - that the amplitude of the Chrominance portion is constant, within 1%/0.6 IRE/4.3 mV_{p-p}, from end to end.

30. Burst Amplitude

- a. Use the Waveform + CAL feature or the VAC to match the top of the lower burst with the bottom of the upper.
- b. Check that burst amplitude is 40 IRE ± 0.8 IRE_{p-p}/287.5 mV ± 5.7 mV_{p-p}.

31. Chrominance Amplitude

- a. Select the Chroma Noise signal.
 - Option 02.** Select the NTC7 Combination (in NTC7 Matrix) signal.
- b. Adjust the test equipment to match the top of the lower waveform with the bottom of the upper.
- c. Check that the chrominance amplitude is 100 IRE ± 1.0 IRE_{p-p} /714.3 mV ± 7.14 mV_{p-p}.

32. Chrominance-to-Luminance Gain

Check that the chrominance amplitude and the previously noted luminance amplitude (step 20) are equal within 1.0 IRE/7.14 mV.

33. Chrominance-Luminance Delay

- a. Connect the equipment as shown in Figure 3–10.

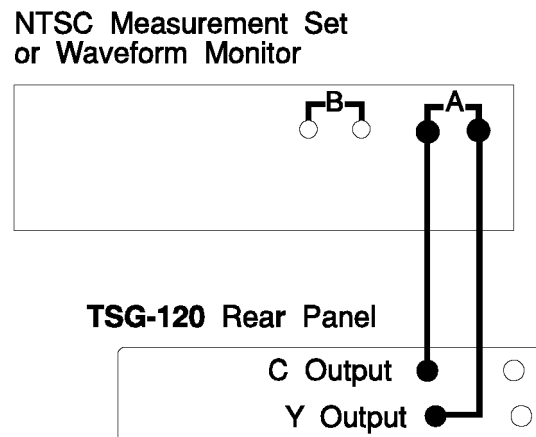

Figure 3–10: Chrominance-luminance delay test setup

- b. Select the Pulse and Bar signal.
- c. Set the equipment to view the bottom of the 12.5T modulated pulse.
- d. Check with graticule or voltage cursors - that the envelope at the base of the modulated pulse is no more than 1.2 IRE_{p-p}/8.6 mV_{p-p}, equivalent to 12 ns delay.

(Or, use the Chroma/Luma measurement mode of the Tek 1780 to get an estimate of both C/Y delay and gain. Check that delay is no greater than 12 ns.)

**Audio Output and
Subcarrier Frequency Test
Procedures**

34. Total Harmonic Distortion

- a. Disable the channel one ID click by moving jumper J12 to pins 2 and 3.
- b. Connect the equipment as in Figure 3–11, placing a 600 Ohm resistor (to represent the load of your system) across the analyzer's + and - terminals.

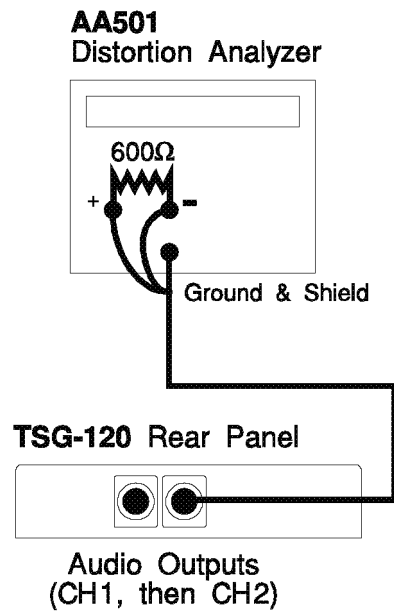

Figure 3-11: Total harmonic distortion test setup

- c. Set the distortion analyzer to measure THD.
- d. Check that THD on channel one is no more than 0.5%.
- e. Return jumper J12 to pins 1 and 2.
- f. Move the cable from audio channel 1 to audio channel 2.
- g. Check that THD on channel two is no more than 0.5%.

35. Free-Running Frequency

NOTE. After initial delivery or long storage, allow a two-hour warm-up to re-age the crystal. Thereafter, 30 minutes warm-up is sufficient.

- a. Remove the cover from the generator and connect the equipment as shown in Figure 3–12.

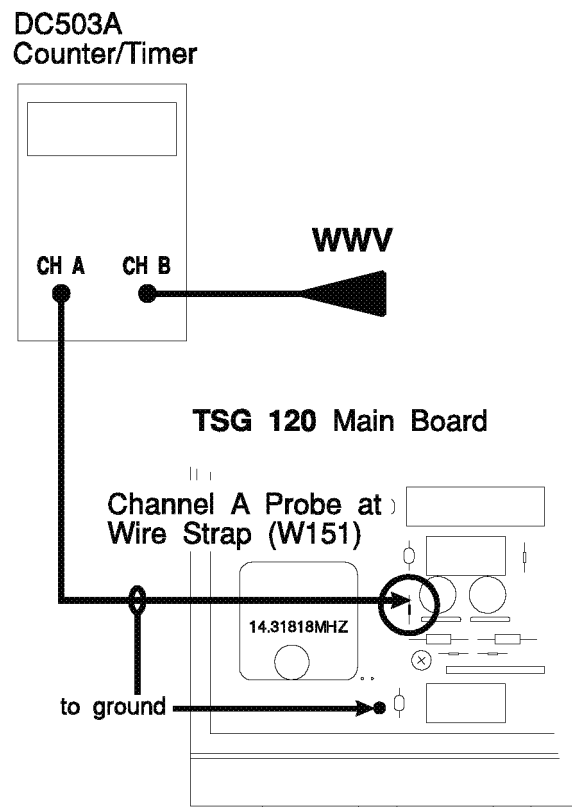

Figure 3–12: Free-running frequency test setup

- b. Set the frequency counter to count at a 4x-subcarrier rate.
- c. Check that the measured oscillator frequency is within 15 Hz of 14.31818 MHz at normal operating temperature.



Adjustment Procedure

Adjustment Procedure

This section consists of checklists and detailed procedures to use in adjusting performance parameters for the TSG 120 YC/NTSC Signal Generator.

This procedure is intended to be done in sequence. If only selected parameters are to be checked or adjusted, always begin at a step with a setup illustration.

The following is a list of equipment required for performance verification and calibration. If alternate equipment is used, make sure that it meets the minimum requirements given. Use of inadequate equipment may result in inaccurate measurements or calibration.

1. NTSC Video Measurement Set. For measuring and displaying field-rate and line-rate waveforms, differential phase and gain, and SCH phase. Example: Tektronix 1780R NTSC Video Measurement Set.
2. Instead of the Video Measurement Set, you may substitute the following test equipment:
 - a. NTSC Waveform Monitor. For displaying and measuring field-rate and line-rate waveforms. Example: Tektronix 1480 Waveform Monitor, Mod W5F.
 - b. NTSC Vectorscope. With specific modes for measuring differential phase and gain. Example: Tektronix 520A.
 - c. Video Amplitude Calibration Fixture (VAC). Provides a chopped voltage reference accurate to $\pm 0.05\%$ from 0 to 1 V in 0.1 mV increments. This fixture is used with the waveform monitor. Example: Tektronix part number 067-0916-00 (plugs into Tektronix TM 503 Power Mainframe).
 - d. Test Oscilloscope. With the following vertical amplifiers:
 1. 50 MHz bandwidth, 1 mV sensitivity, 5 MHz switchable bandwidth, DC offset.
 2. Dual trace with minimum deflection factor of 50 mV/div with 10x probe.
 3. Time Base: 5 ns/div to 5 μ s/div sweep speeds, triggering to 5 MHz, and capable of accepting both direct and delayed external triggers. Example: Tektronix 7603 Oscilloscope with a 7A13 Differential Comparator, 7A26 Dual Trace Amplifier, and 7B53A Dual Time Base. Use with P6106 10x probes (part number 010-610-03).

4. Frequency Counter. Must be accurate to within 2.5 Hz out of 5 MHz. Example: Tektronix DC 501, Option 01: plugs into a TM 503 Power Mainframe.
5. Distortion Analyzer. Must test power output over range of 0 – 8 dBm and be capable of detecting THD of 0.01% or less. Example: Tektronix AA501.
6. Audio Amplifier. 600 Ω impedance.
7. BNC Coax Cables. 75 Ω impedance. Example: Tektronix part number 012-0074-00.
8. End-Line Termination. 75 Ω termination equipped with a BNC connector. Example: Tektronix part number 011-0102-00.
9. Feed-Through Termination. 75 Ω termination equipped with BNC connectors. Example: Tektronix part number 011-0103-00.
10. Audio Connector-to-Triple Banana Cable. Must be configured to match the generator's audio output. Pin 1, shield; pin 2, +; pin 3, -. Example: ITT Pamona Electronics, Model 4953-J-36.

Adjustment Check List

Table 4-1: List of adjustment procedures

Steps	Procedure	Adjustment
1	Audio Tone Levels	R122 and R123
2	Audio ID Frequency	R126
3	Oscillator Frequency	Oscillator adjustment
Steps 4 – 11 are interactive. Repeat them in sequence until the best possible results are obtained.		
4	NTSC Sync Amplitude	R18
5	NTSC Luminance Gain	R18
6	NTSC Chrominance Gain	R23
7	Y Signal Gain	R79
8	C Signal Gain	R60
9	NTSC Signal Blanking Level	R20
10	Y signal Blanking Level	R82
11	C signal Blanking Level	R63
Steps 12 – 17 are interactive. Repeat them in sequence until the best possible results are obtained.		

Table 4–1: List of adjustment procedures (Cont.)

Steps	Procedure	Adjustment
12	NTSC Multiburst (luminance) Frequency Response	L14, L15, L16, L17 and L18
13	NTSC (Sin X)/X Compensation	C19 and C21
14	Y Signal (Sin X)/X Compensation	C69
15	NTSC Chrominance Frequency Response	L8, L9, L10, L11 and L12
16	C Signal (Sin X)/X Compensation	C47
17	NTSC Chrominance-to-Luminance Delay	L8 & L9 and L14 & L15

Adjustment Procedures

1. Audio Tone Level

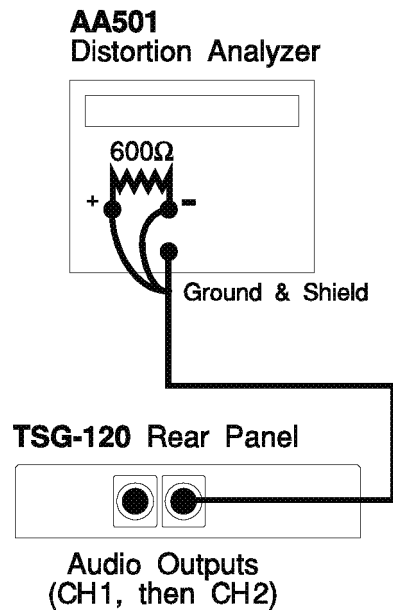

Figure 4-1: Audio tone level test setup

- a. Connect the equipment as shown in Figure 4-1 with the following settings:

AA501 (Distortion Analyzer):

Function	Setting
Input Level Range	Auto range
dBm Switch	In
Level Switch	In
All Filter Switches	Out

- b. Disable the channel 1 ID click by moving jumper J12 to pins 2 and 3.
- c. Adjust R123 to obtain the desired dB output for Audio 1. (Factory setting is + 8 dBm.)
- d. Return jumper J12 to the 1-2 position.
- e. Move the audio cable from Audio channel 1 to Audio channel 2.

- f. Adjust R122 to obtain the desired output level for Audio 2. (Factory setting is + 8 dBm.)
2. ID Click Frequency
 - a. Connect the equipment as shown in Figure 4–2.

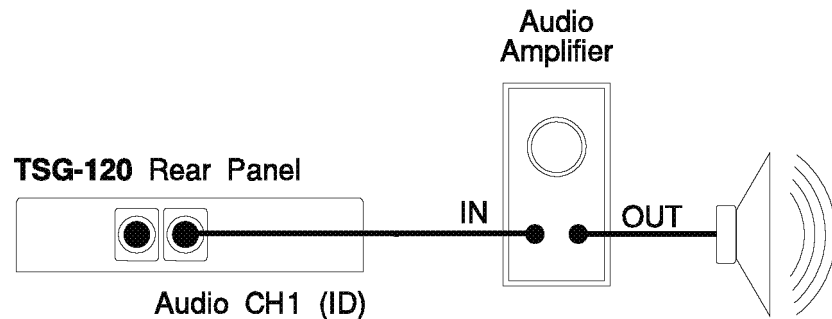

Figure 4–2: ID click frequency test setup

- b. Adjust R126 for the desired interval between ID clicks. The range of adjustment is from approximately 0.2 seconds to over 4 seconds.
3. Oscillator Frequency
 - a. Connect the equipment as shown in Figure 4–3.
 - b. Set the DC503A to count a frequency of 14.31818 MHz.
 - c. Remove the round plastic cap from the top of the oscillator.
 - d. Fine-adjust the oscillator frequency to bring $4 F_{sc}$ to $14.31818 \text{ MHz} \pm 15 \text{ Hz}$.
 - e. Reinstall the plastic cap.

NOTE. Steps 4 – 11 are interactive. Repeat them, in sequence, until the best possible results are obtained.

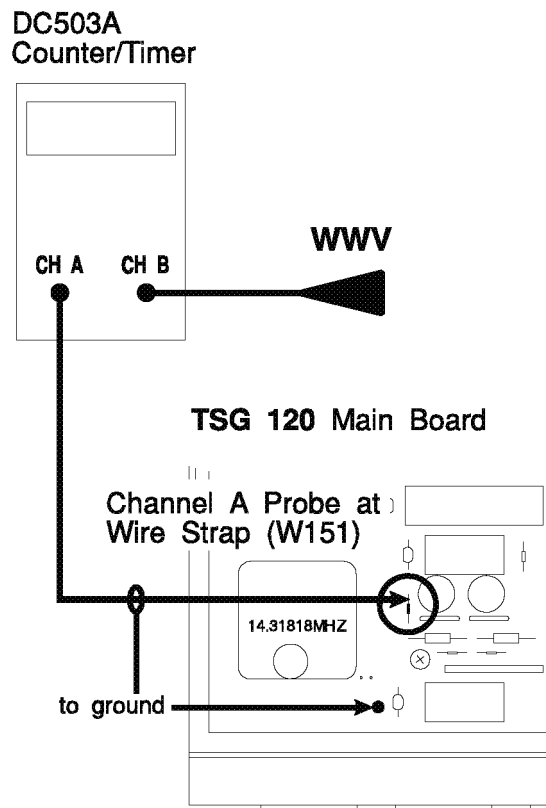

Figure 4-3: Oscillator frequency test setup

4. NTSC Sync Amplitude
 - a. Connect the equipment as shown in Figure 4-4 or 4-5.
 - b. Select the 5 Step signal.
 - c. Select the Slow DC Restorer feature of the test equipment.
 - d. Use the Waveform + CAL feature of the measurement set (or use a VAC) to add a second waveform 40 IRE/285.7 mV above (or below) the original.
 - e. Adjust R18 to match the sync tip of the upper waveform to the blanking level of the lower within ± 0.8 IRE/5.7 mV.

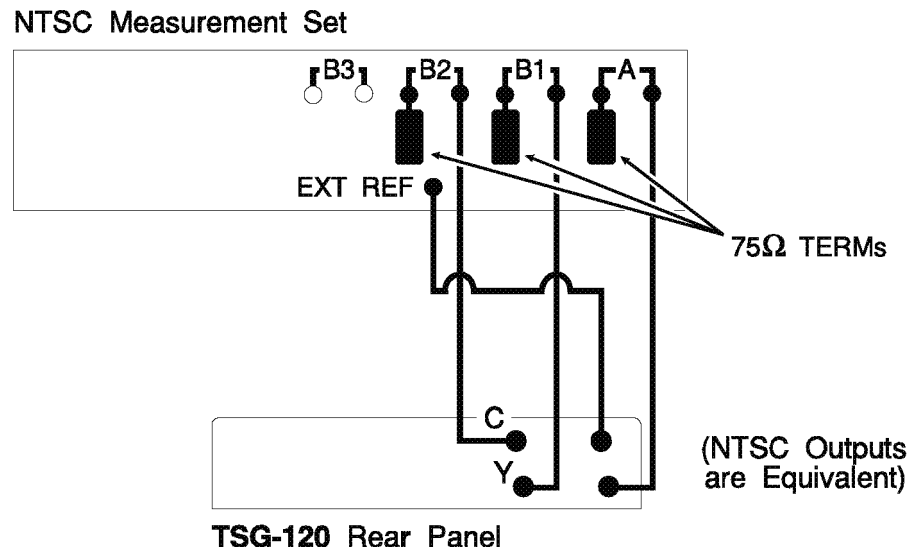

Figure 4-4: NTSC sync amplitude test setup (video measurement set)

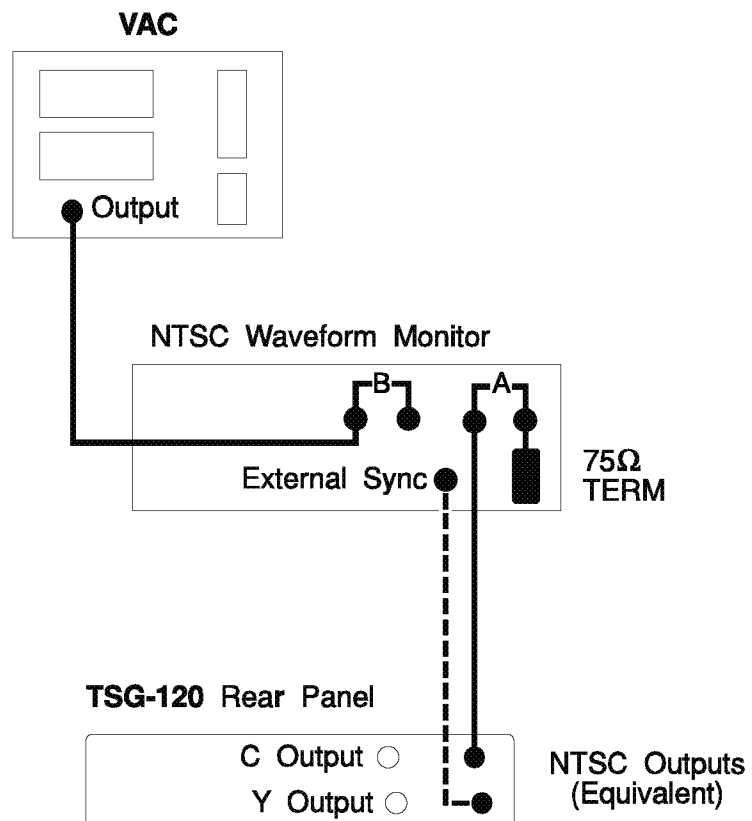

Figure 4-5: NTSC sync amplitude test setup (vac and waveform monitor)

5. NTSC Luminance Gain

- a. Use the Waveform + CAL feature of the measurement set (or use a VAC) to move the second waveform to 100 IRE/714.3 mV above (or below) the original.
- b. Adjust R18 to match the top of the lower waveform to the blanking level of the upper within ± 1.0 IRE/7.14 mV.

6. NTSC Chrominance Gain

- a. Select the Chroma Noise signal.
Option 02. Select the NTC7 Combination (in NTC7 Matrix) signal.
- b. Adjust R23 to match the top of the lower waveform to the blanking level of the upper within ± 1.0 IRE/7.14 mV.

7. Y Signal Gain

- a. Change equipment settings or connections as necessary to view the Y-only output.
- b. Select the 5-Step signal.
- c. Adjust R79 to match the top of the lower waveform to the blanking level of the upper within ± 1.0 IRE/7.14 mV.

8. C Signal Gain

- a. Change equipment settings or connections as necessary to view the C-only output. Use one of the NTSC outputs as an external reference or sync.
- b. Select the Chroma Noise signal.
Option 02. Select the NTC7 Combination (in NTC7 Matrix) signal.
- c. Adjust R60 to match the top of the lower waveform to the bottom of the upper within ± 1.0 IRE/7.14 mV.

9. NTSC Signal Blanking Level

- a. Connect the equipment as shown in Figure 4-4 (channel A selected) or 4-6.

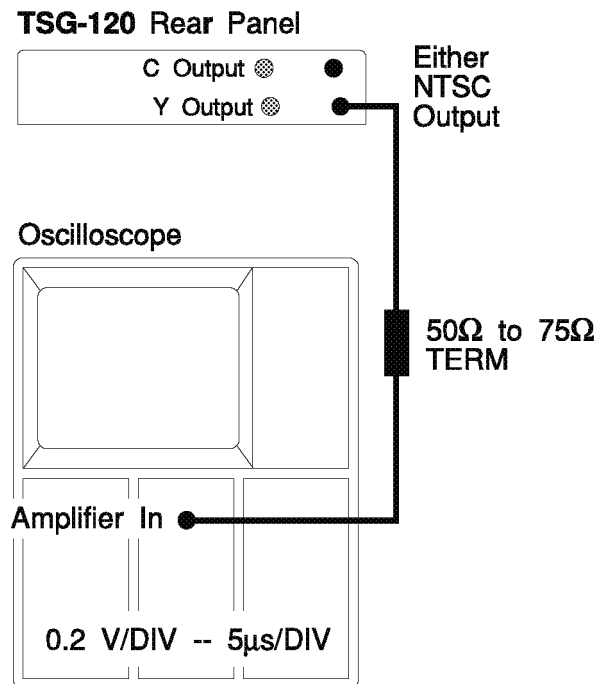

Figure 4-6: NTSC signal blanking level test setup

- b. Select the 5-Step signal.
- c. Switch the DC Restorer feature of the test equipment OFF.
- d. Set the test equipment to view the signal at line rate, then select ground reference. Center the trace on the display graticule.
- e. Switch back to DC coupled and adjust R20 for a blanking level of $0\text{ V} \pm 50\text{ mV}$.

10. Y Signal Blanking Level

- a. Change equipment settings or connections as necessary to view the Y-only output.
- b. Set the test equipment to ground reference and center the trace on the display graticule, if necessary.
- c. Switch back to DC coupled. Adjust R82 for a blanking level of $0\text{ V} \pm 50\text{ mV}$.

11. C Signal Blanking Level

- a. Change equipment settings or connections as necessary to view the C-only output.
- b. Set the test equipment to ground reference and center the trace on the display graticule, if necessary.
- c. Switch back to DC coupled and adjust R63 for a blanking level of $0\text{ V} \pm 50\text{ mV}$.
- d. Repeat steps 4 through 11 as necessary to produce the best results.

NOTE. Steps 12 through 17 are interactive. Repeat them, in sequence, until the best possible results are obtained.

12. Multiburst (Luminance) Frequency Response

- a. Connect the equipment as shown in Figure 4–4 (channel A selected) or 4–5.
- b. Select the Multiburst signal.
- c. Use the Waveform + CAL feature of the measurement set (or use a VAC) to add a second waveform approximately 60.5 IRE /432 mV above (or below) the original. Set the test equipment to view the bottoms of the upper burst packets and the tops of the lower at greatest magnification. Adjust the CAL or VAC for best comparison of the waveforms; use the double trace to aid adjustment.
- d. Adjust L14, L15, L16, L17, and L18 so that the displayed Multiburst is as flat as possible. (The packets should be equal within 2%/1.2 IRE/8.6 mV.)

13. NTSC Chrominance to Luminance Gain (Sin X)/X Compensation

- a. Adjust C19 as needed, using the Multiburst signal from step 12, to make the 3.58 MHz packet amplitude match the 500 kHz packet.

- b. Select a Chroma Response signal.

Option 02. Select the NTC7 Matrix signal, and select Line Select to view line 150.

- c. Adjust C21 for as flat a frequency response as possible.
- d. Note that these steps may be interactive with step 12 and may also necessitate readjustment of R23 to return packet amplitude to 60 IRE ± 1.2 IRE or 428.6 mV ± 8.6 mV.

14. Y Signal (Sin X)/X Compensation

- a. With Multiburst still selected, change settings or connections as necessary to view the Y-only output.
- b. Adjust C69 to make the 3.58 MHz and 500 kHz packet amplitudes match.

15. Chrominance Frequency Response

- a. Select the Chroma Response signal, and change settings or connections to view the NTSC output.
Option 02. Select the NTC7 Combination (in NTC7 Matrix) signal, and change settings or connections to view the NTSC output.
- b. As above, view the top of the bottom chrominance (line) signal with the bottom of the top line signal. Variations in signal amplitude, and the effects of adjustments, will be easier to see.
- c. Adjust L8, L9, L10, L11, and L12 so that the chrominance signal varies no more than 1% in amplitude over its length and is as flat as possible.

16. C Signal (Sin X)/X Compensation

- a. With Chroma Response still selected, change settings or connections as necessary to view the C-only output. Use one of the NTSC outputs as an external reference or sync.
Option 02. With NTC7 Combination (in NTC7 Matrix) still selected, change settings or connections as necessary to view the C-only output. Use one of the NTSC outputs as an external reference or sync.
- b. Adjust C47 to make the chrominance line signal as flat as possible. This may necessitate readjustment of R60 to return the signal to 60 IRE ± 0.6 IRE/428.6 mV ± 4.3 mV.

17. Chrominance-to-Luminance Delay

- a. Disable the CAL feature or VAC.
- b. Select the Modulated Pulse and Bar signal.
Option 02. Select the NTC7 Combination (in NTC7 Matrix) signal.
- c. Looking at the bottom of the modulated pulse waveform, adjust L8 & L9 and L14 & L15 for a chrominance response that is as flat as possible.

NOTE. *There is a trade-off between 2T pulse ringing and chrominance-luminance delay. Check both the 2T and 12.5T pulses as you make this adjustment. Ringing must remain no more than 1.0 IRE/7.14 mV peak.*

- d. Check with voltage cursors or graticule - that the envelope at the bottom of the 12.5T pulse is no more than 1.2 IRE_{p-p} (8.6 mV_{p-p}).
- e. Repeat steps 12 through 17 for the best possible results.



Maintenance

Maintenance

Configuring the Power Supply

This section describes configuring the power supply for 230 VAC operation.



WARNING. *Dangerous voltages are present in the power supply. To ensure safety, only qualified service personnel may perform the following procedure.*

Selecting the Power Supply Mains Voltage

The TSG 120 YC/NTSC Signal Generator is shipped from the factory configured for 115 VAC, 60 Hz operation. To configure the power supply for 230 VAC operation, follow this procedure.



WARNING. *Dangerous voltages are present in the power supply. Remove the power cord from the electrical mains supply before attempting this procedure. Failure to remove the power cord can result in life-threatening electrical shock.*

1. Remove the power cord from the electrical mains supply.
2. Remove the instrument access cover.
3. Locate J11 near the AC line filter and power receptacle at the right rear of the main board.
4. For 115 VAC operation (the factory setting), J11 positions 1–2 and 3–4 are strapped. Remove the straps from these positions.
5. For 230 VAC operation, reinstall the J11 straps in positions 2–3 and 4–5.
6. Reinstall the instrument access cover.
7. For 230 VAC operation, remove the 0.5 Amp fuse F1 and replace it with a 0.25 Amp fuse.

TSG 120 Block Diagram

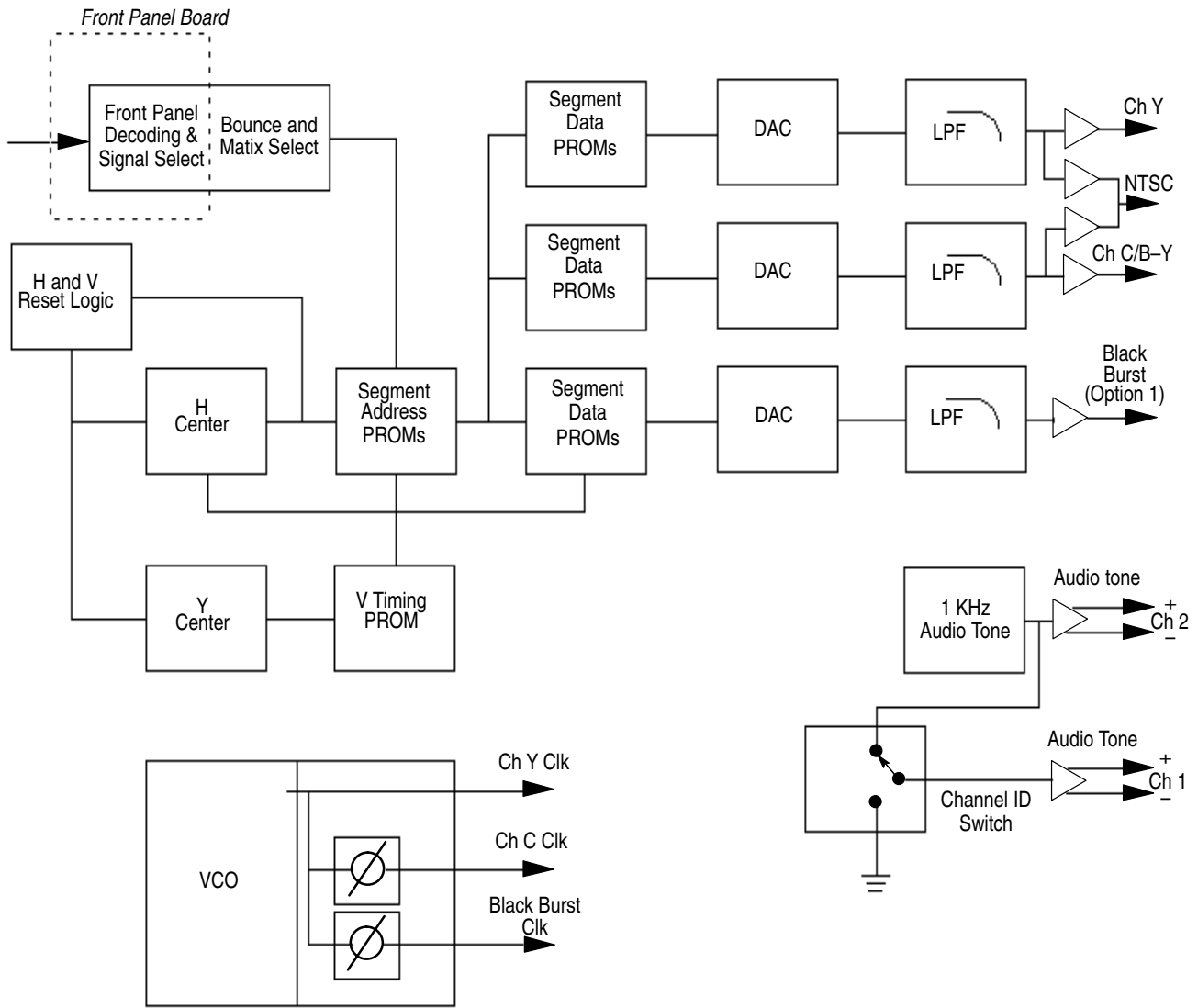

Figure 5-1: TSG 120 Block Diagram



Replaceable Electrical Parts

Replaceable Electrical Parts

This section contains a list of the electrical components for the TSG 120 YC/NTSC Signal Generator. Use this list to identify and order replacement parts.

Parts Ordering Information

Replacement parts are available through your local Tektronix field office or representative.

Changes to Tektronix products are sometimes made to accommodate improved components as they become available and to give you the benefit of the latest improvements. Therefore, when ordering parts, it is important to include the following information in your order:

- Part number
- Instrument type or model number
- Instrument serial number
- Instrument modification number, if applicable

If you order a part that has been replaced with a different or improved part, your local Tektronix field office or representative will contact you concerning any change in part number.

Change information, if any, is located at the rear of this manual.

Using the Replaceable Electrical Parts List

The tabular information in the Replaceable Electrical Parts List is arranged for quick retrieval. Understanding the structure and features of the list will help you find all of the information you need for ordering replacement parts. The following table describes each column of the electrical parts list.

Manufacturers cross index

Mfr. code	Manufacturer	Address	City, state, zip code
00779	AMP INC.	CUSTOMER SERVICE DEPT PO BOX 3608	HARRISBURG, PA 17105-3608
01295	TEXAS INSTRUMENTS INC	SEMICONDUCTOR GROUP 13500 N CENTRAL EXPRESSWAY PO BOX 655303	DALLAS, TX 75272-5303
02111	SPECTROL ELECTRONICS CORP	4051 GREYSTONE DRIVE	ONTARIO, CA 91761
04222	AVX/KYOCERA	PO BOX 867	MYRTLE BEACH, SC 29577
04713	MOTOROLA INC	SEMICONDUCTOR PRODUCTS SECTOR 5005 E MCDOWELL ROAD	PHOENIX, AZ 85008-4229
07263	FAIRCHILD SEMICONDUCTOR CORPORATION	333 WESTERN AVE S.	SOUTH PORTLAND, ME 04106-1705
07716	IRC, INC	2850 MT PLEASANT AVE	BURLINGTON, IA 52601
07933	RAYTHEON COMPANY	SEMICONDUCTOR DIVISION 10 GOODYEAR M/S 10A	IRVINE, CA 92718
08779	SIGNAL TRANSFORMER CO INC	500 BAYVIEW AVE	INWOOD, NY 11096-1792
09023	CORNELL-DUBILIER CORPORATION	C/O EARL & BROWN CO INC 7185 SW SANDBURG RD	TIGARD, OR 97223
0AP78	A C INTERFACE	15560 ROCKFIELD UNIT 1E	IRVINE, CA 92718
0GV52	SCHAFFNER EMC INC	9-B FADEM ROAD	SPRINGFIELD, NJ 07081
0H1N4	PREH	470 EAST MAIN STREET	LAKE ZURICH, IL 60047
0JR03	ZMAN MAGNETICS INC	7633 S 180TH	KENT, WA 98032
0UAU4	E-SWITCH	DIV OF STEIN INDUSTRIES 26 NORTH 5TH STREET	MINNEAPOLIS, MN 55403
11236	CTS CORPORATION	406 PARR ROAD	BERNE, IN 46711-9506
12969	MICROSEMI CORP	WATERTOWN DIVISION 530 PLEASANT STREET	WATERTOWN, MA 02172
13919	BURR-BROWN CORPORATION	CORP OFFICE 6730 S TUCSON BLVD PO BOX 11400	TUCSON, AZ 85706
16546	PHILIPS COMPONENTS	CHIP CAP/CHIP RES FACILITY 4561 COLORADO BLVD	LOS ANGELES, CA 90039-1103
18796	MURATA ELECTRONICS N AMERICA	1900 WEST COLLEGE AVE.	STATE COLLEGE, PA 16801-2723
22526	BERG ELECTRONICS INC	825 OLD TRAIL ROAD	ETTERS, PA 17319
24355	ANALOG DEVICES	1 TECHNOLOGY DRIVE	NORWOOD, MA 02062
26364	COMPONENTS CORPORATION	6 KINSEY PLACE	DENVILLE, NJ 07834
27014	NATIONAL SEMICONDUCTOR CORP	2900 SEMICONDUCTOR DR PO BOX 58090 MS 30-115	SANTA CLARA, CA 95051-0606
32997	BOURNS INC	TRIMPOT DIVISION 1200 COLUMBIA AVE	RIVERSIDE, CA 92507-2114
33095	SPECTRUM CONTROL INC	8061 AVONIA RD	FAIRVIEW, PA 16415
34335	ADVANCED MICRO DEVICES INC	ONE AMD PLACE PO BOX 3453	SUNNYVALE, CA 94088-3453

Manufacturers cross index (Cont.)

Mfr. code	Manufacturer	Address	City, state, zip code
34899	FAIR RITE PRODUCTS CORP.	1 COMMERCIAL ROW PO BOX J	WALLKILL, NY 12589
50139	ALLEN-BRADLEY COMPANY INC	ELECTRONIC COMPONENTS DIVISION 1414 ALLEN BRADLEY DRIVE	EL PASO, TX 79936
54937	DEYOUNG MFG INC	12920 NE 125TH WAY	KIRKLAND, WA 98034
55680	NICHICON (AMERICA) CORP	927 E STATE PARKWAY	SCHAUMBURG, IL 60195-4526
56845	DALE ELECTRONIC COMPONENTS	2300 RIVERSIDE BLVD PO BOX 74	NORFOLK, NE 68701
57027	IRC INC.	4222 SOUTH STAPLES ST	CORPUS CHRISTI, TX 78411
57668	ROHM CORPORATION	15375 BARRANCA PARKWAY SUITE B207	IRVINE, CA 92718
61058	MATSUSHITA ELECTRIC CORP OF AMERICA	PANASONIC INDUSTRIAL CO DIV TWO PANASONIC WAY	SECAUCUS, NJ 07094
61857	SAN-O INDUSTRIAL CORP	91-3 COLIN DRIVE	HOLBROOK, NY 11741
61964	OMRON ELECTRONICS	CUSTOMEER SERVICE DEPT. 1 EAST COMMERCE DRIVE	SCHAUMBURG, IL 60173
62643	UNITED CHEMI-CON INC	9801 W HIGGINS RD	ROSEMONT, IL 60018-4771
65786	CYPRESS SEMICONDUCTOR CORP	3901 N FIRST ST	SAN JOSE, CA 95134-1506
67183	ALTERA CORP	2610 ORCHARD PKWY	SAN JOSE, CA 95134-2020
80009	TEKTRONIX INC	14150 SW KARL BRAUN DR PO BOX 500	BEAVERTON, OR 97077-0001
82389	SWITCHCRAFT	DIV OF RAYTHEON 5555 N. ELSTON AVENUE	CHICAGO, IL 60630-1314
82567	REEVES-HOFFMAN	DIV OF DYNAMICS CORP. AMERICA 400 W. NORTH STREET	CARLISLE, PA 17013
91637	DALE ELECTRONIC COMPONENTS	1122 23RD ST	COLUMBUS, NE 68601
TK0198	AVNET INC	AVNET ELECTRONICS MARKETING 9750 SW NIMBUS AVE	BEAVERTON, OR 97005
TK2058	TDK CORPORATION OF AMERICA	1600 FEEHANVILLE DRIVE	MOUNT PROSPECT, IL 60056
TK6138	VANTIS CORPORATION	920 DEGUIGNE DRIVE PO BOX 3755	SUNNYVALE, CA 94088

Replaceable electrical parts list

Component number	Tektronix part number	Serial no. effective	Serial no. discont'd	Name & description	Mfr. code	Mfr. part number
A1	671-1863-05			CIRCUIT BD ASSY:FRONT PANEL	80009	671-1863-05
A2	671-1862-04			CIRCUIT BD ASSY:MAIN (STANDARD)	80009	671-1862-04
A2	671-2089-04			CIRCUIT BD ASSY:MAIN (OPTION 01)	80009	671-2089-04
A2	671-2950-00			CIRCUIT BD ASSY:MAIN (OPTION 02)	80009	671-2050-00
A2	671-3464-00			CIRCUIT BD ASSY:MAIN (OPTION 01 & 02)	80009	671-2050-00
A3	671-1865-00			CIRCUIT BD ASSY:TOP BNC	80009	671-1865-00
A4	671-1866-01			CIRCUIT BD ASSY:BOTTOM BNC	80009	671-1866-01
A1	671-1863-05			CIRCUIT BD ASSY:FRONT PANEL	80009	671-1863-05
A1C201	281-0775-01			CAP,FXD,CERAMIC:MCL,0.1UF,20%,50V	04222	SA105E104MAA
A1C202	281-0775-01			CAP,FXD,CERAMIC:MCL,0.1UF,20%,50V	04222	SA105E104MAA
A1C250	281-0775-01			CAP,FXD,CERAMIC:MCL,0.1UF,20%,50V	04222	SA105E104MAA
A1C251	281-0775-01			CAP,FXD,CERAMIC:MCL,0.1UF,20%,50V	04222	SA105E104MAA
A1C252	281-0775-01			CAP,FXD,CERAMIC:MCL,0.1UF,20%,50V	04222	SA105E104MAA
A1C253	281-0775-01			CAP,FXD,CERAMIC:MCL,0.1UF,20%,50V	04222	SA105E104MAA
A1J201	150-1029-00			DIODE,OPTO:LED,GRN,565NM,1MCD AT 20MA	0AP78	SPG3431
A1R201	322-3114-00			RES,FXD,FILM:150 OHM,1%,0.2W,TC=100 PPM,T&R,SMALL BODY	57668	CRB20-FX-150E-AXIAL
A1R204	322-3143-00			RES,FXD,FILM:301 OHM,1%,0.2W,TC=T0	57668	CRB20 FXE 301E
A1R207	322-3143-00			RES,FXD,FILM:301 OHM,1%,0.2W,TC=T0	57668	CRB20 FXE 301E
A1R208	322-3143-00			RES,FXD,FILM:301 OHM,1%,0.2W,TC=T0	57668	CRB20 FXE 301E
A1S202	260-2675-00			SWITCH,PUSH:SPST,MOM,NO,150 GRM FRC,SEA LED,50MA,24VDC,100M OHM, W/GRN LED 20 MA MAX,TL124	0UUAU4	TL1240G-W/RED-DOTS
				ATTACHED PARTS		
	366-0682-01			PUSH BUTTON:LIGHTED CAP,INSERT ASSY	80009	366-0682-01
				END ATTACHED PARTS		
A1S203	260-2675-00			SWITCH,PUSH:SPST,MOM,NO,150 GRM FRC,SEA LED,50MA,24VDC,100M OHM, W/GRN LED 20 MA MAX,TL124	0UUAU4	TL1240G-W/RED-DOTS
				ATTACHED PARTS		
	366-0682-01			PUSH BUTTON:LIGHTED CAP,INSERT ASSY	80009	366-0682-01
				END ATTACHED PARTS		
A1S204	260-2675-00			SWITCH,PUSH:SPST,MOM,NO,150 GRM FRC,SEA LED,50MA,24VDC,100M OHM, W/GRN LED 20 MA MAX,TL124	0UUAU4	TL1240G-W/RED-DOTS
				ATTACHED PARTS		
	366-0682-01			PUSH BUTTON:LIGHTED CAP,INSERT ASSY	80009	366-0682-01
				END ATTACHED PARTS		

Replaceable electrical parts list (Cont.)

Component number	Tektronix part number	Serial no. effective	Serial no. discont'd	Name & description	Mfr. code	Mfr. part number
A1S205	260-2675-00			SWITCH,PUSH:SPST,MOM,NO,150 GRM FRC,SEA LED,50MA,24VDC,100M OHM, W/GRN LED 20 MA MAX,TL124	0UUA4	TL1240G-W/RED-DOTS
				ATTACHED PARTS		
	366-0682-01			PUSH BUTTON:LIGHTED CAP,INSERT ASSY	80009	366-0682-01
				END ATTACHED PARTS		
A1S206	260-2675-00			SWITCH,PUSH:SPST,MOM,NO,150 GRM FRC,SEA LED,50MA,24VDC,100M OHM, W/GRN LED 20 MA MAX,TL124	0UUA4	TL1240G-W/RED-DOTS
				ATTACHED PARTS		
	366-0682-01			PUSH BUTTON:LIGHTED CAP,INSERT ASSY	80009	366-0682-01
				END ATTACHED PARTS		
A1S207	260-2675-00			SWITCH,PUSH:SPST,MOM,NO,150 GRM FRC,SEA LED,50MA,24VDC,100M OHM, W/GRN LED 20 MA MAX,TL124	0UUA4	TL1240G-W/RED-DOTS
				ATTACHED PARTS		
	366-0682-01			PUSH BUTTON:LIGHTED CAP,INSERT ASSY	80009	366-0682-01
				END ATTACHED PARTS		
A1S208	260-2675-00			SWITCH,PUSH:SPST,MOM,NO,150 GRM FRC,SEA LED,50MA,24VDC,100M OHM, W/GRN LED 20 MA MAX,TL124	0UUA4	TL1240G-W/RED-DOTS
				ATTACHED PARTS		
	366-0682-01			PUSH BUTTON:LIGHTED CAP,INSERT ASSY	80009	366-0682-01
				END ATTACHED PARTS		
A1S209	260-2675-00			SWITCH,PUSH:SPST,MOM,NO,150 GRM FRC,SEA LED,50MA,24VDC,100M OHM, W/GRN LED 20 MA MAX,TL124	0UUA4	TL1240G-W/RED-DOTS
				ATTACHED PARTS		
	366-0682-01			PUSH BUTTON:LIGHTED CAP,INSERT ASSY	80009	366-0682-01
				END ATTACHED PARTS		
A1S214	361-1593-00			SPACER,SLEEVE:PLASTIC 0.475 L	80009	361-1593-00
A1S220	150-1029-00			DIODE,OPTO:LED,GRN,565NM,1MCD AT 20MA	0AP78	SPG3431
				MOUNTING PARTS		
	136-0252-07			SOCKET,PIN CONN:SINGLE,PCB,T/G,0.030	80009	136-0252-07
	361-1593-00			SPACER,SLEEVE:PLASTIC,0.475 L	80009	131-1593-00
	352-1012-00			HOLDER LED:BLACK ABS	80009	352-1012-00
				END MOUNTING PARTS		
A1S221	150-1029-00			DIODE,OPTO:LED,GRN,565NM,1MCD AT 20MA	0AP78	SPG3431
				MOUNTING PARTS		
	136-0252-07			SOCKET,PIN CONN:SINGLE,PCB,T/G,0.030	80009	136-0252-07
	361-1593-00			SPACER,SLEEVE:PLASTIC,0.475 L	80009	131-1593-00
	352-1012-00			HOLDER LED:BLACK ABS	80009	352-1012-00

Replaceable electrical parts list (Cont.)

Component number	Tektronix part number	Serial no. effective	Serial no. discount'd	Name & description	Mfr. code	Mfr. part number
END MOUNTING PARTS						
A1U204	156-1215-01			IC,DIGITAL:CMOS,MUX/ENCODER 156-1215-00,74C923,DIP20.3,TUBE	07263	MM74C923N
A1U207	156-3045-00			IC,MEMORY:CMOS,PROM,2K X 8,REGISTERD,35NS,7C245,DIP24.3	65786	CY7C245-35PC
MOUNTING PARTS						
	136-0925-00			SOCKET,DIP:	91506	224-AG30D
END MOUNTING PARTS						
A1U209	156-2983-00			IC,DIGITAL:CMOS,PLD,EEPLD,16V8,25NS,90MA,16V8-2 5,DIP20.3,TUBE	TK6138	PALCE16V8H-25PC/4
MOUNTING PARTS						
	136-0752-00			SKT,PN-IN ELEK:MICROCIRCUIT,20 DIP	09922	DILB20P-106
END MOUNTING PARTS						
A1U210	156-4054-00			IC,DIGITAL:CMOS,PLD,OTP,16,MACROCELL,DUAL CLOCK,25NS,20IN,16,OUTPUT,EP610-30,DIP24.3,TUBE	67183	EP610PC-25
MOUNTING PARTS						
	136-0925-00			SOCKET,DIP:	91506	224-AG30D
END MOUNTING PARTS						
A2	671-1862-04			CIRCUIT BD ASSY:MAIN (STANDARD)	80009	671-1862-04
A2	671-2089-04			CIRCUIT BD ASSY:MAIN (OPTION 01)	80009	671-2089-04
A2	671-2950-00			CIRCUIT BD ASSY:MAIN (OPTION 02)	80009	671-2050-00
A2	671-3464-00			CIRCUIT BD ASSY:MAIN (OPTION 01 & 02)	80009	671-2050-00
ATTACHED PARTS						
	337-3760-00			SHEILD,ELECT:TIM PLATED BRS (OPTION 02)	80009	337-3760-00
END ATTACHED PARTS						
A2C1	281-0775-01			CAP,FXD,CER:MCL,0.1UF,20%,50V,Z5U,0.170 X 0.100,AXIAL	04222	SA105E104MAA
A2C2	281-0775-01			CAP,FXD,CER:MCL,0.1UF,20%,50V,Z5U,0.170 X 0.100,AXIAL	04222	SA105E104MAA
A2C4	281-0775-01			CAP,FXD,CERAMIC:MCL,0.1UF,20%,50V,Z5U	04222	SA105E104MAA
A2C9	290-0973-01			CAP,FXD,ALUM:100UF,20%,25VDC,8X11.5MM,0.2 LS,RADIAL,T&A	62643	SME35VB101M8X11F T
A2C10	290-0973-01			CAP,FXD,ALUM:100UF,20%,25VDC,8X11.5MM,0.2 LS,RADIAL,T&A	62643	SME35VB101M8X11F T
A2C13	283-0177-05			CAP,FXD,CER,1UF,+80-20%,25V	20932	5030ES25RD105Z
A2C15	283-0177-05			CAP,FXD,CER,1UF,+80-20%,25V	20932	5030ES25RD105Z
A2C18	281-0797-00			CAP,FXD,CER:MLC,15PF,5%,100V,SAFETY ,0.100 X 0.170,AXIAL,MI	12969	CGB150KFN
A2C19	281-0153-00			CAP,VAR,AIR,1.7-10PF,150V		187-0106-055
A2C20	283-0159-02			CAP,FXD,CER,18PF,5%,50V	18796	RPE121-911C0G181J 50V
A2C21	281-0153-00			CAP,VAR,AIR,1.7-10PF,150V		187-0106-055

Replaceable electrical parts list (Cont.)

Component number	Tektronix part number	Serial no. effective	Serial no. discont'd	Name & description	Mfr. code	Mfr. part number
A2C22	281-0775-01			CAP,FXD,CER:MCL,0.1UF,20%,50V	04222	SA105E104MAA
A2C23	281-0775-01			CAP,FXD,CER:MCL,0.1UF,20%,50V	04222	SA105E104MAA
A2C30	281-0123-00			CAP,VAR,CER,5-25PF,100V	59660	518-000A5-25
A2C31	283-0648-00			CAP,FXD,MICA,10PF,+/-0.5PF,500V	80009	283-0648-00
A2C32	281-0123-00			CAP,VAR,CER,5-25PF,100V	33095	281-0123-00
A2C33	283-0648-00			CAP,FXD,MICA,10PF,+/-0.5PF,500V	09023	CD15CD100D03
A2C37	281-0775-01			CAP,FXD,CER:MCL,0.1UF,20%,50V,Z5U,0.170 X 0.100,AXIAL	04222	SA105E104MAA
A2C38	281-0775-01			CAP,FXD,CER:MCL,0.1UF,20%,50V,Z5U,0.170 X 0.100,AXIAL	04222	SA105E104MAA
A2C39	283-0204-00			CAP,FXD,CER,0.01UF,20%,50V	51406	RPE110Z5U103M50V
A2C40	281-0775-01			CAP,FXD,CER:MCL,0.1UF,20%,50V,Z5U,0.170 X 0.100,AXIAL	04222	SA105E104MAA
A2C41	281-0775-01			CAP,FXD,CER:MCL,0.1UF,20%,50V	04222	SA105E104MAA
A2C42	283-0177-05			CAP,FXD,CER,1UF,+80-20%,25V	20932	5030ES25RD105Z
A2C43	283-0220-02			CAP,FXD,CER,0.01UF,20%,50V	18796	RPE121-911X7R103M 50
A2C46	281-0898-00			CAP,FXD,CER,7.5PF,+/-0.5PF,500V	04222	MA107A7R5DAA
A2C47	281-0153-00			CAP,VAR,AIR,1.7-10PF,150V		187-0106-055
A2C48	283-0788-01			CAP,FXD,MICA,267PF,1%,500V	09023	CDA15FD(267)F03
A2C49	283-0596-00			CAP,FXD,MICA,528PF,1%,300V	09023	CD15FC(528)F03
A2C50	283-0688-01			CAP,FXD,MICA,464PF,1%,500V	09023	CDA15FD(464)F03
A2C51	283-0638-01			CAP,FXD,MICA,130PF,1%,500V	09023	CDA15FD131F03
A2C52	283-0594-02			CAP,FXD,MICA,1000PF,1%,500V	00853	D155F1250FO
A2C53	283-0666-00			CAP,FXD,MICA,890PF,2%,100V	09023	CD15FA891G03
A2C54	283-0644-01			CAP,FXD,MICA,150PF,1%,500V	TK0891	ADVISE
A2C55	283-0625-01			CAP,FXD,MICA,220PF,1%,500V	09023	CDA10FD221F03
A2C56	283-0631-01			CAP,FXD,MICA,95PF,1%,500V	TK0891	RDM15FD950F03
A2C57	283-0784-01			CAP,FXD,MICA,40PF,2%,500V	09023	CDA15ED400G03
A2C59	281-0775-01			CAP,FXD,CER:MCL,0.1UF,20%,50V,Z5U,0.170 X 0.100,AXIAL	04222	SA105E104MAA
A2C60	281-0775-01			CAP,FXD,CER:MCL,0.1UF,20%,50V,Z5U,0.170 X 0.100,AXIAL	04222	SA105E104MAA
A2C61	283-0220-02			CAP,FXD,CER,0.01UF,20%,50V	18796	RPE121-911X7R103M 50
A2C62	281-0775-01			CAP,FXD,CER:MCL,0.1UF,20%,50V,Z5U,0.170 X 0.100,AXIAL	04222	SA105E104MAA
A2C63	281-0775-01			CAP,FXD,CER:MCL,0.1UF,20%,50V,Z5U,0.170 X 0.100,AXIAL	04222	SA105E104MAA
A2C64	283-0177-05			CAP,FXD,CER,1UF,+80-20%,25V	20932	5030ES25RD105Z
A2C65	283-0220-02			CAP,FXD,CER,DI:0.01UF,20%,50V	18796	RPE121-911X7R103M 50

Replaceable electrical parts list (Cont.)

Component number	Tektronix part number	Serial no. effective	Serial no. discount'd	Name & description	Mfr. code	Mfr. part number
A2C68	281-0898-00			CAP,FXD,CER,DI:7.5PF,+/-0.5PF,500V	04222	MA107A7R5DAA
A2C69	281-0153-00			CAP,VAR,AIR,1.7-10PF,150V	?	187-0106-055
A2C70	283-0788-01			CAP,FXD,MICA,DI:267PF,1%,500V	09023	CDA15FD(267)F03
A2C71	283-0596-00			CAP,FXD,MICA,DI:528PF,1%,300V	09023	CD15FC(528)F03
A2C72	283-0688-00			CAP,FXD,MICA,DI:464PF,1%,300V	80009	283-0688-00
A2C73	283-0638-01			CAP,FXD,MICA,DI:130PF,1%,500V	09023	CDA15FD131F03
A2C74	283-0594-02			CAP,FXD,MICA,DI:1000PF,1%,100V	09023	CDA15FA102F03
A2C75	283-0666-00			CAP,FXD,MICA,DI:890PF,2%,100V	09023	CD15FA891G03
A2C76	283-0644-01			CAP,FXD,MICA,DI:150PF,1%,500V	TK0891	ADVISE
A2C77	283-0625-01			CAP,FXD,MICA,DI:220PF,1%,500V	09023	CDA10FD221F03
A2C78	283-0631-01			CAP,FXD,MICA,DI:95PF,1%,500V	TK0891	RDM15FD950F03
A2C79	283-0784-01			CAP,FXD,MICA,DI:40PF,2%,500V	09023	CDA15ED400G03
A2C81	281-0775-01			CAP,FXD,CERAMIC:MCL,0.1UF,20%,50V,Z5U	04222	SA105E104MAA
A2C82	290-0973-01			CAP,FXD,ALUM:100UF,20%,25VDC	62643	SME35VB101M8X11F T
A2C83	281-0775-01			CAP,FXD,CERAMIC:MCL,0.1UF,20%,50V,Z5U	04222	SA105E104MAA
A2C84	281-0775-01			CAP,FXD,CERAMIC:MCL,0.1UF,20%,50V,Z5U	04222	SA105E104MAA
A2C85	281-0775-01			CAP,FXD,CERAMIC:MCL,0.1UF,20%,50V,Z5U	04222	SA105E104MAA
A2C86	281-0775-01			CAP,FXD,CERAMIC:MCL,0.1UF,20%,50V,Z5U	04222	SA105E104MAA
A2C87	290-0973-01			CAP,FXD,ALUM:100UF,20%,25VDC	62643	SME35VB101M8X11F T
A2C88	281-0775-01			CAP,FXD,CER:MCL,0.1UF,20%,50V,Z5U,0.170 X 0.100,AXIAL	04222	SA105E104MAA
A2C89	281-0775-01			CAP,FXD,CER:MCL,0.1UF,20%,50V,Z5U,0.170 X 0.100,AXIAL(Opt. 01 Only)	04222	SA105E104MAA
A2C90	290-0973-01			CAP,FXD,ALUM:100UF,20%,25VDC	62643	SME35VB101M8X11F T
A2C91	283-0220-02			CAP,FXD,CER,DI:0.01UF,20%,50V	18796	RPE121-911X7R103M 50
A2C92	283-0177-05			CAP,FXD,CER,DI:1UF,+80-20%,25V (Opt. 01 Only)	20932	5030ES25RD105Z
A2C93	283-0220-02			CAP,FXD,CER,DI:0.01UF,20%,50V (Opt. 01 Only)	18796	RPE121-911X7R103M 50
A2C94	281-0775-01			CAP,FXD,CER:MCL,0.1UF,20%,50V (Opt. 01 Only)	04222	SA105E104MAA
A2C95	281-0775-01			CAP,FXD,CER:MCL,0.1UF,20%,50V (Opt. 01 Only)	04222	SA105E104MAA
A2C96	290-0973-01			CAP,FXD,ALUM:100UF,20%,25VDC (Opt. 01 Only)	62643	SME35VB101M8X11F T
A2C98	281-0898-00			CAP,FXD,CER,DI:7.5PF,+/-0.5PF,500V (Opt. 01 Only)	04222	MA107A7R5DAA
A2C99	281-0153-00			CAP,VAR,AIR,1.7-10PF,150V (Opt. 01 Only)		187-0106-055
A2C100	283-0788-01			CAP,FXD,MICA,267PF,1%,500V (Opt. 01 Only)	09023	CDA15FD(267)F03
A2C101	283-0596-00			CAP,FXD,MICA,528PF,1%,300V (Opt. 01 Only)	09023	CD15FC(528)F03
A2C102	283-0688-01			CAP,FXD,MICA,464PF,1%,500V (Opt. 01 Only)	09023	CDA15FD(464)F03

Replaceable electrical parts list (Cont.)

Component number	Tektronix part number	Serial no. effective	Serial no. discont'd	Name & description	Mfr. code	Mfr. part number
A2C103	283-0638-01			CAP,FXD,MICA,130PF,1%,500V (Opt. 01 Only)	09023	CDA15FD131F03
A2C104	283-0594-02			CAP,FXD,MICA,1000PF,1%,100V (Opt. 01 Only)	09023	CDA15FA102F03
A2C105	283-0666-00			CAP,FXD,MICA,890PF,2%,100V (Opt. 01 Only)	09023	CD15FA891G03
A2C106	283-0644-01			CAP,FXD,MICA,150PF,1%,500V (Opt. 01 Only)	TK0891	ADVISE
A2C107	283-0625-01			CAP,FXD,MICA,220PF,1%,500V (Opt. 01 Only)	09023	CDA10FD221F03
A2C108	283-0631-01			CAP,FXD,MICA,95PF,1%,500V (Opt. 01 Only)	TK0891	RDM15FD950F03
A2C109	283-0784-01			CAP,FXD,MICA,40PF,2%,500V (Opt. 01 Only)	09023	CDA15ED400G03
A2C110	283-0594-00			CAP,FXD,MICA,DI:0.001UF,1%,100V	80009	283-0594-00
A2C111	283-0594-00			CAP,FXD,MICA,DI:0.001UF,1%,100V	80009	283-0594-00
A2C112	283-0177-00			CAP,FXD,CER,DI:1UF,+80-20%,25V	04222	SR303E105ZAA
A2C113	283-0175-01			CAP,FXD,CER,DI:0.1UF,20%,50V	04222	SR303E105ZAA
A2C114	290-0990-00			CAP,FXD,ELCTLT,DI:10UF,20%,50V	24165	502D437
A2C115	283-0177-05			CAP,FXD,CER,1UF,+80-20%,25V	20932	5030ES25RD105Z
A2C117	281-0788-00			CAP,FXD,CER:MLC,470PF,10%,100V,0.100 X 0.170,AXIAL,MI	04222	SA102C471KAA
A2C118	290-0919-00			CAP,FXD,ALUM:470UF,+50-20%,35V	61058	ECEA1VFS471
A2C122	281-0788-00			CAP,FXD,CER:MLC,470PF,10%,100V,0.100 X 0.170,AXIAL,MI	04222	SA102C471KAA
A2C141	281-0775-01			CAP,FXD,CER:MCL,0.1UF,20%,50V	04222	SA105E104MAA
A2C142	281-0775-01			CAP,FXD,CER:MCL,0.1UF,20%,50V,	04222	SA105E104MAA
A2C150	290-0990-00			CAP,FXD,ELCTLT,20%,10V,50V	24165	502D437
A2C151	290-1301-00			CAP,FXD,ALUM:2700UF,20%,10V	62643	CEEFM1A272M7
A2C152	290-1301-00			CAP,FXD,ALUM:2700UF,20%,10V	62643	CEEFM1A272M7
A2C153	281-0775-01			CAP,FXD,CER:MCL,0.1UF,20%,50V	04222	SA105E104MAA
A2C154	281-0775-01			CAP,FXD,CER:MCL,0.1UF,20%,50V	04222	SA105E104MAA
A2C155	283-0238-01			CAP,FXD,CER,0.01UF,10%,50VWDC,X7R	04222	SR295C103KAAAP1
A2C160	281-0775-01			CAP,FXD,CER:MCL,0.1UF,20%,50V	04222	SA105E104MAA
A2C161	281-0775-01			CAP,FXD,CER:MCL,0.1UF,20%,50V	04222	SA105E104MAA
A2C162	281-0775-01			CAP,FXD,CER:MCL,0.1UF,20%,50V	04222	SA105E104MAA
A2C163	281-0775-01			CAP,FXD,CER:MCL,0.1UF,20%,50V	04222	SA105E104MAA
A2C164	281-0775-01			CAP,FXD,CER:MCL,0.1UF,20%,50V	04222	SA105E104MAA
A2C165	281-0775-01			CAP,FXD,CER:MCL,0.1UF,20%,50V	04222	SA105E104MAA
A2C166	281-0775-01			CAP,FXD,CER:MCL,0.1UF,20%,50V	04222	SA105E104MAA
A2C167	281-0775-01			CAP,FXD,CER:MCL,0.1UF,20%,50V	04222	SA105E104MAA
A2C168	281-0775-01			CAP,FXD,CER:MCL,0.1UF,20%,50V	04222	SA105E104MAA
A2C169	281-0775-01			CAP,FXD,CER:MCL,0.1UF,20%,50V	04222	SA105E104MAA
A2C170	281-0775-01			CAP,FXD,CER:MCL,0.1UF,20%,50V	04222	SA105E104MAA
A2C172	281-0775-01			CAP,FXD,CER:MCL,0.1UF,20%,50V	04222	SA105E104MAA
A2C173	281-0775-01			CAP,FXD,CER:MCL,0.1UF,20%,50V	04222	SA105E104MAA

Replaceable electrical parts list (Cont.)

Component number	Tektronix part number	Serial no. effective	Serial no. discount'd	Name & description	Mfr. code	Mfr. part number
A2C174	281-0775-01			CAP,FXD,CER:MCL,0.1UF,20%,50V	04222	SA105E104MAA
A2C175	281-0775-01			CAP,FXD,CER:MCL,0.1UF,20%,50V	04222	SA105E104MAA
A2C176	281-0775-01			CAP,FXD,CER:MCL,0.1UF,20%,50V	04222	SA105E104MAA
A2C177	281-0775-01			CAP,FXD,CERAMIC:MCL,0.1UF,20%,50V,Z5U	04222	SA105E104MAA
A2C178	281-0775-01			CAP,FXD,CER:MCL,0.1UF,20%,50V	04222	SA105E104MAA
A2C180	290-0919-00			CAP,FXD,ALUM:470UF,+50-20%,35V	61058	ECEA1VFS471
A2C181	290-0919-00			CAP,FXD,ALUM:470UF,+50-20%,35V	61058	ECEA1VFS471
A2C182	290-0919-00			CAP,FXD,ALUM:470UF,+50-20%,35V	61058	ECEA1VFS471
A2C183	290-1034-00			CAP,FXD,ALUM:330UF,20%,25V,13 X 25MM,RADIAL	62643	CEUFM1E331
A2C186	281-0775-01			CAP,FXD,CER:MCL,0.1UF,20%,50V	04222	SA105E104MAA
A2C187	283-0177-05			CAP,FXD,CER,1UF,+80-20%,25V	20932	5030ES25RD105Z
A2C188	290-0943-02			CAP,FXD,ELCLT:47UF,20%,25V	62643	CEUSM1E470-T
A2C189	281-0775-01			CAP,FXD,CER:MCL,0.1UF,20%,50V	04222	SA105E104MAA
A2C190	283-0177-05			CAP,FXD,CER,1UF,+80-20%,25V	20932	5030ES25RD105Z
A2C191	281-0775-01			CAP,FXD,CER:MCL,0.1UF,20%,50V	04222	SA105E104MAA
A2C192	281-0775-01			CAP,FXD,CER:MCL,0.1UF,20%,50V	04222	SA105E104MAA
A2C193	283-0177-05			CAP,FXD,CER,1UF,+80-20%,25V	20932	5030ES25RD105Z
A2C194	283-0177-05			CAP,FXD,CER,1UF,+80-20%,25V	20932	5030ES25RD105Z
A2C195	281-0775-01			CAP,FXD,CER:MCL,0.1UF,20%,50V	04222	SA105E104MAA
A2C196	290-0845-00			CAP,FXD,ALUM:330UF,20%,25V	55680	UVX1H331MPA
A2C197	281-0775-01			CAP,FXD,CERAMIC:MCL,0.1UF,20%,50V,Z5U	04222	SA105E104MAA
A2C198	281-0775-01			CAP,FXD,CERAMIC:MCL,0.1UF,20%,50V,Z5U	04222	SA105E104MAA
A2C254	281-0775-01			CAP,FXD,CER:MCL,0.1UF,20%,50V	04222	SA105E104MAA
A2C255	281-0775-01			CAP,FXD,CER:MCL,0.1UF,20%,50V	04222	SA105E104MAA
A2C257	281-0775-01			CAP,FXD,CER:MCL,0.1UF,20%,50V	04222	SA105E104MAA
A2C258	281-0775-01			CAP,FXD,CER:MCL,0.1UF,20%,50V	04222	SA105E104MAA
A2C259	281-0777-00			CAP,FXD,CERAMIC:MLC,51PF,5%,200V	04222	SA102A510JAA
A2C260	281-0777-00			CAP,FXD,CERAMIC:MLC,51PF,5%,200V	04222	SA102A510JAA
A2C261	281-0777-00			CAP,FXD,CERAMIC:MLC,51PF,5%,200V	04222	SA102A510JAA
A2C262	281-0777-00			CAP,FXD,CERAMIC:MLC,51PF,5%,200V	04222	SA102A510JAA
A2C263	283-0637-01			CAP,FXD,MICA,20PF,2.5%,500V	TK0891	RDM15ED200D03
A2C264	281-0775-01			CAP,FXD,CER:MCL,0.1UF,20%,50V	04222	SA105E104MAA
A2C265	281-0775-01			CAP,FXD,CER:MCL,0.1UF,20%,50V	04222	SA105E104MAA
A2C266	281-0775-01			CAP,FXD,CER:MCL,0.1UF,20%,50V	04222	SA105E104MAA
A2C267	281-0775-01			CAP,FXD,CER:MCL,0.1UF,20%,50V	04222	SA105E104MAA
A2CR1	152-0141-02			DIODE,SIG:ULTRA FAST,40V,150MA,4NS,2PF,1N4152	01295	1N4152R
A2CR2	152-0141-02			DIODE,SIG:ULTRA FAST,40V,150MA,4NS,2PF,1N4152	01295	1N4152R
A2CR4	152-0601-01			DIODE,RECT:ULTRAFast,150V,25NS,35A IFSM,MUR120,T&R	12969	UES1103

Replaceable electrical parts list (Cont.)

Component number	Tektronix part number	Serial no. effective	Serial no. discont'd	Name & description	Mfr. code	Mfr. part number
A2CR5	152-0601-01			DIODE,RECT:ULTRAFAS	12969	UES1103
A2CR6	152-0601-01			DIODE,RECT:ULTRAFAS	12969	UES1103
A2CR7	152-0601-01			DIODE,RECT:ULTRAFAS	12969	UES1103
A2CR160	152-0582-00			DIODE,RECT:SCHTKY,20V,3A,.475VF,80A IFSM,1N5820	04713	1N5820
A2CR161	152-0582-00			DIODE,RECT:SCHTKY,20V,3A,.475VF,80A IFSM,1N5820	04713	1N5820
A2CR162	152-0582-00			DIODE,RECT:SCHTKY,20V,3A,.475VF,80A IFSM,1N5820	04713	1N5820
A2CR163	152-0141-02			DIODE,SIG:ULTRA FAST,40V,150MA,4NS,2PF,1N4152,DO-35,T&R	01295	1N4152R
A2E1	276-0818-00			COIL,EM:BEAD ON LEAD,Z=100 OHM (100MHZ,OD=0.138,LENGTH=0.263	34899	2743003112
A2E2	276-0818-00			COIL,EM:BEAD ON LEAD,Z=100 OHM (100MHZ,OD=0.138,LENGTH=0.263	34899	2743003112
A2F1	159-0025-00			FUSE,CARTRIDGE;3AG,0.5A,250V,0.25SEC (FOR 90-250VAC OPERATION)	71400	AGC-CW-1/2
A2F1	159-0028-00			FUSE,CARTRIDGE;0.25A,250V,FAST BLOW (FOR 180-132VAC OPERATION)	71400	AGC-1/4
				MOUNTING PARTS		
	344-0329-00			CLIP,ELECTRICAL: (QUANTITY 2)	61857	H-0011-2
				END MOUNTING PARTS		
A2FL1	119-1946-00			FILTER,RFI:1A,250V,400HZ W/PC TERMINAL	0GV52	FX326-1/02-K-D-T
A2J2	131-0608-00			TERMINAL,PIN:0.365 L X 0.025 BRZ GLD PL (QUANTITY 3)	80009	131-0608-00
A2J4	131-0608-00			TERMINAL,PIN:0.365 L X 0.025 BRZ GLD PL (QUANTITY 10)	80009	131-0608-00
A2J6	131-0608-00			TERMINAL,PIN:0.365 L X 0.025 BRZ GLD PL (QUANTITY 3)	80009	131-0608-00
A2J7	131-0608-00			TERMINAL,PIN:0.365 L X 0.025 BRZ GLD PL (QUANTITY 3)	80009	131-0608-00
A2J8	131-0608-00			TERMINAL,PIN:0.365 L X 0.025 BRZ GLD PL (QUANTITY 3) (Opt. 01 Only)	80009	131-0608-00
A2J9	131-3987-00			CONN,CIRC AUDIO:PCB/PNL,XLR,MALE,RTANG,3 POS,1.22 H X 1.024 W,CTR PLZ,LATCHING,	82389	E3MRA
A2J10	131-3987-00			CONN,CIRC AUDIO:PCB/PNL,XLR,MALE,RTANG,3 POS,1.22 H X 1.024 W,CTR PLZ,LATCHING,	82389	E3MRA
A2J11	131-4566-00			BUS,CONDUCTOR:0 OHM,300 SPACING,SM BODY MI,DUMMY RES	91637	FRJ-50
A2J12	131-0608-00			CONN,TERMINAL:PRESSFIT/PCB,MALE,STR,0.025 SQ,0.248 MLG X 0.137 TAIL,50 GOLD,PHZ BRZ,W/FERRULE	22526	48283-018
A2J30	131-0608-00			TERMINAL,PIN:0.365 L X 0.025 BRZ GLD PL (QUANTITY 2)	80009	131-0608-00

Replaceable electrical parts list (Cont.)

Component number	Tektronix part number	Serial no. effective	Serial no. discont'd	Name & description	Mfr. code	Mfr. part number
A2J31	131-0608-00			TERMINAL,PIN:0.365 L X 0.025 BRZ GLD PL (QUANTITY 2)	80009	131-0608-00
A2J105	131-0608-00			TERMINAL,PIN:0.365 L X 0.025 BRZ GLD PL (QUANTITY 2)	80009	131-0608-00
A2J106	131-0608-00			TERMINAL,PIN:0.365 L X 0.025 BRZ GLD PL (QUANTITY 16)	80009	131-0608-00
A2J107	131-0608-00			TERMINAL,PIN:0.365 L X 0.025 BRZ GLD PL (QUANTITY 16) (Opt. 01 Only)	80009	131-0608-00
A2J108	131-0608-00			TERMINAL,PIN:0.365 L X 0.025 BRZ GLD PL (QUANTITY 3)	80009	131-0608-00
A2L4	108-0538-00			INDUCTOR,FXD:CUSTOM,POWER,2.7UH	0JR03	108-0538-00
A2L5	108-0538-00			INDUCTOR,FXD:CUSTOM,POWER,2.7UH (Opt.01)	0JR03	108-0538-00
A2L7	108-1491-00			INDUCTOR,FXD:SIGNAL,9.9UH,5.5%,	0JR03	108-1491-00
A2L8	120-1180-00			TRANSFORMER,RF:VARIABLE	54937	500-3910
A2L9	114-0411-00			INDUCTOR,VAR:0.9-1.0	54937	500-3900
A2L10	114-0364-00			INDUCTOR,VAR:1.42-1.68UH,30/46 AWG	54937	500-3893
A2L11	114-0366-00			INDUCTOR,VAR:2.40-2.70UH,30/46 AWG,Q MIN 190@2.6UH	54937	114-0366-00
A2L12	114-0366-00			INDUCTOR,VAR:2.40-2.70UH,30/46 AWG,Q MIN 190@2.6UH	54937	114-0366-00
A2L13	108-1491-00			INDUCTOR,FXD:SIGNAL,9.9UH,5.5%,	0JR03	108-1491-00
A2L14	120-1180-00			TRANSFORMER,RF:VARIABLE	54937	500-3910
A2L15	114-0411-00			INDUCTOR,VAR:0.9-1.0	54937	500-3900
A2L16	114-0364-00			INDUCTOR,VAR:1.42-1.68UH,30/46 AWG	54937	500-3893
A2L17	114-0366-00			INDUCTOR,VAR:2.40-2.70UH,30/46 AWG,Q MIN 190@2.6UH	54937	114-0366-00
A2L18	114-0366-00			INDUCTOR,VAR:2.40-2.70UH,30/46 AWG,Q MIN 190@2.6UH	54937	114-0366-00
A2L19	108-1491-00			INDUCTOR,FXD:SIGNAL,9.9UH,5.5%, (Opt.01)	0JR03	108-1491-00
A2L20	120-1180-00			TRANSFORMER,RF:VARIABLE,POTCORE (Opt.01)	54937	500-3910
A2L21	114-0411-00			INDUCTOR,VAR:0.9-1.0 (Opt.01)	54937	500-3900
A2L22	114-0364-00			INDUCTOR,VAR:1.42-1.68UH,30/46 AWG, (Opt.01)	54937	500-3893
A2L23	114-0366-00			INDUCTOR,VAR:2.40-2.70UH,30/46 AWG,Q MIN 190@2.6UH (Opt.01)	54937	114-0366-00
A2L24	114-0366-00			INDUCTOR,VAR:2.40-2.70UH,30/46 AWG,Q MIN 190@2.6UH (Opt.01)	54937	114-0366-00
A2L25	120-1889-00			TRANSFORMER,RF:	0JR03	120-1889-00
A2L26	108-1263-00			INDUCTOR,FXD:POWER,10UH,10%,I<2.1A,RDC<0.043 OHM,Q>20,SRF>19MHZ,BOBBIN,RADIAL	TK2058	TSL0707-100K1R9
A2L27	108-1263-00			INDUCTOR,FXD:POWER,10UH,10%,I<2.1A,RDC<0.043 OHM,Q>20,SRF>19MHZ,BOBBIN,RADIAL	TK2058	TSL0707-100K1R9
A2L28	108-0245-01			INDUCTOR,FXD:CUSTOM,POWER,3.9UH,10%,IDC<800 MA,RDC<0.264OHM,Q>35@7.9MHZ,SRF>61MHZ,AXIAL ,T&R	0JR03	108-0245-01

Replaceable electrical parts list (Cont.)

Component number	Tektronix part number	Serial no. effective	Serial no. discont'd	Name & description	Mfr. code	Mfr. part number
A2L29	108-0245-01			INDUCTOR,FXD:CUSTOM,POWER,3.9UH,10%,IDC<800 MA,RDC<0.264OHM,Q>35@7.9MHZ,SRF>61MHZ,AXIAL ,T&R	0JR03	108-0245-01
A2L30	108-0538-00			INDUCTOR,FXD:CUSTOM,POWER,2.7UH	0JR03	108-0538-00
A2P2	131-0993-02			CONN,BOX:SHUNT,FEMALE,RED,JUMPER	00779	1-850100-0
A2P6	131-0993-02			CONN,BOX:SHUNT,FEMALE,RED,JUMPER	00779	1-850100-0
A2P7	131-0993-02			CONN,BOX:SHUNT,FEMALE,RED,JUMPER	00779	1-850100-0
A2P8	131-0993-02			CONN,BOX:SHUNT,FEMALE,RED,JUMPER(Opt.01)	00779	1-850100-0
A2P12	131-0993-05			BUS,CONDUCTOR:SHUNT ASSEMBLY,GREEN	00779	850100-5
A2P30	131-0993-02			CONN,BOX:SHUNT,FEMALE,RED,JUMPER	00779	1-850100-0
A2P31	131-0993-02			CONN,BOX:SHUNT,FEMALE,RED,JUMPER	00779	1-850100-0
A2P108	131-0993-05			BUS,CONDUCTOR:SHUNTASSEMBLY,GREEN	00779	850100-5
A2Q1	151-1045-00			TRANSISTOR,SIG:JFET,P-CH,4.5V(SELECTED),5MA,1 MS,GENERAL,2N5460_SPECIAL,TO-92	04713	SPF628
A2Q2	151-1025-00			TRANSISTOR,SIG:JFET,N-CH,6V,15MA,4.5MS,AMPLIFIER,J304/PN4416,TO-92 SDG	04713	SPF3036
A2Q3	151-1171-00			TRANSISTOR,PWR:MOS,N-CH,50V,12A,0.12 OHM,BUZ71A/IRFZ22/MTP15N06V,TO-220	04713	MTP15N05E
A2Q4	151-0188-05			TRANSISTOR,SIG:BIPOLAR,PNP,40V,200MA,250MHZ,AMPLIFIER,2N3906,TO-92 EBC,T&A	04713	2N3906RLRA
A2R3	315-0471-00			RES,FXD,FILM:470 OHM,5%,0.25W	50139	CB4715
A2R4	322-3193-00			RES,FXD:METAL FILM,1K OHM,1%,0.2W,TC=100 PPM	57668	CRB20T68EFX1001
A2R15	322-3001-00			RES,FXD,FILM:10 OHM,1%,0.2W,TC=100 PPM	57668	CRB20T68EFX10R0
A2R16	322-3133-00			RES,FXD,FILM:237 OHM,1%,0.2W,TC=T0,MI,SMALL BODY	91637	CCF50-2370F-R36
A2R17	322-3193-00			RES,FXD:METAL FILM,1K OHM,1%,0.2W,TC=100 PPM,AXIAL	57668	CRB20T68EFX1001
A2R18	311-2230-00			RES,VAR,TRMR:CERMET,500 OHM,20%,0.5W,0.197 SQ,TOP ADJUST,T&R	TK2073	GF06UT2 501 M L20
A2R19	322-3273-00			RES,FXD:METAL FILM,6.81K OHM,1%,0.2W,TC=100 PPM,AXIAL	57668	CRB20T68EFX6811
A2R20	311-2234-00			RES,VAR,TRMR:CERMET,5K OHM,20%,0.5W,0.197 SQ,TOP ADJUST,T&R	TK2073	GF06UT2 502 M L20
A2R21	322-3133-00			RES,FXD,FILM:237 OHM,1%,0.2W,TC=T0,MI,SMALL BODY	91637	CCF50-2370F-R36
A2R22	322-3193-00			RES,FXD:METAL FILM,1K OHM,1%,0.2W,TC=100 PPM,AXIAL	57668	CRB20T68EFX1001
A2R23	311-2230-00			RES,VAR,TRMR:CERMET,500OHM,20%,0.5W,0.197 SQ,TOP ADJUST,T&R	TK2073	GF06UT2 501 M L20
A2R24	322-3277-00			RES,FXD,FILM:7.5K OHM,1%,0.2W,TC=T0	57668	CRB20 FXE 7K50
A2R29	322-3114-00			RES,FXD,FILM:150 OHM,1%,0.2W,TC=100 PPM	57668	CRB20-FX-150E-AXIAL
A2R30	322-3114-00			RES,FXD,FILM:150 OHM,1%,0.2W,TC=100 PPM	57668	CRB20-FX-150E-AXIAL

Replaceable electrical parts list (Cont.)

Component number	Tektronix part number	Serial no. effective	Serial no. discount'd	Name & description	Mfr. code	Mfr. part number
A2R31	322-3215-00			RES,FXD,FILM:1.69K OHM,1%,0.2W,TC=T0 MI,SMALL BODY	91637	CCF50-1691F-R36
A2R32	322-3223-00			RES,FXD,FILM:2.05K OHM,1%,0.2W,TC=T0 MI,SMALL BODY	57668	CRB20 FXE 2K05
A2R40	322-3085-07			RES,FXD:METAL FILM,75 OHM,0.1%,0.2W,TC=25 PPM,AXIAL	91637	CCF502-C75ROOBT
A2R41	322-3085-07			RES,FXD:METAL FILM,75 OHM,0.1%,0.2W,TC=25 PPM,AXIAL	91637	CCF502-C75ROOBT
A2R42	322-3193-00			RES,FXD:METAL FILM,1K OHM,1%,0.2W,TC=100 PPM,AXIAL	57668	CRB20T68EFX1001
A2R45	322-3056-01			RES,FXD,FILM:37.4 OHM,0.5%,0.2W,TC=T0 TAPED & REELED,SMALL BODY	57668	CRB20 DXE 37E4
A2R46	322-3085-07			RES,FXD:METAL FILM,75 OHM,0.1%,0.2W,TC=25 PPM,AXIAL	91637	CCF502-C75ROOBT
A2R47	322-3001-00			RES,FXD,FILM:10 OHM,1%,0.2W,TC=100 PPM	57668	CRB20T68EFX10R0
A2R48	317-0036-00			RES,FXD,FILM:3.6 OHM,5%,0.125W	50139	BB36G5
A2R49	322-3193-00			RES,FXD:METAL FILM,1K OHM,1%,0.2W,TC=100 PPM,AXIAL	57668	CRB20T68EFX1001
A2R50	322-3126-01			RES,FXD,FILM:200 OHM,0.5%,0.2W,TC=T0 SMALL BODY	57668	CRB 20 FXE 200 OHM
A2R51	322-3226-00			RES,FXD:METAL FILM,2.21K OHM,1%,0.2W,TC=100 PPM,AXIAL	57668	CRB20T68EFX2211
A2R52	322-3213-00			RES,FXD,FILM:1.62K OHM,1%,0.2W,TC=T0	57668	CRB20 FXE 1K62
A2R53	322-3213-00			RES,FXD,FILM:1.62K OHM,1%,0.2W,TC=T0	57668	CRB20 FXE 1K62
A2R54	317-0036-00			RES,FXD,FILM:3.6 OHM,5%,0.125W	50139	BB36G5
A2R57	322-3133-00			RES,FXD,FILM:237 OHM,1%,0.2W,TC=T0,MI,SMALL BODY	91637	CCF50-2370F-R36
A2R58	322-3193-00			RES,FXD:METAL FILM,1K OHM,1%,0.2W,TC=100 PPM,AXIAL	57668	CRB20T68EFX1001
A2R59	322-3218-00			RES,FXD:METAL FILM,1.82K OHM,1%,0.2W,TC=100 PPM,AXIAL	57668	CRB20 FXE 1K82
A2R60	311-0634-00			RES,VAR,TRMR:CERMET,500 OHM,20%,0.5W,0.197 SQ, TOP ADJUST,T&R	80009	311-0634-00
A2R60	311-2230-00			RES,VAR,TRMR:CERMET,500 OHM,20%,0.5W,0.197 SQ, TOP ADJUST,T&R	TK2073	GF06UT2 501 M L20
A2R61	322-3085-07			RES,FXD:METAL FILM,75 OHM,0.1%,0.2W,TC=25 PPM,AXIAL	91637	CCF502-C75ROOBT
A2R62	322-3311-00			RES,FXD,FILM:16.9K OHM,1%,0.2W,TC=T0 MI,SMALL BODY	56845	CCF50-1692F-R36
A2R63	311-2235-00			RES,VAR,TRMR:CERMET,10K OHM,20%,0.5W,0.197 SQ, TOP ADJUST,T&R	TK2073	GF06UT2 103 M L20
A2R64	322-3056-01			RES,FXD,FILM:37.4 OHM,0.5%,0.2W,TC=T0 TAPED & REELED,SMALL BODY	57668	CRB20 DXE 37E4
A2R65	322-3085-07			RES,FXD:METAL FILM,75 OHM,0.1%,0.2W,TC=25 PPM,AXIAL	91637	CCF502-C75ROOBT

Replaceable electrical parts list (Cont.)

Component number	Tektronix part number	Serial no. effective	Serial no. discount'd	Name & description	Mfr. code	Mfr. part number
A2R66	322-3001-00			RES,FXD,FILM:10 OHM,1%,0.2W,TC=100 PPM	57668	CRB20T68EFX10R0
A2R67	317-0036-00			RES,FXD,FILM:3.6 OHM,5%,0.125W	50139	BB36G5
A2R68	322-3193-00			RES,FXD:METAL FILM,1K OHM,1%,0.2W,TC=100 PPM,AXIAL	57668	CRB20T68EFX1001
A2R69	322-3126-01			RES,FXD,FILM:200 OHM,0.5%,0.2W,TC=TO SMALL BODY	57668	CRB 20 FXE 200 OHM
A2R70	322-3226-00			RES,FXD:METAL FILM,2.21K OHM,1%,0.2W,TC=100 PPM,AXIAL	57668	CRB20T68EFX2211
A2R71	322-3213-00			RES,FXD,FILM:1.62K OHM,1%,0.2W,TC=TO	57668	CRB20 FXE 1K62
A2R72	322-3213-00			RES,FXD,FILM:1.62K OHM,1%,0.2W,TC=TO	57668	CRB20 FXE 1K62
A2R73	317-0036-00			RES,FXD,FILM:3.6 OHM,5%,0.125W	50139	BB36G5
A2R76	322-3133-00			RES,FXD,FILM:237 OHM,1%,0.2W,TC=TO,MI,SMALL BODY	91637	CCF50-2370F-R36
A2R77	322-3193-00			RES,FXD:METAL FILM,1K OHM,1%,0.2W,TC=100 PPM,AXIAL	57668	CRB20T68EFX1001
A2R78	322-3212-00			RES,FXD,FILM:1.58K OHM,1%,0.2W,TC=TO MI,SMALL BODY	57668	CRB20 FXE 1K58
A2R79	311-2230-00			RES,VAR,TRMR:CERMET,500 OHM,20%,0.5W,0.197 SQ,TOP ADJUST,T&R	TK2073	GF06UT2 501 M L20
A2R80	322-3085-07			RES,FXD:METAL FILM,75 OHM,0.1%,0.2W,TC=25 PPM,AXIAL	91637	CCF502-C75ROOBT
A2R81	322-3284-00			RES,FXD,FILM:8.87K OHM,1%,0.2W,TC=TO MI,SMALL BODY	57668	CRB20 FXE 8K87
A2R82	311-2234-00			RES,VAR,TRMR:CERMET,5K OHM,20%,0.5W,0.197 SQ,TOP ADJUST,T&R	TK2073	GF06UT2 502 M L20
A2R83	322-3056-01			RES,FXD,FILM:37.4 OHM,0.5%,0.2W,TC=TO(Opt01)	57668	CRB20 DXE 37E4
A2R84	322-3213-00			RES,FXD,FILM:1.62K OHM,1%,0.2W,TC=TO(Opt01)	57668	CRB20 FXE 1K62
A2R85	322-3213-00			RES,FXD,FILM:1.62K OHM,1%,0.2W,TC=TO (Opt01)	57668	CRB20 FXE 1K62
A2R86	322-3193-00			RES,FXD:METAL FILM,1K OHM,1%,0.2W,TC=100 PPM,AXIAL, (Opt01)	57668	CRB20T68EFX1001
A2R87	322-3126-01			RES,FXD,FILM:200 OHM,0.5%,0.2W,TC=TO(Opt01)	57668	CRB 20 FXE 200 OHM
A2R88	322-3226-00			RES,FXD:METAL FILM,2.21K OHM,1%,0.2W,TC=100 PPM,AXIAL (Opt01)	57668	CRB20T68EFX2211
A2R89	317-0036-00			RES,FXD,FILM:3.6 OHM,5%,0.125W (Opt01)	50139	BB36G5
A2R90	317-0036-00			RES,FXD,FILM:3.6 OHM,5%,0.125W (Opt01)	50139	BB36G5
A2R91	322-3001-00			RES,FXD,FILM:10 OHM,1%,0.2W,TC=100 PPM(Opt01)	57668	CRB20T68EFX10R0
A2R92	322-3085-07			RES,FXD:METAL FILM,75 OHM,0.1%,0.2W,TC=25 PPM,AXIAL (Opt01)	91637	CCF502-C75ROOBT
A2R93	322-3056-00			RES,FXD,FILM:37.4 OHM,1%,0.2W,TC=TO,MI,(Opt01)	91637	CCF50-37R4F-R36
A2R94	322-3056-00			RES,FXD,FILM:37.4 OHM,1%,0.2W,TC=TO,MI,(Opt01)	91637	CCF50-37R4F-R36
A2R95	322-3133-00			RES,FXD,FILM:237 OHM,1%,0.2W,TC=TO,MI,(Opt01)	91637	CCF50-2370F-R36

Replaceable electrical parts list (Cont.)

Component number	Tektronix part number	Serial no. effective	Serial no. discount'd	Name & description	Mfr. code	Mfr. part number
A2R96	322-3193-00			RES,FXD:METAL FILM,1K OHM,1%,0.2W,TC=100 PPM,AXIAL,(Opt01)	57668	CRB20T68EFX1001
A2R97	322-3218-00			RES,FXD:METAL FILM,1.82K OHM,1%,0.2W,TC=100 PPM,AXIAL (Opt01)	57668	CRB20 FXE 1K82
A2R98	311-0634-00			RES,VAR,NONWW:TRMR,500 OHM,0.5W CERMET	32997	3329H-L58-501
A2R99	322-3085-07			RES,FXD:METAL FILM,75 OHM,0.1%,0.2W,TC=25 PPM,AXIAL,(Opt01)	91637	CCF502-C75ROOBT
A2R100	322-3311-00			RES,FXD,FILM:16.9K OHM,1%,0.2W,TC=T0	56845	CCF50-1692F-R36
A2R101	311-2235-00			RES,VAR,TRMR:CERMET,10K OHM,20%,0.5W,0.197 SQ, TOP ADJUST,(Opt01)	TK2073	GF06UT2 103 M L20
A2R102	322-3039-00			RES,FXD,FILM:24.9 OHM,1%,0.2W,TC=T0	57668	CRB20T68EFX24R9
A2R103	322-3289-00			RES,FXD:METAL FILM,10K OHM,1%,0.2W,TC=100 PPM	57668	CRB20T29EFX1002
A2R104	322-3039-00			RES,FXD,FILM:24.9 OHM,1%,0.2W,TC=T0	57668	CRB20T68EFX24R9
A2R105	322-3222-00			RES,FXD:METAL FILM,2K OHM,1%,0.2W,TC=100 PPM	57668	CRB20T68EFX2001
A2R106	322-3404-00			RES,FXD,FILM:158K OHM,1%,0.2W,TC=T0	91637	CCF50-1583F-R36
A2R107	322-3404-00			RES,FXD,FILM:158K OHM,1%,0.2W,TC=T0	91637	CCF50-1583F-R36
A2R108	322-3260-00			RES,FXD,FILM:4.99K OHM,1%,0.2W,TC=T0	57668	CRB20T68EFX4991
A2R109	322-3289-00			RES,FXD:METAL FILM,10K OHM,1%,0.2W,TC=100 PPM	57668	CRB20T29EFX1002
A2R110	322-3318-00			RES,FXD,FILM:METAL FILM,20K OHM,1%,0.2W,TC=100 PPM	57668	CRB20T68EFX2002
A2R112	322-3273-00			RES,FXD:METAL FILM,6.81K OHM,1%,0.2W,TC=100 PPM	57668	CRB20T68EFX6811
A2R113	322-3239-00			RES,FXD,FILM:3.01K OHM,1%,0.2W,TC=T0	57668	CRB20T68EFX3011
A2R114	322-3418-00			RES,FXD:METAL FILM,221K OHM,1%,0.2W,TC=100 PPM	57668	CRB20 FXE 221K
A2R115	322-3039-00			RES,FXD,FILM:24.9 OHM,1%,0.2W,TC=T0	57668	CRB20T68EFX24R9
A2R116	322-3289-00			RES,FXD:METAL FILM,10K OHM,1%,0.2W,TC=100 PPM	57668	CRB20T29EFX1002
A2R117	322-3039-00			RES,FXD,FILM:24.9 OHM,1%,0.2W,TC=T0	57668	CRB20T68EFX24R9
A2R118	322-3289-00			RES,FXD:METAL FILM,10K OHM,1%,0.2W,TC=100 PPM	57668	CRB20T29EFX1002
A2R119	322-3289-00			RES,FXD:METAL FILM,10K OHM,1%,0.2W,TC=100 PPM	57668	CRB20T29EFX1002
A2R120	322-3239-00			RES,FXD,FILM:3.01K OHM,1%,0.2W,TC=T0	57668	CRB20T68EFX3011
A2R121	322-3280-00			RES,FXD,FILM:8.06K OHM,1%,0.2W,TC=T0	57668	CRB20T68EFX8061
A2R122	311-0644-00			RES,VAR,NONWW:TRMR,20K OHM,0.5W CERMET	32997	3329H-L58-203
A2R123	311-0644-00			RES,VAR,NONWW:TRMR,20K OHM,0.5W CERMET	32997	3329H-L58-203
A2R124	322-3193-00			RES,FXD:METAL FILM,1K OHM,1%,0.2W,TC=100 PPM	57668	CRB20T68EFX1001
A2R125	322-3326-00			RES,FXD,FILM:24.3K OHM,1%,0.2W,TC=T0	91637	CCF50-2432F-R36
A2R126	311-0698-00			RES,VAR,NONWW:TRMR,1MEG OHM,0.5W CERMET	32997	3329H-L58-105
A2R127	322-3226-00			RES,FXD:METAL FILM,2.21K OHM,1%,0.2W,TC=100 PPM	57668	CRB20T68EFX2211
A2R129	322-3132-00			RES,FXD,FILM:232 OHM,1%,0.2W,TC=150 PPM,MI,AXIAL	91637	CCF50-2320F-R36

Replaceable electrical parts list (Cont.)

Component number	Tektronix part number	Serial no. effective	Serial no. discont'd	Name & description	Mfr. code	Mfr. part number
A2R130	315-0750-00			RES,FXD,FILM:75 OHM,5%,0.25W MI	50139	CB7505
A2R131	308-0702-00			RES,FXD,WW:0.33 OHM,5%,2W	91637	CPF-2-0R33JT1
A2R135	322-3414-00			RES,FXD:METAL FILM,200K OHM,1%,0.2W,TC=100 PPM,AXIAL	57668	CRB 20 FXE 200 K OHM
A2R136	322-3218-00			RES,FXD:METAL FILM,1.82K OHM,1%,0.2W,TC=100 PPM,AXIAL	57668	CRB20 FXE 1K82
A2R137	322-3318-00			RES,FXD,FILM:METAL FILM,20K OHM,1%,0.2W,TC=100 PPM,AXIAL	57668	CRB20T68EFX2002
A2R150	322-3260-00			RES,FXD,FILM:4.99K OHM,1%,0.2W,TC=T0	57668	CRB20T68EFX4991
A2R151	322-3260-00			RES,FXD,FILM:4.99K OHM,1%,0.2W,TC=T0	57668	CRB20T68EFX4991
A2R152	322-3260-00			RES,FXD,FILM:4.99K OHM,1%,0.2W,TC=T0	57668	CRB20T68EFX4991
A2R153	322-3260-00			RES,FXD,FILM:4.99K OHM,1%,0.2W,TC=T0	57668	CRB20T68EFX4991
A2R154	322-3233-00			RES,FXD,FILM:2.61K OHM,1%,0.2W,TC=T0 MI	91637	CCF50-2611F-R36
A2R160	322-3109-00			RES,FXD,FILM:133 OHM,1%,0.2W,TC=T0,MI	91637	CCF50-1330F-R36
A2R161	322-3235-00			RES,FXD:METAL FILM,2.74K OHM,1%,0.2W,TC=100 PPM,AXIAL,T&R	57668	CRB20 FXE 2K74
A2R181	322-3056-01			RES,FXD,FILM:37.4 OHM,1%,0.2W,TC=T0,MI	91637	CCF50-37R4F-R36
A2R182	322-3056-01			RES,FXD,FILM:37.4 OHM,1%,0.2W,TC=T0,MI	91637	CCF50-37R4F-R36
A2R193	322-3012-00			RES,FXD,FILM:13 OHM,1%,0.2W,TC=T0,MI	91637	CCF50-13R0F-R36
A2R194	322-3039-00			RES,FXD,FILM:24.9 OHM,1%,0.2W,TC=T0,MI	57668	CRB20T68EFX24R9
A2R195	322-3056-01			RES,FXD,FILM:37.4 OHM,0.5%,0.2W,TC=T0	57668	CRB20 DXE 37E4
A2R196	322-3114-00			RES,FXD,FILM:150 OHM,1%,0.2W,TC=100 PPM	57668	CRB20-FX-150E-AXIAL
A2R197	322-3114-00			RES,FXD,FILM:150 OHM,1%,0.2W,TC=100 PPM	57668	CRB20-FX-150E-AXIAL
A2R198	307-0503-00			RES NTWK,FXD,FILM:(9)510 OHM,20%,0.125W	91637	CSC10A01511GDO3
A2R199	322-3193-00			RES,FXD,METALFILM:1KOHM,1%,0.2WTC=100	57668	CRB20FXE1K00
A2R208	322-3193-00			RES,FXD:METAL FILM,1K OHM,1%,0.2W,TC=100 PPM	57668	CRB20T68EFX1001
A2R209	321-0673-07			RES,FXD,FILM:17K OHM,0.1%,0.125W,TC=T9 MI	07716	CEAE17001B
A2R210	321-0962-07			RES,FXD,FILM:8K OHM,0.1%,0.125W,TC=T9	57027	8.0K
A2R211	322-3085-00			RES,FXD:METAL FILM,75 OHM,0.1%,0.2W,TC=100 PPM,AXIAL	57668	CRB20FXE75E0
A2R212	307-0650-00			RES NTWK,FXD,FILM:9,2.7KOHM,5%,0.150	11236	750-101-R2.7K
A2R213	322-3193-00			RES,FXD:METAL FILM,1K OHM,1%,0.2W,TC=100 PPM,AXIAL	57668	CRB20T68EFX1001
A2R214	322-3193-00			RES,FXD,METAL FILM:1KOHM,1%,0.2WTC=100	57668	CRB20FXE1K00
A2R235	322-3097-00			RES,FXD,METAL,FI:100OHM,1%,0.2WTC=100,PPM;AXIAL	57668	CRB20FXE100E
A2T1	120-1885-01			TRANSFORMER,PWR:	80009	120-1885-01
A2TP1	214-4085-00			TERM , TEST POINT:0.070 ID,0.220H,0.063 DIA PCB,0.015 X 0.032 BRS,W/RED NYLON COLLAR	26364	104-01-02

Replaceable electrical parts list (Cont.)

Component number	Tektronix part number	Serial no. effective	Serial no. discont'd	Name & description	Mfr. code	Mfr. part number
A2TP2	214-4085-00			TERM, TEST POINT:0.070 ID,0.220H,0.063 DIA PCB,0.015 X 0.032 BRS,W/RED NYLON COLLAR	26364	104-01-02
A2TP3	214-4085-00			TERM,TEST POINT:0.070 ID,0.220 H,0.063 DIA PCB,0.015 X 0.032 BRASS,W/ RED NYLON COLLAR	26364	104-01-02
A2TP4	214-4085-00			TERM,TEST POINT:0.070 ID,0.220 H,0.063 DIA PCB,0.015 X 0.032 BRASS,W/ RED NYLON COLLAR	26364	TP104-01-02
A2TP5	214-4085-00			TERM,TEST POINT:0.070 ID,0.220 H,0.063 DIA PCB,0.015 X 0.032 BRASS,W/ RED NYLON COLLAR	26364	TP104-01-02
A2TP6	214-4085-00			TERM,TEST POINT:0.070 ID,0.220 H,0.063 DIA PCB,0.015 X 0.032 BRASS,W/ RED NYLON COLLAR (Opt01)	26364	TP104-01-02
A2TP7	214-4085-00			TERM,TEST POINT:0.070 ID,0.220 H,0.063 DIA PCB,0.015 X 0.032 BRASS,W/ RED NYLON COLLAR	26364	TP104-01-02
A2TP8	214-4085-00			TERM,TEST POINT:0.070 ID,0.220 H,0.063 DIA PCB,0.015 X 0.032 BRASS,W/ RED NYLON COLLAR	26364	TP104-01-02
A2TP9	214-4085-00			TERM,TEST POINT:0.070 ID,0.220 H,0.063 DIA PCB,0.015 X 0.032 BRASS,W/ RED NYLON COLLAR	26364	TP104-01-02
A2TP10	214-4085-00			TERM,TEST POINT:0.070 ID,0.220 H,0.063 DIA PCB,0.015 X 0.032 BRASS,W/ RED NYLON COLLAR	26364	TP104-01-02
A2TP11	214-4085-00			TERM,TEST POINT:0.070 ID,0.220 H,0.063 DIA PCB,0.015 X 0.032 BRASS,W/ RED NYLON COLLAR (Opt01)	26364	TP104-01-02
A2TP12	214-4085-00			TERM,TEST POINT:0.070 ID,0.220 H,0.063 DIA PCB,0.015 X 0.032 BRASS,W/ RED NYLON COLLAR	26364	TP104-01-02
A2TP13	214-4085-00			TERM,TEST POINT:0.070 ID,0.220 H,0.063 DIA PCB,0.015 X 0.032 BRASS,W/ RED NYLON COLLAR	26364	TP104-01-02
A2U1	156-4024-00			IC,LINEAR:BIPOLAR,OP-AMP,190MHZ,CURRENT FEEDBACK,1 TO 40 GAIN RANGE,AD9617JN,DIP08.3	24355	AD9617JN
A2U2	156-4024-00			IC,LINEAR:BIPOLAR,OP-AMP,190MHZ,CURRENT FEEDBACK,1 TO 40 GAIN RANGE,AD9617JN,DIP08.3	24355	AD9617JN
A2U3	156-0527-00			IC,LINEAR:BIPOLAR,VOLTAGE REGULATOR,NEGATIVE,15V,1.0A,4%,MC7915CT,TO-220	01295	UA7915CKC
A2U4	156-4170-00			IC,LINEAR:BIPOLAR,OP-AMP,CURRENT FEEDBACK,100MHZ,HIGH OUTPUT CURRENT,OPA603AP,DIP08.3 (Opt01)	13919	OPA603AP
A2U5	156-6376-00			IC,CONVERTER:BIPOLAR,D/A,12-BIT,20MHZ,2LSB,CURRENT OUT,LATCHED,TDC1012RSC1,PLCC28.3	07933	TDC1012R3C1
A2U9	156-3373-00			IC,DIGITAL:ACMOS,FLIP FLOP,OCTAL D-TYPE,3-STATE,74AC374,DIP30.3,TUBE	04713	MC74AC374N
A2U21	160-7452-01	671-1862-04		IC,MEMORY:CMOS,PROM 8K X 8,PRGM 156-3836-00,CY7C265-50 (STD)	TK0198	160745201
A2U21	160-7452-01	671-2089-04		IC,MEMORY:CMOS,PROM 8K X 8,PRGM 156-3836-00,CY7C265-50 (OPT 01)	TK0198	160745201
A2U21	160-9659-00	671-2950-00		IC,MEMORY:CMOS,PROM,8K X 8,PRGM 156-3836-00,CY7C265-50 (OPT 02)	TK0198	160965900
A2U21	160-9659-00	671-3464-00		IC,MEMORY:CMOS,PROM,8K X 8,PRGM 156-3836-00,CY7C265-50 (OPT 01 & 02)	TK0198	160965900

Replaceable electrical parts list (Cont.)

Component number	Tektronix part number	Serial no. effective	Serial no. discont'd	Name & description	Mfr. code	Mfr. part number
A2U23	160-7453-01	671-1862-04		IC, MEMORY: CMOS, PROM 8K X 8, PRGM 156-3836-00, CY7C265-50 (STD)	TK0198	160745301
A2U23	160-7453-01	671-2089-04		IC, MEMORY: CMOS, PROM 8K X 8, PRGM 156-3836-00, CY7C265-50 (OPT 01)	TK0198	160745301
A2U23	160-9660-00	671-2950-00		IC, MEMORY: CMOS, PROM, 8K X 8, PRGM 156-3836-00, CY7C265-50 (OPT 02)	TK0198	160966000
A2U23	160-9660-00	671-3464-00		IC, MEMORY: CMOS, PROM, 8K X 8, PRGM 156-3836-00, CY7C265-50 (OPT 01 & 02)	TK0198	160966000
	136-1038-00			*MOUNTING PARTS* SOCKET, DIP:	00779	2-641873-1
				END MOUNTING PARTS		
A2U25	160-8247-00	671-2089-04		MICROCKT, DGTL: CY7C265-50 (OPT 01)	80009	160-8247-00
A2U25	163-0247-00	671-3464-00		MICROCKT, DGTL: CY7C265-50 (OPT 01 & 02)	80009	160-8247-00
	136-1038-00			*MOUNTING PARTS* SOCKET, DIP:	00779	2-641873-1
				END MOUNTING PARTS		
A2U27	160-7454-01	671-1862-04		IC, MEMORY: CMOS, PROM 8K X 8, PRGM 156-3836-00, CY7C265-50 (STD)	TK0198	160745401
A2U27	160-7454-01	671-2089-04		IC, MEMORY: CMOS, PROM 8K X 8, PRGM 156-3836-00, CY7C265-50 (OPT 01)	TK0198	160745401
A2U27	160-9661-00	671-2950-00		IC, MEMORY: CMOS, PROM, 8K X 8, PRGM 156-3836-00, CY7C265-50 (OPT 02)	TK0198	160966100
A2U27	160-9661-00	671-3464-00		IC, MEMORY: CMOS, PROM, 8K X 8, PRGM 156-3836-00, CY7C265-50 (OPT 01 & 02)	TK0198	160966100
A2U29	156-3019-00			IC, LINEAR: BIPOLAR, VOLTAGE REFERENCE, 1.235V, 1.0%, 150PPM, SHUNT, MICROPOWER, LM385BZ-1.2, TO-92	27014	LM385BZ-1.2
A2U30	156-4170-00			IC, LINEAR: BIPOLAR, OP-AMP, CURRENT FEEDBACK, 100MHZ, HIGH OUTPUT CURRENT, OPA603AP, DIP08.3	13919	OPA603AP
A2U31	156-6376-00			IC, CONVERTER: BIPOLAR, D/A, 12-BIT, 20MHZ, 2LSB, CURRENT OUT, LATCHED, TDC1012R3C1, PLCC28.3	07933	TDC1012R3C1
	136-1005-00			*MOUNTING PARTS* SKT, PL-IN ELECK:	00779	3-821581-1
				END MOUNTING PARTS		
A2U32	156-3019-00			IC, LINEAR: BIPOLAR, VOLTAGE REFERENCE, 1.235V, 1.0%, 150PPM, SHUNT, MICROPOWER, LM385BZ-1.2, TO-92	27014	LM385BZ-1.2
A2U33	156-4170-00			IC, LINEAR: BIPOLAR, OP-AMP, CURRENT FEEDBACK, 100MHZ, HIGH OUTPUT CURRENT, OPA603AP, DIP08.3	13919	OPA603AP
A2U34	156-6172-00			IC, CONVERTER: BIPOLAR, D/A, 10 BIT, 20MHZ, CURRENT OUTPUT, 0.5LSBINL, TDC1041R3C1, PLCC28-1, TUBE	07933	TDC1041R3C1
	136-1005-00			*MOUNTING PARTS* SKT, PL-IN ELEK:	00779	3-821581-1

Replaceable electrical parts list (Cont.)

Component number	Tektronix part number	Serial no. effective	Serial no. discount'd	Name & description	Mfr. code	Mfr. part number
				END MOUNTING PARTS		
A2U37	156-3019-00			IC,LINEAR:BIPOLAR,VOLTAGE REFERENCE,1.235V,1.0%,150PPM,SHUNT,MICROPOWER,LM385BZ-1.2,TO-92 (Opt 01)	27014	LM385BZ-1.2
A2U40	156-1291-00			IC,LINEAR:BIFET,OP-AMP,DUAL,LOW POWER,TL062CP,DIP08.3	01295	TL062CP
A2U102	160-7155-01	671-1862-04		IC,DIGITAL:CMOS,2048 X 8,REG PROM,PRGM 156-4025-00,27C020,DIP24 (STD)	TK0198	160715501
A2U102	160-7155-01	671-2089-04		IC,DIGITAL:CMOS,2048 X 8,REG PROM,PRGM 156-4025-00,27C020,DIP24 (OPT 01)	TK0198	160715501
A2U102	160-9662-00	671-2950-00		IC,MEMORY:CMOS,EPROM,256K X 8,200NS,PRGM 156-4025-00,27C020,DIP32.6 (OPT 02)	TK0198	160966200
A2U102	160-9662-00	671-3464-00		IC,MEMORY:CMOS,EPROM,256K X 8,200NS,PRGM 156-4025-00,27C020,DIP32.6 (OPT 01 & 02)	TK0198	160966200
				MOUNTING PARTS		
	136-0963-00			SKT,PL-IN ELECK:MICROCKT,32 PIN	00779	2-644018-3
				END MOUNTING PARTS		
A2U103	156-2951-00			IC,MEMORY:CMOS,PROM,1024 X 8,7C281-45,DIP24.300	65786	CY7C281-45PC
				MOUNTING PARTS		
	136-0925-00			SOCKET,DIP:	91506	224-AG30D
				END MOUNTING PARTS		
A2U104	160-6968-01	671-1862-04		IC,MEMORY:CMOS,EPROM,128K,PRGM (STD)	TK0198	160696801
A2U104	160-6968-01	671-2089-04		IC,MEMORY:CMOS,EPROM,128K,PRGM (OPT 01)	TK0198	160696801
A2U104	160-9663-00	671-2950-00		IC,MEMORY:CMOS,EPROM,256K X 8,200NS,PRGM 156-4025-00,27C020,DIP32.6 (OPT 02)	TK0198	160966300
A2U104	160-9663-00	671-3464-00		IC,MEMORY:CMOS,EPROM,256K X 8,200NS,PRGM 156-4025-00,27C020,DIP32.6 (OPT 01 & 02)	TK0198	160966300
				MOUNTING PARTS		
	136-0963-00			SKT,PL-IN ELECK:MICROCKT,32 PIN	00779	2-644018-3
				END MOUNTING PARTS		
A2U106	156-0368-03			IC,DIGITAL:ECL,TRANSLATOR,QUAD TTL-TO-ECL,10124,DIP16.3,TUBE	04713	MC10124P
A2U108	156-0316-04			IC,DIGITAL:ECL,TRANSLATOR,QUAD ECL TO TTL,10125,DIP16.3,TUBE	04713	MC10125P
A2U150	156-3373-00			IC,DIGITAL:ACMOS,FLIP FLOP,OCTAL D-TYPE,3-STATE,74AC374,DIP30.3,TUBE	04713	MC74AC374N
A2U160	156-4104-00			IC,LINEAR:BIPOLAR,SW-REGULATOR CONTROLLER,PWM,CURRENT MODE,SINGLE TOTEM POLE OUTPUT,UC3843	04713	UC3843N
A2U161	160-9330-00	671-1862-04		IC,DIGITAL:CMOS,PLD,OTP,5064,64 MACROCELL,30NS,PRGM 156-6229-00,5064-30,PLCC44,TUBE (STD)	TK0198	160933000

Replaceable electrical parts list (Cont.)

Component number	Tektronix part number	Serial no. effective	Serial no. discont'd	Name & description	Mfr. code	Mfr. part number
A2U161	160-9330-00	671-2089-04		IC,DIGITAL:CMOS,PLD,OTP,5064,64 MACROCELL,30NS,PRGM 156-6229-00,5064-30,PLCC44,TUBE (OPT 01)	TK0198	160933000
A2U161	160-9664-00	671-2950-00		IC,DIGITAL:CMOS,PLD,OTP,5064,64 MACROCELL,30NS,PRGM 156-6229-00,5064-30,PLCC44,TUBE (OPT 02)	TK0198	160966400
A2U161	160-9664-00	671-3464-00		IC,DIGITAL:CMOS,PLD,OTP,5064,64 MACROCELL,30NS,PRGM 156-6229-00,5064-30,PLCC44,TUBE (OPT 01 & 02)	TK0198	160966400
	136-1047-00			*MOUNTING PARTS* SOCKET,PLCC:PCB,44 POS,0.05 CTR,0.360 H X 0.125 TAILTIN	80009	136-1047-00
				END MOUNTING PARTS		
A2U164	156-3637-00			IC,DIGITAL:ACTCMOS,FLIP FLOP,HEX D-TYPE,CLEAR,74ACT174,DIP16.3,TUBE	04713	MC74ACT174N
A2W151	131-4566-00			BUS,CONDUCTOR:0 OHM,300 SPACING,SM BODY MI,DUMMY RES	91637	FRJ-50
A2W153	131-4566-00			BUS,CONDUCTOR:0 OHM,300 SPACING,SM BODY MI,DUMMY RES	91637	FRJ-50
A2W154	131-4566-00			BUS,CONDUCTOR:0 OHM,300 SPACING,SM BODY MI,DUMMY RES	91637	FRJ-50
A2Y1	119-3175-00			OSCILLATOR:TCXO,14.31818 MHZ	82567	03-02155-002
A3	671-1865-00			CIRCUIT BD ASSY:TOP BNC	80009	671-1865-00
A3J401	131-3378-00			CONN,RF JACK:	00779	227677-1
A3J402	131-5223-00			CONN,CIRC::PCB,MINI DIN,FEMALE,RTANG,4 POS,0.503 H X 0.137 TAIL,SILVER	0H1N4	MRP4FS
A3J403	131-3378-00			CONN,RF JACK:	00779	227677-1
A3J404	131-3378-00			CONN,RF JACK:	00779	227677-1
A3J405	174-2512-00			CA ASSY,SP,ELEC:16,28 AWG,1.8L,RIBBON	80009	174-2512-00
A4	671-1866-00			CIRCUIT BD ASSY:BOTTOM BNC	80009	671-1866-01
A4J501	131-3378-00			CONN,RF JACK	00779	227677-1
A4J502	131-3378-00			CONN,RF JACK	00779	227677-1
A4J503	131-3378-00			CONN,RF JACK	00779	227677-1
A4J504	131-3378-00			CONN,RF JACK	00779	227677-1
A4J505	131-3378-00			CONN,RF JACK	00779	227677-1
A4J506	131-3378-00			CONN,RF JACK	00779	227677-1
A4W4	174-2337-01			CA ASSY,SP,ELEC:3.0L,10.28 AWG,1.6L,RIBBON (CONNECTED FROM A2J4 TO A4J505)	80009	174-2337-01



Diagrams/Circuit Board Illustrations

Section 7

Diagrams/Circuit Board Illustrations

Symbols

Graphic symbols and class designation letters are based on ANSI Standard Y32.2–1975.

Logic symbology is based on ANSI Y32.14–1973 in terms of positive logic. Logic symbols depict the logic function performed and may differ from the manufacturer’s data.

Overline, parenthesis, or leading slash indicate a low asserting state.

Example: $\overline{\text{ID CONTROL}}$, (ID CONTROL), or /ID CONTROL.

Abbreviations are based on ANSI Y1.1–1972.

Other ANSI standards that are used in the preparation of diagrams by Tektronix, Inc. are:

- Y14.15, 1966 -- Drafting Practices.
- Y14.2, 1973 -- Line Conventions and Lettering.
- Y10.5, 1968 -- Letter Symbols for Quantities Used in Electrical Science

and

Electrical Engineering.

American National Standard Institute
1430 Broadway, New York, New York 10018

Component Values

Electrical components shown on the diagrams are in the following units unless noted otherwise:

- Capacitors: Values one or greater are in picofarads (pF).
Values less than one are in microfarads (μF).
- Resistors = Ohms (Ω).

The following information and special symbols may appear in this manual.

Assembly Numbers

Each assembly in the instrument is assigned an assembly number (e.g., A20). The assembly number appears on the diagram (in circuit board outline), circuit board illustration title, and lookup table for the schematic diagram.

The Replaceable Electrical Parts List is arranged by assembly number in numerical sequence; the components are listed by component number. Example:

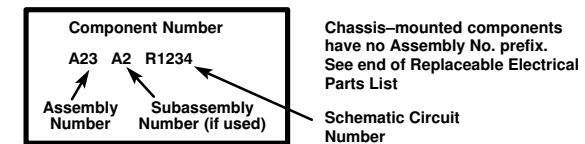

Grid Coordinates

The schematic diagram and circuit board component location illustration have grids. A lookup table with the grid coordinates is provided for ease of locating the component. Only the components illustrated on the facing diagram are listed in the lookup table.

When more than one schematic diagram is used to illustrate the circuitry on a circuit board, the circuit board illustration will only appear opposite the first diagram; the lookup table will list the diagram number of other diagrams that the other circuitry appears on.

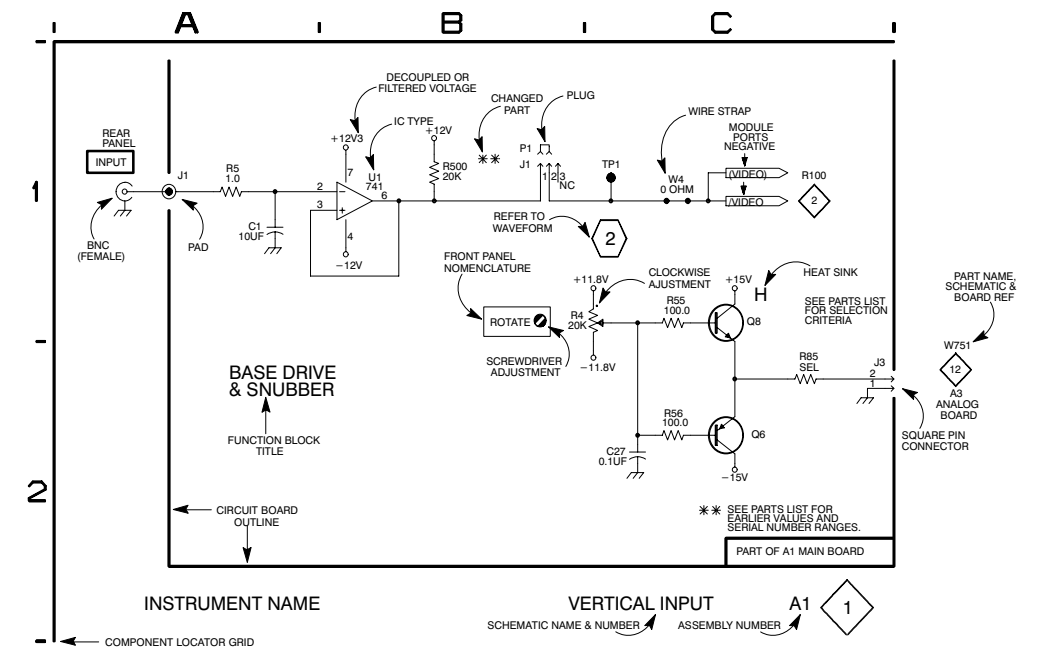

**FRONT PANEL BD.
SCHEMATIC
DIAGRAM <1>
LOOK-UP CHART**

The schematic diagram has an alpha-numeric grid to assist in locating parts within that diagram. The etched circuit boards follow a numbering sequence starting with the lowest number at the upper left corner, as pictured in this manual.

ASSEMBLY A1

CIRCUIT NUMBER	SCHEM LOCATION	BOARD LOCATION
C201	B2	A5
C202	B2	A5
C250	A5	A2
C251	B5	A3
C252	B5	A5
C253	B5	A7
DS220	G2	A1
DS221	G3	A1
J201	A1	B7
R201	G4	A2
R207	G2	A2
S202A	C4	A2
S202B	C4	A2
S203A	C4	A3
S203B	C4	A3
S204A	D4	A4
S204B	D4	A4
S205A	D4	A4
S205B	D4	A4
S206A	F4	A5
S206B	F4	A5
S207A	F4	A6
S207B	F4	A6
S208A	F4	A6
S208B	F4	A6
S209A	G4	A7
S209B	G4	A7
U204	B1	A5
U207	E2	A4
U209	B4	A3
U210	D1	A8

COMPONENT NUMBER EXAMPLE

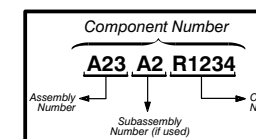

Chassis-mounted components have no Assembly Number prefix—see end of Replaceable Electrical Parts List.

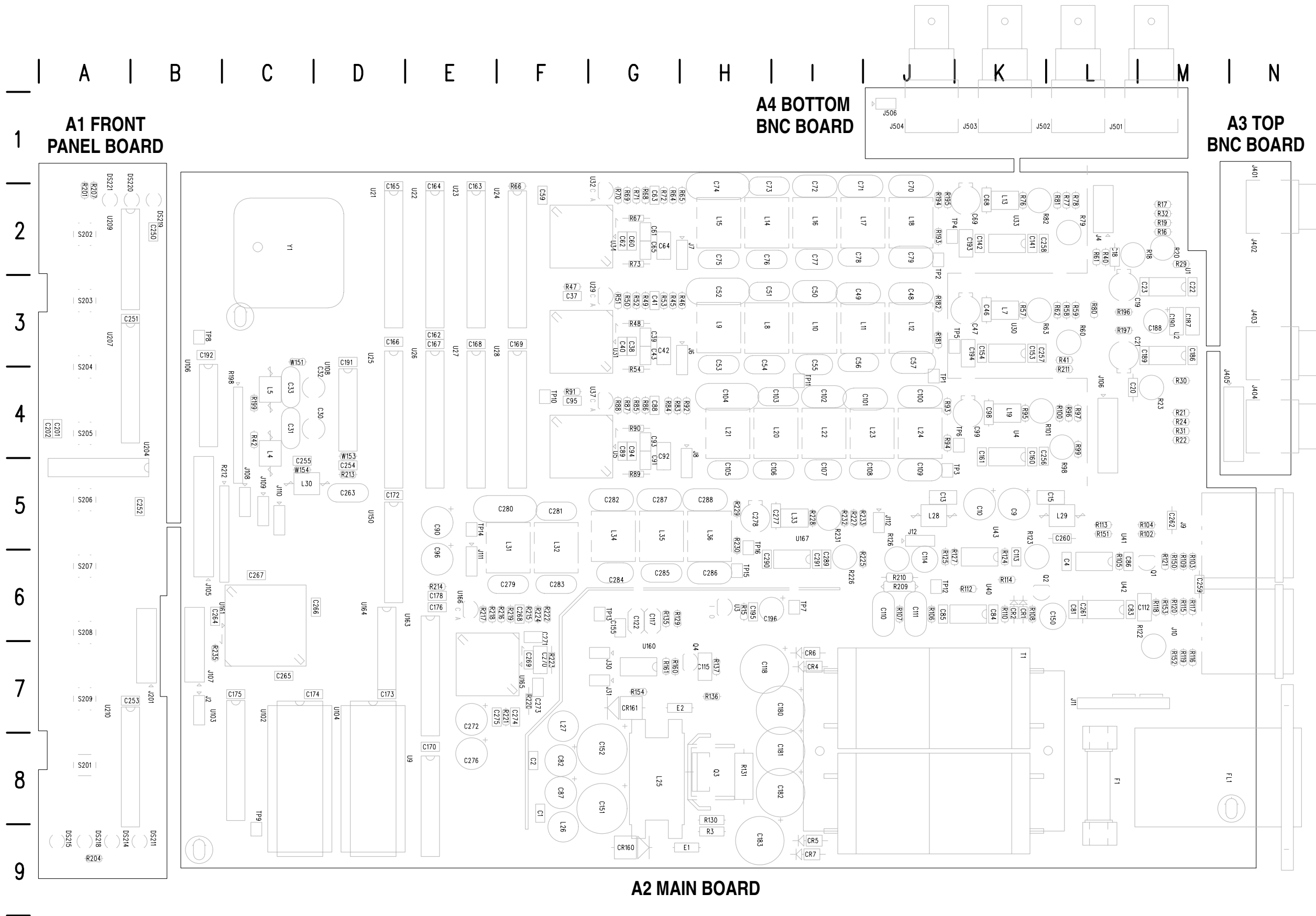

1

2

3

4

5

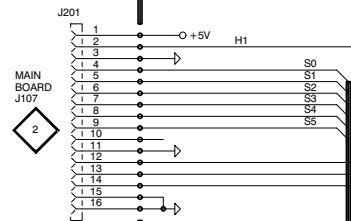

NOTE: PIN 10 WAS
TIED TO
ON SERIAL
NUMBER
B010286 AND
BELOW.

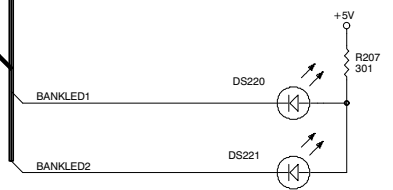
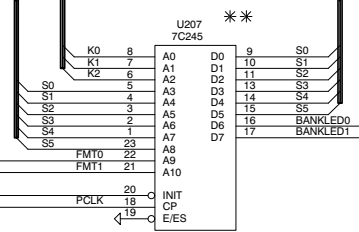
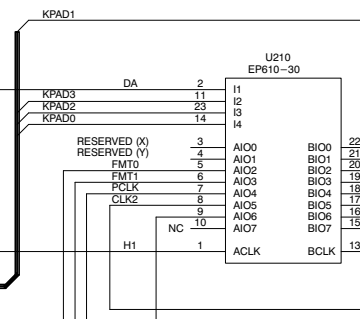
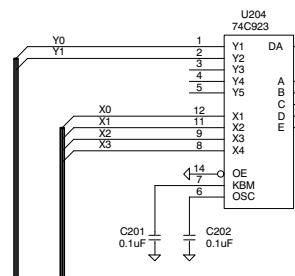

FRONT PANEL SWITCHES

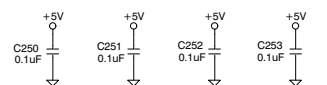
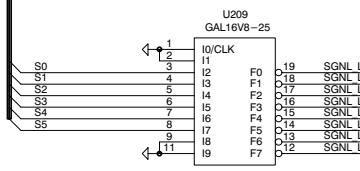
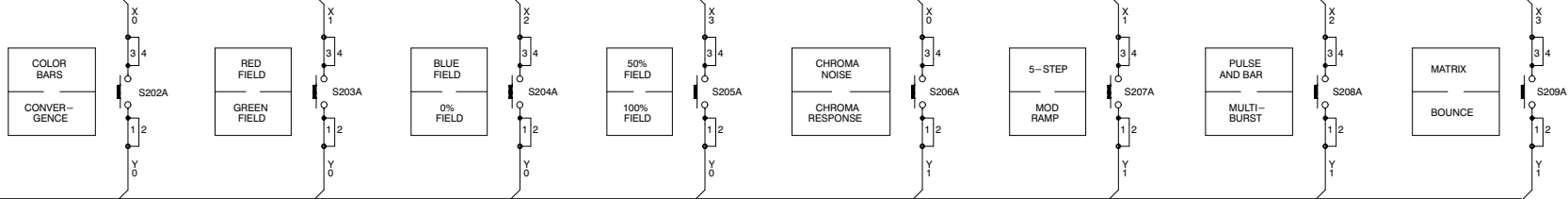

** SEE ELECTRICAL PARTS LIST
FOR EARLIER VALUES AND
SERIAL NUMBER RANGES.

MAIN BOARD SCHEMATIC DIAGRAM <2>

LOOK-UP CHART

The schematic diagram has an alpha-numeric grid to assist in locating parts within that diagram. The etched circuit boards follow a numbering sequence starting with the lowest number at the upper left corner, as pictured in this manual.

ASSEMBLY A2. *Partial Assembly A2 also shown on Schematic Diagrams 3, 4, 5, 6, and 7.*

CIRCUIT NUMBER	SCHEM LOCATION	BOARD LOCATION
C30	F5	C4
C31	F5	C4
C32	F5	C4
C33	F5	C4
C191	G5	D4
C192	D5	B3
C254	F5	D5
C255	G5	C5
C263	F4	D5
C264	B3	B6
C265	B3	C7
C266	B3	D6
C267	B3	C6
J2	E2	B7
J105	A2	B5
J107	A1	B7
J108	D2	
L4	E5	C4
L5	E5	C4
L30	F5	C5
R42	E5	C4
R198	E5	C4
R199	E5	C4
R212A	D2	B5
R212B	D3	B5
R212C	E3	B5
R212D	B2	B5
R212E	A2	B5
R212F	F2	B5
R212G	E1	B5
R213	F4	D5
R235	C1	B7
U103	F1	D8
U106	D5	B4
U108	G5	D4
U161	C2	D8
W151	D4	C4
W153	D4	D5
W154	E3	C5
Y1	C4	C2

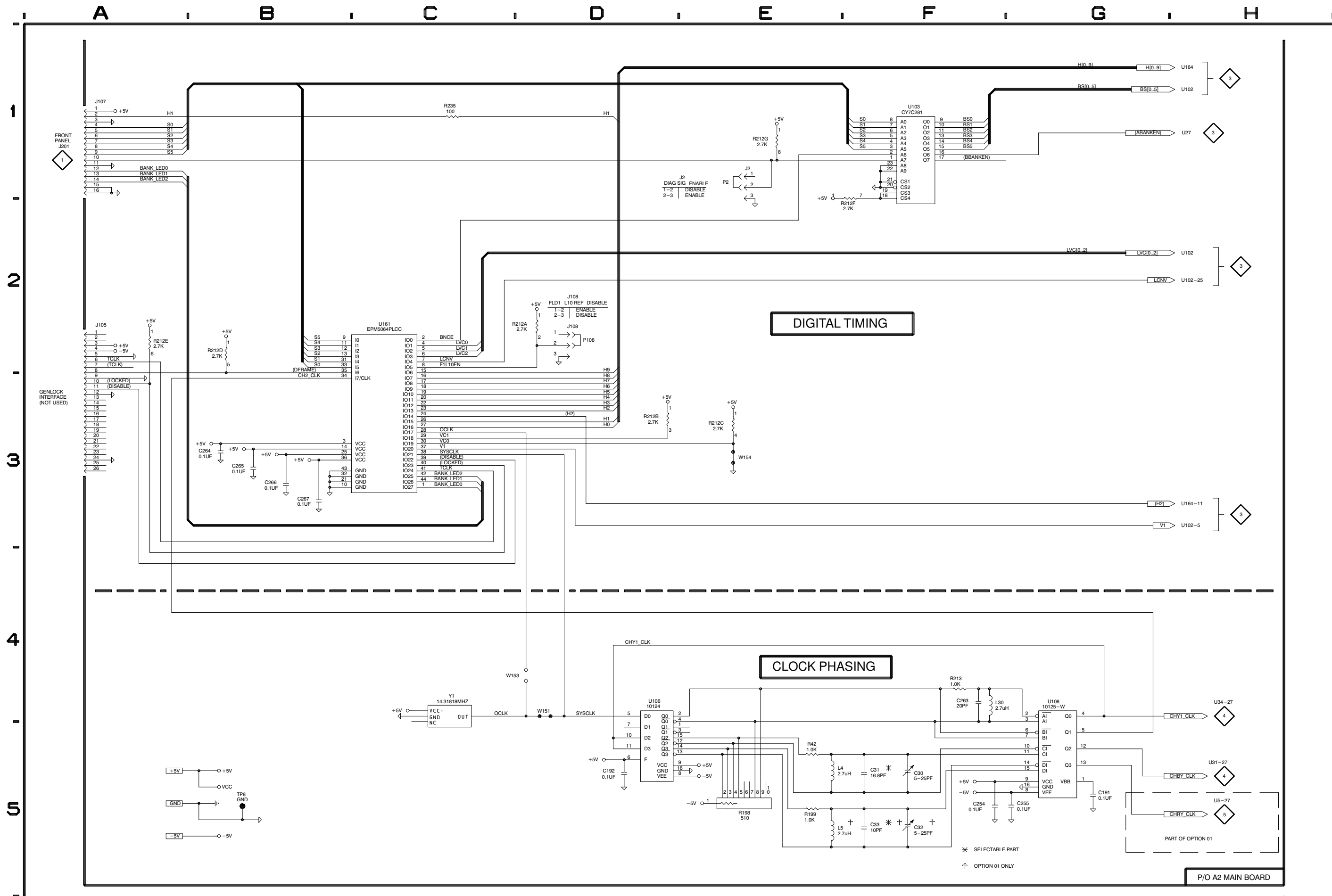

MAIN BOARD SCHEMATIC DIAGRAM < 3 > LOOK-UP CHART

The schematic diagram has an alpha-numeric grid to assist in locating parts within that diagram. The etched circuit boards follow a numbering sequence starting with the lowest number at the upper left corner, as pictured in this manual.

ASSEMBLY A2. *Partial Assembly A2 also shown on Schematic Diagrams 2, 4, 5, 6, and 7.*

CIRCUIT NUMBER	SCHEM LOCATION	BOARD LOCATION
R214 *	B2	E6
U9	C3	E6
U14 *	B2	D5
U21	F2	D2
U23	F3	E2
U25	F4	D4
U27	F2	E4
U102	B3	C7
U104	B2	C6
U150	C2	D5
U164 *	B2	D6

*See Parts List for serial number ranges.

SIGNAL SEGMENT MEMORY

SIGNAL SEGMENT ADDRESS MEMORY

PART OF OPTION ONE

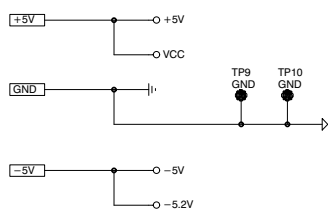
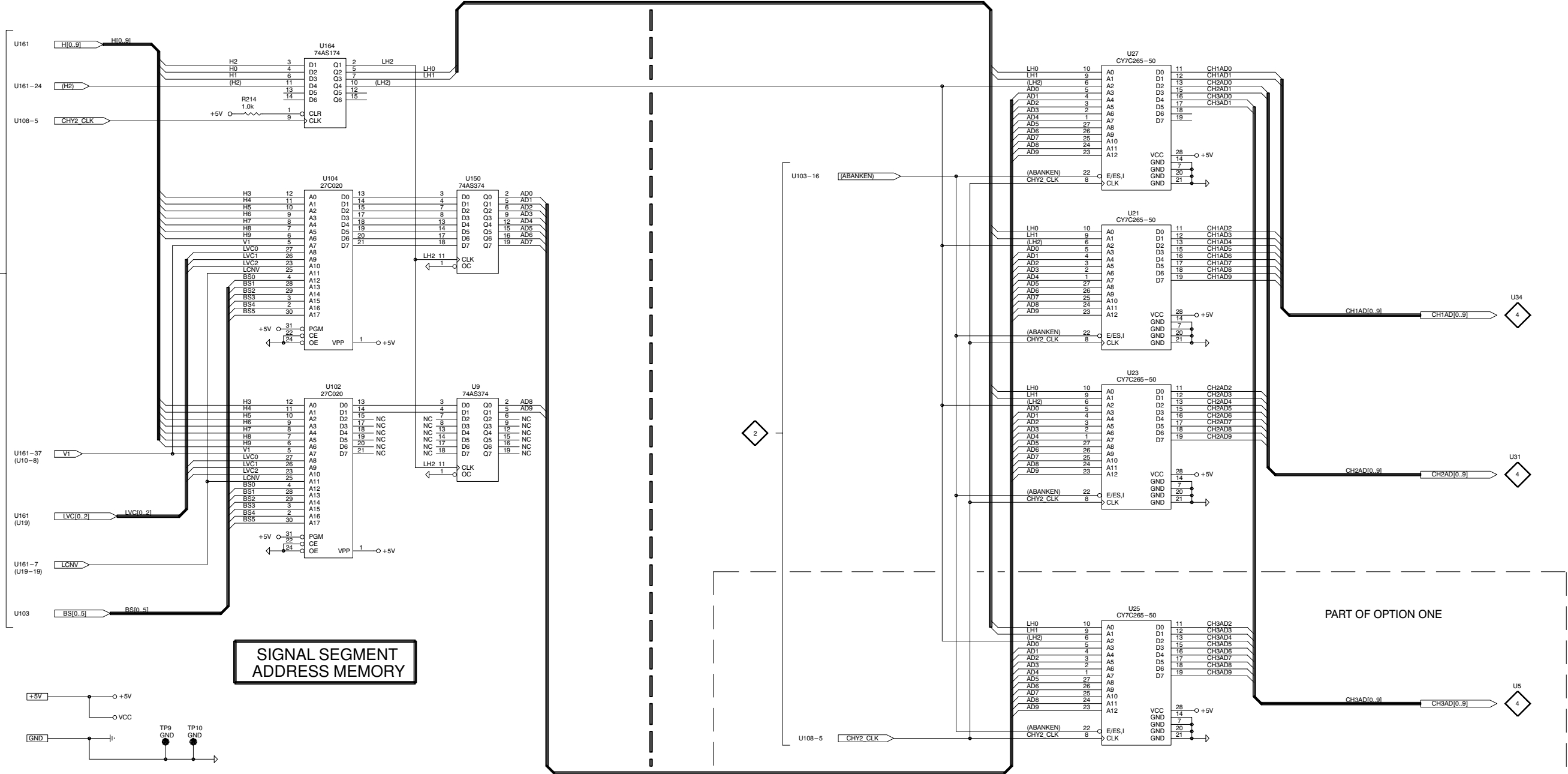

* * SEE ELECTRICAL PARTS LIST FOR EARLIER VALUES AND SERIAL NUMBER RANGES.

MAIN BOARD SCHEMATIC DIAGRAM <4> LOOK-UP CHART

The schematic diagram has an alpha-numeric grid to assist in locating parts within that diagram. The etched circuit boards follow a numbering sequence starting with the lowest number at the upper left corner, as pictured in this manual.

ASSEMBLY A2. *Partial Assembly A2 also shown on Diagrams 2, 3, 5, 6, and 7.*

CIRCUIT NUMBER	SCHEM LOCATION	BOARD LOCATION	CIRCUIT NUMBER	SCHEM LOCATION	BOARD LOCATION	CIRCUIT NUMBER	SCHEM LOCATION	BOARD LOCATION
C18	F2	L2	C190	F4	M3	R64	C1	G2
C19	F2	L3	C193	E2	K2	R65	C1	H2
C20	F4	L4	C194	E5	K3	R66	C1	F2
C21	F4	L3				R67	C2	G2
C22	F1	M3	J4	H1	L2	R68	B2	G2
			J6	C3	H3			
C23	F1	M3	J7	C1	H2	R69	B2	G2
C37	C4	F3	J106	H2	L4	R70	B2	G2
C38	C4	G3				R71	B2	G2
C39	C4	G3	L7	E5	K3	R72	B1	G2
C40	B4	G3	L8	C4	H3	R73	B2	G2
			L9	C4	H3			
C41	B5	G3	L10	D3	I3	R76	E3	K2
C42	C4	G3	L11	D3	I3	R77	F3	L2
C43	C4	G3				R78	F2	L2
C46	E5	K3	L12	D3	J3	R79	F2	L2
C47	E5	K3	L13	E3	K2	R80	G2	L2
			L14	C1	H2			
C48	E4	J3	L15	C2	H2	R81	E3	L2
C49	D4	I3	L16	D1	I2	R82	E3	K2
C50	D4	I3				R181	E4	J3
C51	D4	H3	L17	D1	I2	R182	E4	J3
C52	C4	H3	L18	D1	J2	R194	E2	J2
C53	C4	H3	R16	F1	M2	R195	E2	J2
C54	C3	H3	R17	F1	M2	R196	G1	L3
C55	D3	I3	R18	F1	L2	R197	G3	L3
C56	D3	I3	R19	F1	M2	R211	H2	L4
C57	D3	J3	R20	F2	M2			
						TP1	E3	J4
C59	C2	F2	R21	F4	M4	TP2	E1	J2
C60	C2	G2	R22	G4	M4	TP4	E1	K2
C61	C2	G2	R23	G3	M4	TP5	E3	K3
C62	B2	G2	R24	F4	M4			
C63	B2	G2	R29	G1	M2	U1	F1	M3
						U2	F3	M3
C64	C2	G2	R30	G3	M4	U29	B4	G3
C65	C2	G2	R31	G4	M4	U30	E4	K3
C68	E3	K2	R32	F1	M2			
C69	E3	K2	R40	G1	L2	U31	B3	F3
C70	E1	J2	R41	F4	L4	U32	B2	G2
						U33	E2	K2
C71	D1	I2	R45	C3	G3	U34	B1	F2
C72	D1	I2	R46	C4	H3			
C73	D1	H2	R47	C4	F3			
C74	C1	H2	R48	C4	G3			
C75	C1	H2	R49	B4	G3			
C76	C1	H2	R50	B5	G3			
C77	D1	I2	R51	B5	G3			
C78	D1	I2	R52	B4	G3			
C79	D1	J2	R53	B4	G3			
C141	E2	K2	R54	B4	G4			
C142	E2	K2	R57	E5	K3			
C153	E4	K3	R58	F5	L3			
C154	E5	K3	R59	F5	L3			
C186	F3	M3	R60	F4	L3			
C187	F1	M3	R61	G1	L2			
C188	F3	M3	R62	E5	L3			
C189	F4	M3	R63	E5	K3			

* See parts list for serial number ranges.

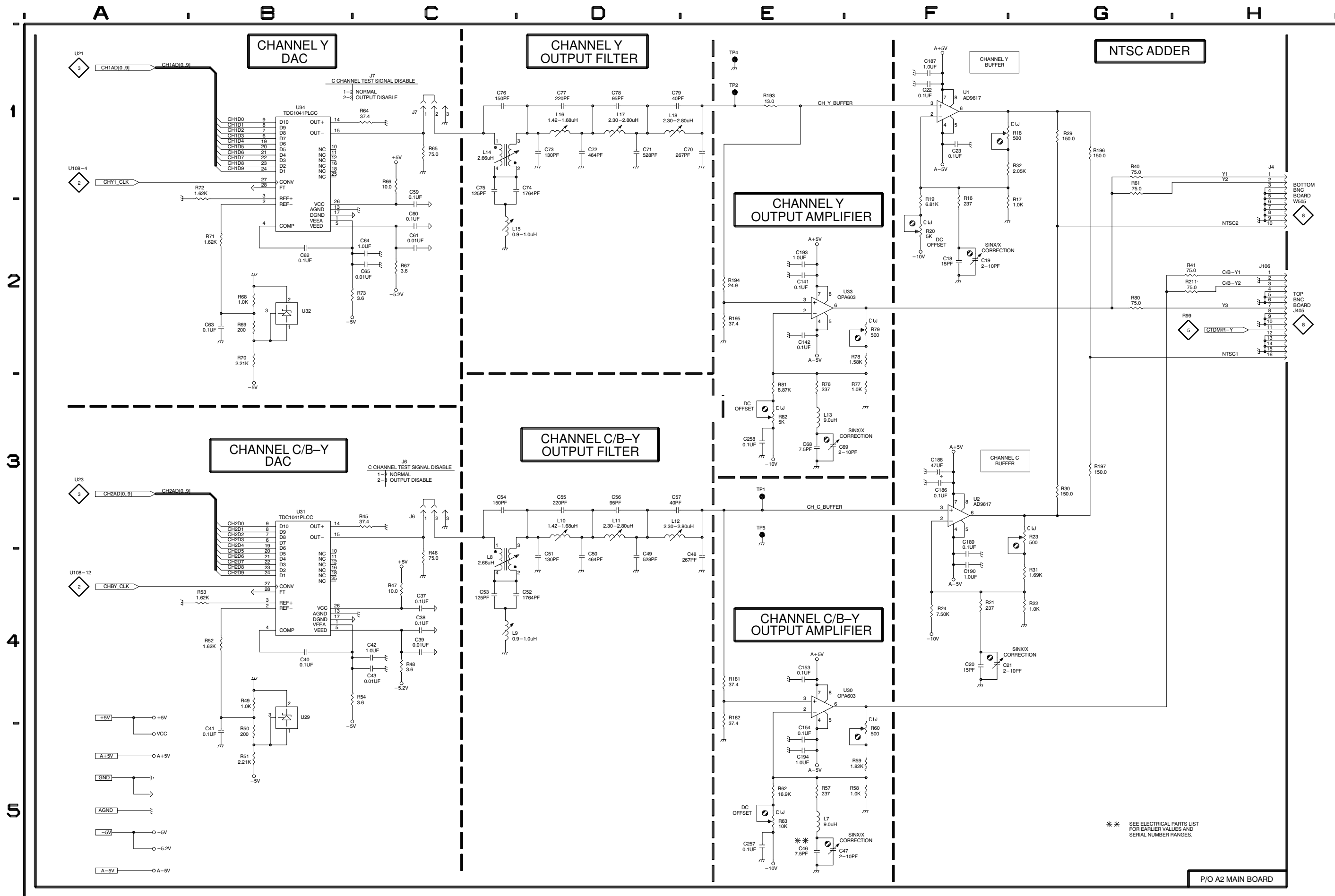

** SEE ELECTRICAL PARTS LIST FOR EARLIER VALUES AND SERIAL NUMBER RANGES.

P/O A2 MAIN BOARD

**MAIN BOARD
SCHEMATIC DIAGRAM <5>
LOOK-UP CHART**

The schematic diagram has an alpha-numeric grid to assist in locating parts within that diagram. The etched circuit boards follow a numbering sequence starting with the lowest number at the upper left corner, as pictured in this manual.

ASSEMBLY A2. *Partial Assembly A2 also shown on Diagrams 2, 3, 4, 6, and 7.*

CIRCUIT NUMBER	SCHEM LOCATION	BOARD LOCATION	CIRCUIT NUMBER	SCHEM LOCATION	BOARD LOCATION
C88	B4	G4	R83	C3	H4
C89	B3	G4	R84	B3	G4
C90	C4	G5	R85	B3	G4
C91	C4	G5	R86	B4	G4
C92	C4	G4	R87	B4	G4
C93	C3	G4	R88	B4	G4
C94	C3	G4	R89	C4	G5
C95	C3	F4	R90	C3	G4
C96	C3	G4	R91	C3	F4
C98	G3	K4	R92	C3	H4
C99	G3	K4	R93	F3	J4
C100	E3	J4	R94	F3	J4
C101	E3	J4	R95	G3	K4
C102	E3	I4	R96	G3	L4
C103	D3	I4	R97	G3	L4
C104	D3	H4	R98	G3	L4
C105	D3	H5	R99	G3	L5
C106	D3	I5	R100	F3	L4
C107	D3	I5	R101	F3	K4
C108	E3	J5	TP3	E2	J5
C109	E3	J5	TP6	E2	K4
C160	G2	K4	U4	G3	K5
C161	G3	K4	U5	B3	F4
J8	C3	H5	U37	B4	G4
L19	G3	K4			
L20	D3	I4			
L21	D3	H4			
L22	D3	I4			
L23	E3	J4			
L24	E3	J4			

BLACK BURST DAC

BLACK BURST OUTPUT FILTER

BLACK BURST OUTPUT AMPLIFIER

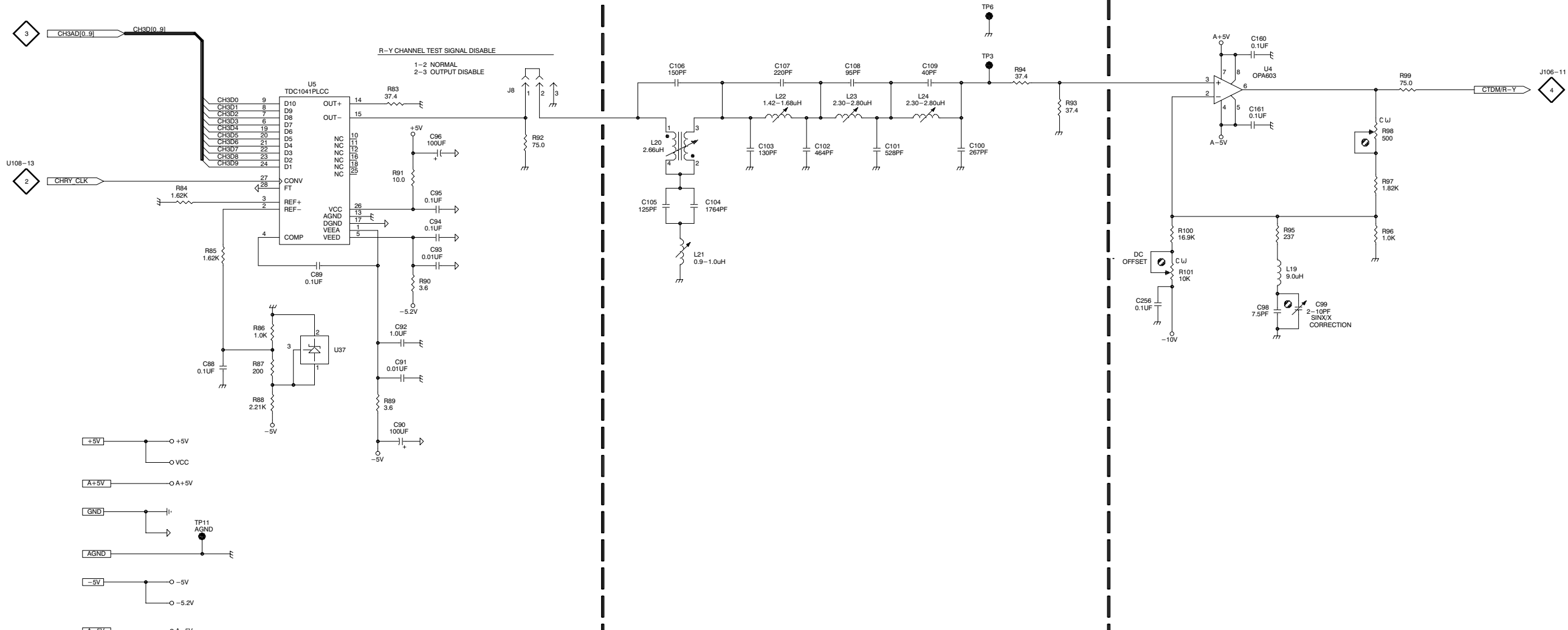

** SEE ELECTRICAL PARTS LIST FOR EARLIER VALUES AND SERIAL NUMBER RANGES.

THIS SCHEMATIC IS FOR CIRCUITRY USED IN OPTION ONE ONLY.

P/O A2 MAIN BOARD

**MAIN BOARD
SCHEMATIC DIAGRAM < 6 >
LOOK-UP CHART**

The schematic diagram has an alpha-numeric grid to assist in locating parts within that diagram. The etched circuit boards follow a numbering sequence starting with the lowest number at the upper left corner, as pictured in this manual.

ASSEMBLY A2. *Partial Assembly A2 also shown on Diagrams 2, 3, 4, 5, and 7.*

CIRCUIT NUMBER	SCHEM LOCATION	BOARD LOCATION	CIRCUIT NUMBER	SCHEM LOCATION	BOARD LOCATION
C4	E4	L6	R110	C2	K6
C81	E2	L6			
C83	E2	L6	R112	C2	K6
C84	B2	K6	R113	E3	L5
C85	B2	J6	R114	B2	K6
C86	E3	L6	R115	F2	M6
C110	B2	J6	R116	F2	M7
C111	B1	J6	R117	G2	M6
C112	D2	M6	R118	D2	M6
C113	D4	K6	R119	F2	M7
C114	C4	J6	R120	E1	M6
C150	B2	L6	R121	D3	M6
C184	F4	L6	R122	E1	M7
C185	F2	L6	R123	E3	K6
			R124	D4	K6
CR1	C2	K6	R125	C4	J6
CR2	C2	K6	R126	C3	J6
			R127	C4	J6
J9	H4	M5	R150	F4	M6
J10	H2	M6	R151	E3	L5
J12	B3	J5			
Q1	D4	M6	R152	F2	M7
Q2	B2	K6	R153	E2	M6
R102	F4	M5	U40A	B2	K6
R103	F4	M6	U40B	C2	K6
R104	G4	M5	U41A	E3	L6
R105	D4	L6	U41B	F4	L6
R106	B2	J6	U42A	E2	L6
R107	B1	J6	U42B	F2	L6
R108	B2	K6	U43	C4	K6
R109	F4	M6			

* See parts list for serial number ranges.

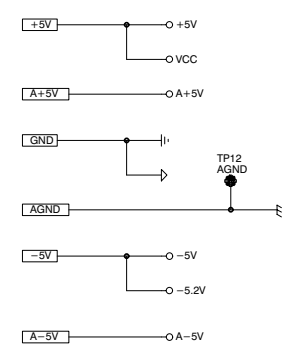
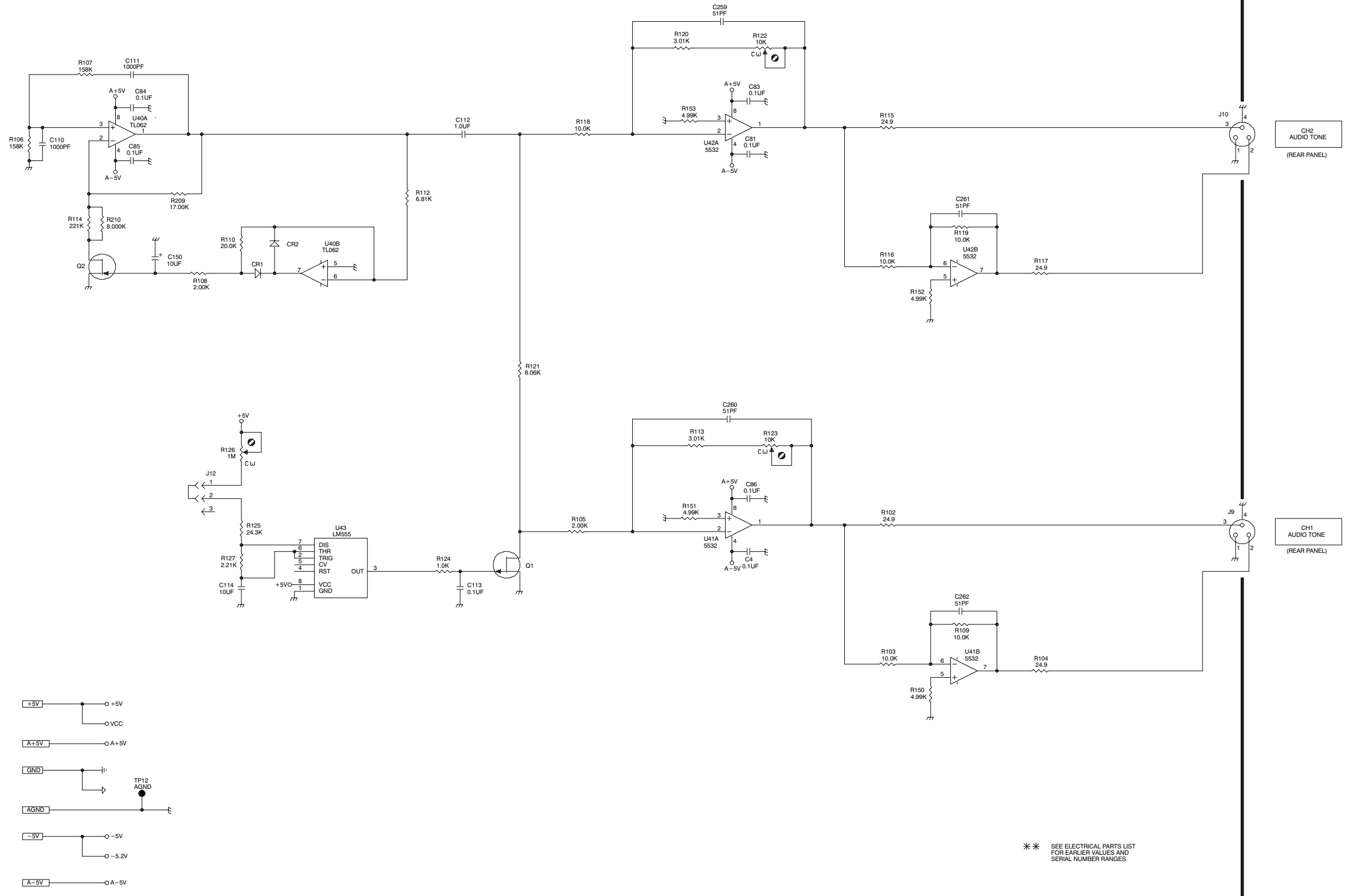

** SEE ELECTRICAL PARTS LIST FOR EARLIER VALUES AND SERIAL NUMBER RANGES.

P/O A2 MAIN BOARD

**MAIN BOARD
SCHEMATIC DIAGRAM <7>
LOOK-UP CHART**

The schematic diagram has an alpha-numeric grid to assist in locating parts within that diagram. The etched circuit boards follow a numbering sequence starting with the lowest number at the upper left corner, as pictured in this manual.

ASSEMBLY A2. *Partial Assembly A2 also shown on Diagrams 2, 3, 4, 5, and 6.*

CIRCUIT NUMBER	SCHEM LOCATION	BOARD LOCATION	CIRCUIT NUMBER	SCHEM LOCATION	BOARD LOCATION
C9	G3	K5	F1	B1	L8
C10	G4	K5			
C13	G4	J5	FL1	A1	M8
C15	G3	L5			
C82	F3	F8	J11	C1	L7
			J30	G2	G7
C87	F2	F8	J31	G3	G7
C115	C3	H7			
C117	B3	G6	L25	E2	H8
C118	F1	H7	L26	F2	F9
C122	C3	G6	L27	F2	F7
C151	F2	G8	Q3	D3	H8
C152	F3	G8	Q4	B3	H7
C155	B3	G6			
C162	B5	E3	R3	D3	H9
C163	B5	E2	R129	B3	G6
			R130	D3	H9
C164	C5	E2	R131	E3	H7
C165	C5	D2	R135	B3	G6
C166	C5	D3			
C167	D5	E3	R136	D3	H7
C168	D5	E3	R137	C3	H7
			R154	C3	G7
C169	D5	F3	R160	B3	G7
C170	E5	E5	R161	B3	G7
C172	E5	C5			
C173	E5	C5	T1	C1	J8
C174	E5	C7			
			U3	F4	H7
C175	F5	D8	U160	C3	G7
C176	F5	E8			
C177	F5	E6			
C178	G5	E8			
C180	F1	I7			
C181	F1	I8			
C182	G1	I8			
C183	G1	H9			
C195	G4	H7			
C196	G4	H7			
CR4	D1	I7			
CR5	D1	I9			
CR6	D1	I7			
CR7	D1	I9			
CR160	E2	G9			
CR161	E2	G7			

*See Parts List for serial number ranges.

A B C D E F G H

1

2

3

4

5

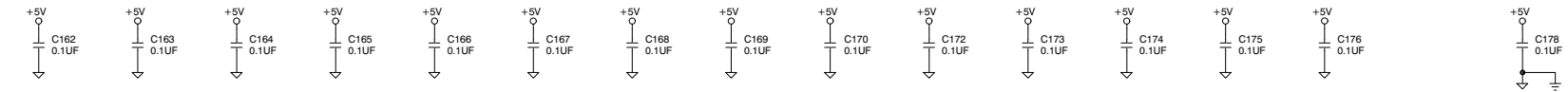
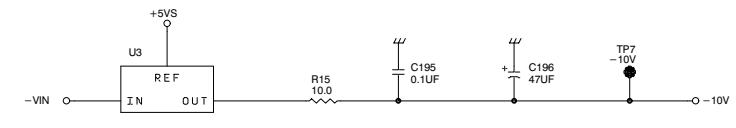
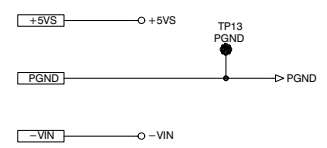
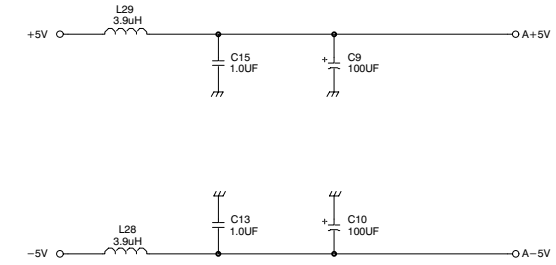
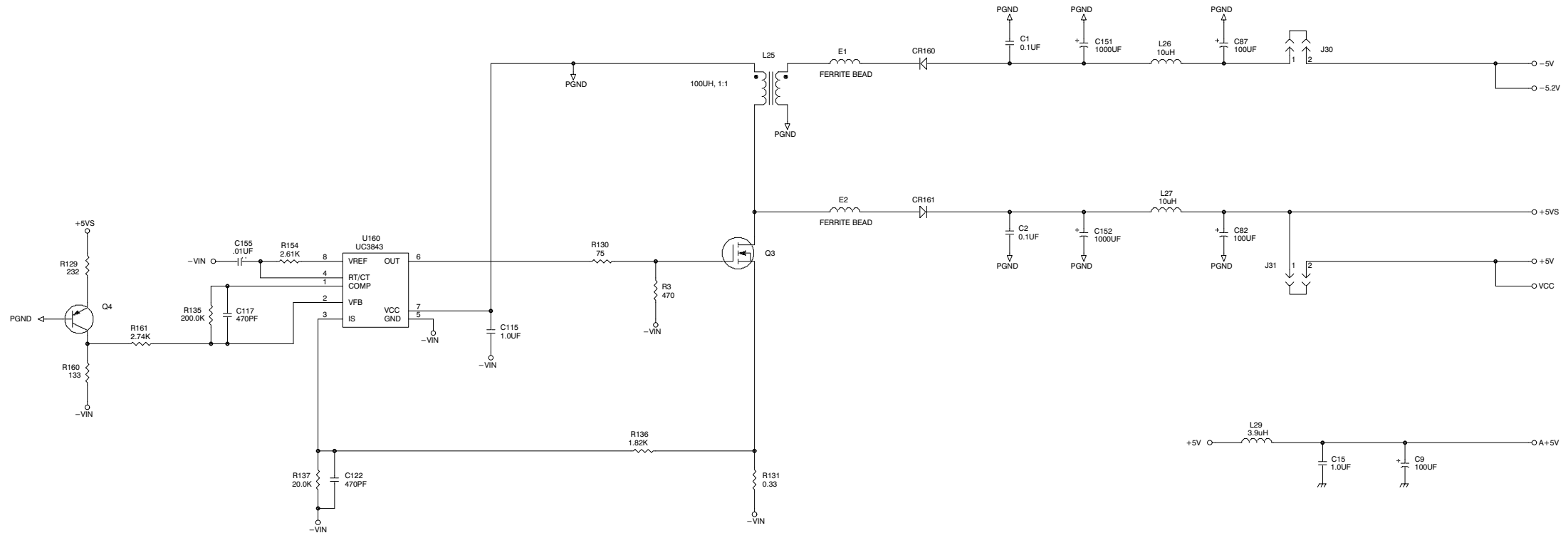
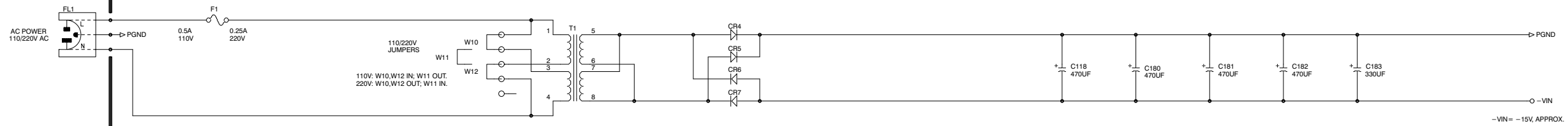

** SEE ELECTRICAL PARTS LIST FOR EARLIER VALUES AND SERIAL NUMBER RANGES.

P/O A2 MAIN BOARD

**BNC BOARDS
SCHEMATIC DIAGRAM
< 8 > LOOK-UP CHART**

The schematic diagram has an alpha-numeric grid to assist in locating parts within that diagram. The etched circuit boards follow a numbering sequence starting with the lowest number at the upper left corner, as pictured in this manual.

ASSEMBLIES A3 AND A4

CIRCUIT NUMBER	SCHEM LOCATION	BOARD LOCATION
A4 BOTTOM BNC BOARD		
J501	H5	M1
J502	H5	L1
J503	H4	K1
J504	H4	J1
J505	A4	M1
J506	G5	L1
A3 TOP BNC BOARD		
J401	H2	N2
J402	H2	N3
J403	H1	N3
J404	H2	N4
J405	A2	N4

A B C D E F G H

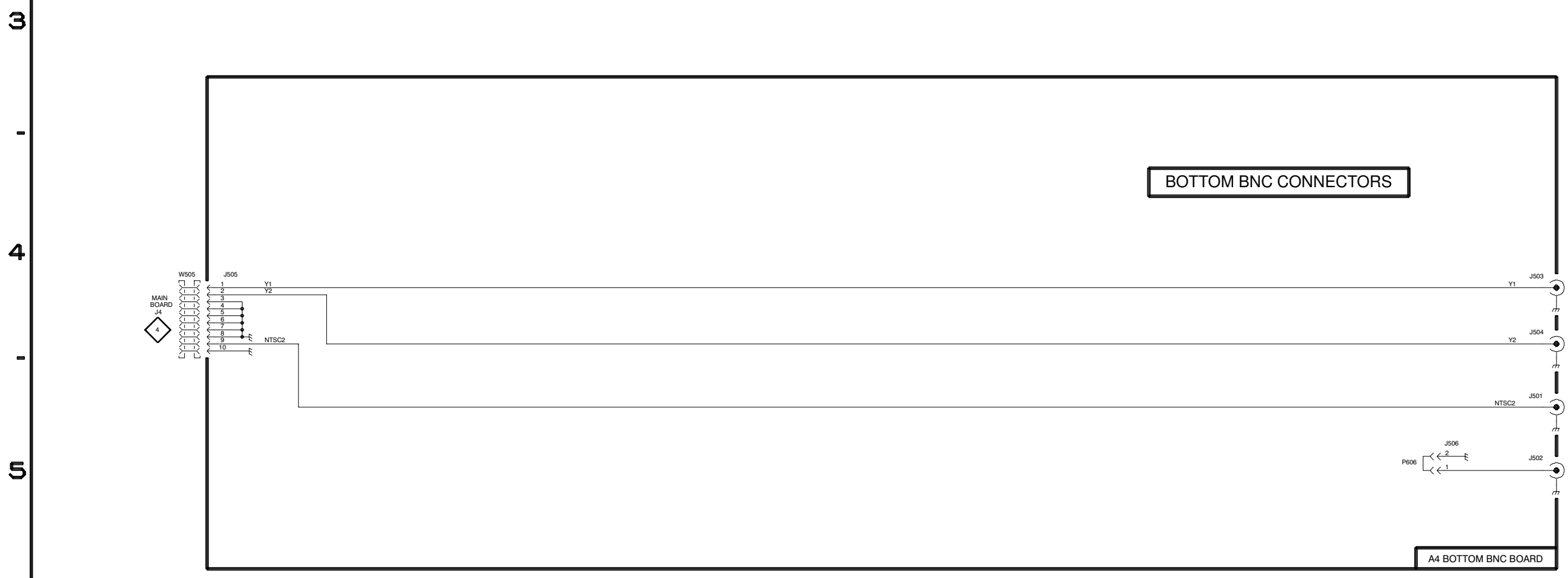
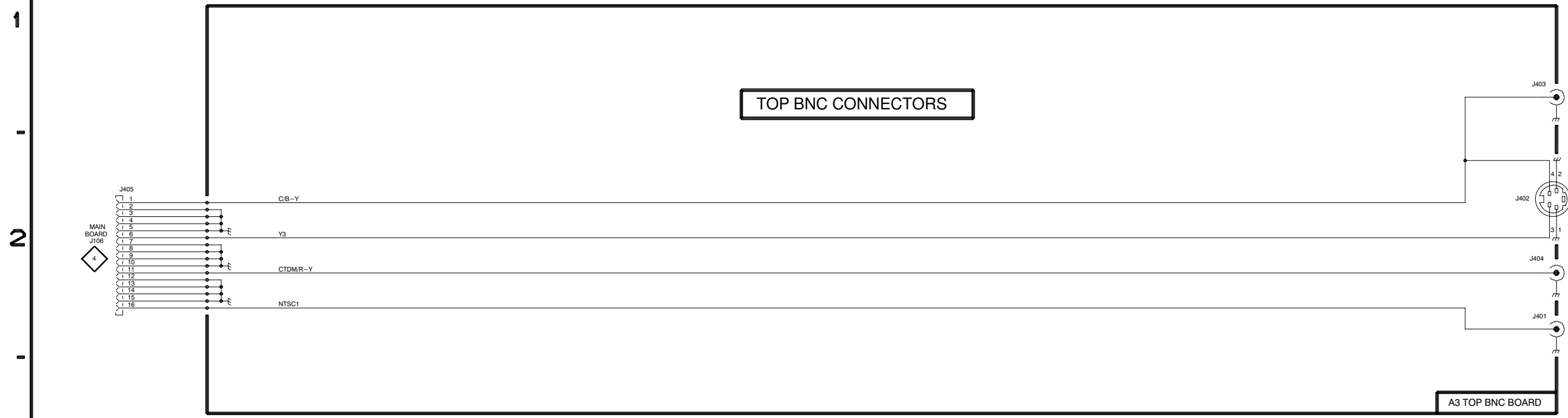



Replaceable Mechanical Parts

Replaceable Mechanical Parts

This section contains a list of the replaceable mechanical components for the TSG 120 YC/NTSC Signal Generator. Use this list to identify and order replacement parts.

Parts Ordering Information

Replacement parts are available through your local Tektronix field office or representative.

Changes to Tektronix products are sometimes made to accommodate improved components as they become available and to give you the benefit of the latest improvements. Therefore, when ordering parts, it is important to include the following information in your order:

- Part number
- Instrument type or model number
- Instrument serial number
- Instrument modification number, if applicable

If you order a part that has been replaced with a different or improved part, your local Tektronix field office or representative will contact you concerning any change in part number.

Change information, if any, is located at the rear of this manual.

Using the Replaceable Mechanical Parts List

The tabular information in the Replaceable Mechanical Parts List is arranged for quick retrieval. Understanding the structure and features of the list will help you find all of the information you need for ordering replacement parts. The following table describes the content of each column in the parts list.

Parts list column descriptions

Column	Column name	Description
1	Figure & index number	Items in this section are referenced by figure and index numbers to the exploded view illustrations that follow.
2	Tektronix part number	Use this part number when ordering replacement parts from Tektronix.
3 and 4	Serial number	Column three indicates the serial number at which the part was first effective. Column four indicates the serial number at which the part was discontinued. No entry indicates the part is good for all serial numbers.
5	Qty	This indicates the quantity of parts used.
6	Name & description	An item name is separated from the description by a colon (:). Because of space limitations, an item name may sometimes appear as incomplete. Use the U.S. Federal Catalog handbook H6-1 for further item name identification.
7	Mfr. code	This indicates the code of the actual manufacturer of the part.
8	Mfr. part number	This indicates the actual manufacturer's or vendor's part number.

Abbreviations Abbreviations conform to American National Standard ANSI Y1.1-1972.

Chassis Parts Chassis-mounted parts and cable assemblies are located at the end of the Replaceable Electrical Parts List.

Mfr. Code to Manufacturer Cross Index The table titled Manufacturers Cross Index shows codes, names, and addresses of manufacturers or vendors of components listed in the parts list.

Manufacturers cross index

Mfr. code	Manufacturer	Address	City, state, zip code
80009	TEKTRONIX, INC.	P.O. BOX 500	BEAVERTON, OR, 97077-0001
01536	TEXTRON INC	1818 CHRISTINA ST	ROCKFORD, IL 61108
01KV9	MERIX CORP	1521 POPLAR LANE PO BOX 3000	FOREST GROVE, OR 97116
07416	NELSON NAME PLATE COMPANY	3191 CASITAS AVENUE	LOS ANGELES, CA 90039-2410
0B445	ELECTRI-CORD MFG CO INC	312 EAST MAIN STREET	WESTFIELD, PA 16950
0J7N4	ARCHERS PRECISION SHEET METAL INC	12700 SW HALL #A	TIGARD, OR 97223
0KB01	STAUFFER SUPPLY CO	810 SE SHERMAN	PORTLAND, OR 97214-4657
0KBZ5	Q & D PLASTICS INC	1812 - 16TH AVENUE PO BOX 487	FOREST GROVE, OR 97116-0487
52152	3M COMPANY	INDUSTRIAL TAPE DIVISION 3M CENTER	ST PAUL, MN 55144-1000
73743	FISCHER SPECIAL MFG CO	111 INDUSTRIAL RD PO BOX 76500	COLD SPRINGS, KY 41076
80009	TEKTRONIX INC	14150 SW KARL BRAUN DR PO BOX 500	BEAVERTON, OR 97077-0001
93907	CAMCAR DIV OF TEXTRON INC	ATTN: ALICIA SANFORD 516 18TH AVE	ROCKFORD, IL 611045181
TK0435	LEWIS SCREW CO.	4300 SOUTH RACINE AVENUE	CHICAGO, IL 60609
TK1295	DAVIS TOOL INC	215 SW WOOD STREET	HILLSBORO, OR 97123
TK1547	MOORE ELECTRONICS INC	19500 SW 90TH CT PO BOX 1030	TUALATIN, OR 97062
TK1943	NEILSEN MANUFACTURING INC	3501 PORTLAND RD NE	SALEM, OR 97303
TK2548	XEROX CORPORATION	14181 SW MILLIKAN WAY	BEAVERTON, OR 97005

Replaceable electrical parts list

Component number	Tektronix part number	Serial no. effective	Serial no. discont'd	Qty	Name & description	Mfr. code	Mfr. part number
-1	200-3898-01			1	COVER, TOP:TSG131A *MOUNTING PARTS*	TK1943	200-3898-01
-2	211-0119-00			8	SCREW, MACHINE:4-40 X 0.25, FLH, 100 DEG, STL BK OXD POZ *END MOUNTING PARTS*	93907	ORDER BY DESCRIPTION
-3	426-2420-01			1	FRAME, FRONT:ALUMINUM *MOUNTING PARTS*	80009	426-2420-01
-4	211-0119-00			2	SCREW, MACHINE:4-40 X 0.25, FLH, 100 DEG, STL BK OXD POZ *END MOUNTING PARTS*	93907	ORDER BY DESCRIPTION
-5	_____				CIRCUIT BD ASSY:FRONT PANEL (SEE A1 REPL) *MOUNTING PARTS*		
-6	211-0244-00			4	SCR, ASSEM WSHR:4-40 X 0.312, PNH, STL (OPTION 02 ONLY)	01536	821-02775
	129-1411-00			1	SPACER, POST:0.280 X 0.200, ABS (OPTION 02 ONLY) *END MOUNTING PARTS*		
-7	333-3910-00			1	PANEL, FRONT:TSG120 (STANDARD, OPTION 02 ONLY)	07416	333-3910-00
	333-4090-00			1	PANEL, FRONT:TSG120 OPT 02 (OPTION 02 ONLY)	80009	333-4090-00
-8	_____				CIRCUIT BD ASSY:MAIN (SEE A2 REPL) *MOUNTING PARTS*		
-9	211-0244-00			6	SCR, ASSEM WSHR:4-40 X 0.312, PNH	01536	821-02775
-10	211-0025-00			2	SCREW, MACHINE:4-40 X 0.375, FLH, 100 DEG	TK0435	ORDER BY DESCRIPTION
-11	210-0586-00			2	NUT, PL, ASSEM WA:4-40 X 0.25, STL CD PL *END MOUNTING PARTS*	0KB01	ORDER BY DESCRIPTION
	174-2378-00			1	CA ASSY, SP, ELEC:26, 28 AWG, 23.0 L, RIBBON	TK1547	174-2378-00
	174-2512-00			1	CA ASSY, SP, ELEC:16, 28 AWG, 1.8 L, RIBBON	TK1547	174-2512-00
-12	_____				CIRCUIT BD ASSY:TOP BNC (SEE A3 REPL) *MOUNTING PARTS*		
-13	220-0497-00			2	NUT, PLAIN, HEX:0.5-28 X 0.562 HEX, BRS CD PL	73743	ORDER BY DESCRIPTION
-14	210-1039-00			2	WASHER, LOCK:0.521 ID, INT, 0.025 THK, SST *END MOUNTING PARTS*	0KB01	1224-02-00-0541C
-15	_____			1	CIRCUIT BD ASSY:BOTTOM BNC (SEE A4 REPL) *MOUNTING PARTS*		

Replaceable electrical parts list (Cont.)

Component number	Tektronix part number	Serial no. effective	Serial no. discount'd	Qty	Name & description	Mfr. code	Mfr. part number
-16	220-0497-00			3	NUT,PLAIN,HEX:0.5-28 X 0.562 HEX,BRS CD PL	73743	ORDER BY DESCRIPTION
-17	210-1039-00			3	WASHER,LOCK:0.521 ID,INT,0.025 THK,SST	0KB01	1224-02-00-0541C
-18	_____			2	CONN,CIRC:PCB,AU-DIO;MALE,RTANG,3POS,1.22HX1.024W,CTR PLX,LATCHING (SEE ALSO A2J9,A2J10 REPL)		
					MOUNTING PARTS		
-19	211-0101-00			4	SCREW,MACHINE:4-40 X 0.25,FLH,100 DEG,STL CD PL,POZ	93907	ORDER BY DESCRIPTION
					END MOUNTING PARTS		
-20	348-0844-00			4	PAD,CUSHIONING:0.05 SQ X 0.23 H,POLYURETHANE,W/PRESSURE SENSIVE ADHESIVE	52152	SJ5518-GRAY
-20	_____			2	PLUG,HOLE COVER: (WAS NOT USED)		
-22	200-3899-02			1	COVER,BOTTOM:TSG120	0J7N4	200-3899-02
-23	337-3784-01			1	SHIELD,ELEC:TSG131A	TK1295	337-3784-01
					STANDARD ACCESSORIES		
-24	161-0066-00			1	CA ASSY,PWR:3,18 AWG,250V/10A,98 INCH,STR,IEC320,RCPT X NEMA 5-15P,US,SAFTEY CONTROLLED	0B445	ECM-161-0066-00
	070-8003-02			1	MANUAL, TECH:USERS, TSG120	TK2548	070-8003-01
					OPTION ACCESSORIES		
	_____			1	TVGF11A;RACK MOUNT KIT		

