

# Instruction Manual



## TSG200 NTSC Signal Generator

**071-0760-00**

### **Warning**

The servicing instructions are for use by qualified personnel only. To avoid personal injury, do not perform any servicing unless you are qualified to do so. Refer to all safety summaries prior to performing service.

[www.tektronix.com](http://www.tektronix.com)

[www.valuetronics.com](http://www.valuetronics.com)

Copyright © Tektronix, Inc. All rights reserved.

Tektronix products are covered by U.S. and foreign patents, issued and pending. Information in this publication supercedes that in all previously published material. Specifications and price change privileges reserved.

Tektronix, Inc., P.O. Box 500, Beaverton, OR 97077

TEKTRONIX and TEK are registered trademarks of Tektronix, Inc.

## WARRANTY

Tektronix warrants that the products that it manufactures and sells will be free from defects in materials and workmanship for a period of one (1) year from the date of shipment. If a product proves defective during this warranty period, Tektronix, at its option, either will repair the defective product without charge for parts and labor, or will provide a replacement in exchange for the defective product.

In order to obtain service under this warranty, Customer must notify Tektronix of the defect before the expiration of the warranty period and make suitable arrangements for the performance of service. Customer shall be responsible for packaging and shipping the defective product to the service center designated by Tektronix, with shipping charges prepaid. Tektronix shall pay for the return of the product to Customer if the shipment is to a location within the country in which the Tektronix service center is located. Customer shall be responsible for paying all shipping charges, duties, taxes, and any other charges for products returned to any other locations.

This warranty shall not apply to any defect, failure or damage caused by improper use or improper or inadequate maintenance and care. Tektronix shall not be obligated to furnish service under this warranty a) to repair damage resulting from attempts by personnel other than Tektronix representatives to install, repair or service the product; b) to repair damage resulting from improper use or connection to incompatible equipment; c) to repair any damage or malfunction caused by the use of non-Tektronix supplies; or d) to service a product that has been modified or integrated with other products when the effect of such modification or integration increases the time or difficulty of servicing the product.

**THIS WARRANTY IS GIVEN BY TEKTRONIX IN LIEU OF ANY OTHER WARRANTIES, EXPRESS OR IMPLIED. TEKTRONIX AND ITS VENDORS DISCLAIM ANY IMPLIED WARRANTIES OF MERCHANTABILITY OR FITNESS FOR A PARTICULAR PURPOSE. TEKTRONIX' RESPONSIBILITY TO REPAIR OR REPLACE DEFECTIVE PRODUCTS IS THE SOLE AND EXCLUSIVE REMEDY PROVIDED TO THE CUSTOMER FOR BREACH OF THIS WARRANTY. TEKTRONIX AND ITS VENDORS WILL NOT BE LIABLE FOR ANY INDIRECT, SPECIAL, INCIDENTAL, OR CONSEQUENTIAL DAMAGES IRRESPECTIVE OF WHETHER TEKTRONIX OR THE VENDOR HAS ADVANCE NOTICE OF THE POSSIBILITY OF SUCH DAMAGES.**

# General Safety Summary

Review the following safety precautions to avoid injury and prevent damage to this product or any products connected to it. To avoid potential hazards, use this product only as specified.

## To Avoid Fire or Personal Injury

**Use Proper Power Cord.** Use only the power cord specified for this product and certified for the country of use.

**Use Proper Voltage Setting.** Before applying power, ensure that the line selector is in the proper position for the power source being used.

**Ground the Product.** This product is grounded through the grounding conductor of the power cord. To avoid electric shock, the grounding conductor must be connected to earth ground. Before making connections to the input or output terminals of the product, ensure that the product is properly grounded.

**Observe All Terminal Ratings.** To avoid fire or shock hazard, observe all ratings and markings on the product. Consult the product manual for further ratings information before making connections to the product.

Do not apply a potential to any terminal, including the common terminal, that exceeds the maximum rating of that terminal.

**Use Proper AC Adapter.** Use only the AC adapter specified for this product.

**Do Not Operate Without Covers.** Do not operate this product with covers or panels removed.

**Use Proper Fuse.** Use only the fuse type and rating specified for this product.

**Avoid Exposed Circuitry.** Do not touch exposed connections and components when power is present.

**Wear Eye Protection.** Wear eye protection if exposure to high-intensity rays or laser radiation exists.

**Do Not Operate With Suspected Failures.** If you suspect there is damage to this product, have it inspected by qualified service personnel.

**Do Not Operate in an Explosive Atmosphere.**

**Do Not Service Alone.** Do not perform internal service or adjustments of this product unless another person capable of rendering first aid and resuscitation is present.

**Symbols and Terms**

**Terms in this Manual.** These terms may appear in this manual:



---

**WARNING.** *Warning statements identify conditions or practices that could result in injury or loss of life.*

---



---

**CAUTION.** *Caution statements identify conditions or practices that could result in damage to this product or other property.*

---

**Terms on the Product.** These terms may appear on the product:

DANGER indicates an injury hazard immediately accessible as you read the marking.

WARNING indicates an injury hazard not immediately accessible as you read the marking.

CAUTION indicates a hazard to property including the product.

**Symbols on the Product.** The following symbols may appear on the product:





# Table of Contents

## SECTION 1 INTRODUCTION

---

## SECTION 2 CONTROLS, INDICATORS, & CONNECTORS

---

Front Panel Controls .....	2-1
SIGNAL SELECT .....	2-1
FUNCTIONS ENABLE .....	2-1
TAPE LEADER (Tape Leader Countdown) .....	2-2
AUDIO CLICK .....	2-2
CHAR ID (Display the Character ID on Active Video) .....	2-2
ID CYCLE .....	2-2
VBI CHAR ID (Vertical Blanking Interval Character ID) .....	2-3
SID (Vertical Interval Source Identification Code) .....	2-3
ID SETUP & Direction Arrows .....	2-3
ID TEXT .....	2-3
ID DISPLAY .....	2-4
ID STORE/RECALL .....	2-4
ID CYCLE .....	2-4
Using the ID SETUP Commands .....	2-4
General Information .....	2-4
Setting the ID TEXT .....	2-5
Setting the ID DISPLAY .....	2-6
Using the ID STORE/RECALL .....	2-7
Setting the ID CYCLE .....	2-9
FRONT PANEL LOCKOUT .....	2-10
REAR PANEL CONNECTORS .....	2-11
Using the REMOTE .....	2-13
Pin 1 – Tape Leader .....	2-13
Pin 2 – Signal Selection .....	2-13
Pin 3 – Function Enable/Disable .....	2-14
Pin 4 – ID Recall .....	2-14
Pin 5 – Front Panel Lockout .....	2-14
<b>SECTION 3</b> <b>SIGNAL GENERATOR SPECIFICATIONS</b>	
Reference Documentation .....	3-1
Performance Conditions .....	3-1
Safety Standards .....	3-1
TEST SIGNALS .....	3-11

## Table of Contents

### SECTION 4

#### PERFORMANCE CHECKS & ADJUSTMENT PROCEDURES

---

List of Required Test Equipment .....	4-1
PERFORMANCE CHECK PROCEDURES .....	4-2
Oscillator Frequency .....	4-2
Test Signal .....	4-2
Black Outputs .....	4-2
Audio Output .....	4-2
PERFORMANCE CHECK PROCEDURES .....	4-3
Oscillator Frequency .....	4-3
Test Signal .....	4-4
Black Outputs .....	4-7
Audio Output .....	4-7
ADJUSTMENT PROCEDURE CHECKLIST .....	4-9
ADJUSTMENT PROCEDURES .....	4-10

### SECTION 5

#### INSTALLATION

---

Selecting the Power Supply Mains Voltage .....	5-1
Selecting the Audio Tone Frequency .....	5-1
Adjusting the Audio Click Frequency .....	5-2
Configuring NTSC/BLACK Output .....	5-2
Setting the SID .....	5-2
Initializing the Non-Volatile Memory .....	5-3
Customizing the Settings .....	5-4
List of Jumpers and Switches .....	5-5

### SECTION 6

#### OPTIONS

---

OPTION – 1J — (0% Setup) .....	6-1
Changes to: Section 3 – Specifications .....	6-1
Changes to: Section 5 – Performance Check and Adjustment Procedure .....	6-4

### SECTION 7

#### BLOCK DIAGRAM

---

### SECTION 8

#### REPLACEABLE ELECTRICAL PARTS

---

### SECTION 9

#### DIAGRAMS/CIRCUIT BOARD ILLUSTRATIONS

---

### SECTION 10

#### REPLACEABLE MECHANICAL PARTS

---



# List of Figures

## SECTION 1 INTRODUCTION

---

Fig. 1-1. Front Panel of the TSG 200 .....	1-1
Fig. 1-2. Rear Panel of the TSG 200 .....	1-1

## SECTION 2 CONTROLS, INDICATORS, & CONNECTORS

---

Fig. 2-1. The SIGNAL SELECT control block .....	2-1
Fig. 2-2. The FUNCTIONS ENABLE control block .....	2-1
Fig. 2-3. Location of the Vertical Interval ID (Monitor set to display the Vertical Interval) .....	2-3
Fig. 2-4. ID SETUP and direction arrows .....	2-3
Fig. 2-5. Legal range for Character ID diplay. The Safe Title area is defined by the inner lines while the Safe Action area is marked by the outer set of lines. ....	2-4
Fig. 2-6. How to change the character in the CHARACTER ID .....	2-5
Fig. 2-7. How to select a character .....	2-5
Fig. 2-8. Legal range for Character ID diplay. The Safe Title area is defined by the inner lines while the Safe Action area is marked by the outer set of lines. It is recommended that the ID be in the Safe Title area .....	2-6
Fig. 2-9. Monitor display when in ID STORE/RECALL .....	2-7
Fig. 2-10. The monitor display to set the POWER UP DEFAULT .....	2-8
Fig. 2-11. Monitor display when in ID CYCLE Setup .....	2-9
Fig. 2-12. Location of the FRONT PANEL LOCKOUT indicator .....	2-10
Fig. 2-13. Rear panel of the TSG 200 .....	2-11
Fig. 2-14. DC IN connector values .....	2-11
Fig. 2-15. The REMOTE connector pinout (Looking into the TSG 200) .....	2-12
Fig. 2-16. FRONT PANEL LOCKOUT indicator .....	2-14

## SECTION 3 SIGNAL GENERATOR SPECIFICATIONS

---

Fig. 3-1. Physical deminsions of the TSG 200 .....	3-8
Fig. 3-2. SMPTE Color Bars .....	3-11
Fig. 3-3. SMPTE Reverse Blue Bars .....	3-11
Fig. 3-4. SMPTE IYQB .....	3-12
Fig. 3-5. 5-Step (Gray Scale) .....	3-12
Fig. 3-6. Convergence (vertical) .....	3-13
Fig. 3-7. Convergence (horizontal) .....	3-13
Fig. 3-8. NTC 7 Composite .....	3-14
Fig. 3-9. Multiburst .....	3-14
Fig. 3-10 Safe Area for lines: 33, 45, 238, & 250 .....	3-15
Fig. 3-11. Safe Area for lines: 69-132 & 149-214 .....	3-15
Fig. 3-12. Safe Area for lines: 133-140 & 142-148 .....	3-16
Fig. 3-13. Safe Area for line 141 .....	3-16
Fig. 3-14. Safe Area for all other lines .....	3-17
Fig. 3-15. Video monitor display of Safe Area signal .....	3-17
Fig. 3-16. Black Burst .....	3-18

## Table of Contents

### **SECTION 4** **PERFORMANCE CHECKS & ADJUSTMENT PROCEDURES**

---

Fig. 4-1. Setup to check the crystal frequency .....	4-3
Fig. 4-2. Basic setup for the Performance Checks .....	4-4
Fig. 4-3. Setup to measure the total harmonic distortion .....	4-7
Fig. 4-4. Setup to adjust the oscillator frequency .....	4-10
Fig. 4-5. Audio amplitude calibration setup .....	4-10
Fig. 4-6. Audio ID click frequency adjustment setup .....	4-11
Fig. 4-7. Basic setup for the calibration procedures .....	4-11
Fig. 4-8. New functions of the Signal Select buttons in the Diagnostic Test Signal mode .....	4-12

### **SECTION 5** **INSTALLATION**

---

Fig. 5-1. Audio ID click frequency adjustment setup .....	5-2
Fig. 5-2. Monitor display to set "FACTORY SETTING" .....	5-3
Fig. 5-3. Monitor display to customize the TSG 200 .....	5-4

### **SECTION 6** **OPTIONS**

---

Fig. 6-1. SMPTE Color Bars .....	6-2
Fig. 6-2. SMPTE Reverse Blue Bars .....	6-2
Fig. 6-3. SMPTE IYQB .....	6-3
Fig. 6-4. Black Burst .....	6-3

# List of Tables

## SECTION 2

### CONTROLS, INDICATORS, & CONNECTORS

---

Table 2-1. Binary Code for Signal Selection .....	2-13
Table 2-2. Binary Code for Function Enable/Disable .....	2-14
Table 2-3. Binary Code for Character ID Recall .....	2-14

## SECTION 3

### SIGNAL GENERATOR SPECIFICATIONS

---

Table 3-1. General Test Signal Characteristics .....	3-2
Table 3-2. Test Signals .....	3-4
Table 3-3. Test Signal Generator – Black Burst Output .....	3-5
Table 3-4. Character Identification .....	3-6
Table 3-5. Audio Tone Characteristics .....	3-6
Table 3-6. Power Supply Specifications .....	3-7
Table 3-7. Physical Characteristics .....	3-8
Table 3-8. Environmental Characteristics .....	3-9
Table 3-9. Certifications and Compliances .....	3-9

## SECTION 4

### PERFORMANCE CHECKS & ADJUSTMENT PROCEDURES

---

Table 4-1. Basic setup for the 1780 .....	4-3
Table 4-2. Setup for the AA501 Distortion Analyzer .....	4-8
Table 4-3. Setup for the AA501 Distortion Analyzer .....	4-10
Table 4-4. Initial setup of the 1780 .....	4-11

## SECTION 5

### INSTALLATION

---

Table 5-1. Jumpers and switches in the TSG 200 .....	5-5
--	-----

## SECTION 6

### OPTIONS

---

Table 3-2. Test Signals .....	6-1
Table 3-3. Test Signal Generator – Black Burst Output .....	6-1



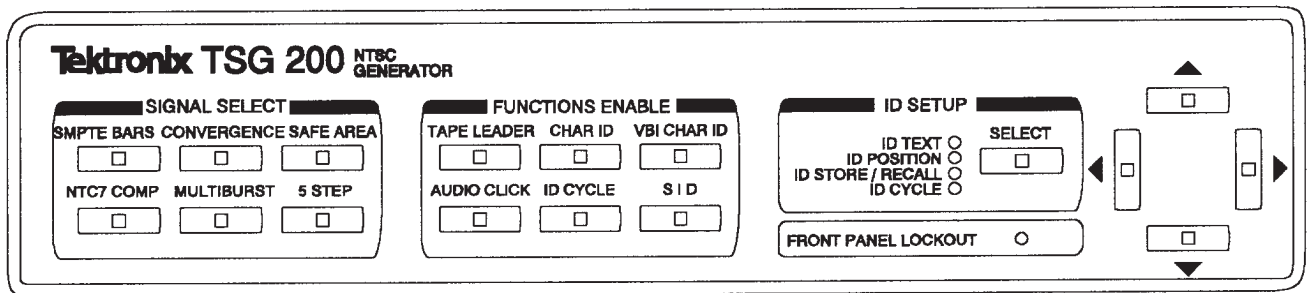

Fig. 1-1. Front Panel of the TSG 200.

## SECTION 1 INTRODUCTION

The TSG 200 NTSC Generator is a simple, cost-effective test signal and black burst generator with Character ID capabilities. It is designed for news gathering and low-cost production markets (such as schools and industry). The TSG 200 digitally generates a mix of test signals in the NTSC format. It features:

- Six test signals with 10 bit resolution
  - \* SMPTE Bars
  - \* Convergence
  - \* Safe Area
  - \* NTC7 Composite
  - \* Multiburst
  - \* 5 Step
- Tape Leader countdown sequence
- Selectable vertical interval source code
- Multiple Black Burst outputs
- Very flexible Character ID
  - \* Up to 2 lines of 16 characters per line
  - \* Positionable throughout active video
  - \* First line insertable in the Vertical Blanking Interval
  - \* 8 IDs stored in memory
  - \* A rotating display of 4 IDs in the active field.
- Ground closure remote control
- Stereo audio tone selectable between 400 Hz and 1 kHz with ID click on CH 1
- Front Panel Lockout
- 12 V<sub>dc</sub>, 110 V<sub>ac</sub>, or 220 V<sub>ac</sub> voltage input for field or bench operation
- Compact package — 1/2 rack width by 1 rack high

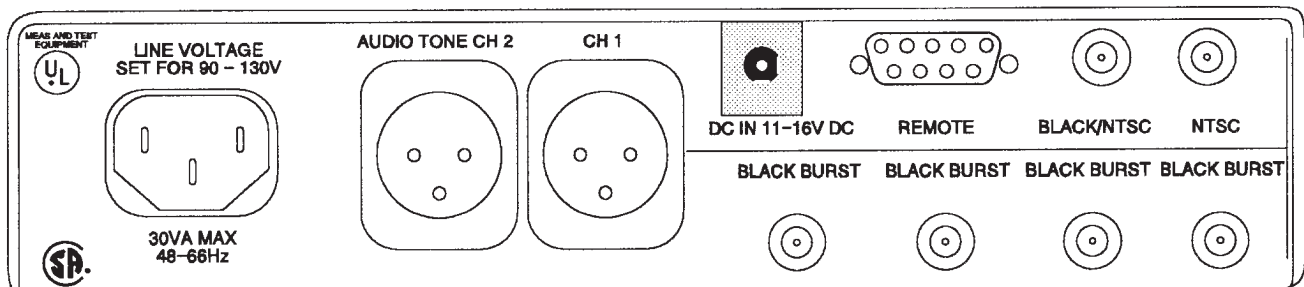

Fig. 1-2. Rear Panel of the TSG 200.



# SECTION 2

## CONTROLS, INDICATORS, & CONNECTORS

This section describes the front and rear panel controls, indicators, and connectors and how to use them. For information on configuring the power supply for 110 V<sub>ac</sub> or 220 V<sub>ac</sub> operation, see Section 5.

### CAUTION

*The TSG 200 is shipped from the factory configured for 110 V<sub>ac</sub> operation. Attempting to operate the TSG 200 at any other voltage without reconfiguring the power supply may cause damage. Refer to Section 5, Installation, for more information.*

## Front Panel Controls

The front panel is divided into four sections: SIGNAL SELECT, FUNCTIONS ENABLE, ID SETUP, and the Direction Arrows. Each is described below.

### SIGNAL SELECT (See Fig. 2-1)

This set of six buttons selects which NTSC test signal will be available at the NTSC and NTSC/BLACK ports on the rear panel. The test signal list includes: SMPTE Bars, Convergence, Safe Area, NTC7 Composite, Multiburst, and 5 Step. The LED in the center of each button lights when selected. Only one signal from this control block can be selected at a time.

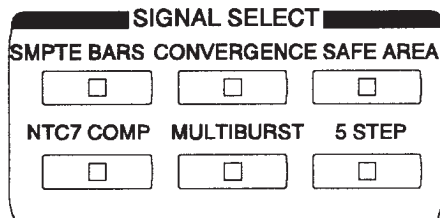

Fig. 2-1. The SIGNAL SELECT control block.

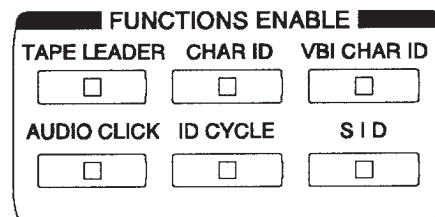

Fig. 2-2. The FUNCTIONS ENABLE control block.

### FUNCTIONS ENABLE (See Fig. 2-2)

This control block enables some of the special features of the TSG 200. These functions include:

- Tape Leader Countdown Sequence
- Character ID
- Character ID in the Vertical Blanking Interval
- Vertical Interval Source Code (SID)
- Audio Channel ID Click inserted on Audio Channel 1
- Rotating display of character IDs (ID CYCLE)

The LED in the center of each button lights indicating that a function is operational. More than one

## TSG 200 — Controls, Indicators, & Connectors

function can be enabled at a time in this control block, but some obviously conflict and cannot operate simultaneously. The conflicting pairs are CHAR ID—ID CYCLE and VBI CHAR ID—SID. If one of these is already operating and the other is selected, the old one will drop out and the newly selected one will operate.

Below is a description of each of the buttons in the FUNCTIONS ENABLE control block, their use, and operation.

### TAPE LEADER (Tape Leader Countdown)

When the TAPE LEADER button is pressed, lighting its LED, the following sequence begins:

TIME (in seconds)	OPERATION
90 → 15	SMPTE Bars and Audio Tone.
15 → 10	Black Burst and no Audio Tone.
10 → 2	Display of countdown (10 to 2) on a black screen. On Audio Channel 1 there is a beep for each count.
2 → 0	Black Burst with no Audio Tone.

The Black Burst signal will continue to be output as long as the TAPE LEADER button is enabled. To disable the Tape Leader function, the TAPE LEADER button must be pressed again (turning off its LED). No other function will operate while the Tape Leader function is enabled.

The length of the Tape Leader sequence is user selectable from a maximum of 90 seconds (45 seconds of SMPTE Bars and Audio Tone) to a minimum of 10 seconds (only countdown). See the Installation Section for how to set the length.

### AUDIO CLICK

The AUDIO CLICK button enables/disables the Audio Click ID on Channel 1 of the AUDIO TONE output on the rear panel. The click frequency is adjustable with internal controls. (See Section 4, Performance Checks and Adjustment Procedures, to adjust the frequency of the audio click.)

### **WARNING**

*High voltages exist inside this instrument. Only qualified service personnel should make this adjustment.*

### CHAR ID (Display the Character ID on Active Video)

The CHAR ID button turns on/off the character ID displayed during the active video. What the ID is and how it is displayed is determined using the buttons in the ID SETUP control block. See ID SETUP later in this section for more information.

### ID CYCLE

The ID CYCLE button initiates a routine that displays up to four Character IDs in rotating sequence. Each ID is displayed for a set length of time between 1 and 10 seconds. The length of the display is user selectable from a maximum of 10 seconds (40 seconds for the complete cycle) to a minimum of 1 second (4 seconds for the complete cycle). See the Installation Section for how to set the length.



**VBI CHAR ID**  
(Vertical Blanking Interval Character ID)

The VBI CHAR ID button displays the first line of the Character ID during the vertical blanking interval. See Fig. 2-3.

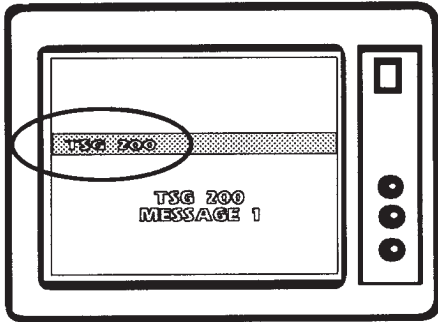

Fig. 2-3. Location of the Vertical Interval ID. (Monitor set to display the Vertical Interval.)

**NOTE**

*The Character ID inserted in the vertical interval is the first line of the ID displayed when the CHAR ID button is enabled.*

**SID**  
(Vertical Interval Source Identification Code)

The SID button turns on the source identification code (SID). This is a digital signal that appears on line 16 as a series of white & black bars. It is recognized and can be used by the Tektronix VM 700A NTSC Video Measurement set.

Which SID, of the 16,384 available, is selected by internal switches. (See Section 5, Installation, for how to set the switches for the desired SID.)

**WARNING**

*High voltages exist inside this instrument. Only qualified service personnel should attempt to set these switches.*

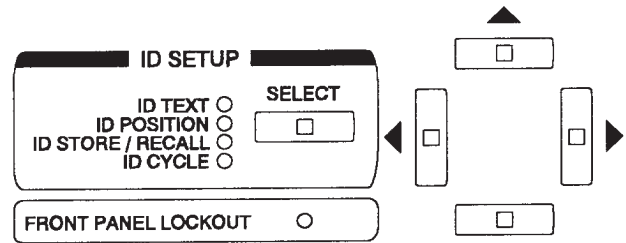

Fig. 2-4. ID SETUP and direction arrows.

**ID SETUP & Direction Arrows**  
(See Fig. 2-4)

The ID SETUP control block uses the Arrows to make choices within a setup parameter. For example, the setup parameter ID TEXT uses the right/left arrows to select the character location and the up/down arrows to choose its value.

There are four Setup parameters in the ID SETUP: ID TEXT, ID DISPLAY, ID STORE/RECALL, and ID CYCLE. The SELECT button scrolls through the choices. Which parameter is operating at any given time is indicated by lighting the LED next to it. This mode is exited by either scrolling through to the end or pressing any other front panel button. It will also time out and return to its previous state after approximately 60 seconds.

Next is a brief description of each parameter and following is an explanation of how to set each one.

**ID TEXT**

This parameter defines the Character ID. It can be up to two lines with 16 characters on each line. The characters available are:

A	B	C	D	E	F	G	H
I	J	K	L	M	N	O	P
Q	R	S	T	U	V	W	X
Y	Z	;	<	=	>	?	}
{	)	)	(	((	*	'	→
←	■	space 1	+	!	↓	↑	0
1	2	3	4	5	6	7	8
9	:	X	,	-	.	/	space 2

space 1 is space with test signal background.  
space 2 is space with black background.

**NOTE**

The Setup Mode will time itself out after approximately 60 seconds of no action.

**ID DISPLAY**

This parameter defines the active video location where the Character ID is displayed. The range of possibilities is shown in Fig. 2-5. The ID can be moved beyond the Safe Title area but not the Safe Action area. It is recommended that the ID stay in the Safe Title area.

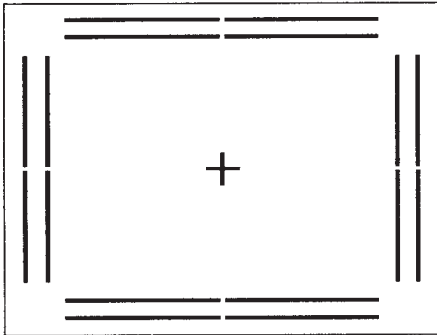

**Fig. 2-5. Legal range for Character ID display. The Safe Title area is defined by the inner lines while the Safe Action area is marked by the outer set of lines.**

**ID STORE/RECALL**

This command allows up to 8 IDs to be stored in memory and recalled for use at a later time. These IDs are the full two lines of 16 characters that are set using the ID TEXT command and whose position is determined by ID DISPLAY.

This command is also used to set the power up configuration of the instrument. All front panel settings can be saved and then recalled as the default when the instrument is powered back up.

The entire instrument can be "reset" back to the factory presets using this command in the diagnostic mode. (See Section 5, Installation, for how to initialize the non-volatile memory.)

**NOTE**

Setting the instrument to Factory Setting is necessary to initialize the non-volatile memory if a new one is installed.



High voltages exist inside this instrument. Only qualified service personnel should attempt to set these switches.

**ID CYCLE**

This button sets up an ID cycling routine. It displays up to four Character IDs in rotating sequence. Each one is displayed for about 2½ seconds.

**Using the ID SETUP Commands**

**General Information**

It is necessary to connect the NTSC output to a picture monitor during setup to display the ID and view the menu.

After the desired setup parameter has been changed, it can be saved and exited by pressing any of the buttons except the arrow buttons. If another setup parameter is desired to be changed, then press the select button to move to it.

The ID Setup function will time out after about 60 seconds of inactivity. The following happens if timeout occurs:

**ID TEXT:** If the character ID has been changed, it will be saved as the new current ID.

**ID POSITION:** If the Character ID position has been changed, it will be saved as the new current position.

**ID STORE/RECALL:** If changes have been made they will NOT be saved.

**ID CYCLE:** If changes have been made they will be saved.

**Setting the ID TEXT**

- a. Press the SELECT button until ID TEXT is lit.
- b. A Character Select box will highlight one of the characters.
- c. Press the right (▶) or left (◀) button to highlight the desired character. (See Fig. 2-7.)
- d. The up (▲) and down (▼) buttons are then used to change the highlighted character as shown in Fig. 2-6. The available characters are listed on page 2-3.
- e. To select characters on the second line, scroll right or left until the Character Select box wraps around to the second line. (See Fig. 2-7.)
- f. Repeat as necessary to change the characters to the desired ID.
- g. To save the ID as the "current ID" and leave the ID TEXT setup mode, press any button (except the arrow keys).

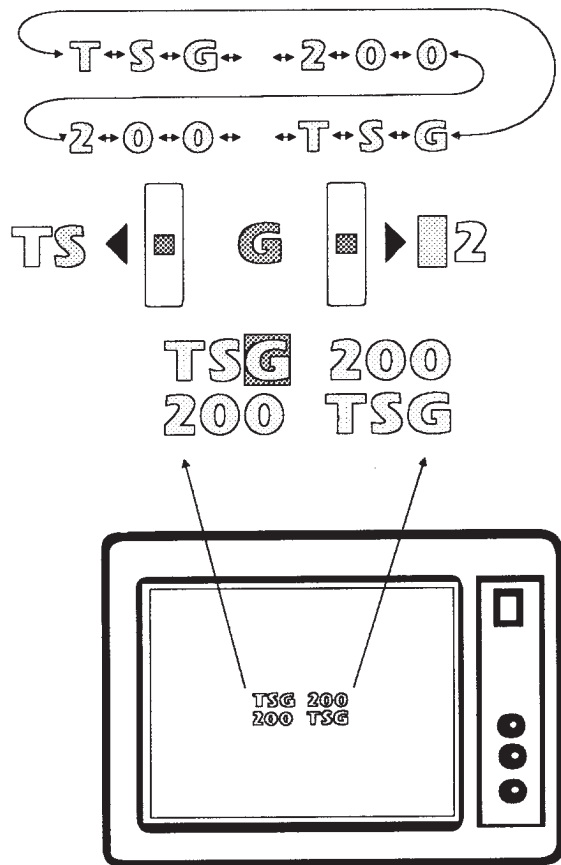

Fig. 2-7. How to select a character.

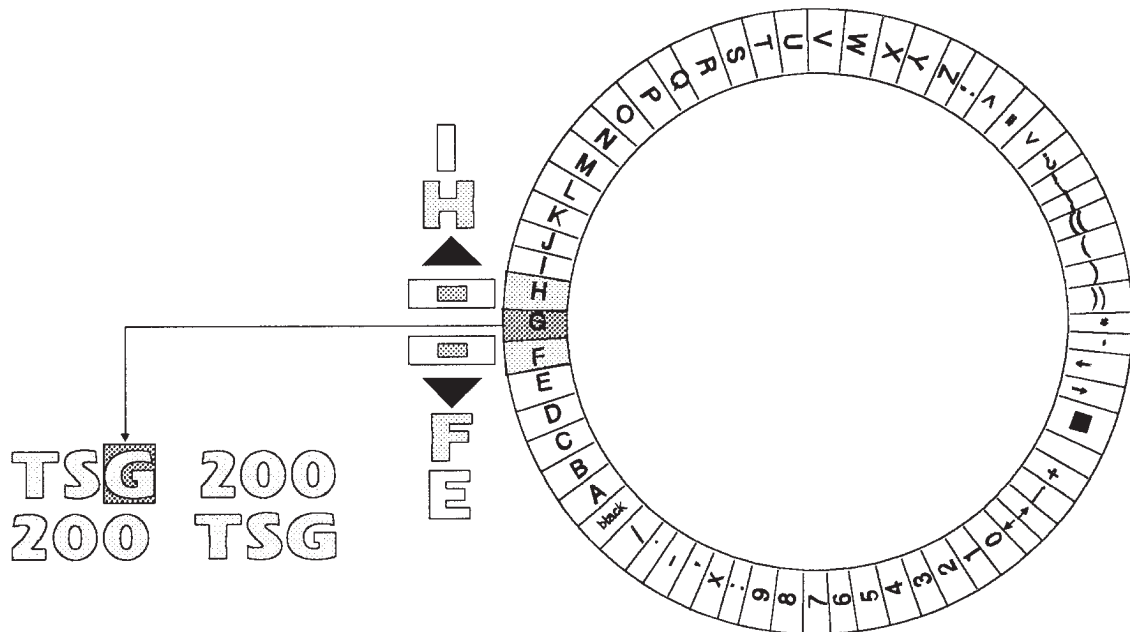
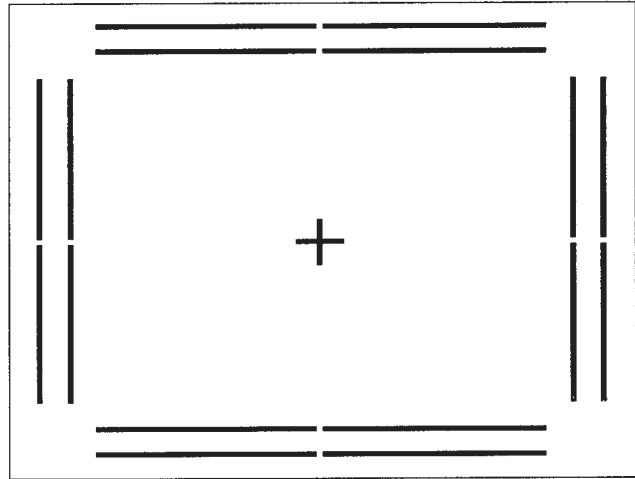

Fig. 2-6.  
How to change the character in the CHARACTER ID.

**Setting the ID DISPLAY**

- a. Press the SELECT button until ID DISPLAY is lit.
- b. Press the right (▶), left (◀), up (▲), or down (▼) button to move the ID to its desired position. The allowable range is within the outer set of lines shown in Fig. 2-8. It is recommended, though, that the ID be placed within the inner set of lines.
- c. Press any button (except the arrow buttons), to save the display as the "current ID" and exit the ID DISPLAY setup mode.



**Fig. 2-8. Legal range for Character ID display. The Safe Title area is defined by the inner lines while the Safe Action area is marked by the outer set of lines. It is recommended that the ID be in the Safe Title area.**

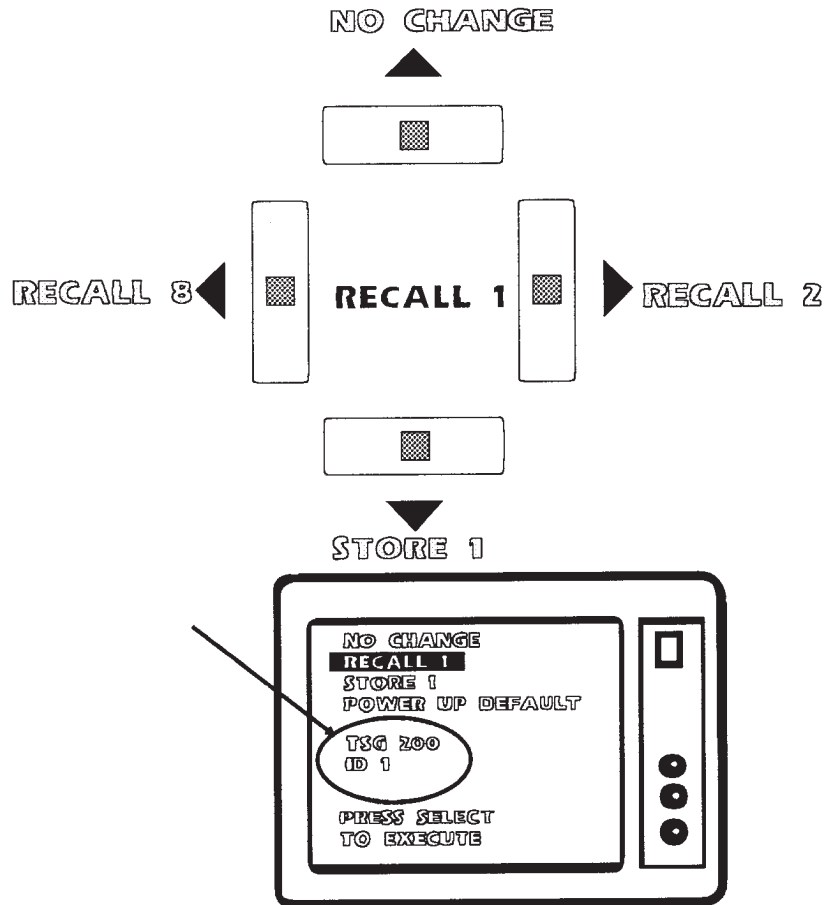

Fig. 2-9. Monitor display when in ID STORE/RECALL.

**Using the ID STORE/RECALL**  
(see Fig. 2-9)

**NOTE**

*If the Setup Mode times out from this menu (after approximately 60 seconds), any changes made to the Store or Recall values will **NOT** be saved.*

**1. To make no changes:**

- a. Press the SELECT button until ID Store/Recall is lit.
- b. Highlight the NO CHANGE option.
- c. Press the SELECT (or any non-arrow) button to leave ID Store/Recall.

**2. To save the presently displayed ID:**

- a. Press the SELECT button until ID Store/Recall is lit.
- b. Highlight the STORE option using the up (▲) / down (▼) arrow buttons.
- c. Use the right (▶) / left (◀) arrows to change the STORE number to the desired value.
- d. The ID that is being stored will be shown on the lower portion of the monitor display.
- e. Press the SELECT (or any non-arrow) button to leave ID Store/Recall.
- f. The ID displayed on the monitor ("current ID") is now stored under the selected number (STORE #).

**3. To recall a previously saved ID:**

- a. Press the SELECT button until ID Store/Recall is lit.
- b. Highlight RECALL.
- c. Use the right (▶) / left (◀) arrows to change the RECALL number to the desired value.
- d. The ID selected is shown on the lower portion of the monitor display.
- e. Press the SELECT (or any non-arrow) button to leave the ID Store/Recall mode.
- f. When CHAR ID is enabled this ID will be displayed.

**4. To Set the Power Up Default:**

- a. Set the TSG 200 to its desired default mode of operation. (Select a test signal and the functions that should be enabled.)
- b. Press the SELECT button until ID Store/Recall is lit.
- c. Highlight the POWER UP DEFAULT option as shown in Fig. 2-10.
- d. Press the SELECT (or any non-arrow) button to leave ID Store/Recall.
- e. The present setup will now be the default whenever the instrument is powered up.

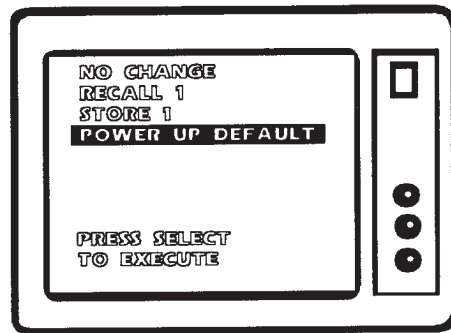

**Fig. 2-10. The monitor display to set the POWER UP DEFAULT.**

Setting the ID CYCLE

**NOTE**

There is **NOT** an UNDO command. Once a change has been made, it must be manually corrected.

**NOTE**

ID can be set to "no character", which means skip this ID in the cycle.

- a. Press the SELECT button until ID CYCLE is lit.
- b. Press the up (▲) or down (▼) button to highlight the CAPTION ID number that needs to be changed as shown in Fig. 2-11.
- c. Use the right or left button to change the ID to the desired number. (The number corresponds to the ID saved in the ID STORE / RECALL operation.) The ID selected will be displayed on the lower portion of the monitor.
- d. When all the IDs are the desired value, then press the SELECT (or any non-arrow) button to leave the ID CYCLE mode. Changes are then saved.
- e. Check that the setup is as expected by running the ID CYCLE routine. (Press the ID CYCLE button in the Function Enable block.)

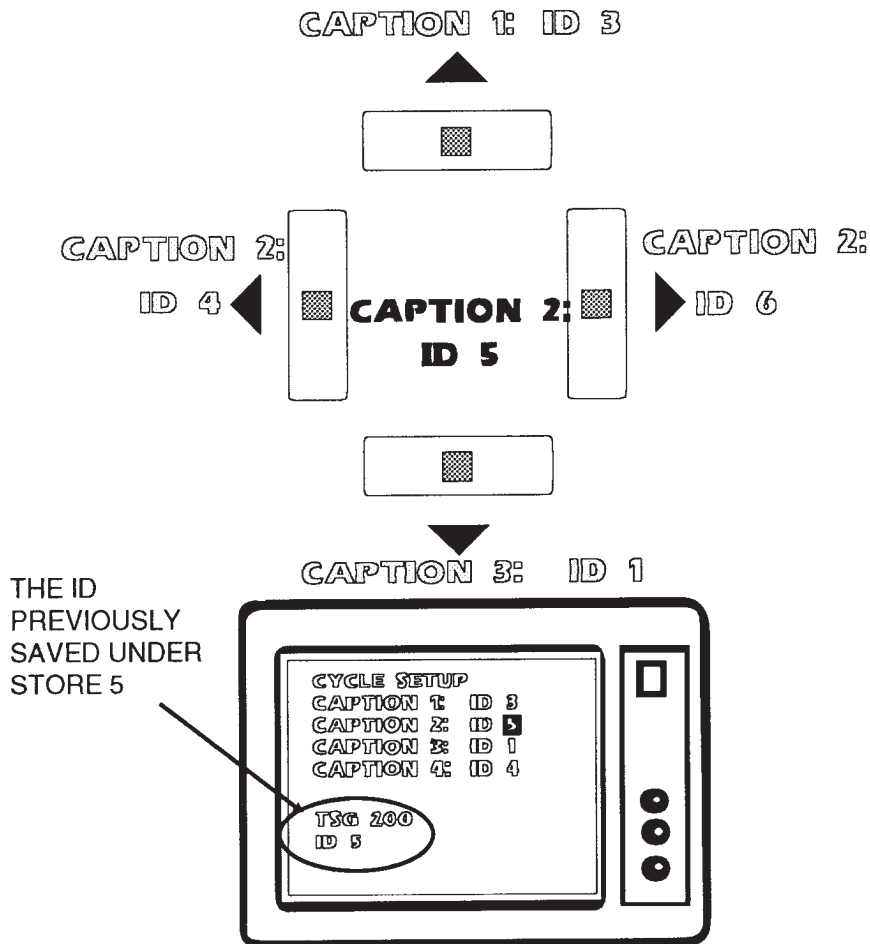

Fig. 2-11. Monitor display when in ID CYCLE Setup.



**Fig. 2-12. Location of the FRONT PANEL LOCKOUT indicator.**

### **FRONT PANEL LOCKOUT (See Fig. 2-12.)**

The Front Panel can only be locked out through commands from the Remote port. Either a Front Panel Lockout command (ground pin 5) or a Tape Leader enable (ground pin 1) will disable the front panel controls. This condition is flagged by lighting the red FRONT PANEL LOCKOUT LED on the front panel. The front panel will remain locked until these pins are ungrounded.



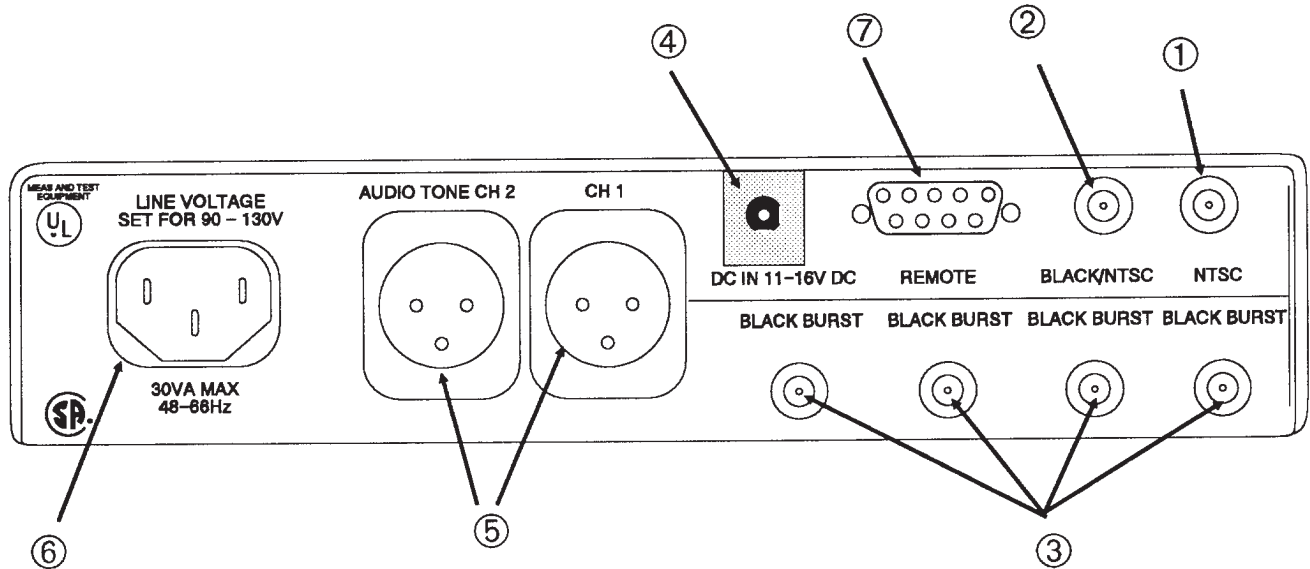

Fig. 2-13. Rear panel of the TSG 200.

## REAR PANEL CONNECTORS (See Fig. 2-13)

This section describes the rear panel connectors and their functions.

The connectors on the rear panel are:

- NTSC
- BLACK/NTSC
- 4 BLACK BURSTS
- REMOTE
- DC IN 11-16V DC
- AUDIO TONE CH1 & CH2
- LINE VOLTAGE

① **NTSC** — NTSC test signal output. The signal is selectable from the SIGNAL SELECT buttons on the front panel. The choices are: SMPTE Bars, Convergence, Safe Area, NTC7 Composite, Multiburst, and 5 Step.

② **BLACK/NTSC** — This output is configurable as either an additional copy of the NTSC signal or Black Burst. The choice is made by an internal jumper. The jumper is explained in the Installation section.

③ **BLACK BURST** — Four identical copies of the Black Burst signal.

④ **DC IN 11-16V DC** — Input for the optional battery power source. This allows the TSG 200 to be portable.

### CAUTION

The DC IN connector is wired to accept a Sony BP90 battery pack. THE CENTER PIN OF THIS CONNECTOR IS GROUND, as shown in Fig. 2-14.

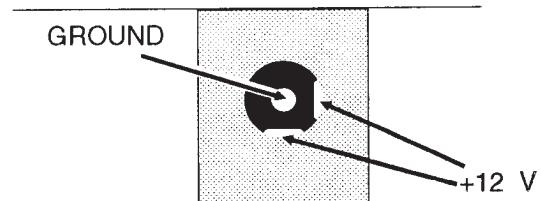

### DC IN 11-16V DC

Fig. 2-14. DC IN connector values.

If the DC IN voltage polarity is accidentally reversed, the DC power supply 2A fuse will blow. The allowable voltage variation is +11 V<sub>dc</sub> to 16 V<sub>dc</sub>. Typical power consumption in DC operation is 13 watts.

## TSG 200 — Controls, Indicators, & Connectors

⑤ **AUDIO TONE CH 1 & CH 2** — The TSG 200's AUDIO TONE output is a balanced 1 kHz or 400 Hz XLR audio tone. The frequency is chosen independently by internal jumpers (see the Installation section). The amplitude is also internally adjustable (see the Performance Checks and Adjustments Section).

A channel ID click is provided on CH1. The frequency of the ID click may be changed by an internal adjustment (see Section 4, Performance Checks and Adjustments). It can be enabled/disabled by the front panel AUDIO CLICK button in the FUNCTIONS ENABLE section.

⑥ **LINE VOLTAGE** — Electrical mains input, factory set for 110 V<sub>ac</sub> (to change the operating voltage to 220 V<sub>ac</sub> see the Installation section.)

⑦ **REMOTE** — The Remote input is a simple ground closure remote control. The functions accessed by the REMOTE are:

- Test signal selection
- Enable/disable of Character ID in the active video field
- Enable/disable of Character ID in the vertical interval
- Initialize the Tape Leader countdown sequence
- Enable/disable source identification (SID)
- Enable/disable audio click on CH 1
- Recall a stored ID
- Enable/Disable the ID Cycling routine
- Disable front panel controls

### NOTE

*If in the Setup mode (entered from the front panel), and a command is issued from the Remote, the Setup mode will be exited and **NONE** of the changes made will be saved.*

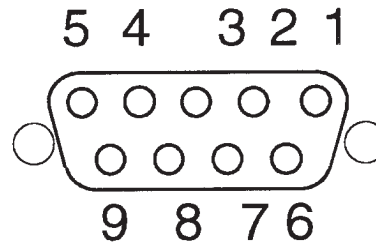

**Fig. 2-15. The REMOTE connector pinout. (Looking into the TSG 200)**

PIN #	FUNCTION
1	Tape Leader
2	Signal Select
3	Function Enable/Disable
4	ID Recall
5	Front Panel Lockout
6	Binary Code (LSB)
7	Binary Code
8	Binary Code (MSB)
9	Ground

### NOTE

*Ground = 0 and open = 1 are the binary codes for the remote controls.*

## Using the REMOTE

### Pin 1 — Tape Leader

When this pin is grounded the Tape Leader countdown sequence is activated and will remain in this mode of operation as long as this pin is grounded.

The Tape Leader sequence is:

TIME (in seconds)	OPERATION
90 → 15	SMPTE Bars and Audio Tone.
15 → 10	Black Burst and no Audio Tone.
10 → 2	Display of countdown (10 to 2) on a black screen. On Audio Channel 1 there is a beep for each count.
2 → 0	Black Burst with no Audio Tone.

The Black Burst signal will continue to be output as long as this pin is grounded. The front panel is also locked out until the ground is removed.

The length of the Tape Leader sequence is user selectable from a maximum of 90 seconds (45 seconds of SMPTE Bars and Audio Tone) to a minimum of 10 seconds (only countdown). See the Installation Section for how to set the length.

### Pin 2 — Signal Selection

When this pin is momentarily grounded the signal selected will correspond to the binary code set with pins 6, 7, and 8 as shown in Table 2-1.

**Table 2-1. Binary Code for Signal Selection.**

PIN			SIGNAL SELECTED
8	7	6	
0	0	0	SMPTE Bars
0	0	1	Convergence
0	1	0	Safe Area
0	1	1	NTC 7 Composite
1	0	0	Multiburst
1	0	1	5 Step
1	1	0	no change
1	1	1	no change

**Pin 3 — Function Enable/Disable**

When this pin is momentarily grounded, the function that corresponds to the binary code set with Pins 6, 7, and 8 will be toggled on or off. See Table 2-2 for the binary code for each function.

**Table 2-2. Binary Code for Function Enable/Disable.**

PIN			FUNCTION
8	7	6	
0	0	0	Tape Leader
0	0	1	Character ID
0	1	0	VBI Character ID
0	1	1	Audio Click
1	0	0	ID Cycle
1	0	1	SID
1	1	0	No Action
1	1	1	No Action

**NOTE**

*In order to disable the Tape Leader function from this control block, pin 3 must be momentarily grounded. This is different from the Tape Leader on pin 1 which must be removed from ground to disable the Tape Leader.*

**Pin 4 — ID Recall**

When this pin is momentarily grounded, the Character ID caption that has been stored from the front panel can be recalled according to the binary code set on Pins 6, 7, and 8. See Table 2-3 for the binary code for each ID Recall.

**Table 2-3. Binary Code for Character ID Recall.**

PIN			ID CAPTION RECALL
8	7	6	
0	0	0	Recall 1
0	0	1	Recall 2
0	1	0	Recall 3
0	1	1	Recall 4
1	0	0	Recall 5
1	0	1	Recall 6
1	1	0	Recall 7
1	1	1	Recall 8

**Pin 5 — Front Panel Lockout**

When this pin is grounded the buttons on the front panel of the instrument are disabled. The LED on the front panel will be lit to indicate that the front panel has been disabled as shown in Fig. 2-16.



**Fig. 2-16.**  
**FRONT PANEL LOCKOUT indicator.**

# SECTION 3

## SIGNAL GENERATOR SPECIFICATIONS

The material in this section is organized into two main groupings: the specification tables and the supporting figures. The specification tables include:

1. NTSC general signal characteristics and test signal specifications
2. Signal level specifications
3. Power supply, physical, and environmental specifications

The supporting figures (waveform diagrams and related data) follow the specification tables.

### Reference Documentation

The following documents were used as references in the preparation of this specification:

1. Product Classification Environmental Test Summary, 13 June 1977  
Tektronix Standard 062-2853-00
2. Electromagnetic Compatibility Environmental Test, 31 March 1977  
Tektronix Standard 062-2866-00
3. Recommendations and Reports of the CCIR, 1978; Transmission of Sound Broadcasting and Television Signals Over Long Distances (CMTT)
4. IEEE Standard Dictionary of Electrical Terms, Second Edition (1977)  
IEEE Standard 100-1977
5. Safety Standard for Electrical and Electronic Equipment, Draft 6, June 1978  
ANSI C39.5

6. International Electrotechnical Commission Standard, "Safety Requirements for Electronic Measuring Apparatus"  
IEC 348
7. Canadian Standards Association Electrical Standard for Electrical and Electronic Measuring and Testing Equipment  
CAN/CSA C22.2 No. 231

### Performance Conditions

The Performance Requirements are valid within the environmental limits if the instrument is adjusted at  $25^{\circ}\text{C} \pm 5^{\circ}\text{C}$ , and a minimum warm-up time of 20 minutes is allowed.

### Safety Standards

The following safety standards apply to the TSG 200:

- ANSI/ISA-S82.01
- IEC 348
- CAN/CSA C22.2 No. 231
- UL 1244

### NOTE

*Shielded cables were used in the certification of this instrument; therefore, shielded cables should be used in its operation. (EC 92)*

**NOTE**

All figures referenced in this section are found after the Specification tables.

**Table 3-1.  
General Test Signal Characteristics.**

CHARACTERISTICS	PERFORMANCE REQUIREMENTS	SUPPLEMENTAL INFORMATION	PER. CHECK STEP #
Luminance Amplitude Accuracy	$\pm 1\%$	Measured at 100 IRE.	6.
Chrominance-to-Luminance Gain	$\pm 1\%$	Measured at white flag and 3.58 MHz of the Multiburst signal.	7.
Blanking Level	0 mV $\pm$ 50 mV		2.
Luminance Rise Time	250 ns $\pm$ 25 ns	Except where specified otherwise.	
Chrominance Rise Time	400 ns $\pm$ 40 ns	Except where specified otherwise.	
Burst Amplitude	285.7 mV (40 IRE) $\pm$ 2%		4.
Burst Rise Time	400 ns $\pm$ 40 ns		
Sync Amplitude	285.7 mV (40 IRE) $\pm$ 2%		3.
Sync Rise Time	140 ns $\pm$ 20 ns		9.
Line Timing	See Figs. 3-2 to 3-8.		
Front Porch Duration	1.5 $\mu$ s $\pm$ 0.1 $\mu$ s		
Line Blanking Interval	10.9 $\mu$ s $\pm$ 0.2 $\mu$ s	Measured at the 20 IRE point of active video.	11.
Breezeway Duration	600 ns $\pm$ 50 ns		
Line Sync Duration	4.7 $\mu$ s $\pm$ 50 ns	50% amplitude point.	10.
Vertical Serration Duration	4.7 $\mu$ s $\pm$ 50 ns	50% amplitude point.	10.
Equalizing Pulse Duration	2.3 $\mu$ s $\pm$ 50 ns	50% amplitude point.	10.
Burst Delay from Sync Burst Duration	5.308 $\mu$ s $\pm$ 35 ns 2.51 $\mu$ s $\pm$ 0.1 $\mu$ s	19 cycles of subcarrier. 9 cycles of subcarrier.	
Output Impedance		75 $\Omega$	
Return Loss		$\geq 36$ dB to 4.2 MHz	
Crosstalk		$\geq 60$ dB down	

Table 3-1. Cont.

CHARACTERISTICS	PERFORMANCE REQUIREMENTS	SUPPLEMENTAL INFORMATION	PER. CHECK STEP #
Residual Subcarrier		≥ 60 dB down	
Subcarrier Stability	$3.579545 \pm 5$ Hz	Over temperature range of 5°C to 35°C. Annual adjustment required.	1.
Signal-to-Noise Ratio		≥ 60 dB Signal passed through a continuous random noise 5 MHz low-pass filter.	16.
Chrominance-to-Luminance Delay	≤ 12 ns	10 ns typical. Measured with the NTC7 Composite signal.	7.
Frequency Response	Flat within 2% to 4.2 MHz		14.

**Table 3-2.  
Test Signals.**

CHARACTERISTICS	PERFORMANCE REQUIREMENTS	SUPPLEMENTAL INFORMATION	PER. CHECK STEP #
SMPTE Bars Luminance Rise Times Field Timing Color Bars Reverse Blue Bars IQB  White Yellow Cyan Green Magenta Red Blue -I Q	140 ns ± 25 ns  Lines 21 - 182 Lines 183 - 202 Lines 203 - 262  Luminance Amplitude <i>mV</i> Subcarrier Amplitude <i>mV<sub>p-p</sub></i> Subcarrier Phase <i>degree</i>	See Fig. 3-2. See Fig. 3-3. See Fig. 3-4.	
Convergence Amplitude Pattern  Pulse HAD	549.1 mV (76.9 IRE)  225 ns ± 25 ns	See Figs. 3-6 and 3-7.  Crosshatch — 14 horizontal lines and 17 vertical lines per field.	13.
5-Step Staircase Amplitude Linearity Error	714.3 mV (100 IRE) ≤ 1%	See Fig. 3-5.  Relative step matching.	5.
Safe Area Amplitude Safe Title Horizontal Bar Vertical Timing Safe Action Horizontal Bar Vertical Timing	549.1 mV  lines 45 & 238 14.925 & 56.525 μs  lines 33 & 250 12.325 & 59.125 μs	See Figs. 3-10 through 3-15.	



Table 3-2 . Cont.

CHARACTERISTICS	PERFORMANCE REQUIREMENTS	SUPPLEMENTAL INFORMATION	PER. CHECK STEP #
Multiburst White Reference Bar Amplitude Packet Amplitudes Pedestal Burst Frequencies Packet Rise Time 0.5 MHz  Other Packets	500 mV (70 IRE) 428.6 mV <sub>p-p</sub> (60 IRE) 285.7 mV (40 IRE) 0.5, 1.0, 2.0, 3.0, 3.58, & 4.2 MHz	See Fig. 3-9.  Equal width packets  140 ns typical (sine-squared shaped packets) 400 ns typical (sine-squared shaped packets)	
NTC 7 Composite Bar Amplitude Rise Time 2T pulse Pulse-to-Bar Ratio HAD Ringing Modulated Sine-Squared Pulse Pulse-to-Bar  HAD Chrominance-to-Luminance Delay Modulated 5-Step Staircase Luminance Chrominance Diff Gain Diff Phase	100 IRE 125 ns ± 25 ns  100% ± 1.0 % (1:1 within 1%) 250 ns ± 25 ns 1% peak  100% ± 1% (1:1 within 1%)  1.563 μs ± 150 ns ≤ 12 ns  90.2 IRE 40 IRE 0.6% or less 0.3° or less	See Fig. 3-8.      Measured at peak amplitude.  10 ns typical.	   12. 13. 8.  12. 13.  7.   15. 15.

Table 3-3. Test Signal Generator - Black Burst Output.

CHARACTERISTICS	PERFORMANCE REQUIREMENTS	SUPPLEMENTAL INFORMATION	PER. CHECK STEP #
Black Amplitude	7.5 IRE ± 1 IRE		17.
Blanking Width	10.9 μs ± 0.2 μs		18.
Sync Timing	See Fig. 3-16		

**Table 3-4. Character Identification.**

CHARACTERISTICS	SUPPLEMENTAL INFORMATION
Number of Characters Displayed	2 lines of up to 16 characters per line.
Display Position	Movable over the active field. Also first line may be displayed in the Vertical Blanking Interval.
Character Amplitude	7.5 IRE — Black 90 IRE — White

**Table 3-5.  
Audio Tone Characteristics.**

CHARACTERISTICS	PERFORMANCE REQUIREMENTS	SUPPLEMENTAL INFORMATION	PER. CHECK STEP #
Amplitude	0 to +8 dBu into 600 $\Omega$ , or a high impedance load.		
Frequency	1 kHz or 400 Hz	Selected by an internal jumper.	
Distortion (THD)	$\leq 0.5\%$ THD		19.
Audio ID "click" Frequency Range (one channel only)	Rate adjustable from 0.2 Hz to 4 Hz.		

**Table 3-6.**  
**Power Supply Specifications.**

CHARACTERISTICS	PERFORMANCE REQUIREMENT	SUPPLEMENTAL INFORMATION	PER. CHECK STEP #
Supply Accuracy +5 V -5.2 V +12 V -12 V		5 V $\pm$ 150 mV -5.2 V $\pm$ 300 mV +12 V $\pm$ 400 mV -12 V $\pm$ 400 mV	
Hum +5 V -5.2 V +12 V -12 V		Typical 10 mV <sub>p-p</sub> 20 mV <sub>p-p</sub> 10 mV <sub>p-p</sub> 10 mV <sub>p-p</sub>	
Noise +5 V -5.2 V +12 V -12 V		$\leq$ 50 mV (5 MHz bandwidth) $\leq$ 50 mV (5 MHz bandwidth) $\leq$ 50 mV (5 MHz bandwidth) $\leq$ 50 mV (5 MHz bandwidth)	
Line Voltage Range 115 VAC 240 VAC	90 - 130 VAC 180 - 250 VAC	Jumper Selectable	
Fuse Data 110 VAC Setting 220 VAC Setting		0.4 A Med. Blow 0.2 A Med. Blow	
Power Limit		18 Watts	
Power Consumption, Typical		13 Watts	
Line Frequency		48 - 62 Hz	

Table 3-7.  
Physical Characteristics.

CHARACTERISTICS	SUPPLEMENTAL INFORMATION
Dimensions Height Width Length	43.4 mm (1.71 in) 205.7 mm (8.10 in) 342.9 mm (13.5 in)
Net Weight	1.47 kg (4 lbs 6 oz)
Shipping Weight	3.2 kg (7 lbs 1 oz)

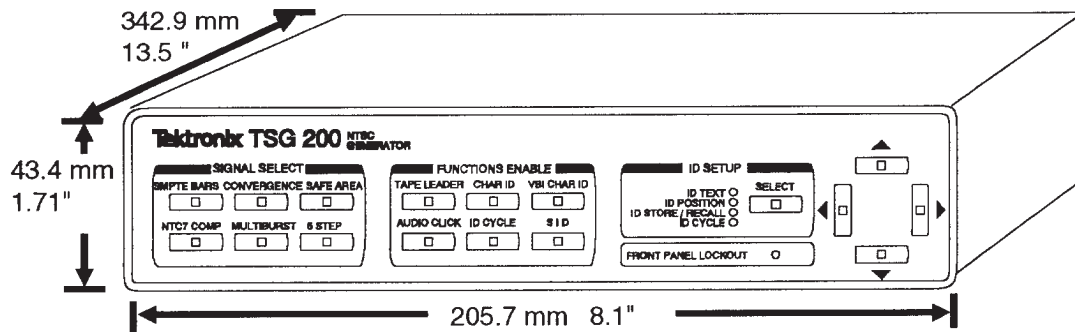

Fig. 3-1. Physical dimensions of the TSG 200.

**Table 3-8.**  
**Environmental Characteristics**

CHARACTERISTICS	SUPPLEMENTAL INFORMATION
Temperature Non-Operating Operating	-40 to +65°C 0 to +35°C
Altitude Non-Operating Operating	To 50,000 feet To 15,000 feet
Vibration (Operating)	15 minutes each axis at 0.025 inch, with frequency varied from 10-55-10 cycles per second in 4 minute cycles with instrument secured to vibration platform. Ten minutes each axis at any resonant point or at 55 cycles per second.
Shock	50 g, 1/2 sine, 11 ms duration, 3 guillotine-type shocks per side.
Transportation	Qualified under NTSC Test Procedure 1A, Category II (24 inch drop).

**Table 3-9.**  
**Certifications and Compliances**

Category	Standards or description
FCC Compliance	Emissions comply with FCC Code of Federal Regulations 47, Part 15, Subpart B, Class A Limits.



## TEST SIGNALS

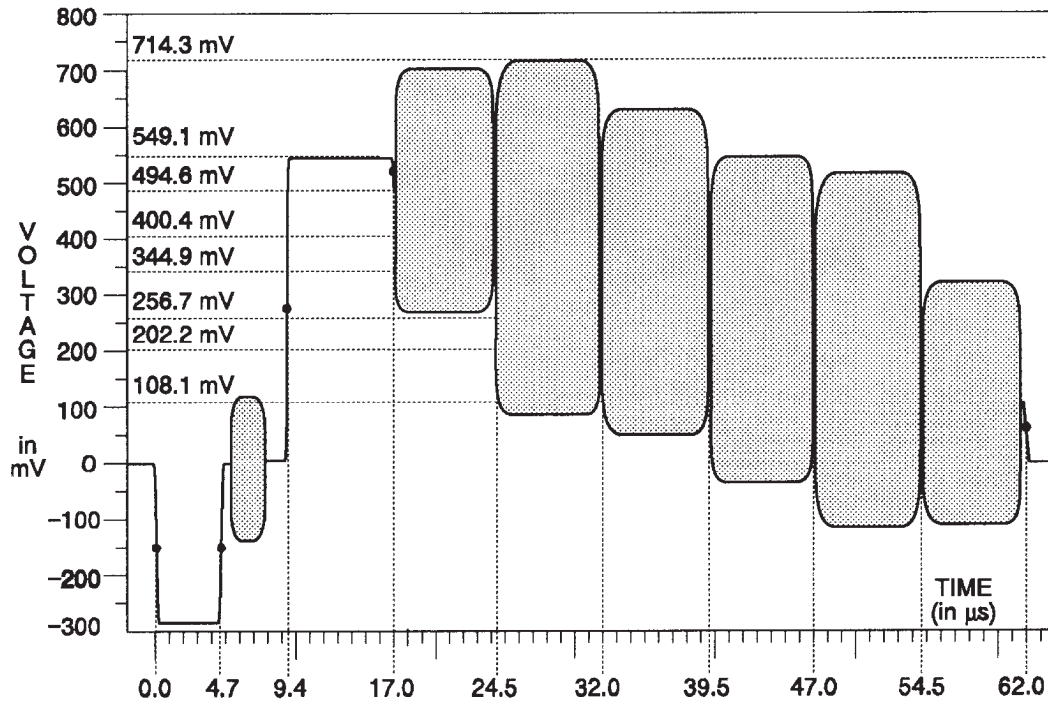

Fig. 3-2. SMPTE Color Bars.

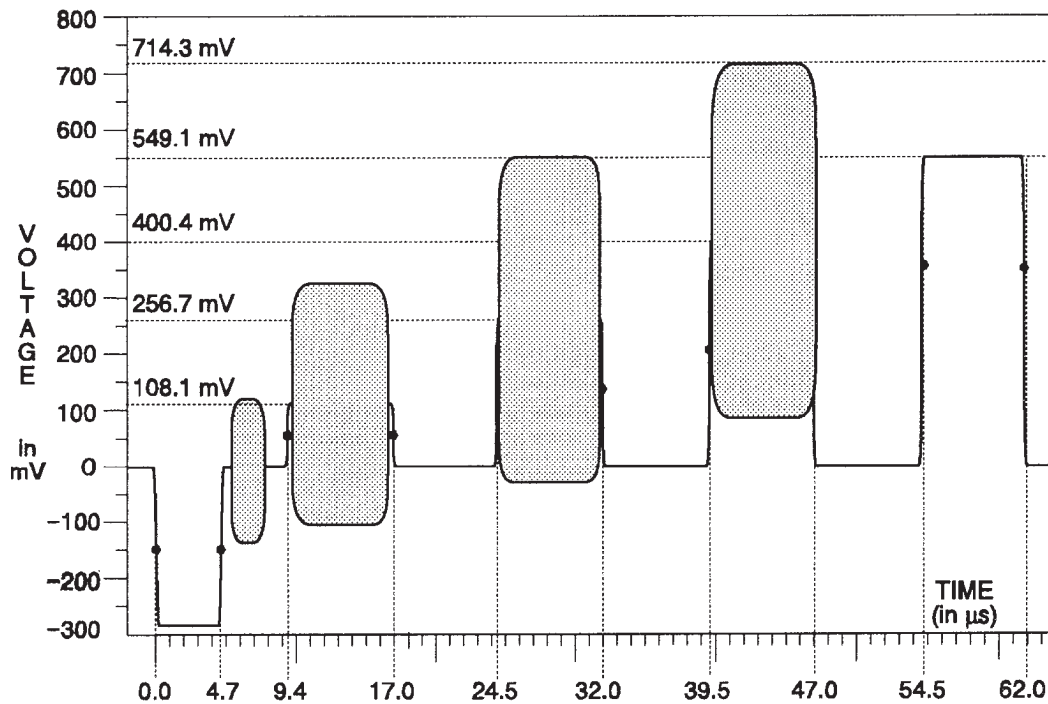

Fig. 3-3. SMPTE Reverse Blue Bars.

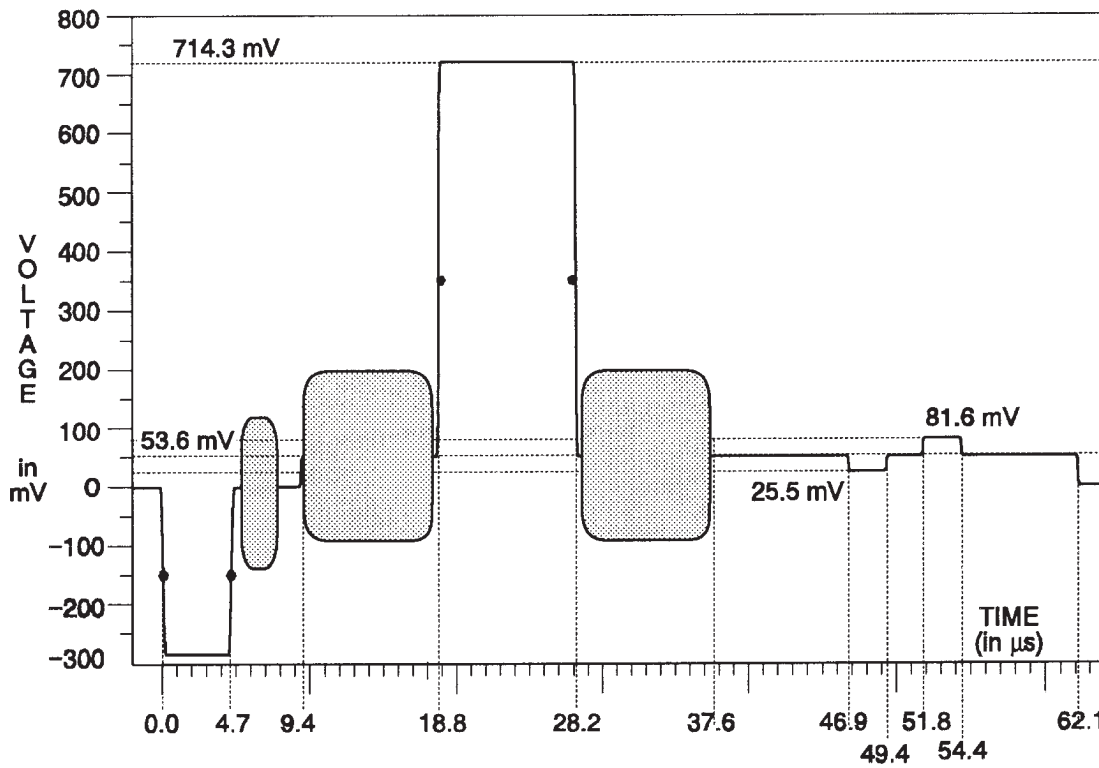

Fig. 3-4. SMPTE IYQB.

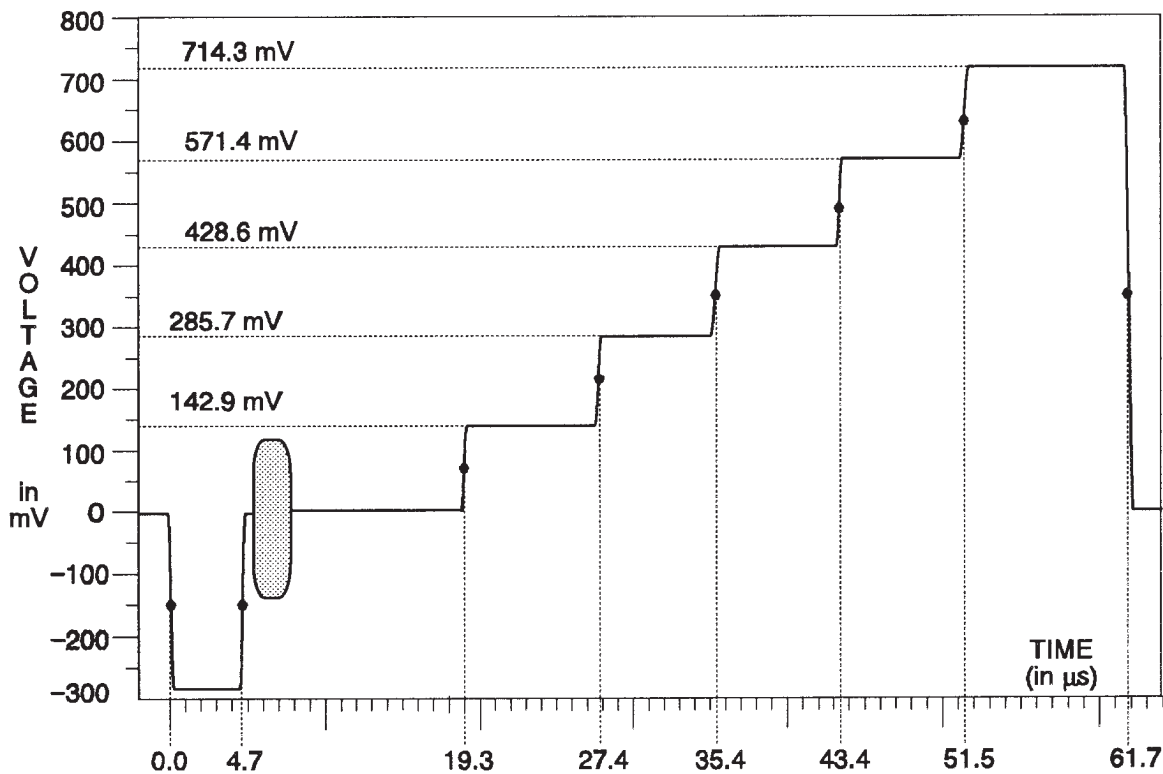

Fig. 3-5. 5-Step (Gray Scale).



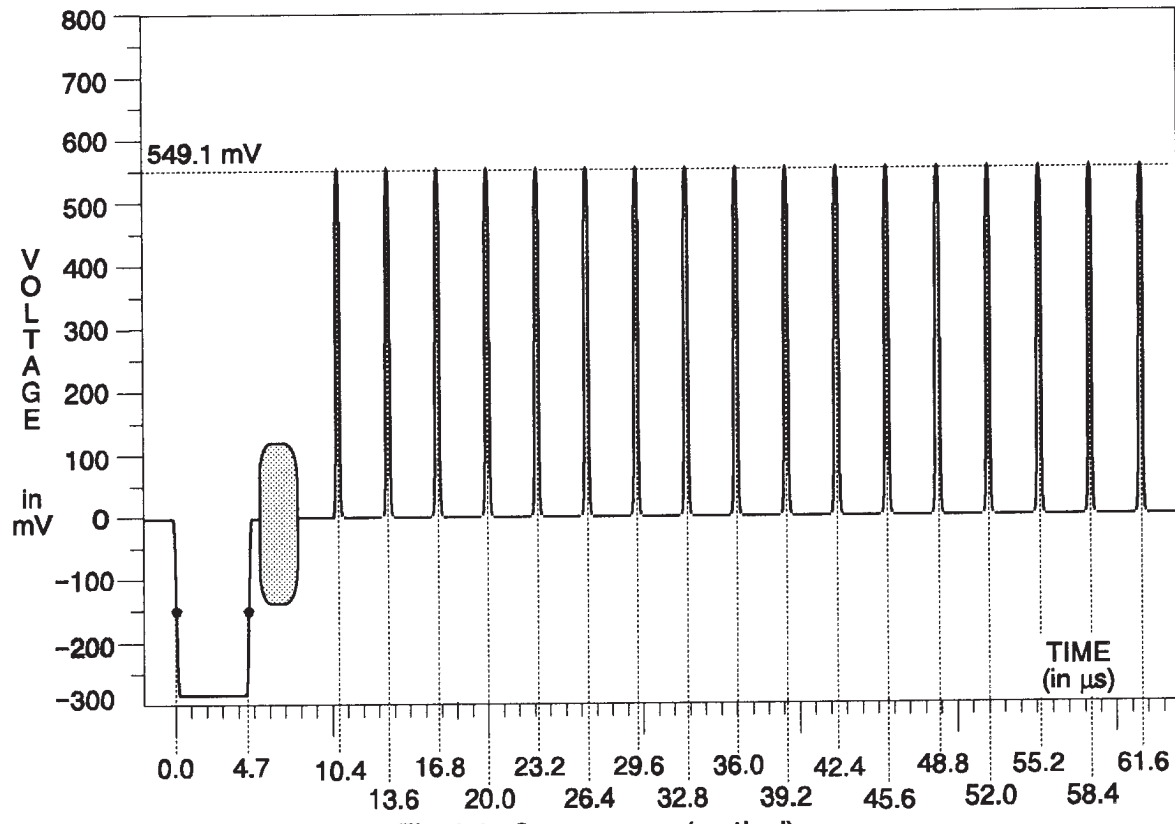

Fig. 3-6. Convergence (vertical).

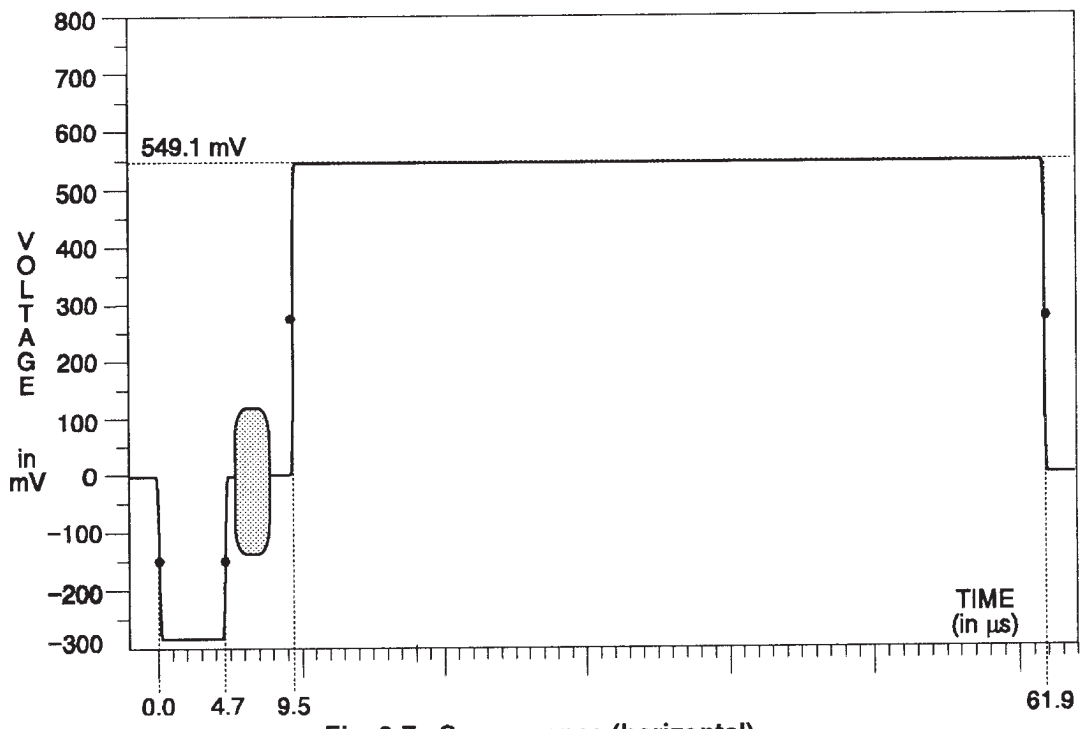

Fig. 3-7. Convergence (horizontal).

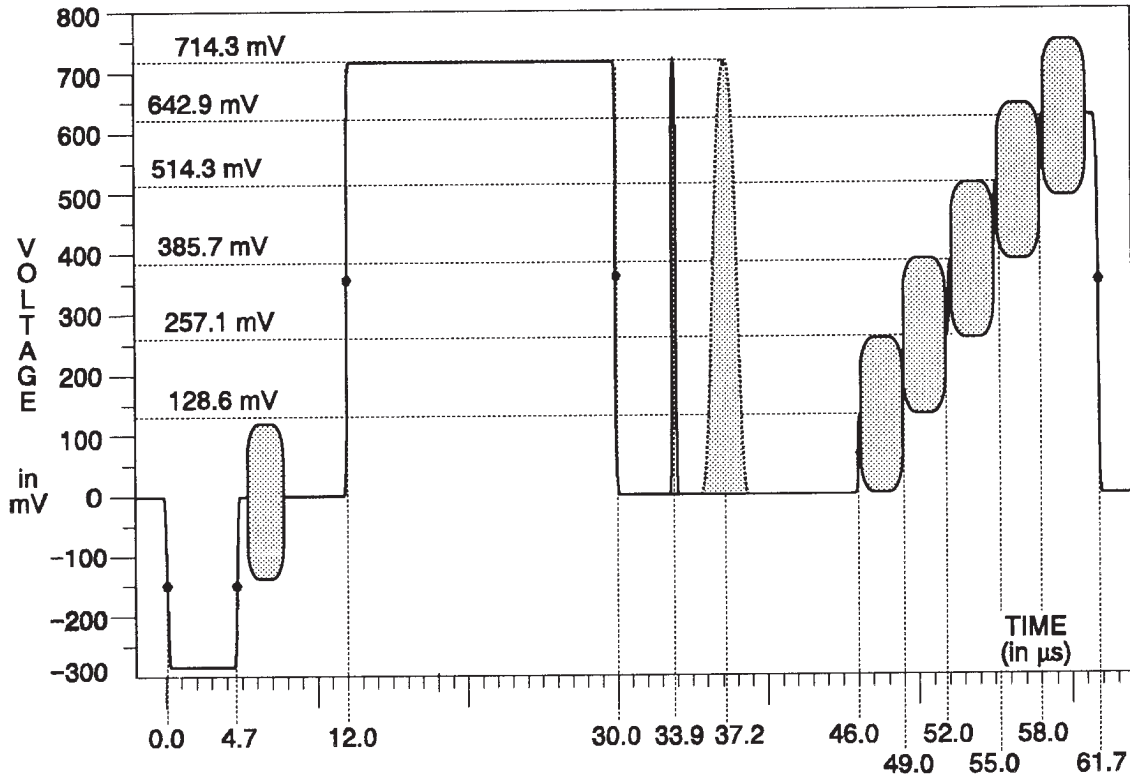

Fig. 3-8. NTC 7 Composite.

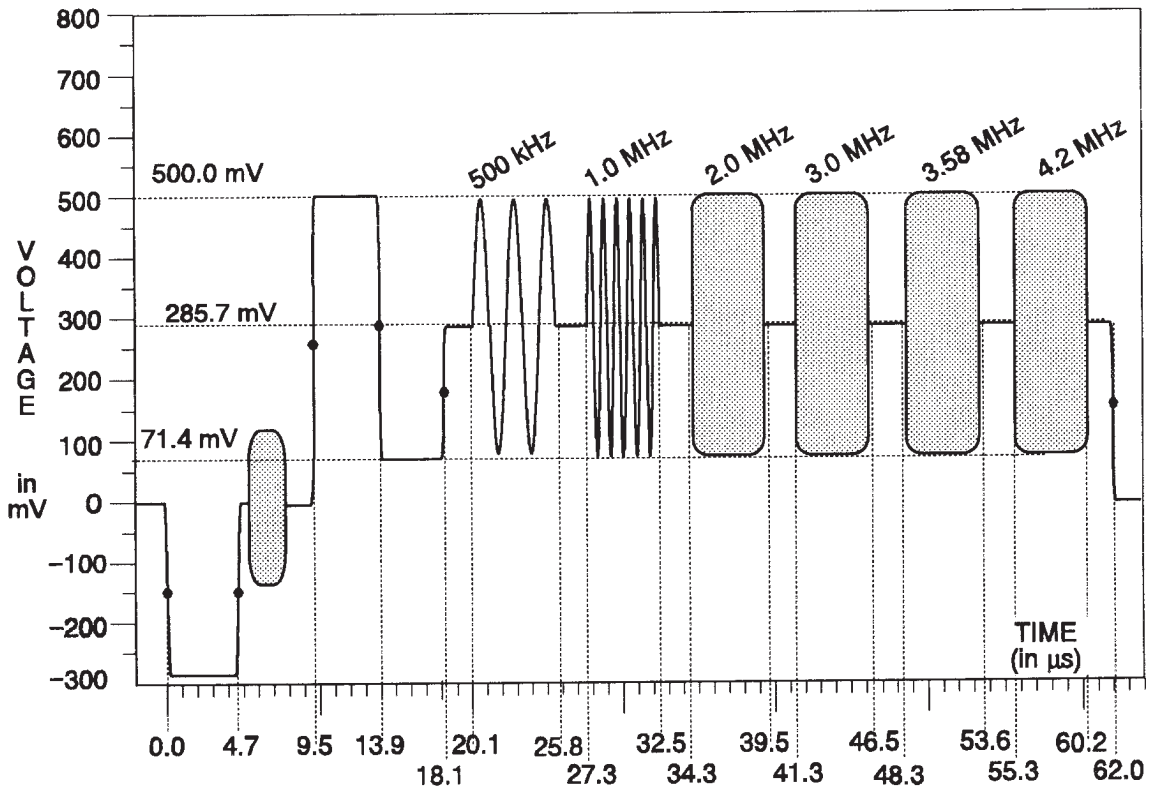

Fig. 3-9. Multiburst.

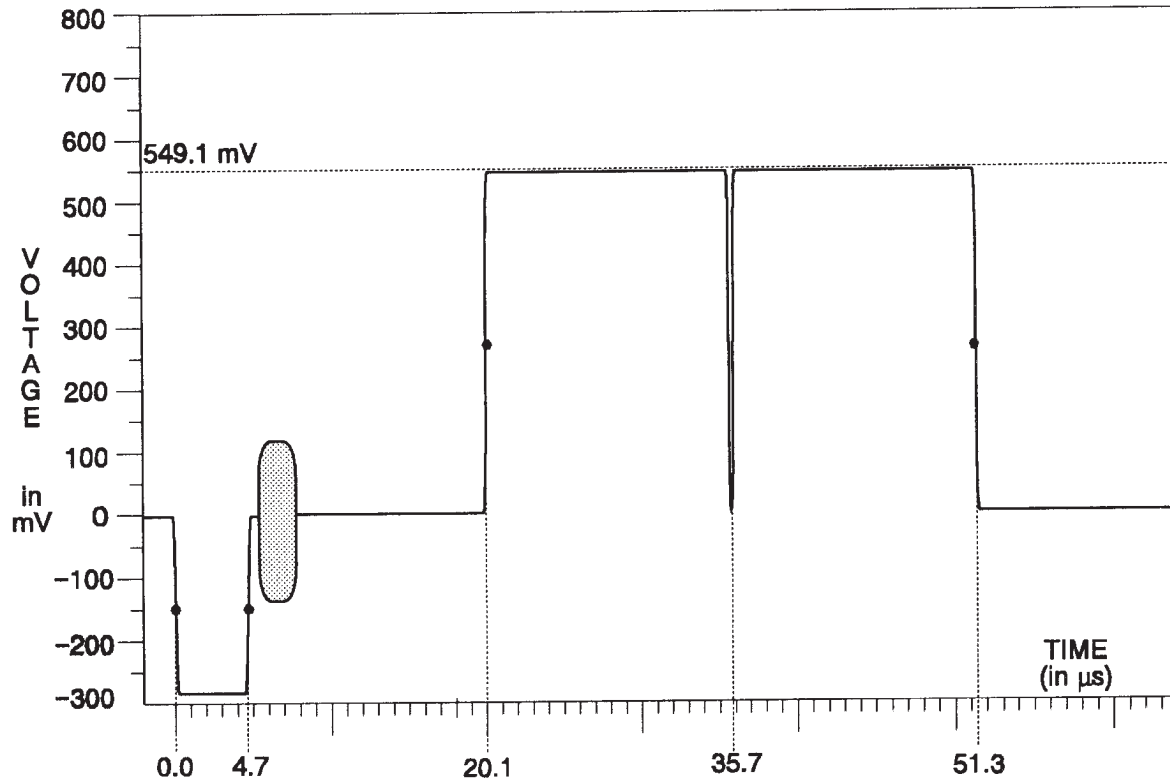

Fig. 3-10. Safe Area for lines: 33, 45, 238, & 250.

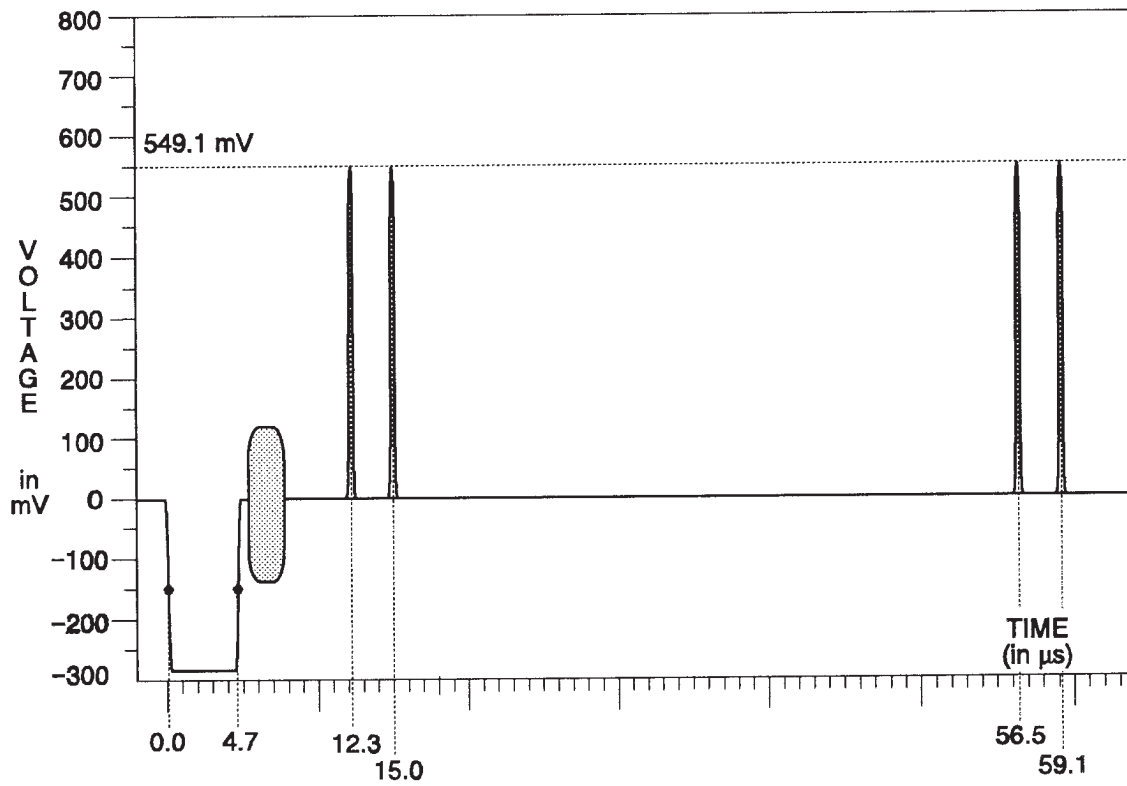

Fig. 3-11. Safe Area for lines: 69-132 & 149-214.

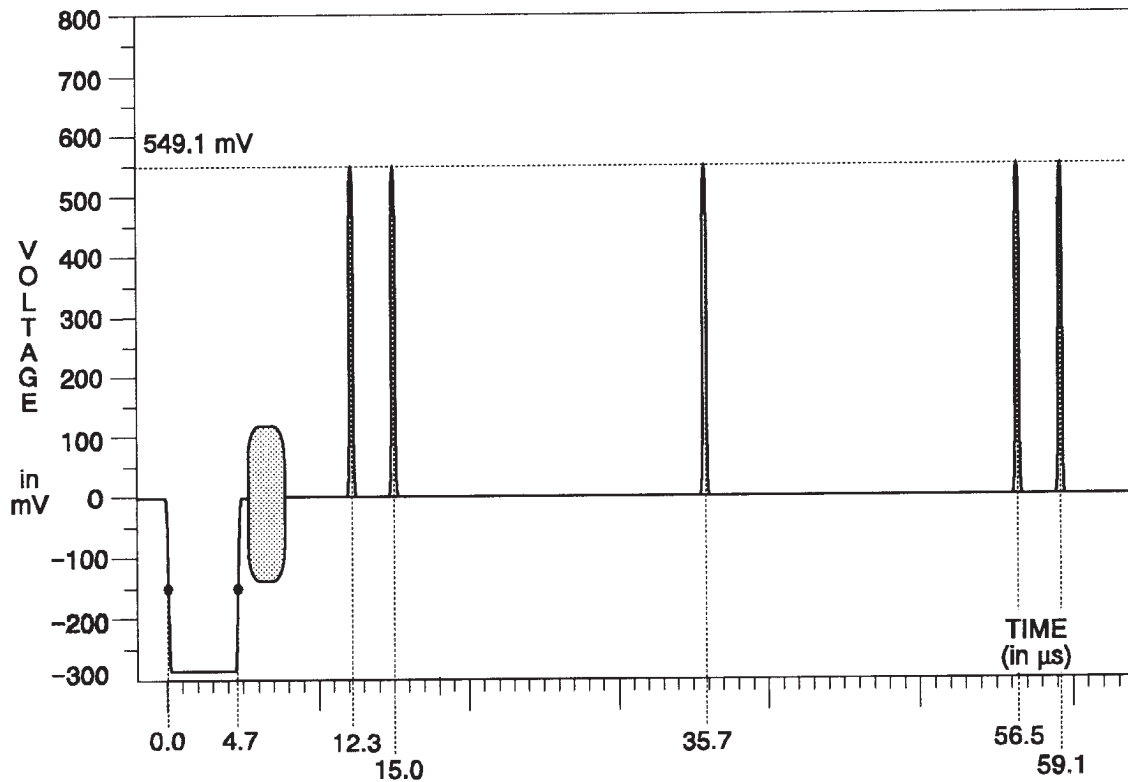

Fig. 3-12. Safe Area for lines: 133-140 & 142-148.

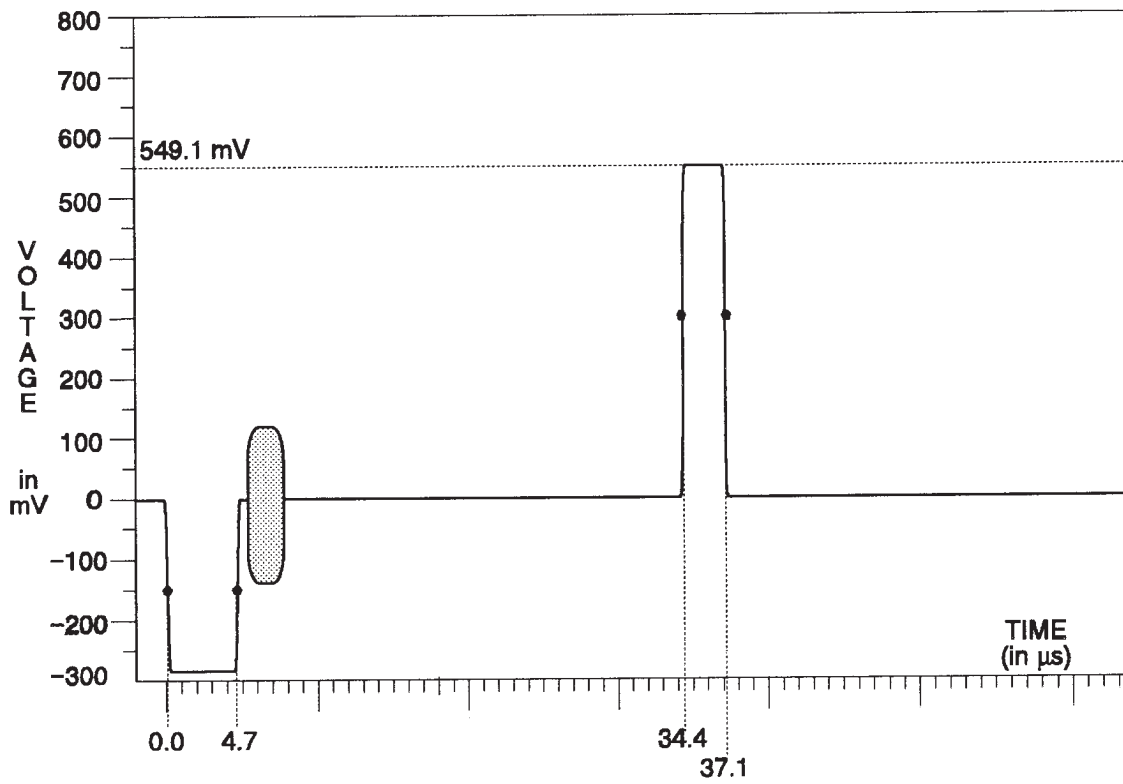

Fig. 3-13. Safe Area for line 141.

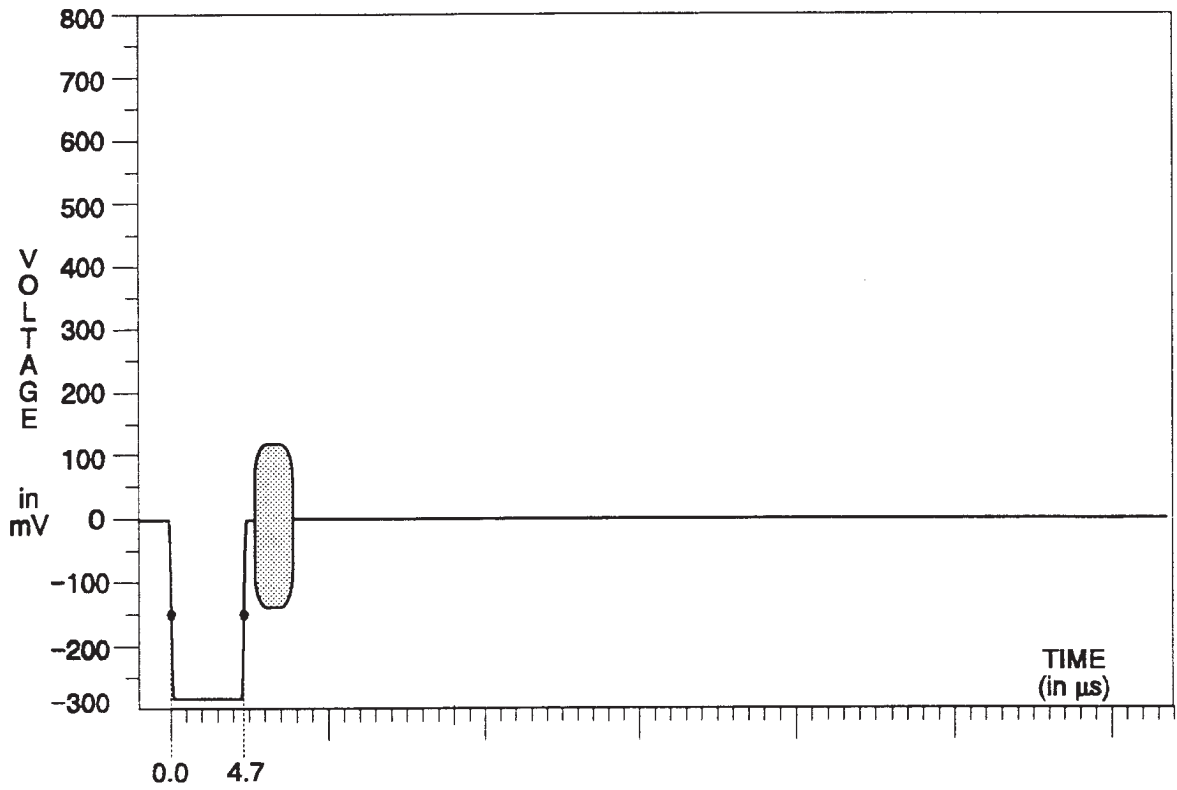

Fig. 3-14. Safe Area for all other lines.

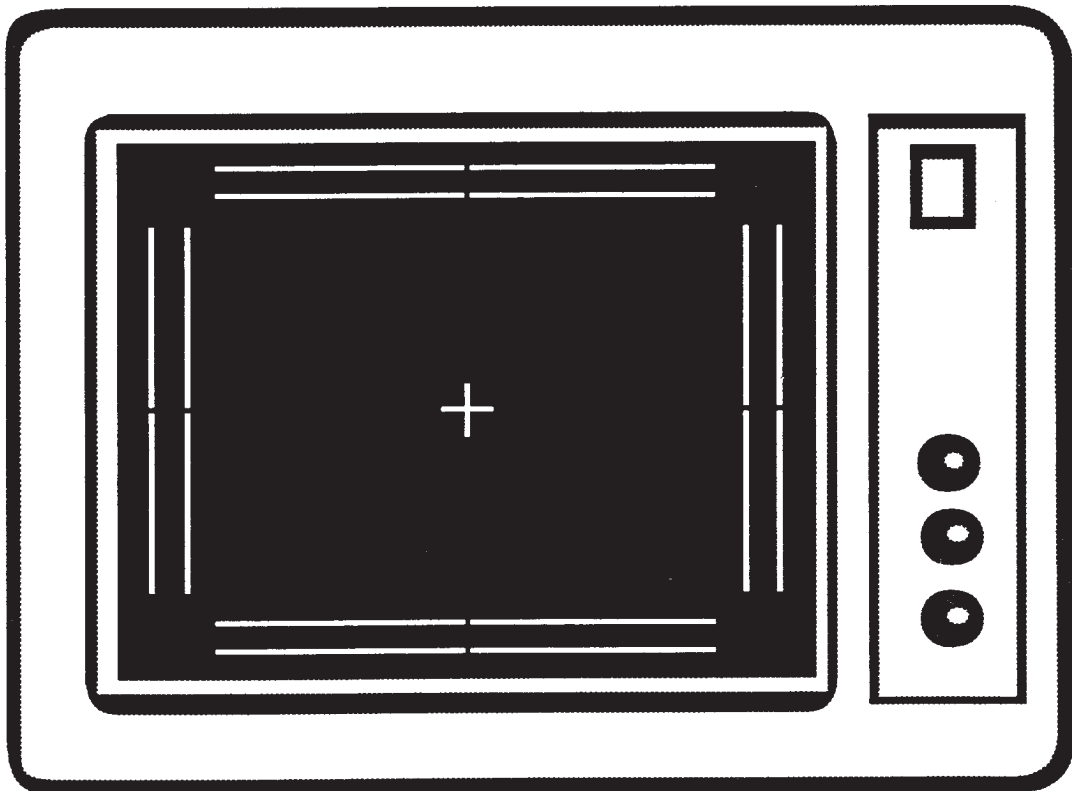

Fig. 3-15. Video monitor display of Safe Area signal.

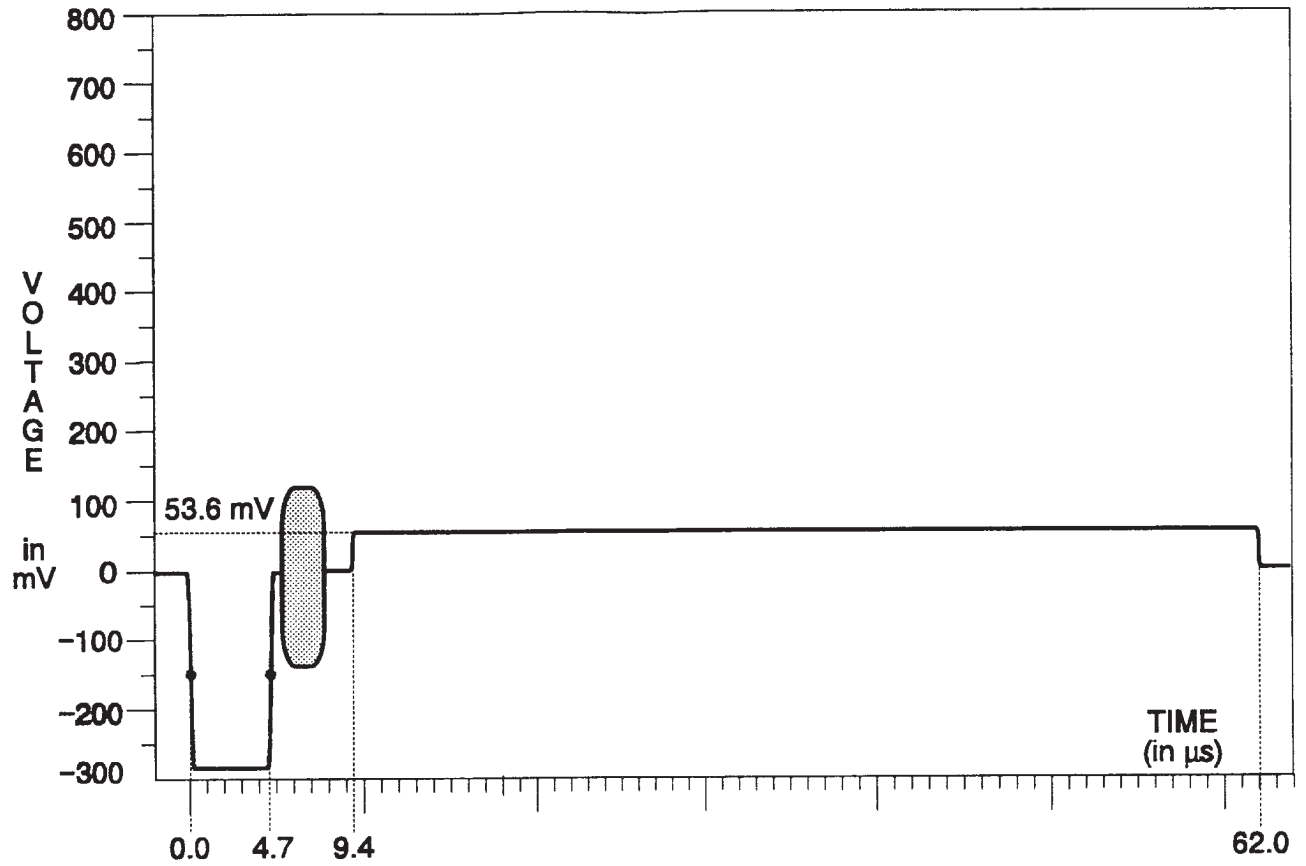

Fig. 3-16. Black Burst.



**WARNING**

*The following servicing instructions are for use only by qualified personnel. To avoid injury, do not perform any servicing other than that stated in the operating instructions unless you are qualified to do so. Refer to all safety summaries before performing any service.*





# SECTION 4

## PERFORMANCE CHECKS & ADJUSTMENT PROCEDURES

This section consists of checklists and detailed procedures to use in verifying and calibrating TSG 200 performance parameters.

The order of these procedures has been chosen to minimize changes in equipment setup. Performance parameters may be checked in any order. However, because many calibration steps are interactive, care must be taken when adjusting individual parameters to ensure that all others remain within specification.

The following is a list of equipment required for the Performance Check and Adjustment Procedure. While alternate equipment may be used for the Performance Check, it is not recommended for the Adjustment Procedure. Use of inadequate equipment may result in faulty measurements or calibration.

### List of Required Test Equipment

1. **NTSC Video Measurement Set.** For measuring and displaying field-rate and line-rate waveforms, and differential phase and gain.  
Example: Tektronix 1780 Video Measurement Set.

#### **NOTE**

*For calibration, it is recommended that a Tektronix 1780 or equivalent test set be used. For Performance Check only, the following equipment may be used in place of the 1780.*

- a. **NTSC Waveform Monitor.** For displaying and measuring field-rate and line-rate waveforms.  
Example: Tektronix 1480 Mod W5F.
  - b. **NTSC Vectorscope.** With specific modes for measuring differential phase and gain.  
Example: Tektronix 520A.
  - c. **Video Amplitude Calibration Fixture (VAC).** Provides a chopped voltage reference accurate to 0.05% from 0 to 1 V in 0.1 mV increments (used with the waveform monitor).  
Example: Tektronix part number 067-0916-00: plugs into Tektronix TM 503B Power Mainframe.
2. **Frequency Counter.** Must be accurate to within 2.5 Hz out of 15 MHz.  
Example: Tektronix DC 503A: plugs into a TM 503B Power Mainframe.
  3. **Distortion Analyzer.** Must test power output over 0 - 8 dBm and be capable of detecting THD of 0.01% or less.  
Example: Tektronix AA501.
  4. **Audio Amplifier.** 600  $\Omega$  impedance.
  5. **BNC Coax Cables.** 75  $\Omega$  impedance.  
Example: Tektronix part number 012-0074-00.
  6. **End-Line Termination.** 75  $\Omega$  termination equipped with a BNC connector.  
Example: Tektronix part number 011-0102-00.
  7. **Feed-Through Termination.** 75  $\Omega$  termination equipped with BNC connectors.  
Example: Tektronix part number 011-0103-00.
  8. **Audio Connector-to-Triple Banana Cable.**  
Example: ITT Pamona Electronics, Model 4953-J-36. Must be configured to match the TSG 200 audio output. Pin 1, shield; pin 2, +; pin 3, -.
  9. **Noise Measurement Filter.** Continuous random noise 5 MHz low-pass filter. Tektronix part number 015-0213-00.

## PERFORMANCE CHECK PROCEDURES

### Oscillator Frequency

1. Oscillator Frequency  
14.31818 MHz  $\pm$  20 Hz

#### **NOTE**

*After initial delivery or long storage, allow a two-hour warm up to re-age the crystal. Thereafter, 30 minutes warm up is sufficient.*

### Test Signal

2. Blanking Level  
0 V  $\pm$  50 mV
3. Sync Amplitude  
285.7  $\pm$  57 mV (40  $\pm$  8 IRE)
4. Burst Amplitude  
285.7  $\pm$  57 mV (40  $\pm$  8 IRE)
5. 5-Step Staircase Linearity  
< 1% Error
6. Luminance Amplitude Accuracy  
714  $\pm$  7.14 mV (100  $\pm$  10 IRE)
7. Chrominance-to-Luminance Delay and Gain  
Delay:  $\leq$  12 ns  
Gain:  $\leq$  1%
8. Ringing  
< 1%
9. Sync Rise Times  
140  $\pm$  20 ns
10. Sync Timing  
Horizontal Sync Duration: 4.7  $\mu$ s  $\pm$  50 ns  
HAD Vertical Serrations: 4.7  $\mu$ s  $\pm$  50 ns  
HAD Equalizing Pulses: 2.3  $\mu$ s  $\pm$  50 ns
11. Line Blanking Interval  
10.9  $\pm$  0.2  $\mu$ s
12. Pulse to Bar Ratio  
1:1  $\pm$  1%
13. Pulse Half Amplitude Duration (HAD)  
2T Pulse: 250  $\pm$  25 ns  
Modulated Pulse: 1.563  $\mu$ s  $\pm$  150 ns  
Convergence Pulse: 225 ns  $\pm$  150 ns
14. Multiburst Frequency Response  
within 2% to 4.2 MHz
15. Differential Phase and Gain  
Differential Phase:  $\leq$  0.3 $^{\circ}$   
Differential Gain:  $\leq$  0.6%
16. Signal to Noise Ratio  
 $\geq$  60 dB

### Black Outputs

17. Black Amplitude  
7.5  $\pm$  1 IRE
18. Black Blanking Width  
10.9  $\pm$  0.2  $\mu$ s

### Audio Output

19. Total Harmonic Distortion  
 $\leq$  0.5%
20. Audio Output Amplitude  
0 to +8 dBu

# PERFORMANCE CHECK PROCEDURES

## Oscillator Frequency

The following table lists the suggested Tektronix 1780 setup for the rest of the Performance Checks for the TSG 200.

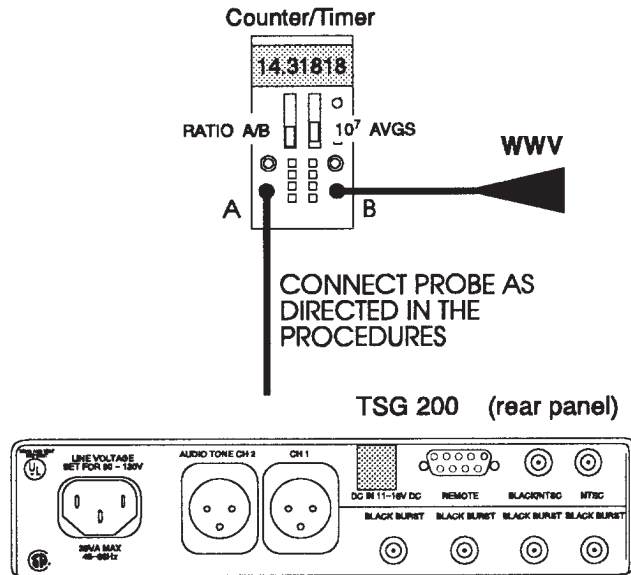

Fig. 4-1. Setup to check the crystal frequency.

### 1. Oscillator Frequency 14.31818 MHz ± 20 Hz

**NOTE**

After initial delivery or long storage, allow a two-hour warm up to re-age the crystal. Thereafter, 30 minutes warm up is sufficient.

- Connect the equipment as shown in Fig. 4-1, attaching the probe to W152.
- Set the frequency counter to count at a rate using ratio A/B.
- CHECK** — that the measured oscillator frequency is 14.31818 MHz ± 20 Hz at room temperature.

Table 4-1. Basic setup for the 1780.

Configure	
Coupling	DC
Vector Grat	INT
WFM Grat	INT
ABS Units	mV
Vector Readout	ON
WFM Readout	ON
Front Panel	
Left Display	VECT
Right Display	WFM
WFM Horizontal	ONE/LINE
REF	INT
Filter	FLAT
Waveform Gain	OFF

## TSG 200 — Performance Checks and Adjustment Procedure

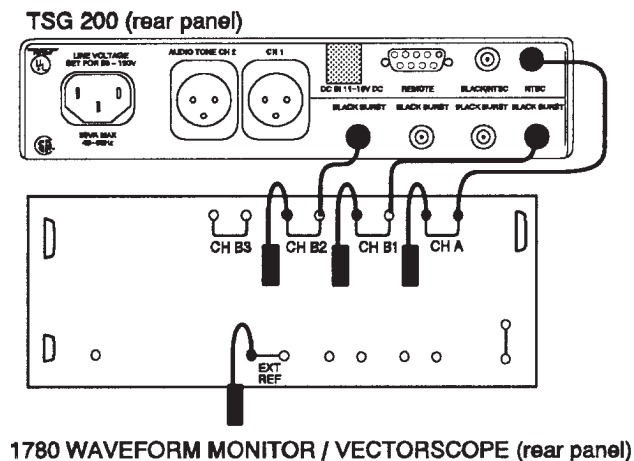

Fig. 4-2. Basic setup for the Performance Checks.

### Test Signal

#### 2. Blanking Level

$0\text{ V} \pm 50\text{ mV}$

- Connect the equipment as shown in Fig. 4-2.
- Display CH A on the waveform monitor.
- Select the 5-Step signal from the TSG 200.
- Confirm that any DC-restorer feature of the monitor or oscilloscope is off.
- Toggle the display between DC coupled and ground reference.
- CHECK** — that the dc level is  $0\text{ V} \pm 50\text{ mV}$ .

#### 3. Sync Amplitude

$285.7 \pm 57\text{ mV}$  ( $40 \pm 8\text{ IRE}$ )

- Connect the test equipment as shown in Fig. 4-2.
- Display CH A on the waveform monitor.
- Select the 5-Step signal from the TSG 200.
- With the WFM + CAL function of the measurement set match the dc level of the lower waveform to the sync tip of the upper waveform.

- CHECK** — that the sync amplitude is  $285.7 \pm 57\text{ mV}$  ( $40 \pm 8\text{ IRE}$ ).

#### 4. Burst Amplitude

$285.7 \pm 57\text{ mV}$  ( $40 \pm 8\text{ IRE}$ )

- Connect the test equipment as shown in Fig. 4-2.
- Display CH A on the waveform monitor.
- If necessary, adjust the measurement set to match the top of the lower burst to the bottom of the upper burst.
- CHECK** — for a burst amplitude of  $285.7 \pm 57\text{ mV}$  ( $40 \pm 8\text{ IRE}$ ).

#### 5. 5-Step Staircase Linearity < 1% Error

- Connect the test equipment as shown in Fig. 4-2.
- Display CH A on the waveform monitor.
- With the 5-Step signal selected, set the test equipment to view the signal through the differentiated step filter.
- CHECK** — that the difference between the highest and lowest spikes (differentiated steps) is < 1%.

#### 6. Luminance Amplitude Accuracy

$714 \pm 7.14\text{ mV}$  ( $100 \pm 10\text{ IRE}$ )

- Connect the test equipment as shown in Fig. 4-2.
- Display CH A on the waveform monitor.
- Put the waveform monitor in WFM+CAL mode.
- Set the test equipment to match the top of the lower 5-Step waveform with the dc level of the upper waveform.
- CHECK** — that the 5-Step amplitude is  $714 \pm 7.14\text{ mV}$  ( $100 \pm 10\text{ IRE}$ ).

#### 7. Chrominance-to-Luminance Delay and Gain

**Delay:**  $\leq 12\text{ ns}$

**Gain:**  $\leq 1\%$

- Connect the test equipment as shown in Fig. 4-2.

- b. Display CH A on the waveform monitor.
- c. Select the NTC 7 Composite signal from the TSG 200.
- d. Set the waveform monitor to view the bottom of the modulated pulse.
- e. Use the Chroma/Luma measurement mode of the Tektronix 1780 to measure both C/Y delay and gain.
- f. **CHECK** — that the delay is  $\leq 12$  ns and the gain is  $\leq 1\%$ .

**8. Ringing**  
**< 1%**

- a. Connect the test equipment as shown in Fig. 4-2.
- b. With the TSG 200's NTC 7 Composite still selected, set the waveform monitor to display the bottom of the 2T pulse.
- c. **CHECK** — with voltage cursors or graticule that ringing is  $< 1\%$  (7.14 mV or 1 IRE peak).

**9. Sync Rise Times**  
**140  $\pm$  20 ns**

- a. Connect the test equipment as shown in Fig. 4-2.
- b. Display CH A on the waveform monitor.
- c. Set the waveform monitor to display the sync on any TSG 200 test signal.
- d. Identify the 10% and 90% points of the sync transitions. This can be done with voltage cursors or graticule, and may be aided by using variable gain to normalize the sync to 1000 mV.
- e. **CHECK** — that rise and fall times between 10% and 90% are  $140 \pm 20$  ns, using the timing cursors or graticule.

**10. Sync Timing**

**Horizontal Sync Duration: 4.7  $\mu$ s  $\pm$  50 ns**  
**HAD Vertical Serrations: 4.7  $\mu$ s  $\pm$  50 ns**  
**HAD Equalizing Pulses: 2.3  $\mu$ s  $\pm$  50 ns**

- a. Connect the test equipment as shown in Fig. 4-2.
- b. Display CH A on the waveform monitor.

- c. **CHECK** — that horizontal sync duration between 50% points is  $4.7 \mu\text{s} \pm 50$  ns.
- d. Set the waveform monitor to display the serrations and equalizing pulses in the vertical interval.
- e. **CHECK** — that the half-amplitude duration of the vertical serrations is  $4.7 \mu\text{s} \pm 50$  ns.
- f. **CHECK** — that the half-amplitude duration of the equalizing pulses is  $2.3 \mu\text{s} \pm 50$  ns.

**11. Line Blanking Interval**

**10.9  $\pm$  0.2  $\mu$ s**

- a. Connect the test equipment as shown in Fig. 4-2.
- b. Display CH A on the waveform monitor.
- c. Select the 5 Step signal from the TSG 200.
- d. Set the waveform monitor to display horizontal blanking.
- e. **CHECK** — that the horizontal blanking interval is  $10.9 \pm 0.2 \mu\text{s}$  between the 350 mV points of the signal.

**12. Pulse to Bar Ratio**

**1:1  $\pm$  1%**

- a. Connect the test equipment as shown in Fig. 4-2.
- b. Display CH A on the waveform monitor.
- c. Select the NTC 7 Composite signal from the TSG 200.
- d. Use the Line Select feature of the waveform monitor to display a line with the 2T Pulse and White Bar.
- e. Maximize the vertical magnification and use the Voltage cursors to compare the amplitudes of the pulse and bar.
- f. **CHECK** — that the pulse and bar have equal amplitudes within 1% (1 IRE or 7.14 mV).
- g. Use the Line Select feature of the waveform monitor to display a line with the Modulated Pulse and White Bar.
- h. Maximize the vertical magnification and use the Voltage cursors to compare the amplitudes of the pulse and bar.

## TSG 200 — Performance Checks and Adjustment Procedure

- i. **CHECK** — that the pulse and bar have equal amplitudes within 1% (1 IRE or 7.14 mV).

### 13. Pulse Half Amplitude Duration (HAD)

**2T Pulse:  $250 \pm 25$  ns**

**Modulated Pulse:  $1.563 \mu\text{s} \pm 150$  ns**

**Convergence Pulse:  $225 \pm 150$  ns**

- a. Connect the test equipment as shown in Fig. 4-2.
- b. Display CH A on the waveform monitor.
- c. Select the NTC 7 Composite signal from the TSG 200.
- d. Use the Line Select feature of the waveform monitor to display a line with the 2T Pulse.
- e. Use the Voltage cursors to mark the 50 IRE point of the 2T Pulse.
- f. Use the Timing cursors and high horizontal magnification to measure the HAD.
- g. **CHECK** — that the HAD for the 2T Pulse is  $250 \pm 25$  ns.
- h. Use the Line Select feature of the waveform monitor to display a line with the Modulated Pulse.
- i. Use the Voltage cursors to mark the 50 IRE point of the Modulated Pulse.
- j. Use the Timing cursors and high horizontal magnification to measure the HAD.
- k. **CHECK** — that the HAD for the Modulated Pulse is  $1.563 \mu\text{s} \pm 150$  ns.
- l. Select the Convergence signal from the TSG 200.
- m. Use the Line Select feature of the waveform monitor to display a line with the Pulses.
- n. Use the Voltage cursors to marker the 38.45 IRE point of a Pulse.
- o. Use the Timing cursors and high horizontal magnification to measure the HAD.
- p. **CHECK** — that the HAD for the Pulse is  $225 \text{ ns} \pm 150$  ns.

### 14. Multiburst Frequency Response within 2% to 4.2 MHz

- a. Connect the test equipment as shown in Fig. 4-2.
- b. Display CH A on the waveform monitor.
- c. Select the Multiburst signal from the TSG 200.
- d. **CHECK** — that the packets are flat and equal amplitude within 2% to 4.2 MHz.

### 15. Differential Phase and Gain

**Differential Phase:  $\leq 0.3^\circ$**

**Differential Gain:  $\leq 0.6\%$**

- a. Connect the test equipment as shown in Fig. 4-2.
- b. Display CH A on the waveform monitor.
- c. Select the Mod 5-Step signal from the TSG 200.
- d. Set the vectorscope to measure differential phase. (Use the double trace method, if possible.)
- e. **CHECK** — for differential phase of  $\leq 0.3^\circ$ .
- f. Set the test equipment to measure differential gain. (Again, use a double trace, if possible.)
- g. **CHECK** — that the differential gain of the modulated ramp is  $\leq 0.6\%$ .

### 16. Signal to Noise Ratio

**$\geq 60$  dB**

- a. Connect the test equipment as shown in Fig. 4-2 except inset the 5 MHz low-pass filter before the CH A input of the waveform monitor.
- b. Display CH A on the waveform monitor.
- c. Select the 5 Step signal from the TSG 200.
- d. Use the Noise Measurement feature of the 1780 to measure the signal to noise ratio.
- e. **CHECK** — that the SNR is  $\geq 60$  dB.



## Black Output

### 17. Black Amplitude $7.5 \pm 1$ IRE

- Connect the test equipment as shown in Fig. 4-2.
- Display CH B1 on the waveform monitor.
- With the WFM + CAL function of the measurement set match the dc level of the lower waveform to the black level of the upper waveform.
- CHECK** — that the black amplitude is  $7.5 \pm 1$  IRE.
- Display CH B2 on the waveform monitor.
- With the WFM + CAL function of the measurement set match the dc level of the lower waveform to the black level of the upper waveform.
- CHECK** — that the black amplitude is  $7.5 \pm 1$  IRE.

### 18. Black Blanking Width $10.9 \pm 0.2 \mu\text{s}$

- Connect the test equipment as shown in Fig. 4-2.
- Display CH B1 on the waveform monitor.
- Set the waveform monitor to display horizontal blanking.
- CHECK** — that the horizontal blanking interval is  $10.9 \mu\text{s} \pm 0.2 \mu\text{s}$ .
- Display CH B2 on the waveform monitor.
- Set the waveform monitor to display horizontal blanking.
- CHECK** — that the horizontal blanking interval is  $10.9 \mu\text{s} \pm 0.2 \mu\text{s}$ .

### AA501 DISTORTION ANALYZER

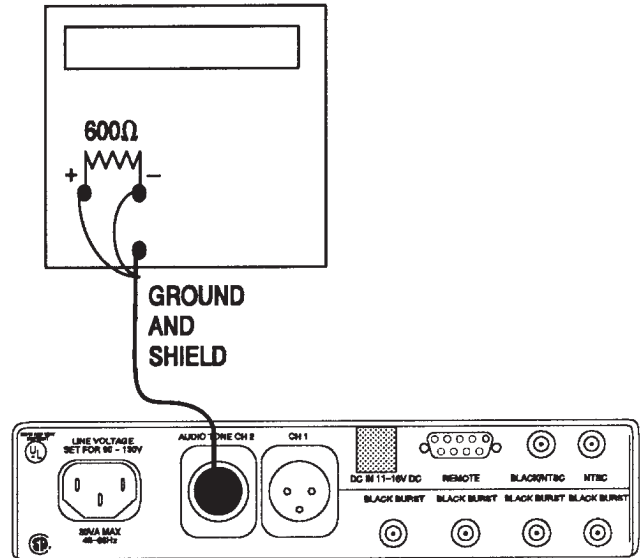

**Fig. 4-3.**  
Setup to measure the total harmonic distortion.

## Audio Output

### 19. Total Harmonic Distortion $\leq 0.5\%$

- Connect the equipment as shown in Fig. 4-3, placing a  $600 \Omega$  resistor across the analyzer's + and - terminals (to represent the system load).
- Set the distortion analyzer to measure THD.
- CHECK** — that the THD on CH 2 is  $\leq 0.5\%$ .
- Move the cable at the TSG 200 from audio CH 2 to audio CH 1.
- Disable the CH 1 ID click via the front panel AUDIO CLICK button.
- CHECK** — that the THD on CH 1 is  $\leq 0.5\%$ .
- Return the AUDIO CLICK button to its previous position.

## TSG 200 — Performance Checks and Adjustment Procedure

### 20. Audio Output Amplitude 0 to +8 dBu

- a. Connect the equipment as shown in Fig. 4-3, with the following AA501 (Distortion Analyzer) settings:

Table 4-2. Setup for the AA501 Distortion Analyzer

Function	Setting
Input Level Range	Auto range
dBm Switch	In
Level Switch	In
All Filter Switches	Out

- b. Adjust R122 to vary the output level for audio CH 2. (Factory setting is + 8 dBu.)
- c. **CHECK** — that the amplitude can be varied from 0 to +8 dBu.
- d. Return R122 to its desired position.
- e. Move the cable at the TSG 200 from audio CH 1 to audio CH 2.
- f. Disable the CH 1 ID click through the AUDIO CLICK button on the front panel.
- g. Adjust R123 to vary the output level for CH 1. (Factory setting is + 8 dBu).
- h. **CHECK** — that the amplitude can be varied from 0 to +8 dBu.
- i. Return R123 to its desired position.
- j. Return the AUDIO CLICK button to its original position.



## ADJUSTMENT PROCEDURE CHECKLIST

1. Oscillator Frequency  
Y1
2. Audio Output Amplitude  
CH 1: R123  
CH 2: R122
3. Audio ID Click Frequency  
R649
4. Test Signal DC Offset  
R63
5. Test Signal Gain  
R60
8. Black 1 DC Offset  
R20
9. Black 1 Gain  
R18
10. Black 2 DC Offset  
R655
11. Black 2 Gain  
R650

### NOTE

*Steps 6 and 7 are interactive. Repeat them in sequence until the best possible results are obtained.*

6. Test Signal (Sin(x))/x Compensation  
C47
7. Test Signal Frequency Response and 2T Ringing  
L8, L9, L10, L11, & L12
12. Black 1 (Sin(x))/x Compensation  
C19
13. Black 2 (Sin(x))/x Compensation  
C660
14. Black Frequency Response and 2T Ringing  
L14, L15, L16, L17, & L18
15. Timing Between Black Burst and Test Signal  
C30

### NOTE

*Steps 12, 13, and 14 are interactive. Repeat them in sequence until the best possible results are obtained.*

## ADJUSTMENT PROCEDURES

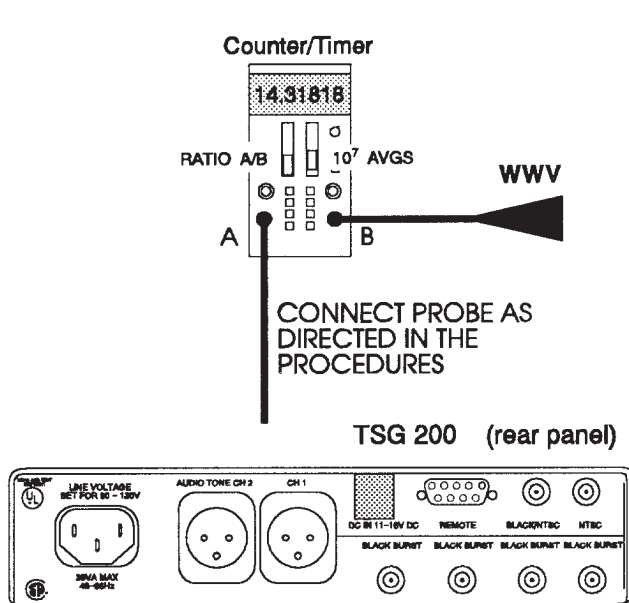

Fig. 4-4. Setup to adjust the oscillator frequency.

### 1. Oscillator Frequency Y1

**NOTE**

The crystal may drift after adjustment. Leave the TSG 200 powered up for 20 minutes after adjustment, then recheck the frequency to assure that it stays within spec.

- Connect the equipment as shown in Fig. 4-4, attaching the probe to W152.
- Set the DC503A to count a frequency referenced to channel B (ratio A/B).
- Remove the round plastic cap from the top of the oscillator, Y1.
- Fine-adjust the oscillator frequency to bring  $4F_{sc}$  to 14.31818 MHz  $\pm$  4 Hz.

**NOTE**

The specification for this frequency is  $\pm$  20 Hz, but it is recommended that the adjustment be made to within 4 Hz to maximize performance.

- Reinstall the plastic cap.

### AA501 DISTORTION ANALYZER

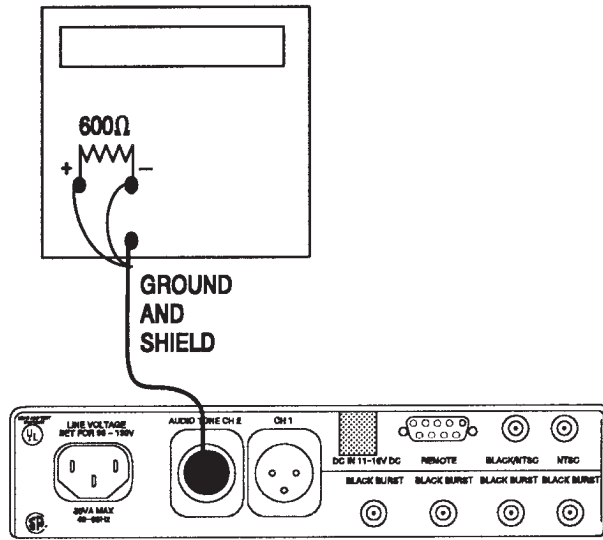

Fig. 4-5. Audio amplitude calibration setup.

### 2. Audio Output Amplitude

- CH 1: R123
- CH 2: R122

- Connect the equipment as shown in Fig. 4-5 with the following AA501 (Distortion Analyzer) settings:

Table 4-3. Setup for the AA501 Distortion Analyzer.

Function	Setting
Input Level Range	Auto range
dBm Switch	In
Level Switch	In
All Filter Switches	Out

- Adjust R122 to obtain the desired output level for audio CH 2. (Factory setting is + 8 dBm.)
- Move the cable at the TSG 200 from audio CH 1 to audio CH 2.

- d. Disable the CH 1 ID click through the AUDIO CLICK button on the front panel.
- e. Adjust R123 to obtain the desired dB output for Audio 1 (factory setting is + 8 dBm).
- f. Return the AUDIO CLICK button to its original position.

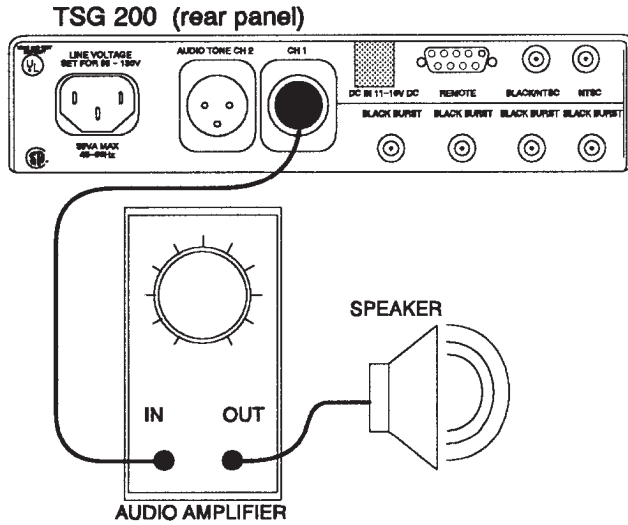

Fig. 4-6. Audio ID click frequency adjustment setup.

3. Audio ID Click Frequency R649

- a. Connect the equipment as shown in Fig. 4-6.
- b. Adjust R649 for the desired interval between ID clicks. The range of adjustment is about 0.2 to 4 seconds.

**NOTE**

Connect the equipment as shown in Fig. 4-7 for all remaining calibration procedures.

TSG 200 (rear panel)

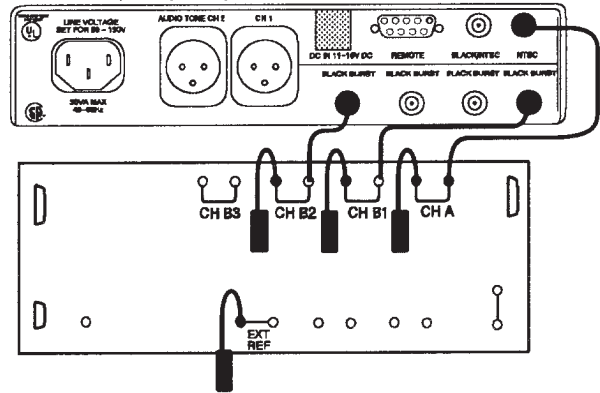

1780 WAVEFORM MONITOR / VECTORSCOPE (rear panel)

Fig. 4-7. Basic setup for the calibration procedures.

The Table 4-4 shows the suggested Tektronix 1780 setup for the following procedures.

Table 4-4. Initial setup of the 1780.

Configure	Front Panel
Coupling	DC
Left Display	VECT
Vector Grat	INT
Right Display	WFM
WFM Grat	INT
REF	EXT
ABS Units	IRE
Filter	FLAT
Vector Readout	ON
WFM Horizontal	ONE/LINE
WFM Readout	ON
Waveform Gain	X5

## TSG 200 — Performance Checks and Adjustment Procedure

### NOTE

The TSG 200 needs to be put into Diagnostic Test Signal Mode in order to finish the calibration procedure. Move Jumper J604 to the 2-3 position and cycle the power.

In the Diagnostic Mode, the following front panel Signal Select buttons have these new functions (see Fig. 4-8):

MULTIBURST = Sweep  
5 STEP = 2T Pulse and Ramp

These signals are available from both the NTSC and BLACK outputs on the rear panel.

The rest of the Signal Select buttons retain their original functions.

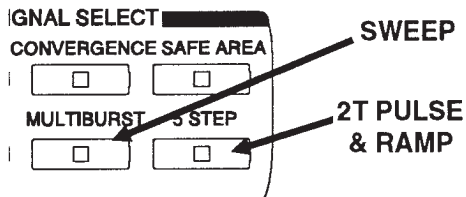

Fig. 4-8. New functions of the Signal Select buttons in the Diagnostic Test Signal mode.

#### 4. Test Signal DC Offset R63

- Begin with the 1780 reference setup (Fig. 4-7) and select CH A as the input.
- Select the 2T Pulse and Ramp signal from the TSG 200.
- Set the waveform monitor to GND coupling and adjust the ground line to a convenient reference point.
- Change the waveform monitor coupling to DC.
- Adjust R63 to match the 0 IRE point of the 2T Pulse and Ramp signal to the established ground reference.

#### 5. Test Signal Gain R60

- Begin with the 1780 reference setup (Fig. 4-7) and select CH A as the input.
- Select the 2T Pulse and Ramp signal from the TSG 200.
- Select WFM + CAL at the right display section of the 1780, set CAL for 714 mV, and adjust R60 to match the top of the ramp of the lower waveform with the dc level of the upper.
- Repeat steps 4 & 5 as necessary for best results.

### NOTE

Steps 6 and 7 are interactive. Repeat them in sequence until the best possible results are obtained.

#### 6. Test Signal (Sin(x))/x Compensation C47

- Begin with the reference setup (Fig. 4-7) of the measurement set and select CH A as the input.
- Select the 2T Pulse and Ramp signal from the TSG 200.
- Set the waveform monitor to view the bottom of the Modulated Pulse.
- Adjust C47 to make the bottom of the Modulated Pulse as flat as possible (within 1 IRE).

#### 7. Test Signal Frequency Response and 2T Ringing L8, L9, L10, L11, & L12

- Begin with the reference setup (Fig. 4-7) of the measurement set and select CH A as the input.
- Select the Sweep signal from the TSG 200.
- Adjust L8, L9, L10, L11, and L12 to make the frequency response as flat as possible. Use WFM + CAL to confirm that the Sweep is flat within 2% out to 4.2 MHz.
- Select the 2T Pulse & Ramp signal from the TSG 200.

- e. Display the bottom of the Pulse, using horizontal magnification, to view the ringing.
- f. Adjust L8 and L9 for symmetrical ringing. Use the 1780's voltage cursors or K Factor graticule to confirm that ringing (overshoot) is < 1% peak.
- g. Repeat steps 6 and 7 for the best results.

**8. Black 1 DC Offset  
R20**

- a. Begin with the 1780 reference setup (Fig. 4-7) and select CH B1 as the input.
- b. Select the 2T Pulse and Ramp signal from the TSG 200.
- c. Set the waveform monitor to GND coupling and adjust the ground line to a convenient reference point.
- d. Return the waveform monitor coupling to DC.
- e. Adjust R20 to match the 0 IRE point of the 2T Pulse and Ramp signal to the established ground reference.

**9. Black 1 Gain  
R18**

- a. Begin with the 1780 reference setup (Fig. 4-7) and select CH B1 as the input.
- b. Select the 2T Pulse and Ramp signal from the TSG 200.
- c. Select WFM + CAL at the right display section of the 1780, set CAL for 714 mV, and adjust R18 to match the top of the lower waveform's ramp with the dc level of the upper waveform.

**10. Black 2 DC Offset  
R655**

- a. Begin with the 1780 reference setup (Fig. 4-7) and select CH B2 as the input.
- b. Select the 2T Pulse and Ramp signal from the TSG 200.
- c. Set the waveform monitor to GND coupling and adjust the ground line to a convenient reference point.
- d. Return the waveform monitor coupling to DC.

- e. Adjust R655 to match the 0 IRE point of the 2T Pulse and Ramp signal to the established ground reference.

**11. Black 2 Gain  
R650**

- a. Begin with the 1780 reference setup (Fig. 4-7) and select CH B2 as the input.
- b. Select the 2T Pulse and Ramp signal from the TSG 200.
- c. Select WFM + CAL at the right display section of the 1780, set CAL for 714 mV, and adjust R650 to match the top of the lower waveform's ramp with the dc level of the upper waveform.

**NOTE**

*Steps 12, 13, and 14 are interactive.  
Repeat them in sequence until the  
best possible results are obtained.*

**12. Black 1 (Sin(x))/x Compensation  
C19**

- a. Begin with the reference setup (Fig. 4-7) of the measurement set and select CH B1 as the input.
- b. Select the 2T Pulse and Ramp signal from the TSG 200.
- c. Set the waveform monitor to view the bottom of the Modulated Pulse.
- d. Adjust C19 to make the bottom of the Modulated Pulse as flat as possible (within 1 IRE).

**13. Black 2 (Sin(x))/x Compensation  
C660**

- a. Begin with the reference setup (Fig. 4-7) of the measurement set and select CH B2 as the input.
- b. Select the 2T Pulse and Ramp signal from the TSG 200.
- c. Set the waveform monitor to view the bottom of the Modulated Pulse.
- d. Adjust C660 to make the bottom of the Modulated Pulse as flat as possible (within 1 IRE).

**14. Black Frequency Response and 2T Ringing  
L14, L15, L16, L17, & L18**

- a. Begin with the reference setup (Fig. 4-7) of the measurement set and select CH B1 as the input.
- b. Select the Sweep signal from the TSG 200.
- c. Adjust L14, L15, L16, L17, and L18 to make the frequency response as flat as possible. Use WFM + CAL to confirm that the Sweep is flat within 2% out to 5 MHz.
- d. Select the 2T Pulse & Ramp signal from the TSG 200.
- e. Display the bottom of the Pulse, using horizontal magnification, to view the ringing.
- f. Adjust L14 and L15 for symmetrical ringing. Use the 1780's voltage cursors or K Factor graticule to confirm that ringing (overshoot) is < 1% peak.
- g. Repeat steps 12, 13, and 14 for the best results.

**15. Timing Between Signal and Black Burst  
Outputs  
C30**

- a. Begin with the reference setup (Fig. 4-7) of the measurement set and select CH A as the input.
- b. Select the SMPTE Bars signal from the front of the TSG 200.
- c. Move the cable from the CH B2 input to the EXT REF of the waveform monitor.
- d. Change the 1780 REF setting to EXT and the left display to SCH.
- e. Remove the cable from the NTSC output of the TSG 200 and connect it to one of the unused BLACK BURST outputs. (CH A should have a Black Burst signal).
- f. Use the phase adjustment on the waveform monitor to set the burst vector to the 180° reference line.
- g. Reference set this point to be the 0° point.
- h. Return the NTSC signal to the waveform monitor CH A input. (CH A should be SMPTE Bars.) Use the SAME cable as in part e.
- i. Adjust C30 for a < 5° phase difference from the reference established in part f.

# SECTION 5 INSTALLATION

## WARNING

*Dangerous voltages are present in the power supply. To ensure safety, only qualified service personnel should perform the following procedures.*

## WARNING

*Dangerous voltages are present in the power supply. Remove the power cord from the electrical mains supply before attempting the following procedures: Selecting the Power Supply Mains Voltage, Selecting the Audio Tone Frequency, Configuring NTSC/BLACK Output, and Setting the SID. Failure to remove the power cord can result in life-threatening electrical shock.*

This section explains how to do the TSG 200 setup for individual applications. It includes:

- Selecting the Power Supply Mains Voltage
- Selecting the Audio Tone Frequency
- Adjusting the Audio Click Frequency
- Configuring NTSC/BLACK Output
- Setting the SID
- Initializing the Non-Volatile Memory
- Customizing the Settings
- List of Jumpers and Switches

### Selecting the Power Supply Mains Voltage

The TSG 200 is shipped from the factory configured for 110 V<sub>ac</sub>, 60 Hz operation. To configure the TSG 200 for 110 V<sub>ac</sub> or 220 V<sub>ac</sub> operation, follow this procedure.

1. Remove the TSG 200 power cord from the electrical mains supply.
2. Remove the instrument access cover.
3. Locate J122 near the AC line filter and power receptacle at the right rear of the Main board.

4. For 110 V<sub>ac</sub> operation (the factory setting), the jumper should be positioned so that its connections match the 110 V illustration on the board next to it.
5. For 220 V<sub>ac</sub> operation, the jumper should be positioned so that its connections match the 220 V illustration on the board next to it.
6. **CHECK** — that the fuse is the proper value. For 220 V<sub>ac</sub> operation, fuse F1 should be 0.2 Amp Med blow. For 110 V<sub>ac</sub> operation the fuse should be 0.4 Amp Med blow.
7. Reinstall the instrument access cover and the power cord.

### Selecting the Audio Tone Frequency

1. Remove the TSG 200 power cord from the electrical mains supply.
2. Remove the instrument access cover.
3. Locate J613 & J614 (in the rear of the instrument).
4. For CH 1 J613 should be in the 1-2 position for 1 kHz or in the 2-3 position for 400 Hz.
5. For CH 2 J614 should be in the 1-2 position for 1 kHz or in the 2-3 position for 400 Hz.
6. Reinstall the instrument access cover and the power cord.



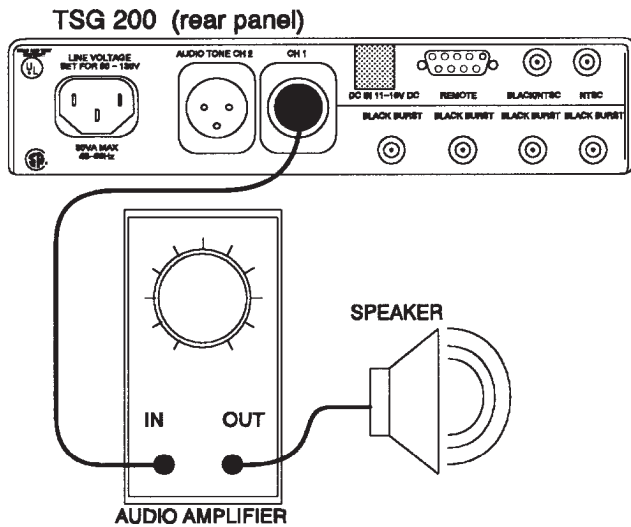

Fig. 5-1. Audio ID click frequency adjustment setup.

### Adjusting the Audio Click Frequency

1. Remove the TSG 200 power cord from the electrical mains supply.
2. Remove the instrument access cover.
3. Connect the equipment as shown in Fig. 5-1.
4. Reconnect the instruments power cord — USE CAUTION.
5. Enable the AUDIO CLICK on the front panel of the TSG 200.
6. Adjust R649 (located in the front of the instrument) for the desired interval between ID clicks. The range of adjustments available is between 0.2 to 4 seconds.
7. Remove the power cord.
8. Reinstall the instrument access cover and the power cord.

### Configuring NTSC/BLACK Output

1. Remove the TSG 200 power cord from the electrical mains supply.
2. Remove the instrument access cover.
3. Locate J606 (in the rear portion of the instrument).
4. For Black Burst output the jumper should be in the 1-2 position.
5. For NTSC output the jumper should be in the 2-3 position.
6. Reinstall the instrument access cover and the power cord.

### Enabling/Disabling the F1L10 Reference Pulse

1. Remove the TSG 200 power cord from the electrical mains supply.
2. Remove the instrument access cover.
3. Locate J108.
4. Set the jumper for the desired output (1-2 normal operation, 2-3 disables the F1L10 Reference Pulse).
5. Reinstall the instrument access cover and the power cord.

### Setting the SID

1. Remove the TSG 200 power cord from the electrical mains supply.
2. Remove the instrument access cover.
3. Locate S1 & S2 (towards the front of the instrument).
4. Set the switches for the desired SID value. (Switch closed = 1; S1-1 is the LSB and S2-6 is the MSB.)
5. Reinstall the instrument access cover and the power cord.
6. The binary Source Code is updated every time the instrument is powered up or the SID function is enabled.



## Initializing the Non-Volatile Memory

### NOTE

*This procedure is necessary if a new NVEEPROM (U606) is installed.*

### CAUTION

*If the TSG 200 is set to Factory Reset all IDs, etc. stored in memory will be erased and replaced with the factory settings.*

1. Remove the TSG 200 power cord from the electrical mains supply.
2. Remove the instrument access cover.
3. Move jumper J604 to the 2-3 (diagnostic) position.
4. Reinstall the instrument access cover and the power cord.
5. Connect the NTSC output to a video monitor.
6. Use the SELECT button in the ID SETUP block to enter the "SETTINGS" menu. (The front panel ID SETUP LEDs are off but the arrow keys are all lit.)
7. Highlight FACTORY RESET as shown in Fig. 5-2 to initialize the non-volatile memory.
8. Press the SELECT button until none of the functions in the ID SETUP block are selected.
9. Remove the TSG 200 power cord from the electrical mains supply.
10. Remove the instrument access cover.
11. Move jumper J604 back to the 1-2 (normal) position.
12. Reinstall the instrument access cover and the power cord.
13. All IDs, etc. in the TSG 200 memory are now the values set at the factory.

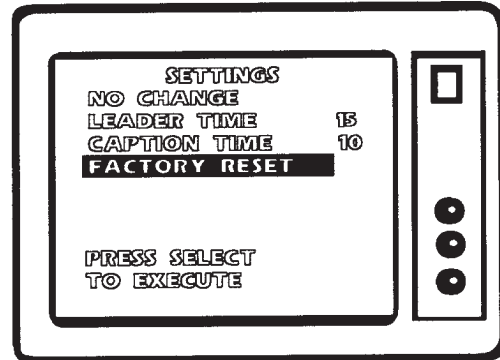

**Fig. 5-2. Monitor display to set "FACTORY SETTING".**

## Customizing the Settings

The following parameters can be customized in this menu:

**LEADER TIME** adjusts the length of the Tape Leader from 10 seconds (only countdown) to 90 seconds (45 seconds of SMPTE Bars). See Section 2 for more information on the Tape Leader function.

**CAPTION TIME** is the length of time that each ID in the ID CYCLE function is displayed. The maximum is 10 seconds and the minimum is 1 second. For example if 10 is selected and there are 4 IDs in the cycle the time to complete an ID cycle is 40 seconds.

1. Remove the TSG 200 power cord from the electrical mains supply.
2. Remove the instrument access cover.
3. Move jumper J604 to the 2-3 (diagnostic) position.
4. Reinstall the instrument access cover and the power cord.
5. Connect the NTSC output to a video monitor.
6. Use the SELECT button in the ID SETUP block to enter the "SETTINGS" menu. (The front panel ID SETUP LEDs are off but the arrow keys are all lit.)

7. Highlight whatever values need to be customized as shown in Fig. 5-3. The choices are:  
Leader Time: 10-90 seconds  
Caption Time: 1-10 seconds

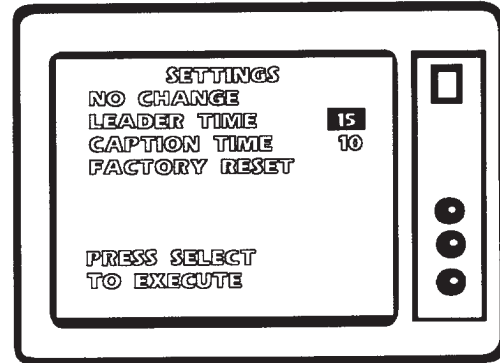

Fig. 5-3. Monitor display to customize the TSG 200.

8. Press the SELECT button to save the changes.
9. Remove the TSG 200 power cord from the electrical mains supply.
10. Remove the instrument access cover.
11. Move jumper J604 back to the 1-2 (normal) position.
12. Reinstall the instrument access cover and the power cord.

## List of Jumpers and Switches

Table 5-1. Jumpers and Switches in the TSG 200.

JUMPER	NAME	FUNCTION	
J604	Diagnostic Signals	1-2	Normal
		2-3	Diagnostic Signals
J603	Reset Enable	1-2	Reset Enabled
		2-3	All Resets Disabled
J602	Hard Reset	1-2	Normal Operation
		2-3	Hard Reset
J108	Black Burst F1L10 Reference Disable	1-2	Normal Operation
		2-3	Disabled
J7	Black Burst Disable	1-2	Normal Operation
		2-3	Black Burst Output Disabled
J6	Test Signal Disable	1-2	Normal Operation
		2-3	Test Signal Output Disable
J606	Black Burst/Test Signal	1-2	Black Burst
		2-3	Test Signal
J614	Audio Frequency CH 2	1-2	1 kHz
		2-3	400 Hz
J613	Audio Frequency CH 1	1-2	1 kHz
		2-3	400 Hz
J122	Line Voltage Selection	1-2 & 3-4	110 V Operation (0.4 A fuse installed)
		2-3	220 V Operation (0.2 A fuse installed)
J40	+12 V Enable	IN	+12 V Operational
		OUT	+12 V Disabled
J50	-12 V Enable	IN	-12 V Operational
		OUT	-12 V Disabled

Table 5-1. (cont.)

JUMPER	NAME	FUNCTION	
J60	-5 V Enable	IN	-5 V Operational
		OUT	-5 V Disabled
J70	+5 V Enable	IN	+5 V Operational
		OUT	+5 V Disabled
S1 & S2	SID Selection	Set for the desired SID in binary (S1-1 is LSB and S2-6 is MSB).	

# SECTION 6 OPTIONS

This section lists of all options that are available for the TSG 200.

## OPTION -1J — (0% Setup)

This option provides 0% setup for the black burst and SMPTE Bars.

### Changes to: Section 3 — Specifications

All specifications and other manual information applies to the Option -1J except for the following:

Table 3-2 and Table 3-3 changes. (Changes are highlighted.) Also Figs. 3-2, 3-3, 3-4, and 3-16 change.

Table 3-2. Test Signals.

CHARACTERISTICS	PERFORMANCE REQUIREMENTS	SUPPLEMENTAL INFORMATION	PER. CHECK STEP #
SMPTE Bars			
Luminance Rise Times	140 ns ± 25 ns		
Field Timing			
Color Bars	Lines 21 - 182	See Fig. 6-1.	
Reverse Blue Bars	Lines 183 - 202	See Fig. 6-2.	
IYQB	Lines 203 - 262	See Fig. 6-3.	
	Luminance Amplitude <i>mV</i>	Subcarrier Amplitude <i>mV<sub>p-p</sub></i>	Subcarrier Phase <i>degree</i>
White	535.7	000.0	000.0
Yellow	476.8	480.2	167.1
Cyan	375.0	681.2	283.5
Green	316.1	636.3	240.7
Magenta	219.7	636.3	60.7
Red	160.7	681.2	103.5
Blue	58.9	480.2	347.1
-I	0.0	285.7	303.0
Q	0.0	285.7	33.0

Table 3-3. Test Signal Generator - Black Burst Output

CHARACTERISTICS	PERFORMANCE REQUIREMENTS	SUPPLEMENTAL INFORMATION	PER. CHECK STEP #
Black Amplitude	0 IRE ± 1 IRE		17.
Blanking Width	10.9 μs ± 0.2 μs		18.
Sync Timing	See Fig. 6-4		

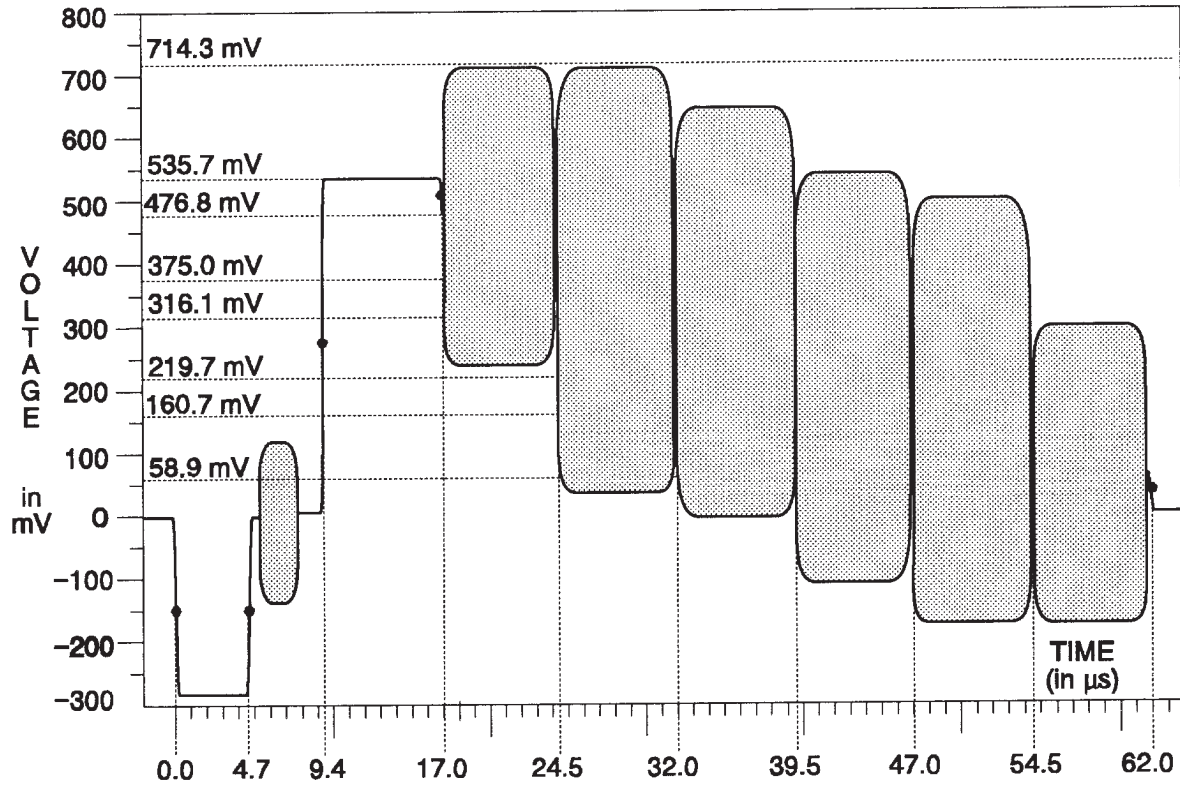

Fig. 6-1. SMPTE Color Bars.

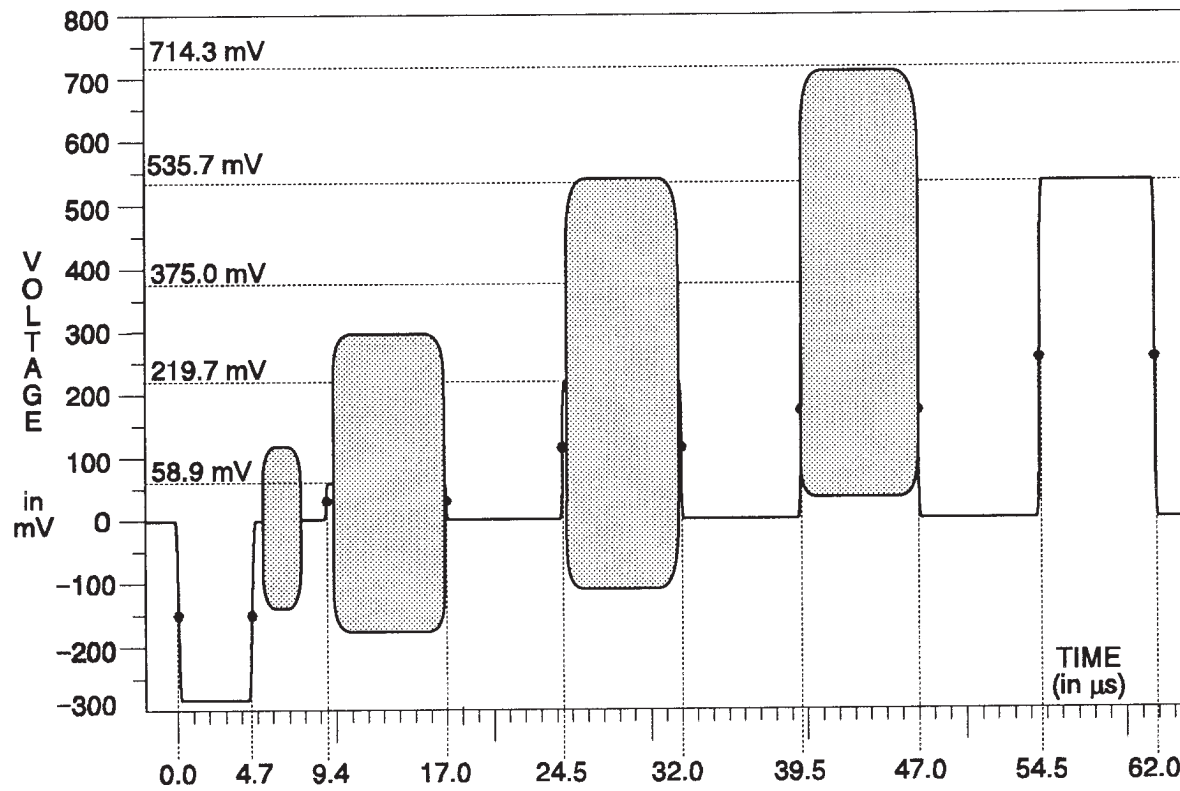

Fig. 6-2. SMPTE Reverse Blue Bars.

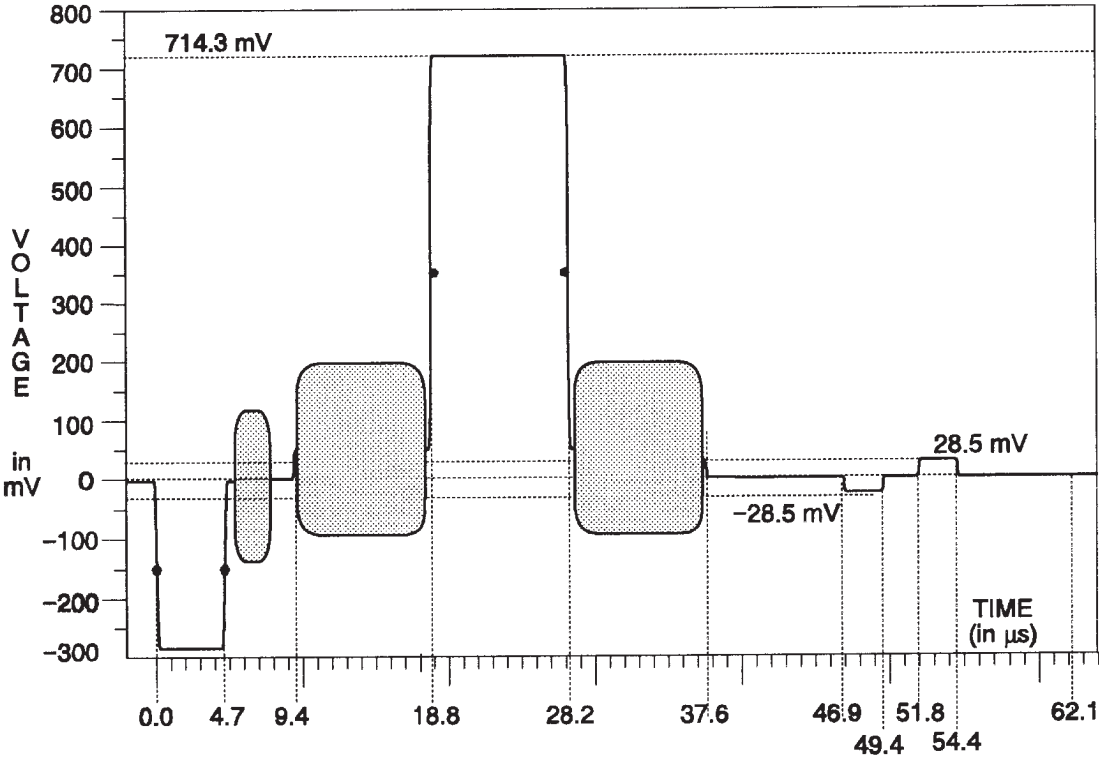

Fig. 6-3. SMPTE IYQB.

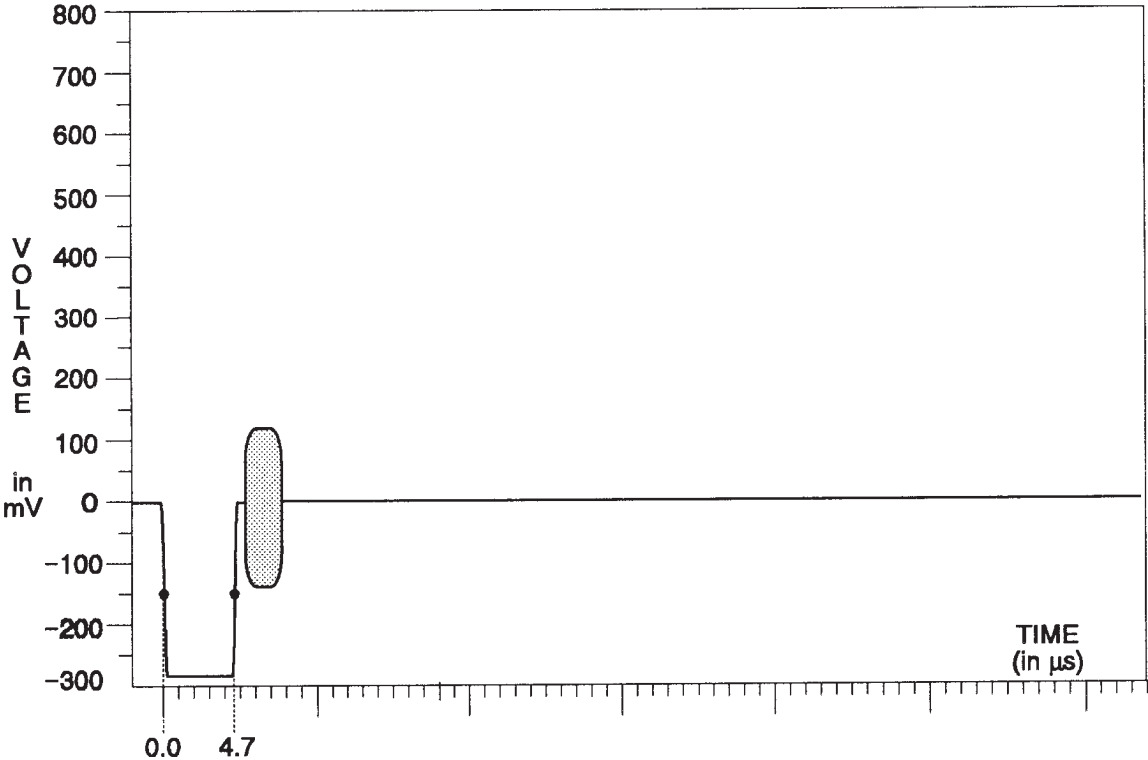

Fig. 6-4. Black Burst.

**Changes to:  
Section 5 — Performance Check &  
Adjustment Procedure**

Step 17 changes to:

**17. Black Amplitude  
 $0 \pm 1$  IRE**

- a. Connect the test equipment as shown in Fig. 4-2.
- b. Display CH B1 on the waveform monitor.
- c. With the WFM + CAL function of the measurement set match the dc level of the

lower waveform to the black level of the upper waveform.

- d. **CHECK** — that the black amplitude is  $0 \pm 1$  IRE.
- e. Display CH B2 on the waveform monitor.
- f. With the WFM + CAL function of the measurement set match the dc level of the lower waveform to the black level of the upper waveform.
- g. **CHECK** — that the black amplitude is  $0 \pm 1$  IRE.



# SECTION 7 BLOCK DIAGRAM

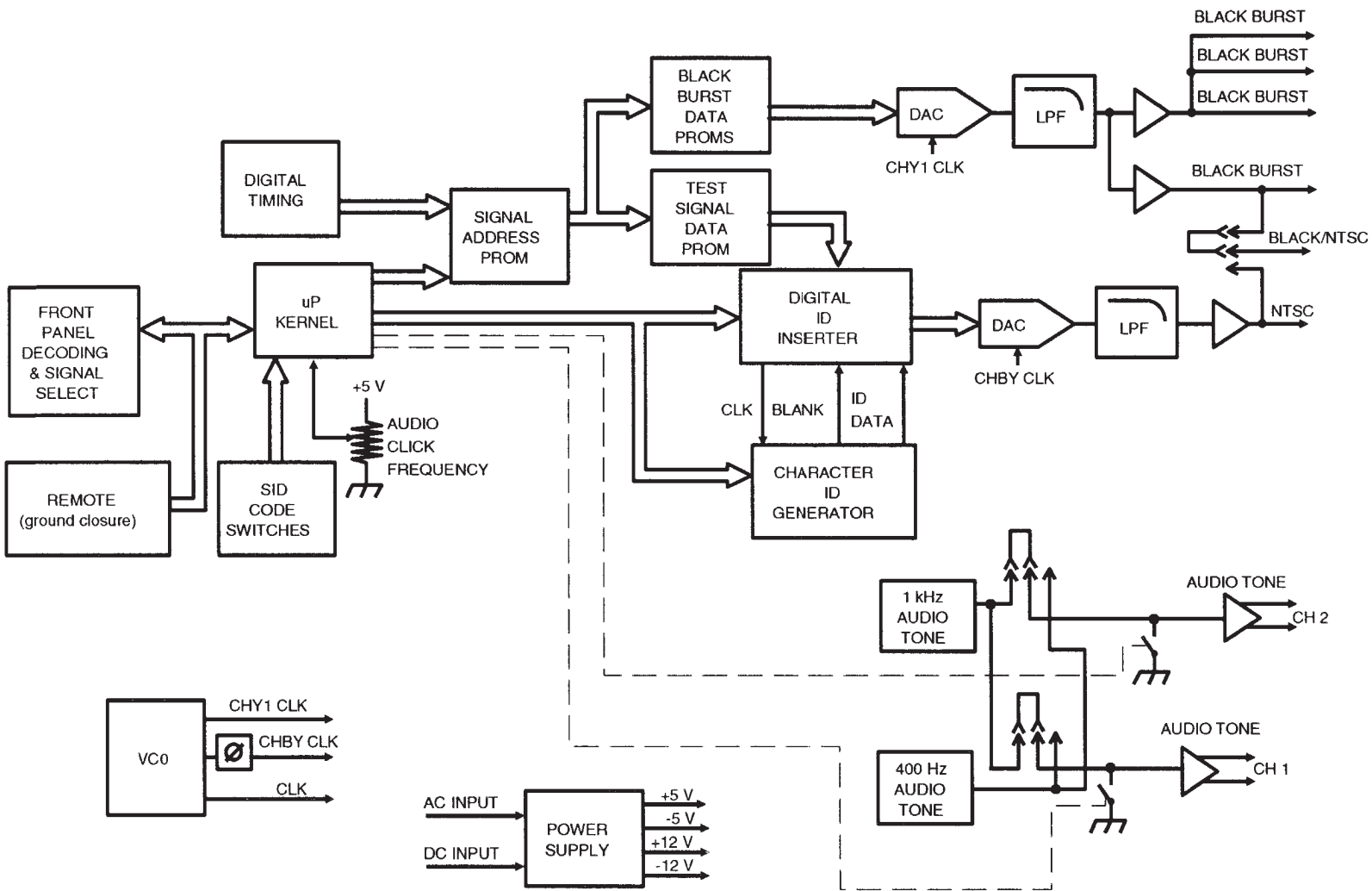



# SECTION 8

## REPLACEABLE ELECTRICAL PARTS

This section contains a list of the components that are replaceable for the TSG 200. Use this list to identify and order replacement parts. There is a separate Replaceable Electrical Parts list for each instrument.

### Parts Ordering Information

Replacement parts are available from or through your local Tektronix, Inc., Field Office or representative.

Changes to Tektronix instruments are sometimes made to accommodate improved components as they become available and to give you the benefit of the latest circuit improvements. Therefore, when ordering parts, it is important to include the following information in your order.

- Part number
- Instrument type or model number
- Instrument serial number
- Instrument modification number, if applicable

If a part you have ordered has been replaced with a new or improved part, your local Tektronix, Inc., Field Office or representative will contact you concerning any change in part number.

Change information, if any, is located at the rear of this manual.

### Using the Replaceable Electrical Parts List

The tabular information in the Replaceable Electrical Parts list is arranged for quick retrieval. Understanding the structure and features of the list will help you find all of the information you need for ordering replaceable parts.

#### Cross Index—Mfr. Code Number to Manufacturer

The Mfg. Code Number to Manufacturer Cross Index for the electrical parts list is located immediately after this page. The cross index provides codes, names, and addresses of manufacturers of components listed in the electrical parts list.

### Abbreviations

Abbreviations conform to American National Standards Institute (ANSI) standard Y1.1.

### List of Assemblies

A list of assemblies can be found at the beginning of the electrical parts list. The assemblies are listed in numerical order. When the complete component number of a part is known, this list will identify the assembly in which the part is located.

### Column Descriptions

#### Component No. (Column 1)

The component circuit number appears on the diagrams and circuit board illustrations, located in the diagrams section. Assembly numbers are also marked on each diagram and circuit board illustration, in the Diagram section and on the mechanical exploded views, in the mechanical parts list. The component number is obtained by adding the assembly number prefix to the circuit number.

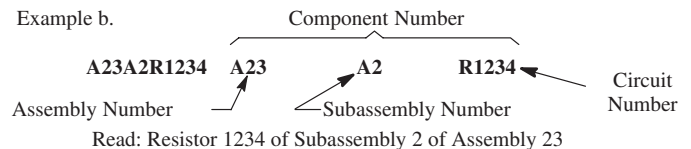
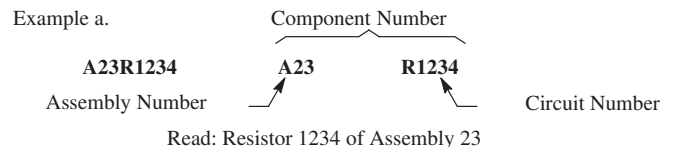

The electrical parts list is arranged by assemblies in numerical sequence (A1, with its subassemblies and parts, precedes A2, with its subassemblies and parts).

Mechanical subparts to the circuit boards are listed in the electrical parts list. These mechanical subparts are listed

## TSG 200 — Replaceable Electrical Parts

with their associated electrical part (for example, fuse holder follows fuse).

Chassis-mounted parts and cable assemblies have no assembly number prefix and are located at the end of the electrical parts list.

### **Tektronix Part No. (Column 2)**

Indicates part number to be used when ordering replacement part from Tektronix.

### **Serial/Assembly No. (Column 3 and 4)**

Column three (3) indicates the serial or assembly number at which the part was first used. Column four (4) indicates the serial or assembly number at which the part was removed. No serial or assembly number entered indicates part is good for all serial numbers.

### **Name and Description (Column 5)**

An item name is separated from the description by a colon (:). Because of space limitations, an item name may sometimes appear as incomplete. Use the U.S. Federal Catalog handbook H6-1 for further item name identification.

The mechanical subparts are shown as \*ATTACHED PARTS\* / \*END ATTACHED PARTS\* or \*MOUNTING PARTS\* / \*END MOUNTING PARTS\* in column five (5).

### **Mfr. Code (Column 6)**

Indicates the code number of the actual manufacturer of the part. (Code to name and address cross reference can be found immediately after this page.)

### **Mfr. Part No. (Column 7)**

Indicates actual manufacturer's part number.

**Manufacturers Cross Index**

<b>Mfr. Code</b>	<b>Manufacturer</b>	<b>Address</b>	<b>City, State, Zip Code</b>
00779	AMP INC.	CUSTOMER SERVICE DEPT PO BOX 3608	HARRISBURG, PA 17105-3608
01295	TEXAS INSTRUMENTS INC	SEMICONDUCTOR GROUP 13500 N CENTRAL EXPRESSWAY PO BOX 655303	DALLAS, TX 75272-5303
04222	AVX/KYOCERA	PO BOX 867	MYRTLE BEACH, SC 29577
04713	MOTOROLA INC	SEMICONDUCTOR PRODUCTS SECTOR 5005 E MCDOWELL ROAD	PHOENIX, AZ 85008-4229
07716	IRC, INC	2850 MT PLEASANT AVE	BURLINGTON, IA 52601
07933	RAYTHEON COMPANY	SEMICONDUCTOR DIVISION 10 GOODYEAR M/S 10A	IRVINE, CA 92718
08779	SIGNAL TRANSFORMER CO INC	500 BAYVIEW AVE	INWOOD, NY 11096-1792
09023	CORNELL-DUBILIER CORPORATION	C/O EARL & BROWN CO INC 7185 SW SANDBURG RD	TIGARD, OR 97223
0B0A9	DALLAS SEMICONDUCTOR	4350 BELTWOOD PKWY S	DALLAS, TX 75244
0GV52	SCHAFFNER EMC INC	9-B FADEM ROAD	SPRINGFIELD, NJ 07081
0JR03	ZMAN MAGNETICS INC	7633 S 180TH	KENT, WA 98032
0KBZ5	Q & D PLASTICS INC	1812 - 16TH AVENUE PO BOX 487	FOREST GROVE, OR 97116-0487
0UUA4	E-SWITCH	DIV OF STEIN INDUSTRIES 26 NORTH 5TH STREET	MINNEAPOLIS, MN 55403
11236	CTS CORPORATION	406 PARR ROAD	BERNE, IN 46711-9506
12969	MICROSEMI CORP	WATERTOWN DIVISION 530 PLEASANT STREET	WATERTOWN, MA 02172
14936	GENERAL INSTRUMENT CORP	POWER SEMICONDUCTOR DIVISION 602 W JOHN STREET	HICKSVILLE, NY 11802-1802
16546	PHILIPS COMPONENTS	CHIP CAP/CHIP RES FACILITY 4561 COLORADO BLVD	LOS ANGELES, CA 90039-1103
17856	TEMIC NORTH AMERICA	(SILICONIX & MATRA MHS) 2201 LAURELWOOD RD	SANTA CLARA, CA 95954-1516
19701	PHILIPS COMPONENTS	AIRPORT RD P.O.BOX 760	MINERAL WELLS, TX 76067
20932	KYOCERA AMERICA INC	8611 BALBOA AVE	SAN DIEGO, CA 92123-1580
22526	BERG ELECTRONICS INC	825 OLD TRAIL ROAD	ETTERS, PA 17319
22670	GM NAMEPLATE INCORPORATED	2040 15TH AVE WEST	SEATTLE, WA 98119-2783
24355	ANALOG DEVICES	1 TECHNOLOGY DRIVE	NORWOOD, MA 02062
26364	COMPONENTS CORPORATION	6 KINSEY PLACE	DENVILLE, NJ 07834
26742	METHODE ELECTRONICS INC	BACKPLAIN DIVISION 7444 WEST WILSON AVE	CHICAGO, IL 60656-4548
27014	NATIONAL SEMICONDUCTOR CORP	2900 SEMICONDUCTOR DR PO BOX 58090 MS 30-115	SANTA CLARA, CA 95051-0606
32997	BOURNS INC	TRIMPOT DIVISION 1200 COLUMBIA AVE	RIVERSIDE, CA 92507-2114
33095	SPECTRUM CONTROL INC	8061 AVONIA RD	FAIRVIEW, PA 16415

## TSG 200 — Replaceable Electrical Parts

### Manufacturers Cross Index (Cont.)

Mfr. Code	Manufacturer	Address	City, State, Zip Code
33096	COLORADO CRYSTAL CORPORATION	2303 W 8TH ST	LOVELAND, CO 80537
34371	INTERSIL CORPORATION	SEMICONDUCTOR SECTOR MS 58-71 PO BOX 883	MELBOURNE, FL 32902-0883
4T165	NEC ELECTRONICS, INC.	2880 SCOTT BLVD PO BOX 58062	SANTA CLARA, CA 95052-8062
50139	ALLEN-BRADLEY COMPANY INC	ELECTRONIC COMPONENTS DIVISION 1414 ALLEN BRADLEY DRIVE	EL PASO, TX 79936
50434	HEWLETT PACKARD	370 W TRIMBLE ROAD	SAN JOSE, CA 95131-1008
54331	MONITOR PRODUCTS COMPANY, INC.	502 VIA DEL MONTE	OCEANSIDE, CA 92054
54937	DEYOUNG MFG INC	12920 NE 125TH WAY	KIRKLAND, WA 98034
55680	NICHICON (AMERICA) CORP	927 E STATE PARKWAY	SCHAUMBURG, IL 60195-4526
56845	DALE ELECTRONIC COMPONENTS	2300 RIVERSIDE BLVD PO BOX 74	NORFOLK, NE 68701
57027	IRC INC.	4222 SOUTH STAPLES ST	CORPUS CHRISTI, TX 78411
57668	ROHM CORPORATION	15375 BARRANCA PARKWAY SUITE B207	IRVINE, CA 92718
60395	XICOR INC	851 BUCKEYE CT	MILPITAS, CA 95035-7408
61857	SAN-O INDUSTRIAL CORP	91-3 COLIN DRIVE	HOLBROOK, NY 11741
61964	OMRON ELECTRONICS	CUSTOMER SERVICE DEPT. 1 EAST COMMERCE DRIVE	SCHAUMBURG, IL 60173
62643	UNITED CHEMI-CON INC	9801 W HIGGINS RD	ROSEMONT, IL 60018-4771
63058	BERG ELECTRONICS INC.	MCKENZIE SOCKET DIV 910 PAGE AVE	FREMONT, CA 94538-7340
71400	BUSSMANN	DIVISION COOPER INDUSTRIES INC PO BOX 14460	ST LOUIS, MO 63178
74970	E F JOHNSON CO	299 JOHNSON AVE	WASECA, MN 56093
75498	MULTICOMP INC	3005 SW 154TH TERRACE SUITE #3	BEAVERTON, OR 97006
80009	TEKTRONIX INC	14150 SW KARL BRAUN DR PO BOX 500	BEAVERTON, OR 97077-0001
82389	SWITCHCRAFT	DIV OF RAYTHEON 5555 N. ELSTON AVENUE	CHICAGO, IL 60630-1314
91637	DALE ELECTRONIC COMPONENTS	1122 23RD ST	COLUMBUS, NE 68601
93907	CAMCAR DIV OF TEXTRON INC	ATTN: ALICIA SANFORD 516 18TH AVE	ROCKFORD, IL 611045181
98291	ITT CANNON RF PRODUCTS	585 EAST MAIN STREET	NEW BRITAIN, CT 06051
9M860	ESAM INC	PO BOX 376	GRANTS PASS, OR 97526
TK0198	HAMILTON HALLMARK	9750 SW NIMBUS AVE	BEAVERTON, OR 97005
TK0891	MICONICS	1 FAIRCHILD AVE	PLAINVIEW, NY 11803
TK1547	MOORE ELECTRONICS INC	19500 SW 90TH CT PO BOX 1030	TUALATIN, OR 97062
TK1947	NORTHWEST ETCH TECHNOLOGY	2601 S HOOD ST PO BOX 110610	TACOMA, WA 98411-0610

**Manufacturers Cross Index (Cont.)**

---

<b>Mfr. Code</b>	<b>Manufacturer</b>	<b>Address</b>	<b>City, State, Zip Code</b>
TK2058	TDK CORPORATION OF AMERICA	1600 FEEHANVILLE DRIVE	MOUNT PROSPECT, IL 60056
TK2262	RPM ENTERPRISES	735 S VINEWOOD STREET	ESCONDIDO, CA 92029

---

## TSG 200 — Replaceable Electrical Parts

### Replaceable Electrical Parts List

Component Number	Tektronix Part Number	Serial No. Effective	Serial No. Discont'd	Name & Description	Mfr. Code	Mfr. Part Number
A1	671-1930-00		B010998	CIRCUIT BD ASSY:FRONT PANEL	80009	671-1930-00
A1	671-1930-02	B010999		CIRCUIT BD ASSY:FRONT PANEL,TSG200	80009	671-1930-02
A2	671-1927-00	B010100	B010164	CIRCUIT BD ASSY:MAIN	80009	671-1927-00
A2	671-1927-01	B010165	B019999	CIRCUIT BD ASSY:MAIN	80009	671-1927-01
A2	671-1927-02	B020000	B029999	CIRCUIT BD ASSY:MAIN,	80009	671-1927-02
A2	671-1927-03	B030000		CIRCUIT BD ASSY:MAIN,389-2542-00 WIRED,TSG200 (STANDARD ONLY)	80009	671-1927-03
A2	671-2507-00	B010100	B010164	CIRCUIT BD ASSY:TSG200 OPT 1J	80009	671-2507-00
A2	671-2507-01	B010165	B019999	CIRCUIT BD ASSY:MAIN OPT 1J	80009	671-2507-01
A2	671-2507-02	B020000	B029999	CIRCUIT BD ASSY:MAIN OPT 1J	80009	671-2507-02
A2	671-2507-03	B030000		CIRCUIT BD ASSY:MAIN,389-2542-00 WIRED,TSG200 (OPTION 1J ONLY)	80009	671-2507-03
A3	671-2320-00			CIRCUIT BD ASSY:TOP BNC	80009	671-2320-00
A4	671-1931-00			CIRCUIT BD ASSY:BOTTOM BNC	80009	671-1931-00
A5	671-2190-01			CIRCUIT BD ASSY:REMOTE CONTROL FILTER	80009	671-2190-01
A6	671-4085-00	B020000		CIRCUIT BD SUBASSY:ID GENERATOR	80009	671-4085-00
A1	671-1930-00		B010998	CIRCUIT BD ASSY:FRONT PANEL	80009	671-1930-00
A1	671-1930-02	B010999		CIRCUIT BD ASSY:FRONT PANEL	80009	671-1930-02
A1C201	281-0775-01			CAP,FXD,CERAMIC:MCL,0.1UF,20%,50V	04222	SA105E104MAA
A1C202	281-0775-01			CAP,FXD,CERAMIC:MCL,0.1UF,20%,50V	04222	SA105E104MAA
A1C250	281-0775-01			CAP,FXD,CERAMIC:MCL,0.1UF,20%,50V	04222	SA105E104MAA
A1C251	281-0775-01			CAP,FXD,CERAMIC:MCL,0.1UF,20%,50V	04222	SA105E104MAA
A1C252	281-0775-01			CAP,FXD,CERAMIC:MCL,0.1UF,20%,50V	04222	SA105E104MAA
A1C253	281-0775-01			CAP,FXD,CERAMIC:MCL,0.1UF,20%,50V	04222	SA105E104MAA
A1C254	281-0775-01			CAP,FXD,CERAMIC:MCL,0.1UF,20%,50V	04222	SA105E104MAA
A1DS211	150-1109-00			DIODE,OPTO:LED,GRN,565NM,1.5MCD AT 20MA	50434	HLMP-0503 OPT S02
	352-1016-00			*MOUNTING PARTS* HOLDER,LED:PLASTIC,BLACK,4 *END MOUNTING PARTS*	0KBZ5	352-1016-00
A1DS214	150-1109-00			DIODE,OPTO:LED,GRN,565NM,1.5MCD AT 20MA	50434	HLMP-0503 OPT S02
	352-1016-00			*MOUNTING PARTS* HOLDER,LED:PLASTIC,BLACK,4 *END MOUNTING PARTS*	0KBZ5	352-1016-00
A1DS215	150-1109-00			DIODE,OPTO:LED,GRN,565NM,1.5MCD AT 20MA	50434	HLMP-0503 OPT S02
	352-1016-00			*MOUNTING PARTS* HOLDER,LED:PLASTIC,BLACK,4 *END MOUNTING PARTS*	0KBZ5	352-1016-00
A1DS220	150-1109-00			DIODE,OPTO:LED,GRN,565NM,1.5MCD AT 20MA	50434	HLMP-0503 OPT S02
	352-1016-00			*MOUNTING PARTS* HOLDER,LED:PLASTIC,BLACK,4 *END MOUNTING PARTS*	0KBZ5	352-1016-00



Replaceable Electrical Parts List (Cont.)

Component Number	Tektronix Part Number	Serial No. Effective	Serial No. Discont'd	Name & Description	Mfr. Code	Mfr. Part Number
A1DS221	150-1138-00			DIODE,OPTO:LED,RED,626NM,1MCD AT 20MA,RECTANGULAR CASE,HLMP-0300	50434	HLMP-0300
	352-1015-00			*MOUNTING PARTS* HOLDER,LED:PLASTIC,BLACK,1 *END MOUNTING PARTS*	0KBZ5	352-1015-00
A1J201	174-2405-00			CA ASSY,SP,ELE:16,28 AWG,3.0 L,RIBBON	TK1547	174-2405-00
A1R14	315-0272-00			RES,FXD,FILM:2.7K OHM,5%,0.25W	50139	CB2725
A1R15	315-0272-00			RES,FXD,FILM:2.7K OHM,5%,0.25W	50139	CB2725
A1R650	322-3143-00	671-1930-00	671-1930-00	RES,FXD,FILM:301 OHM,1%,0.2W,TC=T0	57668	CRB20 FXE 301E
A1R650	322-3114-00	671-1930-01		RES,FXD:METAL FILM,150 OHM,1%,0.2W	57668	CRB20-FX-150E-AXIAL
A1R651	322-3143-00	671-1930-00	671-1930-00	RES,FXD,FILM:301 OHM,1%,0.2W,TC=T0	57668	CRB20 FXE 301E
A1R651	322-3114-00	671-1930-01		RES,FXD:METAL FILM,150 OHM,1%,0.2W	57668	CRB20-FX-150E-AXIAL
A1R652	322-3143-00	671-1930-00	671-1930-00	RES,FXD,FILM:301 OHM,1%,0.2W,TC=T0	57668	CRB20 FXE 301E
A1R652	322-3114-00	671-1930-01		RES,FXD:METAL FILM,150 OHM,1%,0.2W	57668	CRB20-FX-150E-AXIAL
A1R653	322-3143-00	671-1930-00	671-1930-00	RES,FXD,FILM:301 OHM,1%,0.2W,TC=T0	57668	CRB20 FXE 301E
A1R653	322-3114-00	671-1930-01		RES,FXD:METAL FILM,150 OHM,1%,0.2W	57668	CRB20-FX-150E-AXIAL
A1R654	322-3143-00	671-1930-00	671-1930-00	RES,FXD,FILM:301 OHM,1%,0.2W,TC=T0	57668	CRB20 FXE 301E
A1R654	322-3114-00	671-1930-01		RES,FXD:METAL FILM,150 OHM,1%,0.2W	57668	CRB20-FX-150E-AXIAL
A1R655	322-3143-00	671-1930-00	671-1930-00	RES,FXD,FILM:301 OHM,1%,0.2W,TC=T0	57668	CRB20 FXE 301E
A1R655	322-3114-00	671-1930-01		RES,FXD:METAL FILM,150 OHM,1%,0.2W	57668	CRB20-FX-150E-AXIAL
A1R658	322-3143-00			RES,FXD,FILM:301 OHM,1%,0.2W,TC=T0	57668	CRB20 FXE 301E
A1R659	322-3143-00			RES,FXD,FILM:301 OHM,1%,0.2W,TC=T0	57668	CRB20 FXE 301E
A1R660	322-3143-00			RES,FXD,FILM:301 OHM,1%,0.2W,TC=T0	57668	CRB20 FXE 301E
A1R661	322-3143-00			RES,FXD,FILM:301 OHM,1%,0.2W,TC=T0	57668	CRB20 FXE 301E
A1R662	322-3143-00	671-1930-00	671-1930-00	RES,FXD,FILM:301 OHM,1%,0.2W,TC=T0	57668	CRB20 FXE 301E
A1R662	322-3114-00	671-1930-01		RES,FXD:METAL FILM,150 OHM,1%,0.2W	57668	CRB20-FX-150E-AXIAL
A1R663	322-3143-00	671-1930-00	671-1930-00	RES,FXD,FILM:301 OHM,1%,0.2W,TC=T0	57668	CRB20 FXE 301E
A1R663	322-3114-00	671-1930-01		RES,FXD:METAL FILM,150 OHM,1%,0.2W	57668	CRB20-FX-150E-AXIAL
A1R664	322-3143-00	671-1930-00	671-1930-00	RES,FXD,FILM:301 OHM,1%,0.2W,TC=T0	57668	CRB20 FXE 301E
A1R664	322-3114-00	671-1930-01		RES,FXD:METAL FILM,150 OHM,1%,0.2W	57668	CRB20-FX-150E-AXIAL
A1R665	322-3143-00	671-1930-00	671-1930-00	RES,FXD,FILM:301 OHM,1%,0.2W,TC=T0	57668	CRB20 FXE 301E
A1R665	322-3114-00	671-1930-01		RES,FXD:METAL FILM,150 OHM,1%,0.2W	57668	CRB20-FX-150E-AXIAL
A1R666	322-3143-00	671-1930-00	671-1930-00	RES,FXD,FILM:301 OHM,1%,0.2W,TC=T0	57668	CRB20 FXE 301E
A1R666	322-3114-00	671-1930-01		RES,FXD:METAL FILM,150 OHM,1%,0.2W	57668	CRB20-FX-150E-AXIAL
A1R667	322-3143-00	671-1930-00	671-1930-00	RES,FXD,FILM:301 OHM,1%,0.2W,TC=T0	57668	CRB20 FXE 301E
A1R667	322-3114-00	671-1930-01		RES,FXD:METAL FILM,150 OHM,1%,0.2W	57668	CRB20-FX-150E-AXIAL
A1R668	322-3143-00	671-1930-00	671-1930-00	RES,FXD,FILM:301 OHM,1%,0.2W,TC=T0	57668	CRB20 FXE 301E
A1R668	322-3114-00	671-1930-01		RES,FXD:METAL FILM,150 OHM,1%,0.2W	57668	CRB20-FX-150E-AXIAL
A1R669	322-3143-00	671-1930-00	671-1930-00	RES,FXD,FILM:301 OHM,1%,0.2W,TC=T0	57668	CRB20 FXE 301E

## TSG 200 — Replaceable Electrical Parts

### Replaceable Electrical Parts List (Cont.)

Component Number	Tektronix Part Number	Serial No. Effective	Serial No. Discont'd	Name & Description	Mfr. Code	Mfr. Part Number
A1R669	322-3114-00	671-1930-01		RES,FXD:METAL FILM,150 OHM,1%,0.2W	57668	CRB20-FX-150E-AXIAL
A1R670	322-3143-00	671-1930-00	671-1930-00	RES,FXD,FILM:301 OHM,1%,0.2W,TC=T0	57668	CRB20 FXE 301E
A1R670	322-3114-00	671-1930-01		RES,FXD:METAL FILM,150 OHM,1%,0.2W	57668	CRB20-FX-150E-AXIAL
A1R671	322-3143-00	671-1930-00	671-1930-00	RES,FXD,FILM:301 OHM,1%,0.2W,TC=T0	57668	CRB20 FXE 301E
A1R671	322-3114-00	671-1930-01		RES,FXD:METAL FILM,150 OHM,1%,0.2W	57668	CRB20-FX-150E-AXIAL
A1R672	322-3143-00			RES,FXD,FILM:301 OHM,1%,0.2W,TC=T0	57668	CRB20 FXE 301E
A1S202	260-2402-00	671-1930-00	671-1930-00	SWITCH,PUSH:SPST,W/GRN LED	61964	B3E-1300
A1S202	260-2675-00	671-1930-01		SWITCH,PUSH:SPST,W/GRN LED	0UUA4	TL1240G
A1S203	260-2402-00	671-1930-00	671-1930-00	SWITCH,PUSH:SPST,W/GRN LED	61964	B3E-1300
A1S203	260-2675-00	671-1930-01		SWITCH,PUSH:SPST,W/GRN LED	0UUA4	TL1240G
A1S204	260-2402-00	671-1930-00	671-1930-00	SWITCH,PUSH:SPST,W/GRN LED	61964	B3E-1300
A1S204	260-2675-00	671-1930-01		SWITCH,PUSH:SPST,W/GRN LED	0UUA4	TL1240G
A1S205	260-2402-00	671-1930-00	671-1930-00	SWITCH,PUSH:SPST,W/GRN LED	61964	B3E-1300
A1S205	260-2675-00	671-1930-01		SWITCH,PUSH:SPST,W/GRN LED	0UUA4	TL1240G
A1S206	260-2402-00	671-1930-00	671-1930-00	SWITCH,PUSH:SPST,W/GRN LED	61964	B3E-1300
A1S206	260-2675-00	671-1930-01		SWITCH,PUSH:SPST,W/GRN LED	0UUA4	TL1240G
A1S207	260-2402-00	671-1930-00	671-1930-00	SWITCH,PUSH:SPST,W/GRN LED	61964	B3E-1300
A1S207	260-2675-00	671-1930-01		SWITCH,PUSH:SPST,W/GRN LED	0UUA4	TL1240G
A1S208	260-2402-00	671-1930-00	671-1930-00	SWITCH,PUSH:SPST,W/GRN LED	61964	B3E-1300
A1S208	260-2675-00	671-1930-01		SWITCH,PUSH:SPST,W/GRN LED	0UUA4	TL1240G
A1S209	260-2402-00	671-1930-00	671-1930-00	SWITCH,PUSH:SPST,W/GRN LED	61964	B3E-1300
A1S209	260-2675-00	671-1930-01		SWITCH,PUSH:SPST,W/GRN LED	0UUA4	TL1240G
A1S210	260-2402-00	671-1930-00	671-1930-00	SWITCH,PUSH:SPST,W/GRN LED	61964	B3E-1300
A1S210	260-2675-00	671-1930-01		SWITCH,PUSH:SPST,W/GRN LED	0UUA4	TL1240G
A1S211	260-2402-00	671-1930-00	671-1930-00	SWITCH,PUSH:SPST,W/GRN LED	61964	B3E-1300
A1S211	260-2675-00	671-1930-01		SWITCH,PUSH:SPST,W/GRN LED	0UUA4	TL1240G
A1S212	260-2402-00	671-1930-00	671-1930-00	SWITCH,PUSH:SPST,W/GRN LED	61964	B3E-1300
A1S212	260-2675-00	671-1930-01		SWITCH,PUSH:SPST,W/GRN LED	0UUA4	TL1240G
A1S213	260-2402-00	671-1930-00	671-1930-00	SWITCH,PUSH:SPST,W/GRN LED	61964	B3E-1300
A1S213	260-2675-00	671-1930-01		SWITCH,PUSH:SPST,W/GRN LED	0UUA4	TL1240G
A1S214	260-2401-00	671-1930-00	671-1930-00	SWITCH,PUSH:SPST,NO LED,B3E-1000	61964	B3E-1000
A1S214	260-2673-00	671-1930-01		SWITCH,PUSH:SPST,NO LED,B3E-1000,	0UUA4	TL1240N
A1S215	260-2402-00	671-1930-00	671-1930-00	SWITCH,PUSH:SPST,W/GRN LED	61964	B3E-1300
A1S215	260-2675-00	671-1930-01		SWITCH,PUSH:SPST,W/GRN LED 20	0UUA4	TL1240G
A1S216	260-2402-00	671-1930-00	671-1930-00	SWITCH,PUSH:SPST,W/GRN LED 20	61964	B3E-1300
A1S216	260-2675-00	671-1930-01		SWITCH,PUSH:SPST,W/GRN LED 20	0UUA4	TL1240G
A1S217	260-2402-00	671-1930-00	671-1930-00	SWITCH,PUSH:SPST,W/GRN LED 20	61964	B3E-1300
A1S217	260-2675-00	671-1930-01		SWITCH,PUSH:SPST,W/GRN LED 20	0UUA4	TL1240G

Replaceable Electrical Parts List (Cont.)

Component Number	Tektronix Part Number	Serial No. Effective	Serial No. Discot'd	Name & Description	Mfr. Code	Mfr. Part Number
A1S218	260-2402-00	671-1930-00	671-1930-00	SWITCH,PUSH:SPST,W/GRN LED 20	61964	B3E-1300
A1S218	260-2675-00	671-1930-01		SWITCH,PUSH:SPST,W/GRN LED 20	0UAU4	TL1240G
A1U204	156-1215-01			IC,DIGITAL:CMOS,MUX/ENCODER,DUPLICATE OF 156-1215-00,74C923,DIP20.3,TUBE	27014	MM74C923N
A1U205	156-0956-02			IC,DIGITAL:LSTTL,BUFFER/DRIVER,DUPLICATE OF 156-0956-00,74LS244,DIP20.3,TUBE	01295	SN74LS244N
A1U207	156-1998-00			IC,DIGITAL:ALSTTL,FLIP FLOP,OCTAL D-TYPE,CLEAR,74ALS273,DIP20.3,TUBE	01295	SN74ALS273N
A1U209	156-1998-00			IC,DIGITAL:ALSTTL,FLIP FLOP,OCTAL D-TYPE,CLEAR,74ALS273,DIP20.3,TUBE	01295	SN74ALS273N
A1U210	156-1998-00			IC,DIGITAL:ALSTTL,FLIP FLOP,OCTAL D-TYPE,CLEAR,74ALS273,DIP20.3,TUBE	01295	SN74ALS273N
A2	671-1927-00	B010100	B010164	CIRCUIT BD ASSY:MAIN	80009	671-1927-00
A2	671-1927-01	B010165	B019999	CIRCUIT BD ASSY:MAIN	80009	671-1927-01
A2	671-1927-02	B020000	B029999	CIRCUIT BD ASSY:MAIN	80009	671-1927-02
A2	671-1927-03	B030000		CIRCUIT BD ASSY:MAIN,TSG200 (STANDARD ONLY)	80009	671-1927-03
A2	671-2507-00	B010100	B010164	CIRCUIT BD ASSY:TSG200 OPT 1J	80009	671-2507-00
A2	671-2507-01	B010165	B019999	CIRCUIT BD ASSY:TSG200 OPT 1J	80009	671-2507-01
A2	671-2507-02	B020000	B029999	CIRCUIT BD ASSY:MAIN OPT 1J	80009	671-2507-02
A2	671-2507-03	B030000		CIRCUIT BD ASSY:MAIN,TSG200 (OPTION 1J ONLY)	80009	671-2507-03
	334-3379-02 337-3760-00			*ATTACHED PARTS* MARKER,IDENT:MARKED GROUND SYMBOL SHIELD,ELEC:TIN PLATED BRASS *END ATTACHED PARTS*	22670 TK1947	ORDER BY DESC 337-3760-00
A2C4	281-0775-01			CAP,FXD,CERAMIC:MCL,0.1UF,20%,50V	04222	SA105E104MAA
A2C9	290-0973-00		671-1927-02	CAP,FXD,ELCTLT:100UF,20%,25VDC	55680	UVX1V101MPA
A2C9	290-1296-01	671-1927-03		CAP,FXD,ALUM:100UF,20%,25V,RADIAL,T&A	55680	URT1E101MNH1TA
A2C9	290-0973-00		671-2507-02	CAP,FXD,ELCTLT:100UF,20%,25VDC	55680	UVX1V101MPA
A2C9	290-1296-01	671-2507-03		CAP,FXD,ALUM:100UF,20%,25V,RADIAL,T&A	55680	URT1E101MNH1TA
A2C10	290-0973-00		671-1927-02	CAP,FXD,ELCTLT:100UF,20%,25VDC	55680	UVX1V101MPA
A2C10	290-1296-01	671-1927-03		CAP,FXD,ALUM:100UF,20%,25V,RADIAL,T&A	55680	URT1E101MNH1TA
A2C10	290-0973-00		671-2507-02	CAP,FXD,ELCTLT:100UF,20%,25VDC	55680	UVX1V101MPA
A2C10	290-1296-01	671-2507-03		CAP,FXD,ALUM:100UF,20%,25V,RADIAL,T&A	55680	URT1E101MNH1TA
A2C13	283-0177-05			CAP,FXD,CER DI:1UF,+80-20%,25V	20932	5030ES25RD105Z
A2C15	283-0177-05			CAP,FXD,CER DI:1UF,+80-20%,25V	20932	5030ES25RD105Z
A2C18	281-0797-00			CAP,FXD,CERAMIC:MLC,15PF,5%,100V	12969	CGB150KFN
A2C19	281-0153-00		671-1927-02	CAP,VAR,AIR DI:1.7-10PF,150V	74970	187-0106-055
A2C19	281-0203-00	671-1927-03		CAP,VAR,PLASTIC:2-10PF,100V TOP/BOT ADJ	19701	2807C00210MJ02F00
A2C19	281-0153-00		671-2507-0	CAP,VAR,AIR DI:1.7-10PF,150V	74970	187-0106-055

## TSG 200 — Replaceable Electrical Parts

### Replaceable Electrical Parts List (Cont.)

Component Number	Tektronix Part Number	Serial No. Effective	Serial No. Discont'd	Name & Description	Mfr. Code	Mfr. Part Number
A2C19	281-0203-00	671-2507-03		CAP,VAR,PLASTIC:2-10PF,100V TOP/BOT ADJ	19701	2807C00210MJ02F00
A2C22	281-0775-01			CAP,FXD,CERAMIC:MCL,0.1UF,20%,50V	04222	SA105E104MAA
A2C23	281-0775-01			CAP,FXD,CERAMIC:MCL,0.1UF,20%,50V	04222	SA105E104MAA
A2C30	281-0123-00			CAP,VAR,CER DI:5-25PF,100V	33095	53-709-001 A5-25
A2C31	283-0663-00		671-1927-02	CAP,FXD,MICA DI:16.8PF,+0.5PF,500V	09023	CD15CD(16.8)D03
A2C31	283-0779-01	671-1927-03		CAP,FXD,MICA:27PF,2%,500V,T&A	09023	CDA15ED270G03
A2C31	283-0663-00		671-2507-02	CAP,FXD,MICA DI:16.8PF,+0.5PF,500V	09023	CD15CD(16.8)D03
A2C31	283-0779-01	671-2507-03		CAP,FXD,MICA:27PF,2%,500V,T&A	09023	CDA15ED270G03
A2C37	281-0775-01			CAP,FXD,CERAMIC:MCL,0.1UF,20%,50V	04222	SA105E104MAA
A2C38	281-0775-01			CAP,FXD,CERAMIC:MCL,0.1UF,20%,50V	04222	SA105E104MAA
A2C39	283-0204-00			CAP,FXD,CER DI:0.01UF,20%,50V	04222	SR155E103MAA
A2C40	281-0775-01			CAP,FXD,CERAMIC:MCL,0.1UF,20%,50V	04222	SA105E104MAA
A2C41	281-0775-01			CAP,FXD,CERAMIC:MCL,0.1UF,20%,50V	04222	SA105E104MAA
A2C42	283-0177-05			CAP,FXD,CER DI:1UF,+80-20%,25V	20932	5030ES25RD105Z
A2C43	283-0204-00			CAP,FXD,CER DI:0.01UF,20%,50V	04222	SR155E103MAA
A2C46	281-0797-00			CAP,FXD,CERAMIC:MLC,15PF,5%,100V	12969	CGB150KFN
A2C47	281-0153-00		671-1927-02	CAP,VAR,AIR DI:1.7-10PF,150V	74970	187-0106-055
A2C47	281-0203-00	671-1927-03		CAP,VAR,PLASTIC:2-10PF,100V TOP/BOT ADJ	19701	2807C00210MJ02F00
A2C47	281-0153-00		671-2507-02	CAP,VAR,AIR DI:1.7-10PF,150V	74970	187-0106-055
A2C47	281-0203-00	671-2507-03		CAP,VAR,PLASTIC:2-10PF,100V TOP/BOT ADJ	19701	2807C00210MJ02F00
A2C48	283-0646-00			CAP,FXD,MICA DI:170PF,1%,500V	09023	CD15FD171F03
A2C49	283-0689-00			CAP,FXD,MICA DI:550PF,1%,300V	09023	CD15FC551F03
A2C50	283-0687-00			CAP,FXD,MICA DI:560PF,2%,300V	09023	CD15FC561G03
A2C51	283-0672-00			CAP,FXD,MICA DI:200PF,1%,500V	09023	CD15FD201F03
A2C52	283-0775-00		671-1927-02	CAP,FXD,MICA DI:1764 PF,1%,500V	09023	CD19FD(1764)F03
A2C52	283-0623-00	671-1927-03		CAP,FXD,MICA DI:1200PF,1%,100V	09023	CD19FD122F03
A2C52	283-0775-00		671-2507-02	CAP,FXD,MICA DI:1764 PF,1%,500V	09023	CD19FD(1764)F03
A2C52	283-0623-00	671-2507-03		CAP,FXD,MICA DI:1200PF,1%,100V	09023	CD19FD122F03
A2C53	283-0780-00	671-1927-00	671-1927-02	CAP,FXD,MICA DI:125PF,1%,500V	09023	CD15FD(125)F03
A2C53	283-0620-01	671-1927-03		CAP,FXD,MICA DI:470PF,1%,500V,TAPE & AMMO PACK	09023	CDA15FD471F03
A2C53	283-0633-00	671-2507-00	671-2507-02	CAP,FXD,MICA DI:77PF,1%,100V	09023	CD15ED770F03
A2C53	283-0620-01	671-2507-03		CAP,FXD,MICA DI:470PF,1%,500V,TAPE & AMMO PACK	09023	CDA15FD471F03
A2C54	283-0631-01			CAP,FXD,MICA DI:95PF,1%,500V	TK0891	RDM15FD950F03
A2C55	283-0615-00			CAP,FXD,MICA DI:33PF,5%,500V	09023	CD15ED330J03
A2C56	283-0674-00			CAP,FXD,MICA DI:85PF,1%,500V	09023	CD15FD850F03
A2C57	283-0647-00			CAP,FXD,MICA DI:70PF,1%,100V	09023	CD15ED700F03
A2C59	281-0775-01			CAP,FXD,CERAMIC:MCL,0.1UF,20%,50V	04222	SA105E104MAA
A2C60	281-0775-01			CAP,FXD,CERAMIC:MCL,0.1UF,20%,50V	04222	SA105E104MAA

Replaceable Electrical Parts List (Cont.)

Component Number	Tektronix Part Number	Serial No. Effective	Serial No. Discont'd	Name & Description	Mfr. Code	Mfr. Part Number
A2C61	283-0204-00			CAP,FXD,CER DI:0.01UF,20%,50V	04222	SR155E103MAA
A2C62	281-0775-01			CAP,FXD,CERAMIC:MCL,0.1UF,20%,50V	04222	SA105E104MAA
A2C63	281-0775-01			CAP,FXD,CERAMIC:MCL,0.1UF,20%,50V	04222	SA105E104MAA
A2C64	283-0177-05			CAP,FXD,CER DI:1UF,+80-20%,25V	20932	5030ES25RD105Z
A2C65	283-0204-00			CAP,FXD,CER DI:0.01UF,20%,50V	04222	SR155E103MAA
A2C70	283-0646-00			CAP,FXD,MICA DI:170PF,1%,500V	09023	CD15FD171F03
A2C71	283-0689-00			CAP,FXD,MICA DI:550PF,1%,300V	09023	CD15FC551F03
A2C72	283-0687-00			CAP,FXD,MICA DI:560PF,2%,300V	09023	CD15FC561G03
A2C73	283-0672-00			CAP,FXD,MICA DI:200PF,1%,500V	09023	CD15FD201F03
A2C74	283-0775-00		671-1927-02	CAP,FXD,MICA DI:1764 PF,1%,500V	09023	CD19FD(1764)F03
A2C74	283-0623-00	671-1927-03		CAP,FXD,MICA DI:1200PF,1%,100V	09023	CD19FD122F03
A2C74	283-0775-00		671-2507-02	CAP,FXD,MICA DI:1764 PF,1%,500V	09023	CD19FD(1764)F03
A2C74	283-0623-00	671-2507-03		CAP,FXD,MICA DI:1200PF,1%,100V	09023	CD19FD122F03
A2C75	283-0780-00	671-1927-00	671-1927-02	CAP,FXD,MICA DI:125PF,1%,500V	09023	CD15FD(125)F03
A2C75	283-0620-01	671-1927-03		CAP,FXD,MICA DI:470PF,1%,500V,TAPE & AMMO PACK	09023	CDA15FD471F03
A2C75	283-0633-00	671-2507-00	671-2507-02	CAP,FXD,MICA DI:77PF,1%,100V	09023	CD15ED770F03
A2C75	283-0620-01	671-2507-03		CAP,FXD,MICA DI:470PF,1%,500V,TAPE & AMMO PACK	09023	CDA15FD471F03
A2C76	283-0631-01			CAP,FXD,MICA DI:95PF,1%,500V	TK0891	RDM15FD950F03
A2C77	283-0615-00			CAP,FXD,MICA DI:33PF,5%,500V	09023	CD15ED330J03
A2C78	283-0674-00			CAP,FXD,MICA DI:85PF,1%,500V	09023	CD15FD850F03
A2C79	283-0647-00			CAP,FXD,MICA DI:70PF,1%,100V	09023	CD15ED700F03
A2C81	281-0775-01			CAP,FXD,CERAMIC:MCL,0.1UF,20%,50V	04222	SA105E104MAA
A2C83	281-0775-01			CAP,FXD,CERAMIC:MCL,0.1UF,20%,50V	04222	SA105E104MAA
A2C84	281-0775-01			CAP,FXD,CERAMIC:MCL,0.1UF,20%,50V	04222	SA105E104MAA
A2C85	281-0775-01			CAP,FXD,CERAMIC:MCL,0.1UF,20%,50V	04222	SA105E104MAA
A2C86	281-0775-01			CAP,FXD,CERAMIC:MCL,0.1UF,20%,50V	04222	SA105E104MAA
A2C110	283-0594-00			CAP,FXD,MICA DI:0.001UF,1%,100V	09023	CD15FA102F03
A2C111	283-0594-00			CAP,FXD,MICA DI:0.001UF,1%,100V	09023	CD15FA102F03
A2C112	283-0177-05			CAP,FXD,CER DI:1UF,+80-20%,25V	20932	5030ES25RD105Z
A2C113	281-0775-01			CAP,FXD,CERAMIC:MCL,0.1UF,20%,50V	04222	SA105E104MAA
A2C150	290-1313-00			CAP,FXD,ALUM:10UF,20%,50V	55680	UET1H100MPH1TA
A2C153	281-0775-01			CAP,FXD,CERAMIC:MCL,0.1UF,20%,50V	04222	SA105E104MAA
A2C154	281-0775-01			CAP,FXD,CERAMIC:MCL,0.1UF,20%,50V	04222	SA105E104MAA
A2C180	290-1290-00			CAP,FXD,ALUM:2200UF,20%,25V	62643	CEAFM1E222M-E
A2C187	283-0177-05			CAP,FXD,CER DI:1UF,+80-20%,25V	20932	5030ES25RD105Z
A2C191	281-0775-01			CAP,FXD,CERAMIC:MCL,0.1UF,20%,50V	04222	SA105E104MAA
A2C192	281-0775-01			CAP,FXD,CERAMIC:MCL,0.1UF,20%,50V	04222	SA105E104MAA
A2C194	283-0177-05			CAP,FXD,CER DI:1UF,+80-20%,25V	20932	5030ES25RD105Z

## TSG 200 — Replaceable Electrical Parts

### Replaceable Electrical Parts List (Cont.)

Component Number	Tektronix Part Number	Serial No. Effective	Serial No. Discont'd	Name & Description	Mfr. Code	Mfr. Part Number
A2C255	281-0775-01			CAP,FXD,CERAMIC:MCL,0.1UF,20%,50V	04222	SA105E104MAA
A2C257	281-0775-01			CAP,FXD,CERAMIC:MCL,0.1UF,20%,50V	04222	SA105E104MAA
A2C259	281-0777-00			CAP,FXD,CERAMIC:MLC,51PF,5%,200V	04222	SA102A510JAA
A2C260	281-0777-00			CAP,FXD,CERAMIC:MLC,51PF,5%,200V	04222	SA102A510JAA
A2C261	281-0777-00			CAP,FXD,CERAMIC:MLC,51PF,5%,200V	04222	SA102A510JAA
A2C262	281-0777-00			CAP,FXD,CERAMIC:MLC,51PF,5%,200V	04222	SA102A510JAA
A2C263	283-0648-01		671-1927-02	CAP,FXD,MICA DI:10PF,5%,500V	TK0891	RDM15CD100D03
A2C263	283-0648-01		671-2507-02	CAP,FXD,MICA DI:10PF,5%,500V	TK0891	RDM15CD100D03
A2C264	281-0775-01			CAP,FXD,CERAMIC:MCL,0.1UF,20%,50V	04222	SA105E104MAA
A2C265	281-0775-01			CAP,FXD,CERAMIC:MCL,0.1UF,20%,50V	04222	SA105E104MAA
A2C266	281-0775-01			CAP,FXD,CERAMIC:MCL,0.1UF,20%,50V	04222	SA105E104MAA
A2C267	281-0775-01			CAP,FXD,CERAMIC:MCL,0.1UF,20%,50V	04222	SA105E104MAA
A2C268	281-0775-01			CAP,FXD,CERAMIC:MCL,0.1UF,20%,50V	04222	SA105E104MAA
A2C269	281-0775-01			CAP,FXD,CERAMIC:MCL,0.1UF,20%,50V	04222	SA105E104MAA
A2C270	281-0775-01			CAP,FXD,CERAMIC:MCL,0.1UF,20%,50V	04222	SA105E104MAA
A2C271	281-0775-01			CAP,FXD,CERAMIC:MCL,0.1UF,20%,50V	04222	SA105E104MAA
A2C272	281-0775-01			CAP,FXD,CERAMIC:MCL,0.1UF,20%,50V	04222	SA105E104MAA
A2C273	281-0775-01			CAP,FXD,CERAMIC:MCL,0.1UF,20%,50V	04222	SA105E104MAA
A2C274	281-0775-01			CAP,FXD,CERAMIC:MCL,0.1UF,20%,50V	04222	SA105E104MAA
A2C275	281-0775-01			CAP,FXD,CERAMIC:MCL,0.1UF,20%,50V	04222	SA105E104MAA
A2C276	281-0775-01			CAP,FXD,CERAMIC:MCL,0.1UF,20%,50V	04222	SA105E104MAA
A2C277	281-0775-01			CAP,FXD,CERAMIC:MCL,0.1UF,20%,50V	04222	SA105E104MAA
A2C281	281-0775-01			CAP,FXD,CERAMIC:MCL,0.1UF,20%,50V	04222	SA105E104MAA
A2C282	281-0775-01			CAP,FXD,CERAMIC:MCL,0.1UF,20%,50V	04222	SA105E104MAA
A2C290	283-0203-00			CAP,FXD,CER DI:0.47UF,20%,50V	04222	SR305C474MAA
A2C291	283-0203-00			CAP,FXD,CER DI:0.47UF,20%,50V	04222	SR305C474MAA
A2C292	283-0203-00			CAP,FXD,CER DI:0.47UF,20%,50V	04222	SR305C474MAA
A2C293	283-0203-00			CAP,FXD,CER DI:0.47UF,20%,50V	04222	SR305C474MAA
A2C294	290-0845-00			CAP,FXD,ELCTLT:330UF,+50-10%,25V	55680	UVX1H331MPA
A2C295	290-0845-00			CAP,FXD,ELCTLT:330UF,+50-10%,25V	55680	UVX1H331MPA
A2C296	290-0845-00			CAP,FXD,ELCTLT:330UF,+50-10%,25V	55680	UVX1H331MPA
A2C297	290-1069-00			CAP,FXD,ALUM:1000UF,20%, 25V	62643	CEUFM0J102-E
A2C298	283-0203-00			CAP,FXD,CER DI:0.47UF,20%,50V	04222	SR305C474MAA
A2C299	283-0203-00			CAP,FXD,CER DI:0.47UF,20%,50V	04222	SR305C474MAA
A2C300	290-0755-00		671-1927-02	CAP,FXD,ELCTLT:100UF,+50%-20%,10WVDC	62643	CEUSM1C101
A2C300	290-1296-01	671-1927-03		CAP,FXD,ALUM:100UF,20%,25V,RADIAL,T&A	55680	URT1E101MNH1TA
A2C300	290-0755-00		671-2507-02	CAP,FXD,ELCTLT:100UF,+50%-20%,10WVDC	62643	CEUSM1C101
A2C300	290-1296-01	671-2507-03		CAP,FXD,ALUM:100UF,20%,25V,RADIAL,T&A	55680	URT1E101MNH1TA



Replaceable Electrical Parts List (Cont.)

Component Number	Tektronix Part Number	Serial No. Effective	Serial No. Discont'd	Name & Description	Mfr. Code	Mfr. Part Number
A2C301	290-0755-00		671-1927-02	CAP,FXD,ELCTLT:100UF,+50%-20%,10WVDC	62643	CEUSM1C101
A2C301	290-1296-01	671-1927-03		CAP,FXD,ALUM:100UF,20%,25V,RADIAL,T&A	55680	URT1E101MNH1TA
A2C301	290-0755-00		671-2507-02	CAP,FXD,ELCTLT:100UF,+50%-20%,10WVDC	62643	CEUSM1C101
A2C301	290-1296-01	671-2507-03		CAP,FXD,ALUM:100UF,20%,25V,RADIAL,T&A	55680	URT1E101MNH1TA
A2C302	283-0398-00			CAP,FXD,CER DI:680PF,2%,100V	04222	SR201A681GAA
A2C303	283-0398-00			CAP,FXD,CER DI:680PF,2%,100V	04222	SR201A681GAA
A2C304	283-0204-00			CAP,FXD,CER DI:0.01UF,20%,50V	04222	SR155E103MAA
A2C305	281-0775-01			CAP,FXD,CERAMIC:MCL,0.1UF,20%,50V	04222	SA105E104MAA
A2C306	283-0203-00			CAP,FXD,CER DI:0.47UF,20%,50V	04222	SR305C474MAA
A2C307	283-0005-00			CAP,FXD,CER DI:0.01UF,+100-0%,250V	04222	SR30VE103ZAA
A2C308	283-0032-00			CAP,FXD,CER DI:470PF,5%,500V	16546	2DD60L471J
A2C600	283-0648-01			CAP,FXD,MICA DI:10PF,5%,500V	TK0891	RDM15CD100D03
A2C601	283-0648-01			CAP,FXD,MICA DI:10PF,5%,500V	TK0891	RDM15CD100D03
A2C609	281-0563-00	671-1927-03		CAP,FXD,CERAMIC:MLC,0.47UF,20%,50V,AXIAL,MI	04222	SA305E474MAA
A2C609	281-0563-00	671-2507-03		CAP,FXD,CERAMIC:MLC,0.47UF,20%,50V,AXIAL,MI	04222	SA305E474MAA
A2C611	281-0775-01			CAP,FXD,CERAMIC:MCL,0.1UF,20%,50V	04222	SA105E104MAA
A2C616	281-0775-01			CAP,FXD,CERAMIC:MCL,0.1UF,20%,50V	04222	SA105E104MAA
A2C617	281-0775-01			CAP,FXD,CERAMIC:MCL,0.1UF,20%,50V	04222	SA105E104MAA
A2C618	281-0775-01			CAP,FXD,CERAMIC:MCL,0.1UF,20%,50V	04222	SA105E104MAA
A2C619	281-0775-01			CAP,FXD,CERAMIC:MCL,0.1UF,20%,50V	04222	SA105E104MAA
A2C620	281-0775-01			CAP,FXD,CERAMIC:MCL,0.1UF,20%,50V	04222	SA105E104MAA
A2C641	281-0775-01			CAP,FXD,CERAMIC:MCL,0.1UF,20%,50V	04222	SA105E104MAA
A2C642	281-0775-01			CAP,FXD,CERAMIC:MCL,0.1UF,20%,50V	04222	SA105E104MAA
A2C643	281-0775-01			CAP,FXD,CERAMIC:MCL,0.1UF,20%,50V	04222	SA105E104MAA
A2C644	281-0775-01			CAP,FXD,CERAMIC:MCL,0.1UF,20%,50V	04222	SA105E104MAA
A2C645	281-0775-01			CAP,FXD,CERAMIC:MCL,0.1UF,20%,50V	04222	SA105E104MAA
A2C646	281-0775-01			CAP,FXD,CERAMIC:MCL,0.1UF,20%,50V	04222	SA105E104MAA
A2C650	281-0775-01			CAP,FXD,CERAMIC:MCL,0.1UF,20%,50V	04222	SA105E104MAA
A2C651	281-0775-01			CAP,FXD,CERAMIC:MCL,0.1UF,20%,50V	04222	SA105E104MAA
A2C652	281-0775-01			CAP,FXD,CERAMIC:MCL,0.1UF,20%,50V	04222	SA105E104MAA
A2C653	281-0775-01			CAP,FXD,CERAMIC:MCL,0.1UF,20%,50V	04222	SA105E104MAA
A2C654	281-0775-01			CAP,FXD,CERAMIC:MCL,0.1UF,20%,50V	04222	SA105E104MAA
A2C655	281-0775-01			CAP,FXD,CERAMIC:MCL,0.1UF,20%,50V	04222	SA105E104MAA
A2C656	281-0814-00		671-1927-02	CAP,FXD,CERAMIC:MLC,100 PF,10%,100V	04222	SA102A101KAA
A2C656	281-0814-00		671-2507-02	CAP,FXD,CERAMIC:MLC,100 PF,10%,100V	04222	SA102A101KAA
A2C657	281-0814-00		671-1927-02	CAP,FXD,CERAMIC:MLC,100 PF,10%,100V	04222	SA102A101KAA
A2C657	281-0814-00		671-2507-02	CAP,FXD,CERAMIC:MLC,100 PF,10%,100V	04222	SA102A101KAA
A2C658	281-0775-01			CAP,FXD,CERAMIC:MCL,0.1UF,20%,50V	04222	SA105E104MAA

## TSG 200 — Replaceable Electrical Parts

### Replaceable Electrical Parts List (Cont.)

Component Number	Tektronix Part Number	Serial No. Effective	Serial No. Discont'd	Name & Description	Mfr. Code	Mfr. Part Number
A2C659	281-0775-01			CAP,FXD,CERAMIC:MCL,0.1UF,20%,50V	04222	SA105E104MAA
A2C660	281-0153-00		671-1927-02	CAP,VAR,AIR DI:1.7-10PF,150V	74970	187-0106-055
A2C660	281-0203-00	671-1927-03		CAP,VAR,PLASTIC:2-10PF,100V TOP/BOT ADJ	19701	2807C00210MJ02F00
A2C660	281-0153-00		671-2507-02	CAP,VAR,AIR DI:1.7-10PF,150V	74970	187-0106-055
A2C660	281-0203-00	671-2507-03		CAP,VAR,PLASTIC:2-10PF,100V TOP/BOT ADJ	19701	2807C00210MJ02F00
A2C661	283-0177-05			CAP,FXD,CER DI:1UF,+80-20%,25V	20932	5030ES25RD105Z
A2C662	281-0797-00			CAP,FXD,CERAMIC:MLC,15PF,5%,100V	12969	CGB150KFN
A2C663	283-0635-00			CAP,FXD,MICA DI:51PF,1%,500V	09023	CD15ED510F03
A2C664	283-0635-00			CAP,FXD,MICA DI:51PF,1%,500V	09023	CD15ED510F03
A2C665	283-0177-05			CAP,FXD,CER DI:1UF,+80-20%,25V	20932	5030ES25RD105Z
A2C666	281-0775-01			CAP,FXD,CERAMIC:MCL,0.1UF,20%,50V	04222	SA105E104MAA
A2C667	281-0775-01			CAP,FXD,CERAMIC:MCL,0.1UF,20%,50V	04222	SA105E104MAA
A2C668	283-0776-00			CAP,FXD,MICA DI:2130 PF,1%,500V	09023	CD19FD(2130)F03
A2C669	283-0776-00			CAP,FXD,MICA DI:2130 PF,1%,500V	09023	CD19FD(2130)F03
A2C670	290-0755-00		671-1927-02	CAP,FXD,ELCTLT:100UF,+50%-20%,10WVDC	62643	CEUSM1C101
A2C670	290-1296-01	671-1927-03		CAP,FXD,ALUM:100UF,20%,25V,RADIAL,T&A	55680	URT1E101MNH1TA
A2C670	290-0755-00		671-2507-02	CAP,FXD,ELCTLT:100UF,+50%-20%,10WVDC	62643	CEUSM1C101
A2C670	290-1296-01	671-2507-03		CAP,FXD,ALUM:100UF,20%,25V,RADIAL,T&A	55680	URT1E101MNH1TA
A2C671	290-0973-03		671-1927-02	CAP,FXD,ALUM:100UF,20%,35V	55680	UVX1V101MPA1TD
A2C671	290-1296-01	671-1927-03		CAP,FXD,ALUM:100UF,20%,25V,RADIAL,T&A	55680	URT1E101MNH1TA
A2C671	290-0973-03		671-2507-02	CAP,FXD,ALUM:100UF,20%,35V	55680	UVX1V101MPA1TD
A2C671	290-1296-01	671-2507-03		CAP,FXD,ALUM:100UF,20%,25V,RADIAL,T&A	55680	URT1E101MNH1TA
A2C672	281-0812-00	671-1927-03		CAP,FXD,CERAMIC:MLC,1000PF,10%,100V,AXIAL,MI	04222	SA101C102KAA
A2C672	281-0812-00	671-2507-03		CAP,FXD,CERAMIC:MLC,1000PF,10%,100V,AXIAL,MI	04222	SA101C102KAA
A2C673	281-0812-00	671-1927-03		CAP,FXD,CERAMIC:MLC,1000PF,10%,100V,AXIAL,MI	04222	SA101C102KAA
A2C673	281-0812-00	671-2507-03		CAP,FXD,CERAMIC:MLC,1000PF,10%,100V,AXIAL,MI	04222	SA101C102KAA
A2C674	281-0812-00	671-1927-03		CAP,FXD,CERAMIC:MLC,1000PF,10%,100V,AXIAL,MI	04222	SA101C102KAA
A2C674	281-0812-00	671-2507-03		CAP,FXD,CERAMIC:MLC,1000PF,10%,100V,AXIAL,MI	04222	SA101C102KAA
A2C675	281-0812-00	671-1927-03		CAP,FXD,CERAMIC:MLC,1000PF,10%,100V,AXIAL,MI	04222	SA101C102KAA
A2C675	281-0812-00	671-2507-03		CAP,FXD,CERAMIC:MLC,1000PF,10%,100V,AXIAL,MI	04222	SA101C102KAA
A2C676	281-0893-00	671-1927-03		CAP,FXD,CERAMIC:MLC,4.7PF,+/-0.5PF,100V,AXIAL,MI	04222	SA102A4R7DAA
A2C676	281-0893-00	671-2507-03		CAP,FXD,CERAMIC:MLC,4.7PF,+/-0.5PF,100V,AXIAL,MI	04222	SA102A4R7DAA
A2C677	281-0893-00	671-1927-03		CAP,FXD,CERAMIC:MLC,4.7PF,+/-0.5PF,100V,AXIAL,MI	04222	SA102A4R7DAA
A2C677	281-0893-00	671-2507-03		CAP,FXD,CERAMIC:MLC,4.7PF,+/-0.5PF,100V,AXIAL,MI	04222	SA102A4R7DAA
A2C678	281-0893-00	671-1927-03		CAP,FXD,CERAMIC:MLC,4.7PF,+/-0.5PF,100V,AXIAL,MI	04222	SA102A4R7DAA
A2C678	281-0893-00	671-2507-03		CAP,FXD,CERAMIC:MLC,4.7PF,+/-0.5PF,100V,AXIAL,MI	04222	SA102A4R7DAA
A2C679	281-0893-00	671-1927-03		CAP,FXD,CERAMIC:MLC,4.7PF,+/-0.5PF,100V,AXIAL,MI	04222	SA102A4R7DAA
A2C679	281-0893-00	671-2507-03		CAP,FXD,CERAMIC:MLC,4.7PF,+/-0.5PF,100V,AXIAL,MI	04222	SA102A4R7DAA



Replaceable Electrical Parts List (Cont.)

Component Number	Tektronix Part Number	Serial No. Effective	Serial No. Disc't'd	Name & Description	Mfr. Code	Mfr. Part Number
A2C680	281-0893-00	671-1927-03		CAP,FXD,CERAMIC:MLC,4.7PF,+/-0.5PF,100V,AXIAL,MI	04222	SA102A4R7DAA
A2C680	281-0893-00	671-2507-03		CAP,FXD,CERAMIC:MLC,4.7PF,+/-0.5PF,100V,AXIAL,MI	04222	SA102A4R7DAA
A2C681	281-0893-00	671-1927-03		CAP,FXD,CERAMIC:MLC,4.7PF,+/-0.5PF,100V,AXIAL,MI	04222	SA102A4R7DAA
A2C681	281-0893-00	671-2507-03		CAP,FXD,CERAMIC:MLC,4.7PF,+/-0.5PF,100V,AXIAL,MI	04222	SA102A4R7DAA
A2CR1	152-0141-02			DIODE,SIG:ULTRA FAST,40V,150MA,4NS,2PF,1N4152,DO-35,T&R	01295	1N4152R
A2CR2	152-0141-02			DIODE,SIG:ULTRA FAST,40V,150MA,4NS,2PF,1N4152,DO-35,T&R	01295	1N4152R
A2CR10	152-0601-00			DIODE,RECT:ULTRA FAST,150V,25NS,35A IFSM,MUR120	04713	MUR115
A2CR11	152-0601-00			DIODE,RECT:ULTRA FAST,150V,25NS,35A IFSM,MUR120	04713	MUR115
A2CR12	152-0601-00			DIODE,RECT:ULTRA FAST,150V,25NS,35A IFSM,MUR120	04713	MUR115
A2CR13	152-0601-00			DIODE,RECT:ULTRA FAST,150V,25NS,35A IFSM,MUR120	04713	MUR115
A2CR40	152-0601-00			DIODE,RECT:ULTRA FAST,150V,25NS,35A IFSM,MUR120	04713	MUR115
A2CR50	152-0601-00			DIODE,RECT:ULTRA FAST,150V,25NS,35A IFSM,MUR120	04713	MUR115
A2CR60	152-0670-00			DIODE,RECT:SCHTKY,40V,3A,1N5822	04713	1N5822
A2CR70	152-0670-00			DIODE,RECT:SCHTKY,40V,3A,1N5822	04713	1N5822
A2CR71	152-0964-00			DIODE,SIG:ULTRA FAST,50V,200MA,4NS,2.5PF,1N4150	TK2262	DM 308BT100SP-4150
A2CR72	152-0964-00			DIODE,SIG:ULTRA FAST,50V,200MA,4NS,2.5PF,1N4150	TK2262	DM 308BT100SP-4150
A2CR600	152-0601-00			DIODE,RECT:ULTRA FAST,150V,25NS,35A IFSM,MUR120	04713	MUR115
A2CR606	152-0676-00			DIODE,RECT:400V,3A,125A IFSM,1VF AT 3A,1N5625	14936	1N5625
A2CR608	152-0141-02			DIODE,SIG:ULTRA FAST,40V,150MA,4NS,2PF,1N4152,DO-35,T&R	01295	1N4152R
A2CR609	152-0141-02			DIODE,SIG:ULTRA FAST,40V,150MA,4NS,2PF,1N4152,DO-35,T&R	01295	1N4152R
A2CR610	152-0141-02			DIODE,SIG:ULTRA FAST,40V,150MA,4NS,2PF,1N4152,DO-35,T&R	01295	1N4152R
A2F1	159-0031-00			FUSE,CARTRIDGE:3AG,0.4A,250V,SLOW BLOW	71400	MDL 4/10
	344-0329-00			*MOUNTING PARTS* CLIP,ELECTRICAL:FUSE,5 X 20MM (QUANTITY 2) *END MOUNTING PARTS*	61857	H-0011-2
A2F600	159-0021-00			FUSE,CARTRIDGE:3AG,2A,250V,FAST BLOW	71400	AGC-2
	344-0329-00			*MOUNTING PARTS* CLIP,ELECTRICAL:FUSE,5 X 20MM (QUANTITY 2) *END MOUNTING PARTS*	61857	H-0011-2
A2J6	131-0608-00			CONN,TERMINAL:MALE,STR,0.025 X 0.137 GOLD,BRZ (QUANTITY 3)	22526	48283-018

## TSG 200 — Replaceable Electrical Parts

### Replaceable Electrical Parts List (Cont.)

Component Number	Tektronix Part Number	Serial No. Effective	Serial No. Discont'd	Name & Description	Mfr. Code	Mfr. Part Number
A2J7	131-0608-00			CONN,TERMINAL:MALE,STR,0.025 X 0.137 GOLD,BRZ (QUANTITY 3)	22526	48283-018
A2J9	131-3987-00			CONN,CIRC AUDIO:PCB/PNL,XLR,MALE,RTANG,3 POS,1.22 H X 1.024 W,CTR PLZ,LATCHING,	82389	E3MRA
	213-0055-00			*MOUNTING PARTS* SCREW,TPG,TF:2-32 X 0.188,TYPE B,PNH,STL *END MOUNTING PARTS*	93907	ORDER BY DESC
A2J10	131-3987-00			CONN,CIRC AUDIO:PCB/PNL,XLR,MALE,RTANG,3 POS,1.22 H X 1.024 W,CTR PLZ,LATCHING,	82389	E3MRA
	213-0055-00			*MOUNTING PARTS* SCREW,TPG,TF:2-32 X 0.188,TYPE B,PNH,STL *END MOUNTING PARTS*	93907	ORDER BY DESC
A2J40	131-0608-00			CONN,TERMINAL:MALE,STR,0.025 X 0.137 GOLD,BRZ (QUANTITY 2)	22526	48283-018
A2J50	131-0608-00			CONN,TERMINAL:MALE,STR,0.025 X 0.137 GOLD,BRZ (QUANTITY 2)	22526	48283-018
A2J60	131-0608-00			CONN,TERMINAL:MALE,STR,0.025 X 0.137 GOLD,BRZ (QUANTITY 2)	22526	48283-018
A2J70	131-0608-00			CONN,TERMINAL:MALE,STR,0.025 X 0.137 GOLD,BRZ (QUANTITY 2)	22526	48283-018
A2J108	131-0608-00			CONN,TERMINAL:MALE,STR,0.025 X 0.137 GOLD,BRZ (QUANTITY 3)	22526	48283-018
A2J122	131-0608-00			CONN,TERMINAL:MALE,STR,0.025 X 0.137 GOLD,BRZ (QUANTITY 5)	22526	48283-018
A2J504	136-0729-00	671-1927-02		SOCKET,DIP,PCB,;FEMALE,STR,2 X 8,16 POS	00779	2-641600-3
A2J504	136-0729-00	671-2507-02		SOCKET,DIP,PCB,;FEMALE,STR,2 X 8,16 POS	00779	2-641600-3
A2J601	131-0608-00			CONN,TERMINAL:MALE,STR,0.025 X 0.137 GOLD,BRZ (QUANTITY 16)	22526	48283-018
A2J602	131-0608-00			CONN,TERMINAL:MALE,STR,0.025 X 0.137 GOLD,BRZ (QUANTITY 3)	22526	48283-018
A2J603	131-0608-00			CONN,TERMINAL:MALE,STR,0.025 X 0.137 GOLD,BRZ (QUANTITY 3)	22526	48283-018
A2J604	131-0608-00			CONN,TERMINAL:MALE,STR,0.025 X 0.137 GOLD,BRZ (QUANTITY 3)	22526	48283-018
A2J606	131-0608-00			CONN,TERMINAL:MALE,STR,0.025 X 0.137 GOLD,BRZ (QUANTITY 3)	22526	48283-018
A2J608	131-0608-00			CONN,TERMINAL:MALE,STR,0.025 X 0.137 GOLD,BRZ (QUANTITY 10)	22526	48283-018
A2J609	131-0608-00			CONN,TERMINAL:MALE,STR,0.025 X 0.137 GOLD,BRZ (QUANTITY 2)	22526	48283-018
A2J610	131-0608-00			CONN,TERMINAL:MALE,STR,0.025 X 0.137 GOLD,BRZ (QUANTITY 10)	22526	48283-018
A2J613	131-0608-00			CONN,TERMINAL:MALE,STR,0.025 X 0.137 GOLD,BRZ (QUANTITY 3)	22526	48283-018
A2J614	131-0608-00			CONN,TERMINAL:MALE,STR,0.025 X 0.137 GOLD,BRZ (QUANTITY 3)	22526	48283-018

Replaceable Electrical Parts List (Cont.)

Component Number	Tektronix Part Number	Serial No. Effective	Serial No. Discont'd	Name & Description	Mfr. Code	Mfr. Part Number
A2L4	108-0538-00			INDUCTOR,FXD:CUSTOM,POWER,2.7UH	0JR03	108-0538-00
A2L8	120-1180-00			TRANSFORMER,RF:VARIABLE	54937	500-3910
A2L9	114-0415-00			INDUCTOR,VAR:775-925NH	54937	500-3901
A2L10	114-0366-00			INDUCTOR,VAR:2.40-2.70UH	54937	114-0366-00
A2L11	114-0367-00			INDUCTOR,VAR:2.70-3.30UH	54937	500-3895
A2L12	114-0369-00			INDUCTOR,VAR:2.18-2.3UH	54937	500-3896
A2L14	120-1180-00			TRANSFORMER,RF:VARIABLE	54937	500-3910
A2L15	114-0415-00			INDUCTOR,VAR:775-925NH	54937	500-3901
A2L16	114-0366-00			INDUCTOR,VAR:2.40-2.70UH	54937	114-0366-00
A2L17	114-0367-00			INDUCTOR,VAR:2.70-3.30UH	54937	500-3895
A2L18	114-0369-00			INDUCTOR,VAR:2.18-2.3UH	54937	500-3896
A2L28	108-0245-00			INDUCTOR,FXD:CUSTOM,POWER,3.9UH	0JR03	108-0245-00
A2L29	108-0245-00			INDUCTOR,FXD:CUSTOM,POWER,3.9UH	0JR03	108-0245-00
A2L30	108-0538-00		671-1927-02	INDUCTOR,FXD:CUSTOM,POWER,2.7UH	0JR03	108-0538-00
A2L30	108-0538-00		671-2507-02	INDUCTOR,FXD:CUSTOM,POWER,2.7UH	0JR03	108-0538-00
A2L60	108-1263-00			INDUCTOR,FXD:POWER,10UH	TK2058	TSL0707-100K1R9
A2L70	108-1263-00			INDUCTOR,FXD:POWER,10UH	TK2058	TSL0707-100K1R9
A2L605	108-1263-00			INDUCTOR,FXD:POWER,10UH	TK2058	TSL0707-100K1R9
A2LF1	119-1946-00			FILTER,RFI:1A,250V,400HZ W/PC TERMINAL	0GV52	FX326-1/02-K-D-T
A2P6	131-0993-02			CONN,BOX:SHUNT,FEMALE,RED,JUMPER	00779	1-850100-O
A2P7	131-0993-02			CONN,BOX:SHUNT,FEMALE,RED,JUMPER	00779	1-850100-O
A2P40	131-0993-02			CONN,BOX:SHUNT,FEMALE,RED,JUMPER	00779	1-850100-O
A2P50	131-0993-02			CONN,BOX:SHUNT,FEMALE,RED,JUMPER	00779	1-850100-O
A2P60	131-0993-02			CONN,BOX:SHUNT,FEMALE,RED,JUMPER	00779	1-850100-O
A2P70	131-0993-02			CONN,BOX:SHUNT,FEMALE,RED,JUMPER	00779	1-850100-O
A2P108	131-0993-05			BUS,CONDUCTOR:SHUNT ASSEMBLY,GREEN	00779	850100-5
A2P122	198-5783-00			WIRE,SET ELEC:TSG111/TSG121/TSG131	TK1547	198-5783-00
A2P602	131-0993-02			CONN,BOX:SHUNT,FEMALE,RED,JUMPER	00779	1-850100-O
A2P603	131-0993-02			CONN,BOX:SHUNT,FEMALE,RED,JUMPER	00779	1-850100-O
A2P604	131-0993-05			BUS,CONDUCTOR:SHUNT ASSEMBLY,GREEN	00779	850100-5
A2P606	131-0993-05			BUS,CONDUCTOR:SHUNT ASSEMBLY,GREEN	00779	850100-5
A2P613	131-0993-05			BUS,CONDUCTOR:SHUNT ASSEMBLY,GREEN	00779	850100-5
A2P614	131-0993-05			BUS,CONDUCTOR:SHUNT ASSEMBLY,GREEN	00779	850100-5
A2Q1	151-1121-00			TRANSISTOR,PWR:MOS,N-CH,60V,0.5A,3.0 OHM,VN0106N3/VN0606L,TO-92	17856	VN0606L
A2Q2	151-1025-00			TRANSISTOR,SIG:JFET,N-CH,6V,15MA,4.5MS,AMPLIFIER,J304/PN4416,TO-92	04713	SPF3036
A2Q30	151-0190-00			TRANSISTOR,SIG:BIPOLAR,NPN,40V,200MA,300MHZ,AMPLIFIER,2N3904,TO-92	04713	2N3904

## TSG 200 — Replaceable Electrical Parts

### Replaceable Electrical Parts List (Cont.)

Component Number	Tektronix Part Number	Serial No. Effective	Serial No. Discont'd	Name & Description	Mfr. Code	Mfr. Part Number
A2Q100	151-1171-00			TRANSISTOR,PWR:MOS,N-CH,50V,12A,0.12 OHM,BUZ71A/IRFZ22/MTP15N06V,TO-220	04713	MTP15N05E
A2Q600	151-1121-00			TRANSISTOR,PWR:MOS,N-CH,60V,0.5A,3.0 OHM,VN0106N3/VN0606L,TO-92	17856	VN0606L
A2Q603	151-1025-00			TRANSISTOR,SIG:JFET,N-CH,6V,15MA,4.5MS,AMPLIFIER,J304/PN4416,TO-92	04713	SPF3036
A2R14	307-0051-00			RES,FXD,CMPSN:2.7 OHM,5%,0.5W	50139	EB27G5
A2R15	307-0051-00			RES,FXD,CMPSN:2.7 OHM,5%,0.5W	50139	EB27G5
A2R16	322-3133-00			RES,FXD,FILM:237 OHM,1%,0.2W,TC=T0	91637	CCF50-2F237R0F
A2R17	322-3193-00			RES,FXD:METAL FILM,1K OHM,1%,0.2W,TC=100	91637	CCF501G10000F
A2R18	311-0634-00			RES,VAR,NONWW:TRMR,500 OHM,0.5W	32997	3329H-L58-501
A2R19	322-3296-00			RES,FXD,FILM:11.8K OHM,1%,0.2W,TC=T0	57668	CRB20 FXE 11K8
A2R20	311-0633-00			RES,VAR,NONWW:TRMR,5K OHM,0.5W	32997	3329H-L58-502
A2R32	322-3224-00			RES,FXD,FILM:2.1K OHM,1%,0.2W,TC=T0	91637	CCF50-2F21000F
A2R40	322-3085-07			RES,FXD:METAL FILM,75 OHM,0.1%,0.2W,TC=25	91637	CCF502-C75ROOBT
A2R41	322-3085-07			RES,FXD:METAL FILM,75 OHM,0.1%,0.2W,TC=25	91637	CCF502-C75ROOBT
A2R42	322-3193-00			RES,FXD:METAL FILM,1K OHM,1%,0.2W,TC=100	91637	CCF501G10000F
A2R43	322-3085-07			RES,FXD:METAL FILM,75 OHM,0.1%,0.2W,TC=25	91637	CCF502-C75ROOBT
A2R45	322-3056-01			RES,FXD,FILM:37.4 OHM,0.5%,0.2W,TC=T0	57668	CRB20 DXE 37E4
A2R46	322-3085-00			RES,FXD:METAL FILM,75 OHM,1%,0.2W,TC=100	91637	CCF501G75R00F
A2R47	322-3001-00			RES,FXD:METAL FILM,10 OHM,1%,0.2W,TC=100	91637	CCF501G10R00F
A2R48	317-0036-00			RES,FXD,CMPSN:3.6 OHM,5%,0.125W	50139	BB36G5
A2R49	322-3193-00		671-1927-02	RES,FXD:METAL FILM,1K OHM,1%,0.2W,TC=100	91637	CCF501G10000F
A2R49	322-3193-00		671-2507-02	RES,FXD:METAL FILM,1K OHM,1%,0.2W,TC=100	91637	CCF501G10000F
A2R50	322-3126-00		671-1927-02	RES,FXD,FILM:200 OHM,1%,0.2W,TC=T0	91637	CCF501G200ROF
A2R50	322-3126-00		671-2507-02	RES,FXD,FILM:200 OHM,1%,0.2W,TC=T0	91637	CCF501G200ROF
A2R51	322-3226-00			RES,FXD:METAL FILM,2.21K OHM,1%,0.2W,TC=100	91637	CCF501G22100F
A2R52	322-3213-00		671-1927-02	RES,FXD,FILM:1.62K OHM,1%,0.2W,TC=T0	57668	CRB20 FXE 1K62
A2R52	322-3213-00		671-2507-02	RES,FXD,FILM:1.62K OHM,1%,0.2W,TC=T0	57668	CRB20 FXE 1K62
A2R53	322-3213-00		671-1927-02	RES,FXD,FILM:1.62K OHM,1%,0.2W,TC=T0	57668	CRB20 FXE 1K62
A2R53	322-3277-00	671-1927-03		RES,FXD,FILM:7.5K OHM,1%,0.2W,TC=T0	57668	CRB20 FXE 7K50
A2R53	322-3213-00		671-2507-02	RES,FXD,FILM:1.62K OHM,1%,0.2W,TC=T0	57668	CRB20 FXE 1K62
A2R53	322-3277-00	671-2507-03		RES,FXD,FILM:7.5K OHM,1%,0.2W,TC=T0	57668	CRB20 FXE 7K50
A2R54	317-0036-00			RES,FXD,CMPSN:3.6 OHM,5%,0.125W	50139	BB36G5
A2R57	322-3133-00			RES,FXD,FILM:237 OHM,1%,0.2W,TC=T0	91637	CCF50-2F237R0F
A2R58	322-3193-00			RES,FXD:METAL FILM,1K OHM,1%,0.2W,TC=100	91637	CCF501G10000F
A2R59	322-3224-00			RES,FXD,FILM:2.1K OHM,1%,0.2W,TC=T0	91637	CCF50-2F21000F
A2R60	311-0634-00			RES,VAR,NONWW:TRMR,500 OHM,0.5W	32997	3329H-L58-501
A2R61	322-3085-07			RES,FXD:METAL FILM,75 OHM,0.1%,0.2W,TC=25	91637	CCF502-C75ROOBT

Replaceable Electrical Parts List (Cont.)

Component Number	Tektronix Part Number	Serial No. Effective	Serial No. Discont'd	Name & Description	Mfr. Code	Mfr. Part Number
A2R62	322-3296-00			RES,FXD,FILM:11.8K OHM,1%,0.2W,TC=T0	57668	CRB20 FXE 11K8
A2R63	311-0633-00			RES,VAR,NONWW:TRMR,5K OHM,0.5W	32997	3329H-L58-502
A2R64	322-3056-01			RES,FXD,FILM:37.4 OHM,0.5%,0.2W,TC=T0	57668	CRB20 DXE 37E4
A2R65	322-3085-00			RES,FXD:METAL FILM,75 OHM,1%,0.2W,TC=100	91637	CCF501G75R00F
A2R66	322-3001-00			RES,FXD:METAL FILM,10 OHM,1%,0.2W,TC=100	91637	CCF501G10R00F
A2R67	317-0036-00			RES,FXD,CMPSN:3.6 OHM,5%,0.125W	50139	BB36G5
A2R68	322-3193-00		671-1927-02	RES,FXD:METAL FILM,1K OHM,1%,0.2W,TC=100	91637	CCF501G10000F
A2R68	322-3193-00		671-2507-02	RES,FXD:METAL FILM,1K OHM,1%,0.2W,TC=100	91637	CCF501G10000F
A2R69	322-3126-00		671-1927-02	RES,FXD,FILM:200 OHM,1%,0.2W,TC=T0	91637	CCF501G200ROF
A2R69	322-3126-00		671-2507-02	RES,FXD,FILM:200 OHM,1%,0.2W,TC=T0	91637	CCF501G200ROF
A2R70	322-3226-00			RES,FXD:METAL FILM,2.21K OHM,1%,0.2W,TC=100	91637	CCF501G22100F
A2R71	322-3213-00		671-1927-02	RES,FXD,FILM:1.62K OHM,1%,0.2W,TC=T0	57668	CRB20 FXE 1K62
A2R71	322-3213-00		671-2507-02	RES,FXD,FILM:1.62K OHM,1%,0.2W,TC=T0	57668	CRB20 FXE 1K62
A2R72	322-3213-00		671-1927-02	RES,FXD,FILM:1.62K OHM,1%,0.2W,TC=T0	57668	CRB20 FXE 1K62
A2R72	322-3277-00	671-1927-03		RES,FXD,FILM:7.5K OHM,1%,0.2W,TC=T0	57668	CRB20 FXE 7K50
A2R72	322-3213-00		671-2507-02	RES,FXD,FILM:1.62K OHM,1%,0.2W,TC=T0	57668	CRB20 FXE 1K62
A2R72	322-3277-00	671-2507-03		RES,FXD,FILM:7.5K OHM,1%,0.2W,TC=T0	57668	CRB20 FXE 7K50
A2R73	317-0036-00			RES,FXD,CMPSN:3.6 OHM,5%,0.125W	50139	BB36G5
A2R101	307-0648-00			RES NTWK,FXD,FI:8,100 OHM,2%,0.125 W	11236	761-3-R100
A2R102	322-3039-00			RES,FXD,FILM:24.9 OHM,1%,0.2W,TC=T0	91637	CCF50-2-G24R90FT
A2R103	322-3289-00			RES,FXD:METAL FILM,10K OHM,1%,0.2W,TC=100	91637	CCF50G10001F
A2R104	322-3039-00			RES,FXD,FILM:24.9 OHM,1%,0.2W,TC=T0	91637	CCF50-2-G24R90FT
A2R105	322-3222-00			RES,FXD:METAL FILM,2K OHM,1%,0.2W,TC=100	91637	CCF501G20000F
A2R106	322-3404-00			RES,FXD,FILM:158K OHM,1%,0.2W,TC=T0	91637	CCF50-2F15802F
A2R107	322-3404-00			RES,FXD,FILM:158K OHM,1%,0.2W,TC=T0	91637	CCF50-2F15802F
A2R108	322-3222-00			RES,FXD:METAL FILM,2K OHM,1%,0.2W,TC=100	91637	CCF501G20000F
A2R109	322-3289-00			RES,FXD:METAL FILM,10K OHM,1%,0.2W,TC=100	91637	CCF50G10001F
A2R110	322-3318-00			RES,FXD,FILM:METAL FILM,20K OHM,1%,0.2W,TC=100	91637	CCF501G20001F
A2R112	322-3273-00			RES,FXD:METAL FILM,6.81K OHM,1%,0.2W,TC=100	91637	CCF50-2-G68100F
A2R113	322-3239-00			RES,FXD,FILM:3.01K OHM,1%,0.2W,TC=T0	91637	CCF501G30100F
A2R114	322-3418-00			RES,FXD:METAL FILM,221K OHM,1%,0.2W,TC=100	57668	CRB20 FXE 221K
A2R115	322-3039-00			RES,FXD,FILM:24.9 OHM,1%,0.2W,TC=T0	91637	CCF50-2-G24R90FT
A2R116	322-3289-00			RES,FXD:METAL FILM,10K OHM,1%,0.2W,TC=100	91637	CCF50G10001F
A2R117	322-3039-00			RES,FXD,FILM:24.9 OHM,1%,0.2W,TC=T0	91637	CCF50-2-G24R90FT
A2R118	322-3222-00			RES,FXD:METAL FILM,2K OHM,1%,0.2W,TC=100	91637	CCF501G20000F
A2R119	322-3289-00			RES,FXD:METAL FILM,10K OHM,1%,0.2W,TC=100	91637	CCF50G10001F
A2R120	322-3239-00			RES,FXD,FILM:3.01K OHM,1%,0.2W,TC=T0	91637	CCF501G30100F
A2R121	322-3280-00			RES,FXD,FILM:8.06K OHM,1%,0.2W,TC=T0	91637	CCF501G80600F

## TSG 200 — Replaceable Electrical Parts

### Replaceable Electrical Parts List (Cont.)

Component Number	Tektronix Part Number	Serial No. Effective	Serial No. Discont'd	Name & Description	Mfr. Code	Mfr. Part Number
A2R122	311-0644-00			RES,VAR,NONWW:TRMR,20K OHM,0.5W	32997	3329H-L58-203
A2R123	311-0644-00			RES,VAR,NONWW:TRMR,20K OHM,0.5W	32997	3329H-L58-203
A2R124	322-3193-00			RES,FXD:METAL FILM,1K OHM,1%,0.2W,TC=100	91637	CCF501G10000F
A2R140	315-0100-00			RES,FXD,FILM:10 OHM,5%,0.25W	50139	CB1005
A2R150	322-3260-00			RES,FXD,FILM:4.99K OHM,1%,0.2W,TC=T0	91637	CCF501G49900F
A2R151	322-3260-00			RES,FXD,FILM:4.99K OHM,1%,0.2W,TC=T0	91637	CCF501G49900F
A2R152	322-3260-00			RES,FXD,FILM:4.99K OHM,1%,0.2W,TC=T0	91637	CCF501G49900F
A2R153	322-3260-00			RES,FXD,FILM:4.99K OHM,1%,0.2W,TC=T0	91637	CCF501G49900F
A2R181	322-3056-01		671-1927-02	RES,FXD,FILM:37.4 OHM,0.5%,0.2W,TC=T0	57668	CRB20 DXE 37E4
A2R181	322-3056-01		671-2507-02	RES,FXD,FILM:37.4 OHM,0.5%,0.2W,TC=T0	57668	CRB20 DXE 37E4
A2R182	322-3056-01		671-1927-02	RES,FXD,FILM:37.4 OHM,0.5%,0.2W,TC=T0	57668	CRB20 DXE 37E4
A2R182	322-3085-00	671-1927-03		RES,FXD,FILM:75 OHM,1%,0.2W,TC=100 PPM	57668	CRB20T68EFX75R0
A2R182	322-3056-01		671-2507-02	RES,FXD,FILM:37.4 OHM,0.5%,0.2W,TC=T0	57668	CRB20 DXE 37E4
A2R182	322-3085-00	671-2507-03		RES,FXD,FILM:75 OHM,1%,0.2W,TC=100 PPM	57668	CRB20T68EFX75R0
A2R193	322-3056-01		671-1927-02	RES,FXD,FILM:37.4 OHM,0.5%,0.2W,TC=T0	57668	CRB20 DXE 37E4
A2R193	322-3056-01		671-2507-02	RES,FXD,FILM:37.4 OHM,0.5%,0.2W,TC=T0	57668	CRB20 DXE 37E4
A2R209	321-0673-07			RES,FXD,FILM:17K OHM,0.1%,0.125W,TC=T9	07716	CEAE17001B
A2R210	321-0962-07			RES,FXD,FILM:8K OHM,0.1%,0.125W,TC=T9	57027	8.0K
A2R212	307-0650-00			RES NTWK,FXD,FI:9,2.7K OHM,5%,0.150W	11236	750-101-R2.7K
A2R213	322-3193-00		671-1927-02	RES,FXD:METAL FILM,1K OHM,1%,0.2W,TC=100	91637	CCF501G10000F
A2R213	322-3193-00		671-2507-02	RES,FXD:METAL FILM,1K OHM,1%,0.2W,TC=100	91637	CCF501G10000F
A2R261	315-0101-00			RES,FXD,FILM:100 OHM,5%,0.25W	50139	CB1015
A2R262	315-0331-00			RES,FXD,FILM:330 OHM,5%,0.25W	50139	CB3315
A2R263	322-3235-00			RES,FXD:METAL FILM,2.74K OHM,1%,0.2W,TC=100	57668	CRB20 FXE 2K74
A2R264	322-3235-00			RES,FXD:METAL FILM,2.74K OHM,1%,0.2W,TC=100	57668	CRB20 FXE 2K74
A2R265	322-3235-00	671-1927-00	671-1927-00	RES,FXD:METAL FILM,2.74K OHM,1%,0.2W,TC=100	57668	CRB20 FXE 2K74
A2R265	322-3233-00	671-1927-01		RES,FXD,FILM:2.61K OHM,1%,0.2W,TC=T0	91637	CCF50-2-G2611FT
A2R265	322-3235-00	671-2507-00	671-2507-00	RES,FXD:METAL FILM,2.74K OHM,1%,0.2W,TC=100	57668	CRB20 FXE 2K74
A2R265	322-3233-00	671-2507-01		RES,FXD,FILM:2.61K OHM,1%,0.2W,TC=T0	91637	CCF50-2-G2611FT
A2R266	322-3414-00			RES,FXD:METAL FILM,200K OHM,1%,0.2W,TC=100	57668	CRB 20 FXE 200 K OHM
A2R267	322-3258-00			RES,FXD:METAL FILM,4.75K OHM,1%,0.2W,TC=100	56845	CCF50-2-G4751FT
A2R268	322-3181-00			RES,FXD,FILM:750 OHM,1%,0.2W,TC=T0	91637	CCF501G750ROF
A2R269	308-0463-00			RES,FXD,WW:0.3 OHM,1%,3W,0.560 X 0.187,AXIAL LEADS	91637	RS-2B-60-R3000F-T/R
A2R270	322-3222-00			RES,FXD:METAL FILM,2K OHM,1%,0.2W,TC=100	91637	CCF501G20000F
A2R271	315-0100-00			RES,FXD,FILM:10 OHM,5%,0.25W	50139	CB1005
A2R375	322-3034-00	671-1927-03		RES,FXD,FILM:22.1 OHM,1%,0.2W,TC=100 PPM	91637	CCF50-22R1F-R36
A2R375	322-3034-00	671-2507-03		RES,FXD,FILM:22.1 OHM,1%,0.2W,TC=100 PPM	91637	CCF50-22R1F-R36
A2R376	322-3034-00	671-1927-03		RES,FXD,FILM:22.1 OHM,1%,0.2W,TC=100 PPM	91637	CCF50-22R1F-R36



Replaceable Electrical Parts List (Cont.)

Component Number	Tektronix Part Number	Serial No. Effective	Serial No. Discot'd	Name & Description	Mfr. Code	Mfr. Part Number
A2R376	322-3034-00	671-2507-03		RES,FXD,FILM:22.1 OHM,1%,0.2W,TC=100 PPM	91637	CCF50-22R1F-R36
A2R600	322-3289-00			RES,FXD:METAL FILM,10K OHM,1%,0.2W,TC=100	91637	CCF50G10001F
A2R601	322-3289-00			RES,FXD:METAL FILM,10K OHM,1%,0.2W,TC=100	91637	CCF50G10001F
A2R604	307-0526-00			RES,NTWK:THICK FILM,(5)510 OHM,10%,0.125W EACH,TC=100	11236	750-61-R510 OHM OR 770-61R510
A2R605	322-3056-01		671-1927-02	RES,FXD,FILM:37.4 OHM,0.5%,0.2W,TC=T0	57668	CRB20 DXE 37E4
A2R605	322-3085-00	671-1927-03		RES,FXD,FILM:75 OHM,1%,0.2W,TC=100 PPM	57668	CRB20T68EFX75R0
A2R605	322-3056-01		671-2507-02	RES,FXD,FILM:37.4 OHM,0.5%,0.2W,TC=T0	57668	CRB20 DXE 37E4
A2R605	322-3085-00	671-2507-03		RES,FXD,FILM:75 OHM,1%,0.2W,TC=100 PPM	57668	CRB20T68EFX75R0
A2R606	322-3085-07			RES,FXD:METAL FILM,75 OHM,0.1%,0.2W,TC=25	91637	CCF502-C75ROOBT
A2R640	322-3193-00			RES,FXD:METAL FILM,1K OHM,1%,0.2W,TC=100	91637	CCF501G10000F
A2R641	322-3280-00			RES,FXD,FILM:8.06K OHM,1%,0.2W,TC=T0	91637	CCF501G80600F
A2R642	307-0650-00			RES NTWK,FXD,FI:9,2.7K OHM,5%,0.150W	11236	750-101-R2.7K
A2R645	315-0391-00			RES,FXD,FILM:390 OHM,5%,0.25W	50139	CB3915
A2R646	315-0332-00			RES,FXD,FILM:3.3K OHM,5%,0.25W	50139	CB3325
A2R647	307-0650-00			RES NTWK,FXD,FI:9,2.7K OHM,5%,0.150W	11236	750-101-R2.7K
A2R648	307-0650-00			RES NTWK,FXD,FI:9,2.7K OHM,5%,0.150W	11236	750-101-R2.7K
A2R649	311-0633-00			RES,VAR,NONWW:TRMR,5K OHM,0.5W	32997	3329H-L58-502
A2R650	311-0634-00			RES,VAR,NONWW:TRMR,500 OHM,0.5W	32997	3329H-L58-501
A2R651	322-3085-07			RES,FXD:METAL FILM,75 OHM,0.1%,0.2W,TC=25	91637	CCF502-C75ROOBT
A2R653	322-3193-00			RES,FXD:METAL FILM,1K OHM,1%,0.2W,TC=100	91637	CCF501G10000F
A2R654	322-3133-00			RES,FXD,FILM:237 OHM,1%,0.2W,TC=T0	91637	CCF50-2F237R0F
A2R655	311-0633-00			RES,VAR,NONWW:TRMR,5K OHM,0.5W	32997	3329H-L58-502
A2R656	322-3085-07			RES,FXD:METAL FILM,75 OHM,0.1%,0.2W,TC=25	91637	CCF502-C75ROOBT
A2R657	322-3296-00			RES,FXD,FILM:11.8K OHM,1%,0.2W,TC=T0	57668	CRB20 FXE 11K8
A2R658	322-3224-00			RES,FXD,FILM:2.1K OHM,1%,0.2W,TC=T0	91637	CCF50-2F21000F
A2R659	322-3318-00			RES,FXD,FILM:METAL FILM,20K OHM,1%,0.2W,TC=100	91637	CCF501G20001F
A2R660	321-0673-07			RES,FXD,FILM:17K OHM,0.1%,0.125W,TC=T9	07716	CEAE17001B
A2R661	321-0962-07			RES,FXD,FILM:8K OHM,0.1%,0.125W,TC=T9	57027	8.0K
A2R662	322-3222-00			RES,FXD:METAL FILM,2K OHM,1%,0.2W,TC=100	91637	CCF501G20000F
A2R663	322-3246-00			RES,FXD,FILM:3.57K OHM,1%,0.2W,TC=T0	57668	CRB20 FXE 3K57
A2R664	322-3411-00			RES,FXD,FILM:187K OHM,1%,0.2W,TC=T0	91637	CCF501G1873FT
A2R665	322-3411-00			RES,FXD,FILM:187K OHM,1%,0.2W,TC=T0	91637	CCF501G1873FT
A2R666	322-3275-00			RES,FXD,FILM:7.15K OHM,1%,0.2W,TC=T0	57668	CRB20 FXE 7K15
A2R667	322-3289-00			RES,FXD:METAL FILM,10K OHM,1%,0.2W,TC=100	91637	CCF50G10001F
A2R668	322-3085-00	671-1927-03		RES,FXD,FILM:75 OHM,1%,0.2W,TC=100 PPM	57668	CRB20T68EFX75R0
A2R668	322-3085-00	671-2507-03		RES,FXD,FILM:75 OHM,1%,0.2W,TC=100 PPM	57668	CRB20T68EFX75R0
A2R669	322-3085-00	671-1927-03		RES,FXD,FILM:75 OHM,1%,0.2W,TC=100 PPM	57668	CRB20T68EFX75R0
A2R669	322-3085-00	671-2507-03		RES,FXD,FILM:75 OHM,1%,0.2W,TC=100 PPM	57668	CRB20T68EFX75R0

## TSG 200 — Replaceable Electrical Parts

### Replaceable Electrical Parts List (Cont.)

Component Number	Tektronix Part Number	Serial No. Effective	Serial No. Discont'd	Name & Description	Mfr. Code	Mfr. Part Number
A2S1	260-1721-00			SWITCH,ROCKER:SPST,8 POS DIP,125MA,30VDC	00779	5-435166-3
A2S2	260-1589-00			SWITCH,ROCKER:(6)SPST,125MA,30VDC	00779	435166-4
A2T1	120-1902-00			TRANSFORMER,PWR:	08779	LP40-600
A2T2	120-1785-00			TRANSFORMER:FLYBACK,+/- 5V 2A, +/- 15V 0.2A, 20W, POT CORE	75498	128-7045-00
A2TP4	214-4085-00			TERM,TEST POINT:0.070 ID,0.220 H,0.063 DIA	26364	TP104-01-02
A2TP5	214-4085-00			TERM,TEST POINT:0.070 ID,0.220 H,0.063 DIA	26364	TP104-01-02
A2TP6	214-4085-00			TERM,TEST POINT:0.070 ID,0.220 H,0.063 DIA	26364	TP104-01-02
A2TP7	214-4085-00			TERM,TEST POINT:0.070 ID,0.220 H,0.063 DIA	26364	TP104-01-02
A2TP8	214-4085-00			TERM,TEST POINT:0.070 ID,0.220 H,0.063 DIA	26364	TP104-01-02
A2TP9	214-4085-00			TERM,TEST POINT:0.070 ID,0.220 H,0.063 DIA	26364	TP104-01-02
A2TP10	214-4085-00			TERM,TEST POINT:0.070 ID,0.220 H,0.063 DIA	26364	TP104-01-02
A2TP12	214-4085-00			TERM,TEST POINT:0.070 ID,0.220 H,0.063 DIA	26364	TP104-01-02
A2TP13	214-4085-00			TERM,TEST POINT:0.070 ID,0.220 H,0.063 DIA	26364	TP104-01-02
A2TP14	214-4085-00			TERM,TEST POINT:0.070 ID,0.220 H,0.063 DIA	26364	TP104-01-02
A2TP15	214-4085-00			TERM,TEST POINT:0.070 ID,0.220 H,0.063 DIA	26364	TP104-01-02
A2U1	156-4024-00			IC,LINEAR:BIPOLAR,OP-AMP,190MHZ,CURRENT FEEDBACK,1 TO 40 GAIN RANGE,AD9617JN,DIP08.3	24355	AD9617JN
A2U21	160-8592-00	671-1927-00		IC,MEMORY:CMOS,PROM,8K X 8,PRGM 156-3836-00,REGISTERED,CY7C265-50,DIP28.3	80009	160-8592-00
A2U21	160-8958-00	671-2507-00		IC,MEMORY:CMOS,PROM,8K X 8 REGISTERED,PRGM 156-3836-00,CY7C265-50,DIP28.3	80009	160-8958-00
	136-1038-00			*MOUNTING PARTS* SOCKET,DIP: *END MOUNTING PARTS*	00779	2-643543-1
A2U23	160-8593-00	671-1927-00		IC,MEMORY:CMOS,PROM,8K X 8,PRGM 156-3836-00,REGISTERED,CY7C265-50,DIP28.3	80009	160-8593-00
A2U23	160-8959-00	671-2507-00		IC,MEMORY:CMOS,PROM,8K X 8 REGISTERED,PRGM 156-3836-00,CY7C265-50,DIP28.3	80009	160-8959-00
	136-1038-00			*MOUNTING PARTS* SOCKET,DIP: *END MOUNTING PARTS*	00779	2-643543-1
A2U27	160-8594-00	671-1927-00		IC,MEMORY:CMOS,PROM,8K X 8,PRGM 156-3836-00,REGISTERED,CY7C265-50,DIP28.3	80009	160-8594-00
A2U27	160-8960-00	671-2507-00		IC,MEMORY:CMOS,PROM,8K X 8 REGISTERED,PRGM 156-3836-00,CY7C265-50,DIP28.3	80009	160-8960-00
	136-1038-00			*MOUNTING PARTS* SOCKET,DIP: *END MOUNTING PARTS*	00779	2-643543-1
A2U29	156-3019-00			IC,LINEAR:BIPOLAR,VOLTAGE REFERENCE,1.235V, 1.0%,150PPM,SHUNT,MICROPOWER,LM385BZ-1.2,TO -92	27014	LM385BZ-1.2
A2U30	156-4024-00			IC,LINEAR:BIPOLAR,OP-AMP,190MHZ,CURRENT FEEDBACK,1 TO 40 GAIN RANGE,AD9617JN,DIP08.3	24355	AD9617JN



Replaceable Electrical Parts List (Cont.)

Component Number	Tektronix Part Number	Serial No. Effective	Serial No. Discont'd	Name & Description	Mfr. Code	Mfr. Part Number
A2U31	156-6172-00		671-1927-02	IC, CONVERTER: BIPOLAR, D/A, 10 BIT, 20MHZ, CURRENT OUTPUT, 0.5LSBINL, TDC1041R3C1, PLCC28-1, TUBE	07933	TDC1041R3C1
A2U31	156-6345-00	671-1927-03		IC, CONVERTER: BIPOLAR, D/A, 12 BIT, 80MHZ, TTL INPUT, W/LATCHES, CURRENT OUT, REFERENCE, AD9713BAP, PLC	24355	AD9713BAP
A2U31	156-6172-00		671-2507-02	IC, CONVERTER: BIPOLAR, D/A, 10 BIT, 20MHZ, CURRENT OUTPUT, 0.5LSBINL, TDC1041R3C1, PLCC28-1, TUBE	07933	TDC1041R3C1
A2U31	156-6345-00	671-2507-03		IC, CONVERTER: BIPOLAR, D/A, 12 BIT, 80MHZ, TTL INPUT, W/LATCHES, CURRENT OUT, REFERENCE, AD9713BAP, PLC	24355	AD9713BAP
	136-1005-00			*MOUNTING PARTS* SOCKET, PLCC: *END MOUNTING PARTS*	00779	3-821581-1
A2U32	156-3019-00			IC, LINEAR: BIPOLAR, VOLTAGE REFERENCE, 1.235V, 1.0%, 150PPM, SHUNT, MICROPOWER, LM385BZ-1.2, TO-92	27014	LM385BZ-1.2
A2U34	156-6172-00		671-1927-02	IC, CONVERTER: BIPOLAR, D/A, 10 BIT, 20MHZ, CURRENT OUTPUT, 0.5LSBINL, TDC1041R3C1, PLCC28-1, TUBE	07933	TDC1041R3C1
A2U34	156-6345-00	671-1927-03		IC, CONVERTER: BIPOLAR, D/A, 12 BIT, 80MHZ, TTL INPUT, W/LATCHES, CURRENT OUT, REFERENCE, AD9713BAP, PLC	24355	AD9713BAP
A2U34	156-6172-00		671-2507-02	IC, CONVERTER: BIPOLAR, D/A, 10 BIT, 20MHZ, CURRENT OUTPUT, 0.5LSBINL, TDC1041R3C1, PLCC28-1, TUBE	07933	TDC1041R3C1
A2U34	156-6345-00	671-2507-03		IC, CONVERTER: BIPOLAR, D/A, 12 BIT, 80MHZ, TTL INPUT, W/LATCHES, CURRENT OUT, REFERENCE, AD9713BAP, PLC	24355	AD9713BAP
	136-1005-00			*MOUNTING PARTS* SOCKET, PLCC: *END MOUNTING PARTS*	00779	3-821581-1
A2U40	156-1291-00			IC, LINEAR: BIFET, OP-AMP, DUAL, LOW POWER, TL062CP, DIP08.3	01295	TL062CP
A2U41	156-1272-00			IC, LINEAR: BIPOLAR, OP-AMP, DUAL, HIGH OUTPUT DRIVE, LOW NOISE, NE5532N, DIP08.3	01295	NE5532P
A2U42	156-1272-00			IC, LINEAR: BIPOLAR, OP-AMP, DUAL, HIGH OUTPUT DRIVE, LOW NOISE, NE5532N, DIP08.3	01295	NE5532P
A2U50	156-1207-00		671-1927-02	IC, LINEAR: BIPOLAR, VOLTAGE REGULATOR, NEGATIVE, -12V, 500MA, 3%, LM320H-12, TO-39	04713	MC79L12ACG
A2U50	156-2263-00	671-1927-03		IC, LINEAR: BIPOLAR, VOLTAGE REGULATOR, NEGATIVE, -12V, 100MA, 4%, MC79L12ACP, TO-92	04713	MC79L12ACP
A2U50	156-1207-00		671-2507-02	IC, LINEAR: BIPOLAR, VOLTAGE REGULATOR, NEGATIVE, -12V, 500MA, 3%, LM320H-12, TO-39	04713	MC79L12ACG
A2U50	156-2263-00	671-2507-03		IC, LINEAR: BIPOLAR, VOLTAGE REGULATOR, NEGATIVE, -12V, 100MA, 4%, MC79L12ACP, TO-92	04713	MC79L12ACP
A2U106	156-0368-03		671-1927-02	IC, DIGITAL: ECL, TRANSLATOR, QUAD TTL-TO-ECL, 10124, DIP16.3, TUBE	04713	MC10124P
A2U106	156-2289-00	671-1927-03		IC, DIGITAL: ECL, TRANSLATOR, QUAD TTL-TO-ECL, 10H124, DIP16.3, TUBE	04713	MC10H124P

## TSG 200 — Replaceable Electrical Parts

### Replaceable Electrical Parts List (Cont.)

Component Number	Tektronix Part Number	Serial No. Effective	Serial No. Discont'd	Name & Description	Mfr. Code	Mfr. Part Number
A2U106	156-0368-03		671-2507-02	IC,DIGITAL:ECL,TRANSLATOR,QUAD TTL-TO-ECL,10124,DIP16.3,TUBE	04713	MC10124P
A2U106	156-2289-00	671-2507-03		IC,DIGITAL:ECL,TRANSLATOR,QUAD TTL-TO-ECL,10H124,DIP16.3,TUBE	04713	MC10H124P
A2U108	156-0316-04		671-1927-02	IC,DIGITAL:ECL,TRANSLATOR,QUAD ECL TO TTL,10125,DIP16.3,TUBE	04713	MC10125P
A2U108	156-2290-00	671-1927-03		IC,DIGITAL:ECL,TRANSLATOR,QUAD ECL-TO-TTL,10H125,DIP16.3,TUBE	04713	MC10H125P
A2U108	156-0316-04		671-2507-02	IC,DIGITAL:ECL,TRANSLATOR,QUAD ECL TO TTL,10125,DIP16.3,TUBE	04713	MC10125P
A2U108	156-2290-00	671-2507-03		IC,DIGITAL:ECL,TRANSLATOR,QUAD ECL-TO-TTL,10H125,DIP16.3,TUBE	04713	MC10H125P
A2U161	160-8595-00			IC,DIGITAL:CMOS,PLD,OTP,5064,64 MACROCELL,30NS,PRGM 156-6229-00,5064-30,PLCC44,TUBE	TK0198	160859500
	136-1047-00			*MOUNTING PARTS* SOCKET,PLCC:PCB,44 POS,0.05 CTR,0.360 H X 0.125 TAIL,TIN, *END MOUNTING PARTS*	26742	213-044-101
A2U164	156-2928-00		671-1927-02	IC,DIGITAL:ASTTL,FLIP FLOP,HEX D-TYPE,CLEAR,74AS174,DIP16.3,TUBE	01295	SN74AS174N
A2U164	156-1911-00	671-1927-03		IC,DIGITAL:FTTL,FLIP FLOP,HEX D-TYPE,CLEAR,74F174,DIP16.3,TUBE	04713	MC74F174N
A2U164	156-2928-00		671-2507-02	IC,DIGITAL:ASTTL,FLIP FLOP,HEX D-TYPE,CLEAR,74AS174,DIP16.3,TUBE	01295	SN74AS174N
A2U164	156-1911-00	671-2507-03		IC,DIGITAL:FTTL,FLIP FLOP,HEX D-TYPE,CLEAR,74F174,DIP16.3,TUBE	04713	MC74F174N
A2U200	156-4104-00			IC,LINEAR:BIPOLAR,SW-REGULATOR CONTROLLER	04713	UC3843N
A2U212	156-1160-00		671-1927-02	IC,LINEAR:BIPOLAR,VOLTAGE REGULATOR,POSITIVE	04713	MC78L12ACG
A2U212	156-2735-00	671-1927-03		IC,LINEAR:BIPOLAR,VOLTAGE REGULATOR, POSITIVE,12V,100MA,5%,MC78L12ACP,TO-92	01295	UA78L12ACLP
A2U212	156-1160-00		671-2507-02	IC,LINEAR:BIPOLAR,VOLTAGE REGULATOR,POSITIVE	04713	MC78L12ACG
A2U212	156-2735-00	671-2507-03		IC,LINEAR:BIPOLAR,VOLTAGE REGULATOR, POSITIVE,12V,100MA,5%,MC78L12ACP,TO-92	01295	UA78L12ACLP
A2U600	160-8600-00			IC,DIGITAL:CMOS,PLD,EEPLD,20V8,25NS,90MA,PRGM 156-3012-00,20V8-25,DIP24.3	TK0198	160860000
	136-1166-00			*MOUNTING PARTS* SOCKET,DIP:PCB,FEMALE,2 X 32,14 POS,0.07 X 0.750,0.770 H X 0.120 TAIL,TIN, *END MOUNTING PARTS*	63058	DIP 70-7564-SAF
A2U601	156-3050-00			IC,MISC:CMOS	0B0A9	DS1232
A2U604	156-4219-00		671-1927-01	IC,MEMORY:CMOS,12 LINE X 4 COLUMNS TV CHARACTER DISPLAY ROM	4T165	UPD6142C001
A2U604	156-4219-00		671-2507-01	IC,MEMORY:CMOS,12 LINE X 4 COLUMNS TV CHARACTER DISPLAY ROM	4T165	UPD6142C001
A2U605	156-4219-00		671-1927-01	IC,MEMORY:CMOS,12 LINE X 4 COLUMNS TV CHARACTER DISPLAY ROM	4T165	UPD6142C001

Replaceable Electrical Parts List (Cont.)

Component Number	Tektronix Part Number	Serial No. Effective	Serial No. Discont'd	Name & Description	Mfr. Code	Mfr. Part Number
A2U605	156-4219-00		671-2507-01	IC, MEMORY: CMOS, 12 LINE X 4 COLUMNS TV CHARACTER DISPLAY ROM	4T165	UPD6142C001
A2U606	156-4220-00			IC, MEMORY: CMOS, EEPROM, 512 X 8, SERIAL, X24C04P, DIP8.3	60395	X24C04P
A2U607	160-8597-00			IC, DIGITAL: CMOS, PLD, PRGM 156-3825-01, OPT, 32 MICROCELL, 20NS, 83.3MHZ, 5032-2, DIP28.3	TK0198	160859700
	136-1038-00			*MOUNTING PARTS* SOCKET, DIP: *END MOUNTING PARTS*	00779	2-643543-1
A2U608	156-0956-02		671-1927-02	IC, DIGITAL: LSTTL, BUFFER/DRIVER, DUPLICATE OF 156-0956-00, 74LS244, DIP20.3, TUBE	01295	SN74LS244N
A2U608	156-1920-00	671-1927-03		IC, DIGITAL: HCTCMOS, BUFFER, OCTAL, 3-STATE, 74HCT244, DIP20.3, TUBE	04713	MC74HCT244AN
A2U608	156-0956-02		671-2507-02	IC, DIGITAL: LSTTL, BUFFER/DRIVER, DUPLICATE OF 156-0956-00, 74LS244, DIP20.3, TUBE	01295	SN74LS244N
A2U608	156-1920-00	671-2507-03		IC, DIGITAL: HCTCMOS, BUFFER, OCTAL, 3-STATE, 74HCT244, DIP20.3, TUBE	04713	MC74HCT244AN
A2U609	156-4741-00	671-1927-03		IC, LINEAR: BIPOLAR, MISC, ESD/OVERVOLTAGE PROTECTION SCR ARRAY, 14 INPUT, SP720AP, DIP16.3	34371	SP720AP
A2U609	156-4741-00	671-2507-03		IC, LINEAR: BIPOLAR, MISC, ESD/OVERVOLTAGE PROTECTION SCR ARRAY, 14 INPUT, SP720AP, DIP16.3	34371	SP720AP
A2U610	160-8598-00	671-1927-00		IC, MEMORY: CMOS, EPROM, 64K X 8, PRGM 156-3381-00, 250NS, 27C512, DIP28.6	80009	160-8598-00
A2U610	160-8956-00	671-2507-00		IC, MEMORY: CMOS, EPROM, 64K X 8, PRGM 1563381-00, 250NS, 27C512, DIP28.6	80009	160-8956-00
	136-0755-00			*MOUNTING PARTS* SOCKET, DIP: *END MOUNTING PARTS*	98291	DIPS28PIT
A2U611	160-8599-00	671-1927-00		IC, MEMORY: CMOS, EPROM, 64K X 8, PRGM 156-3381-00, 250NS, 27C512, DIP28.6	80009	160-8599-00
A2U611	160-8957-00	671-2507-00		IC, MEMORY: CMOS, EPROM, 64K X 8, PRGM 1563381-00, 250NS, 27C512, DIP28.6	80009	160-8957-00
	136-0755-00			*MOUNTING PARTS* SOCKET, DIP: *END MOUNTING PARTS*	98291	DIPS28PIT
A2U612	156-2928-00		671-1927-02	IC, DIGITAL: ASTTL, FLIP FLOP, HEX D-TYPE, CLEAR, 74AS174, DIP16.3, TUBE	01295	SN74AS174N
A2U612	156-1911-00	671-1927-03		IC, DIGITAL: FTTL, FLIP FLOP, HEX D-TYPE, CLEAR, 74F174, DIP16.3, TUBE	04713	MC74F174N
A2U612	156-2928-00		671-2507-02	IC, DIGITAL: ASTTL, FLIP FLOP, HEX D-TYPE, CLEAR, 74AS174, DIP16.3, TUBE	01295	SN74AS174N
A2U612	156-1911-00	671-2507-03		IC, DIGITAL: FTTL, FLIP FLOP, HEX D-TYPE, CLEAR, 74F174, DIP16.3, TUBE	04713	MC74F174N
A2U613	156-2928-00		671-1927-02	IC, DIGITAL: ASTTL, FLIP FLOP, HEX D-TYPE, CLEAR, 74AS174, DIP16.3, TUBE	01295	SN74AS174N
A2U613	156-1911-00	671-1927-03		IC, DIGITAL: FTTL, FLIP FLOP, HEX D-TYPE, CLEAR, 74F174, DIP16.3, TUBE	04713	MC74F174N

## TSG 200 — Replaceable Electrical Parts

### Replaceable Electrical Parts List (Cont.)

Component Number	Tektronix Part Number	Serial No. Effective	Serial No. Discont'd	Name & Description	Mfr. Code	Mfr. Part Number
A2U613	156-2928-00		671-2507-02	IC,DIGITAL:ASTTL,FLIP FLOP,HEX D-TYPE,CLEAR,74AS174,DIP16.3,TUBE	01295	SN74AS174N
A2U613	156-1911-00	671-2507-03		IC,DIGITAL:FTTL,FLIP FLOP,HEX D-TYPE,CLEAR,74F174,DIP16.3,TUBE	04713	MC74F174N
A2U614	160-8596-00	671-1927-00	671-1927-00	IC,DIGITAL:CMOS,PLD,PRGM 156-6229-00,OPT,32 MICROCELL,20NS,83.3MHZ,EPM5064,PLCC,DIP28.3	80009	160-8596-00
A2U614	160-8596-01	671-1927-01		IC,DIGITAL:CMOS,PLD,OTP,5064,64 MACROCELL,30NS,PRGM 156-6229-00,5064-30, PLCC44,TUBE	TK0198	160859601
A2U614	160-8596-00	671-2507-00	671-2507-00	IC,DIGITAL:CMOS,PLD,PRGM 156-6229-00,OPT,32 MICROCELL,20NS,83.3MHZ,EPM5064,PLCC,DIP28.3	80009	160-8596-00
A2U614	160-8596-01	671-2507-01		IC,DIGITAL:CMOS,PLD,OTP,5064,64 MACROCELL,30NS,PRGM 156-6229-00,5064-30, PLCC44,TUBE	TK0198	160859601
	136-1047-00			*MOUNTING PARTS* SOCKET,PLCC:PCB,44 POS,0.05 CTR,0.360 H X 0.125 TAIL,TIN, *END MOUNTING PARTS*	26742	213-044-101
A2U625	156-4024-00			IC,LINEAR:BIPOLAR,OP-AMP,190MHZ,CURRENT FEEDBACK,1 TO 40 GAIN RANGE,AD9617JN,DIP08.3	24355	AD9617JN
A2U627	156-1291-00			IC,LINEAR:BIFET,OP-AMP,DUAL,LOW POWER,TL062CP,DIP08.3	01295	TL062CP
A2VR30	152-0520-00			DIODE,ZENER:12V,5%,1W,1N4742A,DO-41,TR	04713	1N4742ARL
A2W151	131-4566-00		671-1927-02	BUS,CONDUCTOR:0 OHM,300 SPACING,SM BODY	91637	FRJ-50
A2W151	131-4566-00		671-2507-02	BUS,CONDUCTOR:0 OHM,300 SPACING,SM BODY	91637	FRJ-50
A2W152	131-4566-00			BUS,CONDUCTOR:0 OHM,300 SPACING,SM BODY	91637	FRJ-50
A2W213	131-4566-00	671-1927-03		BUS,CONDUCTOR:0 OHM,300 SPACING,SM BODY	91637	FRJ-50
A2W213	131-4566-00	671-2507-03		BUS,CONDUCTOR:0 OHM,300 SPACING,SM BODY	91637	FRJ-50
A2Y1	119-4342-00			OSCILLATOR,RF:14.31818MHZ,+/-1.0PPM,TCXO,TUNE RANGE +/-5PPM,TTL,PKG 1.2 SQ X 0.68 H	54331	7320-01
A2Y600	158-0135-00			XTAL UNIT,QTZ:14.7456 MHZ 0.01%,SERIES	33096	CCAT101124
A3	671-2320-00			CIRCUIT BD ASSY:FAMILY FLAT	80009	671-2320-00
A3J611	131-3378-00			CONN,RF JACK:BNC	00779	227677-1
A3J612	131-3378-00			CONN,RF JACK:BNC	00779	227677-1
A3W610	174-2512-00			CA ASSY,SP,ELEC:16,28 AWG,1.8 L,RIBBON	TK1547	174-2512-00
A4	671-1931-00			CIRCUIT BD ASSY:BOTTOM BNC	80009	671-1931-00
A4J501	131-3378-00			CONN,RF JACK:BNC	00779	227677-1
A4J502	131-3378-00			CONN,RF JACK:BNC	00779	227677-1
A4J503	131-3378-00			CONN,RF JACK:BNC	00779	227677-1
A4J504	131-3378-00			CONN,RF JACK:BNC	00779	227677-1
A4W505	174-2337-01			CA ASSY,SP,ELEC:10,28 AWG,1.6 L,RIBBON	TK1547	174-2337-01
A5	671-2190-01			CIRCUIT BD ASSY:REMOTE CONTROL FILTER	80009	671-2190-01
A5C1	283-0197-02			CAP,FXD,CER DI:470PF,5%,50V	04222	SR591A471JAAAP1
A5C2	283-0197-02			CAP,FXD,CER DI:470PF,5%,50V	04222	SR591A471JAAAP1
A5C3	283-0197-02			CAP,FXD,CER DI:470PF,5%,50V	04222	SR591A471JAAAP1

Replaceable Electrical Parts List (Cont.)

Component Number	Tektronix Part Number	Serial No. Effective	Serial No. Discont'd	Name & Description	Mfr. Code	Mfr. Part Number
A5C4	283-0197-02			CAP,FXD,CER DI:470PF,5%,50V	04222	SR591A471JAAAP1
A5C5	283-0197-02			CAP,FXD,CER DI:470PF,5%,50V	04222	SR591A471JAAAP1
A5C6	283-0197-02			CAP,FXD,CER DI:470PF,5%,50V	04222	SR591A471JAAAP1
A5C7	283-0197-02			CAP,FXD,CER DI:470PF,5%,50V	04222	SR591A471JAAAP1
A5C8	283-0197-02			CAP,FXD,CER DI:470PF,5%,50V	04222	SR591A471JAAAP1
A5C9	283-0197-02			CAP,FXD,CER DI:470PF,5%,50V	04222	SR591A471JAAAP1
A5C10	283-0197-02			CAP,FXD,CER DI:470PF,5%,50V	04222	SR591A471JAAAP1
A5C11	283-0197-02			CAP,FXD,CER DI:470PF,5%,50V	04222	SR591A471JAAAP1
A5C12	283-0197-02			CAP,FXD,CER DI:470PF,5%,50V	04222	SR591A471JAAAP1
A5C13	283-0197-02			CAP,FXD,CER DI:470PF,5%,50V	04222	SR591A471JAAAP1
A5C14	283-0197-02			CAP,FXD,CER DI:470PF,5%,50V	04222	SR591A471JAAAP1
A5C15	283-0197-02			CAP,FXD,CER DI:470PF,5%,50V	04222	SR591A471JAAAP1
A5C16	283-0197-02			CAP,FXD,CER DI:470PF,5%,50V	04222	SR591A471JAAAP1
A5C17	283-0197-02			CAP,FXD,CER DI:470PF,5%,50V	04222	SR591A471JAAAP1
A5C18	283-0197-02			CAP,FXD,CER DI:470PF,5%,50V	04222	SR591A471JAAAP1
A5FL1	119-3580-00			FILTER,EMI:T-CIRCUIT	TK2058	ZJSR-5101-102TA
A5FL2	119-3580-00			FILTER,EMI:T-CIRCUIT	TK2058	ZJSR-5101-102TA
A5FL3	119-3580-00			FILTER,EMI:T-CIRCUIT	TK2058	ZJSR-5101-102TA
A5FL4	119-3580-00			FILTER,EMI:T-CIRCUIT	TK2058	ZJSR-5101-102TA
A5FL5	119-3580-00			FILTER,EMI:T-CIRCUIT	TK2058	ZJSR-5101-102TA
A5FL6	119-3580-00			FILTER,EMI:T-CIRCUIT	TK2058	ZJSR-5101-102TA
A5FL7	119-3580-00			FILTER,EMI:T-CIRCUIT	TK2058	ZJSR-5101-102TA
A5FL8	119-3580-00			FILTER,EMI:T-CIRCUIT	TK2058	ZJSR-5101-102TA
A5FL9	119-3580-00			FILTER,EMI:T-CIRCUIT	TK2058	ZJSR-5101-102TA
A5J1	174-2553-00			CA ASSY,SP:RIBBON, IDC,10.28 AWG,10.5 L,2X5,0.1 CTR,RCPT X 2X5,0.1 CTR,PCB,	TK1547	174-2553-00
A5J2	131-3925-00			CONN,DSUB:PCB,FEMALE	00779	747844-4
A6	671-4085-00	B020000		CIRCUIT BD SUBASSY:ID GENERATOR	80009	671-4085-00
A6C1	283-5114-00			CAP,FXD,CERAMICMLC;0.1UF,10%,50V	04222	12065C104KAT
A6C2	283-5114-00			CAP,FXD,CERAMICMLC;0.1UF,10%,50V	04222	12065C104KAT
A6P504	131-6129-00			CONN,HDR PCB,ADAPTER;MALE	22526	DST 316-876S
A6U604	156-6491-00			IC MEMORY CMOS ROM 12 LINE X 24 COLUMN	4T165	UPD6142G-101
A6U605	156-6491-00			IC MEMORY CMOS ROM 12 LINE X 24 COLUMN	4T165	UPD6142G-101
W609	174-1281-00		B010457	CA ASSY,SP,ELEC:2,22 AWG,5.0 L (CONNECTED FROM REAR PANEL TO A2J609)	9M860	ORDER BY DESCRIPTION
W609	174-1281-01	B010458		CABLE ASSY:CABLE ASSY,SP,ELEC,5.00 L, (CONNECTED FROM REAR PANEL TO A2J609)	80009	174-1281-01



# Diagrams and Circuit Board Illustrations

This section contains the troubleshooting procedures, block diagrams, circuit board illustrations, component locator tables, waveform illustrations, and schematic diagrams.

## Symbols

Graphic symbols and class designation letters are based on ANSI Standard Y32.2-1975. Abbreviations are based on ANSI Y1.1-1972.

Logic symbology is based on ANSI/IEEE Standard 91-1984 in terms of positive logic. Logic symbols depict the logic function performed and can differ from the manufacturer's data.

The tilde (~) preceding a signal name indicates that the signal performs its intended function when in the low state.

Other standards used in the preparation of diagrams by Tektronix, Inc., include the following:

- Tektronix Standard 062-2476 Symbols and Practices for Schematic Drafting
- ANSI Y14.159-1971 Interconnection Diagrams
- ANSI Y32.16-1975 Reference Designations for Electronic Equipment
- MIL-HDBK-63038-1A Military Standard Technical Manual Writing Handbook

## Component Values

Electrical components shown on the diagrams are in the following units unless noted otherwise:

Capacitors: Values one or greater are in picofarads (pF).  
Values less than one are in microfarads ( $\mu$ F).

Resistors: Values are in Ohms ( $\Omega$ ).

## Graphic Items and Special Symbols Used in This Manual

Each assembly in the instrument is assigned an assembly number (for example A5). The assembly number appears in the title on the diagram, in the lookup table for the schematic diagram, and corresponding component locator illustration. The Replaceable Electrical Parts list is arranged by assembly in numerical sequence; the components are listed by component number.

## Component Locator Diagrams

The schematic diagram and circuit board component location illustrations have grids marked on them. The component lookup tables refer to these grids to help you locate a component. The circuit board illustration appears only once; its lookup table lists the diagram number of all diagrams on which the circuitry appears.

Some of the circuit board component location illustrations are expanded and divided into several parts to make it easier for you to locate small components. To determine which part of the whole locator diagram you are looking at, refer to the small locator key shown below. The gray block, within the larger circuit board outline, shows where that part fits in the whole locator diagram. Each part in the key is labeled with an identifying letter that appears in the figure titles under component locator diagrams.

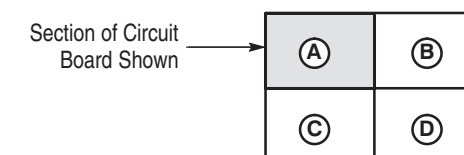

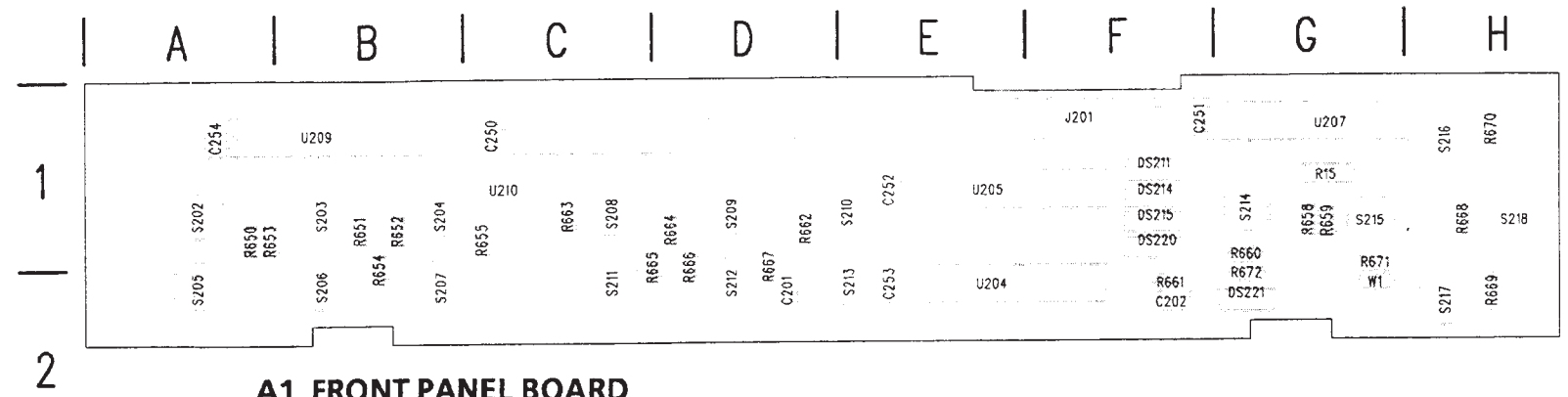

**A1 FRONT PANEL BOARD**  
671-1930-00

**SCHEMATIC DIAGRAM <1>**  
**FRONT PANEL BOARD**

The schematic diagram has an alphanumeric grid to assist in locating parts within that diagram.

**ASSEMBLY A1.**

CIRCUIT NUMBER	SCHEM LOCATION	BOARD LOCATION	CIRCUIT NUMBER	SCHEM LOCATION	BOARD LOCATION
C201	A2	D2	S204B	H1	B1
C202	B2	F2	S205A	D3	A2
C250	F5	C1	S205B	H1	A2
C251	F5	F1	S206A	D3	B2
C252	F5	E1	S206B	H2	B2
C253	F5	E2	S207A	E3	B2
C254	G5	A1	S207B	H2	B2
DS211	H4	F1	S208A	B4	C1
DS214	H4	F1	S208B	H2	C1
DS215	H4	F1	S209A	B4	D1
DS220	H4	F1	S209B	H2	D1
DS221	H3	G2	S210A	C4	E1
J201	A1	F1	S210B	H2	E1
R15	F1	G1	S211A	D4	C2
R650	G1	A1	S211B	H3	C2
R651	G1	B1	S212A	D4	D2
R652	G1	B1	S212B	H3	D2
R653	G1	A1	S213A	E4	E2
R654	G2	B2	S213B	H3	E2
R655	G2	C1	S214	B5	G1
R658	G4	G1	S215A	B5	G1
R659	G4	G1	S215B	H5	G1
R660	G4	G1	S216A	C5	H1
R661	G4	F2	S216B	H5	H1
R662	G3	D1	S217A	D5	H2
R663	G2	C1	S217B	H5	H2
R664	G2	D1	S218A	D5	H1
R665	G3	D2	S218B	H5	H1
R666	G3	D2	U204	B2	E2
R667	G3	D2	U205	D2	E1
R668	G5	H1	U207	F4	G1
R669	G5	H2	U209	F1	B1
R670	G5	H1	U210	F2	C1
R671	G5	G2	W1	G3	G2
R672	G3	G2			
S202A	B3	A1			
S202B	H1	A1			
S203A	B3	B1			
S203B	H1	B1			
S204A	C3	B1			



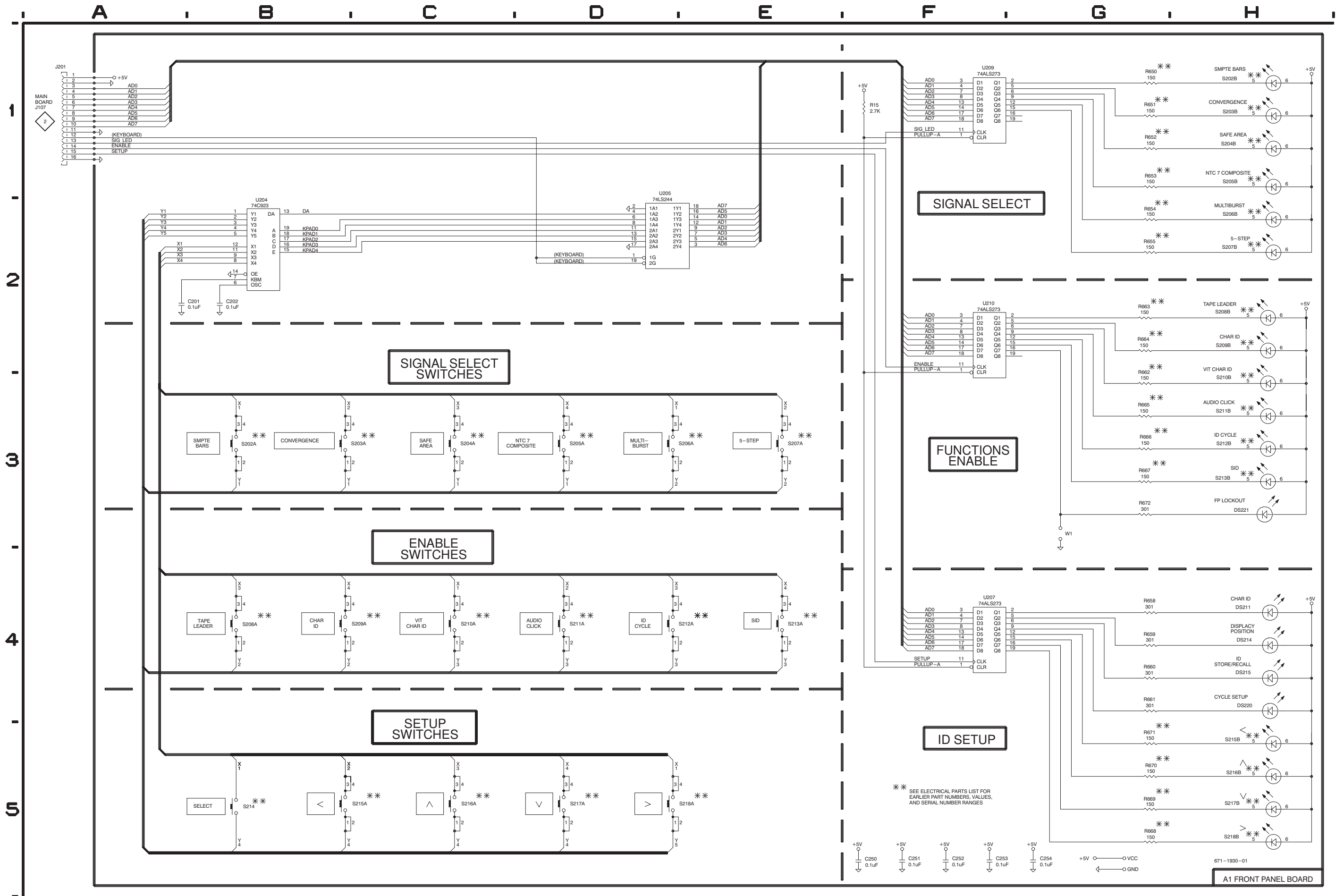

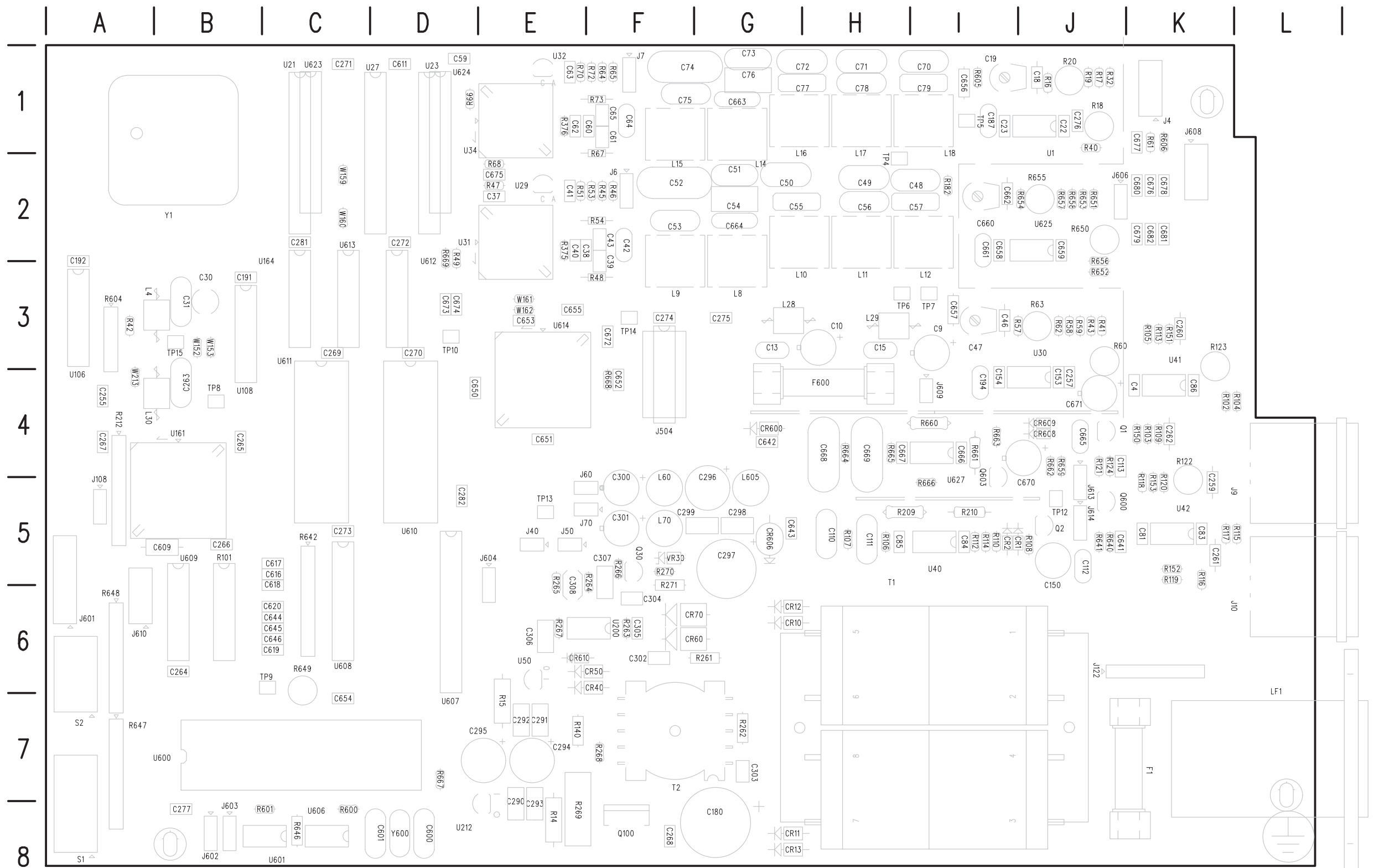

**A2 MAIN BOARD**  
070-1927-03 (Std)  
070-2507-03 (Opt 1J)



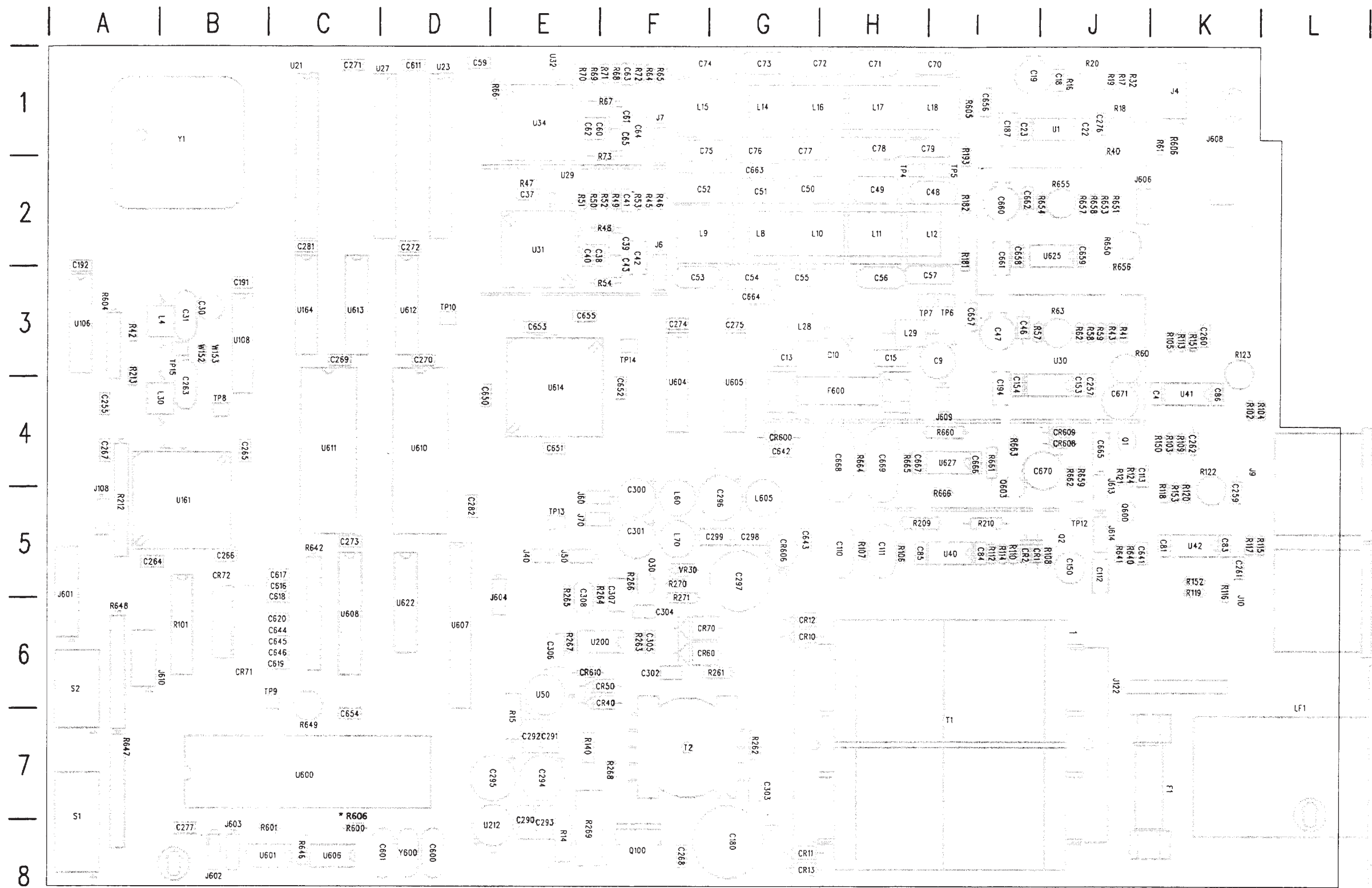

**A2 MAIN BOARD**  
070-1927-00/02 (Std)  
070-2507-00/02 (Opt 1J)







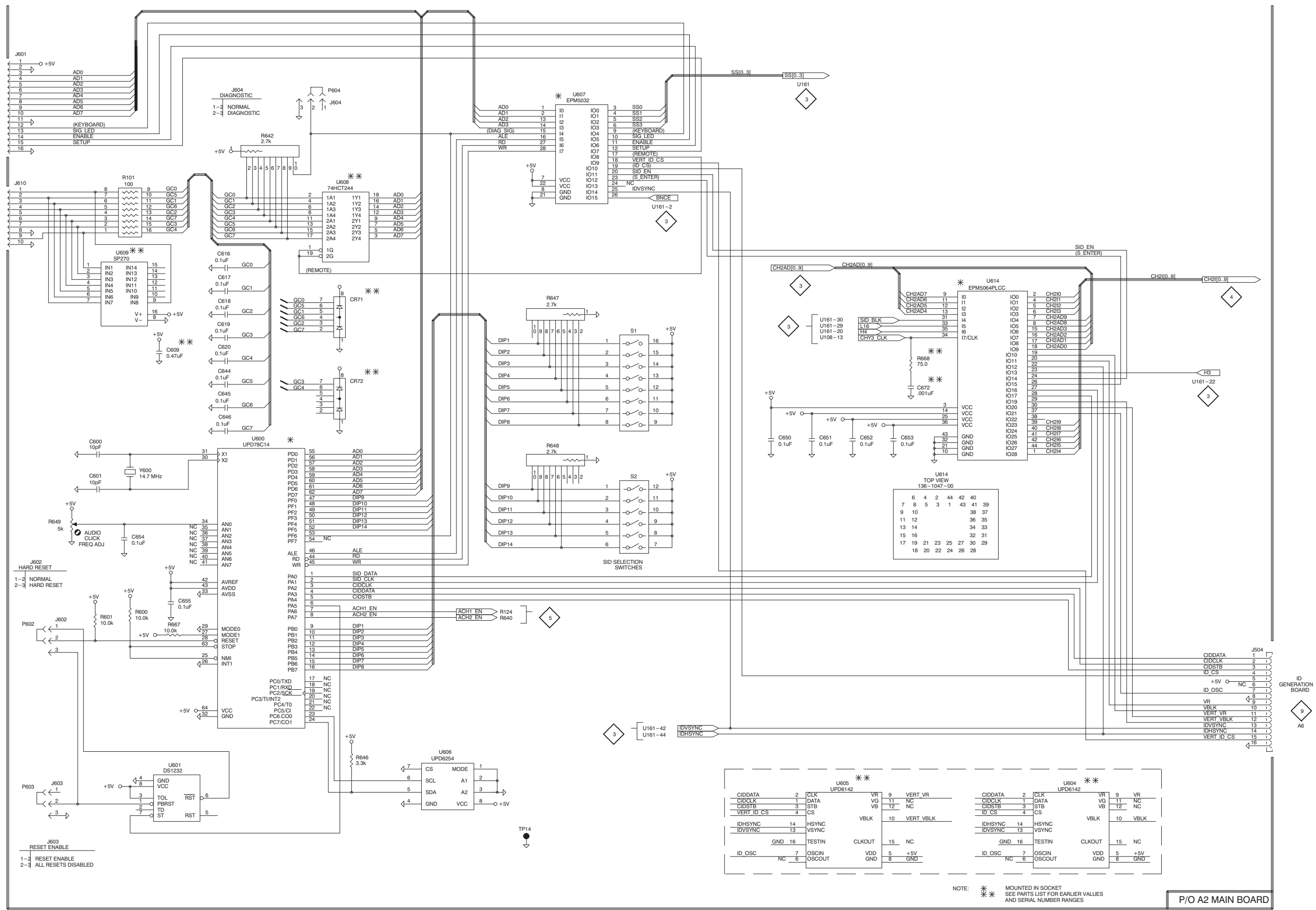

U614 TOP VIEW  
136-1047-00

6	4	2	44	42	40
7	8	5	3	1	43
9	10				38
11	12				36
13	14				34
15	16				32
17	19	21	23	25	27
18	20	22	24	26	28

NOTE: \* MOUNTED IN SOCKET  
\*\* SEE PARTS LIST FOR EARLIER VALUES AND SERIAL NUMBER RANGES

P/O A2 MAIN BOARD





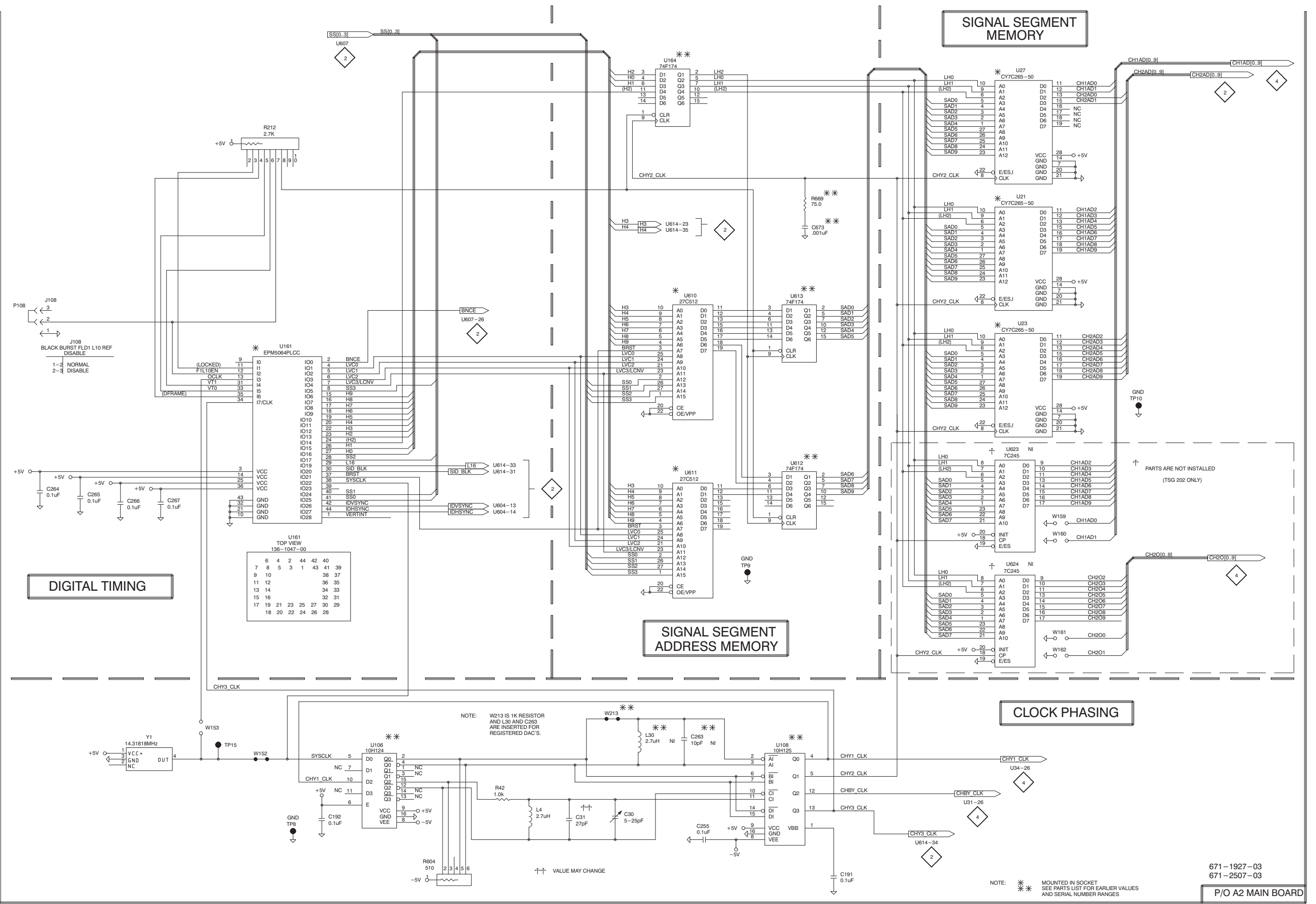

671-1927-03  
671-2507-03

P/O A2 MAIN BOARD



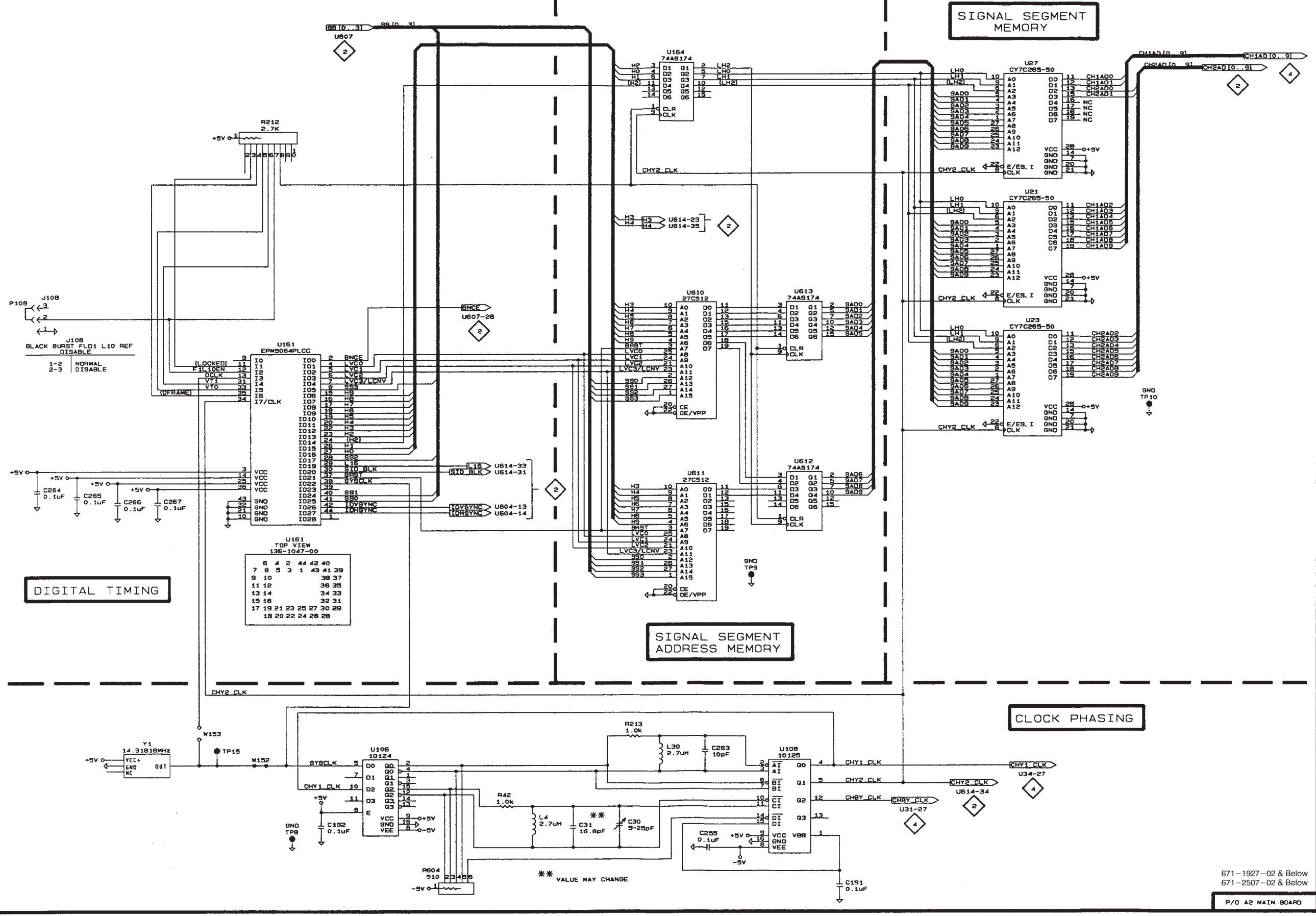



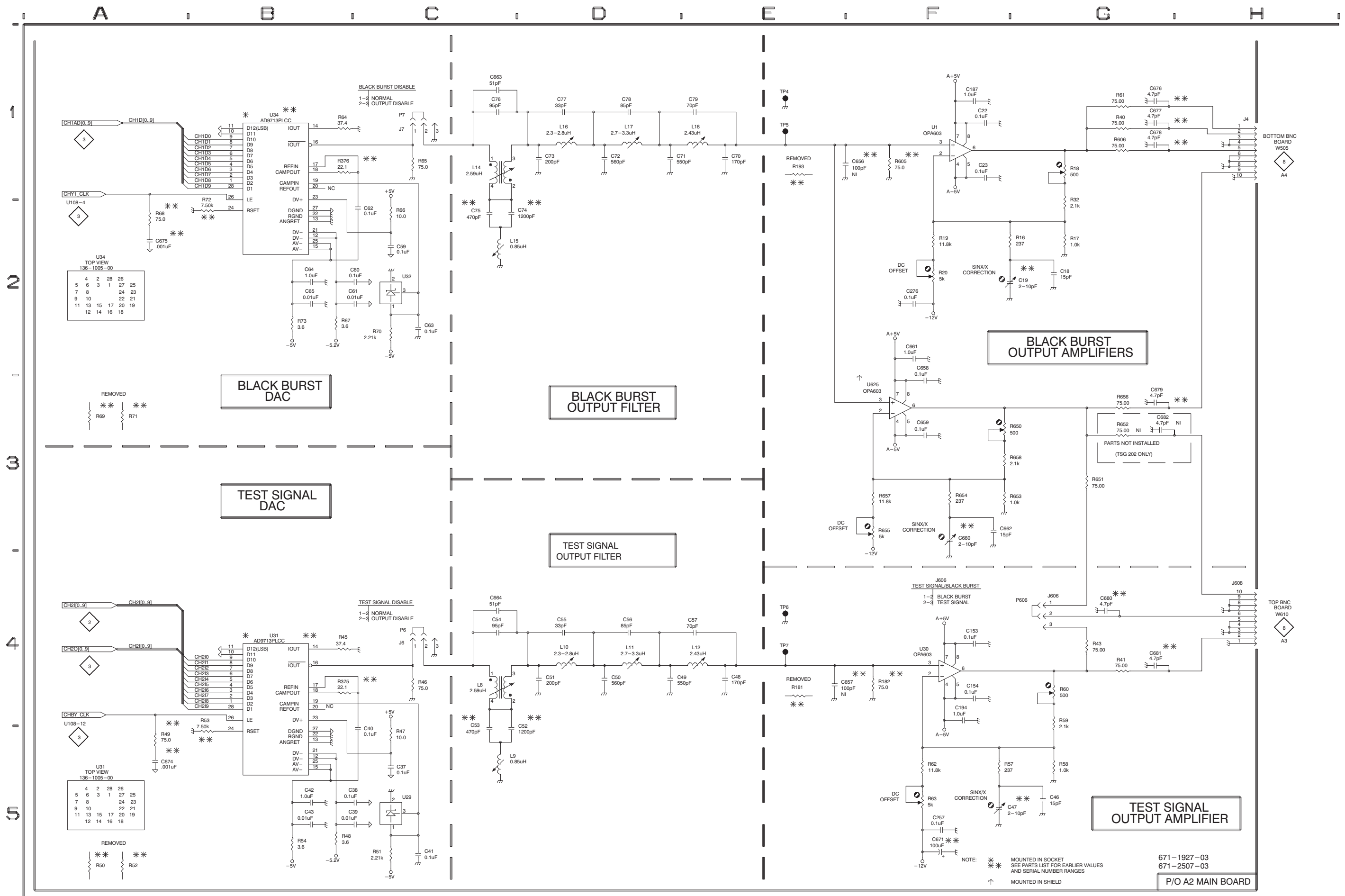



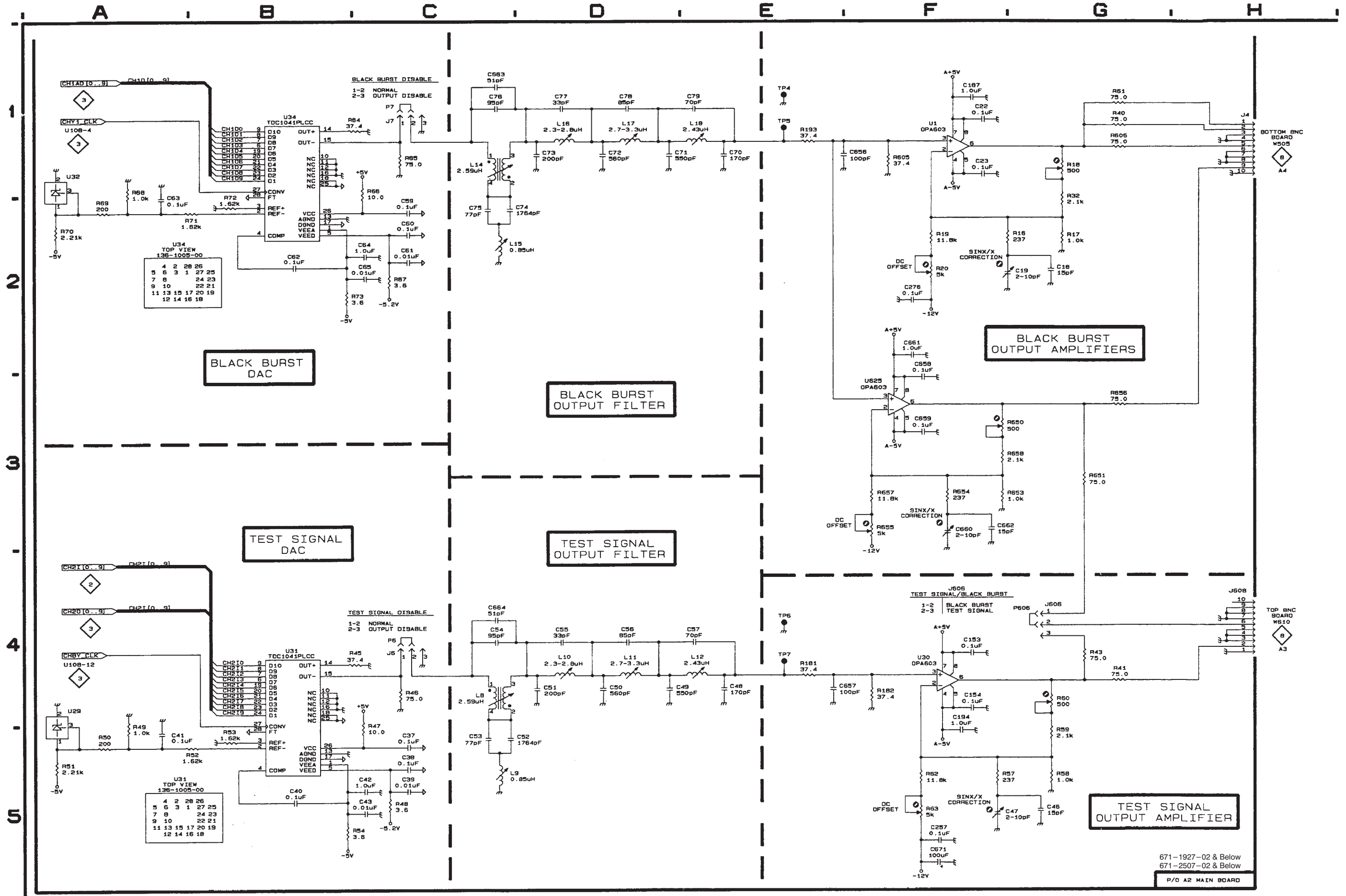

U34 TOP VIEW 138-1005-00

4	2	28	26
5	6	3	1
7	8	24	23
9	10	22	21
11	13	15	17
12	14	16	18

U31 TOP VIEW 138-1005-00

4	2	28	26
5	6	3	1
7	8	24	23
9	10	22	21
11	13	15	17
12	14	16	18

671-1927-02 & Below  
671-2507-02 & Below  
P/O A2 MAIN BOARD





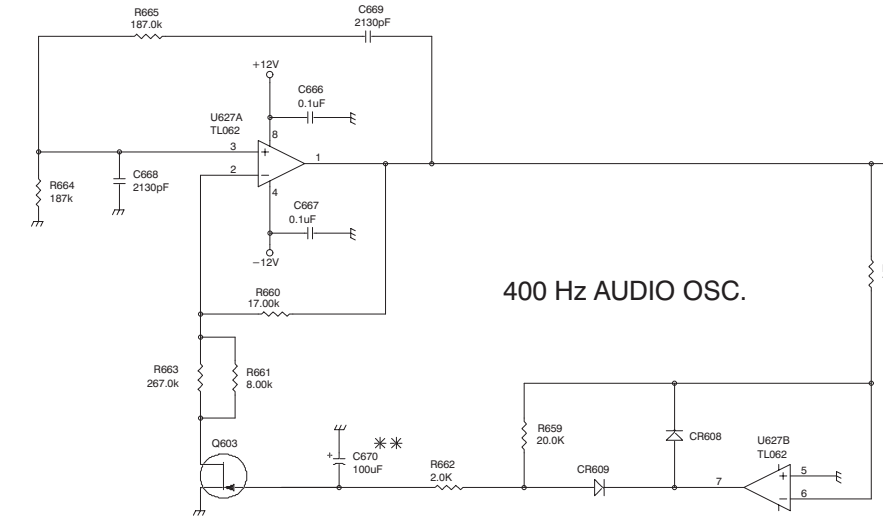
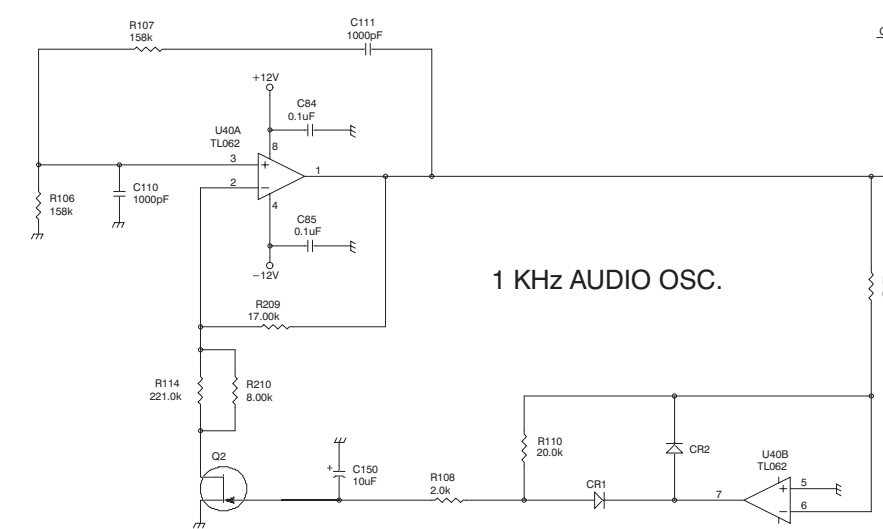

J614  
CH2 FREQUENCY SELECTION  
1-2 1KHz  
2-3 400Hz

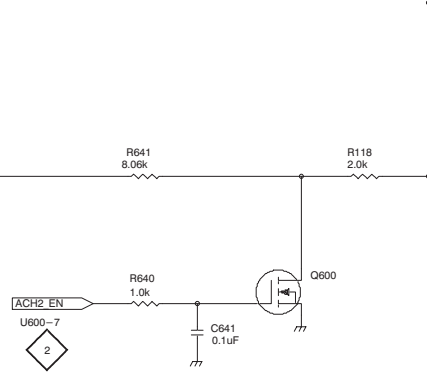

J613  
CH1 FREQUENCY SELECTION  
1-2 1KHz  
2-3 400Hz

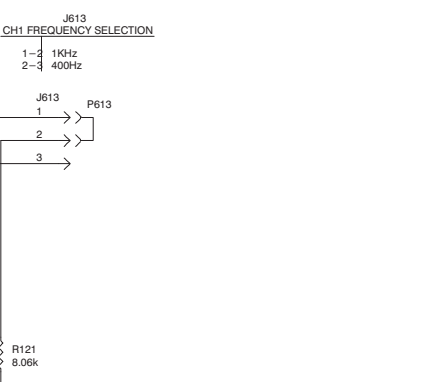

CH2  
AUDIO TONE  
(REAR PANEL)

CH1  
AUDIO TONE  
(REAR PANEL)

NOTE: \*\* SEE PARTS LIST FOR EARLIER VALUES AND SERIAL NUMBER RANGES

P/O A2 MAIN BOARD



A B C D E F G H

1  
2  
3  
4  
5

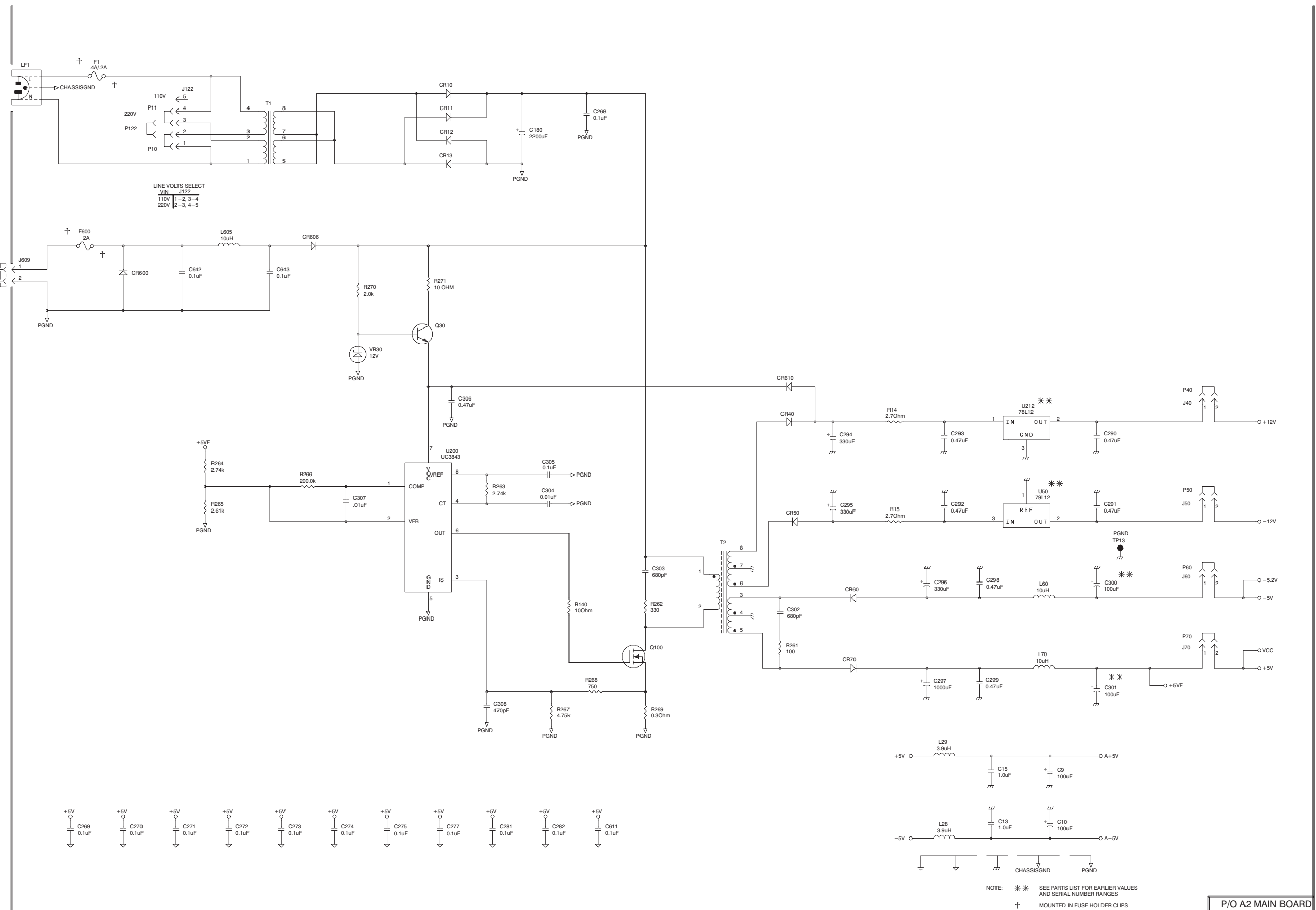

P/O A2 MAIN BOARD

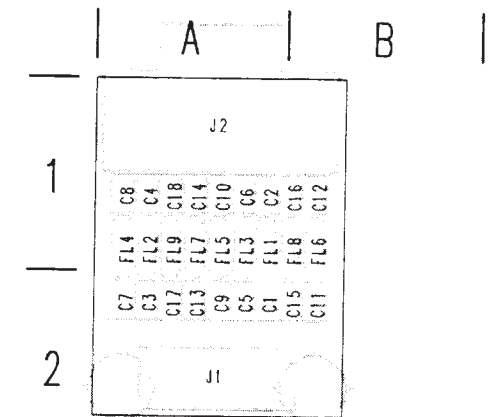

**A5 REMOTE CONTROL  
FILTER BOARD  
671-2190-00**

**SCHEMATIC DIAGRAM <7>  
REMOTE CONTROL BOARD**

The schematic diagram has an alphanumeric grid to assist in locating parts within that diagram.

**ASSEMBLY A5**

CIRCUIT NUMBER	SCHEM LOCATION	BOARD LOCATION
C1	D2	A2
C2	E2	A1
C3	D2	A2
C4	E2	A1
C5	D2	A1
C6	E2	A1
C7	D3	A2
C8	E3	A1
C9	D3	A2
C10	E3	A1
C11	D3	B2
C12	E3	B1
C13	D4	A2
C14	E4	A1
C15	D4	B2
C16	E4	B1
C17	D4	A2
C18	E4	A1
FL1	D2	A
FL2	D2	A1
FL3	D2	A1
FL4	D3	A1
FL5	D3	A
FL6	D3	B1
FL7	D4	A1
FL8	D4	B1
FL9	D4	A1
J1	B2	A2
J2	F2	A1

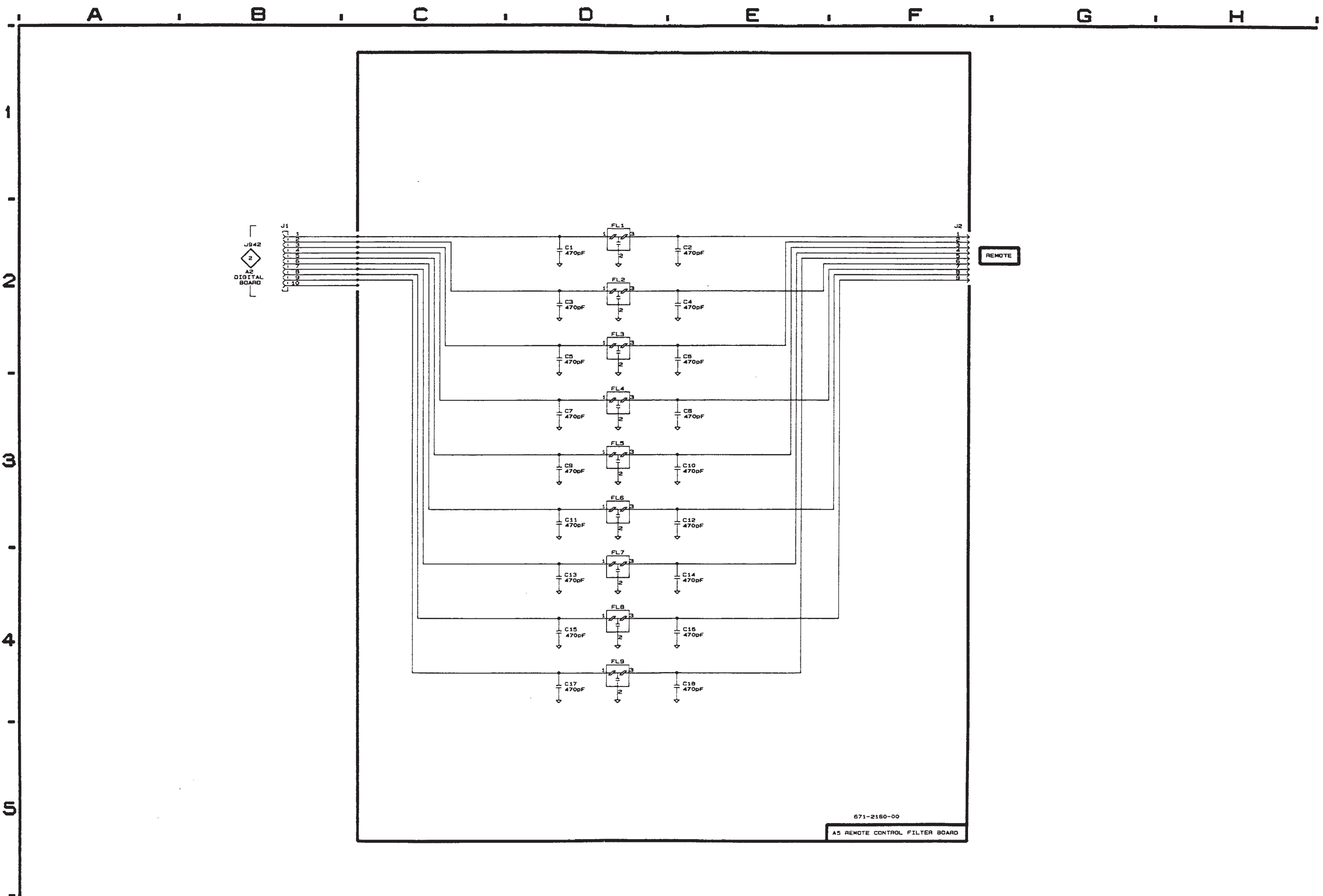

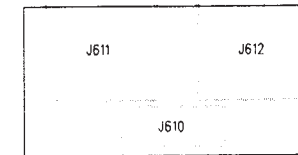

**A3 TOP BNC BOARD**  
671-2320-00

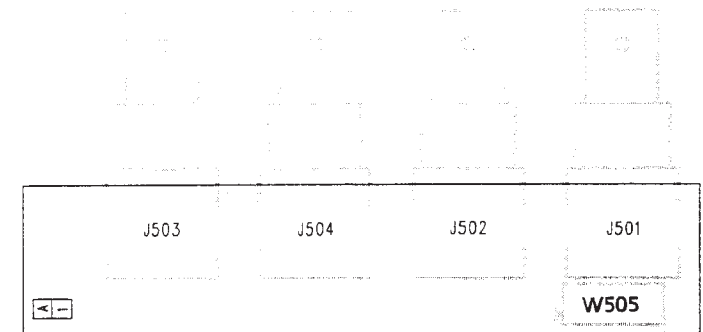

**A4 BOTTOM BNC BOARD**  
671-1931-00

**SCHEMATIC DIAGRAM < 8 >**  
**BNC BOARDS**  
**(TOP & BOTTOM)**

The schematic diagram has an alphanumeric grid to assist in locating parts within that diagram.

**ASSEMBLIES A3 & A4.**

CIRCUIT NUMBER	SCHEM LOCATION	BOARD LOCATION	CIRCUIT NUMBER	SCHEM LOCATION	BOARD LOCATION
<b>ASSEMBLY A3 (TOP)</b>			<b>ASSEMBLY A4 (BOTTOM)</b>		
J611	H2	A1	J501	H5	D1
J612	H2	B1	J502	H5	C1
			J503	H4	B1
W610	A2	A1	J504	H4	B1
			W505	A4	C1

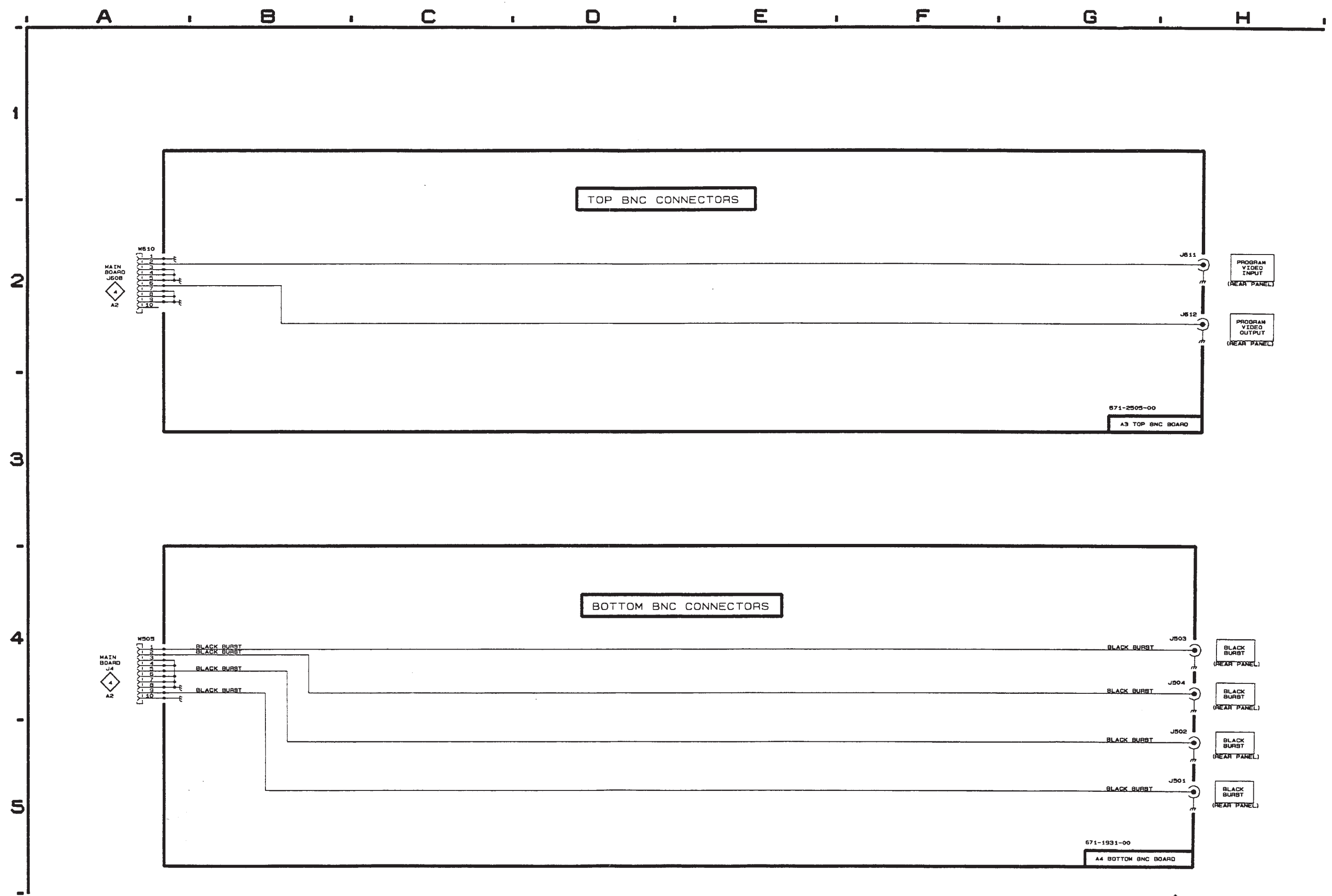

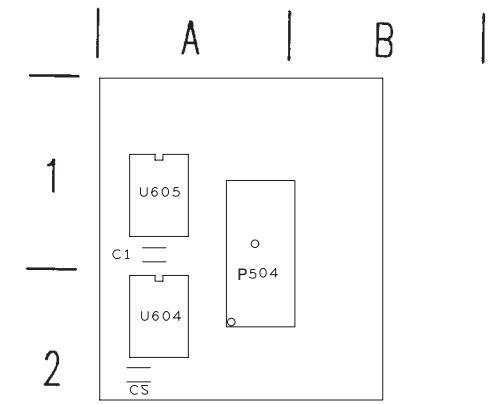

**ID GENERATION BOARD**

**SCHEMATIC DIAGRAM <9>  
ID GENERATION BOARD**

The schematic diagram has an alphanumeric grid to assist in locating parts within that diagram.

**Assembly A6**

CIRCUIT NUMBER	SCHEM LOCATION	BOARD LOCATION
C1	C5	A1
C2	D5	A2
P504	C3	A1
U604	C4	A2
U605	C4	A1



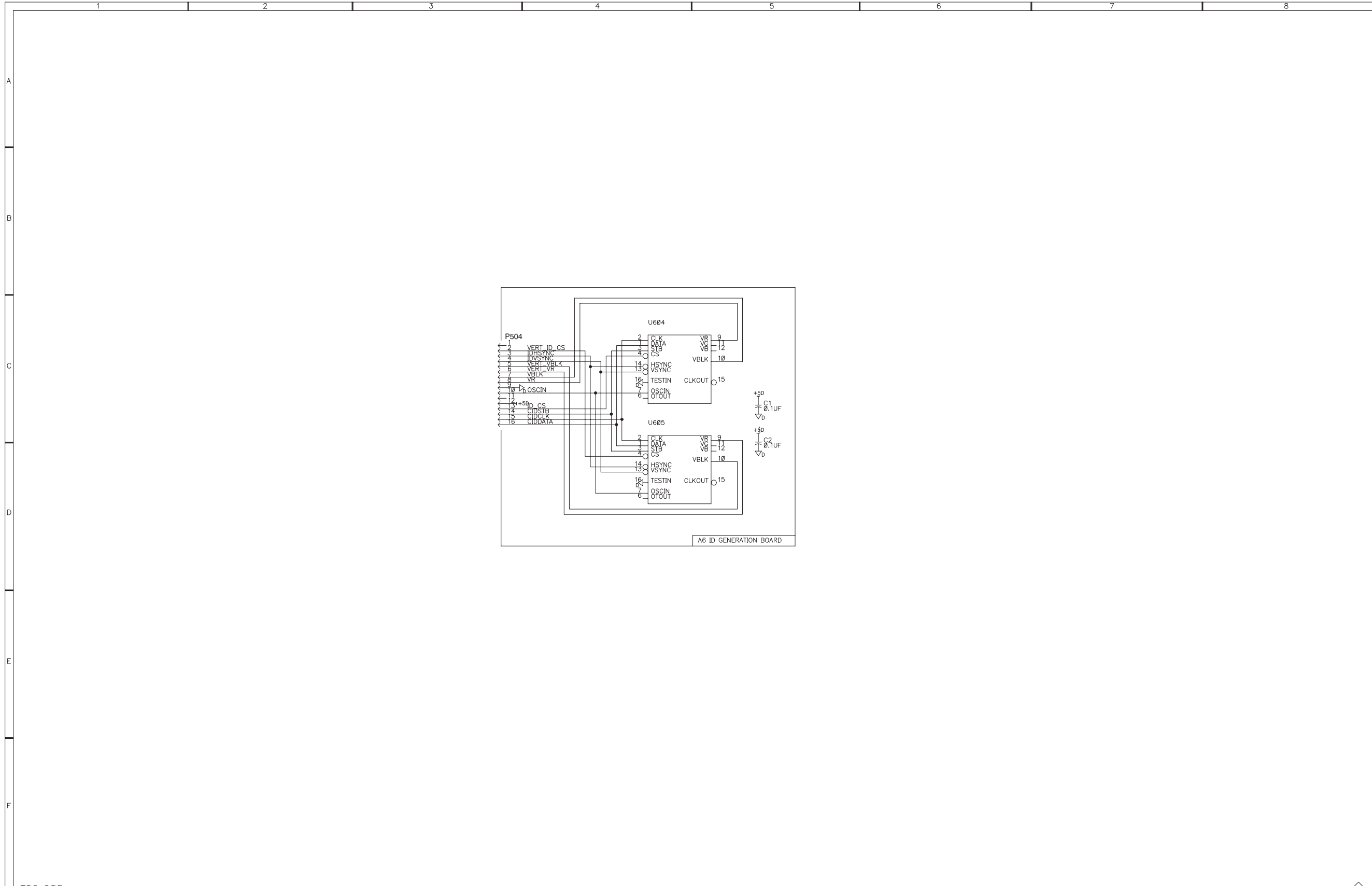



# SECTION 10

## REPLACEABLE MECHANICAL PARTS

This section contains a list of the replaceable mechanical components for the TSG 200 generator. Use this list to identify and order replacement parts.

### Parts Ordering Information

Replacement parts are available through your local Tektronix field office or representative.

Changes to Tektronix products are sometimes made to accommodate improved components as they become available and to give you the benefit of the latest improvements. Therefore, when ordering parts, it is important to include the following information in your order:

- Part number
- Instrument type or model number
- Instrument serial number
- Instrument modification number, if applicable

If you order a part that has been replaced with a different or improved part, your local Tektronix field office or representative will contact you concerning any change in part number.

Change information, if any, is located at the rear of this manual.

### Using the Replaceable Mechanical Parts List

The tabular information in the Replaceable Mechanical Parts List is arranged for quick retrieval. Understanding the structure and features of the list will help you find all of the information you need for ordering replacement parts. The table below describes the content of each column in the parts list.

#### Abbreviations

Abbreviations conform to American National Standard ANSI Y1.1–1972.

#### Chassis Parts

Chassis-mounted parts and cable assemblies are located at the end of the Replaceable Electrical Parts List.

#### Mfr. Code to Manufacturer Cross Index

The table titled Manufacturers Cross Index shows codes, names, and addresses of manufacturers or vendors of components listed in the parts list.

#### Parts list column descriptions

Column	Column name	Description
1	Figure & index number	Items in this section are referenced by figure and index numbers to the exploded view illustrations that follow.
2	Tektronix part number	Use this part number when ordering replacement parts from Tektronix.
3 and 4	Serial number	Column three indicates the serial number at which the part was first effective. Column four indicates the serial number at which the part was discontinued. No entry indicates the part is good for all serial numbers.
5	Qty	This indicates the quantity of parts used.
6	Name & description	An item name is separated from the description by a colon (:). Because of space limitations, an item name may sometimes appear as incomplete. Use the U.S. Federal Catalog handbook H6-1 for further item name identification.
7	Mfr. code	This indicates the code of the actual manufacturer of the part.
8	Mfr. part number	This indicates the actual manufacturer's or vendor's part number.

## TSG 200 — Replaceable Mechanical Parts

### Manufacturers Cross Index

<b>Mfr. Code</b>	<b>Manufacturer</b>	<b>Address</b>	<b>City, State, Zip Code</b>
01536	TEXTRON INC	1818 CHRISTINA ST	ROCKFORD, IL 61108
0B445	ELECTRI-CORD MFG CO INC	312 EAST MAIN STREET	WESTFIELD, PA 16950
0J7N4	ARCHERS PRECISION SHEET METAL INC	12700 SW HALL #A	TIGARD, OR 97223
0KB01	STAUFFER SUPPLY CO	810 SE SHERMAN	PORTLAND, OR 97214-4657
52152	3M COMPANY	INDUSTRIAL TAPE DIVISION 3M CENTER	ST PAUL, MN 55144-1000
5Y400	TRIAx METAL PRODUCTS INC	1880 SW MERLO DRIVE	BEAVERTON, OR 97006
73743	FISCHER SPECIAL MFG CO	111 INDUSTRIAL RD PO BOX 76500	COLD SPRINGS, KY 41076
80009	TEKTRONIX INC	14150 SW KARL BRAUN DR PO BOX 500	BEAVERTON, OR 97077-0001
93907	CAMCAR DIV OF TEXTRON INC	ATTN: ALICIA SANFORD 516 18TH AVE	ROCKFORD, IL 611045181
TK0435	LEWIS SCREW CO.	4300 SOUTH RACINE AVENUE	CHICAGO, IL 60609
TK0588	UNIVERSAL PRECISION PRODUCT	1775 NW CORNELIUS PASS RD	HILLSBORO, OR 97124
TK1155	QUALITY PLASTIC INJECTION MOLD	3910 INDUSTRIAL AVE	COEUR D'ALENE, ID 83814
TK1943	NEILSEN MANUFACTURING INC	3501 PORTLAND RD NE	SALEM, OR 97303
TK2548	XEROX CORPORATION	DIV OF XEROX CORPORATION 14181 SW MILLIKAN WAY	BEAVERTON, OR 97005

Replaceable Mechanical Parts List

Fig. & Index Number	Tektronix Part Number	Serial No. Effective	Serial No. Discont'd	Qty	Name & Description	Mfr. Code	Mfr. Part Number
1-1	200-3898-01			1	COVER, TOP:TSG131A	TK1943	200-3898-01
					*MOUNTING PARTS*		
-2	211-0119-00			8	SCREW, MACHINE:4-40 X 0.25, FLH, 100 DEG, STL	93907	ORDER BY DESC
					*END MOUNTING PARTS*		
-3	426-2420-00			1	FRAME, FRONT:ALUMINUM, ASG100	5Y400	426-2420-00
					*MOUNTING PARTS*		
-4	211-0119-00			2	SCREW, MACHINE:4-40 X 0.25, FLH, 100 DEG, STL	93907	ORDER BY DESC
					*END MOUNTING PARTS*		
-5	— —			1	CIRCUIT BD ASSY: FRONT PANEL (SEE A1 REPL)		
					*MOUNTING PARTS*		
-6	211-0244-00			5	SCR, ASSEM WSHR:4-40 X 0.312, PNH, STL	01536	821-02775
-7	129-1411-00			1	SPACER, POST:0.280 X 0.200, ABS	TK0588	129-1411-00
					*END MOUNTING PARTS*		
-8	333-3967-00			1	PANEL, FRONT:TSG200	80009	333-3967-00
-9	337-3784-01			1	SHIELD, ELEC:ALUMINUM	80009	337-3784-00
					*MOUNTING PARTS*		
-10	211-0244-00			2	SCR, ASSEM WSHR:4-40 X 0.312, PNH, STL	01536	821-02775
					*END MOUNTING PARTS*		
-11	— —			1	CIRCUIT BD ASSY: MAIN (SEE A2 REPL)		
					*MOUNTING PARTS*		
-12	211-0244-00			8	SCR, ASSEM WSHR:4-40 X 0.312, PNH, STL	01536	821-02775
-13	211-0025-00			2	SCREW, MACHINE:4-40 X 0.375, FLH, 100 DEG, STL	TK0435	ORDER BY DESC
-14	210-0586-00			2	NUT, PL, ASSEM WA:4-40 X 0.25, STL CD PL	0KB01	ORDER BY DESC
-15	211-0101-00			4	SCREW, MACHINE:4-40 X 0.25, FLH, 100 DEG, STL	93907	ORDER BY DESC
					*END MOUNTING PARTS*	TK1155	337-3750-00
-16	337-3750-00			1	SHIELD, ELEC:PLASTIC		
-17	— —			1	CIRCUIT BD ASSY: REMOTE CONTROL FILTER (SEE A5 REPL)		
					*MOUNTING PARTS*		
-18	214-3903-01			2	SCREW, JACK:4-40 X 0.312 EXT THD, 4-40 INT THD, 0.188 HEX, STEEL, CADPLATE	0KB01	214-3903-01
					*END MOUNTING PARTS*		
-19	— —			1	CIRCUIT BD ASSY: TOP BNC (SEE A3 REPL)		
					*MOUNTING PARTS*		
-20	220-0497-00			2	NUT, PLAIN, HEX:0.5-28 X 0.562 HEX, BRS CD PL	73743	ORDER BY DESC
-21	210-1039-00			2	WASHER, LOCK:0.521 ID, INT, 0.025 THK, SST	0KB01	1224-02-00-0541C
					*END MOUNTING PARTS*		
-22	— —			1	CIRCUIT BD ASSY: BOTTOM BNC (SEE A4 REPL)		
					*MOUNTING PARTS*		
-23	220-0497-00			4	NUT, PLAIN, HEX:0.5-28 X 0.562 HEX, BRS CD PL	73743	ORDER BY DESC
-24	210-1039-00			4	WASHER, LOCK:0.521 ID, INT, 0.025 THK, SST	0KB01	1224-02-00-0541C
					*END MOUNTING PARTS*		
-25	348-0844-00			5	PAD, CUSHIONING:0.05 SQ X 0.23 H, POLYURETHANE W/PRESSURE SENS ADHESIVE	52152	SJ5518-GRAY
-26	200-3936-00		B010457	1	COVER, BOTTOM:TSG130	0J7N4	200-3936-00
-26	200-3976-01	B010458		1	COVER, BOTTOM:ALUMINIUM, TSG200, STANDARD ACCESSORIES	80009	200-3976-01
-27	161-0066-00			1	CA ASSY, PWR:3, 18 AWG, 250V/10A, 98 INCH	0B445	ECM-161-0066-00
	071-0760-00			1	MANUAL, TECH:TSG200 INSTRUCTION	80009	071-0760-00

## TSG 200 — Replaceable Mechanical Parts

