

PLEASE CHECK FOR CHANGE INFORMATION
AT THE REAR OF THIS MANUAL.

TM 5003 POWER MODULE

INSTRUCTION MANUAL

Tektronix, Inc.
P.O. Box 500
Beaverton, Oregon 97077
070-2955-00
Product Group 75

Serial Number _____

First Printing JAN 1981
Revised DEC 1981

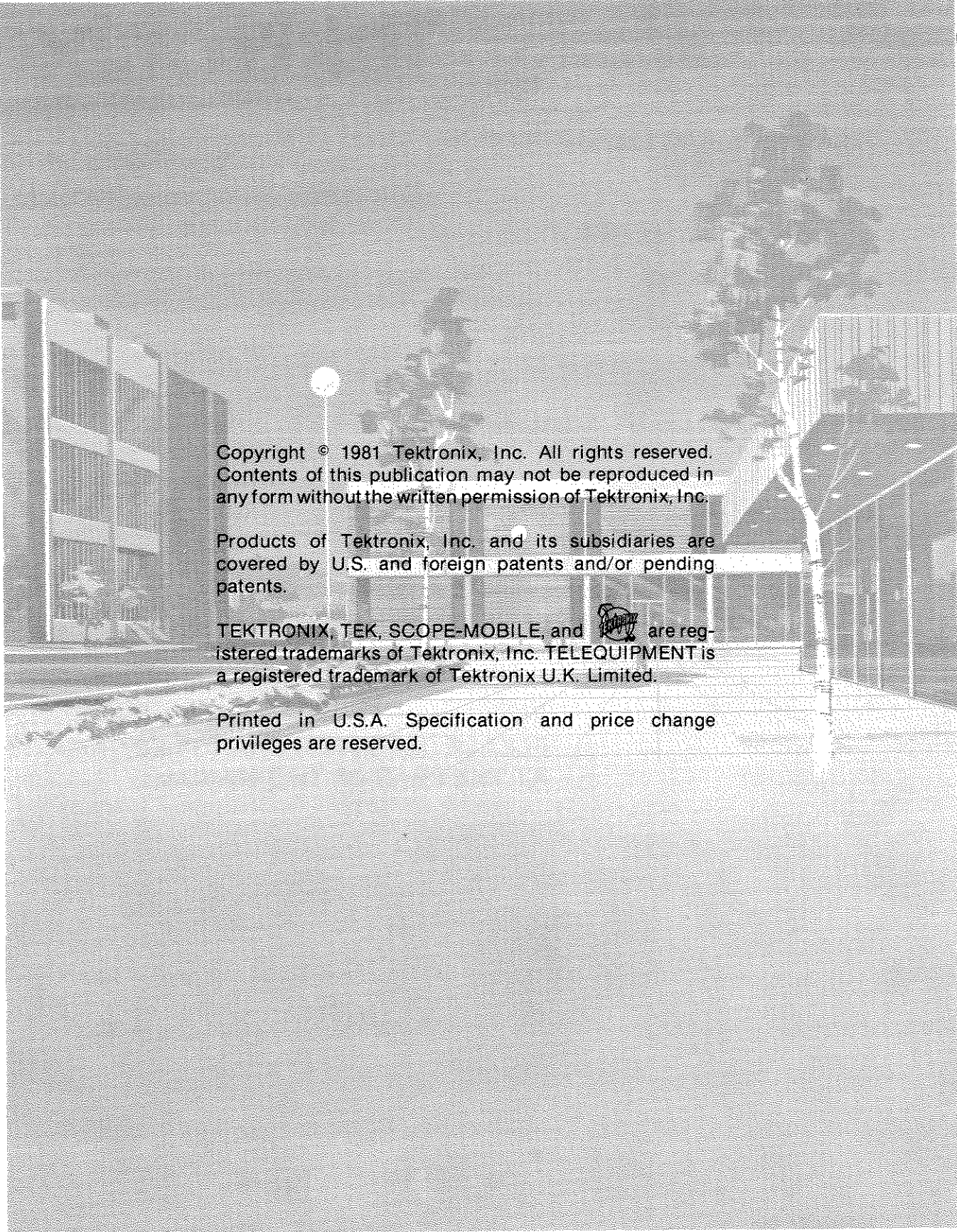

Copyright © 1981 Tektronix, Inc. All rights reserved.
Contents of this publication may not be reproduced in
any form without the written permission of Tektronix, Inc.

Products of Tektronix, Inc. and its subsidiaries are
covered by U.S. and foreign patents and/or pending
patents.

TEKTRONIX, TEK, SCOPE-MOBILE, and  are reg-
istered trademarks of Tektronix, Inc. TELEQUIPMENT is
a registered trademark of Tektronix U.K. Limited.

Printed in U.S.A. Specification and price change
privileges are reserved.

SERVICE SAFETY SUMMARY

FOR QUALIFIED SERVICE PERSONNEL ONLY

Refer also to the preceding Operators Safety Summary.

Do Not Service Alone

Do not perform internal service or adjustment of this product unless another person capable of rendering first aid and resuscitation is present.

Use Care When Servicing With Power On

Dangerous voltages may exist at several points in this product. To avoid personal injury, do not touch exposed connections and components while power is on.

Disconnect power before removing protective panels, soldering, or replacing components.

Power Source

This product is intended to operate from a power source that will not apply more than 250 volts rms between the supply conductors or between either supply conductor and ground. A protective ground connection by way of the grounding conductor in the power cord is essential for safe operation.

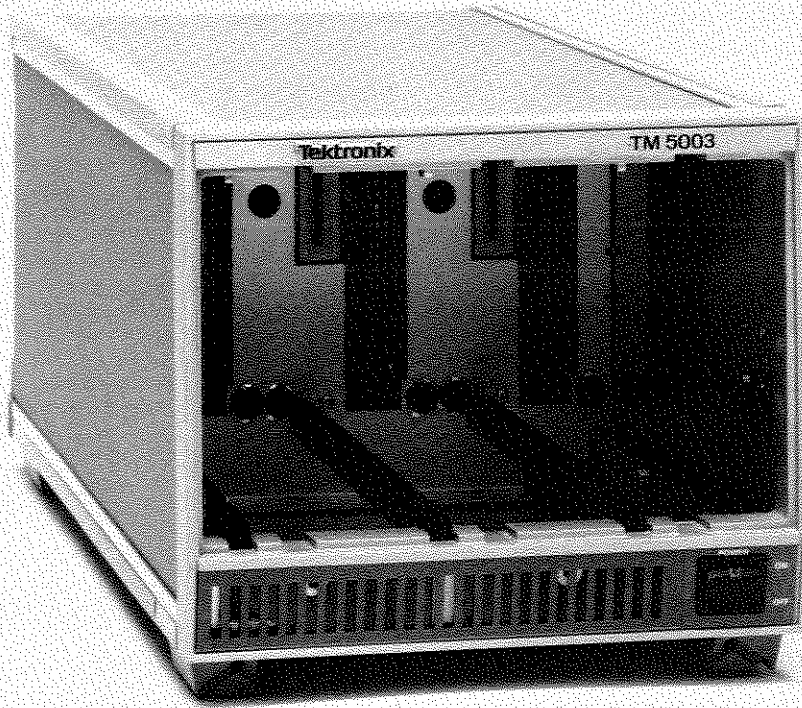

2955-00

TM 5003 Power Module

SPECIFICATION

Instrument Description

The TM 5003 is a three compartment power module compatible with TM 500 - 5000 series plug-ins. The power module features a pulse width modulated switching dc power supply. All dc voltages are regulated. The unit has forced air cooling.

Three individual connectors, one for each compartment, provide connections to each GPIB compatible plug-in. These connectors feed to a GPIB interface board, then to a standard GPIB connector on the rear panel. All GPIB connections are separate from the board rear interface connector.

Performance Conditions

The electrical characteristics in this specification are valid only if the TM 5003 has been adjusted at an ambient temperature between +20°C and +30°C. The instrument must

be in a noncondensing environment whose limits are described under the environmental part. Allow 30 minutes warm-up time for operation to specified accuracy; 60 minutes after exposure to or storage in a high humidity (condensing) environment. Any conditions that are unique to a particular characteristic are expressly stated as part of that characteristic.

The electrical and environmental performance limits; together with their related validation procedures, comprise a complete statement of the electrical and environmental performance of a calibrated instrument.

Items listed in the Performance Requirements column of the Electrical Characteristics are verified by completing the Performance Check in the Calibration section of this manual. Items listed in the Supplemental Information column are not verified in this manual.

Table 1-1
ELECTRICAL CHARACTERISTICS

Characteristics	Performance Requirements	Supplemental Information
Supplies		
+26 V dc		
Tolerance ^a	+23.7 V to 28.3 V	
PARD ^b		≤2.5 V peak to peak
Maximum load		1 A per compartment
Maximum load $\frac{di}{dt}$		10 mA/μs
-26 V dc		
Tolerance ^a	-23.7 V to -28.3 V	
PARD ^b		≤2.5 V peak to peak
Maximum load		1 A per compartment
Maximum load $\frac{di}{dt}$		10 mA/μs

Table 1-1 (cont)

Characteristics	Performance Requirements	Supplemental Information
+8 V dc		
Tolerance ^a	+7.6 V to +8.5 V	
PARD ^b		≤600 mV peak to peak
Maximum load		3 A per compartment
Maximum load $\frac{di}{dt}$		20 mA/μs
25 V ac (2 each compartment)		
Range		25.0 V rms +10%, -15% floating
Maximum load		1 A rms per winding
Maximum floating voltage		350 V peak from chassis ground
17.5 V		
Range		20.5 V +10%, -20% with grounded center tap
Maximum load		350 mA per compartment
Maximum plug-in power ^c draw from mainframe		30 watts dc or 50 VA ac
Combined power draw ^c Sharing Limitation		$VA_{ac} + 2.67 (\text{watts}_{dc}) \leq 100$
Series Pass Transistors		
Type		One NPN and PNP per compartment
Maximum dissipation		10 W each, 20 W total
Maximum floating voltage		350 V peak
Source Power Requirements		
Voltage Ranges		Selectable (nominal): 100 V, 110 V, 120 V, 200 V, 220 V, and 240 V. (250 V maximum on 240 V range)
Tolerance		+7% - 10%
Line Frequency		48 Hz to 60 Hz
Maximum Power Consumption		300 VA

Table 1-1 (cont)

Characteristics	Performance Requirements	Supplemental Information
Fuse Data		
100 V, 110 V, 120 V ranges		4 A, 3 AG, medium blow
200 V, 220 V, 240 V ranges		2 A, 3 AG, fast blow
Miscellaneous		
Maximum recommended plug-In power dissipation		
One-wide		15 W
Two-wide		35 W
Recommended adjustment interval		1000 hours or 6 months

^aWorst case: Low line with full load and high line with no load. These limits include PARD.

^bPeriodic and Random Deviation. See National Electrical Manufacturers Association (NEMA) Standards Publication No. PY1-1972.

^cAt nominal line voltage.

**Table 1-2
ENVIRONMENTAL CHARACTERISTICS**

Characteristics	Description
Temperature	Meets MIL-T-28800B, class 5.
Operating ^a	0°C to +50°C
Non-operating	-55°C to +75°C
Humidity ^a	95% RH, 0°C to 30°C 75% RH, to 40°C 45% RH, to 50°C Exceeds MIL-T-28800B, class 5.
Altitude	Exceeds MIL-T-28800B, class 5.
Operating ^a	4.6 Km (15,000 ft)
Non-operating	15 Km (50,000 ft)
Vibration ^c	0.38 mm (0.015") peak to peak, 5 Hz to 55 Hz, 75 minutes. Meets MIL-T-28800B, class 5.
Shock ^c	30 g's (1/2 sine) 11 ms duration, 3 shocks in each direction along 3 major axes, 18 total shocks. Meets MIL-T-28800B, class 5.
Bench Handling ^c	12 drops from 45° 4" or equilibrium, which- ever occurs first. Meets MIL-T-28800B, class 5.
Transportation ^d	Qualified under National Safe Transit Association Preshipment Test Procedures 1A-B-1 and 1A-B-2.
EMC	Within limits of MIL-461A tests RE02, CE01, CE03, RS01, CS01, CS02 and VDE 0871.
Electrical Discharge	20 kV maximum charge applied to instrument case.

^aElectrical load in accordance with Section 2.2.1.

^bSystem environmental specifications subject to individual plug-in specifications.

^cTested with mechanical load of 9.5 lbs. ± 1/2 lb. evenly distributed. (A three-wide plug-in with three rear support pins and two rear interface ECB's.) Requires retainer clips.

^dWithout mechanical load (plug-ins).

**Table 1-3
PHYSICAL CHARACTERISTICS**

Characteristics	Description
Maximum recommended plug-in weight	
One wide	3 lbs (1.4 kg)
Two wide	6 lbs (2.7 kg)
Net weight (without plug-ins)	19 lbs (8.6 kg)
Maximum overall dimensions	
Height	193.8 mm (7.63 inches)
Width	229.84 mm (9.049 inches)
Length	476 mm (18.74 inches)
Enclosure type and style per MIL-T-28800B	
Type	III
Style	E (with 040 rackmount kit style F)
Finish	
Frame	Powder coated aluminum
Covers	Vinyl clad aluminum

OPERATING INSTRUCTIONS

Introduction

The TM 5003 Power Module is calibrated and ready for use when received. A list of standard accessories (and part numbers) is located in the back of this manual.

CAUTION

To ensure proper cooling, do not operate the power module with any cover removed.

Power Source Requirements

WARNING

AC Power Source and Connection. *This instrument operates from a single-phase power source. It has a three-wire power cord and two-pole, three-terminal grounding type plug. The voltage to ground (earth) from either pole of the power source must not exceed the maximum rated operating voltage, 250 volts.*

Before making connection to the power source, determine that the instrument is adjusted to match the voltage of the power source, and has a suitable two-pole, three-terminal grounding-type plug. Refer any changes to qualified service personnel.

Grounding. *This instrument is safety class I equipment (IEC designation). All accessible conductive parts are directly connected through the grounding conductor of the power cord to the grounding contact of the power plug.*

The power input plug must only be inserted in a mating receptacle with a grounding contact. Do not defeat the grounding connection. Any interruption of the grounding connection can create an electric shock hazard.

For electric shock protection, the grounding connection must be made before making connection to the instrument's input or output terminals.

See Fig. 2-1. Refer to the line voltage and fuse data label on the rear panel.

Fuse Replacement

Turn the slotted section of the line fuse holder counter-clockwise and remove the fuse. Replace the fuse with the proper type as shown on the rear panel label.

Table Top Use

The power module may be operated with the front raised. To raise the front of the instrument extend the front feet as shown in Fig. 2-2.

Plug-In Installation and Removal

CAUTION

Turn the power module off before inserting or removing the plug-in; otherwise, damage may occur to the plug-in circuitry.

NOTE

The DC 505, DC 505A and LA 501W plug-ins are not compatible with this power module.

Check to see that the plastic barriers on the interconnecting jack of the selected power module compartment match the cutouts in the plug-in circuit board edge connector. Align the plug-in chassis with the upper and lower guides (see Fig. 2-3 and 2-4) of the selected compartment. Push the plug-in chassis in and press firmly to seat the circuit board edge connector in the interconnecting jack. Turn the power module on.

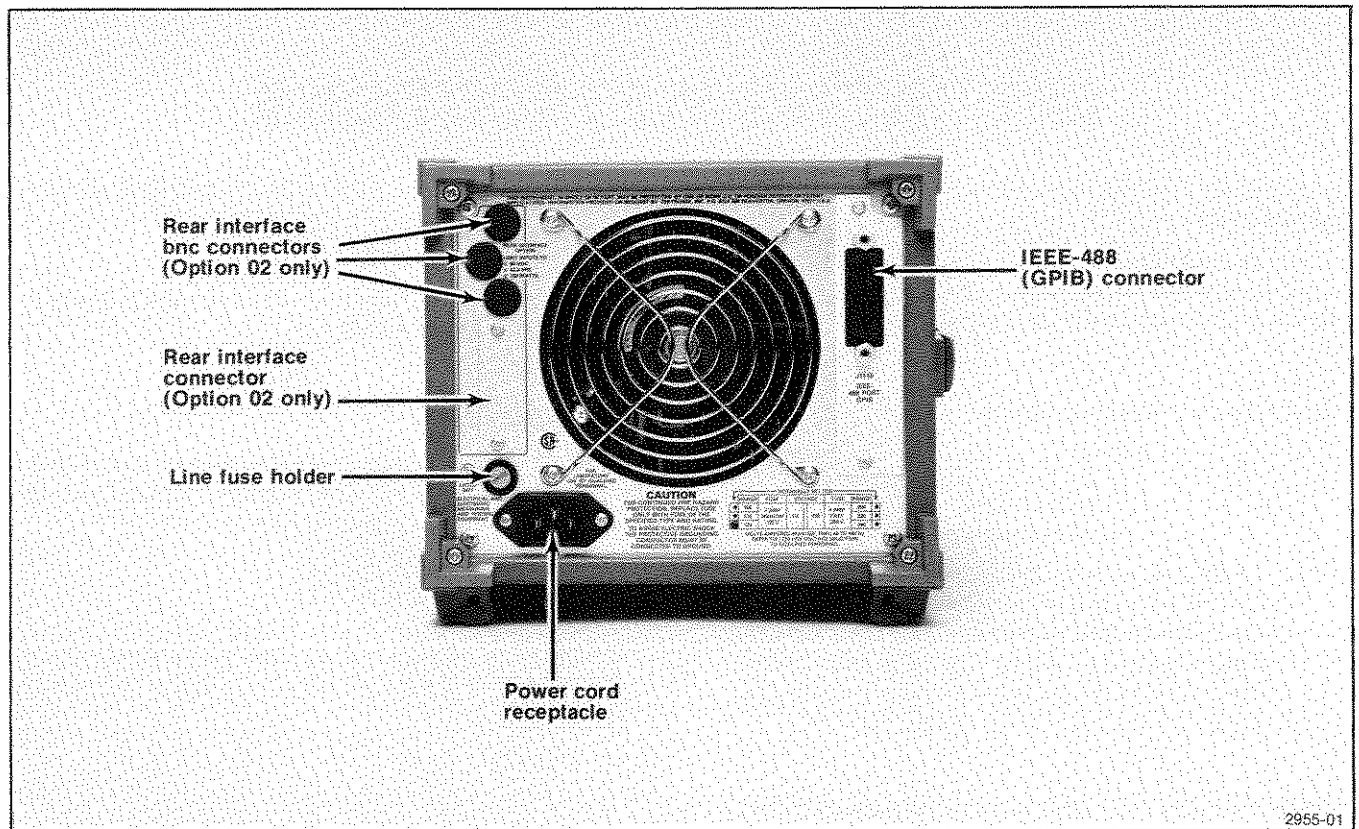

Fig. 2-1. TM 5003 rear panel.

Family Compatibility

Mechanically, TM 500 - 5000 plug-in modules are very similar to other Tektronix product families. However, they are not electrically compatible. Therefore, the TM 5003 interface has barriers on the mating connectors between pins 6 and 7 to ensure that incompatible plug-ins cannot be inserted. See Fig. 2-5. A compatible module will have a matching slot between pins 6 and 7 of its main circuit board edge connector. This slot and barrier combination is the primary keying assignment.

TM 500-5000 compatible plug-in modules are also identified by the white color of the release latch.

Customizing the Interface

The modularity of this instrumentation system provides for many different functions to be performed by the plug-in modules. Specific functions are grouped into families or classes, of which there may be several plug-in module members. For instance, some classes are Power Supplies, Signal Sources, Measurement, and so forth. Each module member of a functional family will have a second slot, peculiar to its family assignment, located in its edge connector. The TM 5003 user can select one or more compartments, to accept only members of that family, by installing a second

barrier in the interface connector to match the module's slot location. An entire TM 5003 can be set up in this manner for specific work functions. For extra barriers, order Tektronix Part No. 214-1593-02.

Rear Panel

The rear subpanel has a connector mounting plate for bnc and multipin connector mountings. Customer or factory-installed connectors and wiring (Option 02) can provide external access to the interface. This feature makes the TM 500-5000 Series Modular Instrumentation System very flexible in bench-top or rack mounted systems.

Option 02

Qualified service personnel see Section 6 in the Service Section of this manual for information on Option 02.

Repackaging Information

If the Tektronix instrument is shipped to a Tektronix Service Center for service or repair, attach a tag showing owner (with address) and the name of an individual at your firm to contact. Include the complete instrument serial number and a description of the service required.

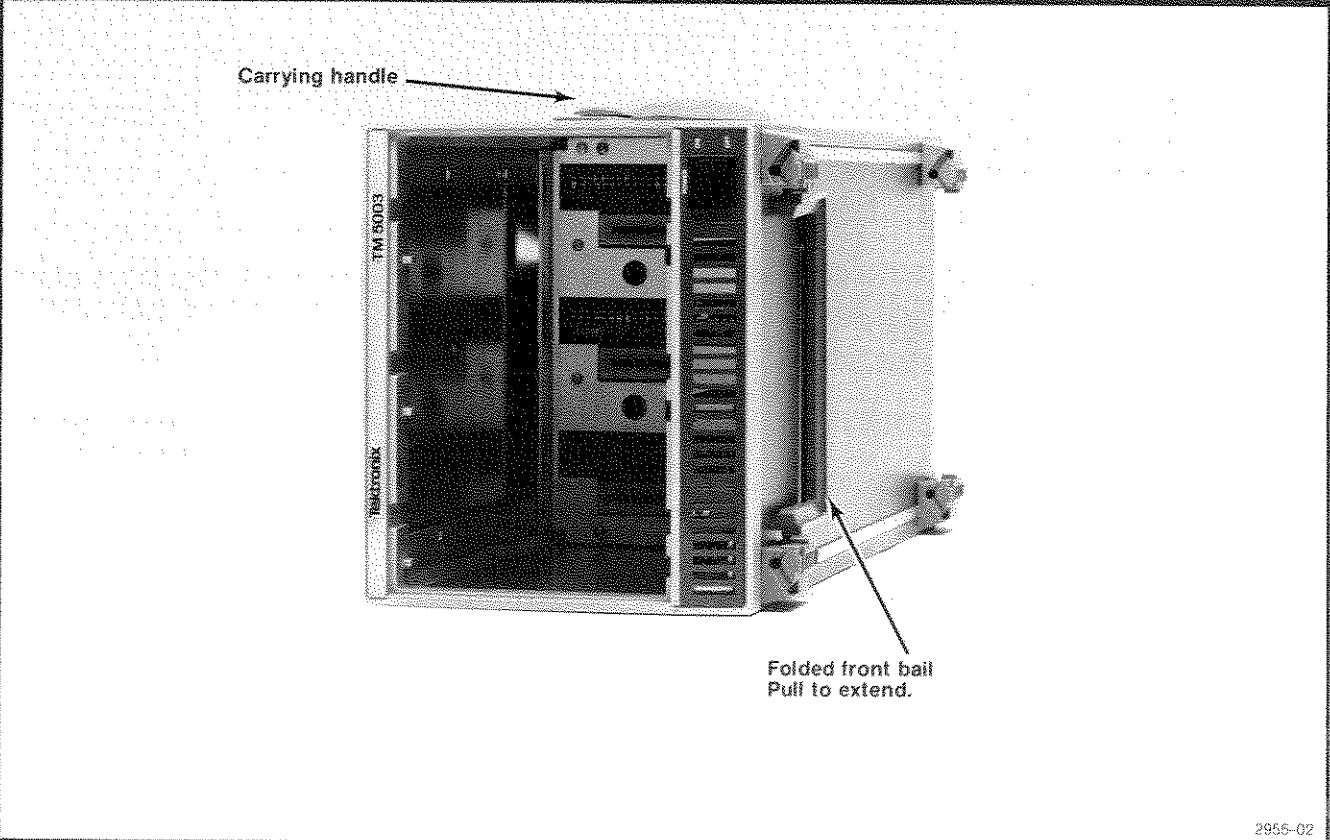
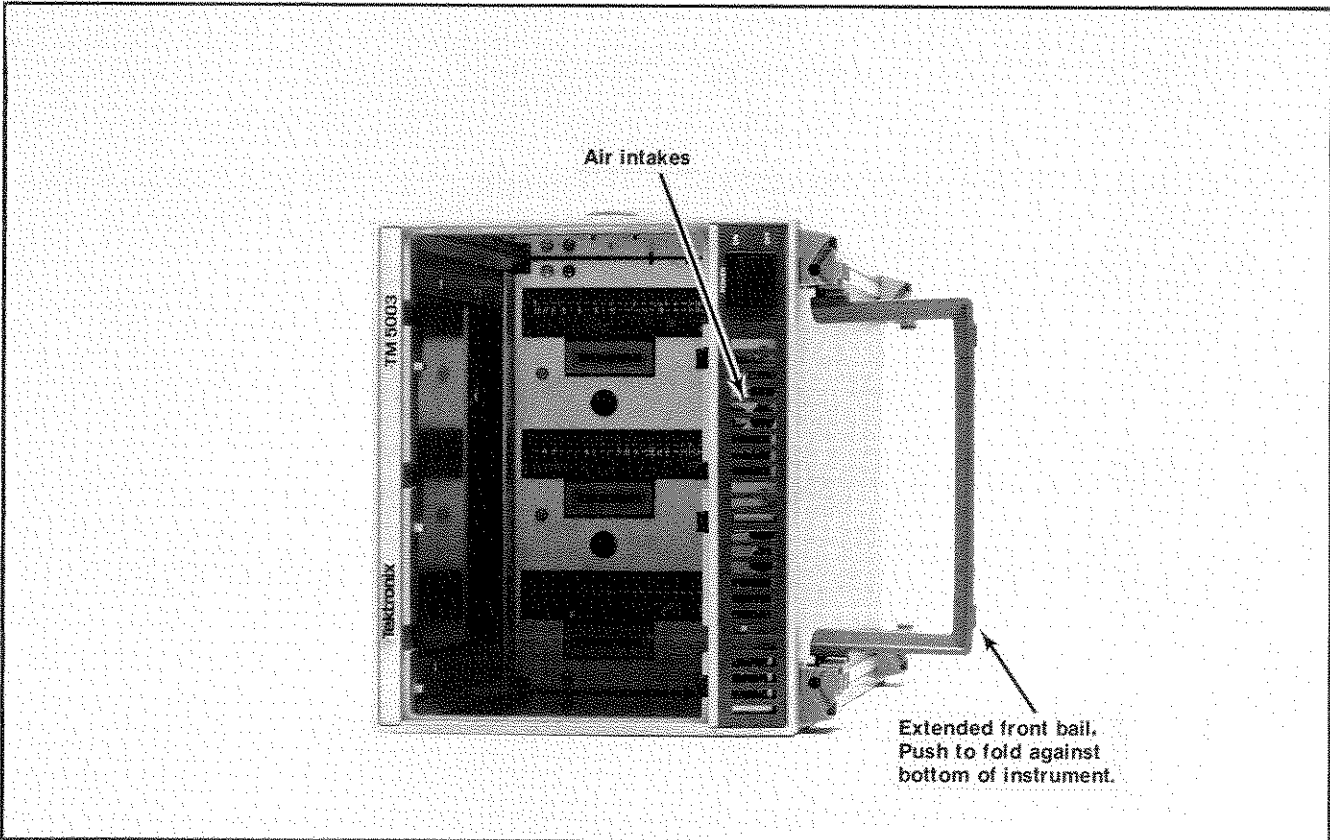

2956-02

Fig. 2-2. TM 5003 bottom view.

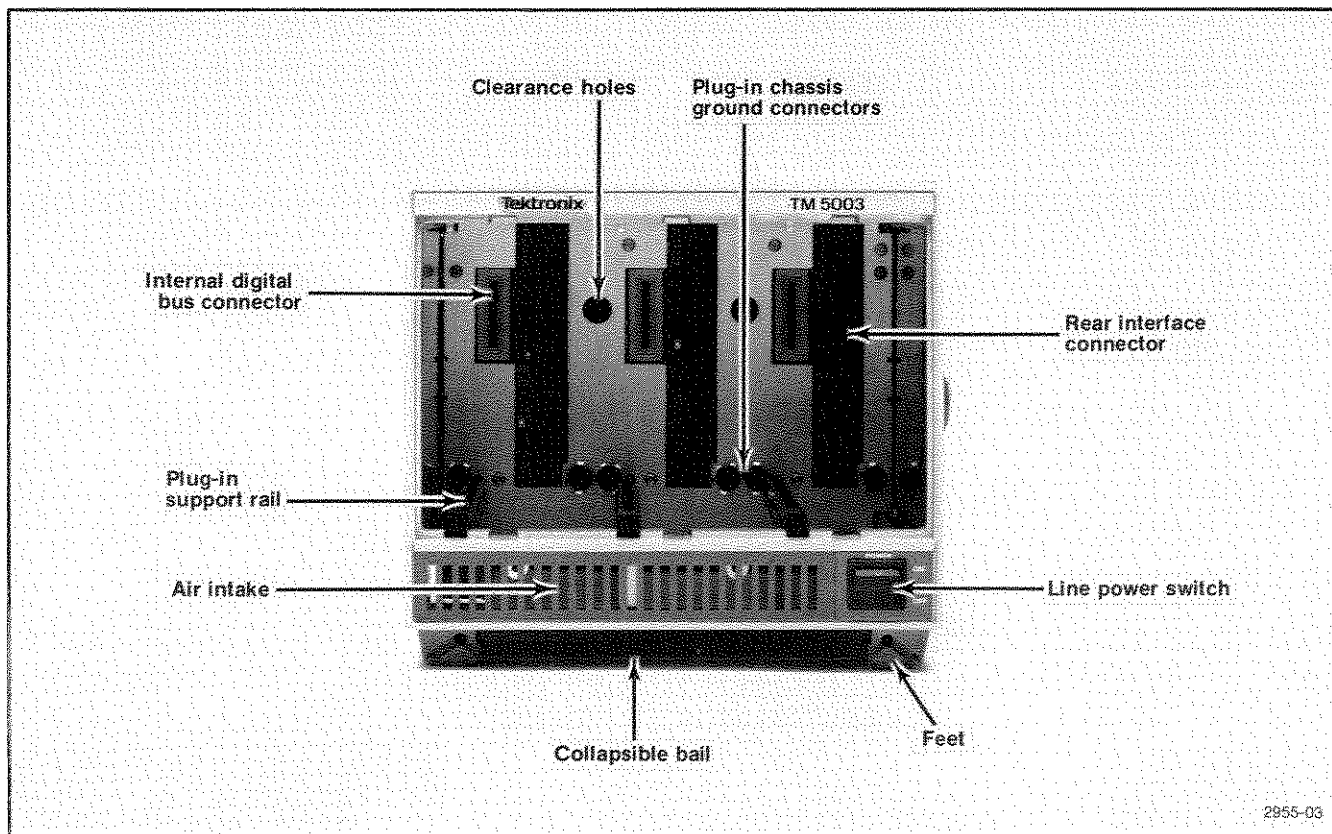

Fig. 2-3. TM 5003 front view.

Save and reuse the package in which your instrument was shipped. If the original packaging is unfit for use or not available, repackage the instrument as follows:

Surround the instrument with polyethylene sheeting to protect the instrument finish. Obtain a carton of corrugated cardboard of the correct carton strength having inside dimensions of no less than six inches more than the instrument dimensions. Cushion the instrument by tightly packing three inches of dunnage or urethane foam between carton and instrument on all sides. Seal the carton with shipping tape or an industrial stapler.

The carton test strength for this instrument is 350 pounds per square inch.

Stacking and Rackmounting

TM 5003s with their cabinets and feet in place may be stacked on top of each other. Give adequate spacing for the necessary ventilation.

The TM 5003 is designed to be half-rack width. Field conversion kits with slide-out tracks are available to mount one or two TM 5003s or a TM 5003 and other instruments, in a standard 19-inch rack. Vertical space needed is 7 inches.

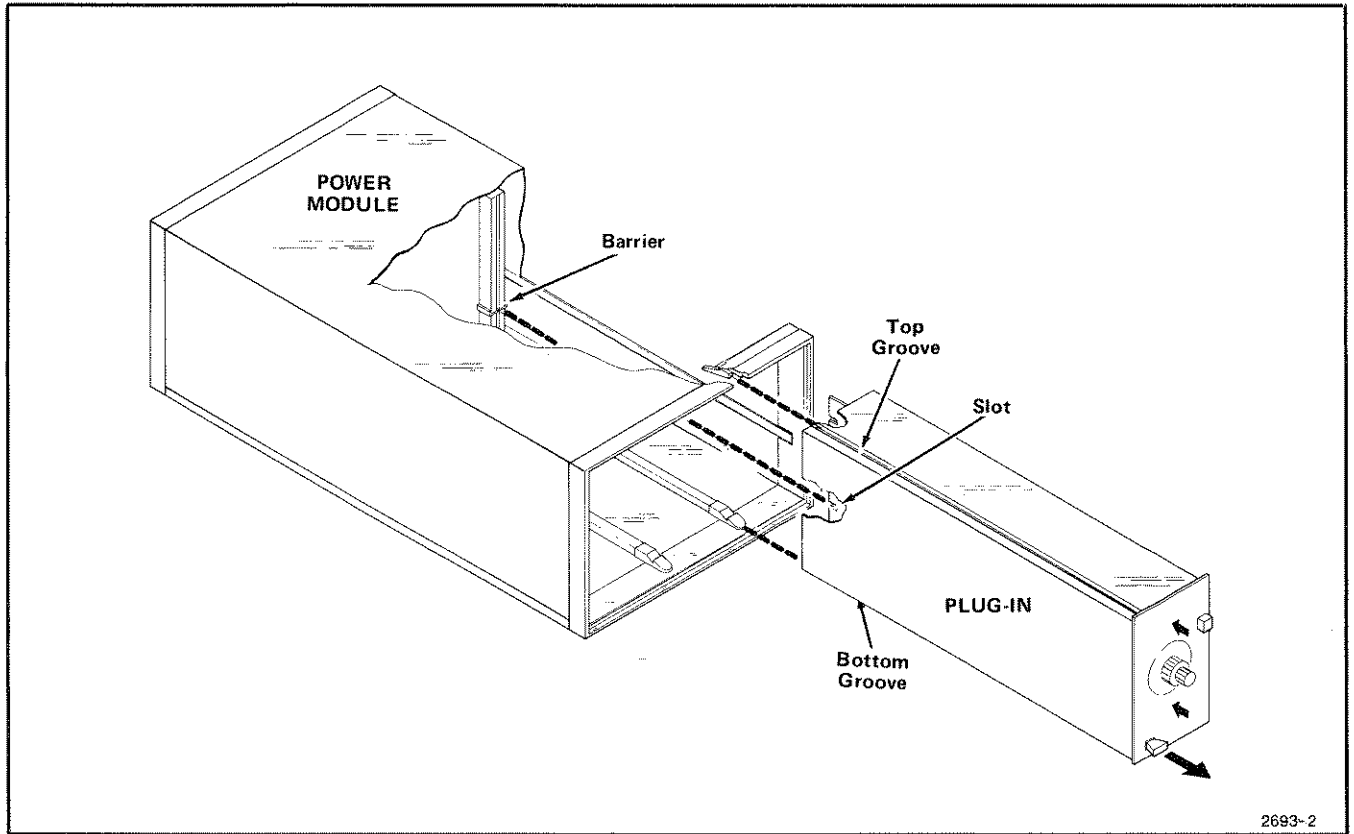

2693-2

Fig. 2-4. Plug-in installation and removal.

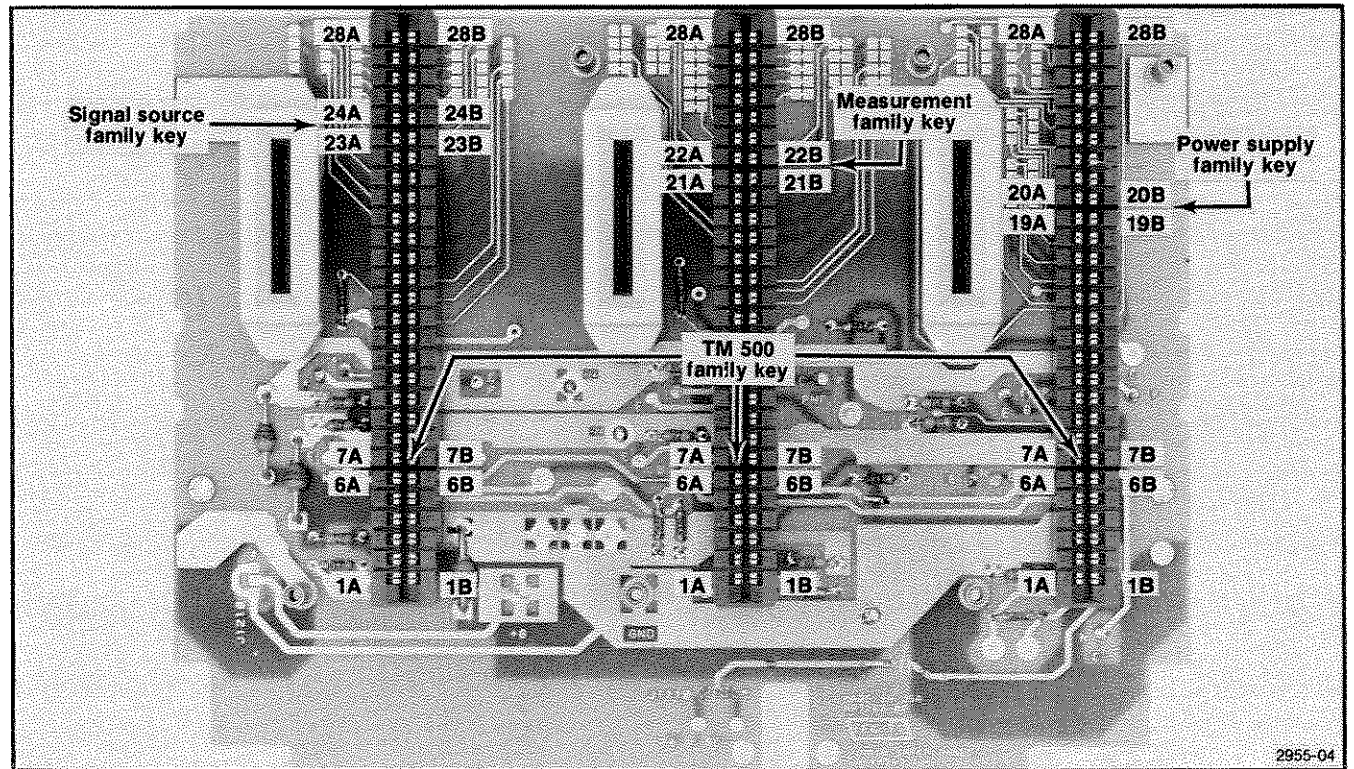

2955-04

Fig. 2-5. Keying assignments for family functions. One of many possible sequence combinations.

WARNING

THE FOLLOWING SERVICING INSTRUCTIONS ARE FOR USE BY QUALIFIED PERSONNEL ONLY. TO AVOID PERSONAL INJURY, DO NOT PERFORM ANY SERVICING OTHER THAN THAT CONTAINED IN OPERATING INSTRUCTIONS UNLESS YOU ARE QUALIFIED TO DO SO.

THEORY OF OPERATION

Introduction

For ease in understanding, this description refers to the schematics located in the pullout pages at the rear of this manual. Also refer to the block diagram located in the pullout pages and the timing diagram in Fig. 3-1. Each block in the block diagram is outlined on the schematics.

The TM 5003 uses a pulse width modulated switching supply for dc voltages. A 60 Hz transformer provides the ac voltages necessary for plug-in operation. Connections to the six plug-in compartments as well as the series pass transistors are shown on schematic .

Line Selector and 60 Hz Transformer

Ac power is applied to the voltage-select terminals through FL500 and a discrete line filter composed of T1000, L1000 and L1100. Line transients are filtered to ground through C1000 and C1100.

The two primary windings on T500 are connected in parallel for 115 V operation or in series for 230 V operation. Winding taps are provided for various line voltages around the nominal values. The secondaries provide ac voltages to the various plug-in compartments.

Rectifiers and Filters

The ac line voltage is applied through negative temperature coefficient resistances RT1020 and RT1110 to the rectifier diodes. As these resistances are highest when cold, the surge currents, charging the high voltage capacitors when line voltage is applied, are limited, thus preventing component failure. These resistors then self heat to a low resistance.

In 220 V operation the four diodes function as a bridge rectifier. See Fig. 3-2. When the voltage select circuit is set for 110 V operation only the two series diodes operate. The circuit then becomes a voltage doubler with an output of approximately 350 V dc. The neon bulb in this circuit flashes to indicate when dc voltage is present.

The rectified and filtered dc is applied through L1220 and C1210, a low pass filter, and passes through R1210 and CR1303, to the collector of Q1301.

20 kHz Output Stage

The output stage is a half bridge type with proportional base drive. The turns' ratios and phasing of T1430 are such that only a small amount of base drive power is needed to start conduction in either Q1301 or Q1300. Positive feedback from T1430 supplies base current for the remainder of the power cycle. When both base drive transistors, Q1400 and Q1401, (shown on schematic ) are saturated, T1740 is essentially shorted, terminating base current for either output transistor. Output transistors Q1300 and Q1301 alternately conduct at a 20 kHz rate. Their on and off times are adjusted by the regulation circuitry. Diodes CR1300 and CR1301 prevent base to collector current flow in Q1300 and Q1301 at turn off. The base switching action of these transistors is improved by networks C1401 and R1400 for Q1301, and C1411 and R1410 for Q1300. A series resonant filter between the transistors and the output transformer, T1210, is composed of C1320 and L1200. During Q1300 and Q1301 off time, the tank current generated by L1200 and C1320 passes through CR1302 and CR1300.

The 20 kHz output voltage is stepped down to the correct levels by T1210.

Three sets of full wave diode rectifiers are provided for each of the three dc voltage outputs. Schottky diodes are used in the +8 V supply for reduced forward voltage drop. All filters are L-C pi-sections. Bleeder resistors are provided for all filter capacitors.

Control Logic and Drivers

U1620E and U1620F are inverting amplifiers. Their outputs control the base drive transistors Q1401 and Q1400. Collector voltage for these transistors is applied from the 10 V bus through a center tapped winding on the base drive transformer (T1430). Reverse polarities across Q1401 or Q1400 are prevented by CR1501 and CR1500. When either one or both of these transistors (Q1730, Q1731) are on, either one or both of the output transistors (Q1300, Q1301) are off. The bases of Q1400 and Q1401 are also controlled, through R1511 and R1520, by the collector of Q1650. During power up or power down, the collector of Q1650 goes positive. This action turns Q1401 and Q1400 on to turn the output transistors off. This is necessary as the control circuitry is undefined during power up or power down.

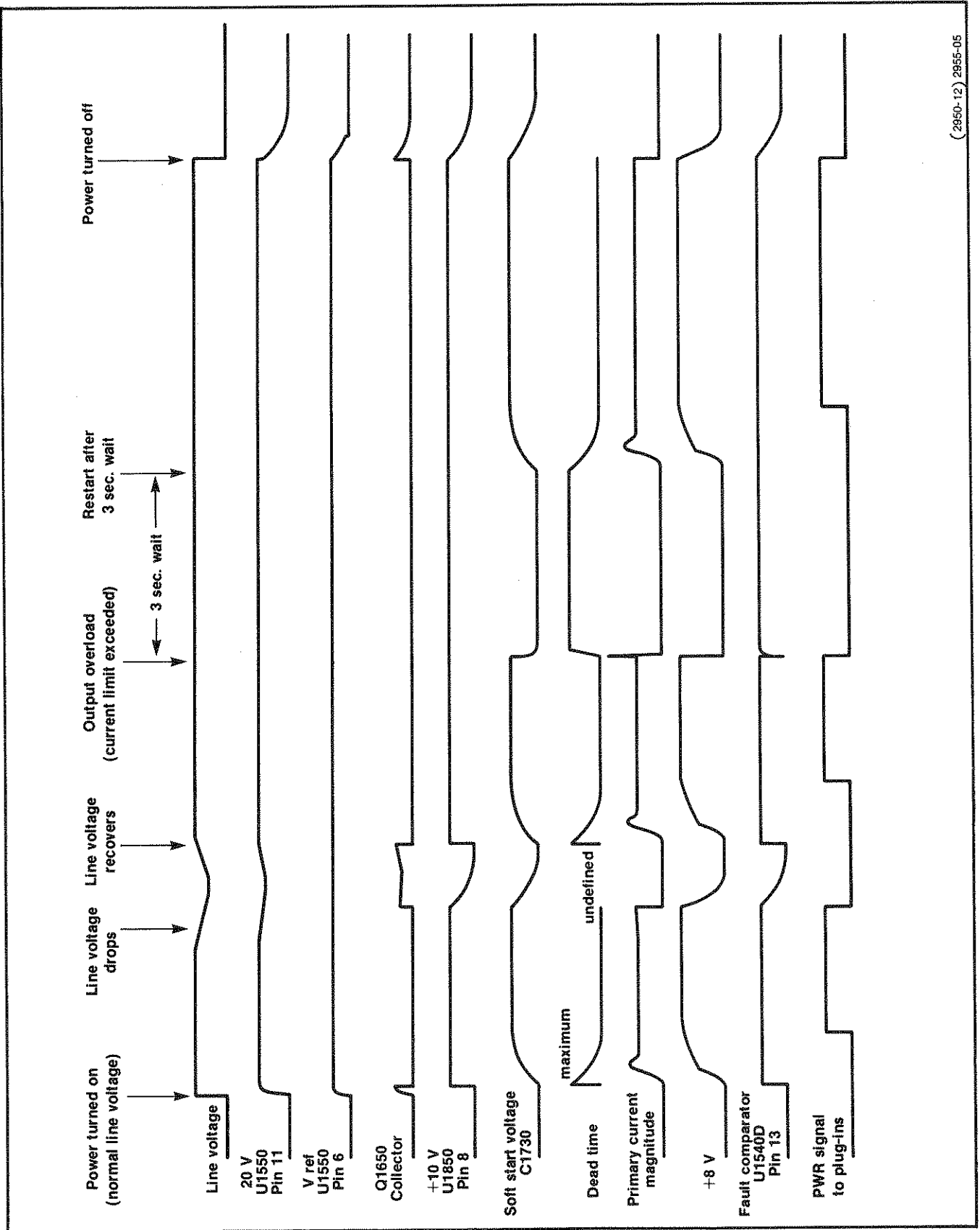

(2950-12) 2955-05

Fig. 3-1. Various waveforms and time relationships for power on, off, fault and low line.

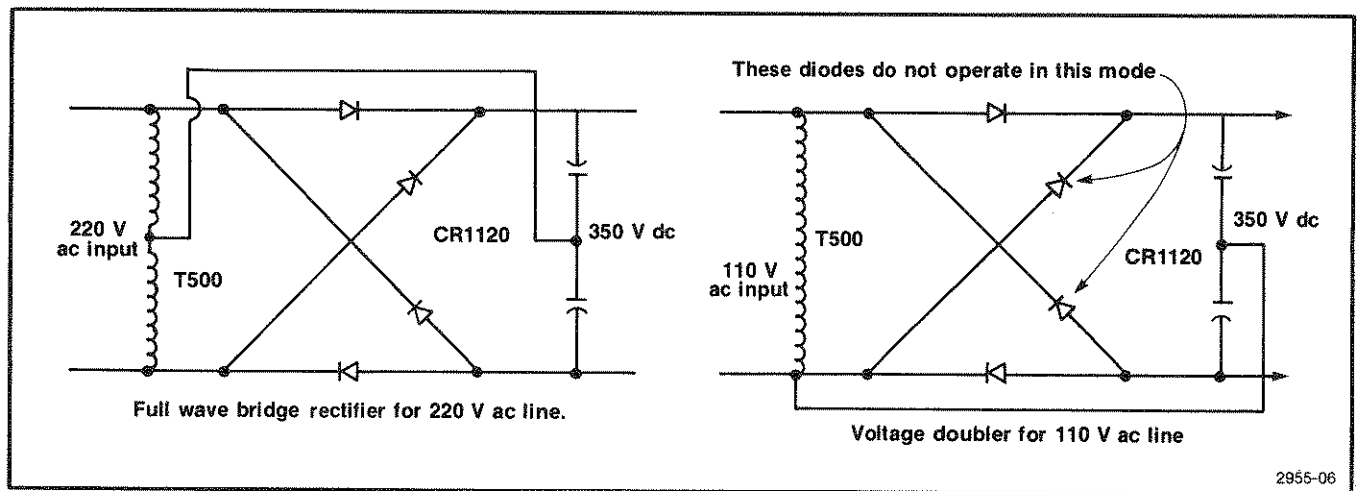
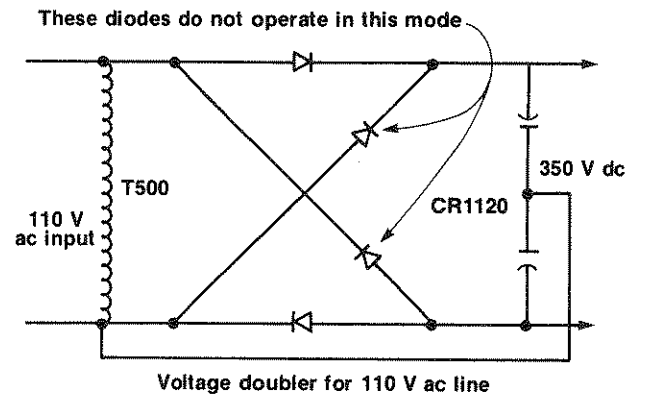

Fig. 3-2. Input line connections for 110 V and 220 V operation.

When pins 1 of U1610A and 13 of U1610B are low, no drive is applied to the output stage. With one gate output high and the other low base drive is applied to one output transistor. Input pins 5 and 10 connect to the wait flip flop, U1720A. Input pins 3 and 12 connect to U1720B, the dead time multivibrator. Input pins 4 and 1 connect to the output of the stop monostable, U1600A. Pins 2 and 9 connect to the complement outputs of the divide by 2 flip flop, U1600B. With any one or all of these inputs high, the output lines are low and no drive is applied to one or both of the output transistors.

The dead time multivibrator circuitry determines the minimum off time of the output transistors. Dead time is necessary to allow one output transistor to completely turn off before the other turns on. At start up the A input (pin 12) of U1720B goes low. This allows U1720B to trigger on the clock signal at the B input (pin 11). The minimum timing period of U1720B, determined by R1610 and C1700, is 5 μ s. This pulse width is lengthened by C1710, CR1710 and CR1711 as the voltage on C1730 and C1831 is decreased. The pulse width of the power supply output varies for soft start and power limit. When pin 10 of U1720B is high, both output transistors are off.

Dead time or output transistor off time is maximum with C1730 and C1831 discharged and minimum charged. The output power available gradually increases as these capacitors charge during soft start. The soft start prevents high input currents, to capacitors, from damaging circuit components. When pin 6 of the wait multivibrator U1720A goes high for any reason (fault), pin 8 of U1620D goes low discharging C1730 and C1831. Under normal operation, when power is turned on, C1730 and C1831 charge to the voltage at pin 8 of U1620D as determined by R1820 and R1830. This takes approximately 1/2 second.



The power limit control is R1830. For maximum power this control must be in the full clockwise position (maximum resistance). For servicing the control can be adjusted for reduced power output levels. This is accomplished by reducing the resistance of R1830, limiting the voltage across C1730 and C1831.

The purpose of flip flop U1600A is to vary the on time of the output transistors consistent with the output voltage level. When pin 6 of U1600A goes high, pin 1 also goes high. This action shuts down the base drive circuitry, reducing power output. The length of time pin 6 remains high is controlled by the Output Regulator circuitry. The rising portion of the waveform at pin 4 of U1600A resets the flip flop for a low condition at pin 1.

Flip flop U1600B divides the 40 kHz output waveform from U1720B to 20 kHz. The pulse from the dead time multivibrator, U1720B, is applied to the clock terminal (pin 11) of U1600B. The Q terminal of U1600B is connected to its D input. The multivibrator U1600B toggles on the rising edges of the dead time multivibrator (U1720B) output.

Output Regulator

2

The 40 kHz clock oscillator, which provides the basic timing necessary for the control circuitry, is composed of U1620A, B and C. Feedback occurs from pin 6 of U1620C and pin 4 of U1620B to pin 1 of U1620A. The output voltage at pin 4 of U1620B is high for about 4 μ s and low about 21 μ s. This nonsymmetrical duty cycle is accomplished by CR1720 and is necessary for proper operation of U1720B.

Theory of Operation—TM 5003

The positive going output pulses from the clock oscillator charge C1450 to about 9.5 V through CR1610. When the positive pulse at pin 4 of U1620B drops to 0 V, C1450 discharges through R1452 causing a falling ramp waveform of about 50 mV peak to peak amplitude to appear at pin 4 of U1540A.

The +8 V from the power supply output is applied to voltage adjust potentiometer R1530. The voltage on pin 4 of U1540A is +7.15 V, the reference voltage generated in U1550. Also, on pin 4 is a negative going 40 kHz ramp as previously described. This ramp is ac coupled to pin 4 through C1451. On the rising edge of each clock pulse, the ramp goes positive rapidly. Pin 2 of U1540A is low. At some point, during the ramp decay, the ramp voltage and the feedback voltage at pin 5 are equal. At this point, pin 2 goes high, terminating the drive pulse through the logic circuitry. The higher the output voltage, the earlier in the ramp cycle pin 2 goes high.

Overvoltage and Overcurrent Detectors

Pin 11 of U1540D, the negative overvoltage detector, connects to a voltage divider between the -26 V supply and the reference +7.15 V. Should pin 11 go more negative than pin 10, pin 13 goes low shutting off the output. The input of U1540D is protected from a negative voltage by CR1840.

Primary current in output transformer T1210 flows through T1000. The secondary voltage of T1000 is proportional to the primary current. The secondary voltage of T1000 is rectified by CR1511, CR1512, CR1502 and CR1510 and terminated in R1510. When the primary current in T1000 exceeds a predetermined limit, the voltage at pin 6 of U1540B exceeds the 7.15 V reference at pin 7. Pin 1 goes low turning off the output transistors via the wait multivibrator.

The +26 V is applied through R1462 and CR1451 to pin 8 of U1540C, the positive overvoltage detector. The +8 V is also applied through R1453 and CR1450 to pin 8. Pin 9 of comparator U1540C connects to the +7.15 V reference voltage. If pin 8 of U1540C goes more positive, pin 14 goes low. This action triggers U1720A the wait multivibrator, turning the supply off for about 3 seconds. The soft start cycle follows. The negative going pulse from U1540C is time delayed by R1840 and C1830.

When +10 V is applied at power up, C1630 holds pin 3 (clear) of U1720A low for a short period. This overrides the A and B inputs of U1720A, causing pin 6, the Q output, to remain low. Overvoltage or overcurrent causes a low at pin 4 of U1720A causing one high level pulse of about 3 seconds duration at pin 6. This 3 second pulse duration time is

determined by C1620 and R1720. The clock pulse retriggers U1720A if the fault persists. The purpose of CR1730 is to discharge C1630 when ac power is removed from the supply. Noise from the limit circuitry is filtered by C1830.

Control Circuit Regulator

The 16 V ac winding on T500 is applied through F1660 to rectifier diode CR1561, which charges filter capacitor C1761 to approximately +20 V. The +20 V is applied to voltage regulator U1550. This regulator outputs two voltages: +10 V which is used throughout the entire supply and +7.15 V, a reference voltage, at pin 6.

The line detector circuitry is composed of CR1560, C1851, Q1650 and associated components. When normal line voltage is applied, the voltage across C1851 is approximately 20 V. Transistor Q1650 is on and pin 2 of U1550 is about 0.2 V above ground. If about two cycles of line voltage are missed or the line voltage goes low Q1650 no longer saturates. The collector of Q1650 rises, disabling the series pass transistor located internally in U1550. The +10 V is removed from the power supply during line drop out to prevent discharge of the main filter capacitors in the output stage. Positive feedback is provided through R1750 to the base of Q1650 to improve the switching action.

The PWR signal circuitry (U1850) provides a signal to each compartment in the power module to give power supply status information to the plug-ins. See the rear interface information part of the Maintenance section (Section 50 of this manual for timing information).

Pin 7 of U1850 goes low when the rising voltage at pins 2 and 6 reaches 2/3 of the value of the voltage connected to pin 4 (+10 V). Pin 7 of U1850 connects to the base of Q1125. This transistor inverts the signal from pin 7 to the plug-in compartments.

When the line power goes low or off, pin 13 of U1550 goes low. This action raises pin 7 of U1850 turning off the PWR signal. Pin 7 of U1720A is also low during the 3 second wait state. The cathode of CR1830 is pulled low which turns off the PWR signal.

The soft start feature also controls the PWR signal. This is accomplished through R1821.

When a fault occurs, pin 6 of U1720A goes high. When the fault is removed pin 6 of U1720A goes low causing pin 8 of U1620D to go high. As the voltage at the junction of R1821 and R1820 goes high pin 6 and 2 of U1860 also go high causing the PWR signal to go high.

Main Interface



The various ac and dc supply voltages as specified are available at the rear interface connectors for each plug-in

compartment. Each compartment has a pnp and an npn transistor intended as series pass elements. Connecting pins to these elements are shown on the schematic.

