

# User Manual

**Tektronix**

**TDS 820  
Digitizing Oscilloscope**

**070-8512-01**

Please check for change information at the rear of this manual.

First Printing: February 1993

### Instrument Serial Numbers

Each instrument manufactured by Tektronix has a serial number on a panel insert or tag, or stamped on the chassis. The first letter in the serial number designates the country of manufacture. The last five digits of the serial number are assigned sequentially and are unique to each instrument. Those manufactured in the United States have six unique digits. The country of manufacture is identified as follows:

B010000	Tektronix, Inc., Beaverton, Oregon, USA
E200000	Tektronix United Kingdom, Ltd., London
J300000	Sony/Tektronix, Japan
H700000	Tektronix Holland, NV, Heerenveen, The Netherlands

Instruments manufactured for Tektronix by external vendors outside the United States are assigned a two digit alpha code to identify the country of manufacture (e.g., JP for Japan, HK for Hong Kong, IL for Israel, etc.).

Tektronix, Inc., P.O. Box 500, Beaverton, OR 97077

Printed in U.S.A.

Copyright © Tektronix, Inc., 1993. All rights reserved. Tektronix products are covered by U.S. and foreign patents, issued and pending. The following are registered trademarks: TEKTRONIX, TEK, TEKPROBE, and SCOPE-MOBILE.

## WARRANTY

Tektronix warrants that this product will be free from defects in materials and workmanship for a period of three (3) years from the date of shipment. If any such product proves defective during this warranty period, Tektronix, at its option, either will repair the defective product without charge for parts and labor, or will provide a replacement in exchange for the defective product.

In order to obtain service under this warranty, Customer must notify Tektronix of the defect before the expiration of the warranty period and make suitable arrangements for the performance of service. Customer shall be responsible for packaging and shipping the defective product to the service center designated by Tektronix, with shipping charges prepaid. Tektronix shall pay for the return of the product to Customer if the shipment is to a location within the country in which the Tektronix service center is located. Customer shall be responsible for paying all shipping charges, duties, taxes, and any other charges for products returned to any other locations.

This warranty shall not apply to any defect, failure or damage caused by improper use or improper or inadequate maintenance and care. Tektronix shall not be obligated to furnish service under this warranty a) to repair damage resulting from attempts by personnel other than Tektronix representatives to install, repair or service the product; b) to repair damage resulting from improper use or connection to incompatible equipment; or c) to service a product that has been modified or integrated with other products when the effect of such modification or integration increases the time or difficulty of servicing the product.

**THIS WARRANTY IS GIVEN BY TEKTRONIX WITH RESPECT TO THIS PRODUCT IN LIEU OF ANY OTHER WARRANTIES, EXPRESSED OR IMPLIED. TEKTRONIX AND ITS VENDORS DISCLAIM ANY IMPLIED WARRANTIES OF MERCHANTABILITY OR FITNESS FOR A PARTICULAR PURPOSE. TEKTRONIX' RESPONSIBILITY TO REPAIR OR REPLACE DEFECTIVE PRODUCTS IS THE SOLE AND EXCLUSIVE REMEDY PROVIDED TO THE CUSTOMER FOR BREACH OF THIS WARRANTY. TEKTRONIX AND ITS VENDORS WILL NOT BE LIABLE FOR ANY INDIRECT, SPECIAL, INCIDENTAL, OR CONSEQUENTIAL DAMAGES IRRESPECTIVE OF WHETHER TEKTRONIX OR THE VENDOR HAS ADVANCE NOTICE OF THE POSSIBILITY OF SUCH DAMAGES.**





# Safety

Please take a moment to review these safety precautions. They are provided for your protection and to prevent damage to the digitizing oscilloscope. This safety information applies to all operators and service personnel.

---

## Symbols and Terms

These two terms appear in manuals:

-  statements identify conditions or practices that could result in damage to the equipment or other property.
-  statements identify conditions or practices that could result in personal injury or loss of life.

These two terms appear on equipment:

- *CAUTION* indicates a personal injury hazard not immediately accessible as one reads the marking, or a hazard to property including the equipment itself.
- *DANGER* indicates a personal injury hazard immediately accessible as one reads the marking.

This symbol appears in manuals:



Static-Sensitive Devices

These symbols appear on equipment:



DANGER  
High Voltage



Protective  
ground (earth)  
terminal



ATTENTION  
Refer to  
manual

---

## Specific Precautions

Observe all of these precautions to ensure your personal safety and to prevent damage to either the digitizing oscilloscope or equipment connected to it.

### Power Source

The digitizing oscilloscope is intended to operate from a power source that will not apply more than 250 V rms between the supply conductors or between either supply conductor and ground. A protective ground connection, through the grounding conductor in the power cord, is essential for safe system operation.

### Grounding the Digitizing Oscilloscope

The digitizing oscilloscope is grounded through the power cord. To avoid electric shock, plug the power cord into a properly wired receptacle where earth ground has been verified by a qualified service person. Do this before making connections to the input or output terminals of the digitizing oscilloscope.

Without the protective ground connection, all parts of the digitizing oscilloscope are potential shock hazards. This includes knobs and controls that may appear to be insulators.

### Use the Proper Power Cord

Use only the power cord and connector specified for your product. Use only a power cord that is in good condition.

### Use the Proper Fuse

To avoid fire hazard, use only the fuse specified in the parts list for your product, matched by type, voltage rating, and current rating.

### Do Not Remove Covers or Panels

To avoid personal injury, do not operate the digitizing oscilloscope without the panels or covers.

### Take Antistatic Precautions

Wear an antistatic grounding wrist strap when working with the input connectors on the digitizing oscilloscope.

### Electric Overload

Never apply to a connector on the digitizing oscilloscope a voltage that is outside the range specified for that connector.

## Do Not Operate in Explosive Atmospheres

The digitizing oscilloscope provides no explosion protection from static discharges or arcing components. Do not operate the digitizing oscilloscope in an atmosphere of explosive gases.

1  
2  
3  
4  
5  
6  
7  
8  
9  
10  
11  
12  
13  
14  
15  
16  
17  
18  
19  
20  
21  
22  
23  
24  
25  
26  
27  
28  
29  
30  
31  
32  
33  
34  
35  
36  
37  
38  
39  
40  
41  
42  
43  
44  
45  
46  
47  
48  
49  
50  
51  
52  
53  
54  
55  
56  
57  
58  
59  
60  
61  
62  
63  
64  
65  
66  
67  
68  
69  
70  
71  
72  
73  
74  
75  
76  
77  
78  
79  
80  
81  
82  
83  
84  
85  
86  
87  
88  
89  
90  
91  
92  
93  
94  
95  
96  
97  
98  
99  
100





# Preface

This is the User Manual for the TDS 820 Digitizing Oscilloscope.

The *Getting Started* section familiarizes you with the operation of your digitizing oscilloscope.

*Operating Basics* covers basic principles of the operation of the oscilloscope. These articles help you understand why your instrument works the way it does.

The *Reference* section teaches you how to perform specific tasks. See page 3-1 for a complete list of tasks covered in that section.

The *Appendices* provide an option and accessories listing, product specifications, and other useful information.

---

## Related Manuals

The following documents are related to the use or service of the digitizing oscilloscope.

- The *TDS 820 Programmer Manual* describes using a computer to control the digitizing oscilloscope through the GPIB interface.
- The *TDS TDS 820 Reference* gives you a quick overview of how to operate your digitizing oscilloscope.
- The *TDS 820 Service Manual* provides information for maintaining and servicing your digitizing oscilloscope.

---

## Conventions

In the *Getting Started* and *Reference* sections, you will find various procedures which contain steps of instructions for you to perform. To keep those instructions clear and consistent, this manual uses the following conventions:

- Names of front panel controls and menu labels appear in boldface print.
- Names also appear in the same case (initial capitals, all uppercase, etc.) in the manual as is used on the oscilloscope front panel and menus. Front panel names are all upper case letters, for example, **VERTICAL MENU**, **CH 1**, etc.
- Instruction steps are numbered. The number is omitted if there is only one step.
- When steps require that you make a sequence of selections using front panel controls and menu buttons, an arrow ( → ) marks each transition between a front panel button and a menu, or between menus. Also, when a name is a main menu or side menu item it is clearly indicated: Press **VERTICAL MENU** → **Offset** (main) → **Set to 0 V** (side) → **Position** (main) → **Set to 0 V** (side).

Using the convention just described results in instructions that are graphically intuitive and simplifies procedures. For example, the instruction just given replaces these five steps:

1. Press the front panel button **VERTICAL MENU**.
  2. Press the main menu button **Offset**.
  3. Press the side-menu button **Set to 0 V**.
  4. Press the main menu button **Position**
  5. Press the side menu button **Set to 0 divs**
- Sometimes you may have to make a selection from a popup menu: Press **SHIFT** → **UTILITY** → **System** (main) → **Config** (popup). In this example, you repeatedly press the main menu button **System** until **Config** is highlighted in the pop-up menu.



# Overview

---

## Overview

This section presents a product description, start up information, and four examples discussing the digitizing oscilloscope's basic functions. Use the *At a Glance* section (starting on page 2-3) to help you locate the correct knobs, buttons, and menus.

- *Example 1* teaches you how to reset the digitizing oscilloscope, use the autoset function, and display and adjust waveforms.
- *Example 2* explains how to add, control, and delete multiple waveforms.
- *Example 3* introduces you to the automated measurement system.
- *Example 4* discusses saving and recalling the digitizing oscilloscope's setups.

If you do not perform the examples, use the *Operating Basics* and *Reference* sections to learn about the digitizing oscilloscope's front panel and menu arrangement and specific functions.

# Product Description

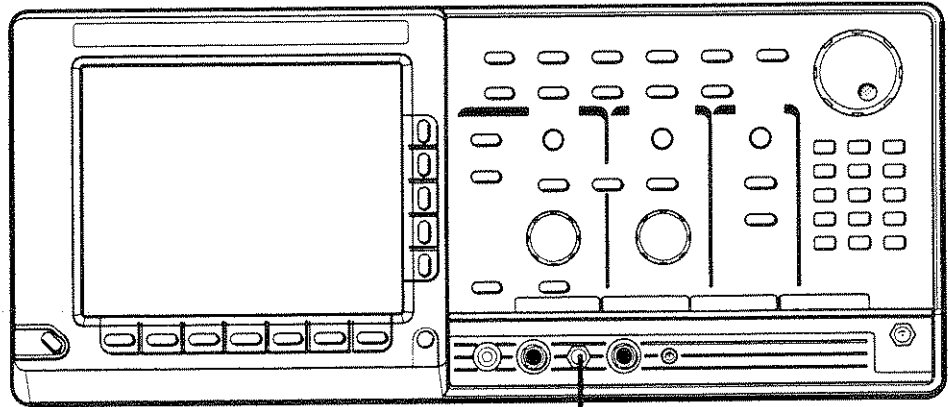

Your Tektronix TDS 800 Digitizing Oscilloscope is a superb tool for acquiring, displaying, and measuring waveforms. Its performance addresses the needs of both benchtop lab and portable applications with:

- 8 GHz maximum repetitive analog bandwidth in TDS 820 Option 1D; 6 GHz in the standard TDS 820.
- Pretrigger view (not available with Option 1D).
- Acquisition channels—The TDS 820 has two. You may use and display all channels simultaneously.
- Two 14-bit digitizers.
- Up to 15,000-point record length per channel.
- Waveform Math—Invert a single waveform and add, subtract, and multiply two waveforms. On option 2F equipped instruments, integrate or differentiate a single waveform or perform an FFT (fast fourier transform) on a waveform to display its frequency spectra.
- Full GPIB software programmability. GPIB hardcopy output. On instruments equipped with option 13, hardcopy output using the RS-232 or Centronics ports.
- Complete measurement and documentation ability.
- Intuitive graphical icon operation blended with the familiarity of traditional horizontal and vertical knobs.
- On-line help at the touch of a button.

The *Appendices* list the options and accessories and the product specifications.



# Start Up

Before you use the digitizing oscilloscope, ensure that it is properly installed and powered on.

---

## Operation

To properly install and power on the digitizing oscilloscope, do the following:

### Installation

1. Be sure you have the appropriate operating environment. Specifications for temperature, relative humidity, altitude, vibrations, and emissions are included in *Appendix B: Specification* at the rear of this manual.
2. Leave space for cooling. Do this by verifying that the air intake and exhaust holes on the sides of the cabinet (where the fan operates) are free of any airflow obstructions. Leave at least 2 inches (5.1 cm) free on each side.

**WARNING**

*To avoid electrical shock, be sure that the power cord is disconnected before checking the fuse.*

3. Check the fuse to be sure it is the proper type and rating (Figure 1-1). You can use either of two fuses. Each fuse requires its own cap (see Table 1-1). The digitizing oscilloscope is shipped with the UL approved fuse installed.
4. Check that you have the proper electrical connections. The digitizing oscilloscope requires 90 to 250 VAC rms, continuous range, 47 Hz to 63 Hz, and may require up to 300 W.
5. Connect the proper power cord from the rear-panel power connector (Figure 1-1) to the power system.

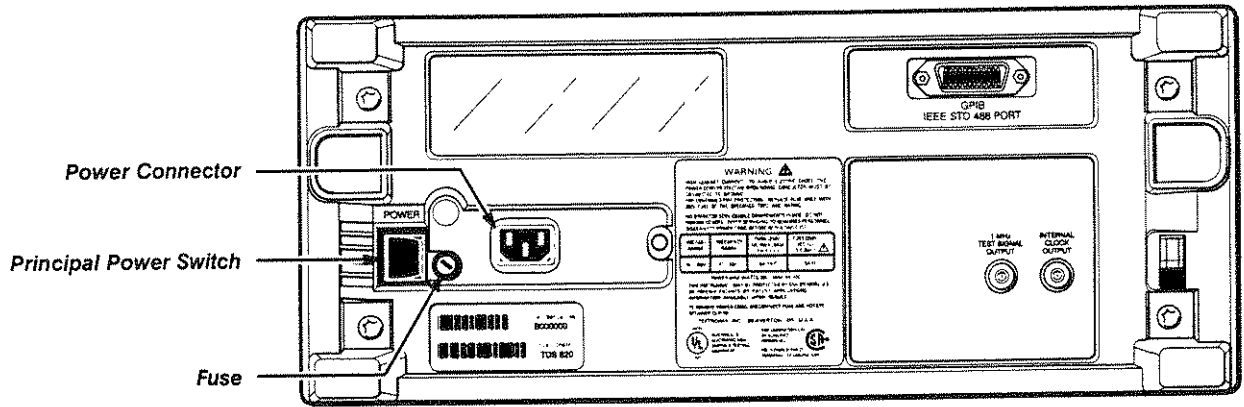

Figure 1-1: Rear Panel Controls Used in Start Up

Table 1-1: Fuse and Fuse Cap Part Numbers

Fuse	Fuse Part Number	Fuse Cap Part Number
.25 inch × 1.25 inch (UL 198.6, 3AG): 6 A FAST, 250 V.	159-0013-00	200-2264-00
5 mm × 20 mm (IEC 127): 5 A (T), 250 V.	159-0210-00	200-2265-00

**Power On**

1. Check that the rear-panel principal power switch is on (Figure 1-1). The principal power switch controls all AC power to the instrument.
2. If the oscilloscope is not powered on (the screen is blank), push the front-panel **ON/STBY** button to toggle it on (Figure 1-2).

The **ON/STBY** button controls power to most of the instrument circuits. Power continues to go to certain parts even when this switch is set to **STBY**.

Once the digitizing oscilloscope is installed, it is typical to leave the principal power switch on and use the **ON/STBY** button as the power switch.

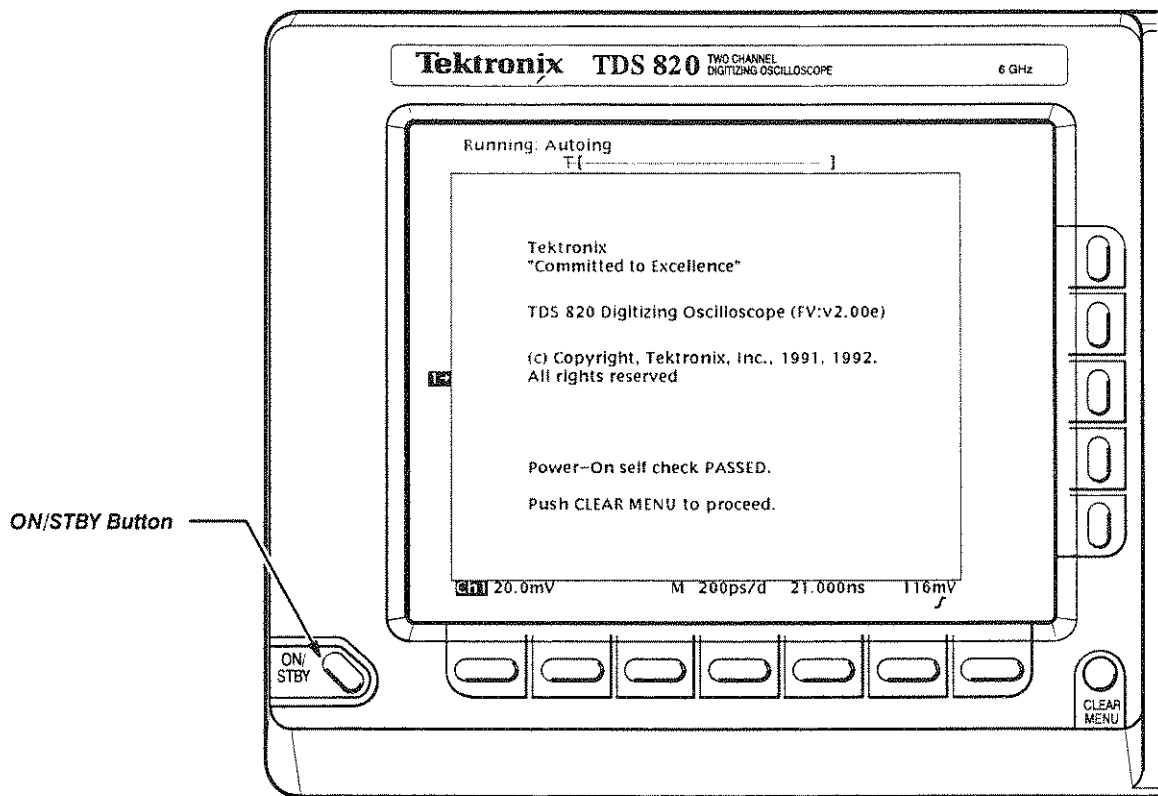

Figure 1-2: ON/STBY Button

### Self Test

Check the self test results. The digitizing oscilloscope automatically performs power-up tests each time it is turned on. It will come up with a display screen that states whether or not it passed self test. (If the self test passes, the status display screen will be removed after a few seconds.)

If the self test fails, call your local Tektronix Service Center. Depending on the type of failure, you may still be able to use the oscilloscope before it is serviced.

### Power Off

Toggle the **ON/STBY** switch to turn off the oscilloscope.

# Setting Up for the Examples

All the examples use the same setup. Once you perform this setup, you do not have to change the signal connections for any of the other examples.

When you finish, the setup should appear as shown in Figure 1-3.

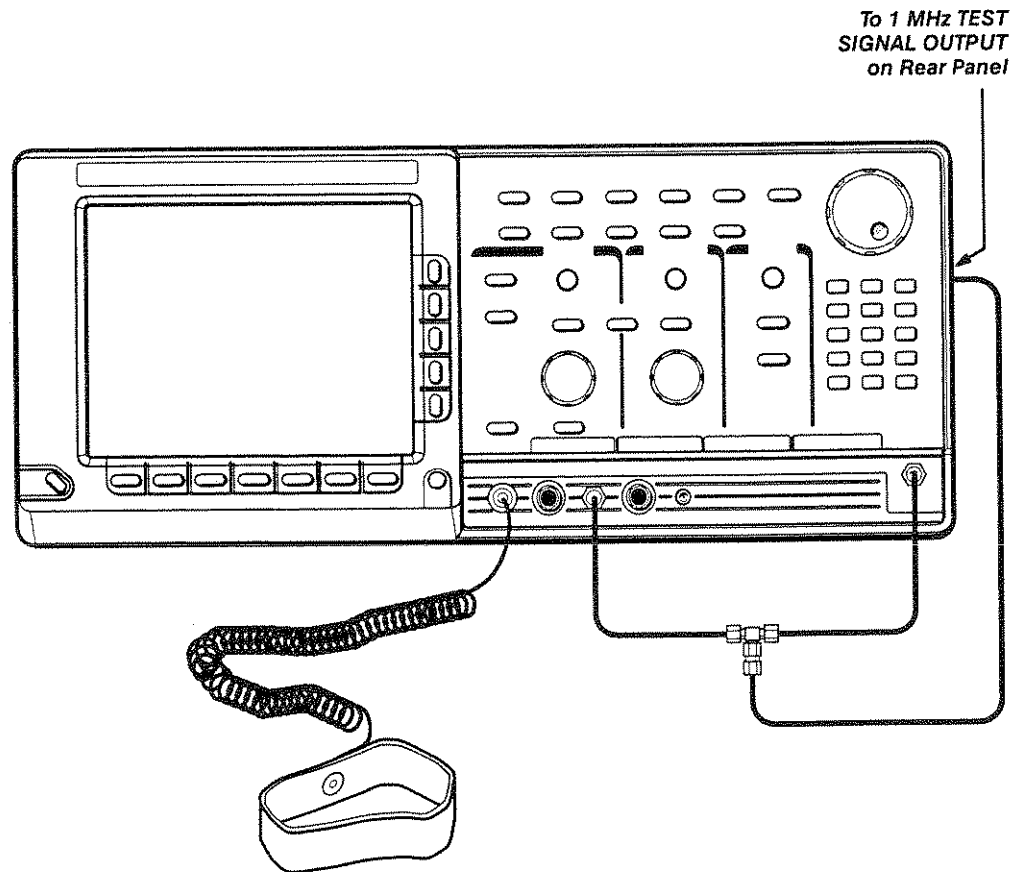

Figure 1-3: The Example Setup

1. Put on the antistatic grounding wrist strap provided.

**CAUTION**

*Be sure to wear the antistatic wrist strap when making connections to the front panel. The front panel input connectors are highly susceptible to damage from electrostatic discharge.*



2. Remove all probes, cables, short-circuit terminations, and signal inputs from the input SMA connectors along the lower part of the front panel.
3. Connect the long SMA cable supplied with the digitizing oscilloscope to the **1 MHz TEST SIGNAL OUTPUT** connector on the rear panel.
4. Connect the front panel **CH 1** SMA connector to one of the two short SMA cables supplied with the digitizing oscilloscope.
5. Connect the front panel external **TRIGGER INPUT** SMA connector to the other short SMA cable supplied with the digitizing oscilloscope.
6. Connect the SMA female-to-female adapter to the male connection in the center of the SMA T supplied with the digitizing oscilloscope.
7. Connect the other end of the SMA cable attached to **CH 1** to one end of the SMA T.
8. Connect the other end of the SMA cable attached to the external **TRIGGER INPUT** to the other end of the SMA T.

#### NOTE

*Splitting the signal using the SMA T does not preserve the 50  $\Omega$  environment. As a result, you will see aberrations of the signal due to this impedance mismatch. The aberrations are of no consequence for the examples. However, to obtain accurate measurements, be sure you split signals using a 50  $\Omega$  power divider to match the impedance of the test setup.*

9. Connect the other end of the long cable attached to the rear panel **1 MHz TEST SIGNAL OUTPUT** connector to the SMA female-to-female adapter.



*To prevent damage to the inputs do not attempt to measure any signals greater than 3 V peak-to-peak with the TDS 820 with Option 1D (6 V peak-to-peak with the standard TDS 820).*



# Example 1: Displaying a Waveform

In this first example you learn about resetting the digitizing oscilloscope, using the autoset function, and displaying and adjusting a waveform.

## Resetting the Digitizing Oscilloscope

All examples begin by resetting the digitizing oscilloscope to a known, factory default state. That is useful when you begin a new task and need to “start fresh” with known default settings.

1. Press the save/recall **SETUP** button to display the Setup menu (Figure 1-4).

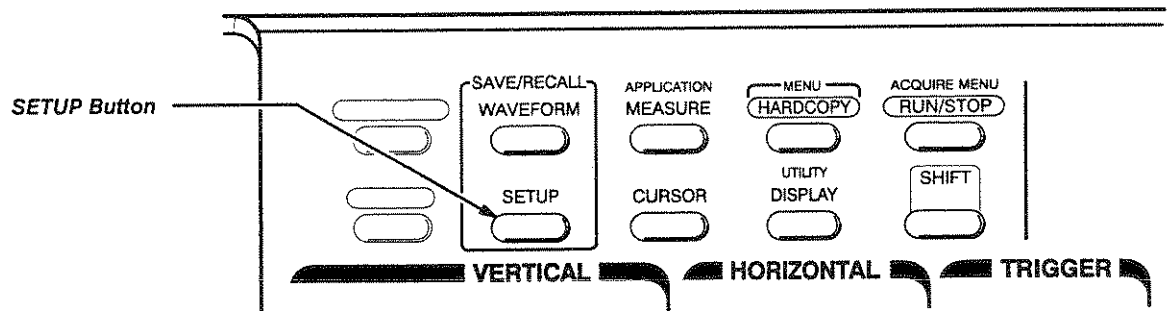

Figure 1-4: Menu Button Locations (Gray Buttons)

The digitizing oscilloscope displays main menus along the bottom of the screen. Figure 1-5 shows the Setup main menu.

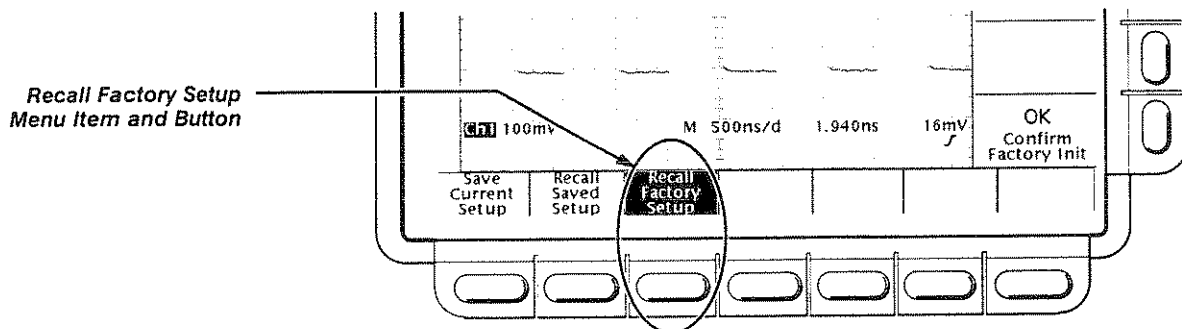

Figure 1-5: The Displayed Setup Menu

To select menu items from a displayed main menu, you press the button below the desired menu item. For example, the third menu item from the left is **Recall Factory Setup**, which is the default factory setup that you want for this example.

2. Press the button directly below the **Recall Factory Setup** menu item.

The display shows side menus along the right side of the screen. The buttons to select these side menu items are to the right of the screen.

Because an accidental instrument reset could destroy a setup that took a long time to create, the digitizing oscilloscope asks you to verify the **Recall Factory Setup** main menu selection (see Figure 1-6).

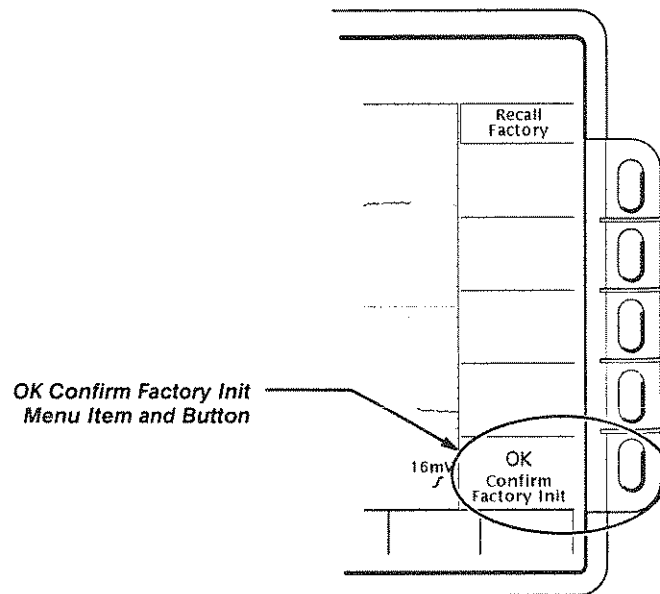

Figure 1-6: The Recall Factory Side Menu

3. Press the button to the right of the **OK Confirm Factory Init** side menu item.

**NOTE**

*This manual uses the following notation to represent the sequence of selections you made in steps 1, 2 and 3: Press save/recall **SETUP** → **Recall Factory Setup** (main) → **OK Confirm Factory Init** (side).*

## Using Autoset

When you first connect a signal to a channel and display it, the signal displayed may not be usable. Use the digitizing oscilloscope's autoset function when that happens and you will quickly get a meaningful display.

For example, the factory default settings are useful for many of the signals you will be viewing with your digitizing oscilloscope. However, they are not appropriate for the rear panel test signal output. You therefore do not have a particularly usable display.

Now use the **AUTOSET** button to quickly get a clear, stable display.

1. Press the **AUTOSET** button (see Figure 1-7) and observe the stable waveform display.

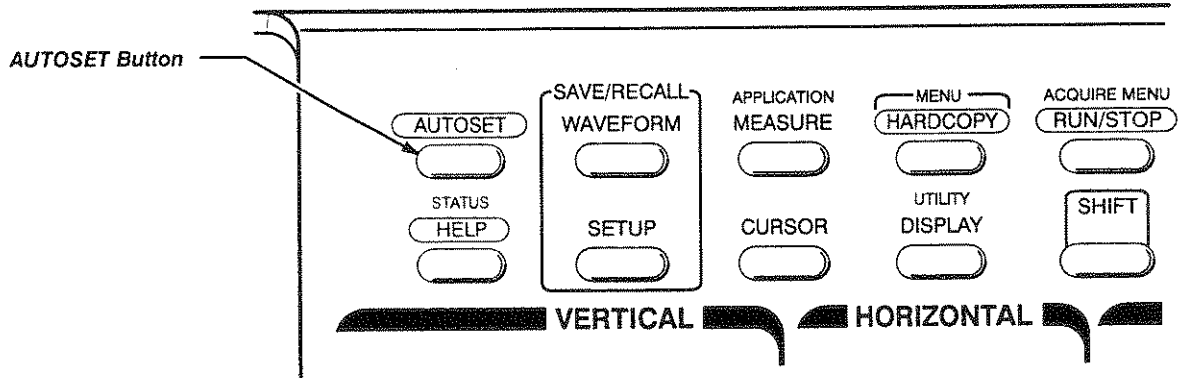

Figure 1-7: AUTOSET Button Location

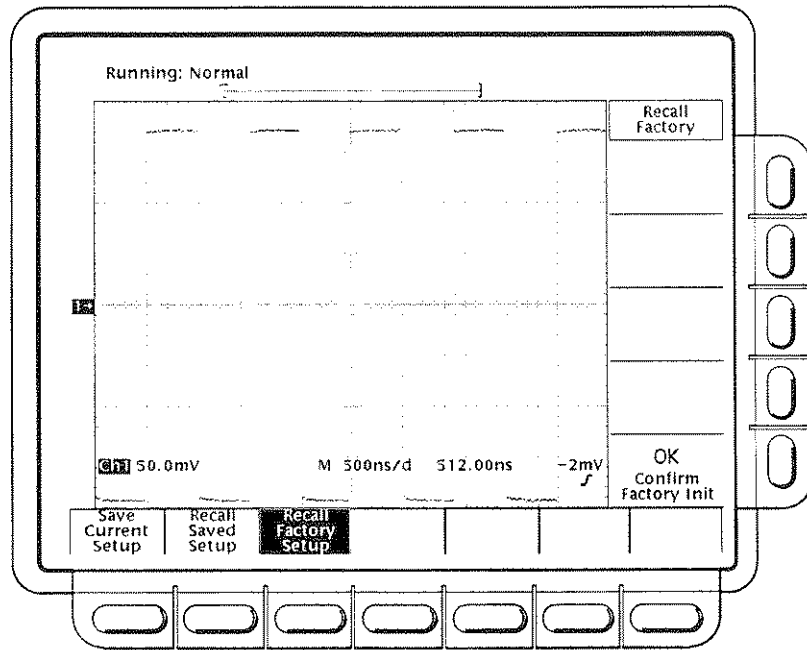

Figure 1-8: The Display After Pressing Factory Initialization and Autoset

Figure 1-8 shows the display after pressing **AUTOSET** for an instrument with delay lines.

#### NOTE

*If you have an instrument without delay lines (TDS 820 Option 1D), your display may appear slightly different, but the following steps will still function as described.*

2. To remove a menu from the display, press the **CLEAR MENU** button below the side menu buttons.

## Display Elements

There are several important points to observe about the digitizing oscilloscope display:

- The channel reference indicator shows the vertical position of channel 1 ground when offset is to 0 V. (Otherwise, it shows ground plus offset.)
- The trigger readout shows that the digitizing oscilloscope is triggering on a rising edge. It also indicates the trigger level.
- The time base position readout shows the value of the main time base position (the time from the trigger to the first sample).

## Example 1: Displaying a Waveform

- The time base readout shows that the time base is showing a horizontal scale of 500 ns/div. The “M” indicates that it is the main time base. A “D” indicates a delayed time base.
- The channel readout indicates that channel 1 (Ch1) is selected. Its vertical scale is also displayed. The digitizing oscilloscope always displays channel 1 at reset.

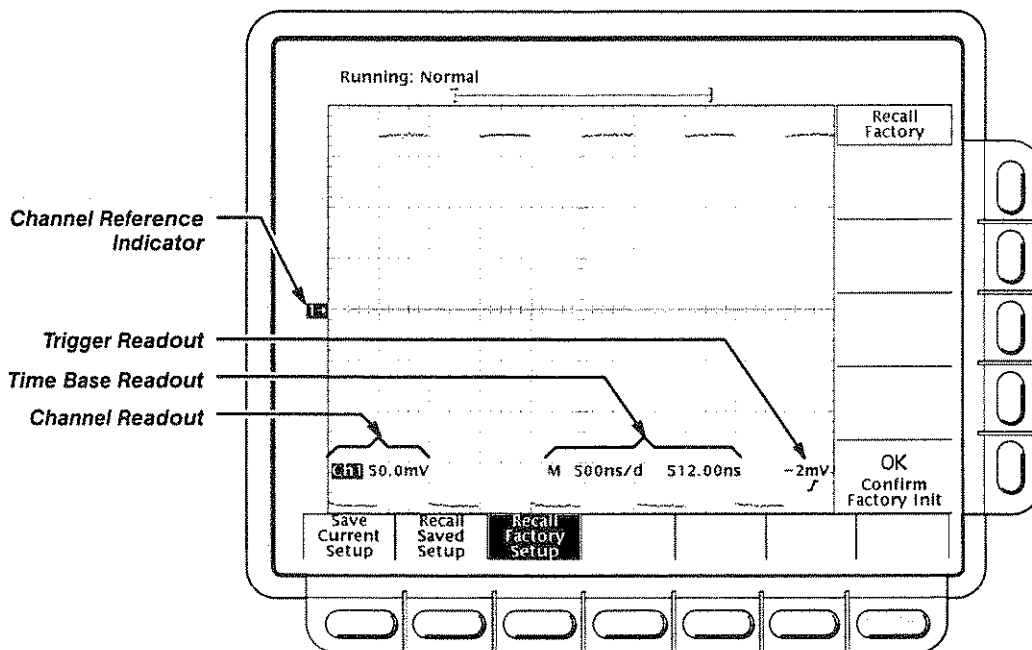

Figure 1-9: Display Elements

When a menu is displayed, the channel, time base, and trigger readouts appear in the graticule area. After you press the **CLEAR MENU** button, the readouts move below the graticule.

## Adjusting the Display

After factory initialization, the display is in dots mode. You can adjust various display parameters using the **DISPLAY** button, which brings up the display menu (Figure 1-10).

1. Press the **DISPLAY** button.

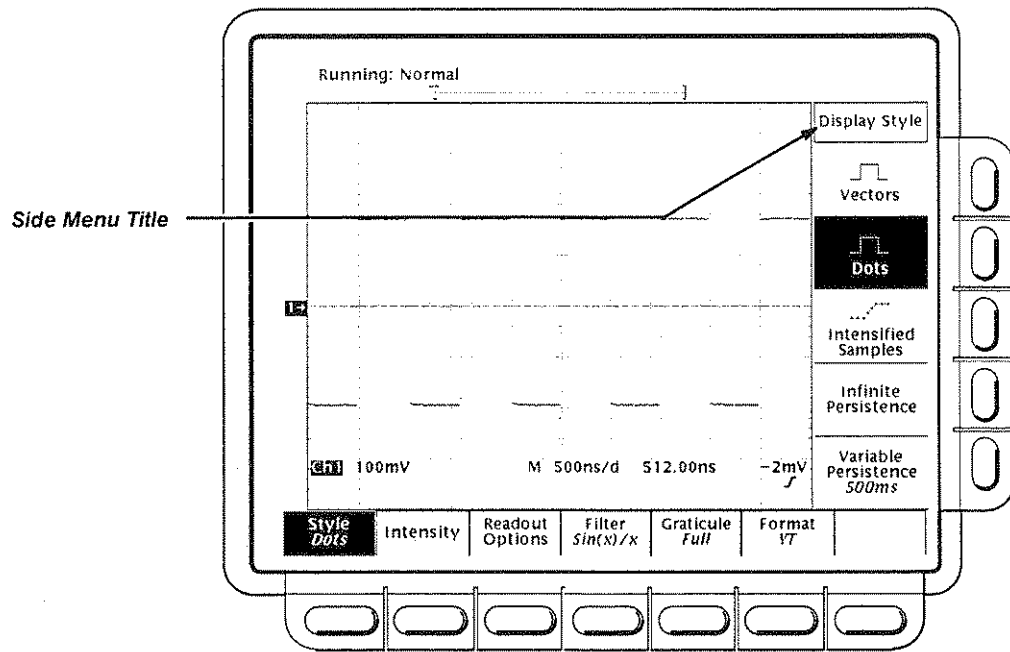

Figure 1-10: The Display Main Menu and Style Side Menu

Each menu item in the Display menu shows a side menu. Right now, the **Style** item in the main menu is highlighted, which means that the side menu shows the style choices. (If it is not, press the **Style** menu button to display them.)

2. Press the **Vectors** button on the side menu. Observe that the display switches from dots (the factory default setting) to vectors.

## Adjusting the Waveform Display

The display shows the rear panel test signal. It is a 1 MHz square wave of approximately 300 mV amplitude. To adjust the size and placement of the waveform use the front-panel knobs.

Figure 1-11 shows the main **VERTICAL** and **HORIZONTAL** sections of the front panel. Each section has **SCALE** and **POSITION** knobs.

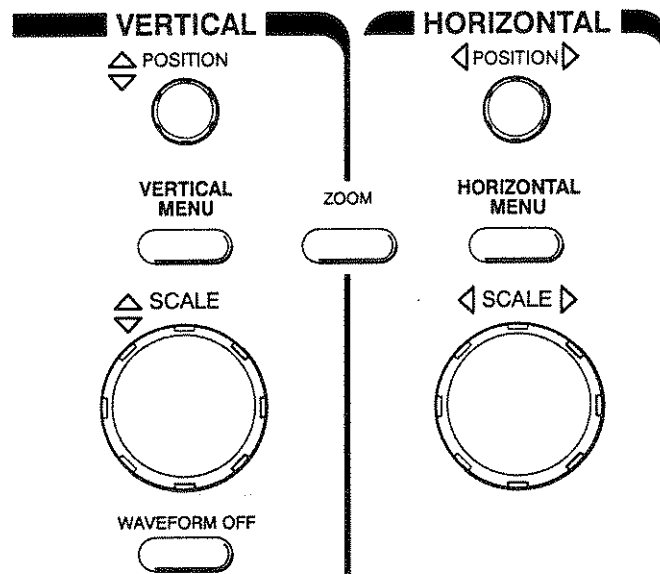

Figure 1-11: The VERTICAL and HORIZONTAL Controls

1. Turn the vertical **SCALE** knob a few clicks in first one direction, then the other. Observe the change in the displayed waveform and the channel readout at the bottom of the display.
2. Turn the vertical **POSITION** knob in first one direction, then the other. Observe the change in the displayed waveform. Then return the waveform to the center of the graticule.

Hint: To make large changes quickly with the position knob, press the **SHIFT** button before turning the knob. When the light above the **SHIFT** button is illuminated and the display says **Coarse Knobs** in the upper-right corner, the knob speeds up significantly.

3. Turn the horizontal **SCALE** knob one click clockwise. Observe the time base readout at the bottom of the display. The time base should be set to 200 ns/div now, and you should see two complete waveform cycles on the display.





## Example 2: Multiple Waveforms

In this example you learn how to display and control more than one waveform at a time.

1. If you are not continuing from the previous example, follow the instructions on page 1-6 under the heading "Setting Up for the Examples."
2. Reset the digitizing oscilloscope. (Press **SETUP** → **Recall Factory Setup** (main) → **OK Confirm Factory Init** (side).)
3. Press the **AUTOSET** button.

---

### Adding a Waveform

The **VERTICAL** section of the front panel contains the channel selection buttons. On the TDS 820 these are **CH 1**, **CH 2**, and **MORE** (Figure 1-12).

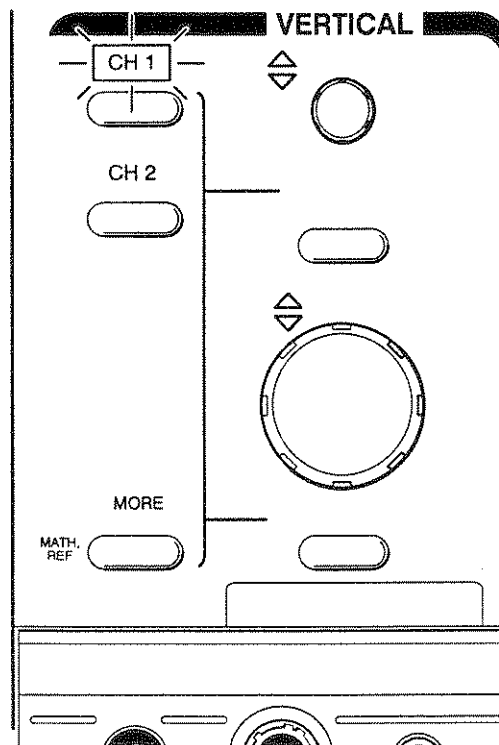

Figure 1-12: The Channel Buttons and Lights

Each of the channel (**CH**) buttons has a light above its label. Right now, the **CH 1** light is on. That indicates that the vertical controls are set to adjust channel 1.

4. Press **CH 2**.

The display shows a second waveform, which represents the signal on channel 2 superimposed on the first waveform.

There are several other important things to observe:

- The channel readout on the display now shows the settings for both **Ch1** and **Ch2**.
  - There are two channel indicators at the left edge of the graticule. Right now, they overlap.
  - The light next to the **CH 2** button is now on and the **CH 1** light is off. Because the knobs control only one channel at a time, the vertical controls are now set to adjust channel 2.
  - The trigger is still detecting trigger events from the external **TRIGGER INPUT**. This has not changed by your adding a channel. (You can change the trigger source by using the **TRIGGER MENU** button to display the trigger menu.)
5. Turn the vertical **POSITION** knob clockwise to move the channel 2 waveform up on the graticule. You will notice that the channel ground reference indicator for channel 2 moves with the waveform.
  6. Now press **AUTOSET** again. You will see the two waveforms, channel 2 below channel 1, sized appropriately so that they are both entirely visible on the display. Channel 1 becomes the selected waveform.
  7. Press the **VERTICAL MENU** button.

The **VERTICAL MENU** button displays a menu that gives you control over many vertical channel parameters (Figure 1-13). Although you can display more than one channel, the vertical menu and buttons only adjust the selected channel.

Each menu item in the Vertical menu displays a side menu. Right now, the **Offset** item in the main menu is highlighted, which means that the side menu shows the vertical offset choices. (Press the **Offset** (main) button if it is not.) At the top of the side menu, the menu title shows the channel affected by the menu choices. It always matches the lighted channel button.

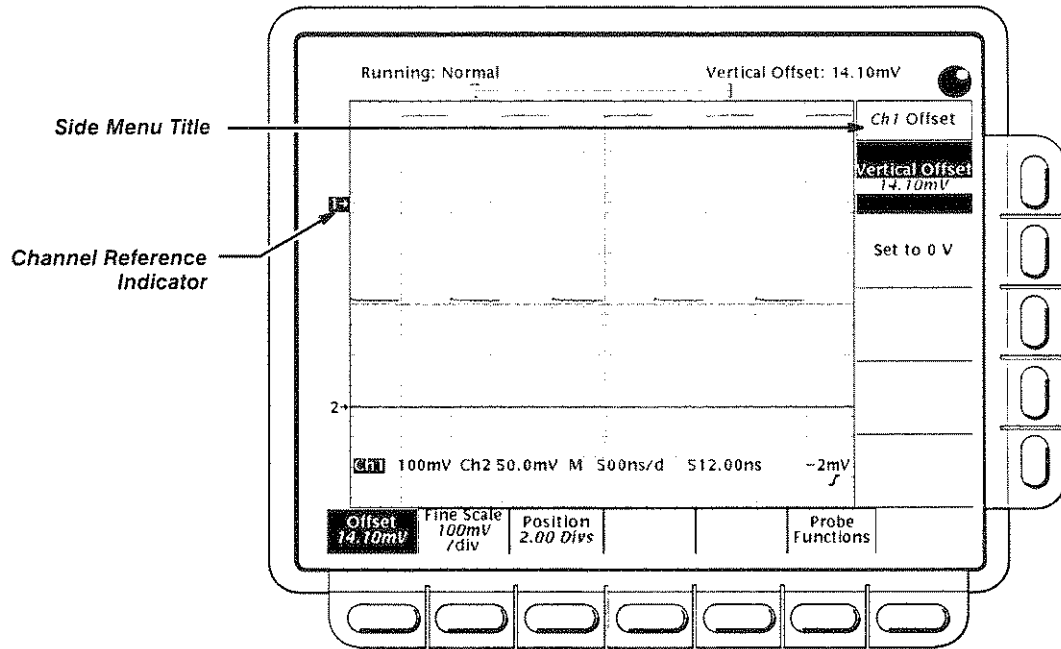

Figure 1-13: The Vertical Main Menu and Offset Side Menu

8. Press the side menu item that sets the vertical offset to 0 V. This changes the vertical offset for channel 1.

## Changing Controls to Another Channel

Pressing a channel (**CH**) button sets the vertical controls to that channel. It also adds the channel to the display if that waveform is not already displayed.

1. Press the **CH 2** button in the vertical section of the front panel.

Observe that now the side menu title shows **Ch2** and that the light above **CH 2** is lighted (Figure 1-14). The highlighted menu item in the side menu has changed from the vertical offset channel 1 setting to the vertical offset setting of channel 2.

Because channel 2 has no signal, **AUTOSET** may have chosen an inappropriately sensitive vertical scale setting, and you may see random noise. To reduce this random noise, turn the vertical scale knob counter-clockwise until channel 2 appears as you would like.

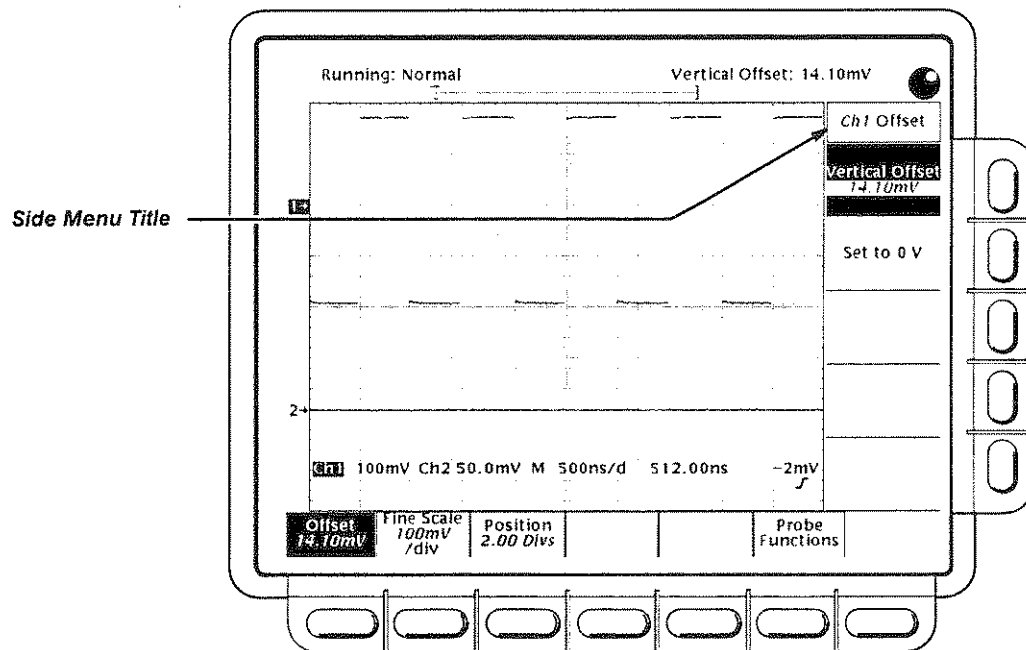

Figure 1-14: The Menus After Changing Channels

2. Press **Fine Scale** (main) to adjust the channel 2 vertical scale.
3. Use the numeric keypad to set the vertical scale to 125 mV per division. Enter **125**, then **SHIFT**, then **m** (the shifted **9** key). Then press **ENTER**.

## Removing a Waveform

You use a two-step process to remove waveforms from the display. First, select the channel using the channel (**CH**) button. Second, press the **WAVEFORM OFF** button.

4. Press the **WAVEFORM OFF** button (see Figure 1-15).

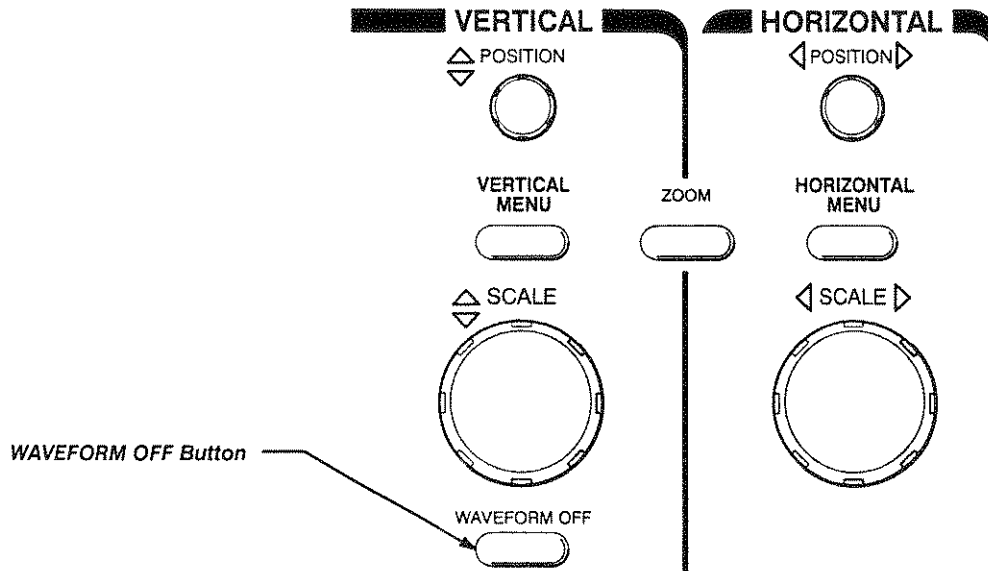

Figure 1-15: WAVEFORM OFF Button Location

Because the **CH 2** light was on when you pressed the **WAVEFORM OFF** button, the oscilloscope removed the channel 2 waveform.

The channel (**CH**) lights now indicate channel 1. Channel 1 has become the selected channel.

5. Press the **WAVEFORM OFF** button again to remove channel 1's waveform.

When you remove the last waveform, all the **CH** lights turn off.



## Example 3: Automated Measurements

In this example you learn how to use the automated measurement system to get numeric readouts of important waveform characteristics.

1. If you are not continuing from the previous example, follow the instructions on page 1-6 under the heading "Setting Up for the Examples."
2. Reset the digitizing oscilloscope. (Press the **SETUP** → **Recall Factory Setup** (main) → **OK Confirm Factory Init** (side).)
3. Press the **AUTOSET** button.

### Displaying Automated Measurements

To use the automated measurement system, you must have a stable display of your signal. Also, the waveform must have all the segments necessary for the measurement you want. For example, a rise time measurement requires at least one rising edge and a frequency measurement needs at least one complete cycle.

1. Press **MEASURE** to display the Measure main menu (see Figure 1-16).

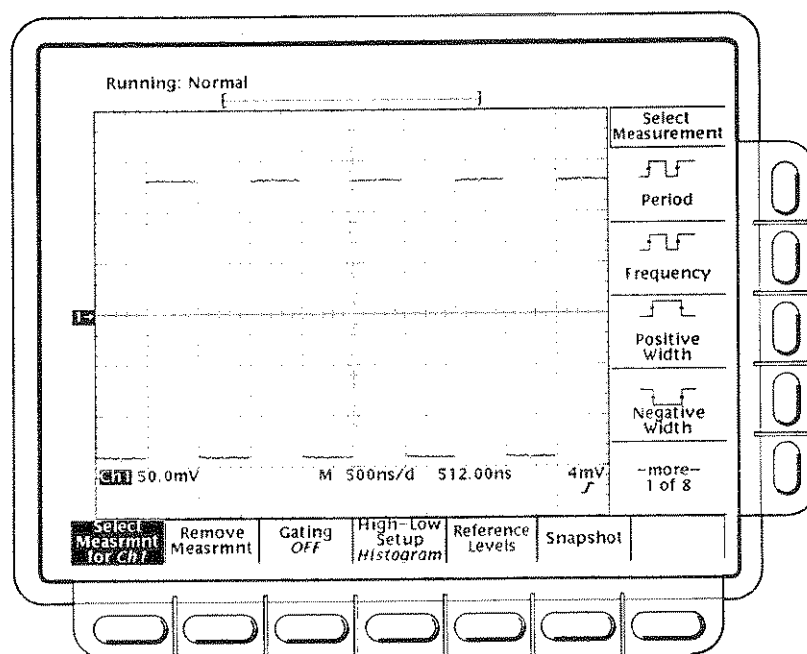

Figure 1-16: Measure Main Menu and Select Measurement Side Menu

2. If it is not already selected, press **Select Measrmt** (main). The readout for that menu item indicates which channel the measurement will be taken from. All automated measurements are made on the selected channel.

The right side of the display shows the Select Measurement side menu. That menu lists some of the possible waveform measurements.

There are many different measurements available. You can select up to four measurements to be taken and displayed at any one time. Pressing the button next to the **–more–** menu item brings up the other measurement selections.



3. Press **Frequency** (side). If the **Frequency** menu item is not visible, press the **–more–** (side) repeatedly until the **Frequency** item appears. Then press **Frequency** (side).

Observe that the frequency measurement appears within the right side of the graticule area. The measurement readout includes the notation **Ch1**, meaning that that measurement is taken on the channel 1 waveform. (To take a measurement on another channel, you would select that channel and then select the measurement.)

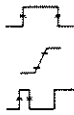

4. Press **Positive Width** (side) → **–more–** (side) → **Rise time** (side) → **Positive Duty Cycle** (side).

**NOTE**

*If the instrument displays the words "Low Resolution" under the rise time readout, it cannot take enough samples on the leading edge of the waveform to ensure accuracy. Use a faster time per division setting to correct the problem.*

Observe that all four measurements are displayed. Right now, they cover a part of the graticule area, including the displayed waveforms.

5. To move the measurement readouts outside the graticule, press **CLEAR MENU** (Figure 1-17).

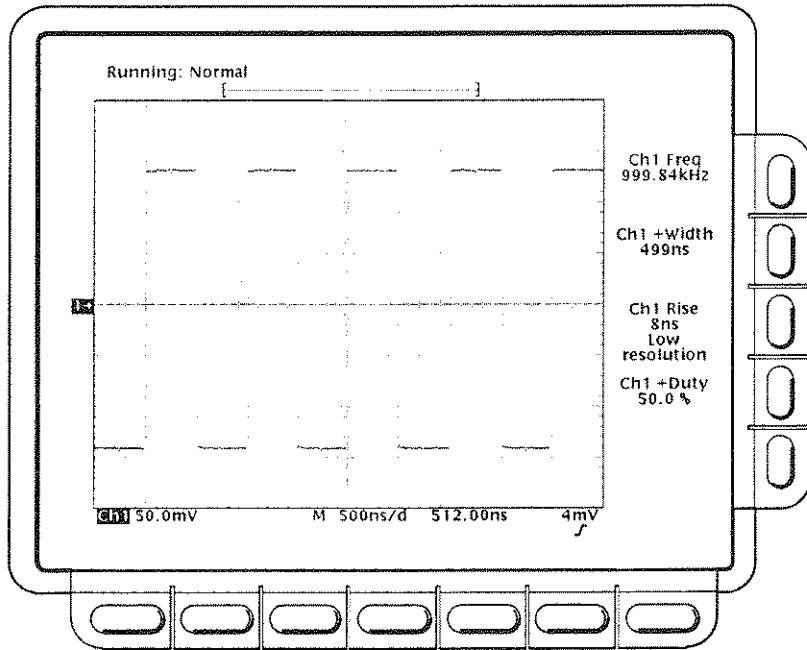

Figure 1-17: Four Simultaneous Measurement Readouts

---

## Removing Measurement Readouts

The Measure menu lets you remove measurements you no longer want displayed. You can remove any one measurement or you can remove them all with a single menu item.

Press **MEASURE** → **Remove Measrmt** (main) → **Measurement 1**, **Measurement 2**, and **Measurement 4** (side) to remove those measurements. Leave the rise time measurement displayed.

---

## Changing the Measurement Reference Levels

*f*

By default, the measurement system will use the 10% and 90% levels of the waveform for taking the rise time measurement. You can change these values to other percentages, or change them to absolute voltage levels.

To examine the current values, press the **Reference Levels** (main) → **High Ref** (side).

## The General Purpose Knob

The general purpose knob, the large knob with the indentation, is now set to adjust the high reference level (Figure 1-18).



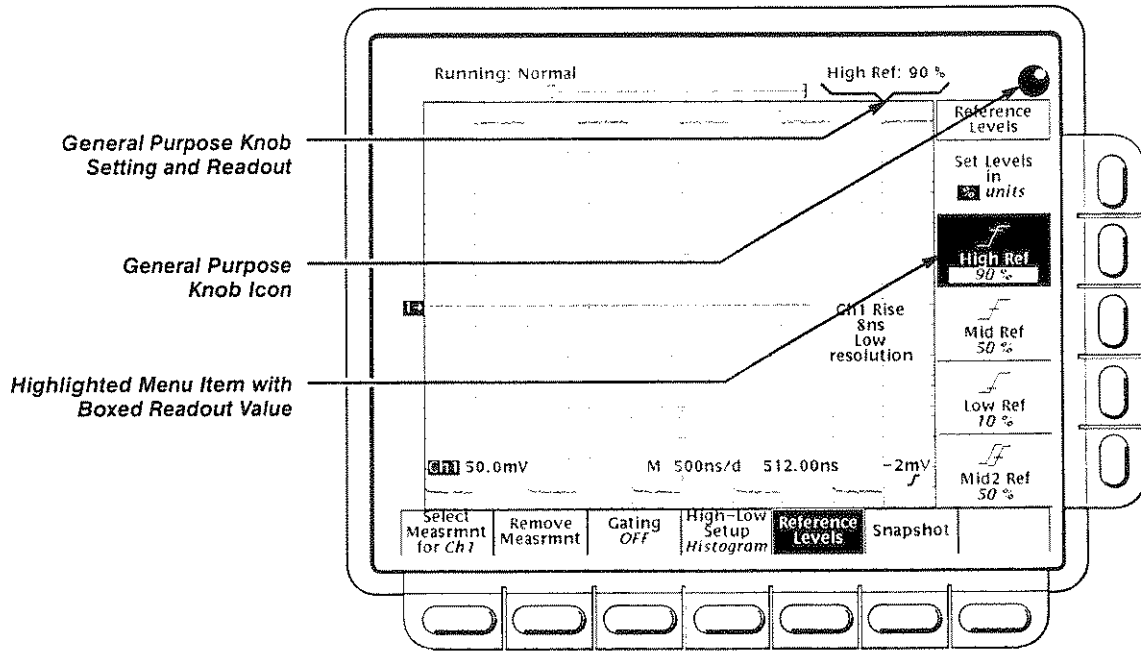

Figure 1-18: General Purpose Knob Indicators

There are several important things to observe on the screen:

- The knob icon appears at the top of the screen. That indicates that the general purpose knob can adjust a parameter.
- The upper right corner of the screen shows the readout **High Ref: 90%**.
- The **High Ref** side menu item is highlighted and a box drawn around the 90% readout in the **High Ref** menu item. The box indicates that the general purpose knob can adjust that parameter.

Turn the general purpose knob left and right, and then use it to adjust the high level to 80%. That sets the high measurement reference to 80%.

Hint: To make large changes quickly with the general purpose knob, press the **SHIFT** button before turning the knob. When the light above the **SHIFT** button is illuminated and the display says **Coarse Knobs** in the upper-right corner, the general purpose knob speeds up significantly.

### The Numeric Keypad

Any time the general purpose knob can adjust a parameter, instead of using the knob you can enter the value as a number using the keypad. Always end the entry of a number by pressing the **ENTER** (↵) button.

The numeric keypad also provides multipliers for engineering exponents, such as **m** for milli, **M** for mega, and **μ** for micro. To enter these multiplier values, press the **SHIFT** button, then press the multiplier.

1. Press **Low Ref** (side).

### Example 3: Automated Measurements

2. On the numeric keypad, press the **2** button, the **0** button, and the **ENTER** (↵) button.

This step sets the low measurement reference to 20%. Observe that the rise time value has changed.

Now you want to return the display to its original state.

3. Press **Remove Measrmt** (main) → **All Measurements** (side).



## Example 4: Saving Setups

This example shows you how to save all the settings of the digitizing oscilloscope and how to recall the setup later to quickly reestablish the previously saved state. The oscilloscope provides 10 storage locations where you can save the setups.

Besides being able to save several complete setups, the digitizing oscilloscope saves all the parameter settings when you power off. That feature lets you power on and continue where you stopped without having to reconstruct the state of the digitizing oscilloscope.

1. If you are not continuing from the previous example, follow the instructions on page 1-6 under the heading "Setting Up for the Examples."
2. Reset the digitizing oscilloscope. (Press **SETUP** → **Recall Factory Setup** (main) → **OK Confirm Factory Init** (side).)
3. Press the **AUTOSET** button.

---

### Saving a Setup



In this example you first need to create an instrument setup you want to save. The next several steps establish a display with a measurement on one waveform. That setup is complex enough that you would prefer not to go through all these steps each time you want that display.

1. Press **MEASURE** → **Select Measrmnt** (main) → **Frequency** (side). (Press the **—more—** side menu item if the **Frequency** selection does not appear in the side menu.)
2. Press the **CLEAR MENU** button.

Once you have established an instrument setup, you can save it in any of several setup locations.

#### NOTE

*The next step asks you to save a setup in a setup location of your choice. If you work in a laboratory environment where several people share the digitizing oscilloscope, check with the other users to be certain the setup location you are using is not already being used by someone else.*

3. Press the **SETUP** button to display the Setup main menu (see Figure 1-19). Press the **Save Current Setup** main menu button.

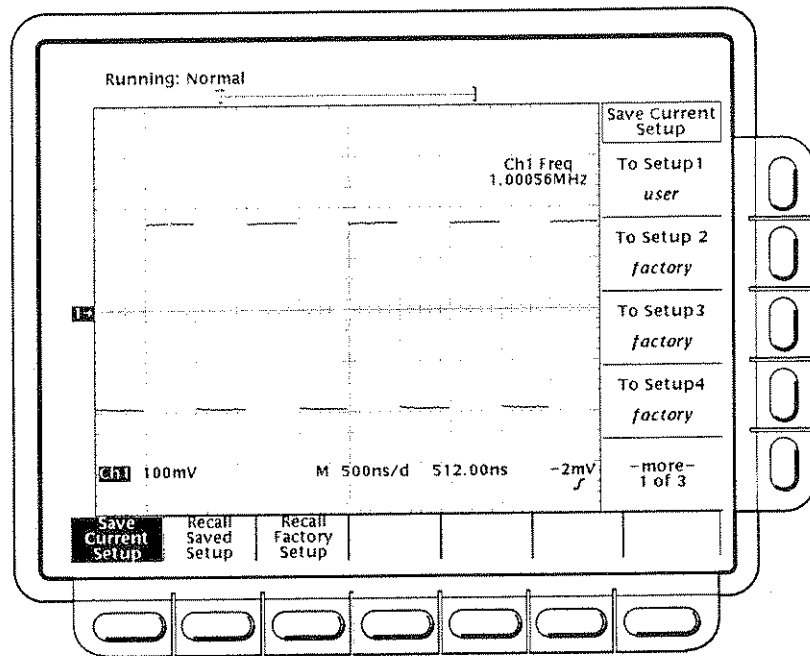

Figure 1-19: Save/Recall Setup Menu

4. To store the current instrument settings into that setup location, press one of the **To Setup** side menu buttons.

There are more setup locations than can be listed at one time in the side menu. The **-more-** side menu item gives you access to all the setup locations.

Once you have saved a particular setup, you can change the settings as you wish, knowing that you can come back to that setup at any time.



5. Press the **MEASURE** button to display the Measure main menu. Select the **Positive Width** side menu item to add that measurement to the display.

## Recalling a Setup

To recall the setup, press **SETUP** → **Recall Saved Setup** (main) → **Recall Setup** (side) for the setup location you used in Step 4. The oscilloscope returns to the setup you saved in Step 4. The positive width measurement is now removed from the display because you selected it after you saved the setup.

This completes the examples. You can restore the default settings by pressing **SETUP** → **Recall Factory Setup** (main) → **OK Confirm Factory Init** (side).

# Overview

This section describes the basic concepts of operating the digitizing oscilloscope. Understanding the basic concepts of your digitizing oscilloscope will help you use it much more effectively.

*At a Glance*, quickly shows you how the oscilloscope is organized and gives some very general operating instructions. It also contains an overview of all the main menus. This part includes:

- Front Panel Map
- Rear Panel Map
- Display Map
- Basic Menu Operation
- Menu Map

Following *At a Glance* the following concepts are explained:

- The **triggering** system, which establishes conditions for acquiring signals. Properly set, triggers can convert displays from unstable jumbles or blank screens into meaningful waveforms (Figure 2-1). See page 2-13.

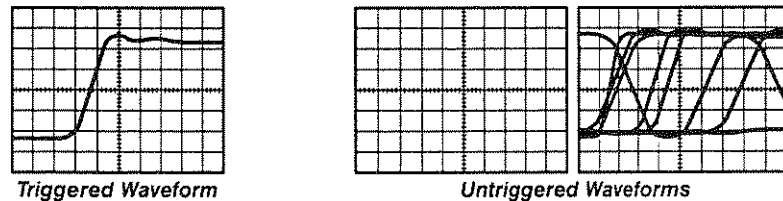

Figure 2-1: Examples of Triggered Waveforms

- The **acquisition** system, which lets you select the modes for converting analog data into digital form (Figure 2-2). See page 2-17.



Figure 2-2: Acquisition: Input Analog Signal, Sample, and Digitize

- The **waveform scaling and positioning** system, which changes the dimensions of the waveform display. Scaling waveforms involves increasing or decreasing their displayed size (Figure 2-3). Positioning means moving them up, down, right, and left on the display. See page 2-21.

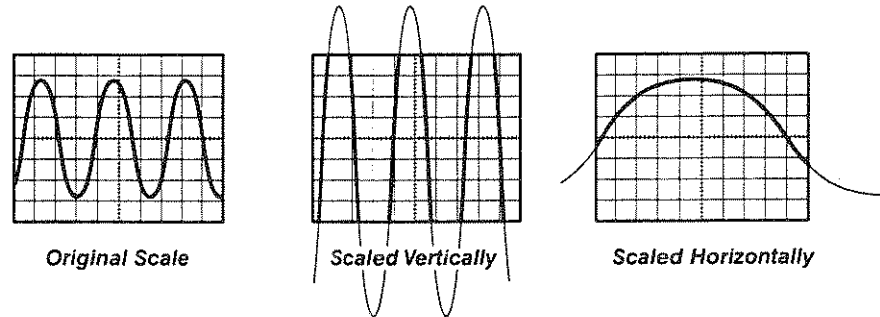

Figure 2-3: Examples of Scaling

- The **measurement** system, which provides numeric information on the displayed waveforms. There are three measurement classes: graticule, cursor, and automated (Figure 2-4). See page 2-25.

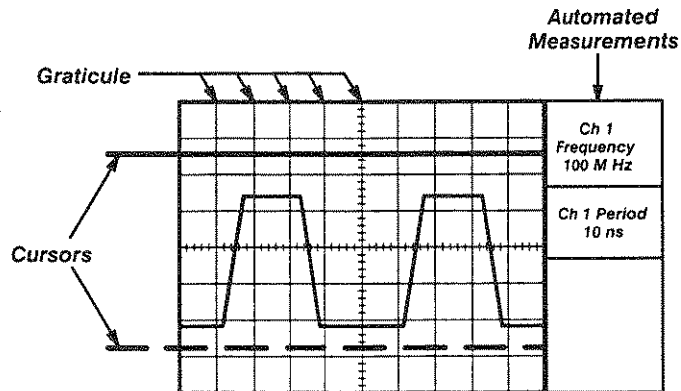

Figure 2-4: Examples of Three Measurement Classes



# At a Glance

*At a Glance* contains maps of the display, front and rear panels, and menu system. These maps will help you understand and operate the digitizing oscilloscope. This part also contains a visual guide to using the menu system. For more information see the pages referenced in the maps.

- *Front Panel Map* shows the locations and describes the purposes of the various buttons and knobs on the front panel of the digitizing oscilloscope.
- *Rear Panel Map* shows the various parts of your instrument rear panel.
- *Display Map* shows a typical display and explains the various icons and menus you might see.
- *To Operate a Menu* shows how to select and use menus including pop-ups.
- *Menu Map* shows each of the main menus (the menus that appear on the bottom of the display) and the buttons that access them.

# Front Panel Map — Left Side

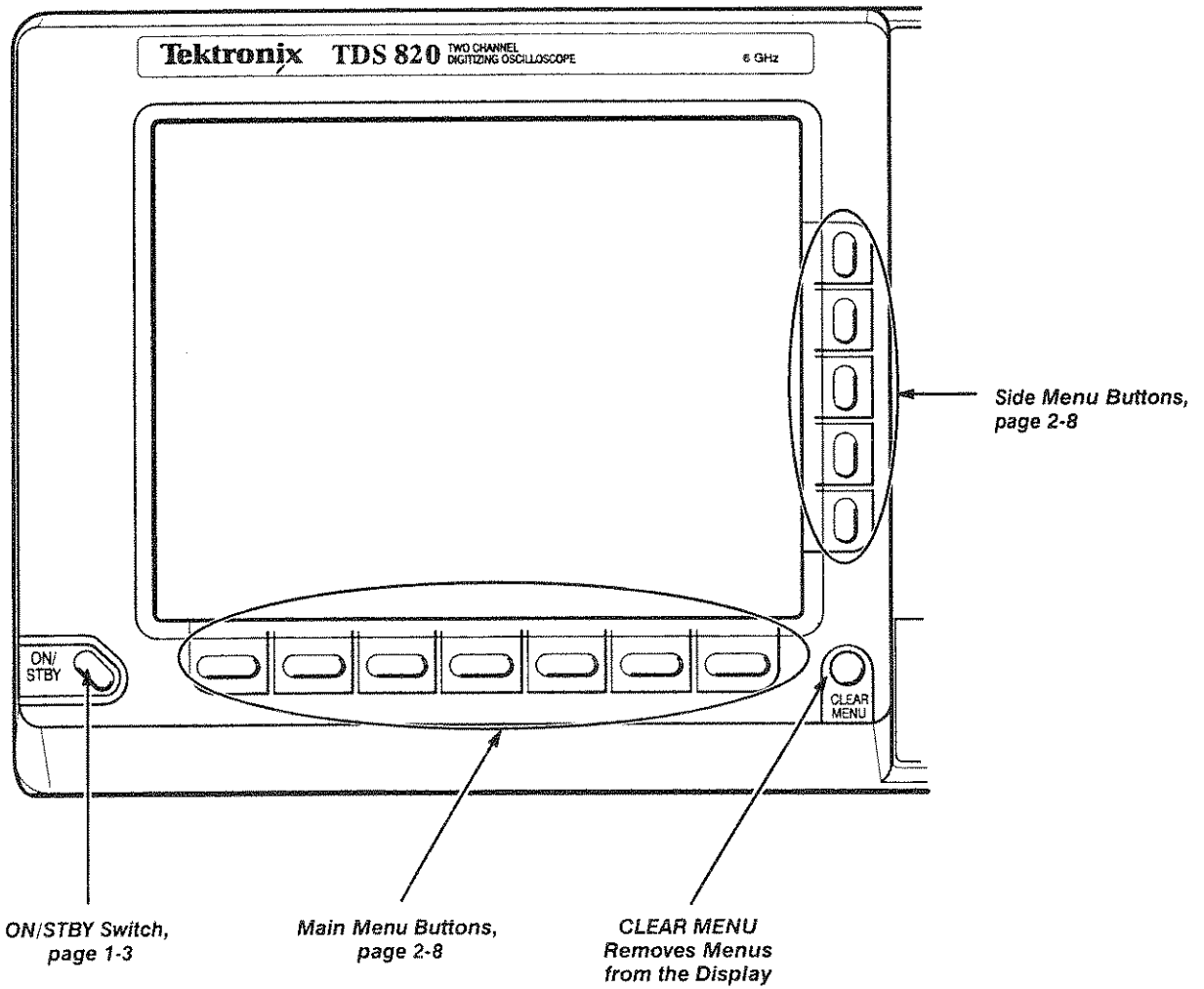



# Front Panel Map — Right Side

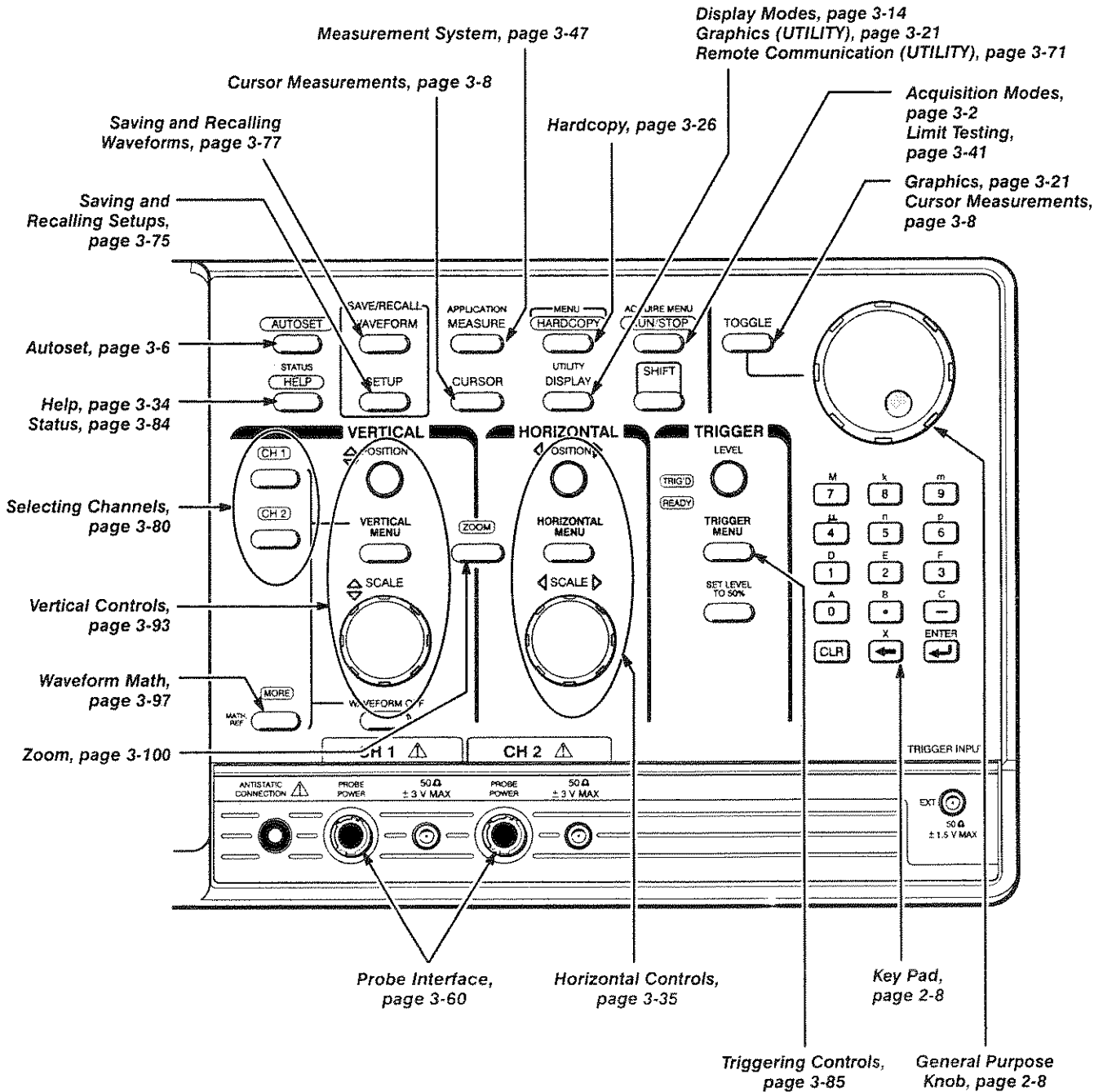

# Rear Panel Map

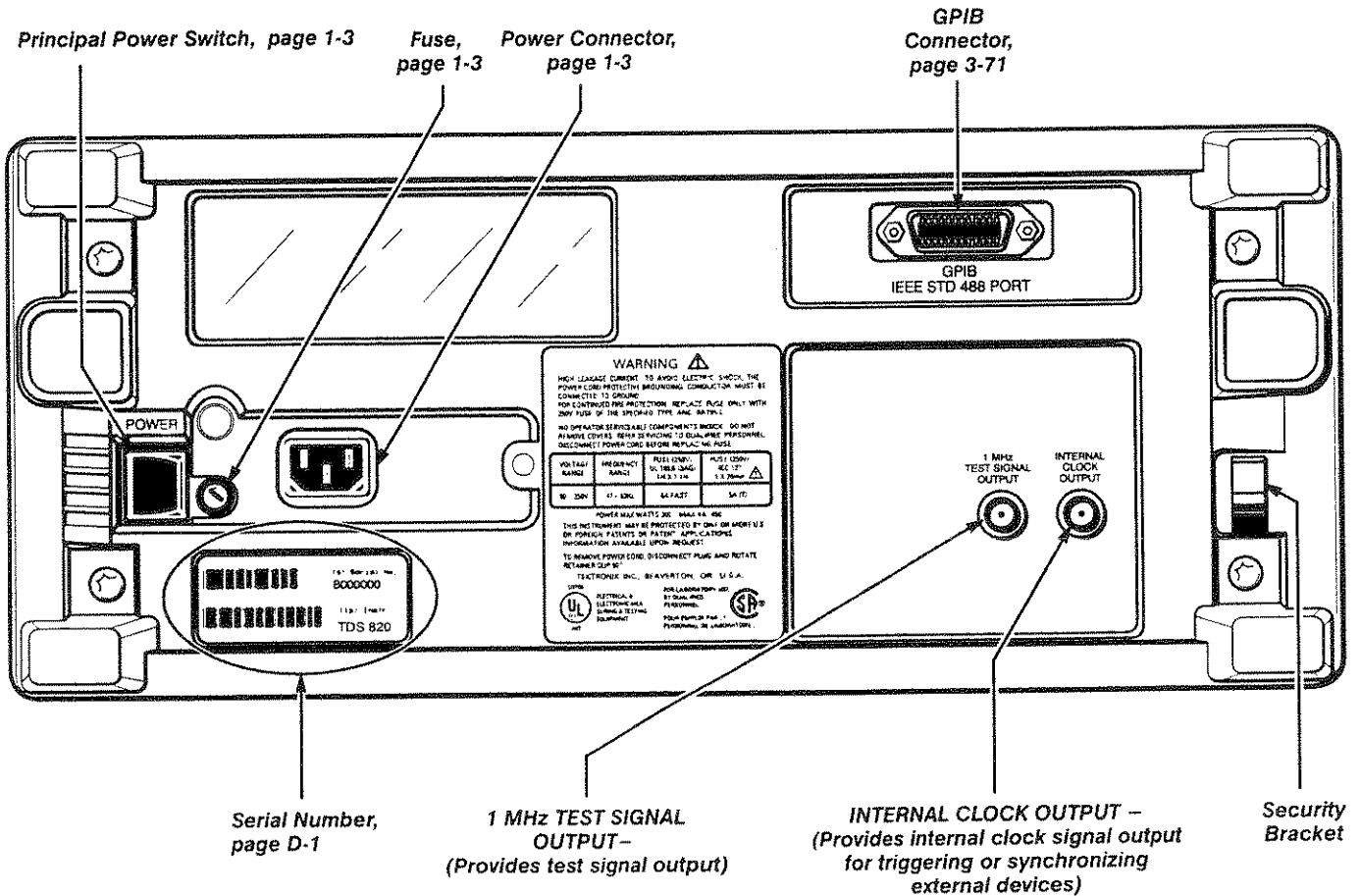

# Display Map

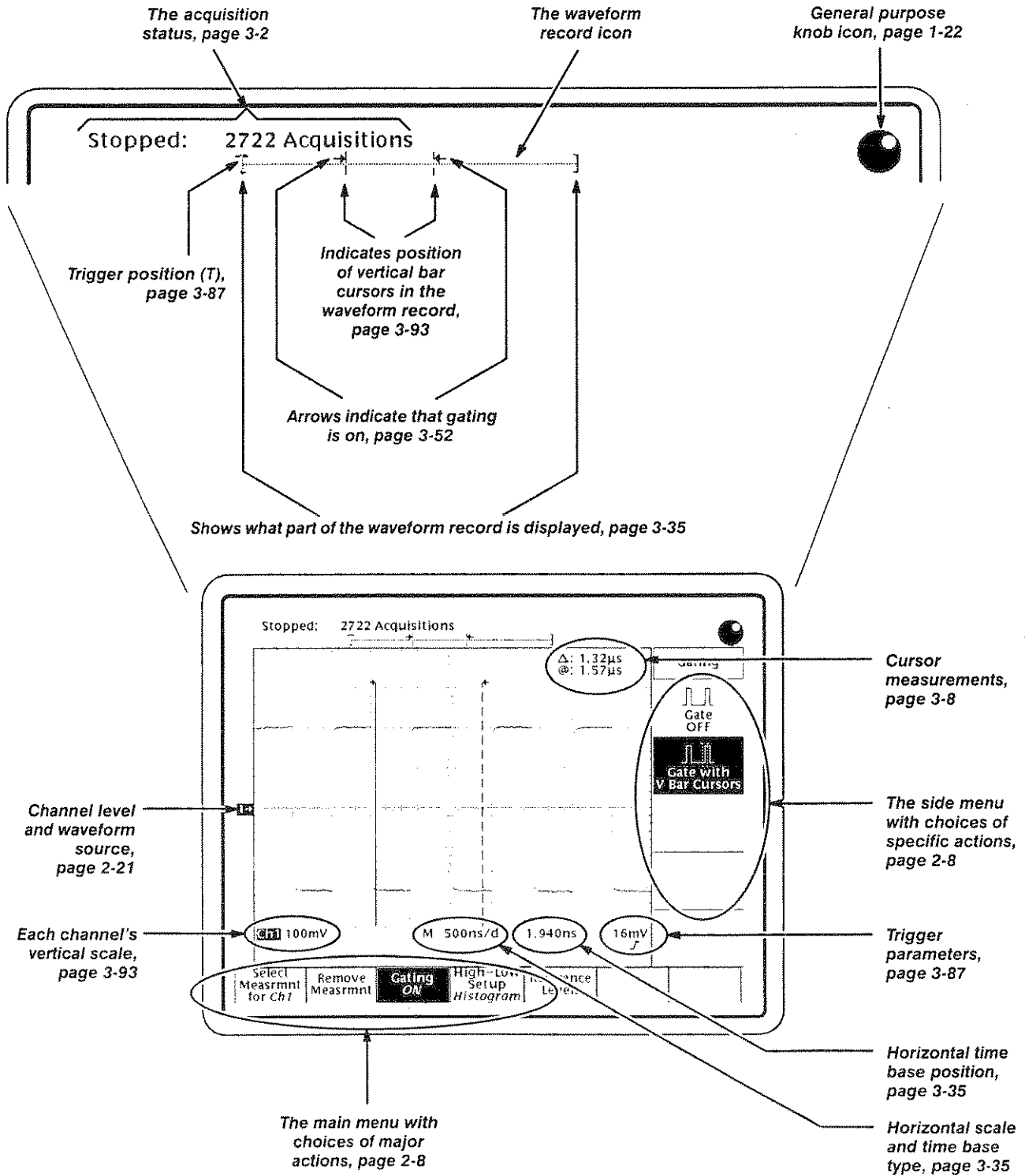

## To Operate A Menu

1. Press front-panel menu button.

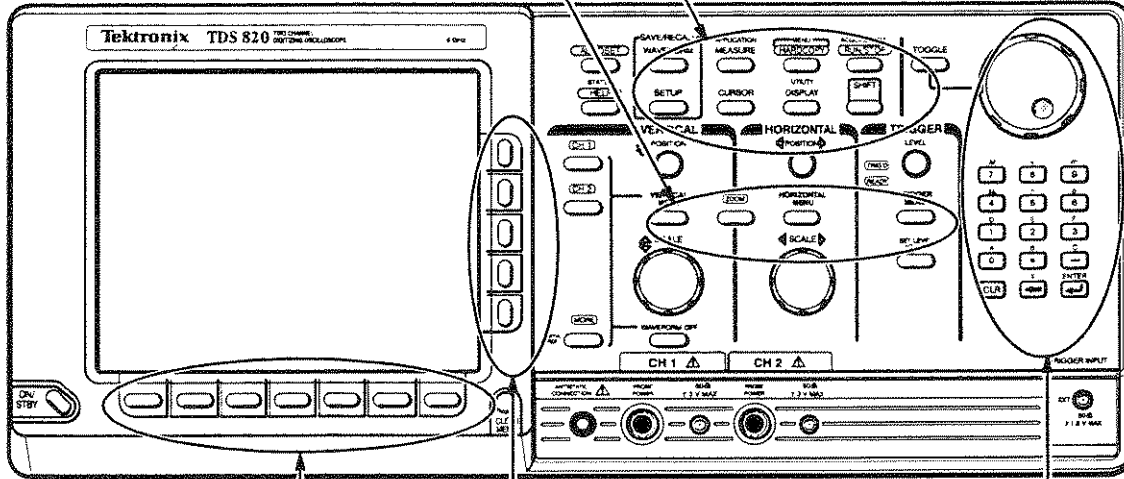

2. Press one of these buttons to select from main menu.

3. Press one of these buttons to select from side menu (if displayed).

4. If side menu item has an adjustable value (shown in reverse video), adjust it with the general purpose knob or keypad.

## To Operate A Pop-Up Menu

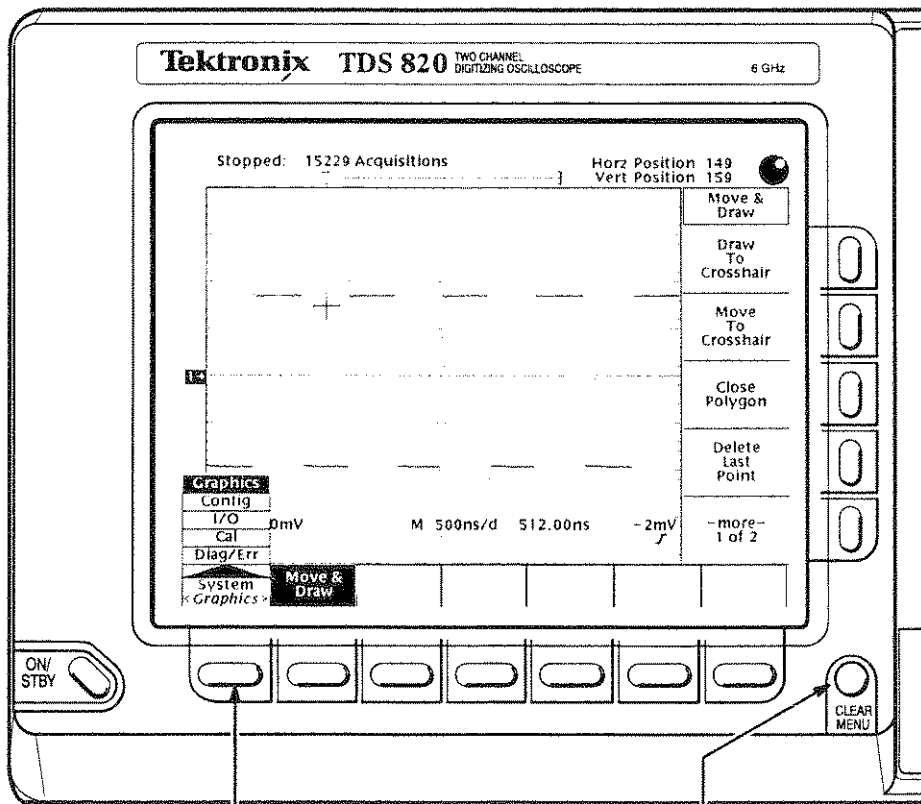

Press  
to display pop-ups

Press here to  
remove menus  
from screen

Press it again  
to make selection

A pop-up selection changes the other  
main menu titles (see page 2-12)

# Menu Map

Press these buttons:

To bring up these menus:

**Acquire Menu**  
(see page 3-2)



Mode <i>Normal</i>	Stop After <i>A/S button</i>		Limit Test Setup	Limit Test Sources	Create Limit Test Template	
-----------------------	---------------------------------	--	---------------------	-----------------------	----------------------------------	--

**Application Menu**  
(see the Programmer manual for more details)

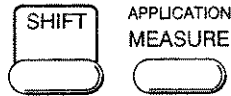

--	--	--	--	--	--	--

**Cursor Menu**  
(see page 3-8)

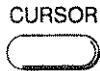

Function <i>OFF</i>	Mode <i>Indep</i>	Time Units <i>seconds</i>				
------------------------	----------------------	---------------------------------	--	--	--	--

**Display Menu**  
(see page 3-14)

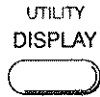

Style <i>Dots</i>	Intensity	Readout Options	Filter <i>Sin(x)/x</i>	Graticule <i>Full</i>	Format <i>VT</i>	
----------------------	-----------	--------------------	---------------------------	--------------------------	---------------------	--

**Hardcopy Menu**  
(see page 3-26)



Format <i>Interleaf</i>	Layout <i>Portrait</i>	Port <i>GPIB</i>	Clear Spool			
----------------------------	---------------------------	---------------------	----------------	--	--	--

**Horizontal Menu**  
(see page 3-35)



Time Base <i>Main</i>	Time Base Position	Record Length <i>500</i>	Fine Scale	Horiz Pos	Manual Deskew	
--------------------------	-----------------------	--------------------------------	---------------	--------------	------------------	--

**Trigger Menu**  
(see page 3-85)



Source <i>Ext</i>	Slope <i>J</i>	Mode <i>Auto</i>	Level <i>16mV</i>	Requested Holdoff <i>15.0000µs</i>		
----------------------	-------------------	---------------------	----------------------	--	--	--

Press these buttons:

To bring up these Menus:

**Measure Menu**  
(see page 3-47)



Selected Measurement for Ch2	Remove Measurement	Gating OFF	High-Low Setup Histogram	Reference Levels	Snapshot	
------------------------------	--------------------	------------	--------------------------	------------------	----------	--

**More Menu**  
(see page 3-97)



Math1 Ch1+Ch2	Math2 Ch1-Ch2	Math3 inv(Ch1)	Rel1	Rel2	Rel3	Rel4
---------------	---------------	----------------	------	------	------	------

**Save/Recall Setup Menu**  
(see page 3-75)

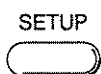

Save Current Setup	Recall Saved Setup	Recall Factory Setup				
--------------------	--------------------	----------------------	--	--	--	--

**Save/Recall Waveform Menu**  
(see page 3-77)



Save Waveform ch1	Recall waveform	Delete Rels				
-------------------	-----------------	-------------	--	--	--	--

**Status Menu**  
(see page 3-84)



Status Snapshot
System
Trigger
Waveforms
I/O

Press these buttons:

To bring up these Menus:

**Utility Menu – Graphics**  
(see page 3-21)



**Utility Menu – Config**  
(see pages 3-76 and 3-29)



**Utility Menu – I/O**  
(see page 3-71)



**Utility Menu – Calibration**  
(see the Performance Verification Instruction manual)



**Utility Menu – Diagnostics**  
(see the Service manual)

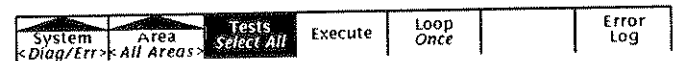

**Vertical Channel Menu**  
(see page 3-93)



**Zoom Menu**  
(see page 3-100)

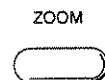



# Triggering

Triggers determine when the digitizing oscilloscope starts acquiring and displaying a waveform. They help create meaningful waveforms from unstable jumbles or blank screens (see Figure 2-5).

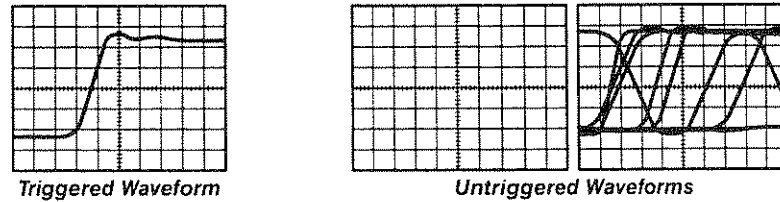

Figure 2-5: Examples of Triggered Waveforms

When a trigger event occurs, the digitizing oscilloscope acquires a sample in the process of building a waveform record. The trigger event establishes the time-zero point in the waveform record and all samples are measured with respect to that event.

The trigger signal starts waveform acquisition. A trigger event occurs when the trigger *source* (the signal that the trigger circuit monitors) passes through a specified voltage *level* in a specified direction (the trigger *slope*). When a trigger event occurs, the digitizing oscilloscope acquires one sample of the input waveform. When the next trigger event occurs, the digitizing oscilloscope acquires the next sample. This process continues until the entire record is filled with acquired points. Without a trigger, the digitizing oscilloscope does not acquire any points.

---

## Trigger Sources

You can derive your trigger from various sources. Trigger sources can be:

- either of the two input channels (not available for Option 1D instruments)
- the internal clock
- the external trigger input

## Input Channels

The normal trigger source is either one of the input channels. The channel you select as a trigger source functions whether it is displayed or not. (Instruments without delay lines cannot use the input channels as a trigger source.)

### Internal Clock

TDS 800 oscilloscopes allow you to use the internal clock as a trigger source. The internal clock runs at a rate that you can set from a front panel menu or a remote controller. The internal clock signal is also available from a rear-panel connector for triggering external devices.

### External Trigger

The external trigger input is useful when a signal is synchronously related to the signal to be acquired. For example, the pulse generator of a digital integrated circuit often supplies a trigger output that can drive the external trigger input of the digitizing oscilloscope.

---

## Trigger Modes

The trigger mode determines how the oscilloscope behaves in the absence of a trigger event. The digitizing oscilloscope provides two different trigger modes: *normal* and *automatic*.

*Normal* trigger mode lets the oscilloscope acquire a waveform only when it is triggered. If no triggers occur, the oscilloscope will not acquire a waveform.

*Automatic* trigger mode (auto mode) lets the oscilloscope acquire a waveform even if triggers do not occur. This mode uses a timer that starts after a trigger event occurs. If the timer runs out before another trigger event occurs, the oscilloscope generates triggers sufficient to complete the acquisition of a waveform.

---

## Holdoff

The trigger signal can be a complex waveform with many possible trigger points on it. Though the waveform is repetitive, a simple trigger might get you a series of patterns on the screen instead of the same pattern each time.

Digital pulse trains are good examples (see Figure 2-6). Each pulse looks like any other, so many possible trigger points exist. Not all of these will result in the same display. The holdoff period allows the digitizing oscilloscope to trigger on the correct edge resulting in a stable display.

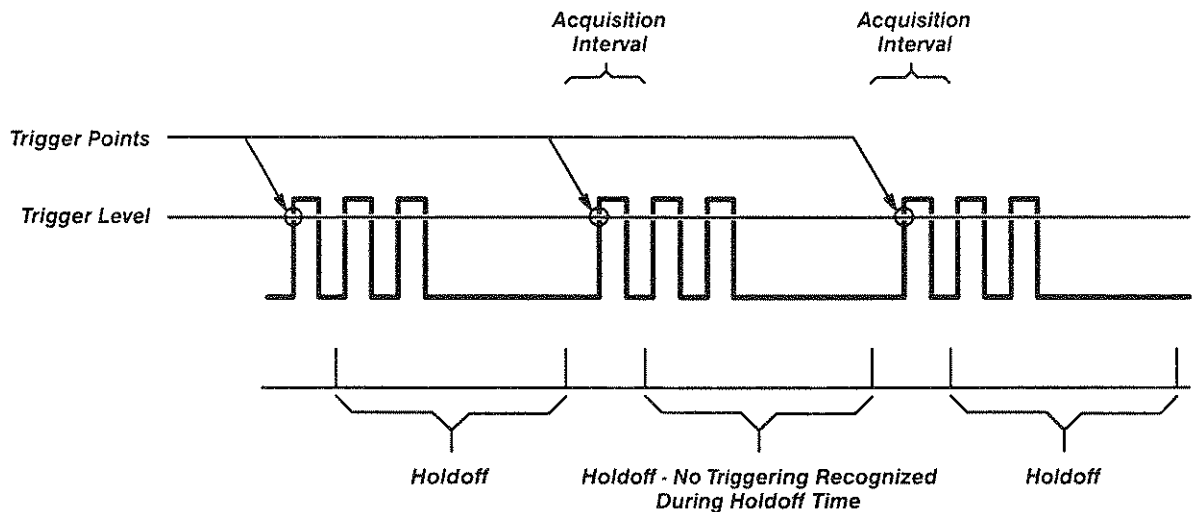

Figure 2-6: Trigger Holdoff Time Ensures Valid Triggering

When a trigger event occurs, the digitizing oscilloscope disables the trigger system until acquisition of the sample is complete. In addition, the trigger system remains disabled during the holdoff period that follows each acquisition. That adjustable holdoff time ensures a stable display.

## Slope and Level



The slope control determines whether the oscilloscope finds the trigger point on the rising or the falling edge of a signal (see Figure 2-7).

To set trigger slope, use the Trigger menu **Slope** item and the resulting side menu rising or falling slope icons.

The level control determines where on that edge the trigger point occurs (see Figure 2-7).

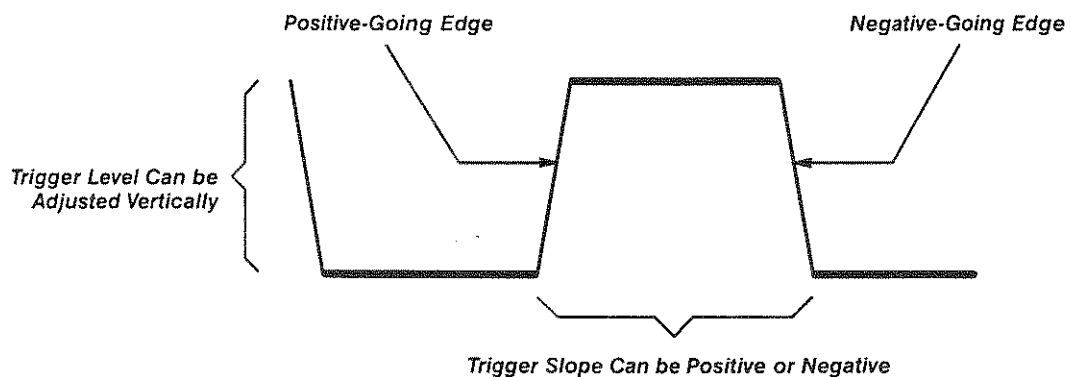

Figure 2-7: Slope and Level Controls Help Define the Trigger

The digitizing oscilloscope lets you set the main trigger level with the trigger **LEVEL** knob.

---

**For More  
Information**

See *Triggering*, on page 3-85.

# Acquisition

The acquisition process converts the analog input signal to digital. The oscilloscope creates a digital representation of the input signal by sampling the voltage level of the signal at regular time intervals (Figure 2-8).

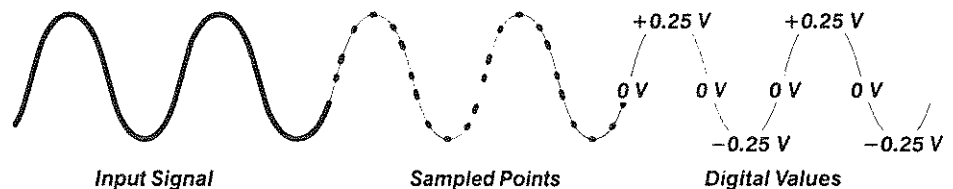

Figure 2-8: Acquisition: Input Analog Signal, Sample, and Digitize

The sampled points are stored in memory in the order they are acquired. Use this digital representation of the signal for display, measurements, or further processing.

You specify how the digitizing oscilloscope acquires data points and assembles them into the waveform record.

---

## Sampling and Digitizing

The trigger marks a time-zero point in a waveform record. The trigger starts the acquisition of waveform samples on the selected input channels. All timing measurements in the waveform record are made relative to the trigger event. Each time the oscilloscope takes a sample, the digitizer produces a numeric representation of the signal.

The digitizing oscilloscope creates a waveform record containing a user-specified number of data points. Each record point represents a certain voltage level that occurs at a specific time with respect to the trigger event.

### Record Length

The number of points that make up the waveform record is the *record length*. Use the horizontal menu to set the record length. The digitizing oscilloscope provides record lengths of 500, 1000, 2500, 5000, and 15,000 points.

### Sampling

Sampling is the process of converting the analog input signal to digital for display and processing. The two general methods of sampling are *real-time* and *equivalent-time*.

TDS 800 Digitizing Oscilloscopes use equivalent-time sampling. In equivalent-time (ET) sampling the oscilloscope acquires samples over many repetitions of the event (Figure 2-9).

**NOTE**

*Equivalent-time sampling requires repetitive signals to give meaningful results.*

TDS 800 Digitizing Oscilloscopes use a type of equivalent-time sampling called *sequential equivalent-time sampling*. With this method, the oscilloscope acquires one sample for each trigger event. At the first trigger, the oscilloscope samples the voltage at the time after the trigger event specified by the time base position. At the next trigger, the oscilloscope delays slightly longer before acquiring the next sample, so that the next point is slightly later on the input waveform.

Each subsequent trigger increases the delay interval before acquisition of the next sample, so that each successive sample represents voltage later in the input waveform. The delay interval increments until the waveform record is filled. The delay interval is then reset to the time base position.

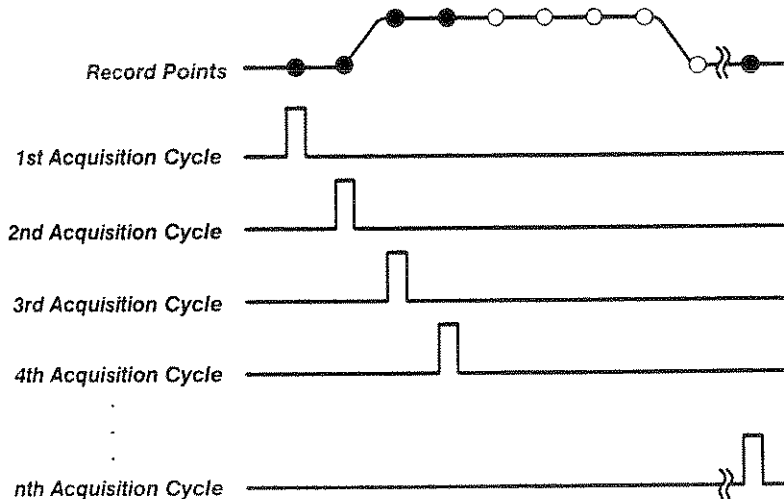

**Figure 2-9: Sequential Equivalent-Time Sampling**

The oscilloscope eventually constructs a waveform record using the samples from multiple acquisitions. This method lets you accurately acquire signals with frequencies much higher than the digitizing oscilloscope could acquire in real time.

---

## Acquisition Modes

The acquisition mode you select determines how the several samples taken during a single acquisition interval are combined into a record point. The digitizing oscilloscope supports three acquisition modes:

- *normal*
- *envelope*
- *average*

### Normal Mode

In Normal mode, the oscilloscope creates a record by acquiring one sample per trigger event. When the record is full, it acquires new samples; these samples overwrite the previously acquired waveform. This is the default mode.



### Envelope Mode

Envelope mode lets you acquire and display a waveform record that shows the extremes in variation over several acquisitions. You specify the number of acquisitions over which to accumulate the data. The oscilloscope saves the highest and lowest values in two adjacent intervals. Envelope mode gathers peaks over many trigger events.



After acquiring each record, the oscilloscope compares the min/max values from the current acquisition with those stored from previous acquisitions. The final display shows the most extreme values for all the acquisitions for each point in the waveform record.

### Average Mode

Average mode lets you acquire and display a waveform record that is the averaged result of several acquisitions. This mode reduces random noise. The oscilloscope acquires data after each trigger event using the normal mode. It then averages the record point from the current acquisition with those stored from previous acquisitions.



---

## Limit Testing

Limit testing compares incoming waveforms to a waveform template that you create. You can add vertical and horizontal tolerances to a waveform to make an envelope. You then specify that the instrument compare each waveform acquired to that envelope (see Figure 2-10). If waveform data exceeds the limits you have set, the digitizing oscilloscope can ring a bell, make a hardcopy, or stop and wait for you to take some action.

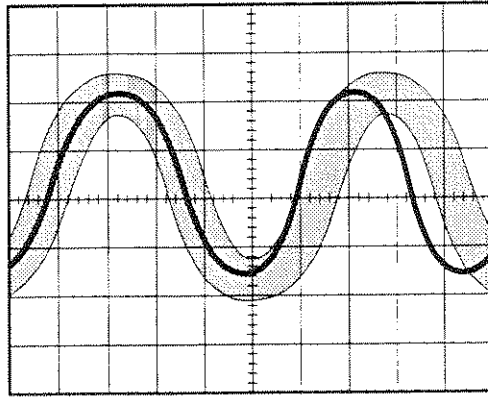

Figure 2-10: Comparing a Waveform to a Limit Template

---

**For More  
Information**

See *Scaling and Positioning Waveforms*, on page 2-21.

See *Acquisition Modes*, on page 3-2.

See *Limit Testing*, on page 3-41.





# Scaling and Positioning Waveforms

Scaling and positioning waveforms means increasing or decreasing their displayed size and moving them up, down, right, and left on the display.

Two display icons, the channel reference indicator and the record view, help you quickly see the position of the waveform in the display (see Figure 2-11). The ground icon points to the ground of the waveform record. The record view, at the top of the display, indicates what part of the waveform record is displayed.

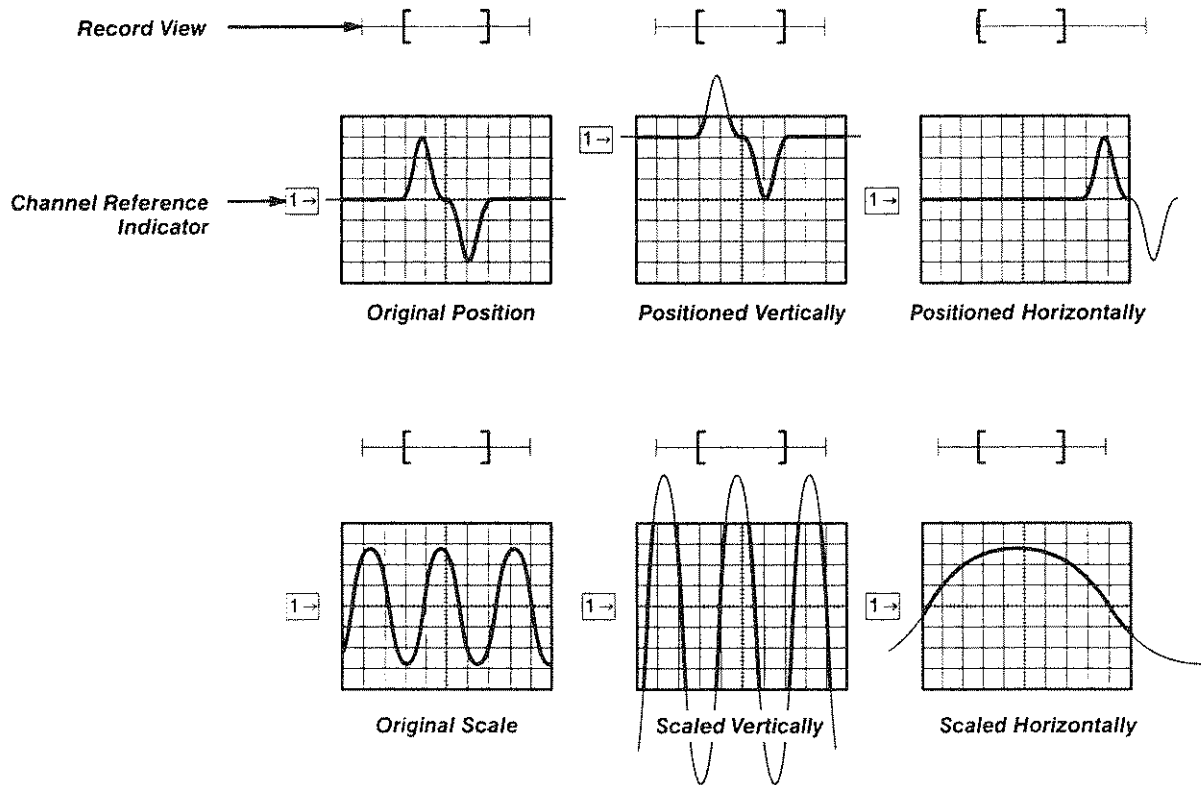

Figure 2-11: Scaling and Positioning

## Vertical System

You can adjust the vertical scale. The digitizing oscilloscope shows the scale (in volts per division) for each selected channel toward the bottom left of the display. As you turn the vertical **SCALE** knob clockwise, the value decreases resulting in higher resolution because you see a smaller part of the waveform. As you turn it counterclockwise the scale increases allowing you to see more of the waveform but with lower resolution.

You can also alter the vertical position of the selected waveform by moving it up or down on the display. For example, when trying to compare multiple waveforms, you can put one above another and compare them, or you can overlay the two waveforms on top of each other. To move the selected waveform turn the vertical **POSITION** knob clockwise.

Besides using the scale and position knobs, you can set the vertical scale and position with exact numbers. You do that with the Vertical menu **Fine Scale** and **Position** selections and the general purpose knob and/or the keypad.

### Offset

Vertical offset adds a voltage to the reference point without changing the scale. This feature allows you to move the waveform up and down over a large area without decreasing the resolution.

Offset is useful in cases where a waveform has a DC bias. One example is looking at a small ripple on a power supply output. You may be trying to look at a 50 mV ripple on top of a 200 mV DC level. The range available with offset can prove valuable as you try to move and scale the ripple.

For many applications, vertical position and offset provide essentially the same function. However, they are different. For the digitizing oscilloscope, vertical position has a range of  $\pm 5$  divisions from center screen. Thus, the range of vertical position depends on the vertical scale setting. At 200 mV per division, vertical position has a range of  $\pm 1$  V. At 2 mV per division, it has a range of  $\pm 10$  mV.

Vertical offset, on the other hand, always provides a range of  $\pm 2$  V ( $\pm 1$  V with the TDS 820 Option 1D), regardless of the scale.

Vertical position changes the point about which the waveform expands or contracts when you change the scale. The point is indicated by the waveform ground reference indicator at the left edge of the display. It is therefore convenient for stacking several waveforms on the display and viewing them neatly separated.

Offset changes the position of the waveform on the display but not the point around which a waveform expands or contracts when vertical scale changes. Thus, if you change the offset of a waveform and then change its scale, the waveform changes both its size and its location on the display.

Use vertical position whenever the vertical position has sufficient range to position the waveform appropriately on the display. For small signals with large DC offsets, use vertical offset to move the signal into the display range, especially if vertical scale is at a highly sensitive setting.

---

## Horizontal System

Adjusting the horizontal position of waveforms moves them right or left on the display. That is useful when the waveform record length is so large (greater than 500 points) that the digitizing oscilloscope cannot display the

entire waveform record at one time. You can also adjust the scale of the waveform. For example, you might want to see just one cycle of a waveform to measure the overshoot on its rising edge.

To adjust the horizontal scale of the displayed waveform records use the horizontal **SCALE** knob and the horizontal position using the horizontal **POSITION** knob.

The digitizing oscilloscope shows the actual scale in the bottom right of the display. The scale readout shows the time per division used. Since all live waveforms use the same time base, the digitizing oscilloscope only displays one value for all the active channels.

### Main and Delayed Time Bases

You can set a main time and delayed time base. The delayed time base runs after a user-specified time from the trigger event.

### Time Base Position

The time base position determines when acquisition begins relative to the trigger. The difference between the horizontal position and the time base position is that horizontal position is a graphical control having to do with the position of the waveform on the display. It has no effect on the initial delay from the trigger to the first acquired point. To change this delay, use the time base position control in the Horizontal menu. The time base position affects acquisition.

### Aliasing

When *aliasing* happens, you see a waveform record with a frequency lower than the actual waveform or the waveform is not stable but the light next to **TRIG'D** is on. Aliasing occurs because the oscilloscope is not acquiring with a high enough sample density to construct an accurate waveform record (Figure 2-12).

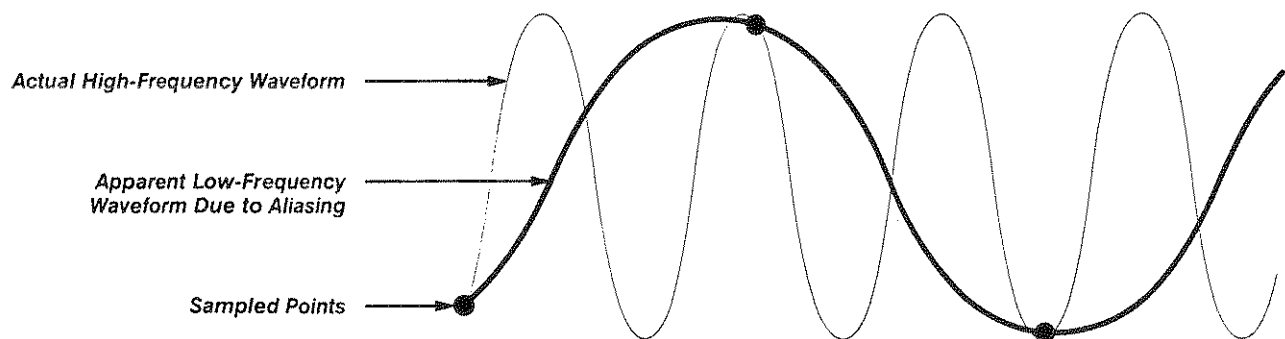

Figure 2-12: Aliasing

One simple way to check for aliasing is to slowly change the horizontal scale (time per division setting). If the shape of the displayed waveform changes drastically, you may have aliasing.

To represent a signal accurately and avoid aliasing, you must sample the signal at least twice as fast as the highest frequency component in equivalent time. For example, a signal with frequency components of 50 MHz would need to be sampled at an interval equivalent to 10 ns per sample or faster.

A pure sine wave has no frequency components beyond its fundamental frequency. However, typical square pulses have frequency components that are ten times or more the fundamental frequency.

### NOTE

*Because the digitizing oscilloscope is an equivalent-time digitizer, the sample interval is not the reciprocal of the sample rate. Instead, the sample interval represents equivalent time and depends only on the time per division. See page 2-18 for further information about sequential equivalent time acquisition.*

There are various ways to prevent aliasing. Try adjusting the horizontal scale to a faster time per division to increase sample density. Or simply press the **AUTOSET** button.

---

## Zoom

Use zoom to see more detail without changing the acquired signal. When you press the **ZOOM** button, a portion of the waveform record expands or compresses on the display but the record points stay the same. Zooming provides a convenient way to expand a waveform on the display even when acquisition is stopped. For example, you can use zoom to expand a stored waveform.

---

## Autoset

Autoset lets you quickly obtain a stable waveform display. It automatically adjusts a wide variety of settings including vertical and horizontal scaling. Other settings affected include trigger slope and level, and display intensities. *Autoset* on page 3-6 describes in detail what autoset does.

---

## For More Information

See *Autoset*, on page 3-6.

See *Horizontal Control*, on page 3-35.

See *Vertical Control*, on page 3-93.

See *Zoom*, on page 3-100.

# Measurements

The digitizing oscilloscope not only displays graphs of voltage versus time, it also can help you measure the displayed information (see Figure 2-13).

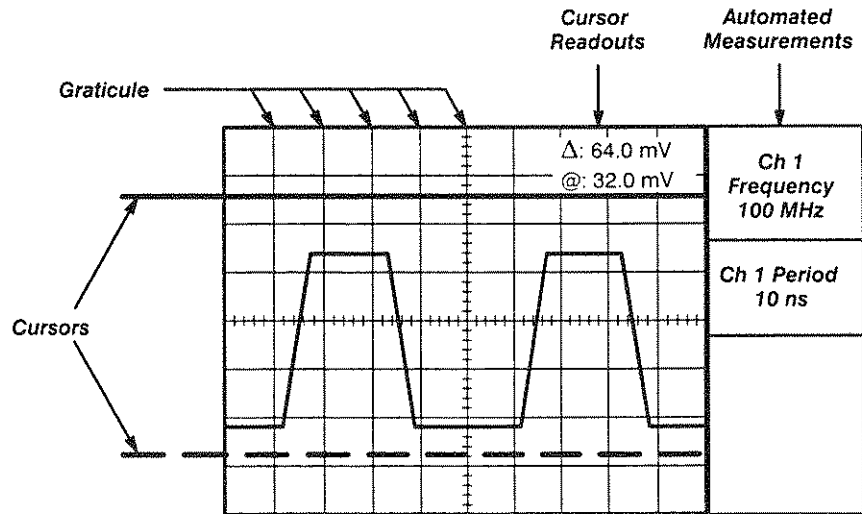

Figure 2-13: Graticule, Cursor, and Automated Measurements

## Measurement Sources

The oscilloscope provides three measurement classes: automated, cursor, and graticule.

### Automated Measurements

You take automated measurements merely by pressing a few buttons. The digitizing oscilloscope does all the calculating for you. Because these measurements use the waveform record points, they are more accurate than cursor or graticule measurements.

Press the **MEASURE** button for the automated measurement menus. These menus let you make *amplitude* and *timing* measurements. (See Appendix C for details on how the digitizing oscilloscope calculates each measurement.) You can select and display up to four measurements.

You can make automated measurements on the entire waveform record or just on a specific part. The gating option in the Measurement menu lets you use the vertical cursors to limit the measurement to a section of the waveform record.

The snapshot option in the Measurement menu lets you display almost all the measurements at once. You can read about snapshot in *Measurement System*, which begins on page 3-47.

*Amplitude measurements* are made on vertical parameters. The units of such measurements are typically volts (sometimes %). The amplitude measurements are minimum, maximum, high, low, positive overshoot, negative overshoot, peak to peak, amplitude, mean, cycle mean, RMS, and cycle RMS.

*Area measurements* are made on vertical and horizontal parameters. More specifically, they measure voltage over time. The units of area measurements are volt-seconds. There are two such measurements—area and cycle area.

*Timing measurements* are made on horizontal parameters. The units of such measurements are typically seconds or Hertz. The time measurements are period, frequency, positive width, negative width, rise time, fall time, positive duty cycle, negative duty cycle, propagation delay, phase, burst width, positive cross, and negative cross.

Automated measurements use readouts to show measurement status. These readouts update as the oscilloscope acquires new data or if you change settings.

### Cursor Measurements

Cursors are fast and easy-to-understand measurements. You take measurements by moving the cursors and reading their numeric values.

Cursors appear in pairs. One part of the pair is *active* and the other *inactive*. You move the active cursor (the solid line) using the general purpose knob. The **TOGGLE** button lets you select (toggle) which cursor bar is active or inactive. The inactive cursor is a dashed line on the display.

The screen readout shows not only the values of the cursors but also the difference between them. The oscilloscope updates the readouts as you adjust cursor positions.

To get the cursor menu, press the **CURSOR** button. There are three kinds of cursors available in that menu: horizontal bar, vertical bar, and paired (Figure 2-14).

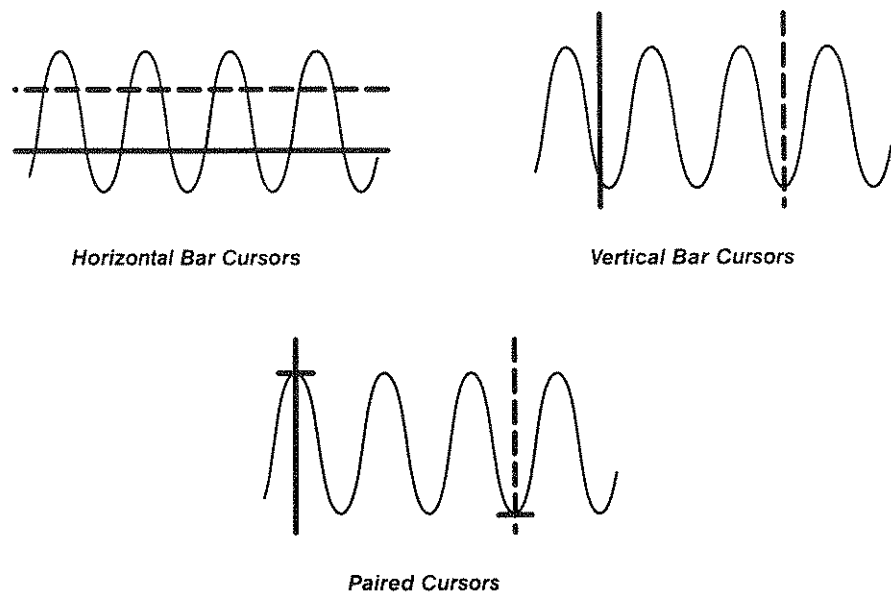

**Figure 2-14: Cursor Types**

*Horizontal bar cursors* measure vertical parameters (typically volts). When using these cursors the screen readout shows the voltage level of the active horizontal bar relative to ground and the voltage difference between the two horizontal bars.

*Vertical bar cursors* measure horizontal parameters (typically time). When using these cursors the screen readout shows the time of the active vertical bar relative to the trigger and the time difference between the two vertical bars.

*Paired cursors* measure both vertical parameters (typically volts) and horizontal parameters (typically time). Look at Figure 2-14. Note that each of the two cursors has a long vertical bar paired with a short horizontal bar. The screen readout operates as follows:

- shows the time of the vertical bar in the active paired cursor relative to the trigger and the time difference between the two vertical bars, one in each paired cursor (just as was described for vertical bar cursors).
- also shows the voltage difference between the short horizontal bar on one paired cursor and the short horizontal bar on the other paired cursor.

There are also two modes for cursor operation available in the cursor menu—*independent* and *tracking*.

*Independent mode* cursors operate as described earlier; that is, you move *one* cursor at a time (the active cursor) using the general purpose knob, and you use the **TOGGLE** button to toggle which cursor bar is active. (See Figure 2-15.)

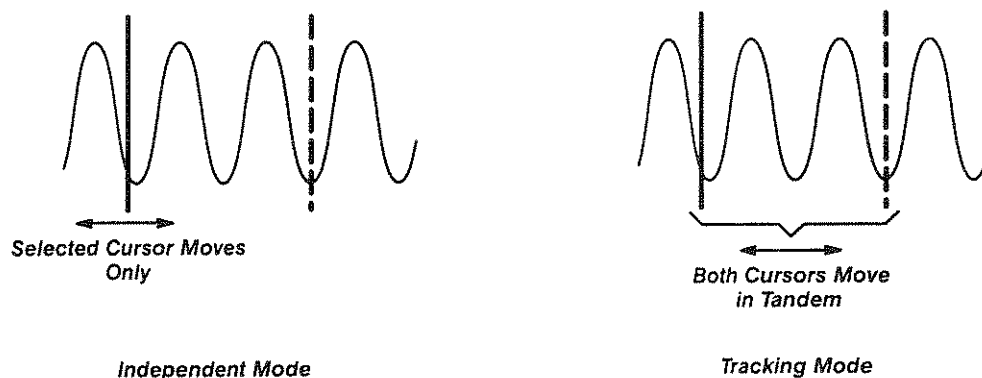

Figure 2-15: Cursor Modes

*Tracking mode* cursors operate in tandem: you move *both* cursors at the same time using the general purpose knob. (See Figure 2-15.) To adjust the solid cursor relative to the dashed cursor, you push the **TOGGLE** button to suspend cursor tracking and use the general purpose knob make the adjustment. A second push toggles the cursors back to tracking.

### Graticule Measurements

Graticule measurements provide you with quick, visual estimates. For example, you might look at a waveform amplitude and say “it is a little more than 100 mV.”

You can perform simple measurements by counting the number of major and minor graticule divisions involved and multiplying by the scale factor.

For example, if you counted five major vertical graticule divisions between a minimum and maximum values of a waveform and knew you had a scale factor of 100 mV per division, then you could easily calculate your peak-to-peak voltage:

$$5 \text{ divisions} \times 100 \text{ mV/division} = 500 \text{ mV}$$

---

### For More Information

See *Getting Started Example 3: Automated Measurements*, on page 1-20.

See *Cursor Measurements*, on page 3-8.

See *Measurement System*, on page 3-47.

See *Appendix C: Algorithms*, on page C-1.

See the *TDS Family Option 2F Instruction Manual* (if your oscilloscope is equipped with that option) for using cursors to measure Fast Fourier Transformed, integrated, or differentiated math waveforms.

See *Waveform Math*, on page 3-97 (Option 2F equipped oscilloscopes only) for using cursors to measure math waveforms.





# Overview

This section describes the details of operating the digitizing oscilloscope. It contains an alphabetical list of tasks you can perform with the digitizing oscilloscope. Use this section to answer specific questions about instrument operation. These tasks include:

- Acquisition Modes
- Autoset
- Cursor Measurements
- Display Modes
- Graphics
- Hardcopy
- Help
- Horizontal Control
- Limit Testing
- Measurement System
- Probe Interface
- Probe Selection
- Remote Communication
- Saving and Recalling Setups
- Saving and Recalling Waveforms
- Selecting Channels
- Status
- Triggering
- Vertical Control
- Waveform Math
- Zoom

# Acquisition Modes

The acquisition system has several options for converting analog data into digital form. The Acquisition menu lets you determine the acquisition mode and how to start and stop acquisitions.

## Acquisition Readout

The Acquisition readout at the top of the display (Figure 3-1) shows the state of the acquisition system (running or stopped). The “running” state shows the acquisition mode. The “stopped” state shows the number of acquisitions acquired since the last stop or major change.

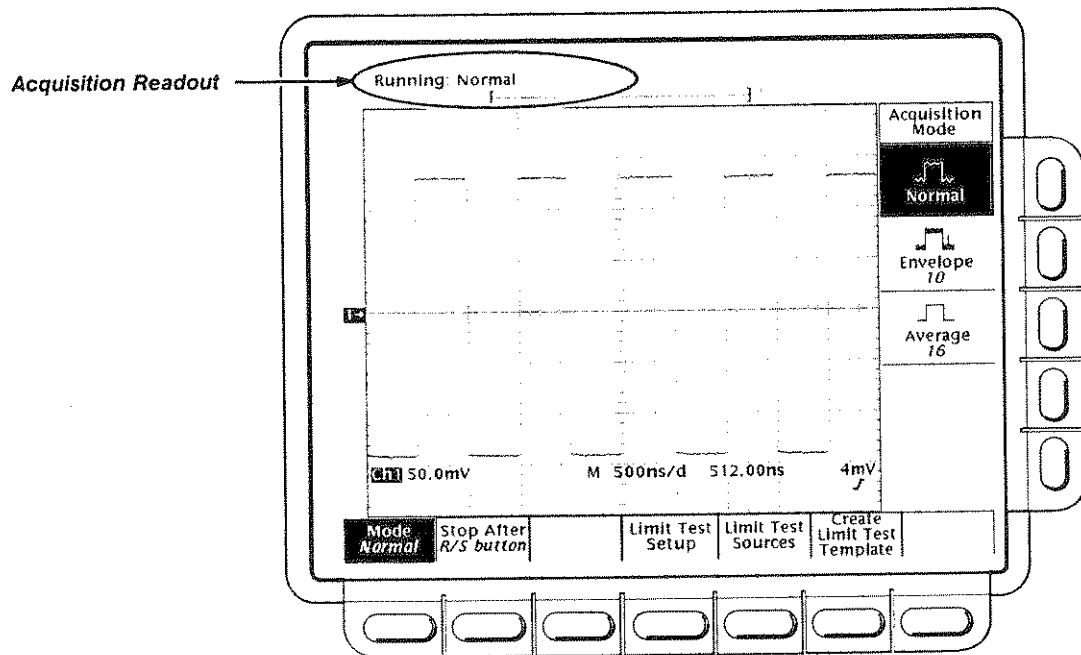

Figure 3-1: Acquisition Readout

## Operation

To bring up the acquisition menu (Figure 3-2) press **SHIFT → ACQUIRE MENU**.

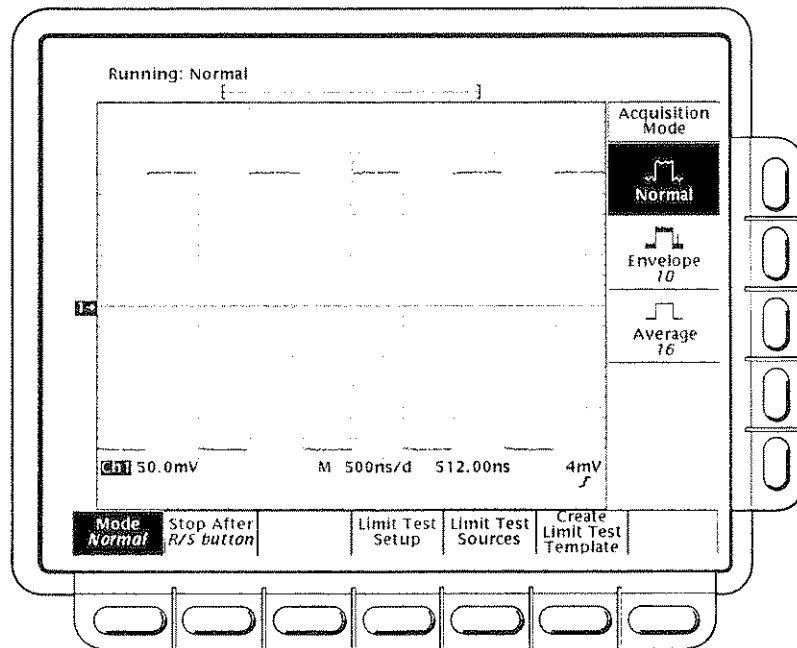

Figure 3-2: Acquire Menu

### Acquisition Mode

The **Mode** option lets you choose how the digitizing oscilloscope will create points in the waveform record.

Press **SHIFT → ACQUIRE MENU → Mode (main) → Normal, Envelope, or Average (side)**.

- **Normal** mode (default mode) acquires one sample point per trigger and displays the results without further processing.
- **Envelope** uses the highest and lowest samples across several waveform records.
- **Average** calculates the average value for each record point over many waveform records.

When you select **Envelope** or **Average**, you can enter the number of waveform records using the general purpose knob.

Hint: To make large changes quickly with the general purpose knob, press the **SHIFT** button before turning the knob. When the light above the **SHIFT** button illuminates and the display says **Coarse Knobs** in the upper-right corner, the general purpose knob speeds up significantly.

### Stop After

You can choose to acquire exactly one waveform sequence or to acquire waveforms continuously under manual control.

Press **SHIFT** → **ACQUIRE MENU** → **Stop After** (main) → **RUN/STOP button only**, **Single Acquisition Sequence**, or **Limit Test Condition Met** (side) (see Figure 3-3).

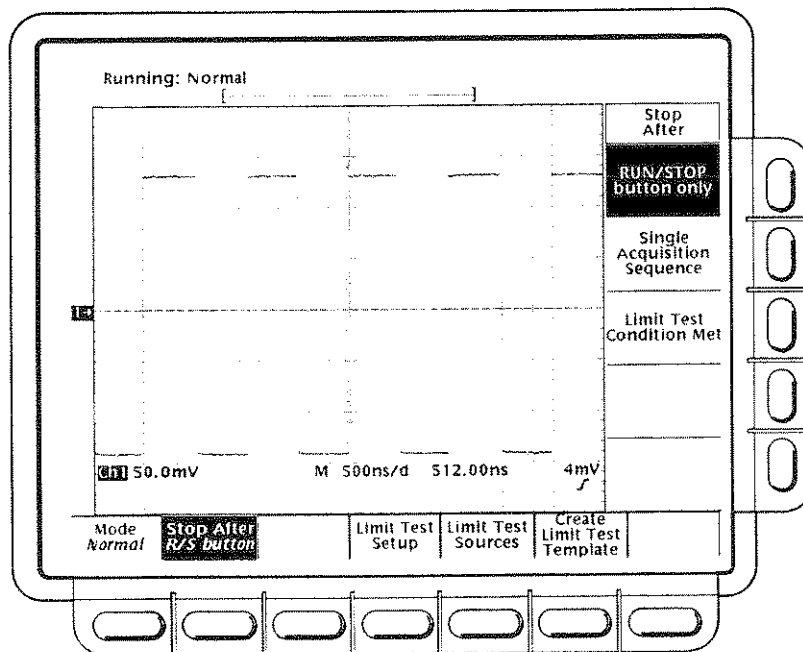

Figure 3-3: Acquire Menu—Stop After

- **RUN/STOP button only** lets you start or stop acquisitions by toggling the **RUN/STOP** button. Pressing the **RUN/STOP** button once will stop the acquisitions. The upper left hand corner in the display will say **Stopped** and show the number of acquisitions. If you press the bottom again, the digitizing oscilloscope will resume taking acquisitions.
- **Single Acquisition Sequence** lets you run a single sequence of acquisitions by pressing the **RUN/STOP** button. In normal mode, the instrument will acquire a waveform record when valid trigger events occur, and then stop.

Even when using **Single Acquisition Sequence**, the digitizing oscilloscope requires a repetitive signal. Completing a single acquisition sequence requires at least one trigger event for every sample acquired.

In envelope or average mode, the digitizing oscilloscope will acquire the specified number of acquisitions to complete the averaging or enveloping task.

- **Limit Test Condition Met** lets you acquire waveforms until waveform data exceeds the limits specified in the limit test. Then acquisition stops. At that point, you can also specify other actions for the oscilloscope to take, using the selections available in the **Limit Test Setup** main menu.

#### **NOTE**

*In order for the digitizing oscilloscope to stop an acquisition when limit test conditions are met, turn limit testing **ON**, using the **Limit Test Setup** main menu.*

Setting up limit testing requires several more steps. Specify the template waveform to which to compare incoming waveforms, using the **Create Limit Test Template** main menu item. Then enable the comparison, and specify the channel against which to compare the template, using the **Limit Test Sources** main menu item. See *Limit Testing* on page 3-41 for further details.

---

### **For More Information**

See *Acquisition*, on page 2-17.

See *Limit Testing*, on page 3-41.



The autoset function lets you quickly obtain and display a stable waveform of usable size. Autoset automatically sets up the front panel controls based on the characteristics of the input signal. That is much faster and easier than a manual control-by-control setup.

Autoset makes adjustments in these areas:

- Acquisition,
- Display,
- Horizontal,
- Trigger, and
- Vertical.

#### **NOTE**

*Autoset may change vertical offset to position the waveform appropriately. When offset is not set to 0 V, the channel reference indicator points to ground plus the offset, and not to ground.*

---

## **Operation**

1. Press the Channel Selection button (such as **CH 1**) corresponding to your input channel to make it active.
2. Press **AUTOSET**.

If you use autoset when one or more channels are displayed, the digitizing oscilloscope selects the lowest numbered channel for horizontal scaling and triggering. Vertically, it scales all channels that are being used.

If you use autoset when no channels are displayed, the digitizing oscilloscope will turn on channel one (**CH 1**) and scale it.

---

## **Autoset Defaults**

Table 3-1 on the following page lists the autoset defaults.

Table 3-1: Autoset Defaults

Control	Changed by Autoset to
Selected channel	Numerically lowest of the displayed channels
Acquire Mode	Normal
Acquire Stop After	RUN/STOP button only
Display Intensity—Overall	If less than 50%, set to 75%
Display Format	YT
External Attenuation	Unchanged
Horizontal Position	Centered within the graticule window
Horizontal Scale	As determined by the signal frequency
Horizontal Time Base	Main Only
Horizontal Record Length	Unchanged
Time Base Position	As determined by the signal
Trigger Source	If the current source triggers, unchanged. Else:  With delay lines: Numerically lowest of the displayed channels  Without delay lines: Unchanged
Trigger Level	Midpoint of data for the trigger source
Trigger Slope	Positive
Trigger Holdoff	Minimum
Vertical Scale	As determined by the signal level
Vertical Offset	To center the signal
Zoom	Off

# Cursor Measurements

Use the cursors to measure the difference (either in time or voltage) between two locations in a waveform record.

Cursors are two markers that you position with the general purpose knob. You move one cursor independently or both cursors in tandem, depending on the cursor mode. The non-selected cursor is a dashed line on the display. You use the **TOGGLE** button to change which cursor is selected. As you position the cursors, readouts on the display report measurement information.

There are three cursor types: *horizontal bar*, *vertical bar*, and *paired* (Figure 3-4).

*Horizontal bar cursors* measure vertical parameters (typically volts).

*Vertical bar cursors* measure horizontal parameters (typically time or frequency).

*Paired cursors* measure both vertical parameters (typically volts) and horizontal parameters (typically time) simultaneously.

Look at Figure 3-4. Note that each of the two paired cursors has a long vertical bar paired with a short horizontal bar. The short horizontal bars measure vertical parameters (typically volts); the long vertical bars measure horizontal parameters (typically time or frequency). (See *Cursor Readouts* on page 3-10 for more information.)

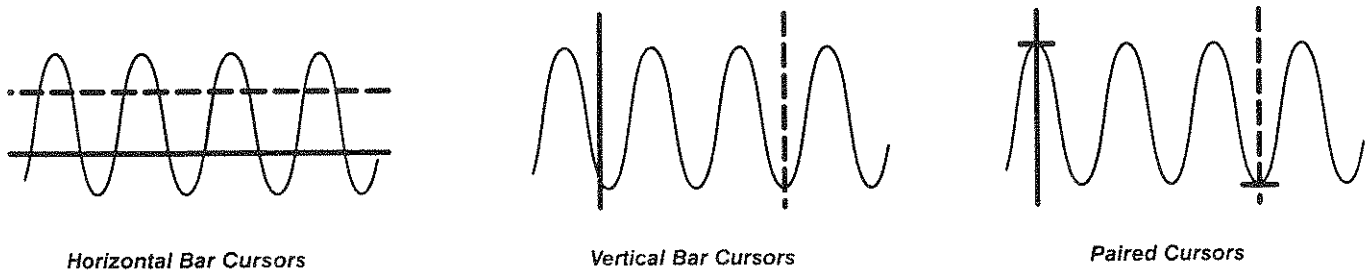

Figure 3-4: Cursor Types



**NOTE**

When voltage cursors measure certain math waveforms, the measurement may not be of time, frequency, or voltage. For instance, for a math waveform that is the product of two waveforms, the horizontal cursors measure voltage<sup>2</sup> (VV). Waveform Math, which begins on page 3-97, describes cursor measurement of those math waveforms that are not of time, frequency or voltage. For those oscilloscopes equipped with option 2F, the advanced DSP math option, the instruction manual shipped with the option describes the use of cursors to measure such waveforms and the measurement units that result.

There are two cursor modes: *independent* and *tracking*.

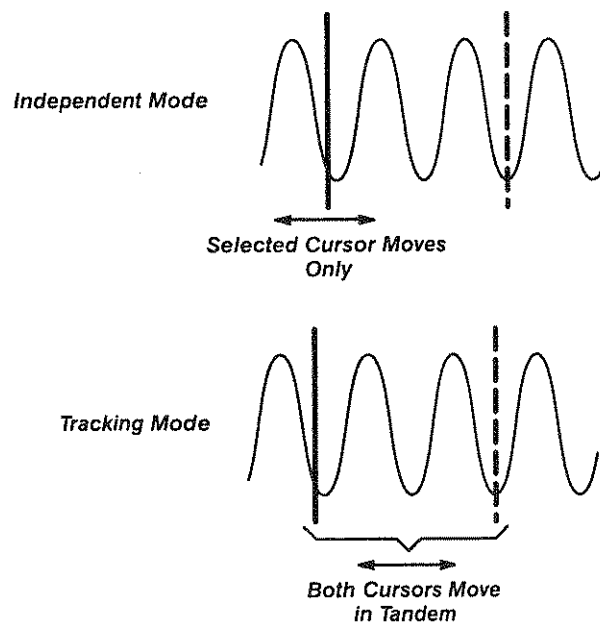

**Figure 3-5: Cursor Modes**

Operation of independent mode is as follows:

In independent mode you move only one cursor at a time using the general purpose knob. The active, or selected, cursor is a solid line. Press **TOGGLE** to change which cursor is selected.

In tracking mode you normally move both cursors in tandem using the general purpose knob. The two cursors remain a fixed distance (time or voltage) from each other. Press **TOGGLE** to temporarily suspend cursor tracking. You can then use the general purpose knob to adjust the distance of the solid cursor relative to the dashed cursor. A second push toggles the cursors back to tracking.

## Cursor Readouts

The cursor readout shows the absolute location of the selected cursor and the difference between the selected and non-selected cursor. The readouts differ depending on whether you are using **H Bars** or **V Bars**.

- **H Bars:** the value after  $\Delta$  shows the voltage difference between the cursors. The value after @ shows the voltage of the selected cursor relative to ground (see Figure 3-6).
- **V Bars:** the value after  $\Delta$  shows the time (or, optionally, frequency) difference between the cursors. The value after @ shows the time (frequency) of the selected cursor relative to the trigger (see Figure 3-7).

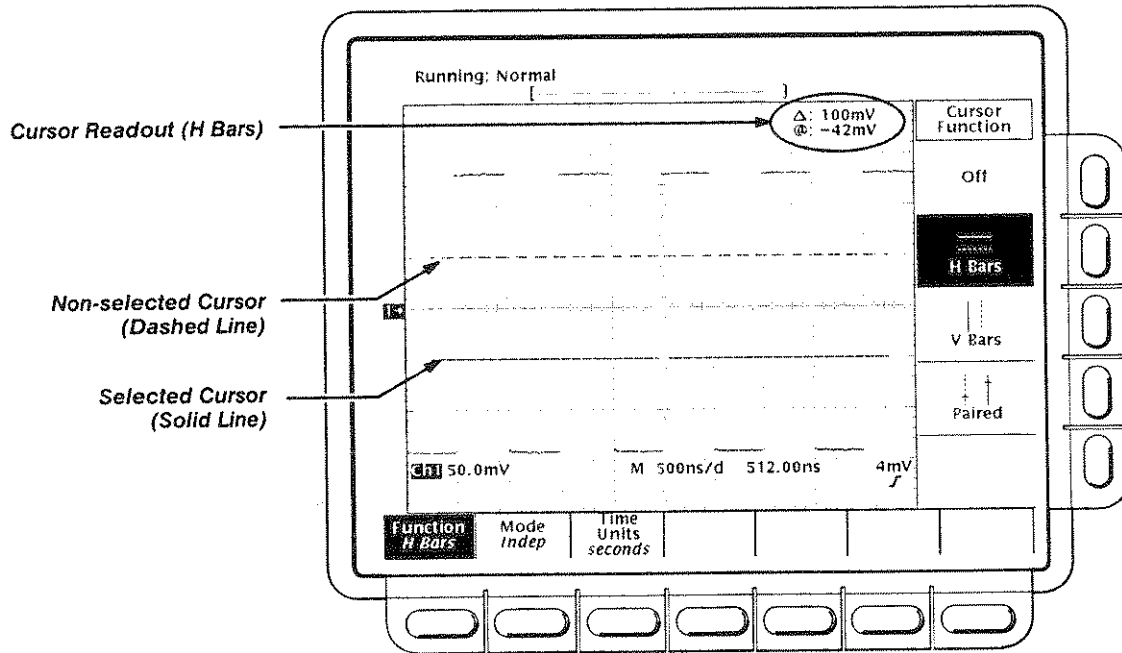

Figure 3-6: H Bars Cursor Menu and Readouts

- **Paired:** the value after one  $\Delta$  shows the voltage difference between the two short horizontal bars; the other  $\Delta$  shows the time (or frequency) difference between the two long vertical bars. The value after @ shows the voltage at the short horizontal bar of the selected cursor relative to ground (see Figure 3-8).

Paired cursors can only show voltage differences when they remain on screen. If you move the paired cursors off screen horizontally, **Edge** will replace the voltage values in the cursor readout.

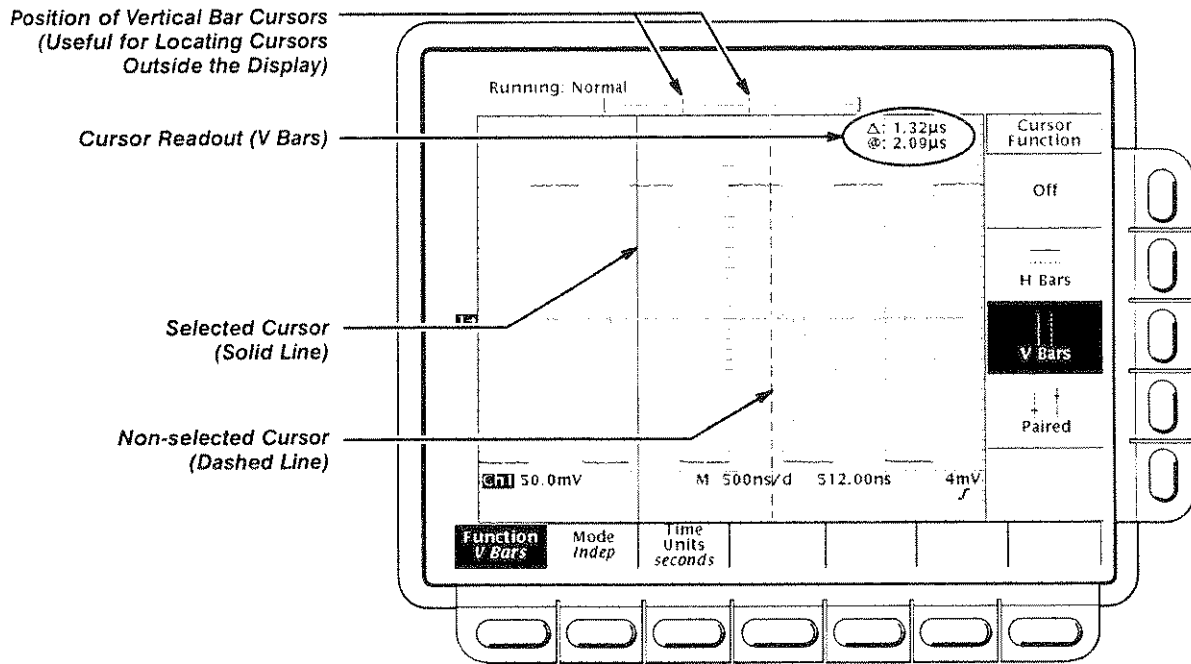

Figure 3-7: V Bars Cursor Menu and Readouts

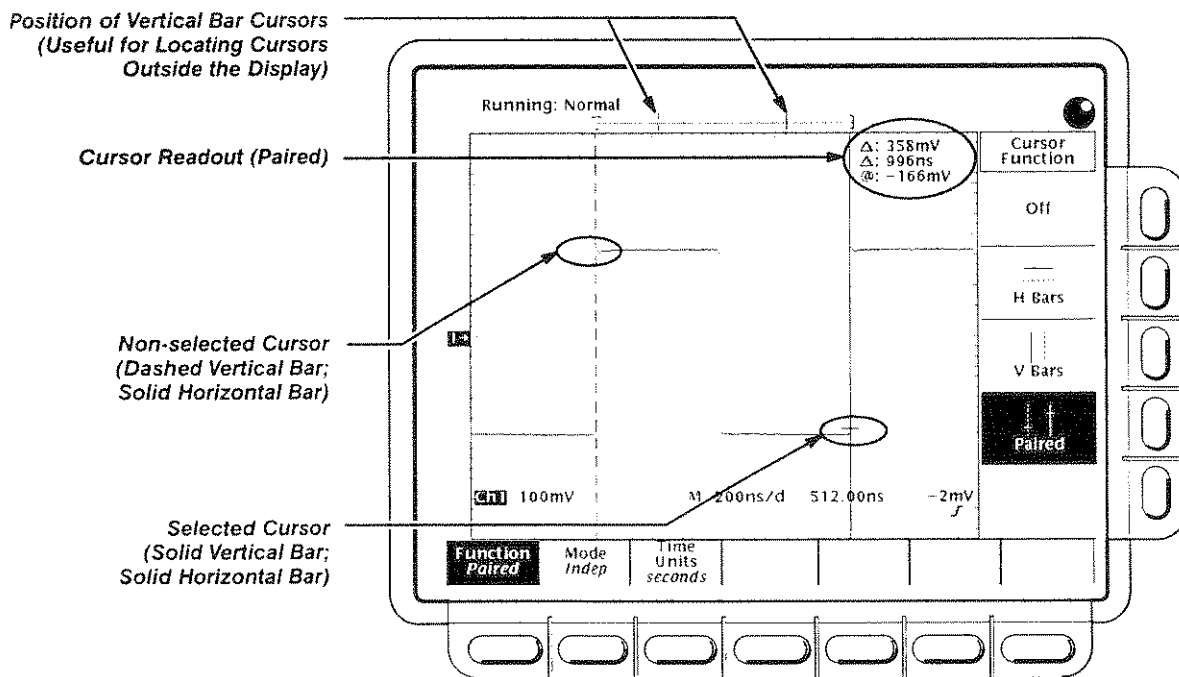

Figure 3-8: Paired Cursor Menu and Readouts

---

## Operation

To take cursor measurements press the **CURSOR** button to display the Cursor menu (Figure 3-7).

### Function

You can select the type of cursors you want using the **Function** menu item. Press **CURSOR** → **Function** (main) → **H Bars**, **V Bars**, **Paired**, or **Off** (side).

### Mode

You can select the cursor mode you want using the **Function** menu item.

1. Press **CURSOR** → **Mode** (main) → **Independent** or **Tracking** (side):
  - **Independent** makes each cursor positionable without regard to the position of the other cursor.
  - **Tracking** makes both cursors positionable in tandem; that is, both cursors move in unison and maintain a fixed horizontal or vertical distance between each other.
2. Use the general purpose knob to move the selected (active) cursor if independent was selected in step 1. Use the **TOGGLE** button to change which cursor is active and moves. A solid line indicates the active cursor and a dashed line the inactive cursor.

or

Use the general purpose knob to move both cursors in tandem if tracking was selected in step 1. Use the **TOGGLE** button to temporarily suspend cursor tracking; then use the general purpose knob to adjust the distance of the solid cursor relative to the dashed cursor. Push **TOGGLE** again to resume tracking. A solid line indicates the adjustable cursor and a dashed line the fixed cursor.

### Time Units

You can choose to display vertical bar cursor results in units of time or frequency (see Figure 3-9).

Press **CURSOR** → **Time Units** (main) → **seconds** or **1/seconds (Hz)** (side).

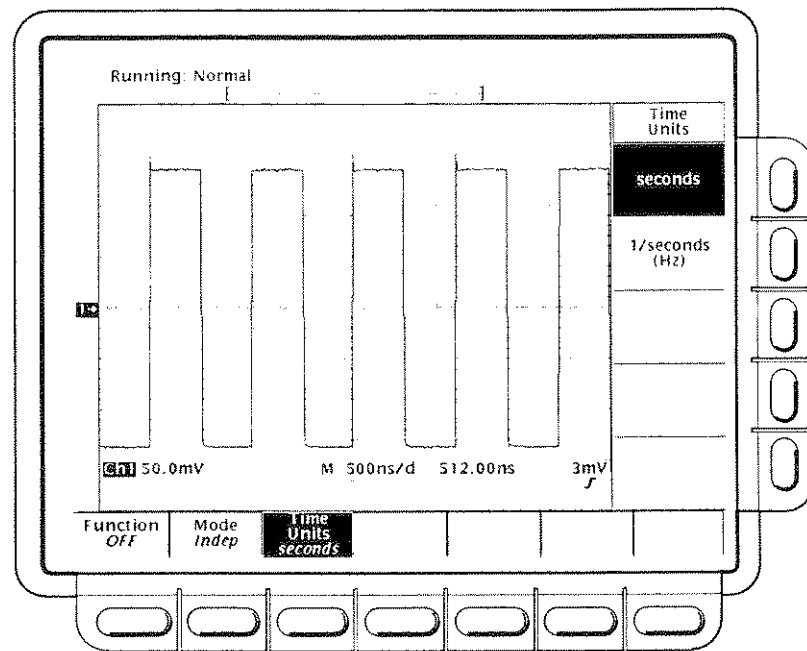

Figure 3-9: Cursor Menu—Time Units

### Cursor Speed

You can change the cursors speed by pressing **SHIFT** before turning the general purpose knob. The cursor moves faster when the **SHIFT** button is lighted and the display says **Coarse Knobs** in the upper right corner. This feature is particularly useful when moving V Bar cursors through waveforms with long record lengths.

### For More Information

See *Measurements*, on page 2-25.

See *Waveform Math*, on page 3-97, for information on cursor units with multiplied waveforms.

See the *TDS Family Option 2F Instruction Manual*, if your oscilloscope has the advanced DSP math option, for information on cursor units with integrated, differentiated, and FFT waveforms.

See *Probe Functions*, on page 3-96.

# Display Modes

The digitizing oscilloscope can display waveform records in different ways. The Display menu lets you adjust the oscilloscope display style, intensity level, graticule, and format.

## Operation

Press **DISPLAY** to show the Display menu.

### Display Style

Select the **Style** menu item to select the display style for the waveform record (Figure 3-10).

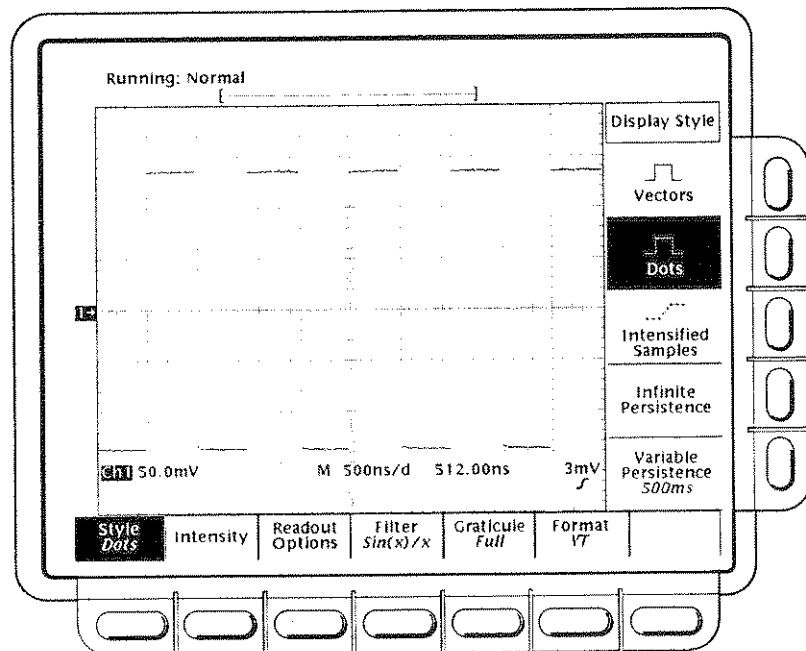

Figure 3-10: Display Menu—Style

Press **DISPLAY** → **Style** (main) → **Vectors**, **Intensified Samples**, **Dots**, **Infinite Persistence**, or **Variable Persistence** (side) (Figure 3-10).

- **Dots** display waveform record points as dots.
- **Vectors** has the display draw vectors (lines) between the record points. That does not affect the value of the waveform record points.

- **Intensified Samples** also displays waveform record points as dots. However, the points actually sampled are displayed intensified relative to the interpolated points. (The contrast between real and interpolated points is set to a fixed value.)
- **Variable Persistence** lets the record points accumulate on screen over many acquisitions and remain displayed only for a specific time interval. In that mode, the display behaves like an analog oscilloscope's screen. You enter the time for that option with the general purpose knob.
- **Infinite Persistence** lets the record points accumulate until you change some control (such as scale factor) causing the display to be erased.

## Intensity

Intensity lets you set overall, text/graticule, and waveform intensity (brightness) levels. You can also set the contrast intensity of the delay portion of a waveform.

Press **DISPLAY** → **Intensity** (main) → **Overall, Text/Grat, Waveform,** or **Contrast** (side) (Figure 3-11). Enter the intensity percentage values with the general purpose knob.

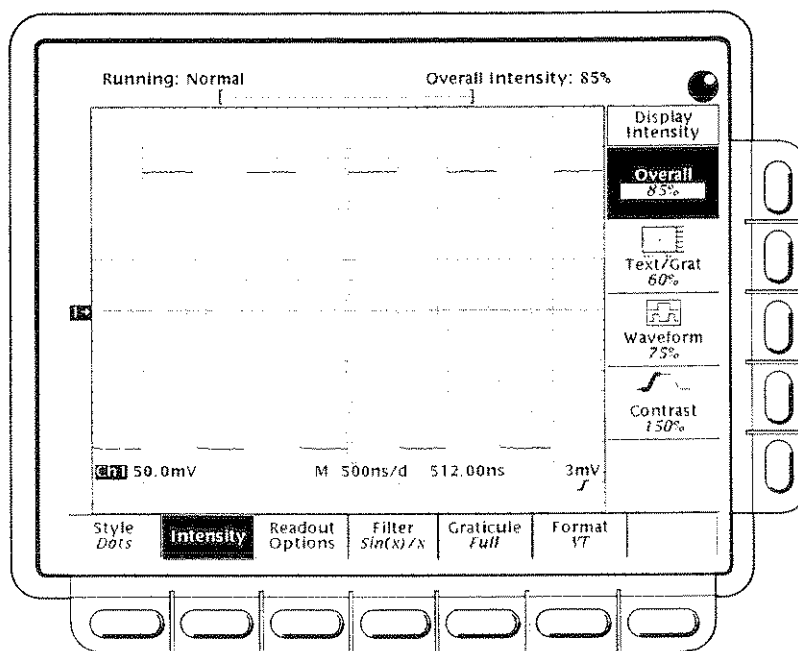

Figure 3-11: Display Menu—Intensity

All intensity adjustments operate over a range from 20% (close to fully off) to 100% (fully bright).

Contrast operates over a range from 100% (no contrast) to 250% (intensified portion at full brightness).

**NOTE**

*If you set the contrast to 100%, you will not be able to distinguish the intensified portion from the rest of the waveform because both are the same brightness.*

**Display Readout**

Readout options control whether the trigger level bar and current date and time appear on the display. The options also control what style trigger level bar, long or short, is displayed.

**NOTE**

*The Trigger Bar feature was disabled for initial releases of the TDS 820 Digitizing Oscilloscope.*

1. Press **DISPLAY → Readout** (main).
2. Toggle **Trigger Bar Style** (side) to select either the short or the long trigger bar or to turn the trigger bar off. (See Figure 3-12. Note that the figure shows both styles for illustrating purposes, but you can only display one style at a time.)

The trigger bar is only displayed if the trigger source is an active, displayed waveform (**CH 1** or **CH 2**). The trigger bar is a visual indicator of the trigger level.

Sometimes, especially when using the hardcopy feature, you may wish to display the current date and time on screen. For more information about displaying and setting date and time, see *Date/Time Stamping Your Hardcopy* on page 3-29.)

3. Press **Display Date/Time** (side) to turn it on or off. Push **Clear Menu** to see the current date and time. (Note that if the date and time have not been set since the oscilloscope was last powered on, a message is displayed with instructions for setting date and time.)



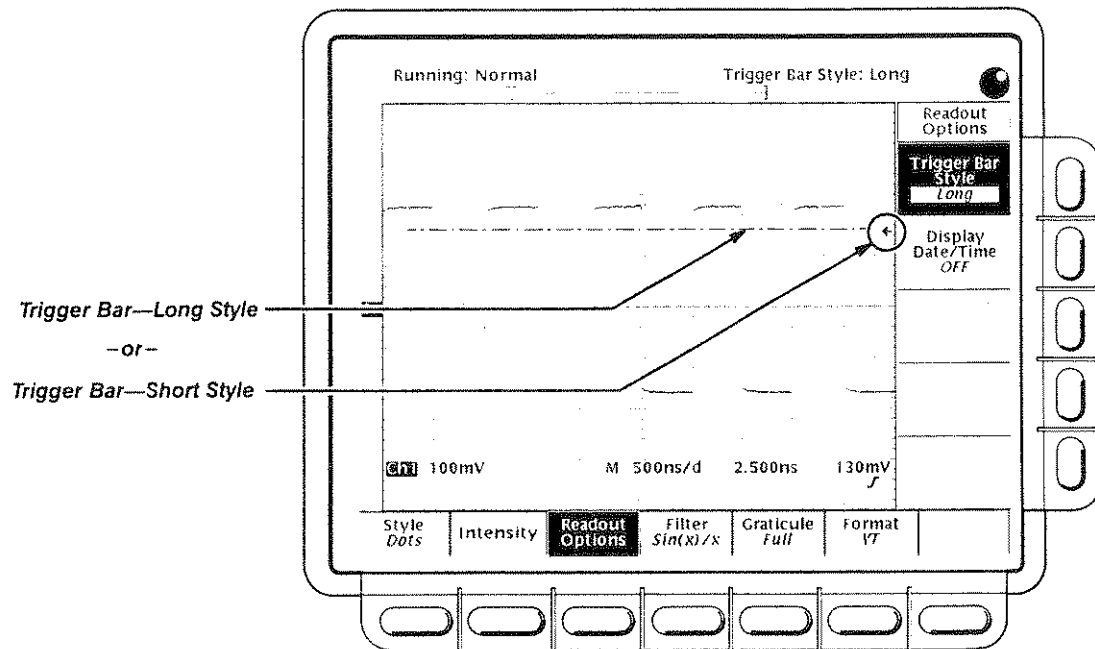

Figure 3-12: Level Indicators

### Filter Type

The display filter types are  $\sin(x)/x$  interpolation and linear interpolation.

- **Linear Interpolation** computes record points between actual acquired samples by using a straight line fit. It assumes all the interpolated points fall on that straight line. This is useful for many linear waveforms like pulse trains.
- **$\sin(x)/x$  Interpolation** computes record points using a curve fit between the actual values acquired. It assumes all the interpolated points fall along that curve. This is particularly useful when acquiring more rounded waveforms like sine waves. It is also appropriate for general use, although it may introduce some overshoot or undershoot in signals with fast rise times.

To change the filter type, follow these steps.

Press **DISPLAY** → **Filter** (main) →  **$\sin(x)/x$  Interpolation** or **Linear Interpolation** (side).

### Graticule Type

To change the graticule:

Press **DISPLAY** → **Graticule** (main) → **Full**, **Grid**, **Cross Hair**, or **Frame** (side) (Figure 3-13).

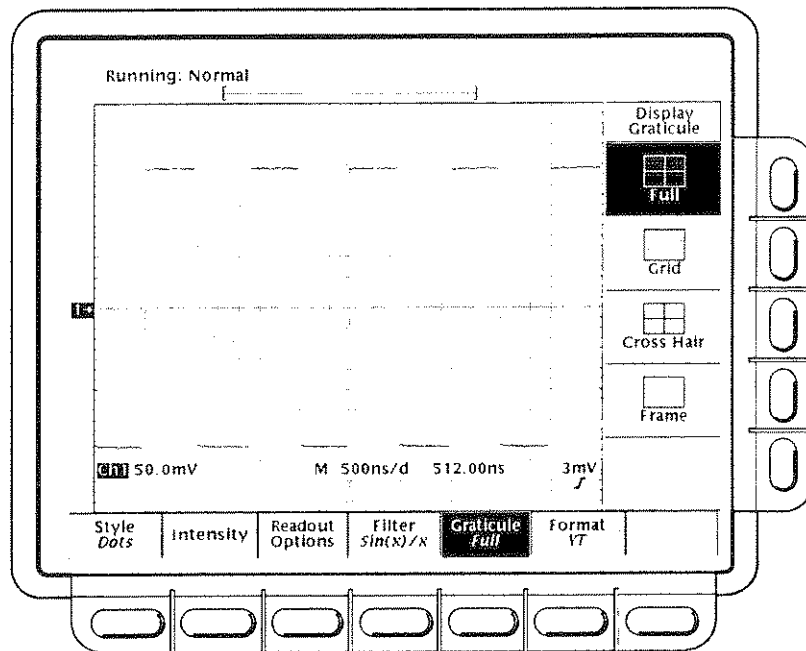
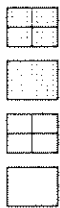

Figure 3-13: Display Menu—Graticule



- **Full** provides a grid, cross hairs and a frame.
- **Grid** displays a frame and a grid.
- **Cross Hair** provides cross hairs and a frame.
- **Frame** displays just a frame.

### Format

There are two kinds of format: YT and XY.



**YT** is the conventional oscilloscope display format. It shows a signal voltage (the vertical axis) as it varies over time (the horizontal axis).



**XY** format compares the voltage levels of two waveform records point by point. That is, the digitizing oscilloscope displays a graph of the voltage of one waveform record against the voltage of another waveform record. That mode is particularly useful for studying phase relationships.

To set the display axis format:

Press **DISPLAY** → **Format** (main) → **XY** or **YT** (side) (Figure 3-14).

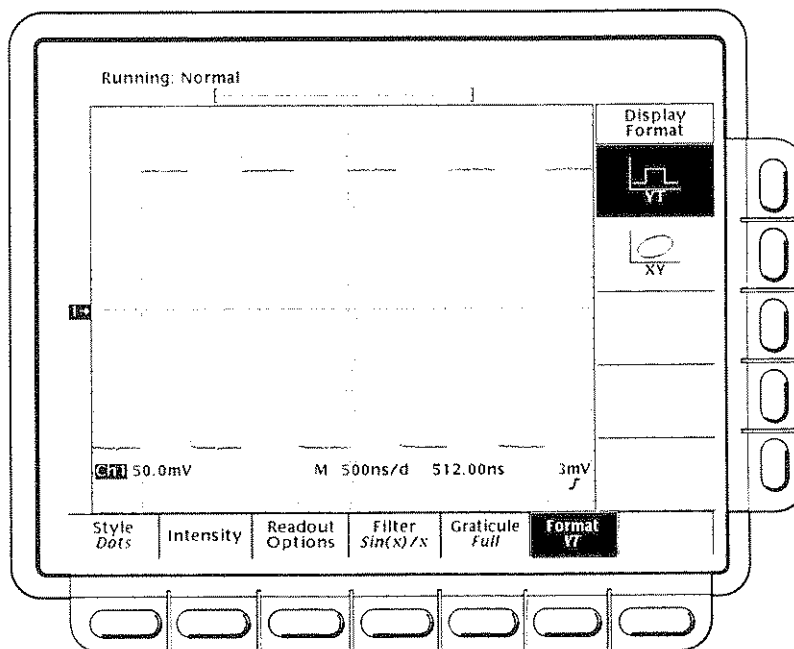

Figure 3-14: Display Menu—Format

When you choose the XY mode, you assign the input you have selected to the X-axis and the digitizing oscilloscope automatically chooses the Y-axis input (see Table 3-2).

Table 3-2: XY Format Pairs

X-Axis Channel (User Selectable)	Y-Axis Channel (Fixed)
Ch 1	Ch 2
Ref 1	Ref 2
Ref 3	Ref 4

For example, if you press the **CH 1** button, the digitizing oscilloscope will display a graph of channel 1 voltage levels on the X-axis against channel 2's voltage levels on the Y-axis. That will occur whether or not you are displaying channel 2's waveform in YT format. If you sometime later press the **WAVE-FORM OFF** button for either channel 1 or 2, the digitizing oscilloscope will delete the XY graph of channel 1 versus channel 2.

Since selecting **YT** or **XY** only affects the display, the horizontal and vertical scale and position knobs and menus control the same parameters regardless of the mode selected. Specifically, in XY mode, the horizontal scale will continue to control the time base and the horizontal position will continue to control which portion of the waveforms are displayed.

XY format is a dot-only display, although it can have persistence. The **Vector** style selection has no effect when you select XY format.

You cannot display Math waveforms in XY format. They will disappear from the display when you select XY.

---

**For More  
Information**

See *Acquisition* on page 2-17.

# Graphics

The digitizing oscilloscope allows you to draw lines and polygons on the display. You can use this feature to draw masks around areas that should include or exclude waveform data. Then you can more easily see if your signal strays out of bounds.

## Operation

To access the graphics drawing feature:

1. Press **SHIFT UTILITY** to bring up the Utility menu.
2. Press **System** (main) → **Graphics** (pop-up) (see Figure 3-15).

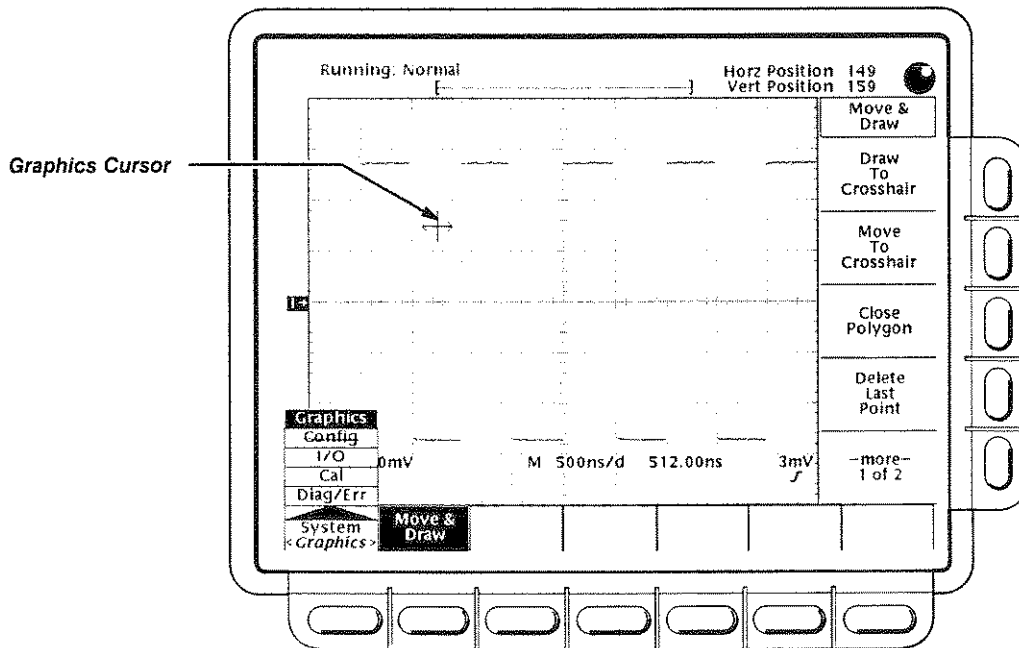

Figure 3-15: Graphics Menu

3. When you bring up the Graphics menu, a crosshair cursor appears on the screen. You use this cursor to draw lines. Move the cursor using the general purpose knob and **TOGGLE** button.

The first time you see the crosshair cursor, the horizontal lines terminate in arrowheads, indicating that the general purpose knob controls horizontal motion. Rotate the general purpose knob and watch the cursor move horizontally across the display.

4. Now press **TOGGLE**. The arrowheads move to terminate the vertical lines, and the general purpose knob now moves the cursor vertically across the display.

Push **TOGGLE** and rotate the general purpose knob until you have placed the crosshair cursor where you want your first line to start.

### Drawing

5. When the cursor is at an appropriate place, press **Draw To Crosshair** (side). This places the present cursor position in the list of points that the digitizing oscilloscope maintains.
6. Now move the cursor. A rubberband line appears from the position of the first point to the present cursor position. Using the general purpose knob and the **TOGGLE** button, move the cursor until it is at a point to which you wish to draw a line.
7. Press **Draw To Crosshair** (side). The present cursor position becomes the point next in the list of points, and a line appears between the two points (see Figure 3-16).
8. Repeat to add another point and draw another line.

The list of points can contain up to 100 points. This means that you can draw up to 99 line segments on the display, although there will be fewer if some of the points have been moved to without drawing a line between them.

If you want to close the figure you have been drawing, press **Close Polygon** (side). The instrument draws a line to the first point in its list from the last point drawn to. The crosshair cursor also moves back to the first point.

### NOTE

*If you move the cursor between drawing the previous line and closing the polygon, the present cursor position is ignored. The instrument draws the same line it would have drawn if you had not moved the cursor.*

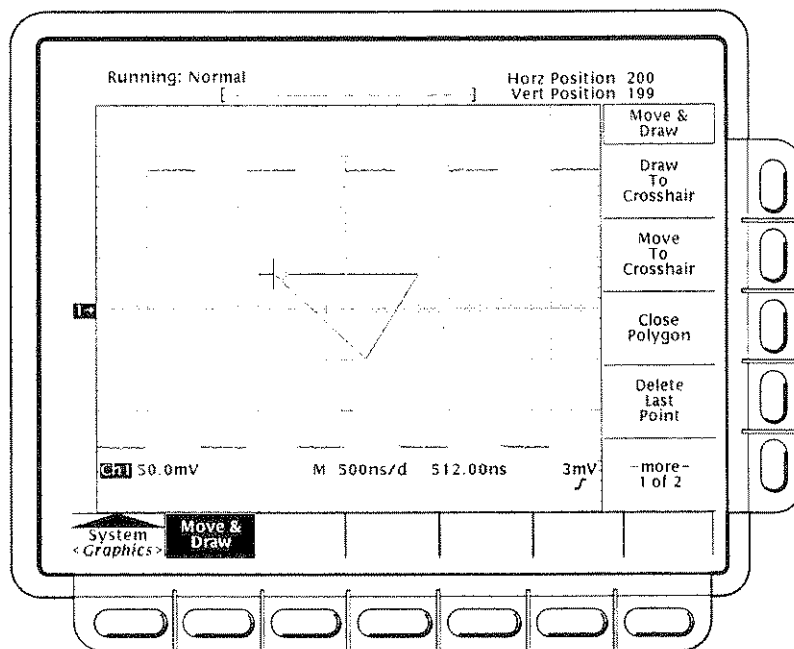

Figure 3-16: Drawing Lines

## Moving

You can also move the cursor without drawing, allowing you to start a different figure in another location.

1. Move the cursor to where you wish the new figure to start.
2. Press **Move To Crosshair** (side). The rubberbanding line disappears, no line is drawn, and the present cursor position is added to the list of points.

Experiment with moving and drawing until you are comfortable with these capabilities.

### NOTE

*Ordinarily, the **Move To Crosshair** menu item is for moving, and the **Draw To Crosshair** menu item is for drawing. However, for the first point in the list, the actions of **Move To Crosshair** and **Draw To Crosshair** are equivalent.*

## Removing Points

1. If you add a point in error, you can remove it. Press **Delete Last Point** (side) to remove the last point you added from the list of points.

2. If you press **Delete Last Point** repeatedly, you can remove all the points you added in the reverse order from the order in which you added them.
3. You can clear the display of all lines by removing all the points in the list. To do so, press **Delete All Points** (side). The list of points is now empty and no lines appear on the display, but the crosshair cursor remains, ready to draw new lines if you wish.

If this item is not visible, press **—more—** (side) to see the second page of items. (See Figure 3-17.)

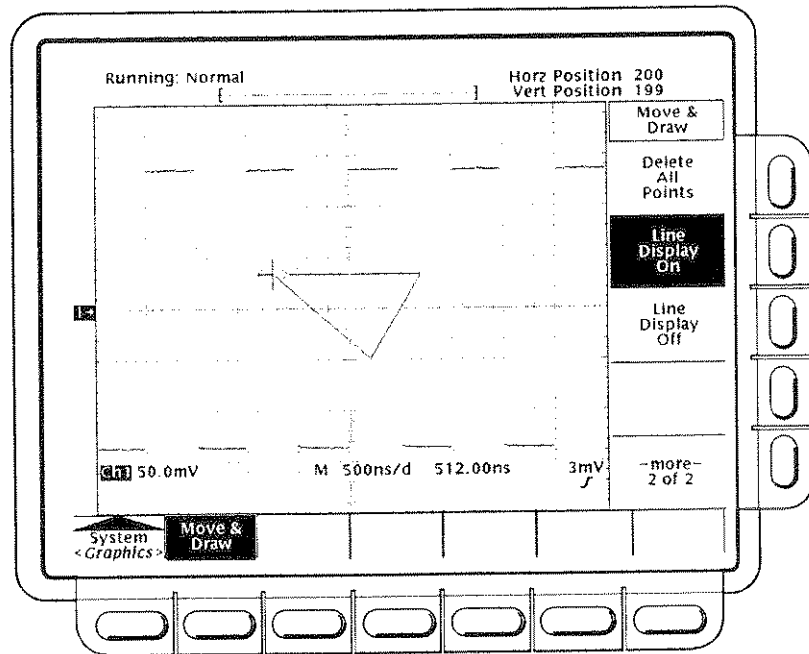

Figure 3-17: Graphics Menu, Page Two

### Line Display

You may wish to clear the display of all lines but nevertheless to save a figure you have drawn for later use. To do so, you can turn line display on or off as necessary.

1. To turn off line display, press **Line Display Off** (side). Lines you have drawn no longer appear on the display, but the list of points (and lines to draw between them) remains, and will appear when you turn line display back on. This is true even if you turn off the digitizing oscilloscope in the interim.
2. To see the figures you have drawn again, press **Line Display On** (side).

If you start to draw a line by pressing **Draw To Crosshair**, the digitizing oscilloscope turns line display on automatically.



## Saving Lines and Figures

If you have used the graphics feature when you want to save an instrument setting, the points, lines, and line display status are saved with the setup. When you recall the setup, it also restores these items.

---

### For More Information

See *Saving and Recalling Setups*, on page 3-75.



# Hardcopy

You can get a hardcopy of the digitizing oscilloscope display by using the hardcopy feature. Depending on the output format you select, you create either an image or a plot. Images are direct bit map representations of the digitizing oscilloscope display. Plots are vector (plotted) representations of the display.

---

## Hardcopy Formats

Different hardcopy devices use different formats. The digitizing oscilloscope supports the following formats:

- HP Thinkjet
- HP Deskjet
- HP Laserjet
- HPGL Color Plot
- Epson®
- Interleaf®
- Tag Image File Format (TIFF®)
- PC Paintbrush® (PCX®)
- Microsoft Windows® file format (BMP®)
- Encapsulated Postscript® (Image, Mono Plot, and Color Plot)

Some formats, particularly Interleaf, Postscript, TIFF, PCX, BMP, and HPGL, are compatible with various desktop publishing packages. That means you can paste files created from the oscilloscope directly into a document on any of those desktop publishing systems.

EPS Mono and Color formats are compatible with the Tektronix Phaser Color Printer, HPGL is compatible with the Tektronix HC100 Plotter, and Epson is compatible with the Tektronix HC200 Printer.

---

## Operation

Before you make a hardcopy, you need to set up communications and hardcopy parameters. This discussion assumes that the hardcopy device is already connected to the GPIB port on the rear panel. If that is not the case see *Connection Strategies* on page 3-30.

### Setting Communication Parameters

To set up the communication parameters:

Press **SHIFT UTILITY** → **System** (main) → **I/O** (pop-up) → **Configure** (main) → **Hardcopy (Talk Only)** (side) (see Figure 3-18).

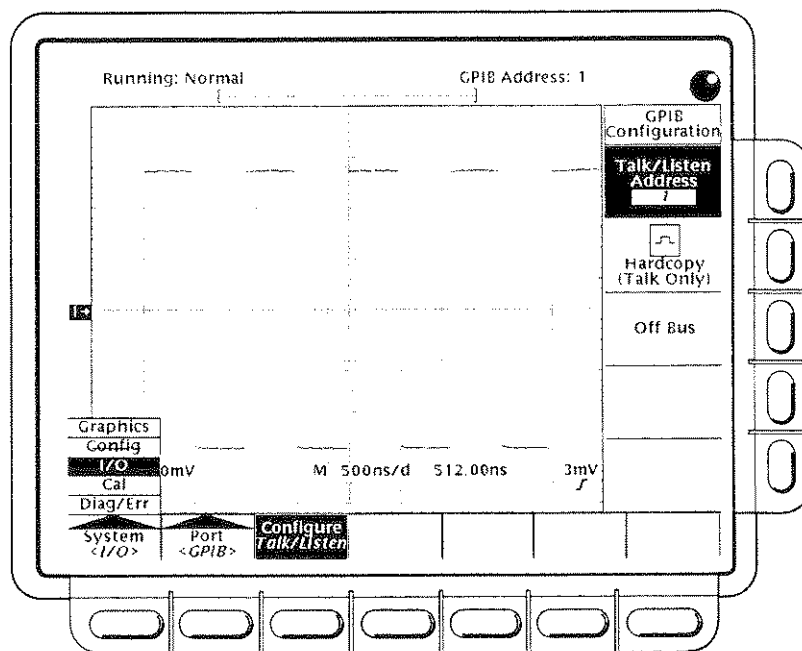

Figure 3-18: Utility Menu—System I/O

### Setting Hardcopy Parameters

To specify the hardcopy format, layout, and type of port using the hardcopy menu:

1. Press **SHIFT HARDCOPY MENU** to bring up the Hardcopy menu.
2. Press **Format** (main) → **Thinkjet, Deskjet, Laserjet, Epson, Interleaf, TIFF, PCX, BMP, EPS Image, EPS Mono, EPS Color** (EPS stands for Encapsulated Postscript), or **HPGL** (side). (Press **–more–** (side) to see all of these format choices.)
3. Press **SHIFT HARDCOPY MENU** → **Layout** (main) → **Landscape** or **Portrait** (side) (see Figure 3-19).
4. Press **SHIFT HARDCOPY MENU** → **Port** (main) to specify the output channel to send your hardcopy through. Unless your instrument is equipped with Option 13, the only choice is **GPIB**. (If your instrument is equipped with Option 13, see the *TDS Family Option 13 Instruction Manual* for setting up hardcopy over the RS-232 and Centronics ports.)

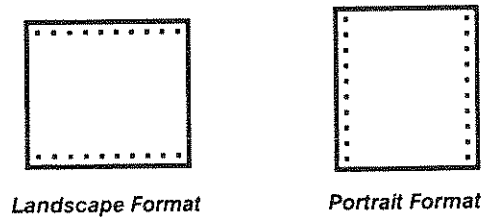

Figure 3-19: Hardcopy Formats

The **Port** main menu item lets you specify the output channel to send your hardcopy through. The only choice is  **GPIB**.

### Printing the Hardcopy

You can print a single hardcopy or send additional hardcopies to the spool (queue) while waiting for earlier hardcopies to finish printing. To print your hardcopy(ies):

Press **HARDCOPY** to print your hardcopy.

While the hardcopy is being sent to the printer, the oscilloscope will display the message "Hardcopy in process—Press **HARDCOPY** to abort."

To stop and discard the hardcopy being sent, press **HARDCOPY** again *while* the hardcopy in process message is still on screen.

To add additional hardcopies to the printer spool, press **HARDCOPY** again *after* the hardcopy in process message is removed from the screen.

You can add hardcopies to the spool until it is full. When the spool is filled by adding a hardcopy, the message "Hardcopy in Process—Press **HARDCOPY** to abort" remains displayed. You can abort the *last* hardcopy sent by pressing the button while the message is still displayed. When the printer empties enough of the spool to finish adding the last hardcopy it does so and then removes the message.

To remove all hardcopies from the spool:

Press **SHIFT HARDCOPY MENU** → **Clear Spool** (main) → **OK Confirm Clear Spool** (side).

This oscilloscope takes advantage of any unused RAM when spooling hardcopies to printers. The size of the spool is, therefore, variable. The number of hardcopies that can be spooled depends on three variables:

- the amount of unused RAM
- the hardcopy format chosen
- the complexity of the display

Although not guaranteed, usually the oscilloscope can spool about 2.5 hardcopies before it must wait to send the rest of the third copy.

## Date/Time Stamping Your Hardcopy

You can display the current date and time on screen so that it appears on the hardcopies you print. To date and time stamp your hardcopy:

1. Press **DISPLAY** → **Readout Options** (main) → **Display Date and Time** (side) to toggle the setting to **On**.
2. If you have not set the date and time since the instrument was last powered on, the instrument displays a message instructing you to set the date and time. If that is the case, skip steps 3 and 4 and continue with step 5.
3. Press **Clear Menu** to remove the menu from the display so the date and time can be displayed. See Figure 3-20. (The date and time are removed from the display when menus are displayed.)
4. Press **HARDCOPY** to print your date/time stamped hardcopy.

If you need to set the date and time of the oscilloscope:

5. Press **SHIFT UTILITY** → **Config** (pop-up) → **Set Date & Time** (main) → **Year, Day Month, Hour, or Minute**.

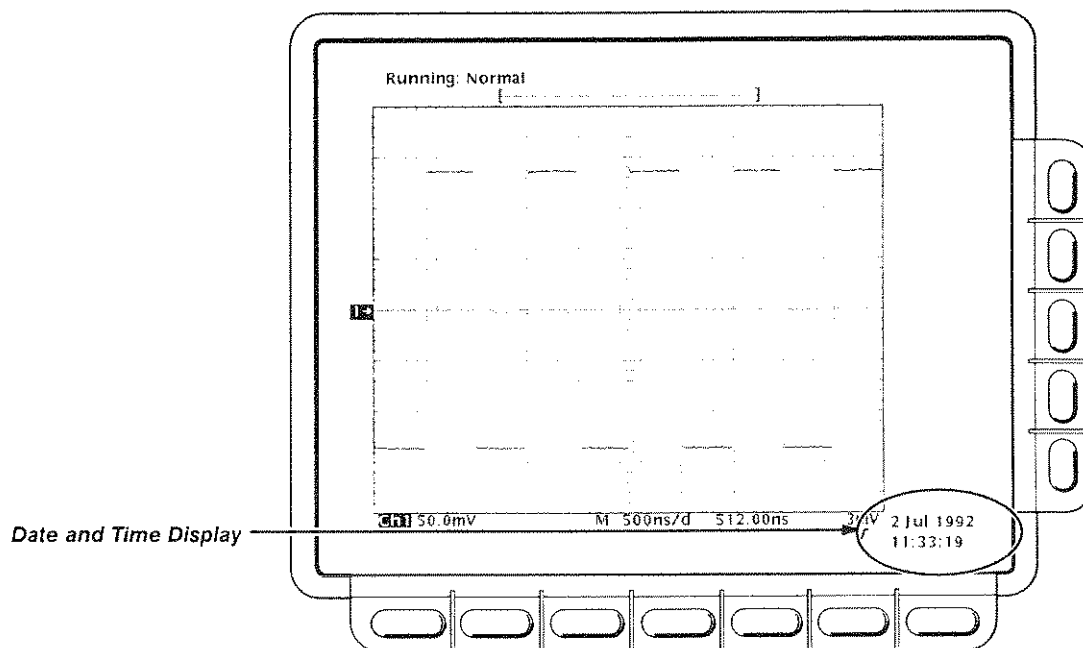

Figure 3-20: Date and Time Display

6. Use the general purpose knob or the keypad to set the parameter you have chosen to the value desired. (The format when using the keypad is day.month. For example, use 23.6 for the 23<sup>rd</sup> of June.)
7. Repeat steps 5 and 6 to set other parameters as desired.

8. Press **OK Enter Date/Time** (side) to put the new settings into effect. This sets the seconds to zero.

**NOTE**

*When setting the clock, you can set to a time slightly later than the current time and wait for it to catch up. When current time catches up to the time you have set, pressing **OK Enter Date/Time** (side) synchronizes the set time to the current time.*

*The date and time are not backed up by a battery. To use the date and time stamp, you must set it each time you power up the digitizing oscilloscope.*

9. Press **CLEAR MENU** to see the date/time displayed with the new settings.
10. Press **HARDCOPY** to print your date/time stamped hardcopy.

---

## Connection Strategies

The ability of the digitizing oscilloscope to print a copy of its display in many formats (Thinkjet, Deskjet, Laserjet, Epson, Interleaf, EPS Image (Postscript), and HPGL) gives you flexibility in choosing a hardcopy device. It also makes it easier for you to read oscilloscope screen copies into a desktop publishing system.

However, since the digitizing oscilloscope has only a GPIB interface port and many hardcopy devices have only RS-232 or Centronics ports, you need a connection strategy for sending the hardcopy data from the digitizing oscilloscope to the printer or plotter. Three such strategies exist; choose from the following strategies:

**NOTE**

*If your instrument has Option 13, your oscilloscope has an RS-232 port and a Centronics port in addition to the GPIB port. See the TDS Family Option 13 Instruction Manual for setting up to hardcopy directly through the RS-232 and Centronics ports.*

- use a printer or plotter with a GPIB connector,
- use a GPIB-to-Centronics or GPIB-to-RS232 converter box, or
- send the data to a computer with both GPIB and RS-232 or Centronics ports.

### Using a GPIB-Based Hardcopy Device

You can connect the digitizing oscilloscope directly to a GPIB-based hardcopy device (see Figure 3-21). An example of a GPIB hardcopy device is the Tektronix HC100 Plotter.

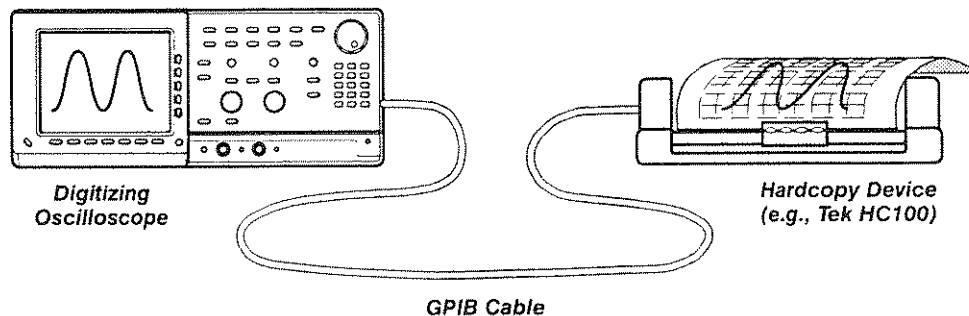

Figure 3-21: Connecting the Digitizing Oscilloscope Directly to the Hardcopy Device

### Using a GPIB-to-Centronics or GPIB-to-RS232 Converter

You can put a GPIB-to-Centronics or GPIB-to-RS232 interface converter box between the TDS and the RS-232 or Centronics hardcopy device (see Figure 3-22). For example, a National Instruments GPIB-PRL (a GPIB-to-Centronics converter) will permit you to make screen prints on a Tektronix HC200 Dot Matrix printer with just a Centronics port.

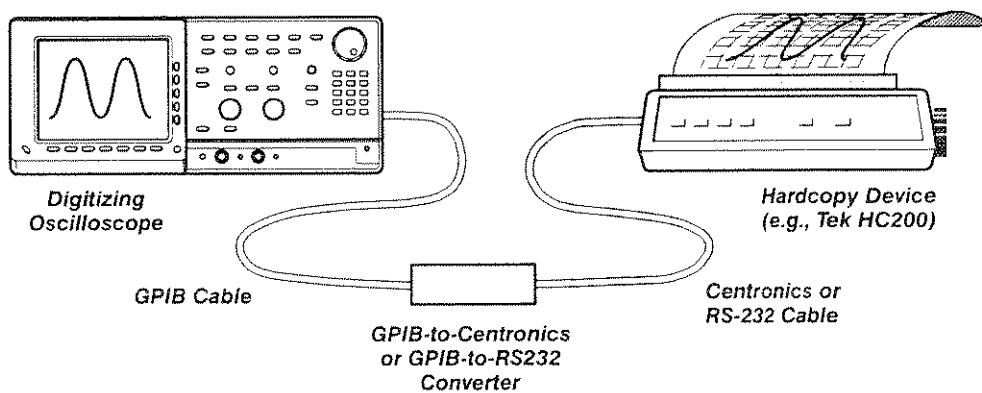
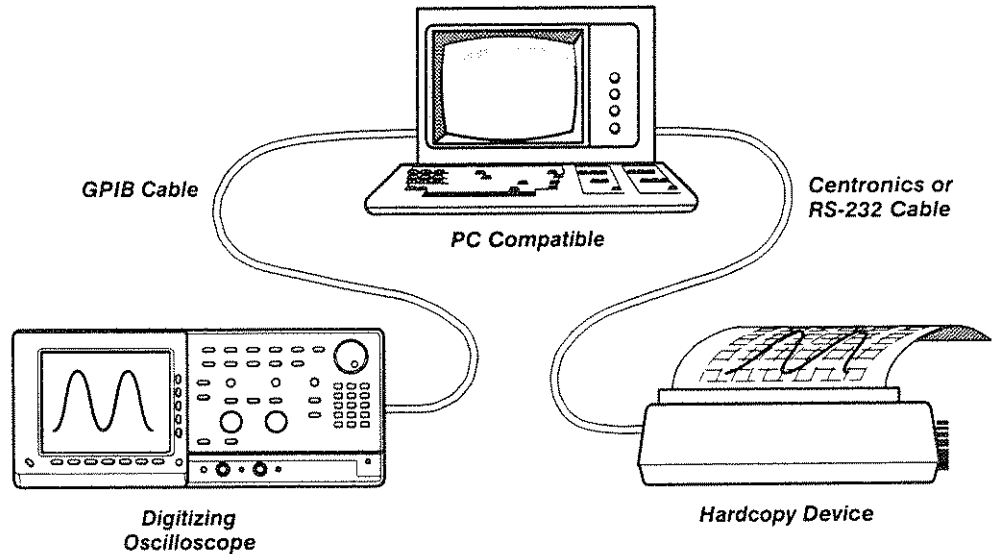

Figure 3-22: Connecting the TDS and Hardcopy Device Via a Converter

## Using a Controller

You can put a controller with two ports between the TDS and the hardcopy device (see Figure 3-23). One port must be a GPIB and the other must be either an RS-232 or a Centronics port.



**Figure 3-23: Connecting the TDS and Hardcopy Device Via a PC**

If your controller is PC-compatible and it uses the Tektronix GURU or S3FG210 (National Instruments GPIB-PCII/IIA) GPIB package, you can operate this setup as follows:

1. Use the MS-DOS `cd` command to move to the directory that holds the software that came with your GPIB board. For example, if you installed the software in the GPIB-PC directory, type: **cd GPIB-PC**
2. Run the IBIC program that came with your GPIB board. Type: **IBIC**
3. Type: **IBFIND DEV1**  
 where "DEV1" is the name for the digitizing oscilloscope you defined using the IBCONF.EXE program that came with the GPIB board. Note: if you defined another name then, of course, use it instead of "DEV1". Also, remember that the device address of the digitizing oscilloscope as set with the IBCONF.EXE program should match the address set in the digitizing oscilloscope Utility menu (typically, use "1").
4. Type: **IBWRT "HARDCOPY START"**  
 Be sure the digitizing oscilloscope Utility menu is set to **Talk/Listen** and not **Hardcopy (Talk Only)** or you will get an error message at this step. Setting the digitizing oscilloscope Utility menu was described in the start of this Hardcopy section under the heading *Setting Communication Parameters*.



5. Type: **IBRDF <Filename>**  
where <Filename> is a valid DOS file name you want to call your hardcopy information. It should be  $\leq 8$  characters long with up to a 3 character extension. For example, you could type "ibrdf screen1".
6. Exit the IBIC program by typing: **EXIT**
7. Type: **COPY <Filename> <Output port> </B>** where <Filename> is the name you defined in step 5 and <Output port> is the PC output port your hardcopy device is connected to (such as LPT1 or LPT2).  
Copy the data from your file to your hardcopy device. First, ensure your printer or plotter is properly attached to your PC. Then copy the file. For example, if your file is called *screen1* and your printer is attached to the *lpt1* parallel port, type "copy screen1 lpt1:".

Your hardcopy device should now print a picture of the digitizing oscilloscope screen.

---

## For More Information

See *Remote Communication*, on page 3-71.

See the *TDS Family Option 13 Instruction Manual*, Tektronix part number 070-8567-00 (Option 13 equipped instruments only).

# Help

The on-line help system provides brief information about each of the digitizing oscilloscope controls.

## Operation

To use the on-line help system

Press **HELP** to provide on-screen information on any front panel button, knob or menu item (see Figure 3-24).

When you press that button, the instrument changes mode to support on-line help. Press **HELP** again to return to regular operating mode. Whenever the oscilloscope is in help mode, pressing any button (except **HELP** or **SHIFT**), turning any knob, or pressing any menu item displays help text on the screen that discusses that control.

The menu selections displayed when **HELP** was first pressed remain on the screen. On-line help is available for each menu selection displayed at the time the **HELP** button was first pressed. If you are in help mode and want to see help on selections from non-displayed menus, you first exit help mode, display the menu you want information on, and press the **HELP** button again to re-enter help mode.

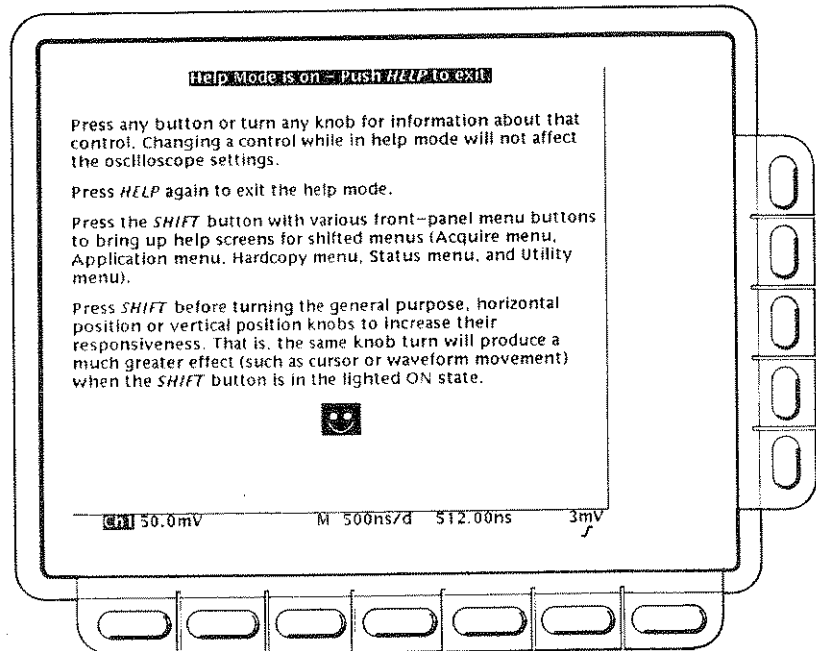

Figure 3-24: Initial Help Screen

# Horizontal Control

You can control the horizontal part of the display (the time base) using the horizontal menu and knobs.

## Horizontal Knobs

By changing the horizontal scale, you can focus on a particular portion of a waveform. By adjusting the horizontal position, you can move the waveform right or left on the display to see different portions of it. That is particularly useful when you are using larger record sizes and can't view the entire waveform on one screen.

To change the horizontal scale and position, use the horizontal **POSITION** and horizontal **SCALE** knobs (see Figure 3-25). These knobs manage the time base and horizontal waveform positioning on the screen.

When you use either the horizontal **SCALE** or **POSITION** knobs, you will affect all the waveform records displayed. If you want the **POSITION** knob to move faster, press the **SHIFT** button. When the light above the **SHIFT** button is on and the display says **Coarse Knobs** in the upper right corner, the **POSITION** knob speeds up significantly.

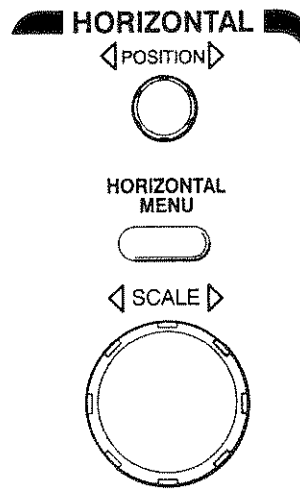

Figure 3-25: Horizontal Controls

## Horizontal Readouts

At the top of the display, the *Record View* shows the size and location of the waveform record and the location of the trigger relative to the display (see Figure 3-26).

The *Time Base* readout at the lower right of the display shows the time per division and time base position settings and the time base (main or delayed) being referred to (see Figure 3-26).

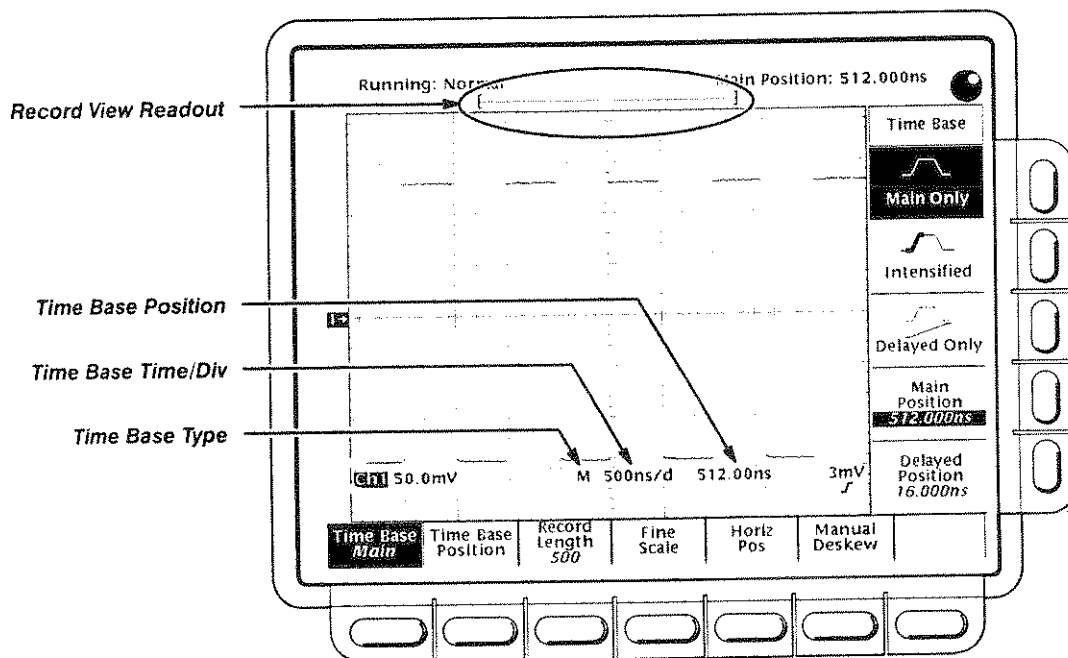

Figure 3-26: Record View and Time Base Readouts

## Horizontal Menu

The Horizontal menu lets you select either a main or delayed view of the time base for acquisitions. It also lets you set the record length, and change the horizontal position, scale, or manual deskew.

Press the **HORIZONTAL MENU** button to bring up the Horizontal menu (Figure 3-27).

### Main and Delayed Time Base

You can select between the Main and Delayed views of the time base.

Press **HORIZONTAL MENU** → **Time Base** (main) → **Main Only**, **Intensified**, or **Delay Only** (side) (see Figure 3-27).

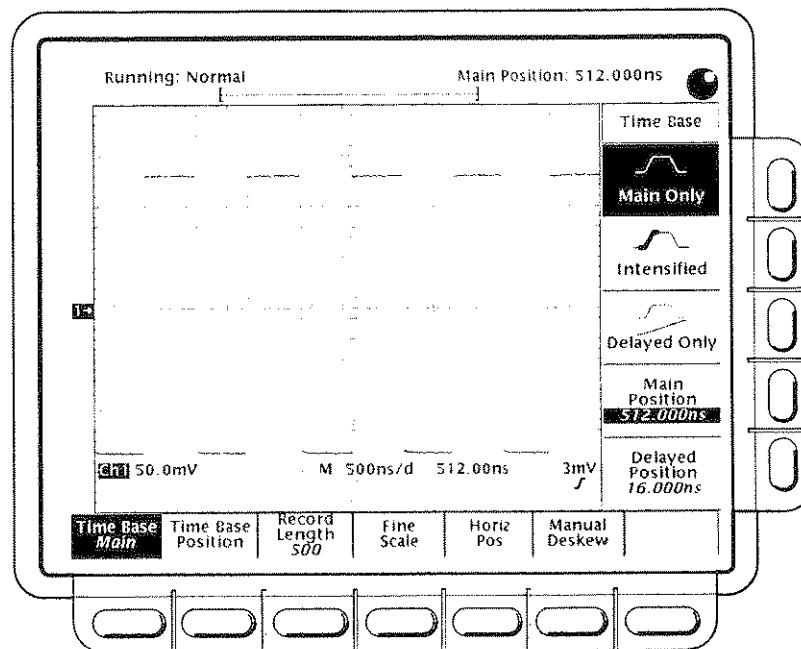

Figure 3-27: Horizontal Menu—Time Base

Pressing **Intensified** displays an intensified zone in the main waveform record. The intensified zone represents the delayed time base record; this view shows you the delayed time base relative to the main time base. The start of the intensified zone corresponds to the start point of the delayed time base waveform record. The end of the zone corresponds to the end of the delayed time base waveform record. The general purpose knob or keypad is now set to change the delayed time base position.

#### NOTE

*If the delayed time base record starts after the main time base record ends, no intensified zone appears on the main waveform record.*

To learn how to change the intensity of the normal and intensified waveform, see *Display Modes* on page 3-14.

Pressing **Delayed Only** displays the delayed time base. The general purpose knob or keypad is now set to change the delayed time base position.

Pressing **Main Position** sets the general purpose knob or keypad to set the main time base position, but does not change the view displayed. The main time base position appears in the readout below the menu item.

Pressing **Delayed Position** sets the general purpose knob or keypad to set the delayed time base position, but does not change the view displayed. The main time base position appears in the readout below the menu item.

### Time Base Position

You can also set the main and delayed time base positions using the **Time Base Position** menu item. The time base position is the time from the trigger event to the first point in the waveform record.

Press **HORIZONTAL MENU** → **Time Base Position** (main) → **Main Position** or **Delayed Position** (side) (see Figure 3-28).

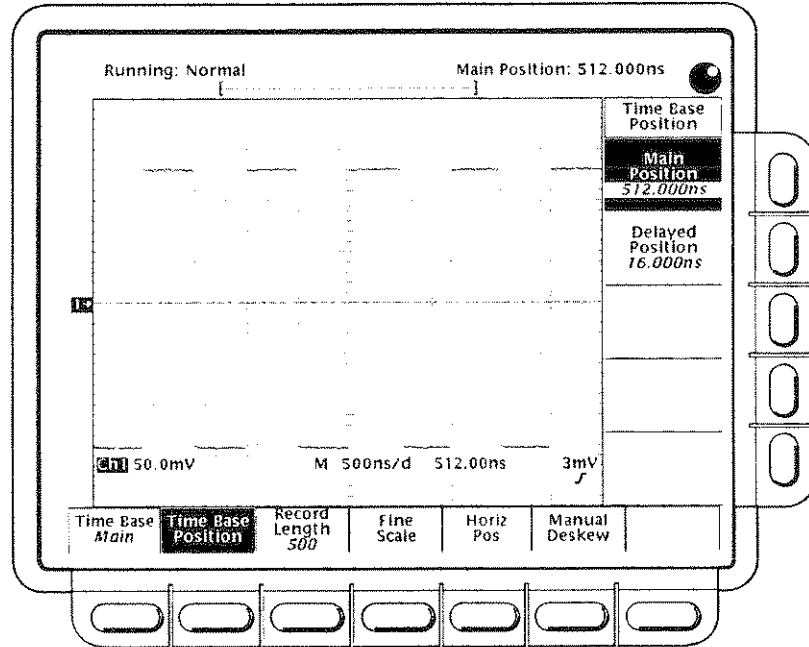

Figure 3-28: Horizontal Menu—Time Base Position

Pressing either of these sets the general purpose knob or keypad to set the corresponding time base position. The current time base position appears in the readout below the menu item.

### Record Length

To set the waveform record length, press **HORIZONTAL MENU** → **Record Length** (main). The side menu lists various discrete record length choices.

### Fine Scale

You can change the horizontal scale (time per division) numerically in the menu instead of using the Horizontal **SCALE** knob. This menu allows you to set the time per division using the general purpose knob or keypad. With these, you can set the time per division in finer increments than the 1-2-5 sequence available from the Horizontal **SCALE** knob.

Press **HORIZONTAL MENU** → **Fine Scale** (main) → **Main Fine Scale** or **Delayed Fine Scale** (side) and change the scale values with the keypad or general purpose knob.

## Horizontal Position

To set the horizontal position to specific values in the menu instead of using the Horizontal **POSITION** knob:

Press **HORIZONTAL MENU** → **Horiz Pos** (main) → **Set to 10%**, **Set to 50%** or **Set to 90%** (side) to choose how much of the waveform will be displayed to the left of the display center.

You can also control whether changing the horizontal position setting affects all displayed waveforms, just the live waveforms, or only the selected waveform. The Horizontal Lock setting in the Zoom menu determines which waveforms the horizontal position knob adjusts whether zoom is on or not. Specifically, it acts as follows:

- **None**—only the waveform currently selected can be zoomed and positioned horizontally
- **Live**—all channels can be zoomed and positioned horizontally at the same time
- **All**—all waveforms displayed (channels, math, and/or reference) can be zoomed and positioned horizontally at the same time

See *Zoom*, on page 3-100 for the steps to set the horizontal lock feature.

## Manual Deskew

The TDS 820 allows you to align a signal horizontally one channel at a time using manual deskew. Use manual deskew to align the signal from one channel precisely with the signal from the other. Manual deskew allows you to compensate for the fact that the two signals may be coming in from cables of different lengths.

Setting a deskew time is similar to setting a time base position, but it applies to only one channel. The total time delay for each channel is its time base position plus its deskew time.

To set the deskew value:

Press **HORIZONTAL MENU** → **Manual Deskew** (main) → **Ch1** or **Ch2** (side) and change the deskew values with the keypad or general purpose knob. Valid deskew values are 0 to 10 ns in increments of 1 ps.

For best accuracy, adjust the deskew with your setup signal at the same time base position setting you will use to take the measurements. If this is not possible, use a time base position value for setting up that is as close as possible to that used for making the measurement.

---

**For More  
Information**

See *Scaling and Positioning Waveforms*, on page 2-21.

See *Zoom*, on page 3-100.





# Limit Testing

Limit testing gives you a way to automatically compare each incoming waveform against a template waveform. You set an envelope of limits around a waveform and let the digitizing oscilloscope find waveforms that fall outside those limits. When it finds such a waveform, the digitizing oscilloscope can generate a hardcopy, ring a bell, stop and wait for your input, or any combination of these actions.

When you use the limit testing feature, the first logical task is to create the limit test template from a waveform. You then specify the channel to compare to the template. Then you specify the action to take if incoming waveform data exceeds the limits set in the limit test. Finally, turn limit testing on so that the parameters you have specified will take effect.

The following sections describe these tasks in detail.

---

## Operation

To access limit testing:

Press **SHIFT ACQUIRE MENU** to bring up the Acquire menu.

### Create Limit Test Template

First use an incoming or stored waveform to create the limit test template; first select a source:

1. Press **Create Limit Test Template** (main) → **Template Source** (side) → **Ch1, Ch2, Math1, Math2, Math3, Ref1, Ref2, Ref3, or Ref4** (side). (See Figure 3-29.)

#### NOTE

*The template will be smoother if you acquire the template waveform using **Average** acquisition mode. If you are unsure how to do this, see Acquisition Modes on page 3-3.*

Once you have selected a source, select a destination for the template.

2. Press **Template Destination** (side) → **Ref1, Ref2, Ref3, or Ref4**.

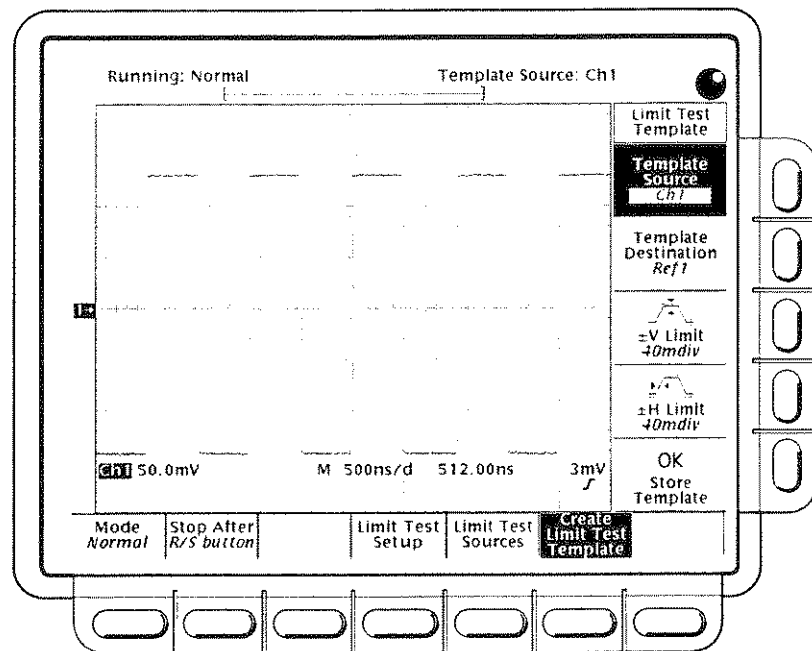

Figure 3-29: Acquire Menu—Create Limit Test Template

3. Create the envelope by specifying the amount of variation from the template that you will tolerate. Tolerance values are expressed in fractions of a major division. They represent the amount by which incoming waveform data can deviate without having exceeded the limits set in the limit test. The range is from 0 (the incoming waveform must be exactly like the template source) to 5 major divisions of tolerance.

Press **±V Limit** (side) and use the general purpose knob or keypad to enter the vertical (voltage) tolerance value.

Press **±H Limit** (side) and use the general purpose knob or keypad to enter the horizontal (time) tolerance value.

4. When you have specified the limit test template as you wish, press **OK Store Template** (side). This action stores the specified waveform in the specified destination, using the specified tolerances. Until you have done so, the template waveform has been defined but not created.

If you wish to create another limit test template, you can do so. Store it in another destination to avoid overwriting the template you have just created.

If you wish to view the template you have created, press the **MORE** button. Then press the button corresponding to the destination reference memory you have used. The waveform appears on the display.

**NOTE**

*To view the waveform data as well as the template envelope, use the **Dots** display style. If you are unsure how to do this, see Display Modes on page 3-14.*

**Limit Test Sources**

Now specify the channel to compare to the template you have created.

1. Press **SHIFT ACQUIRE MENU** → **Limit Test Sources** (main) to specify which waveforms to compare to the template. (See Figure 3-30.)
2. If the waveforms you wish to compare to the template are being acquired through channel 1, press **Compare Ch1 to** (side). If they are being acquired through channel 2, press **Compare Ch2 to** (side). Cycle through the valid selections by pressing the side menu button repeatedly, or use the general purpose knob.

Valid selections are any or the four reference waveforms **Ref1** through **Ref4**, or **None**. Choosing **None** turns limit testing off for the specified channel.

**NOTE**

*Specify the same reference memory you chose as the template destination if you wish to use the template you just created.*

If you have created more than one template, you can compare one channel to one template and the other channel to another template.

**Limit Test Setup**

Now specify the action to take if waveform data exceeds the limits set by the limit test template. The digitizing oscilloscope can ring its bell, take a hard-copy of the screen, stop acquiring new data and wait, or perform any combination of these actions (see Figure 3-31).

1. Press **SHIFT ACQUIRE MENU** → **Limit Test Setup** (main) to bring up a side menu of possible actions.

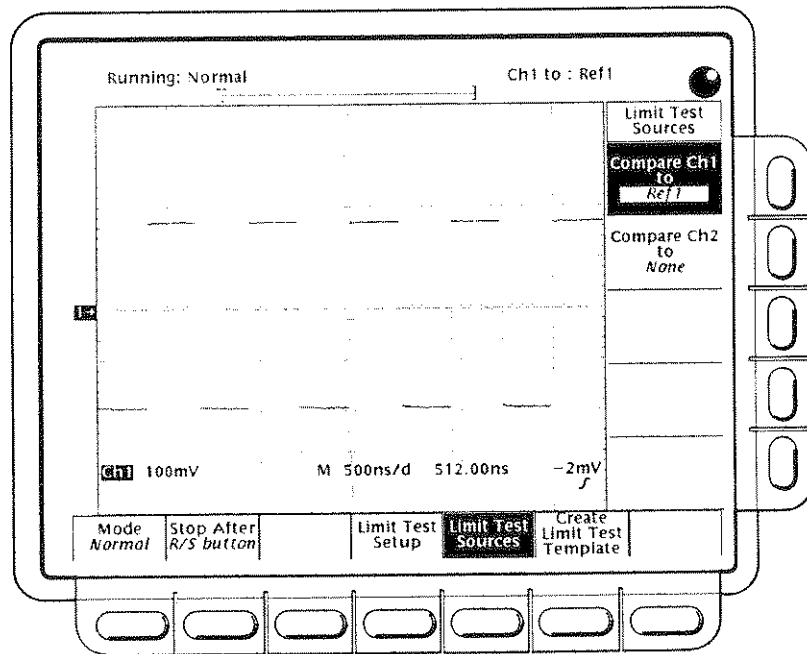

Figure 3-30: Acquire Menu—Limit Test Sources

2. Ensure that the side button corresponding to the desired action reads **ON**.
  - If you want the digitizing oscilloscope to send a hardcopy command when waveform data exceeds the limits set, toggle **Hardcopy if Condition Met** (side) to **ON**. (Also set up the hardcopy system. See the *Hardcopy* task reference on page 3-26 for details.)
  - If you want the digitizing oscilloscope to ring a bell when waveform data exceeds the limits set, toggle **Ring Bell if Condition Met** (side) to **ON**.
  - If you want the digitizing oscilloscope to stop when waveform data exceeds the limits set, toggle **Stop After Limit Test Condition Met** (side) to **ON**.

#### NOTE

The button labeled **Stop After Limit Test Condition Met** corresponds to the **Limit Test Condition Met** menu item in the **Stop After** main menu. You can turn this button on in the **Limit Test Setup** menu, but you cannot turn it off. To turn it off, press **Stop After** and specify one of the other choices in the **Stop After** side menu.

Now that you have set the instrument up for limit testing, you must turn limit testing on in order for any of these actions to take effect.

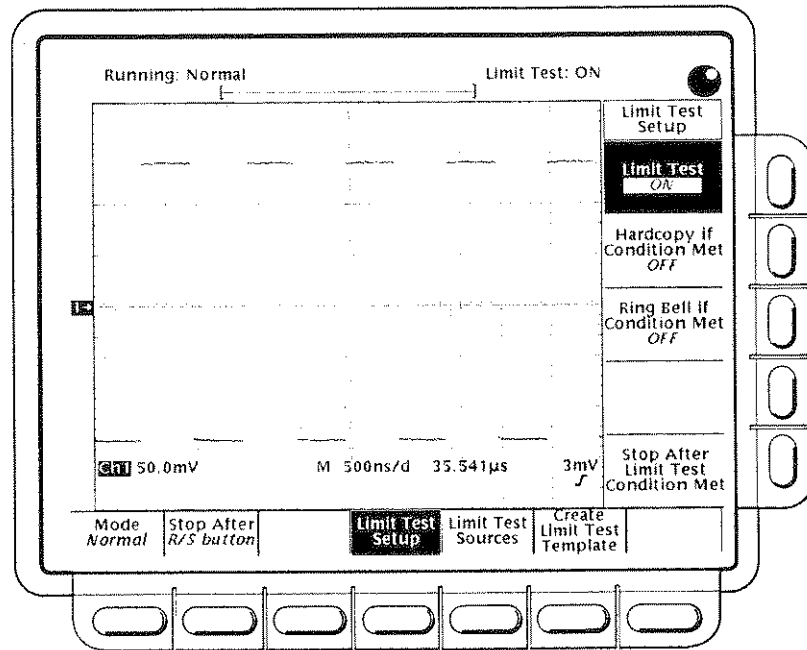

Figure 3-31: Acquire Menu—Limit Test Setup

3. Ensure that **Limit Test** (side) reads **ON**. If it reads **OFF**, press **Limit Test** (side) once to toggle it to **ON**.

When you set **Limit Test** to **ON**, the digitizing oscilloscope compares incoming waveforms with the waveform template stored in reference memory according to the settings in the **Limit Test Sources** side menu.

## Single and Multiple Waveforms

You can compare a single waveform with a single template, more than one waveform against a single template, or more than one waveform with each one compared with its own template. How Limit Test operates depends on which type of these comparisons you choose and whether ZOOM mode is on or off. (Page 3-100 describes ZOOM mode.)

### Single Waveform Comparisons

When making a single waveform versus a single template comparison, consider the following operating characteristics:

- The waveform will be repositioned horizontally to move the first sample in the waveform record that is outside template limits to center screen.
- The position of the waveform template will track that of the waveform.
- You may turn ZOOM on or off to suit your application.

## Multiple Waveform Comparisons

When comparing one or more waveforms, each against a common template or against its own template, consider the following operating characteristics:

- You should turn ZOOM on. (Press **ZOOM → On** (side).) You can use horizontal and vertical magnification or not as suits your application.
- You should set **Horizontal Lock to None** in the Zoom side menu (press **ZOOM** and toggle **Horizontal Lock to None**).
- With horizontal lock set as just described, the oscilloscope will reposition each waveform horizontally to move the first sample in the waveform record that is outside template limits to center screen.
- With Zoom and horizontal lock set as just described, the oscilloscope will reposition each waveform horizontally to move the first sample in the waveform record that is outside template limits to center screen.
- If you are comparing each waveform to its own template, the position of each waveform template will track that of its waveform.
- If you are comparing two or more waveforms to a common template, that template will track the position of the failed waveform. If more than one waveform fails *during the same acquisition*, the template will track the position of the waveform in the highest numbered channel.

---

### For More Information

See *Acquisition*, on page 2-17.

See *Acquisition Modes*, on page 3-2.

See *Display Modes*, on page 3-14.

See *Zoom*, on page 3-100.



# Measurement System

There are various ways to measure properties of waveforms. You can use graticule, cursor, or automatic measurements. The cursors and graticules are described elsewhere. (See *Cursor Measurements* on page 3-8 and *Measurements* on page 2-25.) This section describes *automatic measurements*. These are generally more accurate and quicker than, for example, manually counting graticule divisions. The oscilloscope will continuously update and display these measurements. (There is also a way to display all the measurements at once—see *Snapshot of Measurements* on page 3-57.)

Automatic measurements calculate waveform parameters from acquired data. Measurements are performed over the entire waveform record or the region specified by the vertical cursors, if gated measurements have been requested. (See page 3-52 for a discussion of gated measurements.) They are not performed just on the displayed portions of waveforms.

The TDS 800 Series Digitizing Oscilloscopes provide you with 27 automatic measurements (see Table 3-3).

## Definitions

The following are brief definitions of the automated measurements in the digitizing oscilloscope (for more details see *Appendix C: Algorithms*, page C-1):

Table 3-3: Measurement Definitions





Name	Definition
 <b>Amplitude</b>	Voltage measurement. The high value less the low value measured over the entire waveform or gated region. $\text{Amplitude} = \text{High} - \text{Low}$
 <b>Area</b>	Voltage over time measurement. The area over the entire waveform or gated region in volt-seconds. Area measured above ground is positive; area below ground is negative.
 <b>Burst Width</b>	Timing measurement. The duration of a burst. Measured over the entire waveform or gated region.
 <b>Cycle Area</b>	Voltage over time measurement. The area over the first cycle in the waveform, or the first cycle in the gated region, in volt-seconds. Area measured above ground is positive; area below ground is negative.

Table 3-3: Measurement Definitions (Cont.)











Name	Definition
 <b>Cycle Mean</b>	Voltage measurement. The arithmetic mean over the first cycle in the waveform, or the first cycle in the gated region.
 <b>Cycle RMS</b>	Voltage measurement. The true Root Mean Square voltage over the first cycle in the waveform, or the first cycle in the gated region.
 <b>Delay</b>	Timing measurement. The time between the MidRef crossings of two different traces, or the gated region of the traces.
 <b>Fall Time</b>	Timing measurement. Time taken for the falling edge of the first pulse in the waveform or gated region to fall from a High Ref value (default = 90%) to a Low Ref value (default = 10%) of its final value.
 <b>Frequency</b>	Timing measurement for the first cycle in the waveform or gated region. The reciprocal of the period. Measured in Hertz (Hz) where 1 Hz = 1 cycle per second.
 <b>High</b>	The value used as 100% whenever High Ref, Mid Ref, and Low Ref values are needed (as in fall time and rise time measurements). Calculated using either the min/max or the histogram method. The <i>min/max</i> method uses the maximum value found. The <i>histogram</i> method uses the most common value found above the mid point. Measured over the entire waveform or gated region.
 <b>Low</b>	The value used as 0% whenever High Ref, Mid Ref, and Low Ref values are needed as in fall time and rise time measurements. May be calculated using either the min/max or the histogram method. With the min/max method it is the minimum value found. With the histogram method, it refers to the most common value found below the mid point. Measured over the entire waveform or gated region.
 <b>Maximum</b>	Voltage measurement. The maximum amplitude. Typically the most positive peak voltage. Measured over the entire waveform or gated region.
 <b>Mean</b>	Voltage measurement. The arithmetic mean over the entire waveform or gated region.
 <b>Minimum</b>	Voltage measurement. The minimum amplitude. Typically the most negative peak voltage. Measured over the entire waveform or gated region.



Table 3-3: Measurement Definitions (Cont.)













Name	Definition
 <b>Negative Cross</b>	Timing measurement. The time from the trigger to the point in the waveform that crosses the midlevel voltage on a negative slope. Measured over the entire waveform or gated region.
 <b>Negative Duty Cycle</b>	Timing measurement of the first cycle in the waveform or gated region. The ratio of the negative pulse width to the signal period expressed as a percentage. $\text{NegativeDutyCycle} = \frac{\text{NegativeWidth}}{\text{Period}} \times 100\%$
 <b>Negative Overshoot</b>	Voltage measurement. Measured over the entire waveform or gated region. $\text{NegativeOvershoot} = \frac{\text{Low} - \text{Min}}{\text{Amplitude}} \times 100\%$
 <b>Negative Width</b>	Timing measurement of the first pulse in the waveform or gated region. The distance (time) between MidRef (default 50%) amplitude points of a negative pulse.
 <b>Peak to Peak</b>	Voltage measurement. The absolute difference between the maximum and minimum amplitude in the entire waveform or gated region.
 <b>Period</b>	Timing measurement. Time it takes for the first complete signal cycle to happen in the waveform or gated region. The reciprocal of frequency. Measured in seconds.
 <b>Phase</b>	Timing measurement. The amount one waveform leads or lags another in time. Expressed in degrees, where 360° comprise one waveform cycle.
 <b>Positive Cross</b>	Timing measurement. The time from the trigger to the point in the waveform that crosses the midlevel voltage on a positive slope. Measured over the entire waveform or gated region.
 <b>Positive Duty Cycle</b>	Timing measurement of the first cycle in the waveform or gated region. The ratio of the positive pulse width to the signal period expressed as a percentage. $\text{PositiveDutyCycle} = \frac{\text{PositiveWidth}}{\text{Period}} \times 100\%$
 <b>Positive Overshoot</b>	Voltage measurement over the entire waveform or gated region. $\text{PositiveOvershoot} = \frac{\text{Max} - \text{High}}{\text{Amplitude}} \times 100\%$

Table 3-3: Measurement Definitions (Cont.)

Name	Definition
 <b>Positive Width</b>	Timing measurement of the first pulse in the waveform or gated region. The distance (time) between MidRef (default 50%) amplitude points of a positive pulse.
 <b>Rise time</b>	Timing measurement. Time taken for the leading edge of the first pulse in the waveform or gated region to rise from a Low Ref value (default = 10%) to a High Ref value (default = 90%) of its final value.
 <b>RMS</b>	Voltage measurement. The true Root Mean Square voltage over the entire waveform or gated region.

### Measurement Display

The readout area for measurements is on the right side of the waveform window. You can display and continuously update as many as four measurements at any one time.

When you display menus, the readouts appear in the graticule area. If the menu area is empty, then the readouts appear to the far right (see Figure 3-32).

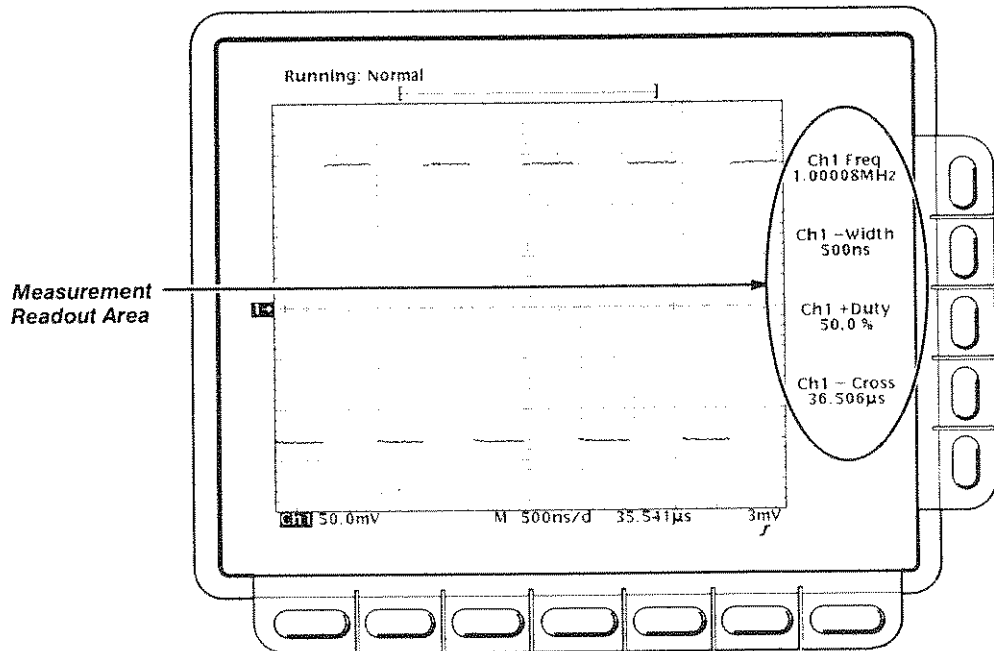

Figure 3-32: Measurement Readouts

## Operation

To use the automatic measurements you first need to obtain a stable display of the waveform. Pressing the **AUTOSET** button may help.

Once you have a stable display, press the **MEASURE** button to bring up the Measure menu (Figure 3-33).

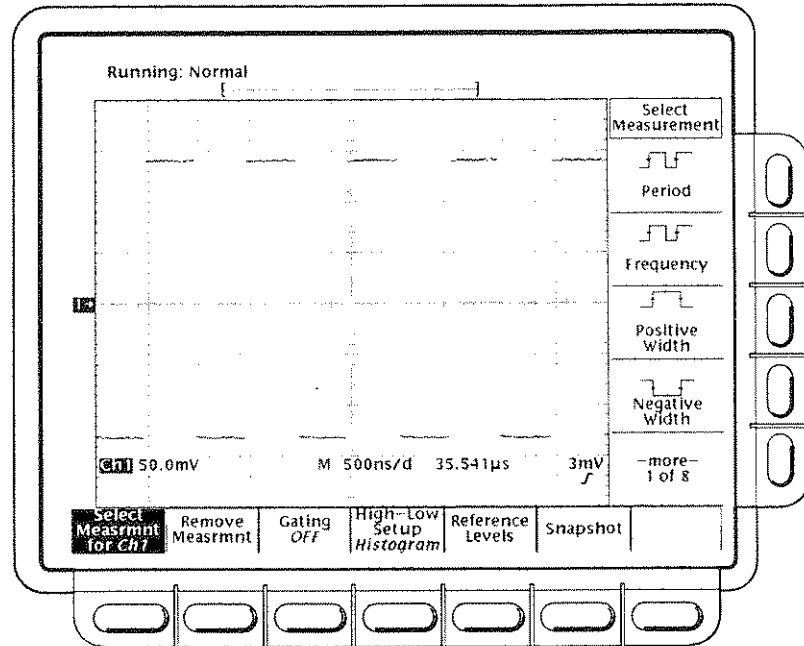

Figure 3-33: Measure Menu

### Selecting a Measurement

You can choose up to four measurements at any one time. Measurements are made on the selected waveform. The measurement display tells you the channel the measurement is being made on.

1. Press **MEASURE** → **Select Measrmt** (main).
2. Select a measurement from the side menu.

The following are hints on making automatic measurements:

- You can only take a maximum of four measurements at a time. To add a fifth, you must remove one or more of the existing measurements.
- To vary the source for measurements, simply select the other channel and then choose the measurements you want.
- Be careful when taking automatic measurements on noisy signals. You might measure the frequency of the noise and not the desired waveform.

Your digitizing oscilloscope helps identify such situations by displaying a *low signal amplitude* or *low resolution* warning message.

You can minimize most noise problems by changing the acquisition mode to averaging to reduce random noise.

## Removing Measurements

The **Remove Measrmt** selection provides explicit choices for removing measurements from the display according to their readout position.

Measurement 1 is the top readout. Measurement 2 is below it, and so forth. A measurement readout stays in its displayed position even when you remove measurement readouts above it.

To remove measurements:

1. Press **MEASURE** → **Remove Measrmt** (main).
2. Select the measurement to remove from the side menu. If you want to remove all the measurements at one time, press **All Measurements** (side).

## Gated Measurements

The gating feature lets you limit measurements to a specified portion of the waveform. When gating is **Off**, the oscilloscope makes measurements over the entire waveform record.

When you activate gating, vertical cursors are displayed and you use these to define the section of the waveform you want the oscilloscope to measure. This is called the *gated region*.

1. Press **MEASURE** → **Gating** (main) → **Gate with V Bar Cursors** (side) (see Figure 3-34).
2. Using the general purpose knob, move the selected (the active) cursor. Use the **TOGGLE** button to change which cursor is active. A solid line indicates the active cursor and a dashed line shows the inactive cursor.

### NOTE

*Cursors are displayed relative to the selected waveform. If you are making a measurement using two waveforms, this can be a source of confusion. If you turn off horizontal locking and adjust the horizontal position of one waveform independent of the other, the cursors appear at the requested position with respect to the selected waveform. Gated measurements remain accurate, but the displayed position of the cursors changes when you change the selected waveform.*

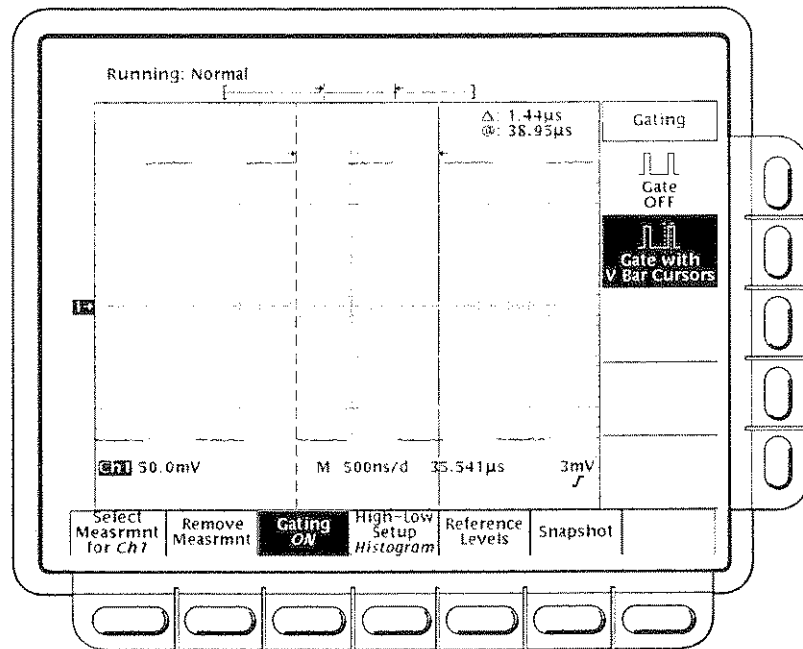

Figure 3-34: Measure Menu—Gating

### High-Low Setup

The **High-Low Setup** item provides two choices for how the oscilloscope determines the High and Low levels of waveforms. These are *histogram* and *min/max*.

- Histogram sets the values statistically. It selects the most common value either above or below the mid point (depending on whether it is defining the high or low reference level). That method is useful when examining pulses.
- Min/max uses the highest and lowest values of the waveform record.

To use the high-low setup:

Press **MEASURE** → **High-Low Setup** (main) → **Histogram** or **Min-Max** (side) (Figure 3-35). If you select **Min-Max**, you may also want to check and/or revise values using the Reference Levels main menu.

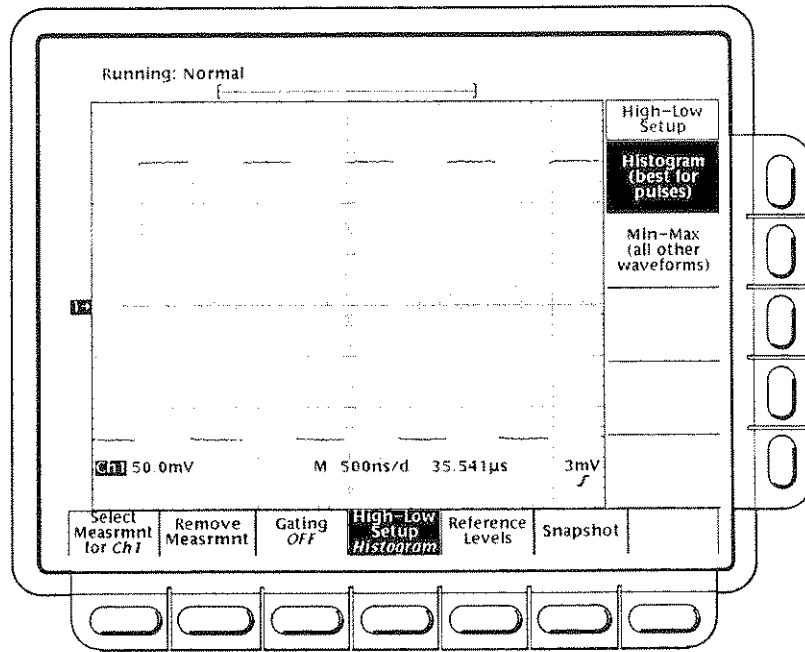

Figure 3-35: Measure Menu—High-Low Setup

### Reference Levels

You can set the vertical reference levels of the measurement system with the **Reference Levels** main menu item. Once you define these levels, the digitizing oscilloscope will use them for all measurements requiring those levels.

1. Press **MEASURE** → **Reference Levels** (main) → **Set Levels** (side) to choose whether the References are set in % relative to High (100%) and Low (0%) or set explicitly in the units of the selected waveform (typically volts). See Figure 3-36. Use the general purpose knob to enter the values.
  - % is the default selection. It's useful for many general purpose applications.
  - **Units** is helpful for setting precise values. For example, if you're trying to measure specifications on an ECL circuit, you can set the levels precisely to ECL threshold voltage values by defining the high and low references in absolute units.
2. Press **High Ref**, **Mid Ref**, **Low Ref**, or **Mid2 Ref** (side).
  - **High Ref**—Sets the high reference level. The default is 90%.
  - **Mid Ref**—Sets the middle reference level. The default is 50%.

f

f

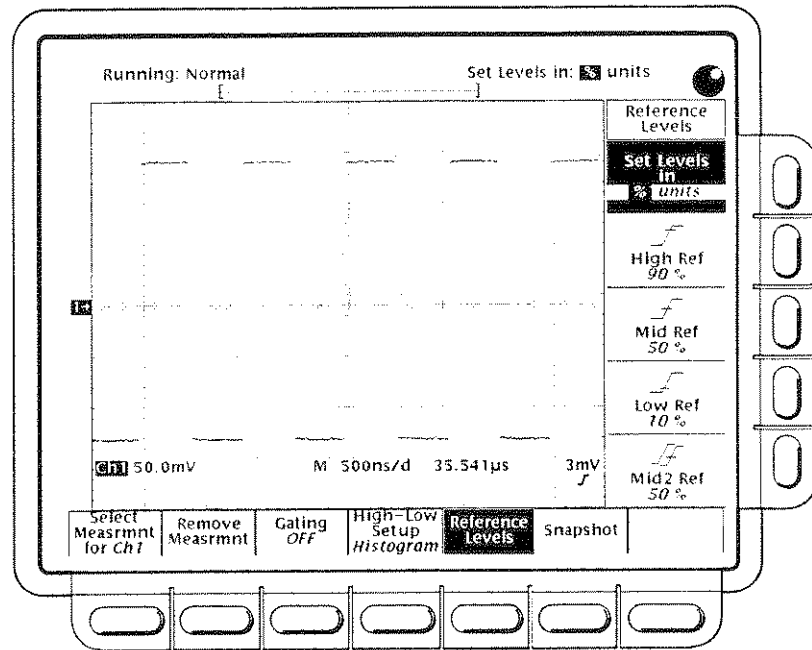

Figure 3-36: Measure Menu—Reference Levels



- **Low Ref**—Sets the low reference level. The default is 10%.



- **Mid2 Ref**—Sets the middle reference level used on the second waveform specified in the Delay Measurements. The default is 50%.

### Delay Measurement

The delay measurement lets you measure from the selected waveform to another waveform. You access the Delay Measurement menu through the Measure main menu:

Press **MEASURE** → **Select Measrmt** (main) → **Delay** (side). This brings up the Measure Delay main menu (Figure 3-37).

**Delay to**—To select the waveform you want to measure *to*, use the main menu item **Delay to**. The waveform you are measuring *from* is the selected waveform.

1. Press **MEASURE** → **Select Measrmt** (main) → **Delay** (side) → **Delay To** (main) → **Measure Delay to**.
2. Press the side menu button repeatedly or turn the general purpose knob to choose the delay to waveform. The choices are: **Ch1**, **Ch2**, **Math1**, **Math2**, **Math3**, **Ref1**, **Ref2**, **Ref3**, and **Ref4**.

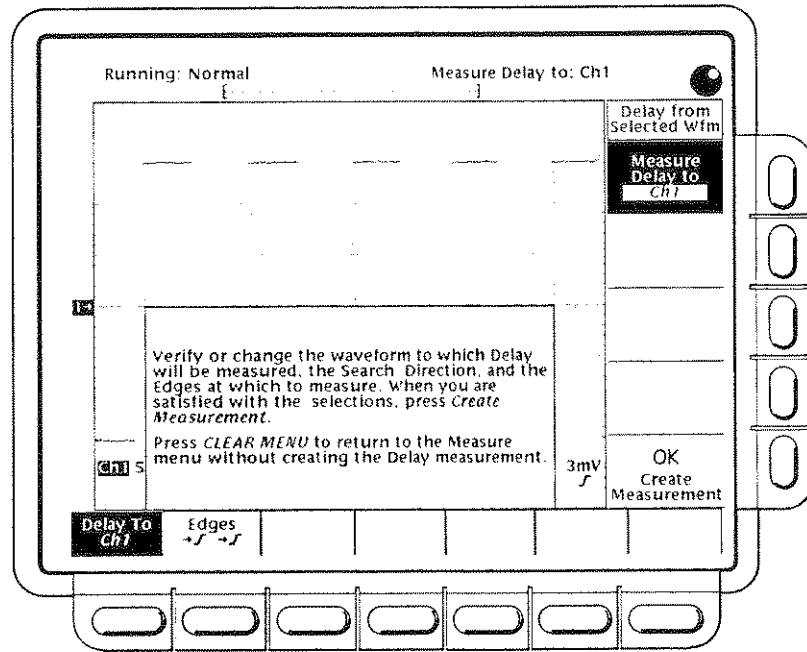

Figure 3-37: Measure Delay Menu—Delay To

**Delay Edges**—The main menu item **Edges** lets you specify which edges you want the delayed measurement to be made between.

Press **MEASURE** → **Select Measrmt** (main) → **Delay** (side) → **Delay To** (main) → **Edges** (side). A side menu of delay edges and directions will appear (Figure 3-38). Choose from one of the combinations displayed on the side menu.

The upper waveform on each icon represents the *from* waveform and the lower one represents the *to* waveform.

The direction arrows on the choices let you specify a forward search on both waveforms, or a forward search on the *from* waveform and a backwards on the *to* waveform. The latter choice is useful for isolating a specific pair of edges out of a stream.

**Creating the Delay Measurement**—Once you have specified the waveforms you are measuring between and which edges to use, you need to notify the digitizing oscilloscope to proceed with the measurement.

Press **Delay To** (main) → **OK Create Measurement** (side). The oscilloscope will then make the specified delay measurement and return you to the Measure menu.

To exit the Measure Delay menu without creating a delay measurement, press the **CLEAR MENU** button, which returns you to the Measure menu.



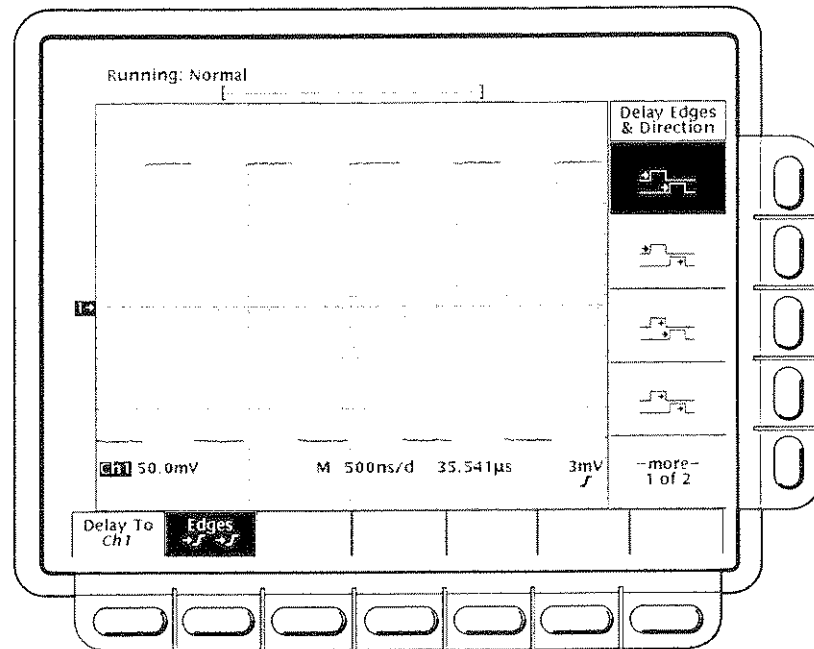

Figure 3-38: Measure Delay Menu—Edges

## Snapshot of Measurements

Sometimes you may want to see all the automated measurements on screen at the same time. To do so, use Snapshot. Snapshot executes all the single waveform measurements available on the selected waveform *once* and displays the results. (The measurements are not continuously updated.) All the measurements listed in Table 3-3 on page 3-47 except for Delay and Phase are displayed. (Delay and Phase are dual waveform measurements and are not available with Snapshot.)

The readout area for a snapshot of measurements is a pop up display that covers about 80% of the graticule area when displayed (see Figure 3-39). You can display a snapshot on any channel or ref memory, but only one snapshot can be displayed at a time.

To use snapshot, obtain a stable display of the waveform. Pressing **AUTO-SET** may help.

1. Press **MEASURE** → **SNAPSHOT** (main).
2. Press either **SNAPSHOT** (main) or **AGAIN** (side) to take another snapshot.
3. Push **Remove Measrmt.**

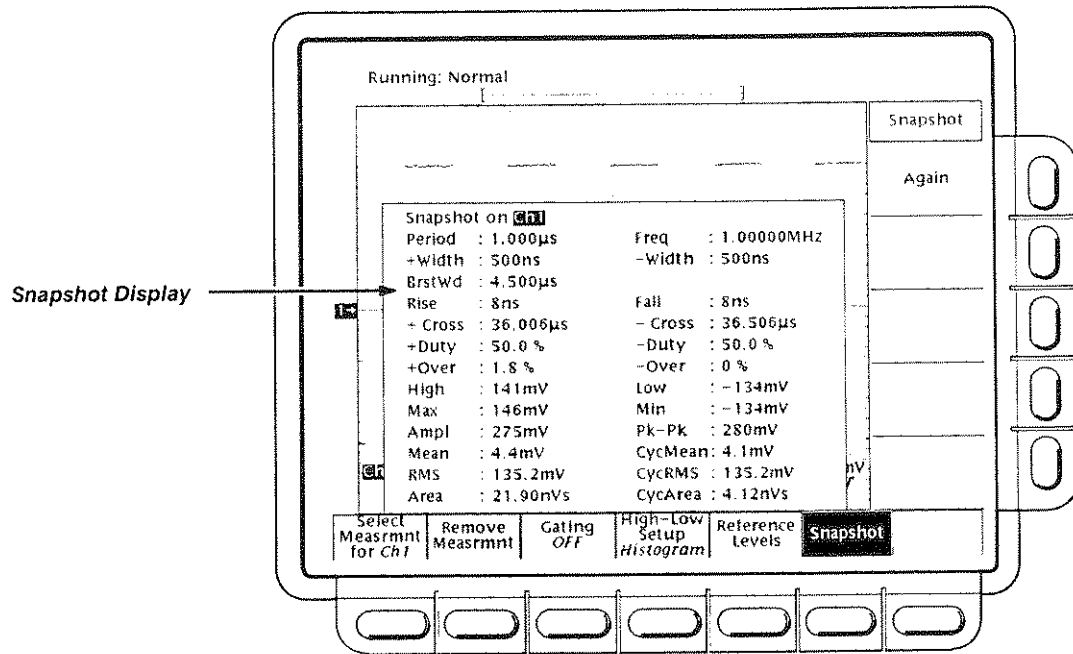

Figure 3-39: Snapshot Menu and Readout

### Considerations When Taking Snapshots

Be aware of the following items when using snapshot:

- Be sure to display the waveform properly before taking a snapshot. Snapshot does not warn you if a waveform is improperly scaled (clipped, low signal amplitude, low resolution, etc.).
- To vary the source for taking a snapshot, simply select another channel, math, or ref memory waveform and then execute snapshot again.
- You take a snapshot on a single waveform acquisition (or acquisition sequence). The measurements in the snapshot display are not continuously updated.
- Be careful when taking automatic measurements on noisy signals. You might measure the frequency of the noise and not the desired waveform.
- Note that pushing any button in the main menu (except for Snapshot) or any front panel button that displays a new menu removes the snapshot from display.
- Use High-Low Setup (page 3-53), Reference Levels (page 3-54), and Gated Measurements (page 3-52) with snapshot exactly as you would when you display individual measurements from the **Select Measrmt** menu.

---

**For More  
Information**

See *Measurements*, on page 2-25.

See *Cursor Measurements* on page 3-8.

See *Appendix C: Algorithms*, on page C-1.

See *Probe Functions*, on page 3-96.

# Probe Interface

The **PROBE POWER** connector on the digitizing oscilloscope front panel provides a TEKPROBE-compatible SMA interface between the digitizing oscilloscope and probes that support TEKPROBE capability with SMA connectors, such as the P6206 probe.

The interface connector provides power to active probes. It also allows the digitizing oscilloscope to read probe configuration data, and can allow you to set vertical offset at the probe tip, for probes that have offset capability.

## Connection

Figure 3-40 shows the connectors for the TEKPROBE interface. Connect the probe's signal connector to the channel input connector, and the TEKPROBE interface connector to the **PROBE POWER** connector.

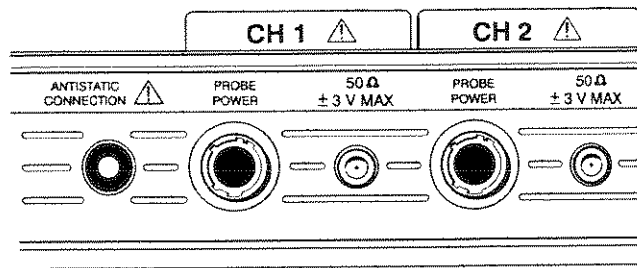

Figure 3-40: The Probe Interface Connectors

## Power

When you connect an active probe to the digitizing oscilloscope using the **PROBE POWER** connector, it draws power from the digitizing oscilloscope.

### NOTE

*The digitizing oscilloscope does not support the Probe ID button.*

---

## Capabilities

When you connect an active probe to the digitizing oscilloscope using the **PROBE POWER** connector, the instrument reads the probe type, its attenuation factor, and its capabilities. Thereafter, all vertical scale readouts display values scaled to the probe's attenuation factor:

- volts per division,
- vertical offset,
- trigger level,
- cursor voltage values, and
- automated measurement voltage values.

### NOTE

*Displayed units are always volts for the digitizing oscilloscope. If your measurements use other units, such as watts or amps, the values will be accurate, but the unit readouts will read "Volts." For example, if you are using a current probe, interpret a vertical scale factor of 100 mV/div as 100 mA/div.*

## Manual Probe Scaling (External Attenuation)

When you connect a probe without using the **PROBE POWER** connector, press **VERTICAL MENU → Probe Functions** (main) to adjust the external attenuation using the general purpose knob or the keypad. The side menu items show the **External Attenuation** setting.

External attenuation affects volts scaling, measurements, cursors, triggers, autoset, and setup (see Probe Functions on page 3-96).

## Vertical Offset at Probe Tip

If the probe you are using supports the capability, you can set vertical offset at the probe tip instead of within the digitizing oscilloscope. This allows you to use the probe's larger dynamic range.

For example, the dynamic range of the TDS 820 is 2 V peak-to-peak (1 V peak-to-peak for Option 1D). It has an additional offset capability of  $\pm 2$  V ( $\pm 1$  V for Option 1D). If you set offset to 0, you can view signals from 1 V to  $-1$  V. Using the digitizing oscilloscope's offset capability of 2 V, you can move this 2 V window up or down an additional two volts, allowing you to look at signals as high as from 3.0 V to 1.0 V peak-to-peak, or as low as from  $-3.0$  V to  $-1.0$  V peak-to-peak (see Figure 3-41).

Suppose that you have a 10X probe that supports the TEKPROBE interface. If the probe's dynamic range is 20 V peak-to-peak, setting offset to 0 allows you to view signals from 10 V to  $-10$  V (see Figure 3-42).

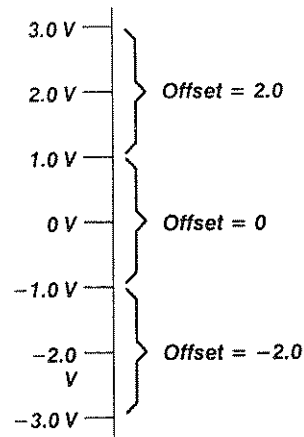

Figure 3-41: TDS 820 Offset and Dynamic Range

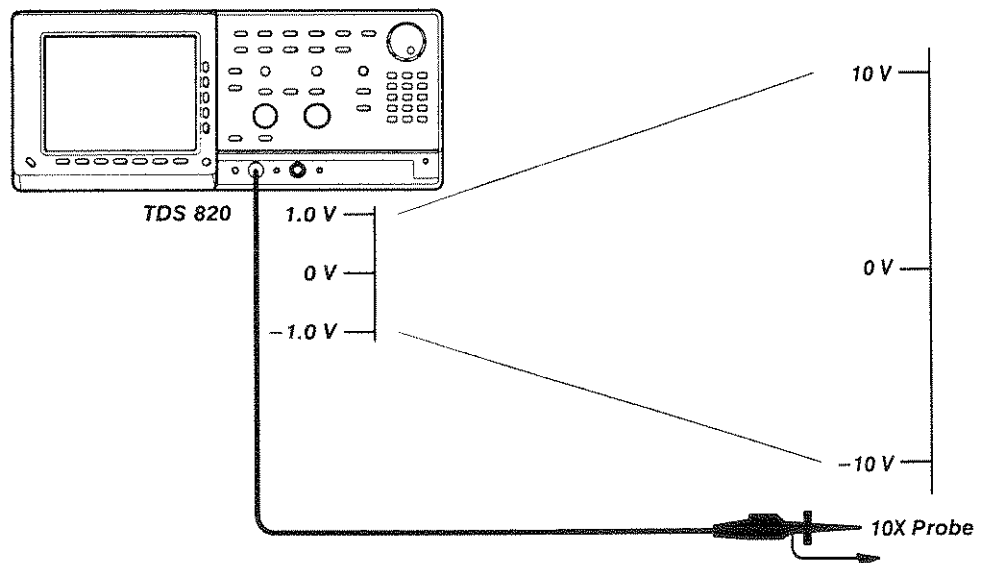

Figure 3-42: TDS 820 Vertical Scale and Probe Attenuation Factor

If the 10X probe includes the probe tip offset function and its offset capabilities are  $\pm 10$  V, you can move this 20 V window up or down an additional 10 volts, allowing you to look at signals as high as 0 V to 20 V peak-to-peak, or as low as  $-20$  V to  $-0$  V peak-to-peak (see Figure 3-43).

However, some active probes do not have a 20 V dynamic range, and the dynamic range of the probe you are using can limit the range of signals you can view. The range of signals you can view is the smaller of the following two ranges:

- the dynamic range of the probe, or
- the dynamic range of the oscilloscope times the probe attenuation factor.

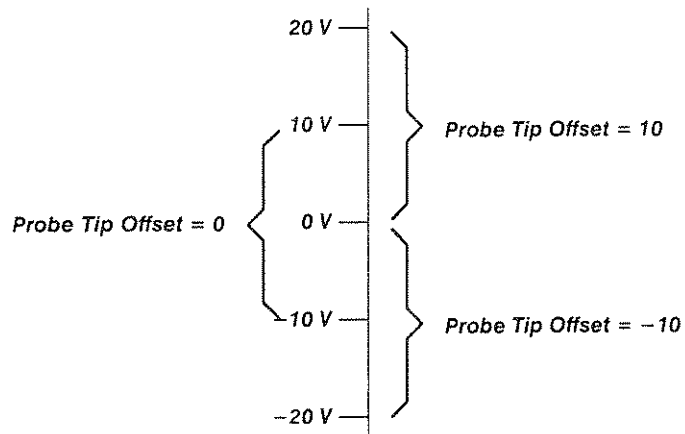

Figure 3-43: Probe Tip Offset and Dynamic Range

#### NOTE

*In order for the TDS 820 to measure the signal accurately, the signal divided by the probe attenuation factor must be less than or equal to 2 V peak-to-peak (1 V peak-to-peak for Option 1D instruments)—the dynamic range of the digitizing oscilloscope.*

#### CAUTION

*To avoid damaging the digitizing oscilloscope, the signal you wish to look at divided by the probe attenuation factor must be less than or equal to the  $\pm 6$  V maximum input to the TDS 820 ( $\pm 3$  V for Option 1D instruments).*

#### For More Information

See *Vertical Control*, on page 3-93.

See *Scaling and Positioning Waveforms*, on page 2-21.

See *Probe Functions*, on page 3-96.

# Probe Selection

The probes available for your digitizing oscilloscope are useful for a wide variety of tasks. However, for special measurement situations you sometimes need different probes. This section helps you select the right probe for the job.

The following section discusses the importance of ground lead inductance for measuring signals accurately. Following that, the different types of probes are discussed.

## Ground Lead Inductance

The probe you use and how you connect it to a signal source affects the oscilloscope's acquisition of the waveform record. Two important factors are:

- ground lead inductance (introduced by the probe), and
- the physical layout of your circuit and component devices.

The physical characteristics of the device under test are beyond the scope of this manual. However, you should understand how ground lead inductance may affect your results.

For measurements to be meaningful, you must give the measurement some point of reference. Your probe offers you the capability for referencing the voltage at its tip to ground. To make your measurement as accurate as possible, the probe's ground lead should be as short as possible and connected to the ground reference.

However, when you touch your probe tip to a circuit element, you are introducing new resistance, capacitance, and inductance into the circuit (Figure 3-44).

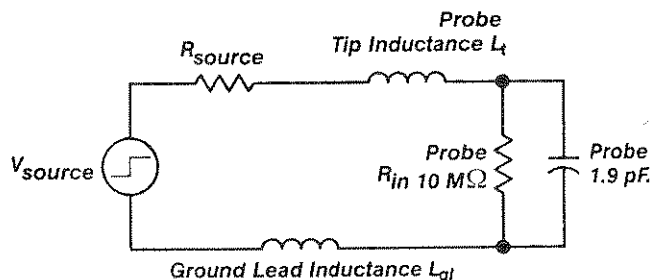

Figure 3-44: A Probe Adds Resistance, Capacitance, and Inductance



For most circuits, the high input resistance of a passive probe has a negligible effect on the signal. The series inductances represented by the probe tip and ground lead, however, can result in a parasitic resonant circuit that may “ring” within the bandwidth of the oscilloscope. Figure 3-45 shows the effect of the same signal through the same probe with different ground leads.

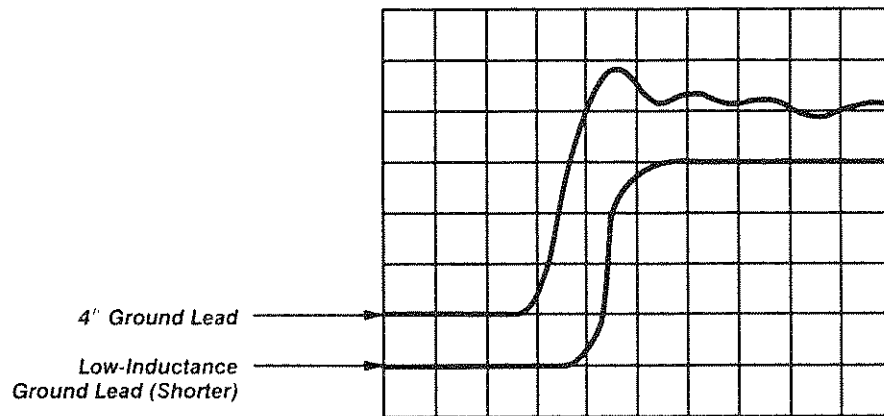

Figure 3-45: Signal Variation Introduced by Probe Ground Lead  
(1 ns per division)

Ringing and rise time degradation may be hidden if the frequency of the induced ringing is beyond the bandwidth of the oscilloscope. If you know the self-inductance ( $L$ ) and capacitance ( $C$ ) of your probe and ground lead, you can calculate the approximate resonant frequency ( $f_0$ ) at which that parasitic circuit will resonate:

$$f_0 = \frac{1}{2\pi \times \sqrt{LC}}$$

Reducing the ground lead inductance (by making the probe shorter, larger in diameter, or both) will raise the resonant frequency. Ideally, the inductance is low enough that the resulting frequency is above the frequency at which you want to take measurements. For that purpose, many probes include several accessories to help reduce ground lead inductance.

## Types of Probes

Once you have decided the type of probe you need, use Table 3-4 to determine the specific probe compatible with your digitizing oscilloscope.

To select the probe by application, use Table 3-5.

There are five types of probes: passive, active, current, optical, and time-to-voltage probes.

## Passive Voltage Probes

Passive voltage probes measure voltage. They employ passive circuit components such as resistors, capacitors, and inductors. Although several kinds of passive voltage probes are commonly used, the digitizing oscilloscope uses only low impedance ( $Z_0$ ) passive voltage probes.

Low impedance probes measure frequency more accurately than general purpose probes, but they make less accurate amplitude measurements. They offer a higher bandwidth to cost ratio.

These probes must be terminated in a  $50\ \Omega$  scope input. Input capacitance is much lower than high  $Z$  passive probes, typically  $1\ \text{pF}$ , but input resistance is also lower ( $500$  to  $5000\ \Omega$  typically). Although that DC loading degrades amplitude accuracy, the lower input capacitance reduces high frequency loading to the circuit under test. That makes  $Z_0$  probes ideal for timing and phase measurements.

$Z_0$  probes are useful for measurements up to  $40\ \text{V}$ .

### NOTE

*These voltages are much higher than you can measure with the TDS 820, which is damaged by input voltages greater than  $6\ \text{V}$  peak-to-peak ( $3\ \text{V}$  peak-to-peak for Option 1D instruments).*

## Active Voltage Probes

Active voltage probes, sometimes called "FET" probes, use active circuit elements such as transistors. The P6206 probe recommended for use with the digitizing oscilloscope is an active probe.

Active voltage-measuring probes use active circuit elements to process signals from the circuit under test. All active probes require a source of power for their operation. Active probes obtain power either from an external power supply or from the oscilloscope itself. Power can be obtained through the oscilloscope using either the TEKPROBE or TEKPROBE SMA interfaces.

Active probes offer low input capacitance ( $0.2$  to  $2\ \text{pF}$  typically) while maintaining the higher input resistance of passive probes ( $10\ \text{k}\Omega$  to  $10\ \text{M}\Omega$ ). They therefore feature minimum loading of the circuit under test. Like  $Z_0$  probes, active probes are useful for making accurate timing and phase measurements. However, they do not degrade the amplitude accuracy.

Active probes are useful for various applications, such as measuring both rise time and amplitude simultaneously with great accuracy, making measurements of high-speed logic circuitry, and measuring propagation delays. Active probes typically have a dynamic range of  $\pm 10$  to  $\pm 15\ \text{V}$ .

**NOTE**

*This dynamic range is greater than that provided by the TDS 820, whose range extends from 1.25 mV to 2 V (1.25 mV to 1 V for Option 1D instruments).*

Two common classes of active probes are:

- *Differential active*
- *Fixtured active*

**Differential Probes**—Differential probes determine the voltage drop between two points in a circuit under test. Differential probes let you simultaneously measure two points and to display the difference between the two voltages.

An active differential amplifier in the probe head results in high common-mode signal rejection at higher frequencies. That amplifier minimizes the measurement errors caused by differences in probes, cable lengths, and input attenuators.

The common mode rejection ratio is a measure of how effectively the probe cancels signals that are common to both inputs. The common mode range indicates the maximum amplitude the common signal can reach before the probe circuitry saturates.

Active differential probes are stand-alone products designed for 50  $\Omega$  inputs.

**Fixtured Active Probes**—In some small-geometry or dense circuitry applications, such as surface mounted devices (SMD), a hand-held probe is too big to be practical. You can instead use fixtured (or probe card mounted) active probes (or buffered amplifiers) to precisely connect your instrument to your device-under-test. These probes have the same electrical characteristics as high speed, active probes but use a smaller mechanical design. They allow you to repeat the same measurement with precision for a whole series of components.

**Current Probes**

Current probes enable you to directly observe and measure current waveforms, which can be very different from voltage signals. Tektronix current probes are unique in that they can measure from DC to 1 GHz.

Two types of current probes are available: one that measures AC current only, and AC/DC probes that use the Hall effect to accurately measure the AC and DC components of a signal. AC-only current probes use a transformer to convert AC current flux into a voltage signal to the oscilloscope and have a frequency response from a few hundred Hertz up to 1 GHz. AC/DC current probes include Hall effect semiconductor devices and provide frequency response from DC to 50 MHz.

Use a current probe by clipping its jaws around the wire carrying the current that you want to measure. (That is not like an ammeter, which you must connect in series with the circuit.) Because current probes are non-invasive, with loading typically in the  $m\Omega$  to low  $\Omega$  range, they are especially useful where low loading of the circuit is important. Current probes can also make differential measurements by measuring the results of two opposing currents in two conductors in the jaws of the probe.

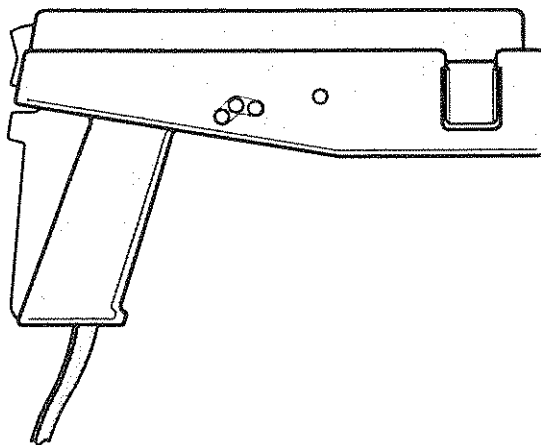

Figure 3-46: A6303 Current Probe Used in the AM 503S Opt. 03

### Time-to-Voltage Converters

Instantaneous time-interval to voltage converters (TVC) continuously convert consecutive timing measurements to a time-interval versus time waveform.

Timing variations typically appear as left-to-right motion, or jitter, on an oscilloscope. Time base or trigger holdoff adjustments may improve display stability, but they do not show timing dynamics. The TVC untangles the often confusing waveforms and delivers a coherent real-time view.

The TVC adds three measurement functions to your oscilloscope's voltage versus time capability: time delay versus time, pulse-width versus time, and period versus time.

The TVC continuously measures the timing parameter and instantaneously generates a voltage proportional to the measurement. Since the TVC generates voltages proportional to time-intervals, you can set your scope to trigger on timing violations such as a time-delay that exceeds a threshold or an incorrectly narrow pulse or glitch.

---

## Choosing a Probe

Table 3-4 lists TDS 800 compatible probes classified by type.

Table 3-4: TDS 800 Compatible Probes

Probe Type	Tektronix Model	Description
Passive, low impedance Zo (low capacitance)	P6150 <sup>1</sup>	10X, 9 GHz, for 50 $\Omega$ inputs (1X optional)
	P6156 Opt. 28 <sup>1</sup>	10X, 3.5 GHz, for 50 $\Omega$ inputs (1X, 20X, 100X optional)
Active, high speed voltage	P6205 <sup>1</sup>	DC to 750 MHz FET
	P6204 <sup>1</sup>	DC to 1 GHz. DC offset
	P6206	DC to 1 GHz (with TDS 800)
	P6207	DC to 3.5 GHz (with TDS 800)
Active, differential voltage	P6046 <sup>1</sup>	1X/10X, DC to 100 MHz. Needs SMA-to-BNC adapter.
Active, fixtured voltage	A6501 <sup>1</sup>	Buffer Amplifier, 1 GHz, 1 M $\Omega$ , 10X
	P6501 Opt. 02 <sup>1</sup>	Microprobe with TekProbe Power Cable, 750 MHz, 1 M $\Omega$ , 10X Needs SMA-to-BNC adapter.
Current	AM 503S <sup>1</sup>	AC/DC. Uses A6302 Current Probe.
	AM 503S <sup>1</sup>	AC/DC. Uses A6303 Current Probe.
	Opt. 03 <sup>1</sup>	Needs SMA-to-BNC adapter.
	CT-1/CT-2 <sup>1</sup>	Designed for permanent or semi- permanent in-circuit installation CT-1: 25 kHz to 1 GHz, 50 $\Omega$ input CT-2: 1.2 kHz to 200 MHz, 50 $\Omega$ input Needs SMA-to-BNC adapter.
Time-to-Voltage Converter	TVC 501	Time delay, pulse width and period measurements

<sup>1</sup>Manual probe scaling required—Probe does not use TDS 800 probe interface.

Another way to classify probes is by application. Different applications demand different probes. Use Table 3-5 to select a probe for your application.

Table 3-5: Probes by Application

Probe Type	Telecommunications & High-Speed Logic	Industrial Electronics	Consumer/Computer Electronics	High Energy Pulsed Power/Laser Research	Certification, Regulatory, & Compliance Testing
Active, high-speed digital voltage	P6205 <sup>2,3</sup> P6204 <sup>2,3</sup> P6206 <sup>2,3</sup> P6207 <sup>2,3</sup>	P6205 <sup>2,3</sup> P6206 <sup>2,3</sup> P6207 <sup>2,3</sup>	P6205 <sup>2,3</sup> P6204 <sup>2,3</sup> P6206 <sup>2,3</sup> P6207 <sup>2,3</sup>	P6205 <sup>2,3</sup> P6204 <sup>2,3</sup> P6206 <sup>2</sup> P6207 <sup>2,3</sup>	P6205 <sup>2,3</sup> P6206 <sup>2</sup> P6207 <sup>2</sup>
Low impedance Zo (low capacitance)	P6156 <sup>1,2,3</sup> P6150 <sup>1,2,3</sup>		P6156 <sup>1,2,3</sup> P6150 <sup>1,2,3</sup>	P6156 <sup>1,2,3</sup> P6150 <sup>1,2,3</sup>	P6150 <sup>1,2,3</sup>
Active, differential voltage	P6046 <sup>2,3</sup>	P6046 <sup>2,3</sup>	P6046 <sup>2,3</sup>		
Current	AM 503S <sup>2,3</sup> CT1/2 <sup>2,3</sup>	AM 503S <sup>2,3</sup>	AM 503S <sup>2,3</sup>	AM 503S <sup>2,3</sup>	AM 503S <sup>2,3</sup> CT1/2 <sup>2,3</sup>
Fixtured	A6501 <sup>2,3</sup> P6501 <sup>2,3</sup>		A6501 <sup>2,3</sup> P6501 <sup>2,3</sup>	A6501 <sup>2,3</sup> P6501 <sup>2,3</sup>	
Time-to-voltage converter	TVC 501 <sup>2,3</sup>	TVC 501 <sup>2,3</sup>	TVC 501 <sup>2,3</sup>	TVC 501 <sup>2,3</sup>	

<sup>1</sup>Qualitative signal evaluation—use when a great deal of accuracy isn't required, such as in go/no go measurement.

<sup>2</sup>Functional testing—use when the device under test is being compared to some standard.

<sup>3</sup>Quantitative Signal Evaluation—use when detailed evaluation is needed.



# Remote Communication

You may want to integrate your oscilloscope into a benchtop or rack system environment and remotely control your oscilloscope or exchange measurement or waveform data with a computer. You can control your oscilloscope remotely using the IEEE Std 488.2-1987 (GPIB) interface.

---

## GPIB Protocol

GPIB enables data transfers between instruments that support the GPIB protocols. It provides:

- remote instrument control
- bidirectional data transfer
- device compatibility
- status and event reporting

Besides the base protocols, Tektronix has defined codes and formats for messages to travel over GPIB. Each device that follows these codes and formats, such as the TDS 820, supports standard commands. Use of instruments that support these commands can greatly simplify development of GPIB systems.

## GPIB Interface Requirements

You can connect GPIB networks in many configurations if you follow these rules:

- You can include no more than 15 devices, including the controller, on a single bus.
- You must connect one device load every two meters (about six feet) of cable length to maintain bus electrical characteristics. Generally, each instrument represents one device load on the bus.
- The total cumulative cable length must not exceed 20 meters.
- You must power on at least two-thirds of the device loads when you use your network.
- You must have only one cable path from each device to each other device on your network (see Figure 3-47). You must not create loop configurations.

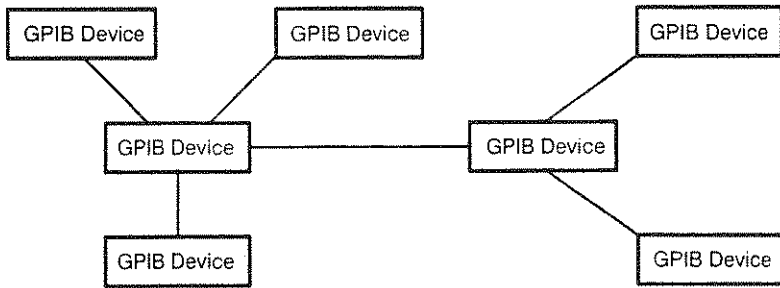

Figure 3-47: Typical GPIB Network Configuration

**Cables**—You must use an IEEE Std 488.1-1987 GPIB cable (available from Tektronix) to connect two GPIB devices.

**Connector**—A 24-pin GPIB connector is located on the oscilloscope rear panel. The connector has a D-type shell and conforms to IEEE Std 488.1-1987. You can stack GPIB connectors on top of each other (see Figure 3-48).

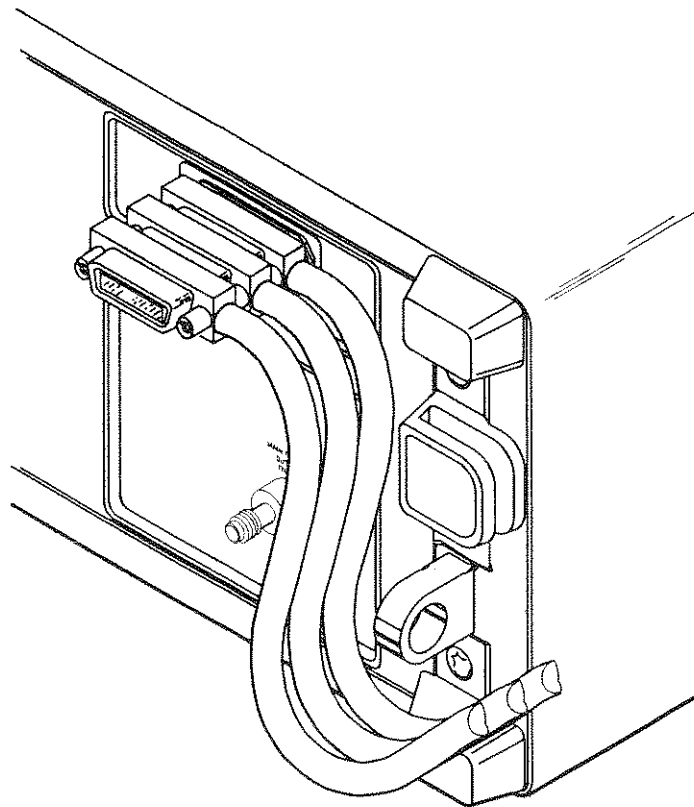

Figure 3-48: Stacking GPIB Connectors



## GPIB Parameters

In the Utility menu you need to define two important GPIB parameters: *mode* and *address*. You need to set the mode to talker/listener, talk only, or off the bus. You also need to specify the primary communication address.

## Operation

To set up remote communications, you must physically cable your oscilloscope to the controller and correctly set your oscilloscope parameters. Plug an IEEE Std 488.2-1987 GPIB cable (available as Tektronix part number 012-0991-00) into the GPIB connector on your oscilloscope rear panel and into the GPIB port on your controller (see Figure 3-49).

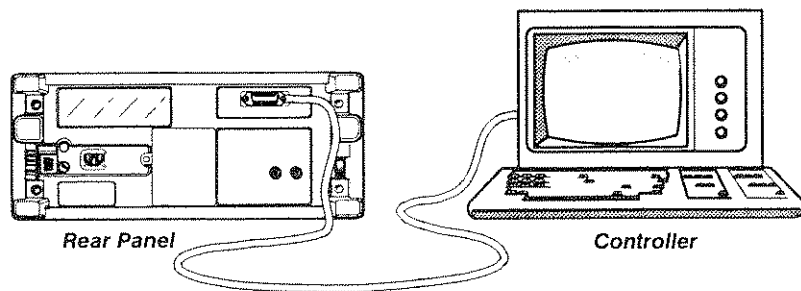

Figure 3-49: Connecting the Digitizing Oscilloscope to a Controller

To set remote communications parameters:

Press **SHIFT UTILITY** → **System** (main) → **I/O** (pop-up) (Figure 3-50).

### Port Selection

Now you need to configure the port to match the controller.

Press **SHIFT UTILITY** → **System** (main) → **I/O** (pop-up) → **Port** (main) → **GPIB** (pop-up) → **Configure** (main) → **Talk/Listen Address**, **Hardcopy (Talk Only)**, or **Off Bus** (side)

- Choose **Talk/Listen Address** for normal, controller-based system operation. Use the general purpose knob to define the address.
- Use **Hardcopy (Talk Only)** when you want to use the hardcopy port of your digitizing oscilloscope. Once you configure the port this way, the oscilloscope will send the hardcopy data to any listeners on the bus when you press the **HARDCOPY** button.

If you configure the port any other way and press the **HARDCOPY** button, an error occurs and the digitizing oscilloscope displays a message saying the selected hardcopy port is currently unavailable.

- **Off Bus** disconnects the digitizing oscilloscope from the bus.

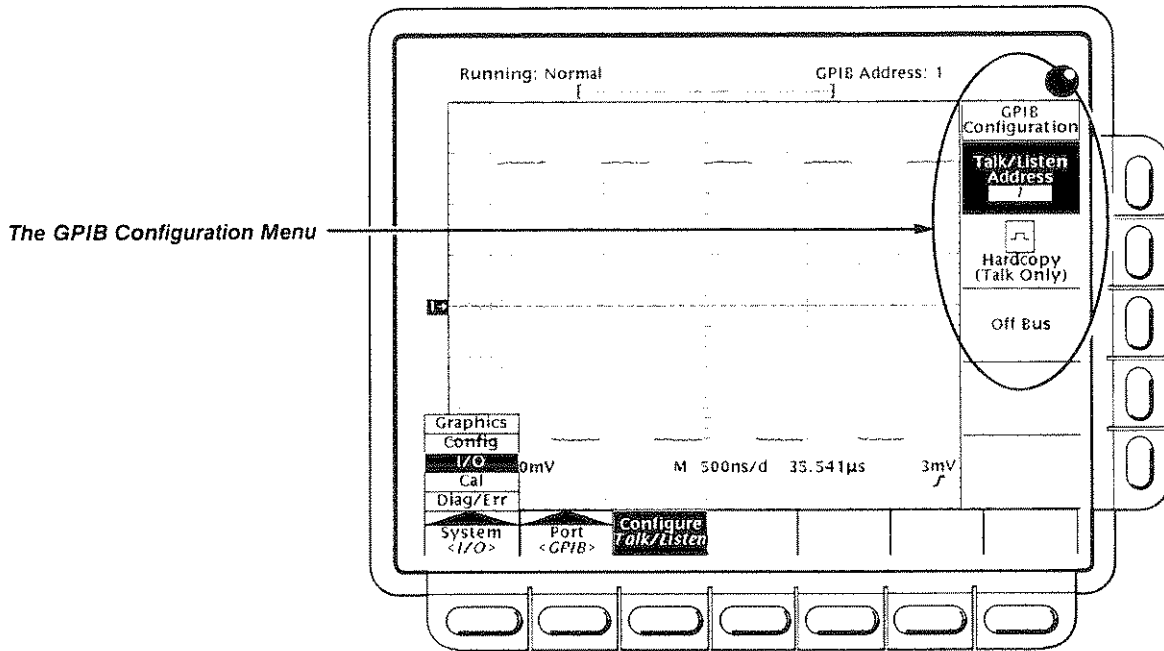

Figure 3-50: Utility Menu

**For More Information**

See *Hardcopy*, on page 3-26.

See *TDS 820 Programmer Manual*.

See the *TDS Family Option 13 Instruction Manual* (Option 13 equipped instruments only).



# Saving and Recalling Setups

You may want to save and reuse setups for many reasons. For example, after changing the setting during an experiment, you may want to quickly return to your original setup.

You can save and recall up to ten instrument setups from internal oscilloscope memory. The information is retained even when you turn the oscilloscope off or unplug it.

## Operation

To save the current setup of the digitizing oscilloscope (Figure 3-51):

1. Press **SETUP** → **Save Current Setup** (main).



Before doing step 2 that follows, note that if you choose a setup location labeled **user**, you will overwrite the user setup previously stored there. You can store setups in setup locations labeled **factory** without disturbing previously stored setups.

2. Choose one of the ten storage locations from the side menu **To Setup 1**, **To Setup 2**, ... (see Figure 3-51). Now the current setup is stored in that location.

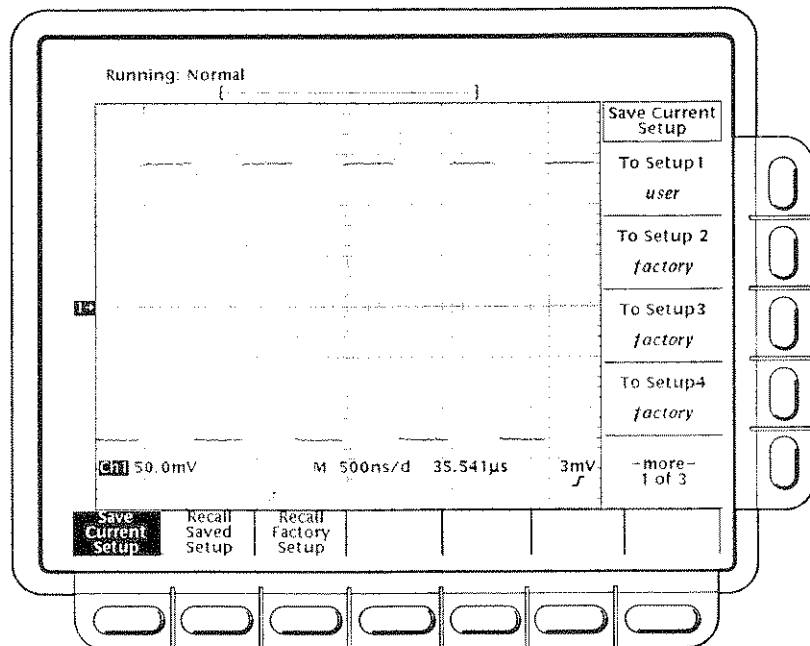

Figure 3-51: Save/Recall Setup Menu

## Recalling a Setup

To recall a setup, press **SETUP** → **Recall Saved Setup** (main) → (**Recall Setup 1, Recall Setup 2 ...** (side).

Recalling a setup will not change the menu that is currently displayed. If you recall a setup labeled **factory** in the side menu, you will recall the factory setup. (The conventional method for recalling the factory setup is described below.)

## Recalling the Factory Setup

To reset your oscilloscope to the factory defaults:

Press **SETUP** → **Recall Factory Setup** (main) → **OK Confirm Factory Init** (side).

You may want to reset your oscilloscope to the factory defaults. See *Factory Initialization Settings* on page E-1 for a list of the factory defaults.

## Deleting All Setups and Waveforms—Tek Secure®

Sometimes you might use the digitizing oscilloscope to acquire waveforms that are confidential. Furthermore, before returning the oscilloscope to general usage, you might want to remove all such waveforms and any setups used to acquire them. (Be sure you want to remove *all* waveforms and setups, because once you remove them, you cannot retrieve them.) To use Tek Secure to remove all stored setups and waveforms:

Press **SHIFT UTILITY** → **System** (main) → **Config** (pop-up) → **Tek Secure Erase Memory** (main) → **OK Erase Ref & Panel Memory** (side).

Executing Tek Secure accomplishes the following tasks:

- Replaces all waveforms in reference memories with zero sample values.
- Replaces the current front panel setup and all setups stored in setup memory with the factory setup.
- Calculates the checksums of all waveform memory and setup memory locations to verify successful completion of setup and waveform erasure.
- If the checksum calculation is unsuccessful, Tek Secure displays a warning message; if the checksum calculation is successful, Tek Secure displays a confirmation message.

---

## For More Information

See *Getting Started Example 4: Saving Setups*, on page 1-25.

See *Factory Initialization Settings*, on page E-1.



# Saving and Recalling Waveforms

You can store a waveform in any of the four internal reference memories of the digitizing oscilloscope. That information is retained even when you turn the oscilloscope off or unplug it. You can save any combination of different size waveform records up to 50,000 record points.

The digitizing oscilloscope can display up to 9 waveforms at one time. That includes waveforms from the input channels, four reference waveforms, and three math waveforms.

You will find saving waveforms useful when working with many waveforms and channels. If you have more waveforms than you can display, you can save one of the waveforms and then stop acquiring it. That lets you display another waveform without forcing you to lose the first one.

---

## Operation

To save a waveform, do the following steps:

1. Select the channel that has the waveform you want to save.



Before doing step 2 that follows, note that if you choose a reference memory location labeled **active** (see Figure 3-52), you will overwrite the waveform previously stored there. You can store waveforms in reference locations labeled **empty** without disturbing previously stored waveforms.

2. Press save/recall **WAVEFORM** → **Save Waveform** (main) → **Ref1, Ref2, Ref3, or Ref4** (side) (Figure 3-52).

## Deleting Waveforms

If you run out of memory when you try to save a waveform, you can choose the **Delete Refs** main menu item and then select the references you no longer need from the side menu (**Delete Ref1, Delete Ref2, Delete Ref3, Delete Ref4, or Delete All Refs**). You will know if you run out of memory because the digitizing oscilloscope will display a message.

### NOTE

*There is also a feature, called Tek Secure, that removes all stored waveforms and setups and then confirms that they have been removed. This feature finds use where this digitizing oscilloscope is used to gather security sensitive data, such as is done for research or development projects. See "Deleting All Setups and Waveforms" on page 3-76.*

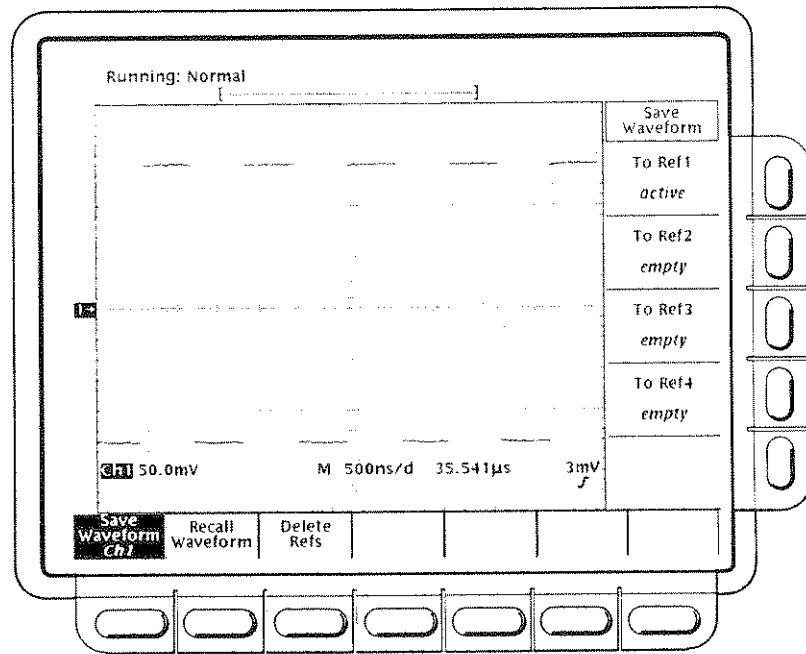

Figure 3-52: Save Waveform Menu

### Deleting All Waveforms and Setups

The simultaneous removal of all stored waveforms and setups using the feature called Tek Secure is described under *Saving and Recalling Setups*. See “Deleting All Setups and Waveforms” on page 3-76.

### Recalling a Waveform

To recall a waveform:

Press MORE → Ref1, Ref2, Ref3, or Ref4 (main).

#### NOTE

*In Figure 3-53, the main menu items Ref2, Ref3, and Ref4 appear shaded while Ref1 does not. References that are empty appear shaded in the More main menu.*

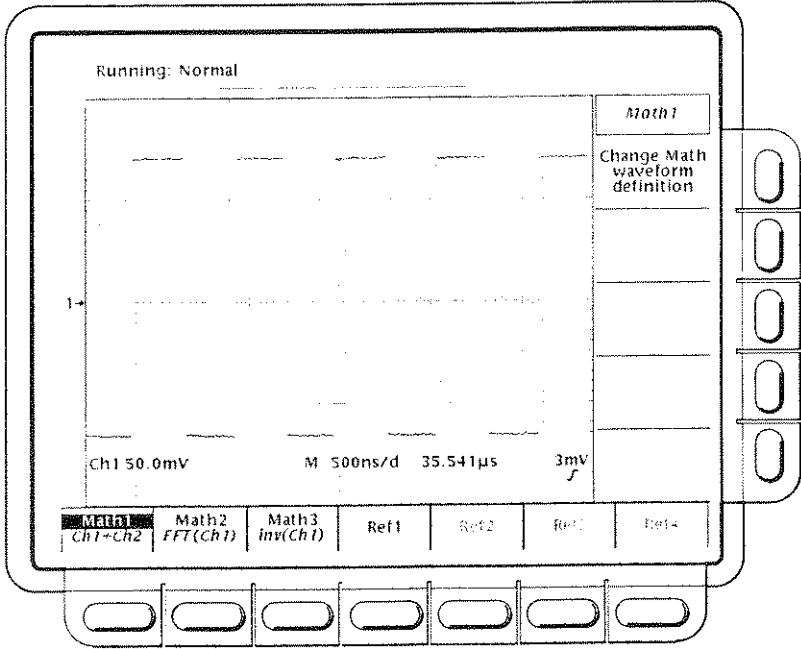

Figure 3-53: More Menu

**For More Information**

See *Selecting Channels*, on page 3-80.

# Selecting Channels

The *selected channel* is the channel that the digitizing oscilloscope applies all waveform-specific activities to (such as measurements or vertical scale and position).

---

## Channel Readout

The channel readout shows the selected channel in inverse video in the lower left corner of the display (see Figure 3-54).

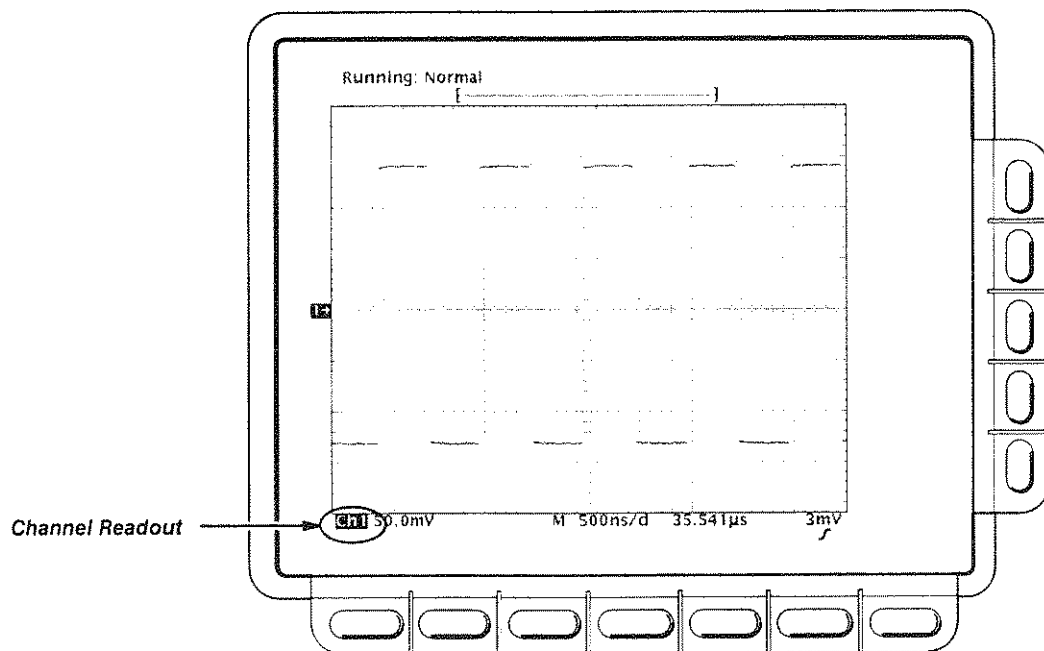

Figure 3-54: The Channel Readout

---

## Channel Selection Buttons

Selecting channels on a TDS 800 series oscilloscope is straightforward and easy.

The *channel selection* buttons are on the right of the display and are labeled **CH 1**, **CH 2**, and **MORE** (Figure 3-55). They determine the selected channel. The **MORE** button allows you to select internally stored *Math* and *Ref* waveforms for display and manipulation.



A lighted LED, above each button, indicates the selected channel. Figure 3-55 shows Channel 1 as the currently selected channel.

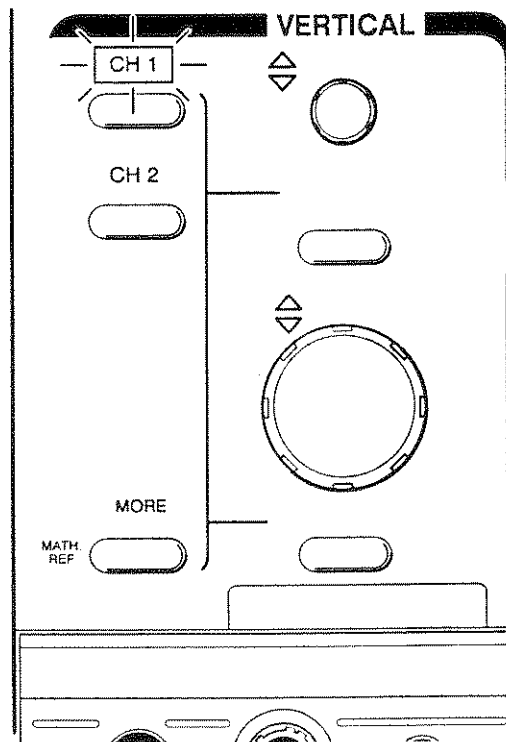

Figure 3-55: Channel Selection Buttons

## Operation

Selecting or removing a waveform is as simple as pushing a button.

### Selecting a Waveform

Pressing **CH 1** or **CH 2** turns the channel on if it is not already on. When you press the **MORE** button, the More menu appears with Math and Ref selections. See *Saving and Recalling Waveforms* on page 3-77 and *Waveform Math* on page 3-97 for information on how to use the More menu.

You do not use the channel selection buttons when triggering. Instead you select the trigger source in the Trigger menu.

### Removing Waveforms From the Display

The **WAVEFORM OFF** button turns OFF the display of the selected channel waveform. It will also remove from the display any automated measurements being made on that waveform.

When you turn off a waveform, the digitizing oscilloscope automatically selects the next highest priority waveform. Figure 3-56 shows how the oscilloscope prioritizes waveforms.

1. CH1
2. CH2
3. MATH1
4. MATH2
5. MATH3
  
6. REF1
7. REF2
8. REF3
9. REF4

**Figure 3-56: Waveform Selection Priority**

If you are turning off more than one waveform and you start by turning off a channel waveform, all selected channels turn off before the MORE waveforms. If you start by turning off the MORE waveforms, all MORE waveforms turn off before the channel waveforms.

If you turn off a channel that happens to be a trigger source, the trigger circuitry will continue monitoring that channel even though the waveform is not displayed.

---

### For More Information

See *Saving and Recalling Waveforms*, on page 3-77.

See *Waveform Math*, on page 3-97.



# Status

The Status menu lets you see information about the oscilloscope state.

## Operation

To operate the Status menu:

Press **SHIFT STATUS** → **System**, **Trigger**, **Waveforms**, or **I/O** (side).

The Status menu is unusual because it only has a side (vertical) menu. There are no choices along the main (horizontal) axis.

- Select **System** from the side menu to display information about the Horizontal, Zoom, Acquisition, Display, Measure, and Hardcopy systems (Figure 3-57). This also tells you what version of firmware the oscilloscope is using.
- Select **Trigger** from the side menu to display parameter information about the triggers.
- Select **Waveforms** from the side menu to display information about the various waveforms. That includes live, math, and reference waveforms.
- Select **GPIO** from the side menu to display information about the GPIO system.

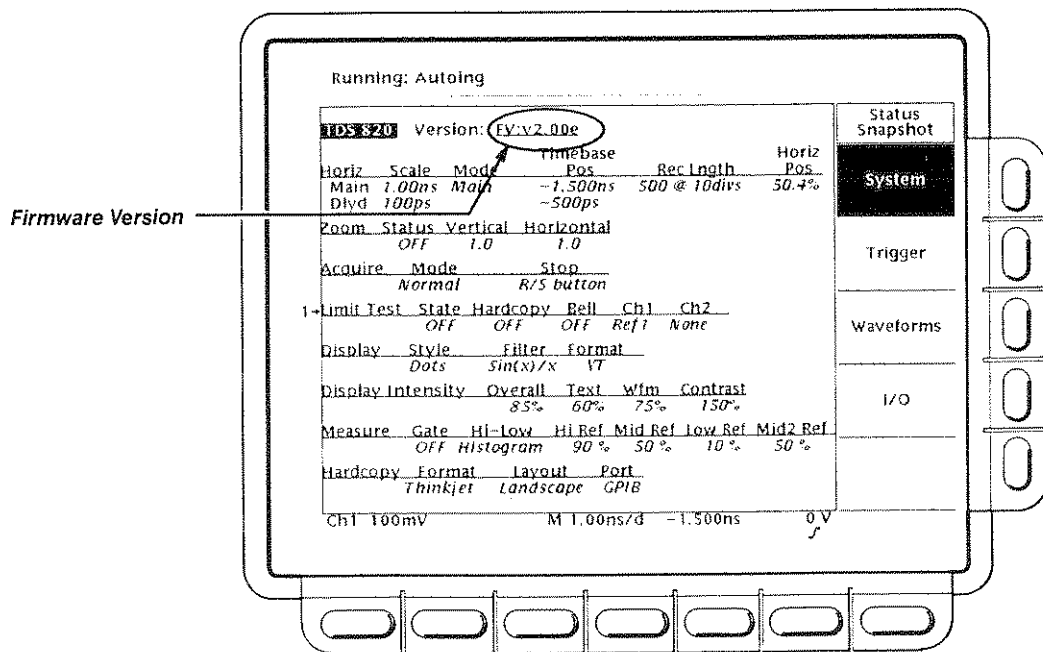

Figure 3-57: Status Menu—System

# Triggering

Triggers determine when the digitizing oscilloscope starts acquiring and displaying a waveform. A *trigger* event occurs when the trigger source passes through a specified voltage level in a specified direction (the trigger slope).

You can select the source, slope, level, mode (auto or normal), and requested trigger holdoff.

## Trigger Button and Knobs

The trigger buttons and knob let you quickly adjust the trigger level (see Figure 3-58).

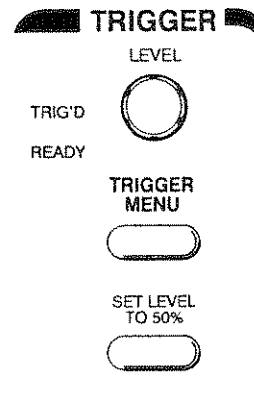

Figure 3-58: TRIGGER Controls

### LEVEL Knob

The **LEVEL** knob lets you manually change the trigger level. You adjust the trigger level instantaneously no matter what menu, if any, is displayed.

### To Set to 50%

If you press the **SET LEVEL TO 50%** button, the oscilloscope searches for the halfway point between the peaks of the trigger signal and sets the trigger level to that point. When finished, the trigger circuitry returns to normal operation.

You can also set the level to 50% in the Trigger menu under the main menu item **Level**.

## Readouts

The digitizing oscilloscope has display readouts and status lights dedicated to monitoring the trigger circuitry.

### Trigger Status Lights

There are two status lights in the Trigger control area (see Figure 3-59) indicating the state of the trigger circuitry. The lights are labeled **TRIG'D** and **READY**.

- When **READY** is lighted, the digitizing oscilloscope can accept a valid trigger event and it is waiting for that event to occur.
- When **TRIG'D** is lighted, the digitizing oscilloscope is recognizing valid triggers and is acquiring a waveform record.

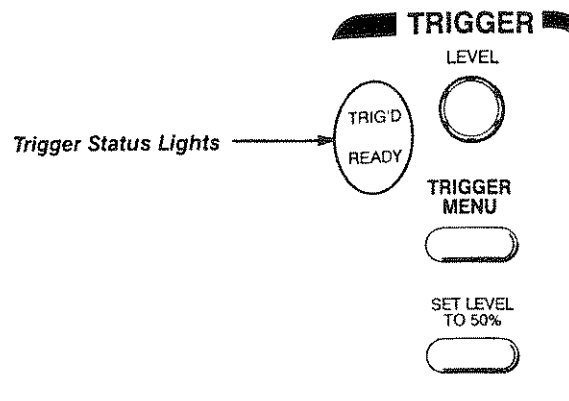

Figure 3-59: Trigger Status Lights

### Trigger Display Readout

At the bottom of the display, the Trigger readout shows some of the trigger parameters (Figure 3-60).

The record view at the top of the display shows the location of the trigger signal in the waveform record and with respect to the display (see Figure 3-61).

#### NOTE

*In Option 1D instruments, the trigger position indicator always appears at the left edge of the display, regardless of the time base position setting.*

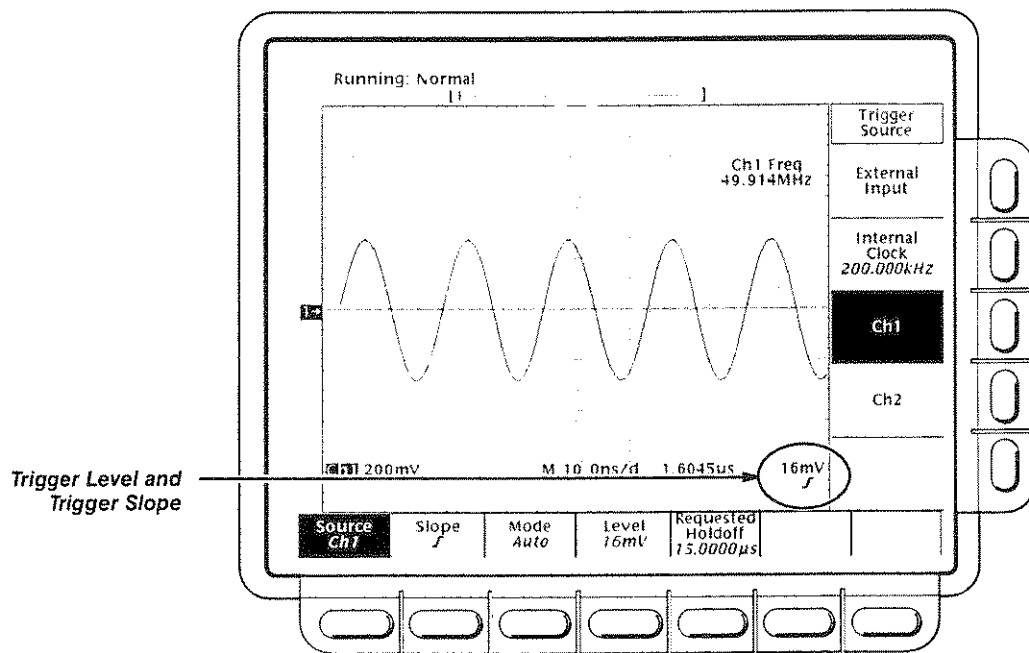

Figure 3-60: Example Trigger Readouts

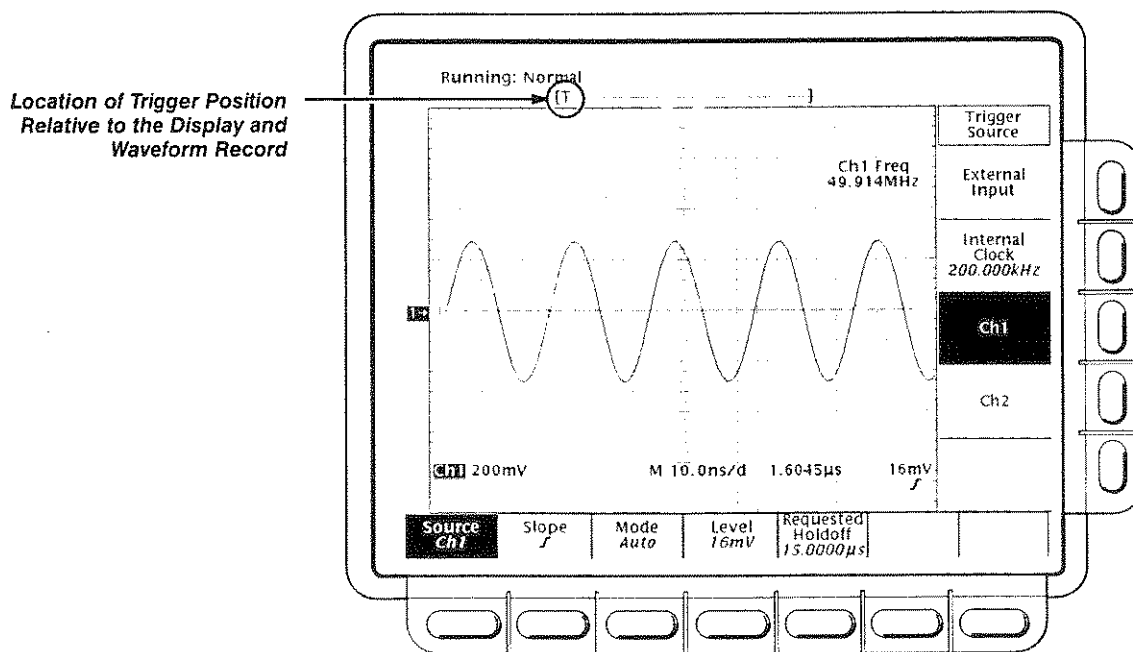

Figure 3-61: Record View Readout Showing Trigger Position

## Trigger Level Indicators

In addition to the numerical readouts of trigger level, there are also graphic indicators of trigger level that you can optionally display. These indicators are the long trigger level bar, and the short trigger level bar. Figure 3-62 shows the short-style trigger level bar.

The trigger level bar shows only the trigger level, and it remains on screen regardless of the horizontal position as long as the channel providing the trigger source is displayed.

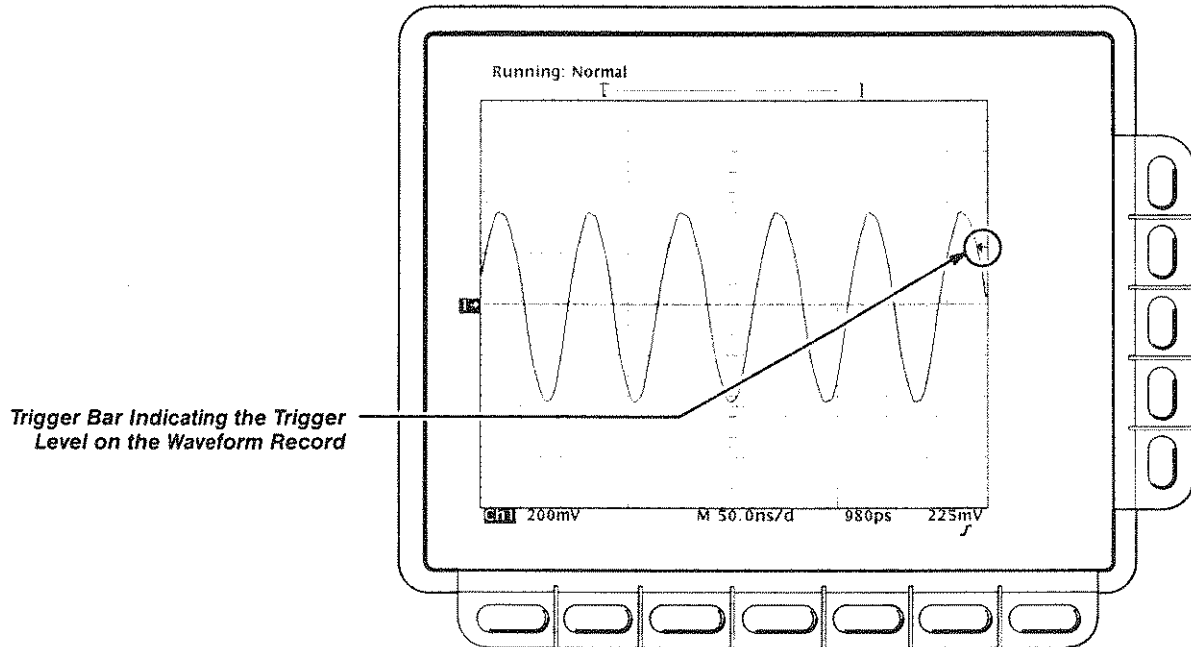

Figure 3-62: Trigger Level Bar Readout

You display the trigger level bar from the Display menu. See *Display Readout* on page 3-16 for more information.

---

## Operation

The Trigger menu lets you select the source, slope, trigger level, mode, and holdoff (see Figure 3-63).

To bring up the Trigger menu:

Press **TRIGGER MENU**.



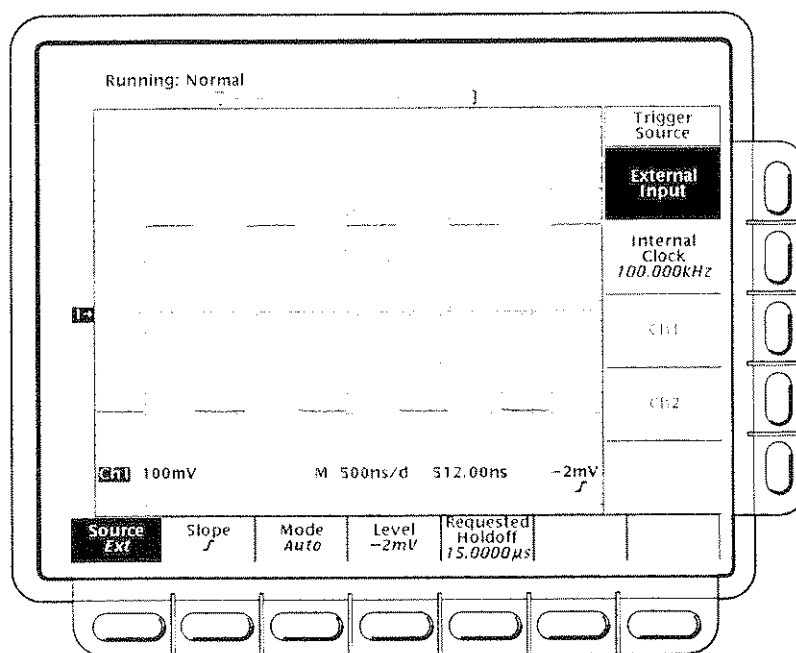

Figure 3-63: Trigger Menu

## Source

To select which source you want for the trigger:

1. Press **TRIGGER MENU** → **Source** (main) → **External Input**, **Internal Clock**, **Ch1**, or **Ch2** (side). (Ch1 and Ch2 are not valid trigger sources for Option 1D instruments.)

If you wish to use the internal clock as a trigger source, you can set the clock rate to any value in a 1,2,5 sequence from 10 Hz to 500 kHz. The internal clock signal output is also available from a rear panel connector for triggering or synchronizing external devices.

2. To change the internal clock rate, first select it as the trigger source.
3. Then rotate the general purpose knob, or enter the value desired using the keypad. If you want to enter a large number using the general purpose knob, press the **SHIFT** button before turning the knob. When the light above the **SHIFT** button is on and the display says **Coarse Knobs** in the upper right corner, the general purpose knob speeds up significantly.

## Slope

To select the slope that the trigger will occur on:

Press **TRIGGER MENU** → **Slope** (main). Alternatives for slope are rising edge and falling edge.

## Mode

To select the trigger mode:

Press **TRIGGER MENU** → **Mode** (main) → **Auto** or **Normal** (side) (see Figure 3-64).

- In **Auto** mode the oscilloscope acquires a waveform after 50 ms has elapsed even if a trigger does not occur.
- In **Normal** mode the oscilloscope acquires a waveform only if there are valid triggers.

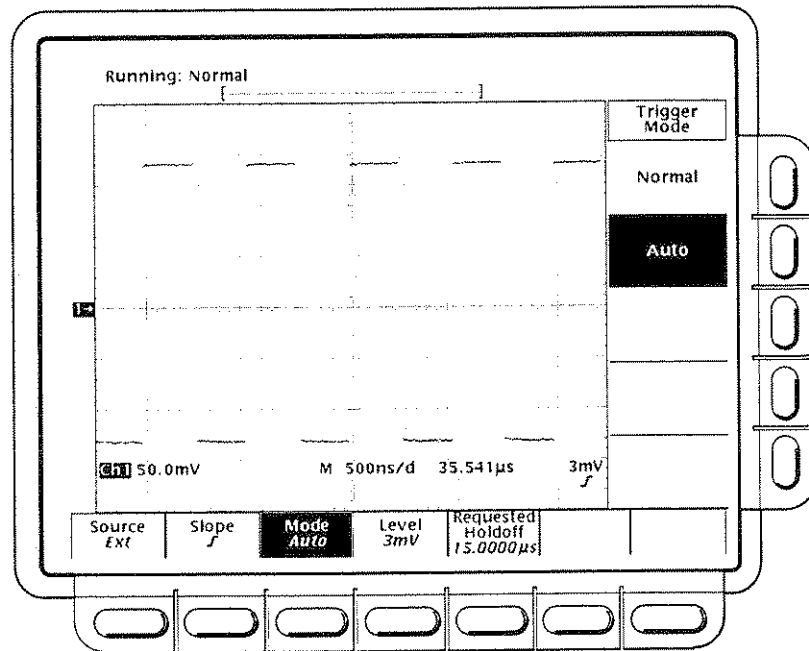

Figure 3-64: Trigger Menu—Mode

## Level

Press **TRIGGER MENU** → **Level** (main) → **Level** or **Set to 50%** (side) to bring up a side menu of alternative ways to enter the trigger level (Figure 3-65).

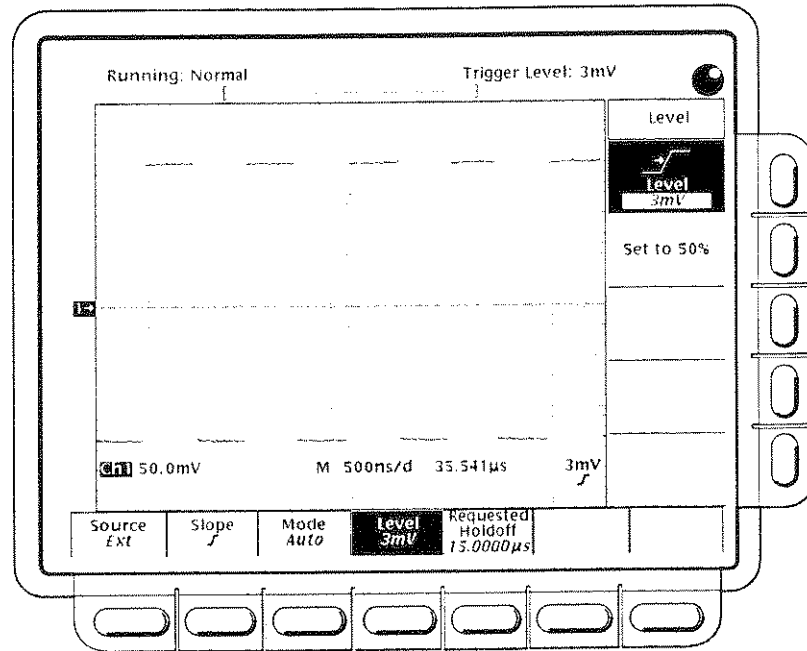

Figure 3-65: Trigger Menu—Level

There are two ways to set the trigger level:

- **Level** lets you enter the trigger level using the general purpose knob or the keypad. If you want to enter a large number using the general purpose knob, press **SHIFT** before turning the knob. When the light above the **SHIFT** button is on and the display says **Coarse Knobs** in the upper right corner, the general purpose knob speeds up.
- **Set to 50%** fixes the trigger level to 50% of the peak-to-peak value of the trigger source signal. You can also set the trigger level to 50% by pressing **SET LEVEL TO 50%**.

### Requested Holdoff

Trigger holdoff is the minimum time between triggers. You can use trigger holdoff to ignore signals that would otherwise cause the digitizing oscilloscope to trigger.

You can change the requested holdoff time using this menu item. If possible, the requested holdoff becomes the actual holdoff time (see Figure 3-66).

The minimum possible trigger holdoff is 15  $\mu$ s, but the oscilloscope may have to use a greater holdoff time if you set a long record length, a large time per division, a large time base position, or a large deskew value. The maximum possible trigger holdoff is 2 s.

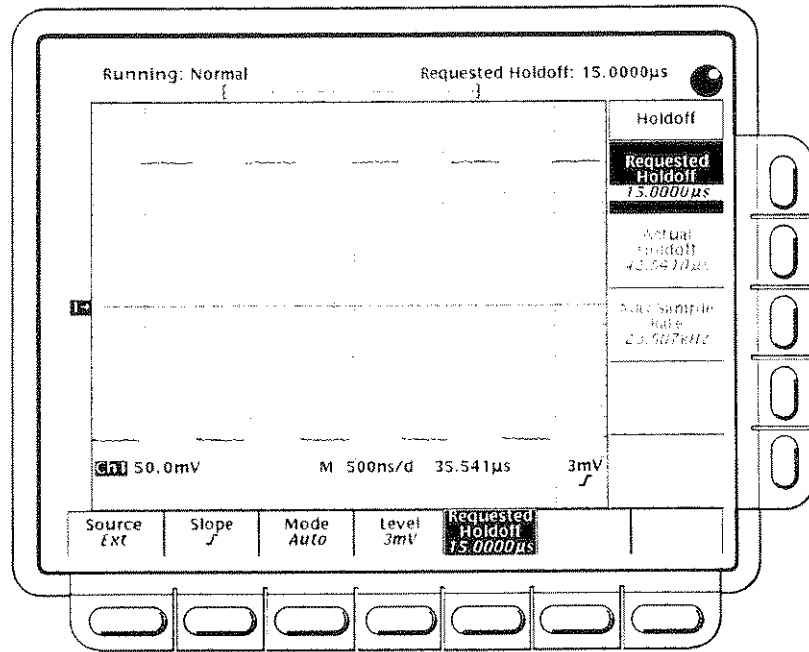

Figure 3-66: Trigger Menu—Holdoff

The actual holdoff time is visible below the **Actual Holdoff** side menu item. This menu item is dimmed because you cannot set the actual holdoff directly. The oscilloscope calculates **Actual Holdoff** from the requested holdoff and the other time base parameters mentioned above.

To change the requested holdoff time, Press **TRIGGER MENU → Requested Holdoff** (main). Enter the value using the general purpose knob or the keypad.

### Maximum Sample Rate

Also in the **Requested Holdoff** side menu is the *maximum sample rate*, the fastest rate at which points can be sampled and placed in the waveform record. This item is also dimmed because you cannot set the maximum sample rate directly. Instead, it is a function of the trigger source and the actual holdoff. If the trigger source is external input or either input channel, the maximum sample rate is the reciprocal of the actual trigger holdoff. If the trigger source is the internal clock, the maximum sample rate is the internal clock rate or the reciprocal of the actual trigger holdoff, whichever is slower.

### For More Information

See *Triggering*, on page 2-13.

See *Probe Functions*, on page 3-96.

# Vertical Control

You can control the vertical position and scale of the selected waveform using the vertical menu and knobs.

## Vertical Knobs

By changing the vertical scale, you can focus on a particular portion of a waveform. By adjusting the vertical position, you can move the waveform up or down on the display. That is particularly useful when you are comparing two or more waveforms.

To change the vertical scale and position, use the vertical **POSITION** and vertical **SCALE** knobs. The vertical controls (see Figure 3-67) only affect the selected waveform.

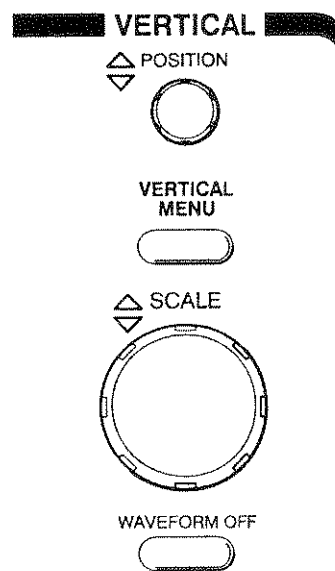

Figure 3-67: Vertical Controls

The **POSITION** knob simply adds screen divisions to the reference point of the selected waveform. Adding divisions moves the waveform up and subtracting them moves the waveform down. You also can adjust the waveform position using the offset option in the Vertical menu (discussed later in this article).

If you want the **POSITION** knob to move faster, press **SHIFT**. When the light above the **SHIFT** button is on and the display says **Coarse Knobs** in the upper right corner, the **POSITION** knob speeds up significantly.

## Vertical Readouts

The *Vertical readout* at the lower part of the display shows each displayed channel (the selected channel is in inverse video), and its volts per division setting (see Figure 3-68).

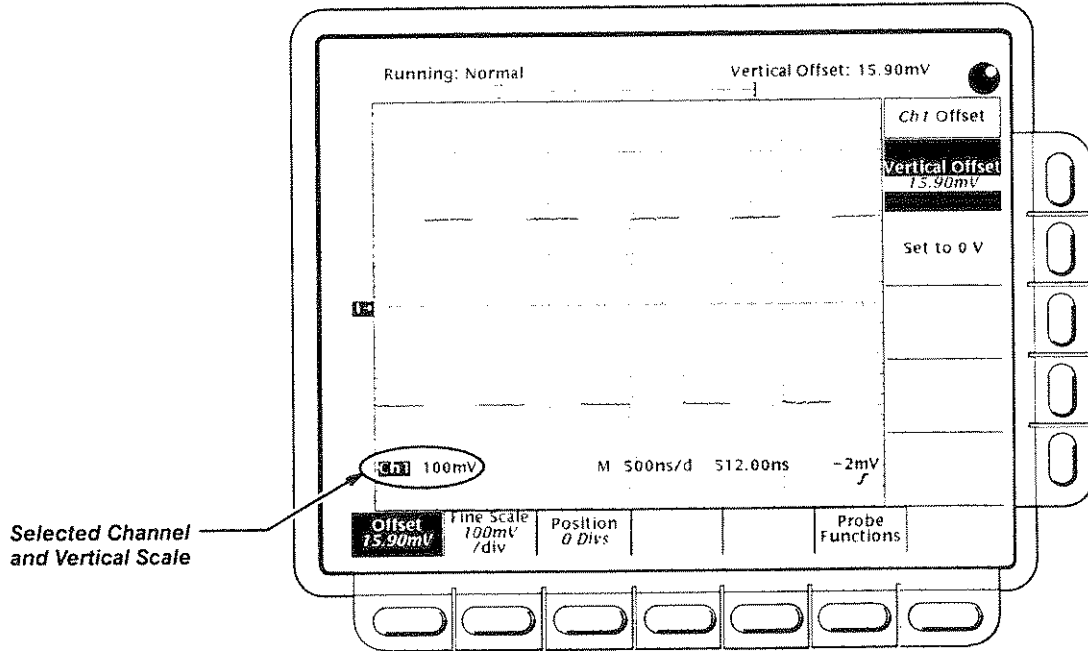

Figure 3-68: Vertical Readouts

## Vertical Menu

The Vertical menu lets you select the offset for the selected waveform. It also lets you numerically change the position or scale instead of using the vertical knobs.

Press **VERTICAL MENU** to call up the menu (Figure 3-69).

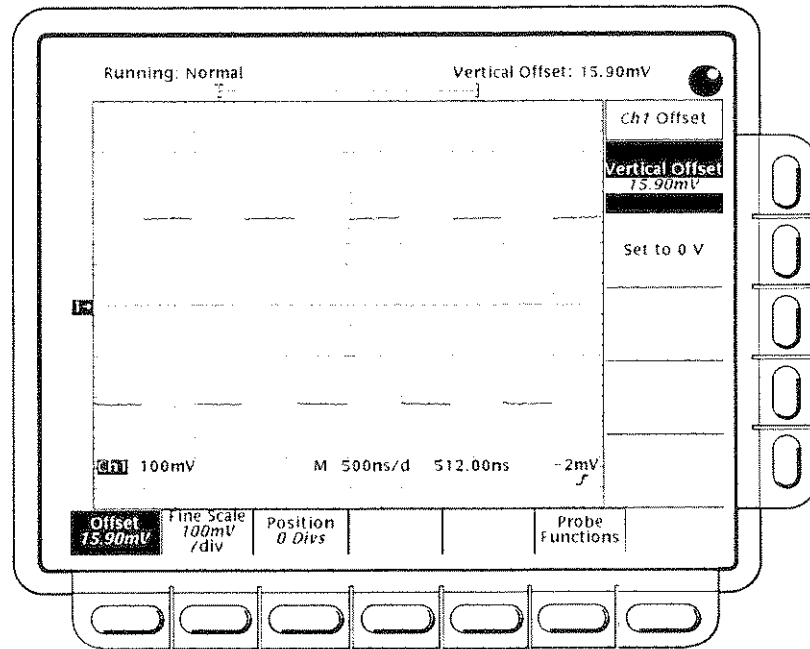

Figure 3-69: Vertical Channel Menu

## Offset

Offset lets you add DC bias to the waveform, so the oscilloscope can acquire the exact part of the waveform you are interested in.

Offset is useful when you want to examine a waveform with a DC bias. For example, you might be trying to look at a small ripple on a DC level. It may be a 10 mV ripple on top of a 250 mV DC level. With offset's range you can display the ripple and scale it to meet your needs. (If you are using a probe that supports TEKPROBE capability, you may be able to set offset at the probe tip, thus allowing you to use the probe's greater dynamic range. See page 3-60 for further details.)

To use offset, press **VERTICAL MENU** → **Offset** (main). Use the general purpose knob or the keypad to control the vertical offset. Press **Set to 0 V** (side) if you want to reset the offset to zero.

For a discussion of the difference between vertical position and offset, see page 2-21.

## NOTE

*Autoset may change vertical offset to position the waveform appropriately. When offset is not set to 0 V, the ground reference indicator points to ground plus the offset, and not to ground.*

## Fine Scale

Press **VERTICAL MENU** → **Fine Scale** (main) to make fine adjustments to the vertical scale using the general purpose knob or the keypad. The side menu item shows the setting of the **Fine Scale** parameter. That readout and the display's vertical readout will show any changes to the volts per division.

## Position

Press **VERTICAL MENU** → **Position** (main) to let the general purpose knob or the keypad control the vertical position. Press **Set to 0 divs** (side) if you want to reset the reference point of the selected waveform to the center of the display.

## Probe Functions

Press **VERTICAL MENU** → **Probe Functions** (main) to adjust the external attenuation using the general purpose knob or the keypad. The side menu items show the **External Attenuation** setting.

### NOTE

*The probe attenuation of an active probe attached to a channel and the user-supplied external attenuation for that channel are multiplied. For example, if you attach a P6205 (with 10X attenuation) to **Ch1** and you request 2X external attenuation, the combined attenuation is 20X.*

External attenuation affects volts scaling, measurements, cursors, triggers, autoset, and setup:

- Vertical measurements reflect the scaled value.
- Horizontal and paired cursors readouts are rescaled.
- If a vertical channel is the trigger source, the trigger level is rescaled.
- Autoset does not reset attenuation.
- External attenuation is saved and restored with settings. Factory reset restores the factory 1X and 0 dB values.

---

## For More Information

See *Acquisition*, on page 2-17.

See *Scaling and Positioning Waveforms*, on page 2-21.

See *Probe Interface*, on page 3-60.



# Waveform Math

You can mathematically manipulate your waveforms. For example, you might have a waveform clouded by background noise. You can obtain a cleaner waveform by subtracting the background noise from your original waveform.

This manual describes the standard waveform math features (invert, add, subtract, and multiply). See the *TDS Family Option 2F Instruction Manual*, if your oscilloscope has that option.

## Operation

To perform waveform math press the **MORE** button to bring up the More menu (Figure 3-70). The More menu allows you to display, define, and manipulate three math functions.

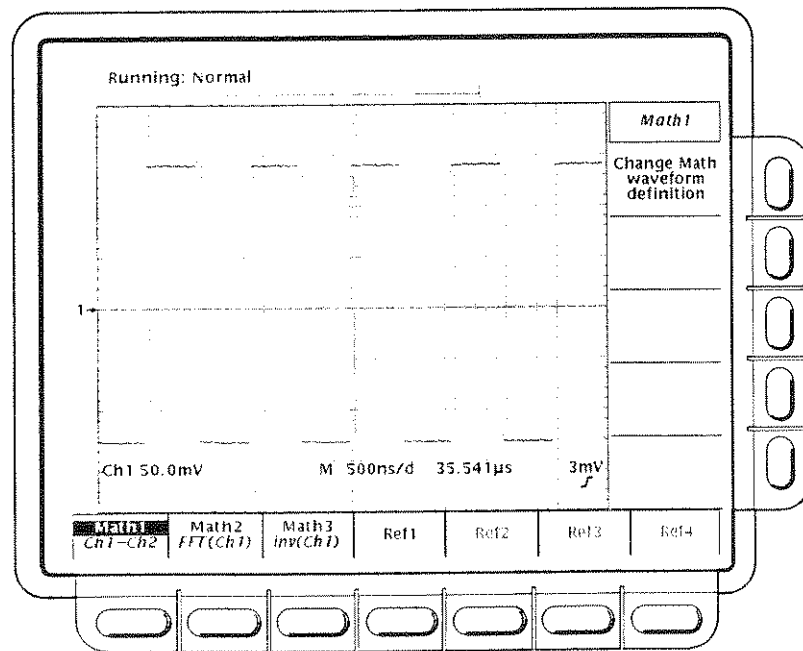

Figure 3-70: More Menu

### Math1, Math2, and Math3

1. Press **MORE** → **Math1**, **Math2**, or **Math3** (main) to select the waveform that you want to display or change (Figure 3-70).

**NOTE**

If your digitizing oscilloscope contains Option 2F, Advanced DSP Math, the menu item **FFT** will be at the same brightness as the menu items **Single Wfm Math** and **Dual Wfm Math**; otherwise, **FFT** will be dimmed. See the TDS Family Option 2F Instruction Manual for information on FFTs and other advanced math waveforms.

2. Press **Change Math waveform definition** (side) → **Single Wfm Math** or **Dual Wfm Math** (main) to alter the present math waveform definition (see Figure 3-71).

The following topics describe single and dual waveform operations.

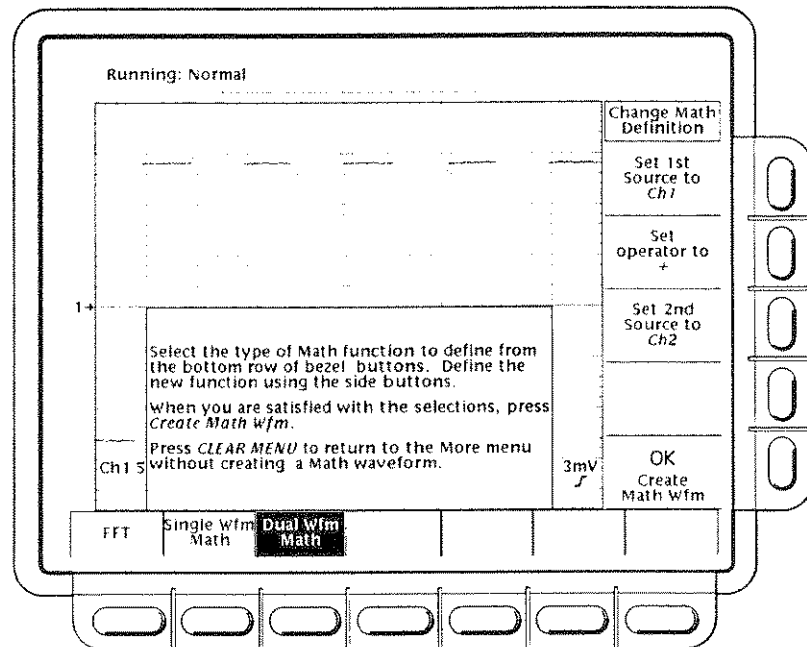

Figure 3-71: Dual Waveform Math Main and Side Menus

### Single Wfm Math

1. Press **MORE** → **Math1**, **Math2**, or **Math3** (main) → **Set Function to** (side) → **inv** (invert).
2. To define the source waveform toggle **Set Single Source to** (side) or select that item and use the general purpose knob.
3. When you're ready to perform the function, press **OK Create Math Wfm**.

## Dual Wfm Math

1. Select the sources with **MORE** → **Math1**, **Math2**, or **Math3** (main) → **Set 1st Source to** and **Set 2nd Source to** (side). Enter the sources by toggling the appropriate channel selection button or by using the general purpose knob.
2. To enter the math operator press **Set operator to** (side). Toggle the button next to this side menu selection or use the general purpose knob. Supported operators are +, −, and \*.
3. Press **OK Create Math Wfm** (side) to perform the function.

### NOTE

*If you select \*, for multiply, in step 2, the cursor feature will measure amplitude in the units volts squared **VV** rather than in volts **V**.*

---

## For More Information

If your oscilloscope contains option 2F, you can also create integrated, differentiated, and Fast Fourier Transform waveforms. If your oscilloscope contains the option, see the *TDS Family Option 2F Instruction Manual*.



At times, you may want to expand or compress a waveform on the display without changing the acquisition parameters. You can do that with the zoom feature.

---

## Zoom and Interpolation

When you zoom in on a waveform on the display, you expand a portion of it. The digitizing oscilloscope must show more points for that portion than it has acquired. To do this, it interpolates. The instrument can interpolate in either of two ways: linear or  $\sin(x)/x$ .

*Linear interpolation* computes record points between actual acquired samples by using a straight line fit. It assumes all the interpolated points fall in their appropriate time on that straight line. That is useful for many waveforms such as pulse trains.

*Sin(x)/x interpolation* computes record points using a curve fit between the actual values acquired. It assumes all the interpolated points fall along that curve. That is particularly useful when acquiring more rounded waveforms such as sine waves. Actually, it is appropriate for general use, although it may introduce some overshoot or undershoot in signals with fast rise times.

The default interpolation method is  $\sin(x)/x$ . If you wish to change this setting, follow the steps starting on page 3-17.

To differentiate between the real and interpolated samples, set the display style to **Intensified Samples**.

---

## Operation

When you turn on the zoom feature, the vertical and horizontal scale and vertical position knobs control the displayed size and position of waveforms, allowing them to be expanded and repositioned on screen. They cease to affect waveform acquisition. However, the corresponding menu items continue to affect waveform acquisition.

To use zoom:

1. Press **ZOOM → ON** (side). (See Figure 3-72.) The **ZOOM** front-panel button should light up.

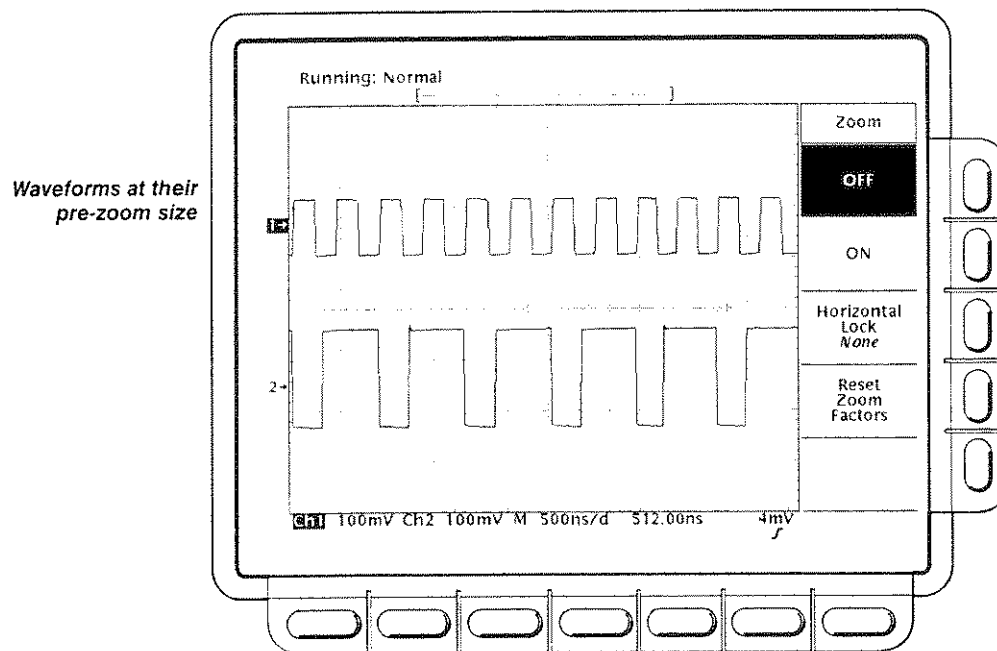

Figure 3-72: Zoom Menu

**NOTE**

When you zoom, the display redraws the waveforms using the interpolation method you selected in the Display menu (linear or  $\sin(x)/x$  interpolation). If you selected  $\sin(x)/x$  it may introduce some overshoot or undershoot to the waveform edges. If that happens, change the interpolation method to linear.

For information on how to change the interpolation method, see Display Modes on page 3-17.

2. Choose which waveforms to zoom by toggling **Horizontal Lock** (side) or by using the general purpose knob.
  - **None**—only the waveform currently selected can be magnified and positioned horizontally (Figure 3-73).
  - **Live**—all channels can be magnified and positioned horizontally at the same time (Figure 3-74). (Waveforms displayed from an input channel are live; math and reference waveforms are not live.)
  - **All**—all waveforms displayed (channels, math, and/or reference) can be magnified and positioned horizontally at the same time.

*Only the selected waveform (the top one) changes size*

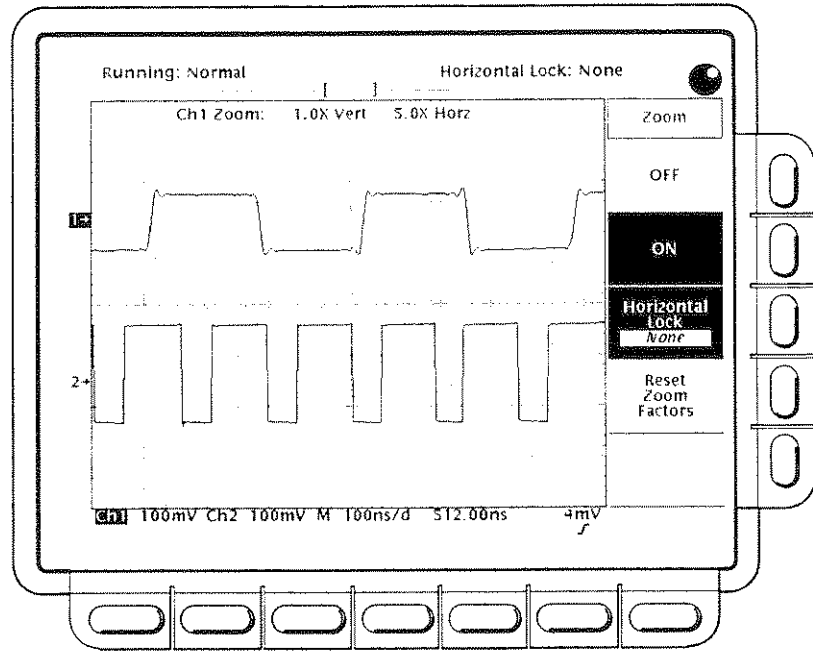

Figure 3-73: Zoom Mode with Horizontal Lock Set to None

*All displayed input channels change size*

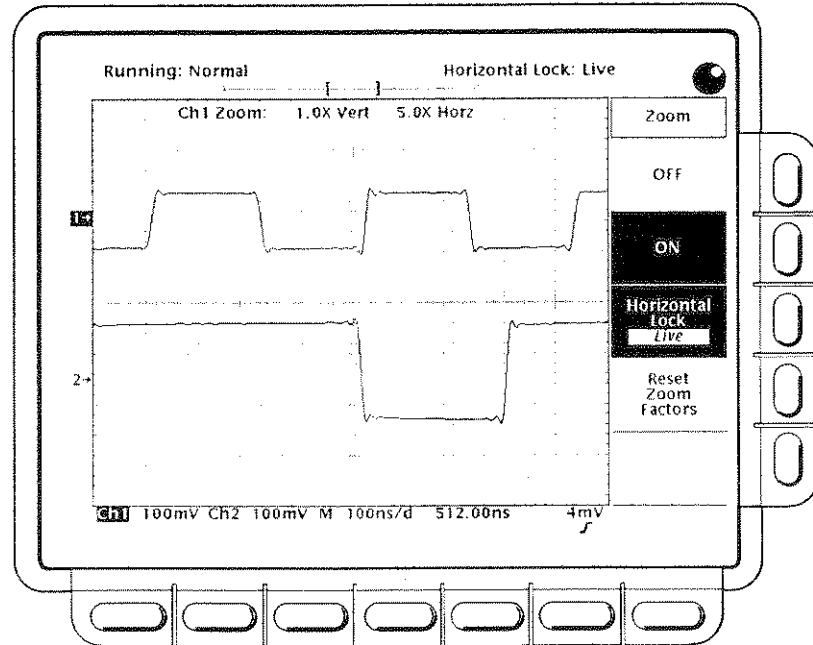

Figure 3-74: Zoom Mode with Horizontal Lock Set to Live

**NOTE**

Although zoom must be turned on to control which waveforms zoom affects, the setting for **Horizontal Lock** affects which waveforms the horizontal control positions whether zoom is on or off. The rules for the three settings are as is listed in step 2.

**Reset Zoom**

To reset all zoom factors to their defaults (Table 3-6), press **ZOOM → Reset Zoom Factors** (side).

**Table 3-6: Zoom Defaults**

Parameter	Setting
Zoom Vertical Position	0
Zoom Vertical Gain	1X
Zoom Horizontal Position	Tracking Horizontal Position
Zoom Horizontal Gain	1X

Press **ZOOM → Off** (side) to return to normal (non-zoom) operation.

---

**For Further Information**

See *Acquisition*, on page 2-17.

See *Display Modes*, on page 3-14.

1  
2  
3  
4  
5  
6  
7  
8  
9  
10  
11  
12  
13  
14  
15  
16  
17  
18  
19  
20  
21  
22  
23  
24  
25  
26  
27  
28  
29  
30  
31  
32  
33  
34  
35  
36  
37  
38  
39  
40  
41  
42  
43  
44  
45  
46  
47  
48  
49  
50  
51  
52  
53  
54  
55  
56  
57  
58  
59  
60  
61  
62  
63  
64  
65  
66  
67  
68  
69  
70  
71  
72  
73  
74  
75  
76  
77  
78  
79  
80  
81  
82  
83  
84  
85  
86  
87  
88  
89  
90  
91  
92  
93  
94  
95  
96  
97  
98  
99  
100