

User Manual



**TDS 420A, TDS 430A, TDS 460A & TDS 510A
Digitizing Oscilloscopes**

070-9701-03

Copyright © Tektronix, Inc. All rights reserved.

Tektronix products are covered by U.S. and foreign patents, issued and pending. Information in this publication supercedes that in all previously published material. Specifications and price change privileges reserved.

Tektronix, Inc., P.O. Box 500, Beaverton, OR 97077

TEKTRONIX and TEK are registered trademarks of Tektronix, Inc.

WARRANTY

Tektronix warrants that the products that it manufactures and sells will be free from defects in materials and workmanship for a period of three (3) years from the date of shipment. If a product proves defective during this warranty period, Tektronix, at its option, either will repair the defective product without charge for parts and labor, or will provide a replacement in exchange for the defective product.

In order to obtain service under this warranty, Customer must notify Tektronix of the defect before the expiration of the warranty period and make suitable arrangements for the performance of service. Customer shall be responsible for packaging and shipping the defective product to the service center designated by Tektronix, with shipping charges prepaid. Tektronix shall pay for the return of the product to Customer if the shipment is to a location within the country in which the Tektronix service center is located. Customer shall be responsible for paying all shipping charges, duties, taxes, and any other charges for products returned to any other locations.

This warranty shall not apply to any defect, failure or damage caused by improper use or improper or inadequate maintenance and care. Tektronix shall not be obligated to furnish service under this warranty a) to repair damage resulting from attempts by personnel other than Tektronix representatives to install, repair or service the product; b) to repair damage resulting from improper use or connection to incompatible equipment; c) to repair any damage or malfunction caused by the use of non-Tektronix supplies; or d) to service a product that has been modified or integrated with other products when the effect of such modification or integration increases the time or difficulty of servicing the product.

THIS WARRANTY IS GIVEN BY TEKTRONIX IN LIEU OF ANY OTHER WARRANTIES, EXPRESS OR IMPLIED. TEKTRONIX AND ITS VENDORS DISCLAIM ANY IMPLIED WARRANTIES OF MERCHANTABILITY OR FITNESS FOR A PARTICULAR PURPOSE. TEKTRONIX' RESPONSIBILITY TO REPAIR OR REPLACE DEFECTIVE PRODUCTS IS THE SOLE AND EXCLUSIVE REMEDY PROVIDED TO THE CUSTOMER FOR BREACH OF THIS WARRANTY. TEKTRONIX AND ITS VENDORS WILL NOT BE LIABLE FOR ANY INDIRECT, SPECIAL, INCIDENTAL, OR CONSEQUENTIAL DAMAGES IRRESPECTIVE OF WHETHER TEKTRONIX OR THE VENDOR HAS ADVANCE NOTICE OF THE POSSIBILITY OF SUCH DAMAGES.

Table of Contents

	General Safety Summary	vii
	Preface	ix
Getting Started		
	Product Description	1-1
	Start Up	1-3
Operating Basics		
	Overview	2-1
	At a Glance	2-3
	Tutorial	2-11
Reference		
	Overview	3-1
	Accessing Help	3-3
	Acquisition Modes	3-5
	Delayed Triggering	3-11
	Determining Status	3-15
	Display Modes	3-17
	Edge Triggering	3-21
	Fast Fourier Transforms (Optional)	3-27
	File System	3-43
	Hardcopy	3-47
	Horizontal Control	3-55
	Limit Testing	3-63
	Logic Triggering (TDS 510A Only)	3-67
	Measuring Waveforms	3-73
	Probe Cal (TDS 510A Only)	3-83
	Probe Compensation	3-89
	Pulse Triggering (TDS 510A Only)	3-91
	Remote Communication	3-97
	Roll Mode (TDS 400A Only)	3-99
	Saving and Recalling Setups	3-103
	Saving and Recalling Waveforms	3-105
	Selecting Channels	3-111
	Setting Up Automatically: Autoset and Reset	3-113

Signal Path Compensation	3-115
Taking Cursor Measurements	3-117
Vertical Control	3-123
Video Triggering (TDS 400A)	3-127
Waveform Differentiation (Optional)	3-131
Waveform Integration (Optional)	3-135
Waveform Math	3-139
Zoom	3-143

Appendices

Appendix A: Options and Accessories	A-1
Appendix B: Packaging for Shipment	B-1
Appendix C: Remote Display	C-1
Appendix D: Programmer Disk	D-1

Glossary

Index

List of Figures

Figure 1–1: Rear Panel Controls Used in Start Up	1–4
Figure 1–2: ON/STBY Button	1–5
Figure 2–1: Connecting a Probe for the Examples	2–11
Figure 2–2: SETUP Button Location	2–12
Figure 2–3: The Displayed Setup Menu	2–12
Figure 2–4: SET LEVEL TO 50% Button	2–13
Figure 2–5: The Display After Factory Initialization	2–14
Figure 2–6: The VERTICAL and HORIZONTAL Controls	2–15
Figure 2–7: TRIGGER Controls	2–16
Figure 2–8: AUTOSET Button Location	2–16
Figure 2–9: The Display After Pressing Autoset	2–17
Figure 2–10: Display Signals Requiring Probe Compensation	2–17
Figure 2–11: The Channel Buttons and Lights	2–18
Figure 2–12: The Vertical Main Menu and Coupling Side Menu	2–20
Figure 2–13: The Menus After Changing Channels	2–21
Figure 2–14: Measure Main Menu and Select Measurement Side Menu	2–22
Figure 2–15: Four Simultaneous Measurement Readouts	2–23
Figure 2–16: General Purpose Knob Indicators	2–24
Figure 2–17: Snapshot of Channel 1	2–25
Figure 2–18: Save/Recall Setup Menu	2–27
Figure 3–1: Initial Help Screen	3–3
Figure 3–2: Acquisition Menu and Readout	3–8
Figure 3–3: Acquire Menu — Stop After	3–9
Figure 3–4: Delayed Runs After Main	3–11
Figure 3–5: Delayed Triggerable	3–11
Figure 3–6: Delayed Trigger Menu (TDS 400A shown)	3–14
Figure 3–7: Status Menu — System (TDS 400A shown)	3–15
Figure 3–8: Banner Display	3–16
Figure 3–9: Display Menu — Style	3–17
Figure 3–10: Trigger Point and Level Indicators	3–19
Figure 3–11: Edge Trigger Readouts	3–21
Figure 3–12: Record View, Trigger Position, and Trigger Level Bar Readouts	3–22

Figure 3–13: Main Trigger Menu — Edge Type	3–23
Figure 3–14: TRIGGER Controls and Status Lights	3–26
Figure 3–15: System Response to an Impulse	3–28
Figure 3–16: Define FFT Waveform Menu	3–29
Figure 3–17: FFT Math Waveform in Math1	3–31
Figure 3–18: Cursor Measurement of an FFT Waveform	3–32
Figure 3–19: Waveform Record vs. FFT Time Domain Record	3–34
Figure 3–20: FFT Time Domain Record vs. FFT Frequency Domain Record	3–34
Figure 3–21: How Aliased Frequencies Appear in an FFT	3–37
Figure 3–22: Windowing the FFT Time Domain Record	3–40
Figure 3–23: FFT Windows and Bandpass Characteristics	3–41
Figure 3–24: File Utilities	3–43
Figure 3–25: File System — Labelling Menu	3–44
Figure 3–26: Utility Menu — System I/O	3–48
Figure 3–27: Date and Time Display	3–49
Figure 3–28: Connecting the Digitizing Oscilloscope Directly to the Hardcopy Device	3–50
Figure 3–29: Connecting the Digitizing Oscilloscope and Hardcopy Device Via a PC	3–52
Figure 3–30: Record View and Time Base Readouts	3–55
Figure 3–31: Horizontal Controls	3–56
Figure 3–32: Aliasing	3–58
Figure 3–33: Comparing a Waveform to a Limit Template	3–63
Figure 3–34: Acquire Menu — Create Limit Test Template	3–64
Figure 3–35: Logic Trigger Readouts	3–68
Figure 3–36: Logic Trigger Menu	3–70
Figure 3–37: Logic Trigger Menu — Time Qualified TRUE	3–72
Figure 3–38: Measurement Readouts	3–75
Figure 3–39: Measure Menu	3–76
Figure 3–40: Measure Menu — Gating	3–78
Figure 3–41: Measure Menu — Reference Levels	3–79
Figure 3–42: Measure Delay Menu — Delay To	3–80
Figure 3–43: Snapshot Menu and Readout	3–81
Figure 3–44: Probe Cal Menu and Gain Compensation Display	3–85
Figure 3–45: Re-use Probe Calibration Data Menu	3–87
Figure 3–46: How Probe Compensation Affects Signals	3–89
Figure 3–47: Probe Adjustment	3–90
Figure 3–48: Pulse Trigger Readouts	3–91

Figure 3-49: Main Trigger Menu — Glitch Class	3-92
Figure 3-50: Main Trigger Menu—Runt Class	3-95
Figure 3-51: Connecting the Digitizing Oscilloscope to a Controller	3-97
Figure 3-52: Utility Menu	3-98
Figure 3-53: Roll Mode (500 Point Record Length)	3-100
Figure 3-54: Trigger Mode Menu	3-102
Figure 3-55: Save/Recall Setup Menu	3-104
Figure 3-56: Save Waveform Menu (TDS 400A shown)	3-106
Figure 3-57: More Menu	3-107
Figure 3-58: Save Format Menu	3-108
Figure 3-59: The Channel Readout	3-111
Figure 3-60: Waveform Selection Priority	3-112
Figure 3-61: Performing a Signal Path Compensation	3-116
Figure 3-62: Cursor Types	3-117
Figure 3-63: Cursor Modes	3-118
Figure 3-64: H Bars Cursor Menu and Readouts	3-119
Figure 3-65: Paired Cursor Menu and Readouts	3-119
Figure 3-66: Video Line and IRE Units (TDS 400A shown)	3-121
Figure 3-67: Vertical Readouts and Channel Menu	3-124
Figure 3-68: Main Trigger Menu — Video Type	3-127
Figure 3-69: Video Trigger Menu — Class	3-128
Figure 3-70: Video Trigger Menu — TV Delay Mode	3-129
Figure 3-71: Video Trigger — Scan Parameter	3-130
Figure 3-72: Video Trigger — Scan Rate & Interlace	3-130
Figure 3-73: Derivative Math Waveform	3-132
Figure 3-74: Peak-Peak Amplitude Measurement of a Derivative Waveform	3-133
Figure 3-75: Integral Math Waveform	3-136
Figure 3-76: H Bars Cursors Measure an Integral Math Waveform	3-137
Figure 3-77: More Menu	3-139
Figure 3-78: Dual Waveform Math Menus	3-141
Figure 3-79: Zoom Mode with Horizontal Lock Set to None	3-145
Figure 3-80: Zoom Preview Mode	3-146
Figure D-1: Equipment Needed to Run the Example Programs	D-1

List of Tables

Table 1–1: Fuse and Fuse Cap Part Numbers	1–4
Table 3–1: TDS 460A, TDS 430A, and TDS 420A Resolution Bits ..	3–6
Table 3–2: TDS 510A Resolution Bits	3–6
Table 3–3: XY Format Pairs	3–20
Table 3–4: Logic Triggers	3–68
Table 3–5: Measurement Definitions	3–73
Table 3–6: Probe Cal Status	3–86
Table 3–7: Pulse Trigger Definitions	3–91
Table A–1: International Power Cords	A–2
Table A–2: Standard Accessories	A–3
Table A–3: Optional Accessories	A–3
Table A–4: Compatible Probes	A–4
Table A–5: Accessory Software	A–5

General Safety Summary

Review the following safety precautions to avoid injury and prevent damage to this product or any products connected to it.

Only qualified personnel should perform service procedures.

Injury Precautions

Use Proper Power Cord. To avoid fire hazard, use only the power cord specified for this product.

Avoid Electric Overload. To avoid electric shock or fire hazard, do not apply a voltage to a terminal that is outside the range specified for that terminal.

Avoid Overvoltage. To avoid electric shock or fire hazard, do not apply potential to any terminal, including the common terminal, that varies from ground by more than the maximum rating for that terminal.

Avoid Electric Shock. To avoid injury or loss of life, do not connect or disconnect probes or test leads while they are connected to a voltage source.

Ground the Product. This product is grounded through the grounding conductor of the power cord. To avoid electric shock, the grounding conductor must be connected to earth ground. Before making connections to the input or output terminals of the product, ensure that the product is properly grounded.

Do Not Operate Without Covers. To avoid electric shock or fire hazard, do not operate this product with covers or panels removed.

Use Proper Fuse. To avoid fire hazard, use only the fuse type and rating specified for this product.

Do Not Operate in Wet/Damp Conditions. To avoid electric shock, do not operate this product in wet or damp conditions.

Do Not Operate in an Explosive Atmosphere. To avoid injury or fire hazard, do not operate this product in an explosive atmosphere.

Product Damage Precautions

Use Proper Power Source. Do not operate this product from a power source that applies more than the voltage specified.

Provide Proper Ventilation. To prevent product overheating, provide proper ventilation.

Do Not Operate With Suspected Failures. If you suspect there is damage to this product, have it inspected by qualified service personnel.

Symbols and Terms

Terms in this Manual. These terms may appear in this manual:



WARNING. *Warning statements identify conditions or practices that could result in injury or loss of life.*



CAUTION. *Caution statements identify conditions or practices that could result in damage to this product or other property.*

Terms on the Product. These terms may appear on the product:

DANGER indicates an injury hazard immediately accessible as you read the marking.

WARNING indicates an injury hazard not immediately accessible as you read the marking.

CAUTION indicates a hazard to property including the product.

Symbols on the Product. The following symbols may appear on the product:



DANGER
High Voltage



Protective Ground
(Earth) Terminal



ATTENTION
Refer to Manual

**Certifications and
Compliances**

Refer to the specifications chapter of the performance verification and specifications manual for a listing of certifications and compliances that apply to this product.

Preface

This is the User Manual for the TDS 420A, TDS 430A, TDS 460A, and TDS 510A Digitizing Oscilloscopes.

The *Getting Started* chapter briefly describes the digitizing oscilloscope, prepares you to install it, and tells you how to put it into service.

The *Operating Basics* chapter covers basic principles of the operation of the oscilloscope. These articles help you understand why your oscilloscope works the way it does.

The *Reference* chapter teaches you how to perform specific tasks. See page 3–1 for a complete list of tasks covered in that chapter.

The *Appendices* provide an option and accessories listing and other useful information.

Related Manuals

The following documents are related to the use or service of the digitizing oscilloscope:

- The *TDS Family Programmer Manual* describes using a computer to control the digitizing oscilloscope through the GPIB interface.
- The *TDS 420A, TDS 430A, TDS 460A & TDS 510A Reference* gives you a quick overview of how to operate your digitizing oscilloscope.
- The *TDS 420A, TDS 430A & TDS 460A Performance Verification* and *TDS 510A Performance Verification* manuals tell how to verify the performance of the digitizing oscilloscope.
- The *TDS Family Option 13 Instruction Manual* describes using the optional Centronics® and RS-232 interfaces for obtaining hardcopy (only for TDS oscilloscopes equipped with that option).
- The *TDS 420A, TDS 430A & TDS 460A Service Manual* and the *TDS 510A Service Manual* provide information for maintaining and servicing your digitizing oscilloscope to the module level.

Conventions

In the *Getting Started* and *Reference* chapters, you will find various procedures which contain steps of instructions for you to perform. To keep those instructions clear and consistent, this manual uses the following conventions:

- Names of front panel controls and menu labels appear in boldface print.
- Names also appear in the same case (initial capitals, all uppercase, etc.) in the manual as is used on the oscilloscope front panel and menus. Front panel names are all upper case letters, for example, **VERTICAL MENU**, **CH 1**, and **SETUP**.
- Instruction steps are numbered. The number is omitted if there is only one step.
- When steps require that you make a sequence of selections using front panel controls and menu buttons, an arrow (→) marks each transition between a front panel button and a menu, or between menus. Also, whether a name is a main menu or side menu item is clearly indicated: Press **VERTICAL MENU** → **Coupling** (main) → **DC** (side) → **Bandwidth** (main) → **100 MHz** (side).

Using the convention just described results in instructions that are graphically intuitive and simplifies procedures. For example, the instruction just given replaces these five steps:

1. Press the front panel button **VERTICAL MENU**.
 2. Press the main menu button **Coupling**.
 3. Press the side-menu button **DC**.
 4. Press the main menu button **Bandwidth**,
 5. Press the side menu button **100 MHz**.
- Sometimes you may have to make a selection from a pop-up menu: Press **TRIGGER MENU** → **Type** (main) → **Edge** (pop-up). In this example, you repeatedly press the main menu button **Type** until **Edge** is highlighted in the pop-up menu.

Product Description

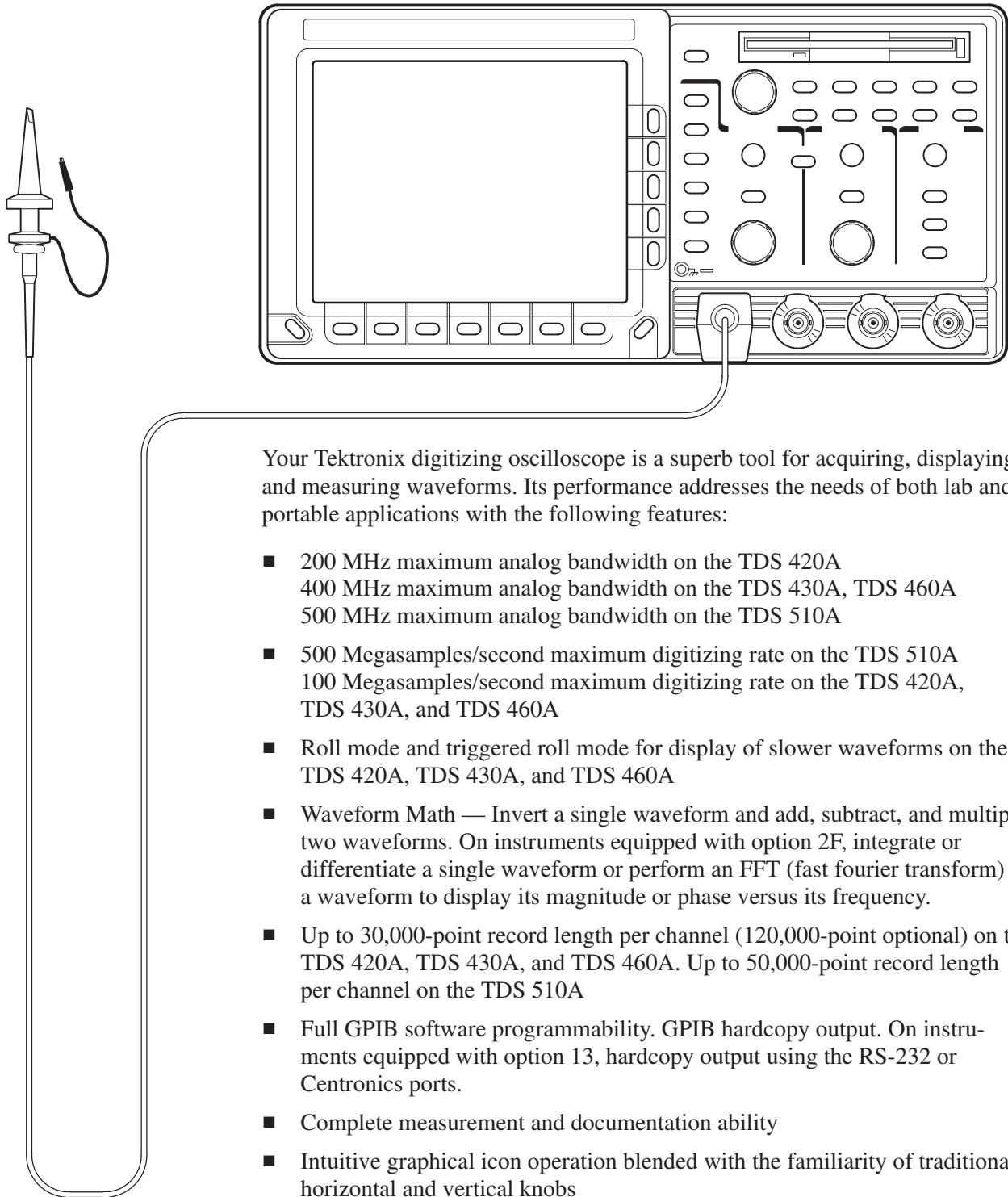

Your Tektronix digitizing oscilloscope is a superb tool for acquiring, displaying, and measuring waveforms. Its performance addresses the needs of both lab and portable applications with the following features:

- 200 MHz maximum analog bandwidth on the TDS 420A
400 MHz maximum analog bandwidth on the TDS 430A, TDS 460A
500 MHz maximum analog bandwidth on the TDS 510A
- 500 Megasamples/second maximum digitizing rate on the TDS 510A
100 Megasamples/second maximum digitizing rate on the TDS 420A, TDS 430A, and TDS 460A
- Roll mode and triggered roll mode for display of slower waveforms on the TDS 420A, TDS 430A, and TDS 460A
- Waveform Math — Invert a single waveform and add, subtract, and multiply two waveforms. On instruments equipped with option 2F, integrate or differentiate a single waveform or perform an FFT (fast fourier transform) on a waveform to display its magnitude or phase versus its frequency.
- Up to 30,000-point record length per channel (120,000-point optional) on the TDS 420A, TDS 430A, and TDS 460A. Up to 50,000-point record length per channel on the TDS 510A
- Full GPIB software programmability. GPIB hardcopy output. On instruments equipped with option 13, hardcopy output using the RS-232 or Centronics ports.
- Complete measurement and documentation ability
- Intuitive graphical icon operation blended with the familiarity of traditional horizontal and vertical knobs

- Four channels and four eight-bit digitizers on the TDS 420A, TDS 460A, and TDS 510A. Two channels and two eight-bit digitizers on the TDS 430A
- On-line help at the touch of a button

Appendix A lists the options and accessories.

The product specification is in the performance verification manual that is shipped as a standard accessory with the digitizing oscilloscope.

Start Up

Before you use the digitizing oscilloscope, ensure that it is properly installed and powered on.

Operation

To properly install and power on the digitizing oscilloscope, do the following steps:

Installation

1. Be sure you have the appropriate operating environment. Specifications for temperature, relative humidity, altitude, vibrations, and emissions are included in performance verification and specification manuals (Tektronix part numbers 070-9705-xx and 070-9706-xx).
2. Leave space for cooling. Do this by verifying that the air intake and exhaust holes on the sides of the cabinet (where the fan operates) are free of any airflow obstructions. Leave at least 2 inches (5.1 cm) free on each side.



WARNING. To avoid electrical shock, be sure that the power cord is disconnected before checking the fuse.

3. Check the fuse to be sure it is the proper type and rating (see Figure 1-1 for the fuse location). You can use either of two fuses (see Table 1-1 for the fuse data).
4. Check that you have the proper electrical connections:
 - For TDS 400A serial number below B080000: 90 to 132 V for 48 Hz through 62 Hz, 100 to 132 V or 180 to 250 V for 48 through 440 Hz, and may require up to 240 W.
 - For TDS 400A serial number B080000 - Up: 100 to 240 V $\pm 10\%$, 50/60 Hz nominal, or 115 V $\pm 10\%$ for 400 Hz, and may require up to 240 W.
 - For TDS 510A all serial numbers: 90 to 250 V for 45 Hz to 440 Hz, and may require up to 300 W.
5. Connect the proper power cord from the rear-panel power connector (see Figure 1-1 for the connector location) to the power system.

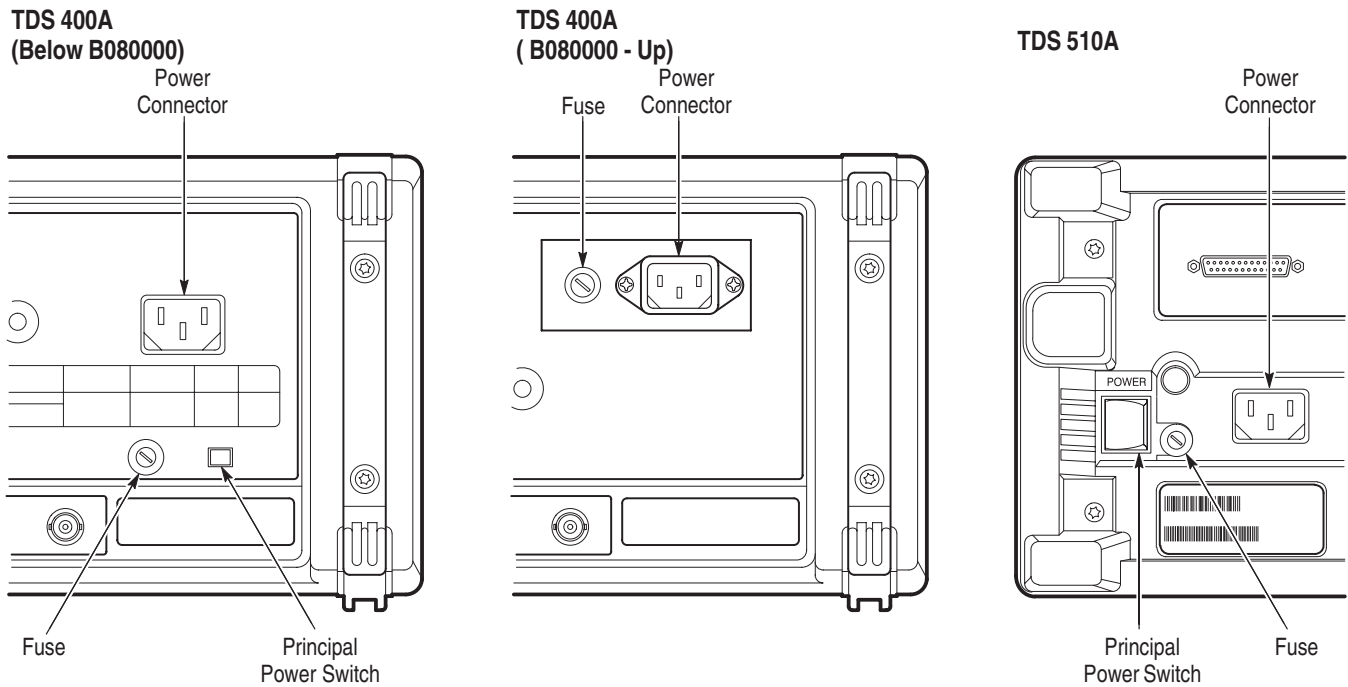

Figure 1-1: Rear Panel Controls Used in Start Up

Table 1-1: Fuse and Fuse Cap Part Numbers

Oscilloscope	Fuse	Fuse Part Number	Fuse Cap Part Number
TDS 420A, TDS 430A, and TDS 460A	Below B080000: 5 A FAST, 250 V, 3AG	159-0014-00	200-2264-00
	B080000 - Up: 8 A, 250V, 3AG	159-0046-00	200-2264-00
	Below B080000: 4 A (T), 250 V. B080000 - Up: 6.3 A FAST, 250 V	159-0255-00 159-0381-00	200-2265-00 200-2265-00
TDS 510A	.25 inch y 1.25 inch (UL 198.6, 3AG): 6 A FAST, 250 V	159-0013-00	200-2264-00
	5 mm y 20 mm (IEC 127): 5 A (T), 250 V	159-0210-00	200-2265-00

Front Cover Removal Remove the front cover by grasping its left and right edges and snapping it off of the front subpanel. (When reinstalling, align and snap back on.)

Power On 1. Check that the rear-panel principal power switch is on (see Figure 1-1 for the location of the switch). The principal power switch controls all AC power to the instrument.

NOTE. *TDS400A instruments with serial number B080000 or above do not have a principal power switch.*

2. If the oscilloscope is not powered on (the screen is blank), push the front-panel **ON/STBY** button to toggle it on (Figure 1-2).

Once the digitizing oscilloscope is installed, you can leave the principal power switch on (TDS400A instruments below B080000 and all TDS510A instruments) and use the ON/STBY button .

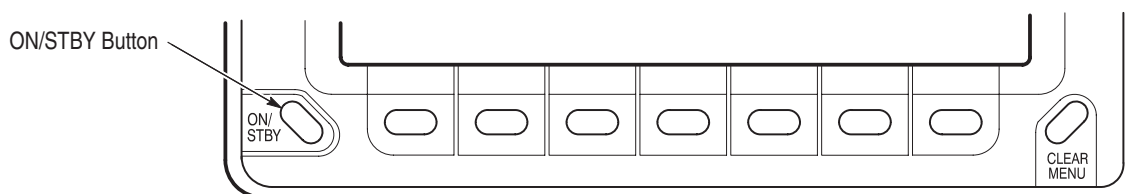

Figure 1-2: ON/STBY Button

Self Test The digitizing oscilloscope automatically performs power-on tests each time it is turned on. It comes up with a display screen that states whether or not it passed self test. If the self test does not detect any problems, the status display screen disappears a few seconds after the self test is complete.

Check the self test results.

If the self test fails, call your local Tektronix Service Center. Depending on the type of failure, you may still be able to use the oscilloscope before it is serviced.

Power Off Press the **ON/STBY** switch to turn off the oscilloscope.

Before You Begin

Signal Path Compensation (SPC) lets you compensate your oscilloscope for the current ambient temperature. SPC helps ensure maximum possible accuracy for your most critical measurements. See *Signal Path Compensation* in Section 3 for information on this feature.

Overview

This chapter describes the basic concepts of operating the digitizing oscilloscope. Understanding the basic concepts of your digitizing oscilloscope helps you use it much more effectively.

At a Glance quickly shows you how the oscilloscope is organized and gives some very general operating instructions. It also contains an overview of the following maps:

- Front Panel Map
- Rear Panel Map
- Display Map
- Basic Menu Operation

The *Tutorial* contains tutorial examples and explains basic system concepts:

- *Setting Up for the Examples* explains how to set up the digitizing oscilloscope to use the examples.
- *Example 1: Displaying a Waveform* teaches you how to reset the digitizing oscilloscope, display and adjust waveforms, and use the autoselect function.
- *Example 2: Displaying Multiple Waveforms* explains how to add, control, and delete multiple waveforms.
- *Example 3: Taking Automated Measurements* introduces you to the automated measurement system.
- *Example 4: Saving Setups* discusses saving and recalling the digitizing oscilloscope setups.
- *Triggering* explains how to set the triggers to convert unstable displays or blank screens into meaningful waveforms.
- *Scaling and Positioning Waveforms* explains how to change the position and displayed size of waveforms.
- *Measurements* explains using automated, cursor, and graticule measurements to display numeric information on the displayed waveforms.

To explore these topics in more depth and to read about topics not covered in this chapter, see *Reference*. Page 3–1 lists the topics covered.

At a Glance

The *At a Glance* section contains illustrations of the display and the front and rear panels. These illustrations help you understand and operate the digitizing oscilloscope. This section also contains a visual guide to using the menu system.

Front Panel Map — Left Side

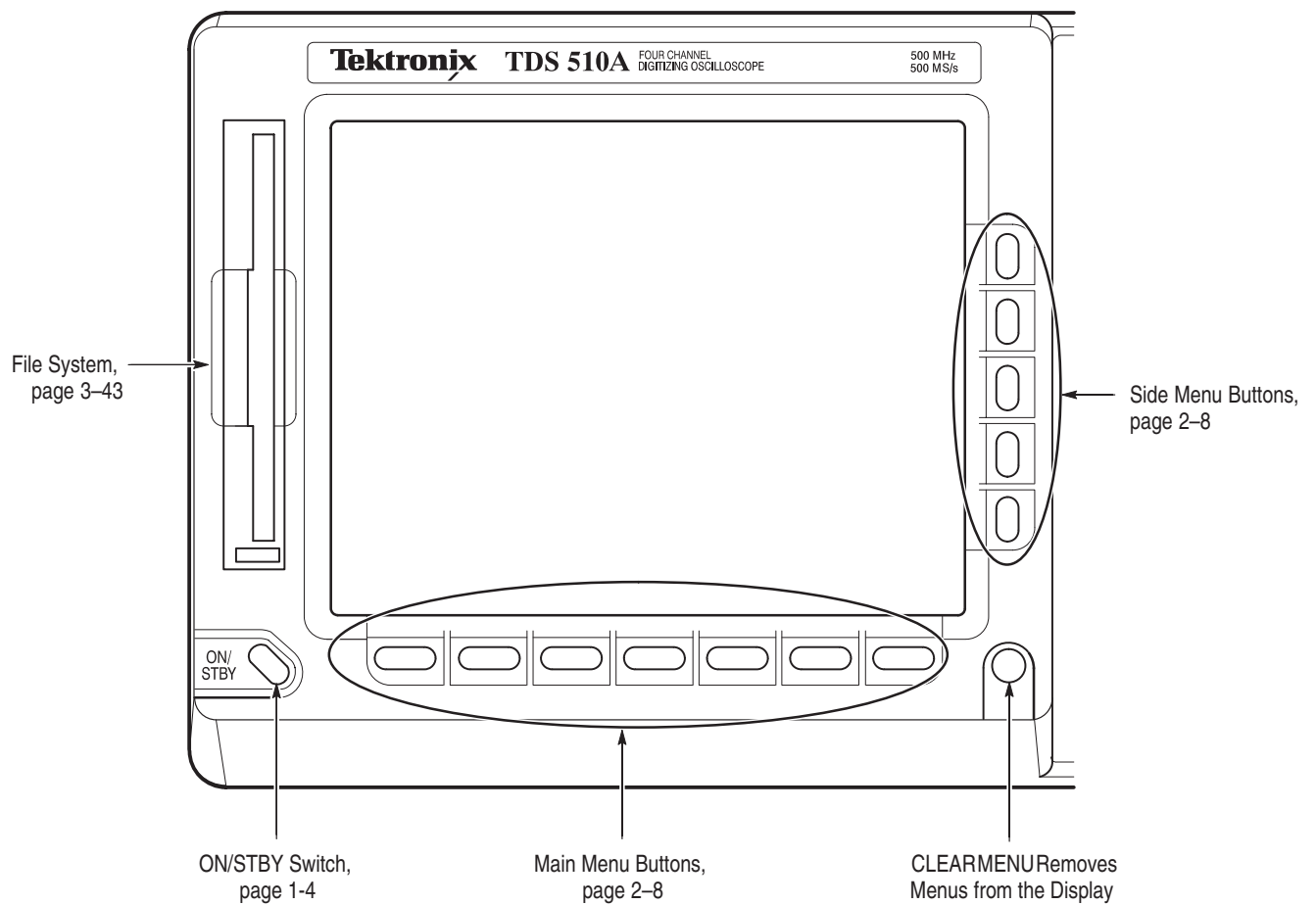

Front Panel Map — Right Side (TDS 400A)

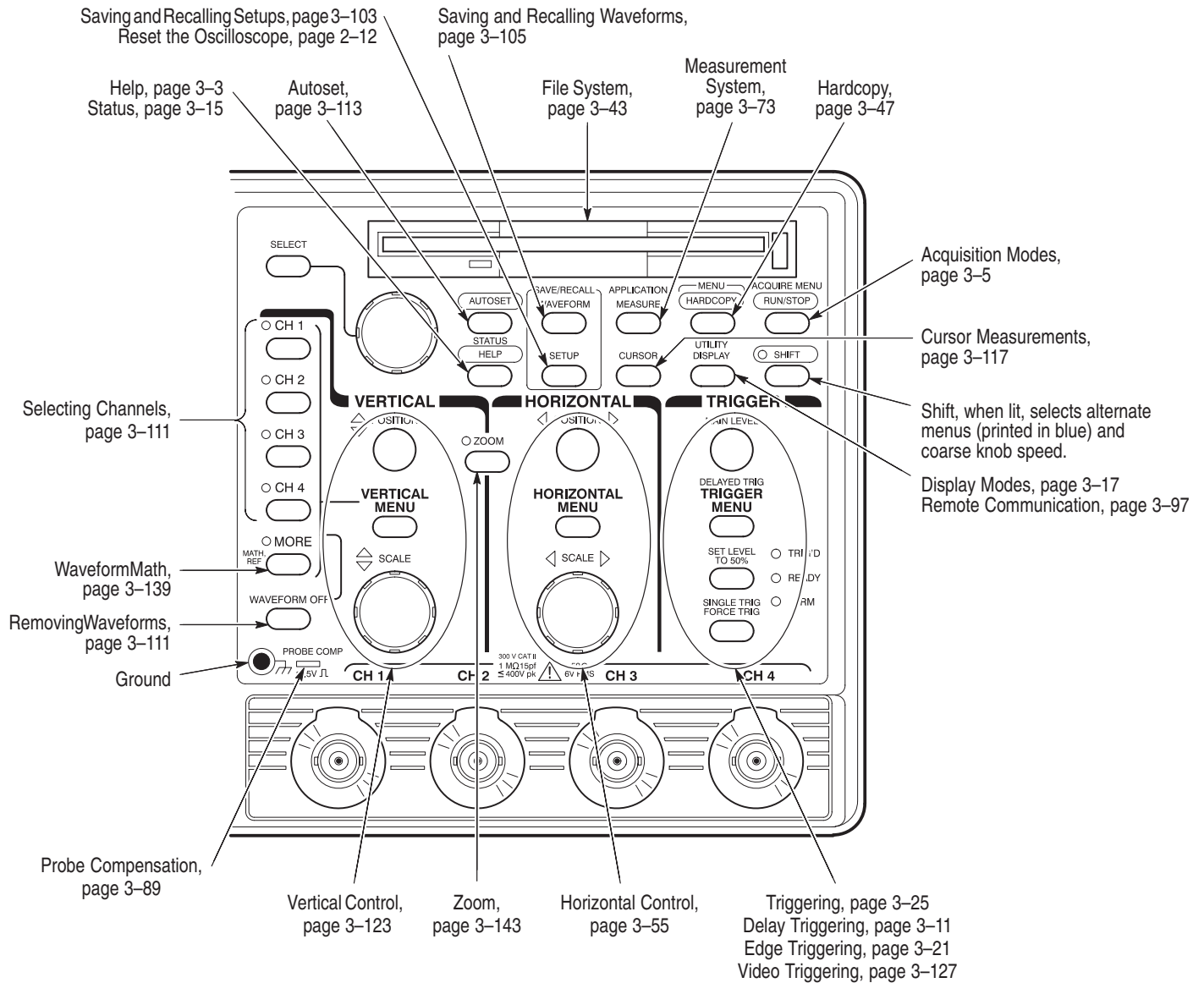

Front Panel Map — Right Side (TDS 510A)

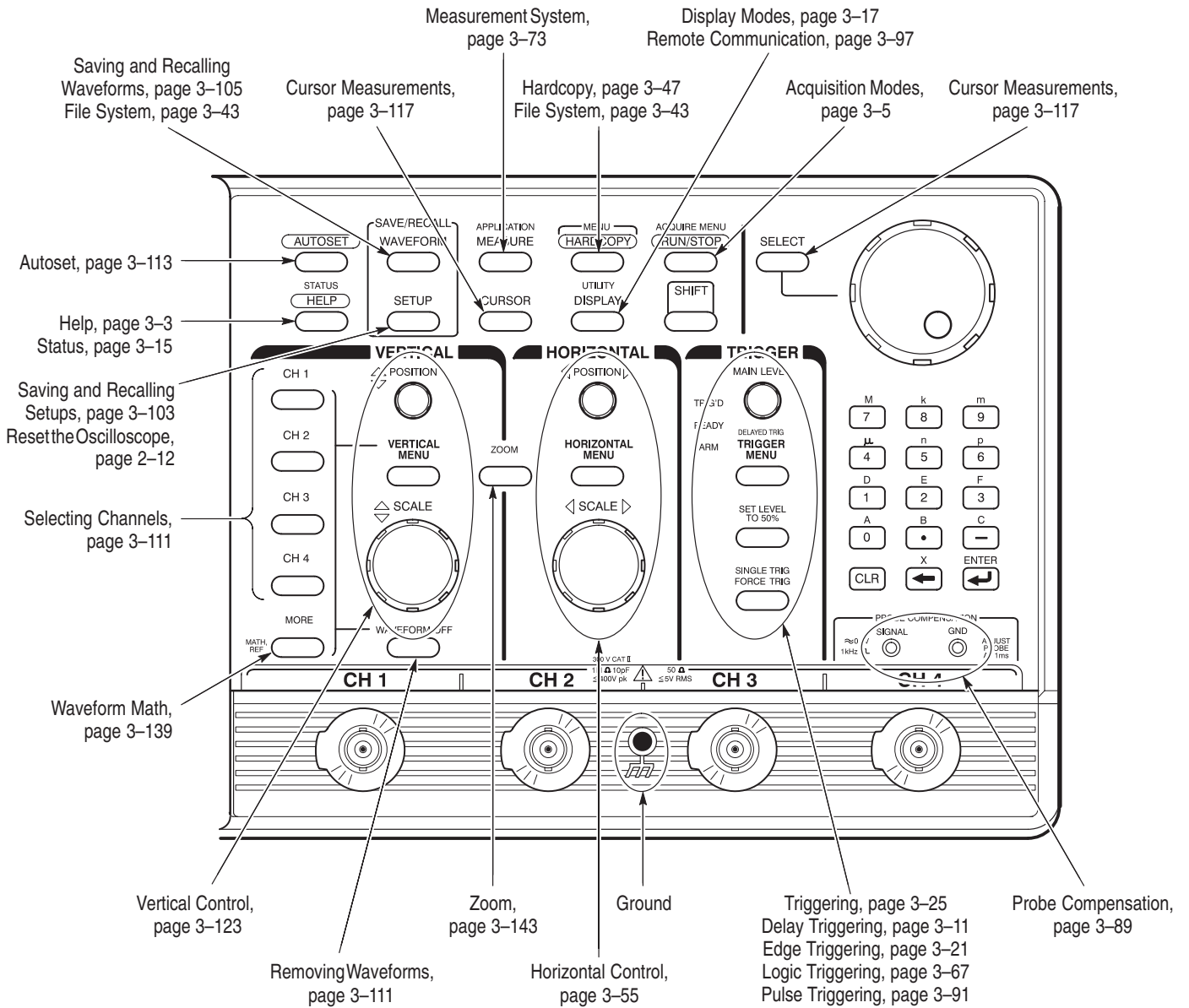

Rear Panel Map

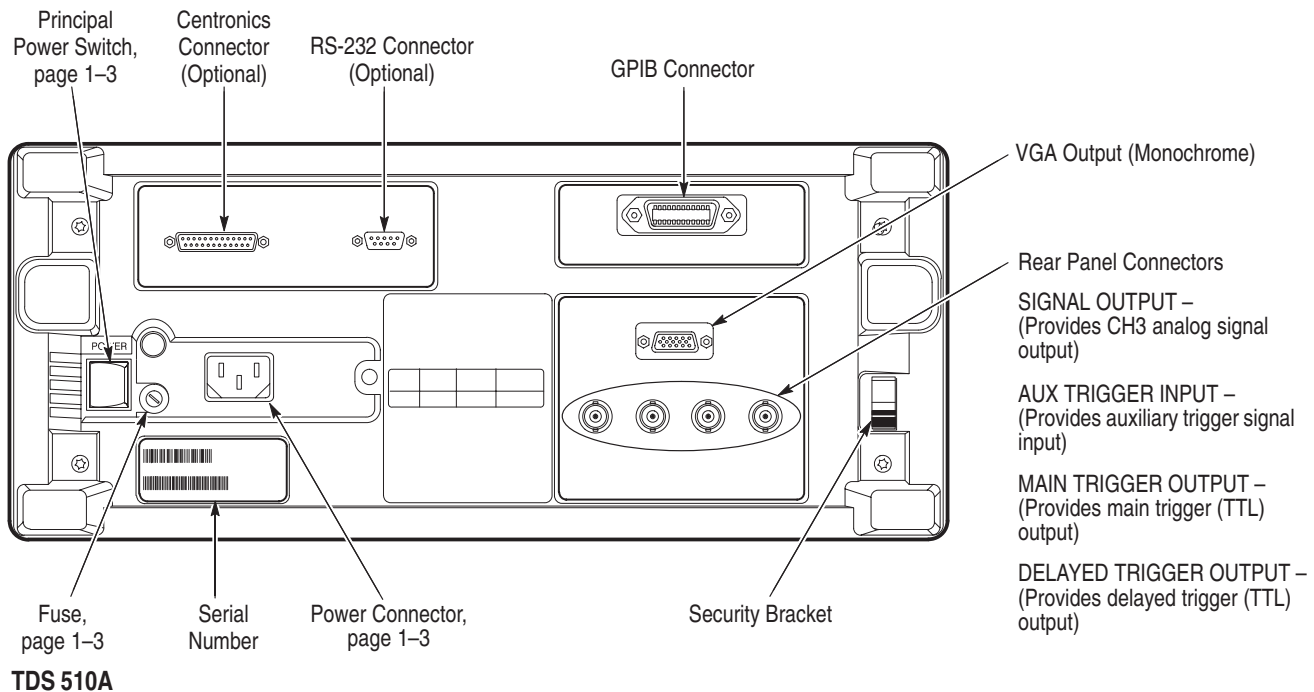
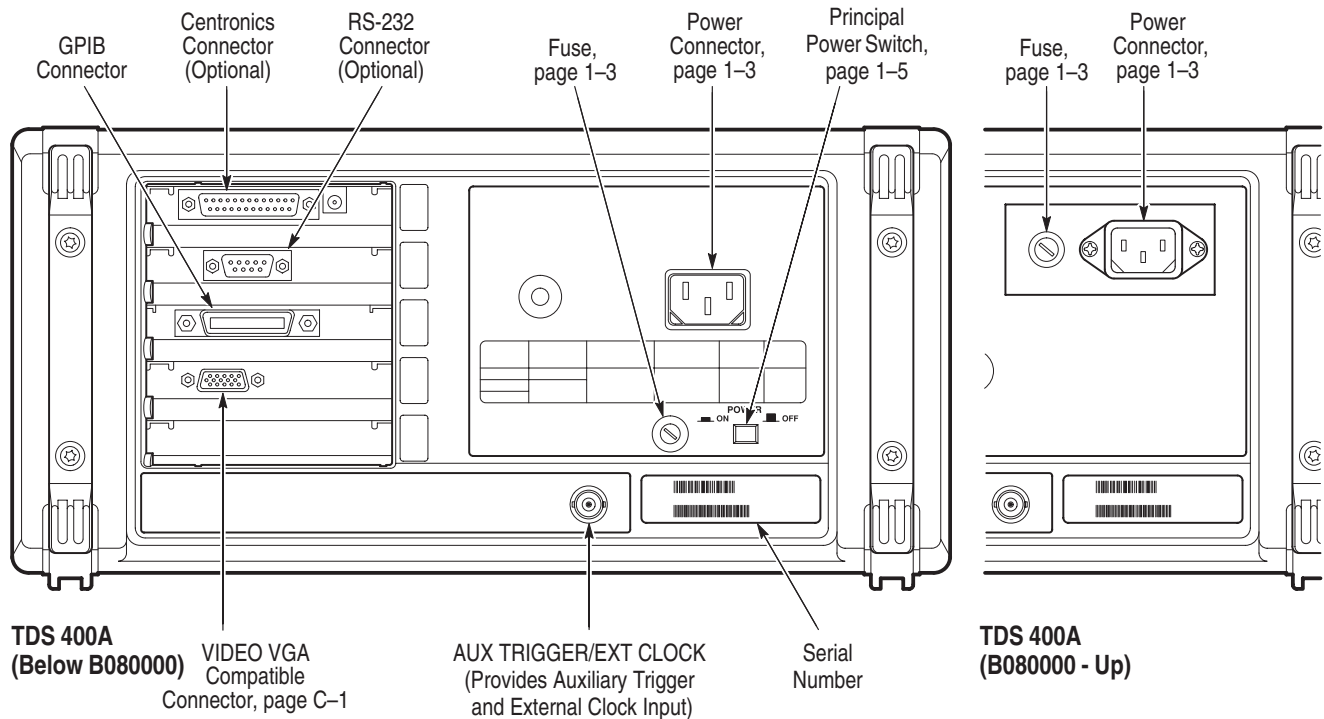

Display Map

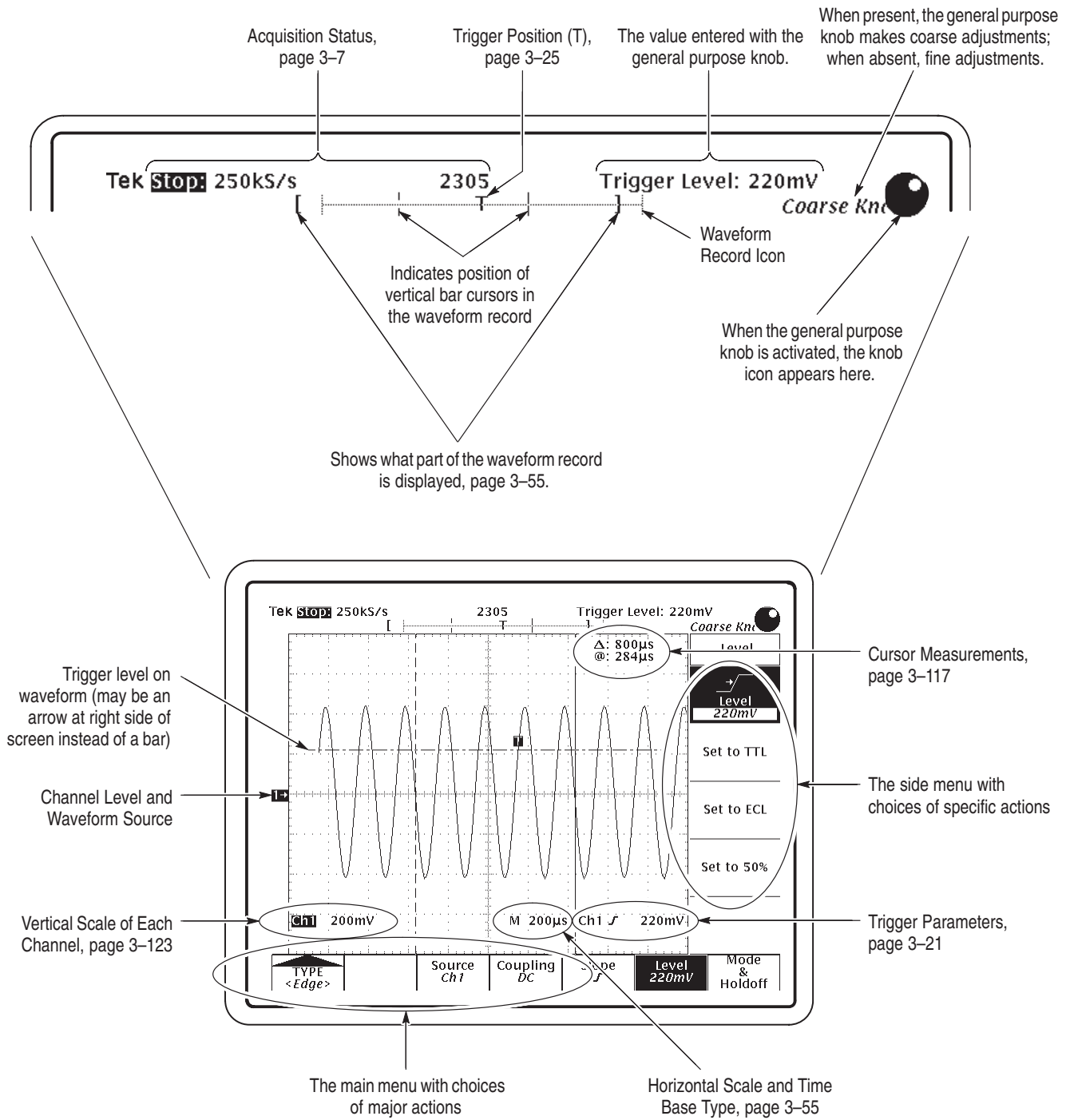

To Operate a Menu (TDS 400A)

1 Press front-panel menu button.

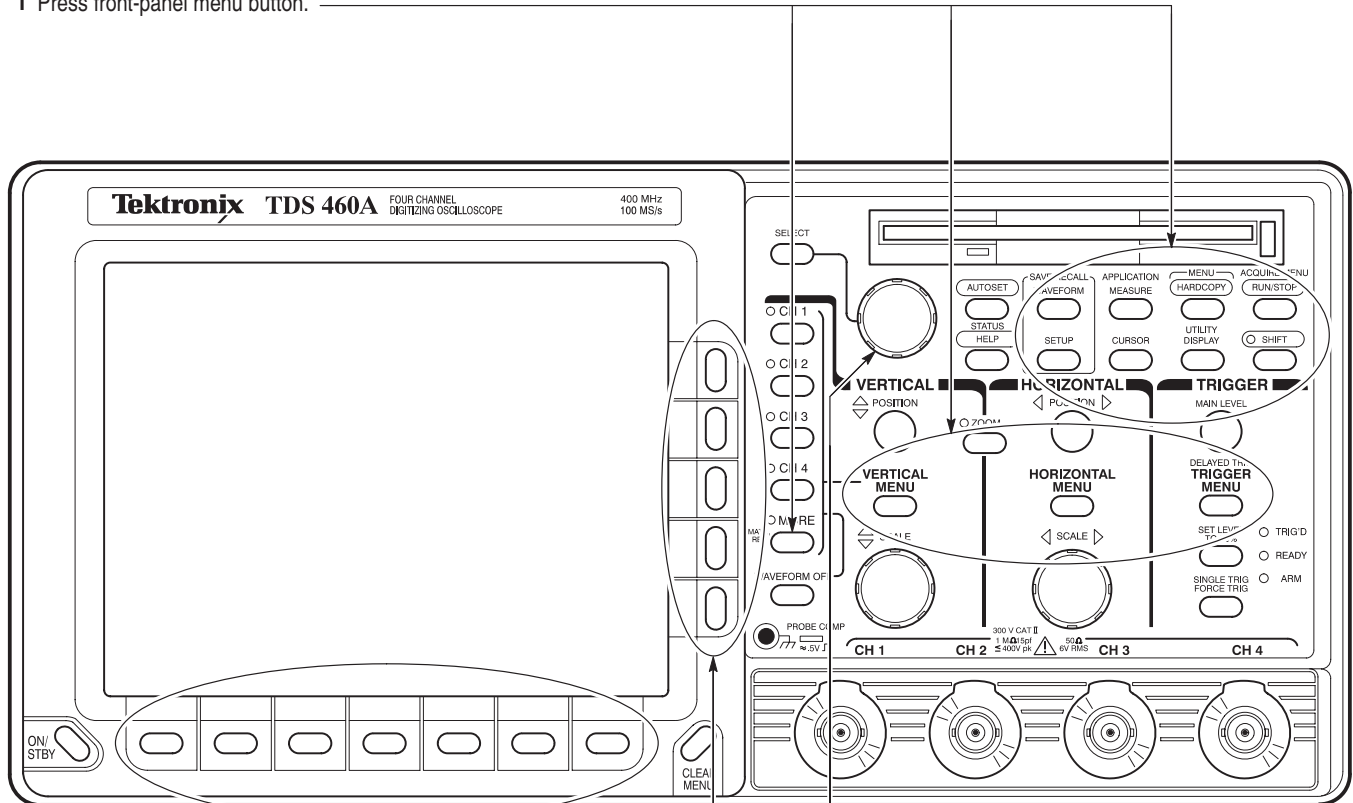

2 Press one of these buttons to select from main menu.

3 Press one of these buttons to select from side menu (if displayed).

4 If side menu item has an adjustable value (shown in reverse video), adjust it with the general purpose knob.

To Operate a Menu (TDS 510A)

- 1 Press front-panel menu button. (Press **SHIFT** first if button label is blue.)

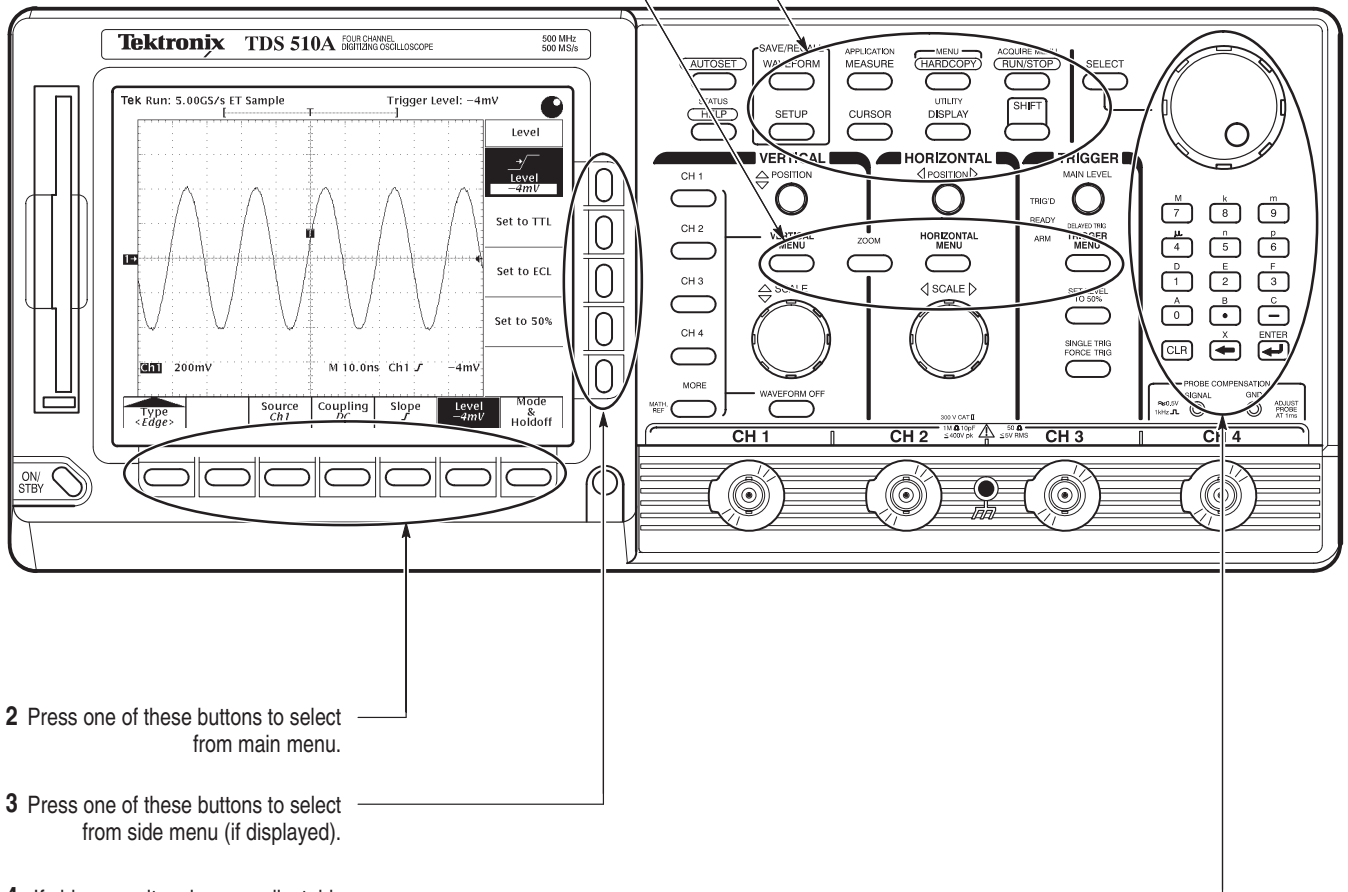

- 2 Press one of these buttons to select from main menu.

- 3 Press one of these buttons to select from side menu (if displayed).

- 4 If side menu item has an adjustable value (shown in reverse video), adjust it with the general purpose knob or keypad.

To Operate a Pop-Up Menu

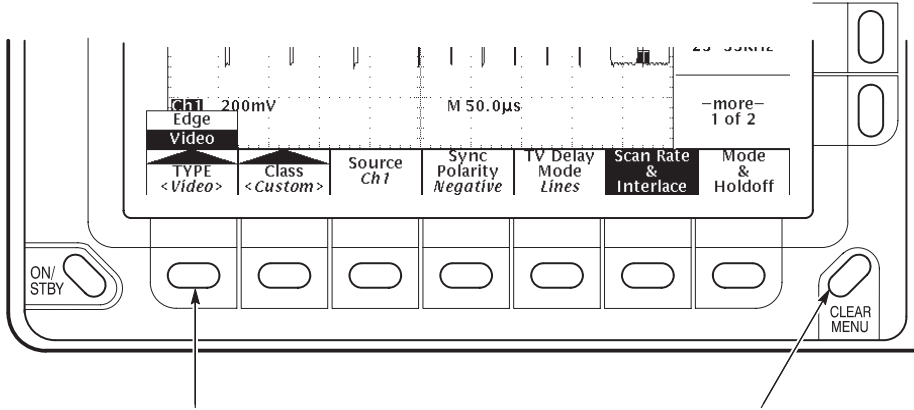

Press
to display pop-ups.

Press again
to make selection.

Alternatively, press SHIFT
first to make selection in the
opposite direction.

A pop-up selection changes the other
main menu titles.

Press to remove
menus from screen.

Tutorial

This section quickly acquaints you with some of the fundamental operations required to use your digitizing oscilloscope to take measurements. Start this tutorial by doing *Setting Up for the Examples*.

Setting Up for the Examples

Perform the following tasks to connect input signals to the digitizing oscilloscope, to reset it, and to become acquainted with its display screen. Once completed, these tasks ready the digitizing oscilloscope for use in the examples that follow.

Connect the Input Signal

Remove all probes and signal inputs from the input BNC connectors along the lower right of the front panel. Then, using one of the probes supplied with the digitizing oscilloscope, connect from the **CH 1** connector of the digitizing oscilloscope to the Probe Compensation connector (Figure 2-1).

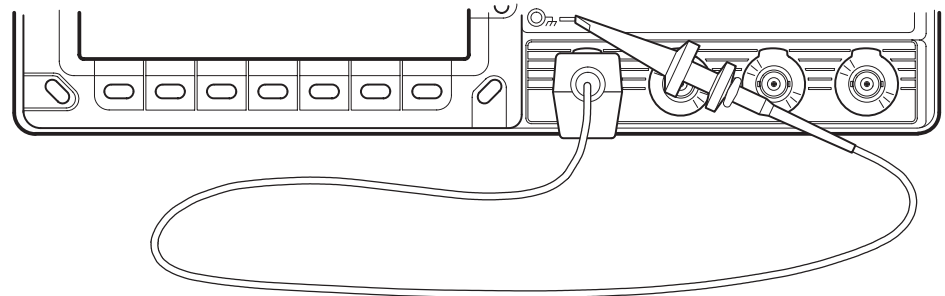

TDS 400A

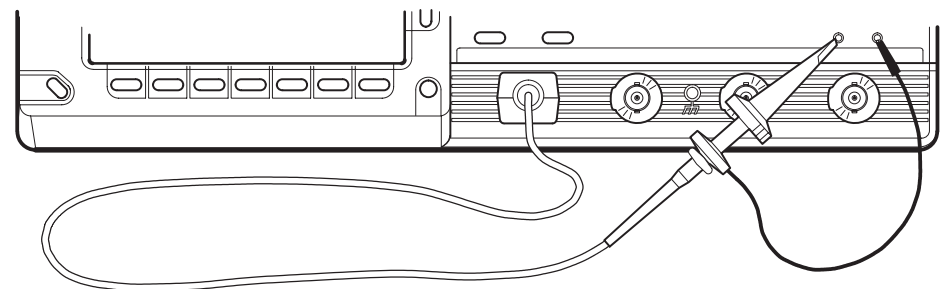

TDS 510A

Figure 2-1: Connecting a Probe for the Examples

Reset the Oscilloscope

Do the following steps to reset the digitizing oscilloscope to a known factory default state. (Reset the oscilloscope anytime you begin a new task and need to “start fresh” with known default settings.)

1. Press the save/recall **SETUP** button to display the Setup menu (see Figure 2-2).

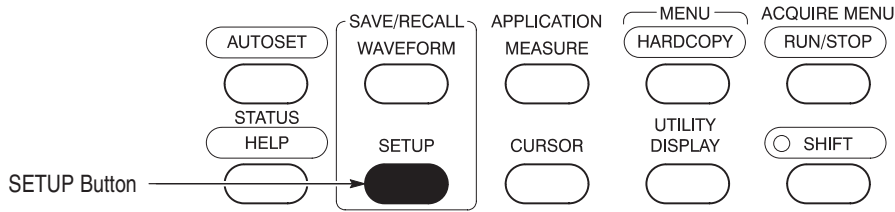

Figure 2-2: SETUP Button Location

The digitizing oscilloscope displays *main menus* along the bottom of the screen. Figure 2-3 shows the Setup main menu.

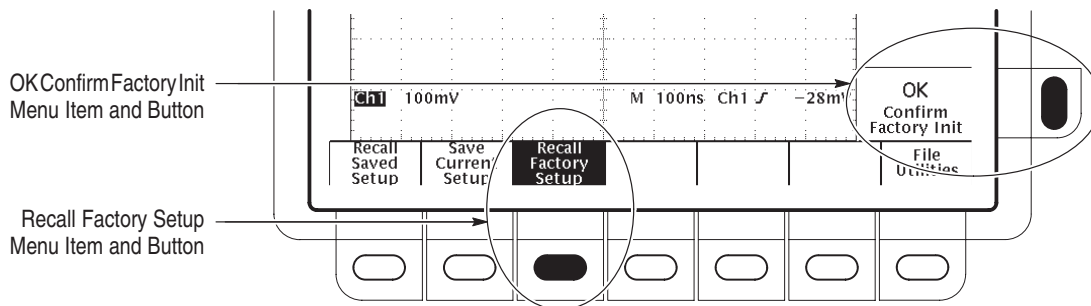

Figure 2-3: The Displayed Setup Menu

2. Press the button directly below the **Recall Factory Setup** menu item.

The display shows *side menus* along the right side of the screen. The buttons to select these side menu items are to the right of the side menu.

Because an accidental instrument reset could destroy a setup that took a long time to create, the digitizing oscilloscope asks you to verify the Recall Factory Setup selection (see Figure 2-3).

3. Press the button to the right of the **OK Confirm Factory Init** side menu item.

NOTE. This manual uses the following notation to represent the sequence of selections you made in steps 1, 2 and 3: Press save/recall **SETUP** → **Recall Factory Setup** (main) → **OK Confirm Factory Init** (side).



Note that a clock icon appears on screen. The oscilloscope displays this icon when performing operations that take longer than several seconds.

4. Press **SET LEVEL TO 50%** (see Figure 2-4) to be sure the oscilloscope triggers on the input signal.

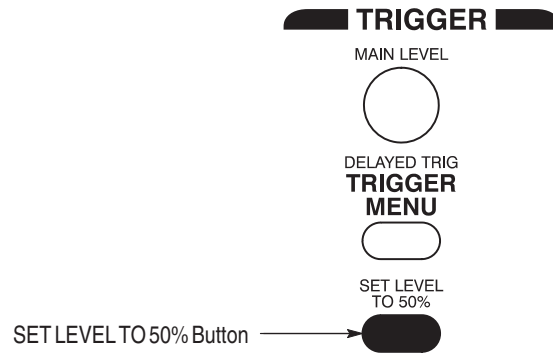

Figure 2-4: SET LEVEL TO 50% Button

Examine the Display Elements

Read the following information to become familiar with the oscilloscope display. Figure 2-5 shows the display that results from the oscilloscope reset. There are several important points to observe:

- The *trigger level bar* shows that the waveform is triggered at a level near 50% of its amplitude (from step 4).
- The *trigger position indicator* shows that the trigger position of the waveform is located at the horizontal center of the graticule.
- The *channel reference indicator* shows the vertical position of channel 1 with no input signal. This indicator points to the ground level for the channel when its vertical offset is set to 0 V in the vertical menu; when vertical offset is *not* set to 0 V, the indicator points to the vertical offset level.
- The *trigger readout* shows that the digitizing oscilloscope is triggering on channel 1 (Ch1) on a rising edge and that the trigger level is about 200-300 mV.
- The *time base readout* shows that the main time base is set to a horizontal scale of 500 $\mu\text{s}/\text{div}$.

- The *channel readout* indicates that channel 1 (Ch1) is displayed with DC coupling. (In AC coupling, ~ appears after the volts/div readout.) The digitizing oscilloscope always displays channel 1 at reset.

Right now, the channel, time base, and trigger readouts appear in the graticule area because a menu is displayed. You can press the CLEAR MENU button at any time to remove any menus and to move the readouts below the graticule.

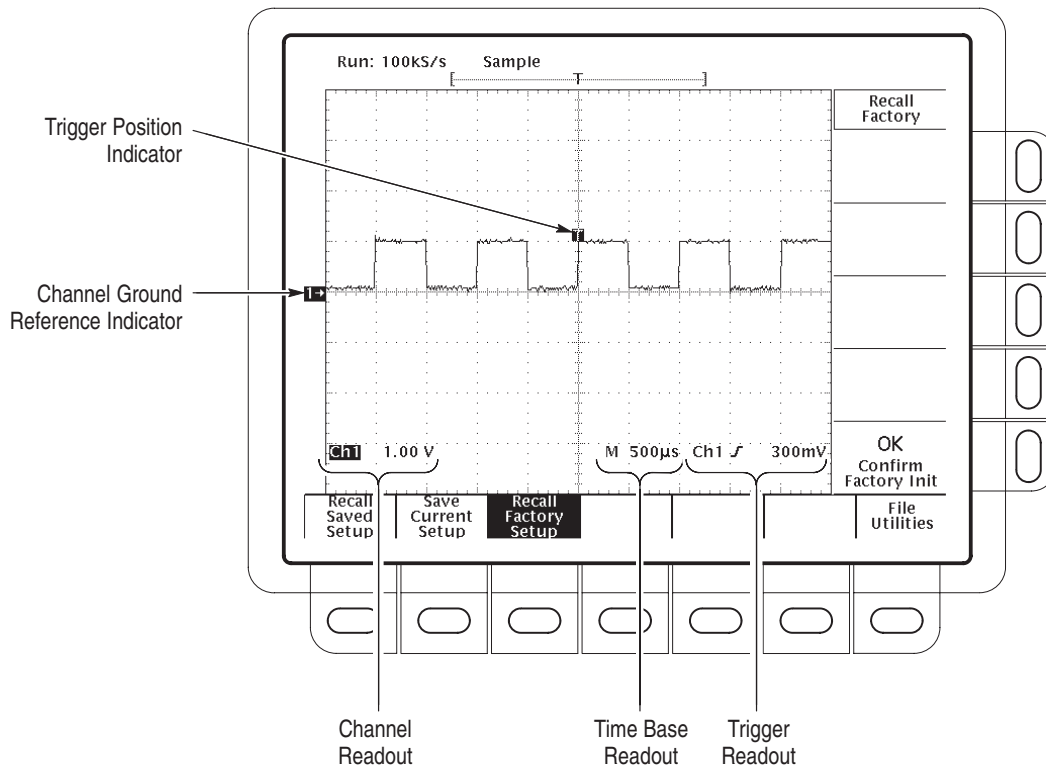

Figure 2-5: The Display After Factory Initialization

Example 1: Displaying a Waveform

The digitizing oscilloscope provides front panel knobs for you to adjust a waveform, or it can automatically set up its controls to display a waveform. Do the following tasks to learn how to adjust a waveform and how to autoset the digitizing oscilloscope.

Adjusting the Waveform Display

The display shows the probe compensation signal. It is a 1 kHz square wave of approximately 0.5 V amplitude. Do the following steps to adjust the size and placement of the waveform using the front-panel knobs.

Figure 2-6 shows the main VERTICAL and HORIZONTAL sections of the front panel. Each has SCALE and POSITION knobs.

1. Turn the vertical **SCALE** knob clockwise. Observe the change in the displayed waveform and the channel readout at the bottom of the display.

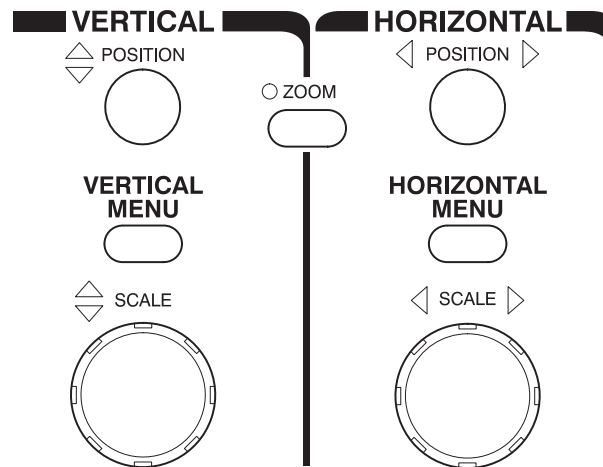

Figure 2-6: The VERTICAL and HORIZONTAL Controls

2. Turn the vertical **POSITION** knob first one direction, then the other. Observe the change in the displayed waveform. Then return the waveform to the center of the graticule.

3. Turn the horizontal **SCALE** knob one click clockwise. Observe the time base readout at the bottom of the display. The time base should be set to 200 $\mu\text{s}/\text{div}$ now, and you should see two complete waveform cycles on the display.

Autoset the Oscilloscope

When you first connect a signal to a channel and display it, the signal displayed may not be scaled and triggered correctly. Use the autoset function and you should quickly get a meaningful display.

You should have a stable display of the probe compensation waveform from the last step. Do the following steps to first create an unstable display and then to automatically obtain a stable display:

1. To create an unstable display, slowly turn the trigger **MAIN LEVEL** knob (see Figure 2-7) first one direction, then the other. Observe what happens when you move the trigger level above the highest part of the displayed waveform. Leave the trigger level in that untriggered state.
2. Press **AUTOSET** (see Figure 2-8) and observe the stable waveform display.

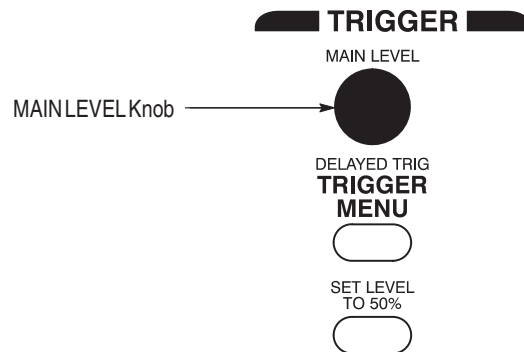

Figure 2-7: TRIGGER Controls

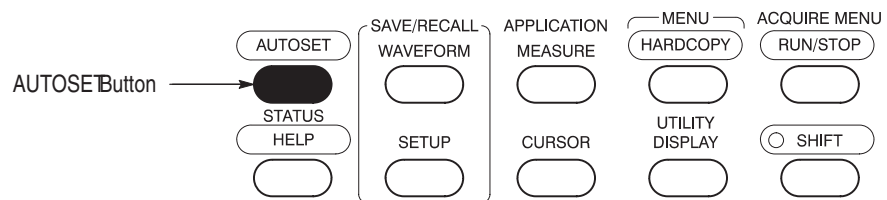

Figure 2-8: AUTOSET Button Location

Figure 2-9 shows the display after pressing AUTOSET. If necessary, you can adjust the waveform using the knobs discussed earlier in this example.

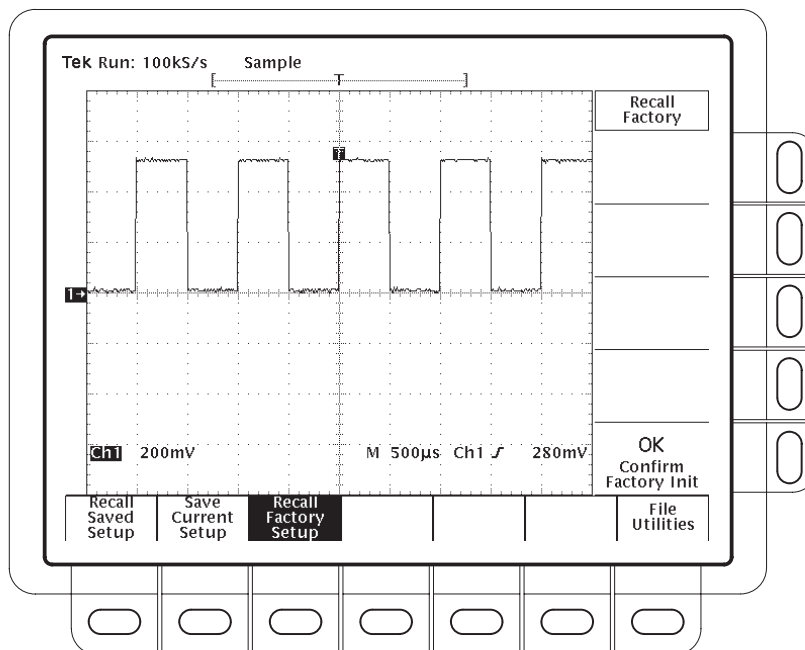

Figure 2-9: The Display After Pressing Autoset

NOTE. If the corners on your displayed signal look rounded or pointed (see Figure 2-10), then you may need to compensate your probe. See pages 3–83 and 3–89 for probe calibration and compensation procedures.



Figure 2-10: Display Signals Requiring Probe Compensation

Example 2: Displaying Multiple Waveforms

In this example you learn how to display and control more than one waveform at a time.

Adding a Waveform

The VERTICAL section of the front panel contains the channel selection buttons. On the TDS 420A, TDS 460A, and TDS 510A Digitizing Oscilloscopes, they are CH 1, CH 2, CH 3, CH 4, and MORE (Figure 2-11). On the TDS 430A, they are CH 1, CH 2, and MORE.

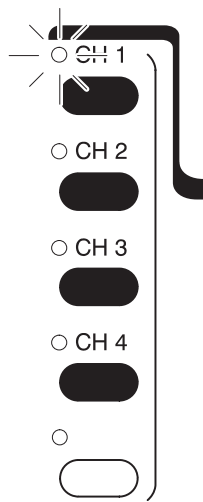

Figure 2-11: The Channel Buttons and Lights

Each of the channel (CH) buttons has a light above or beside its label. Do the following steps to add a waveform to the display:

1. If you are not continuing from the previous example, follow the instructions on page 2–11 under the heading *Setting Up for the Examples*.
2. Press **SETUP** → **Recall Factory Setup** (main) → **OK Confirm Factory Init** (side).
3. Press **AUTOSET**.
4. Press **CH 2**.

The display shows a second waveform, which represents the signal on channel 2.

There are several other things to observe:

- The channel readout on the display now shows the settings for both Ch1 and Ch2.
 - There are two channel indicators at the left edge of the graticule. Right now, they overlap.
 - The light by the CH 2 button is now on, and the vertical controls are now set to adjust channel 2.
 - The trigger source is not changed by adding a channel. (You can change the trigger source by using the TRIGGER MENU.)
5. Turn the vertical **POSITION** knob clockwise to move the channel 2 waveform up on the graticule. Notice that the channel reference indicator for channel 2 moves with the waveform.
 6. Press **VERTICAL MENU** → **Coupling** (main).

The vertical menu gives you control over many vertical channel parameters (Figure 2-12). Although there can be more than one channel displayed, the vertical menu and buttons only adjust the selected channel.

Each menu item in the Vertical menu displays a side menu. Right now, the Coupling item in the main menu is highlighted, which means that the side menu shows the coupling choices.

7. Press **Ω** (side) to toggle the selection to **50 Ω**; this changes the input coupling of channel 2 from 1 MΩ to 50 Ω. The channel readout for channel 2 (near the bottom of the graticule) now shows an Ω indicator.

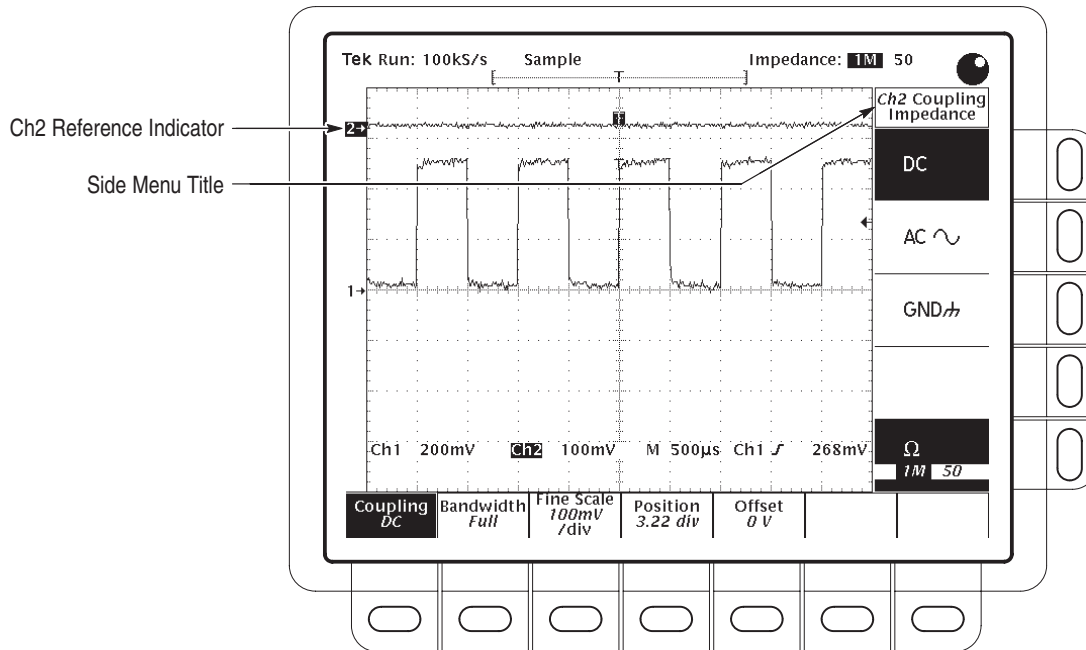

Figure 2-12: The Vertical Main Menu and Coupling Side Menu

Assign Controls to Another Channel

Pressing a channel (CH) button sets the vertical controls to that channel. It also adds the channel to the display if that waveform is not already displayed. To explore assigning controls to different channels, do the following steps:

1. Press **CH 1**.

Observe that the side menu title shows Ch1 (see Figure 2-13) and that the indicator next to CH 1 is on. Note the highlighted menu item in the side menu also changes from the 50 Ω channel 2 setting to the 1 M Ω impedance setting of channel 1.

2. Press **CH 2** \rightarrow Ω (side) to toggle the selection to 1 M Ω . This returns the coupling impedance of channel 2 to its initial state.

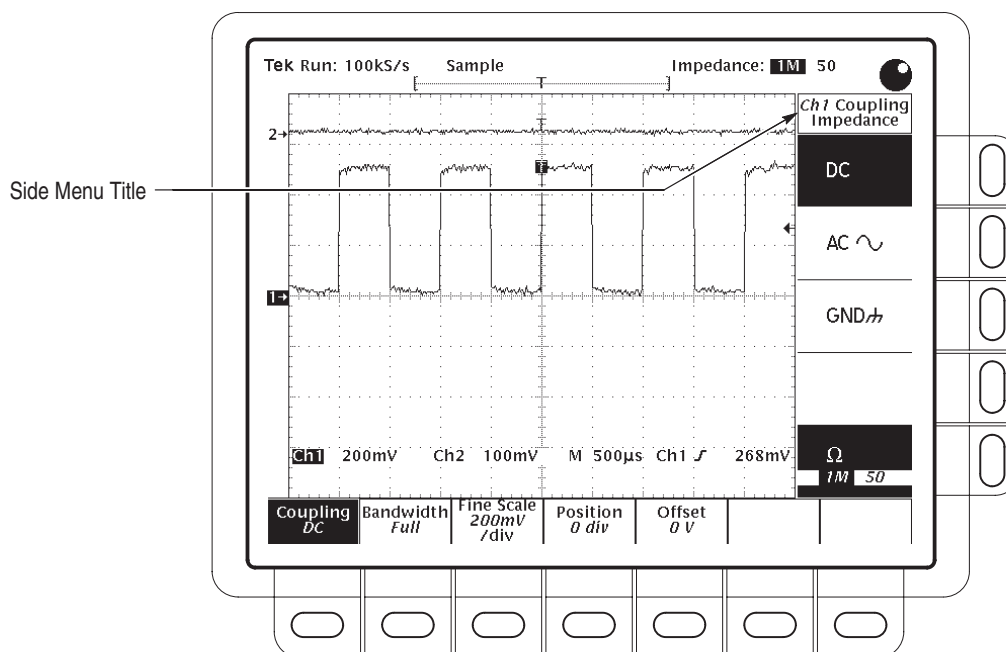

Figure 2-13: The Menus After Changing Channels

Remove a Waveform

Pressing the WAVEFORM OFF button removes the waveform for the currently selected channel. If the waveform you want to remove is not already selected, select that channel using the channel (CH) button. To remove a waveform from the display, do the following steps:

1. Press **WAVEFORM OFF** (under the vertical **SCALE** knob).

Since the CH 2 light was on when you pressed the WAVEFORM OFF button, the channel 2 waveform was removed.

The channel (CH) lights now indicate channel 1. Channel 1 has become the selected channel. When you remove the last waveform, all the CH lights are turned off.

2. Press **WAVEFORM OFF** again to remove the channel 1 waveform.

Example 3: Taking Automated Measurements

The digitizing oscilloscope can measure many waveform parameters automatically and read out the results on screen. Do the following tasks to discover how to set up the oscilloscope to measure waveforms automatically.

Display Measurements Automatically

To take automated measurements, do the following steps:

1. If you are not continuing from the previous example, follow the instructions on page 2–11 under the heading “Setting Up for the Examples.”
2. Press **SETUP** → **Recall Factory Setup** (main) → **OK Confirm Factory Init** (side).
3. Press **AUTOSET**.
4. Press **MEASURE** to display the Measure main menu (see Figure 2-14).

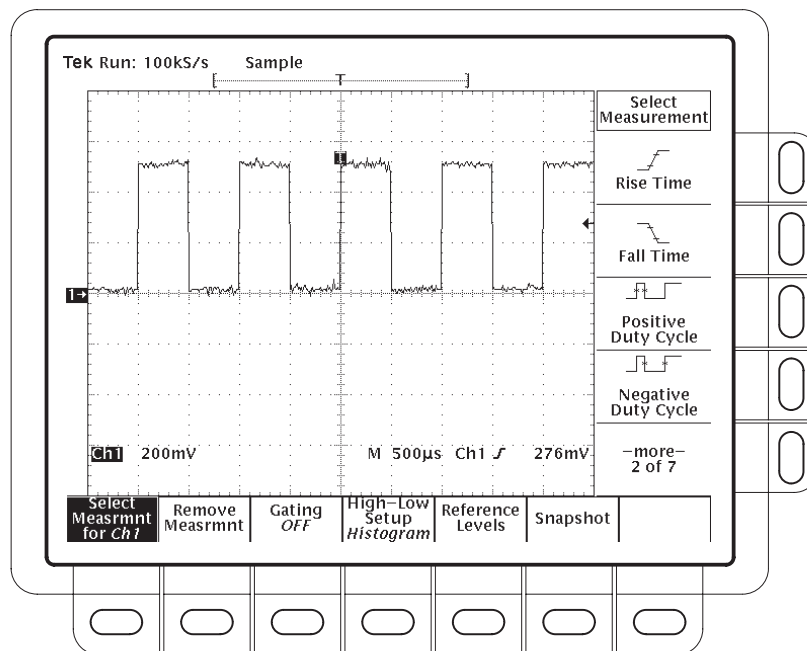

Figure 2-14: Measure Main Menu and Select Measurement Side Menu

5. If it is not already selected, press **Select Measrmt** (main). The readout for that menu item indicates which channel the measurement will be taken from. All automated measurements are made on the selected channel.

The Select Measurement side menu lists the measurements that can be taken. Up to four can be taken and displayed at any one time. Pressing the button next to the **–more–** menu item displays the other measurement selections.



6. Press **Frequency** (side). If the **Frequency** menu item is not visible, press **–more–** (side) repeatedly until the **Frequency** item appears, then press **Frequency** (side).

Observe that the frequency measurement appears within the right side of the graticule area. The measurement readout includes the notation Ch1, meaning that the measurement is taken on the channel 1 waveform. (To take a measurement on another channel, select that channel, and then select the measurement.)

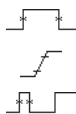

7. Press **Positive Width** (side) → **–more–** (side) → **Rise Time** (side) → **Positive Duty Cycle** (side).

All four measurements are displayed.

8. To move the measurement readouts outside the graticule area, press **CLEAR MENU** (see Figure 2-15).

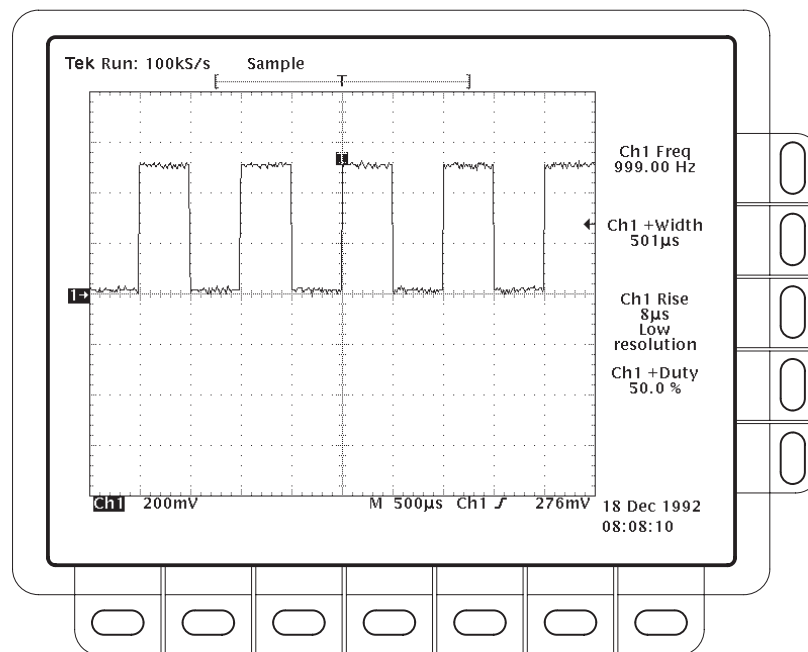

Figure 2-15: Four Simultaneous Measurement Readouts

Remove Measurement Readouts

To remove measurements you no longer want displayed:

Press **MEASURE** → **Remove Measrmt** (main) → **Measurement 1**, **Measurement 2**, and **Measurement 4** (side) to remove those measurements. Leave the rise time measurement displayed.

Examine the Measurement Reference Levels

To examine the current values:



Press **Reference Levels** (main) → **High Ref** (side).

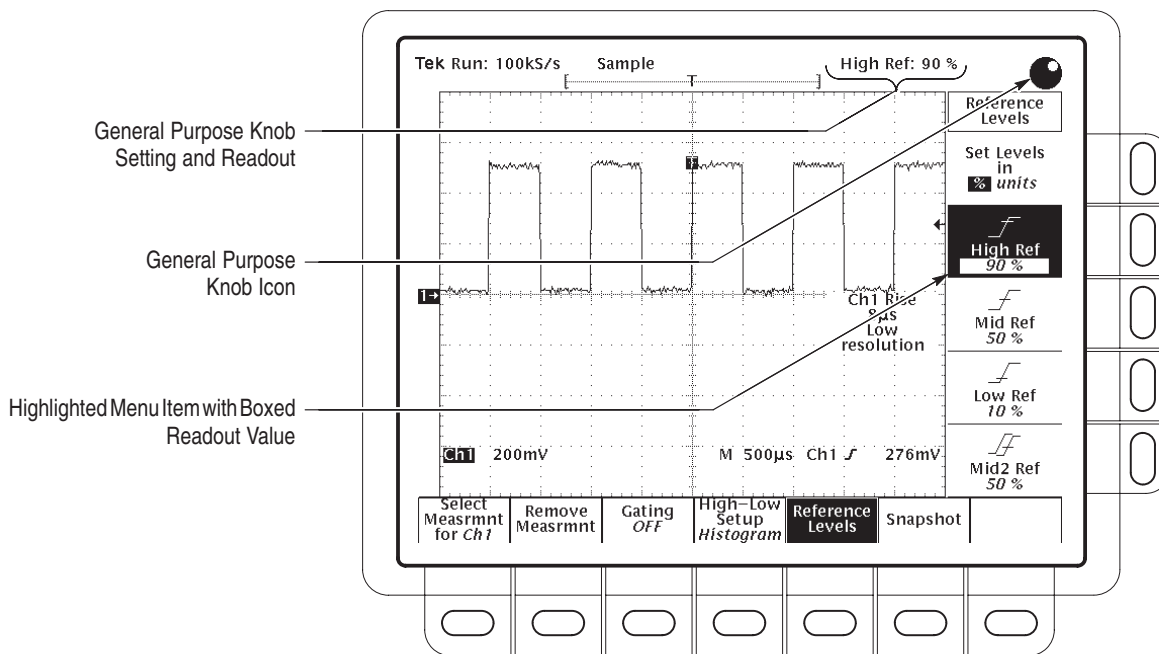

Figure 2-16: General Purpose Knob Indicators

Change the Measurement Reference Levels

By default, the measurement system uses the 10% and 90% levels of the waveform for taking the rise time measurement. You can change these values to other percentages or change them to absolute voltage levels.



To examine the current values, press **Reference Levels** (main) → **High Ref** (side).

The general purpose knob is now set to adjust the high reference level (Figure 2-16).

There are several important things to observe on the screen:

- The knob icon appears at the top of the screen. The knob icon indicates that the general purpose knob is set to adjust a parameter.
- The upper right corner of the screen shows the readout High Ref: 90%.
- The High Ref side menu item is highlighted, and a box appears around the 90% readout in the High Ref menu item. The box indicates that the general purpose knob is currently set to adjust that parameter.

To adjust the high level to 80%, turn the general purpose knob.

Display a Snapshot of Automated Measurements

You can pop up a display of almost all of the automated measurements. To display a snapshot of automated measurements of the selected channel, do the following steps:

1. Press **Snapshot** (main) to pop up a snapshot of all available single waveform measurements. (See Figure 2-17).

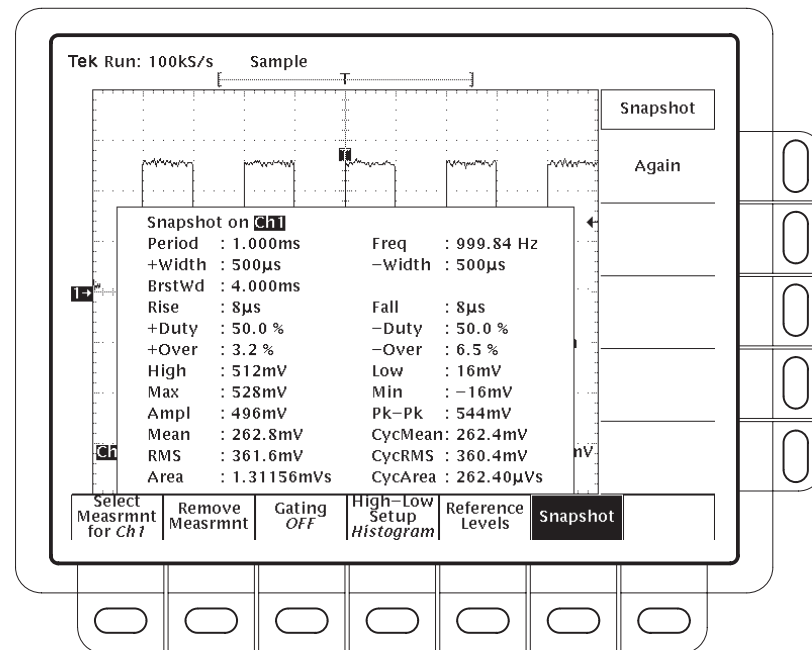

Figure 2-17: Snapshot of Channel 1

Example 4: Saving Setups

The digitizing oscilloscope can save its control settings and recall them later to quickly re-establish the previously saved state. Do the following tasks to learn how to save, and then recall, a setup.

Save a Setup

First, you need to create an instrument setup you want to save. Perform the following steps to create and save a setup that is complex enough that you might prefer not to go through all these steps each time you want that display:

1. If you are not continuing from the previous example, follow the instructions on page 2–11 under the heading *Setting Up for the Examples*.
2. Press **SETUP** → **Recall Factory Setup** (main) → **OK Confirm Factory Init** (side).
3. Press → **AUTOSET**.
4. Press **MEASURE** → **Select Measrmt** (main) → **Frequency** (side). (Press the **–more–** side menu item if the **Frequency** selection does not appear in the side menu.)
5. Press **CH 2** → **CLEAR MENU**.



To save the setup, do the following steps:

6. Press **SETUP** → **Save Current Setup** (main) to display the Setup main menu (see Figure 2-18).

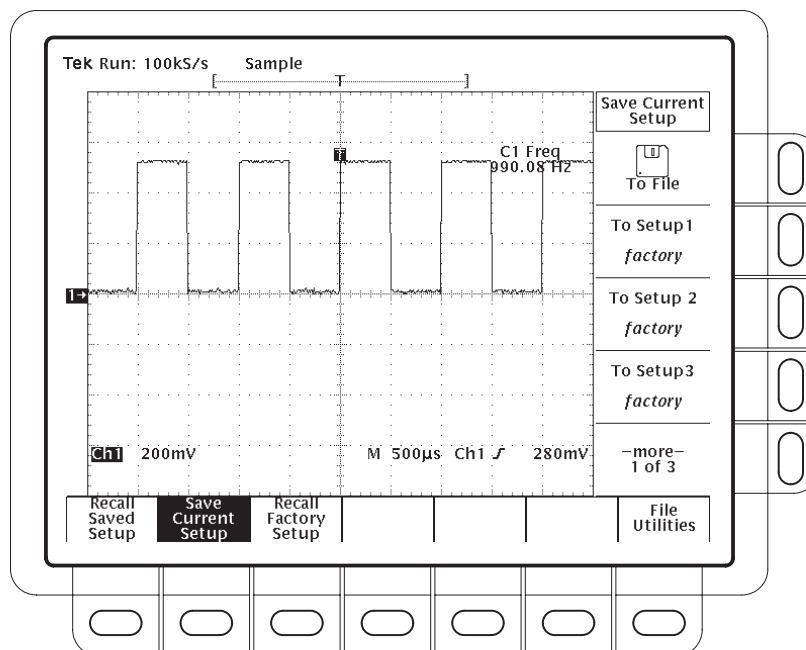

Figure 2-18: Save/Recall Setup Menu

7. Press one of the **To Setup** side menu buttons to store the current instrument settings into that setup location. Remember which setup location you selected for use later.

Once you have saved a particular setup, you can change the settings as you wish, knowing that you can come back to that setup at any time.



8. Press **MEASURE** → **Positive Width** (side) to add that measurement to the display.

Recall a Setup

To recall the setup, press **SETUP** → **Recall Saved Setup** (main) → **Recall Setup** (side) for the setup location you used in the last exercise.

Overview

This chapter describes the details of operating the digitizing oscilloscope. It contains an alphabetical list of tasks you can perform with the digitizing oscilloscope. Use this chapter to answer specific questions about instrument operation. The following tasks are included:

- Accessing Help
- Acquisition Modes
- Delayed Triggering
- Determining Status
- Display Modes
- Edge Triggering
- Fast Fourier Transforms
- File System
- Hardcopy
- Horizontal Control
- Limit Testing
- Measuring Waveforms
- Probe Cal
- Probe Compensation
- Pulse Triggering
- Remote Communication
- Roll Mode
- Saving and Recalling Setups
- Saving and Recalling Waveforms
- Selecting Channels
- Setting up Automatically
- Signal Path Compensation
- Taking Cursor Measurements
- Vertical Control
- Video Triggering
- Waveform Differentiation
- Waveform Integration
- Waveform Math
- Zoom

Many of these tasks list steps you perform to accomplish the task. You should read *Conventions* on page x of *Preface* before reading about these tasks.

Accessing Help

The on-line help system provides brief information about each of the digitizing oscilloscope controls.

To use the on-line help system:

Press **HELP** to display information on any front panel button, knob, or menu item (see Figure 3-1).

Press **HELP** again to return to the regular operating mode. Whenever the oscilloscope is in help mode, pressing any button (except **HELP** or **SHIFT**), turning any knob, or pressing any menu item displays help text on the screen that discusses that control.

On-line help is available for each menu selection displayed at the time the **HELP** button is first pressed. If you are in help mode and want to see help on selections from non-displayed menus, you first exit help mode, display the menu you want information on, and press **HELP** again to re-enter help mode.

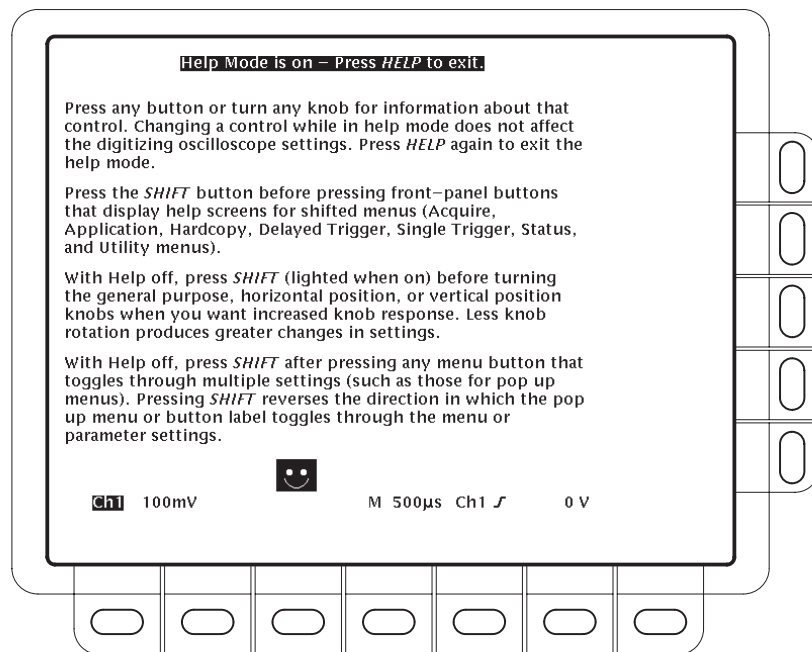

Figure 3-1: Initial Help Screen

Acquisition Modes

The acquisition system has several options for converting analog data into digital form. The Acquisition menu lets you determine the acquisition mode, whether or not to permit equivalent time sampling, and how to start and stop acquisitions.

Description of Modes

The digitizing oscilloscope supports five acquisition modes:

- *Sample*
- *Peak Detect*
- *Hi Res*
- *Envelope*
- *Average*

The Sample, Peak Detect, and Hi Res modes operate in real-time on a single trigger event, provided the digitizing oscilloscope can acquire enough samples for each trigger event. Envelope and Average modes operate on multiple acquisitions. The digitizing oscilloscope averages or envelopes several waveforms on a point-by-point basis.

Sample Mode



In Sample mode, the oscilloscope creates a record point by saving the first sample (of perhaps many) during each acquisition interval. (An acquisition interval is the time covered by the waveform record divided by the record length.) This is the default mode.

Peak Detect Mode



Peak Detect mode alternates between saving the highest sample in one acquisition interval and lowest sample in the next acquisition interval. This mode only works with real-time, non-interpolated sampling.

If you set the time base so fast that it requires real-time interpolation or equivalent-time sampling, the mode automatically changes from Peak Detect to Sample, although the menu selection does not change.

Hi Res Mode



In Hi Res mode, the digitizing oscilloscope averages all samples taken during an acquisition interval to create a record point. That average results in a higher-resolution, lower-bandwidth waveform.

NOTE. In Hi Res mode the frequency of the external clock signal (TDS 460A, TDS 430A, and TDS 420A only) must be less than or equal to the frequency set in the external clock menu. If the frequency of the external clock signal is greater than the frequency in the menu, the displayed waveform will have the wrong amplitude.

This mode only works with real-time, non-interpolated sampling. If you set the time base so fast that it requires real-time interpolation or equivalent-time sampling, the mode automatically becomes Sample, although the menu selection does not change.

A key advantage of Hi Res is its potential for increasing resolution regardless of the input signal. Tables 3–1 and 3–2 illustrate how you can obtain up to 15 significant bits with Hi Res mode. Note that resolutions above 15 bits are not allowed. The bits of resolution shown in the tables are theoretically achievable. Actual resolution may vary as a function of the correlated noise sources in the test environment.

Table 3–1: TDS 460A, TDS 430A, and TDS 420A Resolution Bits

Time Base Speed	Bits of Resolution
1 μ s and faster	8 bits
2 μ s to 5 μ s	9 bits
10 μ s to 20 μ s	10 bits
50 μ s to 100 μ s	11 bits
200 μ s to 500 μ s	12 bits

Table 3–2: TDS 510A Resolution Bits

Time Base Speed	Bits of Resolution
400 ns and faster	8 bits
1 μ s to 2 μ s	9 bits
5 μ s to 10 μ s	10 bits
20 μ s to 50 μ s	11 bits
50 μ s to 100 μ s	11 bits
100 μ s to 200 μ s	12 bits
500 μ s	13 bits
1 ms to 2 ms	14 bits
5 ms and slower	15 bits

Envelope Mode



Envelope mode lets you acquire and display a waveform record that shows the extremes in variation over several acquisitions. You specify the number of acquisitions over which to accumulate the data. The oscilloscope saves the highest and lowest values in two adjacent intervals similar to the Peak Detect mode. But Envelope mode, unlike Peak Detect, gathers peaks over many trigger events.

The final display shows the most extreme values for all the acquisitions for each point in the waveform record.

NOTE. *Envelope and Average acquisition modes disable Roll mode. See Roll Mode beginning on page 3-99.*

Average Mode



Average mode lets you acquire and display a waveform record that is the averaged result of several acquisitions. This mode reduces random noise. The oscilloscope acquires data after each trigger event using Sample mode.

Checking the Acquisition Readout

To determine the acquisition sampling rate, the acquisition state (running or stopped), and the acquisition mode, check the acquisition readout at the top of the display (see Figure 3-2). The “running” state shows the sample rate (or External Clock when external clock is enabled) and acquisition mode. The “stopped” state shows the number of acquisitions acquired since the last stop or major change.

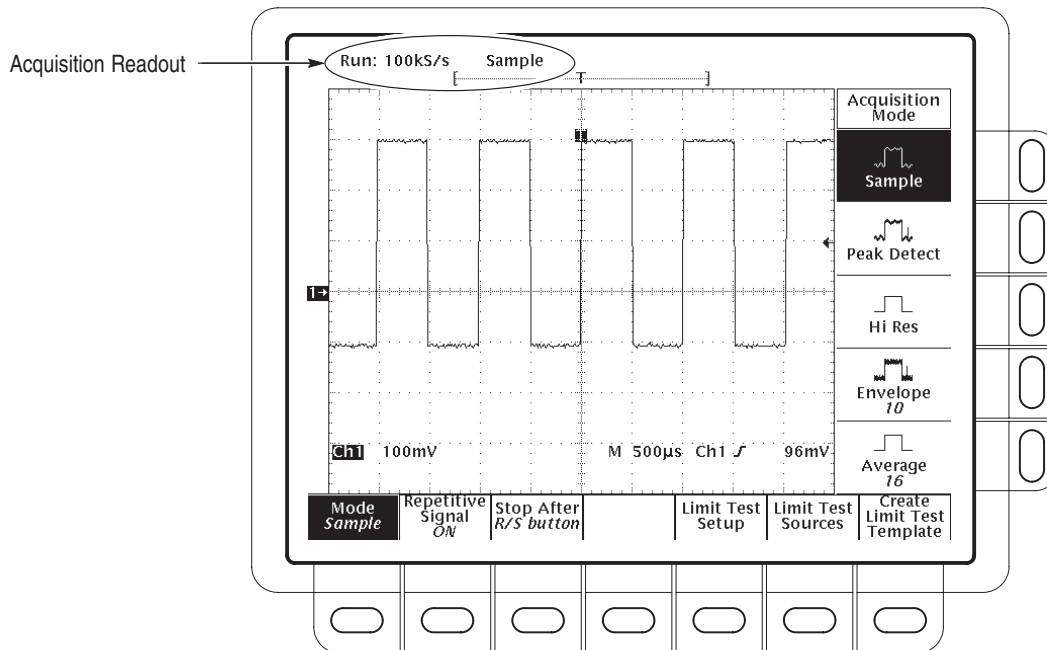

Figure 3-2: Acquisition Menu and Readout

Selecting an Acquisition Mode

The oscilloscope provides several acquisition modes. To bring up the acquisition menu (Figure 3-2) and choose how the digitizing oscilloscope creates points in the waveform record:

Press **SHIFT ACQUIRE MENU** → **Mode** (main) → **Sample, Peak Detect, Hi Res, Envelope**, or **Average** (side).

NOTE. With some longer record lengths, the digitizing oscilloscope will not allow selecting **Hi Res** mode or will reduce the record length setting.

When you select **Envelope** or **Average**, you can enter the number of waveform records to be enveloped or averaged using the general purpose knob.

Selecting Repetitive Sampling

To limit the digitizing oscilloscope to real-time sampling or let it choose between real-time or equivalent-time sampling:

Press **SHIFT ACQUIRE MENU** → **Repetitive Signal** (main) → **ON** or **OFF** (side).

ON (Enable ET) uses both the real time and the equivalent time features of the digitizing oscilloscope.

OFF (Real Time Only) limits the digitizing oscilloscope to real time sampling. If the digitizing oscilloscope cannot accurately get enough samples for a complete waveform, the oscilloscope uses the interpolation method selected in the display menu to fill in the missing record points.

To Stop After

To choose the event that signals the oscilloscope to stop acquiring waveforms, do the following step:

Press **SHIFT ACQUIRE MENU** → **Stop After (main)** → **RUN/STOP button only**, **Single Acquisition Sequence**, or **Limit Test Condition Met** (side) (see Figure 3-3).

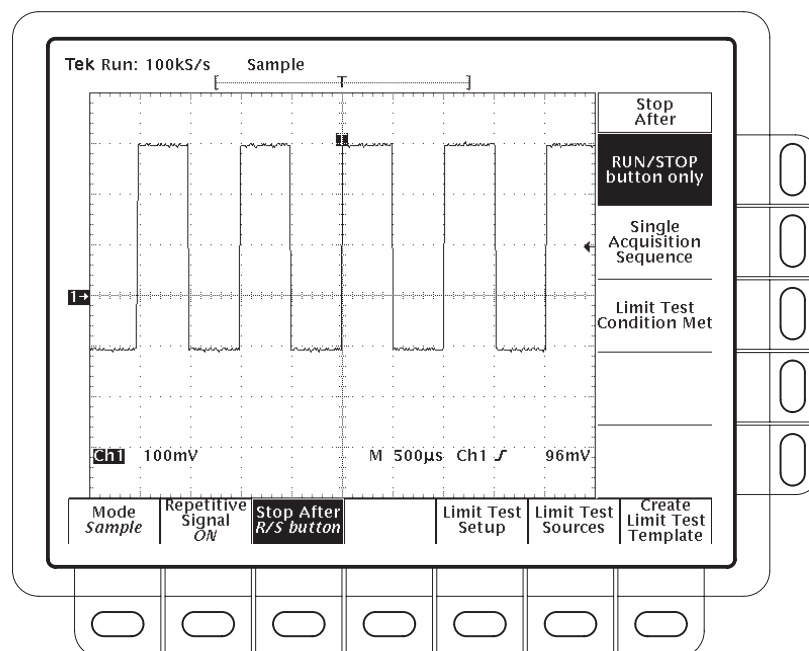

Figure 3-3: Acquire Menu — Stop After

RUN/STOP button only (side) lets you start or stop acquisitions by toggling the RUN/STOP button. Pressing the RUN/STOP button once stops the acquisitions. The upper left hand corner in the display indicates Stopped and shows the number of acquisitions. If you press the button again, the digitizing oscilloscope resumes taking acquisitions.

Single Acquisition Sequence (side) lets you run a single sequence of acquisitions by pressing the RUN/STOP button.

In Envelope or Average mode, the digitizing oscilloscope makes the specified number of acquisitions to complete the averaging or enveloping task.

If the oscilloscope is in equivalent-time mode and you press Single Acquisition Sequence (side), it continues to recognize trigger events and acquire samples until the waveform record is filled.

NOTE. *To quickly select Single Acquisition Sequence without displaying the Acquire and Stop After menus, press SHIFT FORCE TRIG. (You still must display the Acquire menu and then the Stop After menu to leave Single Acquisition Sequence operation.)*

Limit Test Condition Met (side) lets you acquire waveforms until waveform data exceeds the limits specified in the limit test. Then acquisition stops. At that point, you can also specify other actions for the oscilloscope to take using the selections available in the Limit Test Setup main menu.

NOTE. *In order for the digitizing oscilloscope to stop acquisition when limit test conditions are met, limit testing must be turned ON, using the Limit Test Setup main menu.*

Setting up limit testing requires several more steps. See *Limit Testing*, on page 3–63.

Delayed Triggering

The digitizing oscilloscope provides a main time base and a delayed time base. The delayed time base, like the main time base, requires a trigger signal and an input source dedicated to that signal. You can only use delay with the edge trigger and certain classes of main pulse triggers. This section describes how to delay the acquisition of waveforms.

There are two different ways to delay the acquisition of waveforms: *delayed runs after main* and *delayed triggerable*. Only *delayed triggerable* uses the delayed trigger system.

Delayed runs after main looks for a main trigger, then waits a user-defined time, and then starts acquiring (see Figure 3-4).



Figure 3-4: Delayed Runs After Main

Delayed triggerable looks for a main trigger and then, depending on the type of delayed trigger selected, makes one of the types of delayed triggerable mode acquisitions listed below (see Figure 3-5).

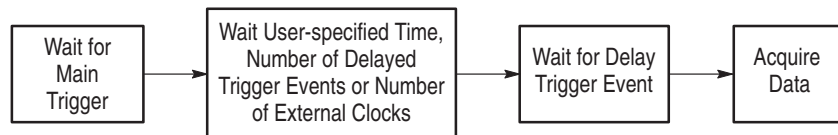

Figure 3-5: Delayed Triggerable

After Time waits the user-specified time, then waits for the next delayed trigger event, and then acquires.

After Events waits for the specified number of delayed trigger events and then acquires.

After Events/Time (TDS 510A only) waits for the specified number of delayed trigger events, then waits the user-specified time, and then acquires.

External clks (TDS 400A) waits for the specified number of external clocks and then acquires.

NOTE. When using the delayed triggerable mode, the digitizing oscilloscope provides a conventional edge trigger for the delayed time base. The delayed time base will not trigger if the main trigger type (as defined in the Main Trigger menu) is logic, or if the main trigger type is pulse with the runt trigger class selected.

To Run After Delay

You use the Horizontal menu to select and define either delayed runs after main or delayed triggerable. Delayed triggerable, however, requires further selections in the Delayed Trigger menu. Do the following steps to set the delayed time base to run immediately after delay:

1. Press **HORIZONTAL MENU** → **Time Base** (main) → **Delayed Only** (side) → **Delayed Runs After Main** (side).
2. Use the general purpose knob to set the delay time.

If you press Intensified (side), you display an intensified zone on the main timebase record that shows where the delayed timebase record occurs relative to the main trigger. For Delayed Runs After Main mode, the start of the intensified zone corresponds to the start of the delayed timebase record. The end of the zone corresponds to the end of the delayed record.

To learn how to set the intensity level, see *Display Modes* on page 3–17.

To Trigger After Delay

The Main Trigger menu settings must be compatible with Delayed Triggerable. To select Delayed Triggerable mode, do the following steps:

1. Press **TRIGGER MENU**.
2. Press **Type** (main) and either **Edge** or **Pulse** as fits your application.
3. Press **HORIZONTAL MENU** → **Time Base** (main) → **Delayed Only** (side) → **Delayed Triggerable** (side).

NOTE. The Delayed Triggerable menu item is not selectable unless incompatible Main Trigger menu settings are eliminated. If such is the case, the Delayed Triggerable menu item is dimmer than other items in the menu.

By pressing Intensified (side), you can display an intensified zone that shows where the delayed timebase record *may* occur (a valid delay trigger event must be received) relative to the main trigger on the main timebase. For Delayed Triggerable After mode, the start of the intensified zone corresponds to the possible start point of the delayed timebase record. The end of the zone continues to the end of main timebase, since a delayed time base record may be triggered at any point after the delay time elapses.

To learn how to define the intensity level of the normal and intensified waveform, see *Display Modes* on page 3–17.

Now you need to bring up the Delayed Trigger menu so you can define the delayed trigger event.

4. On a TDS 400A, press **SHIFT DELAYED TRIG** → **Delay by** (main) → **Triggerable After Time, Events, or Ext clks** (side) (Figure 3-6).
5. On the TDS 510A, press **SHIFT DELAYED TRIG** → **Delay by** (main) → **Triggerable After Time, Events, or Events/Time** (side).
6. Enter the delay time or events using the general purpose knob or the keypad.

Hint: You can go directly to the Delayed Trigger menu (see steps 4 and 5). By selecting either Triggerable After Time, Events, or Events/Time, the oscilloscope automatically switches to Delayed Triggerable in the Horizontal menu. If you wish to leave Delayed Triggerable, you still need to display the Horizontal menu.

The Source menu lets you select which input is the delayed trigger source.

7. Press **Source** (main) → **Ch1, Ch2, Ch3, Ch4, DC Aux, or Auxiliary** (side).

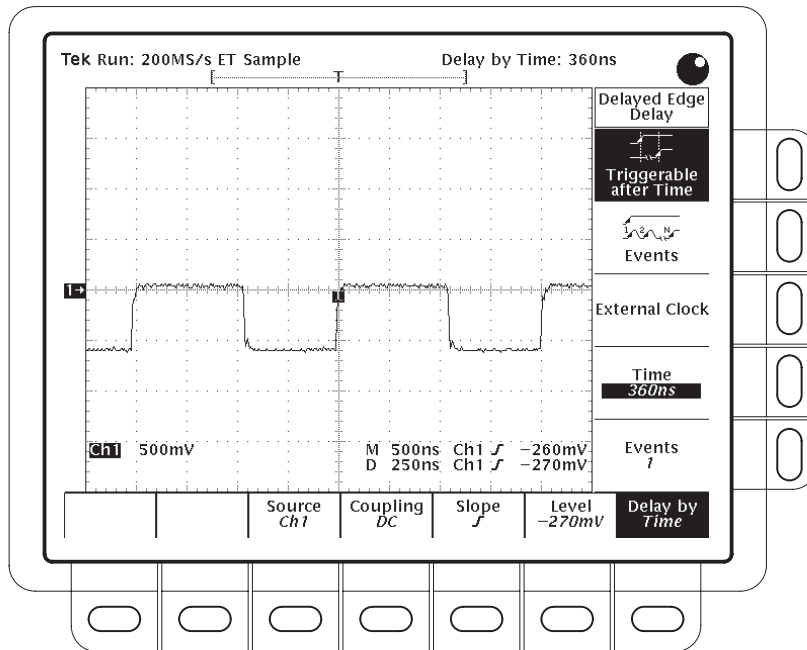

Figure 3-6: Delayed Trigger Menu (TDS 400A shown)

8. To define how the input signal is coupled to the delayed trigger, press **Coupling** (main) → **DC**, **AC**, **HF Rej**, **LF Rej**, or **Noise Rej** (side). For descriptions of these coupling types, see *To Specify Coupling* on page 3–23.
9. To select the slope that the delayed trigger occurs on, press **Slope** (main). Choose between the rising edge and falling edge slopes.

When using Delayed Triggerable mode to acquire waveforms, two trigger bars are displayed. One trigger bar indicates the level set by the main trigger system; the other indicates the level set by the delayed trigger system.

10. Press **Level** (main) → **Level**, **Set to TTL**, **Set to ECL**, or **Set to 50%** (side). For a description of these level settings, see *To Set Level* on page 3–24.

Determining Status

The Status menu lets you see information about the oscilloscope state.

To Display the Status

To display the Status menu (see Figure 3-7):

Press **SHIFT STATUS** → **Status (main)** → **System, Trigger, Waveforms, or I/O (side)**.

System displays information about the firmware, Horizontal, Zoom, Acquisition, Limit Test, Measure, and Hardcopy (TDS 510A) systems.

Display displays information about the display system.

Trigger displays information about the triggers.

Waveforms displays information about the various waveforms, including live, math, and reference.

I/O displays information about the I/O port(s).

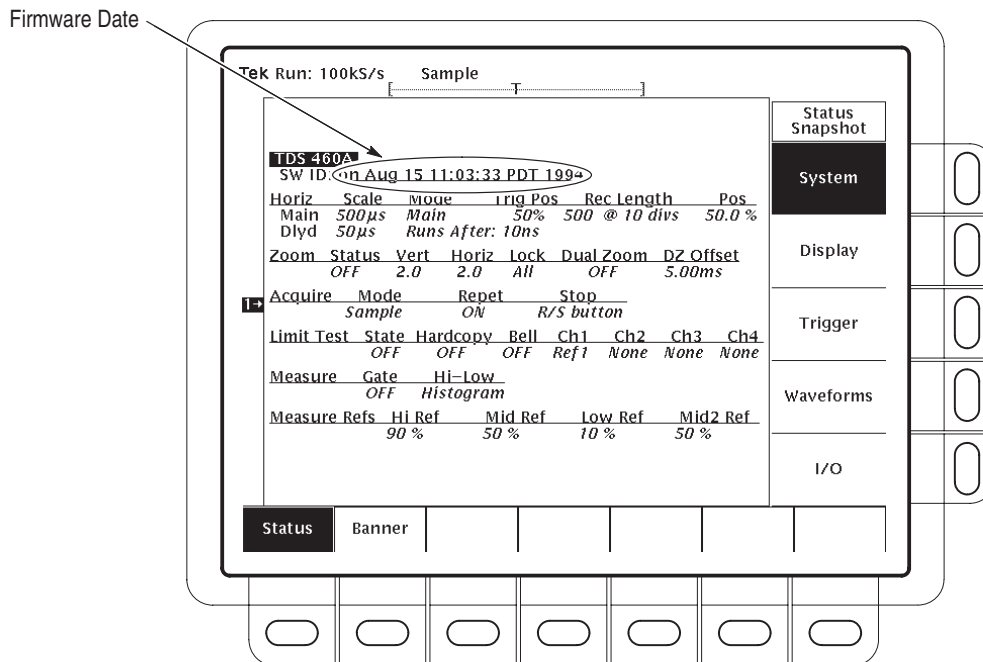

Figure 3-7: Status Menu — System (TDS 400A shown)

To Display the Banner

To display the banner (firmware version, options, and copyright):

Press **SHIFT STATUS** → **Banner** (main). (See Figure 3-8.)

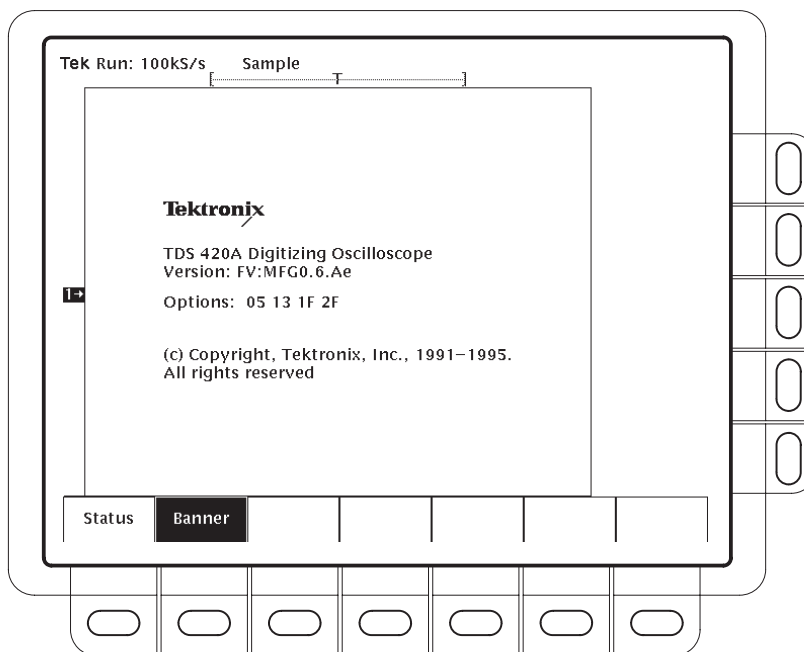

Figure 3-8: Banner Display

Display Modes

This section describes how to adjust the oscilloscope display style, intensity level, graticule, and format.

Change Display Settings

To bring up the Display menu, press **DISPLAY**.

Select the Display Style

Press **DISPLAY** → **Style** (main) → **Vectors**, **Intensified Samples**, **Dots**, **Infinite Persistence**, or **Variable Persistence** (side) (Figure 3-9).

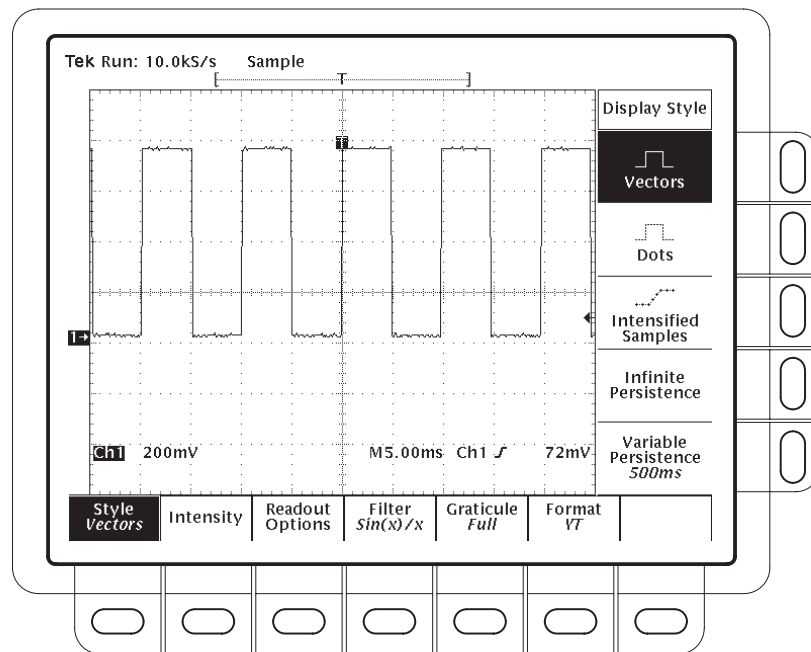

Figure 3-9: Display Menu — Style

Vectors style displays draw vectors (lines) between the record points.

Dots style displays waveform record points as dots.

Intensified Samples style also displays waveform record points as dots. However, the points actually sampled are displayed intensified relative to the interpolated points.

In addition to choosing Intensified Samples in the side menu, the oscilloscope must be interpolating (equivalent time must be off) or Zoom must be on with its horizontal expansion greater than 1X. See Zoom beginning on page 3–143.

Variable Persistence accumulates the record points on screen over many acquisitions and displays them only for a specific time interval. In that mode, the display behaves like that of an analog oscilloscope.

Infinite Persistence accumulates the record points until you change some control (such as scale factor) causing the display to be erased.

Adjust Intensity

Intensity lets you set overall, text/graticule, and waveform intensity (brightness) levels. To set the intensity:

Press **DISPLAY** → **Intensity** (main) → **Overall, Text/Grat, Waveform, or Contrast** (side). Enter the intensity percentage values with the general purpose knob or keypad.

NOTE. *The Intensified setting for Timebase in the horizontal menu causes a zone on the waveform to be intensified relative to the rest of the waveform. If the contrast is set to 100%, you can not distinguish the intensified portion from the rest of the waveform because both are the same brightness.*

Set Display Readout Options

To control whether the trigger indicator, trigger level bar, and current date and time appear on the display and what style trigger level bar, long or short, is displayed:

1. Press **DISPLAY** → **Readout** (main).
2. To select whether or not to display a 'T' indicating the trigger point, Toggle **Display 'T' @ Trigger Point** (side). You can select **ON** or **OFF**. (The trigger point indicates the position of the trigger in the waveform record.)
3. To select either the short or the long trigger bar or to turn the trigger bar off, toggle **Trigger Bar Style** (side). (See Figure 3-10. Note that both styles are shown for illustrating purposes, but you can only display one style at a time.)

The trigger bar is only displayed if the trigger source is an active, displayed waveform. Also, two trigger bars are displayed when delay triggerable acquisitions are displayed. The trigger bar is a visual indicator of the trigger level.

4. Press **Display Date/Time** (side) to turn it on or off. Push **Clear Menu** to see the current date and time. See *To Date/Time Stamp Your Hardcopy* on page 3–49 for more information.

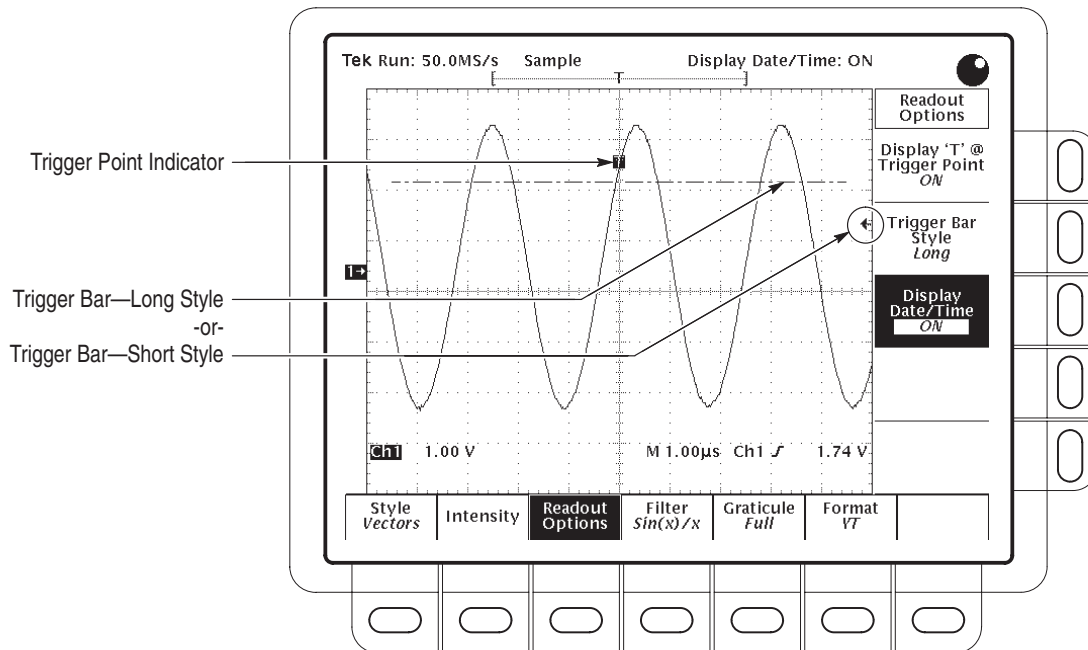

Figure 3-10: Trigger Point and Level Indicators

Select Interpolation Filter

To select the display filter type (sin(x)/x interpolation and linear interpolation):
 Press **DISPLAY** → **Filter** (main) → **Sin(x)/x Interpolation** or **Linear Interpolation** (side).

Select the Graticule Type

To select the graticule type:
 Press **DISPLAY** → **Graticule** (main) → **Full**, **Grid**, **Cross Hair**, **Frame**, **NTSC** or **PAL** (side).

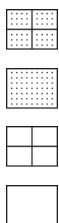

Full provides a grid, cross hairs, and a frame.

Grid displays a frame and a grid.

Cross Hair provides cross hairs and a frame.

Frame displays just a frame.

NTSC provides a grid useful for measuring NTSC-class waveforms.

PAL provides a grid useful for measuring PAL-class waveforms.

NOTE. Selecting either NTSC or PAL graticule automatically changes the vertical scale, position settings, coupling, and sets to zero any vertical offset of any channel displayed. These settings are not restored after switching to other graticule types.

Select the Display Format



There are two display formats: YT and XY.

YT is the conventional oscilloscope display format. It shows a signal voltage (the vertical axis) as it varies over time (the horizontal axis).



XY format compares the voltage levels of two waveform records point by point. That is, the digitizing oscilloscope displays a graph of the voltage of one waveform record against the voltage of another waveform record. This mode is particularly useful for studying phase relationships.

To set the display axis format:

Press **DISPLAY** → **Format** (main) → **XY** or **YT** (side).

When you choose the XY mode, the input you have selected is assigned to the X-axis and the digitizing oscilloscope automatically chooses the Y-axis input (see Table 3–3).

Table 3–3: XY Format Pairs

X-Axis Channel (User Selectable)	Y-Axis Channel (Fixed)
Ch 1	Ch 2
Ch 3 (TDS 420A, TDS 460A, and TDS 510A only)	Ch 4 (TDS 420A, TDS 460A, and TDS 510A only)

If you press the WAVEFORM OFF button for an XY channel, the digitizing oscilloscope deletes the XY graph of of the channels.

Since selecting YT or XY affects only the display, the horizontal and vertical scale and position knobs and menus control the same parameters regardless of the mode selected. Specifically, in XY mode, the horizontal scale continues to control the time base and the horizontal position continues to control which portion of the waveforms are displayed.

XY format is a dot-only display, although it can have persistence. The Vector style selection has no effect when you select XY format.

You cannot display Math waveforms in XY format. They disappear from the display when you select XY.

Edge Triggering

An *edge trigger* event occurs when the trigger source passes through a specified voltage level (the trigger level) in a specified direction (the trigger slope). You will likely use edge triggering for most of your measurements. This section describes how to use edge triggering. It also explains how to select the trigger mode, auto or normal, for all trigger types.

To Check Edge Trigger Status

To quickly check if edge triggers are selected, check the Trigger readout. When edge triggers are selected, the trigger readout displays the trigger source, as well as the trigger slope and level (see Figure 3-11).

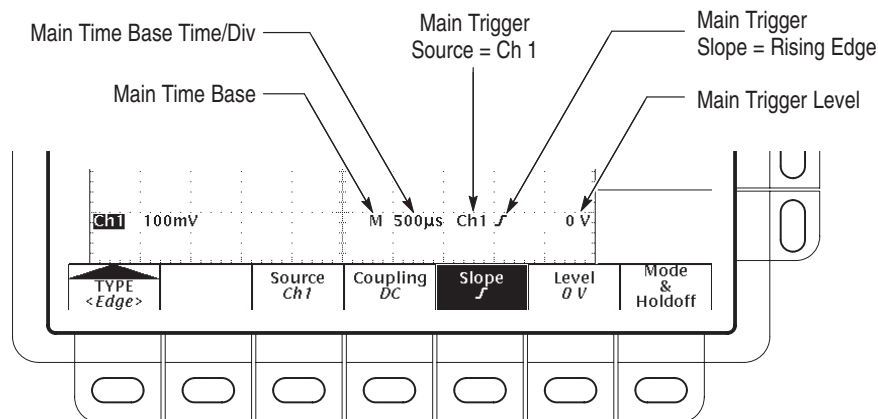

Figure 3-11: Edge Trigger Readouts

To determine the trigger status, check the **TRIG'D**, **READY**, and **ARM** status lights in the Trigger control area (see Figure 3-26):

- When TRIG'D is lighted, the digitizing oscilloscope has recognized a valid trigger and is filling the posttrigger portion of the waveform.
- When READY is lighted, the digitizing oscilloscope can accept a valid trigger event and it is waiting for that event to occur.
- When ARM is lighted, the trigger circuitry is filling the pretrigger portion of the waveform record.

- When both TRIG'D and READY are lighted, the digitizing oscilloscope has recognized a valid main trigger and is waiting for a delayed trigger. When it recognizes a delayed trigger it will fill in the posttrigger portion of the delayed waveform.
- When ARM, TRIG'D, and READY are all off, the digitizer is stopped.

To determine where the trigger point is located in the waveform record and with respect to the display, check the record view at the top of the display (see Figure 3-12).

To see the trigger point and level on the waveform display, check the graphic indicators of trigger position and level, which you can optionally display. Figure 3-12 shows the trigger position indicator and the short-style trigger level bar. See *Set Display Readout Options* on page 3-18 for more information.

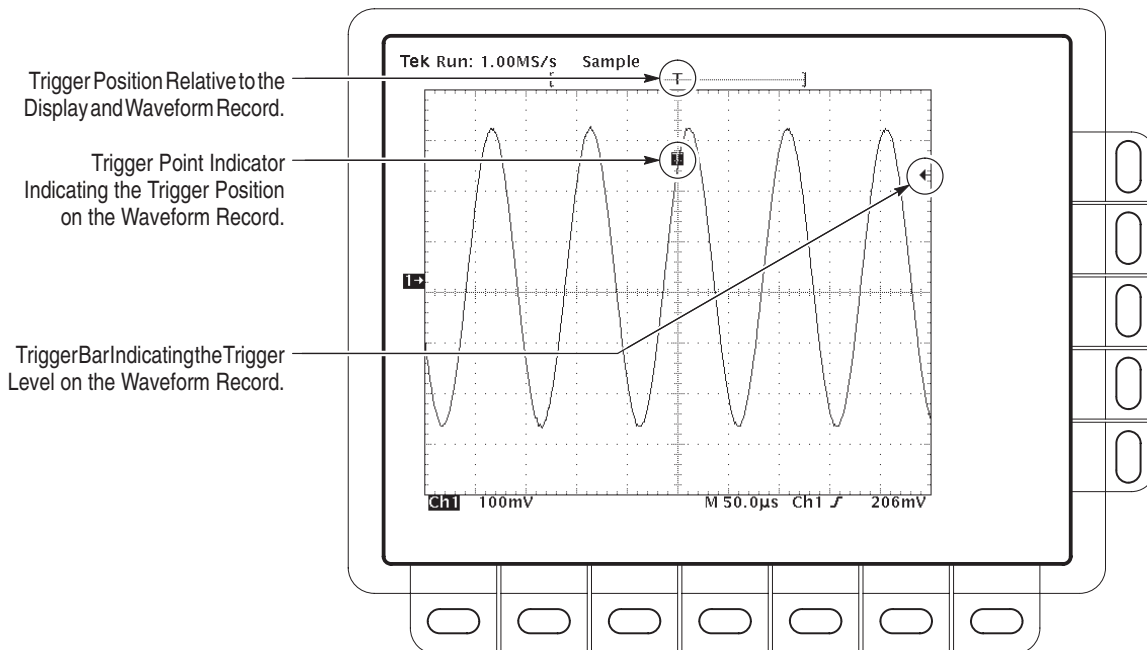

Figure 3-12: Record View, Trigger Position, and Trigger Level Bar Readouts

To Select Edge Triggering

Use the Edge Trigger menu to select edge triggering and to perform the procedures for selecting the source, coupling, slope, trigger level, mode, and holdoff that follow.

To bring up the Edge Trigger menu, press **TRIGGER MENU** → **Type** (main) → **Edge** (pop-up) (see Figure 3-13).

To Select a Source To select which source you want for the trigger:

Press **TRIGGER MENU** → **Type** (main) → **Edge** (pop-up) → **Source** (main) → **Ch1, Ch2, Ch3, Ch4, AC Line, or Auxiliary** (side).

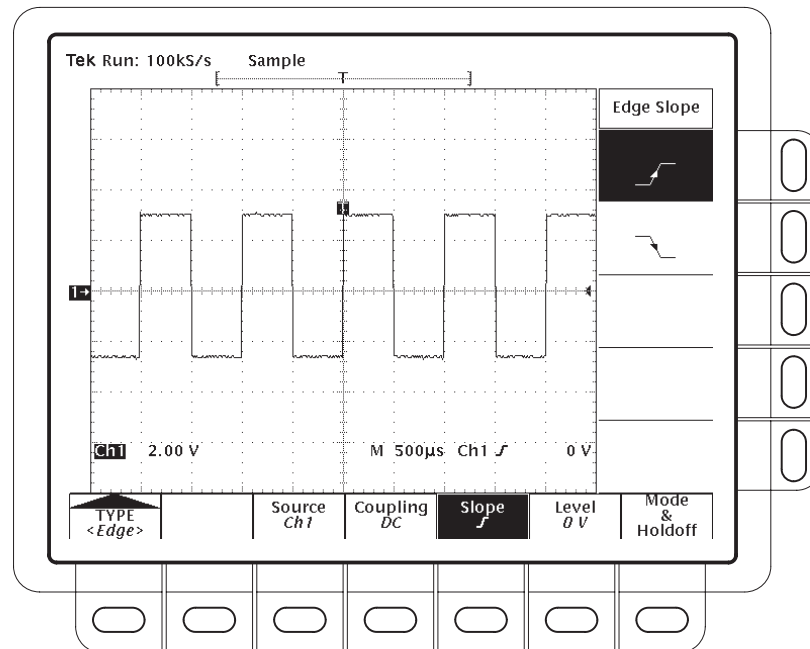

Figure 3-13: Main Trigger Menu — Edge Type

To Specify Coupling

To select the coupling you want, press **TRIGGER MENU** → **Type** (main) → **Edge** (pop-up) → **Coupling** (main) → **DC, AC, HF Rej, LF Rej, or Noise Rej** (side).

NOTE. If you select the Auxiliary trigger source, select DC or HF Rej coupling.

DC

DC passes all of the input signal. In other words, it passes both AC and DC components to the trigger circuit.

AC 

AC passes only the alternating components of an input signal (above 30 Hz). It removes the DC component from the trigger signal.



HF Rej removes the high frequency portion of the triggering signal. That allows only the low frequency components to pass on to the triggering system. High frequency rejection attenuates signals above 30 kHz.



LF Rej does the opposite of high frequency rejection. Low frequency rejection attenuates signals below 80 kHz.



Noise Rej provides lower sensitivity. It requires additional signal amplitude for stable triggering, reducing the chance of falsely triggering on noise.

To Set Slope

To select the slope that the edge trigger occurs on:

1. Press the **TRIGGER MENU** → **Type** (main) → **Edge** (pop-up) → **Slope** (main).



2. Select the rising or falling edge from the side menu.

To Set Level

Press the **TRIGGER MENU** → **Type** (main) → **Edge** (pop-up) → **Level** (main) → **Level, Set to TTL, Set to ECL, or Set to 50%** (side).

Level lets you enter the trigger level using the general purpose knob or the keypad. (You may also change the level using the MAIN LEVEL knob.)

Set to TTL fixes the trigger level at +1.4 V.

Set to ECL fixes the trigger level at -1.3 V.

NOTE. When you set the volts/div smaller than 200 mV, the oscilloscope reduces the Set to TTL or Set to ECL trigger levels below standard TTL and ECL levels. This happens because the trigger level range is fixed at ±12 divisions from the center. At 100 mV (the next smaller setting after 200 mV) the trigger range is ±1.2 V, which is smaller than the typical TTL (+1.4 V) or ECL (-1.3 V) level.

Set to 50% fixes the trigger level to approximately 50% of the peak-to-peak value of the trigger source signal.

To Set Mode & Holdoff

To select the trigger mode and change the holdoff time:

1. Press the **TRIGGER MENU** → **Mode & Holdoff** (main) → **Auto** or **Normal** (side). The trigger modes operate as follows:

- In *Auto* mode the oscilloscope acquires a waveform after a specific time has elapsed even if a trigger does not occur. The amount of time the oscilloscope waits depends on the time base setting.
- In *Normal* mode the oscilloscope acquires a waveform only if there is a valid trigger.

2. To change the holdoff time, press **Holdoff** (side). Enter the value in % using the general purpose knob or keypad.

If you want to enter a large number using the general purpose knob, press the **SHIFT** button before turning the knob. When the light next to the **SHIFT** button

is on and the display says **Coarse Knobs** in the upper right corner, the general purpose knob speeds up significantly.

Holdoff is automatically reset to 0% when you change the main time base time/division setting. However, it is not reset if you change the delayed time base time/division (that is, Intensified or Delayed Only).

To Force a Trigger To force the oscilloscope to immediately start acquiring a waveform record even without a trigger event, press the **FORCE TRIG** front panel button.

To Single Trigger To trigger on the next valid trigger event and then stop, press **SHIFT FORCE TRIG**. Now press the **RUN/STOP** button each time you want to initiate a single sequence of acquisitions.

Triggering From the Front Panel

The trigger buttons and knob let you quickly adjust the trigger level or force a trigger (see Figure 3-14). You use the following trigger controls for all trigger types, except where noted.

To Set the MAIN LEVEL. To manually change the trigger level, turn the **MAIN LEVEL** knob. It adjusts the trigger level (or threshold level) no matter what menu, if any, is displayed.

To Set to 50%. To quickly obtain an edge trigger, press **SET LEVEL TO 50%**. The oscilloscope sets the trigger level to the halfway point between the peaks of the trigger signal. Set Level to 50% has no effect when the trigger type is video.

Note that the **MAIN LEVEL** knob and menu items apply only to the main trigger level. To modify the delayed trigger level, use the **Level** item in the **Delayed Trigger** menu.

To Force a Trigger. To force the oscilloscope to immediately start acquiring a waveform record even without a trigger event, press the **FORCE TRIG** front panel button.

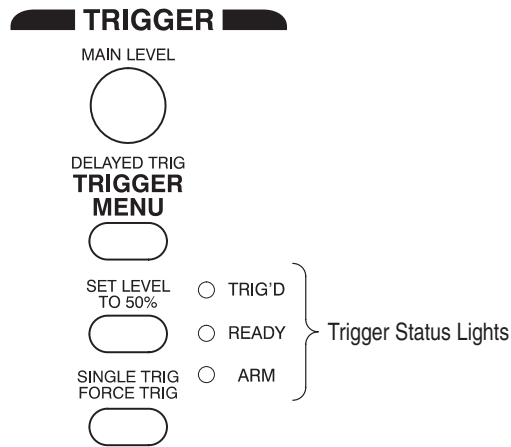

Figure 3-14: TRIGGER Controls and Status Lights

To Single Trigger. To trigger on the next valid trigger event and then stop, press **SHIFT FORCE TRIG**. Now press the **RUN/STOP** button each time you want to initiate a single sequence of acquisitions.

Fast Fourier Transforms (Optional)

Advanced DSP Math, provides the Fast Fourier Transform (FFT). (For more information see *Waveform Differentiation*, on page 3–131, *Waveform Integration*, on page 3–135, and *Waveform Math*, on page 3–139.) The FFT allows you to transform a waveform from a display of its amplitude against time to one that plots the amplitudes of the various discrete frequencies the waveform contains. You can also display the phase shifts of those frequencies. Use FFT math waveforms in the following applications:

- Testing impulse response of filters and systems
- Measuring harmonic content and distortion in systems
- Characterizing the frequency content of DC power supplies
- Analyzing vibration
- Analyzing harmonics in 50 and 60 cycle lines
- Identifying noise sources in digital logic circuits

Description

The FFT computes and displays the frequency content of a waveform you acquire as an FFT math waveform. The resulting waveform is a display of the magnitude or phase angle of the various frequencies the waveform contains with respect to those frequencies. For example, Figure 3-15 shows the non-transformed impulse response of a system in channel 2 at the top of the screen. The FFT-transformed magnitude and phase appear in the two math waveforms below the impulse.

The horizontal scale for FFT math waveforms is always expressed in frequency per division with the beginning (left-most point) of the waveform representing zero frequency (DC).

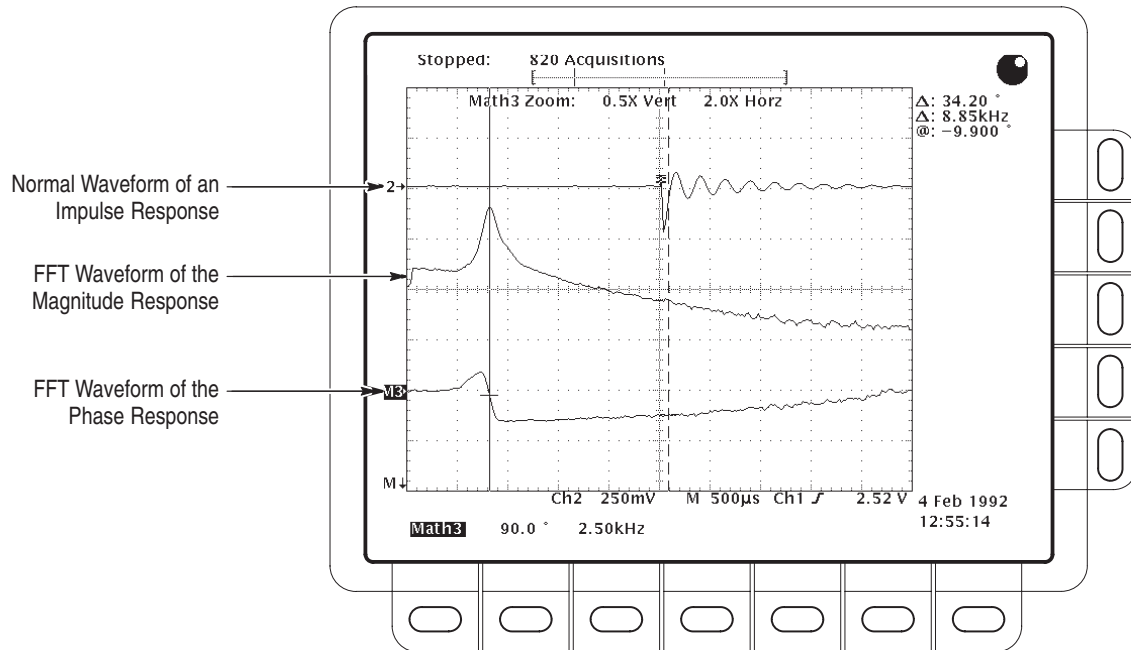

Figure 3-15: System Response to an Impulse

Operation

To obtain an FFT of your waveform:

1. Connect the waveform to the desired channel input and select that channel.
2. Adjust the vertical and horizontal scales and trigger the display (or press **AUTOSET**).

The topic *Offset, Position, and Scale*, on page 3–34, provides information about optimizing your setup for FFT displays.

3. Press **MORE** to access the menu for turning on math waveforms.
4. Select a math waveform. Your choices are **Math1**, **Math2**, and **Math3** (main).
5. If the selected math waveform is not FFT, press **Change Math Definition** (side) → **FFT** (main). See Figure 3-16.

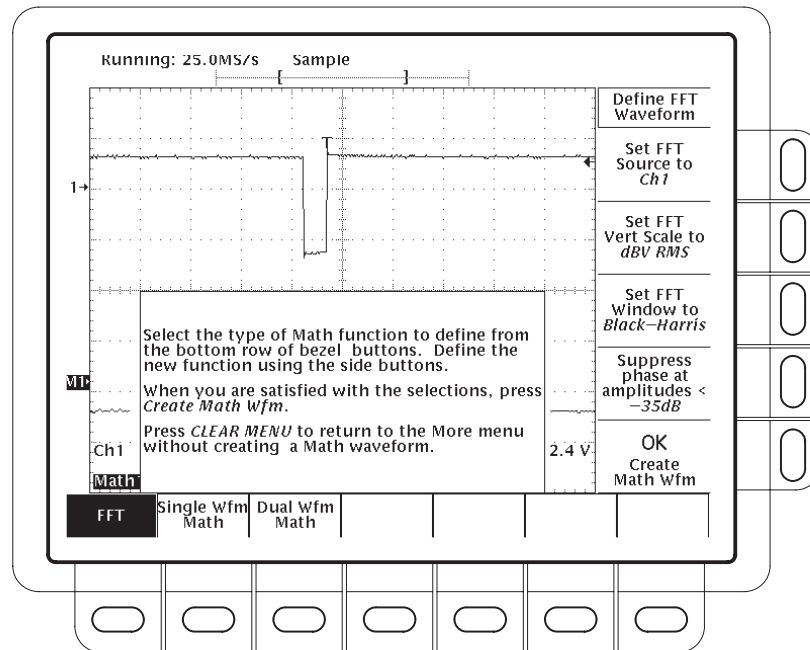

Figure 3-16: Define FFT Waveform Menu

6. Press **Set FFT Source to** (side) repeatedly until the channel source selected in step 1 appears in the menu label.
7. Press **Set FFT Vert Scale to** (side) repeatedly to choose from the following vertical scale types:
 - **dBV RMS** — Magnitude is displayed using log scale, expressed in dB relative to $1 V_{RMS}$ where $0 \text{ dB} = 1 V_{RMS}$.
 - **Linear RMS** — Magnitude is displayed using voltage as the scale.
 - **Phase (deg)** — Phase is displayed using degrees as the scale, where degrees wrap from -180° to $+180^\circ$.
 - **Phase (rad)** — Phase is displayed using radians as the scale, where radians wrap from $-\pi$ to $+\pi$.

The topic *Considerations for Phase Displays*, on page 3–37, provides in depth information on setup for phase displays.

8. Press **Set FFT Window to** (side) repeatedly to choose from the following window types:
 - **Rectangular** — Best type for resolving frequencies that are very close to the same value but worst for accurately measuring the amplitude of those

frequencies. Best type for measuring the frequency spectrum of non-repetitive signals and measuring frequency components near DC.

- **Hamming** — Very good for resolving frequencies that are very close to the same value with somewhat improved amplitude accuracy over the rectangular window.
- **Hanning** — Very good for measuring amplitude accuracy but degraded for resolving frequencies.
- **Blackman-Harris** — Best window for measuring the amplitude of frequencies but worst at resolving frequencies.

See *Selecting a Window*, on page 3–39, provides in depth information on choosing the right window for your application.

9. If you did not select **Phase (deg)** or **Phase (rad)** in step 7, skip to step 12. Phase suppression is only used to reduce noise in phase FFTs.
10. If you need to reduce the effect of noise in your phase FFT, press **Suppress phase at amplitudes <** (side).
11. Use the general purpose knob or the keypad to adjust the phase suppression level. FFT magnitudes below this level will have their phase set to zero.

See *Adjust Phase Suppression*, on page 3–38, provides additional information on phase suppression.

12. Press **OK Create Math Wfm** (side) to display the FFT of the waveform you input in step 1 (see Figure 3-17).

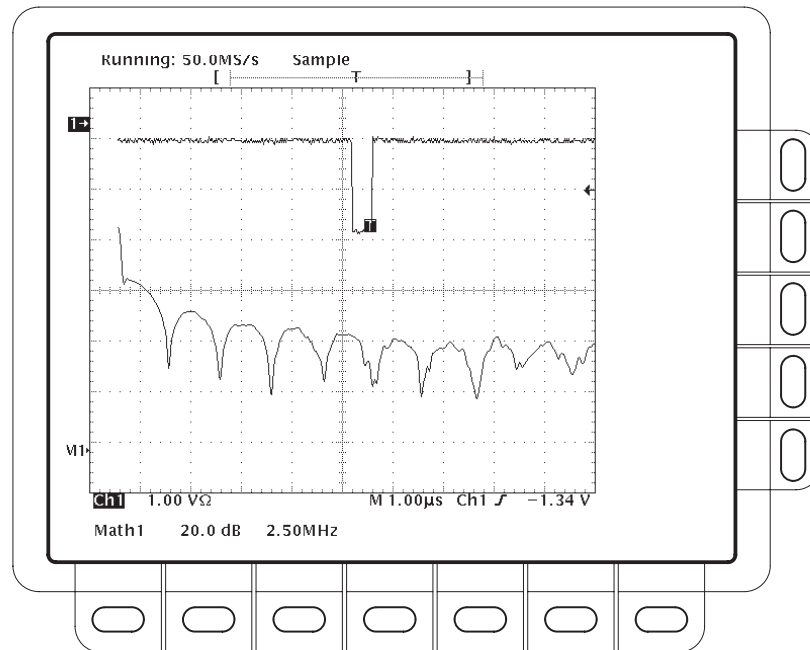

Figure 3-17: FFT Math Waveform in Math1

Cursor Measurements of an FFT

Once you have displayed an FFT math waveform, use cursors to measure its frequency amplitude or phase angle.

1. Be sure **MORE** is selected in the channel selection buttons and that the FFT math waveform is selected in the **More** main menu.
2. Press **CURSOR** → **Mode** (main) → **Independent** (side) → **Function** (main) → **H Bars** (side).
3. Use the general purpose knob to align the selected cursor (solid line) to the top (or to any amplitude on the waveform you choose).
4. Press **SELECT** to select the other cursor. Use the general purpose knob to align the selected cursor to the bottom (or to any amplitude on the waveform you choose).
5. Read the amplitude between the two cursors from the **Δ**: readout. Read the amplitude of the selected cursor relative to either $1 V_{RMS}$ (0 dB), ground (0 volts), or the zero phase level (0 degrees or 0 radians) from the **@**: readout. (The waveform reference indicator at the left side of the graticule indicates the level where phase is zero for phase FFTs.)

Figure 3-18 shows the cursor measurement of a frequency magnitude on an FFT. The @: readout reads 0 dB because it is aligned with the 1 V_{RMS} level. The Δ : readout reads 24.4 dB indicating the magnitude of the frequency it is measuring is -24.4 dB relative to 1 V_{RMS} . The source waveform is turned off in the display.

The cursor units will be in dB or volts for FFTs measuring magnitude and in degrees or radians for those FFTs measuring phase. The cursor unit depends on the selection made for **Set FFT Vert Scale to** (side). See step 7 on page 3–29 for more information.

6. Press **V Bars** (side). Use the general purpose knob to align one of the two vertical cursors to a point of interest along the horizontal axis of the waveform.
7. Press **SELECT** to select the alternate cursor.
8. Align the selected cursor to another point of interest on the math waveform.
9. Read the frequency difference between the cursors from the Δ : readout. Read the frequency of the selected cursor relative to the zero frequency point from the @: readout.

The cursor units will always be in Hz, regardless of the setting in the **Time Units** side menu. The first point of the FFT record is the zero frequency point for the @: readout.

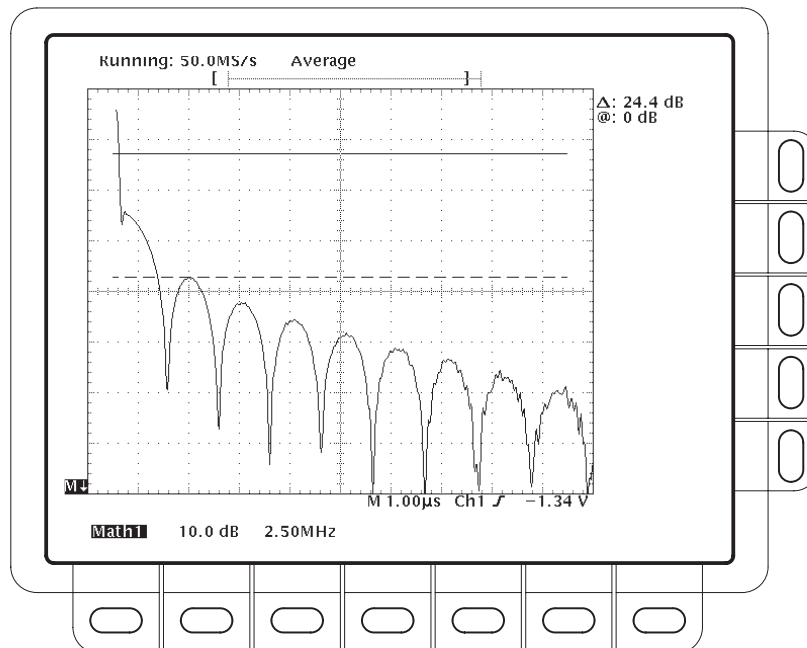

Figure 3-18: Cursor Measurement of an FFT Waveform

10. Press **Function** (main) → **Paired** (side).
11. Place the vertical bar of each paired cursor to the points along the horizontal axis you are interested in.
12. Read the amplitude between the X of the two paired cursors from the top-most **Δ**: readout. Read the amplitude of the short horizontal bar of the selected (solid) cursor relative to either 1 V_{RMS} (0 dB), ground (0 volts), or zero phase level (0 degrees or 0 radians) from the **@**: readout. Read the frequency between the long horizontal bars of both paired cursors from the bottom **Δ**: readout.

Automated Measurements of an FFT

You can also use automated measurements to measure FFT math waveforms. Use the same procedure as is found under *Waveform Differentiation* on page 3–132.

Considerations for Using FFTs

There are several characteristics of FFTs that affect how they are displayed and should be interpreted. Read the following topics to learn how to optimize the oscilloscope setup for good display of your FFT waveforms.

The FFT Frequency Domain Record

The following topics discuss the relation of the source waveform to the record length, frequency resolution, and frequency range of the FFT frequency domain record. (The FFT frequency domain waveform is the FFT math waveform that you display.)

FFTs May Not Use All of the Waveform Record. The *FFT math waveform* is a display of the magnitude or phase data from the *FFT frequency domain record*. This frequency domain record is derived from the FFT time domain record, which is derived from the *waveform record*. All three records are described below.

Waveform Record — the complete waveform record acquired from an input channel. The waveform record is not a DSP Math waveform.

FFT Time Domain Record — that part of the waveform record that is input to the FFT. This time domain record waveform becomes the FFT math waveform. Its record length depends on the length of the waveform record defined above.

FFT Frequency Domain Record — the FFT math waveform after digital signal processing converts the FFT time domain record into a frequency domain record.

Figure 3-19 compares the waveform record to the FFT time domain record.

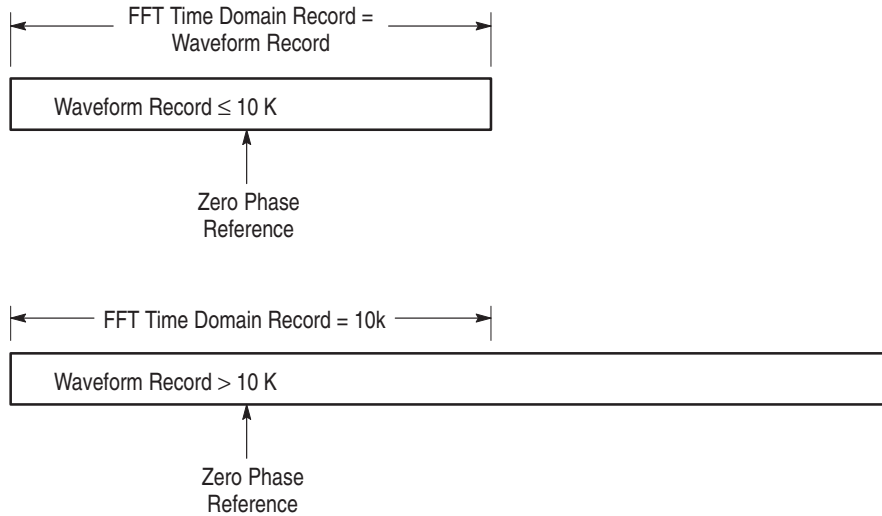

Figure 3-19: Waveform Record vs. FFT Time Domain Record

FFTs Transform Time Records to Frequency Records. The FFT time domain record is input for the FFT. The resulting record is one half the length of the FFT input (see Figure 3-20) because the FFT computes both positive and negative frequencies. Since the negative values mirror the positive values, only the positive values are displayed.

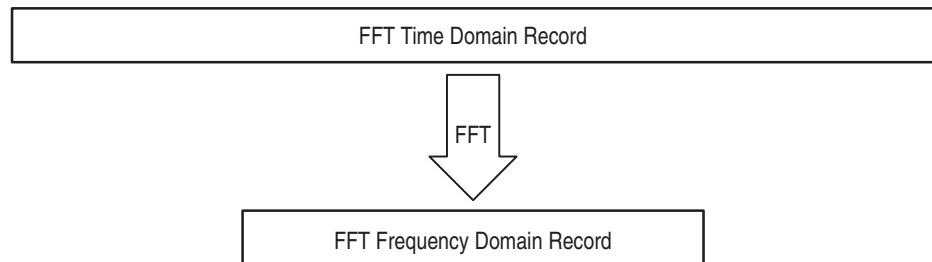

Figure 3-20: FFT Time Domain Record vs. FFT Frequency Domain Record

Offset, Position, and Scale

The following topics contain information to help you display your FFT properly.

Adjust for a Non-Clipped Display. To properly display your FFT waveform, scale the source waveform so it is not clipped:

- Scale and position the source waveform so it is contained on screen. (Off screen waveforms may be clipped, resulting in errors in the FFT waveform. If you use off screen waveforms, turn on **Pk-Pk** in the measurement menu and monitor the source waveform for clipping.)
- Use vertical position and vertical offset to position your *source* waveform. As long as the source waveform is not clipped, its vertical position and vertical offset will not affect your FFT waveform except at DC. (DC correction is discussed below.)

Adjust Offset and Position to Zero for DC Correction. Normally, the output of a standard FFT computation yields a DC value that is twice as large as it should be with respect to the other frequencies. Also, the selection of window type introduces errors in the DC value of an FFT.

The displayed output of the FFT on TDS oscilloscopes is corrected for these errors to show the true value for the DC component of the input signal. The **Position** and **Offset** must be set to zero for the source waveform in the Vertical menu. When measuring the amplitude at DC, remember that 1 VDC equals 1 V_{RMS} and the display is in dB.

Record Length

Most often, you will want to use a short record length because more of the FFT waveform can be seen on screen and long record lengths can slow oscilloscope response. However, long record lengths lower the noise relative to the signal and increase the frequency resolution for the FFT. More important, they might be needed to capture the waveform feature you want to include in the FFT.

To speed up oscilloscope response when using long record lengths, you can save your source waveform in a reference memory and perform an FFT on the saved waveform. That way the DSP will compute the FFT based on saved, static data and will only update if you save a new waveform.

Acquisition Mode

Selecting the right acquisition mode can produce less noisy FFTs.

Set up in Sample or Normal Mode. Use sample mode until you have set up and turned on your FFT. Sample mode can acquire repetitive and nonrepetitive waveforms and does not affect the frequency response of the source waveform.

Hi Res and Average Reduce Noise. After the FFT is set up and displayed, it might be useful to turn on Hi Res mode, to reduce the effect of noise in the signal. However, Hi Res does affect the frequency response of the source waveform.

If the pulse is repetitive, Average mode may be used to reduce noise in the signal at a cost of slower display response. However, averaging does affect the frequency response of the source waveform.

Do not use Peak Detect and Envelope mode. They can add significant distortion to the FFT results.

Zoom and Interpolation

Once you have your waveform displayed optimally, you may magnify (or reduce) it vertically and horizontally to inspect any feature you desire. Just be sure the FFT waveform is the selected waveform. Depending upon the record length, FFT math waveforms may be zoomed or not.

Sin(x)/x interpolation may distort the magnitude and phase displays of the FFT depending on which window was used. You can easily check the effects of the interpolation by switching between sin(x)/x and linear interpolation and observing the difference in measurement results on the display. If significant differences occur, use linear interpolation.

Undersampling (Aliasing)

Aliasing occurs when the oscilloscope acquires a source waveform with frequency components outside of the frequency range for the current sample rate. In the FFT waveform, the actual higher frequency components are under-sampled, and therefore, they appear as lower frequency aliases that “fold back” around the Nyquist point (see Figure 3-21).

The greatest frequency that can be input into any sampler without aliasing is $\frac{1}{2}$ the sample frequency. Since source waveforms often have a fundamental frequency that does not alias but have harmonic frequencies that do, use the following methods to recognize and deal with aliases:

- A source waveform with fast edge transition times creates many high frequency harmonics.
- Sample the source signal at rates that are at least 2X that of the highest frequency component having significant amplitude.
- Filter the input to bandwidth limit it to frequencies below that of the Nyquist frequency.
- Recognize and ignore the aliased frequencies.

If you think you have aliased frequencies in your FFT, select the source channel and adjust the horizontal scale to increase the sample rate. Since you increase the Nyquist frequency as you increase the sample rate, the alias signals should appear at their proper frequency.

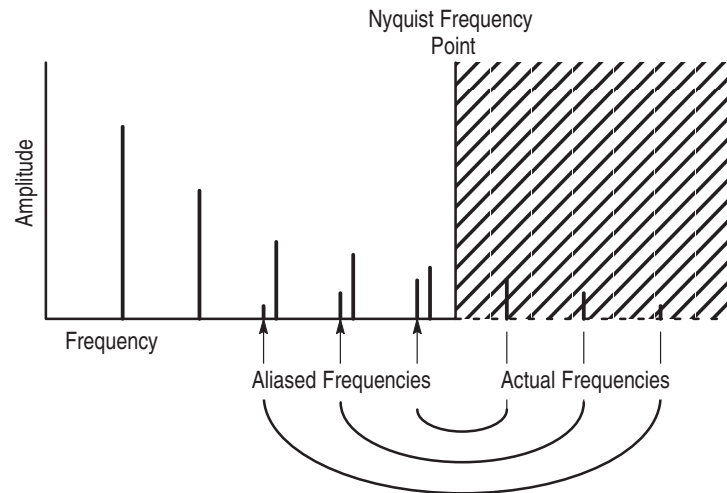

Figure 3-21: How Aliased Frequencies Appear in an FFT

Considerations for Phase Displays

When you set up an FFT math waveform to display the phase angle of the frequencies contained in a waveform, take into account the reference point the phase is measured against. You may also need to use phase suppression to reduce noise in your FFTs.

Establish a Zero Phase Reference Point. The phase of each frequency is measured with respect to the zero phase reference point. The zero reference point is the point at the center of the FFT math waveform but corresponds to various points on the *source* (time domain) record. (See Figure 3-19 on page 3–34.)

To measure the phase relative to most source waveforms, you need only to center the positive peak around the zero phase point. (For instance, center the positive half cycle for a sine or square wave around the zero phase point.) Use the following method:

- First be sure the FFT math waveform is selected in the More menu, then set horizontal position to 50% in the Horizontal menu. This positions the zero phase reference point to the horizontal center of the screen.
- In the Horizontal menu, vary the trigger position to center the positive peak of the source waveform at the horizontal center of screen. Alternately, you can adjust the trigger level (knob) to bring the positive peak to center screen if the phase reference waveform has slow enough edges.

When impulse testing and measuring phase, align the impulse input into the system to the zero reference point of the FFT time domain waveform:

- Set the trigger position to 50% and horizontal position to 50% for all record lengths less than 15 K.

- For records with a 15 K length, set the trigger position to 33%. Use the horizontal position knob to move the trigger T on screen to the center horizontal graticule line.
- For records with 30 K, 50 K, or 60 K lengths, set the trigger position to 16.6%, 10%, or 8.3%, respectively. Use the horizontal position knob to move the trigger T on screen and to the center horizontal graticule line.
- Trigger on the input impulse.

Adjust Phase Suppression. Your source waveform record may have a noise component with phase angles that randomly vary from $-\pi$ to π . This noise could make the phase display unusable. In such a case, use phase suppression to control the noise.

You specify the phase suppression level in dB with respect to $1 V_{\text{RMS}}$. If the magnitude of the frequency is greater than this threshold, then its phase angle will be displayed. However, if it is less than this threshold, then the phase angle will be set to zero and be displayed as zero degrees or radians. (The waveform reference indicator at the left side of the graticule indicates the level where phase is zero for phase FFTs.)

It is easier to determine the level of phase suppression you need if you first create a *frequency* FFT math waveform of the source and then create a *phase* FFT waveform of the same source. Do the following steps to use a cursor measurement to determine the suppression level:

1. Do steps 1 through 7 of *Operation* that begins on page 3–28. Select **dBV RMS** (side) for the **Set FFT Vert Scale to** (side).
2. Press **CURSOR** → **Mode** (main) → **Independent** (side) → **Function** (main) → **H Bars** (side). Use the general purpose knob to align the selected cursor to a level that places the tops of the magnitudes of frequencies of interest above the cursor but places other magnitudes completely below the cursor.
3. Read the level in dB from the @: readout. Note the level for use in step 5.
4. Press **MORE** (main) → **Change Waveform Definition menu** (side). Press **Set FFT Vert Scale to** (side) repeatedly to choose either **Phase (rad)** or **Phase (deg)**.
5. Press **Suppress Phase at Amplitudes** (side). Use the general purpose knob or keypad to set phase suppression to the value obtained using the H Bar cursor. Do not change the window selection or you will invalidate the results obtained using the cursor.

FFT Windows

To learn how to optimize your display of FFT data, read about how the FFT windows data before computing the FFT math waveform.

Windowing Process. The oscilloscope multiplies the FFT time domain record by one of four FFT windows before it inputs the record to the FFT function. Figure 3-22 shows how the time domain record is processed.

The FFT windowing acts like a bandpass filter between the FFT time domain record and the FFT frequency domain record. The shape of the window controls the ability of the FFT to resolve (separate) the frequencies and to accurately measure the amplitude of those frequencies.

Selecting a Window. You can select your window to provide better frequency resolution at the expense of better amplitude measurement accuracy in your FFT, better amplitude accuracy over frequency resolution, or to provide a compromise between both. You can choose from these four windows: Rectangular, Hamming, Hanning, and Blackman-Harris.

In step 8 (page 3–29) in *Operation*, the four windows are listed. In general, choose a window that can just resolve between the frequencies you want to measure. That way, you will have the best amplitude accuracy and leakage elimination while still separating the frequencies.

You can often determine the best window empirically by first using the window with the most frequency resolution (rectangular), and then proceeding toward that window with the least (Blackman-Harris) until the frequencies merge. Use the window just before the window that lets the frequencies merge for best compromise between resolution and amplitude accuracy.

NOTE. *If the Hanning window merges the frequencies, try the Hamming window before settling on the rectangular window. Depending on the distance of the frequencies you are trying to measure from the fundamental, the Hamming window sometimes resolves frequencies better than the Hanning.*

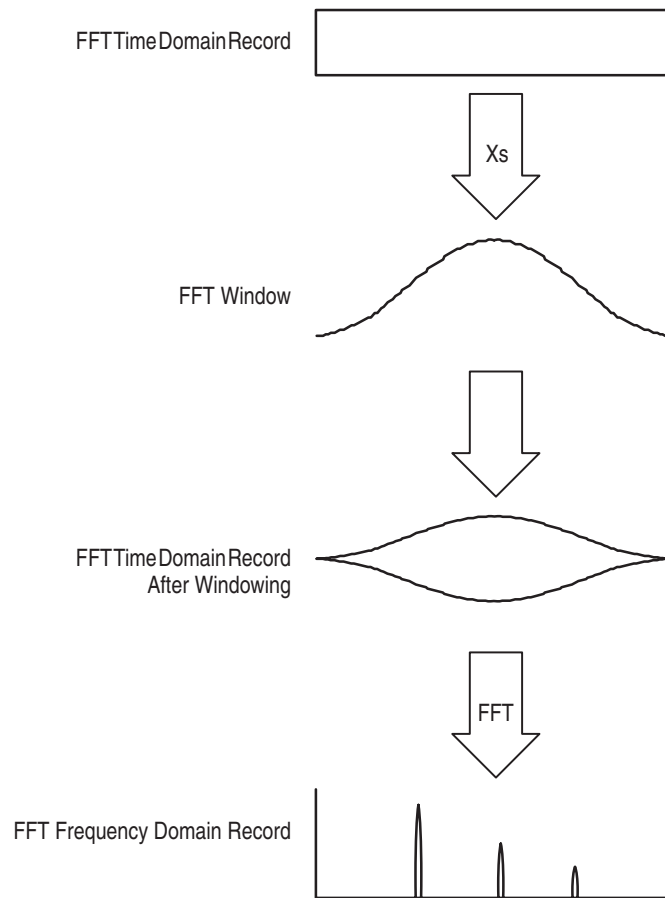

Figure 3-22: Windowing the FFT Time Domain Record

Window Characteristics. When evaluating a window for use, you may want to examine how it modifies the FFT time domain data. Figure 3-23 shows each window, its bandpass characteristic, bandwidth, and highest side lobe. Consider the following characteristics:

- The narrower the central lobe for a given window, the better it can resolve a frequency.
- The lower the lobes on the side of each central lobe are, the better the amplitude accuracy. The Hanning and Blackman/Harris windows taper the data at the end of the record to zero.
- Narrow lobes increase frequency resolution because they are more selective. Lower side lobe amplitudes increases accuracy because they reduce leakage.

When using bell shaped widows, be sure that the most interesting parts of the signal in the time domain record are positioned in the center region of the window so that the tapering does not cause severe errors.





FFT Window Type	Bandpass Filter	-3 dB Bandwidth	Highest Side Lobe
 Rectangular Window		0.89	-13 dB
 Hamming Window		1.28	-43 dB
 Hanning Window		1.28	-32 dB
 Blackman-Harris Window		1.28	-94 dB

Figure 3-23: FFT Windows and Bandpass Characteristics

File System

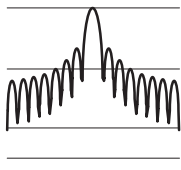
The file system provides file utilities and a floppy disk drive for saving hardcopies, setups, and waveforms. This section describes how to manage (delete, rename, and so forth) these files using the file system.

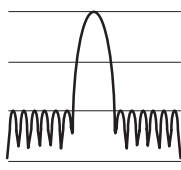
To Access the File Utilities

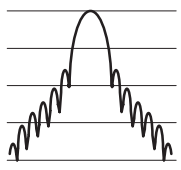
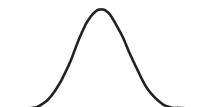
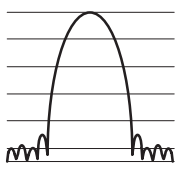
To bring up the File Utilities menu:

1. Press the **SETUP** button to bring up the Save/Recall Setup menu, or press the **WAVEFORM** button to bring up the Save/Recall Waveform menu, or press the **Shift HARDCOPY** button to bring up the Hardcopy menu.
2. Press **File Utilities** in the main menu to bring up the File Utilities side menu. (See Figure 3-24.)

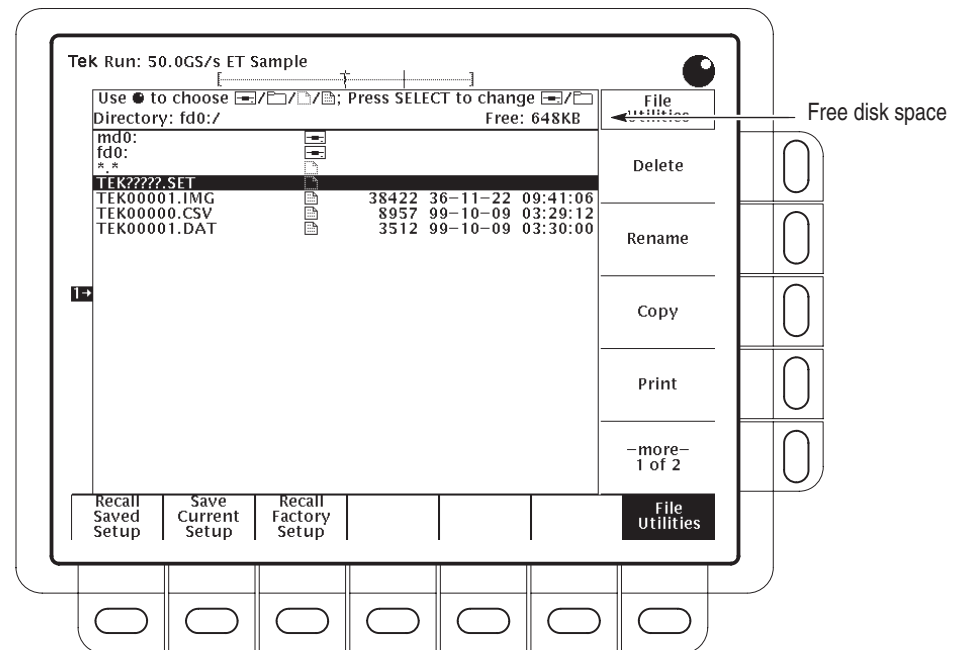

Figure 3-24: File Utilities

To Delete a File or Directory

To delete a file or directory, turn the general purpose knob until it scrolls the cursor over the name of the file or directory to delete. Then, press the side menu **Delete** button.

To delete all files in the file list, set the cursor to the *.* selection.

The digitizing oscilloscope deletes a directory and all its contents.

To Rename a File or Directory

To rename a file or directory, turn the general purpose knob until it scrolls the cursor over the name of the file or directory to delete. For example, to rename the target file whose default name is TEK????? set the cursor over its name. Then, press the side menu **Rename** button.

The labelling menu should appear. Turn the general purpose knob or use the main-menu arrow keys to select each letter. Press **Enter Char** from the main menu to enter each letter. When you have entered the name, press the side menu **OK Accept** item. (See Figure 3-25).

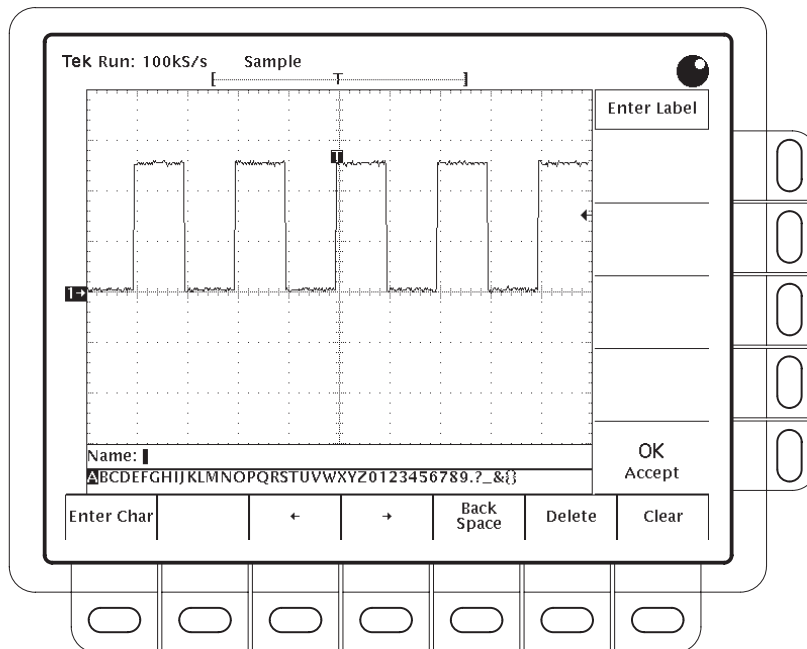

Figure 3-25: File System — Labelling Menu

To Copy a File or Directory

To copy a file or directory, turn the general purpose knob until it scrolls the cursor over the name of the file to copy. Then, press the side menu **Copy** button. The file menu reappears with the names of directories to copy to. Select a directory and press the side-menu button labelled **Copy <name> to Selected Directory**.

To copy all files, select the *.* entry.

The digitizing oscilloscope copies a directory and all its contents.

To Print a File or Directory

To print a file, turn the general purpose knob until it scrolls the cursor over the name of the file to print. Then, press the side-menu **Print** button.

The Print-To side menu should appear. Select the port to print to from **GPIB**, **RS-232**, or **Centronics**. (See Figure 3-25.) Then the digitizing oscilloscope sends the file in its raw form out the port.

To Create a Directory

To create a new directory, press the side menu **Create Directory** button.

The labelling menu appears. Turn the general purpose knob or use the main-menu arrow keys to select each letter. Press **Enter Char** from the main menu to enter each letter. When you have entered the name, press the side menu **OK Accept** item. (See Figure 3-25.)

To Set Confirm Delete

To turn on or off the confirm delete message, toggle the side menu **Confirm Delete** button.

When the confirm delete option is OFF, the digitizing oscilloscope immediately deletes files or directories. When the confirm option is ON, the digitizing oscilloscope warns you before it deletes files and gives you a chance to reconsider.

To Set Overwrite Lock

To turn on or off the file overwrite lock, toggle the side menu **Overwrite Lock** button.

When overwrite lock is on, the digitizing oscilloscope will not permit you to write over an existing file of the same name. An important reason to allow overwriting is to let you write files using a target file name that contains wild card characters (“?”). This means the digitizing oscilloscope creates sequential files whose names are similar except for the sequential numbers that go in the real name in the place of the question marks.

To Format a Disk

To format a 720 Kbyte or 1.44 Mbyte disk, turn the general purpose knob until it scrolls the cursor over the name of the drive to format (**fd0:**). Then, press the side menu **Format** button.

Hardcopy

You can get a copy of the digitizing oscilloscope display by using the hardcopy feature. This section lists hardcopy formats and describes how to setup and execute a hardcopy.

Supported Formats

Different hardcopy devices use different formats. The digitizing oscilloscope supports the following formats:

- HP Thinkjet inkjet printer
- HP Deskjet inkjet printer
- HP Laserjet laser printer
- Seiko DPU 411/412 portable thermal printer
- HPGL Color Plot
- Epson®
- Interleaf®
- Tag Image File Format (TIFF®)
- PC Paintbrush® (PCX®)
- Microsoft Windows® file format (BMP®)
- Encapsulated Postscript® (Image, Mono Plot, and Color Plot)

Some formats, particularly Interleaf, Postscript, TIFF, PCX, BMP, and HPGL, are compatible with various desktop publishing packages. You can paste files created from the oscilloscope directly into a document when using any of those desktop publishing systems.

EPS Mono and Color formats are compatible with the Tektronix Phaser Color Printer, HPGL is compatible with the Tektronix HC100 Plotter, and Epson is compatible with the Tektronix HC200 Printer.

To Set Up for Making Hardcopies

Before you make a hardcopy, you need to set up communications and hardcopy parameters. This discussion assumes that the hardcopy device is already connected to the GPIB port on the rear panel.

To Set Communication Parameters

To set up the communication parameters to talk to a printer attached directly to the oscilloscope GPIB port:

1. Press **SHIFT UTILITY** → **System** (main) → **I/O** (pop-up) → **Configure** (main) (see Figure 3-26).
2. Press **Hardcopy (Talk Only)** (side).

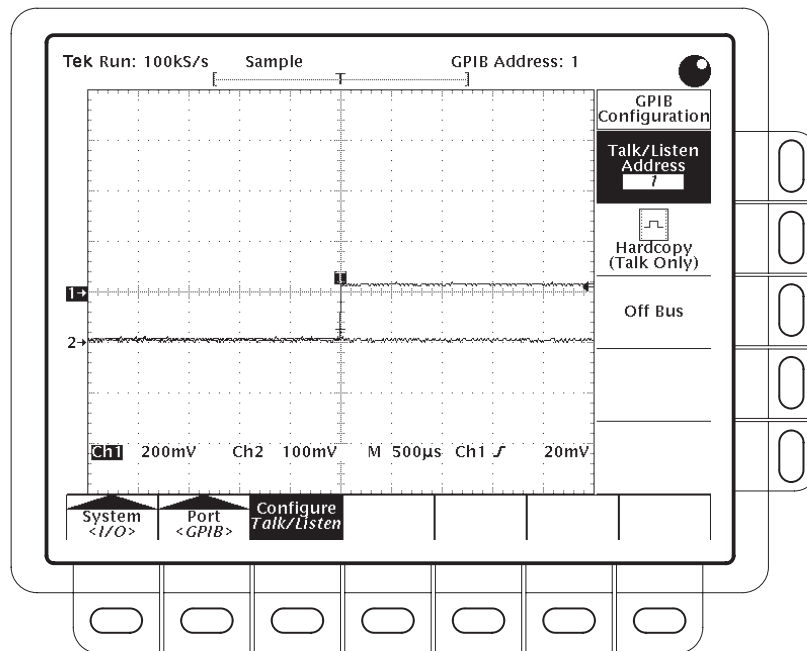

Figure 3-26: Utility Menu — System I/O

To Set Hardcopy Parameters

To specify the hardcopy format, layout, and type of hardcopy port:

1. Press **SHIFT HARDCOPY MENU**.
2. Press **Format** (main) → **Thinkjet, Deskjet, Laserjet, Epson, DPU-411, DPU-412, PCX, TIFF, BMP, EPS Image, EPS Mono, EPS Color** (EPS stands for Encapsulated Postscript), **Interleaf, or HPGL** (side). (Press **-more-** (side) to see all of these format choices.)
3. Press **SHIFT HARDCOPY MENU** → **Layout** (main) → **Landscape** or **Portrait** (side).
4. Press **SHIFT HARDCOPY MENU** → **Port** (main) to specify the output channel to send your hardcopy through. Select one of the optional hardcopy ports: **GPIB, RS-232, Centronics, or File**.

To Date/Time Stamp Your Hardcopy

To date and time stamp your hardcopy, do the following steps:

1. Press **DISPLAY** → **Readout Options** (main) → **Display Date and Time** (side) to toggle the setting to **On**.
2. If the date and time are not set, a message instructing you to do so is displayed. If that is the case, skip steps 3 and 4 and continue with step 1 of *To Set the Date and Time* below. Then redo this procedure.
3. Press **Clear Menu** to remove the menu from the display so the date and time can be displayed. See Figure 3-27. (The date and time is removed from the display when menus are displayed.)
4. Press **HARDCOPY** to print your date/time stamped hardcopy.

To Set the Date and Time

If you need to set the date and time of the oscilloscope, do the following steps:

1. Press **SHIFT UTILITY** → **Config** (pop-up) → **Set Date & Time** (main) → **Year, Day Month, Hour, or Minute**.

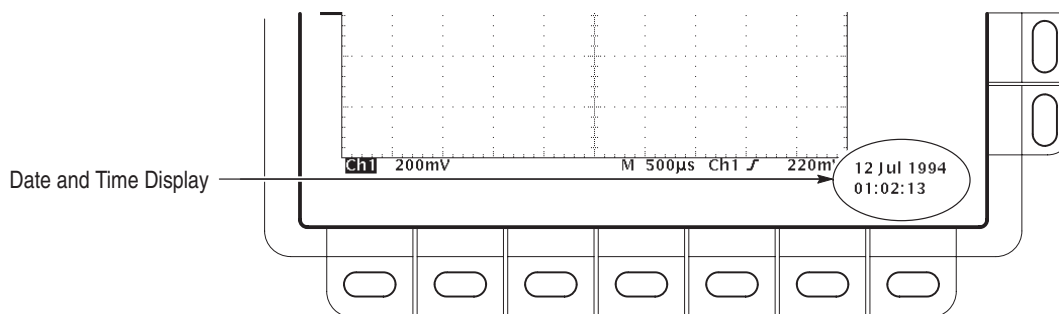

Figure 3-27: Date and Time Display

2. Use the general purpose knob to set the parameter you have chosen to the value desired.
3. Repeat steps 1 and 2 to set other parameters as desired.
4. Press **OK Enter Date/Time** (side) to put the new settings into effect. This sets the seconds to zero.
5. Press **CLEAR MENU** to see the date/time displayed with the new settings.

To Print Directly to a Hardcopy Device

To make your hardcopies, use the procedures that follow.

Connect to a Hardcopy Device. To connect the digitizing oscilloscope directly to a hardcopy device, determine which interface and cable the device uses, and connect accordingly. (See Figure 3-28.)

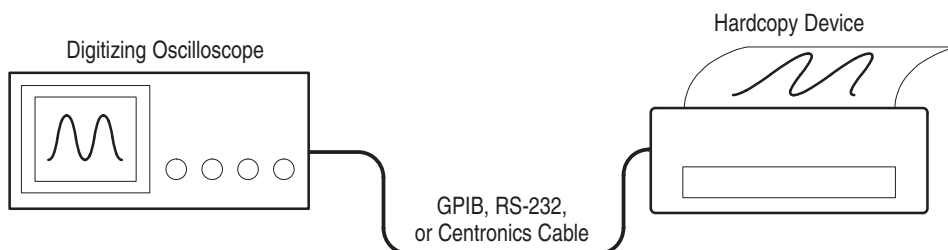

Figure 3-28: Connecting the Digitizing Oscilloscope Directly to the Hardcopy Device

Print. To print a single hardcopy or send additional hardcopies to the digitizing oscilloscope spool (queue) while waiting for earlier hardcopies to finish printing, press **HARDCOPY**.

Abort. To stop and discard the hardcopy being sent, press **HARDCOPY** again *while* the hardcopy in process message is still on screen.

Add to the Spool. To add additional hardcopies to the printer spool, press **HARDCOPY** again *after* the hardcopy in process message is removed from the screen.

You can add hardcopies to the spool until it is full. When the spool is filled by adding a hardcopy, the message “Hardcopy in Process — Press **HARDCOPY** to abort” remains displayed. When the printer empties enough of the spool to finish adding the last hardcopy it does so and then removes the message.

Clear the Spool. To remove all hardcopies from the spool, press **SHIFT → HARDCOPY MENU → Clear Spool (main) → OK Confirm Clear Spool (side)**.

The oscilloscope takes advantage of unused RAM when spooling hardcopies. The size of the spool is, therefore, variable. The number of hardcopies that can be spooled depends on three variables:

- The amount of unused RAM
- The hardcopy format chosen
- The complexity of the display

To Save to a Floppy Disk

To send hardcopies to a floppy disk (see File System on page 3–43), do the following steps:

1. Set up the digitizing oscilloscope communication and hardware parameters as outlined in *To Set Up for Making Hardcopies* on page 3–47.
2. Insert a formatted 720 Kbyte or 1.44 Mbyte floppy disk into the disk slot of the digitizing oscilloscope.

NOTE. See page 3–43 for information on formatting disks, deleting and renaming files, setting overwrite lock, and using wild card characters.

3. Press **SHIFT** → **HARDCOPY MENU** → **Port** (main) → **File** (side) to specify that any hardcopy will be output to a file on the floppy drive. The file list and its scrollbar will appear.
4. Turn the general purpose knob to place the scroll bar over the file in which to store the hardcopy.

NOTE. Upon power on, the digitizing oscilloscope creates the “wild card” file TEK?????.FMT for storing hardcopies, where “.FMT” is replaced by the hardcopy format you select. Selecting this file and pressing **Hardcopy** stores a hardcopy in a uniquely named, sequentially numbered file. For instance, the digitizing oscilloscope saves the first hardcopy you save to the file TEK00001.FMT, the second to TEK00002.FMT, and so on.

5. Display what you want on your hardcopy.
6. Press **HARDCOPY** to print your hardcopy to the selected file.

To Print Using a Controller

To make your hardcopies, use the procedures that follow.

Connect to a Hardcopy Device. To connect to a controller with two ports between the digitizing oscilloscope and the hardcopy device, connect from the digitizing oscilloscope GPIB connector (rear panel) to the controller GPIB port and from the controller RS-232 or Centronics port to the hardcopy device (see Figure 3-29). Use the GPIB port to remotely request and receive a hardcopy from the digitizing oscilloscope. Use the RS-232 or a Centronics port on the controller to print output.

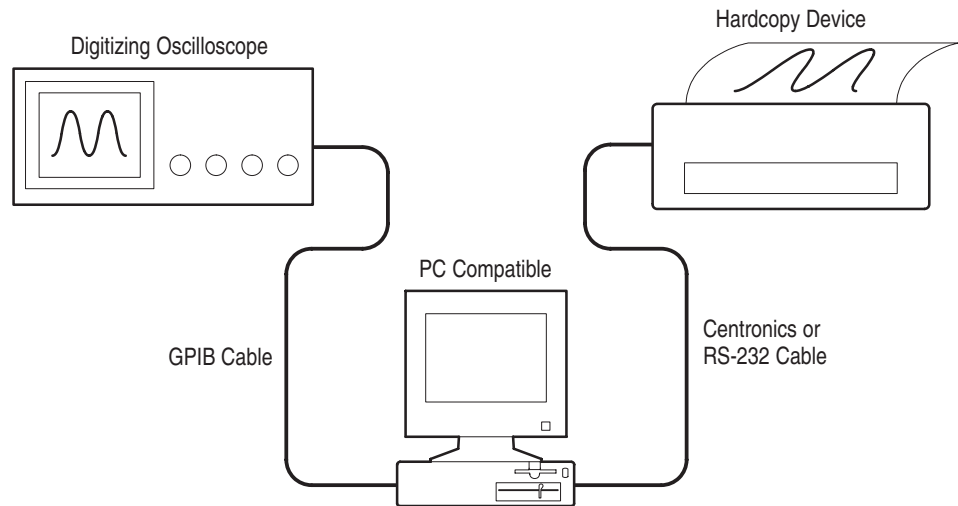

Figure 3-29: Connecting the Digitizing Oscilloscope and Hardcopy Device Via a PC

Print. If your controller is PC-compatible and it uses the Tektronix GURU or S3FG210 (National Instruments GPIB-PCII/IIA) GPIB package, do the following steps to print a hardcopy:

1. Use the MS-DOS *cd* command to move to the directory that holds the software that came with your GPIB board. For example, if you installed the software in the GPIB-PC directory, type: **cd GPIB-PC**
2. Run the IBIC program that came with your GPIB board. Type: **IBIC**
3. Type: **IBFIND DEV1** where “DEV1” is the name for the digitizing oscilloscope you defined using the IBCONF.EXE program that came with the GPIB board.

NOTE. If you defined another name, use it instead of “DEV1”. Also, remember that the device address of the digitizing oscilloscope as set with the IBCONF.EXE program should match the address set in the digitizing oscilloscope Utility menu (typically, use “1”).

Making hardcopies using some hardcopy formats may generate a time-out on your controller. If a time-out occurs, increase the time-out setting of your controller software.

4. Type: **IBWRT “HARDCOPY START”**.

NOTE. Be sure the digitizing oscilloscope Utility menu is set to *Talk/Listen* and not *Hardcopy (Talk Only)* or you will get an error message at this step. Setting the digitizing oscilloscope Utility menu was described in *To Set Up for Making Hardcopies* on page 3–47.

5. Type: **IBRDF <Filename>** where <Filename> is a valid DOS file name you want to call your hardcopy information. It should be ≤8 characters long with up to a 3 character extension. For example, you could type “*ibrdf screen1*”.
6. Exit the IBIC program by typing: **EXIT**
7. Copy the data from your file to your hardcopy device. Type:
**COPY <Filename> <Output port> ** where:

<Filename> is the name you defined in step 5.

<Output port> is the PC output port your hardcopy device is connected to (such as LPT1 or LPT2).

For example, to copy (print) a file called *screen1* to a printer attached to the *lpt1* parallel port, type “*copy screen1 lpt1: /B*”.

Your hardcopy device should now print a picture of the digitizing oscilloscope screen.

NOTE. If you transmit hardcopy files across a computer network, use a binary (8-bit) data path.

Horizontal Control

You can control the horizontal part of the display (the time base) using the horizontal menu and knobs. This section describes how to use the horizontal controls and menus.

To Check the Horizontal Status

Check the *Record View* to determine the size and location of the waveform record and the location of the trigger relative to the display. (See Figure 3-30.) Check the *Time Base readout* to see the time/division settings and the time base (main or delayed) being referred to. (See Figure 3-30.) Since all live waveforms use the same time base, the digitizing oscilloscope only displays one value for all the active channels.

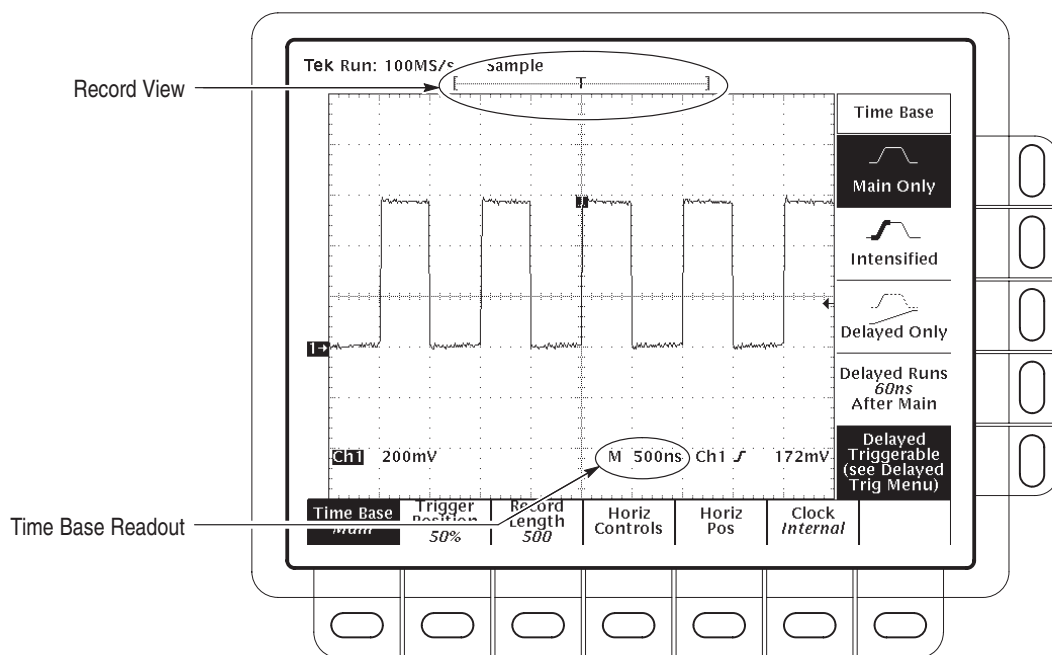

Figure 3-30: Record View and Time Base Readouts

To Change Horizontal Scale and Position

The Digitizing Oscilloscope provides control of horizontal position and scale using either the horizontal front panel knobs or the horizontal menu. This section describes how to use both the knobs and the menu to adjust your waveforms.

By changing the horizontal scale, you can focus on a particular portion of a waveform. By adjusting the horizontal position, you can move the waveform right or left to see different portions of the waveform.

NOTE. *If external clock (TDS 400A only) is enabled and zoom is disabled, the horizontal scale is set to 50 c (indicating 50 clocks per division) and the Horizontal SCALE knob has no effect.*

To change the horizontal scale and position:

1. Turn the horizontal **SCALE** and horizontal **POSITION** knobs (see Figure 3-31).
2. If you want the POSITION knob to move faster, press the SHIFT button.

When you use the horizontal SCALE knob and select a channel, you scale all channel waveforms displayed at the same time. If you select a math or reference waveform, you scale only the selected waveform.

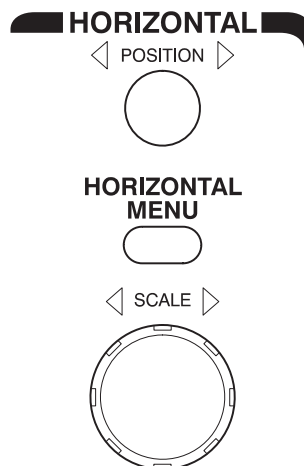

Figure 3-31: Horizontal Controls

When you use the horizontal POSITION knob and select a channel, you position all channel, reference, and math waveforms displayed at the same time *when* Horizontal Lock is set to All in the Zoom menu. For more information on zoom see page 3-143.

To Change Horizontal Parameters

To set the record length, set the trigger position, and change the position or scale, use the *Horizontal menu*. The Horizontal menu also lets you select either a main or delayed view of the time base for acquisitions.

Trigger Position

To define how much of the record is pretrigger and how much posttrigger information, use the Trigger Position menu:

Press **HORIZONTAL MENU** → **Trigger Position** (main) → **Set to 10%**, **Set to 50%**, or **Set to 90%** (side), or press **Pretrigger** (side) and use the general purpose knob to change the value.

Record Length

The number of points that make up the waveform record is defined by the record length. To set the waveform record length:

1. press **HORIZONTAL MENU** → **Record Length** (main). The side menu lists various discrete record length choices.
2. To fit all (or most) of an acquired waveform to the visible screen, regardless of record length, press **HORIZONTAL MENU** → **Record Length** (main). Then toggle **Fit to Screen** to **ON** from the side menu. This provides similar functionality to being in zoom mode and changing the time/division until the waveform fits the screen. To turn off this feature, toggle **Fit to Screen** to **OFF**.

NOTE. *With Option 1M (TDS 400A only), there are only 120K points available for reference waveforms. If you select the 120K record length in the Horizontal menu, you can only save one reference waveform. Also, you can only use/display four waveforms. Even if you do not display the source waveforms, dual waveform math uses three of the four waveforms. For example: if you display a math waveform that is the sum of CH 1 and CH 2, even if CH 1 and CH 2 are not displayed, you have used three waveforms. Therefore, you can only display one additional waveform.*

Horizontal Scale

To change the horizontal scale (time per division) numerically in the menu instead of using the Horizontal SCALE knob:

NOTE. *If external clock (TDS 400A only) is enabled and zoom is disabled, the Horizontal SCALE knob has no effect and both the Horizontal Main Scale and Delayed Scale are the same (50 c). If zoom is enabled, you can change the displayed scale, but the Delayed Scale is locked to the Main Scale.*

Press **HORIZONTAL MENU** → **Horiz Controls** (main) → **Main Scale** or **Delayed Scale** (side) and use the general purpose knob to change the scale values.

Aliasing

When a waveform aliases, it appears on screen with a frequency lower than the actual waveform being input or it appears unstable even though the light next to TRIG'D is illuminated. Aliasing occurs because the oscilloscope is not sampling the signal fast enough to construct an accurate waveform record (see Figure 3-32).

In order to represent a signal accurately and avoid aliasing, you must sample the signal more than twice as fast as the highest frequency component. For example, a signal with frequency components of 400 MHz would need to be sampled at a rate faster than 800 Megasamples/second.

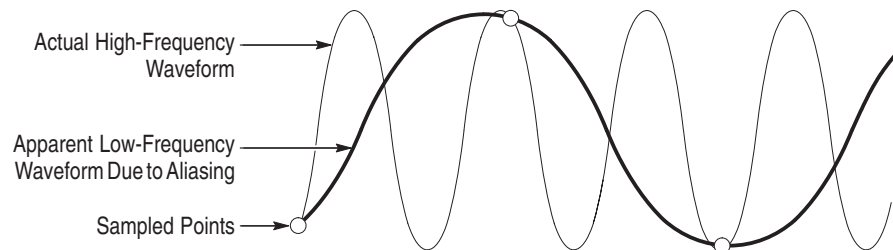

Figure 3-32: Aliasing

One simple way to check for aliasing is to slowly change the horizontal scale (time per division setting). If the shape of the displayed waveform changes drastically, you may have aliasing.

There are various ways to prevent aliasing. Try adjusting the horizontal scale, or simply press the **AUTOSET** button. You can also counteract some aliasing by changing the acquisition mode. For example, if you are using the sample mode and suspect aliasing, you may want to change to the peak detect mode. Since the peak detect mode searches for samples with the highest and lowest values, it can detect faster signal components over time.

NOTE. On a TDS 400A, when you set the Horizontal SCALE to 50 ms or slower and the Roll Mode Status is Automatic or if the horizontal Clock menu is set to External and the maximum external sample rate is set to 1 kc per second maximum or less, the oscilloscope enters Roll mode. You can read about Roll mode beginning on page 3–99.

Roll Mode (TDS 400A Only)

You can turn Roll Mode off or allow roll mode to turn on and off automatically (see *Roll Mode* on page 3–99 for more information):

Horizontal Position

To set the horizontal position to specific values in the menu instead of using the Horizontal POSITION knob:

Press **HORIZONTAL MENU** → **Horiz Pos** (main) → **Set to 10%**, **Set to 50%** or **Set to 90%** (side) to choose how much of the waveform is displayed to the left of the display center.

You can also control whether changing the horizontal position setting affects all displayed waveforms, just the live waveforms, or only the selected waveform. See *Zoom*, on page 3–143 for the steps to set the horizontal lock feature.

To Select the Delayed Time Base

To select between the Main and Delayed views of the time base:

Press **HORIZONTAL MENU** → **Time Base** (main) → **Main Only**, **Intensified**, or **Delayed Only** (side).

NOTE. If external clock is enabled, selecting *Intensified* intensifies the entire time base.

By pressing *Intensified*, you display an intensified zone that shows where the delayed trigger record length could occur relative to the main trigger.

You also can select *Delayed Runs After Main* or *Delayed Triggerable*. For more information on the delayed trigger, see *Delayed Triggering* on page 3–11.

Horizontal Clock (TDS 400A only)

To change the horizontal clock:

Press **HORIZONTAL MENU** → **Clock** (main) → **Internal** or **External** (side) and use the general purpose knob to change the scale values.

NOTE. When you select External clock (TDS 400A only) the unzoomed horizontal scale changes to 50 c (indicating 50 clocks per division). When using Option 2F, external clock, and cursors to measure frequency, the displayed frequency is normalized to the external Clock frequency. To calculate the actual frequency, multiply the displayed frequency by the external clock frequency divided by Hertz. For example: if the displayed cursor frequency is 500 Hz and the external clock frequency is 2 kHz:

$$500 \text{ Hz} \times \frac{2 \text{ kHz}}{\text{Hz}} = 1.0 \text{ MHz}$$

To Acquire a waveform Using an External Clock (TDS 400A Only)

A disk drive, turbine, and a punch press all have parts that move or turn. Their behavior is often best observed using an external Clock. By using a Tachometer or a Optical Encoder, you can precisely convert the revolution or travel of the systems into electric pulses. By using an external clock, you can see the angle or position at which events occur. As the system speed changes, the display shows each event at the same position on the screen; the displayed waveform will not stretch or compress with system speed changes, as it would using the internal clock.

In external clock mode, you can still trigger the oscilloscope to cause the acquired waveforms to lock to a certain position of an encoder which is providing the external clock. For example, some encoders provide a trigger out signal. Another example of a signal that you could use as a trigger is the sector 0 signal in a computer hard disk; observing the acquired waveform, the trigger T shows where in the record the hard disk returns to sector 0.

To acquire a waveform using an external clock:

1. Press **HORIZONTAL MENU** → **Clock** (main) → **External** (side) and, if in Hi Res mode, use the general purpose knob to set the maximum external clock frequency.

NOTE. In Hi Res mode the frequency of the external clock signal must be less than or equal to the frequency set in the external clock side menu. If the frequency of the external clock signal is greater than the frequency set in the side menu, the displayed waveform will have the wrong amplitude and often the wrong shape. Hi Res mode increases resolution and limits bandwidth (see Table 3-1 on page 3-6). As the Max Ext Clk rate is reduced, resolution increases and bandwidth decreases.



CAUTION. To prevent damage to the external clock and external trigger circuitry, do not exceed the input voltage rating of the **EXT CLOCK/AUX TRIGGER** input (see Auxiliary Trigger Input, External Clock Input in your Performance Verification manual).

2. Connect your TTL-like external clock signal to the **EXT CLOCK/AUX TRIGGER** BNC at the rear of the oscilloscope. If your EXT CLK source can drive 50Ω to TTL levels, use a 50Ω terminator. Before connecting your external clock signal, make certain the signal has TTL levels and a 30 μs or faster falling edge. (In External Clock mode, sampling occurs on the falling edge of the clock.)
3. Connect the signals you wish to acquire to the input channels.

NOTE. If you set the maximum clock frequency to 1 kHz, do not connect an external clock with a frequency greater than 1 kHz. If you do, you may need to remove the external clock signal and turn the oscilloscope power off and then on.

4. To bring up the Edge Trigger menu and select which source you want for the trigger, press **TRIGGER MENU** → **Type** (main) → **Edge** (pop-up) → **Source** (main) → **Ch1, Ch2, Ch3, Ch4, AC Line**, or **Auxiliary** (side), and then press **SET LEVEL TO 50%**.
5. Set all other oscilloscope controls (the horizontal **SCALE** has no effect except in **ZOOM**) as you would for an internally clocked acquisition.

Limit Testing

Limit testing automatically compares each incoming or math (TDS 510A only) waveform against a template waveform. You set an envelope of limits around a waveform and let the digitizing oscilloscope find waveforms that fall outside those limits (see Figure 3-33). When it finds such a waveform, the digitizing oscilloscope can generate a hardcopy, ring a bell, stop and wait for your input, or any combination of these actions. This section describes how to use limit testing.

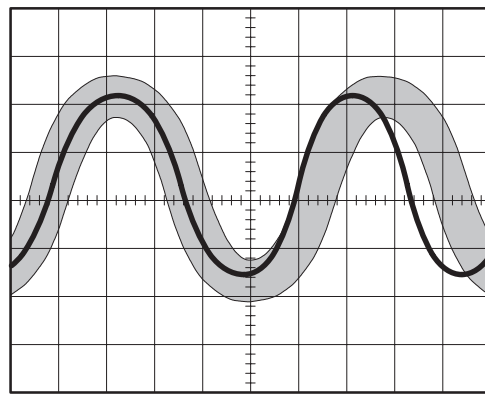

Figure 3-33: Comparing a Waveform to a Limit Template

To Create a Limit Test Template

To use an incoming or stored waveform to create the limit test template, first select a source:

1. To access limit testing, press **SHIFT ACQUIRE MENU** to bring up the Acquire menu.
2. Press **Create Limit Test Template** (main) → **Template Source** (side) → **Ch1, Ch2, Ch3, Ch4, Math1, Math2, Math3, Ref1, Ref2, Ref3, or Ref4** (side).

NOTE. *The template will be smoother if you acquire the template waveform using Average acquisition mode.*

Once you have selected a source, select a destination for the template.

3. Press **Template Destination** (side) → **Ref1, Ref2, Ref3, or Ref4**.

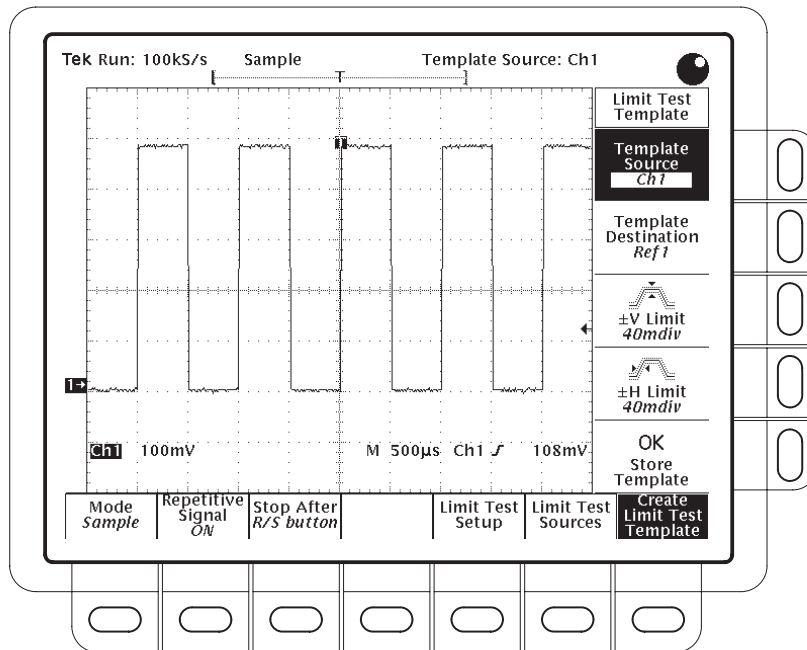

Figure 3-34: Acquire Menu — Create Limit Test Template

Now create the envelope by specifying the amount of variation from the template that you will tolerate. Tolerance values are expressed in fractions of a major division. They represent the amount by which incoming waveform data can deviate without having exceeded the limits set in the limit test.

4. Press **±V Limit** (side). Enter the vertical (voltage) tolerance value.
5. Press **±H Limit** (side). Enter the horizontal (time) tolerance value.
6. When you have specified the limit test template as you wish, press **OK Store Template** (side). This action creates the template waveform.

To view the template you created, press the **MORE** button. Then press the button corresponding to the destination reference memory you used.

NOTE. When *Limit Testing* is on, the template waveform is dimmed so you can see the waveform through the template. When *limit testing* is off, use the *Dots display style* (see *Display Modes* on page 3–17).

To Select a Limit Test Source

To specify the channel that will acquire the waveforms to be compared against the template:

1. Press **SHIFT ACQUIRE MENU** → **Limit Test Sources** (main) → **Compare Ch1 to**, **Compare Ch2 to**, **Compare Ch3 to**, or **Compare Ch4 to** (side). On the TDS 510A you may also select **Compare Math1 to**, **Compare Math2 to**, or **Compare Math3 to** (side).
2. Once you select one of the channels as a waveform source from the side menu, press the same side menu button to toggle to the reference memory in which you stored the template.

Choosing **None** turns limit testing off for the specified channel.

To Specify the Limit Test Response

To specify the action to take if waveform data exceeds the limits set by the limit test template:

1. Press **SHIFT ACQUIRE MENU** → **Limit Test Setup** (main) to bring up a side menu of possible actions.
2. Ensure that the side button corresponding to the desired action reads **ON**:
 - To send a hardcopy command when waveform data exceeds the limits set, toggle **Hardcopy if Condition Met** (side) to **ON**. (Do not forget to set up the hardcopy system. See *Hardcopy* on page 3–47 for details.)
 - To ring the bell when waveform data exceeds the limits set, toggle **Ring Bell if Condition Met** (side) to **ON**.
 - To stop the digitizing oscilloscope when waveform data exceeds the limits set, toggle **Stop After Limit Test Condition Met** (side) to **ON**.

NOTE. The button labeled *Stop After Limit Test Condition Met* corresponds to the *Limit Test Condition Met* menu item in the *Stop After* main menu. You can turn this button on in the *Limit Test Setup* menu, but you cannot turn it off. In order to turn it off, press **Stop After** and specify one of the other choices in the *Stop After* side menu.

To turn limit testing on:

3. Press **Limit Test** (side) to toggle it to **ON**.

Single Waveform Comparisons

When making a single waveform versus a single template comparison, consider the following operating characteristics:

- The waveform is repositioned horizontally to move the first sample in the waveform record that is outside of template limits to center screen.

- The position of the waveform template tracks that of the waveform.

Multiple Waveform Comparisons

When comparing multiple waveforms, consider the following operating characteristics:

- Set Horizontal Lock to None in the Zoom side menu (push **ZOOM** and toggle **Horizontal Lock to None**).
- With horizontal lock set as just described, the oscilloscope repositions each waveform horizontally to move the first sample in the waveform record that is outside of template limits to center screen.
- If you are comparing each waveform to its own template, the position of each waveform template tracks that of its waveform.
- If you are comparing two or more waveforms to a common template, the template tracks the position of the failed waveform. If more than one waveform fails *during the same acquisition*, the template tracks the position of the waveform in the highest numbered channel. For example, CH 2 is higher than CH 1.

Logic Triggering (TDS 510A Only)

There are two classes of logic triggering: pattern and state.

A *pattern* trigger occurs when the logic inputs to the logic function you select cause the function to become TRUE (or at your option FALSE). When you use a pattern trigger, you define:

- The precondition for each logic input — logic high, low, or do not care
- The Boolean logic function — select from AND, NAND, OR, and NOR
- The condition for triggering — whether the trigger occurs when the Boolean function becomes TRUE (logic high) or FALSE (logic low), and whether the TRUE condition is time qualified (see page 3–71)

A *state* trigger occurs when the logic inputs to the logic function cause the function to be TRUE (or at your option FALSE) *at the time* the clock input changes state. When you use a state trigger, you define:

- The precondition for each logic input, channels 1, 2, and 3
- The direction of the state change for the clock input, channel 4
- The Boolean logic function — select from clocked AND, NAND, OR, and NOR
- The condition for triggering — whether the trigger occurs when the Boolean function becomes TRUE (logic high) or FALSE (logic low)

Table 3–4 on page 3–68 lists the preconditions required for each logic function to issue a pattern or state logic trigger.

Logic Trigger Readouts

At the bottom of the display, the Trigger readout shows some of the key parameters of the logic trigger (see Figure 3-35).

NOTE. When Logic is the selected trigger type, the threshold levels that help determine triggering are set for each channel individually in the Set Thresholds menu. Therefore, the Trigger Level readout will disappear on the display and the Trigger Level knob can be used to set the threshold level while the Main Trigger menu is set to Logic.

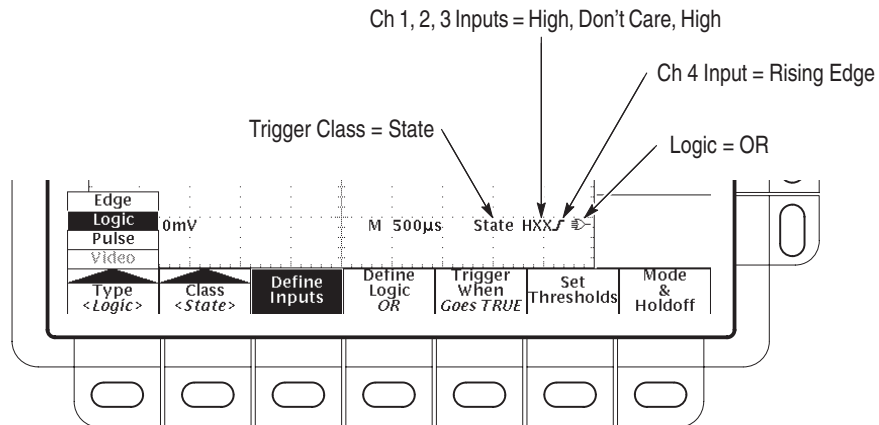









Figure 3-35: Logic Trigger Readouts

Definitions

Table 3–4 lists the definitions for the four types of logic functions available. Keep in mind the following operating modes for the two classes, pattern and state, of logic triggers as you apply the definitions.

Table 3–4: Logic Triggers

Pattern	State	Definition 1,2
 AND	 Clocked AND	If <i>all</i> the preconditions selected for the logic inputs ³ are true, then the oscilloscope triggers.
 NAND	 Clocked NAND	If <i>not all</i> of the preconditions selected for the logic inputs ³ are true, then the oscilloscope triggers.
 OR	 Clocked OR	If <i>any</i> of the preconditions selected for the logic inputs ³ are true, then the oscilloscope triggers.
 NOR	 Clocked NOR	If <i>none</i> of the preconditions selected for the logic inputs ³ are true, then the oscilloscope triggers.

¹ Note that for State class triggers, the definition must be met at the time the clock input changes state. See the descriptions for Pattern and State in this section.

² The definitions given here are correct for the Goes True setting in the Trigger When menu. If that menu is set to Goes False, swap the definition for AND with that for NAND and for OR with NOR for both pattern and state classes.

³ The logic inputs are channels 1, 2, 3, and 4 when using Pattern Logic Triggers. For State Logic Triggers, channel 4 becomes the clock input.

When triggering on a pattern, the oscilloscope samples the inputs from all the channels. The oscilloscope then triggers if the conditions defined in Table 3–4 and the Trigger When menu are met. (The other settings in that menu are described in *Define a Time Qualified Pattern Trigger* on page 3–71.)

When triggering on a state, the oscilloscope waits until the edge of channel 4 transitions in the specified direction. At that point, the oscilloscope samples the inputs from the other channels and triggers if the conditions defined in Table 3–4 and the Trigger When menu are met.

Operations Common to Pattern and State

To select when to trigger (true or false), set the thresholds for each channel, select the mode (auto or normal), and adjust the holdoff.

Press **TRIGGER MENU** → **Type** (main) → **Logic** (pop-up) → **Class** (main) → **Pattern** or **State** (pop-up).

Trigger When

To trigger when the logic condition is met (**Goes TRUE**) or when the logic condition is not met (**Goes FALSE**):

Press **TRIGGER MENU** → **Type** (main) → **Logic** (pop-up) → **Class** (main) → **Pattern** or **State** (pop-up) → **Trigger When** (main) → **Goes TRUE** or **Goes FALSE** (side).

Set Thresholds

To set the logic threshold for each channel:

1. Press **TRIGGER MENU** → **Type** (main) → **Logic** (pop-up) → **Class** (main) → **Pattern** or **State** (pop-up) → **Set Thresholds** (main) → **Ch1**, **Ch2**, **Ch3**, or **Ch4** (side).
2. Use the **MAIN TRIGGER LEVEL** knob, the general purpose knob, or the keypad to set each threshold.

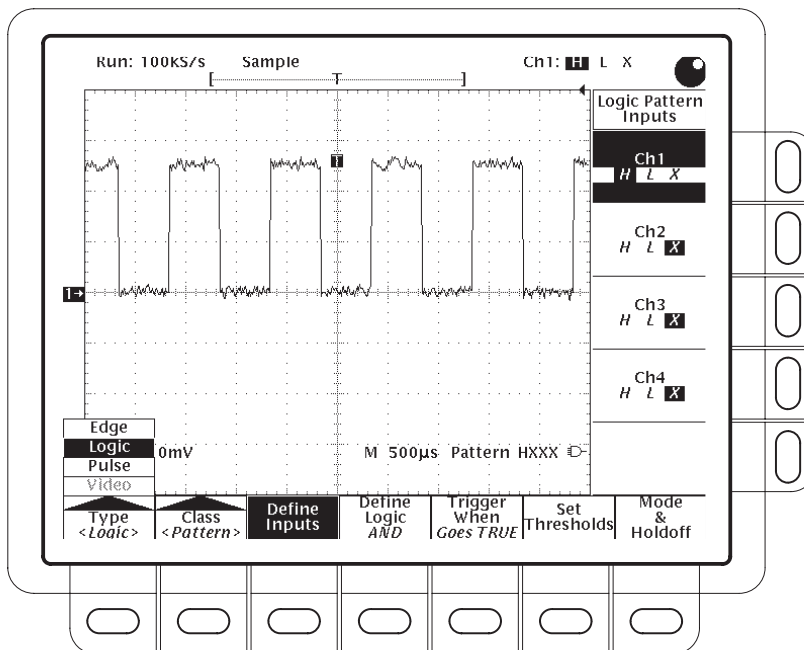

Figure 3-36: Logic Trigger Menu

Mode & Holdoff

To change the holdoff time and select the trigger mode using this menu item:

Press **TRIGGER MENU** → **Type** (main) → **Logic** (pop-up) → **Class** (main) → **Pattern** or **State** (pop-up) → **Mode & Holdoff** (main) → **Auto** or **Normal** (side). See *To Set Mode and Holdoff*, on page 3–24, for more information.

Pattern Operations

When you select **Pattern**, the oscilloscope will trigger on a specified logic combination of the four input channels. See page 3–69 for details on operations common to both pattern and state triggers.

Define Inputs

To set the logic state for each of the input channels (Ch1, Ch2, ...):

1. Press **TRIGGER MENU** → **Type** (main) → **Logic** (pop-up) → **Class** (main) → **Pattern** (pop-up) → **Define Inputs** (main) → **Ch1**, **Ch2**, **Ch3**, or **Ch4** (side).
2. Repeatedly press each input selected in step 1 to choose either High (*H*), Low (*L*), or Don't Care (*X*) for each channel.

Define Logic

To choose the logic function you want applied to the input channels (see page 3–68 for definitions of the logic functions):

Press **TRIGGER MENU** → **Type** (main) → **Logic** (pop-up) → **Class** (main) → **Pattern** (pop-up) → **Define Logic** (main) → **AND, OR, NAND, or NOR** (side).

Define a Time Qualified Pattern Trigger

You can also time qualify a pattern logic trigger. That is, you specify a time that the boolean logic function (AND, NAND, OR, or NOR) must be TRUE (logic high). You also choose the type of time qualification (greater or less than the time limit specified) as well as the time limit using the Trigger When menu selection.

1. Press **TRIGGER MENU** → **Type** (main) → **Logic** (pop-up) → **Class** (main) → **Pattern** (pop-up) → **Trigger When** (main) → **True for less than** or **True for more than** (side).
2. Use the general purpose knob or keypad to set the time in the side menu.

When you select True for less than and specify a time using the general purpose knob, the input conditions you specify must drive the logic function high (TRUE) for less than the time you specify. Conversely, True for more than requires the boolean function to be TRUE for longer than the time you specify.

Note the position of the trigger indicator in Figure 3-37. Triggering occurs at the point the logic function you specify is determined to be true within the time you specify. The digitizing oscilloscope determines the trigger point in the following manner:

- It waits for the logic condition to become true.
- It starts timing and waits for the logic function to become false.
- It compares the times and, if the time TRUE is longer (for True for more than) or shorter (for True for less than), then it triggers a waveform display *at the point the logic condition became false*. This time can be, and usually is, different from the time set for True for more than or True for less than.

In Figure 3-37, the delay between the vertical bar cursors is the time the logic function is TRUE. Since this time is more (216 μ s) than that set in the True for more than menu item (150 μ s), the oscilloscope issues the trigger at that point, not at the point at which it has been true for 216 μ s.

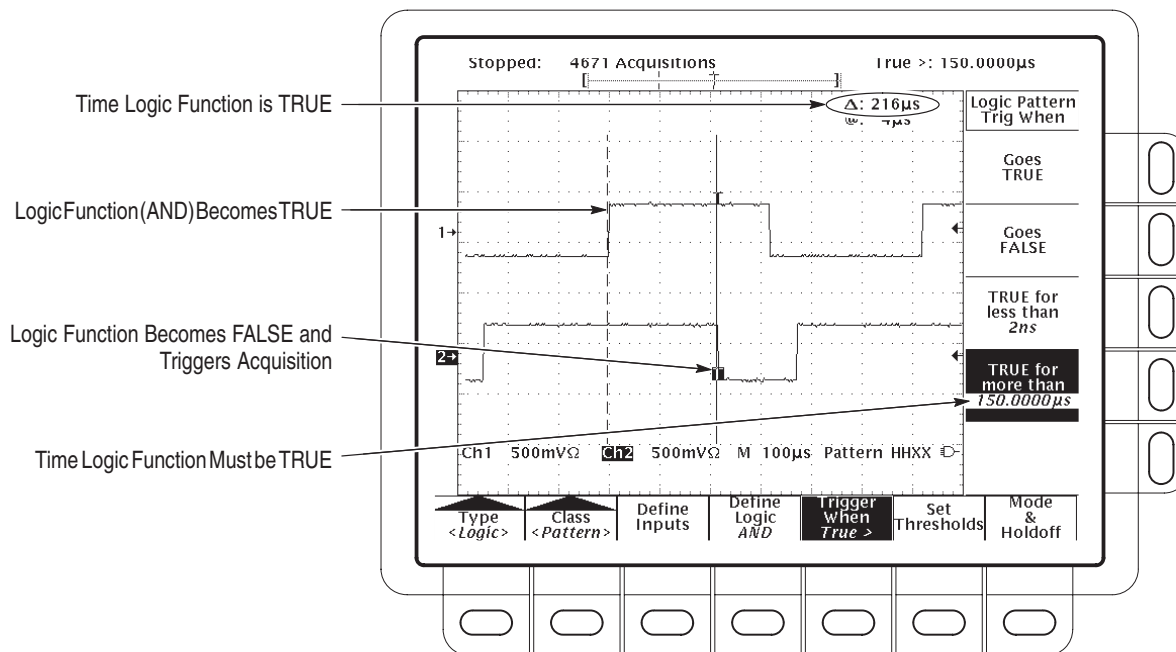

Figure 3-37: Logic Trigger Menu — Time Qualified TRUE

State Operations

When you select **State** logic triggering, the oscilloscope uses channel 4 as a clock for a logic circuit made from the rest of the channels. See page 3–69 for details on operations common to both pattern and state triggers.

Define Inputs

To set the logic state for each of the input channels (**Ch1**, **Ch2**, ...):

1. Press **TRIGGER MENU** → **Type** (main) → **Logic** (pop-up) → **Class** (main) → **State** (pop-up) → **Define Inputs** (main).
2. Choose either High (**H**), Low (**L**), or Don't Care (**X**) (side) for the first three channels. The choices for **Ch4** are rising edge and falling edge.

Define Logic

To choose the type of logic function you want applied to the input channels:

Press **TRIGGER MENU** → **Type** (main) → **Logic** (pop-up) → **Class** (main) → **State** (pop-up) → **Define Logic** (main) → **AND**, **OR**, **NAND**, or **NOR** (side).

Measuring Waveforms

There are various ways to measure properties of waveforms. You can use graticule, cursor, or automatic measurements. This section describes *automatic measurements*. (For cursor and graticule measurements, see *Taking Cursor Measurements* on page 3–117 and *Taking Graticule Measurements* on page 3–82.)

Automatic measurements are generally more accurate and are quicker than, for example, manually counting graticule divisions. The oscilloscope continuously updates and displays automatic measurements. (There is also a way to display all the measurements at once — see *Take a Snapshot of Measurements* on page 3–81.)

Automatic measurements are taken over the entire waveform record or, if you specify gated measurements, over the region specified by the vertical cursors. (See *Gated Measurements* on page 3–77.) Automated measurements are not performed just on the displayed portions of waveforms.

Measurement List

The Digitizing Oscilloscope provides you with 25 automatic measurements. Table 3–5 lists brief definitions of the measurements.

Table 3–5: Measurement Definitions







Name	Definition
 Amplitude	Voltage measurement. The high value less the low value measured over the entire waveform or gated region. $\text{Amplitude} = \text{High} - \text{Low}$
 Area	Voltage over time measurement. The area over the entire waveform or gated region in volt-seconds. Area measured above ground is positive; area below ground is negative.
 Burst Width	Timing measurement. The duration of a burst. Measured over the entire waveform or gated region.
 Cycle Area	Voltage over time measurement. The area over the first cycle in the waveform, or the first cycle in the gated region, in volt-seconds. Area measured above ground is positive; area below ground is negative.
 Cycle Mean	Voltage measurement. The arithmetic mean over the first cycle in the waveform, or the first cycle in the gated region.
 Cycle RMS	Voltage measurement. The true Root Mean Square voltage over the first cycle in the waveform, or the first cycle in the gated region.
 Delay	Timing measurement. The time between the MidRef crossings of two different traces, or the gated region of the traces.

Table 3–5: Measurement Definitions (Cont.)



















Name	Definition
 Fall Time	Timing measurement. Time taken for the falling edge of the first pulse in the waveform or gated region to fall from a High Ref value (default = 90%) to a Low Ref value (default = 10%) of its final value.
 Frequency	Timing measurement for the first cycle in the waveform or gated region. The reciprocal of the period. Measured in Hertz (Hz) where 1 Hz = 1 cycle per second.
 High	The value used as 100% whenever High Ref, Mid Ref, and Low Ref values are needed (as in fall time and rise time measurements). Calculated using either the min/max or the histogram method. The <i>min/max</i> method uses the maximum value found. The <i>histogram</i> method uses the most common value found above the mid point. Measured over the entire waveform or gated region.
 Low	The value used as 0% whenever High Ref, Mid Ref, and Low Ref values are needed (as in fall time and rise time measurements). May be calculated using either the min/max or the histogram method. With the min/max method it is the minimum value found. With the histogram method, it refers to the most common value found below the mid point. Measured over the entire waveform or gated region.
 Maximum	Voltage measurement. The maximum amplitude. Typically the most positive peak voltage. Measured over the entire waveform or gated region.
 Mean	Voltage measurement. The arithmetic mean over the entire waveform or gated region.
 Minimum	Voltage measurement. The minimum amplitude. Typically the most negative peak voltage. Measured over the entire waveform or gated region.
 Negative Duty Cycle	Timing measurement of the first cycle in the waveform or gated region. The ratio of the negative pulse width to the signal period expressed as a percentage. $NegativeDutyCycle = \frac{NegativeWidth}{Period} \times 100\%$
 Negative Overshoot	Voltage measurement. Measured over the entire waveform or gated region. $NegativeOvershoot = \frac{Low - Min}{Amplitude} \times 100\%$
 Negative Width	Timing measurement of the first pulse in the waveform or gated region. The distance (time) between MidRef (default 50%) amplitude points of a negative pulse.
 Peak to Peak	Voltage measurement. The absolute difference between the maximum and minimum amplitude in the entire waveform or gated region.
 Period	Timing measurement. Time it takes for the first complete signal cycle to happen in the waveform or gated region. The reciprocal of frequency. Measured in seconds.
 Phase	Timing measurement. The amount one waveform leads or lags another in time. Expressed in degrees, where 360° comprise one waveform cycle.
 Positive Duty Cycle	Timing measurement of the first cycle in the waveform or gated region. The ratio of the positive pulse width to the signal period expressed as a percentage. $PositiveDutyCycle = \frac{PositiveWidth}{Period} \times 100\%$

Table 3-5: Measurement Definitions (Cont.)

Name	Definition
 Positive Overshoot	Voltage measurement over the entire waveform or gated region. $PositiveOvershoot = \frac{Max - High}{Amplitude} \times 100\%$
 Positive Width	Timing measurement of the first pulse in the waveform or gated region. The distance (time) between MidRef (default 50%) amplitude points of a positive pulse.
 Rise time	Timing measurement. Time taken for the leading edge of the first pulse in the waveform or gated region to rise from a Low Ref value (default = 10%) to a High Ref value (default = 90%) of its final value.
 RMS	Voltage measurement. The true Root Mean Square voltage over the entire waveform or gated region.

Measurement Readouts

With no menus displayed, the measurement readouts appear at the right of the display (see Figure 3-38). When menus are displayed, the readouts appear in the graticule area. You can display and continuously update as many as four measurements at any one time.

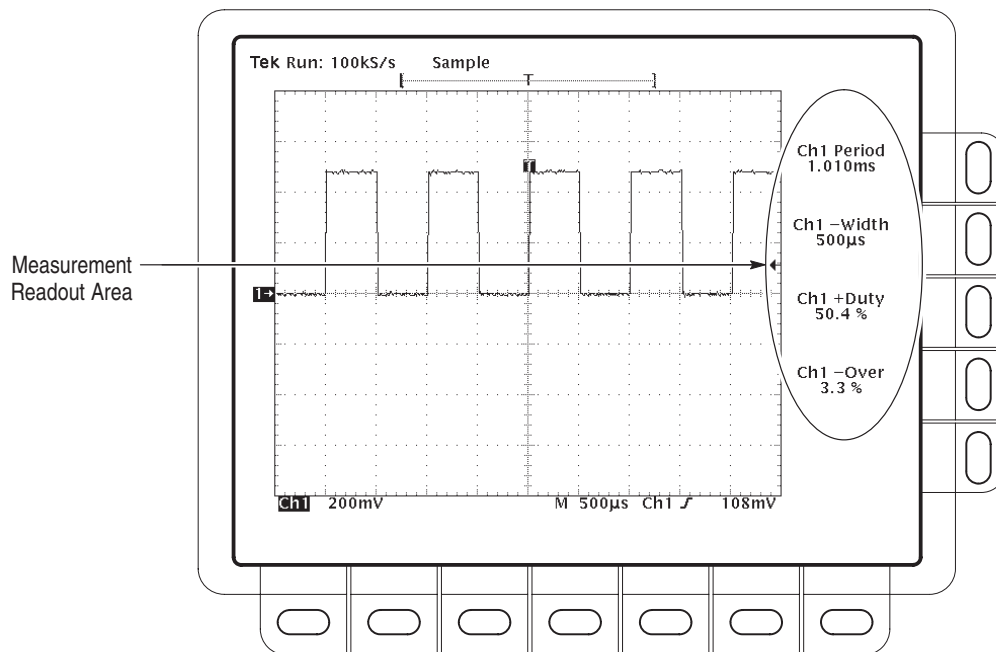

Figure 3-38: Measurement Readouts

Measurement Units (TDS 400A Only)

When switching from internal to external clocks, units of seconds become clocks, units of Hertz become /clock, and units of Vsec become Vclocks.

Select and Display Measurements

To use the automatic measurements you first need to obtain a stable display of the waveform to be measured. Pressing **AUTOSET** may help. Once you have a stable display, press **MEASURE** to bring up the Measure menu (Figure 3-39).

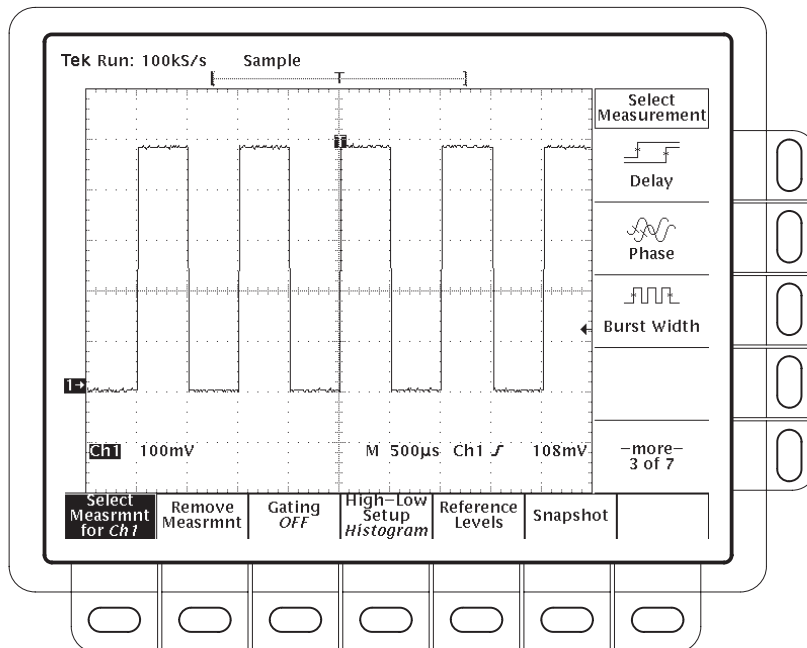

Figure 3-39: Measure Menu

Measurements are made on the selected waveform. The measurement display tells you the channel the measurement is being made on.

1. Press **MEASURE** → **Select Measrmnt** (main).
2. Select a measurement from the side menu.

Remove Measurements

To remove measurements, do the following steps:

1. Press **MEASURE** → **Remove Measrmnt** (main).

2. Select the measurement to remove from the side menu. If you want to remove all the measurements at one time, press **All Measurements** (side).

Gate Measurements

The gating feature lets you limit measurements to the portion of the waveform between cursors (the *gated region*). When gating is Off, the oscilloscope makes measurements over the entire waveform record.

When gating is ON, vertical cursors are displayed. Use these cursors to define the gated region. Do the following steps to gate a measurement:

1. Press **MEASURE** → **Gating** (main) → **Gate with V Bar Cursors** (side) (see Figure 3-40).
2. Move the cursors to the area of the waveform of interest.

Displaying the cursor menu and turning V Bar cursors off does *not* turn gating off. (Gating arrows remain on screen to indicate the area over which the measurement is gated.) You must turn gating off in the Gating side menu.

NOTE. *Cursors are displayed relative to the selected waveform. If you are making a measurement using two waveforms, this can cause confusion. If you turn off horizontal locking and adjust the horizontal position of one waveform, the cursors appear at the requested position with respect to the selected waveform. Gated measurements remain accurate, but the displayed positions of the cursors change when you change the selected waveform.*

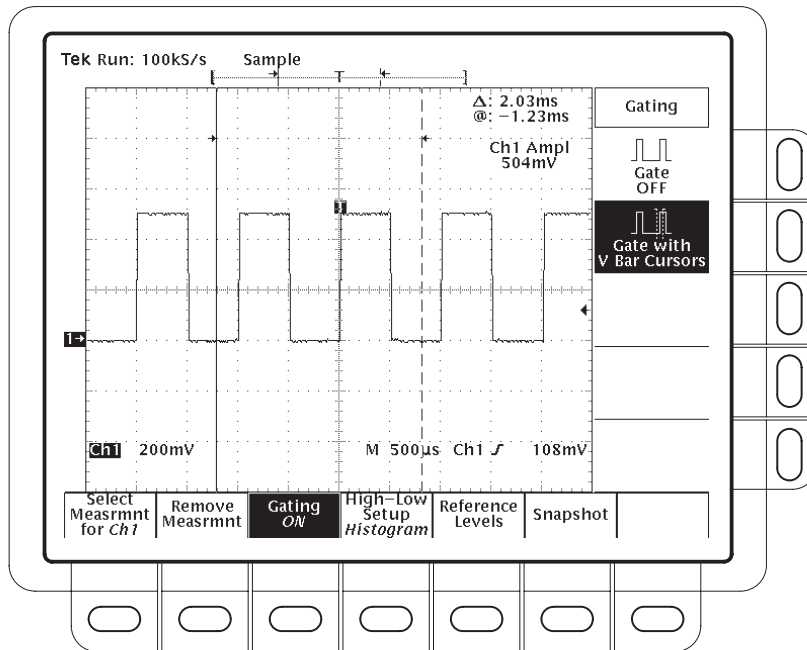

Figure 3-40: Measure Menu — Gating

Define High-Low Setup

To specify how measure determines the High and Low levels of waveforms, do the following step:

Press **MEASURE** → **High-Low Setup** (main) → **Histogram** or **Min-Max** (side). If you select Min-Max, you may also want to define reference levels.

Histogram sets the values statistically. It selects the most common value either above or below the mid point (depending on whether it is defining the high or low reference level). Since this statistical approach ignores short term aberrations (overshoot, ringing, and so forth), histogram is the best setting for examining pulses.

Min-max uses the highest and lowest values of the waveform record. This setting is best for examining waveforms that have no large, flat portions at a common value, such as sine wave and triangle waves—almost any waveform except for pulses.

Define Reference Levels

To set the reference levels, do the following steps:

1. Press **MEASURE** → **Reference Levels** (main) → **Set Levels** (side) to choose whether the References are set in % relative to High (100%) and Low (0%) or set explicitly in the units of the selected waveform (typically volts). See Figure 3-41. Use the general purpose knob to enter the values.

% is the default selection. It is useful for general purpose applications.

Units is helpful for setting precise values. For example, if you are measuring specifications on an RS-232-C circuit, set the levels precisely to RS-232-C specification voltage values by defining the high and low references in units.

2. Press **High Ref**, **Mid Ref**, **Low Ref**, or **Mid2 Ref** (side).



High Ref sets the high reference level. The default is 90%.



Mid Ref sets the middle reference level. The default is 50%.



Low Ref sets the low reference level. The default is 10%.



Mid2 Ref sets the middle reference level used on the second waveform specified in Delay or Phase Measurements. The default is 50%.

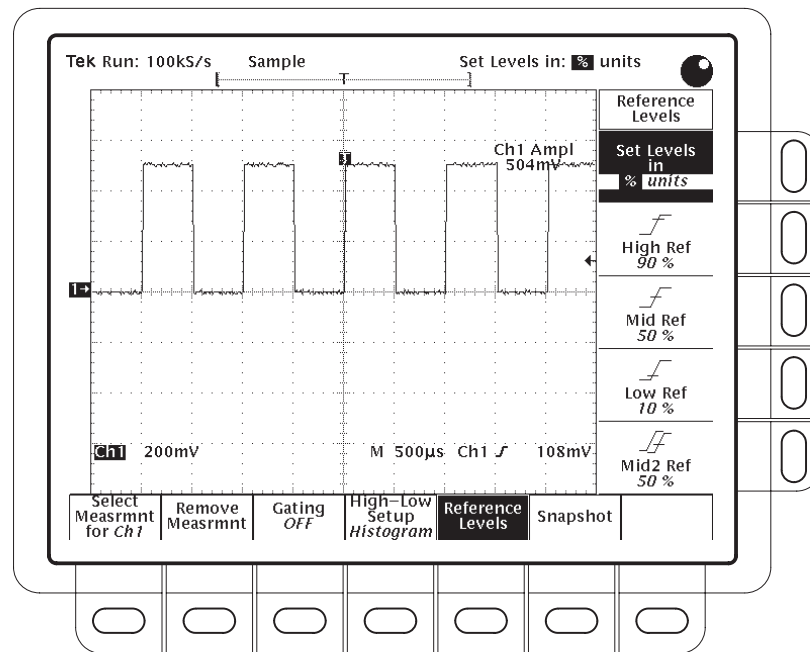

Figure 3-41: Measure Menu — Reference Levels

Take a Delay Measurement

The delay measurement lets you measure from an edge on the selected waveform to an edge on another waveform. To make a delay measurement, do the following steps:

1. Press **MEASURE** → **Select Measrmt** (main) → **Delay** (side) → **Delay To** (main) → **Measure Delay to**.
2. Press **Measure Delay to** (side) repeatedly to choose the delay *to* waveform.

The steps just performed select the waveform you want to measure *to*; note that the waveform you are measuring the delay *from* is the selected waveform. (See Figure 3-42.)

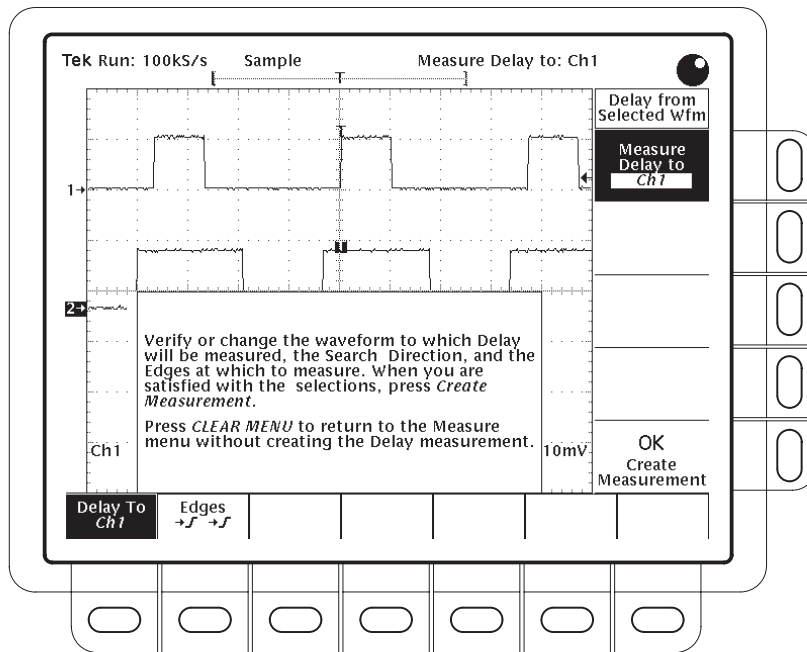

Figure 3-42: Measure Delay Menu — Delay To

3. Press **MEASURE** → **Select Measrmnt** (main) → **Delay** (side) → **Edges** (main). A side menu of delay edges and directions appears. Choose from one of the combinations displayed on the side menu using the following information:
 - The selection you choose defines which edges you want the delayed measurement to be made between.
 - The upper waveform on each icon represents the *from* waveform and the lower one represents the *to* waveform.
 - The direction arrows let you specify a forward search on both waveforms or a forward search on the *from* waveform and a backwards search on the *to* waveform. The latter choice is useful for isolating a specific pair of edges out of a stream.
4. To take the measurement you just specified, press **Delay To** (main) → **OK Create Measurement** (side).

To exit the Measure Delay menu without creating a delay measurement, press **CLEAR MENU**.

Take a Snapshot of Measurements

Snapshot executes all of the single waveform measurements available on the selected waveform *once* and displays the results. (The measurements are not continuously updated.) All of the measurements listed in Table 3–5 on page 3–73 except for Delay and Phase are displayed.

You can display a snapshot (see Figure 3-43) on any channel or ref memory, but only one snapshot can be displayed at a time.

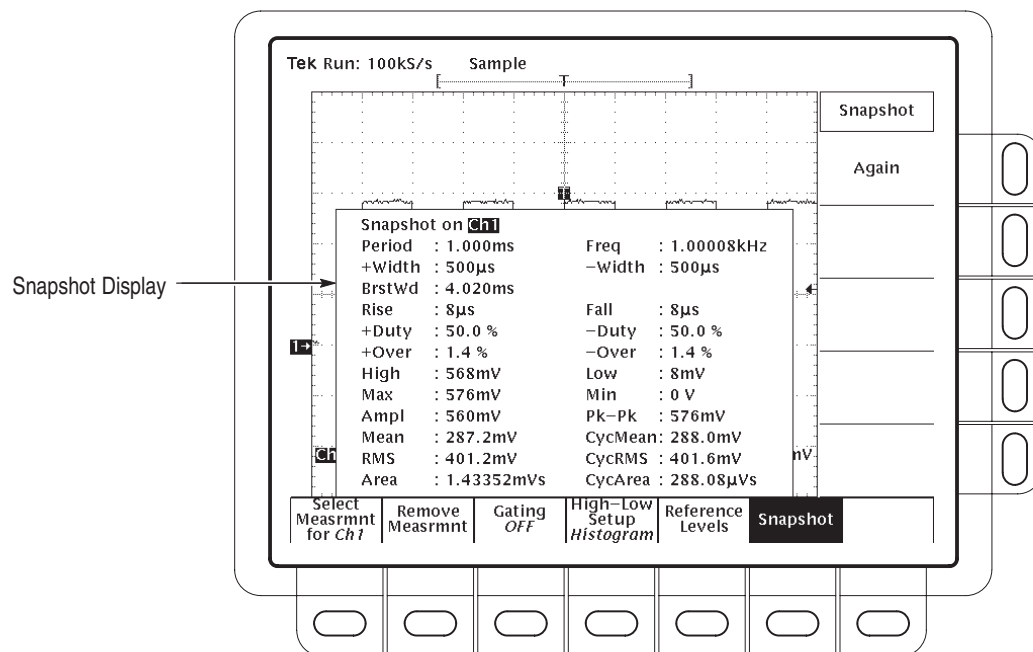

Figure 3-43: Snapshot Menu and Readout

To use snapshot, obtain a stable display of the waveform to be measured (pressing **AUTOSET** may help). Then do the following steps:

1. Press **MEASURE** → **SNAPSHOT** (main).
2. Press either **SNAPSHOT** (main) or **AGAIN** (side) to take another snapshot.
3. Push **Remove Measrmnt**.

Consider the following rules when taking a snapshot:

- Snapshot does not warn you if a waveform is improperly scaled (clipped, low signal amplitude, low resolution, and so on).

- Be careful when taking automatic measurements on noisy signals. You might measure the frequency of the noise and not the desired waveform.
- Use High-Low Setup (page 3–78), Reference Levels (page 3–78), and Gated Measurements (page 3–77) with snapshot exactly as you would when you display individual measurements from the Select Measurements menu.

Taking Graticule Measurements

The oscilloscope provides a graticule for measuring the difference (either in time or amplitude) between two points on a waveform record. Graticule measurements provide you with quick, visual estimates. For example, you might look at a waveform amplitude and say, “It is a little more than 100 mV.”

Measure Waveform Amplitude. To measure the amplitude of a waveform, do the following steps:

1. Press the channel selection button of the channel you wish to measure. Note the vertical scale factor for the channel in the channel readout on screen.
2. Count the graticule divisions between two features to be measured and multiply by the vertical scale factor.

For example, if you count five major vertical graticule divisions between the minimum and maximum values of a waveform at a scale factor of 100 mV/division, then you can easily calculate your peak-to-peak voltage as:

$$5 \text{ divisions} \times 100 \text{ mV/division} = 500 \text{ mV.}$$

NOTE. When you select the NTSC graticule, the volts per division of all selected channels is set to 143 mV/div (152 mV/div for PAL) where the divisions are those of the conventional graticule, not the divisions of the video graticules. For NTSC, the actual grid lines represent 10 IRE, and for PAL the lines are 100 mV apart.

Measure Waveform Time. To measure the time of a waveform, repeat the process just described, but count the horizontal divisions and multiply by the horizontal scale factor. For example, if you count five major horizontal graticule divisions for one waveform cycle at a horizontal scale factor of 50 μ s/division, then you can easily calculate the waveform period as:

$$5 \text{ divisions} \times 50 \mu\text{s/division} = 250 \mu\text{s, or } 400 \text{ kHz.}$$

Probe Cal (TDS 510A Only)

To optimize the oscilloscope capability to make accurate measurements using particular channel and probe, execute *Probe Cal* on a channel with its probe installed.

Run a Probe Cal anytime you wish to ensure that the measurements you make are made with the most accuracy possible. You should also run a Probe Cal if you have changed to a different probe since the last Probe Cal was performed.

Probe Cal Versus Probe Type

Some types of probes can be gain compensated, some can be offset compensated, and some can be compensated for both. *Some probes cannot be compensated.*

If your probe has an attenuation factor of greater than 20X, it cannot be compensated.

The digitizing oscilloscope cannot compensate probes whose gain and/or offset errors are too great ($> 2\%$ gain and/or > 50 mV offset). If these errors are not within specification, have your probe checked by service personnel.

NOTE. *Probe Cal is not recommended with the P6139A passive probe. This probe typically has little gain and offset error, and therefore, the improvement in performance after a Probe Cal is not worth the time needed to do the Probe Cal. Probe Cal makes significant performance improvements when performed with active probes or older passive probes.*

Operation

If you are installing an *active* probe, such as the P6243, there are no prerequisites to performing this procedure. Start at step 1.

If you are compensating for a *passive* probe with this procedure you must first compensate the low frequency response of the probe. First, do steps 1 and 2 below, and then perform the instructions found under *Probe Compensation* on page 3–89. Then continue with step 3 of this procedure.

1. Install the probe on the input channel.
2. Power on the digitizing oscilloscope and allow a 20 minute warm-up before doing this procedure.

3. Press **SHIFT UTILITY** → **System** (main) → **Cal** (pop-up).
4. Look at the status label under **Signal Path** in the main menu. If the status does not read **Pass**, perform a signal path compensation (*Signal Path Compensation*, page 3–115), and then continue with this procedure.
5. Press the front-panel button corresponding to the input channel on which you installed the probe.
6. Press **VERTICAL MENU** → **Cal Probe** (main).

STOP. Your oscilloscope will detect the type of probe you have installed and display screen messages and menu choices for compensation of probe gain, offset, or both (see Figure 3-44). The following steps will have you run probe gain, offset, or both depending on the probe the oscilloscope detects.

7. If the message on screen is *Probe Offset Compensation* rather than *Probe Gain Compensation*, skip to step 15.
8. Connect the probe tip to **PROBE COMPENSATION SIGNAL**; connect the probe ground lead to **PROBE COMPENSATION GND**.
9. Press **OK Compensate Gain** (side).
10. Wait for gain compensation to complete (one to three minutes).



When gain compensation completes, the following actions occur:

- If offset compensation is required for the probe installed, the *Probe Offset Compensation* message will replace the *Probe Gain Compensation* message.
 - If gain compensation did not complete successfully, you may get a “Probe is not connected” message (examine the probe connections to the digitizing oscilloscope, be sure the probe tip is properly installed in its retractor, and repeat step 9).
 - If gain compensation did not complete successfully, you may get the message “Compensation Error.” This error implies that the probe gain or offset is too great to be compensated. You can substitute another probe and continue. Have your probe checked by service personnel.
11. If the *Probe Offset Compensation* message is displayed, continue with step 15; otherwise, continue with step 12.
 12. If the *Compensation Error* message is displayed, continue with step 13; otherwise continue with step 18.

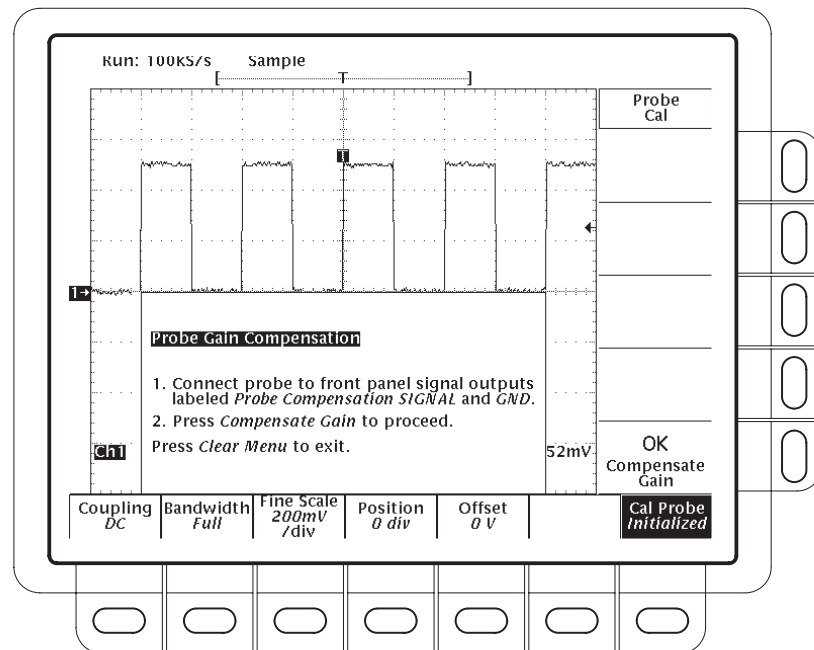

Figure 3-44: Probe Cal Menu and Gain Compensation Display

13. Press **SHIFT UTILITY** → **System** (main) → **Diag/Err** (pop-up) → **Error Log** (main). If there are too many error messages to be seen on screen, rotate the general purpose knob clockwise to scroll to the last message.
14. Note the compensation error amount. Skip to step 19.
15. Disconnect the probe from any signal you may have connected it to. Leave the probe installed on its channel.
16. Press **OK Compensate Offset** (side).
17. Wait for offset compensation to complete (one to three minutes).



If offset compensation does not complete successfully, you may get the message “Compensation Error.” This error implies that the probe offset scale (10% error) and/or offset (50 mV) is too great to be compensated. You can substitute another probe and continue. Have your probe checked by service personnel. You can also check the error log by doing steps 13 through 14.

18. After the clock icon is removed, verify the word **Initialized** changed to **Pass** under **Cal Probe** in the main menu. (See Figure 3-44.)
19. If desired, repeat this procedure beginning at step 1 to compensate for other probe/channel combinations.

Changing Probes After a Probe Cal

Table 3–6 shows the action the oscilloscope takes based on the probe connected and user operation performed.

Table 3–6: Probe Cal Status

Probe Cal'd? ¹	User Action	Type of Probe Connected ²	
		Simple Interface ³	Complex Interface ⁴
No	Doesn't Matter	<i>Initialized</i>	<i>Initialized</i>
Yes	Power Off	<i>Initialized</i> (probe data is retained)	<i>Initialized</i> (probe data is retained)
Yes	Power On	Can not detect different probe: Display a <i>Reuse Probe Calibration Data</i> Menu Different probe: <i>Initialized</i>	Cal'd Probe: <i>Pass</i> Different probe: <i>Initialized</i>
Yes	Disconnect Probe	<i>Initialized</i>	<i>Initialized</i>
Yes	Connect Probe	Can not detect different probe: Display <i>Reuse Probe Calibration Data</i> Menu Different probe: <i>Initialized</i>	Cal'd Probe: <i>Pass</i> Different probe: <i>Initialized</i>

¹ Refers to a channel input that was successfully compensated at the time Probe Cal was last executed for the input channel.

² If no probe is connected, the probe status in the vertical main menu is always initialized.

³ A probe with a simple interface is a probe that can convey very limited information to the oscilloscope. Most passive probes have simple interfaces.

⁴ A probe with a complex interface is a probe that can convey additional information. For instance, it might automatically set the oscilloscope input channel impedance to match the probe, send the oscilloscope a unique probe identification number, etc. Some optical probes and most active probes have complex interfaces.

If the *Re-use Probe Calibration data?* menu (see Figure 3-45) is displayed, choose one of the following options:

- To *use* the Probe Cal data last stored for that channel, press **OK Use Existing Data** (side).
- To *erase* the Probe Cal data last stored and use the probe uncompensated, press **OK Erase Probe Cal Data** (side).
- To *retain* the Probe Cal data last stored and use the probe uncompensated, press **CLEAR MENU**.

NOTE. If the Re-use Probe Calibration data menu is displayed, do not select **OK Use Existing Data** unless the calibration data was created using the currently installed probe.

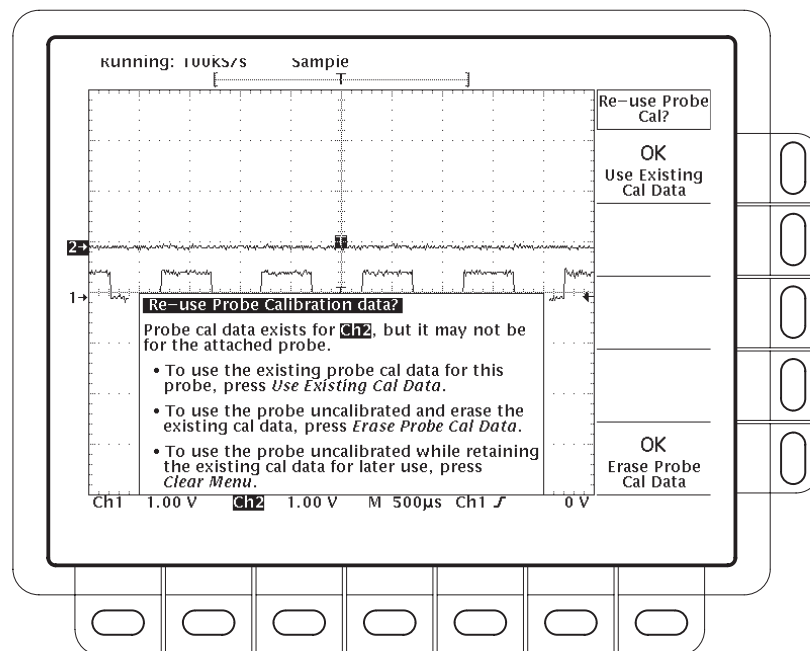

Figure 3-45: Re-use Probe Calibration Data Menu

Probe Compensation

Passive probes require compensation to ensure maximum distortion-free input to the digitizing oscilloscope and to avoid high frequency amplitude errors (see Figure 3-46). If your using a TDS 510A, see Probe Cal on page 3–83.

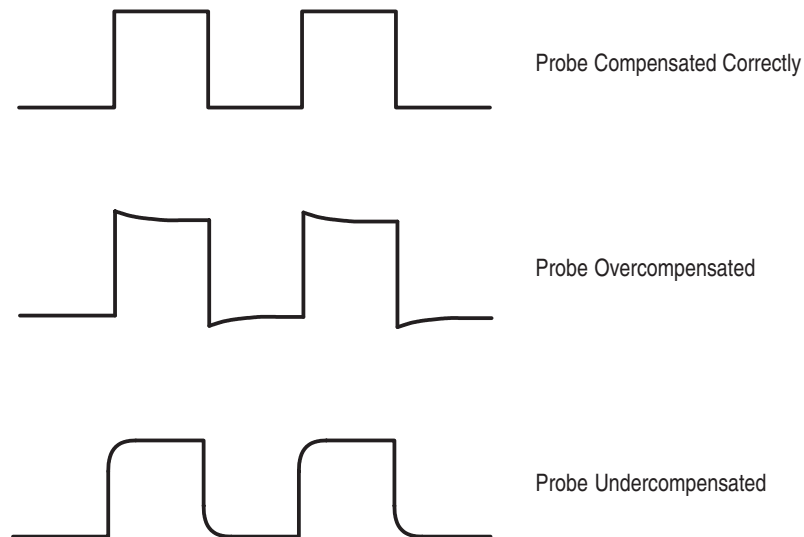

Figure 3-46: How Probe Compensation Affects Signals

To Compensate Passive Probes

Do the following steps to compensate your probe:

1. Connect the probe to the probe compensation signal on the front panel.
2. Press **AUTOSET**.

NOTE. When you connect an active probe to the oscilloscope (such as the P6243), the input impedance of the oscilloscope automatically becomes 50 Ω . If you then connect a high impedance passive probe, you need to set the input impedance back to 1 M Ω . Step 5 explains how to change the input impedance.

3. Press **TRIGGER MENU** → **Type** (main) → **Edge** (pop-up) → **Coupling** (main) → **HF Rej** (side).
4. Press **VERTICAL MENU** → **Bandwidth** (main) → **20 MHz** (side).
5. If you need to change the input impedance, press **Coupling** (main). Then toggle the side menu selection Ω to get the correct impedance.

6. Press **SHIFT ACQUIRE MENU** → **Mode** (main) → **Hi Res** (side).
7. Adjust the probe until you see a perfectly flat top square wave on the display. Figure 3-47 shows where the adjustment is located.

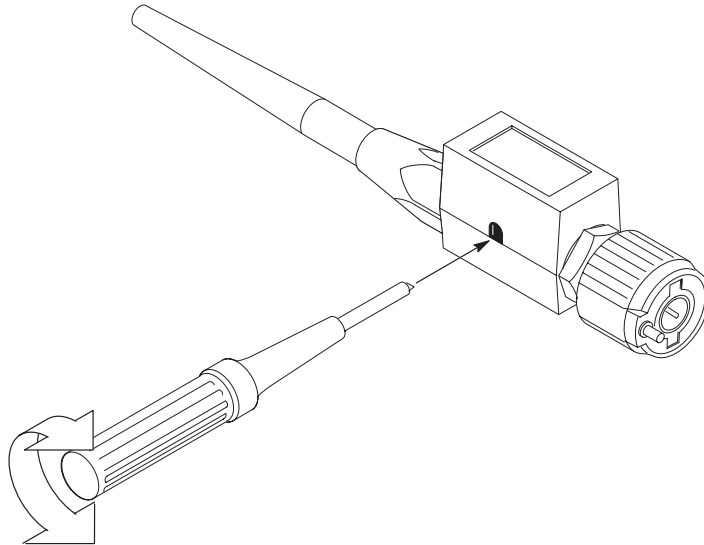

Figure 3-47: Probe Adjustment

Pulse Triggering (TDS 510A Only)

Pulse triggering can be very useful. For example, you might be testing a product with a glitch in the power supply. The glitch appears once a day. So instead of sitting by and waiting for it to appear, you can use pulse triggering to automatically capture your data.

Figure 3-48 shows the pulse trigger readouts. Table 3-7 describes the choices for pulse triggers.

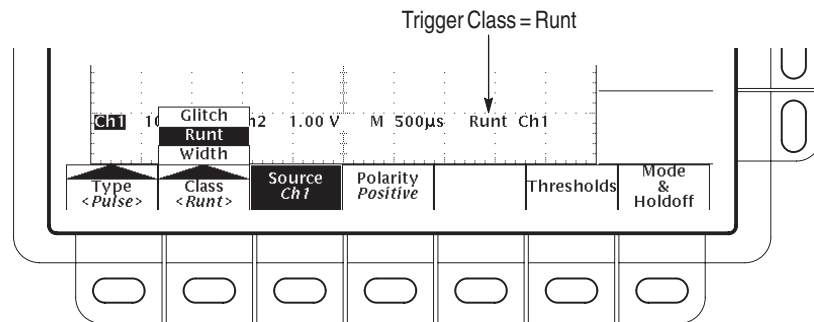

Figure 3-48: Pulse Trigger Readouts

Table 3-7: Pulse Trigger Definitions









Name	Definition
 Glitch positive	Triggering occurs on positive spike widths less than the specified glitch time.
 Glitch negative	Triggering occurs on negative spike widths less than the specified glitch time.
 Glitch either	Triggering occurs on positive or negative widths less than the specified glitch time.
 Runt positive	Triggering occurs on a positive pulse that crosses one threshold going positive but fails to cross a second threshold before recrossing the first going negative.
 Runt negative	Triggering occurs on a negative going pulse that crosses one threshold going negative but fails to cross a second threshold before recrossing the first going positive.

Table 3-7: Pulse Trigger Definitions (Cont.)

Name	Definition
 Runt either	Triggering occurs on a positive or negative going pulse that crosses one threshold but fails to cross a second threshold before recrossing the first.
 Width positive	Triggering occurs on a positive pulse with a width between, or optionally outside, the user-specified lower and upper time limits.
 Width negative	Triggering occurs on a negative pulse with a width between, or optionally outside, the user-specified lower and upper time limits.

Operations Common to Glitch, Runt, and Width

The pulse trigger menus let you define the pulse source, select the mode (auto or normal), and adjust the holdoff. To bring up the Pulse Trigger menu:

Press **TRIGGER MENU** → **Type** (main) → **Pulse** (pop-up) → **Class** (main) → **Glitch, Runt, or Width** (pop-up) (see Figure 3-49).

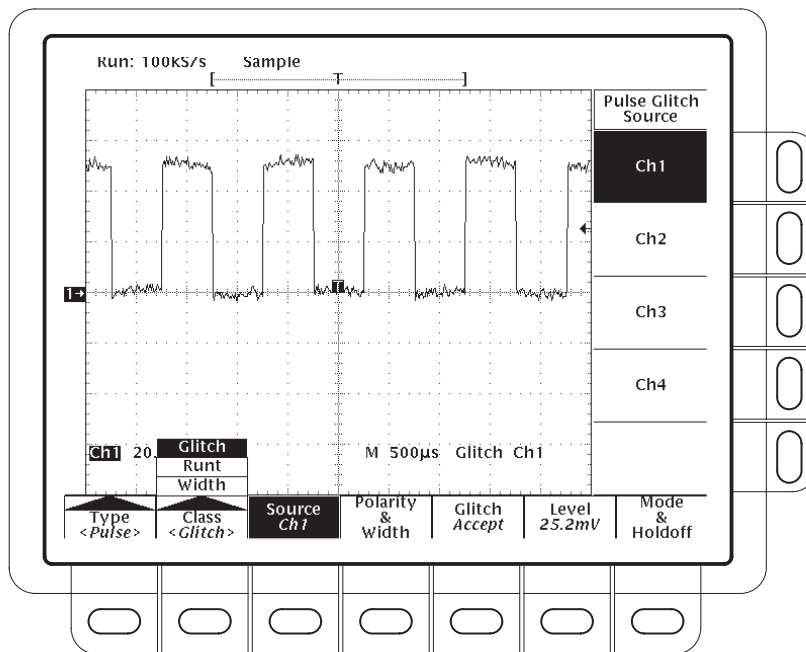

Figure 3-49: Main Trigger Menu — Glitch Class

Source To specify which channel becomes the pulse trigger source:
Press **TRIGGER MENU** → **Type** (main) → **Pulse** (pop-up) → **Source** (main) → **Ch1, Ch2, Ch3, or Ch4** (side).

Mode & Holdoff To change the holdoff time and select the trigger mode:
Press **TRIGGER MENU** → **Type** (main) → **Pulse** (pop-up) → **Mode and Holdoff** (main) → **Auto** or **Normal** (side). See *To Set Mode and Holdoff*, on page 3–24, for more information.

Glitch Operations

When you select the pulse class **Glitch**, the oscilloscope will trigger on a pulse narrower (or wider) in width than some specified time.

Polarity & Width To define the glitch in terms of polarity (positive, negative, or either) and width:



1. Press **TRIGGER MENU** → **Type** (main) → **Pulse** (pop-up) → **Polarity and Width** (main) → **Positive, Negative, or Either** (side).

- Glitch **Positive** looks at positive-going pulses.
- Glitch **Negative** looks at negative-going pulses.
- Glitch **Either** looks at both positive and negative pulses.

2. Press **Width** (side), and set the glitch width using the general purpose knob or keypad.

Glitch (Accept or Reject) To specify whether to trigger on glitches or filter out glitches using the **Glitch** main menu item, press **TRIGGER MENU** → **Type** (main) → **Pulse** (pop-up) → **Class** (main) → **Glitch** (pop-up) → **Glitch** (main) → **Accept Glitch** or **Reject Glitch** (side).

If you choose **Accept Glitch**, the oscilloscope will trigger only on pulses narrower than the width you specified. If you select **Reject Glitch**, it will trigger only on pulses wider than the specified width.

Level To set the trigger level with the **Level** main menu (or the front panel trigger **LEVEL** knob), press **TRIGGER MENU** → **Type** (main) → **Pulse** (pop-up) → **Level** (main) → **Level, Set to TTL, Set to ECL, or Set to 50%** (side). See *To Set Level*, on page 3–93, for more information.

Runt Operation

When you select the pulse class **Runt**, the oscilloscope will trigger on a short pulse that crosses one threshold but fails to cross a second threshold before recrossing the first. To set up runt triggering:

1. Press **TRIGGER MENU** → **Type** (main) → **Pulse** (pop-up) → **Class** (main) → **Runt** (pop-up) → **Source** (main) → **Ch1, Ch2, Ch3, or Ch4** (side). (See Figure 3-50.)
2. Press **Polarity** (main) → **Positive, Negative, or Either** (side).
3. Press **Thresholds** (main), and set the upper and lower thresholds for runt detection with the side menu selections and the keypad or the general purpose knob.

Polarity To specify the direction of the runt pulse:

Press **TRIGGER MENU** → **Type** (main) → **Pulse** (pop-up) → **Class** (main) → **Runt** (pop-up) → **Polarity** (main) → **Positive, Negative, or Either** (side).

- **Positive** looks for positive-going runt pulses.
- **Negative** looks for negative-going runt pulses.
- **Either** looks for both positive and negative runt pulses.

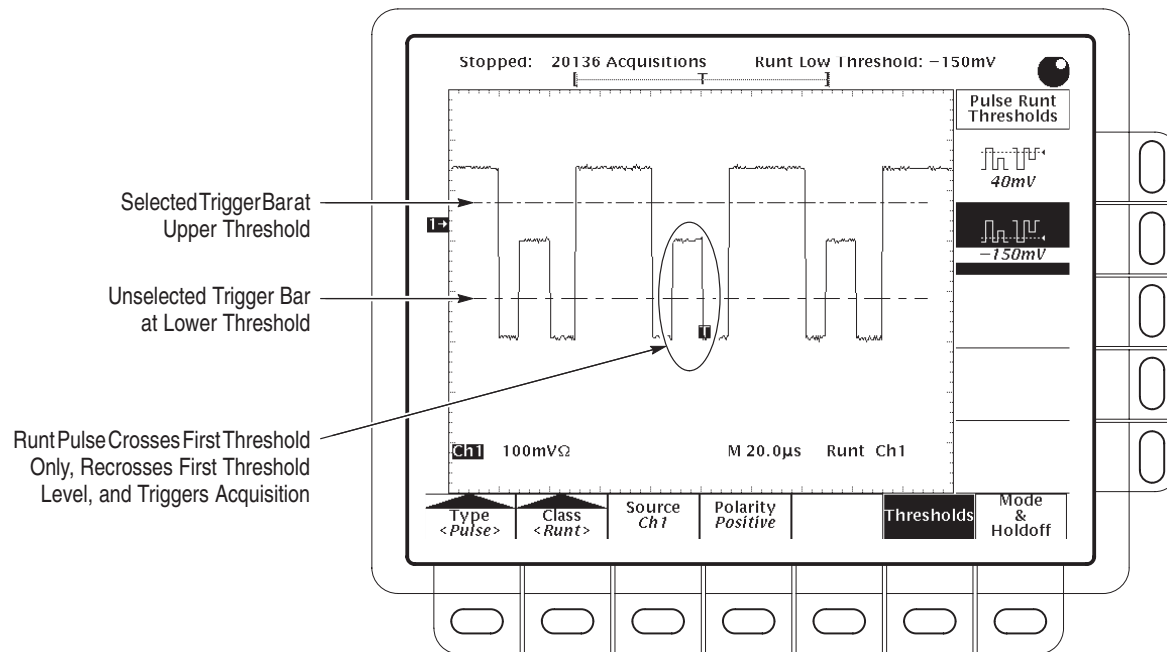

Figure 3-50: Main Trigger Menu—Runt Class

Thresholds

To set the two threshold levels used in detecting a runt pulse:

1. Press **TRIGGER MENU** → **Type** (main) → **Pulse** (pop-up) → **Class** (main) → **Runt** (pop-up) → **Thresholds** (main).
2. Use the general purpose knob or keypad to set the values for the high and low thresholds.

Hint: To use the Trigger Bar feature to set the threshold levels on the pulse train, press **DISPLAY** → **Readout Options** (main) → **Trigger Bar Style** (side) until **Long** appears in that menu item.

Note the position of the trigger indicator in Figure 3-50. Triggering occurs at the point the pulse returns over the first (lower) threshold going negative without crossing the second threshold level (upper). Be aware of the following considerations when using Runt triggering:

- When **Positive** is set in the **Polarity** side menu, the *lower* threshold must be first crossed going *positive*, then recrossed going *negative* without crossing the *upper* threshold at all.
- When **Negative** is set in the **Polarity** side menu, the *upper* threshold must be first crossed going *negative*, then recrossed going *positive* without crossing the *lower* threshold at all.

- When **Either** is set in the **Polarity** side menu, *one* threshold must be first crossed going in *either* direction, then recrossed going in the *opposite* direction without crossing the *other* threshold at all.
- Regardless of the polarity setting, triggering occurs at the point the runt pulse *recrosses* its first threshold.

Width Operation

When you select the pulse class **Width**, the oscilloscope will trigger on a pulse narrower (or wider) than some specified *range* of time (defined by the upper limit and lower limit).

Polarity To define whether the pulses are positive or negative:

Press **TRIGGER MENU** → **Type** (main) → **Pulse** (pop-up) → **Class** (main) → **Width** (pop-up) → **Polarity** (main) → **Positive** or **Negative** (side).

Trig When To establish the range of widths (in units of time) the trigger source will search for and whether to trigger on pulses that are outside this range or ones that fall within the range:

1. Press **TRIGGER MENU** → **Type** (main) → **Pulse** (pop-up) → **Class** (main) → **Width** (pop-up) → **Trig When** (main).
2. Press **Within Limits** (side) to trigger on pulses that fall within the specified range. To trigger on pulses that are outside the range, press **Out of Limits** (side).
3. To set the range of pulse widths in units of time, press **Upper Limit** (side) and **Lower Limit** (side). Enter the values with the general purpose knob or keypad. The **Upper Limit** is the maximum valid pulse width the trigger source will look for. The **Lower Limit** is the minimum valid pulse width.

Level To set the trigger level with the **Level** main menu:

Press **TRIGGER MENU** → **Type** (main) → **Pulse** (pop-up) → **Class** (main) → **Width** (pop-up) → **Level** (main) → **Level, Set to TTL, Set to ECL, or Set to 50%** (side).

Remote Communication

This section explains how to prepare and setup the oscilloscope for control and operation over the IEEE Std 488.2-1987 (GPIB) interface. For more information, see your programmer manual and the *TDS Family Option 13 Instruction Manual* (Option 13 equipped instruments only).

To Set Up for Remote Operation

To set up remote communications, be sure your setup meets GPIB protocol and interface requirements. Then do the following procedures.

Connect the Oscilloscope to the GPIB. To connect the oscilloscope, plug an IEEE Std 488.2-1987 GPIB cable (available from Tektronix, part number 012-0991-00) into the GPIB connector on the oscilloscope rear panel and into the GPIB port on your controller or hardcopy device (see Figure 3-51).

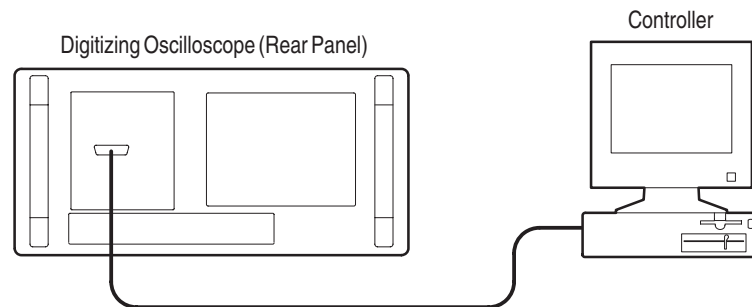

Figure 3-51: Connecting the Digitizing Oscilloscope to a Controller

Select the GPIB Port. To select the GPIB port, press **SHIFT** → **UTILITY** → **System** (main) → **I/O** (pop-up) → **Port** (main) → **GPIB** (pop-up).

Configure the GPIB Port. To set the GPIB mode and address, do the following:

Press **SHIFT UTILITY** → **System** (main) → **I/O** (pop-up) → **Port** (main) → **GPIB** (pop-up) → **Configure** (main) → **Talk/Listen Address**, **Hardcopy** (Talk Only), or **Off Bus** (side). (See Figure 3-52.)

Talk/Listen Address configures the port for normal controller based system operation. Use the general purpose knob to define the address.

Hardcopy (Talk Only) configures the port for hardcopy output without controller supervision. Once the port is configured this way, the oscilloscope will send the hardcopy data to any listeners on the bus when the **HARDCOPY** button is pressed.

If the port is configured any other way when the **HARDCOPY** button is pressed, the digitizing oscilloscope displays a message saying the selected hardcopy port is unavailable.

Off Bus disconnects the digitizing oscilloscope from the bus.

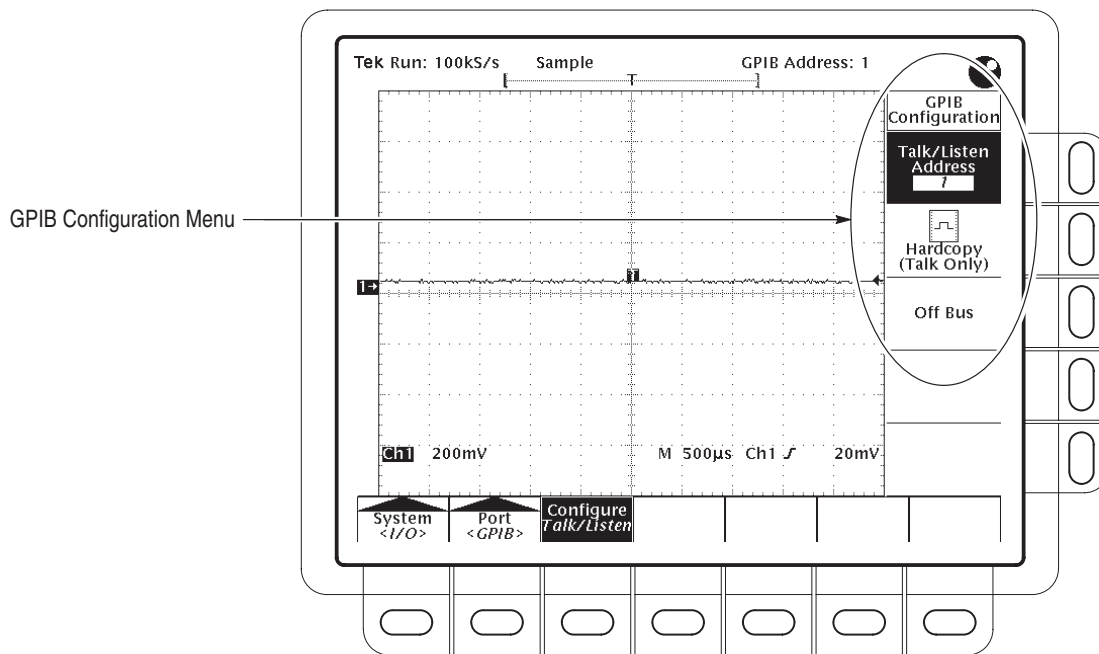

Figure 3-52: Utility Menu

Roll Mode (TDS 400A Only)

Roll mode lets you see acquired data points without waiting for the acquisition of a complete waveform record. For example, when a sweep is 10 divisions long and the sweep rate is 1 second per division, 10 seconds are required to fill the waveform record. Without roll mode you must wait 10 seconds to see that the position control is set wrong. With roll mode you can start seeing results almost immediately.

Roll Modes

The four roll modes (see Figure 3-53) are described below.

Untriggered Roll

Use untriggered roll to continuously observe a slow process, knowing that you can always see the most recent view of that process.

Untriggered Roll with Single Sequence

Use untriggered roll with single sequence to observe data for later viewing. For example, at 20 seconds per division at 30K record length there are 60 screens, 600 divisions, and 12000 seconds of acquired data points. Untriggered roll with single sequence would capture data over a lunch hour and hold it for later viewing.

Triggered Roll

Use triggered roll to capture a succession of triggered events in normal interactive debugging.

Triggered Roll with Single Sequence

Use triggered roll with single sequence to capture one triggered event.

To Turn On Roll Mode

Do the following steps to turn on roll mode:

1. Press **HORIZONTAL MENU** → **Horiz Controls** (main), and set **Roll Mode** (side) to **Automatic** to enable roll mode.

Roll Mode

Untriggered Roll

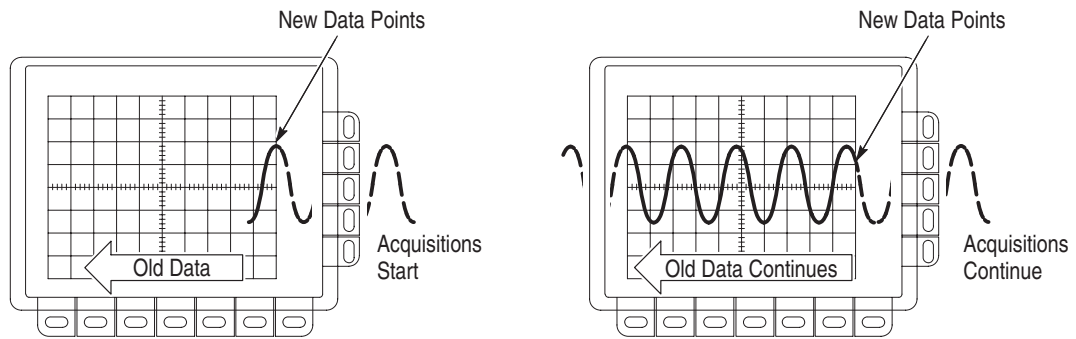

Untriggered Roll With Single Sequence

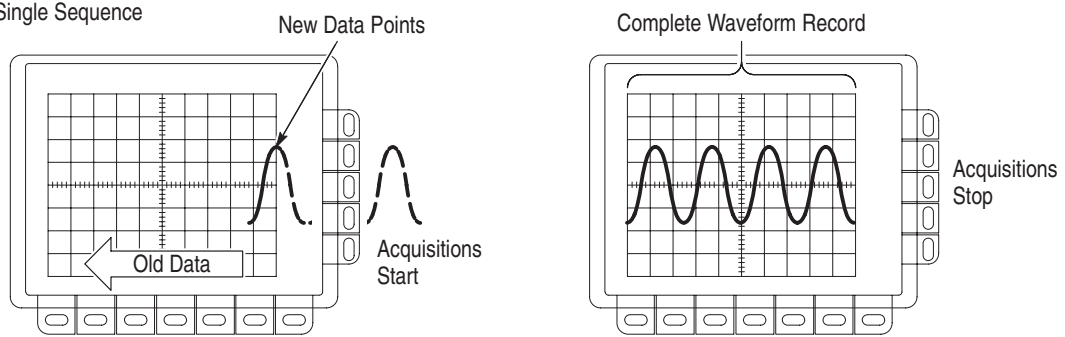

Triggered Roll

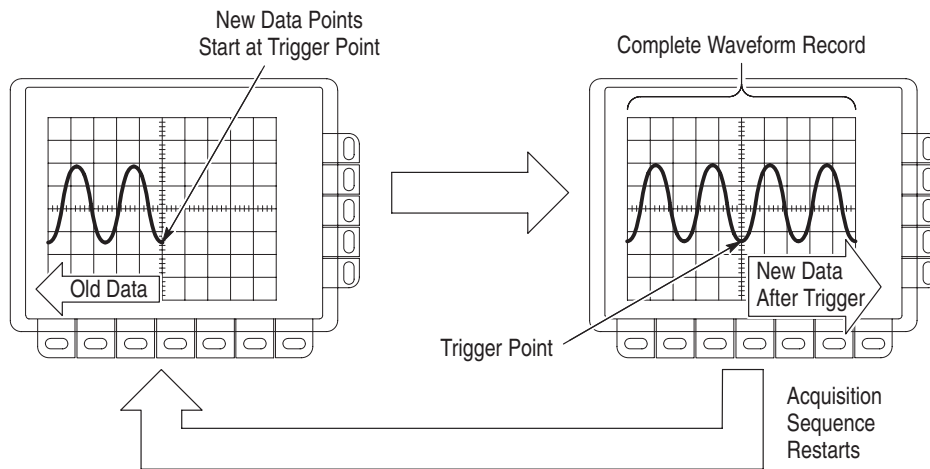

Triggered Roll With Single Sequence

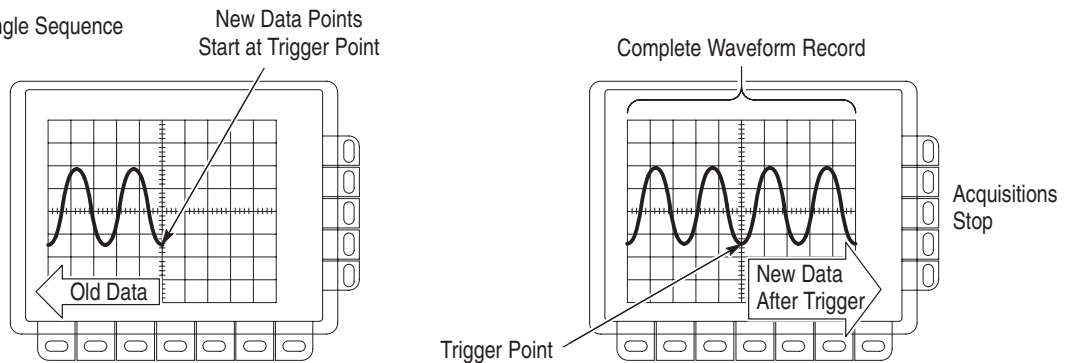

Figure 3-53: Roll Mode (500 Point Record Length)

2. Set the Horizontal **SCALE** to 50 ms per division or slower.

NOTE. *Envelope, Average (acquisition modes), or any of the persistence modes (display modes) inhibit roll mode. You also inhibit roll mode if you set the horizontal Clock menu to External and the maximum external sample rate greater than 1 kc per second.*

3. If you want an untriggered roll mode, press **TRIGGER MENU** → **Mode** (main) → **Auto** (side). If you want a triggered roll mode, press **TRIGGER MENU** → **Mode** (main) → **Normal** (side). (See Figure 3-54.)
4. If you want a single sequence roll mode, press **SHIFT** → **ACQ MENU** → **Stop After** (main) → **Single Sequence** (side).

To Turn Off Acquisitions

Do the following step to stop acquisitions in roll mode:

If you are not in **Single Sequence**, you must press **RUN/STOP** to stop roll mode. If you are in **Single Sequence**, roll mode acquisitions stop automatically when a complete record is acquired.

To Turn Off Roll Mode

Do the following steps to turn off roll mode:

NOTE. *Envelope, Average (acquisition modes), or any of the persistence modes (display modes) also turn off roll mode. You also turn off roll mode if you set the horizontal Clock menu to External and the maximum external sample rate greater than 1 kc per second.*

1. Set the Horizontal **SCALE** to 20 ms per division or faster.
2. To turn off roll mode even if the Horizontal **SCALE** is 50 ms per division or slower, press **HORIZONTAL MENU** → **Horiz Controls** (main), and set **Roll Mode** (side) to **Off**.
3. If you are in a single sequence roll mode and want to leave single sequence mode, press **SHIFT** → **ACQ MENU** → **Stop After** (main) → **RUN/STOP** (side).

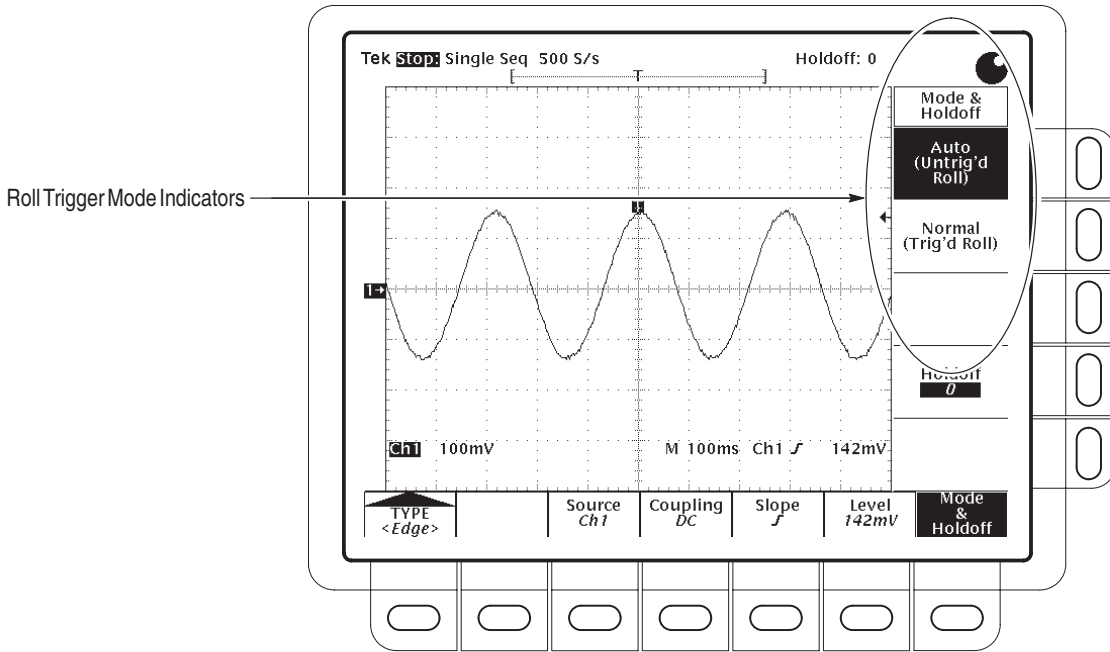

Figure 3-54: Trigger Mode Menu

Saving and Recalling Setups

Your digitizing oscilloscope can store up to ten oscilloscope setups in internal memory that you may later recall. This section describes how you save and recall a setup and how you can recall the factory default setup.

To Save a Setup

To save the current setup of the digitizing oscilloscope:

1. Press **SETUP** → **Save Current Setup** (main).

STOP. Before doing step 2 that follows, note that if you choose a setup location labeled user, you will overwrite the user setup previously stored there.

2. To store a setup internally, choose one of the ten storage locations from the side menu **To Setup 1, To Setup 2, ...** (see Figure 3-55). Now the current setup is stored in that location.
3. To store a setup to disk, press **To File**. Then use the general purpose knob to select the exact file from the resulting scrollbar list. Finally, press the side-menu **Save To Selected File** to complete the operation.

NOTE. Setups are not transferable between different oscilloscope models or software versions.

To Recall a Setup

To recall a setup stored internally, press **SETUP** → **Recall Saved Setup** (main) → (**Recall Setup 1, Recall Setup 2 ...** (side).

To recall a setup stored on disk, press **From File**. Then use the general purpose knob to select the exact file from the resulting scrollbar list. Finally, press **Recall From Selected File** to complete the operation.

Recalling a setup does not change the menu that is currently displayed. If you recall a setup that is labeled *factory* in the side menu, you recall the factory setup. (The conventional method for recalling the factory setup is described below.)

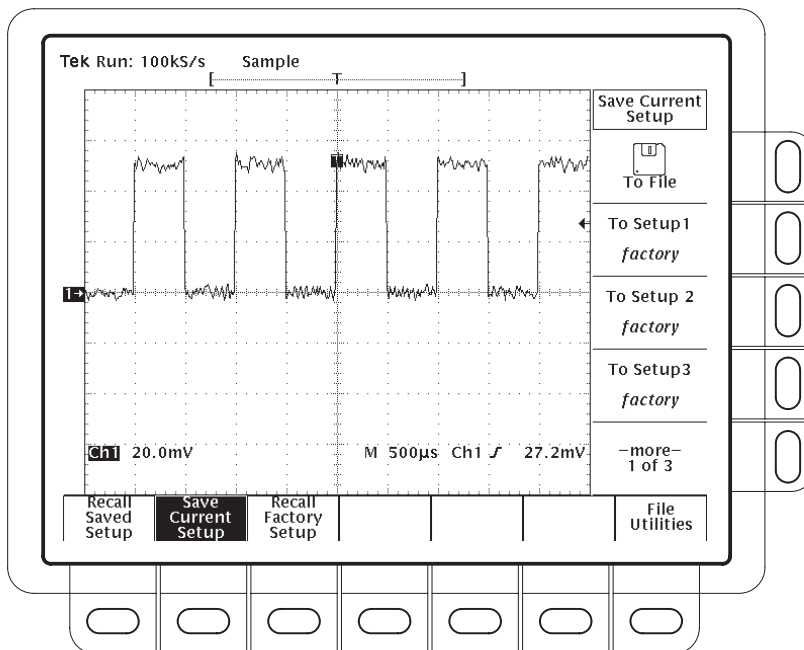

Figure 3-55: Save/Recall Setup Menu

To Recall the Factory Setup

To reset your oscilloscope to the factory defaults:

Press **SETUP** → **Recall Factory Setup** (main) → **OK Confirm Factory Init** (side).

To Delete All Setups and Waveforms — Tek Secure®

To use Tek Secure to remove all stored setups and waveforms (does not affect mass storage disk):

Press **SHIFT UTILITY** → **System** (main) → **Config** (pop-up) → **Tek Secure Erase Memory** (main) → **OK Erase Setup & Ref Memory** (side).

Executing Tek Secure accomplishes the following tasks:

- Replaces all waveforms in reference memories with zero sample values.
- Replaces all setups with the factory setup.
- Verifies successful completion of setup and waveform erasure.
- Displays an unsuccessful or successful completion message.

Saving and Recalling Waveforms

You can store a waveform in any of the four internal reference memories or to the floppy disk. This section describes how to save, delete, and display reference waveforms.

NOTE. *If you select the 120K record length on a TDS 400A, then you can only save one reference waveform. Also, you can only use/display four waveforms. For example: if you display a math waveform that is the sum of CH 1 and CH 2, even if CH 1 and CH 2 are not displayed, you have used three waveforms. Therefore, you can only display one additional waveform.*

The digitizing oscilloscope can display up to 11 waveforms at one time. That includes waveforms from the input channels, four reference waveforms, and three math waveforms. You can save any combination of different size waveform records as long as the total is less than the capacity of nonvolatile waveform memory.

To Save a Waveform

To save a waveform, do the following steps:

1. Select the channel that has the waveform you want to save.

NOTE. *Before doing step 2 that follows, note that if you use a reference memory location labeled active (see Figure 3-56), you overwrite the waveform that was previously stored there.*

2. To store a waveform internally, press save/recall **WAVEFORM** → **Save Waveform** (main) → **Ref1, Ref2, Ref3, or Ref4** (side).

NOTE. *Before doing step 3 on a TDS 400A, note the current Save Format (see Figure 3-58). If you desire to save to a different format, see To Select the Save Format on page 3-107.*

3. To store a waveform to disk, press save/recall **WAVEFORM** → **Save Waveform** (main) → **To File** (side). Then use the general purpose knob to select the exact file from the resulting scrollbar list. Finally, press **Save To Selected File** to complete the operation.

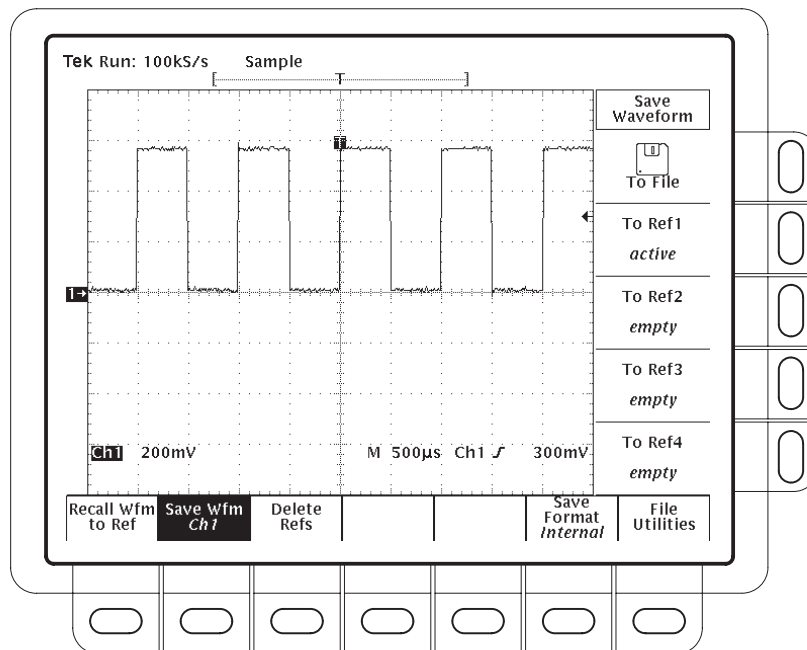

Figure 3-56: Save Waveform Menu (TDS 400A shown)

To Delete Waveforms

To delete a reference waveform(s) that you no longer need:

Press save/recall **WAVEFORM** → **Delete Refs** (main) → **Delete Ref1**, **Delete Ref2**, **Delete Ref3**, **Delete Ref4**, or **Delete All Refs** (side).

To Delete All Waveforms and Setups

To remove *all* stored waveforms and setups, see *To Delete All Setups and Waveforms* on page 3–104.

To Display a Saved Waveform (TDS 400A Only)

To display a waveform in internal reference memory:

Press **MORE** → **Ref1**, **Ref2**, **Ref3**, or **Ref4** (main).

Note that in Figure 3-57, the main menu items Ref2, Ref3, and Ref4 appear shaded while Ref1 does not. References that are empty appear shaded in the More main menu.

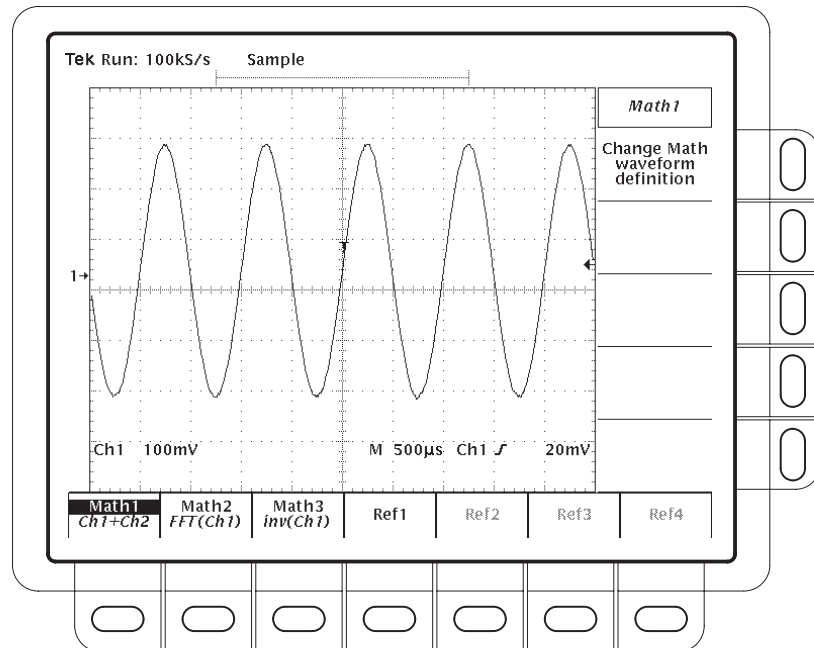

Figure 3-57: More Menu

To Recall a Waveform From Disk

To recall a waveform from disk to an internal reference memory, press save/recall **WAVEFORM** → **Recall Wfm To Ref**. Then use the general purpose knob to select the exact file from the resulting scrollbar list. Finally, press **To Ref1**, **To Ref2**, **To Ref3**, or **To Ref4** to complete the operation.

To Select the Save Format (TDS 400A Only)

To select the format that the oscilloscope uses to save waveforms to a file, press save/recall **WAVEFORM** → **Save Format** (main) → **Internal**, **MathCad**, or **Spreadsheet** (side) (see Figure 3-58). Three formats are available:

- *Internal* creates files (.WFM) in the internal format of the oscilloscope.
- *MathCad* creates files (.DAT) in a format usable by MathCad®.

DAT file data is read line by line and placed into variables in the MathCad document. You then do whatever calculations are required. The DAT format begins with four values acting as a header containing the record length, time per sample interval, trigger location, and trigger offset, followed by a linear array of ASCII floating-point Y values. The recordLength, pre-trigger sample count, and trigger offset are in samples. The horizontal scale per sample is in x units and the y value is in y units.

- *Spreadsheet* creates files (.CSV) in a format usable by most spreadsheets (Excel®, Lotus 1-2-3®, and Quattro Pro®).

CSV files (Comma Separated Values) contain comma separated X and Y ASCII values on CRLF terminated lines (a 2 dimensional array). Each value is a floating point number. There is one line for each point in a waveform record. The X and Y values are displayed in the units of seconds and Volts. All scaling to sample increments and offsetting has been done. Zero on the X scale is the trigger point, with negative values being pretrigger and positive values being posttrigger.

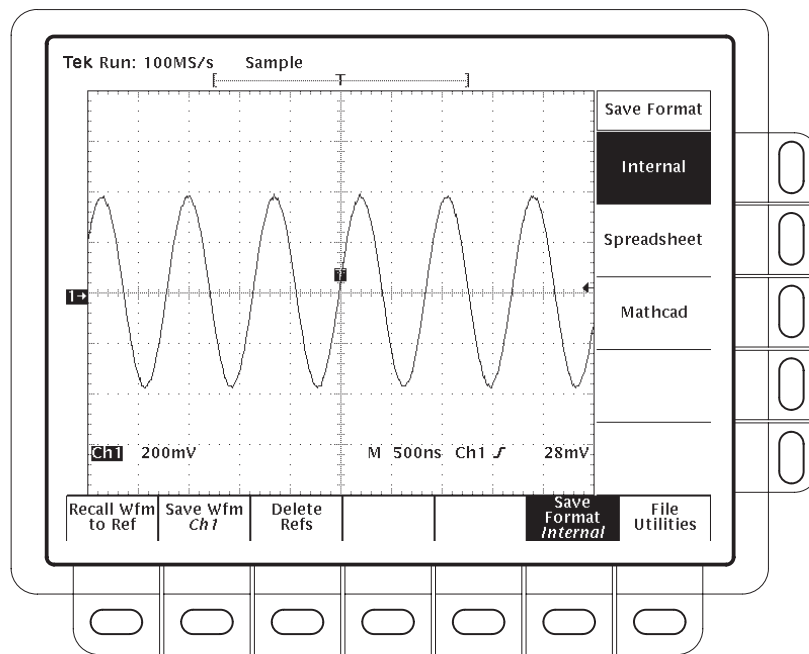

Figure 3-58: Save Format Menu

To View a Waveform on a Spreadsheet (TDS 400A Only)

To save a waveform and view the waveform data using a spreadsheet (this example uses EXCEL):

1. With a disk in the disk drive, press save/recall **WAVEFORM** → **Save Format** (main) → **Spreadsheet** (side).
2. Press **Save Wfm** (main) → **To File** (side). Then press **Save to Selected File** (side).
3. Remove the disk and place it in your computer drive.
4. Start EXCEL.
5. Using the EXCEL File menu, select Open. From the List Files of Type menu, select Text Files (*.prn, *.txt, *.csv). From the Drives menu, select the drive containing the waveform file. From the File Name menu, select the name of the waveform file. Now select OK.

Selecting Channels

The digitizing oscilloscope applies all waveform-specific activities, such as measurements or vertical scale and position, to the *selected channel*. You can select a *channel waveform*, a *math waveform*, or a *reference waveform*. This section describes how to select a waveform and how you can turn the display of a waveform off.

To Identify the Selected Channel

To determine which channel is currently selected, check the *channel readout*. It shows the selected channel in inverse video in the lower left corner of the display. The *channel reference indicator* for the selected channel also appears in reverse video along the left side of the display. See Figure 3-59.

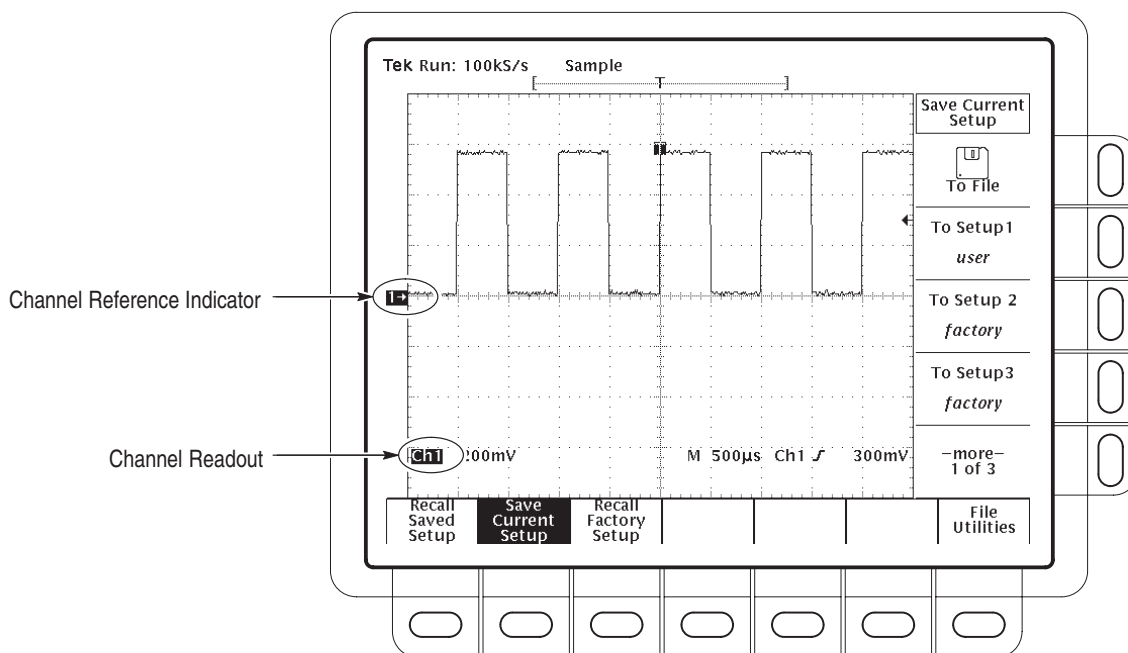

Figure 3-59: The Channel Readout

To Select and Remove Waveforms

To select a channel, use the *channel selection* buttons on the right of the display.

These buttons are labeled **CH 1**, **CH 2**, **CH 3**, **CH 4**, and **MORE**. The **MORE** button allows you to select internally stored *Math* and *Ref* waveforms. The selected channel is indicated by the lighted LED by each button.

NOTE. *If you select the 120K record length on a TDS 400A, then you can only save one reference waveform. Also, you can only use/display four waveforms. For example: if you display a math waveform that is the sum of CH 1 and CH 2, even if CH 1 and CH 2 are not displayed, you have used three waveforms. Therefore, you can only display one additional waveform.*

Do the following steps to first display and then remove waveforms from the display:

1. Press **CH 1**, **CH 2**, **CH 3**, or **CH 4** to turn on as many of these channels as desired. The one you select last becomes the selected channel. Selecting a channel turns it on if it is not already on.
2. To turn OFF the display of the selected waveform, press the **WAVEFORM OFF** button.
3. To select a math waveform or a reference waveform, press **MORE** and select the waveform from the More menu. To remove the display of the waveform selected in the More menu, press **WAVEFORM OFF** while the **MORE** button is lit.

Waveform Priority

When you turn off a waveform, the digitizing oscilloscope automatically selects the next highest priority waveform (see Figure 3-60).

1. **CH1** (All models)
2. **CH2** (All models)
3. **CH3** (TDS 420A, TDS 460A, and TDS 510A)
4. **CH4** (TDS 420A, TDS 460A, and TDS 510A)

5. **MATH1**
6. **MATH2**
7. **MATH3**

8. **REF1**
9. **REF2**
10. **REF3**
11. **REF4**

Figure 3-60: Waveform Selection Priority

Setting Up Automatically: Autoset and Reset

The digitizing oscilloscope can automatically obtain and display a stable waveform of usable size. This section describes how to execute autoset.

Autoset automatically sets up the front panel controls based on the characteristics of the input signal. Autoset makes adjustments in these categories: Acquisition, Display, Horizontal, Trigger, and Vertical.

NOTE. *Autoset may change vertical position in order to position the waveform appropriately. It always sets vertical offset to 0 V.*

Autoset the Oscilloscope

Do the following steps to automatically setup the oscilloscope:

1. Press the Channel Selection button (such as **CH 1**) corresponding to your input channel to make it active.
2. Press **AUTOSET**.

If you use autoset when one or more channels are displayed, the digitizing oscilloscope selects the lowest numbered channel for horizontal scaling and triggering. Vertically, all channels in use are individually scaled.

If you use autoset when no channels are displayed, the digitizing oscilloscope turns on channel one (CH 1) and scales it.

Reset the Oscilloscope

Do the following steps to reset your oscilloscope to its factory default settings:

Press **SETUP** → **Recall Factory Setup** (main) → **OK Confirm Factory Init** (side).

Signal Path Compensation

Signal Path Compensation (SPC) minimizes electrical offsets in the vertical, horizontal, and trigger amplifiers caused by changes in ambient temperature and component aging. This allows you to make accurate measurements over a wide ambient temperature range.

Run an SPC anytime you wish to ensure that the measurements you make are made with the most accuracy possible. You should also run an SPC if the temperature has changed more than 5°C since the last SPC was performed.

NOTE. *When making measurements at volts/division settings less than or equal to 5 mV, you must run SPC at least once per week. Failure to do so may result in the oscilloscope not meeting warranted performance levels at those volts/div settings.*

To run an SPC, do the following steps:

1. Power on the digitizing oscilloscope and allow a 20-minute warm up.
2. Disconnect all input signals.

STOP. *If you interrupt (or lose) power to the instrument while signal-path compensation is running, a message is stored in the oscilloscope error log. If such a case occurs, rerun signal-path compensation. (The error message remains in the error log until cleared using special service software.)*

3. Press **SHIFT UTILITY** → **System** (main) → **Cal** (pop-up) → **Signal Path** (main) → **OK Compensate Signal Paths** (side).
4. Wait for signal path compensation to complete (one to three minutes). While it progresses, a “clock” icon (shown at left) is displayed on-screen. When compensation completes, the status message is updated to *Pass* or *Fail*.
5. Verify the word *Pass* appears under **Signal Path** in the main menu. (See Figure 3-61.)



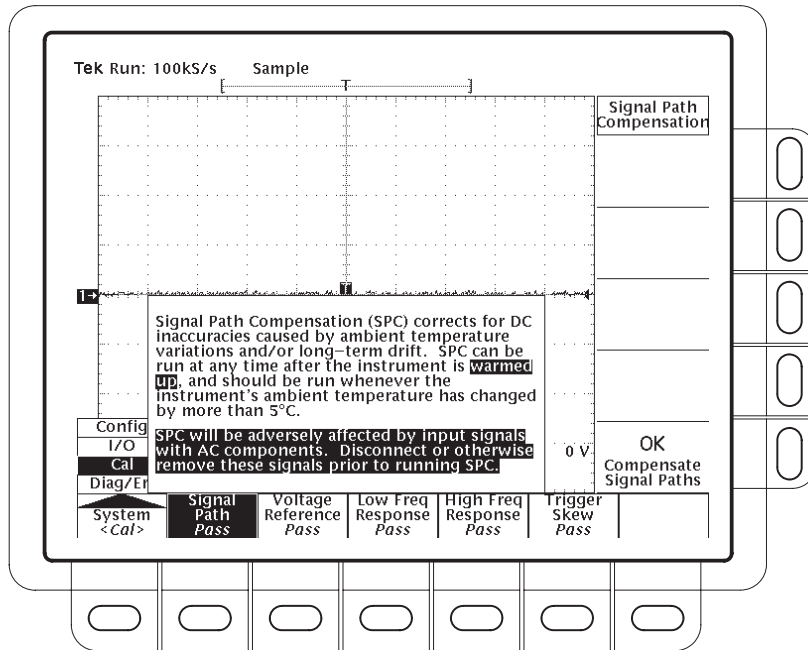

Figure 3-61: Performing a Signal Path Compensation

Taking Cursor Measurements

Use the cursors to measure the difference (either in time or voltage) between two locations in a waveform record. This section describes cursors — how to select their type and mode, how to display them, and how to use them to take measurements.

Description

Cursors are two markers that you position with the general purpose knob. As you position the cursors, readouts on the display report and update measurement information.

Cursor Types

There are three cursor types: *horizontal bar*, *vertical bar*, and *paired* (see Figure 3-62).

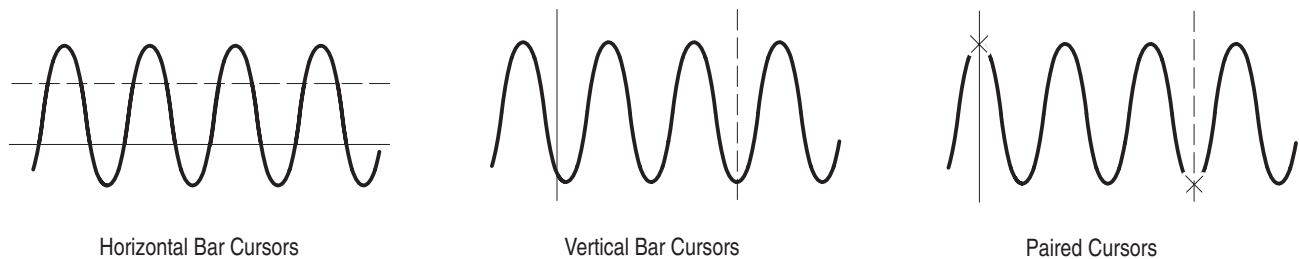

Figure 3-62: Cursor Types

Horizontal bar cursors measure vertical parameters (typically volts).

Vertical bar cursors measure horizontal parameters (typically time or frequency).

Paired cursors measure both vertical and horizontal parameters simultaneously.

Look at Figure 3-62. Note that each of the two paired cursors has a long vertical bar paired with an X. The Xs measure vertical parameters; the long vertical bars measure horizontal parameters.

NOTE. When cursors measure certain math waveforms, the measurement may not be of time, frequency, or voltage. Cursor measurement of those math waveforms are described in *Waveform Math*, which begins on page 3-139.

Cursor Modes There are two cursor modes: *independent* and *tracking* (see Figure 3-63).

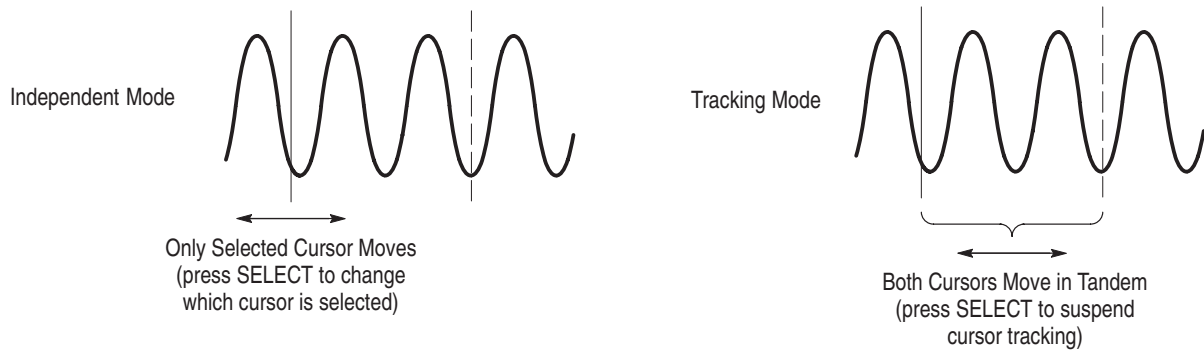

Figure 3-63: Cursor Modes

Cursor Readouts The cursor readouts differ depending on whether you are using H Bars, V Bars, or Paired.

H Bars. The value after Δ shows the voltage difference between the cursors. The value after @ shows the voltage of the selected cursor relative to ground (see Figure 3-64). With video triggers, you can display the voltage in IRE units.

V Bars. The value after Δ shows the time (or frequency) difference between the cursors. The value after @ shows the time (frequency) of the selected cursor relative to the trigger point. With video triggers, you can display the line number.

Paired. The value after one Δ shows the voltage difference between the two Xs; the other Δ shows the time (or frequency) difference between the two long vertical bars. The value after the @ shows the voltage at the X of the selected cursor relative to ground (see Figure 3-65).

If the paired cursors are moved off screen horizontally, Edge replaces the voltage values in the cursor readout.

Select the Cursor Function Do this procedure and those that follow to take a cursor measurement. To select the type of cursors you want, do the following steps:

1. To display the cursor menu, press **CURSOR** (see Figure 3-64).
2. Press **CURSOR** → **Function** (main) → **H Bars, V Bars, Paired, or Off** (side).

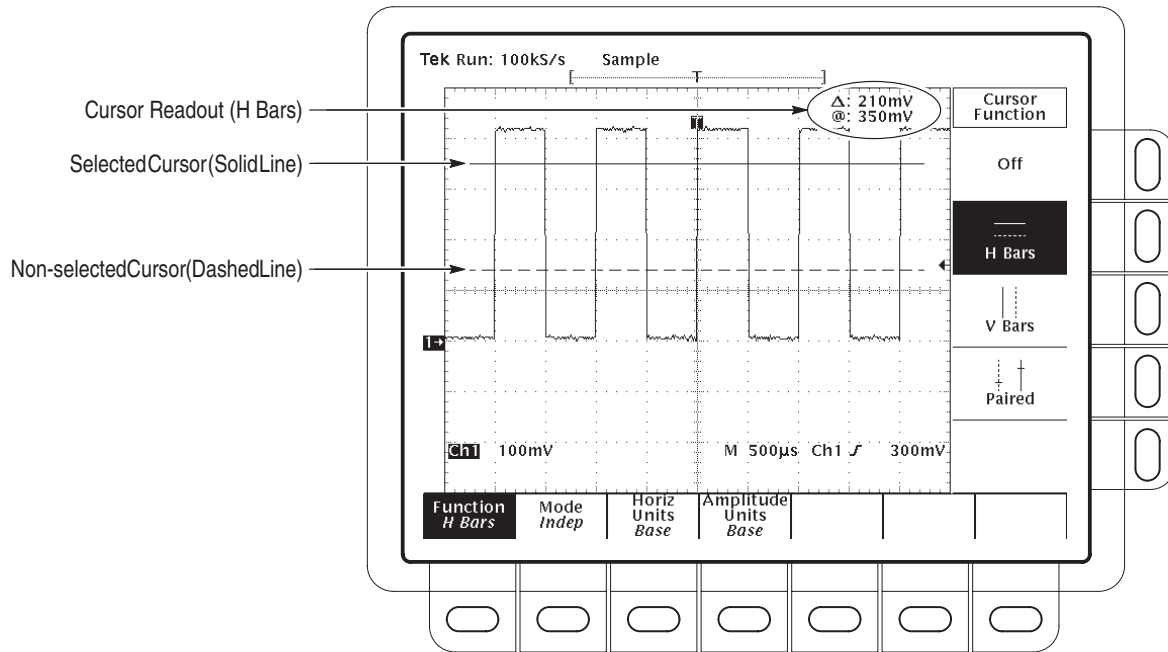

Figure 3-64: H Bars Cursor Menu and Readouts

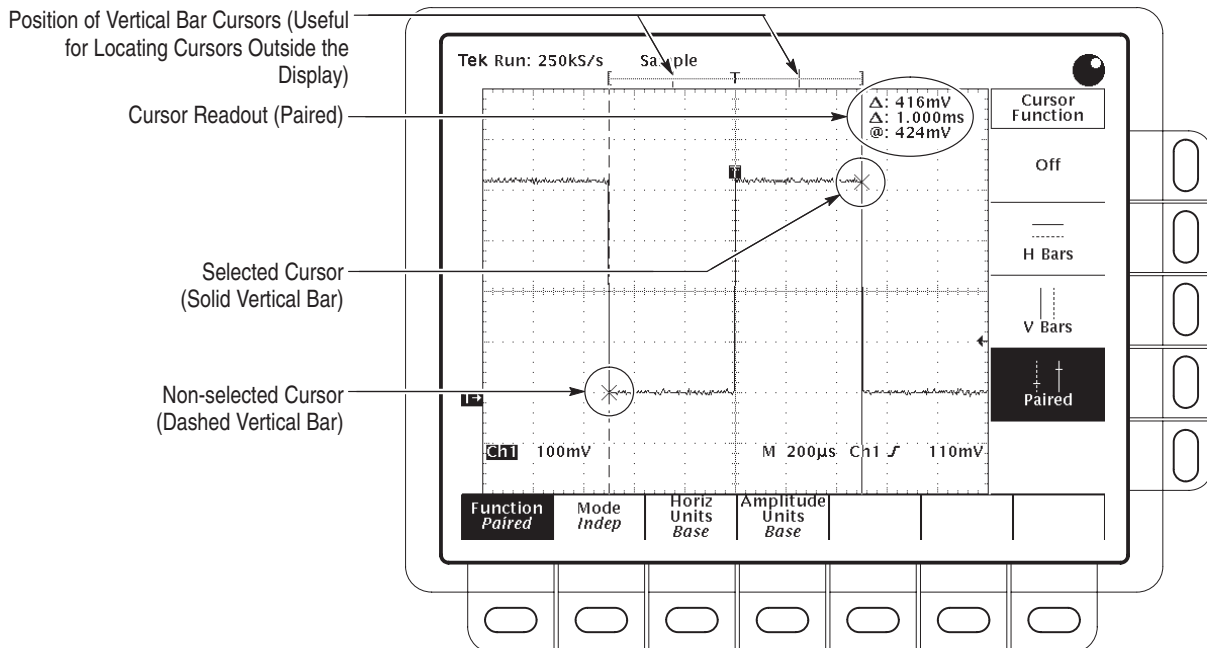

Figure 3-65: Paired Cursor Menu and Readouts

Set Mode and Adjust the Cursors

To select the cursor mode and adjust the cursors in either mode, do the following steps:

1. Press **CURSOR → Mode (main) → Independent** or **Tracking (side)**:

Independent makes each cursor positionable without regard to the position of the other cursor.

Tracking makes both cursors positionable in tandem; that is, both cursors move in unison and maintain a fixed horizontal or vertical distance between each other.

2. Adjust the cursors according to the mode you have selected:

- To adjust either cursor in independent mode, use the general purpose knob to move the selected (active) cursor. A solid line indicates the adjustable cursor, and a dashed line indicates the fixed cursor. Press **SELECT** to toggle between cursors.
- To adjust both cursors in tracking mode, use the general purpose knob.
- To adjust the distance between cursors in tracking mode, press **SELECT** to temporarily suspend cursor tracking. Then use the general purpose knob to adjust the distance of the solid cursor relative to the dashed cursor. Press **SELECT** again to resume tracking.

Select Horizontal Units

You can choose to display vertical bar cursor results in the base horizontal units of the waveform or in 1/base horizontal units of the waveform. For internally clocked waveforms the units are time or frequency; for externally clocked waveforms (TDS 400A only) the units are clocks or 1/clocks. If you have Option 05 Video, you can also display the results in terms of video line number (see Figure 3-66). To choose vertical bar cursor units, do the following step:

NOTE. *If Custom video mode is selected, you also need to set the Scan Period in the Custom Video menu.*

On a TDS 400A press **CURSOR → Horiz Units (main) → Base** or **1/Base**, or with Option 5, **video line number** (side).

On a TDS 510A press **CURSOR → Time Units (main) → seconds** or **1/seconds**, or with Option 5, **video line number** (side).

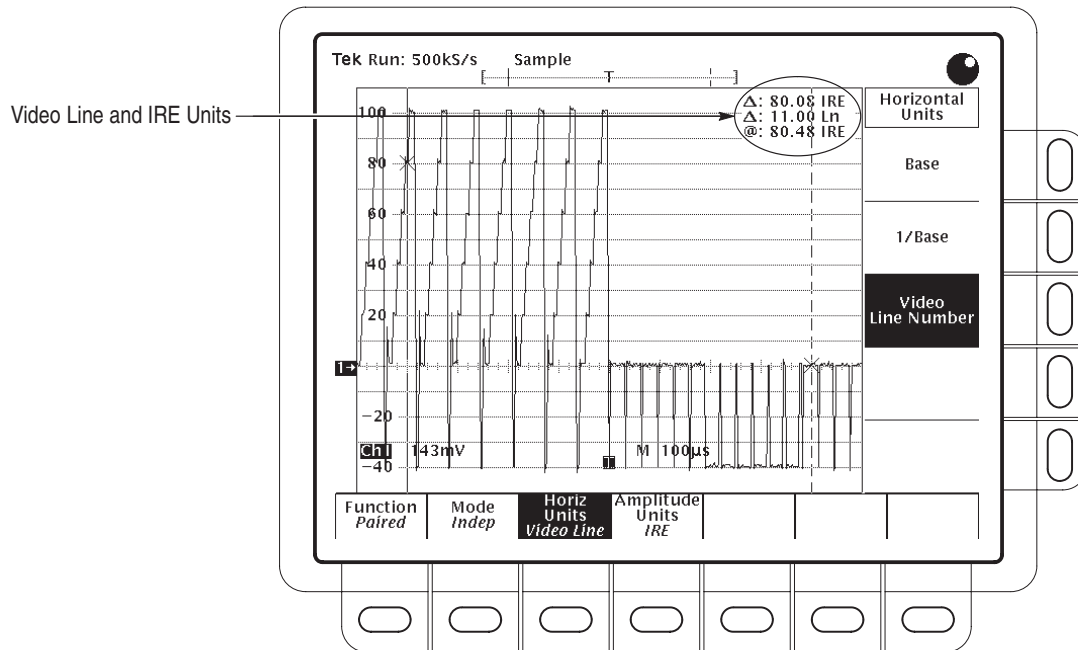

Figure 3-66: Video Line and IRE Units (TDS 400A shown)

Select Amplitude Units

If you have option 05 Video Trigger and are measuring NTSC signals, you can choose to display vertical readings in IRE units (see Figure 3-66). To switch between IRE and base cursor units, do the following steps:

1. Press **CURSOR** → **Amplitude Units** (main) → **IRE** (NTSC).
2. To return to normal, press **CURSOR** → **Amplitude Units** (main) → **Base**.

Select Cursor Speed

To change the cursors speed, press **SHIFT** before turning the general purpose knob. The cursors move faster when the **SHIFT** button is lighted and the display reads *Coarse Knobs* in the upper right corner.

Vertical Control

You can control the vertical position and scale of the selected waveform using the vertical menu and knobs.

To Change Vertical Scale and Position

By changing the vertical scale, you can focus on a particular portion of a waveform. By adjusting the vertical position, you can move the waveform up or down on the display. That is particularly useful when you are comparing two or more waveforms.

If you want the **POSITION** knob to move faster, press the **SHIFT** button. When the light next to the **SHIFT** button is on and the display says **Coarse Knobs** in the upper right corner, the **POSITION** knob speeds up significantly.

To Check the Vertical Scale

Check the *Vertical readout* at the bottom-left part of the display for the volts/division setting of each displayed channel (the selected channel is in inverse video). (See Figure 3-67.)

To Change Vertical Parameters

Use the Vertical menu (see Figure 3-67) to select the coupling, bandwidth, and offset for the selected waveform. This menu also lets you numerically change the position or scale.

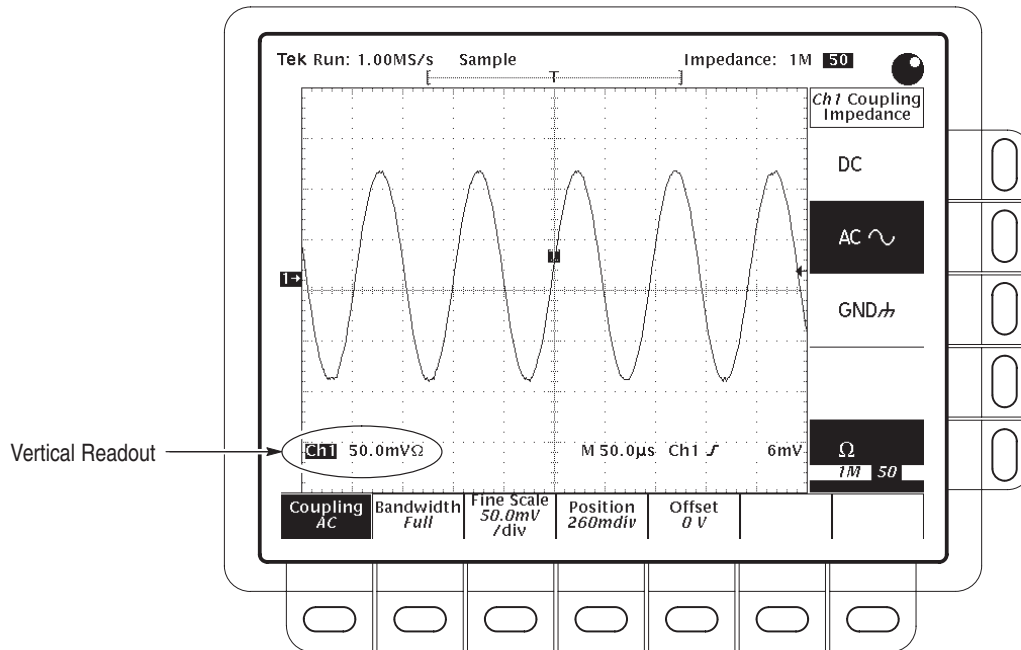

Figure 3-67: Vertical Readouts and Channel Menu

Coupling

To choose the type of coupling for attaching the input signal to the vertical attenuator for the selected channel and to set its input impedance:

Press **VERTICAL MENU** → **Coupling** (main) → **DC**, **AC**, **GND**, or **Ω** (side).

DC

DC coupling shows both the AC and DC components of an input signal.

AC ~

AC coupling shows only the alternating components of an input signal.

GND

GND (ground) coupling disconnects the input signal from the acquisition.

Ω

Ω (input impedance) lets you select either 1 MΩ or 50 Ω impedance.

NOTE. If you select 50 Ω impedance with AC coupling, the digitizing oscilloscope will not accurately display frequencies under 200 kHz.

Also, when you connect an active probe to the oscilloscope, the oscilloscope sets the input impedance to 50 Ω and the input coupling to AC. If you then connect a passive probe you need to set the input impedance back to 1 MΩ.

Bandwidth

Bandwidth refers to the range of frequencies that an oscilloscope can acquire and display accurately (that is, with less than 3 dB attenuation). To select the upper

limit for the higher frequency components, change the bandwidth of the selected channel:

Press **VERTICAL MENU** → **Bandwidth** (main) → **Full, 100 MHz**, or **20 MHz** (side).

- Fine Scale** To make fine adjustments to the vertical scale, press **VERTICAL MENU** → **Fine Scale** (main) and use the general purpose knob to adjust the vertical scale.
- Position** To adjust the vertical position to a specific number of divisions, press **VERTICAL MENU** → **Position** (main) and use the general purpose knob to set vertical position. If you want to reset the reference point of the selected waveform to the center of the display, press **Set to 0 divs** (side).
- Offset** Offset lets you subtract DC bias from the waveform. For example, you might be trying to look at a 100 mV ripple on top of a 15 V supply. Using offset you can display the ripple and scale it to meet your needs.
- To use offset, press **VERTICAL MENU** → **Offset** (main). Then use the general purpose knob to set the vertical offset. If you want to reset the offset to zero, press **Set to 0 V** (side).

Video Triggering (TDS 400A)

If you have a TDS 510A with Option 05, refer to the *TDS Family Option 05 Video Trigger Interface* Instruction manual for video trigger operating information. The optional Video Trigger menu lets you select the source, polarity, class, mode, and holdoff. It also gives you the option to delay by lines or time and lets you trigger on the first field, second field, or both.

A *video trigger* event occurs when a video signal generates a horizontal or vertical sync pulse.

To Select Video Triggering

To bring up the Video Trigger menu:

Press the **TRIGGER MENU** → **Type** (main) → **Video** (side) (see Figure 3-68).

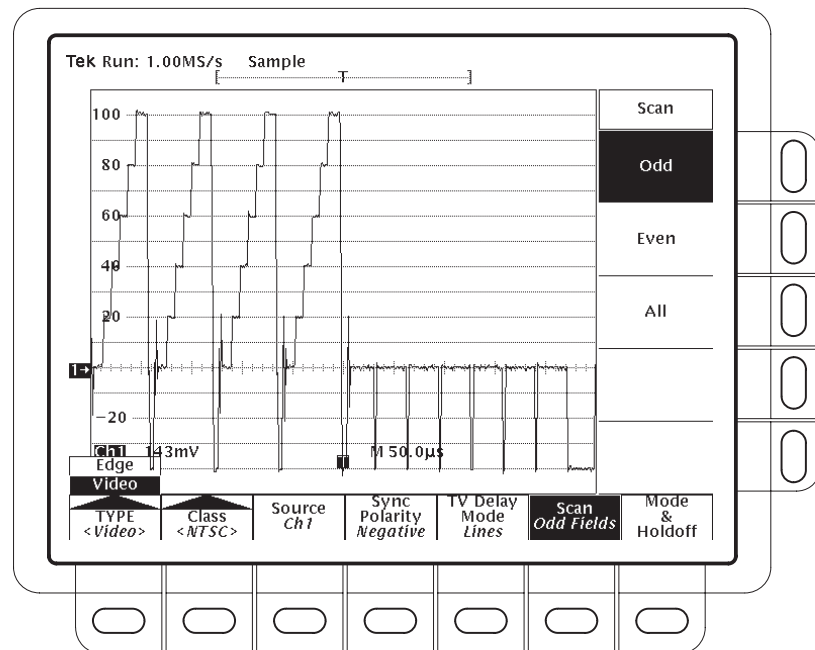

Figure 3-68: Main Trigger Menu — Video Type

To Select Video Class To select predefined setups (NTSC, PAL, or SECAM) or customize the setup:

Press the **TRIGGER MENU** → **Type** (main) → **Video** (pop-up)
Class, (main) → **NTSC**, **PAL**, **SECAM**, or **Custom** (pop-up) (Figure 3-69).

NTSC has a line rate of 525 lines per frame and a field rate of 60 Hz.

PAL has a line rate of 625 lines per frame and a field rate of 50 Hz.

SECAM has a line rate of 625 lines per frame and a field rate of 50 Hz.

Custom lets you specify the frequency range of the video signal. The different ranges are listed in the Scan Parameter side menu (discussed later in this section).

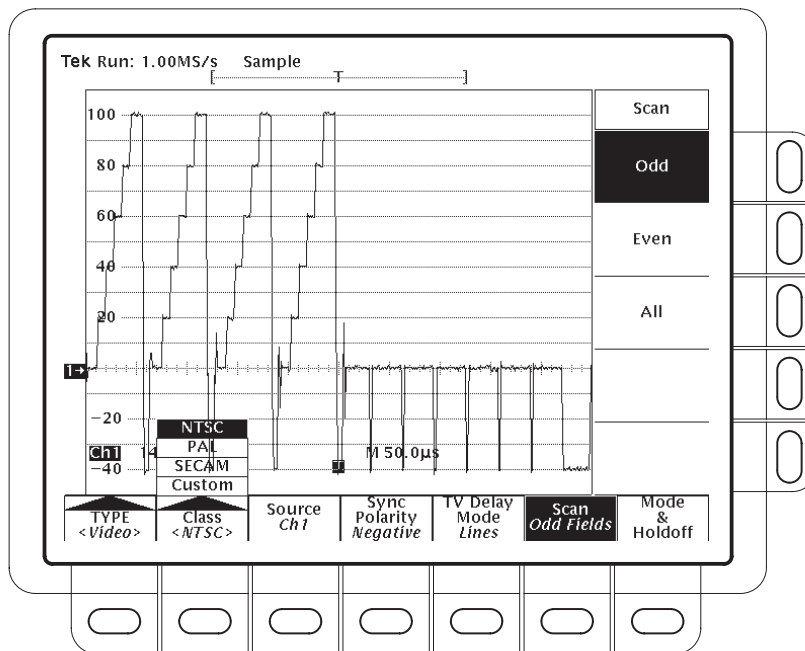

Figure 3-69: Video Trigger Menu — Class

To Select the Source

To select which source you want the trigger to come from:

Press **TRIGGER MENU** → **Source** (main) → **Ch1**, **Ch2**, **Ch3**, or **Ch4** (side).

To Set Sync Polarity



Negative polarity is the standard for horizontal and vertical sync pulses. To set the sync polarity:

Press the **TRIGGER MENU** → **Sync Polarity** (main) → **Neg Sync** or **Pos Sync** (side).

To Specify TV Delay Mode

To specify the TV Delay Mode (see Figure 3-70):

Press the **TRIGGER MENU** → **TV Delay Mode** (main) → **Delay by Lines** or **Delay by Time** (side). Use the general purpose knob to enter the value.

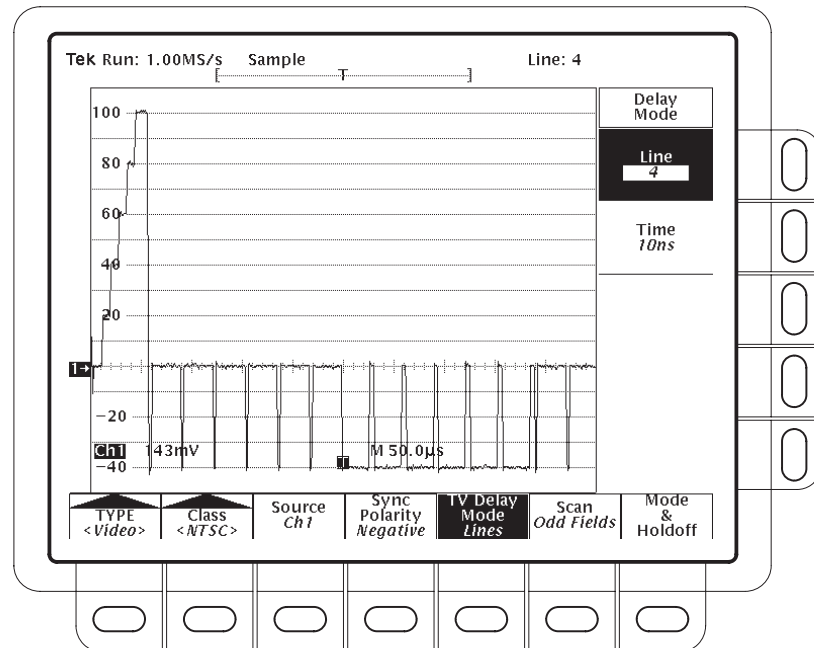

Figure 3-70: Video Trigger Menu — TV Delay Mode

To Select TV Fields

To select the NTSC, PAL, or SECAM field to trigger on:

Press the **TRIGGER MENU** → **Scan** (main) → **Odd**, **Even**, or **All** (side) (see Figure 3-71).

If you choose *Odd*, the digitizing oscilloscope always triggers on the start of the odd field in an interlaced frame.

If you choose *Even*, the digitizing oscilloscope always triggers on the first line of the even field in an interlaced frame.

If you choose *All*, the digitizing oscilloscope alternates between triggering on the start of the odd and even fields.

To Set the Scan Rate & Interlace Mode

If you select Custom in the Class menu, the Scan Rate & Interlace option lists several frequency range options (see Figure 3-72). Precise setting of the Scan Period is only required if the video class is Custom and you use video line cursors; however, adjusting the period also selects the appropriate scan rate. Also, choosing a scan rate incompatible with the current scan period setting forces the scan period to the minimum period implied by the selected rate.

By toggling the button next to the **Interlaced** option, you can trigger on interlaced field one, interlaced field two, or both fields noninterlaced.

To Set Mode & Holdoff See *To Set Mode and Holdoff*, on page 3–24, for mode and holdoff information.

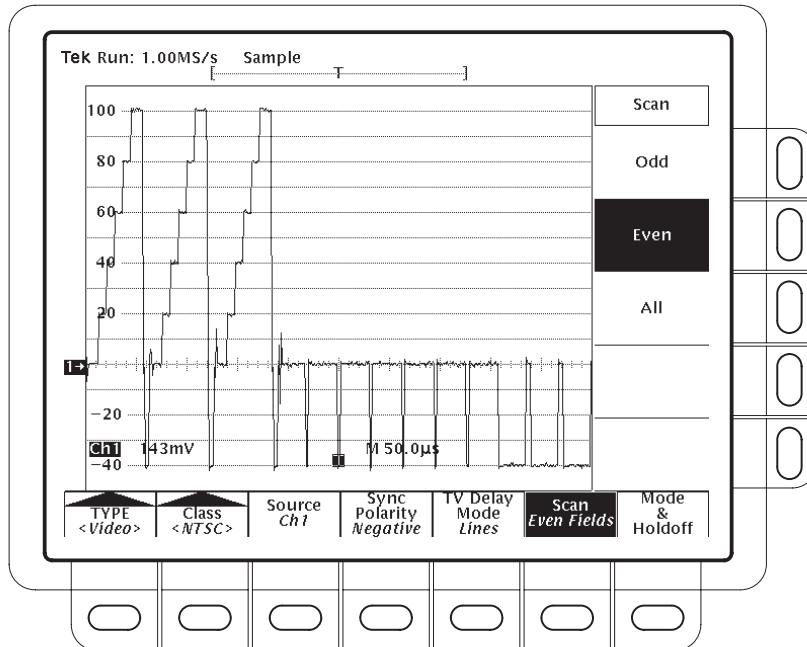

Figure 3-71: Video Trigger — Scan Parameter

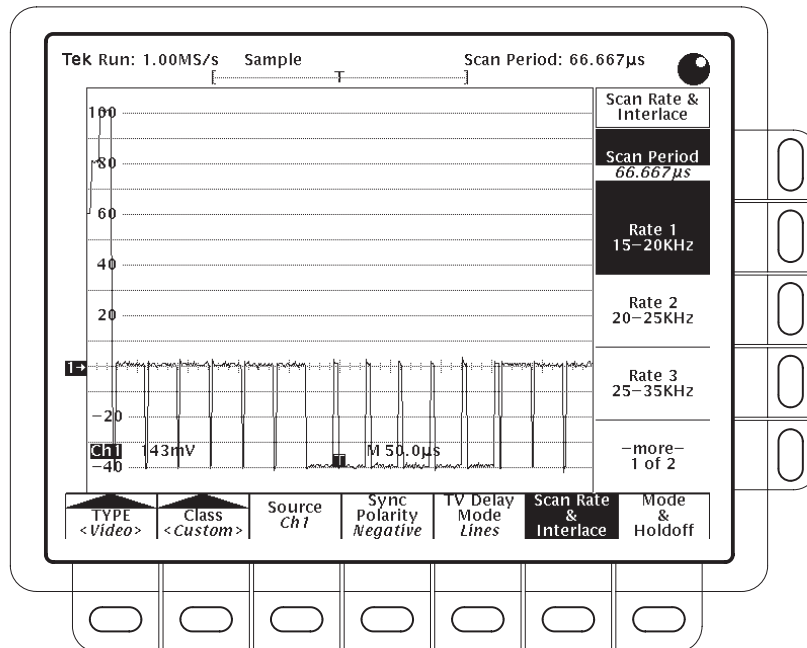

Figure 3-72: Video Trigger — Scan Rate & Interlace

Waveform Differentiation (Optional)

Description

The math waveform is derived from the sampled waveform. Since the resultant waveform is a derivative waveform, its vertical scale is in vertical units per second (its horizontal scale is in seconds).

Operation

To obtain a derivative math waveform:

1. Connect the waveform to the desired channel input and select that channel.
2. Adjust the vertical and horizontal scales and trigger the display (or press **AUTOSET**).
3. Press **MORE** → **Math1**, **Math2**, or **Math3** (main) → **Change Math Definition** (side) → **Single Wfm Math** (main). See Figure 3-73.
4. Press **Set Single Source to** (side). Repeatedly press the same button (or use the general purpose knob) until the channel source selected in step 1 appears in the menu label.
5. Press **Set Function to** (side). Repeatedly press the same button (or use the general purpose knob) until **diff** appears in the menu label.
6. Press **OK Create Math Wfm** (side) to display the derivative of the waveform you input in step 1. Use the Vertical **SCALE** and **POSITION** knobs to size and position your waveform as you require.

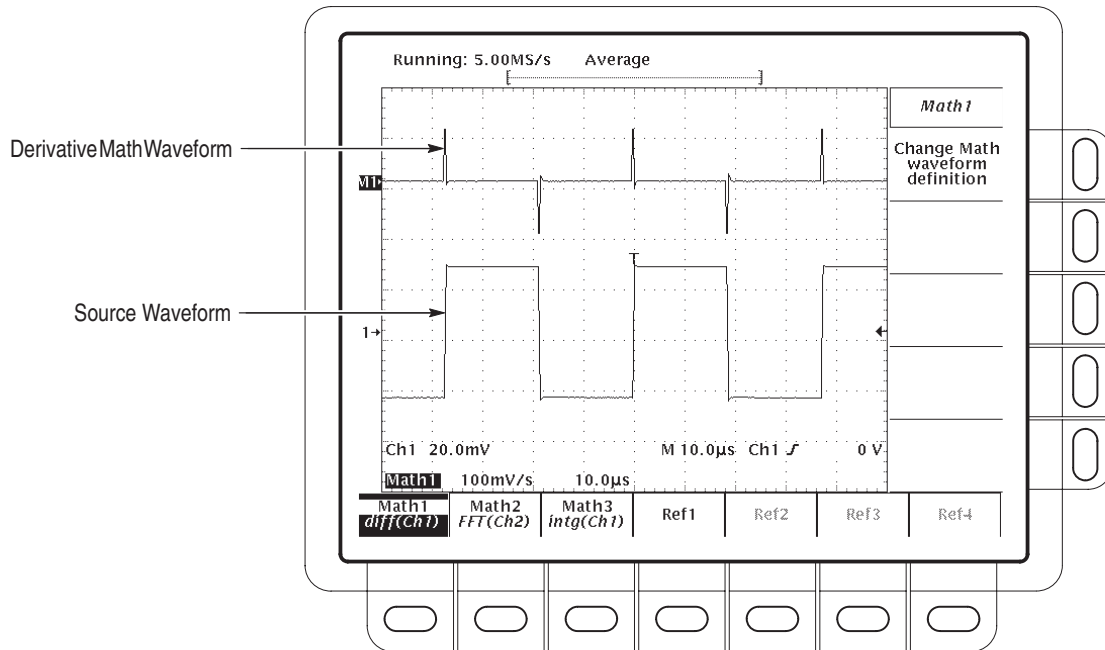

Figure 3-73: Derivative Math Waveform

Automated Measurements of a Derivative Waveform

Do the following steps to display automated measurements of the waveform:

1. Be sure **MORE** is selected in the channel selection buttons and that the differentiated math waveform is selected in the **More** main menu.
2. Press **MEASURE** → **Select Measrmnt** (main).
3. Select up to four measurements in the side menu (see Figure 3-74).

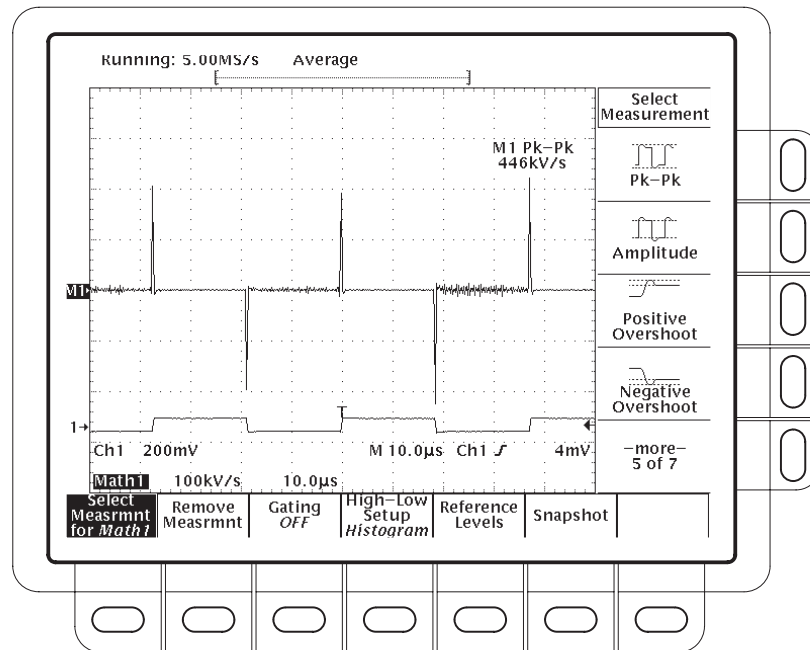

Figure 3-74: Peak-Peak Amplitude Measurement of a Derivative Waveform

Cursor Measurement of a Derivative Waveform

You can also use cursors to measure derivative waveforms. Use the same procedure as is found under *Cursor Measurements of an Integral Waveform* on page 3–136. When using that procedure, note that the amplitude measurements on a derivative waveform will be in volts (vertical units) per second rather than in volt-seconds as is indicated for the integral waveform measured in the procedure.

Usage Considerations

When creating differentiated math waveforms from live channel waveforms, consider the following topics.

Offset, Position, and Scale

Note the following tips for obtaining a good display:

- Scale and position the source waveform so it is contained on screen. (Off screen waveforms may be clipped, resulting in errors in the derivative waveform).
- Use vertical position and vertical offset to position your *source* waveform. The vertical position and vertical offset will not affect your derivative waveform unless you position the source waveform off screen so it is clipped.

- When using the vertical scale knob to scale the source waveform, note that it also scales your derivative waveform.

The derivative math waveform may be too large vertically to fit on screen — even if the source waveform is only a few divisions on screen. You can use Zoom to reduce the size of the waveform on screen (see *Zoom* that follows), but if your waveform is clipped before zooming, it will still be clipped after it is zoomed.

If your math waveform is a narrow differentiated pulse, it may not appear to be clipped when viewed on screen. You can detect if your derivative math waveform is clipped by expanding it horizontally using Zoom so you can see the clipped portion. Also, the automated measurement **Pk-Pk** will display a clipping error message if turned on (see *Automated Measurements of a Derivative Waveform* on page 3–132).

If your derivative waveform is clipped, try either of the following methods to eliminate clipping:

- Reduce the size of the source waveform on screen.
- Expand the waveform horizontally on screen. For instance, if you display the source waveform illustrated in Figure 3-73 on page 3–132 so its rising and falling edges are displayed over more horizontal divisions, the amplitude of the corresponding derivative pulse will decrease.

Whichever method you use, be sure Zoom is off and the zoom factors are reset (see *Zoom* below).

Zoom Once you have your waveform optimally displayed, you can also magnify (or contract) it vertically and horizontally to inspect any feature. Just be sure the differentiated waveform is the selected waveform.

If you wish to see the zoom factor (2X, 5X, etc.), you need to turn zoom on (see *Zoom* on page 3–143).

Waveform Integration (Optional)

Waveform integration that allows you to display a math waveform that is an integrated version of the acquired waveform. Such waveforms find use in the following applications:

- Measuring power and energy, such as in switching power supplies
- Characterizing mechanical transducers, as when integrating the output of an accelerometer to obtain velocity

The waveform vertical scale is in volt-seconds (its horizontal scale is in seconds). If you are not using a voltage probe, some digitizing oscilloscopes can display other vertical units.

Operation

To obtain an integral math waveform:

1. Connect the waveform to the desired channel input and select that channel.
2. Adjust the vertical and horizontal scales and trigger the display (or press **AUTOSET**).
3. Press **MORE** → **Math1**, **Math2**, or **Math3** (main) → **Change Math waveform definition** (side) → **Single Wfm Math** (main).
4. Press **Set Single Source to** (side). Repeatedly press the same button until the channel source selected in step 1 appears in the menu label.
5. Press **Set Function to** (side). Repeatedly press the same button until **intg** appears in the menu label.
6. Press **OK Create Math Waveform** (side) to turn on the integral math waveform (see Figure 3-75).

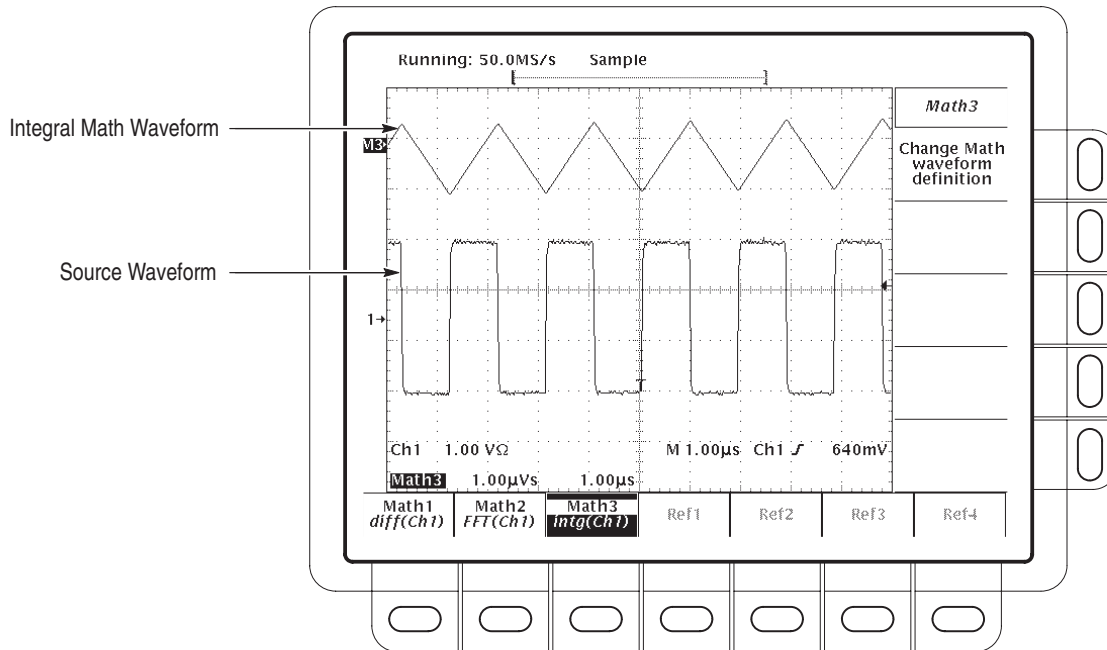

Figure 3-75: Integral Math Waveform

Cursor Measurements of an Integral Waveform

Once you have displayed your integrated math waveform, use cursors to measure its voltage over time:

1. Be sure **MORE** is selected (illuminated) in the channel selection buttons and that the integrated math waveform is selected in the **More** main menu.
2. Press **CURSOR** → **Mode** (main) → **Independent** (side) → **Function** (main) → **H Bars** (side).
3. Use the general purpose knob to align the selected cursor (solid) to the top (or to any amplitude level you choose).
4. Press **SELECT** to select the other cursor.
5. Use the general purpose knob to align the selected cursor (to the bottom (or to any amplitude level you choose)).
6. Read the integrated voltage over time between the cursors in volt-seconds from the **Δ**: readout. Read the integrated voltage (vertical units) over time between the selected cursor and the reference indicator of the math waveform from the **@**: readout. See Figure 3-76.

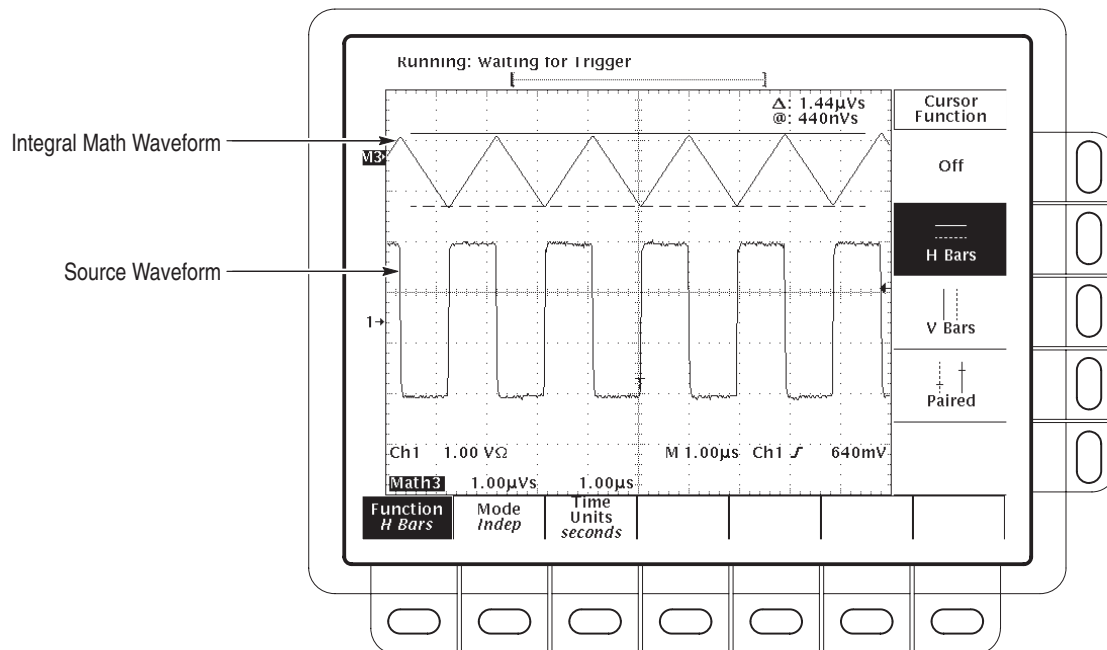

Figure 3-76: H Bars Cursors Measure an Integral Math Waveform

7. Press **Function** (main) → **V Bars** (side). Use the general purpose knob to align one of the two vertical cursors to a point of interest along the horizontal axis of the waveform.
8. Press **SELECT** to select the alternate cursor.
9. Align the alternate cursor to another point of interest on the math waveform.
10. Read the time difference between the cursors from the **Δ:** readout. Read the time difference between the selected cursor and the trigger point for the *source* waveform from the **@:** readout.
11. Press **Function** (main) → **Paired** (side).
12. Use the technique just outlined to place the long vertical bar of each paired cursor to the points along the horizontal axis you are interested in.
13. Read the following values from the cursor readouts:
 - Read the integrated voltage (vertical units) over time between the Xs of both paired cursors in volt-seconds from the **Δ:** readout.
 - Read the integrated voltage over time between the X of the selected cursor and the reference indicator of the math waveform from the **@:** readout.

- Read the time difference between the *long* vertical bars of the paired cursors from the **Δ**: readout.

Automated Measurements of an Integral Waveform

You can also use automated measurements to measure integral math waveforms. Use the same procedure as is found under *Waveform Differentiation* on page 3–132. When using that procedure, note that your measurements on an integral waveform will be in volt-seconds (if the vertical units are volts) rather than in volts per second as is indicated for the differential waveform measured in the procedure.

Usage Considerations

When creating integrated math waveforms from live channel waveforms, consider the following topics.

Offset, Position, and Scale

Note the following requirements for obtaining a good display:

- Scale and position the source waveform so it is contained on screen. (Off screen waveforms may be clipped, resulting in errors in the integral waveform).
- You can use vertical position and vertical offset to position your source waveform. The vertical position and vertical offset will not affect your integral waveform unless you position the source waveform off screen so it is clipped.
- When using the vertical scale knob to scale the source waveform, note that it also scales your integral waveform.

DC Offset

The oscilloscope integrates any DC offset along with the time varying portions of your waveform. Even a few divisions of offset may be enough to ensure that the integral waveform saturates (clips), especially with long record lengths.

You may be able to avoid saturating your integral waveform if you choose a shorter record length. Reducing the sample rate with the source channel selected might also prevent clipping. You can also select AC coupling in the vertical menu of the *source* waveform or otherwise DC filter it before applying it to the oscilloscope input.

Zoom

Once you have your waveform optimally displayed, you may magnify (or reduce) it vertically and horizontally to inspect any feature. Just be sure the integrated waveform is the selected waveform.

If you wish to see the zoom factor (2X, 5X, etc.) you need to turn Zoom on.

Waveform Math

The digitizing oscilloscope allows you to mathematically manipulate your waveforms. For example, you might have a waveform clouded by background noise. You can obtain a cleaner waveform by subtracting the background noise from your original waveform.

This section describes the standard waveform math features.

To Use Single Wfm Math

The More menu (see Figure 3-77) allows you to display, define, and manipulate math functions. To create a math waveform based on a single source waveform:

1. Press **MORE** → **Math1**, **Math2**, or **Math3** (main) → **Change Math waveform definition** (side) → **Single Wfm Math** (main).
2. To define the source waveform, press **Set Function to** (side) repeatedly to cycle it to the desired channel or reference waveform.

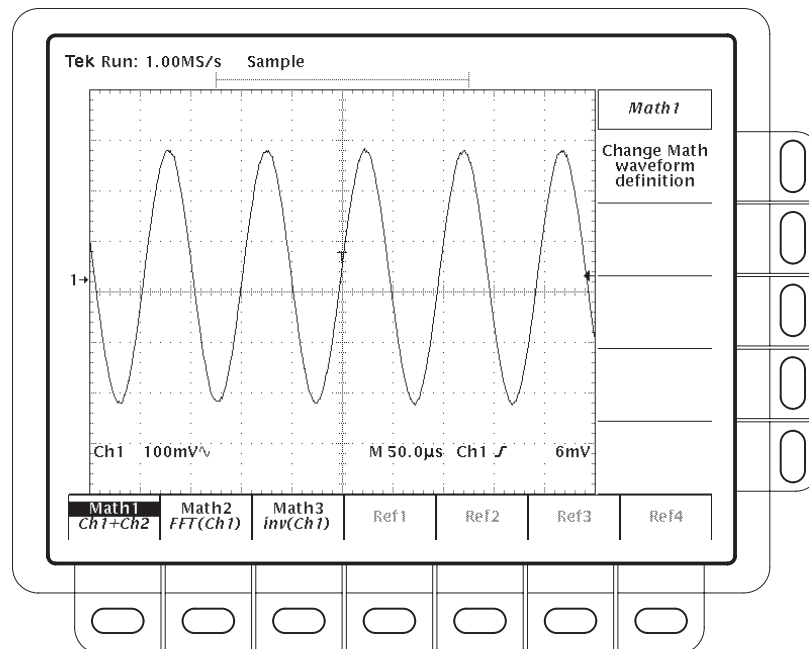

Figure 3-77: More Menu

3. Press **Set Function to** (side) repeatedly to cycle it to **inv** (invert), **intg**, or **diff**. Waveform integration (intg) and waveform differentiation (diff) are part of Option 2F.
4. To create the math waveform, press **OK Create Math Wfm** (side).

To Use Dual Wfm Math

To create a math waveform that requires two waveform sources, do the following steps:

NOTE. *If you select the 120K record length in the Horizontal menu of a TDS 400A, then you can only save one reference waveform. Also, you can only use/display four waveforms. Even if you do not display the source waveforms, Dual waveform math uses three of the four waveforms,. For example: if you display a math waveform that is the sum of CH 1 and CH 2, even if CH 1 and CH 2 are not displayed, you have used three waveforms. Therefore, you can only display one additional waveform.*

1. Press **MORE** → **Math1**, **Math2**, or **Math3** (main) → **Change Math waveform definition** (side) → **Dual Wfm Math** (main) (see Figure 3-78).
2. To define the first source waveform, press **Set 1st Source to** (side) repeatedly to cycle it to the desired channel or reference waveform.
3. To define the second source waveform, press **Set 2nd Source to** (side) repeatedly to cycle it to the desired channel or reference waveform.
4. To enter the math operator, press **Set operator to** (side) repeatedly to cycle it through the choices. Supported operators are +, -, *, and on the TDS 510A /.
5. Press **OK Create Math Wfm** (side) to perform the function.

NOTE. *If you select *, for multiply, in step 4, the cursor feature measures amplitude in the units volts squared VV rather than in volts V.*

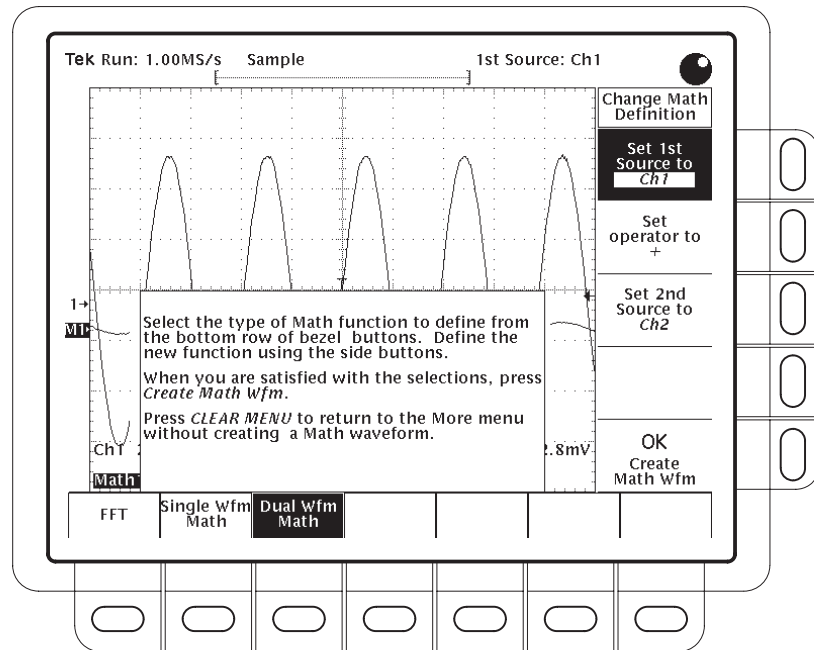

Figure 3-78: Dual Waveform Math Menus

To Select a Math Waveform

To select a waveform that you want to display, press **MORE** → **Math1**, **Math2**, or **Math3** (main).

Single and dual waveform math operations are described separately in the previous topics.

NOTE. If your digitizing oscilloscope is equipped with Option 2F, Advanced DSP Math, the menu item **FFT** will be at the same brightness as the menu items **Single Wfm Math** and **Dual Wfm Math**; otherwise, **FFT** will be dimmed.

Zoom

This section describes how to use zoom and how it interacts with the selected waveform. It also describes how interpolation affects zoom.

Use Zoom when you wish to temporarily expand a waveform to inspect a small feature(s) on that waveform.

Using With Waveforms

When zooming vertically, the digitizing oscilloscope expands or contracts the *selected* waveform only. Also, the oscilloscope only positions the selected waveform when in zoom.

When zooming horizontally, zoom expands either the selected waveform, all live waveforms, or all live and reference waveforms depending on the setting for Horizontal Lock in the Zoom menu.

Interpolation and Zoom

When you zoom in on a waveform on the display, you expand a portion of it. The digitizing oscilloscope may need to show more points for that portion than it has acquired. If it needs to do this, it interpolates. The instrument can interpolate in either of two ways: *linear* or *sin(x)/x*.

When you zoom, the display redraws the waveforms using the interpolation method you selected in the Display menu (linear interpolation or $\sin(x)/x$). If you selected $\sin(x)/x$ (the default), it may introduce some overshoot or undershoot to the waveform edges. If that happens, change the interpolation method to linear, following the instructions on page 3–19.

To differentiate between the real and interpolated samples, set the display style to **Intensified Samples**.

Checking the Zoom Factors

To quickly determine the zoom factors of a zoomed waveform, select the waveform and check the zoom readout. It shows the selected waveform by number, along with the horizontal and vertical expansion factors.

The zoom readout appears at the top of the display when zoom is on. See Figure 3-79 on page 3–145.

To Zoom a Waveform (TDS 400A Only)

To use Zoom, select a waveform, turn zoom on, and magnify it using the vertical and horizontal scale knobs:

1. Press any of the waveform selection buttons (**CH 1** through **CH 4**) on the right side of the display. Or press **MORE** and select a math or reference waveform from the More menu.
2. Press **ZOOM** → **Mode** (main) → **ON** (side). The **ZOOM** front-panel button should light up.
3. Adjust the vertical zoom factor for the selected waveform using the vertical **SCALE** knob. Adjust the vertical position of the zoomed waveform using the vertical **POSITION** knob.
4. Adjust the horizontal zoom factor using the horizontal **SCALE** knob. Adjust the horizontal position of the zoomed waveform using the horizontal **POSITION** knob.
5. Press **ZOOM** → **Lock** (main) → **All, Live, or None** (side) to choose which waveforms to zoom:

None — only the waveform currently selected can be magnified and positioned horizontally (Figure 3-79).

Live — all “live” (as opposed to reference) waveforms can be magnified and positioned horizontally at the same time. If a *reference* or *math* waveform is selected, only the selected waveform is magnified and positioned.

All — all waveforms displayed (live, math, and reference) can be magnified and positioned horizontally at the same time.

NOTE. Although zoom must be turned on to control which waveforms zoom affects, the setting for Lock affects which waveforms the horizontal control positions whether zoom is on or off.

Select Zoom or Dual Zoom

To select between waveform zoom and dual waveform zoom, press **ZOOM** → **Mode** (main). Then press **Dual Zoom** (side) to toggle Dual Zoom **OFF** or **ON**.

NOTE. Dual zoom displays a second zoomed view of the selected unzoomed waveform. The second zoomed view is offset in time from the first zoomed view. Also, zoom must be enabled (On or Preview) to see the dual zoom displays.

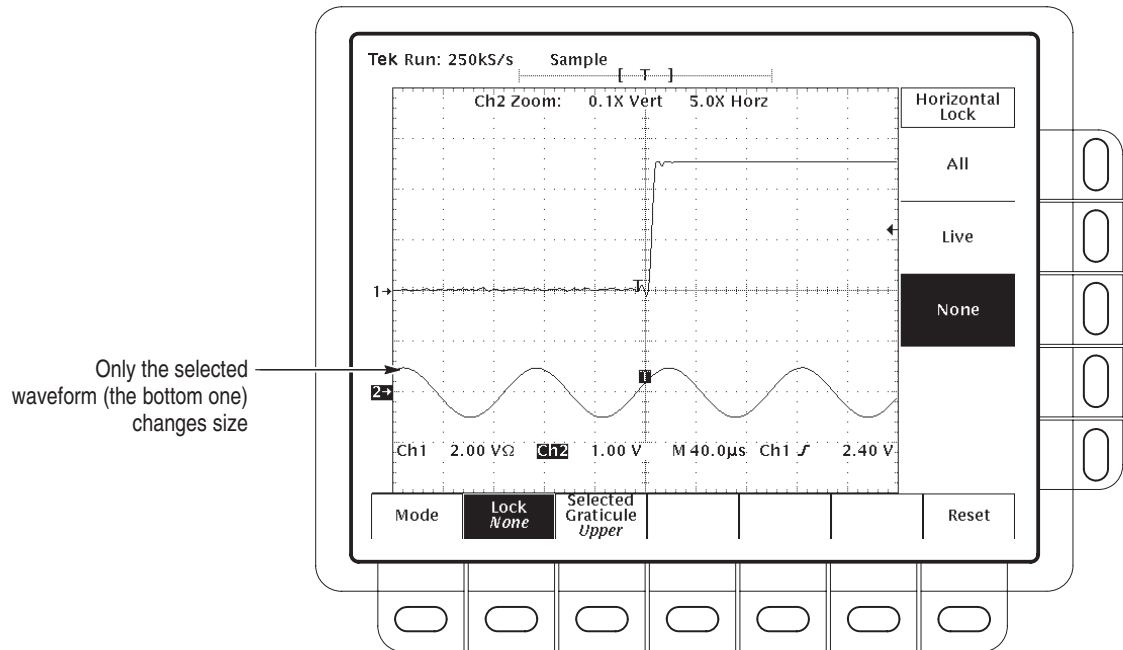

Figure 3-79: Zoom Mode with Horizontal Lock Set to None

To Set Dual Zoom Offset

To set the offset in time of the second zoomed waveform from the first, press **ZOOM** → **Mode** (main) → **Dual Zoom Offset** (side). Then turn the general purpose knob to set the offset.

Dual zoom offset is always positive. The oscilloscope sets the offset as close to the requested value as possible. An offset request of 0.0 insures that the zoom boxes are butted against each other, regardless of the zoom factor.

To Preview Zoom

Zoom Preview draws a box around the zoomed portion(s) of the unmagnified selected waveform. It also displays both the magnified and unmagnified waveforms in separate half-height graticules (see Figure 3-80). To preview zoom, press **Zoom** → **Mode** (main) → **Preview** (side).

In preview mode, the zoom magnification factors are not displayed. However, scale factors for the zoomed waveform are displayed.

To select which waveforms are controlled by the horizontal and vertical scale and offset controls, indicated by “photo-corners” on the graticule corners containing the waveforms (see Figure 3-80), press **Selected Graticule** (main) → **Upper** or **Lower** (side).

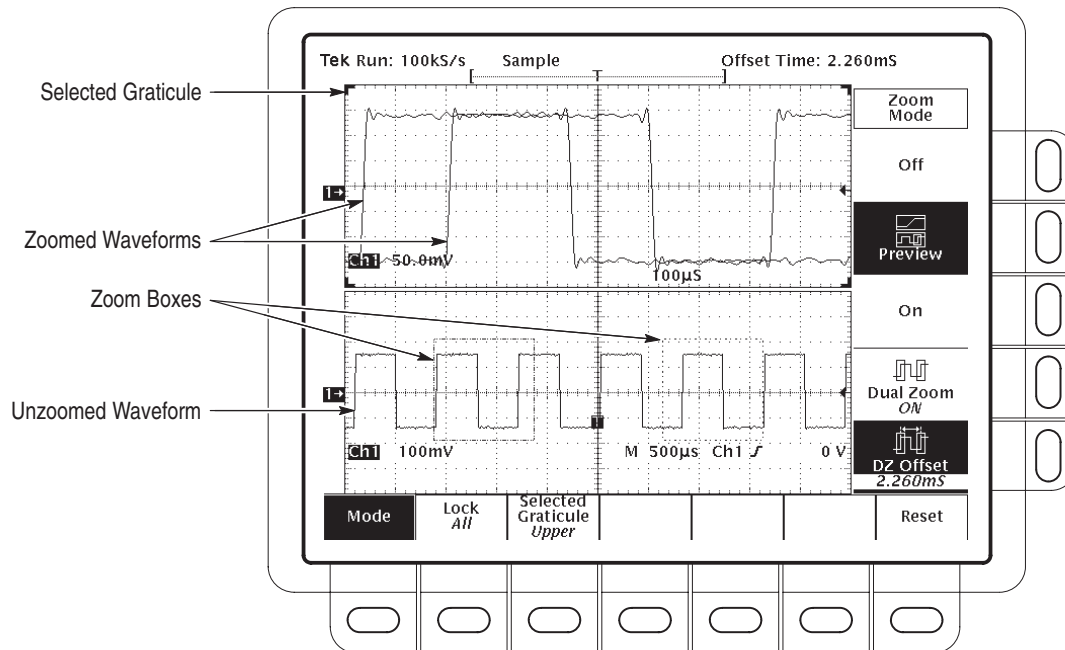

Figure 3-80: Zoom Preview Mode

Reset Zoom To reset all zoom factors to their defaults, press **ZOOM** → **Reset** (main) → **Reset All Factors** (side).

To reset only “live” waveform zoom factors to their defaults, press **ZOOM** → **Reset** (main) → **Reset Live Factors** (side).

Press **ZOOM** → **Mode** (main) → **Off** (side) to return to normal oscilloscope (non-zoom) operation.

To Zoom a Waveform (TDS 510A Only)

To use Zoom, turn zoom on and magnify the waveforms using the vertical and horizontal scale knobs:

1. Press **ZOOM** → **ON** (side). The ZOOM front-panel button should light up.
2. Choose which waveforms to zoom by repeatedly pressing **Horizontal Lock** (side): **None**, **Live**, or **All**.

NOTE. Although zoom must be turned on to control which waveforms zoom affects, the setting for Horizontal Lock affects which waveforms the horizontal control positions whether zoom is on or off.

Appendix A: Options and Accessories

This appendix describes the various options and accessories that are available for the TDS 420A, TDS 430A, TDS 460A, and TDS 510A Digitizing Oscilloscopes.

Options

The following options are available:

Option 02: Front Cover and Pouch (TDS 400A Only)

See Option XL.

Option 05: Video Trigger

This option (standard on the TDS 400A) provides a video trigger. It lets you trigger on positive or negative sync pulses. It allows you to investigate a range of NTSC, PAL, SECAM, and high definition TV signals.

Option 13: RS-232/Centronics Hardcopy Interface

TDS 510A only. With this option, Tektronix ships the oscilloscope equipped with an RS-232 and a Centronics interface that can be used to obtain hardcopies of the oscilloscope screen.

TDS 400A only. See Option XL.

Option 1K: Instrument Cart (TDS 510A Only)

With this option, Tektronix ships a K420 instrument cart.

Option 1R: Rackmounted Digitizing Oscilloscope

Tektronix ships the digitizing oscilloscope, when ordered with Option 1R, configured for installation in a 19 inch wide instrument rack. Customers with instruments not configured for rackmounting can order a rackmount kit (016-1166-00) for field conversions.

Option 2F: Advanced DSP Math

TDS 510A only. With this option, the oscilloscope can compute and display three advanced math waveforms: integral of a waveform, differential of a waveform, and an FFT (Fast Fourier Transform) of a waveform.

TDS 400A only. See Option XL.

Option 1M: 120,000 Point Record Length (TDS 400A Only)

See Option XL.

Option 95: Test Data Report

With this option, Tektronix ships a test data report for the oscilloscope.

Options A1–A5: International Power Cords

Besides the standard North American, 110 V, 60 Hz power cord, Tektronix ships any of five alternate power cord configurations (listed in Table A–1) with the oscilloscope when ordered by the customer.

Table A–1: International Power Cords

Option	Power Cord
A1	Universal European — 220 V, 50 Hz
A2	UK — 240 V, 50 Hz
A3	Australian — 240 V, 50 Hz
A4	North American — 240 V, 60 Hz
A5	Switzerland — 220 V, 50 Hz

Option L1: French User Manual

With this option, Tektronix ships a French language user manual.

Option L3: German User Manual

With this option, Tektronix ships a German language user manual.

Option L5: Japanese User Manual

With this option, Tektronix ships a Japanese language user manual.

Option R2: Service Assurance, Repair

With this option Tektronix provides an additional two years of warranty repair support.

Option C5: Service Assurance, Calibration

With this option Tektronix provides an additional five years of calibration support.

Option XL: Options 02, 13, 1M, and 2F (TDS 400A Only)

With this option, Tektronix ships a front cover and pouch, RS-232 and a Centronics interface that can be used to obtain hardcopies of the oscilloscope screen, a 120,000 Point Record Length, and advanced DSP math (the oscilloscope can compute and display three advanced math waveforms: integral of a waveform, differential of a waveform, and an FFT (Fast Fourier Transform) of a waveform).

Standard Accessories

Table A–2 lists the standard accessories that are included with the digitizing oscilloscope.

Table A–2: Standard Accessories

Accessory	Part Number
User Manual	070-9701-XX
Reference	020-2192-XX
Performance Verification TDS 400A TDS 510A	070-9705-XX 070-9706-XX
U.S. Power Cord	161-0230-01
Front Cover TDS 510A	200-3696-00
Probes (one per channel) P6138/P6138A 10X Passive (TDS 420A) P6138A 10X Passive (TDS 430A) P6138A 10X Passive (TDS 460A) P6139A 10X Passive (TDS 510A)	P6138A (single unit) P6139A (single unit)

Optional Accessories

You can also order the optional accessories listed in Table A–3.

Table A–3: Optional Accessories

Accessory	Part Number
Front Cover TDS 400A	200-3232-00
Current Probe/Calibrator	TCP202
High Voltage Differential Probe	P5205
High Voltage Differential Probe	P5200
Analog Differential Amplifier	ADA400A
Service Manual TDS 400A TDS 510A	070-9703-XX 070-9704-XX
Printed Programmer Manual	070-9876-XX
Video Clamp TDS 400A	013-0278-00
Plotter (GPIB and Centronics Standard)	HC100
Plotter (Centronics Standard)	HC200
Oscilloscope Cart TDS 400A TDS 510A	K212 K420

Table A–3: Optional Accessories (Cont.)

Accessory	Part Number
Rackmount Kit (for field conversion) TDS 400A TDS 510A	016-1166-00 016-1236-00
Oscilloscope Camera	C9
Oscilloscope Camera Adapter	016-1154-00
Soft-Sided Carrying Case TDS 400A TDS 510A	016-1158-01 016-0909-01
Transit Case TDS 400A TDS 510A	016-1157-00 016-1135-01
GPIB Cable (1 meter)	012-0991-01
GPIB Cable (2 meter)	012-0991-00
TDS 400A only: Printer Pack with Seiko DPU-411 printer and accessory pouch	TDS4F5P
Pouch (includes mounting plate) TDS 400A TDS 510A	016-1159-00 016-1268-00
VGA Cable (Required to meet all emissions specifications)	CTL3VGAMM-5 (LCOM part number)

Accessory Probes

Table A–4 lists an optional accessory amplifier and probes recommended for use with your digitizing oscilloscope.

Table A–4: Compatible Probes

Probe Type	Tektronix Model	Description
Passive, high impedance voltage	P6138A (TDS 400A) P6139A (TDS 510A) P6101B	10X, 400 MHz 10X, 500 MHz 1X, 15 MHz
Passive, SMD	P6563A	20X, 500 MHz
Passive, low impedance Zo	P6156	10X, 3.5 GHz, for 50 Ω inputs (1X, 20X, 100X optional)
Passive, high voltage	P5100 P6015A	100X, 2.5 kV, DC + peak AC 1000X, 20 kV, DC + peak AC
Active, high speed voltage	P6243 P6204	DC to 1 GHz FET, TekProbe powered DC to 1 GHz FET, DC Offset capability (requires Tektronix 1103 TekProbe Power Supply for offset capability)
Active, differential voltage	P6046 P5205	1X/10X, 250 V, DC to 100 MHz 50X/500X, 1300 V, DC to 100 MHz

Table A–4: Compatible Probes (Cont.)

Probe Type	Tektronix Model	Description
Current	AM 503S AM 503S Opt. 03 AM 503S Opt. 05 TCP202 P6021 P6022 CT-1/CT-2 CT-4	AC/DC, Uses DC to 50 MHz A6302 Current Probe AC/DC, Uses DC to 15 MHz A6303 Current Probe AC/DC, Uses DC to 100 MHz A6312 Current Probe AC/DC, DC to 50 MHz, TekProbe powered AC, 120 Hz to 60 MHz AC, 935 kHz to 120 MHz Designed for permanent or semi-permanent in-circuit installation CT-1: 25 kHz to 1 GHz, 50 Ω input CT-2: 1.2 kHz to 200 MHz, 50 Ω input Current Transformer for use with AM 503S and P6021. Peak pulse 1 kA, 0.5 Hz to 20 MHz with AM 503S
Logic Word Trigger	P6408	16 channel, one qualifier channel, TTL compatible, +5 V power supply required
Optical (Opto-Electric Converters)	P6701A P6703A P6711 P6713	500 to 950 nm, DC to 850 MHz, 1 V/mW 1100 to 1700 nm, DC to 1 GHz, 1 V/mW 500 to 950 nm, DC to 250 MHz, 5 V/mW 1100 to 1700 nm, DC to 300 MHz, 5 V/mW

Accessory Software

Table A–5 lists optional accessories that are Tektronix software products recommended for use with your digitizing oscilloscope.

Table A–5: Accessory Software

Software	Part Number
Wavewriter: AWG and waveform creation	S3FT400
LabWindows for DOS for CVI	LWDOS LWCVI
WaveStar	WSTR31

Warranty Information

The warranty statement for this product is after the title page of this manual.

Service Assurance

Tektronix offers the following services that you can purchase any time during the warranty period of this product:

- *REP* (Repair) Service Assurance provides one year of post-warranty repair support. It is available in one year increments up to two years.
- *CAL* (Calibrate) Service Assurance provides one year of calibration support. It is available in one year increments up to five years.

For further information contact your Tektronix Representative.

Appendix B: Packaging for Shipment

If you ship the digitizing oscilloscope, pack it in the original shipping carton and packing material. If the original packing material is not available, package the oscilloscope as follows:

1. Obtain a corrugated cardboard shipping carton with inside dimensions at least 15 cm (6 in) taller, wider, and deeper than the digitizing oscilloscope. The shipping carton must be constructed of cardboard with 170 kg (375 pound) test strength.
2. If you are shipping the digitizing oscilloscope to a Tektronix field office for repair, attach a tag to the digitizing oscilloscope showing the oscilloscope owner and address, the name of the person to contact about the oscilloscope, the oscilloscope type, and the serial number.
3. Wrap the digitizing oscilloscope with polyethylene sheeting or equivalent material to protect the finish.
4. Cushion the digitizing oscilloscope in the shipping carton by tightly packing dunnage or urethane foam on all sides between the carton and the digitizing oscilloscope. Allow 7.5 cm (3 in) on all sides, top, and bottom.
5. Seal the shipping carton with shipping tape or an industrial stapler.



CAUTION. Do not ship the digitizing oscilloscope with a disk inside the disk drive. When the disk is inside the drive, the disk release button sticks out. This makes the button more prone to damage than otherwise.

Appendix C: Remote Display

You can connect a remote display to the VGA connector on the rear panel. Table A-3 on page A-3 gives the part number of a properly shielded cable that is commercially available.

NOTE. *Both the red and blue signal lines are grounded. This configuration results in a green display on a color monitor.*

Appendix D: Programmer Disk

The TDS Family Programmer disk is a Microsoft Windows help file that covers operating your oscilloscope using the General Purpose Interface Bus (GPIB) (optional on some digitizing oscilloscopes). The disk also includes some example programs.

The program runs on a PC-compatible system with Microsoft Windows or Windows 95. (See Figure D-1).



Figure D-1: Equipment Needed to Run the Example Programs

Loading the Programs

For instructions on installing the programmer manual and the other software on the *TDS Family Programmer Manual* disk, read the readme file on the disk.

Running the Help Program

To run the programmer manual help file using Windows 3.1, perform the following:

1. Double click on the TDS Family Programmer program group.
2. Double click on the TDS Family Programmer icon.

If you have not created a program group or a Windows 95 shortcut, use the File Manager (Windows 3.1) or Explorer (Windows 95) to select and run the `tds-pgm.hlp` program.

Glossary

Accuracy

The closeness of the indicated value to the true value.

Acquisition

The process of sampling signals from input channels, digitizing the samples into data points, and assembling the data points into a waveform record. The waveform record is stored in memory. The trigger marks time zero in that process.

Acquisition interval

The time duration of the waveform record divided by the record length. The digitizing oscilloscope displays one data point for every acquisition interval.

Active cursor

The cursor that moves when you turn the general purpose knob. It is represented in the display by a solid line. The @ readout on the display shows the absolute value of the active cursor.

Attenuation

The degree the amplitude of a signal is reduced when it passes through an attenuating device such as a probe or attenuator. That is, the ratio of the input measure to the output measure. For example, a 10X probe will attenuate, or reduce, the input voltage of a signal by a factor of 10.

Automatic trigger mode

A trigger mode that causes the oscilloscope to automatically acquire if triggerable events are not detected within a specified time period.



Average acquisition mode

In this mode the oscilloscope acquires and displays a waveform that is the averaged result of several acquisitions. That reduces the apparent noise. The oscilloscope acquires data as in sample mode and then averages it according to a specified number of averages.



Bandwidth

The highest frequency signal the oscilloscope can acquire with no more than 3 dB ($\times 0.707$) attenuation of the original (reference) signal.

Delay time

The time between the trigger event and the acquisition of data.

Digitizing

The process of converting a continuous analog signal, such as a waveform, to a set of discrete numbers representing the amplitude of the signal at specific points in time. Digitizing is composed of two steps: sampling and quantizing.

**Envelope acquisition mode**

A mode in which the oscilloscope acquires and displays a waveform that shows the variation extremes of several acquisitions.

Equivalent-time sampling (ET)

A sampling mode in which the oscilloscope acquires signals over many repetitions of the event. The digitizing oscilloscope use a type of equivalent time sampling called *random equivalent time sampling*. It utilizes an internal clock that runs asynchronously with respect to the input signal and the signal trigger. The oscilloscope takes samples continuously, independent of the trigger position, and displays them based on the time difference between the sample and the trigger. Although the samples are taken sequentially in time, they are random with respect to the trigger.

**Hi Res acquisition mode**

An acquisition mode in which the digitizing oscilloscope averages all samples taken during an acquisition interval to create a record point. That average results in a higher-resolution, lower-bandwidth waveform. That mode only works with real-time, non-interpolated sampling.

Holdoff, trigger

A specified amount of time after a trigger signal that elapses before the trigger circuit will accept another trigger signal. Holdoff helps ensure a stable display.

Interpolation

The way the digitizing oscilloscope calculates values for record points when the oscilloscope cannot acquire all the points for a complete record with a single trigger event. That condition occurs when the oscilloscope is limited to real time sampling and the time base is set to a value that exceeds the effective sample rate of the oscilloscope. The digitizing oscilloscope has two interpolation options: *linear* or *sin(x)/x interpolation*.

Linear interpolation calculates record points in a straight-line fit between the actual values acquired. Sin(x)/x computes record points in a curve fit between the actual values acquired. It assumes all the interpolated points fall in their appropriate point in time on that curve.

Main menu buttons

Bezel buttons under the main menu display. They allow you to select items in the main menu.

Pixel

A visible point on the display. The oscilloscope display is 640 pixels wide by 480 pixels high.

Pop-up menu

A sub-menu of a main menu. Pop-up menus temporarily occupy part of the waveform display area and are used to present additional choices associated

with the main menu selection. You can cycle through the options in a pop-up menu by repeatedly pressing the main menu button underneath the pop-up.

Posttrigger

The specified portion of the waveform record that contains data acquired after the trigger event.

Pretrigger

The specified portion of the waveform record that contains data acquired before the trigger event.

Quantizing

The process of converting an analog input that was sampled, such as a voltage, to a digital value.

Probe compensation

Adjustment that improves the low-frequency response of a probe.

Real-time sampling

A sampling mode where the digitizing oscilloscope samples fast enough to completely fill a waveform record from a single trigger event. Use real-time sampling to capture single-shot or transient events.

Record length

The specified number of samples in a waveform.

Reference memory

Memory in a oscilloscope used to store waveforms or settings. You can use that waveform data later for processing. The digitizing oscilloscope saves the data even when the oscilloscope is turned off or unplugged.

Roll

An acquisition mode useful at slow Horizontal SCALE settings. Roll mode allows the waveform to be viewed as it is acquired point-by-point. The waveform appears to roll across the display.

Sample interval

The time interval between successive samples in a time base. For real-time digitizers, the sample interval is the reciprocal of the sample rate. For equivalent-time digitizers, the time interval between successive samples represents equivalent time, not real time.

Sampling

The process of capturing an analog input, such as a voltage, at a discrete point in time and holding it constant so that it can be quantized. Two general methods of sampling are: *real-time sampling* and *equivalent-time sampling*.

Tek Secure

This feature erases all waveform and setup memory locations (setup memories are replaced with the factory setup). Then it checks each location

to verify erasure. This feature finds use where this digitizing oscilloscope is used to gather security sensitive data, such as is done for research or development projects.

Time base

The set of parameters that let you define the time and horizontal axis attributes of a waveform record. The time base determines when and how long to acquire record points.

Trigger

An event that marks time zero in the waveform record. It results in acquisition and display of the waveform.

Waveform interval

The time interval between record points as displayed.



XY format

A display format that compares the voltage level of two waveform records point by point. It is useful for studying phase relationships between two waveforms.



YT format

The conventional oscilloscope display format. It shows the voltage of a waveform record (on the vertical axis) as it varies over time (on the horizontal axis).

Index

Numbers

- 1/Base**, Cursor menu, 3–120
- 1/Clocks**, Cursor menu, 3–120
- 1/seconds (Hz)**, Cursor menu, 3–120
- 100 MHz**, Vertical menu, 3–125
- 20 MHz**, Vertical menu, 3–125

A

- AC coupling, 3–124
- AC**, Main Trigger menu, 3–23
- Accept Glitch**, Main Trigger menu, 3–93
- Accessories, A–1–A–6
 - Optional, A–3
 - Probes, A–4
 - Software, A–5
 - Standard, A–3, A–5
- Accuracy, Glossary–1
- Acquire menu, 3–8, 3–63
 - Average**, 3–8
 - Compare Ch1 to**, 3–65
 - Compare Ch2 to**, 3–65
 - Create Limit Test Template**, 3–63
 - Envelope**, 3–8
 - H Limit**, 3–64
 - Hardcopy if Condition Met**, 3–65
 - Hi Res**, 3–8
 - Limit Test**, 3–65
 - Limit Test Condition Met**, 3–65
 - Limit Test Setup**, 3–65
 - Limit Test Sources**, 3–65
 - Mode**, 3–8
 - OFF (Real Time Only)**, 3–8
 - OK Store Template**, 3–64
 - ON (Enable ET)**, 3–8
 - Peak Detect**, 3–8
 - Repetitive Signal**, 3–8
 - Ring Bell if Condition Met**, 3–65
 - RUN/STOP**, 3–9
 - Sample**, 3–8
 - Single Acquisition Sequence**, 3–10
 - Stop After**, 3–9, 3–65
 - Stop After Limit Test Condition Met**, 3–65
 - Template Source**, 3–63
 - V Limit**, 3–64
- ACQUIRE MENU** button, 3–8, 3–63
- Acquisition, 3–113, Glossary–1
 - Interval, Glossary–1

Modes

- Average, 3–7
- Envelope, 3–7
- Hi Res, 3–5
- Peak detect, 3–5
- Sample, 3–5
- Readout, 3–7
- Active cursor, Glossary–1
- active**, Saved waveform status, 3–105
- Aliasing, 3–36, 3–58
- Amplitude, 3–73
- Amplitude Units**, Cursor menu, 3–121
- AND**, Main Trigger menu, 3–68
- AND**, Main Trigger menu, 3–71, 3–72
- Applications
 - FFT math waveforms, 3–27
 - integral math waveforms, 3–135
- Area, 3–73
- Attenuation, Glossary–1
- Auto trigger mode, 3–24
- Auto**, Main Trigger menu, 3–24, 3–70, 3–93
- Automated Measurements, Snapshot of, 2–25
- Automated measurements, 2–22, 3–73
 - of derivative math waveforms, 3–132 (procedure), 3–132
 - of FFT math waveforms, 3–33
 - of integral math waveforms, 3–138
- Automatic trigger mode, Glossary–1
- Autoset, 2–16, 3–113
 - How to execute, 3–113
- AUTOSET** button, 2–16, 3–113
- AUX TRIGGER INPUT**, BNC, 2–6
- Average acquisition mode, 3–7, Glossary–1
- Average**, Acquire menu, 3–8

B

- Bandwidth, 1–1, 3–124, Glossary–1
- Bandwidth**, Vertical menu, 3–125
- Banner menu, 3–16
- Base**, Cursor menu, 3–121
- Before you begin, 1–5–1–6
- Blackman-Harris window, 3–30
- BMP, 3–47
- BMP Color**, Hardcopy menu, 3–48
- BMP Mono**, Hardcopy menu, 3–48
- BNC
 - AUX TRIGGER INPUT**, 2–6
 - DELAYED TRIGGER OUTPUT**, 2–6

- MAIN TRIGGER OUTPUT, 2-6
 - SIGNAL OUTPUT, 2-6
 - Burst width, 3-73
 - Button
 - ACQUIRE MENU, 3-8, 3-63
 - AUTOSET, 2-16, 3-58, 3-113
 - CLEAR MENU, 2-3, 2-10, 2-14, 2-23, 3-80
 - CURSOR, 3-118
 - DELAYED TRIG, 3-12
 - DISPLAY, 3-17
 - FORCE TRIG, 3-25
 - HARDCOPY, 3-43, 3-48, 3-98
 - HELP, 3-3
 - HORIZONTAL MENU, 3-12
 - MEASURE, 3-76
 - MORE, 3-106, 3-111, 3-112, 3-139
 - ON/STBY, 1-5, 2-3
 - Save/Recall SETUP, 2-12, 3-43, 3-103
 - Save/Recall WAVEFORM, 3-43, 3-105
 - SELECT, 3-120
 - SET LEVEL TO 50%, 3-25
 - SINGLE TRIG, 3-10, 3-25, 3-26
 - STATUS, 3-15
 - TRIGGER MENU, 3-22, 3-69, 3-92, 3-94, 3-127
 - UTILITY, 3-48, 3-97
 - VERTICAL MENU, 2-19
 - WAVEFORM OFF, 2-21, 3-20, 3-112
 - ZOOM, 3-144, 3-146
 - Buttons
 - CH1, CH2 ..., 3-111, 3-112
 - Channel selection, 2-18, 3-111, 3-112
 - Main menu, 2-3
 - Side menu, 2-3
- ## C
- Cables, 3-97
 - Cal Probe, Vertical menu, 3-83
 - Cart, Instrument, A-3
 - K212, A-1
 - Centronics, Port (optional), 3-97
 - CH1, CH2 ... buttons, 3-111, 3-112
 - Ch1, Ch2 ..., Delayed Trigger menu, 3-13
 - Ch1, Ch2 ..., Main Trigger menu, 3-23, 3-61, 3-69, 3-70, 3-72, 3-93, 3-94
 - Ch1, Ch2 ..., Video Trigger menu, 3-128
 - Change Math waveform definition, More menu, 3-139
 - Channel, 3-111-3-112
 - Readout, 2-7, 3-111, 3-143
 - Reference Indicator, 2-7, 3-111
 - Selection buttons, 2-18, 3-111, 3-112
 - Class, Main Trigger menu, 3-69, 3-92, 3-94
 - CLEAR MENU button, 2-3, 2-10, 2-14, 2-23, 3-80
 - Clear Spool, Hardcopy menu, 3-50
 - Clipping
 - derivative math waveforms, 3-133
 - FFT math waveforms, 3-35
 - how to avoid, 3-35, 3-133, 3-138
 - integral math waveforms, 3-138
 - Clock, Horizontal menu, 3-59
 - Compare Ch1 to, Acquire menu, 3-65
 - Compare Ch2 to, Acquire menu, 3-65
 - Compensation, 3-89
 - Configure, Utility menu, 3-48, 3-97
 - Confirm Delete, File Utilities menu, 3-45
 - Connector
 - AUX TRIGGER INPUT, 2-6
 - DELAYED TRIGGER OUTPUT, 2-6
 - GPIB, 2-6
 - MAIN TRIGGER OUTPUT, 2-6
 - SIGNAL OUTPUT, 2-6
 - Contrast, Display menu, 3-18
 - Conventions, x
 - Copy, File Utilities menu, 3-45
 - Coupling, 2-19
 - Coupling, Delayed Trigger menu, 3-14
 - Coupling, Main Trigger menu, 3-23
 - Coupling, Vertical menu, 3-124
 - Create Directory, File Utilities menu, 3-45
 - Create Limit Test Template, Acquire menu, 3-63
 - Create Measrmnt, Measure Delay menu, 3-80
 - Cross Hair, Display menu, 3-19
 - Cursor
 - Horizontal bar, 3-117
 - Paired, 3-117
 - Vertical bar, 3-117
 - CURSOR button, 3-118
 - Cursor menu, 3-31, 3-118, 3-136
 - 1/Base, 3-120
 - 1/Clocks, 3-120
 - 1/seconds (Hz), 3-120
 - Amplitude Units, 3-121
 - Base, 3-121
 - Function, 3-118, 3-120
 - H Bars, 3-118, 3-120
 - Horizontal Units, 3-120
 - Independent, 3-120
 - IRE (NTSC), 3-121
 - seconds, 3-120
 - Tracking, 3-120
 - Video Line Number, 3-120
 - Cursor readout
 - H-Bars, 3-31, 3-133, 3-136

- Paired, 3-133
- Paired cursors, 3-33, 3-137
- V-Bars, 3-32, 3-133, 3-137
- Cursor Readouts, 3-118
- Cursor Speed, 3-121
- Cursors, 3-117-3-122
 - How to use, 3-118
 - with derivative waveforms, 3-133
 - with FFT waveforms, 3-31
- Custom**, Video Trigger menu, 3-128
- Cycle area, 3-73
- Cycle mean, 3-73
- Cycle RMS, 3-73

D

- Date/Time
 - On hardcopies, 3-49
 - To set, 3-49
- DC coupling, 3-124
- DC offset, 3-35
 - for DC correction of FFTs, 3-35
 - with math waveforms, 3-35, 3-138
- DC, Main Trigger menu, 3-23
- Define Inputs**, Main Trigger menu, 3-70, 3-72
- Define Logic**, Main Trigger menu, 3-71, 3-72
- Delay by Events**, Delayed Trigger menu, 3-13
- Delay by Lines**, Video Trigger menu, 3-128
- Delay by Time**, Delayed Trigger menu, 3-13
- Delay by Time**, Video Trigger menu, 3-128
- Delay by**, Delayed Trigger menu, 3-13
- Delay measurement, 3-79
- Delay time, Glossary-1
- Delay To**, Measure Delay menu, 3-79
- Delayed Only**, Horizontal menu, 3-12
- Delayed Runs After Main**, Horizontal menu, 3-12, 3-59
- Delayed Scale**, Horizontal menu, 3-58
- DELAYED TRIG** button, 3-12
- Delayed trigger, 3-11-3-14
 - How to set up, 3-12
- Delayed Trigger menu, 3-12
 - Ch1, Ch2 ...**, 3-13
 - Coupling**, 3-14
 - Delay by**, 3-13
 - Delay by Events**, 3-13
 - Delay by Time**, 3-13
 - Falling edge, 3-14
 - Level**, 3-14
 - Rising edge, 3-14
 - Slope**, 3-14
 - Source**, 3-13

- DELAYED TRIGGER OUTPUT**, BNC, 2-6
- Delayed Triggerable**, Horizontal menu, 3-12, 3-59
- Delete Refs**, Save/Recall Waveform menu, 3-106
- Delete**, File Utilities menu, 3-44
- Derivative math waveform
 - procedure for displaying, 3-131
 - procedure for measuring, 3-132, 3-133
- Deskjet, 3-47
- Deskjet**, Hardcopy menu, 3-48
- Differentiation, waveform, 3-131
- Digitizing, Glossary-1
- Digitizing rate, 1-1
- Disk, How to save a hardcopy to, 3-51
- Disk drive, 3-43
- Display, 2-7, 3-113
 - Options, 3-17-3-20
 - Record View, 3-22
- Display 'T' @ Trigger Point**, Display menu, 3-18
- DISPLAY** button, 3-17
- Display menu, 3-17
 - Contrast**, 3-18
 - Cross Hair**, 3-19
 - Display 'T' @ Trigger Point**, 3-18
 - Dots**, 3-17
 - Dots style**, 3-64
 - Filter**, 3-19
 - Format**, 3-20
 - Frame**, 3-19
 - Full**, 3-19
 - Graticule**, 3-19
 - Grid**, 3-19
 - Infinite Persistence**, 3-18
 - Intensified Samples**, 3-17
 - Intensity**, 3-18
 - Linear interpolation**, 3-19
 - NTSC, 3-19
 - Overall**, 3-18
 - PAL**, 3-19
 - Readout**, 3-18
 - Sin(x)/x interpolation**, 3-19
 - Style**, 3-17
 - Text/Grat**, 3-18
 - Trigger Bar**, 3-18
 - Variable Persistence**, 3-18
 - Vectors**, 3-17
 - Waveform**, 3-18
 - XY**, 3-20
 - YT**, 3-20
- Display**, Status menu, 3-15
- Dots, 3-17
- Dots style**, Display menu, 3-64
- Dots**, Display menu, 3-17

DPU411-II, Hardcopy menu, 3-48
DPU412, Hardcopy menu, 3-48
Dual Wfm Math, More menu, 3-140
Dual Zoom, Zoom menu, 3-144
Dual Zoom Offset, Zoom menu, 3-145
Duty cycle, 2-23

E

Edge trigger, 3-21
 Readout, 3-21, 3-67
Edge, Main Trigger menu, 3-22
Edges, Measure Delay menu, 3-80
Either, Main Trigger menu, 3-93, 3-94
empty, Saved waveform status, 3-105
Encapsulated Postscript, 3-47
Enter Char, Labelling menu, 3-44, 3-45
Envelope acquisition mode, 3-7, Glossary-2
Envelope, Acquire menu, 3-8
EPS Color Img, Hardcopy menu, 3-48
EPS Color Plt, Hardcopy menu, 3-48
EPS Mono Img, Hardcopy menu, 3-48
EPS Mono Plt, Hardcopy menu, 3-48
Epson, 3-47
Epson, Hardcopy menu, 3-48
Equivalent-time sampling, random, Glossary-2
External Clock, Horizontal menu, 3-59, 3-60

F

factory, Saved setup status, 3-103
Fall time, 3-74
Falling edge, Delayed Trigger menu, 3-14
Falling edge, Main Trigger menu, 3-24, 3-72
Fast Fourier Transforms, description, 3-27
Fast Fourier Transforms (FFTs), applications, 3-27
FFT frequency domain record, 3-33
 defined, 3-33
 length of, 3-34
FFT math waveform
 acquisition mode, 3-35
 aliasing, 3-36
 automated measurements of, 3-33
 DC correction, 3-35
 displaying phase, 3-29
 interpolation mode, 3-36
 magnifying, 3-36
 phase display, setup considerations, 3-37
 phase suppression, 3-30, 3-38
 procedure for displaying, 3-28
 procedure for measuring, 3-31
 record length, 3-34

 reducing noise, 3-35
 undersampling, 3-36
 zero phase reference, 3-37
FFT time domain record, defined, 3-33
File System, 3-43
File Utilities, File Utilities menu, 3-43
File Utilities menu, 3-43
 Confirm Delete, 3-45
 Copy, 3-45
 Create Directory, 3-45
 Delete, 3-44
 File Utilities, 3-43
 Format, 3-46
 Overwrite Lock, 3-45
 Print, 3-45
 Rename, 3-44
Filter, Display menu, 3-19
Fine Scale, Vertical menu, 3-125
Firmware version, 3-15
Fit to screen, Horizontal menu, 3-57
FORCE TRIG button, 3-25
Format, Display menu, 3-20
Format, File Utilities menu, 3-46
Format, Hardcopy menu, 3-48
Frame, Display menu, 3-19
Frequency, 2-23, 3-74
Front Cover removal, 1-4
Front panel, 2-4, 2-5
Full, Display menu, 3-19
Full, Vertical menu, 3-125
Function, Cursor menu, 3-118, 3-120
Fuse, 1-3, 2-6

G

Gated Measurements, 3-77
Gating, Measure menu, 3-77
General purpose knob, 2-8, 2-9, 2-24
Glitch trigger, 3-91
Glitch, Main Trigger menu, 3-92, 3-93
GND coupling, 3-124
Goes FALSE, Main Trigger menu, 3-69
Goes TRUE, Main Trigger menu, 3-69
GPIO, 2-6, 3-97
 Procedures for using, 3-97
 Selecting and configuring the port, 3-97
GPIO Programming, D-1
GPIO, Hardcopy menu, 3-48
GPIO, Utility menu, 3-97
Graticule, 3-19
 Measurements, 3-82
Graticule, Display menu, 3-19

Grid, Display menu, 3–19
 ground coupling, 3–124
GROUP 1, GROUP 2 ... buttons, 3–144

H

H Bars, Cursor menu, 3–118, 3–120
H Limit, Acquire menu, 3–64
 Hamming window, 3–30
 Hanning window, 3–30
 Hardcopy, 3–47–3–54
 How to print (controller), 3–51
 How to print (no controller), 3–49
 How to save to disk, 3–51
 Spool, 3–50
Hardcopy (Talk Only), Utility menu, 3–48
HARDCOPY button, 3–43, 3–48, 3–98
Hardcopy if Condition Met, Acquire menu, 3–65
 Hardcopy Interface, Optional RS-232/Centronic, A–1
 Hardcopy menu
 BMP Color, 3–48
 BMP Mono, 3–48
 Clear Spool, 3–48, 3–50
 Deskjet, 3–48
 DPU411-II, 3–48
 DPU412, 3–48
 EPS Color Img, 3–48
 EPS Color Plt, 3–48
 EPS Mono Img, 3–48
 EPS Mono Plt, 3–48
 Epson, 3–48
 Format, 3–48
 GPIB, 3–48
 HPGL, 3–48
 Interleaf, 3–48
 Landscape, 3–48
 Laserjet, 3–48
 Layout, 3–48
 OK Confirm Clear Spool, 3–50
 PCX, 3–48
 PCX Color, 3–48
 Port, 3–48
 Portrait, 3–48
 RLE Color, 3–48
 Thinkjet, 3–48
 TIFF, 3–48
Hardcopy, Utility menu, 3–98
HELP button, 3–3
 Help system, 3–3
HF Rej, Main Trigger menu, 3–23
 Hi Res acquisition mode, 3–5
 Hi res acquisition mode, Glossary–2

Hi Res, Acquire menu, 3–8
 High, 3–74
High Ref, Measure menu, 3–79
High-Low Setup, Measure menu, 3–78
Histogram, Measure menu, 3–78
Holdoff, Main Trigger menu, 3–70, 3–93
 Holdoff, trigger, 3–24, Glossary–2
Horiz Pos, Horizontal menu, 3–59
Horiz Scale, Horizontal menu, 3–58
 Horizontal, 3–113
 Bar cursors, 3–117
 Control, 3–55–3–62
 Position, 3–56
 Readouts, 3–55
 Scale, 3–56
 SCALE knob, 2–15
 System, 2–15
Horizontal Lock, Zoom menu, 3–144, 3–146
 Horizontal menu, 3–12
 Clock, 3–59
 Delayed Only, 3–12
 Delayed Runs After Main, 3–12, 3–59
 Delayed Scale, 3–58
 Delayed Triggerable, 3–12, 3–59
 External Clock, 3–59, 3–60
 Fit to screen, 3–57
 Horiz Pos, 3–59
 Horiz Scale, 3–58
 Intensified, 3–12, 3–13
 Internal Clock, 3–59
 Main Scale, 3–58
 Record Length, 3–57
 Set to 10%, 3–59
 Set to 50%, 3–59
 Set to 90%, 3–59
 Time Base, 3–12, 3–59
 Trigger Position, 3–57
HORIZONTAL MENU button, 3–12
 Horizontal **POSITION** knob, 3–56, 3–144
 Horizontal Readouts, 3–55
 Horizontal **SCALE** knob, 3–56, 3–144
Horizontal Units, Cursor menu, 3–120
 HPGL, 3–47
HPGL, Hardcopy menu, 3–48

I

I/O, Status menu, 3–15
I/O, Utility menu, 3–48, 3–97
 Icons, 1–1
Independent, Cursor menu, 3–120
Infinite Persistence, Display menu, 3–18

Installation, 1–3
 Integral math waveform
 applications, 3–135
 automated measurements of, 3–138
 magnifying, 3–134, 3–138
 procedure for displaying, 3–135
 Integration, Waveform, 3–135
Intensified Samples, Display menu, 3–17
Intensified, Horizontal menu, 3–12, 3–13
 Intensity, 3–18
Intensity, Display menu, 3–18
Interlaced Field One, Video Trigger menu, 3–129
Interlaced Field Two, Video Trigger menu, 3–129
 Interleaf, 3–47
Interleaf, Hardcopy menu, 3–48
Internal Clock, Horizontal menu, 3–59
 Interpolation, 3–19, Glossary–2
 FFT distortion, 3–36
 linear versus $\sin(x)/x$, 3–36
IRE (NTSC), Cursor menu, 3–121

K

Knob
 General purpose, 2–8, 2–9, 2–24
 Horizontal **POSITION**, 2–15, 3–56
 Horizontal **SCALE**, 2–15, 3–56
 speed up, 3–25
 Trigger **MAIN LEVEL**, 2–16
 Vertical **POSITION**, 2–15
 Vertical **SCALE**, 2–15, 3–123

L

Labelling menu, **Enter Char**, 3–44, 3–45
Landscape, Hardcopy menu, 3–48
 Laserjet, 3–47
Laserjet, Hardcopy menu, 3–48
Layout, Hardcopy menu, 3–48
Level, Delayed Trigger menu, 3–14
Level, Main Trigger menu, 3–24, 3–93, 3–96
LF Rej, Main Trigger menu, 3–23
Limit Test Condition Met, Acquire menu, 3–65
Limit Test Setup, Acquire menu, 3–65
Limit Test Sources, Acquire menu, 3–65
Limit Test, Acquire menu, 3–65
 Limit testing, 3–63
 Linear interpolation, 3–19, Glossary–2
Linear interpolation, Display menu, 3–19
 Logic trigger, 3–68
 Definitions, 3–68
 Pattern, 3–69

 State, 3–69
 Logic triggering, 3–67
 Low, 3–74
Low Ref, Measure menu, 3–79

M

MAIN LEVEL, 3–24
 Main menu, 2–7
 Main menu buttons, 2–3, Glossary–2
Main Scale, Horizontal menu, 3–58
 Main Trigger Menu
 Falling edge, 3–24
 Rising edge, 3–24
 Main Trigger menu, 3–22, 3–69, 3–92, 3–94
AC, 3–23
Accept Glitch, 3–93
AND, 3–71, 3–72
Auto, 3–24, 3–70, 3–93
Ch1, Ch2 ..., 3–23, 3–61, 3–69, 3–70, 3–72, 3–93, 3–94
Class, 3–69, 3–92, 3–94
Coupling, 3–23
DC, 3–23
Define Inputs, 3–70, 3–72
Define Logic, 3–71, 3–72
Edge, 3–22
Either, 3–93, 3–94
 Falling edge, 3–72
Glitch, 3–92, 3–93
Goes FALSE, 3–69
Goes TRUE, 3–69
HF Rej, 3–23
Holdoff, 3–70, 3–93
Level, 3–24, 3–93, 3–96
LF Rej, 3–23
Mode & Holdoff, 3–24, 3–70, 3–93
NAND, 3–71, 3–72
Negative, 3–93, 3–94
Noise Rej, 3–23
NOR, 3–71, 3–72
Normal, 3–24, 3–70, 3–93
OR, 3–71, 3–72
Pattern, 3–69
Polarity, 3–94
Polarity and Width, 3–93
Positive, 3–93, 3–94
Pulse, 3–92, 3–94
Reject Glitch, 3–93
 Rising edge, 3–72
Runt, 3–94
Set Thresholds, 3–69

- Set to 50%**, 3–24, 3–25
- Set to ECL**, 3–24
- Set to TTL**, 3–24
- Slope**, 3–24
- Source**, 3–23, 3–93, 3–94
- State**, 3–69, 3–72
- Thresholds**, 3–94
- Trigger When**, 3–69, 3–71
- True for less than**, 3–71
- True for more than**, 3–71
- Type**, 3–22, 3–92, 3–94, 3–127
- Video**, 3–127
- Width**, 3–93
- MAIN TRIGGER OUTPUT**, BNC, 2–6
- Math Waveform
 - Differential, A–1
 - FFT, A–1
 - Integral, A–1
 - Optional Advanced, A–1
- Math waveforms, 3–141
- Math1/2/3**, More menu, 3–141
- Maximum, 3–74
- Mean, 3–74
- MEASURE** button, 3–76
- Measure Delay menu
 - Create Measrmnt**, 3–80
 - Delay To**, 3–79
 - Edges**, 3–80
 - Measure Delay To**, 3–79
 - OK Create Measurement**, 3–80
- Measure Delay To**, Measure Delay menu, 3–79
- Measure menu, 3–76, 3–81
 - Gating**, 3–77
 - High Ref**, 3–79
 - High-Low Setup**, 3–78
 - Histogram**, 3–78
 - Low Ref**, 3–79
 - Mid Ref**, 3–79
 - Mid2 Ref**, 3–79
 - Min-Max**, 3–78
 - Reference Levels**, 3–78
 - Remove Measrmnt**, 3–76, 3–81
 - Select Measrmnt**, 3–76, 3–79
 - Set Levels in % units**, 3–78
 - Snapshot**, 3–81
- Measurement
 - Amplitude, 3–73
 - Area, 3–73
 - Burst width, 3–73
 - Cycle area, 3–73
 - Cycle mean, 3–73
 - Cycle RMS, 3–73
 - Delay, 3–79
 - Duty cycle, 2–23
 - Fall time, 3–74
 - Frequency, 2–23, 3–74
 - High, 3–74
 - Low, 3–74
 - Maximum, 3–74
 - Mean, 3–74
 - Minimum, 3–74
 - Negative duty cycle, 3–74
 - Negative overshoot, 3–74
 - Negative width, 3–74
 - Peak to peak, 3–74
 - Period, 3–74
 - Phase, 3–74
 - Positive duty cycle, 3–74
 - Positive overshoot, 3–75
 - Positive width, 3–75
 - Propagation delay, 3–73
 - Readout, 3–75
 - Reference levels, 2–24
 - Rise time, 2–23, 3–75
 - RMS, 3–75
 - Width, 2–23
- Measurement Accuracy, Ensuring maximum, 3–83–3–88, 3–115
- Measurements, 3–73–3–82
 - Automated, 2–22
 - Cursor, 3–117
 - Gated, 3–77
 - Graticule, 3–82
 - Snapshot of, 3–81
- Memory, Waveform, 3–106
- Menu
 - Acquire, 3–8, 3–63
 - Banner, 3–16
 - Cursor, 3–118
 - Delayed Trigger, 3–12
 - Display, 3–17
 - File Utilities, 3–43
 - Horizontal, 3–12
 - Main, 2–7
 - Main Trigger, 3–22, 3–69, 3–92, 3–94
 - Measure, 3–76, 3–81
 - More, 3–28, 3–106, 3–131, 3–139
 - See also More menu*
 - Operation, 2–8, 2–9
 - Pop-up, 2–10, Glossary–2
 - Save/Recall, 3–103
 - Save/Recall Waveform, 3–105
 - Setup, 2–12
 - Status, 3–15–3–16
 - Utility, 3–47, 3–97
 - Video Trigger, 3–127

Mid Ref, Measure menu, 3-79
Mid2 Ref, Measure menu, 3-79
Min-Max, Measure menu, 3-78
 Minimum, 3-74
Mode & Holdoff, Main Trigger menu, 3-24, 3-70, 3-93
Mode, Acquire menu, 3-8
 Model number location, 2-3
MORE button, 3-64, 3-106, 3-111, 3-112, 3-139
 More menu, 3-106, 3-131, 3-139
 Blackman-Harris, 3-30
 Change Math waveform definition, 3-28, 3-131, 3-135, 3-139
 dBV RMS, 3-29
 diff, 3-131
 Dual Wfm Math, 3-140
 FFT, 3-28
 Hamming, 3-30
 Hanning, 3-30
 intg, 3-135
 Linear RMS, 3-29
 Math1, Math2, Math3, 3-28, 3-131, 3-135
 Math1/2/3, 3-141
 OK Create Math Waveform, 3-135, 3-140
 Phase (deg), 3-29
 Phase (rad), 3-29
 Rectangular, 3-30
 Reference waveform status, 3-106
 Set 1st Source to, 3-140
 Set 2nd Source to, 3-140
 Set FFT Source to:, 3-29
 Set FFT Vert Scale to:, 3-29
 Set FFT Window to:, 3-29
 Set Function to, 3-139
 Set Function to:, 3-131, 3-135
 Set operator to, 3-140
 Set Single Source to, 3-139
 Set Single Source to:, 3-131, 3-135
 Single Wfm Math, 3-131, 3-135, 3-139

N

NAND, Main Trigger menu, 3-68
NAND, Main Trigger menu, 3-71, 3-72
 Neg Sync, Video Trigger menu, 3-128
 Negative duty cycle, 3-74
 Negative overshoot, 3-74
 Negative width, 3-74
Negative, Main Trigger menu, 3-93, 3-94
 Noise
 reducing in FFTs, 3-35
 reducing in phase FFTs, 3-30, 3-38

Noise Rej, Main Trigger menu, 3-23
NonInterlaced Both Fields, Video Trigger menu, 3-129
 NOR, Main Trigger menu, 3-68
NOR, Main Trigger menu, 3-71, 3-72
 Normal trigger mode, 3-24
Normal, Main Trigger menu, 3-24, 3-70, 3-93
 NTSC Video Standard, 3-128
NTSC, Display menu, 3-19
NTSC, Video Trigger menu, 3-128
 Nyquist frequency, 3-36

O

OFF (Real Time Only), Acquire menu, 3-8
Off Bus, Utility menu, 3-98
 Offset
 DC. *See DC Offset*
 Vertical, 3-125
 vertical, 3-34, 3-133, 3-138
Offset, Vertical menu, 3-125
OK Confirm Clear Spool, Hardcopy menu, 3-50
OK Create Math Wfm, More menu, 3-140
OK Create Measurement, Measure Delay menu, 3-80
OK Erase Ref & Panel Memory, Utility menu, 3-104
OK Store Template, Acquire menu, 3-64
ON (Enable ET), Acquire menu, 3-8
ON/STBY button, 1-5, 2-3
 Options, A-1
 OR, Main Trigger menu, 3-68
OR, Main Trigger menu, 3-71, 3-72
Overall, Display menu, 3-18
Overwrite Lock, File Utilities menu, 3-45

P

Packaging, B-1
 Paired cursor, 3-117
 PAL Video Standard, 3-128
PAL, Display menu, 3-19
PAL, Video Trigger menu, 3-128
 Pattern trigger, 3-67, 3-70
Pattern, Main Trigger menu, 3-69
 PCX, 3-47
PCX Color, Hardcopy menu, 3-48
PCX, Hardcopy menu, 3-48
 Peak detect acquisition mode, 3-5
Peak Detect, Acquire menu, 3-8
 Peak to peak, 3-74
 Period, 3-74
 Persistence, 3-18

- Phase, 3-74
 - Phase suppression, 3-38
 - Pixel, Glossary-2
 - Polarity and Width**, Main Trigger menu, 3-93
 - Polarity**, Main Trigger menu, 3-94
 - Pop-up menu, 2-10, Glossary-2
 - Port**, Hardcopy menu, 3-48
 - Port**, Utility menu, 3-97
 - Portrait**, Hardcopy menu, 3-48
 - Pos Sync, Video Trigger menu, 3-128
 - Position, vertical, 3-34, 3-133, 3-138
 - Position**, Vertical menu, 3-125
 - Positive duty cycle, 3-74
 - Positive overshoot, 3-75
 - Positive width, 3-75
 - Positive**, Main Trigger menu, 3-93, 3-94
 - Postscript, 3-47
 - Posttrigger, Glossary-3
 - Power connector, 1-3
 - Power cords, A-1, A-2
 - Power off, 1-5
 - Power on, 1-4
 - Pretrigger, Glossary-3
 - Preview**, Zoom menu, 3-145
 - Principal power switch, 1-4, 2-6
 - Print**, File Utilities menu, 3-45
 - Probe Cal, 1-5, 3-83-3-88
 - Probes
 - Accessories, A-4
 - Calibration, 3-83
 - Compensation, 2-15, 3-89, Glossary-3
 - Connection, 2-11
 - Passive, 3-89
 - Programmer manual, D-1
 - Programming, GPIB, D-1
 - Programming Examples, *D-1*
 - Propagation delay, 3-73
 - Pulse trigger, 3-91
 - Pulse**, Main Trigger menu, 3-92, 3-94
- Q**
- Quantizing, Glossary-3
- R**
- Rack mounting, A-1
 - Rate 1**, Video Trigger menu, 3-129
 - Rate 2**, Video Trigger menu, 3-129
 - Rate 3**, Video Trigger menu, 3-129
 - Rate 4**, Video Trigger menu, 3-129
 - Readout
 - Acquisition, 3-7
 - Channel, 2-7, 3-111, 3-143
 - Cursors, 2-7
 - Edge trigger, 3-21, 3-67
 - General purpose knob, 2-7
 - Measurement, 3-75
 - Record view, 2-7
 - Snapshot, 3-81
 - Time base, 2-7
 - Trigger, 2-7
 - Trigger Level Bar, 3-18
 - Trigger Point, 3-18
 - Readout, Cursor, Paired, 3-133
 - Readout, cursor
 - H-Bars, 3-31, 3-133, 3-136
 - Paired cursors, 3-33, 3-137
 - V-Bars, 3-32, 3-133, 3-137
 - Readout**, Display menu, 3-18
 - Real-time sampling, Glossary-3
 - Rear panel, 2-6, 3-97
 - Recall, Setups, 3-103
 - Recall Factory Setup**, Save/Recall Setup menu, 3-104, 3-113
 - Recall Saved Setup**, Save/Recall Setup menu, 3-103
 - Recalling, Waveforms, 3-105
 - Record length, 1-1, 3-57, A-1, Glossary-3
 - Record Length**, Horizontal menu, 3-57
 - Record View, 3-22, 3-55
 - Record view, 2-7
 - Rectangular window, 3-30
 - Ref1, Ref2, Ref3, Ref4**, Reference waveform status, 3-106
 - Ref1, Ref2, Ref3, Ref4**, Save/Recall Waveform menu, 3-106
 - Reference Indicator, Channel, 3-111
 - Reference levels, 2-24, 3-78
 - Reference Levels**, Measure menu, 3-78
 - Reference memory, Glossary-3
 - Reject Glitch**, Main Trigger menu, 3-93
 - Remote communication, 3-97
 - Remote operation
 - Procedures for, 3-97
 - Selecting and configuring the port, 3-97
 - Remove Measrmt**, Measure menu, 3-76, 3-81
 - Rename**, File Utilities menu, 3-44
 - Repetitive Signal**, Acquire menu, 3-8
 - Reset Zoom Factors**, Zoom menu, 3-146
 - Ring Bell if Condition Met**, Acquire menu, 3-65
 - Rise time, 2-23, 3-75
 - Rising edge, Delayed Trigger menu, 3-14
 - Rising edge, Main Trigger menu, 3-24, 3-72

- RLE Color**, Hardcopy menu, 3–48
 - RMS, 3–75
 - Roll, Glossary–3
 - Roll Mode, 3–99
 - Triggered, 3–99
 - Triggered, with Single Sequence, 3–99
 - Untriggered, 3–99
 - Untriggered, with Single Sequence, 3–99
 - Using, 3–99
 - RS-232, **Port** (optional), 3–97
 - RUN/STOP**, Acquire menu, 3–9
 - Runt trigger, 3–91, 3–94
 - Runt**, Main Trigger menu, 3–94
- S**
- Sample acquisition mode, 3–5
 - Sample interval, Glossary–3
 - Sample**, Acquire menu, 3–8
 - Sampling, Glossary–3
 - Save, Setups, 3–103
 - Save Current Setup**, Save/Recall Setup menu, 3–103
 - Save Format**, Save/Recall Waveform menu, 3–107
 - Save Waveform**, Save/Recall Waveform menu, 3–105
 - Save/Recall **SETUP** button, 3–43, 3–103
 - Save/recall **SETUP** button, 2–12
 - Save/Recall Setup menu, 3–103
 - factory** status, 3–103
 - Recall Factory Setup**, 3–104, 3–113
 - Recall Saved Setup**, 3–103
 - Save Current Setup**, 3–103
 - user** status, 3–103
 - Save/Recall **WAVEFORM** button, 3–43, 3–105
 - Save/Recall Waveform menu, 3–105
 - active** status, 3–105
 - Delete Refs**, 3–106
 - empty** status, 3–105
 - Ref1, Ref2, Ref3, Ref4**, 3–106
 - Save Format**, 3–107
 - Save Waveform**, 3–105
 - Saving and recalling setups, 3–103
 - Saving and recalling waveforms, 3–105
 - Scale, vertical, 3–34, 3–133, 3–138
 - Scan Parameter**, Video Trigger menu, 3–129
 - SECAM Video Standard, 3–128
 - SECAM**, Video Trigger menu, 3–128
 - seconds**, Cursor menu, 3–120
 - SELECT** button, 3–120
 - Select Measrmnt**, Measure menu, 3–76, 3–79
 - Selected waveform, 3–111
 - Selecting channels, 3–111
 - Self test, 1–5
 - Service Assurance, A–5
 - Set 1st Source to**, More menu, 3–140
 - Set 2nd Source to**, More menu, 3–140
 - Set Function to**, More menu, 3–139
 - SET LEVEL TO 50%** button, 3–25
 - Set Levels in % units**, Measure menu, 3–78
 - Set operator to**, More menu, 3–140
 - Set Single Source to**, More menu, 3–139
 - Set Thresholds**, Main Trigger menu, 3–69
 - Set to 10%**, Horizontal menu, 3–59
 - Set to 50%**, Horizontal menu, 3–59
 - Set to 50%**, Main Trigger menu, 3–24, 3–25
 - Set to 90%**, Horizontal menu, 3–59
 - Set to ECL**, Main Trigger menu, 3–24
 - Set to TTL**, Main Trigger menu, 3–24
 - Set to Zero**, Vertical menu, 3–125
 - Setting Up for the Examples, 2–11
 - Setup menu, 2–12
 - Setups, Save and recall, 3–103
 - Shipping, B–1
 - side menu, 2–7
 - Side menu buttons, 2–3
 - SIGNAL OUTPUT**, BNC, 2–6
 - Signal Path Compensation, 1–5–1–6, 3–115
 - Sin(x)/x interpolation, 3–19, Glossary–2
 - Sin(x)/x interpolation**, Display menu, 3–19
 - Single Acquisition Sequence**, Acquire menu, 3–10
 - SINGLE TRIG** button, 3–10, 3–25, 3–26
 - Single Wfm Math**, More menu, 3–139
 - Slope, 3–21
 - Slope**, Delayed Trigger menu, 3–14
 - Slope**, Main Trigger menu, 3–24
 - Snapshot, Readout, 3–81
 - Snapshot of Measurements, 2–25, 3–81
 - Snapshot**, Measure menu, 3–81
 - Software, 1–1
 - Software version, 3–15
 - Source**, Delayed Trigger menu, 3–13
 - Source**, Main Trigger menu, 3–23, 3–93, 3–94
 - Source**, Video Trigger menu, 3–128
 - Spooler, Hardcopy, 3–50
 - Start up, 1–3
 - State trigger, 3–72
 - State**, Main Trigger menu, 3–69, 3–72
 - STATUS** button, 3–15
 - Status menu, 3–15–3–16
 - Display**, 3–15
 - Firmware version, 3–15
 - I/O**, 3–15
 - System**, 3–15
 - Trigger**, 3–15
 - Waveforms**, 3–15

Stop After Limit Test Condition Met, Acquire menu, 3–65
Stop After, Acquire menu, 3–9, 3–65
Style, Display menu, 3–17
 Switch, principal power, 1–4, 2–6
Sync Polarity, Video Trigger menu, 3–128
System, Status menu, 3–15
System, Utility menu, 3–48, 3–97

T

Talk/Listen Address, Utility menu, 3–97
 Tek Secure, 3–104, Glossary–3
Tek Secure Erase Memory, Utility menu, 3–104
 Temperature compensation, 3–115
Template Source, Acquire menu, 3–63
 Test Data Report, A–2
Text/Grat, Display menu, 3–18
 Thinkjet, 3–47
Thinkjet, Hardcopy menu, 3–48
Thresholds, Main Trigger menu, 3–94
 TIFF, 3–47
TIFF, Hardcopy menu, 3–48
 Time base, Glossary–4
Time Base, Horizontal menu, 3–12, 3–59
Tracking, Cursor menu, 3–120
 Trigger, 3–113, Glossary–4
 Delayed, 3–11–3–14
 Edge, 3–21
 Glitch, 3–91
 Logic, 3–67, 3–68
 Pattern, 3–67, 3–70
 Position, 3–57
 Pulse, 3–91
 Readout, 3–21
 Runt, 3–91, 3–94
 State, 3–72
 Status Lights, 3–21
 Video, 3–127
 Width, 3–96
 Trigger Bar, 2–7
Trigger Bar Style, Display menu, 3–18
 Trigger level, 3–21
 Trigger Level Bar, Readout, 3–18
 Trigger MAIN LEVEL knob, 2–16, 3–25
TRIGGER MENU button, 3–22, 3–69, 3–92, 3–94, 3–127
 Trigger Point, Readout, 3–18
Trigger Position, Horizontal menu, 3–57
 Trigger Status Lights, 3–21
Trigger When, Main Trigger menu, 3–69, 3–71
 Trigger, delayed, How to set up, 3–12

Trigger, Status menu, 3–15
True for less than, Main Trigger menu, 3–71
True for more than, Main Trigger menu, 3–71
 Tutorial, 2–11
TV Delay Mode, Video Trigger menu, 3–128
Type, Main Trigger menu, 3–22, 3–92, 3–94, 3–127

U

user, Saved setup status, 3–103
UTILITY button, 3–48, 3–97
 Utility Menu
 OK Erase Ref & Panel Memory, 3–104
 Tek Secure Erase Memory, 3–104
 Utility menu, 3–47, 3–97
 Configure, 3–48, 3–97
 GPIB, 3–97
 Hardcopy, 3–98
 Hardcopy (Talk Only), 3–48
 I/O, 3–48, 3–97
 Off Bus, 3–98
 Port, 3–97
 System, 3–48, 3–97
 Talk/Listen Address, 3–97

V

V Limit, Acquire menu, 3–64
Variable Persistence, Display menu, 3–18
 Vectors, 3–17
Vectors, Display menu, 3–17
 Vertical, 3–113
 Bar cursors, 3–117
 Control, 3–123
 Offset, 3–125
 Readout, 3–123
 Scale, 3–123
 SCALE knob, 2–15, 3–123
 System, 2–15
 Vertical Menu, **Cal Probe**, 3–83
 Vertical menu
 100 MHz, 3–125
 20 MHz, 3–125
 Bandwidth, 3–125
 Coupling, 3–124
 Fine Scale, 3–125
 Full, 3–125
 Offset, 3–125
 Position, 3–125
 Set to Zero, 3–125
VERTICAL MENU button, 2–19

Vertical position, for DC correction of FFTs, 3–35
 Vertical **POSITION** knob, 3–144
 Vertical Readout, 3–123
 Vertical **SCALE** knob, 3–144
 VGA display, C–1
Video Class, Video Trigger menu, 3–127
Video Line Number, Cursor menu, 3–120
 Video Standards, 3–127
 Video Trigger
 NTSC Standard, 3–128
 PAL Standard, 3–128
 SECAM Standard, 3–128
 Standards, 3–127
 Video trigger, 3–127
 Video Trigger Menu
 Neg Sync, 3–128
 Pos Sync, 3–128
 Video Trigger menu, 3–127
 Ch1, Ch2 ..., 3–128
 Custom, 3–128
 Delay by Lines, 3–128
 Delay by Time, 3–128
 Interlaced Field One, 3–129
 Interlaced Field Two, 3–129
 NonInterlaced Both Fields, 3–129
 NTSC, 3–128
 PAL, 3–128
 Rate 1, 3–129
 Rate 2, 3–129
 Rate 3, 3–129
 Rate 4, 3–129
 Scan Parameter, 3–129
 SECAM, 3–128
 Source, 3–128
 Sync Polarity, 3–128
 TV Delay Mode, 3–128
 Video Class, 3–127
Video, Main Trigger menu, 3–127

W

Waveform
 Interval, Glossary–4
 Math, 3–139
 Off priority, 3–112
 Waveform clipping. *See Clipping*
 Waveform differentiation, 3–131
 Waveform FFTs, 3–27
 Waveform integration, 3–135
 Waveform memory, 3–106
WAVEFORM OFF button, 2–21, 3–20, 3–112

Waveform record
 FFT, 3–33
 FFT frequency domain, 3–33
 length of, 3–33
 FFT source, 3–33
 acquisition mode, 3–35
 defined, 3–33
 long versus short, 3–35
 FFT time domain, 3–33
Waveform, Display menu, 3–18
 Waveforms
 And zoom, 3–143
 Math, 3–141
Waveforms, Status menu, 3–15
 Width, 2–23
 Width trigger, 3–96
Width, Main Trigger menu, 3–93
 Window, 3–39
 Blackman-Harris, 3–30, 3–39, 3–41
 characteristics of, 3–40
 Hamming, 3–30, 3–39, 3–41
 Hanning, 3–30, 3–39, 3–41
 rectangular, 3–30, 3–39, 3–41
 selecting, 3–39
 Windowing, process, 3–39
 Windows, descriptions of, 3–29

X

XY, Format, 3–20
 XY format, Glossary–4
XY, Display menu, 3–20

Y

YT, Format, 3–20
 YT format, Glossary–4
YT, Display menu, 3–20

Z

Zero phase reference point, 3–37
 establishing for impulse testing, 3–37–3–38
 Zoom, 3–143–3–146
 And waveforms, 3–143
 derivative math waveforms, 3–134
 Dual Zoom, 3–144
 Dual Zoom Offset, 3–145
 Horizontal lock, 3–144, 3–146
 on FFT math waveforms, 3–36

on integral math waveforms, 3-138
Preview, 3-145
ZOOM button, 3-144, 3-146
Zoom menu
 Dual Zoom, 3-144
 Dual Zoom Offset, 3-145

Horizontal Lock, 3-144, 3-146
Preview, 3-145
Reset Zoom Factors, 3-146
Zoom Off, 3-146
Zoom Off, Zoom menu, 3-146

