

User Manual

Tektronix

**TDS 410A, TDS 420A & TDS 460A
Digitizing Oscilloscopes**

070-9219-00

Copyright © Tektronix, Inc. 1995. All rights reserved.

Tektronix products are covered by U.S. and foreign patents, issued and pending. Information in this publication supercedes that in all previously published material. Specifications and price change privileges reserved.

Printed in the U.S.A.

Tektronix, Inc., P.O. Box 1000, Wilsonville, OR 97070-1000

TEKTRONIX and TEK are registered trademarks of Tektronix, Inc.

WARRANTY

Tektronix warrants that this product will be free from defects in materials and workmanship for a period of three (3) years from the date of shipment. If any such product proves defective during this warranty period, Tektronix, at its option, either will repair the defective product without charge for parts and labor, or will provide a replacement in exchange for the defective product.

In order to obtain service under this warranty, Customer must notify Tektronix of the defect before the expiration of the warranty period and make suitable arrangements for the performance of service. Customer shall be responsible for packaging and shipping the defective product to the service center designated by Tektronix, with shipping charges prepaid. Tektronix shall pay for the return of the product to Customer if the shipment is to a location within the country in which the Tektronix service center is located. Customer shall be responsible for paying all shipping charges, duties, taxes, and any other charges for products returned to any other locations.

This warranty shall not apply to any defect, failure or damage caused by improper use or improper or inadequate maintenance and care. Tektronix shall not be obligated to furnish service under this warranty a) to repair damage resulting from attempts by personnel other than Tektronix representatives to install, repair or service the product; b) to repair damage resulting from improper use or connection to incompatible equipment; or c) to service a product that has been modified or integrated with other products when the effect of such modification or integration increases the time or difficulty of servicing the product.

THIS WARRANTY IS GIVEN BY TEKTRONIX WITH RESPECT TO THIS PRODUCT IN LIEU OF ANY OTHER WARRANTIES, EXPRESSED OR IMPLIED. TEKTRONIX AND ITS VENDORS DISCLAIM ANY IMPLIED WARRANTIES OF MERCHANTABILITY OR FITNESS FOR A PARTICULAR PURPOSE. TEKTRONIX' RESPONSIBILITY TO REPAIR OR REPLACE DEFECTIVE PRODUCTS IS THE SOLE AND EXCLUSIVE REMEDY PROVIDED TO THE CUSTOMER FOR BREACH OF THIS WARRANTY. TEKTRONIX AND ITS VENDORS WILL NOT BE LIABLE FOR ANY INDIRECT, SPECIAL, INCIDENTAL, OR CONSEQUENTIAL DAMAGES IRRESPECTIVE OF WHETHER TEKTRONIX OR THE VENDOR HAS ADVANCE NOTICE OF THE POSSIBILITY OF SUCH DAMAGES.

German Postal Information

Certificate of the Manufacturer/Importer

We hereby certify that the **TDS 410A, TDS 420A, and TDS 460A Digitizing Oscilloscopes** and all factory-installed options comply with the RF Interference Suppression requirements of Postal Regulation Vfg. 243/1991, amended per Vfg. 46/1992.

The German Postal Service was notified that the equipment is being marketed.

The German Postal Service has the right to re-test the series and to verify that it complies.

TEKTRONIX

Bescheinigung des Herstellers/Importeurs

Hiermit wird bescheinigt, daß das **TDS 410A, TDS 420A, and TDS 460A Digitizing Oscilloscopes** und alle fabrikinstallierten Optionen in Übereinstimmung mit den Bestimmungen der Amtsblatt-Verfügung Vfg. 243/1991 und Zusatzverfügung 46/1992 funkentstört sind.

Der Deutschen Bundespost wurde das Inverkehrbringen dieses Gerätes angezeigt und die Berechtigung zur Überprüfung der Serie auf Einhalten der Bestimmungen eingeräumt.

TEKTRONIX

NOTICE to the user/operator:

The German Postal Service requires that systems assembled by the operator/user of this instrument must also comply with Postal Regulation, Vfg. 243/1991, Par. 2, Sect. 1.

HINWEIS für den Benutzer/Betreiber:

Die vom Betreiber zusammengestellte Anlage, innerhalb derer dieses Gerät eingesetzt wird, muß ebenfalls den Voraussetzungen nach Par. 2, Ziff. 1 der Vfg. 243/1991, genügen.

NOTICE to the user/operator:

The German Postal Service requires that this equipment, when used in a test setup, may only be operated if the requirements of Postal Regulation, Vfg. 243/1991, Par. 2, Sect. 1.8.1 are complied with.

HINWEIS für den Benutzer/Betreiber:

Dieses Gerät darf in Meßaufbauten nur betrieben werden, wenn die Voraussetzungen des Par. 2, Ziff. 1.8.1 der Vfg. 243/1991 eingehalten werden.



EC Declaration of Conformity

We

Tektronix Holland N.V.
Marktweg 73A
8444 AB Heerenveen
The Netherlands

declare under sole responsibility that the

TDS 410A Digitizing Oscilloscope
TDS 420A Digitizing Oscilloscope
TDS 460A Digitizing Oscilloscope

meet the intent of Directive 89/336/EEC for Electromagnetic Compatibility. Compliance was demonstrated to the following specifications as listed in the official Journal of the European Communities:

EN 50081-1 Emissions:

EN 55011	Radiated, Class A
EN 55011	Conducted, Class A
EN 60555-2	Power Harmonics

EN 50082-1 Immunity:

IEC 801-2	Electrostatic Discharge
IEC 801-3	RF Radiated
IEC 801-4	Fast Transients
IEC 801-5	Surge

Table of Contents

List of Figures	iii
List of Tables	vii
General Safety Summary	ix
Preface	xi
Getting Started	
Product Description	1-1
Start Up	1-3
Operating Basics	
Functional Overview	2-1
At a Glance	2-3
Tutorial	2-13
Reference	
Overview	3-1
Accessing Help	3-3
Acquisition Modes	3-5
Delayed Triggering	3-13
Determining Status	3-19
Display Modes	3-21
Edge Triggering	3-27
File System	3-31
Hardcopy	3-35
Horizontal Control	3-45
Limit Testing	3-53
Measuring Waveforms	3-59
Probe Accessories	3-71
Probe Compensation	3-81
Probe Selection	3-83
Remote Communication	3-89
Roll Mode	3-93
Saving and Recalling Setups	3-97
Saving and Recalling Waveforms	3-101
Selecting Channels	3-107
Setting Up Automatically: Autoset and Reset	3-111

Signal Path Compensation	3-113
Taking Cursor Measurements	3-115
Vertical Control	3-121
Video Triggering	3-125
Waveform Math	3-131
Zoom	3-135

Appendices

Appendix A: Options and Accessories	A-1
Appendix B: Specification	B-1
Appendix C: Algorithms	C-1
Appendix D: Packaging for Shipment	D-1
Appendix E: Factory Initialization Settings	E-1
Appendix F: Remote Display	F-1

Glossary

Index

List of Figures

Figure 1-1: Rear Panel Controls Used in Start Up	1-4
Figure 1-2: ON/STBY Button	1-5
Figure 2-1: Connecting a Probe for the Examples	2-13
Figure 2-2: SETUP Button Location	2-14
Figure 2-3: The Displayed Setup Menu	2-14
Figure 2-4: SET LEVEL TO 50% Button	2-15
Figure 2-5: The Display After Factory Initialization	2-16
Figure 2-6: The VERTICAL and HORIZONTAL Controls	2-17
Figure 2-7: TRIGGER Controls	2-18
Figure 2-8: AUTOSSET Button Location	2-18
Figure 2-9: The Display After Pressing Autoset	2-19
Figure 2-10: Display Signals Requiring Probe Compensation	2-19
Figure 2-11: The Channel Buttons and Lights	2-20
Figure 2-12: The Vertical Main Menu and Coupling Side Menu	2-22
Figure 2-13: The Menus After Changing Channels	2-23
Figure 2-14: Measure Main Menu and Select Measurement Side Menu	2-24
Figure 2-15: Four Simultaneous Measurement Readouts	2-26
Figure 2-16: General Purpose Knob Indicators	2-26
Figure 2-17: Snapshot of Channel 1	2-28
Figure 2-18: Save/Recall Setup Menu	2-30
Figure 2-19: Triggered Versus Untriggered Displays	2-31
Figure 2-20: Trigger Holdoff Time Ensures Valid Triggering	2-33
Figure 2-21: Slope and Level Controls Help Define the Trigger	2-35
Figure 2-22: TRIGGER Controls and Status Lights	2-36
Figure 2-23: Example Trigger Readouts	2-37
Figure 2-24: Record View, Trigger Position, and Trigger Level Bar Readouts	2-38
Figure 2-25: Acquisition: Input Analog Signal, Sample, and Digitize	2-39
Figure 2-26: Several Points May be Acquired for Each Point Used	2-39
Figure 2-27: Real-Time Sampling	2-40
Figure 2-28: Equivalent-Time Sampling	2-41
Figure 2-29: Scaling and Positioning	2-43
Figure 2-30: Aliasing	2-45

Figure 2–31: Graticule, Cursor, and Automated Measurements	2–47
Figure 2–32: Cursor Modes	2–49
Figure 3–1: Initial Help Screen	3–4
Figure 3–2: How the Acquisition Modes Work	3–6
Figure 3–3: Acquisition Menu and Readout	3–9
Figure 3–4: Acquire Menu — Stop After	3–11
Figure 3–5: Delayed Runs After Main	3–13
Figure 3–6: Delayed Triggerable	3–13
Figure 3–7: How the Delayed Triggers Work	3–15
Figure 3–8: Delayed Trigger Menu	3–17
Figure 3–9: Status Menu — System	3–19
Figure 3–10: Banner Display	3–20
Figure 3–11: Display Menu — Style	3–21
Figure 3–12: Trigger Point and Level Indicators	3–23
Figure 3–13: Edge Trigger Readouts	3–27
Figure 3–14: Main Trigger Menu — Edge Type	3–28
Figure 3–15: File Utilities	3–31
Figure 3–16: File System — Labelling Menu	3–33
Figure 3–17: Utility Menu — System I/O	3–36
Figure 3–18: Hardcopy Formats	3–37
Figure 3–19: Date and Time Display	3–38
Figure 3–20: Connecting the Digitizing Oscilloscope Directly to the Hardcopy Device	3–39
Figure 3–21: Connecting the Digitizing Oscilloscope and Hardcopy Device Via a PC	3–41
Figure 3–22: Connecting the Digitizing Oscilloscope and Hardcopy Device Via a Converter	3–44
Figure 3–23: Record View and Time Base Readouts	3–45
Figure 3–24: Horizontal Controls	3–46
Figure 3–25: Comparing a Waveform to a Limit Template	3–53
Figure 3–26: Acquire Menu — Create Limit Test Template	3–54
Figure 3–27: Measurement Readouts	3–61
Figure 3–28: Measure Menu	3–62
Figure 3–29: Measure Menu — Gating	3–64
Figure 3–30: Measure Menu — Reference Levels	3–66
Figure 3–31: Measure Delay Menu — Delay To	3–67
Figure 3–32: Snapshot Menu and Readout	3–68

Figure 3–33: A Probe Adds Resistance, Capacitance, and Inductance	3–71
Figure 3–34: Signal Variation Introduced by Probe Ground Lead (1 ns/division)	3–72
Figure 3–35: Probe Accessories	3–73
Figure 3–36: How Probe Compensation Affects Signals	3–81
Figure 3–37: Probe Adjustment	3–82
Figure 3–38: Typical High Voltage Probes	3–84
Figure 3–39: A6303 Current Probe Used in the AM 503S Opt. 03 ...	3–86
Figure 3–40: Typical GPIB Network Configuration	3–90
Figure 3–41: Stacking GPIB Connectors	3–90
Figure 3–42: Connecting the Digitizing Oscilloscope to a Controller	3–91
Figure 3–43: Utility Menu	3–92
Figure 3–44: Roll Mode (500 Point Record Length)	3–94
Figure 3–45: Trigger Mode Menu	3–96
Figure 3–46: Save/Recall Setup Menu	3–98
Figure 3–47: Save Waveform Menu	3–102
Figure 3–48: More Menu	3–103
Figure 3–49: Save Format Menu	3–105
Figure 3–50: The Channel Readout	3–107
Figure 3–51: Waveform Selection Priority	3–109
Figure 3–52: Performing a Signal Path Compensation	3–114
Figure 3–53: Cursor Types	3–115
Figure 3–54: Cursor Modes	3–116
Figure 3–55: H Bars Cursor Menu and Readouts	3–117
Figure 3–56: Paired Cursor Menu and Readouts	3–118
Figure 3–57: Video Line and IRE Units	3–119
Figure 3–58: Vertical Readouts and Channel Menu	3–122
Figure 3–59: Main Trigger Menu — Video Type	3–125
Figure 3–60: Video Trigger Menu — Class	3–126
Figure 3–61: Video Trigger Menu — TV Delay Mode	3–127
Figure 3–62: Video Trigger — Scan Parameter	3–128
Figure 3–63: Video Trigger — Scan Rate & Interlace	3–129
Figure 3–64: Video Trigger Menu — Mode & Holdoff	3–130
Figure 3–65: More Menu	3–131
Figure 3–66: Dual Waveform Math Menus	3–133
Figure 3–67: Zoom Mode with Horizontal Lock Set to None	3–137
Figure 3–68: Zoom Preview Mode	3–138

Figure B-1: TDS 400A Dimensional Drawing	B-9
Figure C-1: MCross Calculations	C-4
Figure C-2: Fall Time	C-7
Figure C-3: Rise Time	C-11
Figure C-4: Choosing Minima or Maxima to Use for Envelope Measurements	C-14

List of Tables

Table 1-1: Fuse and Fuse Cap Part Numbers	1-4
Table 3-1: Resolution Bits	3-8
Table 3-2: XY Format Pairs	3-25
Table 3-3: Measurement Definitions	3-59
Table 3-4: Autoset Defaults	3-111
Table 3-5: Zoom Defaults	3-139
Table A-1: International Power Cords	A-2
Table A-2: Standard Accessories	A-4
Table A-3: Probe Accessories	A-4
Table A-4: Optional Accessories	A-5
Table A-5: Probe Accessories	A-6
Table A-6: Accessory Software	A-8
Table B-1: Key Features of the TDS 400A Oscilloscopes	B-1
Table B-2: Nominal Traits — Signal Acquisition System	B-3
Table B-3: Nominal Traits — Time Base System	B-5
Table B-4: Nominal Traits — Triggering System	B-5
Table B-5: Nominal Traits — Display System	B-6
Table B-6: Nominal Traits — Data Storage	B-6
Table B-7: Nominal Traits — GPIB Interface, Video Output, and Power Fuse	B-6
Table B-8: Nominal Traits — Mechanical	B-7
Table B-9: Warranted Characteristics — Signal Acquisition System	B-11
Table B-10: Warranted Characteristics — Time Base System	B-13
Table B-11: Warranted Characteristics — Triggering System	B-14
Table B-12: Warranted Characteristics — Probe Compensator Output	B-14
Table B-13: Warranted Characteristics — Power Requirements ...	B-14
Table B-14: Warranted Characteristics — Environmental, Safety, and Reliability	B-15
Table B-15: Typical Characteristics — Signal Acquisition System ..	B-17
Table B-16: Typical Characteristics — Time Base System	B-18
Table B-17: Typical Characteristics — Triggering System	B-19
Table B-18: Typical Characteristics — Data Handling	B-20

Table E-1: Factory Initialization Defaults E-1

General Safety Summary

Review the following safety precautions to avoid injury and prevent damage to this product or any products connected to it.

Only qualified personnel should perform service procedures.

Injury Precautions

- | | |
|---|--|
| Use Proper Power Cord | To avoid fire hazard, use only the power cord specified for this product. |
| Avoid Electric Overload | To avoid electric shock or fire hazard, do not apply a voltage to a terminal that is outside the range specified for that terminal. |
| Ground the Product | This product is grounded through the grounding conductor of the power cord. To avoid electric shock, the grounding conductor must be connected to earth ground. Before making connections to the input or output terminals of the product, ensure that the product is properly grounded. |
| Do Not Operate Without Covers | To avoid electric shock or fire hazard, do not operate this product with covers or panels removed. |
| Use Proper Fuse | To avoid fire hazard, use only the fuse type and rating specified for this product. |
| Do Not Operate in Wet/Damp Conditions | To avoid electric shock, do not operate this product in wet or damp conditions. |
| Do Not Operate in Explosive Atmosphere | To avoid injury or fire hazard, do not operate this product in an explosive atmosphere. |

Product Damage Precautions

- | | |
|-----------------------------------|---|
| Use Proper Power Source | Do not operate this product from a power source that applies more than the voltage specified. |
| Provide Proper Ventilation | To prevent product overheating, provide proper ventilation. |

Do Not Operate With Suspected Failures

If you suspect there is damage to this product, have it inspected by qualified service personnel.

Safety Terms and Symbols

Terms in This Manual

These terms may appear in this manual:



WARNING. Warning statements identify conditions or practices that could result in injury or loss of life.



CAUTION. Caution statements identify conditions or practices that could result in damage to this product or other property.

Terms on the Product

These terms may appear on the product:

DANGER indicates an injury hazard immediately accessible as you read the marking.

WARNING indicates an injury hazard not immediately accessible as you read the marking.

CAUTION indicates a hazard to property including the product.

Symbols on the Product

The following symbols may appear on the product:



DANGER
High Voltage



Protective Ground
(Earth) Terminal



ATTENTION
Refer to
Manual



Double
Insulated

OPERATING INSTRUCTIONS

PREPARATION

The PS 501 (-1) (-2) is calibrated and ready for use when received. It is designed to operate in any compartment of a TM 500 Series Power Module. Refer to the Power Module Instruction Manual for line voltage requirements.

To install the PS 501 (-1) (-2), align the upper and lower rails of the plug-in with the Power Module tracks and insert until the plug-in panel is flush with the Power Module panel (see Fig. 2-1). To remove, pull the release latch to disengage the PS 501 (-1) (-2) from the Power Module.

CAUTION

Turn the Power Module off before inserting the plug-in; otherwise, damage may occur to the plug-in circuitry.

The following procedure is intended to prepare the instrument for immediate use and demonstrate the basic function of the unit. Operation of the Power Module and other plug-ins in this system are described in their respective instruction manuals. Functions of front-panel controls, indicators and connectors are described in Fig. 2-2 and Fig. 2-3.

NOTE

Before using the PS 501 (-1) (-2) read the Operating Considerations in this section regarding proper techniques for connecting various loads, etc.

The presence of output voltage is verified by a voltage indicator light on the front panel. The brightness of this light varies with output voltage.

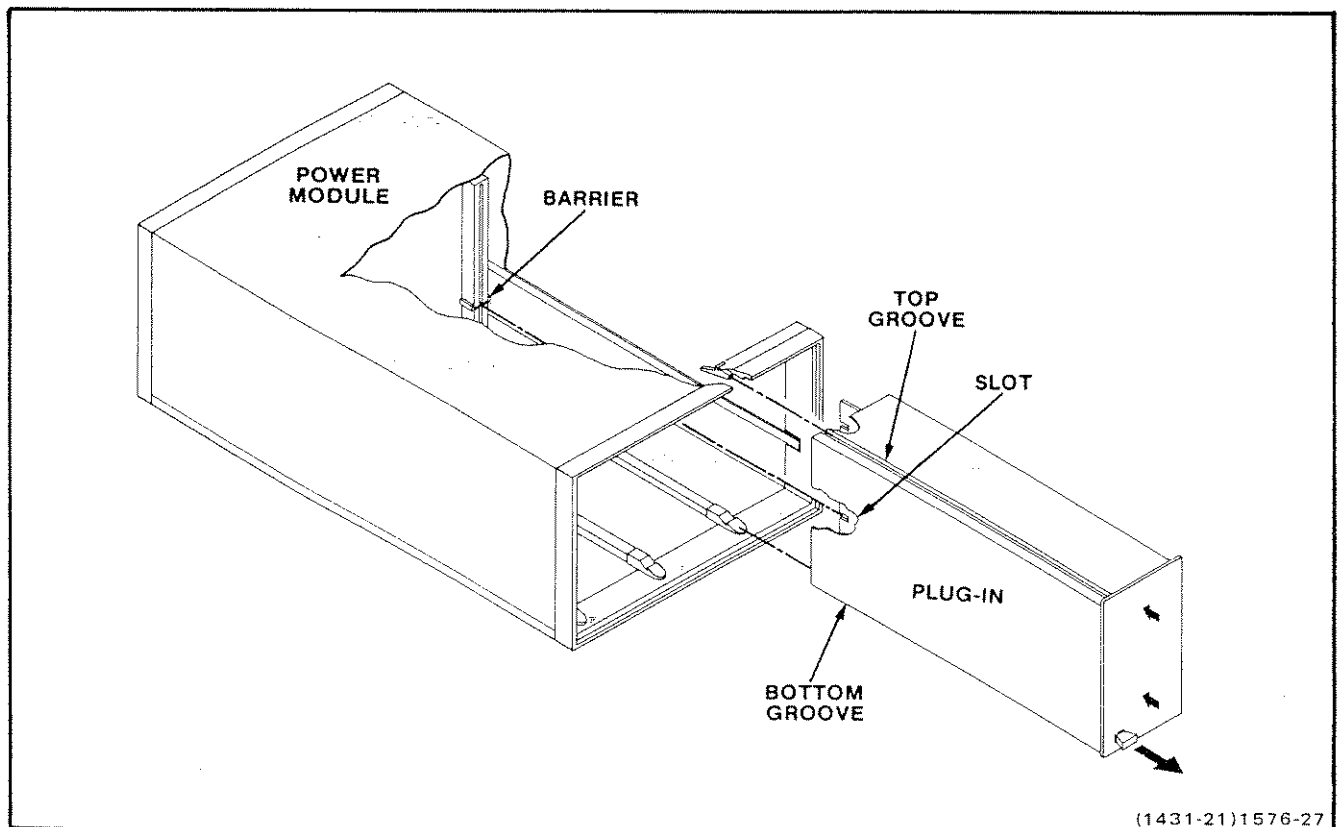

Fig. 2-1. PS 501 (-1, -2) Installation and removal.

Operating Instructions—PS 501 (-1, -2)

A panel-mounted, light-emitting diode lights when the PS 501 goes into current-limiting. This is a very sensitive indicator that starts to glow before hard limiting occurs. Hard limiting is indicated by maximum brightness of the light-emitting diode as well as a dimming of the voltage indicator light. These functions are easily evaluated by momentarily shorting the output of the supply.

PS 501-1 is identical to the PS 501 except that the output voltage is selected by a 10-turn precision potentiometer with a 3-digit in-line dial and a range pushbutton. The turns-counting dial allows the output of the PS 501-1 to be set accurately without an expensive external meter. The dial provides accuracy equivalent to that obtained with a 3 1/2 digit DVM.

The PS 501-2 is identical to the PS 501 except that a front-panel meter is provided to aid in accurately setting the output current or voltage of the PS 501-2. See Figs. 2-2 and 2-3, Controls and Connectors.

Constant Voltage/Current Limited Output

1. Press the OUTPUT button to apply power to the plug-in. Observe that the VOLTS indicator light comes on (the light will be very dim at low voltages).

2. Adjust the VOLTS control for approximately 2 V.

NOTE

The use of an external meter is not required for the PS 501-2. The PS 501-2 internal meter can perform the function described in step 3.

3. Set the CURRENT LIMIT control fully ccw (to protect the ammeter). Connect an ammeter across the + and - terminals and adjust the CURRENT LIMIT control for the maximum desired current output.

4. Remove the ammeter, connect the load to the + and - terminals and adjust the VOLTS control for the desired output.

Series Operation

The outputs of two or more supplies can be connected in series as shown in Fig. 2-4 to obtain an output voltage equal to the sum of the output voltages from each supply. The maximum output is limited to 350 Vdc + peak ac (i.e., the isolation voltage rating between the output terminals and ground). Each supply must be adjusted individually to obtain the desired output voltage.

NOTE

The PS 501 (-1) (-2) has internal diodes connected across the output to protect any of the series-connected supplies against reverse polarity if the load is shorted, or one of the supplies is not on.

Parallel Operation

The outputs of two or more current-limiting, automatic-crossover supplies can be connected in parallel as shown in Fig. 2-5 to obtain an output current equal to the sum of the output currents from each supply. Each supply must be adjusted individually to obtain the desired output current.

One supply should be set for the desired output voltage and the other should be set for a slightly higher voltage. The supply set for the desired voltage will then become a constant voltage source, while the supply with the higher voltage output becomes a current-limited source (due to automatic crossover) which results in their output voltage decreasing to that of the supply with the lowest output voltage.

APPLICATIONS

Differential Voltage Measurements

Very small dc voltage changes or unknown voltages can be measured by connecting the PS 501-1, a null detector, and the source under test in a differential configuration as shown in Fig. 2-6. Inexpensive comparison measurements at nearly the accuracy and sensitivity of costly differential voltmeters can be made with the PS 501-1. The ultimate accuracy and sensitivity of the measurement depends on the PS 501-1 and the type of null detector used. A calibrated dc amplifier in a high-gain oscilloscope such as the TEKTRONIX 5100-Series Oscilloscope with a 5A20N Differential Amplifier plug-in will serve as a convenient null detector, or a sensitive milliammeter with a series resistor is also satisfactory.

NOTE

Examine the circuit for ground loops when using a null detector with one input terminal grounded (see Grounded and Floating Operation).

Series- and Parallel-Connected Stair-Step Operation

Series- and parallel-connected PS 501 (-1) (-2)'s can be operated to provide a "stair-step" output characteristic by choosing proper load limits and control settings. For example, Fig. 2-7 shows the stair-step output from two series-connected supplies. With each supply set for

Preface

This is the User Manual for the TDS 410A, TDS 420A, and TDS 460A Digitizing Oscilloscopes.

If you are a new user, use the *Getting Started* section to become familiar with the operation of your digitizing oscilloscope.

The *Concepts* section covers basic principles of the operation of the oscilloscope. These articles help you understand why your oscilloscope works the way it does.

Use the *In Detail* section to learn how to perform specific tasks. See page 3–1 for a complete list of tasks covered in that section.

The *Appendices* provide an option and accessories listing, product specification, and other useful information.

Related Manuals

The following documents are related to the use or service of the digitizing oscilloscope.

- The *TDS Family Programmer Manual* describes using a computer to control the digitizing oscilloscope through the GPIB interface.
- The *TDS 410A, TDS 420A, & TDS 460A Reference* gives you a quick overview of how to operate your digitizing oscilloscope.
- The *TDS 410A, TDS 420A, & TDS 460A Performance Verification* tells how to verify the performance of the digitizing oscilloscope.
- The *TDS Family Option 2F Instruction Manual* describes use of the Advanced DSP Math option (for TDS oscilloscopes equipped with that option only).
- The *TDS Family Option 13 Instruction Manual* describes using the optional Centronics® and RS-232 interfaces for obtaining hardcopy (for TDS oscilloscopes equipped with that option only).
- The *TDS Family Option 3P Printer Pack Instruction Manual* describes using the optional printer pack for obtaining hardcopy (for TDS oscilloscopes equipped with that option only).
- The *TDS 410A, TDS 420A, & TDS 460A Service Manual* provides information for maintaining and servicing your digitizing oscilloscope to the module level.

Conventions

In the *Getting Started* and *Reference* sections, you will find various procedures which contain steps of instructions for you to perform. To keep those instructions clear and consistent, this manual uses the following conventions:

- Names of front panel controls and menu labels appear in boldface print.
- Names also appear in the same case (initial capitals, all uppercase, etc.) in the manual as is used on the oscilloscope front panel and menus. Front panel names are all upper case letters, for example, **VERTICAL MENU**, **CH 1**, and **SETUP**.
- Instruction steps are numbered. The number is omitted if there is only one step.
- When steps require that you make a sequence of selections using front panel controls and menu buttons, an arrow (→) marks each transition between a front panel button and a menu, or between menus. Also, whether a name is a main menu or side menu item is clearly indicated: Press **VERTICAL MENU** → **Coupling** (main) → **DC** (side) → **Bandwidth** (main) → **100 MHz** (side).

Using the convention just described results in instructions that are graphically intuitive and simplifies procedures. For example, the instruction just given replaces these five steps:

1. Press the front panel button **VERTICAL MENU**.
 2. Press the main menu button **Coupling**.
 3. Press the side-menu button **DC**.
 4. Press the main menu button **Bandwidth**,
 5. Press the side menu button **100 MHz**.
- Sometimes you may have to make a selection from a pop-up menu: Press **TRIGGER MENU** → **Type** (main) → **Edge** (pop-up). In this example, you repeatedly press the main menu button **Type** until **Edge** is highlighted in the pop-up menu.

Product Description

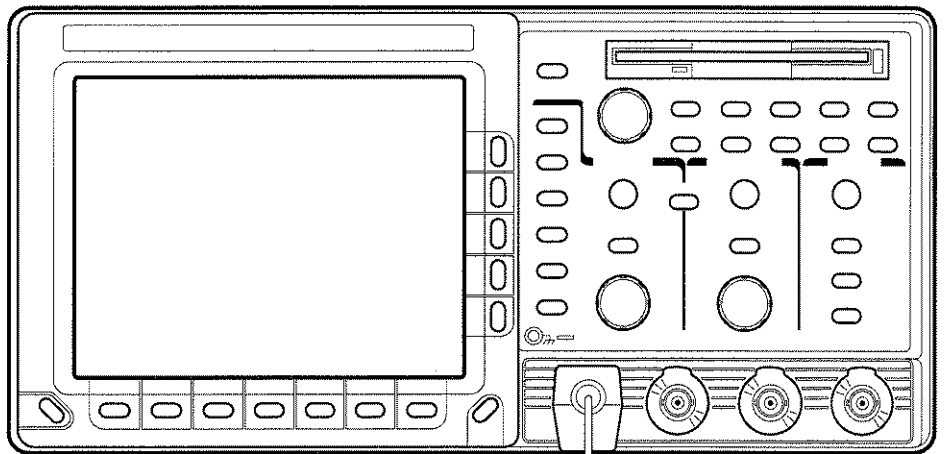

Your Tektronix digitizing oscilloscope is a superb tool for acquiring, displaying, and measuring waveforms. Its performance addresses the needs of both lab and portable applications with the following features:

- 400 MHz maximum analog bandwidth on the TDS 460A
200 MHz maximum analog bandwidth on the TDS 410A and TDS 420A
- 100 Megasamples/second maximum digitizing rate
- Roll mode and triggered roll mode for display of slower waveforms
- Waveform Math — Invert a single waveform and add, subtract, and multiply two waveforms. On instruments equipped with option 2F, integrate or differentiate a single waveform or perform an FFT (fast fourier transform) on a waveform to display its magnitude or phase versus its frequency.
- Up to 30,000-point record length per channel (120,000-point optional)
- Full GPIB software programmability. GPIB hardcopy output. On instruments equipped with option 13, hardcopy output using the RS-232 or Centronics ports. On-board printer capability with option 3P instruments.
- Complete measurement and documentation ability
- Intuitive graphical icon operation blended with the familiarity of traditional horizontal and vertical knobs
- Four channels and four eight-bit digitizers on TDS 420A and TDS 460A. Two channels and two eight-bit digitizers on TDS 410A.
- On-line help at the touch of a button

The *Appendices* list options, accessories, and the product specifications.

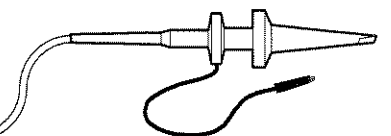

The product specification is in *Appendix B: Specifications* and in the *TDS 410A, TDS 420A & TDS 460A Performance Verification and Specifications* that is shipped as a standard accessory with TDS 400A Digitizing Oscilloscopes.

Start Up

Before you use the digitizing oscilloscope, ensure that it is properly installed and powered on.

Operation

To properly install and power on the digitizing oscilloscope, do the following steps:

Installation

1. Be sure you have the appropriate operating environment. Specifications for temperature, relative humidity, altitude, vibrations, and emissions are included in *Appendix B: Specifications* at the rear of this manual.
2. Leave space for cooling. Do this by verifying that the air intake and exhaust holes on the sides of the cabinet (where the fan operates) are free of any airflow obstructions. Leave at least 2 inches (5.1 cm) free on each side.



WARNING. *To avoid electrical shock, be sure that the power cord is disconnected before checking the fuse.*

3. Check the fuse to be sure it is the proper type and rating (see Figure 1-1 for the fuse location). You can use either of two fuses (see Table 1-1 for the fuse data).
4. Check that you have the proper electrical connections. The digitizing oscilloscope requires 90 to 132 V for 48 through 62 Hz, 100 to 132 V or 180 to 250 V for 48 through 440 Hz, and may require up to 240 W.
5. Connect the proper power cord from the rear-panel power connector (see Figure 1-1 for the connector location) to the power system.

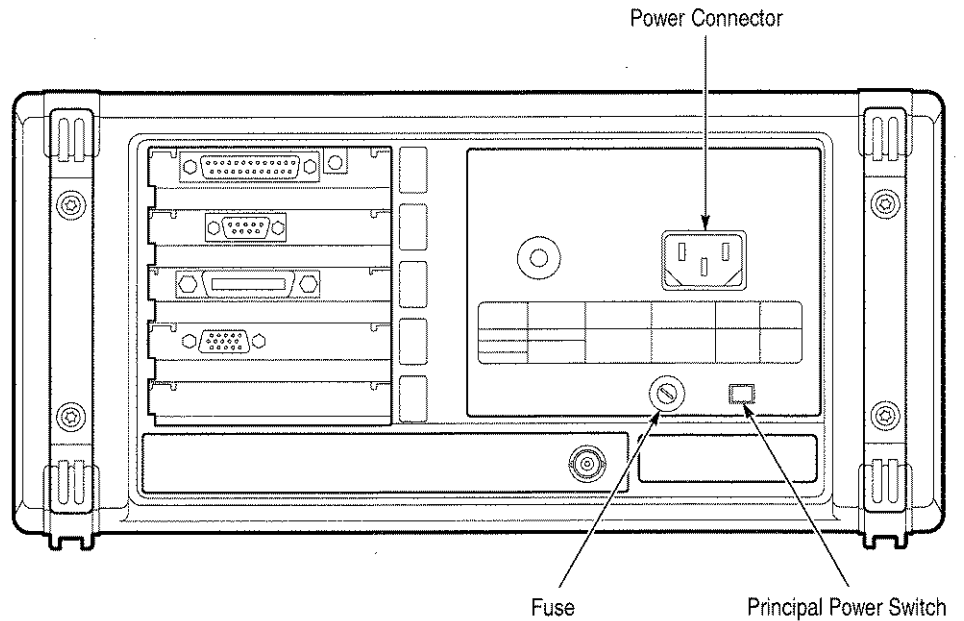

Figure 1-1: Rear Panel Controls Used in Start Up

Table 1-1: Fuse and Fuse Cap Part Numbers

Fuse	Fuse Part Number	Fuse Cap Part Number
.25 inch × 1.25 inch (UL 198.6, 3AG); 5 A FAST, 250 V.	159-0014-00	200-2264-00
5 mm × 20 mm (IEC 127); 4 A (T), 250 V.	159-0255-00	200-2265-00

Power On

1. Check that the rear-panel principal power switch is on (see Figure 1-1 for the location of the switch). The principal power switch controls all AC power to the instrument.
2. If the oscilloscope is not powered on (the screen is blank), push the front-panel **ON/STBY** button to toggle it on (Figure 1-2).

The ON/STBY button controls power to most of the instrument circuits. power continues to go to certain parts even when this switch is set to STBY.

Once the digitizing oscilloscope is installed, you can leave the principal power switch on and use the ON/STBY button.

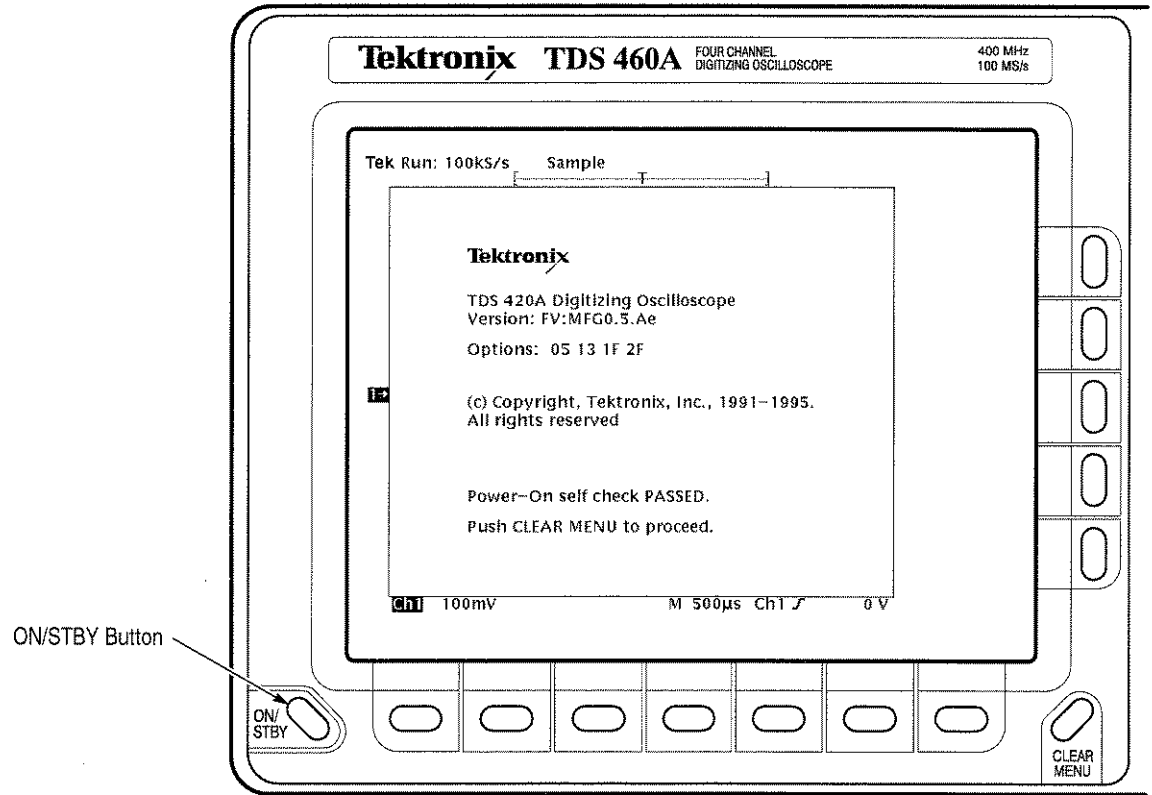

Figure 1-2: ON/STBY Button

Self Test The digitizing oscilloscope automatically performs power-on tests each time it is turned on. It comes up with a display screen that states whether or not it passed self test. (If the self test does not detect any problems, the status display screen disappears a few seconds after the self test is complete.)

Check the self test results.

If the self test fails, call your local Tektronix Service Center. Depending on the type of failure, you may still be able to use the oscilloscope before it is serviced.

Power Off Press the **ON/STBY** switch to turn off the oscilloscope.

Before You Begin

Signal Path Compensation (SPC) lets you compensate your oscilloscope for the current ambient temperature. SPC helps ensure maximum possible accuracy for your most critical measurements. See *Signal Path Compensation* on page 3-113 for a description of and operating information on this key feature.

Functional Overview

This chapter describes the basic concepts of operating the digitizing oscilloscope. Understanding the basic concepts of your digitizing oscilloscope helps you use it much more effectively.

At a Glance quickly shows you how the oscilloscope is organized and gives some very general operating instructions. It also contains an overview of all the main menus and the following maps:

- Front Panel Map
- Rear Panel Map
- Display Map
- Basic Menu Operation
- Menu Map

The *Tutorial* contains tutorial examples and explains basic system concepts:

- *Setting Up for the Examples* explains how to set up the digitizing oscilloscope to use the examples.
- *Example 1: Displaying a Waveform* teaches you how to reset the digitizing oscilloscope, display and adjust waveforms, and use the autoset function.
- *Example 2: Displaying Multiple Waveforms* explains how to add, control, and delete multiple waveforms.
- *Example 3: Taking Automated Measurements* introduces you to the automated measurement system.
- *Example 4: Saving Setups* discusses saving and recalling the digitizing oscilloscope setups.
- *Triggering* explains how to set the triggers to convert unstable displays or blank screens into meaningful waveforms.
- *Acquisition* explains converting analog data into digital data.
- *Scaling and Positioning Waveforms* explains how to change the position and displayed size of waveforms.
- *Measurements* explains using automated, cursor, and graticule measurements to display numeric information on the displayed waveforms.

To explore these topics in more depth and to read about topics not covered in this section, see *Reference*. Page 3-1 lists the topics covered.

At a Glance

The *At a Glance* section contains illustrations of the display, the front and rear panels, and the menu system. These illustrations help you understand and operate the digitizing oscilloscope. This section also contains a visual guide to using the menu system.

Front Panel Map — Left Side

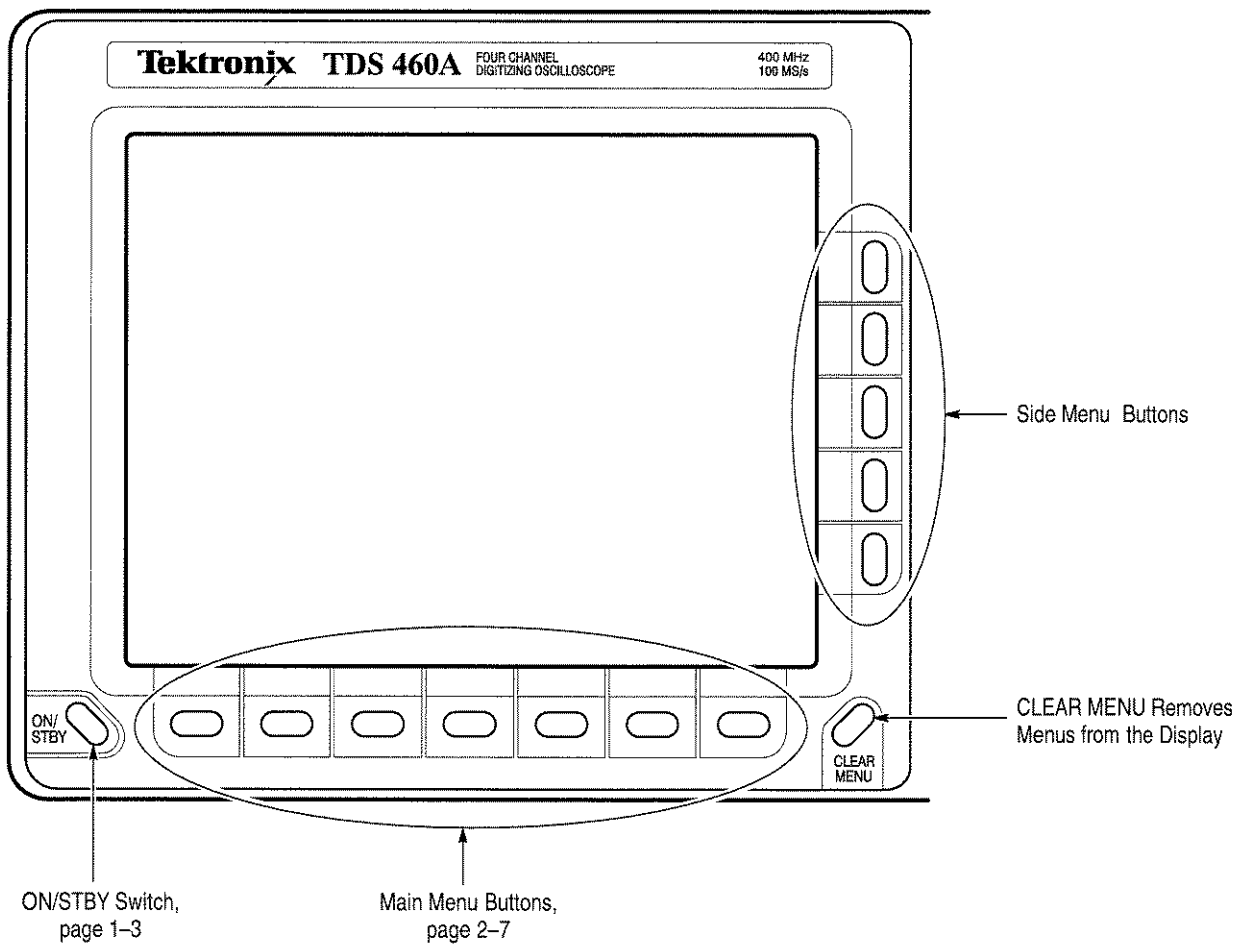

Front Panel Map — Right Side

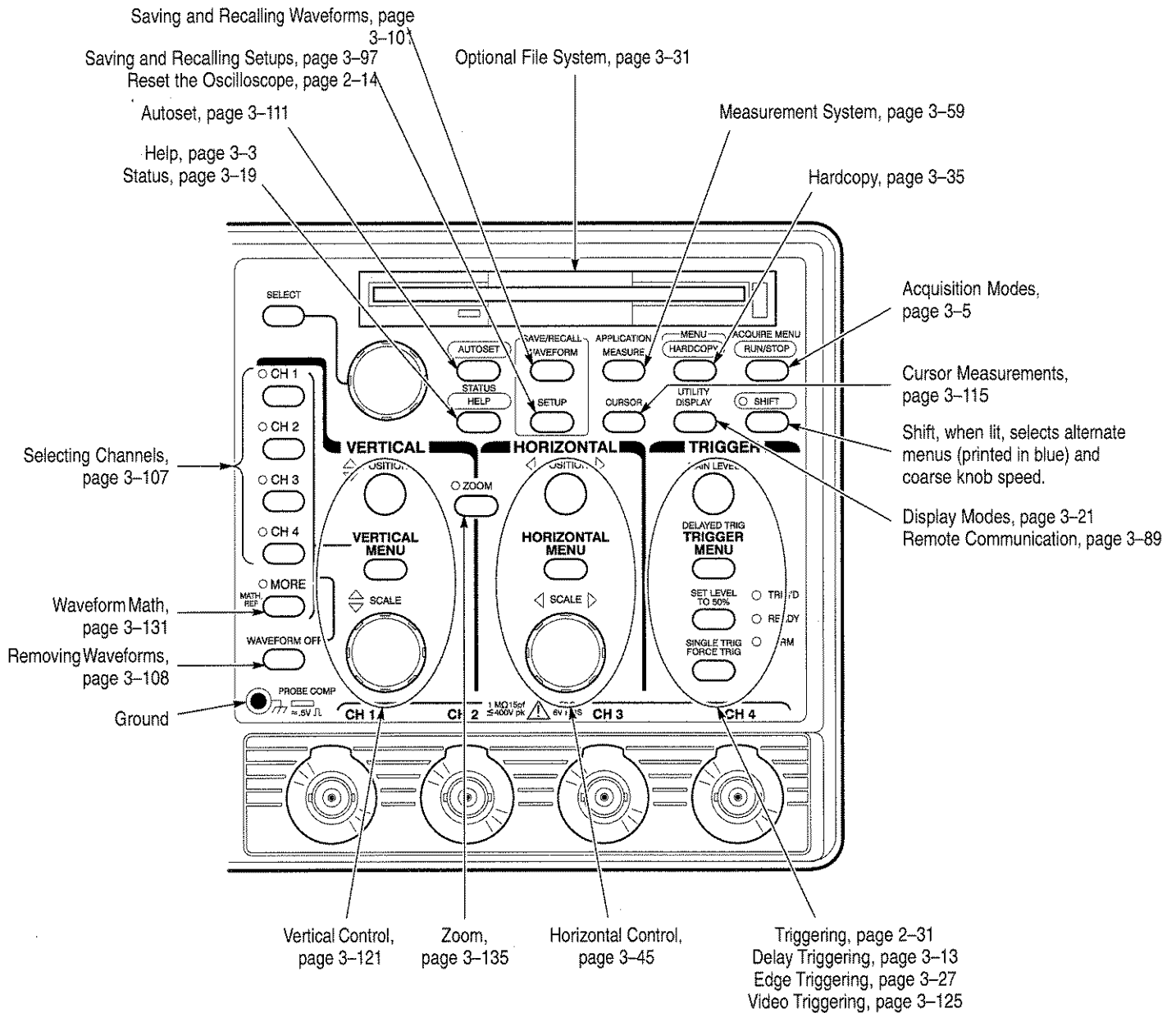

Rear Panel Map

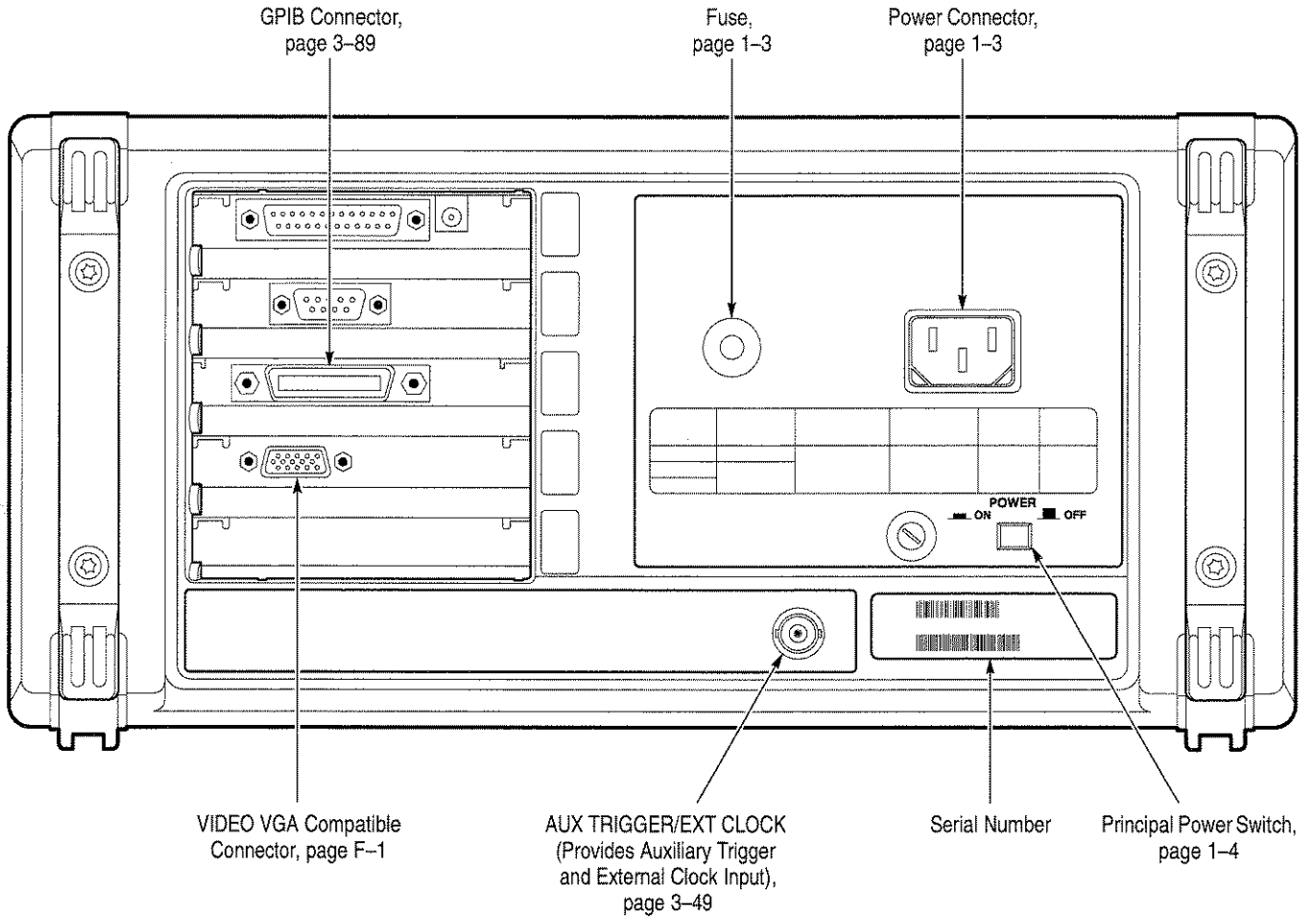

Display Map

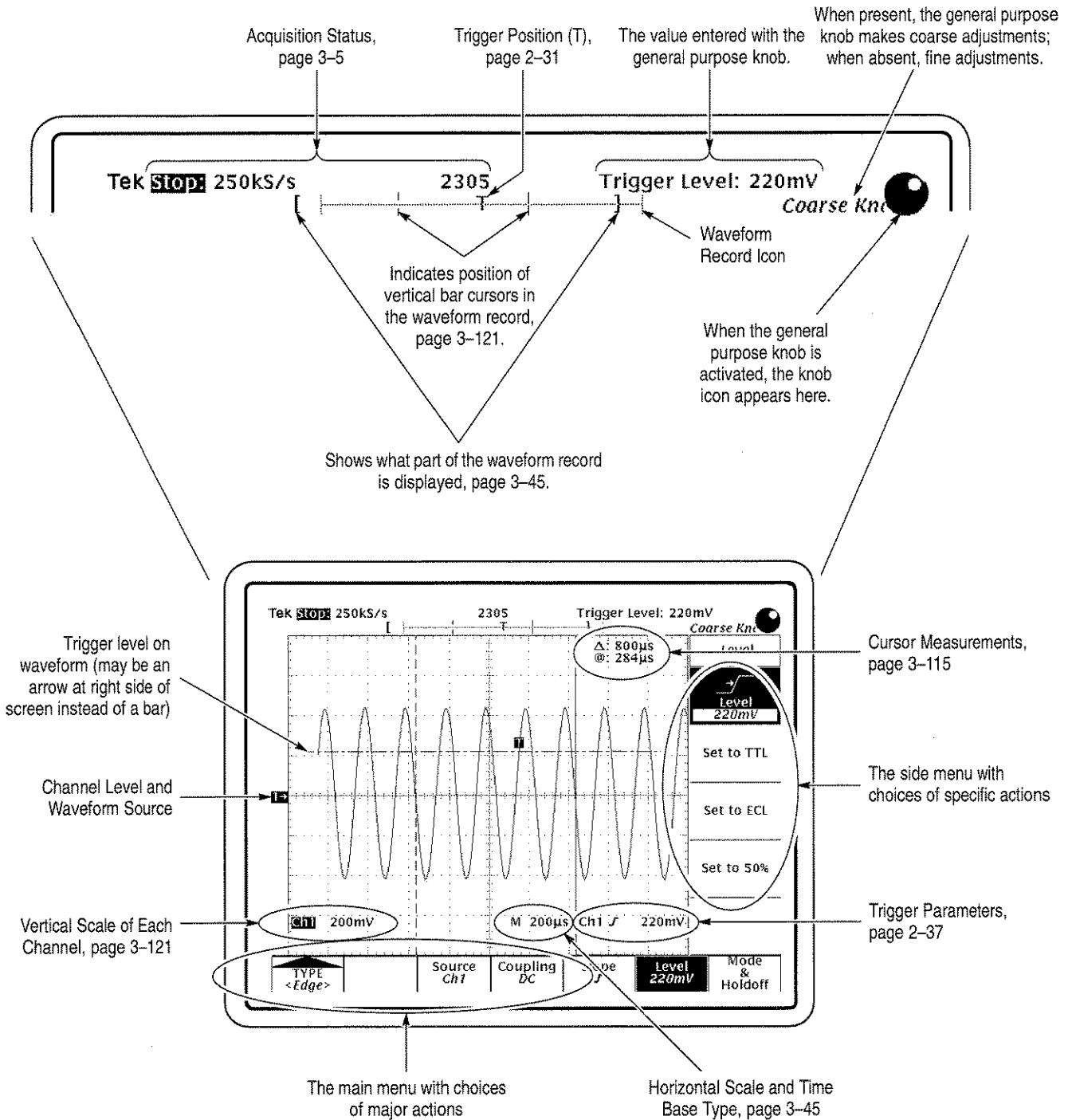

To Operate a Menu

1 Press front-panel menu button.

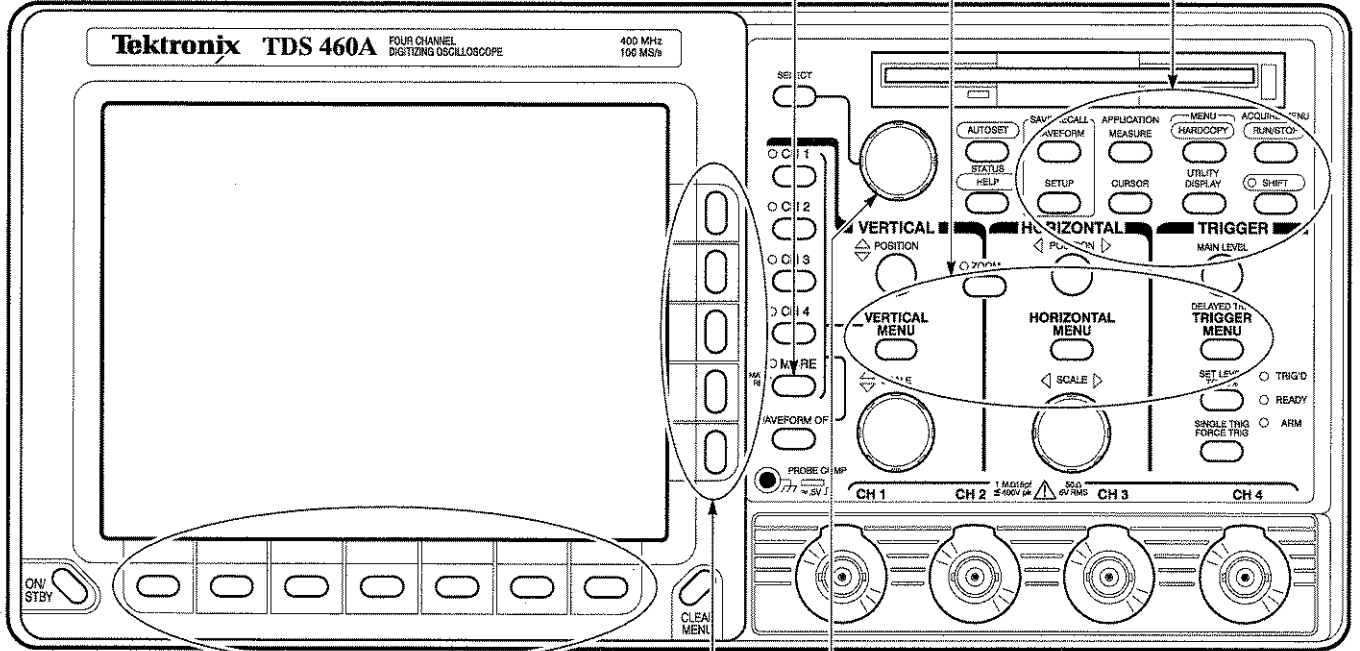

2 Press one of these buttons to select from main menu.

3 Press one of these buttons to select from side menu (if displayed).

4 If side menu item has an adjustable value (shown in reverse video), adjust it with the general purpose knob.

To Operate a Pop-Up Menu

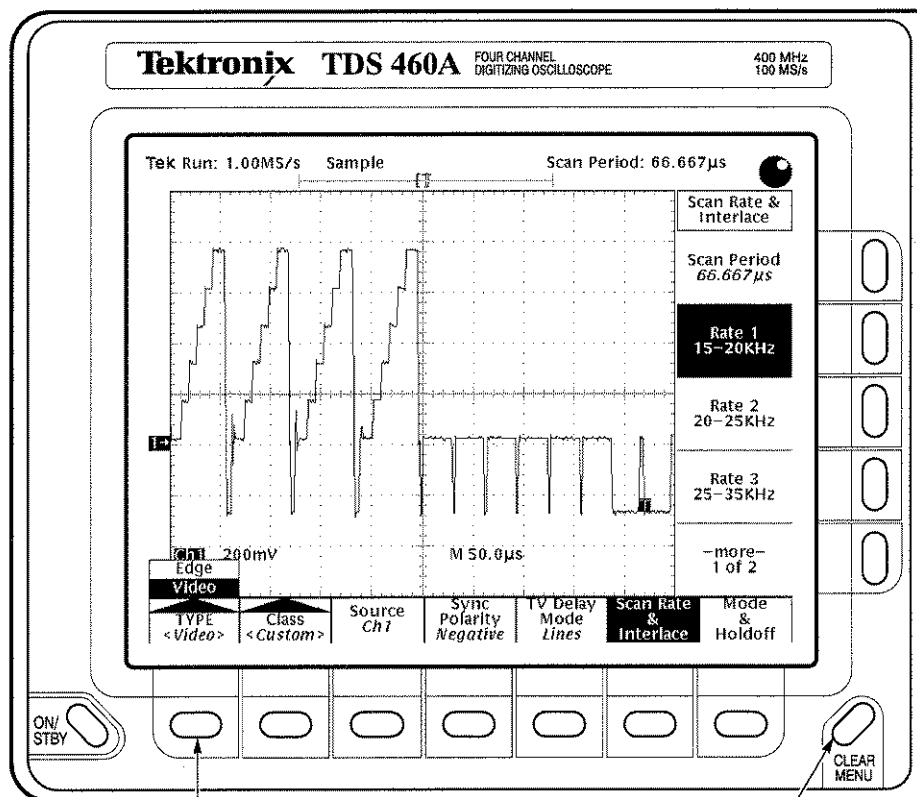

Press
to display pop-ups.

Press again
to make selection.

Alternatively, press SHIFT
first to make selection in the
opposite direction.

A pop-up selection changes the other
main menu titles.

Press to remove
menus from screen.

Menu Map

Press these buttons:

To bring up these menus:

Acquire Menu
(see page 3-5)

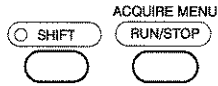

Mode <i>Sample</i>	Repetitive Signal <i>ON</i>	Stop After R/S button		Limit Test Setup	Limit Test Sources	Create Limit Test Template
-----------------------	-----------------------------------	--------------------------	--	---------------------	-----------------------	----------------------------------

Application Menu
(see the Programmer manual for more details)

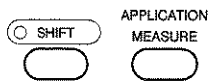

--	--	--	--	--	--	--

Cursor Menu
(see page 3-115)



Function <i>OFF</i>	Mode <i>Indep</i>	Horiz Units <i>Base</i>	Amplitude Units <i>Base</i>			
------------------------	----------------------	-------------------------------	-----------------------------------	--	--	--

Delayed Trigger Menu
(see page 3-13)



		Source <i>Ch 1</i>	Coupling <i>DC</i>	Slope <i>f</i>	Level <i>16mV</i>	Delay by <i>Time</i>
--	--	-----------------------	-----------------------	-------------------	----------------------	-------------------------

Display Menu
(see page 3-21)



Style <i>Vectors</i>	Intensity	Readout Options	Filter <i>Sin(x)/x</i>	Graticule <i>Full</i>	Format <i>V7</i>	
-------------------------	-----------	--------------------	---------------------------	--------------------------	---------------------	--

Hardcopy Menu
(see page 3-35)

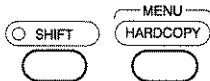

Format <i>Interleaf</i>	Layout <i>Portrait</i>		Port <i>File</i>	Clear <i>Spool</i>		File Utilities
----------------------------	---------------------------	--	---------------------	-----------------------	--	-------------------

Horizontal Menu
(see page 3-45)



Time Base <i>Main</i>	Trigger Position <i>50%</i>	Record Length <i>500</i>	Horiz Controls	Horiz Pos	Clock <i>Internal</i>	
--------------------------	-----------------------------------	--------------------------------	-------------------	--------------	--------------------------	--

Press these buttons:

To bring up these menus:

Main Trigger Menu – Edge
(see page 3-27)



Type <Edge>	Source Ch1	Coupling DC	Slope J	Level -30mV	Mode & Holdoff
----------------	---------------	----------------	------------	----------------	-------------------

Measure Menu
(see page 3-59)



Select Measrmt for Ch1	Remove Measrmt	Gating OFF	High-Low Setup Histogram	Reference Levels	Snapshot	
---------------------------	----------------	---------------	--------------------------------	---------------------	----------	--

More Menu
(see page 3-131)



Math1 Ch1+Ch2	Math2 Ch1-Ch2	Math3 inv(Ch1)	Ref1	Ref2	Ref3	Ref4
------------------	------------------	-------------------	------	------	------	------

Save/Recall Setup Menu
(see page 3-97)



Recall Saved Setup	Save Current Setup	Recall Factory Setup				File Utilities
--------------------------	--------------------------	----------------------------	--	--	--	-------------------

Save/Recall Waveform Menu
(see page 3-101)



Recall wfm to Ref	Save wfm Ch1	Delete Refs			Save Format Internal	File Utilities
----------------------	-----------------	----------------	--	--	----------------------------	-------------------

Status Menu
(see page 3-19)

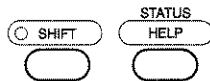

Status	Banner					
--------	--------	--	--	--	--	--

Trigger Menu – Video
(see page 3-125)



TYPE <Video>	Class <Custom>	Source Ch1	Sync Polarity Negative	TV Delay Mode Lines	Scan Rate & Interlace	Mode & Holdoff
-----------------	-------------------	---------------	------------------------------	---------------------------	-----------------------------	----------------------

Press these buttons:

To bring up these menus:

Utility Menu – Calibration
(see page 3–113)



System <Cal>	Signal Path Pass	Voltage Reference Pass	Low Freq Response Pass	High Freq Response Pass	Trigger Skew Pass	
-----------------	---------------------	---------------------------	---------------------------	----------------------------	----------------------	--

Utility Menu – Config
(see page 3–38)

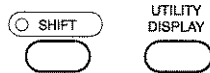

System <Config>	Tek Secure Erase Memory	Set Date & Time				
--------------------	----------------------------	-----------------	--	--	--	--

Utility Menu – Diagnostics
(see the Service manual)

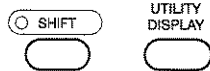

System <Diag/Err>	Area <All Areas>	Tests Select All	Execute	Loop Once		Error Log
----------------------	---------------------	---------------------	---------	--------------	--	--------------

Utility Menu – I/O
(see pages 3–89 and 3–36)



System <I/O>	Port <GPIB>	Configure Talk/Listen				
-----------------	----------------	--------------------------	--	--	--	--

Vertical Channel Menu
(see page 3–121)



Coupling DC	Bandwidth Full	Fine Scale 50mV/div	Position 0 div	Offset 0 V		
----------------	-------------------	------------------------	-------------------	---------------	--	--

Zoom Menu
(see page 3–135)



Mode	Lock All	Selected Graticule Upper				Reset
------	-------------	--------------------------------	--	--	--	-------

Tutorial

This section quickly acquaints you with some of the fundamental operations required to use TDS 400A Digitizing Oscilloscopes to take measurements. Start this tutorial by doing *Setting Up for the Examples* on this page.

Setting Up for the Examples

Perform the following tasks to connect input signals to the TDS 400A Digitizing Oscilloscopes, to reset it, and to become acquainted with its display screen. Once completed, these tasks ready the digitizing oscilloscope for use in the examples that follow.

Connect the Input Signal

Remove all probes and signal inputs from the input BNC connectors along the lower right of the front panel. Then, using one of the probes supplied with the digitizing oscilloscope, connect from the **CH 1** connector of the digitizing oscilloscope to the **PROBE ADJ** connector (Figure 2-1).

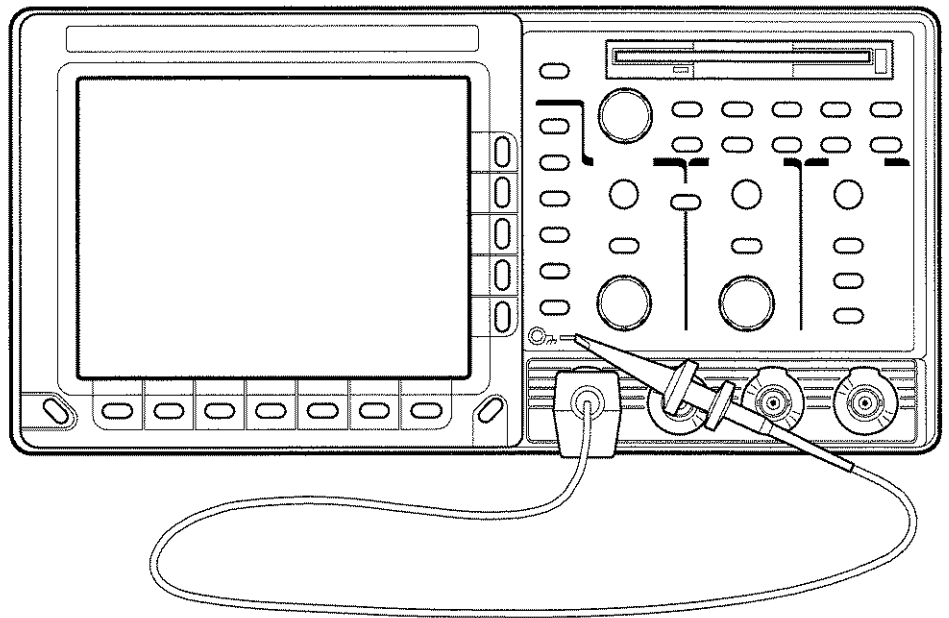

Figure 2-1: Connecting a Probe for the Examples

Reset the Oscilloscope

Do the following steps to reset the digitizing oscilloscope to a known factory default state. (Reset the oscilloscope anytime you begin a new task and need to “start fresh” with known default settings.)

1. Press the save/recall **SETUP** button to display the Setup menu (see Figure 2–2).

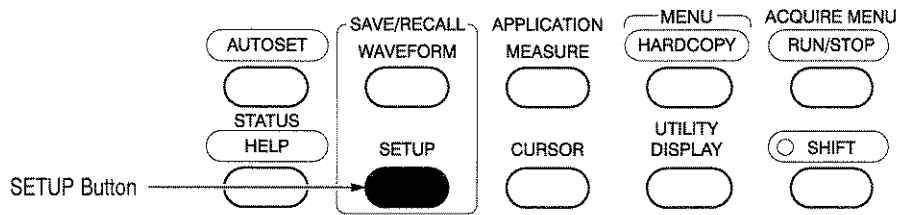

Figure 2–2: SETUP Button Location

The digitizing oscilloscope displays *main menus* along the bottom of the screen. Figure 2–3 shows the Setup main menu.

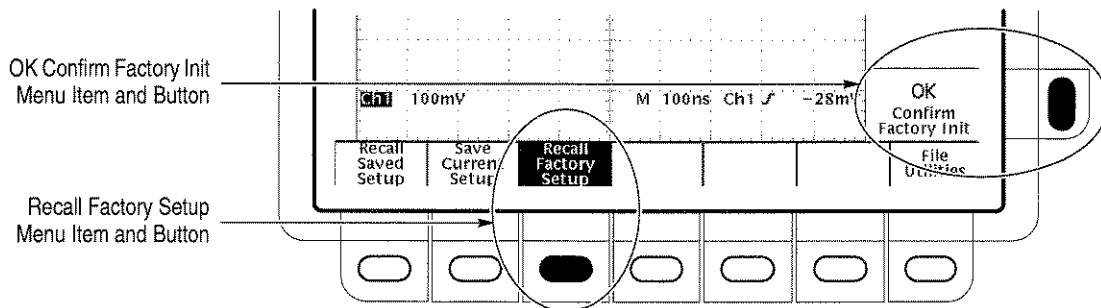

Figure 2–3: The Displayed Setup Menu

2. Press the button directly below the **Recall Factory Setup** menu item.

The display shows *side menus* along the right side of the screen. The buttons to select these side menu items are to the right of the side menu.

Because an accidental instrument reset could destroy a setup that took a long time to create, the digitizing oscilloscope asks you to verify the Recall Factory Setup selection (see Figure 2–3).

3. Press the button to the right of the **OK Confirm Factory Init** side menu item.

NOTE. This manual uses the following notation to represent the sequence of selections you made in steps 1, 2 and 3: Press save/recall **SETUP** → **Recall Factory Setup** (main) → **OK Confirm Factory Init** (side).



Note that a clock icon appears on screen. The oscilloscope displays this icon when performing operations that take longer than several seconds.

4. Press **SET LEVEL TO 50%** (see Figure 2–4) to be sure the oscilloscope triggers on the input signal.

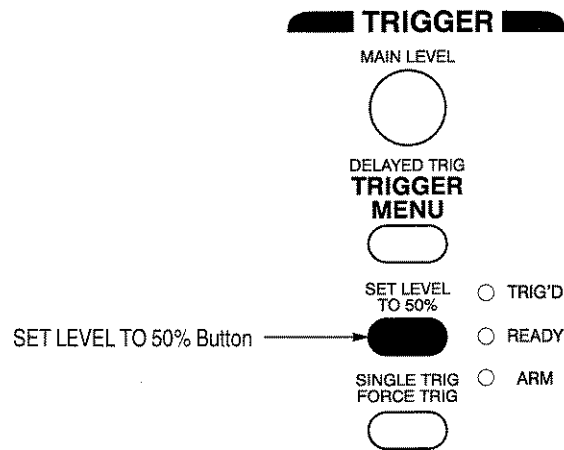

Figure 2–4: SET LEVEL TO 50% Button

Examine the Display Elements

Read the following information to become familiar with the oscilloscope display. Figure 2–5 shows the display that results from the oscilloscope reset. There are several important points to observe:

- The *trigger level bar* shows that the waveform is triggered at a level near 50% of its amplitude (from step 4).
- The *trigger position indicator* shows that the trigger position of the waveform is located at the horizontal center of the graticule.
- The *channel reference indicator* shows the vertical position of channel 1 with no input signal. This indicator points to the ground level for the channel when its vertical offset is set to 0 V in the vertical menu; when vertical offset is *not* set to 0 V, the indicator points to the vertical offset level.
- The *trigger readout* shows that the digitizing oscilloscope is triggering on channel 1 (Ch1) on a rising edge and that the trigger level is about 200-300 mV.

- The *time base readout* shows that the main time base is set to a horizontal scale of 500 μ s/div.
- The *channel readout* indicates that channel 1 (Ch1) is displayed with DC coupling. (In AC coupling, ~ appears after the volts/div readout.) The digitizing oscilloscope always displays channel 1 at reset.

Right now, the channel, time base, and trigger readouts appear in the graticule area because a menu is displayed. You can press the CLEAR MENU button at any time to remove any menus and to move the readouts below the graticule.

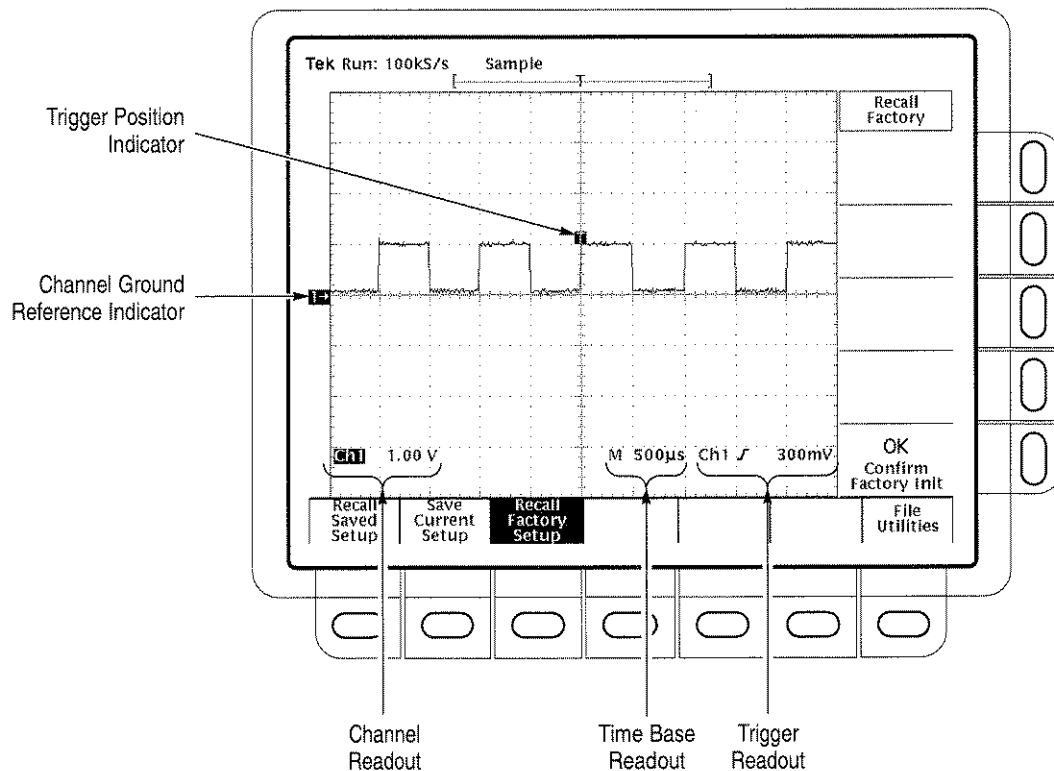

Figure 2-5: The Display After Factory Initialization

Example 1: Displaying a Waveform

The TDS 400A Digitizing Oscilloscopes provides front panel knobs for you to adjust a waveform, or it can automatically set up its controls to display a waveform. Do the following tasks to learn how to adjust a waveform and how to autoset the TDS 400A Digitizing Oscilloscopes.

Adjusting the Waveform Display

The display shows the probe compensation signal. It is a 1 kHz square wave of approximately 0.5 V amplitude. Do the following steps to adjust the size and placement of the waveform using the front-panel knobs.

Figure 2–6 shows the main VERTICAL and HORIZONTAL sections of the front panel. Each has SCALE and POSITION knobs.

1. Turn the vertical **SCALE** knob clockwise. Observe the change in the displayed waveform and the channel readout at the bottom of the display.

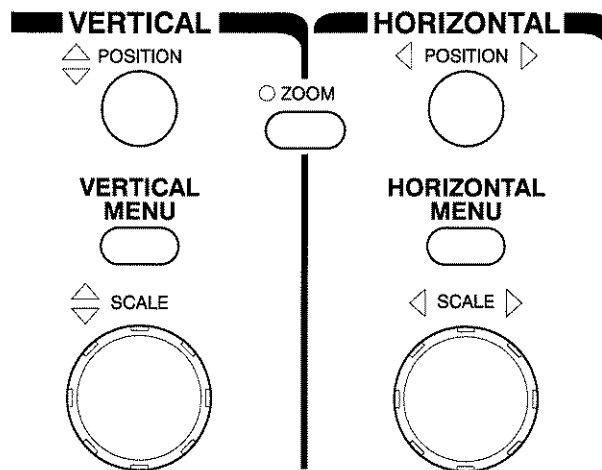

Figure 2–6: The VERTICAL and HORIZONTAL Controls

2. Turn the vertical **POSITION** knob first one direction, then the other. Observe the change in the displayed waveform. Then return the waveform to the center of the graticule.

3. Turn the horizontal **SCALE** knob one click clockwise. Observe the time base readout at the bottom of the display. The time base should be set to 200 $\mu\text{s}/\text{div}$ now, and you should see two complete waveform cycles on the display.

Autoset the Oscilloscope

When you first connect a signal to a channel and display it, the signal displayed may not be scaled and triggered correctly. Use the autoset function and you should quickly get a meaningful display.

You should have a stable display of the probe compensation waveform from the last step. Do the following steps to first create an unstable display and then to automatically obtain a stable display:

1. To create an unstable display, slowly turn the trigger **MAIN LEVEL** knob (see Figure 2-7) first one direction, then the other. Observe what happens when you move the trigger level above the highest part of the displayed waveform. Leave the trigger level in that untriggered state.
2. Press **AUTOSET** (see Figure 2-8) and observe the stable waveform display.

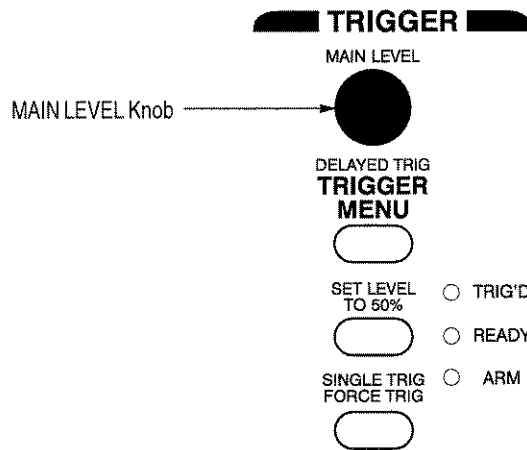

Figure 2-7: TRIGGER Controls

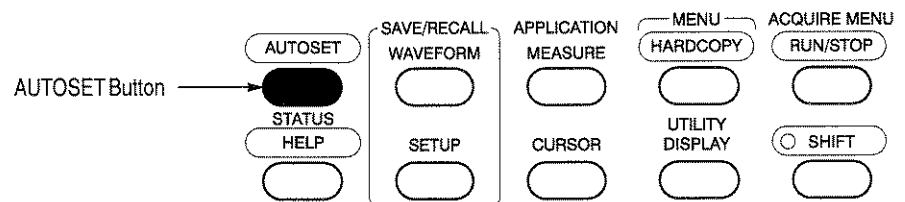

Figure 2-8: AUTOSET Button Location

Figure 2–9 shows the display after pressing AUTOSET. If necessary, you can adjust the waveform using the knobs discussed earlier in this example.

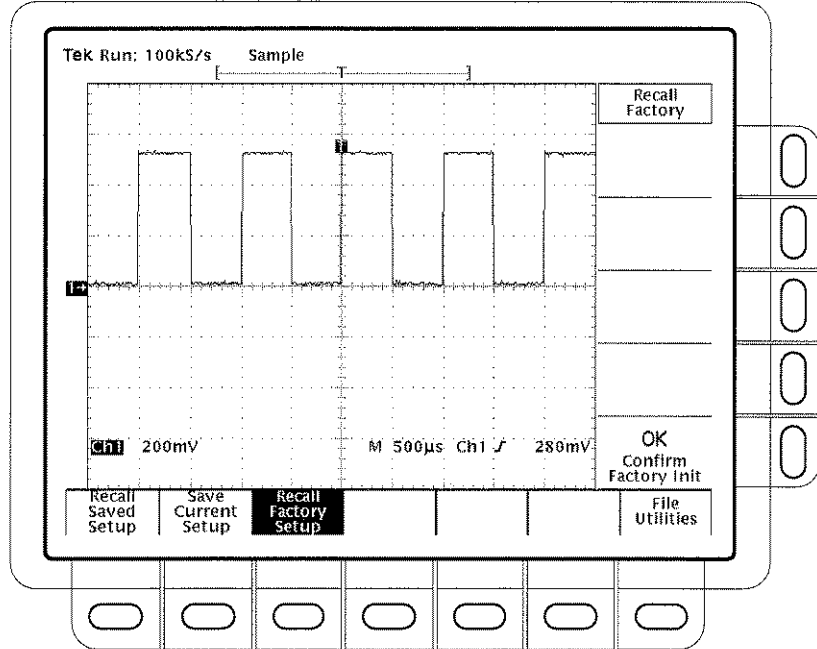

Figure 2–9: The Display After Pressing Autoset

NOTE. If the corners on your displayed signal look rounded or pointed (see Figure 2–10), then you may need to compensate your probe. The Probe Compensation section on page 3–81 explains how to compensate your probe.



Figure 2–10: Display Signals Requiring Probe Compensation

Example 2: Displaying Multiple Waveforms

In this example you learn how to display and control more than one waveform at a time.

Adding a Waveform

The VERTICAL section of the front panel contains the channel selection buttons. On the TDS 420 and TDS 460 Digitizing Oscilloscope, they are CH 1, CH 2, CH 3, CH 4, and MORE (Figure 2–11). On the TDS 410, they are CH 1, CH 2, and MORE.

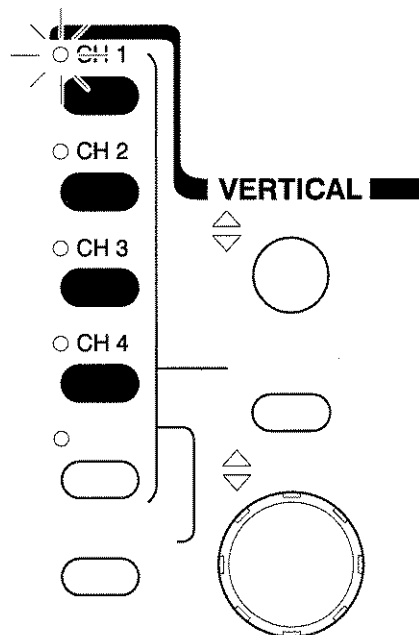

Figure 2–11: The Channel Buttons and Lights

Each of the channel (CH) buttons has a light beside its label. Right now, the CH 1 light is on to indicate the vertical controls are set to adjust channel 1. Do the following steps to add a waveform to the display:

1. If you are not continuing from the previous example, follow the instructions on page 2–13 under the heading *Setting Up for the Examples*.
2. Press **SETUP** → **Recall Factory Setup** (main) → **OK Confirm Factory Init** (side).
3. Press **AUTOSET**.
4. Press **CH 2**.

The display shows a second waveform, which represents the signal on channel 2. Since there is nothing connected to the CH 2 input connector, this waveform is a flat line.

There are several other important things to observe:

- The channel readout on the display now shows the settings for both Ch1 and Ch2.
 - There are two channel indicators at the left edge of the graticule. Right now, they overlap.
 - The light next to the CH 2 button is now on, and the CH 1 light is off. Because the knobs control only one channel at a time, the vertical controls are now set to adjust channel 2.
 - The trigger readout still indicates that the trigger is detecting trigger events on Ch1. The trigger source is not changed simply by adding a channel. (You can change the trigger source by using the TRIGGER MENU button to display the trigger menu.)
5. Turn the vertical **POSITION** knob clockwise to move the channel 2 waveform up on the graticule. Notice that the channel reference indicator for channel 2 moves with the waveform.
 6. Press **VERTICAL MENU** → **Coupling** (main).

The VERTICAL MENU button displays a menu that gives you control over many vertical channel parameters (Figure 2-12). Although there can be more than one channel displayed, the vertical menu and buttons only adjust the selected channel.

Each menu item in the Vertical menu displays a side menu. Right now, the Coupling item in the main menu is highlighted, which means that the side menu shows the coupling choices. At the top of the side menu, the menu title shows the channel affected by the menu choices. The menu title always matches the lighted channel button.

7. Press **Ω** (side) to toggle the selection to **50 Ω**; this changes the input coupling of channel 2 from **1 MΩ** to **50 Ω**. The channel readout for channel 2 (near the bottom of the graticule) now shows an **Ω** indicator.

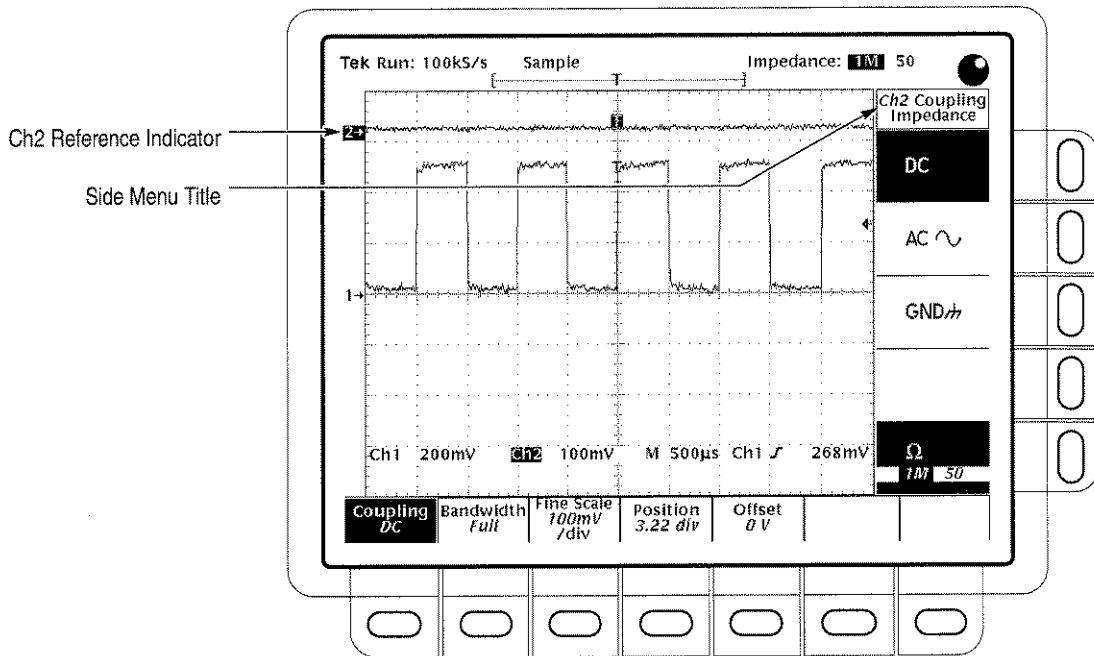

Figure 2-12: The Vertical Main Menu and Coupling Side Menu

Assign Controls to Another Channel

Pressing a channel (CH) button sets the vertical controls to that channel. It also adds the channel to the display if that waveform is not already displayed. To explore assigning controls to different channels, do the following steps:

1. Press **CH 1**.

Observe that the side menu title shows Ch1 (see Figure 2-13) and that the indicator next to CH 1 is lit. Note the highlighted menu item in the side menu also changes from the 50 Ω channel 2 setting to the 1 M Ω impedance setting of channel 1.

2. Press **CH 2** \rightarrow Ω (side) to toggle the selection to **1 M Ω** . This returns the coupling impedance of channel 2 to its initial state.

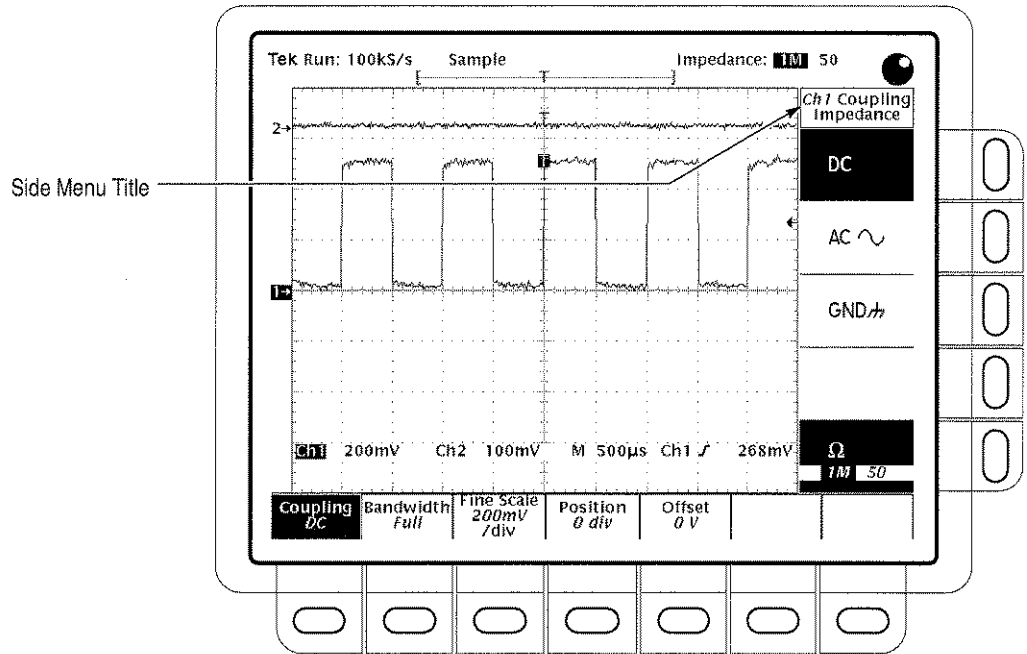

Figure 2-13: The Menus After Changing Channels

Remove a Waveform

Pressing the WAVEFORM OFF button removes the waveform for the currently selected channel. If the waveform you want to remove is not already selected, select that channel using the channel (CH) button. To remove a waveform from the display, do the following:

1. Press **WAVEFORM OFF** (under the vertical **SCALE** knob).

Since the CH 2 light was on when you pressed the WAVEFORM OFF button, the channel 2 waveform was removed.

The channel (CH) lights now indicate channel 1. Channel 1 has become the selected channel. When you remove the last waveform, all the CH lights are turned off.

2. Press **WAVEFORM OFF** again to remove the channel 1 waveform.

Example 3: Taking Automated Measurements

The TDS 400A Digitizing Oscilloscopes can measure many waveform parameters automatically and read out the results on screen. Do the following tasks to discover how to set up the oscilloscope to measure waveforms automatically.

Display Measurements Automatically

To use the automated measurement system, you must have a stable display of your signal. Also, the waveform must have all the segments necessary for the measurement you want. For example, a rise time measurement requires at least one rising edge, and a frequency measurement needs at least one complete cycle. To take automated measurements, do the following steps:

1. If you are not continuing from the previous example, follow the instructions on page 2–13 under the heading “Setting Up for the Examples.”
2. Press **SETUP** → **Recall Factory Setup** (main) → **OK Confirm Factory Init** (side).
3. Press **AUTOSET**.
4. Press **MEASURE** to display the Measure main menu (see Figure 2–14).

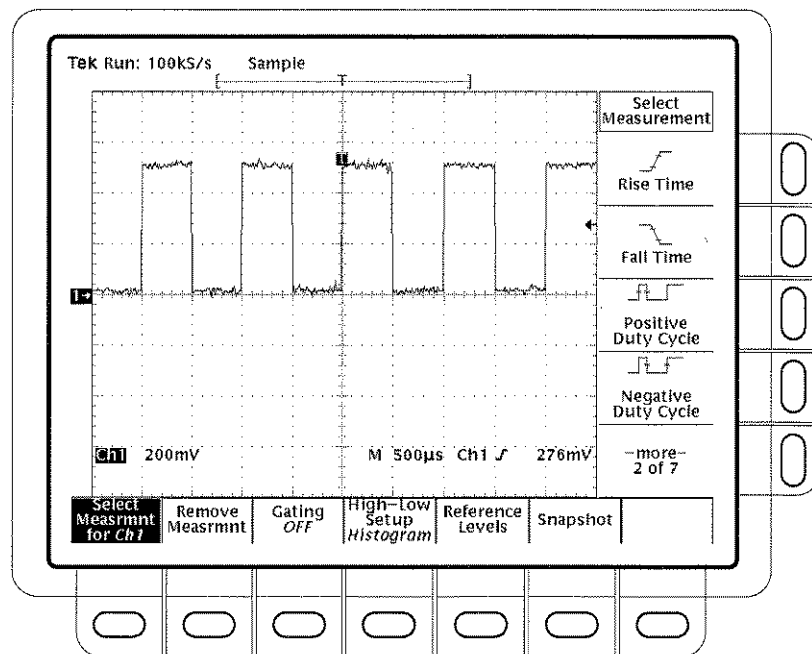

Figure 2–14: Measure Main Menu and Select Measurement Side Menu

5. If it is not already selected, press **Select Measrmnt** (main). The readout for that menu item indicates which channel the measurement will be taken from. All automated measurements are made on the selected channel.

The Select Measurement side menu lists some of the measurements that can be taken on waveforms. There are many different measurements available; up to four can be taken and displayed at any one time. Pressing the button next to the **-more-** menu item displays the other measurement selections.



6. Press **Frequency** (side). If the **Frequency** menu item is not visible, press **-more-** (side) repeatedly until the **Frequency** item appears, then press **Frequency** (side).

Observe that the frequency measurement appears within the right side of the graticule area. The measurement readout includes the notation Ch1, meaning that the measurement is taken on the channel 1 waveform. (To take a measurement on another channel, select that channel, and then select the measurement.)



7. Press **Positive Width** (side) → **-more-** (side) → **Rise Time** (side) → **Positive Duty Cycle** (side).

All four measurements are displayed. Right now, they cover a part of the graticule area, including the displayed waveforms.

8. To move the measurement readouts outside the graticule area, press **CLEAR MENU** (see Figure 2-15).

Remove Measurement Readouts

The Measure menu lets you remove measurements you no longer want displayed. You can remove any one measurement, or you can remove them all with a single menu item.

Press **MEASURE** → **Remove Measrmnt** (main) → **Measurement 1**, **Measurement 2**, and **Measurement 4** (side) to remove those measurements. Leave the rise time measurement displayed.

Change the Measurement Reference Levels

By default, the measurement system uses the 10% and 90% levels of the waveform for taking the rise time measurement. You can change these values to other percentages or change them to absolute voltage levels.



To examine the current values, press **Reference Levels** (main) → **High Ref** (side).

The general purpose knob, the large knob, is now set to adjust the high reference level (Figure 2-16).

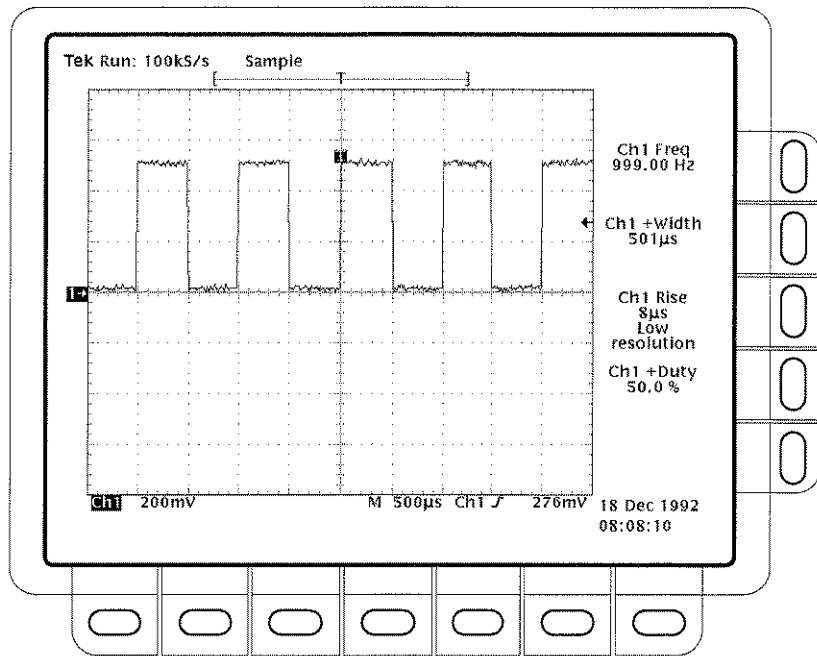

Figure 2-15: Four Simultaneous Measurement Readouts

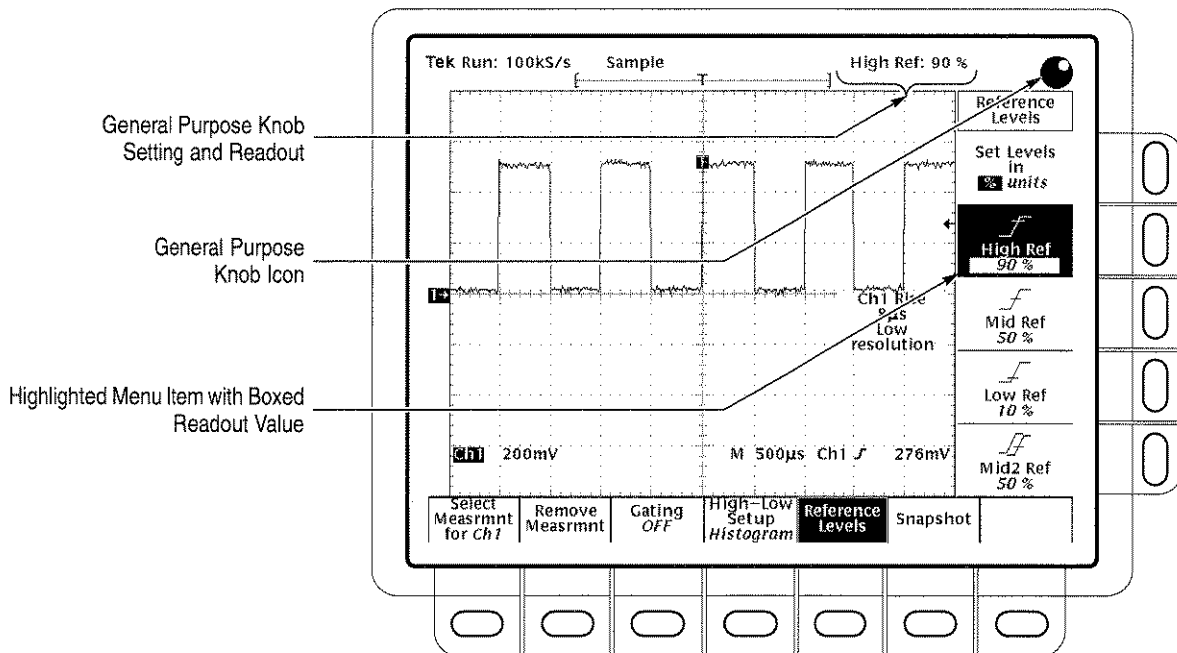

Figure 2-16: General Purpose Knob Indicators

Change the Measurement Reference Levels



By default, the measurement system uses the 10% and 90% levels of the waveform for taking the rise time measurement. You can change these values to other percentages or change them to absolute voltage levels.

To examine the current values, press **Reference Levels** (main) → **High Ref** (side).

The general purpose knob, the large knob, is now set to adjust the high reference level (Figure 2–16).

There are several important things to observe on the screen:

- The knob icon appears at the top of the screen. The knob icon indicates that the general purpose knob has just been set to adjust a parameter.
- The upper right corner of the screen shows the readout High Ref: 90%.
- The High Ref side menu item is highlighted, and a box appears around the 90% readout in the High Ref menu item. The box indicates that the general purpose knob is currently set to adjust that parameter.

Turn the general purpose knob left and right, and then use it to adjust the high level to 80%. That sets the high measurement reference to 80%.

Hint: To make large changes quickly with the general purpose knob, press the **SHIFT** button before turning the knob. When the light above the **SHIFT** button is lit and the display says *Coarse Knobs* in the upper-right corner, the general purpose knob speeds up significantly.

Display a Snapshot of Automated Measurements

You have seen how to display up to four individual automated measurements on screen. You can also pop up a display of almost all of the automated measurements available in the Select Measurements side menus. This snapshot of measurements is taken on the waveform currently selected using the channel selection buttons.

As when displaying individual measurements, you must have a stable display of your signal, and that signal must have all the segments necessary for the measurement you want. To display a snapshot of automated measurements, do the following steps:

1. Press **Snapshot** (main) to pop up a snapshot of all available single waveform measurements. (See Figure 2–17).

The snapshot display includes the label Ch 1, meaning that the measurements displayed are taken on the channel 1 waveform. You take a snapshot of a waveform in another channel by first selecting that channel using the channel selection buttons.

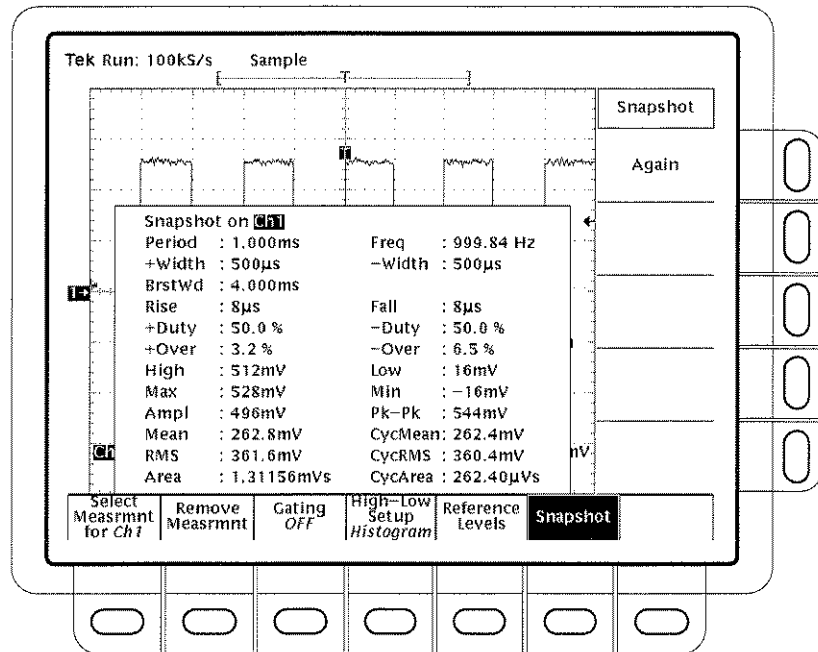

Figure 2-17: Snapshot of Channel 1

The snapshot measurements do not continuously update. Snapshot executes a one-time capture of all measurements and does not update those measurements unless it is performed again.

2. Press **Again** (side) to do another snapshot and update the snapshot measurements.
3. Press **Remove Measrmt** (main) to remove the snapshot display. (You can also press **CLEAR MENU**, but a new snapshot will be executed the next time you display the Measure menu.)

Example 4: Saving Setups

The digitizing oscilloscope can save its control settings and recall them later to quickly re-establish the previously saved state. The oscilloscope provides ten storage locations to store up to ten setups. It also provides a file system (requires the optional file system), so that you can also save setups to a floppy disk. Do the following tasks to learn how to save, and then recall, a setup.

NOTE. Besides being able to save several complete setups, the digitizing oscilloscope remembers all the parameter settings when you power it off. This lets you power on and continue where you left off without having to reconstruct the setup in effect when you powered off the digitizing oscilloscope.

Save a Setup

First, you need to create an instrument setup you want to save. Perform the following steps to create and save a setup that is complex enough that you might prefer not to go through all these steps each time you want that display:

1. If you are not continuing from the previous example, follow the instructions on page 2–13 under the heading *Setting Up for the Examples*.
2. Press **SETUP** → **Recall Factory Setup** (main) → **OK Confirm Factory Init** (side).
3. Press → **AUTOSET**.
4. Press **MEASURE** → **Select Measrmt** (main) → **Frequency** (side). (Press the **–more–** side menu item if the **Frequency** selection does not appear in the side menu.)
5. Press **CH 2** → **CLEAR MENU**.
6. Press **SETUP** → **Save Current Setup** (main) to display the Setup main menu (see Figure 2–18).



CAUTION. Setup locations in the side menu are labeled either user or factory. If you save your current setup in a location labeled user, you overwrite (and lose forever) the user setup previously stored there. Setup locations labeled factory have the factory setup stored as a default and can be used to store current setups without disturbing previously stored setups.

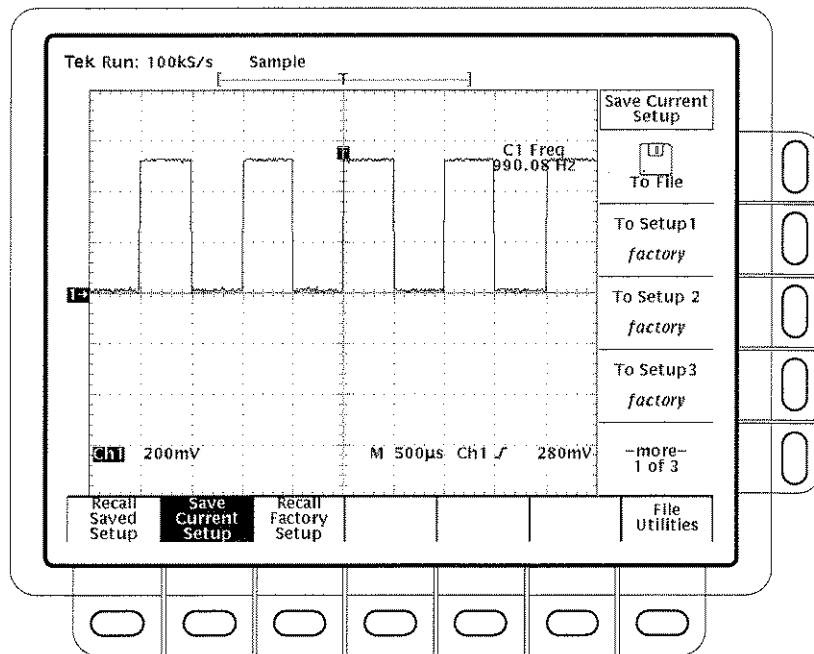

Figure 2-18: Save/Recall Setup Menu

7. Press one of the **To Setup** side menu buttons to store the current instrument settings into that setup location. Remember which setup location you selected for use later.

There are more setup locations than can be listed at one time in the side menu. The **-more-** side menu item gives you access to all the setup locations.

Once you have saved a particular setup, you can change the settings as you wish, knowing that you can come back to that setup at any time.

8. Press **MEASURE** → **Positive Width** (side) to add that measurement to the display.

Recall a Setup

To recall the setup, press **SETUP** → **Recall Saved Setup** (main) → **Recall Setup** (side) for the setup location you used in the last exercise. The positive width measurement is now removed from the display because you selected it after you saved the setup.

This completes the examples. You can restore the default settings by pressing **SETUP** → **Recall Factory Setup** (main) → **OK Confirm Factory Init** (side).

Triggering

To use the TDS 400A Digitizing Oscilloscope to measure or monitor waveforms, you need a stable display of those waveforms. This section covers the basic concepts of triggering and then describes the various types available. This oscilloscope also has a delayed trigger system. It is described starting on page 3–13. If your oscilloscope has the Option 5: Video Trigger, it is described starting on page 3–125.

Triggering Concepts

Triggers determine when the digitizing oscilloscope starts acquiring and displaying a waveform. They help create meaningful waveforms from unstable jumbles or blank screens (see Figure 2–19). The digitizing oscilloscope has two types of triggers: edge and, with option 5, video.

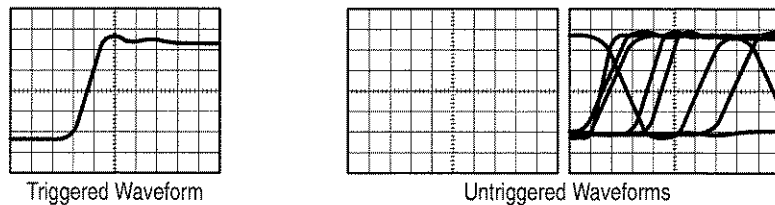

Figure 2–19: Triggered Versus Untriggered Displays

The Trigger Event. The trigger event establishes the time-zero point in the waveform record, and all points in the record are located in time with respect to that point. The digitizing oscilloscope continuously acquires and retains enough sample points to fill the pretrigger portion of the waveform record (that part of the waveform that is displayed *before*, or to the left of, the triggering event on screen).

When a trigger event occurs, the digitizing oscilloscope starts acquiring samples to build the posttrigger portion the waveform record (displayed *after*, or to the right of, the trigger event). Once a trigger is recognized, the digitizing oscilloscope does not accept another trigger until the acquisition is complete.

Trigger Sources. You can derive your trigger from various sources.

Input channels are the most commonly used trigger source. The channel you select as a trigger source functions whether it is displayed or not.

AC 

AC Line is the trigger source most often used when you are looking at signals related to the power line frequency. Examples include devices such as lighting equipment and power supplies. Because the digitizing oscilloscope generates the trigger, you do not have to input a trigger signal.

Auxiliary Trigger is a trigger source useful in digital design and repair. For example, you might want to trigger with an external clock or with a signal from another part of the circuit. To use the auxiliary trigger, connect the external triggering signal to the AUX TRIGGER/EXT CLOCK connector on the oscilloscope rear panel.

Trigger Types. The digitizing oscilloscope provides two types of triggers for the main trigger system: edge and video. These triggers are described in the *Reference* section. *Edge Triggering* starts on page 3-27, and *Video Triggering* starts on page 3-125. A brief definition of each type follows.



Edge is the “basic” trigger. You can use it with both analog and digital test circuits. An edge trigger event occurs when the trigger *source* (the signal the trigger circuit is monitoring) passes through a specified voltage *level* in the specified direction (the trigger *slope*).



Video triggers (available as Option 05) help simplify the triggering and viewing of video (TV) signals. The video trigger option lets you trigger on positive or negative sync pulses. It lets you select interlaced field one, interlaced field two, both fields, or noninterlaced. You also can define the signal to be NTSC, PAL, SECAM, or a custom class.

Trigger Modes. The trigger mode determines how the oscilloscope behaves in the absence of a trigger event. The digitizing oscilloscope provides two different trigger modes, *normal* and *automatic*.

Normal trigger mode enables the oscilloscope to acquire a waveform only when it is triggered. If no trigger occurs, the oscilloscope will not acquire a waveform. (You can push **FORCE TRIGGER** to force the oscilloscope to make a single acquisition.)

Automatic trigger mode (auto mode) enables the oscilloscope to acquire a waveform even if a trigger does not occur. Auto mode uses a timer that starts after a trigger event occurs. If another trigger event is not detected before the timer times out, the oscilloscope forces a trigger anyway. The length of time it waits for a trigger event depends on the time base setting.

Be aware that auto mode, when forcing triggers in the absence of valid triggering events, does not sync the waveform on the display. In other words, successive acquisitions are not triggered at the same point on the waveform; therefore, the waveform appears to roll across the screen. Of course, if valid triggers occur the display becomes stable on screen.

Since auto mode forces a trigger in the absence of one, auto mode is useful in observing signals where you are only concerned with monitoring amplitude level. Although the unsynced waveform may “roll” across the display, it does not freeze as it would in normal trigger mode. Monitoring of a power supply output is an example of such an application.

Normal and auto trigger modes also affect roll mode operation. If roll mode is activated while in Normal trigger mode, the roll mode is triggered. If roll mode is activated while in Auto trigger mode, the roll mode is untriggered. (See *Roll Mode* on page 3–93 for more information.)

Trigger Holdoff. When the oscilloscope recognizes a trigger event, it disables the trigger system until acquisition is complete. In addition, the trigger system remains disabled during the holdoff period that follows each acquisition. You can set holdoff time to help ensure a stable display.

For example, the trigger signal can be a complex waveform with many possible trigger points on it. Though the waveform is repetitive, a simple trigger might get you a series of patterns on the screen instead of the same pattern each time.

Digital pulse trains are good examples of complex waveforms (see Figure 2–20). Each pulse looks like any other, so many possible trigger points exist. Not all of these result in the same display. The holdoff period allows the digitizing oscilloscope to trigger on the correct edge, resulting in a stable display.

Holdoff is settable from 0% (minimum holdoff available) to 100% (maximum available). To see how to set holdoff, see *To Set Mode & Holdoff* on page 3–29. The minimum and maximum holdoff varies with the horizontal scale. See *Holdoff, Variable, Main Trigger* on page B–19 of Appendix B for the typical minimum and maximum values.

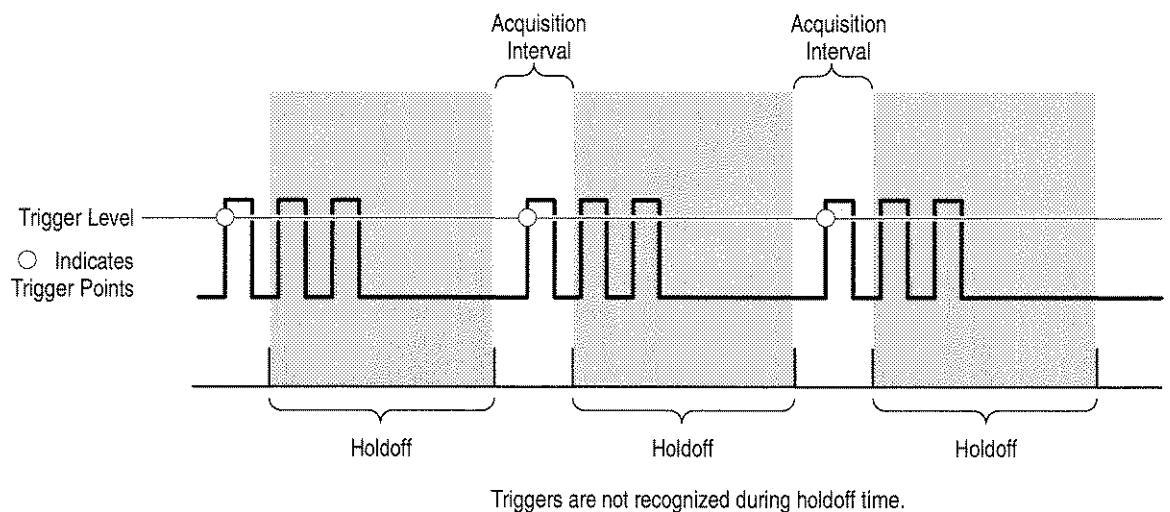

Figure 2–20: Trigger Holdoff Time Ensures Valid Triggering

Trigger Coupling. Trigger coupling determines what part of the signal is passed to the trigger circuit. Available coupling types include AC, DC, Low Frequency Rejection, High Frequency Rejection, and Noise Rejection:

DC

DC coupling passes all of the input signal. In other words, it passes both AC and DC components to the trigger circuit.

AC 

AC coupling passes only the alternating components of an input signal. (AC components above 10 Hz are passed if the source channel is in 1 M Ω coupling; components above 200 kHz are passed in 50 Ω coupling.) It removes the DC components from the trigger signal.



High frequency rejection coupling removes the high frequency portion of the triggering signal. That allows only the low frequency components to pass on to the triggering system to start an acquisition. High frequency rejection attenuates signals above 30 kHz.



Low frequency rejection coupling removes the low frequency portion of the triggering signal. Low frequency rejection attenuates signals below 80 kHz.



Noise Rejection coupling lowers trigger sensitivity. It requires additional signal amplitude for stable triggering, reducing the chance of falsely triggering on noise.

Trigger Position. The adjustable *trigger position* defines where on the waveform record the trigger occurs. It lets you properly align and measure data within records. The part of the record that occurs *before* the trigger is the pretrigger portion. The part that occurs *after* the trigger is the posttrigger portion.



To help you visualize the trigger position setting, the top part of the display has an icon indicating where the trigger occurs in the waveform record. You select in the Horizontal menu what percentage of the waveform record will contain pretrigger information.





Many users find displaying pretrigger information a valuable troubleshooting technique. For example, if you are trying to find the cause of an unwanted glitch in your test circuit, it may prove valuable to trigger on the glitch and make the pretrigger period large enough to capture data before the glitch. By analyzing what happened before the glitch, you may uncover clues about the source of the glitch.

Slope and Level. The slope control determines whether the oscilloscope finds the trigger point on the rising or the falling edge of a signal (see Figure 2–21).



You set trigger slope by selecting Slope in the Main Trigger menu and then selecting from the rising or falling slope icons in the side menu that appears.



The level control determines where on that edge the trigger point occurs (see Figure 2–21).

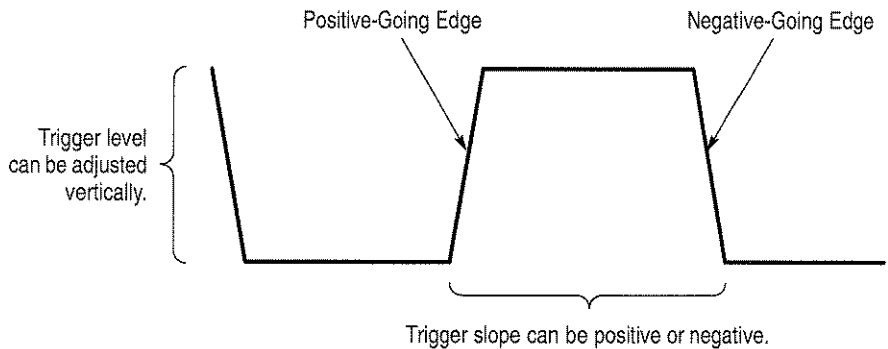

Figure 2–21: Slope and Level Controls Help Define the Trigger

The digitizing oscilloscope lets you set the main trigger level with the trigger MAIN LEVEL knob.

Delayed Trigger System. The oscilloscope also has a delayed trigger system that provides an edge trigger. When using the delayed time base, you can also delay the acquisition of a waveform for a user-specified time or a user-specified number of delayed trigger events (or both) after a main trigger event.

Video Trigger System. If your oscilloscope has the Option 5: Video Trigger, it gives you a variety of selections for triggering on video signals.

Triggering From the Front Panel

The trigger buttons and knob let you quickly adjust the trigger level or force a trigger (see Figure 2–22). The trigger readout and status screen lets you quickly determine the state of the trigger system. You use the following trigger controls and readouts for all trigger types, except where noted.

To Set the MAIN LEVEL. To manually change the trigger level when triggering, turn the MAIN LEVEL knob. It adjusts the trigger level (or threshold level) instantaneously no matter what menu, if any, is displayed.

To Set to 50%. To quickly obtain an edge trigger, press SET LEVEL TO 50%. The oscilloscope sets the trigger level to the halfway point between the peaks of the trigger signal. Set Level to 50% has no effect when the trigger type is video.

If edge trigger is selected, you can also set the level to 50% in the Trigger menu under the main menu item Level.

Note that the MAIN LEVEL knob and menu items apply only to the main trigger level. To modify the delayed trigger level, use the Level item in the Delayed Trigger menu.

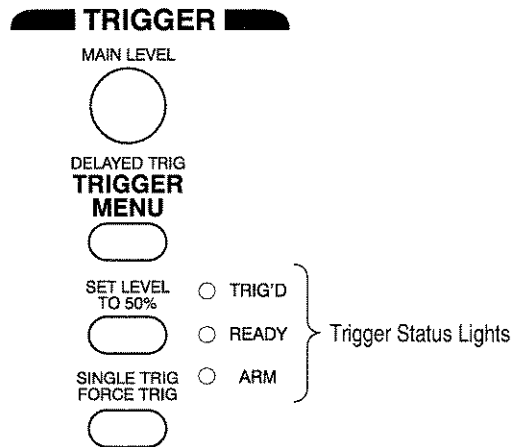

Figure 2–22: TRIGGER Controls and Status Lights

To Force a Trigger. To force the oscilloscope to immediately start acquiring a waveform record even without a trigger event, press the **FORCE TRIG** front panel button.

Forcing a trigger is useful when in normal trigger mode and the input signal is not supplying a valid trigger. By pressing **FORCE TRIG**, you can quickly confirm that there is a signal present for the oscilloscope to acquire. Once that is established, you can determine how to trigger on it (press **SET LEVEL TO 50%**, check trigger source setting, and so forth).

The oscilloscope recognizes and acts upon **FORCE TRIG** even when you press it before the end of pretrigger holdoff. However, the button has no effect if the acquisition system is stopped.

To Single Trigger. To trigger on the next valid trigger event and then stop, press **SHIFT FORCE TRIG**. Now press the **RUN/STOP** button each time you want to initiate a single sequence of acquisitions.

To Check Trigger Status

To ascertain the state and setup of the triggering circuit, use the *trigger status lights, readout, and screen*.

Trigger Status Lights. To determine the trigger status, check the **TRIG'D**, **READY**, and **ARM** status lights in the Trigger control area (see Figure 2–22):

- When **TRIG'D** is lighted, it means the digitizing oscilloscope has recognized a valid trigger and is filling the posttrigger portion of the waveform.
- When **READY** is lighted, it means the digitizing oscilloscope can accept a valid trigger event and it is waiting for that event to occur.

- When ARM is lighted, it means the trigger circuitry is filling the pretrigger portion of the waveform record.
- When both TRIG'D and READY are lighted, it means the digitizing oscilloscope has recognized a valid main trigger and is waiting for a delayed trigger. When it recognizes a delayed trigger it will fill in the posttrigger portion of the delayed waveform.
- When ARM, TRIG'D, and READY are all off, the digitizer is stopped.

Trigger Readout. To determine the settings of some of key trigger parameters, check the Trigger readout at the bottom of the display (see Figure 2–23). The readouts are different for edge and video triggers.

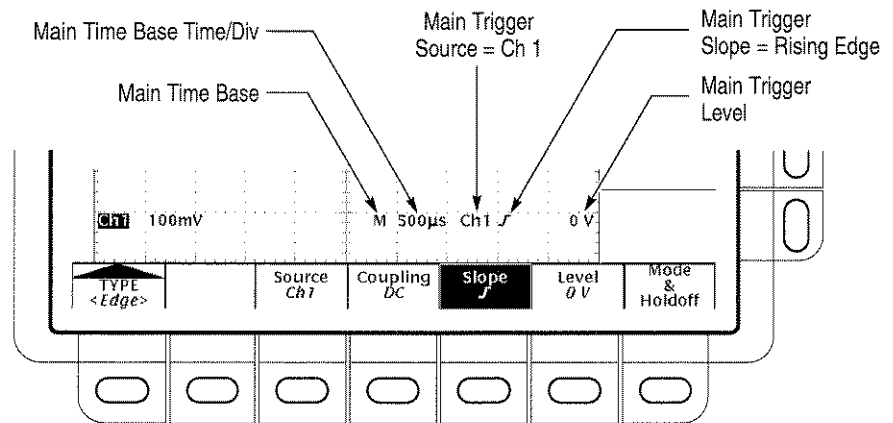

Figure 2–23: Example Trigger Readouts

Record View. To determine where the trigger point is located in the waveform record and with respect to the display, check the record view at the top of the display (see Figure 2–24).

Trigger Position and Level Indicators. To see the trigger point and level on the waveform display, check the graphic indicators of trigger position and level, which you can optionally display. Figure 2–24 shows the trigger position indicator and the short-style trigger level bar.

Both the trigger position indicator and the trigger level bars are displayed from the Display menu. See *Set Display Readout Options* on page 3–22 for more information.

The trigger position indicator shows position. You can position it horizontally off screen, especially with long record length settings. The trigger level bar shows only the trigger level and remains on screen regardless of the horizontal position, as long as the channel providing the trigger source is displayed.

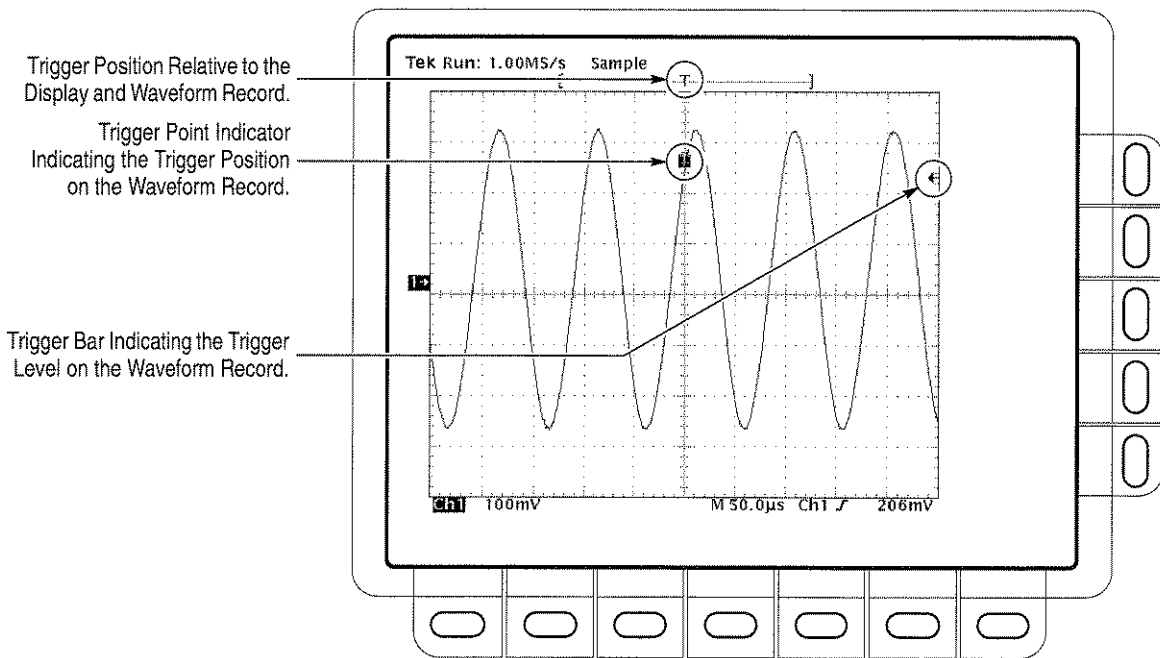

Figure 2-24: Record View, Trigger Position, and Trigger Level Bar Readouts

Trigger Status Screen — To see a more comprehensive status listing of the settings for the main and delayed trigger systems, press **SHIFT STATUS** → **STATUS** (main) → **TRIGGER** (side)

Trigger Menu. Each trigger type (edge and video) has its own main trigger menu, which is described in a separate part of this manual (see *For More Information*). To select the trigger type, press **TRIGGER MENU** → **Type** (main) → **Edge**.

For More Information

For more triggering information see *Edge Triggering* on page 3-27, *Delay Triggering* on page 3-13, *Video Triggering* on page 3-125, and *Horizontal Control* on page 3-45.

Acquisition

Acquisition is the process of sampling the analog input signal, converting it into digital data, and assembling it into a waveform record. The oscilloscope creates a digital representation of the input signal by sampling the voltage level of the signal at regular time intervals (see Figure 2–25). The sampled points are stored in memory along with corresponding timing information. The oscilloscope uses this digital representation of the signal for display, measurements, or further processing.

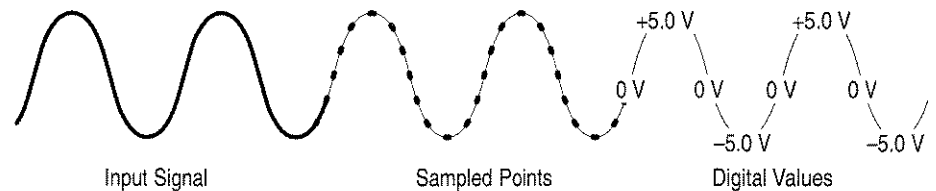

Figure 2–25: Acquisition: Input Analog Signal, Sample, and Digitize

Sampling and Digitizing

Each time it takes a sample, the oscilloscope digitizer produces a numeric representation of the signal. The number of samples may be larger than the number of points in your waveform record. In fact, the oscilloscope may take several samples for each record point (see Figure 2–26).

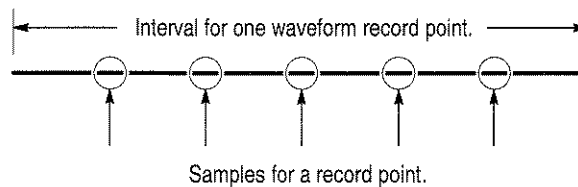

Figure 2–26: Several Points May be Acquired for Each Point Used

The digitizer can use the extra samples to perform additional processing, such as averaging or looking for minimum and maximum values.

The digitizing oscilloscope creates a waveform record containing a user-specified number of data points. Each record point represents a certain voltage level that occurs a determined amount of time from the trigger event.

Trigger Point. The trigger point marks time zero in a waveform record. All record points before the trigger event make up the pretrigger portion of the waveform record. Every record point after the trigger event is part of the posttrigger portion. All timing measurements in the waveform record are made relative to that trigger event.

Record Length. The number of points that make up the waveform record is defined by the record length. You can set the record length in the Horizontal menu. The digitizing oscilloscope provides record lengths of 500, 1000, 2500, 5000, 15000, and 30000 points.

Option 1M provides a maximum record length of 120,000 points. That option is available only at the time of original purchase; it cannot be installed later.

Real-Time Sampling. In real-time sampling, the oscilloscope digitizes all the points it acquires after one trigger event (see Figure 2–27). Use real-time sampling to capture single-shot or transient events.

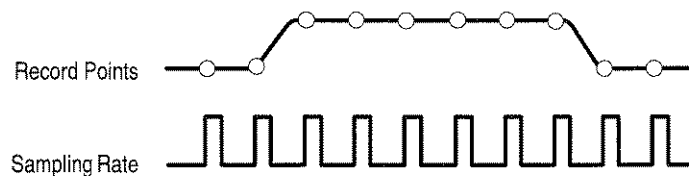

Figure 2–27: Real-Time Sampling

Depending on how many channels you are using and the speed of the time base, at some point the digitizing oscilloscope will not get enough samples to create a waveform record. At that point, the digitizing oscilloscope creates the waveform record in one of two ways depending on whether you have limited the oscilloscope to real-time sampling or enabled equivalent-time sampling (you make that choice in the Acquisition menu).

During real-time sampling, the digitizing oscilloscope uses a process called interpolation to create the intervening points in the waveform record. There are two options for interpolation: linear or $\sin(x)/x$.

Linear interpolation computes record points between actual acquired samples by using a straight line fit. It assumes all the interpolated points fall in their appropriate point in time on that straight line. Linear interpolation is useful for many waveforms such as pulse trains.

$\sin(x)/x$ interpolation computes record points using a curve fit between the actual values acquired. It assumes all the interpolated points fall along that curve. That is particularly useful when acquiring more rounded waveforms such as sine

waves. Actually, it is appropriate for general use, although it may introduce some overshoot or undershoot in signals with fast rise times.

NOTE. When using either type of interpolation, you may wish to set the display style so that the real samples are displayed intensified relative to the interpolated samples. The instructions under To Select the Display Style on page 3-21 explain how to turn on intensified samples.

Equivalent-Time Sampling. The digitizing oscilloscope only uses equivalent-time sampling if you have enabled the equivalent-time option in the Acquisition menu, the oscilloscope is not able to get enough samples with which to create a waveform record, and the time base is faster than 500 ns.

In equivalent-time (ET) sampling the oscilloscope acquires samples over many repetitions of the event (see Figure 2-28). It should only be used on repetitive signals.

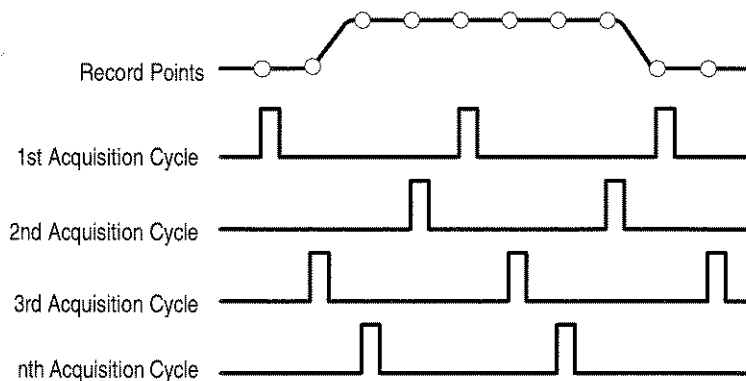

Figure 2-28: Equivalent-Time Sampling

The oscilloscope takes a few samples with each trigger event and eventually constructs a waveform record using the samples from multiple acquisitions. Equivalent-time sampling lets you accurately acquire signals with frequencies much higher than the digitizing oscilloscope real-time bandwidth.

The digitizing oscilloscope uses a type of equivalent-time sampling called *random equivalent-time sampling*. Although the samples are taken sequentially in time, they are random with respect to the trigger. That is because the oscilloscope sample clock runs asynchronously with respect to the input signal and the signal trigger. The oscilloscope takes samples independent of the trigger position and displays them based on the time difference between the sample and the trigger.

Acquisition Modes The digitizing oscilloscope supports five acquisition modes:

- *Sample*
- *Peak Detect*
- *Hi Res*
- *Envelope*
- *Average*



Sample acquisition mode, which acquires in real time, is the mode most commonly used. You can read about Sample and the other acquisition modes in *Acquisition Modes*, beginning on page 3–5.

Envelope and Average acquisition modes disable Roll mode. You can read about Roll mode beginning on page 3–93.

Bandwidth *Bandwidth* refers to the range of frequencies that an oscilloscope can acquire and display accurately (that is, with less than 3 dB attenuation).

You can set different bandwidths with the digitizing oscilloscope. Lower bandwidth settings let you eliminate the higher frequency components of a signal. The TDS 400A offers Full, 100 MHz, and 20 MHz bandwidth settings.

Coupling You can couple your input signal to the digitizing oscilloscope three ways. You can choose between AC, DC, or Ground (GND). You also can set the input impedance. The following selections are available:

- DC ■ DC coupling shows both the AC and DC components of an input signal.
- AC  ■ AC coupling shows only the alternating components of an input signal.
- GND  ■ Ground (GND) coupling disconnects the input signal from the acquisition.
- Ω ■ Input impedance lets you select either 1 M Ω or 50 Ω impedance.

NOTE. *If you select 50 Ω impedance with AC coupling, the digitizing oscilloscope will not accurately display frequencies under 200 kHz.*

For More Information For more acquisition information, see *Scaling and Positioning Waveforms* on page 2–43 and *Acquisition Modes* on page 3–5.

Scaling and Positioning Waveforms

TDS 400A Digitizing Oscilloscopes allow you to scale (change the vertical or horizontal size) and position (move up, down, left, or right) waveforms on screen for best display. (Figure 2–29 shows the results of both vertical and horizontal scaling and positioning.) This section tells you how to quickly check and set vertical and horizontal scales, and positions.

To Check Position

To quickly see the position of the waveform in the display, check the *channel reference indicator* and the *record view* icons (see Figure 2–29).

- The channel reference icon, at the left side of the display, points to ground on the waveform record when offset is set to 0 V. The oscilloscope contracts or expands the selected waveform around this point when you change the vertical scale.
- The record view, at the top of the display, indicates where the trigger occurs and what part of the waveform record is displayed.

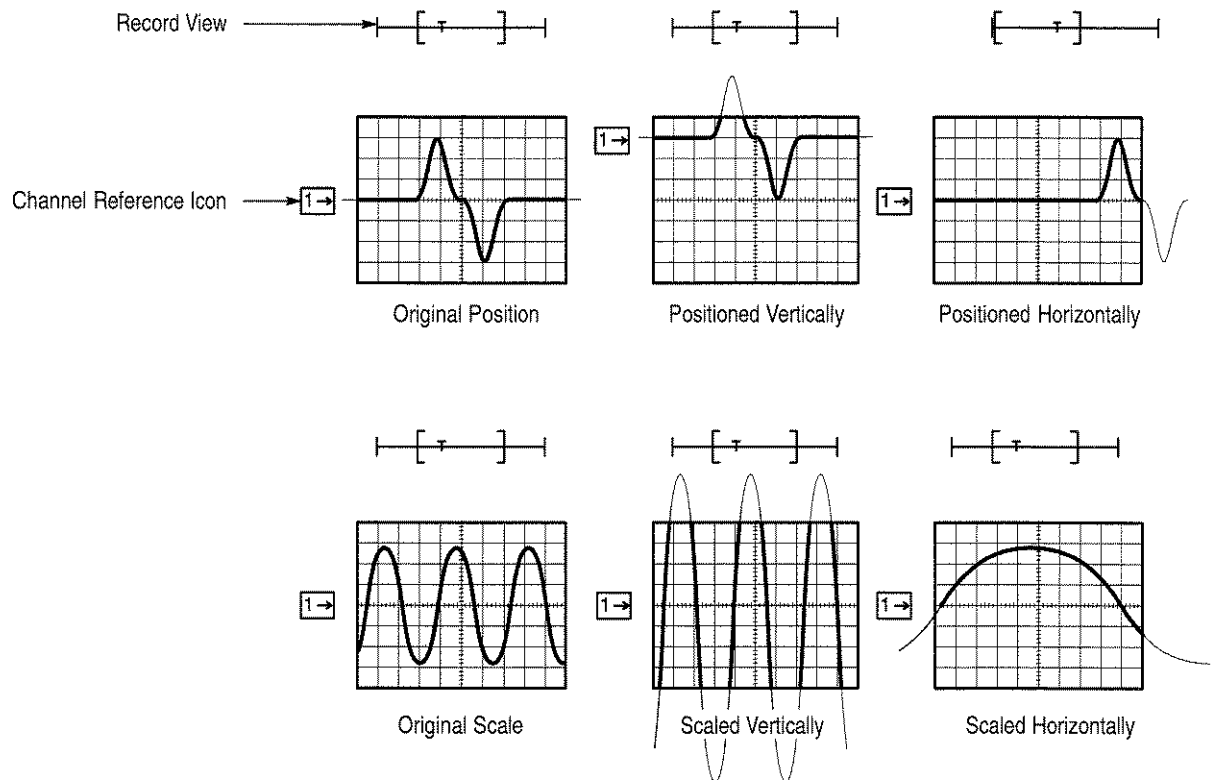

Figure 2–29: Scaling and Positioning

Vertical System

You can adjust the vertical position of the selected waveform by moving it up or down on the display. For example, when trying to compare multiple waveforms, you can put one above another and compare them, or you can overlay the two waveforms on top of each other. To move the selected waveform turn the vertical **POSITION** knob.

You can also alter the vertical scale. The digitizing oscilloscope shows the scale (in volts per division) for each active channel toward the bottom left of the display. As you turn the vertical **SCALE** knob clockwise, the value decreases resulting in higher resolution because you see a smaller part of the waveform. As you turn it counter-clockwise the scale increases allowing you to see more of the waveform but with lower resolution.

Besides using the position and scale knobs, you can set the vertical scale and position with exact numbers. You do that with the Vertical menu Fine Scale and Position selections and the general purpose knob.

Vertical offset changes where the channel reference indicator is shown with respect to the graticule. Offset adds a voltage to the reference indicator without changing the scale. That feature allows you to move the waveform up and down over a large area without decreasing the resolution.

Offset is useful in cases where a waveform has a DC bias. One example is looking at a small ripple on a power supply output. You may be trying to look at a 100 mV ripple on top of a 15 V supply. The range available with offset can prove valuable as you try to move and scale the ripple to meet your needs.

Horizontal System

Adjusting the horizontal position of waveforms moves them right or left on the display. That is useful when the record length of the waveform is so large (greater than 500 points) that the digitizing oscilloscope cannot display the entire waveform record at one time. You can also adjust the scale of the waveform. For example, you might want to see just one cycle of a waveform to measure the overshoot on its rising edge.

NOTE. *If external clock is enabled and zoom is disabled, the Horizontal SCALE knob has no affect.*

To adjust the horizontal scale of the displayed waveform records, turn the horizontal **SCALE** knob. To adjust the horizontal position, turn the horizontal **POSITION** knob.

The digitizing oscilloscope shows the actual scale in the bottom right of the display. The scale readout shows the time per division used. Since all live waveforms use the same time base, the digitizing oscilloscope only displays one value for all the active channels.

Aliasing. When a waveform aliases, it appears on screen with a frequency lower than the actual waveform being input or it appears unstable even though the light next to TRIG'D is illuminated. Aliasing occurs because the oscilloscope cannot sample the signal fast enough to construct an accurate waveform record (see Figure 2–30).

In order to represent a signal accurately and avoid aliasing, you must sample the signal more than twice as fast as the highest frequency component. For example, a signal with frequency components of 400 MHz would need to be sampled at a rate faster than 800 Megasamples/second.

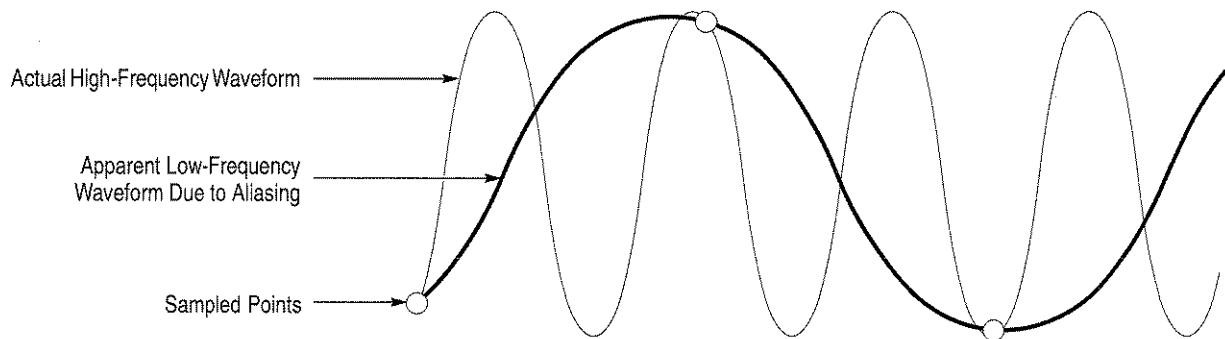

Figure 2–30: Aliasing

One simple way to check for aliasing is to slowly change the horizontal scale (time per division setting). If the shape of the displayed waveform changes drastically, you may have aliasing.

There are various ways to prevent aliasing. Try adjusting the horizontal scale, or simply press the **AUTOSET** button. You can also counteract some aliasing by changing the acquisition mode in the Acquisition menu. For example, if you are using the sample mode and suspect aliasing, you may want to change to the peak detect mode. Since the peak detect mode searches for samples with the highest and lowest values, it can detect faster signal components over time.

Delayed Time Base. You can set a main time base and a delayed time base. Each time base has its own trigger. There are two types of delayed time base acquisitions, with each based on its triggering relationship to the main time base. These are delayed runs after main and delay triggerable (after time, events, or both) acquisitions.

The delayed time base is useful in catching events that follow other events. See *Delay Triggering*, on page 3–13 for more information on the delayed trigger.

Zoom You can use zoom to see more detail without changing the acquired signal. When you press the ZOOM button, a portion of the waveform record can be expanded or compressed on the display, but the record points stay the same.

Zoom is very useful when you wish to temporarily expand a waveform to inspect small feature(s) on that waveform. For example, you might use zoom to temporarily expand the front corner of a pulse to inspect its aberrations. Use zoom to expand it horizontally and vertically. After you are finished, return to your original horizontal scale setting by pressing one menu button. (The zoom feature is also handy if you have acquired a waveform while using the fastest time per division and want to further expand horizontally.) *Zoom* on page 3–135 describe in detail what zoom does.

Autoset Autoset lets you quickly obtain a stable waveform display. Autoset automatically adjusts a wide variety of settings including vertical and horizontal scaling. Other settings affected include trigger coupling, type, position, slope, mode, and display intensities. *Setting Up Automatically: Autoset and Reset* on page 3–111 describes in detail what autoset does.

For More Information For more information on scaling and positioning waveforms, see *Setting Up Automatically: Autoset and Reset* on page 3–111, *Delayed Triggering* on page 3–13, *Horizontal Control* on page 3–45, *Vertical Control* on page 3–121, and *Zoom* on page 3–135.

Measurements

The digitizing oscilloscope not only displays graphs of voltage versus time, it also helps you measure the displayed information (see Figure 2–31). The oscilloscope provides three measurement classes: automated, cursor, and graticule measurements (Figure 2–31 shows all three measurement classes). This section briefly describes how to take measurements.

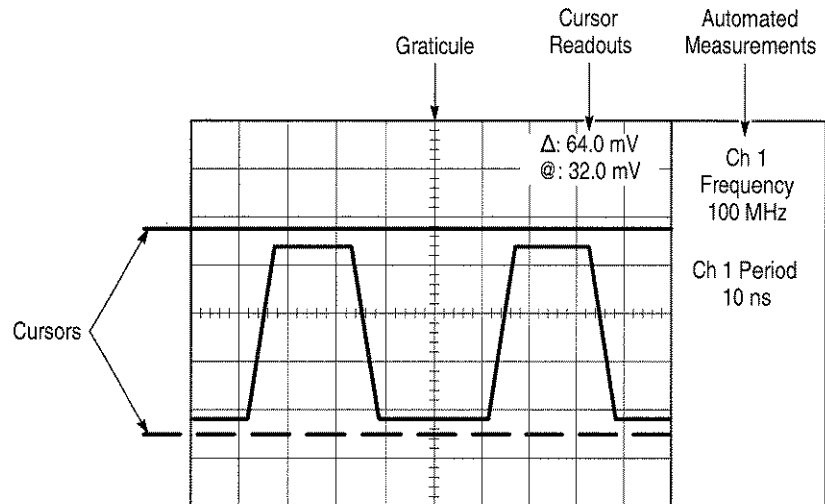

Figure 2–31: Graticule, Cursor, and Automated Measurements

Automated Measurements

You make automated measurements by merely pressing a few buttons. The digitizing oscilloscope does all the calculating for you. Because automated measurements use the waveform record points, they are more accurate than cursor and graticule measurements.

Press the **MEASURE** button for the automated measurement menus. These menus let you make *amplitude* (typically in volts; sometimes in %), *time* (typically in seconds or hertz), and *area* (in volt-seconds) measurements. You can select and display up to four measurements at a time. (See Table 3–3 on page 3–59 for a list of all the automatic measurements and their definitions.)

You can make automated measurements on the entire waveform record or just on a specific part. The gating selection in the Measurement menu lets you use the vertical cursors to limit the measurement to a section of the waveform record.

Automated measurements use readouts to show measurement status. These readouts are updated as the oscilloscope acquires new data or if you change settings.

The snapshot selection in the Measurement menu lets you display almost all of the measurements at once. You can read about snapshot under *Take a Snapshot of Measurements* on page 3–68.

Cursor Measurements

Cursors are fast and easy-to-understand measurements. You take measurements by moving the cursors and reading their numeric values from the on screen readouts, which update as you adjust their positions.

Cursors appear in pairs; one cursor is *active* and the other *inactive*. You move the active cursor (the solid line) using the general purpose knob. Press the **SELECT** button to select (toggle) which cursor bar is active or inactive. The inactive cursor is a dashed line on the display.

To get the cursor menu, press the **CURSOR** button. There are three kinds of cursors available in that menu:

- *Horizontal bar cursors* measure vertical parameters (typically volts).
- *Vertical bar cursors* measure horizontal parameters (typically time or frequency).
- *Paired cursors* measure both vertical parameters (typically volts) and horizontal parameters (typically time or frequency).

There are also two modes for cursor operation available in the cursor menu — *independent* and *tracking* (see Figure 2–32):

- *Independent mode* cursors operate as was earlier described; that is, you move *one* cursor at a time (the active cursor) using the general purpose knob, and you press the **SELECT** button to toggle which cursor bar is active.
- *Tracking mode* cursors operate in tandem: you move *both* cursors at the same time using the general purpose knob. To adjust the solid cursor relative to the dashed cursor, press the **SELECT** button to suspend cursor tracking and use the general purpose knob to make the adjustment. A second push toggles the cursors back to tracking.

You can read more detailed information about how to use cursors in *Taking Cursor Measurements* beginning on page 3–115.



Figure 2-32: Cursor Modes

Taking Graticule Measurements

The oscilloscope provides a graticule for measuring the difference (either in time or amplitude) between two points on a waveform record. Graticule measurements provide you with quick, visual estimates. For example, you might look at a waveform amplitude and say, “It is a little more than 100 mV.”

Measure Waveform Amplitude. To measure the amplitude of a waveform, do the following steps:

1. Press the channel selection button of the channel you wish to measure. Note the vertical scale factor for the channel in the channel readout on screen.
2. Count the graticule divisions between two features to be measured and multiply by the vertical scale factor.

For example, if you count five major vertical graticule divisions between the minimum and maximum values of a waveform at a scale factor of 100 mV/division, then you can easily calculate your peak-to-peak voltage as:

$$5 \text{ divisions} \times 100 \text{ mV/division} = 500 \text{ mV.}$$

NOTE. When you select the NTSC graticule, the volts per division of all selected channels is set to 143 mV/div (152 mV/div for PAL) where the divisions are those of the conventional graticule, not the divisions of the video graticules. For NTSC, the actual grid lines represent 10 IRE, and for PAL the lines are 100 mV apart.

Measure Waveform Time. To measure the time of a waveform, repeat the process just described, but count the horizontal divisions and multiply by the horizontal scale factor. For example, if you count five major vertical graticule divisions for one waveform cycle at a horizontal scale factor of 50 $\mu\text{s}/\text{division}$, then you can easily calculate the waveform period as:

$$5 \text{ divisions} \times 50 \mu\text{S/division} = 250 \mu\text{s}, \text{ or } 400 \text{ kHz.}$$

For More Information

For more information on taking measurements using your oscilloscope, see *Taking Cursor Measurements* on page 3–115, *Measuring Waveforms* on page 3–59, *Example 3: Taking Automated Measurements* on page 2–24, *Waveform Math*, on page 3–131, and the *TDS Family Option 2F Instruction Manual* (if your oscilloscope is equipped with that option).

Overview

This section describes the details of operating the digitizing oscilloscope. It contains an alphabetical list of tasks you can perform with the digitizing oscilloscope. Use this section to answer specific questions about instrument operation. The following tasks are included:

- Accessing Help
- Acquisition Modes
- Delayed Triggering
- Determining Status
- Display Modes
- Edge Triggering
- File System
- Hardcopy
- Horizontal Control
- Limit Testing
- Measuring Waveforms
- Probe Compensation
- Probe Selection
- Remote Communication
- Roll Mode
- Saving and Recalling Setups
- Saving and Recalling Waveforms
- Selecting Channels
- Setting up Automatically
- Signal Path Compensation
- Taking Cursor Measurements
- Vertical Control
- Video Triggering
- Waveform Math
- Zoom

Many of these tasks list steps you perform to accomplish the task. You should read *Conventions* on page xii of *Preface* before reading about these tasks.

Accessing Help

The on-line help system provides brief information about each of the digitizing oscilloscope controls.

To Display Help

To use the on-line help system:

Press **HELP** to provide on-screen information on any front panel button, knob, or menu item (see Figure 3-1).

When you press that button, the oscilloscope changes mode to support on-line help. Press **HELP** again to return to regular operating mode. Whenever the oscilloscope is in help mode, pressing any button (except **HELP** or **SHIFT**), turning any knob, or pressing any menu item displays help text on the screen that discusses that control.

The menu selections that are displayed when **HELP** is first pressed remain on the screen. On-line help is available for each menu selection displayed at the time the **HELP** button is first pressed. If you are in help mode and want to see help on selections from non-displayed menus, you first exit help mode, display the menu you want information on, and press **HELP** again to re-enter help mode.

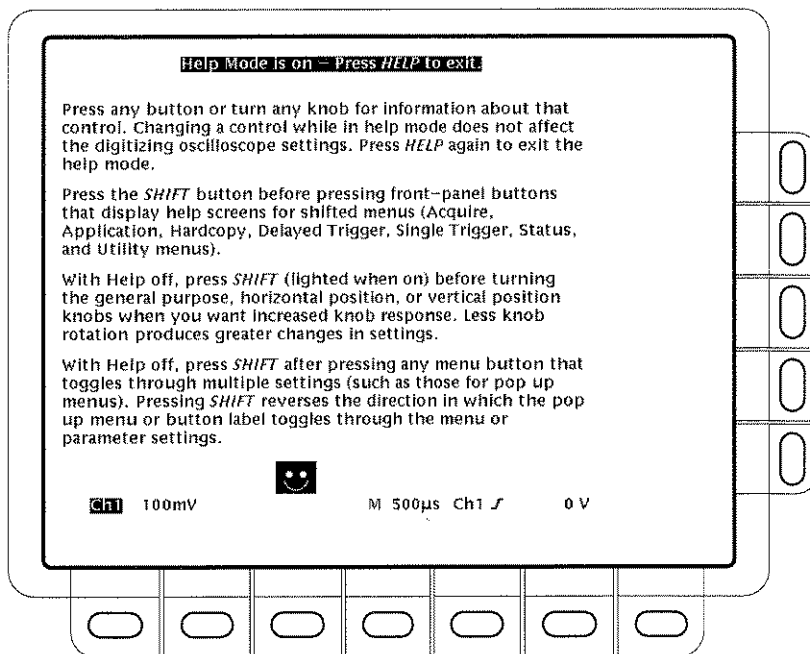

Figure 3–1: Initial Help Screen

Acquisition Modes

The acquisition system has several options for converting analog data into digital form. The Acquisition menu lets you determine the acquisition mode, whether or not to permit equivalent time sampling, and how to start and stop acquisitions.

Description of Modes

The digitizing oscilloscope supports five acquisition modes:

- *Sample*
- *Peak Detect*
- *Hi Res*
- *Envelope*
- *Average*

The Sample, Peak Detect, and Hi Res modes operate in real-time on a single trigger event, provided the digitizing oscilloscope can acquire enough samples for each trigger event. Envelope and Average modes operate on multiple acquisitions. The digitizing oscilloscope averages or envelopes several waveforms on a point-by-point basis.

Figure 3–2 illustrates the different modes and lists the benefits of each. Use it to help select the appropriate mode for your application.

Sample Mode



In Sample mode, the oscilloscope creates a record point by saving the first sample (of perhaps many) during each acquisition interval. (An acquisition interval is the time covered by the waveform record divided by the record length.) This is the default mode.

Peak Detect Mode



Peak Detect mode alternates between saving the highest sample in one acquisition interval and lowest sample in the next acquisition interval. That mode only works with real-time, non-interpolated sampling.

If you set the time base so fast (faster than 500 ns) that it requires real-time interpolation or equivalent-time sampling, the mode automatically changes from Peak Detect to Sample, although the menu selection does not change.

Single Waveform Acquisition

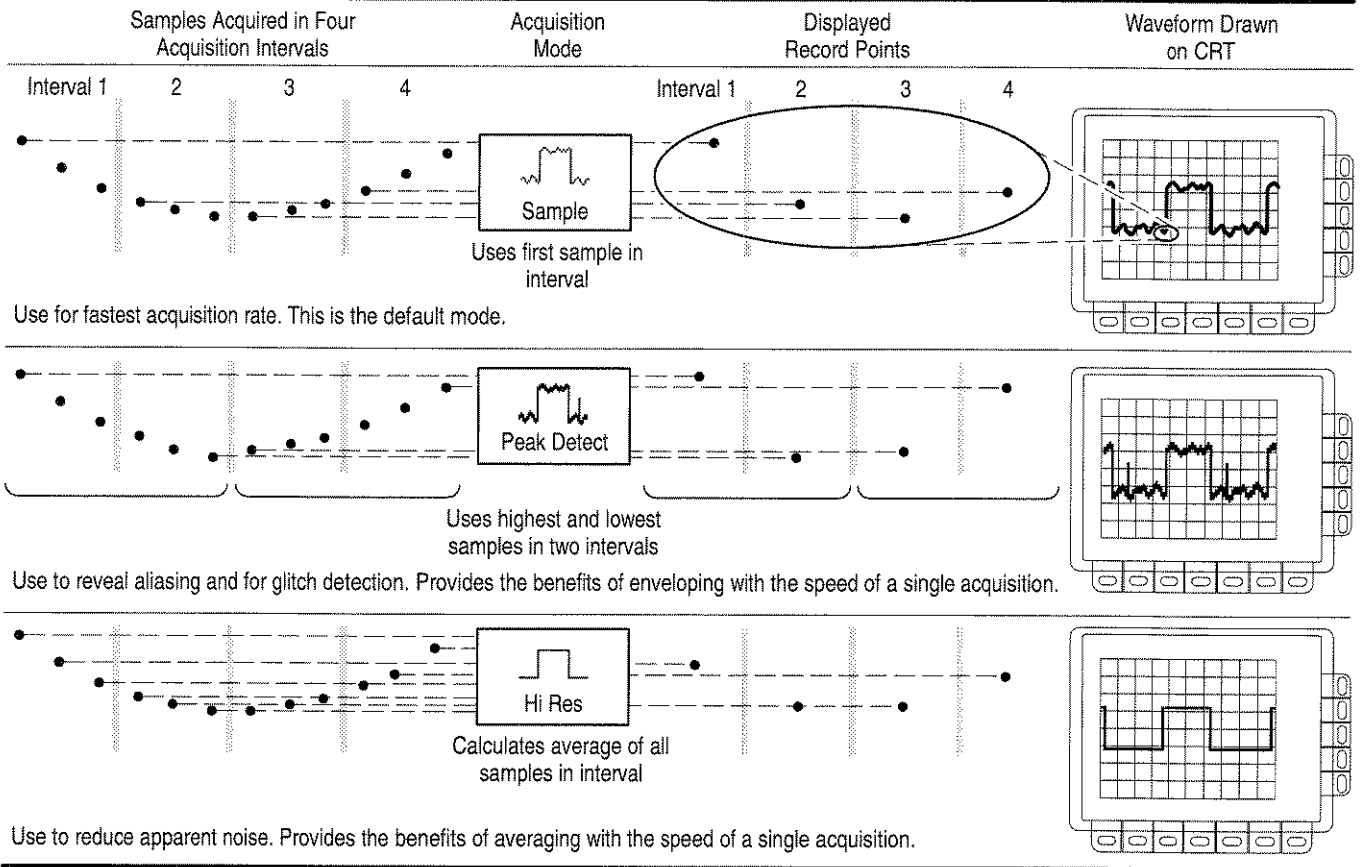

Multiple Waveform Acquisitions

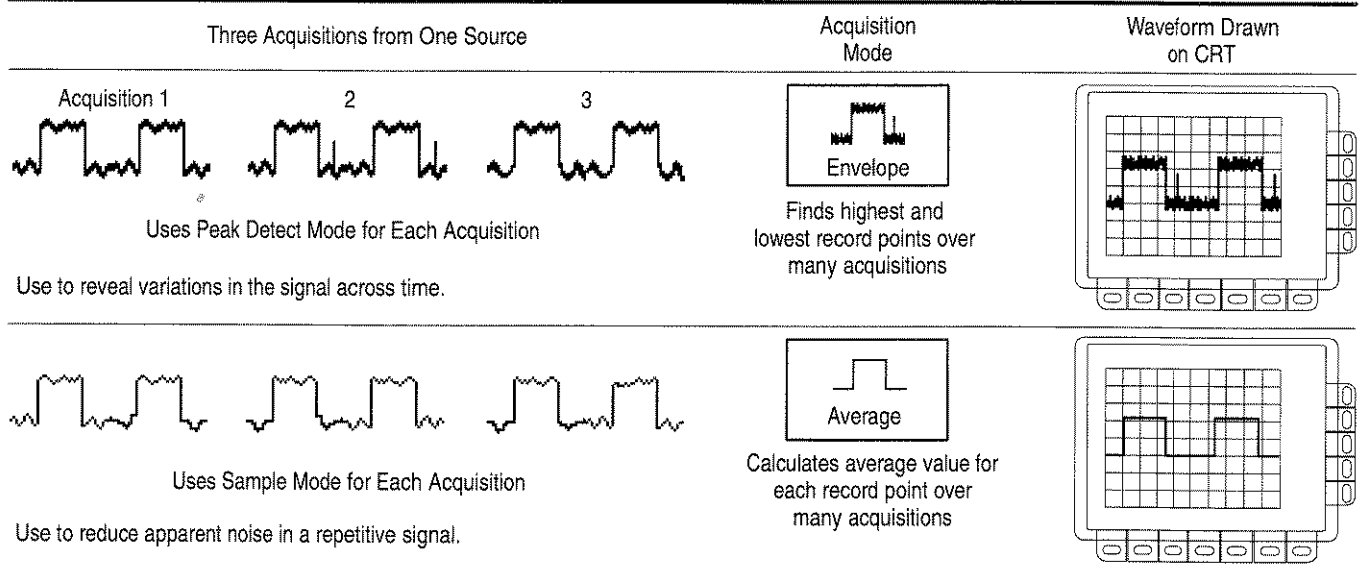

Figure 3-2: How the Acquisition Modes Work

Hi Res Mode

In Hi Res mode, the digitizing oscilloscope averages all samples taken during an acquisition interval to create a record point. That average results in a higher-resolution, lower-bandwidth waveform.

NOTE. *In Hi Res mode the frequency of the external clock signal must be less than or equal to the frequency set in the external clock side menu. If the frequency of the external clock signal is greater than the frequency set in the side menu, the displayed waveform will have the wrong amplitude.*

This mode only works with real-time, non-interpolated sampling. If you set the time base so fast that it requires real-time interpolation or equivalent-time sampling, the mode automatically becomes Sample, although the menu selection does not change.

A key advantage of Hi Res is its potential for increasing resolution regardless of the input signal. Table 3–1 and the equations shown below illustrate how you can obtain up to 15 significant bits with Hi res mode. Note that the resolution improvements are limited to speeds slower than 500 ns/div. Also, resolutions above 15 bits are not allowed by internal hardware and computation limitations. The bits of resolution shown in Table 3–1 are theoretically achievable. Actual resolution may vary as a function of the correlated noise sources in the test environment.

Resolution, Internal Clock:

$$\text{Resolution}_{\text{HiRes}} \cong 8 \leq \left[8 + 0.5 \text{Log}_2 \left(\frac{\text{time/div}}{500 \cdot 10^{-9}} \right) \right] \leq 15 \text{ [bits]}$$

Bandwidth, Internal Clock:

$$\text{For } 1\mu\text{s/div and slower, } \text{BW}_{\text{HiRes}} \cong 0.44 \cdot \left(\frac{50}{\text{time/div}} \right) \text{ [Hz]}$$

Resolution, External Clock:

$$\text{Resolution}_{\text{HiRes}} \cong 8 \leq \left[8 + 0.5 \text{Log}_2 \left(\frac{100,000,000}{\text{ClockExternalMenu}} \right) \right] \leq 15 \text{ [bits]}$$

Bandwidth, External Clock:

$$\text{BW}_{\text{HiRes}} \cong 44 \cdot \left(\frac{\text{ClockExternalMenu}}{100} \right) \text{ [Hz]}$$

Table 3-1: Resolution Bits

Time Base Speed	Bits of Resolution	Bandwidth
1 μ s and faster	8 bits	\geq 22 MHz
2 μ s to 5 μ s	9 bits	\geq 4.4 MHz
10 μ s to 20 μ s	10 bits	\geq 1.1 MHz
50 μ s to 100 μ s	11 bits	\geq 220 MHz
200 μ s to 500 μ s	12 bits	\geq 44 KHz

Envelope Mode

Envelope mode lets you acquire and display a waveform record that shows the extremes in variation over several acquisitions. You specify the number of acquisitions over which to accumulate the data. The oscilloscope saves the highest and lowest values in two adjacent intervals similar to the Peak Detect mode. But Envelope mode, unlike Peak Detect, gathers peaks over many trigger events.

After each trigger event, the oscilloscope acquires data and then compares the min/max values from the current acquisition with those stored from previous acquisitions. The final display shows the most extreme values for all the acquisitions for each point in the waveform record.

NOTE. Envelope and Average acquisition modes disable Roll mode. See Roll Mode beginning on page 3-93.

Average Mode

Average mode lets you acquire and display a waveform record that is the averaged result of several acquisitions. This mode reduces random noise. The oscilloscope acquires data after each trigger event using Sample mode. It then averages the record point from the current acquisition with those stored from previous acquisitions.

Checking the Acquisition Readout

To determine the acquisition sampling rate, the acquisition state (running or stopped), and the acquisition mode, check the acquisition readout at the top of the display (see Figure 3–3). The “running” state shows the sample rate (or External Clock when external clock is enabled) and acquisition mode. The “stopped” state shows the number of acquisitions acquired since the last stop or major change.

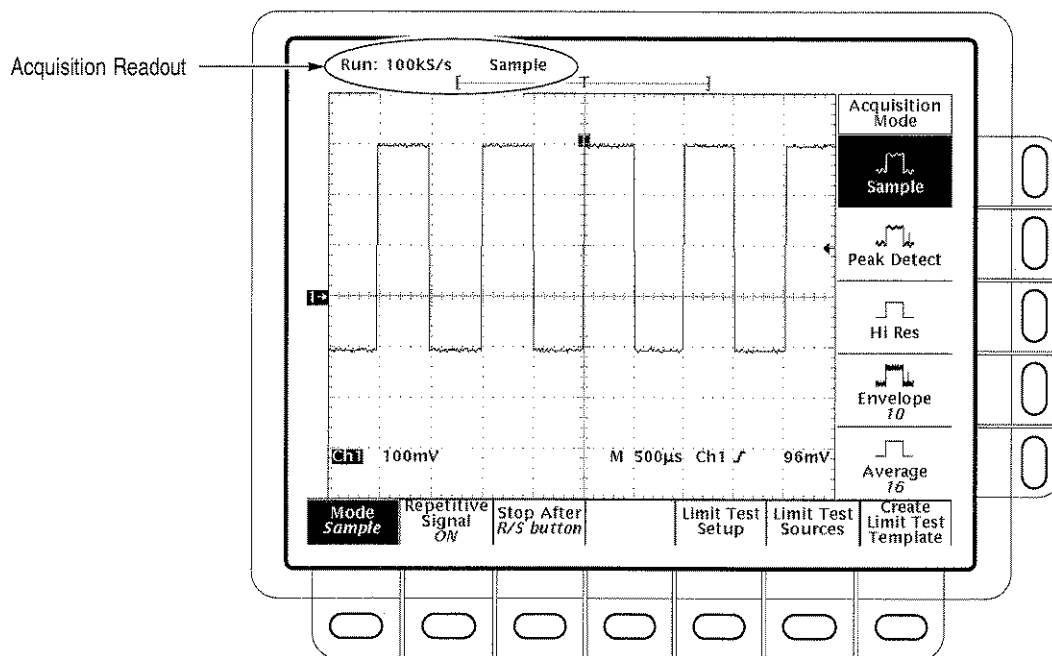

Figure 3–3: Acquisition Menu and Readout

Selecting an Acquisition Mode

The oscilloscope provides several acquisition modes. To bring up the acquisition menu (Figure 3–3) and choose how the digitizing oscilloscope creates points in the waveform record:

Press **SHIFT ACQUIRE MENU** → **Mode** (main) → **Sample, Peak Detect, Hi Res, Envelope, or Average** (side).

NOTE. If you select a 120000 point record length, you cannot select Hi Res mode.

When you select **Envelope** or **Average**, you can enter the number of waveform records to be enveloped or averaged using the general purpose knob.

Selecting Repetitive Sampling

To limit the digitizing oscilloscope to real-time sampling or let it choose between real-time or equivalent-time sampling:

Press **SHIFT ACQUIRE MENU** → **Repetitive Signal** (main) → **ON or OFF** (side).

ON (Enable ET) uses both the real time and the equivalent time features of the digitizing oscilloscope. The digitizing oscilloscope automatically switches to equivalent-time sampling when the horizontal scale is faster than 25 ns, otherwise it uses real-time sampling.

OFF (Real Time Only) limits the digitizing oscilloscope to real time sampling. If the digitizing oscilloscope cannot accurately get enough samples for a complete waveform, the oscilloscope uses the interpolation method selected in the display menu to fill in the missing record points. That is, it uses either the linear or $\sin(x)/x$ interpolation algorithm.

See *Acquisition* on page 2–39 for details about sampling.

To Stop After

To choose the event that signals the oscilloscope to stop acquiring waveforms, do the following step:

Press **SHIFT ACQUIRE MENU** → **Stop After** (main) → **RUN/STOP button only, Single Acquisition Sequence, or Limit Test Condition Met** (side) (see Figure 3–4).

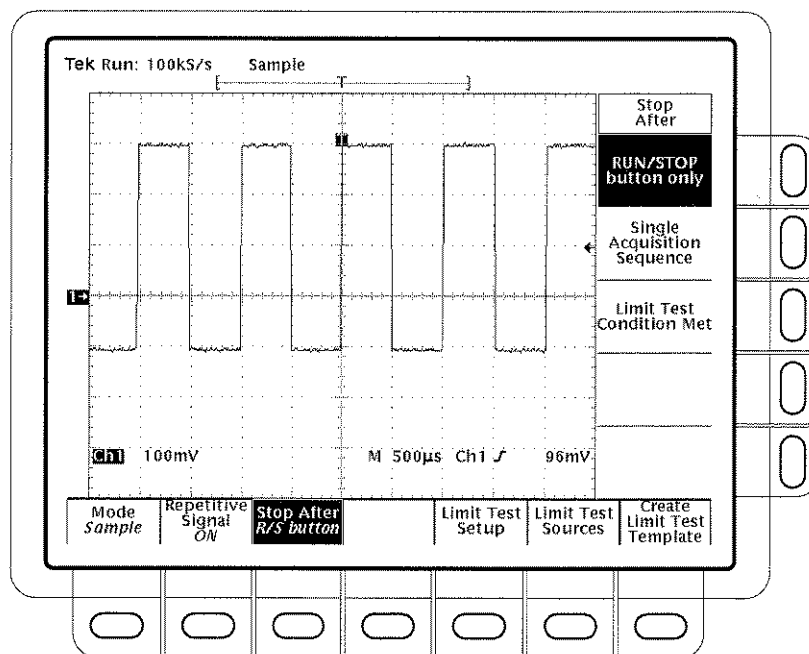

Figure 3-4: Acquire Menu — Stop After

RUN/STOP button only (side) lets you start or stop acquisitions by toggling the RUN/STOP button. Pressing the RUN/STOP button once stops the acquisitions. The upper left hand corner in the display indicates Stopped and shows the number of acquisitions. If you press the button again, the digitizing oscilloscope resumes taking acquisitions.

Single Acquisition Sequence (side) lets you run a single sequence of acquisitions by pressing the RUN/STOP button. In Sample, Peak Detect, or Hi Res mode, the oscilloscope acquires a waveform record with the first valid trigger event and stops.

In Envelope or Average mode, the digitizing oscilloscope makes the specified number of acquisitions to complete the averaging or enveloping task.

If the oscilloscope is in equivalent-time mode and you press Single Acquisition Sequence (side), it continues to recognize trigger events and acquire samples until the waveform record is filled.

NOTE. To quickly select Single Acquisition Sequence without displaying the Acquire and Stop After menus, press SHIFT FORCE TRIG. Now the RUN/STOP button operates as just described. (You still must display the Acquire menu and then the Stop After menu to leave Single Acquisition Sequence operation.)

Limit Test Condition Met (side) lets you acquire waveforms until waveform data exceeds the limits specified in the limit test. Then acquisition stops. At that point, you can also specify other actions for the oscilloscope to take using the selections available in the Limit Test Setup main menu.

NOTE. *In order for the digitizing oscilloscope to stop acquisition when limit test conditions are met, limit testing must be turned ON, using the Limit Test Setup main menu.*

Setting up limit testing requires several more steps. You can create the template waveform against which to compare incoming waveforms, using the Create Limit Test Template main menu item. You can then specify that the comparison is to be made and the channel to compare against the template using the Limit Test Sources main menu item. See *Limit Testing*, on page 3-53.

For More Information

See *Acquisition*, on page 2-39.

See *Limit Testing*, on page 3-53.

Delayed Triggering

The TDS 400A Series oscilloscopes provide a main time base and a delayed time base. The delayed time base, like the main time base, requires a trigger signal and an input source dedicated to that signal. You can only use delay with the edge trigger. This section describes how to delay the acquisition of waveforms.

There are two different ways to delay the acquisition of waveforms: *delayed runs after main* and *delayed triggerable*. Only delayed triggerable uses the delayed trigger system.

Delayed runs after main looks for a main trigger, then waits a user-defined time, and then starts acquiring (see Figure 3-5).

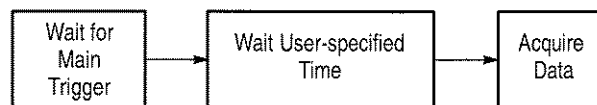

Figure 3-5: Delayed Runs After Main

Delayed triggerable looks for a main trigger and then, depending on the type of delayed trigger selected, makes one of the types of delayed triggerable mode acquisitions listed below (see Figure 3-6).

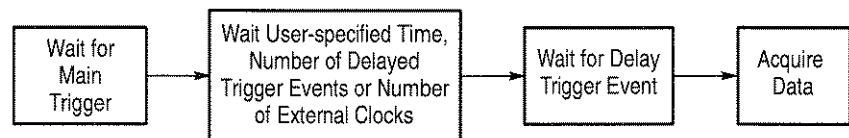

Figure 3-6: Delayed Triggerable

After Time waits the user-specified time, then waits for the next delayed trigger event, and then acquires.

After Events waits for the specified number of delayed trigger events and then acquires.

External clks waits for the specified number of external clocks and then acquires.

The digitizing oscilloscope is always acquiring samples to fill the pretrigger part of the waveform record. When and if delay criteria are met, it takes enough posttrigger samples to complete the delayed waveform record and then displays it. Refer to Figure 3-7 for a more detailed look at how delayed records are placed in time relative to the main trigger.

To Run After Delay

You use the Horizontal menu to select and define either delayed runs after main or delayed triggerable. Delayed triggerable, however, requires further selections in the Delayed Trigger menu. Do the following steps to set the delayed time base to run immediately after delay:

1. Press **HORIZONTAL MENU** → **Time Base** (main) → **Delayed Only** (side) → **Delayed Runs After Main** (side).
2. Use the general purpose knob to set the delay time.

If you press Intensified (side), you display an intensified zone on the main timebase record that shows where the delayed timebase record occurs relative to the main trigger. For Delayed Runs After Main mode, the start of the intensified zone corresponds to the start of the delayed timebase record. The end of the zone corresponds to the end of the delayed record.

To learn how to define the intensity level of the normal and intensified waveform, see *Display Modes* on page 3-21.

Delayed Runs After Main

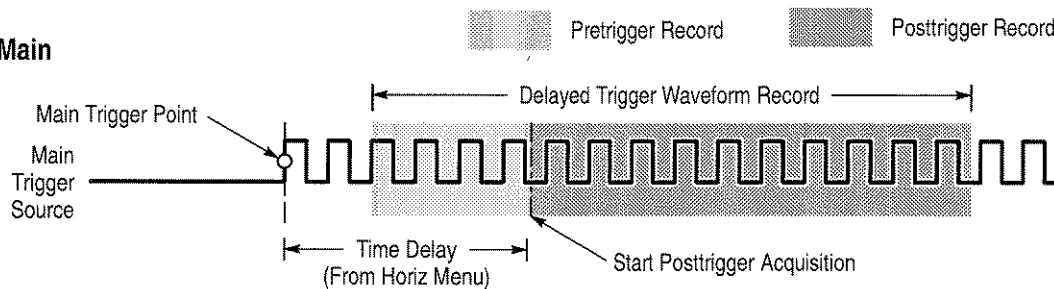

Delayed Triggerable By Events

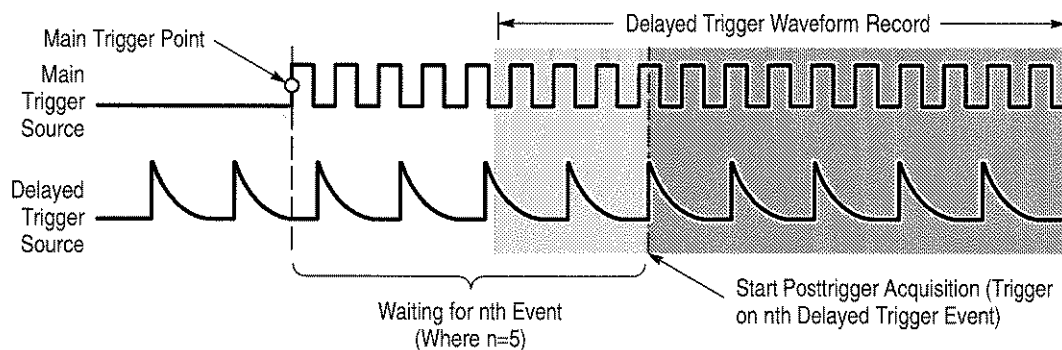

Delayed Triggerable By Time

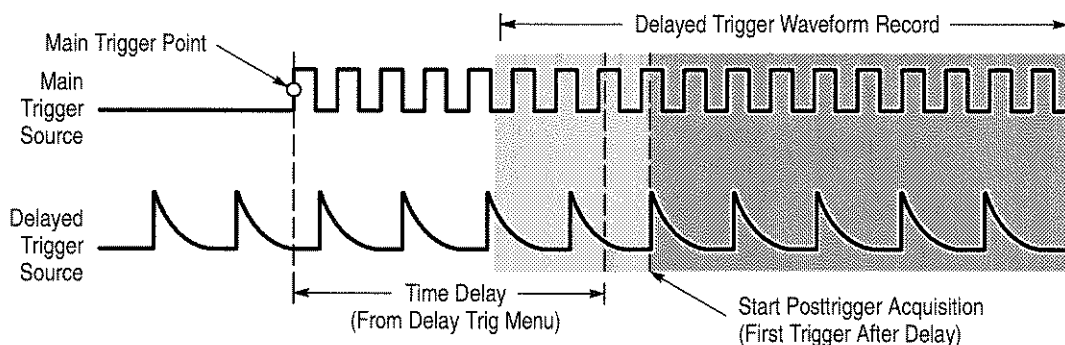

Delayed Triggerable By External Clocks

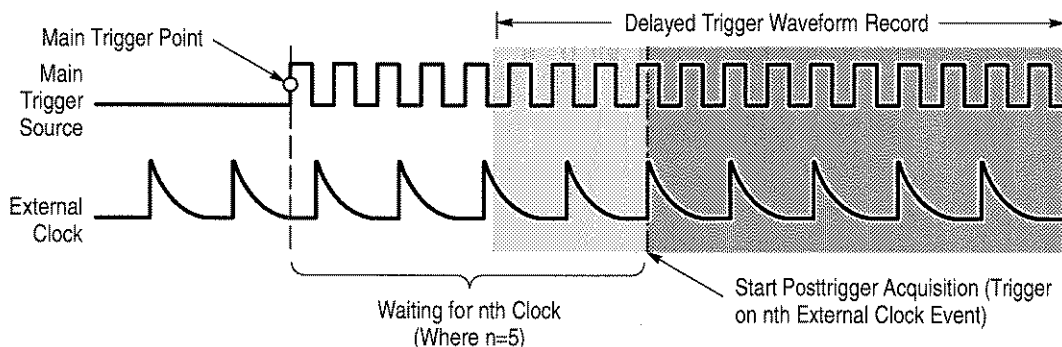

Figure 3-7: How the Delayed Triggers Work

To Trigger After Delay

To select Delayed Triggerable mode, do the following steps:

1. Press **HORIZONTAL MENU** → **Time Base** (main) → **Delayed Only** (side) → **Delayed Triggerable** (side).

By pressing Intensified (side), you can display an intensified zone that shows where the delayed timebase record *may* occur (a valid delay trigger event must be received) relative to the main trigger on the main timebase. For Delayed Triggerable After mode, the start of the intensified zone corresponds to the possible start point of the delayed timebase record. The end of the zone continues to the end of main timebase, since a delayed time base record may be triggered at any point after the delay time elapses.

To learn how to define the intensity level of the normal and intensified waveform, see *Display Modes* on page 3–21.

Now you need to bring up the Delayed Trigger menu so you can define the delayed trigger event.

2. Press **SHIFT DELAYED TRIG** → **Delay by** (main) → **Triggerable After Time, Events, or Ext clks** (side) (Figure 3–8).
3. Enter the delay time or events using the general purpose knob.

Hint: You can go directly to the Delayed Trigger menu (see step 2). By selecting either Triggerable After Time or Events, the oscilloscope automatically switches to Delayed Triggerable in the Horizontal menu. If you wish to leave Delayed Triggerable, you still need to display the Horizontal menu.

The **Source** menu lets you select which input is the delayed trigger source.

4. On the TDS 420A and TDS 460A, press **Source** (main) → **Ch1, Ch2, Ch3, or Ch4** (side). On the TDS 410A, press **Ch1 or Ch2** (side).

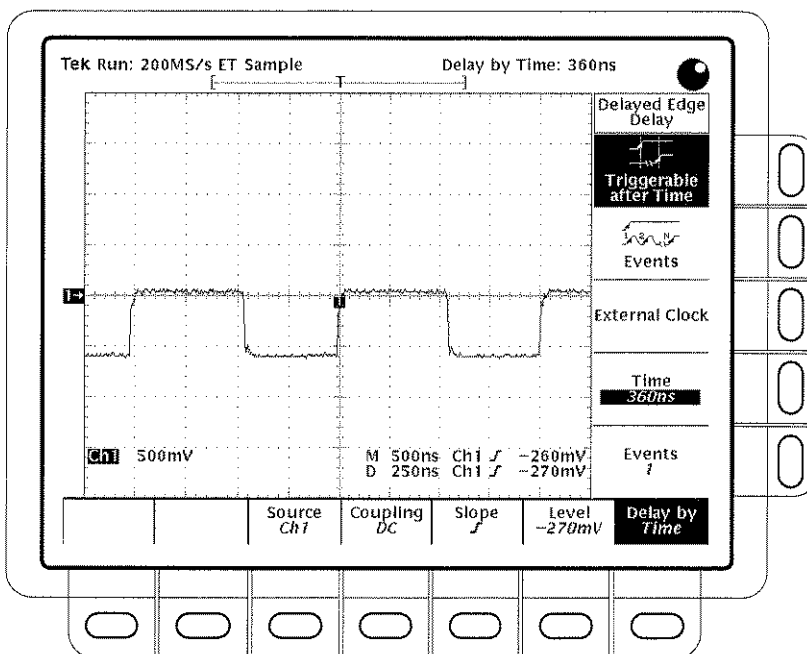

Figure 3-8: Delayed Trigger Menu

5. Press **Coupling** (main) → **DC**, **AC**, **HF Rej**, **LF Rej**, or **Noise Rej** (side) to define how the input signal is coupled to the delayed trigger. For descriptions of these coupling types, see *Triggering* on page 2-31.

6. Press **Slope** (main) to select the slope that the delayed trigger occurs on. Choose between the rising edge and falling edge slopes.

When using Delayed Triggerable mode to acquire waveforms, two trigger bars are displayed. One trigger bar indicates the level set by the main trigger system; the other indicates the level set by the delayed trigger system.

7. Press **Level** (main) → **Level**, **Set to TTL**, **Set to ECL**, or **Set to 50%** (side).

Level lets you enter the delayed trigger level using the general purpose knob.

Set to TTL fixes the trigger level at +1.4 V.

Set to ECL fixes the trigger level at -1.3 V.

NOTE. When you set the Vertical SCALE smaller than 200 mV, the oscilloscope reduces the Set to TTL or Set to ECL trigger levels below standard TTL and ECL levels. That happens because the trigger level range is fixed at ± 12 divisions from the center. At 100 mV (the next smaller setting after 200 mV) the trigger range is ± 1.2 V which is smaller than the typical TTL (+1.4 V) and ECL (-1.3 V) levels.

Set to 50% fixes the delayed trigger level to 50% of the peak-to-peak value of the delayed trigger source signal.

For More Information

See *Triggering*, on page 2-31.

Determining Status

The Status menu lets you see information about the oscilloscope state.

To Display the Status

To display the Status menu:

Press **SHIFT STATUS** → **Status** (main) → **System, Trigger, Waveforms, or I/O** (side).

System displays information about the Horizontal, Zoom, Acquisition, Display, Measure, and Hardcopy systems (see Figure 3–9). This display also tells you the firmware creation date.

Trigger displays information about the triggers.

Waveforms displays information about the various waveforms, including live, math, and reference.

I/O displays information about the I/O port(s).

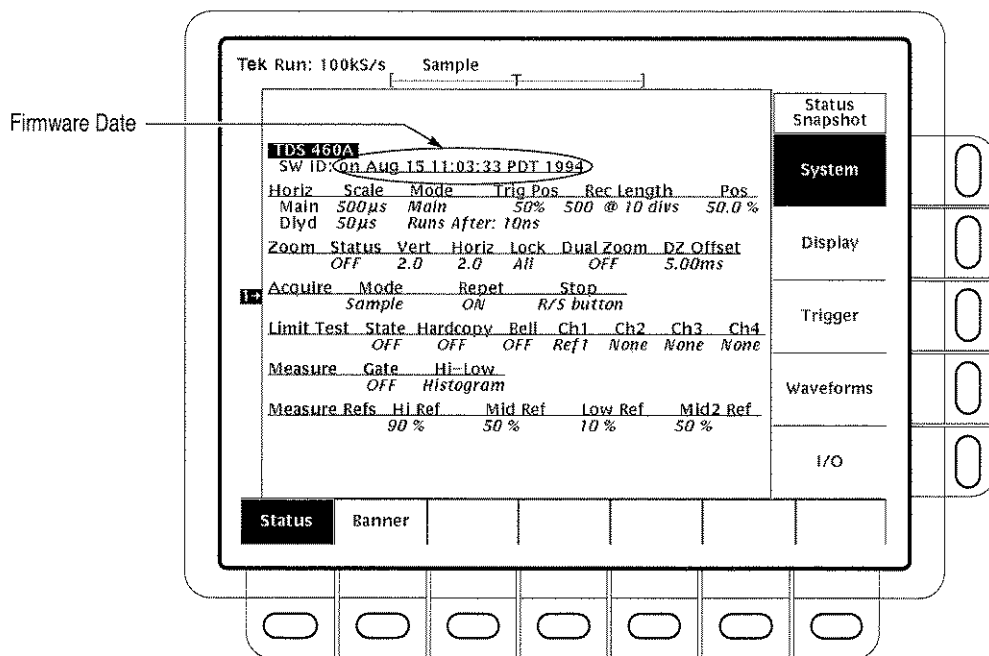

Figure 3–9: Status Menu — System

To Display the Banner

To display the banner (firmware version, options, and copyright):

Press **SHIFT STATUS** → **Banner** (main). (See Figure 3–10.)

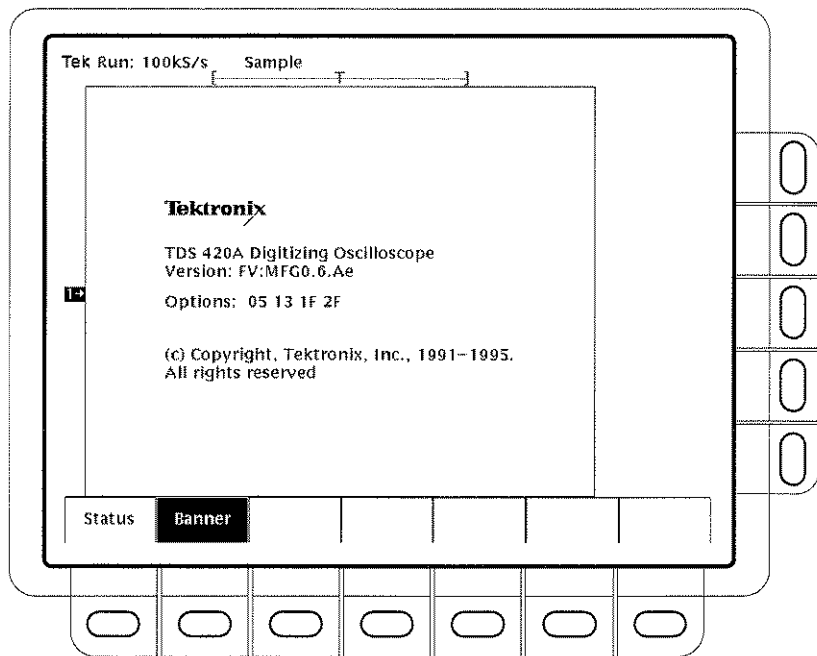

Figure 3–10: Banner Display

Display Modes

The digitizing oscilloscope can display waveform records in different ways. The Display menu lets you adjust the oscilloscope display style, intensity level, graticule, and format. This section describes how to adjust the oscilloscope display style, intensity level, graticule, and format.

Change Display Settings

To bring up the Display menu, press **DISPLAY**.

To Select the Display Style

Press **DISPLAY** → **Style** (main) → **Vectors**, **Intensified Samples**, **Dots**, **Infinite Persistence**, or **Variable Persistence** (side) (Figure 3–11).

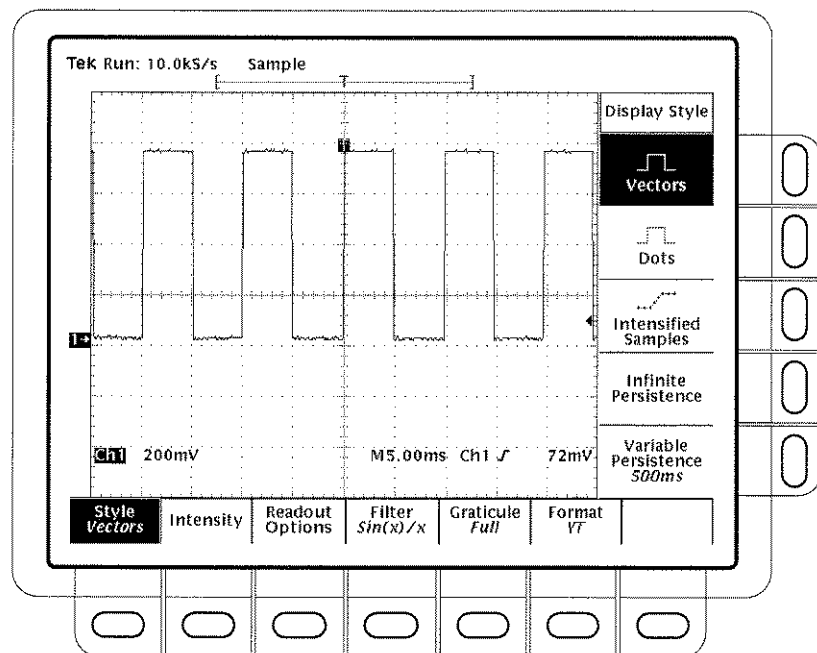

Figure 3–11: Display Menu — Style

Vectors style displays draw vectors (lines) between the record points.

Dots style displays waveform record points as dots.

Intensified Samples style also displays waveform record points as dots. However, the points actually sampled are displayed intensified relative to the interpolated points.

In addition to choosing Intensified Samples in the side menu, the oscilloscope must be interpolating (equivalent time must be off) or Zoom must be on with its horizontal expansion greater than 1X. See interpolation on page 2–40; see Zoom beginning on page 3–135.

Variable Persistence style accumulates the record points on screen over many acquisitions and displays them only for a specific time interval. In that mode, the display behaves like that of an analog oscilloscope. You enter the time for that option with the general purpose knob.

Infinite Persistence lets the record points accumulate until you change some control (such as scale factor) causing the display to be erased.

Adjust Intensity

Intensity lets you set overall, text/graticule, and waveform intensity (brightness) levels. To set the contrast intensity of the intensified portion of a waveform:

Press **DISPLAY → Intensity** (main) → **Overall, Text/Grat, Waveform,** or **Contrast** (side). Enter the intensity percentage values with the general purpose knob.

All intensity adjustments operate over a range from 20% (close to fully off) to 100% (fully bright).

Contrast operates over a range from 100% (no contrast) to 250% (intensified portion at full brightness).

NOTE. *The Intensified setting for Timebase in the horizontal menu causes a zone on the waveform to be intensified relative to the rest of the waveform. If the contrast is set to 100%, you can not distinguish the intensified portion from the rest of the waveform because both are the same brightness.*

Set Display Readout Options

Readout options control whether the trigger indicator, trigger level bar, and current date and time appear on the display. The options also control what style trigger level bar, long or short, is displayed.

1. Press **DISPLAY → Readout** (main).
2. Toggle **Display ‘T’ @ Trigger Point** (side) to select whether or not to display a ‘T’ indicating the trigger point. You can select **ON** or **OFF**. (The trigger point indicates the position of the trigger in the waveform record.)

3. Toggle **Trigger Bar Style** (side) to select either the short or the long trigger bar or to turn the trigger bar off. (See Figure 3–12. Note that both styles are shown for illustrating purposes, but you can only display one style at a time.)

The trigger bar is only displayed if the trigger source is an active, displayed waveform. Also, two trigger bars are displayed when delay triggerable acquisitions are displayed — one for the main and one for the delayed timebase. The trigger bar is a visual indicator of the trigger level.

Sometimes, especially when using the hardcopy feature, you may wish to display the current date and time on screen. For more information about displaying and setting date and time, see *To Date/Time Stamp Your Hardcopy* on page 3–37.)

4. Press **Display Date/Time** (side) to turn it on or off. Push **Clear Menu** to see the current date and time.

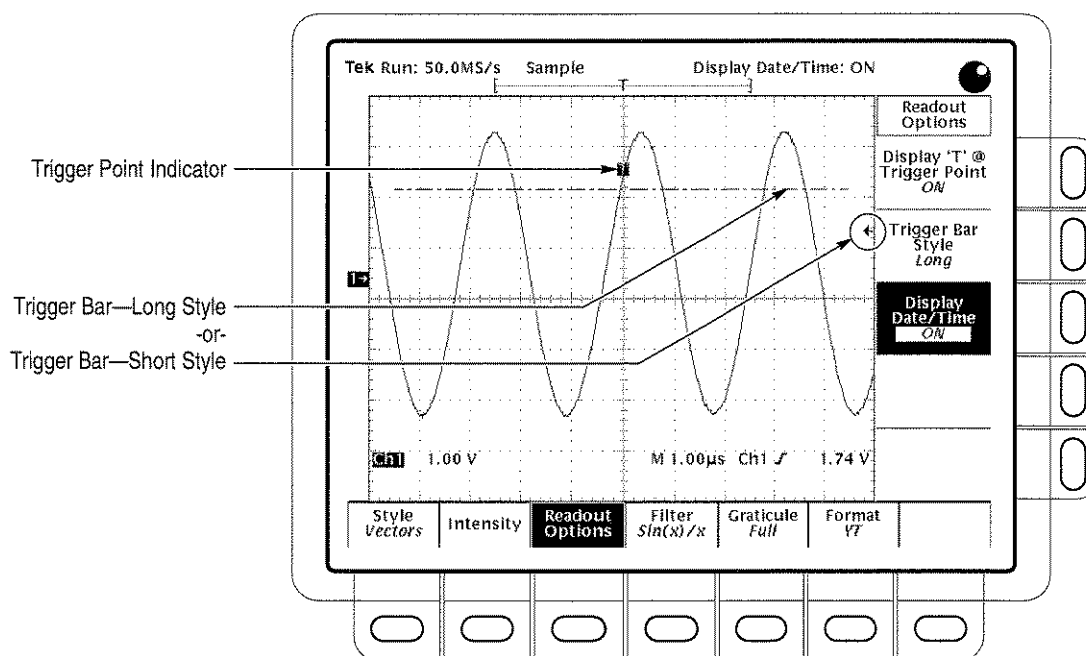

Figure 3–12: Trigger Point and Level Indicators

Select Interpolation Filter

The display filter types are $\sin(x)/x$ interpolation and linear interpolation. For more information see page 2–40.

Press **DISPLAY** → **Filter** (main) → **Sin(x)/x Interpolation** or **Linear Interpolation** (side).

NOTE. Interpolation occurs when the horizontal scale is set to rates faster than 500 ns/div and Repetitive Signal is Off or when using the ZOOM feature to expand waveforms horizontally. (The filter type, linear or $\sin(x)/x$, depends on which is set in the Display menu.) Otherwise, interpolation is not needed. See Sampling and Digitizing on page 2–39 for a discussion of sampling including interpolation.

Select the Graticule Type

To change the graticule:

Press **DISPLAY** → **Graticule** (main) → **Full, Grid, Cross Hair, Frame, NTSC** or **PAL** (side).



Full provides a grid, cross hairs, and a frame.



Grid displays a frame and a grid.



Cross Hair provides cross hairs and a frame.



Frame displays just a frame.

NTSC provides a grid useful for measuring NTSC-class waveforms.

PAL provides a grid useful for measuring PAL-class waveforms.

NOTE. Selecting either *NTSC* or *PAL* graticule automatically changes the vertical scale, position settings, coupling, and sets to zero any vertical offset of any channel displayed. These settings are not restored after switching to other graticule types. Therefore, you might wish to recall the factory setup or other stored setup after selecting a different graticule.

Select the Display Format

There are two display formats: YT and XY.



YT is the conventional oscilloscope display format. It shows a signal voltage (the vertical axis) as it varies over time (the horizontal axis).



XY format compares the voltage levels of two waveform records point by point. That is, the digitizing oscilloscope displays a graph of the voltage of one waveform record against the voltage of another waveform record. This mode is particularly useful for studying phase relationships.

To set the display axis format:

Press **DISPLAY** → **Format** (main) → **XY** or **YT** (side).

When you choose the XY mode, the input you have selected is assigned to the X-axis and the digitizing oscilloscope automatically chooses the Y-axis input (see Table 3–2).

Table 3–2: XY Format Pairs

X-Axis Channel (User Selectable)	Y-Axis Channel (Fixed)
Ch 1 (All models)	Ch 2 (All models)
Ch 3 (TDS 420A and TDS 460A only)	Ch 4 (TDS 420A and TDS 460A only)

For example, if you press the CH 1 button, the digitizing oscilloscope displays a graph of the channel 1 voltage levels on the X-axis against the channel 2 voltage levels on the Y-axis. This occurs whether or not you are displaying the channel 2 waveform in YT format. If you later press the WAVEFORM OFF button for either channel 1 or 2, the digitizing oscilloscope deletes the XY graph of channel 1 versus channel 2.

Since selecting YT or XY affects only the display, the horizontal and vertical scale and position knobs and menus control the same parameters regardless of the mode selected. Specifically, in XY mode, the horizontal scale continues to control the time base and the horizontal position continues to control which portion of the waveforms are displayed.

XY format is a dot-only display, although it can have persistence. The Vector style selection has no effect when you select XY format.

You cannot display Math waveforms in XY format. They disappear from the display when you select XY.

For More Information

See *Acquisition* on page 2–39.

Edge Triggering

This oscilloscope can trigger on the edge of a waveform. An *edge trigger* event occurs when the trigger source passes through a specified voltage level in a specified direction (the trigger slope). You will likely use edge triggering for most of your measurements. This section describes how to use edge triggering (how to select the edge source, coupling, slope, and level). It also explains how to select the trigger mode, auto or normal, for all trigger types.

To Check Edge Trigger Status

To quickly check if edge triggers are selected, check the Trigger readout. When edge triggers are selected, the trigger readout displays the trigger source, as well as the trigger slope and level (see Figure 3–13).

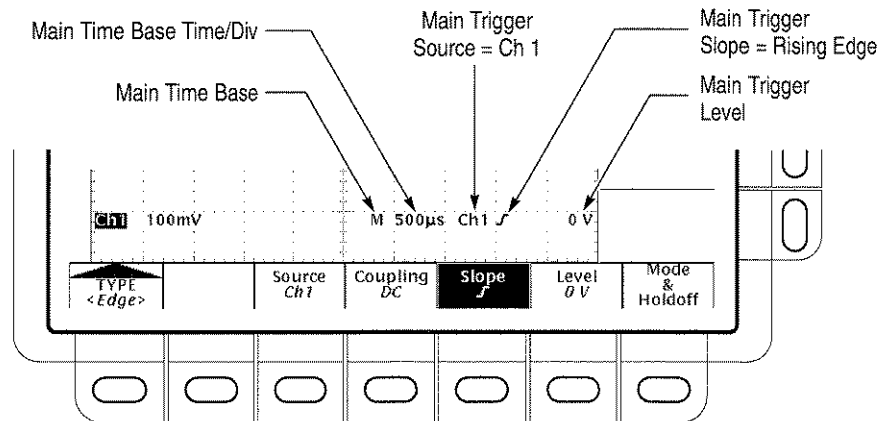

Figure 3–13: Edge Trigger Readouts

To Select Edge Triggering

Use the Edge Trigger menu to select edge triggering and to perform the procedures for selecting the source, coupling, slope, trigger level, mode, and holdoff that follow.

To bring up the Edge Trigger menu, press **TRIGGER MENU** → **Type (main)** → **Edge** (pop-up) (see Figure 3–14).

To Select a Source

To select which source you want for the trigger:

On TDS 420A and TDS 460A, press **TRIGGER MENU** → **Type** (main) → **Edge** (pop-up) → **Source** (main) → **Ch1, Ch2, Ch3, Ch4, AC Line**, or **Auxiliary** (side). On TDS 410A, press **TRIGGER MENU** → **Type** (main) → **Edge** (pop-up) → **Source** (main) → **Ch1, Ch2, AC Line**, or **Auxiliary** (side).

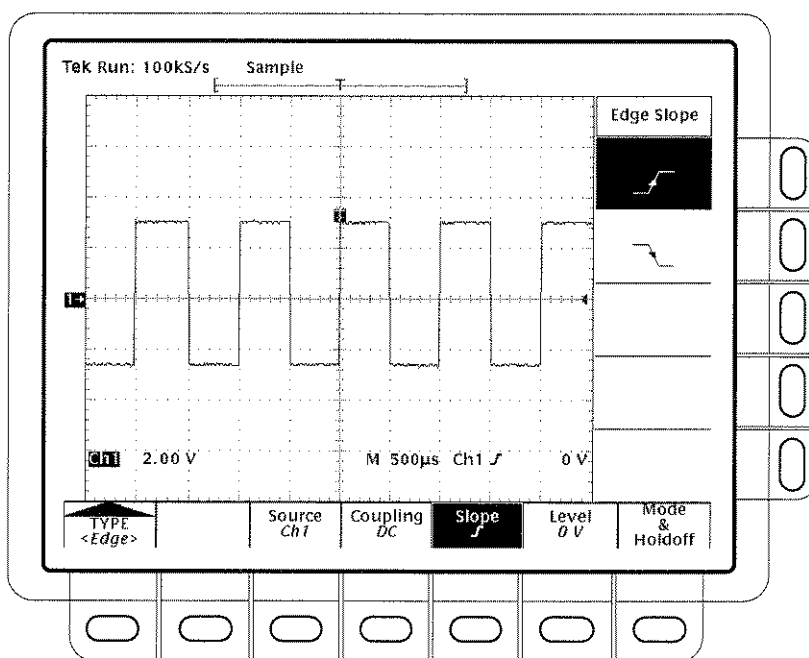

Figure 3-14: Main Trigger Menu — Edge Type

To Specify Coupling

To select the coupling you want, press **TRIGGER MENU** → **Type** (main) → **Edge** (pop-up) → **Coupling** (main) → **DC, AC, HF Rej, LF Rej**, or **Noise Rej** (side).

NOTE. If you select the Auxiliary trigger source, select DC or HF Rej coupling.

DC

DC passes all of the input signal. In other words, it passes both AC and DC components to the trigger circuit.

AC ~

AC passes only the alternating components of an input signal (above 30 Hz). It removes the DC component from the trigger signal.

HF Rej

HF Rej removes the high frequency portion of the triggering signal. That allows only the low frequency components to pass on to the triggering system to start an acquisition. High frequency rejection attenuates signals above 30 kHz.



LF Rej does the opposite of high frequency rejection. Low frequency rejection attenuates signals below 80 kHz.

Noise Rej provides lower sensitivity. It requires additional signal amplitude for stable triggering, reducing the chance of falsely triggering on noise.

To Set Slope

To select the slope that the edge trigger occurs on:

1. Press the **TRIGGER MENU** → **Type** (main) → **Edge** (pop-up) → **Slope** (main).
2. Select the rising or falling edge from the side menu.



To Set Level

Press the **TRIGGER MENU** → **Type** (main) → **Edge** (pop-up) → **Level** (main) → **Level, Set to TTL, Set to ECL, or Set to 50%** (side).

Level lets you enter the trigger level using the general purpose knob.

Set to TTL fixes the trigger level at +1.4 V.

Set to ECL fixes the trigger level at -1.3 V.

NOTE. When you set the volts/div smaller than 200 mV, the oscilloscope reduces the Set to TTL or Set to ECL trigger levels below standard TTL and ECL levels. This happens because the trigger level range is fixed at ± 12 divisions from the center. At 100 mV (the next smaller setting after 200 mV) the trigger range is ± 1.2 V, which is smaller than the typical TTL (+1.4 V) or ECL (-1.3 V) level.

Set to 50% fixes the trigger level to approximately 50% of the peak-to-peak value of the trigger source signal.

To Set Mode & Holdoff

You can select the trigger mode and change the holdoff time using this menu item. See Triggering on page 2–31 for more details.

1. Press the **TRIGGER MENU** → **Mode & Holdoff** (main) → **Auto** or **Normal** (side). The modes operate as follows:
 - In *Auto* mode the oscilloscope acquires a waveform after a specific time has elapsed even if a trigger does not occur. The amount of time the oscilloscope waits depends on the time base setting.
 - In *Normal* mode the oscilloscope acquires a waveform only if there is a valid trigger.
2. To change the holdoff time, press **Holdoff** (side). Enter the value in % using the general purpose knob.

If you want to enter a large number using the general purpose knob, press the **SHIFT** button before turning the knob. When the light next to the **SHIFT** button is on and the display says **Coarse Knobs** in the upper right corner, the general purpose knob speeds up significantly.

Holdoff is settable from 0% (minimum holdoff available) to 100% (maximum available). See *Holdoff, Variable, Main Trigger* on page B-19 of Appendix B for the typical minimum and maximum values. For typical values, see the help text for Trigger Holdoff.

Holdoff is automatically reset to 0% when you change the main time base time/division setting. However, it is not reset if you change the delayed time base time/division (that is, when the time base setting in the Horizontal menu is Intensified or Delayed Only).

For More Information

See *Triggering*, on page 2-31.

File System

With the Option 1F File System, the TDS 400A Digitizing Oscilloscopes provide file utilities and a floppy disk drive for saving hardcopies, setups, and waveforms. This section describes how to manage (delete, rename, and so forth) these files using the file system. Read the sections listed under *For More Information* on page 3–34 for information on saving hardcopies, setups and waveforms.

To Access the File Utilities

The File Utilities menu lets you delete, rename, copy, print files, create a new directory, operate the confirm delete and overwrite lock, and format disks.

To bring up the File Utilities menu:

1. Press the **SETUP** button to bring up the Save/Recall Setup menu, or press the **WAVEFORM** button to bring up the Save/Recall Waveform menu, or press the **Shift HARDCOPY** button to bring up the Hardcopy menu.
2. Press **File Utilities** in the main menu to bring up the File Utilities side menu. (See Figure 3–15.)

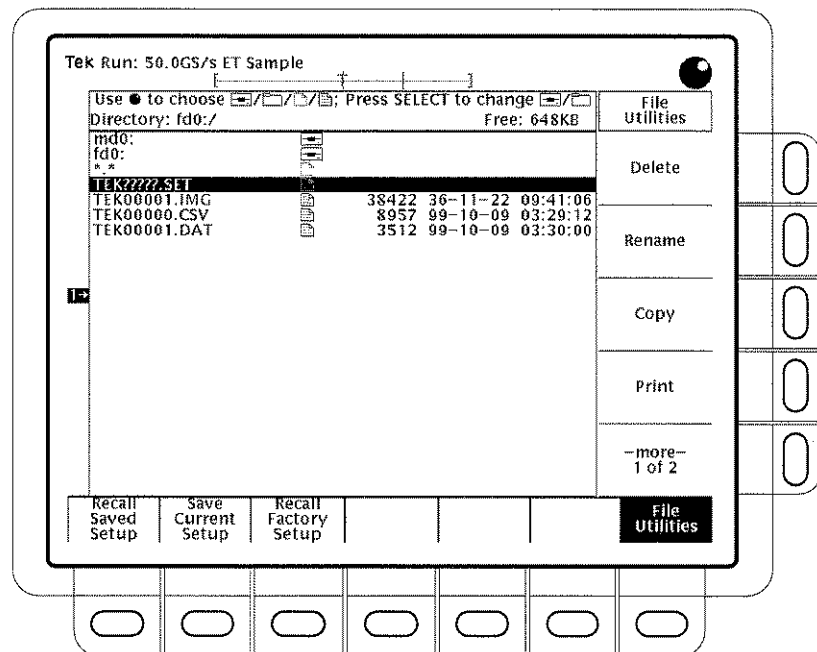

Figure 3–15: File Utilities

NOTE. *The amount of free space on the disk is shown in the upper right corner of the display. The digitizing oscilloscope shows the amount in Kbytes (or in Mbytes if the free space is 1 Mbyte or more). To convert the amount to bytes, you simply multiply the Kbytes amount times 1024. Thus, the 690 Kbytes shown in Figure 3–15 = 690 Kbytes x 1024 bytes/Kbyte = 706,560 bytes.*

Bytes are only shown if the free space is less than 1 Kbyte. Kbytes are only shown if the free space is 1 Kbyte or more, but less than 1 Mbyte. 1 Mbyte is shown if the free space is 1 Mbyte or more.

To Delete a File or Directory

To delete a file or directory, turn the general purpose knob until it scrolls the cursor over the name of the file or directory to delete. Then, press the side menu **Delete** button.

To delete all files in the file list, set the cursor to the *.* selection.

The digitizing oscilloscope deletes directories recursively. That means it deletes both the directory and all its contents.

To Rename a File or Directory

To rename a file or directory, turn the general purpose knob until it scrolls the cursor over the name of the file or directory to delete. For example, to rename the target file whose default name is TEK????? set the cursor over its name. Then, press the side menu **Rename** button.

The labelling menu should appear. Turn the general purpose knob or use the main-menu arrow keys to select each letter. Press **Enter Char** from the main menu to enter each letter. When you have entered the name, press the side menu **OK Accept** item. (See Figure 3–16).

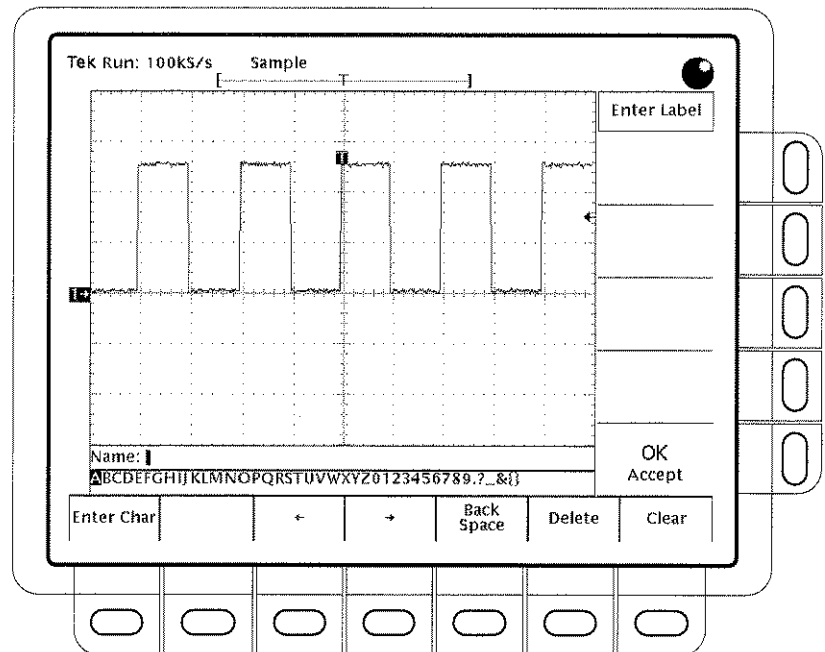

Figure 3-16: File System — Labelling Menu

To Copy a File or Directory

To copy a file or directory, turn the general purpose knob until it scrolls the cursor over the name of the file to copy. Then, press the side menu **Copy** button. The file menu reappears with the names of directories to copy to. Select a directory and press the side-menu button labelled **Copy <name> to Selected Directory**.

To copy all files, select the ***,*** entry.

The digitizing oscilloscope copies all directories recursively. That means it copies both the directory and all its contents.

To Print a File or Directory

To print a file, turn the general purpose knob until it scrolls the cursor over the name of the file to print. Then, press the side-menu **Print** button.

The Print-To side menu should appear. Select the port to print to from **GPIB**, **RS-232**, or **Centronics**. (See Figure 3-16.) Then the digitizing oscilloscope sends the file in its raw form out the port. The device (printer) receiving the file must be capable of printing the particular file format.

To Create a Directory

To create a new directory, press the side menu **Create Directory** button.

The labelling menu appears. Turn the general purpose knob or use the main-menu arrow keys to select each letter. Press **Enter Char** from the main menu to enter each letter. When you have entered the name, press the side menu **OK Accept** item. (See Figure 3–16.)

To Set Confirm Delete

To turn on or off the confirm delete message, toggle the side menu **Confirm Delete** button.

When the confirm delete option is OFF, the digitizing oscilloscope can immediately delete files or directories. When the confirm option is ON, the digitizing oscilloscope warns you before it deletes files and gives you a chance to reconsider.

To Set Overwrite Lock

To turn on or off the file overwrite lock, toggle the side menu **Overwrite Lock** button.

When overwrite lock is on, the digitizing oscilloscope will not permit you to write over an existing file of the same name. An important reason to allow overwriting is to let you write files using a target file name that contains wild card characters (“?”). This means the digitizing oscilloscope creates sequential files whose names are similar except for the sequential numbers that go in the real name in the place of the question marks.

To Format a Disk

To format a 720 Kbyte or 1.44 Mbyte disk, turn the general purpose knob until it scrolls the cursor over the name of the drive to format in. (**fd0:**) Then, press the side menu **Format** button.

For More Information

See *Hardcopy*, on page 3–35.

See *Saving and Recalling Setups*, on page 3–97.

See *Saving and Recalling Waveforms*, on page 3–101.

Hardcopy

You can get a copy of the digitizing oscilloscope display by using the hardcopy feature. This section lists hardcopy formats and describes how to setup and execute a hardcopy.

Supported Formats

Different hardcopy devices use different formats. Depending on the output format you select, you create either an image or a plot. Images are direct bit map representations of the digitizing oscilloscope display. Plots are vector (plotted) representations of the display. The digitizing oscilloscope supports the following formats:

- HP Thinkjet inkjet printer
- HP Deskjet inkjet printer
- HP Laserjet laser printer
- Seiko DPU 411/412 portable thermal printer
- HPGL Color Plot
- Epson®
- Interleaf®
- Tag Image File Format (TIFF®)
- PC Paintbrush® (PCX®)
- Microsoft Windows® file format (BMP®)
- Encapsulated Postscript® (Image, Mono Plot, and Color Plot)

Some formats, particularly Interleaf, Postscript, TIFF, PCX, BMP, and HPGL, are compatible with various desktop publishing packages. That means you can paste files created from the oscilloscope directly into a document on any of those desktop publishing systems.

EPS Mono and Color formats are compatible with the Tektronix Phaser Color Printer, HPGL is compatible with the Tektronix HC100 Plotter, and Epson is compatible with the Tektronix HC200 Printer.

To Set Up for Making Hardcopies

Before you make a hardcopy, you need to set up communications and hardcopy parameters. This discussion assumes that the hardcopy device is already connected to the GPIB port on the rear panel. If that is not the case see *Connection Strategies* on page 3-43.

To Set Communication Parameters

To set up the communication parameters to talk to a printer attached directly to the oscilloscope GPIB port:

1. Press **SHIFT UTILITY** → **System** (main) → **I/O** (pop-up) → **Configure** (main) (see Figure 3-17).
2. Press **Hardcopy (Talk Only)** (side).

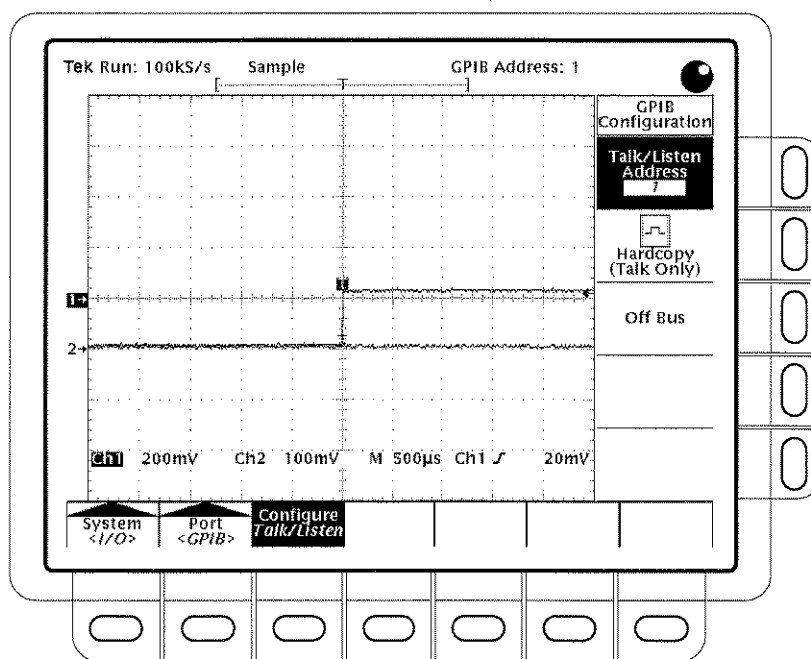

Figure 3-17: Utility Menu — System I/O

To Set Hardcopy Parameters

To specify the hardcopy format, layout, and type of port using the hardcopy menu:

1. Press **SHIFT HARDCOPY MENU** to bring up the Hardcopy menu.
2. Press **Format** (main) → **Thinkjet, Deskjet, Laserjet, Epson, DPU-411, DPU-412, PCX, TIFF, BMP, EPS Image, EPS Mono, EPS Color** (EPS

stands for Encapsulated Postscript), **Interleaf**, or **HPGL** (side). (Press **-more-** (side) to see all of these format choices.)

3. Press **SHIFT HARDCOPY MENU** → **Layout** (main) → **Landscape** or **Portrait** (side) (see Figure 3–18).

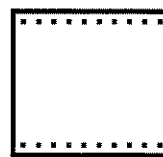

Landscape Format

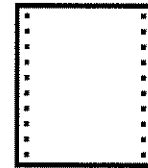

Portrait Format

Figure 3–18: Hardcopy Formats

4. Press **SHIFT HARDCOPY MENU** → **Port** (main) to specify the output channel to send your hardcopy through. Unless your oscilloscope is equipped with Option 13 or Option 1F, the only choice is **GPIB**. (If your oscilloscope is equipped with Option 13, see the TDS Family Option 13 Instruction Manual for setting up hardcopy over the RS-232 and Centronics ports. If your oscilloscope is equipped with Option 1F, you may also select **File** to send your hardcopy to a floppy disk. See *To Save to a Floppy Disk* on page 3–40.)

To Date/Time Stamp Your Hardcopy

You can display the current date and time on screen so that it appears on the hardcopies you print. To date and time stamp your hardcopy, do the following steps:

1. Press **DISPLAY** → **Readout Options** (main) → **Display Date and Time** (side) to toggle the setting to **On**.
2. The date and time are backed up by a battery and need not be set each time you power up the oscilloscope. If the date and time are not set, a message instructing you to do so is displayed. If that is the case, skip steps 3 and 4 and continue with step 1 of *To Set the Date and Time* below. Then redo this procedure.
3. Press **Clear Menu** to remove the menu from the display so the date and time can be displayed. See Figure 3–19. (The date and time is removed from the display when menus are displayed.)
4. Press **HARDCOPY** to print your date/time stamped hardcopy.

To Set the Date and Time

If you need to set the date and time of the oscilloscope, do the following steps:

1. Press **SHIFT UTILITY** → **Config** (pop-up) → **Set Date & Time** (main) → **Year, Day Month, Hour, or Minute**.

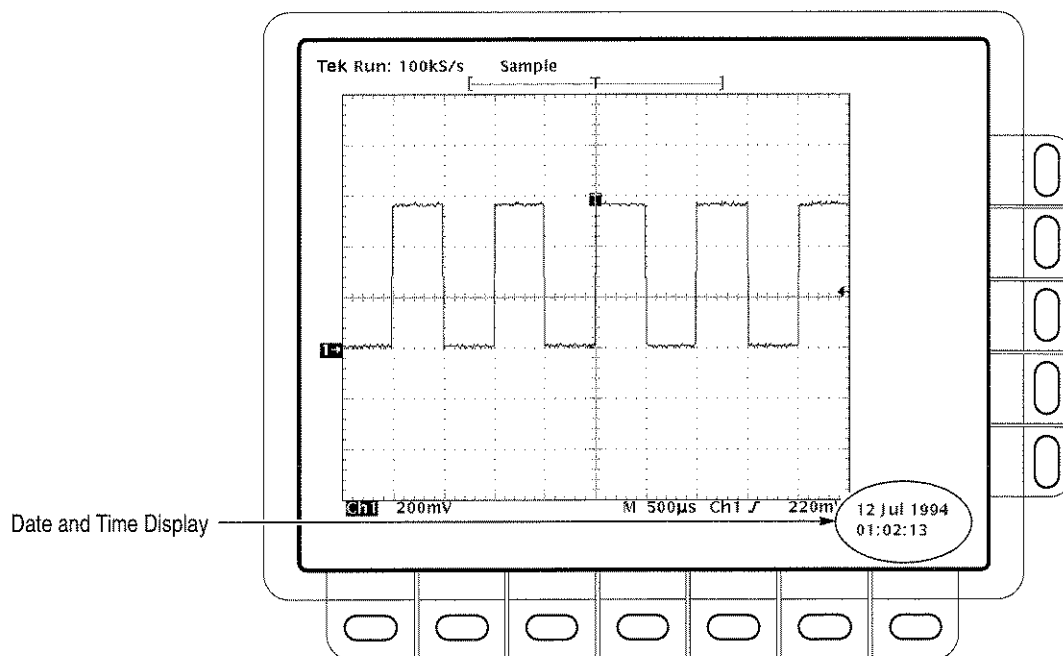

Figure 3-19: Date and Time Display

2. Use the general purpose knob to set the parameter you have chosen to the value desired.
3. Repeat steps 1 and 2 to set other parameters as desired.
4. Press **OK Enter Date/Time** (side) to put the new settings into effect. This sets the seconds to zero.

NOTE. When setting the clock, you can set to a time slightly later than the current time and wait for it to catch up. When current time catches up to the time you have set, pressing **Ok Enter Date/Time** (side) synchronizes the set time to the current time.

5. Press **CLEAR MENU** to see the date/time displayed with the new settings.

To Print Directly to a Hardcopy Device

To make your hardcopies, use the procedures that follow.

Connect to a Hardcopy Device. To connect the digitizing oscilloscope directly to a hardcopy device, determine which interface and cable the device uses, and connect accordingly. (See Figure 3–20.)

Some devices, such as the Tektronix HC100 Plotter, use the GPIB interface. Many printers, such as the Tektronix HC200, use Centronics interfaces (optional on the TDS 400A). Many hardcopy devices, including the HC100 and HC200 with option 03, use RS-232 interfaces (optional on the TDS 400A). Check the documentation for your hardcopy device. If your device uses an RS-232 or Centronics interface and your oscilloscope does not have the Option 13 RS-232/Centronics Hardcopy Interface, see *Connection Strategies* on page 3–43.

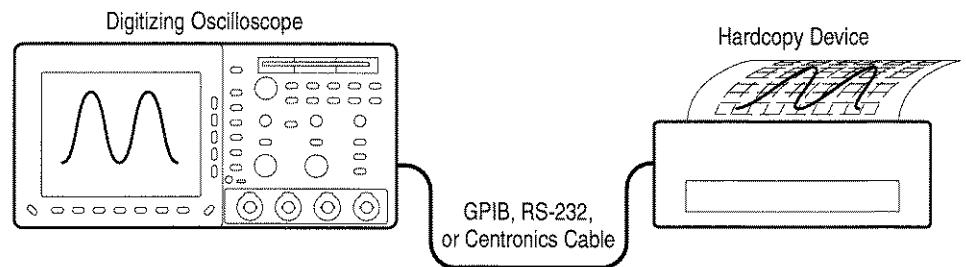

Figure 3–20: Connecting the Digitizing Oscilloscope Directly to the Hardcopy Device

Print. To print a single hardcopy or send additional hardcopies to the digitizing oscilloscope spool (queue) while waiting for earlier hardcopies to finish printing, press **HARDCOPY**.

While the hardcopy is being sent to the printer, the oscilloscope displays the message “Hardcopy in process — Press **HARDCOPY** to abort.”

Abort. To stop and discard the hardcopy being sent, press **HARDCOPY** again *while* the hardcopy in process message is still on screen.

Add to the Spool. To add additional hardcopies to the printer spool, press **HARDCOPY** again *after* the hardcopy in process message is removed from the screen.

You can add hardcopies to the spool until it is full. When the spool is filled by adding a hardcopy, the message “Hardcopy in Process — Press **HARDCOPY** to abort” remains displayed. You can abort the *last* hardcopy sent by pressing the button while the message is still displayed. When the printer empties enough of the spool to finish adding the last hardcopy it does so and then removes the message.

Clear the Spool. To remove all hardcopies from the spool, press **SHIFT → HARDCOPY MENU → Clear Spool (main) → OK Confirm Clear Spool (side)**.

The oscilloscope takes advantage of any unused RAM when spooling hardcopies to printers. The size of the spool is, therefore, variable. The number of hardcopies that can be spooled depends on three variables:

- The amount of unused RAM
- The hardcopy format chosen
- The complexity of the display

To Save to a Floppy Disk

To send hardcopies to a floppy disk, do the following steps:

1. Set up the digitizing oscilloscope communication and hardware parameters as outlined in *To Set Up for Making Hardcopies* on page 3–36.
2. Insert a formatted 720 Kbyte or 1.44 Mbyte floppy disk into the slot at the top of the digitizing oscilloscope.

NOTE. *To format disks, delete hardcopy files you save to disk, and otherwise manage the disk storage, see File System on page 3–31.*

3. Press **SHIFT → HARDCOPY MENU → Port (main) → File (side)** to specify that any hardcopy made be output to a file on the floppy drive. The file list and its scrollbar will appear.
4. Turn the general purpose knob to place the scroll bar over the file in which to store the hardcopy.

NOTE. *Upon power on, the digitizing oscilloscope creates the “wild card” file TEK?????.FMT for storing hardcopies, where “.FMT” is replaced by the hardcopy format you select. Selecting this file and pressing Hardcopy stores a hardcopy in a uniquely named, sequentially numbered file. For instance, the digitizing oscilloscope saves the first hardcopy you save to the file TEK00001.FMT, the second to TEK00002.FMT, and so on.*

5. Press **HARDCOPY** to print your hardcopy to the selected file.

Saving files to the floppy disk provides a convenient way to store hardcopies for later recall and display at a remote site. You can recall them using another digitizing oscilloscope at the remote sight. You might also load them into your desktop publishing software that runs on a PC compatible.

To Print Using a Controller

To make your hardcopies, use the procedures that follow.

Connect to a Hardcopy Device. To connect to a controller with two ports between the digitizing oscilloscope and the hardcopy device, connect from the digitizing oscilloscope GPIB connector (rear panel) to the controller GPIB port and from the controller RS-232 or Centronics port to the hardcopy device (see Figure 3-21). Use the GPIB port to remotely request and receive a hardcopy from the digitizing oscilloscope. Use the RS-232 or a Centronics port on the controller to print output.

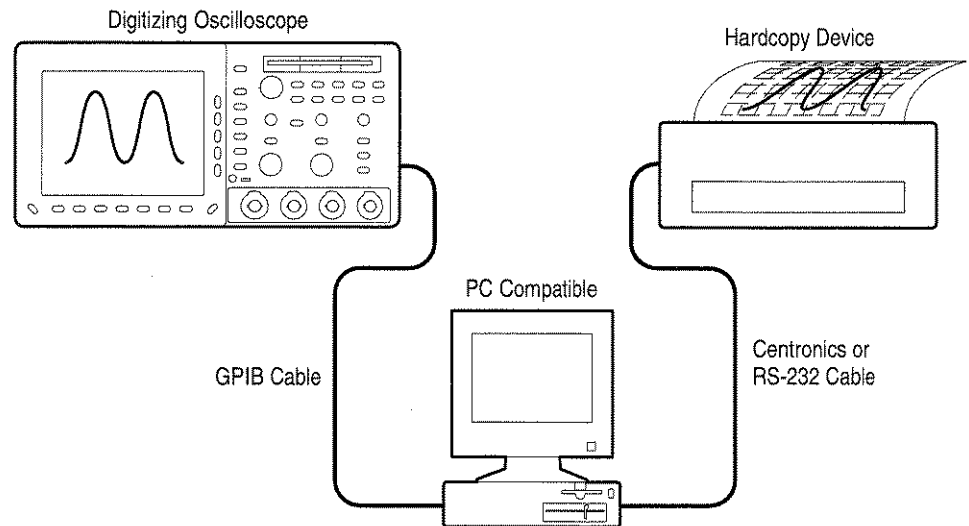

Figure 3-21: Connecting the Digitizing Oscilloscope and Hardcopy Device Via a PC

Print. If your controller is PC-compatible and it uses the Tektronix GURU or S3FG210 (National Instruments GPIB-PCII/IIA) GPIB package, do the following steps to print a hardcopy:

1. Use the MS-DOS *cd* command to move to the directory that holds the software that came with your GPIB board. For example, if you installed the software in the GPIB-PC directory, type: **cd GPIB-PC**
2. Run the IBIC program that came with your GPIB board. Type: **IBIC**

3. Type: **IBFIND DEV1** where “DEV1” is the name for the digitizing oscilloscope you defined using the IBCONF.EXE program that came with the GPIB board.

NOTE. If you defined another name, use it instead of “DEV1”. Also, remember that the device address of the digitizing oscilloscope as set with the IBCONF.EXE program should match the address set in the digitizing oscilloscope Utility menu (typically, use “1”).

Making hardcopies using some hardcopy formats may generate a time-out on your controller. If a time-out occurs, increase the time-out setting of your controller software.

4. Type: **IBWRT “HARDCOPY START”**.

NOTE. Be sure the digitizing oscilloscope Utility menu is set to Talk/Listen and not Hardcopy (Talk Only) or you will get an error message at this step. Setting the digitizing oscilloscope Utility menu was described in To Set Up for Making Hardcopies on page 3–36.

5. Type: **IBRDF <Filename>** where <Filename> is a valid DOS file name you want to call your hardcopy information. It should be ≤8 characters long with up to a 3 character extension. For example, you could type “*ibrdf screen1*”.

6. Exit the IBIC program by typing: **EXIT**

7. Copy the data from your file to your hardcopy device. Type: **COPY <Filename> <Output port> ** where:

<Filename> is the name you defined in step 5

<Output port> is the PC output port your hardcopy device is connected to (such as LPT1 or LPT2)

For example, to copy (print) a file called *screen1* to a printer attached to the *lpt1* parallel port, type “*copy screen1 lpt1: /B*”.

Your hardcopy device should now print a picture of the digitizing oscilloscope screen.

NOTE. If you transmit hardcopy files across a computer network, use a binary (8-bit) data path.

Connection Strategies

The digitizing oscilloscope can print a copy of its display in many formats (see *Supported Formats* page 3–35) to give you a wide choice of hardcopy devices. It also makes it easier for you to place oscilloscope screen copies into a desktop publishing system.

However, since the digitizing oscilloscope has only a GPIB interface port and many hardcopy devices have only RS-232 or Centronics ports, you need a connection strategy for sending the hardcopy data from the digitizing oscilloscope to the printer or plotter. Three such strategies exist:

NOTE. *If your oscilloscope is equipped with Option 13, your oscilloscope has an RS-232 port and a Centronics port in addition to the GPIB port. See the TDS Family Option 13 Instruction Manual for setting up to hardcopy directly through the RS-232 and Centronics ports.*

- Use a printer/plotter with a GPIB connector.
- Use a GPIB-to-Centronics or GPIB-to-RS-232 converter box.
- Send the data to a computer with both GPIB and RS-232 or Centronics ports.

NOTE. *If your oscilloscope is equipped with Option 1F, your oscilloscope has a floppy disk file system. With the file system, you can also send the data to a floppy disk file for later printing from a computer capable of reading the MS-DOS compatible floppy disk.*

Using a GPIB-based Hardcopy Device. You can connect the digitizing oscilloscope directly to a GPIB-based hardcopy device (see Figure 3–20). An example of a GPIB hardcopy device is the Tektronix HC100 Plotter.

Using a GPIB-to-Centronics or GPIB-to-RS-232 Converter. You can put a GPIB-to-Centronics or GPIB-to-RS-232 interface converter box between the digitizing oscilloscope and the RS-232 or Centronics hardcopy device (see Figure 3–22). For example, a National Instruments GPIB-PRL (a GPIB-to-Centronics converter) permits you to make screen prints on a Tektronix HC200 Dot Matrix printer with just a Centronics port.

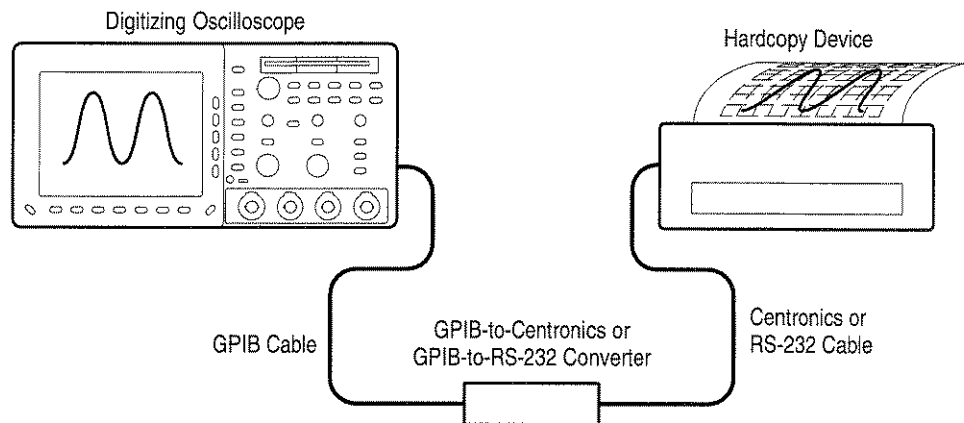

Figure 3-22: Connecting the Digitizing Oscilloscope and Hardcopy Device Via a Converter

For More Information

See *Remote Communication*, on page 3-89.

See the *TDS Family Option 13 Instruction Manual* (Option 13 equipped oscilloscopes only).

See the *File System*, on page 3-31 (Option 1F equipped oscilloscopes only).

Horizontal Control

You can control the horizontal part of the display (the time base) using the horizontal menu and knobs. This section describes how to use the horizontal controls and menus.

To Check the Horizontal Status

Check the *Record View* to determine the size and location of the waveform record and the location of the trigger relative to the display. (See Figure 3–23.) Check the *Time Base readout* at the lower right of the display to see the time/division settings and the time base (main or delayed) being referred to. (See Figure 3–23. Also see Figure 2–29 on page 2–43.) Since all live waveforms use the same time base, the digitizing oscilloscope only displays one value for all the active channels.

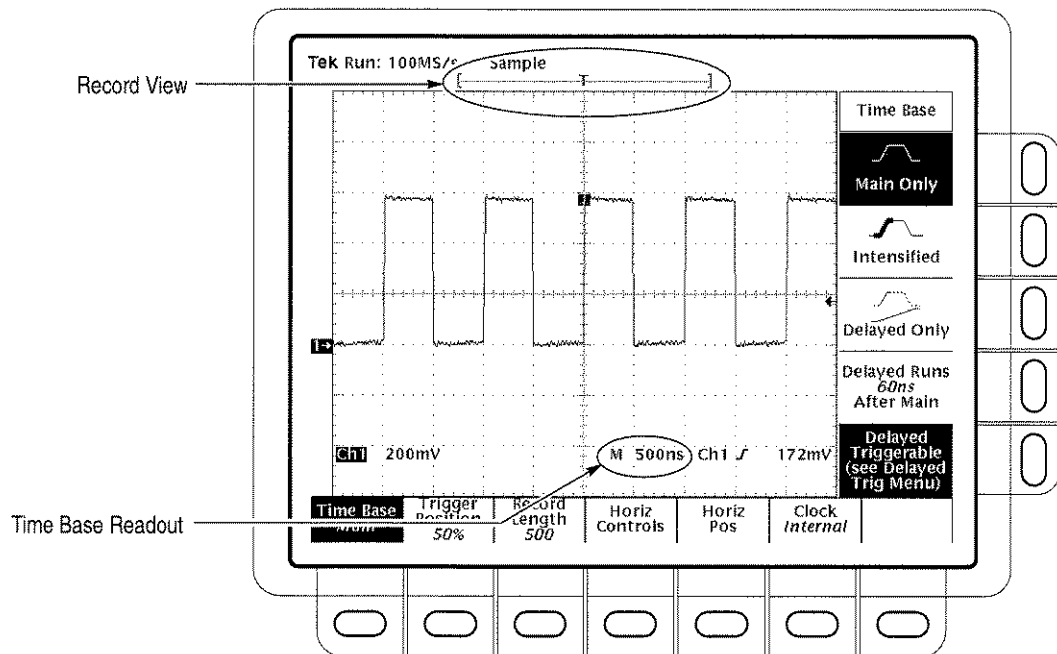

Figure 3–23: Record View and Time Base Readouts

To Change Horizontal Scale and Position

TDS 400A oscilloscopes provide control of horizontal position and scale using either the horizontal front panel knobs or the horizontal menu. This section describes how to use both the knobs and the menu to adjust your waveforms.

By changing the horizontal scale, you can focus on a particular portion of a waveform. By adjusting the horizontal position, you can move the waveform right or left to see different portions of the waveform. That is particularly useful when you are using larger record sizes and cannot view the entire waveform on one screen.

NOTE. *If external clock is enabled and zoom is disabled, the horizontal scale is set to 50 c (indicating 50 clocks per division) and the Horizontal SCALE knob has no effect.*

To change the horizontal scale and position:

1. Turn the horizontal **SCALE** and horizontal **POSITION** knobs (see Figure 3–24).
2. If you want the **POSITION** knob to move faster, press the **SHIFT** button. When the light above the shift button is on and the display reads *Coarse Knobs* in the upper right corner, the **POSITION** knob speeds up significantly.

When you use the horizontal **SCALE** knob and select a channel, you scale all channel waveforms displayed at the same time. If you select a math or reference waveform, you scale only the selected waveform.

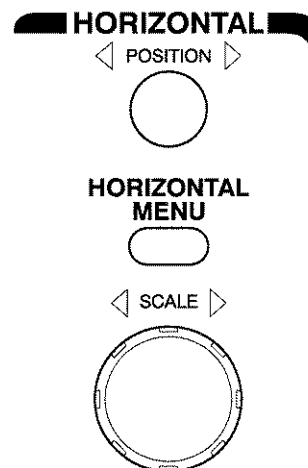

Figure 3–24: Horizontal Controls

When you use the horizontal POSITION knob and select a channel, you position all channel, reference, and math waveforms displayed at the same time *when* Horizontal Lock is set to All in the Zoom menu. For more information on zoom see page 3–135.

To Change Horizontal Parameters

To set the record length, set the trigger position, and change the position or scale, use the *Horizontal menu*. The Horizontal menu also lets you select either a main or delayed view of the time base for acquisitions.

Trigger Position

To define how much of the record is pretrigger and how much posttrigger information, use the Trigger Position menu item:

Press **HORIZONTAL MENU** → **Trigger Position** (main) → **Set to 10%**, **Set to 50%**, or **Set to 90%** (side), or press **Pretrigger** (side) and use the general purpose knob to change the value.

Record Length

The number of points that make up the waveform record is defined by the record length. To set the waveform record length:

1. press **HORIZONTAL MENU** → **Record Length** (main). The side menu lists various discrete record length choices.
2. To fit all (or most) of an acquired waveform to the visible screen, regardless of record length, press **HORIZONTAL MENU** → **Record Length** (main). Then toggle **Fit to Screen** to **ON** from the side menu. This provides similar functionality to being in zoom mode and changing the time/division until the waveform fits the screen. To turn off this feature, toggle **Fit to Screen** to **OFF**.

NOTE. *With Option 1M and 2A, there are only 120K points available for reference waveforms. If you select the 120K record length in the Horizontal menu, you can only save one reference waveform. Also, you can only use/display four waveforms. Even if you do not display the source waveforms, dual waveform math uses three of the four waveforms. For example: if you display a math waveform that is the sum of CH 1 and CH 2, even if CH 1 and CH 2 are not displayed, you have used three waveforms. Therefore, you can only display one additional waveform.*

Horizontal Scale

To change the horizontal scale (time per division) numerically in the menu instead of using the Horizontal SCALE knob:

NOTE. *If external clock is enabled and zoom is disabled, the Horizontal SCALE knob has no effect and both the Horizontal Main Scale and Delayed Scale are the same (50 c). If zoom is enabled, you can change the displayed scale, but the Delayed Scale is locked to the Main Scale.*

Press **HORIZONTAL MENU** → **Horiz Controls** (main) → **Main Scale** or **Delayed Scale** (side) and use the general purpose knob to change the scale values.

NOTE. *When you set the Horizontal SCALE to 50 ms or slower and the Roll Mode Status is Automatic or if the horizontal Clock menu is set to External and the maximum external sample rate is set to 1 kc per second maximum or less, the oscilloscope enters Roll mode. You can read about Roll mode beginning on page 3–93.*

Roll Mode

You can turn Roll Mode off or allow roll mode to turn on and off automatically (see *Roll Mode* on page 3–93 for more information):

Press **HORIZONTAL MENU** → **Horiz Controls** (main). Press **Roll Mode** (side) to toggle Roll Mode between OFF and Auto.

Horizontal Position

To set the horizontal position to specific values in the menu instead of using the Horizontal POSITION knob:

Press **HORIZONTAL MENU** → **Horiz Pos** (main) → **Set to 10%**, **Set to 50%** or **Set to 90%** (side) to choose how much of the waveform is displayed to the left of the display center.

You can also control whether changing the horizontal position setting affects all displayed waveforms, just the live waveforms, or only the selected waveform. See *Zoom*, on page 3–135 for the steps to set the horizontal lock feature.

To Select the Delayed Time Base

To select between the Main and Delayed views of the time base:

Press **HORIZONTAL MENU** → **Time Base** (main) → **Main Only**, **Intensified**, or **Delayed Only** (side).

NOTE. If external clock is enabled, selecting *Intensified* intensifies the entire time base.

By pressing *Intensified*, you display an intensified zone that shows where the delayed trigger record length could occur relative to the main trigger. To learn how to change the intensity of the normal and intensified waveform, see *Display Modes* on page 3–21.

You also can select *Delayed Runs After Main* or *Delayed Triggerable*. For more information on the delayed trigger, see *Delayed Triggering* on page 3–13.

Horizontal Clock

To change the horizontal clock:

Press **HORIZONTAL MENU** → **Clock** (main) → **Internal** or **External** (side) and use the general purpose knob to change the scale values.

NOTE. When you select *External clock*, the unzoomed horizontal scale changes to 50 c (indicating 50 clocks per division). When using *Option 2F*, *external clock*, and cursors to measure frequency, the displayed frequency is normalized to the external Clock frequency. To calculate the actual frequency, multiply the displayed frequency by the external clock frequency divided by Hertz. For example: if the displayed cursor frequency is 500 Hz and the external clock frequency is 2 kHz:

$$500 \text{ Hz} \times \frac{2 \text{ kHz}}{\text{Hz}} = 1.0 \text{ MHz}$$

To Acquire a waveform Using an External Clock

A disk drive, turbine, and a punch press all have parts that move or turn. Their behavior is often best observed using an external Clock. By using a Tachometer or a Optical Encoder, you can precisely convert the revolution or travel of the systems into electric pulses. By using an external clock, you can see the angle or position at which events occur. As the system speed changes, the display shows each event at the same position on the screen; the displayed waveform will not stretch or compress with system speed changes, as it would using the internal clock.

In external clock mode, you can still trigger the oscilloscope to cause the acquired waveforms to lock to a certain position of an encoder which is providing the external clock. For example, some encoders provide a trigger out signal. Another example of a signal that you could use as a trigger is the sector 0 signal in a computer hard disk; observing the acquired waveform, the trigger T shows where in the record the hard disk returns to sector 0.

To acquire a waveform using an external clock:

NOTE. *In Hi Res mode the frequency of the external clock signal must be less than or equal to the frequency set in the external clock side menu. If the frequency of the external clock signal is greater than the frequency set in the side menu, the displayed waveform will have the wrong amplitude and often the wrong shape. Hi Res mode increases resolution and limits bandwidth (see Table 3-1 on page 3-8). As the Max Ext Clk rate is reduced, resolution increases and bandwidth decreases.*

Press **HORIZONTAL MENU** → **Clock** (main) → **External** (side) and, if in Hi Res mode, use the general purpose knob to set the maximum external clock frequency.



CAUTION. *To prevent damage to the external clock and external trigger circuitry, do not exceed the input voltage rating of the **EXT CLOCK/AUX TRIGGER** input (see Auxiliary Trigger Input, External Clock Input on page B-14).*

Connect your TTL-like external clock signal to the **EXT CLOCK/AUX TRIGGER BNC** at the rear of the oscilloscope. If your EXT CLK source can drive 50Ω to TTL levels, use a 50Ω terminator. Before connecting your external clock signal, make certain the signal has TTL levels and a 30 μs or faster falling edge. (In External Clock mode, sampling occurs on the falling edge of the clock.)

Connect the signals you wish to acquire to the input channels.

NOTE. *If you set the maximum clock frequency to 1 kHz, do not connect an external clock with a frequency greater than 1 kHz. If you do, you may need to remove the external clock signal and turn the oscilloscope power off and then on.*

To bring up the Edge Trigger menu and select which source you want for the trigger, on the TDS 420A and TDS 460A, press **TRIGGER MENU** → **Type** (main) → **Edge** (pop-up) → **Source** (main) → **Ch1, Ch2, Ch3, Ch4, AC Line, or Auxiliary** (side). On the TDS 410A, press **TRIGGER MENU** → **Type** (main) → **Edge** (pop-up) → **Source** (main) → **Ch1, Ch2, AC Line, or Auxiliary** (side), and then press **SET LEVEL TO 50%**.

Set all other oscilloscope controls (the horizontal SCALE has no effect except in ZOOM) as you would for an internally clocked acquisition.

For More Information

See *Scaling and Positioning Waveforms*, on page 2–43.

See *Delayed Triggering*, on page 3–13.

See *Zoom*, on page 3–135.

Limit Testing

Limit testing provides a way to automatically compare each incoming or math waveform against a template waveform. You set an envelope of limits around a waveform and let the digitizing oscilloscope find waveforms that fall outside those limits (see Figure 3–25). When it finds such a waveform, the digitizing oscilloscope can generate a hardcopy, ring a bell, stop and wait for your input, or any combination of these actions. This section describes how to use limit testing.

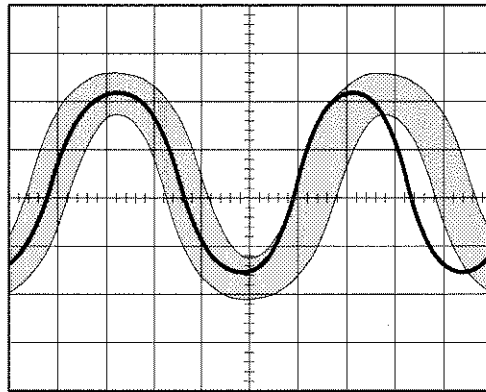

Figure 3–25: Comparing a Waveform to a Limit Template

When you use the limit testing feature, the first task is to create the limit test template from a waveform. Next, specify the channel to compare to the template. Then you specify the action to take if incoming waveform data exceeds the set limits. Finally, turn limit testing on so that the parameters you have specified take effect.

To Create a Limit Test Template

To use an incoming or stored waveform to create the limit test template, first select a source.

1. To access limit testing, press **SHIFT ACQUIRE MENU** to bring up the Acquire menu.

- On TDS 420A and TDS 460A, press **Create Limit Test Template** (main) → **Template Source** (side) → **Ch1, Ch2, Ch3, Ch4, Math1, Math2, Math3, Ref1, Ref2, Ref3, or Ref4** (side). On TDS 410A, press **Create Limit Test Template** (main) → **Template Source** (side) → **Ch1, Ch2, Math1, Math2, Math3, Ref1, Ref2, Ref3, or Ref4** (side). (See Figure 3–26).

NOTE. The template will be smoother if you acquire the template waveform using Average acquisition mode. If you are unsure how to do this, see *Selecting an Acquisition Mode* on page 3–9.

Once you have selected a source, select a destination for the template.

- Press **Template Destination** (side) → **Ref1, Ref2, Ref3, or Ref4**.

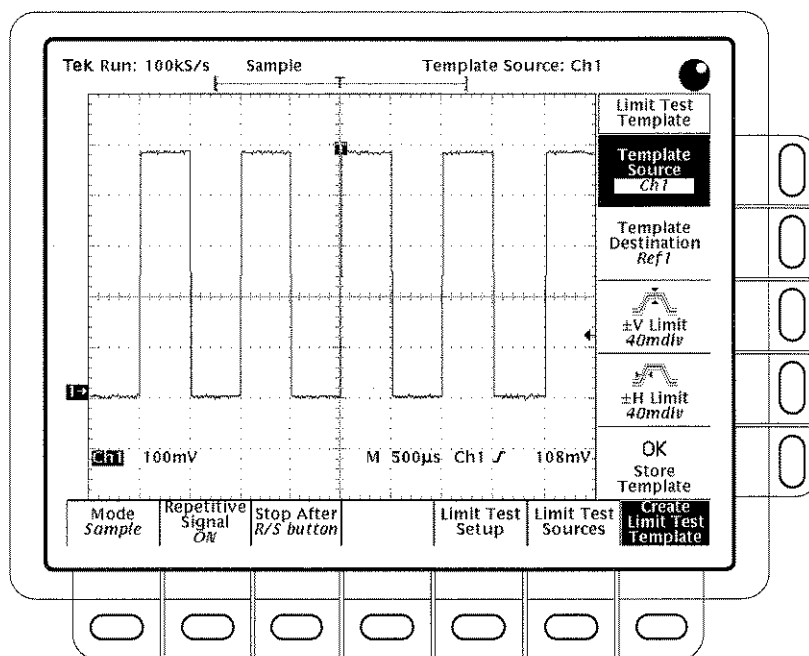

Figure 3–26: Acquire Menu — Create Limit Test Template

Now create the envelope by specifying the amount of variation from the template that you will tolerate. Tolerance values are expressed in fractions of a major division. They represent the amount by which incoming waveform data can deviate without having exceeded the limits set in the limit test. The range is from 0 (the incoming waveform must be exactly like the template source) to 5 major divisions of tolerance.

- Press **±V Limit** (side). Enter the vertical (voltage) tolerance value using the general purpose knob.

5. Press **±H Limit** (side). Enter the horizontal (time) tolerance value using the general purpose knob.
6. When you have specified the limit test template as you wish, press **OK Store Template** (side). This action stores the specified waveform in the specified destination, using the specified tolerances. Until you have done so, the template waveform has been defined but not created.

If you wish to create another limit test template, store it in another destination to avoid overwriting the template you just created.

If you wish to view the template you created, press the **MORE** button. Then press the button corresponding to the destination reference memory you used. The waveform appears on the display.

NOTE. When Limit Testing is on, the template waveform is dimmed so you can see the waveform through the template. However, to view the waveform data as well as the template envelope when limit testing is off, use the Dots display style (see Display Modes on page 3–21).

To Select a Limit Test Source

Now specify the channel that will acquire the waveforms to be compared against the template you created.

1. On TDS 420A and TDS 460A, press **SHIFT ACQUIRE MENU → Limit Test Sources** (main) → **Compare Ch1 to, Compare Ch2 to, Compare Ch3 to, or Compare Ch4 to** (side). On TDS 410A, press **SHIFT ACQUIRE MENU → Limit Test Sources** (main) → **Compare Ch1 to, Compare Ch2 to,** (side).
2. Once you select one of the channels as a waveform source from the side menu, press the same side menu button to toggle to one of the reference memories in which you stored a template.

Valid selections are any of the four reference waveforms **Ref1** through **Ref4** or **None**. Choosing **None** turns limit testing off for the specified channel.

NOTE. Specify the same reference memory you chose as the template destination if you wish to use the template you just created.

If you have created more than one template, you can compare one channel to one template and the other channel to another template.

To Specify the Limit Test Response

Now specify the action to take if waveform data exceeds the limits set by the limit test template.

1. Press **SHIFT ACQUIRE MENU** → **Limit Test Setup** (main) to bring up a side menu of possible actions.
2. Ensure that the side button corresponding to the desired action reads **ON**:
 - If you want to send a hardcopy command when waveform data exceeds the limits set, toggle **Hardcopy if Condition Met** (side) to **ON**. (Do not forget to set up the hardcopy system. See *Hardcopy* on page 3–35 for details.)
 - If you want the bell to ring when waveform data exceeds the limits set, toggle **Ring Bell if Condition Met** (side) to **ON**.
 - If you want the digitizing oscilloscope to stop when waveform data exceeds the limits set, toggle **Stop After Limit Test Condition Met** (side) to **ON**.

NOTE. The button labeled *Stop After Limit Test Condition Met* corresponds to the *Limit Test Condition Met* menu item in the *Stop After* main menu. You can turn this button on in the *Limit Test Setup* menu, but you cannot turn it off. In order to turn it off, press *Stop After* and specify one of the other choices in the *Stop After* side menu.

Now that you have set the oscilloscope up for limit testing, you must turn limit testing on in order for any of these actions to take effect.

3. Ensure that **Limit Test** (side) reads **ON**. If it reads **OFF**, press **Limit Test** (side) once to toggle it to **ON**.

When you set **Limit Test** to **ON**, the digitizing oscilloscope compares incoming waveforms against the waveform template stored in reference memory according to the settings in the **Limit Test Sources** side menu.

Single Waveform Comparisons

You can compare a single waveform against a single template. When making a single waveform versus a single template comparison, consider the following operating characteristics:

- The waveform is repositioned horizontally to move the first sample in the waveform record that is outside of template limits to center screen.
- The position of the waveform template tracks that of the waveform.

Multiple Waveform Comparisons

You can also compare more than one waveform against a single template or more than one waveform with each one compared against its own template. When comparing multiple waveforms, consider the following operating characteristics:

- You should set Horizontal Lock to None in the Zoom side menu (push **ZOOM** and toggle **Horizontal Lock** to **None**).
- With horizontal lock set as just described, the oscilloscope repositions each waveform horizontally to move the first sample in the waveform record that is outside of template limits to center screen.
- If you are comparing each waveform to its own template, the position of each waveform template tracks that of its waveform.
- If you are comparing two or more waveforms to a common template, that template tracks the position of the failed waveform. If more than one waveform fails *during the same acquisition*, the template tracks the position of the waveform in the highest numbered channel. For example, CH 2 is higher than CH 1.

For More Information

See *Acquisition*, on page 2–39.

See *Acquisition Modes*, on page 3–5.

See *Display Modes*, on page 3–21.

See *Zoom*, on page 3–135.

Measuring Waveforms

There are various ways to measure properties of waveforms. You can use graticule, cursor, or automatic measurements. This section describes *automatic measurements*; cursors and graticules are described elsewhere. (See *Taking Cursor Measurements* on page 3–115 and *Measurements* on page 2–47.)

Automatic measurements are generally more accurate and quicker than, for example, manually counting graticule divisions. The oscilloscope continuously updates and displays these measurements. (There is also a way to display all the measurements at once — see *Take a Snapshot of Measurements* on page 3–68.)

Automatic measurements are taken over the entire waveform record or, if you specify gated measurements, over the region specified by the vertical cursors. (See *Gated Measurements* on page 3–63.) Automated measurements are not performed just on the displayed portions of waveforms.

Measurement List

The TDS 400A Series Digitizing Oscilloscopes provide you with 25 automatic measurements. Table 3–3 lists brief definitions of the automated measurements in the digitizing oscilloscope (for more details see *Appendix C: Algorithms*, on page C–1).

Table 3–3: Measurement Definitions







Name	Definition
 Amplitude	Voltage measurement. The high value less the low value measured over the entire waveform or gated region. $Amplitude = High - Low$
 Area	Voltage over time measurement. The area over the entire waveform or gated region in volt-seconds. Area measured above ground is positive; area below ground is negative.
 Burst Width	Timing measurement. The duration of a burst. Measured over the entire waveform or gated region.
 Cycle Area	Voltage over time measurement. The area over the first cycle in the waveform, or the first cycle in the gated region, in volt-seconds. Area measured above ground is positive; area below ground is negative.
 Cycle Mean	Voltage measurement. The arithmetic mean over the first cycle in the waveform, or the first cycle in the gated region.
 Cycle RMS	Voltage measurement. The true Root Mean Square voltage over the first cycle in the waveform, or the first cycle in the gated region.
 Delay	Timing measurement. The time between the MidRef crossings of two different traces, or the gated region of the traces.

Table 3–3: Measurement Definitions (Cont.)



















Name	Definition
 Fall Time	Timing measurement. Time taken for the falling edge of the first pulse in the waveform or gated region to fall from a High Ref value (default = 90%) to a Low Ref value (default = 10%) of its final value.
 Frequency	Timing measurement for the first cycle in the waveform or gated region. The reciprocal of the period. Measured in Hertz (Hz) where 1 Hz = 1 cycle per second.
 High	The value used as 100% whenever High Ref, Mid Ref, and Low Ref values are needed (as in fall time and rise time measurements). Calculated using either the min/max or the histogram method. The <i>min/max</i> method uses the maximum value found. The <i>histogram</i> method uses the most common value found above the mid point. Measured over the entire waveform or gated region.
 Low	The value used as 0% whenever High Ref, Mid Ref, and Low Ref values are needed as in fall time and rise time measurements. May be calculated using either the min/max or the histogram method. With the min/max method it is the minimum value found. With the histogram method, it refers to the most common value found below the mid point. Measured over the entire waveform or gated region.
 Maximum	Voltage measurement. The maximum amplitude. Typically the most positive peak voltage. Measured over the entire waveform or gated region.
 Mean	Voltage measurement. The arithmetic mean over the entire waveform or gated region.
 Minimum	Voltage measurement. The minimum amplitude. Typically the most negative peak voltage. Measured over the entire waveform or gated region.
 Negative Duty Cycle	Timing measurement of the first cycle in the waveform or gated region. The ratio of the negative pulse width to the signal period expressed as a percentage. $\text{NegativeDutyCycle} = \frac{\text{NegativeWidth}}{\text{Period}} \times 100\%$
 Negative Overshoot	Voltage measurement. Measured over the entire waveform or gated region. $\text{NegativeOvershoot} = \frac{\text{Low} - \text{Min}}{\text{Amplitude}} \times 100\%$
 Negative Width	Timing measurement of the first pulse in the waveform or gated region. The distance (time) between MidRef (default 50%) amplitude points of a negative pulse.
 Peak to Peak	Voltage measurement. The absolute difference between the maximum and minimum amplitude in the entire waveform or gated region.
 Period	Timing measurement. Time it takes for the first complete signal cycle to happen in the waveform or gated region. The reciprocal of frequency. Measured in seconds.
 Phase	Timing measurement. The amount one waveform leads or lags another in time. Expressed in degrees, where 360° comprise one waveform cycle.
 Positive Duty Cycle	Timing measurement of the first cycle in the waveform or gated region. The ratio of the positive pulse width to the signal period expressed as a percentage. $\text{PositiveDutyCycle} = \frac{\text{PositiveWidth}}{\text{Period}} \times 100\%$

Table 3–3: Measurement Definitions (Cont.)

Name	Definition
 Positive Overshoot	Voltage measurement over the entire waveform or gated region. $PositiveOvershoot = \frac{Max - High}{Amplitude} \times 100\%$
 Positive Width	Timing measurement of the first pulse in the waveform or gated region. The distance (time) between MidRef (default 50%) amplitude points of a positive pulse.
 Rise time	Timing measurement. Time taken for the leading edge of the first pulse in the waveform or gated region to rise from a Low Ref value (default = 10%) to a High Ref value (default = 90%) of its final value.
 RMS	Voltage measurement. The true Root Mean Square voltage over the entire waveform or gated region.

Measurement Readouts

With no menus displayed, the measurement readouts appear at the right of the display (see Figure 3–27). When menus are displayed, the readouts appear in the graticule area. You can display and continuously update as many as four measurements at any one time.

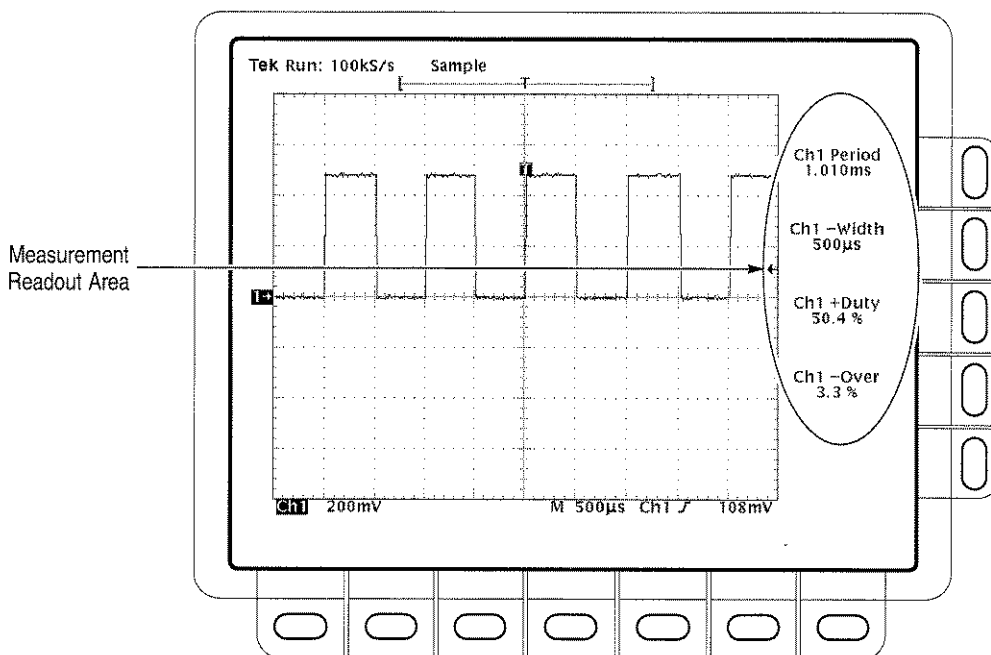

Figure 3–27: Measurement Readouts

Measurement 1 is the top readout. Measurement 2 is below it, and so forth. Once a measurement readout is displayed in the screen area, it stays in its position even when you remove any measurement readouts above it.

Measurement Units

Selecting External clock from the Horizontal Clock menu changes the units of measurements related to the horizontal scale of a waveform. When switching from internal to external clocks, units of seconds become clocks, units of Hertz become /clock, and units of Vsec become Vclocks.

Select and Display Measurements

To use the automatic measurements you first need to obtain a stable display of the waveform to be measured. Pressing **AUTOSET** may help. Once you have a stable display, press **MEASURE** to bring up the Measure menu (Figure 3-28).

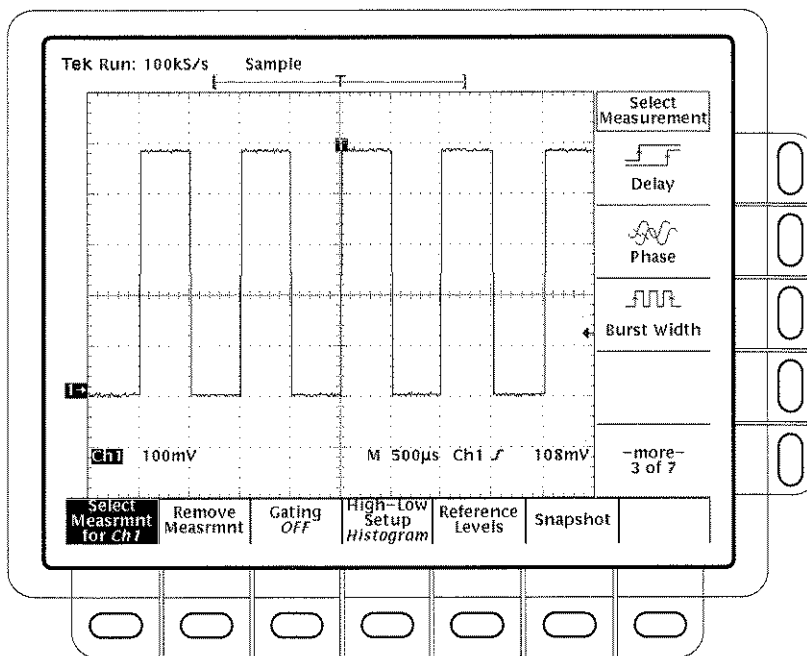

Figure 3-28: Measure Menu

Measurements are made on the selected waveform. The measurement display tells you the channel the measurement is being made on.

1. Press **MEASURE** → **Select Measrmt** (main).

2. Select a measurement from the side menu.

Note the following rules for taking automatic measurements:

- You can only take a maximum of four measurements at a time. To add a fifth, you must remove one or more of the existing measurements.
- To vary the source for measurements, simply select the other channel and then choose the measurements you want.
- Be careful when taking automatic measurements on noisy signals. You might measure the frequency of the noise and not the desired waveform.

Your digitizing oscilloscope helps identify such situations by displaying a *low signal amplitude* or *low resolution* warning message.

Remove Measurements

The Remove Measrmt selection provides explicit choices for removing measurements from the display according to their readout position. To remove measurements, do the following steps:

1. Press **MEASURE** → **Remove Measrmt** (main).
2. Select the measurement to remove from the side menu. If you want to remove all the measurements at one time, press **All Measurements** (side).

Gate Measurements

The gating feature lets you limit measurements to a specified portion of the waveform. When gating is Off, the oscilloscope makes measurements over the entire waveform record.

When gating is ON, vertical cursors are displayed. Use these cursors to define the section of the waveform you want the oscilloscope to measure. (This section is called the *gated region*.) Do the following steps to gate a measurement:

1. Press **MEASURE** → **Gating** (main) → **Gate with V Bar Cursors** (side) (see Figure 3–29).
2. Using the general purpose knob, move the selected (the active) cursor. Press **SELECT** to change which cursor is active.

Displaying the cursor menu and turning V Bar cursors off does *not* turn gating off. (Gating arrows remain on screen to indicate the area over which the measurement is gated.) You must turn gating off in the Gating side menu.

NOTE. Cursors are displayed relative to the selected waveform. If you are making a measurement using two waveforms, this can be a source of confusion. If you turn off horizontal locking and adjust the horizontal position of one waveform independent of the other, the cursors appear at the requested position with respect to the selected waveform. Gated measurements remain accurate, but the displayed positions of the cursors change when you change the selected waveform.

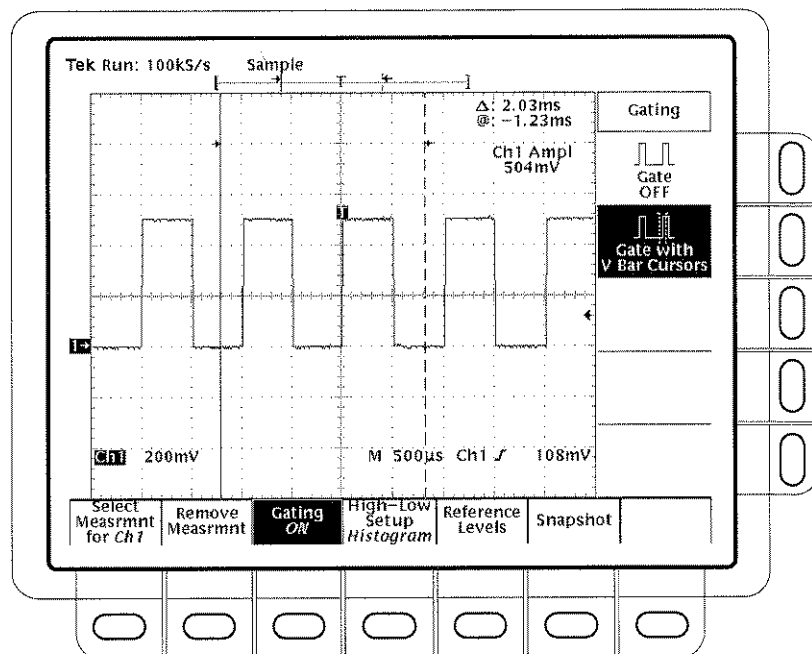

Figure 3–29: Measure Menu — Gating

Define High-Low Setup

The oscilloscope provides two choices, *histogram* and *min-max*, for specifying how measure determines the High and Low levels of waveforms. To use the high-low setup do the following step:

Press **MEASURE** → **High-Low Setup** (main) → **Histogram** or **Min-Max** (side). If you select Min-Max, you may also want to check or revise values using the Reference Levels main menu.

Histogram sets the values statistically. It selects the most common value either above or below the mid point (depending on whether it is defining the high or low reference level). Since this statistical approach ignores short term aberrations (overshoot, ringing, and so forth), histogram is the best setting for examining pulses.

Min-max uses the highest and lowest values of the waveform record. This setting is best for examining waveforms that have no large, flat portions at a common value, such as sine wave and triangle waves—almost any waveform except for pulses.

Define Reference Levels

Once you define the reference levels, the digitizing oscilloscope uses them for all measurements requiring those levels. To set the reference levels, do the following steps:

1. Press **MEASURE** → **Reference Levels** (main) → **Set Levels** (side) to choose whether the References are set in % relative to High (100%) and Low (0%) or set explicitly in the units of the selected waveform (typically volts). See Figure 3–30. Use the general purpose knob to enter the values.

% is the default selection. It is useful for general purpose applications.

Units is helpful for setting precise values. For example, if you are measuring specifications on an RS-232-C circuit, set the levels precisely to RS-232-C specification voltage values by defining the high and low references in units.

2. Press **High Ref**, **Mid Ref**, **Low Ref**, or **Mid2 Ref** (side).

f

High Ref sets the high reference level. The default is 90%.

f

Mid Ref sets the middle reference level. The default is 50%.

f

Low Ref sets the low reference level. The default is 10%.

f

Mid2 Ref sets the middle reference level used on the second waveform specified in Delay or Phase Measurements. The default is 50%.

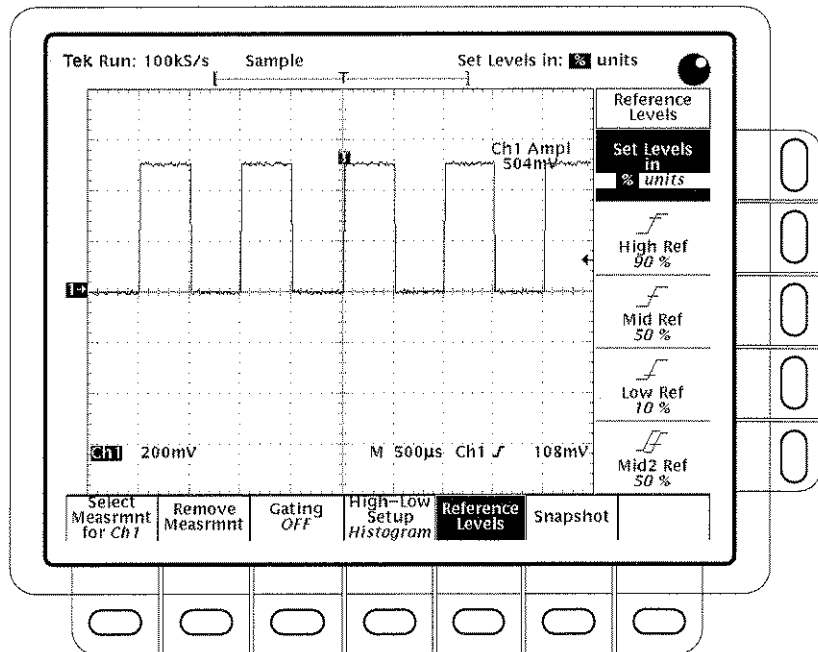

Figure 3-30: Measure Menu — Reference Levels

Take a Delay Measurement

The delay measurement lets you measure from an edge on the selected waveform to an edge on another waveform. To make a delay measurement, do the following steps:

1. Press **MEASURE** → **Select Measrmt** (main) → **Delay** (side) → **Delay To** (main) → **Measure Delay to**.
2. Press **Measure Delay to** (side) repeatedly to choose the delay *to* waveform. For TDS 420A and TDS 460A the choices are **Ch1, Ch2, Ch3, Ch4; and Math1, Math2, Math3, Ref1, Ref2, Ref3, and Ref4**. For TDS 410A the choices are **Ch1, Ch2; and Math1, Math2, Math3, Ref1, Ref2, Ref3, and Ref4**.

The steps just performed select the waveform you want to measure *to*; note that the waveform you are measuring the delay *from* is the selected waveform. (See Figure 3-31.)

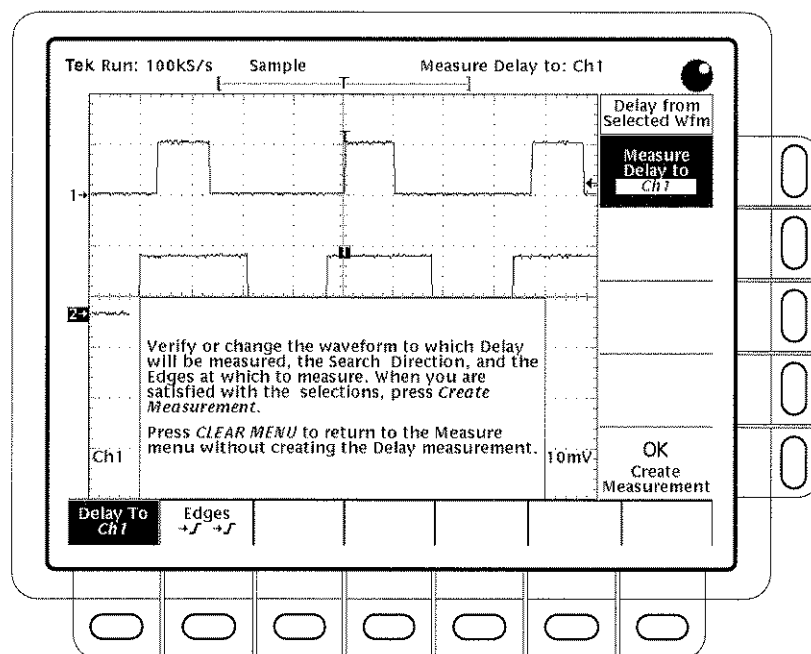

Figure 3-31: Measure Delay Menu — Delay To

3. Press **MEASURE** → **Select Measrmnt** (main) → **Delay** (side) → **Edges** (main). A side menu of delay edges and directions appears. Choose from one of the combinations displayed on the side menu using the following information:
 - The selection you choose defines which edges you want the delayed measurement to be made between.
 - The upper waveform on each icon represents the *from* waveform and the lower one represents the *to* waveform.
 - The direction arrows on the choices let you specify a forward search on both waveforms or a forward search on the *from* waveform and a backwards search on the *to* waveform. The latter choice is useful for isolating a specific pair of edges out of a stream.
4. To take the measurement you just specified, press **Delay To** (main) → **OK Create Measurement** (side).

To exit the Measure Delay menu without creating a delay measurement, press **CLEAR MENU**, which returns you to the Measure menu.

Take a Snapshot of Measurements

Sometimes you may want to see all of the automated measurements on screen at the same time. To do so, use Snapshot. Snapshot executes all of the single waveform measurements available on the selected waveform *once* and displays the results. (The measurements are not continuously updated.) All of the measurements listed in Table 3–3 on page 3–59 except for Delay and Phase are displayed. (Delay and Phase are dual waveform measurements and are not available with Snapshot.)

The readout area for a snapshot of measurements is a pop up display that covers about 80% of the graticule area when displayed (see Figure 3–32). You can display a snapshot on any channel or ref memory, but only one snapshot can be displayed at a time.

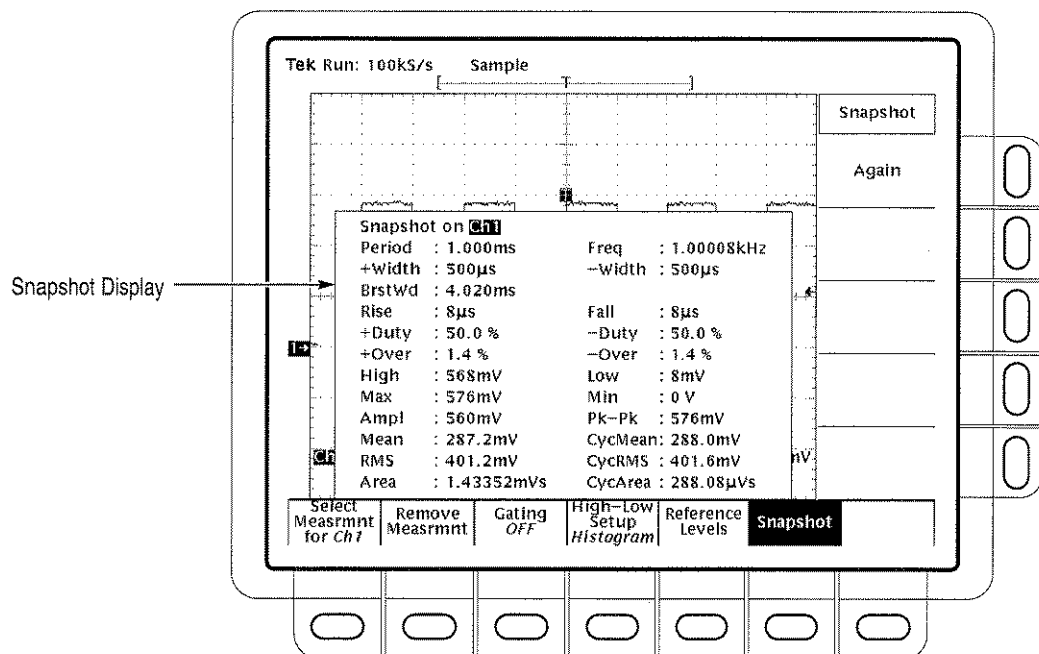

Figure 3–32: Snapshot Menu and Readout

To use snapshot, obtain a stable display of the waveform to be measured (pressing **AUTOSET** may help). Then do the following steps:

1. Press **MEASURE** → **SNAPSHOT** (main).
2. Press either **SNAPSHOT** (main) or **AGAIN** (side) to take another snapshot.

NOTE. The snapshot display tells you the channel that the snapshot is being made on.

3. Push **Remove Measrmt.**

Consider the following rules when taking a snapshot:

- Be sure to display the waveform properly before taking a snapshot. Snapshot does not warn you if a waveform is improperly scaled (clipped, low signal amplitude, low resolution, and so on).
- To vary the source for taking a snapshot, simply select another channel, math, or ref memory waveform and then execute snapshot again.
- A snapshot is taken on a single waveform acquisition (or acquisition sequence). The measurements in the snapshot display are not continuously updated.
- Be careful when taking automatic measurements on noisy signals. You might measure the frequency of the noise and not the desired waveform.
- Note that pushing any button in the main menu (except for Snapshot) or any front panel button that displays a new menu removes the snapshot from display.
- Use High-Low Setup (page 3–64), Reference Levels (page 3–65), and Gated Measurements (page 3–63) with snapshot exactly as you would when you display individual measurements from the Select Measrmt menu.

For More Information

See *Appendix C: Algorithms*, on page C–1, for details on how the digitizing oscilloscope calculates each automatic measurement.

See *Measurements*, on page 2–47, for a brief discussion of automated, cursor, and graticule measurements.

See *Example 3: Taking Automated Measurements*, on page 2–24, for a tutorial example of making automatic measurements.

Probe Accessories

The probe you use and how you connect it to a signal source affect the oscilloscope acquisition of the waveform record. Two important factors are ground lead inductance (introduced by the probe) and the physical layout of your circuit and component devices.

Ground Lead Inductance

For an amplitude measurement to be meaningful, you must give the measurement a point of reference. The probe offers you the capability of referencing the voltage at its tip to ground. To make your measurement as accurate as possible, connect the probe ground lead to the ground reference.

However, when you touch your probe tip to a circuit, you are introducing new resistance, capacitance, and inductance into the circuit (Figure 3–33).

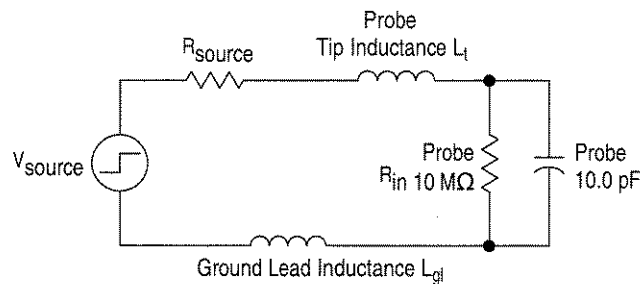

Figure 3–33: A Probe Adds Resistance, Capacitance, and Inductance

For most circuits, the high input resistance of a passive probe has a negligible effect on the signal. The series inductances represented by the probe tip and ground lead, however, can result in a parasitic resonant circuit that may “ring” within the bandwidth of the oscilloscope. Figure 3–34 shows the effect of the same signal through the same probe with different ground leads.

If the frequency of the induced ringing is beyond the bandwidth of the oscilloscope, ringing and rise time degradation may be hidden. If you know the self-inductance (L) and capacitance (C) of your probe and ground lead, you can calculate the approximate resonant frequency (f_0) at which that parasitic circuit resonates:

$$f_0 = \frac{1}{2\pi \times \sqrt{LC}}$$

Reducing the ground lead inductance raises the resonant frequency. Ideally, the inductance is low enough that the resulting frequency is above the frequency at which you want to take measurements. For that purpose, the probes include several accessories to help reduce ground lead inductance.

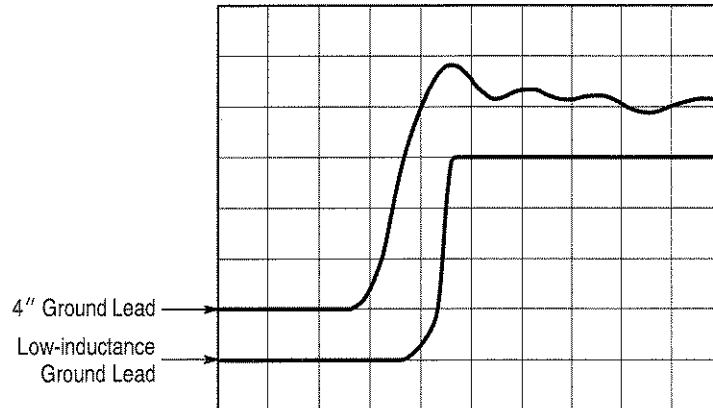

Figure 3–34: Signal Variation Introduced by Probe Ground Lead (1 ns/division)

Standard Probe Accessories

The following descriptions explain how to use many of the accessories that came with your probe. Figure 3–35 shows both standard and optional probe accessories and how they attach to your probe.

These accessories either reduce ground lead inductance or make it physically easier to probe different kinds of circuits.

Standard probe accessories include the following items.

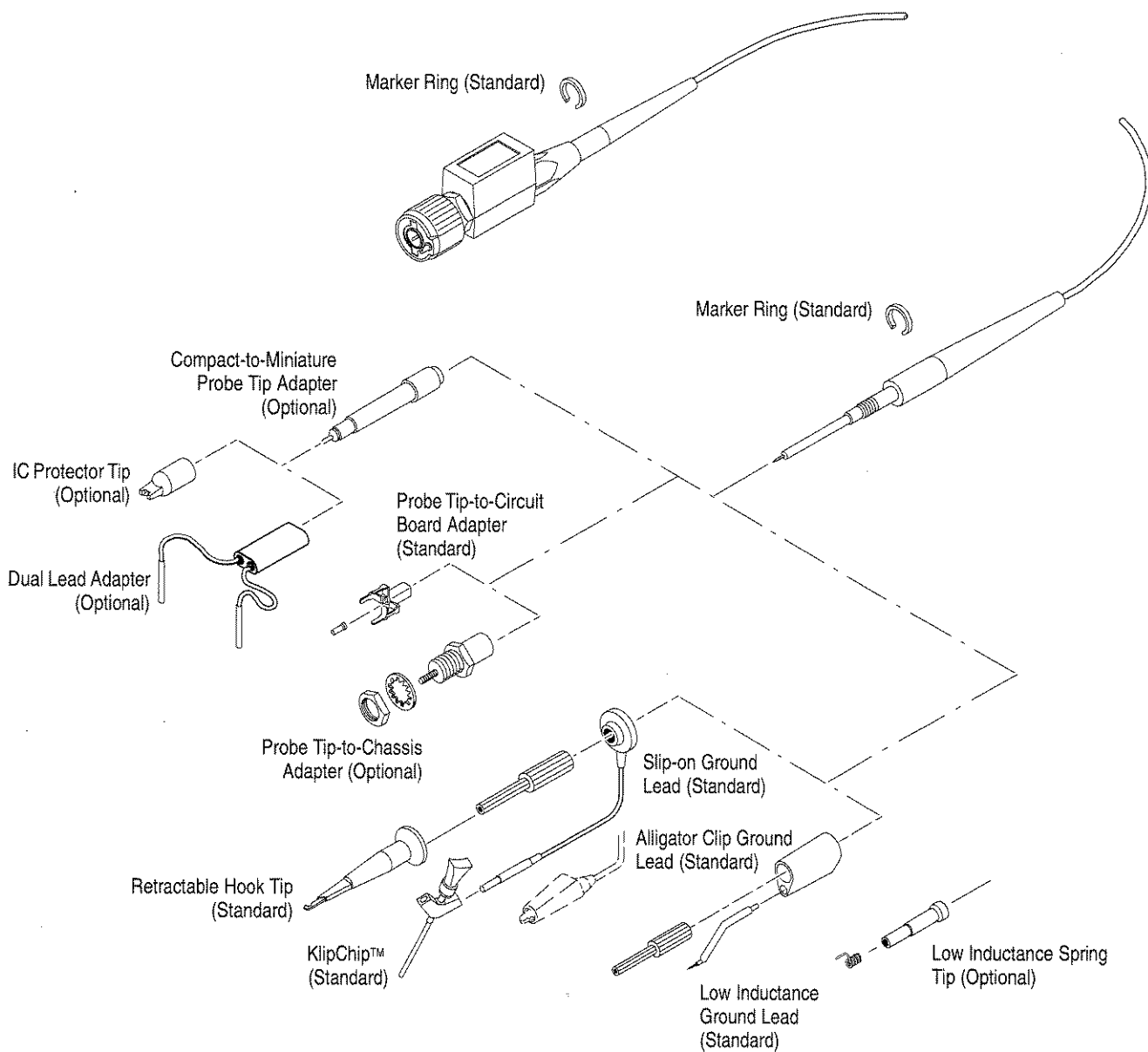
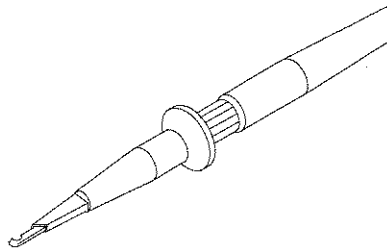

Figure 3-35: Probe Accessories

Retractable Hook Tip

The retractable hook tip attaches to your signal test point for hands-free operation of the probe. The hook tip attaches to components having leads, such as resistors, capacitors, and discrete semiconductors. You can also grip stripped wire, jumpers, busses, and test pins with the retractable hook.



For maximum flexibility with the hook tip, use one of the six-inch ground leads. For precise measurements at high frequency, however, long ground leads may have too much inductance. In these cases you can use one of the low-inductance probe tip configurations instead.

To remove the hook tip, simply pull it off the probe. Reinstall it by pushing it firmly onto the ribbed ferrule of the probe tip (see Figure 3–35).

Marker Rings

The marker rings help you keep track of individual probes and signal sources when you have a complicated test setup. Use the marker rings whenever you want to identify a particular probe.

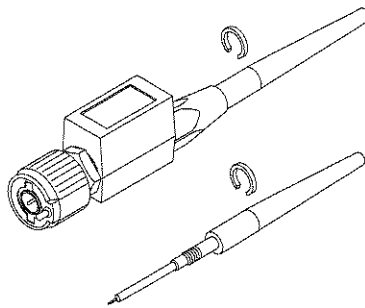

Long Ground Leads

Use long ground leads when a long reach is important and high-frequency information is not. Long ground leads are ideal for quick troubleshooting when you are looking for the presence or absence of a signal and are not concerned with the precision of the measurement.

Because of the high inductance associated with long ground leads, you should not use them for precise measurements above approximately 30 MHz (or for pulses with rise times less than about 11 ns).

You can choose between a ground lead terminated with an alligator clip and a lead terminated with a square-pin receptacle.

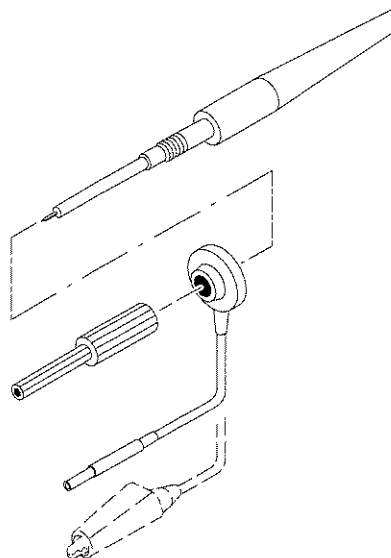

Low-Inductance Ground Lead

Low-inductance ground leads reduce ground lead inductance. Compared to a typical six-inch ground lead with an inductance of approximately 140 nH, the low-inductance tip assembly has an inductance of approximately 32 nH. That means that your measurements are relatively free of probe-related high-frequency degradation up to approximately 250 MHz.

The low-inductance tip has a partially insulated flexible ground pin that allows you to ground the probe and still have a limited amount of reach with the probe tip. Because the ground lead simply contacts the ground reference (instead of clipping onto it) you can move the probe around your device under test with ease. The assembly is well-suited to densely populated circuit boards and multi-pin connectors.

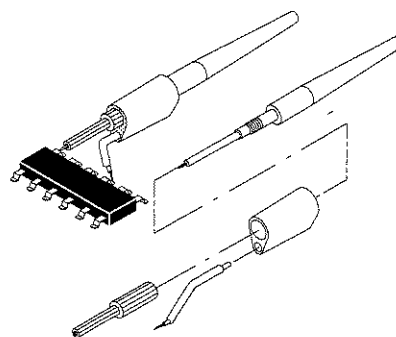

Probe-Tip-to-Circuit Board Adapters

The probe-tip-to-circuit board adapters let you design minimum inductance test points into your next circuit board. That adapter provides maximum performance for the probe, because it virtually eliminates the ground inductance effects of the probe.

Instructions for installing the probe tip-to-circuit board adapters are packaged with the adapters. For the best performance and ease of testing, Tektronix strongly recommends that you incorporate the probe tip-to-circuit board adapters (or the probe tip-to-chassis adapters described below) into your next design.

To use your probe with these adapters, unscrew and remove the ribbed ferrule. Use the probe tip directly with the adapter.

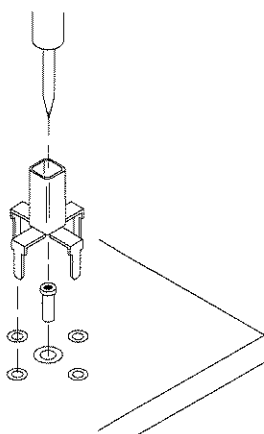

SMT KlipChip™

The SMT KlipChip provides hands-free attachment to a physically small signal or ground source. The low profile of the KlipChip allows you to grasp surface-mounted devices that the full-size retractable hook tip can not grip.

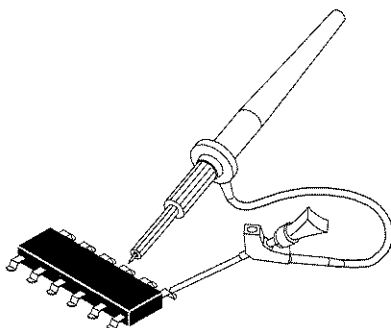

You can use the KlipChip as a ground attachment, as a signal attachment, or to attach both to a ground and a signal:

- For a ground attachment, use the long ground lead (described on page 3–74) terminated with a pin receptacle and connect the termination to the pin in one of the KlipChip shoulders.
- For a signal attachment, use a single-lead adapter (similar to the dual-lead adapter described on page 3–79) and connect the termination to the pin in one of the KlipChip shoulders.
- For both ground and signal attachment, combine two KlipChips with a dual-lead adapter, or use a single-lead adapter and a long ground lead.

Optional Probe Accessories

Optional probe accessories that you can order include the following:

Low-Inductance Spring Tips

Use low-inductance spring tips whenever you are measuring devices with fixed spacings. The spring-tip is ideal for repetitive production use. Select different length springs to match device spacings on a variety of components. Because the spring-tip ground lead simply contacts the ground reference (instead of clipping onto it) you can move the probe around your device-under-test with ease.

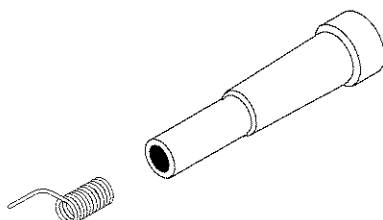

Probe-Tip-to-Chassis Adapter

The probe-tip-to-chassis adapter makes your test point accessible without removing instrument covers or panels. It provides an easy-access, low-inductance test point anywhere on your circuit. The probe-tip-to-chassis adapter has the same low inductance properties as the probe-tip-to-circuit board adapter described previously.

To use your probe with these adapters, unscrew and remove the ribbed ferrule.

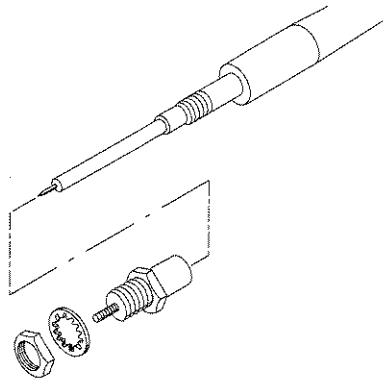

**Compact-to-Miniature
Probe Tip Adapter**

The compact-to-miniature probe tip adapter allows you to use accessories that are designed to accept a larger probe tip. These accessories include the IC protector tip, single- and dual-lead adapters, and others.

To install the adapter, unscrew and remove the ribbed ferrule and screw the adapter on in its place. (The IC protector tip discussed below is installed on the adapter tip when shipped. Remove the protector tip by pulling it off before using the adapter with other accessories.)

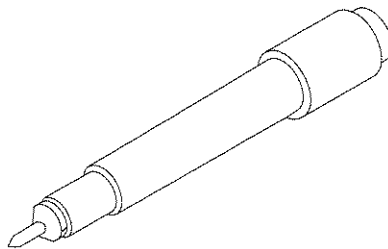

IC Protector Tip

The IC protector tip simplifies probing inline IC packages. The shape of the IC protector guides the probe tip to the IC pin and prevents accidental shorting of pins by the probe tip. It is used with the compact-to-miniature probe tip adapter. When using that tip, the spacing (pitch) between leads should be greater than or equal to 0.100 inches (100 mils).

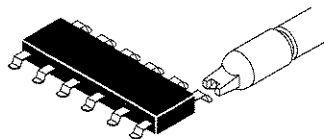

Because the IC protector tip prevents you from using the low-inductance tips, you must use one of the longer ground leads. For that reason you should take into account ground lead inductance effects on measurements at frequencies greater than about 30 MHz.

Dual-Lead Adapter

The dual-lead adapter makes an easy connection to 0.025 diameter connector pins. One lead connects to a ground reference pin, and the other to the signal pin. The adapter prevents burring and pin damage that can result when a retractable hook tip is used on soft pins. A single-lead adapter is also available. These adapters can also be used with the SMT KlipChip to provide access to very small signal and ground test points.

Although the dual-lead adapter is an improvement over the long ground leads in terms of added inductance, measurements at frequencies greater than 30 MHz may require using one of the low-inductance ground leads. Because of the length of the signal lead, the dual-lead configuration is also more susceptible to signal crosstalk than other tip configurations.

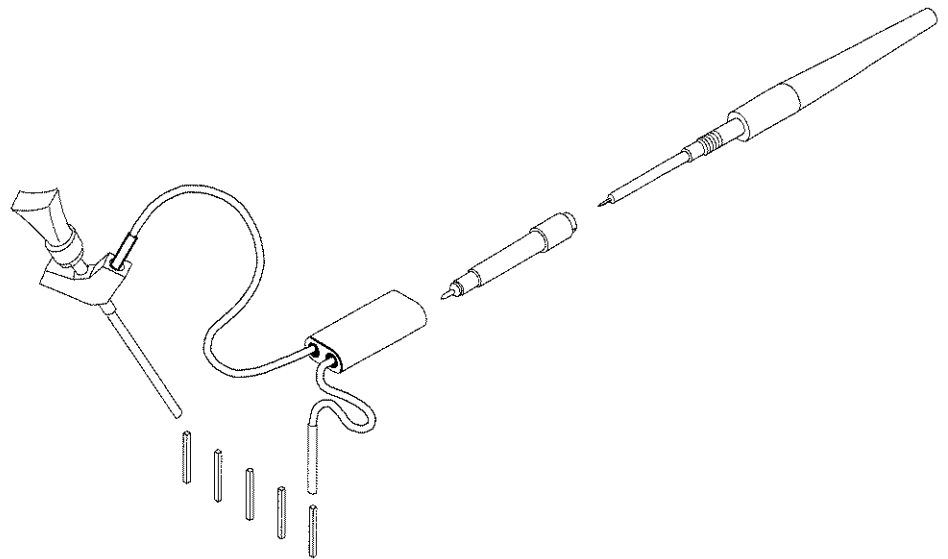

Probe Compensation

Passive probes require compensation to ensure maximum distortion-free input to the digitizing oscilloscope and to avoid high frequency amplitude errors (see Figure 3–36).

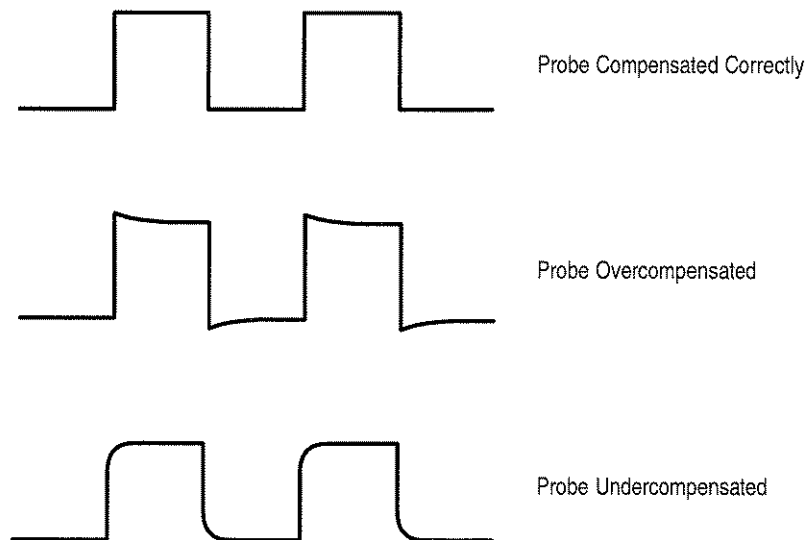

Figure 3–36: How Probe Compensation Affects Signals

To Compensate Passive Probes

Do the following steps to compensate your probe:

1. Connect the probe to the probe compensation signal (PROBE ADJ) on the front panel.
2. Press **AUTOSET**.

NOTE. When you connect an active probe to the oscilloscope (such as the P6205), the input impedance of the oscilloscope automatically becomes 50 Ω . If you then connect a high impedance passive probe (like the P6138), you need to set the input impedance back to 1 M Ω . Step 4 explains how to change the input impedance.

3. Press **VERTICAL MENU** → **Bandwidth** (main) → **20 MHz** (side).

4. If you need to change the input impedance, press **Coupling** (main). Then toggle the side menu selection Ω to get the correct impedance.
5. Press **SHIFT ACQUIRE MENU** → **Mode** (main) → **Hi Res** (side).
6. Adjust the probe until you see a perfectly flat top square wave on the display. Figure 3–37 shows where the adjustment is located.

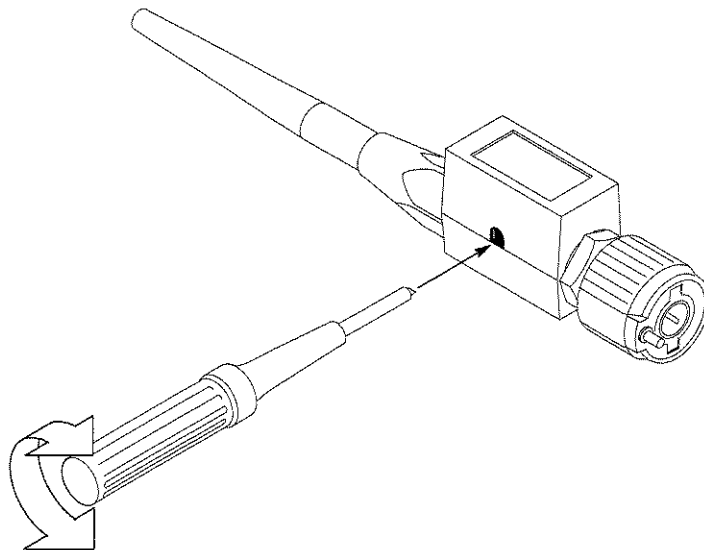

Figure 3–37: Probe Adjustment

For More Information

See *Probe Accessories*, on page 3–71.

See *Probe Selection*, on page 3–83.

Probe Selection

The probes included with your digitizing oscilloscope are useful for a wide variety of tasks. However, for special measurement situations you sometimes need different probes. This section introduces the five major types of probes: passive, active, current, optical, and time-to-voltage, and helps you select the right probe for the job. See your Tektronix Products Catalog for more information.

Passive Voltage Probes

Passive voltage probes measure voltage. They employ passive circuit components such as resistors, capacitors, and inductors. There are three common classes of passive voltage probes:

- *General purpose (high input resistance)*
- *Low impedance (Z_o)*
- *High voltage*

General Purpose (High Input Resistance) Probes

High input resistance probes are considered “typical” oscilloscope probes. The P6138 probes included with the digitizing oscilloscope are passive probes. The high input resistance of passive probes (typically 10 M Ω) provides negligible DC loading and makes them a good choice for accurate DC amplitude measurements.

However, their 8 pF to 12 pF (over 60 pF for 1X) capacitive loading can distort timing and phase measurements. Use high input resistance passive probes for the following measurements:

- Device characterization (above 15 V, thermal drift applications)
- Maximum amplitude sensitivity using 1X high impedance
- Large voltage range (between 15 and 500 V)
- Qualitative or go/no-go measurements

Low Impedance (Z_o) Probes

Low impedance probes measure frequency more accurately than general purpose probes, but they make less accurate amplitude measurements. They offer a higher bandwidth to cost ratio.

These probes must be terminated in a 50 Ω scope input. Input capacitance is much lower than high Z passive probes, typically 1 pF, but input resistance is also lower (500 to 5000 Ω typically). Although that DC loading degrades amplitude accuracy, the lower input capacitance reduces high frequency loading to the circuit under test. That makes Zo probes ideal for timing and phase measurements when amplitude accuracy is not a major concern.

Zo probes are useful for measurements up to 40 V.

High Voltage Probes

High voltage probes (see Figure 3–38) have attenuation factors in the 100X to 1000X range. The considerations that apply to other passive probes apply to high voltage probes with a few exceptions. Since the voltage range on high voltage probes varies from 1 kV to 20 kV (DC + peak AC), the probe head design is mechanically much larger than for a passive probe. High voltage probes have the added advantage of lower input capacitance (typically 2-3 pF).

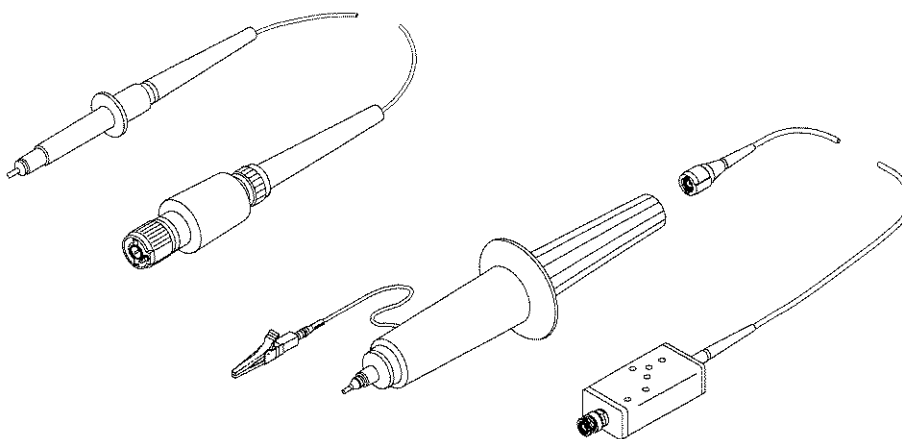

Figure 3–38: Typical High Voltage Probes

Active Voltage Probes

Active voltage probes, sometimes called “FET” probes, use active circuit elements such as transistors. There are three classes of active probes:

- *High speed active*
- *Differential active*
- *Fixtured active*

Active voltage measuring probes use active circuit elements in the probe design to process signals from the circuit under test. All active probes require a source

of power for their operation. Power is obtained either from an external power supply or from the oscilloscope itself.

NOTE. When you connect an active probe to the oscilloscope (such as the P6205), the input impedance of the oscilloscope automatically becomes 50 Ω . If you then connect a passive probe (like the P6138) you need to set the input impedance back to 1 M Ω . Vertical Control on page 3–121 explains how to change the input impedance.

High Speed Active Probes

Active probes offer low input capacitance (1 to 2 pF typical) while maintaining the higher input resistance of passive probes (10 k Ω to 10 M Ω). Like Zo probes, active probes are useful for making accurate timing and phase measurements. However, they do not degrade the amplitude accuracy. Active probes typically have a dynamic range of ± 10 to ± 15 V.

Differential Probes and Preamplifiers

Differential probes and preamplifiers determine the voltage drop between two points in a circuit without reference to ground. Differential probes and amplifiers let you simultaneously measure two points and to display the difference between the two voltages. Common mode rejection removes unwanted common-mode electrical noise from sensitive pickups.

Differential preamplifiers allow direct measurements of very low amplitude voltages and signals without reference to ground.

Active differential probes and preamplifiers are stand-alone products designed to be used with 50 Ω inputs. The same characteristics that apply to active probes apply to active differential probes.

Fixtured Active Probes

In some small-geometry or dense circuitry applications, such as surface mounted devices (SMD), a hand-held probe is too big to be practical. You can instead use fixtured (or probe card mounted) active probes (or buffered amplifiers) to precisely connect your oscilloscope to your device-under-test. These probes have the same electrical characteristics as high speed, active probes but use a smaller mechanical design.

Current Probes

Two types of current probes are available: one that measures AC current only and AC/DC probes that utilize the Hall effect to accurately measure the AC and DC components of a signal. AC-only current probes use a transformer to convert AC current flux into a voltage signal to the oscilloscope and have a frequency response from a few hundred Hertz up to 1 GHz. AC/DC current probes include Hall effect semiconductor devices and provide frequency response from DC to 50 MHz.

Use a current probe (see Figure 3–39) by clipping its jaws around the wire carrying the current that you want to measure. (Unlike an ammeter which you must connect in series with the circuit.) Because current probes are non-invasive, with loading typically in the milliohm to low Ω range, they are especially useful where low loading of the circuit is important. Current probes can also make differential measurements by measuring the results of two opposing currents in two conductors in the jaws of the probe.

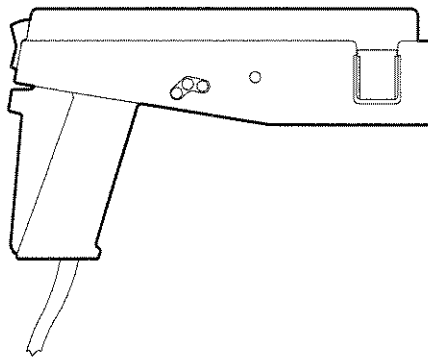

Figure 3–39: A6303 Current Probe Used in the AM 503S Opt. 03

Optical Probes

Optical probes let you blend the functions of an optical power meter with the high-speed analog waveform analysis capability of an oscilloscope. You have the capability of acquiring, displaying, and analyzing optical and electrical signals simultaneously.

Applications include measuring the transient optical properties of lasers, LEDs, electro-optic modulators, and flashlamps. You can also use these probes in the development, manufacturing, and maintenance of fiber optic control networks, local area networks (LANs), fiber-based systems based on the FDDI and SONET standard, optical disk devices, and high-speed fiber optic communications systems.

NOTE. When you connect an optical probe to the oscilloscope, the input impedance of the oscilloscope automatically becomes 50 Ω . If you then connect a high input resistance passive probe you need to set the input impedance back to 1 M Ω . Vertical Control on page 3–121 explains how to change the input impedance.

Time-to-Voltage Converter

The instantaneous time-interval to voltage converter (TVC) continuously converts consecutive timing measurements to a time-interval versus time waveform.

Timing variations typically appear as left-to-right motion, or jitter, on an oscilloscope. Time base or trigger holdoff adjustments may improve display stability, but they do not show timing dynamics. The TVC untangles the often confusing waveforms and delivers a coherent real-time view.

The TVC adds three measurement functions to the voltage versus time capability of your oscilloscope: time delay versus time, pulse-width versus time, and period versus time.

Remote Communication

You may want to integrate your oscilloscope into a system environment and remotely control your oscilloscope or exchange measurement or waveform data with a computer. This section explains how to prepare and setup the oscilloscope for control and operation over the IEEE Std 488.2-1987 (GPIB) interface.

To Prepare for Remote Operation

To transfer data between the digitizing oscilloscope and other instruments over the GPIB, do the following tasks to make sure the instruments support GPIB protocols and observe GPIB Interface requirements.

Check GPIB Protocols

Make sure the instruments you are connecting support GPIB protocols. The GPIB provides the following features:

- Remote instrument control
- Bidirectional data transfer
- Device compatibility
- Status and event reporting

Besides the base protocols, Tektronix has defined codes and formats for messages that travel over the GPIB. Each device that follows these codes and formats, such as the TDS 410A, TDS 420A, and TDS 460A, supports standard commands. Use of instruments that support these commands can greatly simplify development of GPIB systems.

Know the GPIB Interface Requirements

To connect the oscilloscope to GPIB networks, read and follow these rules:

- Connect no more than 15 devices, including the controller, to a single bus.
- Connect one device load every two meters (about six feet) of cable length to maintain bus electrical characteristics. (Generally, each instrument represents one device load on the bus.)
- Do not exceed 20 meters (about 65 feet) total cumulative cable length.
- Turn on at least two-thirds of the device loads present when you use your network.
- Include only one cable path between devices on your network (see Figure 3-40). Do not create loop configurations.

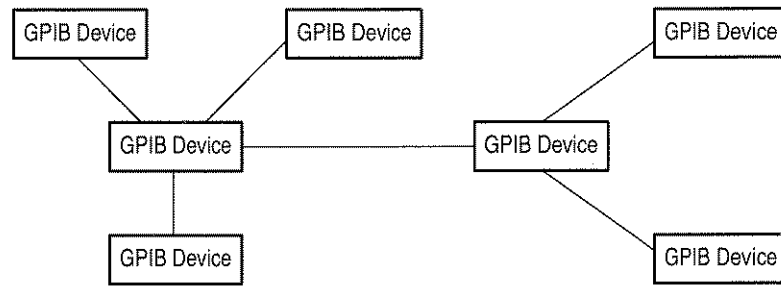

Figure 3-40: Typical GPIB Network Configuration

Use the Proper Interconnect Cables

To connect the digitizing oscilloscope to a GPIB network, use an IEEE Std 488.1-1987 GPIB cable (available from Tektronix, part number 012-0991-00).

The standard GPIB cable connects to a 24-pin GPIB connector located on the oscilloscope rear panel. The connector has a D-type shell and conforms to IEEE Std 488.1-1987. You can stack GPIB connectors on top of each other (see Figure 3-41).

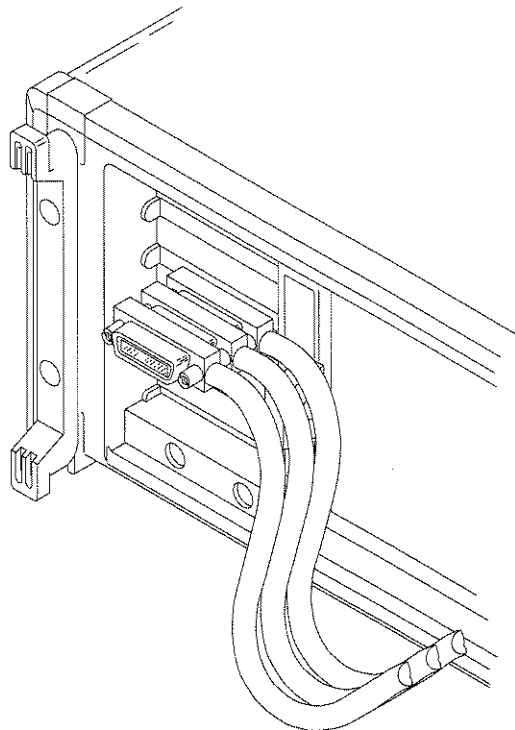

Figure 3-41: Stacking GPIB Connectors

To Set Up for Remote Operation

To set up remote communications, be sure your setup meets the GPIB protocol and interface requirements just described. Then do the following procedures.

Connect the Oscilloscope to the GPIB. To connect the oscilloscope, plug an IEEE Std 488.2-1987 GPIB cable into the GPIB connector on the oscilloscope rear panel and into the GPIB port on your controller (see Figure 3-42).

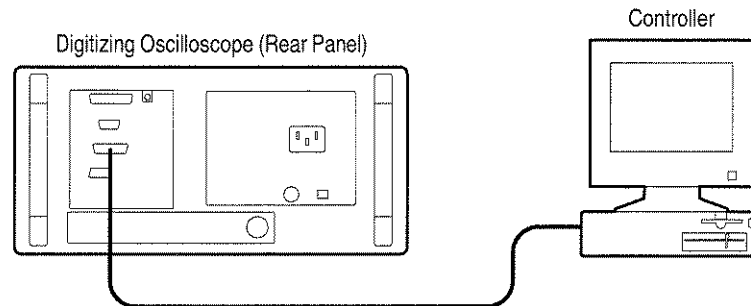

Figure 3-42: Connecting the Digitizing Oscilloscope to a Controller

Select the GPIB Port. To select the GPIB port, press **SHIFT → UTILITY → System (main) → I/O (pop-up) → Port (main) → GPIB (pop-up)**.

Configure the GPIB Port. You must set two important GPIB parameters: mode and address. Do the following to set those parameters:

Press **SHIFT UTILITY → System (main) → I/O (pop-up) → Port (main) → GPIB (pop-up) → Configure (main) → Talk/Listen Address, Hardcopy (Talk Only), or Off Bus (side)**. (See Figure 3-43.)

Talk/Listen Address configures the port for normal controller based system operation. Use the general purpose knob to define the address.

Hardcopy (Talk Only) configures the port for hardcopy output without controller supervision. Once the port is configured this way, the oscilloscope will send the hardcopy data to any listeners on the bus when the **HARDCOPY** button is pressed.

If the port is configured any other way when the **HARDCOPY** button is pressed, an error occurs and the digitizing oscilloscope displays a message saying the selected hardcopy port is currently unavailable.

Off Bus disconnects the digitizing oscilloscope from the bus.

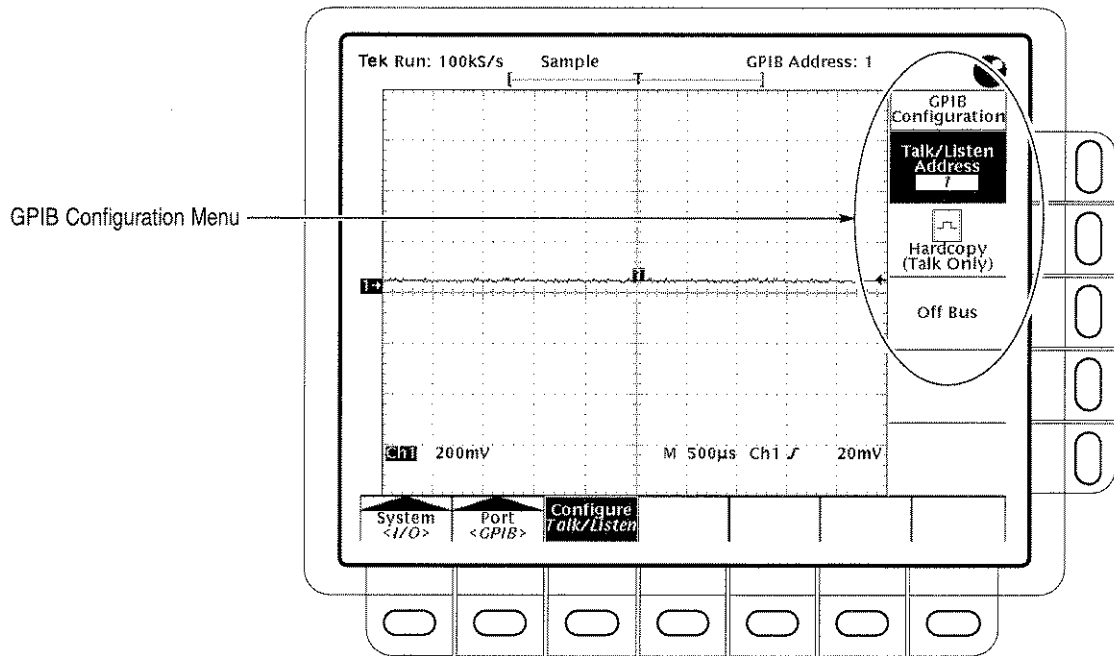

Figure 3-43: Utility Menu

For More Information

See *Hardcopy*, on page 3-35.

See the *TDS Family Programmer Manual*.

See the *TDS Family Option 13 Instruction Manual* (Option 13 equipped instruments only).

Roll Mode

Roll mode lets you see acquired data points without waiting for the acquisition of a complete waveform record. Roll mode gives you almost immediate feedback. For example, when a sweep is 10 divisions long and the sweep rate is 1 second per division, 10 seconds are required to fill the waveform record. Without roll mode you must wait 10 seconds to see that the position control is set wrong. With roll mode you can start seeing results almost immediately.

Roll Modes

There are four roll modes (see Figure 3-44):

- Untriggered roll
- Untriggered roll with single sequence
- Triggered roll
- Triggered roll with single sequence

Untriggered Roll

Untriggered roll mode displays newly acquired data points at the right edge of the waveform record while moving older waveform data points to the left. To stop acquiring data press **RUN/STOP**.

Use untriggered roll to continuously observe a slow process, knowing that you can always see the most recent view of that process.

Untriggered Roll with Single Sequence

Untriggered roll mode with single sequence displays newly acquired data points at the right edge of the waveform record while moving older waveform data points to the left. Acquisitions automatically stop after a complete waveform record is acquired.

Use untriggered roll with single sequence to observe data for later viewing. For example, at 20 seconds per division at 30K record length there are 60 screens or 600 divisions or 12000 seconds of acquired data points. Untriggered roll with single sequence would capture data over a lunch hour and hold it for later viewing.

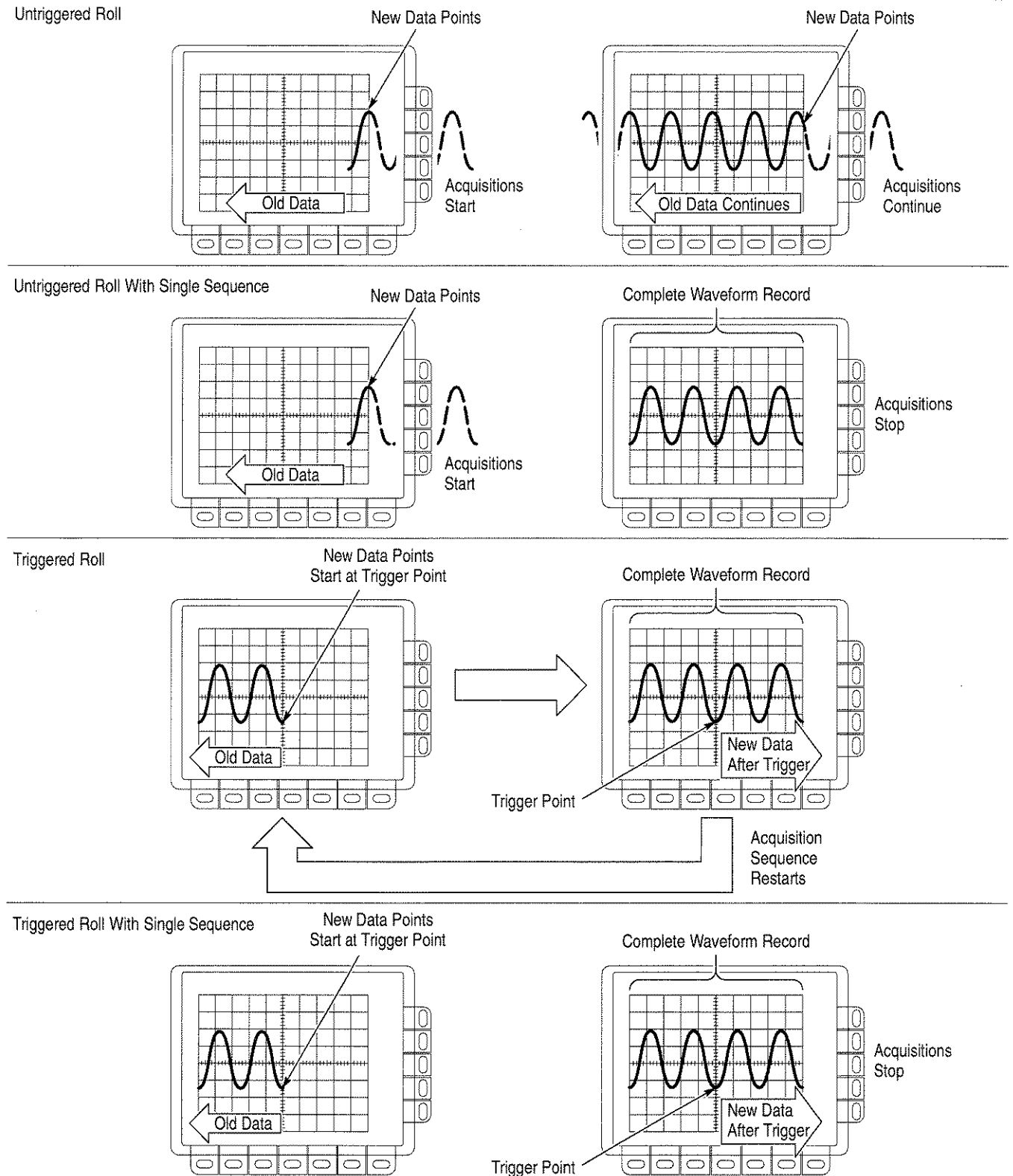

Figure 3-44: Roll Mode (500 Point Record Length)

Triggered Roll

Triggered roll mode displays newly acquired data points at the selected trigger position and moves older waveform data points to the left. When the pretrigger portion of the waveform record is filled and a valid trigger is received, the waveform stops moving left and new data points are displayed to the right of old data points. When a complete waveform record is acquired, the sequence restarts.

Use triggered roll to capture a succession of triggered events in normal interactive debugging.

Triggered Roll with Single Sequence

Triggered roll mode with single sequence displays newly acquired data points at the selected trigger position and moves older waveform data points to the left. When the pretrigger portion of the waveform record is filled and a valid trigger is received, the waveform stops moving left and new data points are displayed to the right of old data points. When the waveform record is full, acquisitions stop.

Use triggered roll with single sequence to capture one triggered event.

To Turn On Roll Mode

Do the following steps to turn on roll mode:

1. Press **HORIZONTAL MENU** → **Horiz Controls** (main), and set **Roll Mode** (side) to **Automatic** to enable roll mode.
2. Set the Horizontal **SCALE** to 50 ms per division or slower.

NOTE. *Envelope, Average (acquisition modes), or any of the persistence modes (display modes) inhibit roll mode. You also inhibit roll mode if you set the horizontal Clock menu to External and the maximum external sample rate greater than 1 kc per second*

3. If you want an untriggered roll mode, press **TRIGGER MENU** → **Mode** (main) → **Auto** (side). If you want a triggered roll mode, press **TRIGGER MENU** → **Mode** (main) → **Normal** (side). (See Figure 3–45.)
4. If you want a single sequence roll mode, press **SHIFT** → **ACQ MENU** → **Stop After** (main) → **Single Sequence** (side).

To Turn Off Acquisitions

Do the following step to stop acquisitions in roll mode:

If you are not in **Single Sequence**, you must press **RUN/STOP** to stop roll mode. If you are in **Single Sequence**, roll mode acquisitions stop automatically when a complete record is acquired.

To Turn Off Roll Mode

Do the following steps to turn off roll mode:

NOTE. *Envelope, Average (acquisition modes), or any of the persistence modes (display modes) also turns off roll mode. You also turn off roll mode if you set the horizontal Clock menu to External and the maximum external sample rate greater than 1 kc per second.*

1. Set the Horizontal **SCALE** to 20 ms per division or faster.
2. To turn off roll mode even if the Horizontal **SCALE** is 50 ms per division or slower, press **HORIZONTAL MENU** → **Horiz Controls** (main), and set **Roll Mode** (side) to **Off**.
3. If you are in a single sequence roll mode and want to leave single sequence mode, press **SHIFT** → **ACQ MENU** → **Stop After** (main) → **RUN/STOP** (side).

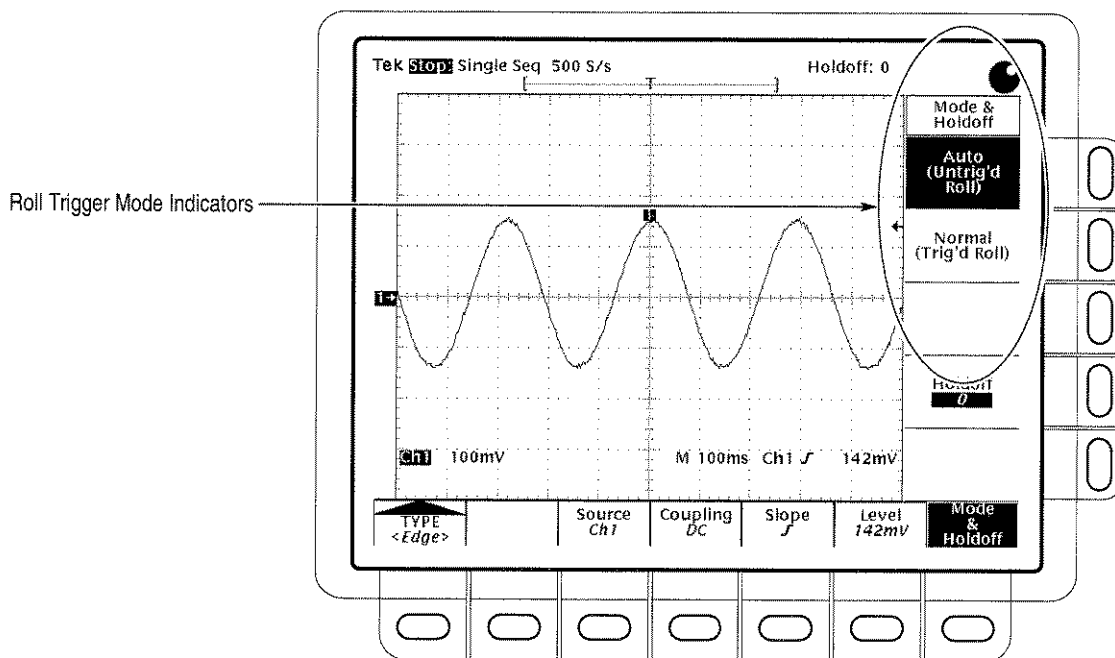

Figure 3-45: Trigger Mode Menu

For More Information

See *Trigger Modes*, on page 2-32.

Saving and Recalling Setups

TDS 400A Digitizing Oscilloscopes can store up to ten oscilloscope setups, in internal memory, that you may later recall. This section describes how you save and recall a setup and how you can recall the factory default setup.

You may want to save and reuse setups for many reasons. For example, after changing the setting during the course of an experiment, you may want to quickly return to your original setup. Saved setups are retained even when you turn the oscilloscope off or unplug it.

To Save a Setup

To save the current setup of the digitizing oscilloscope:

1. Press **SETUP** → **Save Current Setup** (main).

STOP. Before doing step 2 that follows, note that if you choose a setup location labeled user, you will overwrite the user setup previously stored there. You can store setups in setup locations labeled factory without disturbing previously stored setups.

2. To store a setup internally, choose one of the ten storage locations from the side menu **To Setup 1, To Setup 2, ...** (see Figure 3-46). Now the current setup is stored in that location.
3. To store a setup to disk, press **To File**. Then use the general purpose knob to select the exact file from the resulting scrollbar list. Finally, press the side-menu **Save To Selected File** to complete the operation.

NOTE. Setups are not transferable between different oscilloscope models or software versions.

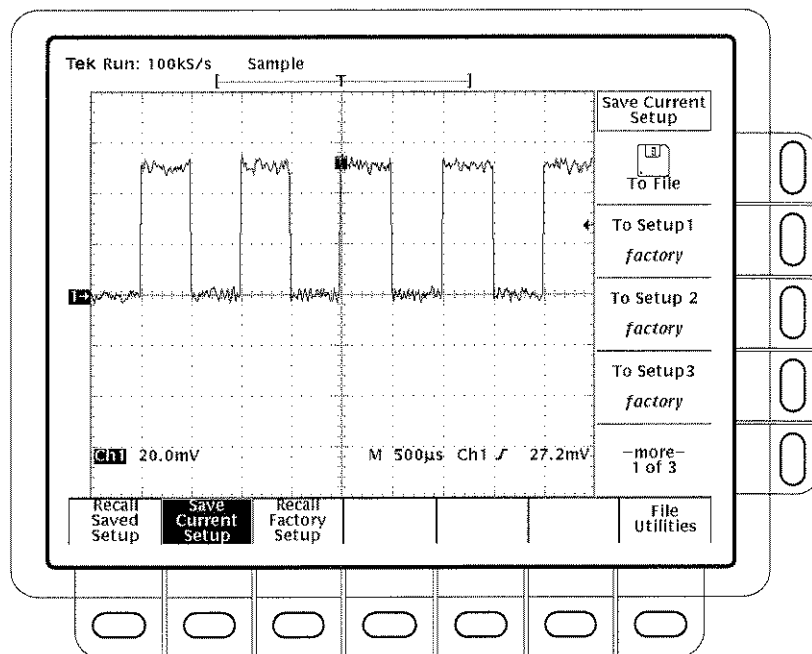

Figure 3-46: Save/Recall Setup Menu

To Recall a Setup

To recall a setup stored internally, press **SETUP** → **Recall Saved Setup** (main) → (**Recall Setup 1**, **Recall Setup 2 ...** (side).

To recall a setup stored on disk, press **From File**. Then use the general purpose knob to select the exact file from the resulting scrollbar list. Only files with *.set* extensions will be displayed. Finally, press the side-menu **Recall From Selected File** to complete the operation.

Recalling a setup does not change the menu that is currently displayed. If you recall a setup that is labeled *factory* in the side menu, you recall the factory setup. (The conventional method for recalling the factory setup is described below.)

To Recall the Factory Setup

To reset your oscilloscope to the factory defaults:

Press **SETUP** → **Recall Factory Setup** (main) → **OK Confirm Factory Init** (side).

See *Factory Initialization Settings* on page E-1 for a list of the factory defaults.

To Delete All Setups and Waveforms — Tek Secure®

Sometimes you might use the digitizing oscilloscope to acquire waveforms that are confidential. Furthermore, before returning the oscilloscope to general usage, you might want to remove all such waveforms and any setups used to acquire them. (Be sure you *want* to remove *all* waveforms and setups, because once they are removed, you cannot retrieve them.) To use Tek Secure to remove all stored setups and waveforms (does not affect mass storage disk):

Press **SHIFT UTILITY** → **System** (main) → **Config** (pop-up) → **Tek Secure Erase Memory** (main) → **OK Erase Setup & Ref Memory** (side).

Executing Tek Secure accomplishes the following tasks:

- Replaces all waveforms in reference memories with zero sample values.
- Replaces the current front panel setup and all setups stored in setup memory with the factory setup.
- Calculates the checksums of all waveform memory and setup memory locations to verify successful completion of setup and waveform erasure.
- If the checksum calculation is unsuccessful, displays a warning message; if the checksum calculation is successful, displays a confirmation message.

To Run the File Utilities

To run file utilities, see the *File System* article on page 3–31.

For More Information

See *Example 4: Saving Setups*, on page 2–29.

See *Factory Initialization Settings*, on page E–1.

See *File System*, on page 3–31.

Saving and Recalling Waveforms

You can store a waveform in any of the four internal reference memories of the digitizing oscilloscope. The waveforms are retained even when you turn the oscilloscope off or unplug it. The oscilloscope can also save waveforms to floppy disk. This section describes how to save, delete, and display reference waveforms.

NOTE. *With Option 1M and 2A, there are only 120K points available for reference waveforms. If you select the 120K record length in the Horizontal menu, then you can only save one reference waveform. Also, you can only use/display four waveforms. Even if you do not display the source waveforms, Dual waveform math uses three of the four waveforms. For example: if you display a math waveform that is the sum of CH 1 and CH 2, even if CH 1 and CH 2 are not displayed, you have used three waveforms. Therefore, you can only display one additional waveform.*

The digitizing oscilloscope can display up to 11 waveforms (9 on the TDS 410) at one time. That includes waveforms from the input channels, four reference waveforms, and three math waveforms. You can save any combination of different size waveform records as long as the total is less than the capacity of nonvolatile waveform memory.

Saving waveforms is useful when working with many waveforms and channels. If you have more waveforms than you can display, you can save one of the waveforms and then stop acquiring it. Use this method to display another waveform without losing the first one.

To Save a Waveform

To save a waveform, do the following steps:

1. Select the channel that has the waveform you want to save.

NOTE. *Before doing step 2 that follows, note that if you use a reference memory location labeled active (see Figure 3-47), you overwrite the waveform that was previously stored there. You can store waveforms in reference locations labeled empty without disturbing previously stored waveforms.*

2. To store a waveform internally, press save/recall **WAVEFORM** → **Save Waveform** (main) → **Ref1, Ref2, Ref3, or Ref4** (side).

NOTE. Before doing step 3 that follows, note the current *Save Format* (see Figure 3–49). If you desire to save to a different format, see *To Select the Save Format on page 3–104*.

3. To store a waveform to disk, press save/recall **WAVEFORM** → **Save Waveform** (main) → **To File** (side). Then use the general purpose knob to select the exact file from the resulting scrollbar list. Finally, press the side-menu **Save To Selected File** to complete the operation.

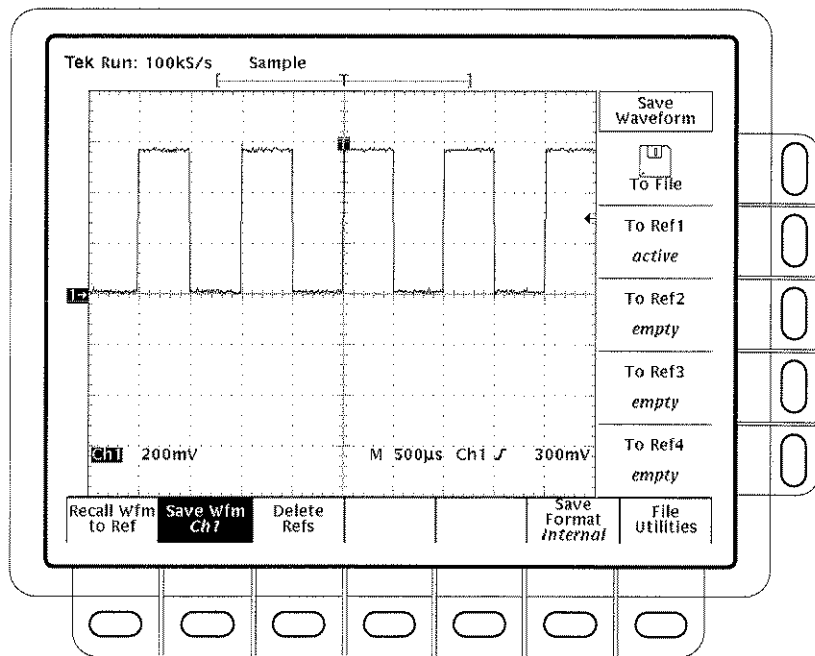

Figure 3–47: Save Waveform Menu

To Delete Waveforms

To delete a reference waveform(s) that you no longer need:

Press save/recall **WAVEFORM** → **Delete Refs** (main) → **Delete Ref1**, **Delete Ref2**, **Delete Ref3**, **Delete Ref4**, or **Delete All Refs** (side).

To Delete All Waveforms and Setups

To remove *all* stored waveforms and setups, use the feature called Tek Secure. It is described under *Saving and Recalling Setups*. See *To Delete All Setups and Waveforms* on page 3–99.

To Display a Saved Waveform

To display a waveform in internal reference memory:

Press **MORE** → **Ref1**, **Ref2**, **Ref3**, or **Ref4** (main).

Note that in Figure 3–48, the main menu items Ref2, Ref3, and Ref4 appear shaded while Ref1 does not. References that are empty appear shaded in the More main menu.

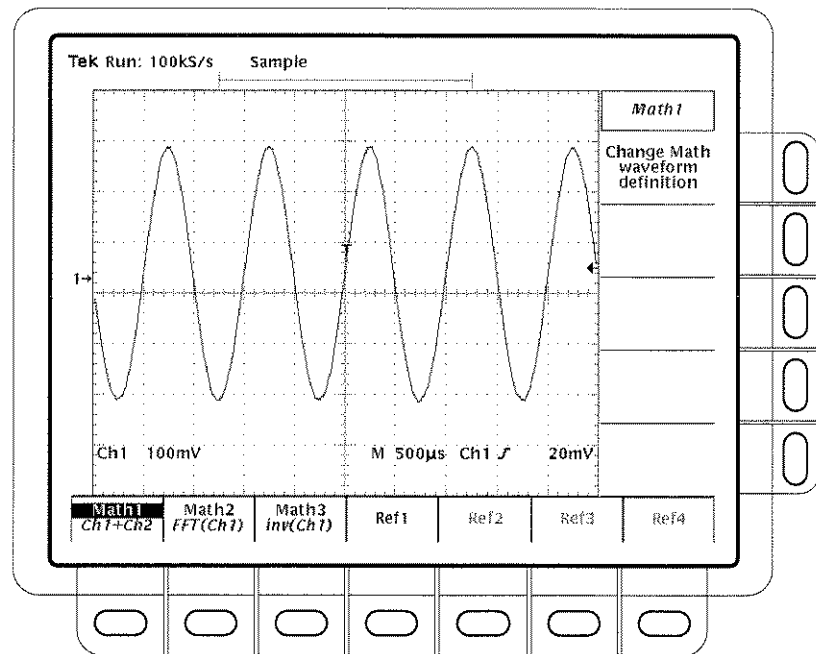

Figure 3–48: More Menu

To Recall a Waveform From Disk

To recall a waveform from disk to an internal reference memory, press save/recall **WAVEFORM** → **Recall Wfm To Ref**. Then use the general purpose knob to select the exact file from the resulting scrollbar list. Only files with **.WFM** extensions are displayed. Finally, press from the side-menu **To Ref1**, **To Ref2**, **To Ref3**, or **To Ref4** choices to complete the operation.

To Run the File Utilities

To run file utilities, see *File System* on page 3–31.

To Select the Save Format

To select the format that the oscilloscope uses to save waveforms to a file, press save/recall **WAVEFORM** → **Save Format** (main) → **Internal**, **MathCad**, or **Spreadsheet** (side) (see Figure 3–49). Three formats are available:

- *Internal* creates files (.WFM) in the internal format of the oscilloscope
- *MathCad* creates files (.DAT) in a format usable by MathCad®

DAT files are supported by the MathCad numerical analysis program. DAT file data is read line by line and placed into variables in the MathCad document. You then do whatever calculations are required. The DAT format begins with four values acting as a header containing the record length, time per sample interval, trigger location, and trigger offset, followed by a linear array of ASCII floating-point Y values. The recordLength, pre-trigger sample count and trigger offset are in samples. The horizontal scale per sample is in x units and the y value is in y units.

- *Spreadsheet* creates files (.CSV) in a format usable by most spreadsheets (Excel®, Lotus 1-2-3®, and Quattro Pro®)

CSV files (Comma Separated Values) contain comma separated X and Y ASCII values on CRLF terminated lines (a 2 dimensional array). Each value is a floating point number. There is one line for each point in a waveform record. The X and Y values are displayed in the units of seconds and Volts. All scaling to sample increments and offsetting has been done. Zero on the X scale is the trigger point, with negative values being pretrigger and positive values being posttrigger.

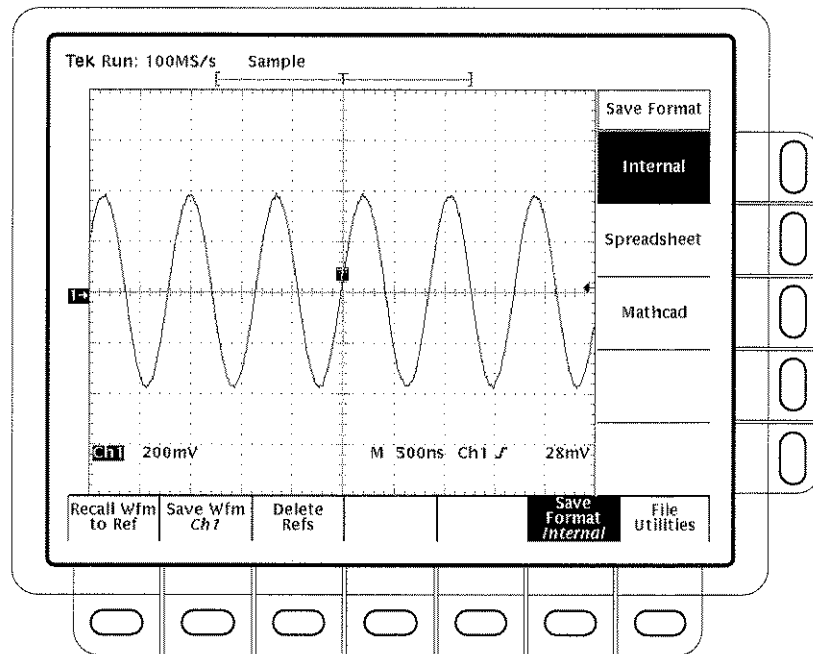

Figure 3-49: Save Format Menu

To View a Waveform on a Spreadsheet

To save a waveform and view the waveform data using a spreadsheet (this example uses EXCEL):

1. With a disk in the disk drive, press save/recall **WAVEFORM** → **Save Format** (main) → **Spreadsheet** (side).
2. Press **Save Wfm** (main) → **To File** (side). Then press **Save to Selected File** (side)
3. Remove the disk and place it in your computer drive.
4. Start EXCEL.
5. Using the EXCEL File menu, select Open. From the List Files of Type menu, select Text Files (*.prn, *.txt, *.csv). From the Drives menu, select the drive containing the waveform file. From the File Name menu, select the name of the waveform file. Now select OK.

For information on the CSV data format, see *To Select the Save Format* on page 3-104.

For More Information

See *Selecting Channels*, on page 3–107.

See *File System*, on page 3–31.

Selecting Channels

The digitizing oscilloscope applies all waveform-specific activities, such as measurements or vertical scale and position, to the *selected channel*. You can select a *channel waveform*, a *math waveform*, or a *reference waveform*. This section describes how to select a waveform and how you can turn the display of a waveform off.

To Identify the Selected Channel

To determine which channel is currently selected, check the *channel readout*. It shows the selected channel in inverse video in the lower left corner of the display. The *channel reference indicator* for the selected channel also appears in reverse video along the left side of the display. See Figure 3–50.

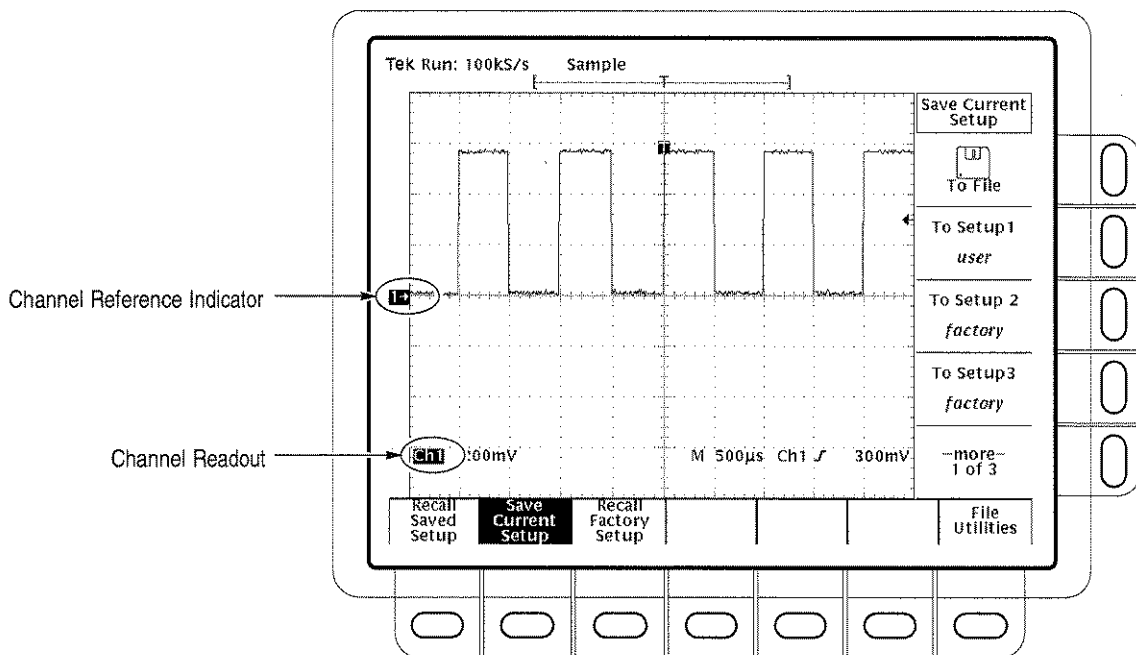

Figure 3–50: The Channel Readout

To Select and Remove Waveforms

To select a channel, use the *channel selection* buttons on the right of the display.

On the TDS 420A and TDS 460A, these buttons are labeled **CH 1**, **CH 2**, **CH 3**, **CH 4**, and **MORE**. On the TDS 410A, these buttons are labeled **CH 1**, **CH 2**, and **MORE**. The **MORE** button allows you to select internally stored *Math* and *Ref* waveforms for display and manipulation. The selected channel is indicated by the lighted LED above each button.

NOTE. *With Option 1M and 2A, there are only 120K points available for reference waveforms. If you select the 120K record length in the Horizontal menu, then you can only save one reference waveform. Also, you can only use/display four waveforms. Even if you do not display the source waveforms, Dual waveform math uses three of the four waveforms. For example: if you display a math waveform that is the sum of CH 1 and CH 2, even if CH 1 and CH 2 are not displayed, you have used three waveforms. Therefore, you can only display one additional waveform.*

Do the following steps to first display and then remove waveforms from the display:

1. Press **CH 1**, **CH 2**, **CH 3**, or **CH 4** (**CH 1** or **CH 2** on the TDS 410A) to turn on as many of these channels as desired. The one you select last (or first if you only select one) becomes the selected channel. Selecting a channel turns it on if it is not already on.

You do not use the channel selection buttons to select the trigger source. Instead you select the trigger source in the Main Trigger menu or Delayed Trigger menu.

2. The **WAVEFORM OFF** button turns OFF the display of the selected channel waveform. It will also remove from the display any automated measurements being made on that waveform.
3. To select a math waveform you have created or a reference waveform you have stored, press **MORE** and select the waveform from the More menu. Press **WAVEFORM OFF** while the MORE button is lit to remove display of the waveform selected in the More menu.

Waveform Priority

When you turn off a waveform, the digitizing oscilloscope automatically selects the next highest priority waveform. Figure 3-51 shows how the oscilloscope prioritizes waveforms.

If you are turning off more than one waveform and you start by turning off a channel waveform, all channels will be turned off before going to the MORE waveforms. If you start by turning off the MORE waveforms, all the MORE waveforms will be turned off before going to the channel waveforms.

If you turn off a channel that is a trigger source, it continues to be the trigger source even though the waveform is not displayed.

1. **CH1** (All models)
2. **CH2** (All models)
3. **CH3** (TDS 420A and TDS 460A)
4. **CH4** (TDS 420A and TDS 460A)

5. **MATH1**
6. **MATH2**
7. **MATH3**

8. **REF1**
9. **REF2**
10. **REF3**
11. **REF4**

Figure 3–51: Waveform Selection Priority

For More Information

See *Saving and Recalling Waveforms*, on page 3–101.

See *Waveform Math*, on page 3–131.

Setting Up Automatically: Autose and Reset

The TDS 400A can automatically obtain and display a stable waveform of usable size. This section describes how to execute autose and lists the default settings in effect after an autose.

Autose automatically sets up the front panel controls based on the characteristics of the input signal. It is much faster and easier than a manual control-by-control setup.

Autose makes adjustments in these categories: Acquisition, Display, Horizontal, Trigger, and Vertical.

NOTE. *Autose may change vertical position in order to position the waveform appropriately. It always sets vertical offset to 0 V.*

Autose the Oscilloscope

Do the following steps to automatically setup the oscilloscope:

1. Press the Channel Selection button (such as **CH 1**) corresponding to your input channel to make it active.
2. Press **AUTOSET**.

If you use autose when one or more channels are displayed, the digitizing oscilloscope selects the lowest numbered channel for horizontal scaling and triggering. Vertically, all channels in use are individually scaled.

If you use autose when no channels are displayed, the digitizing oscilloscope turns on channel one (CH 1) and scales it.

Autose Defaults

Table 3–4 lists the autose defaults.

Table 3–4: Autose Defaults

Control	Changed by Autose to
Acquire Mode	Sample
Acquire Repetitive Signal	On

Table 3–4: Autoset Defaults (Cont.)

Control	Changed by Autoset to
Acquire Stop After	RUN/STOP button only
Display Style	Vectors
Display Format	YT
Display Intensity — Overall	If less than 50%, set to 75%
Horizontal Clock	Internal
Horizontal Position	Centered within the graticule window
Horizontal Record Length	Unchanged
Horizontal Scale	As determined by the signal frequency
Horizontal Time Base	Main Only
Limit Test	Off
Selected channel	Numerically lowest of the displayed channels
Trigger Coupling	DC
Trigger Holdoff	1
Trigger Level	Midpoint of data for the trigger source
Trigger Position	Unchanged
Trigger Slope	Positive
Trigger Source	Numerically lowest of the displayed channels (the selected channel)
Trigger Type	Edge
Vertical Bandwidth	Full
Vertical Coupling	DC unless AC was previously set. AC remains unchanged.
Vertical Offset	0 volts
Vertical Scale	As determined by the signal level
Zoom	Off

Reset the Oscilloscope

Do the following steps to reset your oscilloscope to its factory default settings:

Press **SETUP** → **Recall Factory Setup** (main) → **OK Confirm Factory Init** (side).

See *Appendix E: Factory Initialization Settings* on page E–1 for a list of the factory defaults.

Signal Path Compensation

Signal Path Compensation (SPC) minimizes electrical offsets in the vertical, horizontal, and trigger amplifiers caused by changes in ambient temperature and component aging. This allows you to make accurate measurements over a wide ambient temperature range.

You should run an SPC anytime you wish to ensure that the measurements you make are made with the most accuracy possible. You should also run an SPC if the temperature has changed more than 5°C since the last SPC was performed. Also, run SPC before performing the *Performance Verification* and the *Adjustment Procedures*.

NOTE. When making measurements at volts/division settings less than or equal to 5 mV, you must run SPC at least once per week. Failure to do so may result in the oscilloscope not meeting warranted performance levels at those volts/div settings. (Warranted characteristics are listed in Appendix B.)

Compensate the Signal Path

To run an SPC, do the following steps:

1. Power on the digitizing oscilloscope and allow a 20 minute warm-up before doing this procedure.
2. Disconnect any input signals you may have connected from all input channels.

STOP. When doing steps 3 and 4, do not turn off the oscilloscope until signal-path compensation completes. If you interrupt (or lose) power to the instrument while signal-path compensation is running, a message is stored in the oscilloscope error log. If such a case occurs, rerun signal-path compensation (The error message remains in the error log until cleared using special service software).

3. Press **SHIFT UTILITY** → **System** (main) → **Cal** (pop-up) → **Signal Path** (main) → **OK Compensate Signal Paths** (side).
4. Wait for signal path compensation to complete (one to three minutes). While it progresses, a “clock” icon (shown at left) is displayed on-screen. When compensation completes, the status message is updated to *Pass* or *Fail* in the main menu.



5. Verify the word **Pass** appears under **Signal Path** in the main menu. (See Figure 3-52.)

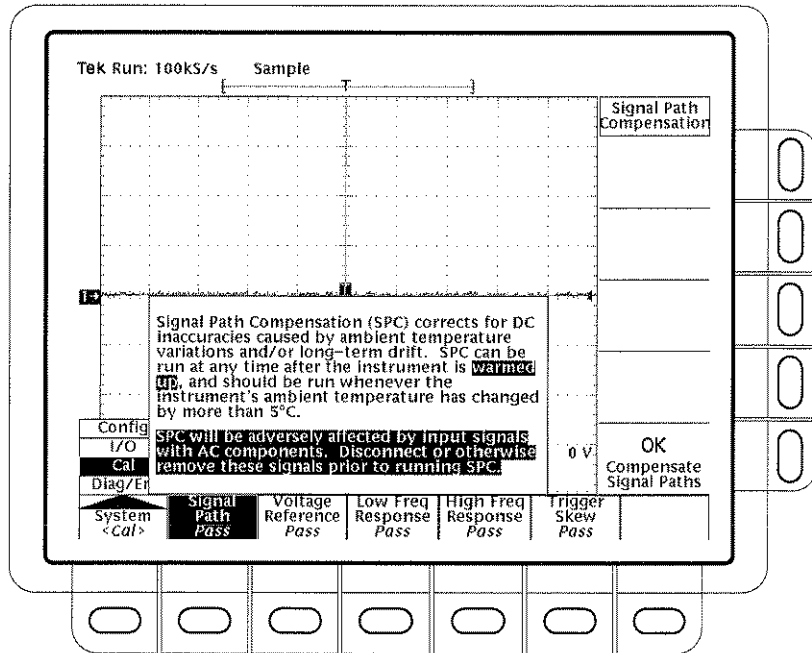

Figure 3-52: Performing a Signal Path Compensation

Taking Cursor Measurements

Use the cursors to measure the difference (either in time or voltage) between two locations in a waveform record. This section describes cursors — how to select their type and mode, how to display them, and how to use them to take measurements.

Description

Cursors are two markers that you position with the general purpose knob. You move one cursor independently or both cursors in tandem, depending on the cursor mode. As you position the cursors, readouts on the display report and update measurement information.

Cursor Types

There are three cursor types: *horizontal bar*, *vertical bar*, and *paired* (see Figure 3–53).

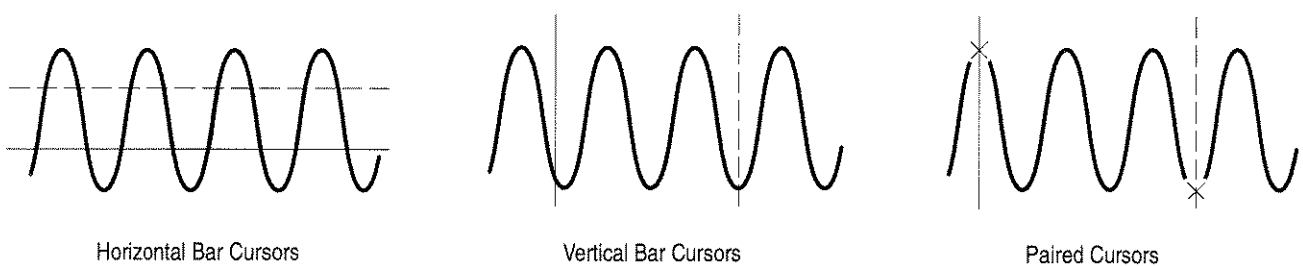

Figure 3–53: Cursor Types

Horizontal bar cursors measure vertical parameters (typically volts).

Vertical bar cursors measure horizontal parameters (typically time or frequency).

Paired cursors measure both vertical parameters (typically volts) and horizontal parameters (typically time) simultaneously.

Look at Figure 3–53. Note that each of the two paired cursors has a long vertical bar paired with an X. The Xs measure vertical parameters (typically volts); the long vertical bars measure horizontal parameters (typically time or frequency). (See *Cursor Readouts* on page 3–116 for more information.)

NOTE. When cursors measure certain math waveforms, the measurement may not be of time, frequency, or voltage. Cursor measurement of those math waveforms that are not of time, frequency, or voltage is described in *Waveform Math*, which begins on page 3-131. For those oscilloscopes equipped with Option 2F, the advanced DSP math option, the instruction manual shipped with the option describes the use of cursors to measure such waveforms and the measurement units that result.

Cursor Modes

There are two cursor modes: *independent* and *tracking* (see Figure 3-54).

In independent mode you move only one cursor at a time using the general purpose knob. The active, or selected, cursor is a solid line. Press **SELECT** to change which cursor is selected.

In tracking mode you normally move both cursors in tandem using the general purpose knob. The two cursors remain a fixed distance (time or voltage) from each other. Press **SELECT** to temporarily suspend cursor tracking. You can then use the general purpose knob to adjust the distance of the solid cursor relative to the dashed cursor. A second push toggles the cursors back to tracking.

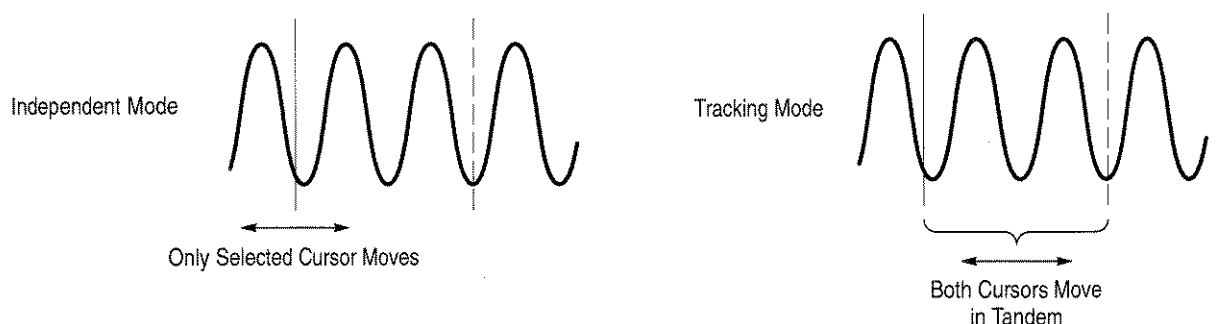

Figure 3-54: Cursor Modes

Cursor Readouts

The cursor readout shows the absolute location of the selected cursor and the difference between the selected and non-selected cursor. The readouts differ depending on whether you are using H Bars, V Bars, or Paired.

H Bars. The value after Δ shows the voltage difference between the cursors. The value after @ shows the voltage of the selected cursor relative to ground (see Figure 3-55). With the video trigger option, you can also display the voltage in IRE units.

V Bars. The value after Δ shows the time (or frequency) difference between the cursors. The value after @ shows the time (frequency) of the selected cursor relative to the trigger point. With the video trigger option, you can also display the line number.

Paired. The value after one Δ shows the voltage difference between the two Xs; the other Δ shows the time (or frequency) difference between the two long vertical bars. The value after the @ shows the voltage at the X of the selected cursor relative to ground (see Figure 3–56).

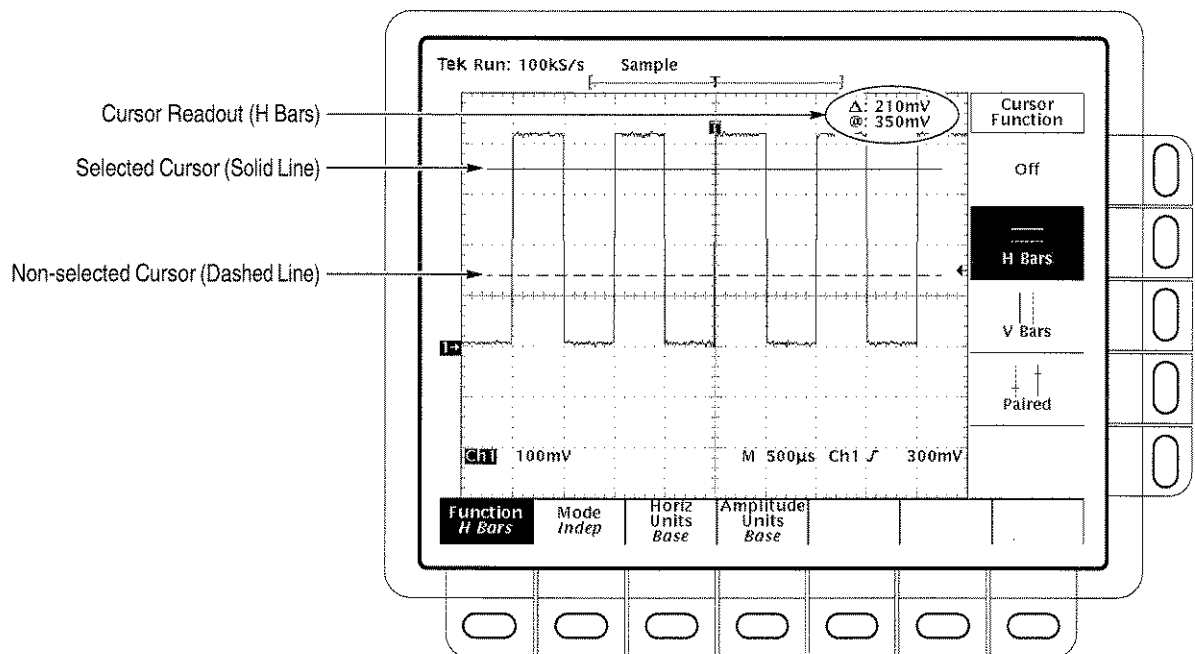

Figure 3–55: H Bars Cursor Menu and Readouts

Paired cursors can only show voltage differences when they remain on screen. If the paired cursors are moved off screen horizontally, Edge replaces the voltage values in the cursor readout.

Select the Cursor Function

Do this procedure and those that follow to take a cursor measurement. To select the type of cursors you want, do the following steps:

1. To display the cursor menu, press **CURSOR** (see Figure 3–55).
2. Press **CURSOR** → **Function** (main) → **H Bars**, **V Bars**, **Paired**, or **Off** (side).

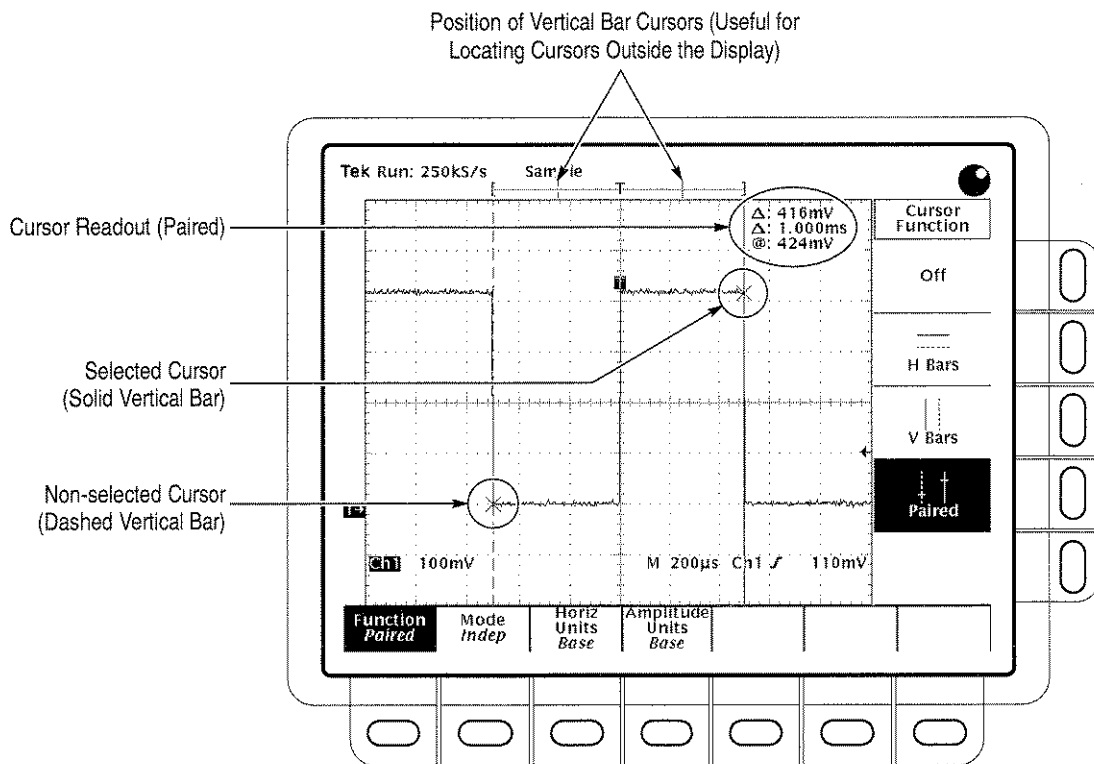

Figure 3-56: Paired Cursor Menu and Readouts

Set Mode and Adjust the Cursors

To select the cursor mode and adjust the cursors in either mode, do the following steps:

1. Press **CURSOR** → **Mode** (main) → **Independent** or **Tracking** (side):

Independent makes each cursor positionable without regard to the position of the other cursor.

Tracking makes both cursors positionable in tandem; that is, both cursors move in unison and maintain a fixed horizontal or vertical distance between each other.

2. Adjust the cursors according to the mode you have selected:

- To adjust either cursor in independent mode, use the general purpose knob to move the selected (active) cursor. A solid line indicates the adjustable cursor, and a dashed line indicates the fixed cursor. Press **SELECT** to toggle between cursors.
- To adjust both cursors in tracking mode, use the general purpose knob to move both cursors.
- To adjust the distance between cursors in tracking mode, press **SELECT** to temporarily suspend cursor tracking. Then use the general purpose knob to

adjust the distance of the solid cursor relative to the dashed cursor. Press **SELECT** again to resume tracking.

- To speed up or slow down adjustment of a cursor, press **SHIFT** before turning the general purpose knob. The cursor moves faster when the **SHIFT** button is lighted and the display reads *Coarse Knobs* in the upper right corner.

Select Horizontal Units

You can choose to display vertical bar cursor results in the base horizontal units of the waveform or in 1/base horizontal units of the waveform. For internally clocked waveforms the units are time or frequency; for externally clocked waveforms the units are clocks or 1/clocks. If you have Option 5 Video, you can also display the results in terms of video line number (see Figure 3–57). To choose vertical bar cursor units, do the following step:

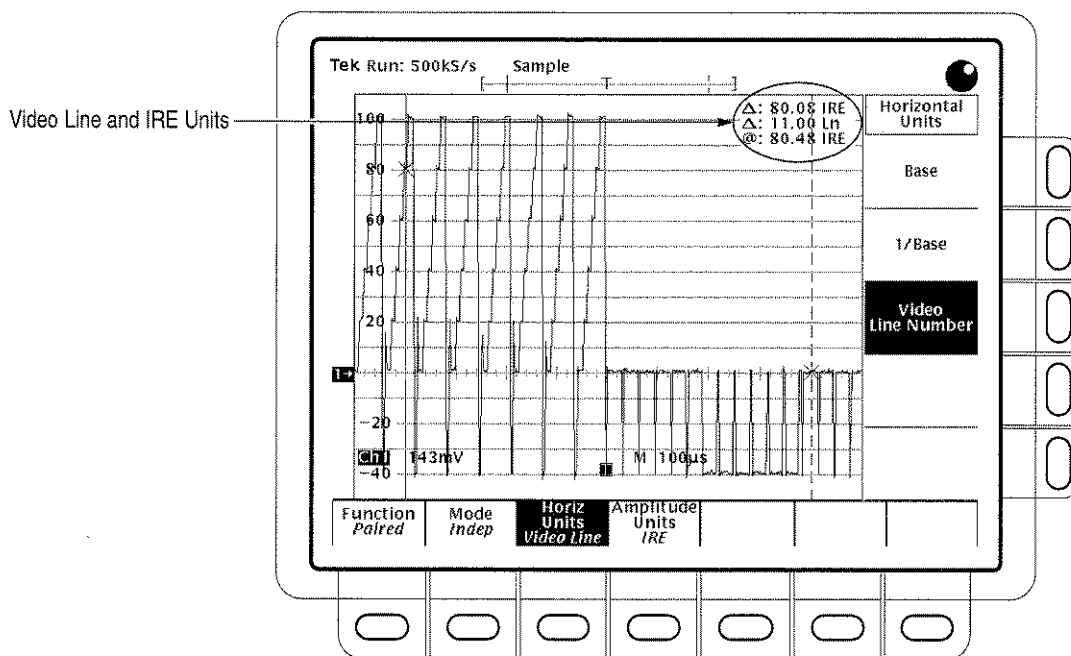

Figure 3–57: Video Line and IRE Units

NOTE. If Custom video mode is selected, you also need to set the Scan Period in the Custom Video menu

Press **CURSOR** → **Horiz Units** (main) → **Base** or **1/Base** or, or with Option 5, **video line number** (side).

Select Amplitude Units

If you are measuring NTSC signals, you can choose to display vertical readings in IRE units (see Figure 3-57). If you are trying to measure such a signal, you should have option 05 Video Trigger installed as it would be difficult to trigger on composite video waveforms without option 05. To switch between IRE and base cursor units, do the following steps:

1. Press **CURSOR** → **Amplitude Units** (main) → **IRE (NTSC)**.
2. To return to normal, press **CURSOR** → **Amplitude Units** (main) → **Base**.

Select Cursor Speed

To change the cursors speed, pressing **SHIFT** before turning the general purpose knob. The cursors move faster when the **SHIFT** button is lighted and the display reads *Coarse Knobs* in the upper right corner.

For More Information

See *Measurements* on page 2-47.

See *Waveform Math*, on page 3-131, for information on cursor units with multiplied waveforms.

If your oscilloscope is equipped with the advanced DSP math option, see the *TDS Family Option 2F Instruction Manual* for information on cursor units with integrated, differentiated, and FFT waveforms.

Vertical Control

You can control the vertical position and scale of the selected waveform using the vertical menu and knobs.

To Change Vertical Scale and Position

By changing the vertical scale, you can focus on a particular portion of a waveform. By adjusting the vertical position, you can move the waveform up or down on the display. That is particularly useful when you are comparing two or more waveforms.

To change the vertical scale and position, use the vertical **POSITION** and vertical **SCALE** knobs. The vertical controls only affect the selected waveform.

The **POSITION** knob simply adds screen divisions to the reference point of the selected waveform. Adding divisions moves the waveform up and subtracting them moves the waveform down. You also can adjust the waveform position using the offset parameter in the Vertical menu (discussed later in this article).

If you want the **POSITION** knob to move faster, press the **SHIFT** button. When the light next to the **SHIFT** button is on and the display says **Coarse Knobs** in the upper right corner, the **POSITION** knob speeds up significantly.

To Check the Vertical Scale

Check the *Vertical readout* at the bottom-left part of the display for the volts/division setting of each displayed channel (the selected channel is in inverse video). (See Figure 3-58.)

To Change Vertical Parameters

Use the Vertical menu (see Figure 3-58) to select the coupling, bandwidth, and offset for the selected waveform. This menu also lets you numerically change the position or scale instead of using the vertical knobs.

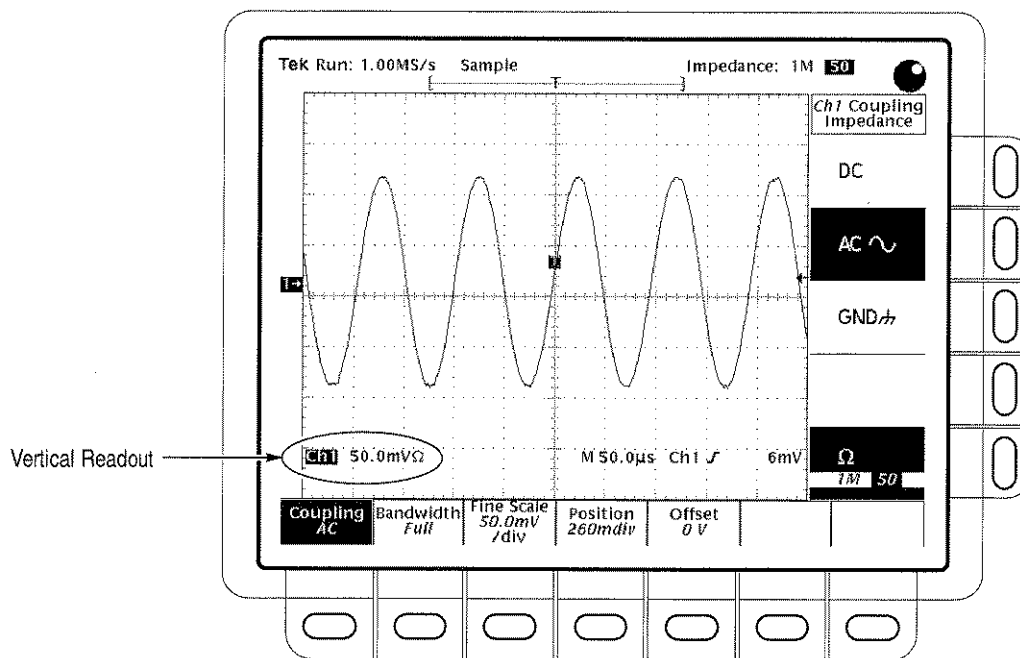

Figure 3-58: Vertical Readouts and Channel Menu

Coupling

To choose the type of coupling for attaching the input signal to the vertical attenuator for the selected channel and to set its input impedance:

Press **VERTICAL MENU** → **Coupling** (main) → **DC**, **AC**, **GND**, or **Ω** (side).

DC

DC coupling shows both the AC and DC components of an input signal.

AC

AC coupling shows only the alternating components of an input signal.

GND

GND (ground) coupling disconnects the input signal from the acquisition.

Ω

Ω (input impedance) lets you select either 1 MΩ or 50 Ω impedance.

NOTE. If you select 50 Ω impedance with AC coupling, the digitizing oscilloscope will not accurately display frequencies under 200 kHz.

Also, when you connect an active probe to the oscilloscope (such as the P6205), the input impedance of the oscilloscope automatically becomes 50 Ω. If you then connect a passive probe (like the P6138) you need to set the input impedance back to 1 MΩ.

Bandwidth

Bandwidth refers to the range of frequencies that an oscilloscope can acquire and display accurately (that is, with less than 3 dB attenuation). To select the upper

limit for the higher frequency components, change the bandwidth of the selected channel:

Press **VERTICAL MENU** → **Bandwidth** (main) → **Full, 100 MHz**, or **20 MHz** (side).

- Fine Scale** To make fine adjustments to the vertical scale, press **VERTICAL MENU** → **Fine Scale** (main) and use the general purpose knob to adjust the vertical scale.
- Position** To adjust the vertical position to a specific number of divisions, press **VERTICAL MENU** → **Position** (main) and use the general purpose knob to set vertical position. If you want to reset the reference point of the selected waveform to the center of the display, press **Set to 0 divs** (side).
- Offset** Offset lets you subtract DC bias from the waveform, so the oscilloscope can acquire the exact part of the waveform you are interested in. For example, you might be trying to look at a small ripple on a power supply output. It may be a 100 mV ripple on top of a 15 V supply. Using offset you can display the ripple and scale it to meet your needs.
- To use offset, press **VERTICAL MENU** → **Offset** (main). Then use the general purpose knob to set the vertical offset. If you want to reset the offset to zero, press **Set to 0 V** (side).

For More Information

See *Acquisition*, on page 2–39.

See *Scaling and Positioning Waveforms*, on page 2–43.

Video Triggering

The optional Video Trigger menu gives you a variety of selections for triggering on a video signal.

A *video trigger* event occurs when a video signal generates a horizontal or vertical sync pulse. For more information, see *Triggering* on page 2–31.

To Select Video Triggering

The Video Trigger menu lets you select the source, polarity, class, mode, and holdoff. It also gives you the option to delay by lines or time and lets you trigger on the first field, second field, or both. To bring up the Video Trigger menu:

Press the **TRIGGER MENU** → **Type** (main) → **Video** (side) (see Figure 3–15).

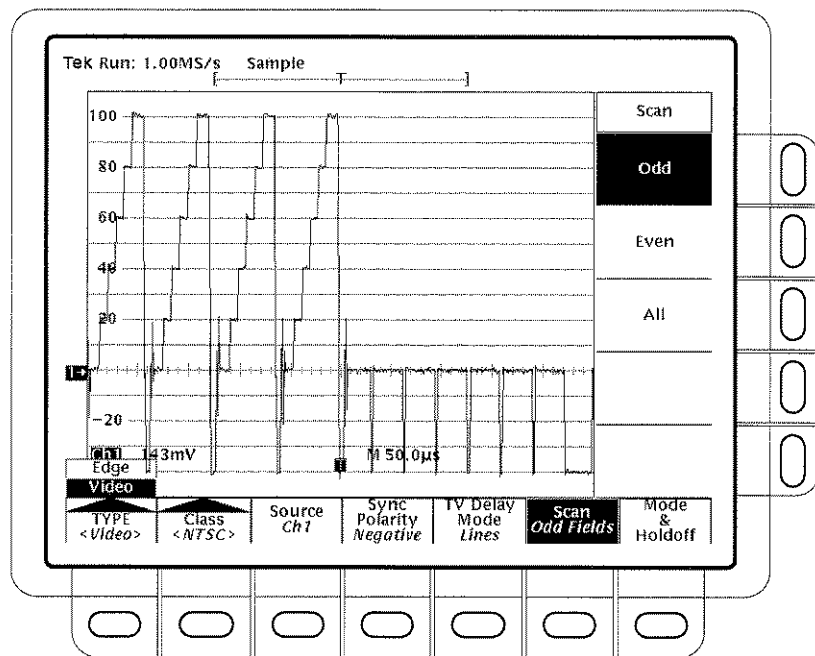

Figure 3–59: Main Trigger Menu — Video Type

To Select Video Class

Using the Class option you can select predefined setups (NTSC, PAL, or SECAM) or customize the setup.

Press the **TRIGGER MENU** → **Type** (main) → **Video** (pop-up) **Class**, (main) → **NTSC**, **PAL**, **SECAM**, or **Custom** (pop-up) (Figure 3–60).

NTSC has a line rate of 525 lines per frame and a field rate of 60 Hz.

PAL has a line rate of 625 lines per frame and a field rate of 50 Hz.

SECAM has a line rate of 625 lines per frame and a field rate of 50 Hz.

Custom lets you specify the frequency range of the video signal. The different ranges are listed in the Scan Parameter side menu (discussed later in this section).

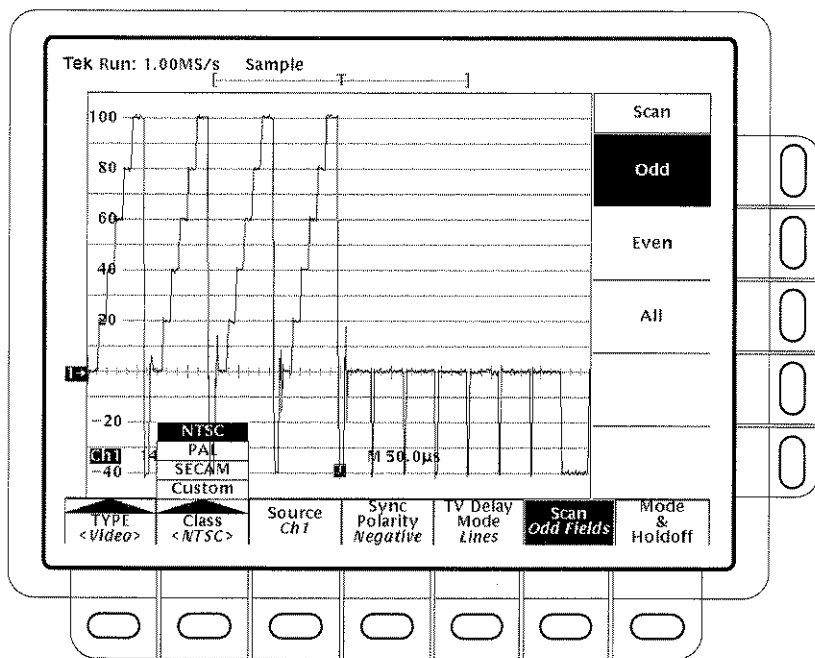

Figure 3–60: Video Trigger Menu — Class

To Select the Source

You need to select which source you want the trigger to come from.

On the TDS 420A and TDS 460A, press the **TRIGGER MENU** → **Source** (main) → **Ch1**, **Ch2**, **Ch3**, or **Ch4** (side).

On the TDS 410A, press the **TRIGGER MENU** → **Source** (main) → **Ch1** or **Ch2** (side)

To Set Sync Polarity

Negative polarity is the standard for horizontal and vertical sync pulses. However, you may want to trigger on a positive polarity pulse when probing circuitry that inverts the video signal. You can easily change the polarity by using the **Sync Polarity** option.

Press the **TRIGGER MENU** → **Sync Polarity** (main) → **Neg Sync** or **Pos Sync** (side).

To Specify TV Delay Mode

You specify the delay for a video trigger with the **TV Delay Mode** option. Since video signals are composed of line information and other time specified components, the **TV Delay Mode** option lets you delay by lines or time (see Figure 3-61).

Press the **TRIGGER MENU** → **TV Delay Mode** (main) → **Delay by Lines** or **Delay by Time** (side). Use the general purpose knob to enter the value.

If you want to enter a large number using the general purpose knob, press the **SHIFT** button before turning the knob. When the light next to the **SHIFT** button is on and the display says **Coarse Knobs** in the upper right corner, the general purpose knob speeds up significantly.

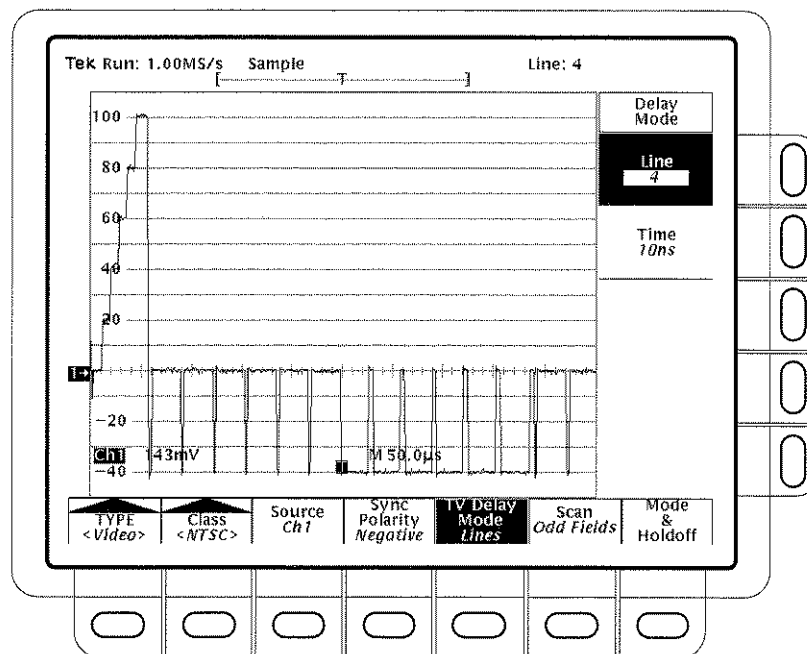

Figure 3-61: Video Trigger Menu — TV Delay Mode

To Select TV Fields

If you selected **NTSC**, **PAL**, or **SECAM** in the Class menu, there is a Scan menu that lets you choose between triggering on the odd fields, the even fields, or all.

Press the **TRIGGER MENU** → **Scan** (main) → **Odd**, **Even**, or **All** (side) (see Figure 3-62).

If you choose *Odd*, the digitizing oscilloscope always triggers on the start of the odd field in an interlaced frame.

If you choose *Even*, the digitizing oscilloscope always triggers on the first line of the even field in an interlaced frame.

If you choose *All*, the digitizing oscilloscope alternates between triggering on the start of the odd and even fields.

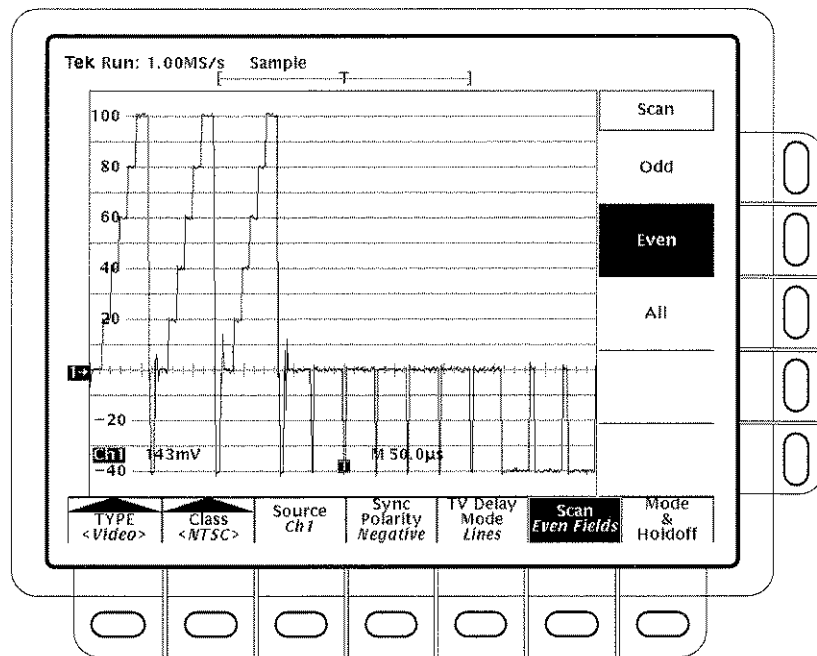

Figure 3-62: Video Trigger — Scan Parameter

To Set the Scan Rate & Interlace Mode

If you select Custom in the Class menu, the Scan Rate & Interlace option lists several frequency range options (see Figure 3–63). The options are: Scan Period (15.625 μ s–66.667 μ s), Rate 1 (15–20 kHz), Rate 2 (20–25 kHz), Rate 3 (25–35 kHz), and Rate 4 (35–64 kHz). Precise setting of the Scan Period is only required if the video class is Custom and you use video line cursors; however, adjusting the period (using the general purpose knob) also selects the appropriate scan rate. Also, choosing a scan rate incompatible with the current scan period setting forces the scan period to the minimum period implied by the selected rate.

By toggling the button next to the **Interlaced** option, you can trigger on interlaced field one, interlaced field two, or both fields noninterlaced.

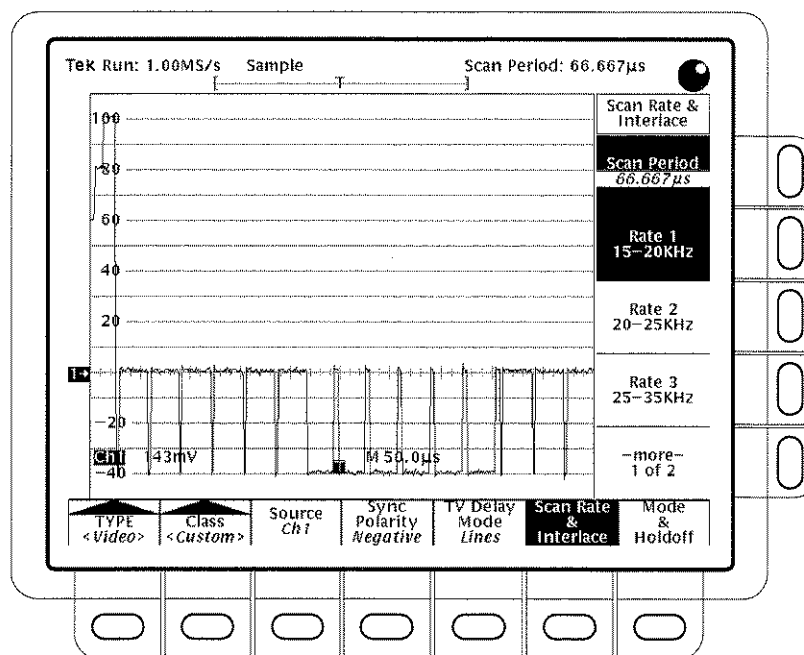

Figure 3–63: Video Trigger — Scan Rate & Interlace

To Set Mode & Holdoff

You can change the holdoff time and select the trigger mode using this menu item. See *Triggering* on page 2–31 for more details on mode and holdoff.

Press the **TRIGGER MENU** → **Mode & Holdoff** (main) → **Auto** or **Normal** (side) (see Figure 3–64).

In *Auto* mode the oscilloscope acquires a waveform even if a trigger does not occur.

In *Normal* mode the oscilloscope acquires a waveform only if there is a valid trigger.

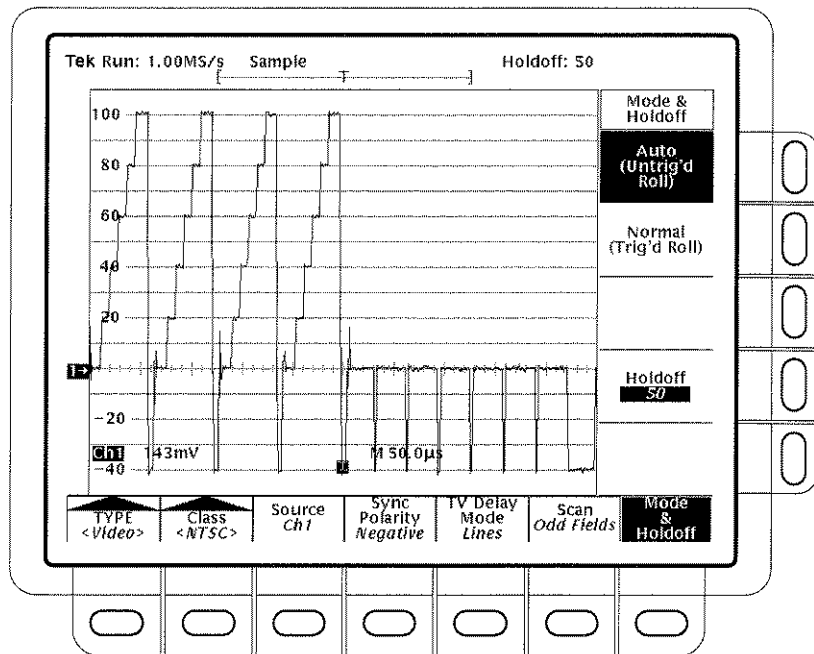

Figure 3-64: Video Trigger Menu — Mode & Holdoff

To change the holdoff time, press **Holdoff** (side). Enter the value using the general purpose knob. If you want to enter a large number, press the **SHIFT** button before turning the knob. When the light next to the **SHIFT** button is on and the display says **Course Knobs** in the upper right corner, the general purpose knob speeds up significantly.

There are different default values for holdoff to insure a stable color burst in the sync pulse. These holdoff values depend on whether you select **NTSC**, **PAL**, or **SECAM** and if you trigger on interlaced field one or two.

For More Information

See *Triggering*, on page 2-31.

See *Role Mode*, on page 3-93.

Waveform Math

The TDS 400A allows you to mathematically manipulate your waveforms. For example, you might have a waveform clouded by background noise. You can obtain a cleaner waveform by subtracting the background noise from your original waveform.

This section describes the standard waveform math features (invert, add, subtract, and multiply). See the *TDS Family Option 2F Instruction Manual* for information on Advanced DSP Math features, if your oscilloscope is equipped with that option.

To Use Single Wfm Math

To perform waveform math, use the More menu (see Figure 3–65). The More menu allows you to display, define, and manipulate math functions; the following steps explain how to create a math waveform based on a single source waveform.

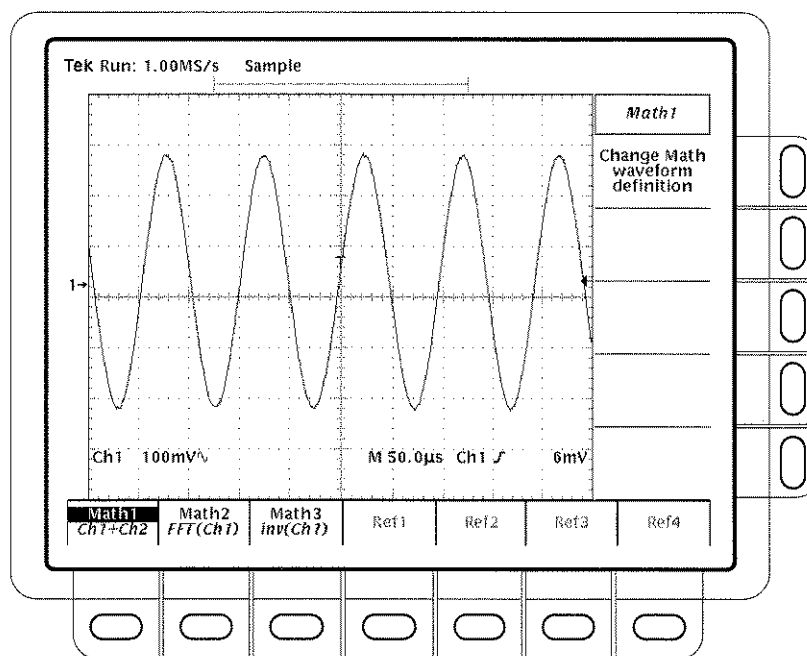

Figure 3–65: More Menu

1. Press **MORE** → **Math1**, **Math2**, or **Math3** (main) → **Change Math waveform definition** (side) → **Single Wfm Math** (main).
2. To define the source waveform, press **Set Function to** (side) repeatedly to cycle it to the desired channel or reference waveform.
3. Press **Set Function to** (side) repeatedly to cycle it to **inv** (invert), **intg**, or **diff**. Waveform integration (**intg**) and waveform differentiation (**diff**) are described in the *TDS Family Option 2F Instruction Manual*.
4. To create the math waveform, press **OK Create Math Wfm** (side).

To Use Dual Wfm Math

To create a math waveform that requires two waveform sources, do the following steps:

NOTE. *With Option 1M and 2A, there are only 120K points available for reference waveforms. If you select the 120K record length in the Horizontal menu, then you can only save one reference waveform. Also, you can only use/display four waveforms. Even if you do not display the source waveforms, Dual waveform math uses three of the four waveforms. For example: if you display a math waveform that is the sum of CH 1 and CH 2, even if CH 1 and CH 2 are not displayed, you have used three waveforms. Therefore, you can only display one additional waveform.*

1. Press **MORE** → **Math1**, **Math2**, or **Math3** (main) → **Change Math waveform definition** (side) → **Dual Wfm Math** (main) (see Figure 3–66).
2. To define the first source waveform, press **Set 1st Source to** (side) repeatedly to cycle it to the desired channel or reference waveform.
3. To define the second source waveform, press **Set 2nd Source to** (side) repeatedly to cycle it to the desired channel or reference waveform.
4. To enter the math operator, press **Set operator to** (side) repeatedly to cycle it through the choices. Supported operators are +, −, and *.
5. Press **OK Create Math Wfm** (side) to perform the function.

NOTE. *If you select *, for multiply, in step 4, the cursor feature measures amplitude in the units volts squared VV rather than in volts V.*

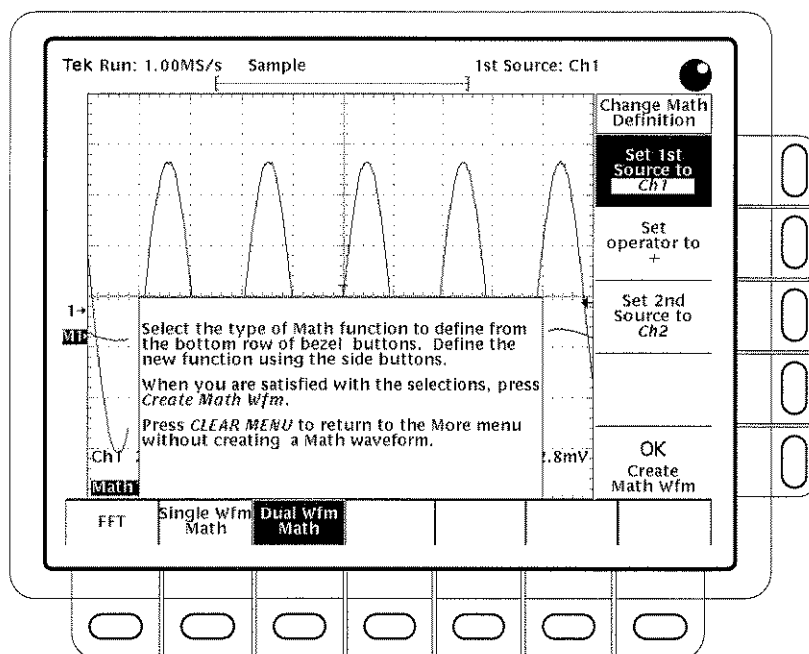

Figure 3-66: Dual Waveform Math Menus

To Select a Math Waveform

To select a waveform that you want to display, press **MORE** → **Math1**, **Math2**, or **Math3** (main).

Single and dual waveform math operations are described separately in the previous topics.

NOTE. If your digitizing oscilloscope is equipped with Option 2F, Advanced DSP Math, the menu item *FFT* will be at the same brightness as the menu items *Single Wfm Math* and *Dual Wfm Math*; otherwise, *FFT* will be dimmed. See the TDS Family Option 2F Instruction Manual for information on *FFTs* and other advanced math waveforms.

For More Information

If your oscilloscope is equipped with option 2F, you can also create integrated, differentiated, and Fast Fourier Transform waveforms. If your oscilloscope is equipped with that option, see the *TDS Family Option 2F Instruction Manual*.

Zoom

At times, you may want to expand or compress (zoom in or out) a waveform on the display without changing the acquisition parameters. You can do that with the zoom feature. This section describes how to use zoom and how it interacts with the selected waveform. It also describes how interpolation affects zoom.

Use Zoom (press the ZOOM button) when you wish to temporarily expand a waveform to inspect a small feature(s) on that waveform. For example, to temporarily expand the front corner of a pulse to inspect its aberrations, use zoom to expand it horizontally and vertically. After you are finished, you can return to your original horizontal scale setting by resetting zoom. (The zoom feature is also handy if you have acquired a waveform while using the fastest time per division and want to further expand the waveform horizontally.)

Using With Waveforms

When zooming vertically, the digitizing oscilloscope expands or contracts the *selected* waveform only. Also, the oscilloscope only positions the selected waveform when in zoom.

When zooming horizontally, zoom expands either the selected waveform, all live waveforms, or all live and reference waveforms depending on the setting for Horizontal Lock in the Zoom menu.

Interpolation and Zoom

When you zoom in on a waveform on the display, you expand a portion of it. The digitizing oscilloscope may need to show more points for that portion than it has acquired. If it needs to do this, it interpolates. The instrument can interpolate in either of two ways: *linear* or *sin(x)/x*. (The interpolation methods are described in *Real-Time Sampling* on page 2–40.)

When you zoom, the display redraws the waveforms using the interpolation method you selected in the Display menu (linear interpolation or *sin(x)/x*). If you selected *sin(x)/x* (the default), it may introduce some overshoot or undershoot to the waveform edges. If that happens, change the interpolation method to linear, following the instructions on page 3–23.

To differentiate between the real and interpolated samples, set the display style to **Intensified Samples**.

Checking the Zoom Factors

To quickly determine the zoom factors of a zoomed waveform, select the waveform and check the zoom readout. It shows the selected waveform by number, along with the horizontal and vertical expansion factors.

The zoom readout appears at the top of the display when zoom is on. See Figure 3–67 on page 3–137.

To Zoom a Waveform

To use Zoom, select a waveform, turn zoom on, and magnify it using the vertical and horizontal scale knobs:

1. Press any of the waveform selection buttons (**CH 1** through **CH 4** on the TDS 420A and TDS 460A, and **CH 1** through **CH 2** on the TDS 410A) on the right side of the display. Or press **MORE** and select a math or reference waveform from the More menu.
2. Press **ZOOM** → **Mode** (main) → **ON** (side). The **ZOOM** front-panel button should light up.
3. Adjust the vertical zoom factor for the selected waveform using the vertical **SCALE** knob. Adjust the vertical position of the zoomed waveform using the vertical **POSITION** knob.
4. Adjust the horizontal zoom factor using the horizontal **SCALE** knob. Adjust the horizontal position of the zoomed waveform using the horizontal **POSITION** knob.
5. Press **ZOOM** → **Lock** (main) → **All**, **Live**, or **None** (side) to choose which waveforms to zoom.

Depending on the selection for Lock in the side menu, zoom affects the displayed waveforms as follows:

None — only the waveform currently selected can be magnified and positioned horizontally (Figure 3–67).

Live — all “live” (as opposed to reference) waveforms can be magnified and positioned horizontally at the same time. If a *reference* or *math* waveform is selected and Horizontal Lock set to Live, only the selected reference or math waveform is magnified and positioned.

All — all waveforms displayed (live, math, and reference) can be magnified and positioned horizontally at the same time.

NOTE. Although zoom must be turned on to control which waveforms zoom affects, the setting for Lock affects which waveforms the horizontal control positions whether zoom is on or off. The rules for the three settings are as listed in step 5.

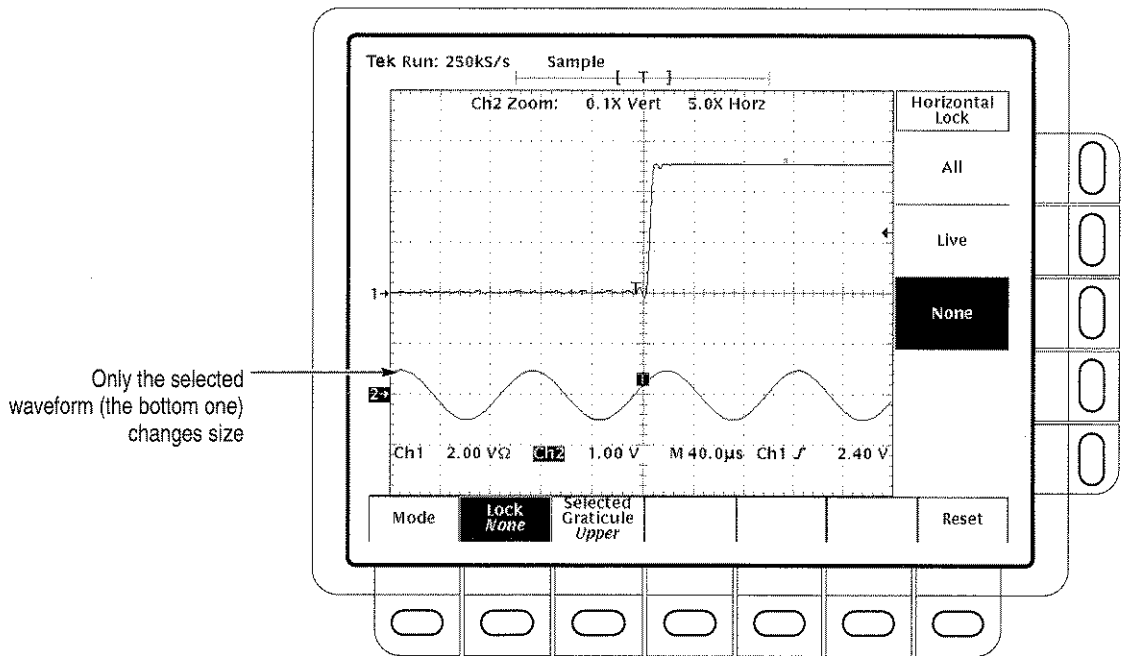

Figure 3-67: Zoom Mode with Horizontal Lock Set to None

Select Zoom or Dual Zoom

To select between waveform zoom and dual waveform zoom, press **ZOOM → Mode** (main). Then press **Dual Zoom** (side) to toggle Dual Zoom **OFF** or **ON**.

NOTE. Dual zoom displays a second zoomed view of the selected unzoomed waveform. The second zoomed view is offset in time from the first zoomed view. Also, zoom must be enabled (*On or Preview*) to see the dual zoom displays.

To Set Dual Zoom Offset

To set the offset in time of the second zoomed waveform from the first, press **ZOOM → Mode** (main) → **Dual Zoom Offset** (side). Then turn the general purpose knob to set the offset.

Dual zoom offset is always positive. The oscilloscope sets the offset as close to the requested value as possible. An offset request of 0.0 insures that the zoom boxes are butted against each other, regardless of the zoom factor.

To Preview Zoom Zoom Preview draws a box around the zoomed portion(s) of the unmagnified selected waveform. It also displays both the magnified and unmagnified waveforms in separate half-height graticules (see Figure 3–68). To preview zoom, press **Zoom** → **Mode** (main) → **Preview** (side).

In preview mode, the zoom magnification factors are not displayed. However, scale factors for the zoomed waveform are displayed.

To select which waveforms are controlled by the horizontal and vertical scale and offset controls, indicated by “photo-corners” on the graticule corners containing the waveforms (see Figure 3–68), press **Selected Graticule** (main) → **Upper** or **Lower** (side).

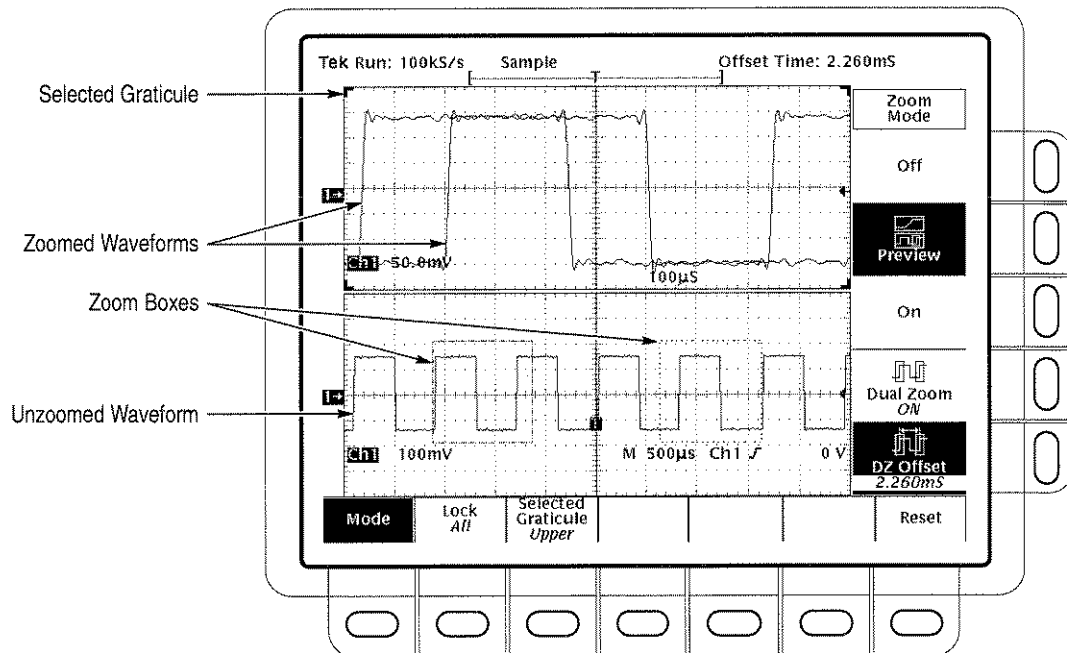

Figure 3–68: Zoom Preview Mode

Reset Zoom To reset all zoom factors to their defaults (see Table 3–5), press **ZOOM** → **Reset** (main) → **Reset All Factors** (side).

To reset only “live” waveform zoom factors to their defaults, press **ZOOM** → **Reset** (main) → **Reset Live Factors** (side).

Table 3-5: Zoom Defaults

Parameter	Setting
Zoom Vertical Position	0
Zoom Vertical Gain	1×
Zoom Horizontal Position	Tracking Horizontal Position
Zoom Horizontal Gain	1×
Dual Zoom Offset	0.0

Press **ZOOM** → **Mode** (main) → **Off** (side) to return to normal oscilloscope (non-zoom) operation.

For More Information

See *Acquisition*, on page 2-39.

See *Display Modes*, on page 3-21.

Appendix A: Options and Accessories

This appendix describes the various options as well as the standard and optional accessories that are available for the TDS 410A, TDS 420A, and TDS 460A Digitizing Oscilloscopes.

Options

The following options are available:

- | | |
|---|---|
| Option 02: Front Cover and Pouch | With this option, Tektronix ships a front cover and pouch with the instrument. |
| Option 05: Video Trigger | This option provides a video trigger. It lets you trigger on positive or negative sync pulses. It also lets you select interlaced field one, interlaced field two, or both fields noninterlaced. You can define the signal class to be NTSC, PAL, SECAM, or you can customize the class. |
| Option 1F: File System | With this option, Tektronix ships the digitizing oscilloscope with a floppy disk drive and a variety of features for managing the floppy disk. With the file system you can save and recall setups, waveforms, and hardcopies on a floppy disk. |
| Option 13: RS-232/Centronics Hardcopy Interface | With this option, Tektronix ships the oscilloscope equipped with an RS-232 and a Centronics interface that can be used to obtain hardcopies of the oscilloscope screen. |
| Option 2F: Advanced DSP Math | With this option, the oscilloscope can compute and display three advanced math waveforms: integral of a waveform, differential of a waveform, and an FFT (Fast Fourier Transform) of a waveform. |
| Option 3P: Printer Pack | With this option, Tektronix ships a Seiko DPU-411 thermal printer, cables, and manual, and an accessory pouch for mounting to the top of the oscilloscope. Hardcopies of the screen are produced on four inch thermal paper. The pouch holds the printer and has additional room for accessories. |
| Option 2A: 120,000 Point Record Length and Video Trigger | This option combines Option 1M (120,000 point records) and Option 05 (Video Trigger). |

**Options A1–A5:
International Power Cords**

Besides the standard North American, 110 V, 60 Hz power cord, Tektronix ships any of five alternate power cord configurations (listed in Table A–1) with the oscilloscope when ordered by the customer.

Table A–1: International Power Cords

Option	Power Cord
A1	Universal European — 220 V, 50 Hz
A2	UK — 240 V, 50 Hz
A3	Australian — 240 V, 50 Hz
A4	North American — 240 V, 60 Hz
A5	Switzerland — 220 V, 50 Hz

**Option 1M: 120,000 Point
Record Length**

This option provides a maximum record length of 120,000 points per acquisition (120,000/channel).

**Option 1K: K212
Instrument Cart**

With this option, Tektronix ships a three tray instrument cart (the K212).

**Option 1R: Rackmounted
Digitizing Oscilloscope**

Tektronix ships the digitizing oscilloscope, when ordered with Option 1R, configured for installation in a 19 inch wide instrument rack. Customers with instruments not configured for rackmounting can order a rackmount kit (016-1166-00) for field conversions.

Instructions for rackmounting the digitizing oscilloscope are shipped with the option 1R.

**Option 22: Additional
Probes**

With this option, Tektronix ships two additional probes identical to the two standard-accessory P6138 probes normally shipped with the instrument. This provides one probe for each front-panel input.

**Option 28: Analog
Differential Amplifier**

With this option, Tektronix ships an ADA400A Analog Differential Amplifier. This provides one differential input pair for a front-panel input.

**Option 95: Test Data
Report**

With this option, Tektronix ships a test data report for the oscilloscope.

Option 96: Certificate of Calibration

Tektronix ships a Certificate of Calibration which states this instrument meets or exceeds all warranted specifications and was calibrated using standards and instruments whose accuracies are traceable to the National Institute of Standards and Technology, an accepted value of a natural physical constant, or a ratio calibration technique. The calibration is in compliance with US MIL-STD-45662A.

Standard Accessories

Table A-2 lists the standard accessories that are included with the digitizing oscilloscope:

Table A-2: Standard Accessories

Accessory	Part Number
User Manual	070-9219-XX
Programmer Manual	070-8709-XX
Reference	070-9220-XX
Performance Verification	070-9218-XX
U.S. Power Cord	161-0230-01
Probes (qty. two) P6138 10X Passive	P6138 (single unit)

Probe Accessories

Table A-3 lists accessories to the standard probe listed previously (P6138). Except for the probe-tip-to-circuit board adapter, you can also order them separately.

Table A-3: Probe Accessories

Accessory	Part Number
Retractable Hook Tip	013-0107-XX
Body Shell, tip cover	204-1049-00
Probe-Tip-to-Circuit Board Adapter (qty. two standard, optionally available in package of 25 as 131-5031-00)	No customer orderable part number for double unit
6-Inch Slip-On Ground Lead	196-3113-02
Low Inductance Ground Lead	195-4240-00
Marker Rings Set (qty. eighteen rings which includes two each of nine colors)	016-0633-00
Ground Collar	343-1003-01
6-Inch Alligator Clip Ground Lead	196-3305-00
Screwdriver: adjustment tool, metal tip	003-1433-00
SMT KlipChip™	206-0364-00
Accessory Pouch	016-0708-00

Optional Accessories

You can also order the optional accessories listed in Table A-4:

Table A-4: Optional Accessories

Accessory	Part Number
High Voltage Differential Probe	P5200
TDS 410A, TDS 420A, & TDS 460A Service Manual	070-9217-XX
Plotter (GPIB and Centronics Standard)	HC100
Plotter (Centronics Standard)	HC200
Oscilloscope Cart	K212
Rackmount Kit (for field conversion)	016-1166-00
Oscilloscope Camera	C9
Oscilloscope Camera Adapter	016-1154-00
Soft-Sided Carrying Case	016-1158-XX
Transit Case	016-1157-00
GPIB Cable (1 meter)	012-0991-01
GPIB Cable (2 meter)	012-0991-00
Front Cover	200-3232-XX
Pouch (includes mounting plate)	016-1159-00
VGA Cable (Required to meet all emissions specifications)	CTL3VGAMM-5 (LCOM part number)

Accessory Probes

The following optional accessory amplifier and probes are recommended for use with your digitizing oscilloscope:

- ADA400A analog differential preamplifier
- P5200 high voltage differential probe (1300 Volts)
- P6101B 1X, 15 MHz, passive probe
- P6156 10X, 3.5 GHz, passive, low capacitance, (low impedance Z_o) probe; Option 25 provides 100X
- P6009 passive, high voltage probe, 100X, 1500 VDC + Peak AC
- P6015A passive high voltage probe, 1000X, 20 kVDC + Peak AC (40 kV peak for less than 100 ms)
- P6205 750 MHz probe bandwidth; Active (FET) voltage probe

- P6204 Active, high speed digital voltage probe. FET. DC to 1 GHz. DC offset. 50 Ω input. Use with 1103 TekProbe Power Supply for offset control.
- P6046 Active, differential probe, 1X/10X, DC to 100 MHz, 50 Ω input
- AM 503S — DC/AC Current probe system, AC/DC; Uses A6302 Current Probe
- AM 503S Option 03: DC/AC Current probe system, AC/DC; Uses A6303 Current Probe
- P6021 AC Current probe; 120 Hz to 60 MHz
- P6022 AC Current probe; 935 kHz to 120 MHz
- CT-1 Current probe — designed for permanent or semi-permanent in-circuit installation; 25 kHz to 1 GHz, 50 Ω input
- CT-2 Current probe — designed for permanent or semi-permanent in-circuit installation; 1.2 kHz to 200 MHz, 50 Ω input
- CT-4 Current Transformer — for use with the AM 503S (A6302) and P6021; Peak pulse 1 kA. 0.5 Hz to 20 MHz with AM 503S (A6302)
- TVC 501 Time-to-voltage converter; Time delay, pulse width and period measurements
- P6562A SMT Probe, 350 MHz

Probe Accessories

Table 3–6 lists optional accessories that are recommended for use with the standard probe listed under *Standard Accessories* on page A–4.

Table A–5: Probe Accessories

Accessory	Part Number
Connector, BNC: BNC to Probe Tip Adapter	013-0226-00
Connector, BNC: 50 Ω , BNC to Probe Tip Adapter	013-0227-00
Connector, Probe: Package of 100, compact	131-4244-00
Connector, Probe: Package of 25, compact	131-5031-00
Screwdriver Adjustment Tool, Package of five	003-1433-01
Compact-to-Miniature Probe Tip Adapter	013-0202-02
Probe Tip Holder: (holds three tips)	352-0670-00
3 Inch Slip-On Ground Lead	196-3113-03
Probe Holder: Black ABS	352-0351-00
IC Protector Tip, Package of 10	015-0201-07

Table A-5: Probe Accessories (Cont.)

Accessory	Part Number
IC Protector Tip, Package of 100	015-0201-08
Marker Ring Set: Two each of nine colors	016-0633-00
SMT KlipChip [®] : 20 Adapters	SMG50
Low-Inductance Spring-Tips: Two each of five different springs and insulator	016-1077-00
Probe Tip-to-Chassis Adapter	131-4210-00
NOTE. The next four items can only be used with the Compact-to-Miniature Probe Tip Adapter.	
Dual-Lead Adapter	015-0325-00
BNC-to-Probe Tip Adapter	013-0084-01
G.R.-to-Probe Tip Adapter, 50 Ω	017-0088-00
Bayonet Ground Assembly	013-0085-00

Accessory Software

Table A-6 lists optional accessories that are Tektronix software products recommended for use with your digitizing oscilloscope:

Table A-6: Accessory Software

Software	Part Number
EZ-Test Program Generator	S45F030
Wavewriter: AWG and waveform creation	S3FT400
LabWindows	063-0169-XX

Warranty Information

Check for the full warranty statements for this product, the probes, and the products listed above after the title page of each product manual.

Service Assurance

Tektronix offers the following services that you can purchase any time during the warranty period of this product:

- *REP* (Repair) Service Assurance provides one year of post-warranty repair support. It is available in one year increments up to two years.
- *CAL* (Calibrate) Service Assurance provides one year of calibration support. It is available in one year increments up to five years.

For further information contact your Tektronix Representative.

Appendix B: Specification

This Chapter begins with a general description of the traits of the TDS 400A Digitizing Oscilloscopes. Three sections follow, one for each of three classes of traits: *nominal traits*, *warranted characteristics*, and *typical characteristics*.

General

The TDS 400A Digitizing Oscilloscopes are portable, four-channel instruments suitable for use in a variety of test and measurement applications and systems. Table B-1 lists key features.

Table B-1: Key Features of the TDS 400A Oscilloscopes

Feature	Description
Digitizing rate, maximum	100 MS/s on each channel simultaneously
Analog bandwidth	TDS 460A: 400 MHz TDS 420A: 200 MHz TDS 410A: 200 MHz
Channels	TDS 460A: Four, each with 8-bit resolution TDS 420A: Four, each with 8-bit resolution TDS 410A: Two, each with 8-bit resolution
Record lengths, maximum	30,000 samples (120,000 with option 1M)
Acquisition modes	Sample, envelope, average, high-resolution, and peak-detect
Trigger modes	Edge With Option 05, video trigger modes include: NTSC, SECAM, PAL, and Custom
Display Modes	Infinite and variable persistence, roll, fit to screen, and dual waveform zoom
Storage	NVRAM storage for saving waveforms, hardcopies, and setups With Option 1F, 1.44 Mbyte, 3.5 inch, DOS 3.3-or-later floppy disk
I/O	Full GPIB programmability Hardcopy output using GPIB and, with Option 13, RS-232 or Centronics ports
Math	Including: invert, add, subtract, multiply, and with Option 2F, integral, differential, and FFT
User interface	A graphical user interface, on-line help, and a logical front-panel layout

Nominal Traits

This section contains a collection of tables that list the various *nominal traits* that describe the TDS 400A Digitizing Oscilloscopes. Included are electrical and mechanical traits.

Nominal traits are described using simple statements of fact such as “Four, all identical” for the trait “Input Channels, Number of,” rather than in terms of limits that are performance requirements.

Table B-2: Nominal Traits — Signal Acquisition System

Name	Description								
Bandwidth Selections	20 MHz, 100 MHz, and FULL (TDS 410A and TDS 420A: 200 MHz, TDS 460A: 400 MHz)								
Digitizers, Number of	TDS 410A: Two, both identical TDS 420A and TDS 460A: Four, all identical								
Digitized Bits, Number of	8 bits ¹								
Digitized Resolution, Hi Res Mode	Clock, Internal: $\text{Resolution}_{\text{HiRes}} \cong 8 \leq \left[8 + 0.5 \text{Log}_2 \left(\frac{\text{time/div}}{500 \cdot 10^{-9}} \right) \right] \leq 15 \text{ bits}$ Clock, External: $\text{Resolution}_{\text{HiRes}} \cong 8 \leq \left[8 + 0.5 \text{Log}_2 \left(\frac{100,000,000}{\text{ClockExternalMenu}} \right) \right] \leq 11.8 \text{ bits}$								
Bandwidth, Hi Res Mode	Clock, Internal: For $1\mu\text{s}/\text{div}$ and slower, $\text{BW}_{\text{HiRes}} \cong 0.44 \cdot \left(\frac{50}{\text{time/div}} \right) \text{ Hz}$ Clock, External: $\text{BW}_{\text{HiRes}} \cong 44 \cdot \left(\frac{\text{ClockExternalMenu}}{100} \right) \text{ Hz}$								
Input Channels, Number of	TDS 410A: Two, both identical, called CH 1 and CH 2 TDS 420A and TDS 460A: Four, all identical, called CH 1 through CH 4								
Input Coupling	DC, AC, or GND								
Input Resistance Selections	1 M Ω or 50 Ω								
Ranges, Offset, All Channels	<table border="1"> <thead> <tr> <th>Volts/Div Setting</th> <th>Offset Range</th> </tr> </thead> <tbody> <tr> <td>1 mV/div to 99.5 mV/div</td> <td>$\pm 1 \text{ V}$</td> </tr> <tr> <td>100 mV/div to 995 mV/div</td> <td>$\pm 10 \text{ V}$</td> </tr> <tr> <td>1 V/div to 10 V/div</td> <td>$\pm 100 \text{ V}$</td> </tr> </tbody> </table>	Volts/Div Setting	Offset Range	1 mV/div to 99.5 mV/div	$\pm 1 \text{ V}$	100 mV/div to 995 mV/div	$\pm 10 \text{ V}$	1 V/div to 10 V/div	$\pm 100 \text{ V}$
Volts/Div Setting	Offset Range								
1 mV/div to 99.5 mV/div	$\pm 1 \text{ V}$								
100 mV/div to 995 mV/div	$\pm 10 \text{ V}$								
1 V/div to 10 V/div	$\pm 100 \text{ V}$								
Range, Position	± 5 divisions								
Range, Sensitivity ²	1 mV/div to 10 V/div								

Table B-2: Nominal Traits — Signal Acquisition System (Cont.)

Name	Description	
Rise Time ³ (TDS 410A and TDS420A)	Volts/Div Setting	Rise Time
	5 mV/div–10 V/div	1.75 ns
	2 mV/div–4.98 mV/div	2.33 ns
	1 mV/div–1.99 mV/div	3.68 ns
Rise Time ³ (TDS 460A)	Volts/Div Setting	Rise Time
	5 mV/div–10 V/div	875 ps
	2 mV/div–4.98 mV/div	1.4 ns
	1 mV/div–1.99 mV/div	3.5 ns

- 1 Displayed vertically with 25 digitization levels (DLs) per division and 10.24 divisions dynamic range with zoom off. A DL is the smallest voltage level change resolved by the 8-bit A-D Converter with the input scaled to the volts/division setting of the channel used. Expressed as a voltage, a DL is equal to 1/25 of a division times the volts/division setting.
- 2 The sensitivity ranges from 1 mV/div to 10 V/div in a 1–2–5 sequence of coarse settings. Between consecutive coarse settings, the sensitivity can be finely adjusted with a resolution of 1% of the more sensitive setting. For example, between 50 mV/div and 100 mV/div, the volts/division can be set with 0.5 mV resolution.
- 3 Rise time is defined by the following formula:
$$Rise\ Time\ (ns) = \frac{350}{BW\ (MHz)}$$

Table B-3: Nominal Traits — Time Base System

Name	Description
Range, Sample-Rate ^{1,3}	2.5 Samples/s to 100 MSamples/s
Range, Equivalent Time or Interpolated Waveform Rate ^{2,3}	200 MSamples/s to 50 GSamples/s
Range, Seconds/Division	1 ns/div to 20 s/div
Range, Time Base Delay Time	0 to 20 seconds
Reference Frequency, Time Base	100 MHz
Record Length Selection	500, 1,000, 2,500, 5,000, 15,000, and 30,000 points. Record lengths of 60,000 and 120,000 points are available with Option 1M ⁴
Sampling Edge, External Clock	Negative edge, with TTL threshold and tolerances
Hi Res Averaging Period, External Clock	Hi Res averaging done over period $1/(\text{maximum external clock rate}^5)$, but within <100 ns to 2 μ s. External clock edge before this period ends, produces an invalid sample

- 1 The range of real-time rates, expressed in samples/second, at which a digitizer samples signals at its inputs and stores the samples in memory to produce a record of time-sequential samples.
- 2 The range of waveform rates for equivalent time or interpolated waveform records.
- 3 The Waveform Rate (WR) is the equivalent sample rate of a waveform record. For a waveform record acquired by real-time sampling of a single acquisition, the waveform rate is the same as the real-time sample rate; for a waveform created by interpolation of real-time samples from a single acquisition or by equivalent-time sampling of multiple acquisitions, the waveform rate is faster than the real time sample rate. For all three cases, the waveform rate is $1/(\text{Waveform Interval})$ for the waveform record, where the waveform interval (WI) is the time between the samples in the waveform record.
- 4 In Hi Res, the maximum Option 1M record length is 60,000 points.
- 5 You set the maximum external clock rate using the Horizontal Clock menu. The Hi Res samples are averaged over a 10 to 40 ns shorter period than shown by the readout.

Table B-4: Nominal Traits — Triggering System

Name	Description	
Range, Events Delay	1 to 9,999,999	
Ranges, Trigger Level or Threshold	Source	Range
	Any Channel	± 12 divisions from center of screen
	Line	± 400 Volts

Table B-5: Nominal Traits — Display System

Name	Description
Video Display Resolution	640 pixels horizontally by 480 pixels vertically in a display area of 5.04 inches horizontally by 3.78 inches vertically
Waveform Display Graticule	A single graticule 401 × 501 pixels (8 × 10 divisions, with divisions that are 1 cm by 1 cm)
Waveform Display Grey Scale	16 levels in variable-persistence display style

Table B-6: Nominal Traits — Data Storage

Name	Description
Capacity, Nonvolatile Waveform Memory	Total capacity is 120,000 points (one to four waveforms acquired with any combination of record lengths that add up to 120,000 points). For available record lengths, see <i>Record Length Selection</i> on page B-5 of this chapter
Capacity, Nonvolatile Setup Memory	Ten setups
Batteries ¹ Required	Two lithium poly-carbon monofluoride. Both are type BR2/3A, UL listed. Both are rated at 3.0 volt, 1.2 amp-hour

¹ Batteries are not accessible from the outside of the instrument; therefore, a service technician must replace them.

Table B-7: Nominal Traits — GPIB Interface, Video Output, and Power Fuse

Name	Description
Interface, GPIB	GPIB interface complies with IEEE Std 488.1-1987 and IEEE Std 488.2-1987
Interface, RS-232 (Option 13 only)	RS-232 interface complies with EIA/TIA 574
Interface, Centronics (Option 13 only)	Centronics interface complies with Centronics interface standard C332-44 Feb 1977, REV A
Power Supply, Printer (Option 13 only)	Supply Voltage: +6.5 VDC Maximum Current: 2 Amps, DC continuous 4 Amps DC maximum for durations < 10 msec
Output, Video	Provides a video signal ¹ , non-interlaced, with levels that comply with ANSI RS343A. Output is through a rear-panel DB-15 connector
Fuse Rating	Either of two fuses ² may be used: a 0.25" × 1.25" (UL 198.6, 3AG); 5 A FAST, 250 V, or a 5 mm × 20 mm, (IEC 127); 4 A (T), 250 V

¹ VGA compatible at 30.6 kHz sync rate.

² Each fuse type requires its own fuse cap.

Table B-8: Nominal Traits — Mechanical

Name	Description
Cooling Method	Forced-air circulation with no air filter
Construction Material	Chassis parts constructed of aluminum alloy; front panel constructed of plastic laminate; circuit boards constructed of glass-laminate. Plastic parts are polycarbonate
Finish Type	Tektronix Blue textured vinyl finish on aluminum cabinet
Weight	<p>Standard digitizing oscilloscope</p> <p>8.6 kg (19.0 lbs), oscilloscope only</p> <p>10.2 kg (22.5 lbs), with front cover, accessories, and accessories pouch installed</p> <p>14.5 kg (32.0 lbs), when packaged for domestic shipment</p> <p>Rackmount digitizing oscilloscope</p> <p>8.2 kg (18.0 lbs) plus the weight of rackmount parts, for the rackmounted digitizing oscilloscope (Option 1R)</p> <p>16.3 kg (36.0 lbs), when the rackmounted digitizing oscilloscope is packaged for domestic shipment</p> <p>Rackmount conversion kit</p> <p>4.5 kg (10.0 lbs), parts only; 7.9 kg (17.5 lbs), parts plus package for domestic shipping</p> <p>Option 1F</p> <p>225 grams (0.5 lbs) Floppy Disk Drive only</p> <p>Option 3P</p> <p>11.3 kg (25 lbs), for the instrument and Printer Pack; includes a pouch, a printer with a full roll of paper, all cables, and three additional rolls of paper</p> <p>4.5 kg (10 lbs), for Printer Pack when packaged for domestic shipping; includes a pouch, a printer as received from the vendor, a Tektronix manual, cables, and five rolls of paper</p>

Table B-8: Nominal Traits — Mechanical (Cont.)

Name	Description
Overall Dimensions	Standard digitizing oscilloscope
	Height 191 mm (7.5 in), when feet and accessories pouch are installed. 165 mm (6.5 in), without the accessories pouch installed
	Width 381 mm (15 in), with handle
	Depth 471 mm (18.55 in), oscilloscope only; 490 mm (19.28 in), with optional front cover installed; 569 mm (22.4 in), with handle fully extended
	Rackmount digitizing oscilloscope
	Height 178 mm (7.0 in)
	Width 483 mm (19.0 in)
	Depth 472 mm (18.6 in), without front-panel handles; 517 mm (20.35 in), with front-panel handles installed
	Option 3P
	Height 241 mm (9.5 in)
	Width 381 mm (15.0 in)
	Depth 569 mm (22.4 in)

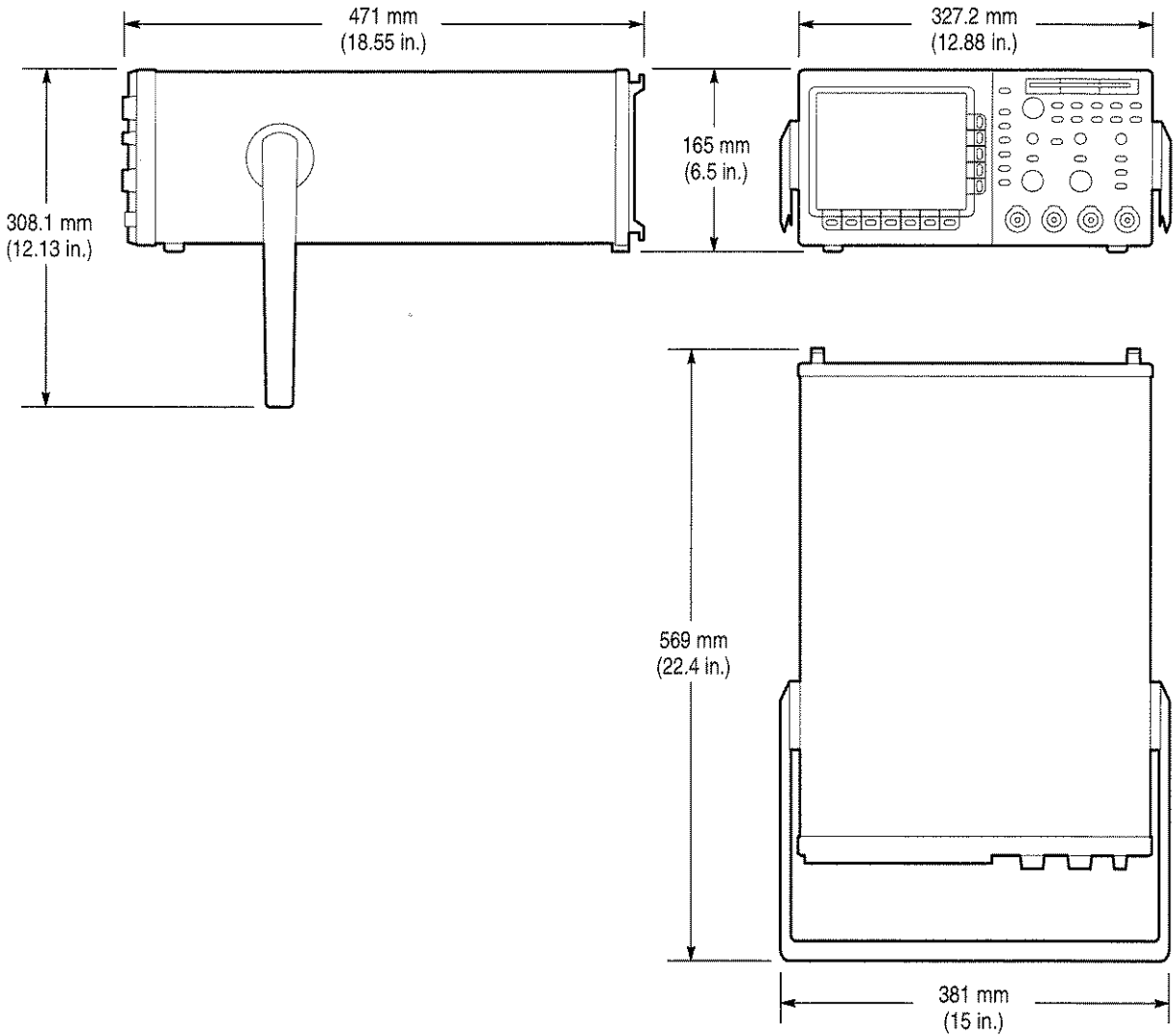

Figure B-1: TDS 400A Dimensional Drawing

Warranted Characteristics

This section lists the various *warranted characteristics* that describe the TDS 400A Digitizing Oscilloscopes. Included are electrical and environmental characteristics.

Warranted characteristics are described in terms of quantifiable performance limits which are warranted. This section lists only warranted characteristics. A list of *typical characteristics* starts on page B-17.

Performance Conditions

The electrical characteristics found in these tables of warranted characteristics apply when the oscilloscope is adjusted at an ambient temperature between +20° C and +30° C, has had a warm-up period of at least 20 minutes, and is operating at an ambient temperature between 0° C and +50° C (unless otherwise noted).

Table B-9: Warranted Characteristics — Signal Acquisition System

Name	Description		
Accuracy, DC Voltage Measurement, Averaged	Measurement Type	DC Accuracy	
	Average of ≥ 16 waveforms	$\pm(1.5\% \times (\text{reading} - \text{Net Offset}^2) + \text{Offset Accuracy} + 0.06 \text{ div})$	
	Delta volts between any two averages of ≥ 16 waveforms ³	$\pm(1.5\% \times \text{reading} + 0.1 \text{ div} + 0.3 \text{ mV})$	
Accuracy, DC Gain ⁴	$\pm 1.5\%$		
Accuracy, Offset	Volts/Div Setting	Offset Accuracy	
	1 mV/div–9.95 mV/div	$\pm(0.4\% \times \text{Net Offset}^2 + (0.9 \text{ mV} + 0.1 \text{ div} \times \text{Vertical Scale}))$	
	10 mV/div–99.5 mV/div	$\pm(0.4\% \times \text{Net Offset}^2 + (1.5 \text{ mV} + 0.1 \text{ div} \times \text{Vertical Scale}))$	
	100 mV/div–995 mV/div	$\pm(0.4\% \times \text{Net Offset}^2 + (15 \text{ mV} + 0.1 \text{ div} \times \text{Vertical Scale}))$	
	1 V/div–10 V/div	$\pm(0.4\% \times \text{Net Offset}^2 + (150 \text{ mV} + 0.1 \text{ div} \times \text{Vertical Scale}))$	
Accuracy, Position ⁵	$\pm(1.5\% \times (\text{Position} \times \text{Volts/div}) + \text{Offset Accuracy} + 0.04 \text{ div})$		
Analog Bandwidth, DC-50 Ω Coupled to BNC or to Recommended Active Probe and Bandwidth Selection is Full	Volts/Div	TDS 410A and TDS 420A Bandwidth⁶	TDS 460A Bandwidth⁶
	5 mV/div–10 V/div	DC–200 MHz	DC–400 MHz
	2 mV/div–4.98 mV/div	DC–150 MHz	DC–250 MHz
	1 mV/div–1.99 mV/div	DC–95 MHz	DC–100 MHz
Analog Bandwidth, DC-1 M Ω Coupled with Standard-Accessory Probe and Bandwidth Selection is Full	Volts/Div	TDS 410A and TDS 420A Bandwidth⁶	TDS 460A Bandwidth⁶
	5 mV/div–10 V/div	DC–200 MHz	DC–350 MHz ¹
	2 mV/div–4.98 mV/div	DC–150 MHz	DC–250 MHz
	1 mV/div–1.99 mV/div	DC–100 MHz	DC–100 MHz

Table B-9: Warranted Characteristics — Signal Acquisition System (Cont.)

Name	Description	
Cross Talk (Channel Isolation)	Volts/Div	Isolation
	> 500 mV/div	≥40:1 at 50 MHz for any two channels having equal volts/division settings
	≤9.95 mV/div	≥40:1 at 50 MHz for any two channels having equal volts/division settings
	10 mV/div–500 mV/div	≥80:1 at 100 MHz and ≥30:1 at full bandwidth for any two channels having equal volts/division settings
Delay Between Channels, Full Bandwidth, Equivalent Time	≤200 ps between CH 1 and CH 2 (all models) and between CH 3 and CH 4 (TDS 420A and TDS 460A) when both channels have equal volts/division and coupling settings ≤450 ps for any other combination of two channels with equal volts/division and coupling settings (TDS 420A and TDS 460A)	
Input Impedance, DC-1 MΩ Coupled	1 MΩ ±0.5% in parallel with 15 pF ±2.0 pF. Matched between channels to within ±1% for resistance and ±1.0 pF for capacitance	
Input Impedance, DC-50 Ω Coupled (TDS 410A and TDS 420A)	50 Ω ±1% with VSWR ≤1.2:1 from DC–200 MHz	
Input Impedance, DC-50 Ω Coupled (TDS 460A)	50 Ω ±1% with VSWR ≤1.6:1 from DC–400 MHz	
Input Voltage, Maximum, DC-1 MΩ, AC-1 MΩ, or GND Coupled	Volt/Div	Rating
	0.1 V/div–10 V/div	±400 V (DC + peak AC); derate at 20 dB/decade above 10 MHz until the minimum rating of ±5 V (DC + peak AC) is reached
	1 mV/div–99.9 mV/div	±400 V (DC + peak AC); derate at 20 dB/decade above 10 kHz until the minimum rating of ±5 V (DC + peak AC) is reached
Input Voltage, Maximum, DC-50 Ω or AC-50 Ω Coupled	5 V _{RMS} , with peaks less than or equal to ±30 V	

Table B-9: Warranted Characteristics — Signal Acquisition System (Cont.)

Name	Description
Lower Frequency Limit, AC Coupled	≤ 10 Hz when AC-1 M Ω coupled; ≤ 200 kHz when AC-50 Ω coupled ⁷
<p>¹ See <i>Analog Bandwidth</i> on page B-17 for the typical analog bandwidth with the standard-accessory probe.</p> <p>² Net Offset = Offset - (Position \times Volts/Div). Net Offset is the voltage level at the center of the A-D converter dynamic range. Offset Accuracy is the accuracy of this voltage level.</p> <p>³ The samples must be acquired under the same setup and ambient conditions.</p> <p>⁴ DC Gain Accuracy is confirmed in the Performance Verification Procedure by passing the checks for Offset Accuracy and DC Voltage Measurement Accuracy (Averaged).</p> <p>⁵ Position Accuracy is confirmed in the Performance Verification Procedure by passing the checks for Offset Accuracy and DC Voltage Measurement Accuracy (Averaged).</p> <p>⁶ The limits given are for the ambient temperature range of 0° C to +30° C. Reduce the upper bandwidth frequencies by 2.5 MHz for each °C above +30° C.</p> <p>⁷ The AC Coupled Lower Frequency Limits are reduced by a factor of 10 when 10X, passive probes are used.</p>	

Table B-10: Warranted Characteristics — Time Base System

Name	Description
Accuracy, Long Term Sample Rate and Delay Time	± 150 ppm over any ≥ 1 ms interval
Accuracy, Absolute Time and Delay Time Measurements ^{1,2}	<p>For single-shot acquisitions using sample or high-resolution acquisition modes and a bandwidth limit setting of 100 MHz:</p> $\pm(1 \text{ WI} + 150 \text{ ppm of } \text{Reading} + 450 \text{ ps})$ <p>For single-shot acquisitions using sample or high-resolution acquisition modes and a bandwidth limit setting of 20 MHz:</p> $\pm(1 \text{ WI} + 150 \text{ ppm of } \text{Reading} + 1.3 \text{ ns})$ <p>For repetitive acquisitions using average acquisition mode with ≥ 8 averages and a bandwidth limit setting of FULL:</p> $\pm(1 \text{ WI} + 150 \text{ ppm of } \text{Reading} + 200 \text{ ps})$
Accuracy, Delta Time Measurement ^{1,2}	<p>For single-shot acquisitions using sample or high-resolution acquisition modes and a bandwidth limit setting of 100 MHz:</p> $\pm(1 \text{ WI} + 150 \text{ ppm of } \text{Reading} + 650 \text{ ps})$ <p>For repetitive acquisitions using average acquisition mode with ≥ 8 averages and a bandwidth limit setting of FULL:</p> $\pm(1 \text{ WI} + 150 \text{ ppm of } \text{Reading} + 300 \text{ ps})$
<p>¹ For input signals ≥ 5 divisions in amplitude and a slew rate of ≥ 2.0 divisions/ns at the delta time measurement points. Signal must have been acquired at a volts/division setting ≥ 5 mV/division and not in Events mode.</p> <p>² The WI (waveform interval) is the time between the samples in the waveform record. Also, see the footnotes for <i>Sample Rate Range and Equivalent Time or Interpolated Waveform Rates</i> in Table B-3 on page B-5.</p>	

Table B-11: Warranted Characteristics — Triggering System

Name	Description
Accuracy, Trigger Level or Threshold, DC Coupled	$\pm(2\% \text{ of } \text{Setting} - \text{Net Offset}^1 + 0.2 \text{ div} \times \text{volts/div setting} + \text{Offset Accuracy})$ for any channel as trigger source and for signals having rise and fall times ≥ 20 ns
Sensitivity, Edge-Type Trigger, DC Coupled ²	0.35 division from DC to 50 MHz, increasing to 1 division at 350 MHz (TDS 410A and TDS 420A) or 500 MHz (TDS 460A) for any channel as trigger source
Sensitivity, Video-Type, TV Field and TV Line ²	0.6 division of video sync signal
Pulse Width, minimum, Events-Delay	5 ns
Auxiliary Trigger Input, External Clock Input	Connector: BNC at rear panel Input Load: equivalent to three TTL gate loads Input Voltage (maximum): -5 VDC to +10 VDC (TTL levels recommended)
Auxiliary Trigger, Maximum Input Frequency	10 MHz Duty Cycle High and low levels must be stable for ≥ 50 ns
Frequency, External Clock	DC to 10 MHz High and low levels must be stable for ≥ 50 ns

¹ Net Offset = Offset - (Position \times Volts/Div). Net Offset is the voltage level at the center of the A-D converter dynamic range. Offset Accuracy is the accuracy of this voltage level.

² The minimum sensitivity for obtaining a stable trigger. A stable trigger results in a uniform, regular display triggered on the selected slope. The trigger point must not switch between opposite slopes on the waveform, and the display must not "roll" across the screen on successive acquisitions. The TRIG'D LED stays constantly lighted when the SEC/DIV setting is 2 ms or faster but may flash when the SEC/DIV setting is 10 ms or slower.

Table B-12: Warranted Characteristics — Probe Compensator Output

Name	Description	
Output Voltage and Frequency, Probe Compensator	Characteristic	Limits
	Voltage	0.5 V (base-top) $\pm 5\%$ into a 1 M Ω load
	Frequency	1 kHz $\pm 5\%$

Table B-13: Warranted Characteristics — Power Requirements

Name	Description
Source Voltage and Frequency	90 to 132 VAC _{RMS} , continuous range, for 48 Hz through 62 Hz 100 to 132 VAC _{RMS} , continuous range, for 48 Hz through 440 Hz 180 to 250 VAC _{RMS} , continuous range, for 48 Hz through 440 Hz
Power Consumption	≤ 240 Watts (370 VA)

Table B-14: Warranted Characteristics — Environmental, Safety, and Reliability

Name	Description
Atmospherics	<p>Temperature¹:</p> <p>Standard Instrument: Operating, 0° C to +50° C; Nonoperating, -40° C to +75° C</p> <p>Instrument with Option 1F: Operating, +4° C to +50° C; Nonoperating, -22° C to +60° C</p> <p>Option 3P: Operating, 0° C to +40° C; Nonoperating, -20° C to +60° C</p> <p>Relative humidity:</p> <p>Standard Instrument: 0 to 95%, at or below +30° C; 0 to 75%, +31° C to +50° C</p> <p>Instrument with Option 1F: Operating without disk, to 80%, at or below +29° C; to 20%, at or below +50° C; Operating with disk, 20% to 80% at or below +32° C; Nonoperating, 20% to 30% at +45° C; To 90%, at or below +40° C; to 50%, at or below +50° C</p> <p>Option 3P: Operating, 30% to 80%; Nonoperating, 95%, at +40° C</p> <p>Altitude:</p> <p>Operating, to 15,000 ft. (4570 m); Nonoperating, to 40,000 ft. (12190 m)</p>
Emissions ^{2,3}	<p>Meets or exceeds the requirements of the following standards:</p> <p>Vfg. 243/1991 Amended per Vfg 46/1992</p> <p>FCC 47 CFR, Part 15, Subpart B, Class A</p> <p>EN50081-1 European Community Requirements</p> <p>EN55022 Radiated Emissions Class B</p> <p>EN55022 Conducted Emissions Class B</p> <p>With Option 3P: VDE 0871, Category B, Vfg. 1046/1984 FCC Rules and Regulations, Part 15, Subpart B, Class A</p>

Table B-14: Warranted Characteristics — Environmental, Safety, and Reliability (Cont.)

Name	Description
Susceptibility	<p>Meets or exceeds the requirements of the following standards:</p> <p>EN50082-1 European Community Requirements</p> <p>IEC 801-3 Radiated Susceptibility 3 V/meter from 27 MHz to 500 MHz unmodulated</p> <p>Performance Criteria: < + 0.2 division waveform displacement, or < 0.4 division increase in p-p noise when the oscilloscope is subjected to the EMI specified in the standard</p> <p>IEC 801-2 Electrostatic Discharge, Performance Criteria B</p> <p>Option 3P: The printer can withstand up to 5 kV with no change to settings or impairment of normal operations or up to 9 kV with no damage that prevents recovery of normal operations</p>
Dynamics	<p>Random vibration^{4,5}:</p> <p>0.31 g rms, from 5 to 500 Hz, 10 minutes each axis, operating;</p> <p>2.46 g rms, from 5 to 500 Hz, 10 minutes each axis, non-operating</p>
Third Party Certification	<p>Conforms to and is certified where appropriate to:</p> <p>UL 1244, Second Edition</p> <p>CAN/CSA-C22.2 No. 231-M89</p>

- ¹ Maximum operating temperature is decreased 1° C per 1000 feet (305 meters) above 5000 feet (1525 meters).
- ² To maintain emission requirements when connecting to the IEEE 488 GPIB interface of this oscilloscope, use only a high-quality, double-shielded (braid and foil) GPIB cable. The cable shield must have low impedance connections to both connector housings. Acceptable cables are Tektronix part numbers 012-0991-00, -01, and -02.
- ³ To maintain emission requirements when connecting to the VGA-compatible video output of this oscilloscope, use only a high-quality double-shielded (braid and foil) video cable with ferrite cores at both ends. The cable shield must have low impedance connections to both connector housings. An acceptable cable is LCOM part number CTL3VGAMM-5.
- ⁴ Does not apply to a rackmounted instrument.
- ⁵ Does not apply to an instrument with Option 1F.

Typical Characteristics

This section contains tables that list the various *typical characteristics* that describe the TDS 400A Digitizing Oscilloscopes.

Typical characteristics are described in terms of typical or average performance. Typical characteristics are not warranted.

This subsection lists only typical characteristics. A list of warranted characteristics starts on page B-11.

Table B-15: Typical Characteristics — Signal Acquisition System

Name	Description		
Accuracy, DC Voltage Measurement, Not Averaged	Measurement Type	DC Accuracy	
	Any Sample	$\pm(1.5\% \times (\text{reading} - \text{Net Offset}^1) + \text{Offset Accuracy} + 0.13 \text{ div} + 0.6 \text{ mV})$	
	Delta Volts between any two samples ²	$\pm(1.5\% \times \text{reading} + 0.26 \text{ div} + 1.2 \text{ mV})$	
Frequency Limit, Upper, 100 MHz Bandwidth Limited	100 MHz		
Frequency Limit, Upper, 20 MHz Bandwidth Limited	20 MHz		
Nonlinearity	< 1 DL, differential; \leq 1 DL, integral, independently based ³		
Analog Bandwidth, DC-1 M Ω Coupled with Standard-Accessory Probe Attached	Volts/Div	TDS 410A and TDS 420A Bandwidth	TDS 460A Bandwidth
	5 mV/div-10 V/div	DC-200 MHz	DC-400 MHz
	2 mV/div-4.98 mV/div	DC-150 MHz	DC-250 MHz
	1 mV/div-1.99 mV/div	DC-100 MHz	DC-100 MHz

Table B-15: Typical Characteristics — Signal Acquisition System (Cont.)

Name	Description				
	Volts/Div Setting	Step Amplitude	Settling Error (%) ⁴		
20 ns			500 ns	20 ms	
Step Response Settling Error	1 mV/div–99.5 mV/div	≤2 V	≤0.5	≤0.2	≤0.1
	100 mV/div–995 mV/div	≤20 V	≤2.0	≤0.5	≤0.2
	1 V/div–10 V/div	≤200 V	≤2.0	≤0.5	≤0.2

- ¹ Net Offset = Offset – (Position x Volts/Div). Net Offset is the voltage level at the center of the A-D converter dynamic range. Offset Accuracy is the accuracy of this voltage level.
- ² The samples must be acquired under the same setup and ambient conditions.
- ³ A DL (digitization level) is the smallest voltage level change that can be resolved by the 8-bit A-D Converter with the input scaled to the volts/division setting of the channel used. Expressed as a voltage, a DL is equal to 1/25 of a division times the volts/division setting.
- ⁴ The values given are the maximum absolute difference between the value at the end of a specified time interval after the mid-level crossing of the step and the value one second after the mid-level crossing of the step, expressed as a percentage of the step amplitude.

Table B-16: Typical Characteristics — Time Base System

Name	Description
Aperture Uncertainty	For real-time or interpolated records having duration ≤1 minute: $\leq(50 \text{ ps} + 0.03 \text{ ppm} \times \text{Record Duration}) \text{ RMS}$ For equivalent time records: $\leq(50 \text{ ps} + 0.06 \text{ ppm} \times \text{WI}^1) \text{ RMS}$
Fixed Error in Sample Time	≤50 ps
External Clock sampling uncertainty	±8 ns
External Clock Edge to Sampling Time Delay	Sample –20 ns (Sample edge is delayed relative the the sample moment.) Hi Res Hi Res averaging starts within ± 8 ns of the clock edge. Averaging stops after 1/(maximum external clock rate ²) Peak Detect Runs continuously at 100 MS/s
External Clock Minimum Prerecord points	55 points before the first visible sample in the record at the maximum clock speed 35 points before the first visible sample in the record at slow clock speeds
External Clock Minimum Postrecord points	25 points after the last visible sample in the record

- ¹ The WI (waveform interval) is the time between the samples in the waveform record. Also, see the footnotes for *Sample Rate Range* and *Equivalent Time or Interpolated Waveform Rates* in Table B-3 on page B-5.
- ² You set the maximum external clock rate using the Horizontal Clock menu.

Table B-17: Typical Characteristics — Triggering System

Name	Description		
Error, Trigger Position, Edge Triggering	Acquire Mode	Trigger-Position Error^{1,2}	
	Sample, Hi-Res, Average	$\pm(1 WI + 1 \text{ ns})$	
	Peak Detect, Envelope	$\pm(2 WI + 1 \text{ ns})$	
Holdoff, Variable, Main Trigger, Internal Clock and non TV Trigger	Main Horizontal Scale	Minimum Holdoff	Maximum Holdoff
	$\leq 100 \text{ ns/div}$	1 μs	5 \times Min Holdoff
	$\geq 100 \text{ ms/div}$	1 s	5 \times Min Holdoff
	Otherwise	10 \times sec/div	5 \times Min Holdoff
Holdoff, Variable, External Clock	0 to 100 ms		
Lowest Frequency for Successful Operation of "Set Level to 50%" Function	20 Hz		
Sensitivity, Edge Trigger, Not DC Coupled ³	Trigger Coupling	Typical Signal Level for Stable Triggering	
	AC	Same as DC-coupled limits ⁴ for frequencies above 60 Hz. Attenuates signals below 60 Hz	
	Noise Reject	Three and one-half times the DC-coupled limits ⁴	
	High Frequency Reject	One and one-half times the DC-coupled limits ⁴ from DC to 30 kHz. Attenuates signals above 30 kHz	
	Low Frequency Reject	One and one-half times the DC-coupled limits ⁴ for frequencies above 80 kHz. Attenuates signals below 80 kHz	
Video Mode (Option 05 Equipped Instruments Only)	<p>Line Rate Class: Four classes are provided as follows</p> <ul style="list-style-type: none"> ■ NTSC, which provides a default line rate compatible with the NTSC standard (525/60) ■ PAL, which provides a default line rate compatible with the PAL standard (625/50) ■ SECAM, which provides a default line rate compatible with the SECAM standard (625/50) ■ Custom, which provides user selectable line rate ranges (see <i>Custom Line Rate Ranges</i> below) <p>Custom Line Rate Ranges: 15 kHz–20 kHz, 20 kHz–25 kHz, 25 kHz–35 kHz, and 35 kHz–64 kHz</p> <p>Holdoff: Automatically adjusts to 58 ms (nominal) for NTSC class; to 150 ms (nominal) for PAL and SECAM</p> <p>Triggerable on Field Selections: Odd, Even, or Both</p> <p>Delayed Acquisition: Settable for delay by line number or runs after time delay</p>		
Frequency, Maximum for Events Delay ⁵	90 MHz		

Table B-17: Typical Characteristics — Triggering System (Cont.)

Name	Description
Width, Minimum Pulse and Rearm, Events Delay ⁶	5 ns

- ¹ The trigger position errors are typically less than the values given here. These values are for triggering signals having a slew rate at the trigger point of ± 0.5 division/ns.
- ² The waveform interval (WI) is the time between the samples in the waveform record. Also, see the footnote for the characteristics *Sample Rate Range* and *Equivalent Time or Interpolated Waveform Rates* in Table B-3 on page B-5.
- ³ The minimum sensitivity for obtaining a stable trigger. A stable trigger results in a uniform, regular display triggered on the selected slope. The trigger point must not switch between opposite slopes on the waveform, and the display must not “roll” across the screen on successive acquisitions. The TRIG'D LED stays constantly lighted when the SEC/DIV setting is 2 ms or faster but may flash when the SEC/DIV setting is 10 ms or slower.
- ⁴ See the characteristic *Sensitivity, Edge-Type Trigger, DC Coupled* in Table B-11, which begins on page B-14.
- ⁵ The maximum frequency for a delaying events input.
- ⁶ The minimum pulse width and rearm width required for recognizing a delaying event.

Table B-18: Typical Characteristics — Data Handling

Name	Description
Time, Data-Retention, Nonvolatile Memory ^{1,2}	Internal batteries, installed at time of manufacture, have a life of ≥ 5 years when operated and/or stored at an ambient temperature from 0° C to 50° C. Retention time of the nonvolatile memories is equal to the remaining life of the batteries
Nonvolatile Memory Save Time	10 seconds
Floppy Disk Drive Capacity, Opt 1F only	3.5 in. floppy disk, 720 KB or 1.44 MB, compatible with DOS 3.3 format for storing waveforms, hard copies, and instrument setups

- ¹ The time that reference waveforms, stored setups, and calibration constants are retained when there is no power to the oscilloscope.
- ² Data is maintained by lithium poly-carbon monofluoride.

Appendix C: Algorithms

Tektronix TDS 400A Digitizing Oscilloscopes can take 25 automatic measurements. By knowing how the oscilloscope makes these calculations, you may better understand how to use your oscilloscope and how to interpret your results.

Measurement Variables

The digitizing oscilloscope uses a variety of variables in its calculations. These include:

High, Low *High* is the value used as the 100% level in measurements such as fall time and rise time. For example, if you request the 10% to 90% rise time, then the oscilloscope will calculate 10% and 90% as percentages with *High* representing 100%.

Low is the value used as the 0% level in measurements such as fall time and rise time.

The exact meaning of *High* and *Low* depends on which of two calculation methods you choose from the *High-Low Setup* item in the Measure menu. These are *Min-max* and *Histogram*.

Min-Max Method — defines the 0% and the 100% waveform levels as the lowest amplitude (most negative) and the highest amplitude (most positive) samples. The min-max method is useful for measuring frequency, width, and period for many types of signals. Min-max is sensitive to waveform ringing and spikes, however, and does not always measure accurately rise time, fall time, overshoot, and undershoot.

The min-max method calculates the High and Low values as follows:

$$High = Max$$

and

$$Low = Min$$

Histogram Method — attempts to find the highest density of points above and below midpoint of a waveform. It attempts to ignore ringing and spikes when determining the 0% and 100% levels. This method works well when measuring square waves and pulse waveforms.

The oscilloscope calculates the histogram-based *High* and *Low* values as follows:

1. It makes a histogram of the record with one bin for each digitizing level (256 total).
2. It splits the histogram into two sections at the halfway point between *Min* and *Max* (also called *Mid*).
3. The level with the most points in the upper histogram is the *High* value, and the level with the most points in the lower histogram is the *Low* value. (Choose the levels where the histograms peak for *High* and *Low*.)

If *Mid* gives the largest peak value within the upper or lower histogram, then return the *Mid* value for both *High* and *Low* (this is probably a very low amplitude waveform).

If more than one histogram level (bin) has the maximum value, choose the bin farthest from *Mid*.

This algorithm does not work well for two-level waveforms with greater than about 100% overshoot.

HighRef, MidRef, LowRef, Mid2Ref

The user sets the various reference levels, through the **Reference Level** selection in the Measure menu. They include the following:

HighRef — the waveform high reference level. Used in fall time and rise time calculations. Typically set to 90%. You can set it from 0% to 100% or to a voltage level.

MidRef — the waveform middle reference level. Typically set to 50%. You can set it from 0% to 100% or to a voltage level.

LowRef — the waveform low reference level. Used in fall and rise time calculations. Typically set to 10%. You can set it from 0% to 100% or to a voltage level.

Mid2Ref — the middle reference level for a second waveform (or the second middle reference of the same waveform). Used in delay time calculations. Typically set to 50%. You can set it from 0% to 100% or to a voltage level.

Other Variables

The oscilloscope also measures several values itself that it uses to help calculate measurements.

RecordLength — is the number of data points in the time base. You set it with the Horizontal menu *Record Length* item.

Start — is the location of the start of the measurement zone (X-value). It is 0.0 samples unless you are making a gated measurement. When you use gated measurements, it is the location of the left vertical cursor.

End — is the location of the end of the measurement zone (X-value). It is (*RecordLength* – 1.0) samples unless you are making a gated measurement. When you use gated measurements, it is the location of the right vertical cursor.

Hysteresis — The hysteresis band is 10% of the waveform amplitude. It is used in *MCross1*, *MCross2*, and *MCross3* calculations.

For example, once a crossing has been measured in a negative direction, the waveform data must fall below 10% of the amplitude from the *MidRef* point before the measurement system is armed and ready for a positive crossing. Similarly, after a positive *MidRef* crossing, waveform data must go above 10% of the amplitude before a negative crossing can be measured. Hysteresis is useful when you are measuring noisy signals, because it allows the digitizing oscilloscope to ignore minor fluctuations in the signal.

MCross Calculations

MCross1, MCross2, and MCross3 — refer to the first, second, and third *MidRef* cross times, respectively. See Figure C–1.

The polarity of the crossings does not matter for these variables, but the crossings alternate in polarity; that is, *MCross1* could be a positive or negative crossing, but if *MCross1* is a positive crossing, *MCross2* is a negative crossing.

The oscilloscope calculates these values as follows:

1. Find the first *MidRefCrossing* in the waveform record or the gated region. This is *MCross1*.
2. Continuing from *MCross1*, find the next *MidRefCrossing* in the waveform record (or the gated region) of the opposite polarity of *MCross1*. This is *MCross2*.
3. Continuing from *MCross2*, find the next *MidRefCrossing* in the waveform record (or the gated region) of the same polarity as *MCross1*. This is *MCross3*.

MCross1Polarity — is the polarity of first crossing (no default). It can be rising or falling.

StartCycle — is the starting time for cycle measurements. It is a floating-point number with values between 0.0 and (*RecordLength* – 1.0), inclusive.

$$StartCycle = MCross1$$

EndCycle — is the ending time for cycle measurements. It is a floating-point number with values between 0.0 and (*RecordLength* – 1.0), inclusive.

$$EndCycle = MCross3$$

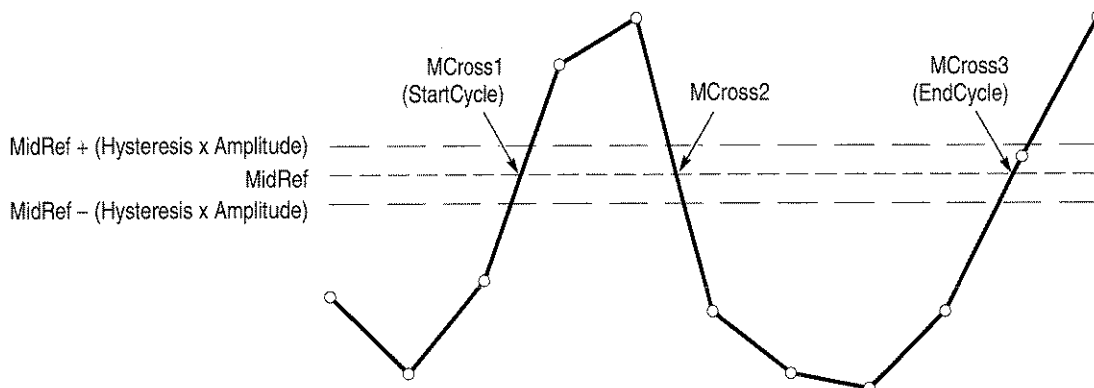

Figure C-1: MCross Calculations

Waveform[<0.0 ... RecordLength-1.0>] — holds the acquired data.

TPOS — is the location of the sample just before the trigger point (the time reference zero sample). In other terms, it contains the domain reference location. This location is where time = 0.

TSOFF — is the offset between *TPOS* and the actual trigger point. In other words, it is the trigger sample offset. Values range between 0.0 and 1.0 samples. This value is determined by the instrument when it receives a trigger. The actual zero reference (trigger) location in the measurement record is at (*TPOS*+*TSOFF*).

Measurement Algorithms

The automated measurements are defined and calculated as follows.

Amplitude $Amplitude = High - Low$

 **Area** The arithmetic area for one waveform. Remember that one waveform is not necessarily equal to one cycle. For cyclical data you may prefer to use the cycle area rather than the arithmetic area.

If $Start = End$, then return the (interpolated) value at $Start$.

Otherwise,

$$Area = \int_{Start}^{End} Waveform(t)dt$$

For details of the integration algorithm, see page C-12.

 **Burst Width** Timing measurement. The duration of a burst.

1. Find $MCross1$ on the waveform. This is $MCrossStart$.
2. Find the last $MCross$ (begin the search at $EndCycle$ and search toward $StartCycle$). This is $MCrossStop$. This could be a different value from $MCross1$.
3. Compute $BurstWidth = MCrossStop - MCrossStart$

 **Cycle Area** Amplitude (voltage) measurement. The area over one waveform cycle. For non-cyclical data, you might prefer to use the Area measurement.

If $StartCycle = EndCycle$, then return the (interpolated) value at $StartCycle$.

$$CycleMean = \int_{StartCycle}^{EndCycle} Waveform(t)dt$$

For details of the integration algorithm, see page C-12.

 **Cycle Mean** Amplitude (voltage) measurement. The mean over one waveform cycle. For non-cyclical data, you might prefer to use the Mean measurement.

If $StartCycle = EndCycle$, then return the (interpolated) value at $StartCycle$.

$$CycleMean = \frac{\int_{StartCycle}^{EndCycle} Waveform(t)dt}{(EndCycle - StartCycle) \times SampleInterval}$$

For details of the integration algorithm, see page C-12.

Cycle RMS

The true Root Mean Square voltage over one cycle.

If $StartCycle = EndCycle$, then $CycleRMS = Waveform[Start]$.

Otherwise,

$$CycleRMS = \sqrt{\frac{\int_{StartCycle}^{EndCycle} (Waveform(t))^2 dt}{(EndCycle - StartCycle) \times SampleInterval}}$$

For details of the integration algorithm, see page C-12.

Delay

Timing measurement. The amount of time between the *MidRef* and *Mid2Ref* crossings of two different traces or two different places on the same trace.

Delay measurements are actually a group of measurements. To get a specific delay measurement, you must specify the target and reference crossing polarities, and the reference search direction.

Delay = the time from one *MidRef* crossing on the source waveform to the *Mid2Ref* crossing on the second waveform.

Delay is not available in the Snapshot display.

Fall Time

Timing measurement. The time taken for the falling edge of a pulse to drop from a *HighRef* value (default = 90%) to a *LowRef* value (default = 10%).

Figure C-2 shows a falling edge with the two crossings necessary to calculate a Fall measurement.

1. Searching from *Start* to *End*, find the first sample in the measurement zone greater than *HighRef*.
2. From this sample, continue the search to find the first (negative) crossing of *HighRef*. The time of this crossing is *THF*. (Use linear interpolation if necessary.)
3. From *THF*, continue the search, looking for a crossing of *LowRef*. Update *THF* if subsequent *HighRef* crossings are found. When a *LowRef* crossing is found, it becomes *TLF*. (Use linear interpolation if necessary.)
4. $FallTime = TLF - THF$

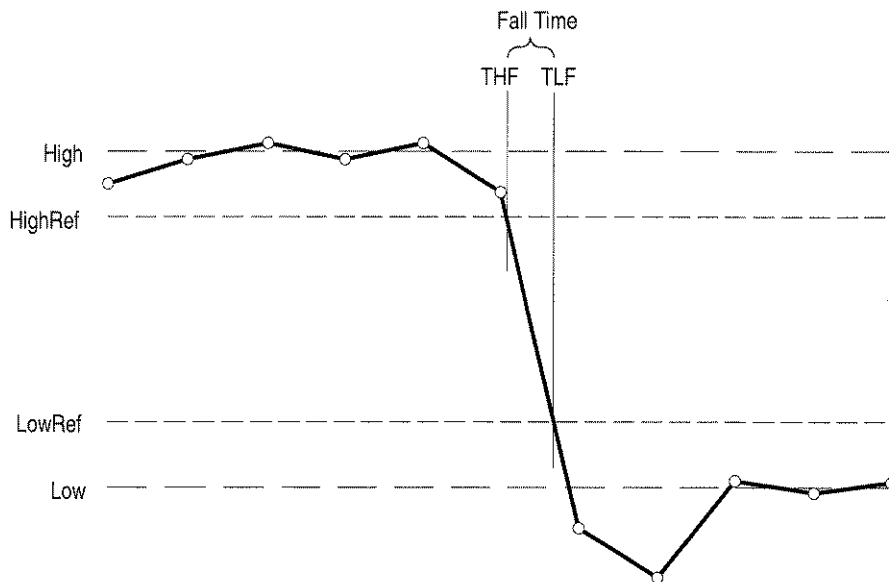







Figure C-2: Fall Time

	Frequency	<p>Timing measurement. The reciprocal of the period. Measured in Hertz (Hz) where 1 Hz = 1 cycle per second.</p> <p>If <i>Period</i> = 0 or is otherwise bad, return an error.</p> <p><i>Frequency</i> = 1/<i>Period</i></p>
	High	<p>100% (highest) voltage reference value. (See <i>High</i>, <i>Low</i> on page C-1)</p> <p>Using the min-max measurement technique:</p> <p><i>High</i> = <i>Max</i></p>
	Low	<p>0% (lowest) voltage reference value calculated. (See <i>High</i>, <i>Low</i> on page C-1)</p> <p>Using the min-max measurement technique:</p> <p><i>Low</i> = <i>Min</i></p>
	Maximum	<p>Amplitude (voltage) measurement. The maximum voltage. Typically the most positive peak voltage.</p> <p>Examine all <i>Waveform[]</i> samples from <i>Start</i> to <i>End</i> inclusive, and set <i>Max</i> equal to the greatest magnitude <i>Waveform[]</i> value found.</p>

Mean  The arithmetic mean for one waveform. Remember that one waveform is not necessarily equal to one cycle. For cyclical data you may prefer to use the cycle mean rather than the arithmetic mean.

If $Start = End$, then return the (interpolated) value at $Start$.

Otherwise,

$$Mean = \frac{\int_{Start}^{End} Waveform(t)dt}{(End - Start) \times SampleInterval}$$

For details of the integration algorithm, see page C-12.

Minimum  Amplitude (voltage) measurement. The minimum amplitude. Typically the most negative peak voltage.

Examine all $Waveform[]$ samples from $Start$ to End inclusive, and set Min equal to the smallest magnitude $Waveform[]$ value found.

Negative Duty Cycle  Timing measurement. The ratio of the negative pulse width to the signal period expressed as a percentage.

$NegativeWidth$ is defined in **Negative Width**, below.

If $Period = 0$ or undefined, then return an error.

$$NegativeDutyCycle = \frac{NegativeWidth}{Period} \times 100\%$$

Negative Overshoot Amplitude (voltage) measurement.



$$NegativeOvershoot = \frac{Low - Min}{Amplitude} \times 100\%$$

Note that this value should never be negative (unless High or Low are set out-of-range).

Negative Width

Timing measurement. The distance (time) between *MidRef* (default = 50%) amplitude points of a negative pulse.

If *MCross1Polarity* = '-'

then

$$\text{NegativeWidth} = (\text{MCross2} - \text{MCross1})$$

else

$$\text{NegativeWidth} = (\text{MCross3} - \text{MCross2})$$

Peak to Peak

Amplitude measurement. The absolute difference between the maximum and minimum amplitude.

$$\text{PeaktoPeak} = \text{Max} - \text{Min}$$

Period

Timing measurement. Time taken for one complete signal cycle. The reciprocal of frequency. Measured in seconds.

$$\text{Period} = \text{MCross3} - \text{MCross1}$$

Phase

Timing measurement. The amount of phase shift, expressed in degrees of the target waveform cycle, between the *MidRef* crossings of two different waveforms. Waveforms measured should be of the same frequency or one waveform should be a harmonic of the other.

Phase is a dual waveform measurement; that is, it is measured from a target waveform to a reference waveform. To get a specific phase measurement, specify the target and reference sources.

Phase is determined in the following manner:

1. The first *MidRefCrossing* (*MCross1Target*) and third (*MCross3*) in the source (target) waveform are found.
2. The period of the target waveform is calculated (see *Period* above).
3. The first *MidRefCrossing* (*MCross1Ref*) in the reference waveform crossing in the same direction (polarity) as that found *MCross1Target* for the target waveform is found.
4. The phase is determined by the following:

$$\text{Phase} = \frac{\text{MCross1Ref} - \text{MCross1Target}}{\text{Period}} \times 360$$

If the target waveform leads the reference waveform, phase is positive; if it lags, phase is negative.

Phase is not available in the Snapshot display.

Positive Duty Cycle



Timing measurement. The ratio of the positive pulse width to the signal period, expressed as a percentage.

PositiveWidth is defined in *Positive Width*, that follows.

If *Period* = 0 or undefined, then return an error.

$$\text{PositiveDutyCycle} = \frac{\text{PositiveWidth}}{\text{Period}} \times 100\%$$

Positive Overshoot



Amplitude (voltage) measurement.

$$\text{PositiveOvershoot} = \frac{\text{Max} - \text{High}}{\text{Amplitude}} \times 100\%$$

Note that this value should never be negative.

Positive Width



Timing measurement. The distance (time) between *MidRef* (default = 50%) amplitude points of a positive pulse.

If *MCross1Polarity* = '+'

then

$$\text{PositiveWidth} = (\text{MCross2} - \text{MCross1})$$

else

$$\text{PositiveWidth} = (\text{MCross3} - \text{MCross2})$$

Rise Time



Timing measurement. Time taken for the leading edge of a pulse to rise from a *LowRef* value (default = 10%) to a *HighRef* value (default = 90%).

Figure C-3 shows a rising edge with the two crossings necessary to calculate a Rise Time measurement.

1. Searching from *Start* to *End*, find the first sample in the measurement zone less than *LowRef*.
2. From this sample, continue the search to find the first (positive) crossing of *LowRef*. The time of this crossing is the low rise time or *TLR*. (Use linear interpolation if necessary.)

3. From *TLR*, continue the search, looking for a crossing of *HighRef*. Update *TLR* if subsequent *LowRef* crossings are found. If a *HighRef* crossing is found, it becomes the high rise time or *THR*. (Use linear interpolation if necessary.)
4. $RiseTime = THR - TLR$

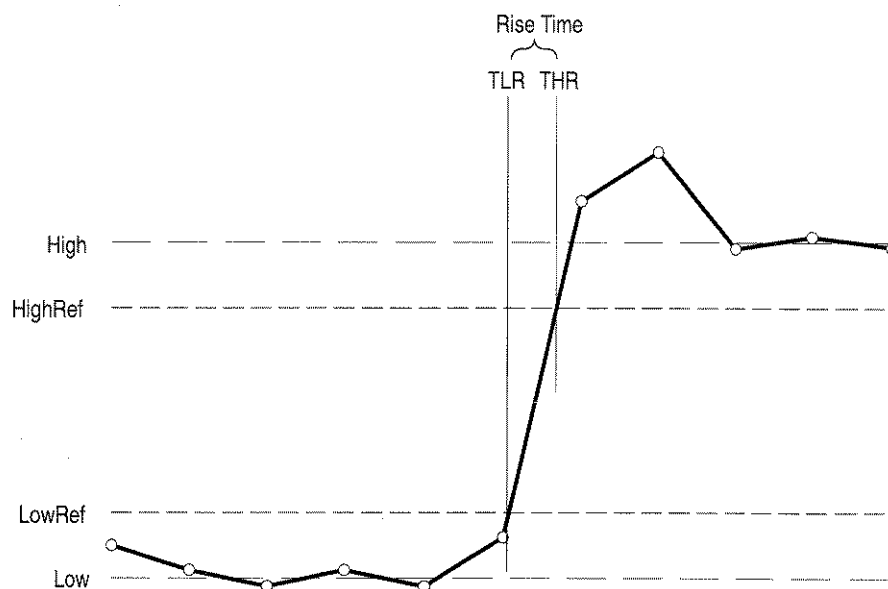

Figure C-3: Rise Time

RMS: Amplitude (voltage) measurement. The true Root Mean Square voltage.

\mathcal{W}

If $Start = End$, then $RMS =$ the (interpolated) value at $Waveform[Start]$.

Otherwise,

$$RMS = \sqrt{\frac{\int_{Start}^{End} (Waveform(t))^2 dt}{(End - Start) \times SampleInterval}}$$

For details of the integration algorithm, see below.

Integration Algorithm

The integration algorithm used by the digitizing oscilloscope is as follows:

$$\int_A^B W(t)dt \text{ is approximated by } \int_A^B \hat{W}(t)dt \text{ where:}$$

$W(t)$ is the sampled waveform

$\hat{W}(t)$ is the continuous function obtained by linear interpolation of $W(t)$

A and B are numbers between 0.0 and $RecordLength-1.0$

If A and B are integers, then:

$$\int_A^B \hat{W}(t)dt = s \times \sum_{i=A}^{B-1} \frac{W(i) + W(i+1)}{2}$$

where s is the sample interval.

Similarly,

$$\int_A^B (W(t))^2 dt \text{ is approximated by } \int_A^B (\hat{W}(t))^2 dt \text{ where:}$$

$W(t)$ is the sampled waveform

$\hat{W}(t)$ is the continuous function obtained by linear interpolation of $W(t)$

A and B are numbers between 0.0 and $RecordLength-1.0$

If A and B are integers, then:

$$\int_A^B (\hat{W}(t))^2 dt = s \times \sum_{i=A}^{B-1} \frac{(W(i))^2 + W(i) \times W(i+1) + (W(i+1))^2}{3}$$

where s is the sample interval.

Measurements on Envelope Waveforms

Time measurements on envelope waveforms must be treated differently from time measurements on other waveforms, because envelope waveforms contain so many apparent crossings. Unless otherwise noted, envelope waveforms use either the minima or the maxima (but not both), determined in the following manner:

1. Step through the waveform from *Start* to *End* until the sample min and max pair *DO NOT* straddle *MidRef*.

2. If the pair $> MidRef$, use the minima, else use maxima.

If all pairs straddle *MidRef*, use maxima. See Figure C-4.

The Burst Width measurement always uses both maxima and minima to determine crossings.

Missing or Out-of-Range Samples

If some samples in the waveform are missing or off-scale, the measurements linearly interpolate between known samples to make an “appropriate” guess as to the sample value. Missing samples at the ends of the measurement record are assumed to have the value of the nearest known sample.

When samples are out of range, the measurement gives a warning to that effect (for example, “CLIPPING”) if the measurement could change by extending the measurement range slightly. The algorithms assume the samples recover from an overdrive condition instantaneously.

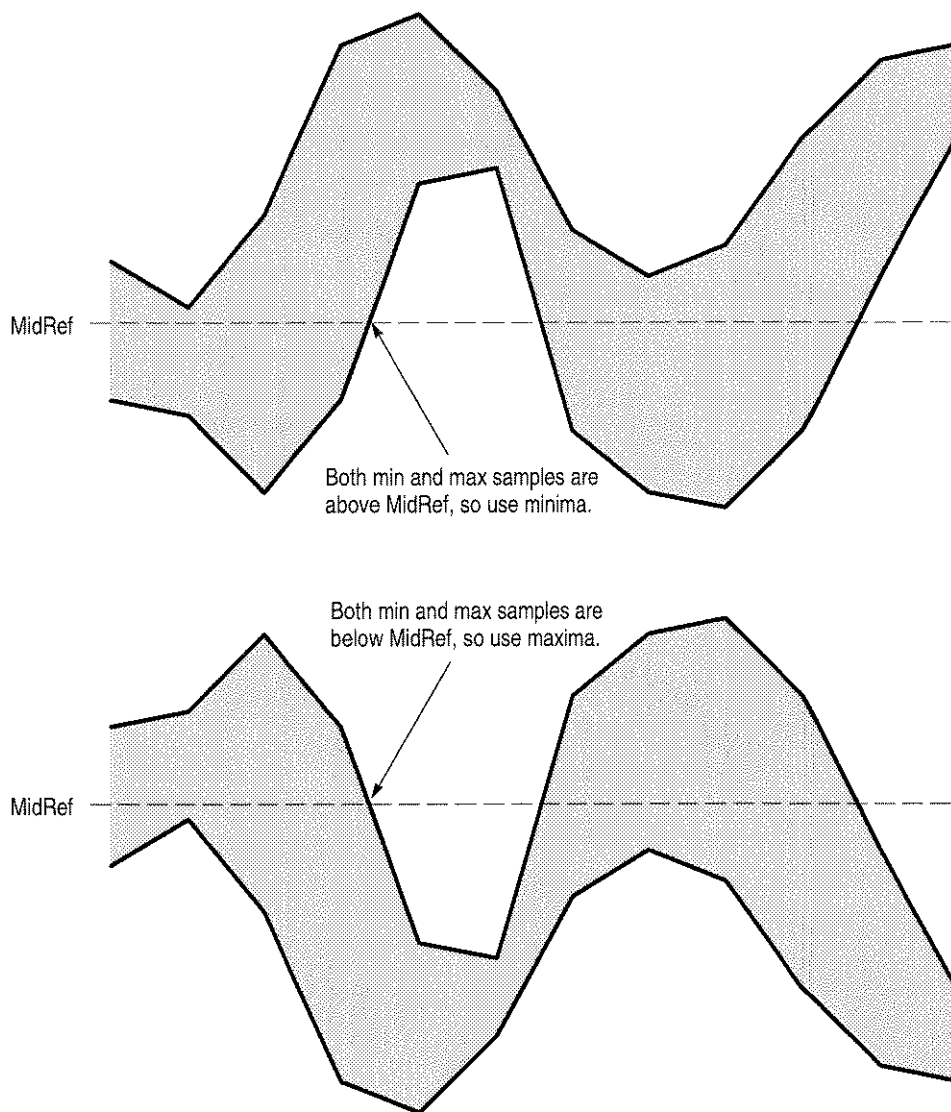

Figure C-4: Choosing Minima or Maxima to Use for Envelope Measurements

For example, if *MidRef* is set directly, then *MidRef* would not change even if samples were out of range. However, if *MidRef* was chosen using the % choice from the *Set Levels in % Units* selection of the Measure menu, then *MidRef* could give a “CLIPPING” warning.

NOTE. When measurements are displayed using *Snapshot*, out of range warnings are NOT available. However, if you question the validity of any measurement in the snapshot display, you can select and display the measurement individually and then check for a warning message.

Appendix D: Packaging for Shipment

If you ship the digitizing oscilloscope, pack it in the original shipping carton and packing material. If the original packing material is not available, package the oscilloscope as follows:

1. Obtain a corrugated cardboard shipping carton with inside dimensions at least 15 cm (6 in) taller, wider, and deeper than the digitizing oscilloscope. The shipping carton must be constructed of cardboard with 170 kg (375 pound) test strength.
2. If you are shipping the digitizing oscilloscope to a Tektronix field office for repair, attach a tag to the digitizing oscilloscope showing the oscilloscope owner and address, the name of the person to contact about the oscilloscope, the oscilloscope type, and the serial number.
3. Wrap the digitizing oscilloscope with polyethylene sheeting or equivalent material to protect the finish.
4. Cushion the digitizing oscilloscope in the shipping carton by tightly packing dunnage or urethane foam on all sides between the carton and the digitizing oscilloscope. Allow 7.5 cm (3 in) on all sides, top, and bottom.
5. Seal the shipping carton with shipping tape or an industrial stapler.



CAUTION. Do not ship the digitizing oscilloscope with a disk inside the disk drive. When the disk is inside the drive, the disk release button sticks out. This makes the button more prone to damage than otherwise.

Appendix E: Factory Initialization Settings

The factory initialization settings provide you a known state for the digitizing oscilloscope.

Settings

Factory initialization sets values as shown in Table E-1.

Table E-1: Factory Initialization Defaults

Control	Changed by Factory Init to
Acquire mode	Sample
Acquire repetitive signal	ON (Enable ET)
Acquire stop after	RUN/STOP button only
Acquire # of averages	16
Acquire # of envelopes	10
Channel selection	Channel 1 on, all others off
Cursor H Bar 1 position	10% of graticule height (-3.2 divs from the center)
Cursor H Bar 2 position	90% of the graticule height (+3.2 divs from the center)
Cursor V Bar 1 position	10% of the record length
Cursor V Bar 2 position	90% of the record length
Cursor mode	Independent
Cursor function	Off
Cursor horizontal units	Base
Cursor amplitude units	Base
Delayed edge trigger coupling	DC
Delayed edge trigger level	0 V
Delayed edge trigger slope	Rising
Delayed edge trigger source	Channel 1
Delay trigger average #	16
Delay trigger envelope #	10
Delay time, delayed runs after main	10 ns
Delay time, delayed triggerable after main	60 ns

Table E-1: Factory Initialization Defaults (Cont.)

Control	Changed by Factory Init to
Delay events, triggerable after main	2
Delayed, delay by ...	Delay by Time
Delayed, time base mode	Delayed Runs After Main
Display clock	No Change
Display format	YT
Display graticule type	Full
Display intensity – contrast	125%
Display intensity – text	60%
Display intensity – waveform	80%
Display intensity – overall	85%
Display interpolation filter	Sin(x)/x
Display style	Vectors
Display trigger bar style	Short
Display trigger "T"	On
Display variable persistence	500 ms
Edge trigger coupling	DC
Edge trigger level	0.0 V
Edge trigger slope	Rising
Edge trigger source	Channel 1
External clock	10 Mc/s Max
Fit to screen	Off
File utilities — confirm delete	On
File utilities — overwrite lock	On
Horizontal – clock	Internal
Horizontal – delay trigger position	50%
Horizontal – delay trigger record length	500 points (10 divs)
Horizontal – delay time/division	50 μ s
Horizontal – main trigger position	50%
Horizontal – main trigger record length	500 points (10 divs)
Horizontal – main time/division	500 μ s
Horizontal – time base	Main only
Limit Testing	Off
Limit Testing – hardcopy if condition met	Off

Table E-1: Factory Initialization Defaults (Cont.)

Control	Changed by Factory Init to
Limit Testing – ring bell if condition met	0%
Main trigger holdoff	Auto
Main trigger type	Edge
Math1 definition	Ch 1 + Ch 2
Math2 definition	Ch 1 – Ch 2 (FFT of Ch 1 for Option 2F instruments)
Math3 definition	Inv of Ch 1
Measure Delay to	Channel 1 (Ch1)
Measure Delay edges	Both rising and forward searching
Measure High-Low Setup	Histogram
Measure High Ref	90% and 0 V (units)
Measure Low Ref	10% and 0 V (units)
Measure Mid Ref	50% and 0 V (units)
Measure Mid2 Ref	50% and 0 V (units)
Roll mode	Automatic
Sample rate	100 kS/s
Save/Recall waveform — Recall format	Internal
Save/Recall waveform — Save format	Internal
Saved setups	No change
Saved waveforms	No change
Trigger — delay by	Runs After
Vertical bandwidth (all channels)	Full
Vertical coupling (all channels)	DC
Vertical impedance (termination) (all channels)	1 M Ω
Vertical offset (all channels)	0 V
Vertical position (all channels)	0 divs
Vertical volts/div. (all channels)	100 mV/div
Video — custom scan period	66.667 μ s
Video — custom rate	Rate 1
Zoom horizontal (all channels)	2.0X
Zoom horizontal lock	All
Zoom horizontal position (all channels)	50% = 0.5 (the middle of the display)

Table E-1: Factory Initialization Defaults (Cont.)

Control	Changed by Factory Init to
Zoom state	Off
Zoom vertical (all channels)	2.0X
Zoom vertical position (all channels)	0 divs

Appendix F: Remote Display

You can connect a remote display to the VGA connector on the rear panel. Table A-4 on page A-5 gives the part number of a properly shielded cable that is commercially available.

NOTE. *Both the red and blue signal lines are grounded. This configuration results in a green display on a color monitor.*

Glossary

AC 

AC coupling

A type of signal transmission that blocks the DC component of a signal but uses the dynamic (AC) component. Useful for observing an AC signal that is normally riding on a DC signal.

Accuracy

The closeness of the indicated value to the true value.

Acquisition

The process of sampling signals from input channels, digitizing the samples into data points, and assembling the data points into a waveform record. The waveform record is stored in memory. The trigger marks time zero in that process.

Acquisition interval

The time duration of the waveform record divided by the record length. The digitizing oscilloscope displays one data point for every acquisition interval.

Active cursor

The cursor that moves when you turn the general purpose knob. It is represented in the display by a solid line. The @ readout on the display shows the absolute value of the active cursor.

Aliasing

A false representation of a signal due to insufficient sampling of high frequencies or fast transitions. A condition that occurs when a digitizing oscilloscope digitizes at an effective sampling rate that is too slow to reproduce the input signal. The waveform displayed on the oscilloscope may have a lower frequency than the actual input signal.

III 

Amplitude

The High waveform value less the Low waveform value.



Area

Measurement of the waveform area taken over the entire waveform or the gated region. Expressed in volt-seconds. Area above ground is positive; area below ground is negative.

Attenuation

The degree the amplitude of a signal is reduced when it passes through an attenuating device such as a probe or attenuator. That is, the ratio of the input measure to the output measure. For example, a 10X probe will attenuate, or reduce, the input voltage of a signal by a factor of 10.

Automatic trigger mode

A trigger mode that causes the oscilloscope to automatically acquire if triggerable events are not detected within a specified time period.

Autoset

A function of the oscilloscope that automatically produces a stable waveform of usable size. Autoset sets up front-panel controls based on the characteristics of the active waveform. A successful autoset sets the volts/div, time/div, and trigger level to produce a coherent and stable waveform display.

**Average acquisition mode**

In this mode the oscilloscope acquires and displays a waveform that is the averaged result of several acquisitions. That reduces the apparent noise. The oscilloscope acquires data as in sample mode and then averages it according to a specified number of averages.

**Bandwidth**

The highest frequency signal the oscilloscope can acquire with no more than 3 dB ($\times 0.707$) attenuation of the original (reference) signal.

**Burst width**

A timing measurement of the duration of a burst.

Channel

One type of input used for signal acquisition.

Channel Reference Indicator

The indicator on the left side of the display that points to the position around which the waveform contracts or expands when vertical scale is changed. This position is ground when offset is set to 0 V; otherwise, it is ground plus offset.

Coupling

The association of two or more circuits or systems in such a way that power or information is transferred from one to the other. You can couple the input signal to the trigger and vertical systems several different ways.

Cursors

Paired markers that you use to make measurements between two waveform locations. The oscilloscope displays the values (expressed in volts or time) of the position of the active cursor and the distance between the two cursors.

**Cycle area**

A measurement of waveform area taken over one cycle. Expressed in volt-seconds. Area above ground is positive; area below ground is negative.

**Cycle mean**

An amplitude (voltage) measurement of the arithmetic mean over one cycle.

**Cycle RMS**

The true Root Mean Square voltage over one cycle.

DC

DC coupling

A mode that passes both AC and DC signal components to the circuit. Available for both the trigger system and the vertical system.

**Delay measurement**

A measurement of the time between the middle reference crossings of two different waveforms.

Delay time

The time between the trigger event and the acquisition of data.

Digitizing

The process of converting a continuous analog signal, such as a waveform, to a set of discrete numbers representing the amplitude of the signal at specific points in time. Digitizing is composed of two steps: sampling and quantizing.

Display system

The part of the oscilloscope that shows waveforms, measurements, menu items, status, and other parameters.

Edge Trigger

Triggering occurs when the oscilloscope detects the source passing through a specified voltage level in a specified direction (the trigger slope).

**Envelope acquisition mode**

A mode in which the oscilloscope acquires and displays a waveform that shows the variation extremes of several acquisitions.

Equivalent-time sampling (ET)

A sampling mode in which the oscilloscope acquires signals over many repetitions of the event. The TDS 400A Series Digitizing Oscilloscopes use a type of equivalent time sampling called *random equivalent time sampling*. It utilizes an internal clock that runs asynchronously with respect to the input signal and the signal trigger. The oscilloscope takes samples continuously, independent of the trigger position, and displays them based on the time difference between the sample and the trigger. Although the samples are taken sequentially in time, they are random with respect to the trigger.

**Fall time**

A measurement of the time it takes the trailing edge of a pulse to fall from a HighRef value (typically 90%) to a LowRef value (typically 10%) of its amplitude.

**Frequency**

A timing measurement that is the reciprocal of the period. Measured in Hertz (Hz) where 1 Hz = 1 cycle per second.

Gated Measurements

A feature that lets you limit automated measurements to a specified portion of the waveform. You define the area of interest using the vertical cursors.

**General purpose knob**

The large front-panel knob. You can use it to change the value of the assigned parameter.

**GPIB (General Purpose Interface Bus)**

An interconnection bus and protocol that allows you to connect multiple instruments in a network under the control of a controller. Also known as the IEEE 488 bus. It transfers data with eight parallel data lines, five control lines, and three handshake lines.

**Graticule**

A grid on the display screen that creates the horizontal and vertical axes. You use it to visually measure waveform parameters.

**Ground (GND) coupling**

Coupling option that disconnects the input signal from the vertical system.

**Hardcopy**

An electronic copy of the display in a format useable by a printer or plotter.

**Hi Res acquisition mode**

An acquisition mode in which the digitizing oscilloscope averages all samples taken during an acquisition interval to create a record point. That average results in a higher-resolution, lower-bandwidth waveform. That mode only works with real-time, non-interpolated sampling.

**High**

The value used as 100% in automated measurements (whenever high ref, mid ref, and low ref values are needed as in fall time and rise time measurements). Calculated using either the min/max or the histogram method. With the min/max method (most useful for general waveforms), it is the maximum value found. With the histogram method (most useful for pulses), it refers to the most common value found above the mid point. See *Appendix C: Algorithms* for details.

Holdoff, trigger

A specified amount of time after a trigger signal that elapses before the trigger circuit will accept another trigger signal. Holdoff helps ensure a stable display.

**Horizontal bar cursors**

The two horizontal bars that you position to measure the voltage parameters of a waveform. The oscilloscope displays the value of the active (moveable) cursor with respect to ground and the voltage value between the bars.

Interpolation

The way the digitizing oscilloscope calculates values for record points when the oscilloscope cannot acquire all the points for a complete record with a single trigger event. That condition occurs when the oscilloscope is limited to real time sampling and the time base is set to a value that exceeds the effective sample rate of the oscilloscope. The digitizing oscilloscope has two interpolation options: *linear* or *sin(x)/x interpolation*.

Linear interpolation calculates record points in a straight-line fit between the actual values acquired. Sin(x)/x computes record points in a curve fit between the actual values acquired. It assumes all the interpolated points fall in their appropriate point in time on that curve.

Intensity

Display brightness.

Knob

A rotary control.

Low

The value used as 0% in automated measurements (whenever high ref, mid ref, and low ref values are needed as in fall time and rise time measurements). The value is calculated using either the min/max or the histogram method. With the min/max method (most useful for general waveforms), it is the minimum value found. With the histogram method (most useful for pulses), it refers to the most common value found below the mid point. See *Appendix C: Algorithms* for details.

Main menu

A group of related controls for a major oscilloscope function that the oscilloscope displays across the bottom of the screen.

Main menu buttons

Bezel buttons under the main menu display. They allow you to select items in the main menu.

Maximum

Amplitude (voltage) measurement of the maximum amplitude. Typically the most positive peak voltage.

Mean

Amplitude (voltage) measurement of the arithmetic mean over the entire waveform.

Minimum

Amplitude (voltage) measurement of the minimum amplitude. Typically the most negative peak voltage.



**Negative duty cycle**

A timing measurement representing the ratio of the negative pulse width to the signal period, expressed as a percentage.

**Negative overshoot measurement**

Amplitude (voltage) measurement.

$$\text{NegativeOvershoot} = \frac{\text{Low} - \text{Min}}{\text{Amplitude}} \times 100\%$$

**Negative width**

A timing measurement of the distance (time) between two amplitude points, falling-edge *MidRef* (default 50%) and rising-edge *MidRef* (default 50%), on a negative pulse.

Normal trigger mode

A mode in which the oscilloscope does not acquire a waveform record unless a valid trigger event occurs. It waits for a valid trigger event before acquiring waveform data.

Oscilloscope

An instrument for making a graph of two factors. These are typically voltage versus time.

**Peak Detect acquisition mode**

A mode in which the oscilloscope saves the minimum and maximum samples over two adjacent acquisition intervals. For many glitch-free signals, that mode is indistinguishable from sample mode. (Peak detect mode works with real-time, non-interpolation sampling only.)

**Peak-to-peak**

Amplitude (voltage) measurement of the absolute difference between the maximum and minimum amplitude.

**Period**

A timing measurement of the time covered by one complete signal cycle. It is the reciprocal of frequency and is measured in seconds.

**Phase**

A timing measurement between two waveforms of the amount one leads or lags the other in time. Phase is expressed in degrees, where 360° comprise one complete cycle of one of the waveforms. Waveforms measured should be of the same frequency or one waveform should be a harmonic of the other.

Pixel

A visible point on the display. The oscilloscope display is 640 pixels wide by 480 pixels high.

Pop-up menu

A sub-menu of a main menu. Pop-up menus temporarily occupy part of the waveform display area and are used to present additional choices associated

with the main menu selection. You can cycle through the options in a pop-up menu by repeatedly pressing the main menu button underneath the pop-up.



Positive duty cycle

A timing measurement of the ratio of the positive pulse width to the signal period, expressed as a percentage.



Positive overshoot

Amplitude (voltage) measurement.

$$PositiveOvershoot = \frac{Max - High}{Amplitude} \times 100\%$$



Positive width

A timing measurement of the distance (time) between two amplitude points, rising-edge *MidRef* (default 50%) and falling-edge *MidRef* (default 50%), on a positive pulse.

Posttrigger

The specified portion of the waveform record that contains data acquired after the trigger event.

Pretrigger

The specified portion of the waveform record that contains data acquired before the trigger event.

Probe

An oscilloscope input device.

Quantizing

The process of converting an analog input that was sampled, such as a voltage, to a digital value.

Probe compensation

Adjustment that improves the low-frequency response of a probe.

Real-time sampling

A sampling mode where the digitizing oscilloscope samples fast enough to completely fill a waveform record from a single trigger event. Use real-time sampling to capture single-shot or transient events.

Record length

The specified number of samples in a waveform.

Reference memory

Memory in an oscilloscope used to store waveforms or settings. You can use that waveform data later for processing. The digitizing oscilloscope saves the data even when the oscilloscope is turned off or unplugged.



Rise time

The time it takes for a leading edge of a pulse to rise from a *LowRef* value (typically 10%) to a *HighRef* value (typically 90%) of its amplitude.



RMS

Amplitude (voltage) measurement of the true Root Mean Square voltage.

Roll

An acquisition mode useful at slow Horizontal SCALE settings. Roll mode allows the waveform to be viewed as it is acquired point-by-point. The waveform appears to roll across the display.



Sample acquisition mode

The oscilloscope creates a record point by saving the first sample during each acquisition interval. That is the default mode of acquisition.

Sample interval

The time interval between successive samples in a time base. For real-time digitizers, the sample interval is the reciprocal of the sample rate. For equivalent-time digitizers, the time interval between successive samples represents equivalent time, not real time.

Sampling

The process of capturing an analog input, such as a voltage, at a discrete point in time and holding it constant so that it can be quantized. Two general methods of sampling are: *real-time sampling* and *equivalent-time sampling*.

Selected waveform

The waveform on which all measurements are performed, and which is affected by vertical position and scale adjustments. The light next to one of the channel selector buttons indicates the current selected waveform.

Side menu

Menu that appears to the right of the display. These selections expand on main menu selections.

Side menu buttons

Bezel buttons to the right of the side menu display. They allow you to select items in the side menu.

Signal Path Compensation (SPC)

The ability of the oscilloscope to minimize the electrical offsets in the vertical, horizontal, and trigger amplifiers caused by ambient temperature changes and component aging. You should run SPC at the following times: when the ambient temperature varies more than 5° C from the last SPC, when using settings equal to or less than 5 mV per division, and when performing critical measurements.

Slope

The direction at a point on a waveform. You can calculate the direction by computing the sign of the ratio of change in the vertical quantity (Y) to the change in the horizontal quantity. The two values are rising and falling.

Tek Secure

This feature erases all waveform and setup memory locations (setup memories are replaced with the factory setup). Then it checks each location to verify erasure. This feature finds use where this digitizing oscilloscope is used to gather security sensitive data, such as is done for research or development projects.

Time base

The set of parameters that let you define the time and horizontal axis attributes of a waveform record. The time base determines when and how long to acquire record points.

Select button

A button that changes which of the two cursors is active.

Trigger

An event that marks time zero in the waveform record. It results in acquisition and display of the waveform.

**Trigger level**

The vertical level the trigger signal must cross to generate a trigger (on edge mode).

**Vertical bar cursors**

The two vertical bars you position to measure the time parameter of a waveform record. The oscilloscope displays the value of the active (moveable) cursor with respect to the trigger and the time value between the bars.

Waveform

The shape or form (visible representation) of a signal.

Waveform interval

The time interval between record points as displayed.

**XY format**

A display format that compares the voltage level of two waveform records point by point. It is useful for studying phase relationships between two waveforms.

**YT format**

The conventional oscilloscope display format. It shows the voltage of a waveform record (on the vertical axis) as it varies over time (on the horizontal axis).

Index

Numbers

- 1/Base, Cursor menu, 3-119
- 1/Clocks, Cursor menu, 3-119
- 1/seconds (Hz), Cursor menu, 3-119
- 100 MHz, Vertical menu, 3-123
- 20 MHz, Vertical menu, 3-123

A

- AC coupling, 2-34, Glossary-1
- AC line voltage, trigger input, 2-31
- AC, Main Trigger menu, 3-28
- Accessories, A-1-A-8
 - Optional, A-5-A-8
 - Probes, A-4, A-5, A-6
 - Software, A-8
 - Standard, A-4, A-6, A-8
- Accuracy, Glossary-1
- Acquire menu, 3-9, 3-53
 - Average, 3-9
 - mode, 3-54
 - Compare Ch1 to, 3-55
 - Compare Ch2 to, 3-55
 - Create Limit Test Template, 3-54
 - Envelope, 3-9
 - H Limit, 3-55
 - Hardcopy if Condition Met, 3-56
 - Hi Res, 3-9
 - Limit Test, 3-56
 - Limit Test Condition Met, 3-56
 - Limit Test Setup, 3-56
 - Limit Test Sources, 3-55
 - Mode, 3-9
 - OFF (Real Time Only), 3-10
 - OK Store Template, 3-55
 - ON (Enable ET), 3-10
 - Peak Detect, 3-9
 - Repetitive Signal, 3-10
 - Ring Bell if Condition Met, 3-56
 - RUN/STOP, 3-11
 - Sample, 3-9
 - Single Acquisition Sequence, 3-11
 - Stop After, 3-10, 3-56
 - Stop After Limit Test Condition Met, 3-56
 - Template Source, 3-54
 - V Limit, 3-54
- ACQUIRE MENU button, 3-9, 3-53
- Acquisition, 2-39-2-42, 3-111, Glossary-1

- Interval, Glossary-1
- Modes
 - Average, 3-8
 - Envelope, 3-8
 - Hi Res, 3-7
 - Peak detect, 3-5
 - Sample, 3-5
 - Readout, 3-9
- Active cursor, Glossary-1
- Active voltage probes, 3-84-3-88
- active, Saved waveform status, 3-101
- Algorithms, C-1-C-14
- Aliasing, 2-45, Glossary-1
- Amplitude, 3-59, Glossary-1
- Amplitude Units, Cursor menu, 3-120
- Area, 3-59, Glossary-1
- Attenuation, Glossary-1
- Auto, Main Trigger menu, 3-29
- Auto, Video Trigger menu, 3-129
- Automated Measurements, Snapshot of, 2-27
- Automated measurements, 2-24, 2-47, 3-59
- Automatic trigger mode, 2-32, Glossary-2
- Autoset, 2-18, 2-46, 3-111-3-112, Glossary-2
 - Defaults, 3-111
 - How to execute, 3-111-3-112
- AUTOSET button, 2-18, 3-111
- Auxiliary trigger, 2-32
- Average, mode, Acquire menu, 3-54
- Average acquisition mode, 3-8, Glossary-2
- Average, Acquire menu, 3-9

B

- Bandwidth, 1-1, 2-42, 3-122, Glossary-2
- Bandwidth, Vertical menu, 3-123
- Banner menu, 3-20
- Base, Cursor menu, 3-120
- Before you begin, 1-5-1-6
- BMP, 3-35
- BMP Color, Hardcopy menu, 3-36
- BMP Mono, Hardcopy menu, 3-36
- Burst width, 3-59
- Button
 - ACQUIRE MENU, 3-9, 3-53
 - AUTOSET, 2-18, 2-45, 3-111
 - CLEAR MENU, 2-3, 2-8, 2-16, 2-25, 3-67
 - CURSOR, 2-48, 3-117
 - DELAYED TRIG, 2-35, 3-16
 - DISPLAY, 3-21

FORCE TRIG, 2-36
HARDCOPY, 3-31, 3-36, 3-91
HELP, 3-3
HORIZONTAL MENU, 2-35, 3-14
MEASURE, 3-62
MORE, 3-103, 3-108, 3-131
ON/STBY, 1-4, 2-3
 Save/Recall **SETUP**, 2-14, 3-31, 3-97
 Save/Recall **WAVEFORM**, 3-31, 3-101
SELECT, 3-118, Glossary-9
SET LEVEL TO 50%, 2-35
SINGLE TRIG, 2-36, 3-11
STATUS, 3-19
TOGGLE, 2-48
TRIGGER MENU, 2-38, 3-27, 3-125
UTILITY, 3-36, 3-91
VERTICAL MENU, 2-21
WAVEFORM OFF, 2-23, 3-25, 3-108
ZOOM, 2-46, 3-136

Buttons

CH1, CH2 ..., 3-108
 Channel selection, 2-20, 3-108
 Main menu, 2-3
 Side menu, 2-3

C

Cables, 3-91
 Cart, Instrument, K212, A-2
 Centronics, **Port** (optional), 3-37, 3-43, 3-89
 Certificate of Calibration, A-3
CH1, CH2 ... buttons, 3-108
Ch1, Ch2 ..., Delayed Trigger menu, 3-16
Ch1, Ch2 ..., Main Trigger menu, 3-28, 3-50
Ch1, Ch2 ..., Video Trigger menu, 3-126
Change Math waveform definition, More menu, 3-132
 Channel, 3-107-3-110, Glossary-2
 Readout, 2-6, 3-107, 3-136
 Reference Indicator, 2-6, 3-107
 Selection buttons, 2-20, 3-108
 Trigger input, 2-31-2-38
 Channel readout, 2-6
 Channel reference indicator, Glossary-2
 Circuit loading, Glossary-2
CLEAR MENU button, 2-3, 2-8, 2-16, 2-25, 3-67
Clear Spool, Hardcopy menu, 3-40
Clock, Horizontal menu, 3-49
 Compact-to-miniature probe tip adapter, 3-78, A-6
Compare Ch1 to, Acquire menu, 3-55
Compare Ch2 to, Acquire menu, 3-55
 Compensation, 3-81

Configure, Utility menu, 3-36, 3-91
Confirm Delete, File Utilities menu, 3-34
 Connector
 BNC, A-6
 GPIB, 2-5, 3-90
Contrast, Display menu, 3-22
 Conventions, xii
Copy, File Utilities menu, 3-33
 Coupling, 2-21
 AC, 2-34
 DC, 2-34
 Ground, Glossary-4
 Input Signal, 2-42
 Trigger, 2-34-2-38
Coupling, Delayed Trigger menu, 3-17
Coupling, Main Trigger menu, 3-28
Coupling, Vertical menu, 3-122
Create Directory, File Utilities menu, 3-34
Create Limit Test Template, Acquire menu, 3-54
Create Measrmnt, Measure Delay menu, 3-67
Cross Hair, Display menu, 3-24
 Current probes, 3-86
 Cursor
 Faster positioning, 3-119
 Horizontal bar, 2-48, 3-115
 Measurements, 2-48
 Mode, 2-48
 Independent, 2-48
 Tracking, 2-48
 Paired, 2-48, 3-115
 Vertical bar, 2-48, 3-115
CURSOR button, 3-117
 Cursor menu, 3-117
 1/Base, 3-119
 1/Clocks, 3-119
 1/seconds (Hz), 3-119
 Amplitude Units, 3-120
 Base, 3-120
 Function, 3-117, 3-118
 H Bars, 3-117, 3-118
 Horizontal Units, 3-119
 Independent, 3-118
 IRE (NTSC), 3-120
 seconds, 3-119
 Tracking, 3-118
 Video Line Number, 3-119
 Cursor Readouts, 3-116
 Cursor Speed, 3-120
 Cursors, 2-48, 3-115-3-120, Glossary-2
 How to use, 3-117
Custom, Video Trigger menu, 3-126
 Cycle area, 3-59, Glossary-2

Cycle mean, 3-59, Glossary-2
 Cycle RMS, 3-59, Glossary-3

D

Date/Time
 On hardcopies, 3-37
 To set, 3-38
 DC coupling, 2-34, Glossary-3
 DC, Main Trigger menu, 3-28
Delay by Events, Delayed Trigger menu, 3-16
Delay by Lines, Video Trigger menu, 3-127
Delay by Time, Delayed Trigger menu, 3-16
Delay by Time, Video Trigger menu, 3-127
Delay by, Delayed Trigger menu, 3-16
 Delay measurement, 3-66, Glossary-3
 Delay time, Glossary-3
Delay To, Measure Delay menu, 3-66
Delayed Only, Horizontal menu, 3-14
 Delayed Runs After Main, 2-35-2-38
Delayed Runs After Main, Horizontal menu, 3-14,
 3-49
Delayed Scale, Horizontal menu, 3-48
DELAYED TRIG button, 2-35, 3-16
 Delayed trigger, 2-35-2-38, 3-13-3-18
 How to set up, 3-14-3-18
 Delayed Trigger menu, 3-16-3-18
 Ch1, Ch2 ..., 3-16
 Coupling, 3-17
 Delay by, 3-16
 Delay by Events, 3-16
 Delay by Time, 3-16
 Falling edge, 3-17
 Level, 3-17
 Rising edge, 3-17
 Set to 50%, 3-18
 Set to ECL, 3-17
 Set to TTL, 3-17
 Slope, 3-17
 Source, 3-16
 Delayed Triggerable, 2-35-2-38
Delayed Triggerable, Horizontal menu, 3-16, 3-49
Delete Refs, Save/Recall Waveform menu, 3-102
Delete, File Utilities menu, 3-32
 Deskjet, 3-35
Deskjet, Hardcopy menu, 3-36
 Differential active probes, 3-85
 Digitizing, Glossary-3
 Digitizing rate, 1-1
 Disk, How to save a hardcopy to, 3-40
 Disk drive, 3-31-3-34
 Display, 2-6, 3-111

Options, 3-21-3-26
 Record View, 2-37
 System, Glossary-3
Display 'T' @ Trigger Point, Display menu, 3-22
DISPLAY button, 3-21
 Display menu, 3-21
 Contrast, 3-22
 Cross Hair, 3-24
 Display 'T' @ Trigger Point, 3-22
 Dots, 3-21
 Dots style, 3-55
 Filter, 3-23
 Format, 3-24
 Frame, 3-24
 Full, 3-24
 Graticule, 3-24-3-26
 Grid, 3-24
 Infinite Persistence, 3-22
 Intensified Samples, 3-22
 Intensity, 3-22-3-26
 Linear interpolation, 3-23
 NTSC, 3-24
 Overall, 3-22
 PAL, 3-24
 Readout, 3-22
 Sin(x)/x interpolation, 3-23
 Style, 3-21
 Text/Grat, 3-22
 Trigger Bar, 3-23
 Variable Persistence, 3-22
 Vectors, 3-21
 Waveform, 3-22
 XY, 3-24
 YT, 3-24

Dots, 3-21
 Dots style, Display menu, 3-55
 Dots, Display menu, 3-21
DPU411-II, Hardcopy menu, 3-36
DPU412, Hardcopy menu, 3-36
Dual Wfm Math, More menu, 3-132
Dual Zoom, Zoom menu, 3-137
Dual Zoom Offset, Zoom menu, 3-137
 Dual-lead adapter, 3-79
 Duty cycle, 2-25, Glossary-6, Glossary-7

E

Edge trigger, 2-32, 3-27, Glossary-3
 Readout, 3-27
Edge, Main Trigger menu, 2-38, 3-27
Edges, Measure Delay menu, 3-67
empty, Saved waveform status, 3-101

Encapsulated Postscript, 3–35
Enter Char, Labelling menu, 3–32, 3–34
 Envelope acquisition mode, 3–8, Glossary–3
Envelope, Acquire menu, 3–9
EPS Color Img, Hardcopy menu, 3–36
EPS Color Plt, Hardcopy menu, 3–36
EPS Mono Img, Hardcopy menu, 3–36
EPS Mono Plt, Hardcopy menu, 3–36
 Epson, 3–35
Epson, Hardcopy menu, 3–36
 Equivalent time sampling, 2–41
 Equivalent-time sampling, random, Glossary–3
External Clock, Horizontal menu, 3–49

F

Factory initialization settings, E–1–E–4
factory, Saved setup status, 3–97
 Fall time, 3–60, Glossary–3
 Falling edge, Delayed Trigger menu, 3–17
 Falling edge, Main Trigger menu, 3–29
 File, **Port** (optional), 3–37
 File System, 3–31–3–34, A–1
File Utilities
 File Utilities menu, 3–31
 Save/Recall Setup menu, 3–99
 Save/Recall Waveform menu, 3–103
 File Utilities menu, 3–31
 Confirm Delete, 3–34
 Copy, 3–33
 Create Directory, 3–34
 Delete, 3–32
 File Utilities, 3–31
 Format, 3–34
 Overwrite Lock, 3–34
 Print, 3–33
 Rename, 3–32
Filter, Display menu, 3–23
Fine Scale, Vertical menu, 3–123
 Firmware version, 3–19
Fit to screen, Horizontal menu, 3–47
 Fixtured active probes, 3–85
FORCE TRIG button, 2–36
Format, Display menu, 3–24
Format, File Utilities menu, 3–34
Format, Hardcopy menu, 3–36
Frame, Display menu, 3–24
 Frequency, 2–25, 3–60, Glossary–3
 Front Cover, A–1
 Front panel, 2–4
Full, Display menu, 3–24
Full, Vertical menu, 3–123

Function, Cursor menu, 3–117, 3–118
 Fuse, 1–3, 2–5

G

Gated Measurements, 3–63, Glossary–4
Gating, Measure menu, 3–63
 General purpose (high input resistance) probes, 3–83
 General purpose knob, 2–7, 2–25, 2–27, Glossary–4
 GPIB, 2–5, 3–89–3–92, Glossary–4
 Interconnect cabling, 3–90
 Procedures for using, 3–91
 Selecting and configuring the port, 3–91
GPIB, Hardcopy menu, 3–37
GPIB, Utility menu, 3–91
 Graticule, 3–24, Glossary–4
 Measurements, 2–49–2–50
Graticule, Display menu, 3–24–3–26
Grid, Display menu, 3–24
 Ground coupling, Glossary–4
 Ground lead inductance, 3–71
GROUP 1, GROUP 2 ... buttons, 3–136

H

H Bars, Cursor menu, 3–117, 3–118
H Limit, Acquire menu, 3–55
 Hardcopy, 3–35–3–44, Glossary–4
 How to print (controller), 3–41
 How to print (no controller), 3–39
 How to save to disk, 3–40
 Spool, 3–39, 3–40
Hardcopy (Talk Only), Utility menu, 3–36
HARDCOPY button, 3–31, 3–36, 3–91
Hardcopy if Condition Met, Acquire menu, 3–56
 Hardcopy Interface, Optional RS-232/Centronic, A–1
 Hardcopy menu
 BMP Color, 3–36
 BMP Mono, 3–36
 Clear Spool, 3–37, 3–40
 Deskjet, 3–36
 DPU411-II, 3–36
 DPU412, 3–36
 EPS Color Img, 3–36
 EPS Color Plt, 3–36
 EPS Mono Img, 3–36
 EPS Mono Plt, 3–36
 Epson, 3–36
 Format, 3–36
 GPIB, 3–37
 HPGL, 3–36

- Interleaf**, 3–36
 - Landscape**, 3–37
 - Laserjet**, 3–36
 - Layout**, 3–37
 - OK Confirm Clear Spool**, 3–40
 - PCX**, 3–36
 - PCX Color**, 3–36
 - Port**, 3–37
 - Portrait**, 3–37
 - RLE Color**, 3–36
 - Thinkjet**, 3–36
 - TIFF**, 3–36
 - Hardcopy**, Utility menu, 3–91
 - HELP** button, 3–3
 - Help system, 3–3
 - HF Rej**, Main Trigger menu, 3–28
 - Hi Res acquisition mode, 3–7
 - Hi res acquisition mode, Glossary–4
 - Hi Res**, Acquire menu, 3–9
 - High, 3–60, Glossary–4
 - High frequency rejection, 2–34
 - High Ref**, Measure menu, 3–65
 - High speed active probes, 3–85
 - High voltage probes, 3–84
 - High-Low Setup**, Measure menu, 3–64
 - Histogram**, Measure menu, 3–64
 - Holdoff, trigger, 2–33, Glossary–4
 - Horiz Pos**, Horizontal menu, 3–48
 - Horiz Scale**, Horizontal menu, 3–48
 - Horizontal, 3–111
 - Bar cursors, 2–48, 3–115, Glossary–4
 - Control, 3–45–3–52
 - Menu, 2–35
 - Position, 3–46
 - POSITION** knob, 2–44
 - Readouts, 3–45
 - Scale, 3–46
 - SCALE** knob, 2–17, 2–44
 - System, 2–17, 2–44
 - Horizontal Lock**, Zoom menu, 3–136
 - Horizontal menu, 3–14
 - Clock**, 3–49
 - Delayed Only**, 3–14
 - Delayed Runs After Main**, 3–14, 3–49
 - Delayed Scale**, 3–48
 - Delayed Triggerable**, 3–16, 3–49
 - External Clock**, 3–49
 - Fit to screen**, 3–47
 - Horiz Pos**, 3–48
 - Horiz Scale**, 3–48
 - Intensified**, 3–14, 3–16
 - Internal Clock**, 3–49
 - Main Scale**, 3–48
 - Record Length**, 3–47
 - Set to 10%**, 3–48
 - Set to 50%**, 3–48
 - Set to 90%**, 3–48
 - Time Base**, 3–14, 3–48
 - Trigger Position**, 3–47
 - HORIZONTAL MENU** button, 2–35, 3–14
 - Horizontal **POSITION** knob, 3–46, 3–136
 - Horizontal Readouts, 3–45
 - Horizontal **SCALE** knob, 3–46, 3–136
 - Horizontal Units**, Cursor menu, 3–119
 - HPGL, 3–35
 - HPGL**, Hardcopy menu, 3–36
- ## I
- I/O**, Status menu, 3–19
 - I/O**, Utility menu, 3–36, 3–91
 - IC protector tip, 3–78
 - Icons, 1–1
 - Independent Mode, Cursor, 2–48
 - Independent**, Cursor menu, 3–118
 - Infinite Persistence**, Display menu, 3–22
 - Installation, 1–3
 - Intensified Samples**, Display menu, 3–22
 - Intensified**, Horizontal menu, 3–14, 3–16
 - Intensity, 3–22, Glossary–5
 - Intensity**, Display menu, 3–22–3–26
 - Interlaced Field One**, Video Trigger menu, 3–128
 - Interlaced Field Two**, Video Trigger menu, 3–128
 - Interleaf, 3–35
 - Interleaf**, Hardcopy menu, 3–36
 - Internal Clock**, Horizontal menu, 3–49
 - Interpolation, 2–40, 3–23, Glossary–5
 - IRE (NTSC)**, Cursor menu, 3–120
- ## K
- Knob, Glossary–5
 - General purpose, 2–7, 2–25, 2–27, Glossary–4
 - Horizontal **POSITION**, 2–17, 2–44, 3–46
 - Horizontal **SCALE**, 2–17, 2–44, 3–46
 - MEASURE**, 2–47
 - Trigger **MAIN LEVEL**, 2–18, 2–35
 - Vertical **POSITION**, 2–17, 2–44, 3–121
 - Vertical **SCALE**, 2–17, 2–44, 3–121
- ## L
- Labelling menu, **Enter Char**, 3–32, 3–34
 - Landscape**, Hardcopy menu, 3–37

Laserjet, 3-35
Laserjet, Hardcopy menu, 3-36
Layout, Hardcopy menu, 3-37
Level, Delayed Trigger menu, 3-17
Level, Main Trigger menu, 3-29
 Level, Trigger, 2-34
LF Rej, Main Trigger menu, 3-28
Limit Test Condition Met, Acquire menu, 3-56
Limit Test Setup, Acquire menu, 3-56
Limit Test Sources, Acquire menu, 3-55
Limit Test, Acquire menu, 3-56
 Limit testing, 3-53-3-58
 Linear interpolation, 2-40, 3-23, Glossary-5
Linear interpolation, Display menu, 3-23
 Long ground leads, 3-74
 Low, 3-60, Glossary-5
 Low frequency rejection, 2-34
 Low impedance Zo probes, 3-83
Low Ref, Measure menu, 3-65
 Low-inductance ground lead, 3-75
 Low-inductance spring-tips, 3-77, A-7

M

Main menu, Glossary-5
 Main menu buttons, 2-3, Glossary-5
Main Scale, Horizontal menu, 3-48
 Main Trigger Menu
 Falling edge, 3-29
 Rising edge, 3-29
 Main Trigger menu, 2-38, 3-27
 AC, 3-28
 Auto, 3-29
 Ch1, Ch2 ..., 3-28, 3-50
 Coupling, 3-28
 DC, 3-28
 Edge, 2-38, 3-27
 HF Rej, 3-28
 Level, 3-29
 LF Rej, 3-28
 Mode & Holdoff, 3-29
 Noise Rej, 3-28
 Normal, 3-29
 Set to 50%, 2-35, 3-29
 Set to ECL, 3-29
 Set to TTL, 3-29
 Slope, 3-29
 Source, 3-28, 3-50
 Type, 2-38, 3-27, 3-125, 3-126
 Video, 3-125, 3-126
 Marker rings, 3-74, A-7
 Math Waveform

Differential, A-1
 FFT, A-1
 Integral, A-1
 Optional Advanced, A-1
 Math waveforms, 3-133
Math1/2/3, More menu, 3-133
 Maximum, 3-60, Glossary-5
 Mean, 3-60, Glossary-5
MEASURE button, 3-62
 Measure Delay menu
 Create Measrmt, 3-67
 Delay To, 3-66
 Edges, 3-67
 Measure Delay To, 3-66
 OK Create Measurement, 3-67
Measure Delay To, Measure Delay menu, 3-66
 Measure menu, 2-10, 3-62, 3-68
 Gating, 3-63
 High Ref, 3-65
 High-Low Setup, 3-64
 Histogram, 3-64
 Low Ref, 3-65
 Mid Ref, 3-65
 Mid2 Ref, 3-65
 Min-Max, 3-64
 Reference Levels, 3-65
 Remove Measrmt, 3-63, 3-69
 Select Measrmt, 3-62, 3-66
 Set Levels in % units, 3-65
 Snapshot, 3-68
 Measurement
 Amplitude, 3-59, Glossary-1
 Area, 3-59, Glossary-1
 Burst width, 3-59, Glossary-2
 Cycle area, 3-59, Glossary-2
 Cycle mean, 3-59, Glossary-2
 Cycle RMS, 3-59, Glossary-3
 Delay, 3-66, Glossary-3
 Duty cycle, 2-25, Glossary-6, Glossary-7
 Fall time, 3-60
 Frequency, 2-25, 3-60, Glossary-3
 Gated, Glossary-4
 High, 3-60, Glossary-4
 Low, 3-60, Glossary-5
 Maximum, 3-60, Glossary-5
 Mean, 3-60, Glossary-5
 Minimum, 3-60, Glossary-5
 Negative duty cycle, 3-60
 Negative overshoot, 3-60
 Negative width, 3-60
 Overshoot, Glossary-7
 Peak to peak, 3-60, Glossary-6

Period, 3-60, Glossary-6
 Phase, 3-60, Glossary-6
 Positive duty cycle, 3-60
 Positive overshoot, 3-61
 Positive width, 3-61
 Propagation delay, 3-59
 Readout, 3-61, 3-63
 Reference levels, 2-25, 2-27
 Rise time, 2-25, 3-61, Glossary-7
 RMS, 3-61, Glossary-8
 Undershoot, Glossary-6
 Width, 2-25, Glossary-6, Glossary-7
 Measurement Accuracy, Ensuring maximum,
 3-113-3-114
 Measurements, 2-47-2-50, 3-59-3-70
 Algorithms, C-1-C-14
 Automated, 2-24, 2-47
 Cursor, 2-48, 3-115
 Gated, 3-63
 Graticule, 2-49-2-50
 Snapshot of, 3-68
 Memory, Waveform, 3-102
 Menu
 Acquire, 3-9, 3-53
 Banner, 3-20
 Cursor, 3-117
 Delayed Trigger, 3-16-3-18
 Display, 3-21
 File Utilities, 3-31
 Horizontal, 2-35, 3-14
 Main, 2-6
 Main Trigger, 2-38, 3-27
 Measure, 2-10, 3-62, 3-68
 More, 2-10, 3-103, 3-131
 Operation, 2-7
 Pop-up, 2-8, Glossary-6
 Save/Recall, 3-97
 Save/Recall Setup, 2-10
 Save/Recall Waveform, 2-10, 3-101
 Setup, 2-14
 Status, 3-19-3-20
 status, 2-10
 Utility, 2-11, 3-36, 3-91
 Video Trigger, 3-125
Mid Ref, Measure menu, 3-65
Mid2 Ref, Measure menu, 3-65
Min-Max, Measure menu, 3-64
 Minimum, 3-60, Glossary-5
 Mode, Cursor, 2-48
Mode & Holdoff, Main Trigger menu, 3-29
Mode & Holdoff, Video Trigger menu, 3-129
Mode, Acquire menu, 3-9
 Model number location, 2-3

MORE button, 3-55, 3-103, 3-108, 3-131
 More menu, 2-10, 3-103, 3-131
 Change Math waveform definition, 3-132
 Dual Wfm Math, 3-132
 Math1/2/3, 3-133
 OK Create Math Waveform, 3-132
 Reference waveform status, 3-103
 Set 1st Source to, 3-132
 Set 2nd Source to, 3-132
 Set Function to, 3-132
 Set operator to, 3-132
 Set Single Source to, 3-132
 Single Wfm Math, 3-131

N

Neg Sync, Video Trigger menu, 3-127
 Negative duty cycle, 3-60
 Negative overshoot, 3-60
 Negative width, 3-60
Noise Rej, Main Trigger menu, 3-28
 Nominal Traits
 Defined, B-3
 Listed, B-3
NonInterlaced Both Fields, Video Trigger menu,
 3-128
 Normal trigger mode, 2-32, Glossary-6
Normal, Main Trigger menu, 3-29
Normal, Video Trigger menu, 3-129
 NTSC Video Standard, 3-126
 NTSC, Display menu, 3-24
 NTSC, Video Trigger menu, 3-126

O

OFF (Real Time Only), Acquire menu, 3-10
Off Bus, Utility menu, 3-91
 Offset, Vertical, 2-44, 3-123
Offset, Vertical menu, 3-123
OK Confirm Clear Spool, Hardcopy menu, 3-40
OK Create Math Wfm, More menu, 3-132
OK Create Measurement, Measure Delay menu, 3-67
OK Erase Ref & Panel Memory, Utility menu, 3-99
OK Store Template, Acquire menu, 3-55
ON (Enable ET), Acquire menu, 3-10
ON/STBY button, 1-4, 2-3
 Optical probes, 3-86
 Option 2A, A-1
 Options, A-1-A-8
 Oscilloscope, Glossary-6
Overall, Display menu, 3-22
 Overshoot, Glossary-7

Overwrite Lock, File Utilities menu, 3-34

P

Packaging, D-1

Paired cursor, 2-48, 3-115

PAL Video Standard, 3-126

PAL, Display menu, 3-24

PAL, Video Trigger menu, 3-126

Passive voltage probes, 3-83-3-88

PCX, 3-35

PCX Color, Hardcopy menu, 3-36

PCX, Hardcopy menu, 3-36

Peak detect acquisition mode, 3-5, Glossary-6

Peak Detect, Acquire menu, 3-9

Peak to peak, 3-60, Glossary-6

Performance Characteristics

Nominal. *See* Nominal Traits

Typical. *See* Warranted Characteristics

Warranted. *See* Warranted Characteristics

Period, 3-60, Glossary-6

Persistence, 3-22

Phase, 3-60, Glossary-6

Pixel, Glossary-6

Pop-up menu, 2-8, Glossary-6

Port, Hardcopy menu, 3-37

Port, Utility menu, 3-91

Portrait, Hardcopy menu, 3-37

Pos Sync, Video Trigger menu, 3-127

Position, Vertical, 2-44, 3-121

Position, Vertical menu, 3-123

Positive duty cycle, 3-60

Positive overshoot, 3-61

Positive width, 3-61

Postscript, 3-35

Posttrigger, Glossary-7

Pouch, A-1

Power connector, 1-3

Power cords, A-1, A-2

Power off, 1-5

Power on, 1-4

Pretrigger, Glossary-7

Preview, Zoom menu, 3-138

Principal power switch, 1-4, 2-5

Print, File Utilities menu, 3-33

Printer

DPU-411, A-1

DPU-412, A-1

Probe accessories

Compact-to-miniature probe tip adapter, 3-78, A-6

Dual-lead adapter, 3-79

IC protector tip, 3-78

Long ground leads, 3-74

Low-inductance ground lead, 3-75

Low-inductance spring-tips, 3-77, A-7

Marker rings, 3-74, A-7

Probe tip-to-chassis adapter, 3-77, A-7

Probe tip-to-circuit board adapters, 3-76

Retractable hook tip, 3-74

SMT KlipChip, 3-76, A-7

Probe Cal, 1-5

Probe tip-to-chassis adapter, 3-77, A-7

Probe tip-to-circuit board adapters, 3-76

Probes

Accessories, 3-72-3-80, A-4, A-5, A-6

Active voltage, 3-84-3-88

Additional, A-2

Analog Differential, A-2

Compensation, 2-17, 3-81, Glossary-7

Connection, 2-13, 3-71-3-80

Current, 3-86

Definition, Glossary-7

Differential active, 3-85

Fixtured active, 3-85

General purpose (high input resistance), 3-83

High speed, 3-85

High voltage, 3-84

Low impedance Z_o , 3-83

Optical, 3-86

Passive, 3-81

Passive voltage, 3-83-3-88

Selection, 3-83-3-88

Time-to-voltage converter, 3-87

Propagation delay, 3-59

Q

Quantizing, Glossary-7

R

Rack mounting, A-2

Rate 1, Video Trigger menu, 3-129

Rate 2, Video Trigger menu, 3-129

Rate 3, Video Trigger menu, 3-129

Rate 4, Video Trigger menu, 3-129

Readout

Acquisition, 3-9

Channel, 2-6, 3-107, 3-136

Cursors, 2-6

Edge trigger, 3-27

General purpose knob, 2-6

Measurement, 2-47, 3-61, 3-63

- Record view, 2-6
 - Snapshot, 3-68
 - Time base, 2-6
 - Trigger, 2-6, 2-37
 - Trigger Level Bar, 3-22
 - Trigger Point, 3-22
 - Readout**, Display menu, 3-22
 - Real-time sampling, 2-40, Glossary-7
 - Rear panel, 2-5, 3-91
 - Recall, Setups, 3-97-3-100
 - Recall Factory Setup**, Save/Recall Setup menu, 3-98, 3-112
 - Recall Saved Setup**, Save/Recall Setup menu, 3-98
 - Recalling, Waveforms, 3-101
 - Record length, 1-1, 2-40, 3-47, A-2, Glossary-7
 - Record Length**, Horizontal menu, 3-47
 - Record View, 2-37, 2-43, 3-45
 - Record view, 2-6
 - Ref1, Ref2, Ref3, Ref4**, Reference waveform status, 3-103
 - Ref1, Ref2, Ref3, Ref4**, Save/Recall Waveform menu, 3-103
 - Reference Indicator, Channel, 3-107
 - Reference levels, 2-25, 2-27, 3-65
 - Reference Levels**, Measure menu, 3-65
 - Reference memory, Glossary-7
 - Remote communication, 3-89-3-92
 - Remote operation
 - Interconnect cabling, 3-90
 - Preparation for, 3-89
 - Procedures for, 3-91
 - Selecting and configuring the port, 3-91
 - Remove Measrmt**, Measure menu, 3-63, 3-69
 - Rename**, File Utilities menu, 3-32
 - Repetitive Signal**, Acquire menu, 3-10
 - Reset Zoom Factors**, Zoom menu, 3-138
 - Retractable hook tip, 3-74
 - Ring Bell if Condition Met**, Acquire menu, 3-56
 - Rise time, 2-25, 3-61, Glossary-7
 - Rising edge, Delayed Trigger menu, 3-17
 - Rising edge, Main Trigger menu, 3-29
 - RLE Color**, Hardcopy menu, 3-36
 - RMS, 3-61, Glossary-8
 - Roll, Glossary-8
 - Roll Mode, 3-93-3-96
 - Triggered, 3-95
 - Triggered, with Single Sequence, 3-95
 - Untriggered, 3-93
 - Untriggered, with Single Sequence, 3-93
 - Using, 3-95
 - RS-232, **Port** (optional), 3-89
 - RS-232, **Port** (optional), 3-37, 3-43
 - RUN/STOP**, Acquire menu, 3-11
- ## S
- Sample acquisition mode, 3-5, Glossary-8
 - Sample interval, Glossary-8
 - Sample**, Acquire menu, 3-9
 - Sampling, 2-40, 2-41, Glossary-8
 - Save, Setups, 3-97-3-100
 - Save Current Setup**, Save/Recall Setup menu, 3-97
 - Save Format**, Save/Recall Waveform menu, 3-104
 - Save Waveform**, Save/Recall Waveform menu, 3-101
 - Save/Recall **SETUP** button, 3-31, 3-97
 - Save/recall **SETUP** button, 2-14
 - Save/Recall Setup menu, 2-10, 3-97
 - factory** status, 3-97
 - File Utilities**, 3-99
 - Recall Factory Setup**, 3-98, 3-112
 - Recall Saved Setup**, 3-98
 - Save Current Setup**, 3-97
 - user** status, 3-97
 - Save/Recall **WAVEFORM** button, 3-31, 3-101
 - Save/Recall Waveform menu, 2-10, 3-101
 - active** status, 3-101
 - Delete Refs**, 3-102
 - empty** status, 3-101
 - File Utilities**, 3-103
 - Ref1, Ref2, Ref3, Ref4**, 3-103
 - Save Format**, 3-104
 - Save Waveform**, 3-101
 - Saving and recalling setups, 2-29, 3-97
 - Saving and recalling waveforms, 3-101
 - Scan Parameter**, Video Trigger menu, 3-128
 - SECAM Video Standard, 3-126
 - SECAM, Video Trigger menu, 3-126
 - seconds**, Cursor menu, 3-119
 - SELECT** button, 3-118, Glossary-9
 - Select Measrmt**, Measure menu, 3-62, 3-66
 - Selected waveform, Glossary-8
 - Selecting channels, 3-107
 - Self test, 1-5
 - Service Assurance, A-8
 - Set 1st Source to**, More menu, 3-132
 - Set 2nd Source to**, More menu, 3-132
 - Set Function to**, More menu, 3-132
 - SET LEVEL TO 50%** button, 2-35
 - Set Levels in % units**, Measure menu, 3-65
 - Set operator to**, More menu, 3-132
 - Set Single Source to**, More menu, 3-132
 - Set to 10%**, Horizontal menu, 3-48
 - Set to 50%**, Delayed Trigger menu, 3-18
 - Set to 50%**, Horizontal menu, 3-48
 - Set to 50%**, Main Trigger menu, 2-35, 3-29
 - Set to 90%**, Horizontal menu, 3-48
 - Set to ECL**, Delayed Trigger menu, 3-17

Set to ECL, Main Trigger menu, 3-29
Set to TTL, Delayed Trigger menu, 3-17
Set to TTL, Main Trigger menu, 3-29
Set to Zero, Vertical menu, 3-123
 Setting Up for the Examples, 2-13
 Setup menu, 2-14
 Setups, Save and recall, 3-97-3-100
 Shipping, D-1
 Side menu, Glossary-8
 Side menu buttons, 2-3, Glossary-8
 Signal Path Compensation, 1-5-1-6, 3-113-3-114,
 Glossary-8
 Sin(x)/x interpolation, 2-40, 3-23, Glossary-5
Sin(x)/x interpolation, Display menu, 3-23
Single Acquisition Sequence, Acquire menu, 3-11
SINGLE TRIG button, 2-36, 3-11
Single Wfm Math, More menu, 3-131
 Single-Shot sampling, 2-40
 Slope, Glossary-8
Slope, Delayed Trigger menu, 3-17
Slope, Main Trigger menu, 3-29
 Slope, Trigger, 2-34
 SMT KlipChip, 3-76, A-7
 Snapshot, Readout, 3-68
 Snapshot of Measurements, 2-27, 3-68
Snapshot, Measure menu, 3-68
 Software, 1-1
 Software version, 3-19
Source, Delayed Trigger menu, 3-16
Source, Main Trigger menu, 3-28, 3-50
Source, Video Trigger menu, 3-126
 SPC, Glossary-8
 Specification, B-1-B-2
 Specifications, B-1-B-2
 Spooler, Hardcopy, 3-40
 Start up, 1-3
STATUS button, 3-19
Status menu, 2-10, 3-19-3-20
 Firmware version, 3-19
 I/O, 3-19
 System, 3-19
 Trigger, 3-19
 Waveforms, 3-19
Stop After Limit Test Condition Met, Acquire menu,
 3-56
Stop After, Acquire menu, 3-10, 3-56
Style, Display menu, 3-21
 Switch, principal power, 1-4, 2-5
Sync Polarity, Video Trigger menu, 3-127
System, Status menu, 3-19
System, Utility menu, 3-36, 3-91

T

Talk/Listen Address, Utility menu, 3-91
 Tek Secure, 3-99, Glossary-9
Tek Secure Erase Memory, Utility menu, 3-99
 Temperature compensation, 3-113-3-114
Template Source, Acquire menu, 3-54
 Test Data Report, A-2
Text/Grat, Display menu, 3-22
 Thinkjet, 3-35
Thinkjet, Hardcopy menu, 3-36
 TIFF, 3-35
TIFF, Hardcopy menu, 3-36
 Time base, Glossary-9
Time Base, Horizontal menu, 3-14, 3-48
 Time-to-voltage converter, 3-87
TOGGLE button, 2-48
 Tracking Mode, Cursor, 2-48
Tracking, Cursor menu, 3-118
 Trigger, 2-31-2-38, 3-111, Glossary-9
 AC Line Voltage, 2-31
 Auxiliary, 2-32
 Coupling, 2-34-2-38
 Delay, 2-35
 Delayed, 3-13-3-18
 Edge, 2-32, 3-27, Glossary-3
 Holdoff, 2-33
 Level, 2-34, Glossary-9
 Mode, 2-32
 Position, 2-34, 3-47
 Readout, 2-37
 Slope, 2-34
 Status Lights, 2-36
 Types, 2-38
 Video, 2-32, 3-125
 Trigger Bar, 2-6
Trigger Bar Style, Display menu, 3-23
 Trigger Level Bar, Readout, 3-22
 Trigger MAIN LEVEL knob, 2-18, 2-35
TRIGGER MENU button, 2-38, 3-27, 3-125
 Trigger Point, Readout, 3-22
Trigger Position, Horizontal menu, 3-47
 Trigger Status Lights, 2-36
 Trigger, delayed, How to set up, 3-14-3-18
Trigger, Status menu, 3-19
 Tutorial, 2-13
TV Delay Mode, Video Trigger menu, 3-127
Type, Main Trigger menu, 2-38, 3-27, 3-125, 3-126
 Typical Characteristics
 Defined, B-17
 Listed, B-17

U

- Undershoot, Glossary-6
- user, Saved setup status, 3-97
- UTILITY button, 3-36, 3-91
- Utility Menu
 - OK Erase Ref & Panel Memory, 3-99
 - Tek Secure Erase Memory, 3-99
- Utility menu, 2-11, 3-36, 3-91
 - Configure, 3-36, 3-91
 - GPIB, 3-91
 - Hardcopy, 3-91
 - Hardcopy (Talk Only), 3-36
 - I/O, 3-36, 3-91
 - Off Bus, 3-91
 - Port, 3-91
 - System, 3-36, 3-91
 - Talk/Listen Address, 3-91

V

- V Limit, Acquire menu, 3-54
- Variable Persistence, Display menu, 3-22
- Vectors, 3-21
- Vectors, Display menu, 3-21
- Vertical, 3-111
 - Bar cursors, 2-48, 3-115, Glossary-9
 - Control, 3-121-3-124
 - Offset, 2-44, 3-123
 - Position, 2-44, 3-121
 - POSITION knob, 2-44
 - Readout, 3-121
 - Scale, 3-121
 - SCALE knob, 2-17, 2-44, 3-121
 - System, 2-17, 2-44-2-46
- Vertical menu
 - 100 MHz, 3-123
 - 20 MHz, 3-123
 - Bandwidth, 3-123
 - Coupling, 3-122
 - Fine Scale, 3-123
 - Full, 3-123
 - Offset, 3-123
 - Position, 3-123
 - Set to Zero, 3-123
- VERTICAL MENU button, 2-21
- Vertical POSITION knob, 3-121, 3-136
- Vertical Readout, 3-121
- Vertical SCALE knob, 3-121, 3-136
- VGA display, F-1
- Video Class, Video Trigger menu, 3-126
- Video Line Number, Cursor menu, 3-119

- Video Output
 - Acceptable Cable, B-16
 - Description, B-6
- Video Standards, 3-126
- Video Trigger
 - NTSC Standard, 3-126
 - PAL Standard, 3-126
 - SECAM Standard, 3-126
 - Standards, 3-126
- Video trigger, 2-32, 3-125
- Video Trigger Menu
 - Neg Sync, 3-127
 - Pos Sync, 3-127
- Video Trigger menu, 3-125
 - Auto, 3-129
 - Ch1, Ch2 ..., 3-126
 - Custom, 3-126
 - Delay by Lines, 3-127
 - Delay by Time, 3-127
 - Interlaced Field One, 3-128
 - Interlaced Field Two, 3-128
 - Mode & Holdoff, 3-129
 - NonInterlaced Both Fields, 3-128
 - Normal, 3-129
 - NTSC, 3-126
 - PAL, 3-126
 - Rate 1, 3-129
 - Rate 2, 3-129
 - Rate 3, 3-129
 - Rate 4, 3-129
 - Scan Parameter, 3-128
 - SECAM, 3-126
 - Source, 3-126
 - Sync Polarity, 3-127
 - TV Delay Mode, 3-127
 - Video Class, 3-126
- Video, Main Trigger menu, 3-125, 3-126

W

- Warranted Characteristics
 - Defined, B-11
 - Listed, B-11
 - Performance Conditions for, B-11
- Waveform, Glossary-9
 - Interval, Glossary-9
 - Math, 3-131-3-134
 - Off priority, 3-108
- Waveform memory, 3-102
- WAVEFORM OFF button, 2-23, 3-25, 3-108
- Waveform Rate, B-5
- Waveform, Display menu, 3-22

Waveforms

- And zoom, 3-135
- Math, 3-133
- Waveforms**, Status menu, 3-19
- Width, 2-25, Glossary-6, Glossary-7

X

- XY, Format, 3-24
- XY format, Glossary-9
- XY, Display menu, 3-24

Y

- YT, Format, 3-24
- YT format, Glossary-9
- YT, Display menu, 3-24

Z

- Zoom, 3-135-3-140
 - And waveforms, 3-135
 - Dual Zoom, 3-137
 - Dual Zoom Offset, 3-137
 - Horizontal lock, 3-136
 - Preview, 3-138
- ZOOM** button, 3-136
- Zoom feature, 2-46
- Zoom menu
 - Dual Zoom**, 3-137
 - Dual Zoom Offset**, 3-137
 - Horizontal Lock**, 3-136
 - Preview**, 3-138
 - Reset Zoom Factors**, 3-138
 - Zoom Off**, 3-139
- Zoom Off**, Zoom menu, 3-139