

RTD 710A DIGITIZER

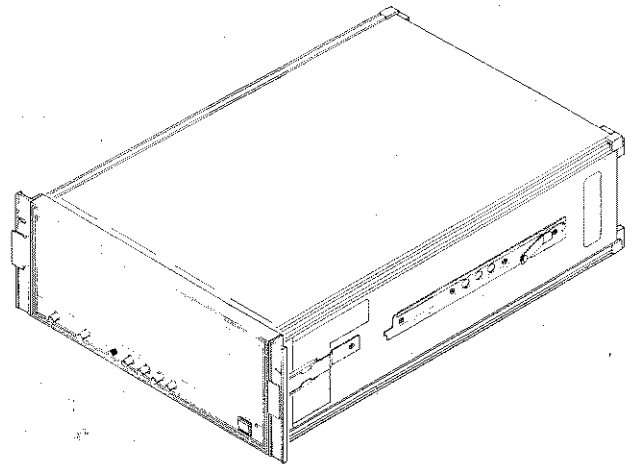
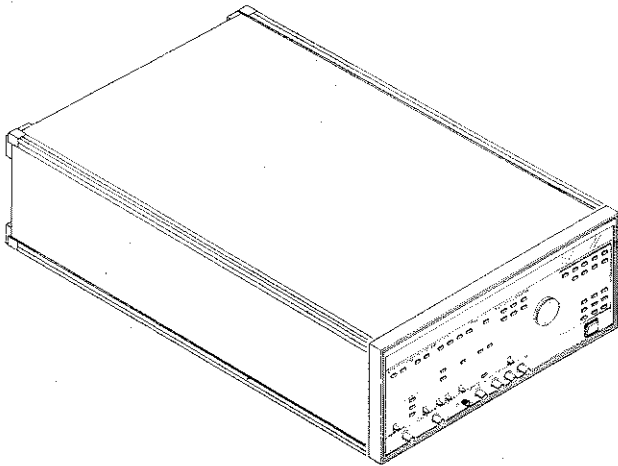

*Please Check for
CHANGE INFORMATION
at the Rear of This Manual*

First Printing AUG 1988

Tektronix
COMMITTED TO EXCELLENCE

IBM is a registered trademark of International Business Machines Corporation.

DEC is a registered trademark of Digital Equipment Corporation.

HP is a registered trademark of Hewlett Packard Corporation.

Copyright © 1988 Tektronix, Inc. All rights reserved.
Contents of this publication may not be reproduced in any form without the written permission of Tektronix, Inc.

Products of Tektronix, Inc. and its subsidiaries are covered by U.S. and foreign patents and/or pending patents.

TEKTRONIX, TEK, SCOPE-MOBILE, and  are registered trademarks of Tektronix, Inc. TELEQUIPMENT is a registered trademark of Tektronix U.K. Limited.

Certificate of the Manufacturer/Importer

We hereby certify that the RTD710A DIGITIZER

AND ALL INSTALLED OPTIONS

complies with the RF Interference Suppression requirements of Amtsbl.-Vfg 1046/1984.

The German Postal Service was notified that the equipment is being marketed.

The German Postal Service has the right to re-test the series and to verify that it complies.

SONY/TEKTRONIX

Bescheinigung des Herstellers/Importeurs

Hiermit wird bescheinigt, daß der/die/das RTD710A DIGITIZER

AND ALL INSTALLED OPTIONS

in Übereinstimmung mit den Bestimmungen der Amtsblatt-Verfügung 1046/1984 funktionsstört ist.

Der Deutschen Bundespost wurde das Inverkehrbringen dieses Gerätes angezeigt und die Berechtigung zur Überprüfung der Serie auf Einhalten der Bestimmungen eingeräumt.

SONY/TEKTRONIX

NOTICE to the user/operator:

The German Postal Service requires that Systems assembled by the operator/user of this instrument must also comply with Postal Regulation, Vfg. 1046/1984, Par. 2, Sect. 1.

HINWEIS für den Benutzer/Betreiber:

Die vom Betreiber zusammengestellte Anlage, innerhalb derer dies Gerät eingesetzt wird, muß ebenfalls den Voraussetzungen nach Par. 2, Ziff. 1 der Vfg. 1046/1984 genügen.

NOTICE to the user/operator:

The German Postal Service requires that this equipment, when used in a test setup, may only be operated if the requirements of Postal Regulation, Vfg. 1046/1984, Par. 2, Sect. 1.7.1 are complied with.

HINWEIS für den Benutzer/Betreiber:

Dies Gerät darf in Meßaufbauten nur betrieben werden, wenn die Voraussetzungen des Par. 2, Ziff. 1.7.1 der Vfg. 1046/1984 eingehalten werden.

PREFACE

GUIDE TO RTD 710A DOCUMENTATION

The RTD 710A Digitizer documentation provides information necessary to install, operate, and service the instrument. It consists of:

- an **Instruction Manual** that describes the instrument, tells how to prepare the instrument for use, explains the controls and connectors, provides operator familiarization, includes the IEEE 488 command set and programming examples, and provides instructions for internal control settings and rackmounting instructions for service personnel.
- an optional two volume **Service Manual** that provides information for qualified service personnel to troubleshoot, repair, and calibrate the instrument.
- an **Instrument Interfacing Guide** that helps the user get started using the instrument by providing more detailed interface and programming information.

Table 0-1 lists the Tektronix part numbers and titles of the available RTD 710A documentation.

Table 0-1
RTD 710A DOCUMENTATION

Part Number	Document Title
070-7204-00	Instruction Manual
070-7292-00	Service Manual, Volume 1
070-7293-00	Service Manual, Volume 2
070-7207-00	Instrument Interfacing Guide

ABOUT THIS MANUAL

The RTD 710A Instruction Manual introduces you to the instrument and helps you learn how to use it. It contains the following sections and appendices:

Section 1—General Information contains an instrument description, a list of standard accessories, and a list of optional accessories.

Section 2—Preparation for Use contains installation instructions, including power, signal cabling, and packaging for reshipment.

Section 3—Operating Instructions contains three major subsections. The first provides initial power-up instructions, the second describes the controls, connectors, and indicators, and the third contains information on instrument familiarization.

Section 4—Interfacing describes the instrument's IEEE-488 (GPIB) Interface and the A/D Output Interface.

Section 5—Programming Command Set describes the complete set of commands to control the instrument through its IEEE 488 interface, and provides programming examples.

Section 6—Instrument Options lists and describes instrument options.

Appendix A—SRQ Status Bytes and Event Codes explains the IEEE 488 status byte and contains tables of event codes returned by the EVENT? query command.

Appendix B—Specifications. Contains tables describing the environmental, electrical, and mechanical characteristics of the instrument.

Appendix C—ASCII & GPIB Code Chart. Contains a standard 7-bit ASCII and GPIB Code chart that includes the decimal, octal, and hexadecimal values for the ASCII character set and the GPIB commands.

WARNING

Servicing instructions are for use by qualified personnel only. To avoid personal injury, do not perform any servicing other than that contained in operating instructions unless you are qualified to do so.

Appendix D—Servicing Instructions. Contains limited servicing instructions for changing the power supply operating voltage, selecting internal CRT monitor output jumpers, and installing rackmounting hardware.

TABLE OF CONTENTS

	Page		Page
PREFACE	i	Section 3 OPERATING INSTRUCTIONS (cont)	
TABLE OF CONTENTS	iii	FRONT PANEL	3-5
LIST OF ILLUSTRATIONS	vi	Rotary Knob	3-5
LIST OF TABLES	vii	Push-to-Select Keys	3-5
OPERATORS SAFETY SUMMARY	viii	Toggle Keys	3-5
SERVICE SAFETY SUMMARY	ix	INPUT	3-6
Section 1 GENERAL INFORMATION		TRIGGER	3-8
DESCRIPTION	1-1	TIME BASE	3-11
SPECIFICATIONS	1-1	RECORDING	3-12
STANDARD ACCESSORIES	1-1	CONTROL	3-15
OPTIONAL ACCESSORIES	1-2	CONNECTORS AND POWER	3-19
Section 2 PREPARATION FOR USE		REAR PANEL	3-20
SAFETY	2-1	INSTRUMENT FAMILIARIZATION	3-22
CHECKING LINE VOLTAGE	2-1	INPUT	3-22
CHECKING THE LINE FUSE	2-2	Probe	3-22
POWER CORD	2-2	Coaxial Cable	3-22
INSTRUMENT COOLING	2-4	RANGE Key	3-22
SIGNAL CABLING	2-4	Overrange	3-23
CRT Monitor Cabling	2-4	OFFSET Key	3-24
IEEE 488 Cabling	2-4	Input Bandwidth Filter	3-24
External Trigger and Clock Cabling	2-4	Automatic Calibration (AUTO CAL)	3-24
Front-to-Rear Panel Connectors	2-4	TRIGGER	3-25
Direct A/D Output	2-4	Trigger Source	3-25
TABLE TOP USE	2-4	Trigger Slope and Level	3-25
RACK LATCHES	2-5	BI SLOPE	3-25
RACKMOUNTING	2-5	HYS SLOPE	3-26
PACKAGING FOR SHIPMENT	2-5	Trigger Mode	3-27
Section 3 OPERATING INSTRUCTIONS		AUTO	3-27
INITIAL INSTRUMENT SETUP	3-1	NORM(al)	3-27
POWER ON/OFF	3-1	SGL (Single)	3-27
Power On	3-1	COMP-IN, COMP-OUT	3-27
OPTION 19 ONLY (Blank Front Panel)	3-2	Manual Trigger	3-28
Power Off	3-2	Arm Delay	3-28
SELF-TEST	3-2	INTERNAL ARM DELAY	3-29
INITIALIZATION	3-2	EXTERNAL ARM DELAY	3-29
CRT MONITOR SETUP	3-4	Trigger Delay	3-29
CONTROLS, CONNECTORS, AND INDICATORS	3-5	PRE-TRIGGER OPERATION	3-30
		POST-TRIGGER OPERATION	3-30
		External Trigger	3-30
		TIME BASE	3-31
		Sample Interval	3-31
		Aliasing	3-32
		Setting Sample Interval	3-33

TABLE OF CONTENTS (cont)

Section 3 OPERATING INSTRUCTIONS (cont)	Page	Section 4 INTERFACING (cont)	Page
Roll Display Mode	3-34	GPIB INTERFACE COMMANDS	4-2
External Clock	3-34	RESPONSES TO INTERFACE	
Reset/Hold Function	3-34	COMMANDS	4-2
HOLD NEXT/HOLD IMMEDIATE		Interface Clear (IFC)	4-2
STATUS	3-36	Device Clear (DCL)	4-2
HOLD STATUS SETTING	3-36	Selected Device Clear (SDC)	4-3
RECORDING	3-37	Remote Enable (REN)	4-3
Record Length and Location	3-37	My Listen Address (MLA) and My	
Sample Rate Switching At		Talk Address (MTA)	4-3
Breakpoints	3-38	Unlisten (UNL) and Untalk (UNT) ..	4-3
SETTING BREAKPOINTS	3-38	Group Execute Trigger (GET)	4-3
DISPLAYING AND CLEARING		Go To Local (GTL)	4-3
BREAKPOINTS	3-39	REMOTE/LOCAL FUNCTION	4-3
Average Mode	3-40	GPIB RQS/ID KEY	4-4
Auto Advance Mode	3-40	GPIB COMMAND SET	4-4
Envelope Mode	3-41	STATUS BYTES AND EVENT CODES	4-4
CONTROL	3-43	A/D OUTPUT INTERFACE	4-4
Cursor Operation	3-43	A/D OUTPUT PORT CONNECTOR ..	4-4
Cursor Measurement	3-43	A/D OUTPUT CABLE	4-4
Waveform Display Control	3-44	A/D OUTPUT TERMINATION	4-4
HORIZONTAL ZOOMING	3-44	A/D OUTPUT OPERATION	4-6
DOT/LINE DISPLAY MODE ...	3-45		
VERTICAL ZOOMING	3-45	Section 5 PROGRAMMING COMMAND SET	
VERTICAL POSITIONING	3-46	INTRODUCTION	5-1
YT/XY Display	3-46	COMMAND FORMAT	5-1
INIT Key	3-46	Case Dependency	5-1
MAKING COPIES WITH-		Header	5-1
OUT A CONTROLLER	3-47	Arguments	5-2
REAR PANEL	3-47	Multiple Arguments	5-2
TRIG'D OUT/EXT ARM IN Connec-		Multiple Commands	5-2
tors (Serial Operation)	3-47	Link Arguments	5-2
CLOCK OUT/EXT CLK IN (Parallel		COMMAND DESCRIPTIONS	5-2
Operation)	3-48	Vertical System Control Group,	
SIMPLE WAVEFORM OPERATIONS		Table 5-2	5-3
Repetative Waveform Acquisition ..	3-49	Time Base and Recording Group,	
Transient Waveform Acquisition ..	3-49	Table 5-3	5-4
Waveform Acquisition with a		Triggering Group, Table 5-4	5-8
Breakpoint	3-50	Cursor and Display Control Group,	
Cursor Measurements on Acquired		Table 5-5	5-10
Waveform	3-51	Waveform Parameter Measurement	
		Group, Table 5-6	5-12
Section 4 INTERFACING		Waveform Transfer Group,	
IEEE 488 INTERFACE	4-1	Table 5-7	5-13
MESSAGE PROTOCOLS	4-1	Calibration Group, Table 5-8	5-16
GPIB CONNECTOR	4-1	Self-Test Group, Table 5-9	5-16
GPIB CONTROLLER		Utility Command Group,	
COMPATIBILITY	4-1	Table 5-10	5-18
IEEE 488 INTERFACE FUNCTION		Device Trigger Group, Table 5-11 ..	5-19
SUBSETS	4-1	Initialization Group, Table 5-12 ...	5-20
GPIB MODE, ADDRESS, AND		WINDOW and DATA Settings,	
MESSAGE TERMINATOR		Table 5-12-1	5-20
SELECTOR	4-2		

TABLE OF CONTENTS (cont)

Section 5 PROGRAMMING COMMAND SET (cont)	Page	Section 6 OPTIONS (cont)	Page
Service Request Control Group, Table 5-13	5-21	PAL SYSTEMS	6-3
Event Query Group, Table 5-14	5-21	Example of TV Signal Measurements	6-4
Internal Waveform Analysis Group, Table 5-15	5-22	Appendix A SRQ STATUS BYTES AND EVENT CODES	
WAVEFORM TRANSMISSION	5-25	INTRODUCTION	A-1
Overview	5-25	STATUS BYTES	A-1
Waveform Preamble	5-25	EVENT CODES	A-1
CURVe/CURVe? Command	5-25	Appendix B SPECIFICATIONS	
WAVfrm Command	5-27	Appendix C ASCII & GPIB CODE CHART	
DATa Command	5-27	Appendix D SERVICING INFORMATION	
REPeat Command	5-27	REMOVAL, REPLACEMENT, AND CLEANING PROCEDURES	D-1
PROGRAMMING EXAMPLES	5-27	AIR FILTERS	D-1
Processing an SRQ	5-27	Removal	D-1
Set/Query Commands and Responses	5-28	Cleaning	D-1
Simple Waveform Data Transfer using Binary Format to the Controller	5-29	Replacement	D-1
Binary Format Block Transfer of Waveform Data	5-30	TOP, BOTTOM, AND SIDE CABINET COVERS	D-1
Arbitrary Format Block Transfer of Waveform Data	5-31	Removal	D-2
Waveform Data Transfers to the RTD 710A	5-31	Replacement	D-2
Using the REPeat Command	5-32	RIGHT SIDE CABINET COVER/CARRYING HANDLE	D-2
Saving/Recalling Front-Panel Settings	5-33	Removal	D-2
Displayed Cursor Position Subprogram	5-33	Replacement	D-3
Initiating a HP-GL Plot From the Controller	5-34	POWER SUPPLY MODULE	D-3
		Removal	D-3
Section 6 OPTIONS		Replacement	D-4
OPTIONS A1-A5	6-1	INTERNAL JUMPER SELECTORS	D-5
OPTION 05 TV TRIGGER	6-1	LINE VOLTAGE SELECTOR	D-5
OPTION 19 BLANK FRONT PANEL	6-1	CRT MONITOR OUTPUT JUMPERS	D-6
OPTION 1P P6106A PROBES	6-2	EXTERNAL ARM SIGNAL JUMPER	D-7
OPTION 1V 620 MONITOR	6-2	RACKMOUNTING INSTRUCTIONS	D-9
TV TRIGGER OPTION OPERATION	6-2	RACKMOUNT COMPONENTS	D-9
TV Option Keys	6-2	RACK REQUIREMENTS	D-10
TV Input Coupling	6-2	INSTALLING THE RACKMOUNT SIDE COVERS	D-12
Trigger Slope for TV Coupling	6-2	INSTALLING THE RACK HARDWARE	D-12
TV Trigger Coupling	6-2	Stationary/Intermediate Section Identification	D-14
LINES	6-2	INSTALLING THE INSTRUMENT IN THE RACK	D-14
FLD1/FLD2	6-2	REMOVING THE INSTRUMENT FROM THE RACK	D-16
System-M vs Nonsystem-M	6-2	RACK ADJUSTEMENTS	D-16
Special TV Measurements	6-3		
OVERSCAN DISPLAY	6-3		
RF INTERFERENCE	6-3		
Field, Frame, and Line Definitions for 525/60 and 625/50 TV Systems	6-3		
CCIR SYSTEM M	6-3		
CCIR SYSTEM B AND SIMILAR 625/50 SYSTEMS	6-3		

LIST OF ILLUSTRATIONS

Fig. No.		Page	Fig. No.		Page
2-1	Location of line voltage indicator	2-1	3-40	Horizontal zoom display	3-45
2-2	Location of the rackmount latch releases	2-5	3-41	DOT waveform display	3-45
2-3	Spring latch catch and cutout for rack handle	2-6	3-42	Line waveform display	3-45
3-1	MON CAL test pattern	3-4	3-43	YT waveform display	3-46
3-2	RTD 710A Digitizer front panel	3-6	3-44	XY waveform display	3-46
3-3	Input section of front panel	3-6	3-45	Serially connected RTD 710As	3-47
3-4	Trigger section of front panel	3-8	3-46	Parallel connected RTD 710As	3-48
3-5	Time Base section of front panel	3-11	3-47	Simple waveform acquisition display	3-49
3-6	Recording section of front panel	3-12	3-48	Transient waveform acquisition display	3-50
3-7	Control section of front panel	3-15	3-49	Transient waveform acquisition with a breakpoint	3-51
3-8	Connectors and power section of front panel	3-19	3-50	Voltage measurement with CURSOR 1	3-51
3-9	RTD 710A Rear panel	3-20	3-51	Voltage measurement with 4X horizontal zoom	3-52
3-10	Input range setting too large	3-22	3-52	Amplitude measurement with CURSOR 1 and 2	3-52
3-11	Input range setting correct	3-23	3-53	Frequency measurement with CURSOR 1 and 2	3-53
3-12	Input range setting too small	3-23	4-1	IEEE 488 Interface connector	4-1
3-13	Overrange display	3-23	4-2	GPIB parameter switch	4-2
3-14	BI slope trigger (Level 1 > Level 2)	3-25	4-3	Direct A/D output port connector	4-5
3-15	BI slope trigger (Level 2 > Level 1)	3-25	4-4	A/D output cable connectors	4-5
3-16	+Hysteresis (Level 1 > Level 2)	3-26	4-5	A/D output receiving circuit	4-6
3-17	+Hysteresis (Level 2 > Level 1)	3-26	4-6	A/D output operation	4-7
3-18	-Hysteresis (Level 1 > Level 2)	3-26	5-1	Transfer of 10-bit waveform data	5-24
3-19	-Hysteresis (Level 2 > Level 1)	3-26	5-2	Binary block data	5-25
3-20	COMP-IN trigger mode representation	3-28	5-3	Arbitrary block data	5-25
3-21	Method of data comparison	3-29	6-1	Option 19 blank front panel	6-1
3-22	Pre-trigger operation	3-30	6-2	Composite video display	6-4
3-23	Post-trigger operation	3-31	6-3	Horizontal sync pulse display	6-4
3-24	Waveform derived with fast sampling interval	3-31	6-4	Vertical sync pulse display using trigger delay	6-4
3-25	Waveform derived with slow sampling interval	3-31	D-1	Cabinet cover removal	D-1
3-26	Examples of sampling rates for noise spikes	3-32	D-2	Right side cabinet cover/carrying handle removal	D-2
3-27	Display of aliasing	3-32	D-3	Power supply removal	D-4
3-28	Display with perceptual aliasing	3-33	D-4	Power supply side panel and line voltage selector	D-5
3-29	Redisplay of perceptual aliasing expanded by 8	3-33	D-5	Main chassis cover and circuit board retainer	D-6
3-30	RESET/HOLD function and data acquisition	3-35	D-6	CRT monitor output jumper locations	D-7
3-31	Memory organization	3-37	D-7	External arm signal jumper location	D-8
3-32	Breakpoint settings with pre-trigger and post-trigger	3-38	D-8	Cabinet-to-rackmount conversion	D-9
3-33	Breakpoint waveform with post-trigger	3-39	D-9	Rackmount assembly sections	D-10
3-34	Breakpoint waveform with pre-trigger	3-39	D-10	Rackmount hole spacing	D-11
3-35	Auto-advance representation	3-41	D-11	Instrument rackmounting length and clearance	D-11
3-36	Envelope peak detection	3-41	D-12	Rackmount slide detail #1	D-13
3-37	Enveloping two or more times	3-42	D-13	Rackmount slide detail #2	D-14
3-38	Envelope display	3-42	D-14	Installing/removing the instrument from the rack	D-15
3-39	Normal waveform display	3-44			

LIST OF TABLES

Table No.		Page	Table No.		Page
0-1	RTD 710A Documentation	i	5-9	Self-Test Group	5-16
2-1	AC Voltage Ranges and Fuses	2-2	5-10	Utility Command Group	5-18
2-2	Power Cord and Plug Identification Information	2-3	5-11	Device Trigger Group	5-19
3-1	Default Control Key Selections/Values	3-3	5-12	Initialization Group	5-20
3-2	7-Segment Display Default Values	3-4	5-12-1	WINdow and DATa Settings	5-20
3-3	Trigger Level Settings	3-8	5-13	Service Request Control Group	5-21
3-4	Record Length Selection	3-13	5-14	Event Query Group	5-21
3-5	Measurements Using Cursors	3-17	5-15	Internal Waveform Analysis Group	5-22
3-6	Initialization Defaults	3-18	A-1	RTD 710A Status Bytes	A-2
3-7	Sample Interval Auto Cal	3-25	A-2	RTD 710A Event Codes	A-2
3-8	Display Conditions Reset-to-Arm'd	3-36	B-1	Environmental Specifications	B-1
3-9	Display Conditions Arm'd-to-Trig'd	3-36	B-2	Electrical Specifications	B-2
3-10	Cursor Measurements with the Measure Function	3-43	B-2-1	Normal Sampling Mode Dynamic Accuracy	B-3
3-11	Horizontal Zooming Rates	3-44	B-2-2	Normal Sampling Mode Dynamic Accuracy (90% of Full Scale Range Analog Input)	B-3
4-1	RTD 710A GPIB Interface Function Subsets	4-2	B-2-3	High-Speed Sampling Mode Dynamic Accuracy	B-4
5-1	Numeric Format for Link Arguments	5-2	B-2-4	High-Speed Sampling Mode Dynamic Accuracy (90% of Full Scale Range Analog Input)	B-4
5-2	Vertical System Control Group	5-3	B-2-5	Trigger Sensitivity to Repetitive Signal	B-4
5-3	Time Base and Recording Group	5-4	B-3	Mechanical Specifications	B-10
5-4	Triggering Group	5-8	B-4	TV Trigger (Option 05) Specifications	B-11
5-5	Cursor and Display Control Group	5-10			
5-6	Waveform Parameter Measurement Group	5-12			
5-7	Waveform Transfer Group	5-13			
5-8	Calibration Group	5-16			

OPERATORS SAFETY SUMMARY

The general safety information in this summary is for the protection of both operating and service personnel. Specific warnings and cautions are found throughout the manual where they apply and do not appear in this summary.

TERMS

Terms in This Manual

CAUTION statements identify conditions or practices that could result in damage to the equipment or other property.

WARNING statements identify conditions or practices that could result in personal injury or loss of life.

Terms as Marked on Equipment

CAUTION indicates a personal injury hazard not immediately accessible as one reads the markings, or a hazard to property, including the equipment itself.

DANGER indicates a personal injury hazard immediately accessible as one reads the marking.

SYMBOLS

Symbols in This Manual



This symbol indicates where applicable cautionary or other information is to be found.



This symbol indicates where special explanatory information is included in the manual. There is no caution or danger associated with the information.

Symbols as Marked on Equipment



DANGER—High voltage.



Protective ground (earth) terminal.



ATTENTION—refer to manual.



Refer to manual before using.

Power Source

The instrument is intended to operate from a power source that will not apply more than 250 Vrms between the supply conductors or between either supply conductor and ground. A protective ground connection by way of the grounding conductor in the power cord is essential for safe operation.

Grounding the Instrument

This instrument is grounded through the grounding conductor of the power cord. To avoid electrical shock, plug the power cord into a properly wired receptacle before making any connections to the instrument input or output connectors. A protective ground connection by way of the grounding conductor in the power cord is essential for safe operation.

Danger Arising From Loss of Ground

Upon loss of the protective-ground connection, all accessible conductive parts (including knobs and controls that may appear to be insulated) can render an electric shock, and there may be high leakage current.

Use the Proper Power Cord

Use only the power cord and connector specified for your instrument.

Use the Proper Fuse

To avoid fire hazard, use only the fuse specified in the instrument parts list. A replacement fuse must meet the type, voltage rating, and current rating specifications required for the fuse that it replaces.

Do Not Operate in Explosive Atmospheres

To avoid explosion, do not operate the instrument in an explosive atmosphere.

Do Not Remove Covers or Panels

To avoid personal injury, the instrument covers or panels should be removed only by qualified service personnel. Do not operate the instrument without covers and panels properly installed.

SERVICE SAFETY SUMMARY

FOR QUALIFIED SERVICE PERSONNEL ONLY

The general safety information in this summary is for the protection of service personnel. Specific warnings and cautions will be found throughout the manual where they apply and do not appear in this summary.

Refer also to the preceding Operators Safety Summary.

Do Not Service Alone

Do not perform internal service or adjustment of this instrument unless another person capable of rendering first aid and resuscitation is present.

Use Care When Servicing With Power On

Dangerous voltages exist at several points inside this instrument. To avoid personal injury, do not touch exposed connections and components while power is on.

Disconnect the power cord before removing protective panels, soldering, or replacing components.

Do Not Wear Jewelry

Remove jewelry prior to servicing. Rings, necklaces, and other metallic objects could come into contact with dangerous voltages and currents.

Power Source

This product is intended to operate from a power module that will not apply more than 250 volts rms between the supply conductors or between either supply conductor and ground. A protective ground connection by way of the grounding conductor in the power cord is essential for safe operation.

Section 1

GENERAL INFORMATION

DESCRIPTION

The Sony/Tektronix RTD 710A Digitizer is a microprocessor-based, fully programmable, true dual-channel digitizing instrument. It provides 10-bit resolution at a 200-MHz maximum sampling rate (high-speed sample mode), or at a 100-MHz maximum sampling rate (normal sample mode).

Vertical signal inputs are through front-panel BNC connectors and 100-MHz bandwidth input amplifiers. Input range scaling is provided in a 1-1.25-1.6-2-2.5-3.2-4-5-6.2-8-10 sequence, which provides much finer input scaling than does the customary 1-2-5 scaling. An auto-calibration feature provides compensation for zero-volt, gain, and phase error in the input amplifiers and A/D converters.

The time base can be clocked internally by a crystal-controlled oscillator, or externally through a rear-panel BNC connector. The sampling interval using the internal clock is selectable from 200 ms to 10 ns (normal sample mode), or 200 ms to 5 ns (high-speed sample mode). The sampling interval using an external clock is DC to 10 ns (normal sample mode), or DC to 5 ns (high-speed sample mode). The time base features a function that allows increasing or decreasing the sampling rate as many as five times during the same record sample.

Data memory is provided by 256K words (10 bits per word) of local high-speed RAM. In the single-channel mode, all of the memory can be allocated to Channel 1. In the dual-channel mode, each channel is allocated 128K. Memory can be partitioned into 1, 2, 4, 8, 16, 32, 64, 128, or 256 (single-channel mode only) records.

A non-volatile memory is provided to store up to 20 sets of front-panel settings. These settings can be "sequenced through" and selected either manually from the front panel, or under program control through the GPIB.

Triggering is provided in both a pretrigger and post-trigger mode, using either internal or external trigger signals. The triggering event can be selected by either time or point

count. Pretriggering is selectable up to one full record length, and post-triggering can be delayed up to 262136 counts (262128 in high-speed sample mode).

A cursor measurement function provides for waveform parameter measurements of voltage, delta voltage, time interval, and frequency.

Instrument functions can be controlled either from the front panel, or through the rear-panel GPIB interface. Waveform data may be transferred between the RTD 710A and a controller, or other peripheral device on the GPIB interface. Maximum data transfer speed on the GPIB is at least 250 Kilobytes per second. The RTD 710A mainframe contains a type 68000, 16-bit microprocessor to control the programmable functions. Internal self-diagnostics provide service personnel an aid for isolating most equipment malfunctions.

To provide for easy systemization of the RTD 710A, many of its internal signals, such as Clock Out, Trigger Out, External Clock In, and External Arm In are provided at rear-panel output connectors.

The RTD 710A operates with HPGL-compatible digital plotters through the GPIB. Plotter control is either front-panel or remote (GPIB).

SPECIFICATIONS

Refer to Appendix B, Specifications.

STANDARD ACCESSORIES

1	Power Cord, 3 wire, 2.5 meter	161-0123-00
2	Fuses	
	8 A, 250 V, Medium Blow (1)	159-0268-00
	4 A, 250 V, Medium Blow (1)	159-0269-00
1	Instruction Manual	070-7204-00
1	Instrument Interfacing Guide	070-7207-00

OPTIONAL ACCESSORIES

Option B1: Service Manual Volume 1	070-7292-00
Service Manual Volume 2	070-7293-00
Calibration Kit	067-1376-00
620 Monitor	See Tektronix Product Catalog
P6106A Probe	See Tektronix Product Catalog
GPIB Cable, 2 meter	012-0991-00
Rackmounting Kit	016-0886-02
A/D Output Cable	012-1117-00

Section 2 PREPARATION FOR USE

SAFETY

Refer to the Operator's Safety Summary at the front of this manual for power source, grounding, and other safety considerations pertaining to the use of the instrument. Before connecting the instrument to a power source, read both this section and the Safety Summary.

the voltage at the power source to make sure it falls within the voltage range shown by the line voltage indicator. If the setting of the line voltage indicator does not match the available line voltage, refer the instrument to qualified service personnel.

CHECKING LINE VOLTAGE

The RTD 710A operates from either a 115 V or 230 V nominal ac power source having a line frequency ranging from 48 Hz to 66 Hz. When the instrument is shipped, its internal power supply line voltage selector is set as indicated by the rear panel line voltage indicator (Fig. 2-1). Before connecting the power cord to a power source, check

CAUTION

This instrument may be damaged if operated on a power source line voltage outside the range selection of the internal power supply jumper, which is indicated by the line voltage indicator on the rear panel of the instrument. Damage may also occur if the wrong size line fuse is installed.

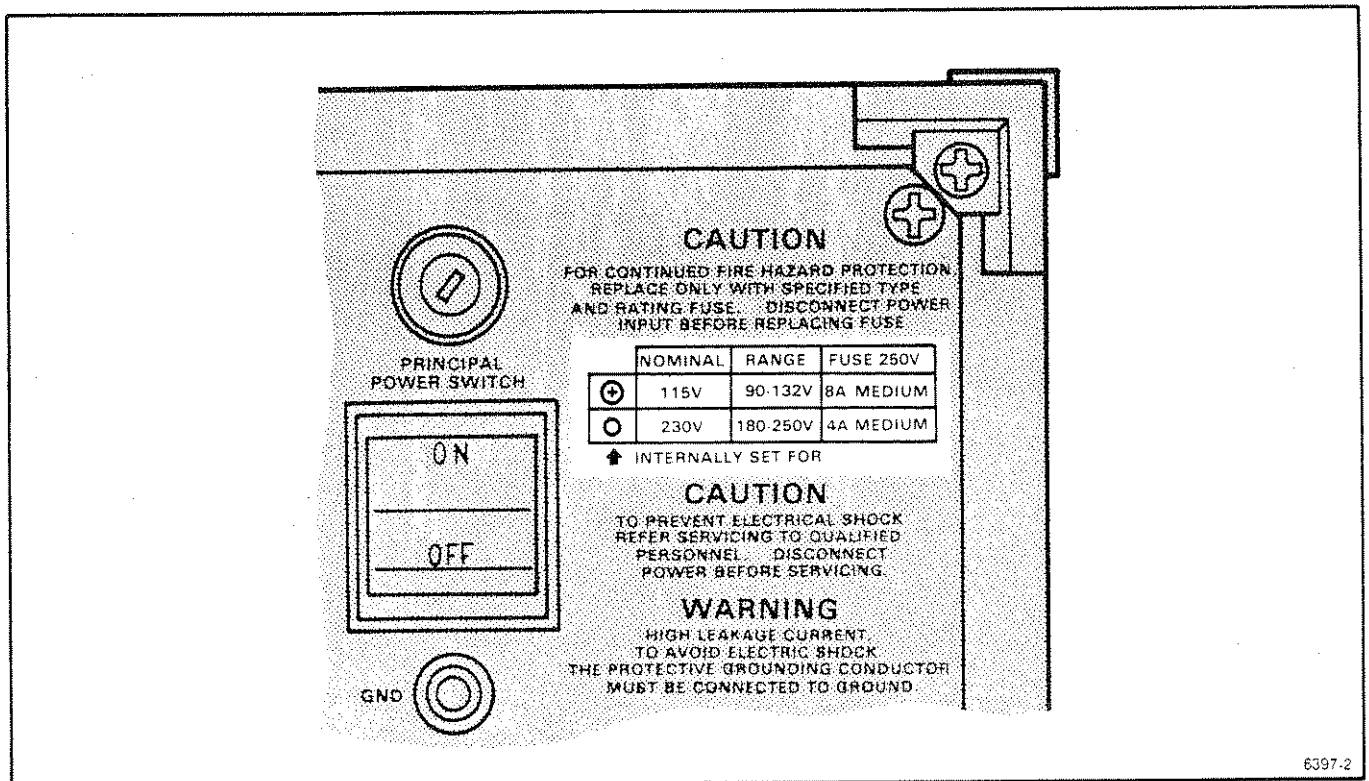

Fig. 2-1. Location of line voltage indicator.

WARNING

If the line voltage indicator shows the wrong voltage for the power source to be used, refer all changes to qualified service personnel.

CHECKING THE LINE FUSE

To verify the proper value of line fuse:

1. Unplug the instrument from line voltage.
2. Press in the fuse-holder cap and release it with a slight counterclockwise (CCW) rotation.
3. Pull the cap (with the attached fuse inside) out of the fuse holder.
4. Verify the proper fuse value (Table 2-1).
5. Install the proper fuse, if required, and reinstall the fuse-holder cap by carefully pushing it in while turning it slightly clockwise (CW).

**Table 2-1
AC VOLTAGE RANGES AND FUSES**

Line Voltage Indicator	Voltage Range	Line Fuse
115 V, nom.	90-132 Vac	8 A, 250 V (medium blow)
230 V, nom.	180-250 Vac	4 A, 250 V (medium blow)

POWER CORD

This instrument has a detachable three-wire power cord with a three-contact plug for connection to both the power

source and protective ground. The protective ground contact on the plug connects (through the power cord protective grounding conductor) to the accessible metal parts of the instrument. For electrical shock protection, insert this plug into a power-source outlet that has a properly grounded protective-ground contact.

WARNING

This instrument operates from a single-phase power source, and has a detachable three-wire power cord with a two-pole, three-terminal grounding-type plug. The voltage to ground (earth) from either pole of the power source must not exceed the maximum rated operating voltage, 250 volts.





Before making connection to the power source, determine that the instrument is adjusted to match the voltage of the power source, and has a suitable plug (two-pole, three-terminal, grounding type).

All accessible conductive parts are directly connected through the grounding conductor of the power cord to the grounding contact of the power plug. Therefore, the power plug must only be inserted in a mating receptacle with a grounding contact. Do not defeat the grounding connection. Any interruption of the grounding connection can create an electric shock hazard.

High leakage current; ensure proper grounding.

Instruments are shipped with the required power cord as ordered by the customer. Information on the available power cords is presented in Table 2-2, and part numbers are listed in Section 6, Instrument Options. Contact your Tektronix representative or local Tektronix Field Office for additional power-cord information.

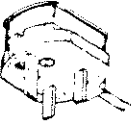
Table 2-2
POWER CORD AND PLUG IDENTIFICATION INFORMATION

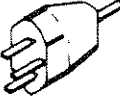
Plug Configuration	Usage	Nominal Line-Voltage (AC)	Reference Standards	Option #
	North American 120V/15A	120 V	¹ ANSI C73.11 ² NEMA 5-15-P ³ IEC 83	STANDARD
	Universal Euro 220V/16A	240 V	⁴ CEE (7), II, IV, VII ³ IEC 83	A1
	UK 240V/13A	240 V	⁵ BS 1363 ³ IEC 83	A2
	Australian 240V/10A	240 V	⁶ AS C112	A3
	North American 240V/15A	240 V	¹ ANSI C73.20 ² NEMA 6-15-P ³ IEC 83	A4
	Switzerland 220V/10A	220 V	⁷ SEV	A5
<p>¹ANSI—American National Standards Institute ²NEMA—National Electrical Manufacturer's Association ³IEC—International Electrotechnical Commission ⁴CEE—International Commission on Rules for the Approval of Electrical Equipment ⁵BS—British Standards Institution ⁶AS—Standards Association of Australia ⁷SEV—Schweizerischer Elektrotechnischer Verein</p>				

6397-1

INSTRUMENT COOLING

The instrument can be operated in ambient air temperatures from 0° to +50°C, and stored in ambient temperatures from -30° to +70°C. After storage at temperatures outside the operating limits, allow the chassis temperature to reach a safe operating limit before applying power.

Instrument cooling is provided by forced air drawn in through holes at the rear of the side panels and in the rear panel, and blown out through holes in the front portion of the side panels. To ensure proper cooling of the instrument, allow at least 2 inches clearance (more if possible) at the sides and at least 3 inches at the rear of the instrument. Air filters located on the side and rear panels should be checked every few weeks and cleaned or replaced, if dirty, to maintain adequate air flow.

If the internal temperature exceeds a safe operating level, a thermal cutout interrupts instrument power, then automatically restores it when the temperature returns to a safe level.

SIGNAL CABLING

Depending upon the intended use of the instrument, make some or all of the following connections for a CRT monitor, the IEEE 488 (GPIB) interface, an external trigger or clock, front-to-rear panel connectors, or the direct A/D Out.

CRT Monitor Cabling

Using coaxial cables, connect the X, Y, and Z outputs on the rear panel of the RTD 710A to the associated X, Y, and Z inputs of a compatible display monitor, such as the Tektronix 600-Series monitors. See the CRT Monitor Output specifications in APPENDIX B to determine compatibility of other monitors. Refer to specific monitor manuals for monitor connection and operating information. Because the signals are of fairly low frequency, the cable and termination impedances are normally not critical (50- or 75-ohm coaxial cable is typical).

When the RTD 710A is shipped, its X, Y, and Z output levels are set for 1 V, its Z polarity is set positive, and its cursor is set for a line. These settings are compatible with the inputs for the Tektronix 600-Series monitors.

WARNING

The RTD 710A uses internal jumpers to select the X, Y, and Z output levels (1 V or 5V), the Z polarity (positive or negative), and the cursor type (line or dots). If these jumpers need to be changed, refer the instrument to qualified service personnel.

IEEE 488 Cabling

Connect the IEEE 488 cable (provided as an optional accessory) from the rear panel IEEE 488 connector to the bus controller or the nearest instrument on the bus, as desired. More information on configuring a system is given as part of the IEEE 488 system discussion at the beginning of Section 4.

External Trigger and Clock Cabling

Make connections to the rear-panel connectors as required. The TRIG'D OUT connector provides an RTD 710A trigger signal for application to a device or instrument under test. An EXT ARM IN connector provides a means to arm the RTD 710A from an external source. An EXT CLK IN connector provides a means to clock the RTD 710A from an external ECL clock signal. A CLK OUT connector provides an ECL output clock from the RTD 710A internal 200-Megahertz clock or the EXT CLK IN connector. Check the specifications for each of these inputs and outputs in Appendix B, SPECIFICATIONS.

WARNING

An internal jumper selects the rear-panel CLOCK OUT signal. Refer changing this jumper to qualified service personnel.

Front-to-Rear Panel Connectors

Three general purpose BNC connectors provide straight-through connections between the instrument's front and rear panels using 50-ohm coaxial cable. These connectors provide a convenient method of routing signals between the front and rear panels of the RTD 710A and a device or instrument under test.

Direct A/D Output

Connect the A/D Out cable (provided as an optional accessory) between the A/D OUT connector on the rear panel and a compatible instrument. This output provides digitized data outputs for CH1 and CH2. For more information, refer to Section 4.

TABLE TOP USE

The RTD 710A may be operated with the front raised by lifting the front of the instrument and extending its front bail.

RACK LATCHES

Before the RTD 710A can be pulled out of a rack, the two (2) security screws that may be installed at the top of the Rack Handles need to be removed, and the Rack Latches need to be unlocked.

The rackmountable RTD 710A incorporates a spring-latch type of rackmount latch release built into the rack handles at each side of the instrument (Fig. 2-2). Once the instrument is installed in the rack, to release the latches, pull out on both rackmount latch releases until they stop. Continuing to pull out on the latches causes the instrument to slide out of the rack. Once the instrument is out of the rack, push in the latches. To relatch the instrument, push it completely into the rack using the rack handles and rackmount latch releases until the spring-latches catch.

For applications where additional racking security is needed, the rack handles at each side of the instrument have holes for screw hold-downs (Fig. 2-2).

NOTE

Because of the spring-latch feature and rack handle requirements, the rackmountable RTD 710A cannot be installed in rack slides for other types of instruments. The slide tracks supplied with the rackmountable RTD 710A are equipped to accommodate the spring latches and rack handles (Fig. 2-3).

RACKMOUNTING

Refer rack selection and actual installation of rack-mounting hardware to qualified service personnel.

PACKAGING FOR SHIPMENT

It is recommended that the original carton and packing material be saved in the event it is necessary for the instrument to be reshipped using a commercial transport carrier. If the original materials are unfit or not available, then repackage the instrument using the following procedure:

1. Use a corrugated cardboard shipping carton having a test strength of at least 375 pounds and with an inside dimension at least six inches greater than the instrument dimensions.

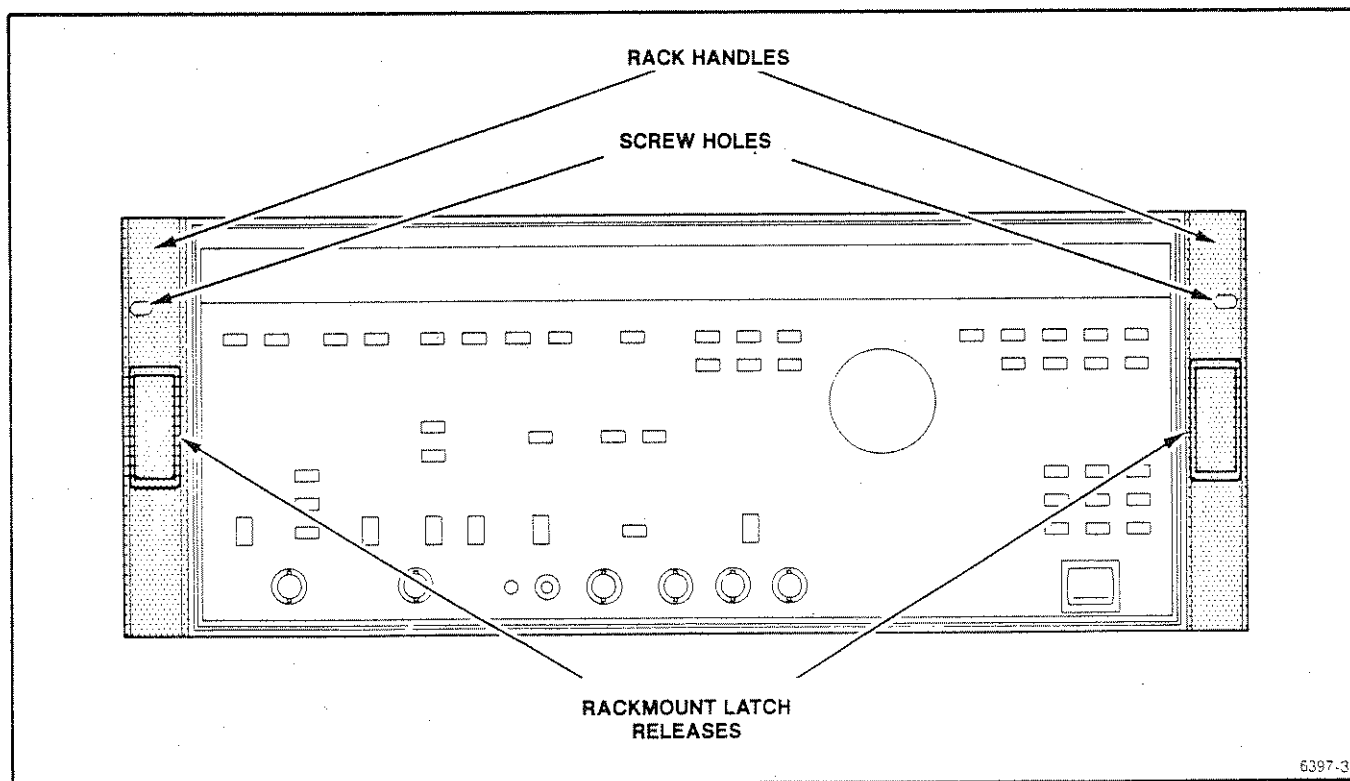

Fig. 2-2. Location of the rackmount latch releases.

Preparation for Use

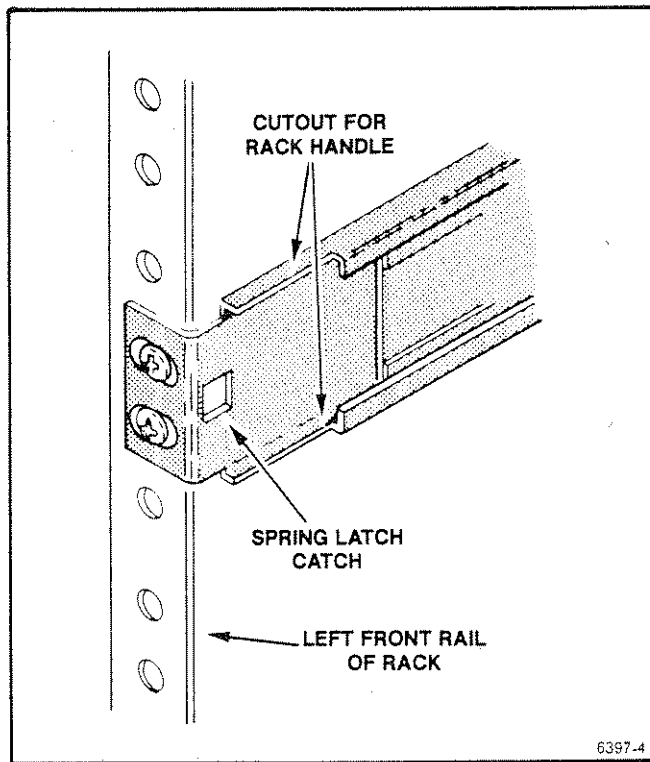

Fig. 2-3. Spring latch catch and cutout for rack handle.

2. If the instrument is being shipped to a Tektronix Service Center, enclose the following information: the owner's address, name and phone number of a contact person, type and serial number of the instrument, reason for return, and a complete description of the service required.

3. Completely wrap the instrument with polyethylene sheeting or equivalent to protect the outside finish and prevent entry of harmful substances into the instrument.

4. Cushion instrument on all sides using three inches of padding material or urethane foam, tightly packed between the carton and the instrument.

5. Seal the shipping carton with an industrial stapler or strapping tape.

6. Mark the address of the Tektronix Service Center and also your own return address on the shipping carton in two prominent locations.

Section 3

OPERATING INSTRUCTIONS

This section is divided into three subsections:

1. Initial Instrument Setup
2. Controls, Connectors, and Indicators.
3. Instrument Familiarization.

INITIAL INSTRUMENT SETUP

This subsection is divided into these topics:

1. Power On/Off
2. Self-Test
3. Initialization
4. CRT Monitor Setup

POWER ON/OFF

Power On

Before turning on the power for the first time, be sure to read the Operator's Safety Summary and Section 2, PREPARATION FOR USE.

To power-up the instrument:



If the instrument has been stored in an environment outside its specified operating temperature, or where it has collected moisture, do not turn on the power until the moisture is gone and the instrument has stabilized to an ambient temperature within its specified operating temperature.

1. Connect the power cord to the instrument and plug it into a power source.
2. Turn on the Principal Power Switch on the rear panel of the instrument. This connects the ac power to the power supply.

3. Turn on the ON/STANDBY switch on the front panel. This connects power to the instrument and initiates the self-test function.

Most of the power-on and self-test indications occur too quickly to be noticed; however, as each self-test is performed, its module number is displayed in the Trigger display.

If the power-on self-tests are successfully completed, control setting initialization occurs and the instrument is ready for use.

If an error is detected during the power-on self-tests, an error code is displayed in the Control display and the instrument enters a Level 2 Extended Diagnostics mode. To exit this mode to attempt normal operation, push the RECALL/LOC key.

The error code is in the format:

Exxxxx

where xxxxx is the error code.

If a fatal error in the operating system occurs, no error code can be displayed, and the instrument should be referred to qualified service personnel for further diagnostics and repair.

Operating Instructions

OPTION 19 ONLY (Blank Front Panel). The power-on sequence for Option 19 is the same as for the standard instrument, except:

1. The front panel ON indicator illuminates when the instrument is turned on.
2. The front panel GPIB SRQ indicator blinks if a self-test error occurs.
3. The ERRor? query must be used to obtain the error code.
4. The TEST OFF command can be used to exit to attempt normal operation.

Power Off

To turn the instrument completely off, turn the front panel ON/STANDBY/SWITCH to STANDBY and the rear panel Principal Power Switch to OFF.

When the power is turned off in a normal manner (no processes are executing), a power-off process stores the current control settings and retains those that were previously saved. However, if power is turned off, interrupted during self-test, or while performing Level 2 diagnostic tests or some waveform functions, the instrument may not power up in normal operation when next turned on.

SELF-TEST

The 5-digit numbers displayed in the Trigger display during the power-up self-test represent the self-test module numbers being executed. The meaning of each of these numbers is described in the Service Manual; however, the general features tested are:

1. *Lamp Test.* Checks all key lamps, LED indicators, and LED displays by lighting them. The 7-segment LED display shows all 8s when tested. This test is not performed on the Option 19 instrument.

2. *Key Switch Test.* Verifies that all key switch contacts are open in their unpressed state. This test is not performed on the Option 19 instrument.

3. *ROM Checksum.* Tests the system ROMs.

4. *System RAM Read/Write Test.* Checks the read/write capabilities of the system RAM.

5. *Waveform Display RAM Read/Write Test.* Checks the read/write capabilities of the waveform display RAM.

6. *GPIB Function Test.* Checks the operation of the GPIB adapter IC and the checksum adder used when transmitting data over the GPIB.

7. *DMA Register Read/Write Test.* Checks the read/write capabilities of the DMA register used during high-speed data transfers over the GPIB.

8. *Circuit Test.* Checks the internal hardware of the instrument.

9. *Waveform Data RAM Read/Write Test.* Checks the read/write capabilities of the waveform data RAM.

INITIALIZATION

Once the self-test is completed, the RTD 710A automatically initializes to the settings that existed prior to the power being turned off the last time and the front-panel seven-segment LED displays show the previous value settings for the functions listed in Table 3-2. If the previous settings were not properly recorded, the instrument initializes to the default settings shown in Table 3-1.

Table 3-1
 DEFAULT CONTROL KEY SELECTIONS/VALUES

Front Panel Key	Selection Value	Programming Command
VERT MODE	DUAL	VMODE DUAL
BW LIM 20 MHz	OFF	BWLIM OFF
RANGE (CH1, CH2)	50 V	CH1 (CH2) RANGE:50
OFFSET CH1 (CH2)	0	CH1 (CH2) OFFSET:0
COUPLING (CH1, CH2)	AC	CH1 (CH2) COUPLING:AC
MODE (Trigger)	AUTO	TRIGGER MODE:AUTO
SOURCE (Trigger)	CH1	TRIGGER SOURCE:CH1
COUPLING (Trigger)	DC	TRIGGER COUPLING:DC
SLOPE (Trigger)	+	TRIGGER SLOPE:POSITIVE
TRIG LEVEL	0	TRIGGER LEV1:0 TRIGGER LEV2:0
TRIG DELAY	-400	TRIGGER DELAY:-400
ARM DELAY	INT, 0	ARM MODE:INT ARM DELAY:0
SAMPLE MODE	NORM	SAMPLE MODE:NORM
CLK SOURCE	INT	SAMPLE CLOCK:INT
SAMPLE INTERVAL	10 ns	SAMPLE INTERVAL:10E-9
RECORD MODE	NORM	RECORD MODE:NORM
RECORD LENGTH	2048	LENGTH 2048
RECORD LOCATION	1	RECORD LOCATION:1
AVE # OF TIMES	2	RECORD AVERAGE:2
ENV # OF TIMES	1	RECORD ENVELOPE:1
BREAK POINT	none	
DISPLAY LOCATION	1	DISPLAY LOCATION:1
VERT POSN	0	VPOSN 0
VERT ZOOM	1	VZOOM X1
CURSOR 1 CURSOR 2	OFF OFF	CURSOR ONE:OFF CURSOR TWO:OFF
HORIZ ZOOM	1	HZOOM X1
SCROLL	ALL	CURSOR SCROLL:ALIGN
DISPLAY	LINE	DISPLAY INTERPOL:LINE
YT/XY	YT	DISPLAY MODE:YT
MEASURE	none	MEASURE <x>:OFF, where <x> is VOLT, TIME or FREQUENCY

Operating Instructions

If the instrument initializes to the default settings, the 7-segment LED displays have the values shown in Table 3-2, and the keys associated with the values have their LEDs illuminated, except CH1 RANGE, which is blinking.

Table 3-2
7-SEGMENT DISPLAY DEFAULT VALUES

Illuminated Key	Displayed Value
CH1 RANGE (blinking)	50 V
CH2 RANGE	50 V
TRIG DELAY	-400
SAMPLE INTERVAL	10 ns
RECORD LENGTH	2048
DISPLAY LOCATION	1

CRT MONITOR SETUP

When a CRT monitor is used with the RTD 710A review the following setup topics/procedures:

1. *RTD 710A Internal Selection Strap Settings.* The X-Level, Y-Level, Z-Level, Z-Polarity, and HAIR (Cursor Type: Line or Dot) for an external monitor are set by jumpers inside the RTD 710A. The Level jumpers can select either a 1 V or 5V output. These are set to 1V at the factory. The Polarity jumper can set either Positive or Negative. It is set Positive at the factory. The HAIR jumper makes the displayed cursor a line or a dot. It is set for a Line at the factory. The factory settings for the internal jumpers are set correctly for a Tektronix 620 monitor. If the factory settings are not correct for the monitor being used, refer the changes to qualified service personnel.

2. *Monitor Connections.* Connect BNC coaxial cables between the RTD 710A X, Y, and Z output connectors and their associated connectors on the CRT monitor. It is recommended that standard one (1) meter coaxial cables be used as longer cables may cause waveform degradation.

3. *Power Application and Test Pattern.* After turning on the RTD 710A Principal Power Switch on the rear panel and the ON/STANDBY switch on the front panel, turn on the monitor. When the RTD 710A enters normal operation, verify Hold is enabled (indicator on), then push the MON CAL key to display the pattern shown in Fig. 3-1. The MON CAL key indicator is on when the pattern is on.

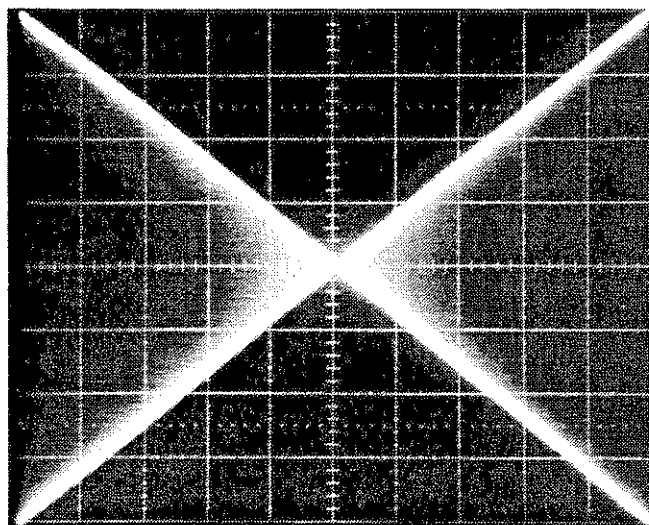

Fig. 3-1 MON CAL test pattern.

4. *CRT Monitor Intensity.* Set the monitor intensity to a comfortable viewing level where the retrace cannot be seen.

5. *Horizontal Position and Gain Controls of CRT Monitor.* Adjust the monitor X-position for a horizontally centered pattern. The full scale pattern width should be 10 divisions. If it isn't, and the monitor has an external horizontal gain control (the 620 doesn't), adjust it for the correct width. If the 620 monitor is used, its external graticule must be in place for checking these adjustments.

6. *Vertical Position and Gain Controls of CRT Monitor.* Adjust the monitor's Y-position for a vertically centered pattern. The full scale pattern height should be 8 divisions. If it isn't, and the monitor has an external vertical gain control (the 620 doesn't), adjust it for the correct height. If the 620 monitor is used, its external graticule must be in place for checking these adjustments.

7. *Test Pattern Removal.* Push the MON CAL key to turn off the calibration pattern. At this point the RTD 710A and monitor should be ready for operation.

CONTROLS, CONNECTORS AND INDICATORS

The following descriptions are provided to familiarize the operator with the location and function of the controls, connectors, and indicators of the RTD 710A Digitizer. More detailed information on the use of the controls is provided in the Instrument Familiarization subsection.

FRONT PANEL

The RTD 710A front panel controls, connectors, and indicators are divided into six functional groups (Fig. 3-2).

Input
Trigger
Time Base
Recording
Control
Connectors and Power

The front panel window is divided into six 7-segment LED displays: CH1 Input, CH2 Input, Trigger, Time Base, Recording and Control. Each display indicates the setting or value of an associated key.

Three types of controls are used on the front panel—a rotary knob, push-to-select keys, and toggle keys. The operation of each control type is described below.

Rotary Knob

The rotary knob is called the Parameter Entry Knob (see item 32, Figure 3-7). It is used to modify the current setting of a key that has been selected (LED blinks) with a push-to-select key. The Parameter Entry Knob can be rotated infinitely in either direction to increase or decrease the setting value. Once a value reaches its design limit, further rotation of the knob has no effect.

Push-to-Select Keys

The physical operation of the push-to-select keys is self-explanatory. However, these keys perform electrically in two ways. Some select their associated function (LED blinks) to allow a change in setting via the Parameter Entry Knob; also, if the setting can be displayed in two units of measure, pressing the key with its indicator blinking alternates the displayed units. The indicator on the selected key toggle blinks until another key is selected. The other keys simply toggle between two mode selections (key indicator turns on or off to indicate selection).

All push-to-select keys, except two (MAN TRIG and BREAK POINT CLR), have self-contained LED status indicators. Depending upon the key function, these indicators have one of three meanings:

- If the control has a settable numeric value, a blinking LED means that the value displayed in the 7-segment LED display above the control is the current setting, and the value can be changed with the Parameter Entry Knob.
- If the control has no settable numeric values, an OFF LED indicates one mode selection while an ON LED indicates another mode selection.

Toggle Keys

Toggle keys are physically pushed up or down to perform their electrical operation. On the RTD 710A, those keys are used to sequence up or down through multiple function selections. The status of any selection is identified by its backlighted function name.

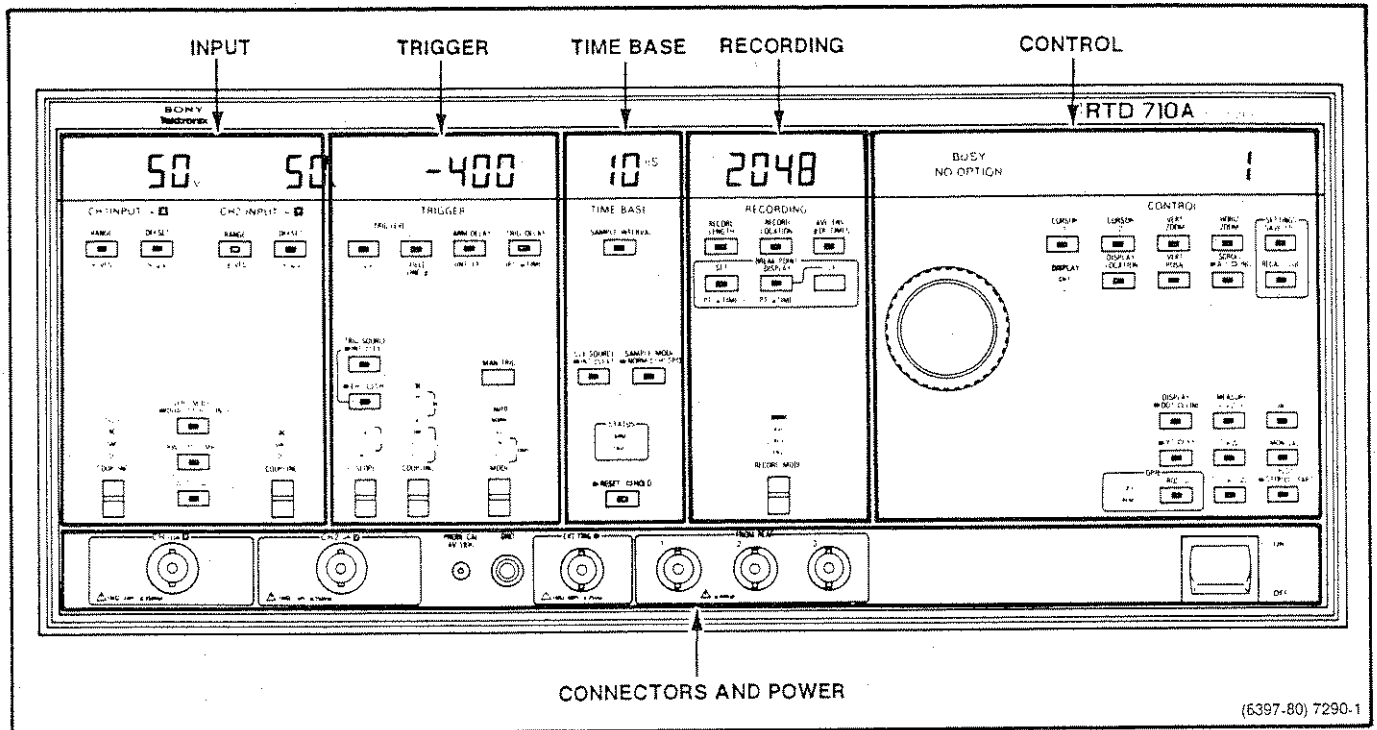

Fig. 3-2. RTD 710A Digitizer front panel.

INPUT

Refer to Fig. 3-3 for location of items 1 through 7.

1 Input Display

For each channel, displays the input voltage sensitivity when setting RANGE; when setting OFFSET, it shows the offset as % of full scale or as the voltage subtracted from the signal input. Units are %, or mV (millivolt) or V (volt). The descriptions for RANGE and OFFSET further describe the displayed units.

For out-of-range inputs, an overrange and underrange LED in the display turns on, and the digitizer asserts RQS on the GPIB if RQS is ON. These indicators reset (turn off) on the next acquisition if the condition goes away.

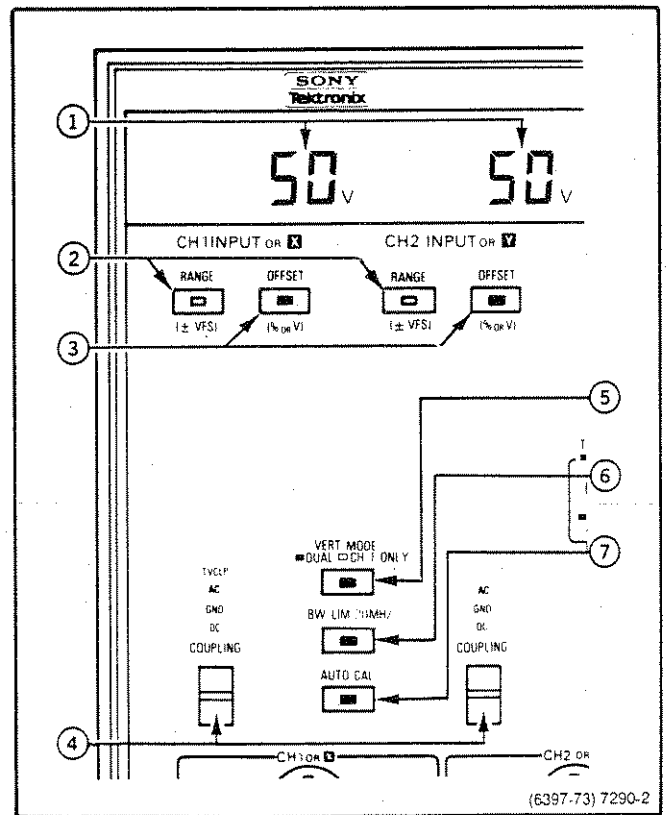

Fig. 3-3. Vertical section of front panel.

2 RANGE

A push-to-select key with LED. When selected, the key's LED blinks to signify that the input voltage range can be changed by turning the Parameter Entry Knob. Also, the current range is displayed in mV or V on the Input display. The range can be set from 100 mV to 50 V in a 1, 1.25, 1.6, 2, 2.5, 3.2, 4, 5, 6.2, 8 sequence (1 V to 500 V when a 10 x probe is used). After a range change, the AUTO CAL function executes.

The overrange indicator (up arrow) turns on when the input signal exceeds the RANGE setting; the underrange indicator (down arrow) turns on when zero data is acquired.

3 OFFSET

A push-to-select key with LED. When selected, the current value of dc offset is displayed in the Input display, and the key's LED blinks to indicate that the dc offset of the input amplifier can be changed by turning the Parameter Entry Knob.

The value of the offset is displayed in either of two units: % or V. The units alternate when the blinking OFFSET key is pressed. Resolution is in 1% units from +199% to -199%. For % units, the display shows the offset voltage in percentage of the current RANGE selection. For V units, the display shows the offset voltage either in V or mV (converted to volts from the equivalent percent of RANGE). The display shows the first three digits (rounded off).

4 COUPLING

A toggle key that selects the coupling mode for the input signal. The indicator above the control displays the selected coupling mode. When TVCLP is selected (Option 5 only), the AC indicator also lights. Each coupling mode is described below.

AC: The input signal is capacitively coupled to the input amplifier; dc components of the input signal are blocked.

GND: The input of the input amplifier is referenced to ground.

DC: All frequency components of the input signal are coupled to the input amplifier.

TVCLP (TV Option 05 only): For channel 1 only. Provides use of the back porch clamp when the input signal is a TV signal. When selected on a non-Option 05 unit, a NO-OPTION indicator lights in the display section above the Parameter Entry Knob.

5 VERT MODE

A push-to-select key. Alternately selects one of two operating modes: DUAL (default value) or CH1 ONLY. When the CH1 ONLY mode is selected, the key LED is on. When the key is pressed again, the operation mode returns to DUAL and the LED turns off. When the sample mode is set to high-speed mode, VERT MODE is automatically set to CH 1 ONLY. If the high-speed sample mode is released, the CH 1 ONLY mode remains set.

DUAL: The channel 1 and channel 2 input signals are simultaneously acquired independently into each channel. The minimum sample interval is 10 ns.

CH 1 ONLY: Only the channel 1 input signal is acquired and saved. (Full memory of 256K is usable.) The minimum sample interval is 10 ns. When the high-speed sample mode is selected, the minimum sample interval is 5 ns.

This key has priority over RECORD LENGTH, HI SPD, and TRIG DELAY. If VERT MODE is changed from CH 1 ONLY to DUAL when the RECORD LENGTH, SAMPLE MODE, TRIG DELAY, and BREAK POINT parameters and/or settings are outside those allowable for dual mode, then those parameters and/or settings are automatically changed to the maximum allowable values.

6 BW LIM 20 MHz

A push-to-select key with LED. When selected, the LED turns on and the bandwidth limit of the input amplifiers are set to 20 MHz. When this key is deselected (LED off), the bandwidth is 100 MHz. The AUTO CAL function executes when the key is pressed.

7 AUTO CAL

A push-to-select key with LED. When selected, the AUTO CAL function executes; the LED turns on until AUTO CAL is complete. For details refer to Auto Calibration in the Instrument Familiarization subsection of this section.

TRIGGER

Refer to Fig. 3-4 for location of items 8 through 16.

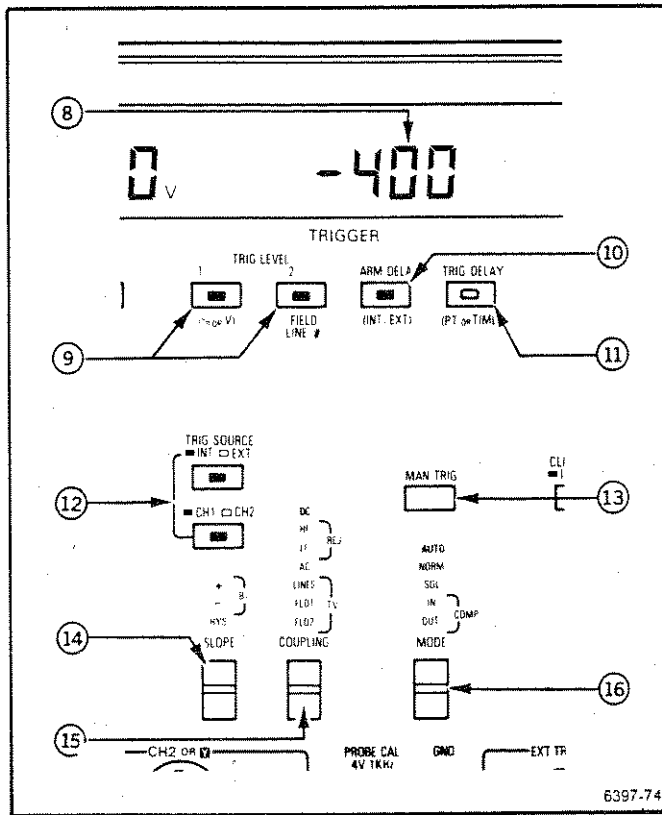

Fig. 3-4. Trigger section of front panel.

8 Trigger Display

Displays the current values for TRIG LEVEL, ARM DELAY, TRIG DELAY, or FIELD LINE # (TV Trigger Option 05 only). For details concerning the display refer to the following descriptions for those keys.

9 TRIG LEVEL 1/TRIG LEVEL 2

Push-to-select keys with LED. Selection (blinking LED) enables setting of the amplitude of the TRIG LEVEL 1 and TRIG LEVEL 2 points that trigger the time base. When this key is selected, rotating the Parameter Entry Knob changes the displayed trigger level. Pressing the TRIG LEVEL key while the LED is blinking alternately displays the setting in either %, or V or mV. Refer to the Instrument Familiarization subsection for more information. With Option 05, TRIG LEVEL 2 displays the field line number for TV signals.

Refer to the following descriptions for each display unit.

%: The default units. When the trigger source is an internal signal, the display shows the trigger level in percentage of the input range of the selected trigger source channel. When the trigger source is an external signal, the display shows the trigger level in percentage of the external trigger source voltage level (+5V is 100%).

V: Displays the trigger level in V or mV. The setting range and resolution are the same as for % display. The display is rounded to three digits.

NOTE

Because the trigger level is always calculated in percentage of input range, its displayed value, which is in volts, is automatically changed as the input voltage range is changed.

Depending on the setting of the trigger slope (refer to the TRIG SLOPE description), the trigger level keys are set as shown in Table 3-3.

Table 3-3
TRIGGER LEVEL SETTINGS

Trigger Slope	Trigger Level To Be Set	
	Level 1 Key	Level 2 Key
+ or -	Positive or negative slopes	Not used
B (\pm)	Positive slope	Negative slope
+ HYS	Trigger level (Positive slope)	Reset level (Negative slope)
- HYS	Reset level (Positive slope)	Trigger level (Negative slope)

FIELD LINE # (TV Option 05 only): When the trigger coupling switch is set to FLD 1 or FLD 2, the FIELD LINE # (TRIG LEVEL 2) key and Parameter Entry Knob set the line number within a field which triggers acquisition of input TV signals. In this case, the LED of the FIELD LINE # (TRIG LEVEL 2) key

blinks and the TRIG LEVEL 1 key is disabled. The range for line numbers is from 1 to the maximum lines in the TV signal frame, or 1280, whichever is less.

Each subsequent pressing of this key toggles the line numbering protocol between system-M and nonsystem-M. When system-M is selected, the line count begins three lines before the field-sync pulse is encountered. When nonsystem-M is selected, the line count begins coincident with the field-sync pulse. When nonsystem-M is selected, the Trigger display indicates a minus sign (-).

When the coupling switch is set to LINES, both TRIG LEVEL 1 and TRIG LEVEL 2 (Field Line #) keys are disabled.

10 ARM DELAY

A push-to-select key with LED. When selected (LED blinking), the time interval (arm delay) from one acquisition to the next can be changed by rotating the Parameter Entry Knob. The value of the arm delay can be set from 0 ms to 10 s (seconds) in a 1-2-5 sequence. If the key is pressed while the LED is blinking, an "E" is displayed on the Trigger display and an external TTL signal is used for arming. For more information on the external arm signal, refer to Appendix B, SPECIFICATIONS.

NOTE

Actual arm delay time is affected by the instrument settings since internal processing time is added to the setting of the ARM DELAY key.

11 TRIG DELAY

A push-to-select key. Selection (LED blinking) enables changing the trigger position within a record by rotating the Parameter Entry Knob. The + setting is for post-trigger while the - setting is for pre-trigger. The default value is -400. The following two types of display can be alternately selected by pressing this key while the key LED is blinking.

PT (Points—Number of Sampling Clocks): Trigger delay is displayed in points (number of sampling clocks). The range is from -(present record length - 8) to 262136 in increments of 8 when sample mode is set to normal. When the sample mode is high speed, the range is from -(present record length - 16) to 262128 in increments of 16.

TIME: Trigger delay is displayed in seconds as a 6-digit rounded value and polarity display. (The time is the product of the number of sampling clocks and the sampling interval.) When the sampling clock source is set to EXT, TIME cannot be displayed.

NOTE

When the record length is shortened while the trigger delay value is negative, the value of the trigger delay is automatically reset to -(record length after shortened - 8 (or 16)) if the trigger delay value is larger than the new record length.

12 TRIG SOURCE

The following two keys select the trigger signal source.

INT/EXT: A push-to-select key with LED that alternately selects either an INT (internal source—the default value) or EXT (external source) trigger. When INT is selected, the source of the trigger signal is either the channel 1 or channel 2 input. When EXT is selected, the key LED lights and the signal supplied to the EXT TRIG IN connector located on the front panel becomes the trigger signal source.

CH 1/CH 2: A push-to-select key with LED that alternately selects either channel 1 or channel 2 as the trigger signal source when the TRIG SOURCE INT/EXT key has been set to INT (internal source). When channel 2 is selected, the key LED lights. Channel 2 cannot be selected if in high-speed sample mode or the trigger coupling switch is set to TV.

13 MAN TRIG

Manually triggers acquisition if the time base is armed (the ARM'D indicator is on) and Hold is OFF. This key is disabled when the ARM'D indicator is off.

14 SLOPE

A toggle key that selects the slope of the trigger signal in the following sequence: + (default value), -, BI(±), +HYS, -HYS, or in the reverse order. The LED of the selected trigger slope lights. Each trigger slope is described below.

+: Generates a trigger pulse when a positive-going trigger signal crosses the trigger level selected by the TRIG LEVEL 1 key.

Operating Instructions

—: Generates a trigger pulse when a negative-going trigger signal crosses the trigger level selected by the TRIG LEVEL 1 key.

BI (\pm): Generates a trigger pulse when a positive-going trigger signal crosses the trigger level selected by the TRIG LEVEL 1 key; or when a negative-going trigger signal crosses the trigger level selected by the TRIG LEVEL 2 key.

+ HYS: Generates a trigger pulse when a positive-going trigger signal crosses the trigger level selected by the TRIG LEVEL 1 key. The next trigger signal is not accepted until a negative-going trigger signal crosses the trigger level selected by the TRIG LEVEL 2 key causing the trigger circuit to reset.

— HYS: Generates a trigger pulse when a negative-going trigger signal crosses the trigger level selected by the TRIG LEVEL 2 key. The next trigger signal is not accepted until a positive-going trigger signal crosses the trigger level selected by the TRIG LEVEL 1 key causing the trigger circuit to reset.

For more detail concerning the bi-slope and hysteresis trigger, refer to the Instrument Familiarization subsection.

15 TRIGGER COUPLING

A toggle key that selects the method used to couple the trigger signal to the trigger generator circuit. The selected coupling mode (or TV trigger for an instrument with Option 05) is backlighted above the switch. If an attempt is made to select LINES, FLD 1, or FLD 2 without Option 05, the NO-OPTION indicator lights in the display section above the Parameter Entry Knob.

DC: Couples all frequency components of the trigger signal to the trigger generator circuitry.

HF REJ: Attenuates high-frequency triggering components above 50 kHz.

LF REJ: Attenuates low-frequency triggering components below 50 kHz and blocks the dc component of the signal.

AC: Attenuates triggering components below 60 Hz and blocks the dc component of the signal.

LINES (TV Option 05 only): Time base is triggered when a TV horizontal line sync pulse is encountered.

FLD 1 (TV Option 05 only): Time base is triggered on a selected line during the first field of the TV signal. The line number is selected with the FIELD LINE # key. For more information, refer to Option Operation in the Instrument Familiarization subsection.

FLD 2 (TV Option 05 only): Time base is triggered on a selected line during the second field of the TV signal. The line number is selected with the FIELD LINE # key. See FLD 1 comment for more information.

TV Option 05 Only: When the coupling is changed from AC to LINES, some settings automatically change, as follows:

- When the trigger slope is set to BI(\pm), +HYS, or —HYS, the —slope is automatically set, and then either + or — can be selected.
- If the Trigger display is displaying the trigger level, the display is erased. Also, the TRIG LEVEL 1 and 2 keys are both disabled.
- If the trigger source is set to CH 2, CH 1 is automatically set.

When coupling is changed from LINES to AC, no automatic change in the settings occurs.

When the TV trigger is switched from LINES to FLD 1, the set value of the FLD 1 line number can be displayed on the Trigger display by pressing the FIELD LINE # key. (The TRIG LEVEL 1 key is disabled.)

When coupling is switched from FLD 1 to LINES, the displayed line number is erased.

16 MODE

A toggle key that selects the operating mode of the trigger circuit. The selected trigger mode is backlighted above the switch. Each mode is described below:

AUTO: Recording free-runs in the absence of a triggering signal for recording the baseline. Permits triggering on signals with repetition rates of more than approximately 50 Hz.

NORM: Recording is initiated at the trigger event following the arm event.

SGL: A recording occurs when triggered. After completing a recording, the instrument enters the HOLD state and displays the acquired waveform. Recording cannot be restarted until the RESET/HOLD key is pressed to reset the HOLD state, or HOLD RESet is sent over the GPIB.

COMP IN: Recording is continuous using the NORM trigger mode until **all** acquired waveform data is within the range determined by the reference waveform. The reference waveform should be enveloped data. The last memory location is automatically assigned to the reference memory in this mode.

COMP OUT: Recording is continuous using the NORM trigger mode until **part** of the acquired waveform data is out of the range determined by the reference waveform. The reference waveform should be enveloped data. The last memory location is automatically assigned to the reference memory in this mode.

When the compare mode is selected, some settings are automatically changed as follows:

- The record length is set to less than 64K words (128K words for the CH 1 ONLY mode)
- The number of envelopes is set to 1 when the record mode is ENVELOPE.
- The record location is set to last location - 1, if it was last location.
- The record mode is set to NORM, if it was ADV.

TIME BASE

Refer to Fig. 3-5 for location of items 17 through 22.

17 Time Base Display

The 7-segment display indicates the current setting of the time base sample interval in seconds. When an external clock is used for the time base clock, the multiplier of the external clock interval is displayed.

18 SAMPLE INTERVAL

A push-to-select key with LED. When selected (LED blinking), this key enables setting the sampling clock interval by rotating the Parameter Entry Knob. The interval can be from 10 ns to 200 ms in a 1, 2, 3, 4, 5, 6, 7, 8, 9 sequence (5 ns can be selected in the high-speed sample mode). When an external clock is used for the time base, the clock period multiplier for

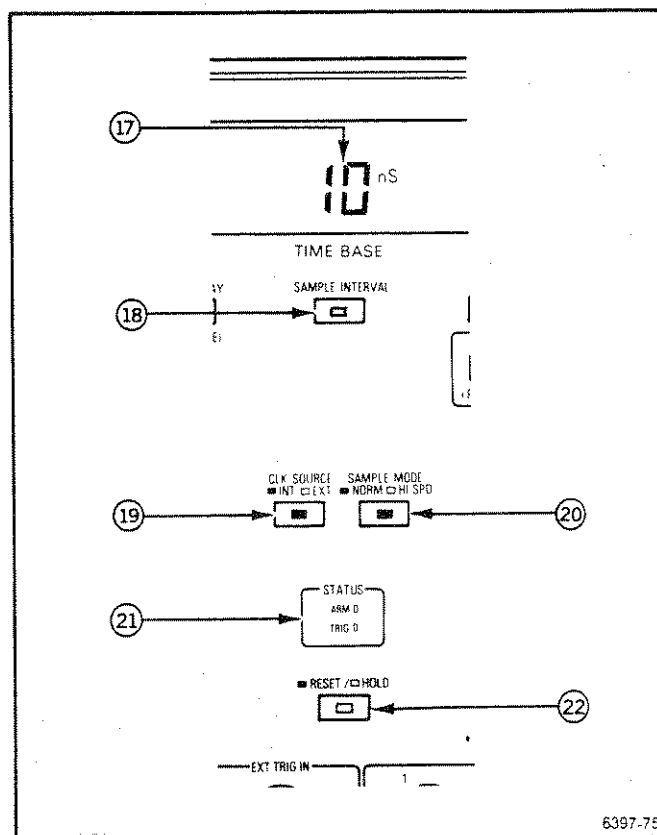

Fig. 3-5. Time base section of front panel.

the sample clock interval can be set from 1 to 4 x 10⁷, in a 1, 2, 4, 6, 8 (high-speed mode), or 1, 2, 3, 4, 5, 6, 7, 8, 9 (normal mode) sequence. In this case the sample interval is displayed in engineering notation in the form "xEy", and indicates that the time base clock is the external clock whose interval is multiplied by x times 10 to the y power.

NOTE

When using the internal clock and the sampling interval is larger than 200 μs the instrument is in the ROLL display mode. For more information refer to the Instrument Familiarization subsection.

19 CLK SOURCE

A push-to-select key with LED that sets the time base clock source to either INT (internal clock—the default value) or to EXT (external clock). When set to EXT (LED on), the Time Base display changes

Operating Instructions

from display of time to the xEy-form display; and, if the TRIG DELAY or BREAK POINT values are displayed in time, each display changes to the sample point number display. When set to EXT, an external clock signal applied to the EXT CLOCK IN connector located on the rear panel is used for the sampling clock. The maximum frequency for the external clock signal is 200 MHz. Selectable sample intervals depend on the sample mode: 100 MHz maximum (10 ns or 2E0 minimum) in NORM; and 200 MHz maximum (5 ns or 1E0 minimum) in HI SPD.

20 SAMPLE MODE

A push-to-select key with LED that sets the sample mode to either NORM (normal sample mode—the default mode) or HI SPD (high-speed sample mode). When the normal sample mode is selected, the minimum sampling interval is 10 ns. When the high-speed sample mode is selected (key LED is on), the operating mode of the input amplifier automatically switches to CH 1 ONLY, and only the channel 1 input is digitized at the minimum sample interval of 5 ns. (Channel 2 is disabled, and the Input display and key LED turn off.)

21 STATUS

Indicates the current acquisition status as follows.

ARM'D: Illuminates if the trigger generator is armed and waiting for a trigger. If the trigger delay is set to a minus value, the ARM'D indicator illuminates when the instrument completes the pretriggering write. This indicator turns off upon acquisition start and while the instrument is waiting for the arm signal.

TRIG'D: Illuminates when the trigger is recognized. The LED turns off when the acquisition operation is started and remains off until the instrument recognizes another trigger event.

22 RESET/HOLD

A push-to-select key with LED that controls the acquisition start and stop as follows.

Steady ON. The instrument is in HOLD state; the last acquisition is finished and further acquisition cannot occur until the HOLD state is reset. Pressing this key resets the HOLD state (LED off) and the next acquisition can begin with the next valid trigger event.

Blinking. If this key is pressed during an acquisition (LED off), the instrument enters the HOLD state upon completion of the current acquisition; the key indicator blinks during the acquisition. If the key is pressed while the LED is blinking, the instrument immediately stops the acquisition without waiting for completion and enters the HOLD state.

RECORDING

Refer to Fig. 3-6 for location of items 23 through 30.

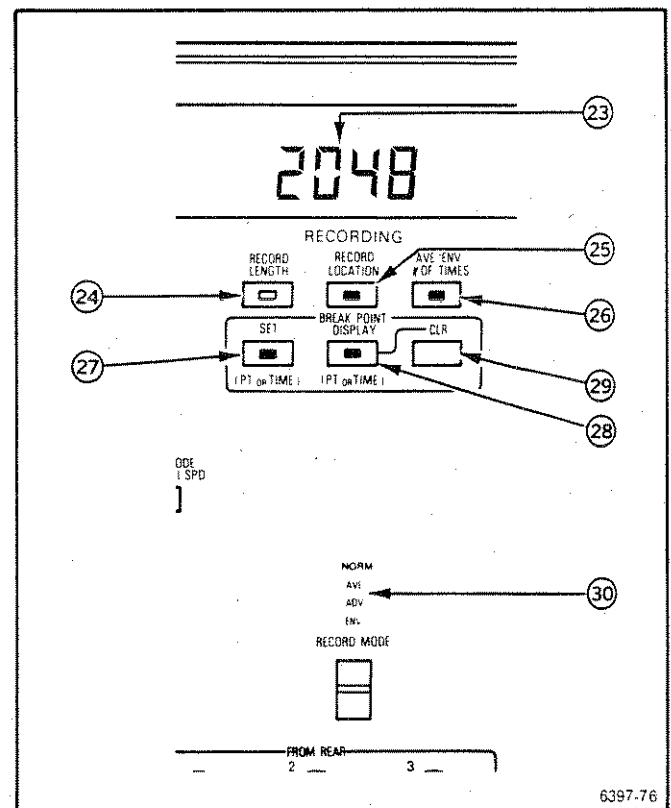

Fig. 3-6. Recording section of front panel.

23 Recording Display

Displays the current record length, record location, or breakpoint. Also displays the averaging and envelope number of times. Time or clock point display can be selected for breakpoint.

24 RECORD LENGTH

A push-to-select key with LED. When selected (LED blinking), the record length of the waveform memory can be changed by rotating the Parameter Entry Knob. The waveform memory can be selected in 1, 2, 4, 8, 16, 32, 64, 128, or 256 equal blocks. Possible record length is 1024 to 131072 words when VERT MODE is set to DUAL, and 1024 to 262144 words when VERT MODE is set to CH1 ONLY. If the record length is changed during acquisition, the instrument stops the acquisition and enters the HOLD state.

25 RECORD LOCATION

A push-to-select key with LED. When selected (LED blinking), the record location of the waveform memory in which waveform data will be recorded can be selected by turning the Parameter Entry Knob. The maximum value for RECORD LOCATION is 128 when VERT MODE is set to DUAL, and 256 when VERT MODE is set to CH 1 ONLY, as shown in Table 3-4.

**Table 3-4
RECORD LENGTH SELECTION**

Record Length	Vertical Mode	
	DUAL	CH1 ONLY
1024	128	256
2048	64	128
4096	32	64
8192	16	32
16384	8	16
32768	4	8
65536	2	4
131072	1	2
262144	---	1

When increasing the record length, if the increase requires the location number to be higher than the maximum record location, the record location number automatically resets to the maximum allowable value.

In Envelope mode with AVE/ENV # of TIMES set to 2 or more, the maximum allowable record location setting is (maximum record length from Table 3-4) - 1.

In the Auto-Advance mode, the RECORD LOCATION key is used to set the last record location for the auto-advance recording. For example, when record length is set to 2048 and the record location is set to 8 (number of record location is 64 in dual mode), the auto-advance recording is performed for record location 1 through 8, but the remaining record locations (9 through 64) remain in the HOLD state.

26 AVE/ENV # OF TIMES

A push-to-select key with LED that allows changing the number of times the acquisition is averaged or enveloped. When first selected, the record mode automatically switches to AVE (except when set to ENV). The number of times for averaging can be set between 2 and 16384 in steps of 2ⁿ. To set the number of times for enveloping, press the RECORD MODE ENV key, then press the AVE/ENV # OF TIMES key. The current number of times for enveloping is shown on the Recording display. It can be set between 1 and 16384 (in 2ⁿ steps), or 99999 (infinite enveloping) with the Parameter Entry Knob.

During averaging or enveloping, the display continuously shows the number of times for averaging or enveloping. If the RESET/HOLD key is pressed before averaging or enveloping is complete, the number of averaging or enveloping repetitions that were executed is displayed and the instrument enters the HOLD state.

NOTE

It is not possible to set or change the number of times for averaging or enveloping while the acquisition is in progress. Such procedures must be done during the HOLD state.

27 BREAK POINT SET

A push-to-select key with LED used to set breakpoints. When pressed, the Recording display shows the current breakpoint location (trigger point is 0). To set a breakpoint, rotate the Parameter Entry Knob to select location in time or sample number, then press the SAMPLE INTERVAL key to lock the breakpoint and display it as a high-intensity dot on

Operating Instructions

the displayed waveform. Now the sample interval beginning at this breakpoint can be set. The effective breakpoint range is as follows:

NORM Sample Mode:

16 to (record length + trigger delay - 16) in multiples of 8 sample points.

HI SPD Sample Mode:

32 to (record length + trigger delay - 32) in multiples of 16 sample points.

When using pre-trigger capture, it is not possible to set a breakpoint for sample points before the trigger point. Also when using post-trigger delay, even if a breakpoint is set for a sample point which is between the trigger point and the post trigger delay, it will not be displayed on the CRT monitor, but the sample interval can be switched.

When the SET key is pressed again while it is blinking, the breakpoint indication on the Recording display changes to the TIME display based on the trigger point. In this case, the number of sample points for the breakpoint is multiplied by the sample interval and the six most significant digits can be displayed. Setting the breakpoints in this manner allows a single record to be divided into blocks with different sample intervals. A maximum of five breakpoints can be set for a single record. CURSOR 1 can be used to quickly measure the locations of desired breakpoints.

28 BREAK POINT DISPLAY

A push-to-select key with LED that displays the currently set breakpoints on the Recording display. When this key is pressed, "0" is displayed when no break points are set; the break point closest to the current BREAK POINT SET key setting is displayed when the breakpoints are set. When the Parameter Entry Knob is rotated, the set break points are displayed in turn; also, the sample intervals of each breakpoint are displayed on the time base display. When the key is pressed again while its LED is blinking, the display changes to the TIME display. The internal calculations and display procedures are the same as for the SET key.

29 BREAK POINT CLR

Pressing this key clears the currently displayed break point. A break point is cleared by pressing the BREAK POINT DISPLAY key to display breakpoints, then using the Parameter Entry Knob to select the breakpoint to be cleared, then pressing the

BREAK POINT CLR key. If all breakpoints are to be cleared, push the BREAK POINT DISPLAY key, then select the highest address breakpoint with the Parameter Entry Knob, then keep pushing the CLR key until the display reads zero (0).

30 RECORD MODE

A toggle key that selects the acquisition mode. There are four record modes, NORM (normal), AVE (averaging), ADV (auto-advance), and ENV (envelope). The backlighted indicator above the key shows the selected mode.

NORM: Waveform data is acquired into the memory location set when the record location key is selected.

AVE: The digitized waveform data is continuously averaged. The number of times that can be set for averaging by rotating the Parameter Entry Knob is from 2 to 16384, in steps of 2ⁿ.

NOTE

Averaging is limited to an 8K record length.

ADV: Acquisition of waveform data begins with record location 1 and advances continuously up to the record location set by the RECORD LOCATION key. In this mode, the record location in acquisition is displayed continuously on the Control display.

ENV: The digitized waveform is continuously enveloped. The number of times for enveloping can be set between 1 and 16384 in steps of 2ⁿ, and 99999 (infinite envelope). The setting can be altered with the Parameter Entry Knob by pressing the AVE/ENV # OF TIMES key after selecting ENV with the RECORD MODE key.

NOTE

When the trigger mode is set to the compare mode, the number of times for the envelope is automatically set to 1.

Enveloping is not possible in the high-speed sample mode. Also, breakpoint settings are ignored in the envelope mode (enveloping is performed at the initial sample interval).

CONTROL

Refer to Fig. 3-7 for the location of items 31 through 47.

31 Control Display

Displays the cursor position, the zoom factors for the vertical or horizontal axes, the vertical position, the memory location number to be displayed on the CRT monitor, or the measurement results by MEASURE keys such as V OR ΔV , T OR ΔT , 1/T OR $1/\Delta T$. Also, the location of the non-volatile memory for storing/recalling the front panel settings is indicated.

32 BUSY

Illuminates when the instrument is executing one of the following:

- Compressed display (LINE selected).
- Acquisition in COMPARE trigger mode.

33 PARAMETER ENTRY KNOB

A rotary knob; used for setting the various parameters and for moving the cursor in the horizontal axis. Pressing the key of the parameter to be changed (LED of the key starts blinking) and then rotating this knob changes the parameter value. It is infinitely variable in both directions.

34 CURSOR 1/CURSOR 2

Push-to-select keys with LED. Pressing these keys once causes a cursor (CURSOR 1 or CURSOR 2) to be displayed as a high-intensity dot (or line) on the channel 1 waveform on the CRT monitor. The cursor can be moved to the left or right by rotating the Parameter Entry Knob while the key LED is blinking. The cursor currently being controlled is indicated by its blinking key LED. This key sequences through the CURSOR 1, CURSOR 2, and OFF positions with multiple presses of the key.

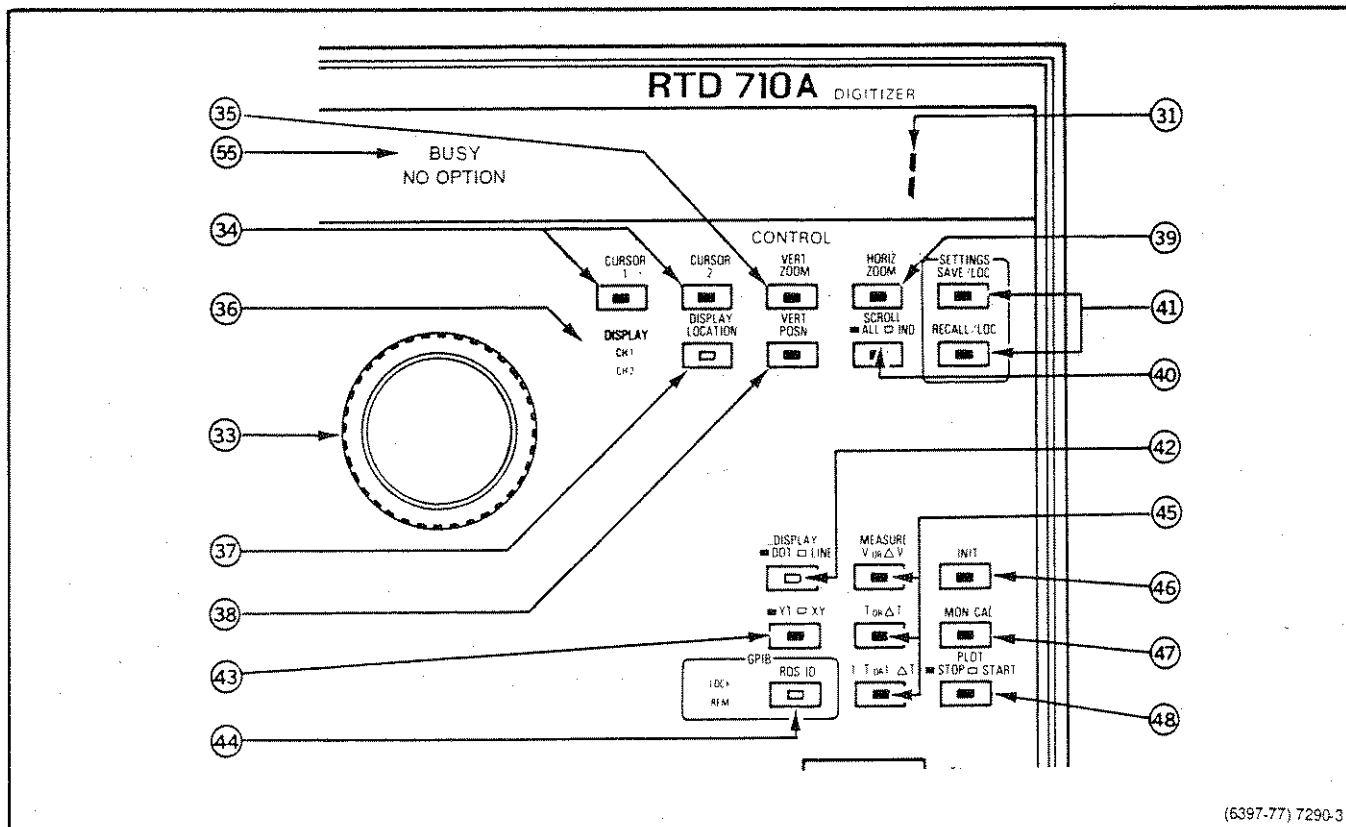

Fig. 3-7. Control section of RTD 710.

Operating Instructions

When either CURSOR 1 or CURSOR 2 is displayed, the Control display shows the number of sample points counted from the trigger point to CURSOR 1 (or CURSOR 2). When both CURSOR 1 and CURSOR 2 are displayed, the display shows the number of sample points counted from CURSOR 2 to CURSOR 1.

A minus sign (-) in the display means that CURSOR 2 is to the right of CURSOR 1 on the CRT monitor. CURSOR 1 is a scroll cursor which is capable of moving the waveform display to the right or left. If an attempt is made to move CURSOR 1 past the right (left) edge of the screen, the displayed waveform moves to the left (right). CURSOR 2 does not cause the waveform to scroll.

NOTE

The RTD 710A must be in the HOLD state to scroll.

35 VERT ZOOM

A push-to-select key that enables vertical zooming of the waveform displayed on the CRT monitor. When this key is pressed (key LED starts blinking), rotation of the Parameter Entry Knob changes the zoom factor for the displayed waveform. Possible settings include 1/4, 1/2, 1 (default value), 2, 4, 8, 16 and 32 times. Pressing the key a second time while the LED is blinking switches the channel for zoom (channel selection indicator shows the selected channel.) Separate zoom factor selection can be made for each channel. The zoom factor is displayed on the Control display. (Factors 1/4 and 1/2 are displayed in the form of 1-4 and 1-2.) VERT POSN is used with VERT ZOOM to allow viewing of a desired portion of a waveform.

36 DISPLAY

Indicators that are backlighted to indicate the channel currently selected by the cursors, the channel of the displayed memory location that is displayed on the CRT monitor, or the channel for vertical zoom or positioning. Refer to the descriptions on the cursor keys: DISPLAY LOCATION, VERT ZOOM, and VERT POSN for more details.

37 DISPLAY LOCATION

A push-to-select key with LED used to select the record location of the waveform memory for display

on the CRT monitor. Pressing this key once (key LED starts blinking) allows selection of the display location for the indicated channel by rotating the Parameter Entry Knob.

If the key is pressed a second time while its LED is blinking, the channel selection changes and the display location for the other channel can be set. A display location for each channel can be selected. The maximum display location value that can be set corresponds to the maximum record location value.

The display can be turned off by setting the display location to 0. Both CH1 and CH2 displays should be turned off when using Auto Advance to speed up the acquisition.

38 VERT POSN

A push-to-select key used to set the vertical position of the waveform to be displayed on the CRT monitor. Pressing this key once (LED starts blinking) and turning the Parameter Entry Knob changes the vertical position of the waveform of the selected channel.

If the key is pressed a second time while the LED is blinking, the channel selection changes and the vertical display position for the other channel can be set.

39 HORIZ ZOOM

A push-to-select key that enables horizontal zoom of the displayed waveform. When this key is pressed (key LED starts blinking), rotation of the Parameter Entry Knob changes the horizontal zoom of the displayed waveform by the factor indicated on the Control display. Possible zoom factors are between 16 and 1/128 times in multiples of 2 or 1/2; however, the lower limit depends upon the record length and is limited to 2K words per record length. For example, if the record length is 4K, reduction to 1/2 is possible; but if the record length is 1K or 2K, reduction is not performed.

40 SCROLL

A push-to-select key used to set the scrolling mode of CURSOR 1. When ALL (default value) is selected, simultaneous scrolling of the displayed waveform for channels 1 and 2 is possible. If the mode is set to IND(ependent), only the displayed waveform for the channel selected by CURSOR 1 is scrolled.

41 SETTINGS SAVE/LOC and RECALL/LOC

Push-to-select keys with LED that allow all front panel settings to be saved in the non-volatile memory, and recalled. When the SAVE/LOC key is pressed once (key LED starts blinking), rotating the Parameter Entry Knob changes the memory location number indicated on the Control display. The memory locations range from 1 to 20. A minus sign (–) indicates that the displayed memory location contains previously saved settings. Pressing the SAVE/LOC key while the LED is blinking saves all the front panel settings in the displayed memory location. The memory location number blinks during the saving process. Usage of the RECALL/LOC key is the same as for the SAVE/LOC key.

NOTE

When new front panel settings are saved into a memory location containing previously saved settings, the old settings are lost.

42 DISPLAY DOT/LINE

A push-to-select key with LED used to set the waveform display method. When DOT is selected, 2048 points of data from the display memory are displayed as dots on the monitor. The even-spaced thin-out algorithm is used in this display mode. This mode has faster display response than does the LINE display mode.

When LINE is selected, the envelope algorithm is used, and the processor calculates the line-interpolated waveform data. The key LED illuminates when LINE is selected.

43 DISPLAY YT/XY

A push-to-select key with LED used to set the waveform to either YT display or XY display (default value) is selected, the usual time domain display is made. When XY display is selected (key LED on), the channel 1 signal is displayed on the X-axis and the channel 2 signal is displayed on the Y-axis.

NOTE

Make sure that both CH1 and CH2 waveforms are displayed before selecting the XY mode.

44 GPIB RQS ID and LOCK/REM

A push-to-select key with LED. When the RTD 710A is in the TALK/LISTEN mode, pressing this key generates an SRQ on the GPIB if the USER SRQ is ON. The key LED illuminates while SRQ is asserted. The Control display indicates the RTD 710A address for about 1 second. A poll by the GPIB controller turns off the illuminated key LED and cancels the SRQ. The LOCK indicator shows the lockout/non-lockout state of the RTD 710A (ON in the lockout state). The REM indicator shows the remote/local state of the RTD 710A (ON in the remote state).

45 MEASURE V OR ΔV, T OR ΔT, and 1/T OR 1/ΔT

Push-to-select keys with LED. When these keys are pressed, various types of cursor measurements are automatically made for the waveform currently selected by the DISPLAY LOCATION key, and the measurement results are indicated on the Control display. The procedures for measurement differ depending on whether the cursors are displayed separately, or both CURSOR 1 and CURSOR 2 are displayed together. In the former case, measurement values are obtained for the cursor position on the displayed waveform; in the latter case, measurement values are obtained for the difference between the CURSOR 1 and CURSOR 2 positions on the displayed waveform, as shown in Table 3-5.

**Table 3-5
MEASUREMENTS USING CURSORS**

Displayed Cursor	Measurement Key	Measurement Item
CURSOR 1 or CURSOR 2	V	Voltage reference to ground at cursor position.
	T	Time measurement from trigger point to cursor position.
	1/T	Reciprocal of T (frequency) is calculated and displayed.
CURSOR 1 and CURSOR 2	ΔV	Voltage at CURSOR 1 position – voltage at CURSOR 2 position.
	ΔT	Time conversion at CURSOR 1 position – time conversion at CURSOR 2 position.
	1/ΔT	Reciprocal of ΔT (frequency) is calculated and displayed.

Operating Instructions

The cursor measurement mode is released when the illuminated measurement key is pressed (key LED turns off and the Control display changes to show the cursor position). Measurement by the T OR ΔT key and 1/T OR 1/ ΔT key is not possible when using an external clock. When the time scales for channels 1 and 2 are different, measurement is made using the time scale for the displayed waveform selected by CURSOR 1.

46 INIT

A push-to-select key with LED used to initialize settings. If the INIT key is pressed once (LED blinks) and then a parameter key is pressed, the current setting of the parameter key resets to its default value. Pressing the INIT key twice initializes the RTD 710A to the settings shown in Table 3-6.

Table 3-6
INITIALIZATION DEFAULTS

Function	Key	Default Value
INPUT	RANGE OFFSET VERT MODE BW LIM 20 MHz COUPLING	50 V 0 DUAL (key LED OFF) 100 MHz (key LED OFF) AC (both CH1 and CH2)
TRIGGER	TRIG LEVEL 1, 2 (FIELD LINE #) ARM DELAY TRIG DELAY SOURCE COUPLING MODE	0 (1) 0 -400 INT (key LED OFF) CH1 (key LED OFF) DC AUTO
TIME BASE	SAMPLE INTERVAL CLK SOURCE SAMPLE MODE	10 ns (1EO for the external clock) INT (key LED OFF) NORM (key LED OFF)
RECORDING	RECORD LENGTH RECORD LOCATION AVE/ENV # OF TIMES BREAK POINT RECORD MODE	2048 1 2/1 NONE NORM
CONTROL	CURSOR 1,2 VERT ZOOM DISPLAY LOCATION VERT POSN HORIZ ZOOM SETTINGS ² SCROLL DISPLAY DOT/LIN DISPLAY YT/XY MEASURE	-400 ¹ 1 1 0 1 1 (SAVE/LOC RECALL/LOC keys) ALL (key LED OFF) LINE (key LED ON) YT (key LED OFF) LEDs of V or ΔV key, T or ΔT key, 1/T OR 1/ ΔT key OFF

¹The cursor position is reset to the left end point of the waveform memory. When the waveform data was acquired with a trigger delay of -400, the left end point of the waveform memory is -400. In this case, the cursor position is reset to -400.

²The current memory location is initialized to 1, but the recorded contents of the non-volatile memory are not erased.

47 MON CAL

A push-to-select key with LED. Pressing this key with the time base set to HOLD mode (MON CAL LED turns on) outputs a pattern signal at the rear panel CRT monitor output connector. This pattern is used for adjustment of the monitor display. The pattern signal output stops when this key is pressed again. If the time base is not in HOLD mode, this key has no effect.

48 PLOT

A push-to-select key with LED. Pressing this key (LED on) outputs the waveform data for the location selected by the DISPLAY LOCATION key to an HPGL plotter connected to the IEEE 488 Port. The key LED remains on during output.

CONNECTORS AND POWER

Refer to Fig. 3-8 for location of items 48 through 53.

49 CH 1 OR X, and CH 2 OR Y Connectors ⚠

BNC input connectors. External signals applied to these connectors are routed to the input attenuators for channel 1 and channel 2. When the XY display mode is selected, a signal applied to the CH 1 OR X connector provides the horizontal deflection, and a signal applied to the CH 2 OR Y connector provides the vertical deflection. Each connector has a coding ring contact that activates the full scale range

switching circuitry when an encoded switching probe is connected. If a 10X probe with a readout pin is connected, the Input display reading is automatically multiplied by 10. The maximum input voltage is 250 V (dc + peak ac).

50 PROBE CAL Output Connector

A pin socket that provides a 4 V p-p, 1 kHz square wave output signal into a 1 MΩ load for probe compensation.

51 GND Connector

Provides an auxiliary signal ground for use when connecting equipment under test to the RTD 710A.

52 EXT TRIG IN Connector ⚠

A BNC connector for applying an external trigger signal. The maximum input voltage is 25 V (dc + peak ac). Terminated in 1 MΩ.

53 FROM REAR 1, 2, 3 Connector ⚠

BNC connectors that provide straight-through connection to the corresponding TO FRONT PANEL 1, 2, and 3 connectors on the rear panel. The maximum input voltage is 40 V (dc + peak ac).

54 Power ON/STANDBY Switch

Turns the RTD 710A power on or to standby, if the rear panel PRINCIPAL POWER SWITCH is on.

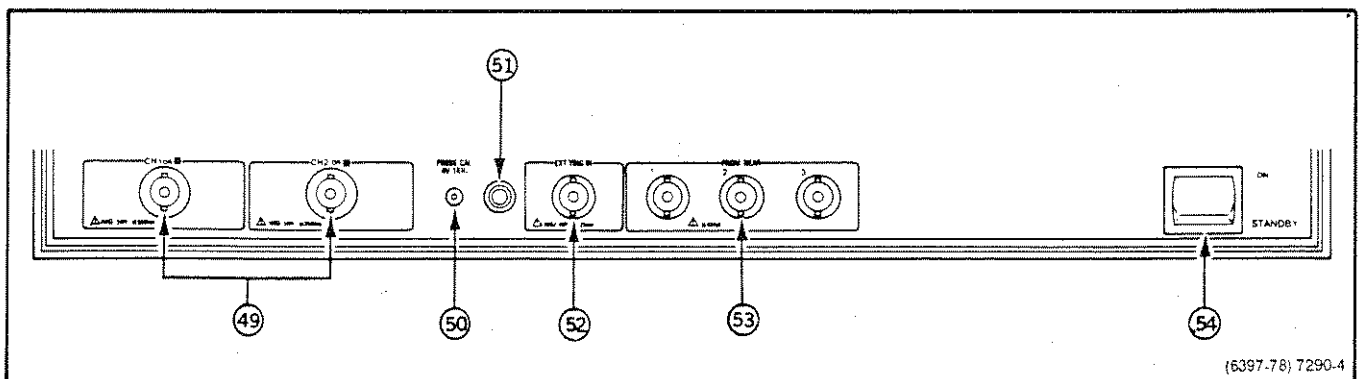



Fig. 3-8. Connectors and power section of front panel.

REAR PANEL

Refer to Fig. 3-9 for location of items 1 through 14.

1 CRT MONITOR OUT X, Y, Z Connectors

BNC connectors that provide the X-Y-Z analog equivalent of the waveform data stored in memory for display on a suitable CRT monitor (Refer to Appendix B for the CRT output specifications). The amplitude of the output voltage is internally selectable for 1 V or 5 V. It is set to 1 V at the factory. If the amplitude needs changing, refer the instrument to qualified service personnel.

2 TO FRONT PANEL 1, 2, 3 Connectors 

BNC connectors that provide straight-through connection to the FROM REAR 1, 2, and 3 connectors on the front panel. The maximum input voltage is 40 V (dc + peak ac).

3 GPIB Connector !

Provides for connection to a standard IEEE-488 bus. The electrical and physical arrangement of the

4 GPIB Parameter Switch !

An eight-element, binary-coded switch that selects the GPIB mode and address. For setting information, see Section 4, INTERFACING.

5 A/D OUT Connector

A 50-pin connector that provides CH 1 and CH 2 digitized data output. The output is an ECL-compatible differential signal. For more information, see Section 4, INTERFACING.

6 TRIG'D OUT Connector

A BNC connector that provides a TTL-compatible, true (high) signal when the instrument has been triggered.

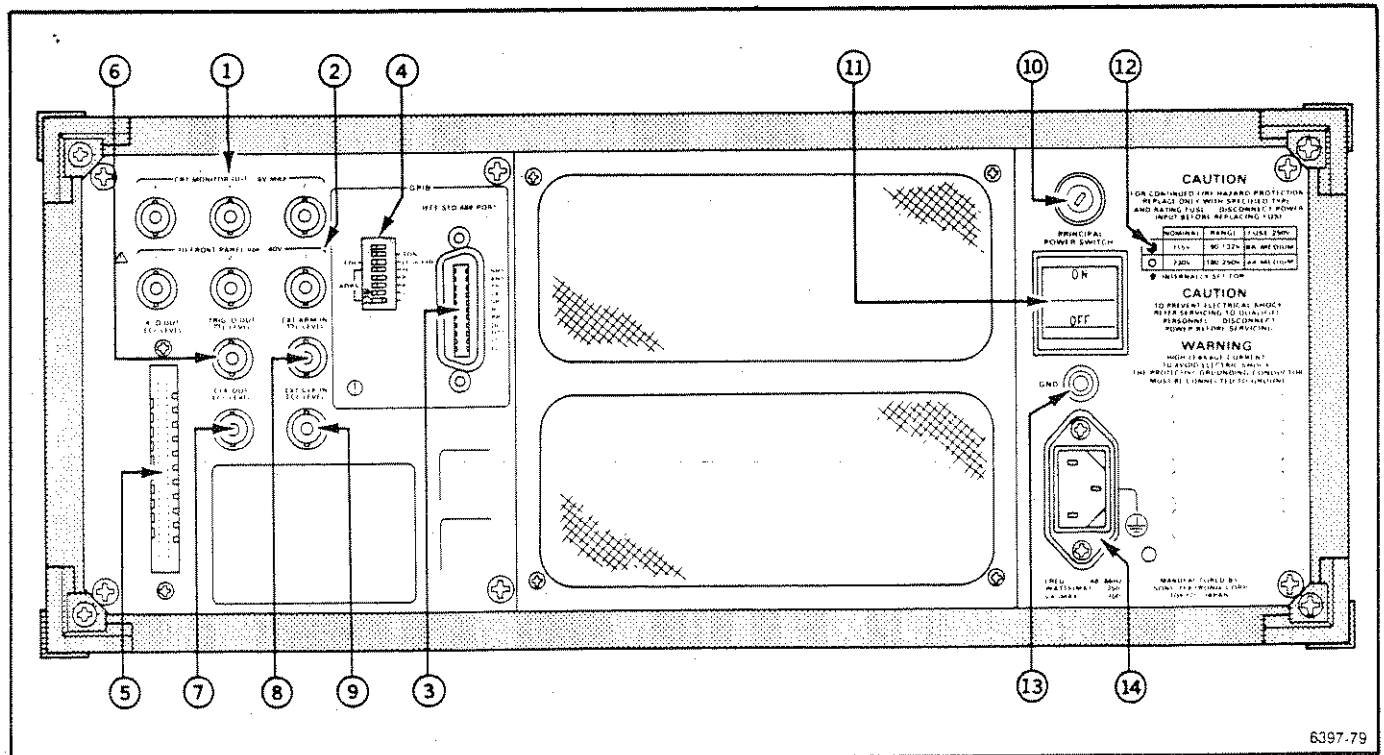

Fig. 3-9. RTD 710A rear panel.

7 CLK OUT Connector

A BNC connector that provides an ECL-level internal sample clock output. Clock output mode is internally selectable for DIRECT or DIVIDED. It is set to DIVIDED at the factory. To change setting, refer to qualified service personnel.

8 EXT ARM IN Connector

A BNC connector that accepts an external arming signal when the arm mode is set to external. The arming is actuated by the edge or level of a positive-going TTL-compatible signal.

An internal Edge or Level selection jumper is provided on the Time Base board. When Edge is selected, the trigger circuit is armed by the positive-going edge of the externally applied arm signal after the instrument has entered the arm wait cycle. When Level is selected, normal acquisition occurs while the external arm signal is true (logical 1). If the arm signal is false (logical 0), the trigger remains in the wait state; thus it may be used as a trigger hold-off signal.

9 EXT CLK IN Connector

A BNC connector used for connecting an ECL-compatible external clock signal to drive the time base

when an external clock source is selected. Input impedance is approximately $50\ \Omega$ (terminated to $-2\ \text{V}$).

10 Fuse Holder

Contains the primary ac power source fuse.

11 PRINCIPAL POWER Switch

Power line switch that controls the line input power to the RTD 710A power supply.

12 Line Voltage Indicator

The position of the screw indicates the internally selected instrument operating voltage.

13 GND Connector

Provides an auxiliary signal ground for use in connecting equipment under test to the RTD 710A.

14 Power-Cord Receptacle

Provides the instrument connection point to the appropriate ac voltage.

INSTRUMENT FAMILIARIZATION

This subsection provides a detailed introduction to the use of the RTD 710A and its controls. It is organized similar to the Controls, Connectors, and Indicators subsection as follows:

- Input
- Trigger
- Time Base
- Recording
- Control
- Rear Panel
- Simple Waveform Operation
- TV Trigger Option Operation

INPUT

The RTD 710A digitizes waveforms fed into the input connectors (CH1 or X, CH2 or Y) with 10-bit resolution over the voltage limits set by RANGE control. The input signal should be connected to the RTD 710A as instructed below to ensure that full bandwidth is maintained.

Probe

The probe is the most convenient means of connecting the input signal to the RTD 710A. A 10X (or 100X), shielded probe is recommended, because the shield reduces outside electrical interference and the high input impedance reduces loading effects on the circuit(s) being measured. If a 10X (100X) probe contains a readout encoding pin, the true input range is displayed automatically on the RANGE display. Non-encoded probes provide an input signal, but the input range indicator may not reflect the probe scale factor.

Coaxial Cable

When using coaxial cable rather than a probe to feed a signal into the instrument, it is essential that high-quality, low loss cable be used to ensure that the true frequency response characteristics of the input signal are transferred. Also, the coaxial cable should be terminated in its characteristic impedance.

RANGE Key

The Input Range represents the RTD 710A input sensitivity. For example, when RANGE is set to 1 V, its input sensitivity is ± 1 V. With 10-bit resolution, its resolution is less than 2 mV. If the RANGE is ± 100 mV, its resolution is less than 200 μ V.

To set the RANGE:

1. Press the RANGE key for the channel to be set. The current RANGE value is displayed in the Input display.

2. Whenever the RANGE key indicator is blinking, the Parameter Entry Knob can be used to set the RANGE value. The available RANGE is ± 100 mV to ± 50 V in 28 steps. The adjusting sequence has been improved from the traditional 1-2-5 sequence to a 1-1.25-1.6-2-2.5-3.2-4-5-6.2-8-10 sequence.

When an input signal exceeds the RANGE setting, the upper and lower portions of a signal displayed on the monitor will be clipped. This is due to the occurrence of overrange, which is discussed further in the next topic. Efficient use of 10-bit resolution requires that RANGE be properly selected so that the input signal fits entirely within the range. Fig. 3-10 through Fig. 3-12 show correct adjustment of the RANGE.

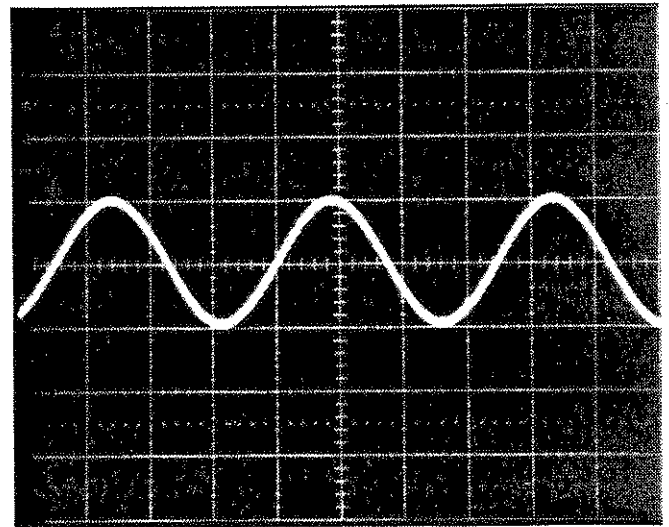

Fig. 3-10. Input range setting too large: Input Signal = ± 0.5 V; RANGE = ± 1.6 V.

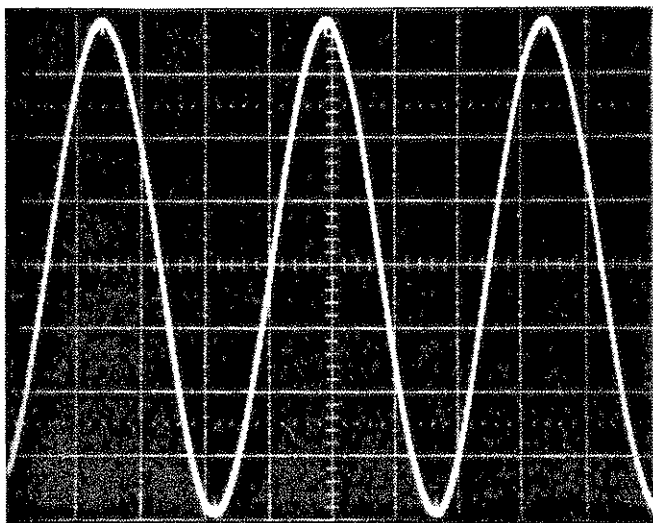

Fig. 3-11. Input range setting correct: Input Signal = ± 0.5 V; RANGE = ± 500 mV.

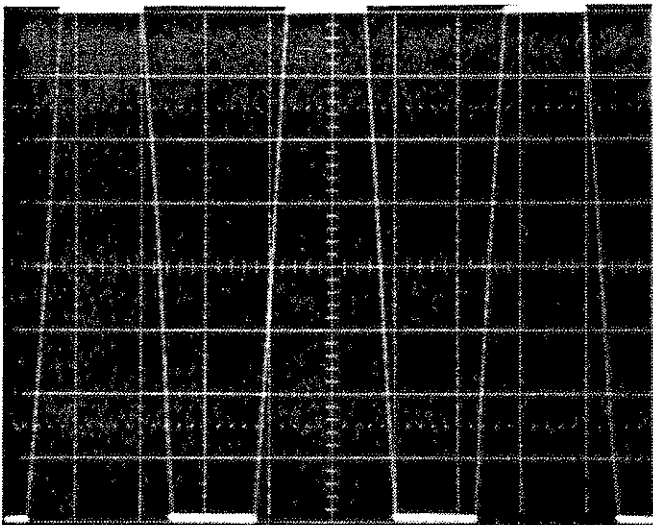
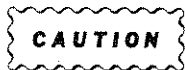

Fig. 3-12. Input range setting too small: Input Signal = ± 0.5 V; RANGE = ± 200 mV.

Overrange



Exceeding the maximum input voltage specification may damage the instrument.

The RTD 710A overrange indicator consists of two illuminated triangles at the left side of the Input display. When a positive input overrange occurs, the upward pointing triangle illuminates, and on negative input overrange, the downward pointing triangle illuminates. If an overrange in both directions occurs, both triangles illuminate.

The overrange level is set such that on a positive overrange all bits of the A/D converted 10-bit digital data are 1s, and on a negative overrange all bits of the converted data are 0s.

Once an overrange occurs, it continues to be indicated for confirmation during measurements. The indicator allows the operator to readily prevent the overrange from occurring without using the monitor. The indicator is reset when starting to write in the waveform memory. To clear the overrange indicator, adjust RANGE and OFFSET until the signal is contained within the input range.

Fig. 3-13 shows the effect of an overranged input signal. In this example, the display monitor is setup to monitor both channels using the upper half for the CH1 display and the lower half for the CH2 display. Then a sine wave of ± 2 V is input to CH1, and the same waveform attenuated by 1/2 is input into CH2. While the true waveform (attenuated) appears on CH2, the waveform on CH1 is clipped because the input signal exceeds the range of CH1.

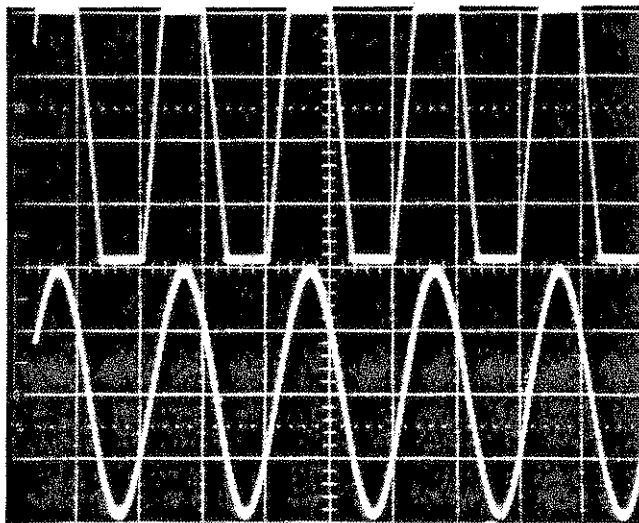

Fig. 3-13. Overrange display.

Operating Instructions

OFFSET Key

Input OFFSET provides a dc offset value as a means to vertically shift the input signal on the monitor screen, or to shift part of an overranged input signal within the RANGE. Because the dc offset can be set from 1% to $\pm 199\%$ of the RANGE, it can be used for measuring low frequency components that are superimposed on dc components within this range that may be attenuated with ac coupling.

To set the Offset:

1. Press the OFFSET key for the channel to be set. The current OFFSET value is displayed in the Input display.

2. Whenever the OFFSET key indicator is blinking, the Parameter Entry Knob can be used to set the OFFSET value. The available OFFSET is $\pm 199\%$ of the input RANGE adjustable in 1% steps.

OFFSET can be set in either % of full scale or the equivalent voltage value in 1% steps. Once the OFFSET key is selected, and is blinking, continuing to push the key toggles the display between % of full scale and volts. For example, if RANGE is selected and set to 10 V, then OFFSET is selected (% of full scale) and set to 10 (representing 10% of full scale), then OFFSET is pushed again (representing volts), the display will show 1.00 V.

To shift a waveform towards the top of the CRT monitor screen, decrease the dc offset by turning the Parameter Entry Knob counterclockwise (CCW). To move the waveform towards the bottom of the screen, increase the dc offset by turning the Parameter Entry Knob clockwise (CW). Operation is similar to a differential amplifier, where the dc offset control adjusts the negative input level.

When reading the voltage with the cursor MEASUREMENT commands, the dc offset value is not included. When the waveform is transferred over the GPIB, the dc offset is included.

Input Bandwidth Filter

The RTD 710A has a 20 MHz low-pass input filter, which can be used to remove unwanted high frequency components (including noise) and reduce aliasing (explained later in the Time Base section).

To select the filter, push the BWLIM 20 MHz key. Its LED indicator should illuminate to show selection. To deselect the filter, push the key again and the LED will go out.

Automatic Calibration (AUTO CAL)

In order to ensure the high analog accuracy of the RTD 710A, an automatic calibration feature (designated simply as Auto Cal hereinafter) for the input amplifiers and A/D converters is included. Auto Cal performs three functions:

1. DC Calibration
2. Gain Calibration
3. Phase Calibration

The DC Calibration function compensates the DC level of the input amplifiers to ensure the digitizing of the dc level of the input signal.

The Gain Calibration function generates a 1 KHz square waveform, which is used to compensate the gain of the input amplifiers to ensure a direct correlation between the \pm Input Range setting and the full-scale range of the A/D converter.

The Phase Calibration function generates a 28.57 MHz sawtooth waveform, which is used to adjust the sampling clock phase when the high-speed sampling mode is selected. In the high-speed sampling mode, the signal input at the CH1 input connector is simultaneously input to both input amplifiers. By shifting the sample clock phasing between the A/D converters by exactly 180° , a high speed sampling of up to 5 ns is achieved. Any shift in the 180° phase relationship between the A/D converters results in a deterioration of accuracy for high-frequency input signals. The Phase Cal function corrects the phase shift to maintain phase shift at 180° .

The Auto Cal function is automatically initiated on any of these conditions:

1. The AUTO CAL key is pushed, or the AUTocal command is received over the GPIB.

2. The RANGE, BW LIM 20 MHz, SAMPLE MODE, or CLK SOURCE is changed either from the front panel or over the GPIB.

3. Whenever one of the SAMPLE INTERVAL changes shown in Table 3-7 occurs.

Table 3-7
SAMPLE INTERVAL AUTO CAL

Sample Mode	Sample Interval Change
HI SPD	<ol style="list-style-type: none"> 1. When setting or exiting a sample interval of 5 ns or 10 ns. 2. When switching the clock source between INT and EXT, and the INT sample interval was or becomes 5 ns or 10 ns.
NORM	<ol style="list-style-type: none"> 1. When setting or exiting a sample interval of 10 ns or 20 ns. 2. When switching the clock source between INT and EXT, and the INT sample interval was or becomes 10 ns or 20 ns.

4. The INIT key is pressed twice or the INIT ALL command is received over the GPIB.

5. When the front panel settings are recalled from the front panel or the RECALL command is received over the GPIB.

NOTE

Auto calibration may be incomplete if made with an input signal applied to the front-panel input. Disconnect vertical input signal before performing auto calibration.

The keys on the front panel are locked out and the data designated by the RECORD LOCATION is erased during Auto Cal execution.

Auto Cal execution normally takes less than 1/2 second; however, there are times when instrument setup may take a few seconds.

TRIGGER

Trigger Source

A trigger signal source is selectable internally from the Channel 1 or Channel 2 input, or externally through the EXT TRIG IN connector on the front panel. Since the external trigger full scale signal range is ± 5 V, the voltage display levels for that trigger differ from that of the internal trigger.

Trigger Slope and Level

The Trigger SLOPE of the RTD 710A can be set to five different settings: +, -, BI, +HYS (Hysteresis), and

-HYS. + and - are those normally found on oscilloscopes, but BI, +HYS, and -HYS are types of triggers more suited for single-shot transient signals (BI) or for signals with high noise levels (\pm HYS). The RTD 710A has two trigger levels: TRIG LEVEL 1 and 2 when BI, +HYS, or -HYS is selected. TRIG LEVEL 1 sets the triggering level for the positive-going portion of the waveform when using BI, +HYS, and -HYS SLOPE. TRIG LEVEL 2 sets the triggering level or the trigger resetting level for the negative-going portion of the waveform in the BI, +HYS, and -HYS SLOPE. When the trigger levels are set, a waveform window is formed between the two levels. Whichever level is the most positive starts the window, while the less positive level ends the window. This is shown in more detail in later figures.

BI Slope. The BI slope trigger is useful when digitizing a single-shot input signal of unknown nature. When selected, a trigger window is formed between TRIG LEVEL 1 and 2 (Figs. 3-14 and 3-15). A triggering pulse is generated when the signal enters the window, or when leaving the window, depending upon whether level 1 is less than or greater than level 2.

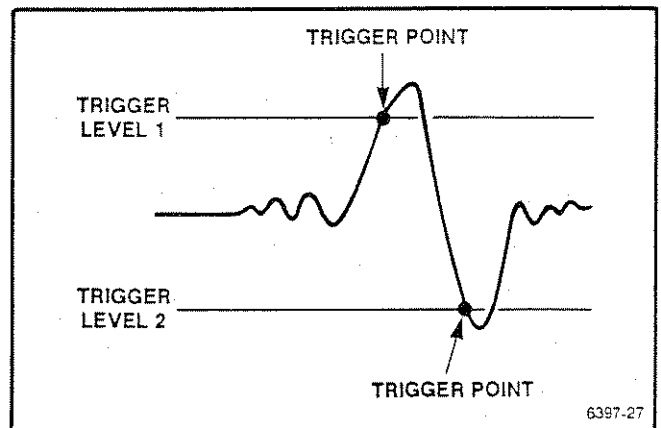

Fig. 3-14. BI slope trigger (Level 1 > Level 2).

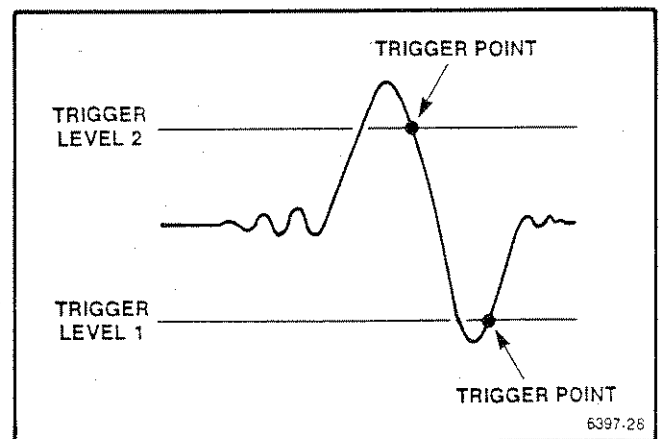

Fig. 3-15. BI slope trigger (Level 2 > Level 1).

Operating Instructions

To select BI Slope and set the trigger levels:

1. Select BI using the TRIG SLOPE toggle key. When selected both the + and - indicators will illuminate.
2. Push the TRIG LEVEL 1 key. Its current value will be displayed in the Trigger display. If the key indicator is blinking, use the Parameter Entry Knob to set trigger level 1, which sets the level for a positive-going signal.
3. Push the TRIG LEVEL 2 key. Its current value will be displayed in the Trigger display. If the key indicator is blinking, use the Parameter Entry Knob to set trigger level 2, which sets the level for a negative-going signal.

NOTE

The trigger level can be set in either % of full scale or voltage. With an internal trigger, the % of full scale or voltage value is set in 1% of input range steps. With external trigger, the trigger level is set in % or a voltage value in 1% of full scale for External Trigger In ($\pm 5 V$).

HYS SLOPE. HYS slope provides a stable trigger pulse when the input signal contains a large amount of noise that may vary around the trigger level causing false triggering. The basics of a hysteresis trigger are that once a triggering level is crossed and the trigger occurs, the trigger is not reset until the waveform crosses another preset level that noise is unlikely to reach.

With +hysteresis, the trigger point is set on the positive-going portion of the signal with trigger level 1, while the hysteresis point (trigger reset) is set on the negative-going portion of the waveform with trigger level 2 (Figs. 3-16 and 3-17).

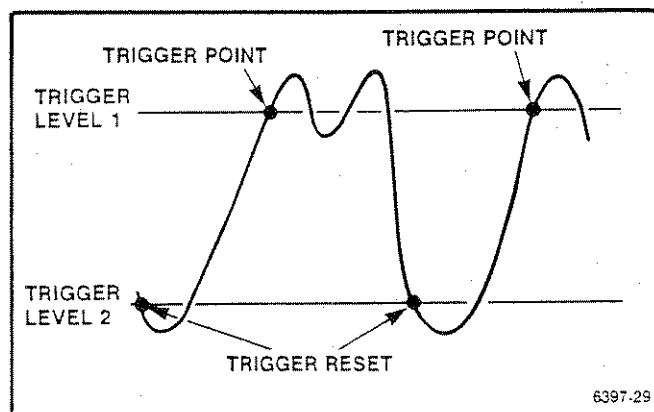

Fig. 3-16. +Hysteresis (Level 1 > Level 2).

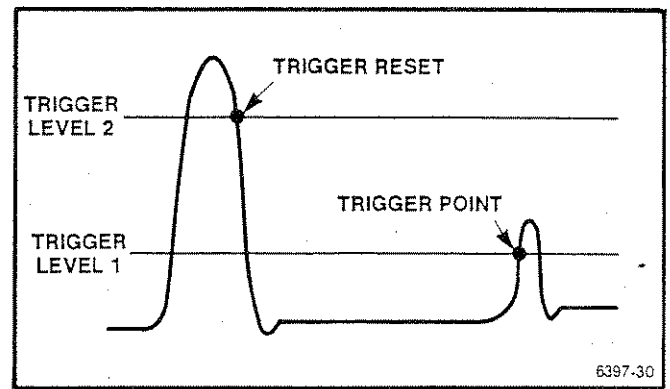

Fig. 3-17. +Hysteresis (Level 2 > Level 1).

With -hysteresis, the trigger point is set on the negative-going portion of the signal with trigger level 2, while the hysteresis point (trigger reset) is set on the positive-going portion of the waveform with trigger level 1 (Figs. 3-18 and 3-19).

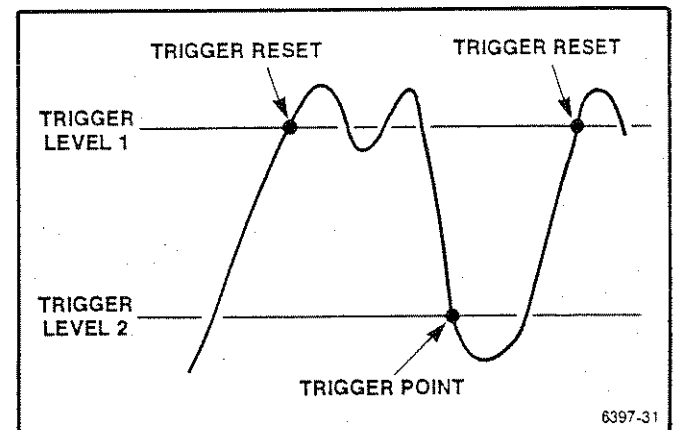

Fig. 3-18. -Hysteresis (Level 1 > Level 2).

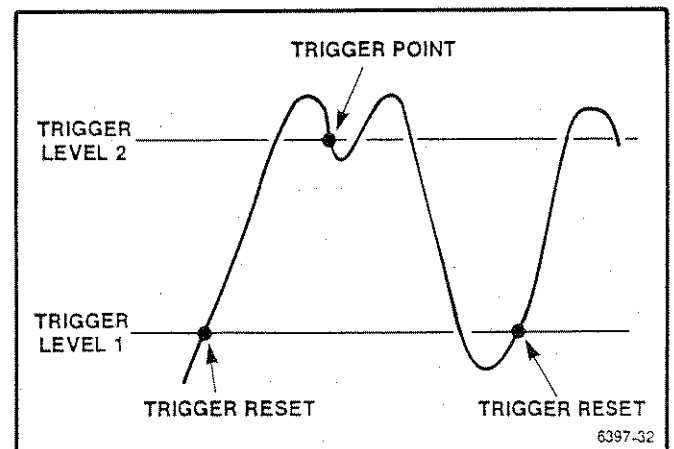

Fig. 3-19. -Hysteresis (Level 2 > Level 1).

NOTE

In the +HYS or -HYS mode, the trigger generator waits for the trigger to reset before it becomes triggerable.

Trigger sensitivity is adjusted by varying the difference between the trigger level 1 and 2 values.

To select HYS slope and set the trigger levels:

1. Select HYS slope using the TRIG SLOPE toggle key. +HYS is first selected. If the lever switch is toggled again, -HYS is selected.

2. Push the TRIG LEVEL 1 key. Its current value will be displayed in the Trigger display. If the key indicator is blinking, use the Parameter Entry Knob to set trigger level 1 to the positive-going trigger level for +HYS, or to the positive-going reset level for -HYS..

3. Push the TRIG LEVEL 2 key. Its current value will be displayed in the Trigger display. If the key indicator is blinking, use the Parameter Entry Knob to set trigger level 2 to the negative-going reset level for +HYS, or to the negative-going trigger level for -HYS.

NOTE

The trigger level can be set in either % of full scale or voltage. With an internal trigger, the % of full scale or voltage value is set in 1% of Input Range steps. With external trigger, the trigger level is set in % or a voltage value in 1% of full scale for External Trigger In (5 V).

Trigger Mode

The RTD 710A features five Trigger Modes: AUTO, NORM(al), SGL (Single), COMP(are)-IN, and COMP(are)-OUT. AUTO, NORM, and SGL operate basically the same as in conventional oscilloscopes, but COMP is a special feature of the RTD 710A.

AUTO. With AUTO trigger, the instrument is triggered by an input signal after the ARM'D lamp illuminates. If no trigger is received within 20 ms, an internal trigger pulse is generated automatically to acquire and display the waveform. Because some input waveforms, such as recurrent signals of periods longer than 20 ms or single shot waveforms, may fail to trigger properly depending upon the arm timing, it is preferable to set TRIG MODE to NORM or SGL in such cases.

NORM(al). With NORM trigger, the instrument is triggered only by an input signal after the ARM'D lamp illuminates. The trigger depends upon the trigger level, trigger slope, trigger source, and trigger coupling. If no trigger occurs after the ARM'D indicator illuminates, check those settings.

After a NORM trigger occurs and data is acquired and displayed, the instrument is re-ARM'D for another acquisition. This sequence repeats continually until the HOLD status is set by pressing the RESET/HOLD key, or by receiving the HOLD command over the GPIB.

SGL (Single). The SGL trigger mode varies with the setting of the record mode.

In NORM record mode, SGL operates basically the same as the NORM trigger mode, except that when the trigger occurs, data is acquired and displayed, then the Hold status is set. In this state, the RESET/HOLD key must be pushed, or the HOLd RESet command received over the GPIB if you want to acquire another waveform.

In the AVE(rage)/ENV(elope) record mode, data is acquired and displayed the number of times set by the Average or Envelope values, then the Hold status is set. If the Envelope value is set to 99999 (no-limit), envelope processing continues until the RESET/HOLD key is pushed, or the HOLd RESet command is received over the GPIB.

In the ADV(ance) record mode, data is sequentially acquired from the first record to the record specified by the RECORD LOCATION function. For example, if RECORD LOCATION is set to 20, and auto ADV(ance) is enabled, 20 trigger events are acquired. To increase thruput, set the CH1 and CH2 displays to zero (0).

COMP-IN, COMP-OUT. This trigger mode operates similar to the NORM mode, except the acquired data is compared with a reference to determine if another acquisition is to be made. The reference data must be envelope waveform data while the acquired data may be either envelope or normal waveform data.

The COMP Trigger modes allow adjustment of a live signal into defined limits of an enveloped reference waveform. It also is an effective means of observing and measuring infrequent signal abnormalities.

Operating Instructions

In COMP-IN, if all data acquired from the trigger point falls within the maximum and minimum reference values, the acquired data is saved and the Hold status is set; otherwise the acquisition/comparison process repeats (Fig. 3-20).

In COMP-OUT the acquired data is compared with the reference data, and if any point falls outside the maximum and minimum reference values, the acquired data is saved and the Hold status is set; otherwise, the process of acquisition and sampling is repeated (Fig. 3-21).

Data is acquired only once for comparison in the NORM(al) or ENV(elope) Record Mode. (If a COMP IN/OUT trigger is selected, ENV # of times is automatically set to 1.) When the record mode is AVE(rage), the data is acquired the AVE # of times and averaged, then it is compared.

When the Input Coupling is set to GND, the Compare Trigger Mode is ignored for the channel with its coupling grounded.

NOTE

When using the COMP modes, the reference data must be stored in the last memory location. The reference data must be enveloped data.

Manual Trigger

Once the ARM'D indicator illuminates, the MAN TRIG key can be pushed to acquire a waveform at any time.

Arm Delay

ARM is a control signal that occurs after a predetermined period set by ARM DELAY. It allows triggering of the RTD 710A, and starts the TRIG DELAY period. Since acquisition cannot start until the ARM DELAY period has elapsed, it can be used for trigger holdoff to control the time between acquisitions in the AUTO, NORMAL, or COMPARE modes.

ARM DELAY is displayed in seconds on the Trigger Display. The time sequence for arming is as follows:

The ARM DELAY range is 0-10 seconds in a 1-2-5 sequence. If it is set to zero (0), the actual trigger holdoff time depends upon display update time, acquisition system reset time, and pretrigger acquisition time. When EXT arm is selected, the ARM DELAY is automatically set to zero (0).

When an acquisition is stopped by the HOLD key (or HOLD ON command over the GPIB) before the ARM'd condition occurs, the last acquired data in the record location is all valid because a new acquisition can't start until ARM'd occurs.

ARM is a control signal that allows triggering of the RTD 710A, or the start of a TRIG DELAY, after some predetermined period set by ARM DELAY. The actual writing of data to memory cannot begin until after the ARM DELAY period. The timing for actual waveform acquisition is determined by the TRIG DELAY period. The acquisition status indicator ARM'D lamp illuminates when the ARM signal occurs and goes out when acquisition starts.

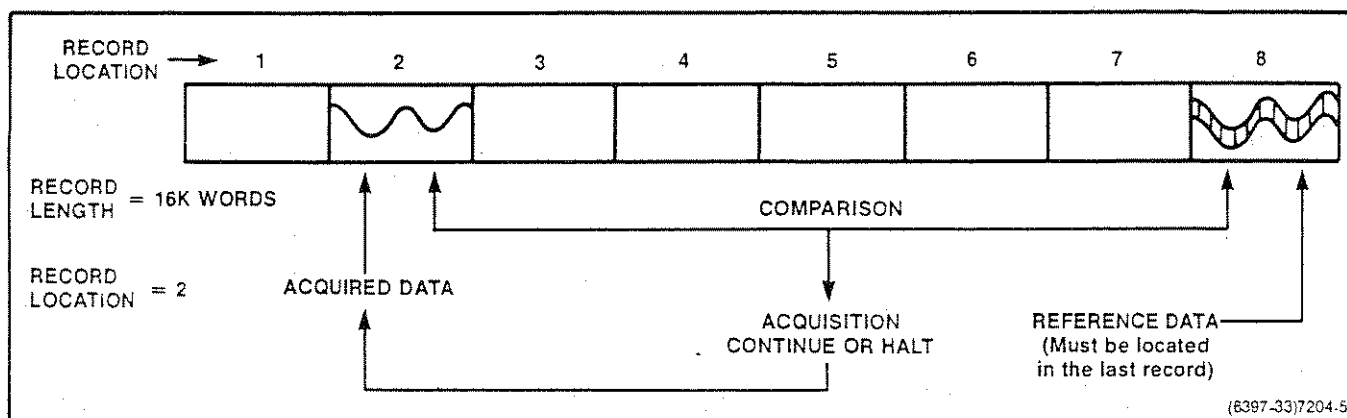

Fig. 3-20. COMP-IN trigger mode representation.

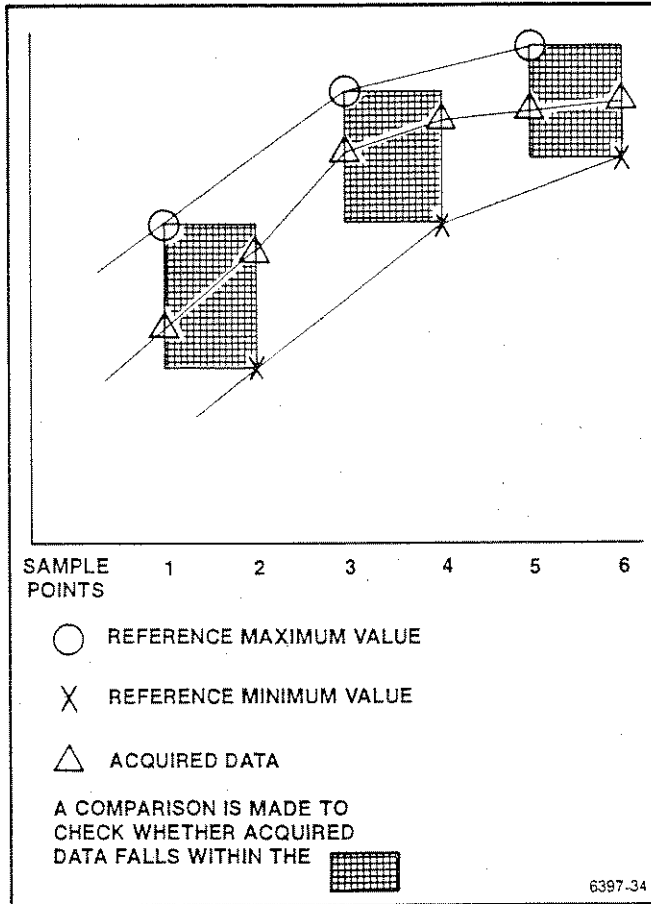

Fig. 3-21. Method of data comparison.

INTERNAL ARM DELAY. The amount of internal Arm Delay that can be set is 0, or 10 milliseconds to 10 seconds in a 1-2-5 sequence.

To set internal ARM DELAY:

1. Press the ARM DELAY key. Its current value will be displayed in the Trigger display.

2. When the key indicator is blinking, use the Parameter Entry Knob to set a new value.

EXTERNAL ARM DELAY. The amount of external Arm Delay that can be set is infinite. If the ARM DELAY key is pushed while its indicator is blinking, the Arm Delay input signal is from the rear panel EXT ARM connector, and the character "E" is displayed on the Trigger display. The instrument is effectively arm'd upon receipt of the leading edge of a positive-going TTL signal level. For additional information, see the Controls, Connectors, and Indicators description.

NOTE

When ARM DELAY is 0 and Trigger MODE is AUTO, NORM, or COMPARE, waveform acquisition is repeated continuously. However, since some amount of time is required to setup for waveform display and acquisition initialization, the delay between subsequent acquisitions is greater than 0. This delay also depends upon the acquisition and display settings.

Trigger Delay

The TRIG DELAY setting determines the trigger position of the waveform data. A positive (+) trigger delay is called post-trigger and a negative (-) trigger delay is called pre-trigger. A pre-trigger delay allows the acquisition of data prior to the trigger event while a post-trigger delay allows acquisition of data after the trigger event.

To set internal TRIG DELAY:

1. Push the TRIG DELAY key. Its current value will be displayed on the Trigger display.

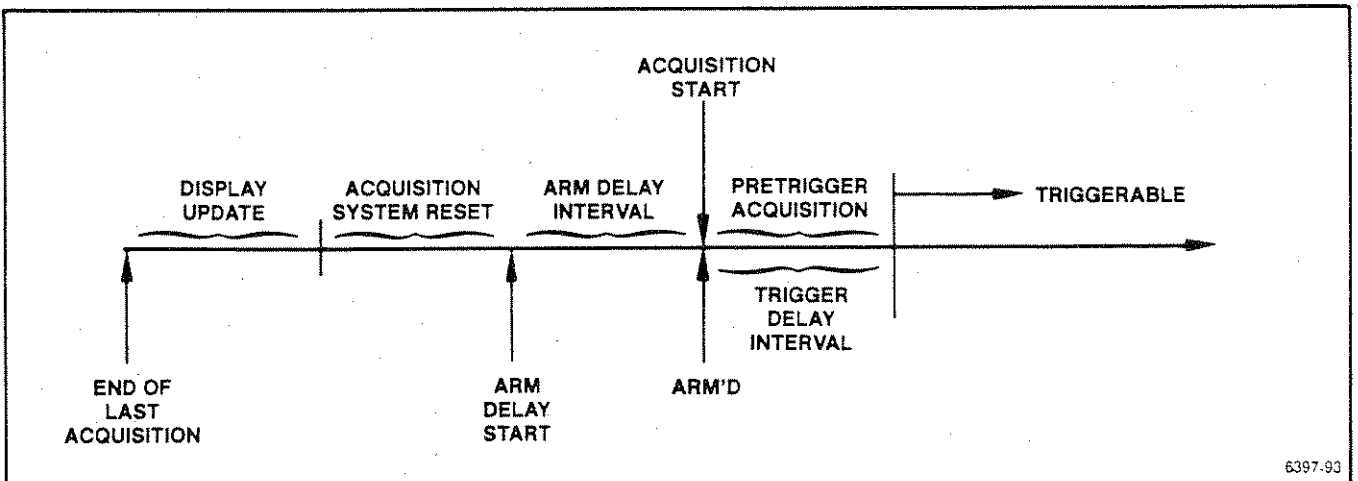

Operating Instructions

2. The value of TRIG DELAY can be set in points of address or time (equivalent of points times the sample interval). Once the TRIG DELAY key indicator starts blinking, additional pushes cause it to toggle between points or time settings, except time settings are not available when the Time Base CLK SOURCE is EXT(ernal).

The available TRIG DELAY is from $-(\text{record length} - 8)$ to $+262136$ in increments of 8 in NORM Sample Mode; or from $-(\text{record length} - 16)$ to $+262128$ in HI SPD Sample Mode.

PRE-TRIGGER OPERATION. In pre-trigger operation, data is written to waveform memory upon receipt of the ARM signal. After one record of pre-trigger data is acquired, the instrument becomes triggerable. When a trigger input occurs, the acquisition is terminated after acquisition of post-trigger data has been completed.

A minus trigger delay value determines the number of points of pretrigger data to be saved in the waveform memory. For example, if the trigger delay is -400 , then 400 points of the pretrigger data is recorded (Fig. 3-22).

POST-TRIGGER OPERATION. In post-trigger operation, only data following the trigger is acquired. When the ARM signal occurs, waveform data is acquired. Upon receipt of the trigger, the TRIG'D indicator illuminates and the TRIG

DELAY count begins. When the TRIG DELAY expires, one record of waveform data is acquired. If the TRIG DELAY value is 0, data is acquired immediately after the trigger is received (Fig. 3-23).

NOTE

There is approximately a 30 ns timing delay between trigger occurrence and trigger recognition in the RTD 710A. This timing delay should be taken into account for the pretriggering setting (TRIG DELAY setting) when the actual trigger occurrence is important. For example, when the sample interval is set to 10 ns, the RTD 710A recognizes the trigger 3 clocks after the actual trigger occurrence. The trigger point on the waveform is displayed by an intensified dot, which is the recognized trigger point. The actual trigger occurred 3 clocks before the displayed point.

External Trigger

The trigger signal can be obtained via CH1 and CH2 input channels when the trigger source is set to INT(ernal). When the displayed waveform requires another trigger source, the desired trigger signal can be input via the EXT TRIG input connector by setting the trigger source to the EXT(ernal) position.

Since the external trigger full-scale signal range is ± 5 V, the voltage display levels for the trigger differs from that used for internal triggers.

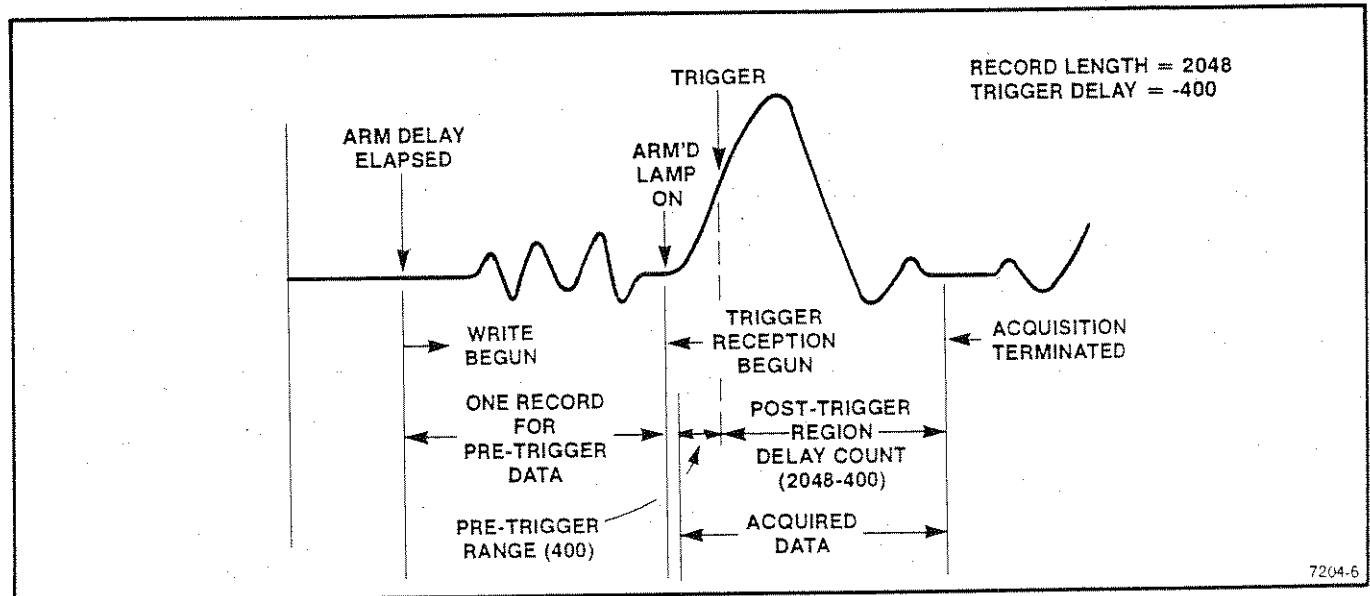

Fig. 3-22. Pre-trigger operation.

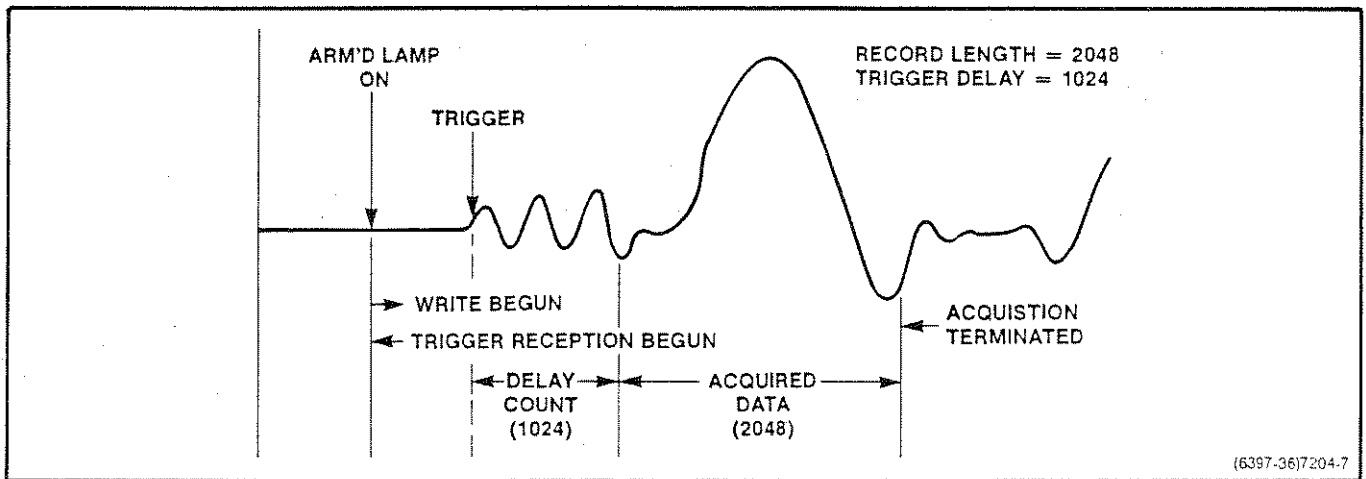
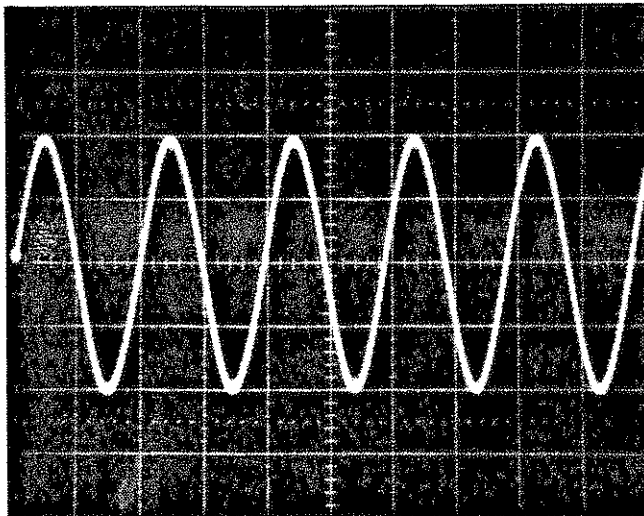

Fig. 3-23. Post-trigger operation.

TIME BASE

Sample Interval

The RTD 710A samples the analog input signal at discrete time intervals, then A/D converts (quantizes) the sampled voltage levels at sampled time points and stores the digitized data into waveform memory. To acquire the analog input signal accurately, the sample interval must be selected carefully. Figure 3-24 shows an example of an input signal that has been sampled at a rate of about 400 times its frequency and digitized, while Fig. 3-25 shows an input analog signal sampled at about 50 times its frequency and digitized. The amount of data that is sampled within a set period increases as the interval time decreases. These two figures show the difference between the reproducibility of waveform data that contains steep rises and falls.



6397-37

Fig. 3-24. Waveform derived with a fast sampling interval.

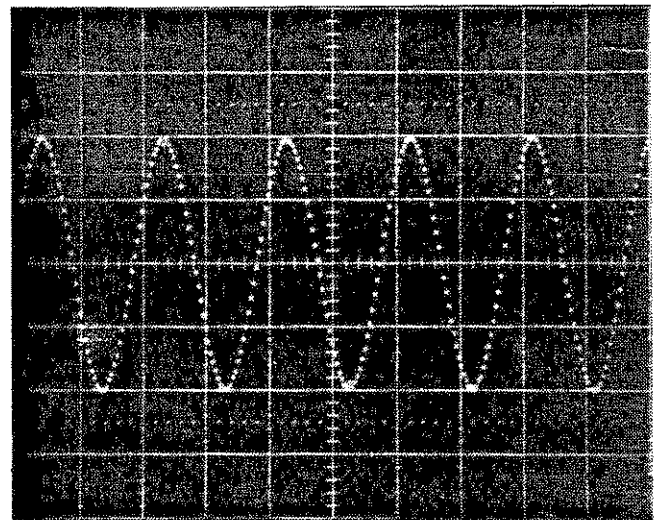

6397-38

Fig. 3-25. Waveform derived with a slow sampling interval.

Figure 3-26a shows a slowly changing waveform example containing a high-frequency spike. It shows what can happen if the sampling interval is slower than the width of the noise spike (low sampling rate), and the spike occurs at a point that isn't sampled. In this case, the spike would not be displayed on the screen (Fig. 3-26b). By decreasing the sampling interval (higher sampling rate), the noise spike should be sampled and displayed as shown in Fig. 3-26c. However, when the spike noise itself is to be observed, the sampling interval should either be shortened (faster sampling rate) or a breakpoint, which is described later, should be used and the noise spike windowed and enlarged.

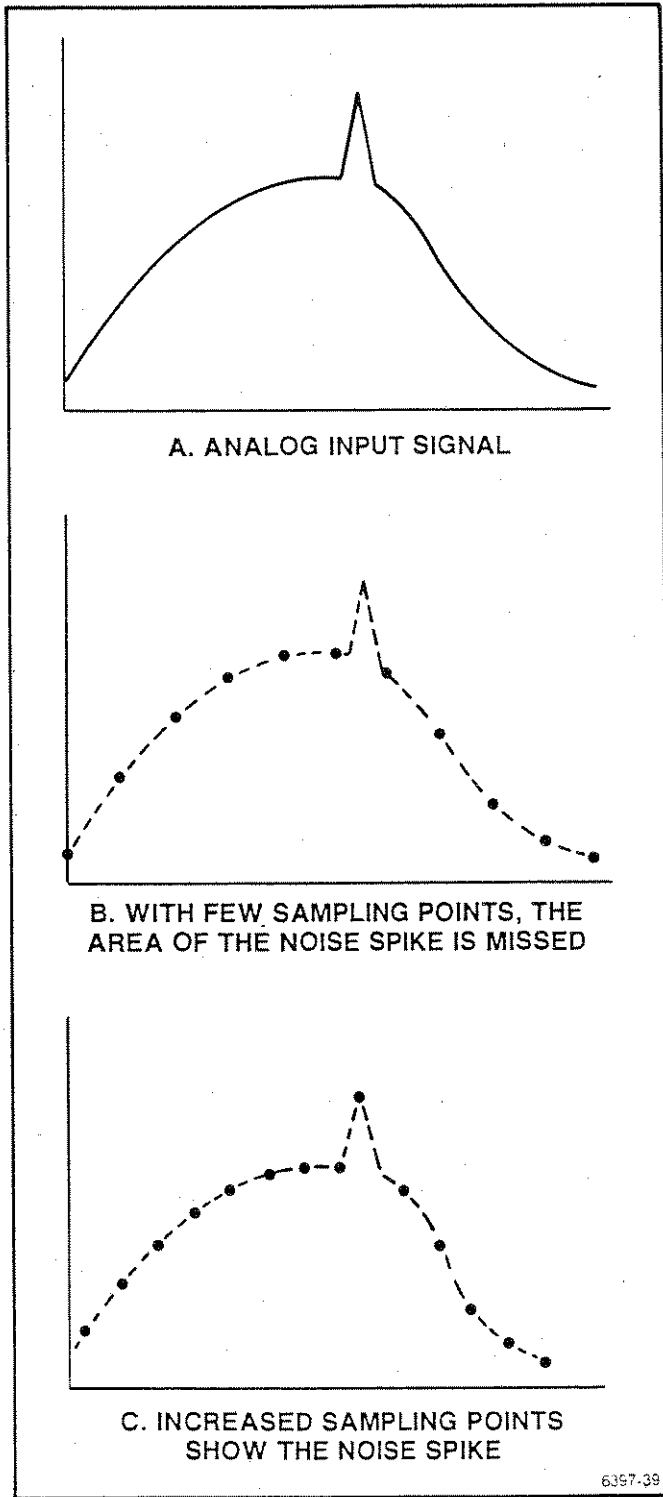

Fig. 3-26. Examples of sampling rates for noise spikes.

Aliasing

A waveform digitizer involves some unique constraints related to sampling that contrast to the conventional oscilloscope. One effect is called aliasing, which occurs when the sample frequency is too low in comparison to the analog input signal.

Fig. 3-27 shows the occurrence of aliasing. When a sine wave (Fig. 3-27a) is digitized at an adequately high sample frequency, the waveform is reproduced on the CRT monitor as shown in Fig. 3-27b. However, if the sample frequency is decreased (slower sample interval), or the analog input signal frequency is increased until the sample frequency is less than the maximum input signal frequency, as shown in Fig. 3-27c, the waveform is recorded as shown by the dotted line in Fig. 3-27c. The signal is called an aliased signal, and differs from the input signal.

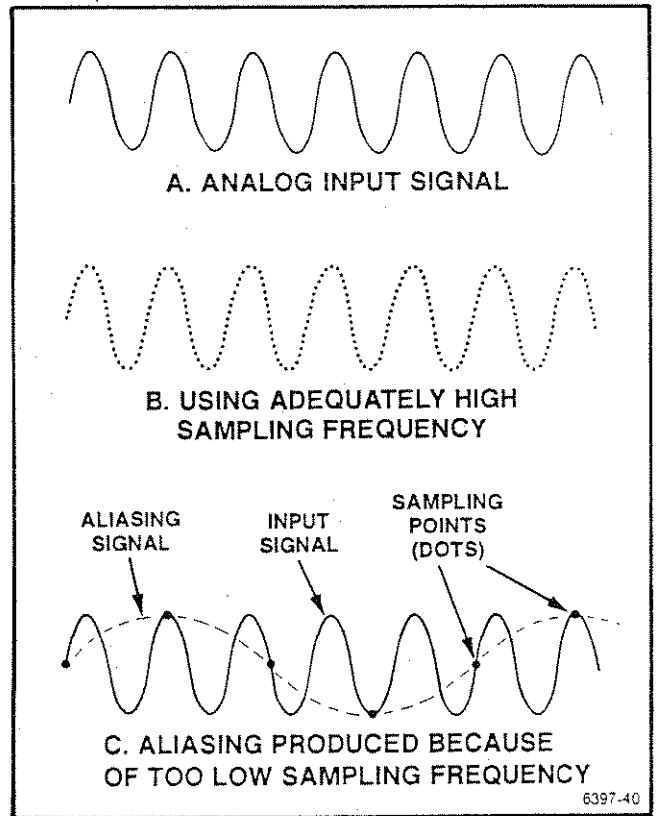

Fig. 3-27. Display of aliasing.

In order to avoid aliasing, it is necessary to select a sample frequency at least twice as high as the highest frequency component of the input signal. If the input signal is unknown, increase the sample frequency until a stable triggered display is obtained.

NOTE

Envelope mode can be used to verify the signal is not aliased. If the signal is aliased, the envelope display will "paint" two horizontal lines representing the maximum and minimum levels. If the signal is sampled correctly, the envelope shows the signal with its maximum and minimum.

If the input signal contains frequency components high enough to cause aliasing even at a 100 MHz sample frequency, the use of a filter to eliminate components of frequencies higher than the Nyquist frequency (1/2 of sample interval frequency) is recommended.

If the sample frequency is an integral multiple of the input signal frequency, even when the former is much higher than twice the input signal frequency, interference stripes appear as shown in Fig. 3-28. This is called perceptual aliasing, a sort of visual illusion caused by dot representation.

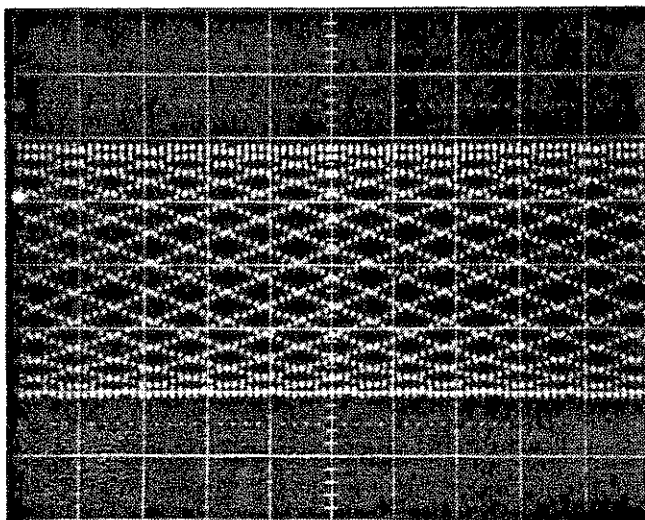

Fig. 3-28. Display with perceptual aliasing.

In Fig. 3-29, where the abscissa of Fig. 3-28 is expanded by 8, the display shows that the input signal is a high-frequency signal, rather than a low-frequency signal as Fig. 3-28 would seem to indicate.

In a normal display, interference stripes appear because adjacent dots are visually connected. In contrast to aliasing that occurs with signals of higher frequency than the Nyquist frequency, perceptual aliasing does not prevent faithful analysis of waveforms. In order to avoid perceptual aliasing, it is necessary to select a sample frequency as high as possible.

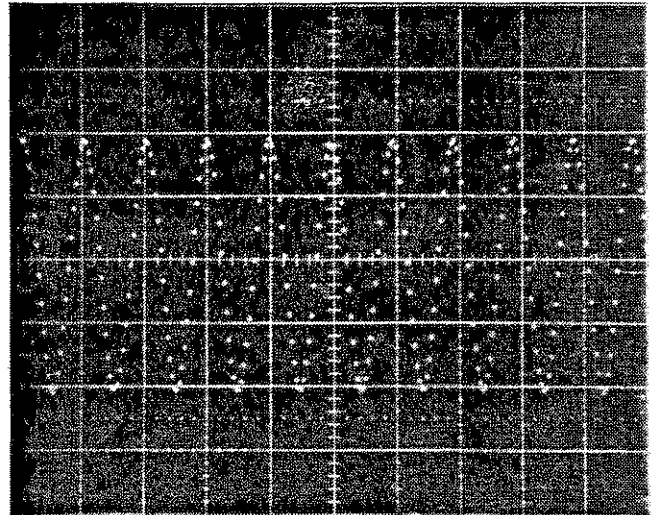

Fig. 3-29. Redisplay of perceptual aliasing expanded by 8.

To eliminate aliasing and reduce perceptual aliasing, it is desirable to use a sample frequency as high as possible. However, a disadvantage of using a high sample frequency is that it reduces the record time. When a slowly changing signal includes a fast signal, more effective recording can be achieved by using the sample rate switching.

Setting Sample Interval

To set the Sample Interval:

1. Select the CLK SOURCE (INT or EXT).

2. Push the SAMPLE INTERVAL key. The sample interval or external division ratio will be displayed in the Time Base display. If the key indicator is blinking, use the Parameter Entry Knob to set a new sample interval.

With an internal clock source and a high-speed sample mode, the SAMPLE INTERVAL can be set to 5 ns, or 10 ns to 200 ms. With an internal clock and normal sample mode, it can be set from 10 ns to 200 ms. In either case, the sample interval can be set in a 1-2-3-4-5-6-7-8-9 sequence (e.g., 10 ns, 20 ns, 30 ns, ..., 200 ms).

Operating Instructions

With an external clock source, the division ratio of the clock signal being input through the rear panel EXT CLK IN connector can be set. This division ratio sets the sampling interval of the divided clock signal. The division ratio that is displayed is defined as:

$$N \times 10^M$$

where $N = 1, 2, 3, 4, 5, 6, 7, 8, \text{ or } 9$, and $M = 0-7$ (normal), and where $N = 1, 2, 4, 6, \text{ or } 8$, and $M = 0-7$ (high speed).

For example, if the division ratio is 1/10, 1E1 is displayed.

Roll Display Mode

The RTD 710A displays acquired data in two different modes: normal and roll mode. Whichever mode is to be used is automatically selected when the sampling interval is set.

When the sample interval is faster than 100 μs , a normal display occurs where data is displayed on the CRT monitor after the waveform acquisition is completed.

When the sample interval is 200 μs or longer, the acquired data is displayed on the CRT monitor as it is acquired. This is a Roll mode display, which displays data similar to a chart recorder. Roll mode allows a continuous view of a slowly changing signal. Newly acquired data points are displayed as a continuous stream with each newly acquired data point appearing at the right side of the CRT monitor. As new data points are acquired, the previous data point "rolls" toward the left side of the monitor, creating a constant flow of data across the screen.

The following control and display limitations exist in the roll mode:

1. The roll mode will not operate with the following settings:

- a. RECORD MODE of AVE.
- b. RECORD MODE of ENV.
- c. CLK SOURCE of EXT.
- d. RECORD LENGTH of 1K words.

2. The horizontal and vertical display multiplier is X1 (It is unchangeable.)

3. Cursor display is unavailable during acquisition. Any attempts to use the cursors result in termination of the acquisition.

External Clock

As indicated earlier, there are two clock sources — internal and external — that can be selected to provide timing for the sample interval. The internal clock can be selected for sampling intervals up to 200 ms (5 Hz).

An external clock can be selected (requires an ECL clock signal input through the EXT CLK IN connector on the rear panel) whenever:

- A slower sampling interval than 200 ms is desired.
- A desired sampling interval isn't available from the internal clock.
- It is necessary to sample with a clock that is in sync with the input signal.

The maximum frequency and minimum pulse width for an external clock signal is contained in Appendix B, SPECIFICATIONS. Always stay within the specifications since an external clock signal that exceeds these specifications may prevent normal sampling and cause misoperation. When using an external clock, time displays such as trigger delay, breakpoint, and time and frequency cursor measurements cannot be made.

RESET/HOLD Function

For the discussion of the RESET/HOLD function, refer to Fig. 3-30.

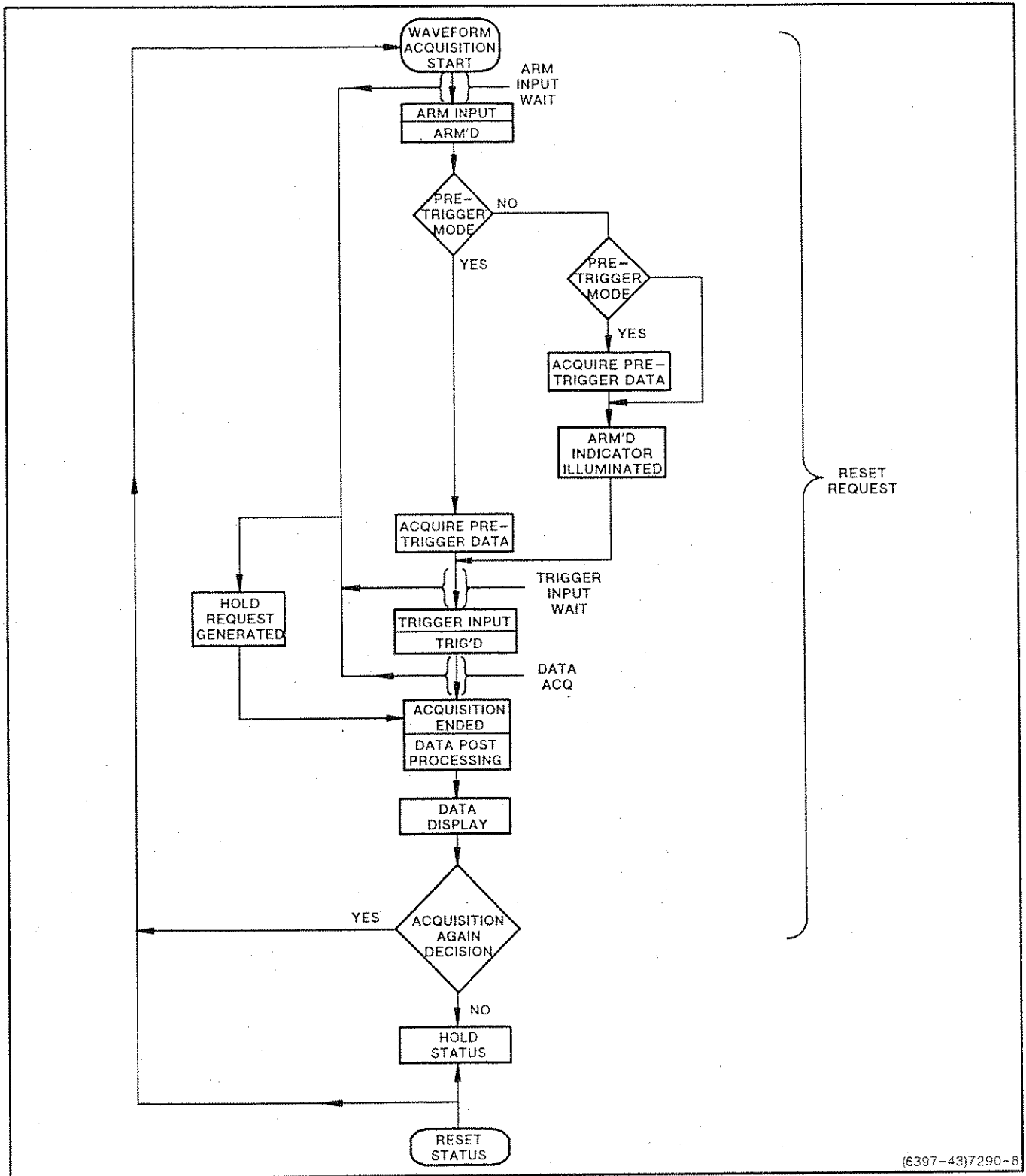

(6397-43)7290-8

Fig. 3-30. RESET/HOLD function and data acquisition.

Operating Instructions

Pressing the RESET/HOLD key during data acquisition causes its indicator to illuminate, data acquisition to stop when the record is filled, and the HOLD status to be set.

HOLD NEXT/HOLD IMMEDIATE STATUS. If the sampling rate is fast, acquisition occurs in the designated location and the HOLD status is set after acquisition completion. If the sampling rate is slow, there are two HOLD status choices available: HOLD Next and HOLD Immediate. The first press of the RESET/HOLD key causes its indicator to begin blinking and sets the HOLD Next status. In this status, waveform data is acquired into the designated location and the HOLD status is set after acquisition completion. If the RESET/HOLD key is pressed again while its indicator is blinking, the HOLD Immediate status is set. In this status, the acquisition is halted immediately, and the HOLD status is set.

HOLD STATUS SETTING. Since acquired data would most likely be altered whenever the Sample Mode, Record Length, or Record Location is modified, the HOLD status is automatically set whenever one of these functions is changed. Other conditions that will set HOLD status are:

- When the trigger mode is SGL and one acquisition has occurred.
- When the trigger mode is either COMP-IN or COMP-OUT and the compare results match with the reference conditions.

After the HOLD status is set, acquisition is resumed by pressing the RESET/HOLD key, which should extinguish the key indicator, or by receiving a HOLD RESet command over the GPIB. To protect the data in waveform memory, no data acquisitions can occur while the HOLD status is set.

If the HOLD status is set during waveform acquisition, the data display integrity varies depending on the point in the acquisition where the HOLD status was set. This is detailed in Tables 3-8 and 3-9.

When the HOLD status is forcibly set once between the reset for the acquisition start and the occurrence of the ARM'D event, the display conditions of Table 3-8 apply.

When the HOLD status is set once between the occurrence of the ARM'D event and the end of acquisition, the display conditions shown in Table 3-9 apply.

**Table 3-8
DISPLAY CONDITIONS RESET-TO-ARM'D**

Display	Record Mode	1: Display Data; 2: Display Effectiveness
Normal	Normal	1. Last acquired data in present location; 2. Depends on the status of previous acquisition.
	Average (count ≥ 2)	1. Gives average of up to last acquisition; 2. All data valid.
	Average (count = 1)	1. Last acquired data in present location; 2. Depends on the status of previous acquisition.
	Envelope (count ≥ 2)	1. Gives envelope of up to last acquisition; 2. All data valid.
	Envelope (count = 1)	1. Last acquired data in present location; 2. Depends on the status of previous acquisition.
	Advance (count ≥ 1)	1. Data of the record location last acquired; 2. All data valid.
	Advance (count = 1)	1. Last acquired data in record location 1; 2. Depends on the status of previous acquisition.
Roll Mode		1. All data displayed as 0 since the memory content is cleared prior to acquisition; 2. All data valid.

NOTE

When HOLD is set prior to TRIG'D, there is no trigger point; therefore, the reference point becomes the same point as the display reference point, which also becomes the first data point. The acquired data can't be sent over the GPIB.

When HOLD is set after TRIG'D, the trigger point becomes the point of reference for measurement and the display reference point is the point at where the data write begins.

Sample Rate Switching At Breakpoints

In many situations, only a small part of the waveform (e.g., the rising edge of a fast pulse) is of major interest. In these cases, sampling at a high rate to provide good time resolution for that particular part of the waveform produces a large amount of unnecessary information for the remainder of the waveform. The RTD 710A sample rate switching capability at breakpoints provides a means of changing the sampling interval during an acquisition to expand the important part(s) of a waveform, while compressing the less important part(s). For example, when acquiring the risetime and width of a square wave pulse, the fast rising edge might be sampled at a 10 ns rate until the pulse reaches its maximum amplitude, then the sampling interval might be changed to 200 ns for the remainder of the acquisition.

A sampling interval change is marked whenever a breakpoint is set using the front-panel Break Point SET key in local mode, or with the BREAKPOINT SET command over the GPIB. Breakpoints are displayed and cleared using the Break Point DISPLAY and CLR keys, or by using the GPIB commands BREAKPOINT CLEAR and BREAKPOINT? commands.

Breakpoints divide a record location into blocks, where each block contains all samples from the specified breakpoint to the next breakpoint (or end of record). Up to five (5) breakpoints can be set by the user for each waveform acquisition. The first breakpoint (unsettable), which is not included in the five user settable breakpoints, is the trigger point. Breakpoints are shown on the display as an intensified dot.

Setting Breakpoints.

Breakpoints can be set in either address (points) or time. When BREAKPOINT SET is first selected, its value is displayed in points. Once the key indicator is blinking, pressing the key causes the displayed value to toggle between points and time. When an external sampling clock source is used, the time feature for setting breakpoints is not available since the external sample interval is unknown.

The breakpoint address has a range of from either 16 (sample mode: NORMAL) or 32 (sample mode: HI-SPEED) to 524264 or 524240. While the values can be designated in steps of either 8 (NORMAL) or 16 (HI-SPEED), the upper limits of the address that is effective for the record is (record length + trigger delay - 16 or 32). Breakpoints exceeding the effective limit may be ignored. Fig. 3-32 shows an example where 4 breakpoints have been set. Figs. 3-33 and 3-34 show an example of a single acquisition where the breakpoint function was used.

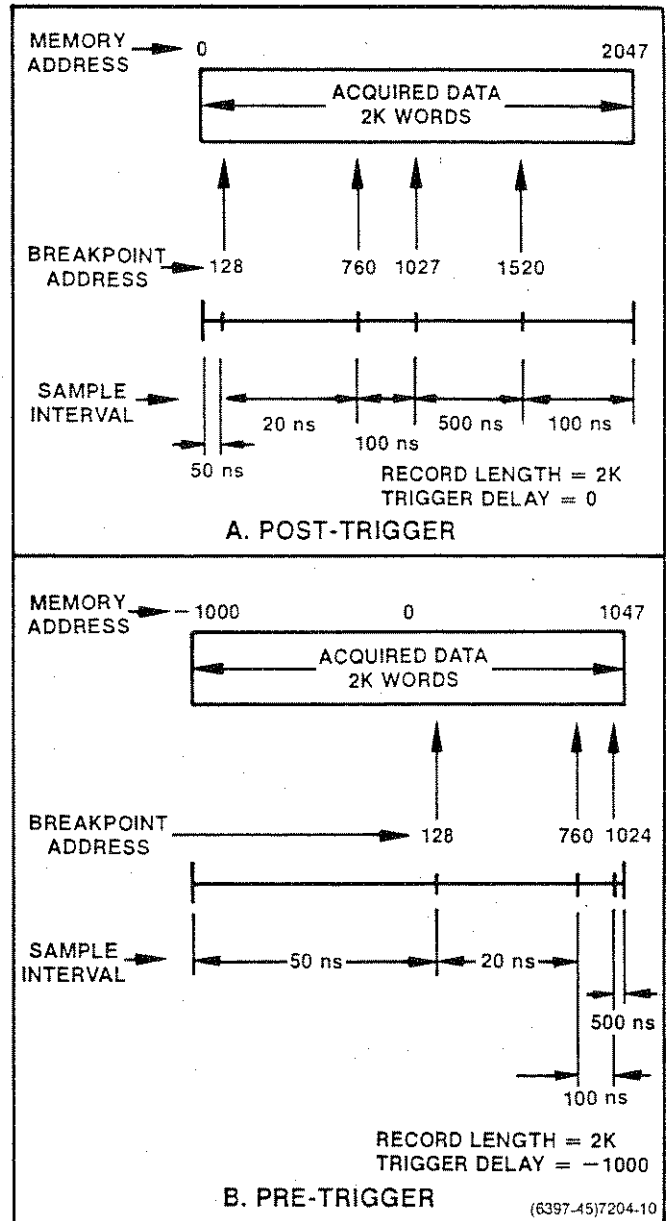

Fig. 3-32. Breakpoint settings with pre-trigger and post-trigger.

NOTE

A breakpoint may be set at address 0, but in such a case the sample interval becomes the area from the first address of the waveform memory to the first breakpoint.

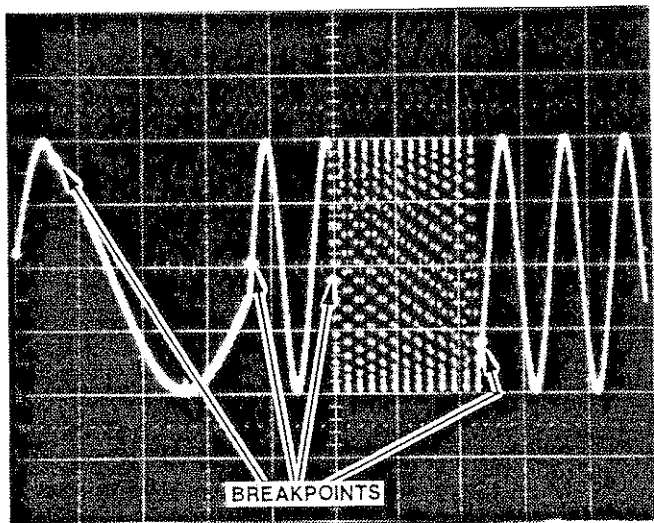

Fig. 3-33. Breakpoint waveform with post-trigger.

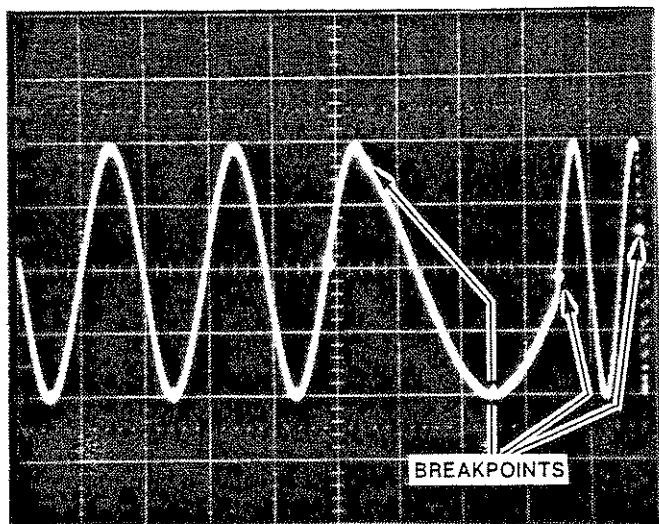

Fig. 3-34. Breakpoint waveform with pre-trigger.

To set breakpoints:

1. Push the BREAKPOINT SET key. This will lock the sample interval between the last breakpoint and the one to be set at this time to whatever is currently displayed. The current breakpoint location (in points) will be displayed in Record display. If the key indicator is blinking, use the Parameter Entry Knob to set a new breakpoint. While the key indicator is blinking, pushing it again will select time as the units for setting the breakpoint.

2. Push the SAMPLE INTERVAL key. The current breakpoint, which is displayed by step 1 above will be entered into the acquisition system. The current sample interval will be displayed in the Time Base display. While the key indicator is blinking, use the Parameter Entry Knob to set the sample interval for the current memory block.

3. Repeat steps 1. and 2. to set up to five (5) breakpoints per waveform acquisition.

NOTE

If no further SAMPLE INTERVAL or BREAK POINT settings are to be made, it is recommended that another key, other than the RESET/HOLD key, be selected to lock the settings. Otherwise, the user may move the Parameter Entry Knob accidentally, which will change the value for whatever key is blinking. A good key to push is the BREAK POINT DISPLAY key, which would allow the user to review the values of the current breakpoints and their associated sample intervals. CURSOR1 may be used to measure (in time or clock points) the location of a desired breakpoint.

Up to five breakpoints can be set. If all have been set, a new breakpoint cannot be set until at least one old setting has been cleared.

DISPLAYING AND CLEARING BREAKPOINTS. To display the breakpoints that are set:

1. Press the BREAKPOINT DISPLAY key. When first pressed, the key indicator will start blinking, and the Recording display will show breakpoints in points. If the key is pressed again, the display will show breakpoints in time (internal clock only).

2. To check where the breakpoints are set, rotate the Parameter Entry Knob. Each time the display changes that is one of the breakpoints that is set. When the last breakpoint is displayed, further rotation of the knob in the same direction causes no further display changes. The displays will range from 0 to the last breakpoint set.

To clear a breakpoint at this point, rotate the Parameter Entry Knob until the breakpoint to be cleared is displayed, then push the BREAKPOINT CLR key.

To clear all breakpoints at this point, rotate the Parameter Entry Knob until the last breakpoint is displayed, then keep pushing the BREAKPOINT CLR key, until the display is zero (0). Zero represents the trigger point.

Operating Instructions

Average Mode

The waveform averaging process is useful for reducing uncorrelated noise in signals, and improves its signal-to-noise ratio. The effectiveness of average processing is dependent on the number of the acquisitions that are added for the average and the characteristic of the noise. The number of acquisitions that can be averaged is 2 to 16384 in 2^n steps. The greater the number of acquisitions averaged, the higher the noise rejection (improvement factor of signal to noise ratio). This is expressed in the following formula.

$$S/N \text{ IF} = 10 \log N \text{ (dB)}$$

where S/N IF is Signal-to-Noise Improvement Factor, and N is equal to the number of the acquisitions.

For example, the S/N IF is about 3dB for every power of 2 increase of N, where $N = 2^n$ and $n = 1-14$.

The results of the average process is displayed on the CRT monitor every 2^n acquisitions, and the reduction in noise can be observed as the average process continues. If the acquisition is set to HOLD status during average processing, the results of the number of acquisitions processed to that point are displayed. If RESET status is set, the average process starts over again. During the period that the waveform data is being acquired in the average mode, the number of the acquisitions being averaged is displayed on the Recording display, if the AVE/ENV # of TIMES key has been selected. This allows the operator to observe the acquisition number when the HOLD status is set during average processing.

Averaging is made at the maximum rate when ARM DELAY is set to 0 and DISPLAY LOCATION is set to 0.

Since it cannot be determined if excessive noise exists in the waveform data when it is being acquired during the average mode, it is necessary to pay attention to the setting of the trigger. If a trigger is generated due to noise, the results of the average processing will be inaccurate. Therefore, it is important that a stable trigger be generated by using the hysteresis trigger slope, an external trigger signal, etc.

To set the average mode:

1. Set RECORD MODE to AVE.
2. Set HOLD/RESET to HOLD.

3. Press the ENV/AVE# OF TIMES key. When selected, the key indicator blinks and the current # of Times setting is displayed in the Recording display.

4. Use the Parameter Entry Knob to set the number of acquisitions that are to be averaged.

NOTE

The maximum length of the waveform data that can be average processed is 8K words per channel. If an amount greater than this is designated, only the first 8K words of data is averaged.

In the average mode, the RECORD LENGTH can be set only to 128K words or less.

Auto Advance Mode

Setting RECORD MODE to ADV(ance) sets the Auto Advance mode permitting data to be written to many memory locations (Fig. 3-35).

The Auto Advance mode is useful for capturing and observing the closely occurring transient waveforms and looking for random events. It also allows for quick acquisition of slow, repetitive, single shot events, such as an echo signal. In this mode the number of auto advance locations determines the number of snapshots that are taken of the input signal and stored in waveform memory.

The number of auto advance locations is set by the RECORD LOCATION key. Maximum is 128 (1K lengths) for DUAL vertical mode or 256 (1K lengths) for CH1 ONLY mode. The location is automatically incremented after each record is acquired until the specified number of locations is reached. The acquisition "dead time" between the last record acquired and the next triggerable event is set by ARM DELAY.

When an acquisition is started, the input signal is first captured into record location 1. After the first acquisition is completed, the RTD 710A will arm, then wait for the next trigger signal before starting the next acquisition. The next acquisition is captured into record location 2. This process continues until the specified number of locations is reached. If the display location is not 0, then the waveform display is updated after each acquisition. Acquisitions are made at the maximum rate when ARM DELAY and DISPLAY LOCATION are set to 0.

To set the Auto Advance mode:

1. Set RECORD MODE to ADV.
2. Press the RECORD LOCATION key. When selected, its indicator blinks and the current record location is displayed in the Recording display.

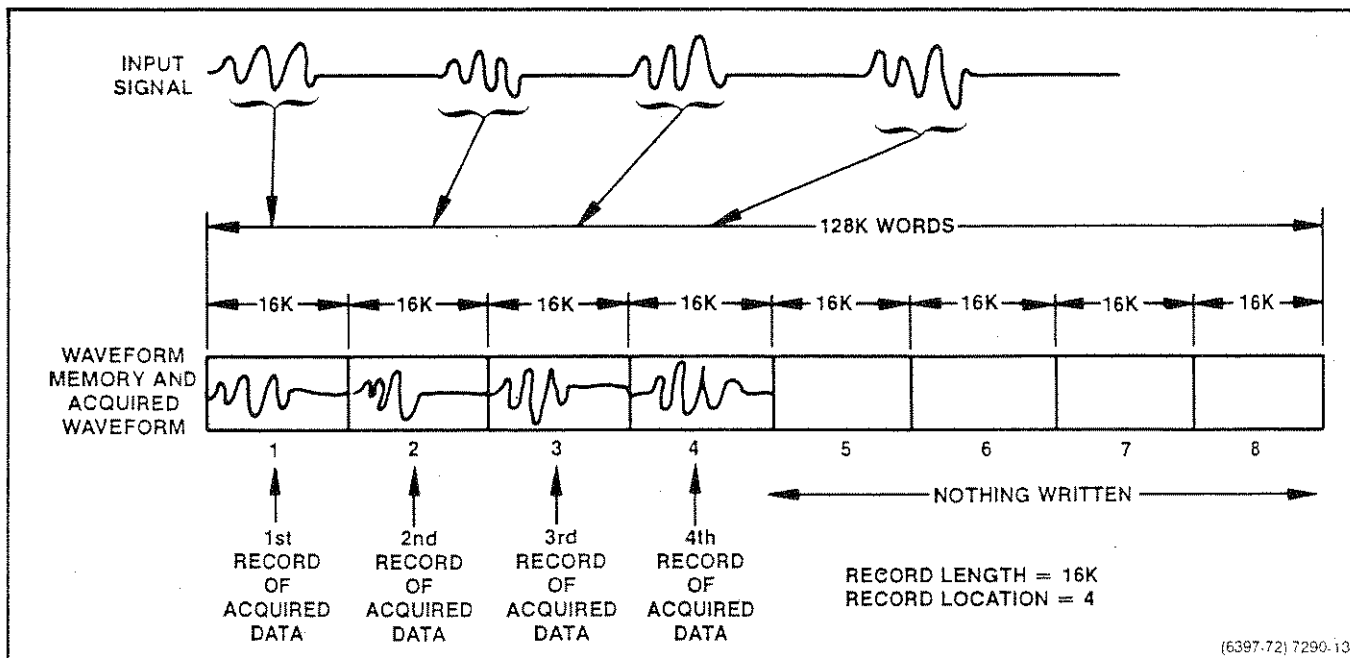

Fig. 3-35. Auto-advance representation.

3. Use the Parameter Entry Knob to set the desired maximum record location number.

NOTE

The COMP-IN and COMP-OUT Trigger MODE cannot be set in the ADVance RECORD MODE. If either of these two trigger modes is selected, RECORD MODE automatically changes to NORMAL.

Envelope Mode

Setting RECORD MODE to ENV(elope) causes waveform data to be acquired using envelope processing. Envelope processing detects and displays the maximum and minimum peak values of the input signal during designated sample intervals. One of the following two sampling methods is automatically selected depending upon the number of envelopes.

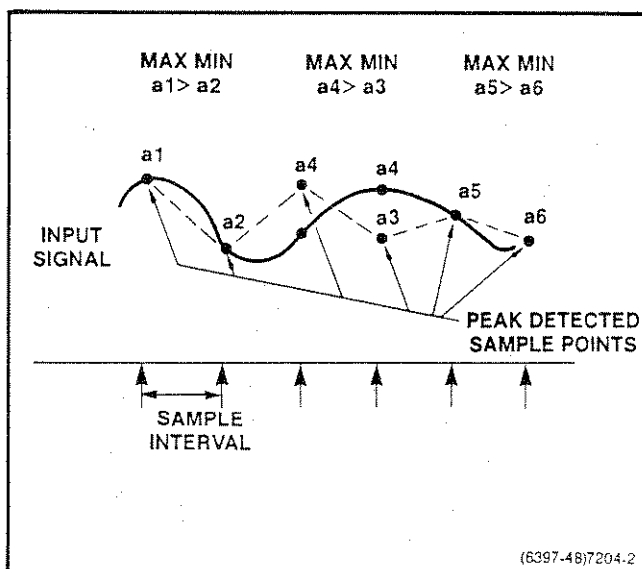

Fig. 3-36. Envelope peak detection.

Operating Instructions

1. If the ENV # of TIMES is 1, the input waveform signal is sampled at the designated sample interval and each two consecutive samples are compared and in sample value order (Fig. 3-36b).

2. If the ENV # of TIMES is 2 or more, the first acquired data is sampled as in method 1 above and stored in the specified RECORD LOCATION and reference memory location (last record of the memory). Then on the next and subsequent envelope times, the acquired waveform samples are compared with the maximum and minimum data of the previously stored data to create envelope data that corresponds to each of the sampling points. The results are stored in the record location and reference memory location (Fig. 3-37).

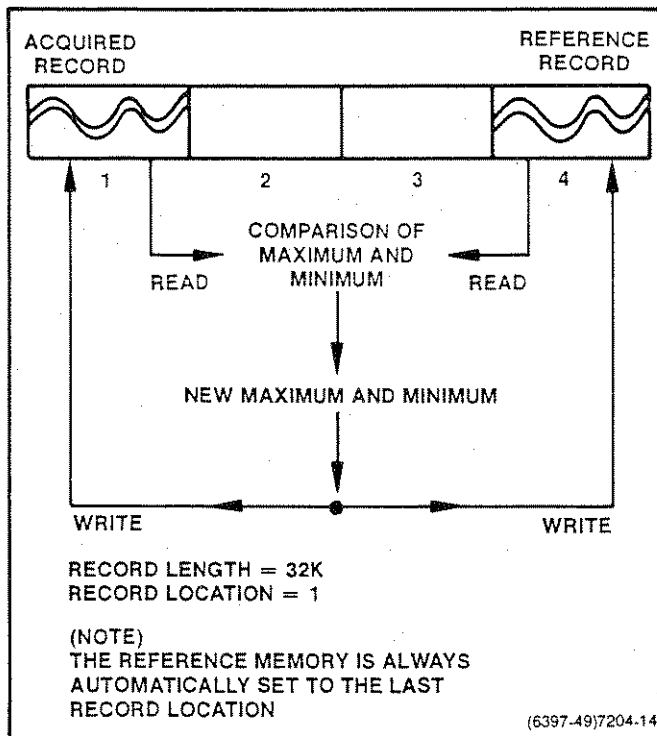

Fig. 3-37. Enveloping two or more times.

Acquired data is displayed two times: first in order, and second by reversing the order in the above consecutive sample set. The resultant display achieves the waveform envelope consisting of groups with two values, maximum and minimum, displayed as shown in Fig. 3-38.

When using the cursor to make measurements on the CRT monitor, the even and odd number addresses contain maximum and minimum values, respectively.

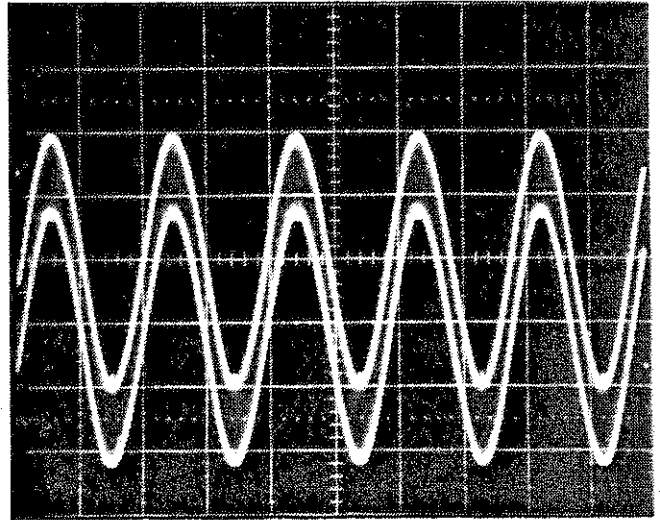

Fig. 3-38. Envelope display.

The ENV # of TIMES can be designated either by 2^n ($n = 0-14$), or by 99999, which designates an endless number of envelopes. In this case, the envelope mode repeats until acquisition is terminated with the RESET/HOLD key. When the ENV # of TIMES is 1, a reference memory location is not used; therefore, full memory length is available.

The ENV # of TIMES is displayed on the Recording display during waveform data acquisition in the envelope mode.

To set Envelope mode:

1. Select the ENV position of the RECORD MODE toggle key.
2. Press HOLD/RESET to stop the acquisition (LED steady on).
3. Press the ENV/AVE# OF TIMES key. When selected, its indicator blinks and the current # of TIMES value is displayed in the Recording display.
4. Use the Parameter Entry Knob to set the desired ENV # of TIMES.

NOTE

When the ENV # of TIMES is two or more, the TRIG MODE COMP-IN and COMP-OUT cannot be set. If either of these trigger modes is selected, the ENV # of TIMES automatically changes to one.

The BREAK POINT function and SAMPLE MODE HI SPD cannot be used in the envelope mode. The envelope record is made at the maximum rate when ARM DELAY and DISPLAY LOCATION are set to 0.

The timing accuracy for the data acquired by envelope mode is 1/2 the sample interval.

CONTROL

Cursor Operation

Cursors allow measurements to be made of various waveform parameters. By pressing either the CURSOR 1 or CURSOR 2 keys, a cursor is displayed on the waveform on the CRT monitor. The waveform channel selected by the cursor is indicated by the DISPLAY indicator (CH1 or CH2). By pressing these keys over again, it is possible to change the channel of the waveform selected by the cursor or to remove the cursor.

Once the cursor is displayed on the waveform, it can be scrolled over the waveform with the Parameter Entry Knob. Whichever cursor indicator is blinking is the one that can be moved. The cursor can be moved only over the acquired waveform point. It can't move over interpolated data.

When CURSOR 1 is moved to the far right or left end of a waveform on the CRT monitor, attempts to move it further causes the display to scroll. This scrolling function is provided only by CURSOR 1. CURSOR 2 can be moved only within the displayed waveform.

NOTE

The RTD 710A must be in the HOLD state to scroll.

There are two cursor scrolling modes selected with the SCROLL MODE key: ALL and IND(ependent). In the ALL mode, the time position of both waveforms remains the same and both cursors are scrolled simultaneously on the waveforms when the Parameter Entry Knob is rotated. In the IND mode, the waveforms are independently scrolled by selection of the CURSOR 1 key.

Cursor Measurement

When a cursor is displayed on the waveform, the MEASURE key functions can be selected to measure waveform parameters, such as voltage differences, time, and frequency. Table 3-10 describes the types of measurements that can be made using the cursor.

**Table 3-10
CURSOR MEASUREMENTS WITH THE
MEASURE FUNCTION**

Displayed Cursor	Measurement Key	Measurement Item
CURSOR 1 or CURSOR 2	V	Voltage reference to ground at cursor position.
	T	Time measurement from trigger point to cursor position.
	1/T	Reciprocal of T (frequency) is calculated and displayed.
CURSOR 1 and CURSOR 2	ΔV	Voltage at CURSOR 1 position – voltage at CURSOR 2 position.
	ΔT	Time conversion at CURSOR 1 position – time conversion at CURSOR 2 position.
	1/ ΔT	Reciprocal of ΔT (frequency) is calculated and displayed.

Cursor measurements can be made in both HOLD or RESET mode of acquisition, but when in ROLL mode, the cursor is displayed only in the HOLD state.

Cursor measurements can be performed in any record containing stored data; however, the measurement is based on the acquisition parameter settings that were set when the waveform was acquired and stored. For example, if the present front panel settings differ from those that were set when the waveform data was acquired, then the settings that were set at the time of acquisition take precedence over those currently set.

NOTE

Time and frequency measurements cannot be made on waveforms that were acquired using an external clock as the external clock frequency is unknown by the RTD 710A.

If two cursors are being used on two different waveforms and the sample intervals for the waveforms are different, the time and frequency measurements are made using the sample interval of the waveform using CURSOR 1. Since there is some delay between an actual trigger occurrence and trigger recognition by the RTD 710A, time measurement is performed as (CURSOR1 position - recognized trigger position). Therefore, when measuring the time interval between the actual trigger point and point of interest as designated by CURSOR1, the ΔT measurement is useful. When the input signal is acquired using a 10 ns sample interval, set the CURSOR2 position to -3 and set the CURSOR1 position to the point of interest, then press the ΔT key. This causes the measurement to be made as (CURSOR1 position - CURSOR2 position), where CURSOR2 is close to the actual trigger point.

Waveform Display Control

The RTD 710A provides a number of display functions such as horizontal expansion and compression, vertical expansion and compression, horizontal positioning (waveform scroll), and vertical positioning to make acquired waveform measurements easier. These allow any portion of a waveform to be selected with vertical and horizontal positioning, then expanded or compressed for more detail. An entire 256K waveform record may be compressed and displayed for a quick observation of the entire waveform. Also, the CRT monitor screen can be split with the CH1 waveform displayed on the upper half and the CH2 waveform displayed on the lower half using vertical compression and positioning.

HORIZONTAL ZOOMING. Horizontal zooming includes both expansion and compression within the 2048 points of horizontal resolution offered by the RTD 710A.

Expansion is intended to provide good horizontal resolution and a scroll function, while compression provides a means to see the entire waveform quickly.

The amount of zooming is expressed as a ratio with a maximum rate of expansion of 16, and a minimum rate of compression based on the record length setting. The available zoom settings and memory windows are shown in Table 3-11.

**Table 3-11
HORIZONTAL ZOOMING RATES**

Record Length	Zooming Rate	Memory Window
1K	2 - 16	1K - 128K
2K	1 - 16	2K - 128K
4K	1:2 - 16	4K - 128K
8K	1:4 - 16	8K - 128K
16K	1:8 - 16	16K - 128K
32K	1:16 - 18	32K - 128K
64K	1:32 - 16	64K - 128K
128K	1:64 - 16	128K
256K	1:128 - 16	128K

CURSOR1 is always the center point for horizontal zooming. If CURSOR1 is not displayed, the RTD 710A keeps the previously set CURSOR1 position and uses it as the center reference point. Fig. 3-39 shows an example of a normal waveform and Fig. 3-40 shows the same waveform with horizontal zoom (expansion).

NOTE

If the waveform is compressed, timing accuracy is reduced by a factor of the compression ratio.

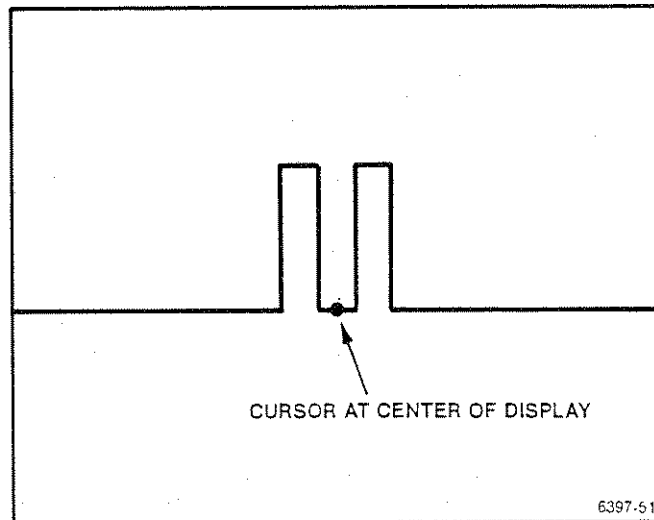

Fig. 3-39. Normal waveform display.

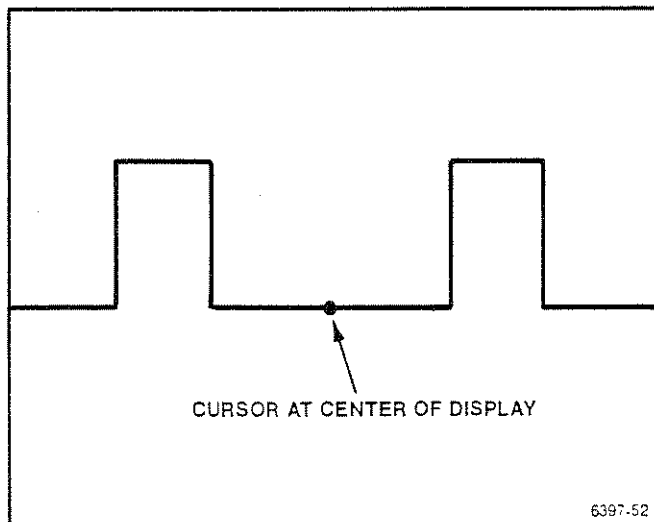

Fig. 3-40. Horizontal zoom display.

DOT/LINE DISPLAY MODE. When a horizontal zooming ratio of two (2) or greater is used, DOT/LINE switching in the interpolative mode can be useful. This function is activated using the DOT/LINE key.

When a DOT display is not being expanded, waveforms are reproduced relatively nicely due to the large number of dots (2048) a high-resolution monitor offers (Fig. 3-41). However, as the waveform is expanded the number of actual waveform samples (dots) decreases (2X: 1024, 4X: 512, etc.) and waveform reproduction may begin to suffer degradation. The use of a LINE display at this point creates new data for the expanded section by using the existing dots and vector interpolation (linear interpolation) to connect the dots with straight lines, thus the expanded waveforms are reproduced with higher visual quality (Fig. 3-42).

When a horizontal zooming ratio of 1/2 or smaller is used, DOT/LINE switching provides the selection of the data thin-out algorithm for compressed waveform display. If the DOT display is compressed, the instrument adopts the even-spaced thin-out algorithm to select data unintentionally; thus, the characteristic data may be lost even though this display is quickly updated. When the LINE display (default value) is compressed, compression is done with an enveloping algorithm; thus, maximum and minimum data is preserved although display update is slower. For example, any narrow spike pulse is displayed, even when compressed at a 1:32 ratio.

During the period that the instrument displays the compressed waveform in LINE mode, the front panel BUSY indicator is lighted.

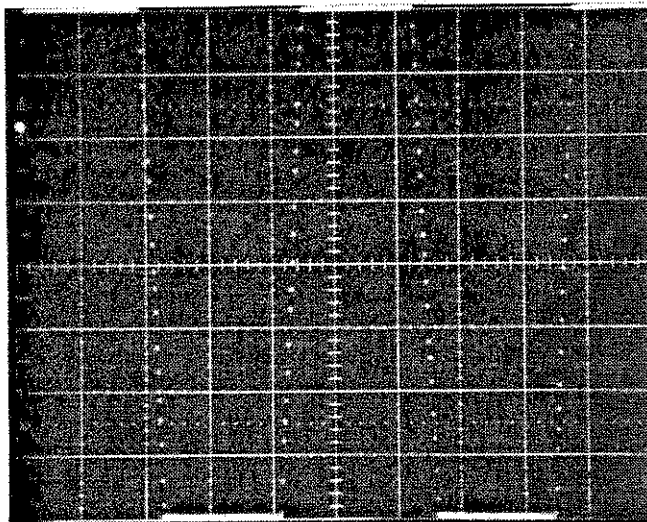

Fig. 3-41. Dot waveform display.

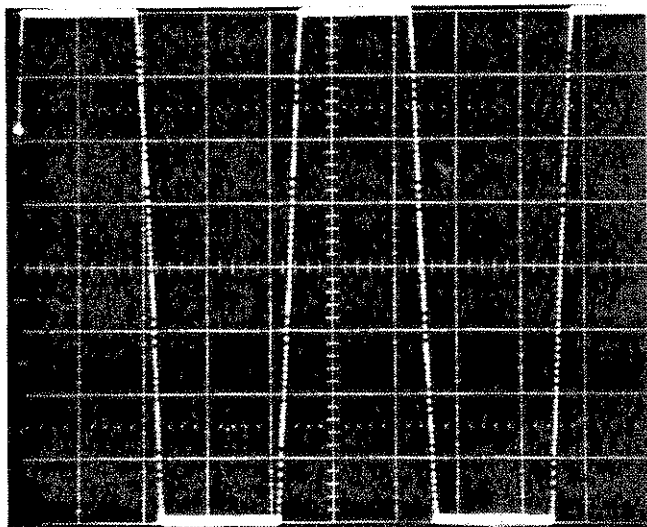

Fig. 3-42. Line waveform display.

VERTICAL ZOOMING. Vertical zooming provides a means to expand or compress the vertical range of the waveform display on the CRT monitor. Pressing this key first starts vertical zooming; pressing it again selects the channel. While the VERT ZOOM key indicator is blinking, use the Parameter Entry Knob to set the zooming factor, which can be selected in a ratio of 1:4, 1:2, 1, 2, 4, 8, 16, or 32.

Operating Instructions

The expansion feature of vertical zooming is useful for examining the vertical waveform in greater detail because it decreases the full scale range of the acquired waveform whenever the vertical zooming factor is greater than 1. For example, the full scale range is ± 100 mV when the Input RANGE setting is 100 mV and the vertical zooming factor is 1. When the vertical zooming factor is set to 2, 4, or 8, the equivalent full scale range decreases to ± 50 mV, ± 25 mV, and ± 12.5 mV, respectively.

The compression feature of vertical zooming is useful with two channel display because both waveforms can be positioned for easy viewing using the vertical zooming and vertical positioning features.

NOTE

When vertical zooming is compressed, the voltage accuracy may be decreased by a factor of the zooming ratio.

VERTICAL POSITIONING. The vertical position of waveform data can be independently set on each of the display channels. It is accomplished by pressing VERT POSN. Pressing VERT POSN once initiates vertical positioning; pressing it again selects the channel. While its indicator is blinking, the Parameter Entry Knob can be used to position the display.

Waveform data is sometimes located off the monitor screen due to vertical zooming and positioning. In these cases, measurement is possible once the display is adjusted so it is displayed on the monitor screen. If the data is located off screen due to an overrange condition, it cannot be displayed on the screen by using vertical positioning.

Proper use of the vertical zooming and positioning functions permits the user to observe any portion of interest on an acquired waveform with good visibility.

YT/XY Display

There are two methods used to display waveform data: YT display and XY display. The YT display provide a normal time domain display where the X-axis displays time and the Y-axis displays voltage (Fig. 3-43).

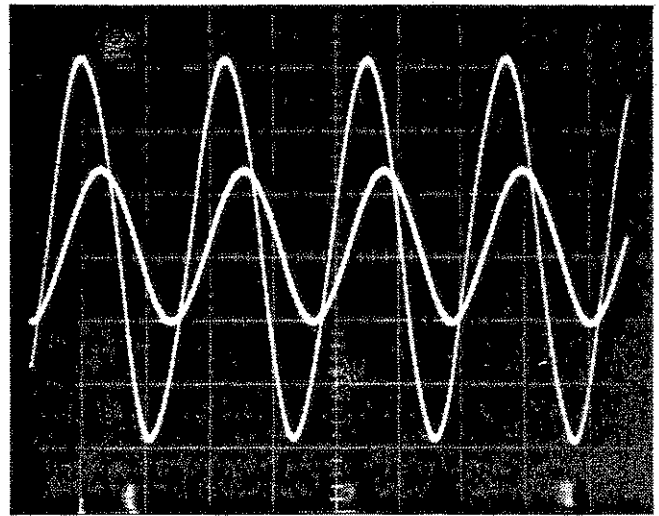

Fig. 3-43. YT waveform display.

In the XY display, the waveform data values for CH1 drive the X-axis while the data values of CH2 drive the Y-axis (Fig. 3-44).

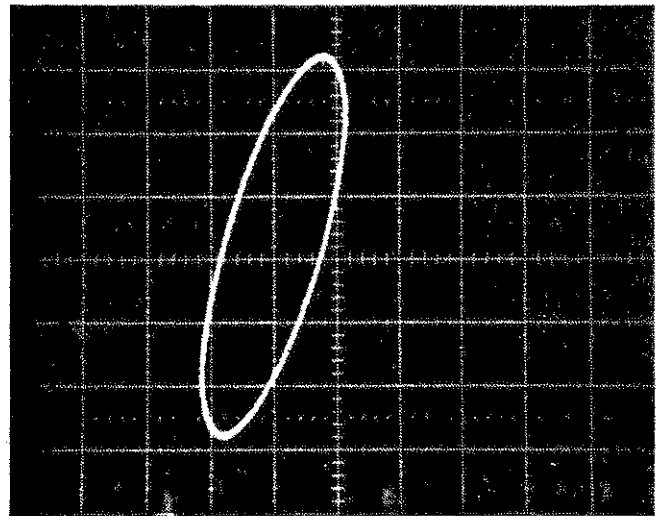

Fig. 3-44. XY waveform display.

INIT Key

The INIT key can be used to initialize an individual front panel control, or to initialize all front panel controls simultaneously.

If the INIT key is pushed once, its indicator starts blinking. At that point, if another key is pushed, its selection or value is initialized.

If the INIT key is pushed twice, all controls are initialized. The selections and values to which they are initialized are contained in Table 3-1 under the INITIALIZATION topic in the Initial Instrument Setup subsection at the beginning of this section.

MAKING COPIES WITHOUT A CONTROLLER

By connecting an HPGL plotter through the GPIB with the RTD 710A, the waveform data presently being displayed on the CRT monitor can be copied. Use the following procedure to output waveform data to a plotter.

1. Select the waveform data that is to be plotted using the DISPLAY LOCATION key and set the instrument to hold status.
2. Switch the GPIB address switch TON to 1 to set the instrument TALK ONLY mode.
3. Connect the instrument with the plotter through the GPIB cable. The instrument and the plotter should be the only items connected to the GPIB.
4. Set the plotter to the LISTEN ONLY mode and confirm it is READY.
5. Press the front panel PLOT key.

The PLOT key indicator should light and output to the plotter should begin. When output is completed, the light extinguishes.

When PLOT is pressed during an acquisition execution, output begins after the current acquisition is finished. When PLOT is pressed during output, the output stops and the key indicator goes off. If PLOT is pressed again, the data is output from the beginning once more. All other controls (including the parameter Entry Knob) are disabled during output.

A controller can also initiate a copy, and conditions for a copy can be set with the GPIB commands. For these conditions, refer to Section 5 (PROGRAMMING COMMAND SET).

REAR PANEL

TRIG'D OUT/EXT ARM IN Connectors (Serial Operation)

When the need arises to have multiple acquisitions where the total record length would exceed the 128K (DUAL) or 256K (CH1 Only) memory, a number of RTD 710A units can be series connected using their TRIG'D OUT/EXT ARM IN connectors.

To setup multiple RTD 710A units (Fig. 3-45):

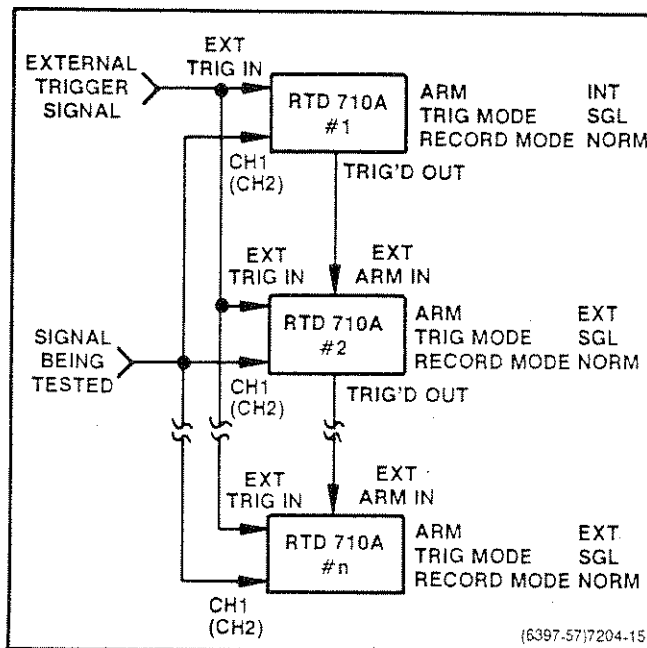

Fig. 3-45. Serially connected RTD 710As.

1. Connect the TRIG'D OUT connector on the rear panel of the first RTD 710A to the EXT ARM IN connector on the rear panel of the second RTD 710A. Connect the TRIG'D OUT connector of the second RTD 710A to the EXT ARM IN input of the third RTD 710A, and so on until all the instruments are connected.

2. On each RTD 710A, connect the input signal to the input connector, and the trigger signal to the EXT TRIG IN connector on the front panel. Set suitable input parameters, sample intervals, and trigger conditions.

3. Set the arm delay of the first RTD 710A to a suitable value and set the rest of the RTD 710A unit to EXT ARM.

4. Set the trigger mode of each RTD 710A to SGL and record mode to NORM.

5. After all the RTD 710A units have been connected, push each of their RESET/HOLD keys beginning with the last RTD 710A and moving backwards.

When the first RTD 710A is reset, acquisition of the waveform data begins and the waveform data is written to the first RTD 710A with the first trigger signal, into the second RTD 710A with the second trigger signal, and so on.

Operating Instructions

CLOCK OUT/EXT CLK IN (Parallel Operation)

Following is an example, and some advantages to using multiple RTD 710A instruments in parallel operation.

1. Simultaneous acquisition of more than two input signals.
2. Simultaneous acquisition of a single input signal under various acquisition conditions.
3. Using different trigger delays for each RTD 710A to acquire slow periods of continuous data (Maximum of 768K words).

Parallel operation may require simultaneous operation; therefore, a sample clock and trigger signal must be provided synchronously to all RTD 710As (Fig. 3-46).

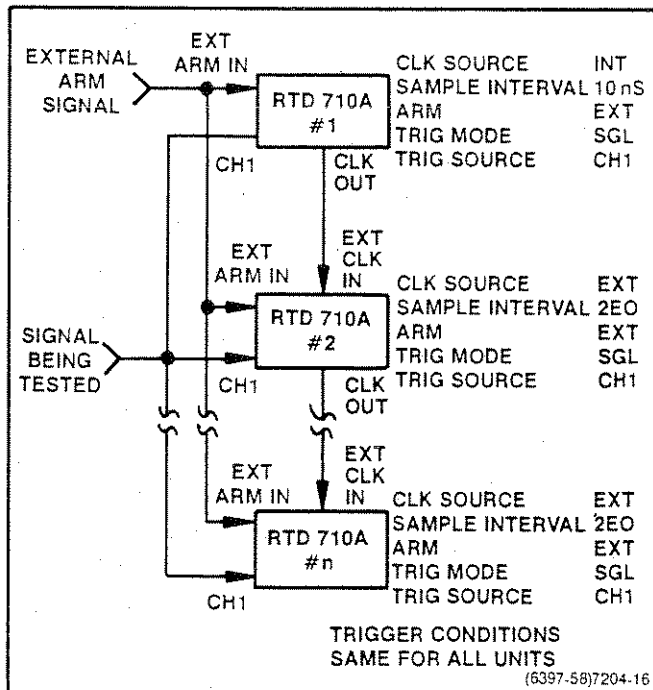

Fig. 3-46. Parallel operation of RTD 710As.

Three methods that may be used to provide a synchronous sample clock signal are:

1. Simultaneously input a suitable external clock to all of the RTD 710A instruments via the EXT CLK IN connector located on the rear panel.

2. When all of the RTD 710A instruments cannot be driven with an external clock due to fanout, the external clock should be input to the EXT CLK IN connector of the first RTD 710A and the CLK OUT connector of that RTD 710A used to drive the EXT CLK IN of the next RTD 710A and so on, until all RTD 710A clock lines are connected in series. The sampling interval (external clock division ratio) must be set the same on all RTD 710A instruments.

3. When an appropriate external clock is not available, the internal clock source of the first RTD 710A can be set to some sample interval and then the other RTD 710A instruments can be connected in series in the manner explained in 2. above. When connected in this manner, the external clock division ratio of the second and following units must be set to unity (1/1).

The following methods may be used for obtaining a synchronous trigger signal:

1. When using an internal trigger, a trigger source signal is input to the same input channel of all the RTD 710A instruments. The trigger status setting must all be the same. In this case the arm signal uses the external arm and should be synchronously supplied to all the units.

2. When using an external trigger, the trigger signal is input to all instruments. Or, the trigger is input into EXT TRIG IN of the first RTD 710A, then its TRIG'D OUT is input to the EXT TRIG IN of the second unit, and so forth until all units are connected. The setting of the arm delay should either use an external arm as in the preceding paragraph, or all the arms should be set to zero and the units should be reset starting with the last unit and working forward to the first.

By using the above methods or a mixture of them, the RTD 710A instruments should be synchronized and parallel operation executed.

NOTE

Prior to parallel operation, auto calibration should be conducted on all the RTD 710A instruments in order to provide units with the least possible variance.

SIMPLE WAVEFORM OPERATIONS

In the next few paragraphs, examples of repetitive waveform acquisition, transient waveform acquisition, acquisition of a waveform using sample rate switching, making cursor measurements, and using the compare trigger modes will be presented. Each of these examples assume the RTD 710A instruments is turned on and ready to operate, and a CRT monitor is connected and operational.

Repetitive Waveform Acquisition

To acquire a repetitive waveform:

1. Connect a signal generator to the CH1 or X BNC input connector and set it for a 50 KHz, ± 0.5 V sine wave.
2. Press the INIT key twice to initialize the RTD 710A.
3. Press the RESET/HOLD key to set the HOLD status.
4. Press the CH1 INPUT or X RANGE key and when its indicator blinks, use the Parameter Entry Knob to set the range voltage to ± 1 V.
5. Press the SAMPLE INTERVAL key and when its indicator blinks, use the Parameter Entry Knob to set the sample interval to 200 ns.
6. Press the RESET/HOLD key, and when the RESET status occurs, the waveform will be acquired and continuously displayed on the CRT monitor.
7. Channel 2 also may be displayed on the CRT monitor even though no waveform data is being input. This display can be removed by pressing the DISPLAY LOCATION key twice turning on the CH2 DISPLAY indicator, then turning the Parameter Entry Knob to set a display location of zero (0).
8. The ARM'D and TRIG'D lamps should be repetitively blinking at this time to show that waveform data is being continuously acquired. By changing the ARM DELAY value, the repetition period can be varied. When the acquisition of one cycle of waveform data, and the observation of the waveform measurements is going to be lengthy, increase the ARM DELAY. The bright dot displayed close to the left edge of the display indicates the trigger point.

9. If the waveform is going to be examined or analyzed in more detail, set the HOLD status by pressing the RESET/HOLD key to stop the acquisition. This causes the waveform to be stored in RECORD LOCATION 1 (Fig. 3-47).

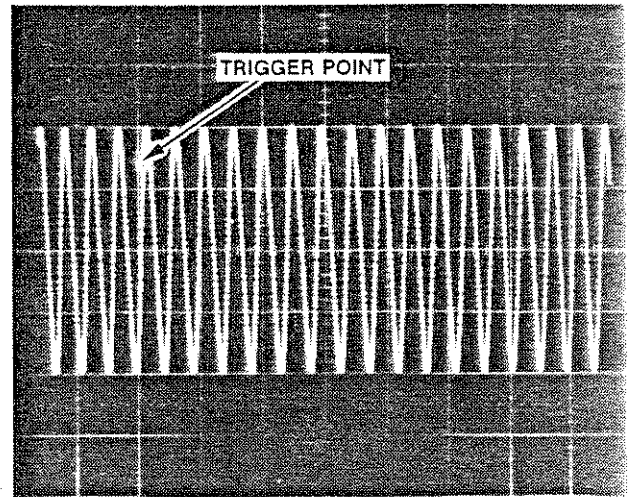

7204-17

Fig. 3-47. Simple waveform acquisition display.

Transient Waveform Acquisition

In this example, a signal generator will be set up to provide a waveform, then turned off until the transient waveform is needed, then turned on again to simulate the transient waveform.

To acquire a transient waveform:

1. Connect a signal generator to the CH1 or X BNC input connector and set it for a 50 Hz, ± 0.5 V sine wave. Then turn off the generator.
2. Press the INIT key twice to initialize the RTD 710.
3. Press the RESET/HOLD key to set the HOLD status.
4. Press the CH1 INPUT or X RANGE key and when its indicator blinks, use the Parameter Entry Knob to set the range voltage to ± 1 V.
5. The period of the simulated transient waveform is estimated to be about 100 ms. Since the present record length is 2K words, the sample interval should be about 100 μ s (100 ms/2048). Press the SAMPLE INTERVAL key and use the Parameter Entry Knob to set the sample interval to 200 μ s.

Operating Instructions

6. In order to observe the acquisition of the simulated transient waveform, the pre-trigger mode is used. Since the default trigger delay is -400 , this places the trigger in the 80 ms area ($400 \cdot 200 \mu\text{s}$).

7. The default trigger source is CH1, but since it is unknown whether the leading edge of the transient signal is going to be positive-going or negative-going, set the Trigger SLOPE to BI using the SLOPE toggle key.

8. To ensure that the trigger does not misoperate on BI slope, use TRIG LEVEL 1 and 2 for setting the trigger level window. Press the TRIG LEVEL 1 key and while its indicator is blinking, use the Parameter Entry Knob to set the TRIG LEVEL 1 value to $+5\%$. Press the TRIG LEVEL 2 key and while its indicator is blinking also set it to -5% .

9. To acquire the simulated transient waveform, set the trigger MODE to SGL, using the MODE toggle key.

10. To start the acquisition, press the RESET/HOLD key. When the ARM'D indicator starts blinking, it indicates that the RTD 710A is waiting for a trigger to start the acquisition.

11. Turn on the sine wave generator. As soon as the signal meets the TRIG LEVEL 1 or 2 requirement, the TRIG'D indicator turns on, indicating that the waveform is being acquired. As soon as the waveform is acquired, the HOLD status is set and the waveform is displayed (Fig. 3-48).

12. Channel 2 also may be displayed on the CRT monitor, even though no waveform data is being input. This display can be removed by pressing the DISPLAY LOCATION key twice, to select the CH2 DISPLAY, then turning the Parameter Entry Knob until a display location of zero (0) is displayed.

Waveform Acquisition with a Breakpoint

This example is essentially the same as the transient waveform example above, except it will use one breakpoint to examine the first 50 points of data on the leading edge of the waveform in more detail. To examine the first 50 points of data, the waveform will be expanded 10 times.

To acquire a transient waveform using a breakpoint:

1. Connect a signal generator to the CH1 or X BNC input connector and set it for a 50 Hz, ± 0.5 V sine wave. Then turn off the generator.

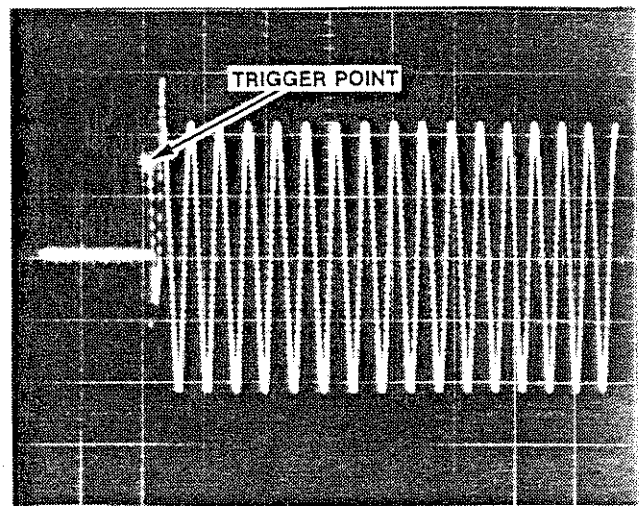

Fig. 3-48. Transient waveform acquisition display.

2. Press the INIT key twice to initialize the RTD 710A.

3. Press the RESET/HOLD key to set the HOLD status.

4. Press the CH1 INPUT or X RANGE key and when its indicator blinks, use the Parameter Entry Knob to set the range voltage to ± 1 V.

5. Press the BREAK POINT DISPLAY key. When its indicator is blinking, verify that the displayed breakpoint address is 0. If it isn't, rotate the Parameter Entry Knob to the highest numbered breakpoint. Then press the BREAK POINT CLR key until the displayed value is 0.

6. Press the SAMPLE INTERVAL key. When its indicator is blinking, use the Parameter Entry Knob to set the sample interval to $20 \mu\text{s}$, which will be the sample interval from 0 to the first breakpoint.

7. Press the BREAK POINT SET key. When its indicator is blinking, use the Parameter Entry Knob to set the first breakpoint at 512.

8. Press the SAMPLE INTERVAL key. When its indicator is blinking, use the Parameter Entry Knob to set the sample interval to $200 \mu\text{s}$. This represents the sample interval from the first breakpoint (512 points) to the end of the acquisition.

9. Press the BREAK POINT DISPLAY key. This locks the last sample interval so that accidentally bumping the Parameter Entry Knob won't change it.

10. In order to observe the acquisition of the simulated transient waveform, the pre-trigger mode is used. Since the default trigger delay is -400 , this places the trigger in the 8 ms area ($400 \cdot 20 \mu\text{s}$).

11. The default trigger source is CH1, but since it is unknown whether the leading edge of the transient signal is going to be positive-going or negative-going, set the Trigger SLOPE to BI using the SLOPE toggle key.

12. To ensure that the trigger does not misoperate on BI slope, set TRIG LEVEL 1 and 2. Press the TRIG LEVEL 1 key and while its indicator is blinking, use the Parameter Entry Knob to set the TRIG LEVEL 1 value to $+5\%$. Press the TRIG LEVEL 2 key and while its indicator is blinking also set it to -5% .

13. To acquire the simulated transient waveform, set the trigger MODE toggle key.

14. To start the acquisition, press the RESET/HOLD key. When the ARM'D indicator starts blinking, it indicates that the RTD 710A is waiting for a trigger before starting the acquisition.

15. Turn on the sine wave generator. As soon as the signal meets the TRIG LEVEL 1 or 2 requirement, the TRIG'D indicator turns on indicating that the waveform is being acquired. As soon as the waveform is acquired, the HOLD status is set and the waveform is displayed (Fig. 3-49).

16. Channel 2 also may be displayed on the CRT monitor, even though no waveform data is being input. This display can be removed by pressing the DISPLAY LOCATION key twice turning on the CH2 DISPLAY indicator, then turning the Parameter Entry Knob until a display location of zero (0) is displayed.

Cursor Measurements on Acquired Waveform

The cursor measurements in this example are a continuation of the previous waveform acquisition with a breakpoint. To perform a cursor measurement:

1. Press the CURSOR 1 key until the CH1 DISPLAY indicator is on. When the cursor dot appears at the left end of the displayed waveform, it is at the -400 point address, referenced to the trigger point.

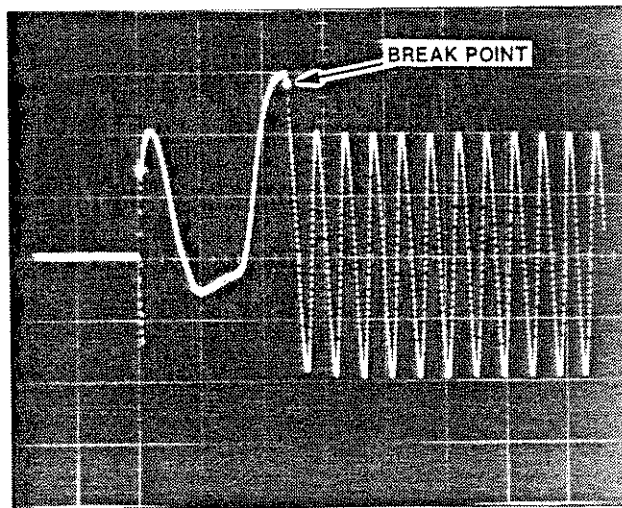

Fig. 3-49. Transient waveform acquisition with a breakpoint.

2. The first measurement to be made is the waveform peak voltage. Press the MEASURE $V/\Delta V$ key to display the voltage at the cursor location. Rotate the Parameter Entry Knob to move the cursor along the waveform to the maximum peak voltage point (Fig. 3-50).

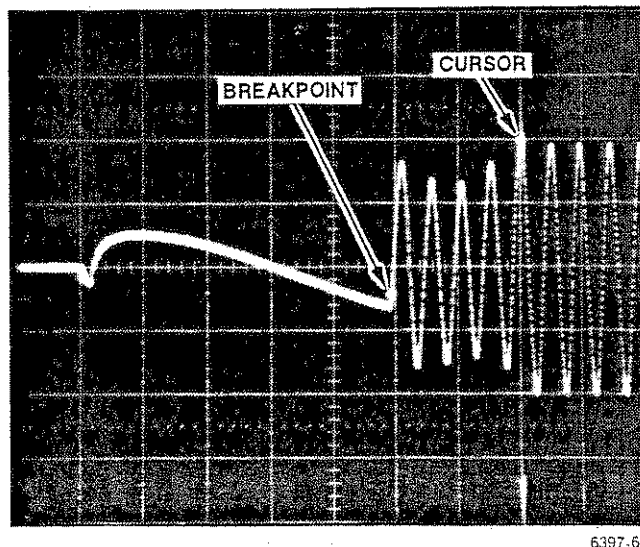

Fig. 3-50. Voltage measurement with CURSOR 1.

As the cursor moves toward the peak voltage, the Control display indicates the voltage at the cursor location relative to ground. Watch this value while moving the cursor to the maximum location. As the cursor enters the peak voltage value, it becomes very sensitive.

Operating Instructions

3. Press the MEASURE T/ Δ T key to display the period between the indicated cursor point and the trigger point on the Control display (Fig. 3-50).

In the remainder of this example, the HORIZ ZOOM feature and both cursors (CURSOR 1 and CURSOR 2) will be involved in the measurements.

4. Since 2048 points are being displayed and waveform detail is small and difficult to see, press the HORIZ ZOOM key. When its indicator is blinking, use the Parameter Entry Knob to set the horizontal zoom factor in the Control display to 4. When this is done, the CURSOR 1 portion of the waveform is expanded in the horizontal direction as shown in Fig. 3-51.

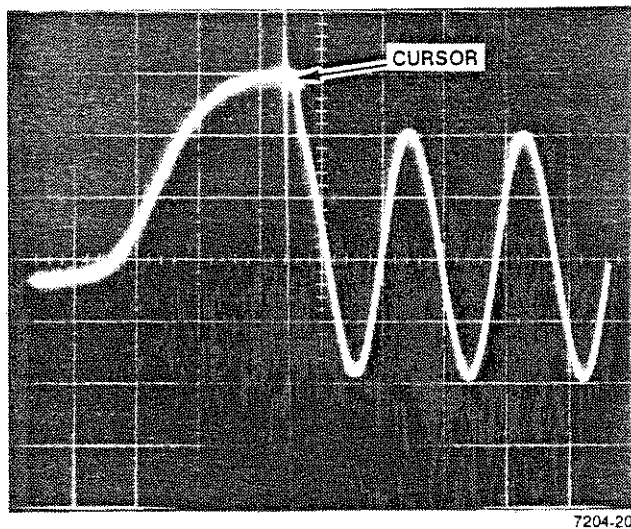

Fig. 3-51. Voltage measurement with 4X horizontal zoom.

Since the stationary portion of the waveform moved outside the screen, press the CURSOR 1 key, then turn the Parameter Entry Knob to move CURSOR 1 towards the right side of the screen. When it reaches the edge, the screen scrolls and the stationary portion of the waveform moves towards the center of the screen.

5. In order to get the minimum peak value as a reference for the amplitude, press the MEASURE V/ Δ V key and move CURSOR 1 to the minimum peak value using the Parameter Entry Knob. Press the CURSOR 2 key. When its indicator is

blinking and CURSOR 2 is displayed on the waveform, the relative voltage measurement by CURSOR 1 and CURSOR 2 is enabled. The voltage values are displayed on the Control display (Fig. 3-52).

While reading the voltages, move CURSOR 2 to the maximum peak voltage of the same waveform as CURSOR 1 (Fig. 3-52).

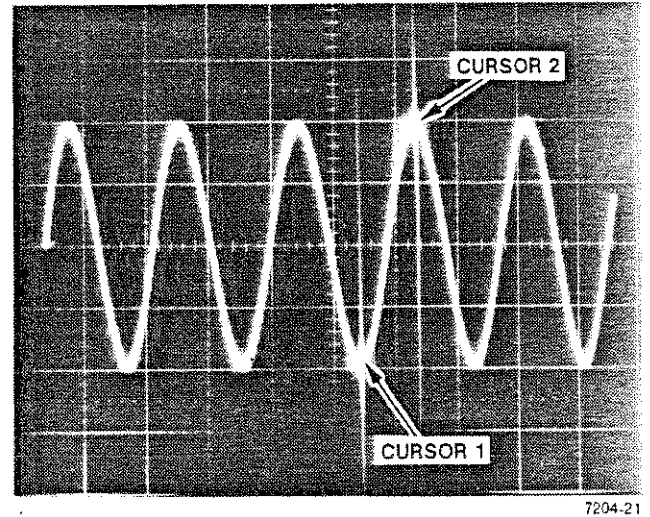

Fig. 3-52. Amplitude measurement with CURSOR 1 and 2.

In the last part of this example, the frequency of the stationary waveform is measured.

6. Press the CURSOR 2 key until its indicator is off, which removes Cursor 2 from the screen. Next, press the CURSOR 1 key until the CH1 DISPLAY indicator is on. Then use the Parameter Entry Knob to move CURSOR 1 as close to the midpoint of the waveform leading edge as possible while watching the voltage display. Next press the CURSOR 2 key until the CH1 DISPLAY indicator is on, then move CURSOR 2 to the middle of the leading edge of the next cycle. Adjust the cursors until the difference in their relative voltages is minimum. If 1/T/1/ Δ T is pressed at this point, a measurement of the frequency of one cycle of waveform between CURSOR 1 and CURSOR 2 can be made (Fig. 3-53).

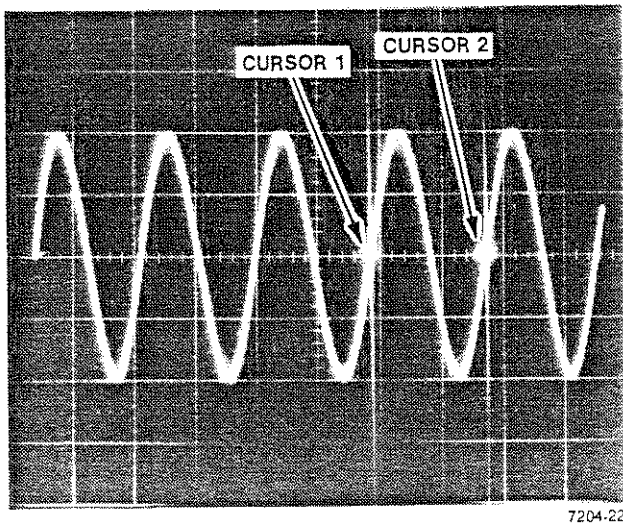

Fig. 3-53. Frequency measurement with CURSOR 1 and 2.

As can be seen from this example, the RTD 710A permits use of the cursors for various types of waveform measurements. If the GPIB is used, an even more detailed analysis can be made of waveform parameters using the special Internal Waveform Analysis Group commands that are provided. This enables the computer to be used for automatic measurements.

Section 4 INTERFACING

The RTD 710A contains two interfaces—the IEEE Std 488 Interface commonly referred as the General Purpose Interface Bus (GPIB) and the Direct A/D Output Port Interface.

A special application of the GPIB interface is used to obtain hard copies on any plotter that uses HPGL (Hewlett-Packard Graphics Language®), such as the Tektronix HC-100 Color Plotter, or the Hewlett-Packard Thinkjet Printer®. The RTD 710A can be instructed to output waveforms via the GPIB, either locally from the front panel, or remotely by a GPIB controller.

The IEEE Std 488 interface allows the instrument to be remotely controlled by a GPIB controller. All front panel controls, except the power-on switch, and the manual trigger key (MAN TRIG), can be controlled through the GPIB using the Programming Command Set (see Section 5). Also, an acquired waveform can be transferred to the controller for further processing, or waveform data can be transferred from the controller for use as a reference waveform.

The Direct A/D Output Interface allows the instrument to be used as a 10-bit, 200 Megasample per second A/D converter. The interface outputs 10 bits of digitized data from each channels A/D converter plus a clock signal. The interface may be connected to an external high-speed memory to provide very long record lengths.

IEEE 488 INTERFACE

MESSAGE PROTOCOLS

The GPIB interface and its message protocols conform to the IEEE Standard 488-1978. The device-dependent message protocols conform to Tektronix GPIB Codes, Formats, Conventions and Features standard.

GPIB CONNECTOR

The GPIB connector is a standard IEEE 488 24-pin connector with pinouts assigned to signal lines as shown in Fig. 4-1.

GPIB CONTROLLER COMPATIBILITY

The IEEE 488 Interface is compatible with all Tektronix desk-top computers used as GPIB controllers, such as the 4041, and PEP-301. It is also compatible with DEC, HP, and IBM PC controllers, and compatible controllers.

IEEE 488 INTERFACE FUNCTION SUBSETS

The IEEE Standard 488 defines the GPIB interface functions and the allowed subsets of those functions. The subsets incorporated into the instrument are shown in Table 4-1.

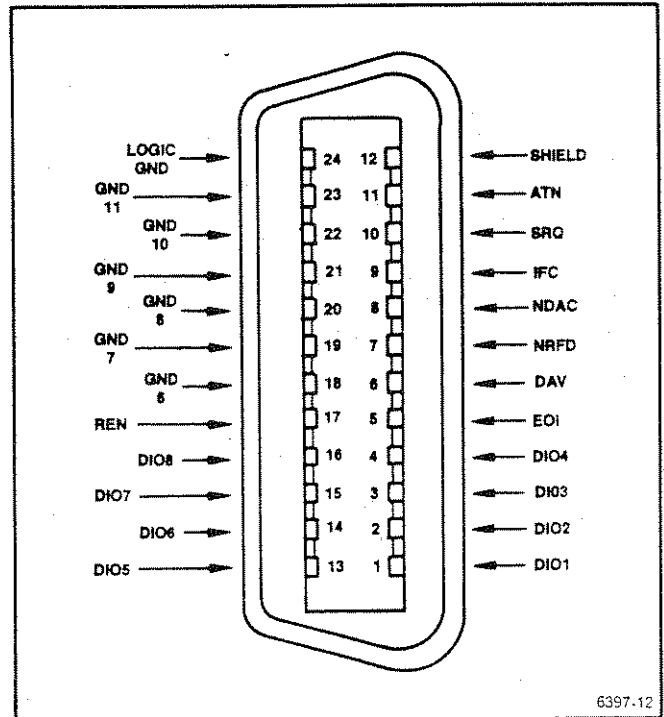

Fig. 4-1 IEEE 488 interface connector.

Table 4-1
RTD 710A GPIB INTERFACE FUNCTION SUBSETS

Function	Subset	Capability
Source Handshake (SH)	SH1	Complete capability.
Acceptor Handshake (AH)	AH1	Complete capability.
Talker (T) or Extended Talker (TE)	T5	Basic talker; serial poll talk only; unaddress if MLA.
Listener (L) or Extended Listener (LE)	L4	Basic listener; no listen only mode; unaddress if MTA.
Service Request (SR)	SR1	Complete capability.
Parallel Poll (PP)	PP0	No capability.
Device Clear (DC)	DC1	Complete capability.
Device Trigger (DT)	DT1	Complete capability.
Controller (C)	C0	No capability.
Remote/Local	RL1	Complete capability

GPIB MODE, ADDRESS, AND MESSAGE TERMINATOR SELECTOR

The GPIB operating mode (talker or talker listener), address (1-30), and message terminator (LF or LF/EOI) selections are made with an 8-section binary switch on the instruments rear panel (Fig. 4-2).

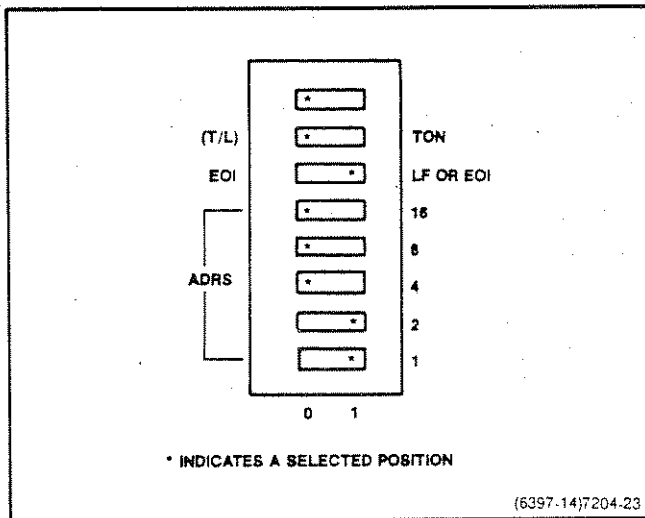

Fig. 4-2 GPIB parameter switch.

The top section of the switch must have its zero (0) position selected for the instrument to respond to the Programming Command Set.

The second section of the switch uses the zero (0) position to select the talker/listener operating mode, and the one (1) position (TON) to select the Talker ONLY operating mode.

The third section selects how the instrument recognizes the termination of a message, and how it terminates its messages. In the zero (0) position (EOI), the instrument interprets a data byte received with EOI true as the end of message; the instrument terminates its messages by setting EOI true with the last message byte. In the one (1) position (LF/EOI), the instrument interprets either an LF or a data byte with EOI true as the end of message; the instrument terminates its messages with a CRLF and sets EOI true.

The fourth through eighth sections set the instruments address in binary format. The address is determined by totaling the values associated with the selected one (1) positions. For example the switch in Fig. 4-2 has the one (1) position selected for the values 1 and 2 giving a total of 3, which represents a primary GPIB address of 3.

GPIB INTERFACE COMMANDS

Refer to Appendix C, ASCII & GPIB CODE CHART.

RESPONSES TO INTERFACE COMMANDS

Interface Clear (IFC)

When the Interface Clear (IFC) signal line is pulsed true, any input to or output from the instrument is interrupted and the instrument enters an unaddressed state. This resembles the same action that occurs when the instrument receives the interface message sequence UNT, UNL. When the instrument is next addressed, the operation being performed when the IFC occurred is resumed.

Device Clear (DCL)

When the Device Clear (DCL) message is received, the following instrument actions occur:

1. Command interpreter processing is reset.
2. Input and output buffers are cleared.
3. All pending SRQ flags, except power-on, are cleared.
4. All pending EVer? query responses, except power-on, are cleared.

5. Any waveform transfers are aborted.
6. Any plots under program control are aborted.

Selected Device Clear (SDC)

If the instrument is listen addressed (MLA), it responds to the Selected Device Clear (SDC) message in the same manner as for the Device Clear (DCL) message; otherwise, it is ignored.

Remote Enable (REN)

The REN signal line must be true and the instrument addressed (MLA) before it will respond to commands. Once this condition occurs and the REN signal line is false, the REN/MLA combination must again occur before commands are recognized.

Messages sent to the instrument while the REN signal line is false and EXR is ON cause an Execution Error SRQ.

For additional information on the REN signal line, see the Remote/Local Function topic below.

My Listen Address (MLA) and My Talk Address (MTA)

The MLA and MTA messages, which are received when the Attention (ATN) signal line is true, condition the instrument to receive commands or respond to queries or serial polls. These messages consist of the decimal values for the MLA, which is 32 + (the address set by the GPIB Parameter Switch), or for the MTA, which is 64 + (the address set by the GPIB Parameter Switch). For example, if the GPIB Parameter Switch is set to 1, MLA is 33 and MTA is 65.

Unlisten (UNL) and Untalk (UNT)

The UNL and UNT messages, which consist of the decimal values 63 and 95, respectively, cancel any previously received MLA or MTA messages.

Group Execute Trigger (GET)

The instrument will respond to a GET message if the Device Trigger command DT is ON and the trigger circuit is ARM'd. If the trigger circuit is not ARM'd, the GET message is ignored. If DT is OFF and EXR is ON, the instrument responds to the GET with an Execution Error SRQ.

Go To Local (GTL)

The GTL message is used to return the instrument from remote operation. Once this message is received, the instrument must be readdressed (MLA) before it will respond to commands.

REMOTE/LOCAL FUNCTION

When the instrument powers up, it defaults to the *local state* (LOCS) and neither its GPIB REM nor LOCK indicators are on. In this state, all front panel controls are fully operational.

When the Remote Enable (REN) signal line is true and the instrument is addressed with a My Listen Address (MLA) message, it enters the *remote without lockout state* (REMS), and its GPIB REM indicator turns on. While in this state, it can be controlled only by the Programming Command Set. The instrument can be returned to the *Local state* (LOCS) by pushing any front panel key except RQS/ID, or by sending a Go To Local (GTL) message, or by cycling the power switch.

If the instrument receives a Local Lock Out (LLO) message while in the *remote without lockout state* (REMS), it enters the *remote with lockout state* (RWLS). In this state, both the REM and LOCK indicators are on and all front panel controls are locked out, except the RQS/ID key. From this state, the instrument is returned to the *local state* (LOCS) by setting the REN signal line false.

If an LLO message is placed on the GPIB while the REN signal line is true, the instrument enters the *local with lockout state* (LWLS). In this state, all front panel controls, remain operable until the instrument is addressed, placing it in the *remote with lockout state* (RWLS).

While in the *local with lockout state* (LWLS), the controller can place the instrument into the *remote with lockout state* (RWLS) by simply sending a MLA message to the instrument. In this state, both the LOCK and REM indicators are on, none of the front panel controls can be used, except the RQS/ID key, and only the controller can return the instrument to the *local state* (LOCS) by setting the REN signal line false.

GPIB RQS/ID KEY

When this key is pressed, the LED display above the Control section shows the address set on the GPIB Parameter Switch for about one second. If the Service Request command USER is ON, pushing the key also generates an SRQ to the controller and reports instrument status. Its LED turns on whenever an SRQ is generated.

GPIB COMMAND SET

Refer to Section 5, PROGRAMMING COMMAND SET.

STATUS BYTES AND EVENT CODES

Refer to Appendix A, SRQ STATUS BYTES AND EVENT CODES

A/D OUTPUT INTERFACE

Whenever the instrument is acquiring a waveform, ECL compatible digital data is sent to the A/D Output Port. Each data bit and clock signal is sent as a differential signal. For more details on specifications, refer to Appendix B, SPECIFICATIONS.

The optional output cable has both connectors keyed for proper connection. The end that fits into the A/D Output Port connector is keyed at the top and bottom with small cutouts to fit the tabs on the connector (Fig. 4-4). The distant end connector is keyed with a small tab at the center. When facing this connector with the tab to the right, pin 1 is at the top left of the plug (Fig. 4-4).

A/D OUTPUT PORT CONNECTOR

CAUTION

Do not connect or disconnect a cable to the A/D Output Port while the instrument is turned on as there is voltage applied to one of the connector pins. Making or breaking the connection with the instrument turned on may cause damage to the instrument or the connected device.

The connector for the A/D Output Port is an AMPMODU MT-type 50-pin connector mounted on the rear panel with pinouts assigned to signal lines as shown in Fig. 4-3.

As shown in Fig. 4-3, the connector is keyed at the top and bottom to ensure that the output cable connector is properly connected.

A/D OUTPUT CABLE

The cable used for connecting to the direct A/D output port should be shielded. The recommended cable is listed in Optional Accessories in Section 1, GENERAL INFORMATION. The signal assignments on the cable connectors are on the same pins as those for the A/D Output Port connector on the RTD 710A. See Fig. 4-4 for the pin locations.

CAUTION

The connector housing of the distant end of the A/D output cable must be fastened to the chassis of the user's instrument with screws for EMI shielding and to avoid any electrical damage to the RTD 710A.

It is recommended that whatever connector is used to interface to the distant end of the A/D output cable, that it be keyed to accommodate the existing connector key to prevent signal mismatching. One type of matching connector is 3M part number 3331-0000.

A/D OUTPUT TERMINATION

The signal outputs from the A/D connector are ECL open emitter, differential drive outputs, which should be terminated through 68 ohms to -2 Vdc. Fig. 4-5 shows one type of data receiver circuit that can be used to terminate the distant end of the A/D output cable. An ECL 10H116 line receiver and 10H176 latch should perform adequately in the circuit.

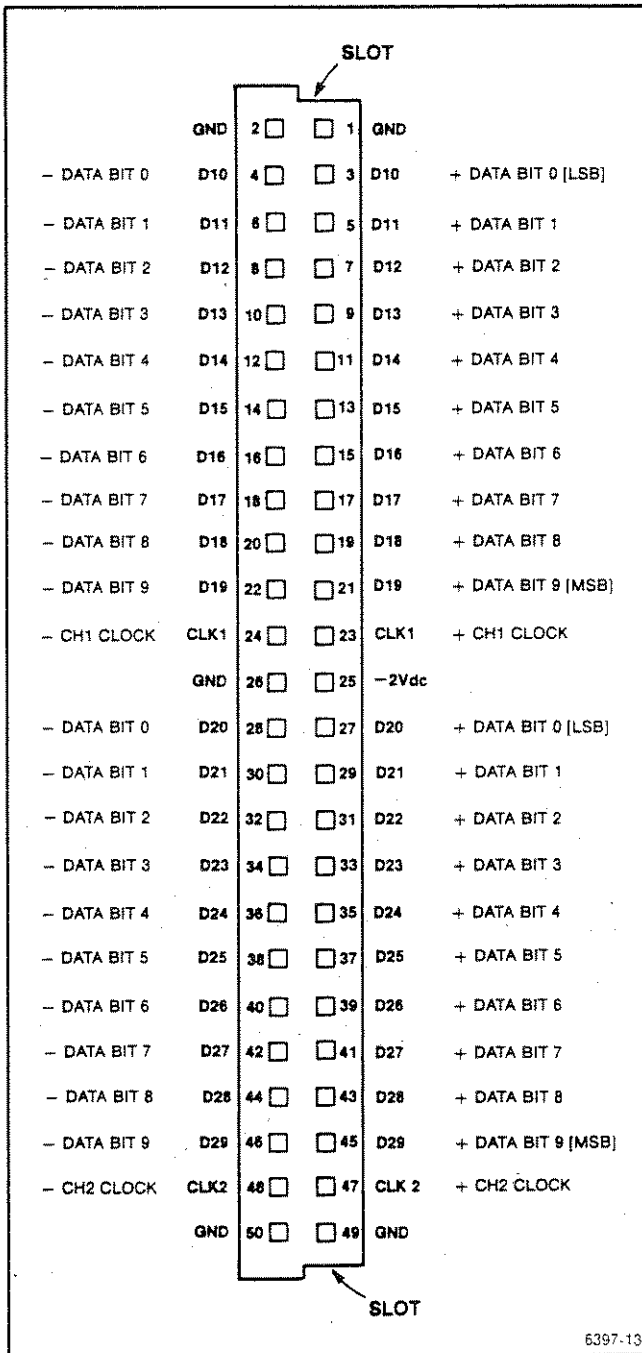

Fig. 4-3 Direct A/D output port connector.

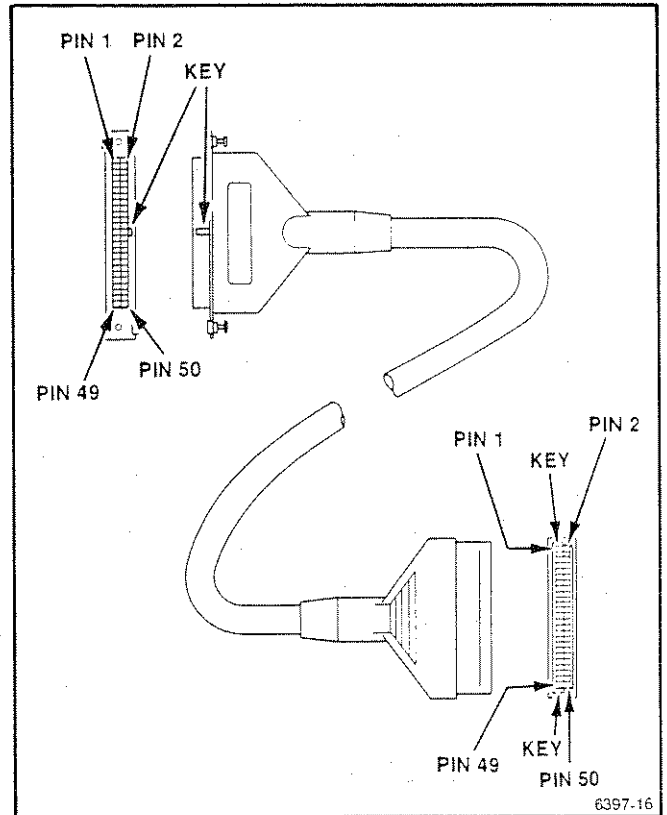
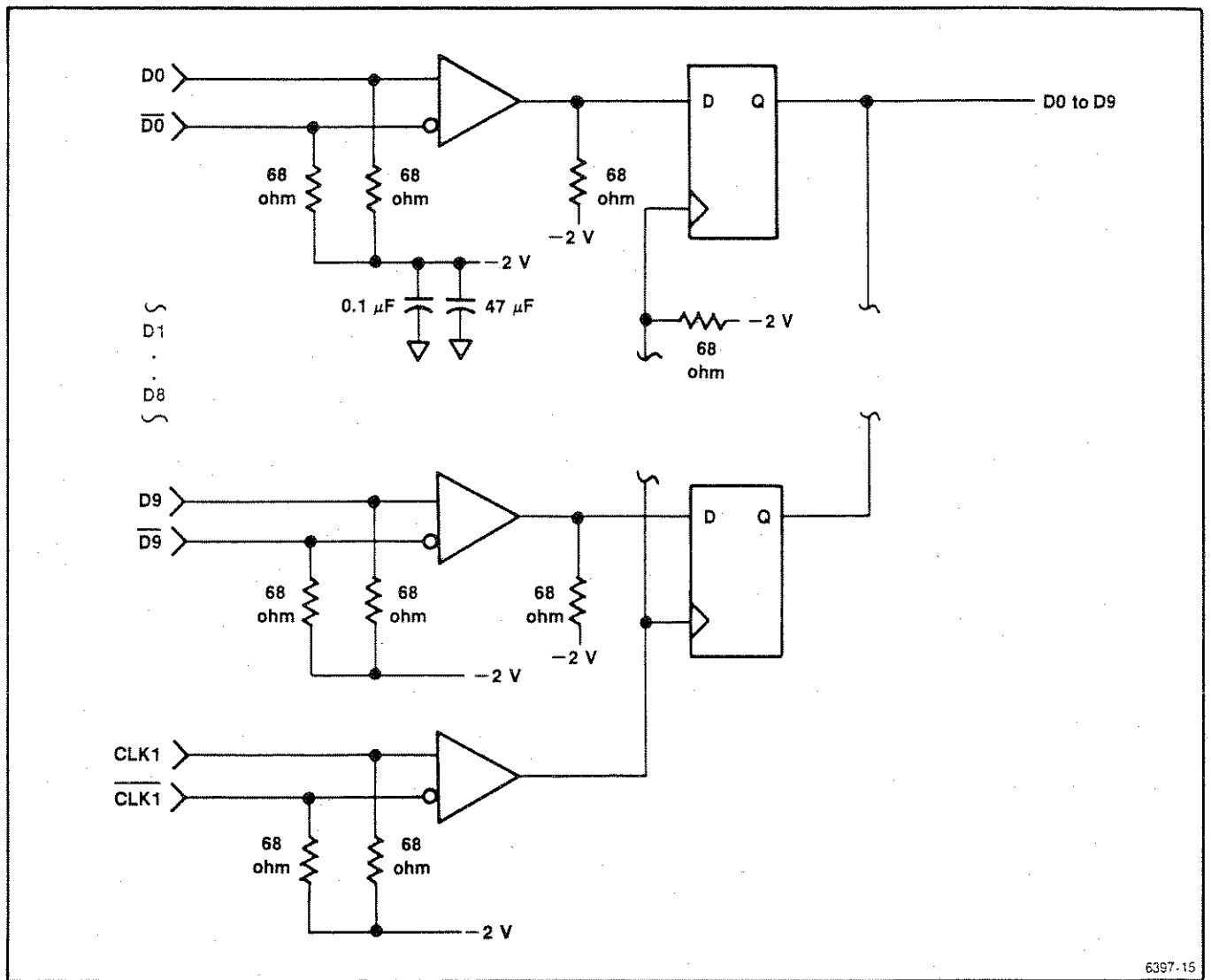

Fig. 4-4 A/D output cable connectors.

Pin 25 provides a -2 Vdc pulldown source, which can provide up to 700 mA of current. This source already provides a large margin for noise; however, it is recommended that it be bypassed with a $47\ \mu\text{F}$ electrolytic capacitor and a $0.1\ \mu\text{F}$ ceramic capacitor for additional noise reduction.



6397-15

Fig. 4-5 A/D output receiving circuit.

A/D OUTPUT OPERATION

No special settings for the RTD 710A are necessary before using the direct A/D Output port on the rear panel. However, when acquisition is started (includes those times when it is started when trigger mode is AUTO, NORM, or COMP) data output is momentarily halted, then restarted. Also, most of the time when settings are changed during acquisition, which will stop an acquisition. When acquisition is made with Trigger Mode SGL (single), data is output without interruption (Fig. 4-6).

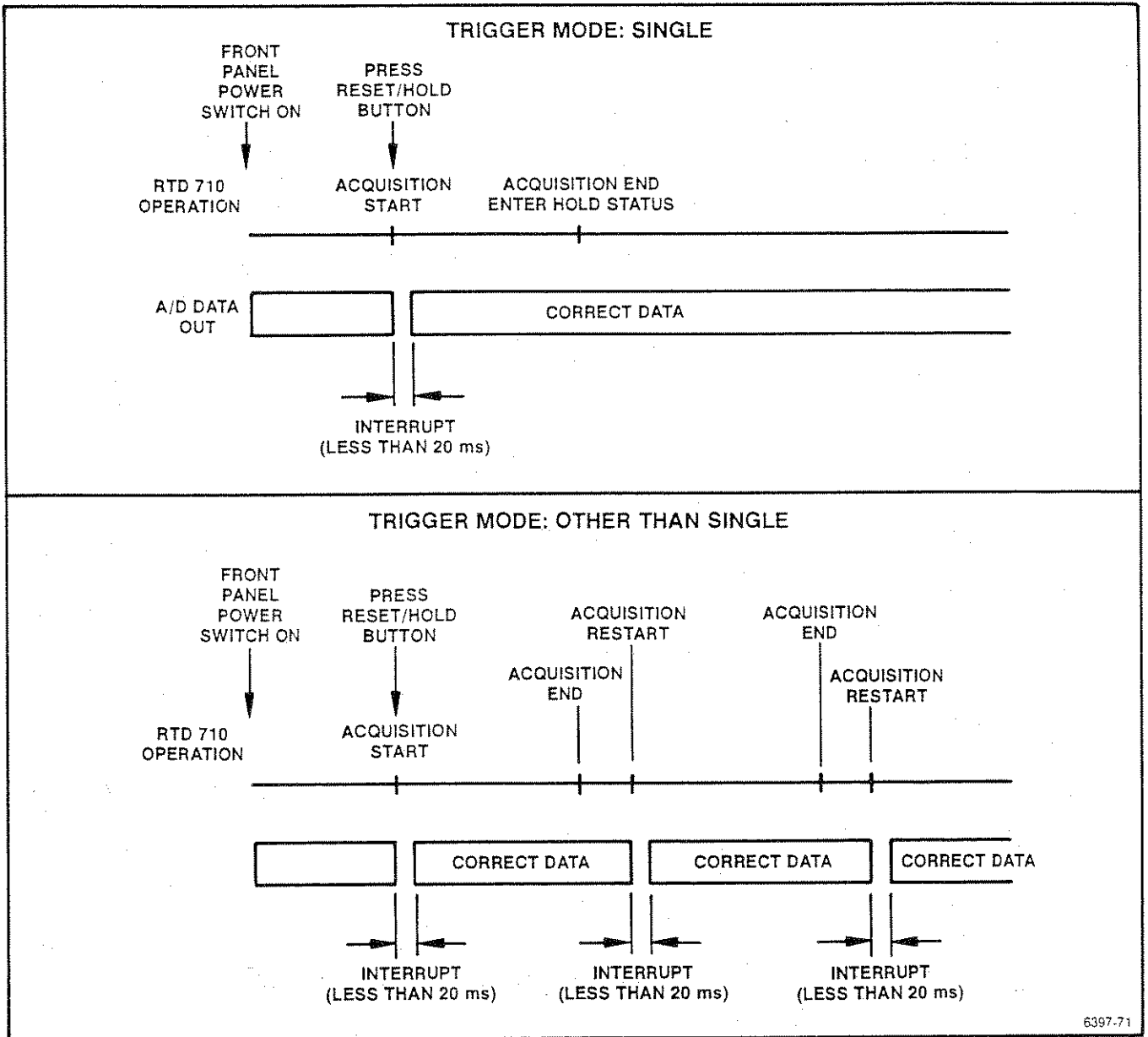

6397-71

Fig. 4-6. A/D output operation.

Section 5

PROGRAMMING COMMAND SET

INTRODUCTION

The command set is used to control the instrument through the GPIB. It can initialize and calibrate the instrument, change its control settings, query the status of the instrument, trigger an acquisition, query the results of an acquisition, transfer waveform data to or from the instrument, call instrument utilities, and initiate other instrument functions.

Commands follow the conventions established in the Tektronix GPIB Codes, Formats, Conventions, and Features Standard. They are specified in mnemonics related to the function being performed, and are similar to the front panel control names.

Commands require the proper syntax to be understood, but they may be abbreviated variations as long as they contain a minimum number of characters to prevent ambiguity.

COMMAND FORMAT

The command format for all RTD 710A commands is:
<header[?]> [<argument> [:<link argument> [,...]]]

where standard notation (BNF) is defined as follows:

- < > delimits required arguments, elements, or parameters.
- [] delimits optional arguments, elements, or parameters.
- ... indicates previous element may be repeated one or more times.
- ::= means "is defined as".
- :
- ,
- ;

In the following command examples,

AUTocal

CH1?

CH1? RANge

CH1 RANge:10

CH1 RANge:10,UNit:VOLts

the first and second contain only a header; the third a header and an argument; the fourth a header, an argument, and a link argument; and the fifth a header and two arguments, each with a link argument.

Case Dependency

In the command set listing, headers, arguments, and link arguments are shown in upper- and lower-case characters. The instrument accepts any abbreviated command that contains at least the characters shown in uppercase. The command can be made more readable by adding the characters shown in lower case. The command may be entered in all upper- or all lower-case characters, or any combination thereof.

Header

Headers represent a major logical grouping of control functions, such as CH1, TRIGGER, and RECORD. Every command contains at least a header, which may comprise the entire command; for example:

AUTocal

Whenever a header is followed by a question mark (?), it makes the command a query command. Most commands can be queried to the argument level by attaching a question mark (?) to the header and adding the appropriate argument. This argument specifies the information level for the requested response. If a link argument is specified in a query command, the query is ignored and an error SRQ is issued.

Programming Command Set

The following are examples of valid queries:

CH1?

CH1? COUpling

and the following are examples of invalid queries, which should invoke an error SRQ:

CH1? COUpling:AC

TRigger? SOUrcE:CH1

Arguments

Most commands have arguments that are used with a header to further define what action to take, or to specify what is being queried. Some arguments are satisfied with a single word; for example:

BWLim ON

while other arguments require a link argument; for example:

TRigger COUpling:AC

where AC is the link argument.

Whenever arguments follow a header, there must be at least one space between the header and the first character of the argument.

Whenever an argument is followed by a link argument, it must be separated by a colon (:).

Multiple Arguments

Whenever a header has multiple arguments, or multiple arguments with link arguments, they may be listed with the same header, but each argument-link argument set must be separated with commas; for example:

CH1 RANge:10,COUpling:AC,OFFset:20

This command string is equivalent to the following individual commands:

CH1 RANge:10

CH1 COUpling:AC

CH1 OFFset:20

Multiple Commands

Multiple commands may be included on the same program line as long as they are separated by semicolons; for example:

CH1 RANge:10;TRigger MODE:AUTO

where CH1 and TRigger are the headers for separate commands.

Link Arguments

Link arguments are used only in conjunction with arguments to define a specific setting to make, value to set,

etc. These link arguments may be alpha characters or numeric formats.

The usable alpha characters are specifically defined in the command set; for example:

```
CH1 COUpling:AC
                :GND
                :DC
                :TVClamp
```

where AC, GND, DC, and TVClamp are the alpha link arguments.

Whenever a numeric link argument is required, it is shown as <NRx> in the command set; for example:

```
CH1 RANge:<NRx>
```

where <NRx> must be a numeric value in one of the NR1, NR2, or NR3 formats shown in Table 5-1.

NOTE

All scientific notation numbers having the exponential "E" must have a plus (+) or minus (-) sign preceding the exponent. The "E" may be entered in either uppercase or lower case.

Numeric arguments may contain both signed and unsigned numbers; unsigned numbers are considered positive.

When numeric values are returned as a result of a query, the format (NR1, NR2, or NR3) will be specified in the command set.

The instrument accepts any numeric argument, but may truncate and limit the number to its nearest legal hardware value.

Table 5-1
NUMERIC FORMAT FOR LINK ARGUMENTS

Numeric Argument Type	Number Format	Examples
<NR1>	Integers	+1, 2, -1, -10
<NR2>	Floating Point	-3.2, +5.1, 1.2
<NR3>	Exponential Notation	1.36E-2, 1E+2, 1E-2, 1.02E+3

COMMAND DESCRIPTIONS

Tables 5-2 through 5-15, which are arranged by functional group, list and describe the command set. To aid in locating command descriptions, an alphabetical list of commands follows Table 5-15.

Table 5-2
VERTICAL SYSTEM CONTROL GROUP

Header	Argument	Link Argument	Description
VMOde	CH1 DUAL		<p>Selects the vertical input mode. CH1 selects CH1 only.</p> <p>DUAL selects both CH1 and CH2. A record Length of 256 K is incompatible with DUAL mode. Selecting DUAL mode limits the record length to 128 K, and a warning SRQ is issued if EXW is ON and 256 K is attempted.</p> <p>DUAL mode and High-speed sample mode are incompatible. Selecting DUAL forces sample mode to NORmal, and the sample interval is set to 10 ns if 5 ns is attempted. Also, a warning SRQ is issued if EXW is on.</p> <p>Record location number or auto advance location is limited to 128 K if vertical mode is set to DUAL, and a warning SRQ is issued if EXW is on.</p> <p>CH1 only mode and XY display mode are mutually exclusive. Selecting CH1 only mode forces display mode to YT.</p>
VMOde?			Queries the vertical mode selection. Example response: VMODE DUAL
BWLim	ON OFF		Enables the 20 MHz bandwidth limiter.
BWLim?			Queries the status of the 20 MHz bandwidth limiter. Example response: BWLIM ON
CH1 (or CH2)	RANge: UNit: OFFset: COUpling:	<NRx> PERcent VOLts <NRx> AC GND DC TVClamp	<p>Sets the CH1 (or CH2) full-scale range to <NRx> volts. <NRx>::=0.1–500 V in a 28-step sequence of 1-1.25-1.6-2-2.5-3.2-4-5-6.2-8. Range is automatically adjusted to a probe attenuation change. Unit is volts.</p> <p><NRx> is truncated and limited to the nearest legal setting, and warning SRQ is issued if EXW is on. When queried, the value is <NR3>.</p> <p>Selects the units of measure for the CH1 (or CH2) input offset.</p> <p>Sets the CH1 (or CH2) input offset value in % of full scale or <volts>. <NRx>::=-199% to +199% in 1% steps. <volts>::=(% value) * (full scale range).</p> <p>The offset automatically adjusts to probe attenuation changes. <NRx> is truncated and limited to the nearest legal setting, and a warning SRQ is issued if EXW is on.</p> <p>When queried, the value is <NR1> for PERcent or <NR3> for VOLts.</p> <p>Selects CH1 (or CH2) coupling. TVClamp cannot be selected for CH2. If TVClamp is selected and the TV Trigger option is not installed, an SRQ is issued (if EXR is on) and the command is ignored.</p>

Table 5-2 (Cont)
VERTICAL SYSTEM CONTROL GROUP

Header	Argument	Link Argument	Description
CH1? (or CH2?)	RANge UNit OFFset COUpling PRObe		Queries the selected CH1 (or CH2) vertical settings. RANge value is in the <NR3> format. OFFset value for % of full scale is in <NR1> format; for <volts> it is in <NR3> format. PRObe reports probe attenuation factor (X1 or X10).
CH1? (or CH2?)			Queries the CH1 (or CH2) vertical settings, except probe attenuation. Example response: CH1 RANGE:2.5E+0,UNIT:PERCENT,OFFSET:0,COUPLING:AC

Table 5-3
TIME BASE AND RECORDING GROUP

Header	Argument	Link Argument	Description
SAMple	MODE:	NORm HISpd	Selects the sampling mode. HISpd forces VMODE:CH1, TRIGGER SOURCE:CH1, DISPLAY MODE:YT. If RECORD MODE:ENV, HISpd forces it to RECORD MODE:NORm. Trigger delay value and Break Point address may be truncated; if setting or value change occurs, an SRQ is issued if EXW is on. When Normal mode is set, sample interval is limited to 10. ns or more.
	CLOCK:	INT EXT	Selects the sampling clock source. EXT forces TRIGGER DUNIT:POINT, BREAKPOINT UNIT:POINT, MEASURE FREQUENCY:OFF, TIME:OFF.
	INTERval:	<NRx>	Sets the sampling rate. <NRx>::=5E-9 to 2E-1 seconds in steps of one for internal clock source. <NRx>::=1 to 4E+7 points in steps of one for external clock source in normal sample mode. <NRx>::=1 to 4E+7 points in a 1-2-4-6-8 sequence for external clock source in high-speed sample mode. <NRx> is truncated or limited to nearest legal setting, and a warning SRQ is issued if EXW is on. When queried, the value is <NR3>.
SAMple?	MODE CLOCK INTERval		Queries the selected SAMple settings. INTERval value is in <NR3> format.
SAMple?			Queries for all SAMple settings. Example response: SAMPLE MODE:NORM,CLOCK:INT,INTERVAL:10.0E-9

Table 5-3 (Cont)
TIME BASE AND RECORDING GROUP

Header	Argument	Link Argument	Description
RECOrd	MODE:	NORm AVE ADV ENV	Selects the recording mode. AVERage forces a record LENGth of 131072. ADV selects the auto-advance mode, and forces TRIGger MODE:NORm if it was INComp or OUTcomp. ENV selects the enveloping mode, which forces SAMple MODE:NORm, and TRIGger MODE:NORm if it was INComp or OUTcomp. In ENVELOpe mode, Record Length value is limited to 128 K. If 256 K is selected in this mode, a warning SRQ is issued if EXW is on.
	ENVELOpe:	<NRx>	Sets number of times to envelope. <NRx>::=1 to 16348 in 2 ⁿ steps. An <NRx> of 99999 causes continuous enveloping until HOLD ON is received. When <NRx> is 2 or more, the last waveform memory segment is used for enveloped waveform accumulation. In this case, record location is changed to the last location minus one, and a warning SRQ is issued if EXW is on. <NRx> is truncated and limited to a legal number, and a warning SRQ is issued if EXW is on. When queried, the value is <NR1>.
	AVERage:	<NRx>	Sets the number of times to average. <NRx>::=2 to 16348 in 2 ⁿ steps. If <NRx> exceeds the range, it is truncated and limited to a legal number, and a warning SRQ is issued if EXW is on. When queried, the value is <NR1>.
	LOCation:	<NRx>	Sets the waveform memory location number as the acquisition segment. <NRx>::=1 to 256 (VMODE CH1) <NRx>::=1 to 128 (VMODE DUAL) If RECOrd MODE:ENV and ENVELOpe is equal to or more than 2: <NRx>::=1 to 255 (VMODE CH1) <NRx>::=1 to 127 (VMODE DUAL) If <NRx> exceeds the range, it is truncated or limited to match a legal value, and a warning SRQ is issued if EXW is on. When queried, the value is <NR1>.
RECOrd?	MODE ENVELOpe AVERage LOCation		Queries the selected RECOrd settings. ENVELOpe value is in <NR1> format. AVERage value is in <NR1> format. LOCation value is in <NR1> format.
RECOrd?			Queries for all RECOrd settings. Example response: RECOrd MODE:NORM,AVERAGE:2,ENVELOPE:1,LOCATION:1

Table 5-3 (Cont)
TIME BASE AND RECORDING GROUP

Header	Argument	Link Argument	Description
LENgth	NRx		<p>Sets the acquisition record length.</p> <p><NRx>::=1024, 2048, 4096, 8192, 16384, 32768, 65536, 131072, or 262144. 262144 is for VMODE CH1 and SAMPLe MODE HISpd only. <NRx> is truncated or limited to the nearest legal setting, and a warning SRQ is issued if EXW is on. Record Length value affects the trigger delay value and record location number. If limitation occurs because of a record length value change, the values are limited to the nearest legal value, and a warning SRQ is issued if EXW is on. Record Length value also affects the Cursor position value, Horiz Zoom value, and Display Location number. These values are also limited to the nearest legal value or number. When queried, the value is <NR1>.</p>
LENgth?			<p>Queries for the record acquisition length. Response is in <NR1> format. Example response: LENGTH 2048</p>
HOLd	ON NEXt RESet		<p>Controls the acquisition (recording) start and stop for time base.</p> <p>ON immediately stops an acquisition operation. Some data may be invalid.</p> <p>NEXt allows the current acquisition operation to continue through its specified record length, then enter the hold state.</p> <p>RESet clears the hold state and initiates the start of a new acquisition.</p>
HOLd?			<p>Reports the acquisition status for both time base channels. Example response: HOLD RESET</p>
BREakpoint	CLEar: UNIt: SEt:	<NRx> POInt TIME <NRx>:<NRx>	<p>Clears the specified breakpoint.</p> <p><NRx>::=1-5. If requested number is illegal and EXR is on, an error SRQ is issued.</p> <p>Selects the units of measure for the breakpoint settings. If SAMPLe CLOCK:EXT is selected, only POInt is available.</p> <p>Sets up to 5 breakpoints. First <NRx> in the argument assigns the break point location. Break point location limit is 10 to 524272 for Normal sampling mode, 10 to 524256 for High-Speed sampling mode. If limitation occurs, a warning SRQ is issued if EXW is on. Actual effective location is limited to the value shown below.</p> <p>First <NRx>::=<address> <time></p> <p><address>::=+16 to (record length+trigger delay-16) in increments of 8 in NORmal SAMPLe MODE.</p> <p><address>::=+32 to (record length+trigger delay-32) in increments of 16 in HISpd SAMPLe MODE.</p> <p><time> is calculated by <address> * (sample interval in seconds). If the external clock source is selected, only <ad-dress> can be set.</p> <p>Second <NRx> sets the sampling interval for the breakpoint defined by the first <NRx>. See SAMPLe INTerval for allow-able <NRx> values.</p>

Table 5-3 (Cont)
TIME BASE AND RECORDING GROUP

Header	Argument	Link Argument	Description
BREakpoint?	UNIt SET		Reports selected BREakpoint settings. For SET, the first <NRx> value is in NR1 format for <points> and <NR3> format for <time>. The second <NRx> value is in <NR3> format.
BREakpoint?			Reports all BREakpoint settings. Example response: BREAKPOINT UNIT:POINT,SET:0:10.0E-9,SET:520:100.0E-9
REPeat		<NRx>	Sets the number of acquisition cycles for the time base (not available via front panel). This command is the equivalent of having the instrument acquire <NRx> times and receiving the CURve? query. <NRx>::=1 to 65536 in increments of 1. Forces TRIGGER MODE:SGL and RECOrd MODE:NORm.
NUMacq?			Reports the number of acquisitions. Response is in <NR1> format. For TRIGGER MODE:INComp or :OUTcomp, the returned value indicates the number of compare operations that occurred before entering the HOLD state. For TRIGGER MODE:AUTO, NORm, or SGL, the returned value indicates the number of acquisitions that occurred before entering the HOLD state. For RECOrd MODE:ADV, the response indicates the last record location that completed acquisition before entering the HOLD state. An intermediate number is returned if the HOLD state has not been entered. The controller should monitor the OPC SRQ to determine when the HOLD state is entered.

Table 5-4
TRIGGERING GROUP

Header	Argument	Link Argument	Description
TRIGGER	MODE:	AUTO NORM SGL INComp OUTcomp	Selects the trigger operating mode. In compare mode (IN or OUT), 256 K record length is not permitted. If record length is 256 K and EXW is on, a warning SRQ is issued. More than two envelope times and compare mode are incompatible. If compare mode is set, envelope # times is set to 1.
	DUNIT:	POINT TIME	Selects the units of measure for the trigger delay value.
	DELAY:	<NRx>	<p>Sets trigger delay value. A negative number indicates pretrigger.</p> <p><NRx>::=<points> or <time>.</p> <p><NRx>::=- (LENGTH:<NRx>-8) to 262136 in increments of 8 for SAMPLE MODE:NORM.</p> <p><NRx>::=- (LENGTH:<NRx>-16) to 262128 in increments of 16 for SAMPLE MODE:HISpd.</p> <p><time>::=(points) * (sample interval).</p> <p>If <NRx> is not legal, it is truncated and limited to a legal hardware setting, and a warning SRQ is issued if EXW is on.</p> <p>When queried, value is <NR1> for Point unit or <NR3> for Time unit.</p> <p>Trigger delay value determines the trigger position where a negative number sets pretrigger and a positive number sets posttrigger. Trigger position is used as a time origin for the break point location, cursor position, PT.Off of waveform preamble, START of DATA command, and START of WINDOW command. Change of trigger delay value may affect the above values, and limitation may occur for those values.</p>
	COUPLING:	AC HFReg LFReg DC LINEs FLD1 FLD2	<p>Selects trigger coupling. HFReg attenuates signals above 50 kHz. LFReg attenuates signals below 50 kHz. AC blocks dc components and attenuates signals below 60 Hz.</p> <p>LINEs, FLD1, and FLD2 are for TV Option only. For FLD1 and FLD2, TRIGGER SOURCE:CH1 is forced and if TRIGGER SLOPE is set to BI, PHYs, or NHYS, it is forced to NEGATIVE.</p> <p>If Trig Source is CH2 and TV trigger coupling is requested, the Trig Source is changed to CH1, and SRQ is issued, if EXW is on.</p> <p>If LINE or FLD1 or FLD2 is requested and TV Trigger option is not installed, an SRQ is issued, if EXR is on, and the command ignored.</p>
	SOURCE:	CH1 CH2 EXT	Selects the trigger source. Selection defaults to CH1 for TV coupling selections and for SAMPLE MODE:HISpd.
	SLOPE:	POSITIVE NEGATIVE BISLOPE PHYs NHYS	Selects trigger slope. Selection defaults to NEGATIVE if BISLOPE, PHYs, or NHYS is selected with TV coupling selections, and an SRQ is issued if EXR is on.

More TRIGGER commands on next page

Table 5-4 (Cont)
TRIGGERING GROUP

Header	Argument	Link Argument	Description
TRigger	LUNit:	PERcent VOLts	Selects the units of measure for trigger level 1 and level 2.
	LEV1:	<NRx>	Sets trigger level 1. <NRx> ::= -99% to +99% in 1% steps. <NRx> in Volts ::= (% value) * RANge. When external trigger source is selected, full scale is ±5v. If <NRx> is illegal, it is truncated or limited to a legal hardware setting, and a warning SRQ is issued if EXW is on. <NRx> in volt value takes Range value into account. If range value is changed or probe attenuation is changed and level unit is VOLts, the level value is automatically changed (see above formula). When queried, the value is <NR1> for Percent unit or <NR3> for Volts unit.
	LEV2:	<NRx>	Sets trigger level 2. <NRx> ::= -99% to +99% in 1% steps. <NRx> in Volts ::= (% value) * RANge. If <NRx> is illegal, it is truncated or limited to a legal hardware setting, and a warning SRQ is issued if EXW is on. <NRx> in volt value takes Range value into account. If range value or probe attenuation factor is changed and level unit is VOLts, level value is automatically changed by formula above. When queried, the value is <NR1> for Percent unit or <NR3> for Volts unit.
	LINE:	<NRx>	TV Option. Selects which TV line number from the selected TRigger COUpling field causes the trigger. <NRx> ::= 1 to 1280 If outside this range, a warning SRQ is issued if EXW is on.
	LCNStart:	PREfid ATFid	TV Option. Defines where the TV line count starts. PREfid line count starts 3 lines before the field-sync pulse (System-M). ATFid line count starts at the field-sync pulse (Nonsystem-M). This setting forces trigger coupling to FLD1. When queried, the value is <NR1>.
TRigger?	MODE DUNit DELay COUpling SOUrce SLOpe LUNit LEV1 LEV2 LINE LCNStart		Reports the selected trigger settings. LEV1 (or LEV2) % value is in <NR1> format; voltage value is in <NR3> format. DELay <points> value is in <NR1> format; <time> value is in <NR3> format. LINE value is in <NR1> format.
TRigger?			Reports all trigger settings. Example response: TRIGGER MODE:AUTO,DUNIT:POINT,DELAY:-400,COUPLING:DC,SOURCE:CH1,SLOPE:POSITIVE,LUNIT:PERCENT,LEV1:0,LEV2:0,LCNSTART:PREFLD

Table 5-4 (Cont)
TRIGGERING GROUP

Header	Argument	Link Argument	Description
ARM	MODE:	INT EXT	Selects the arming signal source.
	DELAy:	<NRx>	Sets the trigger arming delay value. <NRx>::=0, or 10 ms to 10 s in a 1-2-5 sequence. If <NRx> is illegal, it is truncated and limited to a legal hardware setting, and a warning SRQ is issued if EXW is on. When queried, the value is <NR3>.
ARM?	MODE DELAy		Reports the selected trigger ARM settings. DELAy value is in <NR3> format.
ARM?			Reports all trigger ARM settings. Example response: ARM MODE:INT,DELAY:0.0E+0

Table 5-5
CURSOR AND DISPLAY CONTROL GROUP

Header	Argument	Link Argument	Description
CURSor	ONE:	DISP1	Enables cursor 1 on CH1 display.
		DISP2	Enables cursor 1 on CH2 display.
		OFF	Disables cursor 1.
	TWO:	DISP1	Enables cursor 2 on CH1 display.
		DISP2	Enables cursor 2 on CH2 display.
OFF		Disables cursor 2.	
SCROll:	ALIgn INDEp	Selects cursor scroll mode. ALIgn locks CH1 and CH2 displays together during scrolling using cursor 1. INDEp allows scrolling on one display channel while the other remains locked.	
POS1:	<NRx>	Specifies the location of cursor 1 on the display. <NRx>::=(TRIGGER DELAy) to (end of memory segment). (end of memory segment)::=(TRIGGER DELAy)+(LENGth <NRx>). If <NRx> is illegal, the number is truncated or limited to nearest legal value, and a warning SRQ is issued if EXW is on. If the Trigger Delay value is changed, the Cursor Position value may be limited. When queried, the value is <NR1>.	
POS2:	<NRx>	Specifies the location of cursor 2 on the display. See POS1 above for <NRx> values and other limits.	
CURSor?	ONE TWO SCROll POS1 POS2		Reports the selected CURSor setting. POS1 and POS2 values are in NR1 format.
CURSor?			Reports all CURSor settings. Example response: CURSOR ONE:OFF,TWO:OFF,SCROLL:ALIGN

Table 5-5 (Cont)
CURSOR AND DISPLAY CONTROL GROUP

Header	Argument	Link Argument	Description
DISplay	CHAnnel:	CH1 CH2	Selects which display channel is programmed by DISplay LOCation, VZOom, and VPOsn.
	LOCation:	<NRx>	Selects the waveform memory record of the channel to be displayed. <NRx>::=1 to 256 (CH1 or HISpd mode) <NRx>::=1 to 128 (DUAL mode) If <NRx> does not meet the other function settings or is outside range, it is truncated and limited to a legal value, and a warning SRQ is issued if EXW is on. When queried, the value is <NR1>.
	MODe:	YT XY	Selects the display mode. Both channels must be displayed for XY mode. If the Vertical Mode is set to CH1 Only, XY mode is not allowed. If XY is selected in CH1 Only or HISpd modes, an SRQ is issued if EXR is on, and the command ignored.
	INTErpol:	DOT LINE	Selects either dot or vector (line) display mode for the CRT monitor output signal. There are two algorithms for data thin-out method for horizontally compressed display, ranging X1/2 to X1/128. One is Even-Spaced thin-out and the other one is Envelope. The thin-out algorithm is automatically determined by the INTErpol setting. Dot mode uses the Even-Spaced algorithm. Line mode uses the Envelope algorithm. Dot mode offers faster display update.
DISplay?	CHAnnel LOCation MODe INTErpol		Reports the selected DISplay setting. LOCation is in <NR1> format.
DISplay?			Reports all DISplay settings. Example response: DISPLAY CHANNEL:CH1,LOCATION:1,MODE:YT,INTERPOL:LINE
HZOom	X1/128		Selects the horizontal display scaling factor. The display memory is 2048 points. When a fraction is used in HZOom, e.g. 1/128, the data is thinned out to view a longer length waveform in 2K points. The numerator is the length of the data to be displayed. Using the example 1/128, this takes a 256 K waveform and divides it down (using the thin-out algorithm) to the 2 K display memory.
	X1/64		
	X1/32		
	X1/16		
	X1/8		
	X1/4		
	X1/2		
	X1		
	X2		
	X4		
	X8		
X16			
HZOom?			Reports the horizontal scaling factor of the display. Example response: HZOOM X1

Table 5-5 (Cont)
CURSOR AND DISPLAY CONTROL GROUP

Header	Argument	Link Argument	Description
VZOOM	X1/4 X1/2 X1 X2 X4 X8 X16 X32		Selects the vertical scaling factor for the display. A fraction compresses the display data. If an integer number (1-32) is used, the waveform is expanded by that number of times. The VPOsn command is useful for positioning the zoomed waveform.
VZOOM?			Reports the vertical scaling factor of the display. Example response: VZOOM X1
VPOsn	<NRx>		Sets the vertical zero offset for the displayed channel. This is useful when using YZOOM. <NRx>::=-2048 to 2047 in steps of 1. If <NRx> is not within the limitation determined by vertical zoom rate, <NRx> is truncated and limited to a legal value, and a warning SRQ is issued if EXW is on. When queried, the value is <NR1>.
VPOsn?			Reports the vertical zero offset value for the displayed channel, which is returned in <NR1> format. Example response: VPOSN 0

Table 5-6
WAVEFORM PARAMETER MEASUREMENT GROUP

Header	Argument	Link Argument	Description
MEASURE	VOLT: TIME: FREQUENCY:	ON OFF ON OFF ON OFF	Enables voltage measurement mode. Enables time measurement mode. Enables the 1/T or 1/ΔT measurement mode. 1/T, 1/ΔT and external clock are incompatible. If requested, an error SRQ is issued if EXR is on. If one cursor is on (using the CURSOR commands listed in Table 5-5), the measurements are made relative to zero volts and the trigger point. If two cursors are on, the measurements are made relative to the difference between cursor 1 and cursor 2.
MEASURE?	VOLT TIME FREQUENCY		Reports status of the selected measurement mode.
MEASURE?			Reports status of all the measurement modes. Example response: MEASURE VOLT:OFF,TIME:OFF,FREQUENCY:OFF
Value?			Reports the measured value, which is returned in <NR3> format. If the cursor function is off or a measurement cannot be made, ##### is returned. If requested measurement can't be made because time scale is different between CH1 and CH2, an error SRQ is issued if EXR is on.

Table 5-7
WAVEFORM TRANSFER GROUP

Header	Argument	Link Argument	Description
WFMpre	WFId:	"<ascii string>"	Query only; ignored if sent as setting command. Responds with the waveform source and location (e.g., WFMpre WFID: "CH1_LOCATION1").
	ENCdg:	BiNary	Query only; ignored if sent as setting command. Responds with curve encoding, which is fixed at binary (e.g., WFMpre ENCDG:BINARY).
	NR.Pt:	<NR1>	Query only; ignored if sent as setting command. Responds with the number of data points in the source waveform, which is set by the DATA COUNT command (e.g., WFMpre NR.PT:<NRx>).
	PT.Fmt:	Y	Defines how to interpret the curve data. Y format means that x information is implicit and the data points set are the y value, and each point is sequential in time order. ENV format is used for enveloped waveforms. Data is sent in format y1max, y1min, y2max, y2min, . . . , and when received by the RTD 710A, it is treated as enveloped data.
	XINcr:	<NRx>	Sets the sample interval value for waveforms input by the CURVe command. If XUNit is SEC, <NRx> is from 5.0E-9 to 200E-3. If XUNit is EXT, <NRx> is from 4.0E+0 to 1.0E+7.
	YZEro:	<NRx>	Sets the input Offset for waveforms input by the CURVe command. If <NRx> is illegal, it is truncated and limited to match a legal sample interval, and a warning SRQ is issued if EXW is on. When queried, the value is <NR1>. <NRx>:: = -199% to 199% of full scale in 1% steps.
	PT.Off:	<NRx>	Sets trigger delay value for waveforms input by CURVe command. A negative number indicates pretrigger.
	XUNit:	SEC EXT	Sets the unit of measure for the Sample interval value for waveforms input by the CURVe command. If XUNit is SEC, the XINcr value is in seconds. If XUNit is EXT, the XINcr value is the scaling multiplication factor for the external clock.
	YOFf:	512	Query only; ignored if sent as setting command. Responds with the ground level of the input with 0% Offset, which is fixed at the center of full scale range (i.e., 512).
	YMUlt:	<NRx>	Sets the input Range value for waveform input by the CURVe command. <NRx>:: = 1.0E-1 to 5.0E+2. When an illegal value is received, the argument is truncated and limited to a legal value, and a warning SRQ is issued if EXW is on. When queried, the value is <NR3>. Volts per point is determined by: 2 * YMULT/1024.
	YUNit:	V	Query only; ignored if sent as setting command. Responds with the units of measure for the input Range value, which is fixed at Volts.
	BYT/nr:	2	Query only; ignored if sent as setting command. Responds with the width of the binary data field, which is fixed at two bytes per point.

More WFMpre commands on next page

Table 5-7 (Cont)
WAVEFORM TRANSFER GROUP

Header	Argument	Link Argument	Description
WFMpre	BN.Fmt:	RP	Query only; ignored if sent as setting command. Responds with the binary data format of the curve data, which is fixed as a right-justified, binary-positive integer.
	BIT/nr:	10	Query only; ignored if sent as setting command. Responds with the binary data precision, which is 10 bits.
	BKPt:	<NRx>:<NRx>	Sets the breakpoint location and sample interval for waveforms input by the CURVe command. The first <NRx> defines the breakpoint location with reference to the trigger point. The second <NRx> defines the sample interval associated with the breakpoint. If BKPt:0:0 is sent, it clears all previously set breakpoints. If an <NRx> is illegal, it is truncated or limited to a legal value, and a warning SRQ is issued if EXW is on.
WFMpre?	WFId	ENCdg NR.Pt PT.Fmt XINcr PT.Off XUNit YZEro YOFF YMUit YUNit BYT/nr BN.FMT BIT/nr BKPt	Reports the selected waveform preamble item. ENCdg response fixed: BINary. NR.Pt is in <NR1> format. XINcr is in <NR3> format. PT.Off is in <NR1> format. YZEro is in <NR1> format. YOFF response fixed: 512 YMUit is in <NR3> format. YUNit response fixed: V BYT/nr response fixed: 2 BN.Fmt response fixed: RP BIT/nr response fixed: 10 BKPt is in <NR1>:<NR3> format.
WFMpre?			Reports all waveform preamble items. Example response: WFMPRE WFID:"CH1_LOCATION1",ENCDG:BINARY,NR.PT:2048,XUNIT:SEC,XINCR:10.0E-9,PT.FMT:Y,PT.OFF:-400,YZERO:0,YOFF:512,YMULT:2.5E+0,YUNIT:V,BYT/NR:2,BN.FMT:RP,BIT/NR:10,BKPT:0:10.0E-9,BKPT:520:100.0E-9
CURVe	<waveform data>		Sends waveform data from the controller to the RTD 710A without the preamble. The format of the argument <waveform data> is defined by the DATA BFormat command. Target memory channel, memory segment, start address, etc., are also defined by using the DATA command. Repeated binary block transfer is not allowed for this command.
CURVe?			Sends binary block waveform data from the RTD 710A to the controller without sending the preamble. The source memory channel, memory segment, start address, etc., are defined by using the DATA command. For details of <binary block data>, refer to the DATA BFormat command description. Response is: CURVE <binary block data>[{,<binary block data>}. .] Repeated binary block transfer is acceptable when DATA BFormat is set to BINary, not acceptable with ARBitrary mode. For binary block data details, see DATA BFormat command description.

Table 5-7 (Cont)
WAVEFORM TRANSFER GROUP

Header	Argument	Link Argument	Description
WAVfrm?			Performs the same function as sending the WFMpre? and CURVe? queries. The RTD 710A sends the waveform preamble and then the curve data for the waveform specified by the DATA command.
DATA	CHAnnel:	CH1 CH2	Selects the memory channel to be transferred. If an illegal channel is requested, an error SRQ is issued, if EXR is on, and the command is ignored.
	LOCation:	<NRx>	Assigns the memory location number for the selected memory channel. <NRx>::=1 to 256 for VMOde CH1. <NRx>::=1 to 128 for VMOde DUAL. If <NRx> is illegal, an error SRQ is issued if EXR is on, and the command is ignored.
	STArt:	<NRx>	Designates the starting memory address at which waveform data is sent or received. <NRx>::=262136 to 524277. Allowable <NRx> range can be calculated as: (TRigger DELay) + (record LENGTH - 1) - 2. If <NRx> is illegal, an error SRQ is issued if EXR is on, and the command is ignored. Use WFMpre PT.Off to determine start from first point.
	COUnt:	<NRx>	Sets the number of data points to be transferred. <NRx>::=2 to 262144. If <NRx> does not match the other setting, an error SRQ is issued if EXR is on, and the command is ignored.
	BFOrmat:	BINArY ARBitrary	Designates the block format of the curve data transmission. BINArY is conventional binary block format defined in the Codes and Format standard. The format is as follows: CURVE %ccbbb.bbs[{,%ccbbb.bbs}. .] Where c=byte-count; b=binary data, high byte first; s=checksum. ARBitrary is the Definite Length Arbitrary Block format defined in IEEE Std 488.2. The format is as follows: CURVE #xc. cbbb.bbs Where x=number of bytes in the byte-count number; c=byte-count; b=binary data, high byte first; s=checksum.
	BSize:	<NRx>	Sets the block size of the binary data (2-byte data) string when using BFOrmat BINArY. <NRx>::=1024, 2048, 4096, 8192, or 16384. If <NRx> exceeds the value above, an error SRQ is issued if EXR is on, and the command is ignored. This argument is used for BINArY format transfer. It is not used for ARBitrary format transfer.

Table 5-7 (Cont)
WAVEFORM TRANSFER GROUP

Header	Argument	Link Argument	Description
DATA?	CHAnnel LOCation STArt COUnt BSIze		Reports the selected DATA setting. All responses except BFOFormat are in <NR1> format.
DATA?			Reports all DATA settings. Example response: DATA CHANNEL:CH1, LOCATION:1, START:-400, COUNT:2048, BFORMAT: BINARY, BSIZE:2048

Table 5-8
CALIBRATION GROUP

Header	Argument	Link Argument	Description
AUTocal			Initiates the auto-calibration function. If an error SRQ occurs, any command other than TEST causes the error to be ignored and normal operation to resume.
MONcal	STArt RESet		STArt connects the monitor calibration signal to the monitor output (X, Y, and Z). RESet disconnects the monitor calibration signal.

Table 5-9
SELF-TEST GROUP

Header	Argument	Link Argument	Description
TEST	MODE:	ON OFF	Enables the self-test mode. All test commands, including TEST, RUN, ERROR?, STEP, HALT, DEPOSIT, EXECUTE, and FETCH are acceptable when MODE is set to ON, but not when set to OFF. If an attempt is made to select a test command when MODE is off, an error SRQ is issued if EXR is on. TEST MODE is acceptable at any time.
	TYPE:	SELFDiag EXTDiag	Selects the level of self-test diagnostics to be run. SELFDiag selects the standard power on diagnostics (Level 1). EXTDiag selects extended diagnostics (Level 2). See TEST NUMBER below. <NRx> indicates the test number within the TYPE (extended diagnostics) that is to be run. If the TYPE is SELFDiag, NUMBER is reset to 0 when a RUN command is received. If <NRx> is illegal, an error SRQ is issued if EXR is on, and the command is ignored.
	NUMBER:	<NRx>	Selects the extended diagnostics test number. <NRx>::=00000 to 99999; defaults 00000 to TEST TYPE:SELFDiag.

More TEST commands on next page

Table 5-9 (Cont)
SELF-TEST GROUP

Header	Argument	Link Argument	Description
TEST	DATA	<NRx>	Sets data for the test defined by NUMBER:<NRx>. When queried, the value is <NRx> for Range setting and <NR1> for other settings. If <NRx> is illegal, it is truncated to the nearest legal number.
	LOOP:	ONE FAIL PASS CONT	Causes the selected self-test to run in a loop until the link argument condition is satisfied, or a HALT command is received.
TEST?	MODE TYPE NUMBER DATA LOOP		Reports the current TEST setting. Number is in <NR1> format. Data is in <NR3> format for range setting and <NR1> for other settings.
TEST?			Reports all TEST settings. Example response: TEST MODE:OFF,TYPE:EXTDIAG,NUMBER:0,LOOP:ONE,DATA:0
RUN			Starts the self-test function selected by NUMBER:<NRx>. Any tests in this test hierarchy below the selected number, except those requiring operator intervention, are run. If OPC is ON, an operation completion SRQ is issued when the test is finished. If a test is unsuccessful, an SRQ is issued if INR is on. An ERROR? query may then be used to retrieve the error code.
STEP			Causes the current test to advance to the next step in the sequence and execute that step. If OPC is ON, an operation complete SRQ is issued when the step is finished.
ERROR?			Reports the string of error codes (up to 40) that occurred during the last RUN command. Zero is returned when there are no errors.
HALT			Stops any test being executed. Specifically used to stop a looping test.

Table 5-10
UTILITY COMMAND GROUP

Header	Argument	Link Argument	Description
ID?			<p>Queries for the RTD 710A ID message which is returned as: ID SONY_TEK/RTD710A,V81.1,F<rom> <patch> <rom>::=1-character ROM version <patch>::=2-character patch version Example response: ID SONY_TEK/RTD710A,V81.1,F1.00</p>
SET?			<p>Reports the current instrument control settings, which are returned in an ASCII string that can be sent to the RTD 710A for setup. Example response: CH1 RANGE:2.5E+0,UNIT:PERCENT,OFFSET:0,COUPLING:AC;CH2 RANGE:50.0E+0,UNIT:PERCENT,OFFSET:0,COUPLING:AC;VMODE DUAL;BWLIM OFF;ARM MODE:INT,DELAY:0.0E+0;SAMPLE MODE:NORM,CLOCK:INT,INTERVAL:10.0E-9;RECORD MODE:NORM,AVERAGE:2,ENVELOPE:1,LOCATION:1;BREAKPOINT UNIT:POINT,SET:0:10.0E-9,SET:520:100.0E-9;LENGTH 2048;TRIGGER MODE: AUTO,DUNIT:POINT, DELAY: -400, COUPLING: DC, SOURCE: CH1, SLOPE: POSITIVE,LUNIT:PERCENT,LEV1:0,LEV2:0, LCNSTART: PREFLD;DISPLAY CHANNEL:CH1,LOCATION:1,MODE:YT, INTERPOL:LINE;HZOOM X1;VZOOM X1;VPOSN 0; CURSOR ONE:OFF,TWO:OFF,SCROLL:ALIGN</p>
HELp?			<p>Response is a list of all valid command headers available to the user. Example response: HELP ARM,AUTOCAL,BASE, BREAKPOINT,BWLIM,CER,CH1,CH2,CURSOR,CURVE,DATA, DEVICE,DISPLAY,DT,ERROR,EVENT,EXR,EXW,HALT, HELP,HOLD,HZOOM,ID,INIT,INR,LENGTH,MAXIMUM, MEAN,MEASURE,MID,MINIMUM,MONCAL,NCROSS, NUMACQ,OPC,OVER,PCROSS,PEAKTOPEAK,PLOT, RECALL,RECORD,REPEAT,RQS,RUN,SAMPLE,SAVE,SET, SRQ,STEP,TEST, TOP, TRIGGER, USER, VALUE, VMODE, VPOSN,VZOOM,WAVFRM,WFMPRE,WINDOW,WRI</p>
SAVe	<NRx>		<p>Stores the current instrument front panel setting into non-volatile memory at location <NRx>. <NRx>::=1 to 20. If <NRx> is illegal, it is truncated or limited to the nearest legal number and EXW is issued if on.</p>
RECall	<NRx>		<p>Recalls the instrument front panel settings from non-volatile memory location <NRx>. <NRx>::=1 to 20. If <NRx> is illegal, it is truncated or limited to the nearest legal number and EXW is issued if on. If requested recall location is empty, an error SRQ is issued if EXR is on, and the command is ignored.</p>
DEVice	SETtings:	ON OFF	<p>Determines whether instrument settings designated by the DISplay LOCation are plotted.</p>
	GRAt:	ON OFF	<p>Determines whether graticule is plotted.</p>
	WAVfrm	ON OFF	<p>Determines whether waveforms designated by the DISplay LOCation command are plotted.</p>

Table 5-10 (Cont)
UTILITY COMMAND GROUP

Header	Argument	Link Argument	Description
DEvice?	SETtings GRAt WAVfrm		Returns the device mode setting.
PLOt			<p>Command only. Causes the instrument to output a data string whose format is determined by the DEvice command.</p> <p>If the instrument is in acquisition when PLOt is received and is set to talker, the plotting waits until the acquisition is completed and enters the HOLd state.</p> <p>If display location is 0 (display off) when PLOt command is received, an execution error SRQ is issued if EXR is on.</p> <p>During PLOt, all front panel keys are locked except RQS/ID key.</p> <p>DCL or SDC aborts the plot.</p>

Table 5-11
DEVICE TRIGGER GROUP

Header	Argument	Link Argument	Description
DT	ON OFF		Enables the RTD 710A to respond to the GPIB GET command.
DT?			Reports the status of the DT setting. Example response: DT OFF

**Table 5-12
INITIALIZATION GROUP**

Header	Argument	Link Argument	Description
INIt	[ALL]		Executes all of the INIt command arguments (PANel, WAVfrm, and GPIb). The [ALL] argument is optional.
	PANel		Resets all front panel controls to default settings. See Section 3, Operating Instructions for default settings.
	WAVfrm		Clears the waveform memory to zero.
	GPIb		Clears the event buffer; sets DT:OFF, sets Service Request Group commands to: RQS:ON, OVER:OFF, WRI:OFF, CER:ON, EXR:ON, INR:ON, EXW:ON, OPC:OFF, USER:ON; and sets DATA, WINDOW, and DEVICE as shown in Table 5-12-1.

**Table 5-12-1
WINDOW AND DATA SETTINGS**

DATA	CHAnnel:CH1 LOCation:1 STArt:(Trigger Delay value of CH1, Location 1) COUnt:(Record Length value) BSIze:(Record Length value, not to exceed 16384) BFORmat:BINary
WINdow	CHAnnel:CH1 LOCation:1 STArt:(Trigger Delay value of CH1, Location 1) STOp:(Trigger Delay value)+(Record Length value)-1 LEVel:512
DEVICE	SETting:ON GRAt:ON WAVfrm:ON

Table 5-13
SERVICE REQUEST CONTROL GROUP

Header	Argument	Link Argument	Description
RQS	ON OFF		Enables all SRQ functions except power on and fatal error.
RQS?			Reports the RQS status.
OVER	ON OFF		Enables the Overrange SRQ function. Issues a status 193 or 209, event codes 752 through 755, when on.
OVER?			Reports the OVER status.
WRI	ON OFF		Enables the Acquisition Complete SRQ function. When on, the RTD 710A will issue an OPC (status 208) and event code 750.
WRI?			Reports the WRI status.
CER	ON OFF		Enables the Command Error SRQ function. Issues a status 97 or 113 when on.
CER?			Reports the CER status.
EXR	ON OFF		Enables the Execution Error SRQ function. Issues a status 98 or 114 when on.
EXR?			Reports the EXR status.
INR	ON OFF		Enables the Internal Error SRQ function. Issues a status 99 or 115 when on.
INR?			Reports the INR status.
EXW	ON OFF		Enables the Execution Warning SRQ function. Issues a status 101 or 117 when on.
EXW?			Reports the EXW status.
OPC	ON OFF		Enables the Operation Complete SRQ function. Issues a status 66 or 82 when on.
OPC?			Reports the OPC status.
USER	ON OFF		Enables the front-panel generated SRQ. Issues a status 67 or 83 when on.
USER?			Reports the USER status.
SRQ?			Reports the status of all Service Request Group commands. Example response: OVER OFF;USER ON;WRI ON;RQS ON; CER ON;EXR ON;EXW ON;INR ON;OPC OFF

Table 5-14
EVENT QUERY GROUP

Header	Argument	Link Argument	Description
EVENT?			Queries for the most recent event code; returns 0 if none exists. It also clears the event buffer.

Table 5-15
INTERNAL WAVEFORM ANALYSIS GROUP

Header	Argument	Link Argument	Description
WINDow	CHAnnel:	CH1 CH2	Selects the source waveform channel for subsequent waveform analysis commands. If VMODE CH1 is selected, CH2 cannot be selected. If CH2 is requested, an error SRQ is issued if EXR is on.
	LOCation:	<NRx>	Sets the waveform memory segment for subsequent waveform analysis commands. <NRx>::=1 to 256. If <NRx> does not match other settings, an error SRQ is issued if EXR is on, and the command is ignored.
	STArt:	<NRx>	Sets the start of the memory address for the actual measurement queries. <NRx>::=-262136 to 524279. <NRx> may be calculated as follows: (TRIGGER DELAY)+(RECORD LENGTH-1). <NRx> must be less than stop address. If they are not of the proper size relationship, they are swapped. If <NRx> is illegal, an error SRQ is issued if EXR is on, and the command is ignored.
	STOp:	<NRx>	Sets the end of the address for the waveform measurement queries. Refer to STArt for <NRx> values.
	LEVel:	<NRx>	Sets the vertical level for PCROSS and NCROSS. <NRx>::=1 to 1023.
WINDow?	CHAnnel LOCation STArt STOp LEVel		Queries for the selected window settings. LOCation is in <NR1> format. STArt is in <NR1> format. STOp is in <NR1> format. LEVel is in <NR1> format. Example response: WINDOW CHANNEL:CH1,LOCATION:1, START:-400,STOP:1647,LEVEL:512
MAXimum?			Queries for the maximum value of the acquired waveform between the STArt and STOp addresses. The value returned (0-1023) is in <NR1> format.
MINimum?			Queries for the minimum value of the acquired waveform between the STArt and STOp addresses. The value returned (0-1023) is in <NR1> format.
TOP?			Queries for the top value of the acquired waveform between the STArt and STOp addresses. The value returned (0-1023), which is calculated by the histogram method, is in <NR1> format.
BASE?			Queries for the base value of the acquired waveform between the STArt and STOp addresses. The value returned (0-1023), which is calculated by the histogram method, is in <NR1> format.
PCROSS?			Queries for the waveform point within the STArt/STOp window where the positive-going waveform first crosses the LEVel setting. The value returned, which is linearly interpolated, is in <NR1> or <NR2> format. If there is no positive-crossing point, the ASCII string ##### is returned.

Table 5-15 (Cont)
INTERNAL WAVEFORM ANALYSIS GROUP

Header	Argument	Link Argument	Description
NCRoss?			Queries for the waveform point within the STArt/STOp window where the negative-going waveform first crosses the LEVel setting. The value returned, which is linearly interpolated, is in <NR1> or <NR2> format. If there is no negative-crossing point, the ASCII string ##### is returned.
MID?			Queries for the vertical mid level value within the STArt/STOp window of the acquired waveform. The returned value (0-1023) is in <NR1> format, and is calculated as follows: $MID = (\max + \min) / 2.$
MEAN?			Queries for the vertical algebraic mean value within the STArt/STOp window of the acquired waveform. The returned value is in <NR1> format and is calculated as follows: $\text{Mean} = \sum_{i=1}^N W(i) \text{ where } W \text{ is waveform data.}$
PEAKtopeak?			Reports the vertical peak-to-peak value within the STArt/STOp window of the acquired waveform. The returned value (0-1023) is in <NR1> format.

ALPHABETICAL LIST OF COMMANDS

Command	Group	Command	Group
ARM	Triggering Group	MEASURE?	Waveform Parameter Measurement Group
ARM?	Triggering Group	MID?	Internal Waveform Analysis Group
AUTOCAL	Calibration Group	MINIMUM?	Internal Waveform Analysis Group
BASE?	Internal Waveform Analysis Group	MONCAL	Calibration Group
BREAKPOINT	Time Base and Recording Group	NCROSS?	Internal Waveform Analysis Group
BREAKPOINT?	Time Base and Recording Group	NUMACQ?	Time Base and Recording Group
BWLIM	Vertical System Control Group	OPC	Service Request Control Group
BWLIM?	Vertical System Control Group	OPC?	Service Request Control Group
CH1	Vertical System Control Group	OVER	Service Request Control Group
CH1?	Vertical System Control Group	OVER?	Service Request Control Group
CH2	Vertical System Control Group	PCROSS?	Internal Waveform Analysis Group
CH2?	Vertical System Control Group	PEAKTOPEAK	Internal Waveform Analysis Group
CER	Service Request Control Group	PLOT	Utility Group
CER?	Service Request Control Group	RECALL	Utility Group
CURSOR	Cursor and Display Control Group	RECORD	Time Base and Recording Group
CURSOR?	Cursor and Display Control Group	RECORD?	Time Base and Recording Group
CURVE	Waveform Transfer Group	REPEAT	Time Base and Recording Group
CURVE?	Waveform Transfer Group	RQS	Service Request Control Group
DATA	Waveform Transfer Group	RQS?	Service Request Control Group
DATA?	Waveform Transfer Group	RUN	Self-Test Group
DEVICE	Utility Group	SAMPLE	Time Base and Recording Group
DEVICE?	Utility Group	SAMPLE?	Time Base and Recording Group
DISPLAY	Cursor and Display Control Group	SAVE	Utility Group
DISPLAY?	Cursor and Display Control Group	SET?	Utility Group
DT	Device Trigger Group	SRQ?	Service Request Control Group
DT?	Device Trigger Group	STEP	Self-Test Group
ERROR?	Self-Test Group	TEST	Self-Test Group
EVENT?	Error Query Group	TEST?	Self-Test Group
EXR	Service Request Control Group	TOP?	Internal Waveform Analysis Group
EXR?	Service Request Control Group	TRIGGER	Triggering Group
EXW	Service Request Control Group	TRIGGER?	Triggering Group
EXW?	Service Request Control Group	USER	Service Request Control Group
HALT	Self-Test Group	USER?	Service Request Control Group
HELP?	Utility Group	VALUE?	Waveform Parameter Measurement Group
HOLD	Time Base and Recording Group	VMODE	Vertical System Control Group
HOLD?	Time Base and Recording Group	VMODE?	Vertical System Control Group
HZOOM	Cursor and Display Control Group	VPOSN	Cursor and Display Control Group
HZOOM?	Cursor and Display Control Group	VPOSN?	Cursor and Display Control Group
ID?	Utility Group	VZOOM	Cursor and Display Control Group
INIT	Initialization Group	VZOOM?	Cursor and Display Control Group
INR	Service Request Control Group	WAVFRM?	Waveform Transfer Group
INR?	Service Request Control Group	WRI	Service Request Control Group
LENGTH	Time Base and Recording Group	WRI?	Service Request Control Group
LENGTH?	Time Base and Recording Group	WINDOW	Internal Waveform Analysis Group
MAXIMUM?	Internal Waveform Analysis Group	WINDOW?	Internal Waveform Analysis Group
MEAN?	Internal Waveform Analysis Group	WFMPRE	Waveform Transfer Group
MEASURE	Waveform Parameter Measurement Group	WFMPRE?	Waveform Transfer Group

WAVEFORM TRANSMISSION

Overview

Up to 256 different waveforms with a record length of 1024 words each may be acquired and stored in the RTD 710A for later use (CH1 Only Mode). Waveform data stored in the RTD 710A can be selected and transmitted to a GPIB controller.

The general format of the transmitted waveform data closely conforms to the Tektronix Codes and Formats Standard, which specifies the form of transmission required for the waveform data. The two parts of the waveform data are:

1. **Preamble:** The preamble consists of a header string (WFMpre) followed by a series of arguments that identify waveform items such as waveform size, scaling information, format specification, and similar items required to scale the binary waveform into voltage values, and auxiliary information such as identification strings and units.
2. **Curve Data:** The curve data is a set of the actual waveform point data. In the RTD 710A, a waveform point may have a value between 0 and 1023. Waveform transmissions may include either preamble and curve data, or both. Separate queries may be used to elicit preamble or curve data, or both.

Waveform Preamble

The RTD 710A can transmit data of 2 to 262144 points to the controller (or can receive 2 to 262144 points of data from the controller). Each curve, when interpreted in accordance with its corresponding preamble, constitutes a complete waveform transmission. For proper interpretation of curve data, a minimum preamble for the selected waveform destination must be transmitted before any waveforms are sent. Subsequent preambles that are sent need only transmit changed information. Curve data associated with the preamble should be stored together. Following is a sample preamble:

```
WFMpre WFID:"CH1_LOCATION7",ENCDG:BINARY,
NR.PT:8192,PT.FMT:Y,XINCR:5.0E-9,PT.OFF:0,
XUNIT:SEC,YZERO:0,YOFF:512,YMULT:100.0E-3,
YUNIT:V,BYT/NR:2,BN.FMT:RP,BIT/NR:10,
BKPT:0:5.0E-9
```

CURVe/CURVe? Command

The CURVe command transmits waveform point data to the RTD 710A using the following format:

CURVe <waveform data>

where: <waveform data> is set either to <binary block data> or to <arbitrary block data> by DATA BFormat command. When <binary block data> is selected, the format of the waveform point data is as follows:

- <binary block data>::= %<binary count> <binary point>...<checksum>
- <byte count>::= A 2-byte binary number representing the total number of data bytes plus checksum.
- <binary point>::= 10 bits. With 10-bit resolution, each waveform data point is transferred in two bytes: high byte first, then low byte. The 2-MSBs (most significant bits) of the 10-bit waveform data are transferred as the 2-LSBs (least significant bits) of the high byte (the remaining six bits of the high byte are set to zero). The remaining 8 bits of waveform are transferred as the low byte (Fig. 5-1).
- <checksum>::= The 2s complement of the modulo 256 sum of the preceding <binary count> and <binary point>.

When <arbitrary block data> is set, the format of the waveform point data has the following structure:

- <arbitrary block data>::= #<number of digits> <byte count>---<binary point>---<checksum>
- <number of digits>::= The number of bytes in the byte count number. This is an ASCII digit from 1 to 9.
- <byte count>::= ASCII digits from 0 to 9 representing the total number of data bytes plus checksum.
- <binary point>::= Same as the <binary point> defined in <binary block data> above.
- <checksum>::= Same as the <checksum> defined in <binary block data> above.

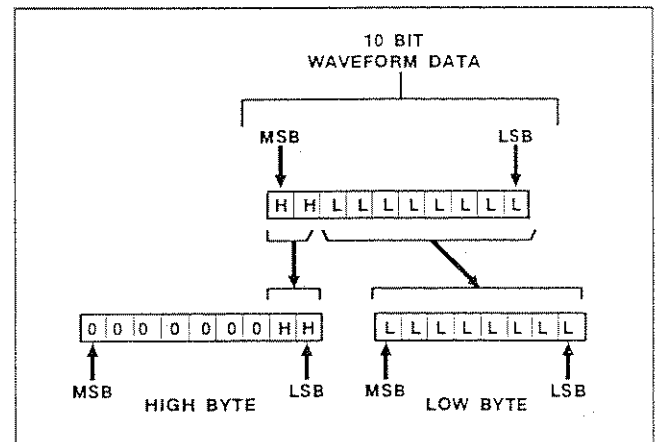

Fig. 5-1. Transfer of 10-bit waveform data.

Programming Command Set

The CURVe? command transmits the waveform point data of the source waveform specified by the DATA command from the RTD 710A to the GPIB controller in the format shown to the right and illustrated below:

CURVE<binary block data>
 [{,<binary block data>}--] or
 CURVE <arbitrary block data>
 which is defined in Fig. 5-2 and Fig. 5-3 respectively.

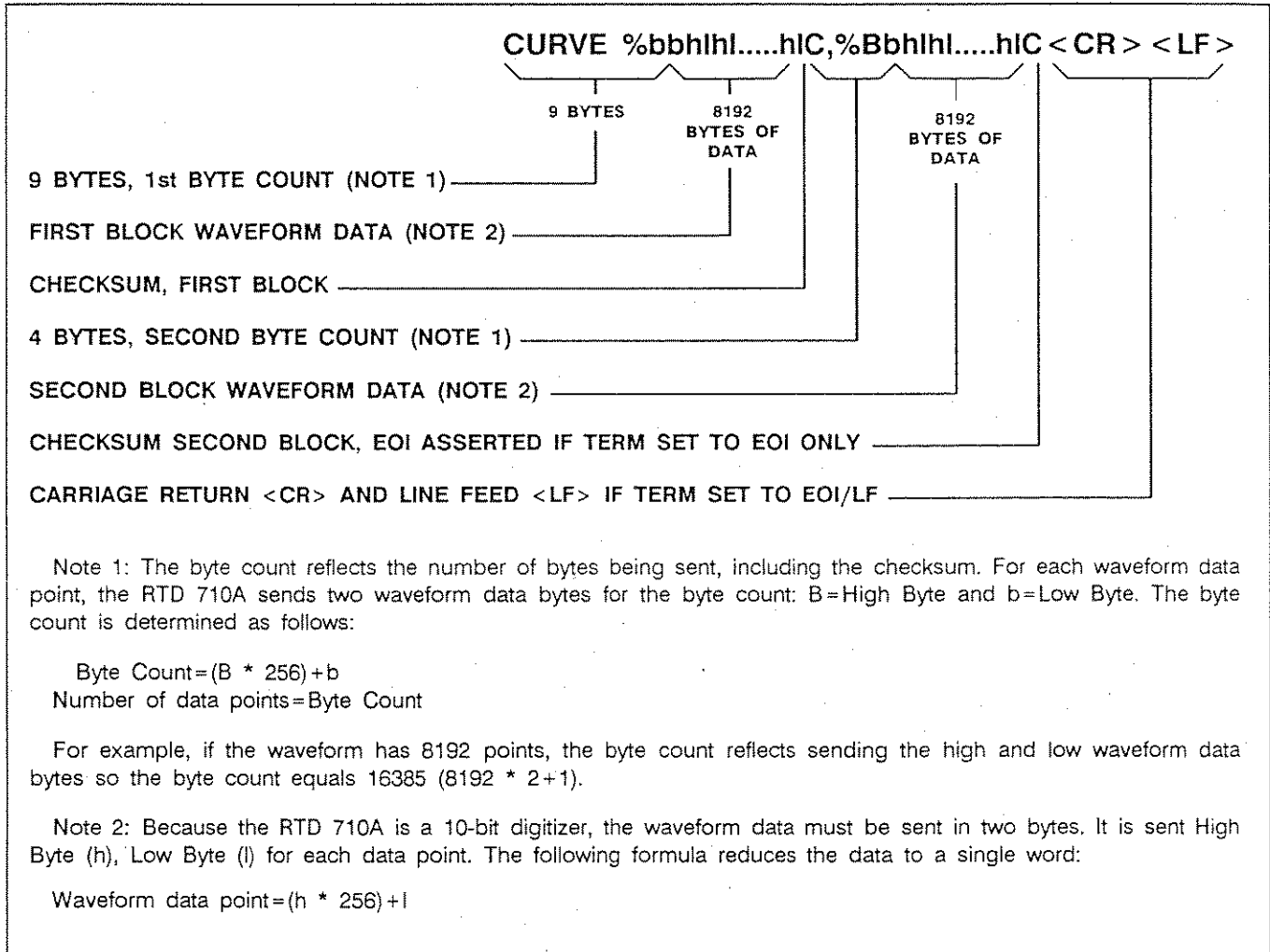

Fig. 5-2. Binary block data.

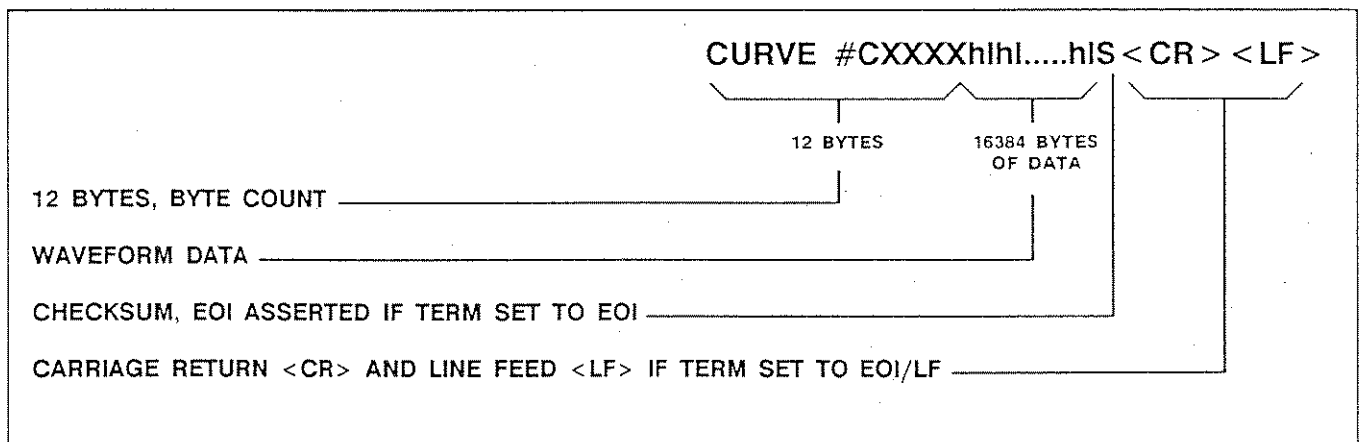

Fig. 5-3. Arbitrary block data.

WAVfrm? Command

The preamble and curve information may be transmitted together from the RTD 710A to the controller using the WAVfrm? command. When the command

WAVfrm?

is sent, the RTD 710A responds:

<preamble>;<curve data>

where:

<preamble>::= response to WFMpre?

<curve>::= response to CURVe?

DATA Command

To transfer waveforms from the RTD 710A, the waveform data source needs to be identified using the DATA command and its arguments: CHANNEL, LOCATION, START, COUNT, BFORMAT, and BSIZE.

DATA CHANnel:[CH1 or CH2] selects which channels data is to be transferred.

DATA LOCation: defines which record (1-256) is to be transferred.

DATA STArt specifies the starting address of the selected data. Use WFMpre:PT.OFF to designate the starting point if the first point in the selected data is desired.

DATA COUnt specifies the number of waveform data points to be transmitted. Use WFMpre COUnt if the entire record is being transferred.

DATA BFOrmat specifies the format of the waveform data that is transferred by the CURVe or CURVe? commands, either Binary or Arbitrary.

DATA BSIze specifies the binary block size of each transfer when data transfer of binary block data format (BFOrmat BINary) is taken. It is useful to control the size of the data Block Size. If a 64K waveform is to be transferred, BSIZE will limit the Block Size to 16K each. The waveform can then be read into four 16K arrays.

REPEAT Command

For transmission of multiple waveform data, the REPEAT command may be used to minimize the access time for the controller by not requiring the controller to send the CURVe? query before each transfer. The REPEAT command uses the format:

REPEAT <NRx>

which performs <NRx> acquisitions and immediate transfer to the waiting controller. If <NRx> is set to 0 or less,

it is rounded to 1. If <NRx> is set greater than 65536, it is limited to that number.

The REPEAT command has these restrictions:

1. For the DATA command:
 - a. DATA CHANnel is set to CH1, if VMODE is CH1.
 - b. DATA LOCation is set to RECORD LOCATION.
 - c. DATA STArt is set to TRIG DELAY.
 - d. DATA COUnt is set to RECORD LENGTH.
2. TRIGGER MODE is set to SGL.
3. RECORD MODE is set to NORM, if it is ADV.
4. The message terminator uses EOI, regardless of rear panel setting of GPIB parameter switch.

PROGRAMMING EXAMPLES

The programming examples presented here show how to control the RTD 710A through a Tektronix GPIB Controller, using the Tektronix 4041 BASIC and the Tektronix SPS BASIC languages. Each example is first listed, then each entry is explained (except remarks entries).

Processing an SRQ

If the RTD 710A asserts the SRQ signal, the GPIB controller can poll each device to determine which is requesting service. The RTD 710A responds only to a serial poll. The next two examples show how to serial poll the RTD 710A:

4041 BASIC Example:

```

100 !
110 ! Poll the RTD 710A in response to SRQ.
120 !
130  Init all
140  Integer status,adrs,event
150  Open #1:"gpiB0 (pri=1,eom=<0>):"
160  On srq then call srqhdlr
170  enable srq

.

500  End
1000 Sub srqhdlr
1010 Poll status,adrs;1
1020 Input #adrs prompt "EVE?":event
1030 Print "SRQ from ";adrs;" , Status =
      ";status;
1040 Print "      Event = ";event
1050 Resume
1060 End

```

Programming Command Set

Program Explanation:

```
130  Initializes the 4041.
140  Creates integer variables: status, adrs, event.
150  Assigns RTD 710A as logical unit 1; at primary
      address 1; with EOM character set to EOI
160  Call subroutine "srqhdlr" when SRQ occurs.
170  Enables the SRQ interrupt.
500  End of main program.
1000 Beginning of subroutine "srqhdlr".
1010 Serial poll device at GPIB address 1 (RTD 710A).
1020 Send EVENT? query to RTD 710A.
1030 Displays the status byte.
1040 Displays the event code.
1050 Returns to main program.
1060 End of subroutine "srqhdlr".
```

SPS BASIC Example:

```
100 REM
110 REM Poll the RTD 710A in response to SRQ.
120 REM
130 LOAD "INS"
140 SRQDISABLE @0
150 ATTACH #1 AS INS:@0,1
160 WHEN #1 HAS "POW" GOSUB 1000
170 WHEN #1 HAS "ABN" GOSUB 2000
180 WHEN #1 HAS "300" GOSUB 3000
190 WHEN #1 HAS "SRQ" GOSUB 4000
200 LOCKSRQ
210 SRQENABLE @0
.
.
1000 REM Process for Power-on SRQ.
.
.
1900 SRQENABLE @0
1910 RETURN
2000 REM Process for Illegal Status SRQ.
.
.
2900 SRQENABLE @0
2910 RETURN
3000 REM Process for Write End SRQ.
.
.
3900 SRQENABLE @0
3910 RETURN
4000 REM Process for Other SRQ.
.
.
4900 SRQENABLE @0
4910 RETURN
```

NOTE

Each SRQ handler must execute an SRQENABLE @0 to enable subsequent SRQs after completion of the necessary processing.

Program Explanation:

```
130  Load the instrument drive.
140  Disable SRQ interrupt on GPIB interface 0.
150  Assign RTD 710A at address 1 as instrument 1.
160  Jump to line 1000 for Power-on SRQ.
170  Jump to line 2000 for Illegal Status SRQ.
180  Jump to line 3000 for a Write End SRQ (300).
190  Jump to line 4000 for other SRQ.
200  Disable subsequent SRQs during SRQ process.
210  Enable for subsequent SRQs.
```

Set/Query Commands and Responses

The next two examples send commands to the RTD 710A and receive responses.

4041 BASIC Example:

```
100 !
110 ! Send commands and queries to RTD 710A,
120 ! and receive responses.
130 !
140  Init all
150  Integer status,adrs,event
160  Open #1:'gpib0 (pri=1,eom=<0>):'
170  On srq then call srqhdlr
180  Enable srq
190  Dim mesag$ to 500,respond$ to 1000
200  Repeat: input prompt "ENTER MESSAGE TO
      SEND TO RTD 710A: ":"mesag$
210  Print #1:mesag$
220  If pos (mesag$,"?",1)<1 then goto repeat
230  Input #1:respond$
240  Print "RESPONSE FROM RTD 710A IS: ";
      respond$
250  Goto repeat
260  End
1000 Sub srqhdlr
1010 Poll status,adrs;l
1020 Input #1 prompt "EVE?":event
1030 Print "Status = ";status'
1040 Print "  Event = ";event
1050 Resume
1060 End
```

Program Explanation:

```
140  Set up the environment.
|
180
200  Input the set or query command (a$).
210  Send the command to the RTD 710A.
220  If set command, go to line 190; otherwise, line
230.
230  Establish response buffer (resp$).
240  Input the response to the query command.
250  Display the response.
260  Go to line 190.
270  End of main program.
1000 SRQ handler; performs serial poll and displays
      status.
|
1060
```

SPS BASIC Example:

```

100 REM
110 REM Send commands and queries to
120 REM RTD 710A, and receive responses.
130 REM
140 LOAD "INS"
150 ATTACH #1 AS INS:@0,1
160 PUT "CH1 RANGE:5.0" INTO #1
.
.
.
200 GET A$ FROM #1, "ID?"
210 PRINT A$
220 GET H$;L FROM #1, "LENGTH?"
230 PRINT "RECORD LENGTH " ";L;" POINT"

```

Program explanation:

```

140 Load the instrument driver.
150 Specify RTD 710A at GPIB address 1 as
    instrument 1.
160 Set CH1 input Range to 5.0 volts.
200 Send query (ID?) and store response (A$).
210 Display the response (A$).
220 Send query (LENGTH?); separately store response
    header (H$) and length (L).
230 Display the response length.

```

Simple Waveform Data Transfer Using Binary Format to the Controller

The next two examples transfer CH1 waveform data from the RTD 710A to the controller.

4041 BASIC Example:

```

100 !
110 ! Get a waveform from Ch1, Location 1,
120 ! Start -400, count 2048, block format binary,
    block size 2048.
130 !
140 Init all
150 Integer status,adrs,event
160 Open #1:'gpib0 (pri=1,eom=<0>,tra=fast):"
170 On srq then call srqhdlr
180 Enable srq
190 Dim curve$ to 2048*2+10
200 Integer wfdata (2048)
210 Print #1:"DAT CHA:CH1,LOC:1,STA:-400,COU:2048,
    BFO:BIN,BSI:2048"
2201 Print #1:"CURV?"
2301 GETARR 1,wfdata,16
240 End
1000 Sub srqhdlr
1010 Poll status,adrs;1
1020 Input #1 prompt "EVENT?";event
1030 Print "Status = ";status;
1040 Print " Event = ";event
1050 Resume
1060 End

```

¹Use lines 220 and 230 as is if 4041 has UTL2 program.

If not, use:

```

220 Input #1 prompt "CURVE?":curve$
230 GETMEM buffer curve$ using "6X,+16%":wfdata

```

Program explanation:

```

140 Set up the environment.
|
180
190 Create curve data array (curve$).
200 Create waveform data array (wfdata).
210 Send DATA command to set: channel to CH1,
    location to 1, start to -400, count to 2048, block
    format to binary, and block size to 2048.
220 Query for curve data (CURVE?).
230 Input data and store (wfdata).
240 End of main program.
1000 SRQ handler; performs serial poll and displays
    status.
|
1060

```

SPS BASIC Example:

```

100 REM
110 REM Get a waveform from CH1, loc 1, start
120 REM -400, count 2048, block format binary, block
    size 2048.
130 REM
140 LOAD "GPI"
150 INTEGER H(8), W(2047)
160 PUT "DATA CHA:CH1,LOC:1,STA:-400,COU:2048,
    BFO:BIN,BSI:2048" INTO @0,33
170 PUT "CURVE?" INTO @0,33
180 IFDTM @0,"UNP"
190 GET H FROM @ 0,65
200 IFDTM @0,"PAK","HBF"
210 GET W FROM @0,65
220 IFDTM @0,"UNP"
230 GET CS FROM @0,65
240 END

```

Program explanation:

```

140 Load the interface driver.
150 Create curve data array (H) and waveform data
    array (W).
160 Send DATA command to set: channel to CH1,
    location to 1, start to -400, count to 2048, block
    format to binary, block size to 2048.
170 Send CURVE? query.
180 Set interface to accept unpacked binary data.
190 Get and store (H) curve data.
200 Set interface to accept packed, high-byte-first
    binary data.
210 Get and store (W) waveform data.
220 Set interface to accept unpacked binary data.
230 Get checksum.
240 End of program.

```

Programming Command Set

Binary Format Block Transfer of Waveform Data

The next two program samples perform a binary format block transfer of CH1 waveform data from the RTD 710A to the controller.

4041 BASIC Example:

```
100 !
110 ! Get CH1 waveform, Loc 1, sta -400,
120 ! cou 8192, bformat binary, bsize 2048. Store
    waveform
130 ! in arrays: iwfm1, iwfm2, iwfm3, iwfm4.
140 !
150 Init all
160 Integer status,adrs,event
170 Open #1:'gpib0(pri=1,eom=<0>):'
180 On srq then call srqhdlr
190 Enable srq
200 Dim hd$ to 6,blk1$ to 4100,blk2$ to
    4100,blk3$ to 4100,blk4$ to 4100
210 Dim c1$ to 1,c2$ to 1,c3$ to 1
220 Integer iwfm1(2048),iwfm2(2048),iwfm3(2048),
    iwfm4(2048)
230 Print #1: "DAT CHANNEL:CH1,LOCATION:1,
    START:-400,COUNT:8192,BFORMAT:BIN,BSIZE:2048
240 Input #1 prompt "CURVE?";hd$,blk1$,c1$,
    blk2$,c2$,c3$,blk4$
250 Getmem buffer blk1$ using "+16%":iwfm1
260 Getmem buffer blk2$ using "+16%":iwfm2
270 Getmem buffer blk3$ using "+16%":iwfm3
280 Getmem buffer blk4$ using "+16%":iwfm4
290 End
1000 Sub srqhdlr
1010 Poll status,adrs;1
1020 Input #adrs prompt "EVENT?":event
1030 Print "SRQ from address=";adrs;";
    Status=";status;
1040 Print ", Event code = ";event
1050 Resume
1060 End
```

Program explanation:

```
150 Set up the environment.
|
190
200 Create header and data arrays.
210 Create checksum arrays.
220 Create waveform point arrays.
230 Send Data command to setup RTD 710A.
240 Query for and store CURVE? data
250 Input data and store as binary.
|
280
290 End of program.
1000 SRQ handler; performs serial poll and displays
    status.
|
1060
```

SPS BASIC Example:

```
100 REM
110 REM Get a waveform from CH1, loc 1, start
120 REM -400, count 8192, block format binary, block
    size 2048.
130 REM
140 LOAD "GPI"
150 PUT "DAT CHA,CH1,STA:-400,COU:8192,BFO:BIN,
    BSI:2048:INTO @0,33
160 INTEGER H(8),W1 (2047),W2(2047),W3(2047),
    W4 (2047),J1(3),J2(3),J3(3)
170 PUT "CURVE?" INTO @0,33
180 IFDTM @0,"UNP"
190 GET H FROM @0,65
200 IFDTM @0,"PAK","HBF"
210 GET W1 FROM @0,65
220 IFDTM @0,"UNP"
230 GET C1,J1 FROM @0,65
240 IFDTM @0,"PAK"
250 GET W2 FROM @0,65
260 IFDTM @0,"UNP"
270 GET C2,J2 FROM @0,65
280 IFDTM @0,"PAK"
290 GET W3 FROM @0,65
300 IFDTM @0,"UNP"
310 GET C3,J3 FROM @0,65
320 IFDTM @0,"PAK"
330 GET W4 FROM @0,65
340 IFDTM @0,"UNP"
350 GET C4 FROM @0,65
360 END
```

Program explanation:

NOTE

Lines 180, 220, 260, 300, and 340 set interface to accept unpacked data, while lines 200, 240, 280, and 320 set interface to accept packed data.

```
140 Load the interface driver.
150 Send DATA command to set: channel to CH1,
    location to 1, start to -400, count to 8192, block
    format to binary, and block size to 2048.
160 Create arrays for header data (H and J) and
    waveform data (W1, W2, W3, and W4).
170 Query for CURVE? data.
190 Store W1 header data.
210 Store W1 data.
230 Get W1 checksum (C1) and store W2 header (J1).
250 Store W2 data.
270 Get W2 checksum (C2) and store W3 header (J2).
290 Store W3 data.
310 Get W3 checksum (C3) and store W4 header (J3).
330 Store W4 data.
350 Get W4 checksum.
360 End of program.
```

Arbitrary Format Block Transfer of Waveform Data

The next two program samples perform an arbitrary format block transfer of CH1 waveform data from the RTD 710A to the controller.

4041 BASIC Example:

```

100 !
110 ! Get a waveform from CH1, location 1, start -400,
    count 2048
120 ! block format arbitrary.
130 !
140 Init all
150 Integer status,adrs,event,i
160 Open #1:"gpib0(pri=1,eom=<0>):"
170 On srq then call srqhdlr
180 Enable srq
190 Dim hd$ to 12
200 Integer rawdata(4096),wfmdata(2048),chksum
210 Print #1:"DAT CHANNEL:CH1,LOCATION:1,START:-400,
    COUNT:2048,BFORMAT:ARBITRARY"
220 Input #1 prompt "CURVE?":hd$,rawdata,chksum
230 For i=2 to 4096 step 2
240   wfmdata (i/2)=rawdata(i-1)*256+rawdata(i)
250 Next i
260 End
1000 Sub srqhdlr
1010 Poll status,adrs;1
1020 Input #1 prompt "EVENT?":event
1030 Print "Status = ";status;
1040 Print " Event = ";event
1050 Resume
1060 End

```

Program Explanation:

```

140 Set up the environment
|
180
190 Create header array (hd$).
200 Create waveform data arrays (rawdata, wfmdata).
210 Send DATA command to set: channel to CH1,
    location to 1, start to -400, count to 2048, block
    format to arbitrary, block size to 2048.
220 Query for curve data (CURVE?) and input raw
    data (rawdata).
230 Make 10 bits data (wfmdata).
|
250
260 End of main program.
1000 SRQ handler; performs serial poll and displays
    | status.
1060

```

SPS BASIC Example:

```

100 REM
110 REM RTD 710A Waveform Data Transfer Program
120 REM Data channel CH1, location 1, start -400,
130 REM count 2048, block format arbitrary.
140 REM
150 LOAD "GPI"
160 INTEGER H(11), W(2047)
170 PUT "DAT CHA:CH1,LOC:1,STA:-400,COU:2048,BFO:
    ARB" INTO @0,33
180 PUT "CURVE?" INTO @0,33
190 IFDTM @0,"UNP"
200 GET H FROM @0,65

```

```

210 IFDTM @0,"PAK","HBF"
220 GET W FROM @0,65
230 IFDTM @0,"UNP"
240 GET CS FROM @0,65
250 END

```

Program Explanation:

```

150 Load the interface driver.
160 Create curve data array (H) and waveform data
    array (W).
170 Send DATA command to set: channel to CH1,
    location to 1, start to -400, count to 2048, block
    format to arbitrary, block size to 2048.
180 Send CURVE? query.
190 Set interface to accept unpacked binary data.
200 Get and store (H) curve data.
210 Set interface to accept packed, high-byte-first
    binary data.
220 Get and store (W) waveform data.
230 Set interface to accept unpacked binary data.
240 Get checksum.
250 End of program.

```

Waveform Data Transfers to the RTD 710A

The next two examples generate a reference sine wave of 2048 points, then transfer it to record location 2 of CH1. See Section 4 of the RTD 710A Instrument Interfacing Guide for more examples.

4041 BASIC Example:

```

100 !
110 ! RTD 710A Waveform Receive program. Array
120 ! iwfm contains sinewave data.
130 ! Send a waveform to CH1, Location 1,
140 ! Start 0, Count 2048, block format binary, block
    size 2048
150 !
160 !
170 Init all
180 Integer status,adrs,event,i,iwfm(2048)
190 Open #1:"GPIB0(pri=1,eom=<0>,tra=fast):"
200 On srq then call srqhdlr
210 Enable srq
220 Print "BUILDING WAVEFORM TO SEND"
230 For i=1 to 2048
240   iwfm(i)=400*sin(i*3.14/180)+511
250 Next i
260 Print "SENDING WAVEFORM"
270 Print #1:"DAT CHANNEL:CH1,LOCATION:1,
    START:0,COUNT:2048,BFORMAT:BINARY,BSIZE:2048"
280 Print #1:"WFM XUN:SEC,XIN:10E-9,
    PT.FMT:Y,YZE:0,YOFF:512,PT.0:0,YMU:5"
290 Dim Curve$ to 2048*2+10
300 Putmem buffer curve$ using "FA,+16%":
    "CURVE ",iwfm
310 Print #1:curve$
320 End
1000 Sub srqhdlr
1010 Poll status,adrs;1
1020 Input #adrs prompt "EVENT?":event
1030 Print "SRQ from address = ";adrs;
    ",Status = ";status;
1040 Print " , Event code = ";event
1050 Resume
1060 End

```

Programming Command Set

Program explanation:

```
170 Set up environment
|
210
220 Send message to user.
230 Create reference waveform.
|
250
260 Send message to user
270 Send Data command to setup RTD 710A.
280 Send waveform preamble data to RTD 710A.
290 Create data array.
300 Put reference waveform in data array.
310 Send dat array to RTD 710A.
320 End of Main Program.
1000 SRQ handler; performs serial poll and displays
| status.
1060
```

SPS BASIC Example:

```
100 REM
110 REM Create/store reference waveform in
variables:
120 REM W(2047) is waveform data.
130 REM
140 WP$="WFMPRE XUNIT:SEC,XINCR:10E-9,
150 PT.FMT:Y,PT.OFF:0,YZERO:0,YMULT:5"
160 DT$"DATA CHANNEL:CH1,LOCATION:2,
170 START:0,COUNT:2048",BFORMAT:BIN,BSIZE:2048
180 LOAD "INS"
190 ATTACH #1 AS INS:@0,1
200 MODE #1 "PAK","HBF"
210 INTEGER W(2047)
220 FOR I=0 TO 2047
230 W(I)=400*SIN((i+1)*3.14/180)+511
240 NEXT I
250 PUT WP$ INTO #1
260 PUT DT$ INTO #1
270 PUT "CURVE ";W INTO #1, "BIN"
280 END
```

Program explanation:

```
180 Load the instrument driver.
190 Specify RTD 710A at GPIB address 1 as
instrument 1.
200 Set interface to accept packed data.
210 Create reference waveform integer array (W).
220 Create reference waveform data.
|
240
250 Send a waveform setup (WP$).
260 Send DATA setup (DT$).
270 Send curve and waveform data.
280 End of program.
```

Using the REPEAT Command

The next two examples repeat the acquisition and transmission of the data 10 times.

4041 BASIC Example:

```
100 !
110 ! Repeat acquisition 10X from CH1, loc 1,
120 ! sta -400, cou 2048, block format binary, block
size 2048.
130 !
140 ! Init all
150 Integer status,adrs,event,i
160 Open #1:"gpib0(pri=1,eom<0>,tra =fast):"
170 On srq then call srqhdlr
180 Enable srq
190 Dim curve$(10) to 2048*2+10
200 Print #1:"DAT CHA:CH1,LOC:1,STA:-400,
COU:2048,BFO:BIN,BS1:2048"
210 Print #1:"REPEAT 10"
220 For i=1 to 10
230 Input #1:curve$(i)
240 Next i
250 End
1000 Sub srqhdlr
1010 Poll status,adrs;1
1020 Input #1 prompt "EVE?":event
1030 Print "Status = ";status;
1040 Print " Event = ";event
1050 Resume
1060 End
```

Program explanation:

```
140 Set up environment.
|
180
190 Create curve data array (curve$).
200 Send DATA command to set: channel to CH1,
location to 1, start to -400, count to 2048, block
format to binary, block size to 2048.
210 Send "REPEAT 10" command.
220 Input one set of waveform data 10 times
| (curve$(i)).
240
250 End of main program
1000 SRQ handling subroutine, which performs a serial
| poll and inputs the event code
1060
```

NOTE

Set CH1 and CH2 displays to zero (off) for faster throughput.

SPS BASIC Example:

```

100 REM Repeat acquisition 10 times from CH1,
110 REM loc 1, 120 REM start -400, count 2048,
120 REM block format binary, block size 2048.
130 REM
140 LOAD "GPI"
150 OPEN #2 AS "WAVE.DAT" FOR WRITE
160 PUT "DAT CHA:CH1,STA:-400,COU:2048,BFO:BIN,
    BSI:2048 INTO @0,33
170 PUT "REP 10" INTO @0,33
180 INTEGER H(8),W(2047)
190 IFDTM @0,"UNP"
200 FOR I=1 TO 10
210 GET H FROM @0,65
220 IFDTM @0,"PAK","HBF"
230 GET W FROM @0,65
240 IFDTM @0,"UNP"
250 GET CS FROM @0,65
260 WRITE #2,W
270 NEXT I
280 CLOSE #2
290 END

```

Program explanation:

```

140 Load the interface driver.
150 Open file "WAVE.DAT" as logical unit 2.
160 Send DATA command to set block size to 2048.
170 Send "REP 10" command.
180 Create header array (H) and waveform data array
    (W).
190 Set interface to accept unpacked data.
200 Acquire data 10 times.
    |
270
280 Close logical unit 2(file "WAVE.DAT").
290 End of program.

```

Saving/Recalling Front-Panel Settings

The next two examples store and recall front panel settings using the SAVE and RECALL commands.

4041 BASIC Example:

```

100 !
110 ! Save/recall RTD 710A front panel settings.
120 !
130 Init all
140 Integer status,adrs,event,number
150 Open #1:"gpib0 (pri=1,eom=<0>):"
160 On srq then call srqhdlr
170 Enable srq
180 Input prompt "Enter location":number
190 Print #1:"SAVE "&str$(number)
.
.
400 Print #1:"RECALL "&str$(number)
410 End
1000 Sub srqhdlr
1010 Poll status,adrs;1
1020 Input #adrs prompt "EVE?":event
1030 Print "Status = ";status;
1040 Print " Event = ";event
1050 Resume
1060 End

```

Program explanation:

```

130 Set up environment
    |
170
180 Input location number (1-20) to store settings.
190 Send SAVE command to store front panel settings.
400 Send RECALL command to restore settings.
410 End of main program.
1000 SRQ handling subroutine, which performs a serial
    | poll and inputs the event code.
1060

```

SPS BASIC Example:

```

100 REM
110 REM Save/recall front panel settings.
120 REM
130 LOAD "INS"
140 ATTACH #1 AS INS:@0,1
150 INPUT NM
160 PUT "SAVE "&STR (NM) INTO #1
.
.
.

```

```

400 PUT "RECALL "&STR (NM) INTO #1
410 END

```

Program explanation:

```

130 Load the instrument driver
140 Specify RTD 710A at GPIB address 1 as
    instrument 1.
150 Input location number (1-20) to store settings.
160 Send SAVE command to store front panel settings.
400 Send RECALL command to restore settings.
410 End of program.

```

Displayed Cursor Position Subprogram

Following is a 4041 only subprogram to read the position of the displayed cursor(s) and return the value(s).

```

.
.
2900 Sub readcur (rtd,cha var start, stoppt)
2910 !
2920 Subprogram to read the position of the
    displayed cursor(s)
2930 ! and return the value(s) for use by the
    waveform location and delta time
2940 ! determination subprograms.
2950 !
2960 Cha$=str$(cha)
2970 Print #rtd:"CURSOR ONE:DISP"&cha$&";
    CURSOR TWO:DISP"&cha$
2980 Input #rtd prompt "CURS? POS1;CURS?
    POS2":cursor$
2990 start=valc(cursor$.pos(cursor$,
    "POS1:",1)+4)
3000 Stoppt=valc(cursor$.pos(cursor$,
    "POS2:",1)+4)
3010 Return
3020 End

```

Programming Command Set

Program explanation:

```
2900 Start of subprogram; identifies variables to
    receive/send data from/to calling program
2960 Converts numeric value of "cha" to a string
    equivalent.
2970 Setup cursor displays for selected Channel "cha".
2980 Query for cursor position.
2990 Make "Start" position of CURSOR 1.
3000 Make "Stoppt" position for CURSOR 2.
3010 Return to main program.
3020 End of program.
```

Initiating a HP-GL Plot From The Controller

The following is a sample program for making a copy using an HP-GL plotter.

```
100 !
110 ! A copy from RTD 710A to a HP-GL plotter
120 ! that's connected the GPIB.
130 ! RTD 710A address 1, Plotter address 2
140 !
150 Init all
160 Open #1:"gpib(pri=1, eom=<0>):"
170 Print #1:"DEVICE SETTINGS:ON,WAVERM:ON,GRAT:ON"
180 Print #1:"PLOT"
190 Wbyte atn(unt,un1,34,65):make plotter listener
200 On eoi then call alldone
```

```
210 Enable eoi
220 Wait
230 End
1000 Sub alldone
1010 Wbyte atn(unt,un1)
1020 Print "Plot is done."
1030 Resume
1040 End
```

Program Explanation:

```
150 Set up the environment.
|
160
170 Send "DEVICE" command.
180 Send "PLOT" command.
190 Make plotter a listener and RTD 710A a talker.
220 Call subroutine "alldone" when EOI interrupt.
210 Enables the EOI interrupt.
220 Wait EOI interrupt.
230 End of main program.
1000 Beginning of subroutine "alldone"
1010 Send UNT, UNL.
1020 Print message.
1030 Returns to main program.
1040 End of subroutine "alldone".
```

Section 6 OPTIONS

OPTIONS A1-A5

The RTD 710A is shipped with a detachable power cord as ordered by the customer. Descriptive information about the international power cords is provided in Section 2, Preparation for Use. The following list identifies the Tektronix part number for the available power cords.

Option A1 (Universal Euro) Power Cord (2.5 m)	161-0104-06
Option A2 (UK) Power Cord (2.5 m)	161-0104-07
Option A3 (Australian) Power Cord (2.5 m)	161-0104-05
Option A4 (North American) Power Cord (2.5 m)	161-0104-08
Option A5 (Switzerland) Power Cord (2.5 m)	161-0154-00

OPTION 05 — TV TRIGGER OPTION

Option 05 provides an aid in examining composite video signals. With the option installed, all basic instrument func-

tions remain the same. Changes or additions to any control operations are included in the descriptions of the controls, connectors, and indicators in Section 3. Features of this option include a sync separator, back-porch clamp circuitry, and TV trigger coupling modes. The option allows the user to trigger on a specific line number within a TV field and provides for sync-polarity switching for either sync-negative or sync-positive composite video signals.

OPTION 19 — BLANK FRONT PANEL

Option 19 provides a Remote Control Only (through GPIB) rackmountable RTD 710A instrument. It replaces the standard front panel key and knob controls and 7-segment LED displays with a nearly blank front panel (Fig. 6-1). The only remaining control is an ON/STANDBY power switch with an ON indicator. The ARM'D and TRIG'D indicators remain, but are identified as ACQUISITION rather than STATUS. All of the standard instrument BNC connectors, GND connector, and PROBE CAL output remain the same. Otherwise, the front panel is blank. The Option 19 instrument also has the rackmountable side panels installed, and includes the remainder of the rackmount kit as a standard accessory.

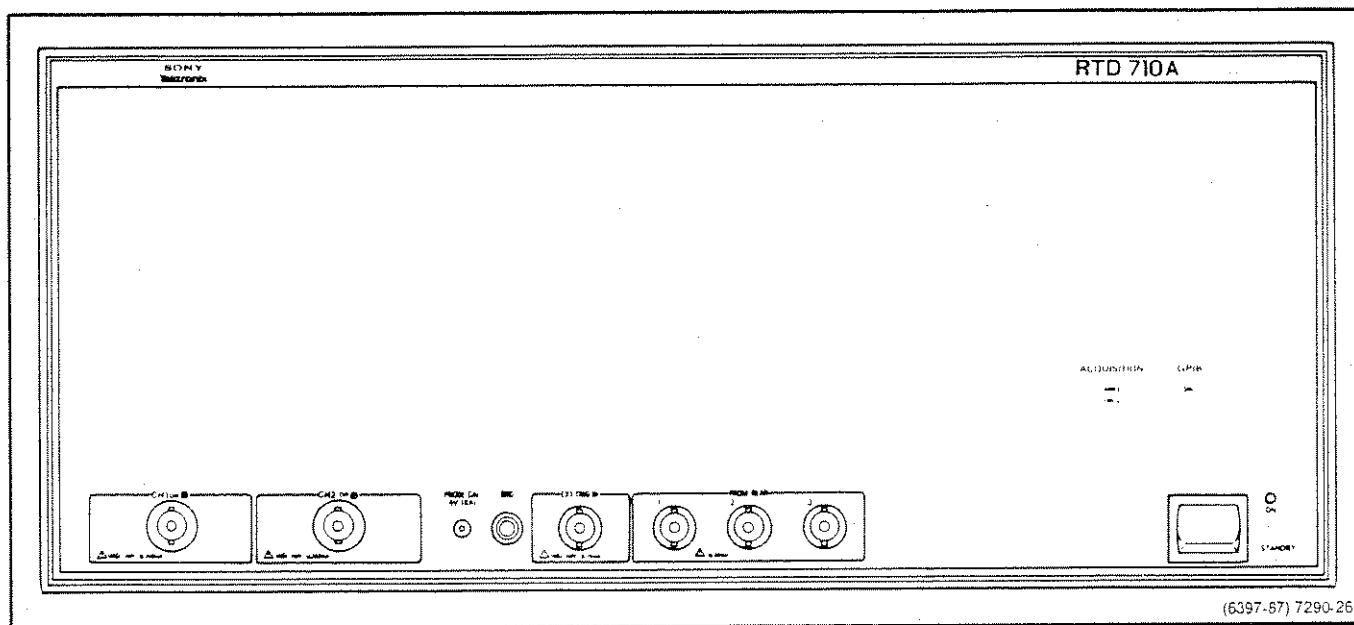

Fig. 6-1 Option 19 blank front panel.

Options

OPTION 1P — P6106A PROBES

Option 1V adds two (2) Tektronix P6106A probes. These are 2 m, dc to 250 MHz, 10X, modular probes with automatic readout pin BNC connectors.

OPTION 1V — 620 MONITOR

Option 1P adds a standard Tektronix 620 Monitor with three (3) BNC coaxial cables.

TV TRIGGER OPTION OPERATING INFORMATION

The TV trigger option, which can be implemented on the front panel of the RTD 710A, or over the GPIB, provides additional trigger circuits for obtaining a more stable display of TV signals.

TV Option Keys

When the TV option is added, a number RTD 710A functions whose names are identified on the front panel, but not activated, are made operational. These are the TV CLP selection on the Input COUPLING toggle key; the TV LINES, FLD1, and FLD2 selections on the Trigger COUPLING toggle key; and the FIELD LINE # feature on the TRIG LEVEL 2 key.

TV Input Coupling

The TV CLP input coupling function removes hum and tilt, and provides a stable TV signal waveform display. If the input signal of CH1 is neither a composite video nor a composite sync, or a trigger is not generated with TV sync, then the TV CLP operation may not stabilize. Also, if the Trigger SLOPE is not set to match the sync pulse polarity of the input signal, it may not stabilize. See Trigger SLOPE for TV COUPLING below.

Trigger Slope for TV Coupling

The Trigger SLOPE function operates differently with the TV Trigger COUPLING functions than with the REJ Trigger COUPLING functions. In the TV Trigger functions, the polarity of the signal to the sync separator can be switched to either + or - using the Trigger SLOPE toggle key. To ensure proper sync operation, the polarity of the sync signal should be selected as follows:

- a. When the composite video signal has a negative (–) sync signal, the Trigger SLOPE should be set to negative (–).

- b. When the composite video signal has a positive (+) sync signal and a negative video signal, the trigger slope should be set to positive (+).

TV Trigger Coupling

The Trigger COUPLING toggle key selects the available TV triggers: LINES, FLD1, or FLD2. These TV triggers enable the RTD 710A TV option video sync separator circuits to provide stable sync triggers for composite TV signals with line counts from 525 to 1280 and 50 to 60 Hz sync pulses. Whenever a horizontal sync pulse occurs during the ARM period, a waveform acquisition trigger occurs.

LINES. In this trigger mode, the waveform acquisition is triggered as soon as a TV horizontal sync pulse is detected on either the CH1 or EXT TRIG IN input. Any horizontal sync pulse will cause a trigger in this mode without a line number being designated; therefore, the FIELD LINE # key is not selectable in this mode.

FLD1/FLD2. In these modes, the waveform acquisition is triggered when a specified TV line number within the selected field occurs. When one of these modes is selected, the FIELD LINE # function is automatically selected, its indicator starts blinking to indicate selection, and the currently selected line number is displayed in the Trigger display. The line number can be changed with the Parameter Entry Knob in a range from 1 to the maximum number of lines per frame. If the highest line number is reached when setting the line number, continuing to turn the knob wraps the number to the lowest number (1). Likewise, turning the knob past 1 wraps to the highest number. If the TV signal changes and its lines per frame changes, the maximum range of lines automatically changes.

NOTE

When acquiring a noninterlaced TV signal, there is no difference between field 1 and 2; therefore, the trigger occurs on the line selected whether FLD1 or FLD2 is selected.

System-M vs Nonsystem-M

Once the FIELD LINE # key indicator is blinking, pushing the key toggles operation between a System-M or Nonsystem-M mode. The Nonsystem-M mode is indicated by a dot (.) on the left side of the line number in the Trigger display.

When the System-M mode is selected, the sync signal line number count starts three lines before the field sync pulse.

When the Nonsystem-M mode is selected, the sync signal line number is the same as the line that generates the field sync pulse.

Special Measurements

OVERSCANNED DISPLAYS. For various video measurements, it may be desirable to expand the video waveform vertically beyond the limits of the screen. Under these circumstances, the Trigger amplifiers or the sync separator circuitry may be overloaded, blocking out sync pulses in the vicinity of large signal transitions or losing sync pulses altogether. Therefore, to avoid overload problems, use the external trigger input to supply a constant amplitude trigger signal to the TV Option while the observations are being made on the expanded waveform.

RF INTERFERENCE. Operation in the vicinity of some FM and TV transmitters may impress objectionable amounts of rf signal energy on the input signal, even when coaxial cables are used to make the signal connections. Using the 20 MHz BW limit feature will usually eliminate such interference from the display, but it does not limit the signal reaching the TV Option circuitry. Where the rf energy interferes with the TV triggering operation, external filters will be required to limit the bandwidth of the trigger signal. In such cases, it is recommended that the external trigger input be used to supply the trigger signal, using the required external bandwidth limiters and attenuators to obtain the necessary trigger amplitudes.

Identifying Fields, Frames, and Lines in 525/60 and 625/50 TV Systems

NTSC (CCIR SYSTEM M). Field 1 is defined as the field whose first equalizing pulse is one full H interval (63.5 μ s) from the preceding horizontal sync pulse. The Field 1 picture starts with a full line of video and its lines are numbered 1 through 263, starting with the leading edge of the first equalizing pulse. The first regular horizontal sync pulse after the second equalizing interval is the start of line 10.

Field 2 starts with an equalizing pulse a half-line interval from the preceding horizontal sync pulse. The Field 2 picture starts with a half line of video and its lines are numbered 1 through 262, starting with the leading edge of the second equalizing pulse. After the second equalizing interval, the first full line is line 9.

CCIR SYSTEM B AND SIMILAR 625/50 SYSTEM.

Except for PAL systems, identification of parts of the picture in most 625-line, 50-Hz field-rate systems relies primarily on continuous line numbering rather than on field-and-line identification.

The CCIR frame starts with the first (wide) vertical sync pulse following a field which ends with a half-line video. The first line after the second equalizing interval is line 6; the first picture line is line 23 (half-line of video). The first field of the frame contains lines 1 through the first half of line 313, and the picture ends with a full line of video (line 310).

The second field of the frame commences with the leading edge of the first (wide) vertical sync pulse (middle of line 313) and runs through line 625 (end of equalizing interval). The first full line after the equalizing interval is line 318; the picture starts on line 336 (full line).

The first field is referred to as 'odd,' and the second field as 'even.' Note that the identification systems for System-M and System-B are reversed.

In the four-field PAL sequence with Bruch Sequence color-burst blanking, the fields are identified as follows:

Field 1: Field that follows a field ending in a half-line of video, when preceding field has color burst on the last full line. Field 1 lines are 1 through 312 and half of line 313. Color burst starts on line 7 of Field 1; a half-line of video appears on line 23.

Field 2: Field that follows a field ending in a full line which does not carry color burst. Field 2 lines are the last half of line 313 through line 625. Color burst starts on line 319 (one line without burst following the last equalizing pulse); a full line of video appears at line 336.

Field 3: Field that follows a field ending in a half line when preceding field has no color burst on its last full line. Field 3 lines are 1 through the first half of line 313. Burst starts on line 6 (immediately following the last equalizing pulse); a half-line of video appears on line 23.

Field 4: Field that follows a field ending in a full line carrying color burst. Field 4 lines are the second half of line 313 through line 625. Color burst for Field 4 starts on line 320 (two full lines without burst follow the last equalizing pulse); video starts with a full line on 336.

NOTES

The TV trigger option for the RTD 710A cannot detect color burst phasing, nor Bruch Sequence color-burst blanking. Therefore, the RTD 710A processes the field 1 and 3 signals of the four field PAL system as the same, and the field 2 and 4 signals as the same. For noninterlaced systems, the TV trigger option detects only the field start signal and cannot discriminate between FLD1 and FLD2, so the line numbers become the same.

TV Signal Measurements

The following example for making a TV signal measurement assumes that the RTD 710A is turned on, and ready for operation, and has a CRT monitor attached that is calibrated and ready to use. To make a TV signal measurement:

1. Press the INIT key twice to initialize the RTD 710A.
2. Press the RESET/HOLD key to set the Hold status.
3. Press the SAMPLE INTERVAL key, and when its indicator blinks use the Parameter Entry Knob to set the sample interval to 50 μ s.
4. Press the CH1 INPUT RANGE key, and when its indicator blinks use the Parameter Entry Knob to set the RANGE to 0.5 V (± 0.5 V).
5. Select the FLD1 position with the Trigger COUPLING toggle key.
6. Select the TV CLP position with the CH1 COUPLING toggle key.
7. Connect a TV composite video signal from a TV signal generator (an NTSC signal with negative sync signal) to the CH1 input connector.
8. Press the RESET/HOLD key again, which will cause a Reset and a trigger to cause the acquisition. The waveform shown in Fig. 6-2 should be displayed.

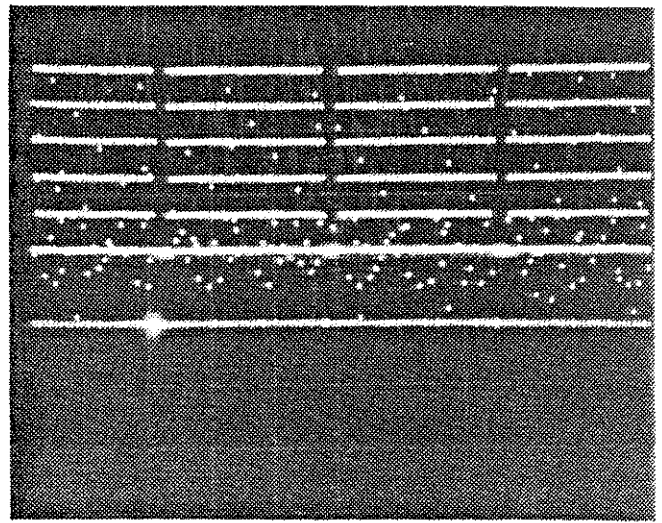

Fig. 6-2 Composite video display.

9. Press the FIELD LINE # key, and when its indicator blinks, use the Parameter Entry Knob to set the Trigger display value to 263. To closely investigate the waveform in the area of the horizontal sync pulse, press the SAMPLE INTERVAL key and use the Parameter Entry Knob to set the sample interval to 2 μ s (Fig. 6-3).

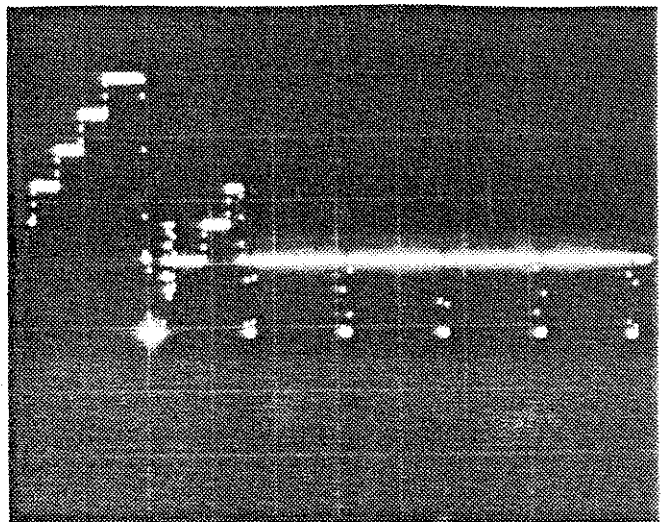
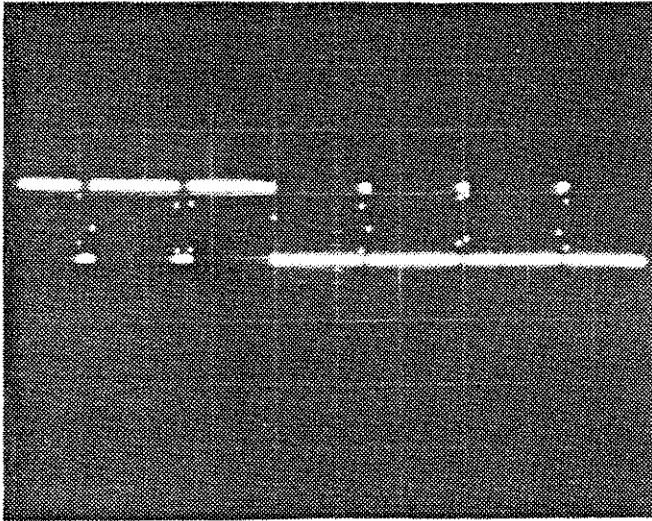

Fig. 6-3 Horizontal sync pulse display.

10. Check that a vertical sync signal exists behind the present horizontal sync pulse. Press the TRIG DELAY key (time position) and use the Parameter Entry Knob to set the trigger delay to about 100 μ s (Fig. 6-4).



6397-70

Fig. 6-4 Vertical sync pulse display using trigger delay.

Appendix A

SRQ STATUS BYTES AND EVENT CODES

INTRODUCTION

Status bytes and event codes are used to report an instrument's operating status to a system controller, which is helpful in program development and troubleshooting.

RTD 710A status responses to a controller are divided into two categories—Status Bytes and Event Codes. Status Bytes indicate general instrument conditions, while Event Codes indicate specific instrument conditions. For example, if the controller sent the message "VMODE CH11" to the RTD 710A, the instrument would set its SRQ line true indicating some type of error had occurred. At that time the controller must serial poll the GPIB instruments to determine which one had its SRQ line set true. When the right instrument is polled (the RTD 710A in this case), it would set its SRQ line false and send its status byte (Command Error, decimal 97 in this case) to the controller. If the controller wants more specific information about the error, it can send an EVENT? query command to the RTD 710A. Whereupon the RTD 710A would respond with an Event Code 103, which translates to a Command Argument Error.

STATUS BYTES

There are two classes of Status Bytes—Device Dependent and System Status. Device-dependent status bytes report status of the RTD 710A, while System status bytes report conditions common to all instruments on the GPIB that conform to the Tektronix Codes and Formats standard. Table A-1 lists the RTD 710A status bytes.

EVENT CODES

An event code is sent to the controller from the RTD 710A only when it receives an EVENT? query from the controller. When this occurs, the response is in the form:

EVENT <NR1>

where the value <NR1> is a 3-digit numerical event code from Table A-2. The event code is cleared from the RTD 710A when it is reported.

The Event Codes listed in Table A-2 fall into general categories as follows:

Command Error: A command error occurs when a message cannot be parsed or lexically analyzed.

Execution Error: An execution error occurs when a message is parsed but cannot be executed.

Internal Error: An internal error occurs on a malfunction or fault condition within the RTD 710A.

System Event: A system event includes all events that are not errors, warnings, or device dependent events.

Execution Warning: An execution warning occurs when a command is being executed, but a potential problem may exist.

Device Dependent Event: A device dependent event is one that is instrument function specific.

SRQ Status Bytes and Event Codes

Table A-1
RTD 710A STATUS BYTES

TITLE	BINARY		DECIMAL				Priority
	Bit ¹		RQS ON		RQS OFF		
	7654	3210	Not Busy	Busy	Not Busy	Busy	
System status:							
Command Error	0R1X	0001	97	113	33	49	2
Execution Error	0R1X	0010	98	114	34	50	2
Internal Error	0R1X	0011	99	115	35	51	2
Power Fail	0R1X	0100	100	116	36	52	2
Execution Warning	0R1X	0101	101	117	37	53	2
Power ON	010X	0001	65	81	1	17	1
Operation Complete	0R0X	0010	66	82	2	18	2
User Request	0R0X	0011	67	83	3	19	2
No Status To Report	000X	0000	0	16	0	16	3
Device Dependent Status:							
Waveform Data Write End for Time Base A	1R0X	0000	192	218	128	154	3
Input Over/Under Range	1R0X	0001	193	219	129	155	3

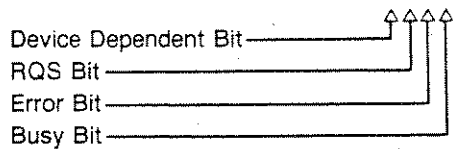

¹R is set to 1 when the GPIB RQS mode is set to RQS:ON. If the RTD 710A is in the RQS:OFF mode and polled, the status byte is sent without DIO6 asserted. X is the busy bit and is set to 1 if the RTD 710A is busy when the status byte is read.

Table A-2
RTD 710A EVENT CODES

EVENT CODE	INSTRUMENT STATUS
Command Error (CER ON; SRQ Status 97 or 113)	
101	Command header error.
102	Header delimiter error.
103	Command argument error.
104	Argument delimiter error.
105	Nonnumeric argument.
106	Missing argument.
107	Invalid message unit delimiter.
108	Checksum error.
109	Byte count error.
151	Symbol or number too long. Command is ignored.

Table A-2 (cont)

Event Code	Instrument Status
Execution Error (EXR ON; SRQ Status 98 or 114)	
201	Command not executable in LOCAL.
203	I/O Buffers full; output dumped.
206	Group Execute Trigger (GET) ignored.
250	CH2 not available in high-speed sampling mode.
251	TV trigger option not installed.
252	Trigger source CH2, BIslope, +HYS, and –HYS not available with TV trigger coupling (Lines, FLD1, or FLD2).
254	CH2 trigger Source not available in high-speed sampling mode.
255	Selected recall memory is empty.
256	XY display mode not allowed when two waveforms are not displayed, or in CH1 only vertical mode.
258	Target channel for Cursor is not displayed.
260	1/T or 1/Δ Measure modes not available with external clock source.
262	Breakpoint requested to be cleared is nonexistent.
263	More than 5 breakpoints were requested.
266	Invalid channel requested for setting; CH2 not valid in CH1 only mode.
267	Requested Data Location is out of range.
268	Requested Data Start is invalid.
269	Requested Data Count is invalid.
270	Requested Data Bsize is invalid.
271	Requested Window Channel is invalid. CH2 not available in CH1 Only mode.
272	Requested Window Location is out of range.
273	Requested Window Start or Stop is out of range.
274	Requested Window Level is invalid.
275	Requested Waveform is invalid or not available.
276	Illegal test number.
277	Self-test group commands are not available with TEST MODE:OFF.
278	Command is not available with TEST MODE:ON; change to TEST MODE:OFF.
279	Plot is not allowed because no waveform on the display.
Internal Errors (INR ON; SRQ Status 99 or 115)	
302	System or DMA controller error.
350	Auto-Calibration failed. Use ERRor? query for failure code.
351	NVM save or recall error (checksum error).
352	Current Level 2 test or Power-On Self-test error; use ERRor? query for failure code.
System Event	
401	Power on.
403 (USER ON)	User request.
450 (OPC ON)	Hold occurred after N times Average or Envelope operation, or after Auto-ADVance operation.
451 (OPC ON)	Hold occurred in Compare Trigger mode.
452 (OPC ON)	Current Level 2 test or Power-On Self-test is finished.
453 (OPC ON)	Plot completed.

Table A-2 (cont)

Event Code	Instrument Status
Execution Warning (EXW ON; SRQ Status 101 or 117)	
550	Requested Range value was rounded or limited.
551	Requested Offset value was rounded or limited.
552	Selecting High-Speed sampling mode forced vertical mode to CH1 only.
553	Requested Trigger Level value was rounded or limited.
554	Requested Record Length value was truncated or limited.
555	Selecting Envelope mode forced record length to 128K; or Record Location number was modified to an allowable number; or sample mode was changed to Normal.
556	Selecting Dual vertical mode forced the following:
	1. Record Length to 128K.
	2. Record Location to an allowable maximum number.
	3. Sample rate from 5 nS to 10 nS.
	4. Sample mode to normal.
557	Selecting Compare Trigger mode forced Record Length to 128K; or Record Location number was modified to the maximum allowable value.
558	Selecting LINES, FLD1, or FLD2 forced Trigger Source to CH1; or Trigger slope was set to minus.
559	Requested Arm Delay value was rounded or limited.
560	Requested TV Line number was rounded or limited.
561	Requested Record Location or Auto-Advance Location number was rounded or limited.
562	Change of Record Length forced Record Location number or Trigger Delay value to a maximum allowable value.
563	Requested Trigger Delay value was truncated or limited.
564	Requested Sample Interval value was rounded or limited; or Sampling Mode was forced to Normal (10 nS).
565	Requested Break Point address was truncated or limited.
566	Requested Average number of times was truncated or limited.
567	Requested Envelope number of times was truncated or limited.
568	Requested Cursor 1 Position value was rounded or limited.
569	Requested Cursor 2 Position value was rounded or limited.
570	Requested Horiz Zoom value was limited.
572	Requested Vert Position value was limited.
573	Requested Display Location number was limited.
574	Requested Save or Recall location number was limited.
578	XINCR value for WFMPRE was rounded or limited.
579	PT.OFF value for WFMPRE was rounded or limited:
580	YZero value for WFMPRE was rounded or limited.
581	YMUlt value for WFMPRE was rounded or limited.
582	Break Point value for WFMPRE was rounded or limited.
583	Requested REPEAT count was rounded or limited.
584	Waveform data STArt or STOp number was swapped because requested STArt position is larger than the STOp position, or requested STOp position is smaller than the STArt position.
Device Dependent Event	
750 (WRI ON)	Single acquisition sequence is completed and the waveform in memory is ready to be read.
752 (OVER ON)	CH1 input overrange has occurred.
753 (OVER ON)	CH1 input underrange has occurred.
754 (OVER ON)	CH2 input overrange has occurred.
755 (OVER ON)	CH2 input underrange has occurred.

Appendix B SPECIFICATIONS

This specification applies when the instrument has been calibrated at an ambient temperature between +20°C and +30°C, has had a warm-up period of at least 20 minutes, and is operating in an ambient temperature between 0°C and +50°C (unless otherwise noted).

**Table B-1
ENVIRONMENTAL SPECIFICATION**

CHARACTERISTIC	PERFORMANCE REQUIREMENT
Temperature	Meets MIL-T-28800C, class 5. Class 5 non-operating temperature exception due to internal LEDs and cooling fan.
Operating	0°C to +50°C
Non-operating	-30°C to +70°C
Humidity	
Operating and Non-operating	0% to 95% relative humidity noncondensing
Altitude	
Operating	15,000 ft. (4.5 Km) maximum
Non-operating	50,000 ft. (15 Km) maximum
Vibration	
Operating	0.015 inch. (0.38 mm) p-p
Shock	
Non-operating	30 g's maximum
Bench Handling	
Operating	Drop from 4 inches or 45 degrees on all significant faces.
Packaged Product Vibration and Drop	Qualifies under the National Safe Transit Association's Pre-shipment Test Procedures, Project 1A-B-1.
Vibration	1 inch (25.4 mm) p-p at 4.63 Hz (1.1G) for 30 minutes.
Drop	24 inch (0.61 m)
Electrostatic Immunity	Withstands discharge through 1 Kohm resistance of a 500 pF capacitor charged to 15 KV, except the GPIB connector.
Electromagnetic Compatibility	Qualifies under the test limits specified in FCC part 15, subpart J, class B; and VDE 0871 class B without direct A/D out cable.

Specifications

Table B-2
ELECTRICAL SPECIFICATION

Characteristic	Performance Requirement	Supplemental Information
VERTICAL SYSTEM - CHANNEL 1 AND CHANNEL 2		
Input Range	± 100 mV to ± 50 V (200 mV p-p to 100 V p-p)	1-1.25-1.6-2-2.5-3.2-4-5-6.2-8 sequence of 28 steps. Full scale range is 1023 LSBs. Center value (0 V input) is 512 LSBs.
Accuracy	Within $\pm 0.4\%$ for an approx. 1 KHz signal with approx. 97% of full scale amplitude when an Auto-Cal is performed.	
Frequency Response (-3dB bandwidth)		
Bandwidth		
0°C to 40°C	DC to 100 MHz	
40°C to 50°C	DC to 90 MHz	
AC Coupled Lower -3dB Point	10 Hz or less.	
Limited Bandwidth	20 MHz \pm 30 MHz.%	
Overdrive Recovery Time		Recovers to within $\pm 5\%$ of 5X or 2X overdrive signal after removal of 5X or 2X input range overdrive signal.
5X Overdrive	30 ns or less	
2X Overdrive	20 ns or less	
Crosstalk	1.5% or less at 100 MHz	From driven input (with full scale driven) to unused input; with equal Input Range settings on both channels.
DC Zero Volt Shift		
Accuracy	$\pm 0.2\%$ or less of full scale range when an Auto-Cal is performed. $\pm 0.6\%$ or less of full scale range when Break Point function includes a 10 ns Sample Interval and an Auto-Cal is performed. $\pm 1.0\%$ or less of full scale range when Break Point function includes a 5 ns Sample Interval and Auto-Cal is performed.	

Table B-2 (cont)

Characteristic	Performance Requirement	Supplemental Information
DC Input Offset Voltage		
Range	0% to $\pm 199\%$ of input range.	Selectable in 1% steps. May be entered in % of Input Range or in absolute Volts that is equivalent to % calculated as follows: $V = (\% \text{ value}) \cdot (\text{Input Range})$; value is rounded to 3 digits.
Accuracy		
0-100%	$\pm 1\%$ or less of full scale range.	
101-150%	Add 1% to 1-100% value.	
151-199%	Add 1% to 101-150% value.	
Input R and C		
Resistance	1 Mohm $\pm 2\%$	
Capacitance	Approx. 24 pF	
Maximum Input Voltage (DC, AC, or GND coupled)	250 V (Dc + peak ac); maximum ac component of 500 V p-p at 1 KHz or less	
A/D CONVERTER		
Resolution	10 Bits (1/1024)	
Maximum Sampling Frequency		
CH 1 Only Mode	200 MHz	
DUAL Mode	100 MHz	
Dynamic Accuracy		Measured at $+25^{\circ}\text{C} \pm 5^{\circ}\text{C}$. by using post-trigger data.
Normal Sampling Mode	See Table B-2-1 and Table B-2-2	Measured at 10 ns sampling interval.

Table B-2-1
NORMAL SAMPLING MODE DYNAMIC ACCURACY

Input Frequency	Effective Bits	Typical
1 MHz (20 MHz) BW limited)	>7.8 bits.	>8.2 bits
10 MHz (20 MHz) BW limited)	>7.6 bits.	>8.0 bits
50 MHz	>7.3 bits.	>7.7 bits

Table B-2-2
NORMAL SAMPLING MODE DYNAMIC ACCURACY
(90% OF FULL SCALE RANGE ANALOG INPUT)

Input Frequency	Effective Bits	Typical
1 MHz (20 MHz BW limited)	>7.4 bits.	>7.7 bits
10 MHz (20 MHz BW limited)	>7.3 bits.	>7.6 bits
50 MHz	>6.9 bits.	>7.2 bits

Specifications

Table B-2-2 (cont)

Characteristic	Performance Requirement	Supplemental Information
High-Speed Sampling Mode	See Table B-2-3 and B-2-4	Measured at 5 ns sampling interval.

Table B-2-3
HIGH-SPEED SAMPLING MODE DYNAMIC ACCURACY:

Input Frequency	Effective Bits	Typical
1 MHz (20 MHz BW Limited)	> 7.4 bits	> 7.9 bits
10 MHz (20 MHz BW Limited)	> 7.3 bits.	> 7.8 bits
50 MHz	> 6.6 bits.	> 7.2 bits
100 MHz	> 6.2 bits.	> 6.7 bits

Table B-2-4
HIGH-SPEED SAMPLING MODE DYNAMIC ACCURACY
(90% OF FULL SCALE RANGE ANALOG INPUT)

Input Frequency	Effective Bits	Typical
1 MHz (20 MHz BW Limited)	> 7.1 bits	> 7.6 bits
10 MHz (20 MHz BW Limited)	> 6.8 bits.	> 7.4 bits
50 MHz	> 6.0 bits.	> 6.6 bits
100 MHz	> 5.2 bits.	> 5.8 bits

TRIGGERING

NOTE

Channel 1 and Channel 2 have identical characteristics.

Sensitivity to Repetitive Signal

See Table B-2-5

Table B-2-5
TRIGGER SENSITIVITY TO REPETITIVE SIGNAL

Coupling	Triggering Frequency Range	Minimum Signal Required	
		Internal	External
AC	30 Hz - 20 MHz	50 LSB	500 mV p-p
	20 MHz - 100 MHz	70 LSB	700 mV p-p
AC LF Rej	50 KHz - 20 MHz	50 LSB	500 mV p-p
	20 MHz - 100 MHz	70 LSB	700 mV p-p
DC HF Rej	DC - 50 KHz	50 LSB	500 mV p-p
DC	DC - 20 MHz	50 LSB	500 mV p-p
	20 MHz - 100 MHz	70 LSB	700 mV p-p

Table B-2 (cont)

Characteristic	Performance Requirement	Supplemental Information
Level Range For both Level 1 and Level 2.		
Internal	0% to $\pm 99\%$ of input range	Selectable in 1 % steps, or voltage steps that are equivalent to % steps calculated as follows: $V = (\% \text{ value}) * (\text{Input Range})$ rounded to 3 digits.
Accuracy	$\pm (5\% \text{ of reading} + 5\% \text{ of full scale})$	
External	0 V to $\pm 4.95 \text{ V}$ (0% to $\pm 99\%$ of 5 V)	Selectable in 1% (0.05 V) steps (1% of 5 V) or voltage steps that are equivalent to % steps calculated as follows: $V = (\% \text{ value}) * (5 \text{ V})$ rounded to 3 digits.
Accuracy	$\pm (15\% \text{ of reading} + 5\% \text{ of full scale})$	
External Trigger Input		
Input R and C	1 Mohm $\pm 10\%$ paralleled by approx. 40 pF.	
Maximum Input Voltage	$\pm 25 \text{ V peak}$.	
Trigger Delay Range (Trigger Point)		– means pre-trigger delay; + means post-trigger delay. Instrument acquires 1 full record of pre-trigger data at the sampling rate of the first breakpoint before becoming triggerable when in minus trigger delay range (pre-trigger mode).
Normal Sampling Mode	–(Full Record Length – 8) to 262136.	Selectable in integer multiples of 8.
High-Speed Sampling Mode	–(Full Record Length – 16) to 262128.	Selectable in integer multiples of 16.
Trigger Point Uncertainty		
Normal Sampling Mode	$\pm 1.5 \text{ clock cycles} + \text{approx. } 30 \text{ ns}$.	
High-Speed Sampling Mode	$\pm 3.0 \text{ clock cycles} + \text{approx. } 30 \text{ ns}$.	
Internal Arm Delay Range	0, or 10 ms to 10 s.	Selectable in a 1-2-5 sequence.
Arm Clock Accuracy	$\pm 5\%$ of reading	Actual arm delay time between the end of acquisition and the time a trigger initiates the next acquisition is affected by instrument control settings.
Ext Arm Input		External Arm function is similar to a trigger qualifier function.
Signal Level	TTL; 0 V to 5.5 V maximum	
Input Impedance	1 TTL load.	

Specifications

Table B-2 (cont)

Characteristic	Performance Requirement	Supplemental Information
TIME BASE		
Internal Clock		
Frequency	200 MHz \pm 0.001%.	0°C to 50°C ambient; checked at 25°C.
External Clock		
Frequency Range		
Normal Sampling Mode	100 MHz max.	
High-speed Sampling Mode	200 MHz max.	
Input Signal Level	ECL.	
Input Impedance	50 ohm nominal.	50 ohm is connected to -2 volts.
Rise and Fall Time	1.0 ns or less.	
Pulse Width		
Normal Sampling Mode	At least 5.0 ns	Positive pulse.
High-Speed Sampling Mode	At least 25 ns	Positive pulse.
Sampling Interval		
Internal Clock		
Normal Sampling Mode		Selectable from 10 ns to 200 ms in a 1-2-3-4-5-6-7-8-9 sequence.
High-speed Sampling Mode		Selectable from 5 ns to 200 ms in a 1-2-3-4-5-6-7-8-9 sequence.
External Clock		
Normal and High-speed Sampling Mode		Selectable multiplier values from 1 to (4x10 ⁷) in a 1,2,3,4,5,6,7,8,9 (normal); or 1,2,4,6,8 (high speed) sequence. Allowable values are derived as follows: Sample Interval = (clock)(x)(10 ^y) where x = 1,2,3,4,5,6,7,8, or 9 (normal); or 1,2,4,6, or 8 (high speed) and Y = 0-7.
Roll Mode	200 μ s or greater	For internal clock source only.
Interval Switching		Sample interval can be switched coherently between the 5 breakpoints per record allowed.

Table B-2 (cont)

Characteristic	Performance Requirement	Supplemental Information
RECORDING		
Waveform Memory Size		131072 10-bit words per channel.
Waveform Memory Format		
CH 1 Mode		May be partitioned into: 1 record of 262144 words, 2 records of 131072 words, 4 records of 65536 words, 8 records of 32768 words, 16 records of 16384 words, 32 records of 8192 words, 64 records of 4096 words, 128 records of 2048 words, 256 records of 1024 words.
DUAL Mode		May be partitioned into: 1 record of 131072 words, 2 records of 65536 words, 4 records of 32768 words, 8 records of 16384 words, 16 records of 8192 words, 32 records of 4096 words, 64 records of 2048 words, 128 records of 1024 words.
Breakpoint Position		1 to 5 breakpoints allowed per record. With internal clock source, Break Point position may be entered in points or time. Time is calculated as: Time = (points) * (Sample Interval) rounded to 5 digits.
Normal Sampling Mode	16 to (record length - 8)	Selectable in integer multiples of 8.
High-speed Sampling Mode	32 to (record length - 16)	Selectable in integer multiples of 16.
Averaging Number of Times	Selectable from 2 to 16384 in a 2-4-8 binary sequence.	Uncorrelated noise; signal-to-noise ratio is improved by the square root of the number of waveforms averaged.
Average Memory Depth		8192 words per channel.
Envelope Number of Times	Selectable 1, 2, to 16384 in a 2-4-8 binary sequence.	When 99999 is selected, an infinite # of Times of Enveloping is performed. With 2 or more # of Times, the last memory segment is used for envelope accumulation.
CURSOR MEASUREMENT		
Cursor Measurement Accuracy		Calculated value is rounded to 8 digits and displayed in the Control display.
Vertical (Voltage Measurement)		Calculation accuracy is $\pm 0.05\%$ of full scale. Total accuracy is influenced by input range accuracy, input offset accuracy, low frequency linearity, frequency bandwidth, and effective bits.
Horizontal (Time Measurement)	$\pm 0.001\%$.	The calculated value is rounded to 8 digits. In the envelope mode, the actual time measurement resolution is limited to (2 * sample interval) (rounded to 8 digits) + 0.001%.
NON-VOLATILE MEMORY		
Memory Size		Up to 20 front-panel settings can be retained.
Front Panel Data Retention Time	>5 years.	Backup memory power is lithium battery.

Specifications

Table B-2 (cont)

Characteristic	Performance Requirement	Supplemental Information
SIGNAL INPUT/OUTPUT		
Display Monitor Output		Tektronix type 620 monitor is recommended.
CRT X Output		BNC connector on rear panel.
Resolution		2048 dots.
Output Voltage	1 Vp-p or 5 Vp-p, $\pm 5\%$.	Internal jumper selectable; set to 1 V at the factory.
Output Resistance	400 ohm $\pm 20\%$.	
Step Speed	Approx. 2.5 μ s per dot.	
CRT Y Output		BNC connector on rear panel.
Resolution		1024 dots.
Output Voltage	1 Vp-p or 5 Vp-p, $\pm 5\%$.	Internal jumper selectable; set to 1 V at the factory.
Output Resistance	400 ohm $\pm 20\%$.	
CRT Z Output		
Output Voltage	1 Vp-p or 5 Vp-p, +5%, -15% for retrace blanking.	
Output Polarity		Positive or negative; internal jumper selectable; set to positive at the factory.
Output Resistance	800 ohm $\pm 20\%$ for 1 Vp-p. 1.75 Kohm $\pm 20\%$ for 5 Vp-p.	
Phase Accuracy in X-Y Mode		Includes phase difference in input amplifiers. For identical input ranges: $<5^\circ$ up to 30 MHz. For different input ranges: $<5^\circ$ up to 20 MHz.
Probe Calibration Output	0 V to +4 V $\pm 1\%$, 1 KHz square wave into 1 Mohm.	Mini jack mounted on front panel.
TRIG'D Output		Initiated high when the trigger is recognized. BNC connector is mounted on rear panel.
Output Voltage High	2.5 V to 5 V for one TTL load	Output is TTL compatible.
Output Voltage Low	0.5 V or less for one TTL load	
Delay from Trigger Recognition		From trigger signal at CH1, CH2, or EXT TRIG in to rear panel TRIG'D OUT.
Internal Trigger		Approximately 40 ns
External Trigger		Approximately 30 ns
Clock Output Signal Level	ECL (Open emitter output into 50 ohm connected to -2 V).	Connector is mounted on rear panel. Clock out signal can drive another RTD 710A.
Frequency	Outputs internal 200 MHz when clock source is internal.	
Direct Mode	Outputs externally supplied clock when clock source is external.	
Divided Mode	Same as sampling clock.	Direct/divided mode can be selected by internal strap. Set to divided at factory.
Through Connectors 1, 2, and 3		Connects respective front- and rear-panel connectors via 50-ohm coaxial cables.

Table B-2 (cont)

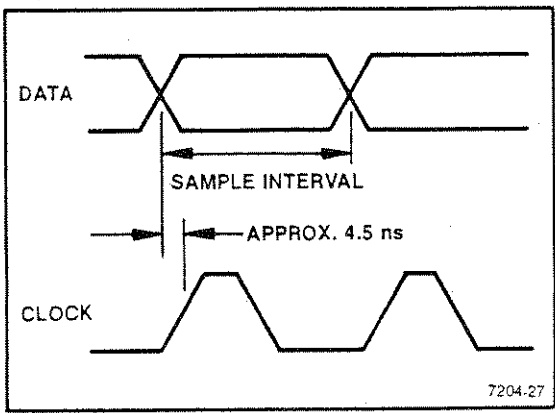
Characteristic	Performance Requirement	Supplemental Information
GPIB INTERFACE		
Interface Function (IEEE 488-1978)	SH1, AH1, T5, L4, SR1, RL1, PP0, DC1, DT1, C0, E2.	
Maximum Data Transfer Rate		At least 250 Kbytes per second.
Parameter Selection Switch		Mounted on rear panel.
Talk/Listen Address	5-bit switch.	Primary address is selectable from 0 to 30. Address 31 is reserved as an OFF-bus.
Terminator Mode	1-bit switch. 1: LF or EOI. 0: EOI.	
Plotter		RTD 710A supports a digital plotter. Outputs waveforms, vertical and time base settings, and cursor measurement information.
Commands		Responds to HPGL.
A/D OUTPUT INTERFACE		
Data Connector		50-pin AMPMODU MT connector.
Signal Levels	ECL compatible.	
Signal timing		<p>Differential data and clock signals have timing as shown below:</p>  <p style="text-align: right;">7204-27</p> <p>In high-speed sampling mode, CH1 and CH2 data and clocks are 180 degrees out of phase.</p>
Maximum Data Rate		100 MHz as determined by front-panel settings.

Specifications

Table B-2 (cont)

Characteristic	Performance Requirement	Supplemental Information
POWER SUPPLY INPUT		
Line Voltage Range		
115 V Nominal	90 to 132 V ac	
230 V Nominal	180 to 250 V ac	
Line Frequency	48 to 66 Hz, single phase	
Power Consumption		
Std Instrument	320 watts.	
Instrument With All Options	350 watts (700 VA).	
Heat Dissipation	Approx. 1195 BTUs per hr.	
Fuse Rating		
115 V ac	8 A, 250 V medium-blow	
230 V ac	4 A, 250 V medium-blow	

**Table B-3
MECHANICAL SPECIFICATIONS**

Characteristic	Description
Standard Instrument Dimensions	
Height	194 mm (7.6 inches) with feet 177 mm (7.0 inches) without feet
Width	443 mm (17.4 inches) with carrying strap 429 mm (16.9 inches) without carrying strap
Depth	643 mm (25.3 inches) front of frame to rear feet (inclusive)
Rack-mount Instrument Dimensions	
Height	177 mm (7.0 inches) without feet
Width	482 mm (19.0 inches) from rackmount handle to handle (inclusive)
Depth	643 mm (25.3 inches) from front of frame to rear feet (inclusive)
Weight	
Net	Approx. 23.5 Kg (51.8 lbs).
Shipping	Approx. 29.5 Kg (65.0 lbs).
Cooling	Forced air circulation. Internal airflow is approx. 1710 liter per minute (58.3 cfm).
Finish	Earth brown vinyl-clad material on an aluminum cabinet.

Table B-4
TV TRIGGER (OPTION 05) SPECIFICATION

Characteristic	Performance Requirement	Supplemental Information
NOTE		
<i>Electrical characteristics for the RTD 710A Option 05 are the same as for the standard instrument, except as shown in this table.</i>		
VERTICAL SYSTEM—CHANNEL 1 AND CHANNEL 2		
TV (Back-Porch) Clamp (CH 1 only)		
60 Hz Attenuation	Greater than 18 dB.	
Back-Porch Reference	Within 25% of full scale of ground reference.	
TRIGGER SYSTEM		
Sync Separation		Stable video rejection and sync separation from sync-positive or sync-negative composite video, 525 to 1280 lines, 50 or 60 Hz, interlaced or noninterlaced.
Trigger Modes		Selectable by the COUPLING switch.
Lines		Time base triggers when holdoff time has elapsed and a TV horizontal line-sync occurs.
Field 1		Time base triggers on the first field of the TV signal input.
Line Selection Range	1 to N.	$N \leq (\text{number of lines per frame}) \leq 1280$
Field 2		Time base triggers on the second field of the TV signal input.
Line Selection Range	1 to N	$N \leq (\text{number of lines per frame}) \leq 1280$
Minimum Input Signal Amplitude for Stable Triggering		
Internal (CH1 or CH2)		
Composite Video	25% of full scale min.	
Composite Sync	10% of full scale min.	
External Trigger Input		
Composite Video	500 mV min.	
Composite Sync	250 mV min.	

ASCII & GPIB CODE CHART

BITS		CONTROL		NUMBERS		SYMBOLS		UPPER CASE		LOWER CASE							
B7	B6 B5	B4 B3 B2 B1															
0	0 0 0 0	0	NUL	20	DLE	40	SP	60	0	16	@	100	P	140	'	160	p
0	0 10	0	0	10	16	20	32	30	48	40	64	50	80	60	96	70	112
1	0 0 0 1	1	SOH	21	DC1	41	!	61	1	17	A	101	Q	141	a	161	q
1	1 11	1	1	17	21	33	31	49	41	65	51	81	61	97	71	113	
2	0 0 1 0	2	STX	22	DC2	42	"	62	2	18	B	102	R	142	b	162	r
2	2 12	2	2	18	22	34	32	50	42	66	52	82	62	98	72	114	
3	0 0 1 1	3	ETX	23	DC3	43	#	63	3	19	C	103	S	143	c	163	s
3	3 13	3	3	19	23	35	33	51	43	67	53	83	63	99	73	115	
4	0 1 0 0	4	EOT	24	DC4	44	\$	64	4	20	D	104	T	144	d	164	t
4	4 14	4	4	20	24	36	34	52	44	68	54	84	64	100	74	116	
5	0 1 0 1	5	ENQ	25	NAK	45	%	65	5	21	E	105	U	145	e	165	u
5	5 15	5	5	21	25	37	35	53	45	69	55	85	65	101	75	117	
6	0 1 1 0	6	ACK	26	SYN	46	&	66	6	22	F	106	V	146	f	166	v
6	6 16	6	6	22	26	38	36	54	46	70	56	86	66	102	76	118	
7	0 1 1 1	7	BEL	27	ETB	47	'	67	7	23	G	107	W	147	g	167	w
7	7 17	7	7	23	27	39	37	55	47	71	57	87	67	103	77	119	
10	0 0 0 0	8	BS	30	CAN	50	(70	8	24	H	110	X	150	h	170	x
8	8 18	8	8	24	28	40	38	56	48	72	58	88	68	104	78	120	
11	0 0 0 1	9	HT	31	EM	51)	71	9	25	I	111	Y	151	i	171	y
9	9 19	9	9	25	29	41	39	57	49	73	59	89	69	105	79	121	
12	0 0 1 0	10	LF	32	SUB	52	*	72	10	26	J	112	Z	152	j	172	z
10	10 1A	10	10	26	2A	42	3A	58	4A	74	5A	90	6A	106	7A	122	
13	0 0 1 1	11	VT	33	ESC	53	+	73	11	27	K	113	[153	k	173	{
11	11 1B	11	11	27	2B	43	3B	59	4B	75	5B	91	6B	107	7B	123	
14	0 1 0 0	12	FF	34	FS	54	,	74	12	28	L	114	\	154	l	174	
12	12 1C	12	12	28	2C	44	3C	60	4C	76	5C	92	6C	108	7C	124	
15	0 1 0 1	13	CR	35	GS	55	-	75	13	29	M	115]	155	m	175	}
13	13 1D	13	13	29	2D	45	3D	61	4D	77	5D	93	6D	109	7D	125	
16	0 1 1 0	14	SO	36	RS	56	.	76	14	30	N	116	^	156	n	176	~
14	14 1E	14	14	30	2E	46	3E	62	4E	78	5E	94	6E	110	7E	126	
17	0 1 1 1	15	SI	37	US	57	/	77	15	31	UNL	117	UNT	157	o	177	DEL (RUBOUT)
15	15 1F	15	15	31	2F	47	3F	63	4F	79	5F	95	6F	111	7F	127	
		ADDRESSED COMMANDS		UNIVERSAL COMMANDS		LISTEN ADDRESSES		TALK ADDRESSES		SECONDARY ADDRESSES OR COMMANDS							

KEY

octal	25	PPU	GPIB code
	NAK		ASCII character
hex	15	21	decimal

Tektronix
COMMITTED TO EXCELLENCE

REF: ANSI STD X3. 4-1977
IEEE STD 488-1978
ISO STD 646-1973

TEKTRONIX STD 062-5435-00 4 SEP 80
COPYRIGHT © 1979, 1980 TEKTRONIX, INC. ALL RIGHTS RESERVED.



WARNING

THE FOLLOWING SERVICING INSTRUCTIONS ARE FOR USE BY QUALIFIED PERSONNEL ONLY. TO AVOID PERSONAL INJURY, DO NOT PERFORM ANY SERVICING OTHER THAN THAT CONTAINED IN OPERATING INSTRUCTIONS UNLESS YOU ARE QUALIFIED TO DO SO. REFER TO OPERATORS SAFETY SUMMARY AND SERVICE SAFETY SUMMARY PRIOR TO PERFORMING ANY SERVICE.

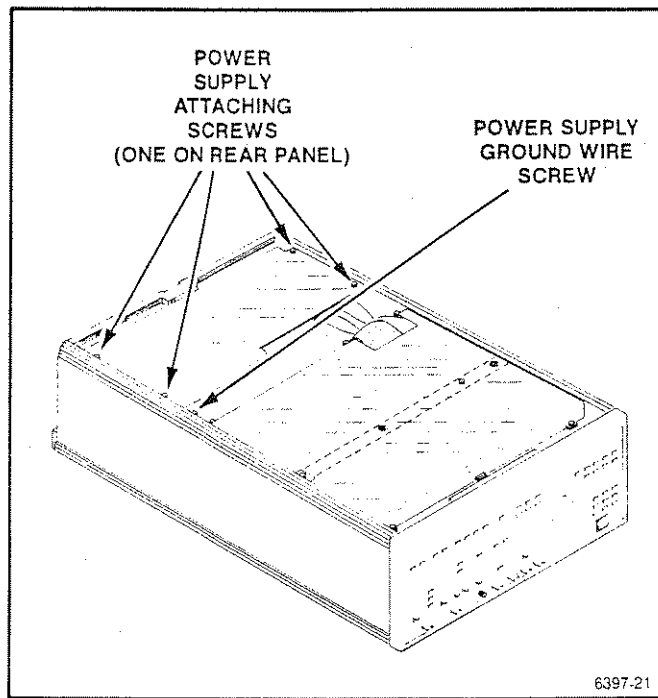

Fig. D-3. Power supply removal.

5. Carefully slide the power supply toward the front of the instrument until the fuse holder, power switch, ground terminal, and power cord receptacle clear the rear panel.

6. Carefully lift the power supply up and out of the main chassis.

Replacement

Install the power supply in the reverse order of removal.

NOTE

Be sure to reconnect the ground wire at the top left corner of the power supply module.



If the power supply was removed to change its line voltage selector jumper, be sure to change the Line Voltage Indicator "INTERNALLY SET FOR" screw on the rear panel to reflect the correct line voltage selected by the jumper. Failure to make this change may cause an operator to connect the instrument to an incorrect line voltage, which may damage the instrument.

INTERNAL JUMPER SELECTORS

LINE VOLTAGE SELECTOR

WARNING

Hazardous voltages exist inside this instrument when the power cord is connected to a power source. To avoid injury, disconnect the power cord before removing any instrument covers.

The RTD 710A will operate on 115 Vac or 230 Vac. To change from one voltage to the other:

1. Remove the top cabinet cover.
2. Remove the power supply.
3. Remove the six (6) attaching screws from the power supply side panel adjacent to the power cord receptacle, power switch, etc. (Fig. D-4).
4. Move the COM line voltage selector jumper to the desired line voltage (115 V or 230 V) selector lug (Fig. D-4).

CAUTION

If the power supply was removed to change its line voltage selector jumper, be sure to change the Line Voltage Indicator "INTERNALLY SET FOR" screw on the rear panel to reflect the correct line voltage selected by the jumper. Failure to make this change may cause an operator to connect the instrument to an incorrect line voltage, which may damage the instrument.

5. Reinstall the power supply side panel.
6. Reinstall the power supply.
7. Reinstall the top cabinet cover.

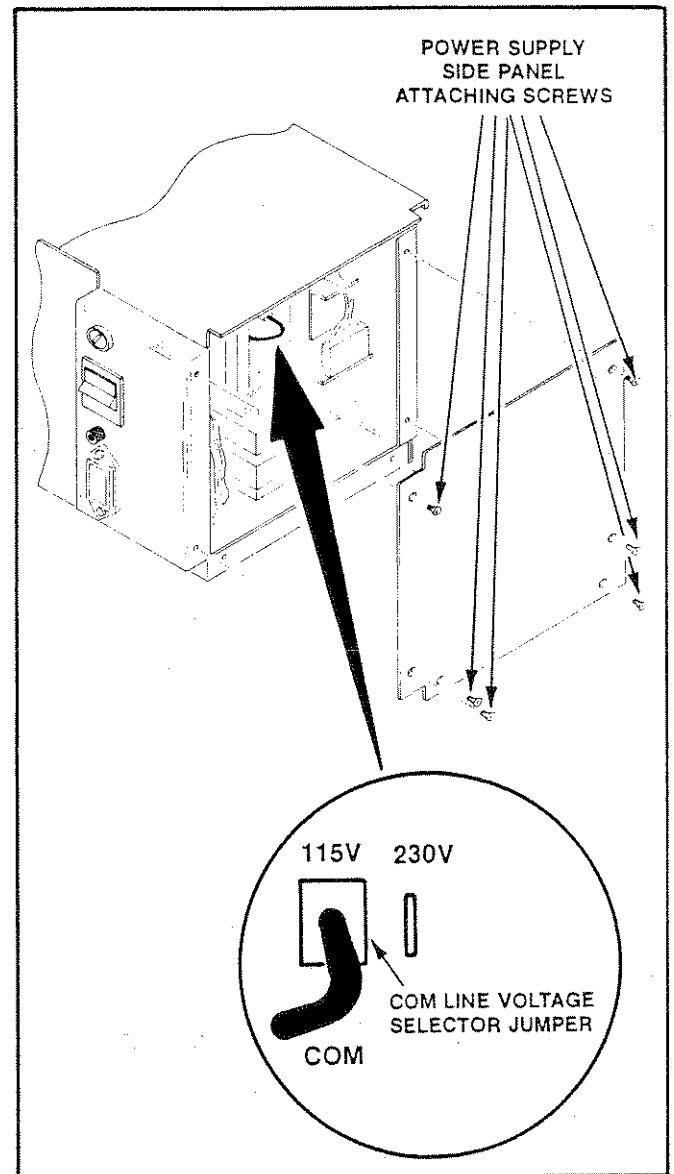

Fig. D-4. Power supply side panel and line voltage selector.

8. Change the Line Voltage Indicator "INTERNALLY SET FOR" screw on the rear panel to the correct line voltage.

CAUTION

If the power supply was removed to change its line voltage selector jumper, be sure to change the Line Voltage Indicator "INTERNALLY SET FOR" screw on the rear panel to reflect the correct line voltage selected by the jumper. Failure to make this change may cause an operator to connect the instrument to an incorrect line voltage, which may damage the instrument.

CRT MONITOR OUTPUT JUMPERS

The output characteristics of the CRT monitor output connectors (X, Y, and Z) are controlled by several internal jumpers, mainly the X-Level, Y-Level, Z-Level, Z-Polarity, and Hair. The Hair jumper selects the type of cursor (vertical line or dot) displayed on the monitor. Table D-1 shows the selections available.

Table D-1
CRT MONITOR JUMPER SELECTIONS

Jumper Name	J-Number	Output Selection	Jumpered Pins
X-Level	J470	5 V 1 V	1-2 2-3 (Factory Setting)
Y-Level	J430	5 V 1 V	1-2 2-3 (Factory Setting)
Z-Level	J481	5 V 1 V	1-2 2-3 (Factory Setting)
Z-Polarity (Unblk)	J480	Positive	1-2 (Factory Setting) 2-3
Hair	J400	Line Dot	1-2 (Factory Setting) 2-3

WARNING

Hazardous voltages exist inside this instrument when the power cord is connected to a power source. To avoid injury, disconnect the power cord before removing any instrument covers.

To change any of the CRT monitor jumper selections:

1. Remove the top cabinet cover.

2. Remove the six (6) Main Chassis Cover attaching screws (Fig. D-5). There are two (2) screws at the front edge, three (3) at the rear edge, and one (1) at the top right center part of the cover.

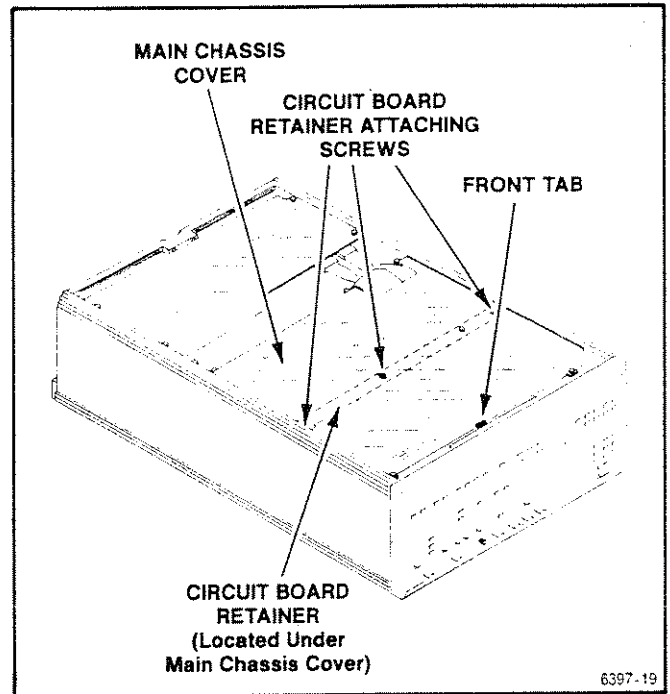

Fig. D-5. Main chassis cover and circuit board retainer.

3. Remove the Main Chassis Cover by sliding it slightly toward the front of the instrument to unhook its Front Tab. Then lift the cover up and out of the chassis.

4. Unscrew the three (3) Circuit Board Retainer attaching screws, but do not unscrew them completely out of the retainer. Then lift the retainer up and out of the chassis.

5. Remove the gray ribbon cable at the end of the A56 GPIB/Monitor board closest to the power supply.

6. Loosen the A-56 board by lifting up on the inner ends of the board ejectors. Do not attempt to completely remove the board until after the next step.

7. Lift the board out of the instrument just enough to unplug the three coaxial cables connected with Peltola connectors. Unplug the coaxial cables and move them aside out of the board removal path.

8. Lift the board straight up and out of the instrument.

9. Set the CRT monitor jumpers as desired using Table D-1 and Fig. D-6.

10. Reinstall the A56 board, Circuit Board Retainer, Main Chassis Cover, and top Cabinet Cover in the reverse order of removal.

WARNING

Hazardous voltages exist inside this instrument when the power cord is connected to a power source. To avoid injury, disconnect the power cord before removing any instrument covers.

To change the External Arm Signal jumper:

1. Remove the top Cabinet Cover.
2. Remove the Main Chassis Cover and Circuit Board Retainer (see steps 2. through 4. under CRT MONITOR OUTPUT JUMPERS above).
3. Remove the ribbon cable connector from the A30 board and move it aside out of the way.
4. Loosen the A32 board by pulling up on the inner ends of the board ejectors.

EXTERNAL ARM SIGNAL JUMPER

The External Arm Signal jumper allows the selection of the external arm mode: Edge or Level. In the Edge mode, the instrument arms on the positive-going edge of the external arm TTL signal. In the Level mode, the instrument arms when the external arm TTL signal reaches the High state.

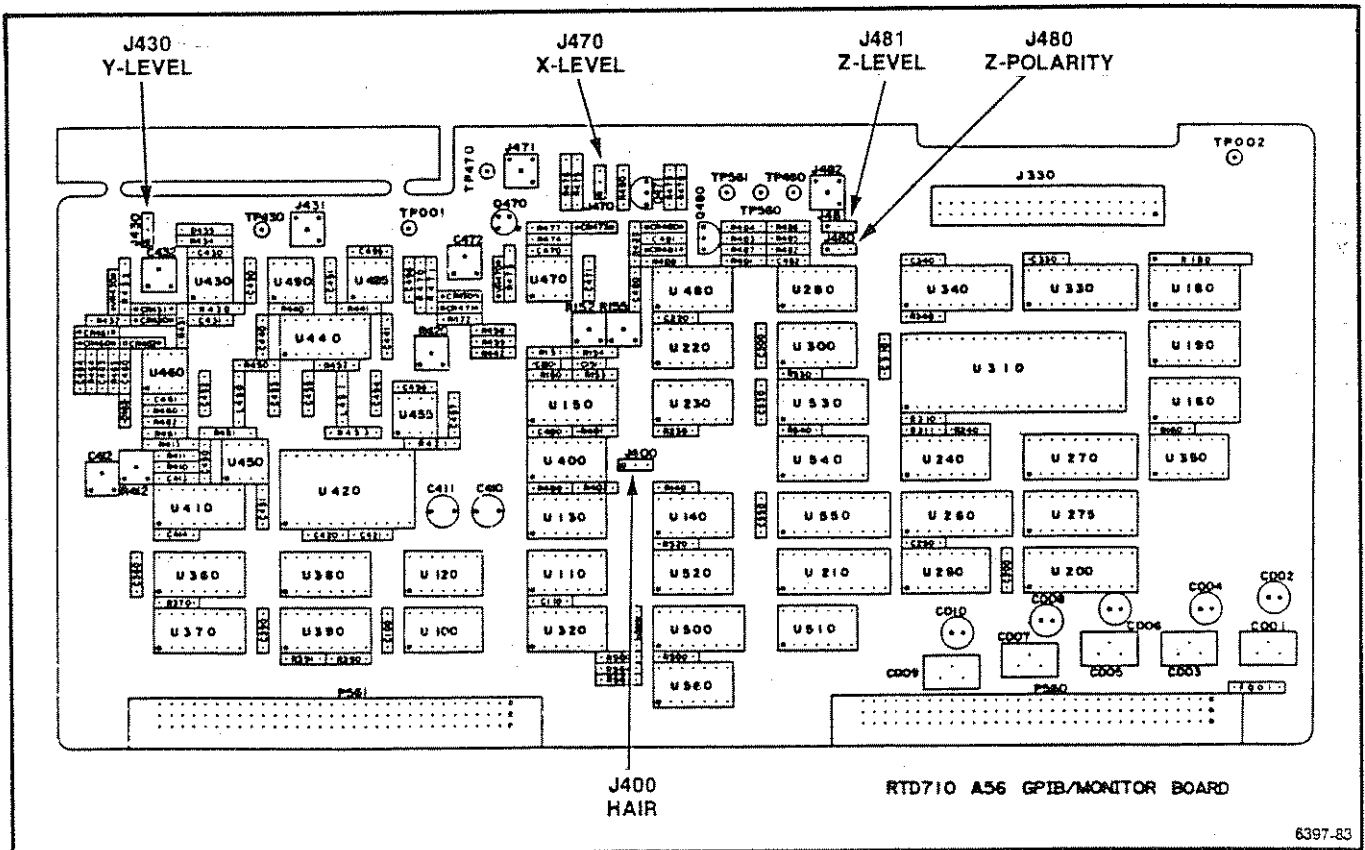

Fig. D-6. CRT monitor output jumper locations.

Servicing Instructions

5. Carefully lift the board up out of the chassis about two (2) inches to access the J122/J124 jumper.
6. Change the J122/J124 jumpers to the External Arm Signal mode as follows (Fig. D-7):
 - a. Edge Mode: 1-2 Jumpered (Factory Setting).
 - b. Level Mode: 2-3 Jumpered.

NOTE

Pin 1 is identified with an arrow symbol on the board.

7. Reinstall the A32 board, A30 board ribbon cable connector, Circuit Board Retainer, Main Chassis Cover, top Cabinet Cover, and Corner Retainers in the reverse order of removal.

Clock Out Jumper

The clock out jumper (Fig. D-7) allows selection of a direct mode or divided mode. The direct mode outputs either the internal 200 MHz signal or the externally supplied clock when the source is external. The divided mode outputs a clock of the same rate as the sampling clock.

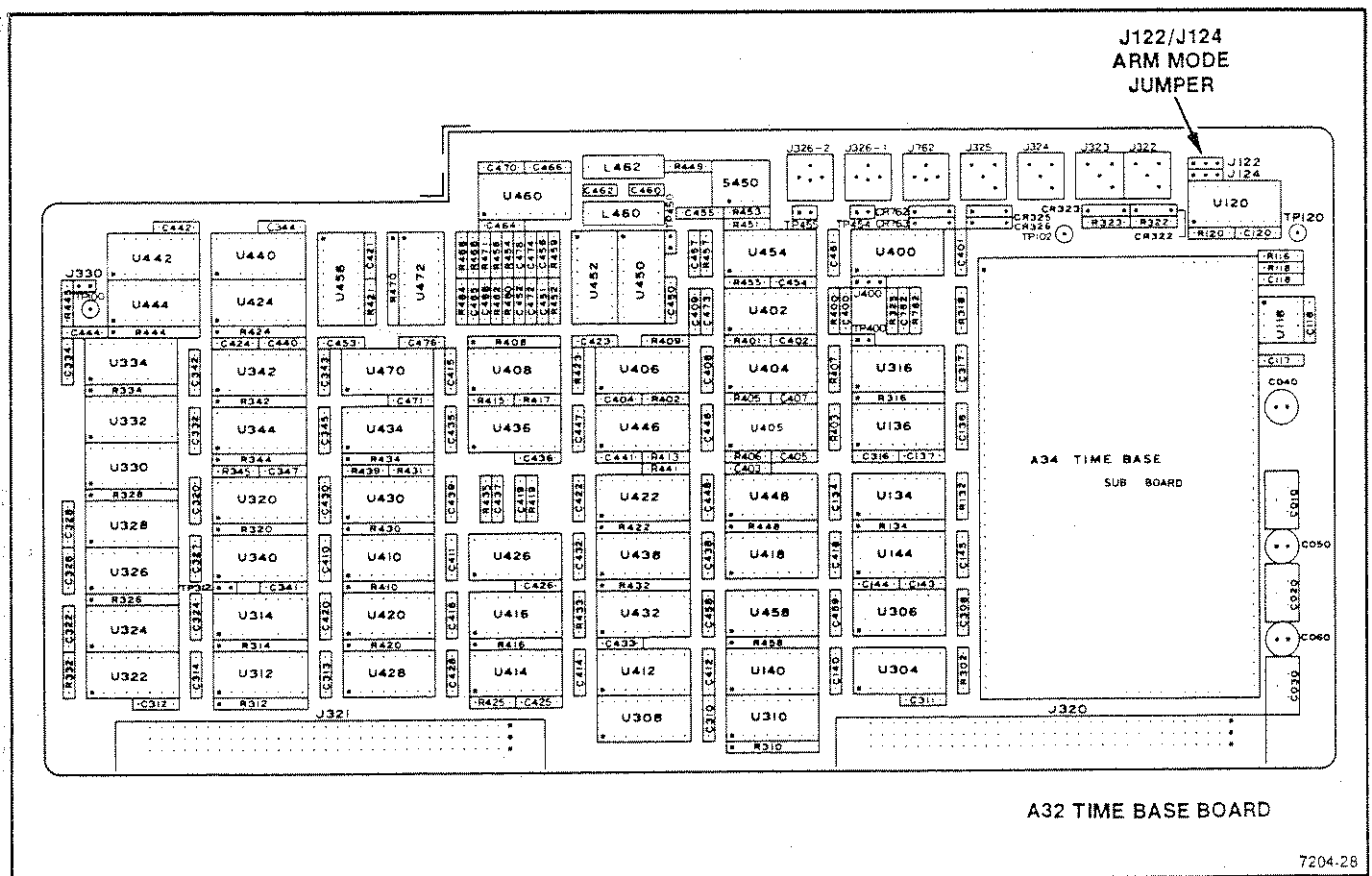

Fig. D-7. External arm signal jumper location.

RACKMOUNTING INSTRUCTIONS

RACKMOUNT COMPONENTS

The rackmount kit contains new Rackmount Side Covers (Fig. D-8), two rackmount assemblies, and mounting hardware. Each rackmount assembly consists of three sections: a Chassis Section, an Intermediate Section, and a Stationary Section (Fig. D-9). When the kit is received, the Chassis Section of each assembly is already mounted on its associated Rackmount Side Cover, and the remaining two sections are assembled and wrapped together.

WARNING

The Chassis, Intermediate, and Stationary Sections are a matched set and are installed on a specific side of the instrument and the rack. When installing the new Rackmount Side Covers with Chassis Sections already installed, be sure to install the covers on the correct side of the instrument. Do not unwrap the Intermediate and Stationary sections until ready to install them as they may slide apart and become intermixed with each other. Installing the sections improperly may cause the instrument to slide out of the rack and injure the operator. Before installing the sections see the Stationary/Intermediate Section Identification Procedure paragraph.

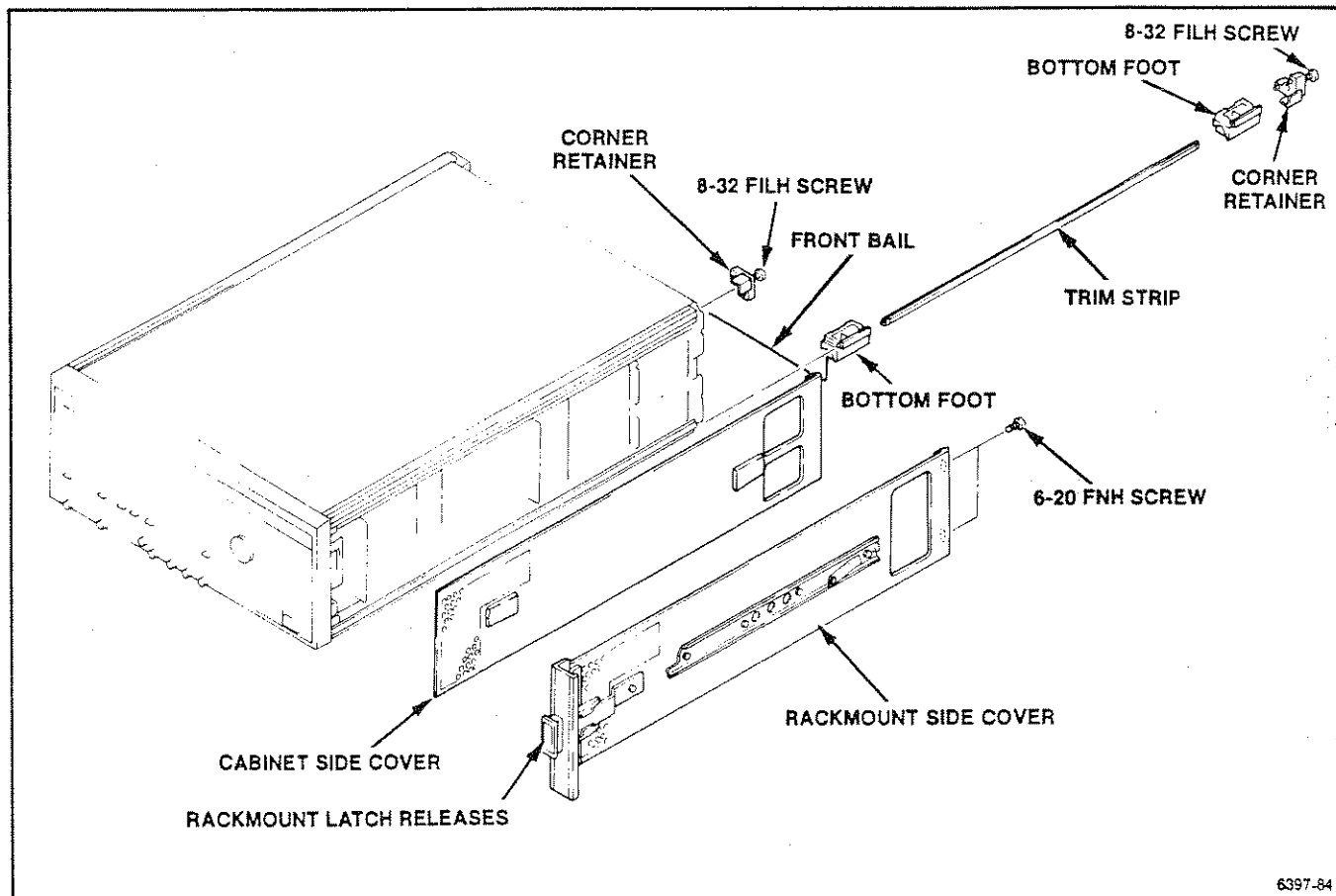

Fig. D-8. Cabinet-to-rackmount conversion.

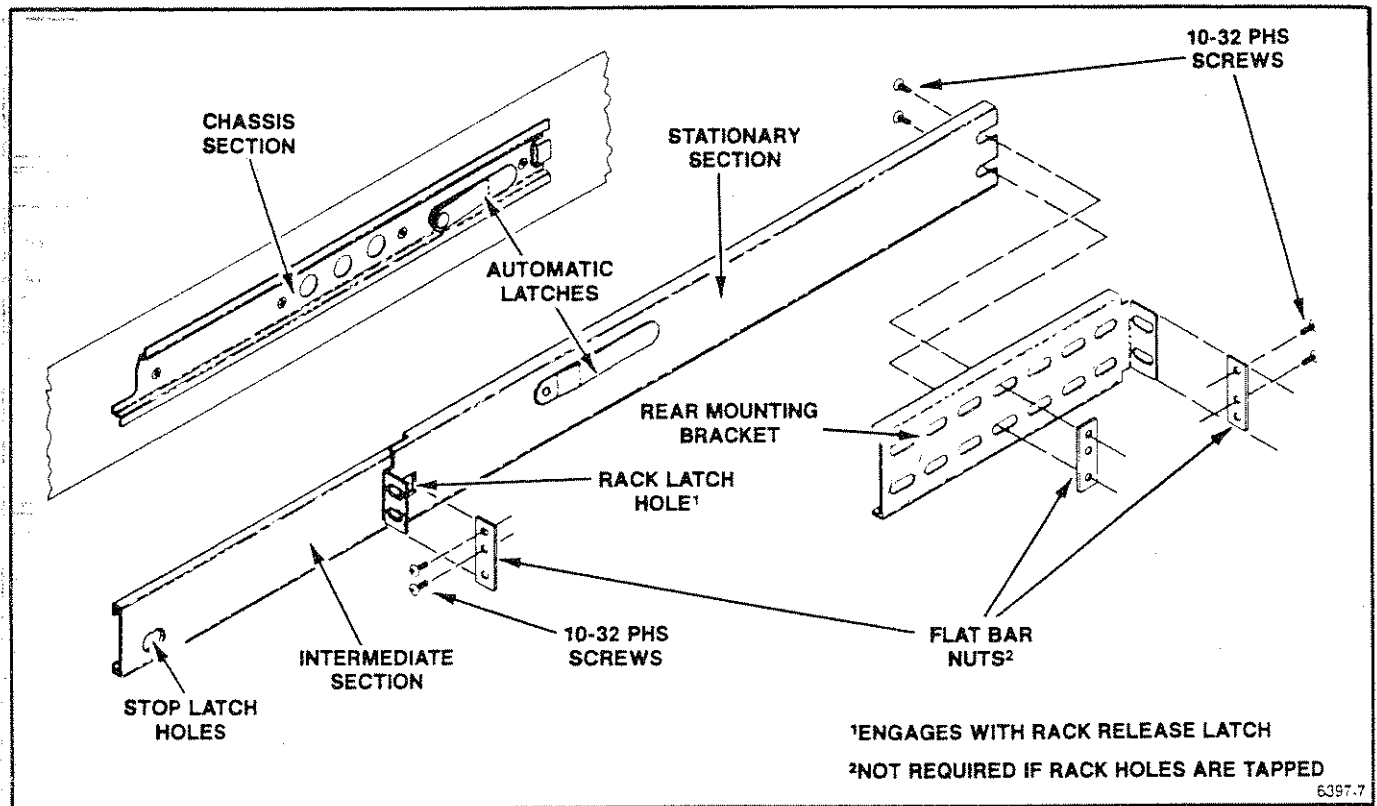

Fig. D-9. Rackmount assembly sections.

If the instrument was shipped as a rackmountable version, the Rackmount Side Covers with Chassis Sections installed are already on the instrument. On these instruments, only the rack hardware needs to be installed.

If the instrument is being converted to a rackmountable version, both the new Rackmount Side Covers and the rack hardware needs to be installed.

RACK REQUIREMENTS

The RTD 710A rackmounting hardware will fit most commercial consoles and 19-inch wide racks whose rail holes conform to universal spacing (Fig. D-10).

Rack enclosures must allow at least two inches clearance between the enclosure and the left and right sides, and at least 3 inches at the rear panel of the instrument for air circulation. It is recommended that a minimum of 3.5 inches be allowed between any enclosure and the rear panel to accommodate the air circulation requirement and to allow cable installation.

The depth of the rackmountable RTD 710A from behind the rack handles to the rear feet is 25.3 inches (Fig. D-11). A recommended rack cabinet depth should be at least 29 inches to meet the rear clearances above.

Service Instructions

The Stationary Sections mount easily to the front and rear vertical rails of racks with a depth of 15 to 28 inches. Racks with a rail depth outside these limits must provide some means of support for the rear ends of the Stationary Sections, such as extensions to the rear mounting brackets.

The rackmountable RTD 710A is 7 inches high, which is a multiple of the 1.75-inch standard rack spacing. As long as the rackmountable RTD 710A is positioned in a conventional rack at some multiple of 1.75 inches from the bottom or top, all holes should line up without drilling additional holes.

The opening between front rack rails must be at least 17 5/8 inches.

INSTALLING THE RACKMOUNT SIDE COVERS

To convert the standard RTD 710A to a rackmountable version:

1. Remove the left and right Cabinet Side Covers (See removal procedure earlier in this section. Also see Fig. D-8.

2. Remove the Bottom Feet (Fig. D-8) at each of the four corners of the bottom panel. They are removed by sliding them toward the rear of the instrument. Remove the front bail with the front feet.

3. Remove the top and bottom trim strips on both sides (Fig. D-8). They are removed by sliding them toward the rear of the instrument.

4. Remove the front bottom feet with front bail. They are removed by sliding them toward the rear of the instrument.

5. Install the left Rackmount Side Cover by sliding the cover into the cover grooves from the rear of the instrument. Once the cover is inserted, install two 6-20 PNH screws (supplied with the rackmount kit) at the rear of the cover, and install the air filter.

NOTE

Remember the left side is identified when facing the front panel of the instrument. To identify the left Rackmount Side Cover, note that (1) when the Chassis Section is installed, the small notch at the front of the section is located at the top, (2) the Automatic Latch is located closest to the bottom of the section when installed (Figs. D-8 and D-9), and (3) the screw holes in the Rackmount Handles are at the top.

6. Install the right Rackmount Side Cover by sliding the cover into the cover grooves from the rear of the instrument. Once the cover is inserted, install two 6-20 PNH screws (supplied with the rackmount kit) at the rear of the cover, and install the air filter.

NOTE

Remember the right side is identified when facing the front panel of the instrument. To identify the right Rackmount Side Cover, note that (1) when the Chassis Section is installed, the small notch at the front of the section is located at the top, (2) the Automatic Latch is located closest to the bottom of the section when installed (Figs. D-8 and D-9), and (3) the screw holes in the Rackmount Handles are at the top.

7. Reinstall the top trim strips on both sides.

8. Reinstall the corner retainers at each of the four rear corners of the instrument.

INSTALLING THE RACK HARDWARE

The rack hardware consists of the Intermediate and Stationary Sections (Fig. D-12). There are two sets of these sections, one for each side of the rack. Each set is separately wrapped as a matched set in the kit. The Stationary Sections attach to the vertical rack rails, while the Intermediate Sections fit between the Stationary Sections and the Chassis Sections on the instrument to allow the instrument to be extended out of the rack.

WARNING

The Chassis, Intermediate, and Stationary Sections are a matched set and are to be installed on a specific side of the rack. When installing the Intermediate and Stationary Sections in the rack be sure to install them on the correct side. Do not unwrap the Intermediate and Stationary Sections until ready to install them as they may slide apart and become intermixed with each other. Installing the sections improperly may cause the instrument to slide out of the rack and injure the operator. Before installing the sections see the Stationary/Intermediate Section Identification Procedure paragraph.

To install the rack hardware:

1. Select the appropriate holes in the front and rear vertical rack rails, using Fig. D-10 as a guide.

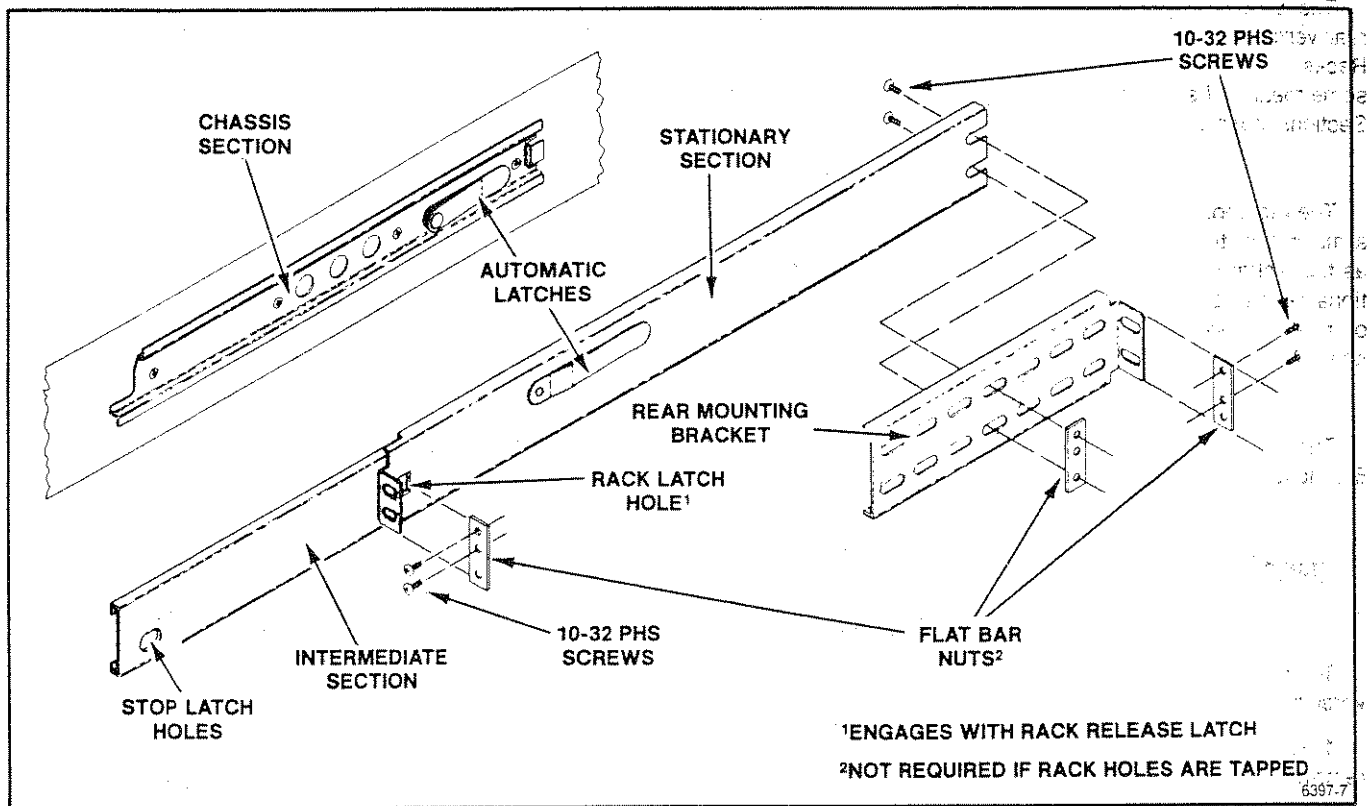

Fig. D-12. Rackmount slide detail #1.

2. Using the 10-32 PHS truss head screws and bar nuts (for untapped rails) provided in the rackmount hardware, mount the Stationary Sections for each side to the front and rear rack rails (Figs. D-12 and D-13). When mounting the sections to the rear rack rails, use either the deep or shallow rack methods shown in Fig. D-13B or D-13C. If the rack rail holes are tapped, the bar nuts may or may not be used.

NOTE

The front lip of the Stationary Section must mount in front of the front rail to allow the spring-latch to function properly (Fig. D-13A.)

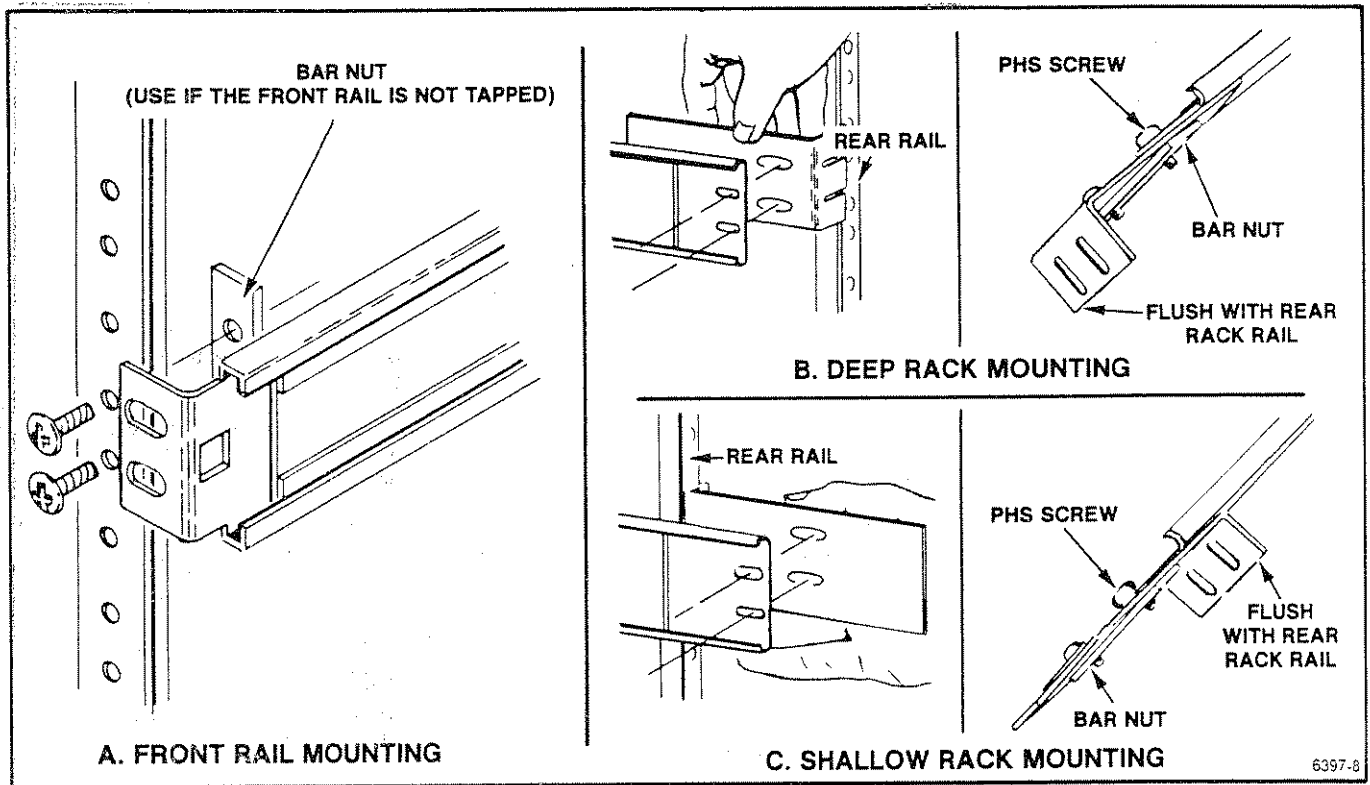

Fig. D-13. Rackmount slide detail #2.

Stationary/Intermediate Section Identification

To determine which sections go on which side of the rack, follow this identification procedure:

- a. When the Stationary Section is installed on the correct side, its Automatic Latch is closest to the top.
- b. Each Intermediate Section has a small notch at one end of the widest part of the section. When the Intermediate section is inserted into the Stationary Section, that notch is toward the rear. Also, when the Intermediate Section is installed in the correct Stationary Section, the Stop Latch Hole at the rear of the section is closest to the top. This causes the Intermediate Section to lock into the Stationary Section before it can be pulled completely out of the Stationary Section. This feature is very important for operator safety and equipment protection. The last feature of the Intermediate Section is a small offset of material in the bottom front part of the slide to keep the section from inserting completely into the Stationary Section. This offset causes the section to stop just after it passes the Rack Latch Hole.

- c. Test the correct installation of the Stationary and Intermediate Sections by pulling the Intermediate Sections completely out of the Stationary Sections. When fully extended, the Automatic Latch of the Stationary Section should lock into the Stop Latch Hole of the Intermediate Section such that the Intermediate Section cannot be pulled completely out of the Stationary Section. Also, when the Intermediate Section is pushed completely into the Stationary Section, it should stop just after its front end passes the Rack Latch Hole.

INSTALLING THE INSTRUMENT IN THE RACK

To install the rackmountable instrument into the rack (Fig. D-14):

1. Pull out both Intermediate Sections as far as they will go. At this point, they should be locked into the Stationary Sections by the Automatic Latches.

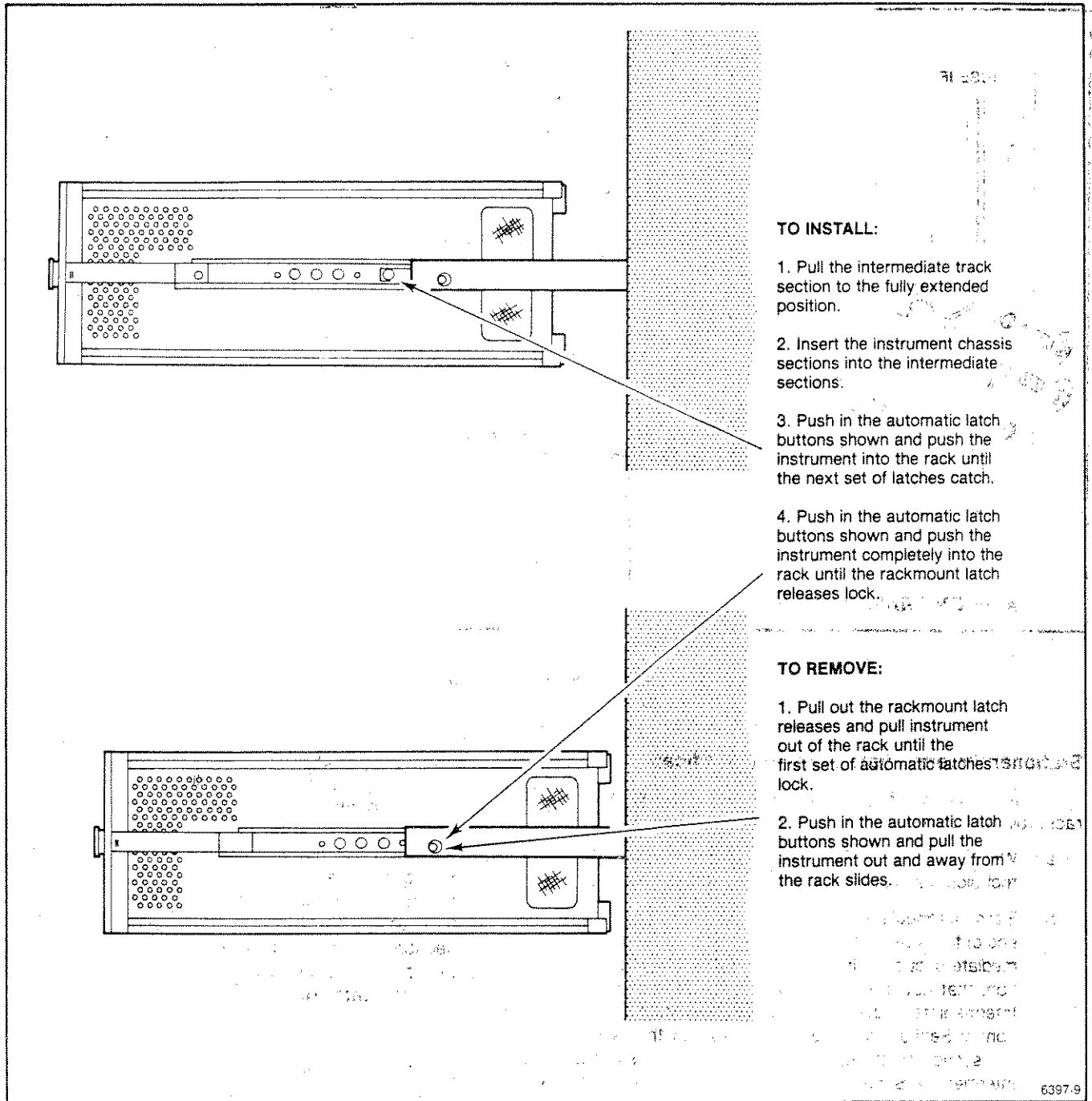

Fig. D-14. Installing/removing the instrument from the rack.

Servicing Instructions

2. Slide the instrument Chassis Sections into the Intermediate Sections until they lock together with the Automatic Latches. Carefully attempt to pull the instrument out of the rack; it should not move. If it does, the rack sections are not properly installed. Recheck the installation.

3. Press in both Automatic Latch buttons in the Intermediate Sections while pushing the instrument into the rack. As soon as the buttons are past the Automatic Latch Holes, the instrument can be pushed completely into the rack. The Automatic Latches locking the Intermediate Sections to the Stationary Sections are automatically operated by the instrument as it is pushed into the rack. If the Rackmount Latch Releases are pushed completely into the instrument, they automatically engage the Rack Latch Holes in the Stationary Sections when the instrument is pushed completely into the rack.

4. Install the two security screws in the top of the Rackmount Handles, if desired.

REMOVING THE INSTRUMENT FROM THE RACK

To remove the instrument from the rack (Fig. D-14):

1. Unscrew the two security screws at the top of the Rackmount Handles, if installed.
2. Pull out both Rackmount Latch-Releases at the sides of the instrument.
3. Using the Rackmount Latch Releases, pull the instrument out of the rack enclosure until the Intermediate Section Automatic Latches Lock.

WARNING

In the next step, when the instrument is removed from its locked and secured rackmounting position, it could drop free and injure the operator. Be sure that you have a firm hold on the instrument when removing it, or have someone assist you in the removal.

4. Press in on both Chassis Section Automatic Latch release buttons and carefully slide the instrument out and away from the rack. When the end of the Chassis Sections clear the Intermediate Sections the instrument is free of the rack.

RACK ADJUSTMENTS

After installing the instrument in the rack, binding of the rack sections may occur if they are not properly adjusted. To adjust the rackmounting hardware:

1. Pull the Rackmount Latch Releases to unlock the instrument, then continue pulling the instrument about 10 inches out of the rack.
2. Slightly loosen the screws holding the left and right front Stationary Sections to the rack rails.
3. Allow the Stationary Sections to seek their normal position.
4. Retighten the screws and check the tracks for smooth operation by sliding the instrument in and out of the rack.
5. If necessary, repeat steps 2 through 4 for the rear vertical rails of the rack.

MANUAL CHANGE INFORMATION

At Tektronix, we continually strive to keep up with latest electronic developments by adding circuit and component improvements to our instruments as soon as they are developed and tested.

Sometimes, due to printing and shipping requirements, we can't get these changes immediately into printed manuals. Hence, your manual may contain new change information on following pages.

A single change may affect several sections. Since the change information sheets are carried in the manual until all changes are permanently entered, some duplication may occur. If no such change pages appear following this page, your manual is correct as printed.

