

**RSA5100B Series  
Real-Time Signal Analyzers  
Quick Start User Manual**



  
071-3224-04

**Tektronix**

[www.valuetronics.com](http://www.valuetronics.com)



**RSA5100B Series  
Real-Time Signal Analyzers  
Quick Start User Manual**

[www.tektronix.com](http://www.tektronix.com)  
071-3224-04

**Tektronix**

[www.valuetronics.com](http://www.valuetronics.com)

Copyright © Tektronix. All rights reserved. Licensed software products are owned by Tektronix or its subsidiaries or suppliers, and are protected by national copyright laws and international treaty provisions.

Tektronix products are covered by U.S. and foreign patents, issued and pending. Information in this publication supersedes that in all previously published material. Specifications and price change privileges reserved.

TEKTRONIX and TEK are registered trademarks of Tektronix, Inc.

Planar Crown is a registered trademark of Aeroflex Inc.

LTE is a trademark of ETSI.

Bluetooth is a registered trademark of Bluetooth SIG, Inc.

## Contacting Tektronix

Tektronix, Inc.  
14150 SW Karl Braun Drive  
P.O. Box 500  
Beaverton, OR 97077  
USA

For product information, sales, service, and technical support:

- In North America, call 1-800-833-9200.
- Worldwide, visit [www.tektronix.com](http://www.tektronix.com) to find contacts in your area.

## Warranty

Tektronix warrants that this product will be free from defects in materials and workmanship for a period of one (1) year from the date of shipment. If any such product proves defective during this warranty period, Tektronix, at its option, either will repair the defective product without charge for parts and labor, or will provide a replacement in exchange for the defective product. Parts, modules and replacement products used by Tektronix for warranty work may be new or reconditioned to like new performance. All replaced parts, modules and products become the property of Tektronix.

In order to obtain service under this warranty, Customer must notify Tektronix of the defect before the expiration of the warranty period and make suitable arrangements for the performance of service. Customer shall be responsible for packaging and shipping the defective product to the service center designated by Tektronix, with shipping charges prepaid. Tektronix shall pay for the return of the product to Customer if the shipment is to a location within the country in which the Tektronix service center is located. Customer shall be responsible for paying all shipping charges, duties, taxes, and any other charges for products returned to any other locations.

This warranty shall not apply to any defect, failure or damage caused by improper use or improper or inadequate maintenance and care. Tektronix shall not be obligated to furnish service under this warranty a) to repair damage resulting from attempts by personnel other than Tektronix representatives to install, repair or service the product; b) to repair damage resulting from improper use or connection to incompatible equipment; c) to repair any damage or malfunction caused by the use of non-Tektronix supplies; or d) to service a product that has been modified or integrated with other products when the effect of such modification or integration increases the time or difficulty of servicing the product.

THIS WARRANTY IS GIVEN BY TEKTRONIX WITH RESPECT TO THE PRODUCT IN LIEU OF ANY OTHER WARRANTIES, EXPRESS OR IMPLIED. TEKTRONIX AND ITS VENDORS DISCLAIM ANY IMPLIED WARRANTIES OF MERCHANTABILITY OR FITNESS FOR A PARTICULAR PURPOSE. TEKTRONIX' RESPONSIBILITY TO REPAIR OR REPLACE DEFECTIVE PRODUCTS IS THE SOLE AND EXCLUSIVE REMEDY PROVIDED TO THE CUSTOMER FOR BREACH OF THIS WARRANTY. TEKTRONIX AND ITS VENDORS WILL NOT BE LIABLE FOR ANY INDIRECT, SPECIAL, INCIDENTAL, OR CONSEQUENTIAL DAMAGES IRRESPECTIVE OF WHETHER TEKTRONIX OR THE VENDOR HAS ADVANCE NOTICE OF THE POSSIBILITY OF SUCH DAMAGES.

[W2 – 15AUG04]



# Table of Contents

Important safety information .....	iii
General safety summary .....	iii
Service safety summary .....	v
Terms in this manual .....	v
Symbols and terms on the product .....	v
Compliance information .....	vi
EMC compliance .....	vi
Safety compliance .....	vii
Environmental considerations .....	ix
Preface .....	x
Key Features .....	x
Documentation .....	xi
Software Upgrades .....	xii
Conventions Used in This Manual .....	xii
Installation .....	1
Before Installation .....	1
Standard Accessories .....	1
Optional Accessories .....	2
Options .....	2
Operating Considerations .....	4
Connecting to the Instrument .....	5
Powering On the Instrument .....	6
Powering Off the Instrument .....	6
Removing the Power .....	7
Operating System Restore .....	7
Adding an External Monitor .....	8
Inspecting the Instrument .....	12
User Maintenance .....	13
Operation .....	15
Getting Acquainted with Your Instrument .....	15
Basic Concepts .....	24
Navigating Displays .....	26
Selecting Displays .....	27
Connecting a Signal .....	36
Starting and Stopping Acquisitions .....	37
Markers .....	39
Touchscreen Actions .....	42
Printing .....	44
Saving Data .....	46
Recalling Data .....	48
Advanced Techniques .....	49
Index .....	





# Important safety information

This manual contains information and warnings that must be followed by the user for safe operation and to keep the product in a safe condition.

To safely perform service on this product, additional information is provided at the end of this section. (See page v, *Service safety summary*.)

## General safety summary

Use the product only as specified. Review the following safety precautions to avoid injury and prevent damage to this product or any products connected to it. Carefully read all instructions. Retain these instructions for future reference.

Comply with local and national safety codes.

For correct and safe operation of the product, it is essential that you follow generally accepted safety procedures in addition to the safety precautions specified in this manual.

The product is designed to be used by trained personnel only.

Only qualified personnel who are aware of the hazards involved should remove the cover for repair, maintenance, or adjustment.

Before use, always check the product with a known source to be sure it is operating correctly.

This product is not intended for detection of hazardous voltages.

Use personal protective equipment to prevent shock and arc blast injury where hazardous live conductors are exposed.

While using this product, you may need to access other parts of a larger system. Read the safety sections of the other component manuals for warnings and cautions related to operating the system.

When incorporating this equipment into a system, the safety of that system is the responsibility of the assembler of the system.

### To avoid fire or personal injury

**Use proper power cord.** Use only the power cord specified for this product and certified for the country of use.

Do not use the provided power cord for other products.

**Ground the product.** This product is grounded through the grounding conductor of the power cord. To avoid electric shock, the grounding conductor must be connected to earth ground. Before making connections to the input or output terminals of the product, make sure that the product is properly grounded.

Do not disable the power cord grounding connection.

**Power disconnect.** The power cord disconnects the product from the power source. See instructions for the location. Do not position the equipment so that it is difficult to disconnect the power cord; it must remain accessible to the user at all times to allow for quick disconnection if needed.

**Connect and disconnect properly.** Do not connect or disconnect probes or test leads while they are connected to a voltage source.

**Observe all terminal ratings.** To avoid fire or shock hazard, observe all ratings and markings on the product. Consult the product manual for further ratings information before making connections to the product.

Do not apply a potential to any terminal, including the common terminal, that exceeds the maximum rating of that terminal.

The measuring terminals on this product are not rated for connection to mains or Category II, III, or IV circuits.

**Do not operate without covers.** Do not operate this product with covers or panels removed, or with the case open. Hazardous voltage exposure is possible.

**Avoid exposed circuitry.** Do not touch exposed connections and components when power is present.

**Do not operate with suspected failures.** If you suspect that there is damage to this product, have it inspected by qualified service personnel.

Disable the product if it is damaged. Do not use the product if it is damaged or operates incorrectly. If in doubt about safety of the product, turn it off and disconnect the power cord. Clearly mark the product to prevent its further operation.

Before use, inspect voltage probes, test leads, and accessories for mechanical damage and replace when damaged.

Examine the exterior of the product before you use it. Look for cracks or missing pieces.

Use only specified replacement parts.

**Wear eye protection.** Wear eye protection if exposure to high-intensity rays or laser radiation exists.

**Do not operate in wet/damp conditions.** Be aware that condensation may occur if a unit is moved from a cold to a warm environment.

**Do not operate in an explosive atmosphere.**

**Keep product surfaces clean and dry.** Remove the input signals before you clean the product.

**Provide proper ventilation.** Refer to the installation instructions in the manual for details on installing the product so it has proper ventilation.

Slots and openings are provided for ventilation and should never be covered or otherwise obstructed. Do not push objects into any of the openings.

**Provide a safe working environment.** Always place the product in a location convenient for viewing the display and indicators.

Avoid improper or prolonged use of keyboards, pointers, and button pads. Improper or prolonged keyboard or pointer use may result in serious injury.

Be sure your work area meets applicable ergonomic standards. Consult with an ergonomics professional to avoid stress injuries.

Use care when lifting and carrying the product. This product is provided with handles for lifting and carrying.



**WARNING.** *The product is heavy. To reduce the risk of personal injury or damage to the device get help when lifting or carrying the product.*

---

Use only the Tektronix rackmount hardware specified for this product.

## Service safety summary

The *Service safety summary* section contains additional information required to safely perform service on the product. Only qualified personnel should perform service procedures. Read this *Service safety summary* and the *General safety summary* before performing any service procedures.

**To avoid electric shock.** Do not touch exposed connections.

**Do not service alone.** Do not perform internal service or adjustments of this product unless another person capable of rendering first aid and resuscitation is present.

**Disconnect power.** To avoid electric shock, switch off the product power and disconnect the power cord from the mains power before removing any covers or panels, or opening the case for servicing.

**Use care when servicing with power on.** Dangerous voltages or currents may exist in this product. Disconnect power, remove battery (if applicable), and disconnect test leads before removing protective panels, soldering, or replacing components.

**Verify safety after repair.** Always recheck ground continuity and mains dielectric strength after performing a repair.

## Terms in this manual

These terms may appear in this manual:



**WARNING.** Warning statements identify conditions or practices that could result in injury or loss of life.



**CAUTION.** Caution statements identify conditions or practices that could result in damage to this product or other property.

## Symbols and terms on the product

These terms may appear on the product:

- DANGER indicates an injury hazard immediately accessible as you read the marking.
- WARNING indicates an injury hazard not immediately accessible as you read the marking.
- CAUTION indicates a hazard to property including the product.



When this symbol is marked on the product, be sure to consult the manual to find out the nature of the potential hazards and any actions which have to be taken to avoid them. (This symbol may also be used to refer the user to ratings in the manual.)

The following symbol(s) may appear on the product:



CAUTION  
Refer to Manual



Protective Ground  
(Earth) Terminal



Chassis Ground



Standby

## Compliance information

This section lists the EMC (electromagnetic compliance), safety, and environmental standards with which the instrument complies.

### EMC compliance

#### EC Declaration of Conformity – EMC

Meets intent of Directive 2004/108/EC for Electromagnetic Compatibility. Compliance was demonstrated to the following specifications as listed in the Official Journal of the European Communities:

**EN 61326-1 2006, EN 61326-2-1 2006.** EMC requirements for electrical equipment for measurement, control, and laboratory use.<sup>1 2 3</sup>

- CISPR 11:2003. Radiated and conducted emissions, Group 1, Class A
- IEC 61000-4-2:2001. Electrostatic discharge immunity
- IEC 61000-4-3:2002. RF electromagnetic field immunity<sup>5</sup>
- IEC 61000-4-4:2004. Electrical fast transient / burst immunity
- IEC 61000-4-5:2001. Power line surge immunity
- IEC 61000-4-6:2003. Conducted RF immunity<sup>6</sup>
- IEC 61000-4-11:2004. Voltage dips and interruptions immunity<sup>4, 7</sup>

**EN 61000-3-2:2006.** AC power line harmonic emissions

**EN 61000-3-3:1995.** Voltage changes, fluctuations, and flicker

#### European contact.

Tektronix UK, Ltd.  
Western Peninsula  
Western Road  
Bracknell, RG12 1RF  
United Kingdom

- <sup>1</sup> This product is intended for use in nonresidential areas only. Use in residential areas may cause electromagnetic interference.
- <sup>2</sup> Emissions which exceed the levels required by this standard may occur when this equipment is connected to a test object.
- <sup>3</sup> For compliance with the EMC standards listed here, high quality shielded interface cables should be used.
- <sup>4</sup> At the IEC 61000-4-11 Voltage-Interruption Transient Immunity test at 0% for 250 cycles, the EUT reboots and can take greater than 10 seconds to recover.
- <sup>5</sup> Performance degradation information for the IEC 61000-4-3 test: Residual spurious signals can typically increase to -55 dBm with exposure to the disturbance levels of this test.
- <sup>6</sup> Performance degradation information for the IEC 61000-4-6 test: Residual spurious signals can typically increase to the worse of either 55 dB below reference level or -75 dBm, with exposure to the disturbance levels of this test.
- <sup>7</sup> Performance Criterion C applied at the 70%/25 cycle Voltage-Dip and the 0%/250 cycle Voltage-Interruption test levels (IEC 61000-4-11).

## Australia / New Zealand Declaration of Conformity – EMC

Complies with the EMC provision of the Radiocommunications Act per the following standard, in accordance with ACMA:

- CISPR 11:2003. Radiated and Conducted Emissions, Group 1, Class A, in accordance with EN 61326-1:2006 and EN 61326-2-1:2006.

### Australia / New Zealand contact.

Baker & McKenzie  
Level 27, AMP Centre  
50 Bridge Street  
Sydney NSW 2000, Australia

## Safety compliance

This section lists the safety standards with which the product complies and other safety compliance information.

### EU declaration of conformity – low voltage

Compliance was demonstrated to the following specification as listed in the Official Journal of the European Union:

Low Voltage Directive 2006/95/EC.

- EN 61010-1. Safety Requirements for Electrical Equipment for Measurement, Control, and Laboratory Use – Part 1: General Requirements.

### U.S. nationally recognized testing laboratory listing

- UL 61010-1. Safety Requirements for Electrical Equipment for Measurement, Control, and Laboratory Use – Part 1: General Requirements.

### Canadian certification

- CAN/CSA-C22.2 No. 61010-1. Safety Requirements for Electrical Equipment for Measurement, Control, and Laboratory Use – Part 1: General Requirements.

### Additional compliances

- IEC 61010-1. Safety Requirements for Electrical Equipment for Measurement, Control, and Laboratory Use – Part 1: General Requirements.

### Equipment type

Test and measuring equipment.

### Safety class

Class 1 – grounded product.

## Pollution degree descriptions

A measure of the contaminants that could occur in the environment around and within a product. Typically the internal environment inside a product is considered to be the same as the external. Products should be used only in the environment for which they are rated.

- Pollution degree 1. No pollution or only dry, nonconductive pollution occurs. Products in this category are generally encapsulated, hermetically sealed, or located in clean rooms.
- Pollution degree 2. Normally only dry, nonconductive pollution occurs. Occasionally a temporary conductivity that is caused by condensation must be expected. This location is a typical office/home environment. Temporary condensation occurs only when the product is out of service.
- Pollution degree 3. Conductive pollution, or dry, nonconductive pollution that becomes conductive due to condensation. These are sheltered locations where neither temperature nor humidity is controlled. The area is protected from direct sunshine, rain, or direct wind.
- Pollution degree 4. Pollution that generates persistent conductivity through conductive dust, rain, or snow. Typical outdoor locations.

## Pollution degree rating

Pollution degree 2 (as defined in IEC 61010-1). Rated for indoor, dry location use only.

## Measurement and overvoltage category descriptions

Measurement terminals on this product may be rated for measuring mains voltages from one or more of the following categories (see specific ratings marked on the product and in the manual).

- Category II. Circuits directly connected to the building wiring at utilization points (socket outlets and similar points).
- Category III. In the building wiring and distribution system.
- Category IV. At the source of the electrical supply to the building.

---

**NOTE.** Only mains power supply circuits have an overvoltage category rating. Only measurement circuits have a measurement category rating. Other circuits within the product do not have either rating.

---

## Mains overvoltage category rating

Overvoltage category II (as defined in IEC 61010-1).

## Environmental considerations

This section provides information about the environmental impact of the product.

### Product end-of-life handling

Observe the following guidelines when recycling an instrument or component:

**Equipment recycling.** Production of this equipment required the extraction and use of natural resources. The equipment may contain substances that could be harmful to the environment or human health if improperly handled at the product's end of life. To avoid release of such substances into the environment and to reduce the use of natural resources, we encourage you to recycle this product in an appropriate system that will ensure that most of the materials are reused or recycled appropriately.



This symbol indicates that this product complies with the applicable European Union requirements according to Directives 2012/19/EU and 2006/66/EC on waste electrical and electronic equipment (WEEE) and batteries. For information about recycling options, check the Support/Service section of the Tektronix Web site ([www.tektronix.com](http://www.tektronix.com)).

**Perchlorate materials.** This product contains one or more type CR lithium batteries. According to the state of California, CR lithium batteries are classified as perchlorate materials and require special handling. See [www.dtsc.ca.gov/hazardouswaste/perchlorate](http://www.dtsc.ca.gov/hazardouswaste/perchlorate) for additional information.

### Restriction of hazardous substances

This product is classified as an industrial monitoring and control instrument, and is not required to comply with the substance restrictions of the recast RoHS Directive 2011/65/EU until July 22, 2017.

## Preface

This manual describes the installation and basic operation of the RSA5100B Series Real-Time Signal Analyzers. For more detailed information, see the instrument help.

- RSA5103B
- RSA5106B
- RSA5115B
- RSA5126B

## Key Features

The RSA5100B Series is a family of high-performance real-time signal analyzers. Key features include:

- Reduce Time-to-Fault and increase design confidence with Real-time Signal Processing
- Swept DPX spectrum enables unprecedented signal discovery over full frequency range
- Advanced DPX including swept DPX, gap-free DPX spectrograms, and DPX zero span with real-time amplitude, frequency, or phase
- DPX density™ trigger on frequency domain events and distinguish between continuous signals vs infrequent events
- Advanced time-qualified, runt, and frequency-edge triggers act on complex signals as brief as 20 ns
- 25, 40, 85, 125, or 165 MHz acquisition bandwidths
- Acquire more than 5 seconds at 165 MHz bandwidth
- Wideband preselection filter provides image free measurements in entire analysis bandwidth up to 165 MHz
- Measurements including channel power, ACLR, CCDF, OBW/EBW, spur search, EMI detectors
- Amplitude, frequency, phase vs. time, DPX spectrum, and spectrograms
- Correlated multi-domain displays



## Documentation

The following documentation is available for your Tektronix RSA5100B Series Signal Analyzers. The product documentation CD provided contains documents available at the time of publication. For the most current documentation, refer to the Tektronix Web site.

To read about	Use these documents
Installation and operation (overviews)	<p><i>Quick Start User Manual</i></p> <p>The quick start user manual contains general information about how to put your instrument into service and guides to user interface controls. This manual is available in printed form and as a PDF file.</p> <p>English, Tektronix part number 071-3224-XX.            Japanese, Tektronix part number 071-3225-XX.            Simplified Chinese, Tektronix part number 071-3226-XX.            Russian, Tektronix part number 071-3227-XX.</p>
In-depth operation and user interface help	<p><i>Instrument help</i></p> <p>The instrument help contains detailed information about how to operate the instrument. The help is available as a PDF file.</p> <p>Tektronix part number 077-0899-XX.</p>
Application examples	<p><i>Application Examples Manual</i></p> <p>This manual provides practical examples of using the analyzer to accomplish tasks. This manual is available as a PDF file.</p> <p>Tektronix part number 071-3283-XX.</p>
Programming commands	<p><i>Programmer Manual</i></p> <p>This manual contains descriptions of programming commands and their use. This manual is available as a PDF file.</p> <p>Tektronix part number 077-0901-XX.</p>
Specifications and performance verification	<p><i>Specifications and Performance Verification Manual</i></p> <p>This manual contains the instrument specifications and a procedure to check instrument performance against warranted characteristics. This manual is available as a PDF file.</p> <p>Tektronix part number 077-0900-XX.</p>
User service	<p><i>Service Manual</i></p> <p>This manual provides a list of replaceable parts, care and maintenance information, and information for servicing the instrument to the module level. This manual is available as a PDF file.</p> <p>Tektronix part number 077-0903-XX.</p>
Data security	<p><i>Declassification and Security Instructions</i></p> <p>This document helps customers with data security concerns to sanitize or remove memory devices. This document is available as a PDF file.</p> <p>Tektronix part number 077-0902-XX.</p>

## Software Upgrades

Software option upgrades are available. Software upgrades for options become operational only after you enter a valid option key for the specific analyzer model and serial number.

To check for upgrades:

1. Use your Web browser to go to [www.tektronix.com/software](http://www.tektronix.com/software).
2. Enter the product name (for example RSA5126B) to find available software upgrades.

## Conventions Used in This Manual

The following icons are used throughout this manual:

Sequence Step



Front panel power



Connect power

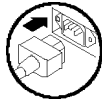

Network

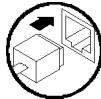

PS2

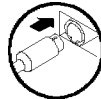

SVGA

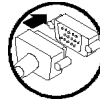

USB

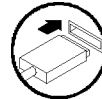

# Installation

## Before Installation

Unpack the instrument, and check that you received all items listed as *Standard Accessories*. Optional accessories and instrument options are also listed in this section. Check the Tektronix Web site ([www.tektronix.com](http://www.tektronix.com)) for the most current information.

## Standard Accessories

Your instrument comes with the following accessories: product documentation (listed below), power cord, USB keyboard, USB mouse, and instrument front cover.

The RSA5103B and RSA5106B also includes a BNC-N adapter.

The RSA5115B also includes a type N female Planar Crown RF input connector.

The RSA5126B also includes a 3.5 mm female Planar Crown RF input connector.

### Product Documentation

- *RSA5100B Series Real-Time Signal Analyzers Quick Start User Manual.*
- *RSA5100B Series Real-Time Spectrum Analyzers Application Examples Manual*
- *RSA5100B Series Product Documentation CD.*

### Power Cords

The analyzer is shipped with one of the following power cord options. Power cords for use in North America are UL listed and CSA certified. Cords for use in areas other than North America are approved by at least one authority acceptable in the country to which the product is shipped.

### International Power Plugs

- Opt. A0 - North America power
- Opt. A1 - Universal EURO power
- Opt. A2 - United Kingdom power
- Opt. A3 - Australia power
- Opt. A4 - 240 V, North America power
- Opt. A5 - Switzerland power
- Opt. A6 - Japan power
- Opt. A10 - China power
- Opt. A11 - India power

- Opt. A12 - Brazil power
- Opt. A99 - No power cord

## Optional Accessories

- RTPA2A – Real-Time Spectrum Analyzer Probe Adapter; Supports TekConnect probes P7225, P7240, P7260, P7313, P7313SMA, P7330, P7340A, P7350, P7350SMA, P7360A, P7380A, P7380SMA, P7500 Series.
- SignalVu-PC – Offline analysis software based on the RSA5000/6000 Series platform.
- RSAVu – Offline analysis software based on the RSA3000 platform for analysis supporting 3G wireless standards
- RSA5BUP Opt. SSD – Additional Removable Hard Drive for use with Opt. 56. (Windows 7 and instrument software pre-installed.)
- Planar Crown 3.5 mm female connector, Tektronix part number 131-9062-00.
- Planar Crown 3.5 mm male connector, Tektronix part number 131-8822-00.
- Planar Crown Type N female connector, Tektronix part number 131-4329-00.
- Planar Crown SMA female connector, Tektronix part number 131-8689-00.
- Transit Case – Tektronix part number 016-1963-00.
- Rackmount Retrofit - RSA56KR.

## Options

You can add the following options to your analyzer:

- Option 09 - Adds Enhanced Real Time.
- Option 10 - Adds AM/FM/PM and Audio Analysis.
- Option 11 - Adds Phase Noise and Jitter Measurement.
- Option 12 - Adds Settling Time Measurement (Frequency and Phase).
- Option 14 - Adds Noise Figure and Gain Measurement.
- Option 20 - Adds advanced signal analysis (including pulse measurements).
- Option 21 - Adds general-purpose digital modulation analysis.
- Option 22 - Adds flexible OFDM analysis.
- Option 23 - Adds WLAN 802.11a/b/g/j/p analysis.
- Option 24 - Adds WLAN 802.11n analysis.
- Option 25 - Adds WLAN 802.11ac analysis.
- Option 26 - Adds APCO P25 measurement application.
- Option 27 - Adds Bluetooth® LE and Bluetooth® Basic Rate RF transmitter measurements.
- Option 28 - Adds LTE™ Downlink (Base Station) RF transmitter measurements (includes Cell ID).

- Option B25 - Adds 25 MHz real-time capture bandwidth (no cost option).
- Option B40 - Adds 40 MHz real-time capture bandwidth.
- Option B85 - Adds 85 MHz real-time capture bandwidth.
- Option B16x - Adds 165 MHz real-time capture bandwidth.
- Option 50 - Adds 1 MHz to 3/6.2 GHz Pre-Amplifier (RSA5103B/RSA5106B only).
- Option 51 - Adds 1 MHz to 15/26.5 GHz Pre-Amplifier (RSA5115B/RSA5126B only).
- Option 53 - Adds Memory, 4 GB Acquisition Memory Total.
- Option 56 - Removable hard disk drive (not compatible with Option 59).
- Option 59 - Internal hard disk drive (no cost option), incompatible with Option 56.
- Option 65 - Adds Digital I and Q outputs.
- Option 66 - Adds Zero-span output.
- Option 6566 - Adds Digital I and Q outputs and Zero-span output.
- Option 300- Adds high performance real time DPX
- Option B85HD- Adds high dynamic range, 85 MHz acquisition bandwidth
- Option B125- Adds 125 MHz acquisition bandwidth
- Option B125HD- Adds high dynamic range, 125 MHz acquisition bandwidth
- Option B16xHD- Adds high dynamic range, 165 MHz acquisition bandwidth
- Option MAP - Adds mapping capability.
- Option PFR - Adds Precision Frequency Reference.
- Option PFR50 - Adds Precision Frequency Reference and Internal Preamp (RSA5103B/RSA5106B only).
- Option SSD - Adds an addition solid-state drive for units equipped with Option 56. Minimum disk capacity is 480 GB. The Windows 7 operating system and instrument software is preinstalled.
- RSA56KR – Rackmount for RSA5100A/B Series, SPECMON/B Series, and RSA6100B Series analyzers.

## Operating Considerations

### Power supply requirements

#### Source voltage and frequency

100 – 240 V<sub>RMS</sub>, 50/60 Hz

115 V<sub>RMS</sub>, 400 Hz

#### Power consumption

450 W maximum (all models)

### Environmental requirements

#### Characteristic

#### Description

Operating temperature

+10 °C to +40 °C

Non-operating temperature

-20 °C to +60 °C

Humidity

Operating

+40 °C at 95% relative humidity, meets intent of EN 60068-2-30.

Frequency amplitude response may vary up to ±3 dB at +40 °C and greater than 45% relative humidity.

Altitude:

Operating

Up to 3000 m (9843 ft)

Non-operating

12190 m (40,000 ft)

Cooling clearance

Bottom

20 mm (0.79 in)

Sides and back

50 mm (1.97 in)

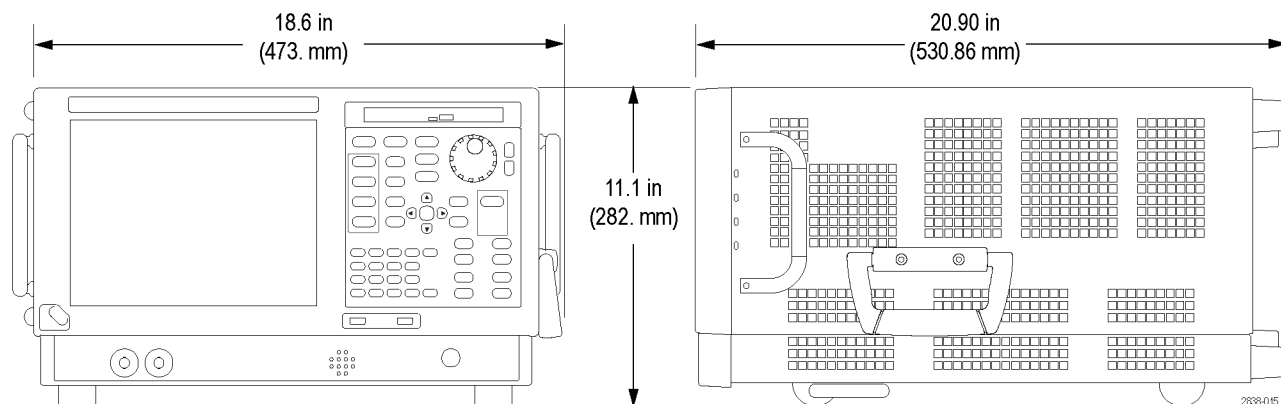

**CAUTION.** To ensure proper cooling, do not operate the instrument on its side. Operate the instrument only when it is resting on its bottom feet or rear feet. Maintain at least 2 inches (5 cm.) clearance around ventilation openings.



**WARNING.** To avoid personal injury, take extra care when lifting or moving the signal analyzer. The instrument is heavy and requires extra care when moving it.

## Connecting to the Instrument

### Connecting to a Network

Connect your keyboard, mouse, printer, and other accessories to your instrument before applying power. (Accessories with USB connectors can be connected before or after applying power.)

You can connect your instrument to a network for printing, file sharing, Internet access, and other functions. Consult your network administrator and use the standard Windows utilities to configure the instrument for your network.

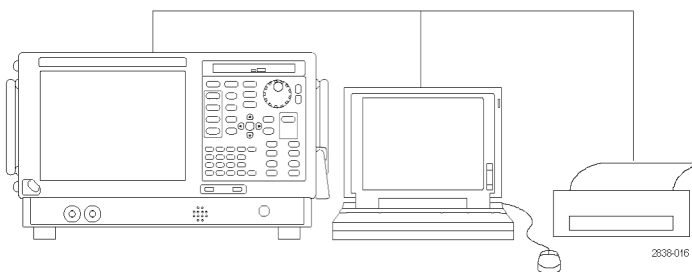

### Quick Tip

- If you connect your instrument to a network, you should protect your instrument by using an internet firewall, installing regular approved operating system updates, and using up-to-date antivirus software.

## Powering On the Instrument

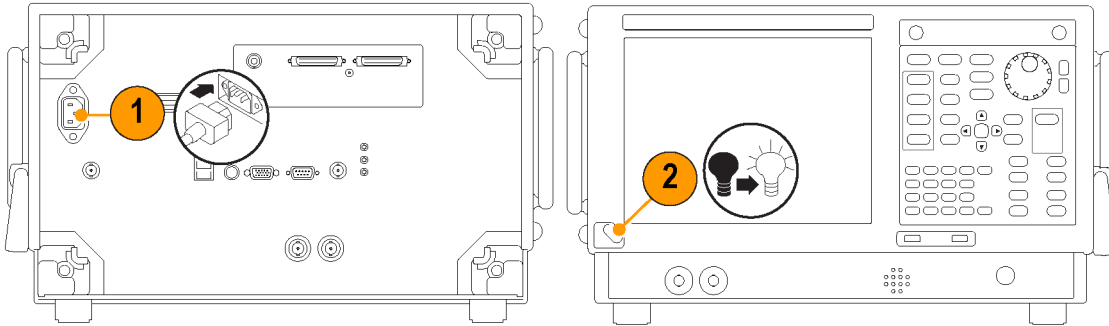

## Powering Off the Instrument

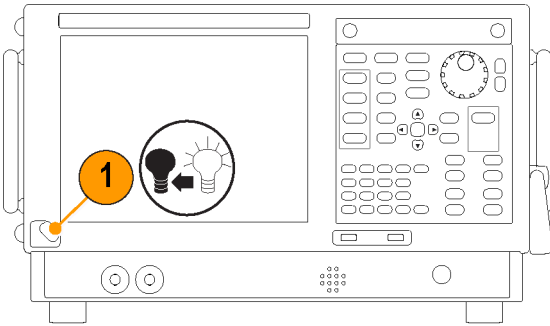



## Removing the Power

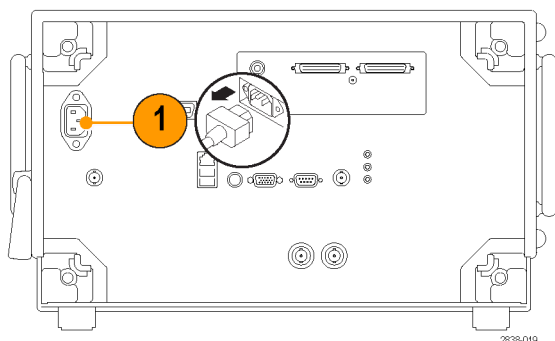

**CAUTION.** Do not remove the power cord while the instrument is running. Power off the instrument first, allowing the instrument to completely shut down before removing the power cord. The fans stopping is a good indicator.

## Operating System Restore

The instrument contains an operating system restore file on a separate partition of the hard drive. Use the following procedure to restore the operating system.



**CAUTION.** Using the restore process reformats the hard drive and reinstalls the operating system. All saved data is lost. If possible, save important files to external media before performing a system restore.

The Windows operating system installed is designed for this instrument's hardware and product software. Installing a version other than the one provided will not function properly.

After the operating system is installed, you need to download the application software package for your product from the Tektronix web site and reinstall the software. Download the software from [www.tektronix.com/software](http://www.tektronix.com/software).

1. Restart the instrument. During the boot-up process you will see the following message at the top of the screen: Starting Acronis Loader... press F5 for Acronis Startup Recovery Manager
2. Repeatedly press the F5 key until the Acronis True Image Tool opens. There is a 5-second time period from when the message appears until the instrument proceeds with the normal instrument startup. If the instrument does not open the Acronis application, power off the instrument, then power on the instrument and try again.
3. Click Restore.
4. In the Confirmation dialog box, click Yes to restore the instrument operating system, or No to exit the restore process. The restore process takes approximately 30 minutes; the actual time depends on the instrument configuration.
5. After the operating system is restored, install the application software for your product.

## Adding an External Monitor

Use the following procedure to add an external monitor for dual monitor configuration. Both the analyzer and the second monitor must have the color set to True Color.

1. Power on the analyzer.

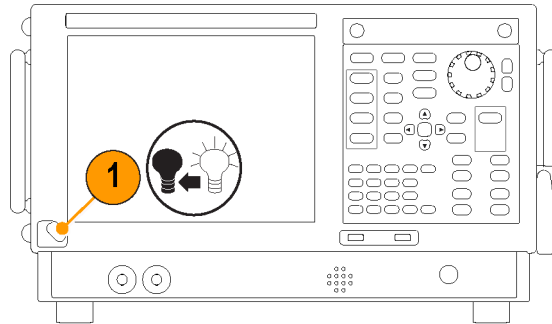

2. Connect the external monitor to the analyzer.

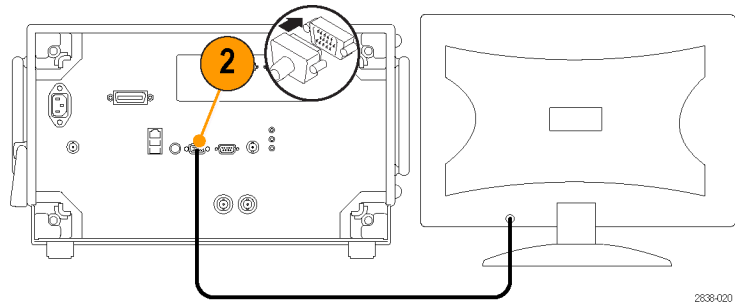

3. Power on the external monitor.

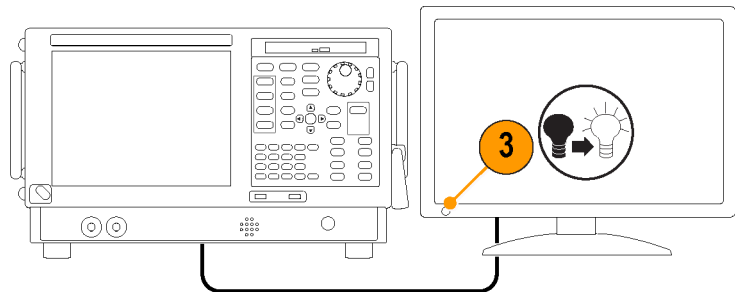

4. Open the Windows Control Panel.
5. Double-click **Intel(R) Graphics and Media** to open the **Intel Graphics and Media Control Panel**.

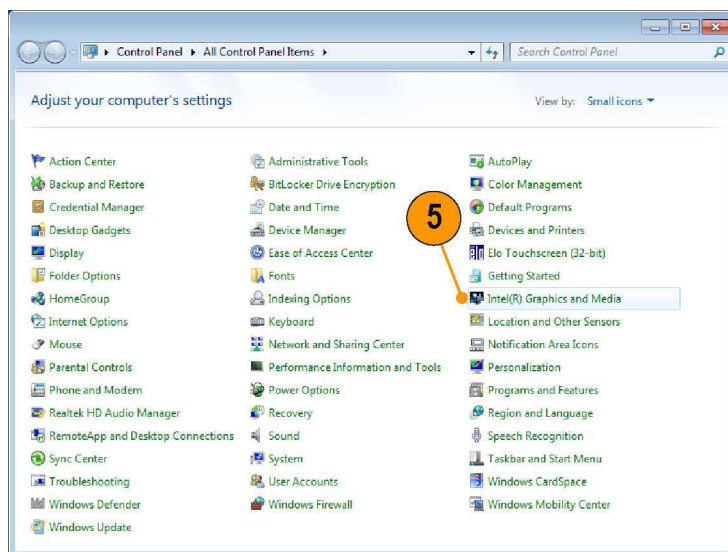

2838-064

6. Set the **Display** setting to **Built-in Display**.



2838-065

- 7. Click **Multiple Displays**.
- 8. Set the **Operating Mode** to **Clone Displays** or **Extended Displays** as preferred.



- 9. If you select **Extended Desktop**, be sure to set the **Positioning** to align the two desktop displays.



## Adjusting the Windows Display Settings

To change the instrument display settings, use the Intel Graphics Driver instead of the default Windows display properties. The Intel Graphics Driver provides additional capabilities that are not accessible from the Windows display properties dialog box.

1. Open the Windows Control Panel.
2. Double-click **Intel(R) Graphics and Media** to open the **Intel Graphics and Media Control Panel**.

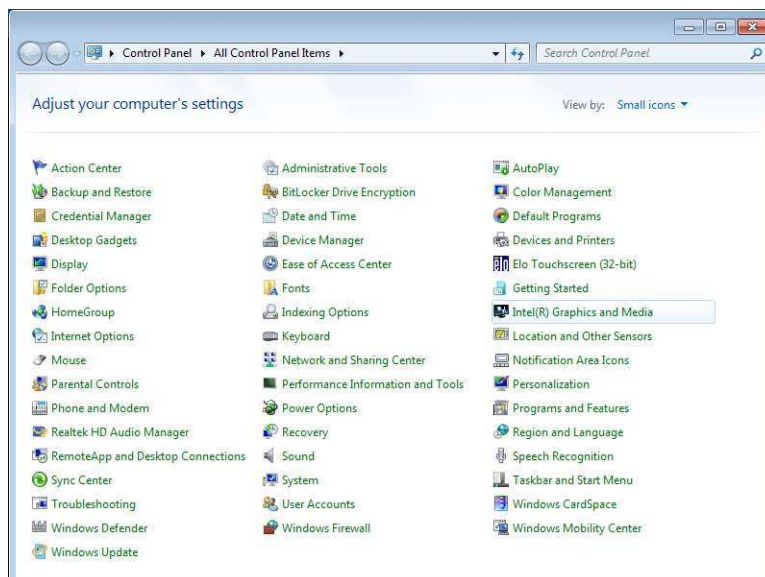

3. Adjust the settings as necessary.

**NOTE.** Not all of the selections in the property page will be available if there is no external monitor connected to the instrument.

4. Click **OK** to apply the settings and to close the properties page.



**NOTE.** You can attach a second monitor after the analyzer is powered on; however, after connecting, you will still need to enable the Extended Desktop from the Intel Extreme Graphics 2M control panel.

## Inspecting the Instrument

Run the diagnostics application (Tools > Diagnostics). If failures occur, perform the following steps to get more information about them. You can also use the following steps as a detailed incoming inspection to verify the functionality of your instrument. If you want to check the accuracy specifications of your instrument, see the *RSA5100B Series Real-Time Signal Analyzers Specifications and Performance Verification Technical Reference* manual PDF located on the Product Documentation CD.

1. Select **Tools > Diagnostics**.

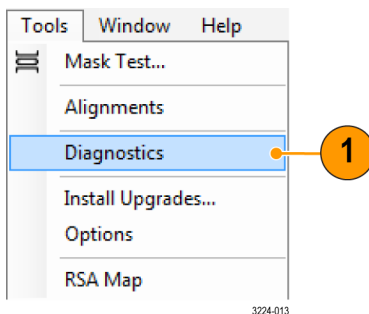

2. On the Diagnostics tab, click **All Modules, All Tests**.

3. Click **Single Test**.

4. Click **RUN**.

The instrument will run through the tests one at a time. A check mark or X icon will appear to the right of each check box as that test is completed. The check icon means the test was passed. An X means the test has failed.

5. For tests that require manual intervention, follow the on-screen instructions to complete the tests.

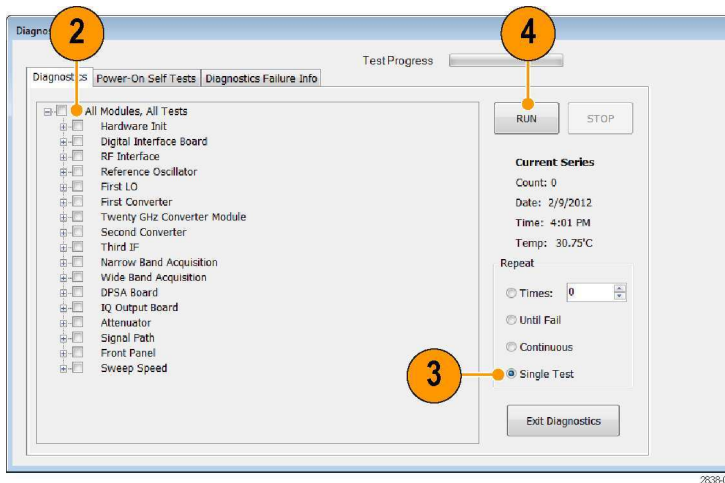

**NOTE.** Select the *Diagnostics Failure Information* tab to see basic diagnostic failure information. Use the *Windows Event Viewer* (*Control Panel > System and Security > Administrative Tools > Event Viewer*) to view failure history and nondiagnostic failures reported by the application.

## User Maintenance

### Caring for the Planar Crown RF Input Connector (RSA5115B/RSA5126B Only)

The Planar Crown input connector consists of two parts. The first part is the Planar Bulkhead, which is mounted in the instrument front panel. The second part of the input connector is the Planar Crown, which mates to the Planar Bulkhead. The Planar Crown can be easily changed should the connector become damaged or a different connector type be required.

No tools are required to remove or install the Planar Crown connector. A reasonable hand tightening of the connector is sufficient to ensure an excellent connection.

When changing connectors, be careful not to touch inner surfaces of the connector halves.

Use only a 75% isopropyl alcohol solution to clean the Planar Crown connector, if needed. Do not use tap water to clean the connector. Do not submerge the connector in a cleaning solution. Do not use abrasive compounds to clean the connector.

### Cleaning Your Instrument

Clean the exterior surfaces of the chassis with a dry lint-free cloth or a soft-bristle brush. If any dirt remains, use a cloth or swab dipped in a 75% isopropyl alcohol solution. Use a swab to clean narrow spaces around controls and connectors. Do not use abrasive compounds on any part of the instrument because they might damage the instrument.



**CAUTION.** Avoid getting moisture inside the instrument during exterior cleaning; use just enough moisture to dampen the cloth or swab. Do not wash the front-panel On/Standby switch. Cover the switch while washing the instrument. Use only deionized or distilled water when cleaning. Use a 75% isopropyl alcohol solution as a cleanser and rinse with deionized or distilled water. Do not use chemical cleaning agents; they might damage the chassis. Avoid chemicals that contain benzene, toluene, xylene, acetone, or similar solvents.

---



**CAUTION.** To prevent damage to the flat panel display, do not use improper cleaning agents or methods. Avoid using abrasive cleaners or commercial glass cleaners to clean the display surface. Avoid spraying liquids directly on the display surface. Avoid scrubbing the display with excessive force.

---

Clean the display surface by gently rubbing the display with a clean-room wipe. If the display is very dirty, moisten the wipe with distilled water or a 75% isopropyl alcohol solution and gently rub the display surface. Avoid using excess force; this might damage the display surface.

## Upgrading the Instrument Software

Software upgrades are available by downloading them from the Tektronix Web site [www.tektronix.com/software](http://www.tektronix.com/software). To add additional software options or features, you will need an option key from Tektronix. When you receive the option key from Tektronix, follow the installation instructions provided with the upgrade.

## Returning Your Instrument

If you return your instrument to Tektronix:

- Back up any user software on the hard disk. You may need to reinstall the software after your instrument is returned.
- When repacking the instrument for shipment, use the original packaging. If the packaging is unavailable or unfit for use, contact your local Tektronix representative to obtain new packaging.
- Seal the shipping carton with an industrial stapler or strapping tape.



# Operation

## Getting Acquainted with Your Instrument

Controls and display elements are shown in the following illustrations and tables.

### Front Panel Controls

Most front panel controls are shortcuts for opening control panels.

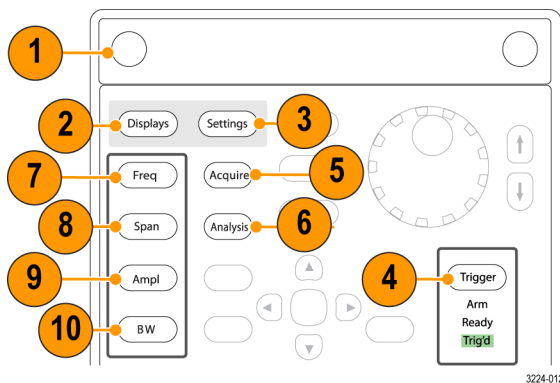

Ref number	Item	Description	Menu equivalent
1	Media	Optional removable solid-state hard drive.	
2	Displays	Opens the Displays dialog box to select measurement displays.	Setup > Displays
3	Settings	Opens the Settings control panel for the selected display.	Setup > Settings
4	Trigger	Opens the Trigger control panel.	Setup > Trigger
5	Acquire	Opens the Acquire control panel.	Setup > Acquire
6	Analysis	Opens the Analysis control panel.	Setup > Analysis
7	Freq	Adjusts the measurement frequency.	Setup > Analysis > Frequency tab
8	Span (Spectrum)	Adjusts the span or frequency range shown in the Spectrum display. <sup>1</sup>	Setup > Settings > Freq & Span <sup>1</sup>
9	Amplitude	Adjusts the reference level.	Setup > Amplitude
10	BW (Spectrum)	Adjust the resolution bandwidth (RBW). <sup>1</sup>	Setup > Settings > BW tab <sup>1</sup>

<sup>1</sup> Applicable only when the selected display is Spectrum, DPX Spectrum, or Spectrogram.

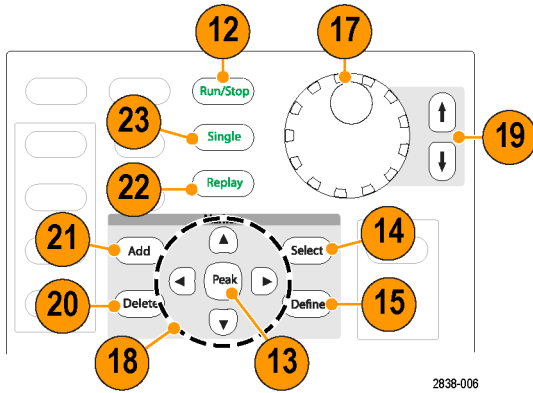

2838-006

Ref number	Item	Description	Menu equivalent
12	Run (Stop)	Push to start and stop acquisitions.	Run > Run
13	Markers, Peak	Moves the active marker to the maximum peak of the trace in the selected display. If markers are turned off, the MR (marker reference) marker will appear at the maximum peak.	
14	Markers, Select	Selects the next marker.	
15	Markers, Define	Opens the Markers control panel.	Markers > Define Markers
17	Control knob	Increments/decrements numbers with fine resolution.	
18	Arrow keys	Move the Markers. The Up arrow moves the selected marker 10 trace points to the right. The down arrow moves the selected marker 10 trace points to the left. The left and right arrows move the selected marker to the next peak. (Turning the knob moves the marker one trace point left or right.)	
19	Increment / decrement keys	Increments or decrements numbers with coarse resolution.	
20	Markers, Delete	Deletes the highest-numbered marker.	
21	Markers, Add	Adds a marker to the selected trace.	
22	Replay	Replays the current acquisition record.	
23	Single	Sets the Run mode to Single Sequence and initiates a single sequence acquisition cycle.	

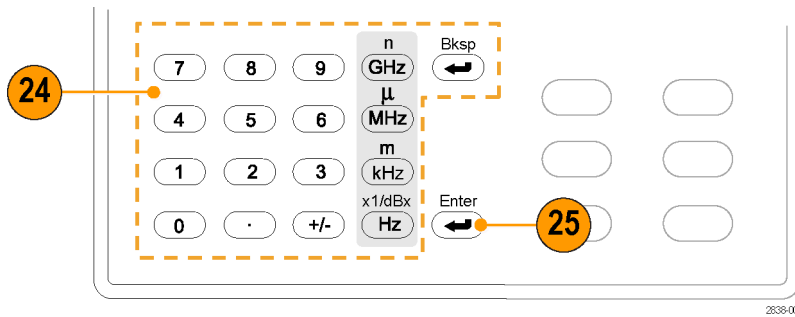

Ref number	Item	Description	Menu equivalent
24	Keypad	Enters values in controls.	
25	Enter	Completes the data entry in controls. Same as pressing the Enter key on the keyboard.	

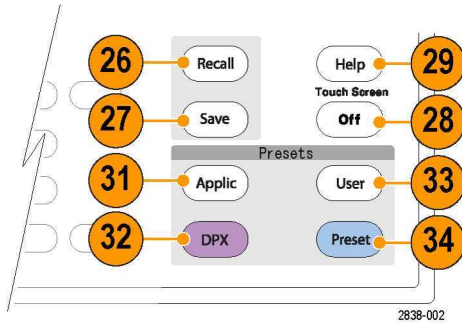

Ref number	Item	Description	Menu equivalent
26	Recall	Opens the Recall dialog box.	File > Recall
27	Save	Saves working file using the same user selections as for the previous Save action.	File > Save
28	Touch Screen Off	Turns the touch screen on and off.	
29	Help	Displays the online help.	Help > User Manual
31	Application	Opens the Application preset dialog box. You can change the effect of pressing Application using the settings at Presets > Preset Options > Preset type/action.	Presets > Application
32	DPX	Opens a DPX display set to the same span as the spectrum display. If the spectrum display is not open, the span is set to the last span of the spectrum display. You can change the effect of pressing DPX using the settings at Presets > Preset Options > Preset and Preset action.	Presets > DPX
33	User	Opens the User preset dialog box. You can change the effect of pressing User using the settings at Presets > Preset Options > Preset type/action.	Presets > User
34	Preset	Resets the instrument to its factory default settings.	Preset

## Front Panel Connectors

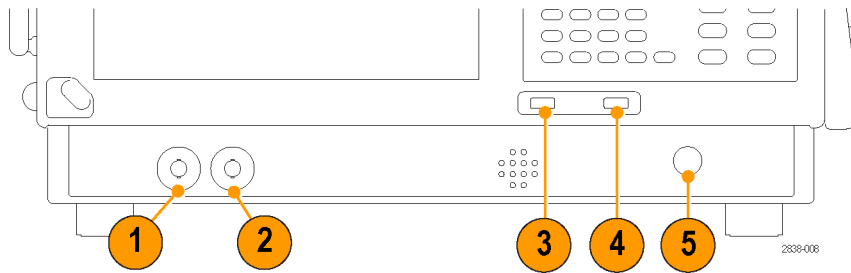

Ref number	Item	Description
1	Trig Out	Trigger output connector. 50 $\Omega$ , BNC, High > 2.0 V, Low < 0.4 V, (output current 1 mA)
2	Trig In	External Trigger input connector, -2.5 V to +2.5 V range, trigger level is user adjustable
3	USB port	USB 2.0 connector
4	USB port	USB 2.0 connector
5	RF Input	RF input connector 50 $\Omega$ + 30 dBm (Pre-amp off) + 20 dBm (Pre-amp on)

### Rear Panel

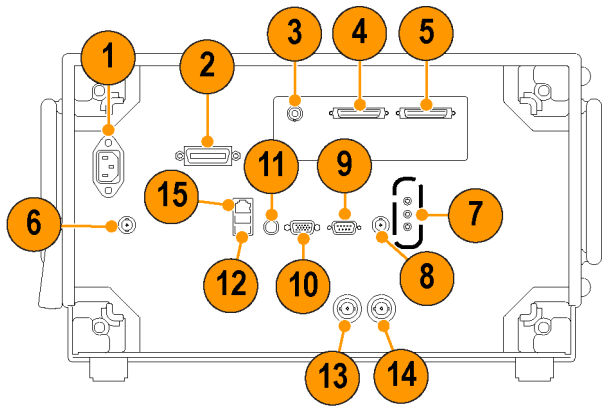



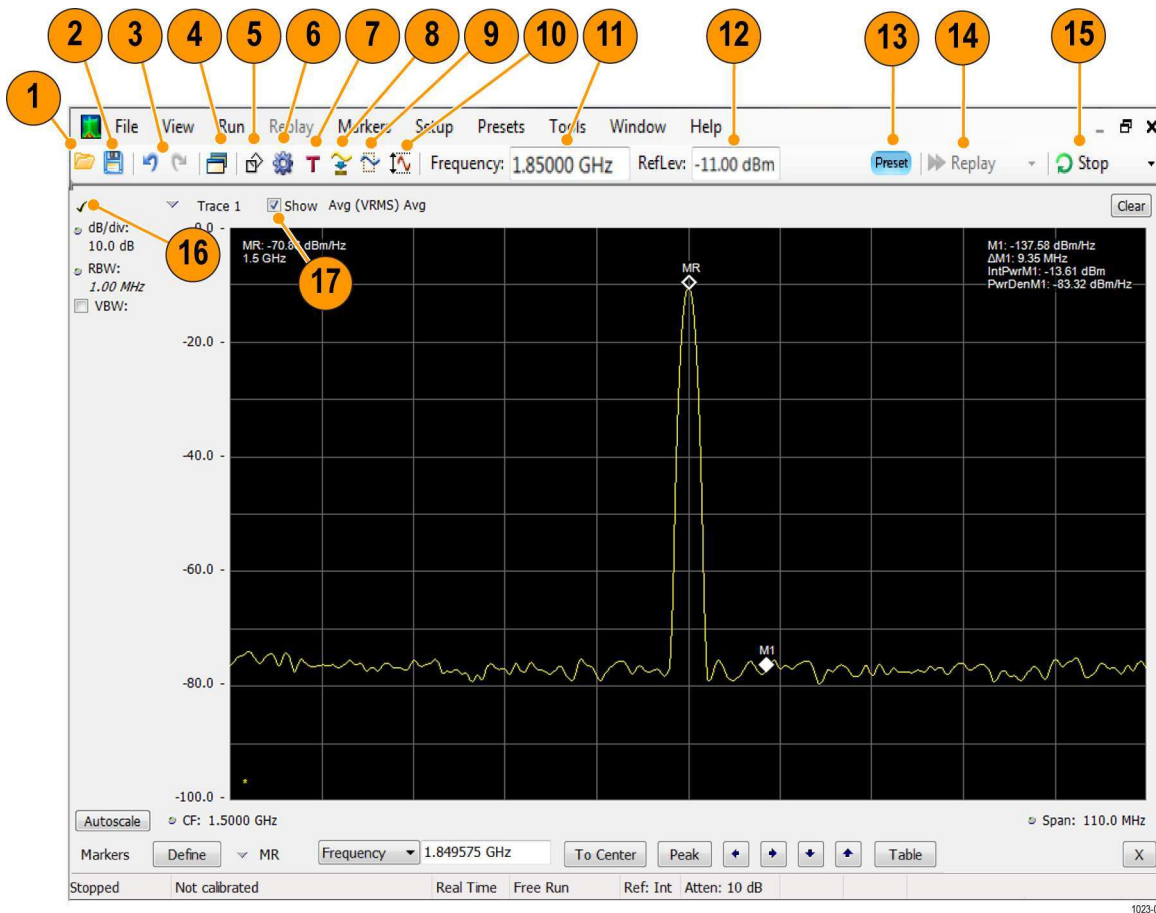

Ref number	Connector, Description
1	AC Input, main power connector
2	GPIB
3	Zero Span Analog Out (Option 66)
4, 5	Real Time I and Q Out (Option 65)
6	+28 VDC output, switched
7	Microphone in; Headphone, audio output; and Line In connectors (Line In not supported)
8	External Trigger 2 Input
9	COM 2, serial port for connecting peripherals
10	VGA external monitor output (resolution not limited to VGA)
11	PS2 Keyboard input
12	USB 2.0 ports for mouse and other peripherals (printers, external hard disks)
13	Ref Out, reference frequency output
14	Ref In, reference frequency input
15	LAN, Ethernet 10/100/1000 Base T network connector

## Interface and Display Elements

Commonly-used buttons and controls are located in the tool bar. Most of the buttons open control panels for changing the instrument setups. The contents of the control panels vary depending on the selected display. You can also access the control panels from the front panel buttons or from the keyboard.



Ref number	Item	Description
1		Displays the Open dialog box so you can recall a setup file or an acquisition data file.
2		Opens the Save As dialog box so you can save a setup, screen capture, acquisition data file, or export results or settings.
3	Undo / Redo	Undoes or redoes the previous edit to a display or measurement setting, preset, or measurement change.
4	Displays	Opens the Select Displays dialog box so that you can select measurement displays.
5	Markers	Opens or closes the Marker toolbar at the bottom of the window.
6	Settings	Opens the Settings control panel for the selected display. Each display has its own control panel.
7	Trigger	Opens the Trigger control panel so that you can define the trigger settings.

Ref number	Item	Description
8	Acquire	Opens the Acquire control panel so that you can define the acquisition settings.
9	Analysis	Opens the Analysis control panel so that you can define the analysis settings such as frequency, analysis time, and units.
10	Amplitude	Opens the Amplitude control panel so that you can define the Reference Level, configure internal attenuation, and enable/disable the (optional) Preamplifier.
11	Measurement Frequency	Displays the Measurement Frequency. To change the value, click the text and use the front panel knob to dial in a frequency. You can also enter a frequency with the front panel keypad or use the front panel up and down buttons.
12	Reference Level	Displays the reference level. To change the value, click the text and enter a number from the keypad or use the front panel up and down buttons.
13		Displays the Main Presets dialog window or recalls Preset (Main), depending on current settings.
14	Replay	Runs a new measurement cycle on the existing acquisition data record using any new settings.
15	Run	Starts and stops data acquisitions. When the instrument is acquiring data, the button label has green lettering. When stopped, the label has black lettering. You can specify the run conditions in the Run menu. For example, if you select Single Sequence in the Run menu, when you click the Run button, the instrument will run a single measurement cycle and stop. If you select Continuous, the instrument will run continuously until you stop the acquisitions.
16	Check Mark indicator	<p>The check mark indicator (  ) in the upper, left-hand corner of the display indicates the display for which the acquisition hardware is optimized.</p> <p><b>NOTE.</b> The Preset condition for RF and IF optimization is “Best for multiple displays”. This sets the RF and IF settings to the best compromise of settings for good results in multiple measurement windows. When other RF/IF optimizations (maximize dynamic range, fastest sweep, minimize noise) are chosen, a check box will appear on the selected display that is receiving optimized settings for that measurement. Normally, the check box is not present because the “Best for multiple displays” condition is selected.</p>
17	Show	Shows / hides the selected trace.



## Display-Specific Controls

Most displays have commonly-used controls arranged around the graph. They provide quick access to common settings; the full control set for the display is in the Settings control panel. The following illustration and table show some of the common icons that appear in most displays.

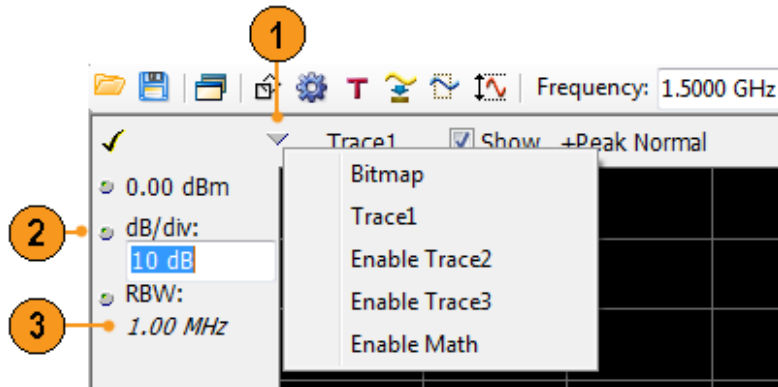

Table 1: Common icons

Ref number	Control icon	Description
1		<b>Drop-down List.</b> Click to select a value from the drop-down list.
2		<b>Knob.</b> Click anywhere on the icon or on the text readout to select the control. You can then change the value with the front panel control knob or arrow keys, or enter a value from the keypad.
3	<i>1.00 MHz</i>	<b>Italicized numbers.</b> These indicate automatically selected control values. Several controls in the instrument (for example, RBW and Analysis Length) allow you to select an Auto mode. In Auto mode, the instrument software automatically sets the value. You can change the control to Manual mode by changing the value. To return to Auto mode, clear the value, and then press the Enter key.

## Basic Concepts

### Real Time Analyzers

Tektronix real-time analyzers have a frequency mask trigger. The frequency mask trigger allows you to set up a spectral mask to capture a signal when a spectral anomaly occurs. This allows the analyzer to check 100% of the input signal before acquiring, and then capture precisely the intermittent RF event of interest.

DPX™ technology allows you to view the RF signal as a live display. You can view very short transient signals, multilevel signals, and time-varying events. You also have the ability to measure and trigger on signal density values in the DPX display.

The analyzers allow you to view the captured signals in a wide variety of time-correlated displays. This is useful for device troubleshooting and signal characterization applications. All measurements are based on the same real-time data, however the DPX display has a unique method for processing, storing, and displaying the data.

### Measurement Displays

The analyzer window can show one or any combination of general purpose and application-specific displays.

This example shows a DPX Spectrum Split display. A DPXogram display appears on the top and a DPX Spectrum display appears on the bottom.

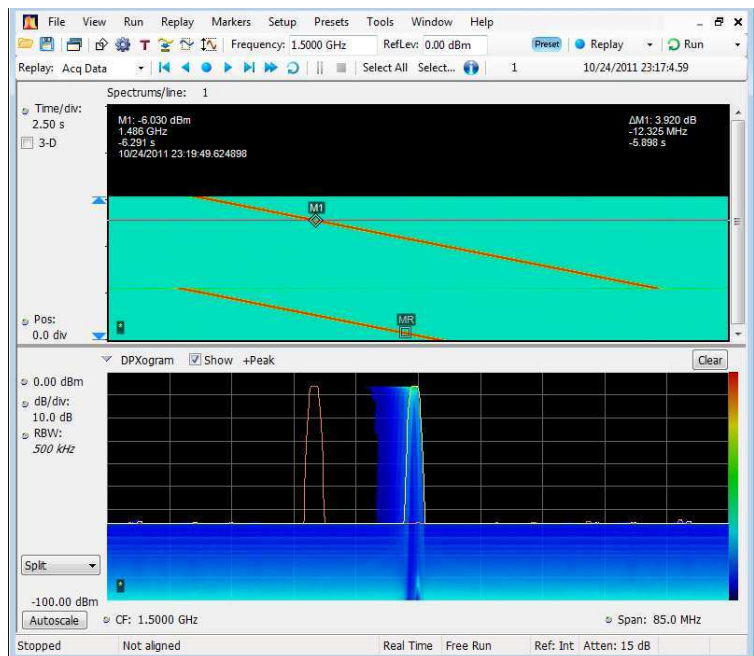

This example shows the window with two displays, a Spectrum display and a DPX spectrum display.

When you have more than one display open, the display with the check mark icon has control over the acquisition hardware. To give a display priority over any others, click its title bar.

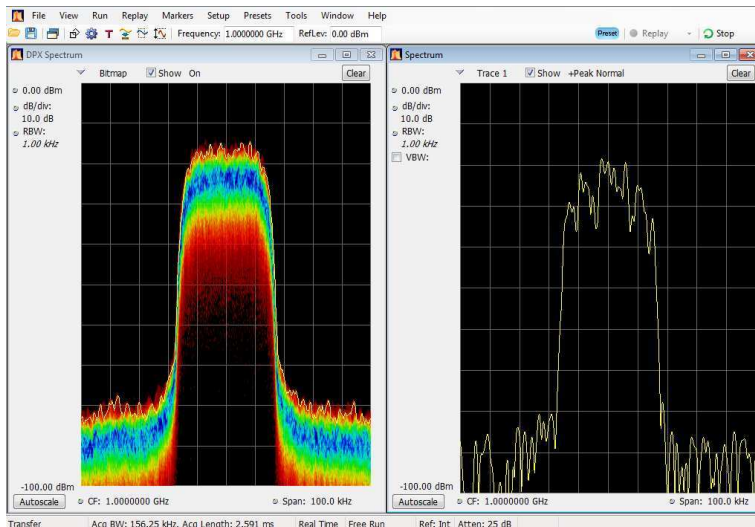

This example shows four displays in the window.

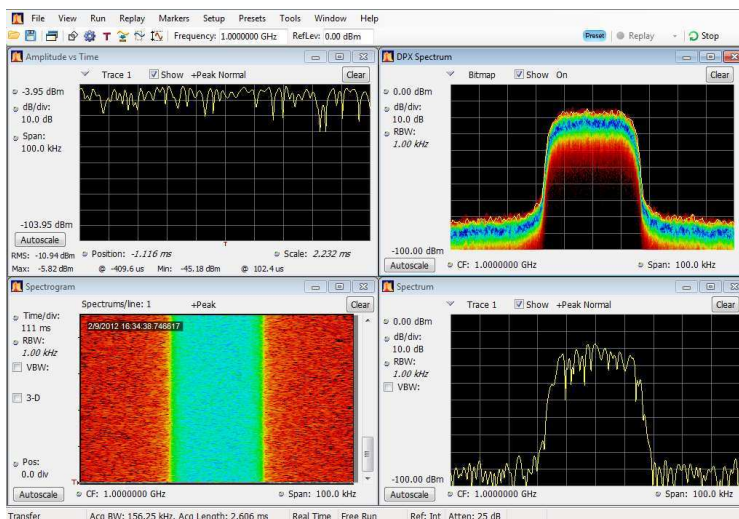

The acquisition data source can be a live acquisition or a saved acquisition data file. The sharing of acquisition data between displays allows you to view the same data in multiple ways. For example, you can display a power versus frequency (spectrum) display and a spectrogram diagram at the same time. Because the data source is shared among the different displays, the displays are correlated. That is, a point or set of points within one display is associated with a point or set of points in every other display in the application window.

## Navigating Displays

The analyzers use multiple displays to keep operations simple, and yet provide advanced functionality when needed. Some of the display categories include:

- **General Signal Viewing displays.** These displays show graphs for basic signal parameters such as amplitude, phase, and frequency plotted against frequency or time. Examples of these displays include: Spectrum, DPX, Spectrogram, Time Overview, and Phase vs Time.
- **Analog Modulation.** These displays show graphs and measurements for Analog Modulation, Frequency Modulation, and Phase Modulation.
- **General Purpose Digital Modulation displays.** Available with Option 21. These displays show the results of demodulating signals and analyzing them in multiple domains. Examples of these displays include: Constellation, EVM vs Time, Eye, Symbol Table, and Trellis diagrams.
- **RF Measurements displays.** Available with Option 11. These displays show the results of automated measurements on RF signals. Examples of these displays include: ACPR, MCPR, Phase Noise, and CCDF.
- **OFDM Analysis.** Available with Option 22. These displays provide OFDM analysis for WLAN 802.11a/j/g and WiMax 802.16-2004 signals.
- **Pulsed RF displays.** Available with Option 20. These displays show the results of advanced analysis for pulsed RF signals. Examples of these displays include: Pulse Statistics, Pulse Table, and Pulse Trace.
- **Audio Analysis.** Available with Option 10. These displays measure basic time- and frequency-domain parameters of analog audio signals modulated on a carrier (AM, FM and PM modulation) or unmodulated (non-carrier) audio signals (Direct).
- **WLAN Analysis.** Available with Options 23, 24, and 25. Each of these options provide OFDM analysis of WLAN802.11 standards. All three options combined provide analysis for WLAN802.11a/b/g/j/p/n/ac signals.
- **Bluetooth® LE and Bluetooth Basic Rate RF.** Available with Option 27. Bluetooth LE (Low Energy) and Bluetooth Basic Rate RF (Radio Frequency) provides 13 transmitter performance measurements for 10 different test setups in compliance with Bluetooth RF PHY Test Specifications 4.1.1 and Radio Frequency (RF) Test Specifications 4.1.1.
- **APCO P25 Analysis.** Available with Option 26. This complete set of push-button Telecommunication Industry Association TIA-102 standard-based transmitter measurements includes modulation measurements, power measurements, and timing measurements. These measurements are also compared with the limits that best fit the signal for which the standard applies to provide pass/fail results.
- **LTE™ Downlink Analysis.** Available with Option 28. LTE Downlink (Base Station) RF analysis provides transmitter performance measurements for both TDD and FDD (for example, Channel Power, Occupied Bandwidth, ACLR, SEM, Cell ID, and TDD LTE Transmit Power Off) in compliance with Test Specifications 36.104 (Base Station radio transmission and reception) and 36.141 (Base Station conformance testing).
- **Noise Figure.** Available with Option 14. These displays measure the noise contributions in a system. Displays include Noise Figure, Gain, Y-factor, Noise Temperature, Uncertainty Calculator, and tabular results. Single-frequency metering and swept-trace results are available, as well as support for industry-standard noise sources. Measurements for amplifiers and other non-frequency converting devices, and fixed local-oscillator up and down converters are also available.

## Selecting Displays

The analyzer provides an easy way to select displays.

1. Click the Displays icon to open the Select Displays dialog box.

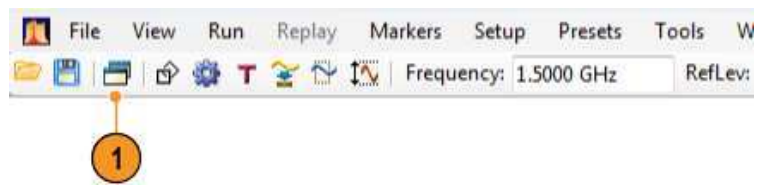

There are two ways to select displays: choose any combination of displays or use an Application Preset.

**Choose any Combination of Displays.** Select displays one by one as needed.

1. Click the desired application folder in the Select Displays dialog box.  
The available displays for each folder are listed in the Available Displays pane.
2. Click one of the display icons.
3. Click **Add** (or double-click the icon) to add the selected display to the Selected displays list. Repeat the procedure to add other displays.
4. Click **OK** to close the dialog box. The selected displays will open.

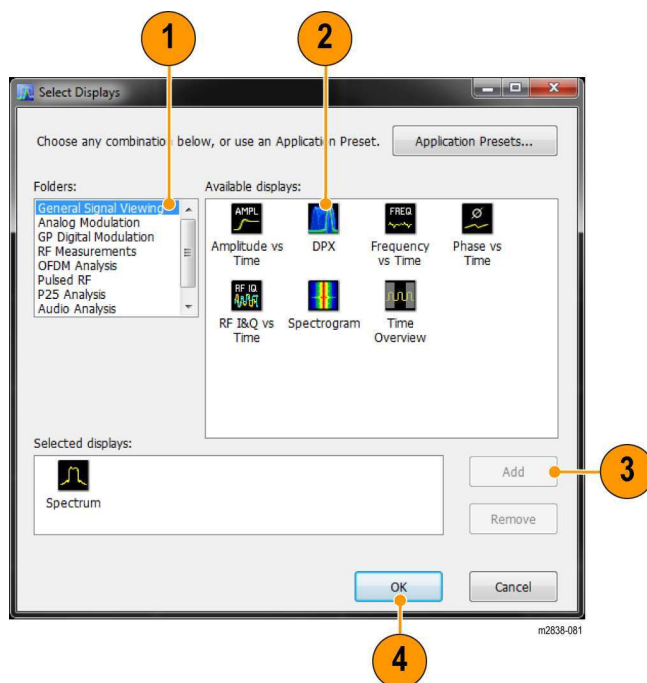

**Use an Application Preset.** Select displays from the presets for your application.

1. Click **Application Presets** in the Select Displays dialog box.

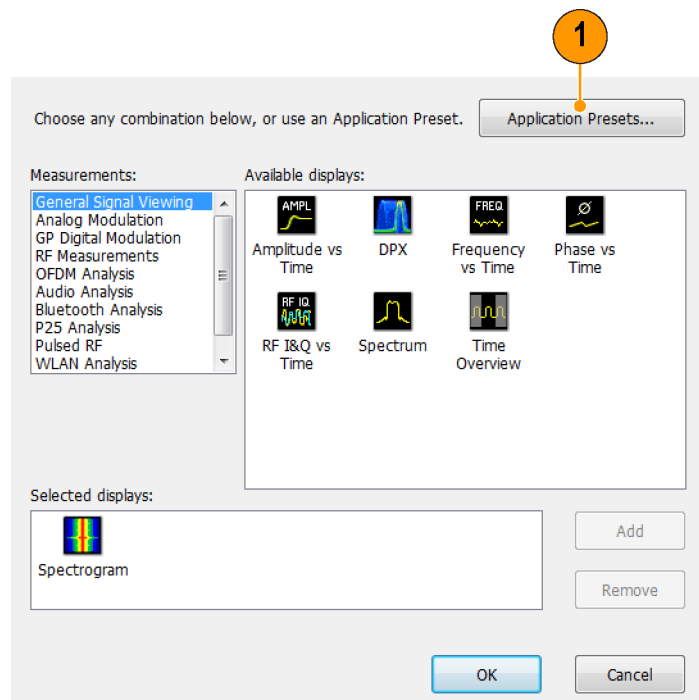

3359-001

2. Use the pull down list to display the presets.

**NOTE.** Some presets appear only if the associated instrument option is installed.

3. Select a preset from the list.

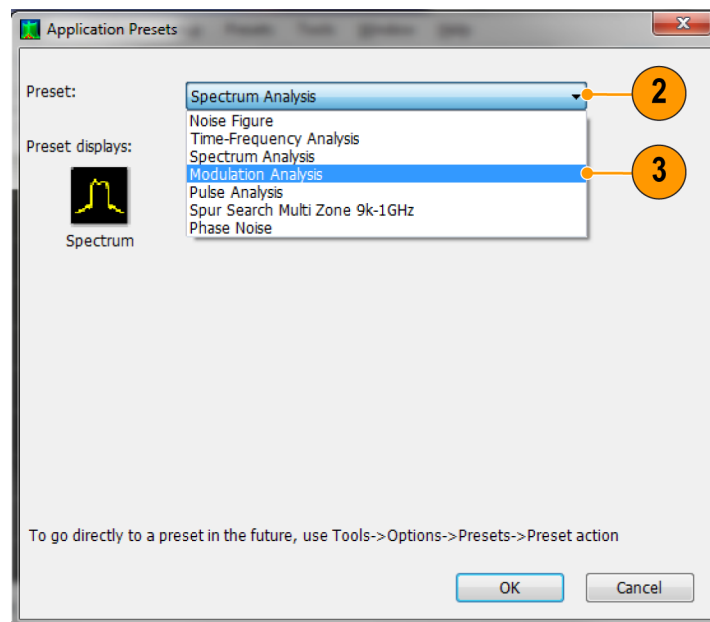

3224-015

4. The default displays for the selected preset are shown.
5. Click **OK** to close the dialog box. The preset displays will open. (See Table 2.)

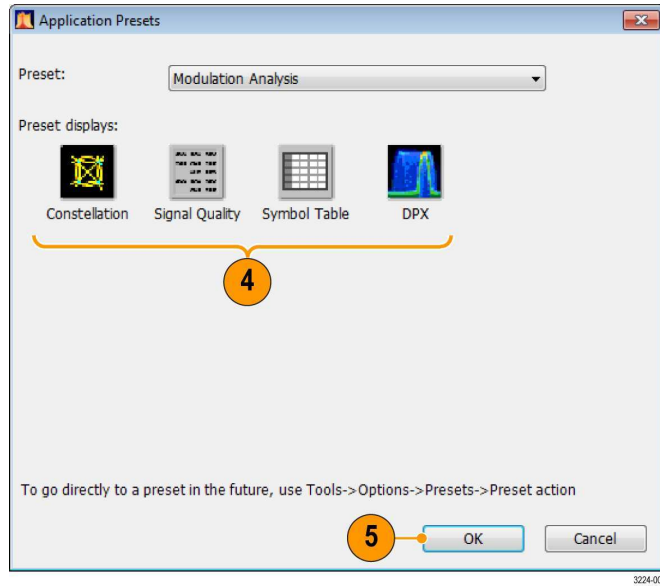
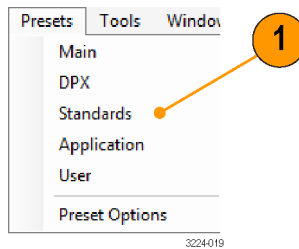

**Table 2: Application presets**

Presets	Displays
Time-Frequency Analysis	Frequency vs Time, Spectrogram, Spectrum, Time Overview
Spectrum Analysis	Spectrum
Modulation Analysis (Option 21 only)	Constellation, DPX Spectrum, Signal Quality, Symbol Table
Pulse Analysis (Option 20 only)	DPX Spectrum, Pulse Table, Pulse Trace, Time Overview
Spur Search Multi Zone 9k-1GHz	Spurious
Noise Figure (Option 14 only)	Gain, Noise Figure, Noise Table
Phase Noise	Phase Noise

**Use a Standards Preset.** When you select a specific standard from the Standards presets, the analyzer automatically loads the displays and settings that are optimal for analysis of signals based on that standard.

1. Select **Presets > Standards** from the main menu bar.



2. Use the Preset pull down list to display and select a preset from the list.

3. The default displays for the selected preset are shown.

4. Click **OK** to close the dialog box. The preset displays will open. (See Table 3.)

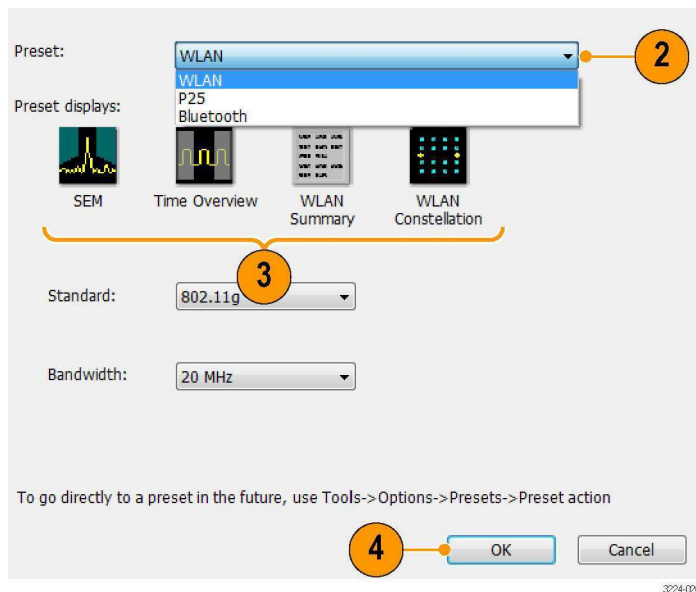

**NOTE.** Some presets appear only if the associated instrument option is installed.

**Table 3: Standards presets**

Presets	Displays
WLAN (Option 25)	SEM, Time Overview, WLAN Summary, WLAN Constellation
P25 (Option 26)	MCPR, Time Overview, P25 Summary, P25 Constellation
Bluetooth® (Option 27)	BT Eye Diagram, BT Frq Dev vs Time, BT Summary, BT CF Offset and Drift, Spectrum, Time Overview
	<b>NOTE.</b> Bluetooth displays vary depending on the selected Test Setup.
LTE™ (Option 28)	LTE Summary, LTE Constellation, Time Overview, Spectrum, LTE ACLR, LTE Channel Spectrum, SEM
	<b>NOTE.</b> LTE displays vary depending on the selected Test Setup.



### Quick Tips

- Push the Displays button on the front panel to open the Select Displays dialog box.
- To add a display, double-click the icon.
- To remove displays, do one of the following:
  - Select a display icon in the Selected Displays list, and then click **Remove**.
  - Double-click a display icon in the Selected Displays list.
  - Click the Close button in the upper right hand corner of the selected display.
- You can mix displays from multiple application folders.

### Common Information Messages

The following table lists some of the common information messages that might appear during normal operation.

**Table 4: Common information messages**

Message	Explanation and recommended action
Acq BW too small for current setup	<p>The display needs a wider acquisition bandwidth than the current data record contains. This can be due to any of the following reasons:</p> <ul style="list-style-type: none"> <li>■ A display other than the one you intended has been selected. The selected display has requested a smaller acquisition bandwidth to achieve a better accuracy or dynamic range for its particular measurement. Select the display that contains the message. Click <b>Run</b> if the instrument is not already acquiring data.</li> <li>■ Acquisitions are not running and the measurement now requests a wider bandwidth than the last acquisition. Click <b>Run</b> to perform a new acquisition with a wider bandwidth.</li> <li>■ The data is from a recalled file. There is no way to increase the acquisition bandwidth for saved data. You must adjust the measurement settings so that less bandwidth is required.</li> </ul>
Need swept acq or larger Acq BW	<p>When any display requires a swept acquisition, the other displays are unable to process the swept data. This is because the swept data is customized for the selected display.</p> <p>Select the display that you are interested in and the acquisition settings will automatically change to meet the requirements of the selected display.</p>
RBW increased to xx kHz	<p>The current Spectrum Length or Analysis Length is not long enough to allow a narrower RBW filter.</p> <p>If the Length control is set to Manual, try increasing it or setting it to Auto so that the Analysis Length will increase to the required value.</p>

## Changing Measurement Settings

The displays have settings that control how signals are acquired and processed. The settings that you can change depend on the selected display.

To access the settings (in this case, for the Spectrum display):

1. Click **Settings** to open the Settings control panel.



2. Adjust the controls as needed for your signal or test. For example, use the Freq & Span tab to set frequency and span. Most of the control panels have tabs that provide easy access to other related controls. (See page 34, *Quick Tip*.)

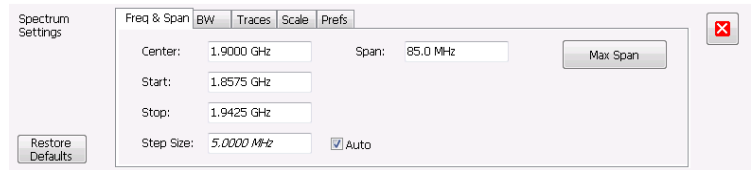

3. You can change the appearance of the display screen in the Prefs tab. Not all of the following controls apply to every display. Some displays have additional controls not described here.

- To turn on or off the graticule, select the **Show graticule** check box.
- To turn on or off the marker readout, select the **Show Marker readout in graph** check box.
- To turn on or off the trace legend, select the **Show trace legend** check box. The trace legend includes information on the trace number, detection, and function (such as average) for each trace on screen.
- To turn on or off the parameter readouts, select the **Show parameter readouts** check box. This reports the time to create and display the sweep of the spectrum analyzer. It includes the entire sweep plus any retrace time. When trace averaging is activated, the sweep reports the time for individual traces while collecting the averages, and reports the time for the entire averaged trace when averaging is complete.

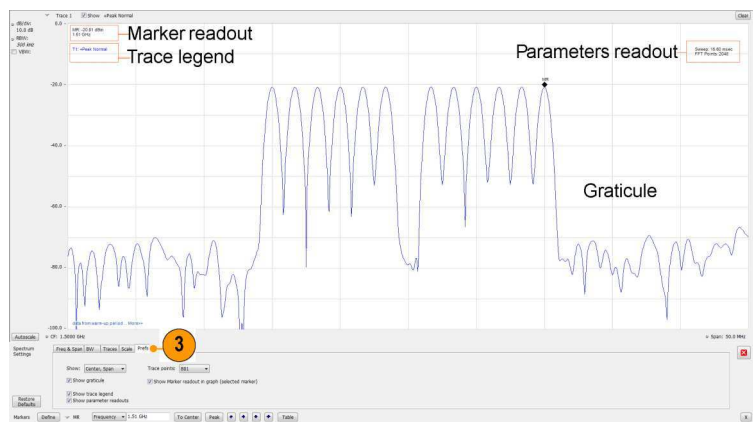

### Quick Tip

- If you have multiple displays on the screen, click anywhere inside one of the other displays to change to the control panel for that display.
- You can adjust many of the parameters of your measurement by clicking on the readout in the display. For example, in the spectrum display, dB/div, RBW, VBW, Span, and Center Frequency can all be accessed on the display without bringing up the Settings panel.

## Presetting the Instrument

You can preset the instrument to restore the setups to their default values.

1. To start with the default instrument settings, push the Preset button on the front panel or select **Preset** from the toolbar.

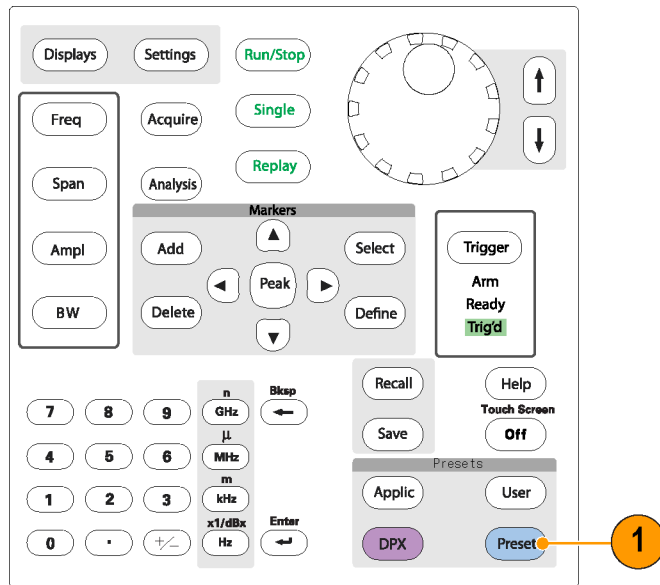

### Quick Tip

- Preset does not change any of the settings specified from the Setup > Configure In/Out control panel or from the Tools menu, such as GPIB address, Save/Export preferences, or the Auto Alignment setting.

## Connecting a Signal

The analyzer has a single RF signal input located on the front panel. Make sure that you observe the input signal requirements before connecting a signal to the input.



**CAUTION.** To prevent static damage to the instrument or to any instrument accessories, discharge to ground any electrostatic charge that may be present on the center and outer conductors of cables, before attaching the cables to the instrument inputs. Do not create an ESD (electrical static damage) antenna by leaving cables attached to the instrument with the other ends of the cables open.

### Required Signal Levels

The following table shows the input signal levels over which the analyzer can be used for measurements. The accuracy is guaranteed at a signal amplitude and frequency (normalization point). Measurements can be made on signals within the entire range of allowable inputs, but the accuracy of the measurement is affected by the frequency and amplitude of the signal to be measured.

#### RF signal input range (CW or peak envelope power)

Characteristic	Description
Maximum DC voltage	±5 V (RF input)
Maximum safe input power	+30 dBm (RF Input, RF ATT≥10dB, Pre-amp Off) +20 dBm (RF Input, RF ATT≥10dB, Pre-amp On) +50 Watts peak (RF Input, RF ATT≥30dB, (<10 μs, 1% Duty Cycle repetitive Pulses))
Maximum measurable input power	+30 dBm (RF Input, RF ATT Auto) +10 Watts peak (RF Input, RF ATT Auto (<10 μs, 1% Duty Cycle repetitive Pulses))



**CAUTION.** To prevent damage to the instrument, do not connect CW signals greater than 1 Watt (+30 dBm). The maximum voltage rating is ±5 V DC. The maximum pulse specifications are 50 W peak, <10 μs pulse width, 0.001 duty cycle and ≥30 dB attenuation.

To connect an RF signal:

- Connect the signal to the RF INPUT connector on the front panel.

**NOTE.** On RSA5115B and RSA5126B instruments, you can change the RF input connector type by using a different Planar Crown connector.

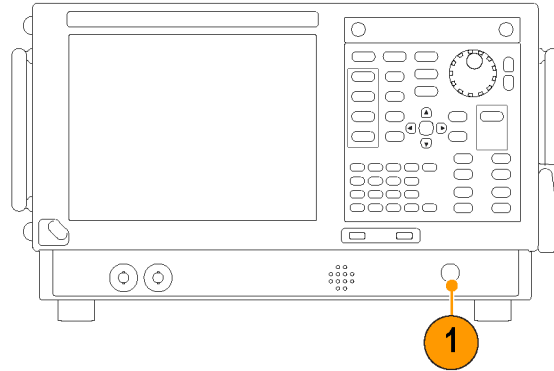

**Quick Tip**

- If the source signal exceeds the specified maximum input rating, connect the source signal to an attenuator. Connect the attenuator output to the RF Input connector.

**Starting and Stopping Acquisitions**

1. Click the Run button to start an acquisition.
- To select the Run mode, click the drop-list icon to the right of the Run button.
  - Select **Single** or **Continuous** to set the Run mode as necessary.

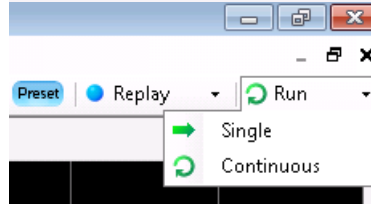

If the analyzer is in Continuous Run mode, the Replay button is dimmed while acquisitions are active. If there are no acquisitions active, the Replay button is blue.

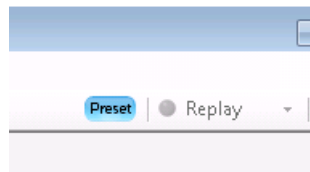

2. Click the **Stop** button again to stop an acquisition. If an analysis is in process, it will finish its sequence and then stop.

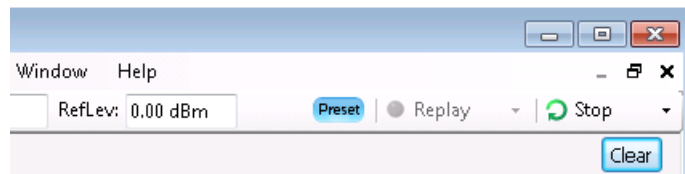

### Quick Tip

- Push the front panel Run button to start and stop acquisitions.

### Run Control

The Run menu provides access to commands that control the acquisition and the measurement sequence. Refer to the online help for information on all of the Run menu selections. Continuous is the default selection. When you select Continuous, the instrument will continuously acquire data until you stop the acquisitions. Select Single Sequence to run a single acquisition every time you click **Run** or push the Run button on the front panel.



## Markers

Use markers to measure time, frequency, power and other results. Markers measure absolute values and can also measure the difference between markers.

### Using Markers to Measure Frequency and Power

The following procedure shows how to use markers in the Spectrum display to measure frequency and power. The example assumes that all markers are turned off and that a signal is on the screen.

1. Click **Markers** to open the Marker toolbar at the bottom of the Analysis window.

Alternately, press the front panel Markers Define button.



2. Select **Add Marker** from the drop down list in the Marker Toolbar.

The first marker is designated the marker reference (MR).



3. Position the marker on the screen using the arrow buttons in the Marker toolbar. The left and right arrows move the marker to the next peak. The up and down arrows move the marker to the next higher or next lower peak.

The peak excursion preferences are set in the Define Peaks menu tab.

You can also drag the marker to the desired position using the touch screen or the mouse.

4. Read the frequency and power level from the marker readout on the display.



### Quick Tip

- Marker controls are available directly from the front panel Marker buttons.

## Markers Display

- **Reference Marker:** This marker type is labeled MR in the graph. It makes absolute measurements and is also used for calculating differences when Delta or Power readouts are enabled.
- **Delta Markers:** This marker type is labeled M1 to M4 in the graph. It is used to measure other points on the trace or the difference between the Marker Reference and the Delta marker.
- **Power Markers:** This marker type is labeled M1 to M4 in the graph. It function the same way as Delta Markers, except it shows power density and integrated power density (dBm/Hz) instead of power level (dBm).

The following information tells you more about how markers function. For more detailed information about markers, see the instrument Help.

- When you drag markers along a trace with either the touch screen or the mouse, the marker will seek the high points. The marker stays within 20 trace points of the mouse position. If there are no peaks within the current range of trace points, the marker finds the highest point.
- When you attach the marker to the bitmap trace in the DPX spectrum display, the marker readout indicates the hit count for pixels (maximum 65,536) along with frequency and power (see the following figure). You can position the marker at any point in the graph.
- Markers attached to the DPX bitmap display the signal density in percent at the selected pixel, rather than the hit count.

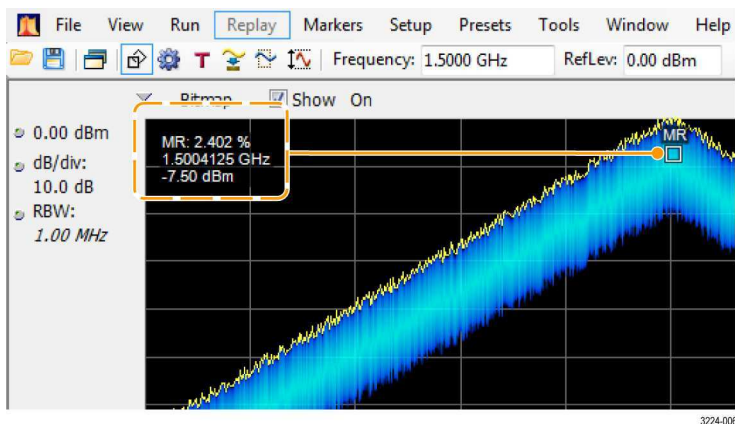









## Quick Tips

- If markers are turned off, click **Peak** in the Marker toolbar or on the front panel to add the marker reference (MR) and to position it on the maximum peak level on the trace in the selected display.
- Click **Table** in the Marker toolbar to open a tabular display showing the marker information.

## Marker Toolbar

The Marker toolbar has several controls to work with markers. (See Table 5.) Some of these controls are similar to those on the front panel.

**Table 5: Marker toolbar**

Icon	Description
	Opens the Define Markers control panel. Use the control panel to add and remove markers and to set marker parameters.
	Sets the Measurement Frequency of the instrument to the frequency of the selected marker. This button is only present when the selected display has frequency on the horizontal axis.
	Moves the marker to the maximum peak level on the trace. The maximum peak can be either the highest or the lowest point in displays with both positive and negative values on their vertical axis (such as Frequency Error or Phase).
	Moves the selected marker to the next peak to the left of the current position.
	Moves the selected marker to the next peak to the right of the current position.
	Moves the selected marker to the next lower peak value. The peak value refers to the absolute value of the peak amplitude. When repeatedly moving the marker, it can move in any direction depending on the location of the next peak. If the marker is attached to the DPX bitmap trace, this button moves it to the next-lower-amplitude density peak at the same frequency.
	Moves the selected marker to the next higher peak value. The peak value refers to the absolute value of the peak amplitude. When repeatedly moving the marker, it can move in any direction depending on the location of the next peak. If the marker is attached to the DPX bitmap trace, this button moves it to the next-higher-amplitude density peak at the same frequency.
	Opens or closes the marker table in the display.

## Adding Markers

You can have up to five markers. The first marker (MR) is a reference marker. The other markers (M1, M2, M3, and M4) can show absolute values or can show both absolute values and the difference values between them and the reference marker.

To add another marker, select **Add Marker** from the drop-down list in the toolbar or from the front panel button.

Markers can also be added by right-clicking in the desired display and selecting Add marker.

## Defining Markers

Use the Define Markers control panel to define the marker settings.

1. Click **Define** to open the Define Markers control panel.

Alternately, press the front panel Markers **Define** button.



Use the control panel to:

- Add or delete markers.
- Turn markers off.
- Assign markers to specific traces.
- Set the marker readouts to absolute or delta.
- Define the threshold and excursion values.

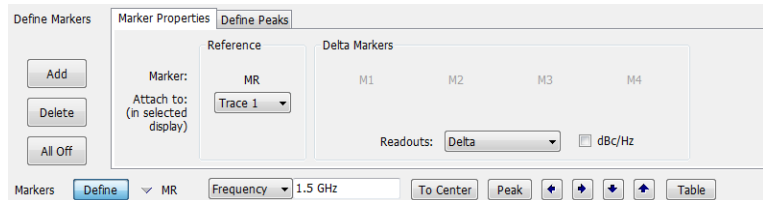

### Quick Tip

- You can add or delete markers using the drop-down list next to Define in the Marker toolbar, or by right-clicking in the desired display and selecting Add marker.

## Touchscreen Actions



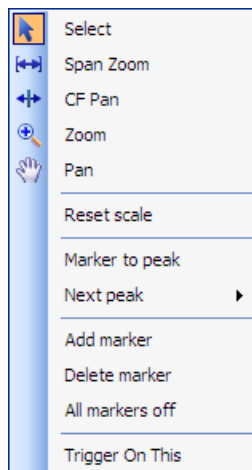

You can use the touchscreen to change marker settings and how waveforms are displayed by using the Touchscreen Actions menu. To use the Touchscreen Actions menu, touch the display and hold for one second, then remove your finger. You can also use a mouse to display the Touchscreen Action menu by clicking the right mouse button.

Some selections in the Touchscreen Actions menu are selectable only when a marker is defined.



Touchscreen Actions menu

Table 6: Touchscreen actions menu

Icon	Menu item	Description
	Select	Selects markers and adjusts their position.
	Span Zoom	Zooms the graph area about the selected point. Touch the graph display at a point of interest and drag to increase or decrease the span about the point of interest. Span Zoom adjusts the span control and can affect the acquisition bandwidth.
	CF Pan	Adjusts the Center Frequency according to horizontal movement.
	Zoom	Adjusts horizontal and vertical scale of the graph. The first direction with enough movement becomes the primary scale of adjustment. Adjustment in the secondary direction does not occur until a threshold of 30 pixels of movement is crossed.  Dragging to the left or down zooms out and displays a smaller waveform (increases the scale value). Dragging to the right or up zooms in and displays a larger waveform (decreases the scale value).
	Pan	Adjusts horizontal and vertical position of the waveform. The first direction with enough movement becomes the primary direction of movement. Movement in the secondary direction does not occur until a threshold of 30 pixels of movement is crossed.
–	Reset Scale	Returns the horizontal and vertical scale and position settings to their default values.
–	Marker to peak	Moves the selected marker to the highest peak. If no marker is turned on, this control automatically adds a marker.
–	Next Peak	Moves the selected marker to the next peak. Choices are Next left, Next right, Next lower (absolute), and Next higher (absolute).
–	Add marker	Defines a new marker located at the horizontal center of the graph.
–	Delete marker	Removes the last added marker.
–	All markers off	Removes all markers.
	Trigger On This	Positions the DPX Density measurement box at the click point, measures the current signal density, sets up the DPX Density Trigger function based on the measurement result, and starts acquisitions.

## Printing

You can print a copy of the screen and its contents (a screen shot) to a printer or a file.

1. Push the Print button on the front panel or select **Print** from the File menu.

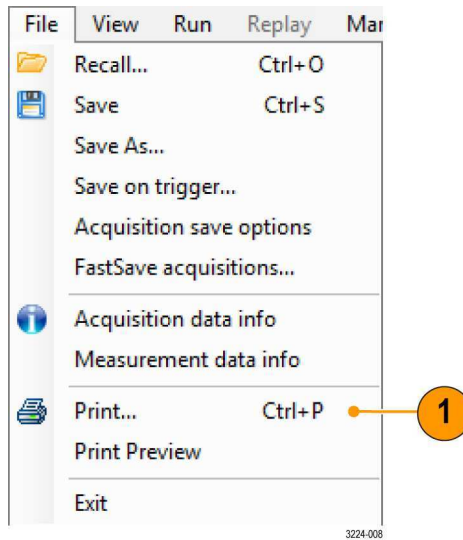

2. Fill out the details in the Print dialog box, and then click **OK**.

The Print dialog box is the standard Microsoft Windows Print dialog box. The printer controls are dependent on your printer.

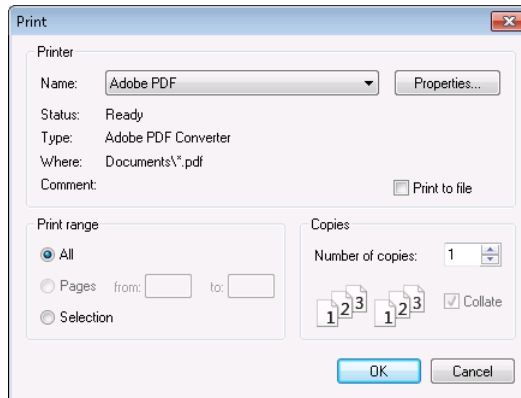

## Ink Saver Mode

You can print screen images with a white background.

1. Select **Options** from the Tools menu.

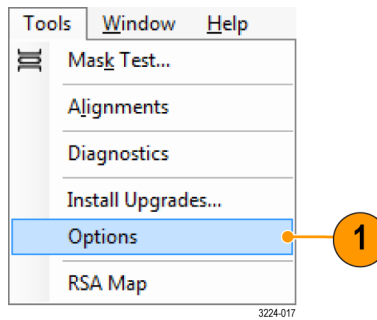

2. Select the Prefs tab in the control panel.
3. Set the Color Scheme to **Blizzard**.  
The background color changes from black to white in the graphs.

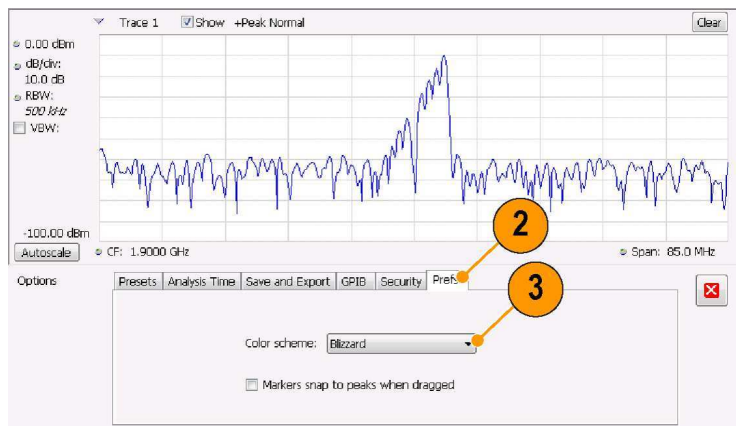

## Saving Data

You can save different types of data for future use.

1. Select **Save As...** from the File menu to open the Save As dialog box.

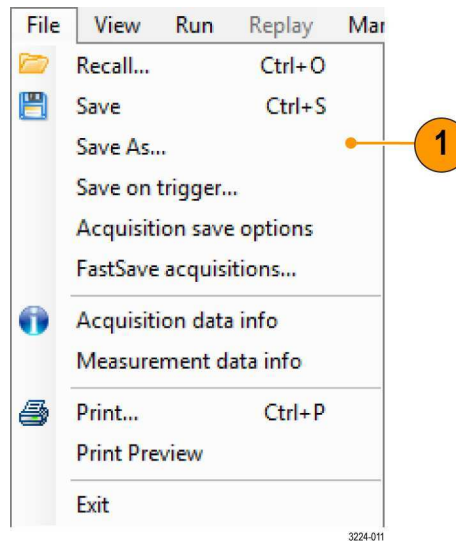

2. Navigate to the folder where you want to save the setups, or use the default location.
3. Enter a file name.
4. Select the type of file to save. (See Table 7.)
5. Click **Save**.

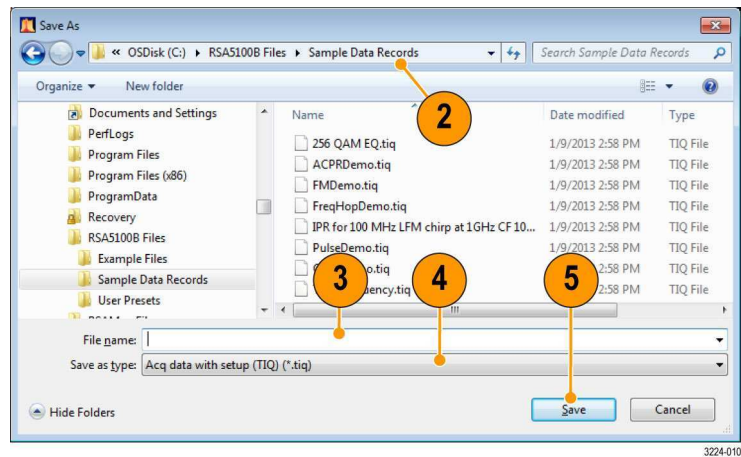

**Table 7: File types for save**

File types	Description
Setup files	Saves all of the setup information for all settings displays, except those settings that are specified under the Tools menu (Alignments and Options) or in the Config In/Out control panel.
Results Export files	Saves the trace and numeric data for the selected display. The trace and numeric data are saved in CSV format as text files.
Picture (PNG/JPG/BMP)	Saves a graphical representation of the screen in the specified format. This option is useful for including the graphic in reports or other applications. Marker readouts and other information are included.
Selected Trace	Saves a trace for later recall back into the display from which it was saved.



**Table 7: File types for save (cont.)**

File types	Description
Acq Data (acquisition data and acquisition data export)	Saves data for reanalysis by the analyzer (.TIQ) or as CSV (comma-separated value) or MAT (Matlab) format to use with external software.
Measurement	Saves a list of settings relevant to the selected measurement to a TXT (text file).

### Quick Tips

- Select **File > Save** or press the Save button to save the information to a file using the same name, path, and data type as the last time that you saved. If the file already exists, the file name suffix number will increment if you previously selected that option in the Tools > Options > Auto Filename control panel tab.
- Select **File > Save As** to open the standard Windows Save dialog box where you can edit the file name, choose what data type to save, and select a folder for storing the file.

## Recalling Data

You can recall and reanalyze acquisition data and setup files previously saved by an RSA6100 Series, RSA5100 Series, or SPECTMON Series analyzer.

1. Push the Recall button on the front panel or select **Recall** from the File menu.

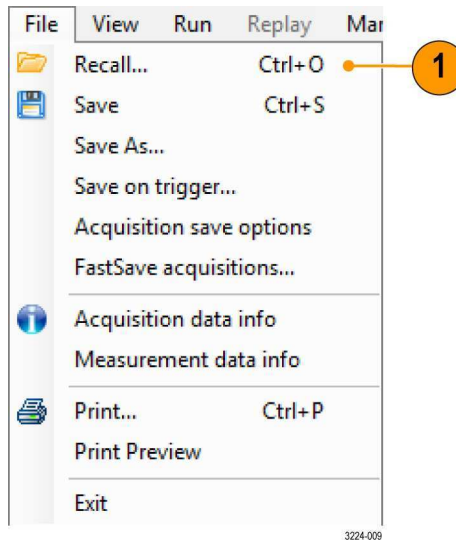

2. In the Open dialog box, browse to the location of the file.
3. If you do not see the file, select the type of file from the drop-down list.
4. Double click the file name to load the file.

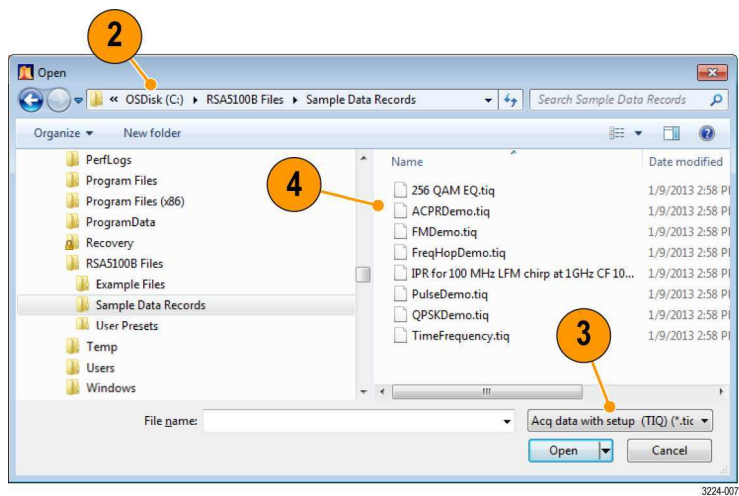

### Quick Tip

If you recall a trace that has an x-axis range that does not fall within the x-axis range of the current graph, the trace will not be visible. A small arrow will point off-screen in the direction of the recalled trace. Use the Frequency and Span (or Span and Offset) controls to bring the trace on the screen in the Spectrum display. In other displays, use Horizontal Scale and Offset (which can also be used in the Spectrum display). These controls are on the Settings > Scale tab.

## Advanced Techniques

This section contains advanced operating techniques. For examples of practical applications, see the *RSA5100B Series Real-Time Signal Analyzers Application Examples Manual*.

### Setting Up Triggering

The analyzers offer real-time power-level triggers, frequency mask trigger, frequency edge trigger, line trigger, runt trigger, DPX density, and external triggers. It uses a trigger event as a reference point in time for the seamless acquisition of the signal. This allows the analyzer to store both pretrigger and posttrigger information.

To set up triggering, first select the Event (source and trigger type). Next, continue to set other optional trigger settings, such as Time Qualified aspects and define specific actions to be taken upon recognition of a trigger event (such as Save data, save picture, etc ).

The analyzer has two triggering modes:

**Free Run mode.** In Free run mode, the instrument initiates acquisitions without considering any trigger conditions. It is a fast and easy way to see the signals. Free Run is usually adequate for the Spectrum display unless you need to specify a particular time at which to collect the data record.

**Triggered mode.** In Triggered mode, the instrument initiates an acquisition when a trigger event is recognized. The conditions that define a trigger event depend on the selected trigger source. There are several source selections available for choosing the signal to monitor for a trigger event.

Once you select the Triggered mode, you must select the source. The trigger sources are:

- RF Input
- Trig In
- Trig 2 In
- Gated
- Line

Once you select the trigger source, you can set additional parameters to specify the trigger event. If you specify the RF Input as the trigger source, you can choose from the following trigger types:

**Power Triggering.** Power triggering triggers the instrument on time-domain signal characteristics. The incoming signal is compared to a user-selected level in dBm. You can select the time-domain bandwidth and trigger on the rising or falling edge.

**Frequency Edge Triggering.** Frequency Edge triggering triggers the instrument on time-domain signal characteristics. The incoming signal is compared to a user-selected level in Hertz. Frequency edge trigger is similar to Power triggering, except you also need to set a power threshold to avoid triggering on the apparent frequency fluctuations that occur at low amplitude. You can select the time-domain bandwidth and trigger on the rising or falling edge.

**Frequency Mask Triggering.** Frequency Mask Triggering allows you to trigger the instrument when a signal in the frequency domain violates the mask. You can draw a mask to define the conditions within the real-time bandwidth that will generate the trigger event. It allows you to trigger on weak signals in the presence of strong signals. This triggering is also useful for capturing intermittent signals.

**DPX Density Triggering.** This trigger type enables the instrument to capture any signal you can see in the DPX display, including difficult to see signals hiding beneath other signals that have a higher amplitude or a greater repetition rate. Using

the Trigger On This™ feature, you can draw a box around the area of interest in the graph, set a Density threshold, and the instrument will trigger when the measured Density exceeds your threshold.

**Runt Triggering.** Runt triggering defines a trigger event based on a pulse amplitude that crosses one threshold but fails to cross a second threshold before recrossing the first.

In addition to defining the trigger event, you can define the following parameters by selecting the Advanced tab in the Trigger control panel:

- Position and Delay parameters that define where a trigger occurs within the acquired data record and whether to delay the trigger for a set amount of time.
- Whether a single event can trigger an entire sweep, or each segment of the sweep requires a new trigger event in swept acquisition mode.

**Time Qualified Triggering.** Time Qualified triggers allow you to trigger the instrument based on when signal transitions occur in time. You can apply time qualification to the basic trigger types. For example, if you select the Power type and configure it to trigger on a rising edge, Time Qualification allows you to screen rising-edge events based on how long the signal stays high after it exceeds the trigger threshold. You may wish to trigger only on pulses that last longer than a specified time or shorter than a specified time. You can set Time Qualified to accept only pulse widths between two specified values, or outside of these two values.

You can time qualify Frequency Edge, Frequency Mask, DPX Density, and Runt trigger events. For each trigger type, the instrument finds all events that meet the basic trigger criteria, then further tests them against your time qualification parameters.

## Accessing Trigger Parameters

1. Click **Trig** to open the Trigger control panel.

Alternately, press the front panel **TRIGGER** button.



2. As shown in the following steps, click one of the tabs in the Trigger control panel to define the trigger parameters.

3. Use the Event tab to set parameters that define trigger events. The parameters vary depending on the trigger Source and Type selections.

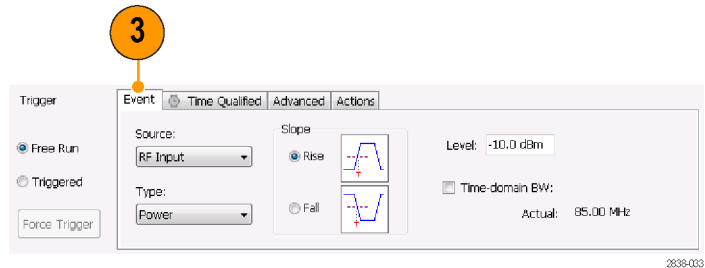

4. Use the Time Qualified tab to set parameters that qualify trigger events based on their time duration.

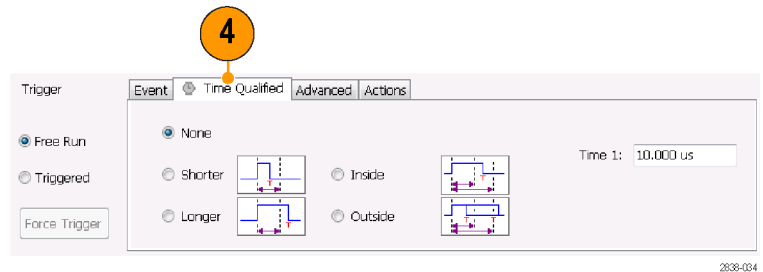

5. Use the Advanced tab to set parameters for trigger position and holdoff settings.

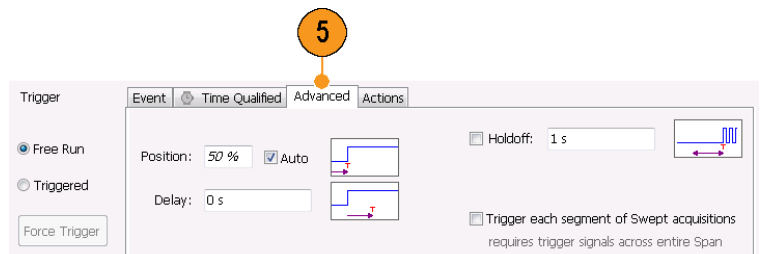

6. Use the Actions tab to set parameters for the Save on trigger function. The Save on trigger function allows you to save an acquisition data file and/or a screen capture when a trigger event occurs.

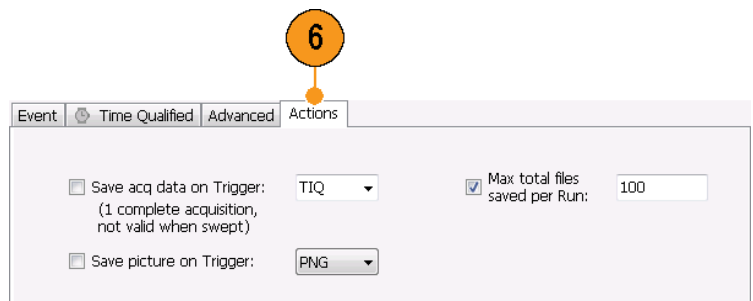

## Quick Tip

- Other ways to access the Trigger control panel:
  - Push the Trigger button on the front panel.
  - Select **Trigger.** from the Setup menu.

## Setting Up a DPX Density Trigger

The DPX Density trigger enables you to capture transient events that may be partially obscured by other higher-amplitude or more frequent signals. If you can see it in the DPX bitmap, you can trigger on it. The DPX Density area measurement is used to select the region of interest in the display and to measure its current density. You set a density threshold, and the instrument triggers when the density measurement exceeds your threshold.

The quickest way to set up a DPX Density trigger is to use a mouse and right-click on a signal of interest in the DPX graph, or press on the screen and hold with your finger for one second. A menu will pop up. Select **Trigger On This.** This action performs several tasks:

- Places the density measurement box at the click point
- Sets the measurement box to its default size
- Measures the average density in the box
- Sets the Trigger mode to Triggered
- Selects the DPX Density "Higher" trigger type
- Adjusts the trigger threshold to a density value slightly below the current measured value
- Starts the acquisition process

To optimize DPX Density trigger settings for your particular signals, open the Trigger control panel. Use the controls for changing the polarity of the trigger's threshold comparison (Higher versus Lower), the Threshold value, and the size and location of the measurement box. Use the Frequency and Amplitude settings to locate the center of the box, and set the +/- values to adjust the width and height of the measurement box.

For events that are partially masked by stronger signals, you will often need to adjust the density Threshold based on density measurements of the event of interest and of the obscuring signal. For example, if the density of the background color representing only the stronger signal is 7% and the density measurement including both signals is 9%, you would set the Threshold to 8%.

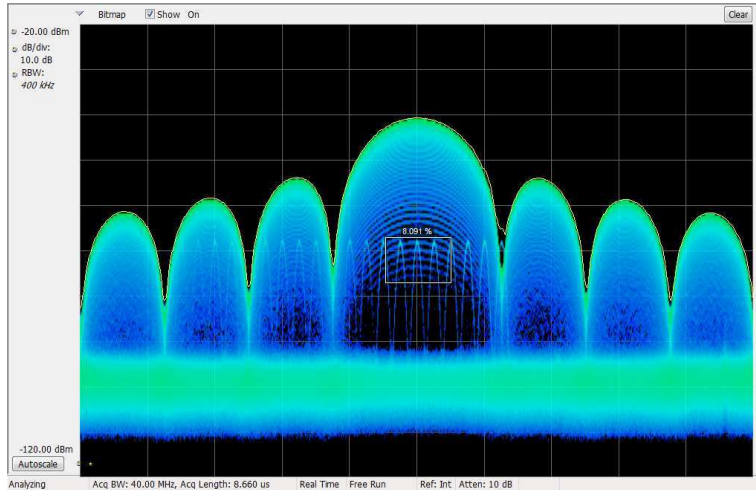

If your expected signal is a continuous tone and you want to capture events when it hops to a different frequency or drops to a lower amplitude, move the Density measurement box to surround the peak of the signal, select **Lower** in the Density control, and set **Threshold** to 100%. The instrument will trigger when the signal is absent from the measurement box.

**Hint.** The density measurement is the average of the densities for each column of pixels in the box. If your measurement box is wider than the peak of a CW signal, the density reading will be less than 100%. To get a 100% reading, you can broaden the peak by increasing RBW or narrow the box until there are no colored pixels either above or below the box. The signal should enter the left side of the box and exit the right side. It should not cross the bottom edge of the box.

## Creating a Frequency Mask

Use the Mask Editor to create a Frequency Mask. The mask is a set of points defined by frequency and amplitude. Access the Mask Editor from the Trigger control panel. (This procedure uses the Spectrum display.)

You can create a Frequency Mask by using either the manual or Auto Draw method. The following procedure explains the manual method. For a procedure on how to use the Auto Draw method, see the topic *Mask Editor (Frequency Mask Trigger)* in the online help.

1. Click **Trig** to open the Trigger control panel.



2. Select the Event tab in the control panel.
3. Set the Source to **RF Input**.
4. Set the Type to **Frequency Mask**.
5. Click **Mask Editor** to open the Mask Editor.

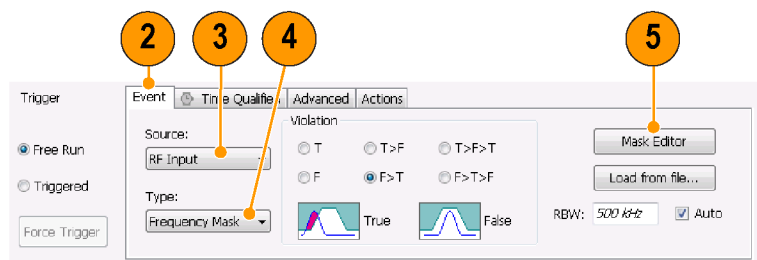

The Mask Editor opens with the traces of the Spectrum display in the graph.

6. Click **New** in the tool bar. This removes the existing mask and then creates a default 6-point mask.

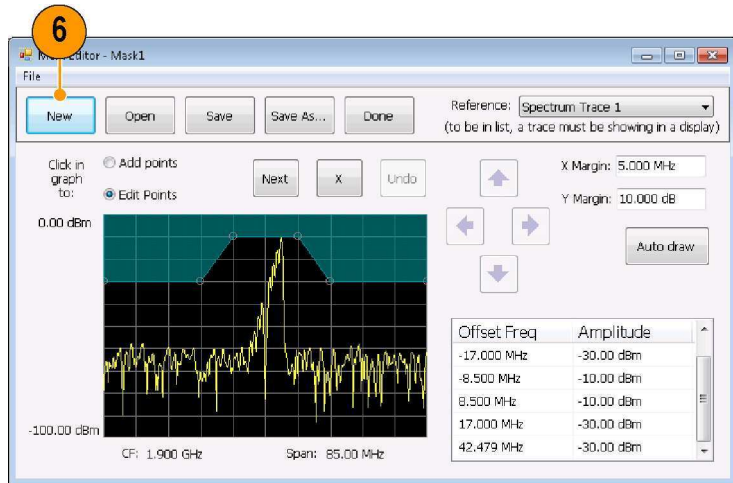



7. Click any point in the mask to select it.  
The frequency and amplitude of the selected point are highlighted in the graph.
8. Edit the point by doing one of the following:
  - Drag and drop the point with the mouse.
  - Enter the frequency and amplitude in the table.
  - Adjust amplitude with the up/down arrow keys and frequency with the left/right arrow keys.

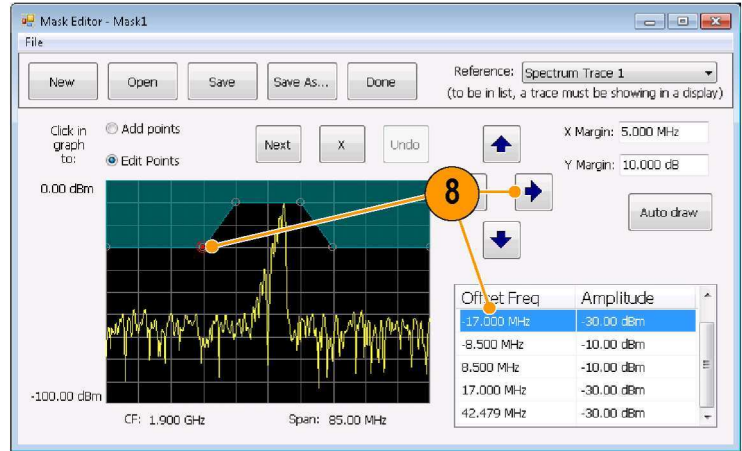

### Quick Tips

- Click **Auto draw** to generate a mask automatically adjusted to the Reference. Set the X Margin (frequency) and Y Margin (amplitude) before pressing Auto draw.
- Right click on the display screen to add a new point.
- Click **Add Points** and then click on the graph to add a new point in the graph.
- Click **Next** to select the next point in the graph.
- Click the **X** (delete button) to delete the selected mask point.
- Click **Save** to save the mask file and continue working with the mask editor.
- Click **Open** to load and edit a previously saved mask file.

### Defining Trigger Conditions

After you have set up the mask, you can select whether to trigger on the presence or absence of mask violations.

1. Select a condition.  
The choices are described in the following table. (See Table 8.) The icons at the bottom of the control panel identify what is considered true or false.
2. Click **Triggered**.  
The instrument will trigger when the trigger conditions are met.

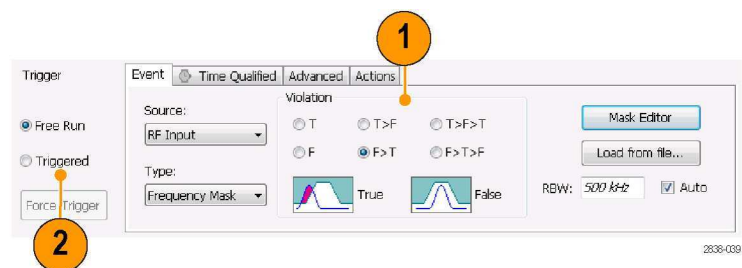

**Table 8: Trigger violations**

Violation	Description
T	The instrument triggers whenever the signal violates the mask (above the line).
F	The instrument triggers whenever the signal has no points in the mask.
T > F	One transition defines the trigger event. The signal must go out of the mask (no violation) after being inside of the mask (violation).
F > T	One transition defines the trigger event. The signal must go into the mask after being outside of the mask.
T > F > T	Two transitions define the trigger event. The signal must start inside of the mask, cross outside of the mask, and then cross back into the mask.
F > T > F	Two transitions define the trigger event. The signal must start outside of the mask (no violation), cross into the mask, and then cross back outside of the mask.

### Controlling Acquisitions

When two or more displays are open, one display controls the acquisition system. The acquisition requirements for the selected display set the acquisition hardware parameters. While the acquisition parameters are optimized for the selected display, they might not be ideal for other displays. In this case, the other displays might be unable to maintain optimum performance and consequently might be unable to produce results. (This also happens when you analyze recalled data: measurements attempt to deliver results, but may not be able to comply with all their settings.)

You can specify which display controls the hardware acquisition parameters by clicking anywhere in that display. When there are multiple displays, the highlighted display controls the hardware acquisition parameters.

In this example, there are two displays, a Spectrum display and a DPX Spectrum display. The highlighted title bar on the Spectrum display indicates that it is the selected display.

The check mark indicator in the upper left corner of the display indicates that acquisition hardware is optimized for the Spectrum display.

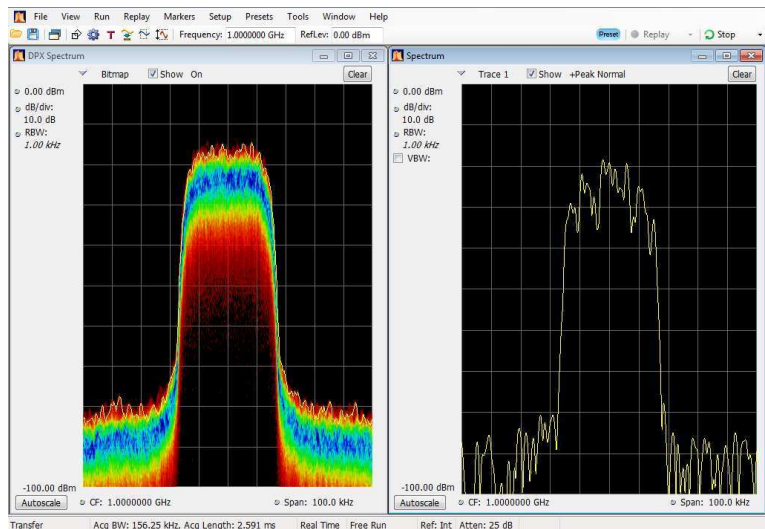

Some displays do not control the acquisition hardware. These displays just show the captured data. Some displays share the same parameters. If any of one of these displays in such a family controls the acquisition hardware, then the acquisition parameters are optimized for all of the displays in that family.

## Measurements with Conflicting Acquisition Requirements

The analyzers let you open any combination of measurements. You can select the displays that you are interested in and the instrument will automatically set up the appropriate analysis and acquisition parameters.

If measurements place conflicting requirements on the acquisition parameters, the current selected display takes priority. The following example shows incompatible measurement settings when one display needs real-time data (such as the Amplitude vs Time measurement) while another display requires swept data (such as a Spectrum graph with a very wide span).

1. Push the Preset button on the front panel to set the instrument to the default settings.
2. Tune the instrument to the frequency of your signal and then set the span.

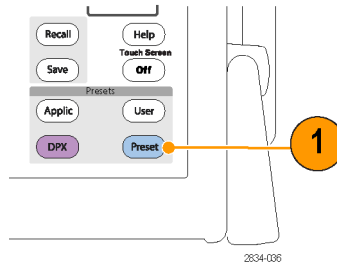

3. Click the Displays icon to open the Select Displays dialog box.

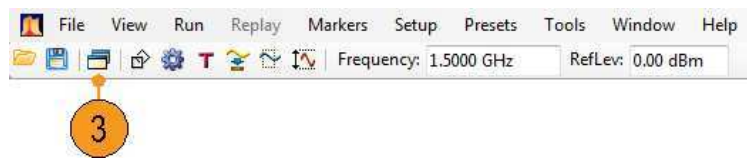

4. Select the **General Signal Viewing** folder.
5. Select the **Amplitude vs Time** icon.
6. Click **Add** to add the icon to the Selected Displays list.

**NOTE.** Add the Spectrum display if it is not already in the Selected Displays list.

7. Click **OK** to accept the changes and close the dialog box.

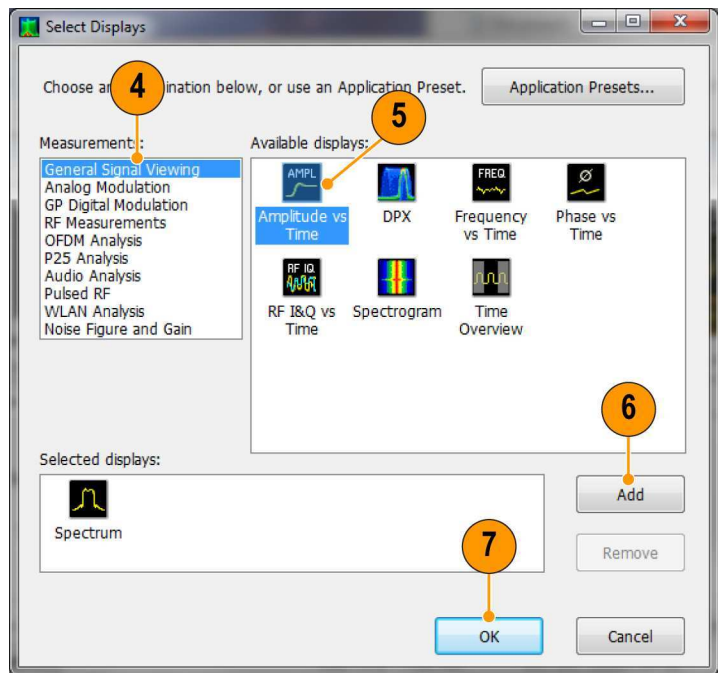

3224-016

8. Increase the span in the Spectrum display to 200 MHz.

Because Spectrum is the selected display, the acquisition parameters adjust automatically to meet the needs of the display. The 200 MHz span exceeds the real-time bandwidth of the instrument. As a result, the instrument will change to swept mode.

9. Look at the Status bar. The readout "Swept" indicates when acquisitions are swept.

When the acquisitions are in "Real Time," all measurements usually run. If the acquisitions are swept, only the selected display can run.

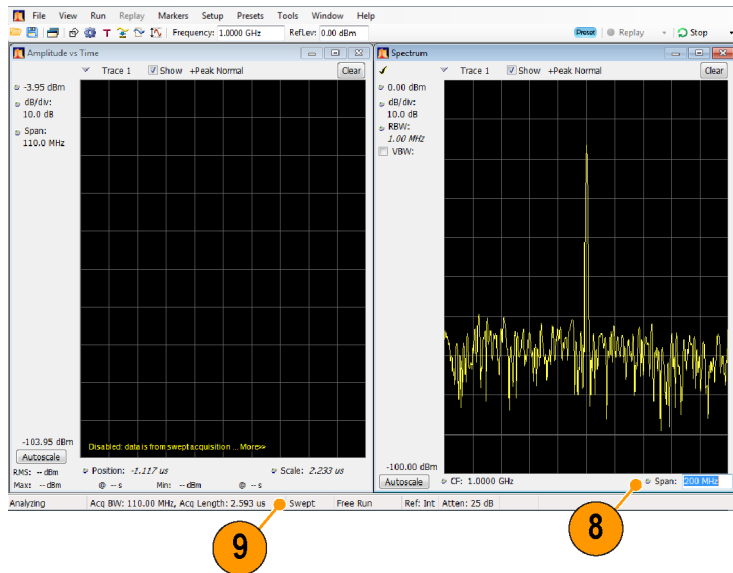

10. Click the Amplitude vs Time display to make it the active display.

The acquisition switches back to real-time because the selected display requires real-time. The data is now suitable for the Amplitude vs Time display but doesn't contain the full range of frequencies needed by the Spectrum display.

In this case, the Spectrum is unable to run.

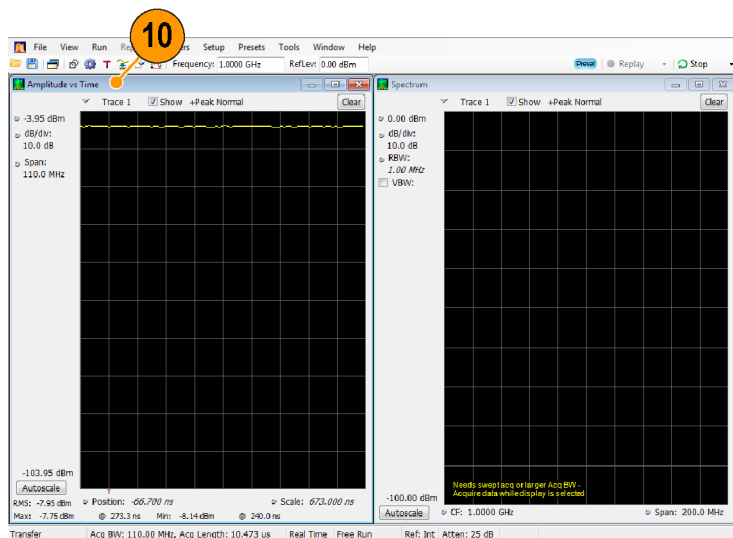

11. Decrease the span to 25 MHz in the Spectrum display. Now the acquisitions are real time again.
12. Check the status bar readout to verify that the acquisition is real-time. Both of the displays can run now.

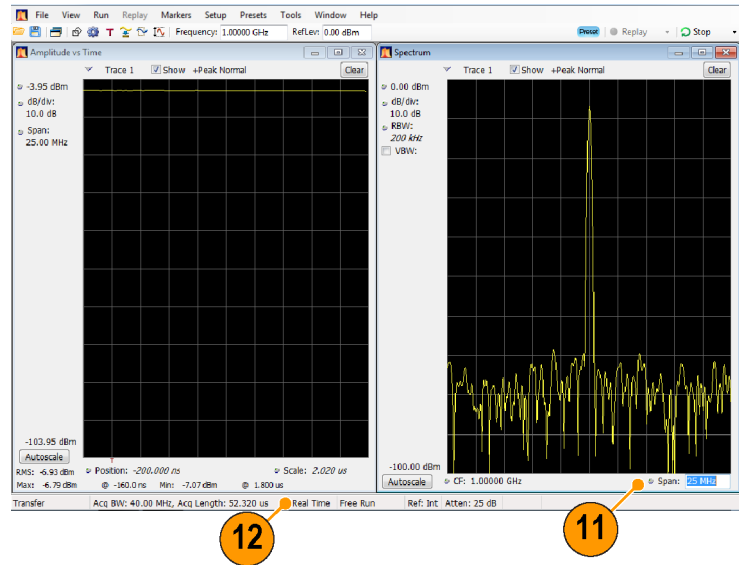

## Mask Testing

The analyzer lets you test many trace results for changes in level. You can identify matches crossing a power level or you can create a mask that specifies power level and frequency range limits. You can select which trace to test and specify an action to take when a test condition is met for traces in the Spectrum, DPX, Noise Figure, Spurious, and Setting Time displays. The Frequency Settling Time, Phase Settling Time, Spurious, Bluetooth InBand Emission, and Occupied Bandwidth measurements tests provide pass/fail results.

The available choices include only results from displays that are currently open.

Selecting **Mask Test** from the Tools menu displays the Mask Test control panel. These settings define test parameters and specify actions to be performed when the test conditions are met.

**To start a mask test.** Perform the following steps to set up for any mask test.

1. Open the Spectrum display or select the Spectrum display if it is already open.
2. Select **Tools > Mask Test**.

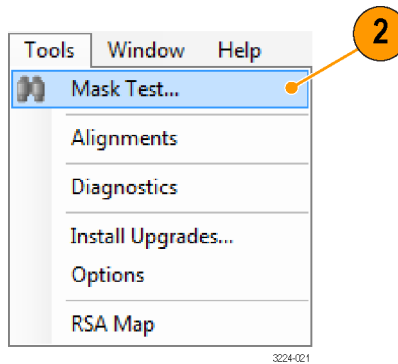

3. Select the **Enable Test** check box to set the application to perform the test once the conditions are defined.

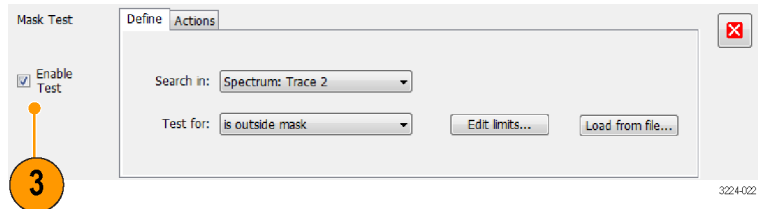

4. Select the trace you wish to test from the **Search in** drop-down list box.

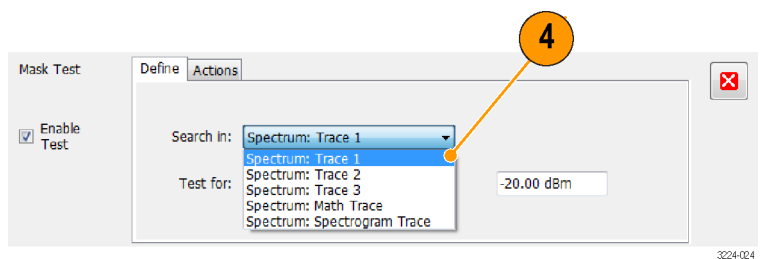

- Verify that the trace you selected in the **Search in** list is the selected trace and that the **Show** box is checked.



- Click the **Actions** tab to specify what actions the analyzer should take when a match occurs.

The analyzer can take up to five actions when a match occurs, depending on the run mode. In Run mode, the analyzer can sound a beep, stop acquisitions, save acquisition data, save trace data, and save a picture of the display. In Replay mode, it can sound a beep and stop analyzing.

- To have the analyzer take an action when a match occurs, select the desired action.

You can select any combination of actions to perform on a match. If you select all actions, they will all occur when a match is found (in Run mode).

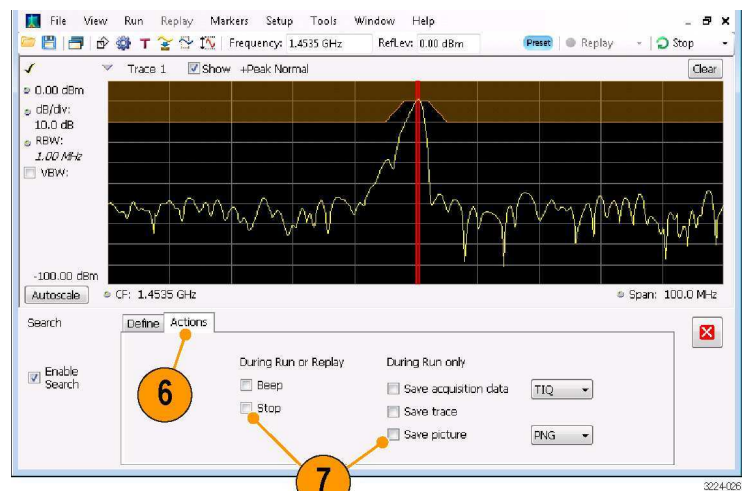

**To perform a Greater Than/ Less Than mask test.**

1. Specify what to test for by making a selection from the **Test for** drop-down list.  
To test for signal levels above or below a specified level, select either **is greater than** or **is less than**.

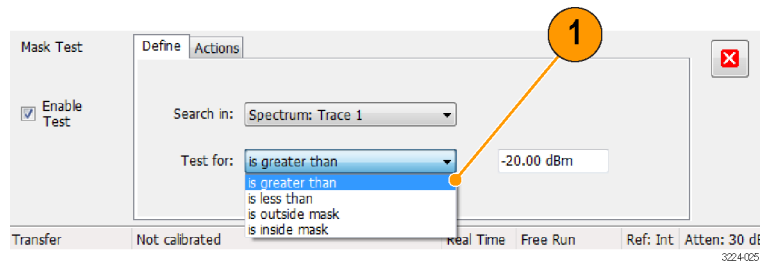

2. Press the Run button to initiate a test. Click the **Replay** button on the toolbar to initiate a test on the current data record.
3. Notice the vertical red bar. It highlights results that match the test definition.

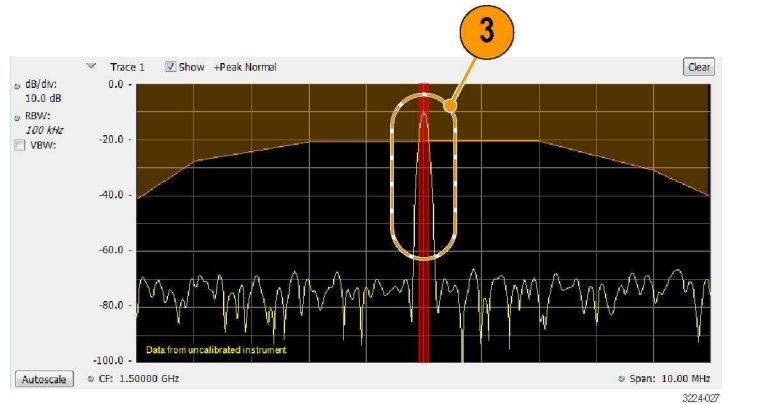

4. Click the close box to remove the Mask Test control panel.



**To perform an Outside/Inside mask test.** If you specify a mask-based test, then you need to edit the mask to specify the levels that define a violation. You can do this as follows.

1. Select **is outside mask** or **is inside mask** from the **Test for** menu.
2. Click the **Edit limits** button to display the Mask Test Editor window.

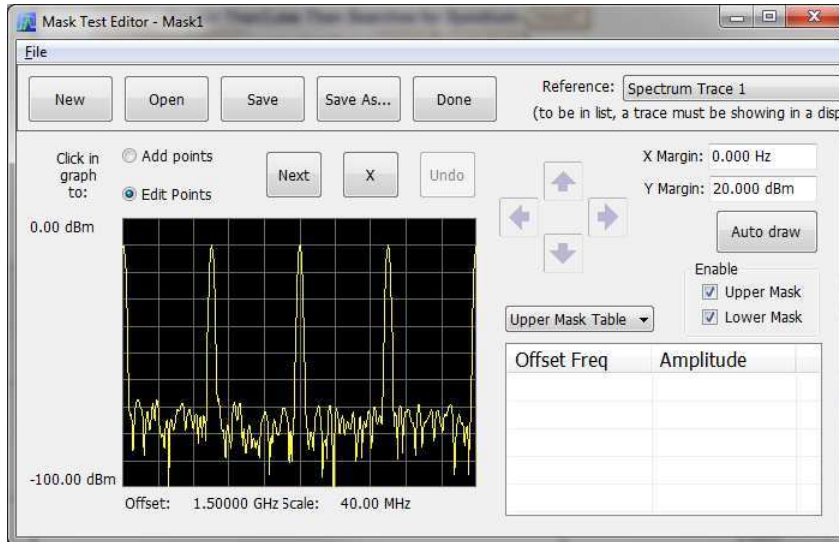

3. Click the **New** button to create a table. This clears the existing points and loads the default table. You can also click **Open** to open an existing table.
4. To edit values, add points, or delete points in a table:
  - a. To edit an existing value, double-click on the cell you want to edit and enter the desired value. The active point shows as a red point on the plot.

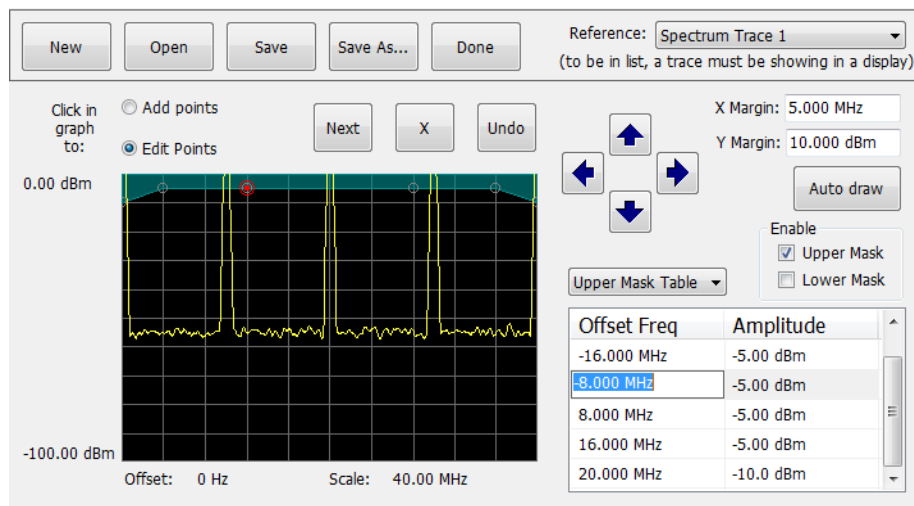

- b. To add a new point, check the box next to the target mask (located below the **Auto draw** button).
- c. Select **Add points** located below the **Open** button.
- d. Select the target mask (Upper Mask Table or Lower Mask Table) from the drop-down menu.
- e. Click in the desired location on the plot to add the point.

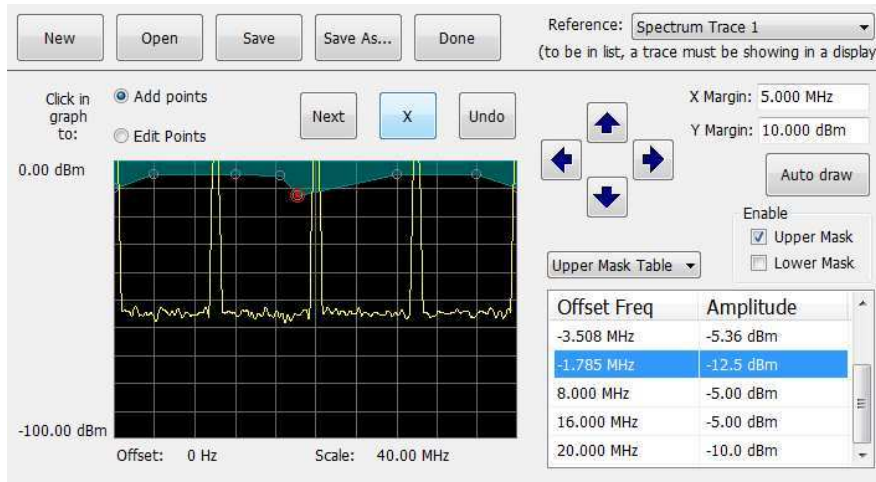

- f. To use the auto draw feature to automatically place points on the chosen mask, enable the desired mask from the drop-down menu and then click the **Auto draw** button.

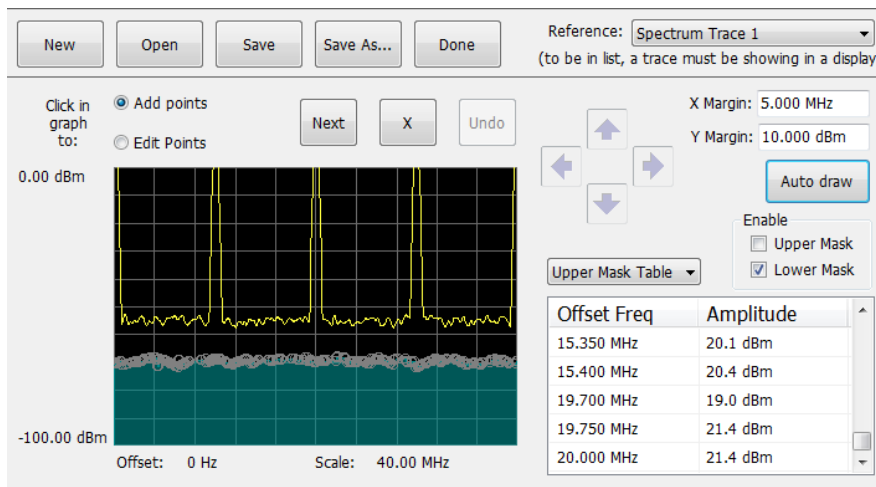

**NOTE.** Units may be changed for measurements other than Noise Figure in Setup > Analysis > Units.

5. To delete a point from the table, select the point to be removed, and click the **X** button.
6. To save the mask to a file for later recall, click **Save As**.
7. From the Save As dialog, name the file and save it in the desired location.

**NOTE.** Masks are saved in XML format with a *.msk* extension.

8. To dismiss the Mask Test Editor window, click **Done**.

**Mask Test result examples.** The following figure shows the results of a Spectrum **is outside mask** test with Upper Mask enabled. The vertical red bar highlights results that have exceeded the test limits. The shaded region shows the mask area.

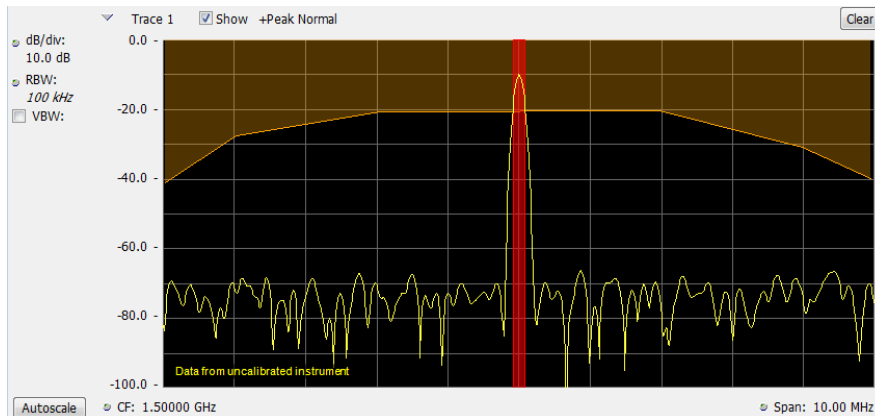

The following figure shows the results of a passing Noise Figure **is outside mask** test with Upper Mask enabled. Markers are also in use.

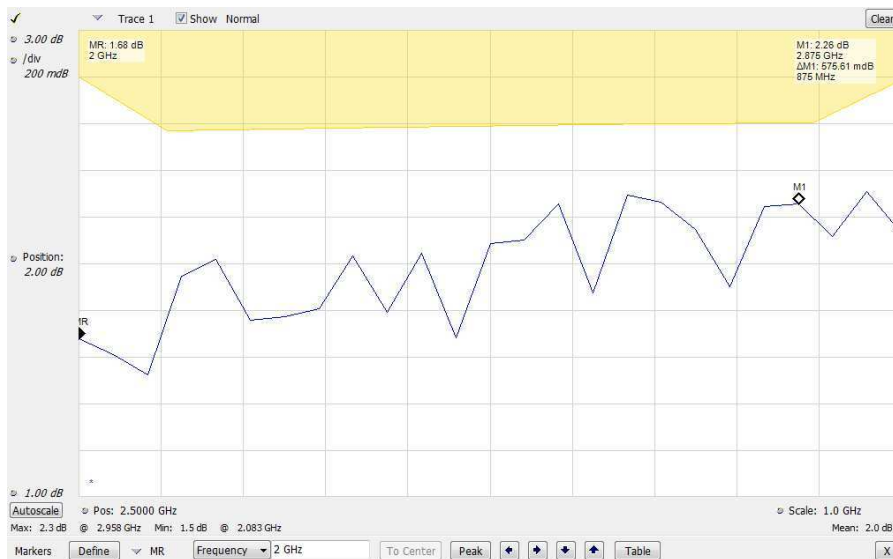

The following figure shows the results of a failing Noise Figure **is outside mask** test with Lower Mask and Upper Mask enabled. The red area highlights the area of failure, which occurs at the lower mask. Markers are also in use.

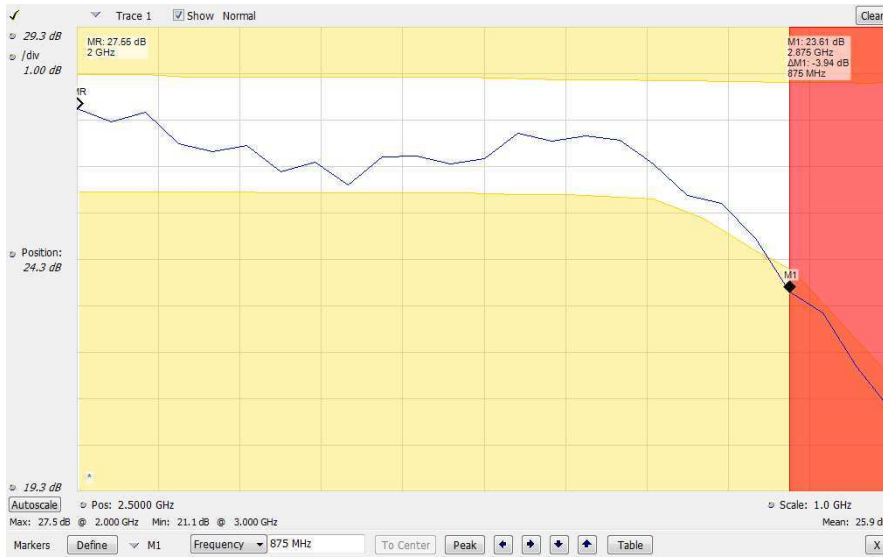

## Using Correction Tables

The analyzers let you correct the signal displays and measurement results to account for gains and losses in external equipment. You can specify a single gain value or you can use an external loss table to adjust the gain/loss value based on frequency.

To specify external gain/loss corrections:

1. Press the Amplitude icon button to display the Amplitude control panel.
2. Select the **External Gain/Loss Correction** tab.

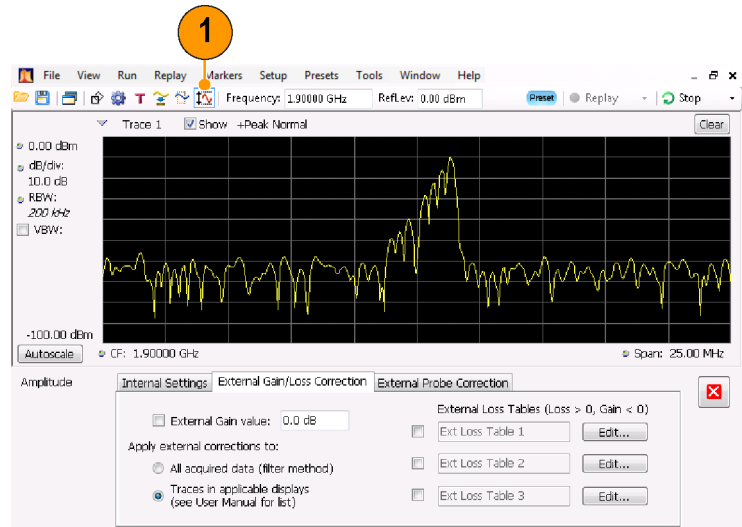

2838-047

3. To apply a constant correction factor, select the **External Gain value** check box. Enter a value into the text entry box.

**NOTE.** You can enter either positive or negative gain values. Positive values represent a gain. Negative values represent a loss.

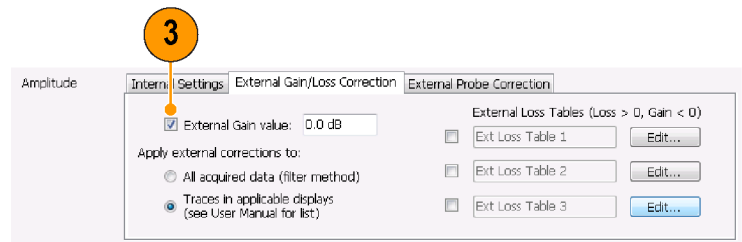

2838-042

4. To use a table that corrects for gain/loss values depending on frequency, click a check box under **External Loss Tables**. You can enable all three external loss tables at the same time. Thus, you could use different external loss tables for an antenna, a preamplifier, and for cabling.
5. To edit the contents of an external loss table, click the **Edit** button for the table you want to edit.

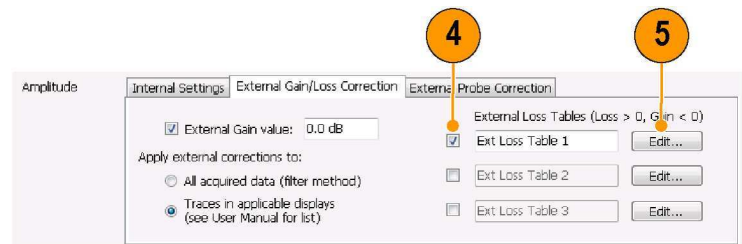

2838-043

6. Edit the contents of the table to match the loss characteristics of the equipment you are correcting for. Click **OK** when you are finished.

**NOTE.** You can enter either positive or negative values into the table. But in contrast to the External Gain value setting, positive values represent a loss and negative values represent a gain.

For detailed information on using the Table Editor, select **Help > User Manual** and look in the Index for *External Loss Tables*.

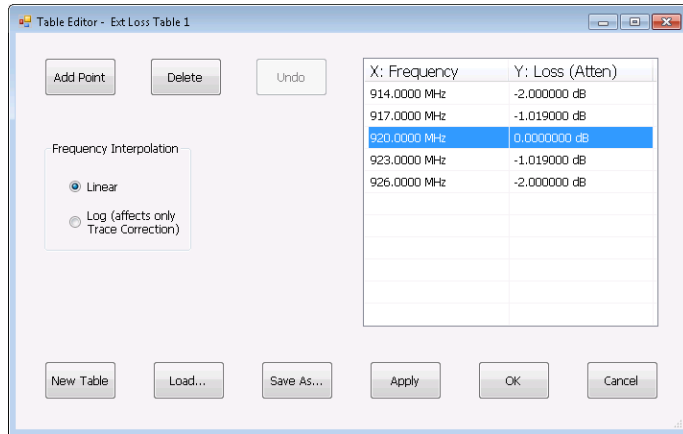

7. You can change the title for each external loss table. Select the title box and type in a new title.

Note that the title is only a label. It is not tied to the file name of any table you have loaded or saved.

8. Specify whether table corrections are applied to *all* acquired data or only to traces in the Spectrum, Spectrogram, Spurious and Amplitude vs Time displays.

Corrections applied to data are performed in real time using the digital filter capabilities of the instrument. While this has the advantage of correcting the data for use in all measurements, digital filtering is limited in its ability to apply corrections that change rapidly in amplitude over small frequency ranges, as may occur when switching between two antennas. When this happens, the filters may result in an amplitude correction that appears to ring in its response, resulting in poorly corrected data. For that reason, the RSA offers trace-only correction for spectrograms, spectrum, spurious, and amplitude vs. time displays. These trace corrections are similar to those applied in traditional spectrum analyzers, and should be used when discontinuities occur in the amplitude/frequency correction table.

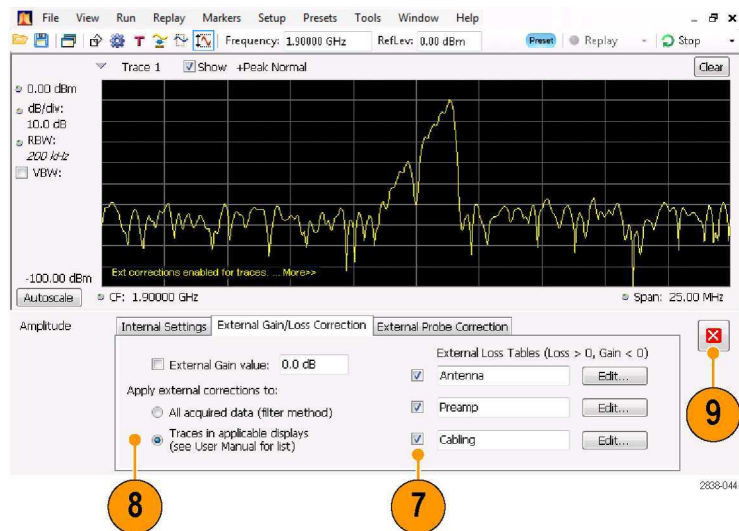

When choosing whether to correct sample data or traces, keep the following in mind:

- If sample data is acquired while data correction is enabled, that data record is permanently corrected. If the acquisition is saved and recalled, the recalled acquisition includes corrections. Corrections are not saved separately from the raw data; they are used during the acquisition process to adjust the data values.
  - Trace corrections can be applied at any time, as they are part of the measurement's computations. Using Replay will apply trace corrections to a trace if this control is enabled (and an external loss table is specified and enabled).
  - Be aware that if you recall acquisition data that was saved with data corrections and you use Replay with trace corrections selected and an external loss table enabled, the trace will be calculated using corrected data and also corrected with trace corrections. This usually creates incorrect traces.
9. Click the close box to remove the Amplitude control panel when you are finished making changes.

## Using Audio Demodulation

The analyzers can demodulate AM and FM signals, which can help you to analyze known and unknown radio signals. You access the Audio Demod tab from the Settings control panel of the DPX Spectrum plot display.

To demodulate an audio signal:

1. Click the **Displays** icon to display the Select Displays dialog box.
2. Select the **General Signal Viewing** folder.
3. Double-click the **DPX Spectrum** icon to add it to the Selected Displays list.
4. Click **OK** to close the dialog box. The DPX display will open.

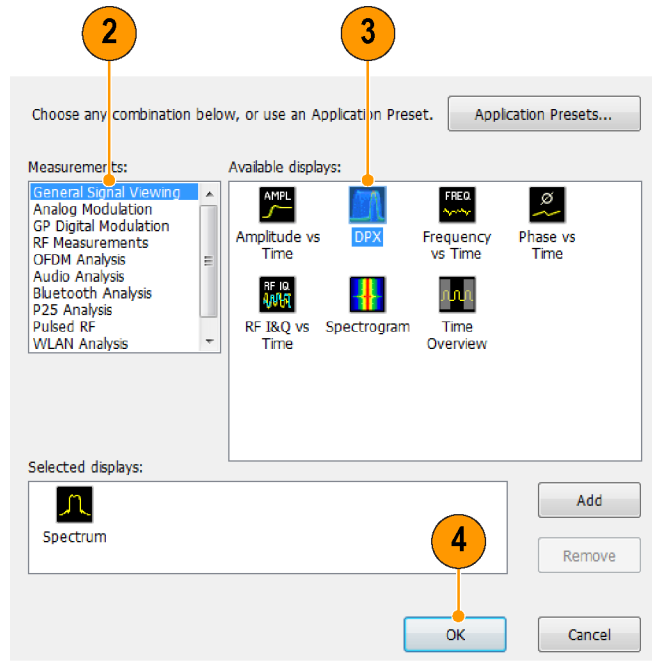

3369-002

5. If necessary, select the Spectrum plot from the drop-down list.
6. Press the **Settings** front-panel button to display the DPX Settings control panel.
7. Click the **Audio Demod** tab to display the Audio Demod control panel.

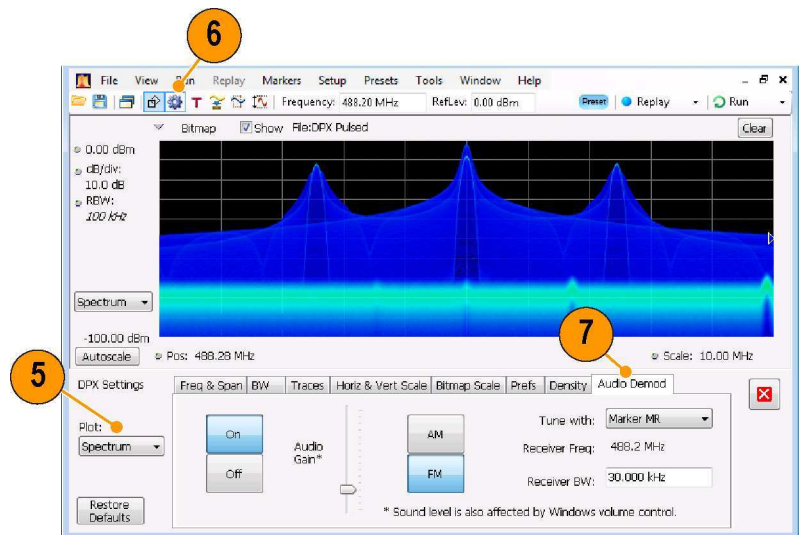

3224-028



8. Click the **On** button to enable audio demodulation.
9. To specify the demodulation type, click either the **AM** or **FM** button.

**NOTE.** Note that the **AM** and **FM** buttons select only the demodulation type; they do not specify a frequency band.

10. Set the center frequency as needed.

The receiver frequency (frequency to be demodulated) is specified with either markers or the frequency control (the front panel Frequency button or the Freq control in the toolbar). Use the **Tune with** setting to specify whether markers or the frequency control is used to specify the receiver frequency.

11. Select either a marker or frequency control from the **Tune with** drop-down list.
12. If the marker you select is not enabled (it will be visible in the display if it is enabled), click the **Markers** button in the toolbar to display the Markers toolbar.

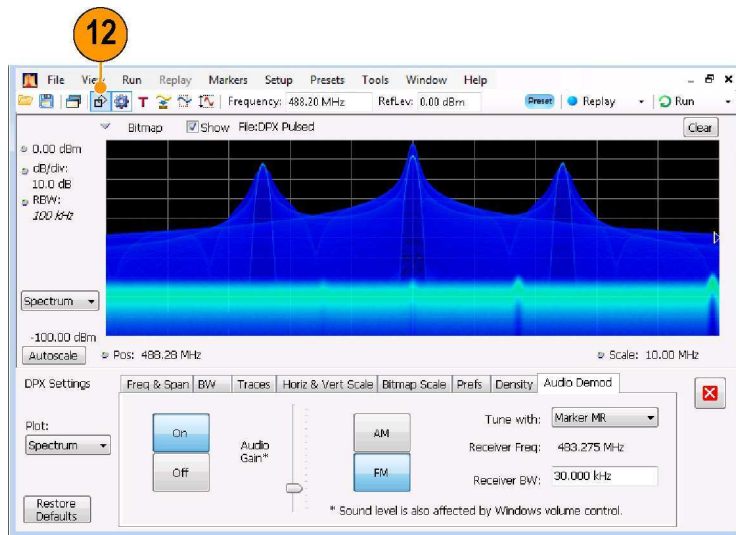
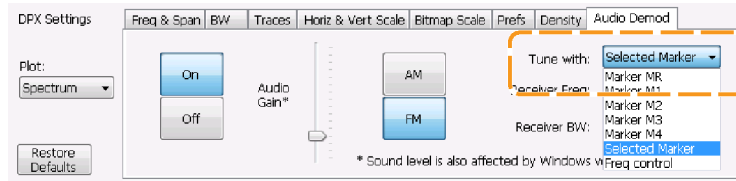
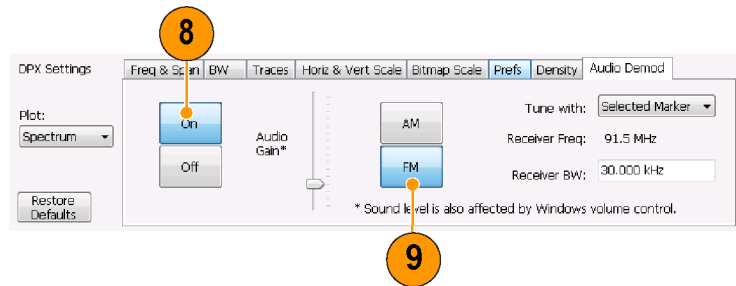

3559-008

13. Click the **Define** button in the Marker toolbar to display the Define Markers control panel.

14. Click **Add** to add markers as needed.

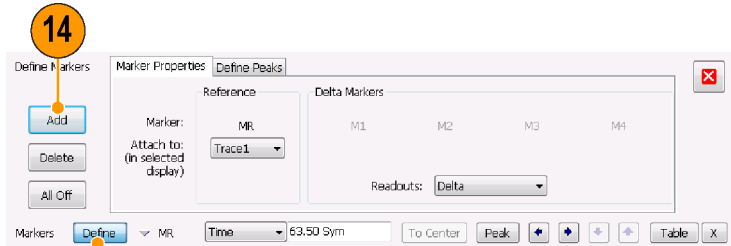

15. Click the **Settings** button to return to the Audio Demod control panel.

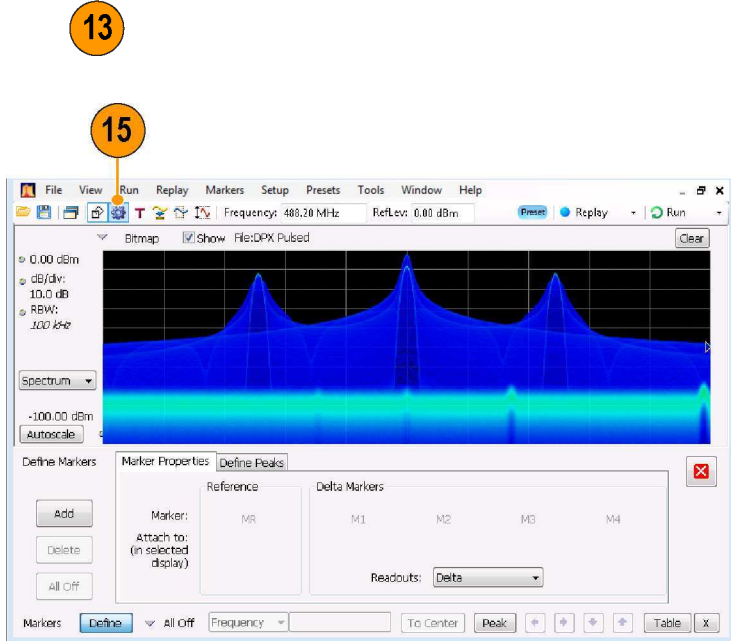

16. Set the required receiver bandwidth by entering a value into the **Receiver BW** value entry box.

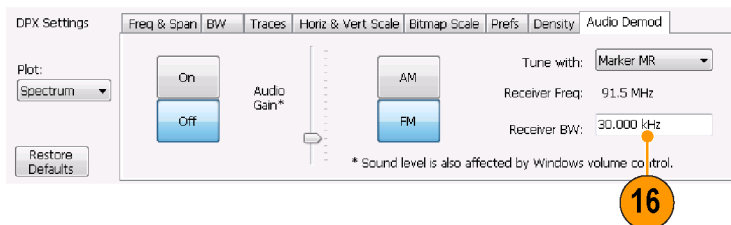

17. Set the receiver frequency.

If you specified a marker with the **Tune with** setting, drag the marker to the required frequency. Fine tune the marker position with the front-panel knob or your mouse wheel. If you selected **Frequency control** in the **Tune with** setting, press the front-panel **FREQ** button, then turn the front-panel knob or use the **Freq** setting in the toolbar to set the required frequency.

The receiver frequency is displayed as **Receiver Freq** between the Tune with and Receiver BW settings.

18. Adjust the **Audio Gain** setting so you can hear the demodulated signal. Note that the sound level is also affected by the setting of the Windows volume control.

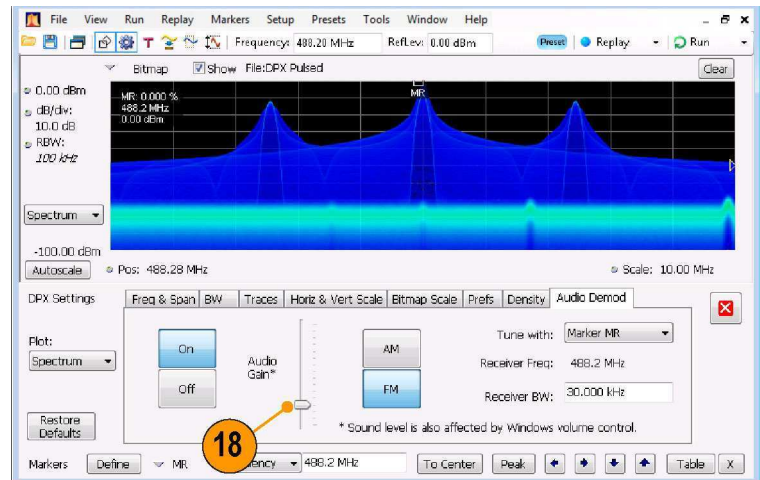



# Index

## A

- Accessories
  - optional, 2
  - power cords, 1
  - Product Documentation, 1
  - standard, 1
- Acquisition
  - conflicts, 57
  - controlling, 56
  - data source, 25
  - starting, 37
  - stopping, 37
- Analysis window, 24, 26
- Application presets, 28
- audio demodulation, 70

## C

- CF Pan
  - Touchscreen actions menu, 42
- check mark indicator, 22, 56
- Cleaning procedures, 13
- Conflicts
  - measurement, 57
- Connectors
  - front panel, 19
  - rear panel, 20
  - RF signal input, 36, 37
- Controlling acquisitions, 56
- Controls
  - display-specific, 23
  - front panel, 15
  - interface, 21
- Cooling clearances, 4
- correction tables, 67

## D

- Data
  - recalling, 48
  - saving, 46
- Default settings, 35
- Diagnostics, 12
- Digital demodulation displays, 26
- Display
  - conflicts, 57
- Display properties
  - changing, 11

- Display settings
  - changing, 32
- Displays
  - general signal viewing, 26
  - GP digital modulation, 26
  - printing, 44
  - Pulsed RF, 26
  - RF measurement, 26
  - selecting, 27
- Documentation, xi
  - Tektronix part numbers, 1
- DPX Density
  - triggering, 49

## E

- Environmental specifications, 4
  - altitude, 4
  - cooling clearances, 4
  - humidity, 4
  - temperature, 4
- Extended desktop, 8
- external gain/loss correction, 67
- External monitor, 8

## F

- Features, x
- File types, 46
- Free Run trigger mode, 49
- Frequency edge
  - triggering, 49
- Frequency mask
  - Mask Editor, 54
  - triggering, 49
- Front panel
  - connectors, 19
  - controls, 15

## G

- General signal viewing displays, 26
- Graphics driver, 11
- Greater than (Mask Test), 62

## I

- Incoming inspection, 12
- Information messages, 31

- Ink saver mode, 45
- Input requirements
  - max DC voltage, 36
  - max measurable input power, 36
  - max safe input power, 36
  - RF signal range, 36
- Installation, 1
  - network connections, 5
- is inside mask (Mask Test), 63
- is outside mask (Mask Test), 63
- Italicized numbers, 23

## K

- Key features, x

## L

- Less than (Mask Test), 62

## M

- Maintenance
  - cleaning procedures, 13
  - repackaging, 14
- Marker toolbar, 41
- Markers, 39
  - absolute, 40
  - adding, 41
  - defining, 42
  - delta, 40
  - DPX bitmap trace, 40
  - power, 40
  - reference, 40
- Mask Editor
  - adding points, 54
  - editing points, 55
- Mask Test, 60
- Measurement
  - conflicts, 57
- Mechanical specifications, 4
- Messages
  - on-screen, 31
- MR, 40

## N

- Network connections, 5

**O**

- Operating system restore, 7
- Optional accessories, 2
- Options
  - Power cords, 1

**P**

- Pan
  - Touchscreen actions menu, 42
- Part numbers, manuals, 1
- Power cord options, 1
- Power level triggering, 49
- Power supply, 4
- Preset, 35
  - selecting displays, 28, 30
  - system settings, 35
- Printing, 44
  - ink saver mode, 45
- Product features, x
- Pulsed RF displays, 26

**R**

- Real-Time signal analyzer, 24
- Rear panel connectors, 20
- Recalling data, 48
- Repackaging, 14
- Reset scale
  - Touchscreen actions menu, 42
- Returning the instrument, 14
- RF measurement displays, 26
- RF signal connections, 36, 37
- RF signal input range, 36
- Run control, 38
- Run menu, 38
- Runt triggering, 50

**S**

- Save options, 46
- Saving data, 46

- Screens, printing, 44
- Select
  - Touchscreen actions menu, 42
- Selected window, 56
- Selecting displays, 27
- Settings
  - changing, 32
  - default, 35
  - preset, 35

**Setups**

- recalling, 48
- saving, 46
- Software upgrades, xii
  - installing, 14

**Span Zoom**

- Touchscreen actions menu, 42

**Specifications**

- altitude, 4
- cooling clearances, 4
- environmental, 4
- humidity, 4
- input requirements, 36
- mechanical, 4
- power supply, 4
- product dimensions, 4
- temperature, 4

**Spectrum analyzer**

- real-time concepts, 24

**Standard accessories, 1**

- power cord, 1
- Product Documentation, 1

**Standards presets, 30****Starting acquisitions, 37****Stopping acquisitions, 37****T**

- Test using a mask, 62, 63
- Testing signals, 60
- Time Qualified
  - triggering, 50
- touchscreen actions menu, 42

**Trace legend, 33****Trigger**

- control panel, 51
- mask, 54
- violations, 56
- Trigger Event parameters, 50
  - accessing, 51
- Triggered trigger mode, 49
- Triggering
  - DPX Density, 49
  - free run, 49
  - frequency edge, 49
  - frequency mask, 49
  - parameters, 50
  - power level, 49
  - Runt, 50
  - time qualified, 50
  - triggered mode, 49

**U****Upgrades**

- software, xii, 14

**V****Violations**

- trigger mask, 56

**W****Window**

- analysis, 24
- selected, 56

**Z****Zoom**

- Touchscreen actions menu, 42