

Instruction Manual

Tektronix

P6205

FET Probe

070-8202-01

Warning

The servicing instructions are for use by qualified personnel only. To avoid personal injury, do not perform any servicing unless you are qualified to do so. Refer to all safety summaries prior to performing service.

Copyright © Tektronix, Inc. All rights reserved.

Tektronix products are covered by U.S. and foreign patents, issued and pending. Information in this publication supercedes that in all previously published material. Specifications and price change privileges reserved.

Printed in the U.S.A.

Tektronix, Inc., P.O. Box 1000, Wilsonville, OR 97070-1000

TEKTRONIX, TEK, and TEKPROBE are registered trademarks of Tektronix, Inc.

KLIPCHIP is a trademark of Tektronix, Inc.

WARRANTY

Tektronix warrants that the products that it manufactures and sells will be free from defects in materials and workmanship for a period of one (1) year from the date of purchase from an authorized Tektronix distributor. If any such product proves defective during this warranty period, Tektronix, at its option, either will repair the defective product without charge for parts and labor, or will provide a replacement in exchange for the defective product. Batteries are excluded from this warranty.

In order to obtain service under this warranty, Customer must notify Tektronix of the defect before the expiration of the warranty period and make suitable arrangements for the performance of service. Customer shall be responsible for packaging and shipping the defective product to the service center designated by Tektronix, shipping charges prepaid, and with a copy of customer proof of purchase. Tektronix shall pay for the return of the product to Customer if the shipment is to a location within the country in which the Tektronix service center is located. Customer shall be responsible for paying all shipping charges, duties, taxes, and any other charges for products returned to any other locations.

This warranty shall not apply to any defect, failure or damage caused by improper use or improper or inadequate maintenance and care. Tektronix shall not be obligated to furnish service under this warranty a) to repair damage resulting from attempts by personnel other than Tektronix representatives to install, repair or service the product; b) to repair damage resulting from improper use or connection to incompatible equipment; c) to repair any damage or malfunction caused by the use of non-Tektronix supplies; or d) to service a product that has been modified or integrated with other products when the effect of such modification or integration increases the time or difficulty of servicing the product.

THIS WARRANTY IS GIVEN BY TEKTRONIX WITH RESPECT TO THE LISTED PRODUCTS IN LIEU OF ANY OTHER WARRANTIES, EXPRESS OR IMPLIED. TEKTRONIX AND ITS VENDORS DISCLAIM ANY IMPLIED WARRANTIES OF MERCHANTABILITY OR FITNESS FOR A PARTICULAR PURPOSE. TEKTRONIX' RESPONSIBILITY TO REPAIR OR REPLACE DEFECTIVE PRODUCTS IS THE SOLE AND EXCLUSIVE REMEDY PROVIDED TO THE CUSTOMER FOR BREACH OF THIS WARRANTY. TEKTRONIX AND ITS VENDORS WILL NOT BE LIABLE FOR ANY INDIRECT, SPECIAL, INCIDENTAL, OR CONSEQUENTIAL DAMAGES IRRESPECTIVE OF WHETHER TEKTRONIX OR THE VENDOR HAS ADVANCE NOTICE OF THE POSSIBILITY OF SUCH DAMAGES.

Table of Contents

General Safety Summary	v
Service Safety Summary	vii
Preface	ix
Contacting Tektronix	x

Getting Started

Product Description	1-1
Oscilloscopes without the TEKPROBE Interface	1-1
Standard Accessories	1-3
Probe Features	1-3
Grounding the Probe	1-7

Operating Basics

Ground Lead Inductance	2-1
Linear Operating Range	2-3
High-Amplitude Frequency Response	2-3
Step Inputs	2-3
Sine Wave Inputs	2-5

Specifications

Performance Verification

Test Equipment	4-1
Attenuation Check	4-2
Rise Time Check	4-5
Rise Time Approximation	4-7
Bandwidth Approximation	4-8
Aberrations Check	4-9
Output Offset Check	4-14

Maintenance

Preventive Maintenance	5-1
Visual Inspection	5-1
Cleaning	5-2
Corrective Maintenance	5-2
Static Sensitive Devices	5-3
Replacing the Probe Tip	5-3
Replacing the TEKPROBE Contact Pins	5-3
Replacing Internal Assemblies: Probe Head and Cable, BNC and Circuit Board Carrier	5-4
Readjustment Following Repair	5-6
Repackaging for Shipment	5-6

Replaceable Parts

Parts Ordering Information	6-1
Module Servicing	6-1
Using the Replaceable Parts List	6-2
Abbreviations	6-3
Mfr. Code to Manufacturer Cross Index	6-3

List of Figures

Figure 1–1: P6205 probe with accessories	1–2
Figure 1–2: Probe finger guard and hand contact area	1–7
Figure 2–1: Equivalent circuit showing added probe and ground lead resistance, capacitance, and inductance ...	2–1
Figure 2–2: Effects of ground lead inductance on waveform fidelity	2–2
Figure 2–3: P6205 typical input vs linear operating range .	2–4
Figure 2–4: Bandwidth vs sine wave input amplitude	2–5
Figure 3–1: Typical input impedance vs frequency	3–5
Figure 3–2: Voltage derating vs frequency	3–5
Figure 3–3: Linearity error vs output voltage	3–6
Figure 3–4: Typical frequency response	3–6
Figure 4–1: Attenuation test setup part 1	4–3
Figure 4–2: Calibrator waveform	4–4
Figure 4–3: Cursors placement for D voltage measurement	4–4
Figure 4–4: Attenuation test setup part 2	4–5
Figure 4–5: Rise time test setup	4–6
Figure 4–6: Rise time waveform	4–7
Figure 4–7: Aberrations test setup part 1	4–9
Figure 4–8: Aberrations waveform	4–10
Figure 4–9: Measuring aberrations	4–11
Figure 4–10: Aberrations test setup part 2	4–12
Figure 5–1: Disassembling the P6205 probe	5–5
Figure 6–1: P6205 probe with standard accessories	6–4
Figure 6–2: P6205 probe optional accessories	6–6

List of Tables

Table 1–1: Standard accessories	1–3
Table 3–1: Electrical characteristics	3–1
Table 3–2: Environmental characteristics	3–4
Table 3–3: Physical characteristics	3–4
Table 3–4: Certifications and compliances	3–4
Table 4–1: Test equipment	4–2

General Safety Summary

Review the following safety precautions to avoid injury and prevent damage to this product or any products connected to it. To avoid potential hazards, use this product only as specified.

Only qualified personnel should perform service procedures.

While using this product, you may need to access other parts of the system. Read the *General Safety Summary* in other system manuals for warnings and cautions related to operating the system.

To Avoid Fire or Personal Injury

Connect and Disconnect Properly. Do not connect or disconnect probes or test leads while they are connected to a voltage source.

Observe All Terminal Ratings. To avoid fire or shock hazard, observe all ratings and markings on the product. Consult the product manual for further ratings information before making connections to the product.

Do not apply a potential to any terminal, including the common terminal, that exceeds the maximum rating of that terminal.

Connect the ground lead of the probe to earth ground only.

Avoid Exposed Circuitry. Do not touch exposed connections and components when power is present.

Do Not Operate With Suspected Failures. If you suspect there is damage to this product, have it inspected by qualified service personnel.

Do Not Operate in Wet/Damp Conditions.

Do Not Operate in an Explosive Atmosphere.

Keep Product Surfaces Clean and Dry.

Safety Terms and Symbols

Terms in This Manual. These terms may appear in this manual:



WARNING. *Warning statements identify conditions or practices that could result in injury or loss of life.*



CAUTION. *Caution statements identify conditions or practices that could result in damage to this product or other property.*

Terms on the Product. These terms may appear on the product:

DANGER indicates an injury hazard immediately accessible as you read the marking.

WARNING indicates an injury hazard not immediately accessible as you read the marking.

CAUTION indicates a hazard to property including the product.

Symbols on the Product. These symbols may appear on the product:



WARNING
High Voltage



Protective Ground
(Earth) Terminal



CAUTION
Refer to Manual



Double
Insulated



Service Safety Summary

Only qualified personnel should perform service procedures. Read this *Service Safety Summary* and the *General Safety Summary* before performing any service procedures.

Do Not Service Alone. Do not perform internal service or adjustments of this product unless another person capable of rendering first aid and resuscitation is present.

Disconnect Power. To avoid electric shock, disconnect the mains power by means of the power cord or, if provided, the power switch.

Use Care When Servicing with Power On. Dangerous voltages or currents may exist in this product. Disconnect power, remove battery (if applicable), and disconnect test leads before removing protective panels, soldering, or replacing components.

To avoid electric shock, do not touch exposed connections.



Preface

This manual provides operating and maintenance information for the Tektronix P6205 FET probe.

The manual is organized into the following sections:

- *Getting Started* provides a product overview and introduction to probe features and accessories.
- *Operating Basics* discusses techniques for improving measurement accuracy.
- *Specifications* lists the probe warranted characteristics.
- *Performance Verification* contains procedures to verify probe performance.
- *Maintenance* contains inspection and cleaning procedures and instructions for replacing probe modules.
- *Replaceable Parts* lists the standard and optional probe parts and accessories and provides ordering information.

Contacting Tektronix

Product Support	<p>For application-oriented questions about a Tektronix measurement product, call toll free in North America: 1-800-TEK-WIDE (1-800-835-9433 ext. 2400) 6:00 a.m. – 5:00 p.m. Pacific time</p> <p>Or contact us by e-mail: tm_app_supp@tek.com</p> <p>For product support outside of North America, contact your local Tektronix distributor or sales office.</p>
Service Support	<p>Contact your local Tektronix distributor or sales office. Or visit our web site for a listing of worldwide service locations.</p> <p>http://www.tek.com</p>
For other information	<p>In North America: 1-800-TEK-WIDE (1-800-835-9433) An operator will direct your call.</p>
To write us	<p>Tektronix, Inc. P.O. Box 1000 Wilsonville, OR 97070-1000</p>



Getting Started

Getting Started

The Tektronix P6205 FET probe is an active 10X-attenuating probe that is compatible with Tektronix TDS 500 Series, DSA 600 Series, 11000 Series, and CSA 404 oscilloscopes and plug-in units.

Product Description

The P6205 probe provides high-frequency measurement capability without the capacitive loading and performance limitations inherent in passive resistive-divider type probes. FETs are used in the P6205 to establish the characteristic high input impedance at high frequency of an active probe. The P6205 features a 750 MHz bandwidth with an input impedance of 1 M Ω in parallel with 2 pF. You must terminate the P6205 probe output into 50 Ω .

The P6205 includes the TEKPROBE™ Level 2 interface. When used with a fully TEKPROBE interface-compatible oscilloscope, the P6205 probe is powered by the host instrument and provides the oscilloscope with the probe model number, serial number, and attenuation factor. When installed on a fully compatible oscilloscope, the oscilloscope channel input is automatically set to 50 Ω and the display readouts are corrected for the probe attenuation factor.

Oscilloscopes without the TEKPROBE Interface

The P6205 is an active probe that requires external power to operate. If your oscilloscope is not equipped with the TEKPROBE interface, we recommend that you use the Tektronix 1103 TEKPROBE Power Supply. By connecting the probe to the 1103 power supply, and the power supply output to your oscilloscope input, you can use the P6205 probe with oscilloscopes having conventional BNC inputs. The 1103 can power two P6205 probes simultaneously.

To maintain the best possible high-frequency response with the 1103 power supply, keep the cable connecting the 1103 output to the oscilloscope input as short as possible. You must use an oscilloscope with 50 Ω input impedance with this system.

NOTE. Using the P6205 probe with an 1103 power supply will not add full TEKPROBE functionality to an incompatible oscilloscope. In addition, the 1103 probe offset adjustment does not apply to P6205 probes.

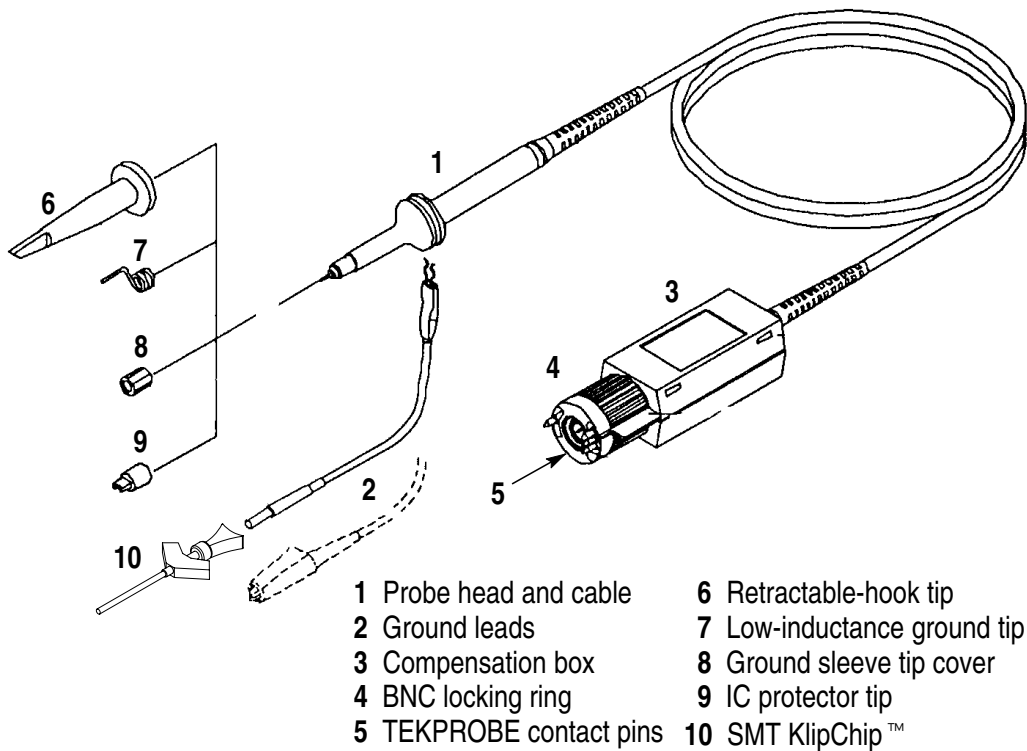

Figure 1-1: P6205 probe with accessories

Standard Accessories

Table 1–1 lists the P6205 probe standard accessories.

Table 1–1: Standard accessories

1	Retractable-hook tip
1	Ground lead with square-pin receptacle
1	Ground lead with alligator clip
1	Ground contact spring
1	Ground sleeve tip cover
1	IC protector tip
1	SMT KlipChip
1	Instruction manual

The *Replaceable Parts* section beginning on page 6–1, contains ordering information for all standard and optional accessories.

Probe Features

The following table introduces P6205 probe components, connectors, and accessories. Refer to Figure 1–1 to identify probe items and where to attach standard accessories.

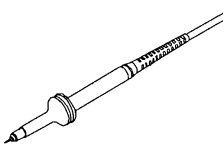
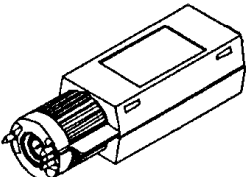
	<p>Probe Head and Cable. The probe tip makes a physical connection to the test point. The flexible cable allows you to make measurements in a variety of applications.</p>
	<p>Compensation Box. The compensation box contains circuitry, including elements of the TEKPROBE interface. There are no internal adjustments.</p>

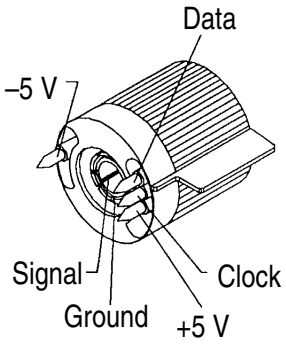
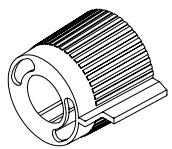
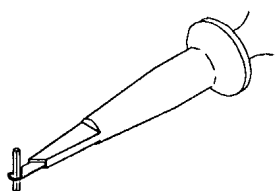
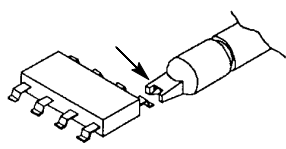
	<p>TEKPROBE Interface (Level 2). The TEKPROBE interface provides a communication path between the probe and the host instrument. Contact pins provide connections for power, signal, and data transfer. The interface allows some oscilloscopes to automatically configure the correct attenuation factor and input impedance and to access the probe serial number.</p> <p>Some features of the TEKPROBE interface, for example probe offset and additional voltage sources, are not required by the P6205; therefore, the contact pins are omitted from the connector.</p> <p>NOTE. <i>Your oscilloscope may not implement all features of the TEKPROBE interface. Refer to your oscilloscope manual for details.</i></p>
	<p>BNC Locking Ring. The BNC locking ring houses the TEKPROBE interface contact pins and provides a positive attachment to the host instrument.</p> <p>To install the probe, open the locking ring by rotating it counterclockwise; push the assembly firmly onto the oscilloscope (or power supply) BNC input connector. Rotate the ring clockwise one-quarter turn to secure it to the input connector.</p>
	<p>Retractable-Hook Tip.¹ Attach the retractable-hook tip to your signal test point for hands-free operation. The hook tip attaches easily to leaded components such as resistors, capacitors, and discrete semiconductors. Stripped wire, jumpers, busses, and test pins can also be gripped with the retractable hook tip.</p> <p>To remove the hook tip (your probe is shipped with the hook tip installed), simply pull it off. Reinstall the hook tip by pushing it firmly onto the molded barrel of the probe tip.</p>
	<p>IC Protector Tip.² Use the IC protector tip to simplify probing of in-line IC packages. The shape of the protector tip guides the probe onto IC pins and prevents accidental shorting of pins by the probe tip.</p> <p>To install the IC protector tip, push it firmly onto the end of the metal barrel of the probe tip while taking care not to pierce yourself with the sharp tip.</p> <p>NOTE: <i>Remove the IC protector tip by pulling it off before installing the retractable-hook tip.</i></p>

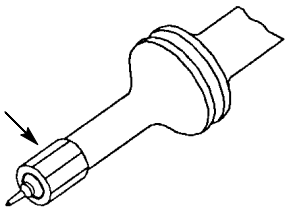
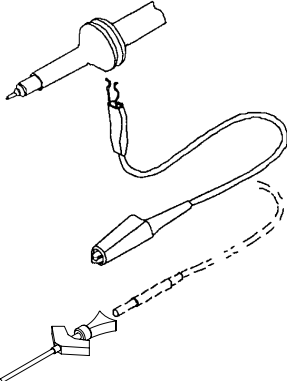
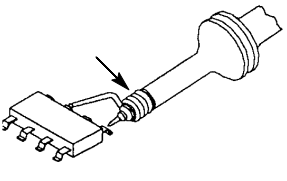
	<p>Ground Sleeve Tip Cover.² Use the ground sleeve tip cover to keep the metal sleeve of the probe tip from accidentally shorting components on your device under test.</p> <p>To install the ground sleeve tip cover, push it onto the metal barrel of the probe tip while taking care not to pierce yourself with the sharp probe tip. Remove the sleeve by pulling it off before installing the retractable hook tip.</p>
	<p>Ground Leads.¹ Use the long ground leads when length is important and precise high-frequency measurement is not. Long ground leads are ideal for quick troubleshooting when you are looking for the presence, absence, or general shape of a signal. For maximum performance, always use the shortest ground lead possible.</p> <p>To attach the ground lead, press the spring clip onto the collar of the probe head. An alternative ground connection can also be made to the metal barrel of the probe tip.</p>
	<p>Low-Inductance Ground Contact (Spring Tip). Use the low-inductance spring-tip ground contact to reduce ground lead inductance. The performance of a probe fitted with the low-inductance ground contact approaches that of no-lead probe fixtures and adapters. With the spring-tip contact installed, you can make measurements up to the system bandwidth of your probe/oscilloscope with negligible signal degradation from ground lead inductance.</p> <p>To install the low-inductance ground contact, push it onto the metal barrel of the probe tip while taking care not to pierce yourself with the sharp probe tip.</p> <p>NOTE: <i>The spring contact installs more easily if you rotate the spring counterclockwise (loosening the spring tension) as you push it onto the probe barrel. Use care to avoid the accidentally shorting of component leads to ground when using this tip.</i></p>

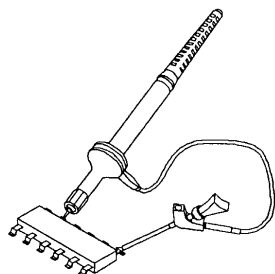

SMT KlipChip™. Use the retractable KlipChip if you need hands-free attachment to a physically small signal or ground source. The low profile of the KlipChip allows you to grasp devices that the Retractable Hook Tip cannot.

To use the KlipChip as a ground connector, attach the long ground lead with square-pin termination to the probe collar. Connect the ground lead termination to one of the KlipChip shoulder pins.

To use the KlipChip as a signal connector, slide the optional single-lead probe tip adapter (see *Replaceable Parts* list) onto the probe tip. Connect the single-lead termination to one of the KlipChip shoulder pins.

To use the KlipChip as both ground and signal connector, slide the optional dual-lead probe tip adapter (See *Replaceable Parts*) onto the probe tip. Connect both single-lead terminations to the shoulder of a separate KlipChip pin. You can also combine the single-lead adapter with a long ground lead to configure dual KlipChip connections.

-
- 1 For maximum flexibility, use one of the six-inch ground leads. For precise measurements at high frequency, the inductance associated with long ground leads may distort the high-frequency component of your signal. Consider whether you can use one of the low-inductance probe tip configurations instead. For tips on minimizing ground lead inductance, refer to the *Operating Basics* section beginning on page 2-1.**
 - 2 Use a ground lead with this accessory. Be sure to take into account ground lead inductance effects on measurements at frequencies approaching 30 MHz. For tips on minimizing ground lead inductance, refer to the *Operating Basics* section beginning on page 2-1.**

Grounding the Probe

Connect the probe to the instrument and connect the ground lead to ground before making any measurements. Ensure that no part of the ground lead contacts voltage in the circuit under test. Except for the probe tip and BNC center conductor, all accessible metal (including the ground clip) is connected to the BNC shell.



WARNING. To avoid electric shock when using the probe, keep your fingers behind the finger guard on the probe body. See Figure 1-2 below.

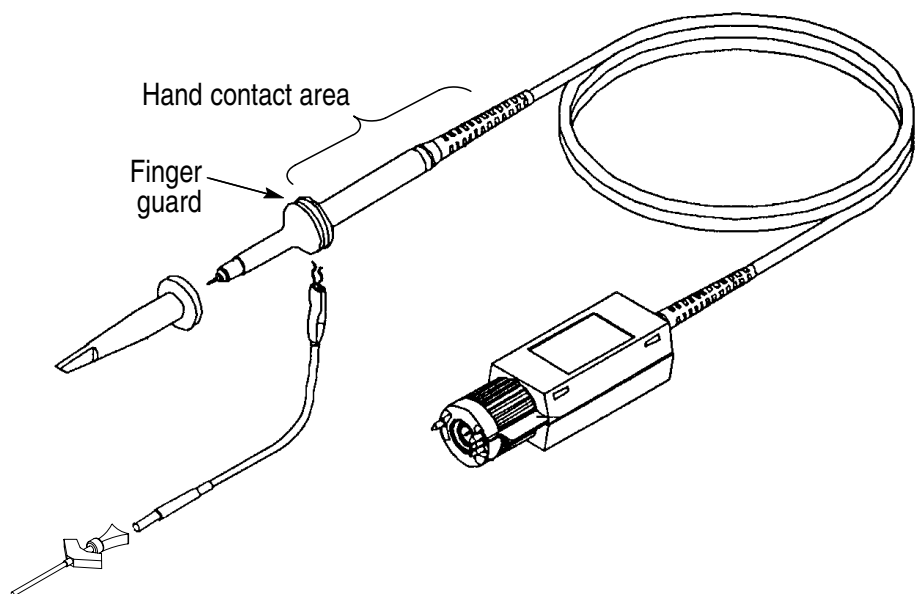

Figure 1-2: Probe finger guard and hand contact area



Operating Basics

Operating Basics

This section discusses technical issues you should consider when using the P6205 probe.

Ground Lead Inductance

When you touch the probe tip to a circuit element you are introducing a new resistance, capacitance, and inductance into the circuit. See Figure 2–1.

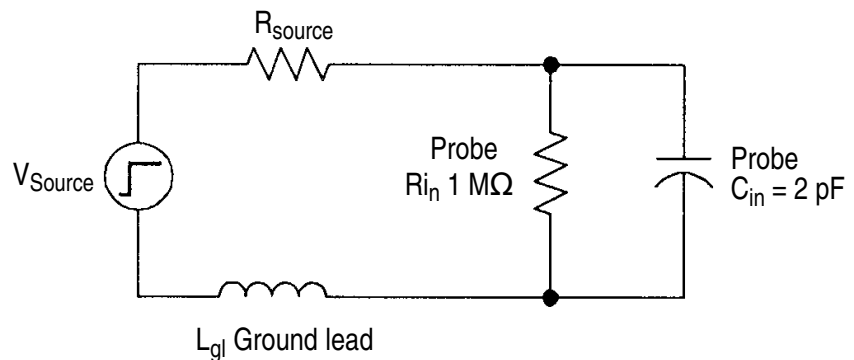

Figure 2–1: Equivalent circuit showing added probe and ground lead resistance, capacitance, and inductance

The high input resistance of the P6205 probe has negligible effect on most circuits. The series inductance introduced by the probe tip and ground lead however, can result in a parasitic resonant circuit that “rings” within the bandwidth of your oscilloscope system. Figure 2–2 shows examples of how different ground leads affect a displayed signal.

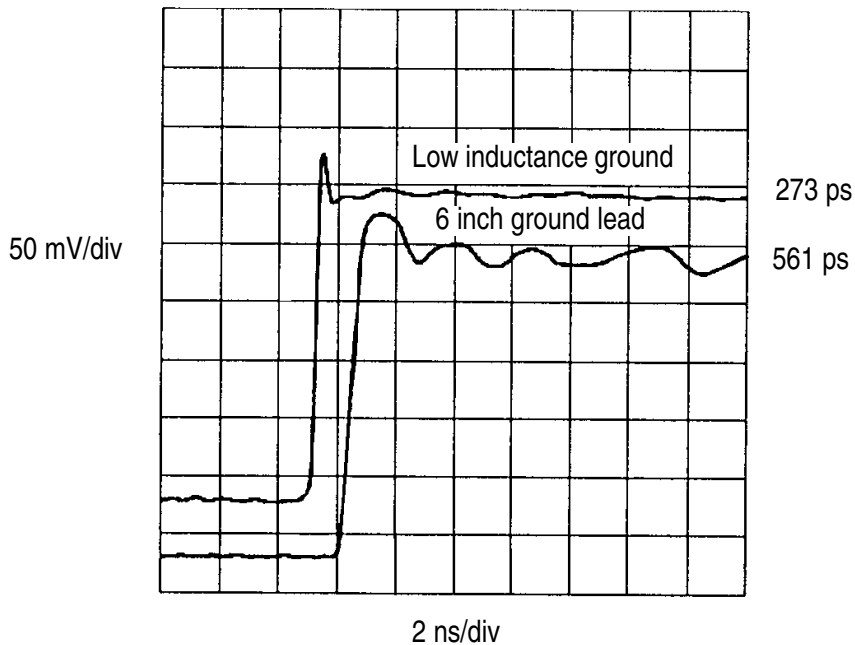

Figure 2–2: Effects of ground lead inductance on waveform fidelity

NOTE. Ringing and rise time degradation can be masked if the frequency content of the signal degradation is beyond the bandwidth of your oscilloscope system.

If you know the self-inductance (L) and capacitance (C) of your probe and ground lead, use the following equation to determine the approximate resonant frequency (f_0) of a parasitic circuit:

$$f_0 = \frac{1}{2\pi\sqrt{LC}}$$

From this equation, you can see that the desired goal is to lower the probe and ground lead inductance until the frequency of any parasitic oscillation is well beyond the desired frequency of the measurement. The low-inductance ground contact can help reduce the effects of ground lead inductance.

Linear Operating Range

The internal probe amplifier has a finite operating range when terminated into a 50 Ω load. To maintain a linearity error below 4%, limit the input signal amplitude to ± 10 V. Refer to Figure 3–3 on page 3–6 for data on linear operating range.

NOTE. *The P6205 probe can sustain input voltages to ± 40 V without damage; however, the linearity error specification does not apply to input voltages exceeding ± 10 V.*

High-Amplitude Frequency Response

Input signal amplitude also affects probe frequency response. Figures 2–3 and 2–4 characterize the effects of probe frequency response in terms of rise time for step inputs and -3 dB bandwidth for sine wave inputs.

Step Inputs

Degradation of high-amplitude step inputs generally appear as slower rise times and distorted responses. Figure 2–3 shows probe linear operating range as a function of input step voltage, in terms of rise time and fall time.

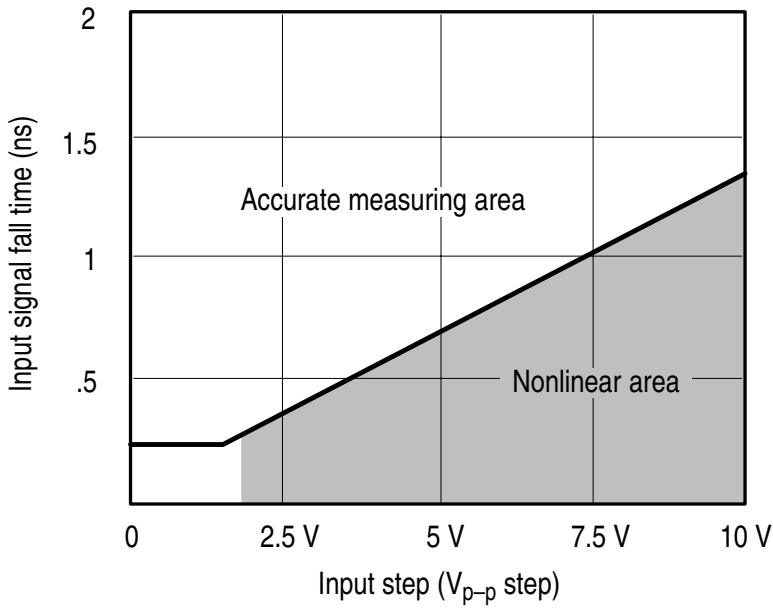
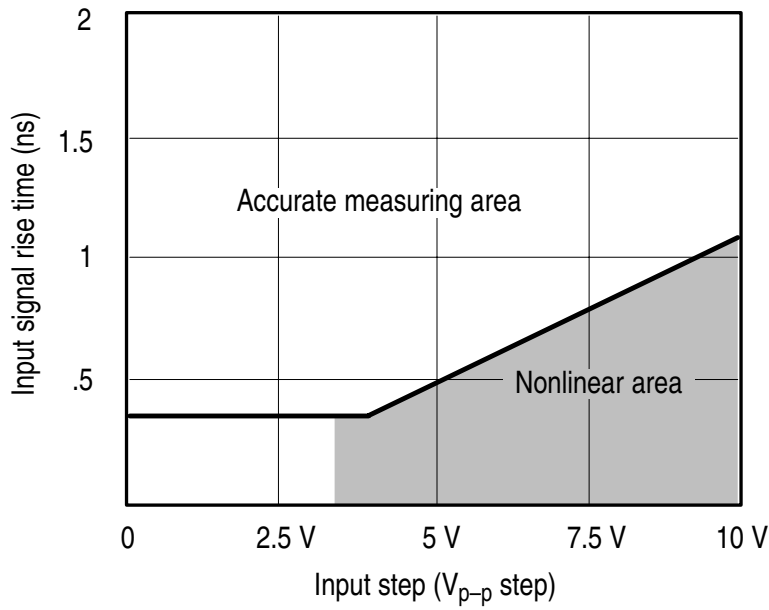

Figure 2-3: P6205 typical input vs linear operating range

Sine Wave Inputs

Degradation of high-amplitude sine wave inputs generally appear as harmonic distortion and reduced peak-to-peak amplitude. Figure 2–4 shows the –3 dB bandwidth of sine wave inputs as a function of amplitude.

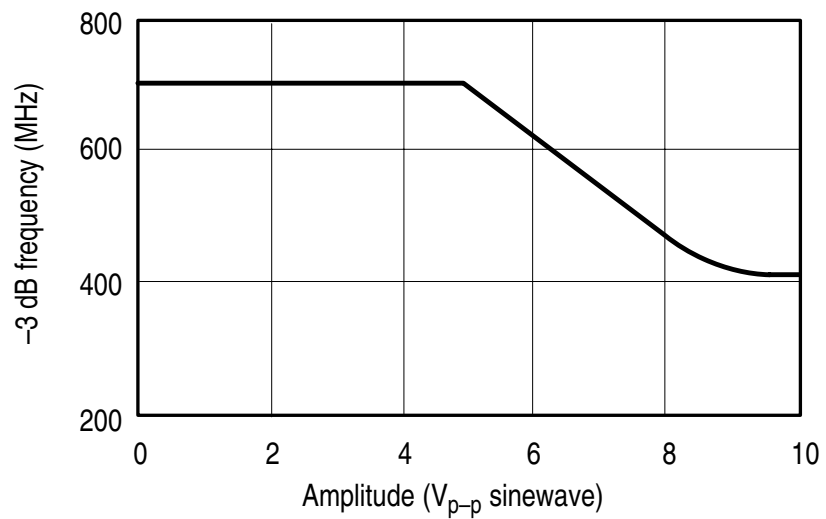

Figure 2–4: Bandwidth vs sine wave input amplitude



Specifications

Specifications

This section lists the electrical, environmental, and physical specifications of the P6205 probe. All specifications are guaranteed unless labeled “typical”. Typical specifications are provided for your convenience and are not guaranteed. Specifications marked with the ✓ symbol are verified in in the *Performance Verification* section beginning on page 4–1.

The electrical characteristics listed in Table 3–1 apply to a probe calibrated between 20° C and 30° C. The instrument system must also be calibrated and operating within the environmental conditions listed in Table 3–2 on page 3–4.

Following the specification tables you will find a series of graphs showing typical probe characteristics.

Table 3–1: Electrical characteristics

Characteristic	Description
✓ Attenuation ¹	10X ±1.8% at DC into 50 Ω ±0.5% load
Input resistance ^{2,3}	1 MΩ ±5% at DC
Input capacitance	≤2 pF
✓ Rise time ³	< 467 ps
Bandwidth ³	Derived from rise time (BW = 0.35/t _r): 750 MHz

Table 3–1: Electrical characteristics (Cont.)

Characteristic	Description
Bandwidth, typical	
<u>Mainframe:</u>	
TDS500/600	450 MHz
TDS400	325 MHz
11402A/11403A	See plug-in unit
<u>Plug-in unit:</u>	
11A32	350 MHz
11A33	125 MHz
11A34V	275 MHz
11A52	475 MHz
11A72	600 MHz
✓ Aberrations ^{3,4}	
first 20 ns	±7%, 10% peak to peak
20 ns to 2 µs	±3%, 5% peak to peak
Propagation delay	Probe tip to output connector measured at waveform 50% points: 6.72 ns ±200 ps
✓ Output offset ^{3,5}	At 25° C (77° F): less than ±10 mV ±100 mV on screen for oscilloscopes that recognize probe coding
Linearity ⁶	
Linear input range	±10 V
Linearity error	Relative to full-scale output with ±10 V input: < 4%
DC Thermal drift ^{3,7}	Less than ±100 mV/°C For scopes that recognize probe coding: ±1 mV on screen
Output load requirement	50 Ω ±0.5%
Maximum nondestructive input voltage	40 VDC + peak AC

Table 3–1: Electrical characteristics (Cont.)

Characteristic	Description
Electrostatic immunity	Sustains discharge from a 500 pF capacitor charged to 10 kV, through a 1 k Ω resistance to the probe tip or a TEKPROBE connector pin.
Power supply requirements ⁸	
+5 V supply	+5 V \pm 2%, 110 mA maximum
–5 V supply	–5 V \pm 2%, 50 mA maximum
Power consumption	Host instrument input power: 1.25 W maximum

- 1 **11000 Series mainframes: use the probe calibrate function to gain additional accuracy.**
- 2 **With probe operating.**
- 3 **Probe only.**
- 4 **When used with a system having a rise time of less than 100 ps, refer to *Aberrations* in the Performance Verification section.**
- 5 **11000 Series oscilloscopes only: less than 2 mV following oscilloscope calibration.**
- 6 **See page 2–4: *Linear Operating Range*.**
- 7 **At probe output.**
- 8 **Less accurate supply levels increase output offset error.**

Table 3–2: Environmental characteristics

Characteristic	Description
Temperature range	
Operating	0° C to +50° C (32° F to 122° F)
Nonoperating	–55° C to +75° C (–67° F to 167° F)
Humidity	Five cycles (120 hr) at 90 to 95% relative humidity
Altitude	
Operating	To 4,600 m (15,000 ft)
Transportation	Qualifies under National Safe Transit Association Preshipment Procedure 1–A–B–1

Table 3–3: Physical characteristics

Characteristic	Description
Shipping weight ¹	0.9 kg (2 lbs)
Probe cable length	1.5 m (60 in) tip to BNC

¹ Includes accessories.

Table 3–4: Certifications and compliances

Pollution degree	Degree 2
Safety class	Class 1 (ground reference)

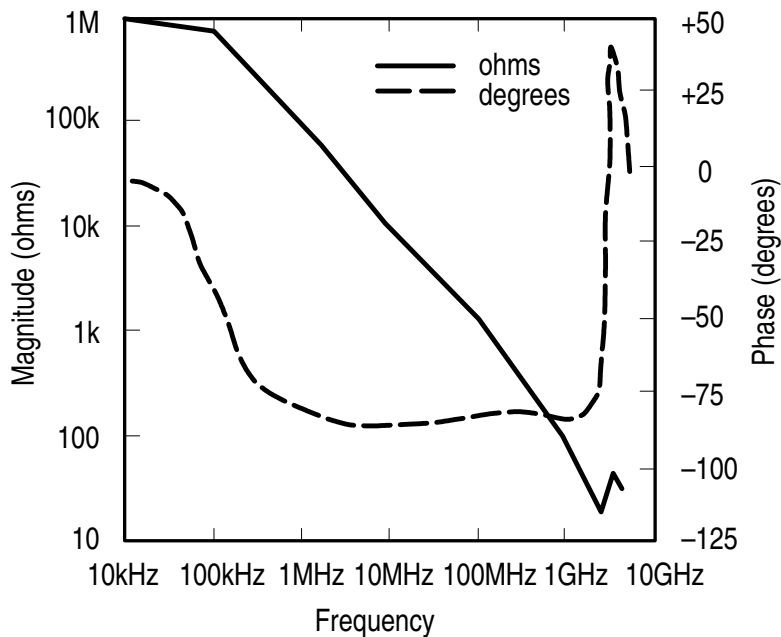

Figure 3-1: Typical input impedance vs frequency

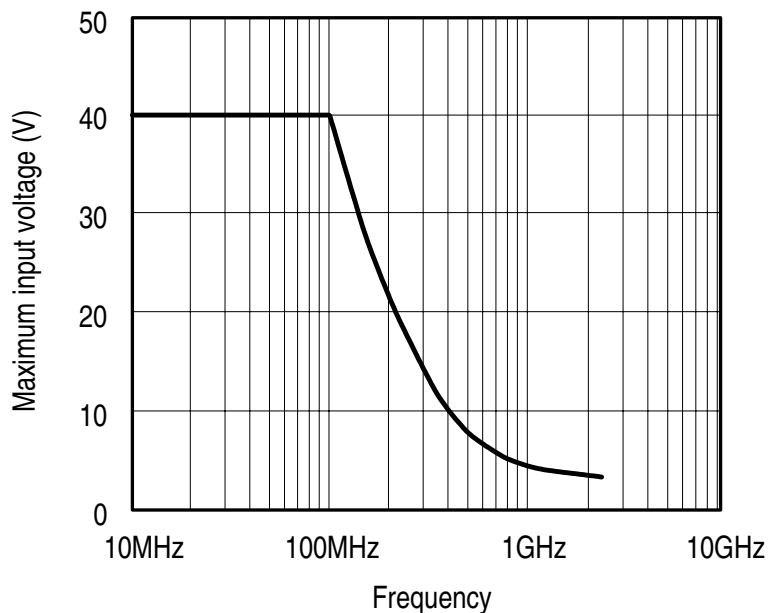

Figure 3-2: Voltage derating vs frequency

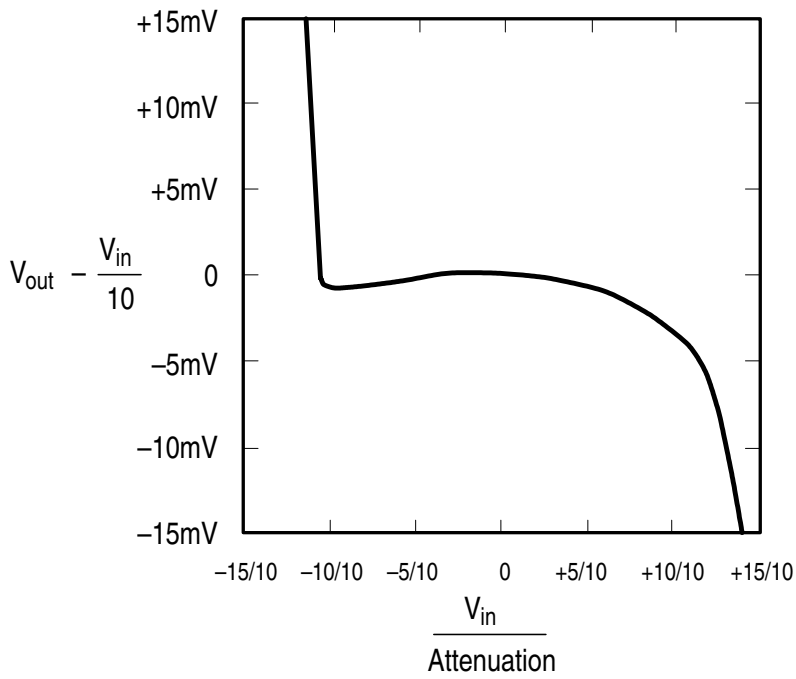

Figure 3-3: Linearity error vs output voltage

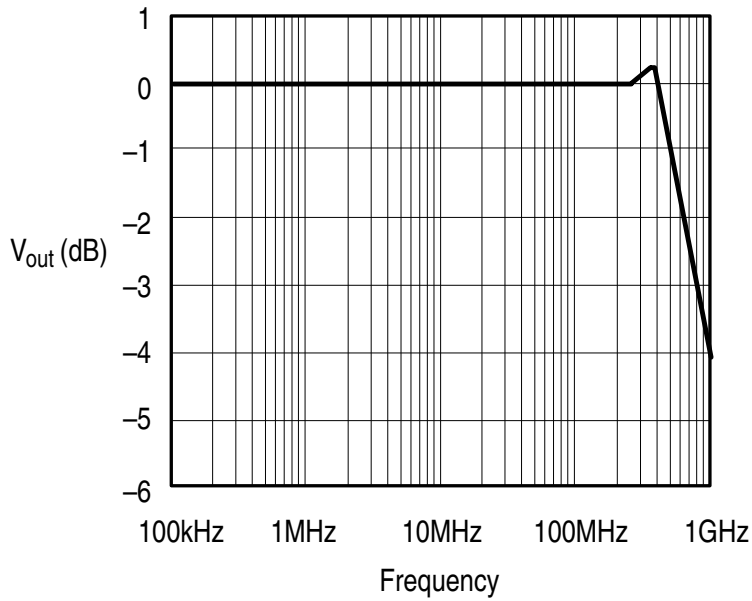

Figure 3-4: Typical frequency response



Performance Verification

Performance Verification

This section contains procedures to verify that the P6205 probe meets the performance requirements listed in the *Specifications* section. The performance verification procedures consists of the following checks:

- Attenuation
- Rise Time
- Aberrations
- Output offset

Performance characteristics not verified by the performance verification procedures are either extremely stable or impractical to verify.

Use the performance verification procedures as an acceptance criteria or to verify probe performance following repair.

Under normal operating conditions, verify the performance of your probe at least once a year.

Test Equipment

Table 4–1 lists the recommended test equipment used in the performance verification procedures. The equipment recommended is the minimum necessary to provide accurate results. Substitute equipment must meet or exceed the specifications listed.

If you are unfamiliar with the operation of the recommended test equipment, refer to the individual users manuals for instructions.

NOTE. *Before beginning any performance verification procedure, warm up all test equipment for at least 20 minutes.*

Table 4–1: Test equipment

Description	Minimum Requirement	Example Product
Oscilloscope	DC to 10 GHz, 50 Ω input	Tektronix 11801B with SD-24 TDR sampling head
Probe power supply	TEKPROBE interface connector	Tektronix 1103 TEKPROBE power supply
Calibration generator	Amplitude accuracy: $\pm 0.25\%$	Calibration signal from 11801B oscilloscope
Pulse generator	Rise time: <100 ps	Calibration signal from 11801B oscilloscope
Termination adapter	50 Ω , probe-to-GR	Tektronix part number 017-0088-00
Female BNC-to-GR adapter		Tektronix part number 017-0063-00
Male SMA-to-BNC female adapters (2)		Tektronix part number 015-0554-00
Male SMA-to-GR adapter		Tektronix part number 015-1007-00
Coaxial cable	50 Ω BNC, 10 inch length	Tektronix part number 012-0208-00

Attenuation Check

Use the following procedure to confirm that the P6205 probe performs within its Attenuation specification limits.

1. Set the oscilloscope controls as indicated in the table below.

Oscilloscope settings

Control	Setting
Volts/division	50 mV
Time/division	2 μ s

Oscilloscope settings (Cont.)

Control	Setting
Trigger source	Internal clock
Trigger mode	Auto
Coupling	DC
Waveform averaging	On
Number of waveforms to average	8
Cursor type	Horizontal bars
Cursor knob resolution	Fine

2. Install one SMA-to-BNC adapter on an SD-24 sampling head input channel and another adapter on the oscilloscope calibrator output. Use the 10-inch coaxial cable to connect the oscilloscope calibrator output to the SD-24 input channel. See Figure 4–1 below.

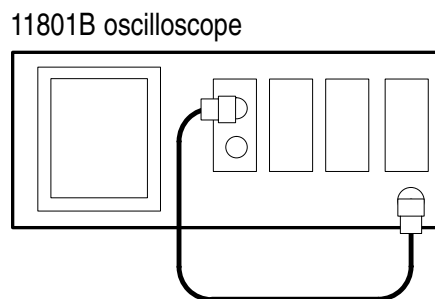

Figure 4–1: Attenuation test setup part 1

3. Press **SELECT CHANNEL** on the sampling head to enable the corresponding input channel.
4. Adjust the oscilloscope controls as necessary to display a waveform similar to the one shown in Figure 4–2 below.

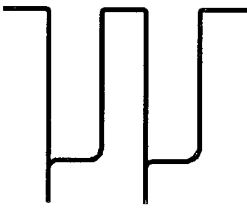

Figure 4-2: Calibrator waveform

5. Store and then recall the waveform.
6. Use the oscilloscope cursors to display the Δ voltage of the recalled waveform. Measure the low-frequency portion of the waveform near the back corner. See figure 4-3 below.

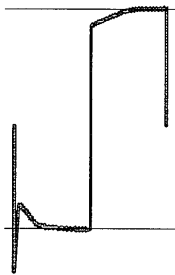

Figure 4-3: Cursors placement for Δ voltage measurement

7. Record the Δ voltage as V_1 .
8. Disconnect the coaxial cable from the oscilloscope calibrator output and reconnect it to the channel 1 output of the 1103 probe power supply. Remove the SMA-to-BNC adapter from the oscilloscope calibrator output.
9. Connect the P6205 probe output to the 1103 power supply channel 1 input. The P6205 does not use the offset capability of the 1103 power supply; the offset control setting is not important.
10. Mate the GR connector ends of the 50 Ω termination adapter and the male SMA-to-GR adapter. Connect the mated assembly to the oscilloscope calibrator output. Insert the probe tip firmly into the 50 Ω termination adapter. See Figure 4-4 below.

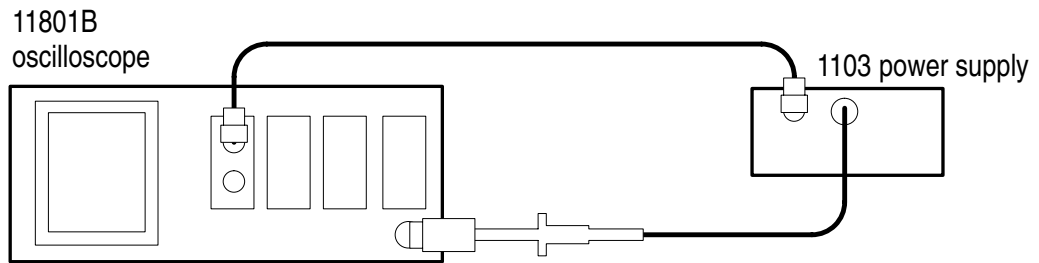

Figure 4-4: Attenuation test setup part 2

11. Adjust the oscilloscope vertical position control if necessary to center the resulting waveform. Store and then recall the waveform.
12. Use the cursor measurement capability of the oscilloscope to display the Δ voltage of the recalled waveform. Measure the low-frequency portion of the waveform near the back corner. Record the Δ voltage as V_2 .
13. Use the following equation to calculate the attenuation error:

$$\%error = \frac{V_2(10) - V_1}{V_1} \times 100$$

14. Verify that the probe attenuation error is $\leq 1.8\%$.

Rise Time Check

Use the following procedure to confirm that the P6205 probe performs within its Rise Time specification limits.

NOTE. If you do not have access to an 11800 Series oscilloscope, a method for approximating probe rise time using a pulse generator and a TDS 500 or 11000 Series oscilloscope follows this procedure.

1. Set the oscilloscope controls as indicated in the table below.

Oscilloscope settings

Control	Setting
Volts/division	5 mV
Time/division	500 ps
Trigger coupling	DC
Trigger source	Internal clock
Trigger mode	Auto
Waveform averaging	On
Number of waveforms to average	8

2. Connect one end of the 10-inch coaxial cable to the channel 1 output of the 1103 probe power supply. Use a male SMA-to-BNC female adapter to connect the free end of the cable to an SD-24 sampling head input. See Figure 4–5 below.

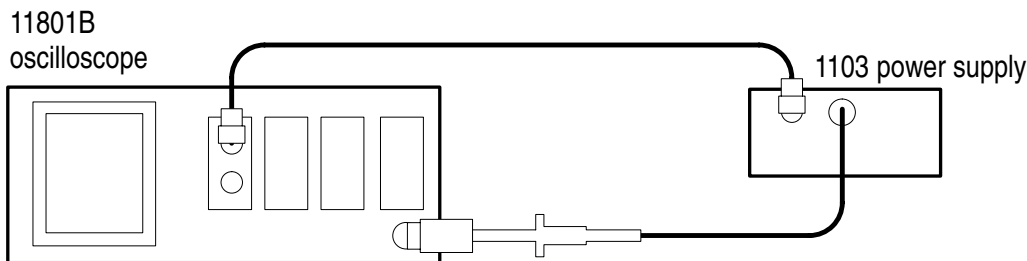

Figure 4–5: Rise time test setup

3. Press **SELECT CHANNEL** on the sampling head to enable the corresponding input channel.
4. Connect the P6205 probe to the 1103 probe power supply channel 1 input. The P6205 does not use the offset capability of

the 1103 probe power supply; the offset control setting is not important.

5. Mate the GR ends of the male SMA-to-GR and 50 Ω termination adapters. Connect the mated assembly to the oscilloscope calibrator output. Insert the P6205 probe tip firmly into the termination adapter. See Figure 4–5 above.
6. Adjust the oscilloscope horizontal and vertical position controls to display a waveform similar to the one shown in Figure 4–6 below.

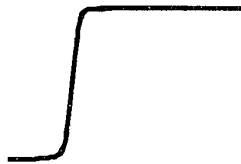

Figure 4–6: Rise time waveform

7. Use the oscilloscope measurement capability to display and measure the waveform rise time (from the 10% to 90% amplitude points).
8. Verify that the probe rise time is equal to or less than 467 ps.

Rise Time Approximation

Use the following procedure to approximate the probe rise time without an 11801B oscilloscope. The procedure requires a pulse generator capable of producing a rise time step of 250 ps or less.

1. Use a 50 Ω coaxial cable to connect the output of the pulse generator directly to the oscilloscope input.
2. Set the time base to 1 ns/division and the vertical amplifier to 50 mV/division. Adjust the pulse for a duration of greater than 10 ns with an amplitude of 250 mV.
3. Save and then recall the waveform.

4. Measure and record as system rise time (t_{r_s}), the rise time of the displayed pulse.
5. Mate the 50 Ω termination adapter to the female BNC-to-GR adapter. Disconnect the coaxial cable at the oscilloscope and attach the mated adapters to the coaxial cable. Connect the P6205 probe to the same oscilloscope input and insert the probe tip firmly into the termination adapter.
6. Save and then recall the waveform.
7. Adjust the oscilloscope controls to display this waveform at the same vertical scale as the first waveform. Measure and record as probe-plus-system rise time ($t_{r_{p+s}}$), the rise time of the displayed pulse.
8. Calculate the probe rise time (t_{r_p}) using the equation below. Accuracy of the approximation is limited by oscilloscope system performance.

$$t_{r_p} = \sqrt{t_{r_{p+s}}^2 - t_{r_s}^2}$$

The calculated probe rise time should be less than 467 ps. If the rise time value exceeds this limit, use the procedure beginning on page 4–5 to more accurately determine the probe rise time.

Bandwidth Approximation

You can calculate the approximate bandwidth from the rise time measurement with the following equation:

$$BW = \frac{.35}{t_r}$$

NOTE. *This calculation does not constitute a valid performance verification criteria.*

Aberrations Check

Use the following procedure to confirm that the P6205 probe performs within its Aberrations specifications limits.

1. Set the oscilloscope controls as indicated in the table below.

Oscilloscope settings

Control	Setting
Volts/division	50 mV
Time/division	500 ps
Trigger coupling	DC
Trigger source	Internal clock
Trigger mode	Auto
Waveform averaging	On
Number of waveforms to average	8

2. Install one SMA-to-BNC adapter on an SD-24 sampling head input channel and another adapter on the oscilloscope calibrator output. Use the 10-inch coaxial cable to connect the oscilloscope calibrator output to the SD-24 input channel. See Figure 4–7 below.

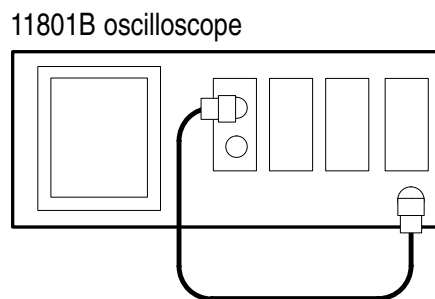

Figure 4–7: Aberrations test setup part 1

3. Press **SELECT CHANNEL** on the sampling head to enable the corresponding input channel.
4. Adjust the oscilloscope controls as necessary to display a waveform similar to the one shown in Figure 4–8 below.

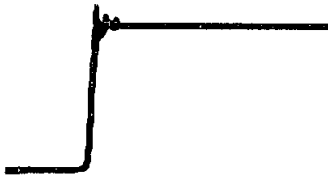

Figure 4–8: Aberrations waveform

5. Use the oscilloscope rise time filter capability to limit the waveform rise time to 100 ps. Use the waveform Vertical Description menu to set the vertical description as follows:

Filter(M1,100E-12)

NOTE. *The filter description above applies to an SD-24 sampling head installed in the 11801B mainframe M1 plug-in compartment; if your sampling head is installed in a different compartment, select the corresponding mainframe designator.*

6. Use the oscilloscope measurement capability to determine the peak-to-peak amplitude of the filtered pulse. Measure, calculate, and record (in percent) the system aberrations (abs_s) in the first 4 ns of the waveform.

NOTE. *Part one of the aberrations specification applies to the first 20 ns of the waveform. Significant aberrations are usually completely damped beyond approximately 4 ns.*

Measure the peak negative-going aberration (if any) and the peak positive-going aberration (if any). The sum of the two is the peak-to-peak aberration, in percent.

NOTE. *If the waveform front corner appears rounded or rolled-off, set the left-limit measurement cursor at the first 100% amplitude point of the waveform to determine aberrations. Refer to Figure 4–9.*

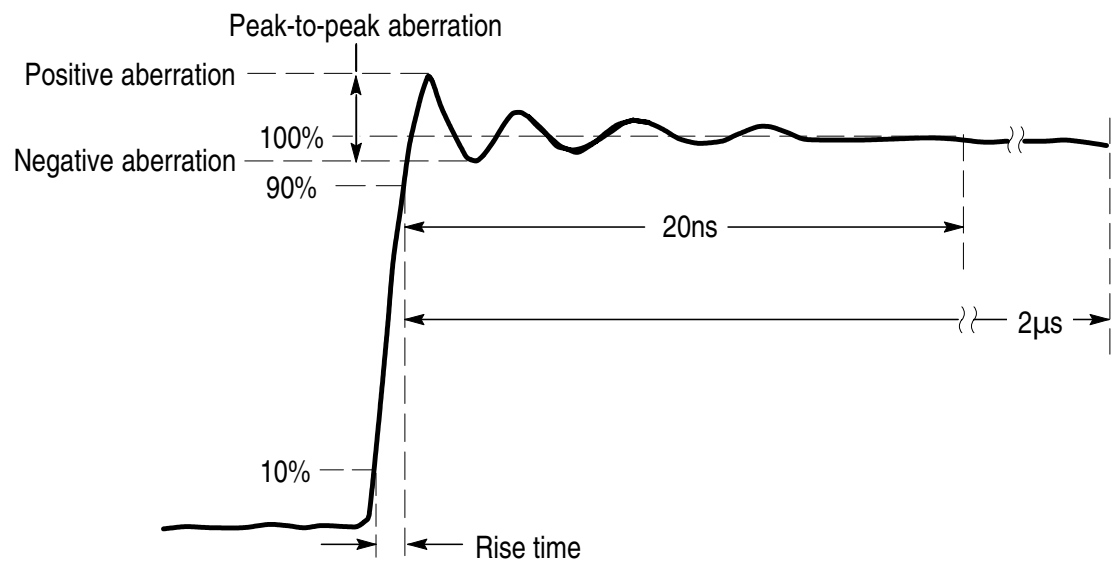

Figure 4–9: Measuring aberrations

7. Disconnect the coaxial cable from the oscilloscope calibrator output and reconnect it to the channel 1 output of the 1103 probe power supply. Remove the SMA-to-BNC adapter from the oscilloscope calibrator output. See Figure 4–10 below.
8. Connect the P6205 probe output to the 1103 power supply channel 1 input. The P6205 does not use the offset capability of the 1103 probe power supply; the offset control setting is not important.

9. Mate the GR connector ends of the 50 Ω termination adapter and the male SMA-to-GR adapter. Connect the mated assembly to the oscilloscope calibrator output. Insert the probe tip firmly into the 50 Ω termination adapter.

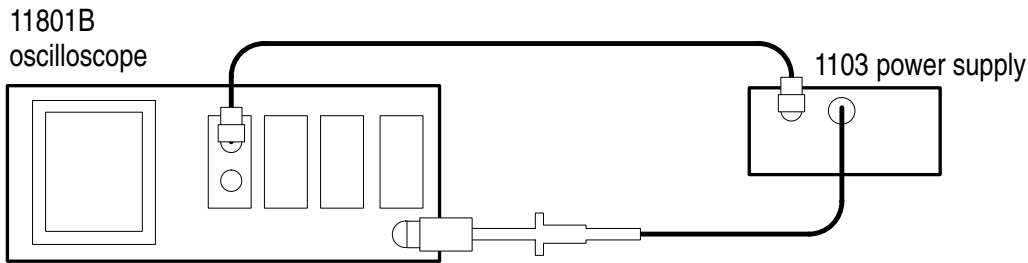

Figure 4–10: Aberrations test setup part 2

10. Press **SELECT CHANNEL** on the sampling head to enable the corresponding input channel.
11. Set the oscilloscope volts/division to 5 mV.
12. Adjust the oscilloscope horizontal and vertical position controls to display a waveform similar to the one shown in Figure 4–8 above.
13. Ensure that Waveform Averaging is enabled. Ensure that the vertical description rise time filter is enabled. If not, repeat Step 5 above.
14. Use the oscilloscope measurement capability to determine the peak-to-peak amplitude of the pulse. Measure, calculate, and record (in percent) the probe-plus-system aberrations (abs_{p+s}) in the first 4 ns of the waveform. Measure the peak negative-going aberration (if any) and the peak positive-going aberration (if any). The sum of the two is the peak-to-peak aberration in percent.

NOTE. *If the waveform front corner appears rounded or rolled-off, set the left-limit measurement cursor at the first 100% amplitude point of the waveform. Refer to Figure 4–9 above.*

- 15.** The probe aberrations are approximately the difference between the measured probe aberrations and the oscilloscope system aberrations. Subtract the system aberrations (Step 6) from the measured aberrations (Step 14) for both the peak and the peak-to-peak aberrations.

$$abs_p = abs_{p+s} - abs_s$$

NOTE. *In some cases the measured aberrations are less than the system aberrations. This situation occurs when the slower rise time of the probe (compared to the oscilloscope/sampling head combination) filters out a portion of the higher-frequency aberrations.*

- 16.** Verify that the probe-only aberrations meet specifications:

peak, first 20 ns	±7%
peak to peak, first 20 ns	10%

- 17.** Repeat steps 1 through 15 above using an oscilloscope sweep speed of 500 ns per division. Adjust the oscilloscope as necessary to display one pulse step and at least 2 μs of settling time.

Optional: Increasing the number of waveforms averaged will reduce the effects of noise on the smaller aberrations in the latter part of the signal.

- 18.** Verify that the probe-only aberrations meet specifications:

peak, 20 ns to 2 μs	±3%
peak to peak, 20 ns to 2 μs	5%

Output Offset Check

Use the following procedure to confirm that the P6205 probe performs within its Output Offset specification limits.

1. Set the oscilloscope controls as indicated in the table below.

Oscilloscope settings

Control	Setting
Volts/division	2 mV
Trigger coupling	DC
Time/division	1 ps
Trigger mode	Auto
Enhanced accuracy	On

2. Install an SMA-to-BNC adapter on one of the SD-24 sampling head inputs. Use a 10-inch coaxial cable to connect the output of the 1103 probe power supply to an SD-24 input channel.
3. Press **SELECT CHANNEL** on the sampling head to enable the corresponding input channel.
4. Adjust the oscilloscope offset or position control to center the trace at 0 V (or less than 1 mV).

Optional method: Use the oscilloscope measurement capability to display the mean voltage of the free-running trace.

5. Insert the P6205 probe tip firmly into the 50 Ω termination adapter. (The BNC end remains unused.)
6. Connect the probe output to the 1103 probe power supply input.
7. Verify that the probe output offset (displacement of the free-running trace) is less than ± 10 mV.



Maintenance

Maintenance

The Maintenance section provides information on the following topics:

- Inspecting and cleaning the probe
- Replacing the probe tip
- Replacing TEKPROBE contact pins
- Replacing internal modules
- Packaging the probe for shipment

Preventive Maintenance

Preventive maintenance consists of visually inspecting and cleaning the probe. Perform preventive maintenance on a regular basis to prevent breakdown and improve reliability. The frequency of maintenance depends on the environmental operating conditions. A good time to perform maintenance is just before a performance verification or calibration.



WARNING. *To prevent electric shock, disconnect the probe from the signal source and oscilloscope or power supply before performing preventive maintenance.*

Visual Inspection

The best indicator of probe condition is performance. In addition to performing the performance verification procedures, occasionally inspect the probe tip, body, cable, compensation box, and BNC connector for bent, broken, or damaged parts. To ensure optimum performance, replace damaged assemblies as soon as practical.

Cleaning

Remove accumulated loose dust from the probe exterior with a soft cloth or small brush. Remaining dirt may be removed with a soft cloth dampened with a mild detergent and water solution. Do not immerse the probe or use abrasive cleaners.

With normal use the interior of the probe compensation box does not require cleaning. If you wish to clean the probe interior while replacing internal assemblies, use dry low-velocity air (approximately 9 lbs/in²) to blow away accumulated dust. Remove any remaining dirt with a soft cloth or small brush or a soft cloth dampened with a nonresidue cleaner, such as isopropyl alcohol (IPA). Use a cotton-tipped swab to clean the circuit board or in narrow spaces.



CAUTION. *To prevent damage to probe materials, avoid using chemicals that contain benzene, toluene, xylene, acetone, or similar solvents.*

Corrective Maintenance

Corrective maintenance consists of replacing defective parts or assemblies. To determine which parts are replaceable, refer to the *Replaceable Parts* section beginning on page 6–1.

To guarantee probe performance, do not attempt to replace the individual components of replaceable assemblies.



WARNING. *To prevent electric shock, disconnect the probe from the signal source and oscilloscope or power supply before performing preventive maintenance.*

Static Sensitive Devices

The P6205 probe contains devices that are susceptible to damage from static discharge. To prevent damage to static-sensitive devices, observe the following precautions whenever the compensation box covers are removed or you are handling component assemblies:

- Minimize the handling of all components; handle components only at a grounded static-free workstation.
- Service component assemblies on metal or other conductive surfaces. Do not slide assemblies across any surface.
- Wear a grounding strap when handling component assemblies to discharge static voltage from your body.
- Avoid materials that are capable of generating a static charge.

Replacing the Probe Tip

To replace the probe tip, use a pair of needle-nosed pliers to carefully unscrew the old tip and install the new tip. Use care to avoid stripping the plastic threads in the tip insulator and to avoid damaging the new tip during installation. Following removal, probe tips should be discarded in the appropriate receptacle. Tektronix recommends that you do not reuse probe tips.

Replacing the TEKPROBE Contact Pins

To replace a TEKPROBE interface contact pin, use a pair of needle-nosed pliers to pull the pin straight out of the BNC assembly. To install a new pin, hold the pin carefully with the needle-nosed pliers while pushing it into the BNC assembly. Use care to avoid crushing or bending the hollow pin. Verify that the installed pin is seated to the same depth as the other pins.

Replacing Internal Assemblies: Probe Head and Cable, BNC and Circuit Board Carrier

The steps required to replace the probe head and cable or BNC and circuit board carrier assemblies are identical.

Probe Disassembly. Refer to Figure 5–1 and use the following procedure to disassemble the P6205 probe.

1. Use a small, flat screwdriver (or the optional compensation box release tool) to pry the compensation box cover slots off the tabs that secure it to the compensation box base.

NOTE. *To prevent destructive cable flex, hold the cable boot and BNC connector securely in the bottom cover as you separate the compensation box halves to remove the top cover.*

2. When all four tabs are released, carefully pry open and remove the top cover.
3. Taking care to minimize cable flex, lift the cable boot and BNC connector from the cradle of the bottom cover.

NOTE. *For subsequent reassembly in the procedures to follow, note the orientation of the BNC locking ring tab with respect to the bottom cover (there is also a small notch in the circuit board carrier with a corresponding tab in the compensation box slot).*

4. Locate and desolder at the circuit board, the red and black wires from the cable assembly. Locate and desolder at the circuit board, the uninsulated ground wire emerging from the cable assembly. Note the position of all wires for reassembly in the procedure to follow.
5. Grasp the probe cable close to the BNC end and withdraw the cable from its connector in the center of the circuit board. Take care to pull the cable straight out.

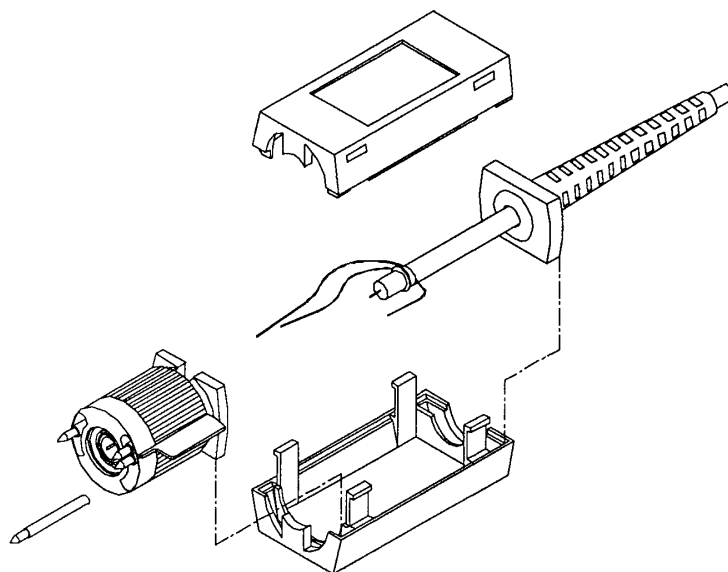

Figure 5–1: Disassembling the P6205 probe

Probe Resassembly. Refer to Figure 5–1 and use the following procedure to reassemble the P6205 probe.

1. Verify that the center conductor of the probe cable is straight and centered in its connector; the center conductor must align with a receptacle seated deeply within the BNC and circuit board carrier assembly.
2. Insert the probe cable into the receptacle in the center of the BNC and circuit board carrier until it is fully seated. After inserting the cable, handle the assembly carefully to minimize strain on the BNC and cable assembly.
3. Taking care to minimize cable flex, insert the cable boot and circuit board carrier into their respective slots in the compensation box bottom cover.
4. Resolder the red and black wires to their respective connections on the circuit board. Resolder the uninsulated ground wire to its connection on the circuit board.
5. Position the red and black wires so they will not be pinched when you attach the compensation box top cover.

6. Align the tabs of the top cover with the slots of the bottom cover and circuit board carrier. Press the cover into place and verify that the bottom cover tabs snapped into the top cover slots.

Readjustment Following Repair

Following probe repair or parts replacement, complete the performance verification procedures to ensure the probe is operating within specifications. The performance verification procedure begins on page 4-1.

Repackaging for Shipment

If you must ship your probe for repair, use the original packaging container if possible. If the container is unfit for use or not available, repackage the probe as follows:

1. Use a carton with a test strength of no less than 175 pounds.
2. Surround the probe with protective polyethylene sheeting.
3. Cushion the probe on all sides with at least two inches of tightly packed urethane foam or other packing material.
4. Seal the carton with shipping tape or an industrial stapler.



Replaceable Parts

Replaceable Parts

This section contains a list of the replaceable modules for the P6205 probe. Use this list to identify and order replacement parts.

Parts Ordering Information

Replacement parts are available through your local Tektronix field office or representative.

Changes to Tektronix products are sometimes made to accommodate improved components as they become available and to give you the benefit of the latest improvements. Therefore, when ordering parts, it is important to include the following information in your order:

- Part number
- Instrument type or model number
- Instrument serial number
- Instrument modification number, if applicable

If you order a part that has been replaced with a different or improved part, your local Tektronix field office or representative will contact you concerning any change in part number.

Change information, if any, is located at the rear of this manual.

Module Servicing

Modules can be serviced by selecting one of the following three options. Contact your local Tektronix service center or representative for repair assistance.

Module Exchange. In some cases you may exchange your module for a remanufactured module. These modules cost significantly less than new modules and meet the same factory specifications. For more information about the module exchange program, call 1-800-TEK-WIDE, extension 6630.

Module Repair and Return. You may ship your module to us for repair, after which we will return it to you.

New Modules. You may purchase replacement modules in the same way as other replacement parts.

Using the Replaceable Parts List

This section contains a list of the mechanical and or electrical components that are replaceable for the P6205 probe. Use this list to identify and order replacement parts. The following table describes each column in the parts list.

Parts list column descriptions

Column	Column name	Description
1	Figure & index number	Items in this section are referenced by figure and index numbers to the exploded view illustrations that follow.
2	Tektronix part number	Use this part number when ordering replacement parts from Tektronix.
3 and 4	Serial number	Column three indicates the serial number at which the part was first effective. Column four indicates the serial number at which the part was discontinued. No entry indicates the part is good for all serial numbers.
5	Qty	This indicates the quantity of parts used.
6	Name & description	An item name is separated from the description by a colon (:). Because of space limitations, an item name may sometimes appear as incomplete. Use the U.S. Federal Catalog handbook H6-1 for further item name identification.
7	Mfr. code	This indicates the code of the actual manufacturer of the part.
8	Mfr. part number	This indicates the actual manufacturer's or vendor's part number.

Abbreviations

Abbreviations conform to American National Standard ANSI Y1.1–1972.

Mfr. Code to Manufacturer Cross Index

The table titled Manufacturers Cross Index shows codes, names, and addresses of manufacturers or vendors of components listed in the parts list.

Manufacturers cross index

Mfr. code	Manufacturer	Address	City, state, zip code
18359	PYLON CO. INC.	51 NEWCOMB ST	ATTLEBORO, MA 02703-1403
24931	BERG ELECTRONICS INC	BERG ELECTRONICS RF/COAXIAL DIV 2100 EARLYWOOD DR PO BOX 547	FRANKLIN, IN 46131
80009	TEKTRONIX INC	14150 SW KARL BRAUN DR PO BOX 500	BEAVERTON, OR 97077-0001
8X345	NORTHWEST SPRING MFG CO	5858 WILLOW LANE	LAKE OSWEGO, OR 97035
TK2548	XEROX CORPORATION	14181 SW MILLIKAN WAY	BEAVERTON, OR 97005
TK2565	VISION PLASTICS INC	26000 SW PARKWAY CENTER DRIVE	WILSONVILLE, OR 97070

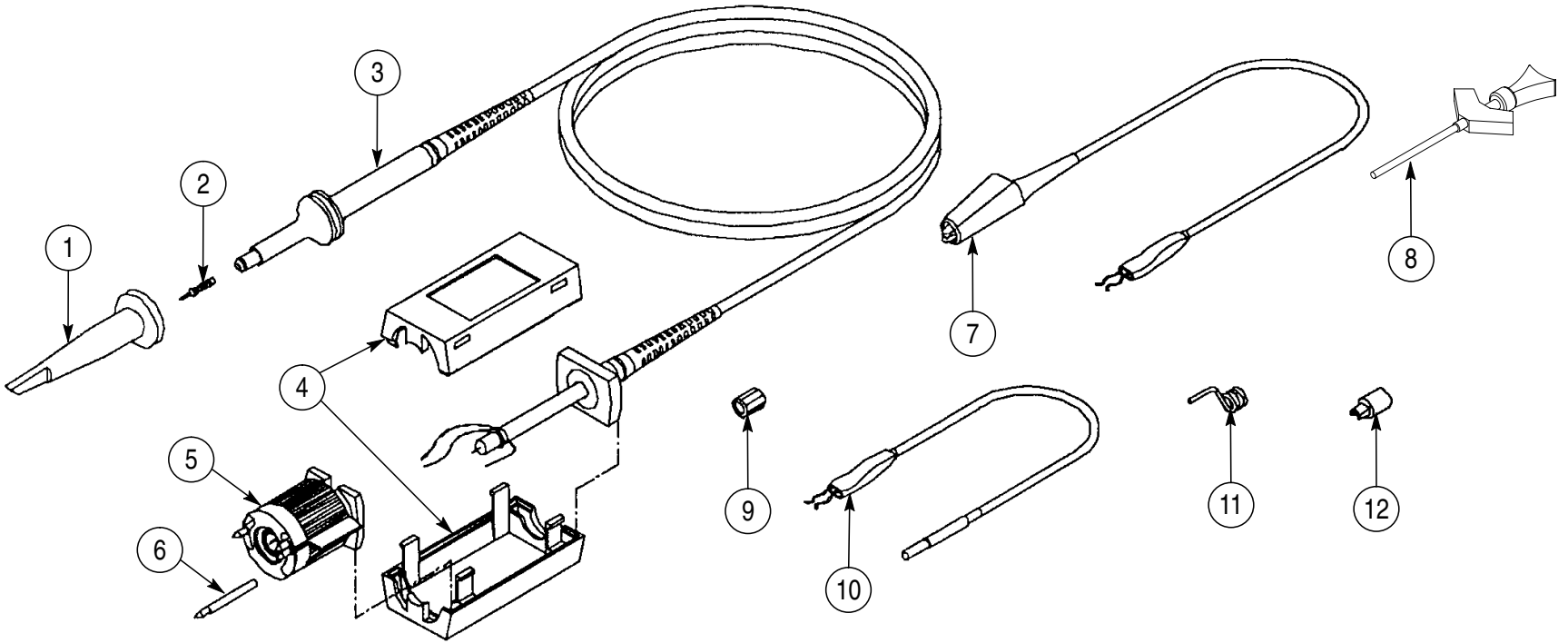

Figure 6-1: P6205 probe with standard accessories

Replaceable parts: P6205 probe and standard accessories

Fig. & index number	Tektronix part number	Serial no. effective	Serial no. discontinued	Qty	Name & description	Mfr. code	Mfr. part number
6-1 -1	013-0107-06			1	TIP,PROBE:MINIATURE/COMPACT SIZE,RETRACTABLE HOOK ASSY	80009	013-0107-06
-2	131-4280-00			1	CONTACT,ELEC:PROBE TIP	80009	131-4280-00
-3	206-0438-00			1	PROBE HEAD ASSY:W/CABLE ASSY,1.5M,P6205	80009	206-0438-00
-4	200-3760-00			1	COVER,COMP BOX:TOP AND BOTTOM,W/LABEL & RELEASE TOOL	80009	200-3760-00
-5	131-5352-00			1	CONNECTOR ASSY:W/CKT BD ASSY,4 PINS & COVER	80009	131-5352-00
-6	131-3627-01			1	CONTACT,ELEC:GOLD PLATED TIP	18359	P-6158-1
					STANDARD ACCESSORIES		
	020-1629-01			1	ACCESSORY KIT:P6203/P6204/P6205/P6206	80009	020-1629-00
-7	196-3120-00			1	LEAD,ELECTRICAL:23 AWG,6.0 L,GROUND	80009	196-3120-00
-8	206-0364-00			1	TIP,PROBE:MICROCKT TEST,0.05 CTR	80009	206-0364-00
-9	166-0404-01			1	COVER,GROUND	80009	66-0404-01
-10	196-3198-00			1	LEAD,ELECTRICAL:26 AWG,6.0 L	80009	196-3198-00
-11	214-4125-00			1	CONTACT,ELEC:TIP,GROUND	80009	214-4125-00
-12	-----			1	TIP,PROBE:IC TEST (SEE FIGURE 6-2)		
	070-8202-01			1	MANUAL,TECH:P6205	80009	070-8202-01

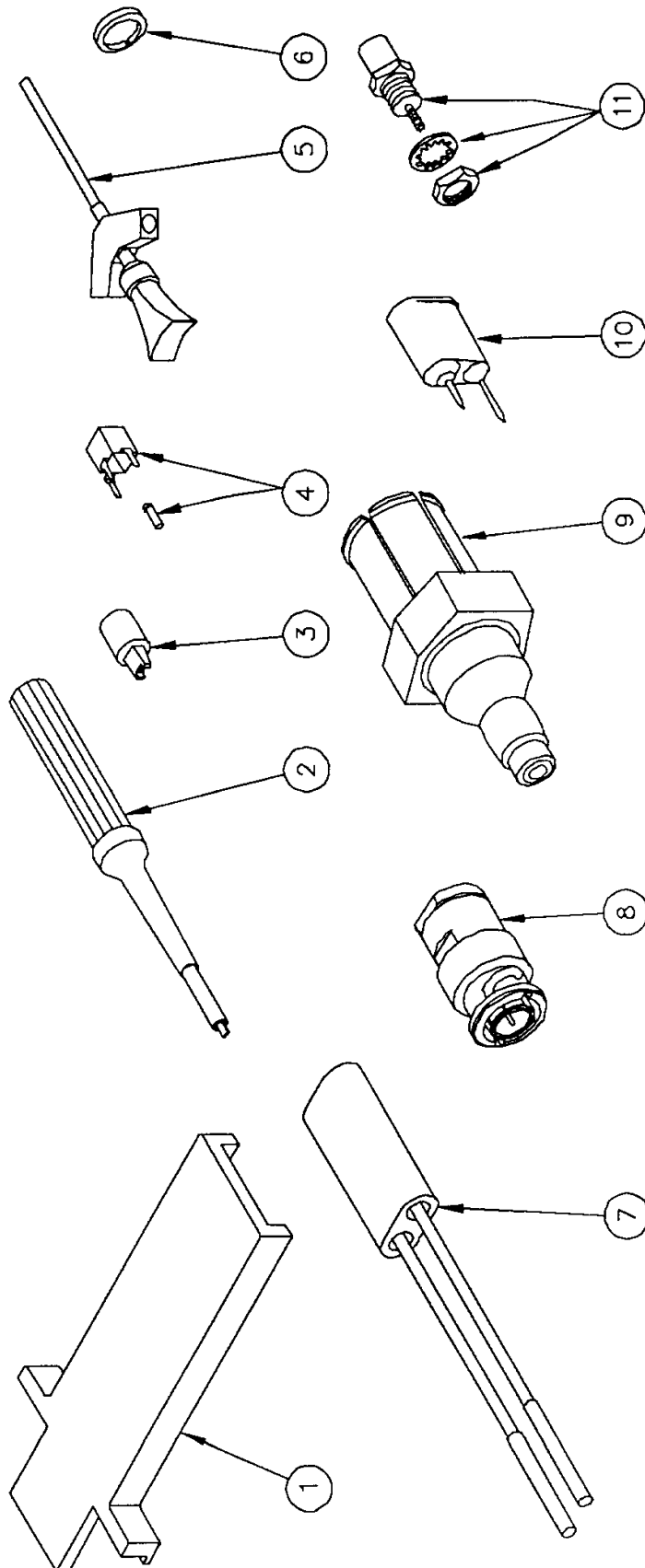

Figure 6-2: P6205 probe optional accessories

Replaceable parts: P6205 probe optional accessories

Fig. & index number	Tektronix part number	Serial no. effective	Serial no. discount'd	Qty	Name & description	Mfr. code	Mfr. part number
OPTIONAL ACCESSORIES							
6-2 -1	003-1383-00			1	RLSE TOOL,COVER:COMP BOX,POLYCARBONATE	TK2565	003-1383-00
-2	003-1433-00			1	SCREWDRIVER:ADJUSTMENT TOOL,METAL TIP	TK2565	003-1433-00
	003-1433-01			1	SCREWDRIVER:ADJUSTMENT TOOL,PKG OF 5	80009	003-1433-01
-3	015-0201-07			1	TIP,PROBE:IC TEST,PKG OF 10	80009	015-0201-07
	015-0201-08			1	TIP,PROBE:IC TEST,PKG OF 100	80009	015-0201-08
-4	031-4353-00			1	CONNECTOR,PROBE:PACK OF 25	80009	031-4353-00
-5	-----			1	SMG50,SMT KLIPCHIP:20 ADAPTERS		
	200-3760-00			1	COVER,COMP BOX:TOP AND BOTTOM,W/LABEL & RELEASE TOOL	80009	200-3760-00
-6	016-0633-00			1	MARKER SET,CA:2 EA VARIOUS COLORS	80009	016-0633-00
-7	015-0325-00			1	ADAPTER,PROBE:PROBE TO CONNECTOR PINS	TK2565	015-0325-00
-8	013-0084-01			1	ADAPTER,CONN:BNC TO PROBE	24931	28P156-1
-9	017-0088-00			1	CONN,PLUG,ELEC:50 OHM,GR	80009	017-0088-00
-10	013-0085-00			1	TIP,PROBE:GROUNDING	80009	013-0085-00
-11	131-0258-00			1	CONN,RCPT,ELEC:MINIATURE TIP SIZE,TEST JACK	24931	33JR115-2

