



**PLEASE CHECK FOR CHANGE INFORMATION
AT THE REAR OF THIS MANUAL.**

A large, grey, textured rectangular box is centered on the page. Inside this box, the product name "P6201 PROBE" is written in a bold, black, sans-serif font.

P6201 PROBE

INSTRUCTION MANUAL

Tektronix, Inc.
P.O. Box 500
Beaverton, Oregon

97077

Serial Number _____

Copyright © 1972 Tektronix, Inc. All rights reserved.
Contents of this publication may not be reproduced in
any form without the written permission of Tektronix, Inc.

Products of Tektronix, Inc. and its subsidiaries are
covered by U.S. and foreign patents and/or pending
patents.

TEKTRONIX, TEK, SCOPE-MOBILE, and  are
registered trademarks of Tektronix, Inc. TELEQUIP-
MENT is a registered trademark of Tektronix U.K.
Limited.

Printed in U.S.A. Specification and price change
privileges are reserved.

Characteristics—P6201 Probe

ELECTRICAL CHARACTERISTICS (cont)

Power Requirements +15 V at $\cong 105$ mA and -15 V at $\cong 110$ mA. Total power, 3.2 W.

PHYSICAL CHARACTERISTICS

Probe Cable Length 72.0 inches, 182.88 cm (nominal).

Probe Power Cable Length 51.0 inches, 129.54 cm (nominal) including Lemo Connector.

Amplifier Box Dimensions Length (including connector and knob) 4.485 inches (11.39 cm) maximum.

Width, $\cong 1.180$ inches (3.0 cm).

Height, $\cong 1.62$ inches (4.11 cm).

Probe Body Dimensions Diameter, 0.58 inch (1.47 cm) maximum outside diameter.

Length, 3.430 inches (8.71 cm).

PHYSICAL CHARACTERISTICS (cont)

Length with attenuator head, 4.780 inches (12.14 cm).

Attenuator Head Dimensions Diameter, 0.690 inch (1.75 cm) maximum outside diameter.

Length, 2.27 inches (5.77 cm).

Weight (Includes Standard Accessories) 24.5 ounces (694.58 grams).

ENVIRONMENTAL CHARACTERISTICS

The probe will operate within specifications over the following ranges; Temperature, 0°C to +50°C. Altitude, to 15,000 feet.

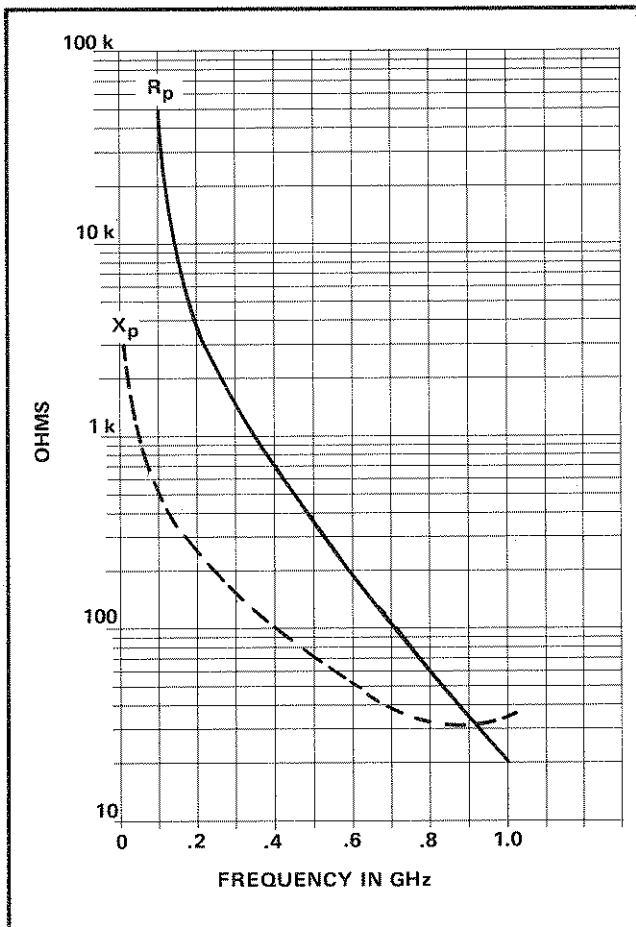

Fig. 1-2. P6201 Probe alone. Input X_p and R_p as a function of frequency.

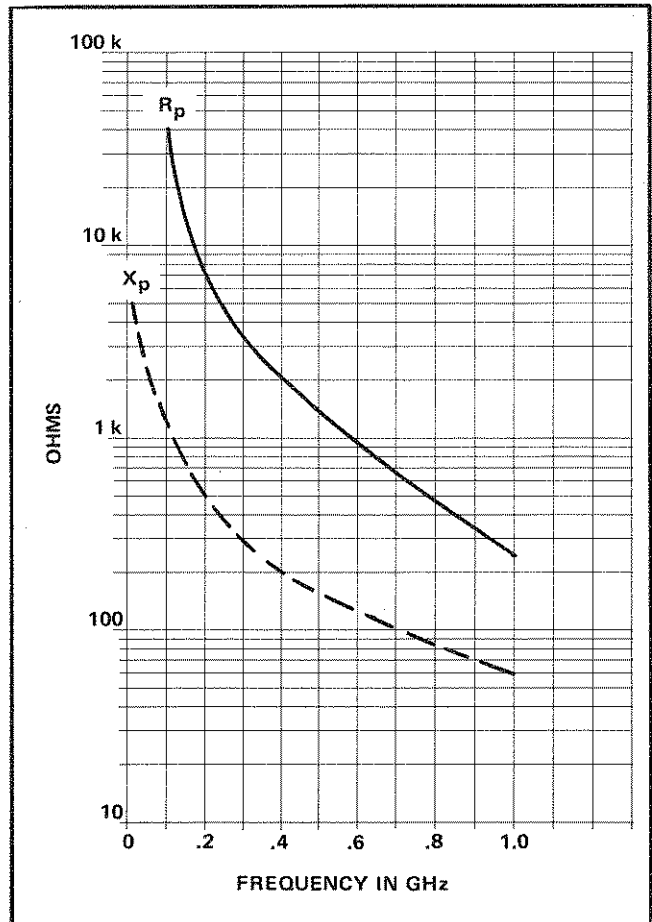

Fig. 1-3. P6201 Probe with 10X or 100X attenuator. Input X_p and R_p as a function of frequency.

CHARACTERISTICS

The P6201 is an active (FET) probe providing unity gain and DC to 900 MHz bandwidth. The low input-capacitance of the probe permits coupling of high-frequency signals to an oscilloscope input with minimum loading on the circuit under test. Plug-on attenuator heads provide higher input resistance, reduced input capacitance, and attenuation of the signal. Effective DC offset range is also increased when using an attenuator head.

The P6201 is designed primarily for use with TEKTRONIX 7000-Series, 475, or 485 Oscilloscopes, but may be used with 50-ohm sampling instruments and conventional oscilloscopes (with 1 M Ω input resistance). The internal 50-ohm termination may be switched in or out to adapt the probe output to either 1-megohm or 50-ohm inputs.

The probe includes a locking-type BNC connector which provides scale-factor readout information to instruments having the readout capability. The 10X and 100X attenuator heads also couple readout information to the instrument via the output connector.

The P6201 may be powered from the probe power output of the 7500, 7700, and 7900-Series Mainframes, the 475 and 485 Oscilloscopes, or by the 1101 Accessory Power Supply.

ELECTRICAL CHARACTERISTICS

Bandwidth	DC to 900 MHz.
Risetime	
Probe Only	0.39 ns or less
	<i>1 GHz AMP = 668 MHz</i>
Probe Attenuation	1X within 3%.
	10X within 4% (with attenuator).
	100X within 4% (with attenuator).
Input Impedance	
Probe Only	100 k Ω (within 1%) shunted by 3.0 pF (within 10%). See R _p , C _p Curves.

Attenuator Heads	1 M Ω (within 1%) shunted by \approx 1.5 pF. See R _p , C _p Curves.
Input Dynamic Range	
1X	\pm 0.6 V (1.2 V peak-to-peak) maximum with \pm 5.6 V DC offset.
10X	\pm 6 V (12 V peak-to-peak) maximum with \pm 56 V DC offset.
100X	\pm 60 V (120 V peak-to-peak) maximum with \pm 200 V DC offset. Not to exceed \pm 200 V (DC + peak AC).
Noise (Tangential)	300 μ V or less at output (150 μ V RMS).
DC Stability (Drift with Temperature Change)	
Probe Only	Less than 50 μ V/ $^{\circ}$ C at output.
Probe and Amplifier	Less than 300 μ V/ $^{\circ}$ C at output.
Output Impedance (50 Ω TERM Switch Set to INT)	25 Ω (for use with 1 M Ω inputs).
Output Load Required (50 Ω TERM Switch Set to EXT)	50 Ω within 1 Ω .
Signal Delay (Probe Tip to Amplifier Output)	\approx 11.2 ns, Differential delay between two probes 0.1 ns or less.
Maximum Input Voltage (AC or DC Coupled)	
1X	\pm 100 V, derated with frequency. See voltage versus frequency curve.
10X and 100X	\pm 200 V (DC + peak AC), derated with frequency.
LF Response (-3 db), AC Coupled	10 Hz or lower. 10X attenuator extends LF response to \leq 1 Hz. With 100X attenuator, LF response is \leq 10 Hz.

P6201 Probe

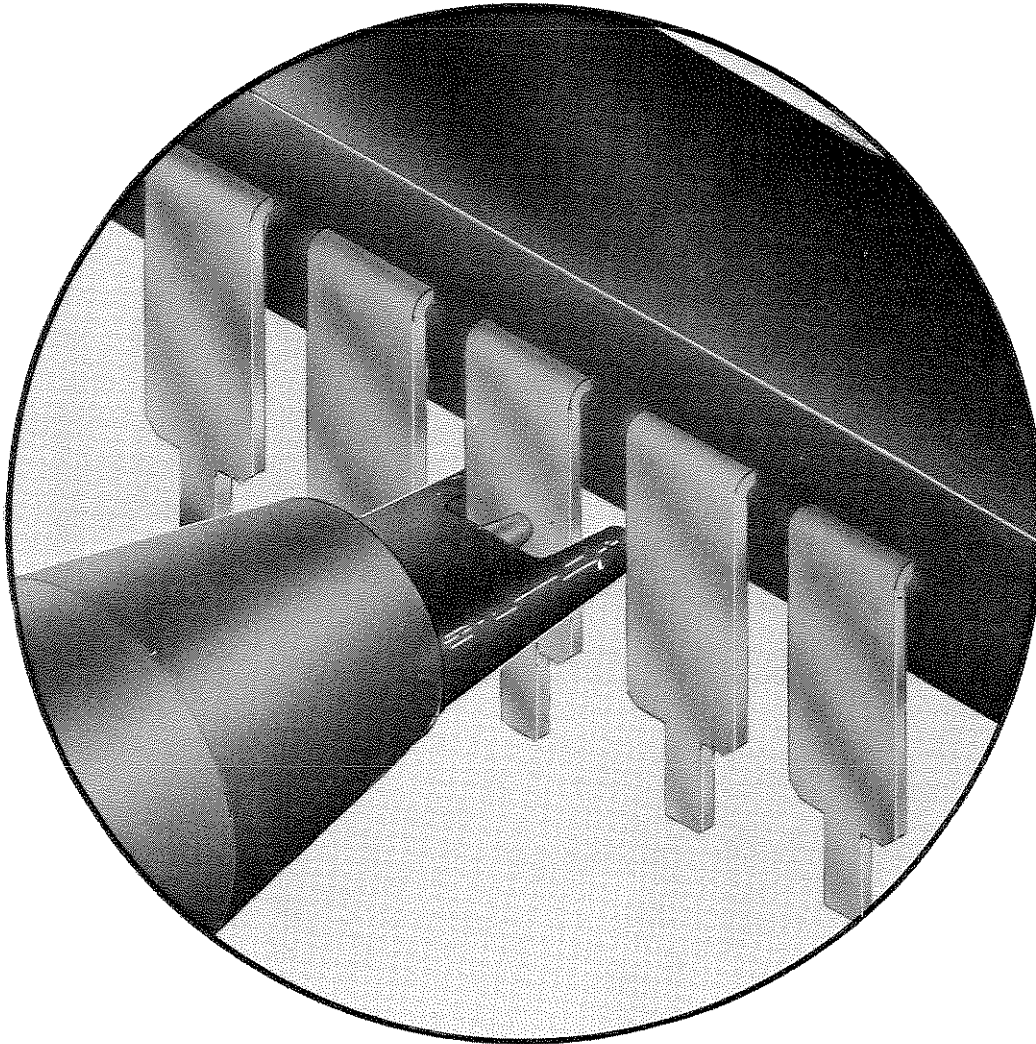

The probe tip (item 56 of the Mechanical Parts List) serves the function of protecting the metal probe tip from damage and as an aid in checking integrated circuits (as illustrated) or other circuitry in close quarters.

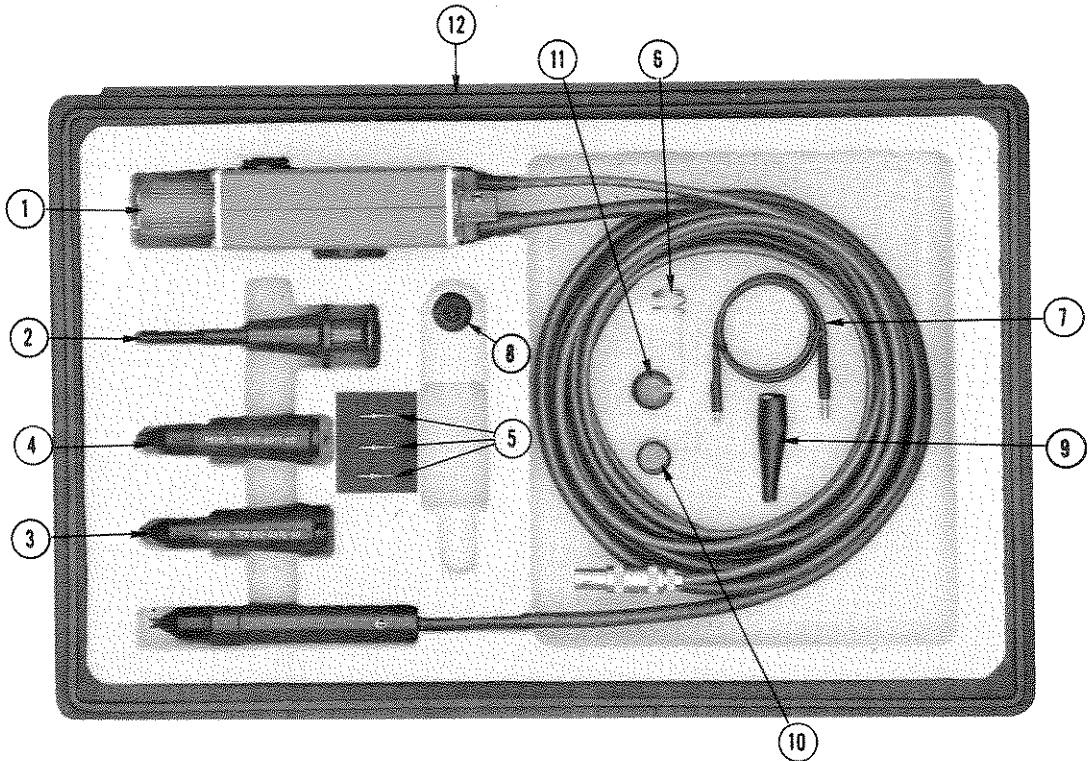

FIG. 1-1

Fig. & Index No.	Tektronix Part No.	Serial/Model No. Eff	Dscont	Qty	1	2	3	4	5	Name & Description	Mfr Code	Mfr Part Number
1-1	010-6201-01			1						PROBE, PACKAGE: P6201	80009	010-6201-01
	010-6201-00			1						PROBE, VOLTAGE: P6201, 72.0 L, 1X, PROBE ONLY	80009	010-6201-00
STANDARD ACCESSORIES												
-2	013-0135-00			1						TIP, PROBE: RETRAC TABLE HOOK	80009	013-0135-00
-3	010-0376-00			1						ATTEN HD, PROBE: P6201, 10X	80009	010-0376-00
-4	010-0377-00			1						ATTEN HD, PROBE: P6201, 100X	80009	010-0377-00
-5	206-0200-00			3						TIP, PROBE:	80009	206-0200-00
-6	131-1302-00			1						CONTACT, ELEC: GROUNDING, SST		
-7	175-0848-02			1						LEAD, ELECTRICAL: STRD, 28AWG, 12.25 L	80009	175-0848-02
-8	103-0164-00			1						ADPTR, PROBE TIP:	80009	103-0164-00
-9	344-0046-00			1						CLIP, ELECTRICAL: ALLIGATOR TYPE, W/COVER	80009	344-0046-00
-10	166-0557-00			1						SLEEVE, INSUL: 0.381 ID X 0.43 OD X 0.385	80009	166-0557-00
-11	342-0180-00			1						INSULATOR, CONT:	80009	342-0180-00
-12	016-0156-02			1						CASE, CRYG, PROBE:	80009	016-0156-02
	070-1306-00			1						MANUAL, TECH: INSTRUCTION (NOT SHOWN)	80009	070-1306-00
	352-0351-00			1						HOLDER, PROBE: BLACK	80009	352-0351-00
OPTIONAL ACCESSORY												
	017-0094-00			1						TERM, PROBE: 50 OHM, 1W FOR 010-6201-00	80009	017-0094-00

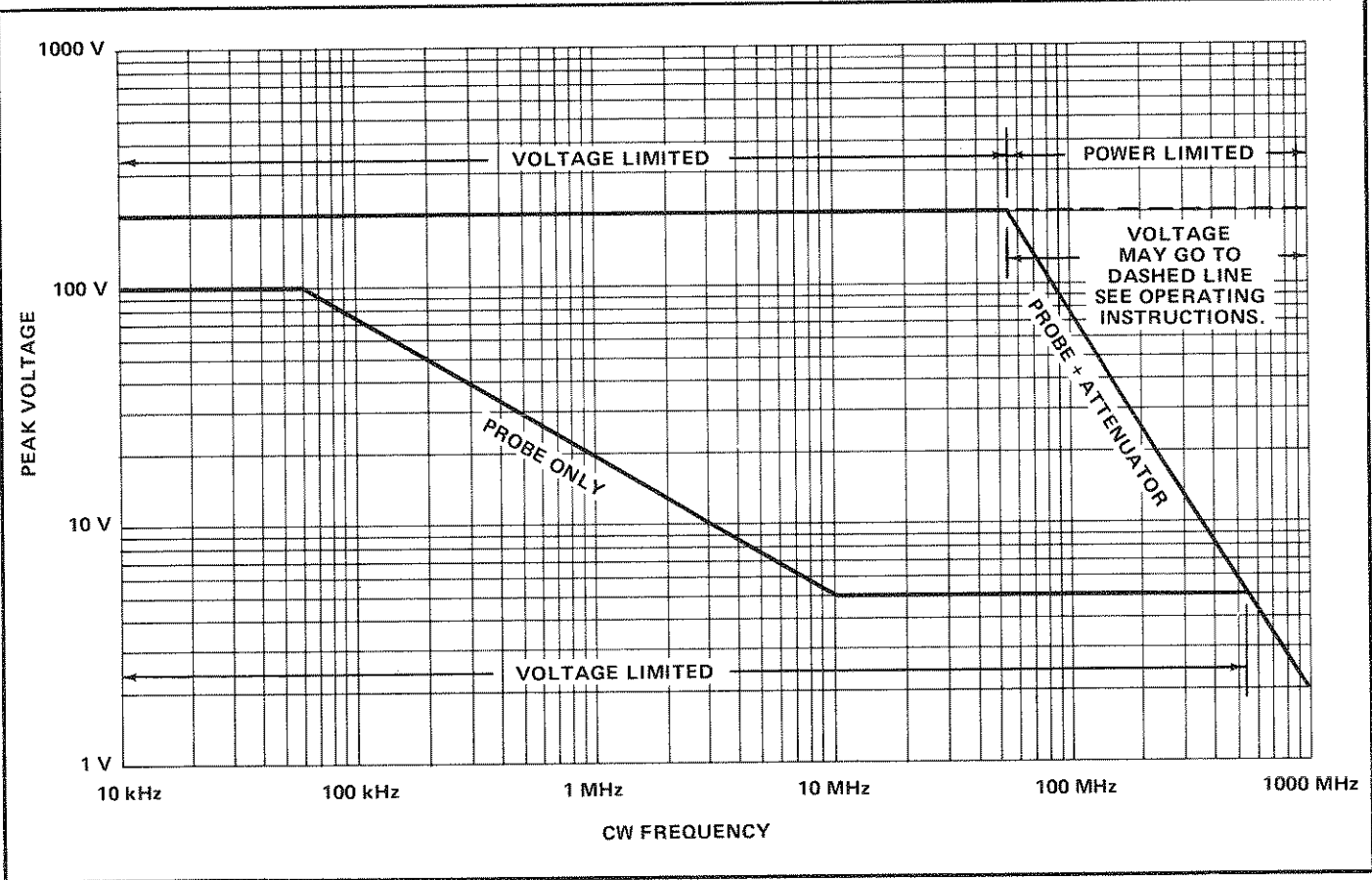

Fig. 1-4. P6201 Probe, and probe with attenuator, typical voltage derating with frequency.

OPERATING INSTRUCTIONS

General

The P6201 Probe is an active probe, designed to use with instruments having either a 50 ohm or a 1 megohm input impedance. The probe is terminated into an internal switchable 50 ohm termination when it is used with instruments that have a 1 megohm input impedance. The P6201 can be powered from the Probe Power output of a 7000-Series indicator, 475 and 485 Oscilloscopes, or from a Type 1101 Accessory Power Supply.

Probe attenuation is 1X within 3% when terminated into 50 ohm. Additional attenuation is provided by two (10X and 100X) accessory attenuators that plug onto the probe head. These provide attenuation up to 100X (1X probe and 100X attenuator). The attenuators cannot be stacked. They are matched or compensated to the probe head, but not to each other. When the probe is properly terminated into 50 ohms, its frequency response is DC to 900 MHz (equivalent to risetime of 389 ps or less).

The probe includes a locking-type BNC connector which provides scale-factor readout information to instruments having the readout capability. The 10X and 100X attenuator heads couple scale-factor readout information to the instrument via the output connector.

Probe Handling

The P6201 Probe has been designed to be as rugged as possible consistent with good high-frequency response and miniature size. However, as with all precision devices, the probe and cable should be handled carefully to avoid damage. Special care should be taken that the cable is not crushed or pulled very hard. The removable probe tip should also be treated with special care. Use caution when inserting the probe tip into attenuators or other jacks to make sure that the tip is aligned with the receptacle. Avoid dropping the probe head. Some of the most sensitive circuitry of the probe is in the probe body. When not in use, protect the probe tip from damage with the IC test tip adapter. Spare probe tips are provided.

Power Source

The probe power connector is designed to connect to the probe power receptacle on the 7000-Series indicator, 475 and 485 Oscilloscopes or the 1101 Accessory Power Supply. The probe requires +15 V DC at approximately 105 mA and -15 V DC at approximately 110 mA to operate. See circuit diagram for pin identification.

Probe Connector and Controls

The P6201 Probe contains an offset adjustment, offset polarity, input coupling and termination switches. Fig. 2-1 shows the location of these controls.

The BNC output connector is an integral part of the offset housing. The locking-type BNC connector couples scale-factor readout information from the 10X and 100X attenuators to instruments having the readout capability.

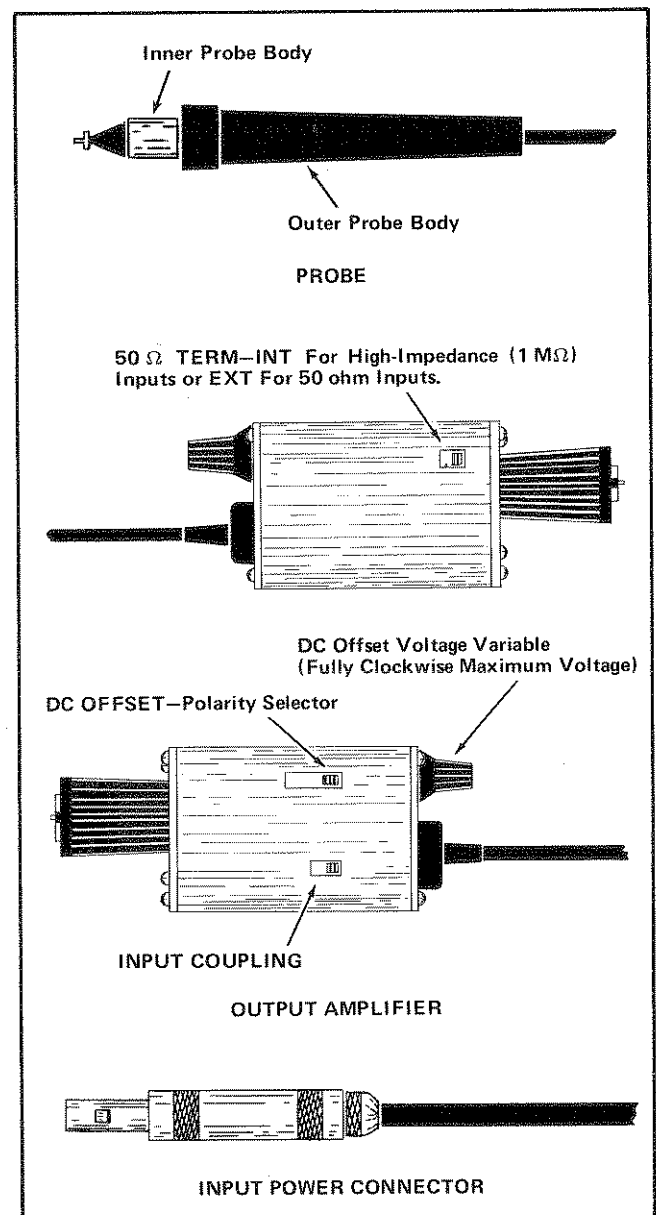

Fig. 2-1. Probe connectors and controls.

Operating Instructions—P6201 Probe

The offset range of the DC OFFSET VARIABLE control is at least 5.6 volts. The DC OFFSET polarity (+ and -) is selected by the + OFF - switch. Adding either of the two attenuators (10X and 100X) increases the offset range by the attenuation factor of the attenuator up to a maximum usable voltage of 200 volts.

The INPUT COUPLING switch selects whether the input signal is AC or DC coupled into the probe.

The output of the P6201 Probe must always be terminated into 50 ohms. This is accomplished by connecting an internal 50 ohm termination (50 Ω TERM switch set to INT) into the probe output circuit when the probe is connected to an oscilloscope having a 1 megohm input impedance. When the probe is connected to an instrument having a 50 ohm input impedance, the 50 Ω TERM switch is set to EXT (internal 50 ohm termination disconnected from probe output circuit).

Dynamic Range

The dynamic (signal) range for the P6201 Probe and the probe with attenuators is illustrated in Fig. 2-2. The dynamic range or maximum input signal capability for the probe alone, properly terminated, is + and -0.6 V peak (1.2 V peak-to-peak). This 0.6 V signal can be offset + and - 5.6 V, so the maximum dynamic window with DC offset is + and -6.2 V (AC + DC). If signals with amplitudes greater than this are to be measured, use the appropriate attenuator to reduce the signal voltage and DC offset down to the probe input limitation.

If the full dynamic range of the probe is used (±600 mV), a signal compression amount of up to 4% may occur. However, by reducing the input signal to ±400 mV, the signal compression drops to 1% or less.

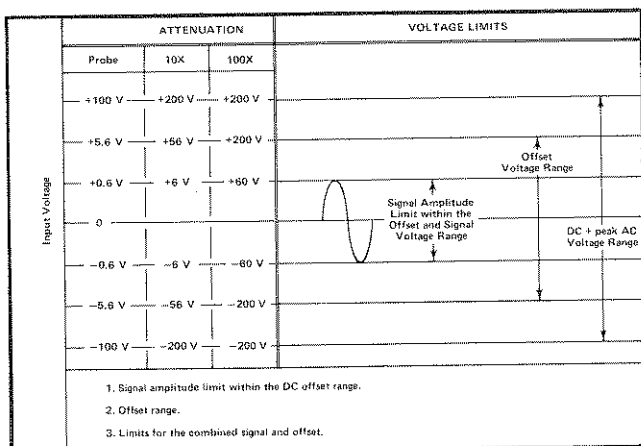

Fig. 2-2. Dynamic and offset limitations for P6201 Probe and the probe with attenuators.

Maximum Voltage and Power Limitations

The power handling capability of the probe and attenuators is dependent on the series resistor inside the probe or attenuator body. The input voltage limitation depends on the input amplifier capabilities and the signal duty factor. The P6201 Probe is designed to withstand up to 100 V (DC + peak AC) at low frequencies. The 10X and 100X attenuators are designed to withstand up to 200 V (DC + peak AC) at low frequencies. Voltage in excess of this may damage the probe or attenuator.

In Section 1 is a Maximum Voltage Derating Curve (Fig. 1-4) for the P6201 Probe and attenuators. The voltage must be reduced to offset the increased power dissipation if a signal with a duty factor of one is to be measured. Pulse peak voltages in excess of the curve can be measured if the average power of the signal is estimated. The following equation may be used to estimate the maximum input voltage for a periodic signal such as a pulsed waveform:

$$E_{\max} = \frac{\text{Voltage from the derating curve}}{\sqrt{\text{Duty Factor}}} + \text{DC Components}$$

$$\text{where duty factor} = \frac{\text{Pulse duration}}{\text{Pulse Period}}$$

Attenuators

The P6201 Probe accessories include two attenuators. The attenuators extend the input signal amplitude range of the probe in multiples of 10X and 100X, when they are attached to the probe head. To attach an attenuator to the probe head, push on the desired attenuator over the probe tip. Only one attenuator can be used at a time with the probe. The attenuators are compensated to the probe head and not each other. Attenuator compensation is possible with an insulating screwdriver through the hole in the side of the attenuator outer body.

First Time Operation

1. Connect the P6201 to the input connector of the test oscilloscope.

NOTE

Push the probe tightly against the instrument panel while tightening the BNC connector shell to assure good contact of the readout tab to the oscilloscope/plug-in readout ring.

2. Set the 50 Ω TERM, DC OFFSET polarity, and INPUT COUPLING switches to their correct or desired positions.

3. Connect the probe power connector to the power receptacle on the back panel of the oscilloscope or the 1101 Accessory Power Supply.

4. Set the oscilloscope Volts/Div to 10 mV. Switch the oscilloscope Input Coupling to GND, center the oscilloscope sweep with the centering controls, then switch the oscilloscope amplifier Input Coupling to DC.

5. Connect the probe to the signal source (see Signal Connectors) and note the oscilloscope display.

6. Adjust the DC Offset controls through their range with the polarity switch in either position and note their effects on the display. See Using DC Offset.

Use of DC Offset

The probe offset capability allows the input signal to be positioned to the center of the dynamic window or operating range of the probe amplifier. This assures optimum probe transient response. To prepare the probe for this operation, switch the Input Coupling of the oscilloscope amplifier unit to GND position or disconnect the probe connector from the oscilloscope input. Center the trace in the graticule area with the oscilloscope Position controls. Reconnect the probe to the oscilloscope input and switch the Input Coupling to DC position. Do not change the oscilloscope Position control setting, but use the P6201 Probe Offset controls to center the signal on the CRT graticule area. This assures that the observed signal is centered within the probe dynamic window.

NOTE

Set DC OFFSET switch to OFF when using AC INPUT COUPLING.

Probe Connections to the Signal Source¹

The input resistance of the probe is 100 k Ω with zero offset voltage. The static input resistance decreases to approximately 90 k Ω when offset is adjusted for 0 V DC output with a DC voltage present at the input. (11.1 μ A/volt of offset is drawn from the source by the probe). Adding an attenuator to the probe reduces this offset loading so the input resistance remains near 1 megohm as DC offset is added. The AC or dynamic loading of the probe is not affected by DC Offset; however, it does depend on frequency. Figs. 1-2 and 1-3 illustrate the shunt input resistance and capacitive loading of the probe and attenuators as a function of frequency. Refer to these

¹TEKTRONIX Measurement Concept booklet on Probe Measurements (Part Number 062-1120-00) is a recommended treatise.

graphs when probe loading is a concern. When possible, the probe should be connected to a low impedance point in the circuit to minimize this circuit loading.

Signal connections should be made directly to the tip of the probe or its attenuators. Establish a good ground connection as directly as possible between the probe ground and the signal source ground. Long ground leads can induce ground loops between the probe amplifier and the signal source, generating considerable signal distortion.¹ Use one of the supplied clips or connectors to ground the probe to an outside terminal. If the ground plane is adjacent to the signal source, the ground electrical contact tip (PN 131-1302-00) is suggested as a grounding method. If the low-frequency signal source has a coaxial connector, a probe tip-to-test point jack adapter (PN 103-0164-00) and a probe tip adapter (PN 013-0084-01 for probe tip to BNC, or 017-0076-00 for probe tip to GR connector) may be used to connect the probe tip to the signal source. If the high-frequency signal is a 50 ohm source and has a coaxial connector, then probe tip adapter (PN 017-0094-00 for probe tip to GR connector) may be used to connect the probe tip to the signal source. This coaxial environment improves performance and reduces interface problems with the signal source. It is good practice to always keep the ground lead as short as possible and to use a ground lead even for low frequency measurements.

Use of Probe Accessories

The standard accessories supplied with the P6201 Probe facilitate connecting the probe into a test circuit. Use as follows:

Retractable Hook Tip—Slip on over probe tip. Pull back at flange while holding probe body to expose the hook tip.

12-inch Ground Lead—Screw one threaded end into side of probe body. The minigator clip may be screwed onto the other end.

Insulating Sleeve—The small plastic tube may be slid over the probe tip to insulate the ground surface (just behind the tip) when probing in compact circuitry.

Ground Electrical Contact and Ground Contact Insulator—The spring is slid over the probe tip for making short signal ground connections. The insulating sleeve is then slipped over the spring to reduce the possibility of shorts.

Probe Tip-to-Test Point Jack Adapter—The adapter is slipped on over probe tip to provide a smaller probe tip diameter. The adapter adds approximately 1 pF to the input capacitance of the probe.

CIRCUIT DESCRIPTION

The P6201 Probe system uses a DC re-insertion amplifier technique to obtain low drift and broad-band performance. The input signal is simultaneously coupled (in parallel paths) to the AC Amplifier and the DC & Low-frequency Amplifier. See Fig. 3-1. Outputs from these stages are combined in the Output Amplifier.

DC & Low-frequency Amplifier

The input signal is coupled through R130 and the INPUT COUPLING switch to U200, an operational amplifier. When AC coupling is selected, C200 blocks the DC signal path.

C220 (5-25 pF variable) bootstraps the input capacitance at pin 2 of U200. This serves to stabilize the crossover of the DC & Low-frequency system to the AC system.

The VARIABLE control (R200) and the position selected on the DC OFFSET switch determine the offset voltage applied to the input (pin 2) of U200. R200 is adjusted to bring pin 2 to zero volts with up to ± 5.6 V at

the input side of R130. The Output Zero adjustment (R250) provides a DC balance between pins 2 and 3.

Ground signals are coupled through R290 to pin 3 of U200, which serves to cancel ground difference signals between the probe body and the output box.

Overall low-frequency gain is set by a 10X division of the input signal (through R130 and R265) and the X10 gain set resistors (R280 and R295) for the low-frequency closed loop gain.

The output signal from U200 is coupled via terminal A and R397 to the base of Q350.

AC & High-frequency Amplifier System

AC signal components are coupled to the gate of Q100 (FET) through R100/R120 and C100. Q100 is connected as a source follower, providing high input-resistance and low-noise performance at the probe input. Q120 and Q130 are emitter follower stages which provide high-frequency current gain and impedance isolation between input and output.

The output signal from the AC Amplifier stage is coupled from the emitter of Q130 through R185/R190 and C300 to the base of Q300.

Output Amplifier

The Output Amplifier includes Q300, Q320, and Q350. Signals from the DC & Low-frequency Amplifier and the AC Amplifier are combined in this stage to form the output signal. A forced cross-over is achieved by means of feedback from the collector of Q320 through R350 to pin 3 of U200.

R370 sets the high-frequency gain of the Output Amplifier to match the gain of the DC & Low-frequency Amplifier. C315, C325, and C358 are high frequency peaking and compensation adjustments. R355 and RT360 form a gain-vs-temperature compensation network.

The parallel 50 Ω strip-line transformer at the output of Q300 and Q320 increases the cutoff frequency of the output stage by inverting the output of Q300, thus adding to the output of Q320 (in the cutoff frequency range only).

R398 provides the necessary 50 Ω load when using the probe with other than 50 Ω systems, such as 1 M Ω oscilloscope inputs. The output amplifier must have the proper load impedance in order to maintain constant gain over the bandpass of the probe.

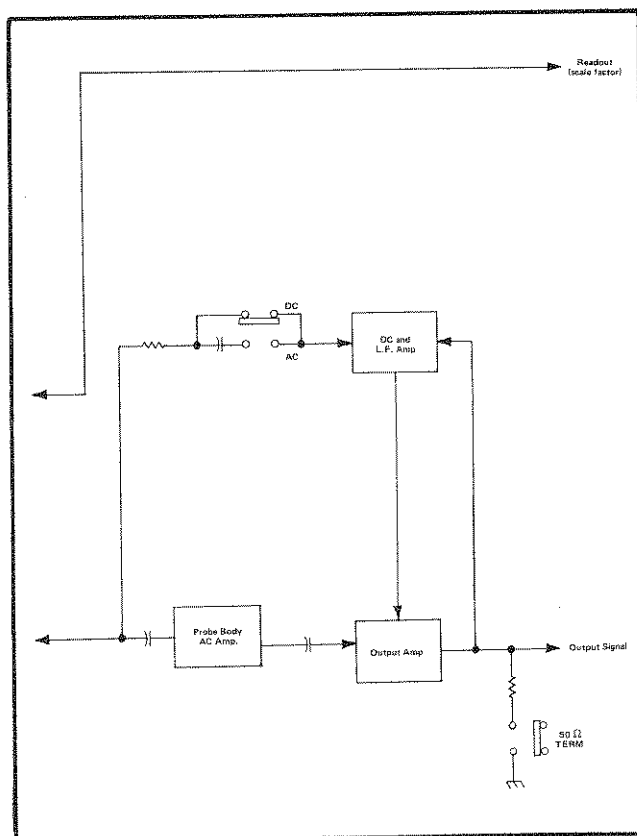

Fig. 3-1. P6201 Probe Block Diagram.

MAINTENANCE

Introduction

This section of the manual contains maintenance information for use in preventive and corrective maintenance.

Cover Removal

CAUTION

Disconnect the probe power before removing the probe head barrel or the covers for the offset housing and output connector box. This will prevent accidental destruction of the solid state devices on the circuit boards.

Probe Body

Access to the circuit board inside the probe is accomplished by unscrewing the outer probe body while holding the inner probe body. See Fig. 4-1.

The outer probe body should only be removed to adjust or troubleshoot the circuitry. The cover protects the circuitry from dust and shields the amplifier from stray electromagnetic fields.

Output Amplifier

The Output Amplifier housing cover consists of two housing halves with each half being held in place by two screws on each end.

Remove either housing half by removing the two screws in each end of the housing half, then pulling the housing half straight out. If the housing half will not pull straight out easily, loosen the rear panel center two screws.

Attenuators

Remove the attenuator from the probe. Access to the interior circuit board is now obtained by unscrewing the attenuator insulator inside the outer attenuator body.

Probe Tip Replacement

Using a pair of pliers unscrew the damaged tip and screw the new tip in, see Fig. 4-1.

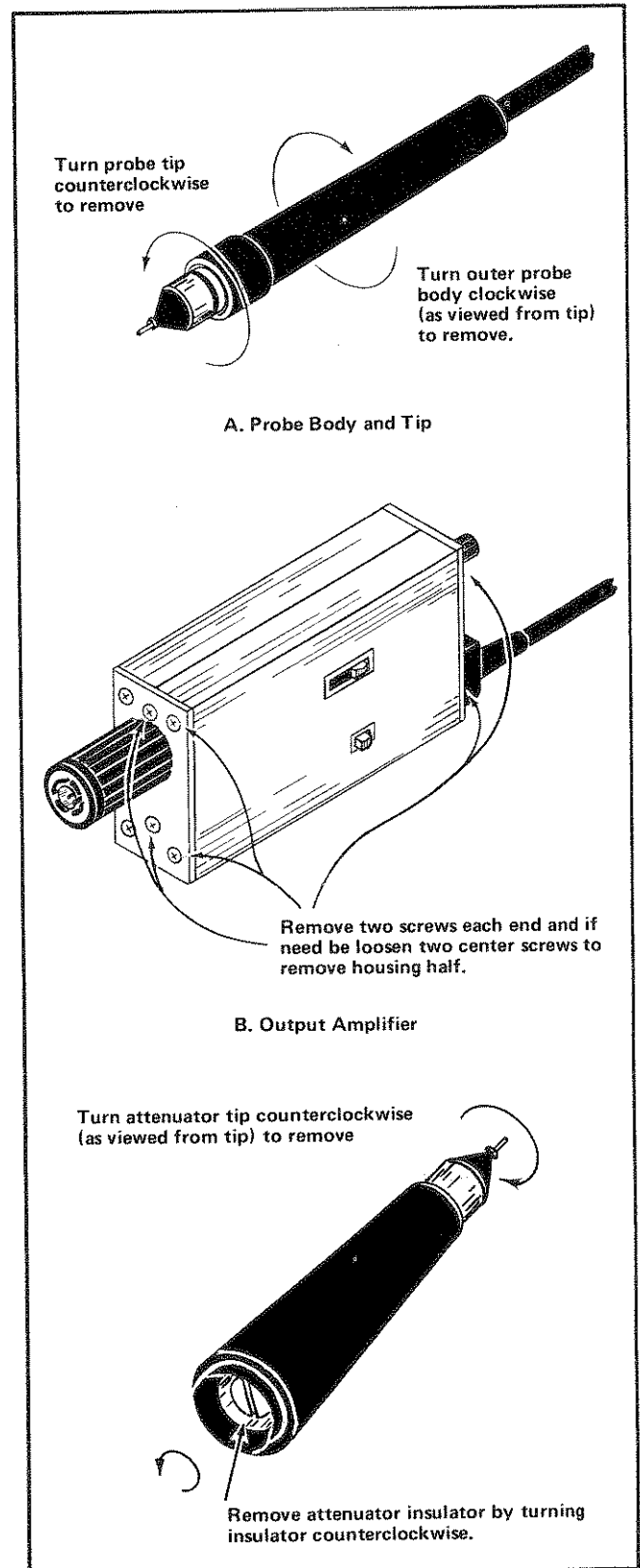

Fig. 4-1. Probe body, output amplifier, and attenuator interior access methods and probe tip replacement.

PREVENTIVE MAINTENANCE

Preventive maintenance consists of recalibration, if needed, visual inspection from damaged components, and cleaning. The schedule for the preventive maintenance depends on the environment in which the probe is operated and the amount of use. With average conditions (laboratory situation) a preventive maintenance program should be conducted about every 1,000 hours of probe operation or every six months if the probe is used only occasionally.

Cleaning

Normally the circuit boards in the interior of the probe, output amplifier, or attenuators will not require cleaning unless a cover has been left off for an extended period. Use low pressure air to blow away accumulated dust, then a cotton-tipped applicator dampened with a solution of mild detergent soap and water may be used for additional cleaning. After cleaning, allow ample time for drying before applying power.



Avoid the use of chemical cleaning agents which might damage the plastics used in this instrument. Avoid chemicals which contain benzene, toluene, xylene, acetone or similar solvents.

Visual Inspection

After cleaning, circuit boards should be carefully checked for such defects as poor connections, damaged parts, and bent leads. The remedy for most defects is obvious; however, if heat damaged components are noticed it is an indication that other trouble is present in the circuit and measures should be taken to check this out.

When inspecting the circuit boards, a good magnifying glass or low power eye glass (approximately 4X) will aid in conducting a thorough visual check.

Transistor and Integrated Circuit Checks

Periodic checks of transistors, FET's and IC's are not recommended. The best measure of semiconductor performance is operation in the circuit. This is checked during the recalibration of the probe. Any substandard components will usually be detected at this time.

Recalibration

To ensure accuracy, the probe should be checked about every 1000 hours of operation or every six months if used occasionally. The calibration procedure will usually indicate potential problems so that corrective measures can be taken before the probe fails to function properly.

TROUBLESHOOTING

The following describes a few aids that may assist in locating any trouble. After the defective component has been located, refer to Corrective Maintenance procedure for removal and replacement instructions.

Before looking for trouble in the probe, check to ensure that the oscilloscope or associated equipment is operating properly.

Diagram. The circuit diagram of the P6201 Probe is given at the rear of the manual. Circuit numbers and electrical values of the components are shown on the diagram. Portions of the circuitry mounted on the circuit boards are within the outline for that board.

Circuit Board Illustrations. All of the electrical components in the P6201 Probe are mounted on the circuit boards, illustrations of which are given at the rear of the manual.

Check Voltages

NOTE

The mounting screws and nuts holding the two circuit boards to the output amplifier box provide the ground return for the boards. If the screws and nuts are loosened or removed, a ground return for each circuit board to the output amplifier box must be provided.

Use a high resistance (20,000 ohms/volt or higher) meter for voltage measurements.

CORRECTIVE MAINTENANCE

Replacement Parts

Replacements for all electrical and mechanical parts used in the P6201 Probe can be obtained through your local TEKTRONIX Field Office or representative. Some of the standard electronic components may be obtained more quickly by purchasing them locally. Before ordering or purchasing any replacement parts, refer to the Parts List in this manual for the required characteristics and correct description.

In addition to the standard electronic components, many special parts and components are used in the P6201 Probe. These parts are manufactured by or for Tektronix, Inc. and are selected to meet specific requirements. Most of

the mechanical parts used in the Probe are manufactured by Tektronix, Inc. and therefore are not available from other sources. Order all special parts directly from your TEKTRONIX Field Office or representative. Include the following information: The instrument type and serial number; a complete description of the part as described in the Parts List; and, if it is an electrical component, give the circuit number.

Circuit Boards

Wired circuit boards for the P6201 Probe and Output Amplifier can be ordered from Tektronix, Inc. Refer to the Parts List for information on how to order. The following procedures describe the removal or replacement of these circuit boards.

Probe Circuit Board Replacement

Remove the outer probe body and probe tip, see Fig. 4-1. Unsolder all wires including the one connected to the readout contact ring. Slide the readout contact ring onto the probe cable to position it out of the way. Use special care when unsoldering the coaxial connections so as not to melt the dielectric.

Using a de-soldering tool such as size 3 solder wick material and a 50 watt soldering iron, remove as much solder as possible from the three circuit board solder connections to the inner probe body. To separate the circuit board from the inner probe body, slide a thin knife blade between the circuit board and the inner probe body. Be careful not to twist the circuit board as it is being separated from the inner probe body.

To install the circuit board, insert the front of the circuit board into the nose of the inner probe body, then align the rear of the circuit board with the step near the rear of the inner probe body, see Fig. 4-2. The remainder of the installation is a reversal of the removal procedure.

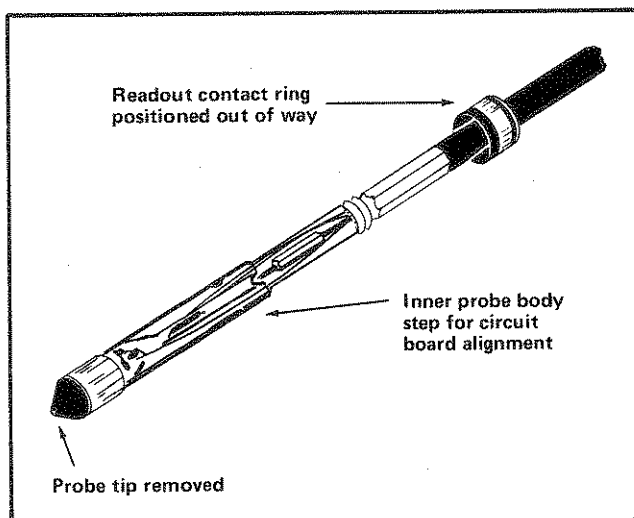

Fig. 4-2. Probe circuit board replacement.

Output Amplifier Circuit Board Replacement

Remove the two housing halves of the cover, see Fig. 4-1. Unsolder all wires including the center conductor of the coaxial cable. Use a de-soldering tool such as size 3 solder wick material to clear the wire holes for later re-insertion of the wires. Remove the screws, washers and nuts and remove the circuit boards.

To install the circuit board, reverse the removal procedure.

Attenuator Circuit Board Replacement

Unscrew the attenuator insulator and attenuator tip, see Fig. 4-1. Using a pair of long nose pliers extract the circuit.

To install the circuit board, reverse the removal procedure. Be careful to position the compensation adjustment opposite the hole in the outer attenuator body.

Probe Cable Replacement

Remove the outer probe body and the two housing halves of the output amplifier cover, see Fig. 4-1. Unsolder all wires including the coaxial wire on both ends of the probe cable. It is not necessary to unsolder the input power cable wires inside the output amplifier. Unsolder and remove the input power connector.

Unscrew (right-hand thread) the probe cable from the inner probe body and slip the outer probe body off the probe cable. Remove the 4-40 hex cap screw from the output amplifier, then slip the cable nipple holder, input power cable nipple off of the input power cable and at the same time remove the probe cable and its attached ferrule holder from the output amplifier.

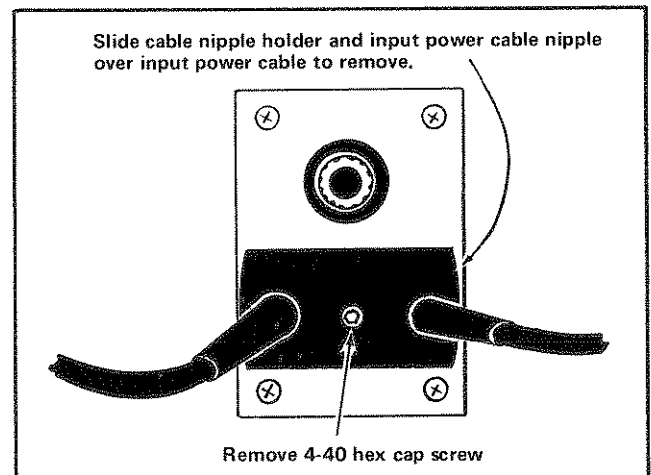

Fig. 4-3. Probe cable replacement.

Maintenance—P6201 Probe

Soldering Suggestions

1. Use a pencil type soldering iron with a power rating of 15 watts for circuit board component replacement and a 50 watt soldering iron for probe circuit board removal.
2. Apply heat for minimum time to the junction between the component and the circuit board to melt the solder.
3. Heat-sink the lead of the component with a pair of long nose pliers.
4. Use electronic grade 60-40 tin-lead solder (PN 251-0738-00).
5. After the new component has been installed, clip off any excess lead extending beyond the circuit board and clean off any residual flux with a flux-removing solvent. Be careful that the solvent does not remove any printing from the circuit board.

Transistor and Integrated Circuit Replacement

Transistors and Integrated Circuits should not be replaced unless actually defective. If removed during routine maintenance, return them to their original sockets. Unnecessary replacement of transistors or IC's may affect the calibration of this instrument. When transistors or IC's are replaced, it will be necessary to completely recalibrate the P6201.

Replacement transistors or IC's should be of the original type or a direct replacement. Fig. 4-4 shows the lead configuration of the transistors and IC's used in this

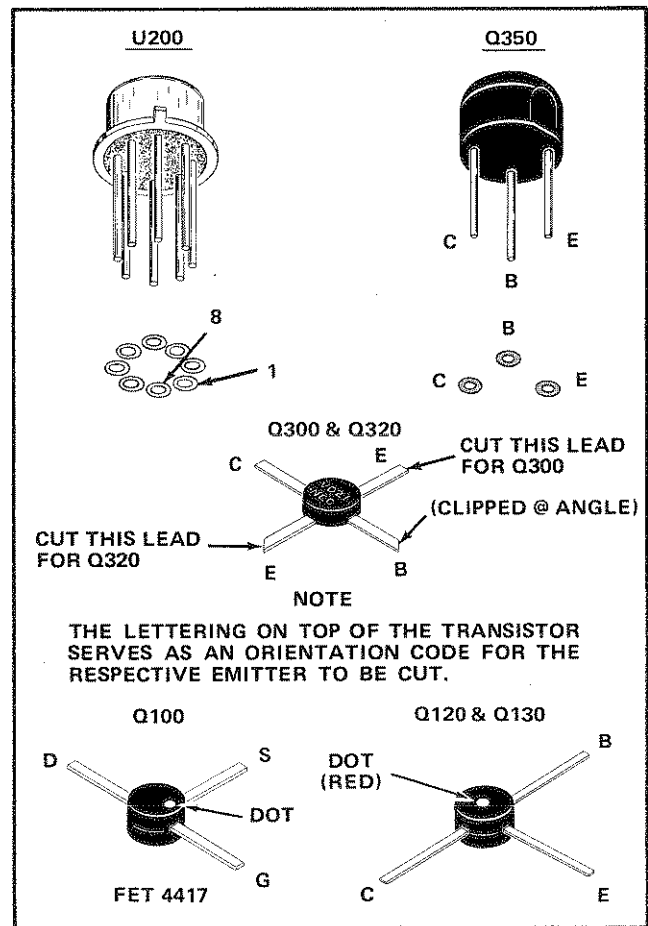

Fig. 4-4. Lead configuration of transistors and integrated circuit used in the P6201 Probe.

instrument. If a transistor is replaced by a transistor made by a different manufacturer than the original, check the manufacturer's basing diagram for correct basing.

CALIBRATION

Introduction

Complete calibration information is given in this section. The probe can be returned to original performance by completion of this procedure. Limits, tolerances, and waveforms in this procedure are given as calibration guides, and are not instrument specifications. To touch up the adjustments, perform only those steps entitled "ADJUST". A short form adjustment procedure is also provided in this section for the convenience of the experienced calibrator.

To ensure accuracy, the probe should be checked and recalibrated about every 1,000 hours of operation, or every six months if used occasionally.

TEST EQUIPMENT REQUIRED

General

The following test equipment, or its equivalent, is required for complete calibration of the P6201. Specifications given are the minimum necessary for accurate calibration. All test equipment is assumed to be correctly calibrated and operating within the given specifications. If equipment is substituted, it must meet or exceed the specifications of the recommended equipment.

1. Real-Time Test Oscilloscope: Bandwidth, DC to at least 150 MHz; minimum deflection factor, 10 mV/division or less; input impedance, 1 M Ω . For example, TEKTRONIX 7704A oscilloscope with 7A16A (vertical) and 7B71 (horizontal) plug-ins.

2. Sampling Test Oscilloscope: Bandwidth, DC to at least 1 GHz; minimum deflection factor, 1 mV/division or less; input impedance, 50 Ω . For example, TEKTRONIX 7S12 (time-domain reflectometer) with S-1 and S-53 (sampling heads), used in conjunction with 7704A oscilloscope.

3. DC Voltmeter (VOM): Minimum sensitivity 20,000 ohms/volt; required scale, 3 V or less. For example, Triplet model 630 NA.

4. Square-wave Generator: Frequency, 1 kHz, 10 kHz, and 100 kHz; output amplitude, adjustable to 1.2 V; risetime, 1 ns or less. For example, TEKTRONIX 106 square-wave generator.

5. Fast-Rise Pulser: Output amplitude, 200 mV; rise-time, 70 ps; pulse width, greater than 1 μ s. For example, TEKTRONIX 284 pulse generator.

6. Cable: Impedance, 50 Ω ; length, 5 ns; connectors, GR. For example, TEKTRONIX Part No. 017-0512-00.

7. Termination: Impedance, 50 Ω ; connectors, GR to BNC male; type, feed-thru; 1 W. TEKTRONIX Part No. 017-0083-00.

8. Termination: Impedance, 50 Ω \pm 0.1%; connectors, BNC; type, feed-thru. TEKTRONIX Part No. 067-0515-00.

9. Termination Adapter: Impedance, 50 Ω ; connectors, probe tip to GR. TEKTRONIX Part No. 017-0094-00.

10. Attenuator: Impedance, 50 Ω ; attenuation, 5X; connectors, GR. TEKTRONIX Part No. 017-0079-00.

11. Adapter: Connectors, GR 'T'. TEKTRONIX Part No. 017-0069-00.

12. Adapter: Connectors, GR to BNC female. TEKTRONIX Part No. 017-0063-00.

13. Adapter: Connectors, GR to BNC male. TEKTRONIX Part No. 017-0064-00.

14. Adjustment tools:

a. Phillips screwdriver, small tip (not available through Tektronix, Inc.).

b. J.F.D. adjustment tool No. 5284¹, or probe adjustment screwdriver (TEKTRONIX Part No. 003-0675-00).

c. Johanson adjustment tool No. 4093² (required for C325).

¹ Order from J.F.D. Electronics Co.; 15th Avenue at 62nd Street, Brooklyn, N.Y. 11219.

² Order from Johanson Manufacturing Corp., Rockaway Valley Road, Boonton, N.J. 07005.

**SHORT FORM CALIBRATION PROCEDURE
and INDEX**

This short form calibration procedure is provided to aid in checking the operation of the probe. It may be used as a calibration guide by the experienced calibrator, or it may be used as a record of calibration. Since the step numbers and titles used here correspond to those used in the complete procedure, this procedure also serves as an index to locate a step in the complete calibration procedure. Performance requirements correspond to those given in the characteristics section.

P6201 _____

Calibration Date _____

Calibration Technician _____

1. Check or Adjust Output Zero and Bias, R250 and R230 Page 5-2

0 V at output.

0 V \pm 25 mV at Q300 collector.

2. Check Low-Frequency Gain Page 5-3

1X, \pm 3% at 1 kHz.

3. Check or Adjust High Frequency Gain, R370 Page 5-4

Leading corner same height as remainder of 10 kHz waveform.

4. Check or Adjust Cross-Over Phase, C220 Page 5-4

Set for flat-topped 10 kHz waveform.

5. Check Internal 50 Ω Termination Page 5-4

Within \pm 1/2% of an external 0.1% resistor.

6. Check Compression Page 5-4

See procedure.

7. Check or Adjust High Frequency Compensation C358, C315, C325, and R393 Page 5-5

See procedure.

8. Check Probe Risetime Page 5-6

See procedure.

9. Check or Adjust 10X and 100X Attenuator Compensation Page 5-6

10X attenuator—C2 for square leading corner on 100 kHz waveform.

100X attenuator—C22 for square leading corner on 100 kHz waveform.

CALIBRATION PROCEDURE

General

Any needed maintenance should be performed before proceeding with the calibration. Troubles which become apparent during the procedure should be corrected immediately.

To prevent readjustment of other circuits when performing a partial procedure, readjust only if the listed tolerance is not met. However, when performing a complete procedure, best overall performance will be provided if each adjustment is made to the exact setting, even if the (CHECK) is within the allowable tolerance.

The following procedure uses equipment listed under Equipment Required. If equipment is substituted, control settings or test equipment setup may need to be altered to meet the requirements of the test equipment used.

1. Check or Adjust Output Zero and Bias, R250 and R230

a. Remove the screws holding the two housing halves onto the output amplifier and remove the two housing halves (covers).

b. Connect the P6201 to the 1 M Ω vertical input of a real-time oscilloscope. Connect the probe input power connector to the power receptacle on the back panel of the oscilloscope or the 1101 Accessory Power Supply.

c. Set the P6201 controls:

50 Ω TERM	INT
DC OFFSET Polarity	OFF
INPUT COUPLING	DC

d. Set the real-time (test) oscilloscope vertical input for DC coupling and maximum sensitivity. Set the time-base of the oscilloscope for a free-running trace. Establish a ground reference point (without probe) on the CRT of the oscilloscope.

e. CHECK—Note position of the test oscilloscope trace with reference to the ground reference point.

f. ADJUST—Output Zero, R250 (Fig. 5-1) to return test oscilloscope trace to ground reference point.

g. Connect a VOM between the collector of Q300 (Fig. 5-1) and ground.

h. CHECK—VOM for a reading of $0\text{ V} \pm 25\text{ mV}$.

i. ADJUST—Bias Adj., R230 (Fig. 5-1) for a meter reading of $0\text{ V} \pm 25\text{ mV}$.

j. Disconnect the meter.

k. Install the two housing halves temporarily onto the output amplifier.

l. Allow the probe a 20 minute warm-up time with the housing halves in place.

m. Remove the probe housing halves.

n. Repeat parts e and f of this step, then proceed to step 2.

2. Check Low-Frequency Gain

a. Disconnect the probe output amplifier from the test oscilloscope.

b. Connect the test equipment as shown in Fig. 5-2.

c. Set the test oscilloscope vertical sensitivity to 10 mV/div . The P6201 $50\ \Omega$ TERM switch should remain set to INT.

d. Adjust the fast-rise square-wave generator for a 1 kHz waveform having a vertical deflection of exactly 5 divisions on the test oscilloscope.

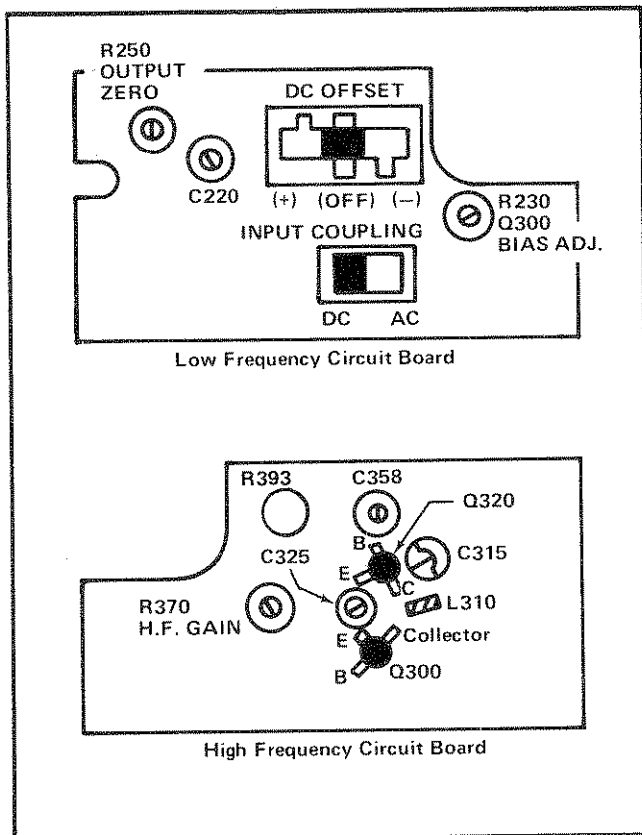

Fig. 5-1. Output amplifier adjustment and test point locations.

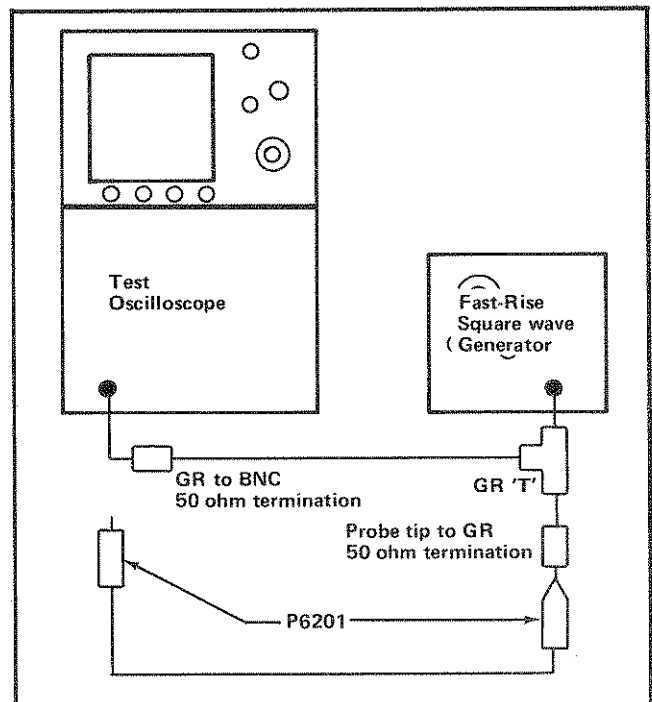

Fig. 5-2. Equipment setup for steps 2 through 5.

Calibration—P6201 Probe

e. Disconnect the GR to BNC $50\ \Omega$ termination and fast-rise square-wave generator from the test oscilloscope vertical input.

f. Connect the probe output amplifier to the test oscilloscope.

g. CHECK—Test oscilloscope amplitude should be 5 divisions, $\pm 3\%$.

3. Check or Adjust High Frequency Gain, R370

a. Check that the probe is still connected to the test oscilloscope vertical input.

b. Set the square-wave generator for a 10 kHz, 5 division test oscilloscope display.

c. CHECK—Test oscilloscope for a waveform whose leading corner is the same height as the low frequency amplitude. See Fig. 5-3.

d. ADJUST—HF Gain, R370 (Fig. 5-1) for a leading corner which is the same height as the low frequency amplitude. See Fig. 5-3.

4. Check or Adjust Cross-Over Phase, C220

a. Set square-wave generator for 10 kHz, 5 division test oscilloscope display.

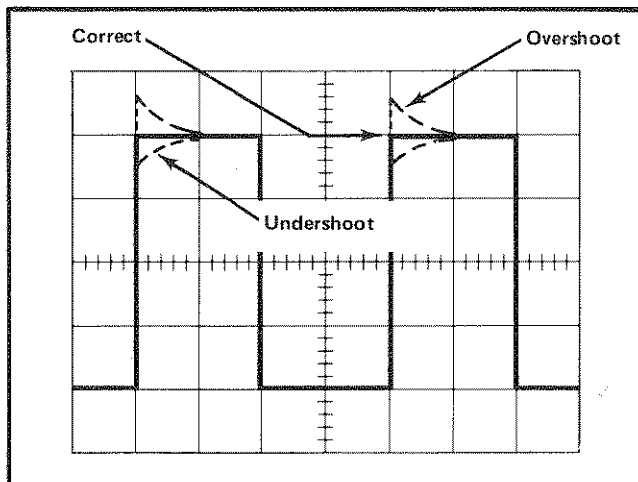

Fig. 5-3. Illustration showing overshoot, correct and undershoot examples of high frequency gain adjustments.

b. CHECK—Test oscilloscope for a flat-topped waveform, see Fig. 5-4.

c. ADJUST—C220 (Fig. 5-1) for a flat top on the waveform.

5. Check Internal $50\ \Omega$ Termination

a. With the probe $50\ \Omega$ TERM switch set to INT, set the 10 kHz square-wave amplitude for exactly 5 divisions on the test oscilloscope display.

b. Remove the probe output amplifier from the test oscilloscope input connector.

c. Install a $50\ \Omega$ precision resistor onto the test oscilloscope input connector, using necessary adapters.

d. Install the probe output amplifier onto the other end of a $50\ \Omega$ precision resistor.

e. Set the probe $50\ \Omega$ TERM switch to EXT.

f. CHECK—Test oscilloscope for a waveform amplitude of 5 divisions, $\pm 1/2\%$. The high-frequency gain change, if any, will occur in the first $10\ \mu\text{s}$ of the square-wave.

6. Check Compression

a. Connect the equipment as shown in Fig. 5-5.

b. Set the test oscilloscope for a vertical deflection factor of 0.2 V and a sweep rate of $50\ \mu\text{s}$.

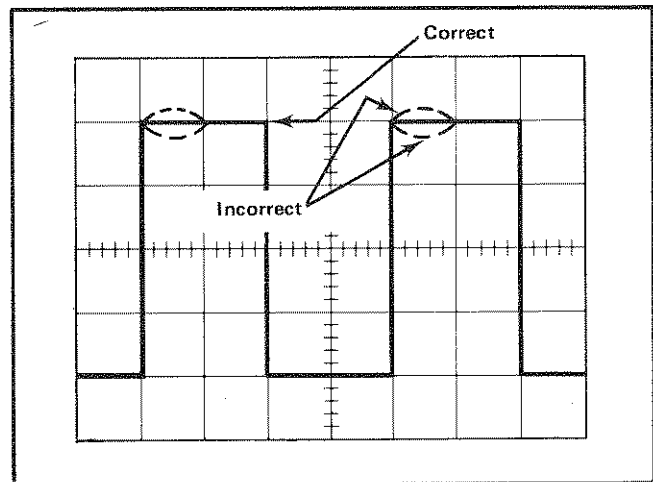

Fig. 5-4. Illustration showing incorrect and correct cross-over phase adjustment.

P6201 Probe

Ckt No.	Tektronix Part No.	Serial/Model No. Eff	Dscont	Name & Description	Mfr Code	Mfr Part Number
	670-2210-00	B010100	B059999	CKT BOARD ASSY:PROBE	80009	670-2210-00
	670-2210-01	B060000		CKT BOARD ASSY:PROBE	80009	670-2210-01
	670-2211-00	B010100	B039999	CKT BOARD ASSY:ATTENUATOR(10X)	80009	670-2211-00
	670-2211-01	B040000	B059999	CKT BOARD ASSY:ATTENUATOR(10X)	80009	670-2211-01
	670-2211-02	B060000		CKT BOARD ASSY:ATTENUATOR(10X)	80009	670-2211-02
	670-2212-00			CKT BOARD ASSY:ATTENUATOR(100X)	80009	670-2212-00
	670-2296-00	B010100	B059999	CKT BOARD ASSY:HIG HIGH FREQUENCY OUTPUT AMPL	80009	670-2296-00
	670-2296-01	B060000		CKT BOARD ASSY:HIG HIGH FREQUENCY OUTPUT AMPL	80009	670-2296-01
	670-2297-00	B010100	B059999	CKT BOARD ASSY:LOW FREQUENCY OUTPUT AMPL	80009	670-2297-00
	670-2297-01	B060000		CKT BOARD ASSY:LOW FREQUENCY OUTPUT AMPL	80009	670-2297-01
C1	283-0310-00	B010100	B039999X	CAP.,FXD,CER DI:2.5PF,+/-0.25PF,100V	72982	A01AL4A4LC0G0259
C2	-----			(FURNISHED AS A UNIT WITH 670-2211-00)		
C3	283-0310-00	B010100	B059999	CAP.,FXD,CER DI:2.5PF,+/-0.25PF,100V	72982	A01AL4A4LC0G0259
C3	283-0311-00	B060000		CAP.,FXD,CER DI:4.7PF,+/-0.25PF,100V	72982	A02AL4AALC0G479C
C21	283-0320-00			CAP.,FXD,CER DI:1PF,50V,LEADLESS	72982	A01DB9A2LC0G109C
C22	-----			(FURNISHED AS A UNIT WITH 670-2212-00)		
C23	283-0332-00			CAP.,FXD,CER DI:47PF,5%,50V	72982	8300003U2J470J
C100	283-0314-00			CAP.,FXD,CER DI:100PF,10%,100V	72982	A02AL9A4LC1G101K
C120	283-0311-00			CAP.,FXD,CER DI:4.7PF,+/-0.25PF,100V	72982	A02AL4AALC0G479C
C130	283-0315-00			CAP.,FXD,CER DI:470PF,10%,100V	72982	A02BL9A4LW5R471K
C140	283-0315-00			CAP.,FXD,CER DI:470PF,10%,100V	72982	A02BL9A4LW5R471K
C150	283-0315-00			CAP.,FXD,CER DI:470PF,10%,100V	72982	A02BL9A4LW5R471K
C155	283-0320-00			CAP.,FXD,CER DI:1PF,50V,LEADLESS	72982	A01DB9A2LC0G109C
C160	283-0310-00			CAP.,FXD,CER DI:2.5PF,+/-0.25PF,100V	72982	A01AL4A4LC0G0259
C170	290-0308-00	B010100	B046190	CAP.,FXD,ELCTLT:1UF,20%,35V	26769	TEK1778-0308-00
C170	290-0267-00	B046191		CAP.,FXD,ELCTLT:1UF,20%,35V	56289	162D105X0035CD2
C180	290-0308-00			CAP.,FXD,ELCTLT:1UF,20%,35V	26769	TEK1778-0308-00
C200	285-0919-00			CAP.,FXD,PLSTC:0.22UF,10%,100V	56289	LP66A1B224K002
C210	283-0176-00			CAP.,FXD,CER DI:0.0022UF,20%,50V	72982	8121B058X7R0222M
C220	281-0123-00	B010100	B046190	CAP.,VAR,CER DI:5-25PF,100V	72982	518-000A5-25
C220	281-0158-00	B046191	B059999	CAP.,VAR,CER DI:7-45PF,50V	73899	DVJ-5006
C220	281-0158-01	B060000		CAP.,VAR,CER DI:7-45PF,25V	72982	518-006G7-45
C230	281-0528-00			CAP.,FXD,CER DI:82PF,+/-8.2PF,500V	72982	301-000U2M0820K
C240	290-0134-00			CAP.,FXD,ELCTLT:22UF,20%,15V	56289	150D226X0015B2
C300	290-0247-00			CAP.,FXD,ELCTLT:5.6UF,10%,6V	56289	162D565X9006CD2
C302	283-0320-00	XB060000		CAP.,FXD,CER DI:1PF,50V,LEADLESS	72982	A01DB9A2LC0G109C
C305	283-0220-00			CAP.,FXD,CER DI:0.01UF,20%,50V	72982	8121N075X7R0103M
C315	281-0218-00			CAP.,VAR,CER DI:1-5PF,+2-2.5%,100V	72982	513-001 1-5
C320	283-0315-00			CAP.,FXD,CER DI:470PF,10%,100V	72982	A02BL9A4LW5R471K
C325	281-0196-00	B010100	B060646	ECAP.,VAR,CER DI:10-38PF,250V	91293	S9410-4PC
C325	281-0219-00	B060647		CAP.,VAR,CER DI:5-35PF,+2-2.5%,100V	72982	513-001 5-30
C330	283-0325-00			CAP.,FXD,CER DI:47PF,10%,100V	72982	A02AL9A4LC1G470K
C350	283-0177-00			CAP.,FXD,CER DI:1UF,+80-20%,25V	56289	273C5
C355	283-0310-00	B010100	B029999	CAP.,FXD,CER DI:2.5PF,+/-0.25PF,100V	72982	A01AL4A4LC0G0259
C355	SELECTED	B030000				
C358	281-0218-00			CAP.,VAR,CER DI:1-5PF,+2-2.5%,100V	72982	513-001 1-5
C360	283-0111-00			CAP.,FXD,CER DI:0.1UF,20%,50V	72982	8121-N088Z5U104M
C365	283-0209-00			CAP.,FXD,CER DI:1UF,20%,50V	72982	8130M050Z5U0105M
C375	283-0311-00			CAP.,FXD,CER DI:4.7PF,+/-0.25PF,100V	72982	A02AL4AALC0G479C
CR200	152-0246-00			SEMICONV DEVICE:SW,SI,40V,200MA	03508	DE140
CR210	152-0246-00			SEMICONV DEVICE:SW,SI,40V,200MA	03508	DE140
L300	108-0737-00	B010100	B029999X	COIL,RF:40NH	80009	108-0737-00
L310	108-0737-00			COIL,RF:40NH	80009	108-0737-00
L393	108-0170-01			COIL,RF:FIXED,360NH	80009	108-0170-01
Q100	151-1023-00	B010100	B053094	TRANSISTOR:FET,N-CHAN,SI	80009	151-1023-00

P6201 Probe

Ckt No.	Tektronix Part No.	Serial/Model No. Eff	Dscont	Name & Description	Mfr Code	Mfr Part Number
Q100	151-1023-01	B053095		TRANSISTOR:FET,N-CHAN,SI	04713	SMCM485
Q120	151-0362-01			TRANSISTOR:SILICON,PNP,SEL FROM 2N4258	80009	151-0362-01
Q130	151-0362-01			TRANSISTOR:SILICON,PNP,SEL FROM 2N4258	80009	151-0362-01
Q300	151-0416-00	B010100	B029999	TRANSISTOR:SILICON,NPN	80009	151-0416-00
Q300	151-0475-00	B030000	B059999	TRANSISTOR:SILICON,NPN	80009	151-0475-00
Q300	151-0475-01	B060000		TRANSISTOR:SILICON,NPN,SCREENED	80009	151-0475-01
Q320	151-0416-00	B010100	B029999	TRANSISTOR:SILICON,NPN	80009	151-0416-00
Q320	151-0475-00	B030000	B059999	TRANSISTOR:SILICON,NPN	80009	151-0475-00
Q320	151-0475-01	B060000		TRANSISTOR:SILICON,NPN,SCREENED	80009	151-0475-01
Q350	151-0341-00			TRANSISTOR:SILICON,NPN	07263	S040065
R1	321-0807-01			RES.,FXD,FILM:900K OHM,0.5%,0.125W	91637	MFF1816G90002D
R2	307-0240-00			RES.,FXD,CMPSN:50 OHM,10%,0.075W	23223	50-A-10-L
R3	317-0680-00			RES.,FXD,CMPSN:68 OHM,5%,0.125W	01121	BB6805
R4	-----			(FURNISHED AS A UNIT WITH 204-0557-00)		
R21	321-0790-01			RES.,FXD,FILM:990K OHM,0.5%,0.125W	91637	HFF1104G99002D
R22	307-0240-00			RES.,FXD,CMPSN:50 OHM,10%,0.075W	23223	50-A-10-L
R23	325-0036-00			RES.,FXD,FILM:11.1K OHM,1%,0.05W	03888	PME50E180ROF
R24	317-0430-00			RES.,FXD,CMPSN:43 OHM,5%,0.125W	01121	BB4305
R25	317-0220-00			RES.,FXD,CMPSN:22 OHM,5%,0.125W	01121	BB2205
R26	-----			(FURNISHED AS A UNIT WITH 204-0558-00)		
R120	307-0240-00	B010100	B059999	RES.,FXD,CMPSN:50 OHM,10%,0.075W	23223	50-A-10-L
R120	307-0514-00	B060000		27 OHM,1%,0.0755W	52262	MCRA270FY
R130	325-0121-00			RES.,FXD,FILM:90K OHM,0.5%,0.05W	03888	PME50-G900001D
R140	317-0106-00			RES.,FXD,CMPSN:10M OHM,5%,0.125W	01121	BB1065
R150	317-0202-00			RES.,FXD,CMPSN:2K OHM,5%,0.125W	01121	BB2025
R160	317-0511-00			RES.,FXD,CMPSN:510 OHM,5%,0.125W	01121	BB5115
R170	317-0161-00			RES.,FXD,CMPSN:160 OHM,5%,0.125W	01121	BB1615
R180	317-0301-00			RES.,FXD,CMPSN:300 OHM,5%,0.125W	01121	BB3015
R185	SELECTED					
R190	307-0240-00			RES.,FXD,CMPSN:50 OHM,10%,0.075W	23223	50-A-10-L
R200	311-1413-00			RES.,VAR,NONWIR:PNL,5K OHM,0.75W	11236	VA305-6P1021
R210	321-0263-00	B010100	B046190	RES.,FXD,FILM:5.36K OHM,1%,0.125W	91637	MFF1816G53600F
R210	315-0512-00	B046191		RES.,FXD,CMPSN:5.1K OHM,5%,0.25W	01121	CB5125
R220	321-0388-00	B010100	B046190	RES.,FXD,FILM:107K OHM,1%,0.125W	91637	MFF1816G10702F
R220	315-0104-00	B046191		RES.,FXD,CMPSN:100K OHM,5%,0.25W	01121	CB1045
R230	311-0634-00	B010100	B046190	RES.,VAR,NONWIR:TRMR,500 OHM,0.5W	32997	3326H-G48-501
R230	311-1263-00	B046191		RES.,VAR,NONWIR:1K OHM,10%,0.50W	32997	3329P-L58-102
R240	321-0452-00	B010100	B046191	RES.,FXD,FILM:499K OHM,1%,0.125W	91637	MFF1816G49902F
R240	315-0474-00	B046191		RES.,FXD,CMPSN:470K OHM,5%,0.25W	01121	CB4745
R250	311-1271-00			RES.,VAR,NONWIR:50K OHM,10%,0.50W	32997	3329P-L58-503
R260	321-0151-00			RES.,FXD,FILM:365 OHM,1%,0.125W	91637	MFF1816G365ROF
R265	321-0978-01			RES.,FXD,FILM:11.02K OHM,0.1%,0.125W	24546	NA55D11021D
R270	317-0514-00			RES.,FXD,CMPSN:510K OHM,5%,0.125W	01121	BB5145
R280	321-0293-03			RES.,FXD,FILM:11K OHM,0.25%,0.125W	24546	NC55C1102C
R290	321-0381-03			RES.,FXD,FILM:90.9K OHM,0.25%,0.125W	91637	MFF1816D90901C
R293	308-0714-00			RES.,FXD,FILM:90K OHM,0.5%,0.05W	03888	PME50-G900001D
R295	325-0121-00			RES.,FXD,WW:46.4 OHM,1%,1W	91637	RS1A-B46R40F
R298	308-0715-00			RES.,FXD,WW:78 OHM,1%	91637	RS1A-B78R00F
R300	321-0223-00	B010100	B046190	RES.,FXD,FILM:2.05K OHM,1%,0.125W	91637	MFF1816G20500F
R300	315-0182-00	B046191		RES.,FXD,CMPSN:1.8K OHM,5%,0.25W	01121	CB1825
R305	317-0150-00	XB030000		RES.,FXD,CMPSN:15 OHM,5%,0.125W	01121	BB1505
	-----			(NOMINAL VALUE,SELECTED)		
	-----			(THESE PARTS ARE SELECTED FOR BEST RESPONSE IN		
	-----			COMBINATION WITH U200,Q300 AND Q320)		
R310	317-0102-00	B010100	B029999	RES.,FXD,CMPSN:1K OHM,5%,0.125W	01121	BB1025
R310	317-0911-00	B030000		RES.,FXD,CMPSN:910 OHM,5%,0.125W	01121	BB9115
R325	322-0126-00			RES.,FXD,FILM:200 OHM,1%,0.25W	91637	MFF1421G200ROF

Ckt No.	Tektronix Part No.	Serial/Model No. Eff	Dscont	Name & Description	Mfr Code	Mfr Part Number
R330	317-0300-00	B010100	B029999X	RES.,FXD,CMPSN:30 OHM,5%,0.125W	01121	BB3005
R335	317-0270-00			RES.,FXD,CMPSN:27 OHM,5%,0.125W	01121	BB2705
R340	321-0080-00			RES.,FXD,FILM:66.5 OHM,1%,0.125W	91637	MFF1816G66R50F
R345	322-0126-00			RES.,FXD,FILM:200 OHM,1%,0.25W	91637	MFF1421G200R0F
R350	315-0102-00			RES.,FXD,CMPSN:1K OHM,5%,0.25W	01121	CB1025
R355	317-0151-00			RES.,FXD,CMPSN:150 OHM,5%,0.125W	01121	BB1515
RT360	307-0343-00			RES.,THERMAL:200 OHM,10%	50157	40C20100
R365	325-0051-00	B010100	B046190	RES.,FXD,FILM:18.2 OHM,1%,0.05W	75042	MMCT0-18R2F
R365	317-0220-00	B046191		RES.,FXD,CMPSN:22 OHM,5%,0.125W	01121	BB2205
R368	SELECTED			(THESE PARTS ARE SELECTED FOR BEST RESPONSE IN COMBINATION WITH U200,Q300 AND Q320)		
R370	311-0978-00			RES.,VAR, NONWIR:250 OHM,10%,0.50W	73138	82-4-2
R375	317-0201-00	B010100	B050863	RES.,FXD,CMPSN:200 OHM,5%,0.125W (NOMINAL VALUE,SELECTED)	01121	BB2015
R375	317-0121-00	B050864		RES.,FXD,CMPSN:120 OHM,5%,0.125W (NOMINAL VALUE,SELECTED)	01121	BB1215
R380	322-0119-00			RES.,FXD,FILM:169 OHM,1%,0.25W	91637	MFF1421G169R0F
R390	322-0119-00			RES.,FXD,FILM:169 OHM,1%,0.25W	91637	MFF1421G169R0F
R393	311-0622-01			RES.,VAR, NONWIR:100 OHM,10%,0.50W	32997	3326H-K28-101
R395	317-0272-00			RES.,FXD,CMPSN:2.7K OHM,5%,0.125W	01121	BB2725
R397	317-0101-00			RES.,FXD,CMPSN:100 OHM,5%,0.125W	01121	BB1015
R398	325-0053-00			RES.,FXD,FILM:50 OHM,1%,0.05W	03888	PME50C50R00F
R399	317-0151-00			RES.,FXD,CMPSN:150 OHM,5%,0.125W	01121	BB1515
S200	260-0984-00			SWITCH,SLIDE:DP3T,0.5A,125V	79727	G-128-S-0012
S250	260-0960-01			SWITCH,SLIDE:0.5A,120VDC,CKT BD MT	10389	23-021-043
S300	260-0960-01			SWITCH,SLIDE:0.5A,120VDC,CKT BD MT	10389	23-021-043
U200	156-0223-00			MICROCIRCUIT,LI:OPERATIONAL AMPLIFIER	27014	LM308H

P6201 Probe

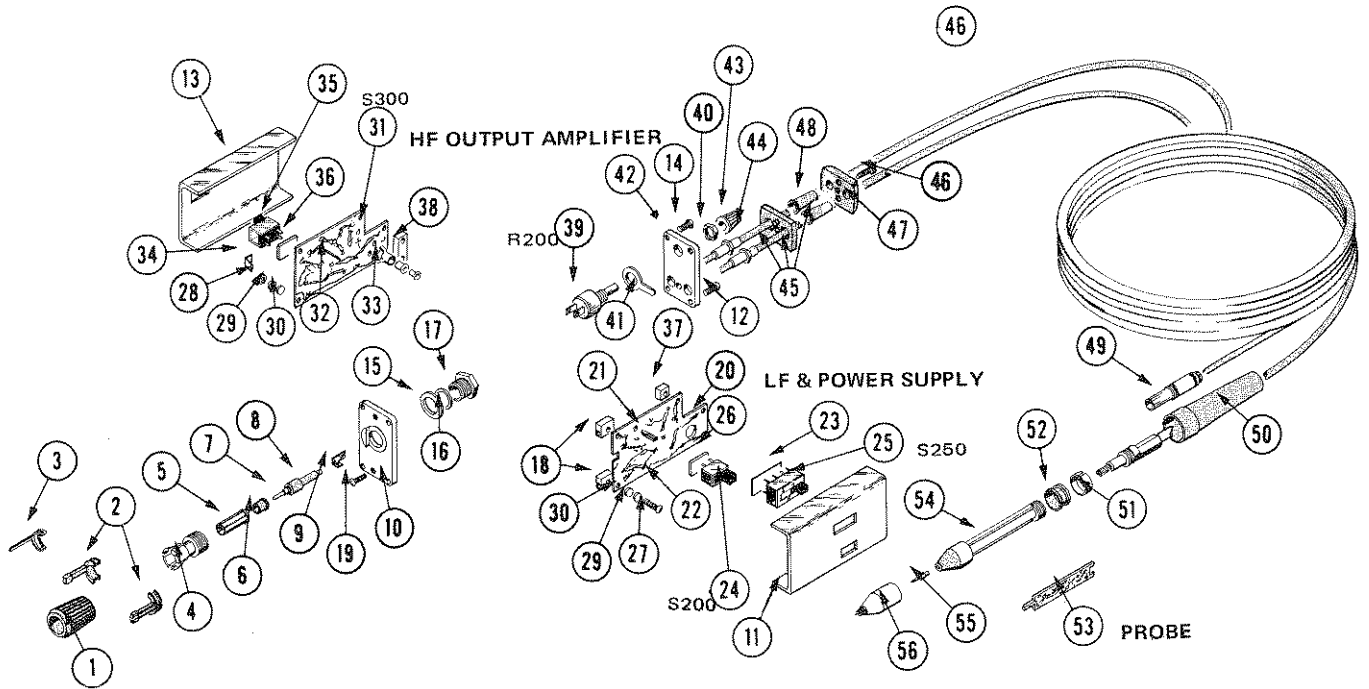

FIG. 6-1

Fig. & Index No.	Tektronix Part No.	Serial/Model No. Eff	Model No. Dscont	Qty	1	2	3	4	5	Name & Description	Mfr Code	Mfr Part Number
6-1	010-6201-00			1						PROBE, VOLTAGE: P6201, 72.0 L, 1X, PROBE ONLY	80009	010-6201-00
-1	205-0142-00			1						. SHELL, ELEC CONN: BNC, LOCKING	80009	205-0142-00
-2	342-0076-00			2						. INSULATOR, CONN:	80009	342-0076-00
-3	131-1049-00			1						. CONTACT, ELEC: CONN READOUT	80009	131-1049-00
-4	204-0473-00			1						. CONN BODY, RCPT: BNC, COMP BOX	80009	204-0473-00
-5	204-0472-00			1						. CONN BODY, RCPT: BNC, LOCKING	80009	204-0472-00
-6	358-0072-00			1						. INSULATOR, BSHG:	80009	358-0072-00
-7	131-1257-00			1						. CONTACT, ELEC: BNC CTR COND, BRS	80009	131-1257-00
-8	342-0134-00			1						. INSULATOR, BSHG:	80009	342-0134-00
-9	131-1135-00			1						. CONTACT, ELEC: CKT BD TO CONN	80009	131-1135-00
-10	386-2264-00			1						. PANEL, REAR:	80009	386-2264-00
-11	380-0286-00			1						. HSG, OUT, AMPL:	80009	380-0286-00
										(ATTACHING PARTS)		
-12	211-0001-00			4						. SCREW, MACHINE: 2-56 X 0.25 INCH, PNH STL	87308	0BD
										- - - * - - -		
-13	380-0287-00			1						. HSG, OUT, AMPL:	80009	380-0287-00
										(ATTACHING PARTS)		
-14	211-0001-00			4						. SCREW, MACHINE: 2-56 X 0.25 INCH, PNH STL	87308	0BD
										- - - * - - -		
-15	210-0021-00			1						. WASHER, LOCK: INTL, 0.476 ID X 0.60"OD STL	78189	1222-01-00-0541C
-16	210-0941-00			1						. WASHER, FLAT: 0.448 ID X 0.688 OD STL	80009	210-0941-00
-17	358-0454-00			1						. BSHG, MACH THD:	80009	358-0454-00
-18	386-2266-00			2						. SUPPORT, CKT BD:	80009	386-2266-00
										(ATTACHING PARTS)		
-19	211-0022-00	B010100	B046190	2						. SCREW, MACHINE: 2-56 X 0.188 INCH, PNH STL	83385	0BD
	210-0001-00	B046191		2						. WASHER, LOCK: INTL, 0.092 ID X 0.18"OD, STL	78189	1202-00-00-0541C
										- - - * - - -		

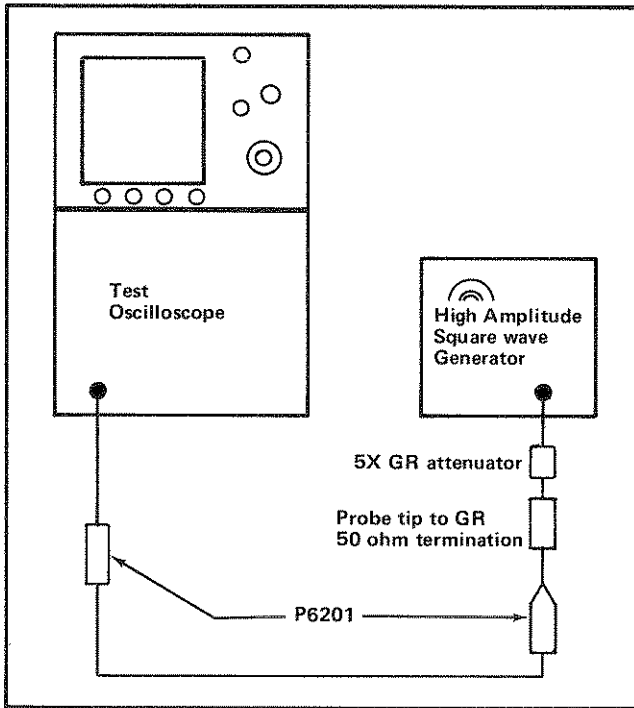

Fig. 5-5. Equipment setup for step 6.

c. Set the probe INPUT COUPLING switch to AC.

d. Set the square-wave generator for a 10 kHz, 6 division, test oscilloscope waveform having a symmetrical shape.

e. CHECK—Percentage of compression for 1.2 V peak-to-peak signal; measured as shown in Fig. 5-6, the percentage must not exceed 4%.

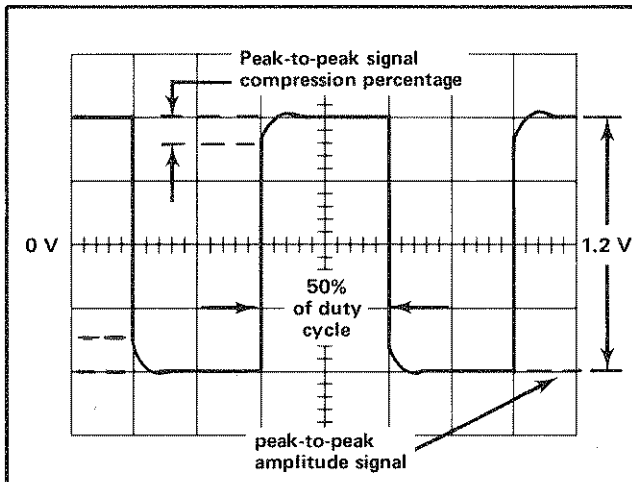

Fig. 5-6. Illustration showing how to measure signal compression.

7. Check or Adjust High Frequency Compensation, C358, C315, C325 and R393

a. Connect the equipment as shown in Fig. 5-7.

b. Set the probe 50 Ω TERM switch to EXT.

c. Set the sampling test oscilloscope for a vertical deflection factor of 50 mV and a sweep rate of 1 ns.

d. CHECK—Waveform aberrations—must be +5%, -3%, or a total of 7% or less peak to peak in the first 5 ns of the waveform following the step transition; and +3%, -3%, or a total of 5% or less peak to peak after the first 5 ns of the waveform.

e. ADJUST—See Table 5-1 and Fig. 5-1 for adjustments. Adjust for optimum transient response and risetime.

TABLE 5-1

Adjustment	Use of Adjustment
C358	Effects primarily front corner and first 1.5 ns of waveform.
C315	Set for minimum effect unless otherwise necessary to reduce aberrations.
C325	Affects first 3 ns of waveform; also has some effect on the front corner amplitude.
R393	Affects the flatness on the top of the waveform after the 3 ns point.

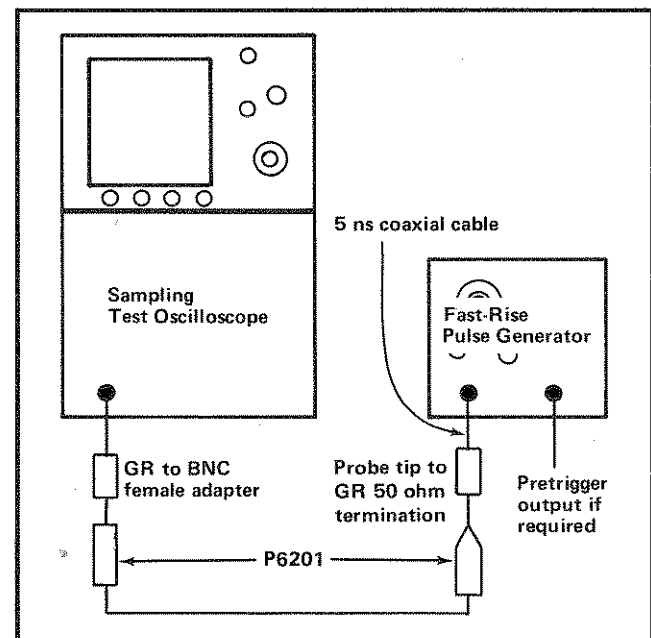

Fig. 5-7. Equipment setup for steps 7 and 8.

Calibration—P6201 Probe

8. Check Probe Risetime

- Perform parts a through c of step 7.
- Measure the system risetime of sampling test oscilloscope plus probe.
- Disconnect the probe, GR to BNC female adapter, probe tip to GR 50 Ω termination and 5 ns coaxial cable from the fast-rise pulse generator and sampling test oscilloscope.
- Connect the pulse output of the fast-rise pulse generator to the sampling test oscilloscope via a 5 ns cable.
- Measure the sampling test oscilloscope risetime.
- Using the following formula, calculate the probe risetime.

$$T_{R(\text{Probe})} = \sqrt{\left[T_{R(\text{Display})} \right]^2 - \left[T_{R(\text{System minus probe})} \right]^2}$$

- CHECK—Probe risetime should be 0.39 ns or less.
- ### 9. Check or Adjust 10X and 100X Attenuator Compensation
- Connect the equipment as shown in Fig. 5-8.
 - Set the probe 50 Ω TERM switch to INT.
 - Set the test oscilloscope for a vertical deflection factor of 10 mV and a sweep rate of 10 μ s.
 - Set the square-wave generator for a 100 kHz, 5 division test oscilloscope waveform having a symmetrical shape.
 - CHECK—Test oscilloscope display for a square leading corner on the waveform.

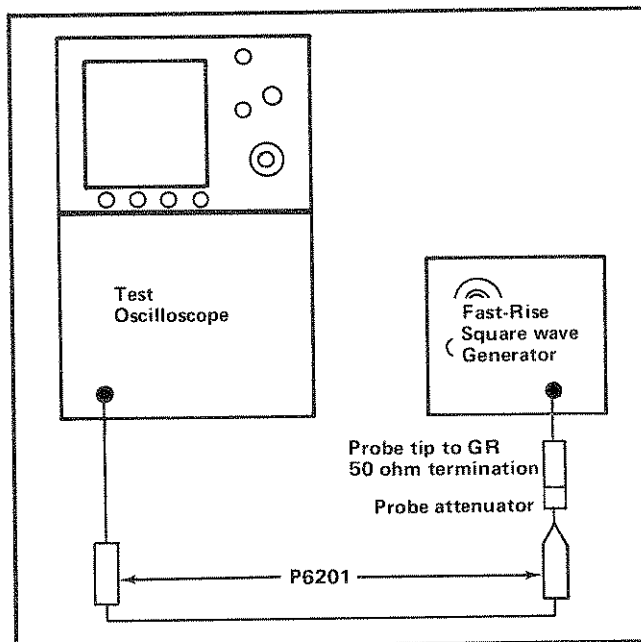

Fig. 5-8. Equipment setup for step 9.

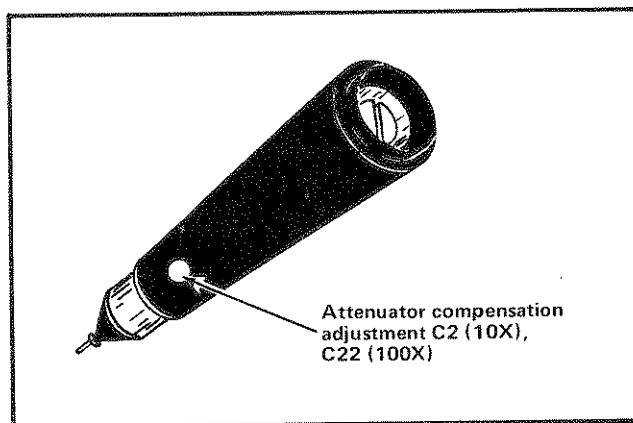

Fig. 5-9. Location of attenuator compensation adjustment.

- ADJUST—C2 (10X) or C22 (100X) attenuator compensation, see Fig. 5-9 for a square leading corner on the test oscilloscope waveform.

This completes the P6201 calibration procedure. Disconnect all test equipment and replace all covers (housing halves).

REPLACEABLE PARTS

PARTS ORDERING INFORMATION

Replacement parts are available from or through your local Tektronix, Inc. Field Office or representative.

Changes to Tektronix instruments are sometimes made to accommodate improved components as they become available, and to give you the benefit of the latest circuit improvements developed in our engineering department. It is therefore important, when ordering parts, to include the following information in your order: Part number, instrument type or number, serial number, and modification number if applicable.

If a part you have ordered has been replaced with a new or improved part, your local Tektronix, Inc. Field Office or representative will contact you concerning any change in part number.

Change information, if any, is located at the rear of this manual.

SPECIAL NOTES AND SYMBOLS

X000	Part first added at this serial number
00X	Part removed after this serial number

FIGURE AND INDEX NUMBERS

Items in this section are referenced by figure and index numbers to the illustrations.

INDENTATION SYSTEM

This mechanical parts list is indented to indicate item relationships. Following is an example of the indentation system used in the description column.

1	2	3	4	5	Name & Description
					<i>Assembly and/or Component</i>
					<i>Attaching parts for Assembly and/or Component</i>
					---*---
					<i>Detail Part of Assembly and/or Component</i>
					<i>Attaching parts for Detail Part</i>
					---*---
					<i>Parts of Detail Part</i>
					<i>Attaching parts for Parts of Detail Part</i>
					---*---

Attaching Parts always appear in the same indentation as the item it mounts, while the detail parts are indented to the right. Indented items are part of, and included with, the next higher indentation. The separation symbol ---*--- indicates the end of attaching parts.

Attaching parts must be purchased separately, unless otherwise specified.

ITEM NAME

In the Parts List, an Item Name is separated from the description by a colon (:). Because of space limitations, an Item Name may sometimes appear as incomplete. For further Item Name identification, the U.S. Federal Cataloging Handbook H6-1 can be utilized where possible.

ABBREVIATIONS

"	INCH	ELECTRN	ELECTRON	IN	INCH	SE	SINGLE END
#	NUMBER SIZE	ELEC	ELECTRICAL	INCAND	INCANDESCENT	SECT	SECTION
ACTR	ACTUATOR	ELECTLT	ELECTROLYTIC	INSUL	INSULATOR	SEMICON	SEMICONDUCTOR
ADPTR	ADAPTER	ELEM	ELEMENT	INTL	INTERNAL	SHLD	SHIELD
ALIGN	ALIGNMENT	EPL	ELECTRICAL PARTS LIST	LPHLDR	LAMPHOLDER	SHLDR	SHOULDERED
AL	ALUMINUM	EQPT	EQUIPMENT	MACH	MACHINE	SKT	SOCKET
ASSEM	ASSEMBLED	EXT	EXTERNAL	MECH	MECHANICAL	SL	SLIDE
ASSY	ASSEMBLY	FIL	FILLISTER HEAD	MTG	MOUNTING	SLFLKG	SELF-LOCKING
ATTEN	ATTENUATOR	FLEX	FLEXIBLE	NIP	NIPPLE	SLVG	SLEEVING
AWG	AMERICAN WIRE GAGE	FLH	FLAT HEAD	NON WIRE	NOT WIRE WOUND	SPR	SPRING
BD	BOARD	FLTR	FILTER	OBD	ORDER BY DESCRIPTION	SO	SQUARE
BRKT	BRACKET	FR	FRAME or FRONT	OD	OUTSIDE DIAMETER	SST	STAINLESS STEEL
BR5	BRASS	FSTNR	FASTENER	OVH	OVAL HEAD	STL	STEEL
BRZ	BRONZE	FT	FOOT	PH BRZ	PHOSPHOR BRONZE	SW	SWITCH
BSHG	BUSHING	FXD	FIXED	PL	PLAIN or PLATE	T	TUBE
CAB	CABINET	GSKT	GASKET	PLSTC	PLASTIC	TERM	TERMINAL
CAP	CAPACITOR	HDL	HANDLE	PN	PART NUMBER	THD	THREAD
CER	CERAMIC	HEX	HEXAGON	PNH	PAN HEAD	THK	THICK
CHAS	CHASSIS	HEX HD	HEXAGONAL HEAD	PWR	POWER	TNSN	TENSION
CKT	CIRCUIT	HEX SOC	HEXAGONAL SOCKET	RCPT	RECEPTACLE	TPG	TAPPING
COMP	COMPOSITION	HLCP5	HELICAL COMPRESSION	RES	RESISTOR	TRH	TRUSS HEAD
CONN	CONNECTOR	HLEXT	HELICAL EXTENSION	RGD	RIGID	V	VOLTAGE
COV	COVER	HV	HIGH VOLTAGE	RLF	RELIEF	VAR	VARIABLE
CRLG	COUPLING	IC	INTEGRATED CIRCUIT	RTNR	RETAINER	W/	WITH
CRT	CATHODE RAY TUBE	ID	INSIDE DIAMETER	SCH	SOCKET HEAD	WSHR	WASHER
DEG	DEGREE	IDENT	IDENTIFICATION	SCOPE	OSCILLOSCOPE	XFMR	TRANSFORMER
DWR	DRAWER	IMPLR	IMPELLER	SCR	SCREW	XSTR	TRANSISTOR

CROSS INDEX—MFR. CODE NUMBER TO MANUFACTURER

Mfr. Code	Manufacturer	Address	City, State, Zip
000AH	STANDARD PRESSED STEEL CO., UNBRAKO DIV.	8535 DICE ROAD	SANTA FE SPRINGS, CA 90670
000CY	NORTHWEST FASTENER SALES, INC.	7923 SW CIRRUS DRIVE	BEAVERTON, OR 97005
0000A	LEMO USA	2015 SECOND ST.	BERKELEY, CA 94710
00779	AMP, INC.	P O BOX 3608	HARRISBURG, PA 17105
01121	ALLEN-BRADLEY COMPANY	1201 2ND STREET SOUTH	MILWAUKEE, WI 53204
03508	GENERAL ELECTRIC COMPANY, SEMI-CONDUCTOR PRODUCTS DEPARTMENT	ELECTRONICS PARK	SYRACUSE, NY 13201
03888	KDI PYROFILM CORPORATION	60 S JEFFERSON ROAD	WHIPPANY, NJ 07981
04713	MOTOROLA, INC., SEMICONDUCTOR PROD. DIV.	5005 E MCDOWELL RD, PO BOX 20923	PHOENIX, AZ 85036
07111	PNEUMO DYNAMICS CORPORATION	4800 PRUDENTIAL TOWER	BOSTON, MA 02199
07263	FAIRCHILD SEMICONDUCTOR, A DIV. OF FAIRCHILD CAMERA AND INSTRUMENT CORP.	464 ELLIS STREET	MOUNTAIN VIEW, CA 94042
10389	CHICAGO SWITCH, INC.	2035 WABANSIA AVE.	CHICAGO, IL 60647
11236	CTS OF BERNE, INC.	406 PARR RD.	BERNE, IN 46711
12360	ALBANY PRODUCTS CO., DIV. OF PNEUMO DYNAMICS CORPORATION	145 WOODWARD AVENUE	SOUTH NORWALK, CT 06586
22526	BERG ELECTRONICS, INC.	YOUK EXPRESSWAY	NEW CUMBERLAND, PA 17070
23223	CTS MICROELECTRONICS, INC.	1201 CUMBERLAND AVENUE P O BOX 1278	WEST LAFAYETTE, IN 47902
24546	CORNING GLASS WORKS, ELECTRONIC COMPONENTS DIVISION	550 HIGH STREET	BRADFORD, PA 16701
26769	NCI INC.	5900 AUSTRALIAN AVENUE	WEST PALM BEACH, FL 33407
27014	NATIONAL SEMICONDUCTOR CORP.	2900 SEMICONDUCTOR DR.	SANTA CLARA, CA 95051
32997	BOURNS, INC., TRIMPOT PRODUCTS DIV.	1200 COLUMBIA AVE.	RIVERSIDE, CA 92507
50157	MIDWEST COMPONENTS INC.	P. O. BOX 787 1981 PORT CITY BLVD.	MUSKEGON, MI 49443
52262	B AND H ELECTRONICS, INC., DBA MICRO COMPONENTS ASSOCIATES	202 E STEVENS ST., SUITE 6	SANTA ANA, CA 92707
56289	SPRAGUE ELECTRIC CO.	87 MARSHALL ST.	NORTH ADAMS, MA 01247
72982	ERIE TECHNOLOGICAL PRODUCTS, INC.	644 W. 12TH ST.	ERIE, PA 16512
73138	BECKMAN INSTRUMENTS, INC., HELIPOT DIV.	2500 HARBOR BLVD.	FULLERTON, CA 92634
73743	FISCHER SPECIAL MFG. CO.	446 MORGAN ST.	CINCINNATI, OH 45206
73899	JFD ELECTRONICS COMPONENTS CORP.	PINETREE ROAD	OXFORD, NC 27565
75042	TRW ELECTRONIC COMPONENTS, IRC FIXED RESISTORS, PHILADELPHIA DIVISION	401 N. BROAD ST.	PHILADELPHIA, PA 19108
78189	ILLINOIS TOOL WORKS, INC. SHAKEPROOF DIVISION	ST. CHARLES ROAD	ELGIN, IL 60120
79727	C-W INDUSTRIES	550 DAVISVILLE RD., P O BOX 96	WARMINISTER, PA 18974
80009	TEKTRONIX, INC.	P O BOX 500	BEAVERTON, OR 97077
83385	CENTRAL SCREW CO.	2530 CRESCENT DR.	BROADVIEW, IL 60153
86928	SEASTROM MFG. COMPANY, INC.	701 SONORA AVENUE	GLENDALE, CA 91201
87308	N. L. INDUSTRIES, INC., SOUTHERN SCREW DIV.	P. O. BOX 1360	STATESVILLE, NC 28677
91293	JOHANSON MFG. COMPANY	P O BOX 329	BOONTON, NJ 07005
91637	DALE ELECTRONICS, INC.	P. O. BOX 609	COLUMBUS, NE 68601

P6201 Probe

Fig. & Index No.	Tektronix Part No.	Serial/Model No. Eff Dscont	Qty	1	2	3	4	5	Name & Description	Mfr Code	Mfr Part Number
6-20	-----		1	CKT BOARD ASSY:L.F. OUTPUT AMPLIFIER(SEE REPL)		
-21	136-0252-04		7	SOCKET,PIN TERM:U/W 0.016-0.018 DIA PINS	22526	75060-007
-22	136-0263-03		5	SOCKET,PIN TERM:FOR 0.025 INCH SQUARE PIN	00779	86250-2
-23	214-2250-00		1	INSULATOR,PLATE:SLIDE SWITCH,FISH PAPER	80009	214-2250-00
-24	260-0960-01		1	SWITCH,SLIDE:0.5A,120VDC,CKT BD MT	10389	23-021-043
-25	260-0984-00		1	SWITCH,SLIDE:DP3T,0.5A,125V	79727	G-128-S-0012
-26	386-2400-00		1	PLATE,SPACER: (ATTACHING PARTS FOR CKT BD)	80009	386-2400-00
-27	211-0181-00		5	SCREW,MACHINE:2-56 X 0.375,PNH,BRS	07111	OBD
-28	220-0627-00		5	NUT,PLAIN,HEX.:2-56 X 0.156 INCH,BRS	73743	10002-56-101
-29	210-0053-00	B010100 B046190	10	WASHER,LOCK:INTL,0.092 ID X 0.175"OD,STL	83385	OBD
	210-0001-00	B046191	10	WASHER,LOCK:INTL,0.092 ID X 0.18"OD,STL	78189	1202-00-00-0541C
-30	210-1008-00		10	WASHER,FLAT:0.09 ID X 0.188" OD,BRS	12360	OBD
				-	-	-	-	-	* - - -		
-31	-----		1	CKT BOARD ASSY:H.F. OUTPUT AMPLIFIER(SEE REPL)		
-32	131-0787-00		5	CONTACT,ELEC:0.64 INCH LONG	22526	47359
-33	131-1003-00		1	CONN,RCPT,ELEC:CKT BD MT,3 PRONG	80009	131-1003-00
-34	131-1134-00		2	CONTACT,ELEC:CKT CARD TO SHIELD	80009	131-1134-00
-35	260-0960-01		1	SWITCH,SLIDE:0.5A,120VDC,CKT BD MT	10389	23-021-043
-36	386-2400-00		1	PLATE,SPACER:	80009	386-2400-00
-37	386-2270-00		1	SUPPORT,CKT BD:	80009	386-2270-00
-38	386-2267-00		1	SUPPORT,CKT BD:	80009	386-2267-00
-39	-----		1	RESISTOR,VAR:(SEE R200 REPL) (ATTACHING PARTS)		
-40	210-0583-00		1	NUT,PLAIN,HEX.:0.25-32 X 0.312 INCH,BRS	73743	2X20317-402
-41	210-0223-00		1	TERMINAL,LUG:0.25 INCH DIA,SE	86928	A313-136
				-	-	-	-	-	* - - -		
-42	386-2265-00		1	PANEL,FRONT:	80009	386-2265-00
-43	366-0494-04		1	KNOB:GRAY	80009	366-0494-04
	213-0153-00		1	SETSCREW:5-40 X 0.125,STL BK OXD,HEX SKT	000CY	OBD
-44	175-1276-00		1	CA ASSY,SP,ELEC:3,26 AWG,54.0 L	80009	175-1276-00
-45	175-1359-02		1	CA ASSY,SP,ELEC:50 OHM COAX,5.56 AWG,77.0 L (ATTACHING PARTS)	80009	175-1359-02
-46	211-0183-00		1	SCREW,MACHINE:4-40 X 0.50 INCH,SOC HEX HD	000AH	OBD
-47	352-0219-00		1	HOLDER,CA NIP:	80009	352-0219-00
-48	200-1063-00		1	CABLE NIP.,ELEC:	80009	200-1063-00
				-	-	-	-	-	* - - -		
-49	131-0778-00		1	CONNECTOR,PLUG:QUICK DISCONNECT	0000A	F 0.304 NYL
-50	204-0533-00		1	BODY,PROBE:OUTER	80009	204-0533-00
-51	131-1271-00		1	CONTACT,ELEC:READOUT RING,BRS	80009	131-1271-00
-52	342-0151-00		1	INSUL,RDOUT CON:	80009	342-0151-00
-53	-----		1	CKT BOARD ASSY:PROBE(SEE REPL)		
-54	204-0532-01		1	BODY,PROBE:INNER W/INSUL	80009	204-0532-01
-55	206-0200-00		1	TIP,PROBE:	80009	206-0200-00
-56	015-0222-00		1	TIP,PROBE:IC TEST	80009	015-0222-00

P6201 Probe

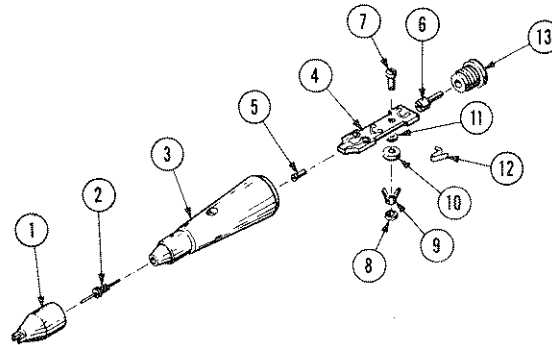
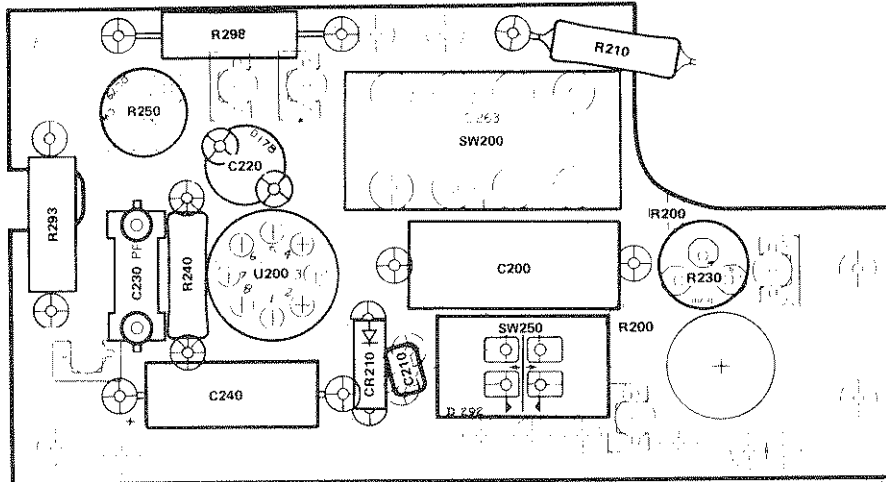
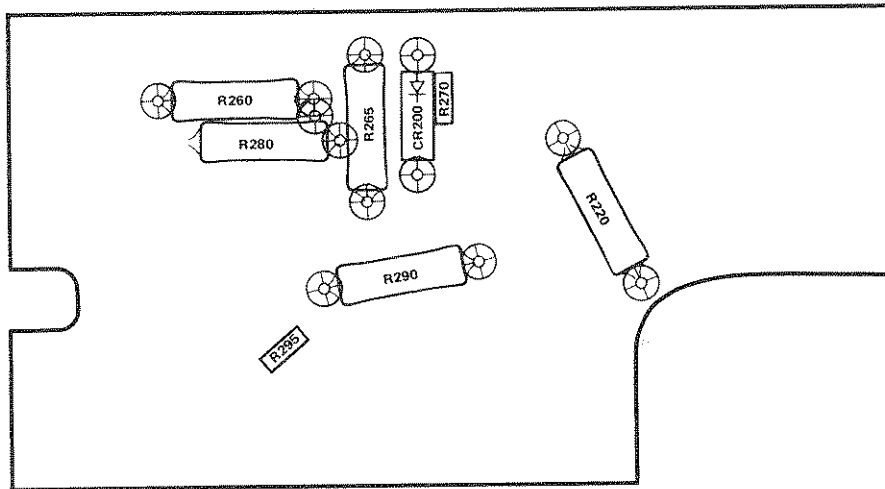

FIG. 6-2

Fig. & Index No.	Tektronix Part No.	Serial/Model No. Eff	Discont	Qty	1	2	3	4	5	Name & Description	Mfr Code	Mfr Part Number
6-2	010-0376-00			1						ATTEN HD, PROBE: 10X	80009	010-0376-00
	010-0377-00			1						ATTEN HD, PROBE: 100X	80009	010-0377-00
-1	015-0222-00			1						TIP, PROBE: IC TEST	80009	015-0222-00
-2	206-0200-00			1						TIP, PROBE:	80009	206-0200-00
-3	204-0557-00			1						BODY ATTENUATOR: 10X	80009	204-0557-00
	204-0558-00			1						BODY ATTENUATOR: 100X	80009	204-0558-00
-4	-----			1						CKT BOARD ASSY: ATTENUATOR 10X (SEE REPL)		
	-----			1						CKT BOARD ASSY: ATTENUATOR 100X (SEE REPL)		
-5	136-0252-00			1						SOCKET, PIN TERM: 0.145 INCH LONG	00779	2-330808-7
-6	131-0845-00			1						CONTACT, ELEC: CTR, PROBE	80009	131-0845-00
-7	384-0680-01			1						PIN, STR, HEADED: 0.16 L X 0.41 OD W/0.094 HD	80009	384-0680-01
-8	210-1045-00			1						WASHER, FLAT: 0.045 ID X 0.1 OD	80009	210-1045-00
-9	210-1047-00			1						WASHER, SPR TNSN: Y-SHAP, NI-BE GOLD PL	80009	210-1047-00
-10	388-0930-00			1						CIRCUIT BOARD: CAPACITOR ROTOR	80009	388-0930-00
-11	214-0971-00			1						INSULATOR, WSHR: 0.047 ID X 0.203 OD MICA	80009	214-0971-00
	214-0971-00	B010100	B039999	1						INSULATOR, WSHR: 0.047 ID X 0.203 OD MICA	80009	214-0971-00
	214-0971-00	B040000		2						INSULATOR, WSHR: 0.047 ID X 0.203 OD MICA	80009	214-0971-00
-12	344-0102-01			2						CLIP, ELECTRICAL:	80009	344-0102-01
	344-0102-01			4						CLIP, ELECTRICAL:	80009	344-0102-01
-13	342-0150-00			1						INSUL SLV, ELEC:	80009	342-0150-00



LOW FREQUENCY (FRONT)



LOW FREQUENCY (BACK)

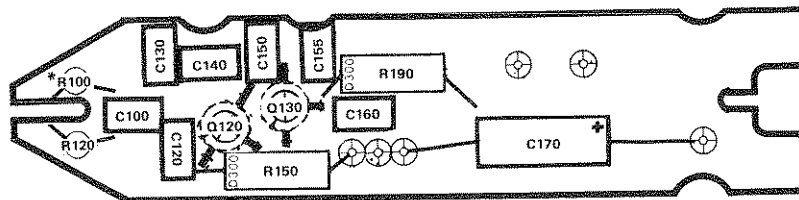

PROBE-FET (FRONT)

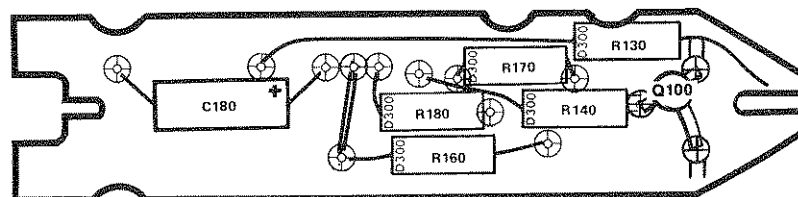

PROBE-FET (BACK)

P6201 Probe

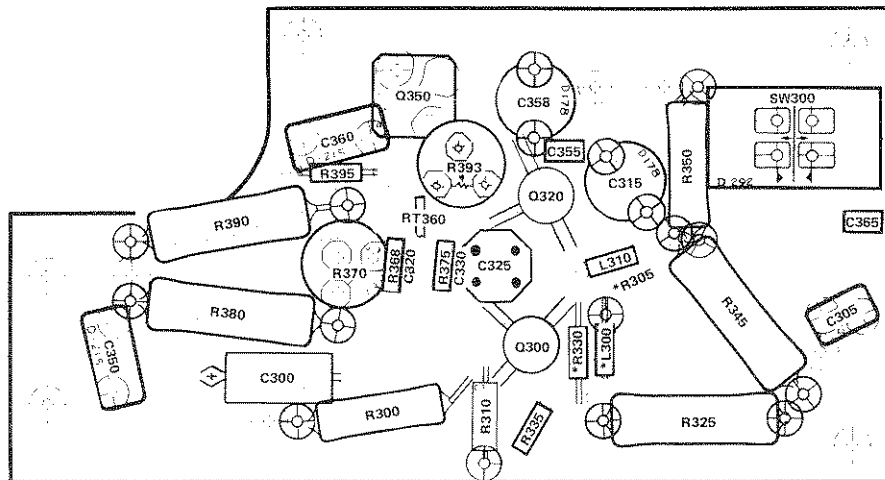

HIGH FREQUENCY OUTPUT (FRONT)

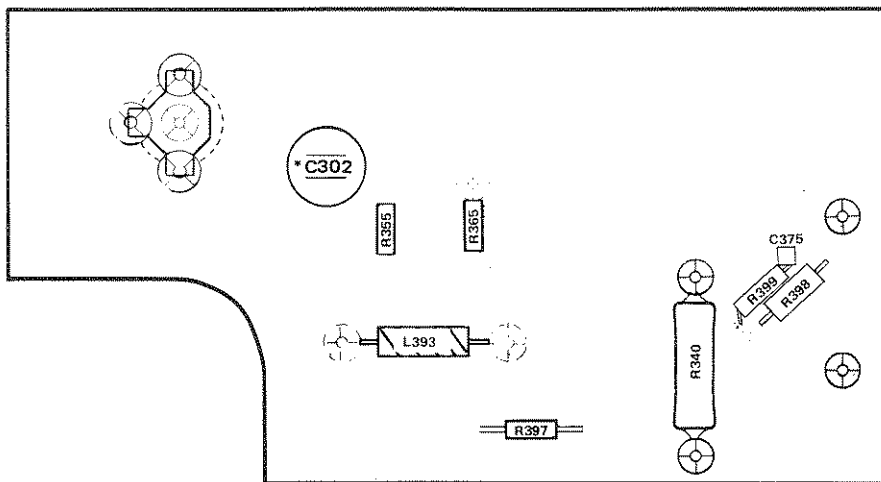

HIGH FREQUENCY OUTPUT (BACK)

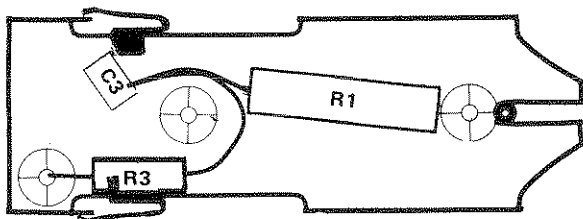

X10 ATTEN (FRONT)

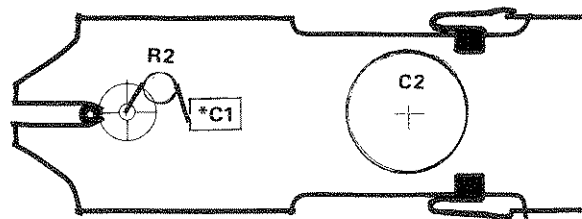

X10 ATTEN (BACK)

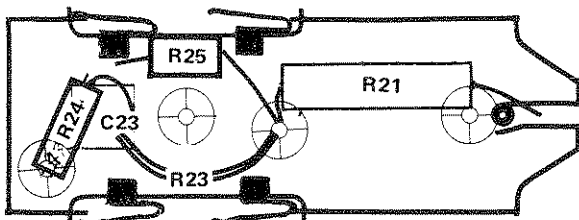

X100 ATTEN (FRONT)

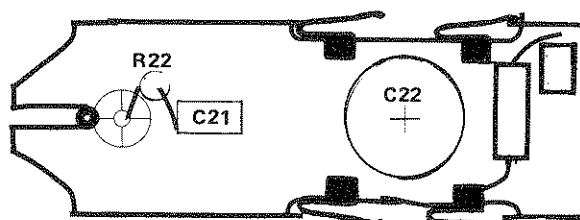

X100 ATTEN (BACK)

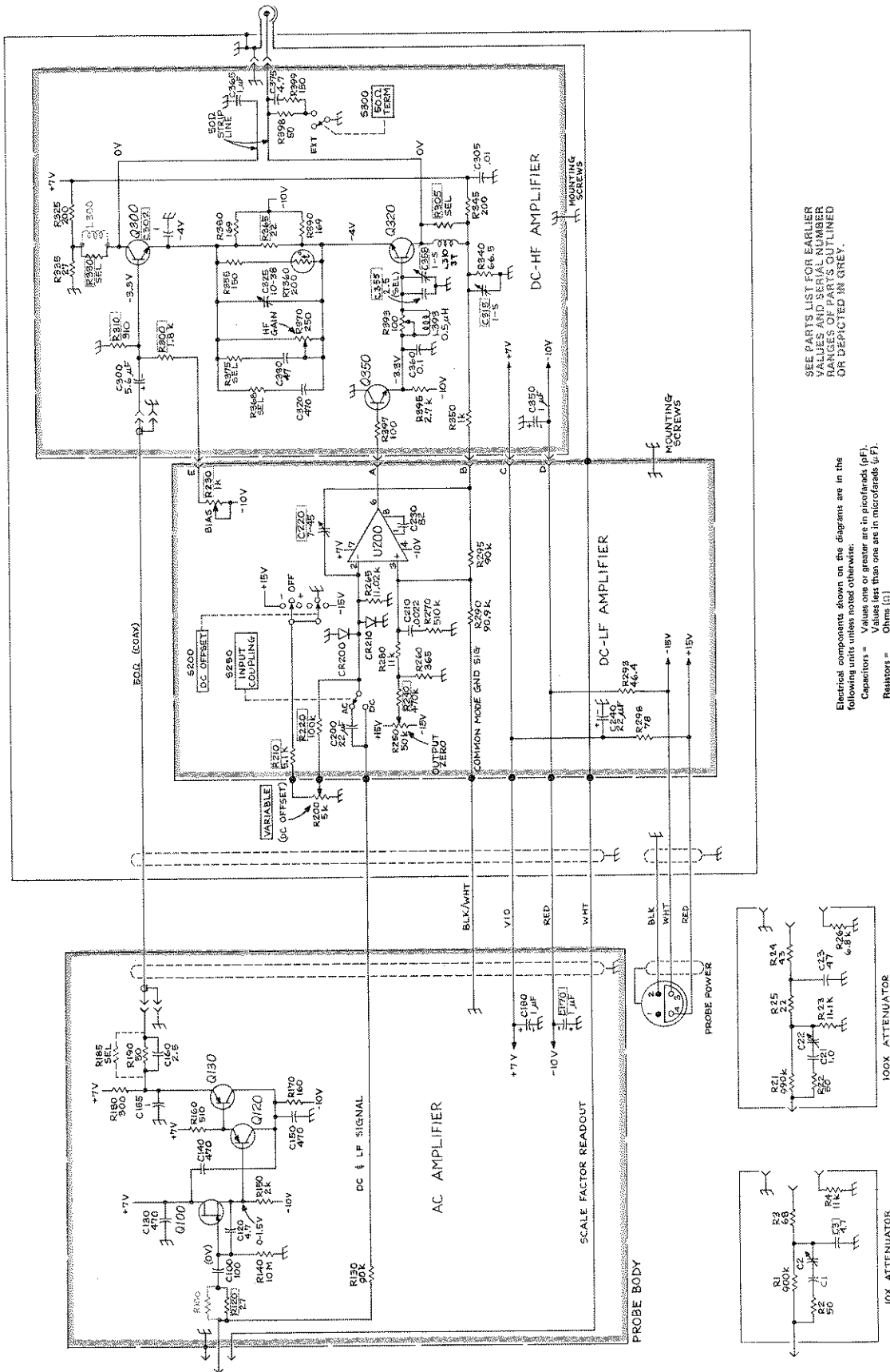

SEE PARTS LIST FOR EARLIER VALUES AND SERIAL NUMBER RANGES OF PARTS OUTLINED OR DEPICTED IN GREY.

Electrical components shown on the diagrams are in the following units unless noted otherwise.
 Capacitors = Values one or greater are in picofarads (pF).
 Values less than one are in microfarads (uF).
 Resistors = Ohms (Ω)

P6201 PROBE

