

Data Pattern Generator

DG2020A Data Sheet



DG2000 Series

Features & Benefits

- Data Rate to 200 Mb/s
- Data Pattern Depth 64 K/channel Speeds Characterization
- Multiple Output Channels Increases Flexibility
 - DG2020A: 12, 24, or 36
- Precise Control of Output Parameters Include:
 - Variable Output Delay
 - Variable Output Level
 - Tri-state Output Control
- Transition Times 2 ns at 5 V_{p-p}
- Flexible Sequence Control with Jump, Event, and Nested Loops
- Large Display for Easy-to-Use Data Editing
- Import Pattern Data with DG-Link Software Utility
- Integrate into ATE Systems through GPIB/RS-232-C Interface

Applications

- Low Jitter for Clock Substitution
- Characterize Device Timing
- Simulate Missing Functions in System or Subsystem Evaluation
- Create Complex Data Patterns with Sophisticated Sequence, Looping, Jump on Event, and Tri-state Output Control
- Characterize and Verify ASIC, FPGA, and DACs
- Test Printer Engines or LCD Display Drivers
- Construct Logic Verification Systems Utilizing Tektronix Oscilloscopes or Logic Scopes
- Use in Conjunction with TLA Logic Analyzer to Provide Digital Stimulus

The DG2020A pattern generator provides digital designers with the high-performance tools needed to evaluate digital semiconductors and logic circuits. Whatever you call your design process - characterization, debug, validation, or verification - as a digital designer you must have a state-of-the-art digital pattern generation as you push the edge of the technology envelope and race to market.

The DG2020A is an appropriate instrument for a wide variety of digital design applications. The table illustrates the principal specifications for the DG2020A.

DG2020A

Characteristic	Description
Data Rate	200 Mb/s
Pattern Depth	64 K/CH.
Rise/Fall Time (20% to 80%)	2 ns at 5 V _{p-p}
No. of channels	12, 24, or 36
Features	Bus-wide testing

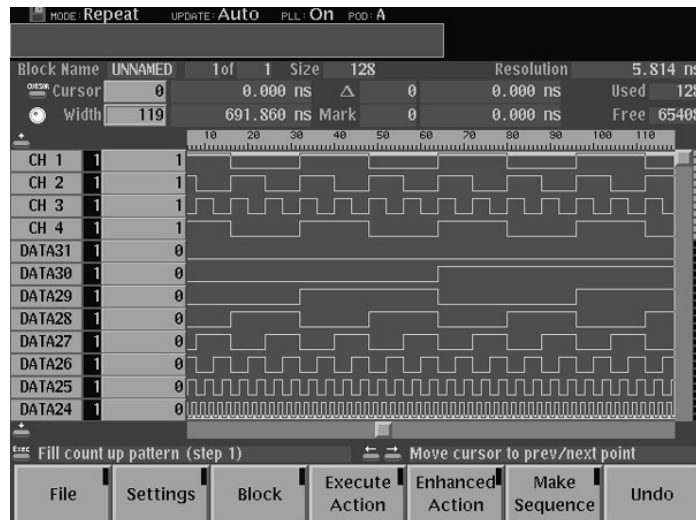
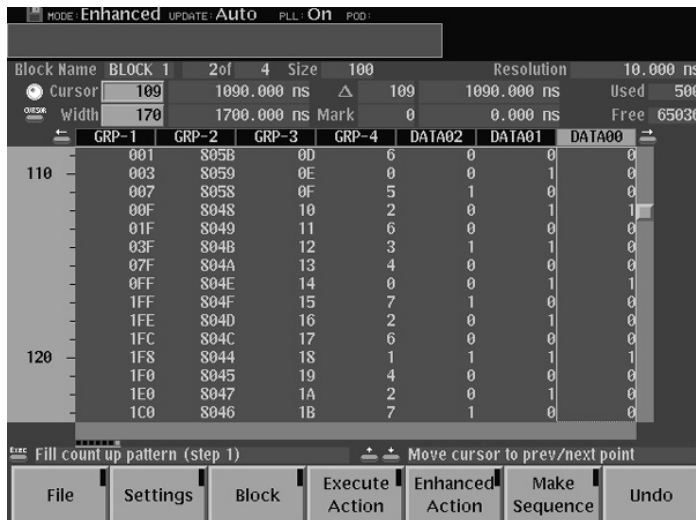

Figure 3. Examples of data entry displays. Data is entered easily as hex data or diagrammatically.

Critical Timing

The DG2020A is the ideal solution for applications where you must characterize device or circuit timing and amplitude margins. The DG2020A graphical user interface allows you to quickly create complex data patterns with a few keystrokes on the front panel. Use the advanced sequence editing capability to insert infrequent faults or glitches in your data patterns to verify device or circuit recovery. The DG2020A is an invaluable tool, allowing you to simulate missing system functionality while meeting critical market windows.

Excellent Signal Flexibility

The DG2020A outputs data at rates up to 200 Mb/s with 64 K data word length on up to 36 channels (12 standard) in 12-channel increments with 100 ps timing control. The P3420 variable output pod provides 500 mV_{p-p} to 9 V_{p-p} (-3 V to 7 V) in 100 mV steps. SMB connectors are used for each channel. The P3420 is capable of sourcing >30 mA current per channel - enough for your most demanding applications.

Pattern Editing

The DG2020A is designed for serious digital designers who create their own digital patterns or rely on a logic simulator to supply digital vectors. A large graphical display simplifies data entry and editing functions, allowing the user to easily view and shape large segments of the data pattern (Figure 3). A wide variety of commonly used data patterns are built into the data editor to further simplify data creation. Built-in data functions include counters, shift registers, serial data converters, and clocks.

Easy-to-use menu-driven editing functions are provided to define data bit, cursor location, and data width. Data can be manipulated at the bit, byte, or word level. Various functions such as data cut/copy/paste, invert, magnify, insert, and delete are supported, as are data shift, add, and rotate. Advanced functions are used to create clock patterns and PRBS data. A variety of data presentations are available to clearly illustrate the data pattern including table, timing, binary, and numeric.

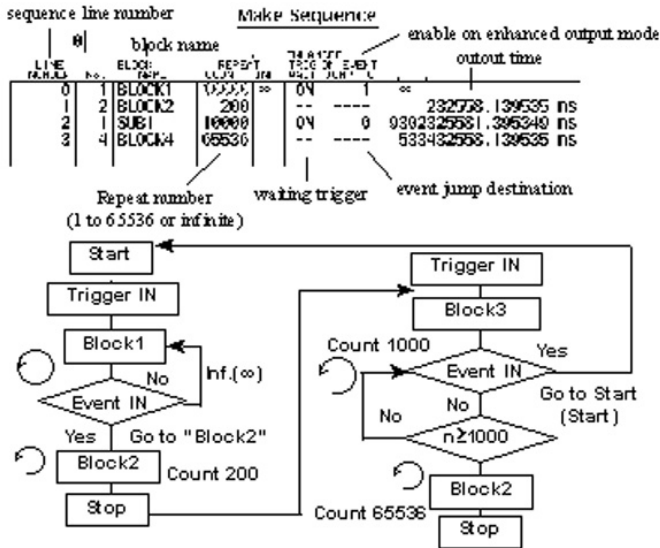

Figure 4. Flow chart illustrates sequence control flow.

Pattern Sequencing

The DG2020A includes advanced data flow sequencing to provide the designer with a flexible digital stimulus source. Pattern sequencing is a capability that can extend the deep DG2000 Series pattern memory almost to infinity. Sequencing allows segments of pattern memory to be looped or repeated until some internal or external event occurs when pattern execution then continues. Each line in the sequence list can be controlled by an external event that can cause a jump to a different block of data. The DG2020A can have up to 2048 jumps at full clock rates.

Three types of sequences are offered:

- Simple Sequence - For repeat, single, or step operation modes
- Enhanced Sequence - Supports more interactive and dedicated sequence control
- Subsequence - Supports defined subsequences that manage multiple blocks as a single block. Uses only one sequence entry in the sequence definition table

Import Data

Tektronix' DG-Link software accessory imports data from Tektronix TDS oscilloscopes, TLS logic scopes, or TLA logic analyzers for use as data

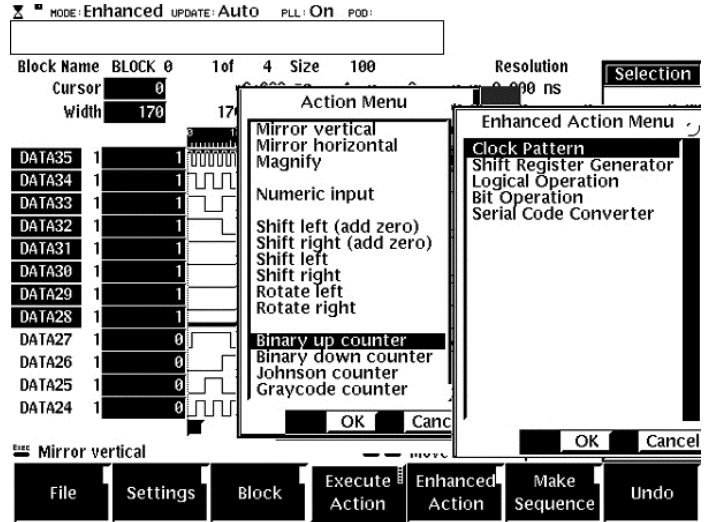

Figure 5. Examples of editing menus showing automatic data pattern generation and editing tools.

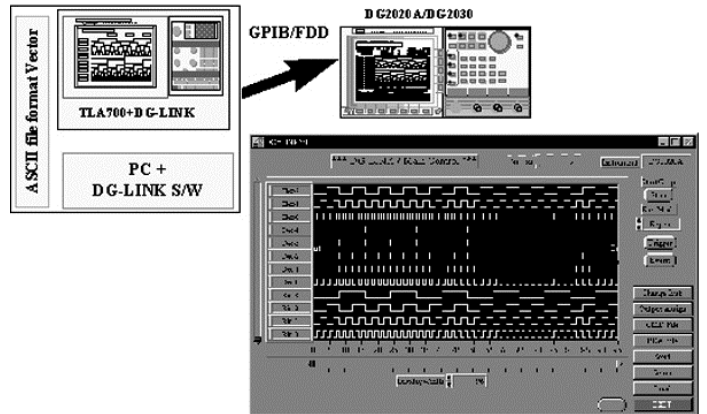

Figure 6. DG-Link software utility imports ASCII data vectors.

pattern sources by the DG2000 Series. Logic simulators that output Comma Separated Value (CSV) format can also be used as a source file for DG-Link and downloaded into the DG2000 Series.

Characteristics

Output Data

Data Rate – 0.1 b/s to 200 Mb/s.

Sampling Rate – 0.1 Hz to 200 MHz.

Resolution – 4 digits.

Clock Output Period Jitter – <50 ps_{p-p} at 200 MHz, typical.

CH0 Period Jitter (clock pattern) – <35 ps_{p-p} at 200 MHz, typical.

Accuracy – PLL On, ±0.005%; PLL Off, ±3%.

Pattern Depth – 64 to 64 Kbits (1 increment).

Data Width –

Standard: 12 bits.

Optional: 24 or 36 bits.

Sequencer

Maximum Number of Blocks – 256.

Maximum Number of Sequence Steps – 2048.

Block Repeats Per Line – 1 to 65536 or infinite.

Auxiliary Inputs

Clock – Rear-panel SMB connector.

Frequency: DC to 200 MHz.

Impedance: 50 Ω, terminated to +0.5 V.

Delay to Clock Out: 36 ns (typical).

Trigger – Front-panel BNC connector.

Level: -5.0 V to +5.0 V.

Resolution: 0.1 V.

Threshold Accuracy: ±(5% of setting) ±0.1 V.

Minimum Pulse Width: ≥10 ns.

Sensitivity: >0.5 V_{p-p}.

Impedance: 1 kΩ or 50 Ω.

Maximum Input: ±10 V into 1 kΩ, ±5 V into 50 Ω.

Polarity: Positive or negative.

Hold Off: 500 ns minimum.

Auxiliary Outputs

SYNC – Front-panel BNC connector.

Level:

V_{OH}, 2.5 V into 50 Ω.

V_{OL}, 0 V into 50 Ω.

Pulse Width: 6 clocks.

Impedance: 50 Ω.

EVENT – Front-panel BNC connector.

Level: Positive TTL pulse, 50 Ω.

Output Term:

DG2020A: 8 clocks.

Delay Time: 22 clocks before data output change.

Impedance: 50 Ω.

CLOCK –

Rear-panel SMB connector.

Level: 1 V (typical) into 50 Ω.

Delay From Trigger Input:

PLL On:

>6.25 MHz: 15 to 40 ns.

<6.25 MHz: 25 to 60 ns.

PLL Off:

>6.25 MHz: 15 to 45 ns.

<6.25 MHz: 25 to 60 ns.

External: 7 ns + 1 clock to 20 ns + 0.5 clock.

Programmable Interface –

GPIB: ANSI/IEEE 488.2-1987.

RS-232-C: 19.2 Kb/s, D-sub 9-Pin connector.

P3420 Variable Data Output Pod Characteristics

Data Output

Channels – 12.

Connector – SMB.

VOH – -2.0 V to +7.0 V into 1 MΩ.

VOL – -3.0 V to +6.0 V into 1 MΩ.

Resolution – 0.1 V.

Maximum Swing – 9.0 V_{p-p}.

Minimum Swing – 0.5 V_{p-p}.

Output Current –

Total Output Current: <500 mA.

Sink: < -30 mA/CH.

Source: > +30 mA/CH.

Rise/Fall Time – <2 ns into 1 MΩ, 10 pF, 5 V_{p-p} swing (20% to 80%).

Internal Clock Out to Data Delay – 20 ns.

External Clock Input to Data Output Delay – 20 to 40 ns.

Trigger Input to Data Output Delay –

Internal Clock:

>6.25 MHz: 30 to 60 ns.

<6.25 MHz: 40 to 70 ns.

External Clock: 20 ns + 0.5 clock to 40 ns + 1.5 clock.

Delayed Channels

Delay Channel – CH 8, CH 9, CH 10, CH 11.

Delay Time – 0 to 20 ns.

Delay Resolution – 0.1 ns.

Channel Skew –

CH 0 and other channels, same pod: <3 ns.

CH 0 and CH 0, two pods of same type: <2 ns.

Event Input

Threshold Level – -5.0 V to +5.0 V.

Resolution – 0.1 V.

Delay to Data Output – ≤45 ns + 50 clock.

Setup Time to Next Block – 47 to 54 clocks.

Inhibit Input

Threshold Level – -5.0 V to +5.0 V, 1 kΩ.

Resolution – 0.1 V.

Delay to Data Output – 16 ns.

Internal Inhibit Delay – -2 ns.

Physical Characteristics

Dimensions	mm	in.
Height*1	51	2
Width	255	10
Depth	161	6.3
Weight	kg	lb.
Net	1	2.2

*1 Including feet.

General Characteristics

Environmental

Temperature –

Operating: +10 °C to +40 °C.

Nonoperating: -20 °C to +60 °C.

Humidity –

Operating: 20% to 80% (no condensation).

Nonoperating: 5% to 90% (no condensation).

Altitude –

Operating: Up to 4.5 km (15,000 ft.).

Nonoperating: Up to 15 km (50,000 ft.).

Vibration – Operating: 0.33 mm p-p, 10 to 55 Hz, 15 minutes.

Shock – Nonoperating: 294 m/s² (30 g), half-sine, 11 ms duration.

Certification and Compliance

EC Declaration of Conformity – Meets intent of Directive 89/336/EEC for electromagnetic compatibility.

Safety – UL1244, CSA231, EN61010-1, IEC61010-1.

Power

AC Line Power –

Voltage Ranges: 90 to 250 VAC.

Nominal Voltage: 100 V, 115 V, 200 V, 230 V, 240 V.

Line Frequency:

90 to 250 VAC: 48 to 63 Hz.

90 to 127 VAC: 48 to 440 Hz.

Power Consumption – 300 W maximum.

Maximum Current – 4 A.

Physical Characteristics

DG2000 Series Mainframe

Dimensions	mm	in.
Height ^{*1}	164	6.4
Width ^{*2}	362	14.3
Depth ^{*3}	491	8.25
Weight	kg	lb.
Net	9.7	21.4

^{*1} Including feet.

^{*2} Including handle.

^{*3} Including front cover. 576 mm (22.2 in.) with handle extended.

Characteristics shown are typical. Please refer to individual product user manuals for complete specifications.

Ordering Information

DG2020A

Data Generator

Includes: User Manual (071-0053-xx), Programmer Manual (071-0054-xx), 3.5 in. Performance Check Disk (063-2918-xx), GPIB Sample Program (063-2919-xx), DG-Link Application Software (063-2920-xx), Pod Connection Cable (174-3548-xx), Power Cord, ISO-qualified Inspection Passed Certificate. Order P3420 Pod separately.

Please specify power plug when ordering.

Options

Opt. 01 – Adds a 12 bit digital port for a total of 24 output channels. Includes pod connection cables (174-3548-xx). Order P3420 pod separately.

Opt. 02 – Adds two 12 bit digital ports for a total of 36 output channels. Includes two pod connection cables (174-3548-xx). Order P3420 pod separately.

Opt. 1R – Rackmount. Floppy drive moved to front panel.

Recommended Accessories

P3420

Variable-level Pod with 12 Output Channels

Includes: SMB to Pin Header Output Cable Set (012-1504-xx) for 12 output channels, ISO Qualified Inspection Passed Certificate.

DG2020A

Power Plug Options

Opt. A0 – US Plug, 115 V, 60 Hz.

Opt. A1 – Euro Plug, 220 V, 50 Hz.

Opt. A2 – UK Plug, 240 V, 50 Hz.

Opt. A3 – Australian Plug, 240 V, 50 Hz.

Opt. A4 – N. American Plug, 240 V, 50 Hz.

Opt. A5 – Swiss Plug, 220 V, 50 Hz.









Service

Opt. C3 – Calibration Service 3 Years.

Opt. D1 – Calibration Data Report.

Opt. D3 – Calibration Data Report 3 Years (with Opt. C3).

Opt. R3 – Repair Service 3 Years.

Item	Description	Part Number
	40-inch (101.6 cm) BNC-to-BNC cable	012-0057-00
	40-inch (101.6 cm) 50 SMB-to-SMB cable	012-1458-00
	40-inch (101.6 cm) 50 SMB-to-BNC cable	012-1459-00
	50-inch (127 cm) 50 SMB-to-pin header cable.	012-1506-00
	7.5-cm one channel lead set (set of 5)	012-1508-00
	12-cm four channel lead set (set of 3)	012-1509-00
	50 SMB female-to-BNC male adapter	015-0671-00
	Pin header connector, 26 Pins	139-5919-00

P3420 POD

Service

- Opt. D1 – Calibration Data Report.
- Opt. R3 – Repair Service 3 Years.

Recommended Accessories

P3420 POD

Cables, adapters, and connectors

- SMB to Pin Header Cable (20 in.) – 012-1503-xx.
- SMB to Pin Header Cable (50 in.) – 012-1506-xx.
- Pin Header to Pin Header Cable – 012-1505-xx.
- SMB to SMB Cable (40 in.) – 012-1458-xx.
- 50 Ω BNC to BNC Cable (single shield) – 012-1342-xx.
- 50 Ω BNC to BNC Cable (double shield) – 012-1256-xx.
- 50 Ω BNC to SMB Cable (40 in.) – 012-1459-xx.
- 50 Ω BNC Male to SMB Male Adapter – 015-0671-xx.
- One-channel Pin Lead Set (set of 5) – 012-1508-xx.
- Four-channel Pin Lead set (set of 3) – 012-1509-xx.
- Connector (for Pin Header) – 131-5919-xx.
- GPIB Cable – 012-0991-xx.
- Replacement 1.2 m POD Connection Cable (standard accessory) – 174-3548-xx.
- 50 Ω SMA male to SMA male; 12 in. – 174-1364-xx.
- 50 Ω SMA male to SMA male; 20 in. – 174-1427-xx.
- 50 Ω SMA male to SMA male; 60 in. – 174-1428-xx.
- 50 Ω SMA male to SMA male; 2 m – 174-0679-xx.
- 50 Ω SMA male to SMA male; 8.5 in. – 174-1120-xx.
- 50 Ω SMA male to SMA male; 1 m – 174-1341-xx.

Documentation

- DG2020A Service Manual – 071-0055-xx.
- DG2020A Twelve-channel Upgrade Kit (provides same function as DG2020A Opt. 01) – 040-1556-xx.









P3420 to DUT Configuration Guide

Connection	Items Required
P3420 SMB to BNC Female	012-1459-xx 40 in. SMB to BNC Cable
P3420 SMB to SMB Female	012-1458-xx 40 in. SMB to BNC Cable
P3420 SMB to Pin Header	012-1503-xx 20 in. or 012-1506-xx 50 in. SMB to Pin Header Cable
P3420 SMB to SMA Female	012-1503-xx 20 in. or 012-1506-xx 50 in. SMB to Pin Header Cable; 015-1018-xx SMA Male to BNC Female Adapter
P3420 SMB to "General" Connection	012-1503-xx 20 in. or 012-1506-xx 50 in. SMB to Pin Header Cable; 012-1508-xx Lead Set

P3420 Optional Accessories

(see Accessories drawings on following page)

Accessory Description	Tektronix Part Number	DG2020A	P3420
SMB to Pin Header 20 in. (50.8 cm) 50 Ω Lead Cable (012-1503-xx, set of 12) plus One Connector (131-5919-xx) for P3420.	012-1504-xx		Std. Acc
20 in. (50.8 cm) 50 Ω SMB to Pin Header Lead Cable	012-1503-xx	X	X
20 in. (50.8 cm) 50 Ω Pin Header to Pin Header Cable	012-1505-xx		
50 in. (127 cm) 50 Ω SMB to Pin Header Cable	012-1506-xx	X	X
50 in. (127 cm) 50 Ω SMB to Pin Header Cable (set of 12)	012-1507-xx	X	X
40 in. (101.6 cm) 50 Ω SMB to SMB Cable	012-1458-xx	X	X
40 in. (101.6 cm) 50 Ω SMB to BNC Cable	012-1459-xx	X	X
50 Ω SMB to BNC Adapter	015-0671-xx	X	X
50 Ω BNC to BNC Cable (double shield)	012-1256-xx	X	
50 Ω BNC to BNC Cable (single shield)	012-1342-xx	X	
One-channel Pin Lead Set (set of five)	012-1508-xx		X
Four-channel Pin Lead Set (set of three)	012-1509-xx		X
Connector (for Pin Header)	131-5919-xx		X

Item	Description	Part Number
	40 inch (101.6 cm) BNC-to-BNC cable	012-0057-01
	40 inch (101.6 cm) 50 SMB-to-SMB cable	012-1458-00
	40 inch (101.6 cm) 50 SMB-to-BNC cable	012-1459-00
	50 inch (127 cm) 50 SMB-to-pin header cable.	012-1506-00
	7.5 cm one channel lead set (set of 5)	012-1508-00
	12 cm four channel lead set (set of 3)	012-1509-00
	50 SMB female-to-BNC male adapter	015-0671-00
	Pin header connector, 26 Pins	131-5919-00

NOTE: drawings are not to scale

DG2020A/P3420

Description	Tektronix Part Number
40 in. (101.6 cm) BNC to BNC Cable	012-0057-xx
40 in. (101.6 cm) 50 Ω SMB to SMB Cable	012-1458-xx
40 in. (101.6 cm) 50 Ω SMB to BNC Cable	012-1459-xx
50 in. (127 cm) 50 Ω SMB to Pin Header Cable	012-1506-xx
7.5 cm One-channel Lead Set (set of 5)	012-1508-xx
12 cm Four-channel Lead Set (set of 3)	012-1509-xx
50 Ω SMB Female to BNC Male Adapter	015-0671-xx
Pin Header Connector, 26 Pins	131-5919-xx

DG2020A and P3420 Optional Accessories

NOTE: Drawings are not to scale.

Warranty – One-year parts and labor.



Tektronix is registered to ISO 9001 and ISO 14001 by SRI Quality System Registrar.



Product(s) complies with IEEE Standard 488.1-1987, RS-232-C, and with Tektronix Standard Codes and Formats.

Contact Tektronix:

- ASEAN / Australasia** (65) 6356 3900
- Austria** 00800 2255 4835*
- Balkans, Israel, South Africa and other ISE Countries** +41 52 675 3777
- Belgium** 00800 2255 4835*
- Brazil** +55 (11) 3759 7627
- Canada** 1 800 833 9200
- Central East Europe and the Baltics** +41 52 675 3777
- Central Europe & Greece** +41 52 675 3777
- Denmark** +45 80 88 1401
- Finland** +41 52 675 3777
- France** 00800 2255 4835*
- Germany** 00800 2255 4835*
- Hong Kong** 400 820 5835
- India** 000 800 650 1835
- Italy** 00800 2255 4835*
- Japan** 81 (3) 6714 3010
- Luxembourg** +41 52 675 3777
- Mexico, Central/South America & Caribbean** 52 (55) 56 04 50 90
- Middle East, Asia, and North Africa** +41 52 675 3777
- The Netherlands** 00800 2255 4835*
- Norway** 800 16098
- People's Republic of China** 400 820 5835
- Poland** +41 52 675 3777
- Portugal** 80 08 12370
- Republic of Korea** 001 800 8255 2835
- Russia & CIS** +7 (495) 7484900
- South Africa** +41 52 675 3777
- Spain** 00800 2255 4835*
- Sweden** 00800 2255 4835*
- Switzerland** 00800 2255 4835*
- Taiwan** 886 (2) 2722 9622
- United Kingdom & Ireland** 00800 2255 4835*
- USA** 1 800 833 9200

* European toll-free number. If not accessible, call: +41 52 675 3777

Updated 10 February 2011

For Further Information. Tektronix maintains a comprehensive, constantly expanding collection of application notes, technical briefs and other resources to help engineers working on the cutting edge of technology. Please visit www.tektronix.com



Copyright © Tektronix, Inc. All rights reserved. Tektronix products are covered by U.S. and foreign patents, issued and pending. Information in this publication supersedes that in all previously published material. Specification and price change privileges reserved. TEKTRONIX and TEK are registered trademarks of Tektronix, Inc. All other trade names referenced are the service marks, trademarks, or registered trademarks of their respective companies.

18 Oct 2011

87W-10799-6

www.tektronix.com

