

User Manual



AWG2021
Arbitrary Waveform Generator
070-9097-50

Copyright © Tektronix Japan, Ltd. All rights reserved.

Copyright © Tektronix, Inc. All rights reserved.

Tektronix products are covered by U.S. and foreign patents, issued and pending. Information in this publication supercedes that in all previously published material. Specifications and price change privileges reserved.

Tektronix Japan, Ltd., 5-9-31 Kitashinagawa, Shinagawa-ku, Tokyo 141-0001 Japan

Tektronix, Inc., P.O. Box 500, Beaverton, OR 97077

TEKTRONIX and TEK are registered trademarks of Tektronix, Inc.

WARRANTY

Tektronix warrants that this product will be free from defects in materials and workmanship for a period of one (1) year from the date of shipment. If any such product proves defective during this warranty period, Tektronix, at its option, either will repair the defective product without charge for parts and labor, or will provide a replacement in exchange for the defective product.

In order to obtain service under this warranty, Customer must notify Tektronix of the defect before the expiration of the warranty period and make suitable arrangements for the performance of service. Customer shall be responsible for packaging and shipping the defective product to the service center designated by Tektronix, with shipping charges prepaid. Tektronix shall pay for the return of the product to Customer if the shipment is to a location within the country in which the Tektronix service center is located. Customer shall be responsible for paying all shipping charges, duties, taxes, and any other charges for products returned to any other locations.

This warranty shall not apply to any defect, failure or damage caused by improper use or improper or inadequate maintenance and care. Tektronix shall not be obligated to furnish service under this warranty a) to repair damage resulting from attempts by personnel other than Tektronix representatives to install, repair or service the product; b) to repair damage resulting from improper use or connection to incompatible equipment; or c) to service a product that has been modified or integrated with other products when the effect of such modification or integration increases the time or difficulty of servicing the product.

THIS WARRANTY IS GIVEN BY TEKTRONIX WITH RESPECT TO THIS PRODUCT IN LIEU OF ANY OTHER WARRANTIES, EXPRESSED OR IMPLIED. TEKTRONIX AND ITS VENDORS DISCLAIM ANY IMPLIED WARRANTIES OF MERCHANTABILITY OR FITNESS FOR A PARTICULAR PURPOSE. TEKTRONIX' RESPONSIBILITY TO REPAIR OR REPLACE DEFECTIVE PRODUCTS IS THE SOLE AND EXCLUSIVE REMEDY PROVIDED TO THE CUSTOMER FOR BREACH OF THIS WARRANTY. TEKTRONIX AND ITS VENDORS WILL NOT BE LIABLE FOR ANY INDIRECT, SPECIAL, INCIDENTAL, OR CONSEQUENTIAL DAMAGES IRRESPECTIVE OF WHETHER TEKTRONIX OR THE VENDOR HAS ADVANCE NOTICE OF THE POSSIBILITY OF SUCH DAMAGES.

Table of Contents

General Safety Summary	xxi
Preface	xxiii
Getting Started	
Overview	1-1
Product Description	1-1
Initial Inspection	1-2
Start Up	1-3
Installation	1-3
Power On	1-5
Start-up Diagnostics	1-7
Power Off	1-8
Operating Basics	
Introduction	2-1
Overview	2-3
Front Panel	2-3
Side Panel	2-8
Rear Panel	2-9
CRT Display	2-13
Basic Menu Operation	2-15
Menu Operations	2-15
Menu Names	2-16
Numeric Input	2-16
Using the General Purpose Knob	2-19
Operating Examples	2-23
Necessary Equipment	2-24
Example 1: Setting the Date & Time and Adjusting the Brightness	2-24
Setting the Date and Time	2-24
Date/Time Display	2-26
Setting the Display Brightness	2-27
Example 2: Output of a Waveform Using the Sample Waveform Library Disk ..	2-28
Loading Sample Waveforms	2-28
Setting the Output Parameters	2-31
Waveform Output	2-34
Example 3: Creating Files and Arbitrary Waveform Outputs	2-36
Creating a Waveform File	2-36
Creating Arbitrary Waveforms Using the Point Draw Function	2-44
Creating Waveforms Arithmetically	2-48
Creating an Equation File	2-50
Creating a Sequence File	2-54
Creating Autostep Files	2-57
Setting the Output Parameters	2-60
Setting Operation Mode and Waveform Output	2-62

Example 4: Loading and Saving Files	2-68
Saving Files	2-68
Loading Files	2-71
Auto Load	2-73
Example 5: Loading Waveforms From Other Instruments	2-74
Example 6: Using the Waveform Function Generator	2-78
CH1 Waveform Settings	2-78
Waveform Output	2-81

Reference

Introduction	3-1
Menu Items Available With Each Editing Function	3-1
EDIT Menu	3-3
General Description	3-3
Initial Menu	3-4
Menu Functions	3-5
CRT Display	3-6
Creating or Editing a File	3-7
Using File Editing Functions	3-8
Locking and Unlocking Files	3-11
Expanding a Sequence File into a Waveform File	3-12
Waveform Editor	3-14
Entering the Waveform Editor	3-14
Opening and Selecting Editing Areas	3-15
Saving Files and Exiting the Editor	3-20
Naming a File	3-21
Graphic Display	3-23
Menu Functions	3-26
Graphic Display Screen	3-27
Settings for the Waveform to be Edited	3-28
Creating a Standard Function Waveform	3-37
Editing Waveforms in Graphic Display	3-41
Timing Display	3-96
Timing Display Menu Structure	3-97
Menu Functions	3-99
Timing Display Screen	3-100
Editing Waveform Data in Timing Display	3-104
Setting Pattern Data	3-106
Shifting Waveform Data	3-117
Inverting Waveform Data	3-118
Copying Lines	3-119
Exchanging Lines	3-120
Applying Logical Operations to Lines	3-121
Expanding Waveform Data	3-122
Inserting Other Waveform Data	3-124
Pseudo-Random Pulse Generator	3-124
Table Display	3-129
Table Display Menu Structure	3-130
Menu Functions	3-131
Table Display Screen	3-132
Settings for the Waveform to be Edited	3-133
Editing Waveform Data	3-135

Editing Waveform Data in Table Display	3-135
Cut, Copy, and Paste Processing Function	3-136
Equation Editor	3-137
Entering the Equation Editor	3-137
Saving Files and Exiting the Editor	3-138
Equation Editor Menu Structure	3-138
Menu Functions	3-139
Equation Editor Menu Display	3-140
Creating and Editing Equation Files	3-142
Editing Functions	3-156
Compiling Equations into Waveform Data	3-159
Sequence Editor	3-161
Entering the Sequence Editor	3-162
Saving Files and Exiting the Editor	3-162
Sequence Editor Menu Structure	3-162
Menu Functions	3-163
Sequence Editor Menu Display	3-164
Creating and Editing Sequence Files	3-166
Editing Functions	3-167
Sequence File Display	3-169
Autostep Editor	3-171
Entering the Autostep Editor	3-172
Saving Files and Exiting the Editor	3-172
Autostep Editor Menu Structure	3-173
Menu Functions	3-174
Autostep Editor Menu Display	3-175
Creating and Editing Autostep Programs	3-177
Editing Functions	3-186
Jumping to a Step	3-188
Convolution Waveform Editor (Option 09)	3-189
Entering the Convolution Waveform Editor	3-189
Saving Files and Exiting the Editor	3-190
Convolution Waveform Editor Menu Structure	3-190
Menu Functions	3-190
Convolution Waveform Editor Menu Display	3-191
Selecting a Waveform File	3-192
Executing Convolution/Correlation	3-193
FFT Editor (Option 09)	3-195
Entering the FFT Editor	3-195
Saving Files and Exiting the Editor	3-197
FFT Editor Menu Structure	3-197
Menu Functions	3-198
FFT Editor Menu Display	3-199
Editing in the Frequency Domain	3-200
Magnifying a Signal	3-204
Selecting a Filter	3-205
Selecting a Limiter	3-207
SETUP Menu	3-211
General Description	3-211
SETUP Menu Structure	3-212
Menu Functions	3-213
SETUP Menu Display	3-214

Selecting the Display Format for the SETUP Menu	3-216
Selecting Output Parameter Fields	3-217
Numeric Input	3-217
Selecting a Waveform or Sequence File	3-217
Setting Clock Source and Frequency	3-219
CH1 Waveform Operations	3-221
Setting Filter	3-225
Setting Amplitude and Offset	3-225
Setting Amplitude	3-226
Setting Offset	3-226
Linking the CH1 Waveform and Amplitude or Offset	3-226
MODE Menu	3-229
General Description	3-229
MODE Menu Structure	3-230
Menu Functions	3-231
MODE Menu Display	3-232
Setting the Operating Mode	3-233
Cont Mode	3-233
Triggered Mode	3-233
Gated Mode	3-234
Burst Mode	3-235
Waveform Advance Mode	3-236
Autostep Mode	3-238
Setting Trigger Parameters for an External Trigger (Gate)	3-241
Setting Sync Signal	3-242
LOAD/SAVE Menu	3-243
General Description	3-243
Memory Capacity	3-244
LOAD/SAVE Menu Structure	3-245
Menu Functions	3-246
LOAD Menu Display	3-247
Selecting the Device	3-249
Loading Files from Mass Memory into Internal Memory	3-251
Saving Files from Internal Memory to Mass Memory	3-253
Saving Data in Text Format	3-254
Transferring Waveform Data Directly	3-255
Loading Waveform Data	3-255
Selecting Instruments Made by Other Manufacturers	3-256
Auto Loading	3-258
Supported Floppy Disk Files	3-259
UTILITY Menu	3-261
General Description	3-261
UTILITY Menu Structure	3-262
Menu Functions	3-263
Disk and Nonvolatile Memory	3-264
Using the Disk Menu	3-264
Internal Non-volatile Memory	3-273
Remote Interface	3-274
GPIB	3-274
Date and Time	3-278
Setting the Date and Time	3-278

Other Settings and Displays	3-279
Setting the Display	3-279
Settings for Hard Copy Output	3-286
Status Display	3-288
Diagnostics and Calibrations	3-290
Function Waveform Generator Mode	3-295
General Description	3-295
Function Generator Menu Structure	3-296
Function Generator Menu Display	3-297
Setting the Output Waveform	3-298
Selecting the Channel	3-298
Selecting the Waveform	3-298
Setting the Output Parameters	3-298
Waveform Output	3-298
Setting the Output Parameters for the Waveform	3-298
Setting the Frequency	3-298
Setting the Amplitude	3-299
Setting the Offset	3-299
Setting the Polarity	3-299
Setting the Duty	3-300
External Output	3-300
Sync Signal	3-300
Marker Signal	3-301

Appendices

Appendix A: Options and Accessories	A-1
Options	A-1
Option 02 (2-Channel Output)	A-1
Option 03 (ECL Digital Data Output)	A-1
Option 04 (Digital Data Output)	A-9
Option 09 (FFT Editor and Convolution Process)	A-16
Option 1R (Rack Mount)	A-16
Option 1S (WaveWriter S3FT400)	A-16
Option 95 (Certificate With Calibration Data)	A-16
Option B1	A-16
Power Cord Options	A-16
Accessories	A-17
Standard Accessories	A-17
Optional Accessories	A-17
Appendix B: Performance Characteristics	B-1
Nominal Traits	B-1
Warranted Characteristics	B-6
Typical Characteristics	B-12
Appendix C: Performance Verification	C-1
Before Verification	C-1
Preparation	C-1
Conventions	C-1
Self Tests	C-2
Diagnostics	C-2
Calibration	C-4

Performance Tests	C-5
Prerequisites	C-5
Related Information	C-6
Equipment Required	C-6
Operating Mode Checks	C-10
Check Cont Mode	C-10
Check Triggered Mode	C-11
Check Burst Mode	C-14
Check Gated Mode	C-15
Check Waveform Advance Mode	C-18
Check Autostep Mode	C-20
Arithmetic Operation Checks	C-22
Check External AM Operation	C-22
Check Internal AM Operation (Option 02 only)	C-25
Check Internal Add Operation (Option 02 only)	C-25
Clock Frequency and Amplitude Checks	C-26
Check Clock Frequency Accuracy	C-26
Check Clock Amplitude	C-28
Gain and Offset Accuracy Checks	C-30
Check Gain Accuracy	C-30
Check Offset Accuracy	C-32
Pulse Response Check	C-33
SYNC Out and MARKER Out Amplitude Checks	C-35
External Trigger Level Accuracy Check	C-37
External CLOCK IN Check	C-40
ECL Digital Data Out Check (Option 03)	C-42
TTL DIGITAL DATA OUT Check (Option 04)	C-46
Floating Point Processor Check (Option 09)	C-49
Appendix D: Sample Waveform Library	D-1
Introduction	D-1
Description of Representative Waveform Files	D-3
Appendix E: Functional Operation Summary	E-1
Introduction	E-1
Block Diagram	E-2
Clock Oscillator	E-4
Trigger Control	E-4
Clock Divider	E-8
Sequence Control	E-9
Waveform Memory	E-10
Multiplier (AM)	E-13
Preamplifier (Adder)	E-15
Filter	E-15
X5 Amplifier	E-17
Attenuator	E-17
Offset	E-18
Appendix F: Miscellaneous	F-1
General Description	F-1
Horizontal Axis Scaling	F-1
Sampling Theorem	F-3
Differentiation	F-3
Integration	F-5
Random (rnd) Function	F-6

Pattern Codes	F-7
Logical Operation	F-13
FFT (Fast Fourier Transforms)	F-16
Repackaging for Shipment	F-23
Factory Settings	F-24
Appendix G: Inspection and Cleaning	G-1

List of Figures

Figure 1-1: Rear Panel Controls Used In Start Up	1-5
Figure 1-2: ON/STBY Switch	1-7
Figure 2-1: Front Panel Overall View	2-3
Figure 2-2: Front Panel Button Detail	2-5
Figure 2-3: Side Panel	2-8
Figure 2-4: Rear Panel Overall View	2-9
Figure 2-5: Rear Panel Detail	2-11
Figure 2-6: CRT Display	2-13
Figure 2-7: Menu Buttons and Bezel Buttons	2-15
Figure 2-8: Numeric Input Using Numeric Keys	2-17
Figure 2-9: Numeric Keys, Unit Keys, Delete Key, and ENTER Key	2-18
Figure 2-10: General Purpose Knob and Arrow Buttons	2-20
Figure 2-11: Knob Icon and Underscore	2-20
Figure 2-12: Menu Display (showing Date/Time item selected)	2-25
Figure 2-13: Date/Time Display	2-26
Figure 2-14: Setting the Display Brightness	2-27
Figure 2-15: Inserting the Floppy Disk	2-28
Figure 2-16: Sample Waveform Library Disk Files	2-29
Figure 2-17: CRT Screen Display When Load All is Selected	2-30
Figure 2-18: SETUP Menu	2-31
Figure 2-19: Waveform File List	2-32
Figure 2-20: GAUSS_P.WFM File Output Parameters	2-33
Figure 2-21: MODE Menu	2-34
Figure 2-22: Connections in Example 2	2-34
Figure 2-23: Channel On/Off Buttons and Indicators	2-35
Figure 2-24: Initial Menu	2-37
Figure 2-25: Waveform Editor Graphic Menu	2-38
Figure 2-26: Setting the Point Value for the Right Side Vertical Bar Cursor	2-39
Figure 2-27: Creating a Sine Waveform	2-40
Figure 2-28: Creating a Ramp Waveform	2-41
Figure 2-29: Naming a File	2-42
Figure 2-30: Initial Menu File List	2-43
Figure 2-31: Entering a Name for the Copied File	2-44

Figure 2-32: Setting the Edit Range	2-45
Figure 2-33: Drawing a Waveform Using the Point Draw Function .	2-46
Figure 2-34: Connecting the Points	2-47
Figure 2-35: Creating a Sine Wave	2-48
Figure 2-36: Sine Wave With Noise Added	2-49
Figure 2-37: Equation Editor Menu Display	2-50
Figure 2-38: Equation List Input	2-51
Figure 2-39: Display of Compiled Waveform Data	2-52
Figure 2-40: Initial Menu File List	2-53
Figure 2-41: Sequence Editor Menu Display	2-54
Figure 2-42: Sequence Example	2-55
Figure 2-43: Sequence Waveform Display With Show Overview Selected	2-56
Figure 2-44: Moving the Cursor	2-57
Figure 2-45: File List	2-58
Figure 2-46: Setting File	2-58
Figure 2-47: Setting the File for Step 2	2-59
Figure 2-48: Setting the File for Step 3	2-59
Figure 2-49: SETUP Menu	2-60
Figure 2-50: Setting Output Parameters	2-61
Figure 2-51: Connections for Example 3	2-62
Figure 2-52: MODE Menu	2-63
Figure 2-53: Setting the Marker Default	2-64
Figure 2-54: Menu Displayed When Triggered is Selected	2-65
Figure 2-55: MANUAL Button and TRIGGER INPUT Connector .	2-65
Figure 2-56: Menu Displayed When Autostep is Selected	2-66
Figure 2-57: Autostep File List	2-67
Figure 2-58: SAVE Menu	2-69
Figure 2-59: Files Saved in NVRam	2-70
Figure 2-60: Internal Memory File List	2-71
Figure 2-61: Files Loaded into Internal Memory	2-72
Figure 2-62: Connections for Example 5	2-74
Figure 2-63: DSO Screen	2-75
Figure 2-64: Confirmation Message (asking if it is O.K. to change the remote port and GPIB configuration settings)	2-75
Figure 2-65: GPIB Source List	2-76
Figure 2-66: Screen When Sine Set for CH1	2-78
Figure 2-67: CH1 Output Parameter Setting Display	2-80
Figure 2-68: Connections for Example 6	2-81

Figure 3-1: Initial EDIT Menu Structure	3-4
Figure 3-2: Display of the Initial Menu	3-6
Figure 3-3: Menu Displayed When Rename is Selected	3-9
Figure 3-4: Menu Displayed When Delete is Selected	3-11
Figure 3-5: Menu Displayed When Lock is Selected	3-12
Figure 3-6: Menu Display When Expand SEQ into WFM is Selected	3-13
Figure 3-7: Graphic CRT Display	3-15
Figure 3-8: Waveform Editor With Three Editing Areas	3-16
Figure 3-9: Menu Display When Another Waveform is Selected	3-17
Figure 3-10: Waveform2 Added	3-18
Figure 3-11: Menu Display When Show Catalog Entry is Selected ..	3-19
Figure 3-12: Waveform3 Added	3-19
Figure 3-13: Menu With File Name	3-21
Figure 3-14: Waveform Editor Graphic Display Menu Structure ...	3-24
Figure 3-15: Graphic Display Screen	3-27
Figure 3-16: Setting the Unit for the Horizontal Axis	3-32
Figure 3-17: Menu Displayed When Clock is Selected	3-33
Figure 3-18: Sub-Menu Showing Cursor Link to... Selected	3-34
Figure 3-19: Grid Set to On	3-36
Figure 3-20: Creating a Sine Wave	3-39
Figure 3-21: Adding Noise to the Sine Wave	3-40
Figure 3-22: Multiplying Sine Waves	3-41
Figure 3-23: Defining the Editing Area	3-43
Figure 3-24: Cutting Waveforms	3-44
Figure 3-25: Pasting Waveforms	3-45
Figure 3-26: Menu Display When Draw... is Selected	3-47
Figure 3-27: Smoothing	3-49
Figure 3-28: Horizontally Shifted Display	3-51
Figure 3-29: Vertically Shifted Display	3-52
Figure 3-30: Display Expanded Horizontally	3-53
Figure 3-31: Display Expanded to x1.5 Vertically	3-54
Figure 3-32: Horizontally Inverted Display	3-55
Figure 3-33: Vertically Inverted Display	3-56
Figure 3-34: Display of Waveform Clipped Above Clip Level	3-57
Figure 3-35: Marker Signal 1 Set High	3-59
Figure 3-36: Entering Pattern Data	3-60
Figure 3-37: Defining the Location for Insertion	3-61

Figure 3-38: List of Files for Insertion	3-62
Figure 3-39: File Waveform Display	3-62
Figure 3-40: Inserting Waveforms	3-63
Figure 3-41: Waveform Example before Calculation	3-64
Figure 3-42: Absolute Calculation	3-65
Figure 3-43: Square Calculation	3-65
Figure 3-44: Cube Calculation	3-66
Figure 3-45: Square Root Calculation	3-66
Figure 3-46: Normalize Calculation	3-67
Figure 3-47: Integral Calculation	3-67
Figure 3-48: Differential Calculation	3-68
Figure 3-49: Example of Waveform Before Arithmetic Operations .	3-69
Figure 3-50: List of Files for Waveform Calculation	3-70
Figure 3-51: Selected File Waveform Display	3-70
Figure 3-52: Waveform Addition Display	3-71
Figure 3-53: Data Shifted Using the “Right” Item	3-73
Figure 3-54: Data Compressed Using the “Compress” Item	3-73
Figure 3-55: Linear Interpolation	3-75
Figure 3-56: Quadratic Interpolation	3-76
Figure 3-57: Shift with “Cursor Point” Set to “Exclude”	3-77
Figure 3-58: Smoothing	3-78
Figure 3-59: Data Shifting	3-78
Figure 3-60: Increasing the Size of the Area	3-79
Figure 3-61: Two Waveform Editing Areas Designated	3-80
Figure 3-62: Setting the Copy Source	3-81
Figure 3-63: Setting the Copy Destination	3-82
Figure 3-64: Waveform Copying (number of points in waveform = Interval value)	3-83
Figure 3-65: Waveform Copying (number of points in waveform < Interval value)	3-84
Figure 3-66: Waveform Copying (number of points in waveform > Interval value)	3-84
Figure 3-67: Waveforms Used for Waveform1 and Waveform2	3-86
Figure 3-68: Convolution	3-87
Figure 3-69: Compare... Item Selected	3-90
Figure 3-70: Comparison Without Hysteresis	3-91
Figure 3-71: Comparison With Hysteresis	3-92
Figure 3-72: Zoom Menu	3-93
Figure 3-73: Horizontal Zoom	3-94

Figure 3-74: Vertical Zoom	3-95
Figure 3-75: Timing Display	3-96
Figure 3-76: Waveform Editor Timing Display Menu Structure	3-97
Figure 3-77: Timing Display Screen	3-100
Figure 3-78: Count Up Pattern Display	3-102
Figure 3-79: Gray Code Pattern Display	3-103
Figure 3-80: Setting Waveform Data to High/Low	3-105
Figure 3-81: Pattern Data Setting Menu	3-106
Figure 3-82: Setting Pattern Data	3-110
Figure 3-83: User defined Code Conversion Menu	3-111
Figure 3-84: Shifting Waveform Data	3-118
Figure 3-85: Inverting Waveform Data State	3-119
Figure 3-86: Copying Lines	3-120
Figure 3-87: Exchanging Lines	3-121
Figure 3-88: Expanding Waveform Data	3-123
Figure 3-89: Shift Register Configuration Menu	3-124
Figure 3-90: Register Values and Taps	3-125
Figure 3-91: Sample Settings for Register Values and Taps	3-126
Figure 3-92: Table Display	3-129
Figure 3-93: Waveform Editor Table Display Menu Structure	3-130
Figure 3-94: Table Display Screen	3-132
Figure 3-95: Numeric Displays for Waveform Data	3-134
Figure 3-96: Example of Equation File Data and Resulting Waveform	3-137
Figure 3-97: Equation Editor Menu Structure	3-138
Figure 3-98: Equation Editor CRT Display	3-140
Figure 3-99: Menu With Operation Selected	3-142
Figure 3-100: Component Menu	3-144
Figure 3-101: Trigonometric Function Waveform Expressed With Variable x	3-146
Figure 3-102: Trigonometric Function Waveform Expressed With Variable t	3-147
Figure 3-103: Equation Using exp(.....	3-147
Figure 3-104: Equation Using log(.....	3-148
Figure 3-105: Equation Using ln(.....	3-148
Figure 3-106: Equation Using sqrt(.....	3-149
Figure 3-107: Equation Using abs(.....	3-149
Figure 3-108: Equation Using int(.....	3-150
Figure 3-109: Equation Using round(.....	3-150

Figure 3-110: Equation Using norm(3-151
Figure 3-111: Equation Using max(and min(3-152
Figure 3-112: Equation Using rnd(3-153
Figure 3-113: Waveform Before Calculation	3-154
Figure 3-114: Waveform After Differentiation Using diff(3-154
Figure 3-115: Waveform After Integration Using integ(3-155
Figure 3-116: Menu Displayed When Insert Other Equation is Selected	3-157
Figure 3-117: Setting Waveform Point Count	3-158
Figure 3-118: Example of Compiled Waveform Display	3-159
Figure 3-119: Sequence File Data and Sample Waveform Display	3-161
Figure 3-120: Sequence Editor Menu Structure	3-162
Figure 3-121: Sequence Editor CRT Display	3-164
Figure 3-122: Example of Waveform Display When Show Catalog Entry is Selected	3-168
Figure 3-123: Example of CRT Display When Show Overview is Selected	3-170
Figure 3-124: Autostep File Data and Output Waveforms	3-172
Figure 3-125: Autostep Editor Menu Structure	3-173
Figure 3-126: Autostep Editor CRT Display	3-175
Figure 3-127: Selecting the Item for File Setting	3-177
Figure 3-128: File Selection List	3-178
Figure 3-129: Sample File Waveform Display	3-178
Figure 3-130: Setting a File	3-179
Figure 3-131: Clock Setting Menu	3-181
Figure 3-132: CH1 Operation Setting Menu	3-182
Figure 3-133: Filter Setting Menu	3-183
Figure 3-134: Amplitude Setting Menu	3-184
Figure 3-135: Offset Setting Menu	3-185
Figure 3-136: Convolution Waveform Editor Menu Structure	3-190
Figure 3-137: Convolution Waveform Editor CRT Display	3-191
Figure 3-138: Selecting a Waveform File	3-192
Figure 3-139: Sample Convolution	3-193
Figure 3-140: Sample Correlation	3-194
Figure 3-141: FFT Window Selection Menu	3-196
Figure 3-142: FFT Editor Menu Structure	3-197
Figure 3-143: FFT Editor CRT Display	3-199
Figure 3-144: Menu Displayed When Draw... is Selected	3-202
Figure 3-145: Drawing a Magnitude	3-204

Figure 3-146: Magnified Signal Display	3-205
Figure 3-147: Low Pass Filter	3-206
Figure 3-148: High Pass Filter	3-206
Figure 3-149: Band Pass Filter	3-206
Figure 3-150: Band Cut Filter	3-207
Figure 3-151: Fundamental, Odd, and Even Components	3-209
Figure 3-152: SETUP Menu Structure	3-212
Figure 3-153: SETUP Menu (Graphic Mode)	3-214
Figure 3-154: SETUP Menu (Text Mode)	3-216
Figure 3-155: Clock and Waveform Points	3-219
Figure 3-156: Multiplying CH1 Waveform by CH2 Waveform	3-222
Figure 3-157: Adding CH1 Waveform and CH2 Waveform	3-223
Figure 3-158: Multiplying CH1 Waveform by an External Waveform	3-224
Figure 3-159: Setting Amplitude and Offset	3-225
Figure 3-160: MODE Menu Structure	3-230
Figure 3-161: MODE Menu CRT Display	3-232
Figure 3-162: Output Waveform for External Trigger Signal in Triggered Mode	3-234
Figure 3-163: Output Waveform for External Gate Signal in Gated Mode	3-235
Figure 3-164: Output Waveform for External Trigger Signal in Burst Mode	3-236
Figure 3-165: Output Waveform for External Trigger Signal in Waveform Advance Mode	3-237
Figure 3-166: Output Waveform for External Trigger Signal in Autostep Mode	3-239
Figure 3-167: Autostep File List	3-240
Figure 3-168: Slope and Level Controls	3-241
Figure 3-169: Relationship Between Memory and Execution of Load/Save	3-244
Figure 3-170: LOAD/SAVE Menu Structure	3-245
Figure 3-171: LOAD Menu CRT Screen Display	3-247
Figure 3-172: LOAD Menu	3-251
Figure 3-173: SAVE Menu	3-253
Figure 3-174: Connecting Instruments	3-255
Figure 3-175: GPIB Source List	3-256
Figure 3-176: List of Supported Models Made by Other Manufacturers	3-257
Figure 3-177: UTILITY Menu Structure	3-262

Figure 3-178: Format... Sub-Menu Display	3-265
Figure 3-179: Write Protect Tab on a Floppy Disk	3-268
Figure 3-180: File and Directory Display in the Root Directory	3-270
Figure 3-181: Directory Name Input	3-271
Figure 3-182: Directory Displayed When Change Directory is Selected	3-271
Figure 3-183: File List for a Newly Created Directory	3-272
Figure 3-184: Menu Displayed When NVRam is Selected	3-273
Figure 3-185: Menu Displayed When GPIB is Selected	3-275
Figure 3-186: Menu Displayed When RS232C is Selected	3-277
Figure 3-187: Menu Displayed When Date Time is Selected	3-278
Figure 3-188: Setting the Display Brightness	3-280
Figure 3-189: Menu Displayed when Catalog Order is Selected	3-281
Figure 3-190: Catalog Files	3-282
Figure 3-191: Catalog With Files Displayed in Type4 Format	3-283
Figure 3-192: Date/Time Display	3-284
Figure 3-193: Format Selection Menu	3-286
Figure 3-194: Port Selection Menu	3-287
Figure 3-195: Menu Displayed When System is Selected	3-289
Figure 3-196: I/O Event Reporting	3-290
Figure 3-197: Diagnostics List	3-291
Figure 3-198: Calibration List	3-292
Figure 3-199: FG Mode Menu Structure	3-296
Figure 3-200: FG Mode Menu Display	3-297
Figure 3-201: Setting the Amplitude	3-299
Figure 3-202: Setting the Offset	3-299
Figure 3-203: Waveform Polarity	3-300
Figure 3-204: Setting the Duty Value for a Pulse Wave	3-300
Figure A-1: Block Diagram	A-2
Figure A-2: Output Connector	A-3
Figure A-3: Generation of Excess Output	A-4
Figure A-4: Output Circuit	A-5
Figure A-5: Output Waveform	A-6
Figure A-6: Data Latching	A-6
Figure A-7: Coaxial Cable End Processing	A-7
Figure A-8: Cable Examples	A-7
Figure A-9: Waveform Reproduction Circuit Example	A-8
Figure A-10: Block Diagram	A-10

Figure A-11: The Shape of the Output Connector	A-10
Figure A-12: Generation of Excess Output	A-11
Figure A-13: Output Circuit	A-12
Figure A-14: Output Waveform	A-13
Figure A-15: Data Latching	A-13
Figure A-16: Digital Data Out Cable	A-14
Figure A-17: Waveform Reproduction Circuit Example	A-15
Figure B-1: Timing for the Data and Clock Signals	B-8
Figure C-1: Diagnostics Menu	C-3
Figure C-2: Calibrations Menu	C-4
Figure C-3: Cont Mode Initial Test Hookup	C-10
Figure C-4: Triggered Mode Initial Test Hookup	C-12
Figure C-5: Burst Mode Initial Test Hookup	C-14
Figure C-6: Gated Mode Initial Test Hookup	C-16
Figure C-7: Relationship between 1 Volt or Greater Gate Signal and Waveform Output Signal	C-18
Figure C-8: Waveform Advance Mode Initial Test Hookup	C-19
Figure C-9: Autostep Mode Initial Test Hookup	C-20
Figure C-10: External AM Operation Initial Test Hookup	C-22
Figure C-11: MODE Menu Autostep Setting	C-24
Figure C-12: Clock Frequency Accuracy Initial Test Hookup	C-26
Figure C-13: Clock Amplitude Initial Test Hookup	C-28
Figure C-14: Gain Accuracy Initial Test Hookup	C-30
Figure C-15: Pulse Response Initial Test Hookup	C-33
Figure C-16: Initial Test Hookup	C-35
Figure C-17: External Trigger Level Accuracy Initial Test Hookup .	C-38
Figure C-18: External CLOCK IN Initial Test Hookup	C-41
Figure C-19: ECL Digital Data Out Initial Test Hookup	C-43
Figure C-20: Output Pins on the Termination Board	C-45
Figure C-21: TTL Digital Data Out Initial Test Hookup	C-46
Figure C-22: Output Pins on the TTL Digital Data Out Cable	C-48
Figure D-1: Gaussian Pulse Formula and Waveform	D-3
Figure D-2: Lorentz Pulse Formula and Waveform	D-5
Figure D-3: Sampling Function SIN(X)/X Pulse Formula and Waveform	D-6
Figure D-4: Squared Sine Pulse Formula and Waveform	D-7
Figure D-5: Double Exponential Pulse Formula and Waveform	D-8

Figure D-6: Nyquist Pulse Formula and Waveform	D-9
Figure D-7: Linear Frequency Sweep Formula and Waveform	D-10
Figure D-8: Log Frequency Sweep Formula and Waveform	D-11
Figure D-9: Amplitude Modulation Formula and Waveform	D-12
Figure D-10: Frequency Modulation Formula and Waveform	D-13
Figure D-11: Damped Sine Wave Formula and Waveform	D-14
Figure D-12: Pulse Width Modulation Waveform	D-15
Figure D-13: Pseudo-Random Pulse Waveform	D-16
Figure D-14: p/4 DQPSK I Axis Signal	D-17
Figure D-15: p/4 DQPSK Q Axis Signal	D-17
Figure D-16: Waveform for Magnetic Disk Readout Signal	D-18
Figure D-17: Waveform for Magnetic Disk Readout Signal	D-19
Figure D-18: Color Bar (Composite) Signal (\$CB1-2H.SEQ)	D-21
Figure D-19: NTSC Y-C separate signals	D-22
Figure D-20: Multiburst Signal (\$M-BURST.SEQ)	D-22
Figure D-21: Modulated Ramp Signal (\$RAMP.SEQ)	D-23
Figure D-22: Sweep Signal (\$SWEEP.SEQ)	D-23
Figure D-23: SMPTE Color Bar Signal (\$SMPTE.SEQ)	D-24
Figure D-24: IYQB Signal (\$IYQB.SEQ)	D-24
Figure D-25: Reversed Blue Bar signal (\$RBLU.SEQ)	D-25
Figure D-26: Color Bar + IYQB signal + Reversed Blue Bar (\$MIX.SEQ)	D-25
Figure E-1: Block Diagram (1)	E-2
Figure E-2: Block Diagram (2)	E-3
Figure E-3: Clock Oscillator Configuration	E-4
Figure E-4: Connection Example 1	E-5
Figure E-5: Connection Example 2	E-6
Figure E-6: Connection Example 3	E-7
Figure E-7: Trigger Input, SYNC Output, and Waveform Timing ..	E-8
Figure E-8: Clock Divider Configuration	E-8
Figure E-9: Relationship Between Sequence Memory and Waveform Memory	E-10
Figure E-10: Waveform Memory Configuration	E-11
Figure E-11: Relationship Between Triangular Wave Resolution and Number of Data Points	E-12
Figure E-12: Relationship Between Waveform Points and SYNC Output in Cont Mode	E-13
Figure E-13: 100% Amplitude Modulation	E-14

Figure E-14: Representative Filter Characteristics	E-16
Figure E-15: Time Difference Between Signals and SYNC Signals ..	E-17
Figure E-16: Attenuator Configuration	E-18
Figure E-17: Offset Circuit	E-18
Figure F-1: Linear Interpolation	F-1
Figure F-2: Point Padding	F-2
Figure F-3: Point Compression	F-2
Figure F-4: Equation Differentiation	F-4
Figure F-5: Equation Integration	F-5
Figure F-6: Phase and Delay	F-18
Figure F-7: Concept of Convolution	F-19
Figure F-8: Square Window and Frequency Characteristic	F-20
Figure F-9: Hanning Window and Frequency Characteristic	F-20
Figure F-10: Hamming Window and Frequency Characteristic	F-21
Figure F-11: Blackman-Harris Window and Frequency Characteristic	F-21
Figure F-12: Blackman Window and Frequency Characteristic	F-22
Figure F-13: Triangle Window and Frequency Characteristic	F-22

List of Tables

Table 1-1: Power Cord Identification	1-6
Table 2-1: Numeric Value Input Example 1	2-18
Table 2-2: Numeric Value Input Example 2	2-19
Table 3-1: Menu Functions	3-5
Table 3-2: Menu Functions	3-26
Table 3-3: Differences Between the Shift Operations	3-72
Table 3-4: Menu Functions	3-99
Table 3-5: Menu Functions	3-131
Table 3-6: Menu Functions	3-139
Table 3-7: Sequence File	3-161
Table 3-8: Menu Functions	3-163
Table 3-9: Autostep File — CH1	3-171
Table 3-10: Menu Functions	3-174
Table 3-11: Menu Functions	3-190
Table 3-12: Menu Functions	3-198
Table 3-13: Menu Functions	3-213
Table 3-14: Output Signal Amplitude Relative to External Modulation Signal	3-224
Table 3-15: Menu Functions	3-231
Table 3-16: Sequence File	3-237
Table 3-17: Autostep File	3-239
Table 3-18: Menu Functions	3-246
Table 3-19: Supported Instruments	3-250
Table 3-20: Supported Floppy Disk Files	3-259
Table 3-21: Menu Functions	3-263
Table 3-22: MS-DOS Formats for 3.5-inch Disks	3-266
Table 3-23: Format Extensions	3-286
Table 3-24: Number of Data Points for Frequencies and Marker Signal Width	3-295
Table A-1: Output Signal	A-3
Table A-2: Connector Pin Assignments	A-10
Table A-3: Power Cord Options	A-16

Table B-1: Electrical Characteristics	B-1
Table B-2: Mechanical Characteristics	B-5
Table B-3: Electrical Characteristics	B-6
Table B-4: Environmental Characteristics	B-10
Table B-5: Electrical Characteristics	B-12
Table B-6: Certifications and Compliances	B-13
Table C-1: Test Equipment	C-6
Table C-2: File List for Performance Check/Adjustment Disk	C-8
Table C-3: Clock Frequency Accuracy	C-28
Table E-1: Sequence File (XXX.SEQ)	E-9
Table E-2: Output Signal Amplitude – External Modulation	E-14
Table E-3: Filter Timer Delay Relative to SYNC Signals	E-16
Table F-1: Factory Settings	F-24
Table G-1: External inspection check list	G-1

General Safety Summary

Review the following safety precautions to avoid injury and prevent damage to this product or any products connected to it.

Only qualified personnel should perform service procedures.

Injury Precautions

- | | |
|---|--|
| Use Proper Power Cord | To avoid fire hazard, use only the power cord specified for this product. |
| Avoid Electric Overload | To avoid electric shock or fire hazard, do not apply a voltage to a terminal that is outside the range specified for that terminal. |
| Ground the Product | This product is grounded through the grounding conductor of the power cord. To avoid electric shock, the grounding conductor must be connected to earth ground. Before making connections to the input or output terminals of the product, ensure that the product is properly grounded. |
| Do Not Operate Without Covers | To avoid electric shock or fire hazard, do not operate this product with covers or panels removed. |
| Use Proper Fuse | To avoid fire hazard, use only the fuse type and rating specified for this product. |
| Do Not Operate in Wet/Damp Conditions | To avoid electric shock, do not operate this product in wet or damp conditions. |
| Do Not Operate in Explosive Atmosphere | To avoid injury or fire hazard, do not operate this product in an explosive atmosphere. |

Product Damage Precautions

- | | |
|-----------------------------------|---|
| Use Proper Power Source | Do not operate this product from a power source that applies more than the voltage specified. |
| Provide Proper Ventilation | To prevent product overheating, provide proper ventilation. |

Do Not Operate With Suspected Failures

If you suspect there is damage to this product, have it inspected by qualified service personnel.

Safety Terms and Symbols

Terms in This Manual

These terms may appear in this manual:



WARNING. Warning statements identify conditions or practices that could result in injury or loss of life.



CAUTION. Caution statements identify conditions or practices that could result in damage to this product or other property.

Terms on the Product

These terms may appear on the product:

DANGER indicates an injury hazard immediately accessible as you read the marking.

WARNING indicates an injury hazard not immediately accessible as you read the marking.

CAUTION indicates a hazard to property including the product.

Symbols on the Product

The following symbols may appear on the product:



DANGER
High Voltage



Protective Ground
(Earth) Terminal



ATTENTION
Refer to
Manual



Double
Insulated

Certifications and Compliances

CSA Certified Power Cords

CSA Certification includes the products and power cords appropriate for use in the North America power network. All other power cords supplied are approved for the country of use.

Preface

This is the User Manual for the AWG2021 250 MHz Arbitrary Waveform Generator.

Getting Started covers the features of the AWG2021, initial inspection, and start up. In particular, the start up section covers the procedures required prior to turning on the unit and points that require special care or caution.

Operating Basics first describes the components of the AWG2021 and their functions. Then it describes the operating procedures used to output waveforms from the AWG2021 by presenting a few simple examples.

Reference explains the specific functions and execution method details for each menu.

Appendices describe options and accessories, product specifications, performance verification instructions, sample waveform library, functional operation, and other information.

Related Manuals

Other documentation for the instrument includes:

- The AWG2021 Programmer Manual (Tektronix part number 070-8657-50) explains how to control the AWG2021 with a computer through the GPIB or RS-232-C interface. This manual is a standard accessory.
- The AWG2021 Service Manual (Tektronix part number 070-9098-50) provides information to maintain and service AWG2021, and provides a complete board-level description of the instrument's operation. This manual is an optional accessory.

Conventions

In sections 2 through 4, you will find various procedures that contain steps of instructions for you to perform. To keep those instructions clear and consistent, this manual uses the following conventions:

- Names of front panel controls and menu item names are printed in the manual in bold with the same case (e.g., initial capitals, all upper case) as they appear on the unit itself.
- Instruction steps are numbered. When the number is omitted there is only one step.

- When menu items are displayed in the manual, the menu type, either bottom menu, side menu, or sub-menu, is distinguished and indicated as shown below.



Bottom Menu

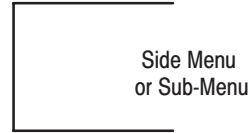

- Consecutive button operations are expressed as shown below.

Setting (bottom) → **View type...** (side) → **Timing** (sub)

This expression describes the following button operations.

- 1) Selecting the “**Setting**” item from the bottom menu
- 2) Selecting the “**View type...**” item from the side menu.
- 3) Selecting the “**Timing**” item from the sub-menu.

Contacting Tektronix

Phone	1-800-833-9200*
Address	Tektronix, Inc. Department or name (if known) 14200 SW Karl Braun Drive P.O. Box 500 Beaverton, OR 97077 USA
Web site	www.tektronix.com
Sales support	1-800-833-9200, select option 1*
Service support	1-800-833-9200, select option 2*
Technical support	Email: techsupport@tektronix.com 1-800-833-9200, select option 3* 1-503-627-2400 6:00 a.m. – 5:00 p.m. Pacific time

-
- * **This phone number is toll free in North America. After office hours, please leave a voice mail message. Outside North America, contact a Tektronix sales office or distributor; see the Tektronix web site for a list of offices.**

Overview

This section describes the features of the AWG2021, initial inspection, and start up.

Product Description

The AWG2021 is a portable arbitrary waveform generator capable of generating both arbitrary and standard function waveforms.

This arbitrary waveform generator provides these major features:

- custom waveforms for simulation and testing
- waveforms that can not be generated with function generators

As an arbitrary waveform generator, this instrument has a clock frequency of 10 Hz to 250 MHz, an independent 256 Kword, 12-bit internal memory for each channel (the second output channel is optional), and an output amplitude to $5 V_{p-p}$ (into 50Ω). It can also generate two one-bit marker outputs which can be placed anywhere within the 256K location memory, corresponding to each arbitrary output channel.

There are several options available for the AWG2021, including two-channel output, ECL or TTL digital data output, and FFT and convolution waveform editor. These options allow the AWG2021 to handle a wide range of applications.

This instrument has four editors for making waveform files. Each editor is equipped with a variety of editing functions, as described below.

1. Waveform Editor creates waveform data. This editor can display its data in three formats: graphical, table, and timing, and the data can be edited in the format appropriate for the application. Furthermore, the waveform editor can edit up to three waveform files at the same time, thus easing the creation of related waveform files.
2. Sequence Editor creates sequences of waveforms by combining waveform files created with the waveform editor.
3. Equation Editor creates files with equations and compiles them into waveform files.
4. Autostep Editor programs waveform files, including output conditions for each channel, in steps.

An FFT editor and a convolution waveform editor are provided with AWG2021 units that include Option 09. These editors support frequency domain editing and waveform convolution calculations.

As a function generator, the AWG2021 can generate sine waves, triangle waves, square waves, ramp waves, and pulse waves. It can set the frequency, amplitude, offset, polarity, and other factors for each of these waveforms independently, for each channel.

The AWG2021 has a 3.5-inch floppy disk drive and non-volatile memory for storing created waveform data and parameter settings. Each of these storage devices can store the files created with the editors.

You control this instrument by way of its front panel hierarchical menu display system or its rear panel GPIB or RS-232-C interfaces. (Instruments with Option 03 or Option 04 don't have the RS-232-C interface installed.)

Waveforms can be transferred directly through the GPIB interface from a digital storage oscilloscope. Such direct waveform transfers allow for many types of applications with other measurement equipment and computers. Supported equipment includes our major digital storage oscilloscopes as well as the digital storage oscilloscopes of other leading manufacturers.

Initial Inspection

Before unpacking the AWG2021 from its shipping carton, inspect it for signs of external damage. If the carton is damaged, notify the carrier. The carton contains the basic instrument and its standard accessories. Refer to the Standard Accessories list in Appendix A.

This instrument was thoroughly inspected for mechanical and electrical defects before shipment. It should be free of marks or scratches. To confirm this, inspect the instrument for physical damage incurred in transit and test instrument functionality by following the Operating Examples in this manual. You can also perform a full Performance Verification as listed in the Appendix C. If a discrepancy is found, contact your local Tektronix Field Office or representative.

NOTE. *At installation time, save the shipping carton and packaging materials for repackaging in case shipment becomes necessary.*

Start Up

This section describes the procedures required prior to turning on the AWG2021.

Installation

Before you begin, refer to the Safety Summary at the front of this manual for power source, grounding, and other safety information.

Before you use the instrument, ensure that it is properly installed and powered on. To properly install and power on the instrument, perform the following steps:

1. Check that the operating environment is correct.

The AWG2021 operates correctly in ambient temperatures from +10° C to +40° C and relative humidity from 20% to 80%. If this instrument is stored at temperatures outside this usage temperature range, do not switch on the power until the chassis has come within the usage temperature range. For the information on the other operating environment, see Appendix B: Performance Characteristics.

NOTE. *If you are installing this instrument in the dedicated rack, refer to the instruction sheet that comes with the rack mounting kit.*

2. Before switching on the power, double check that there is nothing blocking the flow of air at the fan and air intake holes.

This instrument takes in outside air and cools itself by forcibly exhausting air with the fan on its left side. Leave space at the sides of this instrument so that the heat generated within the instrument does not build up and harm the operation. There are holes for air intake on the sides and bottom of this cabinet. After switching on the power, double check that the fan is turning. Here are the minimums for the space at the sides of this instrument.

Top and rear: 7.6cm (3 inches)

Left and right: 15.2cm (6 inches)



WARNING. *Always unplug the power cord from the socket before checking the line fuse to avoid electrical shock.*

- Remove the fuse from the fuse holder on the rear panel and check the fuse.

To remove the fuse, turn it counter-clock-wise with a screwdriver while pushing it in. There are two types of fuses provided. Here is the fuse type and rating.

Fuse	Fuse Part Number	Fuse Cap Part Number
0.25 inch × 1.25 inch (UL 198G,3AG): 6A FAST, 250 V	159-0239-XX	200-2264-XX
5 mm × 20 mm (IEC 127):5A (T), 250 V	159-0210-XX	200-2265-XX

- Check that you have the proper electrical connections.

The AWG2021 operates at the following power supply voltage.

Line Voltage Range	90 V – 250 V
Line Frequency	48 Hz – 440 Hz (90 V – 127 V) 48 Hz – 63 Hz (127 V – 250 V)
Maximum Power	300 W



CAUTION. Instruments are shipped with a power cord appropriate for use with normal 115 V power systems. If the AWG2021 is to be used with 230 V power, the power cord must be replaced with one appropriate for the power source used. See Table 1-1, “Power Cord Identification”, for the available power cord types.

- Connect the proper power cord from the rear-panel power connector to the power system.

Power On

6. Push the **PRINCIPAL POWER SWITCH** (shown in Figure 1 -1) on the rear panel of this instrument. Power is now applied to the standby circuit of this instrument.

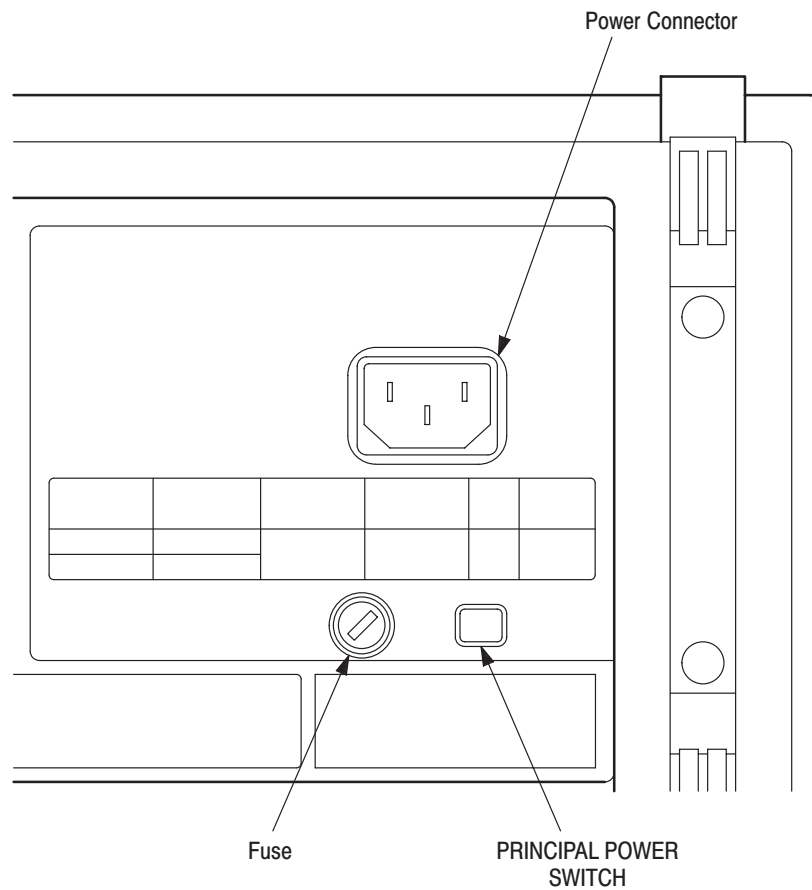
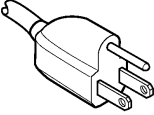
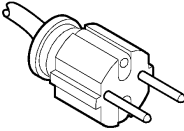
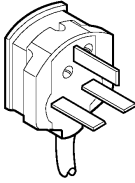
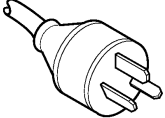
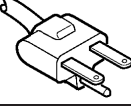
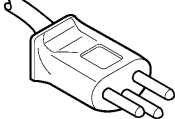
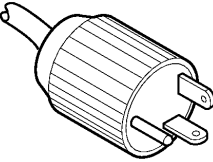
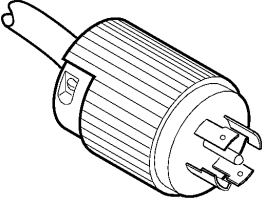

Figure 1 -1: Rear Panel Controls Used In Start Up

Table 1-1: Power Cord Identification

Plug Configuration	Normal Usage	Option Number
	North America 125 V	Standard
	Europe 230 V	A1
	United Kingdom 230 V	A2
	Australia 230 V	A3
	North America 230 V	A4
	Switzerland 230 V	A5
	North American 115V/15A Plug NEMA 5-20P	1A
	North American 120/208V 3-Phase Plug NEMA L21-30P	1B

7. Press the **ON/STBY** switch (shown in Figure 1 -2) on the lower left side of the front panel to switch on the power for this instrument.

Once this instrument is installed, leave the **PRINCIPAL POWER SWITCH** on and use the **ON/STBY** switch as the power switch.

NOTE. This instrument needs to be warmed up for at least 20 minutes in order to operate at its optimum precision.

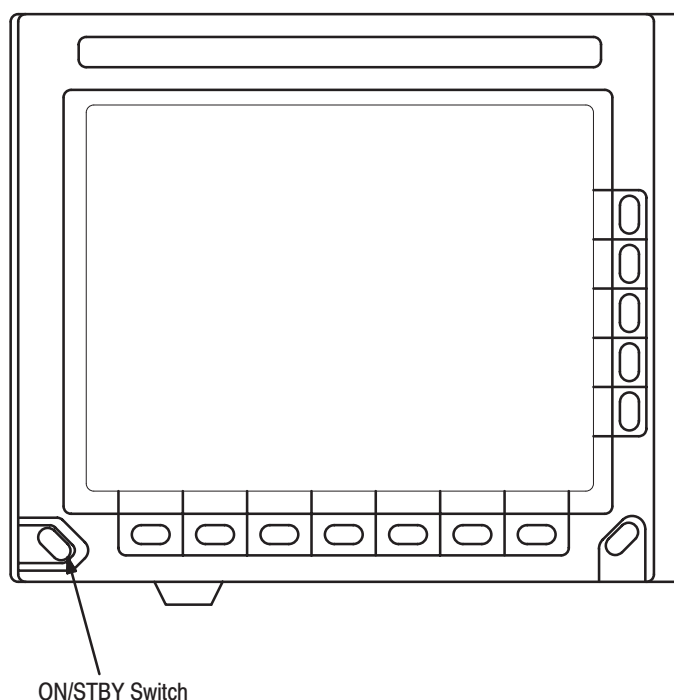

Figure 1 -2: ON/STBY Switch

Start-up Diagnostics

8. Check the results of the start-up diagnostics.

When the power is applied to this instrument, the start-up diagnostics are automatically run. These diagnostics check whether the instrument is performing within its defined operating characteristics.

If all the diagnostic items are completed without error, **Pass** is displayed and the system moves on to the **SETUP** menu.

If an error is detected, **Fail** and the error code are displayed. You can exit this state and operate this instrument, but until the error is corrected, the waveform outputs can not be relied on. If “**Uncal**” error message is

displayed, you should execute the calibrations in the **UTILITY** menu. Still, when the error message is displayed, contact our nearest representative. To exit the diagnostics system, press any of the buttons. The system moves on to the **SETUP** menu.

NOTE. *In order to preserve the precision of the instrument, after the completion of the warm-up or after temperature changes, calibrate the instrument. For details on how to calibrate, see the explanation of the Calibration item on the **UTILITY** menu in Section 3.*

If this instrument is exposed to temperatures outside its usage temperature range and the chassis temperature is inappropriate, an error will occur during the diagnostics when the power is switched on. If this happens, wait until the chassis temperature is appropriate, then switch the power on again.

Power Off

9. Toggle the **ON/STBY** switch.

Introduction

This section will discuss the following:

Overview. The names of the parts of the instrument and their functions.

Basic Menu Operation. Operations commonly performed on the instrument and how to enter numbers

Operating Examples. Simple examples showing how to output waveforms.

These examples are designed to help you gain a basic understanding of the instrument.

Overview

The instrument can be divided into three main areas: the front panel, the side panel and the rear panel. In this section, we will list the names and functions of the parts in each of these areas. We will also list typical display messages that appear on the screen and what they mean.

Front Panel

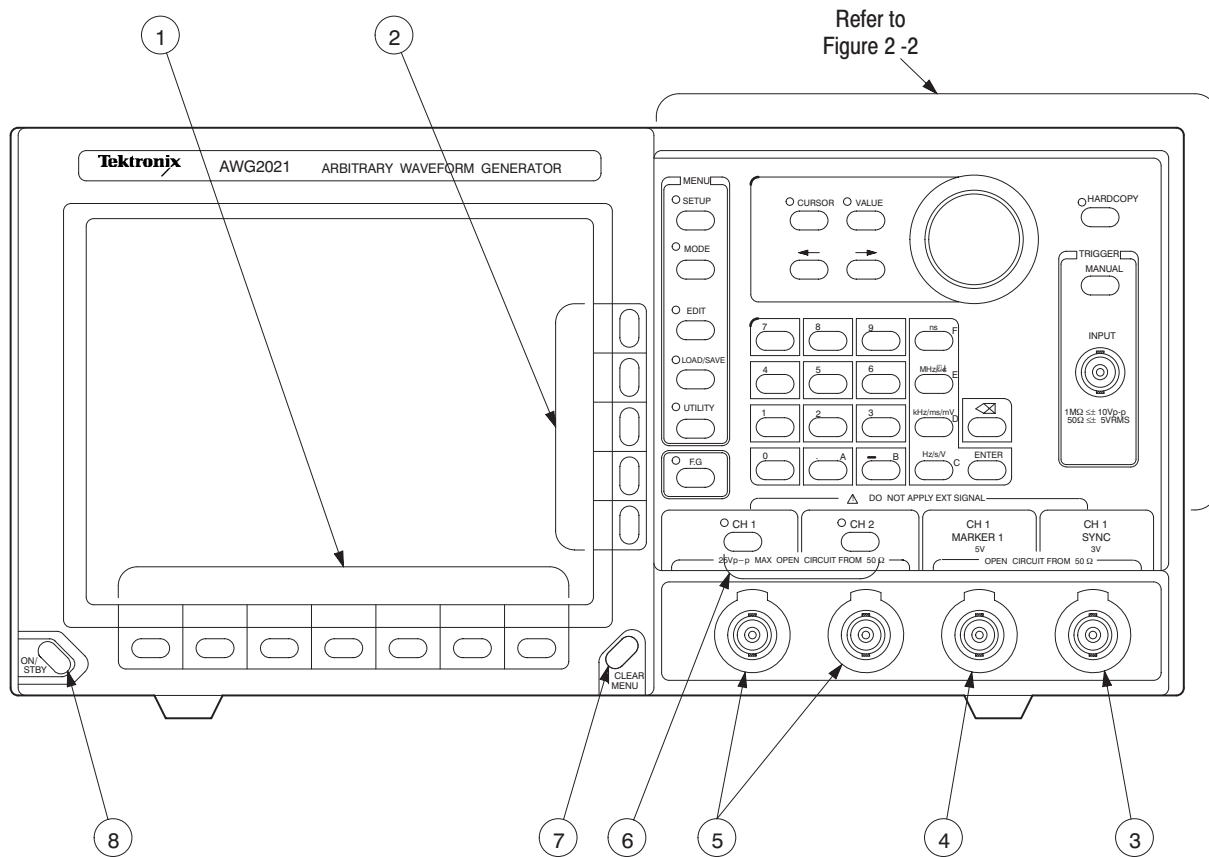



Figure 2 -1: Front Panel Overall View

(1) Bottom Buttons	Use the seven bottom buttons to display corresponding menus. Pressing any button in the MENU column, or the F.G button, displays its corresponding menu. These menus are generally the highest level menus.
(2) Side Buttons	Use the five side buttons to select the side menus displayed on the right side of the screen. Selecting any item from bottom menu displays a side menu. The side menu is generally a lower level menu.
(3) CH1 SYNC Output Connector	The CH1 SYNC output connector provides a CH1 sync signal. The output level is 1.2 V or greater with a 50 Ω termination.
(4) CH1 MARKER1 Output Connector	The CH1 MARKER1 output connector provides a user-specified marker. The output level is 2.5 V with a 50 Ω termination.
(5) Waveform Output Connectors	Provides the waveform output path for each channel. A CH2 waveform output connector is provided only in instruments with Option 02. The maximum output level is 5 V _{p-p} with a 50 Ω termination. Note however, that output may exceed 5 V _{p-p} if AM , Add or Ext AM mode has been selected for CH1 Operation from the SETUP menu.
 CAUTION. Do not apply any external voltage to the output connector of this instrument. Doing so can harm the instrument.	
(6) Channel On/Off Buttons and Indicators	Press the channel on/off buttons to switch the output for each channel on and off. When set to on, the LED indicator is lit and a waveform is output. When set to off, the LED indicator is extinguished and a waveform is not output.
(7) CLEAR MENU Button	Press this button to cancel any entering alphanumeric input and return the system to the data before input. Also, for a side menu item with “...” attached to it, pressing this button returns the system from the sub menu (lower-level menu) to the side menu. Using remote commands, the user may delete a message that has been entered in the message area (see page 2 -14).
(8) ON/STBY Button	When the PRINCIPAL POWER SWITCH on the rear panel has been pressed to supply power to the standby circuit, this button can be pressed to provide power to the other circuits of the instrument. Normally this button is used as a power switch.

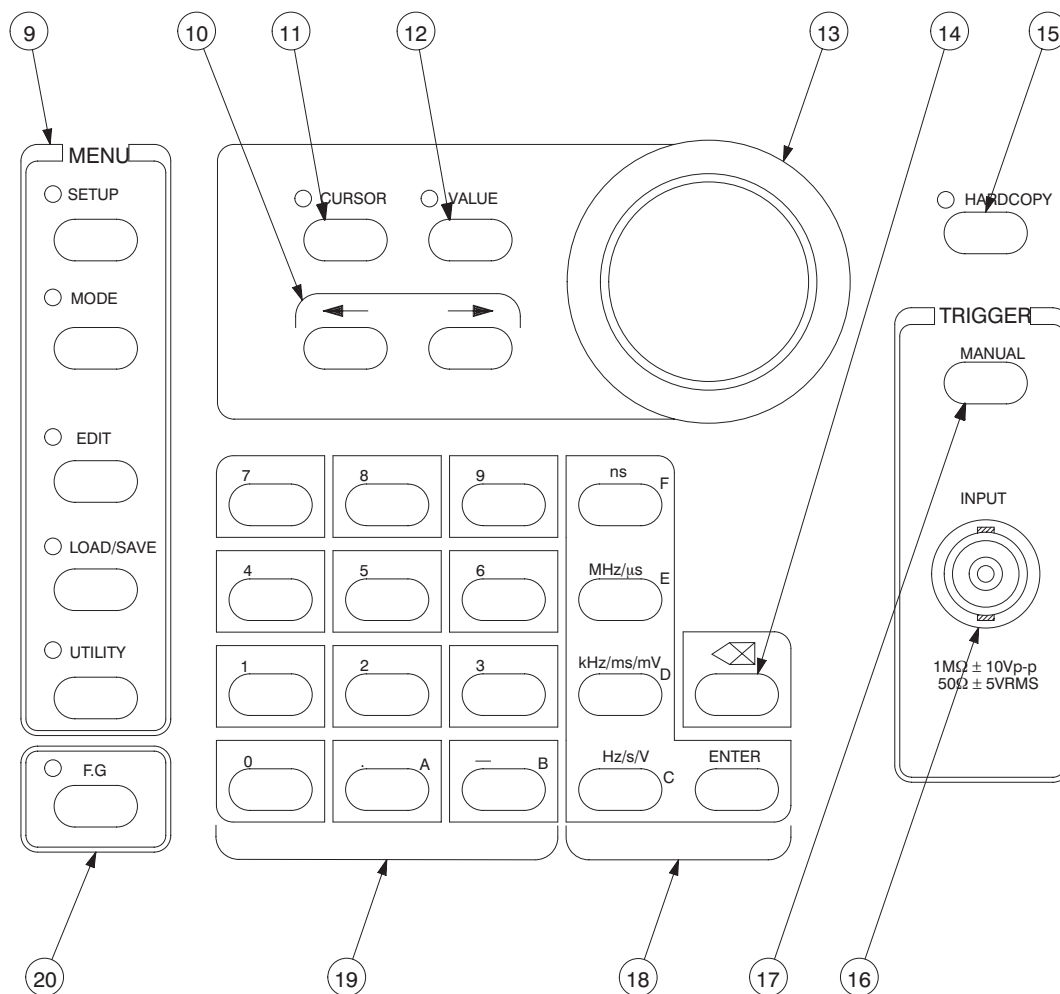

Figure 2 -2: Front Panel Button Detail

<p>(9) Menu Buttons and Indicators</p>	<p>The MENU column comprises the SETUP, MODE, EDIT, LOAD/SAVE and UTILITY buttons. To display one of these five main menus on the screen, press the corresponding button in the MENU column. The corresponding LED indicators show which menu has been selected. Each of these menus is described in detail in Section 3.</p>
<p>SETUP Menu</p>	<p>Use the SETUP menu to set the following waveform output parameters for each channel: clock source and frequency, waveform/sequence file selection, operation, filter, amplitude and offset. See Section 3 for more information.</p>

MODE Menu	Use the MODE menu to set the operation mode. There are two main types of operation modes: the trigger modes (Cont, Triggered, Gated and Burst) and the modes in which waveforms are output in sequence for each trigger (Waveform Advance and Autostep). This menu also has an item for setting the timing with which synchronization signals are generated. See Section 3 for more information.
EDIT Menu	<p>The EDIT menu incorporates four types of editors: the waveform editor, the equation editor, the sequence editor and the autostep editor. Editing can be performed for each file type. Instruments with Option 09 installed have an FFT editor to permit editing in the frequency domain and a convolution editor to operate the waveforms convolution in high speed.</p> <p>The EDIT menu displays a list of files stored in internal memory. New files can be created or existing files can be selected from this list and edited. See Section 3 for further information.</p>
LOAD/SAVE Menu	<p>Press the LOAD/SAVE bottom button to select the appropriate menu.</p> <p>See Section 3 for further information.</p> <p>LOAD Menu. Used when loading files from a floppy disk or non-volatile internal RAM (NVRam) into the internal memory of the AWG2021, or from another instrument through the GPIB interface.</p> <p>SAVE Menu. Used when saving files from the internal memory of the AWG2021 to a floppy disk or to the instrument's NVRam.</p>
UTILITY Menu	Use the UTILITY menu to work on the files saved to a floppy disk or the instrument's NVRam, to set the parameters for the GPIB or RS-232-C interface, to execute diagnosis or calibration of the instrument, or to set other instrument parameters. See Section 3 for further information.
(10) ← and → Buttons	Use the arrow buttons to shift to the right/left of the input digit or position when a numeric value or character is input using the general purpose knob. The digit input numeric value is indicated at the underscore. Hold down these arrow buttons to shift in succession.
(11) CURSOR Button and Indicator	<p>Use the CURSOR button to select a field or switch the active cursor. The function of CURSOR button is different depending on each menu.</p> <p>When the LED indicator is illuminated, cursor function is activated. When special CURSOR button movement is required, a description of the CURSOR button is displayed on the screen.</p>

(12) VALUE Button and Indicator	Press the VALUE button to light the LED indicator. In this state, inputting the numeric values or selecting the item can be done using the numeric keys or the general purpose knob. After input or selection, press the VALUE button to enter the setting. When a special VALUE button movement is required, an explanation of the VALUE button is displayed on the screen.
(13) General Purpose Knob	Use this knob to set a variety of functions and numerical values on the instrument. A knob icon shown on the screen indicates that that item is controlled by this knob.
(14) Delete Key	Use this key to delete the character just in front of the cursor. Hold down the key to delete characters in succession.
(15) HARDCOPY Button	Use this button to output a hard copy of the data displayed on the screen. The hard copy can be output to disk or to either the GPIB or RS-232-C interface.
(16) TRIGGER INPUT Connector	This connector is used to enter an external trigger or gate signal. It allows external signals with a maximum input voltage of $10 V_{p-p}$ into a $1 M\Omega$ input impedance, and a maximum input voltage of $5 V_{RMS}$ into a 50Ω input impedance.
(17) TRIGGER MANUAL Button	When the operation mode is set to Triggered, Burst, Waveform Advance or Autostep , pressing the MANUAL button will cause waveform output to begin. Waveform output will proceed and stop in accordance with the mode that has been set. In Gated mode, the waveform will be output only as long as the MANUAL button is pressed. In Cont mode, pressing the MANUAL button has no effect.
(18) Unit Keys and ENTER Key	The following unit keys are provided: ns, MHz/ms, kHz/ms/mV and Hz/s/V . Press the appropriate unit key to specify the desired numeric value and unit. Also, if a hexadecimal radix is selected from the Waveform Editor Table display, the unit key is used to input C-F . Press the ENTER key to enter the numeric value and selected item.
(19) Numeric Keys	Press the numeric keys to enter numeric data. The numeric keys include the numerals 0 through 9 , and the “.” and “-” symbols. The “.” and “-” numeric keys are also used to input hexadecimal “ A ” and “ B ”, respectively, in the Waveform Editor Table display. Hold down a numeric key as desired to repeat its input.
(20) F.G Button	Press the F.G button to switch from arbitrary waveform generation mode to functional waveform generation mode. Use this mode to select one of the standard function waveforms for each output channel and to set its parameters. The functional waveforms include sine, triangular, square, ramp and pulse waveforms. You can set each function’s parameters. See Section 3 for further information.

Side Panel

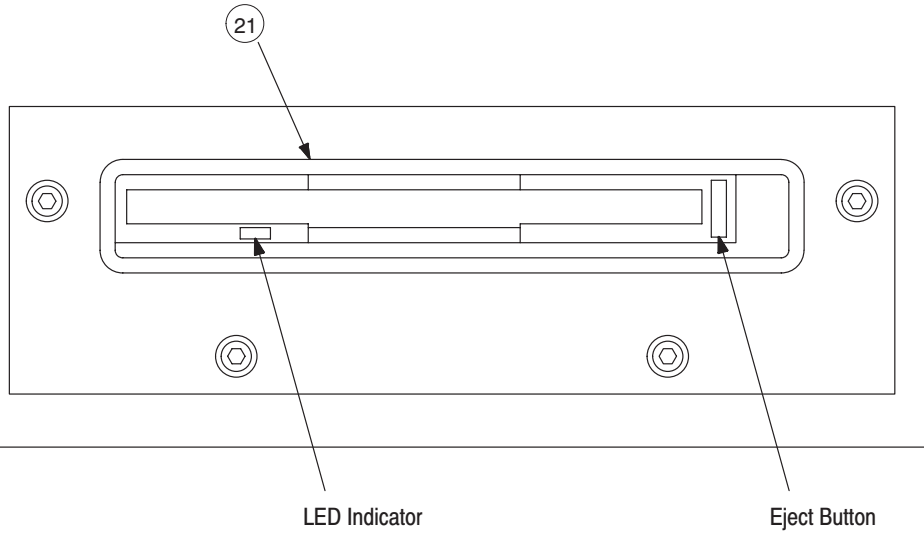

Figure 2 -3: Side Panel

(21) Floppy Disk Drive	The floppy disk drive is used for storing various types of files. Files can be loaded or saved from/to floppy disk using the LOAD/SAVE menu. When the disk drive is in operation, the LED indicator is lit. Remove a floppy disk by pressing the eject button.
Note. Never press the eject button to eject the floppy disk while the disk drive indicator light is lit, as the stored data may be corrupted and errors may result.	

Rear Panel

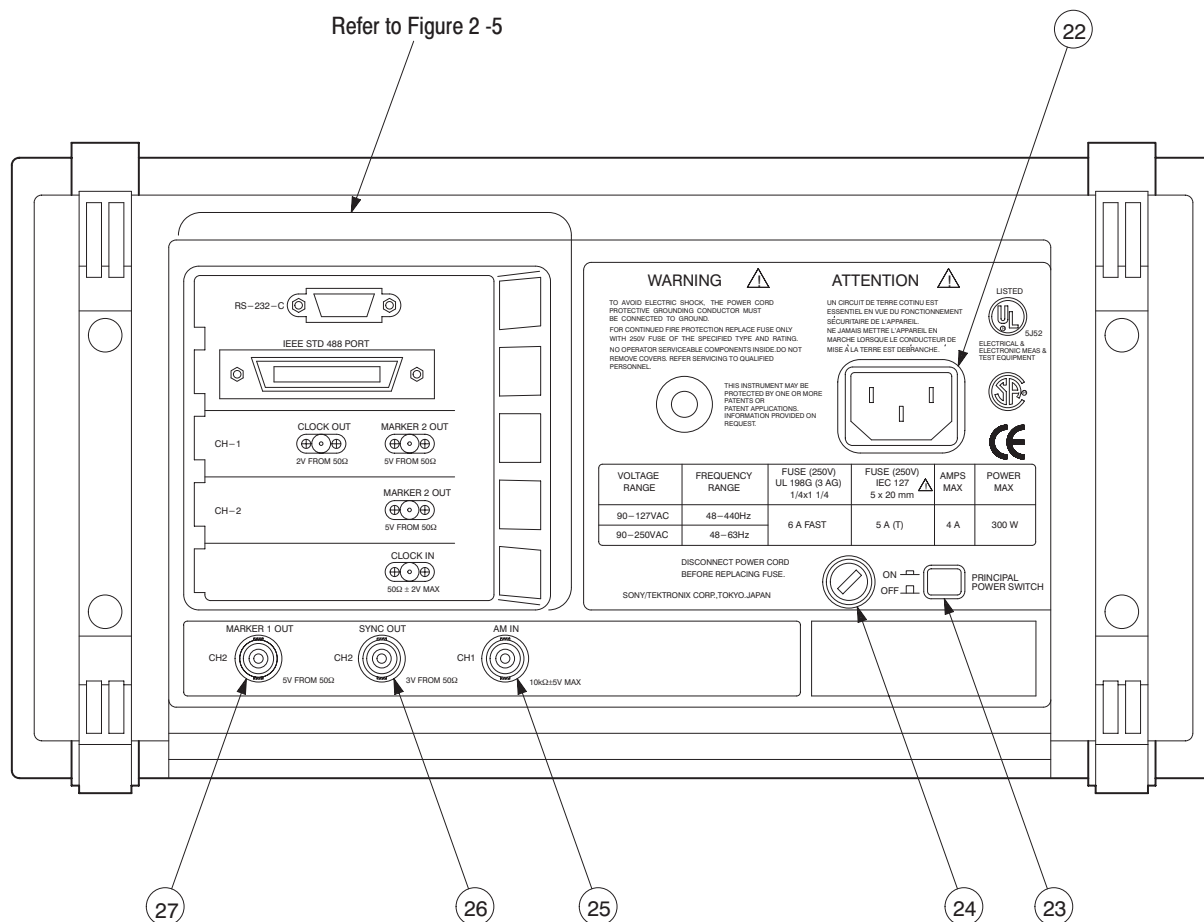

Figure 2 -4: Rear Panel Overall View

(22) Power Source Connector	A power cord is connected to the power source connector.
(23) PRINCIPAL POWER SWITCH	When this switch is on, power is supplied to the standby circuit in the power system. Press the ON/STBY button on the front panel to supply power to the rest of the instrument.
(24) Fuse Holder	The power supply fuse is enclosed in the fuse holder. The same fuse is used for both 115 V and 230 V systems. A 6 A fast-blow fuse is used.

Note. When using the AWG2021 in Europe, you should use an IEC-approved fuse. For details, see page 1 -4.

(25) CH1 AM IN Connector	This connector is used to enter an external AM modulation waveform to CH1. With a nominal input impedance of 10 k Ω , the maximum voltage of the external signal that can be entered is ± 5 V. At ± 1 V input, 100% modulation is possible.
(26) CH2 SYNC OUT Connector (Option 02)	The CH2 SYNC OUT connector provides a CH2 sync signal. The output level is 1.2 V or greater with a 50 Ω termination.
(27) CH2 MARKER 1 OUT Connector (Option 02)	The CH2 MARKER 1 OUT connector provides a user-specified CH2 marker 1. The output level is 2.5 V with a 50 Ω termination.

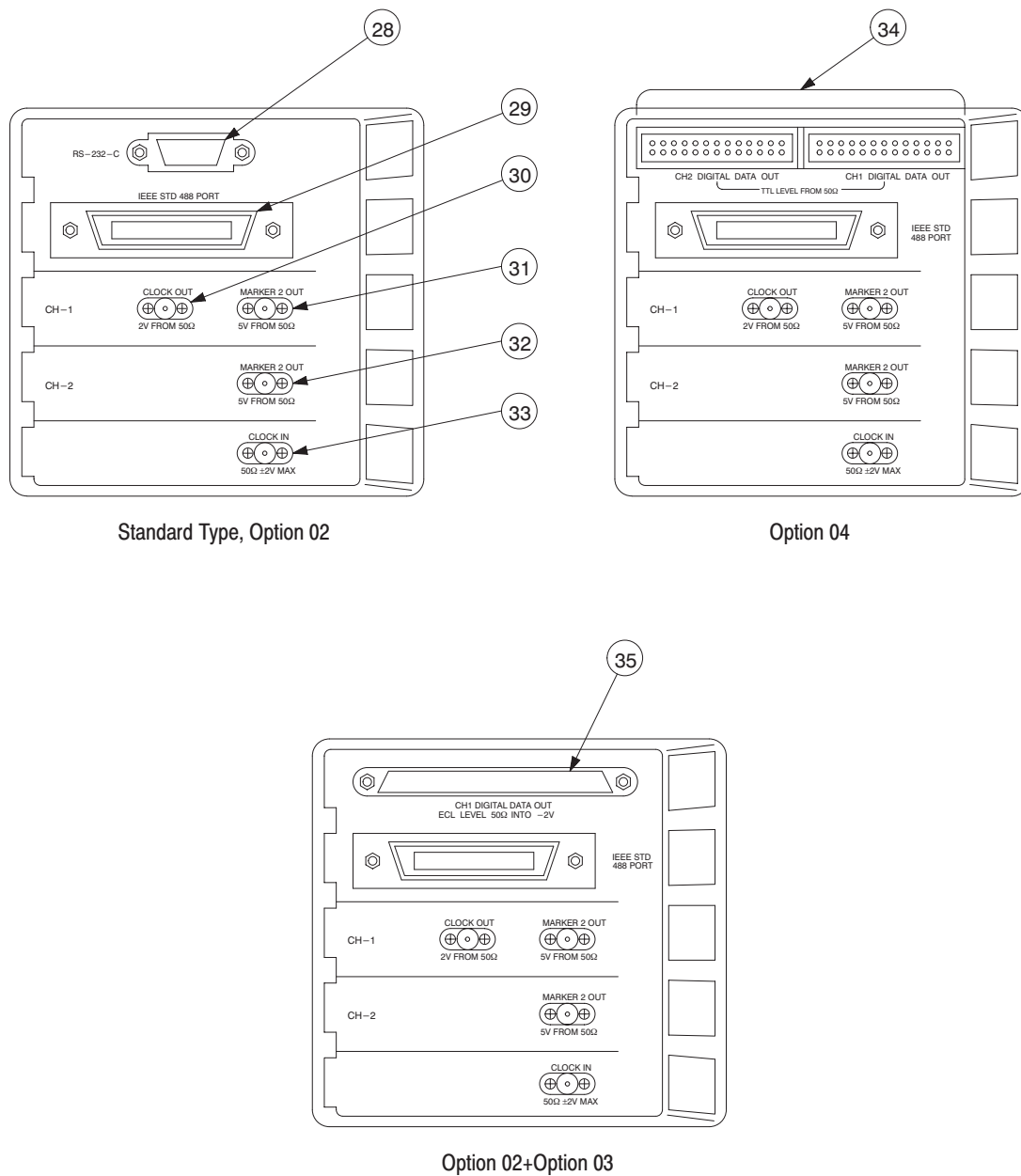

Figure 2 -5: Rear Panel Detail

(28) RS-232-C Connector	The RS-232-C connector enables remote control by a computer via this serial interface.
(29) IEEE STD 488 Connector	The IEEE STD 488 connector enables remote control by a computer via an IEEE STD 488 parallel interface.

(30) CLOCK OUT Connector	This connector is used for internal clock output. The output level is 1 V with a 50 Ω termination.
(31) CH1 MARKER 2 OUT Connector	The CH1 MARKER 2 OUT connector provides a user-specified CH1 marker 2. The output level is 2.5 V with a 50 Ω termination.
(32) CH2 MARKER 2 OUT Connector (Option 02)	The CH2 MARKER 2 OUT connector provides a user-specified CH2 marker 2. The output level is 2.5 V with a 50 Ω termination.
(33) CLOCK IN Connector	This connector is used for external clock input. This connector allows external clock signals with a maximum input voltage of ± 2 V into a nominal 50 Ω input impedance.
(34) CH1/CH2 DIGITAL DATA OUT Connector (Option 04)	These connectors are used to output CH1/CH2 digital data. The output impedance will be at the TTL level at 50 Ω with no termination. For details, see Appendix A "Option 04."
(35) CH1 DIGITAL DATA OUT Connector (Option 03)	This connector provides digital data differential ECL output. It is mounted in the fourth slot from the top. For details, see Appendix A "Option 03."

CRT Display

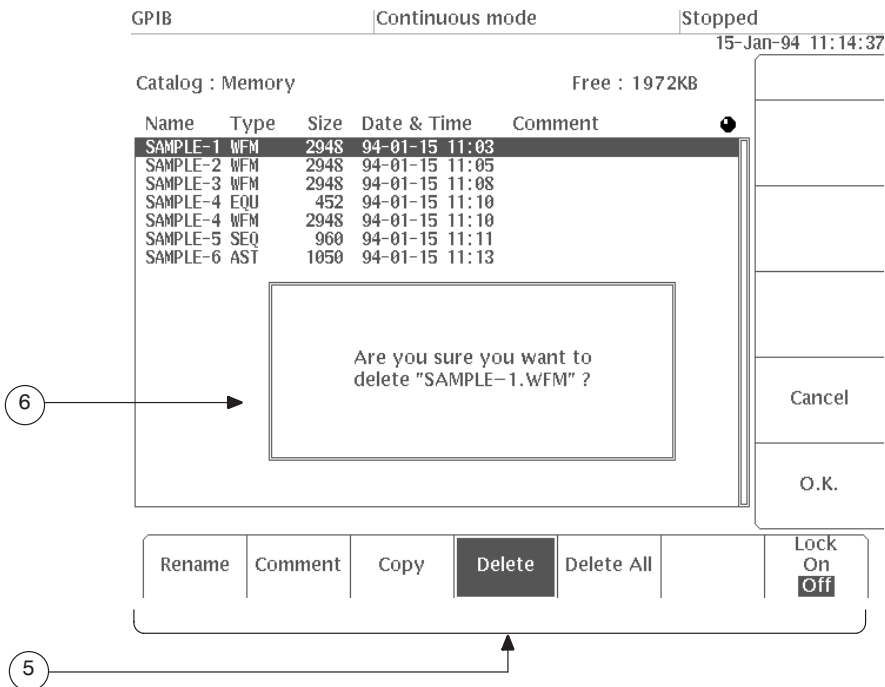
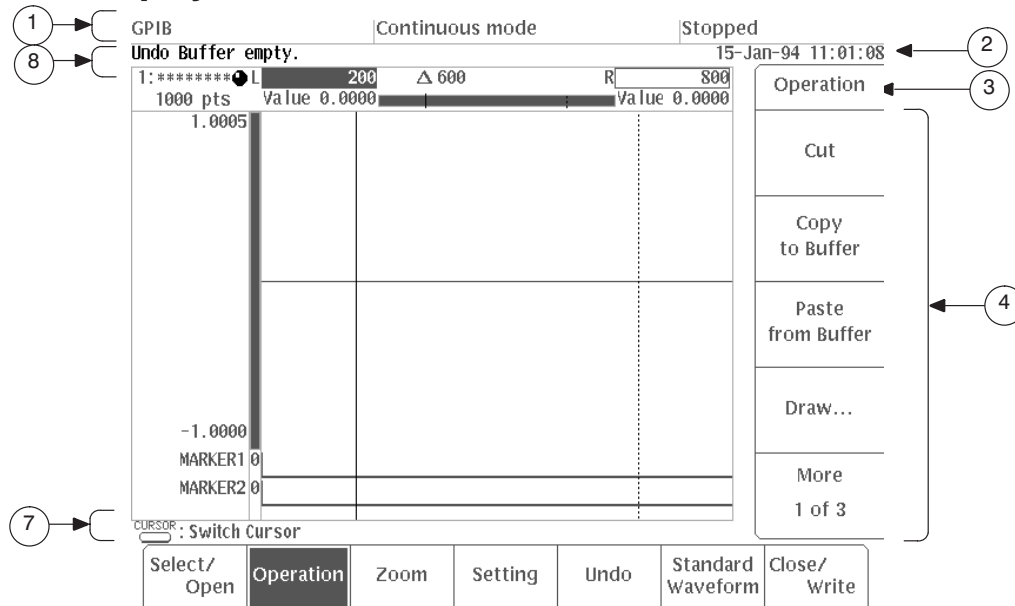



Figure 2 -6: CRT Display

(1) Status Area	The status line always displays the status of the instrument, no matter what menu is displayed on the screen. Five items are shown on the status line: the interface status (see the AWG2000 Series Programmer Manual); the operation mode and the trigger status (see page 3 -233); and the clock icon (which indicates that the instrument is busy and cannot accept input from any other sources)().
(2) Date and Time Area	The date and time are displayed here. The display can be turned on and off in the UTILITY menu (see UTILITY section).
(3) Bottom Menu Label Display	The label for the selected bottom menu item is displayed.
(4) Side Menu	When selecting an item from a bottom menu, the corresponding side menu is displayed at the right of the screen. Item selection, numeral input, and execution of functions are performed by pressing the button corresponding to the side menu item.
(5) Bottom Menu	Press any button of the MENU column or the F.G button to display the corresponding bottom menu in the lower part of the screen. To select an item from a bottom menu, press the corresponding button.
(6) Message Display	This area displays inquiries, or warnings for the user, enclosed in a box.
(7) Button Operation Area	Explanations of each front panel button operation for the current menu are shown in this area.
(8) Message Area	In the event of an error, a message (brighter than normal for easy visibility) is displayed in this area. This is not an interrogative to the user. Remote commands can be used to enter a user-designated message.

Basic Menu Operation

Menu Operations

Operations (settings, procedures and selection of parameters for waveform output) are performed on this instrument by means of the system's menus.

When one of the menu buttons in the center of the front panel is pressed, the menu corresponding to that button will appear. There are six menu buttons: the five buttons used in arbitrary waveform generation mode (**SETUP**, **MODE**, **EDIT**, **LOAD/SAVE** and **UTILITY**) and below them the button used in function waveform generation mode (**F.G**). See Figure 2 -7.

The menu items displayed on the screen are selected by pressing the corresponding bezel buttons at the bottom of the screen (hereafter referred to as bottom buttons) or to the right of the screen (hereafter referred to as side buttons). There are 7 bottom buttons and 5 side buttons. When one of the buttons is pressed to select an item, that item will be displayed inverted on the screen to indicate that it is operational. See Figure 2 -7.

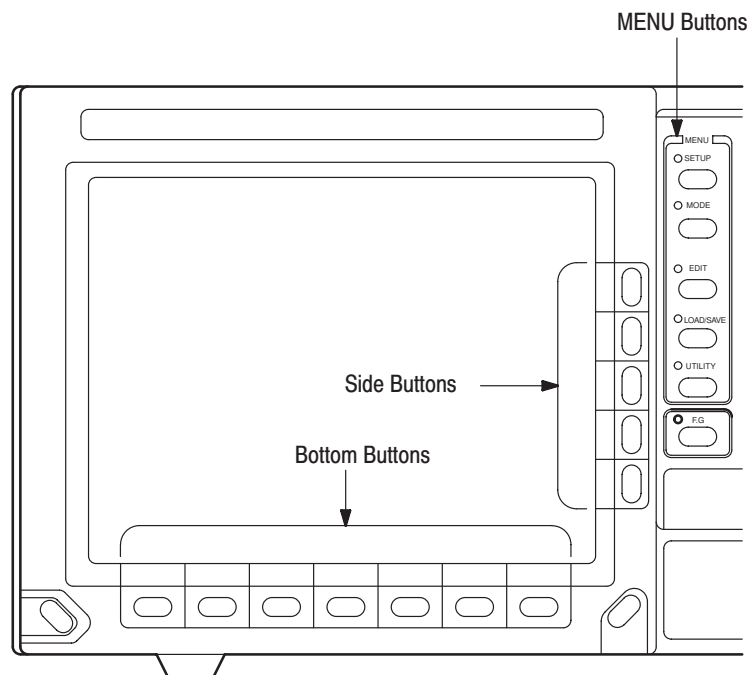

Figure 2 -7: Menu Buttons and Bezel Buttons

When you select the desired menu item, the numeric input columns and the selections controlled by that menu are displayed. To change the selections and numeric values, use the numeric keys or general purpose knob.

When you select a menu item, one of the following occurs.

- The lower-level menu is presented.
- The desired item can be selected and may have these characteristics:
 - each time the bezel button is pressed, the selection changes.
 - a list is presented from which you can select.
- Numeric values can be input.
- The moment the menu item is selected, the function is executed.

Menu Names

The on-screen menus are hierarchical. This section will give the names of the menus in order from top (first level) to bottom.

- | | |
|--------------------|---|
| Main Menu | There are several different main menus. Pressing one of the MENU buttons causes the corresponding main menu to appear. |
| Bottom Menu | This menu is shown at the bottom of the screen. These items can be selected by pressing the corresponding bottom button. |
| Side Menu | This menu is shown in the right-hand side of the screen. These items can be selected by pressing the corresponding side button. |
| Sub-Menus | These menus are shown below the side menu. When an item in the side menu is followed by an ellipsis (...), it indicates that that item has a sub-menu listing additional choices. |

Numeric Input

Generally, numbers are entered using one of the following methods:

- Enter the desired value using the numeric keys
- Turn the general purpose knob to set the desired value

In the following section, we will explain these numeric input methods in more detail.

Using the Front Panel Numeric Keys

To specify numeric values with the numeric keys, **ENTER** key, and unit keys on the front panel, perform the following steps.

1. Press the button for the menu item you want to change.
2. Use the numeric keys to input the desired value.
3. Press one of the unit keys or the **ENTER** key.

Figure 2 -8 shows the menu displayed when **Amplitude** is selected from the **SETUP** menu. In this figure, the numeric keys are used to change the amplitude. Here the asterisk in the numeric input column indicates that the value is being input. Press the front panel **ENTER** key to enter the value and remove the asterisk.

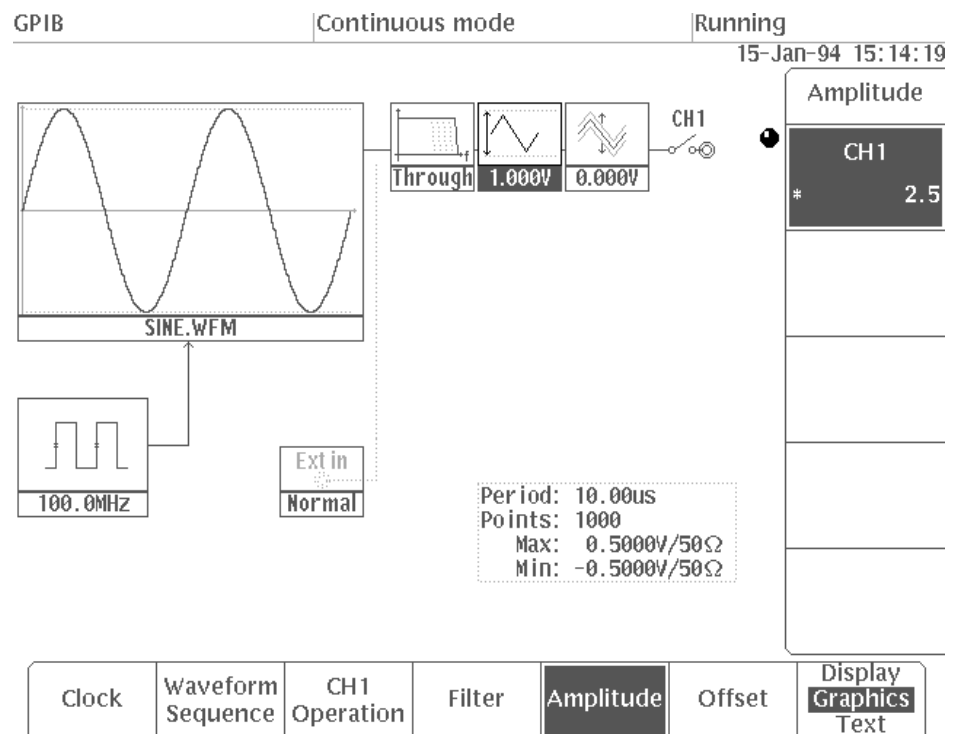

Figure 2 -8: Numeric Input Using Numeric Keys

Numeric Input Keys. Four types of keys are used to enter numeric values: the numeric keys (0 – 9), the unit keys (ns, MHz/ μ s, kHz/ms/mV and Hz/s/V), the Delete key and the **ENTER** key. These are shown in Figure 2 -9.

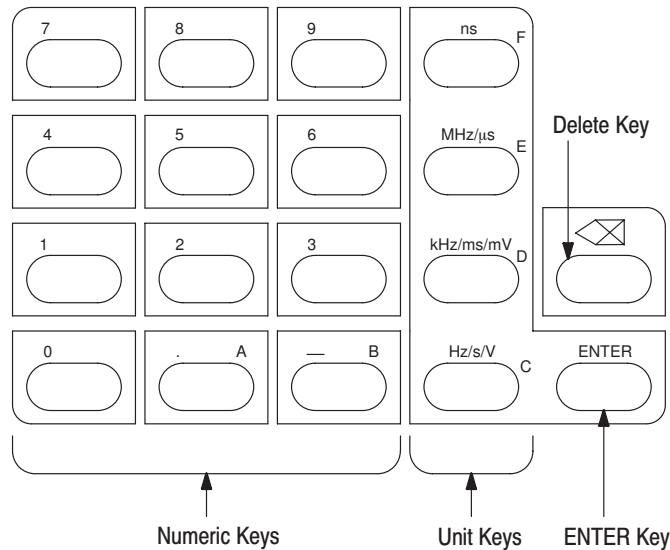

Figure 2 -9: Numeric Keys, Unit Keys, Delete Key, and ENTER Key

Numeric Input Examples.

Example 1: Clock frequency numeric input (**Clock** in **SETUP** menu)

The value before input mode was 100.0 Hz and is to be changed to 12.3 Hz. Pressing the “1”, “2”, “.”, “3”, and **ENTER** keys in order changes the input column this way:

Table 2-1: Numeric Value Input Example 1

Input Key	Numeric Value Column	Numeric Value Status
	100.0 Hz	Before Input
1	* 1	During Input
2	* 12	
.	* 12.	
3	* 12.3	
ENTER	12.30 Hz	Entered

When you press one of the numeric keys, the instrument switches to numeric input status and the value that has been entered is displayed in the input column, preceded by an asterisk. Enter other numbers as desired and then press the **ENTER** key to confirm the value. Unless otherwise designated, the unit that is used for numeric input will be the same as when numbers were previously entered.

To change the unit to MHz, press “1”, “2”, “.”, “3”, and **MHz/μs** keys in order. This changes the value to 12.30 MHz. The frequency is expressed by a four-digit number.

When a value has been entered, pressing one of the unit keys will change the unit to that value and will confirm the number that has been entered. If you press the unit key before the instrument has entered numeric input status), only the unit will change; the numeric value that is currently displayed will be unaffected.

NOTE. *After a value has been entered, if you proceed to another menu item without first pressing either a unit key or **ENTER**, the input operation will be canceled; the value you have entered will be discarded and the previous value will be retained. If you attempt to enter a value outside the allowable range, whether too high or too low, the value will change to the closest allowable value (in other words, either the minimum or the maximum value).*

Example 2: Offset numeric input (**Offset** in **SETUP** menu)

This example changes the offset from 2.500 V to –0.030 V. The input is as shown in this table.

Table 2-2: Numeric Value Input Example 2

Input Key	Numeric Value Column	Numeric Value Status
	2.500 V	Before Input
-	* -	During Input
3	* 3	
0	* 30	
kHz/ms/mV	-0.030 V	Entered

In this case, pressing “-”, “.”, “0”, “3” **Hz/sec/V** also enters a value of –0.030 V. The unit is displayed as “V”.

Using the General Purpose Knob

When the knob icon is displayed on the CRT screen, numeric values can be set using the general purpose knob and the ← (left/down) and → (right/up) buttons. When setting numeric values in this manner, the value in the number column that is underlined will be increased or decreased. Values will decrease when the general purpose knob is turned counter-clockwise and increase when the general purpose knob is turned clockwise. Values cannot be changed outside the parameter range. Figure 2 -10 shows the general purpose knob and arrow buttons. Figure 2 -11 shows the knob icon and the figure in the window with the first decimal place underlined, indicating that this value may be changed.

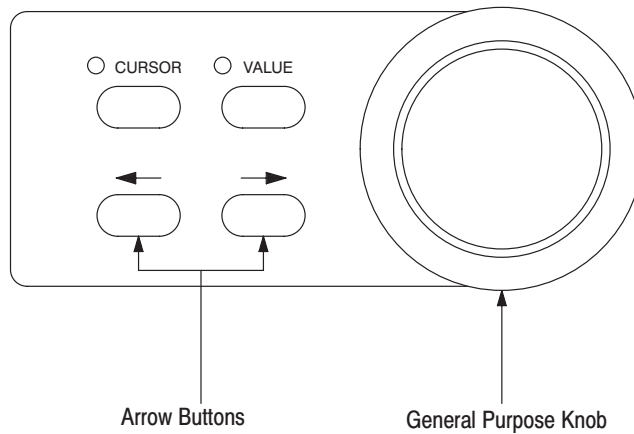

Figure 2 -10: General Purpose Knob and Arrow Buttons

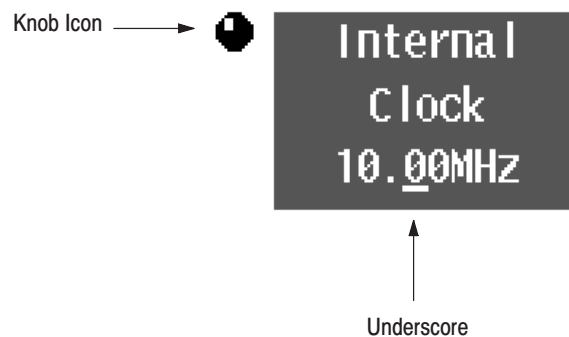

Figure 2 -11: Knob Icon and Underscore

When a numeric value has been changed using the general purpose knob, there is no need to confirm it by pressing the **ENTER** key on the front panel. The numeric value is entered automatically without pressing the **ENTER** key. To change a value using the general purpose knob, perform the following steps.

1. Press the button for the menu item you want to change.
2. Press the ← and → buttons to specify the digit to be the index for input.

The amount of change obtained by turning the general purpose knob is controlled with the front panel ← and → keys. Press the ← key to move the underscore to the left and thus raise the amount of change to 10x. Or press the → key to move the underscore to the right and thus reduce the amount of change for general purpose knob turning to $\frac{1}{10}$ th.

3. Turn the general purpose knob to change the value.

Numeric Specification Example. Turning the general purpose knob one click to the right increases the value of the underscored digit by 1. Turning it one click to the left decreases the value by 1. For example, if the value is 173.0 and the cursor is under the 7, turning the general purpose knob left or right changes the value as shown below. If the underscored value is already 1, turning the general purpose knob left does not decrease the value any further.

173.0	173.0
1 <u>8</u> 3.0	1 <u>6</u> 3.0
1 <u>9</u> 3.0
2 <u>0</u> 3.0	23.00
2 <u>1</u> 3.0	<u>1</u> 3.00

Turning right Turning left

When the value has already been increased to the maximum allowable value for the parameter, turning the general purpose knob further to the right has no effect. Similarly, when the value has already been decreased to the minimum allowable value for the parameter, turning the general purpose knob further to the left has no effect.

Operating Examples

In this section, we will use simple examples to illustrate the basic procedures for waveform output on the AWG2021. Six examples will be given; these are listed below. Buttons and menu items to be used will be shown to the left, and a description of the corresponding operation will appear on the right.

First of all, you should make sure the power to the unit has been turned on; see Section 1 “Start Up” for instructions on how to do this.

Example 1: Setting the Date & Time and Adjusting the Brightness

Example 2: Output of a Waveform Using the Sample Waveform Library Disk

Example 3: Creating Files and Arbitrary Waveform Outputs

- Creating a Waveform File
- Creating Arbitrary Waveforms Using the Point Draw Function
- Creating Waveforms Arithmetically
- Creating an Equation File
- Creating a Sequence File
- Creating Autostep Files
- Setting the Output Parameters
- Setting Operation Mode and Waveform Output

Example 4: Loading and Saving Files

Example 5: Loading Waveforms From Other Instruments

Example 6: Using the Waveform Function Generator

When a detailed description of a function is needed at the operation stage, see the section dealing with that particular menu.

NOTE. *These examples do not cover all of the functions and special features of the instrument. The purpose of the examples is only to give you practice in executing basic operations on the instrument.*

Necessary Equipment

The following equipment is needed to execute Examples 1 – 6:

- Digital storage oscilloscope (Tektronix TDS series instrument or equivalent)
- 50 Ω cables (3)
- GPIB cable (1)
- 50 Ω terminators (2)
- Sample waveform library disk (included with the instrument as a standard accessory)
- Signal generator

Example 1: Setting the Date & Time and Adjusting the Brightness

In Example 1, you will set the date and time on the instrument's built-in clock and adjust the brightness of the screen.

Setting the Date and Time

In this operation, you will set the date and time on the instrument.

Be sure to do this when using the instrument for the first time. Once set, there will usually be no need to reset these values. However, if the instrument has not been used for an extended period of time, the date and time may be incorrect; in such cases, you should set these values again using the same procedure. The date and time are important, as they are used as a time stamp when creating or editing files.

In this example, you will set the date to February 1, 1994 and the time to 15:30, using the following procedure.

1. Press the **UTILITY** button in the **MENU** column.
2. Select **Date Time** from the bottom menu.
The menu shown in Figure 2 -12 will appear.

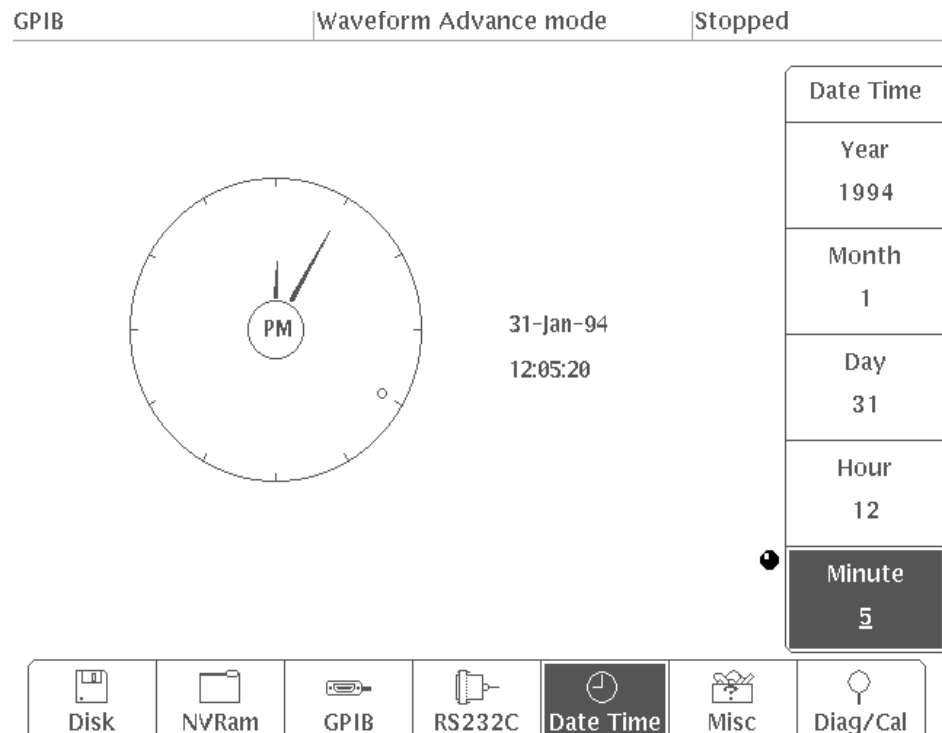

Figure 2 -12: Menu Display (showing Date/Time item selected)

3. Select **Year** from the side menu.
4. Turn the general purpose knob to set the year to **1994**.
5. In the same manner, select **Month**, **Day**, and **Hour** from the side menu and set the values to February, 1 and 15, respectively. The time is displayed in 24-hour fashion.
6. Select **Minute** from the side menu.
7. Use the general purpose knob to set the minute value to **30**.

NOTE. When the setting for **Hour** or **Minute** is changed, the value for seconds will be reset to 0.

Date/Time Display

It is possible to have the date and time constantly displayed on the screen. To do this, use the following procedure:

1. Select **Misc** from the bottom menu.
2. Select **Display...** from the side menu.
3. Press **Date Time** in the sub-menu and select **On**. The current date and time will be displayed in the upper right-hand corner of the screen, as shown in Figure 2 -13.

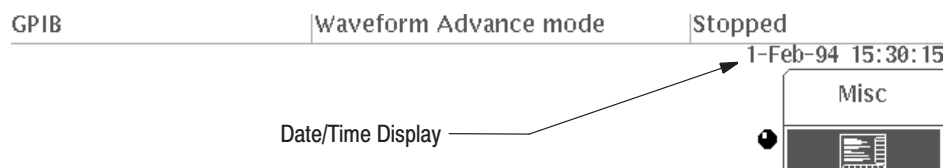

Figure 2 -13: Date/Time Display

Setting the Display Brightness

In this operation, you will set the display brightness of the screen. The display offers three different levels of brightness. Use the following procedure to adjust the overall display brightness to the proper level:

1. Select **Brightness** from the side-menu.



Figure 2 -14: Setting the Display Brightness

2. Turn the general purpose knob to set the brightness to the proper level.
The brightness can be changed between 0% and 100% in 1% increments; the default setting is 70%.

This completes the Example 1.

Example 2: Output of a Waveform Using the Sample Waveform Library Disk

In Example 2, you will output a waveform using the sample waveform library disk, a standard accessory included with the instrument.

Loading Sample Waveforms

The sample waveform should be loaded from the floppy disk to the internal memory of the instrument.

1. Press the **LOAD/SAVE** button in the **MENU** column.
2. Select **Device** from the bottom menu.
3. Select **Disk** from the side menu.
4. Select **Load** from the bottom menu.
5. Insert the sample waveform library disk that comes with this instrument into the floppy disk drive.

NOTE. Do not remove the floppy disk while the floppy disk drive is operating. This can destroy the data and cause errors.

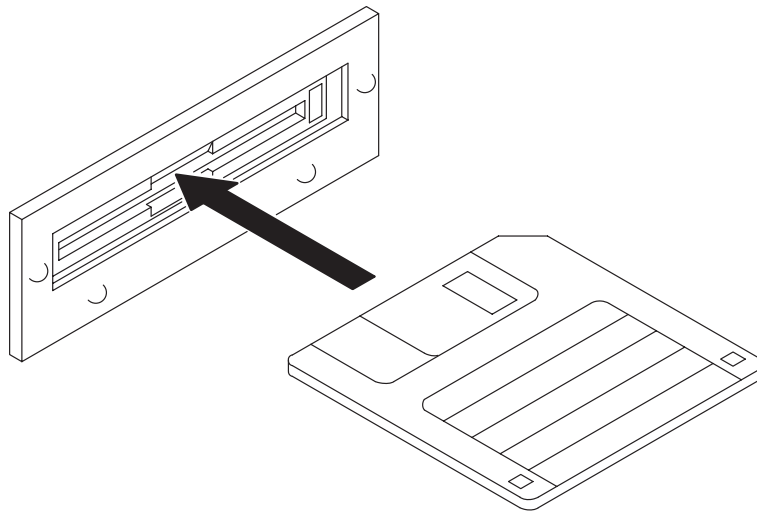

Figure 2 -15: Inserting the Floppy Disk

The files will be displayed in the lower box of the **LOAD** menu. Figure 2 -16 shows how the files on the sample waveform library disk are displayed on the screen.

GPIB | Continuous mode | Stopped

Catalog : Memory Free : 1986KB

Name	Type	Size	Date & Time	Comment

Load

Load

Load All

Catalog : Disk \ Free : 1016KB

Name	Type	Size	Date & Time	Comment
#PRBS15	SEQ	114	94-02-01 00:25	SEQ_WFM PRBS*8
*AM	EQU	822	94-02-01 00:01	AMPLITUDE MODULATION
*AM	WFM	40102	94-02-01 00:01	
*DMP_SIN	EQU	822	94-02-01 00:01	DAMPED SINE WAVE
*DMP_SIN	WFM	8102	94-02-01 00:01	
*DQPSKI	WFM	65638	94-02-01 00:03	P1/4DQPSK In phase signal
*DQPSKQ	WFM	65638	94-02-01 00:03	P1/4DQPSK Quadrature phase
*D_EXP	EQU	744	94-02-01 00:00	DOUBLE EXPONENTIAL PULSE
*D_EXP	WFM	20102	94-02-01 00:00	

Change Directory

Device	Load	Save				Auto Load
Disk						Off

Figure 2 -16: Sample Waveform Library Disk Files

6. Select **Load All** from the side menu. The display shown in Figure 2 -17 will appear.

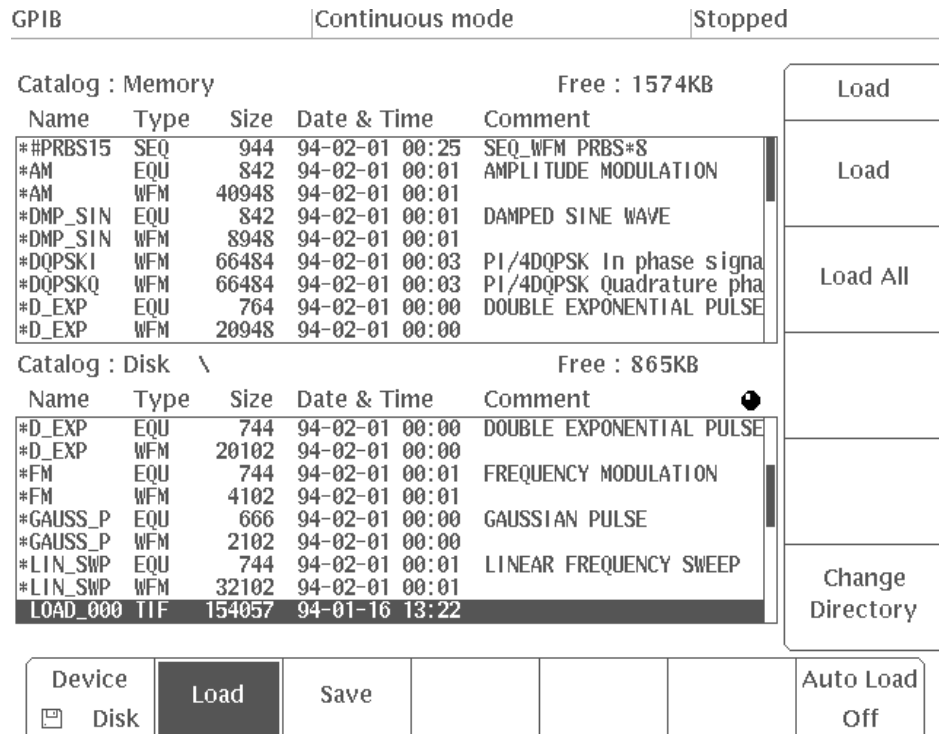

Figure 2 -17: CRT Screen Display When Load All is Selected

All the files in the lower box on the screen are loaded into internal memory. The loaded files are displayed in the internal memory list in the upper box on the screen.

Turn the general purpose knob to scroll through the list of files displayed in the lower box on the screen. For explanations of the waveform in each file, see Sample Waveform Library in Appendix D.

NOTE. The sample waveform library disk files are locked (and * is displayed next to their names). You must unlock these files before you can edit them.

Setting the Output Parameters

These parameters are used for waveform output.

1. Press the **SETUP** button in the **MENU** column. The **SETUP** menu is displayed.

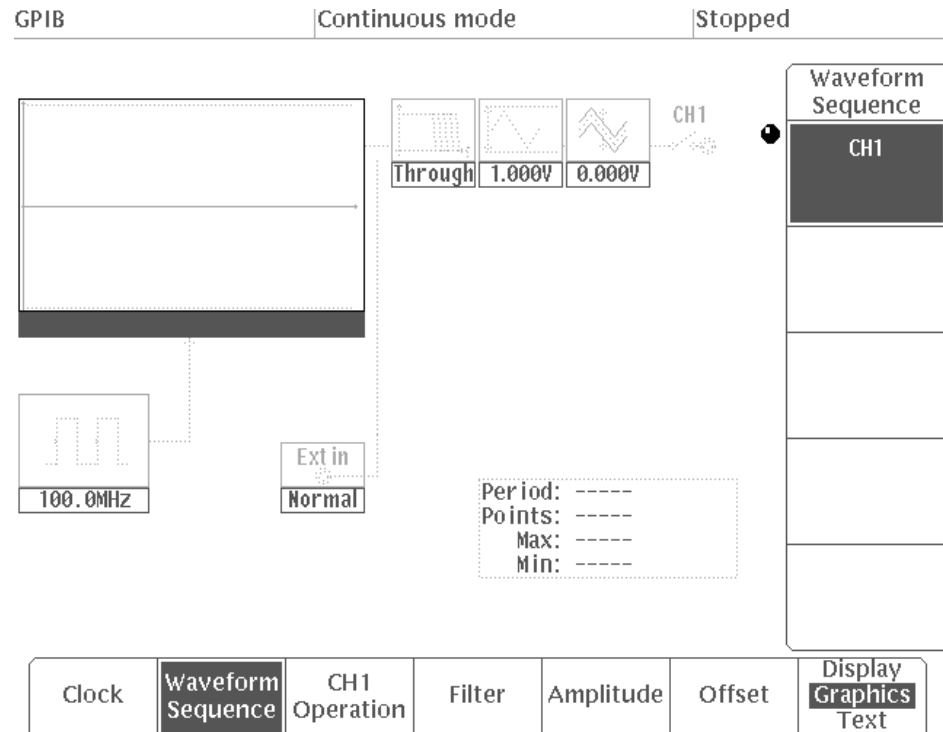

Figure 2 -18: SETUP Menu

2. Select **Waveform Sequence** from the bottom menu.
3. Turn the general purpose knob to develop the waveform file list. Select the file **GAUSS_P.WFM** from this list.

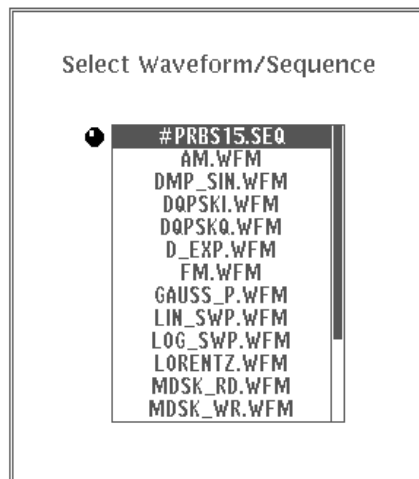

Figure 2 -19: Waveform File List

4. Select **O.K.** from the sub-menu. The selected file will be confirmed and the output conditions will be automatically set. Figure 2 -20 shows the **SETUP** menu with the file **GAUSS_P.WFM** selected.

NOTE. *The selected file is locked. Therefore, although changes can be made to the waveform clock, filter, amplitude, offset and other output conditions, these changes cannot be saved to the file.*

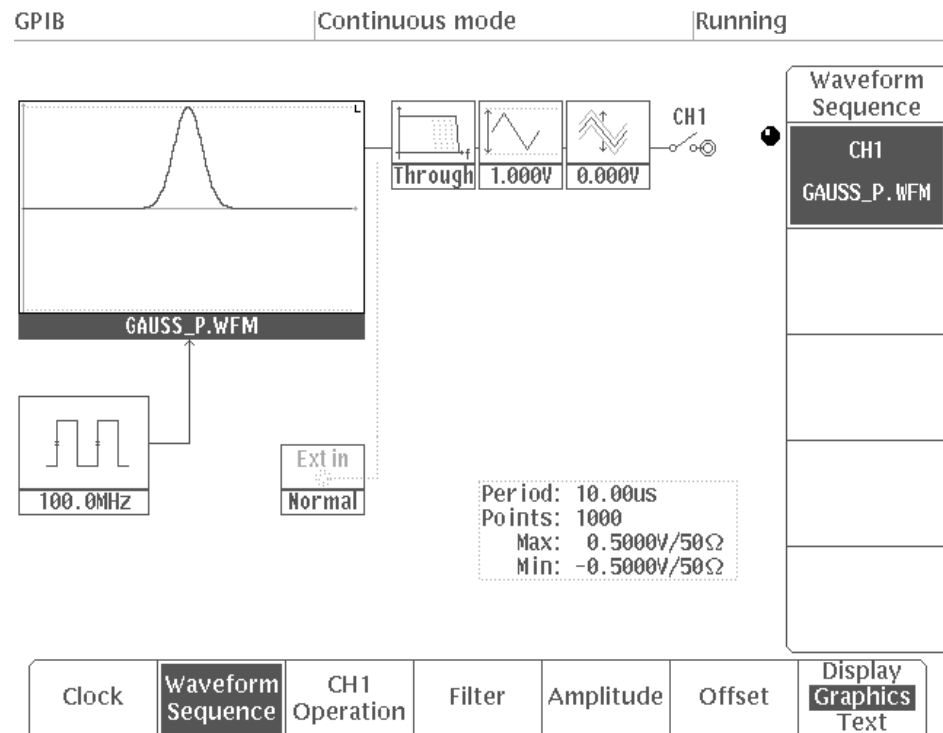

Figure 2 -20: GAUSS_P.WFM File Output Parameters

5. Press the **MODE** button in the **MENU** column. The **MODE** menu is displayed.

The files selected from the **SETUP** menu are displayed in the **MODE** menu.

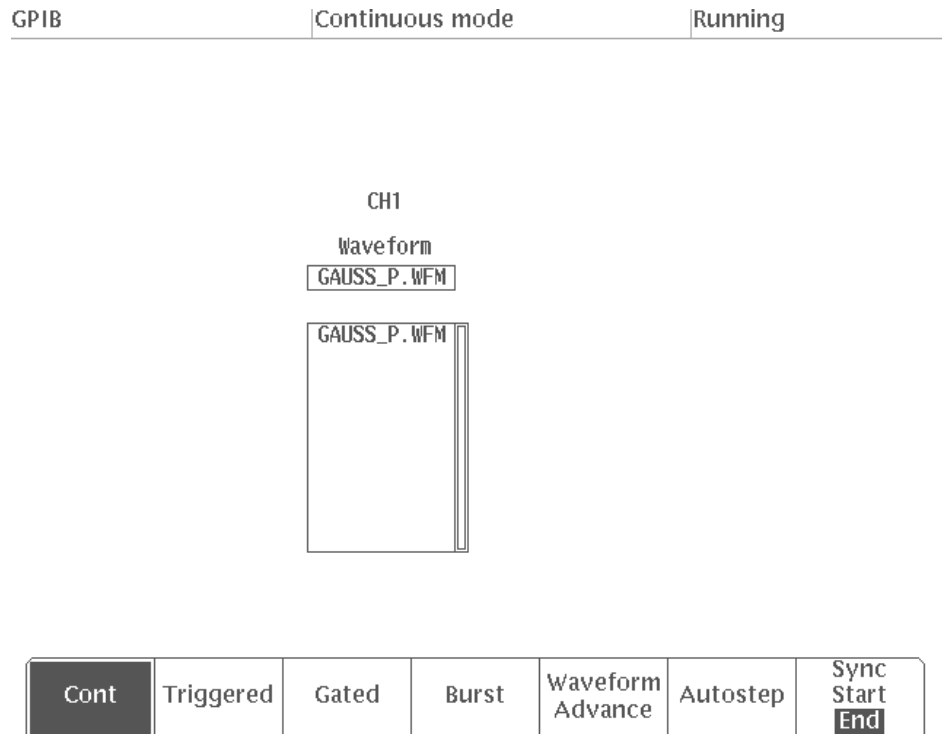

Figure 2 -21: MODE Menu

6. Select **Cont** from the bottom menu. When **Cont** is selected, the waveform is continuously output.

Waveform Output

1. Connect this instrument and the oscilloscope with a 50 Ω cable and a 50 Ω termination as shown in Figure 2 -22. This instrument's waveform output is calibrated to a 50 Ω load.

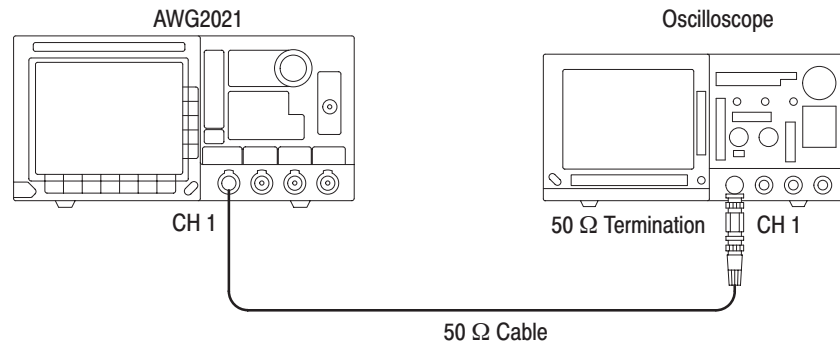

Figure 2 -22: Connections in Example 2

- Press the front panel **CH1** On/Off button to switch on waveform output. Figure 2 -23 shows the channel On/Off button and indicator.

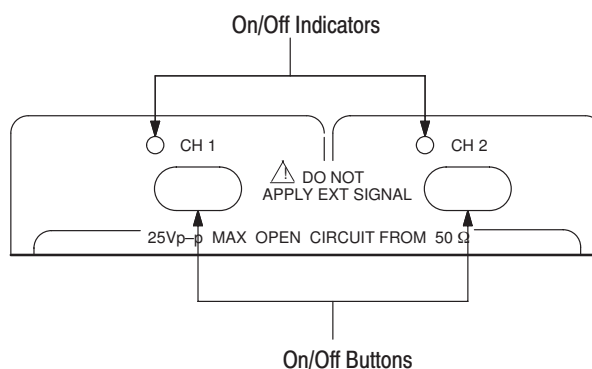

Figure 2 -23: Channel On/Off Buttons and Indicators

When the Channel is on, the indicator lights up and the set waveform is output from the **CH1** output connector.

- Set the parameters for the connected oscilloscope as shown below and display the waveform on the oscilloscope screen.

Volt/Div.	200 mV/Div.
Time/Div.	1 μ s/Div.
Trigger Mode	Auto

When you change the **Clock**, **Amplitude**, or **Offset** items with the **SETUP** menu, the waveform changes in real time.

This completes the example 2.

Example 3: Creating Files and Arbitrary Waveform Outputs

When using the instrument for arbitrary waveform output, you should first use the editors in the **EDIT** menu to create the waveform to be output. In this operation, you will create an arbitrary waveform with the editors, and then you will set the conditions for waveform output (frequency, amplitude, offset, etc.) in the **SETUP** menu. Finally, you will set the operation mode in the **MODE** menu to output the waveform.

In Example 3, we will practice the following series of operations:

- Creating a Waveform File
- Creating Arbitrary Waveforms Using the Point Draw Function
- Creating Waveforms Arithmetically
- Creating an Equation File
- Creating a Sequence File
- Creating Autostep Files
- Setting the Output Parameters
- Setting Operation Mode and Waveform Output

Creating a Waveform File

Use the waveform editor graphic display to create a waveform file by performing the following steps:

1. Press the **EDIT** button in the **MENU** column. Figure 2 -24 shows the initial menu displayed.

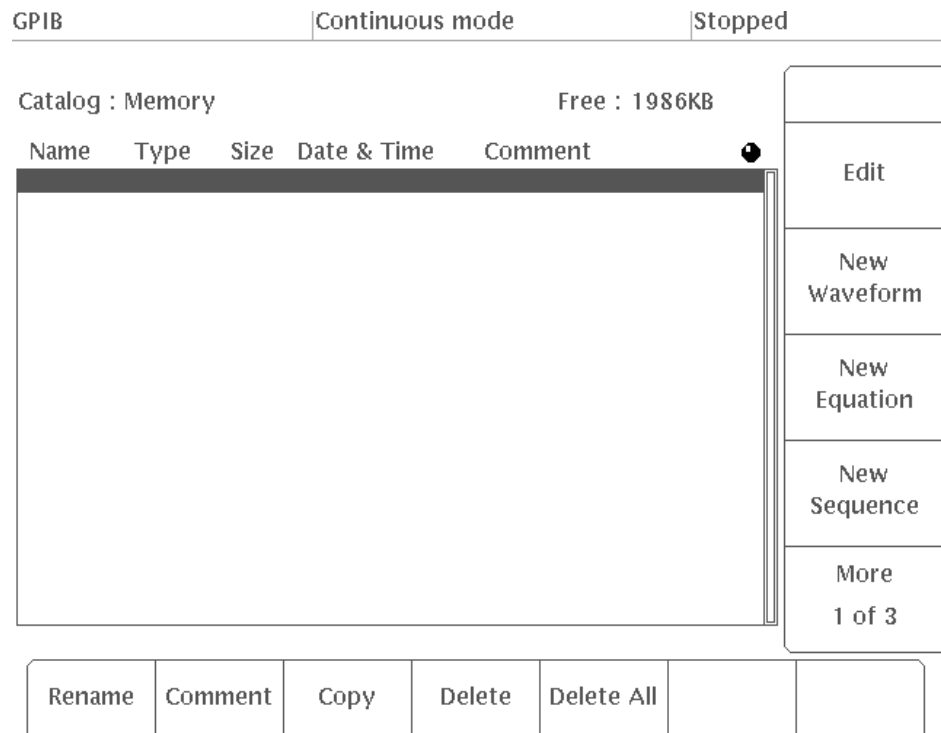

Figure 2 -24: Initial Menu

2. Select **New Waveform** from the side menu. Figure 2 -25 shows the waveform editor graphic menu. The default for the number of points in the waveform is 1000.

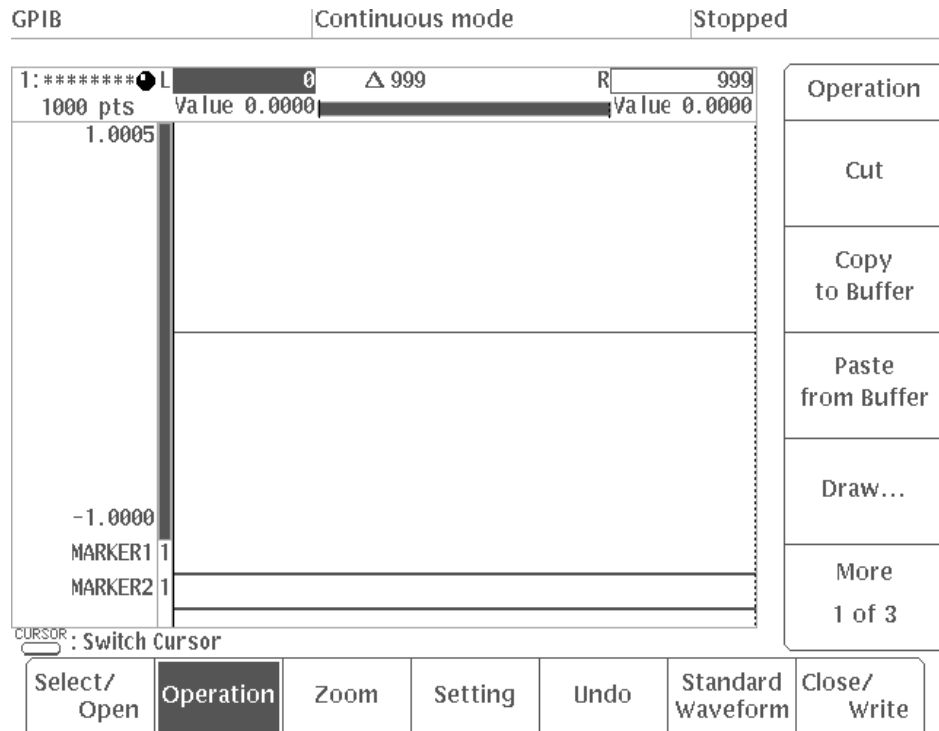

Figure 2 -25: Waveform Editor Graphic Menu

3. Press the front panel **CURSOR** button to activate the right side vertical bar cursor (it becomes a solid line).

Pressing the **CURSOR** button toggles the selected vertical bar cursor from right to left and back again. You can move the selected cursor using the general purpose knob or the numeric keys.

4. Press the following key sequence: 4, 9, 9, **ENTER**. This sets the point value for the right side vertical bar cursor to 499 (see Figure 2 -26).

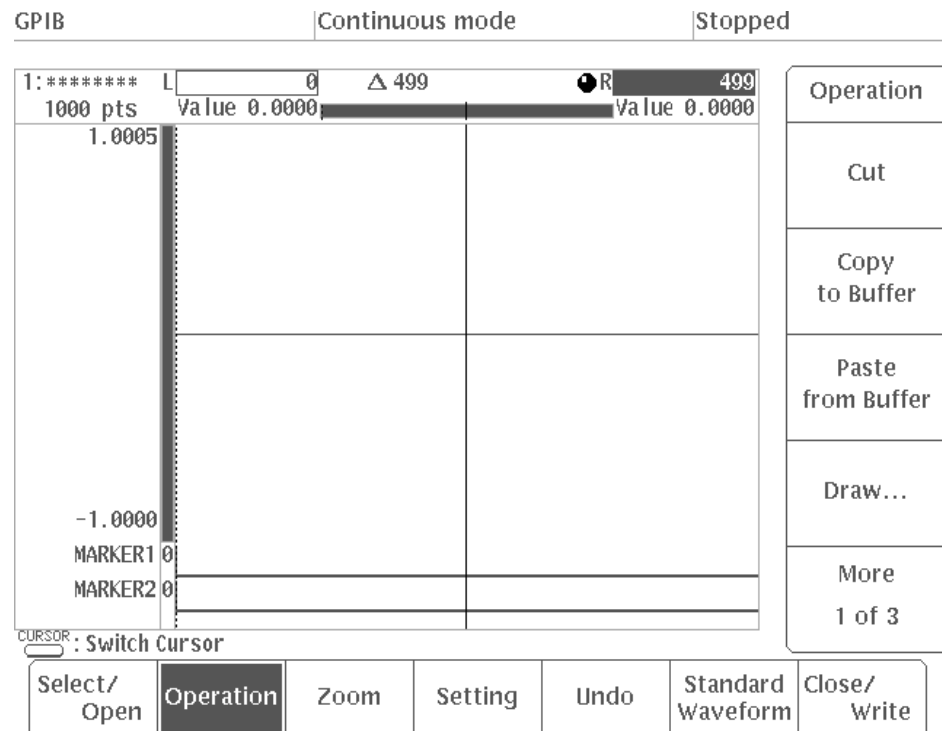

Figure 2 -26: Setting the Point Value for the Right Side Vertical Bar Cursor

5. Select **Standard Waveform** from the bottom menu.
6. Select **Type** from the side menu.
7. Turn the general purpose knob to select **Sine**.
8. Select **Cycle** from the side menu.
9. Press “2” and **ENTER** in that order to set the number of cycles for the sine wave to 2.
10. Select **Execute** from the side menu.

A two-cycle sine waveform is created between the vertical bar cursors (see Figure 2 -27).

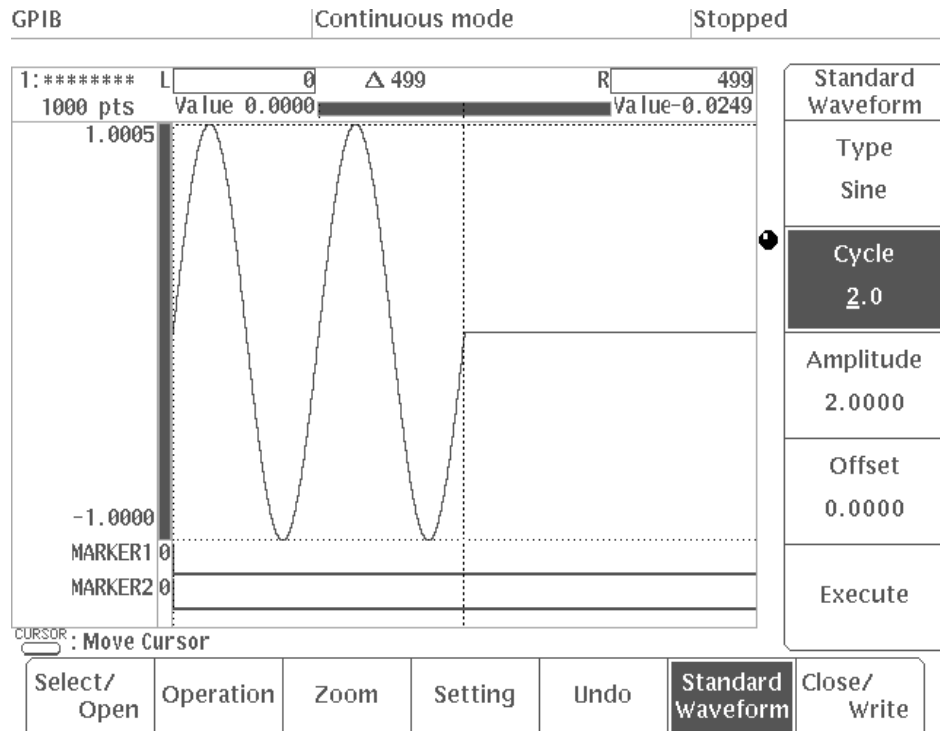

Figure 2 -27: Creating a Sine Waveform

11. Press the **CURSOR** button to activate the right side vertical bar cursor.
12. Press the following key sequence: **9, 9, 9, ENTER**. This sets the point value to **999**.
13. Press the **CURSOR** button to activate the left side vertical bar cursor.
14. Press the following key sequence: **5, 0, 0, ENTER**. This sets the point value to **500**.
15. Select **Type** from the side menu.
16. Turn the general purpose knob to select **Ramp**.
17. Select **Amplitude** from the side menu.
18. Press “**1**” and **ENTER** in that order to set the ramp wave amplitude to **1**.
19. Select **Offset** from the side menu.
20. Press “**.**”, “**5**”, and **ENTER** in that order to set the ramp wave offset to **0.5**.
21. Select **Execute** from the side menu. A two-cycle ramp waveform is created between the vertical bar cursors (see Figure 2 -28).

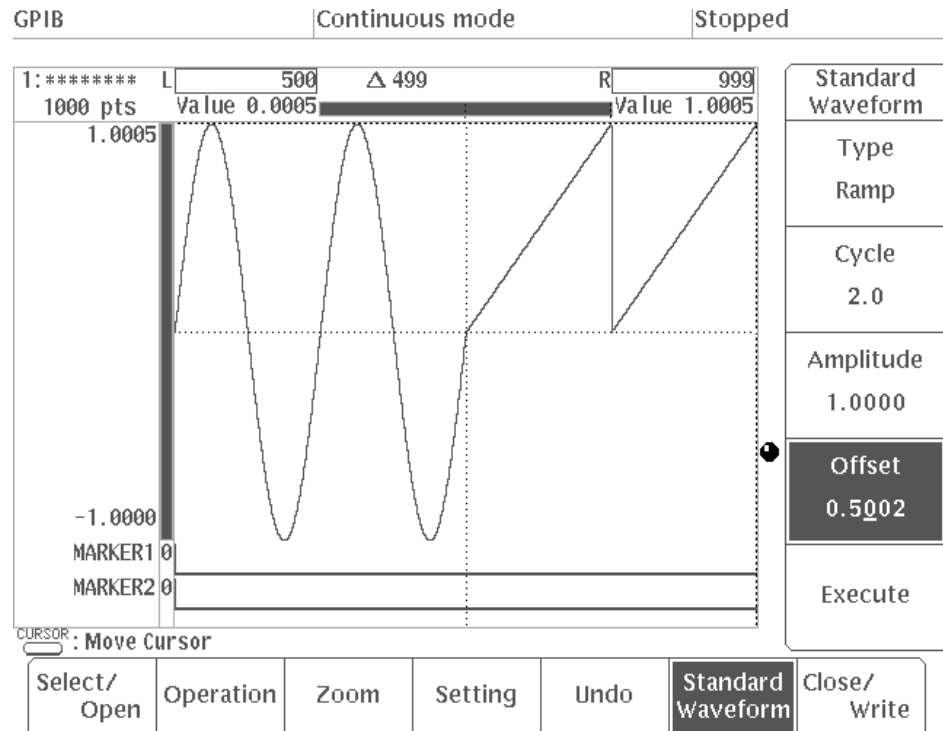

Figure 2 -28: Creating a Ramp Waveform

This completes the waveform creation. Next, name the waveform file and exit the waveform editor.

22. Select **Close/Write** from the bottom menu.
23. Select **Write and Close** from the side menu.
The display used to enter the file name will appear.
24. Input **SAMPLE-1** as the file name. Use the general purpose knob to select **S** from the character menu.

Then press the **VALUE** button. **S** is inserted into the file name input column. In the same manner, input **A, M, P, L, E, -, 1** (see Figure 2 -29).

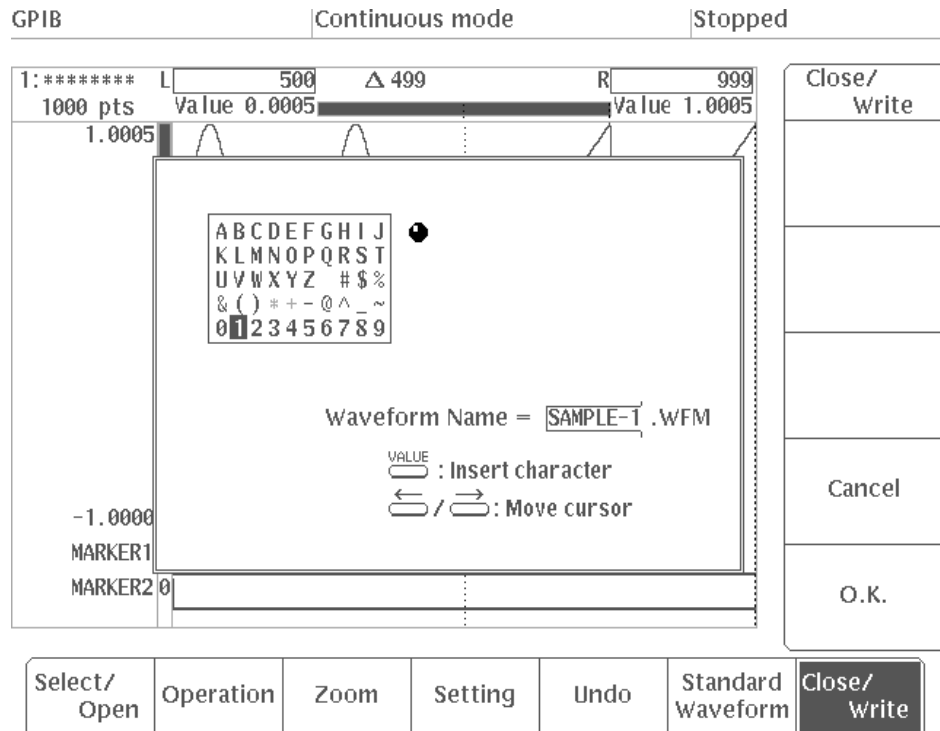

Figure 2 -29: Naming a File

25. When you finish inputting the file name, select **O.K.** from the sub menu. The system returns to the initial menu and displays the waveform file created (see Figure 2 -30). The extender “**WFM**” will be displayed after the file name; this indicates that the file is a waveform file.

GPIB	Continuous mode	Stopped
Catalog : Memory		Free : 1983KB
Name	Type	Size
Date & Time	Comment	▼
SAMPLE-1	WFM	2948 94-02-01 15:36
		Edit
		New Waveform
		New Equation
		New Sequence
		More 1 of 3
Rename	Comment	Copy
Delete	Delete All	Lock On Off

Figure 2 -30: Initial Menu File List

Creating Arbitrary Waveforms Using the Point Draw Function

Arbitrary waveforms can be created on the graphic display with the POINT DRAW function.

Use the following procedure to make a copy of the file **SAMPLE-1.WFM** created in the previous operation.

1. In the initial **EDIT** menu, select **Copy** bottom menu. The display used to enter the name of the copy of the file will appear, as shown in Figure 2 -31.

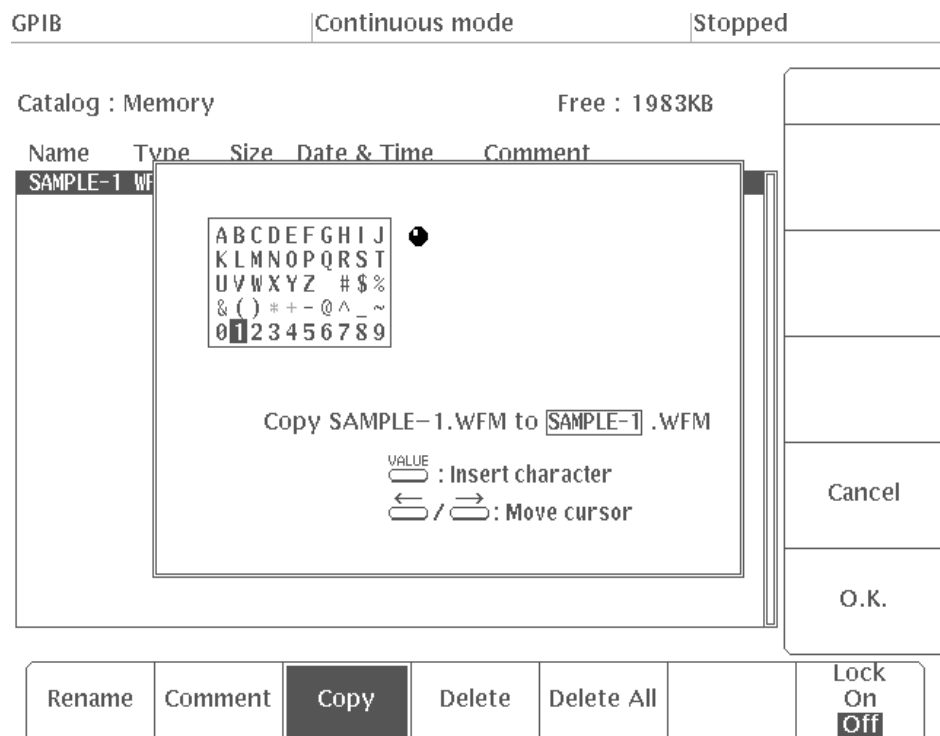

Figure 2 -31: Entering a Name for the Copied File

In this example, you will name the copy **SAMPLE-2**.

2. Press the Delete key on the front panel to delete the “1” in the file name.
3. Press “2.”
4. Select **O.K.** from the side menu.

SAMPLE-1 will be copied as a new waveform file named **SAMPLE-2**.

5. Check to make sure that the **SAMPLE-2** waveform file is displayed inverted in the file list in the initial menu. If it is not selected, turn the general purpose knob until the name **SAMPLE-2** is displayed inverted.

6. Select **Edit** from the side menu.

The **SAMPLE-2** waveform file will appear on the screen.

You will now set the range for waveform creation. The arbitrary waveform will be created within this range using the Point Draw function.

7. Press the **CURSOR** button on the front panel. This will activate the vertical cursor bar in the left-hand side of the screen.
8. Press “2”, “5”, “0”, and **ENTER** to set the point value of the left cursor to 250.
9. Press the **CURSOR** button on the front panel again to activate the vertical cursor bar in the right-hand side of the screen.
10. Press “7”, “5”, “0”, and **ENTER** to set the point value of the right cursor to 750.

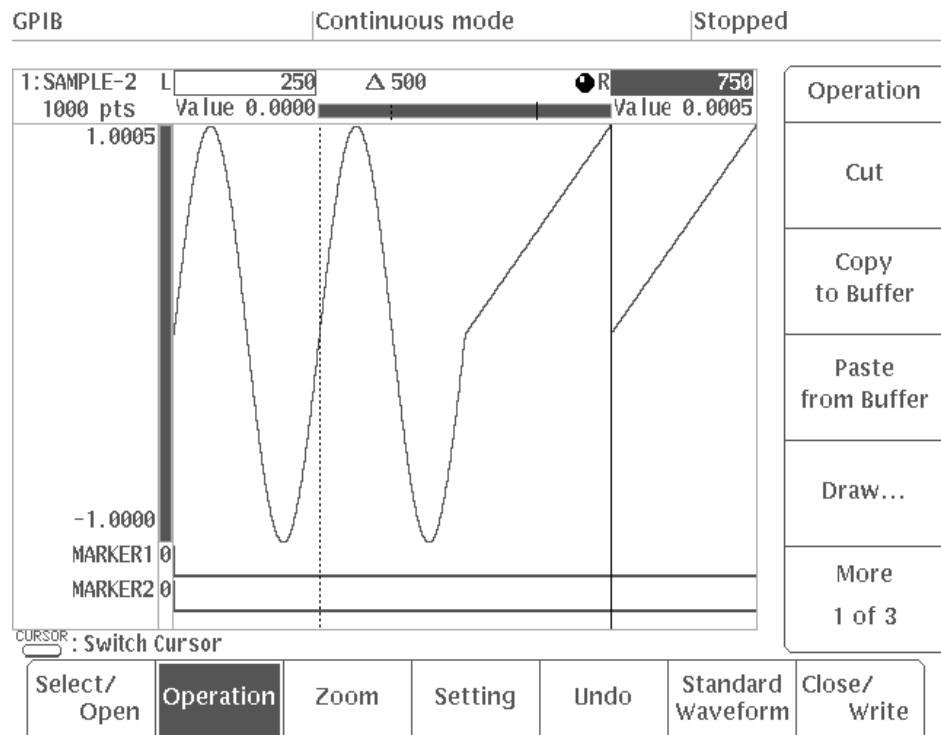

Figure 2 -32: Setting the Edit Range

You may now create the arbitrary waveform within the range designated by these two vertical bar cursors, using the Point Draw function.

11. Select **Operation** from the bottom menu.

12. Select **Draw...** from the side menu.

The first point will be drawn.

13. Press the **VALUE** button on the front panel to determine the direction in which the point cursor will move.

14. Using the general purpose knob, move the point cursor to draw another point.

15. Select **Add Draw Point** from the sub-menu.

The point will be confirmed and an **x** will appear at that position.

16. Repeat steps 13 through 15 to determine other points. An example is shown in Figure 2 -33.

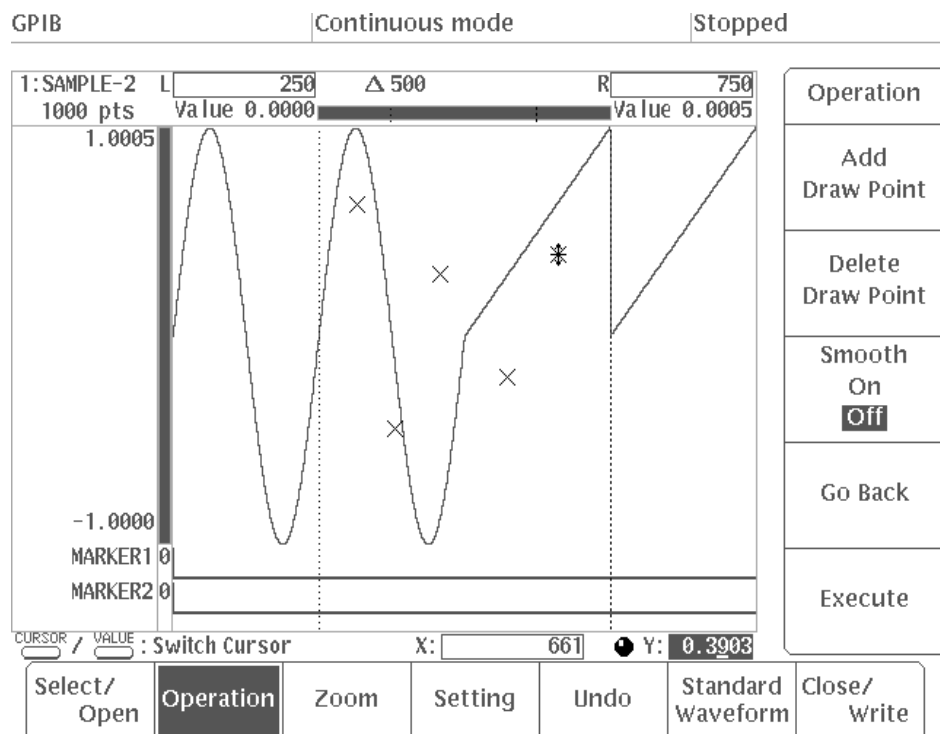

Figure 2 -33: Drawing a Waveform Using the Point Draw Function

17. Select **Smooth** from the sub-menu to turn smoothing on.

When this is done, spline interpolation will be performed and the points that have been drawn and the curve outside the area marked by the vertical bar cursors will be connected in a smooth curve.

If smoothing is turned off, linear interpolation will be performed and the points that have been drawn and the curve outside the area marked by the vertical cursors will be connected using straight lines.

18. Select *Execute* from the sub-menu.

The points between the vertical cursors will be connected in a smooth curve (using spline interpolation), as shown in Figure 2 -34.

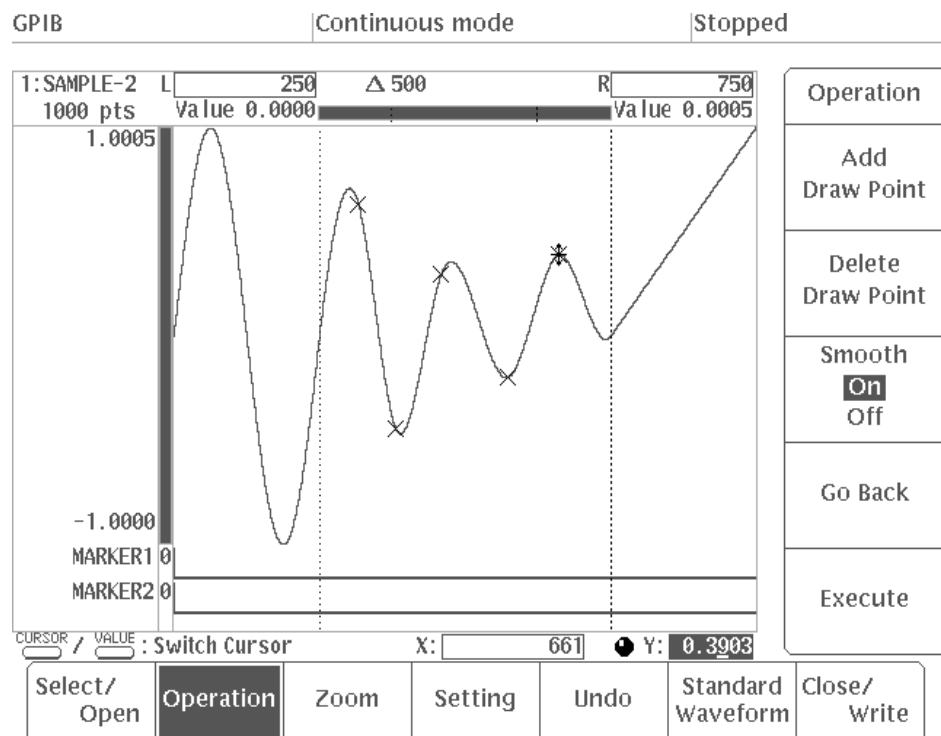

Figure 2 -34: Connecting the Points

19. Select *Close/Write* from the bottom menu.

20. Select *Write and Close* from the side menu.

The data for the **SAMPLE-2** waveform file will be updated and the initial **EDIT** menu will reappear.

Creating Waveforms Arithmetically

You will now add a noise waveform to the sine waveform.

1. Select **New Waveform** from the side menu in the initial **EDIT** menu.
2. Select **Standard Waveform** from the bottom menu.
3. Select **Amplitude** from the side menu.
4. Press “1” and **ENTER** in that order.
5. Check to make sure that the parameters for other items in the side menu are set to the values shown below. If they are different, change them to the values shown below.

Type	Sine
Cycle	1.0
Offset	0.0000

6. Select **Execute** from the side menu.

The sine wave shown in Figure 2 -35 will be created.

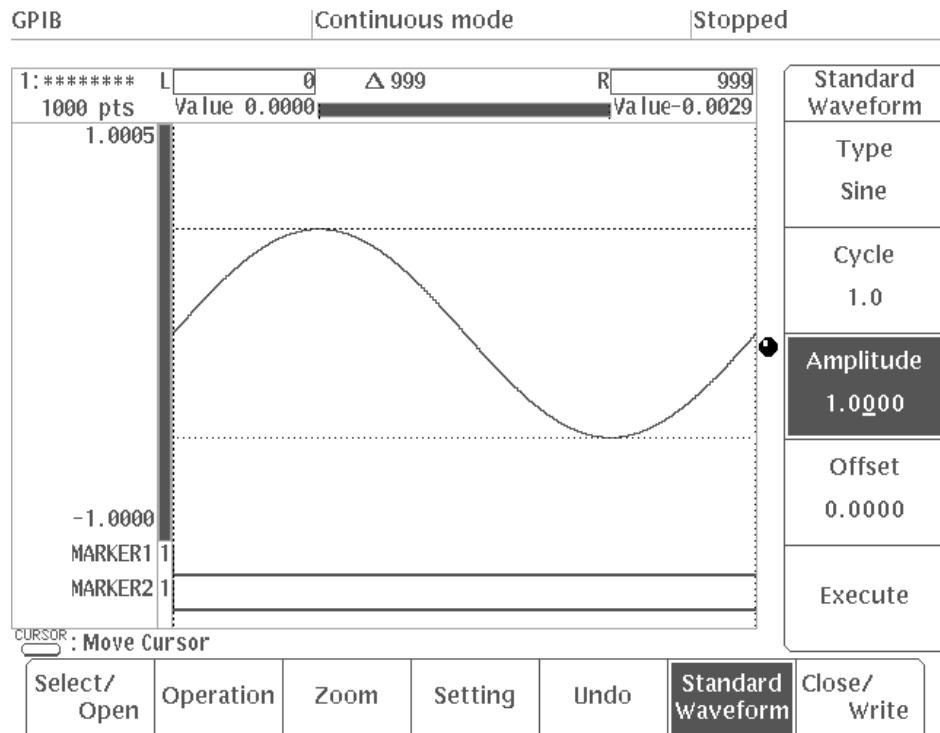

Figure 2 -35: Creating a Sine Wave

7. Select **Type** from the side menu.

8. Using the general purpose knob, select **Add Noise**.
9. Select **Amplitude** from the side menu.
10. Press “.”, “3”, and **ENTER** in that order.
11. Select **Execute** from the side menu.

Noise will be added to the sine wave, as shown in Figure 2 -36.

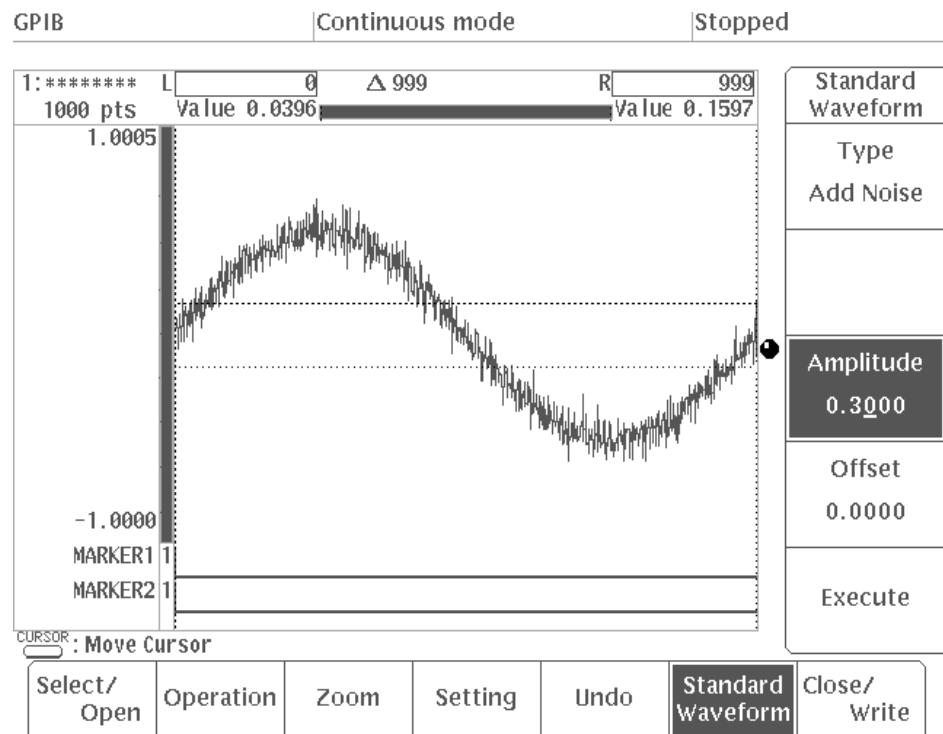

Figure 2 -36: Sine Wave With Noise Added

12. Select **Close/Write** from the bottom menu.
13. Select **Write and Close** from the side menu.
14. Make **SAMPLE-3** the file name. See Step 24 in the waveform file creation procedure for instructions on how to enter the file name.

Creating an Equation File

This procedure is used to create a waveform using an equation.

1. Select **New Equation** from the side menu.

Figure 2 -37 shows the equation editor menu.

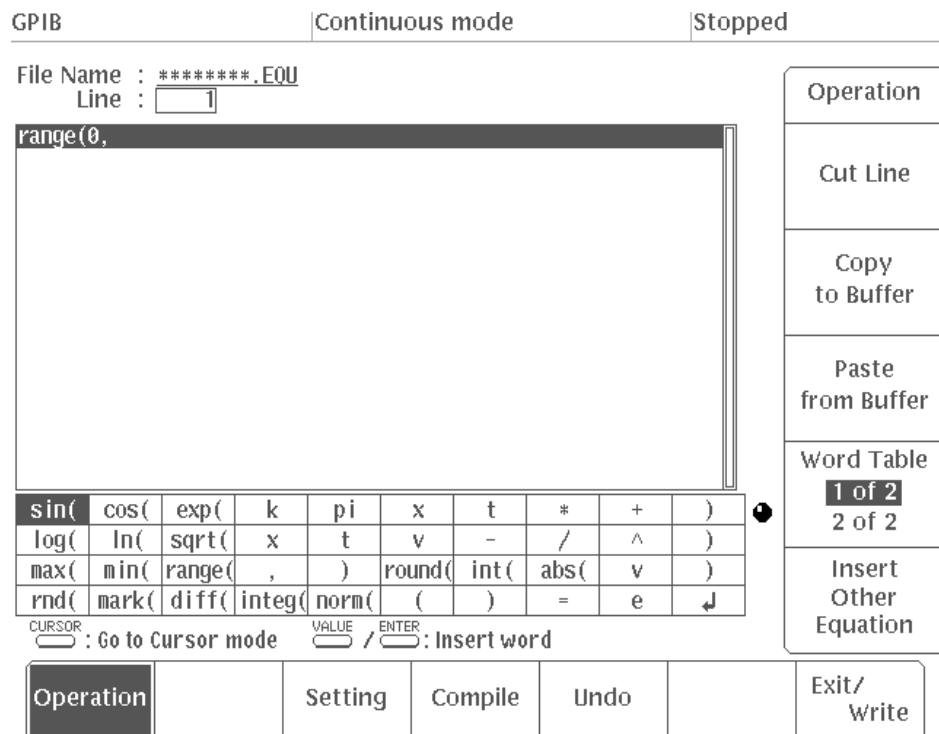

Figure 2 -37: Equation Editor Menu Display

To initially define an equation, you must specify its region in time. Do this by selecting “**range()**” in the component menu. When a new equation file is created, “**range(0,**” will automatically appear in the first line of the equation. Following this notation, you must input the equation end time, as shown in subsequent steps.

Select **Setting** from the bottom menu. When this is done, the default setting (**1000**) for the number of points will appear. If the clock frequency has been set to 1 MHz in the **SETUP** menu, the value will be 1 μ s for each point. Accordingly, for 1000 points the waveform period will be 1 ms.

2. Select **Operation** from the bottom menu.
3. Set the time from 0 to 500 μ s. Press the **5, 0, 0, μ s, “)”**, and “**↵**” (carriage return), in order, using the numeric keys and unit key or by selecting and entering these characters from the items in the component menu.

NOTE. You can use the general purpose knob to select an item from within the component menu. After selecting an item, press the front panel **VALUE** button or **ENTER** button to enter the selected item into the equation list.

Now you will create the equation for the time region set in the previous step.

4. For the equation, enter $0.5*\sin(4*\pi*x)$. Input **0**, **“.”**, **5**, *****, **sin(**, **4**, *****, **pi**, *****, **x**, **)** with the numeric keys or from the component menu.
5. In the same manner, input the data as shown in Figure 2 -38.

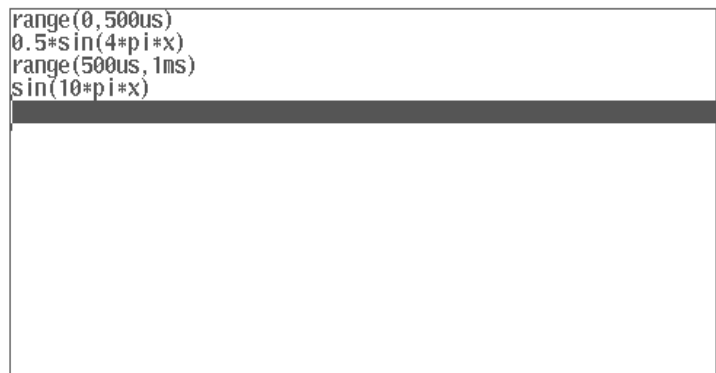

```
range(0, 500us)
0.5*sin(4*pi*x)
range(500us, 1ms)
sin(10*pi*x)
```

Figure 2 -38: Equation List Input

6. Select **Compile** from the bottom menu.

After the compiling is complete, the waveform data is created from the equation and the resultant waveform is displayed on the screen. Figure 2 -39 shows the compiled waveform data.

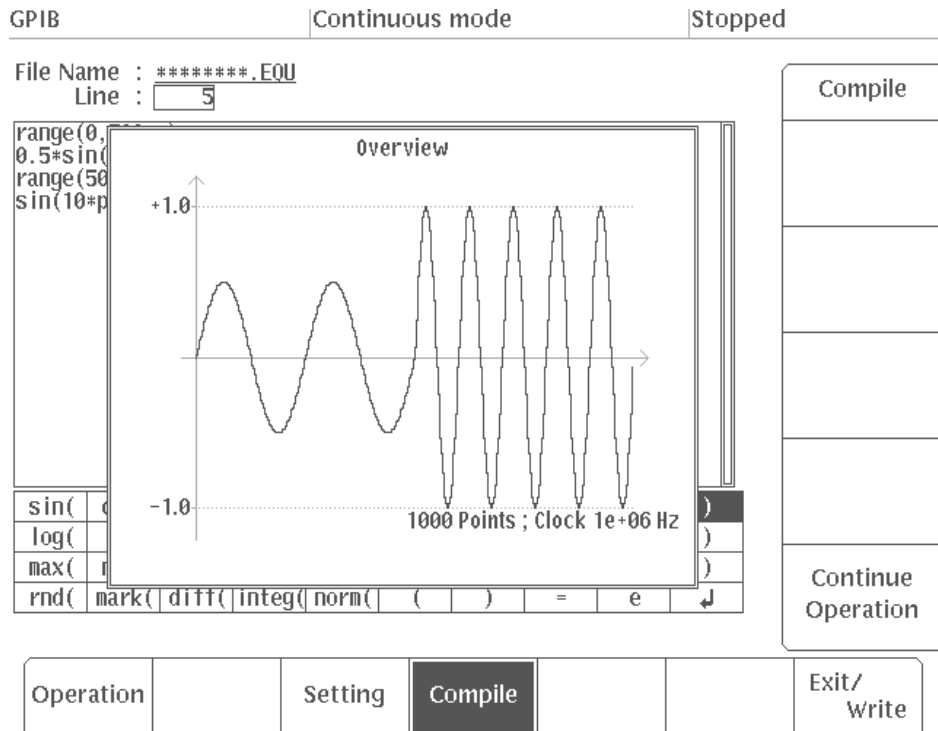

Figure 2 -39: Display of Compiled Waveform Data

7. Select **Continue Operation** from the side menu to return the system to the previous equation edit menu.
8. Select **Exit/Write** from the bottom menu.
9. Select **Write and Exit** from the side menu.
10. Make **SAMPLE-4** the file name. For details on how to input the file name, see Step 24 from the waveform file creation procedure.
11. When you are finished inputting the file name, select **O.K.** from the sub-menu.

The equation file (**SAMPLE-4.EQU**) and the waveform file (**SAMPLE-4.WFM**) of compiled data with the same name are created and the system returns to the initial menu. See Figure 2 -40.

GPIB | Continuous mode | Stopped

Catalog : Memory Free : 1974KB

Name	Type	Size	Date & Time	Comment
SAMPLE-1	WFM	2948	94-02-01 15:36	
SAMPLE-2	WFM	2948	94-02-01 15:41	
SAMPLE-3	WFM	2948	94-02-01 15:42	
SAMPLE-4	EQU	452	94-02-01 15:47	
SAMPLE-4	WFM	2948	94-02-01 15:46	

Edit

New Waveform

New Equation

New Sequence

More

1 of 3

Rename	Comment	Copy	Delete	Delete All	Lock On Off
--------	---------	------	--------	------------	-----------------------

Figure 2 -40: Initial Menu File List

Creating a Sequence File

In this procedure, you will create a sequence file that combines two files: the waveform file created with the waveform editor (**SAMPLE-1.WFM**) and the waveform file created with the equation editor and then compiled (**SAMPLE-4.WFM**).

1. Select **New Sequence** from the side menu. Figure 2 -41 shows the sequence editor menu.

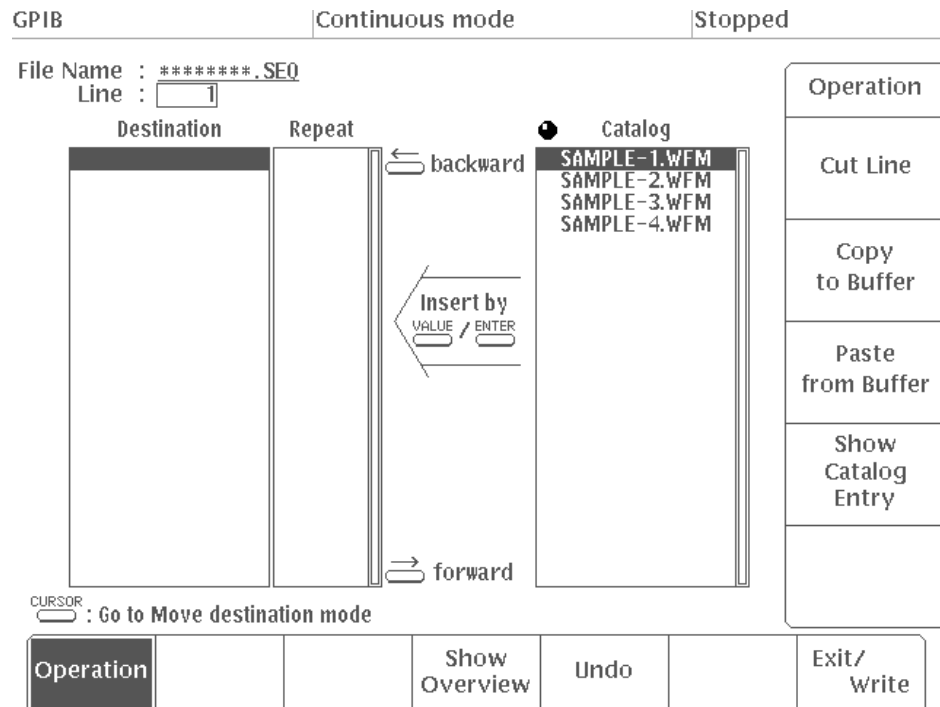

Figure 2 -41: Sequence Editor Menu Display

2. Use the general purpose knob to select the waveform file from the **Catalog** to go on the first line of the **Destination** list. Select **SAMPLE-1.WFM** here.
3. Press the **VALUE** button on the front panel.

The file **SAMPLE-1.WFM** will be inserted in the first line of the **Destination** list. The inverted video cursor will move to the **Repeat** column on the same line.

4. Now you will set the repetition count for the **SAMPLE-1.WFM** file to 2.
Press “2” and **ENTER** in that order. The inverted video cursor will move to the second line in the **Destination** list.

- Repeat Steps 2 through 4 to enter **SAMPLE-4.WFM** in the second line of the **Destination** list. The repetition count for this file should be set to **1**; since this is the default value, there is no need to change it.

This completes the creation of the waveform sequence file. Figure 2 -42 shows the resultant display.

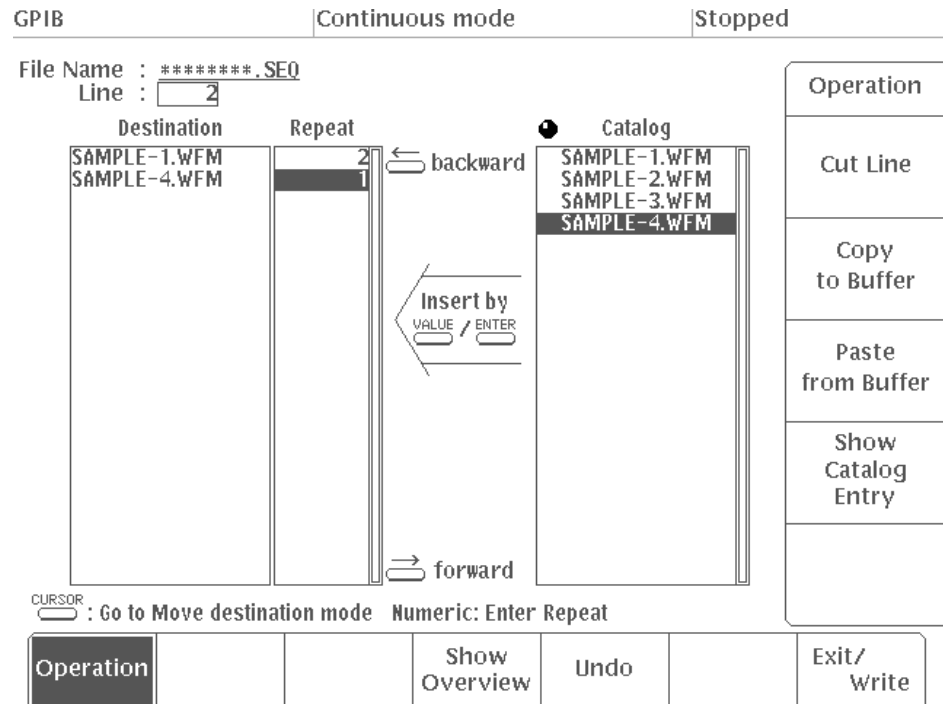

Figure 2 -42: Sequence Example

- Select **Show Overview** from the bottom menu to verify the sequence waveform.

The sequence waveform is combined as the sequence: **SAMPLE-1.WFM** twice and **SAMPLE-4.WFM** once. See Figure 2 -43.

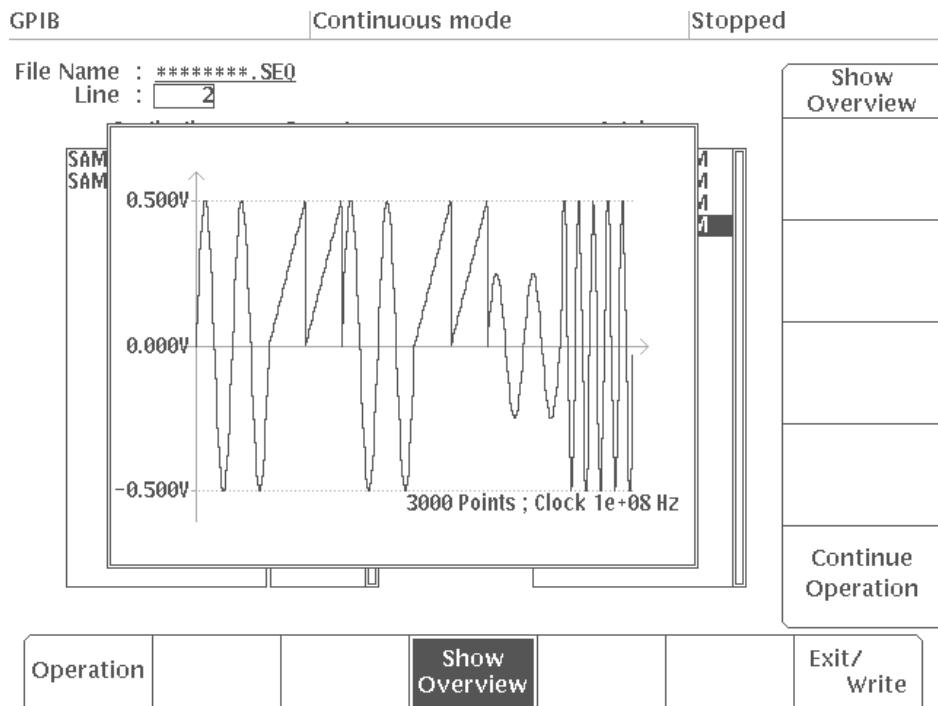

Figure 2 -43: Sequence Waveform Display With Show Overview Selected

7. After verifying waveform, select **Continue Operation** from the side menu to return the system to the previous sequence edit menu.
8. Select **Exit/Write** from the bottom menu.
9. Select **Write and Exit** from the side menu.
10. Input **SAMPLE-5** as the name for this sequence file. For details on how to input the file name, see Step 24 of the procedure for waveform file creation.
11. When you are finished inputting the file name, select **O.K.** from the sub-menu. The sequence (**SAMPLE-5.SEQ**) file is saved to internal memory and the system returns to the initial menu.

Creating Autostep Files

In this operation, you will program waveforms to be output, using the files you have created in the previous operations to form an autostep file.

1. Select **New Autostep** on the second page of the side menu in the initial **EDIT** menu.

NOTE. Select **More** from the side menu to display the next page.

You will set the CH1 file for Step 1.

2. Using the general purpose knob, move the cursor to the CH1 file column.

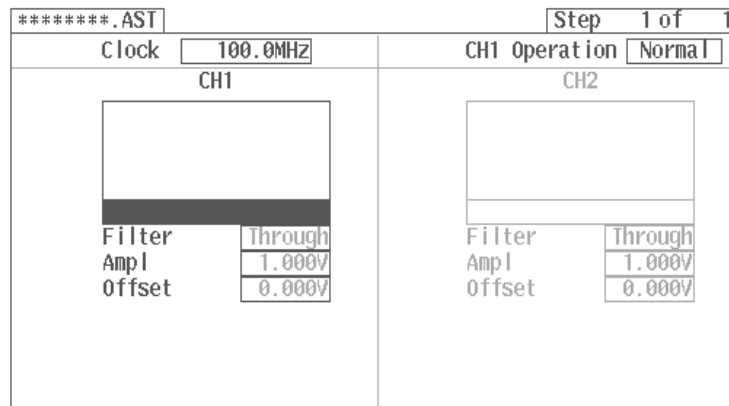

Figure 2 -44: Moving the Cursor

3. Press the **VALUE** button on the front panel.

The list used to select waveforms or sequence files will appear.

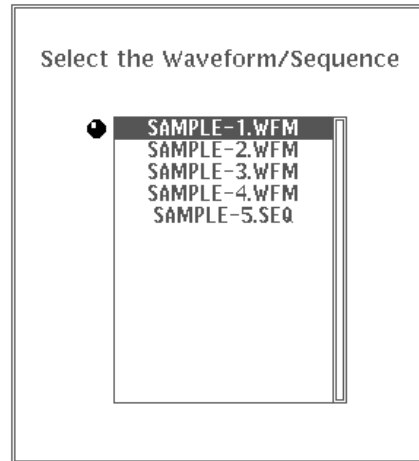

Figure 2 -45: File List

4. Using the general purpose knob, select the **SAMPLE-1.WFM** file.
5. Select **Set** from the side menu.

The waveform and output parameters for the **SAMPLE-1.WFM** file will appear.

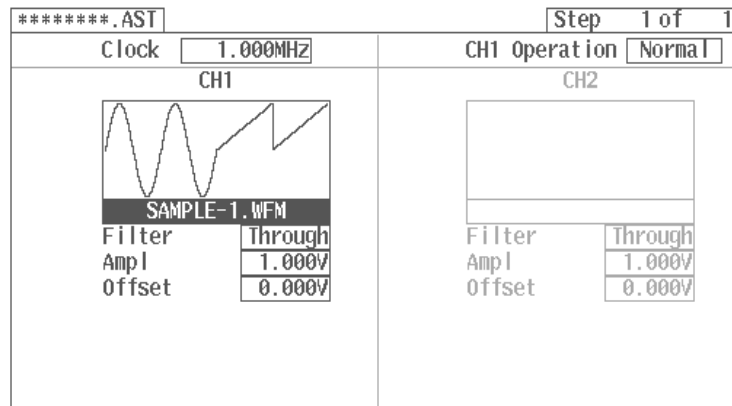

Figure 2 -46: Setting File

You will now set the CH1 file for Step 2.

6. Select **More 1 of 2** from the side menu.
7. Select **Append New Step** from the side menu.

The Step 2 display will appear.

8. Using the procedure described in Steps 2 – 5 above, set the CH1 file for Step 2 (SAMPLE-3).

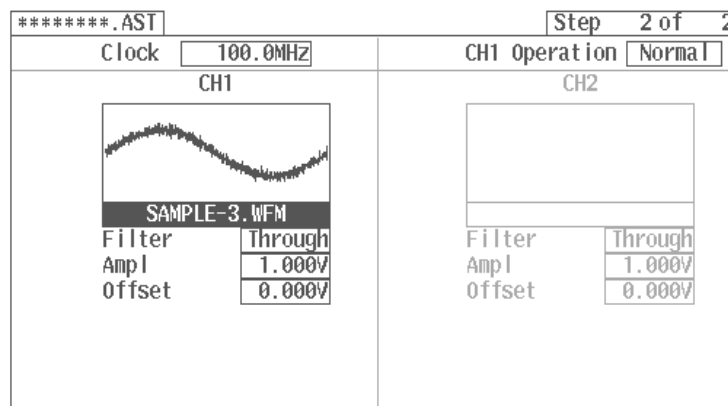

Figure 2 -47: Setting the File for Step 2

9. Using the procedure described in Steps 2 – 8 above, set the CH1 file for Step 3 (SAMPLE-4).

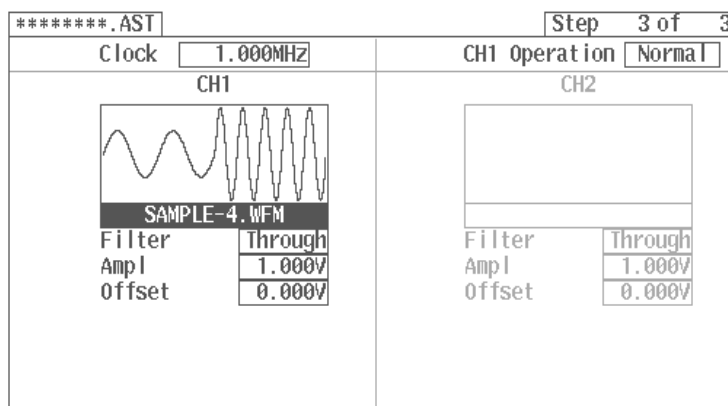

Figure 2 -48: Setting the File for Step 3

10. Select **Exit/Write** from the bottom menu.
11. Select **Write and Exit** from the side menu.

12. Enter **SAMPLE-6** as the name for the autostep file. See Step 24 of the waveform file creation procedure for instructions on how to enter the file name.
13. When the file name has been entered, select **O.K.** from the sub-menu.

The autostep file that you have created will be saved in the internal memory under the name **SAMPLE-6.AST** and the initial menu will reappear.

Setting the Output Parameters

1. Press the **SETUP** button in the **MENU** column. Figure 2 -49 shows the **SETUP** menu displayed.

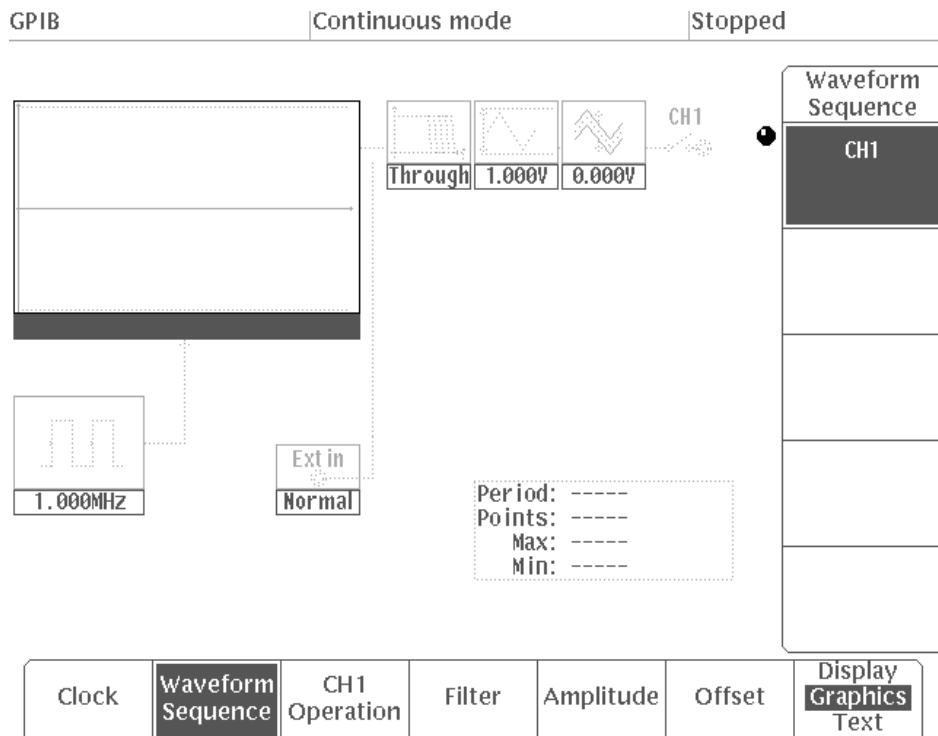

Figure 2 -49: SETUP Menu

2. Select **Waveform Sequence** from the bottom menu.
3. Turn the general purpose knob to select the **SAMPLE-1.WFM** file.
4. Press the front panel **ENTER** button.
5. Select **Clock** from the bottom menu.
6. Select **Internal Clock** from the side menu.

7. Use the numeric and unit keys to input **1, MHz**, in order, to set the clock frequency.
8. Press the **Source** button in the side menu to select **Internal**.
9. Select **Amplitude** from the bottom menu.
10. Select **CH1** from the side menu.
11. Use the numeric and unit keys to input **5, V**, in order, to set the voltage value for full vertical scale.

Figure 2 -50 shows the menu displayed as a result of these settings.

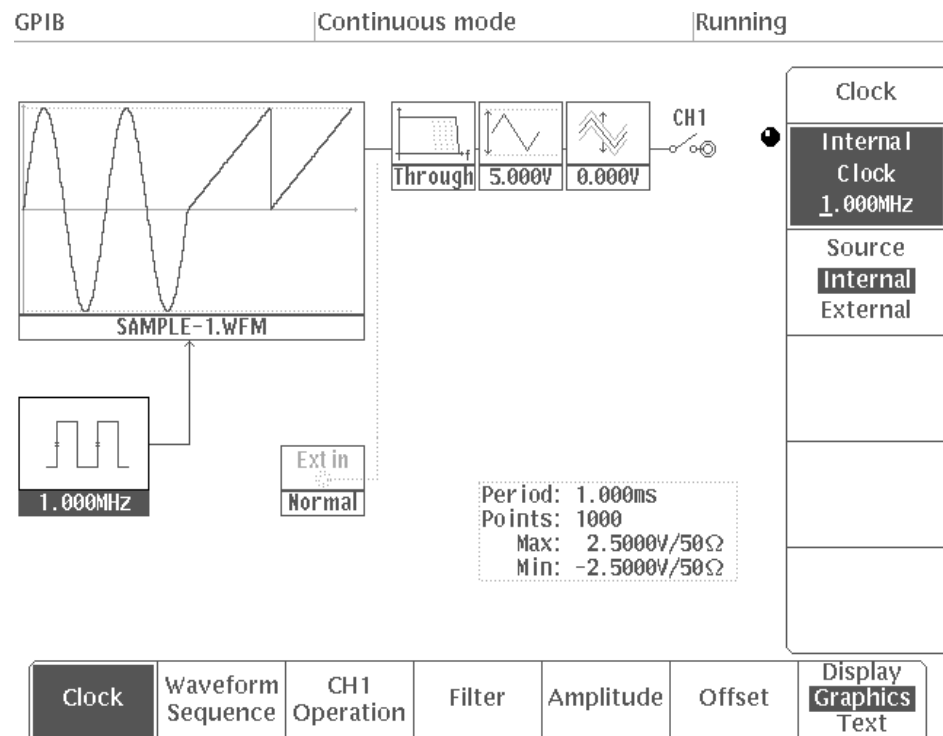

Figure 2 -50: Setting Output Parameters

This completes the output parameter setting.

Setting Operation Mode and Waveform Output

Now use an oscilloscope to see what type of waveform is generated. Connect the AWG2021 to a oscilloscope using a 50 Ω cable and a 50 Ω termination as shown in Figure 2 -51. The waveform output for this instrument is calibrated for a 50 Ω load.

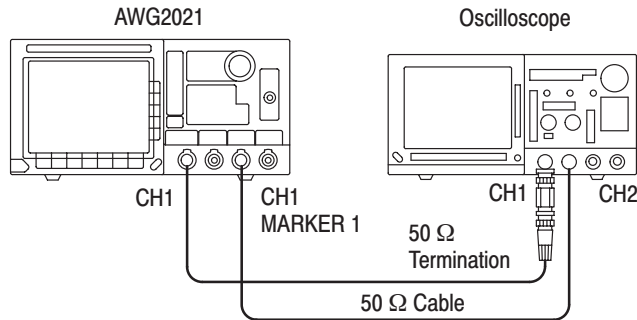

Figure 2 -51: Connections for Example 3

Continuous Mode. Set the operation mode to **Cont.**

1. Press the **MODE** button in the **MENU** column. Figure 2 -52 shows the **MODE** menu.

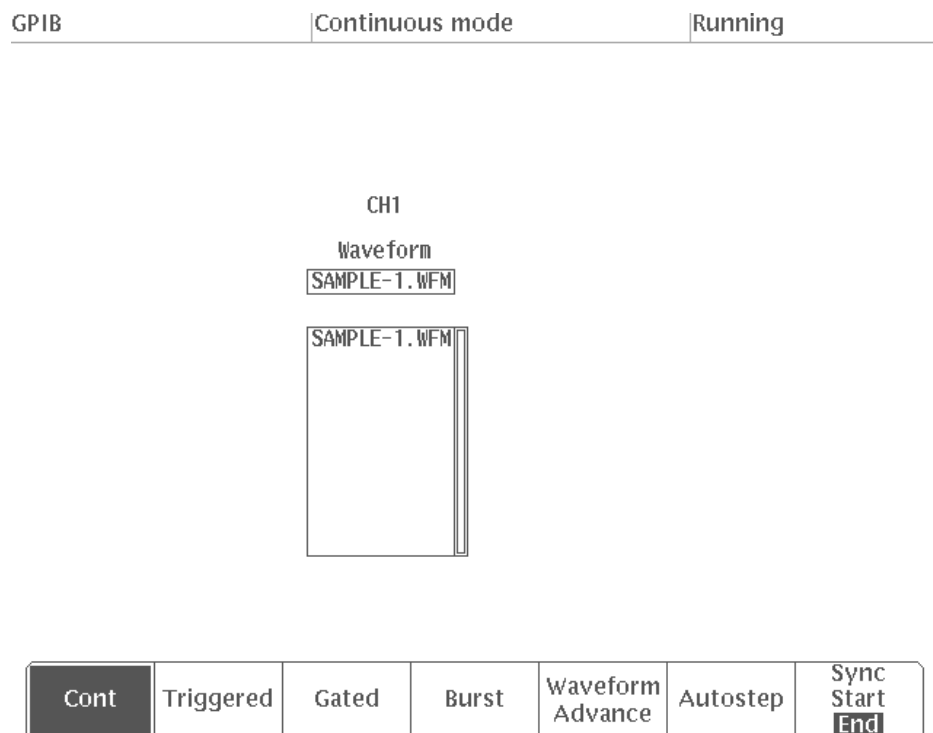

Figure 2 -52: MODE Menu

2. Select **Cont** from the bottom menu.

This operation mode continuously outputs the set waveform. Also, “**Running**” is displayed in the trigger status area on the upper right section of the screen to show that the set waveform is being output.

3. Press the front panel **CH1** On/Off button to enable waveform output.

When the output is on, the On/Off indicator lights up. This operation outputs the specified waveform from the **CH1** output connector. Set the oscilloscope appropriately to display the waveform on the oscilloscope screen.

You can use the marker output from the instrument as the external trigger for the oscilloscope. The marker signal is set in high state at data point 0. See Figure 2 -53. The marker signal can be set to any point using the waveform edit function.

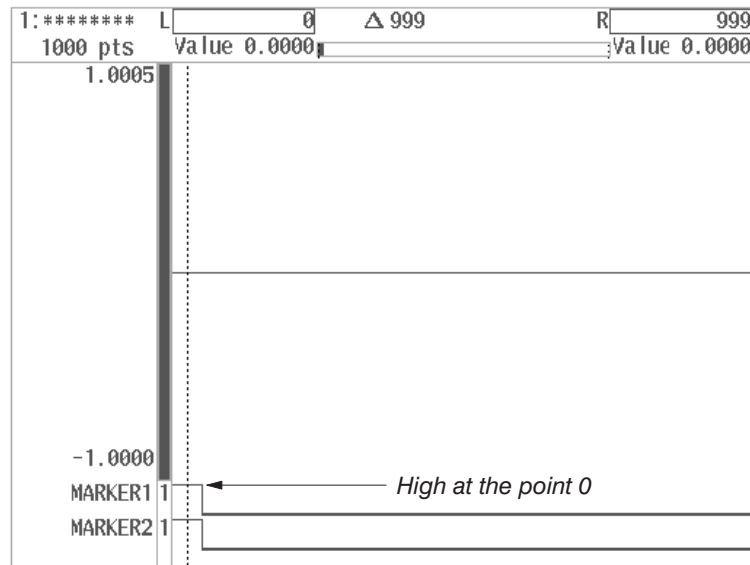

Figure 2 -53: Setting the Marker Default

Triggered Mode. In the following steps, set the operation mode to **Triggered** and generate the trigger signal with the **TRIGGER MANUAL** button to control the waveform output.

4. Select **Triggered** from the bottom menu.

When you select this item, the side menu lists external trigger parameters which allow you to set them. Figure 2 -54 shows the menu set for **Triggered** mode.

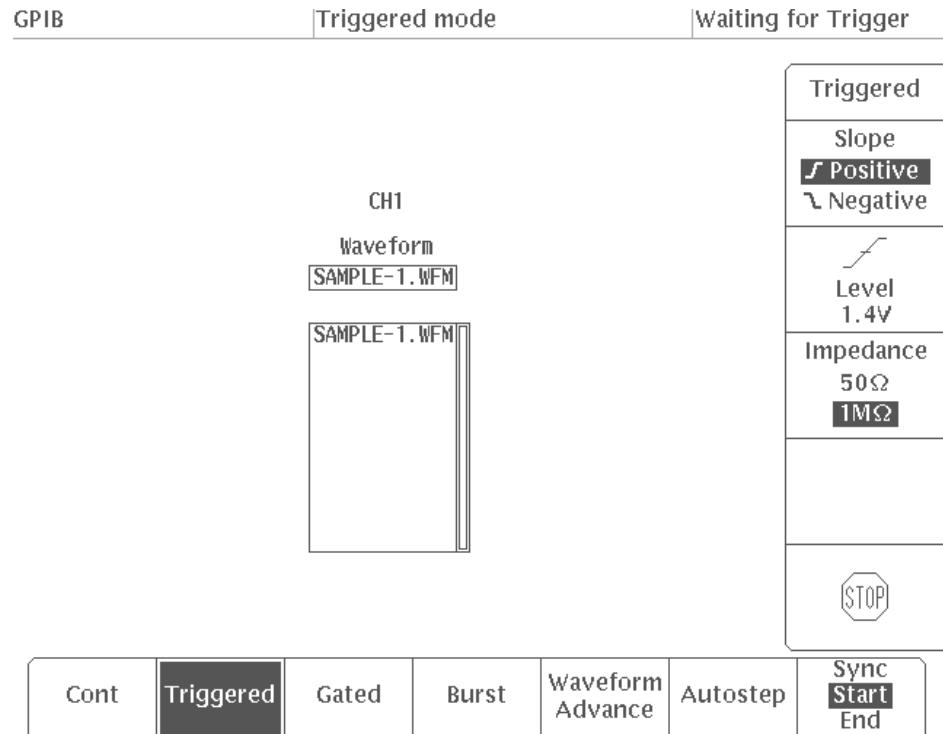

Figure 2 -54: Menu Displayed When Triggered is Selected

Figure 2 -55 shows the **MANUAL** button and the **TRIGGER INPUT** connector for inputting an external trigger signal.

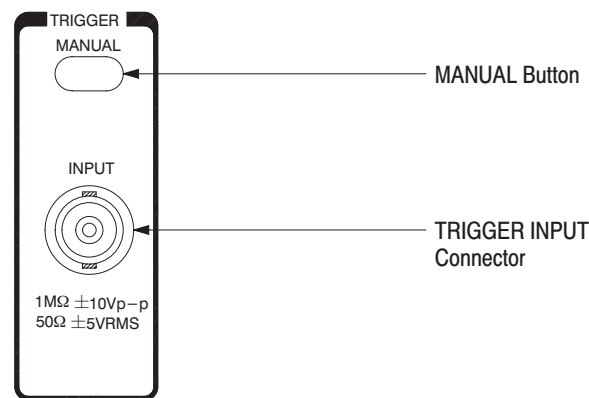

Figure 2 -55: MANUAL Button and TRIGGER INPUT Connector

This procedure does not use an external trigger signal. Rather, it generates the trigger signal when the **MANUAL** button is pressed.

5. Press the **MANUAL** button.

Check the oscilloscope to see that each time you press the **MANUAL** button, a set waveform is output once.

Autostep Mode. Using the following procedure, you can set the operation mode to **Autostep** and use the **MANUAL** button to generate a trigger signal and control step waveform output.

NOTE. When the operation mode is set to **Autostep**, it is not possible to change the output parameters in the **SETUP** menu.

6. Select **Autostep** from the bottom menu.

The menu shown in Figure 2 -56 will appear.

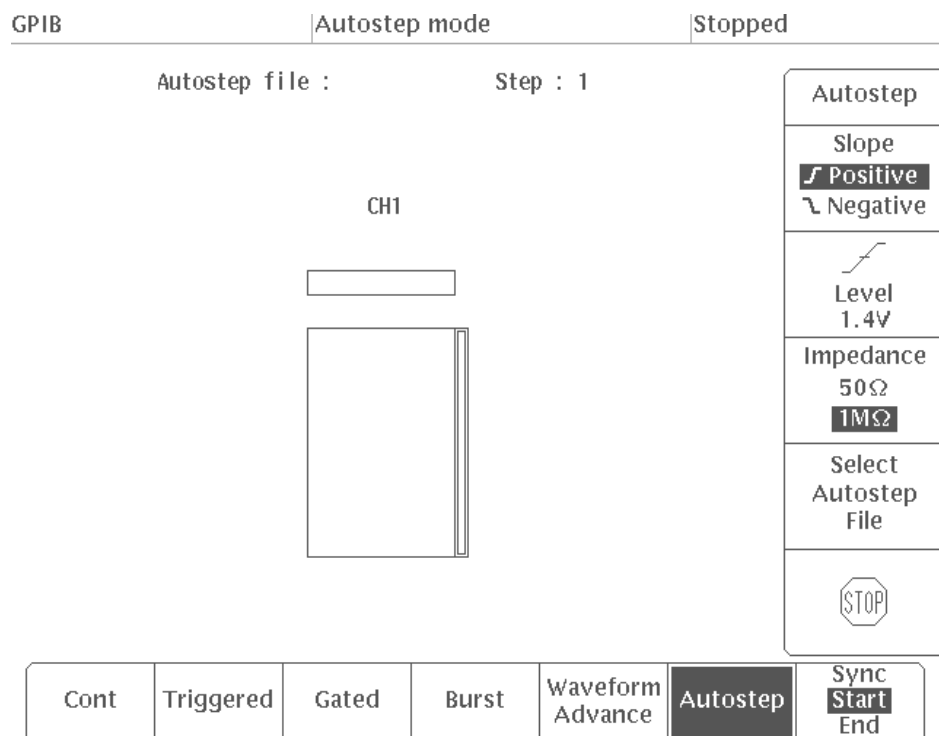

Figure 2 -56: Menu Displayed When Autostep is Selected

7. Choose **Select Autostep File** from the side menu.

A list of autostep files will appear.

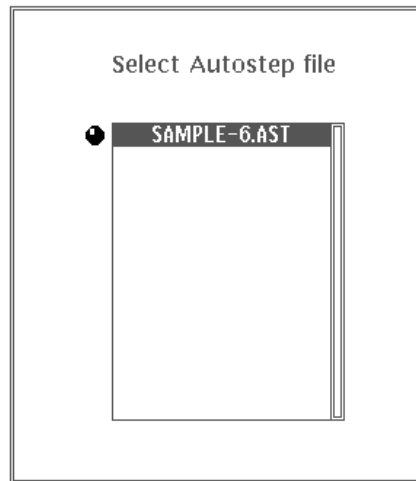

Figure 2 -57: Autostep File List

8. Using the general purpose knob, select the **SAMPLE-6.AST** file.

In this example, there is only one file in the list, so it will already be selected.

9. Select **O.K.** from the sub-menu.
10. Press the **CH1** On/Off button on the front panel to turn on waveform output.
11. Press the **MANUAL** button on the front panel.

Check on the oscilloscope to make sure CH1 waveform output advances one step each time the button is pressed. The waveform or sequence for the step is output once, then output stops.

This completes the Example 3.

Example 4: Loading and Saving Files

NOTE. *When the instrument is switched off, the data in the internal memory is erased. Accordingly, it is necessary to copy any files that have been created or edited onto a floppy disk or into the instrument's internal non-volatile memory (NVRam).*

In Example 4, you will load and save the file created in the previous operation.

LOAD menu. Used to enter files from a floppy disk or the instrument's internal NVRam.

SAVE menu. Used to save files that have been created or changed onto a floppy disk or the instrument's internal NVRam.

Saving Files

To save files into internal non-volatile memory (NVRam), perform the following steps:

1. Press the **LOAD/SAVE** button in the **MENU** column.
2. Select **Device** from the bottom menu.
3. Select **NVRam** from the side menu.
4. Select **Save** from the bottom menu.

Figure 2 -58 shows the **SAVE** menu displayed.

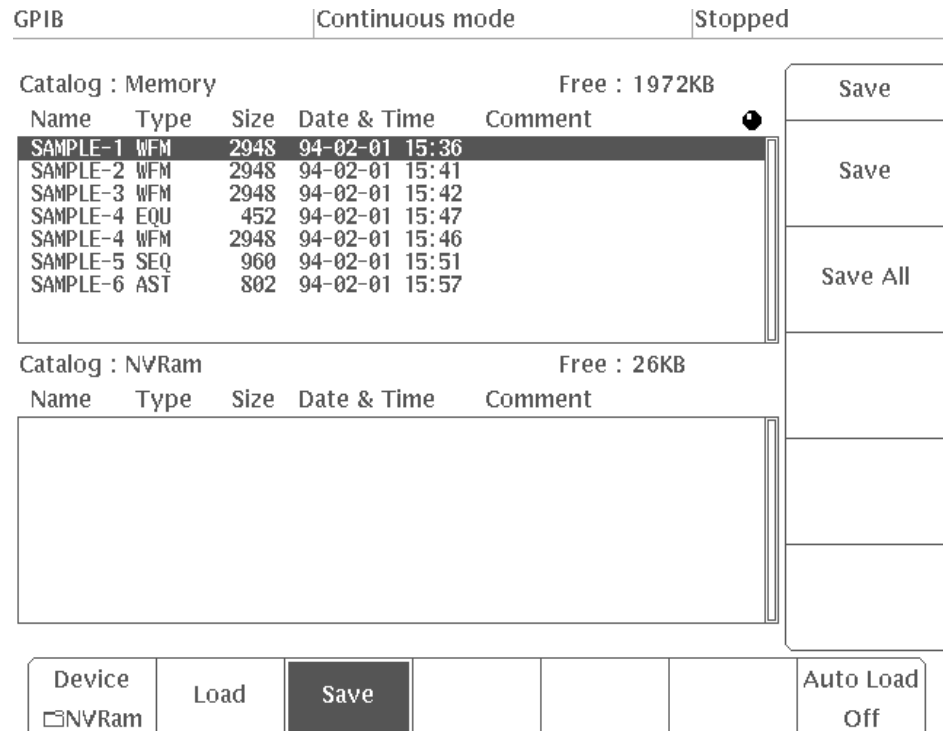

Figure 2 -58: SAVE Menu

5. Select **Save All** from the side menu.

When **Save All** is selected, all the files in internal memory (listed in the upper screen) are saved to the NVRam. See Figure 2 -59.

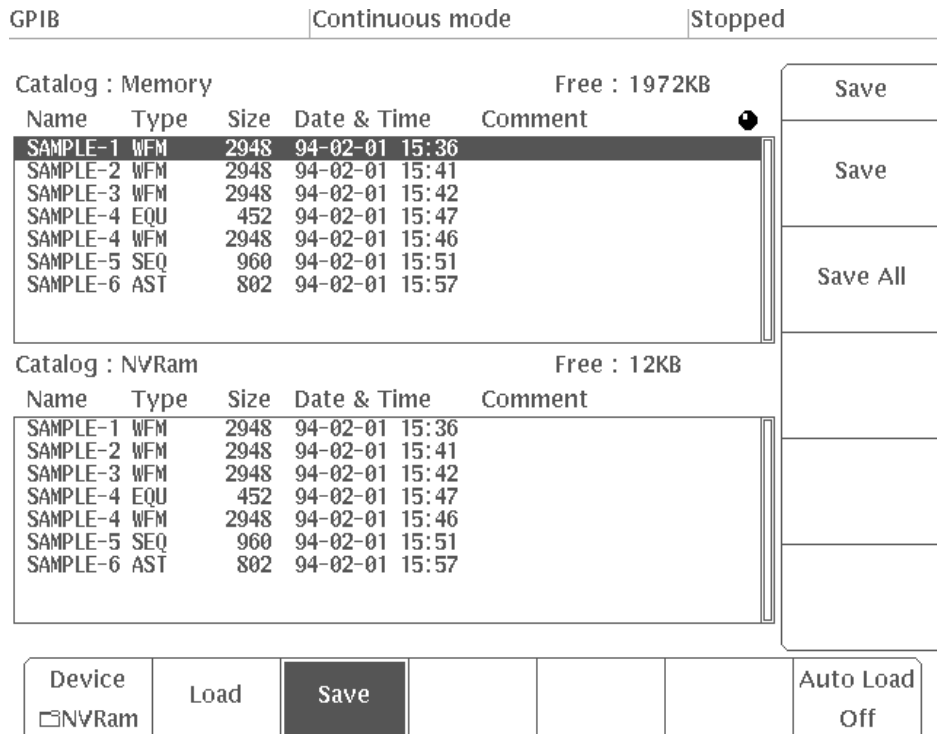

Figure 2 -59: Files Saved in NVRam

When **Save** is selected from the side menu, only the file displayed inverted in the internal memory list is saved to NVRam.

6. Check to make sure that **Auto Load** in the bottom menu is **Off**.

If it is not **Off**, select **Auto Load** from the bottom menu, then select **Off** from the side menu.

7. Power the instrument off, then on again.

Loading Files

The following procedure loads files into internal memory.

1. Press the **LOAD/SAVE** button in the **MENU** column.

Make sure that there are no files in the internal memory file list in the upper screen (see Figure 2 -60).

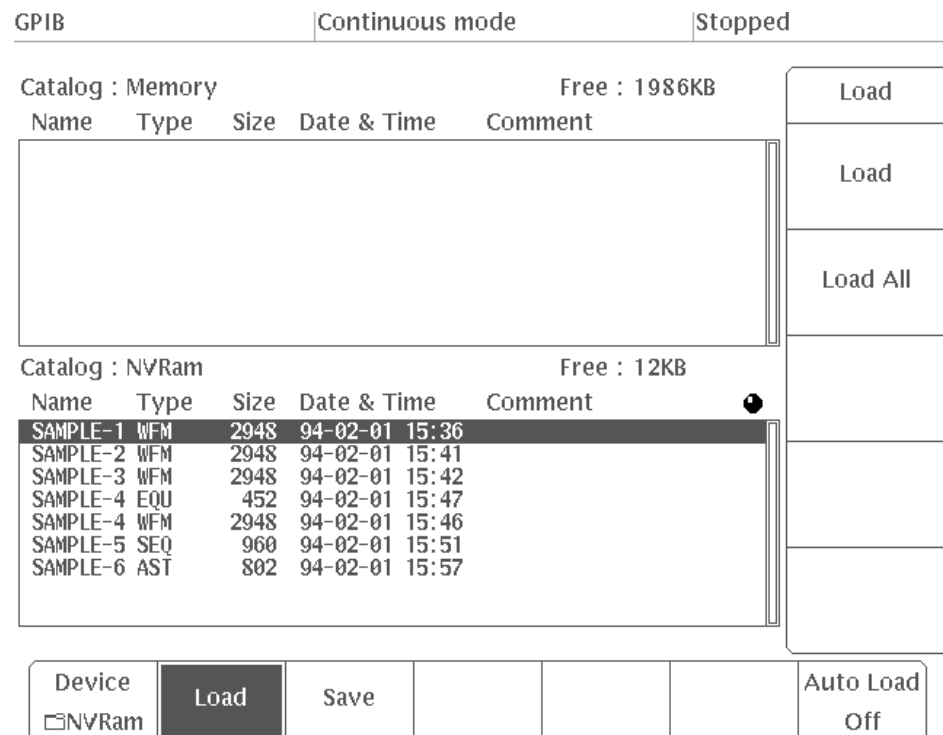

Figure 2 -60: Internal Memory File List

2. Select **Load** from the bottom menu.

Here **NVRam** is selected in the **Device** bottom menu.

3. Select **Load All** from the side menu.

When this item is selected, all the files in the NVRam (listed in the lower screen) are loaded into internal memory. See Figure 2 -61.

GPIB Continuous mode Stopped

Catalog : Memory Free : 1972KB

Name	Type	Size	Date & Time	Comment
SAMPLE-1	WFM	2948	94-02-01 15:36	
SAMPLE-2	WFM	2948	94-02-01 15:41	
SAMPLE-3	WFM	2948	94-02-01 15:42	
SAMPLE-4	EQU	452	94-02-01 15:47	
SAMPLE-4	WFM	2948	94-02-01 15:46	
SAMPLE-5	SEQ	960	94-02-01 15:51	
SAMPLE-6	AST	802	94-02-01 15:57	

Load

Catalog : NVRam Free : 12KB

Name	Type	Size	Date & Time	Comment
SAMPLE-1	WFM	2948	94-02-01 15:36	
SAMPLE-2	WFM	2948	94-02-01 15:41	
SAMPLE-3	WFM	2948	94-02-01 15:42	
SAMPLE-4	EQU	452	94-02-01 15:47	
SAMPLE-4	WFM	2948	94-02-01 15:46	
SAMPLE-5	SEQ	960	94-02-01 15:51	
SAMPLE-6	AST	802	94-02-01 15:57	

Load

Load All

Device	Load	Save					Auto Load
<input type="checkbox"/> NVRam							Off

Figure 2 -61: Files Loaded into Internal Memory

When you select **Load** from the side menu, the file displayed in inverted video in the NVRam list is loaded into internal memory.

Auto Load

Using the Auto Load process, it is possible to automatically load files from a designated device into the instrument's internal memory when the power to the instrument is turned on. You can do this with the following procedure:

1. Select **Auto Load** from the bottom menu.
2. Select **from NVRam** from the side menu.
3. Power the instrument off, then on again.

Check to make sure that the designated files were loaded from the NVRAM to the internal memory when the power to the instrument was turned on.

This completes the Example 4.

Also, note that files are loaded/saved in the same manner when the **Device** is set to **Disk**. For a floppy disk, hierarchical file structures can be created using directories. See the **UTILITY** menu Disk item in Section 3, Reference, for directory creation instructions.

NOTE. *You must format new floppy disks. See the **UTILITY** menu Disk item in Section 3, Reference, for formatting instructions.*

Example 5: Loading Waveforms From Other Instruments

The AWG2021 can transfer waveforms via a GPIB cable from a digital storage oscilloscope (DSO).

In Example 5, you will transfer waveforms from a Tektronix TDS series digital storage oscilloscope.

1. Connect the AWG2021 and the other instruments as shown in Figure 2 -62.

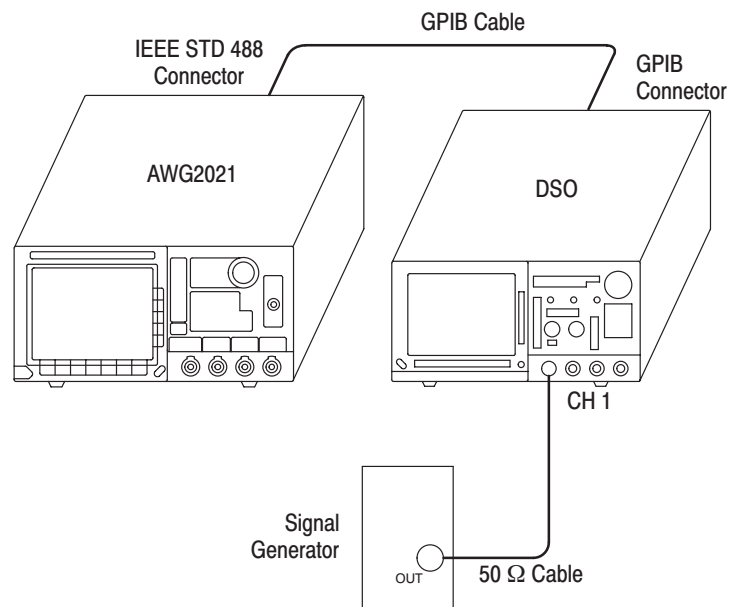

Figure 2 -62: Connections for Example 5

2. Adjust the amplitude of the signals from the signal generator so that the waveform is displayed on the DSO screen with the amplitude and sweep speed shown in Figure 2 -63.

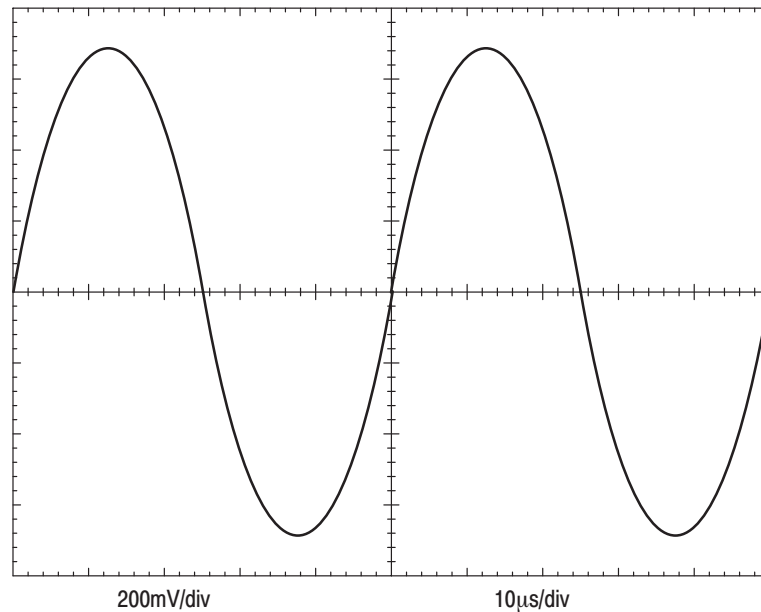

Figure 2 -63: DSO Screen

3. Press the **MENU** column **LOAD/SAVE** button for the AWG2021.
4. Select **Device** from the bottom menu.
5. Select **GPIB** from the side menu.

At this point, if the remote port is not **GPIB** or the GPIB is not configured for waveform transferring, these settings must be changed. In such cases, the message shown in Figure 2 -64 will appear; if you change the setting, select **O.K.** from the sub-menu.

The GPIB configuration is not "waveform Transfer"
and the Remote Port is not "GPIB".

Are you sure of changing the parameters
to match the transfer operation ?

Figure 2 -64: Confirmation Message (asking if it is O.K. to change the remote port and GPIB configuration settings)

To change the settings, select **O.K.** from the sub-menu.

6. Select **Load** from the bottom menu.
7. Use the general purpose knob to select the name of the DSO instrument connected to the instrument and the transferring source from the **Name** column in the **GPIB Source** list. In this example, you should select “**Tek TDS CH1.**” See Figure 2 -65.

Catalog : GPIB Source

Name	Loaded as
Tek TDS CH1	TDSCH1 WFM
Tek TDS CH2	TDSCH2 WFM
Tek TDS CH3	TDSCH3 WFM
Tek TDS CH4	TDSCH4 WFM
Tek TDS REF1	TDSREF1 WFM
Tek TDS REF2	TDSREF2 WFM
Tek TDS REF3	TDSREF3 WFM
Tek TDS REF4	TDSREF4 WFM
Tek 2400 CH1	2400CH1 WFM

Figure 2 -65: GPIB Source List

8. Set the DSO GPIB address to 1 and its communication mode to talk/listen.

NOTE. *If the DSO GPIB debug mode is On, a time-out error may occur. If so, switch off the debug mode.*

9. Select **Select Source Address** from the side menu.
10. Use the general purpose knob to set the address to 1 which is the same as the GPIB address of the load source DSO.
11. Select **Load** from the side menu.

When this is done, the waveform data will be transferred from the DSO instrument to the AWG2021. The transferred waveform data will be loaded into the internal memory of the AWG2021 under the name shown in the “**Loaded as**” column of the GPIB Source list. In this example, the waveform file is named “**TDSCH1.WFM.**” The clock, amplitude, and offset values obtained from the waveform preamble are loaded into the waveform file as setup data, together with the waveform data.

NOTE. *If the amplitude, offset, or clock is outside the range that can be set for the AWG2021, it is replaced with the maximum or minimum value that can be set. If an attempt is made to transfer a waveform that exceeds any of these ranges, a message to that effect is displayed.*

If **Load Without Preamble** in the side menu is selected, the waveform preamble will not be loaded (in other words, only the waveform data will be loaded). In such cases, all parameters will be set to the default values of the output parameters.

This completes the Example 5.

Example 6: Using the Waveform Function Generator

The instrument is equipped with a waveform function generator for generating simple waveform functions. Pressing the **F.G** button on the front panel will change the mode to function generator (**FG**) mode and enable you to set various waveform parameters.

In Example 6, you will select a sine wave for CH1. Then you will set the parameters and output the waveform.

1. Press the front panel **F.G** (Function Generator) button. The **FG** mode menu is displayed.

CH1 Waveform Settings

As described below, you will define a 200 kHz, 5 V amplitude, 0 V offset sine wave on CH1.

1. Select **Sine** from the bottom menu.

Figure 2 -66 shows a sine wave displayed within the CH1 frame on the screen.

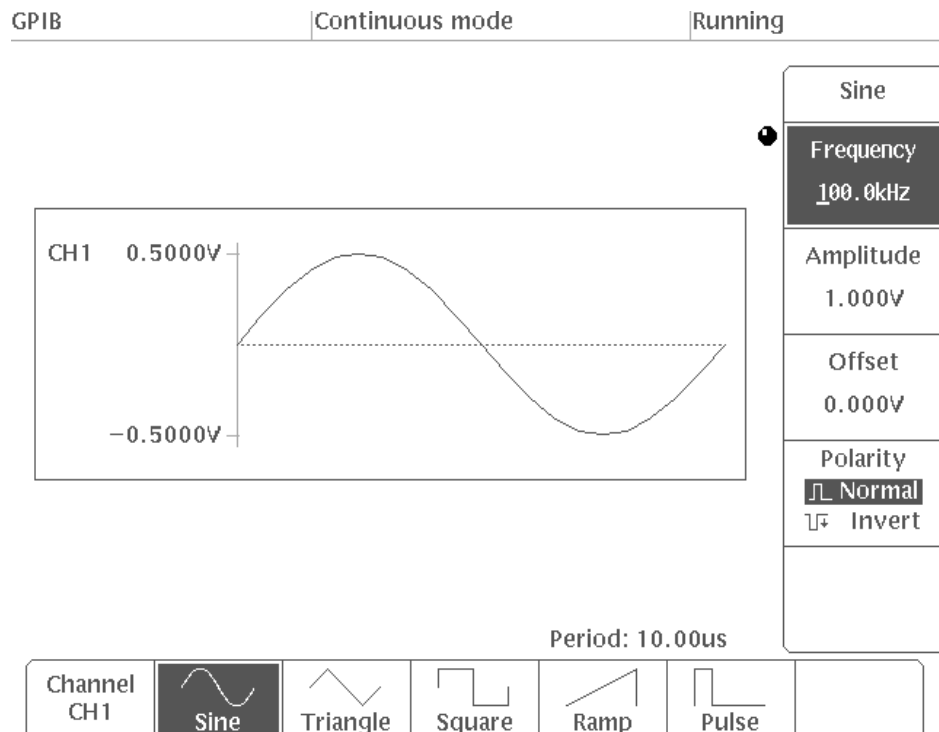

Figure 2 -66: Screen When Sine Set for CH1

Set the frequency to 1 MHz.

2. Select **Frequency** from the side menu.
3. Press **1** and the **MHz/μs** key in the Unit key to input the frequency with the numeric keys.
4. To set the frequency with the general purpose knob, select the index digit for input with the front panel arrow buttons (←/→). Press the ← button to move the underscore to the left or press the → button to move the underscore to the right. Turn the general purpose knob with the index digit selected to get a **1.000 MHz** frequency.

In the same manner as the frequency, above, you will set the amplitude to 5 V and the offset to 0 V.

5. Select **Amplitude** from the side menu.

Use the general purpose knob or numeric keys to set an amplitude of **5.000 V**.

6. Select **Offset** from the side menu.

Turn the general purpose knob and check that the 0 V line (broken line) on the screen moves within a range ± 2.5 V. Then set the offset to **0.000 V**. You could also input the offset value with the numeric keys.

7. Check that when you press the **Polarity** button in the side menu, the polarity toggles between **Normal** and **Invert** and the polarity of the sine wave on the screen is reversed. Then set the polarity to **Normal**.

Figure 2 -67 shows the screen when the output parameters are set for a sine wave on CH1.

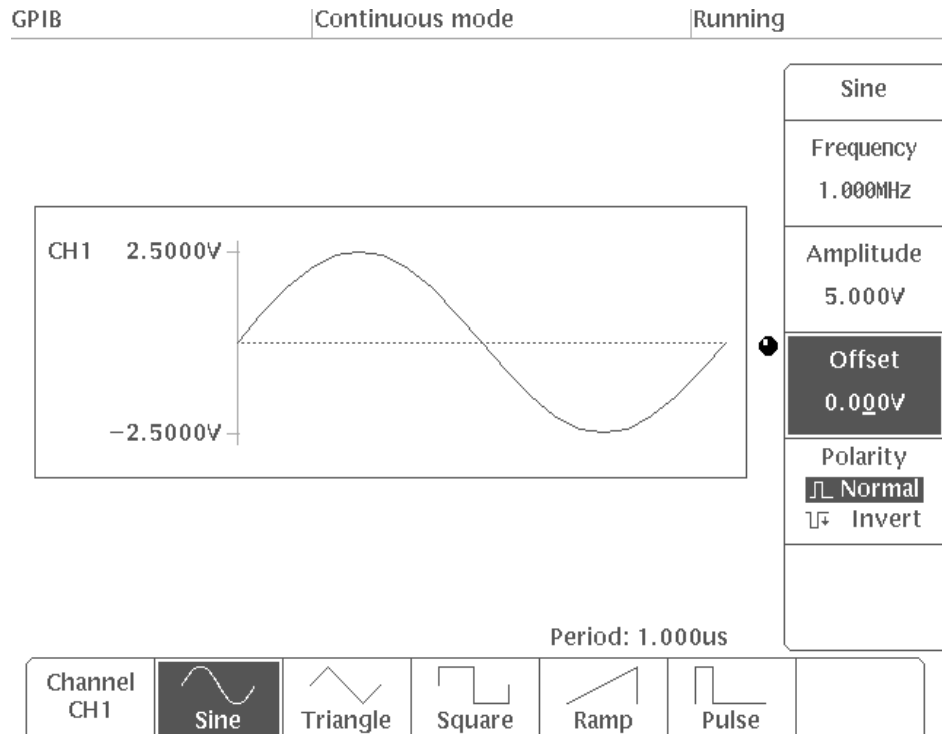

Figure 2 -67: CH1 Output Parameter Setting Display

This completes the sine-wave output parameter setting. Now you will check the actual waveform on the oscilloscope screen.

Waveform Output

Connect the AWG2021 to an oscilloscope with 50 Ω cables and 50 Ω terminations as shown in Figure 2 -68. The waveform output for this instrument is calibrated for a 50 Ω load.

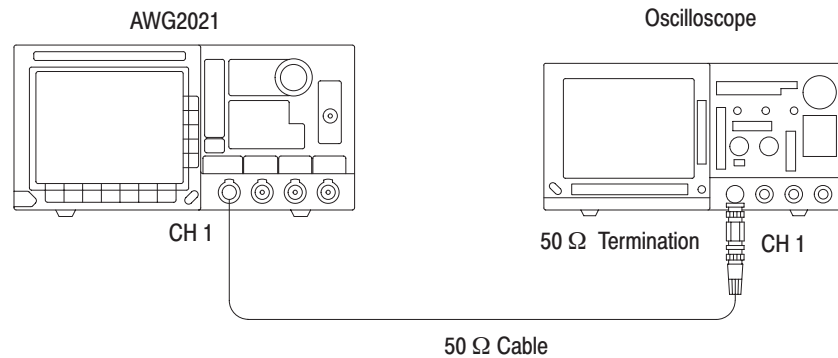

Figure 2 -68: Connections for Example 6

1. Press the front panel **CH1** On/Off button and switch on. The On/Off indicator should light up. In this operation, the waveform outputs continuously from the **CH1** output connector. Set the oscilloscope appropriately to display the waveform on the oscilloscope screen.

This completes the Example 6.

Introduction

Section 3 will describe in detail the functions contained in each of the menus.

EDIT Menu
SETUP Menu
MODE Menu
LOAD/SAVE Menu
UTILITY Menu
FG Menu

Each section will describe menu functions in the following order:

- **Menu Structure.** Each menu will be shown in a diagram listing the menu items from left to right, with the highest menu level on the left and the lowest menu level on the right. There are three types of menus: the bottom menu, the side menu and the sub-menus. An ellipsis (...) in a side menu item indicates that it has a sub-menu. If a menu has many levels, there will be a “Description” section at the beginning which shows the detailed menu configurations for that function.
- **Menu Functions.** This is a list showing the menu functions and the number of the page on which you can find a description of that function.
- **CRT Display.** This shows a typical screen for that menu and a brief explanation.
- **Description.** This section gives a detailed explanation of the functions in each menu. It includes examples with step-by-step instructions showing how the function is used. Menu items in the text are shown in a bold typeface.

Menu Items Available With Each Editing Function

- More** When the side menu consists of two or more pages, this item is used to display the next page. In the example shown at left, the side menu being displayed consists of three pages and the first page is currently being displayed.
- Go Back** This item is displayed when you select a side menu item that has a sub-menu. It allows you to escape from the sub-menu and return to the side menu level. (The **CLEAR MENU** bezel button can also be used for this purpose.)

- Execute** Select this button to execute the currently selected menu function. For example, in the **Draw...** menu, pressing this button will cause the waveform to be drawn; in the **Shift...** menu, it will cause the waveform to move.
- Undo** Select this button to cancel the most previous operation — for example, **Execute**, calculations in the **Math...** sub-menu, or **Marker** settings, or **Cut**, **Paste**, **Insert** or other operation. Pressing **Undo** again will cancel the Undo operation and restore the waveform to the status before **Undo** was pressed.
- O.K.** Select this button to confirm that you really want to perform an operation, or to respond to a query when a popup menu has appeared. A warning message will appear when it is necessary to confirm an operation in this manner. If you are sure you want to execute the operation, press this **O.K.** button.
- Cancel** This button is usually displayed along with the **O.K.** button. Select it when you want to cancel an operation. (You may also use the **CLEAR MENU** bezel button for this purpose.)
- Continue** This item appears in the side menu when a panel containing an error message appears on the screen, or when the **Show Catalog Entry** or **Show Overview** command is used to display a waveform in graphic form. Pressing this button causes the panel to disappear. (You may also use the **CLEAR MENU** bezel button for this purpose.)

EDIT Menu

General Description

To use the AWG2021 to output arbitrary waveforms, you must first create a file for the waveform to be output. There are four file types, each created by a different editor. Files created in this manner will have an extension after the file name that identifies what type of file they are.

Editor	File	Extension
Waveform Editor	Waveform file	.WFM
Equation Editor	Equation file	.EQU
Sequence Editor	Sequence file	.SEQ
Autostep Editor	Autostep file	.AST

NOTE. When option 09 is installed, there are two additional functions: a high-speed convolution function and an FFT editor. These allow you to perform convolution calculations and edit the waveform file within the frequency range.

Pressing the **EDIT** button in the **MENU** causes the initial menu to be displayed. When you want to edit an existing file or create a new file, select the appropriate editor from this initial menu. In this section, we will briefly describe these editors.

Waveform Editor This editor is used to create and edit waveform files. The waveform data display formats are graphic, table, and timing.

Equation Editor This editor is used to create and edit equation files. Equation file data takes the form of mathematical equations. An equation file is compiled to create a waveform file and to output the waveform.

Sequence Editor This editor is used to create and edit sequence files. Sequence files assemble a number of waveforms or sequence files in order.

Autostep Editor This editor is used to create and edit autostep files. Autostep files are created by programming waveforms or sequence files. Each time a trigger is received, the waveform moves on to the next step in this program. Since the output parameters set for each waveform or sequence file are part of the autostep file, the output parameters can change for each waveform.

Initial Menu

To create or edit waveform files, press the **EDIT** button of the **MENU** column to display the initial menu. Figure 3 -1 shows the structure of the initial **EDIT** menu.

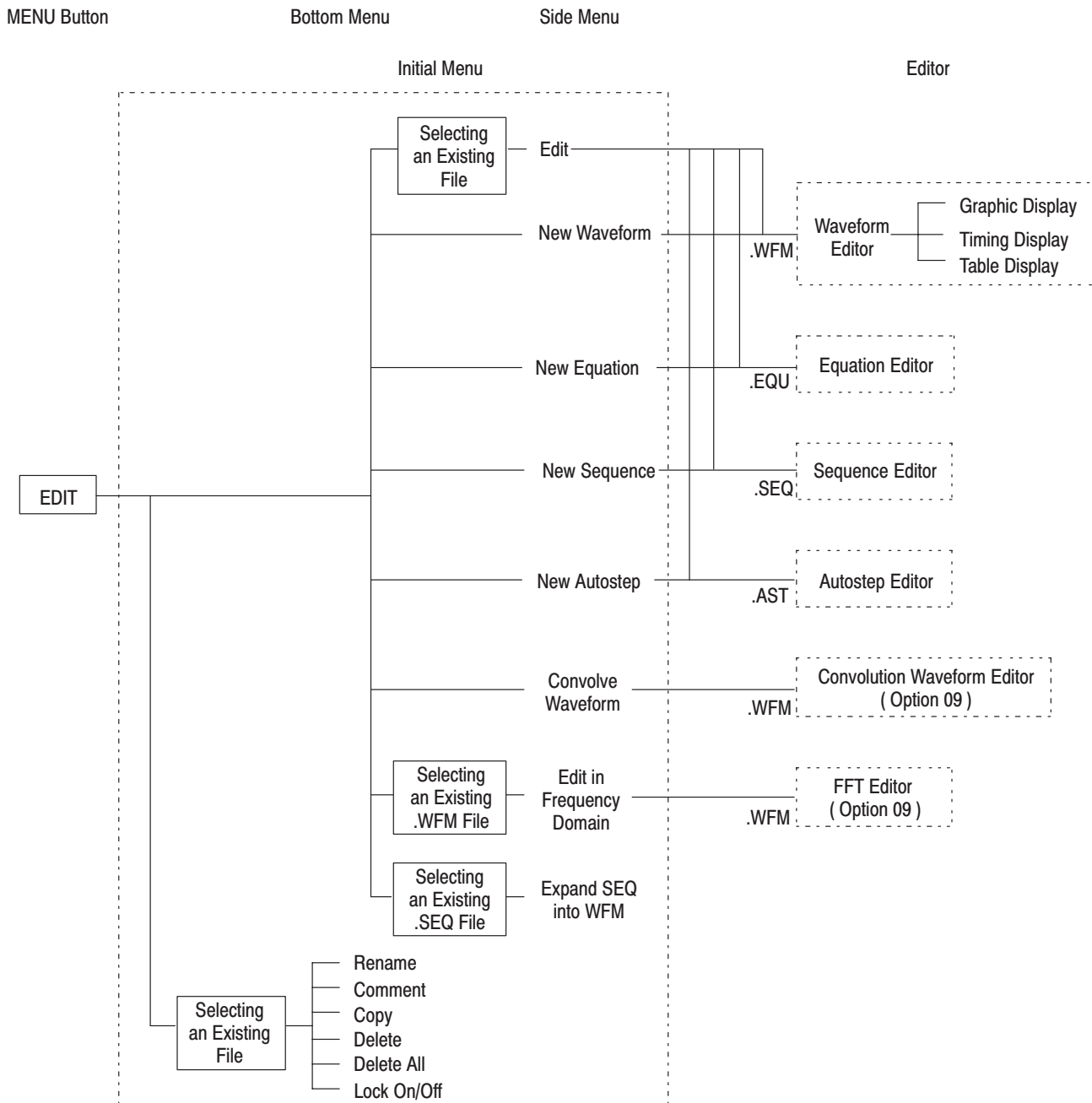

Figure 3 -1: Initial EDIT Menu Structure

Menu Functions The following list shows the functions available for each menu item and the page on which you can find a description of that function.

Table 3-1: Menu Functions

Menu	Function	Page
Edit	Editing an existing file	3 -7
New Waveform	Creating a new file (.WFM)	3 -7
	Waveform editor	3 -14
	Graphic display	3 -23, 3 -29
	Timing display	3 -29, 3 -96
	Table display	3 -29, 3 -129
New Equation	Creating a new file (.EQU)	3 -7
	Equation editor	3 -137
New Sequence	Creating a new file (.SEQ)	3 -7
	Sequence editor	3 -161
New Autostep	Creating a new file (.AST)	3 -7
	Autostep editor	3 -171
Expand SEQ into WFM	Expanding a sequence file into a waveform file	3 -12
Convolve Waveform	Convolution waveform editor (Option 09)	3 -189
Edit in Frequency Domain	FFT editor (Option 09)	3 -195
Rename	Renaming a file	3 -8
Comment	Comment input	3 -10
Copy	Copying a file	3 -10
Delete	Deleting a file	3 -10
Delete All	Deleting a file	3 -10
Lock On/Off	Locking and unlocking files	3 -11

CRT Display Figure 3 -2 shows the initial menu of the **EDIT**. A description for each callout follows.

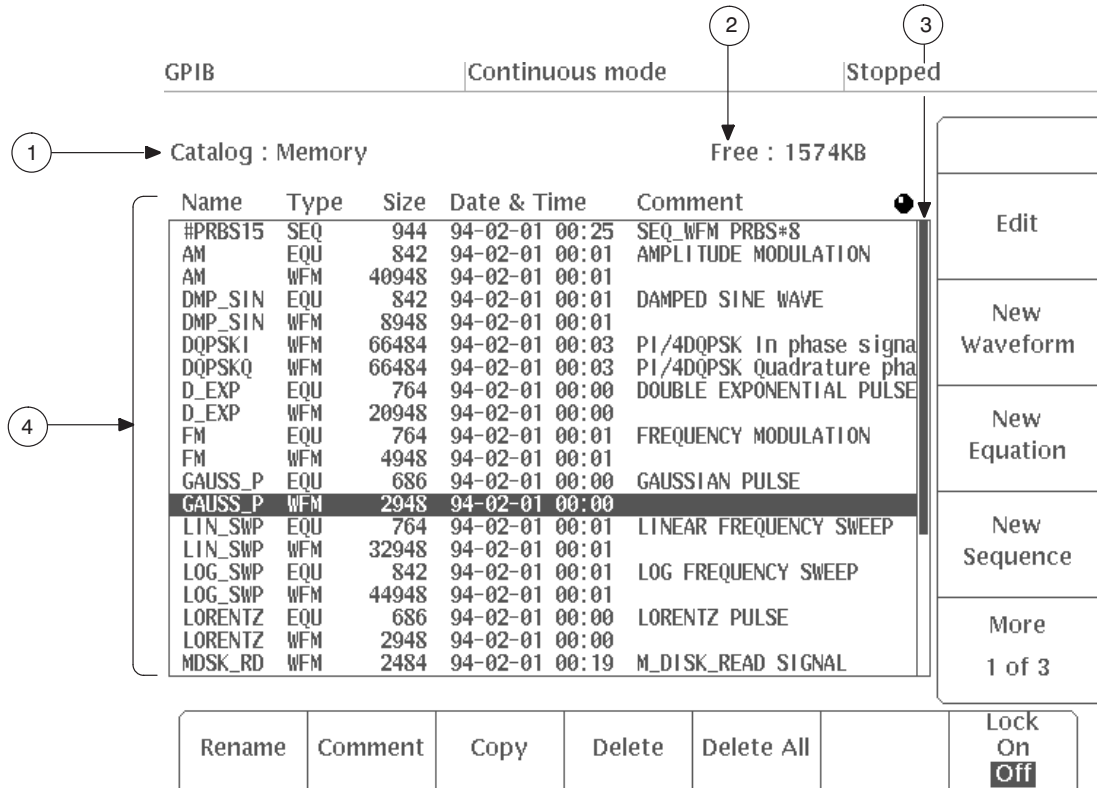

Figure 3 -2: Display of the Initial Menu

(1) Catalog:Memory	The display list shows the files in internal memory.
(2) Free Memory	Available internal memory is indicated.
(3) Scroll Indicator	The file area of memory displayed on the screen is indicated by an inverted display area in the scroll indicator. Up to 20 files can be displayed on the screen. To display more files, scroll the screen up or down by turning the general purpose knob.

(4) File List	<p>This list displays the files in the internal memory of the instrument. The display gives the following information about the file: Name, Type, Size, Date & Time and Comment. Select a file by turning the general purpose knob. The selected file will appear inverted on the display.</p> <p>Name. Files saved in internal memory are displayed in this column.</p> <p>Type. Name extensions of each file are displayed in this column. Name extensions are WFM, EQU, SEQ, and AST. The file is identified by its name extension for each editor.</p> <p>Size. The memory occupied by each file is indicated in bytes.</p> <p>Date & Time. The date and time the file was saved in the internal memory is displayed in this column.</p> <p>Comment. Any comment defined for the file is displayed.</p>
----------------------	--

Creating or Editing a File

Select one of the items from the side menus in the initial menu to create a new file (**New Waveform, New Equation, New Sequence,** or **New Autostep**) or to edit an existing file (**Edit**).

Creating a New File. When a **New** command (**New Waveform, New Equation, New Sequence, New Autostep** or **New Clock Sweep**) is selected, a new file will be created by the appropriate editor.

1. Press the **EDIT** button in the **MENU** column to display the initial menu.
2. Select one of the following editors in the side menu, depending on what type of file you wish to create.

New Waveform	Waveform editor
New Equation	Equation editor
New Sequence	Sequence editor
New Autostep	Autostep editor

To select the autostep editor, select **More** from the side menu in the initial menu and then select **New Autostep** from the second page of the side menu.

3. Select an editor and create the file. The file name in the upper left of the screen has not yet been assigned, so it is ********* extension.

Editing an Existing File. To edit an existing file, select **Edit** and perform the following steps:

1. Press the **EDIT** button in the **MENU** column to display the initial menu.
2. Turn the general purpose knob to select a file from the internal memory file list displayed in the initial menu.

3. Select **Edit** from the side menu. The system automatically enters the editor appropriate for the file-type extension so the selected file can be edited.

Using File Editing Functions

The following operations can be performed for the file that has been created:

Rename	Renaming a file
Comment	Comment input
Copy	Copying a file
Delete	Deleting a file

NOTE. When the file is locked (indicated by an asterisk displayed in front of the file name), it is not possible to change the file name, enter a comment or delete the file. See “Locking and Unlocking Files” in this section.

Renaming a File. The **Rename** item is used to change a file name.

1. Use the general purpose knob to select the file to be renamed from the initial menu file list.
2. Select **Rename** from the bottom menu. The menu for changing the file name is displayed. See Figure 3 -3.

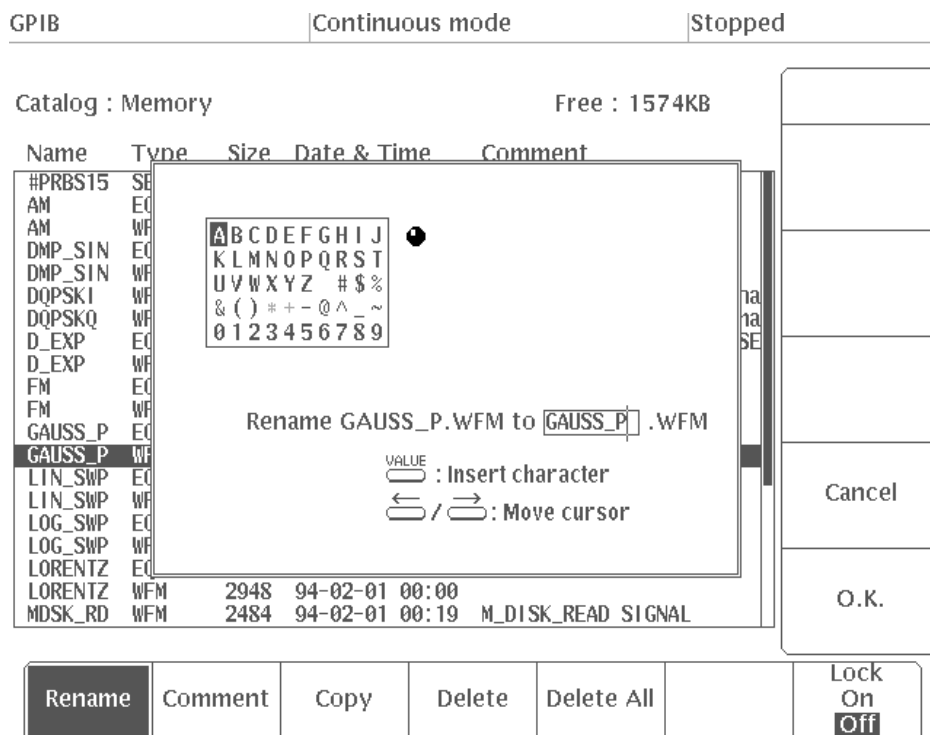

Figure 3 -3: Menu Displayed When Rename is Selected

Before entering the new file name, you must delete the current file name.

3. To delete a character, press the **Delete** button on the front panel. This deletes the character right before the cursor. The cursor can be moved with the front panel ← and → buttons.

Now, input the new file name.

4. Use the general purpose knob to select a character.
5. Press the front panel **VALUE** button. The selected character is inserted immediately before the cursor blinking in the file name input column.
6. Repeat Steps 4 and 5 until the entire name has been entered. Up to 8 characters can be input.

NOTE. The following cannot be used as file names: **CLOCK, CON, AUX, COM1, COM2, LPT1, LPT2, LPT3, NUL, and PRN**. Also, the “ ”, “*”, and “+” characters in the character menu can not be used in file names and cannot be selected.

7. To enter the file name, select **O.K.** To cancel that file name, select **Cancel**.

When **O.K.** is selected, the file is saved into internal memory with the changed file name and displayed in the file list on the CRT screen. Select **O.K.** or **Cancel** to return to the initial menu.

NOTE. *If there is already a waveform file in internal memory with the name the compiled waveform file will be given, a message is displayed asking if you are sure you want to overwrite the old file. Overwriting erases the data in the old file.*

Comment Input. Select **Comment** to input a comment. The input method for the comment is the same as that for **Rename** above. The comment may be up to 24 characters long. All the characters in the character menu can be used.

Copying a File. Select **Copy** to display a menu for inputting the copy destination file name. The input method for the file name is the same as that for **Rename** above.

Deleting a File. Select **Delete** or **Delete All** to delete unnecessary files. **Delete** deletes files in internal memory one at a time; **Delete All** deletes all the files in internal memory.

1. Use the general purpose knob to select the file to be deleted from the file list in the initial menu.
2. Select **Delete** from the bottom menu. This instrument asks you if you are sure you want to delete the selected file. See Figure 3 -4.

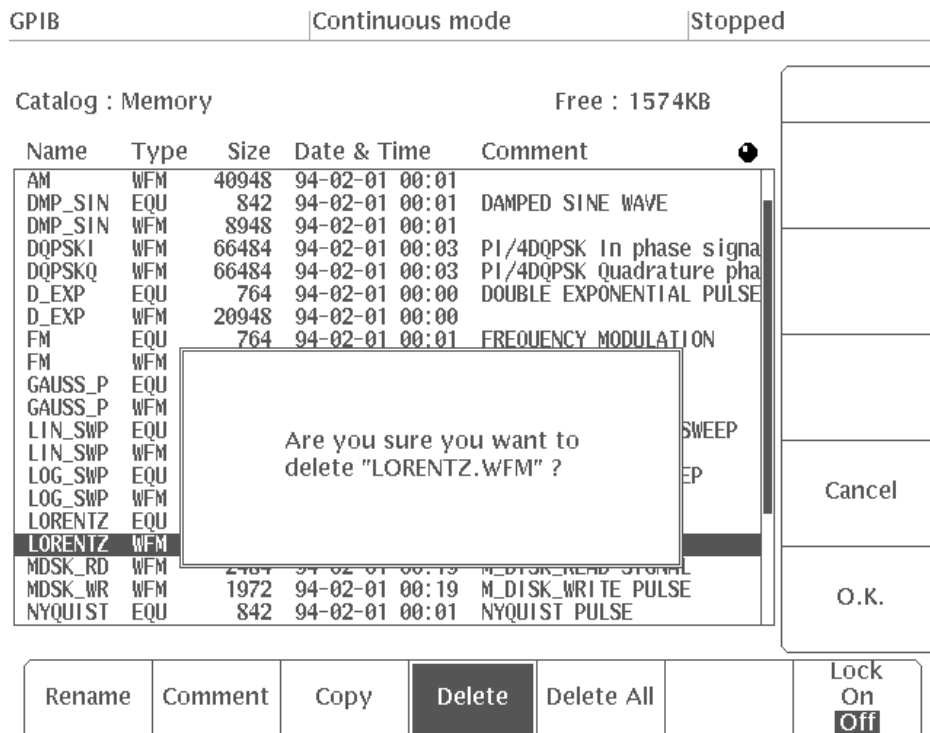

Figure 3 -4: Menu Displayed When Delete is Selected

If you select **O.K.** from the side menu, the file is deleted. If you decide not to delete the file, select **Cancel**. When either **O.K.** or **Cancel** is selected, the system returns to the initial menu.

Locking and Unlocking Files

Select **Lock** to lock or unlock a file. When the file is locked, it is not possible to delete the file or change the file name or the comments for that file.

NOTE. While a locked file can have its output parameters changed with the **SETUP** menu, the original output parameters are retained. Thus, when the locked file is loaded again into waveform memory, the original parameters are set again.

1. Use the general purpose knob to select the file to be locked from the file list in the initial menu.
2. Press the **Lock** bottom menu button. The selected file is locked and **On** is selected for the **Lock** label. Locked files have "*" next to their names in the display. See Figure 3 -5.

GPIB
 Continuous mode
 Stopped

Catalog : Memory
 Free : 1574KB

Name	Type	Size	Date & Time	Comment
#PRBS15	SEQ	944	94-02-01 00:25	SEQ_WFM PRBS#8
AM	EQU	842	94-02-01 00:01	AMPLITUDE MODULATION
*AM	WFM	40948	94-02-01 00:01	
DMP_SIN	EQU	842	94-02-01 00:01	DAMPED SINE WAVE
*DMP_SIN	WFM	8948	94-02-01 00:01	
DQPSKI	WFM	66484	94-02-01 00:03	PI/4DQPSK In phase signal
DQPSKQ	WFM	66484	94-02-01 00:03	PI/4DQPSK quadrature phase
D_EXP	EQU	764	94-02-01 00:00	DOUBLE EXPONENTIAL PULSE
D_EXP	WFM	20948	94-02-01 00:00	
FM	EQU	764	94-02-01 00:01	FREQUENCY MODULATION
*FM	WFM	4948	94-02-01 00:01	
GAUSS_P	EQU	686	94-02-01 00:00	GAUSSIAN PULSE
*GAUSS_P	WFM	2948	94-02-01 00:00	
LIN_SWP	EQU	764	94-02-01 00:01	LINEAR FREQUENCY SWEEP
*LIN_SWP	WFM	32948	94-02-01 00:01	
LOG_SWP	EQU	842	94-02-01 00:01	LOG FREQUENCY SWEEP
*LOG_SWP	WFM	44948	94-02-01 00:01	
LORENTZ	EQU	686	94-02-01 00:00	LORENTZ PULSE
*LORENTZ	WFM	2948	94-02-01 00:00	
MDSK_RD	WFM	2484	94-02-01 00:19	M_DISK_READ SIGNAL

Rename

Comment

Copy

Delete

Delete All

Lock
On
Off

Figure 3 -5: Menu Displayed When Lock is Selected

3. Select **Delete** from the bottom menu. Check to make sure that the words **“File locked.”** is displayed in the message area to indicate that it is not possible to delete the file.
4. If you press the **Lock** bottom menu button again, the file is unlocked and **Off** in the **Lock** label is displayed inverted. Files on a floppy disk or in NVRam can be locked/unlocked in the same manner with the **UTILITY** menu.

Expanding a Sequence File into a Waveform File

The **“Expand SEQ into WFM”** item is displayed when a sequence file has been selected from the file list in the initial menu. It is used to expand a waveform created from a sequence file (.SEQ) into a waveform file (.WFM).

1. Select **More** from the side menu in the initial menu to display the second page of the side menu.
2. Using the general purpose knob, select a sequence file (the file name should end in **.SEQ**) from the file list in the initial menu. The **“Expand SEQ into WFM”** item will appear in the side menu.

3. Select **Expand SEQ into WFM** from the side menu. You will be asked to provide a name for the resulting waveform file. See Figure 3 -6. If necessary, change the default name. See “Renaming a File” described above.

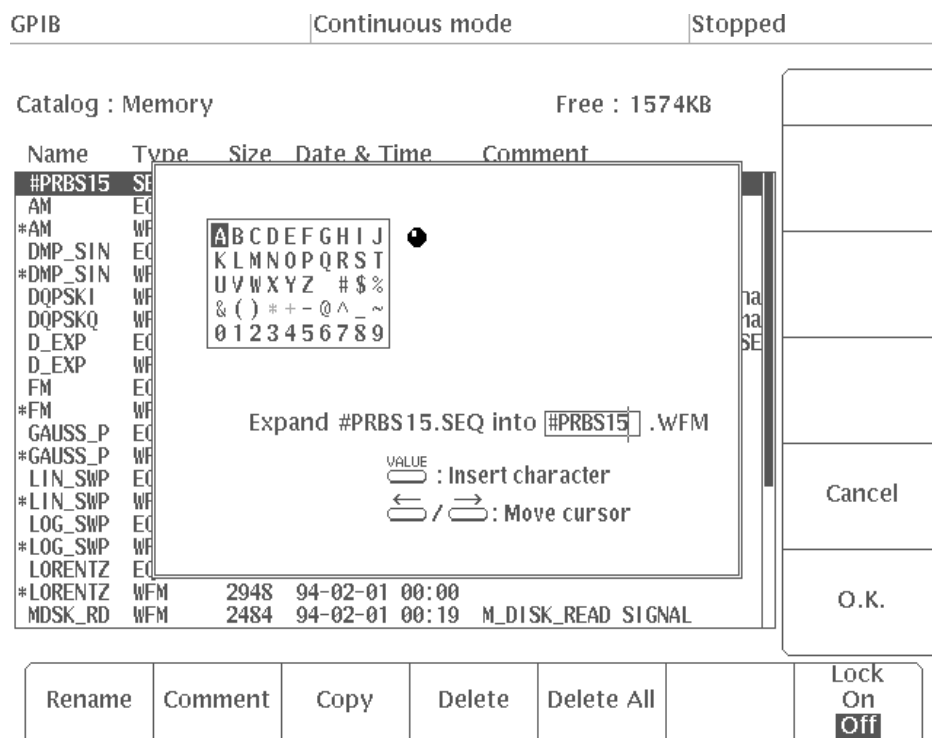

Figure 3 -6: Menu Display When Expand SEQ into WFM is Selected

4. Press **O.K.** to confirm the file name. Press **Cancel** to cancel the operation.

When **O.K.** is pressed, the sequence file will be expanded into a waveform file and the initial menu will reappear. The name of the new file will be added to the file list in the initial menu. If a waveform file with that name already exists, you will be asked whether it is all right to overwrite the existing file with the new data. Be careful when answering this query, as a “yes” will cause the existing data to be deleted and replaced with the new file. Pressing “**Cancel**” will cancel the operation and the initial menu will reappear.

Waveform Editor

Use the waveform editor to create or edit waveform files with the extension of **.WFM**. Waveform files contain waveform data, marker signal data, and the waveform output parameters set with the **SETUP** menu. The waveform data display formats are graphic, table, and timing. The editing functions displayed depend on the data display format.

In the waveform editor, 0 to 4094 in 12-bit resolution on the vertical axis is expressed as -1.0000 to $+1.0000$ (with 4095 as 1.0005). At this level, there is no relationship to the **Amplitude/Offset** setting in the **SETUP** menu used when the waveform is output.

Entering the Waveform Editor

1. Press **EDIT** in the **MENU** column. The initial **EDIT** menu will appear.
2. Select **Edit** or **New Waveform** from the side menu.

Edit Use this command to select and edit an existing waveform file (**.WFM**)

New Waveform Use this command to create a new waveform file

As a result of the procedure described above, the waveform editor will appear on the screen. The waveform editor can be displayed in one of three formats: graphic, timing or table; the default setting is graphic display. Figure 3 -7 shows an example in which an existing waveform file has been selected.

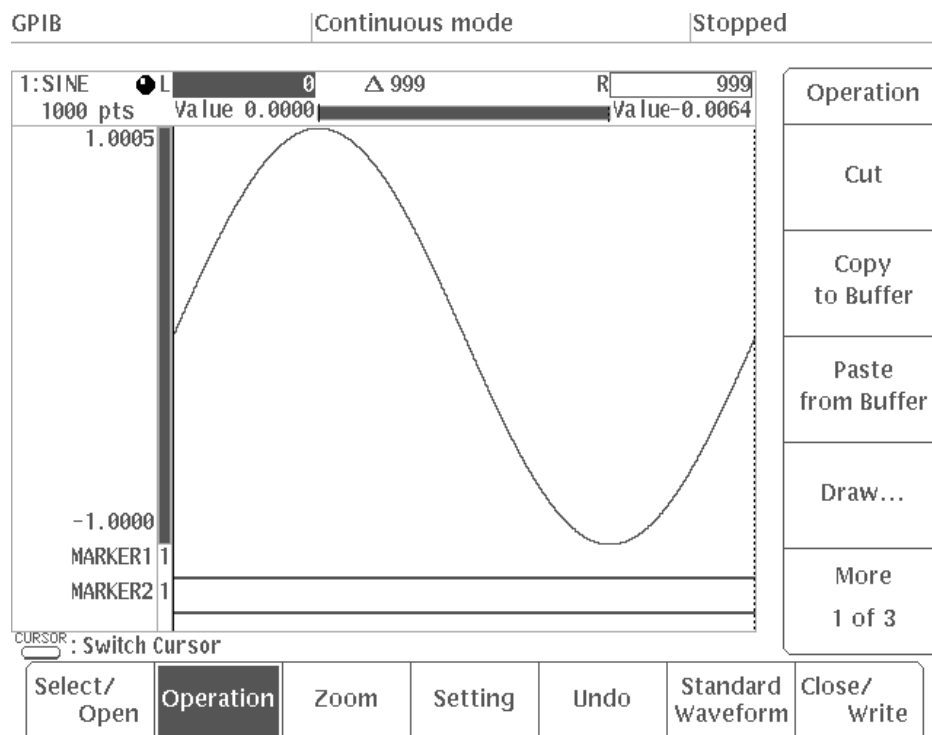

Figure 3 -7: Graphic CRT Display

In graphic display, the waveform is created or edited with the waveform displayed in the waveform editor in graphic display. For details on the different formats, see “Timing Display” and “Table Display”.

Opening and Selecting Editing Areas

Up to three waveforms can be displayed and edited in the waveform editor at the same time. This makes it easy to edit several related waveforms. Figure 3 -8 shows an example in which three waveforms are displayed. In this example, the box around the **Waveform2** area shows that this waveform is selected and is currently being edited.

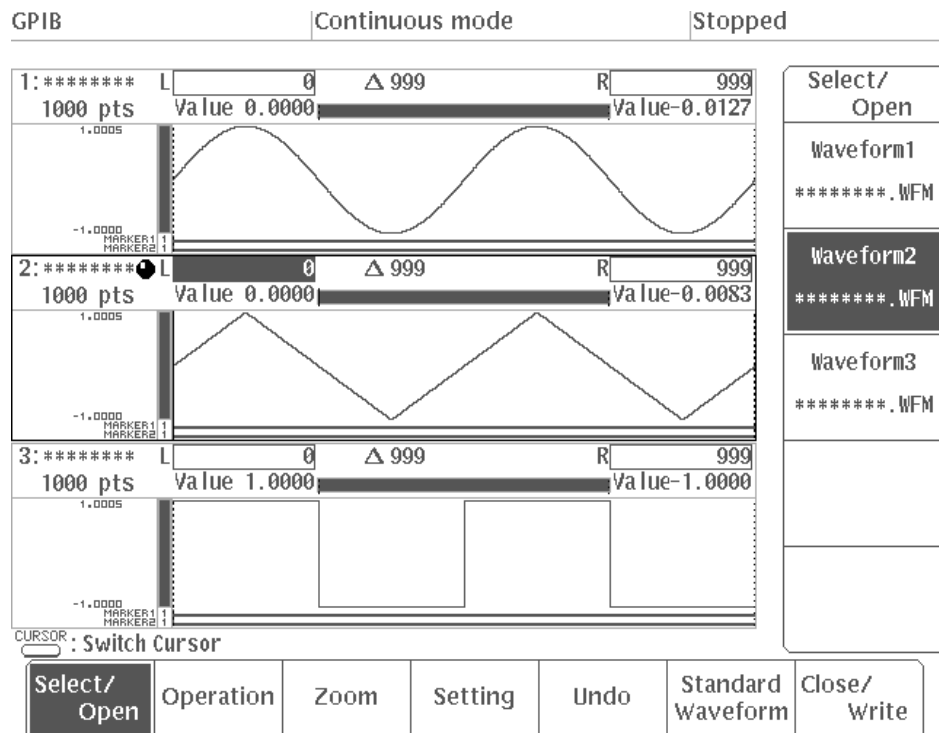

Figure 3 -8: Waveform Editor With Three Editing Areas

When there is more than one waveform displayed in the waveform editor, the following menu items will be added:

- **Cursor Link to...** will be added to the **Setting** menu item. See Page 3 -34.

Cursor Link to.. Used to link the cursors in different editing areas.
- Three additional commands (**Multiple Copy...**, **Convolute...**, **Compare...**) will be added to the **Operation** menu item. See pages 3 -79, 3 -85 and 3 -88, respectively.

Multiple Copy... Used to copy a waveform in one editing area that has been designated with the vertical bar cursors into another editing area (in the space designated with the vertical bar cursors in that area), using the interval specified with Interval.

Convolute... Used to perform convolution calculations for the waveform in one area (in the space designated with the vertical bar cursors) with the part of a waveform in another editing area designated by the vertical bar cursors in that area.

Compare... Used to compare the waveform in the area designated by the vertical bar cursors with the waveform in another editing area.

In this example, you will select three waveforms in the waveform editor. The following procedure starts in the initial **EDIT** menu.

1. Select **New Waveform** from the side menu. The new waveform will be displayed in area 1.
2. Press **Select/Open** from the bottom menu. In the side menu, “**Waveform1**” refers to the waveform file in editing area 1.
3. Select **Another Waveform** from the side menu. A file list will appear, allowing you to select the waveform file to be displayed in editing area 2.

The top item in the list (**New Waveform**) is used to create a new waveform file. The subsequent items are the names of existing waveform files. See Figure 3 -9.

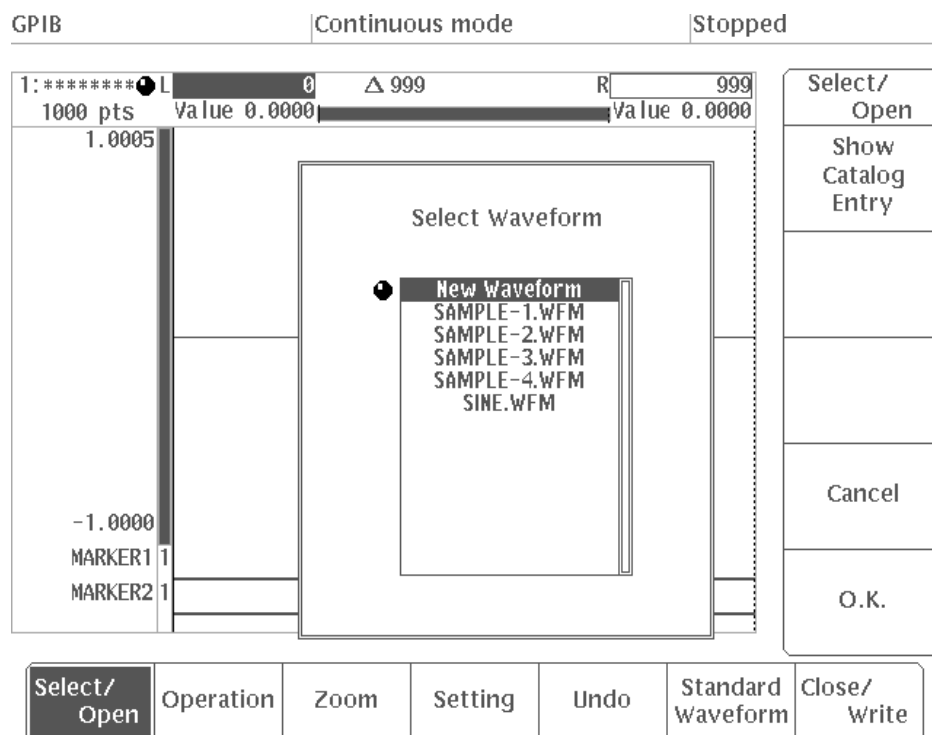

Figure 3 -9: Menu Display When Another Waveform is Selected

4. Using the general purpose knob, select **New Waveform**. The new waveform file created in this step will be assigned to editing area 2.

5. Select **O.K.** from the sub-menu. When this is done, **Waveform2** will be added to the side menu and the **Waveform2** editing area will appear on the screen. See Figure 3 -10.

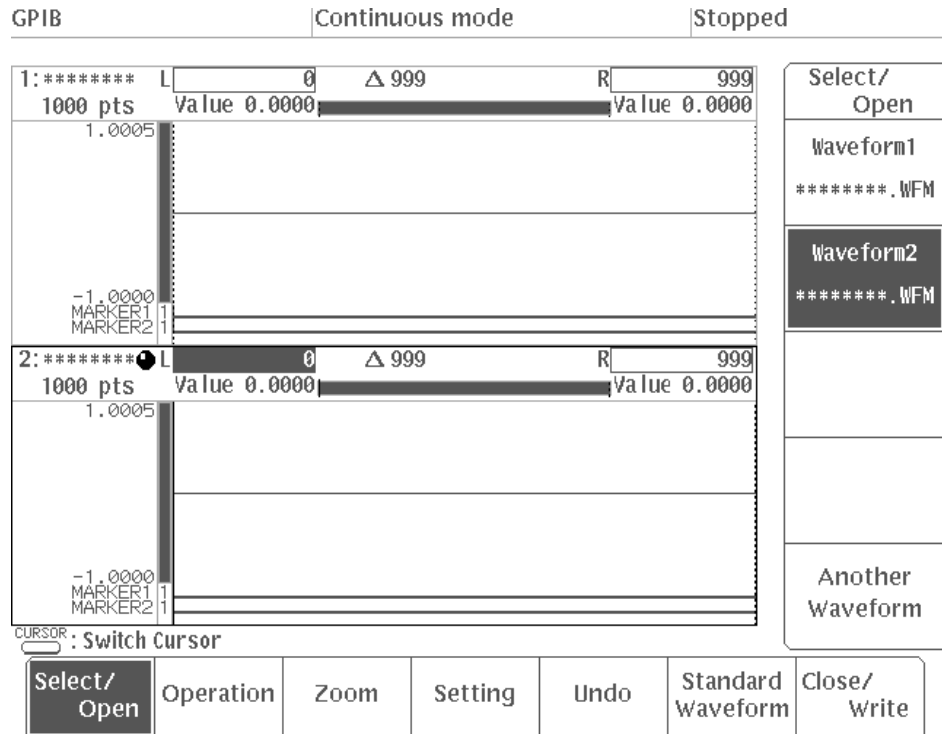

Figure 3 -10: Waveform2 Added

6. Select **Another Waveform** from the side menu.
7. Using the general purpose knob, select a waveform file. In this example, we will select an existing waveform file.
8. Select **Show Catalog Entry** from the sub-menu. This allows you to check the waveform for the selected file on the screen. See Figure 3 -11.

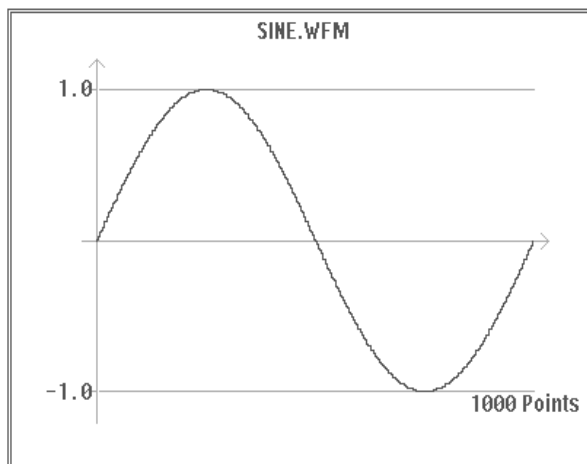

Figure 3 -11: Menu Display When Show Catalog Entry is Selected

9. Select **Continue** from the sub-menu.
10. Select **O.K.** from the sub-menu. **Waveform3** will be added to the side menu and the **Waveform3** editing area will appear on the screen. See Figure 3 -12.

GPIB	Continuous mode	Stopped							
<div style="display: flex; justify-content: space-between;"> <div style="width: 60%;"> <p>1:***** L <input type="text" value="0"/> Δ 999 R <input type="text" value="999"/> 1000 pts Value 0.0000 Value 0.0000</p> </div> <div style="width: 35%; border-left: 1px solid black; padding-left: 5px;"> <p>Select/ Open</p> <p>Waveform1 *****.WFM</p> <p>Waveform2 *****.WFM</p> <p style="background-color: #333; color: white; padding: 2px;">Waveform3 SINE.WFM</p> </div> </div>									
<div style="display: flex; justify-content: space-between;"> <div style="width: 60%;"> <p>2:***** L <input type="text" value="0"/> Δ 999 R <input type="text" value="999"/> 1000 pts Value 0.0000 Value 0.0000</p> </div> <div style="width: 35%; border-left: 1px solid black; padding-left: 5px;"> <p>Waveform3 SINE.WFM</p> </div> </div>									
<div style="display: flex; justify-content: space-between;"> <div style="width: 60%;"> <p>3: SINE ● L <input type="text" value="0"/> Δ 999 R <input type="text" value="999"/> 1000 pts Value 0.0000 Value -0.0064</p> </div> <div style="width: 35%; border-left: 1px solid black; padding-left: 5px;"> </div> </div>									
<p>CURSOR : Switch Cursor</p> <table border="1" style="width: 100%; border-collapse: collapse; text-align: center;"> <tr> <td style="background-color: #333; color: white;">Select/ Open</td> <td>Operation</td> <td>Zoom</td> <td>Setting</td> <td>Undo</td> <td>Standard Waveform</td> <td>Close/ Write</td> </tr> </table>			Select/ Open	Operation	Zoom	Setting	Undo	Standard Waveform	Close/ Write
Select/ Open	Operation	Zoom	Setting	Undo	Standard Waveform	Close/ Write			

Figure 3 -12: Waveform3 Added

The three waveform items (**Waveform1**, **Waveform2** and **Waveform3**) will be displayed in the side menu. You will select the waveform to be edited from these items.

11. Select **Waveform2** from the side menu. A box will appear around the editing area to indicate that this waveform has been selected.

To close a waveform, once again select that **Waveform** from the side menu and then select **Close/Write** from the bottom menu. See “Saving Files and Exiting the Editor” in this section.

Saving Files and Exiting the Editor

When you select **Close/Write** from the bottom menu, the newly created or edited file currently selected in the side menu will be saved to the instrument’s internal memory and the waveform editor will disappear.

NOTE. *The procedure for saving files and exiting the editor is the same for all editors. The only difference is that the **Close/Write** item in the waveform editor changes to **Exit/Write** in the other editor. (The word “**Close**” is used in the waveform editor because more than one waveform is opened in this editor.)*

Select **Close/Write** from the bottom menu to display a side menu containing **Write and Close**, **Close without Writing**, and **Write** menu items. These functions are explained next.

Write and Close. When a new file is created, if you select **Write and Close**, a menu for naming the file is displayed. Input the file name, then select **O.K.** from the sub-menu. The file is saved into internal memory with that name and the system returns to the initial menu. If **Cancel** is selected, the input file name is canceled and the system returns to the editor.

When you exit the editor after editing an existing file and you select **Write and Close**, the menu for naming the file is not displayed. Instead, the system immediately returns to the initial menu and the file created in internal memory is saved with the existing file name.

Close without Writing. When this item is selected, the system returns to the initial menu without saving the created or edited file to internal memory. In this case, a message asking you if it is ok to erase the created data is displayed on the CRT screen. Reply **O.K.** or **Cancel**.

Write. When **Write** is selected, the file name menu is displayed. If you input or change the file name, then select the sub-menu **O.K.** item, the created or edited waveform data is saved into internal memory with that file name and the system returns to the editor it has been in. If the file name is changed, the old file is left

as is and a new file is created with the new file name. If you select **Cancel**, the input file name is canceled and the system returns to the editor without saving the data into internal memory. Although the created or edited data is not saved at this time, it is retained for further editing.

Naming a File

When saving a newly created file, a file name must be created. The menu for creating a file name is the same for all the editors.

1. Select **Close/Write** from the bottom menu.
2. Select **Write and Close** from the side menu. Figure 3 -13 shows the menu with the file name.

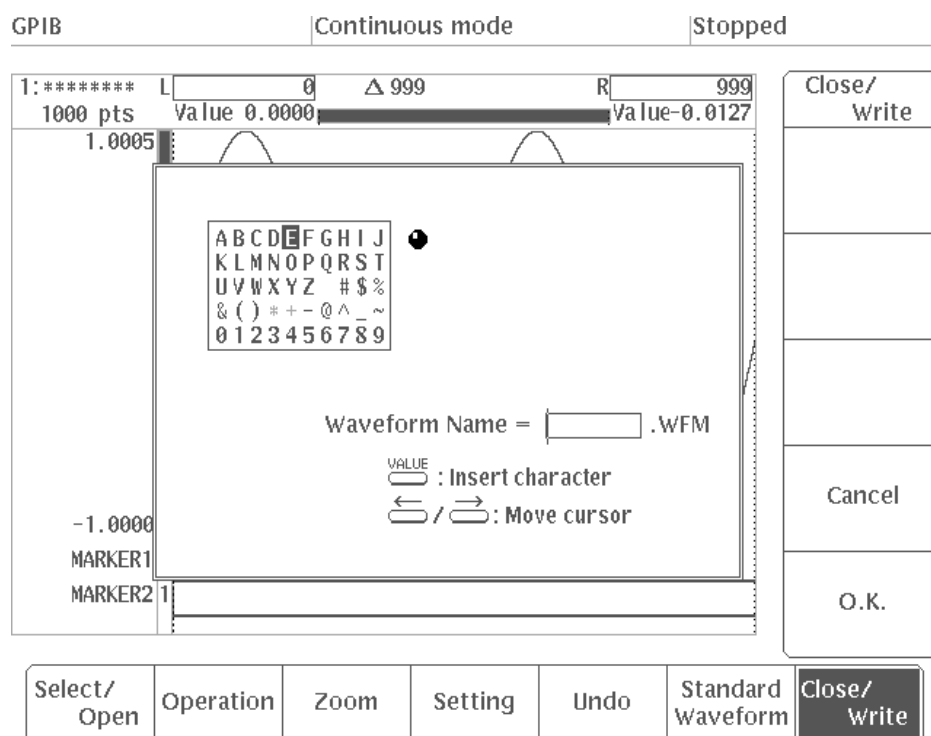
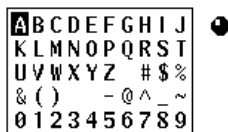

Figure 3 -13: Menu With File Name

NOTE. When no editing has been performed in the editor, selecting the **Write and Close** item will not cause the menu used to enter the file name to appear; the initial menu will reappear instead.

Now, input the file name.

3. Use the general purpose knob to select a character.



4. Press the front panel **VALUE** button. The selected character is inserted immediately before the cursor.

Waveform Name = .WFM

5. Repeat Steps 3 and 4 until the entire file name has been entered. In this example, we will enter the name **SAMPLE**.

Waveform Name = .WFM

Up to 8 characters can be input. To delete a character, press the Delete button on the front panel. This deletes the character right before the cursor. The cursor can be moved with the front panel ← and → buttons.

NOTE. The following can not be used as file names: **CLOCK, CON, AUX, COM1, COM2, LPT1, LPT2, LPT3, NUL, and PRN**. Also, the “ ” and “*” and “+” characters in the character menu can not be used in file names and can not be selected.

6. To enter the file name, select **O.K.** To cancel that file name, select **Cancel** from the side menu.

When **O.K.** is selected, the file will be saved to the internal memory under the file name that has been entered and the initial menu will reappear. The new file name will be displayed in the file list in the initial menu. If **Cancel** is selected, the name that has been entered will be disregarded and the editor screen will reappear.

NOTE. If there is already a waveform file in internal memory with the name the complied waveform file will be given, a message is displayed asking if you are sure you want to overwrite the old file. Overwriting erases the data in the old file.

Graphic Display

In graphic display, the waveform is displayed in graphic form in the waveform editor and it is created or edited in that form. The horizontal axis indicates time or number of points, while the vertical axis indicates the levels. Waveforms are displayed at each data point in 12-bit resolution. On the beneath the waveform, the on/off state of the marker signal is displayed in timing form. All editing operations are performed between the two vertical bar cursors.

Figure 3 -14 is a diagram showing the menu structure for the waveform editor in graphic display. This is not a complete list; for a complete list, see the diagram at the beginning of the section on each menu. An ellipsis (...) next to an item in the side menu indicates that there is a sub-menu below that item listing additional choices. Commands in the sub-menu are executed with the **Execute** command; when **Go Back** is selected, the sub-menu disappears and the side menu reappears.

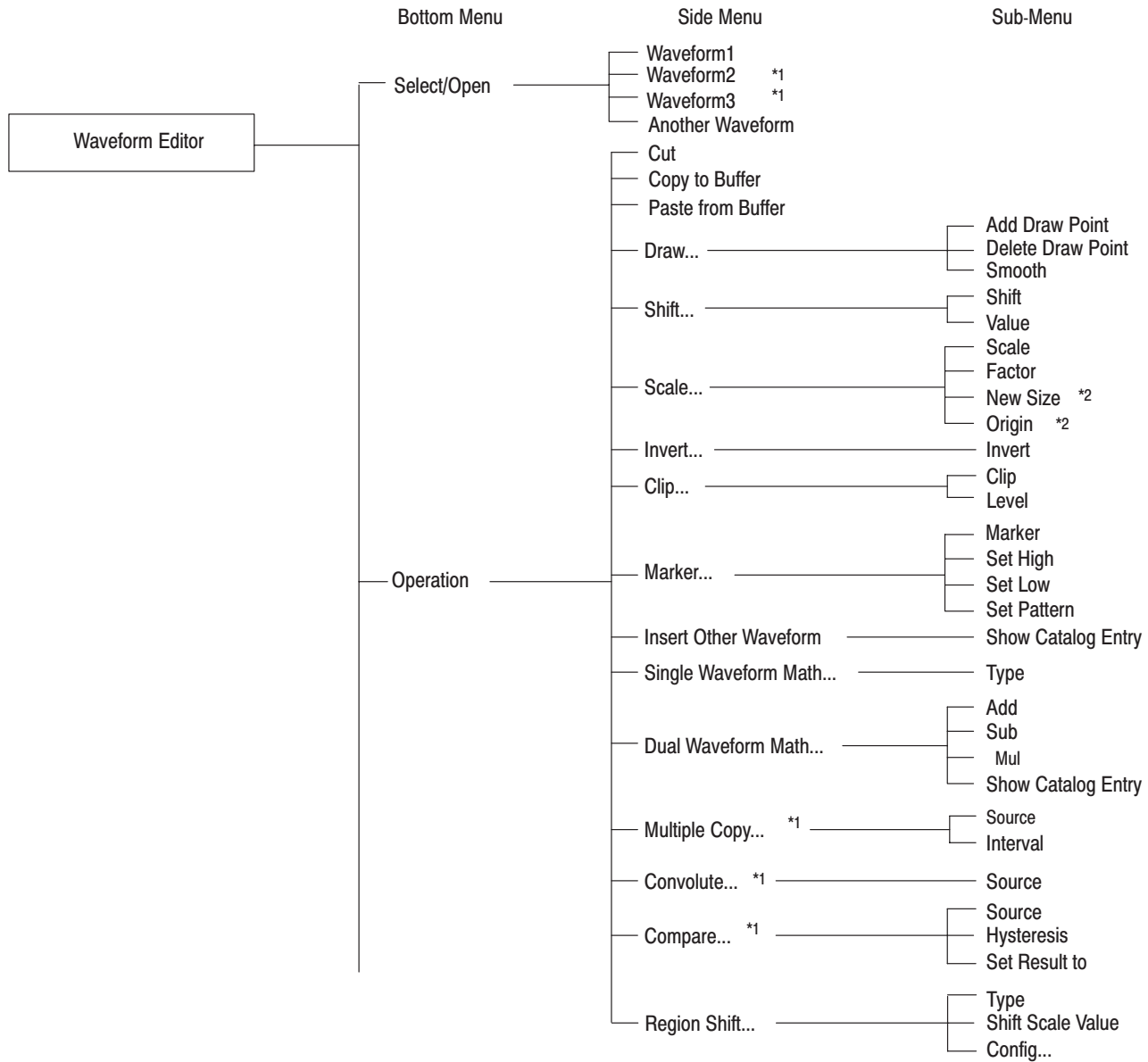
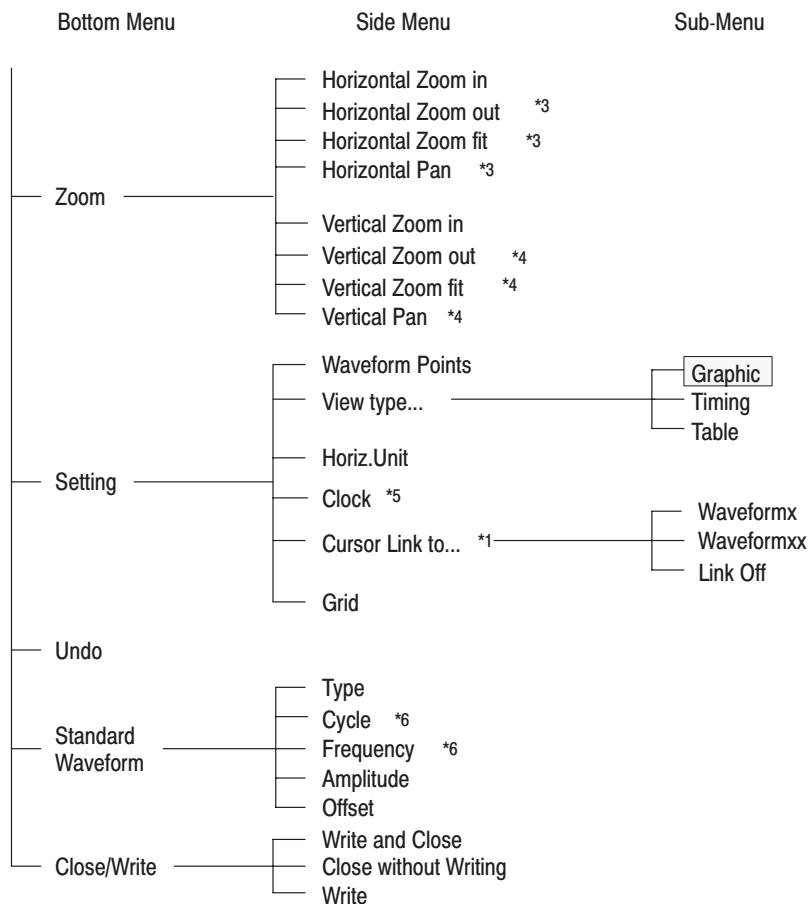

Figure 3 -14: Waveform Editor Graphic Display Menu Structure



- *1 Another Waveform under Select/Open in the bottom menu appears when another editing area has been edited.
- *2 If Horizontal is selected for Scale in the sub-menu, New Size appears; if Vertical is selected, Origin appears.
- *3 The Horizontal Zoom in item under Zoom in the bottom menu item appears when the waveform on the screen has been zoomed in the horizontal direction.
- *4 The Vertical Zoom in item under Zoom in the bottom menu appears when the waveform on the screen has been zoomed in the vertical direction.
- *5 This item appears when Time has been selected for Horiz. Unit in the side menu.
- *6 If Point is selected for Horiz. Unit under Setting in the bottom menu, Cycle appears; if Time is selected for this item, Frequency appears.

Figure 3 -14: Waveform Editor Graphic Display Menu Structure (Cont.)

Menu Functions

The following list describes the functions for each of the menu items and gives the number of the page on which you can find a more detailed explanation of that item.

Table 3-2: Menu Functions

Menu	Function	Page
Select /Open	Opening and selecting the editing area	3 -15
Operation	Editing waveforms in graphic display	3 -41
Cut	Cutting waveforms	3 -43
Copy to Buffer	Copying waveforms	3 -44
Paste from Buffer	Pasting waveforms	3 -44
Draw...	Draw function	3 -46
Shift...	Shift function	3 -49
Scale...	Scaling function	3 -52
Invert...	Invert function	3 -55
Clip...	Clip function	3 -56
Marker...	Setting a marker	3 -57
Insert Other Waveform	Inserting other waveforms	3 -60
Single Waveform Math...	Single waveform calculations	3 -63
Dual Waveform Math...	Calculations with other waveform data	3 -68
Region Shift...	Specified region shift	3-71
Multiple Copy...	Convolution calculations	3 -85
Convolute...	Comparing waveforms	3 -88
Compare...		
Zoom	Zooming waveforms	3 -92
Setting	Settings for the waveform to be edited	3 -28
View type...	Selecting the waveform data display format	3 -29
Waveform Points	Setting waveform point count	3 -29
Horiz. Unit	Setting horizontal axis units	3 -31
Clock	Setting clock frequency	3 -32
Cursor Link to...	Linking the vertical bar cursors	3 -34
Grid	Displaying a grid in the editing area	3 -35
Undo	Canceling function execution	3 -2

Table 3-2: Menu Functions (Cont.)

Menu	Function	Page
Standard Waveform	Creating a standard function waveform	3 -37
Close/Write	Saving files and exiting the editor	3 -20

Graphic Display Screen

The general graphic display is shown in Figure 3 -15. A description for each callout follows.

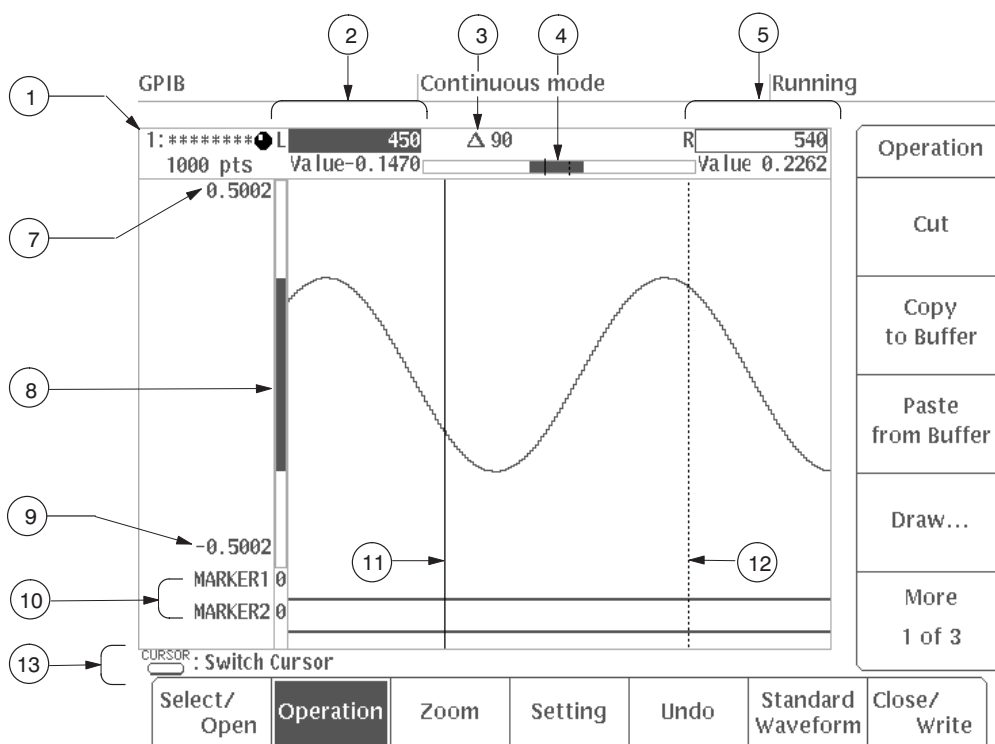



Figure 3 -15: Graphic Display Screen

(1) File Name	The name of the waveform file being edited. The number preceding the file name indicates the sequential number of that editing waveform. In this editor, up to three waveforms can be displayed and edited at the same time. If the name has not been set, ***** is displayed.
(2) L Value	Shows the left vertical bar cursor position time or point value (L) and the vertical level (Value). When the cursor value is displayed inverted, this means the cursor value can be changed with the general purpose knob or numeric keys.

(3) Δ	Shows the time or point count between the left and right vertical bar cursors.
(4) Horizontal Scroll Indicator	When the display is magnified horizontally with Zoom , this indicator is displayed to show where waveform point positions are in the CRT display area. The area displayed on the CRT is shown with inverted display.
(5) R Value	Shows the right vertical bar cursor position time or point value (R) and the vertical level (Value).
(6) No. of Waveform Points	Shows the number of points in the waveform being edited.
(7) Top Waveform Level	Shows the top level for the waveform data displayed on the CRT.
(8) Vertical Scroll Indicator	When the display is magnified vertically with Zoom , this indicator is displayed to show where the CRT display area is in terms of the vertical axis full scale. The area displayed on the CRT is shown with inverted display.
(9) Bottom Waveform Level	Shows the bottom level for the waveform data displayed on the CRT.
(10) Marker	Shows the timing for the marker signals 1 and 2. The number to the right of the word " MARKER " indicates the state value for the marker at which the active vertical bar cursor (the one displayed with a solid line) locates.
(11) Left Vertical Bar Cursor	The active cursor is displayed with solid lines and the non-movable is displayed with broken lines. The left cursor indicates the left starting point for editing.
(12) Right Vertical Bar Cursor	Indicates the right end point for editing.
(13) Button Operations	<p>This area shows how the front panel buttons operate in this menu.</p> <p> : Switch Cursor</p> <p>Press the CURSOR button to toggle the active vertical bar cursor between left and right.</p> <p> : Move Cursor</p> <p>The vertical bar cursor can be moved by pressing the CURSOR button.</p>

Settings for the Waveform to be Edited

Before waveform data is created, you must use the **Setting** item in the side menu to select the environment for editing. The following settings are available:

- View type... Selecting the waveform data display format
- Waveform Points Setting waveform point count
- Horiz. Unit Setting horizontal axis units
- Clock Setting clock frequency

Cursor Link to...	Linking the vertical bar cursors
Grid	Displaying a grid in the editing area

NOTE. *These settings are the same in all display formats (graphic, timing and table).*

In the following section, each of these items will be discussed in detail.

Selecting the Waveform Data Display Format. The **View type...** item allows you to set the display format for the waveform data. There are three choices: graphic, timing and table. The following diagram shows the menu configuration.

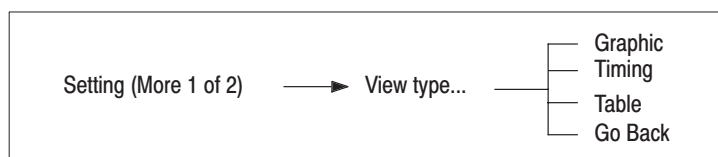

When you open the waveform editor, **Graphic** display is selected as the default option. If you want to change the display format, select **Setting** from the bottom menu and then **View type** from the side menu, then select the desired format (**Timing** or **Table**) from the sub-menu. Pressing the **Go Back** button cancels the operation and causes the side menu to reappear. See page 3 -96 for a discussion of timing display and page 3 -129 for a discussion of table display.

Setting Waveform Point Count. **Waveform Points** sets the number of points for waveform data. The following diagram shows the menu configuration.

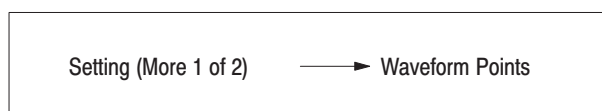

The following formula is used to derive the number of points per period for the waveform to be created:

$$\text{No of points} = \frac{\text{Clock frequency}}{\text{Frequency of output waveforms}}$$

For example, for output of a 20 kHz sine wave, setting the clock frequency to 20 MHz will result in a waveform point value of 20 MHz / 20 kHz = 1000 points.

When you create a new waveform file, the waveform point size is set to the default value of 1000. Technically, you can change this size to any value up to 262,144 points and edit the waveform data as desired. However, due to hardware limitations, the waveform point size on this instrument is limited to 64 – 262,144 points and to the multiple of 8. In the event that you have edited the data to a waveform point size outside this range, you will be given an opportunity to change to the nearest allowable size (in other words, 64 – 262,144 points and the multiple of 8) when you save the file.

- When the waveform point size is less than 64 points:

For example, if the waveform point size is 10 points, the following message will appear:

The data size does not fit to this instrument.
 size = 10 < 64 (Minimum)
 Please select action.

The following items will be displayed in the side menu:

- | | |
|--------------------------|--|
| Append 0 | “0” (7FF) values will be added after the data until a size of 64 points is reached. |
| Expand | The data will be interpolated and expanded to make it 64 points. |
| Expand with Clock | The data will be interpolated and expanded to make it 64 points, and the clock will be speeded up to the same degree. |
| Cancel | The operation will be canceled and the editor screen will reappear. |
| Leave as it is | The operation will be canceled and the data will be written as is. The file that has been created cannot be output on this instrument. |

- When the waveform point size is not the multiple of 8:

For example, if the waveform point size is 500 points which is not a multiple of 8, the following message will appear:

The data size does not fit to this instrument.
 It must be multiple of 8.
 Please select action.

The following items will be displayed in the side menu:

Append 0	“0” (7FF) values will be added after the data until a size of a multiple of 8 is reached.
Expand	The data will be interpolated and expanded to make it a multiple of 8.
Expand with Clock	The data will be interpolated and expanded to make it a multiple of 8, and the clock speed will increase proportionately.
Cancel	The operation will be canceled and the editor screen will reappear.
Leave as it is	The operation will be canceled and the data will be written as is. The file that has been created cannot be output on this instrument.

Select the appropriate command from the side menu and change the waveform point size.

If the data point count is set longer than the current waveform data, new points with a value of zero are added at the right end of the waveform. On the other hand, if the data point count is set shorter than the current waveform data, points are deleted from the right end.

To set the waveform point value to 512:

1. Select **Setting** from the bottom menu.
2. Select **Waveform Points** from the side menu.
3. Use the numeric keys or the general purpose knob to enter a value of 512.

In the case of the numeric keys, press **5, 1, 2** and **ENTER** in that order.

Setting Horizontal Axis Units. **Horiz. Unit** sets the units for the horizontal axis for the displayed waveform in either time or number of points. The following diagram shows the menu configuration.

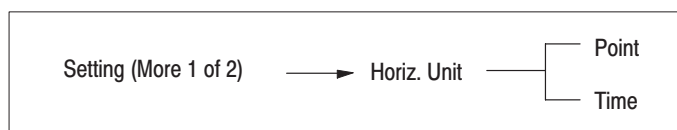

Each time the **Horiz. Unit** button in the side menu is pressed, the units toggle between **Time** and **Point**. When **Time** is selected, the **Clock** item is added to the side menu and the clock frequency can be set.

Time Sets the horizontal axis unit to time. The cursor position data at the top of the CRT is displayed in time and data can be edited in time units.

Point Sets the horizontal axis unit to points. The cursor position data at the top of the CRT is displayed in points and data can be edited in points.

In Figure 3 -16, the display on the left shows the horizontal axis unit set to **Point**, while the display on the right shows this value set to **Time**.

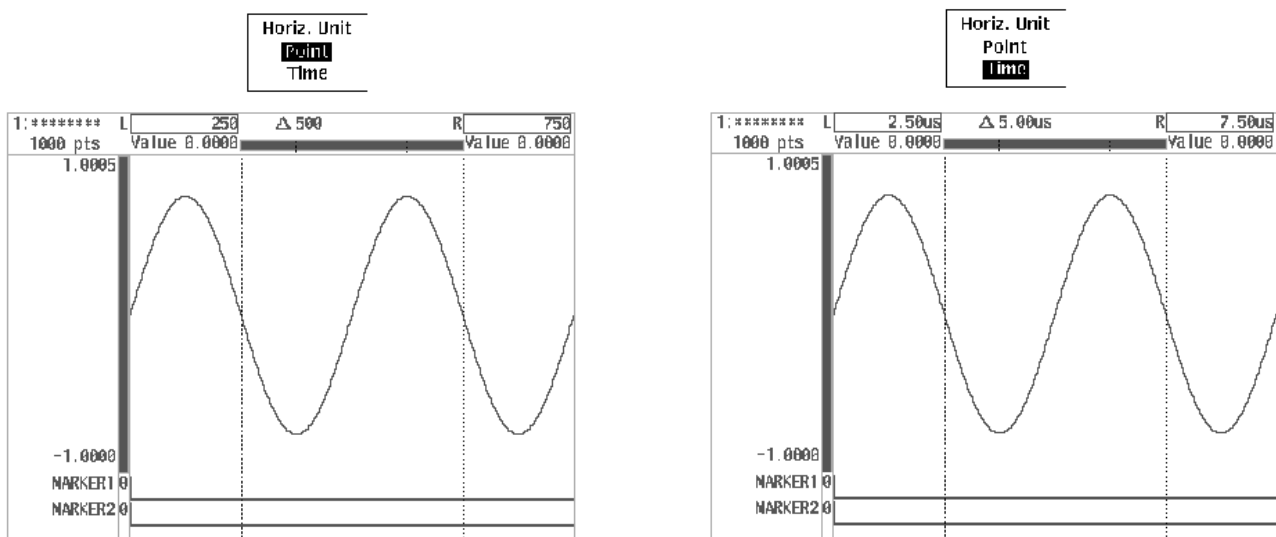
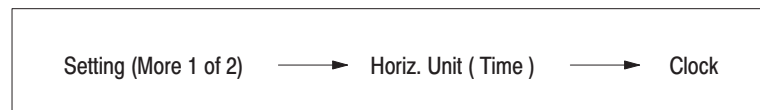

Figure 3 -16: Setting the Unit for the Horizontal Axis

When the horizontal axis unit is changed, even if you switch to table or timing display mode, the horizontal axis there is changed too.

Setting Clock Frequency. When the unit of the horizontal axis is **Time**, the clock frequency can be set. The following diagram shows the menu configuration.



Select **Clock** from the side menu to set the clock frequency. This parameter determines the time between the data points (the inverse of the clock frequency). For example, when the maximum clock frequency on the AWG2021 is set to

250 MHz, waveform data can be edited at a resolution of 4 ns. Figure 3 -17 shows the **Setting** menu for **Clock**.

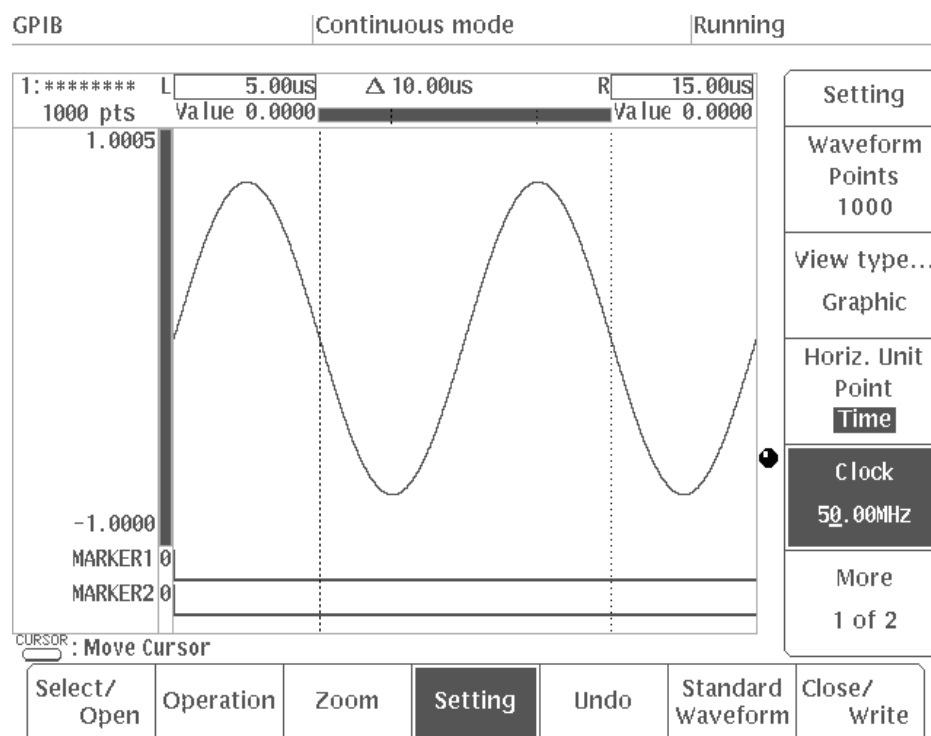

Figure 3 -17: Menu Displayed When Clock is Selected

1. Select **Setting** from the bottom menu.
2. Press the **Horiz. Unit** button in the side menu to select **Time**.
3. Select **Clock** from the side menu.
4. Input the clock frequency with the numeric keys or the general purpose knob.

The default setting for clock frequency is 100 MHz. The clock frequency set in this process will be displayed in the **Internal Clock** item in the **SETUP** menu via the waveform file. When the clock frequency is changed, even if you switch to table or timing display mode, the clock frequency there is changed too.

Linking the Vertical Bar Cursors. The **Cursor Link to...** item appears when two or more waveforms are being edited simultaneously. This item is used to link the movement of the vertical bar cursors in different editing areas. For example, when the cursors in editing area 1 are linked to those in editing area 2, moving the one of the cursors in editing area 1 will cause the corresponding cursor in

editing area 2 to move the same distance. The following diagram shows the menu configuration.

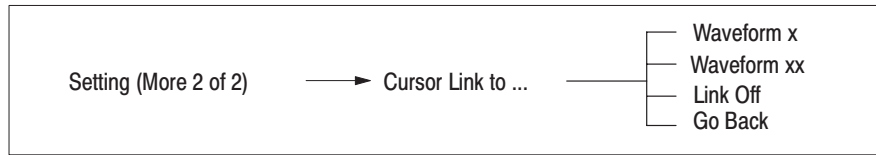

Figure 3 -18 shows a display in which two editing areas have been created and **Cursor Link to...** in the sub-menu has been selected.

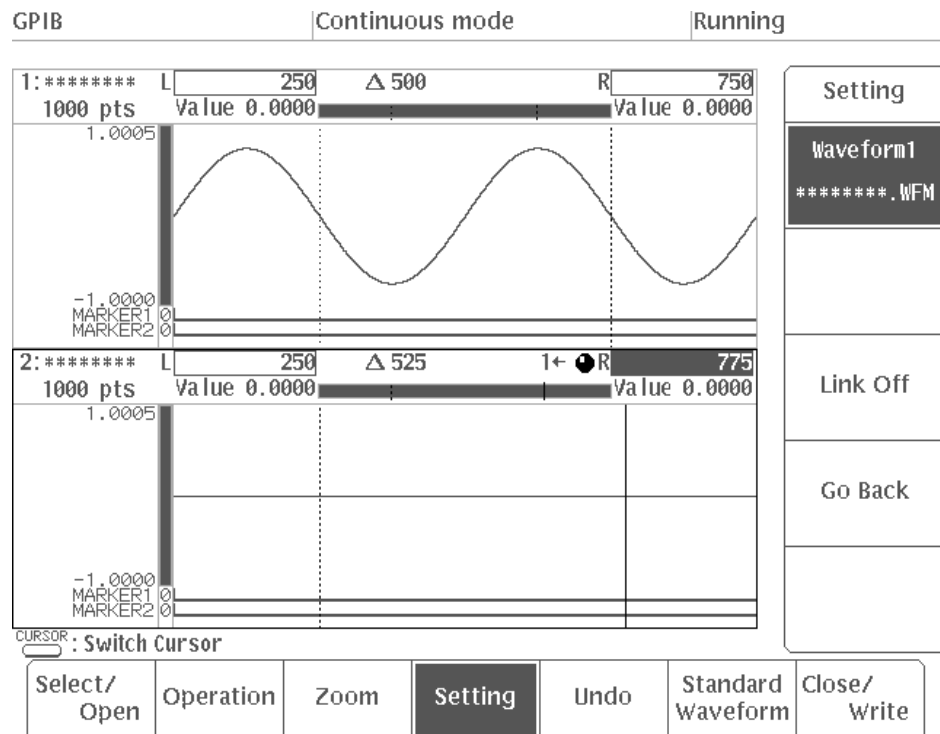

Figure 3 -18: Sub-Menu Showing Cursor Link to... Selected

The **1←** at the top of editing area 2 indicates that this area has been linked to editing area 1.

In the following procedure, you will link the vertical bar cursors in editing area 2 (**Waveform2**) to the ones in editing area 1 (**Waveform1**) while editing area 1 is being edited.

1. Select **Select/Open** from the bottom menu.

2. Select **Waveform2** from the side menu.
3. Select **Setting** from the bottom menu.
4. Select **More 1 of 2** from the side menu and then select **Cursor Link to...**
5. Select **Waveform1** from the sub-menu. **1←** will appear at the top of editing area 2.
6. Select **Go Back** from the sub-menu. The **Setting** side menu will reappear.
7. Select **Select/Open** from the bottom menu.
8. Select **Waveform1** from the side menu.
9. Press the front panel **CURSOR** button.
10. Using the general purpose knob, move the active vertical bar cursor in editing area 1 and check to make sure that the vertical bar cursor in editing area 2 moves to the same degree.

In the following procedure, you will unlink the editing areas that you linked in the previous example while the waveform in editing area 1 is being edited.

1. Select **Select/Open** from the bottom menu.
2. Select **Waveform2** from the side menu.
3. Select **Setting** from the bottom menu.
4. Select **More 1 of 2** from the side menu and then select **Cursor Link to...**
5. Select **Link Off** from the sub-menu. The link will be canceled and the **1←** at the top of editing area 2 will disappear.

Displaying a Grid in the Editing Area. This item is used to display a grid in the editing area to make it easier to edit the waveform. The following diagram shows the menu configuration.

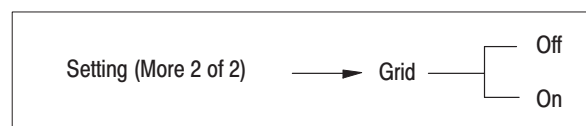

Figure 3 -19 shows an example of an editing area with the grid set to On.

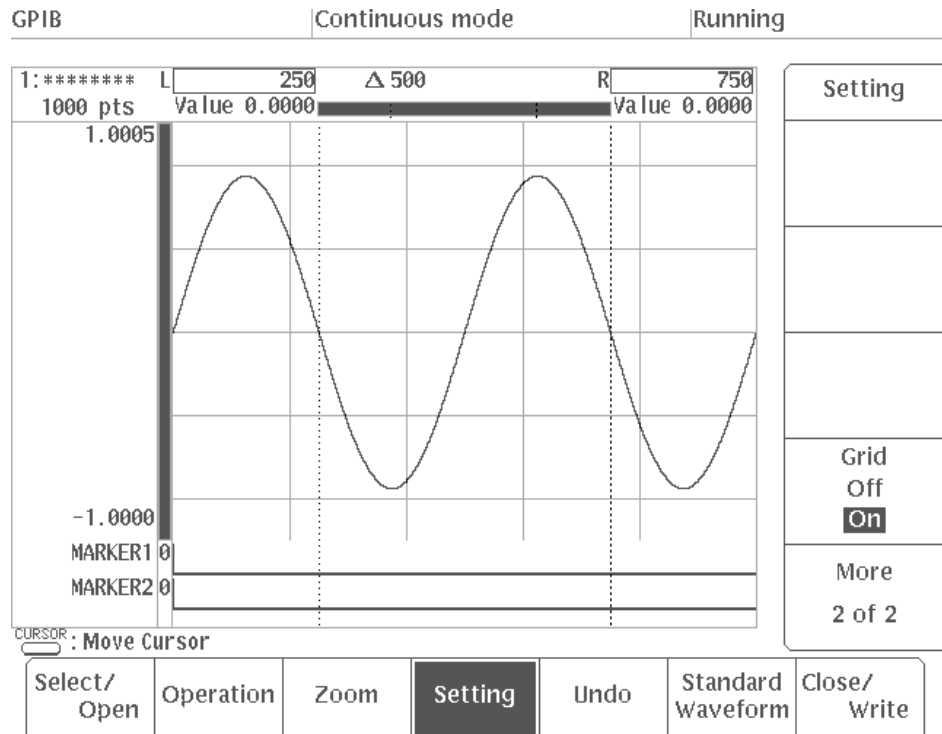

Figure 3 -19: Grid Set to On

1. Select **Setting** from the bottom menu.
2. Select **More 1 of 2** from the side menu.
3. Press the **Grid** button in the side menu and select **On**. A grid will appear in the editing area.

NOTE. *Grid On/Off can be set same as timing and table display. However, grid display is only effect in graphic display.*

Creating a Standard Function Waveform

When you select the **Standard Waveform** item, a function waveform is created in the area between the specified vertical bar cursors, or a waveform is created through calculation of the original waveform and a function waveform.

When you select **Standard Waveform** from the bottom menu, the following items are displayed in the side menu. Some of the items will change depending on the settings. For example, if you press **Setting** in the bottom menu and **Horiz. Unit** in the side menu and then select **Point**, the **Cycle** item appears in the menu; if you press **Setting** and **Horiz. Unit** and select **Time**, the **Frequency** item appears in the menu.

Type	Select the type of function waveform
Cycle	Set the cycle
Frequency	Set the frequency
Amplitude	Set the amplitude
Offset	Set the offset
Execute	Execute the process (draw the waveform)

In the following section, each of these items will be discussed in detail.

Selecting Function Waveform Type and Calculation Method. The **Type** item is used to select the type of function waveform and the calculation method to be created. There are six choices for waveform type and three choices for calculation method, making a total of 18 different ways in which this item can be set.

Type of Function Waveform	Calculation Method
Sine wave(Sine)	Substitute
Triangle wave(Triangle)	Add(Add)
Square wave(Square)	Multiply(Mul)
Ramp wave(Ramp)	
Noise wave(Noise)	
DC(DC)	

For example:

Sine	The data between the vertical bar cursors is replaced by a sine wave
Add Sine	A sine wave is added to the data between the vertical bar cursors
Mul Sine	The data between the vertical bar cursors is multiplied by a sine wave

Setting the Parameters for Function Waveforms. The following parameters can be set for each type of function waveform designated with the **Type** command. Note, however, that only **Amplitude** and **Offset** can be set for a **Noise** waveform, while only **Offset** can be set for a **DC** waveform.

Cycle	0.1 to 100,000 (in 0.1 increments)
Frequency	2 Hz to $f / 5$ ($f =$ Clock frequency set with Setting menu item)
Amplitude	± 2.0005 (if set to a negative number, the wave form will have inverse polarity)
Offset	-1.0000 to +1.0005

Procedure 1: Creating a Sine Wave. In this example, you will replace the data between the vertical bar cursors with a sine wave. The procedure begins at the initial menu level.

1. Select **New Waveform** from the side menu in the initial menu.
2. Select **Standard Waveform** from the bottom menu.
3. Check to make sure that the left and right vertical bar cursors are all the way to the left and right, respectively, to encompass the entire editing area. If they are not, use the general purpose knob to set them in this manner.
4. Press the **Type** button in the side menu and select **Sine**.
5. Select **Cycle** from the side menu. Use the numeric keys or the general purpose knob to set the number of cycles for the sine wave to 2.
6. Select **Amplitude** from the side menu. Use the numeric keys or the general purpose knob to set the p.p amplitude for the sine wave to 1.
7. Select **Execute** from the side menu.

When **Execute** is selected, the sine waveform is created between the vertical bar cursors with the set parameters. See Figure 3 -20.

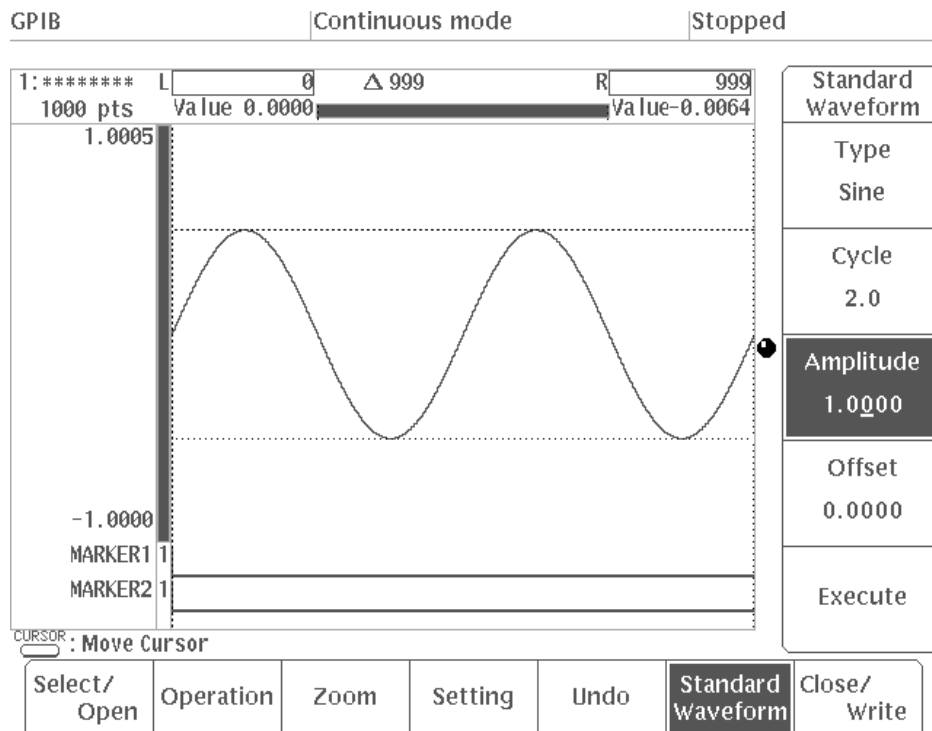

Figure 3 -20: Creating a Sine Wave

Procedure 2: Adding a Waveform to Existing Data. In this example, you will add noise to the sine wave you created in Procedure 1. The procedure starts from where you left off in Procedure 1.

1. Select **Type** from the side menu. Turn the general purpose knob or press the **Type** button in the side menu and select **Add Noise**.
2. Select **Amplitude** from the side menu. Using the numeric keys or the general purpose knob, set the p.p amplitude for the noise to 0.1.
3. Select **Execute** from the side menu.

When you select **Execute**, a noise waveform will be added to the sine wave displayed between the left and right vertical bar cursors. See Figure 3 -21.

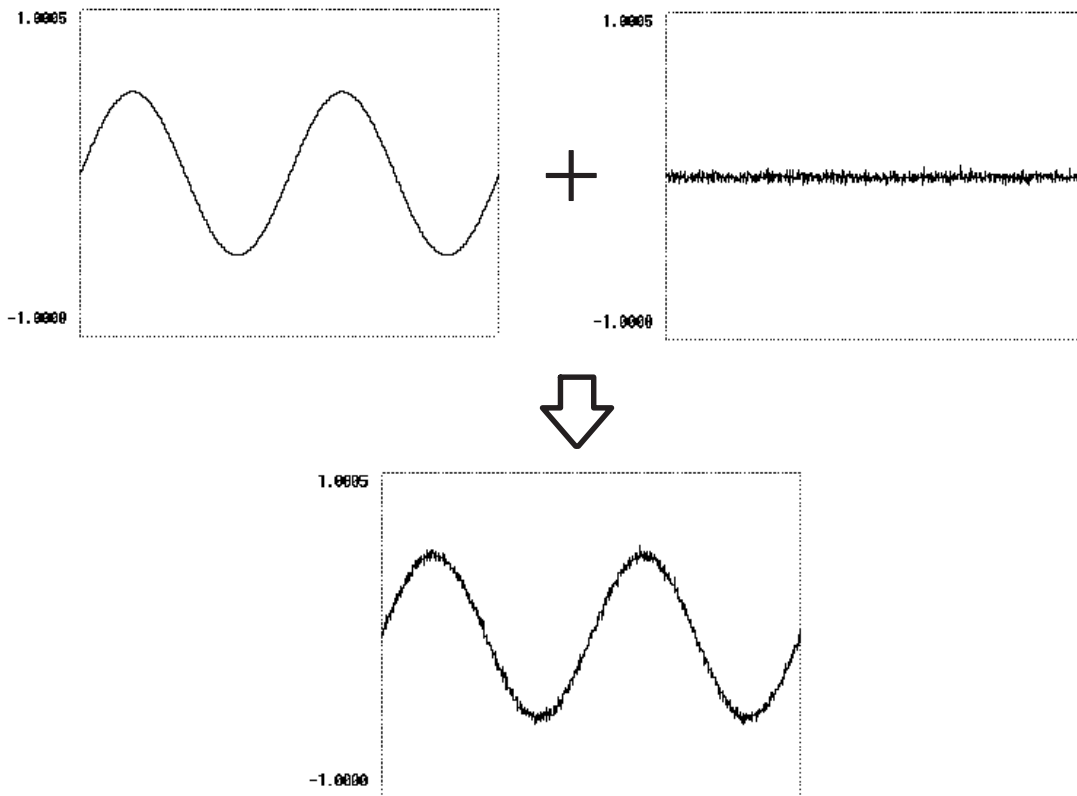

Figure 3 -21: Adding Noise to the Sine Wave

NOTE. Portions of the waveform that protrude outside the editing area when the other waveform is added will be clipped.

Procedure 3: Multiplying Waveforms. In this example, you will multiply the sine wave you created in Procedure 1 by another sine wave with a different frequency. The procedure starts from where you left off in Procedure 2.

1. Select **Undo** from the bottom menu. This will eliminate the noise waveform added in Step 2.
2. Select **Type** from the side menu. Turn the general purpose knob or press the **Type** button in the side menu and select **Mul Sine**.
3. Select **Cycle** from the side menu. Using the numeric keys or the general purpose knob, set the number of cycles for the sine wave to 30.

4. Select **Amplitude** from the side menu. Using the numeric keys or the general purpose knob, set the p-p amplitude for the sine wave to 1.
5. Select **Execute** from the side menu.

When you select **Execute**, the sine wave between the vertical bar cursors will be multiplied by the different frequency sine wave. See Figure 3 -22.

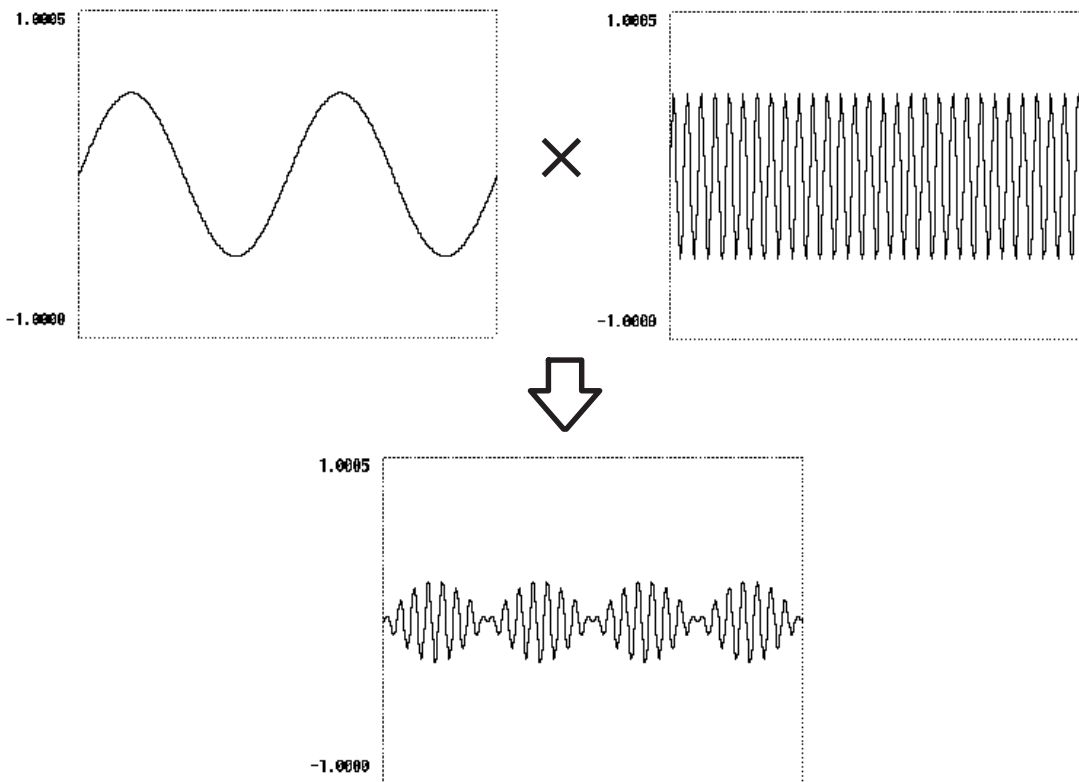

Figure 3 -22: Multiplying Sine Waves

Editing Waveforms in Graphic Display

When **Operation** is selected with the waveform editor set to graphic display, it is possible to edit the waveform data in various ways.

The side menu has three pages. Select **More** to switch the side menu to the next page. The following is a list of the items in the side menu and their functions.

Cut	Cutting waveforms
Copy to Buffer	Copying waveforms
Paste from Buffer	Pasting waveforms
Draw...	Draw function
Shift...	Shift function
Scale...	Scaling function

Invert...	Invert function
Clip...	Clip function
Marker...	Setting a marker
Insert Other Waveform	Inserting other waveforms
Single Waveform Math...	Single waveform calculations
Dual Waveform Math....	Calculations with other waveform data
Region Shift...	Specified region shift

When editing two or more waveforms simultaneously, three more items are added to the side menu (and the size of the menu increases to four pages).

Multiple Copy...	Multiple copy
Convolute...	Convolution calculations
Compare...	Comparing waveforms

Items with “...” have further low-level side menus, called sub-menus.

Setting Editing Areas. The editing operations available under **Operation** are all performed in the editing area located between the left and right vertical bar cursors. Before beginning the editing process, you should define the editing area using the following procedure.

1. Select **Operation** from the bottom menu.
2. Press the **CURSOR** button on the front panel to make the left vertical cursor active (solid line).
3. Using the numeric keys or the general purpose knob, move the left cursor to the starting point for the editing operation you wish to perform.
4. Press the **CURSOR** button on the front panel again to make the right vertical cursor active (solid line).
5. Using the numeric keys or the general purpose knob, move the right cursor to the endpoint for the editing operation you wish to perform.

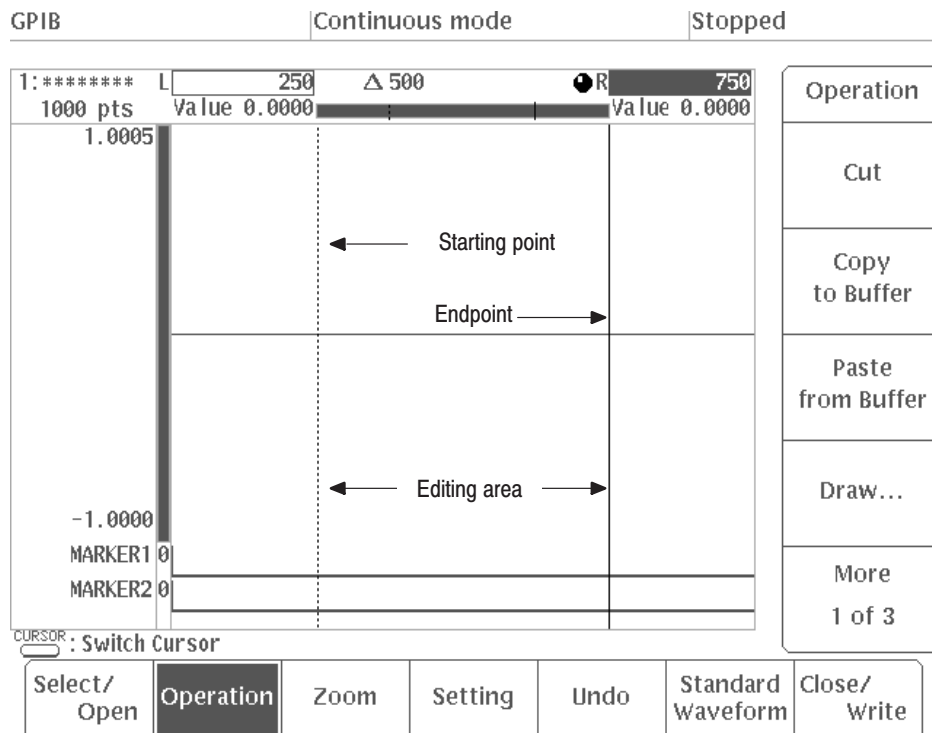
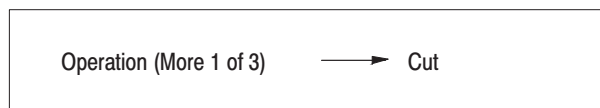

Figure 3 -23: Defining the Editing Area

Subsequent editing operations will be performed in the area that you have set between the left and right vertical bar cursors.

The following section will describe each of the items in the side menu in detail.

Cutting Waveforms. **Cut** is used to remove a portion of the waveform from the editing area. The following diagram shows the menu configuration.



Move the right and left vertical bar cursors to define the area you wish to cut and then select **Cut** from the side menu. There is no sub-menu for this command; when it is selected, the section of the waveform that you have defined is cut instantly. Marker signals associated with that waveform data are also cut. Removing part of a waveform will naturally reduce the number of points in that waveform.

Figure 3 -24 shows an example of a waveform before and after a section is cut. Note that only the section between the two vertical bar cursors is removed including the bar cursors.

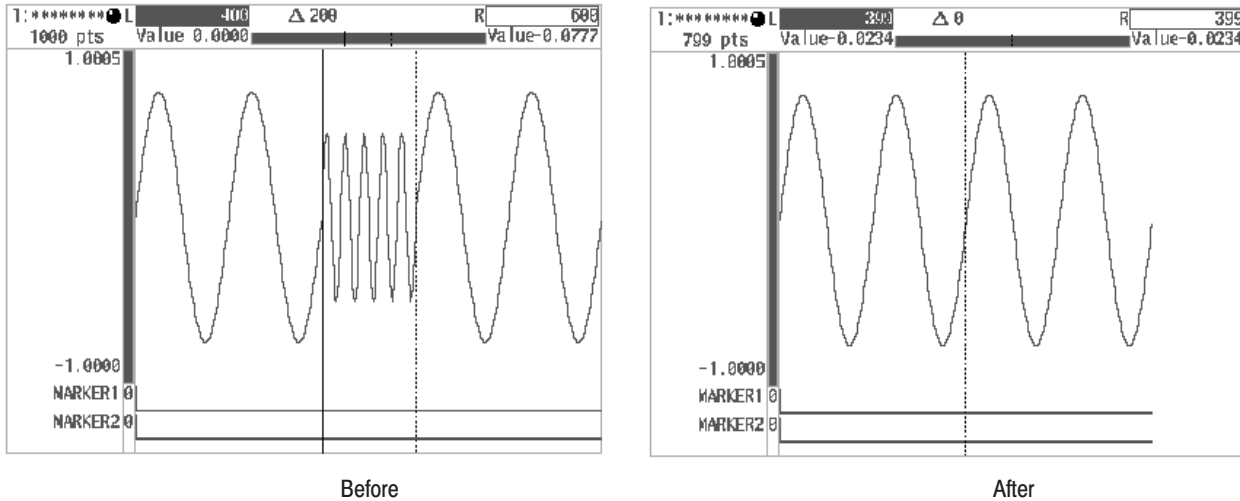
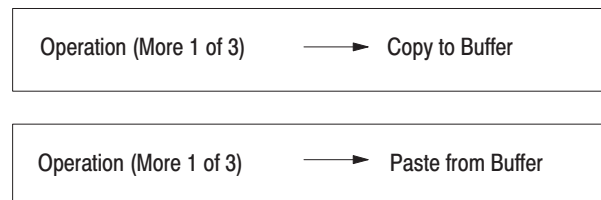

Figure 3 -24: Cutting Waveforms

Waveform data that has been cut is stored in the paste buffer. You can paste this data into another editing area (by selecting **Paste from Buffer**), insert it into another waveform (by selecting **Insert Other Waveform**) or use it to perform calculations with another waveform (by selecting **Math**).

NOTE. If you cut out waveform data by mistake, select **Undo** from the bottom menu to restore the original waveform data.

Copying/Pasting Waveforms. Use the **Copy to Buffer** and **Paste from Buffer** items to copy the edited waveform area and paste it to another location. The following diagram shows the menu configuration.



There are no sub-menus associated with these commands; when they are selected, the copy or paste operation is performed instantly. Marker signals associated with that waveform data are also subjected to the copy and paste operations. Pasting data into a waveform will naturally increase the number of points in that waveform.

1. Specify the waveform to be copied with the left and right vertical bar cursors. Select **Copy to Buffer** from the displayed side menu.

When **Copy to Buffer** is selected, the waveform data between the vertical bar cursors (including the left and right vertical bar cursor data) is copied into the paste buffer. Marker signals associated with that waveform data are also subjected to the copy operation. This operation does not affect the display on the CRT.

2. Press the front panel **CURSOR** button.
3. Use the general purpose knob to specify the position to paste the data with whichever of the vertical bar cursors is active.

The data is pasted directly before the active vertical bar cursor. However, when the cursor is at the end of the waveform, the data is inserted directly after the cursor.

4. Select **Paste from Buffer** from the side menu.

Figure 3 -25 shows an example of a waveform before and after additional data is pasted into that waveform.

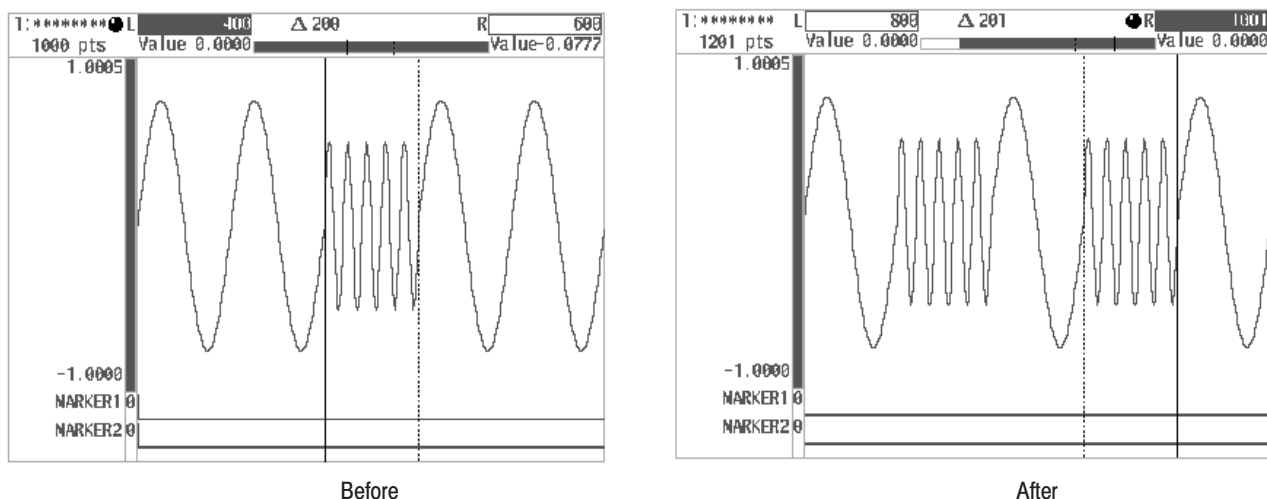

Figure 3 -25: Pasting Waveforms

When **Paste from Buffer** is selected, the waveform data copied into the paste buffer with the copy processing is pasted directly before the active vertical bar cursor. The left and right vertical bar cursors move to the two ends of the pasted waveform data.

The paste buffer data can be inserted into a waveform or used for operations with waveforms by selecting **Insert Other Waveform** or **Math** from the **Operation** menu.

Draw Function. Draw... is used to draw points between the specified vertical bar cursors and connect these points to create an arbitrary waveform. The following diagram shows the menu configuration for the **Draw...** item.

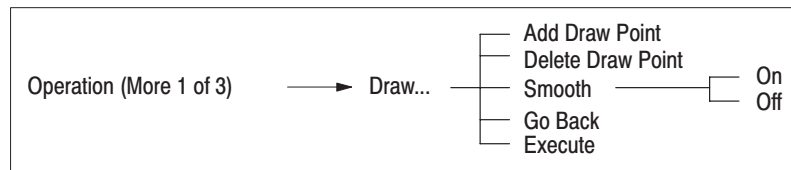

Figure 3 -26 shows an example of the screen with the **Draw...** item selected. This figure will be discussed in the following section.

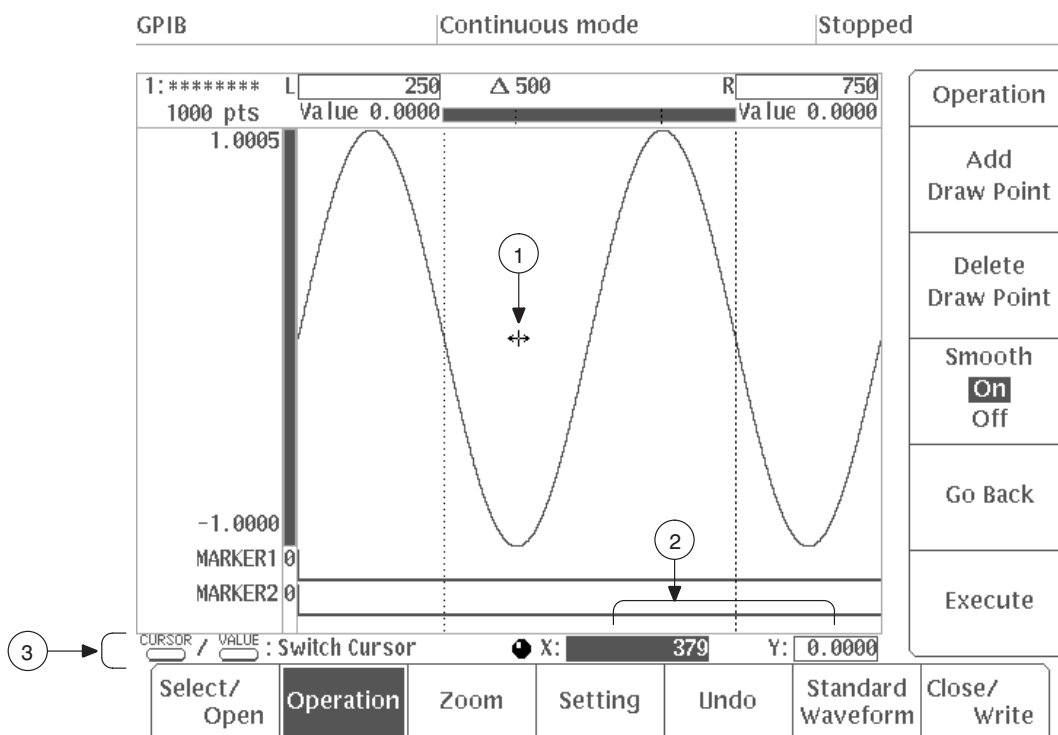



Figure 3 -26: Menu Display When Draw... is Selected

(1) Point Cursor	Is used to draw points. When this cursor can be moved, the direction in which it can be moved is shown by the arrows.
(2) X-Y Coordinate Axis	Shows the X and Y coordinates of the point cursor described in (1) above. When the coordinates for a coordinate axis are displayed inverted, it indicates that the cursor can be moved in that direction.
(3) Button Operations	 : Switch Cursor

Pressing the **CURSOR** button toggles the active vertical bar cursor from left to right and back again. Pressing the **VALUE** button toggles the direction in which the point cursor can be moved from up-down to left-right and back again.

1. Move the left and right vertical bar cursors to define the area within which the waveform will be drawn and then select **Draw...** from the side menu.

The point cursor will appear in the middle of the vertical axis between the left and right vertical bar cursors.

2. Press **VALUE** button on the front panel.

3. Use the general purpose knob to move the point cursor to the location where you want to place a point.

Each time the front panel **VALUE** button is pressed, the direction of movement for the point cursor switches between horizontal (X) and vertical (Y). The X-Y coordinates for the point cursor position are displayed at the bottom right of the CRT display.

4. Select **Add Draw Point** from the sub-menu to place the draw point.

Draw points can be placed outside the left and right vertical bar cursors. However, such points are not drawn when **Execute** is pressed.

NOTE. *You cannot set multiple draw points above the same horizontal position. If you try to do so, the instrument asks you if you want to change the level for the point already above the horizontal position. To do so, select **O.K.** To abort the operation, select **Cancel.***

5. Repeat Steps 3 and 4 to place as many points as desired.
6. To delete a draw point added with **Add Draw Point**, move the point cursor to the point to be deleted, then select **Delete Draw Point**. This deletes the point.

If **Delete Draw Point** is pressed repeatedly, the added points closest to the point cursor are deleted in order.

7. Press the **Smooth** button in the sub-menu to switch on smoothing.

Smoothing can be toggled **On** or **Off** by pressing the **Smooth** button. When smoothing is **On**, the waveform data is spline interpolated and the curve outside the left and right vertical bar cursors and the placed points are connected with a smooth curve. When smoothing is **Off**, the interpolation is linear and the curve outside the left and right vertical bar cursors and the placed points are connected with a straight line. When the vertical bar cursors are at the ends of the waveform being edited, the waveform start and finish are given the values to be smooth waveform as the repetition waveforms whether smoothing is on or off.

8. Select **Execute** from the sub-menu. The points between the vertical bar cursors will be connected with smooth curves, as shown in the left screen in Figure 3 -27. This is called spline interpolation.
9. To return to the original waveform, select **Undo** from the bottom menu.
10. Press the **Smooth** button in the sub-menu to switch off smoothing.

11. Select **Execute** from the sub-menu. The points between the vertical bar cursors will be connected with straight lines, as shown in the right screen in Figure 3 -27. This is called linear interpolation.

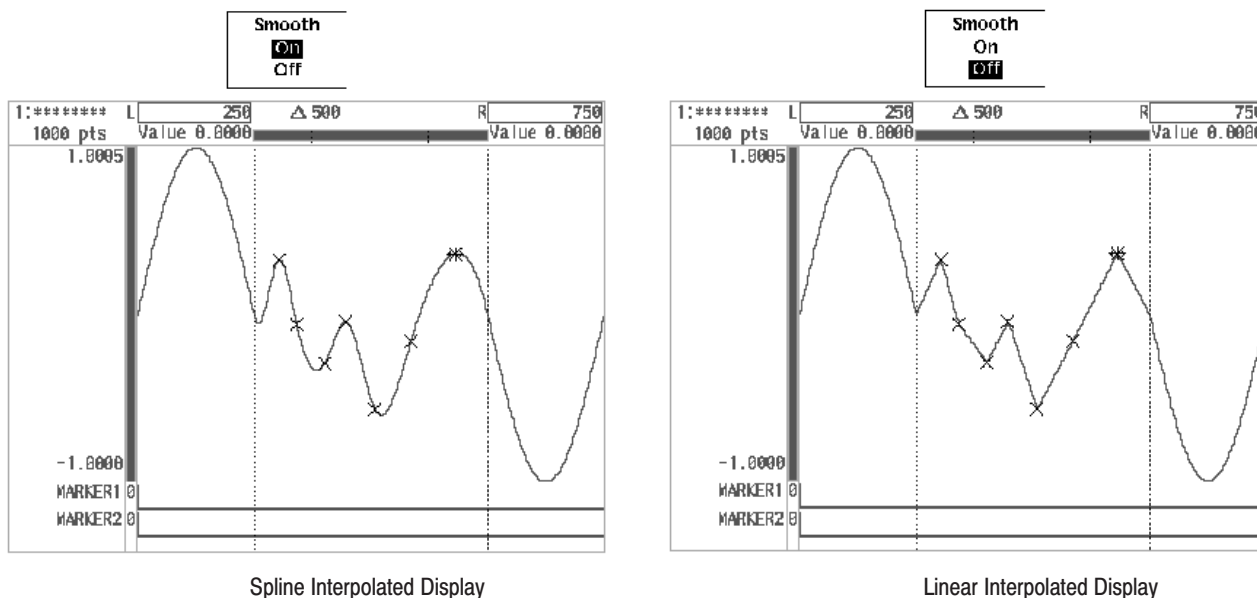

Figure 3 -27: Smoothing

NOTE. To cancel drawing execution, select **Undo** from the bottom menu. The waveform before the drawing is displayed again.

12. Select **Go Back** from the current sub-menu. The display moves from the **Draw...** sub-menu to the side menu.

This completes the drawing procedure.

Shift Function. Use **Shift...** to shift the waveform data in the area specified with the vertical bar cursors in the vertical or horizontal direction. The following diagram shows the menu configuration for the **Shift...** item.

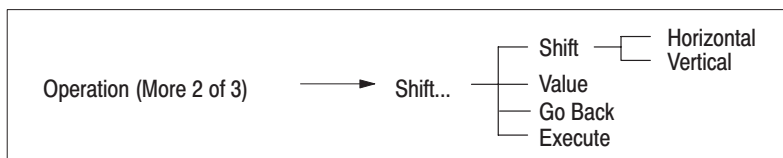

In the horizontal direction, the shift value is the number of points or time; in the vertical direction, the shift value is specified with the vertical value.

1. Move the left and right vertical bar cursors to define the section of the waveform to be shifted. Then select **Shift...** from the second page of the side menu (**More 2 of 3**).
2. Press the **Shift** button in the sub-menu to select **Horizontal**.

The **Shift** side menu item selects the direction in which the waveform data between the vertical bar cursors is to be shifted.

Horizontal shift allows you to shift all of the points or time values in the whole editing area; it can be set to either a positive or a negative value. When the shift value is positive, the waveform moves to the right; when it is negative, the waveform moves to the left. Data that protrudes outside the range defined by the vertical bar cursors as a result of shifting is added to the end of either the right or left vertical bar cursor, depending on whether the shift value is positive or negative.

3. Select **Value** from the sub-menu.
4. Use the general purpose knob or the numeric keys to input the shift point value. This value will be expressed as either number of points or time, depending on the horizontal unit setting (the value set with **Horiz. Unit** under **Setting**).
5. Select **Execute** from the sub-menu. The waveform is shifted horizontally with the specified conditions.

Figure 3 -28 shows the waveform between the vertical bar cursors shifted right 100 points.

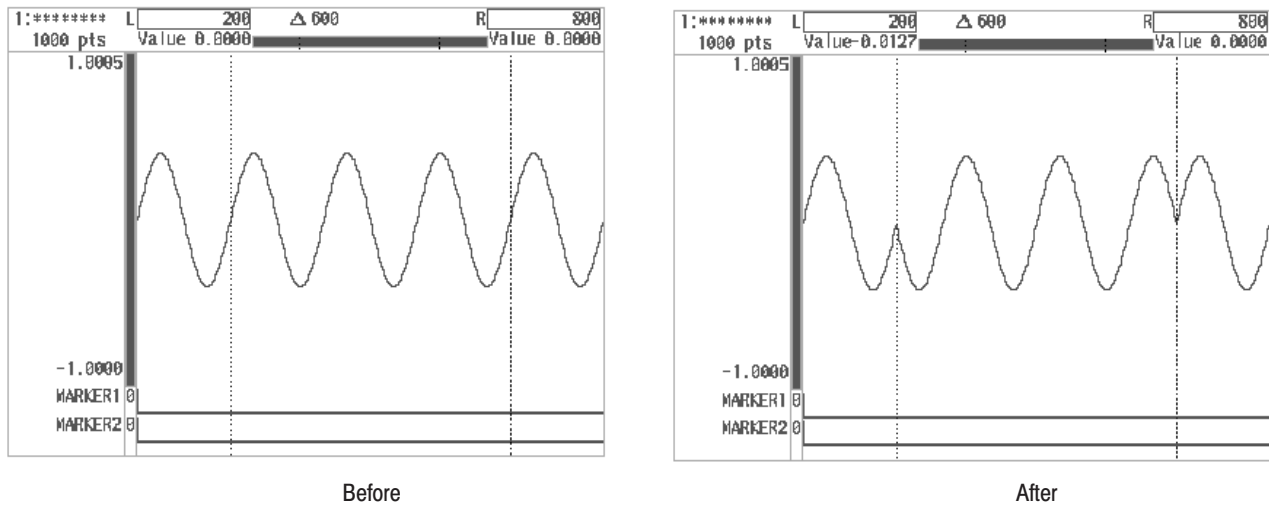

Figure 3 -28: Horizontally Shifted Display

6. Press the **Shift** button in the sub-menu to select **Vertical**.
7. Select **Value** from the sub-menu. Use the general purpose knob or the numeric keys to input the shift point value.

The waveform can be shifted between -1.0000 and $+1.0005$ for the full scale of the vertical axis. A positive shift moves the waveform up, a negative shift down. However, any points shifted beyond the vertical full scale are clipped.

8. Select **Execute** from the sub-menu. The waveform is shifted vertically with the specified conditions. Figure 3 -29 shows the waveform between the vertical bar cursors shifted up 0.3.

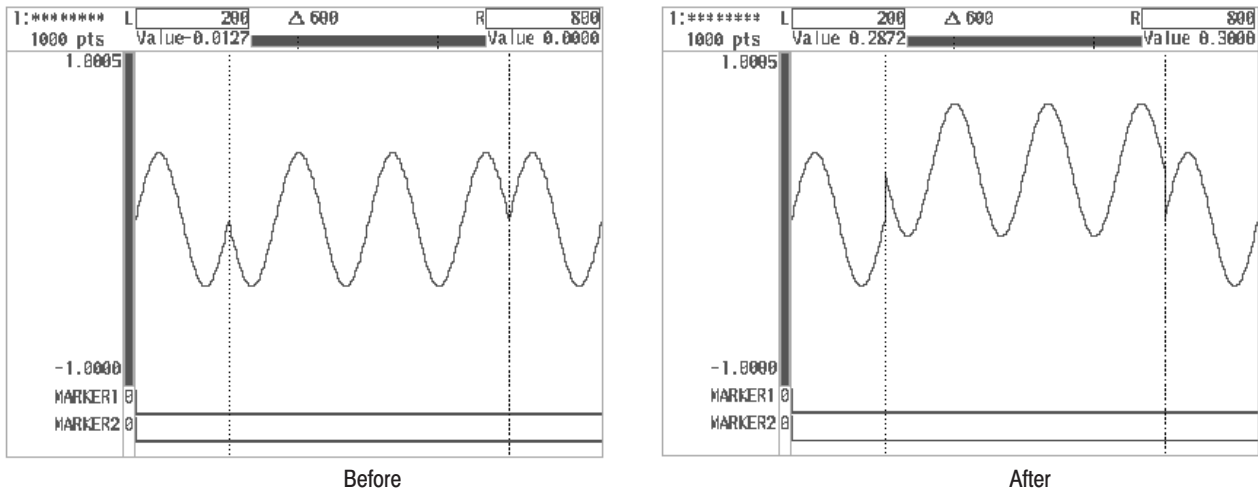
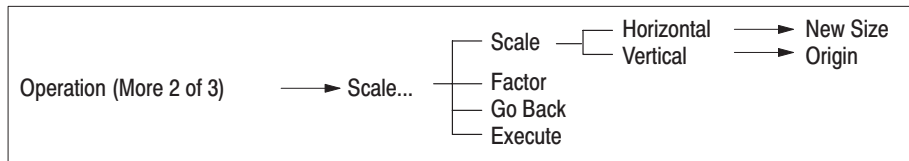

Figure 3 -29: Vertically Shifted Display

9. Select **Go Back** from the sub-menu.

Scaling Function. Use **Scale...** to change the scale for the waveform data between the vertical bar cursors. Executing scaling changes the waveform data. The following diagram shows the menu configuration for the **Scale...** item.



1. Move the left and right vertical bar cursors to define the editing area for scaling, then select **Scale...** from the second page of the side menu (**More 2 of 3**).
2. Press the **Scale** button in the sub-menu to select **Horizontal**.

The **Scale** sub-menu item selects the direction in which the data between the vertical bar cursors is scaled.

3. Select **Factor** or **New Size** from the sub-menu.

The magnification for scaling can be set with either **Factor** or **New Size**.

- **Factor.** The waveform data between the vertical bar cursors is expanded/reduced by this ratio. This parameter is linked with **New Size**. Factor can be set within the range ± 100 in steps of 0.01. However, the total number

of points for the entire waveform can not exceed 262 144, so if x100 scaling would give more total points than that, the maximum setting factor drops to the one that gives 262 144 points. A negative factor reverses the waveform between the vertical bar cursors creating a mirror image.

Scaling with a factor under 1.00 and greater than -1.00 (± 0.99) reduces the waveform horizontally between the vertical bar cursors and reduces the number of points for the entire waveform. Scaling with a factor greater than 1.00 or less than -1.00 expands the waveform horizontally between the vertical bar cursors and increases the number of points for the entire waveform.

- **New Size**. This parameter expands/reduces the waveform data between the vertical bar cursors in units of points. This parameter is linked with **Factor**. The limit on the range of **New Size** is that the number of points between the vertical bar cursors can not be increased to more than x100 their original number and the number of points for the entire waveform can not exceed 262 144.
4. Use the numeric keys or general purpose knob to input the scaling factor or the number of points.
 5. Select **Execute** from the sub-menu. The section of the waveform between the vertical bar cursors will be scaled horizontally in the middle of the left vertical bar cursor.

Figure 3 -30 shows a waveform expanded to x2 horizontally between the vertical bar cursors with a **Factor**.

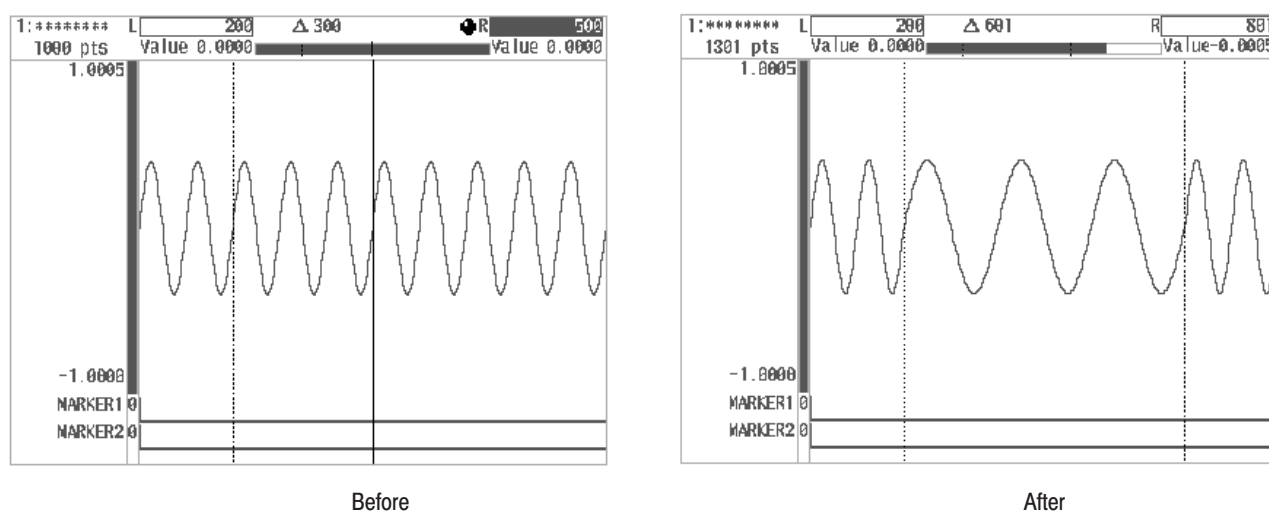

Figure 3 -30: Display Expanded Horizontally

6. Press the **Scale** button in the sub-menu to select **Vertical**.
7. Select **Origin** from the sub-menu. Use the numeric keys or the general purpose knob to input the numeric value of the origin.

This value is used as a reference when scaling vertically. It may be set to any value between -1.0000 and $+1.0005$ for the full scale of the vertical axis.

8. Select **Factor** from the sub-menu.
9. Use the numeric keys or general purpose knob to input the scaling factor.

Factor can be set within the range ± 100 in steps of 0.01. A negative factor causes the waveform between the vertical bar cursors to produce a mirror image about the origin value.

Scaling with a factor under 1.00 and greater than -1.00 (± 0.99) reduces the waveform vertically between the vertical bar cursors. Scaling with a factor greater than 1.00 or less than -1.00 expands the waveform vertically between the vertical bar cursors. Waveform data pushed beyond the full scale of the vertical axis by scaling is clipped.

10. Select **Execute** from the sub-menu. The waveform is scaled with the specified conditions.

Figure 3 -31 shows an example of **Factor** being used to enlarge the section of the waveform between the vertical bar cursors. In this example, the waveform has been enlarged 1.5 times vertically around the reference line.

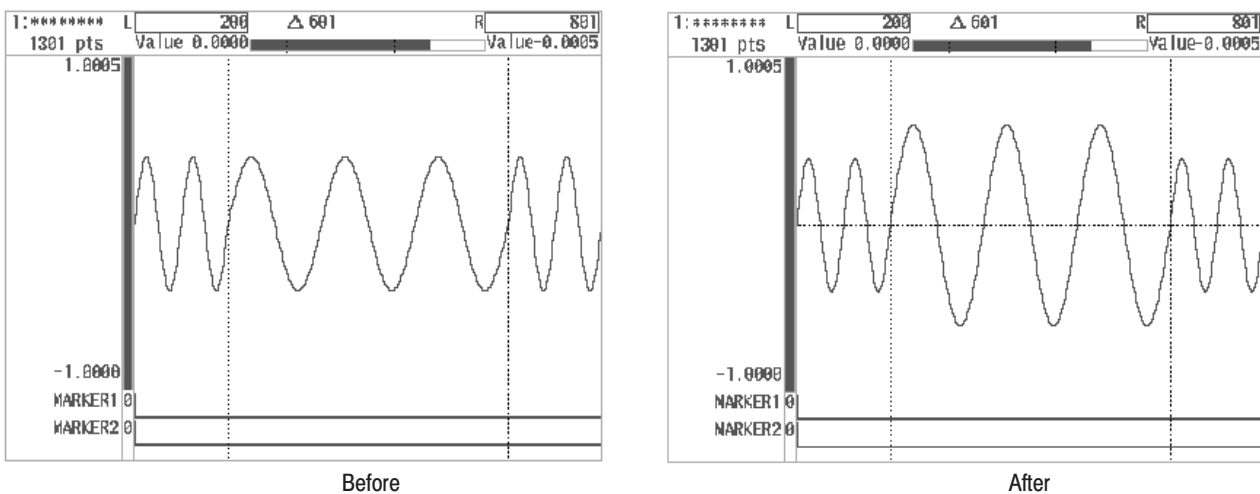
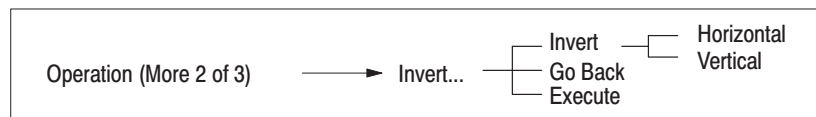

Figure 3 -31: Display Expanded to x1.5 Vertically

11. Select **Go Back** from the sub-menu. The system moves from the **Scale...** sub-menu to the previous side menu.

Invert Function. Use **Invert...** to invert the waveform data in the area specified with the vertical bar cursors either up/down or left/right. The following diagram shows the menu configuration for the **Invert...** item.



1. Move the left and right vertical bar cursors to define the editing area for inversion, then select **Invert...** from the second page of the side menu (**More 2 of 3**).
2. Press the **Invert** button in the sub-menu to select **Horizontal**.

The **Invert** selects the direction in which the waveform data between the vertical bar cursors is inverted.

3. Select **Execute** from the sub-menu. The waveform is inverted horizontally with the specified conditions.

Figure 3 -32 shows an example of the waveform before and after it is inverted horizontally.

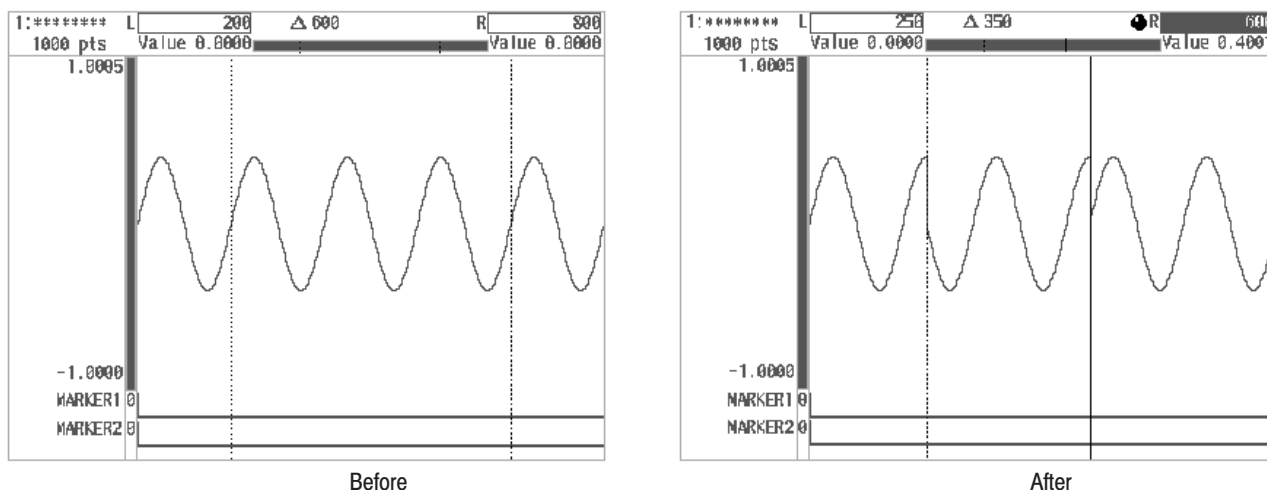

Figure 3 -32: Horizontally Inverted Display

4. Press the **Invert** button in the sub-menu to select **Vertical**.
5. Select **Execute** from the sub-menu. The waveform is inverted vertically with the specified conditions. Figure 3 -33 shows an example of the waveform before and after it is inverted vertically.

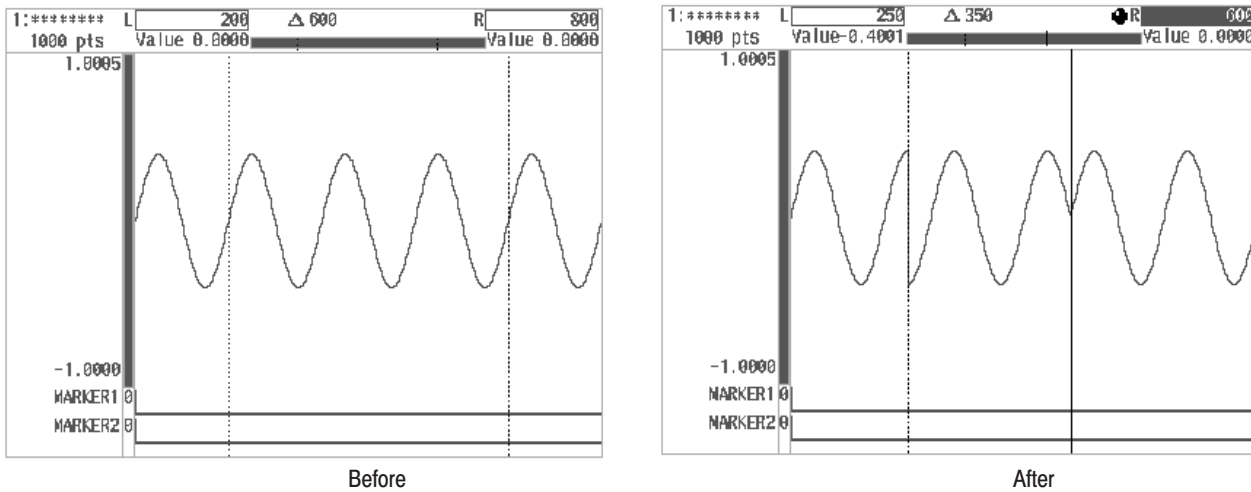
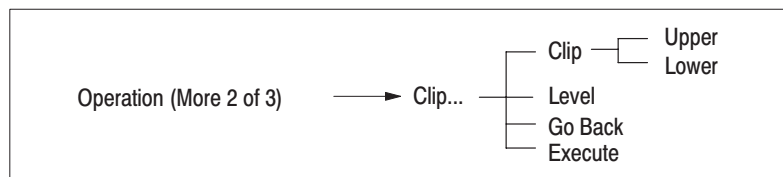

Figure 3 -33: Vertically Inverted Display

6. Select **Go Back** from the current sub-menu. The system returns from the **Invert...** sub-menu to the side menu.

Clip Function. Use **Clip...** to clip (remove) any waveform data between the vertical bar cursors that is above or below the set level. The following diagram shows the menu configuration for the **Clip...** item.



1. Move the left and right vertical bar cursors to define the editing area for clipping, then select **Clip...** from the second page of the side menu (**More 2 of 3**). A horizontal (broken) line showing the clip level will appear.
2. Press the **Clip** button in the sub-menu to select **Upper** or **Lower**.

The **Clip** sub-menu item selects the area of the waveform data between the vertical bar cursors to be clipped. Either the area above the clip level (**Upper**) or below the clip level (**Lower**) can be selected.

3. Select **Level** from the sub-menu.
4. Use the numeric keys or the general purpose knob to input the clip level.
5. Select **Execute** from the sub-menu. The waveform is clipped with the specified conditions. Figure 3 -34 shows the waveform clipped above 0.3.

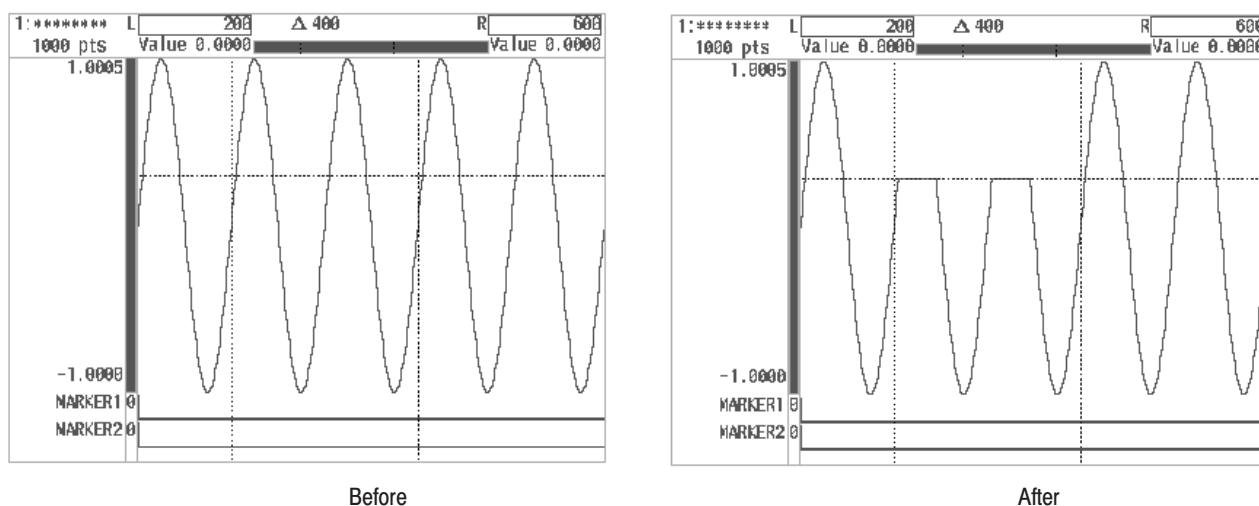
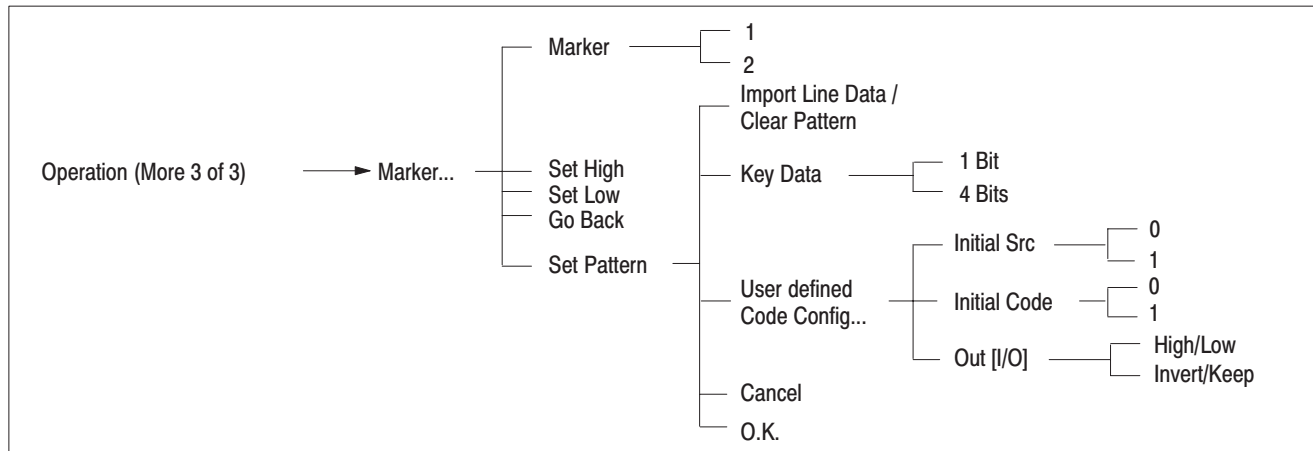

Figure 3 -34: Display of Waveform Clipped Above Clip Level

6. Select **Go Back** from the sub-menu. The system returns from the **Clip...** sub-menu to the side menu.

Setting a Marker. The **Marker...** item is used to set the marker signal (shown at the bottom of the screen) for the section of the waveform between the vertical bar cursors. This signal may be set to High, Low or Pattern. The following diagram shows the menu configuration for the **Marker...** item.



NOTE. When a new waveform file is created, the marker signal for the first point of the waveform data is set to high as a default value.

The output level for the marker signals is 1.2 V with a termination of 50 Ω. The marker signals for CH1 are output from the **CH1 MARKER 1** output connector on the front panel and **CH1 MARKER 2 OUT** connector on the rear panel, respectively. Similarly, when Option 02 is installed, the CH2 marker signals are output from the **CH2 MARKER 1 OUT** and **CH2 MARKER 2 OUT** connectors, respectively, on the rear panel.

The marker level changes to low after waveform output is complete or when the **STOP** button in the **MODE** menu is pressed.

1. Move the left and right vertical bar cursors to define the area for marker setting, then select **Marker...** from the third page of the side menu (**More 3 of 3**).
2. Press the **Marker** button in the side menu to select marker **1** or marker **2**.
3. Press the sub-menu **Set High** or **Set Low** button to set the desired marker state. Figure 3 -35 shows marker signal set high between the vertical bar cursors.
 - Set High. The marker signal for the section of the waveform between the vertical bar cursors will be set to High.
 - Set Low. The marker signal for the section of the waveform between the vertical bar cursors will be set to Low

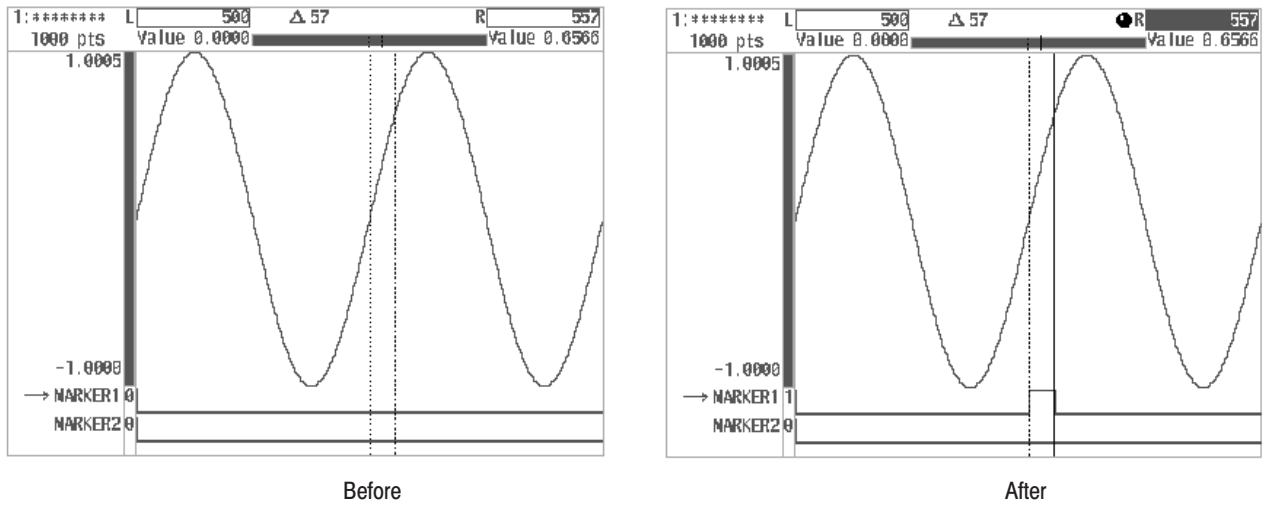

Figure 3-35: Marker Signal 1 Set High

4. Select **Go Back** from the sub-menu. The system returns from the **Marker...** sub-menu to the side menu.

Example: Setting a Marker Pattern. In this example, you will set a pattern for the marker and then create a marker signal with that pattern used as the period. Marker patterns are set with the **Set Pattern** item.

1. Move the left and right vertical bar cursors to define the area for setting a marker pattern, then select **Marker...** from the third page of the side menu (**More 3 of 3**).
2. Select **Set Pattern** from the sub-menu. The sub-menu for this item will appear.
3. Using the numeric keys, enter the data for the marker pattern. Data can be entered in either 1-bit or 4-bits increments.
 - **Key Data.** Pressing this button toggles the increment setting from **1 Bit** to **4 Bits** and back again.
 - **Import Line Data/Clear Pattern.** Pressing the **Import Line Data** button imports the marker data for the designated editor as pattern data. When this is done, the menu item will change to **Clear Pattern**. This command is used to delete all of the pattern data that has been imported or created. When the **Clear Pattern** button is pressed to delete the pattern data, the menu item changes back to **Import Line Data**.
 - **User defined Code Config...** Used to define a custom conversion table for code conversion.

For detailed instructions on pattern setting, see “Setting Pattern Data” in the timing display in this section as well as “Pattern Codes” in Appendix F.

For more detailed information on the method used to set patterns, see “Setting Pattern Data” in the Timing Display in this section and “Pattern Code” in Appendix F.

Figure 3 -36 shows an example of pattern data being entered.

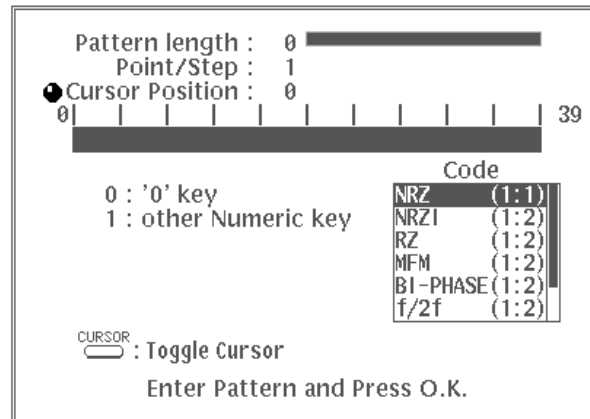

Figure 3 -36: Entering Pattern Data

4. When you have finished creating the pattern data, select **O.K.** The marker data between the left and right vertical bar cursors will be replaced with the pattern data that you have created. To cancel the operation, select **Cancel**. Whichever option you select **O.K.** or **Cancel**, the menu that was displayed before **Set Pattern** was selected will reappear.
5. Select **Go Back** from the sub-menu. The system returns from the **Marker...** sub-menu to the side menu.

Inserting Other Waveforms. Use **Insert Other Waveform** to insert other waveforms into any desired location within the waveform being edited. The following diagram shows the menu configuration.



1. Press the front panel **CURSOR** button.

- Use the general purpose knob to move the active vertical bar cursor to the position where the other waveform is to be inserted.

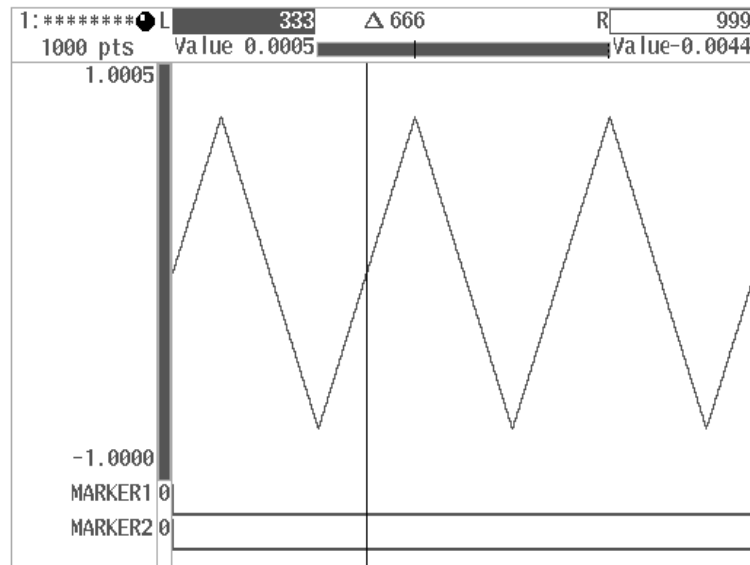

Figure 3 -37: Defining the Location for Insertion

The waveform is inserted right before the active vertical bar cursor. However, if the cursor is at the end of the waveform, the data is inserted directly after the cursor.

- After setting the position to insert the other waveform, select **Insert Other Waveform** from the side menu. A list of waveform files is displayed.

Data placed into the paste buffer with **Cut** or **Copy** is listed at the top of the file list with the name "**Paste Buffer.**" The data in the paste buffer can be inserted into any desired location by selecting this item.

- Use the general purpose knob to select the waveform file to be inserted from the file list.

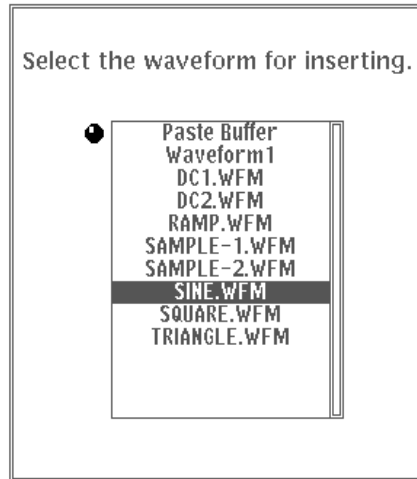

Figure 3 -38: List of Files for Insertion

5. Select the **Show Catalog Entry** from the sub-menu. The waveform for the selected file is displayed.

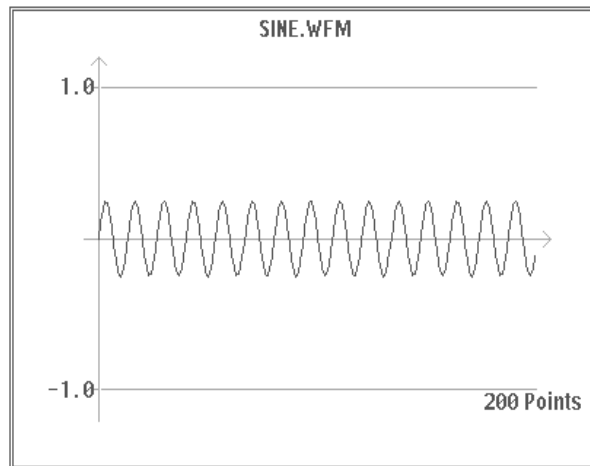

Figure 3 -39: File Waveform Display

6. Select **O.K.** from the sub-menu.

The waveform from the selected file is inserted right before the active vertical bar cursor. Marker signal 1 and 2 belonging to the waveform data are processed at the same time. Select **Cancel** to cancel the waveform insertion. When **O.K.** or **Cancel** is selected, the display returns to the menu displayed before **Insert Other Waveform** was selected.

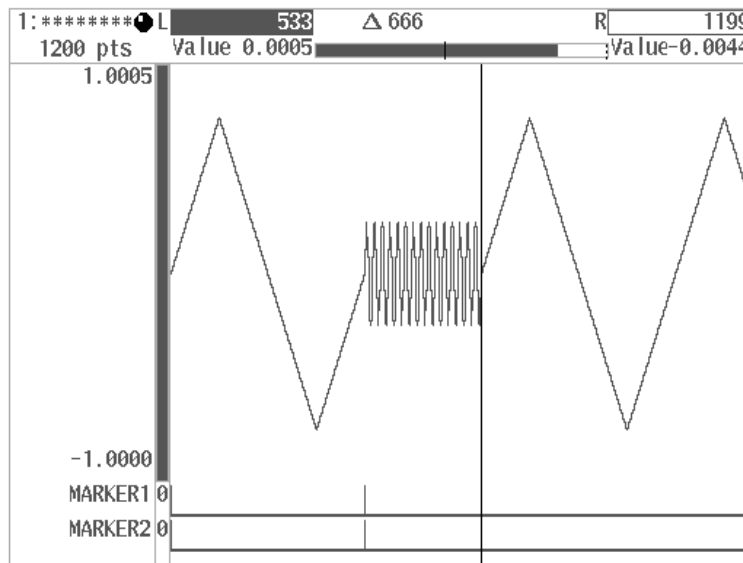
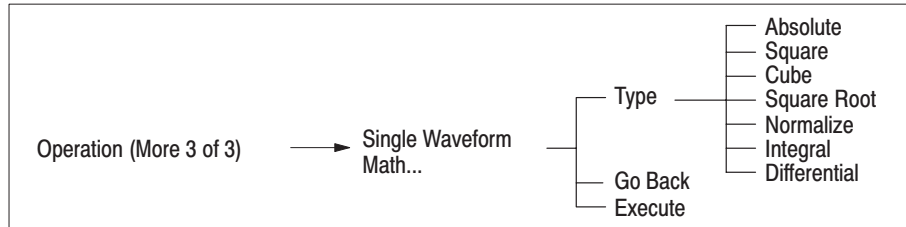

Figure 3 -40: Inserting Waveforms

Single Waveform Calculations. The **Single Waveform Math...** item allows you to perform mathematical calculations for the waveform itself. Calculations are applied to the portion of the waveform between the vertical bar cursors.

Absolute	Determines the absolute value for the amplitude.
Square	Doubles the absolute value for the amplitude. If the amplitude is a negative number, the calculated result is also negative.
Cube	Triplies the amplitude.
Square Root	Determines the square root for the absolute value of the amplitude. If the amplitude is a negative number, the calculated result is also negative.
Normalize	Normalizes the amplitude values so that the maximum absolute value is 1.0 (i.e. a value of +1.0 or -1.0).
Integral	Integrates the amplitude and normalizes.
Differential	Differentiates the amplitude and normalizes.

The following diagram shows the menu configuration for the **Single Waveform Math...** item.



To derive the **Absolute** value for the amplitude of a sine wave between the vertical bar cursors:

1. Create the sine wave to be subjected to **Absolute** calculation. Figure 3 -41 shows the sine wave before calculations are performed.

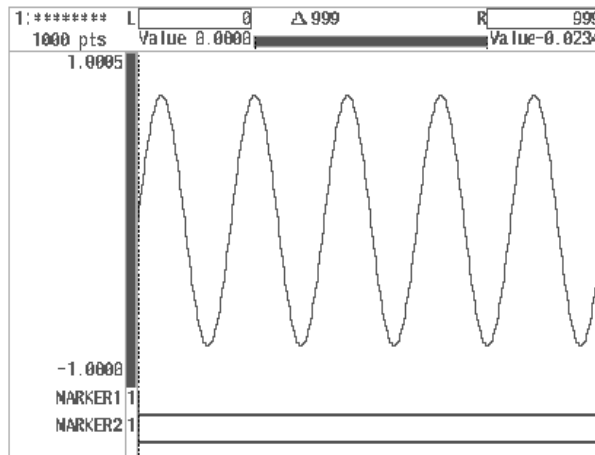

Figure 3 -41: Waveform Example before Calculation

2. Press the **CURS**OR button on the front panel.
3. Using the general purpose knob, move the left and right vertical bar cursors to define the area for calculation.
4. Select **Single Waveform Math...** from the third page of the side menu (**More 3 of 3**).
5. Press the **Type** button in the sub-menu and select **Absolute**.
6. Select **Execute** from the sub-menu. The absolute value will be derived for the section of the waveform located between the vertical bar cursors. Figure 3 -42 shows the waveform after calculation.

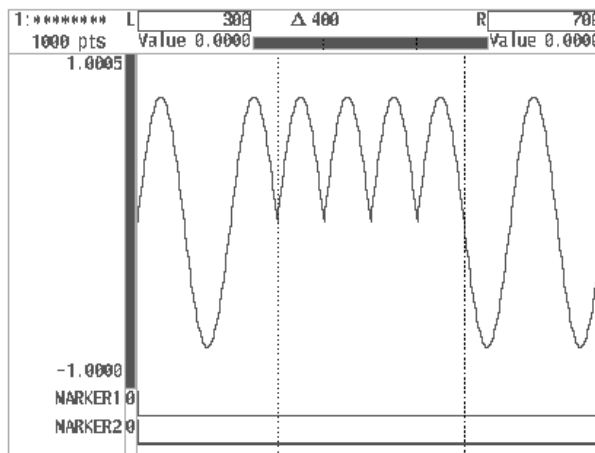
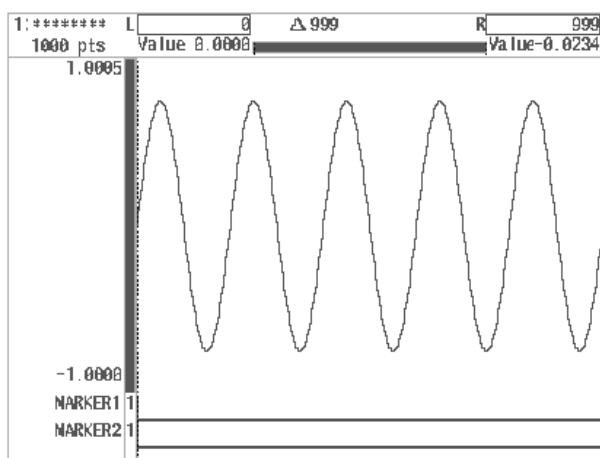

Figure 3 -42: Absolute Calculation

7. Select **Go Back** from the sub-menu. The system returns from the **Single Waveform Math...** sub-menu to the side menu.

Calculation Examples. The following diagrams show examples of a waveform before and after various calculations are performed.

- Square. Doubles the absolute value for the amplitude



Before

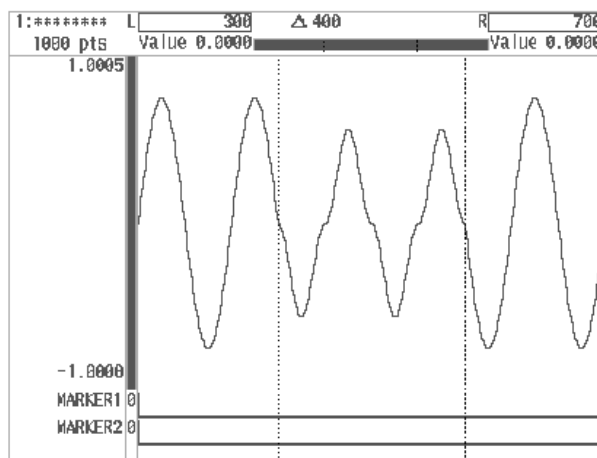

After

Figure 3 -43: Square Calculation

- Cube. Triples the amplitude

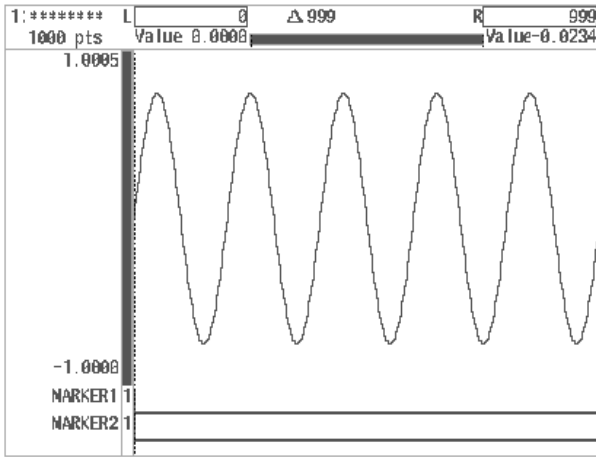

Before

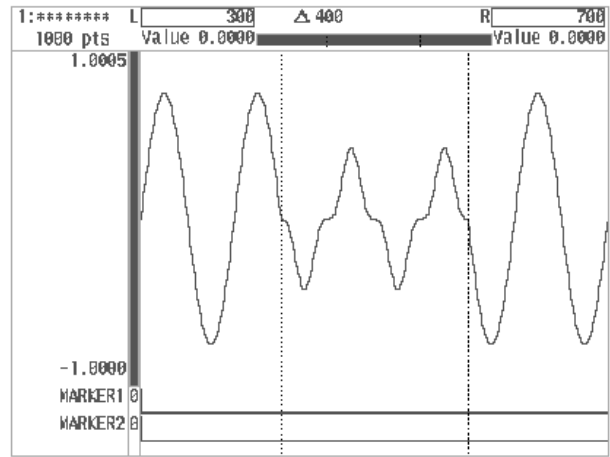

After

Figure 3 -44: Cube Calculation

- Square Root. Determines the square root for the absolute value of the amplitude.

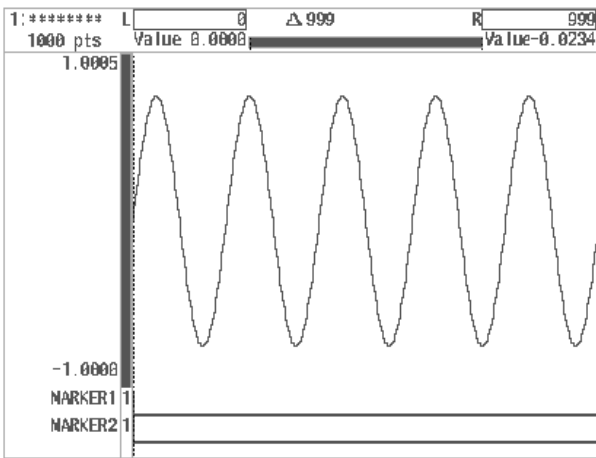

Before

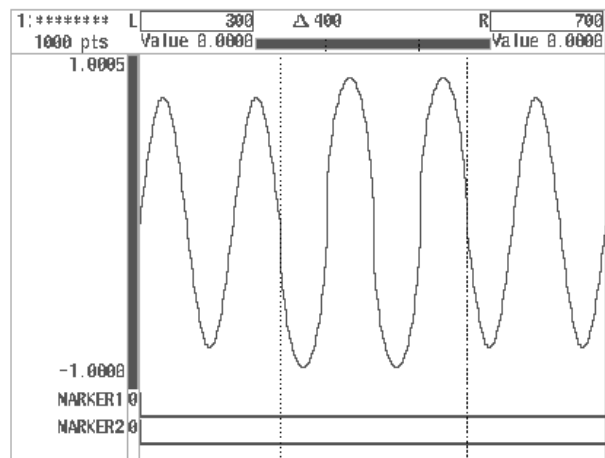

After

Figure 3 -45: Square Root Calculation

- Normalize. Normalizes the amplitude

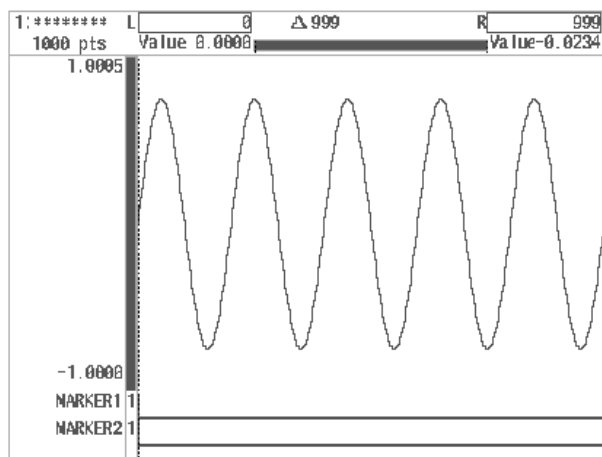

Before

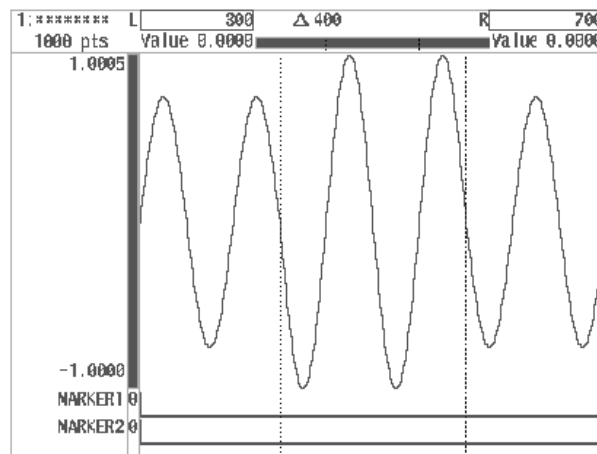

After

Figure 3 -46: Normalize Calculation

- Integral. Integrating the amplitude.

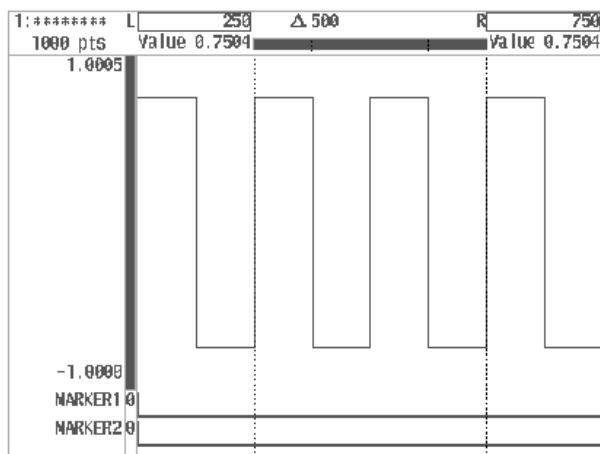

Before

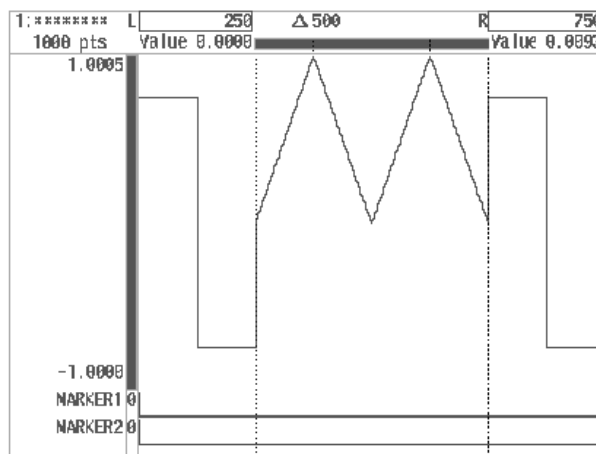

After

Figure 3 -47: Integral Calculation

- Differential. Differentiating the amplitude.

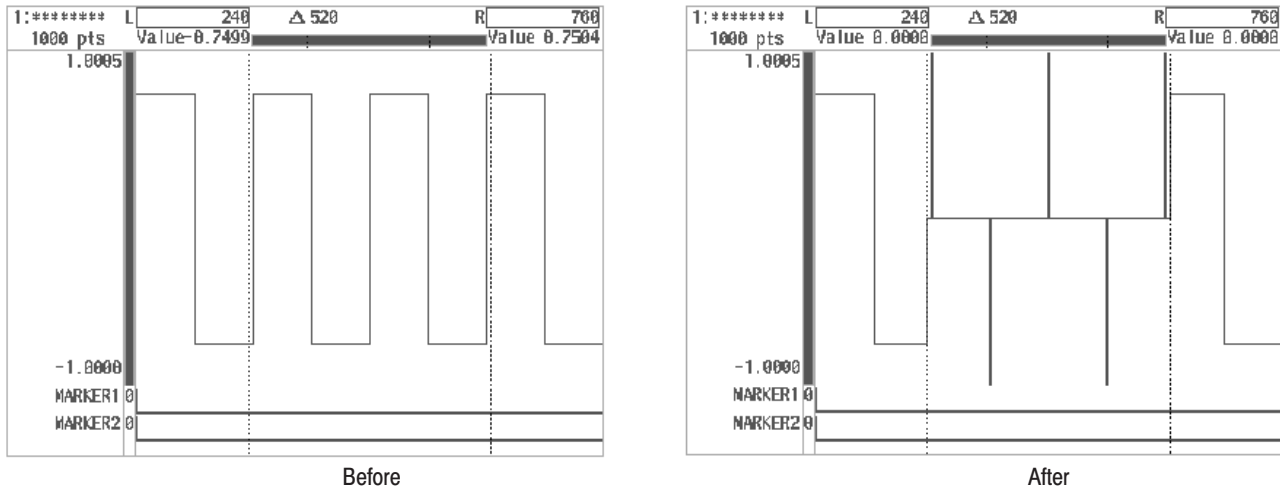

Figure 3 -48: Differential Calculation

Calculations With Other Waveform Data. Use **Dual Waveform Math...** to perform math calculations with the waveform currently being edited and other waveform data. The following calculations can be performed:

- Add Adds the waveform data being edited and the other waveform file data.
- Sub Subtracts the other waveform file data from the wave from data being edited.
- Mul Multiplies the waveform file data being edited by the other waveform file data.

The region pushed out beyond the vertical axis full scale by the calculations is clipped.

The following diagram shows the menu configuration for the **Dual Waveform Math...** item.

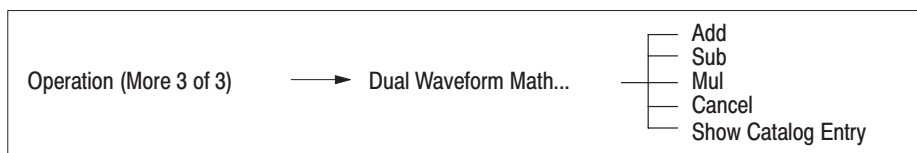

1. Create the waveform to be operated on with the other waveform file data. Figure 3 -49 shows the example of waveform before the arithmetic operations.

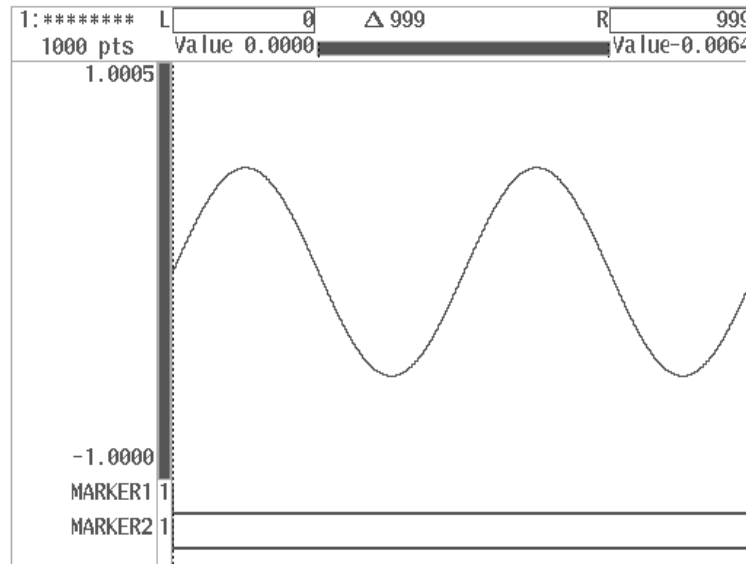

Figure 3 -49: Example of Waveform Before Arithmetic Operations

2. Press the front panel **CURSOR** button.
3. Using the general purpose knob, move the vertical cursor bars to define the area for calculation.
4. Select **Dual Waveform Math...** from the third page of the side menu (**More 3 of 3**).
5. A list of files will be displayed on the screen. Using the general purpose knob, select the file for which the calculations will be performed. Calculations will be executed for both the section of the waveform data being edited between the vertical bar cursors and the selected waveform file.

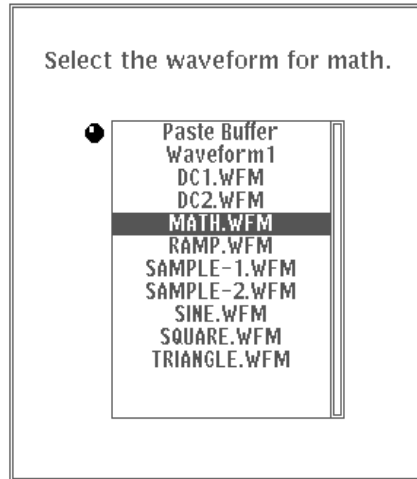

Figure 3 -50: List of Files for Waveform Calculation

6. Select **Show Catalog Entry** from the sub-menu. The waveform for the selected file is displayed. See Figure 3 -51.

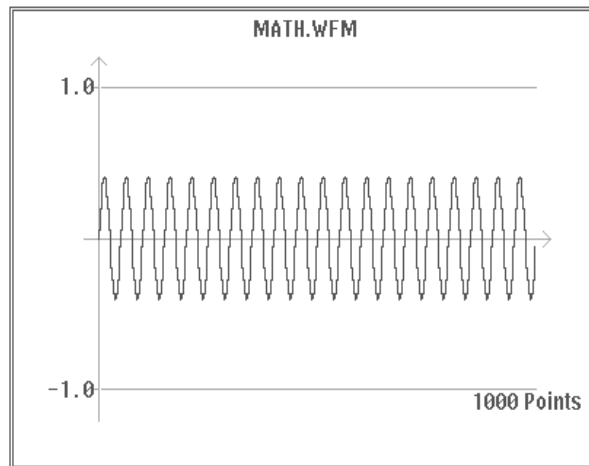

Figure 3 -51: Selected File Waveform Display

7. After verifying the waveform, select **Continue** from the sub-menu. The waveform will disappear and the system returns to previous **Dual Waveform Math...** sub-menu.
8. Select the desired calculation type from the sub-menu. The moment a calculation type is selected, the calculation is carried out and the results are displayed on the CRT screen. The display returns to the menu on display

before **Dual Waveform Math...** was selected. Figure 3 -52 displays the waveforms added (**Add**) between the vertical bar cursors.

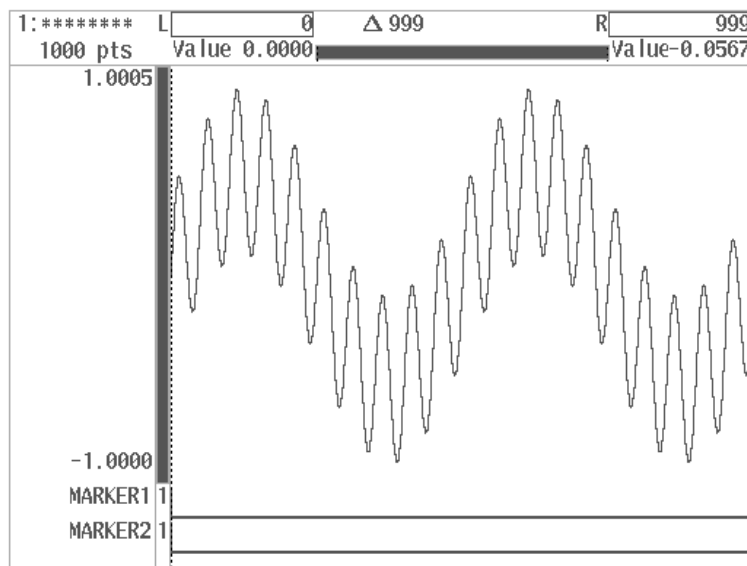

Figure 3 -52: Waveform Addition Display

If you select **Cancel**, the menu returns to the menu on display before **Dual Waveform Math...** was selected without any calculations being made.

Data placed into the paste buffer with **Cut** or **Copy** is listed at the top of the file list with the name "**Paste Buffer**." When this item is selected, an operation is carried out with the data in the paste buffer.

Specified Region Shift. The **Region Shift...** item shifts a specified region of a waveform either right or left, towards the center or away from the center. If the specified amount of the shift is less than the sampling interval, the original waveform is resampled using data interpolation to derive the shifted values. The **Region Shift...** item has the following menu configuration.

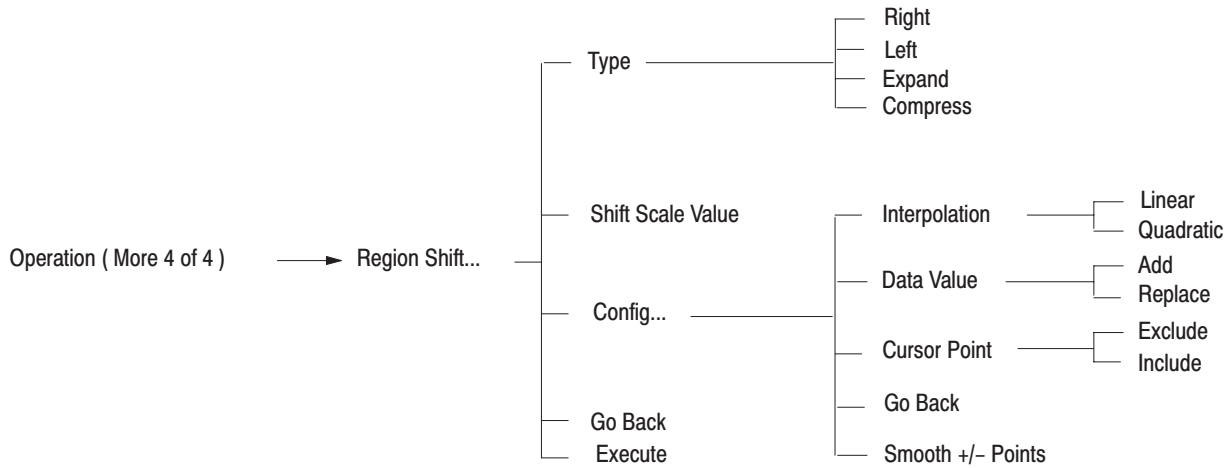

Table 3-3 lists the differences between this function and the **Shift** function .

Table 3-3: Differences Between the Shift Operations

Item	Shift	Region Shift
Area	Rotates the area delimited by the cursors.	Shifts the area delimited by the cursors to a different area.
Shift amount	Data point spacing	Amounts less than the data point spacing
Interpolation at intersection	None	Interpolation performed

Data changed by manipulations performed from **Region Shift...** menu can be restored to a prior state (for one operation only) using the **Undo** item on the bottom menu. If the result of the operation was not what was intended, use the **Undo** function to restore the original data. Iterating parameter modifications and the **Undo** function can be a good way of finding optimal settings for the shift parameters.

- **Shift Type Selection.** There are four types of specified region shifts, **Right** or **Left**, in which a region is shifted to the right or left, and **Expand** or **Compress**, in which the shift moves the data towards the center or away from the center. The **Type** item selects the shift type.

Right or **Left.** Shifts the area bordered by the vertical bar cursors the amount specified by the **Shift Scale Value** item to right or left. Figure 3 -53 shows the data shown in the right figure is shifted by 1.

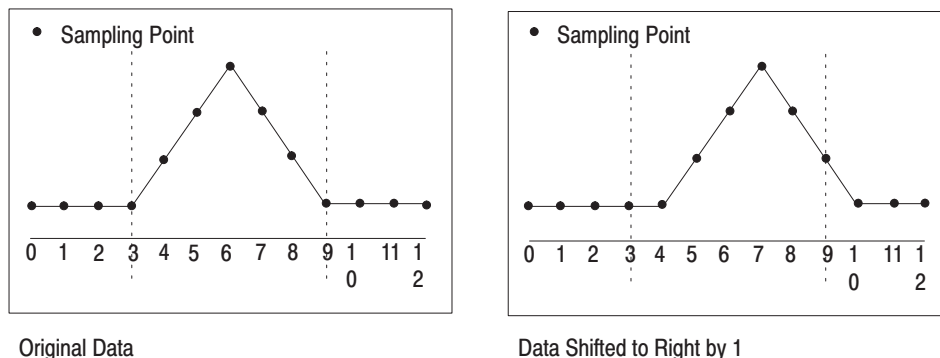

Figure 3 -53: Data Shifted Using the “Right” Item

Although the maximum value that can be specified for the shift is the number of waveform data points, the section of the data that is shifted beyond the maximum number of data points is lost after the shift.

Expand or **Compress**. The area delimited by the left and right vertical bar cursors is divided into two sections at the center of the cursors, and those two regions are shifted towards the center point by shift scale values for **Compress** and away from the center for **Expand**. In Figure 3 -54, when the shift type is **Compress**, the data shown at the right of figure results when the data shown at the left is compressed by 1.

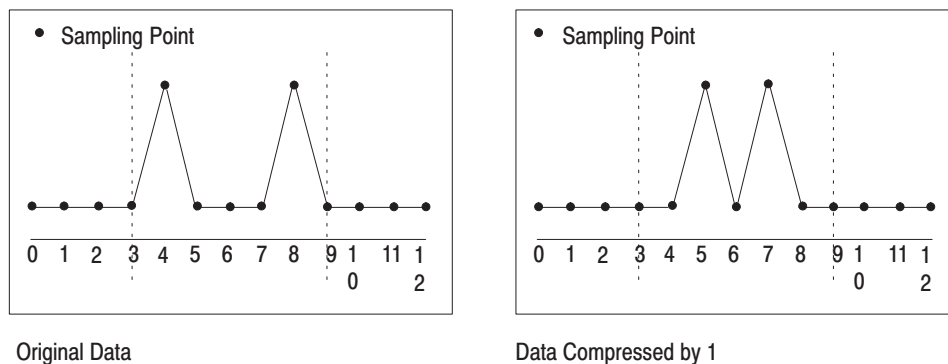

Figure 3 -54: Data Compressed Using the “Compress” Item

The Shift Values For Selecting **Expand** or **Compress**

Expand. Although the maximum value that can be specified for the shift is the number of waveform data points, the section of the data that is shifted beyond the maximum number of data points is lost after the shift.

Compress. In this case the value of the shift must be less than one half the size of the area surrounded by the left and right vertical bar cursors. The section that exceeds the position of one half the region is lost after the shift if the **Data Value** item (described below) is set to **Replace**.

- **Shift Scale Value.** When shifting waveform data, it is possible to specify a **Shift Scale Value** with a precision that exceeds that of the sampling points. In the AWG2021 arbitrary waveform generator, values may be specified with a resolution as fine as $1/1000$ point. However, there are cases where it is not possible to realize a shift of that precision due to the form of the waveform itself. In particular, changes in the lowest digit of the shift value will not be reflected in the output unless the amplitude of the original waveform spans the full scale of the data representation.

***NOTE.** Since data values between the data points are calculated by interpolation when shifting by a fractional value, certain characteristics of the original waveform may be lost. Therefore, a filter must be inserted to prevent aliasing. If the changes in the waveform are extremely smooth, fractional shift amounts may not result in the intended effect.*

1. Specify the region to be shifted with the left and right vertical bar cursors, and select the **Region Shift...** item on the fourth page of the side menu (**More 4 of 4**).
 2. Select the shift type by pressing the sub menu **Type** button.
 3. Select **Shift Scale Value** from the sub menu.
 4. Enter the shift amount using either the general purpose knob or the numeric keys. The shift value can also be displayed as a time value.
 5. If other settings related to the shift need to be specified, select the **Config...** item from the sub menu. See the “Other Shift Settings” item below for more information.
 6. Select **Execute** from the sub menu. The waveform in the edit region will be shifted with the specified conditions.
- **Other Shift Settings.** The following parameters can be set from the **Config...** item.

Interpolation	Selecting the interpolation method
Data Value	Handling of overlapping regions in the shift result
Cursor Point	Interpolation of the data on the cursors
Smooth +/- Points	Setting the smoothing width at the data boundary positions

- Interpolation. The data is re-sampled when shifting by fractional amounts. Data values between data points are acquired by interpolation. The **Interpolation** item selects the interpolation method used. The following two options are provided.

Linear interpolation

Quadratic interpolation

Linear interpolation is appropriate if the original waveform consists of straight lines, such as triangle or square waves. However, the peaks in waveforms with extremely sharp peaks may be flattened somewhat.

Quadratic interpolation is appropriate for waveforms with curves, such as sine waves. However, in waveforms with extremely sharp peaks, some peaks may become wider.

Linear Interpolation. Figure 3 -55 provides an overview of linear interpolation. If the point X_2 is shifted to the left by 0.2, the new value is calculated by interpolating with the next point to the left.

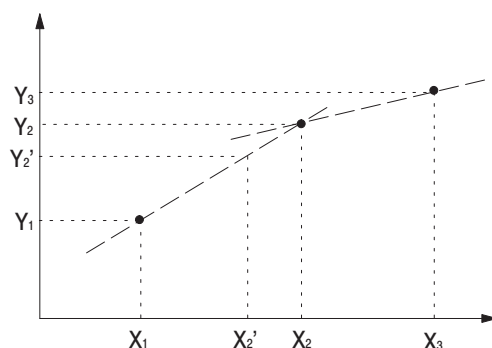

Figure 3 -55: Linear Interpolation

If the coordinate of the shifted point is X_2' , then the value of the point Y_2' is given by the following formula.

$$Y_2' = 0.2 \times Y_1 + (1 - 0.2) \times Y_2$$

Quadratic Interpolation. Figure 3 -56 provides an overview of quadratic interpolation. If the point X_2 is shifted to the left by 0.2, the new value is calculated by interpolating using three points, the shifted point itself and the preceding and following points.

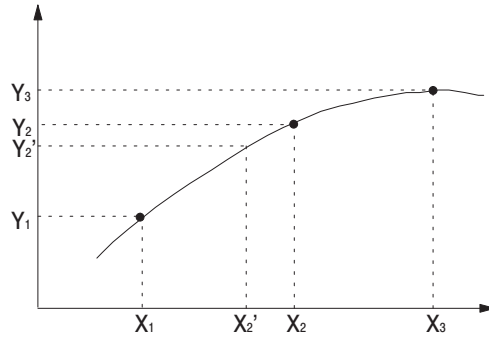

Figure 3 -56: Quadratic Interpolation

Quadratic interpolation is expressed as follows.

$$f(x) = Ax^2 + Bx + C$$

The coefficients A , B , and C in the above formula are derived using the three points including those directly preceding and following the position to be derived.

$$\begin{aligned} y_1 &= Ax_1^2 + Bx_1 + C \\ y_2 &= Ax_2^2 + Bx_2 + C \\ y_3 &= Ax_3^2 + Bx_3 + C \end{aligned}$$

Simplifying by letting $x_1 = -1$, $x_2 = 0$, $x_3 = 1$, gives:

$$\begin{aligned} y_1 &= A - B + C \\ y_2 &= C \\ y_3 &= A + B + C \end{aligned}$$

This allows the coefficients A , B , and C to be derived as follows:

$$\begin{aligned} A &= \frac{y_1 + y_3}{2} - y_2 \\ B &= \frac{y_3 - y_1}{2} \\ C &= y_2 \end{aligned}$$

Using these values, the value y_2' at position x_2' can be derived as follows.

$$y_2' = \left(\frac{y_1 + y_3}{2} - y_2\right) \times (-0.2)^2 + \left(\frac{y_3 - y_1}{2}\right) \times (-0.2) + y_2$$

- **Data Value.** This item selects the handling of overlapping regions in the shift.

Add The shifted data and the overlapping data are added.

Replace Replaces the region with the shifted data. When **Type** is **Compress**, the data for points shifted beyond the center is lost.

- **Cursor Point.** This item selects whether the data boundary points are interpolated.

When the **Cursor Point** is **Exclude**

The points on the left and right vertical bar cursors are not interpolated. Figure 3 -57 shows the original data at the left and the shifted data at the right.

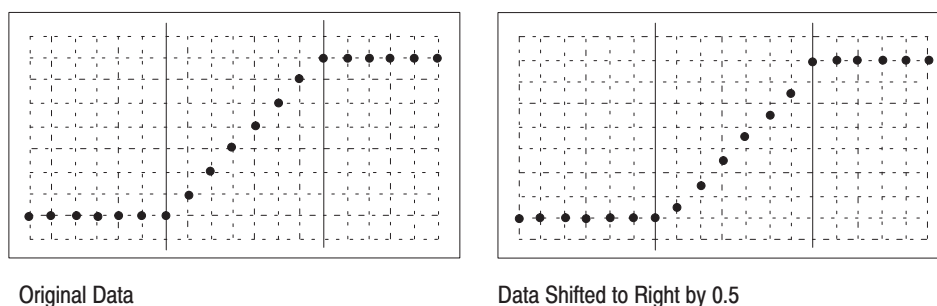

Figure 3 -57: Shift with “Cursor Point” Set to “Exclude”

In this case, the first and last data points remain at their original values, exactly as though they had not been shifted. However, this error can be made inconspicuous by the insertion of an appropriate anti-aliasing filter.

When the **Cursor Point** is **Include**

The points on the left and right vertical bar cursors are interpolated.

- **Smooth +/- Points.** This item specifies the smoothing width with points at the data boundary positions. Smoothing is only performed over the points specified for the area around the boundary positions. No smoothing is performed if this point is set to zero. Points can be set between 0 through 20.

Smoothing is performed on a specified region without regard for the shift. The smoothing technique takes the average of the point itself and the two adjacent points (three points) as the new value.

Figure 3 -58 shows an example, with the original data shown on the left and the smoothed data shown on the right.

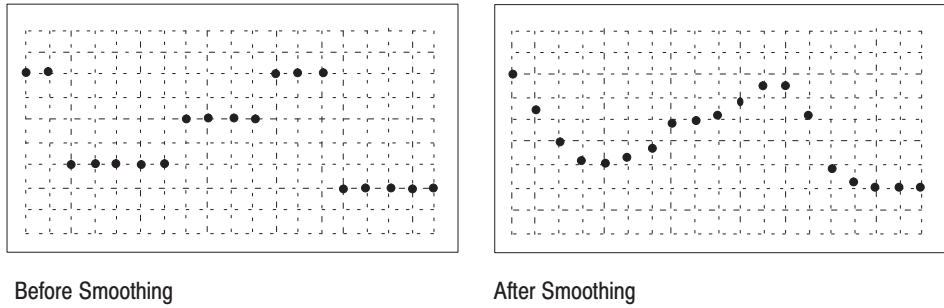

Figure 3 -58: Smoothing

NOTE. Since smoothing is equivalent to low pass filtering, features of the original waveform can be lost resulting in significant changes to the waveform. To acquire appropriate output waveforms, experiment with a variety of values for the **Smooth +/- Points** parameter.

- Side Effects from Shifting. The left side of Figure 3 -59 shows data prior to shifting and the right side shows the result of shifting the data between the cursors indicated with solid lines to right by 0.5. Since shifting to right by 0.5 requires determining the data at the 0.5 location to left, the data in Figure 3 -59 is interpolated to derive the data at locations 0.5 to left from the positions of each data point. **Linear** interpolation is used in this case.

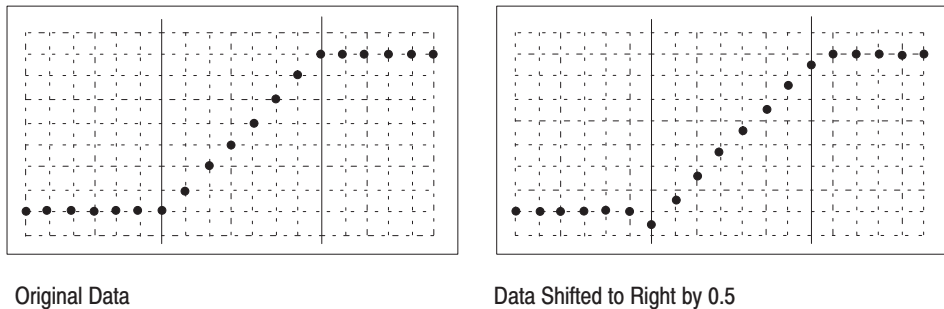

Figure 3 -59: Data Shifting

When this data is output through an appropriate filter, the waveform will be shifted to right by 0.5 point units. When this shift is performed, the data point at the position of the left cursor is lowered. This is a side effect of the interpolation process. There are several techniques for preventing this data lowering phenomenon as follows.

- 1) Increase the size of the area.

- 2) Set the **Cursor Point** setting to **Exclude**.
- 3) Apply smoothing. However, there are waveforms for which smoothing may not be effective.
- **Increasing the Size of the Area.** Data that is identical across the operation can be acquired by increasing the size of the area. (See Figure 3 -60.) Smooth data is acquired when this area is shifted, as shown in the right of the figure.

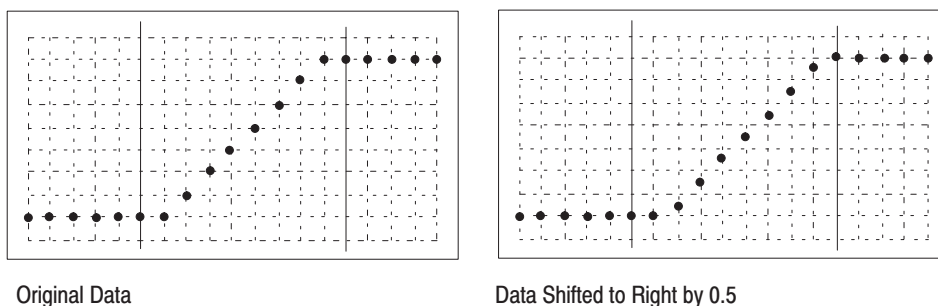

Figure 3 -60: Increasing the Size of the Area

This is due to the fact that when using linear interpolation to derive data values between points, the value of the data does not change when interpolating between points with the same value. The value not changing is equivalent to not performing a shift. However, this error can be made inconspicuous by the insertion of an appropriate anti-aliasing filter.

Multiple Copy. The **Multiple Copy...** item appears in the menu when two or more waveforms are being edited simultaneously. It is used to copy the section of the waveform between the two vertical bar cursors in one editing area to the waveform between the vertical bar cursors in another editing area, at the interval specified with **Interval**. The following diagram shows the menu configuration for the **Multiple Copy...** item.



See Page 3 -15 “Opening and Selecting Editing Areas” for further information on designating multiple editing areas.

In this example, we will copy the waveform between the vertical bar cursors in editing area 1 to editing area 2. We will start from the point at which only one waveform has been designated in the waveform editor.

To designate a second editing area in the waveform editor:

1. Choose **Select/Open** from the bottom menu.
2. Select **Another Waveform** from the side menu.
3. Using the general purpose knob, select **New Waveform** from the waveform list and then select **O.K.** A second editing area will appear, as shown in Figure 3 -61.

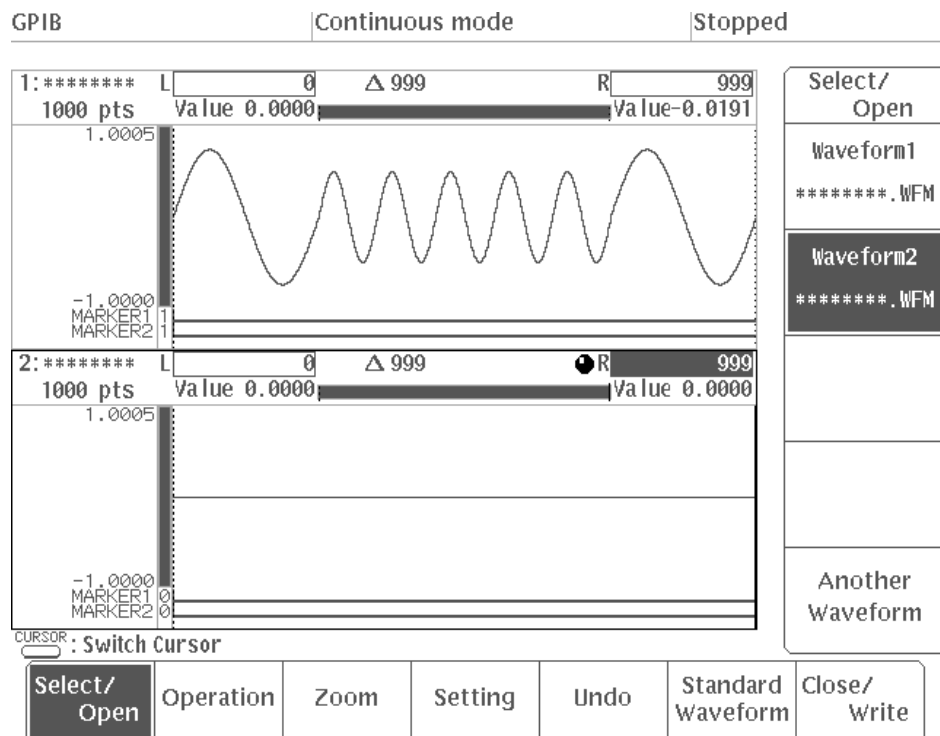

Figure 3 -61: Two Waveform Editing Areas Designated

To select the area for waveform copying:

4. Select **Waveform1** from the side menu to designate this waveform area as the source for copying.
5. Press the **CURSOR** button on the front panel.
6. Using the numeric keys or the general purpose knob, move the vertical bar cursors to designate the section of the waveform to be copied. In this example, we will set the left cursor to point 250 and the right cursor to point 749.

NOTE. Copying will include the point at which the cursor is located. The value indicated by Δ at the top of the waveform area indicates the number of points between the two cursors, so the number of points that will be copied will be this value plus one point (the point at which the cursor is located).

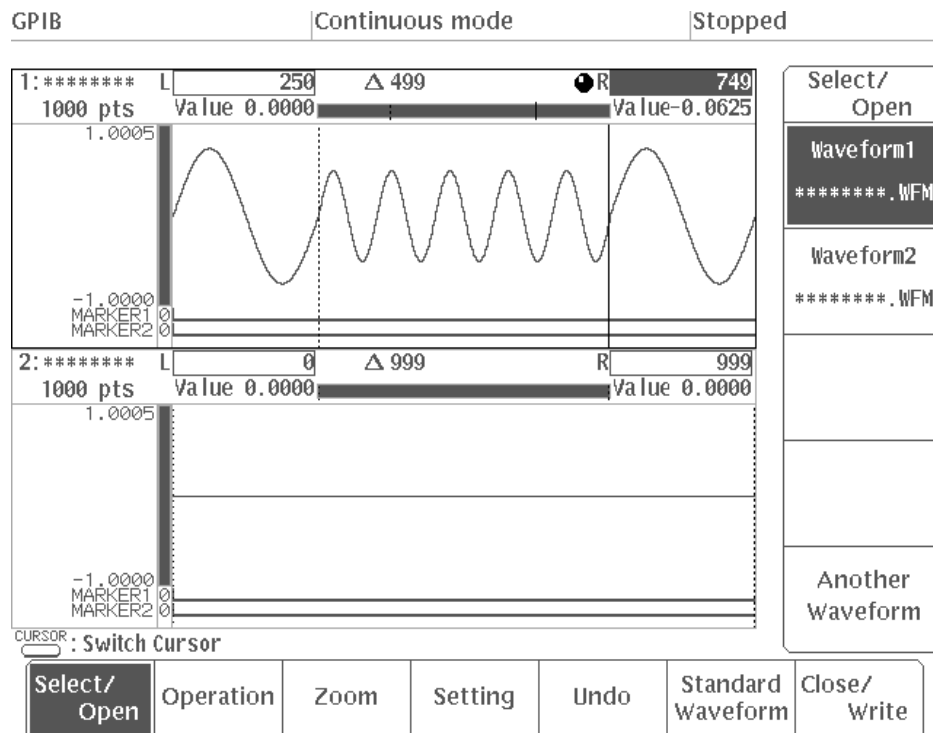

Figure 3 -62: Setting the Copy Source

Setting the Destination for Waveform Copying

7. Select **Waveform2** from the side menu to designate this area as the destination for copying (the area to which the waveform will be copied).
8. Press the **CURSOR** button on the front panel.
9. Using the numeric keys or the general purpose knob, move the vertical bar cursors to set the area within which the waveform will be copied. In this example, we will set the left cursor to point 0 and the right cursor to point 999.

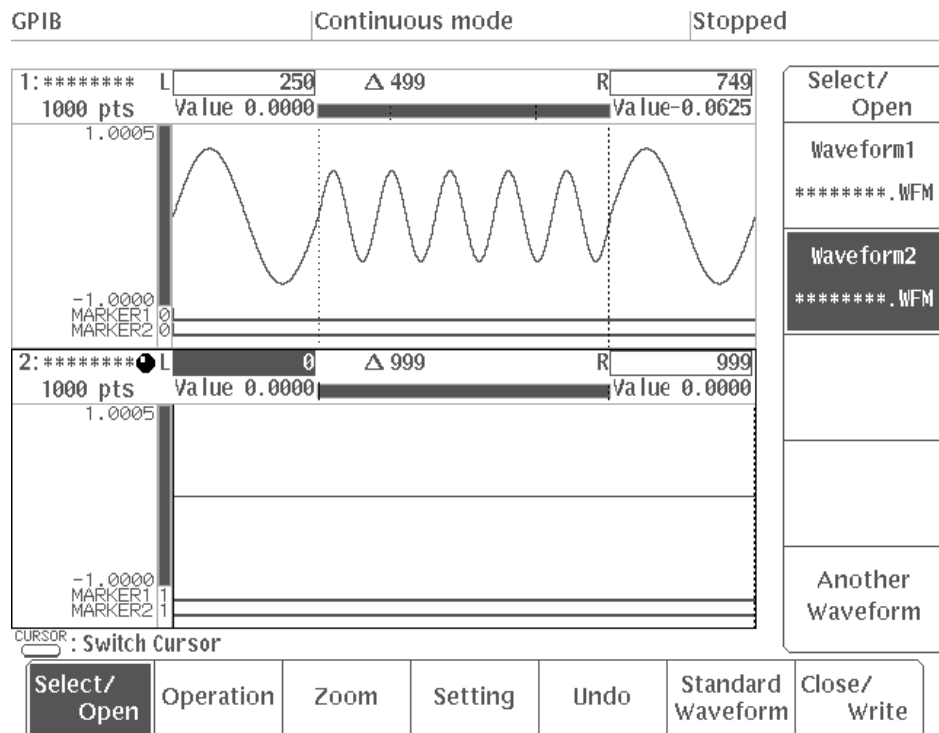

Figure 3 -63: Setting the Copy Destination

To copy the waveform:

10. Select **Operation** from the bottom menu.
11. Select **Multiple Copy...** from the fourth page of the side menu (**More 4 of 4**).

When three waveform areas have been designated in the waveform editor, select one of the remaining two editing areas as the source for waveform copying with **Source** item in the sub-menu.

12. Select **Interval** from the sub-menu.
13. Using the numeric keys, set the interval value to 500 points. When copying the section of a waveform between the bar cursors in one editing area to the area between the bar cursors in another editing area, the **Interval** value determines the interval at which the waveform will be repeated horizontally (in points).

14. Select **Execute** from the sub-menu.

If the number of points in the waveform between the vertical bar cursors in the copy source is the same as the value set for **Interval**, the copied waveform will be displayed repeating at the interval designated with **Interval**. In the example shown in Figure 3 -64, both the waveform point size and the **Interval** value are set to 500.

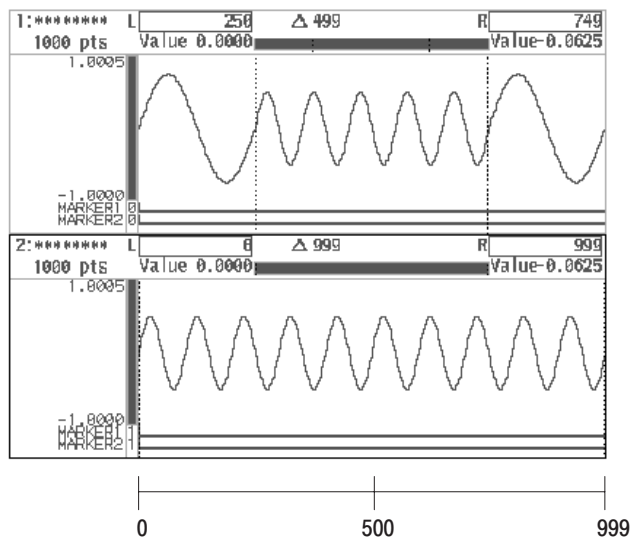

Figure 3 -64: Waveform Copying (number of points in waveform = Interval value)

If the number of points in the waveform between the vertical bar cursors in the copy source is less than the value set for **Interval**, data at level 0 (in other words, a straight line) will be added at the end of the waveform. Figure 3 -65 shows an example in which the waveform point size has been set to 50 and the **Interval** has been set to 600. Data at level 0 has been added from point 500 to point 599; the next waveform begins from point 600.

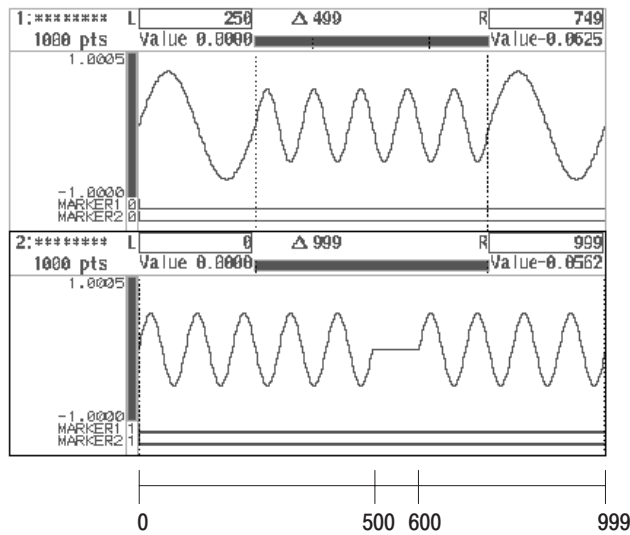

Figure 3 -65: Waveform Copying (number of points in waveform < Interval value)

If the number of points in the waveform between the vertical bar cursors in the copy source is greater than the value set for **Interval**, the overlapping portion will be added to the waveform. Figure 3 -66 shows an example in which the waveform point size has been set to 500 and the **Interval** value has been set to 300. The copied waveform will be pasted at intervals of 300, starting from points 0, 300, 600 and 900, and so the waveform will overlap in phase between points 300 – 499, 600 – 799 and 900 – 999. As a result, the amplitude in these areas will be doubled.

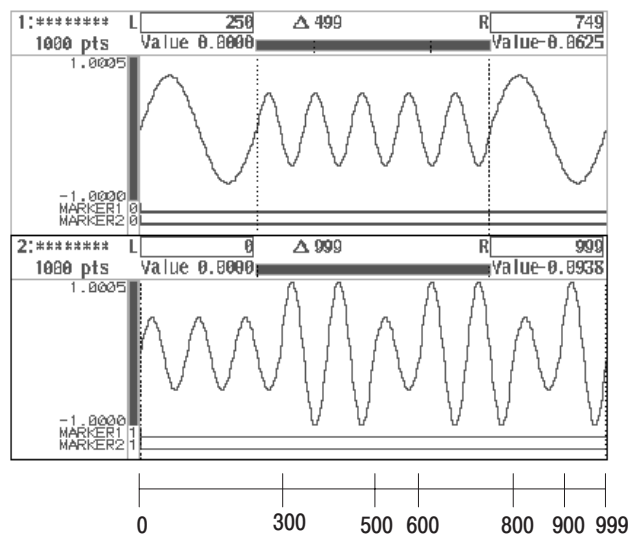
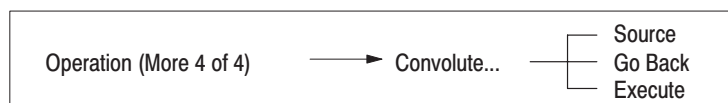

Figure 3 -66: Waveform Copying (number of points in waveform > Interval value)

15. Select **Go Back** from the current sub-menu. The display moves from the **Multiple Copy...** sub-menu to the side menu.

Convolution Calculations. The **Convolute...** menu item appears when two or more waveforms are being edited. It is used to convolute the section of the waveform between the two vertical bar cursors in one editing area with the waveform between the vertical bar cursors in another editing area. The result is normalized. The following diagram shows the menu configuration for the **Convolute...** item.



See Page 3 -15 “Opening and Selecting Editing Areas” for further information on designating multiple editing areas.

On a discrete system, convolution is called discrete convolution. The convolution $y(n)$ of waveform $x(n)$ and waveform $h(i)$ can be expressed by the following formula, where N is the number of data items:

$$y(n) = \sum_{i=0}^{N-1} x(i)h(n-i)$$

The operation expressed by this formula is called convolution.

In this example we will perform convolution with the waveform between the vertical bar cursors in editing area 1 as the **Source**, and the waveform in editing area 2.

A Gaussian pulse of 256 points is used for **Waveform1**, while a Magnetic Disk Writing signal of 512 points is used for **Waveform2**. The Gaussian pulse (**GAUSS_P.WFM**) and Magnetic Disk Writing signal (**MDSK_WR.WFM**) are included on the Sample Waveform Library Disk that came with the instrument. Figure 3 -67 shows the waveforms for **Waveform1** and **Waveform2**.

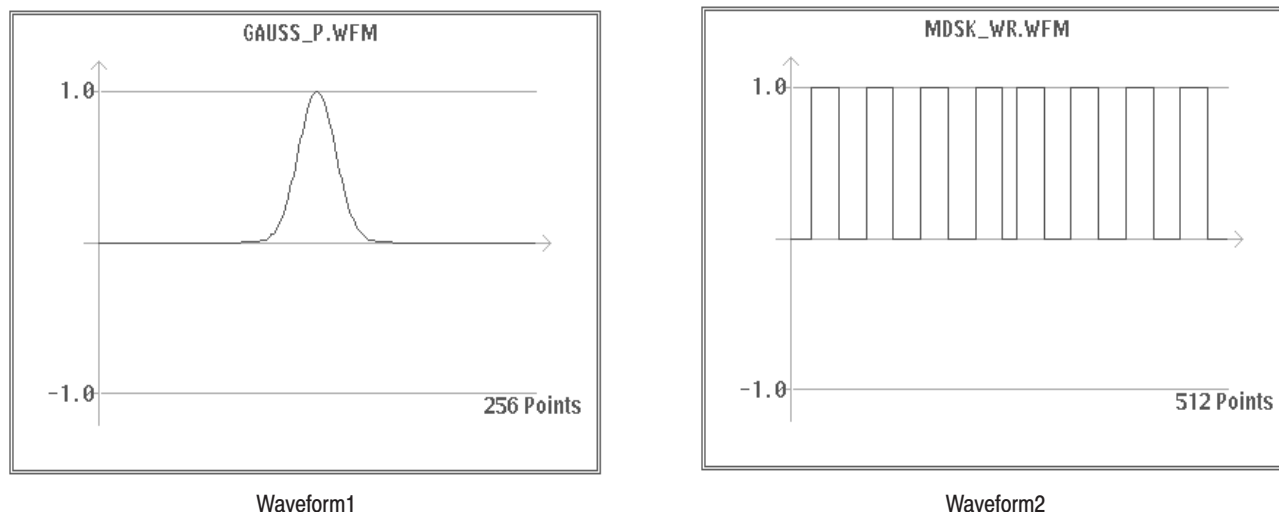

Figure 3 -67: Waveforms Used for Waveform1 and Waveform2

The procedure after the two waveforms have been set in each editing area is as follows:

Setting the convolution range

1. Select **Select/Open** from the bottom menu.
2. Select **Waveform1** from the side menu.
3. Press the **CURS** button on the front panel.
4. Using the numeric keys or the general purpose knob, set the positions of the left and right vertical bar cursors to define the section of the waveform for convolution. In this example, we will set the left cursor to point 0 and the right cursor to point 255.
5. Select **Waveform2** from the side menu.
6. Select **Setting** from the bottom menu.
7. Select **Waveform Points** from the side menu and, using the numeric keys or the general purpose knob, set the waveform point size to 768.

512 points is sufficient for the range of operation for **Waveform2**; in order to display all of the results of operation, the **Waveform2** editing area (where the results will be displayed) must be enlarged. The area needed is the sum of the point sizes for the two waveforms.

8. Press the **CURS** button on the front panel.

9. Using the numeric keys or the general purpose knob, set the positions of the left and right vertical bar cursors to define the section of the waveform for convolution. In this example, we will set the left cursor to point 0 and the right cursor to point 767.

Calculating the waveforms

10. Select **Operation** from the bottom menu.

11. Select **Convolute...** from the fourth page of the side menu (**More 4 of 4**).

When three waveform areas have been designated in the waveform editor, select one of the other two editing areas as the source for waveform convolution with **Source** item in the sub-menu.

12. Select **Execute** from the sub-menu.

Figure 3 -68 shows the screen before and after convolution.

In this example, the results of operation will be displayed between the left and right vertical bar cursors in editing area 2 (the one enclosed by a box on the screen) where editing is being performed. The convolution process will take approximately 20 seconds.

NOTE. The convolution process will take around 80 seconds for two waveforms consisting of 1000 points each; the time will vary slightly depending on the type of waveform. An instrument with Option 09 installed is equipped with the convolution waveform editor which performs convolution at high speed.

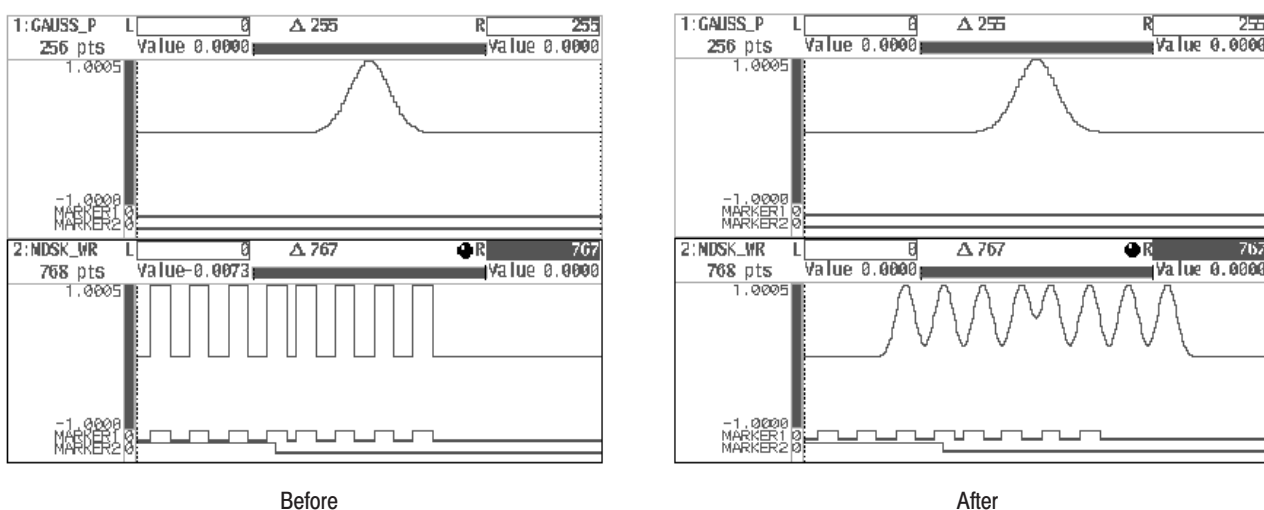
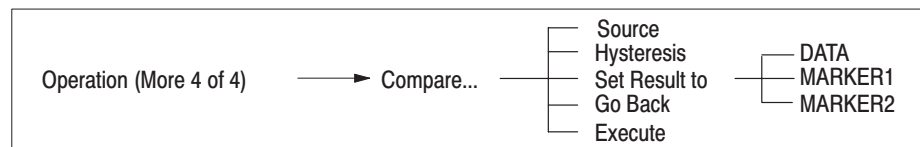

Figure 3 -68: Convolution

13. Select **Go Back** from the current sub-menu. The display moves from the **Convolute...** sub-menu to the side menu.

Comparing Waveforms. The **Compare...** item appears when two or more waveforms are being edited simultaneously. It is used to compare the section of the waveform between the two vertical bar cursors in one editing area to the waveform between the vertical bar cursors in another editing area. The following diagram shows the menu configuration for the **Compare...** item.



See Page 3 -15 “Opening and Selecting Editing Areas” for more detailed information regarding how to designate multiple editing areas.

Depending on whether the result of comparison is displayed in the editing area or in the **MARKER** area (as determined by the **Set Result to** item), the results are displayed as follows:

DATA selected in **Set Result to**

Comparison	Result (waveform level)
Destination > Source	1.000 (FFE in hexadecimal format)
Destination ≤ Source	0.000 (7FF in hexadecimal format)

MARKER1 or **MARKER2** selected in **Set Result to**

Comparison	Result (MARKER)
Destination > Source	1
Destination ≤ Source	0

In this example, we will designate the portion of the waveform between the vertical bar cursors in editing area 1 as the reference (**Source**) and then compare it with the waveform between the vertical bar cursors in editing area 2. The procedure begins from the point at which two waveforms have been selected in the waveform editor.

Designating the Section for Comparison

1. Select **Select/Open** from the bottom menu.

2. Select **Waveform1** from the side menu. This waveform will be the reference for comparison.
3. Press the **CURSOR** button on the front panel.
4. Using the numeric keys or the general purpose knob, set the positions of the left and right vertical bar cursors to define the section of the waveform for comparison. In this example, we will set the left cursor to point 125 and the right cursor to point 625.

NOTE. *The value indicated by Δ shows the difference in points between the left and right vertical bar cursors. This value includes the point occupied by the cursor, so the number of points in the waveform is $\Delta + 1$.*

5. Select **Waveform2** from the side menu. This waveform will be compared to the reference waveform.
6. Press the **CURSOR** button on the front panel.
7. Using the numeric keys or the general purpose knob, set the positions of the left and right vertical bar cursors to define the section of the waveform for comparison. In this example, we will set the left cursor to point 125 and the right cursor to point 875.
8. Select **Operation** from the bottom menu.
9. Select **Compare...** from the fourth page of the side menu (**More 4 of 4**). Figure 3 -69 shows the menu with the **Compare...** item selected.

When three waveform areas have been designated in the waveform editor, select one of the remaining two editing areas as the source for waveform comparison with **Source** item in the sub-menu.

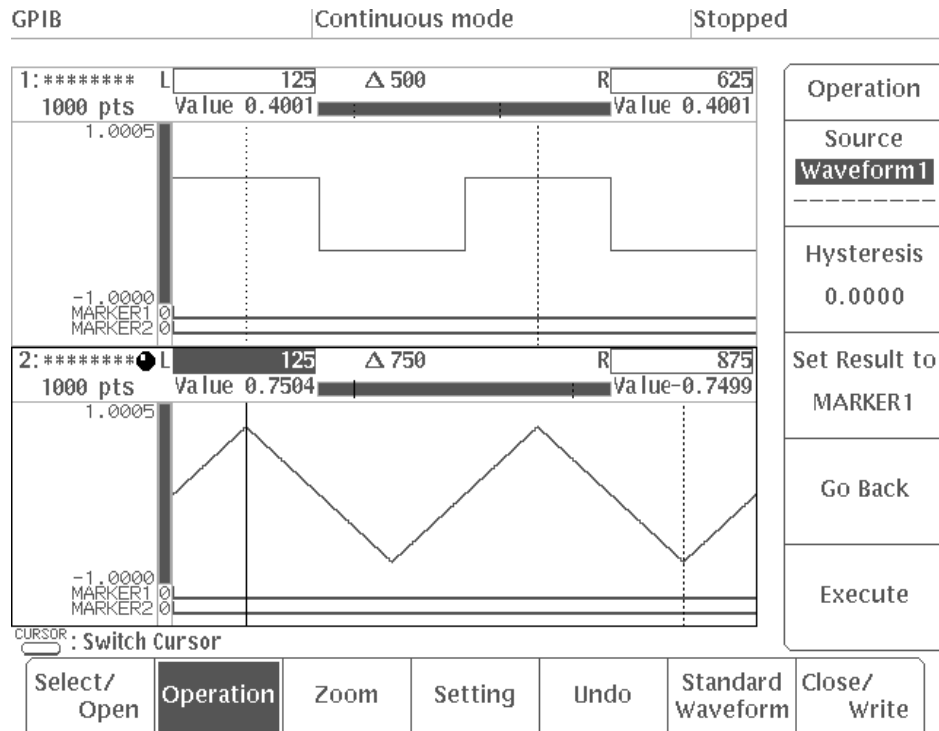

Figure 3 -69: Compare... Item Selected

10. Press the **Set Result to** button in the sub-menu to select **MARKER1**.

This item is used to set where the results of comparison will be displayed.

11. If you would like to apply hysteresis to the reference waveform, select **Hysteresis** and enter a value. If hysteresis is not necessary, this item should be set to 0.

Hysteresis comparison uses a higher and lower signal level than the **Source** signal level; the degree is determined by the value set with the **Hysteresis** item.

12. Select **Execute** from the sub-menu.

Comparison Without Hysteresis — The left part of Figure 3 -70 shows a comparison of a triangular wave for **Waveform2** and a square wave for **Waveform1**, with the results output to the **Waveform2** **MARKER** display area. The figure on the right has been provided as an aid to understanding this process.

Comparison is only performed for the section of **Waveform2** between the vertical bar cursors (in other words, from point 125 to point 875). Data outside this range is preserved as it was before comparison. The figure on the right shows the default marker set at point 0 remains “1.”

As there is less data in the **Source** waveform than the destination waveform, data at level 0 (in other words, a straight line) has been automatically added from point 626 to point 875 in the **Source** waveform.

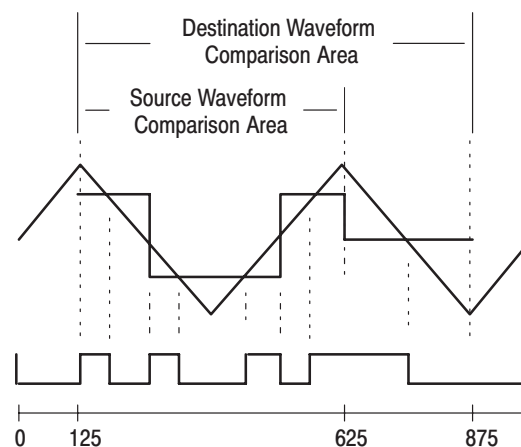
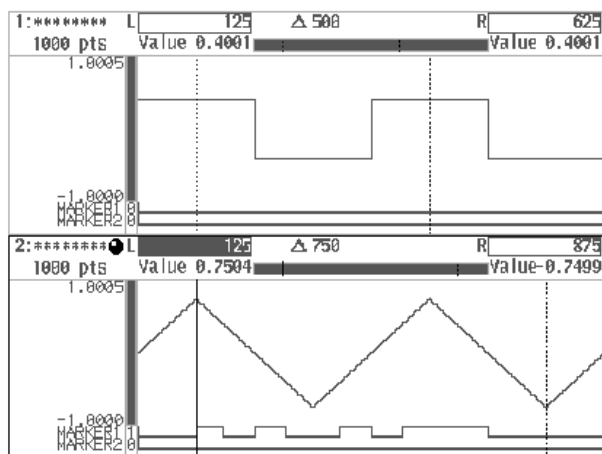

Figure 3 -70: Comparison Without Hysteresis

Comparison With Hysteresis — The left part of Figure 3 -71 shows a hysteresis comparison between a triangular wave as **Waveform2** and a square wave as **Waveform1**, with the results output to the **MARKER1** display area in the **Waveform2** area. The figure on the right has been provided as an aid to understanding this process.

In hysteresis comparison, the waveform only becomes high level when the destination waveform exceeds the level above the **Source** waveform set for **Hysteresis**. The waveform only becomes low level when the destination waveform exceeds the level below the **Source** waveform set for **Hysteresis**.

Comparison is only performed for the section of the waveform between the vertical bar cursors (in this example, from point 0 to point 999).

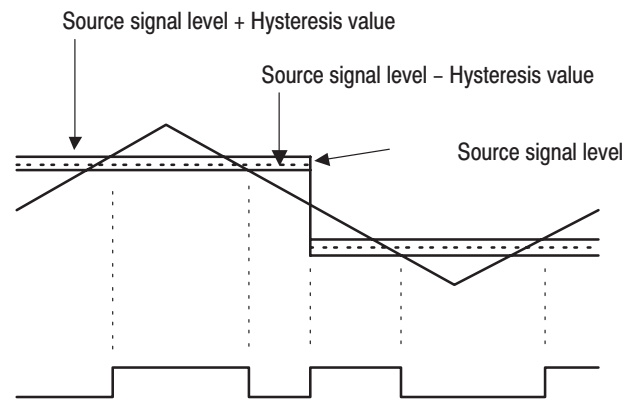
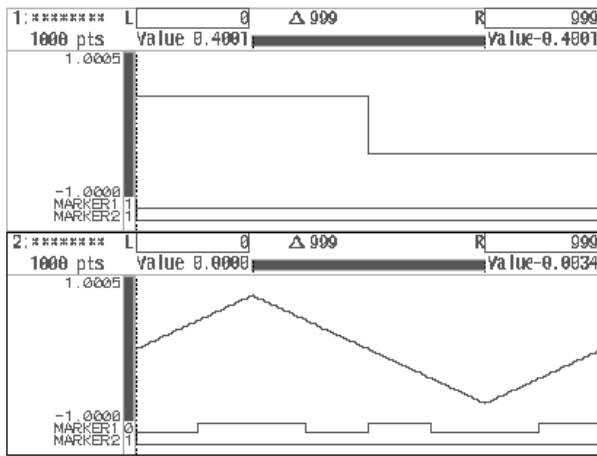

Figure 3 -71: Comparison With Hysteresis

13. Select **Go Back** from the current sub-menu. The display moves from the **Compare...** sub-menu to the side menu.

Zooming Waveforms. The **Zoom** item is used to enlarge or reduce the waveform being displayed, either horizontally or vertically. This process is for display purposes only; it does not affect the waveform data. The side menu consists of 2 pages: the first page contains the horizontal zoom items and the second page contains the vertical zoom items.

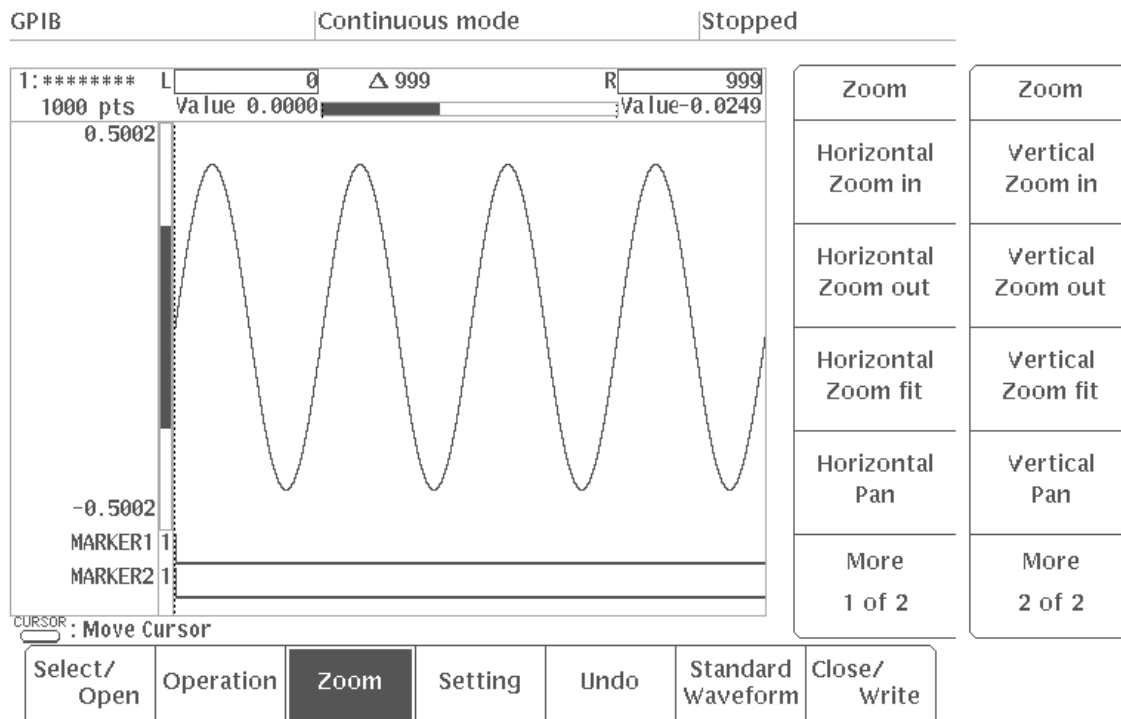

Figure 3 -72: Zoom Menu

Horizontal Zooming. When the waveform is enlarged horizontally using the **Horizontal Zoom in** item, three additional items are displayed in the side menu:

- | | |
|---------------------|---|
| Horizontal Zoom out | Used to reduce the waveform |
| Horizontal Zoom fit | Used to return to normal waveform size (x1) |
| Horizontal Pan | Used to scroll through the waveform when it is enlarged |

1. Select **Zoom** from the bottom menu.
2. Press the **CURS**OR button on the front panel.
3. Using the general purpose knob, move the active vertical bar cursor to the center of the position at which you want the waveform to be displayed.

Horizontal waveform enlargement will be centered around the active vertical bar cursor.

4. Select **Horizontal Zoom in** from the side menu. The waveform will be enlarged horizontally.

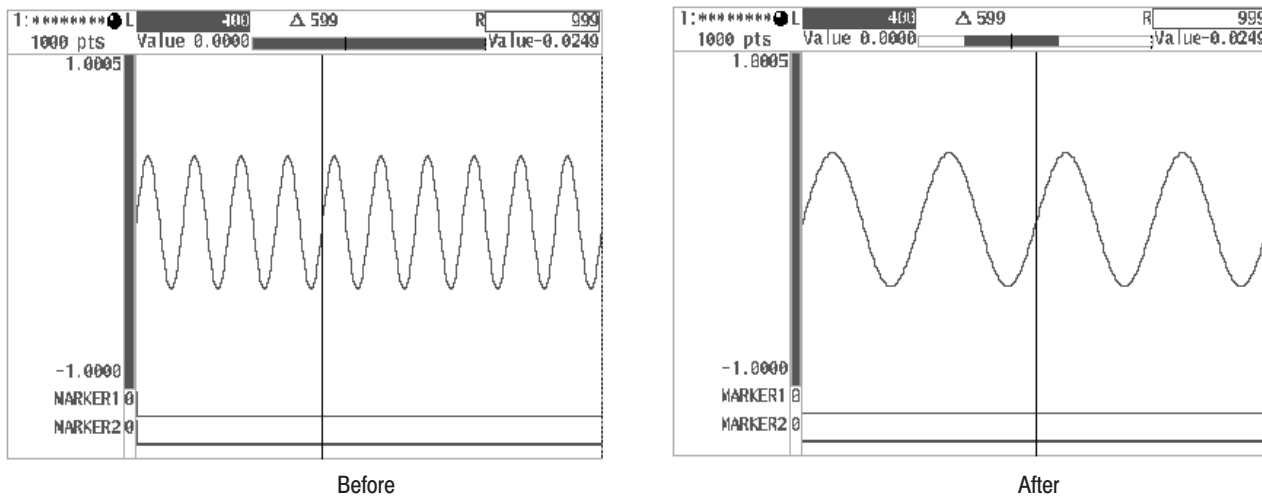

Figure 3 -73: Horizontal Zoom

5. Select **Horizontal Zoom in** again from the side menu.

The degree of enlargement will increase each time the button is pressed. When the maximum enlargement is reached, the **Horizontal Zoom in** item will disappear. The displayed inverted portion of the horizontal scroll indicator above the waveform editing area indicates which section of the waveform is currently being displayed on the screen.

6. Select **Horizontal Zoom out** from the side menu.

The degree of enlargement will decrease each time the button is pressed. When normal size (x1) is reached, the **Horizontal Zoom out** item will disappear.

7. Select the **Horizontal Zoom in** item once again to enlarge the waveform.

8. Select **Horizontal Pan** from the side menu.

This item enables you to scroll through the entire waveform by turning the general purpose knob. The displayed inverted portion of the horizontal scroll indicator above the waveform editing area indicates which section of the waveform is currently being displayed on the screen.

9. Turn the general purpose knob and check to make sure the waveform moves horizontally.

10. Select **Horizontal Zoom fit** from the side menu. The waveform will revert to normal size (x1).

Vertical Zooming. When the waveform is enlarged vertically with the **Vertical Zoom in** item, three new items will be added to the side menu:

Vertical Zoom out	Used to reduce the waveform.
Vertical Zoom fit	Used to return to normal waveform size (x1).
Vertical Pan	Used to scroll through the waveform when it is enlarged.

The process of vertical zooming is the same as that for horizontal zooming. However, the waveform is enlarged/reduced as the reference for the center of the vertical axis.

Figure 3 -74 shows an example of a waveform before and after vertical zooming.

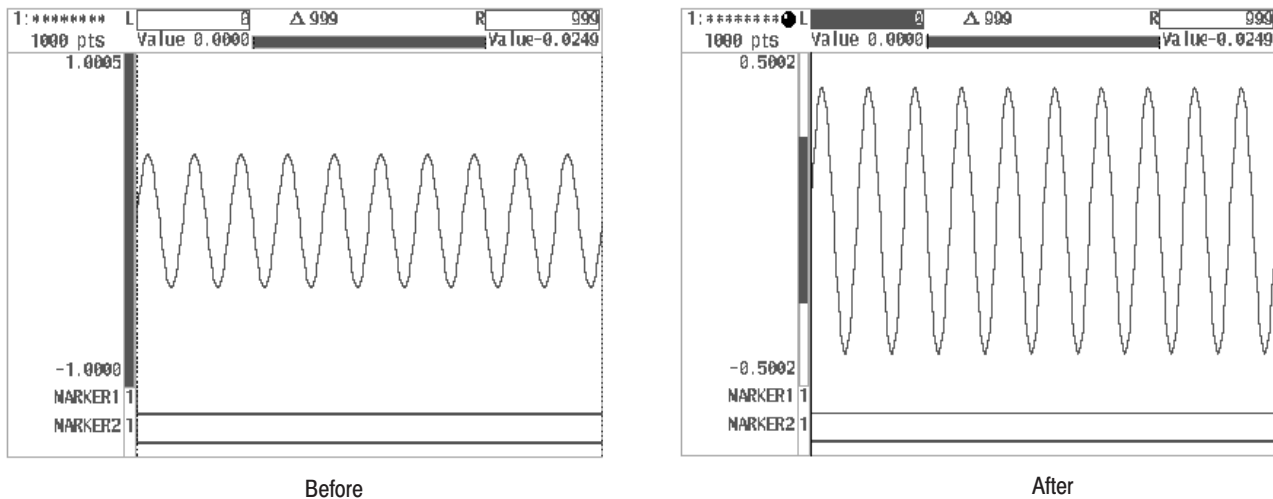

Figure 3 -74: Vertical Zoom

Timing Display

To show the timing display for the waveform editor using the **View type....** item in the **Setting** menu follow this procedure.

1. Select **Setting** from the bottom menu.
2. Select **View type...** from the side menu.

Three items will be displayed in the sub-menu: **Graphic**, **Timing** and **Table**.

3. Select **Timing** from the sub-menu.

The timing display of the waveform editor will appear. See Figure 3 -75.

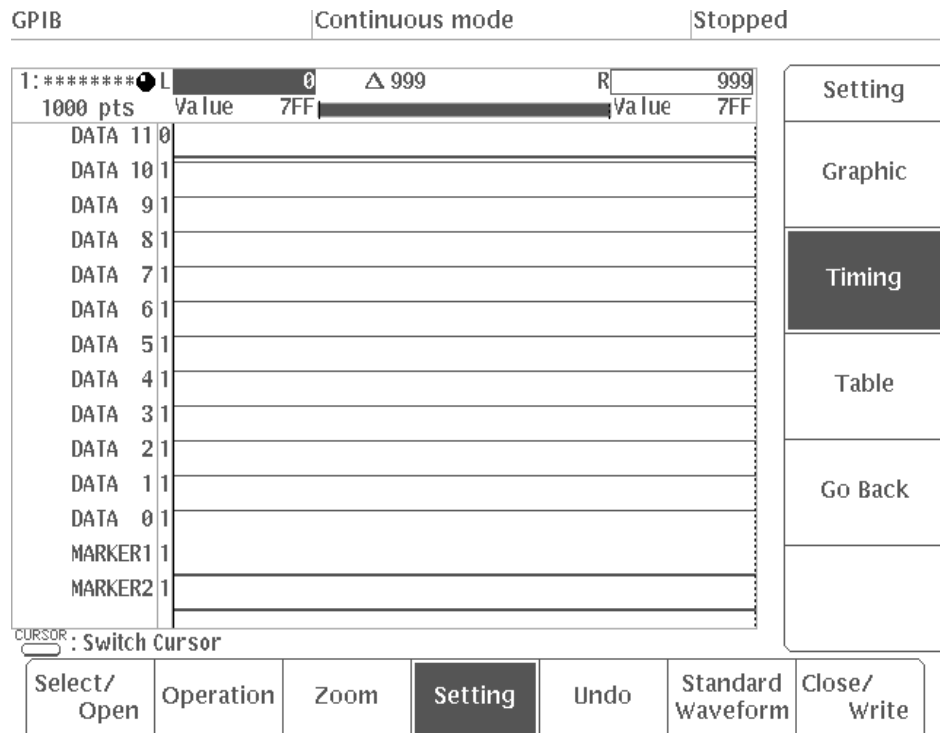

Figure 3 -75: Timing Display

4. Select **Go Back** from the sub-menu. The system moves to the previous **Setting** side menu.

Timing Display Menu Structure

Figure 3 -76 shows the menu configuration for the timing display.

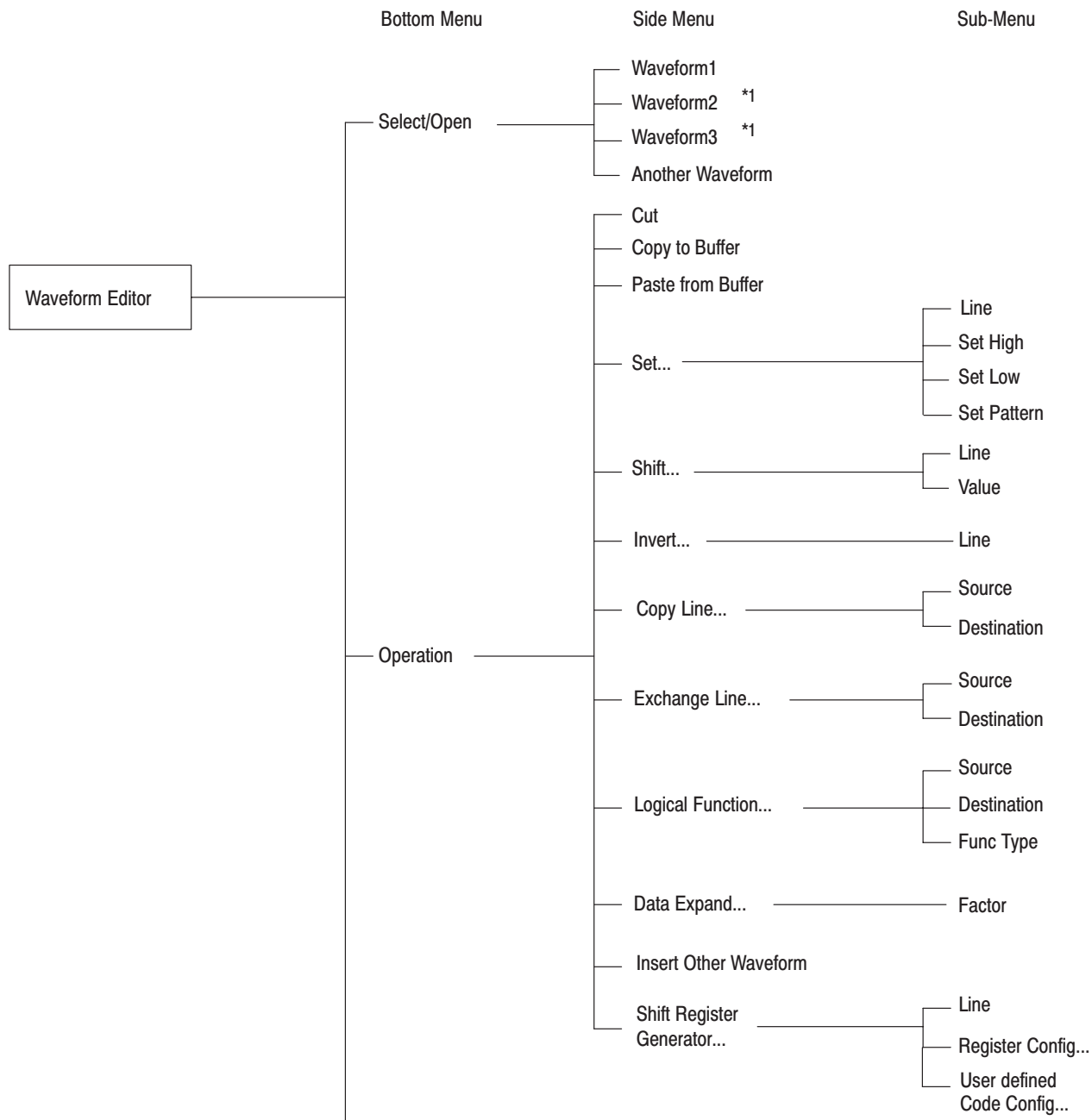
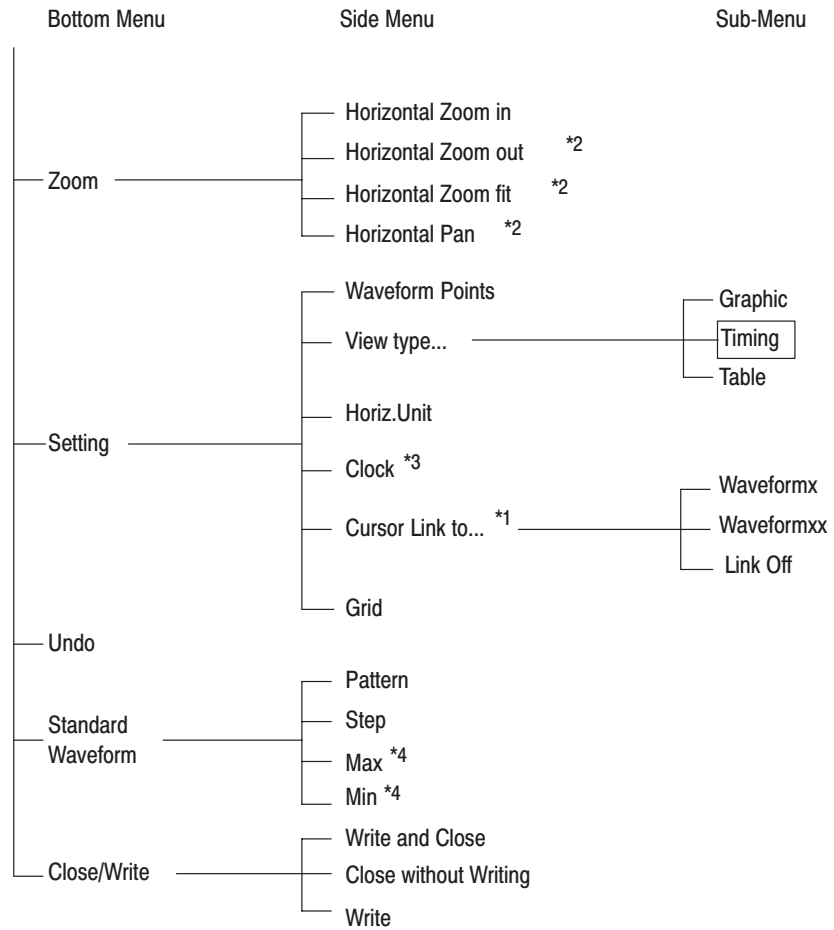

Figure 3 -76: Waveform Editor Timing Display Menu Structure



- *1 This item appears when two or more waveforms are being edited simultaneously with Another Waveform in the side menu (under Select/Open in the bottom menu).
- *2 These items appear when the displayed waveform data has been zoomed in in the horizontal direction with Horizontal Zoom in in the side menu (under Zoom in the bottom menu).
- *3 This item appears when Time has been selected for Horiz. Unit in the side menu (under Setting in the bottom menu).
- *4 These items appear when Count Up or Count Down has been selected for Pattern in the side menu (under Standard Waveform in the bottom menu).

Figure 3 -76: Waveform Editor Timing Display Menu Structure (Cont.)

Menu Functions

The following list shows the functions available for each menu item and the page on which you can find a description of that function.

Table 3-4: Menu Functions

Menu	Function	Page
Select /Open	Opening and selecting the editing area	3 -15
Operation	Editing waveforms in timing display	3 -104
Cut	Cutting waveforms	3 -43, 3 -104
Copy to Buffer	Copying waveforms	3 -44, 3 -104
Paste from Buffer	Pasting waveforms	3 -44, 3 -104
Set...	Setting waveform data	3 -104
Shift...	Shifting waveform data	3 -117
Invert...	Inverting waveform data	3 -118
Copy Line...	Copying lines	3 -119
Exchange Line...	Exchanging lines	3 -120
Logical Function...	Applying logical operations to lines	3 -121
Data Expand...	Expanding waveform data	3 -122
Insert Other Waveform	Inserting other waveform data	3 -60, 3 -124
Shift Register Generator...	Pseudo-random pulse generator using shift register	3 -124
Zoom	Zooming displayed waveforms data	3 -92, 3 -129
Setting	Settings for the waveform to be edited	3 -28, 3 -101
Waveform Points...	Setting waveform point count	3 -29
View type...	Selecting the waveform data display format	3 -29
Horiz. Unit	Setting horizontal axis units	3 -31
Clock	Setting clock frequency	3 -32
Cursor Link to...	Linking the vertical bar cursors	3 -34
Grid	Displaying a grid in the editing area	3 -35
Undo	Canceling function execution	3 -2
Standard Waveform	Creating standard waveform data	3 -101
Close/Write	Saving files and exiting the editor	3 -20

Timing Display Screen

Figure 3 -77 shows the timing display screen. This section will describe each portion of the screen; however, descriptions of areas that are identical to the graphic display will be omitted. See “Graphic Display Screen” for a description of the graphic display.

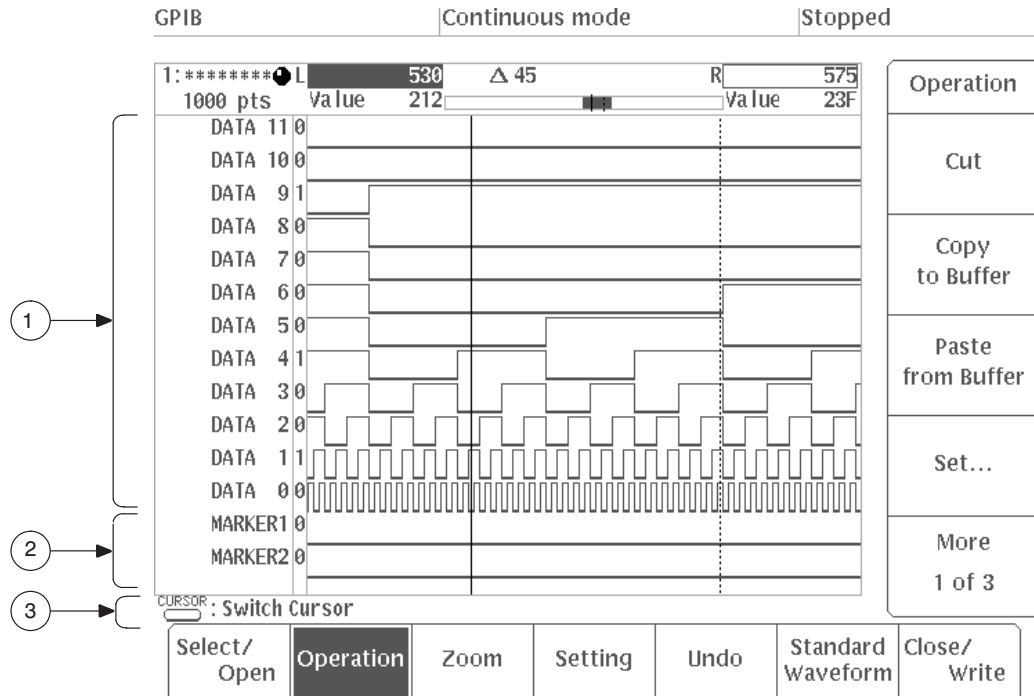



Figure 3 -77: Timing Display Screen

(1) DATA 11 – DATA 0	This area shows the timing for each of the data lines (11 – 0). Data line 11 is the MSB. The number next to the data lines (11 – 0) indicates the time or point value at the location of the active vertical bar cursor.
(2) MARKER1 / MARKER2	This area shows the timing for the marker 1 or 2. The number to the right of the word “ MARKER ” indicates the state of the marker for the time or point value at the location of the active vertical bar cursor.

(3) Button Operations	<p>This area shows how the front panel buttons operate in this menu.</p> <p> : Switch Cursor</p> <p>Pressing the CURSOR button toggles the active vertical bar cursor between left and right.</p> <p> : Move Cursor</p> <p>When the CURSOR button is pressed, the vertical bar cursor can be moved.</p>
------------------------------	---

Settings for the Waveform to be Edited. Before waveform data is created, you must use the **Setting** item in the side menu to set the environment for editing. The method used to set values is the same as for the graphic display. See “Setting for the Waveform to be Edited” for a description of the graphic display.

Creating Standard Waveform Data. Use this item to create waveform data in the area between the designated vertical bar cursors.

The following diagram shows the menu configuration for the **Standard Waveform** item.

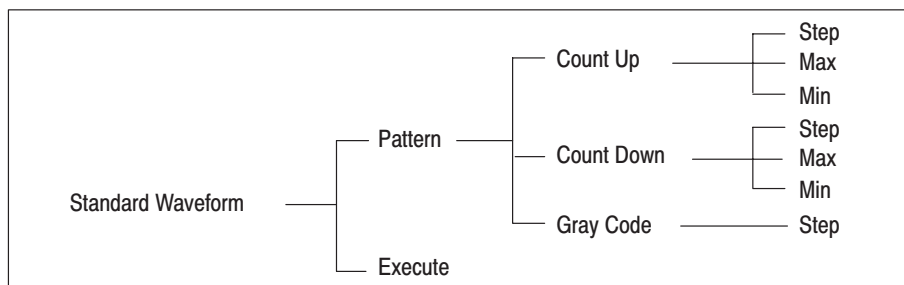

Pattern Types. Use this item to select the waveform to be created. You can choose from the following three pattern options:

- **Count Up.** Data is created sequentially, increasing from the initial value designated with **Min** to the maximum value designated with **Max**. When the maximum value is exceeded, the waveform will return to the initial value and begin counting up again. In the example shown in Figure 3 -78, the waveform point size is 4096, **Step** has been set to 1, and the **Min** and **Max** values have been set to 0 and 4095, respectively.

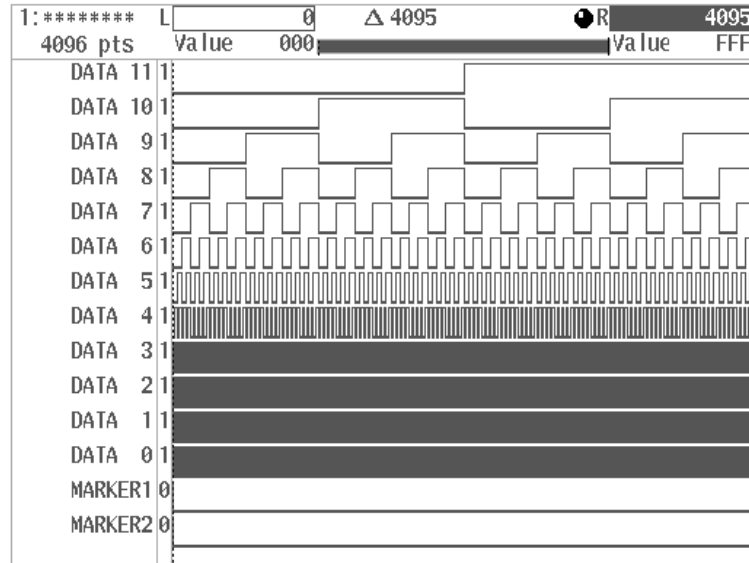

Figure 3 -78: Count Up Pattern Display

The following parameters can be set:

- Step** The number of points for each data item. This value can be set to 1 – 10.
- Max** The maximum value for the data. This value can be set anywhere between (**Min** value + 1) and 4095.
- Min** The minimum value for the data. This value can be set anywhere between 0 and (**Max** value – 1).
- **Count Down.** Data is created sequentially, decreasing from the initial value designated for **Max** to the minimum value designated for **Min**. When the minimum value is exceeded, the value returns to the maximum value and countdown begins again. The values for **Step**, **Max** and **Min** can be set in the same manner as with **Count Up**.
- **Gray Code.** A data pattern is created in which the difference between adjacent data is only 1 bit. When the 4096 items of 12-bit data end, the data repeats from the beginning. In the example shown in Figure 3 -79, the waveform point size has been set to 4096 and **Step** has been set to 1. Only the **Step** parameter is set for the **Gray Code** pattern option.

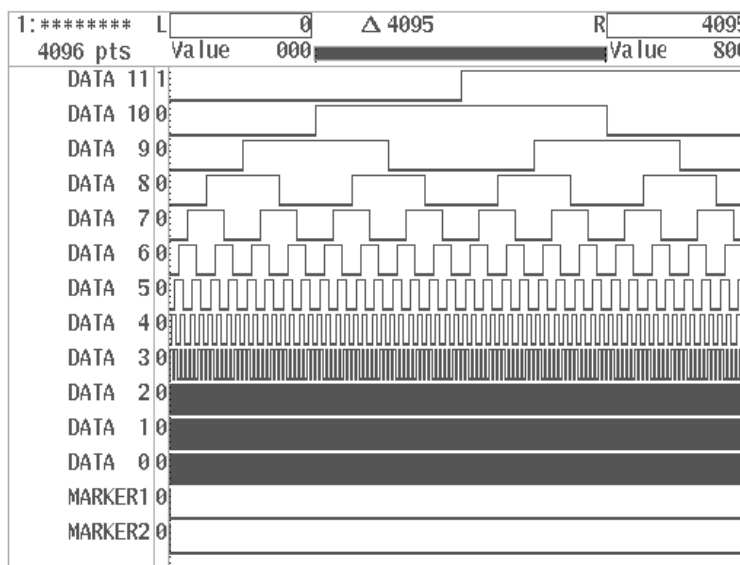

Figure 3 -79: Gray Code Pattern Display

Example of Waveform Data Creation. In the following operation, you will replace the data between the vertical bar cursors with a **Count Up** pattern, with the waveform point size set to 4096.

1. Select **Standard Waveform** from the bottom menu.
2. Press the **CURSOR** button on the front panel. Using the general purpose knob, move the left and right vertical bar cursors all the way to the left and right, respectively, so the entire editing area is selected.
3. Select **Pattern** from the side menu, then select **Count Up** by turning the general purpose knob or pressing the **Pattern** button in the side menu.
4. Select **Step** from the side menu. Using the numeric keys or the general purpose knob, set the step to 1.
5. Select **Max** from the side menu. Using the numeric keys or the general purpose knob, set the end point for the **Count Up** pattern to 4095.
6. Select **Min** from the side menu. Using the numeric keys or the general purpose knob, set the starting point for the **Count Up** pattern to 0.
7. Select **Execute** from the side menu.

The data between the vertical bar cursors will be replaced by the **Count Up** pattern that you have designated. Figure 3 -78 shows the **Count Up** pattern created with the values used in this example.

Editing Waveform Data in Timing Display

Use **Operation** to edit the waveform data in a variety of ways.

The side menu is made up of 3 pages. To get to the next page of the menu, select **More**. The following list shows the names and functions of the items in the side menu.

Cut	Cutting waveforms
Copy to Buffer	Copying waveforms
Paste from Buffer	Pasting waveforms
Set...	Setting the waveform data
Shift...	Shifting waveform data
Invert...	Inverting waveform data
Copy Line...	Copying lines
Exchange Line...	Exchanging lines
Logical Function...	Applying logical operations to lines
Data Expand...	Expanding waveform data
Insert Other Waveform	Inserting other waveform data
Shift Register Generator...	Pseudo-random pulse generator Using shift register

Cut, Copy, and Paste Processing Function. Use these functions cut, copy to the buffer, and paste to any other time or point value within the waveform data area between the vertical bar cursors. The functions for these items are the same as for the corresponding items in waveform editor graphic display. See Pages 3 -43 through 3-46.

Setting Waveform Data. Use **Set...** to designate data for each data line and marker in the editing area between the designated vertical bar cursors. The following diagram shows the menu configuration for the **Set...** item.

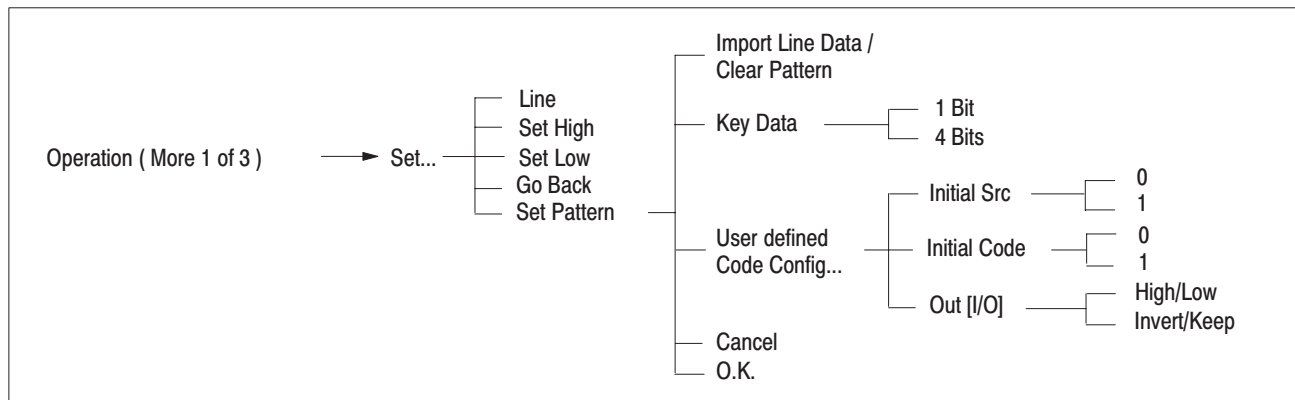

Setting Data to High/Low. Use **Set High** and **Set Low** to set the data lines or marker in the area designated by the right and left vertical bar cursors to either High or Low.

1. Select **Set...** from the side menu displayed.
2. Press the **CURSOR** button on the front panel.
3. Using the general purpose knob, move the vertical bar cursors to designate the area for the High or Low state.
4. Select **Line** from the sub-menu. Using the general purpose knob, select the data line (**DATA 11 – DATA 0**) or the marker (**MARKER**) that you want to set to High or Low.
5. Select **Set High** or **Set Low** to set the state between the vertical bar cursors for the selected line.

Set High Sets the state to High

Set Low Sets the state to Low

Figure 3 -80 shows an example in which the state of the **DATA 5** line between the vertical bar cursors has been set to Low.

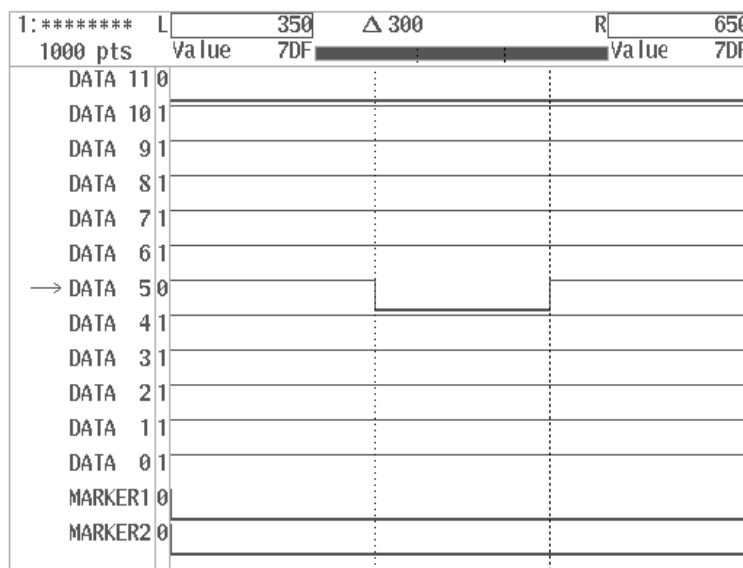

Figure 3 -80: Setting Waveform Data to High/Low

6. Select **Go Back** from the current sub-menu. The system moves from the **Set...** sub-menu to the previous side menu.

Setting Pattern Data

Use **Set Pattern** to designate pattern data for the part of a data line or marker between the designated vertical bar cursors. Figure 3 -81 shows the pattern data menu that appears when you select **Set Pattern** from the sub-menu.

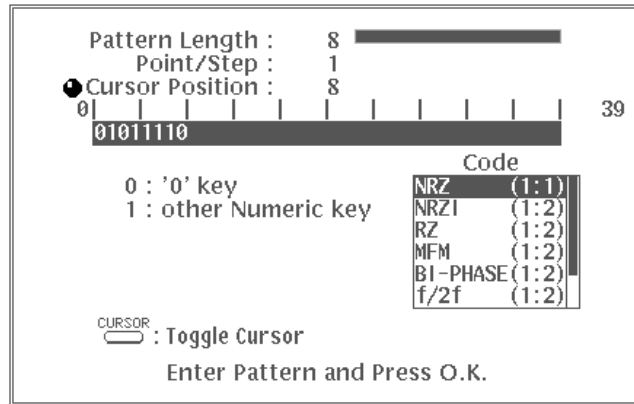

Figure 3 -81: Pattern Data Setting Menu

When the designated pattern is shorter than the area between the vertical bar cursors, the pattern data is repeated. You can create a variety of bit strings for the same pattern data by selecting **Code** in the menu.

Press the **CURSOR** button on the front panel to select the items needed for setting the pattern data. The following items can be selected; use the general purpose knob to set the desired value.

- Cursor Position (sets the position of the cursor)
- Point/Step (sets the number of points per step)
- Code (used to select the data code)

Entering Pattern Data and Pattern Length. To enter the pattern data, press the **CURSOR** button on the front panel and select **Cursor Position**. A knob icon will appear to the left of the **Cursor Position** area. The value next to “**Cursor Position**” in the menu indicates the current position of the cursor.

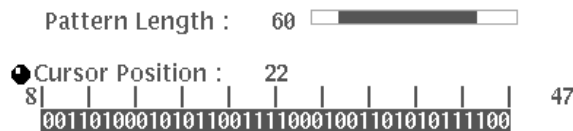

Now you can use the numeric keys to enter the pattern data. Any value up to 32,768 bits can be entered for pattern data. However, only 40 bits can be displayed on the screen at one time; use the general purpose knob to scroll

through the rest of the data. The inverted display area in the **Pattern Length** indicates the portion of the pattern data currently being displayed on the screen.

Pattern Length indicates the length of the pattern data that has been entered. This value will increase each time more pattern data is entered.

Changing the Data Bits. When entering pattern data, you can enter data either 1 bit at a time (for each keystroke) or 4 bits at a time, depending on the setting for **Key Data** in the side menu.

When **Key Data** is set to **1 Bit**, the **0** key has a value of 0 and the other numeric keys have a value of 1, meaning that 1-bit data is inserted each time one of these keys is pressed. In the figure shown below, numeric key values of **0, 1, 0** and **1** have been entered in that order.

● Cursor Position : 4

0| | | | | | | | | | 39

0101

0 : '0' key
1 : other Numeric key

When **Key Data** is set to **4 Bits**, a hexadecimal number (4-bit data) is entered each time one of the numeric keys is pressed. In the figure shown below, numeric key values of **0, 1** and **2** have been entered in that order.

● Cursor Position : 12

0| | | | | | | | | | | | 39

000000010010

0000 : '0' key
0001 : '1' key
0010 : '2' key
:
1110 : 'E' key
1111 : 'F' key

Point/Step. **Point/Step** is used to set how many points make up each item of pattern data. The data after **Code** conversion will be one item of pattern data. For example, when **NRZ** is selected for **Code** and **Point/Step** is set to 2, each pattern will consist of 2 points.

To set the point size for each item of pattern data, press the **CURSOR** button on the front panel and then select **Point/Step**. A knob icon will appear to the left of the **Point/Step** area.

● Point/Step : 2

Pattern Code.Code is used to select the coding system used when the pattern strings are output. Depending on the designated length of the area between the vertical bar cursors, the code may be cut off in the middle.

To select the code, use the following procedure:

1. Press the **CURSOR** button on the front panel and select **Code**. A knob icon will appear in the upper left-hand corner of the **Code** area.

● Code

NRZ	(1:1)
NRZI	(1:2)
RZ	(1:2)
MFM	(1:2)
BI-PHASE	(1:2)
f/2f	(1:2)

2. Using the general purpose knob, select the desired code from the choices listed. The following 8 code options are available:

NRZ
 NRZI
 RZ
 MFM
 BI-PHASE
 f/2f
 1-7 RLL
 2-7 RLL
 user defined

The “**user defined**” code allows the user to create a custom conversion table. See “User defined Code Conversion” later in this section. For a description of the other codes, see “Pattern Codes” in Appendix F.

Sample Pattern Data Setting. In the following example, pattern data (at **DATA 5**; **Point/Step**: 2, **Code**: NRZI) will be created in the area between the vertical bar cursors.

1. Select **Set...** from the side menu.
2. Press the **CURSOR** button on the front panel.

3. Using the general purpose knob, move the vertical bar cursors to define the area in which the pattern will be set. In this example, we will set the left vertical bar cursor to 250 and the right vertical bar cursor to 750.
4. Select **Line** from the sub-menu. Turning the general purpose knob, select **DATA5** for which you want to set the pattern.
5. Select **Set Pattern** from the sub-menu.
6. Press the **CURSOR** button on the front panel to select **Cursor Position**.
7. Press the **Key Data** button in the sub-menu to select **4 Bits**.
8. Press **1, 2** in that order.



9. Press the **CURSOR** button on the front panel to select **Point/Step**.
10. Using the general purpose knob, set **Point/Step** to **2**.



11. Press the **CURSOR** button on the front panel to select **Code**.
12. Using the general purpose knob, select **NRZI**.

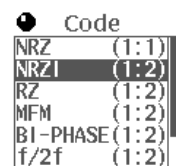

13. Select **O.K.** from the sub-menu. The pattern that you have set in the preceding steps will appear between the vertical bar cursors. See Figure 3 -82.

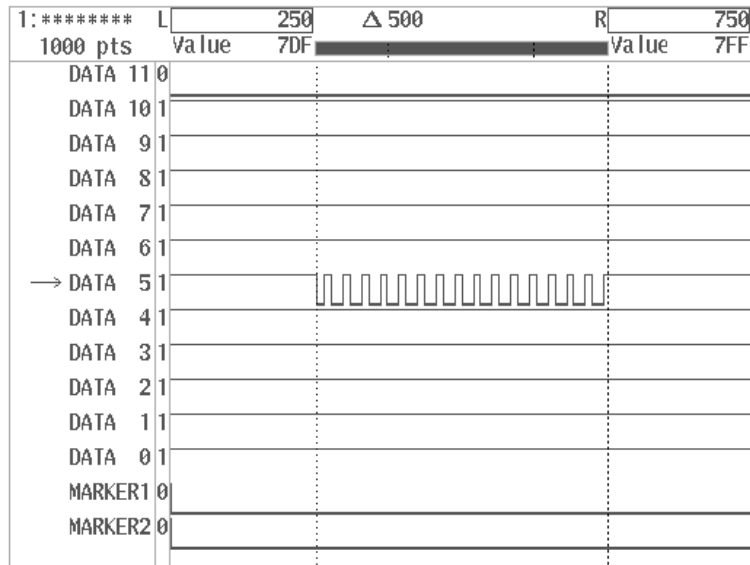

Figure 3 -82: Setting Pattern Data

User defined Code Config... . Users can define their own conversion tables for code conversion. This function enables RLL codes, etc. to be freely defined. For sample codes, see “Pattern Codes” in Appendix F. Conversion tables defined with this menu item are protected by the backup battery, so they are preserved even after the power is turned off. To reset this item to the factory default (NRZ), select **Reset to Factory** in the **UTILITY** menu.

The following process is used to create a user-defined conversion table.

1. Perform steps 1 through 5 of the sample process for defining pattern data.
2. Select **User defined Code Config...** from the side menu. See Figure 3 -83.

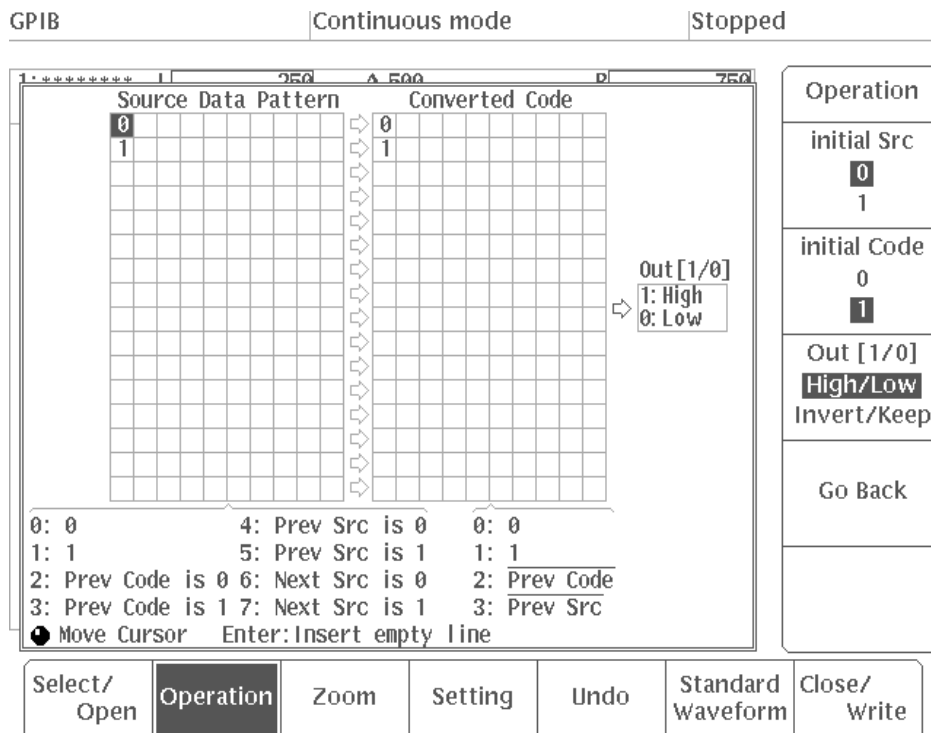

Figure 3 -83: User defined Code Conversion Menu

3. Define the codes as desired (see “Basic Operations” on the following).
4. Select **Go Back** to return to the **Set Pattern** menu.
5. Define the pattern data, using the same procedure as in steps 6 – 10 of the sample process for defining pattern data.
6. Press the **CURSOR** button to select **Code** menu item. A knob icon will appear in the upper left side of the code selection menu.
7. Turn the general purpose knob to select **user defined**.
8. Press **O.K.** in the sub-menu to execute code conversion. The result will be inserted between the cursors on the data line defined in Step 1.

Moving the Cursor. To move the cursor, turn the general purpose knob. The cursor can be moved throughout the area where data has already been defined, plus one more space. From the **Source Data Pattern** item, the cursor moves to the **Converted Code** item. When the cursor reaches the last data item, it will return to the beginning. The cursor can also be moved using the left and right arrow buttons.

Inserting a Blank Line. Pressing the **ENTER** key causes a blank line to be inserted above the data item marked by the cursor.

NOTE. Blank lines cannot be inserted if there are more than two consecutive blank lines or if there are more than 16 lines in all.

Defining Data. Move the cursor to the desired location to enter a value on the numeric keys. The value at that location will be replaced by the one you have entered. Enterable values will vary depending on the location of the cursor:

In the **Source Data Pattern** area, only numeric keys 0 through 7 are operational.

In the **Converted Code** area, only numeric keys 0 through 3 are operational.

Deleting Data. Pressing the delete key will delete the data indicated by the cursor. When a data item is deleted, all of the subsequent data items will move forward one space. If there is no data at the cursor position, the cursor will move one position to the left.

Deleting a Line. When all of the data on the line indicated by the cursor has been deleted, that line will also be deleted and all subsequent data will move up one line.

Setting Items. The **Source Data Pattern** is used to write the pattern for input data.

<p>Source Data Pattern</p> <p>0: 0</p> <p>1: 1</p> <p>2: Prev Code is 0</p> <p>3: Prev Code is 1</p> <p>4: Prev Src is 0</p> <p>5: Prev Src is 1</p> <p>6: Next Src is 0</p> <p>7: Next Src is 1</p>	<p>0 Data at that position is LOW</p> <p>1 Data at that position is HIGH</p> <p>2 The preceding Converted Code data item is 0</p> <p>3 The preceding Converted Code data item is 1</p> <p>4 The preceding Source Data Pattern data item is 0</p> <p>5 The preceding Source Data Pattern data item is 1</p> <p>6 The following Source Data Pattern data item is 0</p> <p>7 The following Source Data Pattern data item is 1</p>
--	--

- 2, 3, 4 and 5 can only be written at the beginning of **Source Data Pattern**
- 6 and 7 cannot be written at the beginning of **Source Data Pattern**
- Only the data for the immediately preceding time can be referenced with 2, 3, 4 and 5
- 6 and 7 are effective as long as the pattern can be written

After the first time 6 and 7 appear, 0 will be treated as 6 and 1 will be treated as 7

- 6 and 7 read the input data and search for the same pattern. When the same pattern has been detected, the portion of the data that has been read is returned to its original status and then the next pattern is analyzed.
- 0, 1, 2, 3, 4, 5, 6 and 7 can be used together

Converted Code writes the output data pattern

Converted Code

0: 0
 1: 1
 2: Prev Code
 3: Prev Src

- | | |
|---|--|
| 0 | Sets the output data to LOW |
| 1 | Sets the output data to HIGH |
| 2 | Turns the inverse of the preceding Converted Code data item into output data |
| 3 | Turns the inverse of the preceding Source Data Pattern data item into output data |

Initial Source is the default value for the source pattern. Affects output data when the **Source Data Pattern** is 4 and 5 and when 3 is used for **Converted Code**.

Initial Code is the default value for the output pattern. Affects output data when the **Source Data Pattern** is 2 and 3; when 2 is used for **Converted Code**; and when **Out [1/0]** is set to **Invert/Keep**.

Out/[1/0] determines the handling of 1/0 for data converted using **Converted Code**.

High/Low 1: data HIGH 0: data LOW

Invert/Keep 1: output is inverted 0: data is output as is

Sample Pattern Conversion. When **Source Data Pattern** is unaffected by other conditions

Initial Src 0
 Initial Code 0
 Out[1/0] High/Low

Source Data Pattern	Converted Code
00	00
01	11
10	20
11	30

In the case of the above conversion, the data will be as follows:

Position	-3	-2	-1	0	1	2	3	4	5	6	7
Source Data Pattern	0	0	0	1	1	0	1	1	0	1	0
Converted Code	0	0	1	3	0	1	1	2	0	2	0
Result	0	0	1	1	0	1	1	0	0	1	0

NOTE. 3 of 30 in pattern 11 starting from position 0 is the inverse of the 0 in the **Source Data Pattern** at position -1.

2 of 20 in pattern 10 starting from position 4 is the inverse of result 1 at position 3.

2 of 20 in pattern 10 starting from position 6 is the inverse of result 0 at position 5.

When **Out[1/0]** is set to **Invert/Keep** for the same table, the data will be as follows:

Source Data Pattern	0	0	0	1	1	0	1	1	0	1	0
Converted Code	0	0	1	3	0	1	1	2	0	2	0
Invert/Keep (Previous)	0	0	1	1	0	1	1	0	0	1	0
Result	0	0	1	0	0	1	0	0	0	1	1

When **Source Data Pattern** is affected by other conditions

If 4 and 5 are used:

Initial Src 0
 Initial Code 0
 Out[1/0] High/Low

Source Data Pattern	Converted Code
40	0001
41	010
50	0100
51	1000

Time	-1	0	1	2	3	4	5	6	7	8
Input	0	0	1	0	1	1	0	1	0	0
Pattern	40	40	41	50	41	51	50	41	50	40

If 6 and 7 are used (1):

Initial Src 0
 Initial Code 0
 Out[1/0] High/Low

Source Data Pattern	Converted Code
07	0001
17	0010
06	0100
16	1000

In the case of the above conversion, the data will be as follows:

Time	-1	0	1	2	3	4	5	6	7	8
Input	0	0	1	0	1	1	0	1	0	0
Pattern	06	07	16	07	17	16	07	16	06	

If 6 and 7 are used (2):

Initial Src 0
 Initial Code 0
 Out[1/0] High/Low

Source Data Pattern	Converted Code
077	00000001
076	00000010
177	00000100
176	00001000
067	00010000
066	00100000
167	01000000
166	10000000

In the case of the above conversion, the data will be as follows:

Time	-1	0	1	2	3	4	5	6	7	8
Input	0	0	1	0	1	1	0	1	0	0
Pattern	067	076	167	077	176	167	076	166		

Importing Waveform or Marker Data as Pattern Data. **Import Line Data** is used to import the selected bit data as pattern data. It can be used to perform code conversion even for waveform data.

The commands in the **Import Line Data** menu will change depending on whether or not there is data in the pattern data area. When there is no data, the **Import Line Data command** will appear in the sub-menu. When data has been entered, this command will change to **Clear Pattern**.

1. Select **Set...** from the side menu.
2. Select the data to be imported and then use the cursors to specify the required range.
3. Select **Set Pattern** from the sub-menu.
4. If pattern data exists, press **Clear Pattern** button in the sub-menu to clear the existing data.
5. Select **Import Line Data** from the sub-menu. The selected bit data will be read into the pattern data input area.

Clear Pattern. When data has been entered in the pattern data input area, the **Import Line Data** item in the sub-menu will change to **Clear Pattern**. Pressing the **Clear Pattern** button will delete all pattern data.

Shifting Waveform Data

Use the shift function to shift the data between the designated vertical bar cursors in individual data lines or markers by the specified points or time. The following diagram shows the menu configuration for the **Shift...** item.

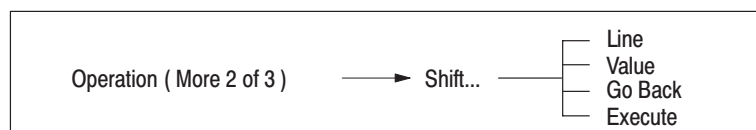

1. Move the vertical bar cursors to define the part of the waveform data to be shifted, then select **Shift...** from the second page of the side menu (**More 2 of 3**).
2. Select **Line** from the sub-menu. Turning the general purpose knob, select the data line (**DATA 11 – DATA 0**) or marker (**MARKER1** or **MARKER2**) on which the data is to be shifted.
3. Select **Value** from the sub-menu. Using the general purpose knob or the numeric keys, input the shift point value.

Value sets the amount of the shift in points or time. The range for the shift value is \pm (designated waveform point size). To shift the data between the vertical bar cursors to the right, enter a positive value; points that shift out beyond the right cursor will be shifted in from the left. To shift the data to the left, enter a negative number; points that shift out beyond the left cursor will be shifted in from the right.

4. Select **Execute** from the side menu. The waveform data is shifted with the specified conditions. Figure 3 -84 shows the screen before and after the data on line **DATA 5** between the vertical bar cursors is shifted 30 points to the right.

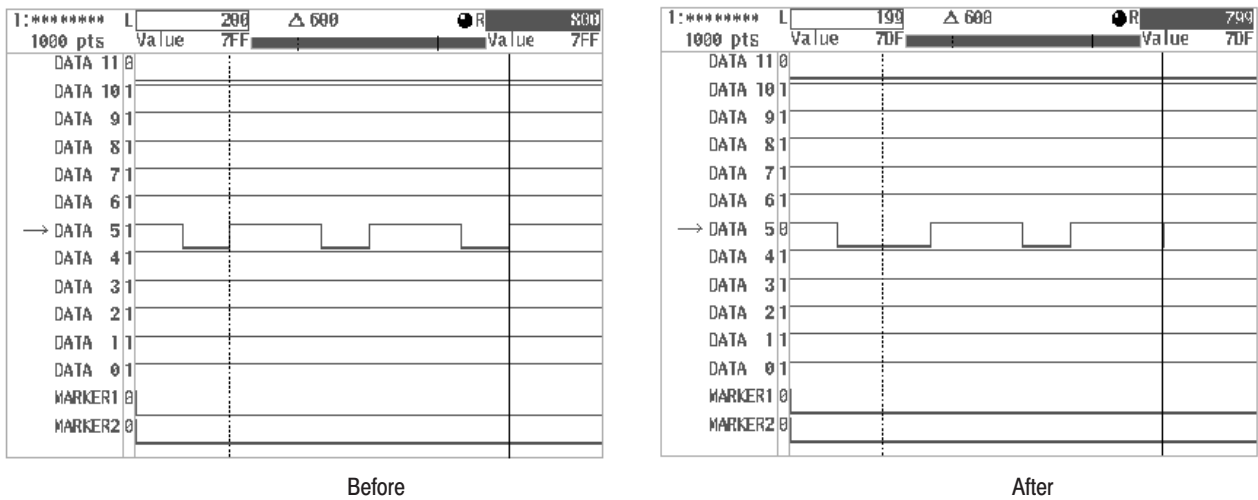
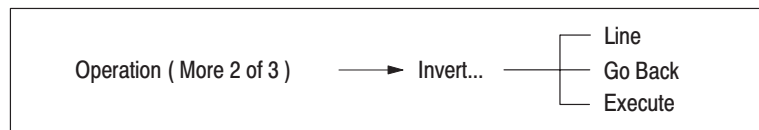

Figure 3 -84: Shifting Waveform Data

5. Select **Go Back** from the current sub-menu. The system returns from the **Shift...** sub-menu to the previous side menu.

Inverting Waveform Data

Use **Invert...** to invert each data line or marker between the designated vertical bar cursors. The following diagram shows the menu configuration for the **Invert...** item.



1. Move the vertical bar cursors to define the section of the data to be inverted. Then select **Invert...** from the second page of the side menu (**More 2 of 3**).
2. Select **Line** from the sub-menu. Turning the general purpose knob, select the data line or marker whose state is to be inverted.
3. Select **Execute** from the sub-menu. The state is inverted with the specified conditions. Figure 3 -85 shows the screen before and after the data between the vertical bar cursors on line **DATA 5** is inverted.

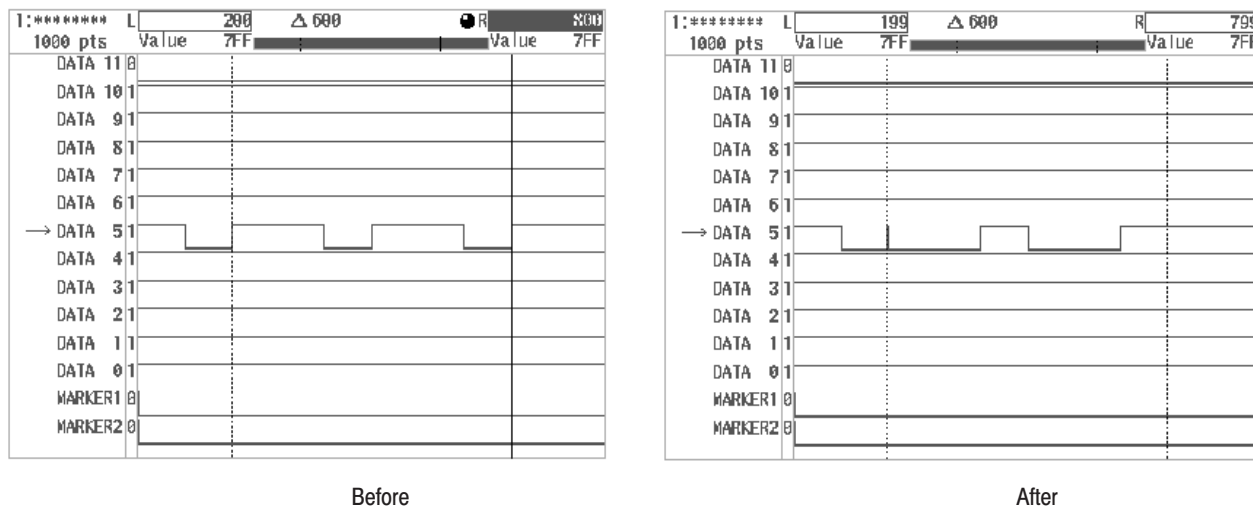
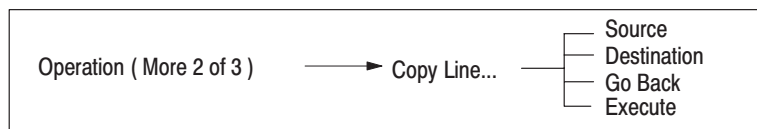

Figure 3 -85: Inverting Waveform Data State

4. Select **Go Back** from the current sub-menu. The system returns from the **Invert...** sub-menu to the previous side menu.

Copying Lines

Use **Copy line...** to copy the waveform data between the designated vertical bar cursors from one data line to another data line. Copy processing replaces the previous value of the copy destination line with the data of the copy source. The following diagram shows the menu configuration for the **Copy Line...** item.



1. Move the vertical bar cursors to define the section of the data to be copied. Then select **Copy Line...** from the second page of the side menu (**More 2 of 3**).
2. Select **Source** from the sub-menu. Turning the general purpose knob, select the copy source data line or marker.

Source selects the waveform data copy source. Data line **DATA 11 – DATA 0** or marker (**MARKER**) can be selected.
3. Select **Destination** from the sub-menu. Turning the general purpose knob, select the copy destination data line or marker.

Destination selects the destination to which the waveform data selected with **Source** will be copied. Data line **DATA 11 – DATA 0** or marker (**MARKER**) can be selected as the copy destination. From the copy source to the copy destination is indicated with an arrow.

4. Select **Execute** from the sub-menu. The data is copied with the specified conditions. Figure 3 -86 shows the screen before and after the section of waveform data between the vertical bar cursors on line **DATA 0** is copied to line **DATA 11**.

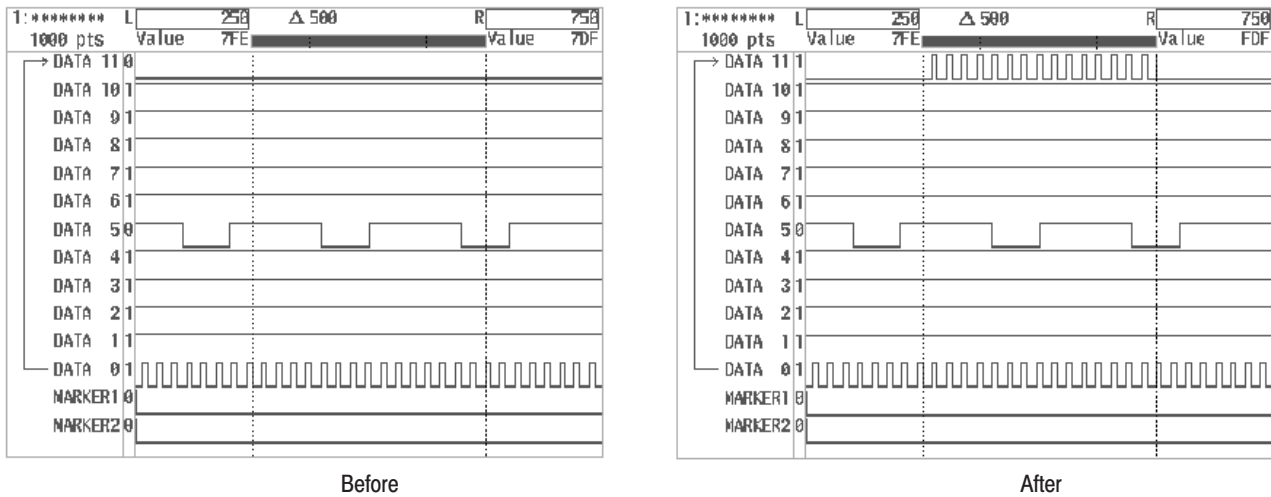

Figure 3 -86: Copying Lines

5. Select **Go Back** from the current sub-menu. The system returns from the **Copy Line...** sub-menu to the previous side menu.

Exchanging Lines

Use **Exchange Line...** to take the data between the designated vertical bar cursors on one line and interchange it with the data on another line. The following diagram shows the menu configuration for the **Exchange Line...** item.



1. Move the vertical bar cursors to define the section of the data to be exchanged. Then select **Exchange Line...** from the second page of the side menu (**More 2 of 3**).

2. Select **Source** from the sub-menu. Turning the general purpose knob, select one of the data lines or marker for data interchange.
3. Select **Destination** from the sub-menu. Turning the general purpose knob, select the other data line or marker for data interchange.
4. Select **Execute** from the sub-menu. The data will be exchanged as designated. Figure 3 -87 shows the screen before and after the data on line **DATA 0** is exchanged with the data on line **DATA 11**.

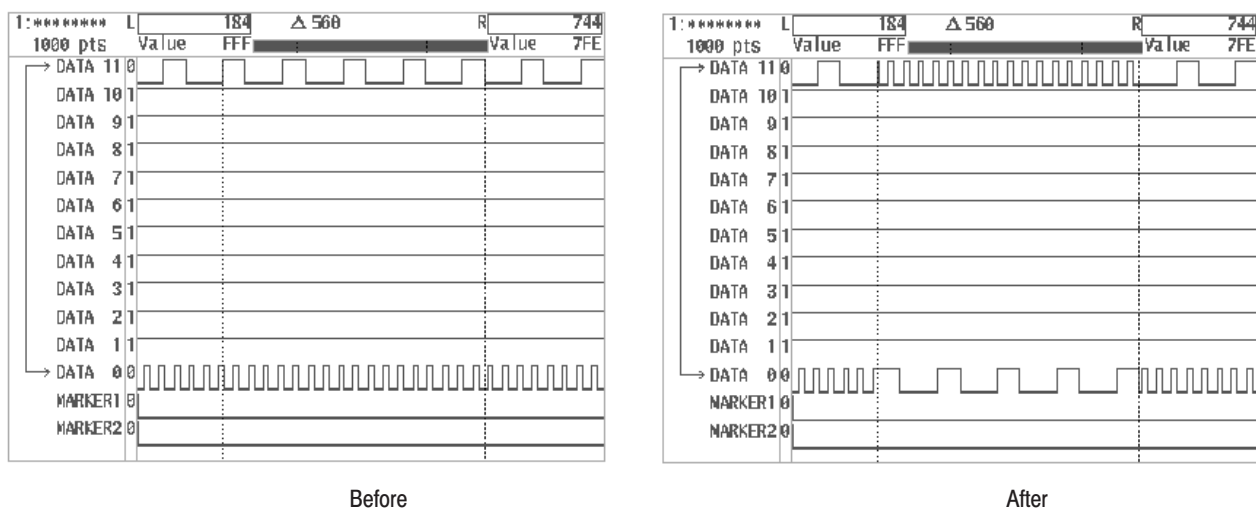
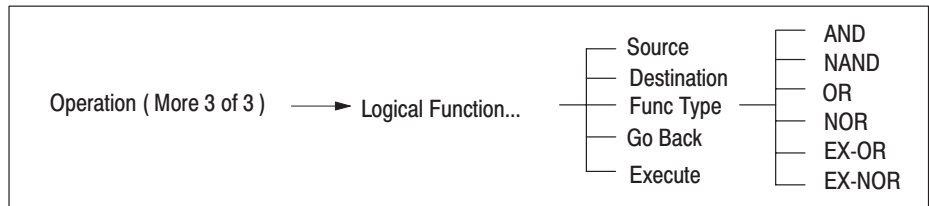

Figure 3 -87: Exchanging Lines

5. Select **Go Back** from the current sub-menu. The system returns from the **Exchange Line...** sub-menu to the previous side menu.

Applying Logical Operations to Lines

Use **Logical Function...** to apply a logical operation to the data between the vertical bar cursors on one data line with the data on another line and replace the data on the designated line with the result. The following diagram shows the menu configuration for the **Logical Function...** item.



Types of Logical Operation. You can choose from the following six logical operation options in the **Func Type** sub-menu:

- AND
- NAND
- OR
- NOR
- EX-OR
- EX-NOR

See “Logical Operation” in Appendix F for a description of each of these operations.

1. Move the vertical bar cursors to define the section of the data to which a logical operation is applied. Then select **Logical Function...** from the third page of the side menu (**More 3 of 3**).
2. Select **Source** from the sub-menu. Turning the general purpose knob, select the first data line or marker for logical operation.
3. Select **Destination** from the sub-menu. Turning the general purpose knob, select the other data line or marker for logical operation. The calculated result will replace the data line or marker designated with **Destination**.
4. Select **Execute** from the sub-menu. Logical operation will be performed for the selected lines.
5. Select **Go Back** from the current sub-menu. The system returns from the **Logical Function...** sub-menu to the previous side menu.

Expanding Waveform Data

Use **Data Expand...** to expand the section between the designated vertical bar cursors for all of the data lines and marker. The following diagram shows the menu configuration for the **Data Expand...** item.

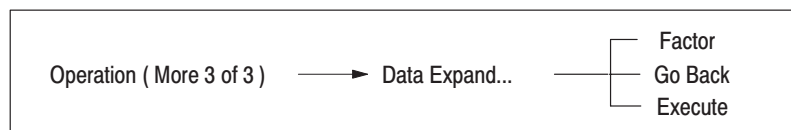

1. Move the vertical bar cursors to define the section of the data to be expanded. Then select **Data Expand...** from the third page of the side menu (**More 3 of 3**).

2. Select **Factor** from the sub-menu.

Factor is used to set the degree of expansion to any value between 2x and 10x.

3. Using the numeric keys or the general purpose knob, set the degree of expansion.
4. Select **Execute** from the sub-menu. The section of the waveform between the vertical bar cursors will be expanded to the designated degree, and the waveform point size will increase accordingly. Figure 3 -88 shows the screen before and after the data between the vertical bar cursors is expanded by a factor of 2.

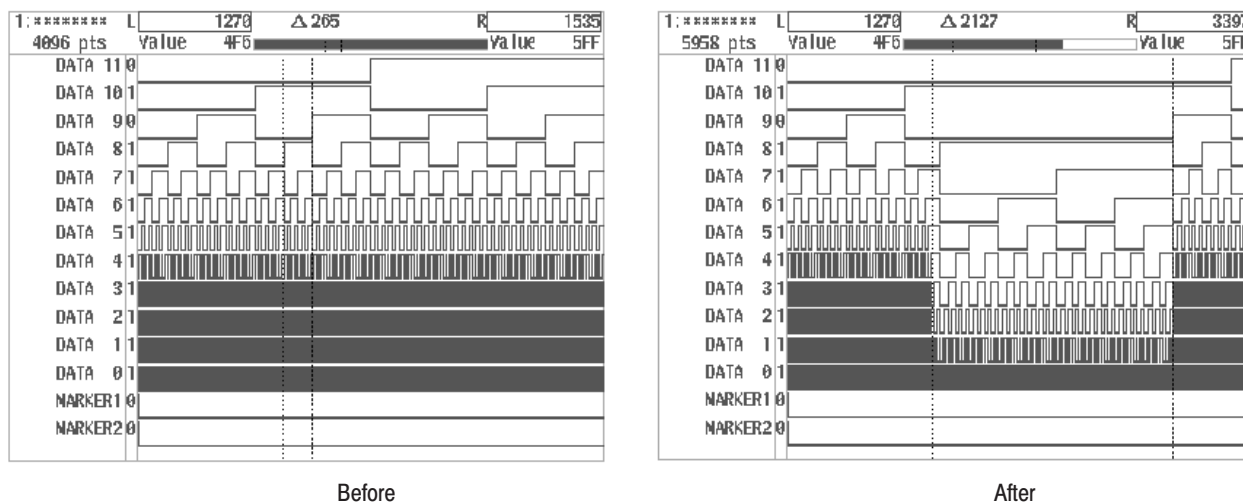

Figure 3 -88: Expanding Waveform Data

5. Select **Go Back** from the current sub-menu. The system returns from the **Data Expand...** sub-menu to the previous side menu.

Inserting Other Waveform Data

Use **Insert Other Waveform** to insert data from another waveform at a designated point in the waveform being edited. This item is located on the third page(**More 3 of 3**) of the side menu. The functions of this item are the same as for the **Insert Other Waveform** item for the graphic display of the waveform editor. See Page 3 -60.

Pseudo-Random Pulse Generator

Use **Shift Register Generator...** to set a pseudo-random pulse pattern using a shift register for the data between the designated vertical bar cursors on a data line or marker. The following diagram shows the menu configuration for the **Shift Register Generator...** item.

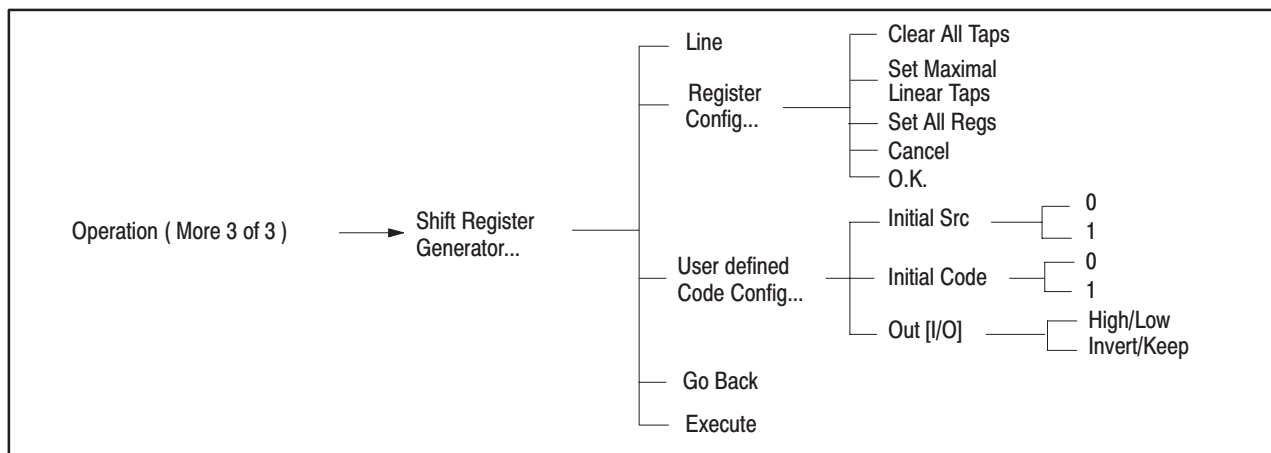

Register Configuration. The pseudo-random pulse generator (with shift register) consists of 2 to 32 registers together with the register output for each and the tap of the feedback loop that performs the EX-OR operation. Selecting **Register Config...** from the sub-menu enables you to set the pattern for the shift register generator. Figure 3 -89 shows the menu used to set the shift register.

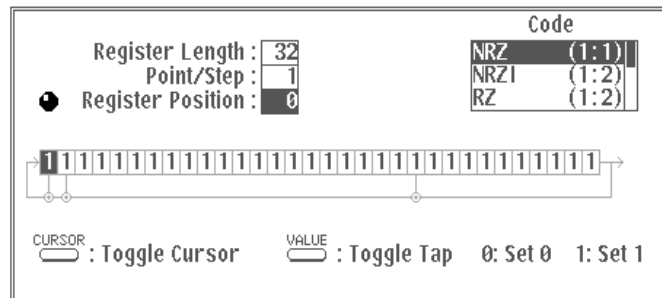

Figure 3 -89: Shift Register Configuration Menu

Use the **CURSOR** button on the front panel to select the items needed for the shift register. The following items can be selected; the general purpose knob is used to set the desired value for each item.

Register Length	(sets the length of the register)
Register Position	(sets the position of the cursor)
Point/Step	(sets the number of points per step)
Code	(used to select the data code)

Setting the Register Length. The register length may be set to any value between 2 and 32. The register length is displayed at the top of the shift register configuration menu, as shown below. In this example, the shift register is made up of 32 items.

● Register Length : 32

Entering the Register Value and Setting Taps. To enter the register value and set taps, press the **CURSOR** button on the front panel and select **Register Position**. A knob icon will be displayed to the left of the **Register Position** area. Turn the general purpose knob to move the cursor. The current location of the cursor is shown beside the **Register Position** item.

● Register Position : 0

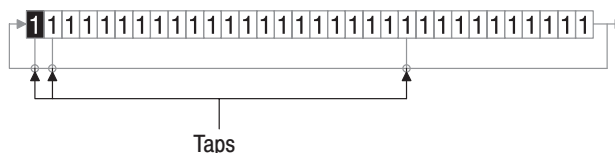

Figure 3 -90: Register Values and Taps

The numeric keys can now be used to enter the register value at the position of the cursor.

- Press **0** to set the register value to 0
- Press **1** to set the register value to 1

Pressing the **VALUE** button on the front panel toggles the tap between on and off.

- **Clearing All Taps.** Use **Clear All Taps** in the sub-menu to delete all taps that have been set.
- **Setting the Maximum Length Code Series for Taps.** **Set Maximal Linear Taps** in the sub-menu allows you to easily create M series (maximum length

code series) bit strings. M series bit strings are combined with several different kinds of tap arrangements. The tap arrangement will change each time the **Set Maximal Linear Taps** button is pressed.

- **Setting Register Values.** Use **Set All Regs** in the sub-menu to set all register values to 1.

Sample Settings for Register Values and Taps

Set simply set register and tap values as follows:

Register Length: 3
 Register Value: 101
 Use **Set Maximal Linear Taps** to set taps

Figure 3 -91 shows the output for the above settings. This output will be the maximum length code series.

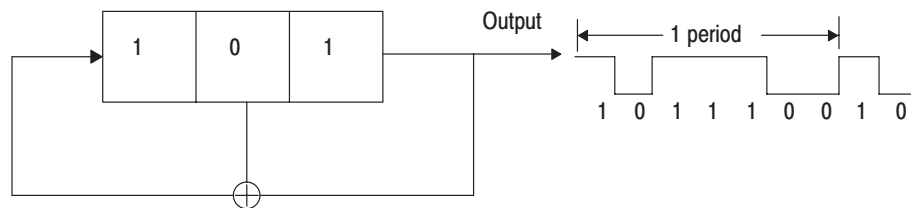

Figure 3 -91: Sample Settings for Register Values and Taps

Point/Step. Point/Step is used to set how many points make up each data bit. The data after **Code** conversion will be one item of bit data. For example, when **NRZI** is selected for **Code** and **Point/Step** is set to 2, each data bit will consist of 4 points.

● Point/Step :

Code. This command selects the code system used when data pattern strings are output. The **user defined** code enables you to define a custom conversion table. For a detailed description of each code, see “Pattern Codes” in Appendix F.

● Code

NRZ	(1:1)
NRZI	(1:2)
RZ	(1:2)

User defined Code Config... The following process is used to execute a user-defined code conversion.

1. Select **Shift Register Generator...** from the side menu.
2. Select **User defined Code Config...** from the sub menu.
3. Define the codes as desired. For the basic operations used when defining codes, see “User defined Code Config...” on Page 3 -110.
4. Select **Go Back** to return to the **Shift Register Generator...** menu.
5. Select **Register Config...** from the side menu.
6. Set the values for **Register Length** and **Point/Step** as well as the register value and tap.
7. Press the **CURSOR** button to select Code menu item. A knob icon will appear in the upper left side of the **Code** selection menu.
8. Turn the general purpose knob to select **user defined**.
9. Press **O.K.** in the sub-menu to confirm the settings. The **Shift Register Generator...** menu will automatically reappear.
10. Using the general purpose knob, define the data line and area where the pattern will be inserted.
11. Press **Execute** in the sub-menu. The result will be inserted between the cursors on the data line selected in the previous step.

Creating the M Series Pseudo-Random Signal. An M series pseudo-random signal has a length of 2^n-1 assuming the number of levels for the shift register is n. In this example, we will create an M series pseudo-random signal of $2^{15}-1$ bits (15 levels) with 1 point for each step. This signal is included on the Sample Waveform Library Disk that came with the AWG2021.

1. Select **Setting** from the bottom menu.
2. Select **Waveform Points** from the side menu. Then set the waveform point size to 32,767 using the numeric keys. The waveform point size needed to display all the bits of the pseudo-random signal is given by the following formula:

$$(\text{Value for Point/Step}) \times (2^n-1) = 1 \times (2^{15}-1) = 32,767$$
3. Select **Shift Register Generator...** from the third page of the side menu (**More 3 of 3**).
4. Press the **CURSOR** button on the front panel.
5. Using the general purpose knob, move the vertical bar cursors to designate the area to which pseudo-random signals are inserted. In this example, we will set the left cursor to point 0 and the right cursor to point 32,766.

6. Select **Line** from the sub-menu. Turning the general purpose knob, select **DATA11** for which you want to set the pattern.
7. Select **Register Config...** from the sub-menu.
8. Press the **CURSOR** button on the front panel to select **Register Length**.
9. Using the general purpose knob, set the register length to 15.

● Register Length : **15**

10. Select **Clear All Taps** in the sub-menu to delete all taps.
11. Select **Set All Regs** in the sub-menu to set all registers to 1.
12. Press the **CURSOR** button on the front panel to select **Register Position**.
13. Using the general purpose knob, set the **Register Position** to 13.
14. Press the **VALUE** button on the front panel to set the tap.

● Register Position : **13**

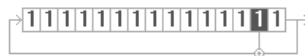

15. Press the **CURSOR** button on the front panel to select **Point/Step**.
16. Using the general purpose knob, set **Point/Step** to 1.

● Point/Step : **1**

17. Press the **CURSOR** button on the front panel to select **Code**.
18. Using the general purpose knob, select **NRZ**.

● Code

NRZ	(1:1)
NRZ1	(1:2)
RZ	(1:2)

19. Select **O.K.** from the sub-menu.
20. Select **Execute** from the sub-menu. The timing display shown below will appear.



21. Select **Go Back** from the sub-menu.

Zooming Waveforms. The function for this item is the same as for the **Zoom** item in waveform editor graphic display. See Page 3 -92.

Table Display

To show the table display for the waveform editor using the **View type....** item in the **Setting** menu:

1. Select **Setting** from the bottom menu.
2. Select **View type...** from the side menu.

Three items will be displayed in the sub-menu: **Graphic**, **Timing** and **Table**.

3. Select **Table** from the sub-menu.

The table display of the waveform editor will appear. See Figure 3 -92.

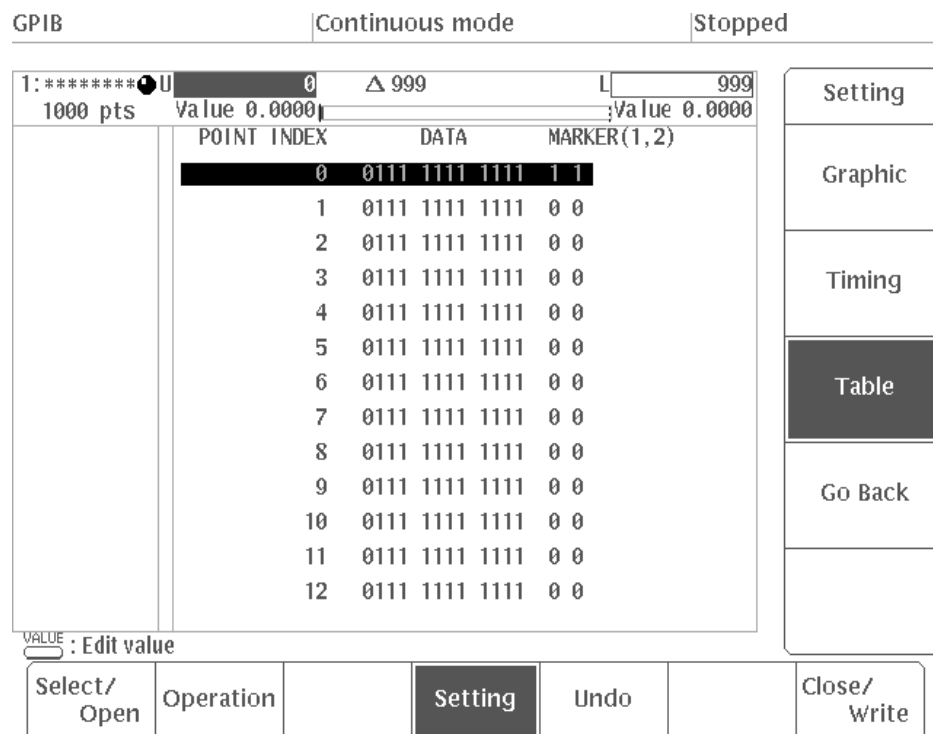
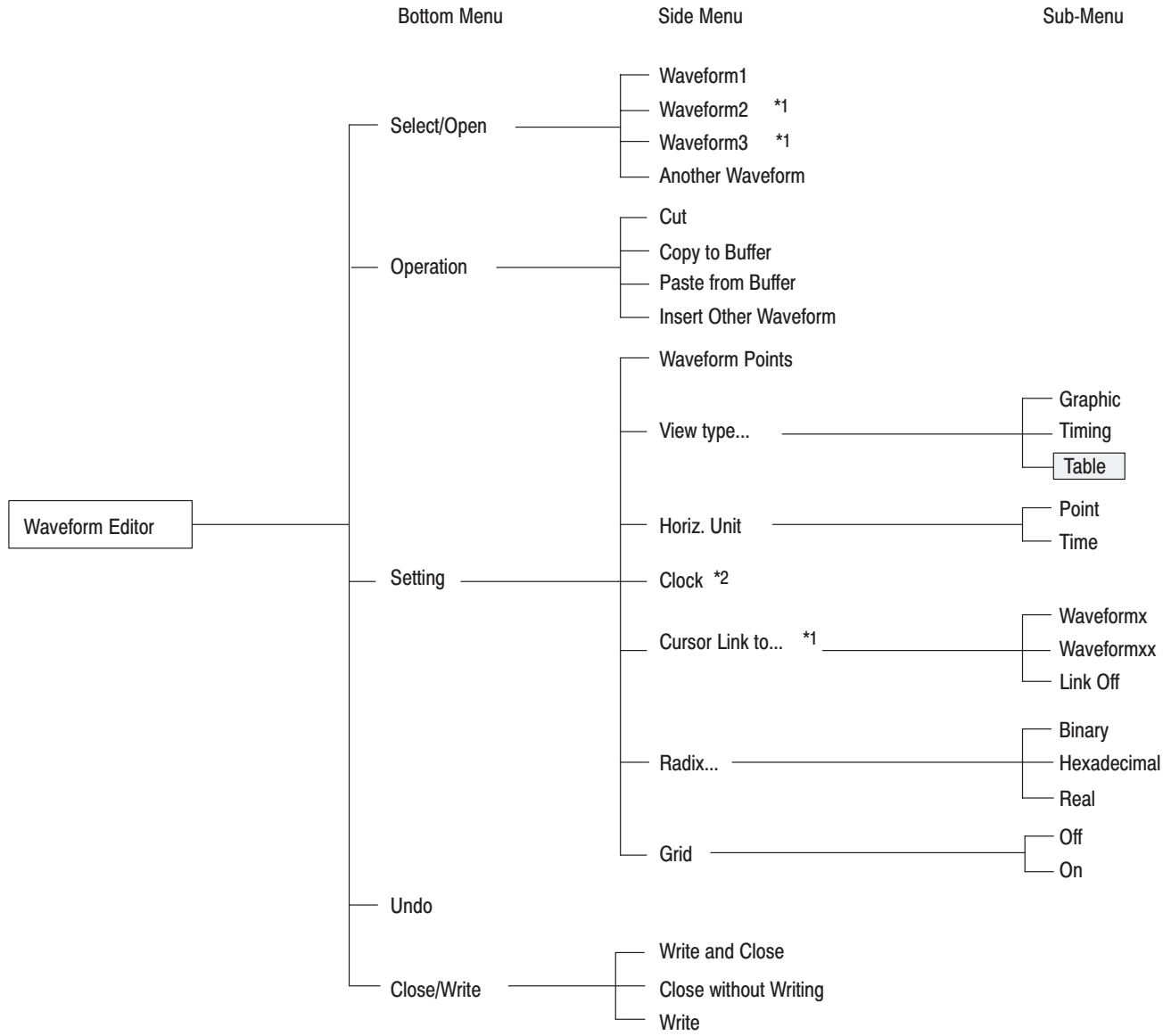

Figure 3 -92: Table Display

4. Select **Go Back** from the sub-menu. The system moves to the previous **Setting** side menu.

Table Display Menu Structure

Figure 3 -93 shows the menu configuration for the table display.



*1 This item appears when two or more waveforms are being edited simultaneously with Another Waveform in the side menu (under Select/Open in the bottom menu).

*2 This item appears when Time has been selected for Horiz. Unit in the side menu (under Setting in the bottom menu).

Figure 3 -93: Waveform Editor Table Display Menu Structure

Menu Functions

The following list shows the functions available for each menu item and the page on which you can find a description of that function.

Table 3-5: Menu Functions

Menu	Function	Page
Select /Open	Opening and selecting the editing area	3 -15
Operation	Editing waveforms in timing display	3 -135
Cut	Cutting waveforms	3 -43, 3 -136
Copy to Buffer	Copying waveforms	3 -44, 3 -136
Paste from Buffer	Pasting waveforms	3 -44, 3 -136
Insert Other Waveform	Inserting other waveform data	3 -60, 3 -136
Setting	Settings for the waveform to be edited	3 -28, 3 -133
Waveform Points...	Setting waveform point count	3 -29
View type...	Selecting the waveform data display format	3 -29
Horiz. Unit	Setting horizontal axis units	3 -31
Clock	Setting clock frequency	3 -32
Cursor Link to...	Linking the vertical bar cursors	3 -34
Radix...	Setting a cardinal number	3 -133
Grid	Displaying a grid in the editing area	3 -35
Undo	Canceling function execution	3 -2
Close/Write	Saving files and exiting the editor	3 -20

Table Display Screen

Figure 3 -94 shows the table display screen. This section will describe each portion of the screen; however, descriptions of areas that are identical to the graphic display will be omitted. See “Graphic Display Screen” for a description of the graphic display.

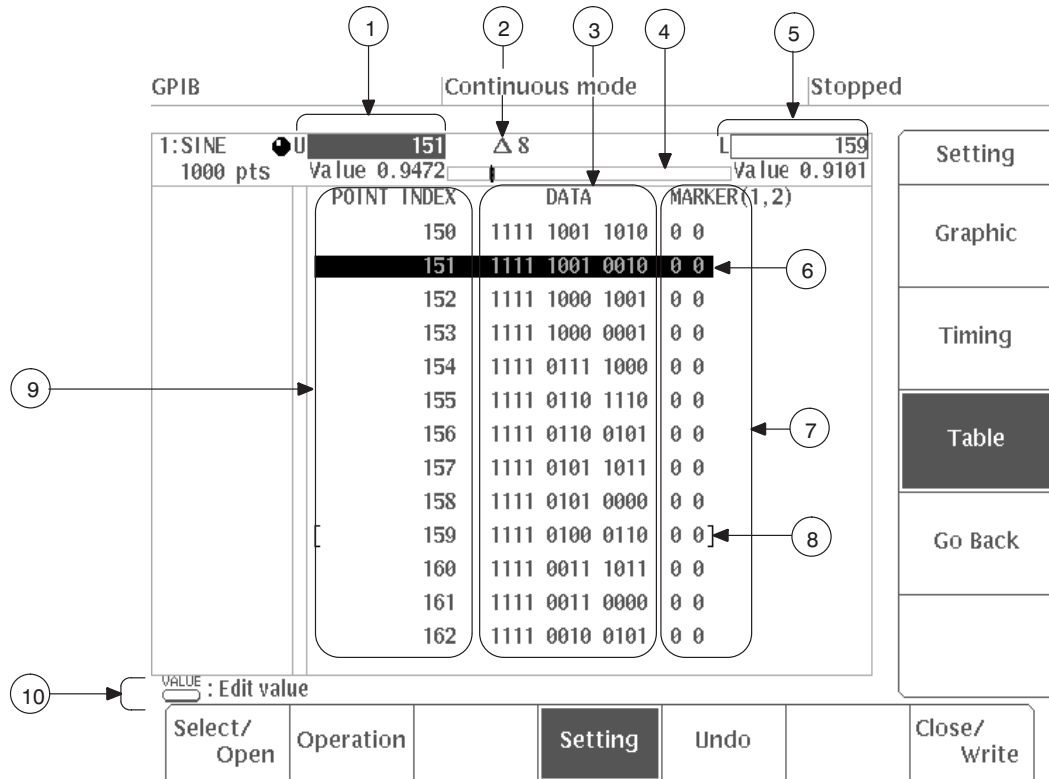



Figure 3 -94: Table Display Screen

(1) U Value	Shows the data value (Value) indicated by a real number and the time or point count (U) for the current position of the upper line cursor. The value in the displayed inverted field can be changed using the numeric keys or the general purpose knob.
(2) Δ	Shows the time or point count between the upper and lower line cursors.
(3) Data	This shows the waveform data for the point count or time. The waveform data can be displayed as binary, hexadecimal, or decimal data, depending which base has been selected. If binary numbers have been selected, the left end of the data is the most significant bit (MSB).
(4) Horizontal Scroll Indicator	Indicates which portion of the waveform is currently displayed on the screen. The displayed inverted portion of the indicator shows the portion of the waveform currently being displayed.

(5) L Value	Shows the data value (Value) indicated by a real number and the time or point count (L) for the current position of the lower line cursor.
(6) Upper Line Cursor	The line that is brightly highlighted by the upper line cursor is active.
(7) MARKER (1,2)	Binary display of the state of Marker 1 or 2 for the waveform point or time.
(8) Lower Line Cursor	The line cursor enclosed in a frame ([]) is inactive.
(9) Point Index or Time	Shows the waveform point or time. The units are set with the Setting item in the bottom menu.
(10) Button Operations	<p>This area shows how the front panel buttons operate in this menu.</p> <p style="text-align: center;"> : Edit value</p> <p>When the VALUE button is pressed, a block cursor appears within the inverted display cursor and the numeric keys can be used to input the data. Pressing an arrow button (←/→) moves the block cursor left/right.</p> <p style="text-align: center;"> : Move Line Cursor</p> <p>When the CURSOR button is pressed, the line cursor can be moved.</p>

Settings for the Waveform to be Edited

Before waveform data is created, you must use the **Setting** item in the side menu to set the environment for editing. Apart from the cardinal number settings, the procedure for setting values is the same as for the graphic display. See “Setting for the Waveform to be Edited” for a description of the graphic display.

Setting a Cardinal Number. Use **Radix...** to set a cardinal number to display waveform data in a table format. Waveform data can be displayed in numeric form as **Binary**, **Hexadecimal** or **Real** numbers.

When **Radix...** is selected, the following items appear in the sub-menu:

Binary
Hexadecimal
Real
Go Back

The description of these cardinal numbers is given below.

Binary 12-bit waveform data is created using the **0** or **1** numeric keys.

Hexadecimal Waveform data is created using the **0–9** and **A–F** numeric keys. When the cardinal numbers are changed to **Hexadecimal**, numeric keys and unit keys are allocated to **A–F**.

Real The data is input, as with regular number input, by pressing numeric keys, then pressing the **ENTER** key to enter the number. Any real number (**Real**), up to the vertical axis full scale, can be entered in the graphic display.

The markers are displayed in binary notation even when the cardinal numbers are set to **Hexadecimal** or **Real**.

1. Select **Setting** from the bottom menu.
2. Select **Radix...** from the second page of the side menu (**More 2 of 2**).
3. Select the desired cardinal number (**Binary**, **Hexadecimal** or **Real**) from the sub-menu. Figure 3 -95 shows how the same waveform data is displayed in each of the cardinal numbers.

Binary				Hexadecimal				Real			
POINT INDEX	DATA	MARKER(1,2)		POINT INDEX	DATA	MARKER(1,2)		POINT INDEX	DATA	MARKER(1,2)	
150	1111 1001 1010	0	0	150	F9A	0	0	150	0.9511	0	0
151	1111 1001 0010	0	0	151	F92	0	0	151	0.9472	0	0
152	1111 1000 1001	0	0	152	F89	0	0	152	0.9428	0	0
153	1111 1000 0001	0	0	153	F81	0	0	153	0.9389	0	0
154	1111 0111 1000	0	0	154	F78	0	0	154	0.9345	0	0
155	1111 0110 1110	0	0	155	F6E	0	0	155	0.9297	0	0
156	1111 0110 0101	0	0	156	F65	0	0	156	0.9253	0	0
157	1111 0101 1011	0	0	157	F5B	0	0	157	0.9204	0	0
158	1111 0101 0000	0	0	158	F50	0	0	158	0.9150	0	0
159	1111 0100 0110	0	0	159	F46	0	0	159	0.9101	0	0
160	1111 0011 1011	0	0	160	F3B	0	0	160	0.9047	0	0
161	1111 0011 0000	0	0	161	F30	0	0	161	0.8994	0	0
[162	1111 0010 0101	0	0]	[162	F25	0	0]	[162	0.8940	0	0]

Figure 3 -95: Numeric Displays for Waveform Data

4. Select **Go Back** from the current sub-menu. The system returns from the **Binary...** sub-menu to the previous side menu.

Editing Waveform Data

Waveform data can be edited at the waveform point, regardless of what item is selected in the bottom menu.

Move the line cursor to the data point to be edited.

1. Press the **CURSOR** button on the front panel to move the line cursor.
2. When the **CURSOR** button is pressed, the active line cursor is toggled between **Upper** and **Lower**.
3. Use the general purpose knob to move the active line cursor to the time or point value to be edited.

Enter the waveform data

4. Press the **VALUE** button on the front panel to input the waveform data with the set cardinal number.

Within the inverted display active line cursor is a block cursor. The data in the block cursor can be changed.

5. Use the ← and → buttons on the front panel to move the block cursor to the data to be changed.

When the block cursor is at the left end of the **DATA**, pressing the ← button moves the block cursor to **MARKER** for the previous waveform point or time value. When the block cursor is at the **MARKER**, pressing the → button moves the block cursor to the left and of the **DATA** for the subsequent waveform point or time value.

6. Data can be input with the numeric keys. Pressing numeric or character keys unrelated to the cardinal number you have designated will have no effect on the data.

When a number or character is input, the block cursor moves to the next character to the right.

Editing Waveform Data in Table Display

Use **Operation** to edit waveform data for the area between the upper and lower line cursors.

The following list shows the names and functions of the items in the side menu.

Cut	Cutting waveforms
Copy to Buffer	Copying waveforms
Paste from Buffer	Pasting waveforms
Insert Other Waveform	Inserting other waveform data

Cut, Copy, and Paste Processing Function

Use these functions cut, copy to the buffer, and paste to any other time or point value within the waveform data area between the upper and lower line cursors. The functions for these items are the same as for the corresponding items in waveform editor graphic display. See Page 3 -43 through 3-46.

Inserting Other Waveform Data. Use **Insert Other Waveform** to insert data from another waveform at a designated point in the waveform being edited. The functions of this item are the same as for the **Insert Other Waveform** item for the graphic display of the waveform editor. See Page 3 -60.

Equation Editor

Use the equation editor to edit files with the extension of **.EQU**. Equation file data takes the form of mathematical equations. An equation program file can have up to 100 lines. An equation file is compiled to create a waveform file and to output the waveform.

Figure 3 -96 shows an example of a waveform obtained by compiling the data from an equation file and its equation.

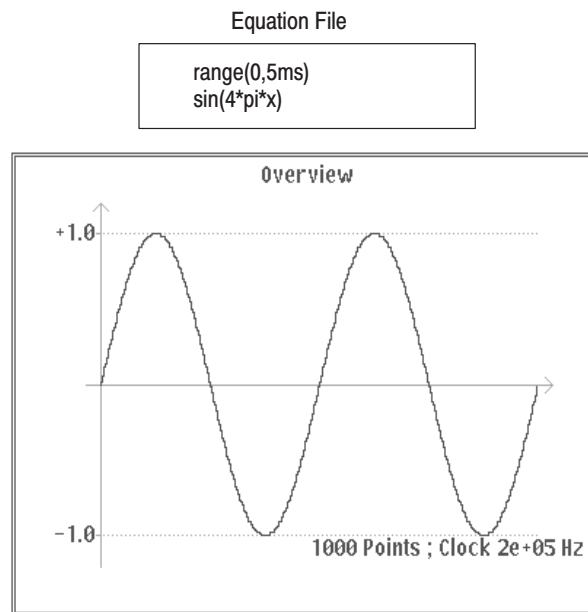

Figure 3 -96: Example of Equation File Data and Resulting Waveform

Entering the Equation Editor

1. Press the **EDIT** button in the **MENU** column. The initial **EDIT** menu will appear.
2. Select **Edit** or **New Equation** from the side menu.

Edit Used to select and edit an existing equation file (**.EQU**)

New Equation Used to create a new equation file

The equation editor screen will appear.

Saving Files and Exiting the Editor

Use **Exit/Write** in the bottom menu to save the file to the internal memory of the AWG2021 and exit from the editor depending on the selected side menu item.

The same procedure is used to save the file and exit from the equation editor as for the waveform editor. See “Saving Files and Exiting the Editor” in the section on the waveform editor.

When you compile the equation then exit the equation editor, the waveform file and the equation file are saved in internal memory with the same name but different extension.

NOTE. *If there is already a waveform file in internal memory with the name the compiled waveform file will be given, a message is displayed asking if you are sure you want to overwrite the old file. Answer either **Cancel** or **O.K.***

Equation Editor Menu Structure

The Equation Editor menu has the structure shown in Figure 3 -97.

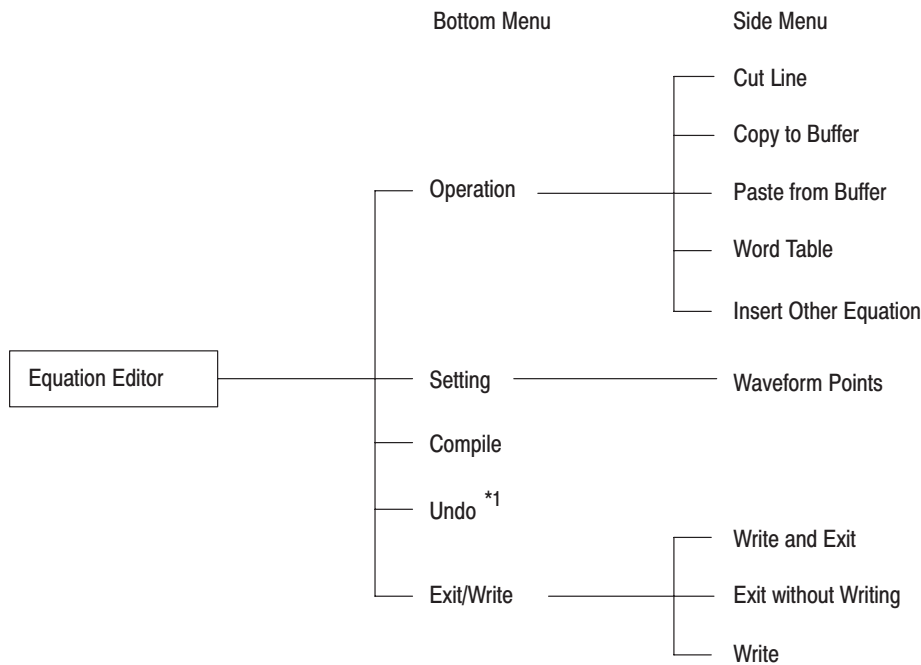

*1 This item appears when Operation in the bottom menu has been selected.

Figure 3 -97: Equation Editor Menu Structure

Menu Functions

The following list shows the functions available for each menu item and the page on which you can find a description of that function.

Table 3-6: Menu Functions

Menu	Function	Page
Operation	Editing functions	3 -156
Cut	Cutting a line	3 -156
Copy to Buffer	Copying a line	3 -156
Paste from Buffer	Pasting a line	3 -156
Word Table	Changing the component menu	3 -144
Insert Other Waveform	Inserting other equation file	3 -157
Setting	Settings for the waveform to be edited	3-149
Waveform Points	Setting waveform point count	3 -157
Compile	Compiling equations into waveform data	3 -159
Undo	Canceling function execution	3 -2
Exit/Write	Saving files and exiting the editor	3 -20, 3 -138

Equation Editor Menu Display

Figure 3 -98 shows the general equation editor display. A description for each callout follows.

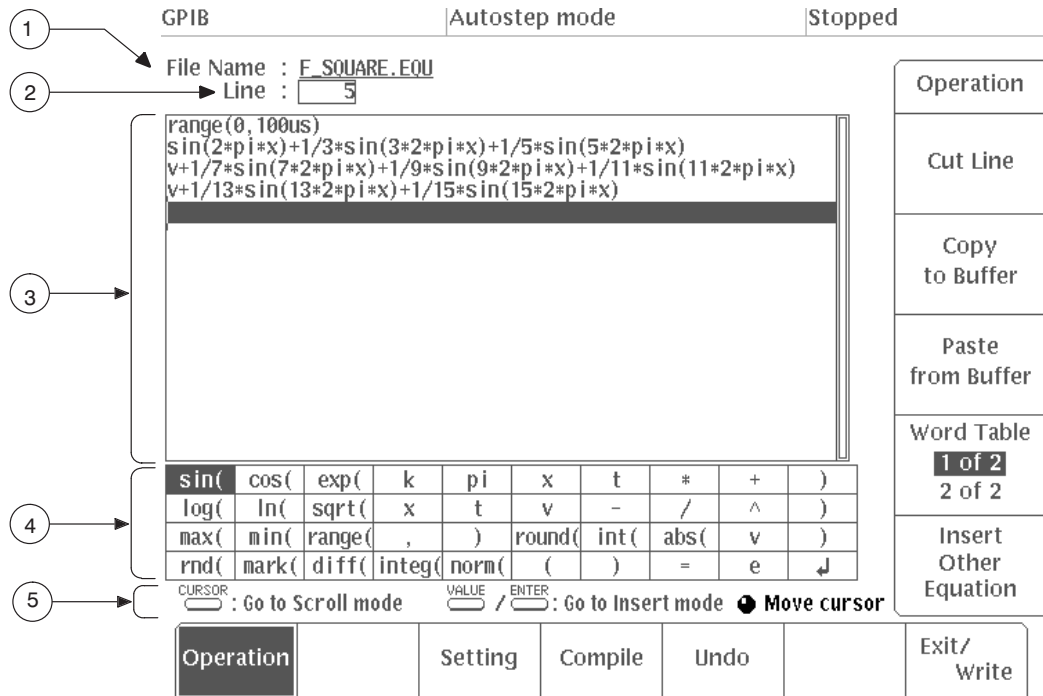



Figure 3 -98: Equation Editor CRT Display



(1) File Name	This is the name of the file being edited. If the file has not been named yet, the display is *****.EQU.
(2) Line	This is the line number of the equation or range displayed inverted within the equation list.
(3) Equation List	An equation list contains two components: equations and a range for which the equations apply. The equation is input from the component menu, with the numeric keys or unit keys.
(4) Component Menu	The component menu contains the elements used to create an equation. The menu consists of two pages. The first page contains functions, operators, constants, variables and syntax items. The second page contains characters and symbols. These items are selected with the general purpose knob. Use Word Table under Operation to move between pages.

(5) Button Operation



This area shows how the front panel buttons operate in this menu.

 : Go to Cursor mode

When you press the **CURSOR** button, the line cursor within the inverted cursor in the equation list can be moved with the general purpose knob.

 /  : Go to Insert mode

When the **VALUE** or **ENTER** button is pressed, the system goes into a mode in which you can insert an item into the equation list from the component menu. Pressing the **VALUE** or **ENTER** button again inserts the item inverted in the component menu.

 /  : Insert word

Pressing the **VALUE** or **ENTER** key inserts the item selected from the component menu into the equation list.

 : Go to Scroll mode

When you press the **CURSOR** button, the inverted cursor in the equation list can be moved with the general purpose knob.

 Move cursor

Turning the general purpose knob moves the cursor (I) in the equation list.

Creating and Editing Equation Files

Select **Operation** in the bottom menu to create or edit an equation file. When this item is selected, the time range can be designated with the component menu and the equation can be created. Figure 3 -99 shows a menu with **Operation** in the bottom menu selected.

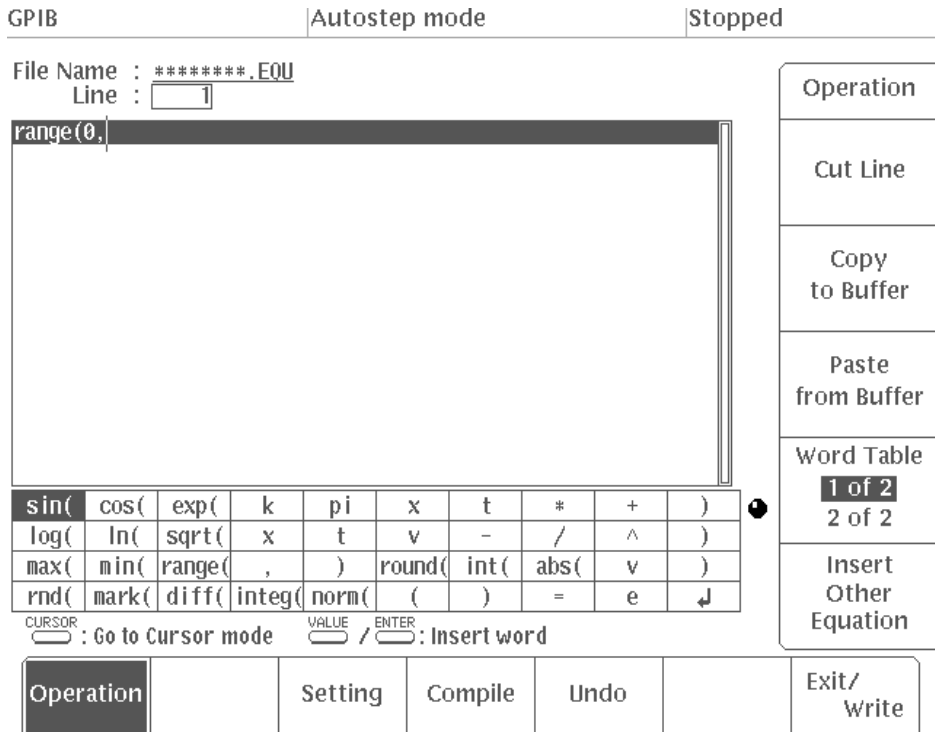

Figure 3 -99: Menu With Operation Selected

Specifying the Time Domain. The equation must specify the time domain. If the time domain is not defined, this is an error. The time domain is specified with **range()**.

When making a new equation file, **range(0,** is input in the first line of equation. Next, the time is specified. This setting is valid until the next **range()** item is specified. With the first **range()** specification, any number of lines of equation can be input. Text written after the **range()** on the same line is invalid. Here is the format for the **range()** item.

range(Equation starting time, Equation ending time)

Specification of subsequent time ranges use the component menu **range(** item. The clock frequency is obtained from the total time (period) set with **range()** and the waveform point count set with **Setting**, thus:

$$\text{Clock frequency} = \frac{\text{Waveform point count}}{\text{Equation period}}$$

In this example, you will create a sine wave with a period of 1ms, using the following equation:

range(0,1ms) Time range
sin(2*pi*x) Equation

1. Select **Operation** from the bottom menu.
2. After **range(0,** in the equation list use the numeric keys and the unit keys to enter **1, ms**. The expression now reads **range(0,1ms**.
3. Using the general purpose knob, select **)** from the component menu.
4. Press **VALUE** or **ENTER** on the front panel. The **)** that you selected in the component menu will be inserted in front of the position of the cursor (I) , in the inverted line cursor in the equation list. The expression now reads **range(0,1ms)**.
5. Press the **→** key. The inverted line cursor will move to the next line.
6. Using the general purpose knob, select **sin(** from the component menu.
7. Press **VALUE** or **ENTER** on the front panel. The expression **sin(** will appear on the screen.
8. Using the numeric keys, enter **2**. The expression now reads **sin(2**.
9. Repeat steps 6 and 7 to enter *****, **pi**, *****, **x**, and **)**. The expression now reads **sin(2*pi*x)**.

Using the Front Panel Buttons in Editing. The functions of the **CURSOR**, **VALUE**, and **ENTER** button affect the operation of the general purpose knob and the cursor. Here are details on these functions.

- **CURSOR.** When you press the **CURSOR** button, you can move the inverted line cursor and the cursor (I) with the general purpose knob. Each time you press the **CURSOR** button, the cursor that can be moved with the general purpose knob toggles between the inverted line cursor and the cursor. While the inverted line cursor can be moved with the general purpose knob, you can also move the inverted line cursor directly to the desired line by using the numeric keys to enter the desired line number.

- **VALUE/ENTER** buttons. After the **CURSOR** button has been pressed, pressing the **VALUE** or **ENTER** button makes it possible to select an item from the component menu. In this state, pressing the **VALUE** or **ENTER** button again inserts the items selected from the component menu into the equation list. At this time, input with the numeric keys is also possible.

The cursor (I) can also be moved using the ← and → keys on the front panel.

Decimal Point. When Option 09 is installed, all internal calculations use 32-bit floating point precision (IEEE 754 compatible). If Option 09 is not installed, 32-bit fixed precision is used when precision is not required (minimum unit 15 ms or greater). When precision is required, 32-bit floating point precision (IEEE 754 compatible) is used.

For fast and highly precise calculations, we recommend that Option 09 be installed.

Component Menu. The component menu contains the items used to set the time range as well as functions, operators, variables, constants, syntax items and characters. You can use these items to create equations and enter comments.

To display the other page of the menu, press **Word Table** in the side menu under **Operation**. Figure 3 -100 shows the two pages of the components menu.

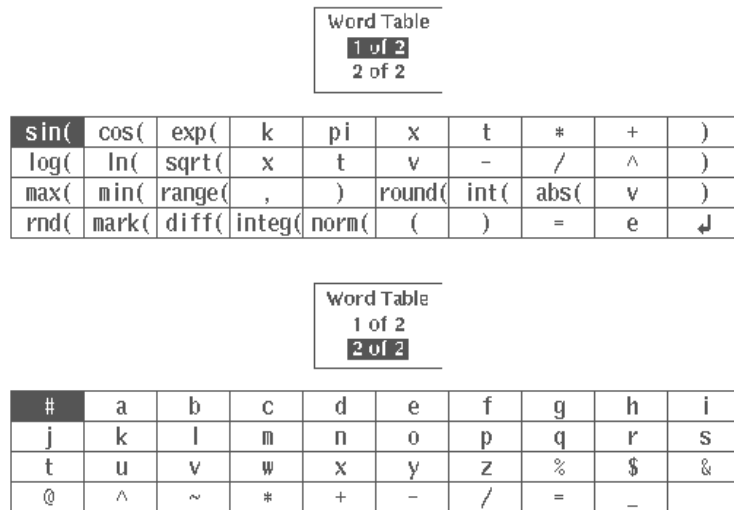

Figure 3 -100: Component Menu

- **Syntax Items.** These are parentheses – (and) – for specifying the order of operations. Each opening (left) parenthesis must be paired with a closing

(right) parenthesis. When there are two arguments – for example, **range**, **max**, **min** – they are separated with a ,(comma).

- Variables. Here are the variables that can be used in an equation.

t : Time from the head of that range() statement.

x : Variable taking on a value from 0.0 to 1.0 within that range () statement.

v : Variable showing the current value of the waveform data at that position.

- Operators

+, −, *, /

These add, subtract, multiply, or divide the components. The priorities are the same as usual for these four operators – * and / have priority over + and −.

- **^**

Expresses exponents. Only integers can be raised to a higher power.

^ has the same priority as * and /. Therefore, parentheses are required to give priority to multiplication.

Example: $\text{pi} * (2^3) * x$ where $2^3 =$ two raised to the third power.

- Comment. Comments are preceded by a number sign (#). When a number sign is entered, all characters after that until the end of the line are treated as a comment. All of the items in the component menu can be used in a comment.
- Characters. The characters available in the component menu are the letters of the alphabet (**a–z**) and several symbols (**%, \$, &, @, A** and **_**). These are used in comments.
- Other items
 - pi, e, k, =, ↵**
 - pi**
The circumferential ratio.
 - e**
Exponent (for an implied 10)
The range for numbers expressed in this scientific notation is from |5.9e−39| to |3.4e38|.

Examples: **1e6=1,000,000, 1e−3=0.001**

k

The **k0–k9** can be specified; these are constants that may be used in equations. Specifying a new value for the same **k#** replaces the old value with the new one. If no constant is defined for **k**, this value will be automatically set to 0.

=

Equals sign. = is used with **k** constants.

Example: **k0=2*pi**

↵

Ends the line for the range or equation; inserting a return (↵) in the middle of the line partitions it.

- Functions. Here are the functions that make up the equation.

sin(, cos(

The arguments for these trigonometric functions are in radians.

Example: **range(0,100 μs)**
cos(2*pi*x)

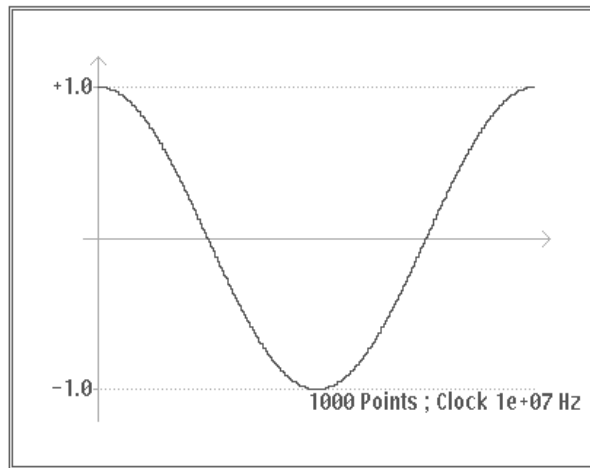

Figure 3 -101: Trigonometric Function Waveform Expressed With Variable x

Example: `range(0,100 μ s)`
 `sin(2*pi*1e4*t)`

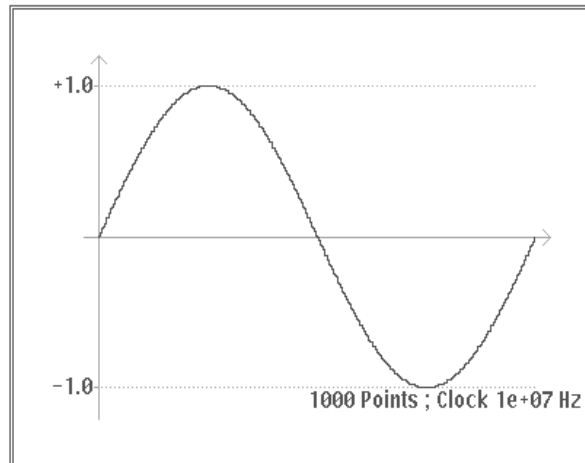

Figure 3 -102: Trigonometric Function Waveform Expressed With Variable t

exp(), log(), ln()

Exponential function, common log function, natural log function. The **log** and **ln** arguments must be positive.

Example: `range(0,50 μ s)`
 `1-exp(-5*x)`
 `range(50 μ s,100 μ s)`
 `exp(-5*x)`

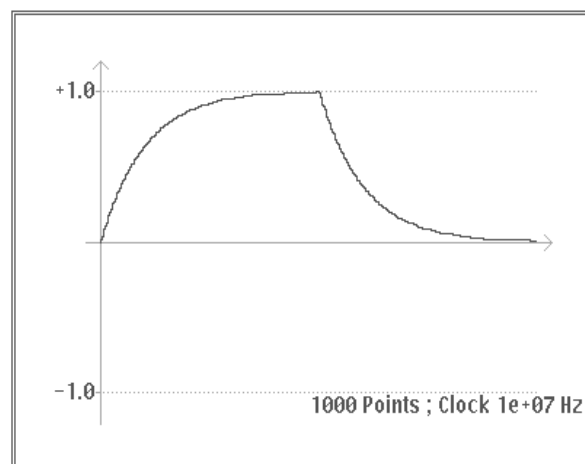

Figure 3 -103: Equation Using exp()

Example: range(0,100 μ s)
 log(10*(x+0.1))

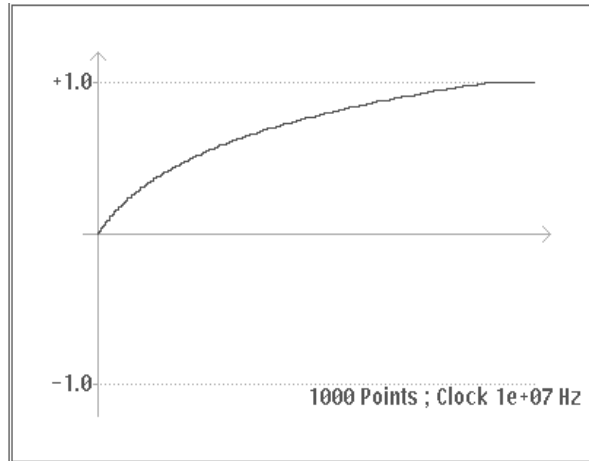

Figure 3 -104: Equation Using log(

Example: range(0,100 μ s)
 ln(2*(x+0.2))

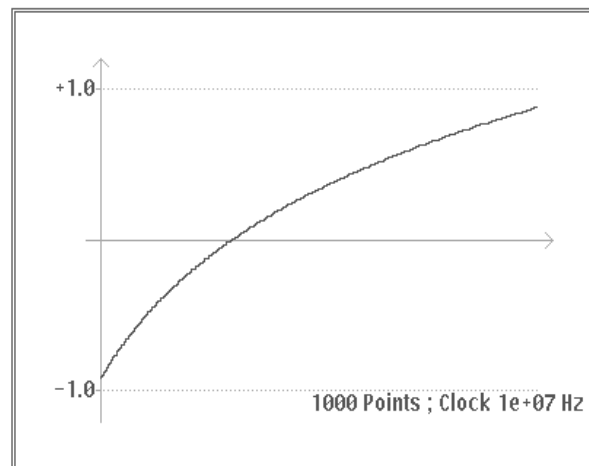

Figure 3 -105: Equation Using ln(

sqrt(

The square root; the argument must be a positive value.

Example: range(0,100 μ s)
 sqrt(sin(pi*x))

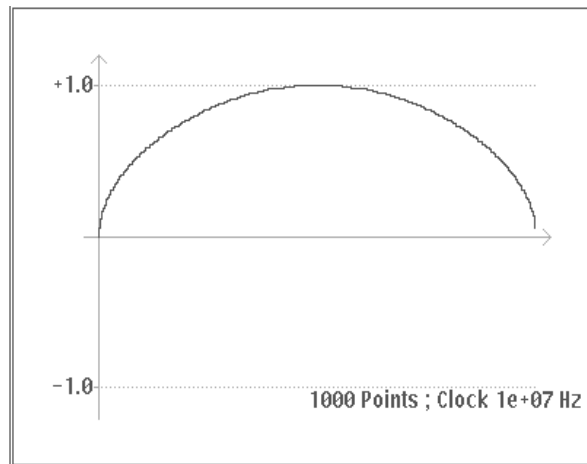

Figure 3 -106: Equation Using sqrt(

abs(

The absolute value.

Example: range(0,100 μ s)
 abs(sin(2*pi*x))

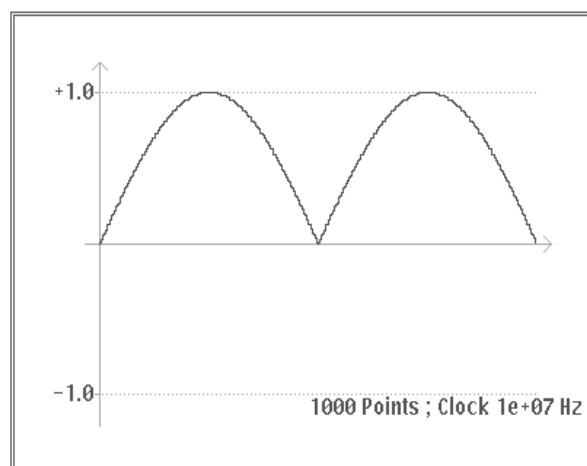

Figure 3 -107: Equation Using abs(

int(

Truncates the fraction to obtain the integer.

Example: range(0,100 μ s)
 int(5*sin(2*pi*x))/5

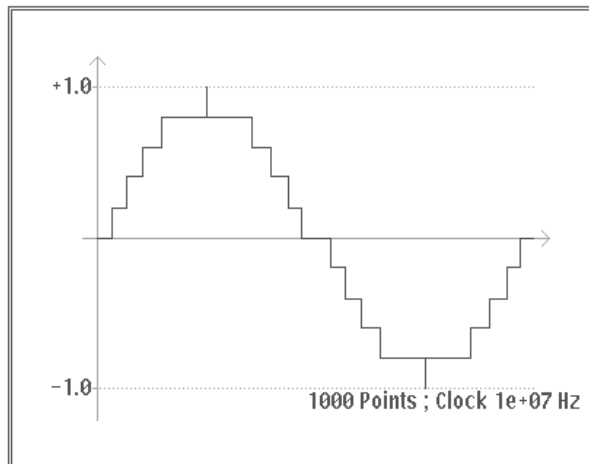

Figure 3 -108: Equation Using int(

round(

Rounds off the fraction to obtain the integer.

Example: range(0,100 μ s)
 round(5*sin(2*pi*x))/5

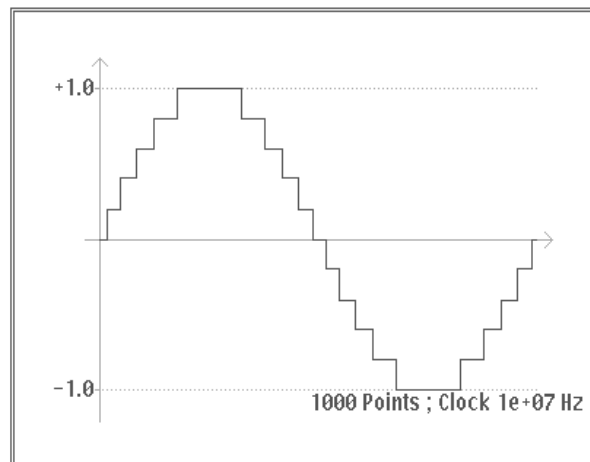

Figure 3 -109: Equation Using round(

norm()

Normalizes the range specified with **range()** and scales the amplitude values so that the maximum absolute value is 1.0 (i.e. a value of +1.0 or -1.0). The **norm()** statement comprises an entire line.

Example: `range(0,100 μs)`
 `sin(2*pi*x)+rnd()/10`
 `norm()`

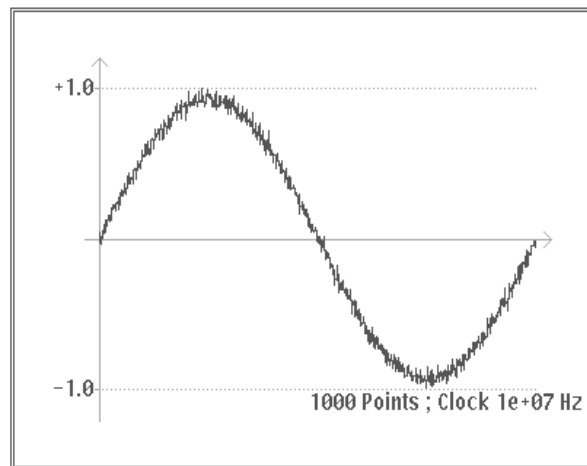

Figure 3 -110: Equation Using norm()

max(

Takes the larger of two values.

min(

Takes the smaller of two values.

Example: range(0,100 μ s)
 sin(2*pi*x)
 range(0,50 μ s)
 min(v,0.5)
 range(50 μ s,100 μ s)
 max(v,-0.5)

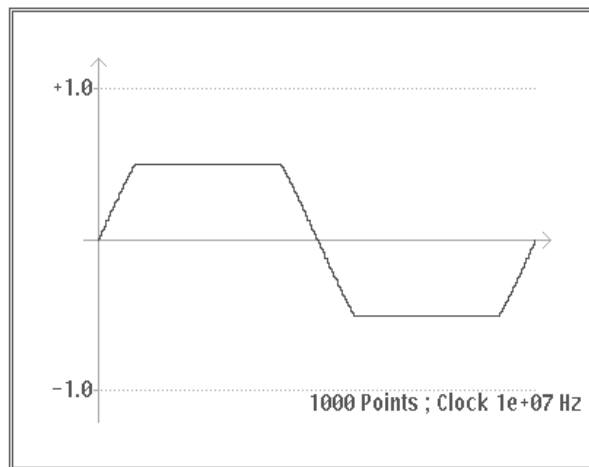

Figure 3 -111: Equation Using max(and min(

rnd (integer from 1 to 16,777,215)

When an argument is specified, generates a random number sequence using that argument as the initial value. If the argument is omitted, 1 is used.

Example: range(0,100 μ s)
 rnd(2)/3

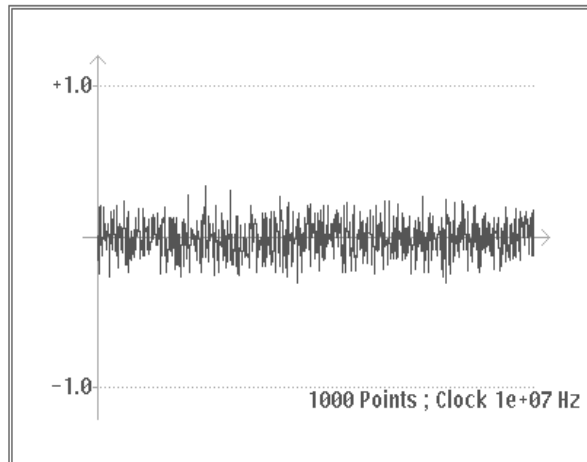

Figure 3 -112: Equation Using rnd()

See “Random (rnd) Function” in Appendix F for a discussion of the algorithms for **rnd** functions.

diff()

Differentiates the function over the range specified with **range()**. Specified with **diff()**. The **diff()** comprises an entire line.

Example: range(0,33 μ s)
 -0.5
 range(33 μ s,66 μ s)
 0.5
 range(66 μ s,100 μ s)
 -0.5
 range(0,100 μ s)
 diff()

Differentiating the waveform in Figure 3 -113 gives the waveform shown in Figure 3 -114.

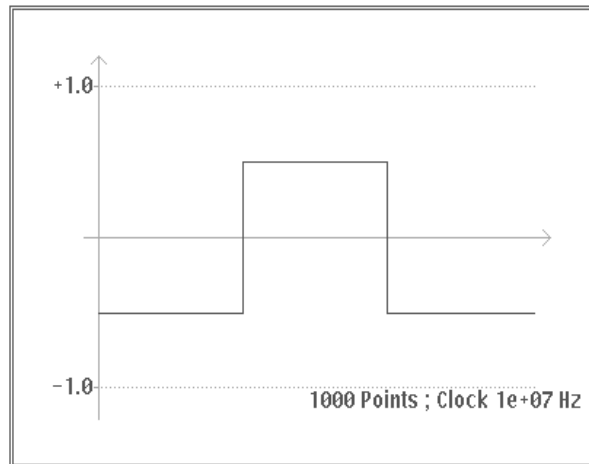

Figure 3 -113: Waveform Before Calculation

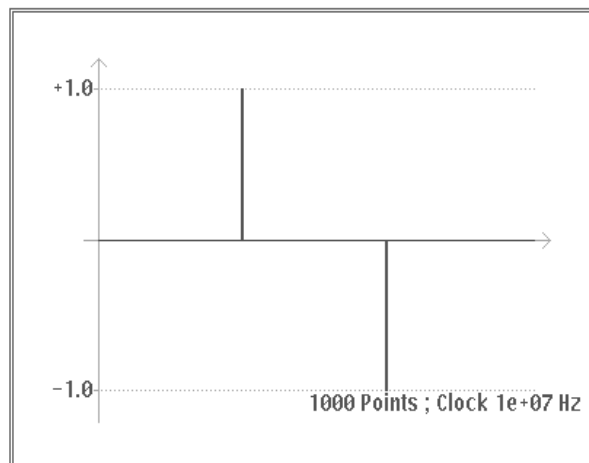

Figure 3 -114: Waveform After Differentiation Using diff(

See “Differentiation” in Appendix F for a discussion of the algorithms for **diff** functions.

integ()

Integrates the function over the range specified with **range()**. Specified with **integ()**. The **integ()** comprises an entire line. After **integ()**, specify normalization (**norm()**) as necessary.

```
Example:   range(0,33 μs)
           -0.5
           range(33 μs,66 μs)
           0.5
           range(66 μs,100 μs)
           -0.5
           range(0,100 μs)
           integ()
           norm()
```

Figure 3 -113 shows the waveform before integration. Figure 3 -115 shows the waveform after integration.

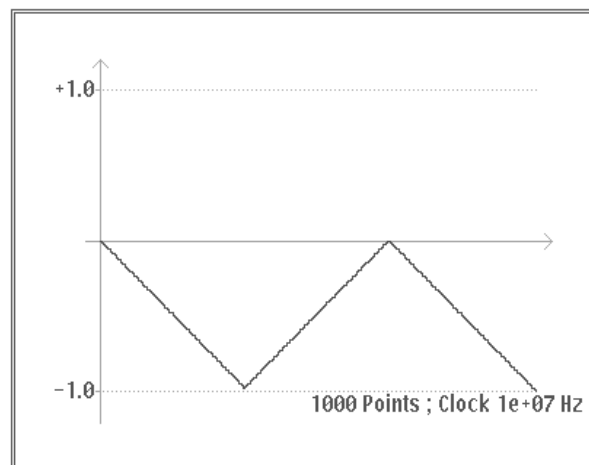

Figure 3 -115: Waveform After Integration Using integ()

See “Integration” in Appendix F for a discussion of the algorithms for **integ** functions.

mark (marker1 or marker2)

Sets the marker for the range set with **range()**. After compiling, there is no marker display, but the set marker can be verified with the waveform editor. The **mark()** statement comprises an entire line. For example, when **mark(1)** is input, nothing else can be input on that line.

Editing Functions

When you select **Operation** in the bottom menu, the following items appear in the side menu:

- Cut Line
- Copy to Buffer
- Paste from Buffer
- Word Table
- Insert Other Equation

Cutting a Line. Use **Cut Line** to cut out a line in the equation list.

1. Select **Operation** from the bottom menu.
2. Pressing the front panel **CURSOR** button twice puts the system into scroll mode. Pressing the **CURSOR** button toggles the unit between cursor mode and scroll mode.
 - Cursor mode. Cursor moves between items in the equation list, item by item.
 - Scroll mode. A inverted line cursor moves through the lines in the equation list, line by line.
3. Use the general purpose knob to move the displayed inverted line cursor to the line to be deleted from the created equation list.
4. Select **Cut Line** from the side menu.

When **Cut Line** is selected, the line displayed inverted in the equation list is deleted. The deleted line is placed in the paste buffer. To restore this line to its original state, select **Undo** from the bottom menu or **Paste from Buffer** from the side menu.

Copying and Pasting a Line. Use the **Copy to Buffer** and **Paste from Buffer** items to copy a line in the equation list and paste it to another line.

1. Use the same procedure as described in Cutting a Line to line up the inverted display cursor with the line to be copied.
2. Select **Copy to Buffer** from the side menu.

When **Copy to Buffer** is selected, the line displayed inverted in the equation list is placed in the paste buffer. This item has no effect on the CRT display.

3. Use the general purpose knob to specify the position to paste the copied line with the inverted display cursor. The position for pasting is directly before the inverted display cursor in the equation list.
4. Select **Paste from Buffer** from the side menu.

Insert Other Equation File. Use **Insert Other Equation** to select an equation file from internal memory (see Figure 3 -116). An equation file is inserted from this list into the equation list.

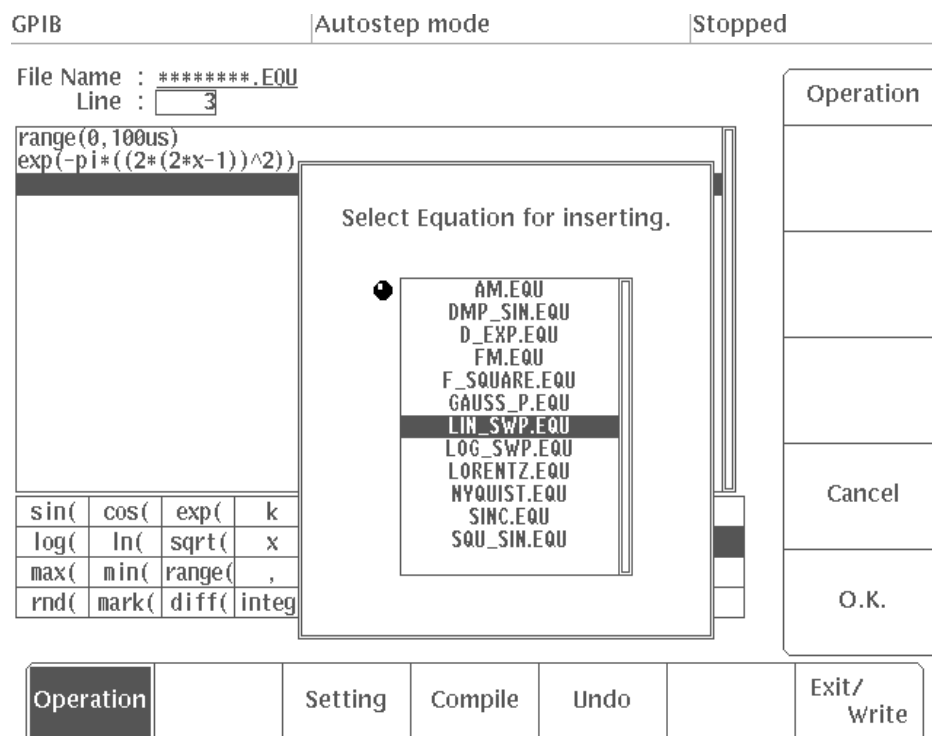

Figure 3 -116: Menu Displayed When Insert Other Equation is Selected

1. Use the same procedure as described in Cutting a Line to line up the inverted display cursor with the line where the other equation file is to be inserted.
2. Select **Insert Other Equation** from the side menu.
3. Use the general purpose knob to select the equation file to be inserted.
4. After selecting the file, press the **O.K.** side menu button to insert the selected file directly before the inverted cursor within the equation list. Press the **Cancel** side menu button to cancel the selection and return the system to the equation editor.

Setting Waveform Point Count

When **Setting** is selected from the bottom menu, the number of waveform points for equation file compilation and waveform file creation can be set. Figure 3 -117 shows the menu for when **Setting** is selected.

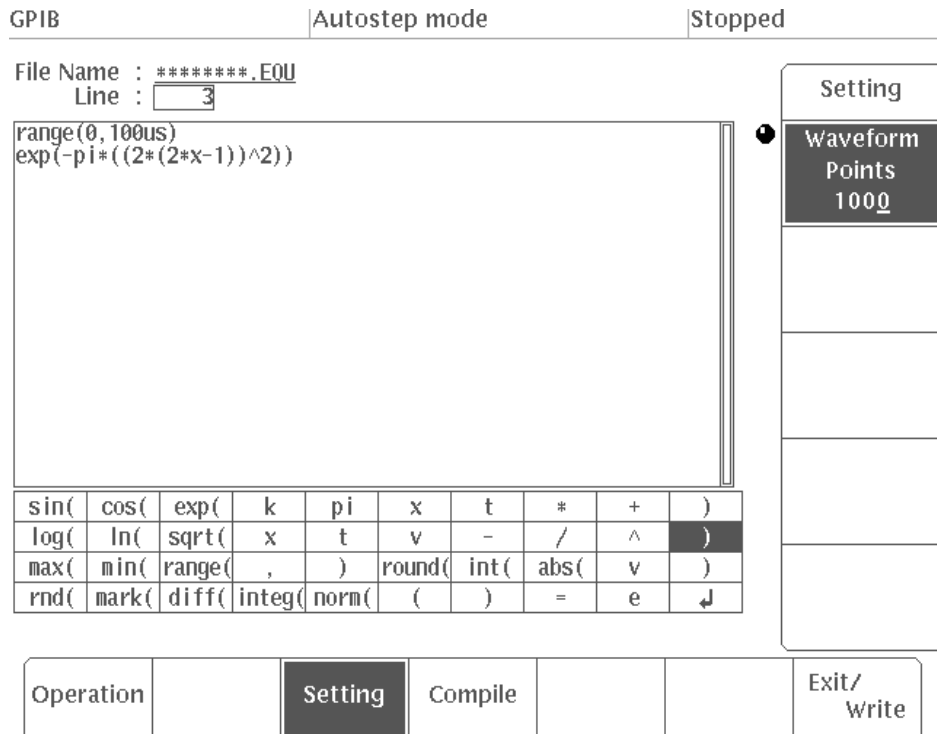

Figure 3 -117: Setting Waveform Point Count

1. Select **Setting** from the bottom menu.
2. Use the numeric keys or the general purpose knob to set the number of waveform points.

The default value for the number of waveform points is 1000. The waveform point size can be set to any value between 1 and 32,768. However, due to limitations in outputting the waveforms from this instrument, the waveform point is limited to 64 – 32,768 points and to a multiple of 8. When the set value causes the calculated clock frequency to become greater than 20 MHz, the clock frequency will be limited to the maximum value of 250 MHz and the following message will appear, asking you to confirm that this is all right. If it is, select **O.K.** from the side menu. In such cases, the waveform period will change.

The clock calculated (xxxx Hz) is not supported by this instrument. The waveform will be output with the maximum clock of 2.5e+08Hz.

Compiling Equations into Waveform Data

Use **Compile** to convert the assembled equation into waveform data and to create a waveform file. This waveform file is given the same name as the equation file it was compiled from.

Here is the procedure for compiling the equation to make a waveform file.

1. Select **Compile** from the bottom menu. The equation is compiled.

The busy icon is displayed on the status line of the CRT display to show that the compilation is being processed. **Cancel** is displayed in the side menu. Selecting this item cancels the compilation.

2. The equation is converted into waveform data and the waveform is displayed. Along with the waveform, the set number of waveform points and clock frequency are displayed. Figure 3 -118 is an example of the display of a compiled waveform.

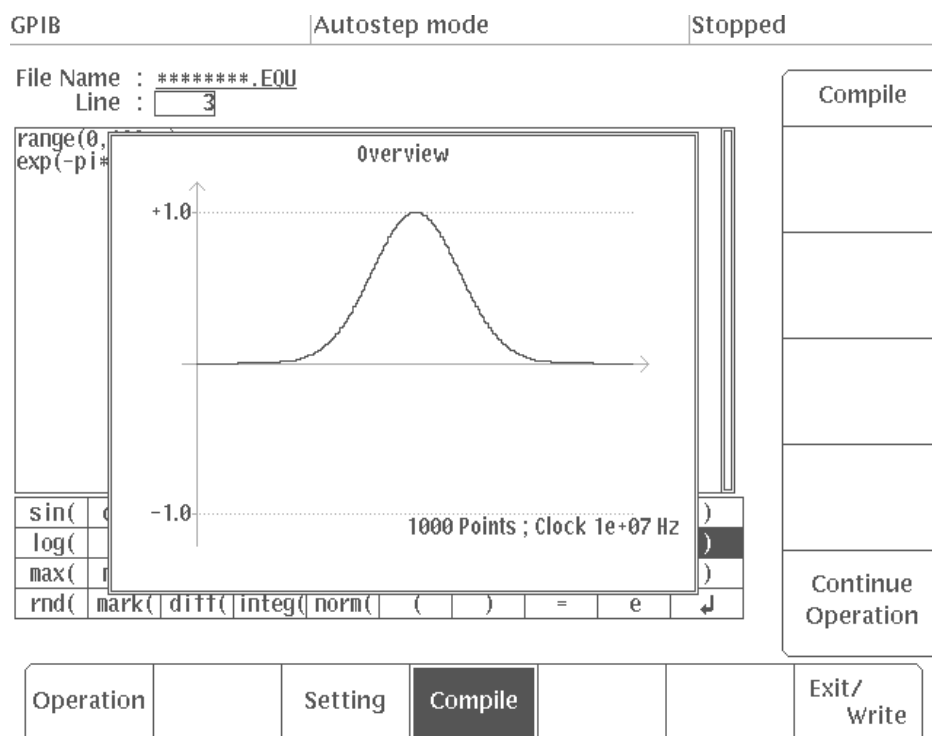

Figure 3 -118: Example of Compiled Waveform Display

3. Verify the waveform, then select **Continue Operation** from the side menu. The system returns to the equation editor.

If an error is detected, an error message is displayed at the top of the screen at high intensity and the inverted display cursor is moved to the equation or

time domain with the syntactical error. Correct the error as instructed by the message, and then compile again.

The compiled waveform file contains the settings for the number of waveform points (set with Setting) and the clock frequency (obtained from the total time set with the range item.) Other output parameters are set to the default values.



The compiled waveform also has a vertical axis on which -1.0 is data value 0 and $+1.0$ is data value 4094. There is no relation between these values and the actual output voltage.

Sequence Editor

Use the sequence editor to edit files with the extension of **.SEQ**. Sequence files assemble a number of waveforms or sequence files in order. The file data contains waveform file names in sequence, their repetition counts, and the sequence waveform output parameters. Sequences may be up to approximately 4000 lines long.

Figure 3 -119 shows an example of the data in a sequence file and the waveform display for that data.

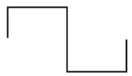
Table 3-7: Sequence File

File Name	Number of Repetitions	Waveform
WAVE-1.WFM	2	
WAVE-2.WFM	1	
WAVE-3.WFM	2	

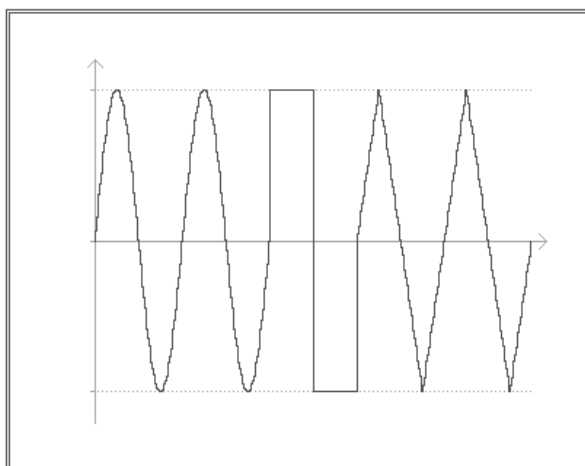

Figure 3 -119: Sequence File Data and Sample Waveform Display

Entering the Sequence Editor

1. Press the **EDIT** button in the **MENU** column. The initial **EDIT** menu will appear.
2. Select **Edit** or **New Sequence** from the side menu.

Edit Used to select and edit an existing sequence file (.SEQ)

New Sequence Used to create a new sequence file

The sequence editor screen will appear.

Saving Files and Exiting the Editor

Use **Exit/Write** in the bottom menu to save the file to the internal memory of the AWG2021 and exit from the editor depending on the selected side menu item.

The same procedure is used to save the file and exit from the equation editor as for the waveform editor. See “Saving Files and Exiting the Editor” in the section on the waveform editor.

Sequence Editor Menu Structure

The Sequence Editor menu has the structure shown in Figure 3 -120.

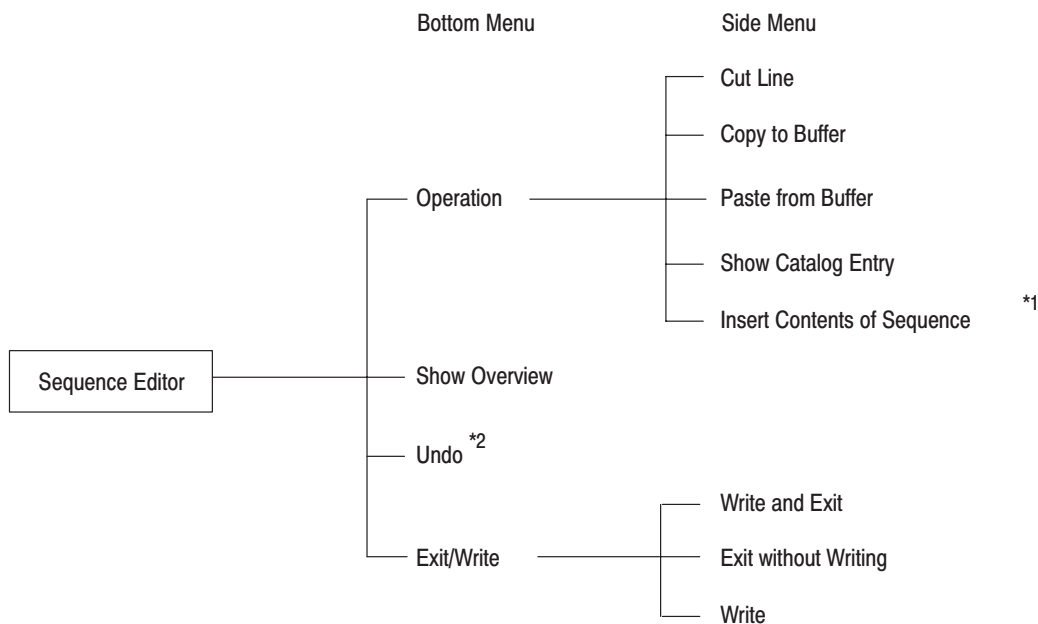

*1 This item appears in the side menu when a sequence file (XXX.SEQ) has been selected with Catalog in the menu.

*2 This item appears when Operation in the bottom menu has been selected.

Figure 3 -120: Sequence Editor Menu Structure

Menu Functions

The following list shows the functions available for each menu item and the page on which you can find a description of that function.

Table 3-8: Menu Functions

Menu	Function	Page
Operation	Editing functions	3 -167
Cut	Cutting a line	3 -167
Copy to Buffer	Copying a line	3 -167
Paste from Buffer	Pasting a line	3 -167
Show Catalog Entry	Changing the waveform display	3 -168
Insert Contents of Sequence	Inserting a sequence file	3 -168
Show Overview	Sequence the display	3 -169
Undo	Canceling function execution	3 -2
Exit/Write	Saving files and exiting the sequence editor	3 -20, 3 -162

Sequence Editor Menu Display

Figure 3 -121 shows the general sequence editor display. A description for each callout follows.

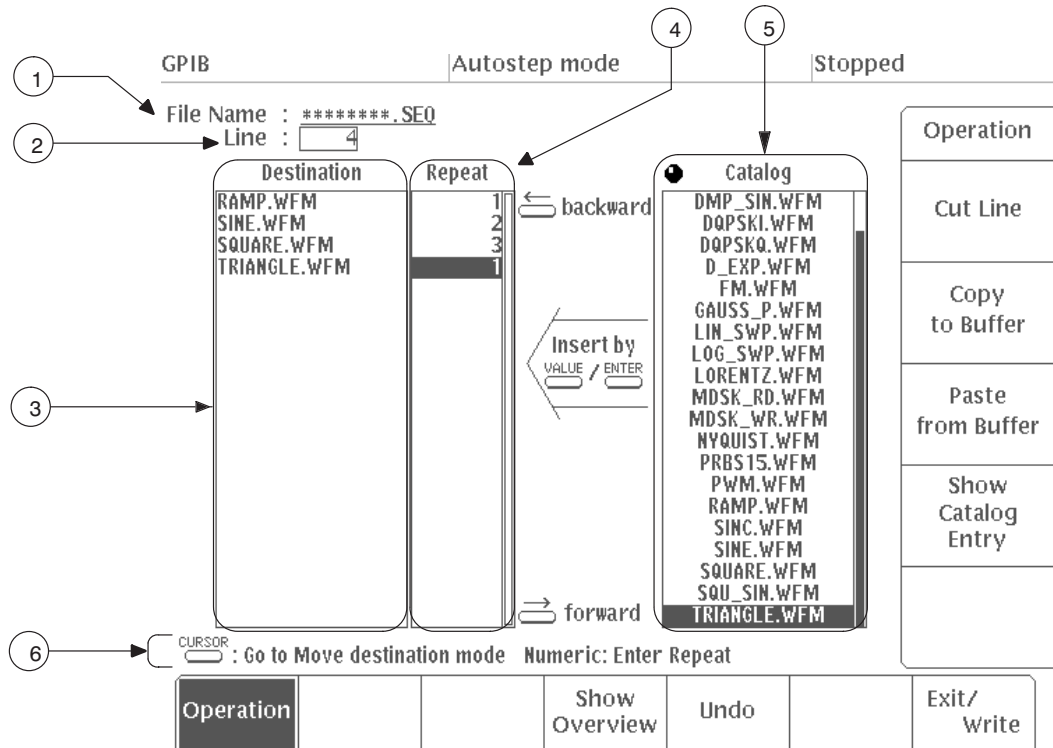

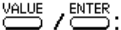





Figure 3 -121: Sequence Editor CRT Display

(1) File Name	The name of the sequence file being edited; if the name has not been set yet, *****.SEQ is displayed.
(2) Line	The line number displayed inverted in the Destination list or Repeat column.
(3) Destination	List of the waveform or sequence files included in the sequence file being edited.
(4) Repeat	The repetition count for the file in (3), above. The waveform or sequence file is repeated the specified number of times. This number can be set from 1 to 65535.

(5) Catalog	List of the waveform or sequence files in internal memory; a sequence file is created by selecting files from this list.
(6) Button Operations	<p>This area shows how the front panel buttons operate in this menu.</p> <p> : Go to Move destination mode</p> <p>When you press the CURSOR button, you can scroll through the files in the Destination list or Repeat column with the general purpose knob.</p> <p>Numeric: Enter Repeat</p> <p>The repetition count is set with the numeric keys. Pressing the VALUE or ENTER button enters the input value into the Repeat column.</p> <p> : Go to Insert mode</p> <p>Pressing the VALUE or ENTER button puts the system into insert mode. In this mode, files can be selected from the Catalog and the selected files can be inserted into the Destination list.</p> <p></p> <p>Pressing the VALUE or ENTER button inserts the file that is displayed inverted within the Catalog directly before the inverted display cursor in the Destination list.</p> <p> backward</p> <p>Pressing the ← button moves the inverted cursor left or up one step in the Destination list or Repeat column.</p> <p> forward</p> <p>Pressing the → button moves the inverted cursor right or down one step in the Destination list or Repeat column.</p>

Creating and Editing Sequence Files

Select **Operation** in the bottom menu to create or edit a sequence file. After you have done this, you can select a waveform or sequence file from **Catalog** and then put together a sequence and set the number of repetitions for that file to create the sequence file.

Creating a Sequence File. In this example you will create a new sequence file.

1. Select **Operation** from the bottom menu.
2. Use the general purpose knob to select the file from the **Catalog** to insert into the **Destination** list.
3. Press the front panel **VALUE** button or **ENTER** button. The file selected from the **Catalog** is inserted into the **Destination** list. The file being inserted is placed directly before the inverted display cursor. When the file is inserted, the inverted cursor will move to **Repeat** on the same line.
4. Use the numeric keys to input the repetition count, then press the **ENTER** button to enter the value. The inverted cursor will move to **Destination** on the next line.

The default value for repetition counts is 1. If there is no need to change this value, press the → button. The inverted cursor will move to **Destination** on the next line.

5. Repeat Steps from 2 to 4 to create the desired sequence. As long as there is enough memory, the sequence may be up to approximately 8192 lines long.

Button Functions. To select files within the **Destination** list, press the **CURSOR** button, then select with the general purpose knob or numeric keys. When the numeric keys are used, input the specified line number in the **Line** input column at the top left of the CRT screen. Pressing the **VALUE** or **ENTER** button enters this line number and moves the inverted display cursor to the specified line number.

When the **CURSOR** button has been pressed, and if the **VALUE** button or **ENTER** button is pressed, the system goes into Insert mode. Pressing either of these buttons again inserts the file selected from the **Catalog** into the **Destination** list.

Pressing the → button causes the inverted cursor to move to the right or downward. Pressing the ← button causes the inverted cursor to move to the left or upward.

Editing Functions

When you select **Operation** in the bottom menu, the following items appear in the side menu:

- Cut Line
- Copy to Buffer
- Paste from Buffer
- Show Catalog Entry
- Insert Contents of Sequence
(Appears when a sequence file has been selected with **Catalog**)

Cutting a Line. Use **Cut Line** from the side menu to cut out a line in the **Destination** list.

1. Select **Operation** from the bottom menu.
2. Press the front panel **CURSOR** button.
3. Use the general purpose knob to select the line to be cut from the **Destination** list.
4. Select **Cut Line** from the side menu.

When **Cut Line** is selected, the line displayed inverted in the **Destination** list is deleted. This deleted line is put into the paste buffer. To return the **Destination** list to its original state, select **Undo** from the bottom menu or **Paste from Buffer** from the side menu.

Copying and Pasting a Line. Use **Copy to Buffer** and **Paste from Buffer** to copy a line in the **Destination** list and paste it to another line.

1. Select **Operation** from the bottom menu.
2. Press the front panel **CURSOR** button. Use the general purpose knob to select the line to copy from the **Destination** list.
3. Select **Copy to Buffer** from the side menu. When **Copy to Buffer** is selected, the line displayed inverted in the **Destination** list is copied into the paste buffer. This operation does not affect the display on the CRT.
4. Use the general purpose knob to specify the position to paste the copied line with the inverted display cursor. The position for pasting is directly before the inverted display cursor in the **Destination** list.
5. Select **Paste from Buffer** from the side menu.

Each time **Paste from Buffer** is selected, the line copied into the paste buffer with the copy processing are pasted into whatever line you want.

Catalog File Waveform Display. Use this item to observe the waveforms of the files being assembled into the sequence.

1. Select **Operation** from the bottom menu.
2. Use the general purpose knob to select the file you want to observe from the **Catalog**.
3. Select **Show Catalog Entry** from the side menu.

The waveform is displayed and the file name, the vertical axis voltage, the number of waveform points, and the clock frequency data are shown. Figure 3 -122 is an example of waveform display for when **Show Catalog Entry** is selected.

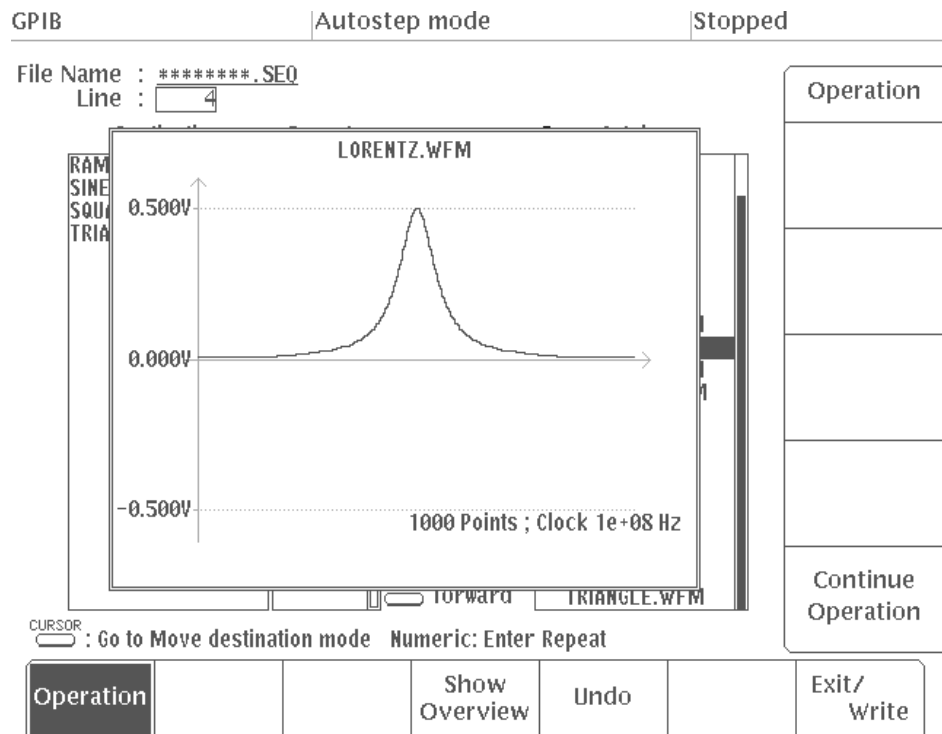

Figure 3 -122: Example of Waveform Display When Show Catalog Entry is Selected

4. After observing the waveform, select **Continue Operation** from the sub menu to return to the sequence editor.

Inserting a Sequence File. Select a sequence file in the **Catalog** to display the **Insert Contents of Sequence** item in the side menu. When this item is selected, the contents of the sequence file are developed and inserted into the **Destination** list.

NOTE. When creating a sequence file you cannot use source–sequence files that contain other sequence files. If you try to do this, a message will be displayed. In this case, you can use the **Insert Contents of Sequence** item to develop the sequence and insert it.

1. Select **Operation** from the bottom menu.
2. Press the front panel **CURSOR** button.
3. Use the general purpose knob to select the line where the sequence file is to be inserted from the **Destination** list. The file is inserted directly before the inverted display cursor in the **Destination** list.
4. Press the front panel **VALUE** button.
5. Use the general purpose knob to select the sequence file from the **Catalog**. The **Insert Contents of Sequence** item will appear in the side menu.
6. Select **Insert Contents of Sequence** from the side menu. The contents of the selected sequence file are inserted directly before the inverted display cursor in the **Destination** list.

Sequence File Display

Use **Show Overview** from the bottom menu to display the waveform for the created or edited sequence file.

1. Select **Show Overview** from the bottom menu.

The waveform will be displayed, together with such information as the voltage indicated by the vertical axis, the waveform point size and the clock frequency. Figure 3 -123 shows an example of a waveform display with the **Show Overview** item selected.

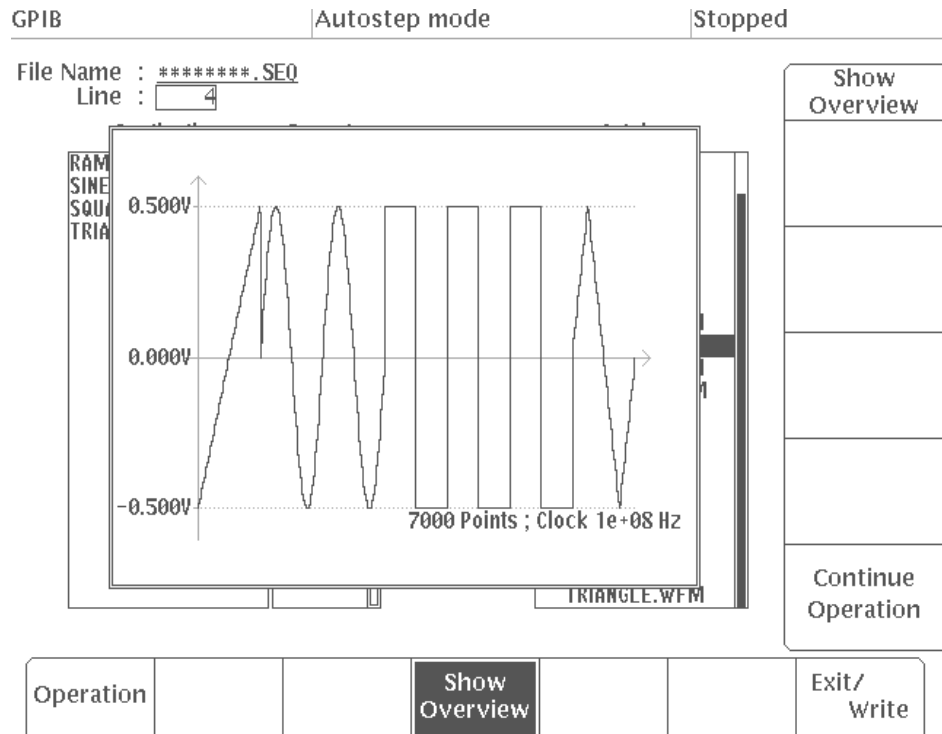

Figure 3 -123: Example of CRT Display When Show Overview is Selected



2. After observing the waveform, select **Continue Operation** from the side menu to return to the sequence editor.

Autostep Editor

Use the autostep editor to edit files with the extension of **.AST**. Autostep files are created by programming waveforms or sequence files. Each time a trigger signal is received, the waveform changes to the waveform for the next step, in accordance with the program. Each waveform or sequence file contains the output conditions that have been set for that file, so the output conditions can be changed for each waveform.

Files created with the autostep editor are started up using **Autostep** in the **MODE** menu. At this point of time, it is not possible to change the output parameters in the **SETUP** menu. Figure 3 -124 shows an example of the data and output waveform for an autostep file.

Table 3-9: Autostep File — CH1

Step	File Name	Output Conditions	Waveform
1	SIN-1.WFM	Amplitude 2 V Offset 0 V	
2	SQUARE.WFM	Amplitude 3 V Offset 0 V	
3	RAMP.WFM	Amplitude 1 V Offset 0.5 V	

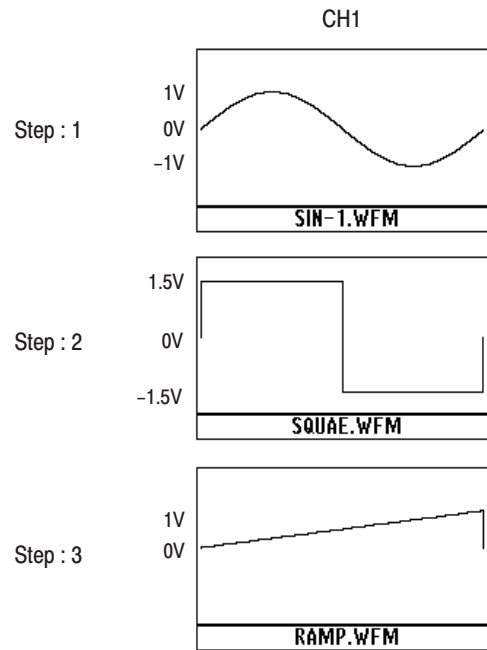

Figure 3 -124: Autostep File Data and Output Waveforms

Entering the Autostep Editor

1. Press the **EDIT** button in the **MENU** column. The initial **EDIT** menu will appear.
2. Select **More** from the side menu to display the second page of the side menu: **More 2 of 2**.
3. Select **Edit** or **New Autostep** from the side menu.

Edit Used to select and edit an existing autostep file (.AST)

New Autostep Used to create a new autostep file

The autostep editor screen will appear.

Saving Files and Exiting the Editor

Select **Exit/Write** from the bottom menu in the autostep editor to save the file (which you have either created or edited, depending on the side menu) to the internal memory of the AWG2021 and exit from the editor.

The same procedure is used to save the file and exit from the autostep editor as for the waveform editor. See “Saving Files and Exiting the Editor” in the section on the waveform editor.

Autostep Editor Menu Structure

The Autostep Editor menu has the structure shown in Figure 3 -125.

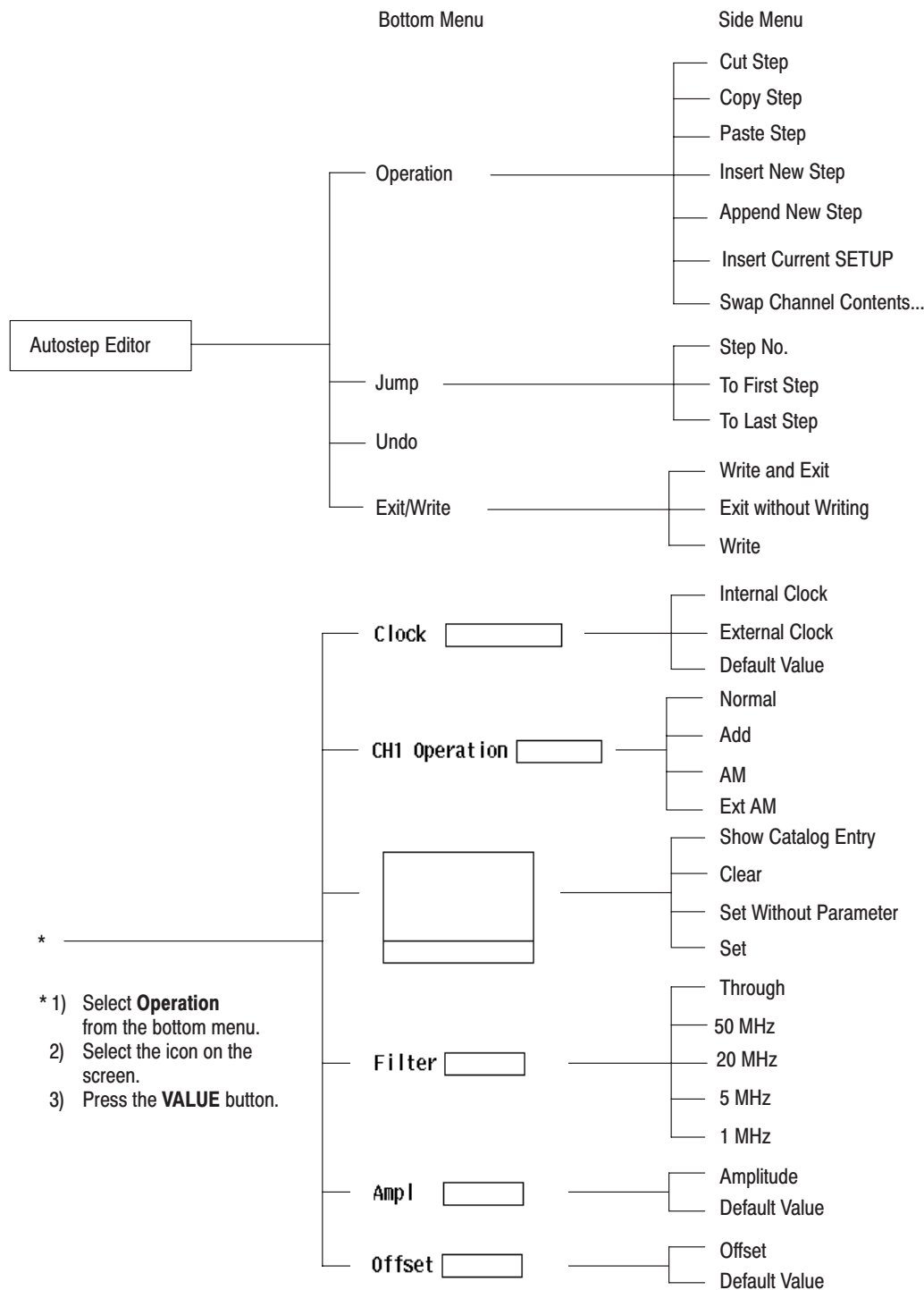

Figure 3 -125: Autostep Editor Menu Structure

Menu Functions

The following list shows the functions available for each menu item and the page on which you can find a description of that function.

Table 3-10: Menu Functions

Menu	Function	Page
Operation	Editing functions	3 -186
Cut Step	Cutting a step	3 -186
Copy Step	Copying a step	3 -186
Paste Step	Pasting a step	3 -186
Insert New Step	Adding a step	3 -187
Append New Step	Adding a step	3 -187
Insert Current SETUP	Inserting SETUP menu waveforms and output parameters	3 -187
Swap Channel Contents...	Swapping steps between channels	3 -187
Jump	Jumping to a step	3 -188
Undo	Canceling function execution	3 -2
Exit/Write	Saving files and exiting the editor	3 -20, 3 -172
Items selected on the screen		
Clock	Clock settings	3 -181
CH1 Operation	CH1 operation settings	3 -182
Waveform/Sequence	Setting files	3 -177
Filter	Filter settings	3 -183
Amplitude	Amplitude settings	3 -184
Offset	Offset settings	3 -185

Autostep Editor Menu Display

Figure 3 -126 shows the general autostep editor display. A description for each callout follows.

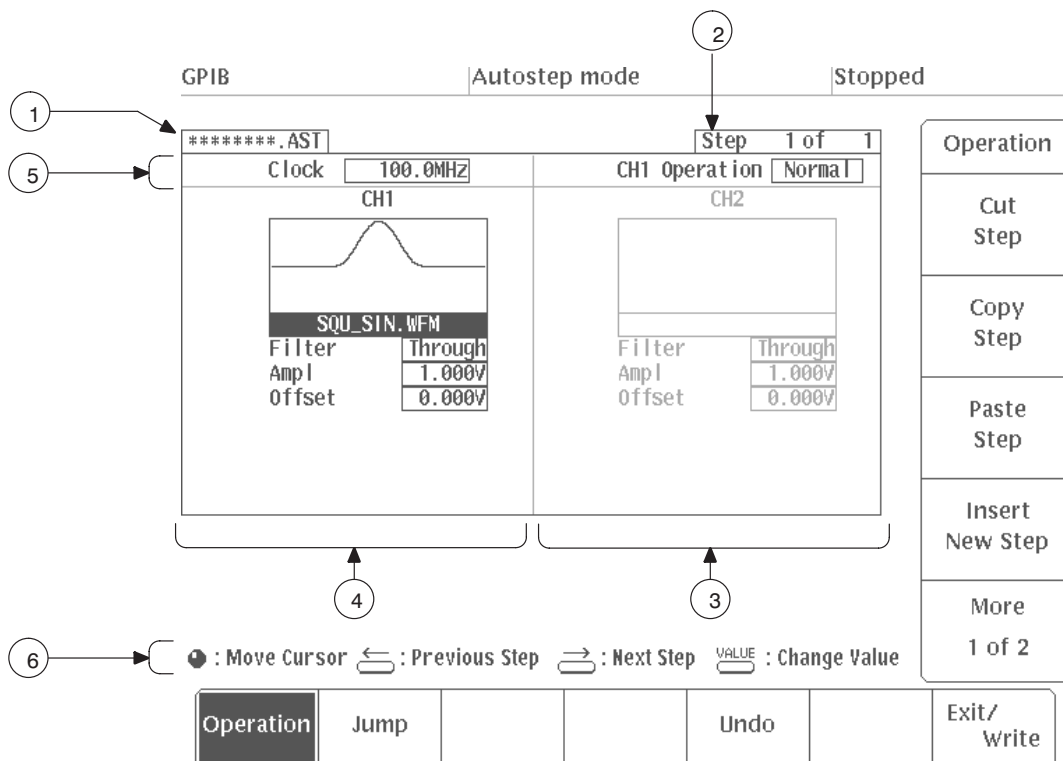





Figure 3 -126: Autostep Editor CRT Display

(1) File Name	The name of the autostep file being edited; if the name has not been set yet, *****.AST is displayed.
(2) Step No.	Indicates the step number in the program.
(3) CH2 File Setting Area (Option 02)	This setting area is only effective when Option 02, with CH2, is installed. Indicates the file set for CH2 in the step indicated by (2). The waveform and output parameters for that file are shown in this area. These output parameters may be changed.
(4) CH1 File Setting Area	Indicates the file set for CH1 in the step indicated by (2). The waveform and output parameters for that file are shown in this area. These output parameters may be changed.

<p>(5) Clock Frequency and CH1 Operation</p>	<p>Indicates the clock frequency and CH1 operation mode that have been saved to the CH1 file. These output parameters may be changed.</p>
<p>(6) Button Operation</p>	<p>This area shows how the front panel buttons operate in this menu.</p> <p> : Move Cursor</p> <p>Output parameters can be selected by turning the general purpose knob.</p> <p> : Previous Step</p> <p>Pressing this key at a programmed step moves to the previous step.</p> <p> : Next Step</p> <p>Pressing this key at a programmed step moves to the next step.</p> <p> : Change Value</p> <p>Pressing the VALUE button makes it possible to set the selected output parameter. Use the general purpose knob to select the output parameter to be set.</p>

Creating and Editing Autostep Programs

Select **Operation** from the bottom menu to create or edit autostep programs. Up to 100 steps can be programmed. If blank steps exist in the autostep program that has been created, these steps will be deleted when you quit the editor. If blank steps exist in CH1 in an autostep file created on an instrument with Option 02 (2-channel output) installed, the instrument will stop at a blank step when the file is started up.

Setting Files. The following procedure is used to set a new file at each step.

1. Select **Operation** from the bottom menu.

To set a file for Step 1 of the autostep program:

2. Using the general purpose knob, select the item for which a file will be set on CH1.

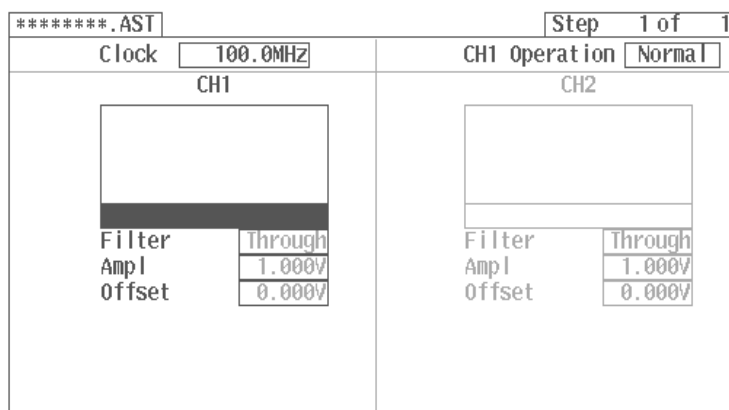

Figure 3 -127: Selecting the Item for File Setting

3. Press the **VALUE** button on the front panel. A list of files that can be set will appear.

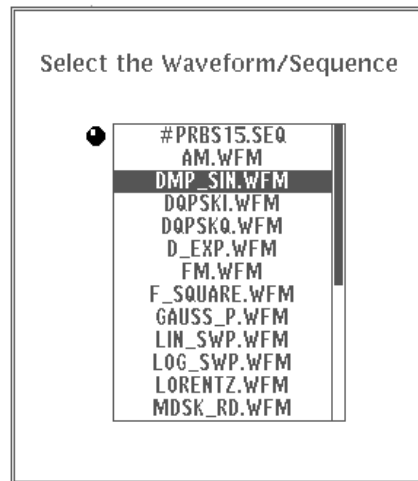

Figure 3 -128: File Selection List

4. Using the general purpose knob, select the desired file.
5. If you want to check the waveform of the selected file, select **Show Catalog Entry** from the side menu.

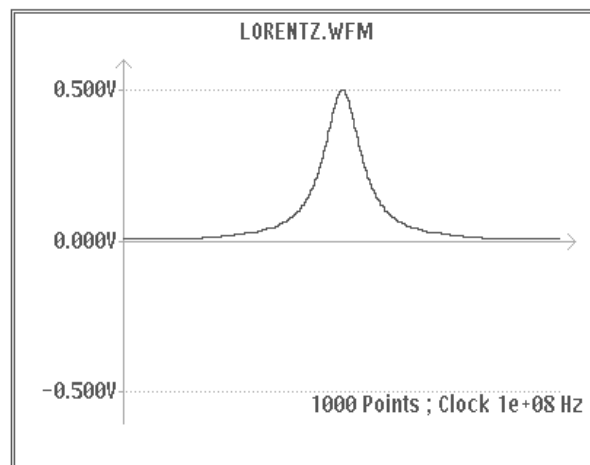

Figure 3 -129: Sample File Waveform Display

The waveform for that file will appear along with the waveform point size, the clock frequency and the voltage value.

6. Select **Continue** from the sub-menu.

The menu shown before you selected **Show Catalog Entry** will reappear.

7. Select **Set** from the side menu.

The selected file will be inserted and the output parameters for that waveform will be set.

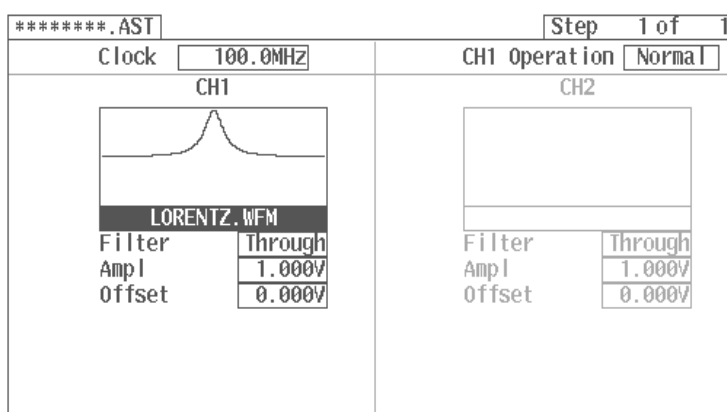

Figure 3 -130: Setting a File

Selecting **Cancel** will cancel the setting operation and the previous menu will appear.

Use **Set Without Parameter** instead of **Set** when you want to designate the waveform without changing the parameters. The default parameters will be set when the editor is opened using **New Autostep** or when a waveform is designated for a new step added with **Insert New Step** or **Append New Step**. The default values for the output parameters are shown below.

Clock	100.0MHz
CH1 Operation	Normal
Filter	Through
Ampl	1.000V
Offset	0.000V

Among them, **Clock** and **CH1 Operation** depend on the CH1 file.

Use **Clear** from the side menu to delete the file setting for the channel indicated by the cursor.

To add a step:

8. Select **More 1 of 2** from the side menu and then select **Append New Step**. The instrument will proceed to Step 2. See “Adding a Step” in this section.

Repeat this procedure to create the program.

Changing Parameters. It is possible to change the output parameters for a file that has been set. Changing the output parameter values does not change the parameters in the original file.

1. Use the ← and → buttons on the front panel or the **Jump** item in the bottom menu to move to the step whose parameters you want to change.
2. Select **Operation** from the bottom menu.
3. Turn the general purpose knob to select the parameter to be changed.
4. Press the **VALUE** button on the front panel. The menu for that parameter will appear.
5. Set the parameters as desired. See the descriptions of the individual parameters on the following pages.
6. Select **O.K.** from the side menu. The parameters will be updated to the selected items or set values. Selecting **Cancel** will cancel the setting operation and the previous menu will reappear.

- Clock Settings. Select **Clock** using the general purpose knob. Then press the **VALUE** button on the front panel. The menu shown in Figure 3 -131 will appear.

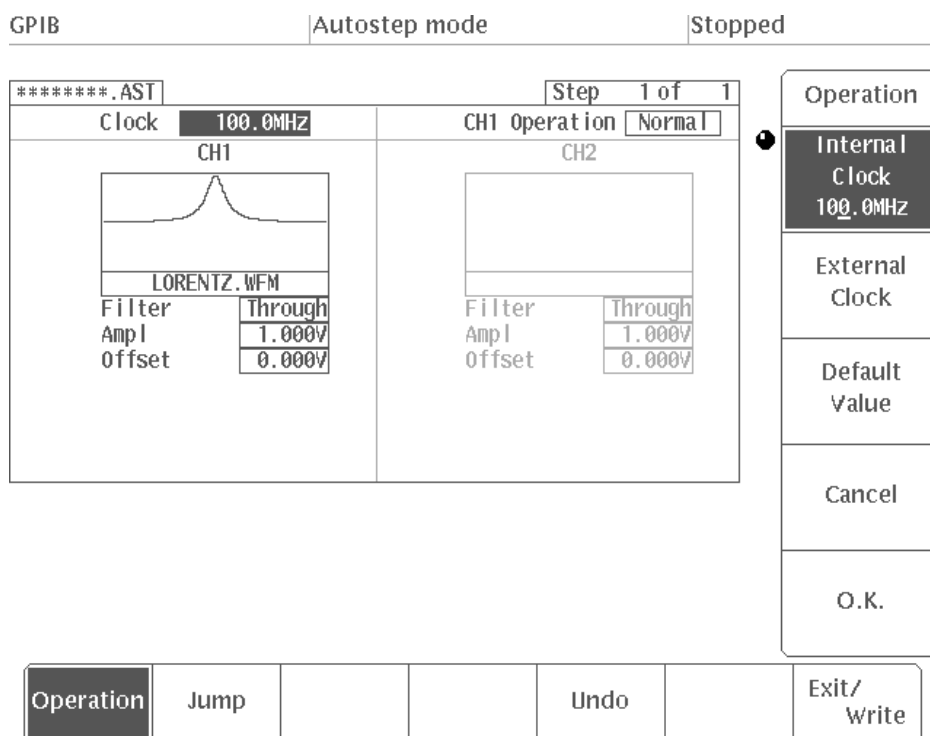

Figure 3 -131: Clock Setting Menu

Set the clock source and the clock frequency by selecting the appropriate items in the side menu. The settings for clock source and clock frequency are used for both channel 1 and channel 2.

Internal Clock	Selects the internal clock. Use the numeric keys or the general purpose knob to set the internal clock frequency.
External Clock	Selects the external clock. The external clock signal is input through the CLOCK IN connector on the rear panel of the instrument.
Default Value	Sets the internal clock frequency to the default value of 100.0 MHz.

After setting the clock source and clock frequency, select **O.K.** from the side menu. The values for

clock source and clock frequency will be updated to the values you have set.

- CH1 Operation Settings. Select CH1 Operation using the general purpose knob. Then press the VALUE button on the front panel. The menu shown in Figure 3 -132 will appear.

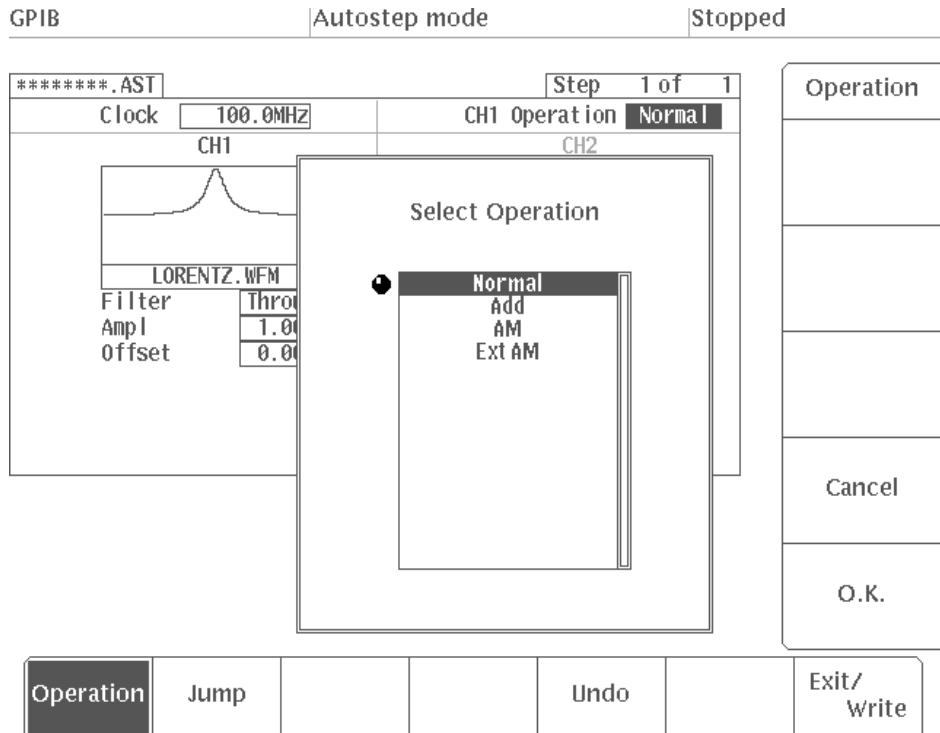

Figure 3 -132: CH1 Operation Setting Menu

Using the general purpose knob, select the type of operation to be performed with the CH1 waveform. You can only selecting Add or AM in instruments that have Option 02 installed. See “CH1 Waveform Operations” in “SETUP Menu.” After selecting the type of operation, select **O.K.** from the side menu. The operation type will be updated to what you have set.

- Filter Settings. Using the general purpose knob, select the Filter for the channel that you want to change and then press the VALUE button on the front panel. The menu shown in Figure 3 -133 will appear.

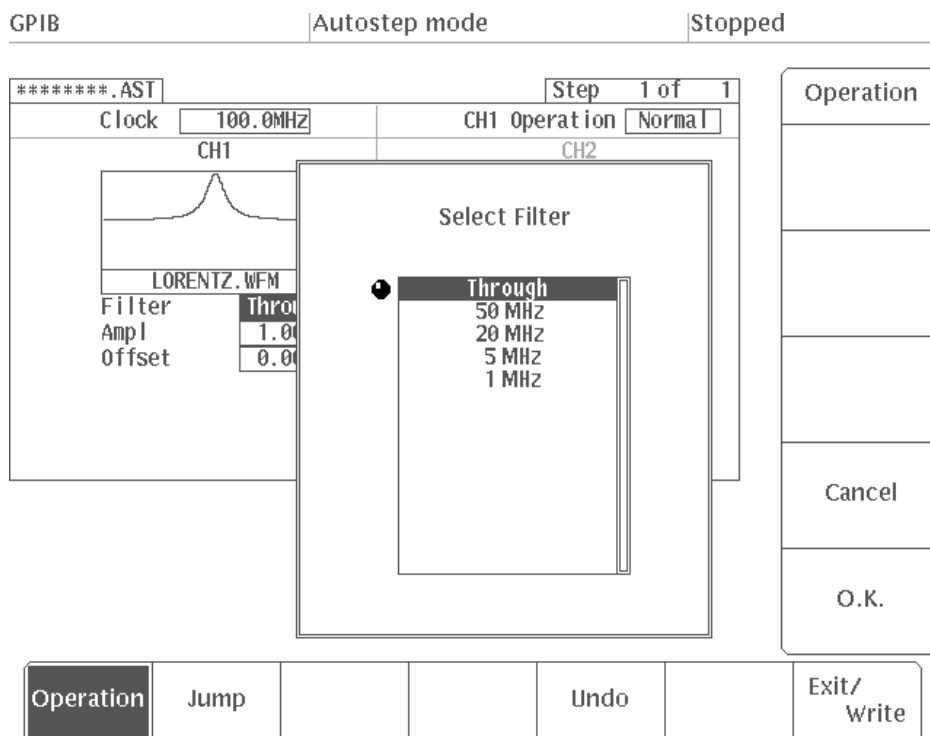

Figure 3 -133: Filter Setting Menu

Using the general purpose knob, select the type of filter. After selecting the filter type, select **O.K.** from the side menu. The filter type will be updated to what you have set.

- Amplitude Settings. Using the general purpose knob, select the **Ampl** for the channel that you want to change and then press the **VALUE** button on the front panel. The menu shown in Figure 3 -134 will appear.

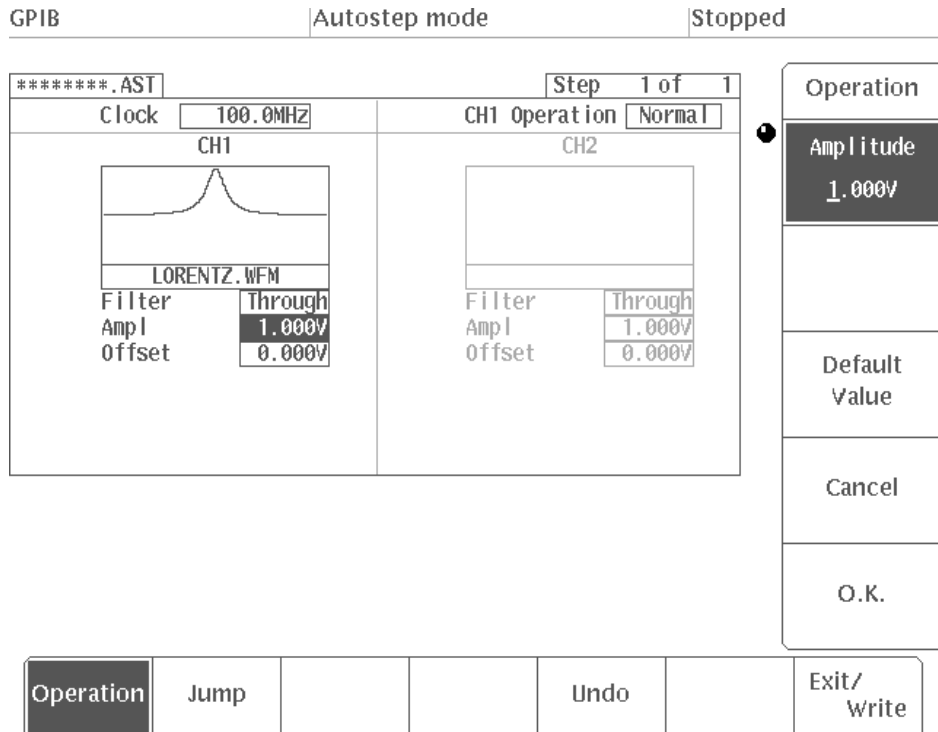

Figure 3 -134: Amplitude Setting Menu

Select the appropriate item in the side menu and set the amplitude.

- Amplitude** Select this item and use the numeric keys or the general purpose knob to set the desired amplitude value.
- Default Value** This item sets the amplitude to the default value of 1.000 V.
After setting the amplitude, select **O.K.** from the side menu. The value for amplitude will be updated to the value you have set.

- Offset Settings. Using the general purpose knob, select the **Offset** for the channel that you want to change and then press the **VALUE** button on the front panel. The menu shown in Figure 3 -135 will appear.

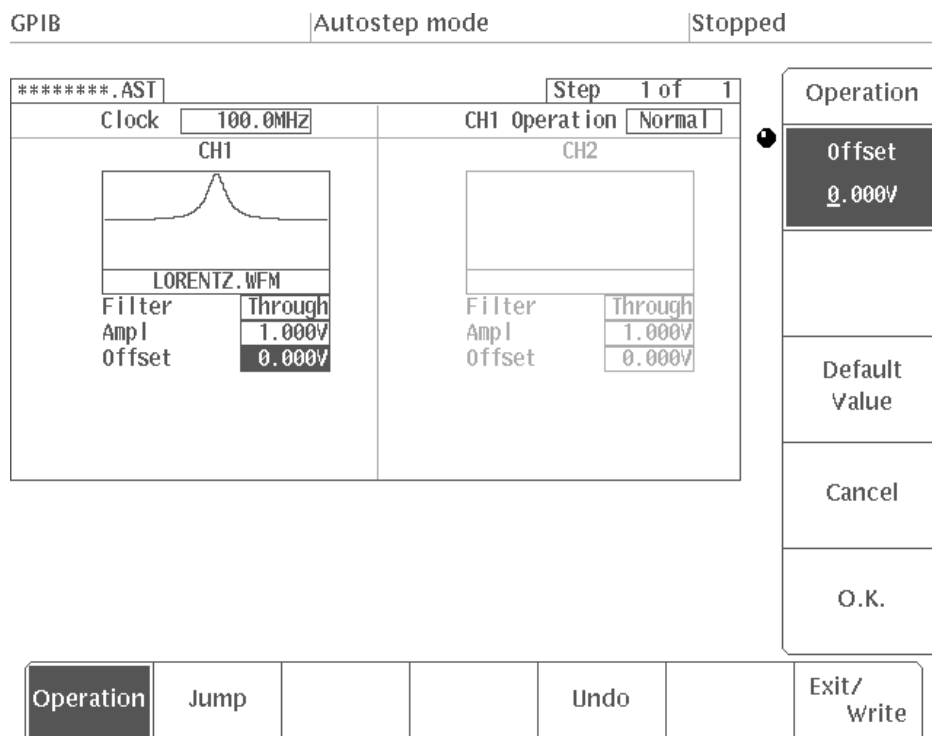

Figure 3 -135: Offset Setting Menu

Select the appropriate item in the side menu and set the offset.

- Offset** Select this item and use the numeric keys or the general purpose knob to set the desired offset value.
- Default Value** This item sets the offset to the default value of 0.000 V.

After setting the offset, select **O.K.** from the side menu. The value for offset will be updated to the value you have set.

Editing Functions

When you select **Operation** in the bottom menu, the following items appear in the side menu:

- Cut Step
- Copy Step
- Paste Step
- Insert New Step
- Append New Step
- Insert Current Setup
- Swap Channel Contents...

Cutting a Step. Use **Cut Step** if you wish to delete a step in the autostep file that you have programmed.

1. Select **Operation** from the bottom menu.
2. Using the ← and → buttons on the front panel, move to the step to be deleted.
3. Select **Cut Step** from the side menu.

When **Cut Step** is selected, the current step is deleted. All of the steps after the one that you have deleted will move up one step. To restore this step to its original state, select **Undo** from the bottom menu or **Paste from Buffer** from the side menu.

Copying and Pasting a Step. Use the **Copy Step** and **Paste Step** items to copy a step in the program and paste it to another step.

1. Move to the step to be copied, using the same procedure as in “Cutting a Step” above.
2. Select **Copy Step** from the side menu.

When **Copy Step** is selected, the current step is placed in the paste buffer. This item has no effect on the CRT display.

3. Use the ← and → buttons on the front panel or the **Jump** item in the bottom menu to move to the step to which the step in the paste buffer is to be pasted.
4. Select **Paste Step** from the side menu.

All of the steps after the one that has been pasted will move down one step.

Adding a Step. Use **Insert New Step** and **Append New Step** from the side menu when you wish to add a step to an autostep file being created.

Insert New Step Used to insert a step at the current step number.

For example, suppose the current step number is **Step 2 of 3**. Selecting **Insert New Step** at this point will add a blank step at Step 2 and the step display will read **Step 2 of 4**.

Append New Step Used to add a step after the current step number.

For example, suppose the current step number is **Step 2 of 3**. Selecting **Append New Step** at this point will add a blank step at Step 3 and the step display will read **Step 3 of 4**.

Inserting the SETUP Menu Waveforms and Output Parameters. Use **Insert Current SETUP** from the side menu to insert the waveforms and output parameters for all channels that are currently set in the **SETUP** menu at the current step.

Swapping Steps Between Channels. Use **Swap Channel Contents...** from the side menu to interchange the contents of steps between channel 1 and channel 2. This item is effective to edit the autostep file created on instrument with Option 02 installed. The following diagram shows the menu configuration.

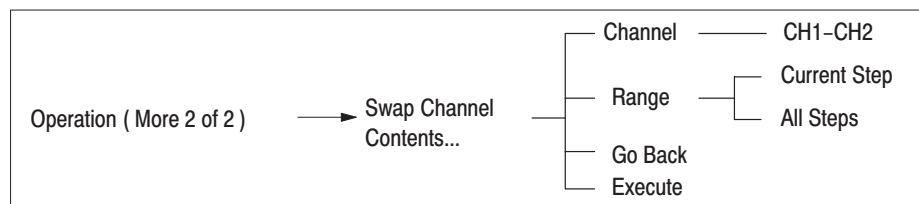

1. Select **Operation** from the bottom menu.
2. Using the ← and → buttons on the front panel, move to the step whose contents are to be swapped with another channel.
3. Select **More 1 of 2** from the side menu and then select **Swap Channel Contents...**
4. Select **Channel** from the sub-menu.
5. Using the general purpose knob, select the channel with which the step contents are to be swapped.

6. Press **Range** in the sub-menu and select **Current Step** or **All Steps**.

Current step Swaps only the contents of the current step.

All Steps Swaps the contents of all steps.

7. Select **Execute** in the sub-menu.

Data will be exchanged between the designated steps in the designated channels.

Jumping to a Step

Use **Jump** in the bottom menu to go quickly to a certain step in the autostep program. Using the items in the side menu, you can jump to the first step, the last step or to any step in between.

Step No. Used to move to a step other than the first or last step.

Use the numeric keys or the general purpose knob to enter the number of the desired step.

To First Step Used to move to the first step.

To Last Step Used to move to the last step.

Convolution Waveform Editor (Option 09)

On instruments with Option 09 installed, high-speed convolution and correlation can be performed for up to 32,000 words of waveform data in existing waveform files (those bearing the extender **.WFM**).

The number of points in the waveform after calculation will be the sum of the point sizes of the two selected waveform files. The calculated amplitude will be normalized.

NOTE. *The calculated result of waveforms consisting of P number of points and N number of points will be P+N-1. For the sake of convenience, however, on this instrument a final value of 0.0 is added, so the result is P+N.*

On discrete systems, the convolution $y(n)$ of waveform $x(n)$ and waveform $h(i)$ is expressed by the following formula. Here N is the number of data items. The operation expressed by this formula is called convolution.

$$y(n) = \sum_{i=0}^{N-1} x(i)h(n-i)$$

Alternately, the correlation $y(n)$ of waveform $x(n)$ and waveform $h(i)$ is expressed by the following formula. Here N is the number of data items. The only difference between this equation and the one expressing convolution above is the minus sign in the parentheses, so with left-right symmetrical waveforms the results will be identical.

$$y(n) = \sum_{i=0}^{N-1} x(i)h(n+i)$$

Entering the Convolution Waveform Editor

In this editor, you select an existing waveform file and perform either convolution or correlation and then create a new file. Use the following procedure to open the editor:

1. Press the **EDIT** button in the **MENU** column. The initial **EDIT** menu will appear.
2. Select **More** from the side menu to display the third page of the side menu: **More 3 of 3**.
3. Select **Convolve Waveform** from the side menu.

The convolution waveform editor screen will appear.

Saving Files and Exiting the Editor

When you select **Exit/Write** from the bottom menu, depending on what you have selected in the side menu, a file name will be assigned to the calculated result and the file will be saved to internal memory, after which the editor will close. When you quit the editor, the initial **EDIT** menu will reappear.

The same procedure is used to save the file and exit from the convolution waveform editor as for the waveform editor. See “Saving Files and Exiting the Editor” in the section on the waveform editor.

Convolution Waveform Editor Menu Structure

The Convolution Waveform Editor menu has the structure shown in Figure 3 -136.

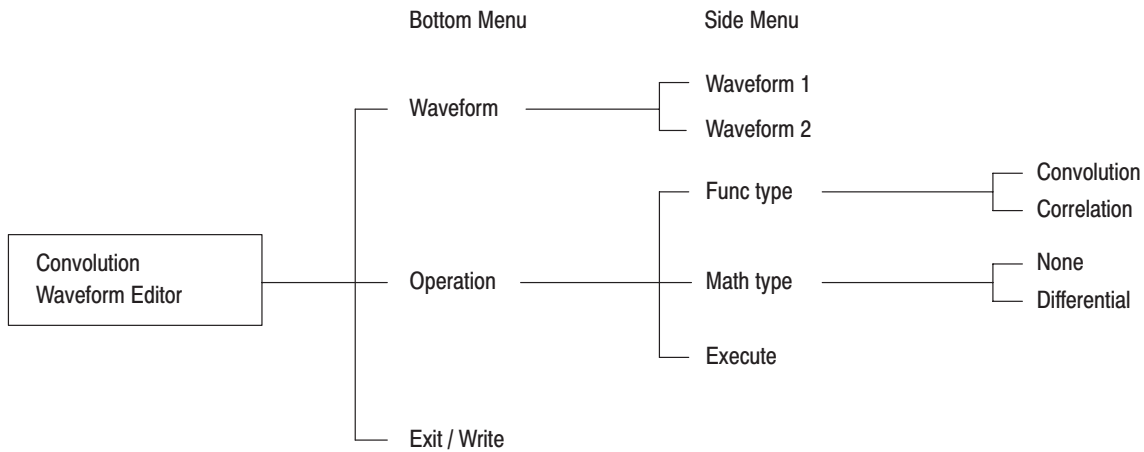

Figure 3 -136: Convolution Waveform Editor Menu Structure

Menu Functions

The following list shows the functions available for each menu item and the page on which you can find a description of that function.

Table 3-11: Menu Functions

Menu	Function	Page
Waveform	Selecting a waveform file	3 -192
Operation	Executing convolution/correlation	3 -193
Exit/Write	Saving files and exiting the editor	3 -20, 3 -190

Convolution Waveform Editor Menu Display

Figure 3 -137 shows the general convolution waveform editor display.

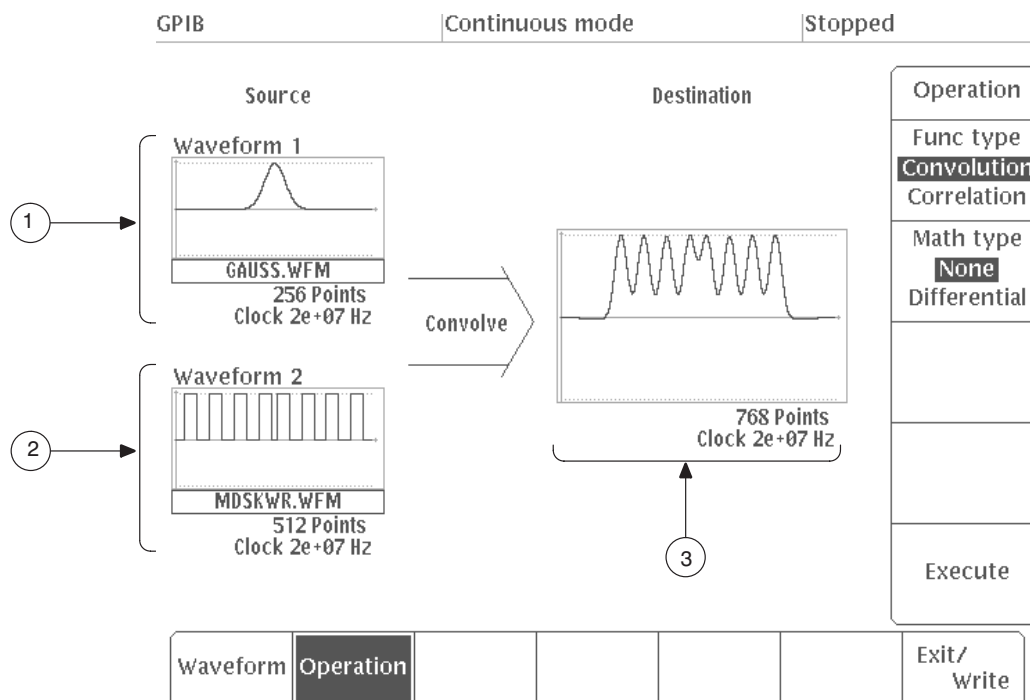

Figure 3 -137: Convolution Waveform Editor CRT Display

(1) Source Waveform1 Display Area	When the waveform file for operation is selected from internal memory, the waveform for that file will be displayed in this area along with the file name, clock frequency and number of points making up the waveform.
(2) Source Waveform2 Display Area	When the other waveform file for operation is selected from internal memory, the waveform for that file will be displayed in this area along with the file name, clock frequency and number of points making up the waveform.
(3) Destination Waveform Display Area	The result of operations for Waveform1 and Waveform2 will be displayed in this area as a waveform. The waveform point size will be the sum of the point sizes for Waveform1 and Waveform2 . When the data is saved, the clock frequency for Waveform1 will be saved to that file.

Selecting a Waveform File

In this example, you will select a waveform file for operation.

1. Select **Waveform** from the bottom menu.
2. Select **Waveform1** from the side menu.
3. Using the general purpose knob, select the waveform file for operation from the **Select Waveform** list and then select **O.K.** The waveform you have selected will be displayed in the **Waveform1** display area under **Source**.
4. Select **Waveform2** from the side menu.
5. Using the general purpose knob, select the other waveform file for operation from the **Select Waveform** list and then select **O.K.** The waveform you have selected will be displayed in the **Waveform2** display area under **Source**.

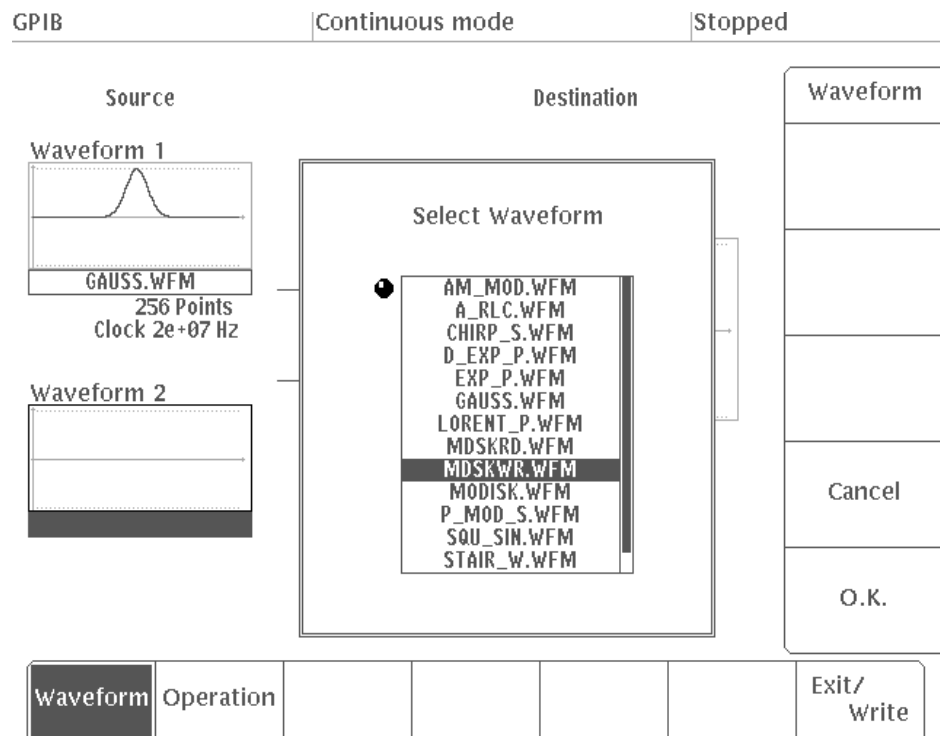

Figure 3 -138: Selecting a Waveform File

Executing Convolution/Correlation

When you select **Operation** in the bottom menu, convolution or correlation will be performed. If **Differential** has been selected for the **Math type** item, the calculated result will be differentiated.

1. Select **Operation** from the bottom menu.
2. Press **Func type** in the side menu and select either **Convolution** or **Correlation**.
3. If you would like to differentiate the calculated result, select **Differential** for the **Math type** item. Differentiation will be used when reading waveforms from magnetic disks.
4. Select **Execute** from the side menu to execute the operation.

The point size of the waveform data after operation will be the sum of the point sizes of the two waveform files you have selected.

Figure 3 -139 shows an example of convolution for which differentiation has been performed. Figure 3 -140 shows an example of correlation.

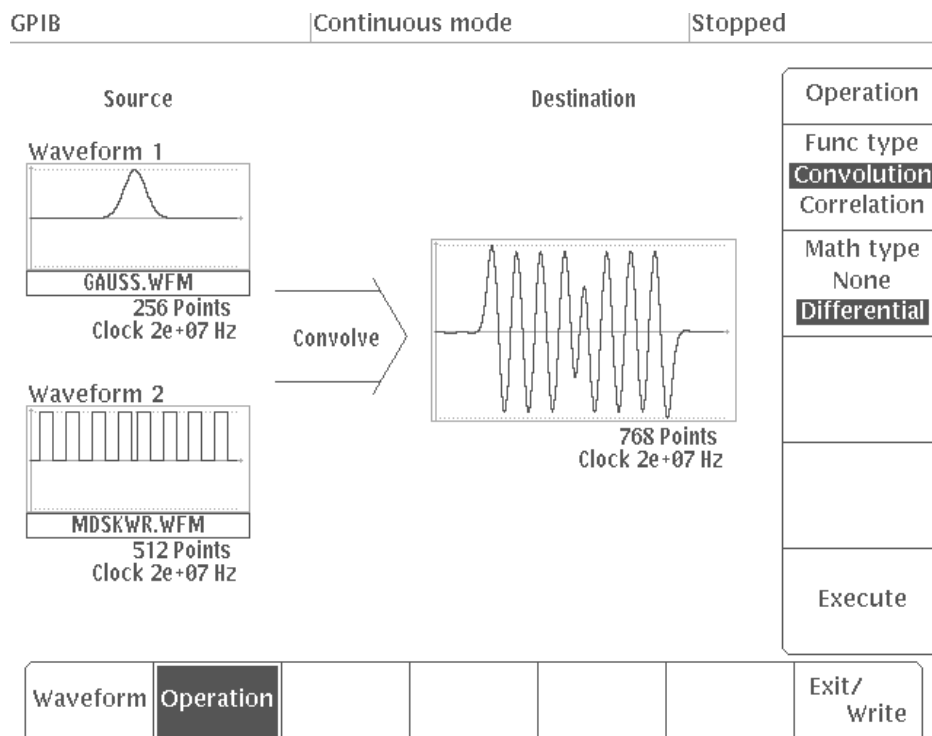

Figure 3 -139: Sample Convolution

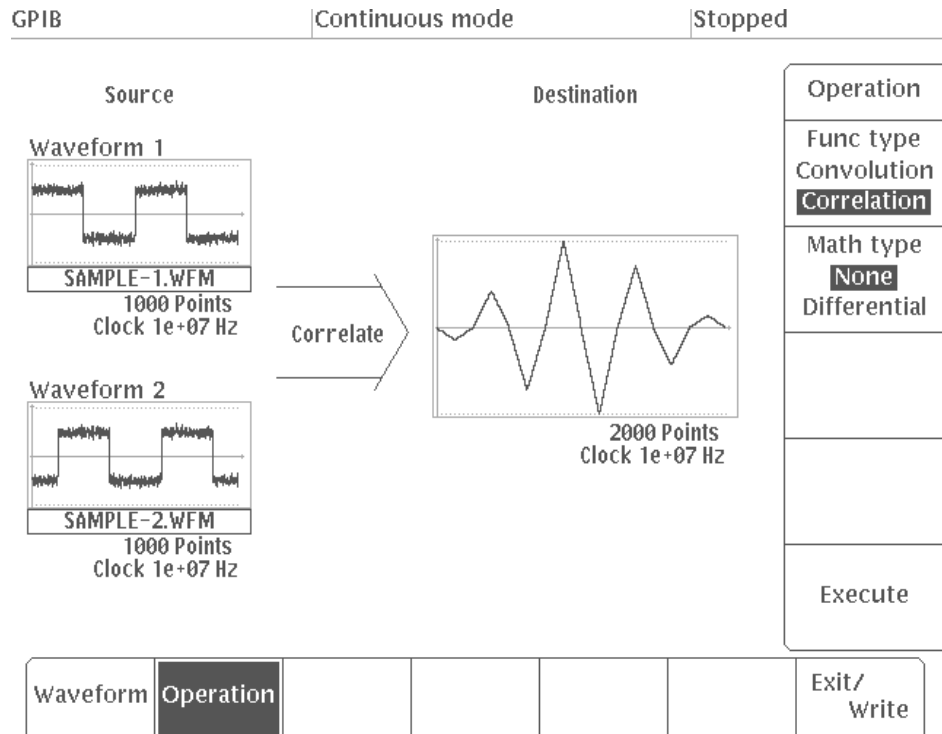

Figure 3 -140: Sample Correlation

FFT Editor (Option 09)

On instruments with Option 09 installed, existing waveform files up to 16,000 waveform points with the extension **.WFM** can be edited in the frequency domain. When the editor is started, Fast Fourier transformation occurs automatically and the data is transformed into the frequency domain. When you leave the editor, inverse fast Fourier transformation is carried out to convert the frequency domain data into time domain data.

The window function for fast Fourier transform is selected when the editor is started. Within the editor, filtering (high pass, low pass, band pass, band cut) and clipping are possible.

Entering the FFT Editor

This editor is not used to make new files. Rather, it edits existing waveform files in the frequency domain. Here is the procedure for editing the FFT editor.

1. Press the **EDIT** button in the **MENU** column. The initial **EDIT** menu will appear.
2. Select **More** from the side menu to display the third page of the side menu: **More 3 of 3**.
3. Using the general purpose knob, select the waveform file (**.WFM**) from the file list.

The **Edit in Frequency Domain** item is added to the side menu.

4. Select **Edit in Frequency Domain** from the side menu. The menu for selecting the window function is displayed. See Figure 3 -141.

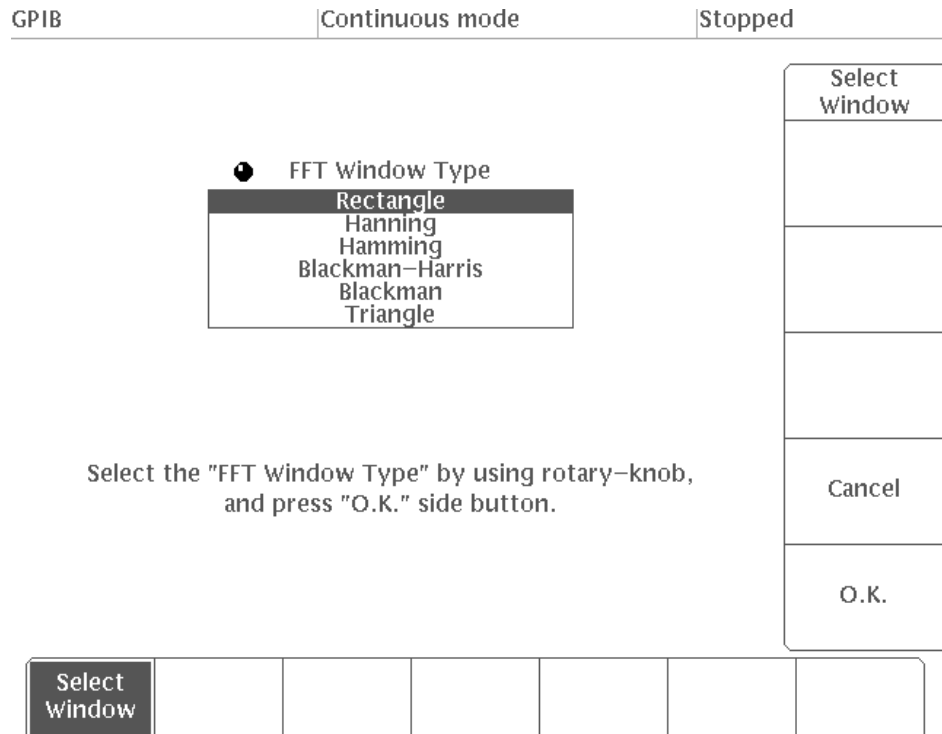

Figure 3 -141: FFT Window Selection Menu

- Using the general purpose knob, select the window function.

When you enter the FFT editor, you must select the window function. This instrument has the following six FFT windows.

- Rectangle
- Hanning
- Hamming
- Blackman-Harris
- Blackman
- Triangle

For repetitive waveforms in which the waveform data starting point and ending point match, the rectangle window is usually used. For details on the window functions, see the FFT (Fast Fourier Transforms) description in Appendix F.

- Next, select **O.K.** from the side menu to enter the FFT editor. The time domain data is transformed into the frequency domain.

To cancel the FFT operation, select **Cancel**. This returns the system to the initial **EDIT** menu.

Saving Files and Exiting the Editor

Select **Exit/Write** from the bottom menu. Then select from the side menu to save the edited file to the internal memory of the AWG2021 and exit from the editor. When this is done, the frequency domain data is converted into time domain data and saved as a waveform file.

The same procedure is used to save the file and exit from the FFT editor as for the waveform editor. See “Saving Files and Exiting the Editor” in the section on the waveform editor.

FFT Editor Menu Structure

The FFT Editor menu has the structure shown in Figure 3 -142.

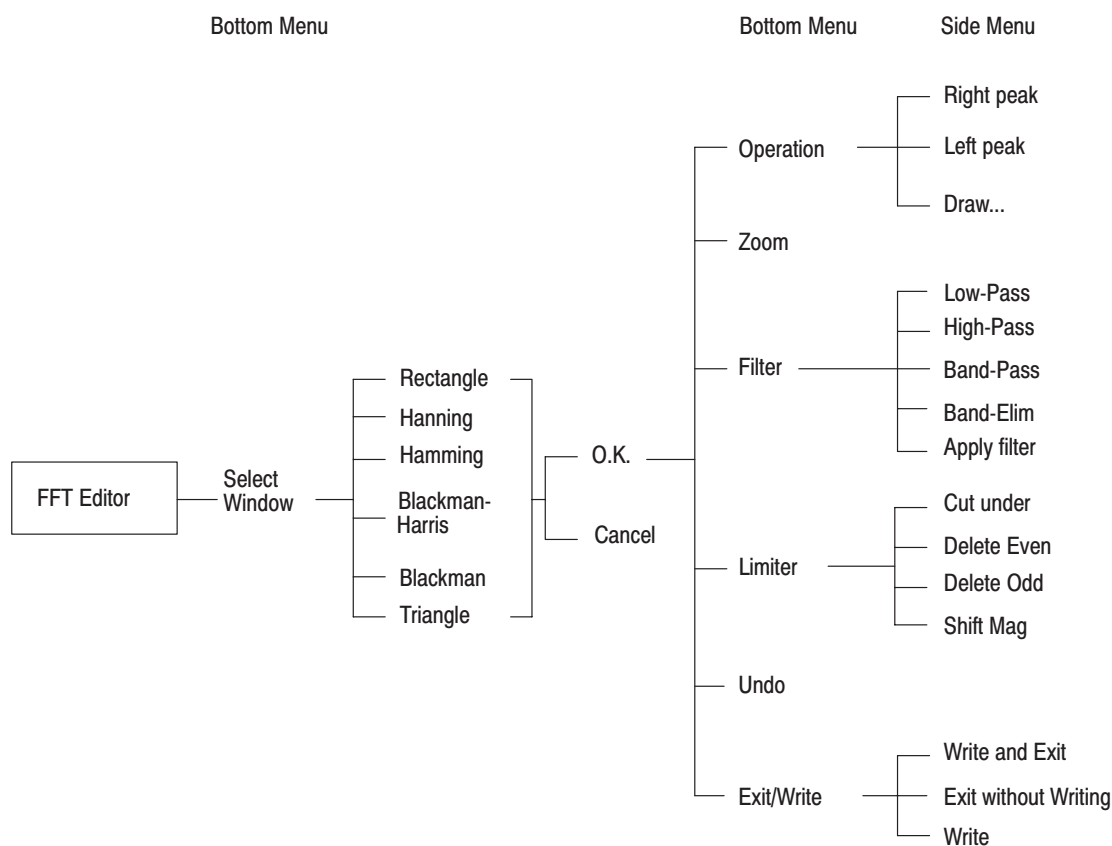

Figure 3 -142: FFT Editor Menu Structure

Menu Functions The following list shows the functions available for each menu item and the page on which you can find a description of that function.

Table 3-12: Menu Functions

Menu	Function	Page
Select Window	Selecting a window	3 -195
Operation	Editing in the frequency domain	3 -200
Right peak, Left peak	Searching for peaks	3 -201
Draw...	Drawing magnitude and phase	3 -201
Zoom	Magnifying a signal	3 -204
Filter	Selecting a filter	3 -205
Limiter	Selecting a limiter	3 -207
Cut under	Cutting extraneous frequency components	3 -208
Delete Even, Delete Odd	Deleting even or odd components	3 -208
Shift Mag	Shifting magnitudes	3 -209
Undo	Canceling function execution	3 -2
Exit/Write	Saving files and exiting the editor	3 -20, 3 -197

FFT Editor Menu Display

Figure 3 -143 shows the general FFT editor display. A description for each callout follows.

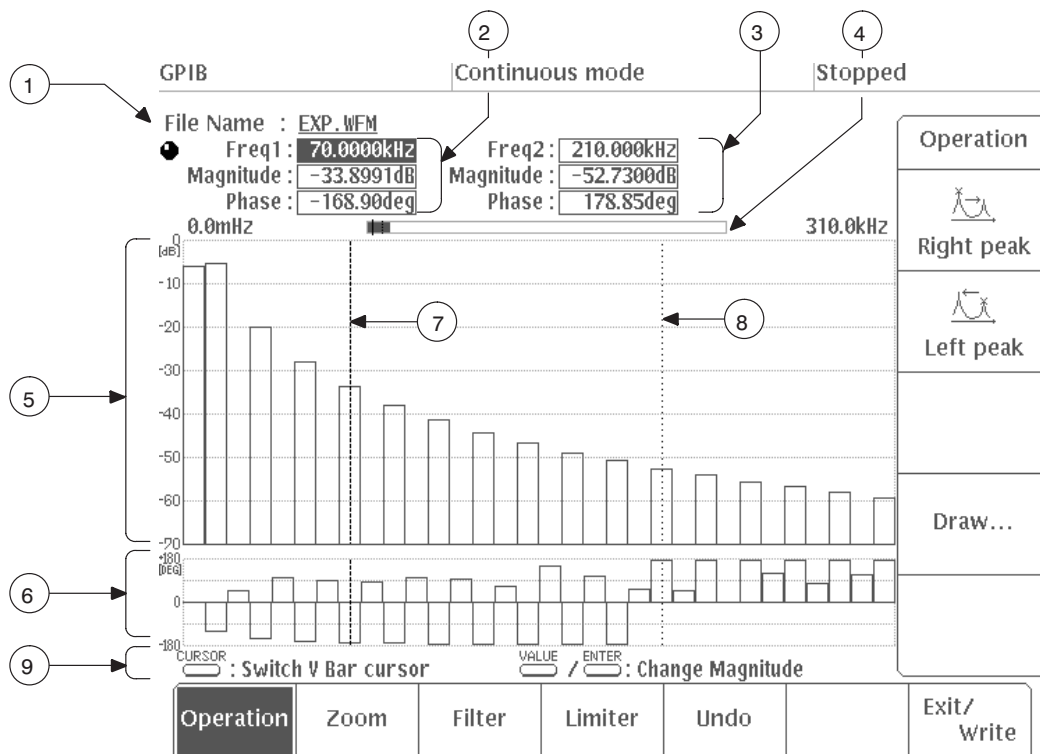











Figure 3 -143: FFT Editor CRT Display

(1) File Name	This is the name of the waveform file being edited.
(2) Freq1: Magnitude: Phase:	This section shows the frequency, magnitude and phase for the position of the left vertical bar cursor. Use the CURSOR button to toggle between the left and right vertical bar cursors. Use the VALUE button to toggle between magnitude and phase. A knob icon indicates that an item is active. Magnitude values are expressed in dB and phase values are expressed in deg.
(3) Freq2: Magnitude: Phase:	This section shows the frequency, magnitude and phase for the position of the right vertical bar cursor.
(4) Scroll Indicator	This item shows the position of the display area within the overall waveform. The area displayed on the screen is displayed inverted.
(5) Magnitude Display Area	This area displays the magnitudes for the frequency components.
(6) Phase Display Area	This area displays the phases for the frequency components.

(7) Left vertical bar cursor	The left cursor indicates the left starting point for editing. The active cursor will be brightly highlighted with dot lines.
(8) Right vertical bar cursor	Indicates the right end point for editing.
(9) Button Operations	<p>This area shows how the front panel buttons operate in this menu.</p> <p> : Switch V Bar cursor</p> <p>Pressing the CURSOR button toggles the active vertical bar cursor.</p> <p> /  : Change Magnitude</p> <p>Pressing the VALUE or ENTER button puts the system into a mode in which the magnitude at the frequency of the active vertical bar cursor can be changed.</p> <p> /  : Change Phase</p> <p>Pressing the VALUE or ENTER button puts the system into a mode in which the phase at the frequency of the active vertical bar cursor can be changed.</p> <p> : Move V Bar cursor</p> <p>When Draw... has been selected, pressing the CURSOR button moves the active vertical bar cursor.</p> <p> /  : Move point cursor</p> <p>When Draw... has been selected, pressing the VALUE or ENTER button moves the point cursor.</p> <p> /  : Switch point cursor dir</p> <p>When Draw... has been selected, pressing VALUE or ENTER toggles the direction in which the point cursor moves from vertical to horizontal or vice-versa.</p>

Editing in the Frequency Domain

Select **Operation** from the bottom menu to change the signal magnitude and phase in the frequency domain. The following items will appear in the side menu:

- Right peak
- Left peak
- Draw...

Editing Magnitude. Here is the procedure for editing the magnitudes.

1. Select **Operation** from the bottom menu.
2. Press the **CURSOR** button on the front panel to select the left/right vertical bar cursor. Using the numeric keys or the general purpose knob, move the active vertical bar cursor to the frequency to be edited.

3. Press the **VALUE** button on the front panel and select **Magnitude**. The knob icon is displayed on the **Magnitude** side.
4. Using the general purpose knob or the numeric keys, change the magnitude.
5. To change the magnitude for another frequency, press the **CURSOR** button on the front panel, and use the general purpose knob to move the active vertical bar cursor to the frequency to be edited. Next, repeat Steps 3 and 4.

Editing Phase. Here is the procedure for editing the phase.

1. Select **Operation** from the bottom menu.
2. Press the **CURSOR** button on the front panel to select the left/right vertical bar cursor. Using the numeric keys or the general purpose knob, move the active vertical bar cursor to the frequency to be edited.
3. Press the **VALUE** button on the front panel and select **Phase**. The knob icon is displayed on the **Phase** side.
4. Using the general purpose knob or the numeric keys, change the phase.
5. To change the phase for another frequency, press the **CURSOR** button on the front panel, and use the general purpose knob to move the active vertical bar cursor to the frequency to be edited. Next, repeat Steps 3 and 4.

Searching for Peaks. Select **Operation** from the bottom menu to display the **Right peak** and **Left peak** items on the side menu. These items detect the signal peaks.

Right peak	The active vertical bar cursor is moved to the peak in the signal to the right of the active vertical bar cursor. Each time this item is selected, the peak value moves to the right.
Left peak	The active vertical bar cursor is moved to the peak in the signal to the left of the active vertical bar cursor. Each time this item is selected, the peak value moves to the left.

Drawing Magnitude and Phase. Use **Draw...** from the side menu to draw points between the left and right vertical bar cursors and then connect the points to create an arbitrary magnitude and phase. Immediately after you select the **Draw...** item, a point cursor will appear midway between the vertical bar cursors, in the center of the vertical axis. The following diagram shows the menu configuration for the **Draw...** item.

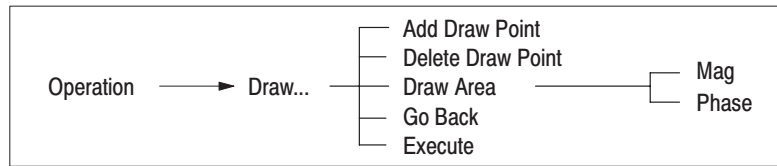

Figure 3 -144 shows an example of the screen with the **Draw...** item selected.

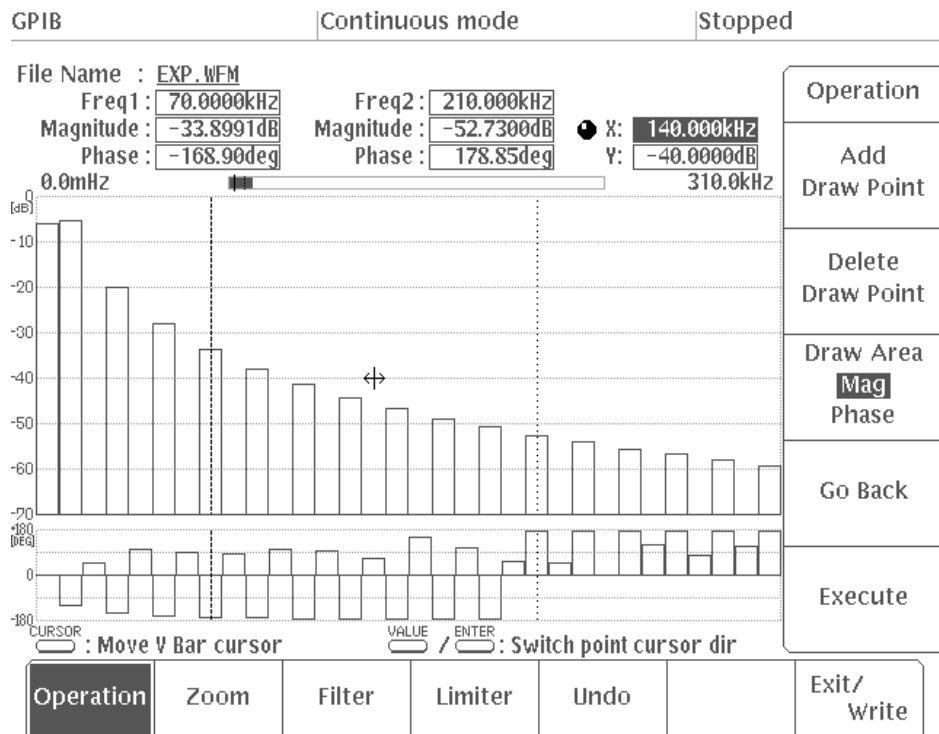

Figure 3 -144: Menu Displayed When Draw... is Selected

When you select **Draw...** from the side menu, the following items will appear in the sub-menu: **Add Draw Point**, **Delete Draw Point**, **Draw Area**, **Go Back** and **Execute**. Each of these items will be explained below in detail.

1. Select **Operation** from the bottom menu, and then select **Draw...** from the side menu.
2. Press the **CURS**OR button on the front panel. Using the general purpose knob, move the left and right vertical bar cursors to define the frequency domain for drawing the magnitude or phase. Use the **CURS**OR button to toggle between the left and right vertical bar cursors.

3. Press **Draw Area** in the sub-menu and select **Mag** (magnitude) or **Phase** (phase).
4. Press the **VALUE** button on the front panel. Using the general purpose knob, move the point cursor to the location of the new point. Pressing the **VALUE** button will toggle the direction of movement from horizontal (**X**) to vertical (**Y**) and vice-versa. The location of the point cursor is displayed in the upper right-hand corner of the screen in **X** (frequency) and **Y** (magnitude or phase) coordinates.
5. When you have placed the point cursor at the desired location, select **Add Draw Point** from the sub-menu to add a point at that location.

It is possible to add points outside the area defined by the vertical bar cursors. However, such points will be ignored when **Execute** is pressed.

NOTE. *It is not possible to draw more than one point at the same location on the horizontal axis. If you attempt to do this, a message will appear asking you to confirm that you want to change the level of the existing point. Press **O.K.** or **Cancel** in response to this message.*

6. Repeat Steps 4 and 5 to add several new points.
7. To delete a point that you have added with **Add Draw Point**, move the point cursor to that point and select **Delete Draw Point**. The point will be deleted.

If you press **Delete Draw Point** several times in succession, the points that you have added will be deleted in sequence starting with that nearest to the point cursor.
8. Select **Execute** from the sub-menu. The points that you have added will be connected to the magnitude or phase on the left and right vertical bar cursors.

Figure 3 -145 shows an example of a magnitude drawn between the vertical bar cursors.

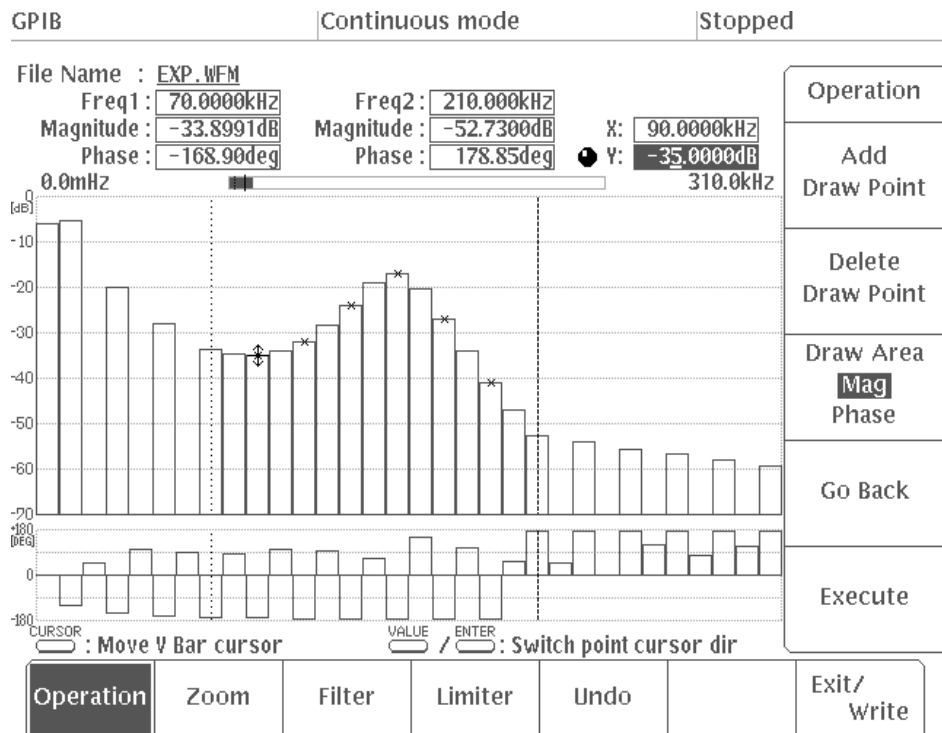

Figure 3 -145: Drawing a Magnitude

9. To cancel the execution of a draw operation, select **Undo** from the bottom menu. The screen will revert to the waveform before **Execute** was selected.

NOTE. When you quit and once again enter the waveform editor, the points you have drawn will disappear.

10. Select **Go Back** from the sub-menu. The system returns from the **Draw...** sub-menu to the previous side menu.

This concludes the draw process.

Magnifying a Signal

Select **Zoom** from the bottom menu to display menu items that magnify the signal to **x1**, **x4**, **x8**, **x16**, or **x64** along the frequency axis. Figure 3 -146 shows the magnified signal display when **Zoom** is selected from the bottom menu with **x16** is selected.

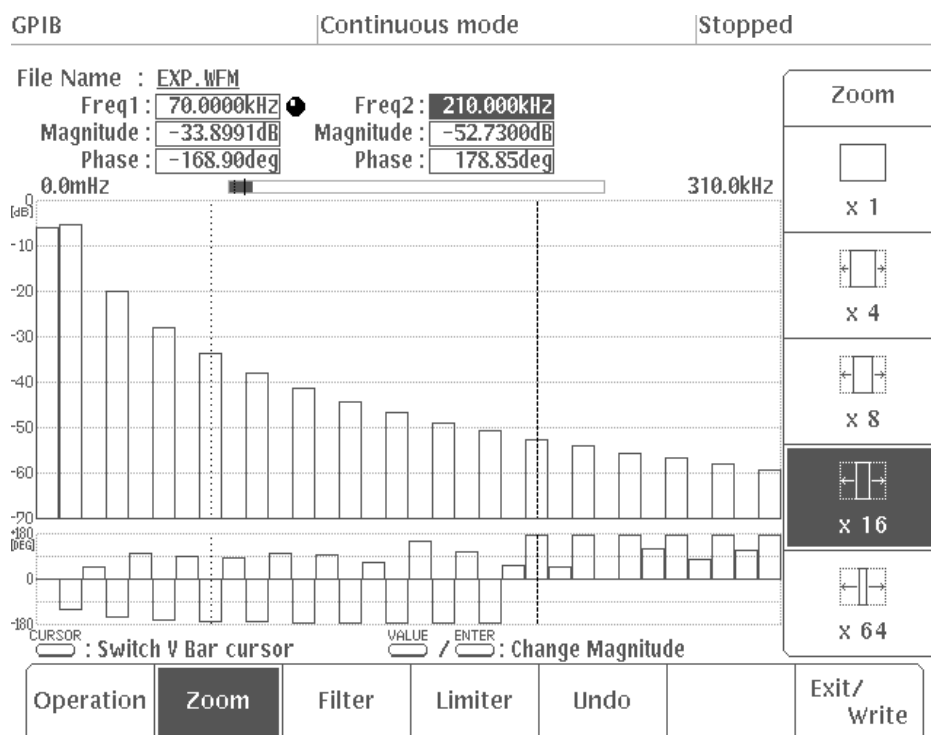

Figure 3 -146: Magnified Signal Display

In the scroll indicator at the top of the screen, the section of the signal being displayed on the screen is displayed inverted. You can scroll through the frequency domain outside the screen by turning the general purpose knob.

Selecting a Filter

When **Filter** is selected from the bottom menu, the following four frequency filters can be selected from the side menu.

- Low Frequency Pass Filter (**Low-Pass**) — This filter eliminates frequencies greater than the specified frequency.
- High Frequency Pass Filter (**High-Pass**) — This filter eliminates frequencies lower than the specified frequency.
- Band Pass Filter (**Band-Pass**) — This filter eliminates frequencies outside the specified band.
- Band Cut Filter (**Band-Elim**) — This filter eliminates frequencies in the specified band.



Figure 3 -147: Low Pass Filter

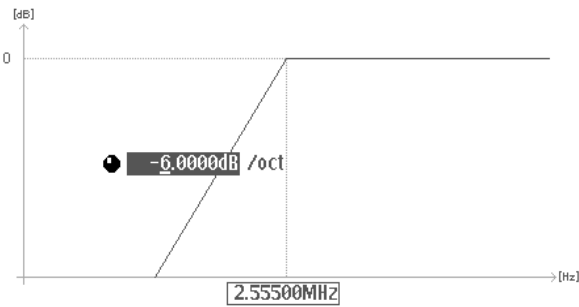

Figure 3 -148: High Pass Filter

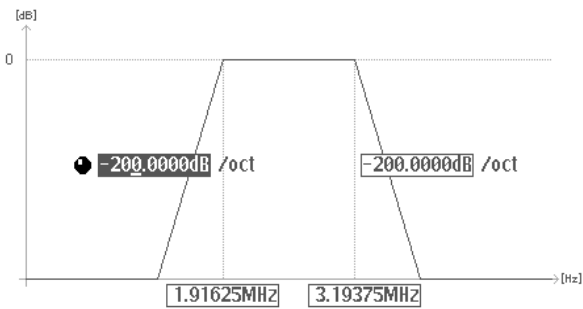

Figure 3 -149: Band Pass Filter

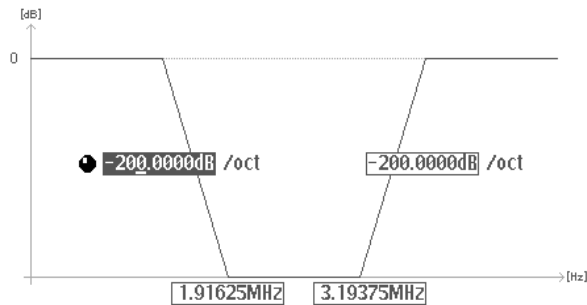

Figure 3 -150: Band Cut Filter

The procedure below applies the filters to the signal.

1. Select **Filter** from the bottom menu.
2. Select **Low-Pass**, **High-Pass**, **Band-Pass**, or **Band-Elim** from the side menu.
3. Press the **VALUE** button on the front panel and select the filter frequency field.
4. Using the general purpose knob or the numeric keys, set the filter frequency.
5. Press the **VALUE** button on the front panel to select the filter slope field.
6. Using the general purpose knob or the numeric keys, set the filter slope. Here octave (**oct**) indicates double the frequency.

For a band filter, set the frequency and slope for both ends of the band.

7. After setting the filter frequency and slope, select **Apply filter** from the side menu. The specified filter is applied to the signal.

Selecting a Limiter

Use **Limiter** from the bottom menu to cut the frequency component below the limit level, to cut the even or odd components on the discrete frequency axis, or to shift the magnitude to the limit level. When **Limiter** is selected from the bottom menu, the following items will appear in the side menu.

Cut under
Delete Even
Delete Odd
Shift Mag

Cutting Extraneous Frequency Components. Here is the procedure for using the **Cut under** item to remove the extraneous frequency component.

1. Select **Limitter** from the bottom menu.
2. Press the **CURSOR** button on the front panel to select the left/right vertical bar cursor. Using the numeric keys or the general purpose knob, set the domain to remove the extraneous frequency component.
3. Press the **VALUE** button on the front panel. Using the general purpose knob or the numeric keys, set the limit level for the magnitude. The limit level is displayed at the top the screen.
4. Select **Cut under** from the side menu. The frequency component under the limit level is cut.

Deleting Even or Odd Components. Here is the procedure for using the **Delete Even** or **Delete Odd** item to delete the even component or odd component in the discrete frequency domain.

1. Select **Limitter** from the bottom menu.
2. Press the **CURSOR** button on the front panel to select the left/right vertical bar cursor. Using the numeric keys or the general purpose knob, set the domain to delete the even component or odd component.
3. Select **Delete Even** (even) or **Delete Odd** (odd) from the side menu. The even or odd component within the left and right vertical bar cursors is cut.

Figure 3 -151 shows the fundamental, even, and odd component.

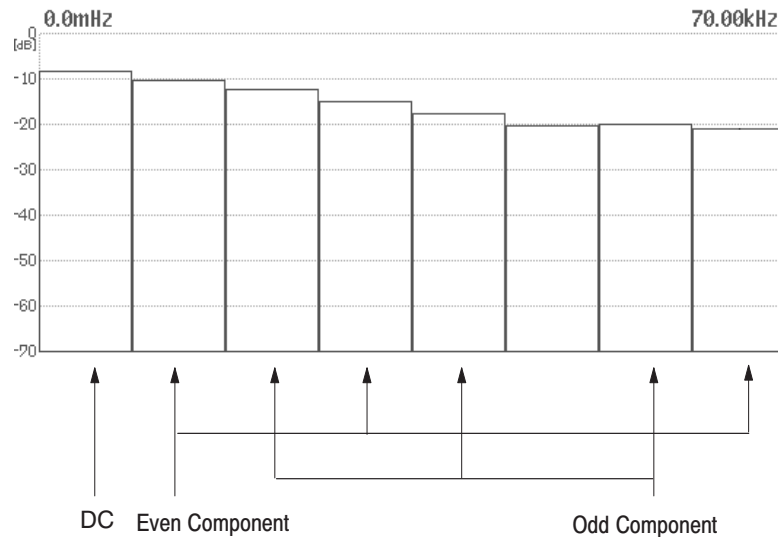

Figure 3 -151: Fundamental, Odd, and Even Components

Shifting Magnitudes. Here is the procedure for using the **Shift Mag** item to shift the magnitude to the limit level.

1. Select **Limit** from the bottom menu.
2. Press the **CURSOR** button on the front panel to select the left/right vertical bar cursor. Using the numeric keys or the general purpose knob, set the domain to be used when shifting the magnitude.
3. Press the **VALUE** button on the front panel. Using the general purpose knob or the numeric keys, set the limit level for the magnitude. The limit level is displayed at the top the screen.
4. Select **Shift Mag** from the side menu. The entire area within the left and right vertical bar cursors will shift so the signal with the maximum magnitude between the cursors becomes the limit level.

SETUP Menu

General Description

The **SETUP** menu is used to set a variety of output parameters during actual output of the waveforms and sequence waveforms that have been created with the editors. The menu can display output parameter values and selected items in both text form and as a graphic (in other words, with items connected in the form of a circuit).

When the power to the instrument is turned on, the **SETUP** menu appears automatically. Also when the power is switched on, if you have select **from Disk** or **from NVRam** in the **Auto Load** item of the **LOAD/SAVE** menu, all the files on the disk or in the NVRam, whichever is selected, are loaded automatically into internal memory. If the waveform or sequence file selected with the **SETUP** menu was in internal memory the last time you switched off the power, then that file is selected.

The bottom menu consists of seven items: the six output parameters that you can set (**Clock**, **Waveform Sequence**, **CH1 Operation**, **Filter**, **Amplitude** and **Offset**) and the **Display** item which allows you to set the format for menu displays. To set these items, press the corresponding button in the bottom menu and use the general purpose knob or the numeric keys to set the desired value.

A waveform or sequence file that is created with the editor has the default output parameters set in it. When the output parameters are changed with the **SETUP** menu, the new settings are saved together with the waveform data in the file.

When the operating mode is **Autostep**, the output parameters cannot be changed at all. If the file is locked and the operating mode is any other mode, the output parameters can be changed, but the changes are not written to the waveform file. For further information on locking files, see “Locking and Unlocking Files” item in the section on editors.

This section will discuss the menus found on the AWG2021 Option 02 with the CH2 output. Instruments without the Option 02 have no channel switching and parameters are only set for CH1.

SETUP Menu Structure

Figure 3 -152 shows the configuration of the **SETUP** menu.

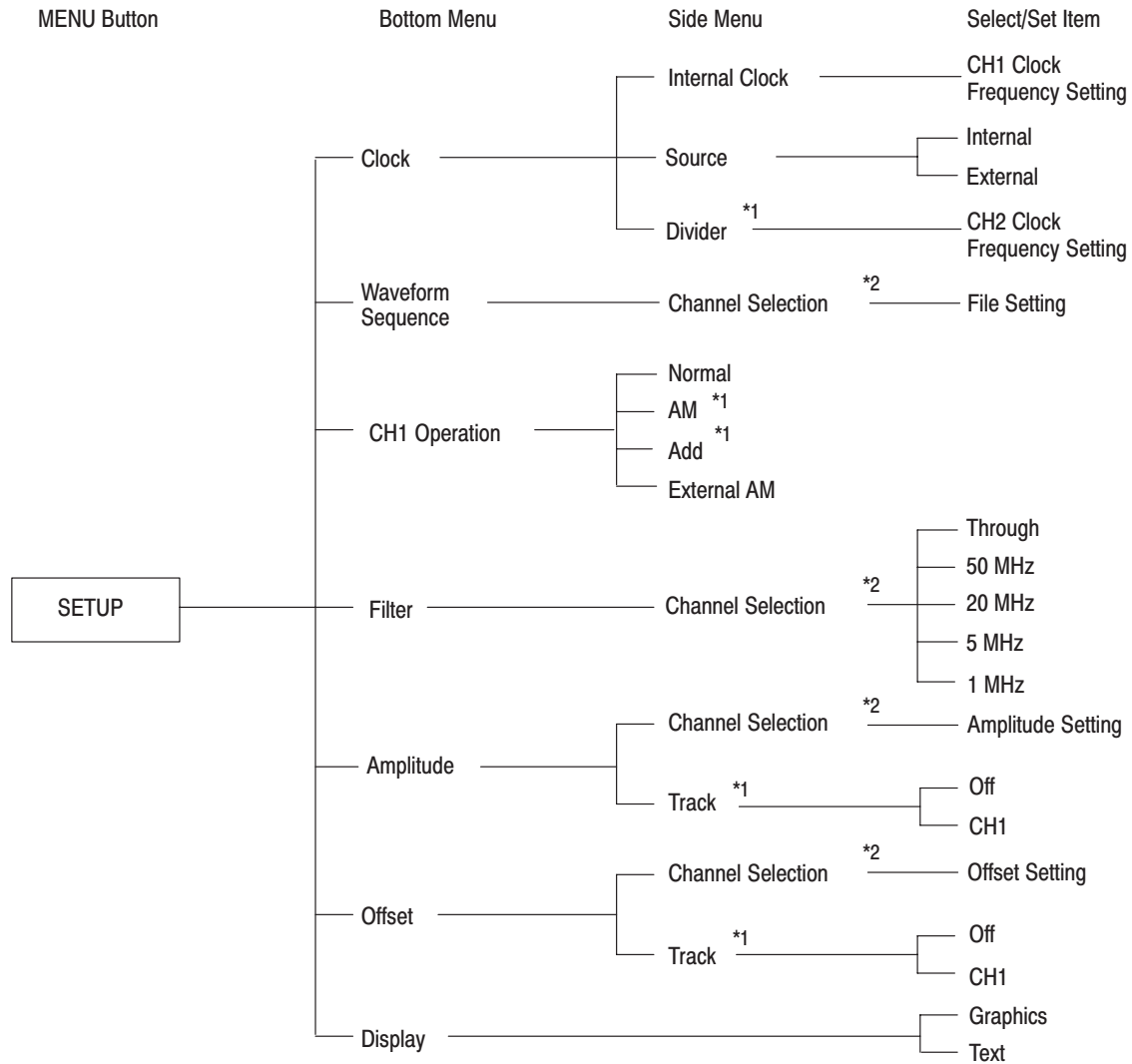

*1 Available when Option 02 has been installed.

*2 For instruments with Option 02 installed (CH2), these items switch between CH1 and CH2.

Figure 3 -152: SETUP Menu Structure

Menu Functions

The following table shows the function of each menu item and the page to refer to for a more detailed explanation.

Table 3-13: Menu Functions

Menu	Function	Page
Clock	Setting clock source and frequency	3 -219
Waveform Sequence	Selecting a waveform or sequence file	3 -217
CH1 Operation	CH1 waveform operation	3 -221
Filter	Setting filter	3 -225
Amplitude	Setting amplitude	3 -226
Offset	Setting offset	3 -226
Display	Selecting the display format for the SETUP menu	3 -216

SETUP Menu Display

Figure 3 -153 shows the graphic mode for **SETUP** menu display. A description for each callout follows.

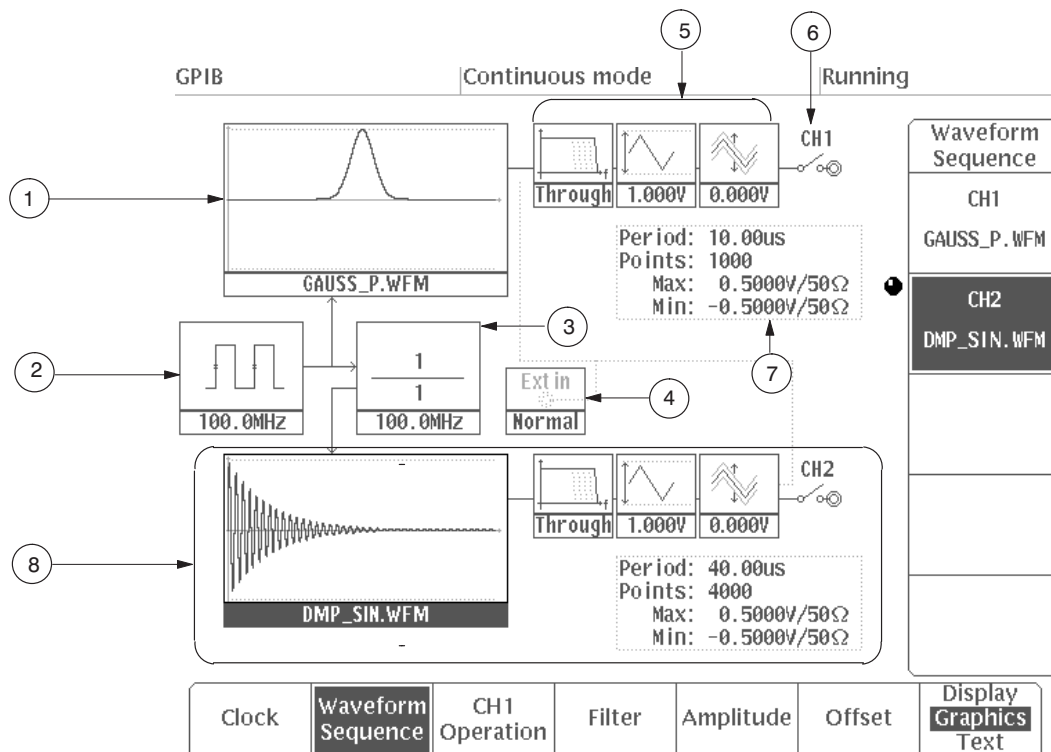

Figure 3 -153: SETUP Menu (Graphic Mode)

(1) Display Area for CH1 Waveform/Sequence Waveform	Shows the waveform or sequence file waveform indicated in the CH1 file input column. If the file is locked, an L is shown in the upper right corner of this area.
(2) CH1 Clock Setting	Shows the clock source and the frequency for the internal clock.
(3) CH2 Clock Setting	For instruments with Option 02 installed (CH2), shows the internal clock frequency for CH2 and the value for frequency division of the CH1 clock.
(4) CH1 Operation Setting	Shows the operation setting for the CH1 waveform.
(5) CH1 Output Parameter Settings	Shows the filter applied to output, the amplitude of the output waveform and the offset setting.
(6) CH1 Output On/Off	Shows whether CH1 output is on or off. To turn CH1 output on or off, use the CH1 On/Off button on the front panel.

(7) CH1 Output Parameter Status	The output status of the waveform or sequence waveform is shown as follows: Period : Period Points : Number of data points Max : Upper voltage for full scale vertical axis when terminated with 50 Ω Min : Lower voltage for full scale vertical axis when terminated with 50 Ω The period is the number of data points in the waveform or sequence, multiplied by the clock frequency.
(8) CH2 Output Parameters	For instruments with Option 02 installed (CH2), shows the CH2 output parameters as well as CH1 output parameters.

Selecting the Display Format for the SETUP Menu

The **SETUP** menu can be displayed in either text or graphic form.

Graphics This is the mode normally used. This format displays the output parameters connected in the form of a circuit. Selected parameters are indicated by a inverted display around them; these values may be changed. See Figure 3 -153.

Text This mode shows the output parameters in text form for each channel. It is convenient for printing a hard copy of the settings. See Figure 3 -154.

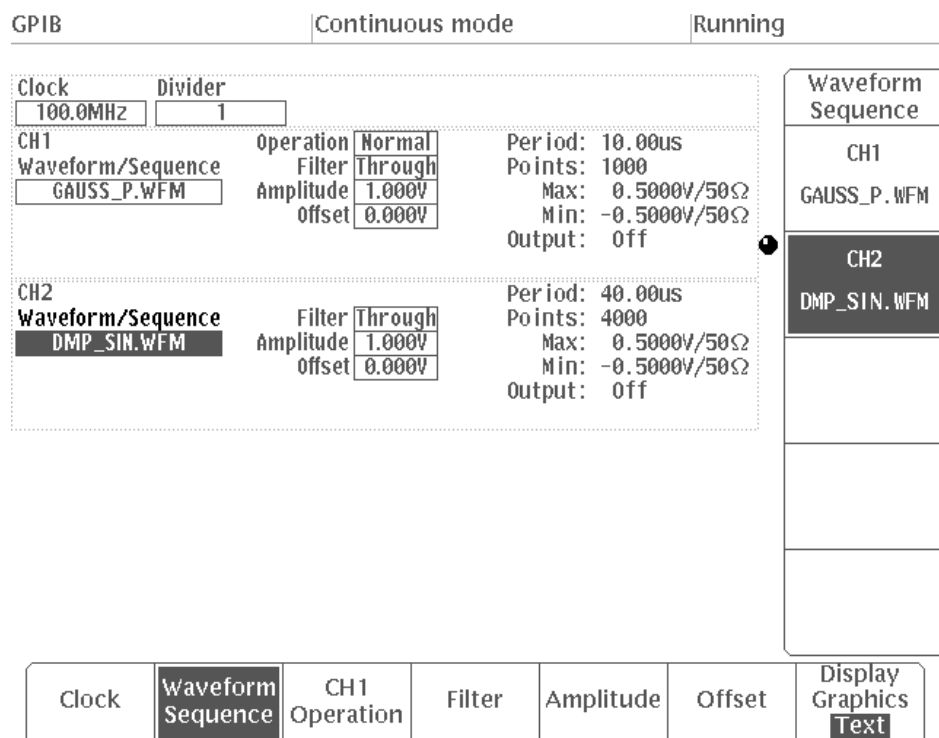

Figure 3 -154: SETUP Menu (Text Mode)

Selecting Output Parameter Fields

There are three ways to select a parameter.

1. Press the bottom button for the item to be set. Then select the channel in the side menu and select the field.
2. Press the bottom button for the item. Then press the bottom button again; each time the button is pressed, the **CURSOR** will move to a different channel. When you reach the desired setting field, set the appropriate value.
3. Press the **CURSOR** key on the front panel and select the field. When the **CURSOR** key is pressed again, the cursor moves to the next setting field for that channel.

Numeric Input

Use the numeric keys or the general purpose knob to input a numeric into the **Clock**, **Amplitude**, and **Offset** item fields.

1. Press the bottom button for the item to be set.
2. Use the numeric keys or general purpose knob to input the number for the parameter.

When using the numeric keys, press the front panel **ENTER** key, **VALUE** key, or the appropriate unit key to enter the number. When this is done, the value will be confirmed and will appear in the icon on the screen.

Each time the general purpose knob is turned, the numeric value is entered. The value in the icon will change accordingly.

Selecting a Waveform or Sequence File

The first step in setting the waveform output parameters is to select the waveform or sequence file.

Each waveform or sequence file has output parameter settings attached. When a file is selected, the output parameters are also automatically changed to the settings for that file. A waveform or sequence file that has just been created with the editor has the default output parameters set.

Clock	100.0 MHz (can also be set using the editor)
Operation	NORMAL
Filter	Through
Amplitude	1 V
Offset	0 V

To select a waveform or sequence file:

1. Select **Waveform Sequence** from the bottom menu. The waveform display area will be highlighted on the screen.



2. Select the channel for setting in the side menu.
3. Turn the general purpose knob to open the file list. Use the general purpose knob to select the desired waveform or sequence file from the list.

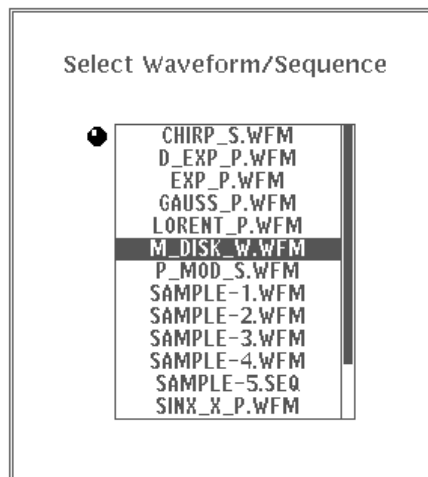

4. After the file has been selected, select **O.K.** in the sub-menu. The selected file will be confirmed and the waveform and file name will appear in the icon, as shown in the figure below.

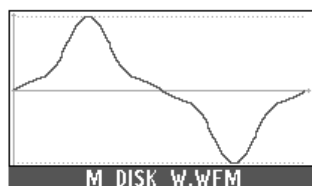

When the file is confirmed, the output parameters for that file will be set automatically.

When a sequence waveform is output, the output parameters for that sequence file are used.

NOTE. When a sequence file is selected, and if the waveform or sequence file making up the sequence is not in internal memory, the waveform display area is blank and the output switch is off. In this case, you must load the waveform or sequence file making up the sequence into internal memory.

Setting Clock Source and Frequency

The **Clock** menu item is used to set the clock source and the clock frequency. The clock source can be set to either internal or external. If the clock source is set to **External**, there is no need to set the frequency.

The clock period is the time between the data points for the waveform created. Therefore, the product of that clock period and the number of waveform points is the period for that waveform or sequence waveform. For example, suppose the clock frequency is 1 MHz (for a period of 1 μsec). If the waveform has 100 points, the period for the entire waveform is 100 μsec .

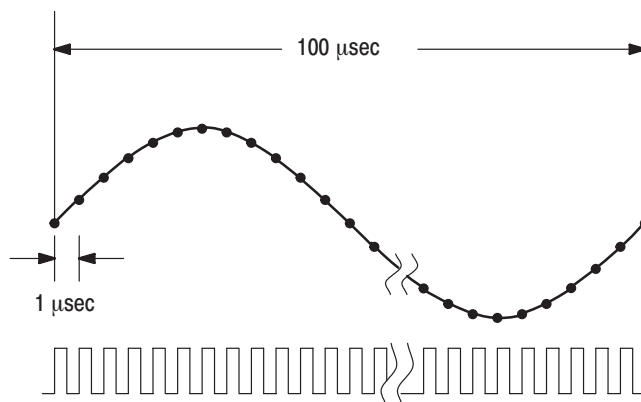

Figure 3 -155: Clock and Waveform Points

To set **Clock**, perform these steps:

To set the Source to Internal and then set the CH1 clock frequency:

1. Select **Clock** from the bottom menu.

2. Press the **Source** button in the side menu and set it to **Internal**. The clock icon shown below will be displayed on the screen.

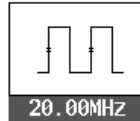

Since the clock frequency for CH2 depends on the clock frequency for CH1, set the clock frequency for CH1 first.

3. Use the numeric keys or general purpose knob to set the internal clock frequency with the **Internal Clock** item.

The clock frequency can be set in four digits between 10.00 Hz and 250.0 MHz.

To set the CH2 clock frequency:

4. Select **Divider** from the side menu. The divider icon shown below will be displayed on the screen.

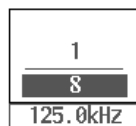

5. Turn the general purpose knob to set the frequency divider.

The clock frequency for CH2 is determined by setting the value for frequency division of the CH1 clock. This frequency division setting can be selected from the multiples of 2 from 1 (2^0) to 16,777,216 (2^{24}). The CH2 clock frequency, after frequency division, is expressed with the four digits under the frequency division value. Depending on the value of the CH1 clock frequency, it may not be possible to set a large frequency division ratio. For example, if the CH1 clock frequency is 10 Hz, then the only frequency division ratio that can be set is 1.

When the CH2 waveform is changed by pressing **Waveform Sequence**, the frequency division value is always reset to 1 to give CH2 the same clock frequency as CH1. If you change the clock frequency for CH1, the frequency division ratio stays the same and the clock frequency for CH2 changes.

To set the Source to External:

6. Press the **Source** button in the side menu and select **External**. The clock icon shown below will be displayed on the screen.

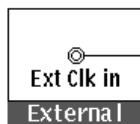

The CH1 and CH2 clocks are controlled with the external clock input from the **CLOCK IN** connector on the rear panel. The external clock frequency that can be input to the connector is up to 250 MHz.

CH1 Waveform Operations

CH1 Operation is used to operate the CH1 waveform and the waveform from CH2, or the CH1 waveform and a waveform input from an external source. It then outputs the result from the CH1 output connector. Two types of operation — addition (**Add**) or multiplication (**AM**) — can be performed for the CH1 waveform and CH2 waveform or external signal.

To set the desired operation process for the CH1 waveform:

1. Select **CH1 Operation** from the bottom menu.
2. Select the desired process from the side menu. The following choices are available:

Standard Type	Option 02
Normal	Normal
External AM	AM
	Add
	External AM

The following is a more detailed description of each process:

- Normal** Waveforms are output separately from each channel.
- AM** CH1 output is the CH1 waveform with the amplitude modulated (multiplied) by the waveform output from CH2. See Figure 3 -156.

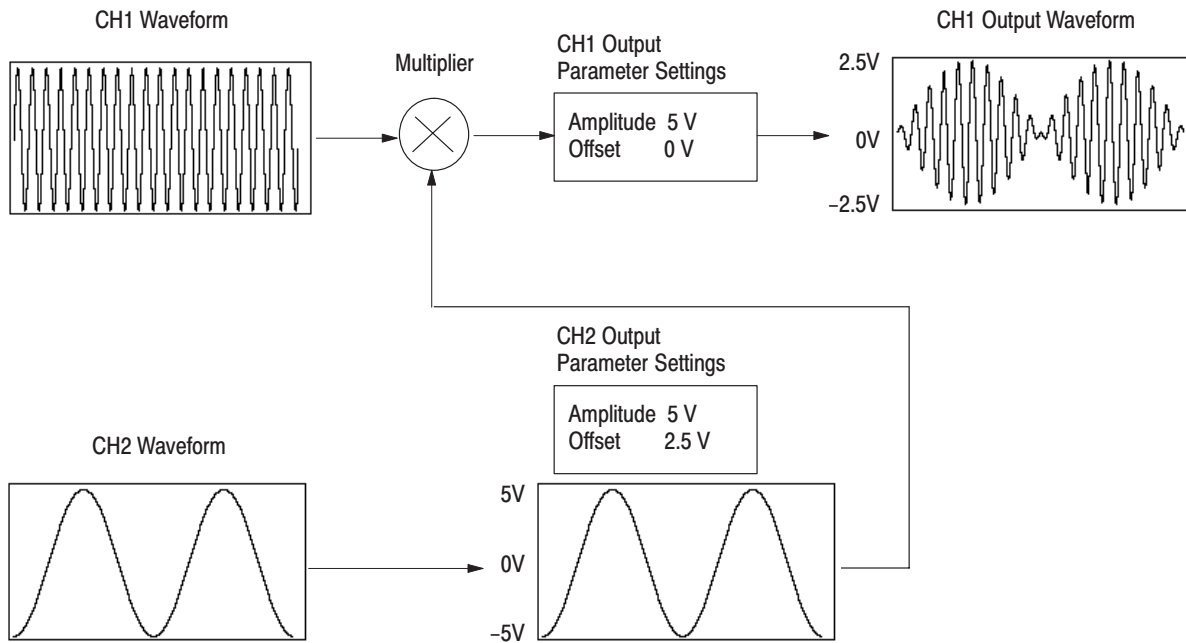

Figure 3 -156: Multiplying CH1 Waveform by CH2 Waveform

This multiplier has a bandwidth of 30 MHz for the carrier (signal) and a bandwidth of 4 MHz for the modulation signal. The waveform output from CH1 is the result of the following calculation.

$$CH1_{out} = CH1 \text{ setting value} \times (CH2 \text{ setting value} + CH2 \text{ offset})$$

A CH2 signal of 5 V (full scale) gives 100% modulation. When the CH2 signal is minus, the CH1 signal is inverted.

The multiplied value of CH2 is expressed as a % and is displayed at the bottom right of the CRT screen (see next example).

Max:	100.00%
Min:	0.00%

NOTE. When multiplication results in an output that exceeds 5 Vp-p, the signal may be distorted.

Add The CH1 waveform is added to the waveform output from CH2. See Figure 3 -157.

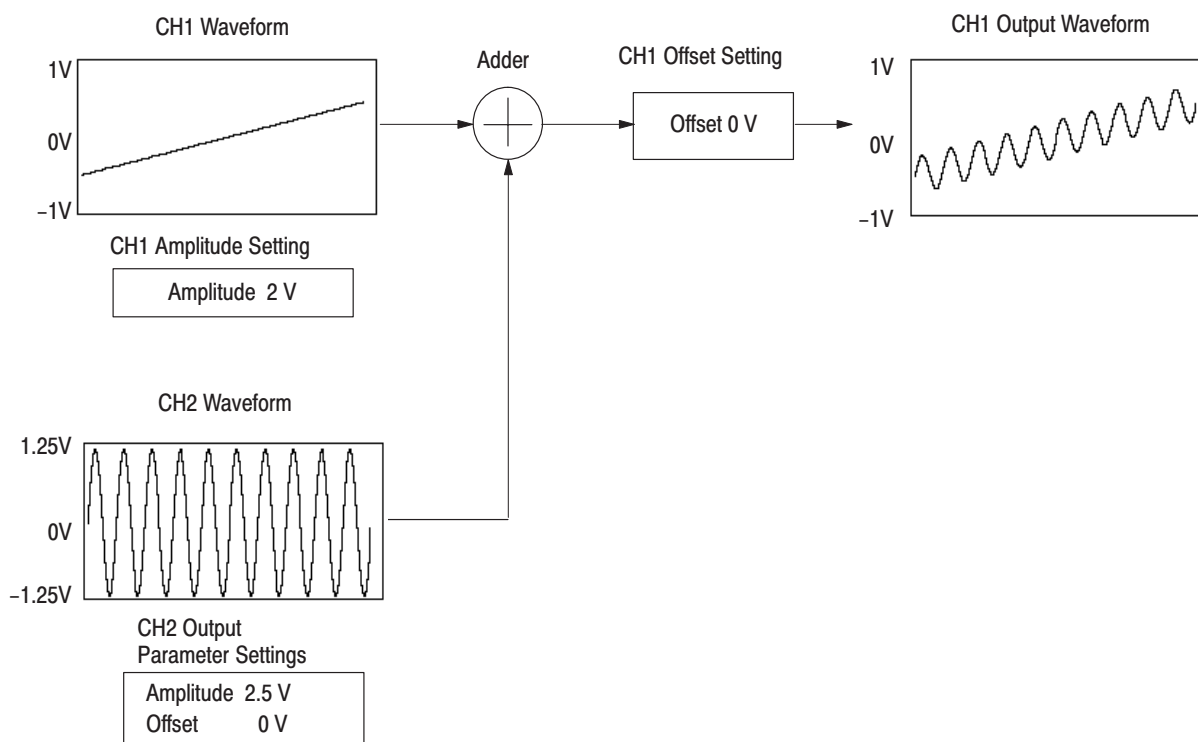

Figure 3 -157: Adding CH1 Waveform and CH2 Waveform

The adder has a 30 MHz bandwidth.

The actual value is ($\frac{1}{5}$ the CH2 setting) + the CH1 setting. The added value of CH2 is $\frac{1}{5}$ the setting and is displayed at the bottom right of the CRT screen (see example below).

Max:	0.2500V/50Ω
Min:	-0.2500V/50Ω

NOTE. When addition results in an output that exceeds 5 Vp-p, the signal may be distorted.

External AM The CH1 waveform output is amplitude modulated by the external signal input from the rear panel **CH1 AM IN** connector. See Figure 3 -158.

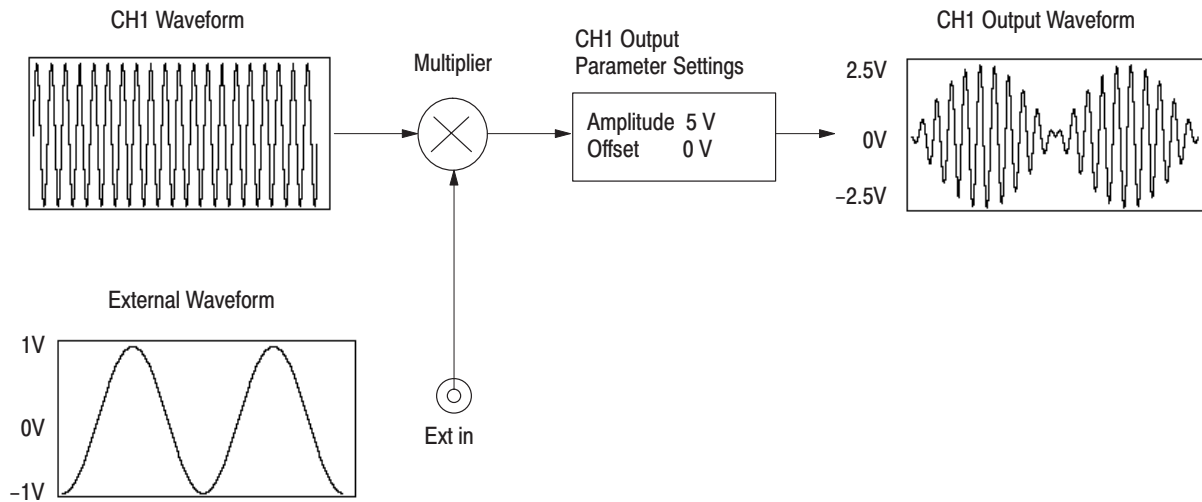

Figure 3 -158: Multiplying CH1 Waveform by an External Waveform

Table 3-14 shows the amplitudes for the output signals relative to the external modulation signals.

Table 3-14: Output Signal Amplitude Relative to External Modulation Signal

External Modulation Signal	Output Signal
0 V	50% of set value
1 V	100% of set value
-1 V	0%

100% amplitude modulation is possible with ± 1 V input.

NOTE. When the external modulation signal is overmodulated 1 V or more, the output will exceed 5 Vp-p and the signal may be distorted.

The maximum signal that can be input to the **CH1 AM IN** connector is ± 5 V: the input impedance is 10 k Ω .

Setting Filter

The filters selections are: **50**, **20**, **5**, **1 MHz** and **Through** (no filter).

To set **Filter**, perform these steps:

1. Select **Filter** from the bottom menu. The filter icon will be highlighted on the screen.



2. Select the channel from the side menu.
3. Turn the general purpose knob to select the desired filter.

Setting Amplitude and Offset

Use **Amplitude** and **Offset** to set the output amplitude and offset for the vertical axis 12-bit full scale voltage. These values are terminated with 50 Ω .

Figure 3 -159 shows the display when the amplitude is set to 5 V and the offset is set to 1 V.

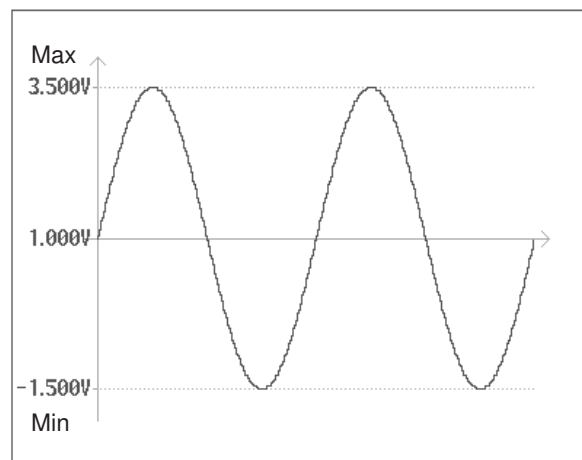
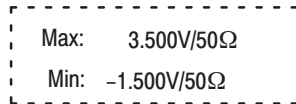

Figure 3 -159: Setting Amplitude and Offset

Setting the amplitude and offset determines **Max** and **Min** values shown to the left of the waveform. In the example shown in Figure 3 -159, the **Max** and **Min** values are as follows:



Setting Amplitude

1. Select **Amplitude** from the bottom menu. The amplitude icon will be highlighted on the screen.



2. Select the channel from the side menu.
3. Use the numeric keys or the general purpose knob to set the amplitude. The output amplitude can be set to any value between 0.05 V and 5 V in minimum increments of 1 mV.

NOTE. The amplitude set gives the top and bottom voltage values for the waveform editor full-scale, not the peak-to-peak value of the waveform.

Setting Offset

1. Select **Offset** from the bottom menu. The offset icon will be highlighted on the screen.



2. Select the channel from the side menu.
3. Use the numeric keys or the general purpose knob to set the desired offset. The offset may be set to any value between -2.5 V and +2.5 V in minimum increments of 5 mV.

Linking the CH1 Waveform and Amplitude or Offset

When Option 02 is installed, it is possible to link the amplitude and offset of CH1 with the corresponding values for CH2. When such linkages are set, changes to CH1 values will also be applied to the CH2.

Use the following procedure to link CH2 amplitude to CH1 amplitude. In such cases, CH1 and CH2 have their own files one for each.

1. Select **Amplitude** from the bottom menu.
2. Select **CH2** from the side menu.
3. Press the **Track** key in the side menu and select **CH1**. The linkage setting will appear below the CH2 amplitude icon.

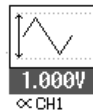

4. Select **CH1** from the side menu.
5. Turn the general purpose knob to change the CH1 amplitude. Check to make sure that the CH2 amplitude has changed accordingly.

The same procedure can be used to link the offset values for other channels to the CH1 waveform. In such cases, the linkage setting will be displayed below the CH2 offset icon.



MODE Menu

General Description

Press the **MODE** button in the **MENU** column to display the **MODE** menu. The **MODE** menu is used to set the operating mode of the waveform output with the conditions set in the **SETUP** menu.

This menu enables you to perform the following functions:

- Setting waveform or sequence waveform output trigger mode
- Waveform Advance and Autostep functions that display the waveform sequence with the trigger
- Determine the timing with which the sync signals are generated

The trigger or gate signal can be generated with external signals from the **TRIGGER INPUT** connector or by pressing the front panel **MANUAL** button.

When the instrument receives the trigger or gate signal, the “**Waiting for Trigger**” display in the status area of the CRT display changes to “**Running**” and the waveform or sequence is output. When output stops, the status area display returns to the original “**Waiting for Trigger**”.

The screen displays a contents list for each channel. This list shows the waveform/sequence file selected with the **SETUP** menu and the contents of the file. The display is almost the same for all operating modes.

The explanations that follow are for an instrument with the Option 02, CH2 output. An instrument without the Option 02 has only the CH1 display.

MODE Menu Structure

Figure 3 -160 shows the configuration of the **MODE** menu.

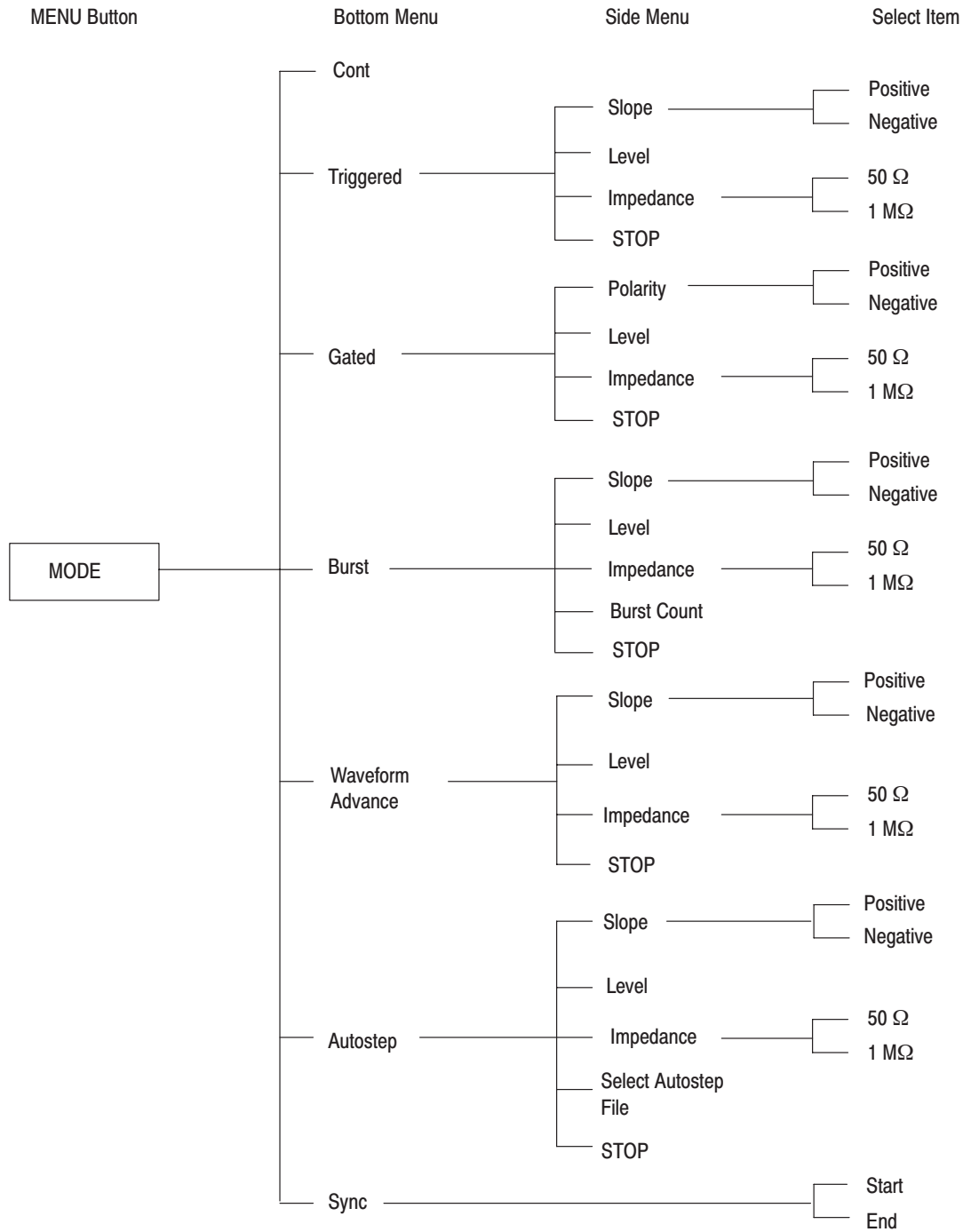

Figure 3 -160: MODE Menu Structure

Menu Functions

The following table describes the function of each of the menu items and gives the number of the page on which you can find a more detailed explanation of that item.

Table 3-15: Menu Functions

Menu	Function	Page
Cont	Setting the operating mode	3 -233
Triggered		3 -233
Gated		3 -234
Burst		3 -235
Waveform Advance		3 -236
Autostep		3 -238
Slope	Setting trigger parameters for an external trigger (gate)	3 -241
Polarity		3 -241
Level		3 -241
Impedance		3 -241
Select Autostep File	Selecting autostep files	3 -239
STOP	Stopping waveform output	3 -233
Sync	Setting sync signal	3 -242

MODE Menu Display

Figure 3 -161 shows the general display for the **MODE** menu.

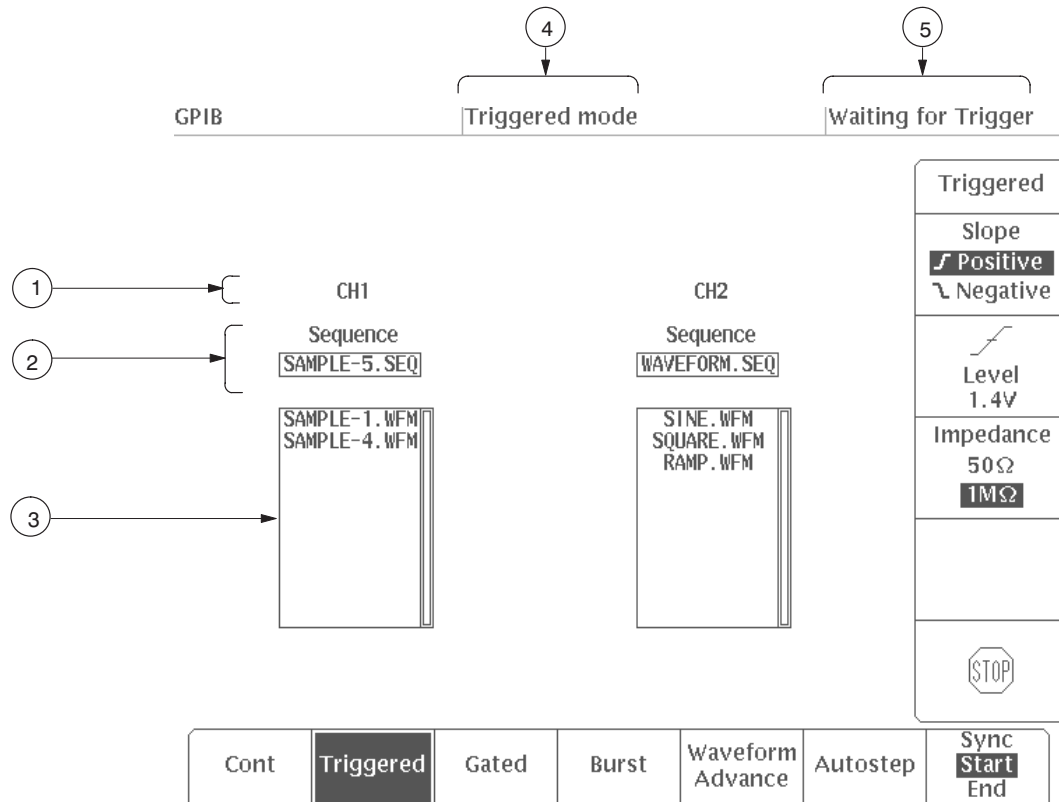

Figure 3 -161: MODE Menu CRT Display

(1) Channel Display	Shows the channel for the waveform/sequence file names and lists.
(2) Waveform/Sequence	The name of the waveform or sequence file being output is shown for each channel. This waveform or sequence file is selected with the SETUP menu Waveform Sequence item. For Autostep mode, the name of the waveform or sequence file for the current output step of the steps programmed with the autostep editor is shown for each channel.
(3) List	The contents of the waveform or sequence files described in (2), above, are displayed for each channel. In Waveform Advance mode, the name of the file being output is displayed in the list inverted.

(4) Operating Mode Status	The operating mode set with the MODE menu is displayed. There are five operating modes: Cont , Triggered , Gated , Burst , Waveform Advance and Autostep .
(5) Trigger Status	One of the following three trigger statuses is displayed in this column.
Stopped	Displayed when no waveform or sequence file has been defined with the SETUP menu.
Waiting for Trigger	Displayed when the waveform or sequence file has been defined with the SETUP menu and the system is waiting for the trigger or gate signal.
Running	Displayed when the trigger or gate signal is generated and the waveform is output.

Setting the Operating Mode

Select the operating (output) mode – either: **Cont**, **Triggered**, **Gated** and **Burst** trigger mode, **Waveform Advance** mode, or **Autostep** mode – by pressing the corresponding button in the bottom menu.

NOTE. *The operating mode set with the **MODE** menu has no effect on the function waveform generation (**FG**) operating mode.*

In the operating mode excluding **Cont**, if the side menu **STOP** item is selected during waveform output, the output is stopped and the system returns to the start of the waveform or sequence.

Here is how each operating mode works.

Cont Mode

As soon as **Cont** mode is selected, continuous output of the specified waveform or sequence waveform begins. No side menu is displayed while **Cont** is selected.

Triggered Mode

In **Triggered** mode, the specified waveform or sequence waveform is output once for each trigger received. The trigger signal depends on the trigger source. It can be generated from the external trigger signal applied to the **TRIGGER INPUT** connector or by pressing the front panel **MANUAL** button. During waveform output, if the **MANUAL** button is pressed or another external trigger signal is generated, such a trigger has no effect.

When **Triggered** is selected, the following items will be displayed in the side menu:

Slope
Level

Impedance
STOP

The **Slope**, **Level** and **Impedance** items are used to set the trigger conditions for the external trigger signal.

Figure 3 -162 shows the output waveform for an external trigger signal.

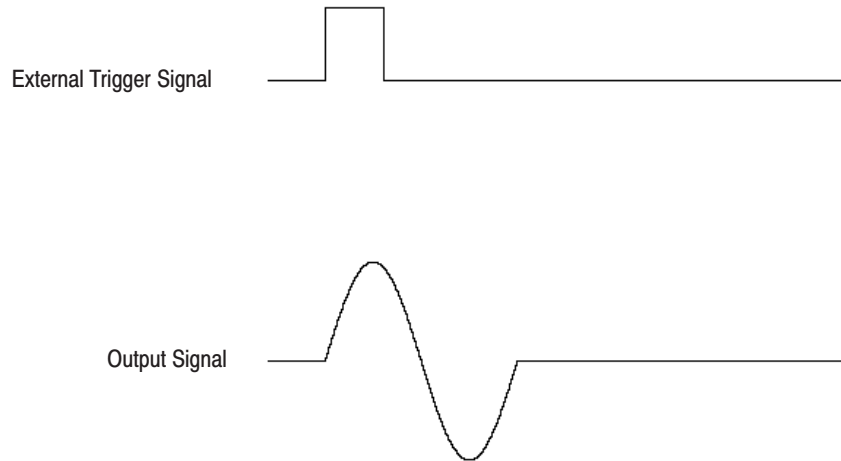

Figure 3 -162: Output Waveform for External Trigger Signal in Triggered Mode

Gated Mode

Use **Gated** mode to control waveform or sequence output with a gate signal. The gate signal depends on the gate source. It can be generated from the external gate signal applied to the **TRIGGER INPUT** connector or while the front panel **MANUAL** button is pressed.

While the front panel **MANUAL** button is pressed, the specified waveform or sequence is output. When you let the **MANUAL** button go, the waveform output stops. When you press the **MANUAL** button again, the waveform or sequence output resumes from the level where it left off. While you are pressing the **MANUAL** button, if you press any other button, the instrument goes back to the mode before the **MANUAL** button was pressed.

The specified waveform or sequence waveform is output while a valid external gate signal is being received through the **TRIGGER INPUT** connector. After output stops, at the next external gate signal, the waveform or sequence resumes from the waveform level where it left off.

When **Gated** is selected, the following items will be displayed in the side menu:

Polarity
Level

Impedance
STOP

The **Polarity**, **Level** and **Impedance** items are used to set the gate conditions for the external gate signal.

Figure 3 -163 shows the output waveform for an external gate signal.

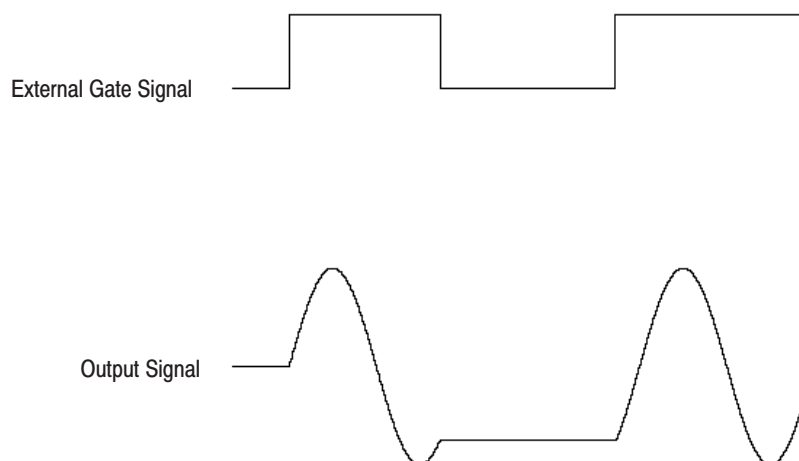

Figure 3 -163: Output Waveform for External Gate Signal in Gated Mode

Burst Mode

Use **Burst** mode to output the specified waveform or sequence for the burst count when a trigger is generated, then stop output. The trigger signal depends on the trigger source. It can be generated from the external trigger signal applied to the **TRIGGER INPUT** connector or by pressing the front panel **MANUAL** button.

During waveform output, if the **MANUAL** button is pressed or another external trigger signal is generated, this trigger has no effect.

When **Burst** is selected, the following items will be displayed in the side menu:

Polarity
Level
Impedance
Burst Count
STOP

The **Slope**, **Level** and **Impedance** items are used to set the trigger conditions for the external trigger signal.

Figure 3 -164 shows the output waveform for an external trigger signal.

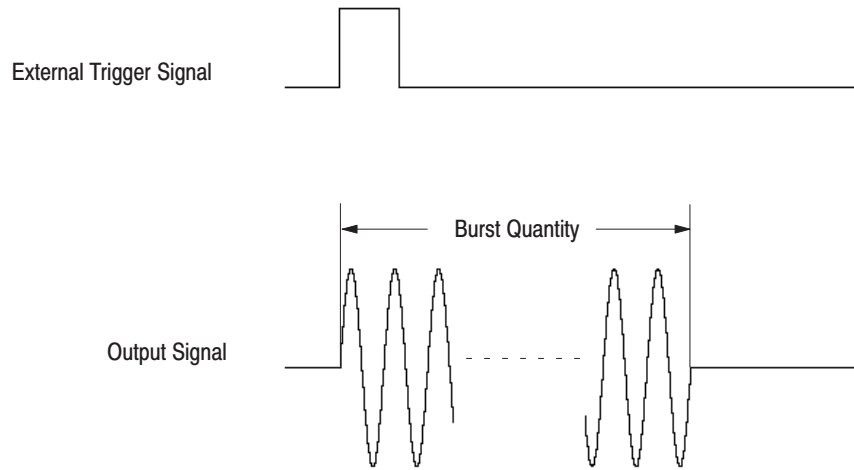

Figure 3 -164: Output Waveform for External Trigger Signal in Burst Mode

Setting Burst Count. **Burst Count** sets the number of repetitions of the waveform or sequence that are output with the trigger signal. This count can be from 1 to 65 535.

Waveform Advance Mode

Use **Waveform Advance** mode to output a series of specified waveforms, in order, with a new trigger initiating the advance to output the next waveform. Thus, in this mode, the repetition count defined for each waveform in the sequence file (defined with the sequence editor) is ignored. Each waveform is output continuously until the next trigger is received. When the last waveform defined is reached, this mode returns to the first waveform again.

NOTE. Waveforms are output in line with the output parameters designated in the **SETUP** menu for that sequence file.

When **Waveform Advance** is selected, the following items will be displayed in the side menu:

- Slope
- Level
- Impedance
- STOP

The **Slope**, **Level** and **Impedance** items are used to set the trigger conditions for the external trigger signal.

When this instrument goes into **Waveform Advance** mode, it waits for a trigger to be generated. This trigger can be generated from the external trigger signal

applied to the **TRIGGER INPUT** connector or by pressing the front panel **MANUAL** button.

In this mode, the first waveform is output over and over again for each channel when a trigger signal is received. When the next trigger signal is received, output of the first waveform stops after the end point of that waveform and then the second waveform is output in the same manner. The next waveform is not started at the moment a trigger is received, but rather at the completion of the previous waveform.

In this way, waveforms are output for each channel one by one in sequence each time a trigger signal is received. When a trigger signal is received while output of the last waveform is in progress, the output stops at the end point of that waveform and then the process begins again from output of the first waveform. Each channel operates independently according to the number of waveform points.

Table 3-15 and Figure 3 -165 show the output waveform for an external trigger signal.

Table 3-16: Sequence File

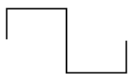
File Name	No. of Repetitions	Output Conditions	Waveform
WAVE1.WFM	2	Amplitude 2 V Offset 0 V	
WAVE2.WFM	2		

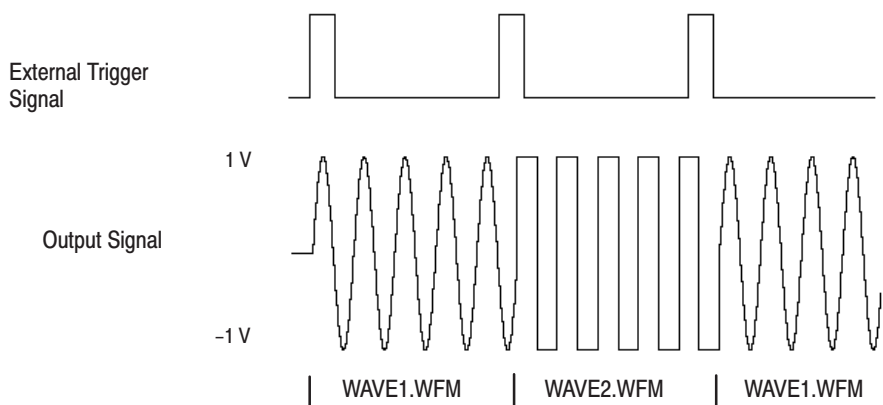

Figure 3 -165: Output Waveform for External Trigger Signal in Waveform Advance Mode

In **Waveform Advance** mode not only sequence files, but also waveform files can be used. In this case when the trigger is received, the file's waveform is output continuously.

When the sub sequences in a sequence file are output, they are expanded individually in the waveform memory. In **Waveform Advance** mode, they may not operate as intended. To avoid this, the function (**Expand SEQ into WFM** item on the initial **EDIT** menu) is used to expand the sequence file into a waveform file. See page 3 -12. Expanding a sub sequence into a waveform file and registering it into the sequence file makes **Waveform Advance** mode easier to use.

Autostep Mode

Use **Autostep** mode to start an Autostep file created with the **EDIT** menu Autostep editor. An Autostep file stores a program that specifies a waveform or sequence file (including output parameters) for each channel for each step.

Autostep mode resembles **Waveform Advance** mode in that each time a trigger is received, the display advances one waveform. However, in this mode the output parameters for each waveform change as well. The operating mode for each step is triggered. The waveform or sequence for the step is output once, then output stops. Just as in other operating modes, the **Autostep** mode trigger signal can be generated from the external trigger signal or by pressing the front panel **MANUAL** button.

NOTE. During **Autostep** mode, changes to the output parameters with the **SETUP** menu have no effect.

When **Autostep** is selected, the following items will be displayed in the side menu:

- Slop
- Level
- Impedance
- Select Autostep File
- STOP

The **Slope**, **Level** and **Impedance** items are used to set the trigger conditions for the external trigger signal.



During waveform output, if **STOP** is selected from the side menu, the waveform output is stopped immediately and the system returns to the start of the **Step:1** waveform or sequence.

When a trigger signal is received, the **Step:1** waveform for each channel is output once; when the next trigger signal is received, the **Step:2** waveform is output (once). When the next trigger signal is received while waveform output is

in progress, output stops after the end point of that waveform and then the waveform for the next step is output.

Figure 3 -166 shows the output waveform for an external trigger signal.

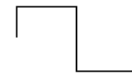
Table 3-17: Autostep File

Step	File Name	Output Conditions	Waveform
Step:1	WAVE1.WFM	Amplitude 2 V Offset 0 V	
Step:2	WAVE2.WFM	Amplitude 3 V Offset 0 V	
Step:3	WAVE1.WFM	Amplitude 4 V Offset 0 V	

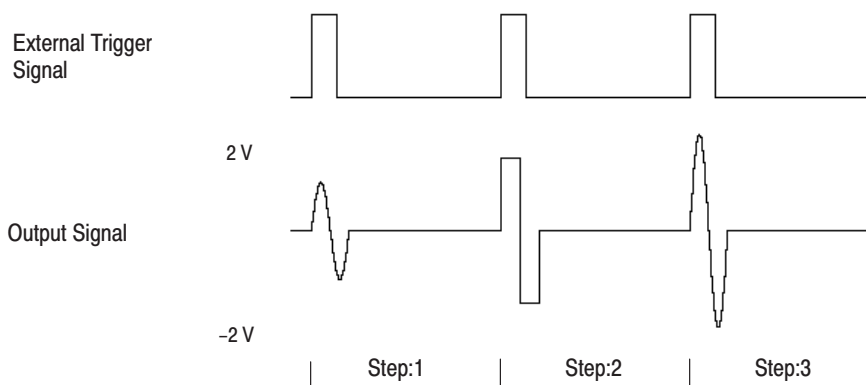

Figure 3 -166: Output Waveform for External Trigger Signal in Autostep Mode

Starting an Autostep Program.

1. Select **Autostep** from the bottom menu.
2. Choose **Select Autostep File** from the side menu. When this item is selected, the list of autostep files created with the autostep editor is displayed. See Figure 3 -167.

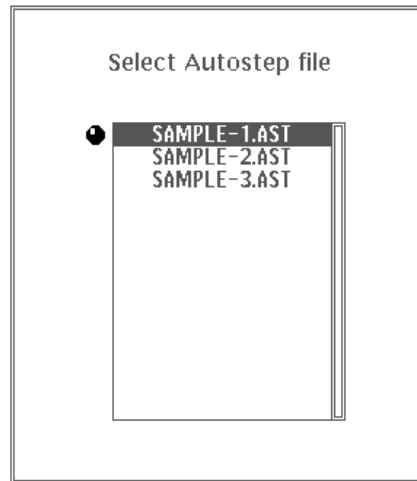

Figure 3 -167: Autostep File List

3. Use the general purpose knob to select the file to start from the displayed list of autostep files.
4. After selecting the file, to enter the selection, select **O.K.** from the sub-menu. To cancel the file selection, select **Cancel** from the sub-menu. When you select **O.K.**, the autostep program starts.

Setting Trigger Parameters for an External Trigger (Gate)

The external trigger (gate) signal is input from the **TRIGGER INPUT** connector on the front panel. The maximum input voltage is ± 10 V into a $1\text{ M}\Omega$ input impedance, and the maximum input voltage is 5 V_{RMS} into a $50\ \Omega$ input impedance.

Use the **Slope** or **Polarity**, and **Level** items in the side menu of the **MODE** menu to set trigger (gate) parameters for an external trigger (gate) signal.

- **Slope.** This menu item sets the slope for the external trigger signal. Press the **Slope** button in the side menu and select either **Positive** or **Negative**. When **Positive** is selected, the output is triggered at the rising edge of the external trigger signal; when **Negative** is selected, the output is triggered at the falling edge of the external trigger signal.
- **Polarity (Gated mode).** This menu item sets the polarity for the gate that outputs the waveform or sequence with an external gate signal. Press the **Polarity** button in the side menu and select either **Positive** or **Negative**. When **Positive** is selected, the waveform or sequence is output while the level of the gate signal is higher than the gate level set with the side menu **Level** item. When **Negative** is selected, the waveform or sequence is output while the level of the gate signal is lower than the set gate level.
- **Level.** This item sets the trigger (gate) level for an external trigger (gate) signal. Press the **Level** button in the side menu, then set the level with the numeric keys or the general purpose knob. The trigger (gate) level can be set in the range -5.0 V to 5.0 V in steps of 0.1 V .

Figure 3 -168 shows the slope (polarity) and level controls.

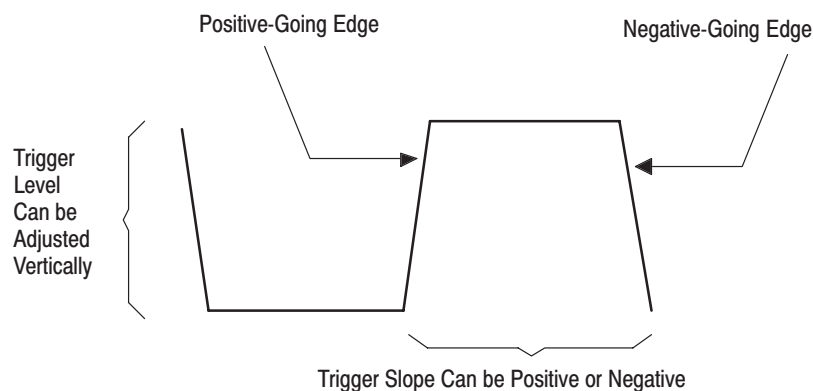

Figure 3 -168: Slope and Level Controls

- Impedance. This menu item sets the external trigger (gate) source input impedance to either **50 Ω** or **1 M Ω** . Press the **Impedance** button in the side menu to select this item.

Setting Sync Signal

Use the **Sync** menu item to select the timing with which the sync signal is generated to either the **Start** or **End** of the waveform or sequence. Each time the **Sync** button is pressed, the selection toggles between **Start** and **End**. This setting is the same for CH1 and CH2.

The sync signals have a pulse width of 100 ns and a level of 1.2 V with a 50 Ω terminator. These signals are output from the front panel **CH1 SYNC** output connector and the rear panel **CH2 SYNC OUT** connector (Option 02).

- Start. In each operating mode, the sync signal is generated when the trigger or gate signal is generated. However, In **Cont** mode, the sync signal can not be set to **Start**.
- End. In each operating mode, the sync signal is generated at the end of the waveform or sequence waveform. In **Burst** mode, the sync signal is generated at the end of the burst count.

NOTE. When the **Sync** setting is switched from **Start** to **End**, the sync output is generated.

LOAD/SAVE Menu

General Description

Press the **LOAD/SAVE** button in the **MENU** column to display the **LOAD** or **SAVE** menu. Press the **Load** or **Save** button in the bottom menu to display the desired menu.

Use the **LOAD** menu to load files into internal (random access) memory from the instrument's internal non-volatile RAM memory (**NVRam**), from a floppy disk (**Disk**), or from another instrument through the **GPIB** interface.

NOTE. *In this section, the internal non-volatile memory and the floppy disks are referred to as mass memory.*

The **SAVE** menu saves files from internal memory of the instrument to mass memory.

NOTE. *When a sequence file is loaded or saved with the **LOAD/SAVE** menu, the waveforms and sequence files used in that sequence file are also loaded or saved.*

Memory Capacity

When you exit from the **EDIT** menu, the files you created with the editors are saved into the AWG2021 internal memory (RAM). Up to 400 files (depending on size) can be saved in the internal memory.

NOTE. *The data in this instrument's internal memory is lost when the power is switched off. Therefore, you must save any necessary data to mass memory.*

Like internal memory, the AWG2021 internal non-volatile memory (NVRam) can hold up to 400 files. The NVRam has 512 Kbytes, almost all of which is used for saving files. The contents of this memory are retained even when the power is switched off.

The capacity of a floppy disk depends on its format. Disks can use directory hierarchies and files can be stored in each of the directories. The extension for a directory is .DIR. For further information on creating directories, see the explanation in "Using the Disk Menu" in Section 4E, "**UTILITY** Menu."

Figure 3 -169 shows the relationship between loading and saving, and the different types of memory.

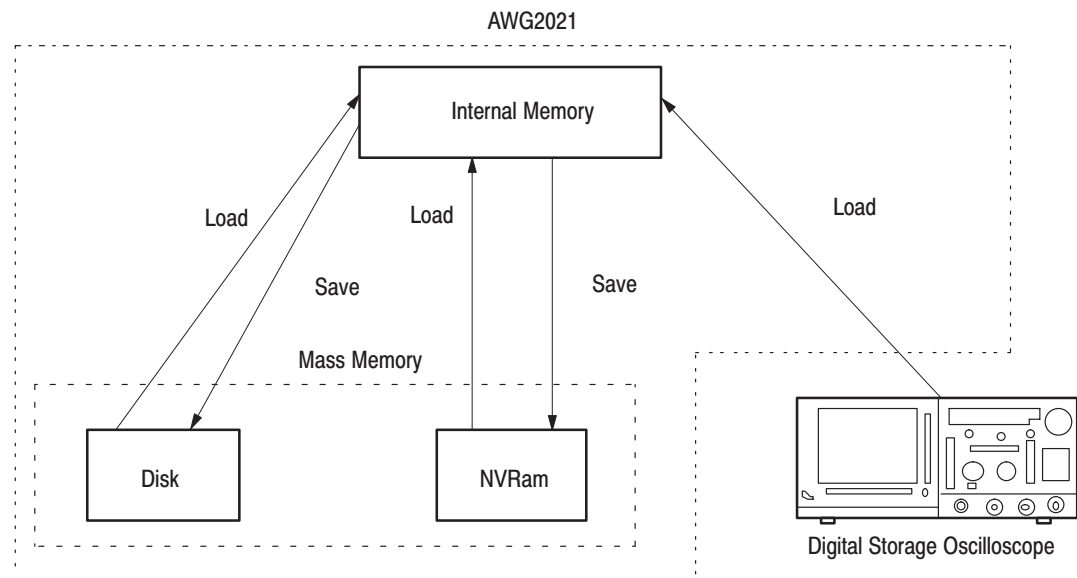
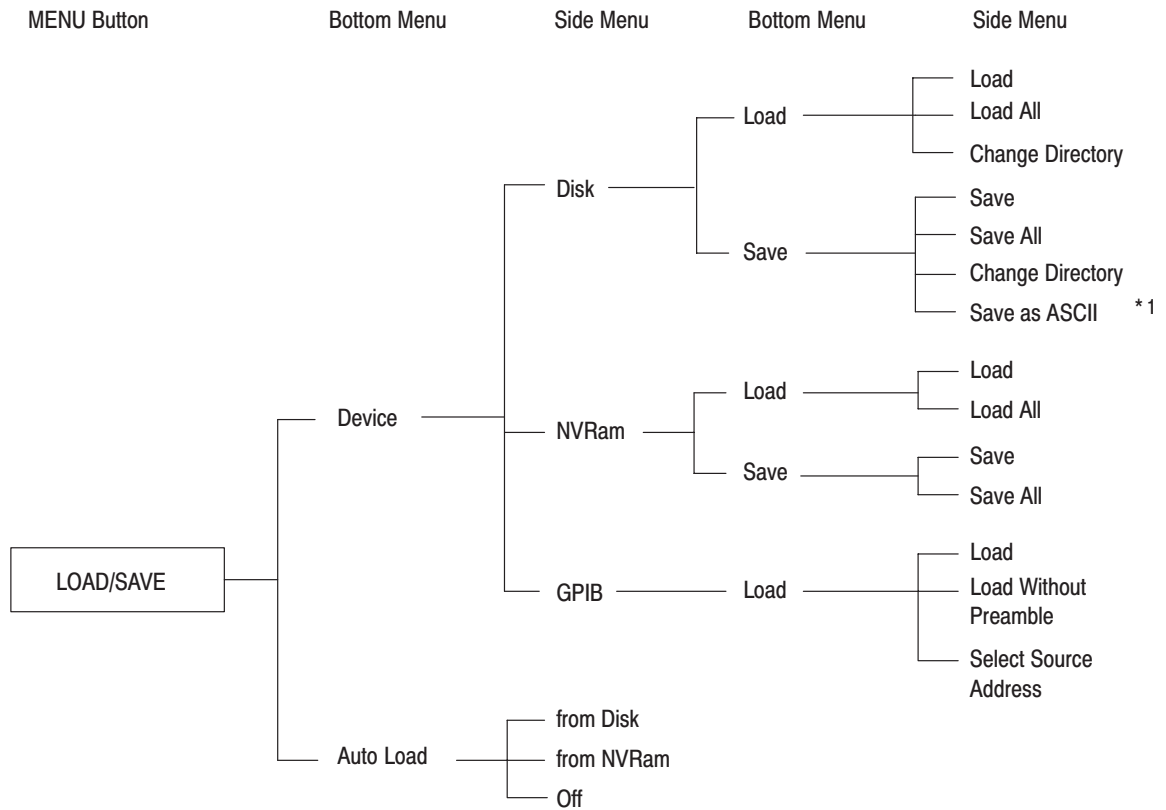

Figure 3 -169: Relationship Between Memory and Execution of Load/Save

LOAD/SAVE Menu Structure

Figure 3 -170 shows the configuration of the **LOAD/SAVE** menu.



*1 This item is displayed when an equation file (.EQU) has been selected in the list of files contained in the instrument's internal memory.

Figure 3 -170: LOAD/SAVE Menu Structure

Menu Functions

The following table describes the function of each menu item and gives the page number where you can find a more detailed explanation of that item.

Table 3-18: Menu Functions

Menu	Function	Page
Device	Selecting the device	3 -249
Load	Loading files from mass memory into internal memory	3 -251
Save	Saving files form internal memory to mass memory	3 -253
GPIB	Transferring waveform data directly	3 -255
Auto Load	Auto loading	3 -258

LOAD Menu Display

Figure 3 -171 shows the general display for the **LOAD** menu. A description for each callout follows.

GPIB | Autostep mode | Stopped

Catalog : Memory Free : 1556KB

Name	Type	Size	Date & Time	Comment
DMP_SIN	WFM	8948	94-02-01 00:11	
DQPSK1	WFM	66484	94-02-01 00:14	P1/4DQPSK In phase signal
DQPSKQ	WFM	66484	94-02-01 00:15	P1/4DQPSK Quadrature phase
D_EXP	EQU	764	94-02-01 00:05	DOUBLE EXPONENTIAL PULSE
D_EXP	WFM	20948	94-02-01 00:05	
FM	EQU	764	94-02-01 00:10	FREQUENCY MODULATION
FM	WFM	4948	94-02-01 00:10	
GAUSS_P	EQU	686	94-02-01 00:01	GAUSSIAN PULSE
GAUSS_P	WFM	1460	94-02-01 00:01	

1 →

Catalog : NVRam Free : 12KB

Name	Type	Size	Date & Time	Comment
SAMPLE-1	WFM	2948	94-02-01 15:36	
SAMPLE-2	WFM	2948	94-02-01 15:41	
SAMPLE-3	WFM	2948	94-02-01 15:42	
SAMPLE-4	EQU	452	94-02-01 15:47	
SAMPLE-4	WFM	2948	94-02-01 15:46	
SAMPLE-5	SEQ	960	94-02-01 15:51	
SAMPLE-6	AST	802	94-02-01 15:57	

2 →

Device	Load	Save				Auto Load
<input type="checkbox"/> NVRam						Off

GPIB | Autostep mode | Stopped

Catalog : Memory Free : 1556KB

Name	Type	Size	Date & Time	Comment
DMP_SIN	WFM	8948	94-02-01 00:11	
DQPSK1	WFM	66484	94-02-01 00:14	P1/4DQPSK In phase signal
DQPSKQ	WFM	66484	94-02-01 00:15	P1/4DQPSK Quadrature phase
D_EXP	EQU	764	94-02-01 00:05	DOUBLE EXPONENTIAL PULSE
D_EXP	WFM	20948	94-02-01 00:05	
FM	EQU	764	94-02-01 00:10	FREQUENCY MODULATION
FM	WFM	4948	94-02-01 00:10	
GAUSS_P	EQU	686	94-02-01 00:01	GAUSSIAN PULSE
GAUSS_P	WFM	1460	94-02-01 00:01	

Catalog : GPIB Source

Name	Loaded as
Tek TDS CH1	TDSCH1 WFM
Tek TDS CH2	TDSCH2 WFM
Tek TDS CH3	TDSCH3 WFM
Tek TDS CH4	TDSCH4 WFM
Tek TDS REF1	TDSREF1 WFM
Tek TDS REF2	TDSREF2 WFM
Tek TDS REF3	TDSREF3 WFM
Tek TDS REF4	TDSREF4 WFM
Tek 2400 CH1	2400CH1 WFM

3 →

The source GPIB address is 1.

Device	Load					Auto Load
<input checked="" type="checkbox"/> GPIB						Off

Figure 3 -171: LOAD Menu CRT Screen Display

(1) Internal memory file list	<p>This is a list of the files currently loaded into internal memory. The list shows the file names, the file types, file sizes (in bytes), the date and time the file was created, and a comment. The space remaining in internal memory, into which files can be loaded, is displayed in the upper right-hand corner of the list.</p> <p>For the LOAD menu, when a file is loaded into internal memory from mass memory or from another instrument through the GPIB interface, that file is added to this list.</p> <p>For the SAVE menu, you can select files to save from this list to mass memory.</p>
(2) Mass memory file list	<p>This list is displayed when mass memory has been selected for Device. It contains all files that have been saved to mass memory. The file data is the same as in (1), above.</p> <p>For the LOAD menu, you can select files to load from this list to the AWG2021 internal memory.</p> <p>For the SAVE menu, when a file is saved from internal memory of the instrument to mass memory, the saved file is added to this list.</p>
(3) GPIB file list	<p>This list is displayed when GPIB has been selected for Device. It shows all other instruments connected to this instrument through the GPIB interface. Waveform data can be sent to the internal memory of this instrument from the instruments shown in this list. When waveform files are loaded in this manner, a name appears in the “Loaded as” column.</p>

Selecting the Device

Select **Device** to select the source from which files are loaded into the AWG2021 internal memory and the destination to which files are saved from internal memory. You may select **Disk**, **NVRam** or **GPIB**.

1. Select **Device** from the bottom menu.
2. Select **Disk**, **NVRam** or **GPIB** from the side menu.

The following items are listed in the side menu:

Disk	A floppy disk. Files are saved to or loaded from a floppy disk inserted into the floppy disk drive on the right side of the instrument.
NVRam	The instrument's internal non-volatile RAM.
GPIB	The GPIB interface. Used to transfer waveform data directly from another instrument to this instrument through a GPIB cable.

To transfer waveform data through the **GPIB** interface, the remote port must be set to **GPIB** and the GPIB operating mode must be set to **Waveform Transfer**. If this is not done, the following message will appear when you select the **GPIB** item:

The GPIB configuration is not "Waveform Transfer"
and the Remote Port is not "GPIB".

Are you sure of changing the parameters
to match the transfer operation ?

Selecting **O.K.** in the sub-menu at this point will cause these items to be set to the above items automatically.

Table 3-19 shows a list of instruments for which direct transfer of waveform data to this instrument is supported.

Table 3-19: Supported Instruments

Manufacturer	Model
Tektronix	TDS Series Digital Storage Oscilloscope TDS300 Series, TDS400 Series, TDS500 [A] Series, TDS600 [A] Series
	2400 Series Digital Storage Oscilloscope 2430 [A], 2432, 2440
	2200 Series Digital Storage Oscilloscope 2212, 2221A, 2224, 2232
	11K Series Digital Storage Oscilloscope 11201 [A], 11401, 11402 [A], 11403 [A]
	DSA Series Digitizing Analyzer DSA601 [A], DSA602 [A]
	RTD720 Waveform Digitizer
	9500 Series First Data Cache 9503, 9504 (Use together with RTD710 [A])
Sony Tektronix	RTD710 Series Waveform Digitizer RTD710[A]
	AWG2000 Series Arbitrary Waveform Generator AWG2005, AWG2020, AWG2021, AWG2040
	AFG2020 Function Waveform Generator
Hewlett Packard	54600 Series Digital Storage Oscilloscope HP54501A, HP54502A, HP54503A, HP54504A, HP54510A
	54500 Series Digital Storage Oscilloscope HP54600A, HP54601A, HP54602A
LeCroy	94x0 Series Digital Storage Oscilloscope 9410, 9414, 9420, 9424, 9430, 9450
Yokogawa Electric	DL1000 Series Digital Storage Oscilloscope DL1100, DL1200 [E]

Loading Files from Mass Memory into Internal Memory

If **Disk** or **NVRam** has been selected for **Device**, the **LOAD** menu appears when the **Load** item in the bottom menu is selected. See Figure 3 -172. The internal memory file list is displayed on the upper screen and the list of files saved onto mass memory is displayed on the lower screen.

GPIB
 Autostep mode
 Stopped

Catalog : Memory Free : 1556KB

Name	Type	Size	Date & Time	Comment
GAUSS_P	WFM	1460	94-02-01 00:01	
LIN_SWP	EQU	764	94-02-01 00:07	LINEAR FREQUENCY SWEEP
LIN_SWP	WFM	32948	94-02-01 00:07	
LOG_SWP	EQU	842	94-02-01 00:08	LOG FREQUENCY SWEEP
LOG_SWP	WFM	44948	94-02-01 00:08	
LORENTZ	EQU	686	94-02-01 00:02	LORENTZ PULSE
LORENTZ	WFM	1460	94-02-01 00:02	
MDSK_RD	WFM	2484	94-02-01 00:16	M_DISK_READ SIGNAL
MDSK_WR	WFM	1972	94-02-01 00:17	M_DISK_WRITE PULSE

Catalog : Disk \ Free : 1410KB

Name	Type	Size	Date & Time	Comment
SAMPLE-1	WFM	2102	94-02-01 15:36	
SAMPLE-2	WFM	2102	94-02-01 15:41	
SAMPLE-3	WFM	2102	94-02-01 15:42	
SAMPLE-4	EQU	432	94-02-01 15:47	
SAMPLE-4	WFM	2102	94-02-01 15:46	
SAMPLE-5	SEQ	130	94-02-01 15:51	
SAMPLE-6	AST	782	94-02-01 15:57	

Device Load Save Auto Load
☐ Disk Off

Figure 3 -172: LOAD Menu

To load files into internal memory from mass memory, perform these steps:

1. Select **Device** from the bottom menu.
2. Select **Disk** or **NVRam** from the side menu.

When the **Device** is **Disk**, the **Change Directory** item is displayed on the side menu. When this item is selected, the current directory can be changed. This item is the same as the **Change Directory** item on the **UTILITY** menu. See the explanation in “Using the Disk Menu” in Section 4E, “UTILITY Menu.”

There is no directory hierarchy for the **NVRam**.

3. Select **Load** from the bottom menu.

4. Use the general purpose knob to select files to load into internal memory from the mass memory file list.
5. Select **Load** from the side menu. The selected file is loaded into internal memory.

When **Load All** is selected from the side menu, all the files in the specified mass memory (for a disk, the current directory) are loaded into internal memory.

NOTE. When **Load** or **Load All** is executed, and there is already a file in internal memory with the same name as a file to be loaded, the system displays a message asking you whether or not to overwrite the file now in internal memory with the one being loaded. Answer **O.K.** or **Cancel**.

Saving Files from Internal Memory to Mass Memory

If **Disk** or **NVRam** has been selected for **Device**, the **SAVE** menu appears when the **Save** item is selected from the bottom menu. See Figure 3 -173. As for the **LOAD** menu, the internal memory file list is displayed on the upper screen. From this list you select the file to be saved to mass memory.

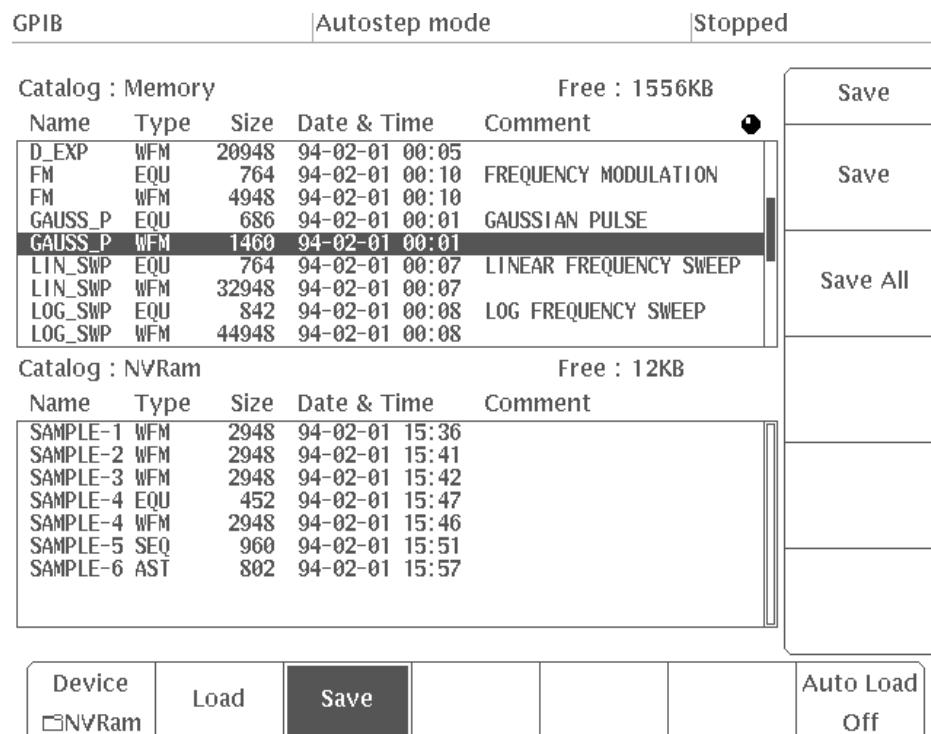

Figure 3 -173: SAVE Menu

To save files into mass memory from internal memory, perform these steps:

1. Select **Device** from the bottom menu.
2. Select **Disk** or **NVRam** from the side menu.

When the **Device** is **Disk**, **Change Directory** is displayed on the side menu and the current directory can be changed.

3. Select **Save** from the bottom menu.
4. Use the general purpose knob to select the file to be saved to mass memory from the internal memory file list.
5. Select **Save** from the side menu. The selected file is saved to the specified mass memory (for a disk, the current directory).

Transferring Waveform Data Directly

When **GPIB** has been selected for **Device**, waveform data can be transferred directly to the instrument from supported digital storage oscilloscopes, etc. through the GPIB interface. See Table 3-19 for a list of supported instruments.

Loading Waveform Data

To load a waveform file directly from one of the instruments for which direct transfer of waveform data is supported:

1. Using a GPIB cable, connect this instrument to the instrument from which waveform data is to be transferred, as shown in Figure 3 -174.

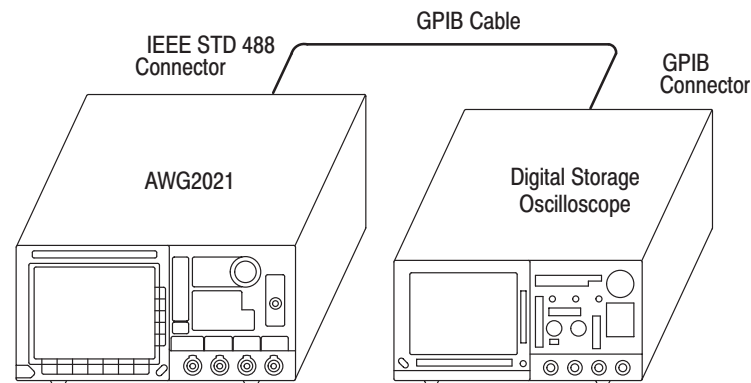

Figure 3 -174: Connecting Instruments

2. Create the waveform to be transferred on the source instrument.
3. Select **Device** from the bottom menu.
4. Select **GPIB** from the side menu.

A message will be displayed when **Remote Port [UTILITY (MENU) → Misc (bottom menu) → Config... (side menu) → Remote Port (sub-menu)]** is set to **RS232C** or when **GPIB** is set to anything other than **Waveform Transfer**. Pressing **O.K.** in response to this message will cause these settings to be automatically changed to **GPIB** and **Waveform Transfer**, respectively, and the instrument will be ready for direct waveform transfer through the **GPIB** interface.

5. Select **Load** from the bottom menu.
6. Using the general purpose knob, select the channel and the name of the instrument from which the data will be loaded from the “**Name**” column in the **GPIB Source** list at the bottom of the screen. When waveform data is loaded into the internal memory of the AWG2021, a waveform file will be

created with the name shown in the “**Loaded as**” column. Figure 3 -175 shows the GPIB Source list.

Catalog : GPIB Source

Name	Loaded as
Tek TDS CH1	TDSCH1 WFM
Tek TDS CH2	TDSCH2 WFM
Tek TDS CH3	TDSCH3 WFM
Tek TDS CH4	TDSCH4 WFM
Tek TDS REF1	TDSREF1 WFM
Tek TDS REF2	TDSREF2 WFM
Tek TDS REF3	TDSREF3 WFM
Tek TDS REF4	TDSREF4 WFM
Tek 2400 CH1	2400CH1 WFM

Figure 3 -175: GPIB Source List

7. Choose **Select Source Address** from the side menu and, using the general purpose knob, select the GPIB address for the instrument from which data is to be loaded.
8. Select **Load** from the side menu.

Data transfer will begin and the transferred file will be added to the list of files stored in internal memory at the top of the screen, under the name shown in the “**Loaded as**” column.

Data transfers can include not only waveform data but output settings such as clock frequency and amplitude as well. When the clock frequency and amplitude exceed the allowable setting range in the **SETUP** menu, these values will be replaced with the nearest allowable value (in other words, the maximum or minimum value).

When **Load Without Preamble** from the side menu is selected, waveform data is loaded by itself, i.e. without output settings. In such cases, the output parameters are set to their default values.

Selecting Instruments Made by Other Manufacturers

The following procedure is used to select digital storage oscilloscopes made by other manufacturers. The procedure up to Step 5 is the same as that for “Loading waveform data”, above.

1. Using the general purpose knob, select **Others...** from the **GPIB Source** list.
2. Press the **Load** button in the side menu. A list of models will appear.

Catalog : GPIB Source

Name	Loaded as
54600 CH1	54600CH1 WFM
54600 CH2	54600CH2 WFM
54600 CH3	54600CH3 WFM
54600 CH4	54600CH4 WFM
54500 CH1	54500CH1 WFM
54500 CH2	54500CH2 WFM
54500 MEM1	54500M1 WFM
54500 MEM2	54500M2 WFM
Others...	

Figure 3 -176: List of Supported Models Made by Other Manufacturers

NOTE. Contact a Tektronix sales office in the event that waveform transfer is not possible from an instrument made by another manufacturer, due to an upgrade or other change.

3. Using the general purpose knob, select the instrument in the list from which data will be loaded.
4. Choose **Select Source Address** from the side menu and then use the general purpose knob to select the GPIB address for the instrument from which files will be loaded.
5. Select **Load** from the side menu. Data transfer will be performed and the waveform file will be added to the list of files stored in internal memory at the top of the screen, under the name shown in the “**Loaded as**” column.

Auto Loading

Use the side menu of the **Auto Load** to automatically load files from the mass memory into the internal memory when the instrument is switched on.

1. Select **Auto Load** from the bottom menu.
2. Select an item from the side menu.

From Disk When the instrument is switched on, files are loaded automatically from the floppy disk to the internal memory. In this case, all the files in the **AWG2021** directory are loaded. If there is no **AWG2021** directory, no auto load is carried out. This directory can be created with Disk on the **UTILITY** menu. For details, see the explanation in “Using the Disk Menu” in Section 4E “**UTILITY** Menu.”

From NVRam When the instrument is switched on, all the files in the non-volatile memory are loaded automatically into the internal memory.

Off Switches off auto loading.

When **from Disk** or **from NVRam** is selected from the side menu, go to the next procedure.

3. Switch the AWG2021 power off, then on again. Double check that files are automatically loaded from mass memory to internal memory the way you selected from the side menu.

Supported Floppy Disk Files

Table 3-20 shows a list of file name extensions denoting the type of disk files that can be loaded to the internal memory of the AWG2021.

Table 3-20: Supported Floppy Disk Files

Extension	Description	Result of Load Operation
.ISF	Waveform data files saved in ISF format (Instrument Specific Format) using the waveform save function in the S34TDS1 Data Manager software.	.ISF, .WVN, .WFB, .WFM, .WAV and .WDT files are automatically converted into .WFM files in the AWG2021 instrument's internal format and then stored in internal memory. When this is done, except for the .WFM file, the name of the file is retained as is, only the extension changed to .WFM . In the .WFM file, file name and extension are as it is.
.WVN	Waveform data files saved using the waveform save function in the S37UT01 Utility software.	
.WFB	Waveform data files saved in binary format on a DSA600A series instrument.	
.WFM	Waveform data files created in a TDS series instrument	
.WAV	Waveform data files created in the LeCroy EASYWAVE software.	
.WDT	Waveform element files created in a Yokogawa Electric AG series arbitrary waveform generator.	
.EQA	Equation files in MS-DOS text format created in a PC editor, etc.	.EQA files are automatically converted into .EQU files in the AWG2021 instrument's internal format and then stored in internal memory. When this is done, the name of the file is retained as is, only the extension changed to .EQU . When the following items are written to the .EQA file, these items are reflected in the .EQU file. # COMMENT: <comment> # WAVEFORM POINTS = <point count>

All of these files are displayed in the Catalog menu screens for **Disk** in the **UTILITY** menu and **Device Disk** in the **LOAD/SAVE** menu, the same as files with other extensions. The extension for each file is shown in the **Type** column.

NOTE. *As with other files on the instrument, the **Rename, Delete, Delete All, Lock** and other operations can be performed for these files, and they are also subject to the **Load All** and **Auto Load** operations in the **LOAD** menu.*

If unexpected file formats or file contents are encountered when loading **.ISF**, **.WVN**, **.WFB**, **.WFM**, **.WAV**, **.WDT** or **.EQA** files, an error usually results and “**Invalid file format**” or a similar message is displayed.

UTILITY Menu

General Description

Press the **MENU** column **UTILITY** button to display the **UTILITY** menu. The bottom menu contains the **Disk**, **NVRam**, **GPIB**, **RS232C**, **Date Time**, **Misc**, and **Diag/Cal** items. Use these items to do the following:

Disk	Floppy disk format Operating files saved onto disks Disk directory creation and current directory change
NVRam	Operating files saved onto internal non-volatile memory (NVRam)
GPIB	Setting GPIB Configuration. See Programmer manual for details.
RS232C	Setting RS-232-C parameters. See Programmer manual for details.
Date Time	Setting the Date and Time
Misc	Setting the Display Brightness Setting the Order of Files Date/Time Display Factory Setting Deleting Data From Memory Remote Port Settings Settings for Hard Copy Output System and GPIB/RS-232-C Status I/O Event Reporting. See Programmer Manual for details.
Diag/Cal	Diagnostics and Calibration

UTILITY Menu Structure

Figure 3 -177 shows the configuration of the **UTILITY** menu.

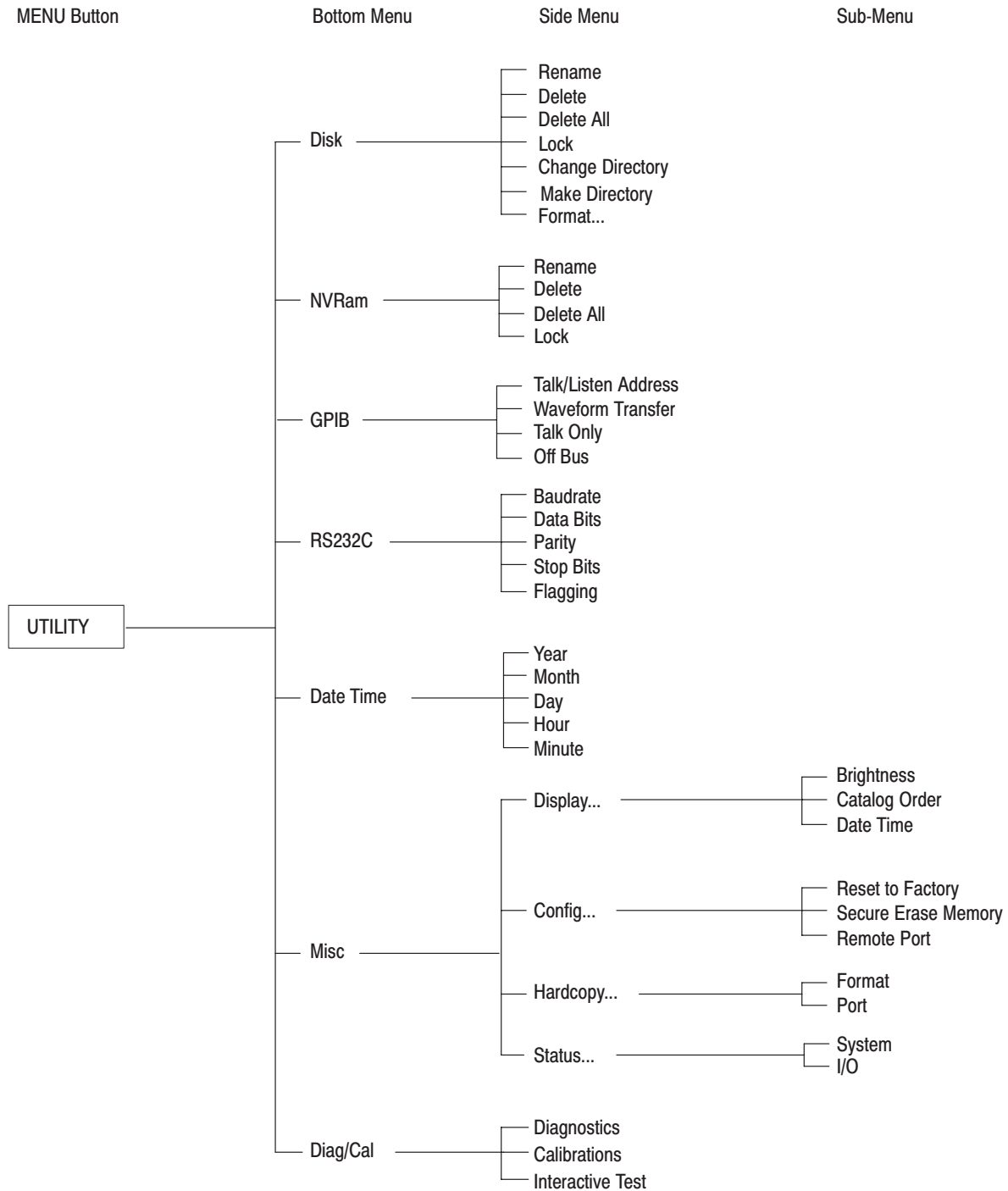

Figure 3 -177: UTILITY Menu Structure

Menu Functions

The following table describes the function of each of the menu items and gives the number of the page on which you can find a more detailed explanation of that item.

Table 3-21: Menu Functions

Menu	Function	Page
Disk	Using the disk menu	3 -264
Rename	Renaming a file	3 -8, 3 -272
Delete	Deleting a file	3 -10, 3 -272
Delete All	Deleting all files	3 -10, 3 -272
Lock	Locking and unlocking a file	3 -11, 3 -272
Change Directory	Changing directories	3 -268
Make Directory	Creating directories	3 -268
Format...	Floppy disk format	3 -265
NVRam	Internal non-volatile memory	3 -273
GPIB	GPIB	3 -274
Talk/Listen Address	Setting the GPIB configuration	3 -275
Waveform Transfer		
Talk Only		
Off Bus		
RS232C	RS-232-C	3 -276
Baudrate	Setting the baud rate	3 -277
Data Bits	Setting the number of data bits	
Parity	Setting the parity	
Stop Bits	Setting the number of stop bits	
Flagging	Setting flags	
Date Time	Setting the date and time	3 -278
Misc	Other settings and displays	3 -279
Display...	Setting the display	3 -279
Brightness	Setting the display brightness	3 -280
Catalog Order	Setting the order of files	3 -280
Date Time	Date/Time display	3 -283

Table 3-21: Menu Functions (Cont.)

Menu	Function	Page
Config...	Configuration	3 -284
Reset to Factory	Factory settings	3 -284
Secure Erase Memory	Deleting data from memory	3 -285
Remote Port	Remote port settings	3 -285
Hardcopy...	Settings for hard copy output	3 -286
Format	Selecting the format	3 -286
Port	Selecting the port	3 -287
Status...	Status display	3 -288
System	System and GPIB/RS-232-C status	3 -288
I/O	I/O event reporting	3 -289
Diag/Cal	Diagnostics and calibrations	3 -290
Diagnostics	Diagnostics	3 -290
Calibrations	Calibrations	3 -292
Interactive Test	Pattern display (For instrument adjustment)	3 -293

Disk and Nonvolatile Memory

Save the files this instrument creates onto internal non-volatile memory and/or 3.5-inch floppy disks.

Using the Disk Menu

This item can format disks, make directories on disks, change the current directory, edit files saved to disk, etc.

Insert the 3.5-inch floppy disk into this instrument's floppy disk drive, then select **Disk** from the bottom menu. The files saved in the root directory and AWG2021 directory are read out and displayed on the CRT screen. When **Disk** is selected in the bottom menu, the following items will appear in the side menu:

- Rename
- Delete
- Delete All
- Lock
- Change Directory
- Make Directory
- Format...

The side menu is made up of 2 pages. Select **More** to display the second page of the side menu.

Floppy Disk Format. This instrument can format 2DD (double density) and 2HD (high density) disks in three different MS-DOS formats: IBM-PC format, NEC PC9800 series format, and Toshiba J3100 series format. Formatted disks are automatically labeled “AWG2021”.

New floppy disks must be formatted before they can be used. Figure 3 -178 shows the sub-menu displayed after formatting the disk.

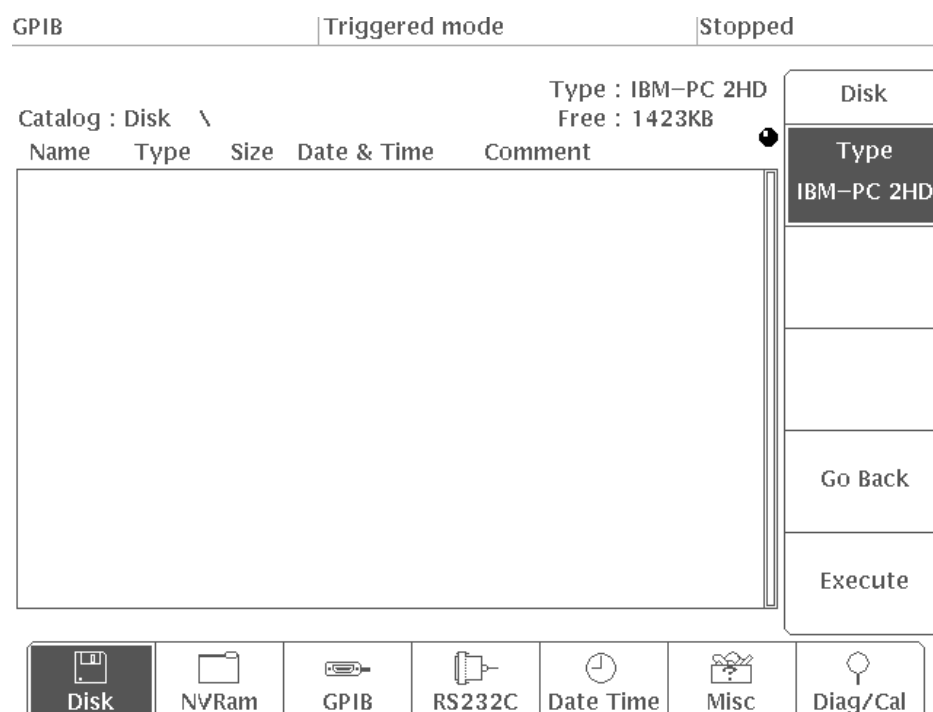

Figure 3 -178: Format... Sub-Menu Display

Formatting disks. To format floppy disks, perform these steps:

1. Select **Disk** from the bottom menu.
2. Insert the 3.5-inch floppy disk to be formatted into the disk drive on the right side panel of this instrument.



CAUTION. *Formatting a disk destroys any data on that disk! Before formatting a disk, make sure it contains no data you might ever need.*

3. Select **Format...** from the second page of the side menu (**More 2 of 2**).
4. The currently selected format will appear in the **Type** item in the sub-menu. Select the correct format with the general purpose knob. The following formats can be selected for **Type**:

IBM-PC 2HD
 PC9800 2HD
 J3100 2HD
 IBM-PC 2DD
 PC9800 2DD

When floppy disks written by this instrument are used in a personal computer, select the correct format type as indicated by Table 3-22.

Table 3-22: MS-DOS Formats for 3.5-inch Disks

Format Type	IBM-PC	PC9800	J3100
1.44 Mbytes/18 sectors (2HD)	1	3	2
1.2 Mbytes/8 sectors (2HD)	3	1	2
1.2 Mbytes/15 sectors (2HD)	3	2	1
720 Kbytes/9 sectors (2DD)	1	2	1
640 Kbytes/8 sectors (2 DD)	2	1	2

- 1 : Format normally used on personal computer (format selected with AWG2021).**
- 2 : Not regular format, but can be read and written.**
- 3 : Can not be read or written.**

NOTE. The IBM-PC and J3100 2DD formats are the same. Thus, use the **IBM-PC 2DD** format for J3100 2DD disks.

5. After selecting the format, select **Execute** from the sub-menu. This starts the disk formatting. During formatting, a message to that effect, “**Formatting disk...**” is displayed on the screen.

NOTE. A disk with its write prevent tab in the write-protected position cannot be formatted. Slide the tab to the write-enable position, then try again. See the discussion below of write prevention.

When formatting is complete, the message on the screen will disappear and an empty file list will appear with the format type and available disk space shown in the upper right-hand corner.

6. Select **Go Back** from the sub-menu. The system returns from the **Format...** current sub-menu to the previous side menu.
7. Pressing the eject button on the right side of the disk drive ejects the floppy disk.

Handling Floppy Disks. 3.5" floppy disks are easy to store and use. However, to prevent them from being damaged and to ensure the integrity of the data stored on them, you should be careful of the following:

- Do not place disks near a strong magnetic field or near a ferromagnetic substance that may cause them to be magnetized, as this will corrupt the data stored on the disk and result in errors.
- Do not expose disks to direct sunlight or high temperatures for long periods of time. Also, avoid storing them in places subject to extreme cold or high humidity. When bringing disks into a room from outside, do not use them immediately; let them become acclimated to the environment before use.
- Do not touch the recording medium on the surface of the disk. Fingerprints on the surface of the disk may cause the heads to skip, resulting in errors.
- When storing disks for long periods of time, be sure to place them in their protective cases.
- Be sure to place labels in the proper location on the disks.
- Do not press the eject button on the disk drive to eject the floppy disk while the indicator light is lit. This may cause the data stored on the disk to become corrupted, resulting in errors.

Protecting Disks From Accidental Erasure. There is a write protect tab on the underside of the floppy disk. To lock the disk, press this tab down toward the edge of the disk to expose the little hole underneath, as shown in Figure 3 -179. Locking the disk will prevent it from being written to or erased. To unlock the disk and enable it to be written to or erased, move the tab back toward the center of the disk so it covers the hole.

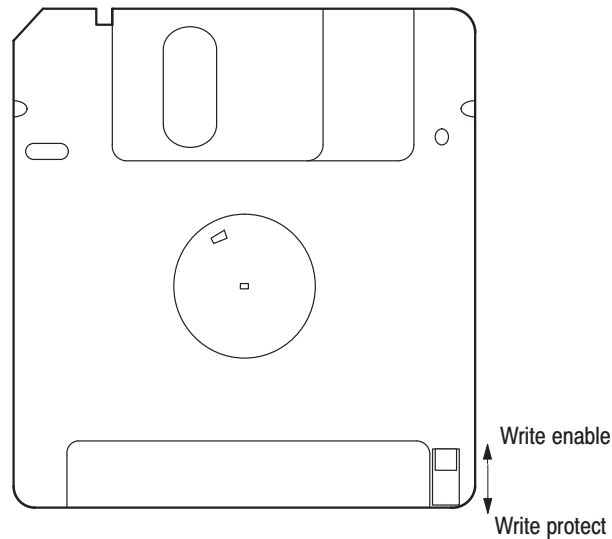

Figure 3 -179: Write Protect Tab on a Floppy Disk

Creating and Changing Directories. When there are many files, it becomes difficult to manage them. Placing all files of the same type into separate directories makes it easier to manage the files.

In addition to files, directories can also contain sub-directories. With directories, hierarchical structures can be constructed with successive directories. Directories are distinguished by their names. The original directory that contains all the files and directories is called the root directory and the directories within it are called sub-directories.

This instrument can make directories to manage files the same as with MS-DOS. Directories are created with the **Make Directory** side menu item. The suffix **“.DIR”** is attached to created directories.

To operate on a certain file within a given sub-directory, it is necessary to move to that sub-directory. Thus, use the **Change Directory** side menu item to move to the desired sub-directory. The next directory is now the object of any future operations and is called the current directory. The **LOAD/SAVE** menu can be used to change directories too.

The setting of the **LOAD/SAVE** menu and **Auto Load** determine the directory at power on. When the **Auto Load** item is set to **Disk**, the **AWG2021** sub-directory is selected automatically. (In this case, this **AWG2021** sub-directory must exist.) If **Auto Load** is **Off**, the current directory is the root directory.

NOTE. A file hierarchy with multiple layers can be created on the disk using up to 54 characters including the \ character. The shorter the directory name, the deeper the levels that you can create. When the directory display becomes too large for the display area window, the initial section is omitted.

Example: Creating a Directory. For example, to create a sub-directory called **AWG2021**, such as root directory: **AWG2021 (DIR)** – perform the following steps.

Root directory ——— AWG2021 (DIR)

If the **AWG2021** sub-directory has been created ahead of time, the files under the **AWG2021** directory are automatically loaded into internal memory by the **LOAD/SAVE** menu **Auto Load** setting, when power is switched on.

The following procedure assumes that the current directory is the root directory. If the current directory is not the root directory, use **Change Directory** to change the current directory to the root directory. (See the Step 5 and the following steps.)

1. Select **Disk** from the bottom menu.

A list of the files and directories in the root directory of the inserted floppy disk is displayed on the screen. See Figure 3 -180. **Catalog:Disk ** on the CRT screen shows that the current directory is the root directory.

GPIB | Triggered mode | Stopped

Catalog : Disk \

Name	Type	Size	Date & Time	Comment
AM	WFM	40102	94-02-01 00:09	
ATS	DIR	---	94-02-01 16:21	
DMP_SIN	WFM	8102	94-02-01 00:11	
D_EXP	WFM	20102	94-02-01 00:05	
EQUATION	DIR	---	94-02-01 16:22	
FM	WFM	4102	94-02-01 00:10	
FUNCTION	DIR	---	94-02-01 16:23	
GAUSS_P	WFM	614	94-02-01 00:01	
LIN_SWP	WFM	32102	94-02-01 00:07	
LOG_SWP	WFM	44102	94-02-01 00:08	
LORENTZ	WFM	614	94-02-01 00:02	
MDSK_RD	WFM	1638	94-02-01 00:16	M_DISK_READ SIGNAL
MDSK_WR	WFM	1126	94-02-01 00:17	M_DISK_WRITE PULSE
NYQUIST	WFM	2102	94-02-01 00:06	
SINC	WFM	8102	94-02-01 00:03	
SQU_SIN	WFM	2102	94-02-01 00:04	

Type : IBM-PC 2HD
Free : 1255KB

- Disk
- Rename
- Delete
- Delete All
- Lock
On
Off
- More
1 of 2

Disk

NVRam

GPIB

RS232C

Date Time

Misc

Diag/Cal

Figure 3 -180: File and Directory Display in the Root Directory

2. Select **More 1 of 2**, then **Make Directory** from the side menu. The menu for naming the directory is displayed.
3. Use the general purpose knob to input a directory name of **AWG2021**. See Figure 3 -181. The method for inputting the directory name is the same as the method for inputting a file name in the waveform editor. See “Naming a File” in the discussion of the waveform editor.

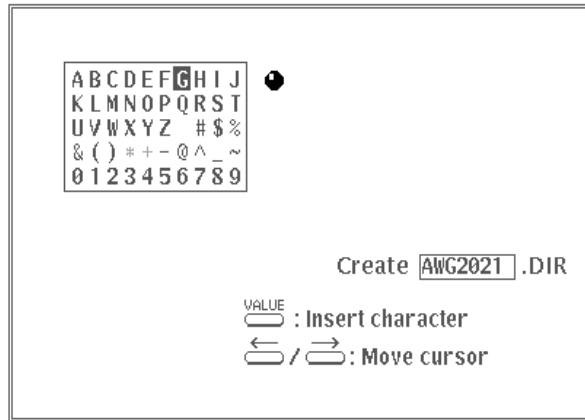

Figure 3 -181: Directory Name Input

4. After you have input the directory name, select **O.K.** from the sub-menu. The **AWG2021** directory is created in the floppy disk.

Example: Changing a Directory.

5. Select **Change Directory** from the side menu.
6. Use the general purpose knob to select the **AWG2021** sub-directory you just created from the directory list. See Figure 3 -182.

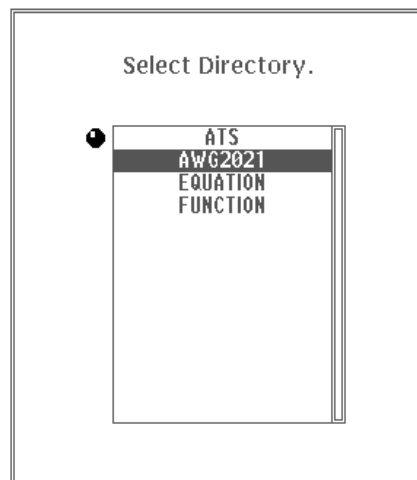

Figure 3 -182: Directory Displayed When Change Directory is Selected

7. Select **O.K.** from the sub-menu. The current directory changes to the **AWG2021** directory you just made and the directory display becomes **Catalog:Disk\AWG2021**. At this time, the **AWG2021** directory is empty. See Figure 3 -183.

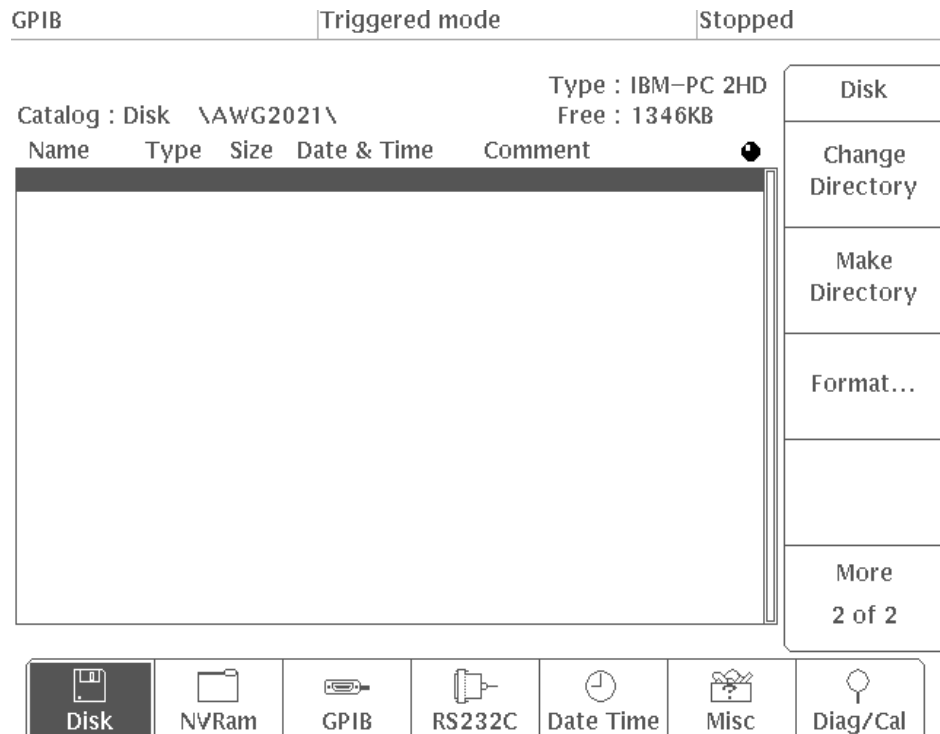

Figure 3 -183: File List for a Newly Created Directory

This completes the move of the current directory to the **AWG2021** sub-directory. Files and new directories can be created in this directory. Next, here is how to return the current directory to the root directory.

8. Again, select **Change Directory** from the side menu. Only “..” is displayed in the directory list. Select **O.K.** from the sub-menu.

Selecting “..” from the directory list moves the current directory to the directory above it. In this case, it is the root directory, so the system is back where it started.

Operating Files Saved to Disk. The side menu has **Rename**, **Delete**, and **Delete All** for to use on files. These items are the same as in the **EDIT** menu. See Page 3 -8 to 3 -10. These functions can rename and delete files. Directories can also be deleted by selecting the **Delete** item. However, this is only possible when there are no files and directories at levels below the directory to be deleted.

Locking and Unlocking a File. This menu item locks a file. When a file is locked, the file can neither be changed nor erased. It locks and unlocks a file the same as the **Lock** item in the **EDIT** menu. See Page 3 -11.

Internal Non-volatile Memory

Files saved to the internal non-volatile memory can be manipulated with this bottom menu. When **NVRam** is selected from the bottom menu, the **Rename**, **Delete**, **Delete All**, and **Lock** side menu items are displayed. These functions can rename, delete, and lock files, the same as those in the **EDIT** menu. See Page 3 -8 to 3 -11.

Figure 3 -184 shows the menu displayed when **NVRam** is selected from the bottom menu.

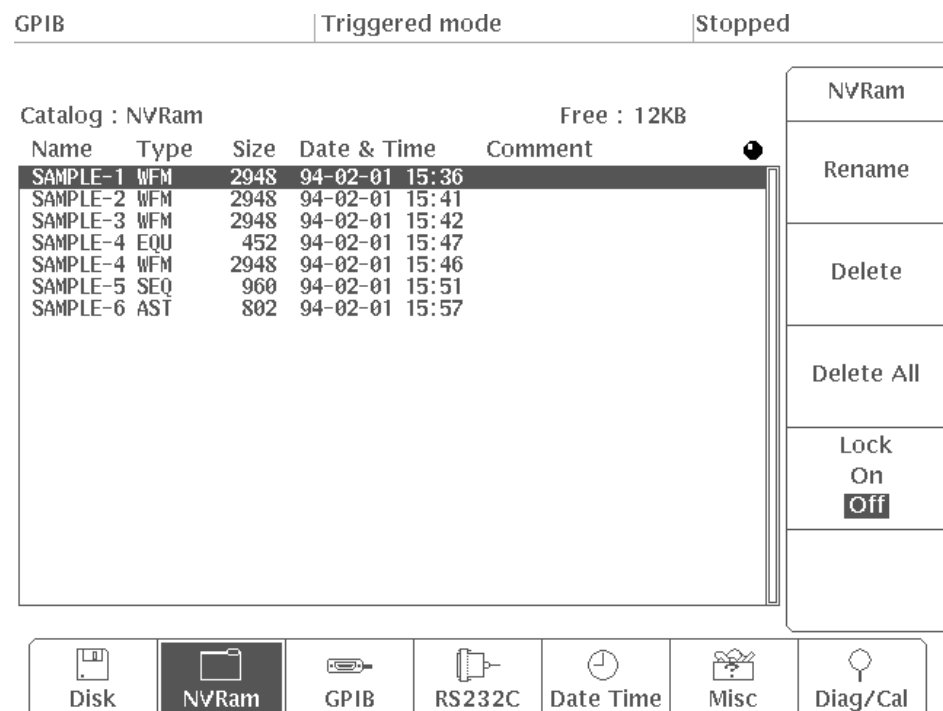

Figure 3 -184: Menu Displayed When NVRam is Selected

Remote Interface

The instrument's rear panel has two remote control interface ports: **IEEE STD 488 (GPIB)** and **RS-232-C**. (Note: There is no RS-232-C port when Option 04 has been installed.) A computer can be used to control the instrument remotely through these interfaces.

The port is selected using the Remote Port item [UTILITY menu → **Misc** (bottom menu) → **Config...** (side menu) → **Remote Port**.

GPIB These are simple descriptions of the GPIB connection and GPIB configuration setting. For further details, see the Programmer Manual.

GPIB Connection. The cable from the GPIB controller (computer) is connected to the **IEEE STD 488** connector on this instrument's rear panel.

Setting GPIB Configuration. Devices on the GPIB bus must be configured compatibly to communicate.

Select **GPIB** from the bottom menu to set the GPIB configuration. See Figure 3 -185. Use the side menu items to set the GPIB configuration and the address of this instrument.

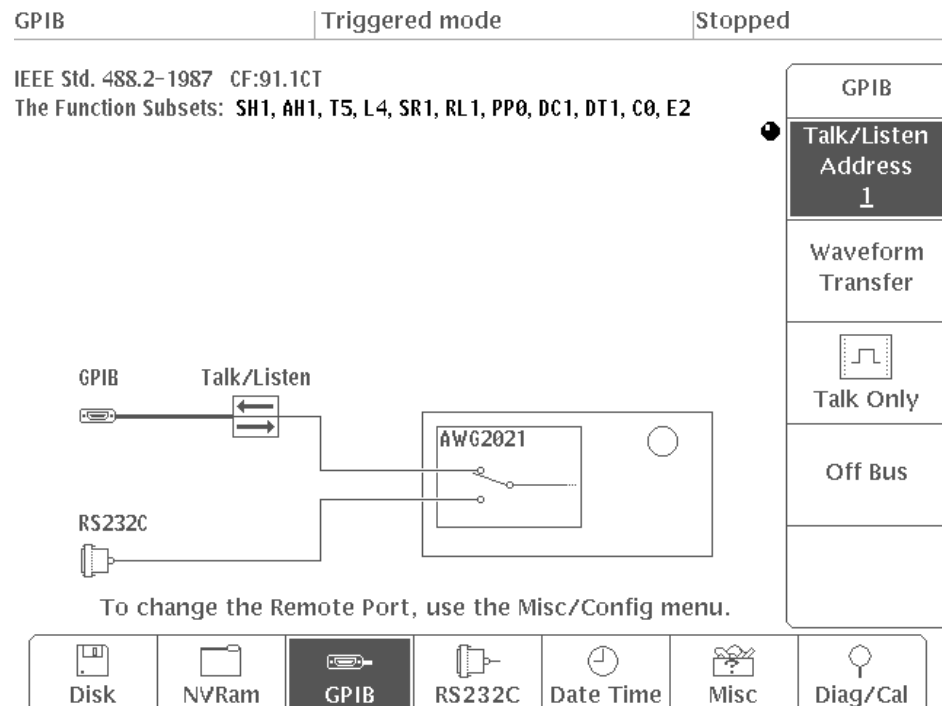

Figure 3 -185: Menu Displayed When GPIB is Selected

The instrument can be set to one of four operating modes: talk/listen, waveform transfer, talk only, or off-bus. However, you should be aware that talk only and waveform transfer modes are not compliant with IEEE 488.2-1987.

Talk/Listen

Select talk/listen mode from the side menu to communicate with the controller via the GPIB. When the **Talk/Listen Address** item is selected, the operating mode for this instrument and other devices is set to talk/listen or the general purpose knob and the numeric keys set the GPIB address for this instrument. The GPIB address setting range is **0–30**. Other devices on the bus cannot use the address number allocated to this instrument.

Waveform Transfer

Select **Waveform Transfer** mode from the side menu to download waveform data. In this mode, waveform data does not go through the controller; it is downloaded directly to the internal memory of the instrument from a digital storage oscilloscope or other instrument. See Table 3-19 in Section 4D LOAD/SAVE menu for a list of supported instruments.

Actual waveform transfer is performed using the **LOAD/SAVE** menu. See Page 3 -255.

Talk Only

Select **Talk Only** from the side menu to output a hard copy of the waveform data. When the Port setting is **GPIB** [UTILITY menu → **Misc** (bottom menu) → **Hardcopy...** (side menu) → **Port** (sub-menu)], pressing the **HARDCOPY** button on the front panel causes a hard copy of the waveform to be output.

Off Bus

Select **Off Bus** from the side menu to disconnect the AWG2021 from the GPIB bus.

RS-232-C

Use the RS-232-C interface on the rear panel to allow remote control by a host computer. These are simple descriptions of the RS-232-C connection and RS-232-C parameter setting. For further details, see the AWG2000 series Programmer Manual.

RS-232-C Connection. To select the RS-232-C port, select **RS232C** for **Remote Port** [UTILITY menu → **Misc** (bottom menu) → **Config...** (side menu) → **Remote Port** (sub-menu)].

A cable is connected between the computer and this instrument's RS-232-C connector. The AWG2021 must be configured as the data communications equipment (DCE) and the host computer must be configured as the data terminal equipment (DTE).

Setting the RS-232-C Parameters. The RS-232-C parameters for both devices must match to allow communication between this instrument and the host computer.

Before communicating with the connected computer, the RS-232-C parameters are set with the menu in Figure 3 -186. Press the side button for the desired parameter and set it with the general purpose knob.

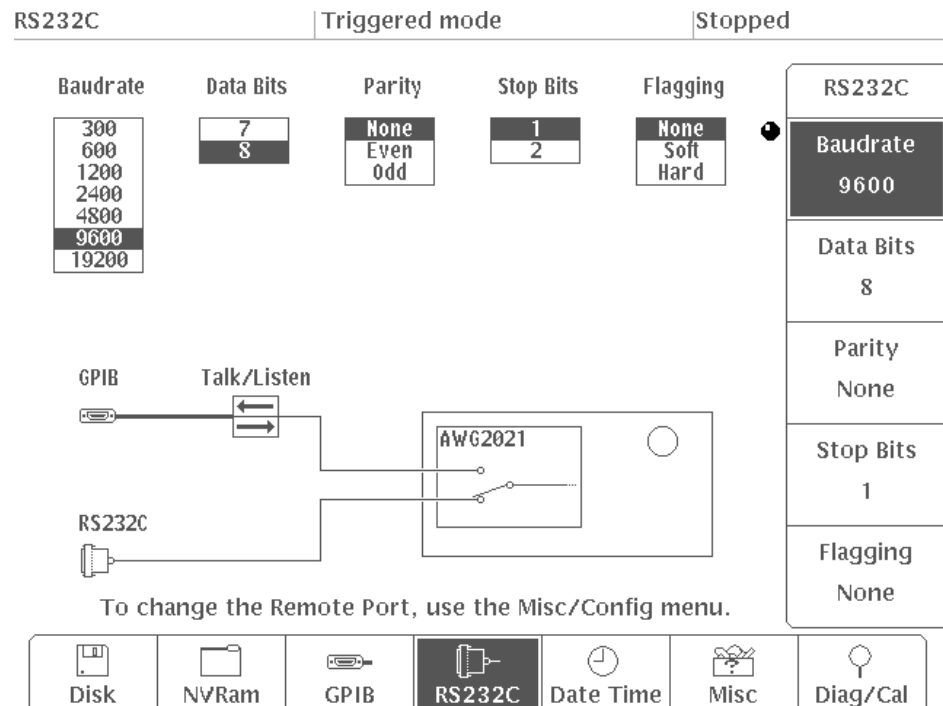

Figure 3 -186: Menu Displayed When RS232C is Selected

Baudrate	Sets the transmission rate. The transmission rate of 300, 600, 1200, 2400, 4800, 9600, and 19200 can be selected with the general purpose knob. Set this parameter to the same value as set on the computer.
Parity	Sets the error detection method. The general purpose knob is used to select parity of None, Odd, or Even . Set this parameter to match the connected computer's parity.
Data Bits	Selects 7 or 8 data bits. Set this parameter to match the connected computer's data bits.
Stop Bits	Selects 1 or 2 stop bits. Set this parameter to match the connected computer's stop bits.
Flagging	Selects None, Soft, or Hard . This item is used to announce that the input buffer is full. Until the transmission allowed instruction is issued, the other device stops the data transfer.

Date and Time

When **Date Time** is selected from the bottom menu, a clock will appear on the screen, allowing you to set the date and time. The side menu will display items for **Year**, **Month**, **Day**, **Hour** and **Minute**. Pressing one of these items in the side menu will make it possible to set that clock parameter using the general purpose knob.

The set date and time are recorded as the time stamp when a file is created. Figure 3 -187 shows the menu displayed when **Date Time** is selected.

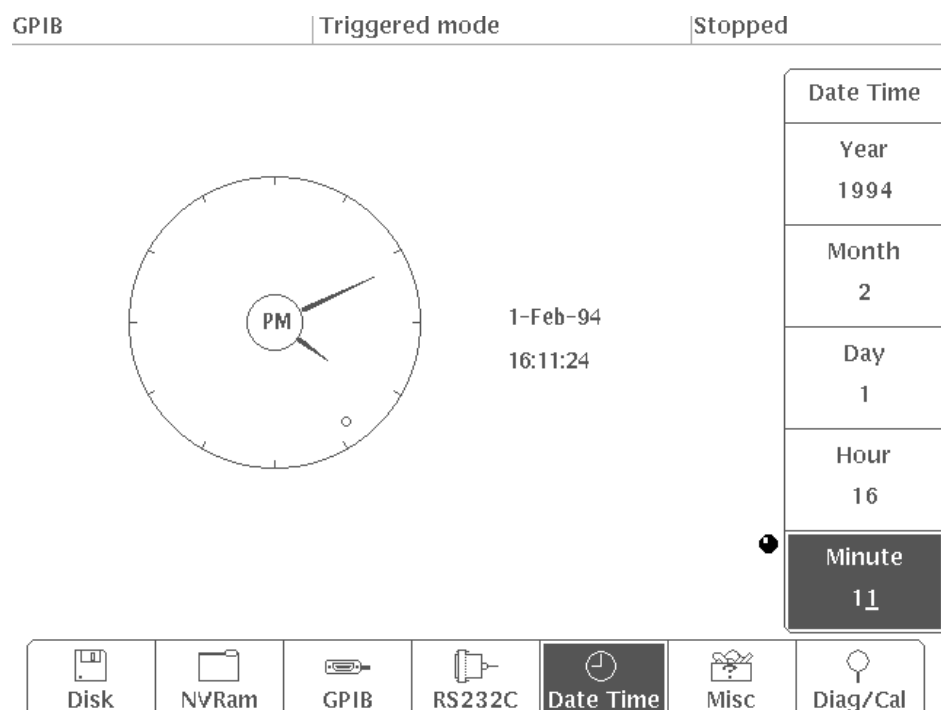

Figure 3 -187: Menu Displayed When Date Time is Selected

Setting the Date and Time

1. Select **Date Time** from the bottom menu.
2. Select **Year** from the side menu. Use the general purpose knob or the numeric keys to set the year.
3. In the same way, select the **Month**, **Day**, and **Hour** and set the month, day, and hour.
4. Select **Minute** from the side menu. Each time the minute is set with the general purpose knob, the second is reset to 00. When the time is set, the

minute is set at the same time the second is reset to 0. (The second is also reset to 00 when the hour is set with **Hour**.)

The date and time can be permanently displayed on the screen if desired. See “Date/Time Display” on Page 3 -283.

Other Settings and Displays

Use **Misc** from the bottom menu to set or display the following:

- **Display...**
 - Brightness Setting the Display Brightness
 - Catalog Order Setting the Order of Files
 - Date Time Date/Time Display
- **Config...**
 - Reset to Factory Factory Settings
 - Secure Erase Memory Deleting Data From Memory
 - Remote Port Remote Port Settings
- **Hardcopy...**
 - Format Selecting the Hard Copy Output Format
 - Port Selecting the Hard Copy Output Port
- **Status...**
 - System System and GPIB/RS-232-C Status
 - I/O I/O Event Reporting

Setting the Display

The following diagram shows the menu configuration for **Display...**

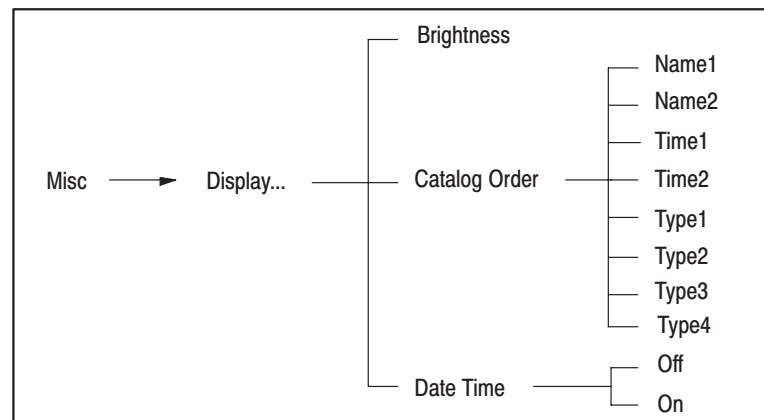

We will discuss the **Brightness**, **Catalog Order** and **Date Time** items in the sub-menu.

Setting the Display Brightness. The AWG2021 screen has three levels of brightness. These levels are set with the **Brightness** menu item.

To set the screen brightness:

1. Select **Misc** from the bottom menu.
2. Select **Display...** from the side menu.
3. Select **Brightness** from the sub-menu.
4. Use the numeric keys or general purpose knob to input the appropriate display brightness. The display brightness can be adjusted in steps of 1% in the range 0 – 100%. The default display brightness is 70%.

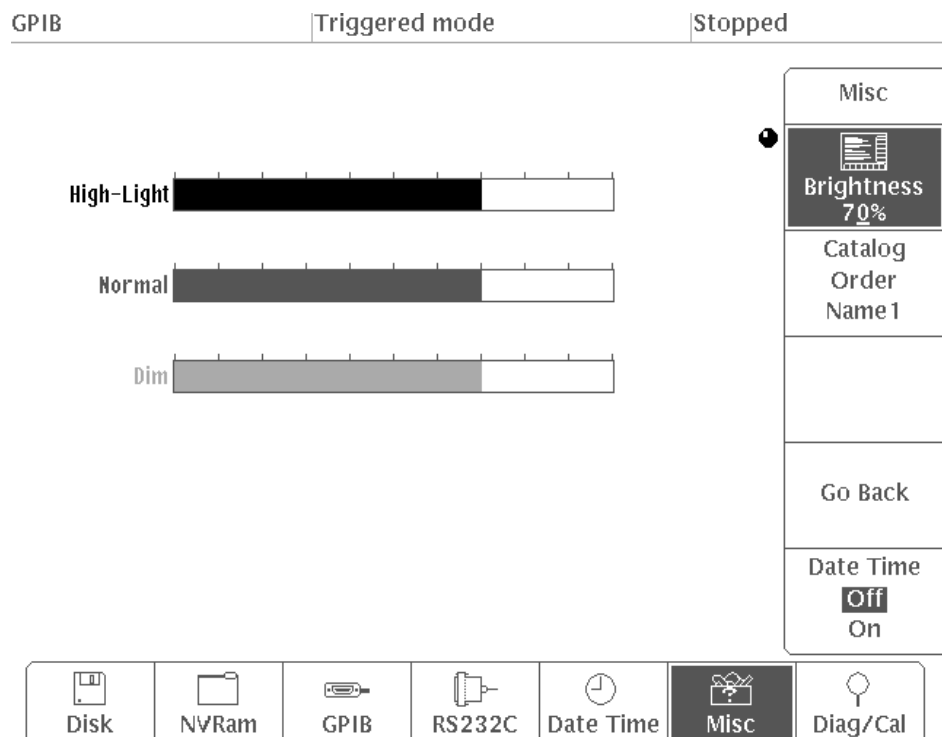

Figure 3 -188: Setting the Display Brightness

Setting the Order of Files. Use this item to set the order in which files are displayed in the catalog. You can display files sorted by file name, date and time or file type (extension). Figure 3 -189 shows the screen when **Catalog Order** has been chosen from the sub-menu.

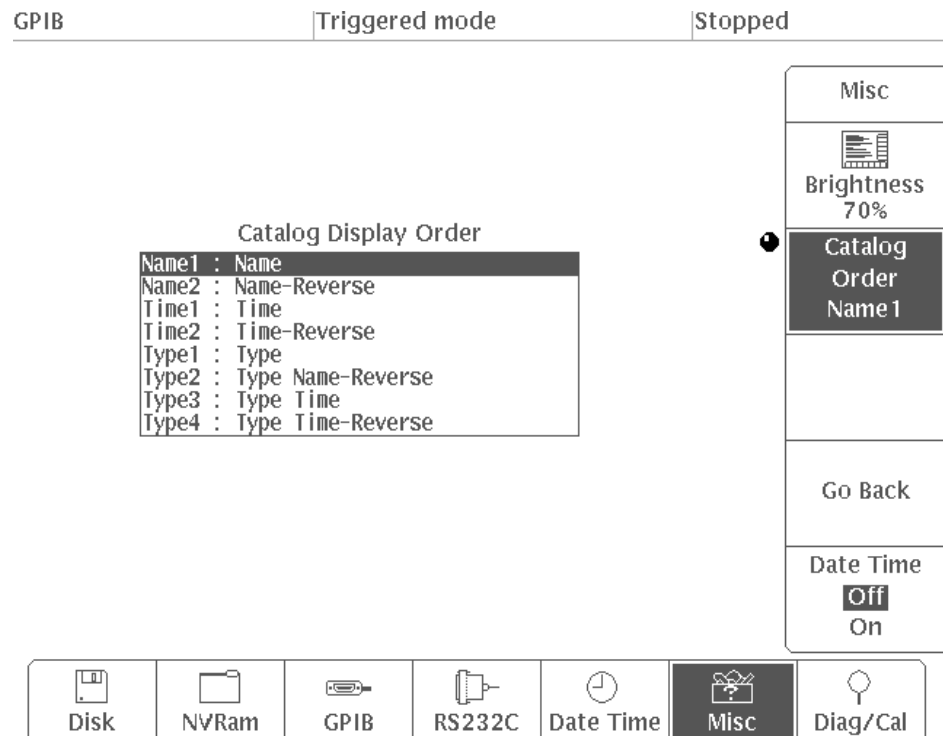

Figure 3 -189: Menu Displayed when Catalog Order is Selected

The files in the catalog are displayed in the initial **EDIT** menu, **LOAD/SAVE** and **UTILITY** menus. Changing the file order in a catalog will change the order in all menus. Figure 3 -190 shows the list of files as shown in the initial **EDIT** menu.

Catalog : Memory Free : 1784KB

Name	Type	Size	Date & Time	Comment
AM	EQU	842	94-02-01 00:09	AMPLITUDE MODULATION
AM	WFM	40948	94-02-01 00:09	
DMP_SIN	EQU	842	94-02-01 00:11	DAMPED SINE WAVE
DMP_SIN	WFM	8948	94-02-01 00:11	
D_EXP	EQU	764	94-02-01 00:05	DOUBLE EXPONENTIAL PULSE
D_EXP	WFM	20948	94-02-01 00:05	
FM	EQU	764	94-02-01 00:10	FREQUENCY MODULATION
FM	WFM	4948	94-02-01 00:10	
GAUSS_P	EQU	686	94-02-01 00:01	GAUSSIAN PULSE
GAUSS_P	WFM	1460	94-02-01 00:01	
LIN_SWP	EQU	764	94-02-01 00:07	LINEAR FREQUENCY SWEEP
LIN_SWP	WFM	32948	94-02-01 00:07	
LOG_SWP	EQU	842	94-02-01 00:08	LOG FREQUENCY SWEEP
LOG_SWP	WFM	44948	94-02-01 00:08	
LORENTZ	EQU	686	94-02-01 00:02	LORENTZ PULSE
LORENTZ	WFM	1460	94-02-01 00:02	
MDSK_RD	WFM	2484	94-02-01 00:16	M_DISK_READ SIGNAL
MDSK_WR	WFM	1972	94-02-01 00:17	M_DISK_WRITE PULSE
NYQUIST	EQU	842	94-02-01 00:06	NYQUIST PULSE
NYQUIST	WFM	2948	94-02-01 00:06	

Figure 3 -190: Catalog Files

Files in a catalog can be displayed by the following sorting conditions:

- Name1: Name
Files are displayed by file name (**Name**) in ASCII code order.
- Name2: Name-Reverse
Files are displayed by file name (**Name**) in reverse ASCII code order.
- Time1: Time
Files are displayed by creation date (**Date & Time**), from newest to oldest.
- Time2: Time-Reverse
Files are displayed by creation date (**Date & Time**), from oldest to newest.
- Type1: Type
Files are displayed by extension (**Type**) in alphabetical order.
- Type2: Type Name-Reverse
Files are displayed by extension (**Type**) in alphabetical order and, within each file type, by name (**Name**) in reverse ASCII code order.
- Type3: Type Time
Files are displayed by extension (**Type**) in alphabetical order and, within each file type, by creation date (**Date & Time**) from newest to oldest.
- Type4: Type Time-Reverse
Files are displayed by extension (**Type**) in alphabetical order and, within each file type, by creation date (**Date & Time**) from oldest to newest.

To change the order in which files are displayed to **Type4**:

1. Select **Misc** from the bottom menu.
2. Select **Display...** from the side menu.
3. Select **Catalog Order** from the sub-menu.
4. Use the general purpose knob to select **Type4**.
5. Press the **EDIT** button in the **MENU** column. Check to make sure that the files are sorted in the order you have selected.

Figure 3 -191 shows the files displayed in **Type4** format, with files sorted by extension (**Type**) in alphabetical order and within each file type by creation date (**Date & Time**), from oldest to newest.

Catalog : Memory Free : 1784KB

Name	Type	Size	Date & Time	Comment
GAUSS_P	EQU	686	94-02-01 00:01	GAUSSIAN PULSE
LORENTZ	EQU	686	94-02-01 00:02	LORENTZ PULSE
SINC	EQU	686	94-02-01 00:03	SINC PULSE
SQU_SIN	EQU	920	94-02-01 00:04	SQUARED SINE PULSE
D_EXP	EQU	764	94-02-01 00:05	DOUBLE EXPONENTIAL PULSE
NYQUIST	EQU	842	94-02-01 00:06	NYQUIST PULSE
LIN_SWP	EQU	764	94-02-01 00:07	LINEAR FREQUENCY SWEEP
LOG_SWP	EQU	842	94-02-01 00:08	LOG FREQUENCY SWEEP
AM	EQU	842	94-02-01 00:09	AMPLITUDE MODULATION
FM	EQU	764	94-02-01 00:10	FREQUENCY MODULATION
DMP_SIN	EQU	842	94-02-01 00:11	DAMPED SINE WAVE
GAUSS_P	WFM	1460	94-02-01 00:01	
LORENTZ	WFM	1460	94-02-01 00:02	
SINC	WFM	8948	94-02-01 00:03	
SQU_SIN	WFM	2948	94-02-01 00:04	
D_EXP	WFM	20948	94-02-01 00:05	
NYQUIST	WFM	2948	94-02-01 00:06	
LIN_SWP	WFM	32948	94-02-01 00:07	
LOG_SWP	WFM	44948	94-02-01 00:08	
AM	WFM	40948	94-02-01 00:09	

Figure 3 -191: Catalog With Files Displayed in Type4 Format

Date/Time Display. Use this item to display the date and time.

1. Select **Misc** from the bottom menu.
2. Select **Display...** from the side menu.
3. Press **Date Time** in the sub-menu and select **On**. The current date and time will be displayed in the upper right-hand corner of the screen, as shown in Figure 3 -192.

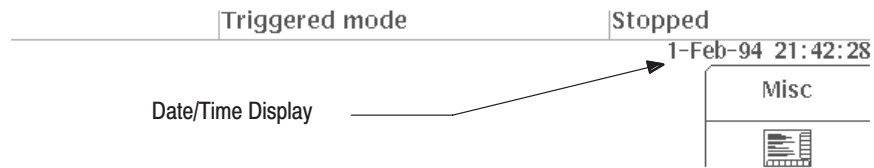
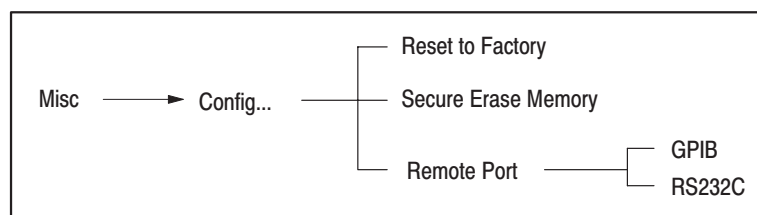

Figure 3 -192: Date/Time Display

Configuration The following diagram shows the menu configuration for the **Config...** item.



In this section, we will discuss the **Reset to Factory**, **Secure Erase Memory**, and **Remote Port** items in the sub-menu.

Factory Settings. Select **Reset to Factory** to reset this instrument’s settings to the factory values.

1. Select **Misc** from the bottom menu.
2. Select **Config...** from the side menu.
3. Select **Reset to Factory** from the sub-menu.
4. The next message is displayed asking if it is OK to reset this instrument.

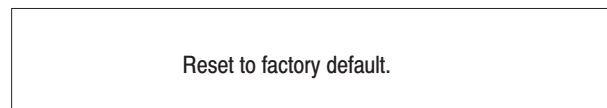

Answer **Cancel** or **O.K.** When you select **O.K.**, the instrument is reset to its factory settings and the **SETUP** menu is displayed. Resetting the instrument to factory default settings will not affect the data stored in the internal memory and the non-volatile RAM (**NVRam**). The factory settings are listed in Appendix F.

Deleting Data From Memory. Use this item to delete the data stored in the internal memory and the non-volatile RAM (**NVRam**). This will also cause all values

with the exception of **Date Time** (date and time) to be restored to their default settings. Default settings consist of the factory settings and the following items:

Remote Port	GPIB
GPIB Operating Mode	Talk/Listen
GPIB Address	1
RS-232-C Parameters	
Baudrate	9600
Data Bits	8
Parity	None
Stop Bits	1
Flagging	None



CAUTION. *Once deleted, data cannot be restored.*

1. Select **Misc** from the bottom menu.
2. Select **Config...** from the side menu.
3. Select **Secure Erase Memory** from the sub-menu.
4. The following message will appear, asking you to confirm that you really want to delete the data from memory:

Initializes both catalog memory and NVRam
then puts all setups in the factory defaults.

Answer **Cancel** or **O.K.** If you select **O.K.**, all data will be deleted from memory and settings will be restored to factory defaults, and then the **SETUP** menu will appear.

Remote Port Settings. The instrument's rear panel has two remote control interface ports: **IEEE STD 488** (GPIB) and **RS-232-C**. (Note: There is no **RS-232-C** port when Option 03 or Option 04 has been installed.) Select the desired port, depending on which interface you will be using.

1. Select **Misc** from the bottom menu.
2. Select **Config...** from the side menu.
3. Press the **Remote Port** button in the sub-menu and select either **GPIB** or **RS232C**. The remote interface port that you have selected will be displayed on the left side of the status line at the top of the screen.

Settings for Hard Copy Output

When you output a hard copy, you can choose to either save the data displayed on the screen on a floppy disk as a file, or output the data through the **IEEE STD 488** (GPIB) or **RS-232-C** interface.

When you select **Hardcopy...** from the side menu, you can select the format for the hard copy and the output port. The following diagram shows the menu configuration for the **Hardcopy...** menu item.

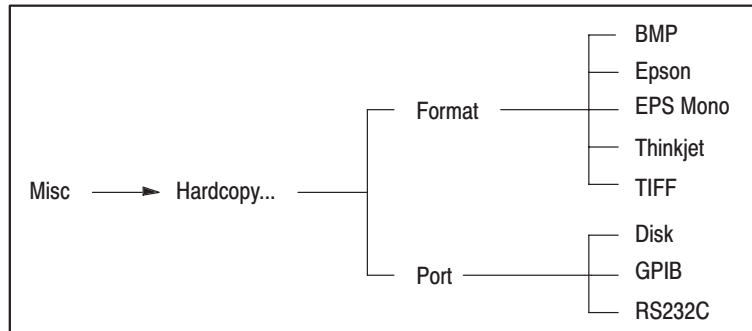

Selecting the Format. Use this item to select the output format for the hard copy. You may select any one of five formats: **BMP**, **Epson**, **EPS Mono**, **Thinkjet** or **TIFF**.

Format	
BMP	: Windows image file format
Epson	: ESC/P 9 & 24 pin dot matrix printer
EPS Mono	: Encapsulated Postscript mono image
Thinkjet	: Ink jet printer
TIFF	: Tag Image File Format

Figure 3 -193: Format Selection Menu

Table 3-23 shows the extension for each format and gives a brief description of that format.

Table 3-23: Format Extensions

Format	Extension	Explanation
BMP	BPM	A format for a Windows black & white image file
Epson	ESC	A format for output to a 9-pin or 24-pin dot matrix printer in ESC/P graphic mode.
EPS Mono	EPS	Encapsulated Postscript format for black & white image files.

Table 3-23: Format Extensions (Cont.)

Format	Extension	Explanation
Thinkjet	TJ	A format used for output to HP (Hewlett Packard) inkjet printers.
TIFF	TIF	TIFF format

Selecting the Port. Use this item to select the port from which the hard copy will be output. Three choices are available: **Disk**, **GPIB** and **RS232C**.

**Figure 3 -194: Port Selection Menu**

In this example, you will print a hard copy of the **SETUP** menu in **TIFF** format from the **Disk** port.

1. Select **Misc** from the bottom menu.
2. Select **Hardcopy...** from the side menu.
3. Select **Format** from the sub-menu.
4. Use the general purpose knob to select **TIFF** format.
5. Select **Port** from the sub-menu.
6. Use the general purpose knob to select **Disc**.
7. Select **Go Back** from the sub-menu.
8. Insert a formatted disk into the disk drive of the instrument.
9. Display the **SETUP** menu on the screen.
10. Press the **HARDCOPY** button on the front panel. A hard copy of the screen will be printed. The following message will appear in the message area:

Hardcopy in progress.

If you want to stop printing the hard copy in mid-process, press the **HARDCOPY** button again.

When the hard copy has been printed, the following message will appear:

Saved in SETUP000.TIF.

This means that the hard copy has been saved to the floppy disk in TIFF format under the file name **SETUP000**.

File names and extensions will be assigned automatically based on the menu and the format of the hard copy.

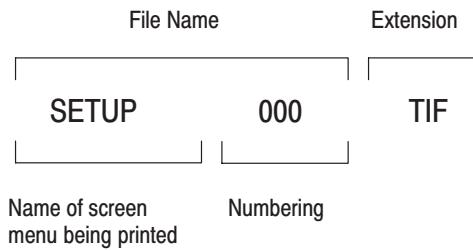

The file name is given the name of the screen menu being printed, as shown below.

Menu	File Name
SETUP	SETUP
MODE	MODE_
EDIT	EDIT_
LOAD/SAVE	LOAD_
UTILITY	UTIL_
F.G	FG__

Numbers will range from 0 to 999 for each menu.

Status Display

The following diagram shows the menu configuration for the **Status...** item.

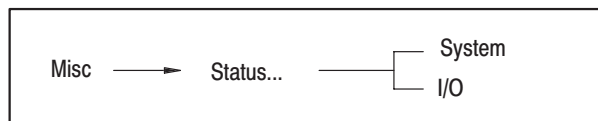

System and GPIB/RS-232-C Status. Select **System** to display system and GPIB/RS-232-C status window. The system status comprises the instrument name, firmware version number, and installation data for each board.

The GPIB status is the address, and configuration. Status items other than the address and configuration are set by the remote controller.

The GPIB/RS-232-C status display consists of the following items: **PSC**, **Header**, **Verbose**, **Data** and **Debug**.

In addition, the cumulative power-on time (**Up Time**) is displayed.

1. Select **Misc** from the bottom menu.
2. Select **Status...** from the side menu.
3. Select **System** from the sub-menu. System and GPIB/RS-232-C status data will be displayed, as shown in Figure 3 -195.

Model	AWG2021		
Version	FV:1.00		
CPU Board	SRAM	512K Bytes,	DRAM 4M Bytes
FPP Board	Not installed		
Clock Board	Installed [Synthesizer]		
CH1	Installed [Analog Output]		
CH2	Not installed		
GPIB/RS232C			
Address	1		
Configuration	Talk/Listen		
PSC	1		
Header	1		
Verbose	1		
Data	Source	"CH1"	
	Destination	"GPIB.WFM"	
	Encdg	Rpbinary	
	Width	2	
Debug	Snoop	0,	Delay 0.2 s
Up Time	5.779 hours		

Figure 3 -195: Menu Displayed When System is Selected

I/O Event Reporting. Use this item to display event reporting for the GPIB or RS-232-C interface. See the programmer manual for more information on event reporting.

1. Select **Misc** from the bottom menu.
2. Select **Status...** from the side menu.
3. Select **I/O** from the sub-menu. Event reporting will be displayed, as shown in Figure 3 -196.

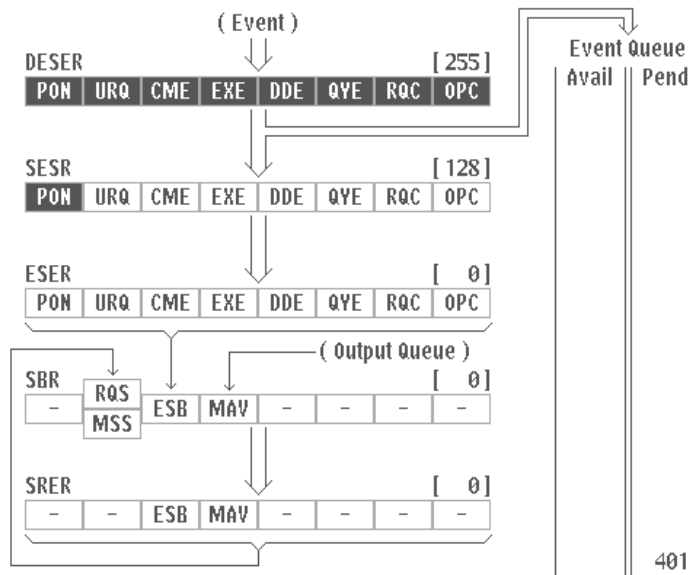

Figure 3 -196: I/O Event Reporting

Diagnostics and Calibrations

Use this item to run the diagnostics function or to calibrate the instrument.

Diagnostics. This instrument is equipped with diagnostics functions to comprehensively test itself. This makes it possible to check whether the instrument is operating correctly. A series of tests are automatically carried out when the instrument is started. These same diagnostics tests can also be initiated by selecting the **Diagnostics** item. These diagnostics are helpful when repairing this instrument. When the **Diagnostics** item is selected, the list of diagnostics items shown in Figure 3 -197 will appear.

Diagnostics	Result	Code
* Cpu	Pass	
* Clock	Pass	
* Display	Pass	
FPP	----	
* FrontPanel	Pass	
* Trigger	Pass	
* Setup CH1	Pass	
Setup CH2	----	
* Waveform Memory CH1	Pass	
Waveform Memory CH2	----	

Figure 3 -197: Diagnostics List

At the top of the diagnostics menu are three columns giving the status of the diagnostic tests. The meaning of these three columns is as follows.

Diagnostics This column gives the name of the diagnostic test item. The diagnostics items are executed individually or all together.

FPP is valid if Option 09 is installed. **Setup CH2** and **Waveform Memory CH2** are valid if Option 02 is installed.

Result This column gives the results of each test item. If no error is found in a test item, **Pass** is displayed. If an error is found, **Fail** is displayed. If Option 02 or Option 09 is not installed, the corresponding diagnostic items are not displayed and only “—” is displayed in their place.

NOTE. *The waveform outputs obtained with an instrument that has not passed all its tests are not reliable.*

Code This column indicates an error code for the item where the error was detected.

NOTE. *If an error occurs, contact our representative closest to you.*

1. Select **Diag/Cal** from the bottom menu.
2. Select **Diagnostics** from the side menu.
3. Turn the general purpose knob to select the desired diagnostic item. To execute all the tests one after another, select **All**.

2. Select **Calibrations** from the side menu.
3. Turn the general purpose knob to select the desired calibration. To execute all the calibrations one after another, select **All**.
4. Select **Execute** from the side menu. The selected calibration item is carried out.

If the calibration finishes without a problem, **Pass** is displayed on the **Result** column. If an error occurs, **Fail** is displayed. If the instrument fails a calibration, an error code is displayed in the **Code** column.

NOTE. *If an error occurs, contact our representative closest to you.*

Pattern Display (For Instrument Adjustment). This item is used when adjusting the instrument. As it is not used for operation, a description is omitted here.

Function Waveform Generator Mode

General Description

Press the front panel **F.G** button to switch from arbitrary waveform generation mode into function waveform generation (**FG**) mode. Select the desired waveform with the bottom button. Then set the output parameters with the side button. Hereafter, function waveform generator mode will be referred to as **FG** mode.

NOTE. *FG mode is an independent of the MENU column arbitrary waveform generation mode menus. Therefore, the output parameters set with the SETUP menu and the operation mode set with the MODE menu have no effect in FG mode.*

The following waveforms may be selected from the bottom menu:

- Sine wave
- Triangle wave
- Square wave
- Ramp wave
- Pulse wave

The following output parameters for these waveforms may be set from the side menu:

- Frequency
- Amplitude
- Offset
- Polarity
- Duty (pulse wave only)

When a sine wave is selected, a 20 MHz cut-off filter is inserted. Table 3-24 shows the relationship between the frequency, the data point count, and the marker signal width.

Table 3-24: Number of Data Points for Frequencies and Marker Signal Width

Frequency	Data Points	Marker Signal Width
10.00 Hz ~ 25.00 kHz	10000	200(points)
25.01 kHz ~ 250.0 kHz	1000	20
250.1 kHz ~ 2.500 MHz	100	2

The descriptions in this section are for an instrument with Option 02, CH2 output installed. Instruments without Option 02 have only the CH1 display.

Function Generator Menu Structure

Figure 3 -199 shows the configuration of the menus in **FG** mode:

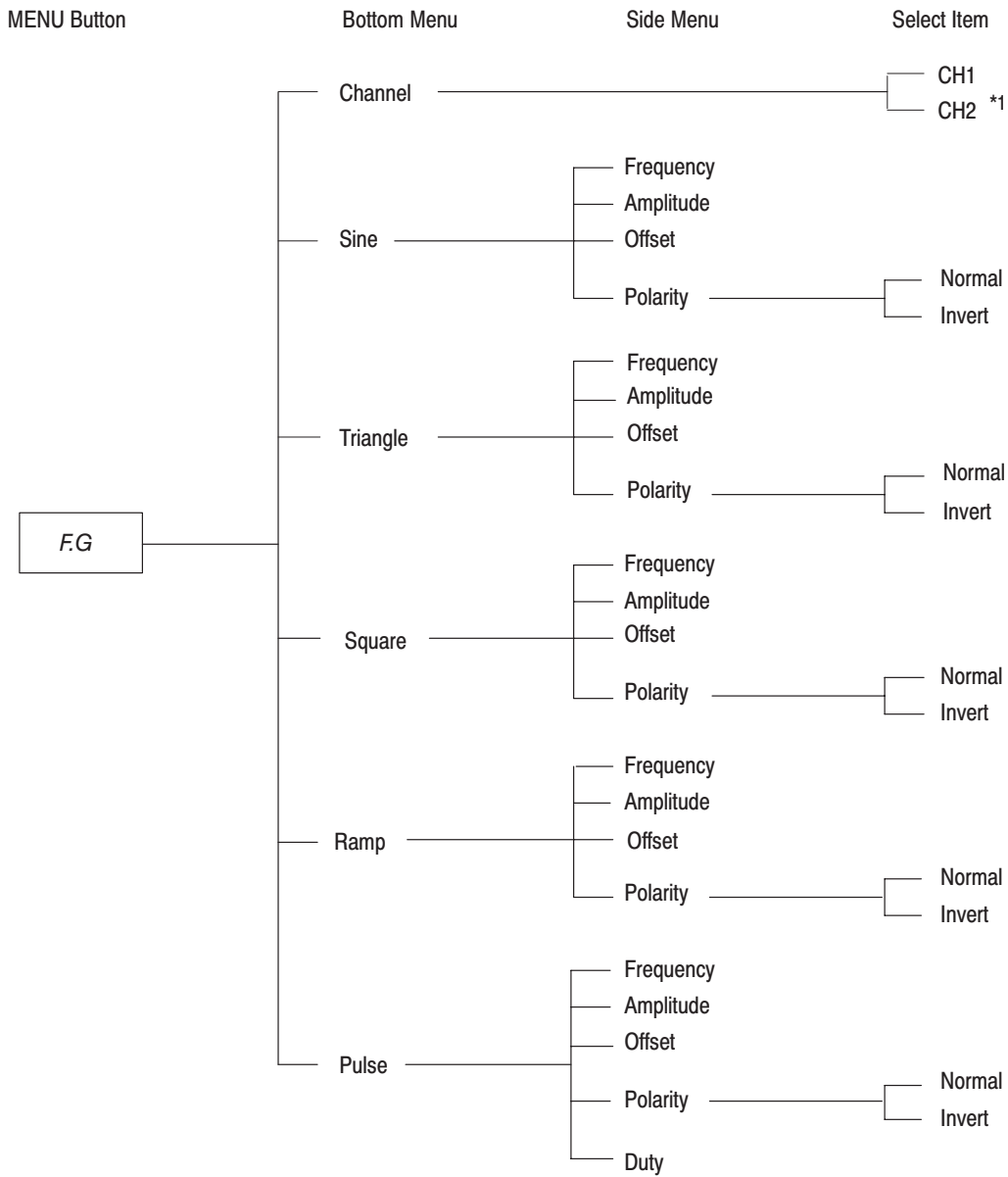

*1 Available when Option 02 has been installed.

Figure 3 -199: FG Mode Menu Structure

Function Generator Menu Display

Figure 3 -200 shows the general display for the **FG** mode menu. A description for each callout follows.

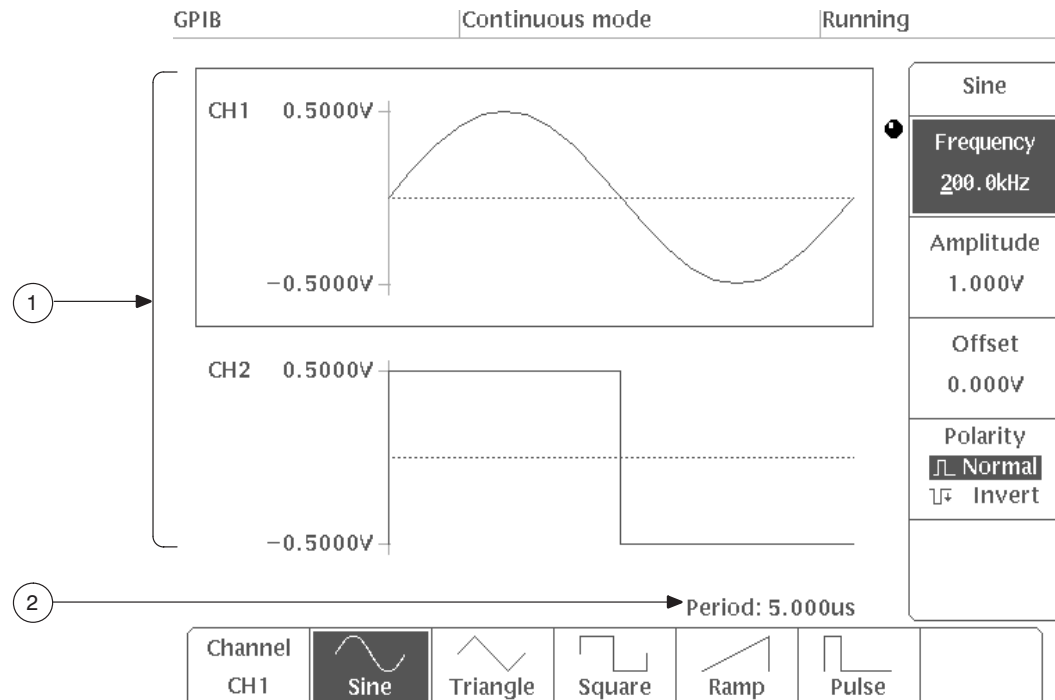

Figure 3 -200: FG Mode Menu Display

(1) Channel waveform display area	Displays the waveform set for that channel. When the channel is enclosed by a box, it is possible to change the output parameters for that waveform. The peak voltage for the waveform is shown on the vertical axis to the left of the waveform; this value is determined by the amplitude or the offset setting. The horizontal axis (the dotted line in the center of the waveform) indicates the zero line; changing the offset will cause the zero line to move up or down.
(2) Waveform period	Shows the period for the waveforms. This value is applied to all waveforms.

Setting the Output Waveform

The following procedure is used to set the output waveform for a channel.

Selecting the Channel

1. Press the “**Channel**” button in the bottom menu and select the channel.

The “**Channel**” item is used to select the channel for which the waveform and its output parameters will be set. The waveform for the selected channel is displayed enclosed in a frame. If the instrument does not have the Option 02, only CH1 is displayed.

Selecting the Waveform

2. Press the bottom button corresponding to the desired type of waveform (**Sine**, **Triangle**, **Square**, **Ramp** or **Pulse**).

Setting the Output Parameters

3. Select the output parameter item from the side menu and enter a value. For details, see “Setting the Output Parameters for the Waveform” on the next page.

Waveform Output

4. Press the On/Off button for the channel to which the waveform is to be output. The selected waveform will be continuously output to that channel.

NOTE. In *FG* mode, the operation mode is always *Cont*, meaning that waveforms are output continuously.

Setting the Output Parameters for the Waveform

The output parameter items are the same for each waveform. However, **Pulse** has one extra side menu item, **Duty**.

NOTE. *Frequency* item is common for all channels. *Amplitude*, *Offset* and *Polarity* items are set separately for each channel.

The following sections will focus on each of the items in the side menu for each waveform type.

Setting the Frequency

The frequency is set with a 4-digit number from 10.00 Hz to 2.500 MHz using the numeric keys or the general purpose knob. Waveform periods(**Period**) are displayed at the bottom of the screen.

Setting the Amplitude

The amplitude can be set in steps of 1 mV within the range 0.050 V – 5.000 V (P-P value), using the numeric keys or the general purpose knob. Figure 3 -201 shows a sine waveform whose amplitude has been set to 5V.

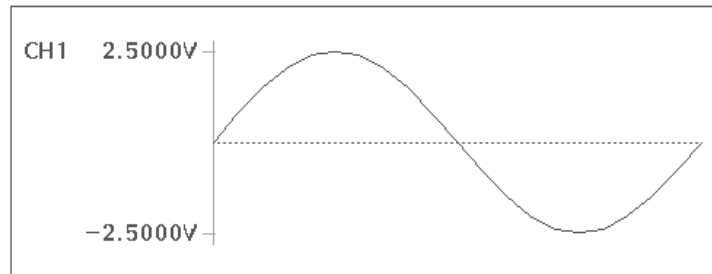

Figure 3 -201: Setting the Amplitude

Setting the Offset

The offset for each waveform can be set in steps of 5 mV within the range ± 2.5 V using the numeric keys or the general purpose knob. Figure 3 -202 shows the waveform used in Figure 3 -201 after an offset of 1 V has been applied. The dotted line in the figure indicates the zero line.

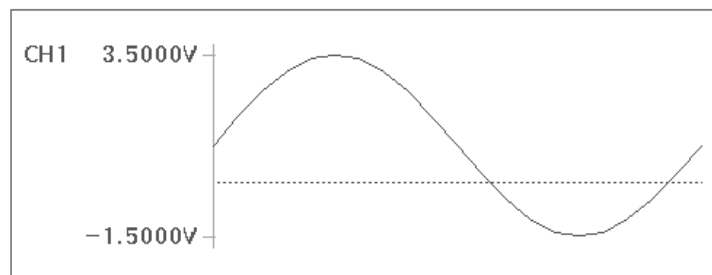

Figure 3 -202: Setting the Offset

Setting the Polarity

This menu item sets the output waveform polarity. Each time the **Polarity** button in the side menu is pressed, the polarity toggles between **Normal** and **Invert** and the polarity of the displayed waveform is reversed. See Figure 3 -203. The figure below at left shows a sine wave whose polarity has been set to “**Normal**,” the figure on the right shows a sine wave whose polarity has been set to “**Invert**.”

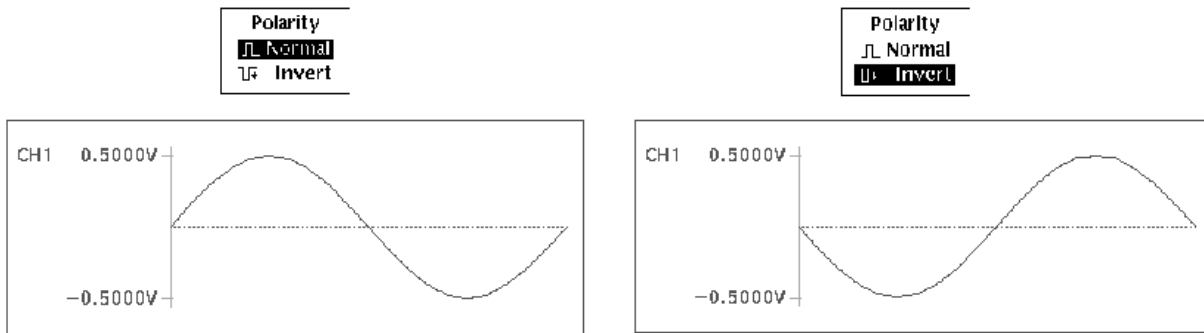

Figure 3 -203: Waveform Polarity

Setting the Duty

Duty is added for the **Pulse** side menu. It allows you to set the duty cycle for pulse waveforms. The duty is set to 0–100% in steps of 1%. **Duty** is set using the numeric keys or the general purpose knob. When the duty is set to 0% or 100%, the wave will be DC. Figure 3 -204 shows a pulse waveform whose duty value has been set to 30%.

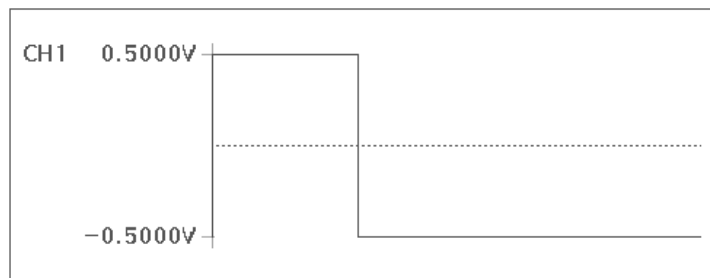

Figure 3 -204: Setting the Duty Value for a Pulse Wave

External Output

The external output signals for FG mode are sync signals and marker signals.

Sync Signal

The sync signal is generated at the end point for the waveform data. In the frequency slower than 250 kHz, the sync signal is generated for every one cycle waveform. In the frequency faster than 250 kHz, the sync signal is generated for every two cycle waveforms. This is because the sync signal is generated for every 200 data points, and 100 data points for the one cycle waveform is not a multiple of 8 as explained at the Data Length in Section 3.

The sync signal is a 1.5 V signal into 50 Ω with a pulse width of 100 ns. These signals are output from the front panel **CH1 SYNC** connector and the rear panel **CH2 SYNC OUT** connector (for Option 02).

Marker Signal

The marker signal is generated at the start point for the waveform data. It is a 2.5 V signal into 50 Ω , whose pulse width varies with the frequency of the output signal (see Table 3-24, earlier in this section). These signals are output from the front panel **CH1 MARKER1** output connector and the rear panel **CH1 MARKER2 OUT** connector. When Option 02, the CH2 option, is installed, the marker signals are output from the rear panel **CH2 MARKER1 OUT** and **CH2 MARKER2 OUT** connectors.

Appendix A: Options and Accessories

This chapter describes the options, and standard and optional accessories available for the AWG2021.

Options

The following options are available.

- Option 02 (2-Channel Output)
- Option 03 (ECL Digital Data Output)
- Option 04 (TTL Digital Data Output)
- Option 09 (FPP Board + FFT Editor/Convolution)
- Option 1R (Rack Mount)
- Option 1S (With WaveWriter S3FT400)
- Option 95 (Certificate With Calibration Data)
- Option B1 (With Service Manual)

Each of these options will be discussed in detail on the following pages.

Option 02 (2-Channel Output)

This option adds second channel. This results in a 2-channel display for **SETUP**, **MODE** and **FG** menus. Also, two additional connectors are added on the rear panel (**CH2 MARKER1 OUT** and **CH2 MARKER2 OUT**). See “Rear Panel” in Section 2 “Overview.”

Option 03 (ECL Digital Data Output)

Option 03 provides the following signals at the rear-panel output connector.

NOTE. An AWG2021 cannot be equipped with Option 03, Option 04 and Option 09 together. Select either Option 03, Option 04 or Option 09.

Data Output. The data (D0–D11) fed to the AWG2021 internal D/A converter is buffered and delivered to the output connector. At the same time that the analog waveform is output, the digital output can be obtained. The output is differential ECL output.

Clock Output. The same clock that is fed to the AWG2021 internal D/A converter is buffered like the data and delivered to the output connector. The clock output is differential ECL output.

Figure A-1 is a block diagram of the digital data output option.

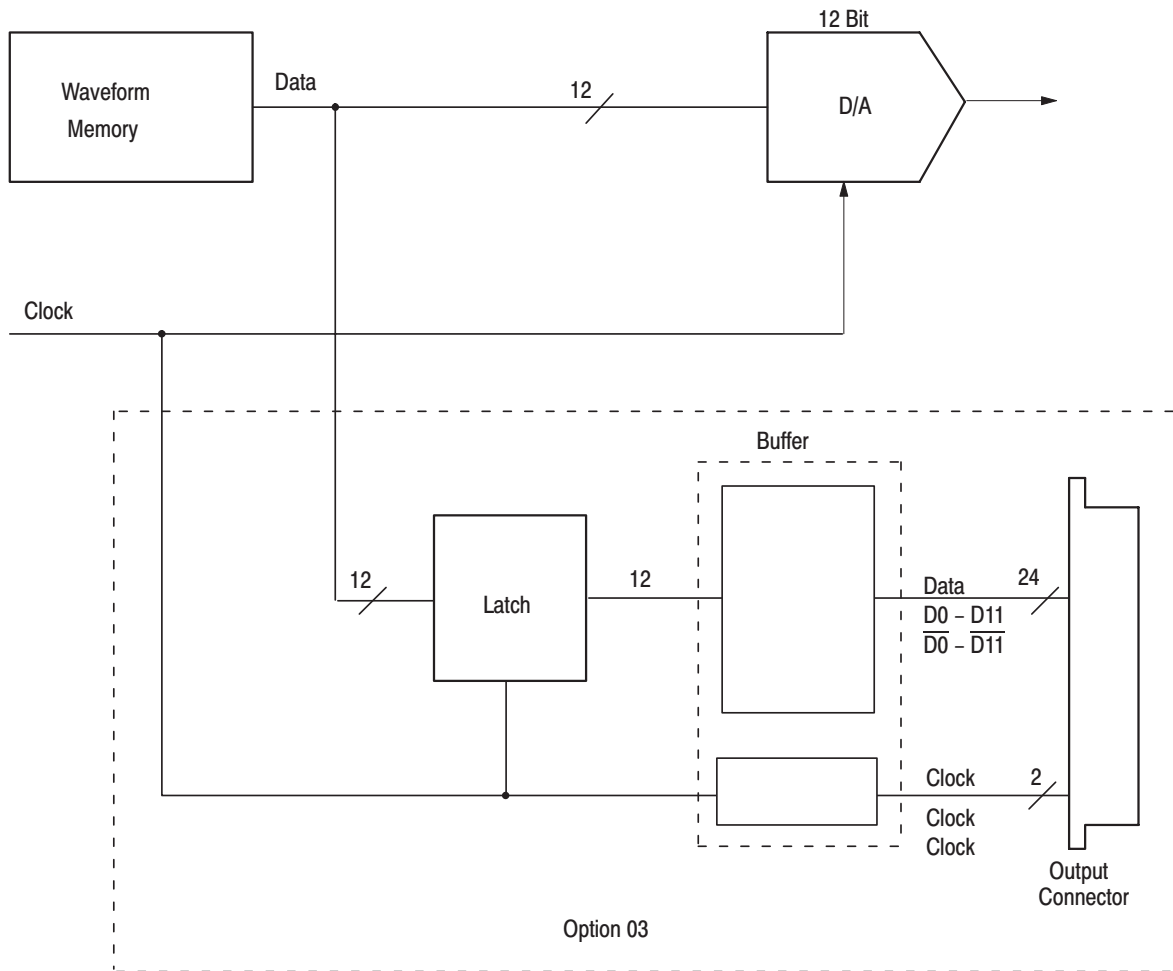

Figure A-1: Block Diagram

Output Connector Configuration. Figure A-2 shows the shape and pin number location of the output connector, and Table A-1 shows the output signal for each pin.

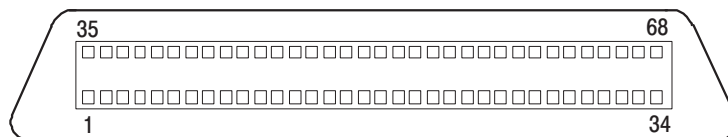

Figure A-2: Output Connector

Table A-1: Output Signal

Pin Number	Signal	Pin Number	Signal
6	$\bar{\text{CLOCK}}$	39	CLOCK
14	$\bar{\text{Data Bit 0}}$	47	Data Bit 0
12	$\bar{\text{Data Bit 1}}$	45	Data Bit 1
10	$\bar{\text{Data Bit 2}}$	43	Data Bit 2
8	$\bar{\text{Data Bit 3}}$	41	Data Bit 3
16	$\bar{\text{Data Bit 4}}$	49	Data Bit 4
20	$\bar{\text{Data Bit 5}}$	53	Data Bit 5
22	$\bar{\text{Data Bit 6}}$	55	Data Bit 6
18	$\bar{\text{Data Bit 7}}$	51	Data Bit 7
30	$\bar{\text{Data Bit 8}}$	63	Data Bit 8
28	$\bar{\text{Data Bit 9}}$	61	Data Bit 9
26	$\bar{\text{Data Bit 10}}$	59	Data Bit 10
24	$\bar{\text{Data Bit 11}}$	57	Data Bit 11

Pins 4, 33, 34, 37, 67, and 68 are not connected.

Pins that are not mentioned are connected to chassis ground.

$\bar{\text{~}}$ = active low signal

Operation. Operation is the same as for the basic instrument. When a waveform is not being output, the waveform's initial data may be output to the connector. At this time, no clock is generated.

When starting the waveform output, the clock is generated and the data is updated.

NOTE. When loading a new waveform into waveform memory, resetting the waveform memory, or during the hold off, excess output can be generated in the data clock (see Figure A-3).

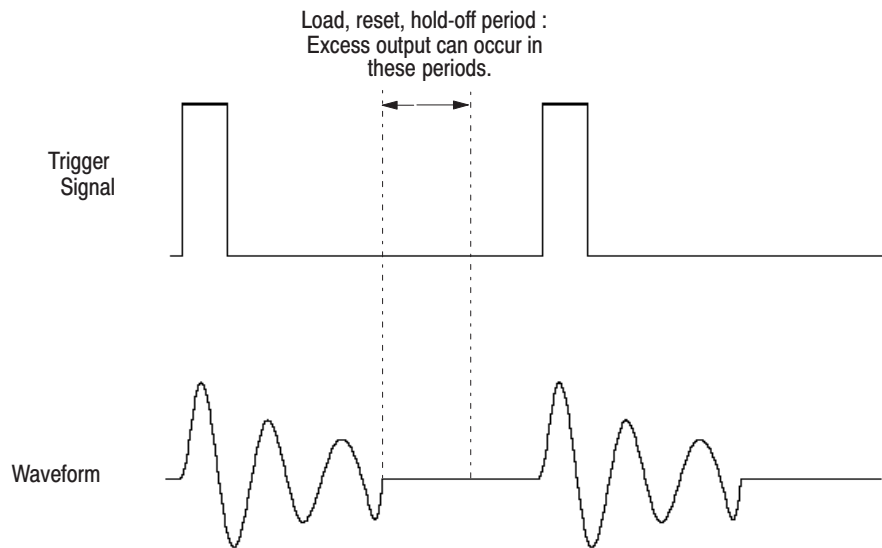

Figure A-3: Generation of Excess Output

Output Circuit and Output Waveform. The ECL buffer (10E116) output is connected directly to the output connector. When used, these signals must be terminated to -2 V with a $50\ \Omega$ resistor at the receiving side (user side). If this termination resistor is missing, the signals do not appear at the output connector. The same is true for the clock output (see Figure A-4).

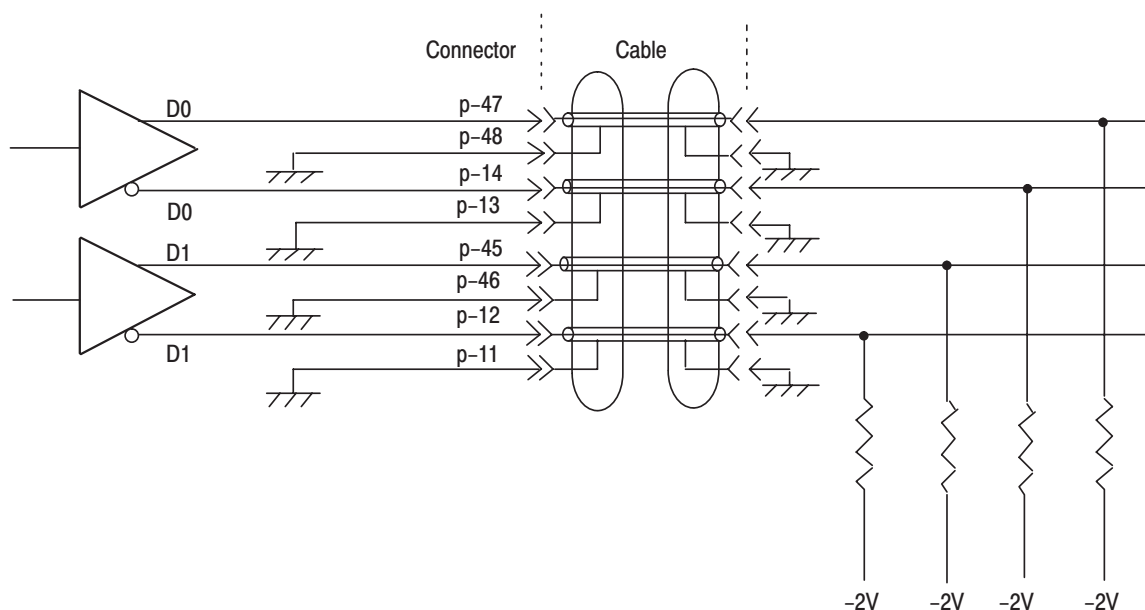

Figure A-4: Output Circuit

The data output signal skew is held to 1 ns max. The rise and fall time depend on the buffer ICs, but neither is greater than 1 ns (see Figure A-5). Neither of these specifications includes cables; it is specified at the output connector.

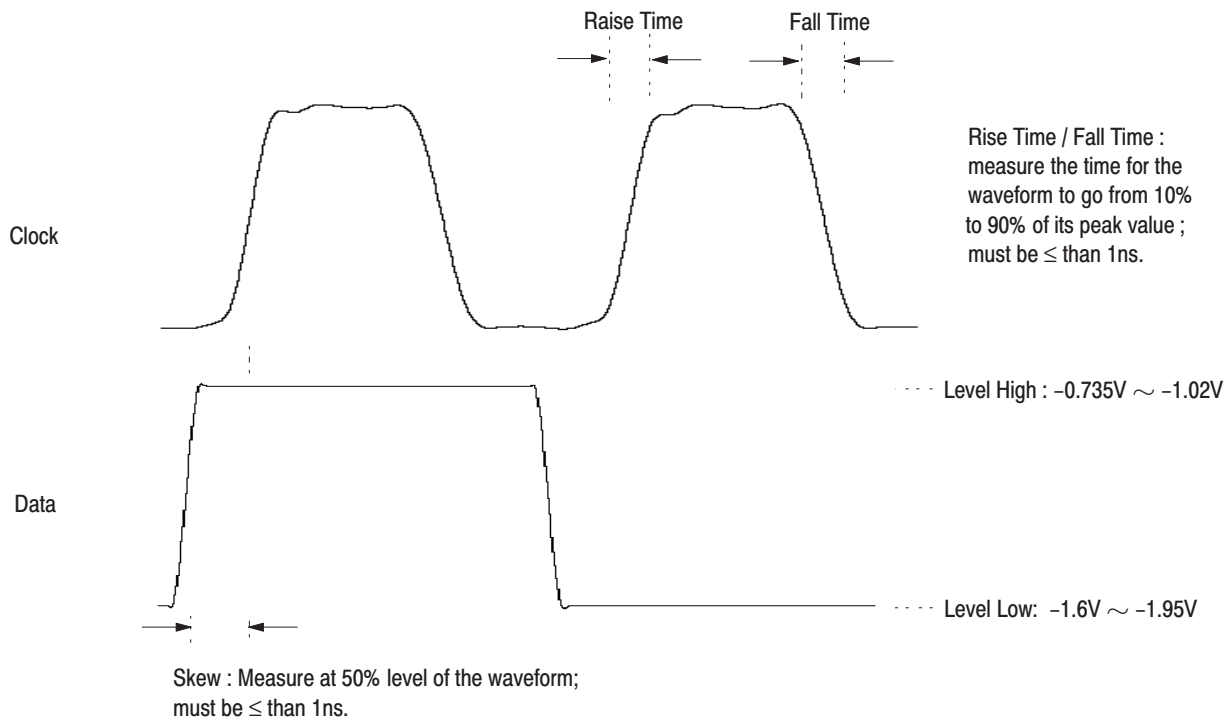

Figure A-5: Output Waveform

If a cable is used, these waveforms have transmission distortion. It is necessary to latch the data with a clock before using the waveform in actual circuits at the cable receiving side (user side) and to reproduce the waveform. Delay the clock with the delay line in order to reproduce the data reliably (see Figure A-6).

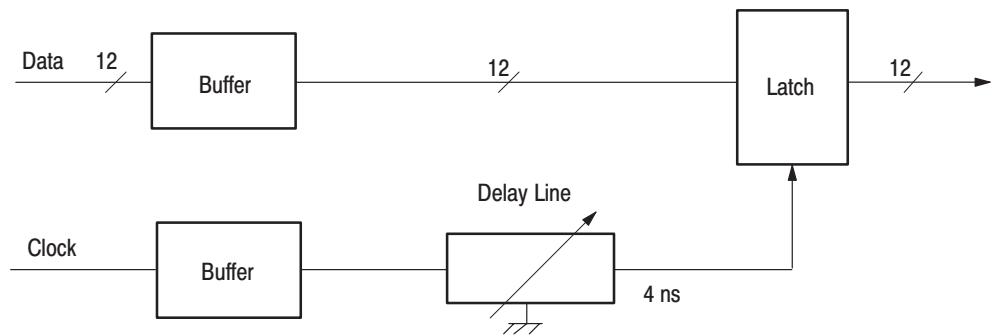

Figure A-6: Data Latching

Cable Application Example. The cable connecting the AWG2021 and the user circuit is extremely critical for reliable operation at the maximum clock frequency.

NOTE. Use a coaxial cable with a characteristic impedance of 50 Ω for all DATA and CLOCK lines.

Keep cables as short as possible. Lengths under 1 meter are desirable.

To minimize signal reflection, carefully process the ends of the cables. Make the section stripped of its outer covering as short as possible and connect the external covering of the cable to the ground for the signals corresponding to each connector. Figure A-7 is the strip length of the coaxial cable.

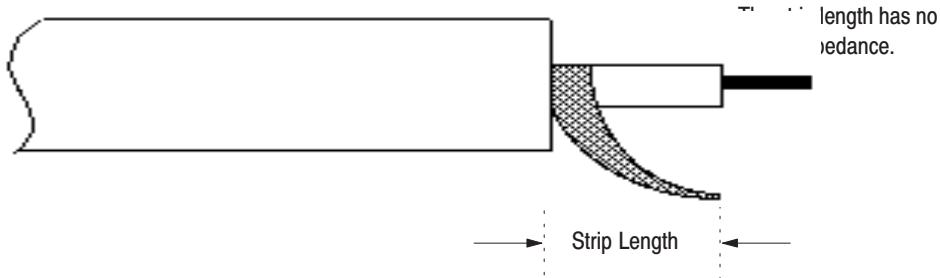

Figure A-7: Coaxial Cable End Processing

A 1-meter long digital data cable (part number 012-1408-00) is supplied with this option as a standard accessory. Figure A-8 shows an example of an optional accessory cable and a receiving connector.

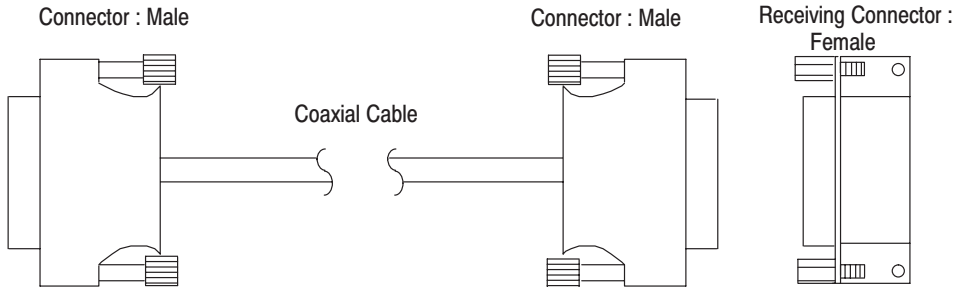

Figure A-8: Cable Examples

Digital Data Latch Example. Figure A-9 shows an example of an external circuit for latching the digital data.

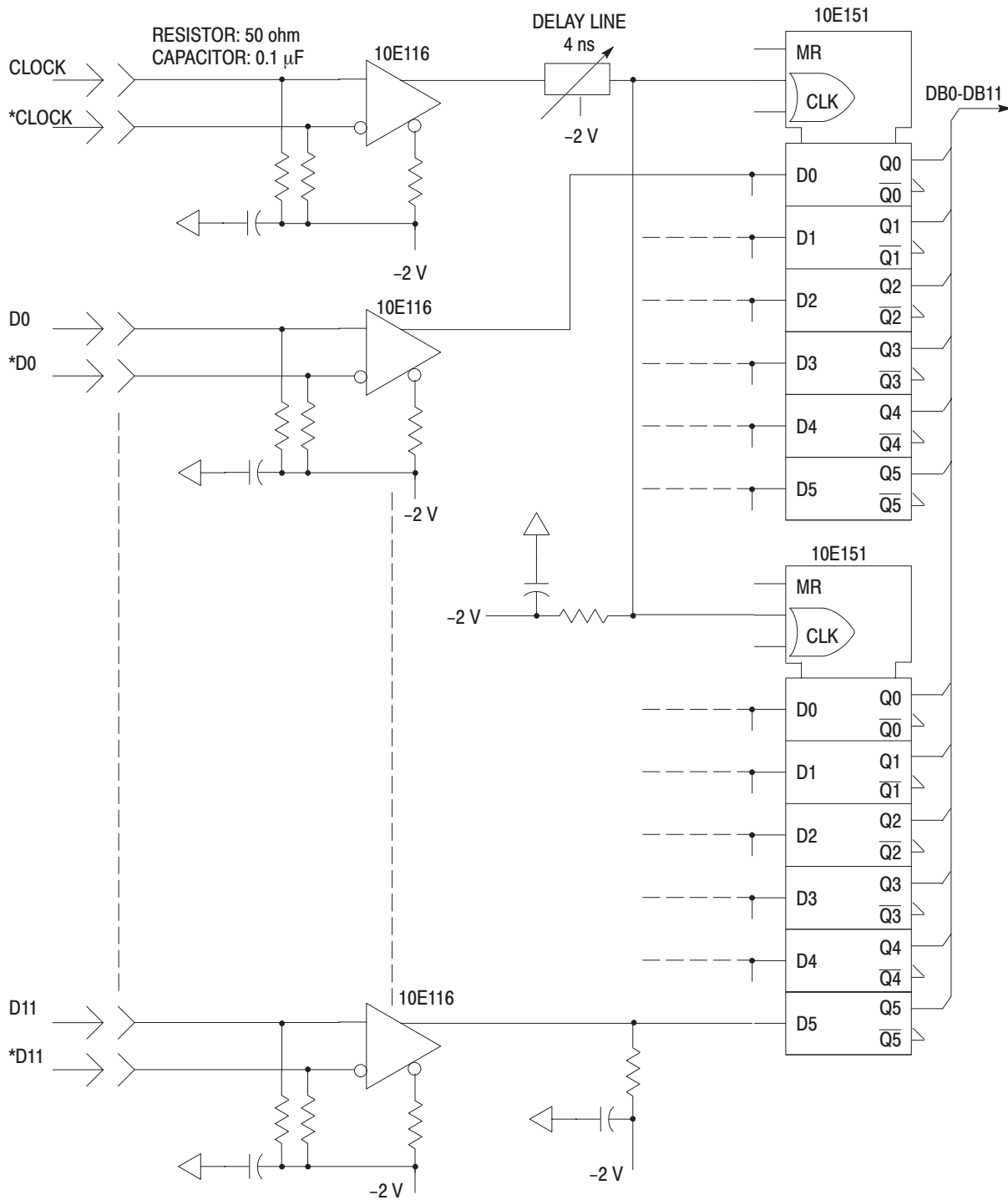

Figure A-9: Waveform Reproduction Circuit Example

NOTE. Tektronix cannot be responsible for the infringement of any third-party industrial proprietary rights, copyrights, or other rights arising from the use of these circuits.

NOTE. The ECB is a multi-layer board. One layer is used as ground, the other as the power supply. The printed circuit pattern uses 50 Ω micro-strip lines and the data lines are wired to the same length so that their delay times will be the same.

Except for the connectors, the parts are all SMD (surface-mounted device) to connect at the minimum distance.

In laying out the runs, the fact that the signals are high frequency was taken into account when leading lines around, etc. For example, the latch IC is right next to the connector to shorten the run from the connector to the IC input. 50 Ω termination resistors are connected to the IC pins. The 50 Ω resistor return is connected through capacitance to the ground for the connector pin input signals.

Option 04 (Digital Data Output)

The AWG2021 arbitrary waveform generator with Option 04 installed can provide the following signals at the rear panel output connector. For the layout of **DIGITAL DATA OUT** connectors on the rear panel, see “Rear Panel” in Section 2 “Overview.”

NOTE. An AWG2021 cannot be equipped with Option 03, Option 04 and Option 09 together. Select either Option 03, Option 04 or Option 09.

Data Output. The data (D0–D11) fed to the internal D/A converter is buffered and connected to the output connector. At the same time that the analog waveform is output, the digital output can be obtained. Output will be at the TTL level.

Clock Output. The same clock that is fed to the internal D/A converter is buffered in the same way as the data and connected to the connector. As in the case of data output, clock output will be at the TTL level.

Figure A-10 is a block diagram of the digital data output Option 04.

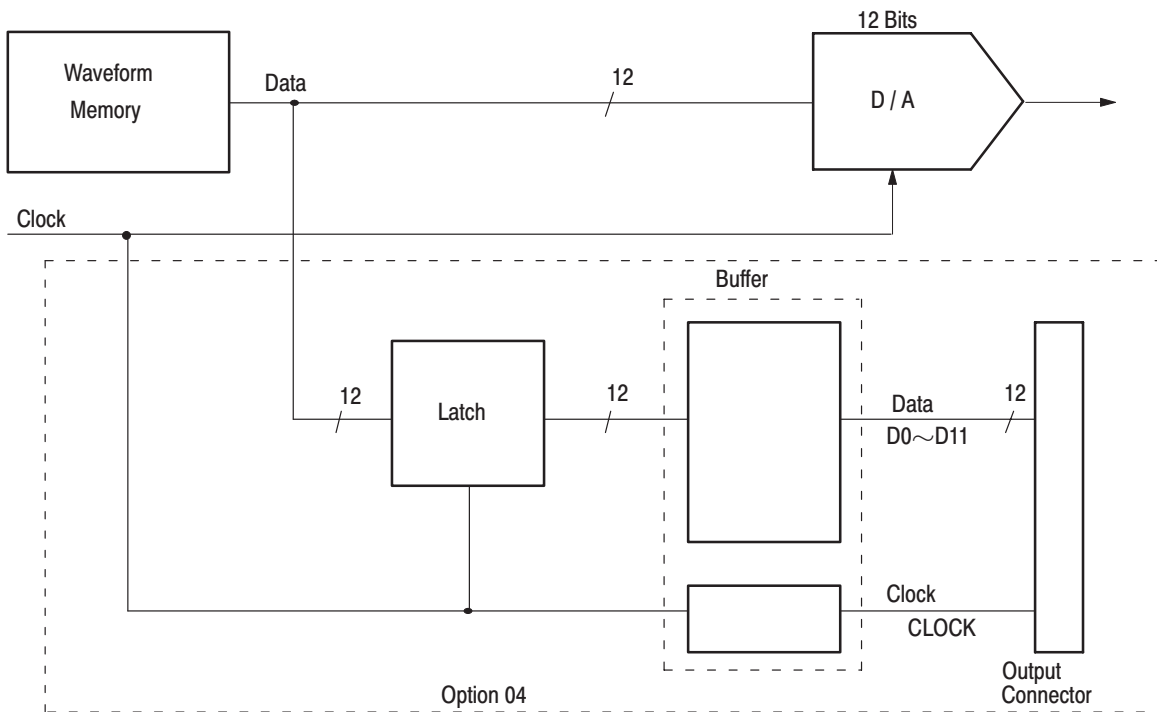

Figure A-10: Block Diagram

Output Connector Configuration. Figure A-11 is the shape and pin number location of the output connector, and Table A-2 is the output signal for each pin.

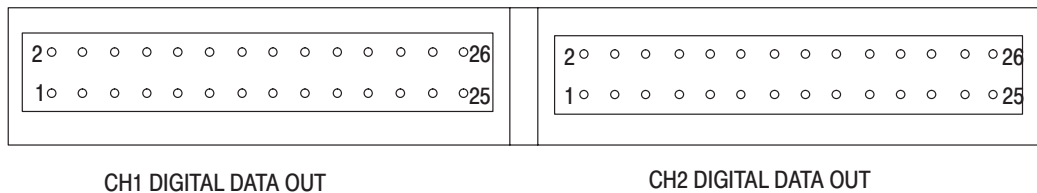

Figure A-11: The Shape of the Output Connector

Table A-2: Connector Pin Assignments

Pin Number	Signal	Pin Number	Signal
1	D0 (LSB)	15	D7
3	D1	17	D8
5	D2	19	D9
7	D3	21	D10

Table A-2: Connector Pin Assignments (Cont.)

Pin Number	Signal	Pin Number	Signal
9	D4	23	D11 (MSB)
11	D5	25	Clock
13	D6		

Pins other than those mentioned are connected to ground. The pin assignments are identical for both CH1 and CH2.

- Operation. Operation is the same as for the basic instrument. When a waveform is not being output, the waveform's initial data may be output to the connector. At this time, no clock is generated.

When starting the waveform output, the clock is generated and the data is updated.

NOTE. When loading a new waveform into waveform memory, resetting the waveform memory, or during the hold off, excess output can be generated in the data clock (see Figure A-12).

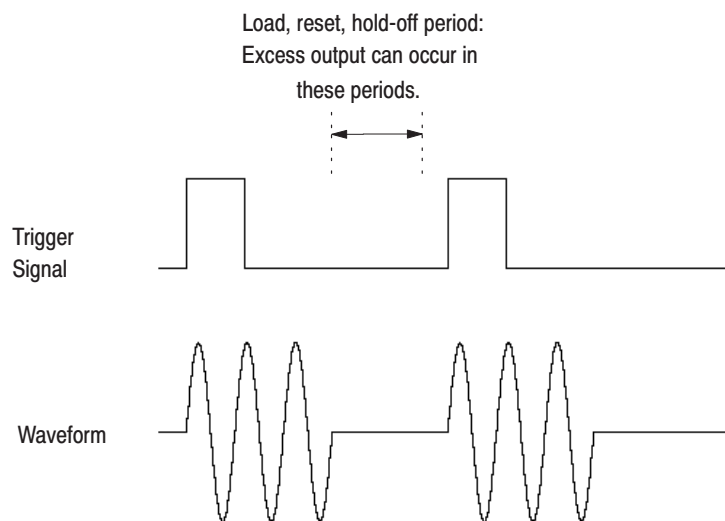
**Figure A-12: Generation of Excess Output**

- Output Circuit and Output Waveform. Figure A-13 shows a diagram of the output circuit. After passing through an output resistance of $50\ \Omega$, the buffer output proceeds to the output connectors. The AWG2021 can be used without terminating the receiving (user) side with a resistance of $50\ \Omega$, but when waveform distortion is great the $50\ \Omega$ termination is required.

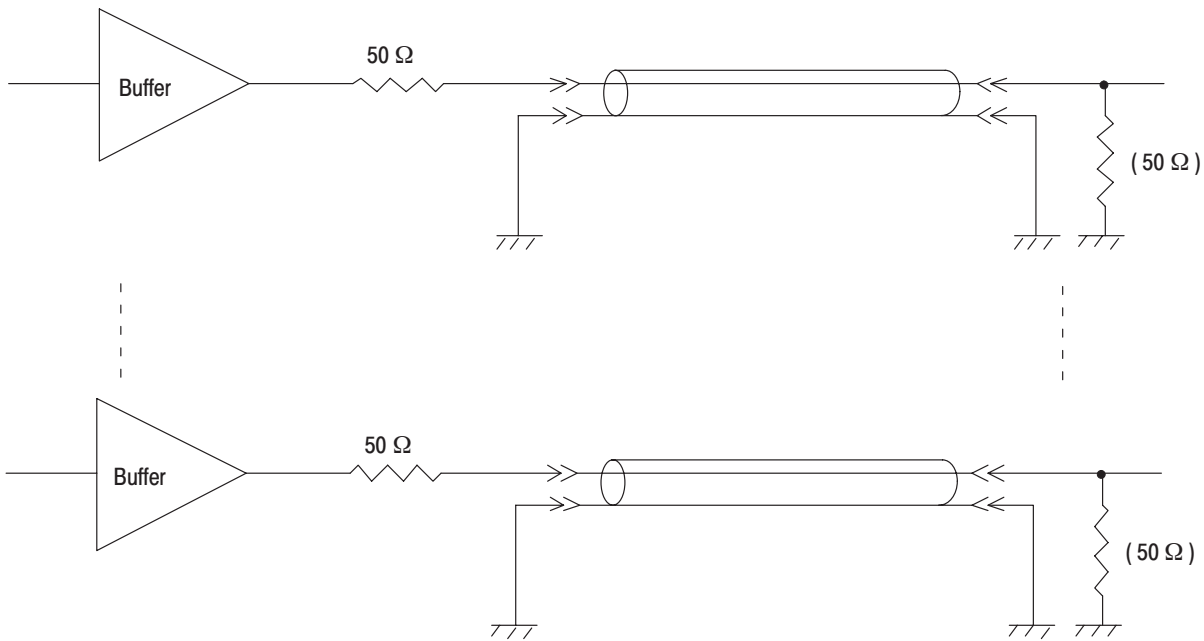

Figure A-13: Output Circuit

The skew of the data output is held to ± 2 ns between same channel, and is held to ± 4 ns between CH1 and CH2. See Figure A-14. This figure shows the specifications for the waveform at the output connector when a cable is not being used.

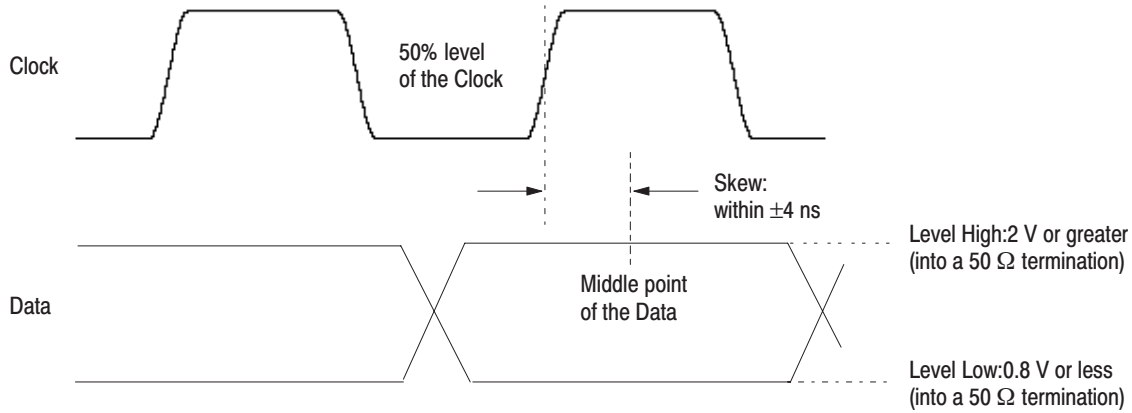

Figure A-14: Output Waveform

If a cable is used, these waveforms have transmission distortion. It is necessary to latch the data with a clock before using the waveform in actual circuits at the cable receiving side (user side) and to reproduce the waveform. Delay the clock with the delay line in order to reproduce the data reliably (see Figure A-15).

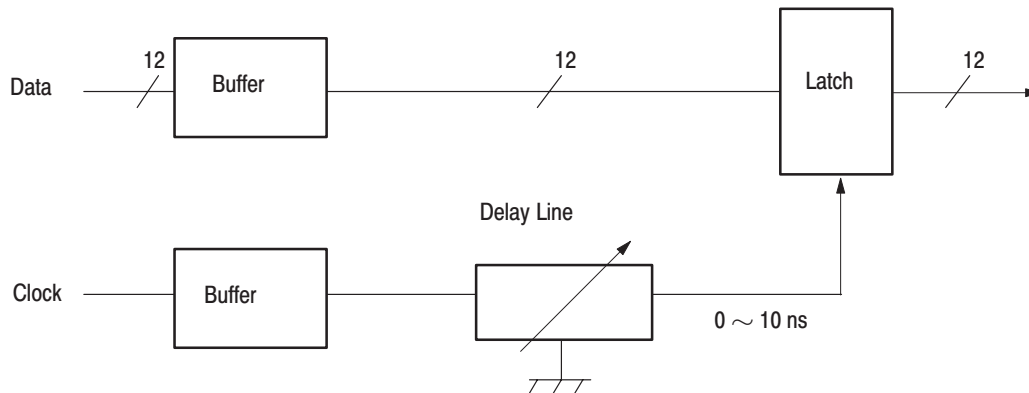

Figure A-15: Data Latching

Cable Application Example. The cable connecting the AWG2021 and the user circuit is extremely critical for reliable operation at the maximum clock frequency.

NOTE. Use a coaxial cable with a characteristic impedance of 50Ω for all DATA and CLOCK lines.

Keep cables as short as possible. Lengths under 1-meter are desirable.

The AWG2021 for Option 04 comes with two digital data out cables as a standard accessory. The cable is 1-meter long and is illustrated in Figure A-16. The part number for the cable is 174-3192-00.

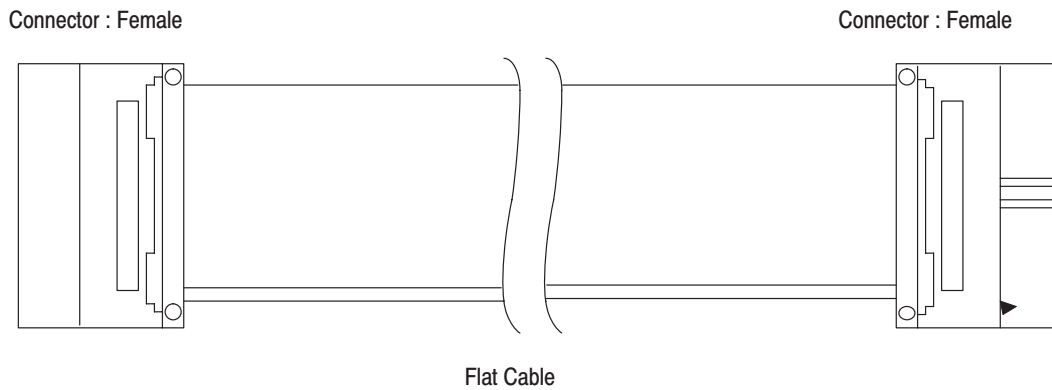

Figure A-16: Digital Data Out Cable

Waveform Regeneration. In some cases, even a cable that has been carefully made will create transmission distortion. Figure A-17 shows a concrete example of a circuit used to regenerate the waveform.

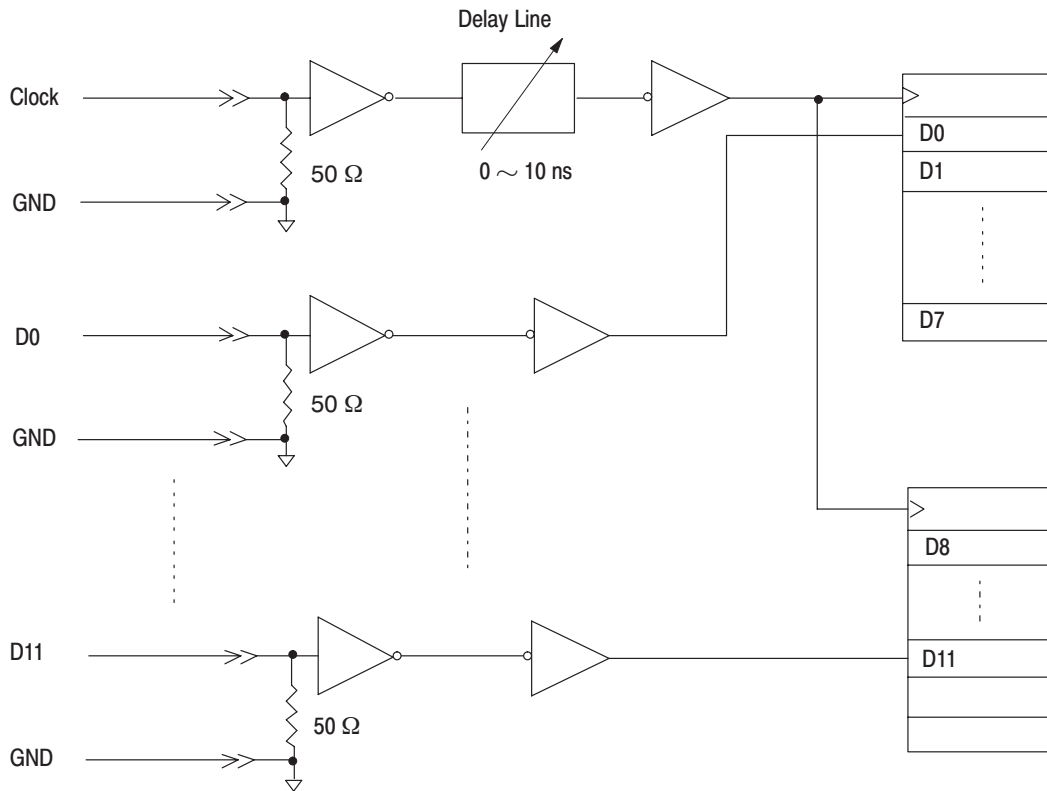

Figure A-17: Waveform Reproduction Circuit Example

NOTE. Tektronix cannot be responsible for the infringement of any third-party industrial proprietary rights, copyrights, or other rights arising from the use of these circuits.

NOTE. The ECB is a multi-layer board. One layer is used as ground and the other as the power supply. The data lines are wired to the same length so that their delay times will be the same.

Option 09 (FFT Editor and Convolution Process)

This option provides increased internal calculation speed and two additional editors: an FFT editor and a convolution editor. See Section 3 for more information on the FFT and convolution waveform editors.

Option 1R (Rack Mount)

The AWG2021 is shipped mounted in a 19-inch wide rack. In this configuration, the floppy disk drive is accessed from the front panel. To change an AWG2021 into a rackmounted version, contact Tektronix for information.

For further information regarding the rack-mount adapter, see the instruction sheet that comes with the rack-mount kit.

Option 1S (WaveWriter S3FT400)

WaveWriter is an application program used to create waveforms for advanced signal generating and processing instruments. Many Tektronix instruments, such as arbitrary waveform generators and oscilloscopes with the “save-on-delta” feature, are enhanced by this program. WaveWriter helps users configure waveforms with a minimum of effort.

With the WaveWriter package, you can create new waveforms or edit waveforms acquired from various instrument sources. WaveWriter gives you interactive control of the waveform generating process. WaveWriter operates within the Microsoft Windows™ environment.

Option 95 (Certificate With Calibration Data)

A test result report will be provided with the AWG2005 when this option is specified.

Option B1

(service manual)

Power Cord Options

The following power cords are available with this instrument.

Table A-3: Power Cord Options

Option	Description	Part Number
A1	Europe, 220V/6A	161-0104-06
A2	United Kingdom, 240V/6A	161-0104-07
A3	Australia, 240V/6A	161-0104-05
A4	North America, 240V/6A	161-0104-08
A5	Switzerland, 220V/6A	161-0167-00

Accessories

Standard Accessories

The AWG2021 includes the following standard accessories:

Standard Accessory	Part Number
Manuals	
User Manual	070-9097-50
Programmer Manual	070-8657-XX
Floppy disk	
Sample Waveform Library Disk, 3.5-inch	063-2169-XX
Sample program, 3.5-inch	063-1708-XX
Performance Check / Adjustment Disk, 3.5-inch	063-2171-XX
Power cord 125V/6A	161-0230-01
Certificate of Calibration	
ECL Digital Data Out Cable (Option 03)	012-1408-XX
TTL Digital Data Out Cable (Option 04)	174-3192-XX

Optional Accessories

The following optional accessories are recommended for use with the instrument.

Optional Accessory	Part Number
Service Manual	070-9098-50
Front Cover	200-3232-XX
Accessory Pouch	016-1159-XX
Fuse 6A Fast (UL198G/3AG)	159-0239-XX
Fuse cap	200-2264-XX
Fuse 5A (T) (IEC127)	159-0210-XX
Fuse cap	200-2265-XX
GPIB Cable	012-0991-XX
ECL Digital Data Out Cable	012-1408-XX
50 Ω BNC Cable	012-1342-XX
50 Ω BNC Cable, double shielded	012-1256-XX
SMA (Ma) - BNC (Fe) Adapter	015-0554-XX
50 Ω BNC Terminator	011-0049-XX
Terminal Board (Option 03)	671-2957-XX

Appendix B: Performance Characteristics

The performance characteristics on the AWG2021 can be divided into three categories:

- **Nominal Traits.** General characteristics are described not by equipment performance and limits but by such things as memory capacity.
- **Warranted Characteristics.** Warranted characteristics are described in terms of quantifiable performance limits which are guaranteed.
- **Typical Characteristics.** Typical characteristics are described in terms of typical or average performance for the AWG2021. The characteristics described herein are not absolutely guaranteed.

Items marked with ** are tested in the Performance Verification (Appendix C)

Nominal Traits

This section will describe general characteristics of the AWG2021. These can be divided into two main categories: electrical characteristics and mechanical characteristics.

Table B-1: Electrical Characteristics

Characteristics	Description
Operating Modes	
Continuous	Generates the waveform continuously.
Triggered	Output quiescent until triggered by an external, GPIB or manual trigger; then generates a waveform or sequence only one time.
Gated	Same as triggered mode except periods are output for the duration of the gated signal.
Burst	Output quiescent until triggered by an external, GPIB or manual trigger; then generates a waveform or sequence predefined count.
Waveform Advance	Continuously generates the waveform in the predefined (edited) sequence and the next trigger advances the waveform.
Autostep	Outputs the first waveform in the predefined Autostep File once. The next trigger advances to output the next waveform once and so on, for each successive trigger.

Table B-1: Electrical Characteristics (Cont.)

Characteristics	Description
Arbitrary Waveforms	
Waveform Memory	
Memory Length	
Waveform	256K × 12 bits
Marker1	256K × 1 bit
Marker2	256K × 1 bit
Waveform	64 to 256K in multiple of 8 data points
Sequence Memory	8K, 32 bits/word
Scan Counter	1 to 64 K (16 bits)
Burst Counter	1 to 64 K (16 bits)
Clock Generator	
Frequency Range	10 Hz to 250 MHz
Display	4 digits
Resolution	0.1% ~ 0.01%
Reference Oscillator	
Type	TCXO
Nominal Frequency	12.8 MHz
Filter	
Characteristics	Bessel
Main Output	
Amplitude	Except multiply(AM) and add(Add) operation
Range	0.05 to 5 V _{p-p} into 50 Ω The amplitude range expands about 2 times (10 V _{p-p}) into open circuit. Its actual value is two times the displayed value. ±10 V ≥ (The absolute peak Amplitude + Offset)
Resolution	1 mV
Offset	
Range	±2.5 V into 50 Ω The offset range expands about 2 times (-5 V ~ +5 V) into open circuit. Its actual value is two times the displayed value. ±10 V ≥ (The absolute peak Amplitude + Offset) -100 mA ~ +100 mA into 50 Ω (current source output)
Resolution	5 mV
Impedance	50 Ω

Table B-1: Electrical Characteristics (Cont.)

Characteristics	Description
Auxiliary Output	
SYNC	When in F.G mode and the frequency is above 250 kHz, the Sync pulse occurs one time per two waveforms.
Amplitude	>1.2 V into 50 Ω , >2.4 V into open circuit
Impedance	50 Ω
MARKER1	
Amplitude	2.5 V (+5%, -10%) into 50 Ω , 5 V (+5%, -10%) into open circuit
Impedance	50 Ω
Period Jitter	Refer to Table B-1-1 (measured by TDS694C-1MHD with TDSJIT1)
Cycle to Cycle Jitter	Refer to Table B-1-2 (measured by TDS694C-1MHD with TDSJIT1)
MARKER2	
Amplitude	2.5 V (+5%, -10%) into 50 Ω , 5 V (+5%, -10%) into open circuit
Impedance	50 Ω
CLOCK	
Amplitude	1 V into 50 Ω
Impedance	50 Ω
Period Jitter	Refer to Table B-1-3 (measured by TDS694C-1MHD with TDSJIT1)
Cycle to Cycle Jitter	Refer to Table B-1-4 (measured by TDS694C-1MHD with TDSJIT1)
ECL DIGITAL DATA OUT (Option 03)	
Level	ECL compatible
Output Signals	Same wires to DAC Data (D0 ~ D11) Clock
TTL DIGITAL DATA OUT (Option 04)	
Output Signals	
CH1	Data (D0 ~ D11), Clock
CH2 (Option 02)	Data (D0 ~ D11), Clock
Amplitude	>2 V into 50 Ω
Impedance	50 Ω
Connector	26-pin header
Auxiliary Input	
Trigger	
Threshold Level	-5 V to 5V
Resolution	0.1 V
Impedance	1 M Ω with 30 pF (max) or 50 Ω

Table B-1: Electrical Characteristics (Cont.)

Characteristics	Description
AM	
Range	2 V _{p-p} (-1V ~ 1V) for 100% modulation
Impedance	10 kΩ
Clock	
Impedance	50 Ω
Function Generator	
Waveform Shape	Sine, Triangle, Square, Ramp, Pulse
Output Parameter	All of these values with the exception of frequency can be set independently for each channel. Frequency settings apply to each channel.
Frequency	1.000 Hz to 2.500 MHz
Amplitude	Can be set between 50 mV and 5 V in 1 mV increments
Offset	Can be set between ±2.5 V in 5 mV increments
Polarity	Normal, Invert
Duty	0% to 100% Pulse only. Can be set in 1% increments
Operating Mode	Continuous mode
Auxiliary Output	
Marker Signal	2.5 V into 50 Ω, generated at the starting point of the waveform. The pulse width will vary depending on the frequency.
Display	
CRT	
Display Area	132mm(5.2 inches) horizontally by 99mm(3.9 inches) vertically
Resolution	640 (H) ± 480 (V) pixels
AC Power Source	
AC Line Power	
Fuse Rating	6A fast blow, 250 V, UL198G(3AG) or 5 A (T), 250 V, IEC127
Battery	
Type	Li3 V, 650 mAH

Table B-1-1  Period Jitter (CH1 Marker 1 Out)

Clock=250MS/s		Clock=100MS/s	
StdDev	Pk-Pk	StdDev	Pk-Pk
11.0 ps	60.0 ps	10.5 ps	50.0 ps

Table B-1-2 Cycle to Cycle Jitter (CH1 Marker 1 Out)

Clock=250MS/s		Clock=100MS/s	
StdDev	Pk-Pk	StdDev	Pk-Pk
20.0 ps	110.0 ps	20.0 ps	90.0 ps

Table B-1-3 Period Jitter (Clock Out)

Clock=250MS/s		Clock=100MS/s	
StdDev	Pk-Pk	StdDev	Pk-Pk
11.0 ps	60.0 ps	10.5 ps	50.0 ps

Table B-1-4 Cycle to Cycle Jitter (Clock Out)

Clock=250MS/s		Clock=100MS/s	
StdDev	Pk-Pk	StdDev	Pk-Pk
20.0 ps	110.0 ps	20.0 ps	90.0 ps

Table B-2: Mechanical Characteristics

Characteristics	Description
Net Weight	
Standard	9.7 kg
Size	
Height	163mm (6.4 inches) with feet
Width	363mm (14.3 inches) with handle
Length	490mm (19.3 inches) with front cover 564mm (22.2 inches) with handle extended

Warranted Characteristics

This section will describe the warranted characteristics of the AWG2021. These can be divided into two main categories: electrical characteristics and environmental characteristics.

Performance Conditions

The electrical characteristics are valid under the following conditions:

1. The instrument must have been calibrated at an ambient temperature between +20° C to +30° C.
2. The instrument must be in an environment whose limits are described in Environmental Characteristics.
3. All tolerance limits apply after a 20 minute warm up and an execution of the self calibration.
4. The instrument is operating at an ambient temperature between +10° C to +40° C, unless otherwise noted.

Items marked with ** are tested in the Performance Verification (Appendix C)

Table B-3: Electrical Characteristics

Characteristics	Description
Clock Generator	
** Accuracy	
** +15° C to +30° C	0.005%
+10° C to +40° C	0.01%
Skew between CH1 and CH2	When Option 02 (second channel) installed within 4 ns
Filter	
Cutoff frequency	-3 dB point
1 MHz	within 20%
5 MHz	within 20%
20 MHz	within 20%
50 MHz	within 20%
Main Output	
** Amplitude	
DC Accuracy	
0.05 V ~ 0.5 V	±(0.5% of Amplitude + 5 mV) No Offset, at 1 MHz clock
** 0.501 V ~ 5 V	±(1% of Amplitude + 25 mV) No Offset, at 1 MHz clock

Table B-3: Electrical Characteristics (Cont.)

Characteristics	Description
** Offset	Waveform is 0 VDC and Amplitude range is 0.05 V
** Accuracy	$\pm(1\% \text{ of Offset} + 5 \text{ mV})$
Cross talk between Channels	Option 02, Sine (512 points), 250 MHz Clock, Amplitude 5 V, No Offset, No Filter <-70 dBc
Noise Floor	Waveform is 0 VDC (7FF), Norm, No Filter, No Offset, at 250 MHz Clock
0.1 V	<-140 dBm/Hz (at 10 MHz)
1.0 V	<-130 dBm/Hz (at 10 MHz)
5.0 V	<-120 dBm/Hz (at 10 MHz)
** Pulse Response	
15° C ~ 30° C	
Flatness	within <3% (After 20 ns from rise/fall edges)
Aberration	$\pm(7\% \text{ of amplitude} + 10 \text{ mV})$
10° C ~ 40° C	
** Rise/Fall Time	<4.2 ns
** Flatness	within <5% (After 20 ns from rise/fall edges)
** Aberration	$\pm(9\% \text{ of amplitude} + 10 \text{ mV})$
Sine Wave Characteristics	F.G mode, 100 kHz to 2.5 MHz, No Offset
Flatness	within 4% Amplitude 1 V, 100 kHz reference
T.H.D.	Including up to 4th Harmonics
1 V	<-50 dBc
0.5 V	<-66 dBc
Spurious	Excluding Clock frequency
1 V	<-66 dBc
0.5 V	<-66 dBc
Auxiliary Output	
** SYNC	
** Amplitude	>1.2 V into 50 Ω , >2.4 V into open circuit
Duration	100 ns \pm 20%
Sync to Signal delay	within 15 ns

Table B-3: Electrical Characteristics (Cont.)

Characteristics	Description
** MARKER1	
** Amplitude	2.5 V (+5%, -10%) into 50 Ω, 5 V (+5%, -10%) into open circuit
Rise/Fall time	< 8 ns
Marker to Signal delay	within 15 ns
** MARKER2	
** Amplitude	2.5 V (+5%, -10%) into 50 Ω, 5 V (+5%, -10%) into open circuit
Rise/Fall time	< 8 ns
Marker to Signal delay	within 15 ns
** CLOCK	
** Amplitude	1 V ±0.3 V into 50 Ω
ECL DIGITAL DATA OUT (Option 03)	
Skew between Data	within 1 ns
Clock to Data delay	within 2 ns
** TTL DIGITAL DATA OUT (Option 04)	
** Amplitude	>2 V into 50 Ω
Output Data rate	100 MB/s minimum
Clock to Data delay (see Figure B-1)	within ±4 ns

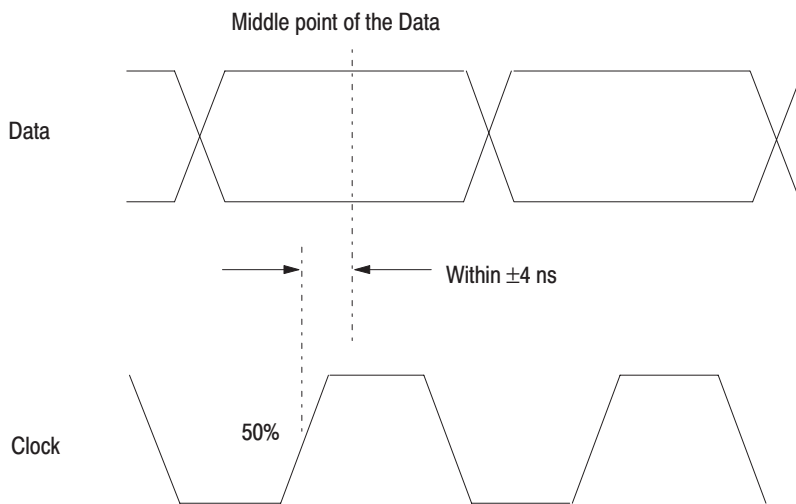

Figure B-1: Timing for the Data and Clock Signals

Table B-3: Electrical Characteristics (Cont.)

Characteristics	Description
Auxiliary Input	
** TRIGGER	
** Accuracy	$\pm(5\% \text{ of Level} + 0.1 \text{ V})$
Pulse Width	15 ns minimum
Input Swing	0.2 V _{p-p} minimum
Maximum Input Volts	10 V _{p-p} when 1 M Ω selected 5 V _{RMS} when 50 Ω selected
Trigger to Signal delay	
Internal Clock	100 ns maximum
External Clock	100 ns maximum + 0.5 Clock + 1 Clock maximum
Trigger Holdoff	1 μ s maximum (Excluding Autostep mode)
AM	
Amplitude Accuracy	within 5%
Maximum Input Volts	$\pm 5 \text{ V}$
** CLOCK	
** Threshold Level	0.5 V
Input Swing	0.8 V _{p-p} minimum
Pulse Width	2 ns minimum
Maximum Input Volts	$\pm 2 \text{ V}$
Frequency Range	250 MHz maximum
AM and ADD	
AM (Multiply)	When Option 02 (second channel) installed
Output	within 5%
	CH2 Signal 5 V 100%
	0 V 0%
	-5 V -100%
Frequency Response	DC to 30 MHz (-3 dB)
** External AM	
** Sensitivity	2 V _{p-p} ($\pm 5\%$) signal causes 100% modulation.
	Ext Signal 1 V 100% modulation
	0 V 50% modulation
	-1 V 0% modulation
Frequency Response	
CH1	DC to 30 MHz (-3 dB)
External Signal	DC to 4 MHz (-3 dB)

Table B-3: Electrical Characteristics (Cont.)

Characteristics	Description
** Add	When Option 02 (second channel) installed
** Output	within 5% CH1 + CH2 (value indicated at the lower right box in SETUP menu) Output can not exceed $5 V_{p-p}$.
Frequency Response	DC to 30 MHz (-3 dB)
Voltage	
AC Power Source	
Rating Voltage	100 VAC to 240VAC Continuous range, CAT II
Range	
90 VAC to 250 VAC	48 Hz to 63 Hz
90 VAC to 127 VAC	48 Hz to 440 Hz
Maximum Power Consumption	300 W
Maximum Current	4 A
Grounding Impedance	The impedance for the chassis ground and power plug ground pins is 0.1Ω at 30 A.
Primary Circuit Dielectric Voltage withstand Test	$1500 V_{RMS}$, 50 Hz for 15 seconds, without breakdown.

Table B-4: Environmental Characteristics

Characteristics	Description
Temperature	
Operating	+10° C to +40° C
Non operating	-20° C to +60° C
Relative Humidity	
Operating	20% to 80% (No condensation) Maximum wet-bulb temperature 29.4° C
Non operating	5% to 90% (No condensation) Maximum wet-bulb temperature 40.0° C
Altitude	
Operating	To 4.5 km (15000 ft). Maximum operating temperature decreases 1° C each 300 m above 1.5 km.
Non operating	To 15 km (50000 ft).

Table B-4: Environmental Characteristics (Cont.)

Characteristics	Description
Dynamics	
Vibration	
Operation	0.33 mm _{p-p} , 10 to 55 Hz, 15 minutes
Shock	
Non operating	294 m/s ² (30 G), half-sine, 11 ms duration.
Installation Requirements	
Power Consumption (Fully Loaded)	300 watts max. Maximum line current is 4 A _{RMS} at 50 Hz, 90 V line.
Surge Current	30 A peak for < 5 line cycles, after product has been off for at least 30 s.
Cooling Clearance	
Top Clearance	76mm (3 inches)
Side Clearance	152mm (6 inches)
Rear Clearance	76mm (3 inches)

Typical Characteristics

This section will describe the typical characteristics for the AWG2021. These values represent typical or average performance and are not absolutely guaranteed.

Table B-5: Electrical Characteristics

Characteristics	Description
Delay	
1 MHz	390 ns
5 MHz	78 ns
20 MHz	18 ns
50 MHz	11 ns
Auxiliary Output	
TTL DIGITAL DATA OUT	Option 04
Skew between Data	Connect a digital data output cable (P/N 174-3192-00) between DIGITAL DATA OUT connector and DUT's header pins with 50 Ω termination.
Same Channel	2 ns
Between CH1 and CH2	4 ns (When Option 02 installed)
Power Supply	
Battery	
Back Up Time	4 years

Table B-6: Certifications and compliances

Category	Standards or description												
EC Declaration of Conformity – EMC	<p>Meets intent of Directive 89/336/EEC for Electromagnetic Compatibility. Compliance was demonstrated to the following specifications as listed in the Official Journal of the European Communities:</p> <p>EMC Directive 89/336/EEC:</p> <table border="0"> <tr> <td data-bbox="561 541 656 569">EN 55011</td> <td data-bbox="850 541 1273 569">Class A Radiated and Conducted Emissions</td> </tr> <tr> <td data-bbox="561 590 818 646">EN 50081-1 Emissions: EN60555-2</td> <td data-bbox="850 617 1195 644">AC Power Line Harmonic Emissions</td> </tr> <tr> <td data-bbox="561 665 818 693">EN 50082-1 Immunity:</td> <td></td> </tr> <tr> <td data-bbox="618 693 716 720">IEC801-2</td> <td data-bbox="850 693 1162 720">Electrostatic Discharge Immunity</td> </tr> <tr> <td data-bbox="618 720 716 747">IEC801-3</td> <td data-bbox="850 720 1182 747">RF Electromagnetic Field Immunity</td> </tr> <tr> <td data-bbox="618 747 716 774">IEC801-4</td> <td data-bbox="850 747 1227 774">Electrical Fast Transient/Burst Immunity</td> </tr> </table>	EN 55011	Class A Radiated and Conducted Emissions	EN 50081-1 Emissions: EN60555-2	AC Power Line Harmonic Emissions	EN 50082-1 Immunity:		IEC801-2	Electrostatic Discharge Immunity	IEC801-3	RF Electromagnetic Field Immunity	IEC801-4	Electrical Fast Transient/Burst Immunity
EN 55011	Class A Radiated and Conducted Emissions												
EN 50081-1 Emissions: EN60555-2	AC Power Line Harmonic Emissions												
EN 50082-1 Immunity:													
IEC801-2	Electrostatic Discharge Immunity												
IEC801-3	RF Electromagnetic Field Immunity												
IEC801-4	Electrical Fast Transient/Burst Immunity												
Australian/New Zealand declaration of Conformity - EMC	<p>Complies with EMC provision of Radio-communications Act per the following standard:</p> <table border="0"> <tr> <td data-bbox="521 898 691 926">AS/NZS 2064.1/2</td> <td data-bbox="850 898 1333 926">Industrial, Scientific, and Medical Equipment: 1992</td> </tr> </table>	AS/NZS 2064.1/2	Industrial, Scientific, and Medical Equipment: 1992										
AS/NZS 2064.1/2	Industrial, Scientific, and Medical Equipment: 1992												
EC Declaration of Conformity – Low Voltage	<p>Compliance was demonstrated to the following specification as listed in the Official Journal of the European Communities:</p> <p>Low Voltage Directive 73/23/EEC, amended by 93/68/EEC</p> <table border="0"> <tr> <td data-bbox="561 1062 764 1089">EN 61010-1/A1:1992</td> <td data-bbox="850 1062 1305 1119">Safety requirements for electrical equipment for measurement, control and laboratory use.</td> </tr> </table>	EN 61010-1/A1:1992	Safety requirements for electrical equipment for measurement, control and laboratory use.										
EN 61010-1/A1:1992	Safety requirements for electrical equipment for measurement, control and laboratory use.												
Approvals	<p>Complies with the following safety standards:</p> <table border="0"> <tr> <td data-bbox="521 1178 748 1205">UL3111-1, First Edition</td> <td data-bbox="850 1178 1360 1205">Standard for electrical measuring and test equipment.</td> </tr> <tr> <td data-bbox="521 1220 818 1247">CAN/CSA C22.2 No.1010.1-92</td> <td data-bbox="850 1220 1305 1276">Safety requirements for electrical equipment for measurement, control and laboratory use.</td> </tr> </table>	UL3111-1, First Edition	Standard for electrical measuring and test equipment.	CAN/CSA C22.2 No.1010.1-92	Safety requirements for electrical equipment for measurement, control and laboratory use.								
UL3111-1, First Edition	Standard for electrical measuring and test equipment.												
CAN/CSA C22.2 No.1010.1-92	Safety requirements for electrical equipment for measurement, control and laboratory use.												
Installation Category Description	<p>Terminals on this product may have different installation (over-voltage) category designations. The installation categories are:</p> <table border="0"> <tr> <td data-bbox="521 1367 610 1394">Category</td> <td data-bbox="716 1367 1073 1394">Examples of products in this category</td> </tr> <tr> <td data-bbox="521 1409 586 1436">CAT III</td> <td data-bbox="716 1409 1435 1465">Distribution-level mains (usually permanently connected). Equipment at this level is typically in a fixed industrial location.</td> </tr> <tr> <td data-bbox="521 1482 586 1509">CAT II</td> <td data-bbox="716 1482 1451 1539">Local-level mains (wall sockets). Equipment at this level includes appliances, portable tools, and similar products. Equipment is usually cord-connected.</td> </tr> <tr> <td data-bbox="521 1556 578 1583">CAT I</td> <td data-bbox="716 1556 1435 1583">Secondary (signal level) or battery operated circuits of electronic equipment.</td> </tr> </table>	Category	Examples of products in this category	CAT III	Distribution-level mains (usually permanently connected). Equipment at this level is typically in a fixed industrial location.	CAT II	Local-level mains (wall sockets). Equipment at this level includes appliances, portable tools, and similar products. Equipment is usually cord-connected.	CAT I	Secondary (signal level) or battery operated circuits of electronic equipment.				
Category	Examples of products in this category												
CAT III	Distribution-level mains (usually permanently connected). Equipment at this level is typically in a fixed industrial location.												
CAT II	Local-level mains (wall sockets). Equipment at this level includes appliances, portable tools, and similar products. Equipment is usually cord-connected.												
CAT I	Secondary (signal level) or battery operated circuits of electronic equipment.												
Pollution Degree	<p>A measure of the contaminates that could occur in the environment around and within a product. Typically the internal environment inside a product is considered to be the same as the external. Products should be used only in the environment for which they are rated.</p> <table border="0"> <tr> <td data-bbox="521 1713 699 1740">Pollution Degree 2</td> <td data-bbox="818 1713 1451 1854">Normally only dry, nonconductive pollution occurs. Occasionally a temporary conductivity that is caused by condensation must be expected. This location is a typical office/home environment. Temporary condensation occurs only when the product is out of service.</td> </tr> </table>	Pollution Degree 2	Normally only dry, nonconductive pollution occurs. Occasionally a temporary conductivity that is caused by condensation must be expected. This location is a typical office/home environment. Temporary condensation occurs only when the product is out of service.										
Pollution Degree 2	Normally only dry, nonconductive pollution occurs. Occasionally a temporary conductivity that is caused by condensation must be expected. This location is a typical office/home environment. Temporary condensation occurs only when the product is out of service.												

Table B-6: Certifications and compliances (cont.)

Category	Standards or description
Conditions of Approval	Safety Certifications/Compliances are made for the following conditions: Altitude (maximum operation): 2000 meters
IEC Characteristics	Equipment type: Test and Measuring Installation Category II (as defined in IEC 61010-1, Annex J) Pollution Degree 2 (as defined in IEC 61010-1) Safety Class I (as defined in IEC 61010-1, Annex H)

Appendix C: Performance Verification

Before Verification

This section describes the verification procedures, tells you when to use the procedures, and gives conventions used in their structure. The procedures are:

- Self Tests
- Performance Tests

Preparation

These procedures verify the AWG2021 Arbitrary Waveform Generator functionality. Which procedure to perform depends on your goal:

- To quickly confirm that the AWG2021 functions correctly and was adjusted properly, do the procedures under *Self Tests*, which begin on page C-2.

Advantages: These procedures are short, require no external equipment, and perform extensive functional and accuracy testing. Use them to quickly determine if the AWG2021 is suitable for use, like when it is first received.

- For a more extensive confirmation of performance, do the *Performance Tests*, beginning on page C-5 after doing the *Self Tests*.

Advantages: These procedures involve direct checking of warranted specifications. They require more time and suitable test equipment. (See *Equipment Required* on page C-6.

Before starting any of these procedures, read Section 2 of this manual. These instructions describe the AWG2021 front-panel controls and menu system.

Conventions

Throughout the procedures in this section, the following conventions apply:

- Each test procedure uses the following general format:
 - Title of Test
 - Equipment Required
 - Prerequisites
 - Procedure
- Each procedure consists of as many steps, substeps, and subparts as required to do the test. Steps, substeps, and subparts are sequenced as follows:
 1. First Step

- a. First Substep
 - First Subpart
 - Second Subpart
- b. Second Substep

2. Second Step

- Instructions for menu selection follow this format: **FRONT PANEL BUTTON→Main Menu Button→Side Menu Button**. For example, “Press **UTILITY→Misc→Config...→Reset to Factory→O.K.**”
- Where instructed to use a front-panel button, key, or knob, or select from the MENU column, or from a bottom or side menu, the name of the item appears in boldface type: “push **MODE**,” or “select **Burst** in the bottom menu.”

Self Tests

This section describes how to use AWG2021 internal self-test routines. No equipment is required to do these procedures. The self tests include these internal routines:

- **Diagnostics**

This self-test procedure uses internal routines to verify that the AWG2021 functions, and passes the internal circuit tests.

- **Calibration**

The second procedure checks the AWG2021 internal calibration constants and changes them if needed.

Diagnostics

The internal diagnostic routines check AWG2021 characteristics such as amplitude, offset, trigger level, clock, filters, X5 output amplifier, and attenuation.

The AWG2021 automatically performs the internal diagnostics at power-on; you can also run the internal diagnostics using the menu selections described in this procedure. The difference between these two methods of initiating the diagnostics is that the menu method does more detailed memory checking than the power-on method.

Equipment Required	None
Prerequisites	Power on the AWG2021 and allow a 20 minute warmup period before doing this procedure.

1. *Verify that internal diagnostics pass:* Do the following substeps to verify passing internal diagnostics.
 - a. *Display the diagnostics menu and select all tests:* Push **UTILITY**→**Diag/Cal**→**Diagnostics xxxx**→**All**.

The list on the left shows the tests available for diagnostics. In addition to selecting all of the tests shown for diagnostics, you can select only the test you want to run using the general purpose knob. In Figure C-1, the symbol (*) to the left of Diagnostics column indicates the tests selected.

	Diagnostics	Result	Code
*	Cpu	Pass	
*	Clock	Pass	
*	Display	Pass	
	FPP	---	
*	FrontPanel	Pass	
*	Trigger	Pass	
*	Setup CH1	Pass	
	Setup CH2	---	
*	Waveform Memory CH1	Pass	
	Waveform Memory CH2	---	

Figure C-1: Diagnostics Menu

- b. *Run the diagnostics:* Select **Execute** from the side menu. This executes all the AWG2021 diagnostics automatically.
 - c. *Wait:* The internal diagnostics do an extensive verification of AWG2021 functions. While it progresses, the screen displays the busy icon. When finished, the resulting status appears on the screen.
 - d. *Confirm that no failures are found:* Verify that no failures are found and reported on-screen. If the diagnostics displays Fail as the result of any test, contact your nearest representative.
2. *Return to regular service:* Push a button (other than UTILITY) in the MENU column to exit the diagnostic menu.

NOTE. *The interactive tests on the Diag/Cal menu are for manufacturing use at the factory.*

Performance Tests

This section contains a series of procedures for checking that the AWG2021 Arbitrary Waveform Generator performs as warranted.

The procedures are arranged in ten logical groupings, presented in the following order:

- Operating Mode Checks
- Arithmetic Operation Checks
- Clock Frequency and Amplitude Checks
- Gain and Offset Accuracy Checks
- Pulse Response Check
- SYNC Out and MARKER Out Amplitude Checks
- External Trigger Level Accuracy Check
- External CLOCK IN Check
- ECL Digital Data Out Check (Option 03)
- TTL Digital Data Out Check (Option 04)

These procedures extend the confidence level provided by the internal diagnostic and calibration routines described on page C-2.

Prerequisites

These tests comprise an extensive, valid confirmation of performance and functionality when the following requirements are met:

- You must have performed and passed the calibration procedure described in *Self Tests*, the previous subsection.

NOTE. *For operation to specified accuracy, allow the AWG2021 to warm up at least 20 minutes before doing the performance tests.*

- Load all the files from the Performance Check/Adjustment disk (063-2171-XX) that comes with this manual into AWG2021 internal

memory. For instructions on loading files, see *Loading Sample Waveforms* on page 2 -28 in section 2.

Related Information Read *Preparation* and *Conventions* on page C-1. Also, if you are not familiar with operating the AWG2021, read in section 2 before doing any of these procedures.

Equipment Required The following equipment is required to check the performance of the AWG2021.

Table C-1: Test Equipment

Item	Minimum Requirements	Example	Purpose
Precision termination	Impedance: 50 Ω , 0.1% Connectors: BNC	Tektronix Part 011-0129-XX	Signal termination.
Adapter	Connectors: BNC female-to-dual banana	Tektronix Part 103-0090-XX	Signal interconnection.
Adapter	Connectors: SMA male-to-BNC female	Tektronix Part 015-0554-XX	Signal interconnection.
BNC dual input (TEE) adapter	Connectors: BNC	Tektronix Part 103-0030-XX	Signal interconnection.
BNC cable (4 required)	Impedance 50 Ω Connectors: BNC Length: 43 inches	Tektronix Part 012-0057-XX	Signal interconnection.
Termination board (Option 03)	Must use example equipment	Tektronix Part 671-2957-XX	Used to check ECL digital data output.
ECL Digital Data Out Cable (Option 03)	Must use example equipment	Tektronix Part 012-1408-XX (Standard accessory for Option 03)	Used to check ECL digital data output.
Test leads (Option 03)	Must use example equipment	Tektronix Part 012-1381-XX	Used to check ECL digital data output.
TTL Digital Data Out Cable (Option 04)	Must use example equipment	Tektronix Part 174-3192-XX (Standard accessory for Option 04)	Used to check TTL digital data output.
2 \times 13 header (Option 04)	Must use example equipment	Tektronix Part 131-3847-XX	Used to check TTL digital data output.
Probe, 10X (Option 04)	10X probe	Tektronix Part P6139A	Used to check TTL digital data output.
Test oscilloscope	Bandwidth: >250 MHz	Tektronix TDS500 Series Digitizing Oscilloscope or 2400 Series Digitizing Oscilloscope	Checks output signals. Used in many procedures.
Frequency counter	Frequency range: 10 Hz to 250 MHz	Tektronix DC 5010 Programmable Universal Counter/Timer*	Used to check clock frequency.

Table C-1: Test Equipment (Cont.)

Item	Minimum Requirements	Example	Purpose
Digital multimeter	DC volts range: 0.05 V to 5 V Accuracy: $\pm 0.1\%$	Fluke 8842A	Used throughout the checks to measure voltage.
Function generator	Output voltage: -5 V to 5 V	Tektronix FG 5010 Programmable Function Generator*	Used to input the trigger signal.
Power supply (Option 03)	Output voltage: -2 V	Tektronix PS 5010 Programmable Power Supply*	Used to check ECL digital data output.
Performance Check/Adjustment disk	Must use example listed	Tektronix Part 063-2171-XX	Used throughout the checks to provide waveform files.

* Requires a TM 5000 Series Power Module Mainframe.

Performance Check/ Adjustment Files

Table C-2 lists the waveform files on the Performance Check/Adjustment disk (063-2171-XX) that are used in these performance tests, the AWG2021 front-panel settings that each file sets up, and the performance test that uses each file.

NOTE. *The files on the Performance Check/Adjustment disk are locked (the files names are displayed with *), so the data in these files cannot be changed unless the lock is opened. The file data includes not only waveform data, but also output parameters.*

When you select a file with the Waveform Sequence item, the AWG2021 output parameters change to those specified in the file, and the waveform output reflects waveform data in the file. After selecting a file, do not change an output parameter with the SETUP menu unless a procedure instructs you to do so. During the procedures, if you are unsure that the AWG2021 settings still match the file's settings, select the waveform again using the Waveform Sequence item on the SETUP menu.

HF_LF.WFM file on the Performance Check/Adjustment disk is used to adjust the AWG2021 externally. On adjustment, see the AWG2021 Service Manual.

Table C-2: File List for Performance Check/Adjustment Disk











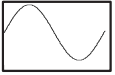
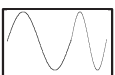
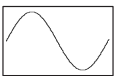
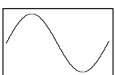
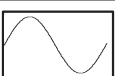
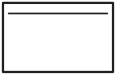

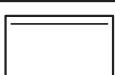
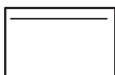
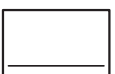
No.	File Name	EDIT Menu		SETUP Menu					Usage
		Wfm Shape	Wfm Point	Clock	Operation	Filter	Amp	Offset	
1	MODE.WFM		1000	1 MHz	Normal	Through	1 V	0 V	Cont, Triggered, Burst, Gated Mode
2	MODE_ADV.SEQ ADV-1.WFM ADV-2.WFM		1200 1000 200	100 MHz	Normal	Through	1 V	0 V	Waveform Advance Mode
3	MODE_AST.AST Step: 1 AST-1.WFM		1000	250 kHz	Normal	Through	3 V	0 V	Autostep Mode
	Step: 2 AST-2.WFM		200	150 kHz	Normal	Through	1.5 V	0 V	
	Step: 3 AST-3.WFM		200	25 kHz	Normal	Through	0.5 V	0 V	
4	OPE.AST Step: 1 EXT_AM.WFM (CH1)		1000	1 MHz	external AM	Through	5 V	0 V	External AM Operation
	Step: 2 AM-1.WFM (CH1)		1000	1 MHz	AM	Through	5 V	0 V	Internal AM Operation
	AM-2.WFM (CH2)		1000	1 MHz	—	Through	5 V	2.5 V	
	Step: 3 AM-1.WFM (CH1)		1000	1 MHz	AM	Through	5 V	0 V	Internal Add Operation
	AM-3.WFM (CH2)		1000	1 MHz	—	Through	5 V	-2.5 V	
	Step: 4 ADD.WFM (CH1)		1000	1 MHz	add	Through	5 V	0 V	
		ADD.WFM (CH2)		1000	1 MHz	—	Through	5 V	0 V
5	CLK_FREQ.WFM		1000	250 MHz	Normal	Through	1 V	0 V	Clock Frequency Accuracy
6	CLK_AMPL.WFM		1000	1 MHz	Normal	Through	1 V	0 V	Clock Amplitude

Table C-2: File List for Performance Check/Adjustment Disk (Cont.)

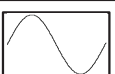
No.	File Name	EDIT Menu		SETUP Menu					Usage
		Wfm Shape	Wfm Point	Clock	Operation	Filter	Amp	Offset	
7	GAIN_OFF.AST Step: 1 GAIN-1.WFM		1000	1 MHz	Normal	Through	0.5 V	0 V	Gain Accuracy
	Step: 2 GAIN-2.WFM		1000	1 MHz	Normal	Through	0.5 V	0 V	
	Step: 3 GAIN-3.WFM		1000	1 MHz	Normal	Through	5.0 V	0 V	
	Step: 4 GAIN-4.WFM		1000	1 MHz	Normal	Through	5.0 V	0 V	
	Step: 5 OFFSET-1.WFM		1000	1 MHz	Normal	Through	0.05 V	2.5 V	Offset Accuracy
	Step: 6 OFFSET-2.WFM		1000	1 MHz	Normal	Through	0.05 V	0 V	
	Step: 7 OFFSET-3.WFM		1000	1 MHz	Normal	Through	0.05 V	-2.5 V	
8	PULSE.WFM		64	250 MHz	—	Through	0.5 V	0 V	Pulse Response
9	SYNC_MKR.WFM		200	1 MHz	—	Through	1 V	0 V	SYNC Out and MARKER OUT Amplitude
10	TRG_IN.WFM		1000	100 MHz	—	Through	1 V	0 V	External Trigger Level Accuracy
11	EXT_CLK.WFM		1000	External Clock	—	Through	1 V	0 V	External Clock In
12	DIGI_OUT.WFM		4096	1 MHz	Normal	Through	1 V	0 V	ECL and TTL DIGITAL DATA OUT Check (Option 03 and 04)

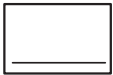
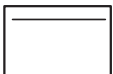
Operating Mode Checks

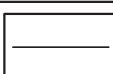
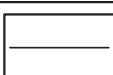
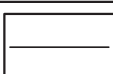
These procedures check operation of the Cont, Triggered, Burst, Gated, Waveform Advance, and Autostep modes.

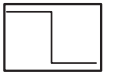
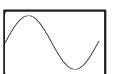
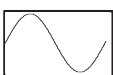
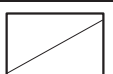
Check Cont Mode

Electrical Characteristic Checked	Operating mode, Continuous, on page B-1.
Equipment Required	A 50 Ω coaxial cable and an oscilloscope.
Prerequisites	The AWG2021 must meet the prerequisites listed on page C-5.

1. *Install the test hookup and set test equipment controls:*

- a. *Hook up the oscilloscope:* Connect the AWG2021 CH1 output connector through the coaxial cable to the CH1 vertical input connector on the oscilloscope (see Figure C-3).

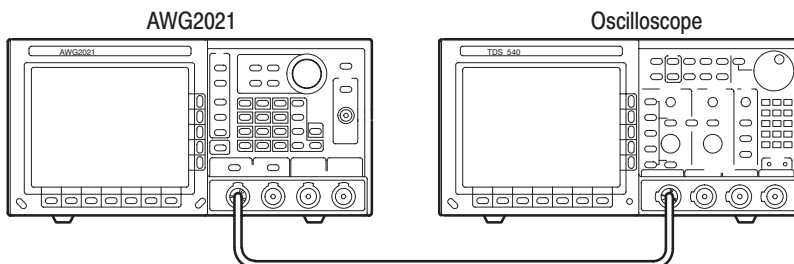

Figure C-3: Cont Mode Initial Test Hookup

- b. *Set the oscilloscope controls:*

Vertical CH1
 CH1 coupling: DC
 CH1 scale 0.2 V/div.
 CH1 input impedance: 50 Ω

Horizontal
 Sweep 500 μ s/div.

Trigger
 Source CH1
 Coupling DC
 Slope Positive
 Level +100 mV
 Mode Auto

2. *Set the AWG2021 controls and select the waveform file:*
 - a. *Initialize AWG2021 controls:* Push **UTILITY**→**Misc**→**Config...**→**Reset to Factory**→**O.K.**
 - b. *Select the file:*
 - Push **SETUP**→**Waveform Sequence**, if necessary, to select a waveform file for CH1. Waveform Sequence toggles between the CH1 files (upper list) and the CH2 files (lower list).
 - Turn the general purpose knob to display the list of waveform files and highlight the **MODE.WFM** file.
 - Push **ENTER** to select the file. This button is located to the lower-right of the numeric keypad.
3. *Turn on the AWG2021 CH1 output:* Push the **CH1** button so that the LED above the CH1 output connector is on.
4. *Check cont mode:* Check that the amplitude of the sine wave displayed on the oscilloscope is 5 vertical divisions and that 5 cycles of the waveform are displayed.
5. *If Option 02 is installed (Option 02 adds the CH2 output channel):* Repeat this procedure, connecting the oscilloscope to the AWG2021 CH2 output connector, pushing **Waveform Sequence** to select the waveform for CH2, and turning on the CH2 output.
6. *End procedure:* Disconnect the oscilloscope.

Check Triggered Mode

Electrical Characteristic Checked	Operating mode, Triggered, on page B-1.
Equipment Required	Two 50 Ω coaxial cables, a function generator, and an oscilloscope.
Prerequisites	The AWG2021 meets the prerequisites listed on page C-5.

1. *Install the test hookup and set test equipment controls:*
 - a. *Hook up the oscilloscope:* Connect the AWG2021 CH1 output connector through the coaxial cable to the CH1 vertical input connector on the oscilloscope.
 - b. *Hook up the function generator:*
 - Connect the AWG2021 TRIGGER INPUT connector through a coaxial cable to the function generator output connector (see Figure C-4).

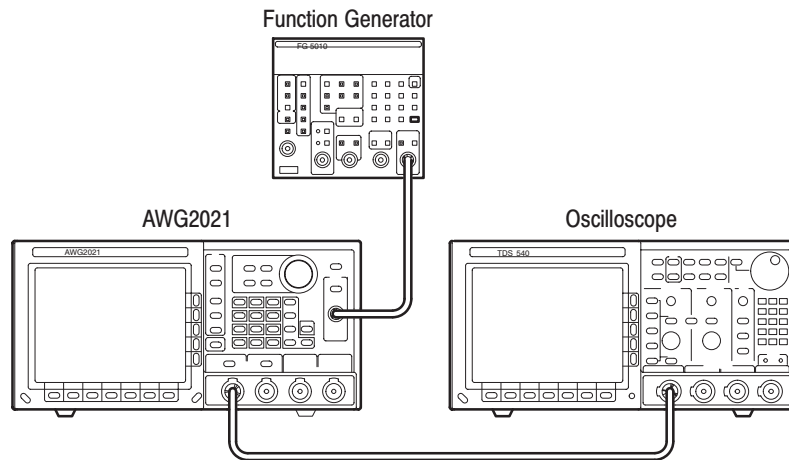

Figure C-4: Triggered Mode Initial Test Hookup

c. Set the oscilloscope controls:

Vertical	CH1
CH1 coupling:	DC
CH1 scale	0.2 V/div.
CH1 input impedance:	50 Ω
Horizontal	
Sweep	500 μ s/div.
Trigger	
Source	CH1
Coupling	DC
Slope	Positive
Level	+100 mV
Mode	Norm

d. Set the function generator controls:

Function	Square
Mode	Continuous
Parameter	
Frequency	100 Hz
Amplitude	4 V
Offset	2 V
Output	Off

2. *Set AWG2021 controls and select the waveform file:*
 - a. *Initialize AWG2021 controls:* Push **UTILITY**→**Misc**→**Config...**→**Reset to Factory**→**O.K.**
 - b. *Modify the AWG2021 default settings:*
 - Push **MODE**→**Triggered**→**Slope** to select Positive slope.
 - Select **Level** from the side menu and turn the general purpose knob to select a 1 V trigger level.
 - Select **Impedance** from the side menu to select 50 Ω impedance.
 - c. *Select the file:*
 - Push **SETUP**→**Waveform Sequence**, if necessary, to select a waveform file for CH1. Waveform Sequence toggles between the CH1 files (upper list) and the CH2 files (lower list).
 - Highlight the **MODE.WFM** file using the general purpose knob.
 - Push **ENTER** to select the file.
3. *Turn on the AWG2021 CH1 output:* Push the **CH1** button so that the LED above the CH1 output connector is on.
4. *Check triggered mode with manual triggering:* Push the AWG2021 **MANUAL TRIGGER** button and check that when the button is pushed, the oscilloscope displays a one-cycle sine wave.
5. *Check triggered mode with external triggering:*
 - a. *Enable function generator output:* Turn on the function generator output.
 - b. *Check triggering:* Check that for each trigger supplied by the function generator, the oscilloscope displays a one-cycle sine wave.
6. *End procedure:* Turn off the function generator output, and disconnect the function generator and oscilloscope.

Check Burst Mode

Electrical Characteristic Checked	Operating mode, Burst, on page B-1.
Equipment Required	A 50 Ω coaxial cable and an oscilloscope.
Prerequisites	The AWG2021 meets the prerequisites listed on page C-5.

1. *Install test hookup and set test equipment controls:*

- a. *Hook up the oscilloscope:* Connect the AWG2021 CH1 output connector through the coaxial cable to the CH1 vertical input connector on the oscilloscope (see Figure C-5).

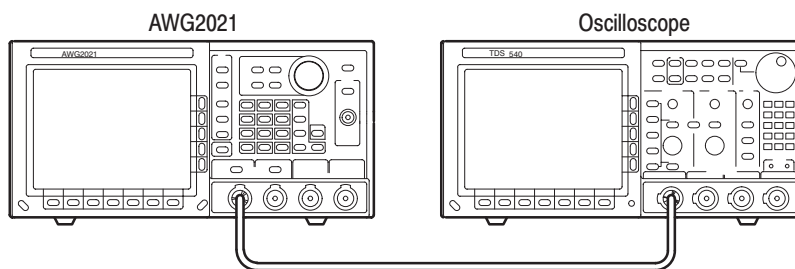

Figure C-5: Burst Mode Initial Test Hookup

- b. *Set the oscilloscope controls:*

- Vertical CH1
- CH1 coupling: DC
- CH1 scale 0.2 V/div.
- CH1 input impedance: 50 Ω
- Horizontal
- Sweep 500 μs/div.
- Trigger
- Source CH1
- Coupling DC
- Slope Positive
- Level +100 mV
- Mode Norm

2. *Set AWG2021 controls and select the waveform file:*

- a. *Initialize AWG2021 controls:* Push **UTILITY**→**Misc**→**Config...**→**Reset to Factory**→**O.K.**
- b. *Modify the AWG2021 default settings:* Push **MODE**→**Burst**→**Burst Count** and turn the general purpose knob to a burst count of 3.

- c. *Select the file:*
 - Push **SETUP**→**Waveform Sequence**, if necessary, to select a waveform file for CH1. Waveform Sequence toggles between the CH1 files (upper list) and the CH2 files (lower list).
 - Turn the general purpose knob to highlight the **MODE.WFM** file.
 - Push **ENTER** to select the file.
3. *Turn on the AWG2021 CH1 output:* Push the **CH1** button so that the LED above the CH1 output connector is on.
4. *Check burst count:* Push the AWG2021 **MANUAL TRIGGER** button and check that when the button is pushed, the oscilloscope displays three cycles of sine wave.
5. *End procedure:* Disconnect the oscilloscope.

Check Gated Mode

Electrical Characteristic Checked	Operating mode, Gated, on page B-1.
Equipment Required	Three 50 Ω coaxial cables, a 50 Ω precision termination, a function generator, and an oscilloscope.
Prerequisites	The AWG2021 meets the prerequisites listed on page C-5.

1. *Install test hookup and set test equipment controls:*
 - a. *Hook up the oscilloscope:* Connect the AWG2021 CH1 output connector through the coaxial cable to the CH1 vertical input connector on the oscilloscope.
 - b. *Hook up the function generator:* Connect the function generator output to both the AWG2021 TRIGGER INPUT and the oscilloscope CH2 input through a coaxial cable, precision termination, and a dual input coupler (see Figure C-6).

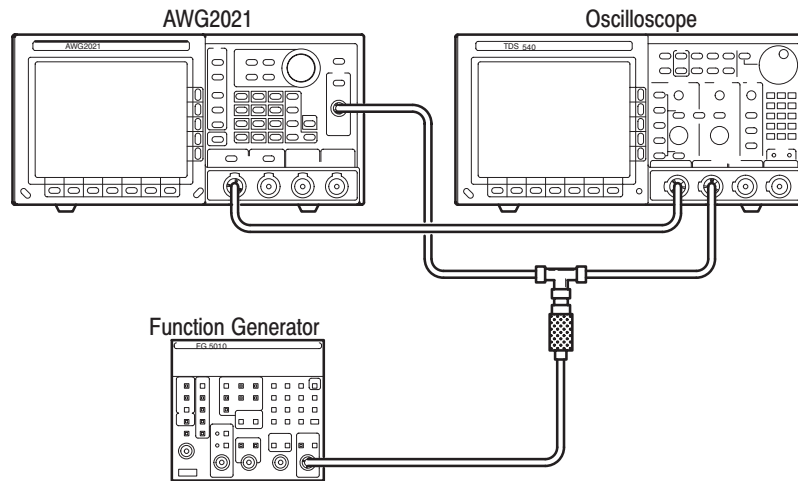

Figure C-6: Gated Mode Initial Test Hookup

c. Set oscilloscope controls:

Vertical	CH1, CH2
CH1, CH2 coupling	DC
CH1, CH2 scale	0.5 V/div.
CH1 input impedance	50 Ω
CH2 input impedance	1 M Ω
Mode	Chop
Horizontal	
Sweep	2 ms/div.
Trigger	
Source	CH2
Coupling	DC
Slope	Positive
Level	500 mV
Mode	Auto

d. Set function generator controls:

Function	Square
Mode	Continuous
Parameter	
Frequency	100 Hz
Amplitude	4.0 V
Offset	2.0 V
Output	Off

2. *Set the AWG2021 controls and select the waveform file:*
 - a. *Initialize AWG2021 controls:* Push **UTILITY**→**Misc**→**Config...**→**Reset to Factory**→**O.K.**
 - b. *Modify the AWG2021 default settings:*
 - Push **MODE**→**Gated**→**Polarity** to highlight Positive.
 - Select **Impedance** from the side menu to highlight 1 M Ω .
 - c. *Select the file:*
 - Push **SETUP**→**Waveform Sequence**, if necessary, to select a waveform file for CH1. Waveform Sequence toggles between the CH1 files (upper list) and the CH2 files (lower list).
 - Highlight the **MODE.WFM** file, using the general purpose knob.
 - Push **ENTER** to select the file.
3. *Turn on the AWG2021 CH1 output:* Push the **CH1** button so that the LED above the CH1 output connector is on.
4. *Check gated mode with manual trigger:* Push and hold the AWG2021 **MANUAL TRIGGER** button, and check that the oscilloscope continuously displays a sine wave while the **MANUAL TRIGGER** button is pushed.
5. *Check gated mode with gate signal:*
 - a. *Apply gate signal:* Turn function generator output on.
 - b. *Check gated mode with positive gate signal:* Check that the oscilloscope displays a sinewave when the gate signal is high.

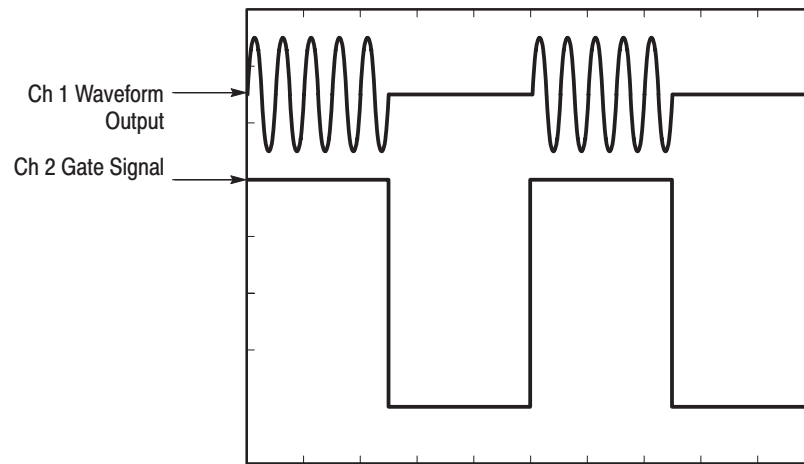

Figure C-7: Waveform Output Signal with Positive Gate Signal

- c. *Change the AWG2021 trigger polarity to negative:* Push **MODE**→**Polarity** to change the polarity to Negative.
- d. *Check gated mode with a negative gate signal:* Check the oscilloscope displays a sinewave when the gate signal is low.

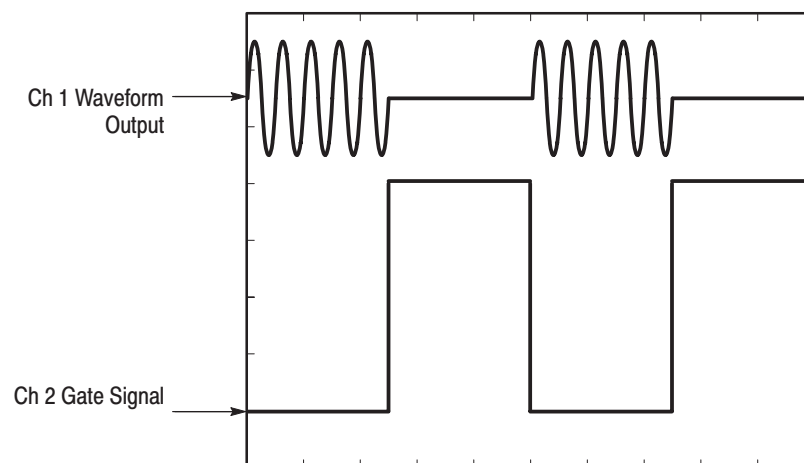

Figure C-8: Waveform Output Signal with Negative Gate Signal

- 6. *End procedure:* Turn the function generator output off and disconnect the function generator.

Check Waveform Advance Mode

Electrical Characteristic Checked	Operating mode, Waveform Advance, on page B-1.
Equipment Required	A 50 Ω coaxial cable and an oscilloscope.
Prerequisites	The AWG2021 meets the prerequisites listed on page C-5.

1. *Install test hookup and set test equipment controls:*
 - a. *Hook up the oscilloscope:* Connect the AWG2021 CH1 output connector through the coaxial cable to the CH1 vertical input connector on the oscilloscope (see Figure C-9).

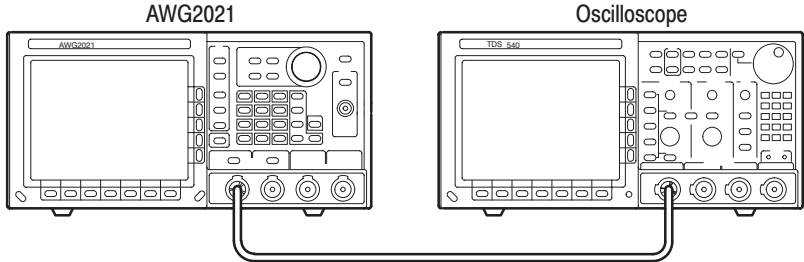

Figure C-9: Waveform Advance Mode Initial Test Hookup

- b. *Set oscilloscope controls:*
 - Vertical CH1
 - CH1 coupling DC
 - CH1 0.2 V/div.
 - CH1 input impedance 50 Ω
 - Horizontal
 - Sweep 5 μs/div.
 - Trigger
 - Source CH1
 - Coupling DC
 - Slope Positive
 - Level 0 V
 - Mode Auto

2. *Set the AWG2021 controls and select the waveform file:*
 - a. *Initialize AWG2021 controls:* Push **UTILITY**→**Misc**→**Config...**→**Reset to Factory**→**O.K.**
 - b. *Set AWG2021 controls:*

- Push **MODE**→**Waveform Advance**→**Slope** to highlight Positive.
 - Select **Level** from the side menu, and turn the general purpose knob to select a 1.0 V level.
 - Select **Impedance** from the side menu to highlight 50 Ω.
- c. *Select waveform file:*
- Push **SETUP**→**Waveform Sequence**, if necessary, to select a waveform file for CH1. Waveform Sequence toggles between the CH1 files (upper list) and the CH2 files (lower list).
 - Highlight the **MODE_ADV.SEQ** file using the general purpose knob.
 - Push **ENTER** to select the file.
3. *Turn on the AWG2021 CH1 output:* Push the **CH1** button so that the LED above the CH1 output connector is on.
 4. *Check waveform advance:* Repeatedly push the AWG2021 **MANUAL TRIGGER** button, and check that the oscilloscope displays a continuous sine wave that switches between two frequencies at each manual trigger.
 5. *End procedure:* Disconnect the oscilloscope.

Check Autostep Mode

Electrical Characteristic Checked	Operating mode, Autostep, on page B-1.
Equipment Required	Two 50 Ω coaxial cables and an oscilloscope.
Prerequisites	The AWG2021 meets the prerequisites listed on page C-5.

1. *Install test hookup and set test equipment controls:*
 - a. *Hook up the oscilloscope:*
 - Connect the AWG2021 CH1 output through a coaxial cable to the oscilloscope CH1 vertical input.
 - Connect the AWG2021 CH1 SYNC Out output through a coaxial cable to the oscilloscope CH1 vertical input (see Figure C-10).

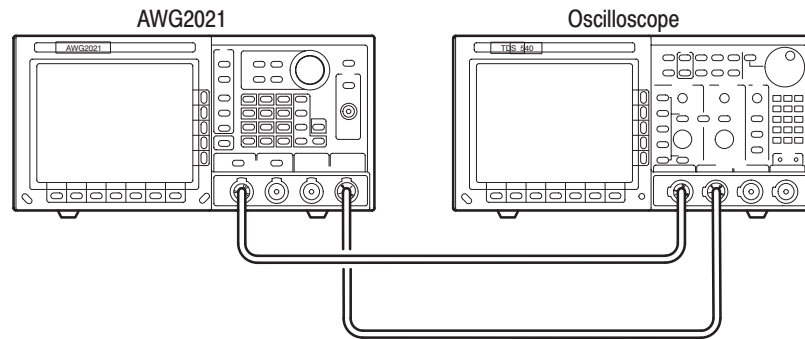

Figure C-10: Autostep Mode Initial Test Hookup

b. Set the oscilloscope controls:

Vertical	CH1
CH1 coupling	DC
CH1 scale	0.5 V/div.
CH1 input impedance	50 Ω
Horizontal	
Sweep	2 ms/div.
Trigger	
Source	CH1
Coupling	DC
Slope	Positive
Level	100 mV
Mode	Normal

2. Set the AWG2021 controls and select the waveform file:

- a. Initialize AWG2021 controls:** Push **UTILITY**→**Misc**→**Config...**→**Reset to Factory**→**O.K.**
- b. Modify AWG2021 default settings:**
 - Push **MODE**→**Autostep**→**Slope** to highlight Positive.
 - Select **Level** from the side menu, and turn the general purpose knob to select 1 V.
 - Select **Select Autostep File** from the side menu to choose from the file list for CH1.
 - Turn the general purpose knob to highlight the **MODE_AST.AST** file.
 - Push **ENTER**.

- Select **Start** within the **Sync** frame at the bottom menu.
- 3. *Turn on the AWG2021 CH1 output:* If the LED above the CH1 output connector is not on, push the **CH1** button.
- 4. *Check autostep mode:* Push the AWG2021 **MANUAL TRIGGER** button, and check that the oscilloscope momentarily displays one sine wave cycle with a different frequency and amplitude each time you push and release the button.
- 5. *End procedure:* Disconnect the oscilloscope.

Arithmetic Operation Checks

These procedures check operation of external AM. For an AWG2021 with Option 02, they check internal AM and internal Add arithmetic functions.

NOTE. *The arithmetic operation checks are structured as a continuous series of tests. After Check External AM Operation, each test uses the control settings from the last test and uses the next step in the sequence file.*

Check External AM Operation

Electrical Characteristic Checked	External amplitude modulation, page B-9.
Equipment Required	Two 50 Ω coaxial cables, a 50 Ω terminator, a function generator, and a digital multimeter (DMM).
Prerequisites	The AWG2021 meets the prerequisites listed on page C-5.

1. *Install test hookup and set test equipment controls:*
 - a. *Hook up DMM:* Connect the AWG2021 CH1 output through a coaxial cable, the 50 Ω terminator, and BNC-to-dual banana connector to the DMM INPUT connector.
 - b. *Hook up function generator:* Connect the AWG2021 rear-panel AM IN input through a coaxial cable to the function generator output (see Figure C-11).

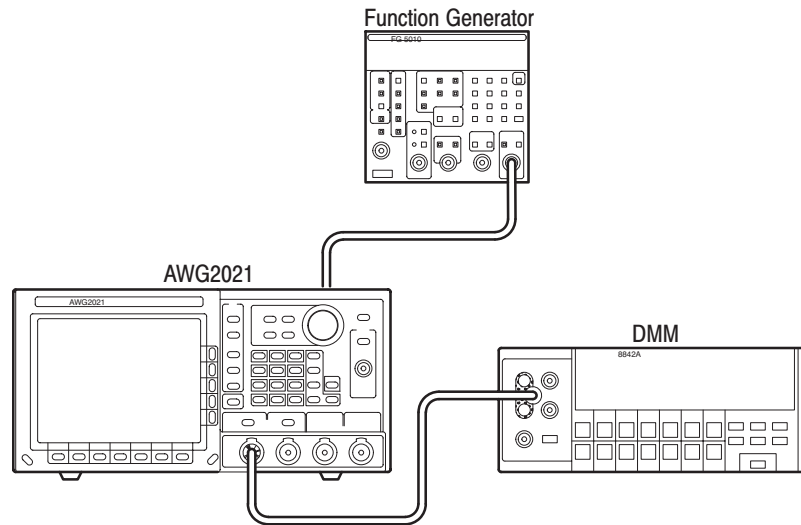

Figure C-11: External AM Operation Initial Test Hookup

c. Set DMM controls:

Mode VDC
 Range 20
 Inputs Front

d. Set function generator controls:

Function Square
 Mode Continuous
 Parameter
 Frequency 1 kHz
 Amplitude 0 V
 Offset 1 V
 Output Off

2. Set the AWG2021 controls and select the waveform file:

a. Initialize AWG2021 controls: Push **UTILITY**→**Misc**→**Config...**→**Reset to Factory**→**O.K.**

b. Modify AWG2021 default settings:

■ Push **MODE**→**Autostep**.

c. Select waveform file:

■ Select **Select Autostep File** from the side menu to choose a waveform file for CH1.

- Turn the general purpose knob to highlight the **OPE.AST** file.
 - Push **ENTER**.
3. *Turn on the AWG2021 CH1 output:* If the LED above the CH1 output connector is not on, push the **CH1** button.
 4. *Enable the function generator output:* Turn on the function generator output.
 5. *Check external AM operation:*
 - Check that the step number displayed on the AWG2021 MODE menu is **Step 1** (see Figure C-12). If it is not, push **MANUAL TRIGGER** to step through the sequence file steps until Step: 1 is displayed.

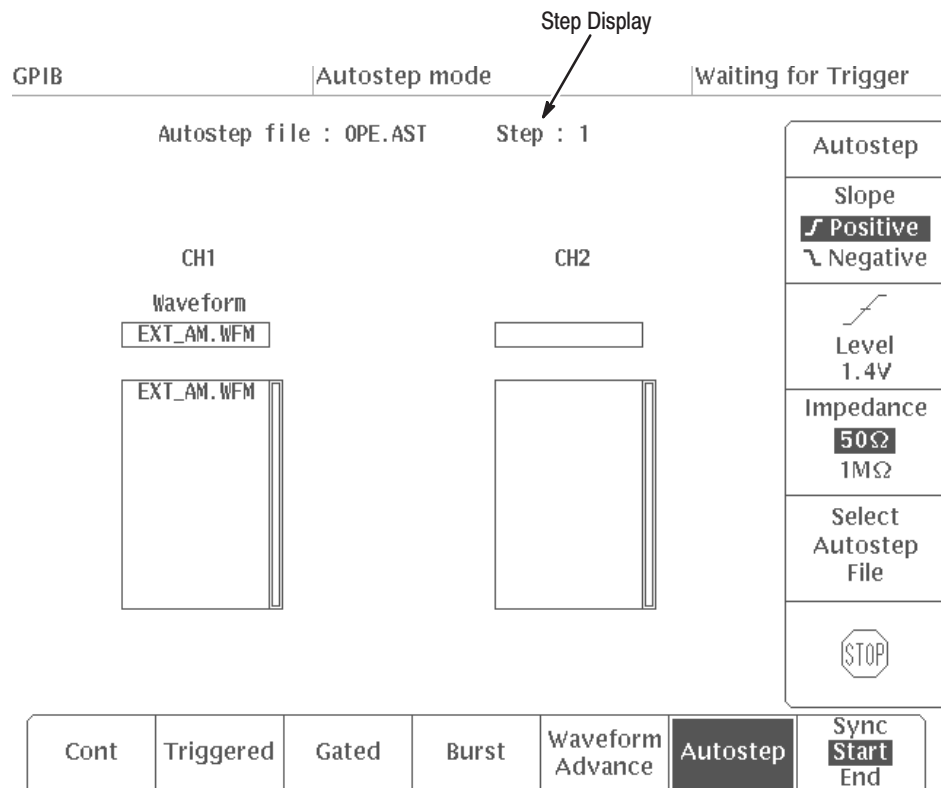

Figure C-12: MODE Menu Autostep Setting

- Check that the DMM reading is in the range from 2.375 to 2.625 V (100% modulation).
- Set the function generator offset value to 0 V. Check that the DMM reading is in the range from 1.125 to 1.375 V (50% modulation).

- Set the function generator offset value to -1 V. Check that the DMM voltage reading is in the range from -0.125 to 0.125 V (0% modulation).
6. *End procedure:* Keep the test connections and instrument settings for the next check.

Check Internal AM Operation (Option 02 only)

Electrical Characteristic Checked	Arithmetic Operation, Amplitude Modulation, on page B-9.
Equipment Required	Two 50 Ω coaxial cables, a function generator, and a digital multimeter (DMM).
Prerequisites	The AWG2021 meets the prerequisites listed on page C-5. It also requires Option 02 (CH2 output channel) in the AWG2021.

1. *Use test hookup and control settings from previous check.*
2. *Check internal AM operation:*
 - a. *Check Autostep Step 2:*
 - Push the AWG2021 **MANUAL TRIGGER** button, and check that the step changes to Step 2 on the MODE menu.
 - Check that the DMM reading is in the range from 2.375 VDC to 2.625 VDC.
 - b. *Check Autostep Step 3:*
 - Push the AWG2021 **MANUAL TRIGGER** button, and check that the Autostep changes to Step: 3 on the MODE menu.
 - Check that the DMM reading is in the range from -2.625 V to -2.375 V.
3. *End procedure:* Retain the test hookup and settings for the next check.

Check Internal Add Operation (Option 02 only)

Electrical Characteristic Checked	Arithmetic Operation, Add, on page B-9.
Equipment Required	Two 50 Ω coaxial cables, a function generator, and a digital multimeter (DMM).
Prerequisites	The AWG2021 meets the prerequisites listed on page C-5. It also requires Option 02 (CH2 output channel) in the AWG2021.

1. *Use test hookup and control settings from previous check.*
2. *Check internal Add operation:*
 - a. *Check Autostep Step 4:*
 - Push the AWG2021 **MANUAL TRIGGER** button, and check that the step changes to Step 4 on the MODE menu.
 - Check that the DMM reading is in the range from 2.85 V to 3.15 V.

3. *End procedure:*
 - a. *Disable function generator output:* Turn the function generator output off.
 - b. *Remove equipment:* Disconnect connections to the test equipment.

Clock Frequency and Amplitude Checks

These procedures check the accuracy of the AWG2021 clock frequency and the waveform output amplitude.

Check Clock Frequency Accuracy

Electrical Characteristic Checked	Clock Generator, Accuracy, on page B-6.
Equipment Required	A 50 Ω coaxial cable, an SMA-BNC adapter, and a frequency counter.
Prerequisites	The AWG2021 meets the prerequisites listed on page C-5.

1. *Install test hookup and set test equipment controls:*
 - a. *Hook up frequency counter:* Connect the AWG2021 rear panel CLOCK OUT connector to the frequency counter input through a coaxial cable and an SMA-BNC adapter (see Figure C-13).

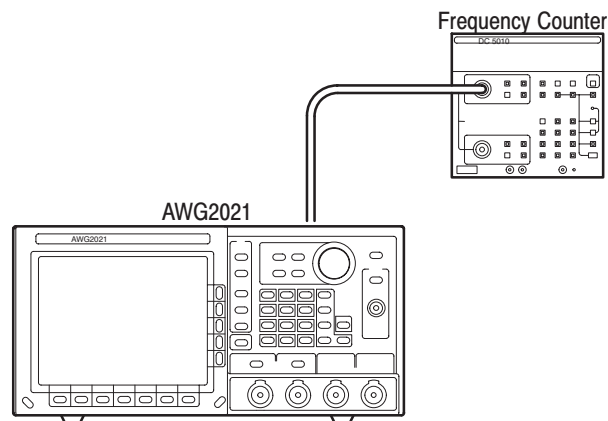

Figure C-13: Clock Frequency Accuracy Initial Test Hookup

b. *Set frequency counter controls:*

CHANNEL A
 Termination 50 Ω
 Slope Negative
 Attenuation X5
 Coupling AC
 FREQ A

2. *Set AWG2021 controls and select the waveform:*

a. *Initialize AWG2021 controls:* Push **UTILITY**→**Misc**→**Config...**→**Reset to Factory**→**O.K.**

b. *Select the waveform file:*

- Push **SETUP**→**Waveform Sequence**, if necessary, to select a waveform file for CH1. Waveform Sequence toggles between the CH1 files (upper list) and the CH2 files (lower list).
- Turn the general purpose knob to select the **CLK_FREQ.WFM** file.
- Push **ENTER**.

3. *Check clock frequency accuracy:*

a. *Check clock frequency accuracy at current clock frequency setting:*
 Check that the frequency counter reading falls between 249.9875 MHz and 250.0125 MHz.

b. *Check clock frequency accuracy for different clock frequency settings:*

- Select **Clock** from the bottom of the **SETUP** menu.
- Turn the general purpose knob (or press the numeric and units keys, and push **ENTER**) to select the first clock frequency listed in Table C-3.
- Check that the frequency counter reading is within the frequency range listed in the table for the clock frequency setting.
- Repeat this step for each clock frequency and frequency range listed in Table C-3.

Table C-3: Clock Frequency Accuracy

Clock Frequency	Frequency Range
150 MHz	149.9925 MHz – 150.0075 MHz
1 MHz	0.99995 MHz – 1.00005 MHz
1 kHz	0.99995 kHz – 1.00005 kHz
10 Hz	9.9995 Hz – 10.0005 Hz

4. *End procedure:* Disconnect the frequency counter.

Check Clock Amplitude

Electrical Characteristic Checked	Auxiliary Outputs, Clock, Amplitude, on page B-8.
Equipment Required	A 50 Ω coaxial cable, an SMA-BNC adapter, and an oscilloscope.
Prerequisites	The AWG2021 meets the prerequisites listed on page C-5.

1. *Install test hookup and set test equipment controls:*
 - a. *Hook up oscilloscope:* Connect the AWG2021 rear-panel CLOCK OUT connector through a coaxial cable and SMA-BNC adapter to the oscilloscope CH1 vertical input (see Figure C-14).

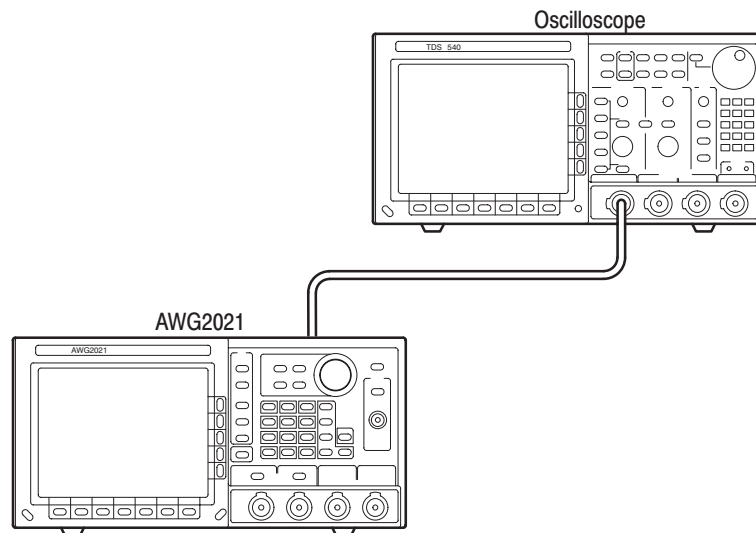

Figure C-14: Clock Amplitude Initial Test Hookup

b. *Set oscilloscope controls:*

Vertical	CH1
Coupling	DC
Scale	500 mV/div.
Input impedance	50 Ω
Horizontal	
Sweep	500 ns/div.
Trigger	
Source	CH1
Coupling	DC
Slope	Positive
Level	500 mV
Mode	Auto

2. *Set the AWG2021 controls and select the waveform file:*

a. *Initialize AWG2021 controls:* Push **UTILITY**→**Misc**→**Config...**→**Reset to Factory**→**O.K.**

b. *Select the waveform file:*

- Push **SETUP**→**Waveform Sequence**, if necessary, to select a waveform file for CH1. Waveform Sequence toggles between the CH1 files (upper list) and the CH2 files (lower list).
- Turn the general purpose knob to select the **CLK_AMPL.WFM** file.
- Push **ENTER**.

3. *Check clock amplitude accuracy:* Check that the pulse displayed on the oscilloscope has an amplitude of $0.7 V_{p-p}$ to $1.3 V_{p-p}$.

4. *End procedure:* Disconnect the oscilloscope.

Gain and Offset Accuracy Checks

These procedures check the accuracy of the AWG2021 gain and offset.

NOTE. The gain and offset accuracy checks are structured as a continuous test. After Check Gain Accuracy, the next test uses the control settings from the last test and uses the next step in the sequence file.

Check Gain Accuracy

Electrical Characteristic Checked	Main Output, Amplitude, Accuracy, on page B-6.
Equipment Required	A 50 Ω coaxial cable, a BNC-to-dual banana adapter, and a digital multimeter (DMM).
Prerequisites	The AWG2021 meets the prerequisites listed on page C-5.

1. *Install test hookup and set controls:*
 - a. *Hook up DMM:* Connect the AWG2021 CH1 output through a 50 Ω coaxial cable, a 50 Ω terminator and a dual banana connector to the DMM INPUT connector (see Figure C-15).

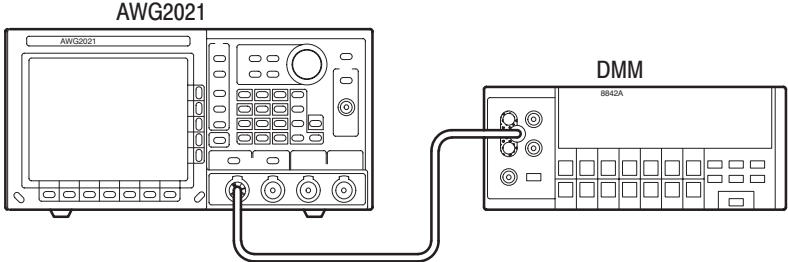

Figure C-15: Gain Accuracy Initial Test Hookup

- b. *Set DMM controls:*
 - Mode VDC
 - Range 20
 - Input Front
2. *Set the AWG2021 controls and select the waveform file:*
 - a. *Initialize AWG2021 controls:* Push **UTILITY**→**Misc**→**Config...**→**Reset to Factory**→**O.K.**

b. *Select the AWG2021 waveform file:*

- Push **MODE**→**Autostep**→**Select Autostep File** to choose a sequence file for CH1.
- Turn the general purpose knob to select the **GAIN_OFF.AST** file.
- Push **ENTER**.

3. *Check gain accuracy:*

- Check that the displayed step is Step 1 on the MODE menu. If it is not, select the side menu **STOP** button to return to Step 1.
- Note the DMM reading as “A” for this value.
- Push the AWG2021 **MANUAL TRIGGER** button, and check that the displayed step is Step 2.
- Note the DMM reading as “B” for this value.
- Do the following calculation.

$$A - B$$

- Check that the calculated value is in the range from 0.4925 V to 0.5075 V.
- Push the AWG2021 **MANUAL TRIGGER** button, and check that the displayed step is Step 3.
- Note the DMM reading as “C” for this value.
- Push the AWG2021 **MANUAL TRIGGER** button, and check that the displayed step is Step 4.
- Record the DMM reading as “D” for this value.
- Do the following calculation.

$$C - D$$

- Check that the calculated value is in the range from 4.925 V to 5.075 V.

4. *End procedure:* Retain the test hookup and control settings.

Check Offset Accuracy

Electrical Characteristic Checked	Main Output, Offset, Accuracy, on page B-6.
Equipment Required	A 50 Ω coaxial cable, 50 Ω termination, BNC-to-dual banana adapter, and a digital multimeter (DMM).
Prerequisites	The AWG2021 meets the prerequisites listed on page C-5.

1. Use the test hookup and test equipment settings from previous check, however, add a 50 Ω termination at the DMM input.
2. Check offset accuracy:
 - Push the AWG2021 **MANUAL TRIGGER** button, and check that the displayed step is Step 5.
 - Check that the DMM voltage reading is in the range from 2.470 V to 2.530 V.
 - Push the AWG2021 **MANUAL TRIGGER** button, and check that the displayed step is Step 6.
 - Check that the DMM voltage reading is in the range from -0.005 V to 0.005 V.
 - Push the AWG2021 **MANUAL TRIGGER** button, and check that the displayed step is Step 7.
 - Check that the DMM voltage reading is in the range from -2.470 V to -2.530 V.
3. Check Option 02: If the AWG2021 has Option 02, repeat the *Gain Accuracy* and *Offset Accuracy Checks* for the AWG2021 channel 2 (CH2).
4. End procedure: Disconnect the DMM.

Pulse Response Check

This procedure checks the pulse response characteristics of the AWG2021 output waveforms at amplitudes of 0.5 and 1 V.

Electrical Characteristic Checked	Main Outputs, Pulse Response, on page B-7.
Equipment Required	A 50 Ω coaxial cable and an oscilloscope.
Prerequisites	The AWG2021 meets the prerequisites listed on page C-5.

1. *Install test hookup and set test equipment controls:*

- a. *Hook up the oscilloscope:* Connect the AWG2021 CH1 output connector through the coaxial cable to the CH1 vertical input connector on the oscilloscope (see Figure C-16).

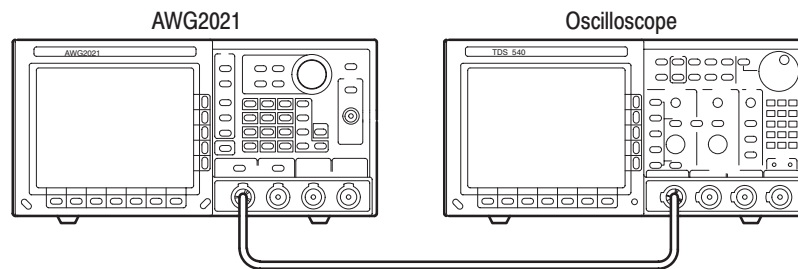

Figure C-16: Pulse Response Initial Test Hookup

b. *Set oscilloscope controls:*

- Vertical CH1
- Coupling DC
- Scale 0.1 V/div.
- Input impedance 50 Ω
- Horizontal
- Sweep 5 ns/div.
- Trigger
- Source CH1
- Coupling DC
- Slope Positive
- Level 0 V
- Mode Auto

2. *Set the AWG2021 controls and select the waveform file:*
 - a. *Initialize AWG2021 controls:* Push **UTILITY**→**Misc**→**Config...**→**Reset to Factory**→**O.K.**
 - b. *Select waveform file:*
 - Push **SETUP**→**Waveform Sequence**, if necessary, to select a waveform file for CH1. Waveform Sequence toggles between the CH1 files (upper list) and the CH2 files (lower list).
 - Turn the general purpose knob to select the **PULSE.WFM** file.
 - Push **ENTER**.
3. *Turn on the AWG2021 CH1 output:* Push the **CH1** button so that the LED above the CH1 output connector is on.
4. *Check pulse response at 0.5 V amplitude:*
 - a. *Check rise time:* Check that the rise time of the waveform displayed on the oscilloscope from the 10% point to the 90% point is 4.2 ns or less.
 - b. *Check aberrations:* Check that the aberrations of the displayed waveform is within 0.45 div.
 - c. *Check flatness:* Check that the flatness of the displayed waveform is within 0.15 div. after 20 ns from the rising edge.
 - d. *Change the oscilloscope controls:*

Horizontal
Sweep 2 ns/div.
Trigger
Slope Negative
 - e. *Check fall time:* Check that the fall time of the displayed waveform from the 10% point to the 90% point is 4.2 ns or less.
5. *Check pulse response at 1 V amplitude:*
 - a. *Change the oscilloscope controls:*

Vertical CH1
CH1 scale 0.2 V/div.
Trigger
Slope Positive
 - b. *Change the AWG2021 controls:*
 - Push **SETUP**→**Ampl** to change the amplitude for CH1.

b. *Set oscilloscope controls:*

Vertical	CH1
CH1 Coupling	DC
CH1 Scale	200 mV/div.
CH1 Input Impedance	50 Ω
Horizontal	
Sweep	50 ns/div.
Trigger	
Source	CH1
Coupling	DC
Slope	Positive
Level	500 mV
Mode	Auto

2. *Set the AWG2021 controls and select the waveform file:*

a. *Initialize AWG2021 controls:* Push **UTILITY**→**Misc**→**Config...**→**Reset to Factory**→**O.K.**

b. *Select waveform file:*

- Push **SETUP**→**Waveform Sequence**, if necessary, to select a waveform file for CH1. Waveform Sequence toggles between the CH1 files (upper list) and the CH2 files (lower list).
- Turn the general purpose knob to highlight the **SYNC_MRK.WFM** file.
- Push **ENTER**.

3. *Check front-panel SYNC Out and MARKER Out amplitude:*

a. *Check SYNC Out pulse amplitude:* Check that the pulse amplitude of the waveform displayed on the oscilloscope is 1.2 V_{p-p} or greater.

b. *Check CH1 MARKER 1 Out pulse amplitude:*

- Move the coaxial cable from the AWG2021 CH1 SYNC Out connector to the CH1 MARKER 1 connector.
- Change the oscilloscope sweep to 5 μ s/div.
- Check that the pulse amplitude of the displayed waveform is from 2.250 V_{p-p} to 2.625 V_{p-p} .

4. *Check rear-panel CH1 MARKER Out 2 pulse amplitude:*
 - a. *Check CH1 MARKER 2 OUT pulse amplitude:*
 - Remove the coaxial cable from the AWG2021 front-panel CH1 MARKER 1 connector and connect it through the SMA-BNC adapter to the rear-panel CH1 MARKER 2 OUT connector.
 - Check that the pulse amplitude of the displayed waveform is from $2.250 V_{p-p}$ to $2.625 V_{p-p}$.
5. *Check Option 02:* If the AWG2021 has a second channel, repeat this entire test, selecting the AWG2021 waveform and setting controls for CH2 and checking:
 - Rear-panel CH2 SYNC Out pulse amplitude
 - Rear-panel CH2 MARKER 1 pulse amplitude
 - Rear-panel CH2 MARKER 2 pulse amplitude
6. *End procedure:* Disconnect the oscilloscope.

External Trigger Level Accuracy Check

This procedure checks the external trigger level accuracy of the AWG2021.

Electrical Characteristic Checked	Auxiliary Inputs, Trigger, Accuracy, on page B-9.
Equipment Required	Two 50 Ω coaxial cables, a function generator, and an oscilloscope.
Prerequisites	The AWG2021 meets the prerequisites listed on page C-5.

1. *Install test hookup and set test equipment controls:*
 - a. *Hook up oscilloscope:* Connect the AWG2021 CH1 output through a coaxial cable to the oscilloscope CH1 vertical input.
 - b. *Hook up function generator:* Connect the AWG2021 TRIGGER INPUT through a coaxial cable to the function generator output (see Figure C-18).

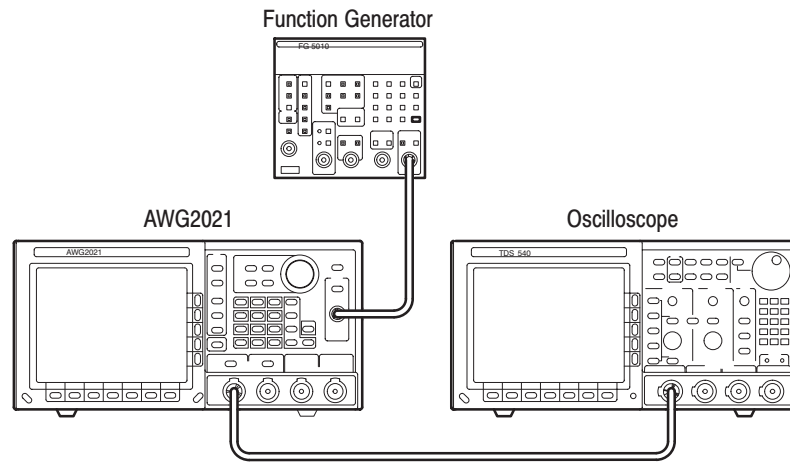

Figure C-18: External Trigger Level Accuracy Initial Test Hookup

c. Set oscilloscope controls:

Vertical	CH1
CH1 Coupling	DC
CH1 Scale	0.2 V/div.
CH1 Input Impedance	50 Ω
Horizontal	
Sweep	50 μ s/div.
Trigger	
Source	CH1
Coupling	DC
Slope	Positive
Level	0 V
Mode	Auto

d. Set function generator controls:

Function	Square
Mode	Continuous
Parameter	
Frequency	1 kHz
Amplitude	0 V
Offset	0.6 V
Output	Off

2. *Select the AWG2021 waveform file and set AWG2021 controls:*
 - a. *Initialize AWG2021 controls:* Push **UTILITY**→**Misc**→**Config...**→**Reset to Factory**→**O.K.**
 - b. *Modify AWG2021 default settings:*
 - Push **MODE**→**Gated**→**Polarity** to highlight **Positive**.
 - Select **Level** from the side menu, and turn the general purpose knob to select 1 V. (You can also use the numeric and units keys to select 1 V; then push **ENTER**.)
 - Select **Impedance** from the side menu to highlight **1 MΩ**.
 - c. *Select waveform file:*
 - Push **SETUP**→**Waveform Sequence**, if necessary, to select a waveform file for CH1. Waveform Sequence toggles between the CH1 files (upper list) and the CH2 files (lower list).
 - Turn the general purpose knob to highlight the **TRG_IN.WFM** file.
 - Push **ENTER**.
3. *Turn on the AWG2021 CH1 output:* Push the **CH1** button so that the LED above the CH1 output connector is on.
4. *Check external trigger high level:*
 - a. *Adjust oscilloscope controls:* Press and hold the AWG2021 **MANUAL TRIGGER** button and adjust the oscilloscope vertical and horizontal position to display the waveform from the AWG2021. Release the **MANUAL TRIGGER** button.
 - b. *Enable function generator output:* Turn on the function generator output.
 - c. *Check external trigger level accuracy:*
 - Gradually increment the function generator offset level until a waveform is displayed on the oscilloscope.
 - Check that the function generator offset level is from 0.85 to 1.15 V, when the waveform is first displayed.
5. *Check external trigger low level:*
 - a. *Change the function generator controls:*

Parameter
 Offset -0.6 V

- b. *Change the AWG2021 controls:*
 - Push **MODE**→**Polarity** to highlight **Negative**.
 - Select **Level** from the side menu, and turn the general purpose knob to select -1 V. (You can also use the numeric and units keys to select -1 V; then push **ENTER**.)
 - c. *Check external trigger level accuracy:*
 - Gradually decrement the function generator offset level until a waveform is displayed on the oscilloscope.
 - Check that that the function generator offset level is from -1.15 V to -0.85 V, when the waveform is first displayed.
6. *End procedure:* Turn off the function generator output and disconnect the function generator.

External CLOCK IN Check

This procedure checks the AWG2021 response to an external CLOCK IN signal.

Electrical Characteristic Checked	Auxiliary Inputs, Clock, Threshold level, on page B-9.
Equipment Required	Two $50\ \Omega$ coaxial cables, a function generator, and an oscilloscope.
Prerequisites	The AWG2021 meets the prerequisites listed on page C-5.

1. *Install test hookup and set test equipment controls:*
 - a. *Hook up oscilloscope:* Connect the AWG2021 CH1 output through a coaxial cable to the oscilloscope CH1 vertical input.
 - b. *Hook up function generator:* Connect the AWG2021 rear-panel CLOCK IN through a coaxial cable and SMA-BNC adapter to the function generator output (see Figure C-19).

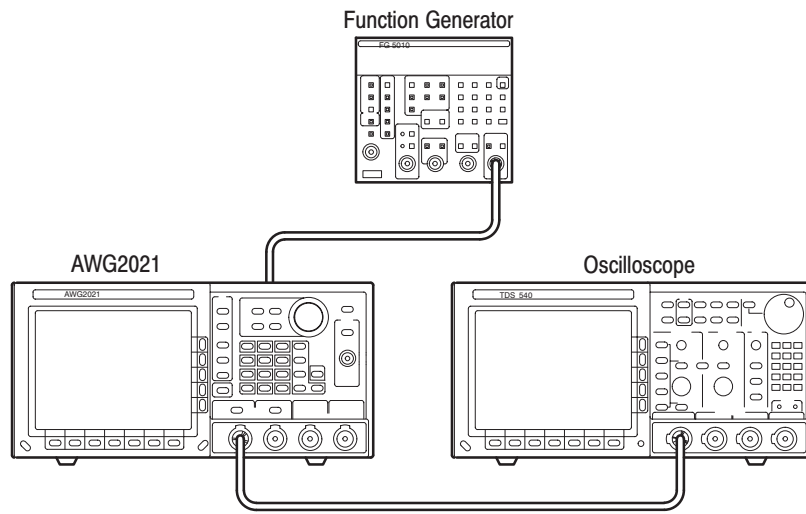

Figure C-19: External CLOCK IN Initial Test Hookup

c. Set oscilloscope controls:

Vertical	CH1
Coupling	DC
Scale	0.2 V/div.
Input Impedance	50 Ω
Horizontal	
Sweep	500 μ s/div.
Trigger	
Source	CH1
Coupling	DC
Slope	Positive
Level	0 mV
Mode	Auto

d. Set function generator controls:

Function	Square
Mode	Continuous
Parameter	
Frequency	1 MHz
Amplitude	1.6 V
Offset	0.6 V
Output	Off

2. *Select the AWG2021 waveform file and set AWG2021 controls:*
 - a. *Initialize AWG2021 controls:* Push **UTILITY**→**Misc**→**Config...**→**Reset to Factory**→**O.K.**
 - b. *Select waveform file:*
 - Push **SETUP**→**Waveform Sequence**, if necessary, to select a waveform file for CH1. Waveform Sequence toggles between the CH1 files (upper list) and the CH2 files (lower list).
 - Turn the general purpose knob to highlight the **EXT_CLK.WFM** file.
 - Push **ENTER**.
3. *Turn on the AWG2021 CH1 output:* Push the **CH1** button so that the LED above the CH1 output connector is on.
4. *Check the external CLOCK IN threshold level:*
 - a. *Enable function generator output:* Turn on function generator output.
 - b. *Check the level:* Check that the waveform displayed on the oscilloscope has an amplitude of 5 divisions and a stable display of 5 cycles.
5. *Turn off equipment output and disconnect test hookup:*
 - a. *Disable function generator output:* Turn off function generator output.
 - b. *Remove connections:* Disconnect all connections to the AWG2021.

ECL Digital Data Out Check (Option 03)

This procedure checks the AWG2021 ECL digital data output at the rear panel. This check requires that the AWG2021 has Option 03 installed.

Electrical Characteristic Checked	Auxiliary Outputs, ECL Digital Data Out, Level, on page B-8.
Equipment Required	Test leads, ECL digital data out cable, power supply, termination board, and oscilloscope.
Prerequisites	The AWG2021 meets the prerequisites listed on page C-5.

1. *Install test hookup and set test equipment controls:*

- a. *Hook up termination board:* Connect the AWG2021 rear ECL digital data output through a digital data output cable to the termination board (see Figure C-20).
- b. *Hook up power supply:* Connect the power supply output through the test leads to the GND TP100 and -2VD TP120 terminals on the termination board.
- c. *Hook up oscilloscope:*
 - Connect the oscilloscope probe to the CH1 vertical input.
 - Connect the probe ground-clip to the GND TP200 terminal on the termination board.

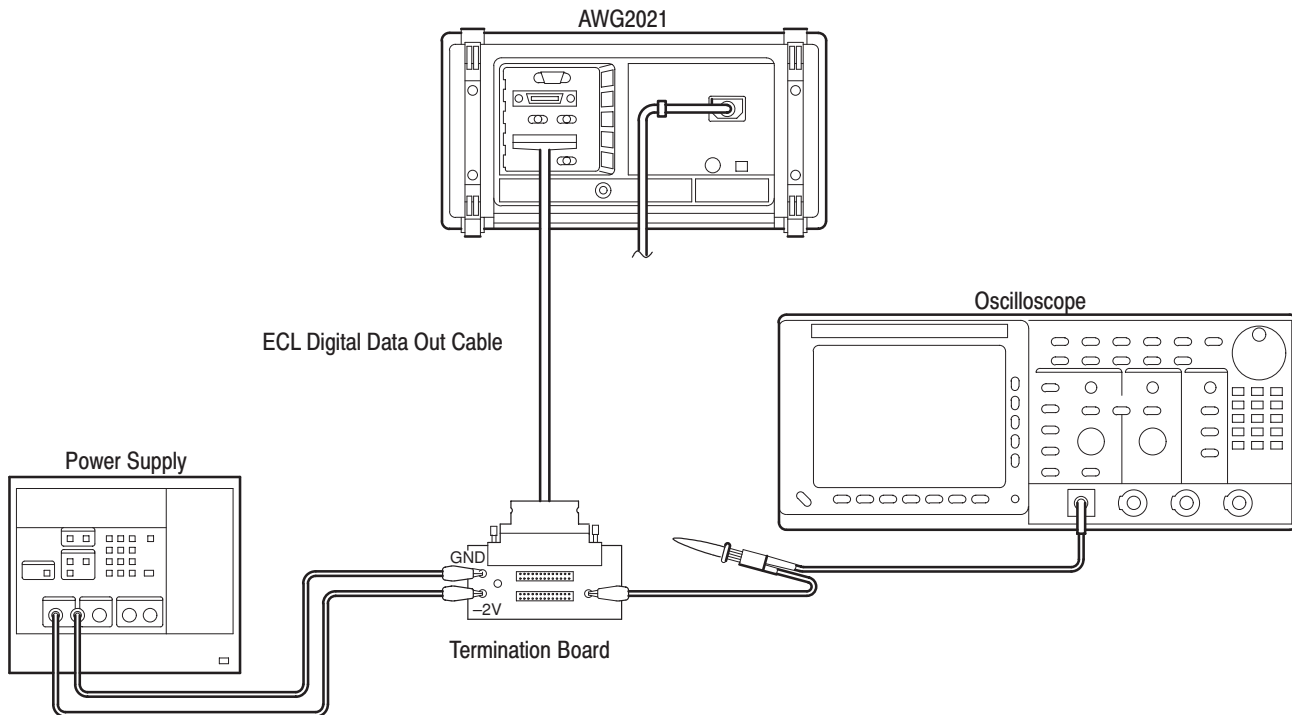

Figure C-20: ECL Digital Data Out Initial Test Hookup

d. *Set oscilloscope controls:*

Vertical CH1
 Scale 0.1 V/div.
 Input Impedance 1 M Ω

Horizontal

Sweep Adjust as needed

Trigger

Mode Auto

e. *Set power supply controls:*

Parameter

Supply select Negative

Voltage 2

2. *Select the AWG2021 waveform file, and set AWG2021 controls:*a. *Initialize AWG2021 controls:* Push **UTILITY**→**Misc**→**Config...**→**Reset to Factory**→**O.K.**b. *Select waveform file:*

- Push **SETUP**→**Waveform Sequence**, if necessary, to select a waveform file for CH1.
- Turn the general purpose knob to highlight the **DIGI_OUT.WFM** file.
- Push **ENTER** to select the file.

c. *Set AWG2021 controls:*

- Push **MODE**→**Cont**

3. *Turn on the AWG2021 CH1 output:* Push the **CH1** button so that the LED above the CH1 output connector is on.4. *Check the digital data output signals:*a. *Enable power supply output:* Turn on power supply output.b. *Check the signal levels:*

- Contact the oscilloscope probe to the pins on J200 and J210 (see Figure C-21). Check that the oscilloscope display shows these signals:

Data signals D0–D11, $\overline{D0}$ – $\overline{D11}$ are differential ECL output.Clock signals CLK and \overline{CLK} are differential ECL output.

All other pins are ground.

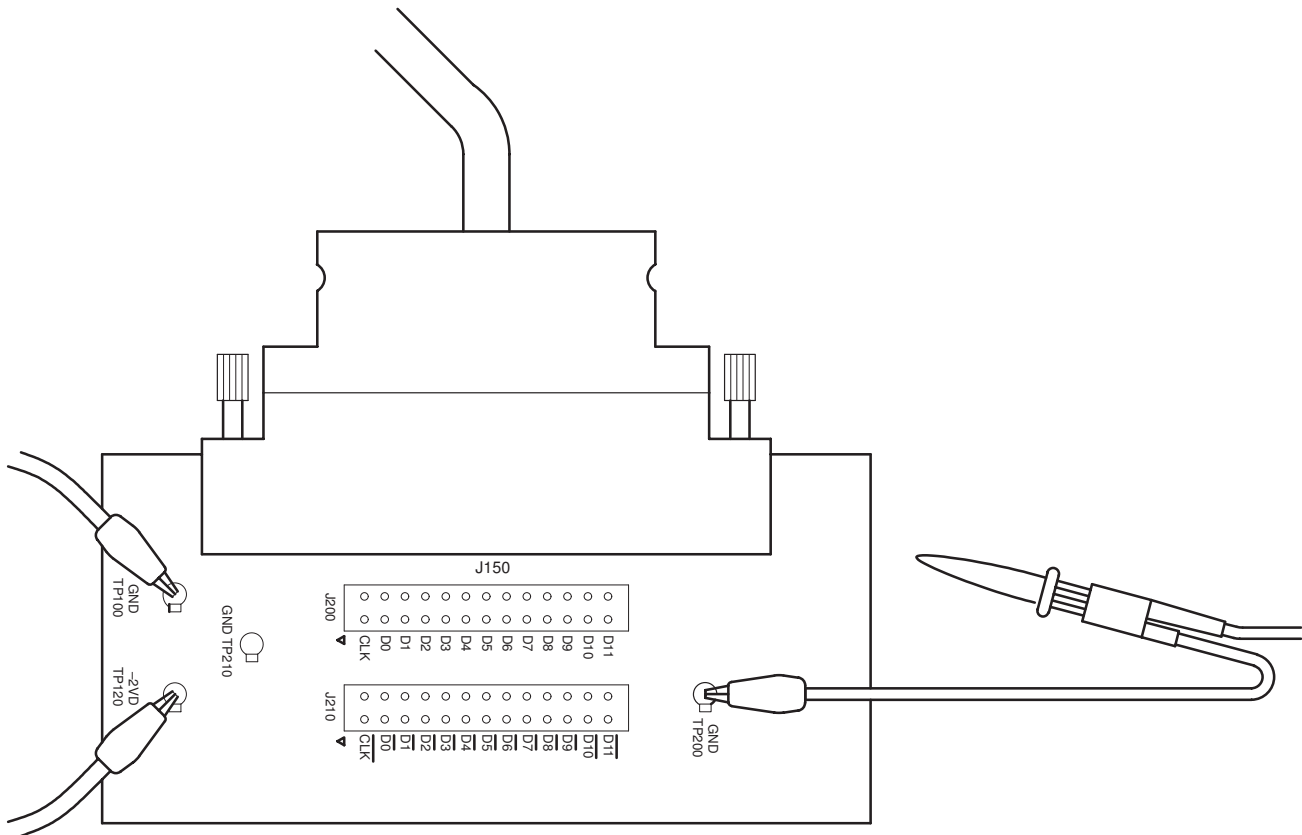

Figure C-21: Output Pins on the Termination Board

5. *Turn off equipment output and disconnect test hookup:*
 - a. *Disable power supply output:* Turn off power supply output.
 - b. *Remove connections:* Disconnect all connections to the AWG2021.

TTL DIGITAL DATA OUT Check (Option 04)

This procedure checks the AWG2021 TTL DIGITAL DATA OUT at the rear panel.

NOTE. This check requires that the AWG2021 has Option 04 installed.

Electrical Characteristic Checked	Auxiliary Output, TTL DIGITAL DATA OUT, Level, on page B-8.
Equipment Required	TTL Digital data out cable, 2 X13 header, probe and oscilloscope.
Prerequisites	The AWG2021 meets the prerequisites listed on page C-5.

1. *Install test hookup and set test equipment controls:*

- a. *Hook up termination board:* Connect a digital data output cable to the AWG2021 rear-pane **CH1 DIGITAL DATA OUT** output (see Figure C-22).

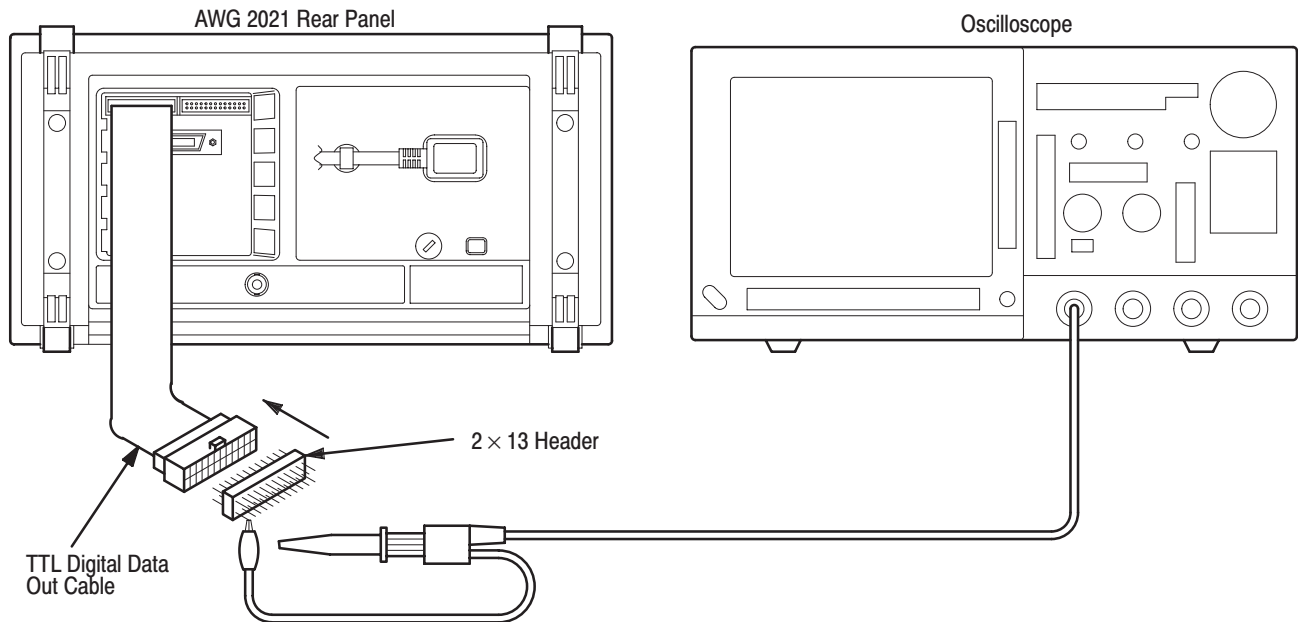

Figure C-22: TTL Digital Data Out Initial Test Hookup

b. *Hook up oscilloscope:*

- Connect the oscilloscope probe to the CH1 vertical input.
- Connect the probe ground-clip to the GND pin of 2 × 13 header.

c. *Set oscilloscope controls:*

Vertical CH1
 Scale 1 V/div.
 Input Impedance 1 MΩ
 Horizontal
 Sweep Adjust as needed
 Trigger
 Mode Auto

2. *Create the AWG2021 waveform file, select waveform file, and set AWG2021 controls:*

a. *Initialize AWG2021 controls:* Push **UTILITY**→**Misc**→**Config...**→**Reset to Factory**→**O.K.**

b. *Select waveform file:*

- Push **SETUP**→**Waveform Sequence**, if necessary, to select a waveform file for CH1. If Option 02 is installed (Option 02 adds the CH2 output channel), **Waveform Sequence** toggles between the CH1 files (upper list) and the CH2 files (lower list).
- Turn the general purpose knob to highlight the **DIGI_OUT.WFM** file.
- Push **ENTER** to select the file.

c. Set AWG2021 controls:

- Push **MODE**→**Cont**

3. *Check the CH1 digital data output signals:*

a. *Check the signal levels:*

- Contact the oscilloscope probe to the pins on 2 × 13 header (see Figure C-23). Check that the oscilloscope display shows these signals:

Data signals D0-D11 and CLK (Clock) are TTL level output.

All other pins are ground.

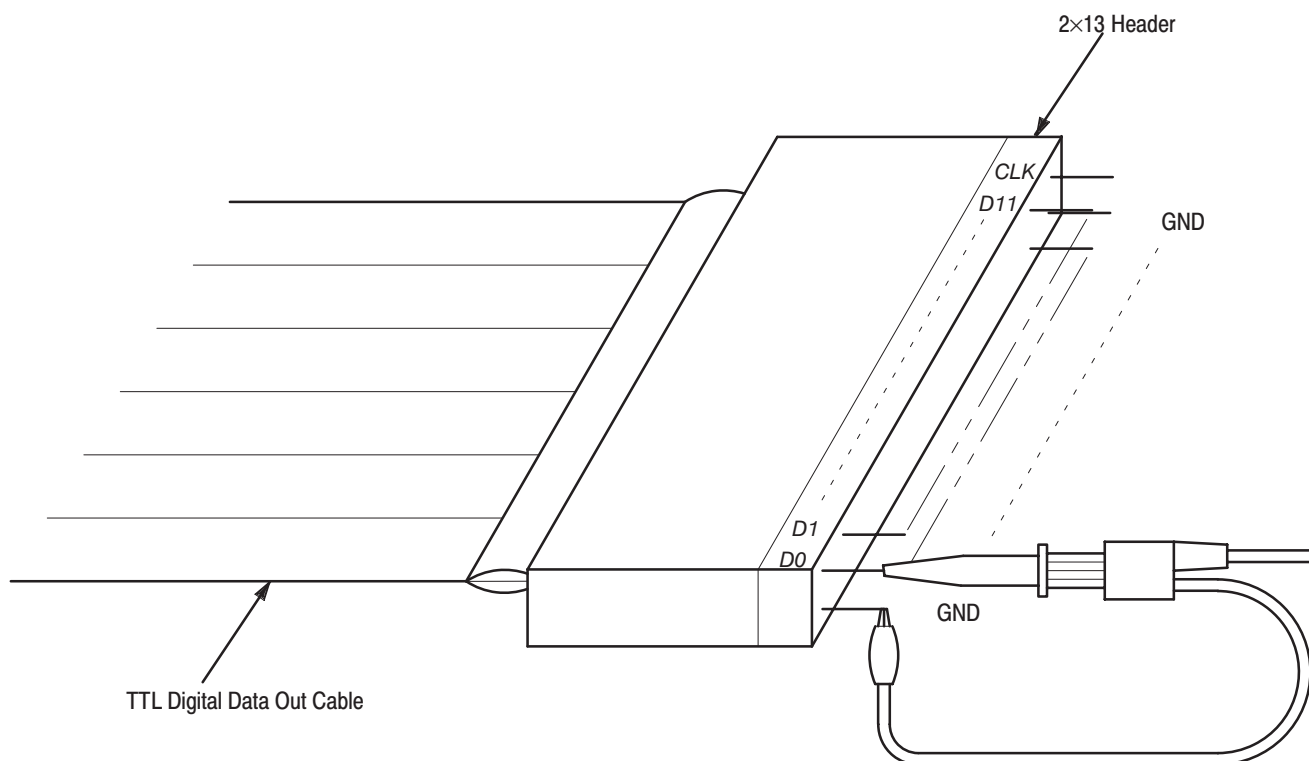

Figure C-23: Output Pins on the TTL Digital Data Out Cable

4. *If Option 02 is installed, check the CH2 digital data output signals:*
 - a. *Change connection:* Change the connection for the TTL digital data out cable from CH1 DIGITAL DATA OUT connector to CH2 DIGITAL DATA OUT connector.
 - b. Repeat the step2 and 3 to check the CH2 digital data output signals.
5. *Turn off equipment output and disconnect test hookup:*
 - a. *Disable power supply output:* Turn off power supply output.
 - b. *Remove connections:* Disconnect all connections to the AWG2021.

Floating Point Processor Check (Option 09)

This procedure checks the AWG2021 floating point processor. This check requires that the AWG2021 has Option 09 installed.

Equipment Required	None.
Prerequisites	The AWG2021 meets the prerequisites listed on page C-5.

1. *Check that floating point processor test in internal diagnostics passes:*
 - a. *Run the AWG2021 internal diagnostics:* Push the AWG2021 **ON/STBY** switch two times so that the AWG2021 runs the power-on diagnostics.
 - b. *Check the FPP test results:* When the AWG2021 finishes the FPP test, check that the test result is Pass.

This completes the performance tests for the AWG2021.

Appendix D: Sample Waveform Library

Introduction

The files and directories listed below are included in the route directory of the Sample Waveform Library Disk that comes with the instrument. All files are locked; this is indicated by an asterisk (*) before the file name.

Representative Waveform Files

There are 16 of these waveform files. If a waveform file (with the extender **.WFM**) has the same name as an equation file (with the extender **.EQU**), the waveform file was derived by compiling that equation file.

Waveform Name	File Name	Page
1. Gaussian Pulse	GAUSS_P.EQU GAUSS_P.WFM	D-3
2. Lorentz Pulse	LORENTZ.EQU LORENTZ.WFM	D-5
3. Sampling Function SIN(X)/X Pulse	SINC.EQU SINC.WFM	D-6
4. Squared Sine Pulse	SQU_SIN.EQU SQU_SIN.WFM	D-7
5. Double Exponential Pulse	D_EXP.EQU D_EXP.WFM	D-8
6. Nyquist Pulse	NYQUIST.EQU NYQUIST.WFM	D-9
7. Linear Frequency Sweep	LIN_SWP.EQU LIN_SWP.WFM	D-10
8. Log Frequency Sweep	LOG_SWP.EQU LOG_SWP.WFM	D-11
9. Amplitude Modulation	AM.EQU AM.WFM	D-12
10. Frequency Modulation	FM.EQU FM.WFM	D-13
11. Damped Sine Wave	DMP_SIN.EQU DMP_SIN.WFM	D-14
12. Pulse Width Modulation	PWM.WFM	D-15
13. Pseudo-Random Pulse	PRBS_15.WFM	D-16
14. $\pi/4$ DQPSK I Axis Signal	DQPSKI.WFM	D-17
15. $\pi/4$ DQPSK Q Axis Signal	DQPSKQ.WFM	D-17

Waveform Name	File Name	Page
16. Waveform for Magnetic Disk Readout Signal	MDSK_RD.WFM	D-18
17. Waveform for Magnetic Disk Writing Signal	MDSK_WR.WFM	D-19

NTSC Directory Contains video signals.

Waveform Name	File Name
1. Color Bar (Composite) signal	\$CB1-2H.SEQ
2. Color Bar (Luminance) signal	\$CB1-(Y).SEQ
3. Color Bar (Chrominance) signal	\$CB1-(C).SEQ
4. Multiburst signal	\$M-BURST.SEQ
5. Modulated Ramp signal	\$RAMP.SEQ
6. Sweep signal (1 ~ 10 MHz)	\$SWEEP10.SEQ
7. SMPTE Color Bar signal	\$SMPTE.SEQ
8. IYQB signal	\$IYQB.SEQ
9. Reversed Blue Bar signal	\$RBLU.SEQ
10. Color Bar + Reversed Blue Bar + IYQB signal	\$MIX.SEQ

Description of Representative Waveform Files

Here we will describe the 17 representative waveform files. Some of the waveform files were obtained by creating an equation file in the equation editor and then compiling it to form a waveform file. Others were created in the waveform editor. To output a waveform file, select the file in the **SETUP** menu.

Gaussian Pulse (GAUSS_P.WFM)

Made with the equation editor.

```
# gaussian pulse
range(0, 2.56us)
k0=0.3e-6      # pulse width
k1=1.28e-6    # peak location
exp(-ln(2)*((2*(t-k1)/k0)^2))
```

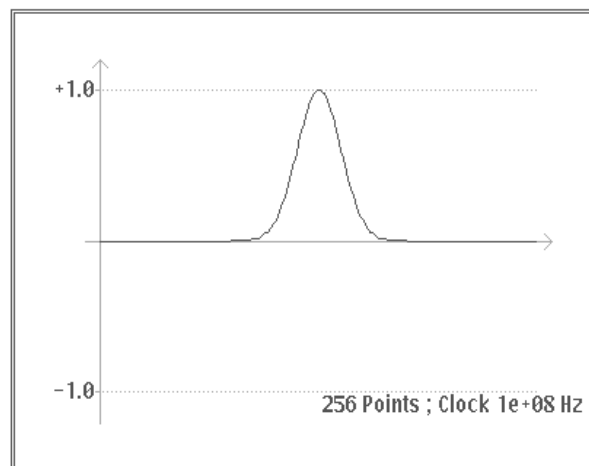

Figure D-1: Gaussian Pulse Formula and Waveform

Constants	k0 indicates the half width (W_{50}) for the pulse; k1 indicates the peak location of the pulse.
Description	<p>The waveform generated when the pulse width is taken to be t_{w50} and the peak location is taken to be 0 can be expressed as</p> $V(t) = \exp \left\{ -\ln(2) \cdot \left(\frac{2t}{t_{w50}} \right)^2 \right\}$ <p>Substituting $\sigma = \frac{t_{w50}}{2\sqrt{2 \ln(2)}}$ gives</p> $f(t) = \exp \left(-\frac{t^2}{2\sigma^2} \right),$ <p>and taking the Fourier transform gives</p> $F(j\omega) = \sqrt{2\pi} \sigma \cdot \exp \left(-\frac{\omega^2 \sigma^2}{2} \right).$ <p>This shows that this signal has a Gaussian form in the frequency domain as well.</p> <p><Example> When t_{w50} is 1 μs, the bandwidth will be 31.2 kHz.</p>
Settings	<p>Waveform points: 256 Clock frequency: 100 MHz Output time: 2.56 μs</p>

Lorentz Pulse (LORENTZ.WFM)

Made with the equation editor.

```
# lorentz pulse
range(0,2.56us)
k0=0.3e-6      # pulse width
k1=1.28e-6    # peak location
1/(1+(2*(t-k1)/k0)^2)
```

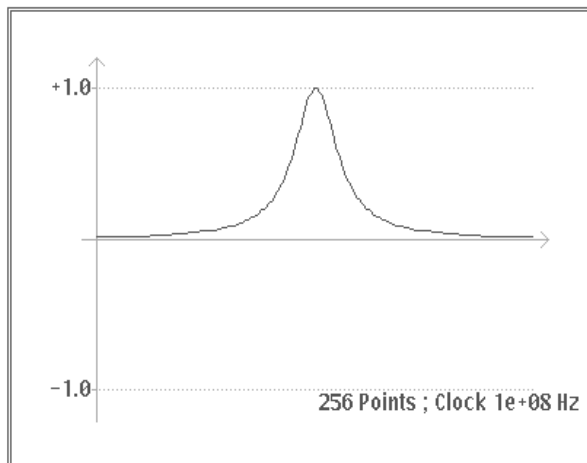

Figure D-2: Lorentz Pulse Formula and Waveform

Constants	k0 indicates the half width (W_{50}) for the pulse; k1 indicates the peak location of the pulse.
Description	When the pulse width is taken to be t_{w50} , the waveform can be expressed by the following formula: $V(t) = \frac{1}{1 + \left(2 \frac{t}{t_{w50}}\right)^2}$
Settings	Waveform points: 256 Clock frequency: 100 MHz Output time: 2.56 μ s

**Sampling Function
SIN(X)/X Pulse
(SINC.WFM)**

Made with the equation editor.

```
# sinc pulse
range(0,40us)
k0=2.5e6      # sine frequency
k1=20e-6     # peak location
sin(2*pi*k0*(t-k1))/(2*pi*k0*(t-k1))
```

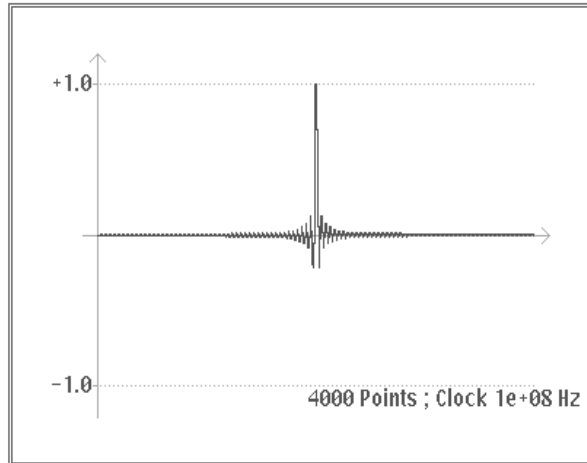

Figure D-3: Sampling Function SIN(X)/X Pulse Formula and Waveform

Constants	k0 indicates the frequency of the sine wave; k1 indicates the peak location of the pulse.
Description	In general, this waveform is expressed by the following formula: $V(t) = \frac{\sin(2\pi ft)}{2\pi ft}$ <p>This is the impulse response for the ideal low pass filter for the frequency bandwidth f. At least 326 periods are required in order to use a vertical resolution of 12 bits.</p>
Settings	Waveform points: 4000 Clock frequency: 100 MHz Output time: 40 μs

Squared Sine Pulse (SQU_SIN.WFM)

Made with the equation editor.

```
# squared sine pulse
range(0, 3us)
0

range(3us, 7us)
(cos(2*pi*(x-0.5))+1)/2

range(7us, 10us)
0
```

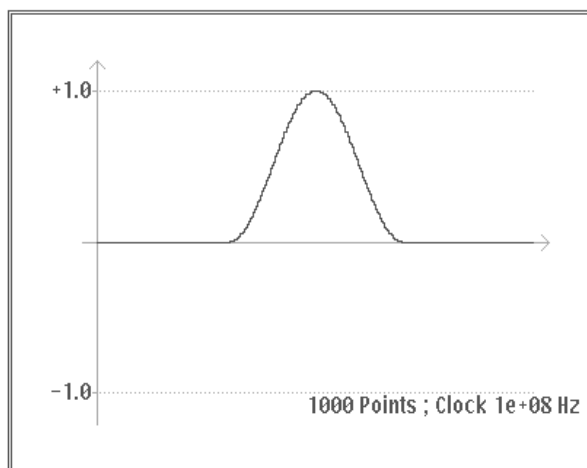

Figure D-4: Squared Sine Pulse Formula and Waveform

Description	The pulse width and peak location are set with range () . The value for x is a value between 0 and 1 for range (a,b) .
Settings	Waveform points: 1000 Clock frequency: 100 MHz Output time: 10 μ s

**Double Exponential Pulse
(D_EXP.WFM)**

This is the rising and falling exponential function pulse. Made with the equation editor.

```
# double exponential pulse
range(0,100us)
k1=1e-6      # rise time constant
k2=10e-6    # fall time constant
exp(-t/k2)-exp(-t/k1)
norm()
```

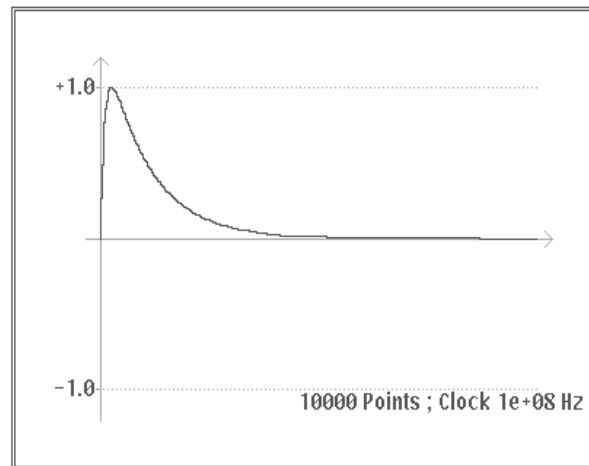

Figure D-5: Double Exponential Pulse Formula and Waveform

Constants	<p>k1 and k2 are the rising and falling time constants, respectively. The peak location for the pulse is derived using the following formula:</p> $\frac{k1 \cdot k2}{k2 - k1} \cdot \ln \frac{k2}{k1}$
Description	<p>This is the waveform when a charged capacitor is discharged to the RC circuit. When the time constants for charging and discharging are taken to be τ_1 and τ_2, respectively, the waveform can be expressed by the following formula:</p> $V(t) = \exp\left(-\frac{t}{\tau_2}\right) - \exp\left(-\frac{t}{\tau_1}\right)$
Settings	<p>Waveform points: 10000 Clock frequency: 100 MHz Output time: 100 μs</p>

Nyquist Pulse (NYQUIST.WFM)

Made with the equation editor.

```
# nyquist pulse
range(0, 10us)
k0=200e-9 # data period
k1=5e-6 # peak location
k2=0.5 # excess bandwidth factor 0 to 1
cos(pi*k2*(t-k1)/k0)/(1-(2*k2*(t-k1)/k0)^2)
v*sin(pi*(t-k1)/k0)/(pi*(t-k1)/k0)
```

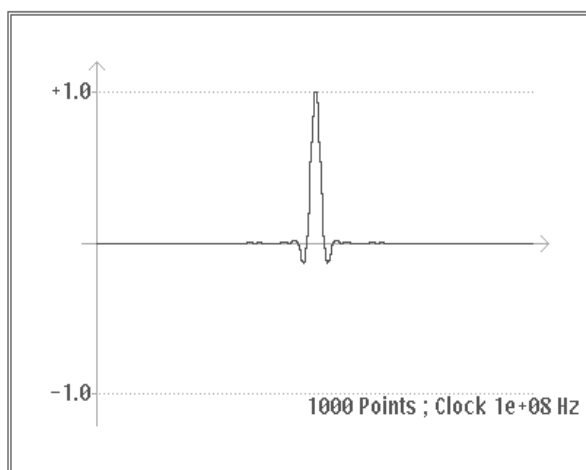

Figure D-6: Nyquist Pulse Formula and Waveform

Constants	k0 is the period of the digital data used in communication or recording. k1 is the pulse peak location. k2 is the excess bandwidth factor, and is a value between 0 to 1.
Description	This is the impulse response of a wave shaping Nyquist filter. The shoulder characteristics of this filter are referred to as "cosine roll-off" characteristics, and the bandwidth used can be varied. This waveform can be expressed by the following formula. $V(t) = \frac{\cos\left(\frac{\pi\alpha t}{T}\right)}{1-\left(\frac{2\alpha t}{T}\right)^2} \cdot \frac{\sin\left(\frac{\pi t}{T}\right)}{\frac{\pi t}{T}}$ <p>Here T is the data period and α is a value between 0 and 1. A wider band is required for values closer to 1, where ripple is reduced and implementation is easier.</p>
Settings	Waveform points: 1000 Clock frequency: 100 MHz Output time: 10 μ s

**Linear Frequency Sweep
(LIN_SWP.WFM)**

Made with the equation editor.

```
# frequency sweep sine (linear)
range(0, 1.6ms)
k0=1.6e-3      # sweep period
k1=5e3        # starting frequency
k2=50e3       # ending frequency
sin(2*pi*k1*t+2*pi*(k2-k1)*(t^2)/2/k0)
```

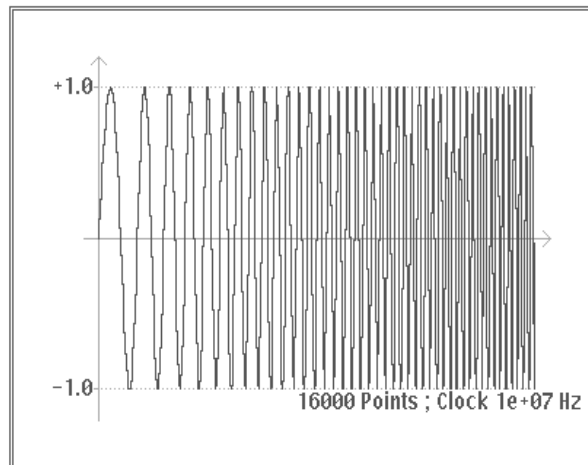

Figure D-7: Linear Frequency Sweep Formula and Waveform

Constants	k0 is the sweep period and k1 and k2 are the starting and ending frequencies.
Description	<p>This waveform can be expressed generally by the following formula.</p> $V(t) = \sin \left[2\pi f_1 t + 2\pi f_2 \int_0^t \frac{t}{T} dt + \phi_0 \right]$ <p>Here f_1 is the starting frequency, f_2 is the ending frequency, ϕ_0 is the initial phase, and T is the sweep period.</p> <p>To assure that the phases match when this waveform is iterated, the sweep period is set to be close to an integer multiple of the reciprocal of the average frequency</p> $\frac{f_1 + f_2}{2}$
Settings	<p>Waveform points: 16000 Clock frequency: 10 MHz Output time: 1.6 ms</p>

Log Frequency Sweep (LOG_SWP.WFM)

Made with the equation editor.

```
# frequency sweep sine (log)
range(0, 0.22ms)
k0=2.2e-3      # sweep period
k1=5e3         # starting frequency
k2=50e3        # ending frequency
k3=ln(k2/k1)
sin(2*pi*k1*k0/k3*(exp(k3*x)-1))
```

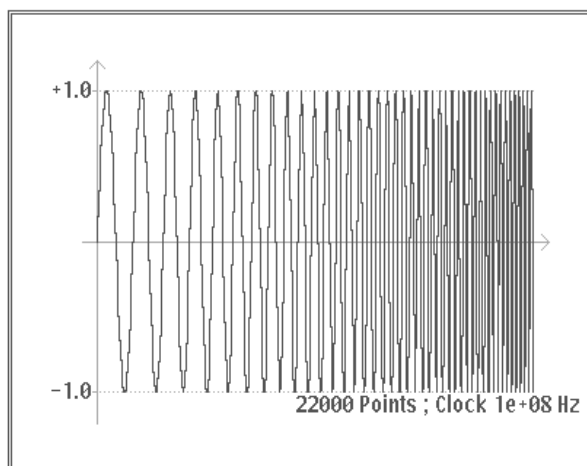

Figure D-8: Log Frequency Sweep Formula and Waveform

Constants	k0 is the sweep period and k1 and k2 are the starting and ending frequencies.
Description	<p>This waveform can be expressed generally by the following formula.</p> $V(t) = \sin \left[2\pi f_1 \int_0^t \exp \left(\frac{t}{T} \cdot \ln \frac{f_2}{f_1} \right) dt + \phi_0 \right]$ <p>Here f_1 is the starting frequency, f_2 is the ending frequency, ϕ_0 is the initial phase, and T is the sweep period.</p> <p>To assure that the phases match when this waveform is iterated, the sweep period is set to be close to an integer multiple of the reciprocal of the average frequency</p> $\left(\frac{f_2 - f_1}{f} \right) / \left(\ln \frac{f_2}{f_1} \right)$
Settings	<p>Waveform points: 22000 Clock frequency: 20 MHz Output time: 0.22 ms</p>

**Amplitude Modulation
(AM.WFM)**

Made with the equation editor.

```
# amplitude modulation
range(0,0.2ms)
k0=5e3      # modulation frequency
k1=5e6      # carrier frequency
k2=0.5      # modulation degree

(1+k2*cos(2*pi*k0*t))*cos(2*pi*k1*t)
norm()
```

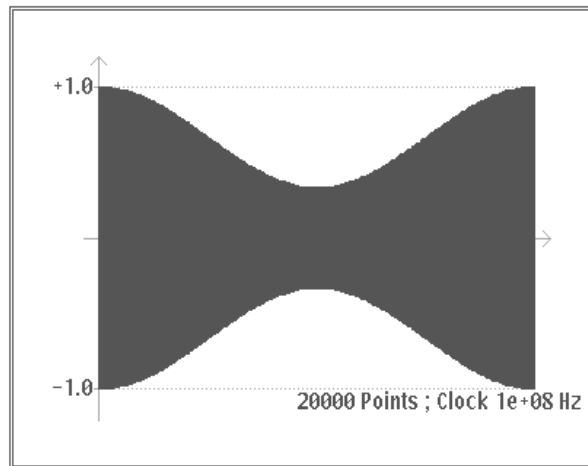

Figure D-9: Amplitude Modulation Formula and Waveform

Constants	k0 is the frequency of the modulating signal, k1 is the carrier frequency, and k2 is the modulation degree.
Description	This example shows a double sideband (DSB) amplitude modulated waveform with a modulation degree of 0.5. The modulating signal is a cosine wave.
Settings	Waveform points: 20000 Clock frequency: 100 MHz Output time: 200 μs

Frequency Modulation (FM.WFM)

Made with the equation editor.

```
# frequency modulation
range(0, 20us)
k0=50e3      # modulation frequency
k1=2.5e6    # carrier frequency
k2=2e6      # frequency deviation

sin(2*pi*k1*t+k2/k0*sin(2*pi*k0*t))
```

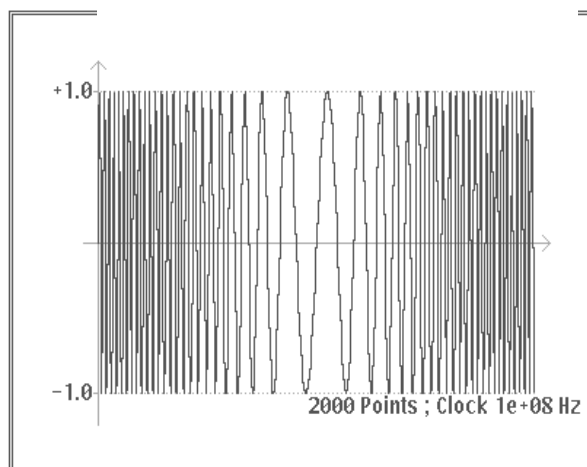

Figure D-10: Frequency Modulation Formula and Waveform

Constant	k0 is the modulation signal frequency, k1 is the carrier frequency, and k2 is the frequency deviation.
Description	k0 is the frequency of the cosine wave that is used to modulate a sine wave of frequency k1. To assure that the phases match when this waveform is iterated, the carrier frequency times the modulating signal period is set to be an integer. The modulation index is given by k2/k0.
Settings	Waveform points: 2000 Clock frequency: 100 MHz Output time: 20 μ s

**Damped Sine Wave
(DMP_SIN.WFM)**

Made with the equation editor.

```
# damped sine wave
range(0, 40us)
k0=2e-3
k1=12.66e-12
k2=k0*k1
k3=6e-6      # exponential damping factor
exp(-t/k3)*sin(1/sqrt(k2)*t)
```

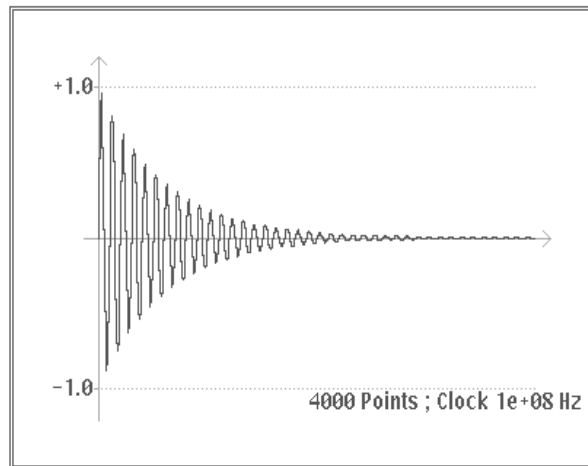
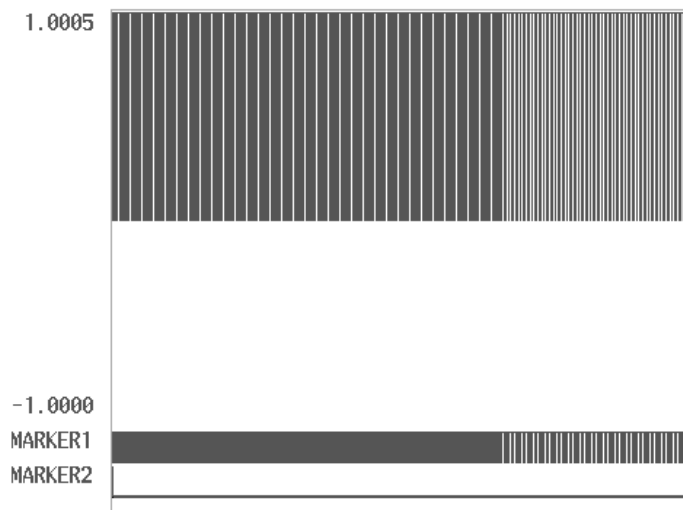

Figure D-11: Damped Sine Wave Formula and Waveform

Constants	k0 indicates the inductance (L), k1 indicates the capacitance (C), and k3 indicates the damping time constant.
Description	This is an attenuated amplitude waveform with a resonance frequency of 1 MHz (L=2 mH, C=12.66 pF) and a damping time constant of 6 μs.
Settings	Waveform points: 4000 Clock frequency: 100 MHz Output time: 40 μs

**Pulse Width Modulation
(PWM.WFM)**

Made with the waveform editor.

**Figure D-12: Pulse Width Modulation Waveform**

Description	The waveform editor is used to create a ramp wave of 2000 periods and a sine wave of 1 period, and these two waveforms are compared to create the PWM.WFM waveform.
Settings	Waveform points: 16000 Clock frequency: 100 MHz Output time: 160 μ s

**Pseudo-Random Pulse
(PRBS_15.WFM)**

Made with the waveform editor.

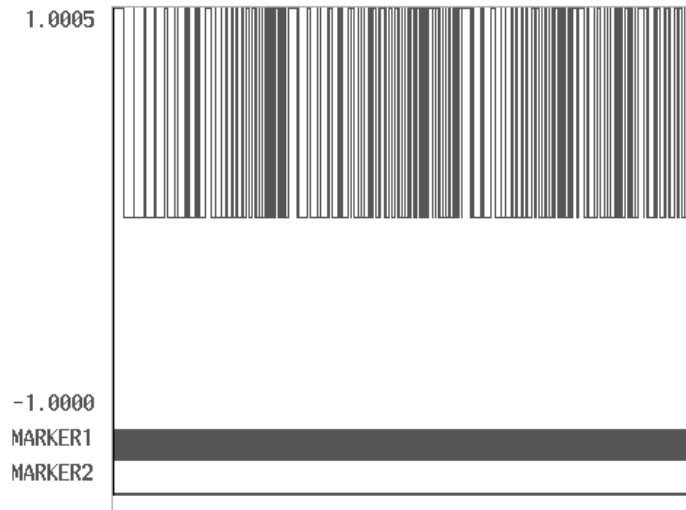
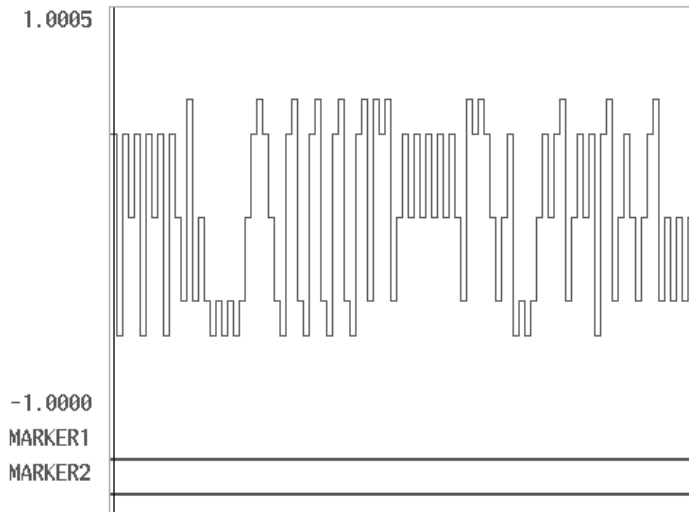

Figure D-13: Pseudo-Random Pulse Waveform

Description	<p>An M-series pseudo-random signal is created using the waveform editor's timing display shift register generator function.</p> <p>Register length = 15 Points/step = 1 The encoding is NRZ.</p> <p>When you output this waveform repeatedly, you create the eight times repetition waveforms with the sequence editor and expand its sequence file into waveform file using the Expand SEQ into WFM function of the waveform editor. Then you enable to output this waveform repeatedly.</p>
Settings	<p>Waveform points: 32767 $(2^{15}-1)$ Clock frequency: 100 MHz Output time: 655.34 μs</p>

**$\pi/4$ DQPSK I Axis Signal
(DQPSKI.WFM)**

The base band I-axis output for a digital cellular car telephone system is created on the Tektronix digital signal processing work system (DSPW).



Bit rate 42 Kbps
Point number 32 Kwords
Clock frequency 21 kHz

Figure D-14: $\pi/4$ DQPSK I Axis Signal

**$\pi/4$ DQPSK Q Axis Signal
(DQPSKQ.WFM)**

The base band Q-axis output for a digital cellular car telephone system is created on the Tektronix digital signal processing work system (DSPW).

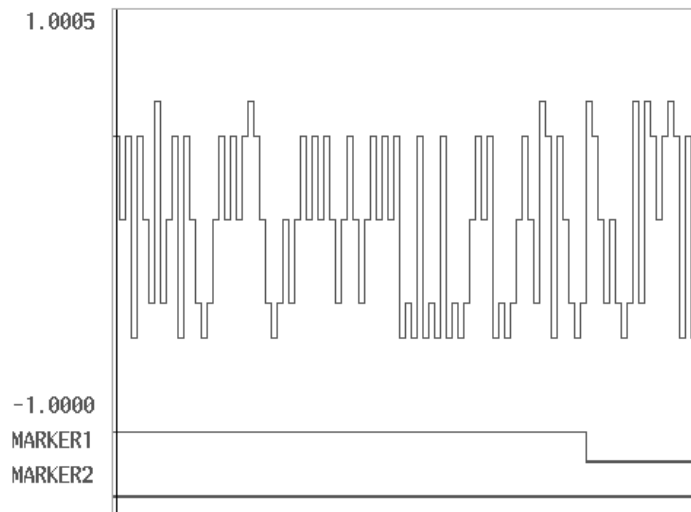

Bit rate 42 Kbps
Point number 32 Kwords
Clock frequency 21 kHz

Figure D-15: $\pi/4$ DQPSK Q Axis Signal

**Waveform for Magnetic
Disk Readout Signal
(MDSK_RD.WFM)**

Made with the convolution waveform editor (Option 09).

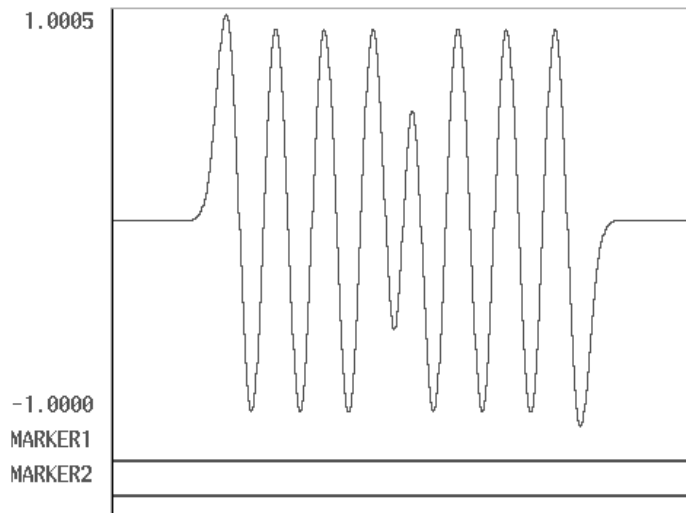

Figure D-16: Waveform for Magnetic Disk Readout Signal

Description	<p>Created using the waveform editor and the optional convolution waveform creation function.</p> <p>This is the waveform for reading stored data written with MDSK_WR.WFM. This is a waveform created assuming a Gaussian pulse (GAUSS_P.WFM) with a system impulse response.</p>
Settings	<p>Waveform points: 768 Clock frequency: 100 MHz Output time: 7.68 μs</p>

**Waveform for Magnetic
Disk Writing Signal
(MDSK_WR.WFM)**

Made with the waveform editor.

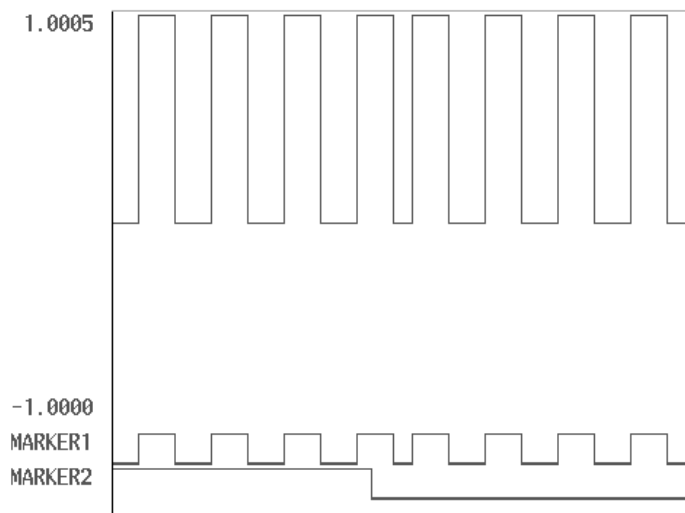

Figure D-17: Waveform for Magnetic Disk Readout Signal

Description	<p>Created a worst-case pattern with NRZI modulation using the bit set function of the waveform editor timing display.</p> <p>*Worst-case pattern (~0101010110101010~)</p> <p>Pattern length = 32</p> <p>Points/step = 8</p> <p>The encoding is NRZI</p> <p>A signal with the same pattern is set for the MARKER1 as well.</p>
Settings	<p>Waveform points: 512</p> <p>Clock frequency: 100 MHz</p> <p>Output time: 5.12 μs</p>

Video Signals in the NTSC Directory

NTSC color bar signals, NTSC Y-C separate signals and various kinds of NTSC signals are stored in the NTSC directory. These are NTSC video signals made up of 1 – 4 color fields and 1050 lines (525 x 2). The clock frequency is 16 times the sub-carrier frequency; a waveform is created on each line and the compiled waveforms are assembled using the sequence editor.

The settings for the signals are described below.

Settings

Waveform points:	1H=3,640
Clock frequency:	57.27 MHz (3.579545 MHz × 16)
Output time:	33.37 ms
Waveform points:	3,822,000

Video signals are output by changing the directory to **NTSC.DIR** and then selecting the following sequence files in the **SETUP** menu:

(1) Color Bar (Composite) signal	\$CB1-2H.SEQ
(2) Color Bar (Luminance) signal	\$CB1-(Y).SEQ
(3) Color Bar (Chrominance) signal	\$CB1-(C).SEQ
(4) Multiburst signal	\$M-BURST.SEQ
(5) Modulated Ramp signal	\$RAMP.SEQ
(6) Sweep signal (1 ~ 10 MHz)	\$SWEEP10.SEQ
(7) SMPTE Color Bar signal	\$SMPTE.SEQ
(8) IYQB signal	\$IYQB.SEQ
(9) Reversed Blue Bar signal	\$RBLU.SEQ
(10) Color Bar + Reversed Blue Bar + IYQB signal	\$MIX.SEQ

Figure D-18 through Figure D-26 shows the **NTSC** composite video signal.

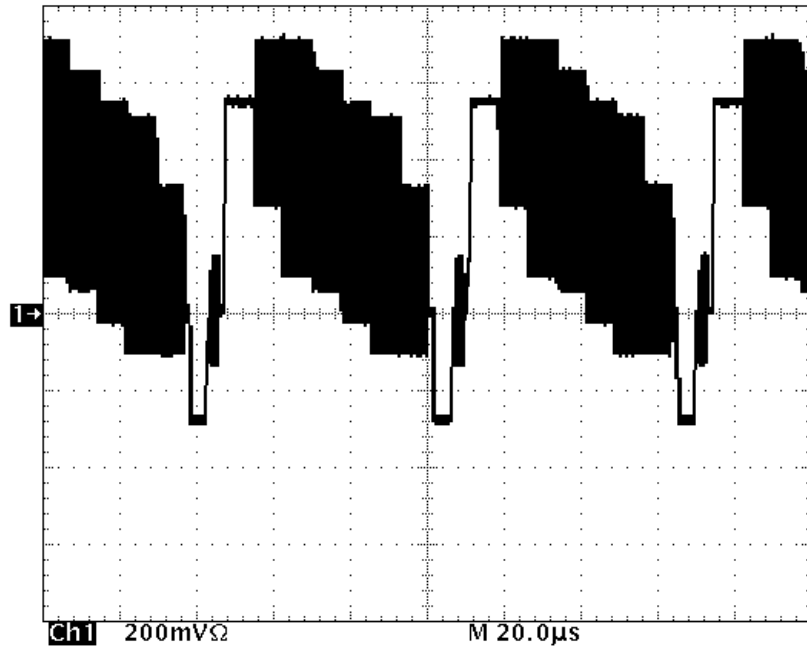
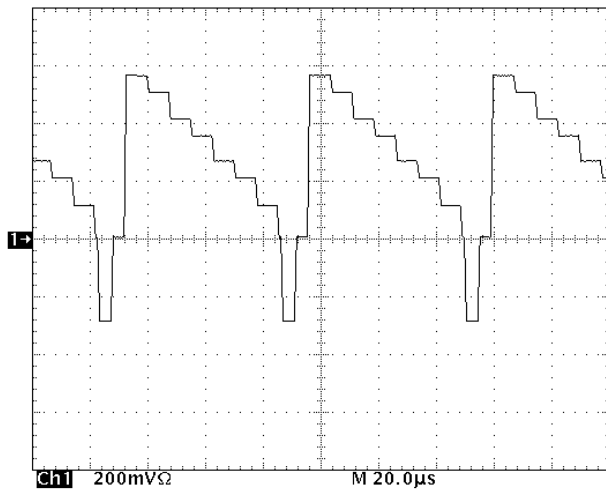
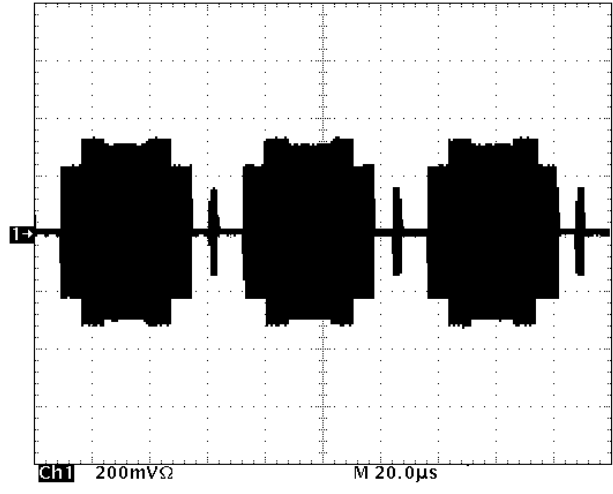

Figure D-18: Color Bar (Composite) Signal (\$CB1-2H.SEQ)

Figure D-19 shows the NTSC Y-C separate signal. Y (luminance signal) and C (chroma signal) have been created separately, so if these are output separately to channel 1 and channel 2 they will become Y-C separate signals; when these are combined and output, they become a composite signal. A 50 Ω /75 Ω conversion adaptor is required for 75 Ω output.



Luminance Signal



Chroma Signal

Figure D-19: NTSC Y-C separate signals

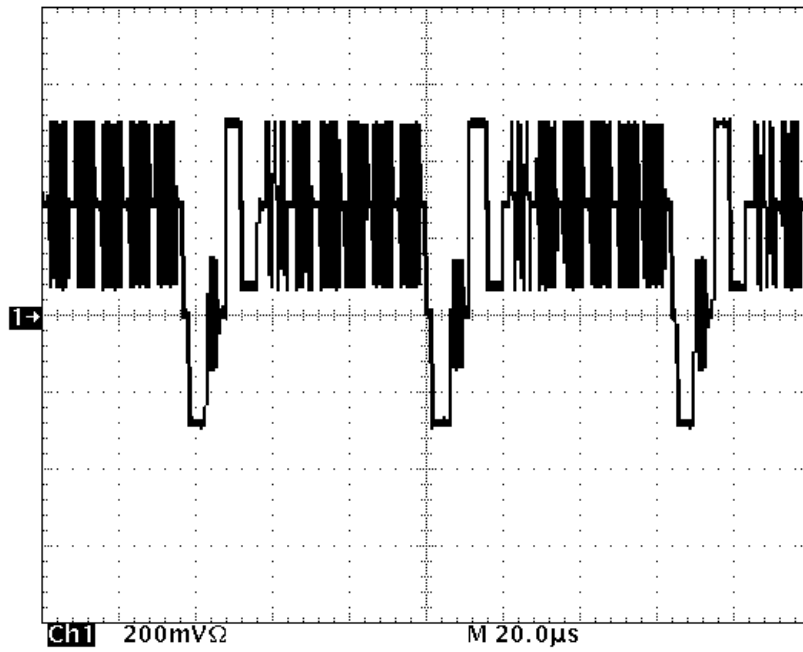

Figure D-20: Multiburst Signal (\$M-BURST.SEQ)

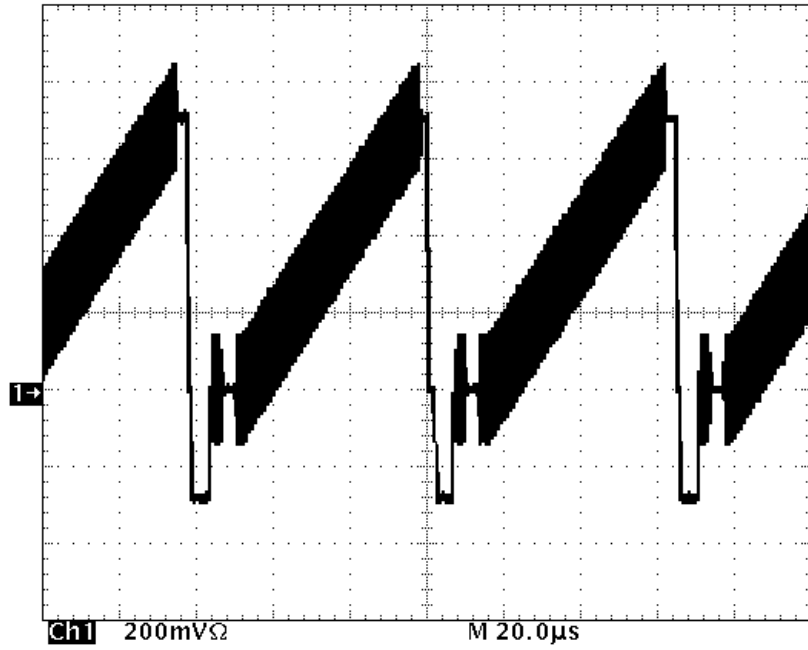

Figure D-21: Modulated Ramp Signal (\$RAMP.SEQ)

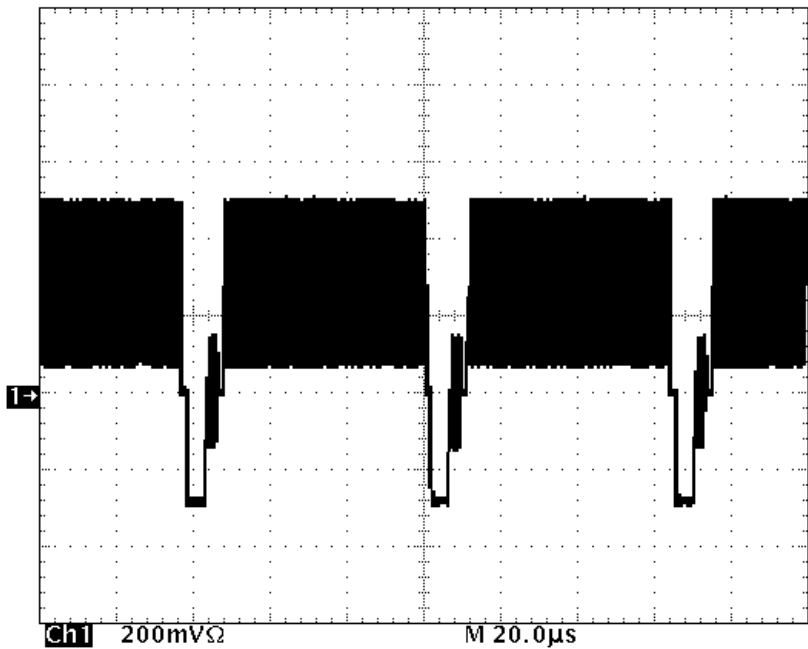

Figure D-22: Sweep Signal (\$SWEEP.SEQ)

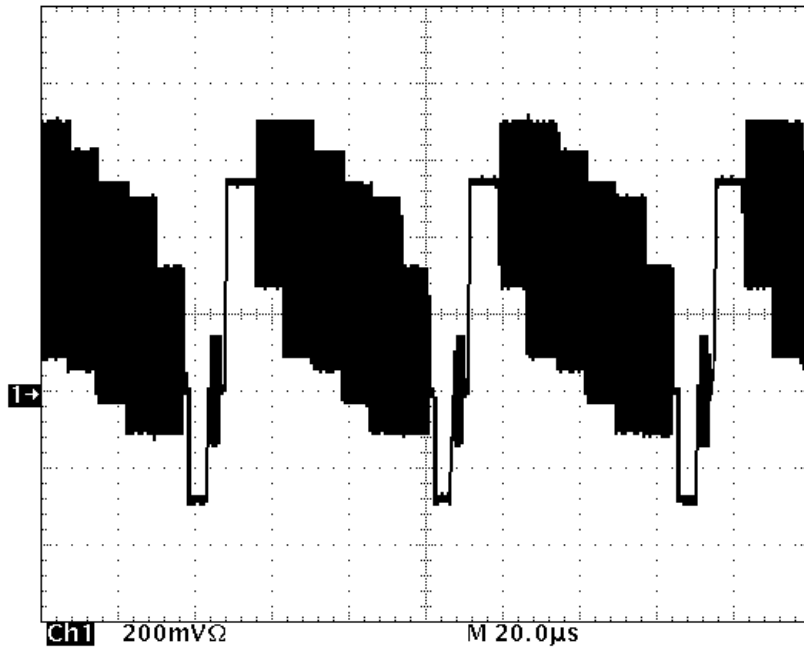

Figure D-23: SMPTE Color Bar Signal (\$SMPTE.SEQ)

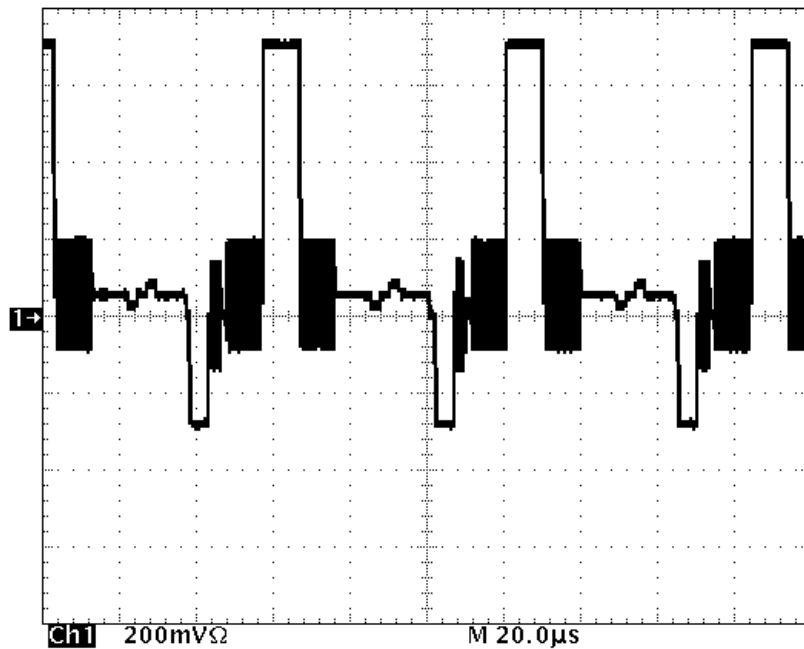

Figure D-24: IYQB Signal (\$IYQB.SEQ)

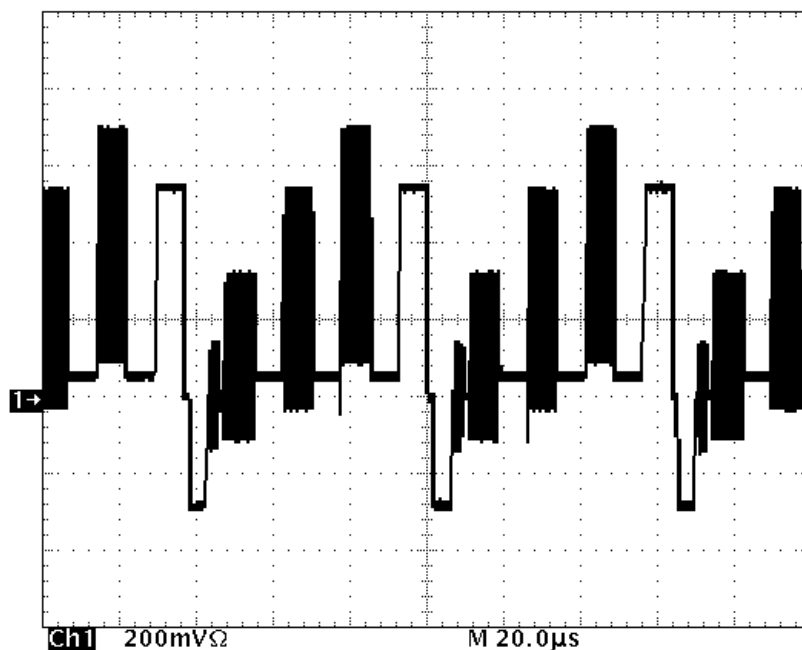

Figure D-25: Reversed Blue Bar signal (\$RBLU.SEQ)

Figure D-26 shows that the Color Bar signal, IYQB signal and Reversed Blue Bar signal are sequenced at the rate of 2:3:4 respectively.

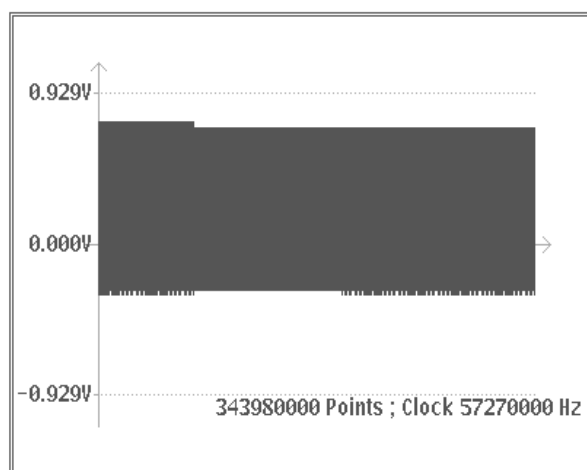

Figure D-26: Color Bar + IYQB signal + Reversed Blue Bar (\$MIX.SEQ)



Appendix E: Functional Operation Summary

Introduction

This summary shows the AWG2021 functional block diagrams, explains each block, and gives some operating precautions which are of practical value in understanding the fundamental operating concepts of the instrument.

For convenience, some functional block diagrams show the configuration with a second channel installed (Option 02). For blocks in which CH1 and CH2 operate the same, only CH1 is explained.

Block Diagram

Figure E-1 is a block diagram of the circuits from the clock oscillator to the digital-to-analog converter (DAC). Figure E-2 shows the block diagram continuing where Figure E-1 left off and goes until the output. The rest of this summary explains the individual blocks.

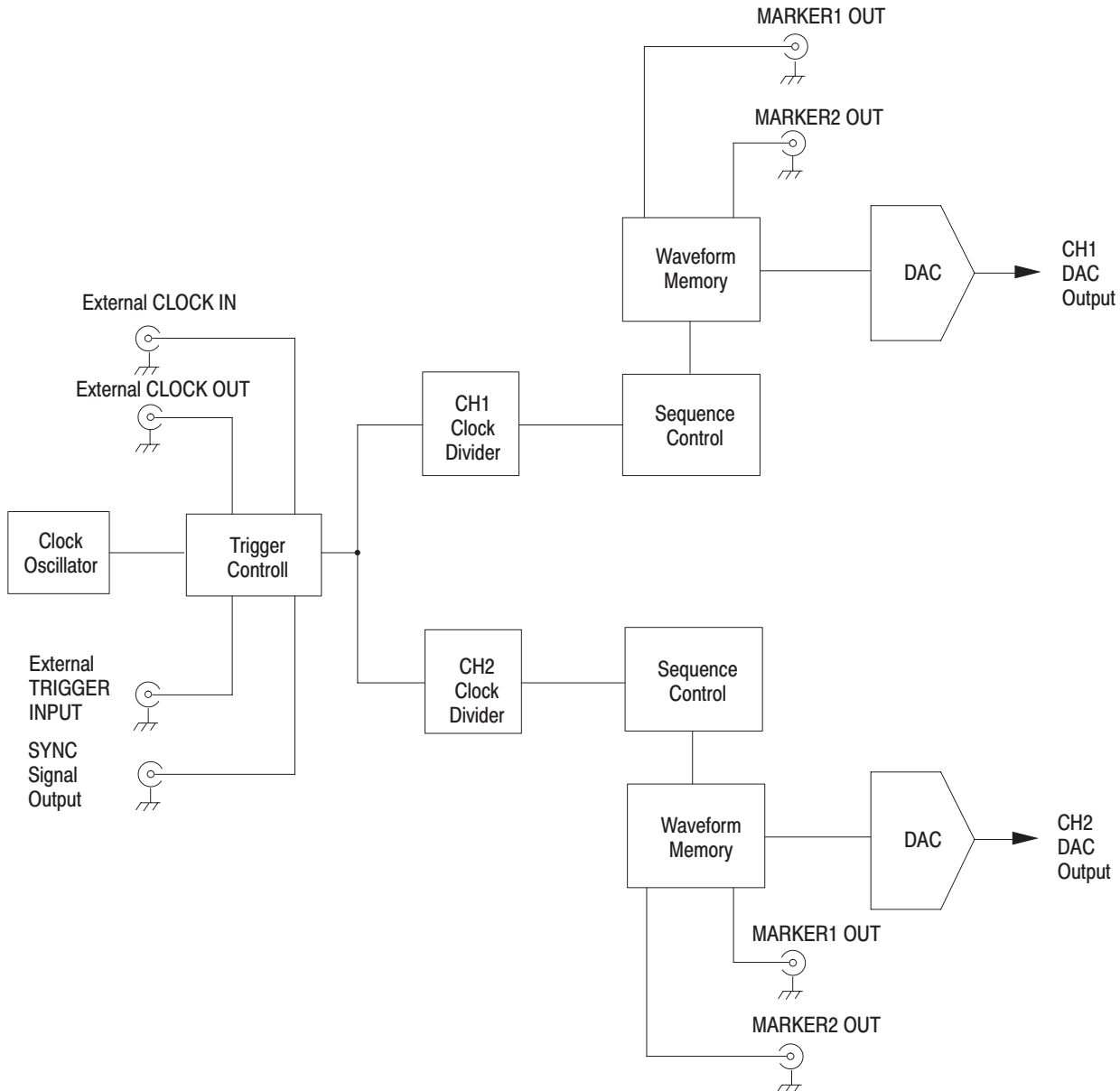

Figure E-1: Block Diagram (1)

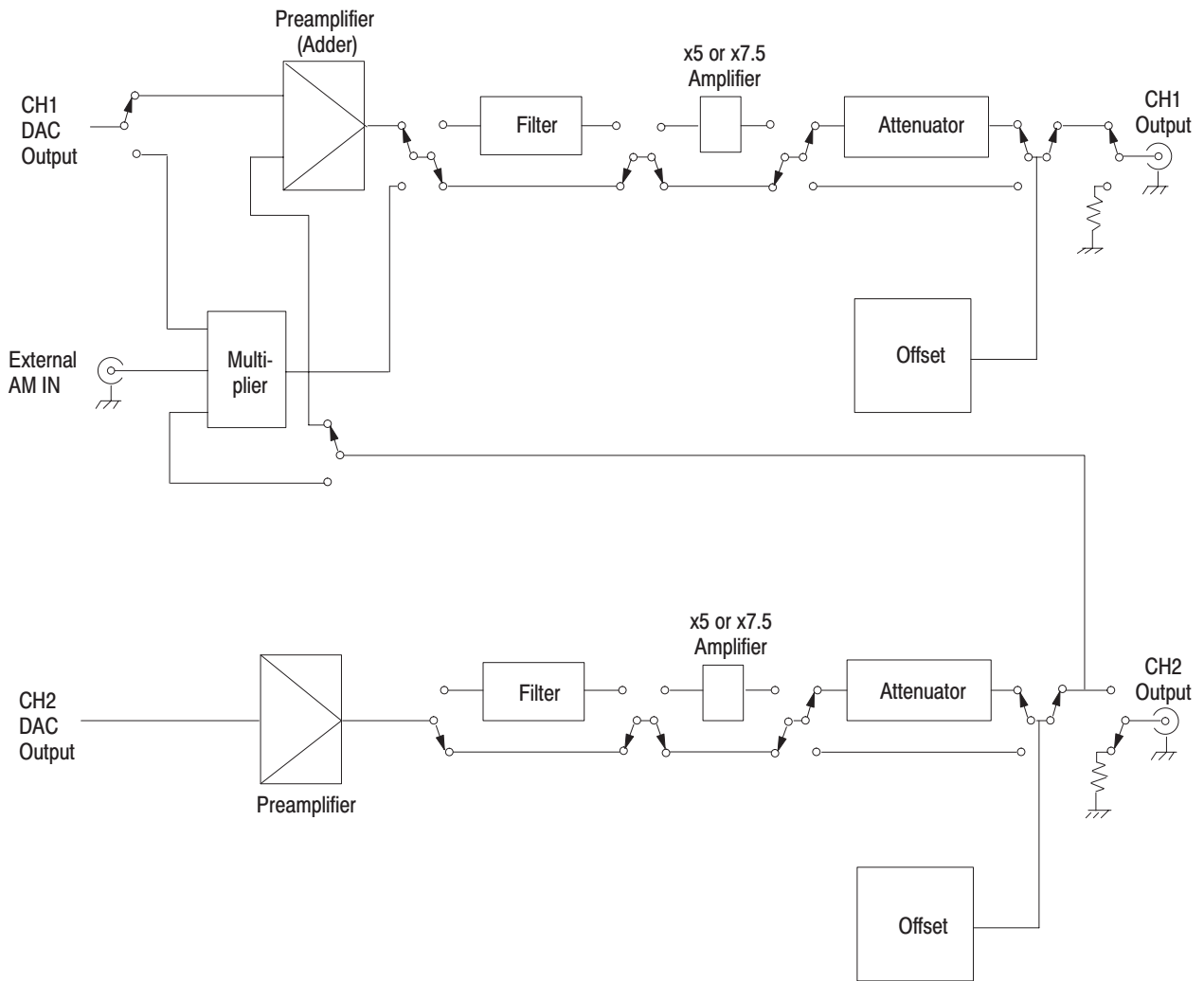

Figure E-2: Block Diagram (2)

Clock Oscillator

The oscillator for internal clock use is normally a PLL (phase lock loop) type. It uses a liquid crystal oscillator that provides a stable 12.8 MHz signal. The clock oscillates from 250 MHz to 125 MHz. The minimum frequency resolution is 5 kHz and the frequency can be set with 4-digit precision.

Frequencies under 125 MHz can be obtained by changing the frequency division of the clock divider. In this way, a clock frequency as low as 10 Hz is possible.

Figure E-3 shows the configuration of the clock oscillator.

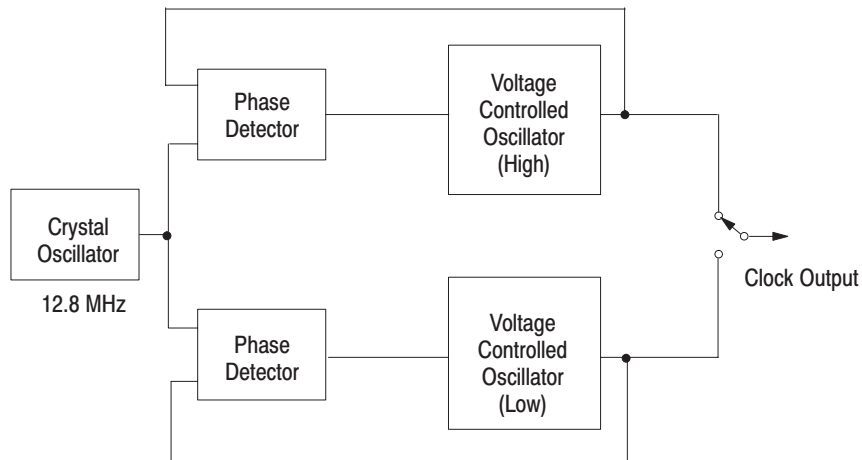

Figure E-3: Clock Oscillator Configuration

Trigger Control

This block controls the AWG2021 **MODE** menu operating (output) mode. First, select the clock source. Normally, the clock oscillator output is used.

NOTE. *The external clock input and output are used when more than 2 channels must be synchronized with the clock. Also, the external clock input can be connected to another oscillator, for example, a frequency sweep signal generator.*

Clock Operations by Operation Mode. There are four output operation modes:

- Cont Mode. The clock is sent to the clock divider regardless of the trigger.
- Trggered and Burst Mode. When the (External or Manual) trigger is generated, the clock is sent to the clock divider to obtain an output signal synchronized with the trigger. If the sync signal is set to **Start**, a pulse of about 100 ns width is output.
- Gated Mode. While the gate signal is True, the clock is sent continuously to the CH1 clock divider.

AWG2021 Parallel Operation. When more than two channel outputs are needed, connect as shown below.

- Simple parallel operation. The **SYNC** output of the master AWG2021 is connected to the **TRIGGER INPUT** of the slave AWG2021. Figure E-4 shows a connection example.

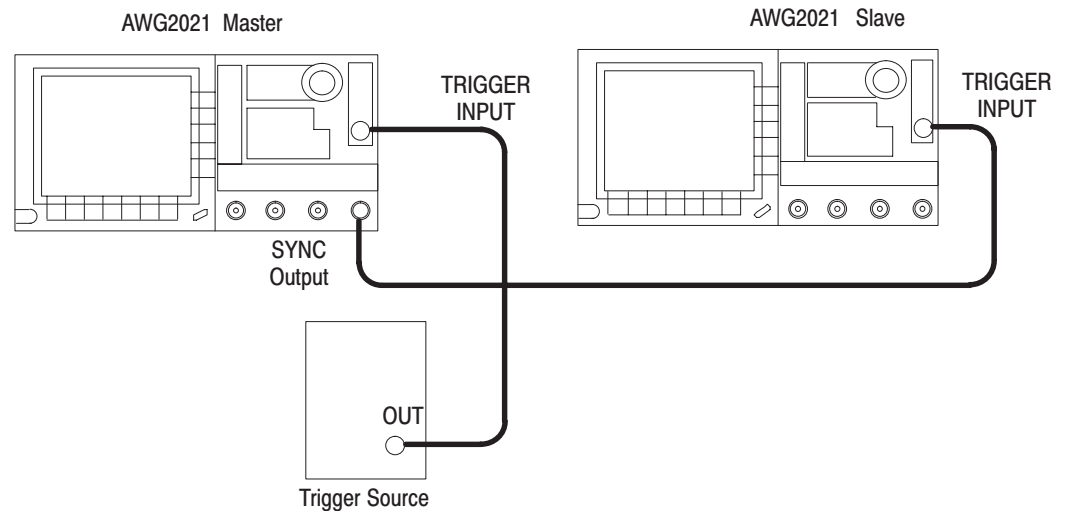

Figure E-4: Connection Example 1

When **Sync** in the **MODE** menu is set to **Start**, a pulse is output at the **SYNC** output when the trigger is generated. This pulse is used as the trigger for the slave AWG2021. In this case, if there is no external trigger source, manual triggers may be used.

NOTE. *Since the sync output is output when the waveform is actually output, it lags somewhat behind the trigger signal.*

- External trigger or gate signals to two AWG2021 instruments. Figure E-5 shows the connection method for applying external trigger or gate signals simultaneously to two AWG2021 instruments. Use BNC 50 Ω cables of the same length to connect the trigger source to both AWG2021 instruments.

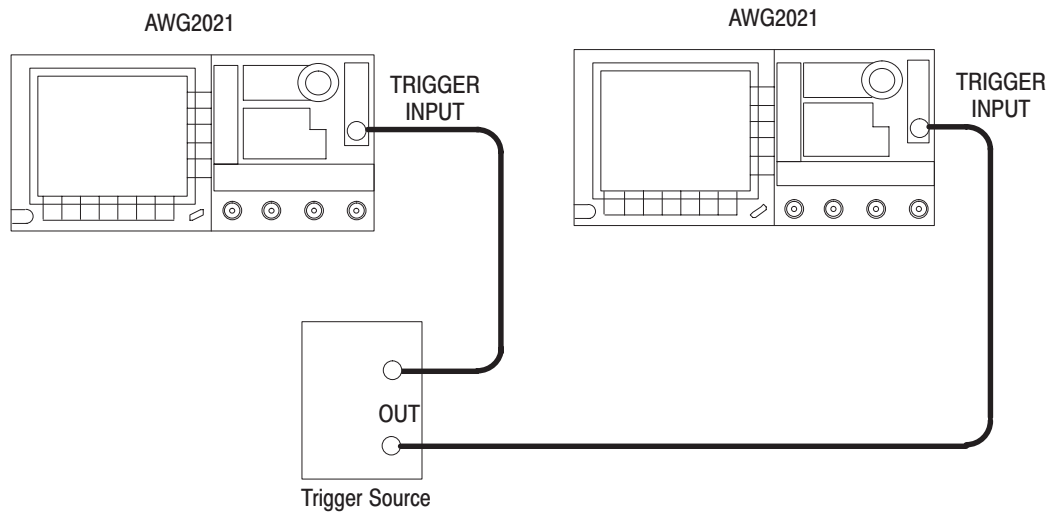

Figure E-5: Connection Example 2

When there is only one trigger source output, connect to both AWG2021 instruments using the same minimum possible length 50 Ω cable and a T adapter.

For **Triggered** or **Burst** mode, output synchronized with the trigger is obtained by applying the external trigger at the same time to the AWG2021 instruments.

When continuous synchronized output is necessary, use **Gated** mode. **SYNC** output is obtained from when the gate signal goes True until it goes False. After the gate signal goes false, to output again, it is necessary to reset the output with the side menu **STOP** item.

- Output synchronized with the clock. Connect the clock output of the master AWG2021 to the clock input of the slave AWG2021 with a 50 Ω cable and set the slave's clock source to **External**.

Figure E-6 shows a connection example.

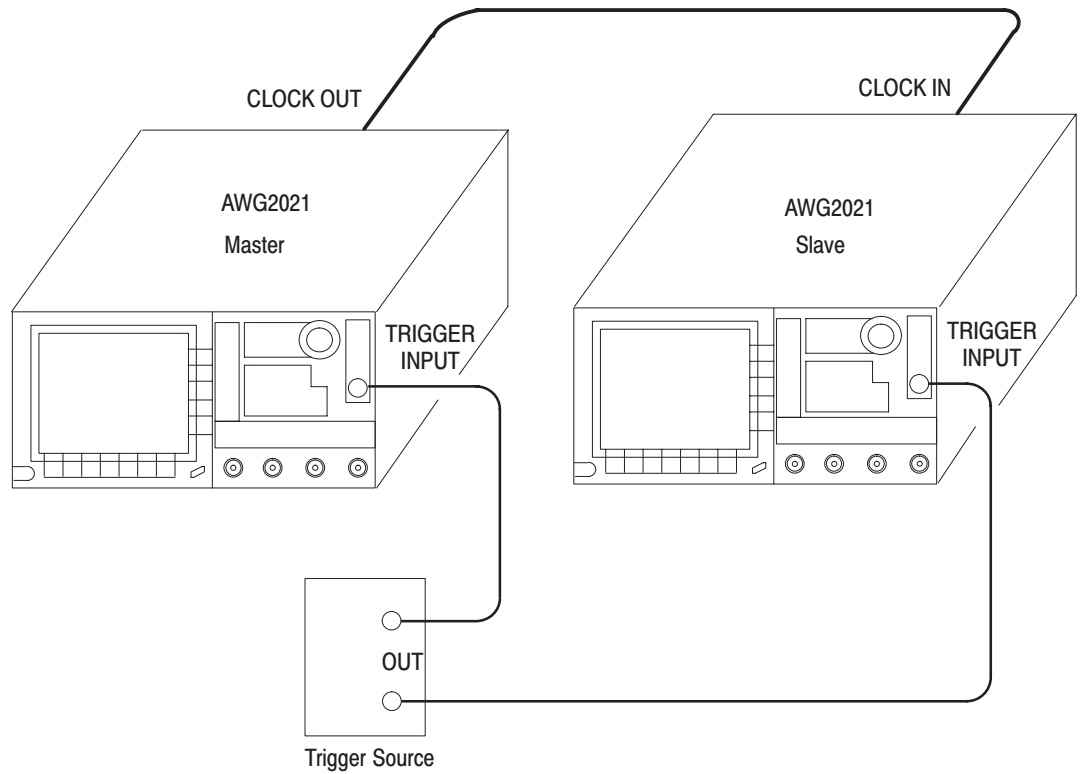
**Figure E-6: Connection Example 3**

NOTE. Since a 1-meter 50 Ω cable gives a delay of about 5 ns, make the cable connecting the clock output and clock input as short as possible. Also, make the cables connecting the trigger input to both the master and the slave the same length.

If the clock delay due to the cable is a problem, use another clock source and connect a cable from the clock source to the both AWG2021 clock inputs. Make the cables the same length.

Trigger Input, SYNC Output, and Waveform Timing. Figure E-7 shows the relationship between trigger input, SYNC output, and waveform timing.

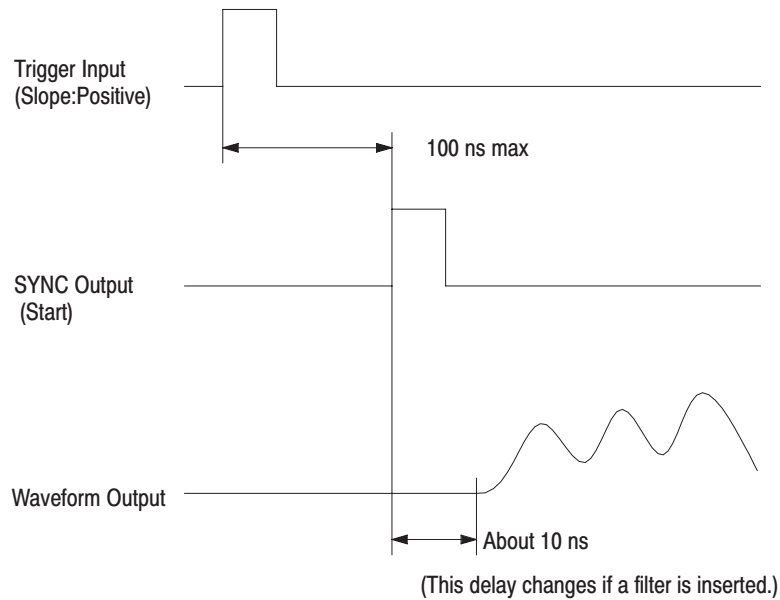

Figure E-7: Trigger Input, SYNC Output, and Waveform Timing

Clock Divider

The CH1 clock divider divides the clock signal from the clock oscillator the amount necessary to obtain the frequency value indicated in the **Clock** box in the **SETUP** menu. Division by up to 2^{24} is possible, and the CH1 and CH2 dividers can have different division ratios. The CH2 clock divider (that is, CH2 clock frequency) is set in the **Divider** box in the **SETUP** menu.

When an external clock source is selected, the CH1 clock divider does not operate and the clock signals are just passed through, as is. However, the CH2 clock divider will still divide the external clock source based on the selected ratio. Figure E-8 shows the configuration of a clock divider.

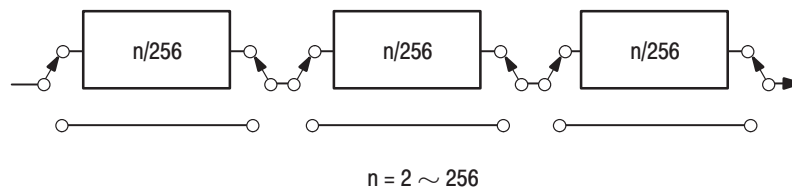

Figure E-8: Clock Divider Configuration

Sequence Control

This block comprises the sequence memory that stores the contents of sequence control, the counters that read out the contents of that memory, and output the actual waveform memory addresses.

Table E-1: Sequence File (XXX.SEQ)

File Name	Repetition Count
.....
AAA.WFM	3
BBB.WFM	16
.....

For a sequence file, such as that shown in Table E-1, here is what is actually stored in sequence memory.

AAA.WFM actual addresses
 AAA.WFM data length
 looping counter value: 3

BBB.WFM actual addresses
 BBB.WFM data length
 looping counter value: 16

The sequence memory capacity is in 8 Kbyte steps for handling even complex waveforms.

The AAA.WFM actual addresses are loaded into the address counter, the AAA.WFM data length is loaded into the length counter, and the looping counter value is loaded into the looping counter.

The address and length counters operate with the clock signal from the clock divider frequency divided by 8 (because the waveform memory is partitioned into 8 banks, this circuit uses a $\frac{1}{8}$ clock).

When the value set in the looping counter is reached, the sequence memory address counter is incremented and the contents of the next step are read.

When the burst count is set, that value is set in the burst counter and output the required number of times.

Figure E-9 shows the relationship between sequence memory and waveform memory.

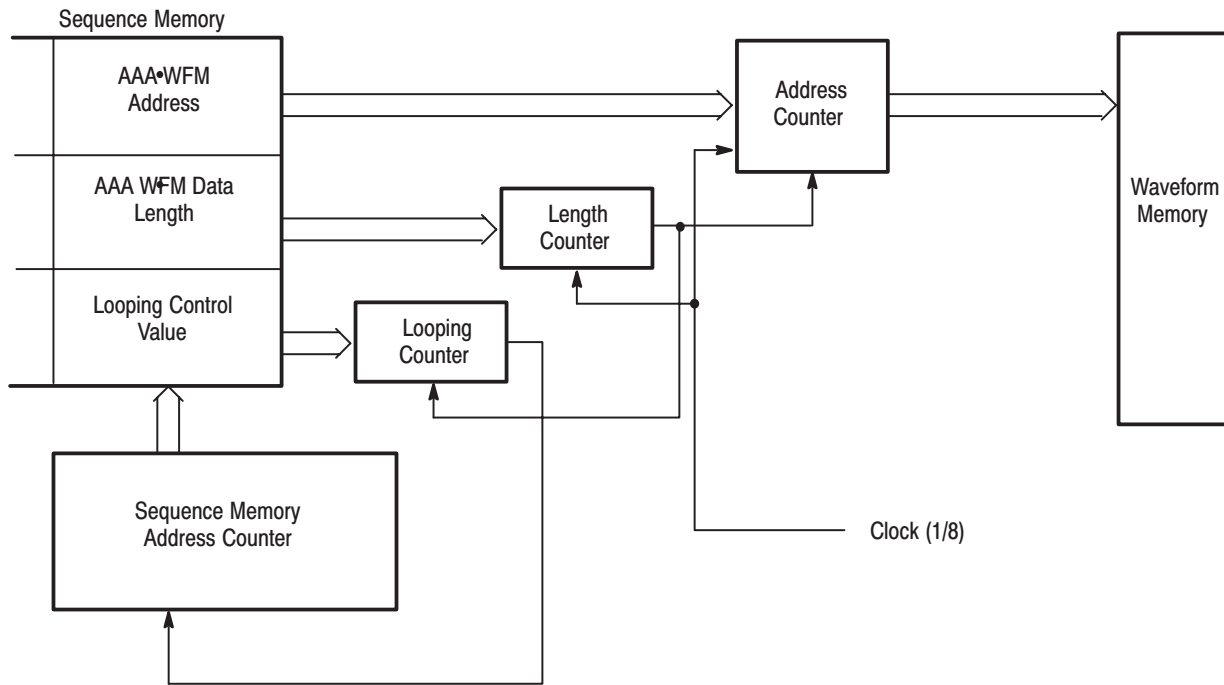

Figure E-9: Relationship Between Sequence Memory and Waveform Memory

Waveform Memory

The waveform memory comprises sixteen $32K \times 8$ SRAM chips for 256K words of 16-bit word memory. Of these 16 bits, 12 bits are waveform data, 1 bit is Marker 1, and 1 bit is Marker 2

The waveform and marker data is loaded into waveform memory when a file is selected with the **SETUP** menu **Waveform Sequence** item.

Since the waveform memory must be read out at high speed (250 MS/s), it is partitioned into 8 banks and read out with 8:1 multiplexing (parallel-serial conversion). Therefore, the memory itself operates with a $1/8$ clock.

Figure E-10 shows the waveform memory configuration.

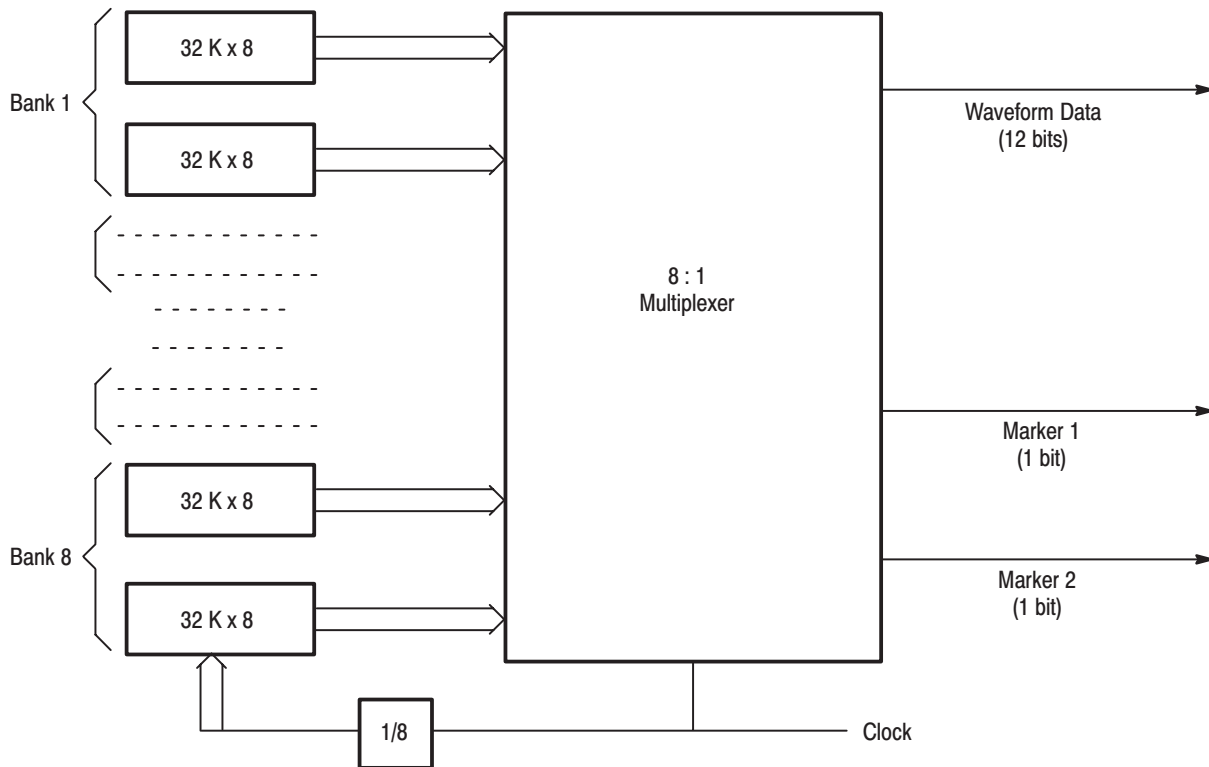

Figure E-10: Waveform Memory Configuration

The waveform data length can be any multiple of 8 points, from a minimum of 64 points to a maximum of 256K points. The total number of waveform data points that can be used in a single sequence file is 256K.

Data Length. Generally, outputting high precision (high S/N ratio) waveforms requires an adequate number of data points.

For example, when outputting triangular waveforms, about 8000 points are needed to minimize the jaggedness of the waveform. That is why the AWG2021 uses a DAC with a resolution of about 4000 (12 bits) for the vertical amplitude.

Figure E-11 shows the relationship between the triangular wave resolution and the number of data points.

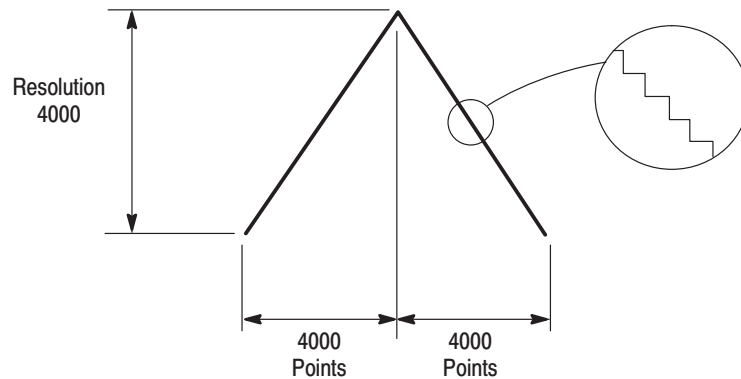

Figure E-11: Relationship Between Triangular Wave Resolution and Number of Data Points

For a triangular wave, extra waveform points beyond 8000 are meaningless. This applies not only to triangular waves but to smooth waveforms, in general.

In normal use, this level of precision is rarely required. When it is not, the number of waveform points may be reduced. In the equation editor and the waveform editor, the default value for the number of waveform points is 1000.

When a sine wave is created with 1000 points, the size of this fold back component is -60 dB, which should be no problem in ordinary use.

When making a waveform with less than 1000 points, because you are using the maximum clock frequency, use a filter. In this case, observe the following points.

- According to sampling theory, if the ideal filter is used, with a mere two points of data for the highest frequency component the waveform has, the waveform can be reproduced. In order to eliminate overshoot and ringing, the filters in the AWG2021 have Bessel characteristics with relatively gentle shoulder characteristics. That is why more points are required.
- The amount of data required depends on the waveform shape, the S/N ratio required, the filter cutoff frequency, and other such factors. Therefore, output the waveform on the oscilloscope, spectrum analyzer, or the like, and check that the waveform is what you need.
- Care is particularly necessary in creating waveforms with the equation editor.

When the Waveform Data Length is Not a Multiple of 8. Earlier, we explained that only multiples of 8 can be set as the data length, but when the data length is small, this becomes a problem.

When this instrument is used in **Triggered** mode, this problem is solved by simply adding data at the end until the total length is a multiple of 8.

In **Cont** mode, the original data length is multiplied to make it a multiple of 8. For example, if the original waveform has 60 points, two of them are strung together to make a waveform with 120 points. However, in this case the **SYNC** output is only generated for every other waveform. Figure E-12 shows the relationship between the waveform points and **SYNC** output in **Cont** mode.

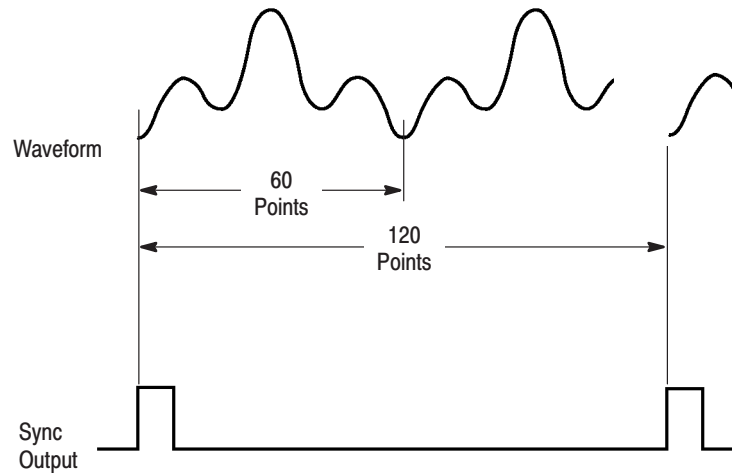

Figure E-12: Relationship Between Waveform Points and SYNC Output in Cont Mode

The marker signals are written into waveform memory in the same manner as waveform data. This data passes through the marker output amplifier as is and is output.

DAC. The DAC converts the digital data from the waveform memory into analog signals. This converter has a resolution of 12 bits.

When the output voltage is set, an attenuator is used, but since this attenuator's voltage division ratio is fixed, the DAC reference voltage is varied to provide continuously variable voltage.

Multiplier (AM)

When this mode is not selected, the multiplier is not included in the signal path. This multiplier has a 30 MHz band for the carrier signal and a 4 MHz band for the modulation signal. When this block is selected, the following two **AM** modes can be used.

External AM Mode. AM modulation is applied to the CH1 signal from the rear panel BNC connector. Table E-2 shows the output signal amplitude for external modulation signals.

Table E-2: Output Signal Amplitude - External Modulation

External Modulation Signal	Output Signal Amplitude
0 V	50% of set value
1 V	100% of set value
-1 V	0%

With ± 1 V input, 100% amplitude modulation is possible. Figure E-13 shows 100% modulation.

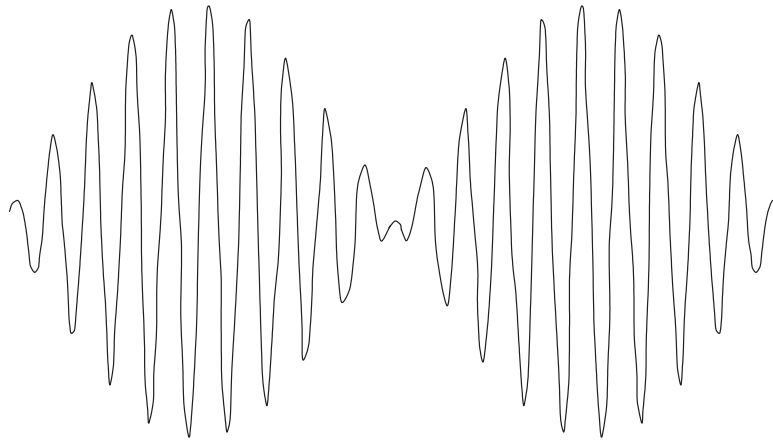

Figure E-13: 100% Amplitude Modulation

Internal AM Mode. This mode can be used when the CH2 output Option 02 is installed. This mode amplitude modulates the CH1 signal with the CH2 signal. Unlike the external AM mode discussed above, in order for this circuit to also be used as a multiplier, such operations as automatically applying an offset to the CH2 signal are not done.

100% modulation occurs when the CH2 signal is 5 V (full scale). When this signal is negative, the CH1 signal is inverted. The value calculated with 5 V set as 100% is displayed at the bottom right of the **SETUP** menu CRT screen.

CH2 : OFF	Upper : 100.00%
50 Ω	Lower : 0.00%

An example is when the CH1 signal is amplitude modulated with the CH2 signal. If CH2 is set to an amplitude of 5 V and an offset of 2.5 V, a 100% modulated waveform is obtained.

Internal **AM** mode is useful for such tasks as varying the amplitude of a certain part of a waveform in real time. Due to the restrictions created by the multiplier bandwidth and the signal delay due to the amplifiers, filter, etc. — as can be seen in the block diagram — this circuit is not meant for applications at high frequencies.

When high frequencies are necessary or when high precision is required, use the editor. It can handle simple multiplication of waveforms.

Preamplifier (Adder)

This block is an adder circuit using an ordinary operational amplifier. This adder has a bandwidth of 30 MHz in **Add** mode. The output is the voltage set for CH1 added to the CH2 signal.

In order to effectively use the CH1 and CH2 filter, offset, and other functions, the CH2 signal is added before the CH1 filter. Therefore, the CH2 signal output is not the value set for CH2.

The actual value is $(\text{CH2 set voltage} \times \frac{1}{5}) + \text{CH1 set up value}$. Adding CH2 value is calculated and displayed at the bottom right of the **SETUP** menu CRT screen.

CH2 : OFF	Upper : 0.2000%
50 Ω	Lower : -0.2000%

An example is the display when an amplitude of 2 V and an offset of 0 V are set for CH2.

For addition, the output size (CH1 + the actual value of CH2) can exceed 5 V. If so, the signal is distorted.

In **Add** mode, if for example noise is created on CH2 and this is added to the CH1 waveform, the amount of noise can be varied in real time. Due to the restrictions created by the adder bandwidth and the signal delay due to the amps, filter, etc. — as can be seen in the block diagram — this circuit is not meant for applications at high frequencies.

When high frequencies are necessary or when high precision is required, use the editor. It can handle simple addition of waveforms.

Filter

The AWG2021 has four low-pass filters, 1 MHz, 5 MHz, 20 MHz, and 50 MHz. They are all Bessel characteristic filters and have soft shoulder characteristics to

avoid overshooting and ringing. Figure E-14 shows representative characteristics.

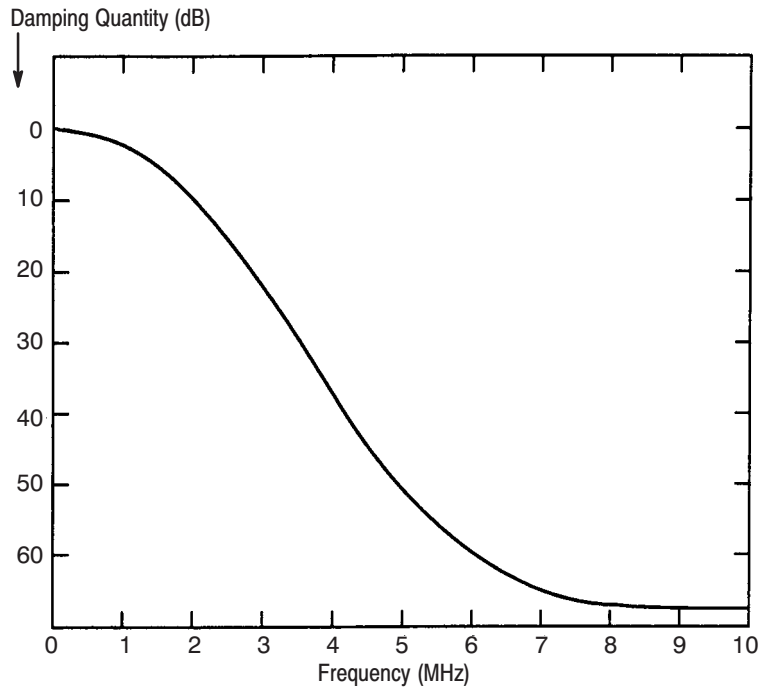

Figure E-14: Representative Filter Characteristics

These filters can be used to eliminate extraneous components of the waveform and to reduce the foldback component when there are a small number of waveform points. Specifically, these filters reduce the jaggedness of the waveform and raise the S/N ratio. The rising and falling time for the waveform when it is not passed through the filters is about 4 ns.

Time Difference from SYNC Signals with Each Filter. Filters have their own unique delay time. This time difference with the SYNC signals, marker signals, and other output signals can be varied by changing the filter value.

Table E-3 shows the delay relative to the sync signals caused by the filters.

Table E-3: Filter Timer Delay Relative to SYNC Signals

Filter	Delay
1 MHz	400 ns
5 MHz	88 ns

Table E-3: Filter Timer Delay Relative to SYNC Signals (Cont.)

Filter	Delay
20 MHz	28 ns
50 MHz	21 ns
Through	10 ns

Figure E-15 shows the time difference (t) between signals and **SYNC** signals.

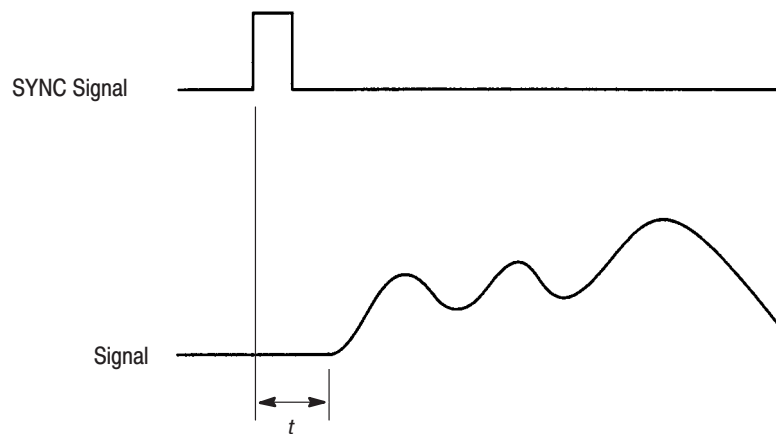
**Figure E-15: Time Difference Between Signals and SYNC Signals**

Time Difference from Markers. Markers are written as data into waveform memory in the same manner as waveform data, but since the waveform goes through amplifiers and other elements, it is output somewhat after the marker. Applying a filter to the waveform increases this time delay. This delay is about the same as the delays relative to the sync signals given in Table E-3.

X5 Amplifier

When the output amplitude is 0.501 V or greater, a x5 amplifier is inserted in the signal path. The waveform is affected by passing through this x5 amp, and some error is generated. If high precision waveform output is required, hold the output amplitude below 0.501 V.

Attenuator

This block comprises two -3 dB attenuators, one -10 dB attenuator, and one -20 dB attenuator.

Including the amount that the DAC reference voltage can be changed, a total of 40 dB of attenuation is possible. Figure E-16 shows the attenuator configuration.

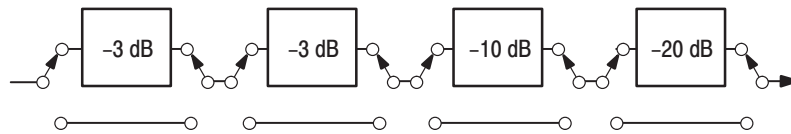

Figure E-16: Attenuator Configuration

These attenuators and the above x5 amp are selected automatically by setting the output voltage.

Offset This block gives an offset voltage to the output. This circuit is a power source that can both push out and pull in. The offset voltage is calculated for output terminated with exactly 50Ω . Since this circuit has a capacity of $\pm 100 \text{ mA}$, an offset of up to $\pm 100 \text{ mA} \times 25 \Omega$ ($50 \Omega \parallel 50 \Omega$) = $\pm 2.5 \text{ V}$ can be applied independent of the output voltage setting.

This makes it possible to simulate a waveform that has a large offset voltage with an extremely small signal. Figure E-17 shows the offset circuit.

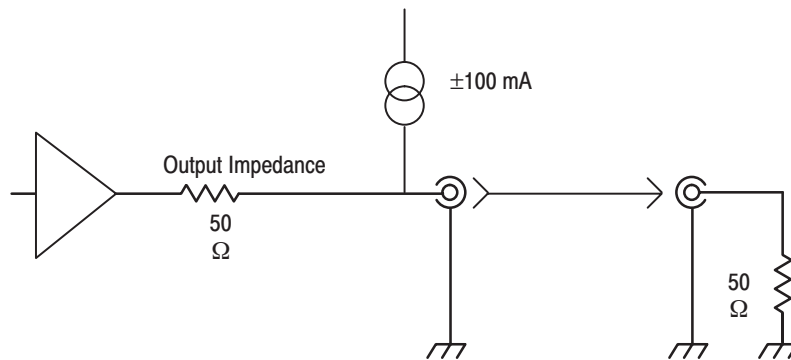

Figure E-17: Offset Circuit

Appendix F: Miscellaneous

General Description

This appendix covers the following items.

- Horizontal axis scaling
- Sampling theorem
- Differentiation
- Integration
- Random (rnd) function
- Pattern code
- Logical operation
- Fast Fourier Transforms (FFT)
- Repackaging for shipment
- Factory settings

Horizontal Axis Scaling

The horizontal axis scaling uses linear interpolation.

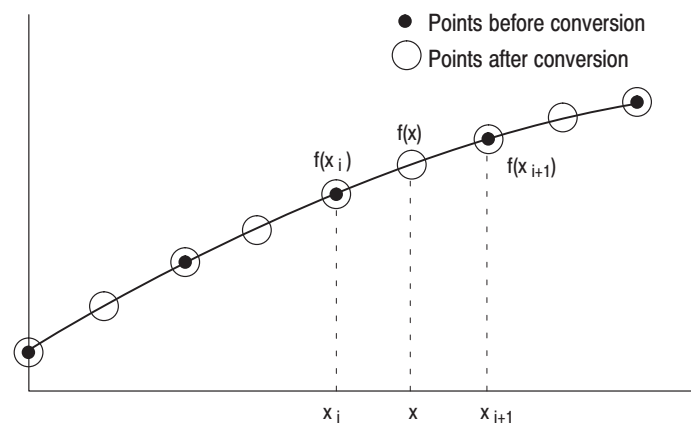

Figure F-1: Linear Interpolation

Here is the equation for linear interpolation.

$$f(x) = \frac{x-x_i}{x_{i+1}-x_i} \{f(x_{i+1})-f(x_i)\} + f(x_i)$$

Here, i is the waveform point number; i takes integer values i = 1, 2, ..., n.

NOTE. *The number of points can be increased or decreased, but the waveform may lose its characteristics when the number of points are decreased.*

Example 1: 5 points padded to 9 points.

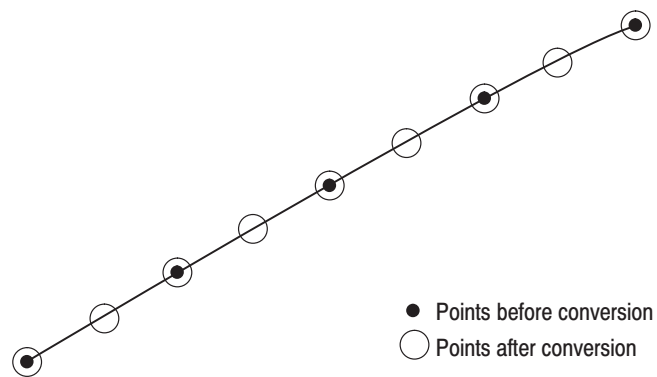

Figure F-2: Point Padding

Example 2: Reducing from 9 points to 6

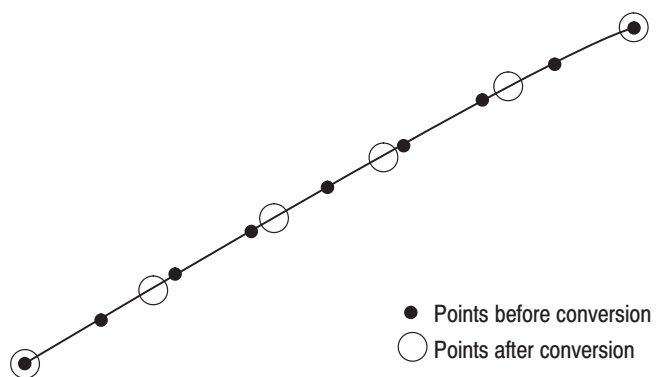

Figure F-3: Point Compression

Sampling Theorem

When the signal is continuous and the highest frequency component of the signal is f_0 , sampling with $T \leq 1/2f_0$ loses none of the data contained in the signal. T is the sampling interval. This theorem is well known as the sampling theorem. If data is created to meet this theorem, the necessary signal can be obtained.

$$X(t) = \sum_{n=-\infty}^{\infty} X(nt) \frac{\sin\{(2\pi/T)(t-nT/2)\}}{(2\pi/T)(t-nT/2)}$$

A continuous analog signal $x(t)$ can be reproduced from the digital data with the above equation.

Differentiation

The $\text{diff}()$ function calculates the central deviation as the differential value. The equation below expresses the central deviation when the function $f(x)$ is given at even intervals of Δx .

$$f'(x) \approx \frac{f(x + \Delta x) - f(x - \Delta x)}{2 \Delta x}$$

In actual practice, when function $f(x)$ is expressed by n values, the differential value $f'(x_i)$ at point x_i is given by the following equation.

$$f'(x_i) \approx n \frac{\{f(x_{i+1}) - f(x_{i-1})\}}{2}$$

Here, n is the number of waveform points and i is an integer in the range, $i = 1, 2, \dots, n$.

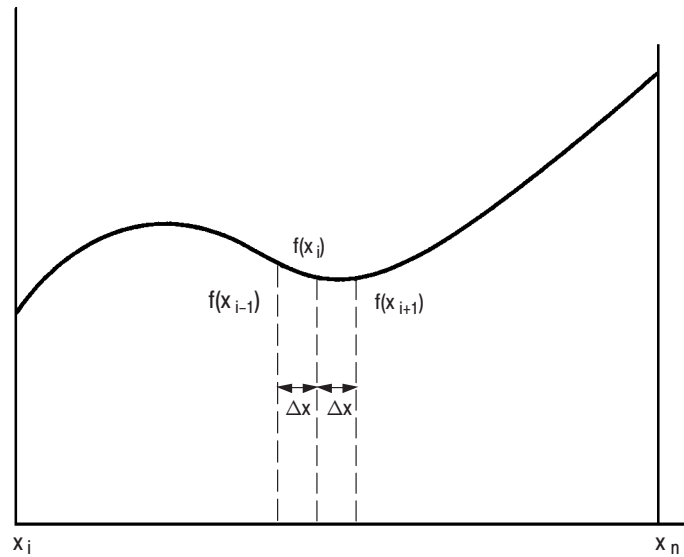

Figure F-4: Equation Differentiation

The values at the first and last points are obtained not from the center deviation, but from the following equations:

First point

$$f'(x_1) \approx \frac{n\{-3f(x_1) + 4f(x_2) - f(x_3)\}}{2}$$

Last point

$$f'(x_n) \approx \frac{n\{f(x_{n-2}) - 4f(x_{n-1}) + 3f(x_n)\}}{2}$$

Integration

The **integ()** function integrates numerically based on a trapezoidal formula. The trapezoidal formula is expressed with the following equation.

$$\int f(x)dx \approx \sum_{i=1}^n \frac{f(x_{i-1}) + f(x_i)}{2} \cdot \Delta x$$

$$= \Delta \frac{x}{2} \{f(x_1) + 2f(x_2) + 2f(x_3) + \dots + 2f(x_{n-1}) + f(x_n)\}$$

Here, n is the number of waveform points and i is an integer in the range, i = 1, 2, ..., n.

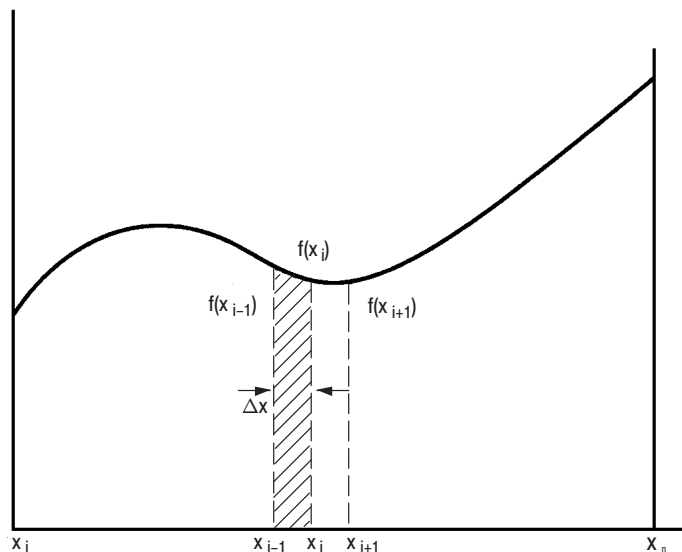

Figure F-5: Equation Integration

The integration is actually calculated with the following formula.

$$\int f(x)dx \approx 1/2 \{f(x_1) + 2f(x_2) + 2f(x_3) + \dots + 2f(x_{n-1}) + f(x_n)\}$$

However, the imaginary initial value $f(x_0)$ always takes a value of 0.

Random (rnd) Function

A random number generation algorithm uses an uniform distribution random generation routine and the central-limit theorem to derive Gaussian distribution random numbers.

Central-limit theorem: when the independent random variables $X_1, X_2, \dots,$ and X_n conform to an identical random distribution, the mean and variance of $x = (X_1 + X_2 + \dots + X_n)/n$ are given as follows:

$$E(n) = \mu \qquad V(n) = \sigma^2/n$$

Even if the initial random distribution is not normal, if a reasonably large value for n is used, the arithmetical mean x of a considerably large number of variables will be close to the normal distribution.

In actuality, 12 is used for n , uniform random numbers are accumulated n times and their arithmetical mean is derived as the ultimate Gaussian distribution random number.

The following algorithm is used to generate uniform distribution random numbers:

$$seed [n] = (253.0 \times seed [n-1] + 1.0) \text{ mod } 16777216$$

$$ran = seed [n] / 16777216$$

Pattern Codes

On the AWG2021, it is possible to select the coding system used when pattern strings are output. If the code will be affected by the immediately preceding data, the data item just before the first item of data will be calculated as 0. The following tables show the coding systems.

- **NRZ:** Normal data format

Pattern	Output Data
0	0
1	1

Example

Input	0	1	0	0	1	1	0	0	0	1	1	1
Output	0	1	0	0	1	1	0	0	0	1	1	1

- **NRZI:** The data changes when a 1 is received.

Each pattern is made up of 2 data items.

Example

Input	0	1	0	0	1	1	0	0	0	1	1	1
Output	00	01	11	11	10	01	11	11	11	10	01	10

- **RZ:** The data always returns to 0.

Each pattern is made up of 2 data items.

Pattern	Output Data
0	00
1	10

Example

Input	0	1	0	0	1	1	0	0	0	1	1	1
Output	00	10	00	00	10	10	00	00	00	10	10	10

- **MFM (Modified FM):** Each pattern is made up of 2 data items. In the table below, data in parentheses () indicates the immediately preceding data of the data for which coding is being attempted. Here the output data is inverted every time when 1 appears in the codes.

Pattern	Code Conversion
1	01
(0)0	10
(1)0	00

Example												
Input	0	1	0	0	1	1	0	0	0	1	1	1
Code Conversion	10	01	00	10	01	01	00	10	10	01	01	01
Output	11	10	00	11	10	01	11	00	11	10	01	10

- **BI-PHASE:** Each pattern is made up of 2 data items.

Pattern	Output Data
0	01
1	10

Example												
Input	0	1	0	0	1	1	0	0	0	1	1	1
Output	01	10	01	01	10	10	01	01	01	10	10	10

- **f/2f**: Each pattern is made up of 2 data items. In the table below, data in parentheses () indicates the immediately preceding data of the data for which coding is being attempted.

Pattern	Output Data
(0)0	11
(1)0	00
(0)1	10
(1)1	01

Example

Input	0	1	0	0	1	1	0	0	0	1	1	1
Output	11	01	00	11	01	01	00	11	00	10	10	10

- **1-7 RLL (Run-length Limited Codes)**: 2-item patterns are made up of 3 data items, and 4-item patterns are made up of 6 data items. In the table below, x indicates that this value will become 1 when the preceding bit is 0, and 0 when the preceding bit is 1. Here the output data is inverted every time when 1 appears in the codes.

Pattern	Code Conversion
01	010
10	x00
11	x01
0001	x00000
0010	x00001
0011	010001
0000	010000

Example

Input	01	10	11	0010	10	0011	11	0001	0011	10	0000
Code Conversion	010	100	101	000001	000	010001	001	000000	010001	000	010000
Output	011	000	110	000001	111	000001	110	000000	011110	000	011111

- **2-7 RLL:** 2-item patterns are made up of 4 data items, 3-items pattern are made up of 6 data items and 4-item patterns are made up of 8 data items. Here the output data is inverted every time when 1 appears in the codes.

Pattern	Code Conversion
11	1000
10	0100
011	001000
010	100100
000	000100
0011	00001000
0010	00100100

Example									
Input	11	10	010	000	0010	011	0011	10	0010
Code Conversion	1000	0100	100100	000100	00100100	001000	00001000	0100	00100100
Output	1111	1000	111000	000111	11000111	110000	00001111	1000	00111000

- **user defined:** When user defined has been selected as the code for pattern setting from the **Code** selection menu, the following pattern systems can be created by setting the values for **Source Data Pattern**, **Converted Code**, **Initial Src**, **Initial Code** and **Out[1/0]**.

NRZ

Initial Src 0
 Initial Code 0
 Out[1/0] High/Low

Source Data Pattern	Converted Code
0	0
1	1

NRZ1

Initial Src 0
Initial Code 0
Out[1/0] Invert/Keep

Source Data Pattern	Converted Code
0	00
1	01

RZ

Initial Src 0
Initial Code 0
Out[1/0] High/Low

Source Data Pattern	Converted Code
0	00
1	10

BIPHASE

Initial Src 0
Initial Code 0
Out[1/0] High/Low

Source Data Pattern	Converted Code
0	01
1	10

MFM

Initial Src 0
 Initial Code 0
 Out[1/0] Invert/Keep

Source Data Pattern	Converted Code
0	30
1	01

f/2f

Initial Src 0
 Initial Code 0
 Out[1/0] Invert/Keep

Source Data Pattern	Converted Code
0	10
1	11

1-7 RLL

Initial Src 0
 Initial Code 0
 Out[1/0] Invert/Keep

Source Data Pattern	Converted Code
10	200
01	010
11	201
0010	20001
0001	20000
0011	010001
0000	010000

2-7 RLL

Initial Src 0
 Initial Code 0
 Out[1/0] Invert/Keep

Source Data Pattern	Converted Code
10	0100
11	1000
000	000100
011	001000
010	100100
0010	00100100
0011	00001000

Logical Operation

In the waveform editor timing display, it is possible to perform logical operations for data on different data lines. The following logical tables and timing charts show examples of each type of operations.

- **AND**

A	B	A*B
0	0	0
0	1	0
1	0	0
1	1	1

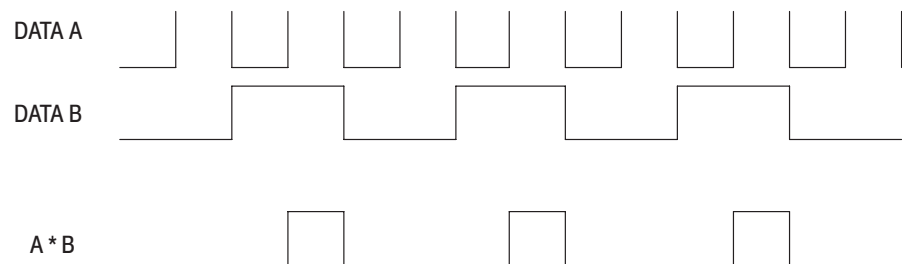

■ **NAND**

A	B	$\overline{A \cdot B}$
0	0	1
0	1	1
1	0	1
1	1	0

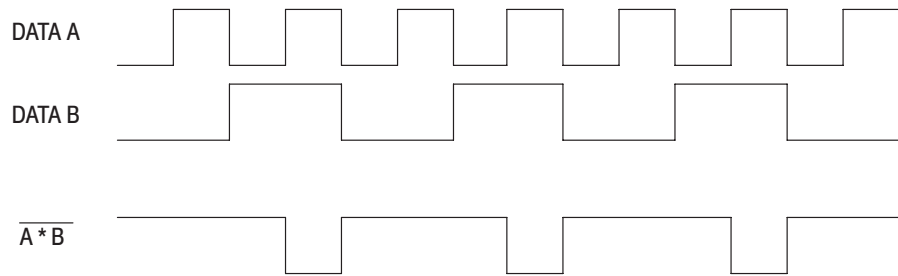

■ **OR**

A	B	$A + B$
0	0	0
0	1	1
1	0	1
1	1	1

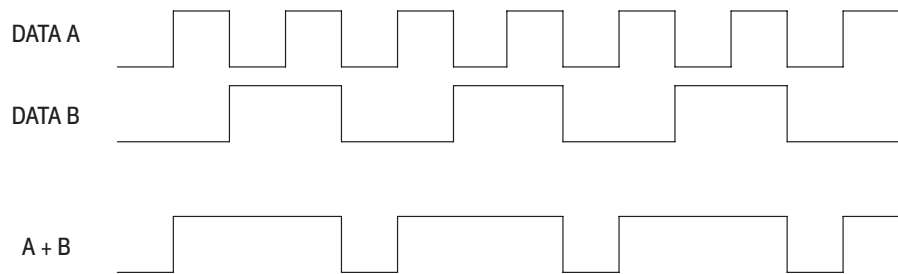

■ NOR

A	B	$\overline{A+B}$
0	0	1
0	1	0
1	0	0
1	1	0

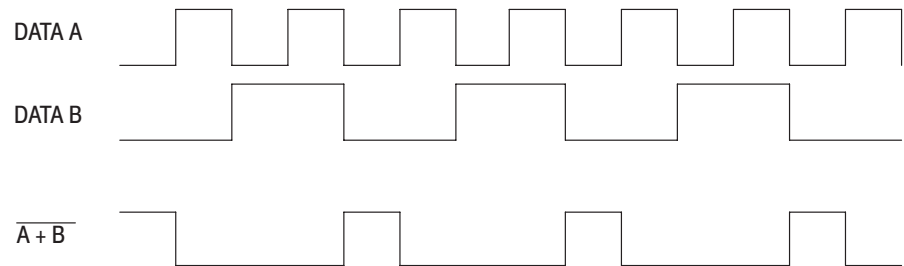

■ EX-OR

A	B	$A \oplus B$
0	0	0
0	1	1
1	0	1
1	1	0

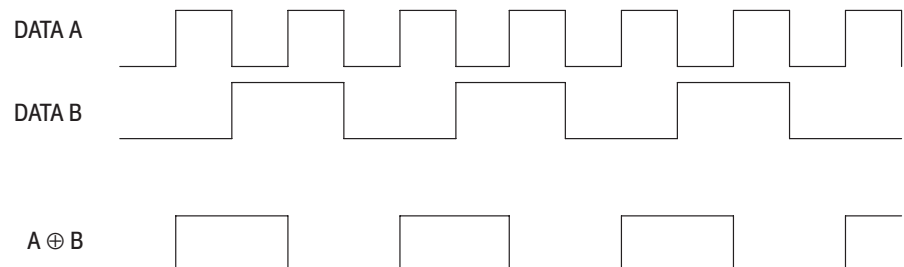

■ EX-NOR

A	B	$\overline{A \oplus B}$
0	0	1
0	1	0
1	0	0
1	1	1

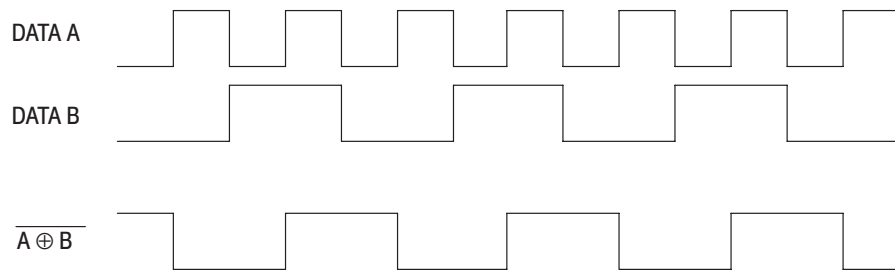

FFT (Fast Fourier Transforms)

FFT is an algorithm for fast calculation of discrete Fourier transform. FFT transforms the time axis signal onto the frequency axis. FFT can also provide the frequency component magnitudes and phases. With the FFT editor, you can use inverse FFT (IFFT) to generate the real time data from the frequency component magnitudes and phases.

Basic FFT Rules

FFT discrete Fourier transforms any number of sample points, but certain rules must be followed.

1. The Record Length must be a Power of 2.

The FFT calculations can only be used when the record length is a power of 2 (2, 4, 8, ... 2^n). The minimum record length for this instrument is 512 points, and the maximum record length is 16384 points.

If the record length is not a power of 2, the waveform is edited expanded to a power of 2. Then when the editing is complete and the waveform is saved, the waveform is reduced to its original record length by interpolating the data. Therefore, it is recommended to use the record length of a power of 2 when accurate data is needed.

2. Nyquist Frequency and Aliasing

FFT transforms the sampled data on the time axis into data on the discrete frequency axis from 0 Hz to the maximum permitted frequency. The

maximum permitted frequency is called the Nyquist frequency and is 1/2 the sampling rate.

If the signal has frequency components above the Nyquist frequency, they appear on this limited discrete frequency axis too. They appear as no different than noise aliased from the Nyquist frequency. For example, if there is a signal 5 MHz above the Nyquist frequency, it appears as if it is 5 MHz below the Nyquist frequency. On the other hand, in the D/A conversion, a frequency component is output aliased above the Nyquist frequency.

To deal with aliasing, first it is necessary to sample with a clock greater than double the highest frequency component in the signal. Second, a low-pass filter is required to block any signal above the Nyquist frequency.

Record Length and Frequency Resolution

The frequency spectrum frequency range and resolution depend on the time axis sampling rate and the record length (N).

For the given data length on the time axis, FFT has frequency components from $-N/2$ to $N/2-1$. However, when the real number data on the time axis is transformed, FFT gives results symmetrical about 0 Hz (DC). Because of this symmetry, all the necessary frequency data is contained between 0 and $N/2 - 1$. Thus, with FFT if values are given from zero to the positive $N/2$ point, this is enough. Since the non-DC components have energy dispersed on both the positive and negative sides, the DC component is 2x the other components. Since the DC component is scaled by 1/2 with the FFT editor, DC and the other components can be handled equally.

Since FFT has $N/2$ sampling points on the discrete frequency axis between DC and the Nyquist frequency (F_N), the frequency resolution is $F_N/(N/2)$. Since the Nyquist frequency is one half the sampling rate (f_s), the frequency resolution can also be expressed as f_s/N .

Therefore, if the sampling rate is fixed, when the record length is increased, the frequency resolution rises. On the other hand, if the record length is fixed, raising the sampling rate raises the Nyquist frequency and lowers the frequency resolution.

Relationship Between Phase and Delay

The phase is the quantitative displacement from the standard time. The $\cos(2 \pi ft)$ has a 0 phase, but $\sin(2 \pi ft)$ has a 90 degree delay. The standard time is the sampling start time.

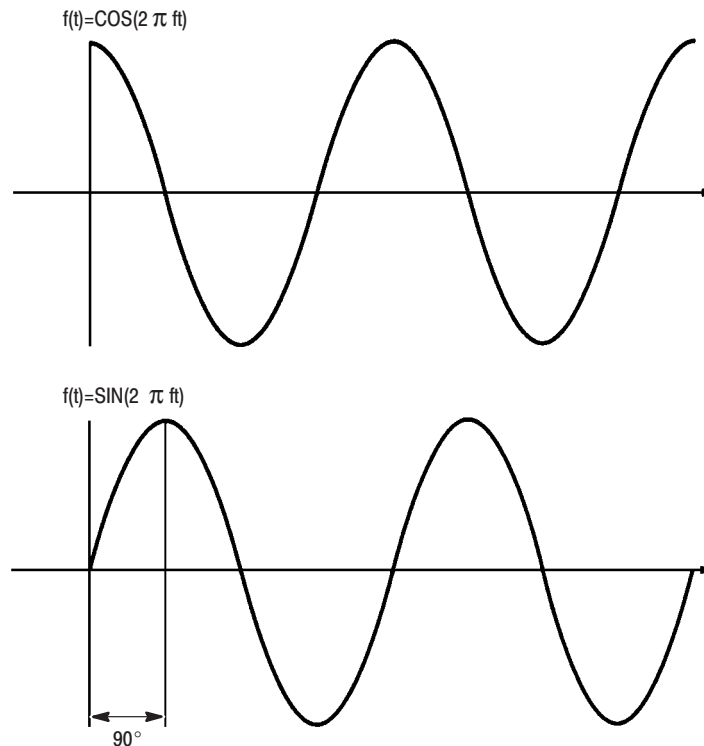

Figure F-6: Phase and Delay

FFT Window Functions

FFT calculates with limited data blocks. Also, since FFT calculations assume that the sampled data blocks are repeated infinitely, frequency error arises from non-continuities generated at the edges of data blocks. This frequency error is called leakage error.

The leakage error depends on the FFT window function selected. The processing to bring the window function at both ends towards 0 in order to give the FFT continuity is called taper processing. This instrument has the square wave window, which does not apply taper processing to the time region data, and five FFT window functions that do carry out taper processing.

The FFT window functions in the time region correspond to filters in the frequency region. This is convolution and it is well known that it has a characteristic of $\sin(x)/x$ for square window. These filters have a high lobe at the center, in other words a transmitting band width,. This lobe determines how great the neighboring frequency components can be separated.

The transmission amount for the side lobes neighboring this center lobe determines the amount of leakage. Leakage is the spread of energy from a certain frequency component for the displayed frequency spectrum. Frequency components with small magnitudes are covered overall by leakage.

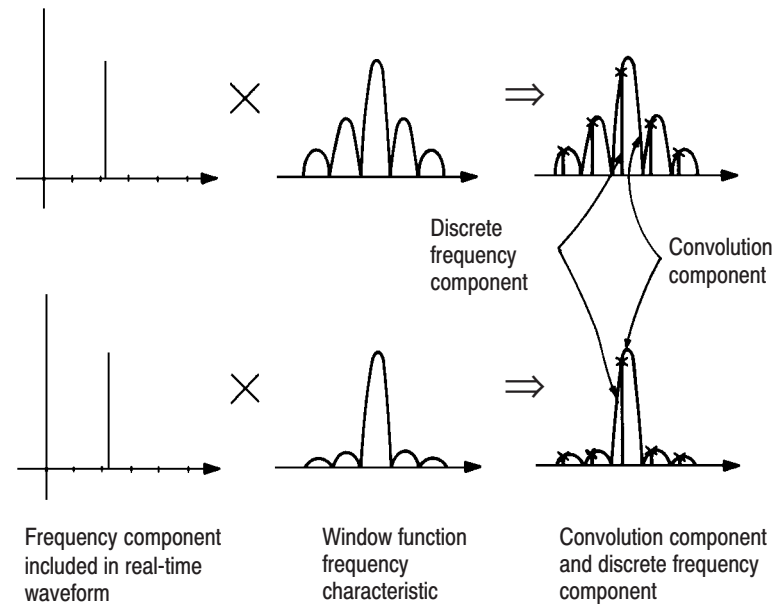

Figure F-7: Concept of Convolution

Figures F-8 through F-13 show the FFT window functions prepared for this instrument and their characteristics. Also, note that if you use a window function with taper processing, then carry out inverse Fourier transformation to make real-time data, that real-time data is tapered.

The window functions are effective for investigating the frequency components of the acquired waveform, but the waveform after the window function is applied differs from the original waveform.

Square Wave Window. The square wave window does not taper the time region data. The filter shape in the frequency region is $\sin(x)/x$. The square wave window is appropriate for observing the frequency spectrum of non-repetitive signals. The square wave window is also used for observing frequency components near DC.

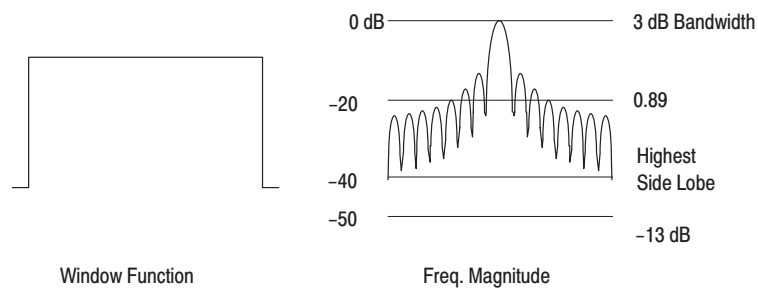

Figure F-8: Square Window and Frequency Characteristic

Hanning Window. The Hanning window is a function derived from the cos function. This window function has superior magnitude precision and leakage elimination characteristics.

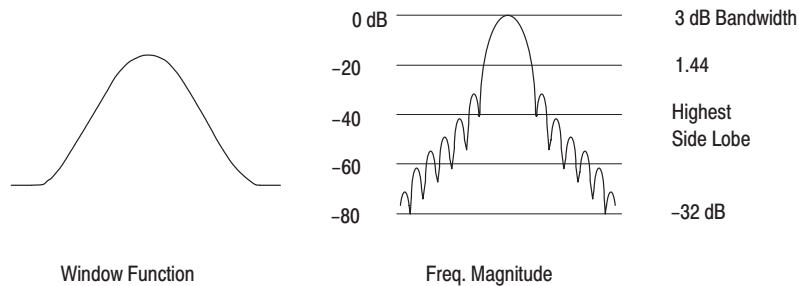

Figure F-9: Hanning Window and Frequency Characteristic

Hamming Window. The hamming window is similar to a hanning window, but it suppresses more the transmissivity for the side lobes next to the transmitting bandwidth. Compared to FFT processing using a hanning window, the degree of separation between two frequencies is greater, as can be seen in Figure F-10. This window is particularly effective for separating close frequencies.

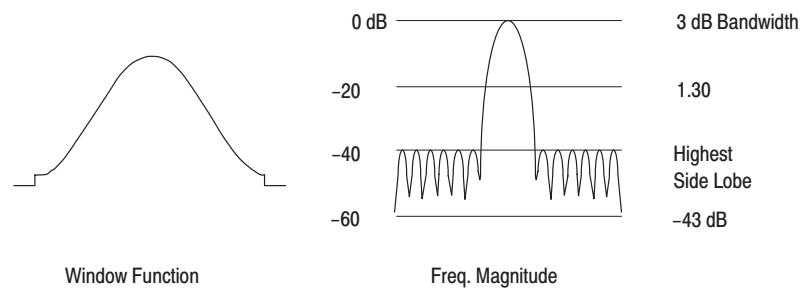

Figure F-10: Hamming Window and Frequency Characteristic

Blackman-Harris Window. Of the six window functions in this instrument, the Blackman-Harris window has the broadest transmission bandwidth (and therefore, lowest frequency resolution) and the lowest side lobe transmission (and therefore, lowest leakage). This window is particularly suited for observing wide range frequency spectra.

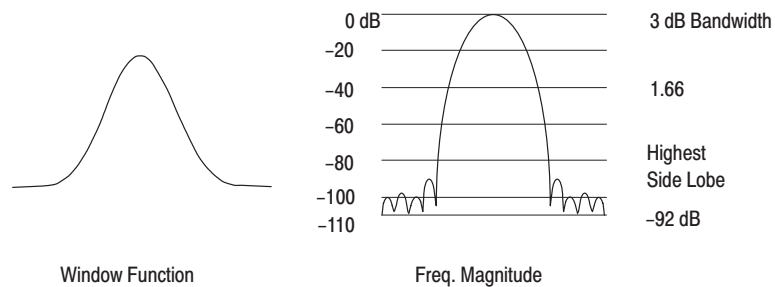

Figure F-11: Blackman-Harris Window and Frequency Characteristic

Blackman Window. The Blackman window suppresses the side lobe magnitudes in the frequency region lower than the hamming window does and suppresses leakage even farther. However, it has inferior frequency resolution.

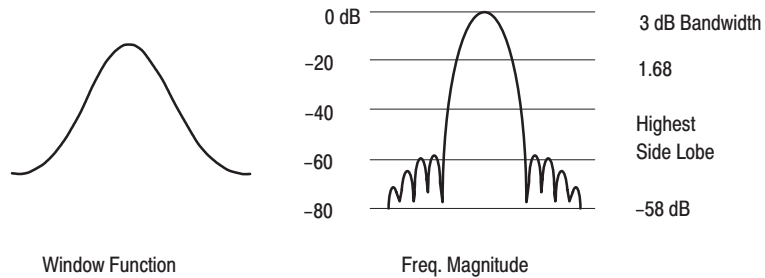

Figure F-12: Blackman Window and Frequency Characteristic

Triangle Wave Window. The triangle wave window is a convolution of two square windows half the width of the window. Therefore, the triangle wave window frequency spectrum is the product of the square wave windows.

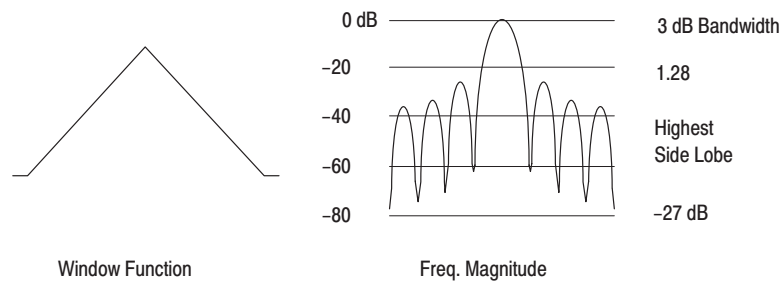

Figure F-13: Triangle Window and Frequency Characteristic

Repackaging for Shipment

If this instrument is shipped by commercial transportation, use the original packaging material. Unpack the instrument carefully from the shipping container to save the carton and packaging material for this purpose.

If the original packaging is unfit for use or is not available, repackage the instrument as follows:

1. Obtain a corrugated cardboard shipping carton having inside dimensions at least six inches greater than the instrument dimensions and having a carton test strength of at least 275 pounds.
2. If the instrument is being shipped to a Tektronix Service Center for repair or calibration, attach a tag to the instrument showing the following: owner of the instrument (with address), the name of a person at your firm who may be contacted if additional information is needed, complete instrument type and serial number, and a description of the service required.
3. Wrap the instrument with polyethylene sheeting or equivalent to protect the outside finish and prevent entry of packing materials into the instrument.
4. Cushion the instrument on all sides by tightly packing dunnage or urethane foam between the carton and the instrument, allowing for three inches of padding on each side (including top and bottom).
5. Seal the carton with shipping tape or with an industrial stapler.
6. Mark the address of the Tektronix Service Center and your return address on the carton in one or more prominent locations.

Factory Settings

When **Reset to Factory** is selected from the **UTILITY Misc** menu, this instrument's parameters are reset to the values they had at the factory. Table F-1 lists these factory settings.

Table F-1: Factory Settings

Setup Menu	
Clock Frequency	100.00 MHz
Clock Source	Internal
CH1 Operation	Normal
Filter	Through
Amplitude	1.000 V
Offset	0.000 V
Display	Graphics
MODE Menu	
Operating mode	Cont
Triggered Slope	Positive
Gated Polarity	Positive
Level	1.4 V
Impedance	1 M Ω
Sync	Start (Sync is End when the operation mode is Cont.)
LOAD/SAVE Menu	
Device	Disk
Auto Load	Off
UTILITY Menu	
Misc Display... Brightness	70%
Misc Display... Catalog Order	Name1
Misc Display... Data Time	Off
Misc Hardcopy... Format	BMP
Misc Hardcopy... Port	Disk
Diag/Cal Diagnostics	All
Diag/Cal Calibrations	All
FG Menu	
Function waveform Selection	Sine
Frequency	2.500 MHz

Table F-1: Factory Settings (Cont.)

FG Menu	
Amplitude	1.000 V
Offset	0.000 V
Polarity	Normal
Pulse Duty	50%

The following **UTILITY** menu settings are not affected by **Reset to Factory**.

Remote Port**GPIB Address**

GPIB operating mode

Setting the RS-232-C parameters

Date/Time

Appendix G: Inspection and Cleaning

Inspect and clean the instrument as often as operating conditions require. The collection of dirt can cause instrument overheating and breakdown. Dirt acts as an insulating blanket, preventing efficient heat dissipation. Dirt also provides an electrical conduction path that can cause an instrument failure, especially under high-humidity conditions.



CAUTION. To prevent damage avoid the use of chemical cleaning agents that might damage the plastics used in this instrument. Use only deionized water when cleaning the menu buttons or front-panel buttons. Use a ethyl alcohol solution as a cleaner and rinse with deionized water.

Avoid the use of high pressure compressed air when cleaning dust from the interior of this instrument. (High pressure air can cause ESD.) Instead, use low pressure compressed air (about 9 psi).

Inspection — Exterior

Using Table G-1 as a guide, inspect the outside of the instrument for damage, wear, and missing parts. You should thoroughly check instruments that appear to have been dropped or otherwise abused to verify correct operation and performance. Immediately repair defects that could cause personal injury or lead to further damage to the instrument.

Table G-1: External inspection check list

Item	Inspect for	Repair action
Cabinet, front panel, and cover	Cracks, scratches, deformations, damaged hardware or gaskets	Replace defective module
Front-panel knobs	Missing, damaged, or loose knobs	Repair or replace missing or defective knobs
Connectors	Broken shells, cracked insulation, and deformed contacts. Dirt in connectors	Replace defective modules; clear or wash out dirt
Carrying handle and cabinet feet	Correct operation	Replace defective module
Accessories	Missing items or parts of items, bent pins, broken or frayed cables, and damaged connectors	Replace damaged or missing items, frayed cables, and defective modules

**Cleaning Procedure —
Exterior**



To clean the instrument exterior, do the following:

WARNING. *To avoid injury or death, unplug the power cord from line voltage before cleaning the instrument. To avoid getting moisture inside the instrument during external cleaning, use only enough liquid to dampen the cloth or applicator.*

1. Remove loose dust on the outside of the instrument with a lint-free cloth.
2. Remove remaining dirt with a lint free cloth dampened in a general purpose detergent-and-water solution. Do not use abrasive cleaners.
3. Clean the monitor screen with a lint-free cloth dampened with either ethyl alcohol or, preferably, a gentle, general purpose detergent-and-water solution.

Lubrication. There is no periodic lubrication required for this instrument.