

# Instruction Manual

**Tektronix**

**ASG 140  
Audio Signal Generator**

**070-8667-04**

**Warning**

The servicing instructions are for use by qualified personnel only. To avoid personal injury, do not perform any servicing unless you are qualified to do so. Refer to all safety summaries prior to performing service.

Copyright © Tektronix, Inc. All rights reserved. Printed in U.S.A.  
Tektronix products are covered by U.S. and foreign patents, issued and pending.

Information in this publication supersedes that in all previously published material. Specifications and price change privileges reserved. The following are registered trademarks: TEKTRONIX and TEK.

For product related information, phone: 800-TEKWIDE (800-835-9433), ext. TV.

For further information, contact: Tektronix, Inc., Corporate Offices, P.O. Box 1000, Wilsonville, OR 97070-1000, U.S.A. Phone: (503) 627-7111; TLX: 192825; TWX: (910) 467-8708; Cable: TEKWSGT.

## WARRANTY

Tektronix warrants that this product will be free from defects in materials and workmanship for a period of one (1) year from the date of shipment. If any such product proves defective during this warranty period, Tektronix, at its option, either will repair the defective product without charge for parts and labor, or will provide a replacement in exchange for the defective product.

In order to obtain service under this warranty, Customer must notify Tektronix of the defect before the expiration of the warranty period and make suitable arrangements for the performance of service. Customer shall be responsible for packaging and shipping the defective product to the service center designated by Tektronix, with shipping charges prepaid. Tektronix shall pay for the return of the product to Customer if the shipment is to a location within the country in which the Tektronix service center is located. Customer shall be responsible for paying all shipping charges, duties, taxes, and any other charges for products returned to any other locations.

This warranty shall not apply to any defect, failure or damage caused by improper use or improper or inadequate maintenance and care. Tektronix shall not be obligated to furnish service under this warranty a) to repair damage resulting from attempts by personnel other than Tektronix representatives to install, repair or service the product; b) to repair damage resulting from improper use or connection to incompatible equipment; c) to repair any damage or malfunction caused by the use of non-Tektronix supplies; or d) to service a product that has been modified or integrated with other products when the effect of such modification or integration increases the time or difficulty of servicing the product.

**THIS WARRANTY IS GIVEN BY TEKTRONIX WITH RESPECT TO THIS PRODUCT IN LIEU OF ANY OTHER WARRANTIES, EXPRESSED OR IMPLIED. TEKTRONIX AND ITS VENDORS DISCLAIM ANY IMPLIED WARRANTIES OF MERCHANTABILITY OR FITNESS FOR A PARTICULAR PURPOSE. TEKTRONIX' RESPONSIBILITY TO REPAIR OR REPLACE DEFECTIVE PRODUCTS IS THE SOLE AND EXCLUSIVE REMEDY PROVIDED TO THE CUSTOMER FOR BREACH OF THIS WARRANTY. TEKTRONIX AND ITS VENDORS WILL NOT BE LIABLE FOR ANY INDIRECT, SPECIAL, INCIDENTAL, OR CONSEQUENTIAL DAMAGES IRRESPECTIVE OF WHETHER TEKTRONIX OR THE VENDOR HAS ADVANCE NOTICE OF THE POSSIBILITY OF SUCH DAMAGES.**

## EC Declaration of Conformity

We

Tektronix Holland N.V.  
Marktweg 73A  
8444 AB Heerenveen  
The Netherlands

declare under sole responsibility that the

***ASG 140 Audio Signal Generator***

meets the intent of Directive 89/336/EEC for Electromagnetic Compatibility.  
Compliance was demonstrated to the following specifications as listed in the Official  
Journal of the European Communities:

EN 50081-1 Emissions:

EN 55022 Class B Radiated and Conducted Emissions

EN 50082-1 Immunity:

IEC 801-2 Electrostatic Discharge Immunity

IEC 801-3 RF Electromagnetic Field Immunity

IEC 801-4 Electrical Fast Transient/Burst Immunity

High-quality shielded cables must be used to ensure compliance to the above listed  
standards.

# OPERATOR'S SAFETY SUMMARY

*The general safety information in this part of the summary is for both operating and servicing personnel. Specific warnings and cautions will be found throughout the manual where they apply, but may not appear in this summary.*

## Terms In This Manual



statements identify conditions or practices that could result in damage to the equipment or other property.



statements identify conditions or practices that could result in personal injury or loss of life.

## Terms As Marked on Equipment



**CAUTION** indicates a personal injury hazard not immediately accessible as one reads the marking, or a hazard to property, including the equipment itself. Refer to the manual for information.



**DANGER** indicates a personal injury hazard immediately accessible as one reads the marking.



Protective ground (earth) terminal.

## SAFETY INFORMATION

**Use the Proper Power Source.** This product is intended to operate from a power source that will not apply more than 250 V rms between the supply conductors or between either supply conductor and ground. A protective-ground connection by way of the grounding conductor in the power cord is essential for safe operation.

**Ground the Product.** This product is grounded through the grounding conductor of the power cord. To avoid electrical shock, plug the power cord into a properly wired receptacle before connecting to the product input or output terminals. A protective-ground connection by way of the grounding conductor in the power cord is essential for safe operation.

**Danger May Arise From Loss of Ground.** Upon loss of the protective-ground connection, all accessible conductive parts (including knobs and controls that may appear to be insulating) can render an electric shock.

**Use the Proper Fuse.** To avoid fire hazard, use only the fuse of correct type, voltage rating, and current rating as specified in the parts list for your product. Refer fuse replacement to qualified service personnel.

**Do Not Operate in Explosive Atmospheres.** To avoid explosion, do not operate this product in an explosive atmosphere.

**Do Not Remove Covers.** To avoid personal injury, do not remove the product covers or panels. Do not operate the product without the covers and panels properly installed.



# Section 1

# INTRODUCTION AND SPECIFICATIONS

## INTRODUCTION

The ASG 140 Audio Signal Generator was developed by Tektronix to meet the audio testing requirements of audio transmission systems. The ASG 140 reduces testing time by transmitting short, predefined audio test sequences that produce precise and easily reproduced results in its AUTO mode. It can also transmit source identification, a voice segment (either continually or as part of the AUTO test) and user defined tones. The user defined tones of LINE UP and MANUAL test signal operation provide the continuous signals needed for adjusting audio levels and manual checking of the left/right audio channels.

## AUTOMATIC AUDIO CHANNEL TESTING

Test equipment for sound programming and the sound channels of television programming must be capable of quickly checking the audio signal path to make sure of the circuit's quality. Automatic equipment must be able to rapidly measure the test signal in ways that give repeatable and meaningful test results.

To assist in the repeatability area, standard test signal sequences have been defined. These sequences begin with the necessary components to start the measurement, identify the source of the test signals, and identify the stored automatic test that is to be done. Then the test signal portion of the sequence runs in predefined frequency, level, and timing patterns that permit automated testing of the signal path characteristics.

Each of the test signals in the automatic test sequence are used to check on the different parameters that are important to signal quality. The tests have defined sequences for both monaural and stereo audio testing, and are based on Recommendation O.33 of the *CCITT Specification For Measuring Equipment, Volume IV, Series O Recommendations-1988*.

When used with a CCITT O.33 compliant receiver, such as the Tektronix VM700A Option 40 or Option 41, the results of the AUTO testing sequence can be documented automatically without the need for human intervention (unless of course, an out-of-tolerance condition is found by the test).

The Tektronix VM700A Option 40 and Option 41 receiving and measuring equipment uses the test signals sent by the companion ASG 140 audio signal generator to measure the following parameters as defined in Recommendation O.33 for monophonic audio paths.

- Insertion Gain
- Frequency Response
- Distortion
- Signal-to-Noise Ratio
- Compressor Linearity
- Expanded Noise

For stereophonic audio paths, additional measurements are done to assure the A/B (left/right) channel parameters of the signal paths are sufficiently matched for proper transmission of the program audio.

The added measurements are:

Interchannel difference in gain and phase

Interchannel crosstalk and circuit transposition

## MANUAL SIGNAL TESTING

### Line Up

The Line Up test signal is selectable in both frequency and amplitude for use in providing a known line up signal for adjusting levels from various audio sources. This signal may be set for a house standard and then fixed (editing disabled) or it may remain controllable from the front panel. The frequency range is from 10 Hz to 20 kHz and the amplitude range is from -90 dBu to +24 dBu. As shipped from the factory (and the default if factory defaults are reloaded), the Line Up signal is 400 Hz at 0.0 dBu.

### Manual

#### Tone

The Tone test signal comes as stereo, left tone, and right tone. The frequency and amplitude are selectable over the same range as the Line Up signal. The factory default for the Tone signals is 440 Hz at 0.0 dBu.

#### Polarity

Polarity also comes as stereo, left polarity, and right polarity. The polarity test signal is the sum of a fundamental sine wave of 440 Hz and its equal amplitude second harmonic sine wave of 880 Hz. The amplitude of the polarity signal is selectable from -90 dBu to +24 dBu with a fixed fundamental frequency of 440 Hz. The factory default for the amplitude is 0.0 dBu.

#### Multitone

The Multitone signals also come as stereo, left channel, and right channel. Multitone signals are composed of a selected set of sine wave frequencies. The amplitude of the Multitone signal is selectable from -90 dBu to +24 dBu. The output signal amplitude for the Multitone signals is the rms value of signal set, not the amplitude of any single frequency component in the set. There are presently four sets of multitone signals covering different bandwidths and providing different sine wave components. The multitone signals are used to check for response and harmonic distortion of audio circuits and devices (amplifiers, tape recorders, cables, etc.). The factory default for the amplitude is 0.0 dBu.

## REMOTE CONTROL

There are two types of remote control possible with the ASG 140. The remote control connector on the rear panel of the instrument may be used as contact closure connections for minimal remote operation. Using contact closure remote, an AUTO sequence may be started and front panel editing may be enabled (if it is internally disabled). The second type of remote control uses the remote control connector as an RS-232C serial port, and the front panel operation may be controlled via a PC or terminal if serial communications is enabled in the ASG 140. The Audio/Video Timing signal synchronization feature is also controlled through the remote port. See *Appendix C* for information on the Audio/Video Timing feature.



# SPECIFICATIONS

## Electrical Characteristics

**Table 1-1**  
Electrical Characteristics

Characteristic	Performance Requirement	Comment
External Power		
Voltage (Nominal)	100 to 240 Vac.	Full range, no selector.
Input Freq Range	47 Hz to 440 Hz.	
Power Consumption	20 W Typical.	
RS-232C Interface		
Baud Rates	1200, 2400, 4800, and 9600 (factory default).	Front panel selection only, no switch settings for baud rate except the factory default of 9600.
Maximum Applied Voltage	25 V (dc + peak ac).	
Signals	RXD (received data), TXD (transmitted data), and GND are used for serial remote control of the ASG 140.	RTS and CTS are not used in the ASG 140. Pins 4, 6, and 9 of the connector are not to be connected to the terminal interconnection cable. Those pins are used for contact closure remote control.
Levels	Compatible with RS-232C.	
Connector	DB-9 DTE (terminal communications device).	Requires a null modem for connection to another DTE device.
Output Signal Frequency		
Range	10 Hz to 20 kHz.	
Multitone	See Table 1-2.	
Resolution	1 Hz.	
Accuracy	$\pm 0.1\%$ .	
Connectors	XLR Female (4 outputs)	
Output Signal Amplitude		
Range	$-90$ dBu to $+24$ dBu ( $24.5 \mu\text{V}$ to $12.2 V_{\text{RMS}}$ ) balanced into a load resistance of $10 \text{ k}\Omega$ or greater with $12 \Omega$ source resistance.	Multitone signal components are not sent at the specified amplitude; the amplitude specification is for the combined Multitone signal rms value.
Accuracy	$\pm 0.2$ dB at 1 kHz from $+24$ dBu to $-80$ dBu into a load resistance of $10 \text{ k}\Omega$ or greater.	Output amplitude is $\approx 0.17$ dB lower with a $600\Omega$ load.
Resolution	$\pm 0.1$ dB.	Typ. $\pm 0.1$ dB, 10 Hz to 19 kHz* Typ. $+0.05/-0.1$ dB, 10 Hz to 15 kHz**
Flatness	$\pm 0.2$ dB, 10 Hz to 20 kHz* $+0.05/-0.2$ dB, 10 Hz to 20 kHz (relative to 1 kHz)**	

\* B019999 and below

\*\* B020000 and above

Table 1-1 (cont)

Characteristic	Performance Requirement	Comment
Total Harmonic Distortion + Noise for outputs $\geq -10$ dBu (245 mV <sub>rms</sub> ) (measured over an 80 kHz bandwidth)	< 0.01% (-80 dB), 20 Hz to 18 kHz*; < 0.025% (-72 dB), 18 kHz to 20 kHz*; < 0.015% (-76.5 dB), 10 Hz to 19 kHz**; < 0.056% (-65 dB), >19 kHz to 20 kHz**	< 0.005% at 1 kHz at full output, measured over a 22 KHz bandwidth (see typical curve in Figure 1-1). This typical specification will also hold at +14 dBu and +4 dBu.
Signal-to-Noise, measured over a 22 kHz bandwidth.	> 90 dB at 1 kHz at 0 dBu output level.	$S/N = 20 \log \frac{V_{Manual}}{V_{Silence}}$  S/N improves as the output signal increases and decreases as output reduces, proportionally.
XLR Outputs	Balanced.	
Output Impedance	12 $\Omega$ ; balanced.	
Level Difference Between Channels	$\leq 0.2$ dB at +14 dBu.	
Phase Difference Between Channels	$\leq 1^\circ$ , 10 Hz to 20 kHz.	
Typical Crosstalk + Noise measured over 80 kHz bandwidth at +24 dBu  Generator to Output	$\leq -90$ dB at 1 kHz and 20 kHz.	Left tone into Right output or Right tone into Left output; generator source resistance 12 $\Omega$ and load termination either open or 600 $\Omega$ .

\* B019999 and below

\*\* B020000 and above

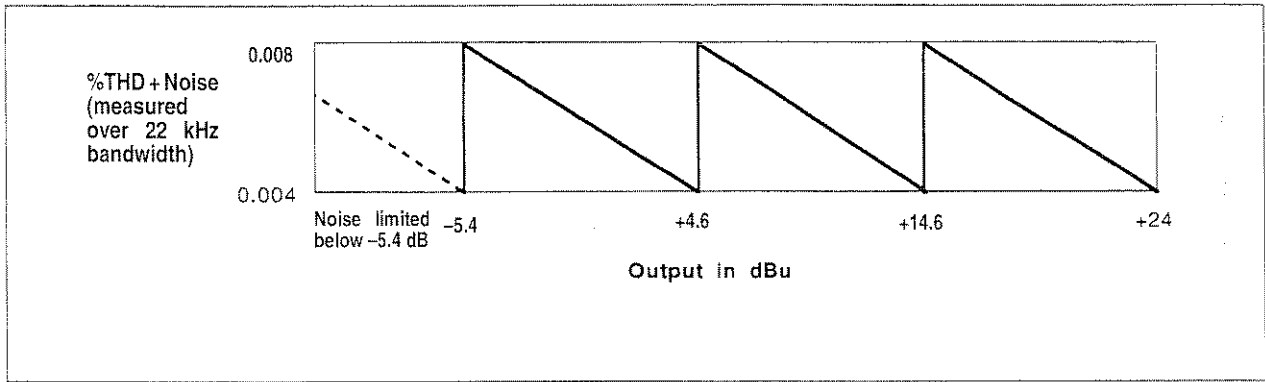

Figure 1-1. Typical 1 kHz THD + Noise versus Output Level.

Table 1-2  
ASG 140 Multitones

Multitone 1	Multitone 2	Multitone 3	Multitone 4
59	23	47	23
117	94	141	117
187	141	281	234
246	223	656	750
293	270	1031	867
375	352	2016	1758
422	562	4031	3492
949	879	8019	6984
1184	1113	15000	13992
1512	1395		20015
1887	1758		
2391	2227		
3000	2789		
3785	3516		
4758	4430		
6012	5590		
7570	7043		
9539	8871		
12012	11180		
15000	14074		
	17742		
	19992		

**NOTE**

The Multitone signals are combined in repetitive blocks. At the end of the block time, all the signals are in phase again for a seamless transition into the next signal block.

## Environmental Characteristics

**Table 1-3**  
**Environmental Characteristics**

Characteristic	Limits
Operating Temp.	0° C to +50° C.
Non-Operating Temp.	-40° C to +65° C.



## Mechanical Characteristics

**Table 1-4**  
**Physical Characteristics**

Characteristic	Value
Length	18.0 in. (458 mm).
Width	8.1 in. (206 mm).
Height	1.7 in. (43 mm).
Weight	3.25 lb. (1.48 kg).

## POWER CORD OPTIONS

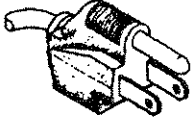
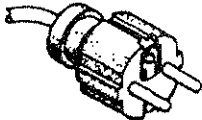
Table 1-5  
Voltage, Fuse,<sup>a</sup> and Power Cord Data

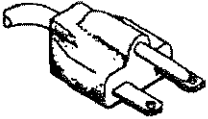
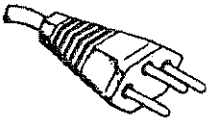
Plug Configuration	Category	Power Cord and Plug Type	Voltage Range	Reference Standards <sup>b</sup>
	U.S. Domestic Standard	U.S. 120 V 15 A	115 V Nominal 90 V to 132 V	ANSI C73.11 NEMA 5-15-P IEC 83 UL 198.6
	Option A1	EURO 240 V 10-16 A	230 V Nominal 180 V to 250 V	CEE(7), II, IV, VII IEC 83 IEC 127
	Option A2	UK <sup>c</sup> 240 V 6 A	230 V Nominal 180 V to 250 V	BS 1363 IEC 83 IEC 127
	Option A3	Australian 240 V 10 A	230 V Nominal 180 V to 250 V	AS C112 IEC 127
	Option A4	North American 240 V 15 A	230 V Nominal 180 V to 250 V	ANSI C73.20 NEMA 6-15-P IEC 83 UL 198.6
	Option A5	Switzerland 220 V 6 A	230 V Nominal 180 V to 250 V	SEV IEC 127

<sup>a</sup>All options listed come with a factory-installed fuse for the selected operating voltage range.

<sup>b</sup>Reference Standards Abbreviations:

- ANSI—American National Standards Institute
- AS—Standards Association of Australia
- BS—British Standards Institution
- CEE—International Commission on Rules for the Approval of Electrical Equipment
- IEC—International Electrotechnical Commission
- NEMA—National Electrical Manufacturer's Association
- SEV—Schweizerischer Elektrotechnischer Verein
- UP—Underwriters Laboratories Inc.

<sup>c</sup>A 6 Ampere, type C fuse is also installed inside the plug of the Option A2 power cord.

www.valuetronics.com

# Section 2 OPERATION AND SETUP

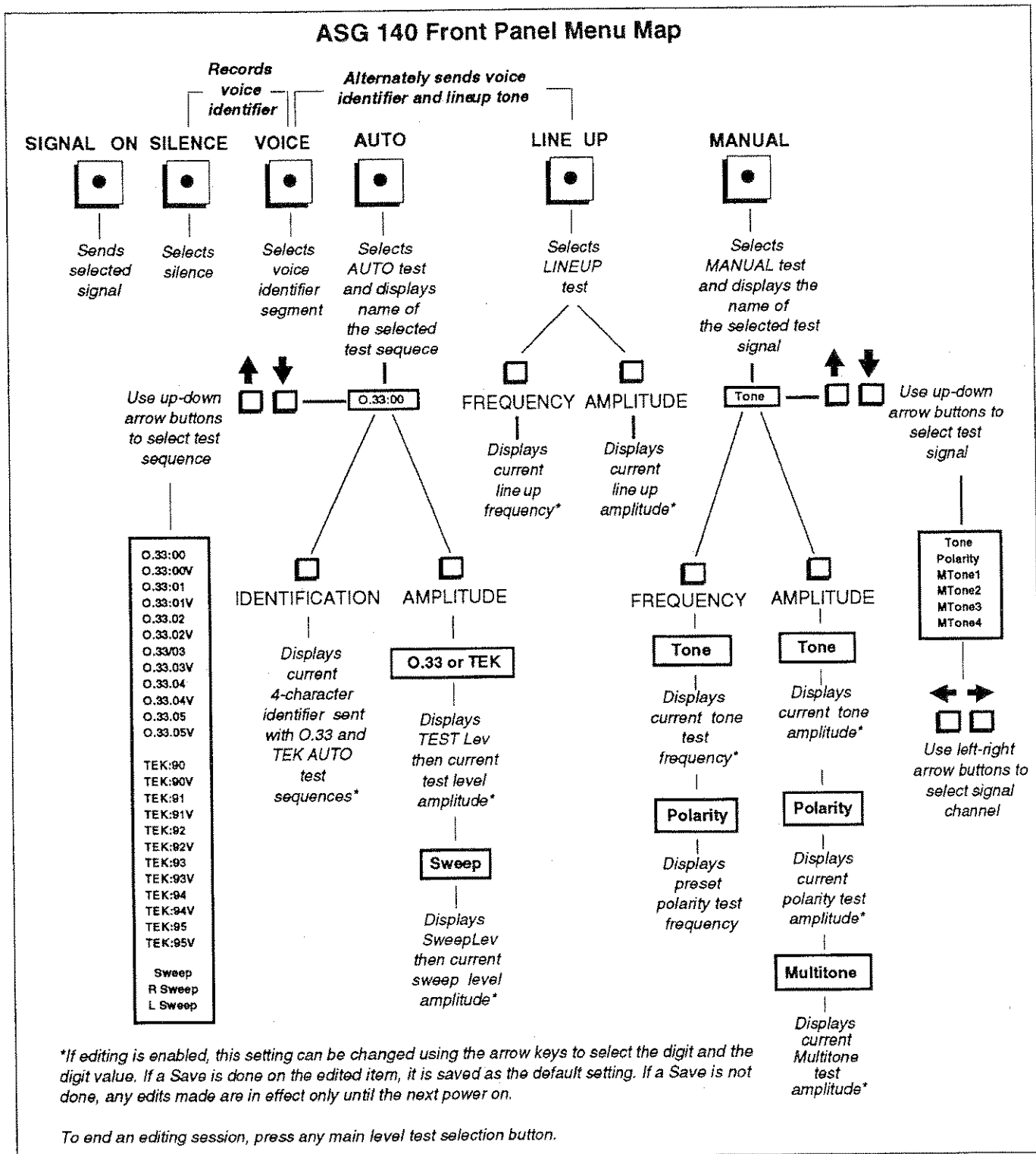

Figure 2-1. ASG 140 menu map.

## SAFETY

Before connecting the ASG 140 to a power source, read both this section and the Operator's Safety Summary at the front of this manual.

## INSTALL THE POWER CORD

Connect the detachable three-wire power cord to the power connector on the rear panel of the ASG 140. Various power cord options are available to match the various international ac mains. The power cord supplied with the ASG 100 is as ordered from the factory. See Section 1, *Introduction and Specifications*, for the power cord options.

## MAINS VOLTAGE

### WARNING

*To avoid electrical shock, the ground safety lead of the power cord must be properly connected to earth ground.*

Plug the power cord into the outlet for any voltage source between 140 and 240 volts. You do not need to make any adjustments on the ASG 140 to accommodate different source voltages in the rated operating range.

## CONNECT TO THE AUDIO PATH

Install the ASG 140 at the head end of the audio path where you want to initiate the test sequence. Connect cables from the equipment to be tested to the Output ports observing the correct left/right channel placement.

When powered off, or off-line (the SIGNAL ON LED not lit), the ASG 140 outputs no signal.

When on-line, the ASG 140 inserts the test sequence you select into the downstream audio equipment.

## INSTALL REMOTE CONTROL CABLE

The remote connector is used when controlling the instrument remotely using the commands available via the RS-232C interface. See Appendix A, *Remote Control*, for using the remote commands. The connections and wiring for a remote control cable are also found in Appendix A.

There is also a simple contact-closure type of remote control available via the REMOTE connector. If you want to initiate AUTO test sequences from an operating position using a this type of remote control, connect pins 4 and 9 in the REMOTE port on the ASG 140 to some contact closure, such as a relay on a control panel. When the relay closes and connects pins 4 and 9 together, the ASG 140 goes ON LINE and sends the selected AUTO test sequence. A momentary contact causes the sequence to be sent once and then return to the previously selected operation. Continuous contact will cause the AUTO test sequence to be repeated until the contact is opened. The editing feature, if it is internally disabled, may also be enabled via the remote connector. This feature permits editing of the signal settings without the need to remove the side panel of installed equipment to reset the editing switches.



## POWER-UP STATE

At power up, the normal state of the ASG 140 is off line with the AUTO test sequence selected. There are two front-panel setup options: factory default and user selected default, default meaning the front panel state that is automatically present on power-on. Factory defaults for the selected tests, test levels, and frequencies are restored each time the ASG 140 is turned on if user selected defaults are not enabled. When user selected defaults are enabled, the "saved" setups for the selected auto and manual tests, and the selectable frequencies and test levels are restored. The front-panel defaults in effect at power on depend on the settings of an internal dip switch. One of the switch settings determines whether the factory default settings are recalled or the user programmed settings that have been saved are recalled. Editing and saving of the changes are discussed later in this section of the manual.

When power is lost (either through a power failure or a normal power), the ASG 140 reverts to the off line state. The ASG 140 remains off line and defaults to AUTO when power is restored. Any LINE UP or MANUAL test that was in progress at power off will have to be reselected and restarted.

## DIAGNOSTICS

The ASG 140 performs several self tests each time you power it up. If it fails one, the display indicates the failed self test and the other functions are disabled. Refer your instrument to a qualified service person or consult your local Tektronix representative for service information if a diagnostic failure occurs.

## INITIAL SETUP

All ASG 140s are shipped with factory settings as listed in Table 2-1.

Initial setup before operation in your system may include changing some or all of the factory settings to settings appropriate for your application. As shipped from the factory, full editing is enabled, and the following functions may be changed:

- Auto test sequence selection (CCITT O.33, TEK, or Sweep)
- Auto-test reference level (for CCITT O.33 and TEK sequences)
- Sweep-test reference level (for Sweep, Sweep Left, and Sweep Right)
- Auto-test four-character identifier (ID)
- Voice identifier (4-seconds of digitally recorded audio)
- Line up frequency and amplitude (local control only)
- Manual Test selection (Tone, Polarity, Multi-tone)
- Tone, Right Tone, or Left Tone
- Tone frequency and amplitude
- Polarity, Left Polarity, or Right Polarity
- Polarity amplitude
- Multi-tone (1, 2, 3, or 4), Left Multi-tone (1, 2, 3, or 4) or Right Multi-tone (1, 2, 3, or 4).
- Multi-tone amplitude
- Source impedance selection (10  $\Omega$  from the factory, requires component changes)
- Control enabling/disabling (local and remote disables with internal switch settings)
- Editing capability (internal switch settings)

**Table 2-1  
Factory Settings for the ASG 140**

Function	Factory Setting	Comments
AUTO	0.33:01	
TEST LEV CCITT 0.33 and TEK Sequences	0.0 dBu	
SweepLev Sweep, R Sweep, and L Sweep	0.0 dBu	
MANUAL	TONE	
Tone and Polarity Amplitude	0.0 dBu	
Frequency	440 Hz	
Multitone Amplitude	0.0 dBu	
LINE UP		Line Up signal parameters are not editable via remote control. This preserves the Line Up signal definition.
Amplitude	0.0 dBu	
Frequency	400 Hz	
IDENTIFICATION	TEK1	
VOICE IDENTIFIER	Blank	Restoring Factory Defaults does not erase a recorded identifier.
COMMUNICATIONS PARAMETERS		
Baud Rate	9600	Rate are 9600, 4800, 2400, and 1200 baud; selectable at power on.
Parity	None	Parity, Stop Bits, and Data Bits are fixed.
Stop Bits	1	
Data Bits	8	
CONTROL ENABLING		
Front Panel Controls	Enabled	These are switch settings that are not controlled by firmware at power on.
Remote Control	Enabled	
POWER UP DEFAULTS	User Defaults Enabled	These will be the factory defaults until they are edited.
EDITING	Enabled	There are 3 sections of editing enables to permit customization for different levels of operating features accessible to the user.

## RACK MOUNTING

The ASG 140 Audio Signal Generator is a half-rack wide instrument. For mounting a single ASG 140 signal generator in a standard 19-inch equipment rack, use the full-rack mounting adapter that is only one rack unit high. A dual half-rack mounting adapter permits stacking two ASG 140 generators in a three rack unit high space. There is also a full-width rack adapter for side-by-side installation of two ASG 140 generators in a two rack unit high space. For information on available rack adapters, refer to the Tektronix Television Products Catalog or contact your local Tektronix Field Office or representative.

## FREEDOM OF OPERATION

The user-definable states of the ASG 140 may be totally accessible or set to preselected setups that can not be accidentally altered in normal use. As shipped from the factory, the total range of user-definable features are available. Once the application needs are determined and programmed, the editing feature may be selectively disabled to prevent accidental changes to the frequency and output levels of the test signal. Refer to *Internal Settings and Setup Editing* for information on enabling and disabling the editing function.

## SETTING UP AND EDITING TEST SIGNALS

The user-definable variables vary for the different tests. When editing is enabled, all the definable choices may be accessed for customizing the frequencies and levels of the test signals for your applications. The default test sequence in the AUTO test, the default MANUAL test type, and the encoded IDENTIFICATION may also be defined and saved. The user-defined defaults are recalled at power on.

When editing is disabled, the various test are still selectable, but the frequency and level of the test signals are unalterable from the front panel.

Selective disabling of the editing function permits a fairly wide range of customization choices for front panel editing of and amplitude choices for the test signals. For instance, the Line Up signal frequency and level may be set to the house standard and fixed to prevent accidental editing from the front panel while leaving the user full access to the MANUAL test editing functions. A second option would be to define the level and frequency of the MANUAL TONE tests for specific applications and then disable the editing feature for those test as well. You would then have a dedicated test frequency and level defined for the MANUAL test choices as well as the LINE UP signal.

Editing enabling and disabling are controlled by setting internal switch positions. An access panel must be removed to make the appropriate switch settings. Refer all internal adjustments to a qualified service person. Information on controlling the editing feature is found later in this section of the manual.

When the contact-closure remote control cable is attached, the editing feature can be temporarily enabled by connecting pins 6 and 9 of the connector together. Make the changes needed, then disconnect the pins. Using RS-232C serial communications remote control, any the test signals and their variable settings may be edited (but not saved as the user defined defaults). See Appendix A, *Remote Operation*, for using the remote commands.

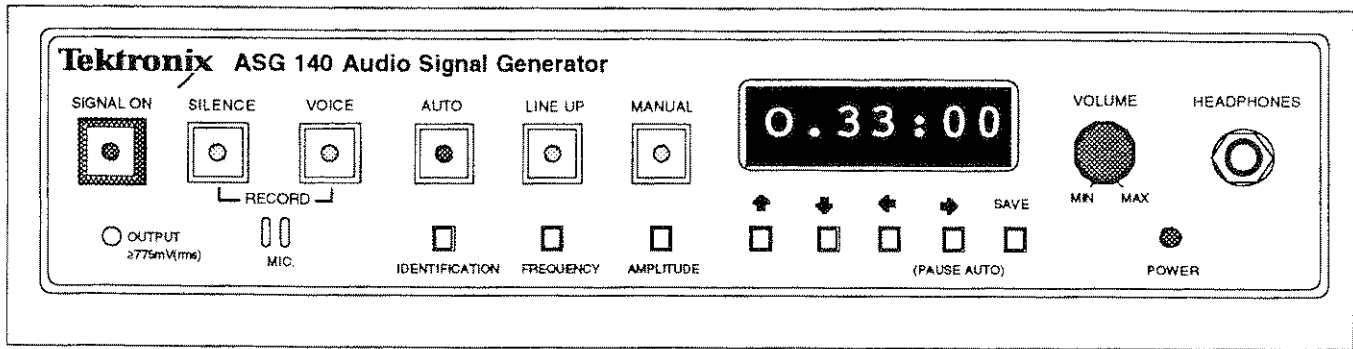

Figure 2-2. ASG 140 front panel controls.

## FRONT PANEL CONTROLS

The following text details the operation of the front panel controls and indicators. A front-panel illustration is shown in Figure 2-2 for reference.

## FUNCTIONS

The ASG 140 is powered on and off with the power switch to the right of the power receptacle on the back panel.

The ASG 140 functions are enabled from the front panel through the six larger buttons. These “main selection” buttons have a LED in the center that indicates the choice is selected. The SIGNAL ON LED is red; the remaining five are green. The smaller buttons are controls that let you display and adjust the values associated with the various test functions.

The test signal functions initiated by the five main selection buttons to the right of the SIGNAL ON button are mutually exclusive in most cases; enabling one of these five signal functions automatically disables the previously selected function. There are two exceptions to this:

- To initiate a continuously alternating voice ID and line-up tone, press the VOICE and LINE UP buttons simultaneously. (Both LEDs will be on and the display is **Voi + Lnup**.)
- To record four seconds of voice for identification purposes, press the VOICE and SILENCE buttons simultaneously. The recording process is cued with **Record;**, **Ready . . .**, and **Begin**; then a four-second countdown is displayed to time the recording. After that time, the selected function returns.

The ASG 140 outputs the selected signal only when the SIGNAL ON function is enabled. The lighted SIGNAL ON button indicates that the ASG 140 is sending a signal to the connected audio equipment. When the SIGNAL ON button LED is off, the SILENCE level is applied to the output connectors. The ASG 140 sends a sample of all the signals it generates to the headphones jack on the front panel.

## SIGNAL ON

When the SIGNAL ON function is enabled (indicated by the red LED in the center of the button), the ASG 140 sends the currently selected test tone or pattern to the connect audio equipment. Selecting any signal choice while the signal is on is permitted. However, when AUTO is selected, that test must be completed before any other choice except turning the signal off is permitted. Signal off is selected from the front panel by pressing the SIGNAL ON button a second time.

When one of the AUTO mode automatic test sequences is selected, the ASG 140 reverts to signal-off status (the red LED turns off) when the selected test sequence is finished. An AUTO test

completion message is sent out over the RS-232 serial port when the test sequence is finished. Signal off applies the SILENCE level to the audio output connectors.

## NOTE

*The ASG 140 will not turn on a signal when the front panel SIGNAL ON button is pressed when the AUTO ID, TESTLev, or SweepLev is being displayed. You must return to the AUTO Test Selection display or select another test signal.*

## SILENCE

The SILENCE function makes the ASG 140 generate *no* signal. The output attenuators are set to their maximum attenuation level and signal generation circuitry is turned off. With SILENCE enabled, any signal shown on the VM700A Option 40 and Option 41 or other monitoring equipment is the noise picked up along the audio path following the ASG 140. The ASG 140 sends silence while SIGNAL ON is enabled and SILENCE is selected and when the signal is off.

## VOICE

The VOICE function continuously replays the 4-second voice identifier the ASG 140 is currently programmed to send. The voice signal level follows the setting of the LINE UP signal amplitude setting.

## RECORD (PRESS SILENCE + VOICE)

The RECORD function records 4 seconds of voice input through the built-in microphone.

You enable this function by pressing the SILENCE and VOICE buttons simultaneously; there is no remote RECORD command. While the two buttons are held in, the display window shows the prompt **Record:**. When the buttons are released, the display changes to **Ready. . .**, then **Begin**, and a countdown from **4.0** to **0.0**. During the 4-second countdown, the ASG 140 records any sounds made within several feet of the microphone; but for the best results when recording a VOICE identification, speak directly into the microphone. When RECORD is started, the front panel controls are disabled until the recording has finished. Upon finishing, the front panel state returns to the state in effect when the recording session was started except SIGNAL ON.

## NOTE

*If the ASG 140 signal is on when a recording session is started, it is switched off; it remains off until SIGNAL ON is again selected, either locally or remotely.*

## AUTO

The AUTO function generates the currently selected automatic predefined test signal sequence, such as CCITT 0.33 and TEK or one of the sweep signals, when SIGNAL ON is enabled.

### AUTO Test Level

While the ASG 140 signal is off, you may display the test level to which the amplitudes of the tones of the CCITT 0.33 and Tek AUTO test sequences are referenced.

For the 0.33 and TEK test sequences, the actual output levels in dBm0 of the ASG 140 test signals (to a 600  $\Omega$  load) equals the sum of the test level and the step levels specified in Appendix B, *Test Sequences*. For example, the first step of the 0.33 test sequence is specified at -12 dBm0. However, if the test level is set to be +4.0 dBu, the actual output level of this signal will be  $(-12 + 4) = -8.0$  dBm0. The test level can be set from a minimum of -6 dBu to a maximum of +14 dBu. The factory default test level is 0 dBu. This level is one that is usually made uneditable from the front panel so that the known reference for the automatic testing sequences is not easily changed.

Typically, if a TESTLev change is needed, editing is enabled by a technician to allow an adjustment, then editing is disabled again to lock in the new values for use by operators in the field. For more information on enabling editing, refer to *Internal Settings and Setup Editing*.

## NOTE

*When monitoring the test signals with test equipment, such as a VM700A Option 40 or Option 41, to get correct readings of insertion gain, be sure the Test Level setting on the VM700A matches the Test Level setting on the ASG 140.*

To display the current TESTLev value, from AUTO with an 0.33 or TEK AUTO Test selected, press the AMPLITUDE button. The TESTLev label is displayed while the button is held in, and the test level setting is displayed when the AMPLITUDE button is released. When editing is enabled and you want to change the TESTLev setting, move the blinking cursor to the digit you want to change by pressing the  $\leftarrow$  or  $\rightarrow$  buttons. Then change the value of the digit by pressing the  $\downarrow$  button or  $\uparrow$  button. If you wish to make the new setting your default value, you must also press the SAVE button after making the edit. You can not select SIGNAL ON from the TESTLev display; you can either press the AMPLITUDE button again or make another selection to clear the TESTLev display.

### Sweep Test Level

The Sweep sequence test level determines the signal level of sweep signals. When setting the SweepLev value, one of the sweep signals (Sweep, R Sweep, or L Sweep) must be the selected AUTO test. Editing is done as above for TESTLev when editing is enabled. As with TESTLev, you cannot select SIGNAL ON with the SweepLev displayed.

## LINE UP

The LINE UP function generates a single tone at a standard frequency and amplitude. The factory default setting is 400 Hz at 0 dBu.

Once you have pressed the LINE UP button, you can display the frequency or amplitude of the tone by pressing the FREQUENCY or AMPLITUDE button. For information on adjusting their values (when editing is enabled to allow this), refer to the *FREQUENCY* and *AMPLITUDE* descriptions.

The frequency and amplitude of the LINE UP tone may be programmable from the front panel. If you change the line-up parameters and want to lock in the new values so they cannot subsequently be changed from the front panel, the editing function can be disabled. For more information, refer to *Internal Settings and Setup Editing*.

## ALTERNATING VOICE AND LINE UP

This feature is not indicated on the front panel of the ASG 140. Pressing the VOICE and LINE UP buttons together makes the ASG 140 continuously send the recorded voice pattern alternated with the specified Line Up tone when SIGNAL ON is active. The voice amplitude level follows the level setting of the Line Up signal.

## MANUAL

The MANUAL function offers Tone, Polarity, and Multitone signals. Each of these has right and left channel only choices. The factory default option is **Tone**. To choose one of the other options, press either the up arrow button or down arrow button until the desired test name appears in the display window. Left and right channel signals are selected using the left-right arrow buttons. The first press of a left or right arrow button selects the left or right channel test signal. If a left or right channel test signal is selected, pressing the opposite arrow returns to the stereo test signal. A second press then selects the opposite channel test signal (see Figure 2-3).

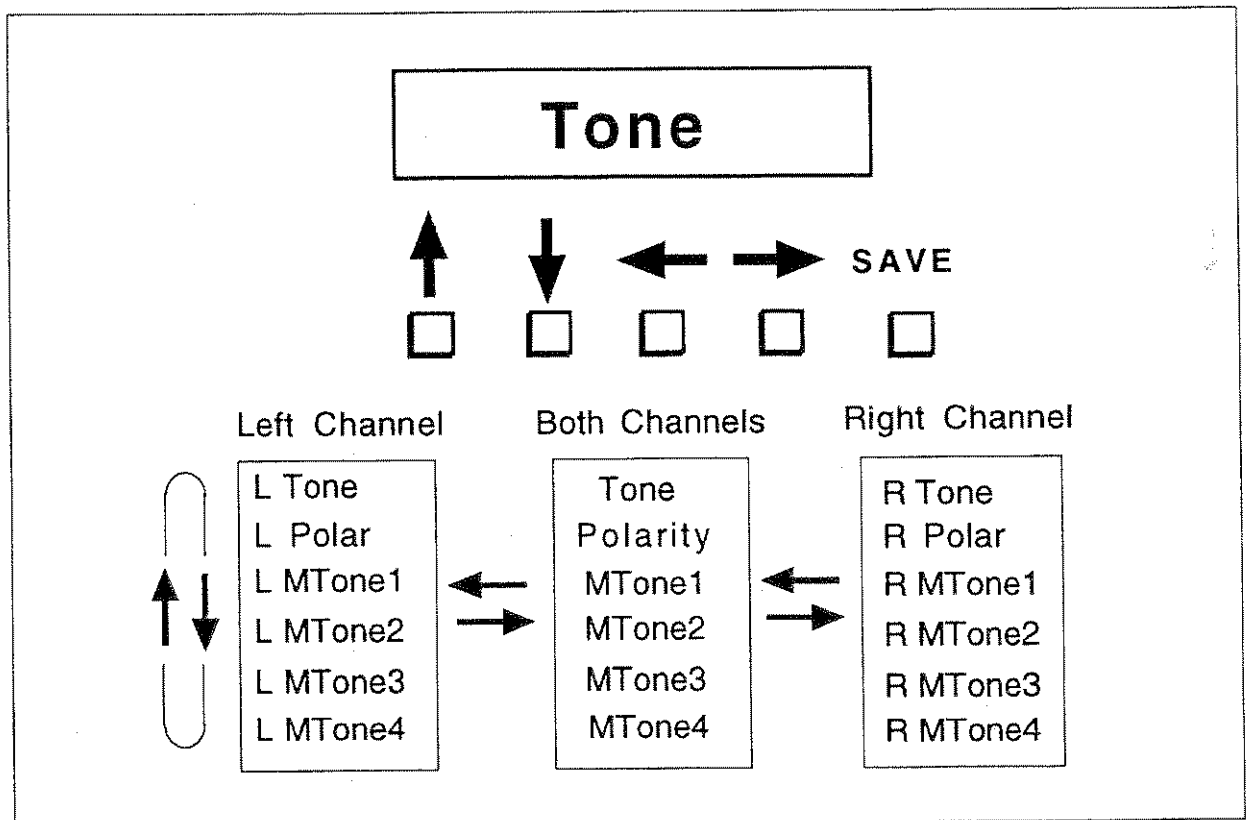

Figure 2-3. Manual test signal selection using arrow keys.

### Tone

The Tone selections (**Tone**, **L Tone**, and **R Tone**) generate a single, continuous sine-wave tone at a specified frequency and level. With a tone choice displayed, you can display the frequency or amplitude of the tone by pressing the FREQUENCY or AMPLITUDE button. When editing is enabled you can edit the frequency or amplitude values for the tone signal using the arrow buttons. For information on enabling editing, refer to *Internal Settings and Setup Editing*. For

more information on adjusting frequency and amplitude values, refer to the *FREQUENCY* and *AMPLITUDE* descriptions.

### **Polarity Tests**

Most audio systems require signal polarity to be preserved through the distribution system. In stereo systems, polarity is especially important for stereo imaging and for monaural compatibility. If polarity is reversed in one channel of the stereo pair, monaural signals cancel.

The Polarity selections (**Polarity**, **L Polar**, and **R Polar**) generate special polarity signals that make it easy to test polarity in the audio path and assure correct wire connections for balanced audio output. This polarity signal is included in the TEK automatic test sequence.

### **Multitone Tests**

The Multitone selections (**MTone1**, **MTone2**, **MTone3**, and **MTone4**) and their right and left channel choices, **R MTonen** and **L MTonen**) provide signals that are composed of selected sets of sine-wave frequencies. These signals are used to check frequency and phase response, total harmonic distortion, and noise levels in audio circuits.

### **Manual Test Level**

You can display the amplitude of the manual signals by pressing the **AMPLITUDE** button when a manual test name is displayed. You can edit the amplitude of any of the manual tests using the arrow buttons when manual test editing is enabled. In normal use, editing of the Manual Test may most often be enabled simply because of the nature of the testing being done when using one of the Manual Test signals. For information on enabling or disabling editing, refer to *Internal Settings and Setup Editing*. For more information on adjusting amplitude values, refer to the *AMPLITUDE* control description.

### **Manual Test Frequency**

You can display the frequency of the manual signals by pressing the **FREQUENCY** button when a manual test name is displayed. The frequency of the polarity signal is 440 Hz and can not be changed. There is no frequency indication for Multitone signals. You can edit the frequency of the Tone tests (**Tone**, **R Tone** and **L Tone**) using the arrow buttons when editing is enabled. For information on enabling editing, refer to *Internal Settings and Setup Editing*. For more information on adjusting the signal frequency, refer to the *FREQUENCY* control description.

## **VOLUME**

The **VOLUME** knob controls the level of the audio output through the headphones. It does *not* affect the level of the signal output through the other signal ports. To increase the volume, turn the knob clockwise.

## **MIC. (MICROPHONE)**

When you enable the **RECORD** function, the microphone picks up sound made in the vicinity of the ASG 140 during the 4-second recording period. Automatic gain control is built into the microphone circuit.

You can then make the ASG 140 replay the recorded sound pattern, either repeatedly with the **VOICE** function, or at the beginning of one of the standard test signal sequences with the **AUTO** function.



The AUTO test sequences that include a voice segment before the test sequence preamble are identified by a "V" suffix on the sequence name. For example the TEK mono test sequence that includes a voice segment is displayed as **TEK:90V**.

## IDENTIFICATION

The identification code, consisting of four alphanumeric characters and various punctuation characters, provides a way to identify the source of the test signals generated. This feature is very useful when there may be multiple signal sources arriving at a central control point for testing audio signal paths.

The IDENTIFICATION control is active only when the signal is off with an AUTO test sequence selected. It displays the current four-character code that is transmitted as part of the *preamble*. The preamble is a set of initializing data the ASG 140 prefixes to some of its standard test signal sequences.

To view the current identification code, press the AUTO button, then the IDENTIFICATION button.

When editing is enabled, you can change the identification code using the arrow buttons. For information on enabling editing, refer to *Internal Settings and Setup Editing*. For more information on adjusting values using the arrow buttons, refer to *Arrow Buttons*.

## FREQUENCY

The FREQUENCY control displays either the frequency of the LINE UP signal or the frequency of the MANUAL function signals of Tone and Polarity (there is no single frequency associated with Multitones). To display the signal frequency, press either the LINE UP button to view the line up signal frequency, or the MANUAL button to view the Tone or Polarity signal frequency. When viewing a manual test signal, use the  $\uparrow$  or  $\downarrow$  buttons to display the Tone or Polarity selection, then press the FREQUENCY button. All the Tone signals (Tone, R Tone, and L Tone) are set to the same frequency, but the LINE UP signal and the Tone signals are separately settable.

### NOTE

*The Polarity signal is the sum of two equal-amplitude sine waves. One has a fundamental frequency of 440 Hz (the displayed frequency for Polarity) and the other is the second harmonic of that frequency, 880 Hz. The frequency of the Polarity signal may not be edited.*

When the DIP switches are set to allow editing, you can change the signal frequency of the line up or manual Tone signals using the arrow buttons. The frequency of the tone signal may also be changed remotely as an argument to asking for the Tone signal via the serial interface. For information on enabling editing, refer to *Internal Settings and Setup Editing*. For more information on adjusting values using the arrow buttons, refer to *Arrow Buttons*.

## AMPLITUDE

The AMPLITUDE control displays the amplitude of the tone generated by the LINE UP function, the MANUAL Tone function, and the MANUAL Polarity function. To display these amplitudes, press the LINE UP button, or the MANUAL button and the  $\uparrow$  or  $\downarrow$  buttons to display the Tone or Polarity function, then press the AMPLITUDE button.

As with FREQUENCY (discussed in the preceding subsection), once you display the LINE UP, MANUAL Tone or Polarity amplitude, if editing is enabled, you can change the amplitude using

the arrow buttons. For information on enabling editing, refer to *Internal Settings and Setup Editing*. For more information on adjusting values using the arrow buttons, refer to *Arrow Buttons*.

When the ASG 140 signal is enabled (SIGNAL ON), and you press the  $\uparrow$  button to increase the amplitude, if the displayed value is greater than or equal to 0 dBu, the cursor automatically locks onto the least significant digit and increases the level by that increment only. This protects against sudden, unintended jumps in volume.

## ARROW BUTTONS

The arrow buttons let you select options and specify values for the AUTO, LINE UP, and MANUAL functions.

For example, the AUTO function offers many standard test signal sequences you can choose. Similarly, the MANUAL function lets you choose a test signal or specify a number of parameters to make the ASG 140 generate a desired test signal. The arrow buttons let you cycle through the available choices and specify characters or numbers.

### $\uparrow$ (Up Arrow), $\downarrow$ (Down Arrow)

When the currently selected function offers a set of choices, pressing the  $\uparrow$  or  $\downarrow$  button cycles up or down through those choices, displaying them in the display window.

If the currently selected function displays a value that may be edited, such as frequency, test level, or the identification code, a blinking cursor indicates the currently editable character. Pressing the  $\uparrow$  or  $\downarrow$  button cycles up or down through the available characters or numerals.

When editing numbers or alpha characters, pressing and immediately releasing the button increments or decrements the value by one number or alpha character. Pressing and holding the button for 1 second initiates automatic incrementing or decrementing, which continues until you release the button. The frequency and level settings have upper and lower limits and cease changing when those limits are reached. The list of character selections for ID is circular and returns to the starting point when continuing a change in the same direction.

When making test name selections, the buttons must be pressed and released for each new choice. The list of test names is also circular and returns to the starting point when continuing a change in the same direction.

### $\leftarrow$ (Left Arrow), $\rightarrow$ (Right Arrow)

The  $\leftarrow$  and  $\rightarrow$  buttons are used to select the left or right manual test signal and allow you to select a digit for editing when editing is enabled.

If a value you can edit is displayed, pressing the  $\leftarrow$  or  $\rightarrow$  buttons moves a blinking cursor one character to the left or the right. When the cursor is on a character, the character blinks off and on, indicating you can edit it. When editing the alphanumeric encoded IDENTIFICATION, the character to edit must be explicitly selected to be controlled by the  $\uparrow$  and  $\downarrow$  buttons. When editing a number value, the selected digit to edit will increment and decrement the total value of the displayed value, not just the digit column selected. If editing is not enabled, there will be no flashing digit or space in the display.

## PAUSE AUTO

During an AUTO test signal sequence, pressing the PAUSE AUTO ( $\Rightarrow$ ) button pauses the sequence at the current signal step.

For example, suppose you press the ⇒ (PAUSE AUTO) button during the step of the O.33 sequence when the ASG 140 is generating a tone of 80 Hz at -12 dB. The ASG 140 will continue generating that tone, rather than progressing to the next step in the sequence.

Once you have paused the test sequence, you can advance it one step at a time by pressing the ↑ button. You can reverse the sequence steps by pressing the ↓ button. You can advance to the last test in the sequence or reverse to the first test in a sequence, but you cannot step the test sequence off line. To resume automatic generation of the rest of the test sequence, press the (PAUSE AUTO) button a second time.

## SAVE

If SAVE is pressed when saving is not enabled, the word **Disabled** will be displayed.

If the SAVE function is enabled, pressing the SAVE button stores the function value currently displayed as the default and **Saved** will appear in the display. Once you save a function value, powering on the unit restores that value if user-defined settings are enabled. If user-defined settings are not enabled, the new value saved will be in effect for the time the power is on only. When the power is turned off and back on, the factory defaults will be returned. The normal setting is for user-defined settings to be enabled and recalled on power on.

## NOTE

*When the factory defaults are restored, all user-selected values are written over in the NVRAM, and the user defaults become the same as the factory defaults.*

Saving can be done either from the main selection level or at the level of the individual parameter. For example, if the LINE UP function is currently displayed and you press the SAVE button, the frequency and the amplitude parameters currently specified for the line up tone are stored. If the frequency value itself is displayed and you press the SAVE button, only the frequency value is stored.

A selected auto test sequence may be saved as the power-on choice as well as a selected manual test signal. Just select the one you want the start-up setting to be and press SAVE. The ASG 140 powers up each time with the AUTO choice selected, and the selected test will be the one that you saved. When MANUAL is selected, the test name you selected and saved will be the one that appears.

For more information on the enabling edits and saves refer to *Internal Settings and Setup Editing*.

## STATUS FEEDBACK

### POWER

When the ASG 140 is powered on, the POWER LED lights up.

### POWER-ON DIAGNOSTICS

When you power on the ASG 140, it performs a numbered series of tests of its memories and their interconnections, and then tests the backup battery.

The display window shows the number of each test as the ASG 140 performs it, in the format shown below:

DSP 1/4 . . . 2/4 . . . 3/4 . . . 4/4

The sequence of messages above indicates the ASG 140 is performing the self tests, but only the first and last will be evident in the display for a normal power-on. When it completes the numbered tests, the ASG 140 tests its backup battery. A status message is displayed if the battery is not good.

If the ASG 140 fails one of the numbered self tests, it keeps trying to perform that test and displaying its number. When the ASG 140 indicates a failed self test, you cannot make it perform its other functions. Contact your Tektronix representative for service information.

After repeated iterations, the unit may pass a test it failed initially, and proceed to the next test in the sequence. However, you should still stop using the unit and have it serviced.

## OUTPUT $\geq 775\text{MV(RMS)}$

The LED above this label blinks when the amplitude of the selected signal is greater than or equal to 0 dBu, as required by the CCITT 0.33 Standard. This is to alert you to the possibility of levels that could overload or damage equipment. Whenever this LED is blinking, the signal level is increased in tenth dBu steps only when you raise the level using the front panel controls. It may be decreased normally.

## DISPLAY WINDOW

The ASG 140 lets you set a number of parameters affecting the signal it generates. Using the panel controls you can specify the parameter you want to check or modify. The display window shows the current signal pattern for whatever signal parameter you last chose. When you select the RECORD function, the window also displays cues for recording a four-second voice identification.

When you power up the ASG 140, the display window shows the name of the default automatic test sequence (either the factory default of 0.33:01 or a user-selected automatic test sequence).

## HEADPHONES

The stereo HEADPHONES port may be used to monitor the output signal. If the ASG 140 signal is on, this is the signal pattern currently selected on the ASG 140. If it is turned off, the SILENCE level (no output) is present. The VOLUME knob controls the level of the signal through this port.



*It is possible to set levels and adjust the volume so the output through the headphones is excessively loud. For safety, set the volume level control to minimum when making level adjustments.*

## REAR PANEL, POWER SWITCH, AND SIGNAL CONNECTORS

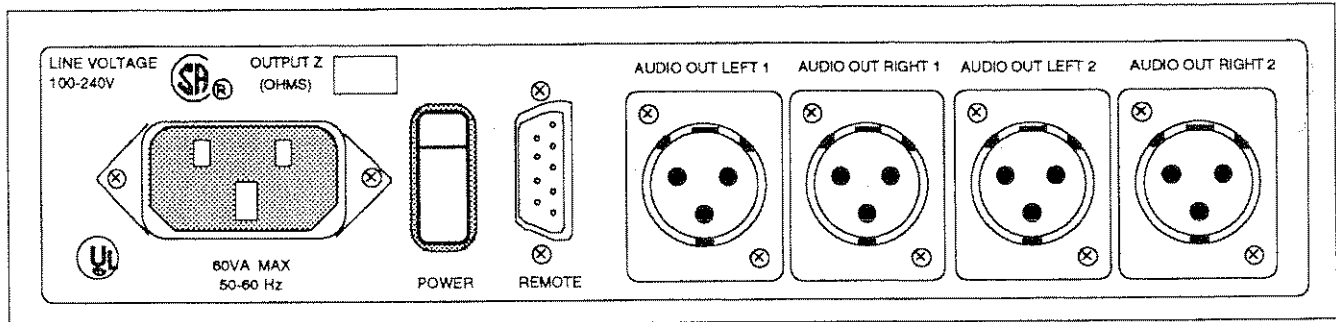

Figure 2-4. ASG 140 rear panel connectors.

### POWER SWITCH

The ASG 140 power switch is immediately to the right of the power plug receptacle on the back panel (see Figure 2-4). In the off position, the top of the switch, which has a red “O” engraved in it, is out. When the ASG 140 is connected to a power source, power it up by pressing the top of the switch. Power it off by pressing the bottom of the switch.

### NOTE

*When power is turned on, the selections for the settings will be determined by the stored defaults that are recalled.*

### AUDIO SIGNAL CONNECTORS

The AUDIO OUT LEFT (1 and 2) and AUDIO OUT RIGHT (1 and 2) for the left and right channels are female XLR connectors. When the ASG 140 signal is on, the selected test signal is available at the connectors. The output test signal may be monitored at the front panel stereo headphone jack. When the signal is off, the SILENCE level is applied to the output connectors.

### REMOTE CONNECTOR

This DB-9 connector is used to access two types of remote control. It may be used to connect switching contacts that are used to start the AUTO Test or to override the editing locked feature so new setups may be saved without removing the ASG 140 from a rack installation to reset the internal DIP switches. Its second purpose is to provide an RS-232C interface for remote control of all the instruments functions. See Appendix A, *Remote Control*, for using the RS-232C interface to control the operation of the ASG 140 remotely. An additional feature controlled via the remote connector is the Audio/Video Timing measurement signal synchronization. See Appendix C, *Audio/Video Timing*, for information on how this feature is used.

## INTERNAL SETTINGS AND SETUP EDITING

The ASG 140 allows you to enable and disable editing of various signal features, such as amplitude, frequency, and signal identification. Front panel control or remote control or both may also be either enabled or disabled. This section describes how to make these changes.

You control signal editing through the 10-pole DIP switch labeled "S1" on the circuit board. The settings of the first four switches control editability of the user-definable test variables and the default values used when the ASG 140 is powered on.

### ENABLING AND DISABLING SIGNAL EDITING

On the ASG 140 circuit board is a DIP switch you can set to enable or disable editing of ASG 140 functions, and to select the type of values used as the defaults for user-definable functions.

As you face the ASG 140, on the left side, near the front is a small screw-on access panel. Removing the side panel reveals the DIP switch, as shown in Figure 2-5. The individual switches that affect editing and what each does are shown in Figure 2-6.

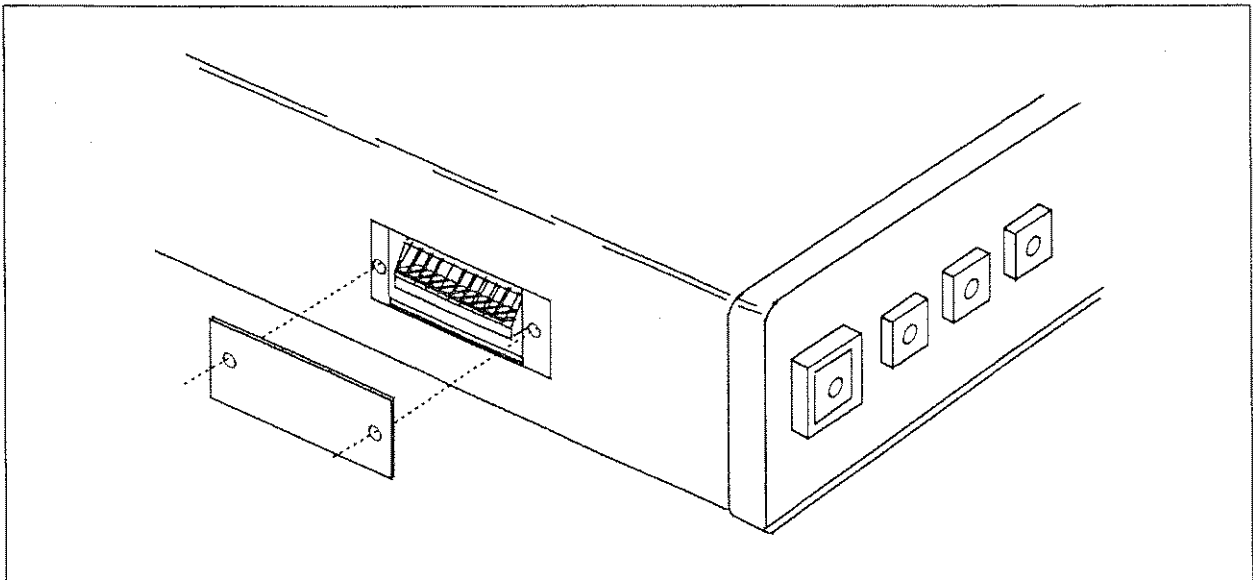

Figure 2-5. Remove the side panel access cover to set the DIP switch.

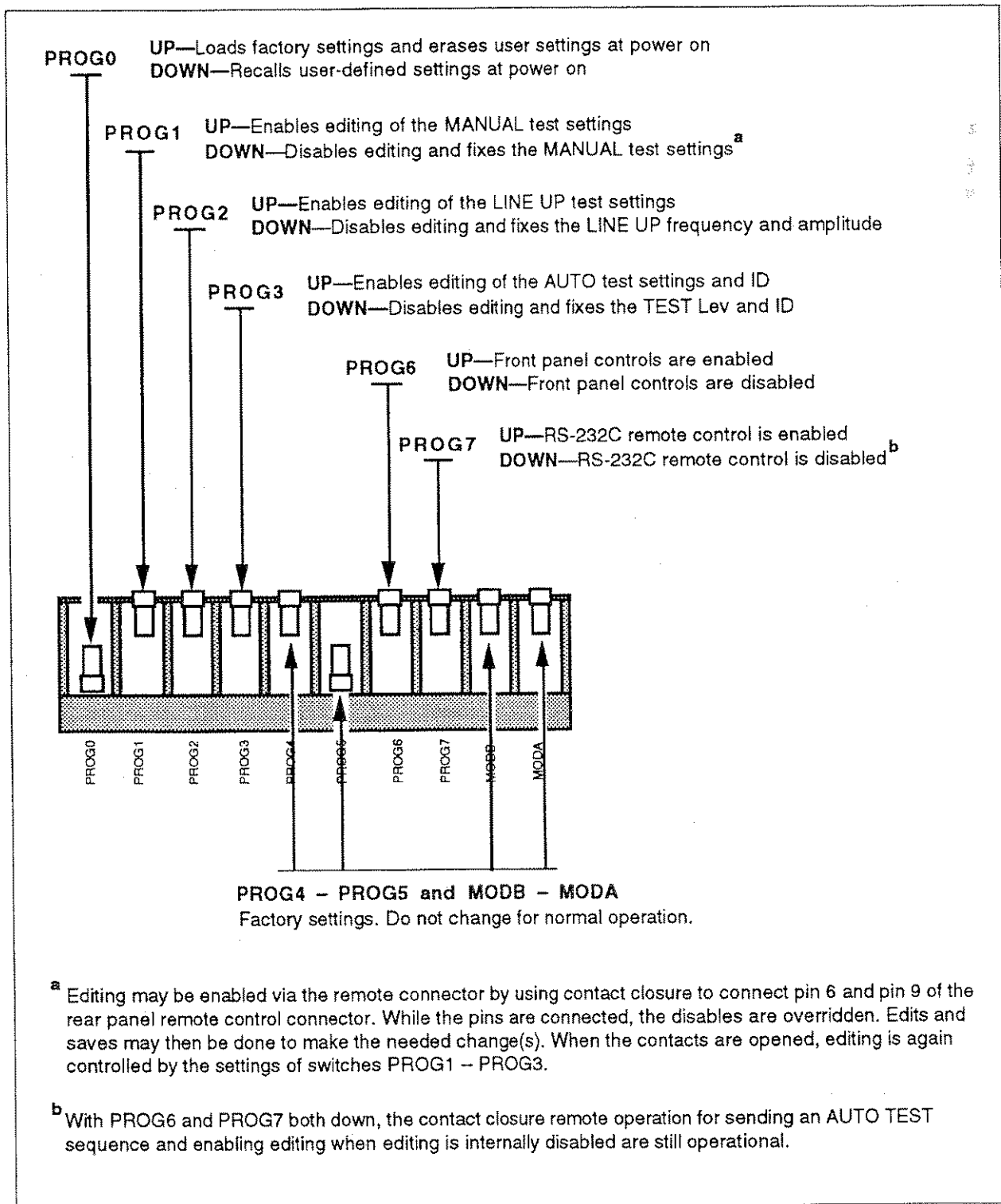

Figure 2-6. DIP switch settings for editing.

## EDITING SIGNAL PARAMETERS

After you enable editing of a signal parameter, you can adjust that parameter value from the front panel. To edit a signal parameter, press the front panel buttons required to display the current value. For example, to edit the frequency of the line up tone press the **LINE UP** button, then press the **FREQUENCY** button.

The digit currently active for editing is indicated by a blinking character, numeral or underscore. To change the active digit, use the  $\Leftarrow$  and  $\Rightarrow$  buttons. To change the value of the active digit, press either the  $\Uparrow$  or  $\Downarrow$  button to increment or decrement the value until you get the desired character or number.

## SAVING SIGNAL PARAMETERS

When you have changed the parameter to the value you want, save it as the default by pressing the **SAVE** button.

If a top-level function (**Line Up** or one of the **Manual** test signals) is displayed, pressing the button saves as defaults the values of all parameter settings beneath that function (both frequency and amplitude in the case of **Line Up**).

If it is a test signal parameter, such as the frequency, that is displayed, pressing the **SAVE** button saves only that parameter value as a default; the default values of any other parameters under the function (such as the amplitude) are not updated.

To leave a signal parameter you have been editing, press any of the main-level function buttons: **SILENCE**, **VOICE**, **AUTO**, **LINE UP**, or **MANUAL**.

When you finish editing signal parameters and saving the desired default values, ensure the DIP switches are set as follows:

**PROG0**        **Down.** This preserves the saved values as defaults that will be restored whenever the operator powers up the instrument. (Placing DIP switch S-1 in the up position erases all user-defined settings and returns factory settings when the operator powers up the instrument.)

**PROG1**

**PROG3**        **Down.** This prevents further editing of signal parameters.

## NOTE

*You may choose to leave all, any, or none of the user-definable frequency and level choices of a testing option editable from the front panel by the technician or engineer using the ASG 140. A normal choice may be to fix the **AUTO** and **LINE UP** test to known settings and leave the **MANUAL** test editable for setting levels and frequencies that may be needed for manual testing. Your application will determine how you decide to customize the test signals and the freedom of operation for the user.*

Table 2-2 shows the present assignment of all the switches of the DIP switch package, and the factory setting of each switch.



**Table 2-2  
DIP Switch Functions**

Switch Name	Switch Action		Factory Setting
	Up	Down	
Prog 0	At power up, ASG 140 recalls factory settings for all functions.	At power up, ASG 140 recalls values last saved (with the SAVE button) for user-definable functions. <sup>a</sup>	Down
Prog 1	MANUAL functions can be edited.	MANUAL functions can NOT be edited.	Up
Prog 2	LINE UP function can be edited.	LINE UP function can NOT be edited.	Up
Prog 3	AUTO TEST Level and SOURCE ID can be edited.	AUTO TEST Level and SOURCE ID can NOT be edited.	Up
Prog 4	Normal operating state.	Reserved.	Up
Prog 5	Reserved.	Normal operating state.	Down
Prog 6	Front Panel Controls Enabled.	Front Panel Controls Disabled.	Up
Prog 7	Remote Control Enabled.	Remote Control Disabled.	Up
MOD B	Factory setting required for correct performance. DO NOT CHANGE.		Up
MOD A	Factory setting required for correct performance. DO NOT CHANGE.		Up

<sup>a</sup> As shipped from the factory, the factory default settings are stored in the memory reserved for custom settings. This means that when you use the ASG 140 for the first time, the factory defaults will be used, even if DIP switch 1 is in the DOWN (user-defined settings enabled) position.

### EXTERNAL EDIT ENABLE

When the editing features are disabled internally, they may be enabled via the rear-panel REMOTE connector. This method of operation permits editing from the front panel when needed without having to remove the installed equipment to access the side panel and internal switches. Editing is enabled by connecting pins 4 and 6 of the Remote connector together. This connection may be made via a jumper, switch, or remote-controlled relay contact.

If activation of the AUTO test sequence using external contact closures is a part of your normal operation, you may also want to add the Remote Edit enable capability. If the need to change a programmed frequency, amplitude, or ID, etc., arises, the feature can be enabled, the edit made by the on-site operator, and then disabled again. When the connection between pin 4 and pin 6 is removed, the settings of internal DIP switches again control the state of the editing and saving function for the AUTO, LINE UP, and MANUAL test settings. Note however, that the settings that were edited will now be in effect for the remainder of the test session. If those edits were also SAVED, they will be in effect when the ASG 140 is again turned on.

Front-panel editing may not be enabled via the RS-232C serial commands. However, even with front-panel editing disabled, the remote command arguments for editing still function.

**NOTE**

*There is no remote command for saving an edit to make it a new default, so at the next power on of the ASG 140, the previously "saved" defaults are restored.*

**FRONT PANEL AND REMOTE CONTROL ENABLING**

Depending on the mode of operation needed, you may choose to disable the control capabilities of the ASG 140. If remote control alone is needed, and you want no local front panel access, you may disable the front panel controls by setting PROG6 (switch section 7) of S1 to the down position. This effectively prevents any changes from the front panel of the instrument; the front panel is locked out.

The remote control capability of the ASG 140 may be locked out by setting PROG7 (switch section 8) of S1 to the down position. If access is attempted when the RS-232C serial port is shut off, a message is sent to that effect. The ASG 140 still responds to the control signals it recognizes (control C, control Q, and control S) and sends out the sign on messages, but it will not respond to any commands.

Even if both the front panel and the remote access are disabled, the contact closure operation via the remote connector for sending an AUTO test sequence and enabling the editing features still works. This state of the controls provides minimal access to making any signal level or auto test type changes, and may be used when those sort of changes to operation are to be restricted.

**OUTPUT IMPEDANCE**

The output impedance is 12 Ω and is not switchable.

The output level indicated by the ASG 140 display is in dBu (a voltage reference), not dBm (a power reference), and is not compensated for load impedance changes. The voltage output of the ASG 140 is shown for a range of dBu indications in Table 2-3. The dBu output level displayed by the ASG 140 is calibrated for open circuit voltage. The voltage decreases below the dBu readout indicated as the output is loaded. A 600 Ω load reduces the output voltage of the ASG 140 by approximately 0.17 dBu.

**Table 2-3  
dBu Voltage**

dBu	Voltage (unterminated)	dBu	Voltage (unterminated)
12	3.084 V	-3	0.5484 V
9	2.183 V	-6	0.3882 V
6	1.5455 V	-9	0.2748 V
3	1.094 V	-12	0.1946 V
0	0.7746 V	-15	0.1377 V

If you use a lower impedance load, the actual voltage to the load will decrease slightly as the load impedance decreases due to the voltage drop across the internal resistance. Use the curve of Figure 2-8 to compensate the dBu readout for a lower load impedance. From Figure 2-8, you can see that a 150 Ω load will cause about a -0.67 dBu difference between the readout and the actual voltage from the ASG 140.

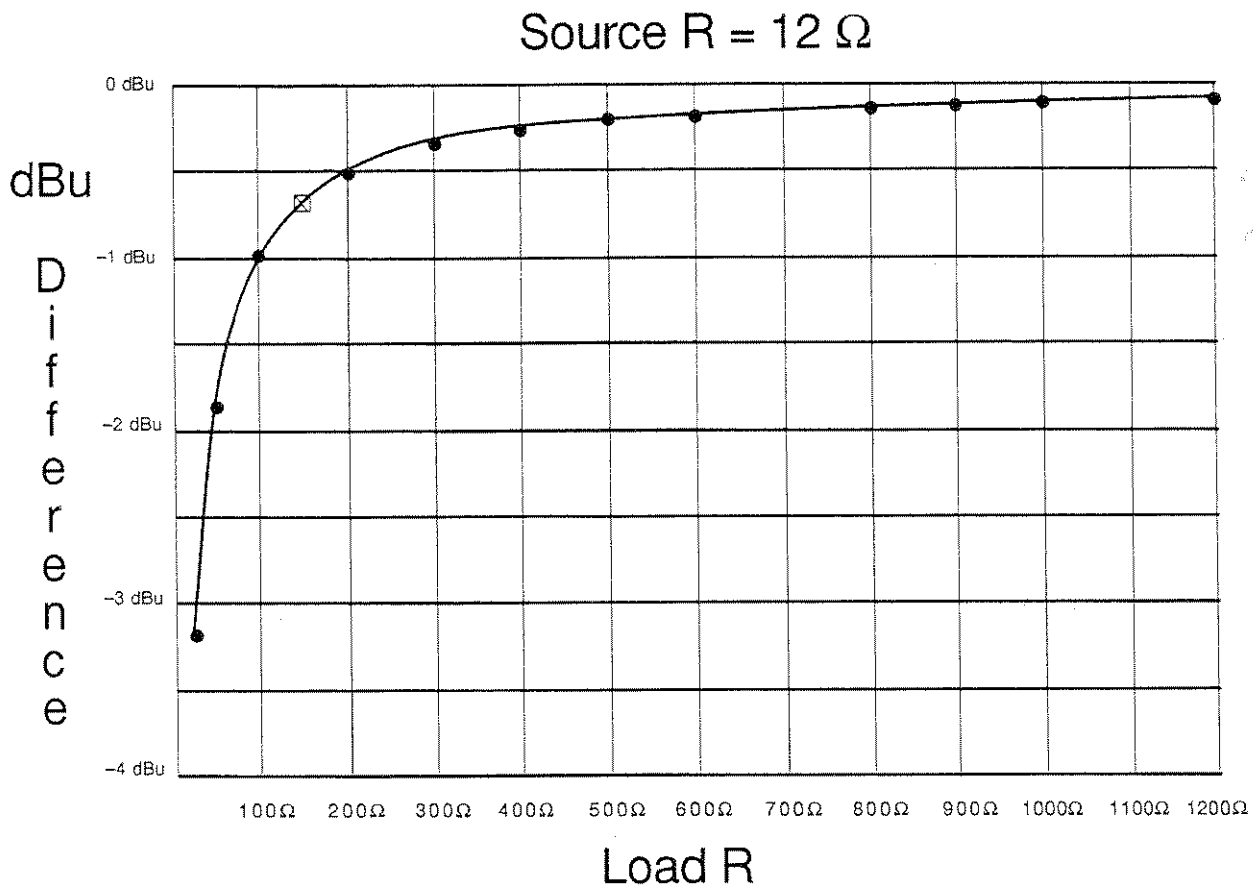

The general formula for calculating the dBu difference when the source resistance is held at 12 Ω and the load resistance varies is:

$$dBu_{diff} = 20 \log \left( 1 - \frac{12 \Omega}{R_{Load} + 12 \Omega} \right)$$

Using the above formula it can be seen that the front panel ASG 140 dBu reading approximately corresponds to dBm when driving a 600 Ω load. The difference between actual dBm and the ASG 140 readout is -0.17 dB with a 600 Ω load.

The output amplifiers of the ASG 140 are current limited. The load resistance should not be less than 150 Ω.

Figure 2-8. Effects of a changing load resistance on the dBu output indication of the ASG 140.

A dBu is referenced to the voltage developed across a 600 Ω load that is dissipating 1 mW (0 dBm). That calculates out to 0.7746 volt. It is also 0.7746 volt to a 1200 Ω load at 0 dBu. While dBu and dBm are the same when a 600 Ω load is used, changing the load impedance changes the power in the load when the voltage is held constant. Hence, a 1200 Ω load at 0 dBu is 0.5 mW. If a 300 Ω load is used, the voltage is still 0.7746 volt, but the actual power in the load is now 2 mW. This effect is illustrated in Figure 2-9.

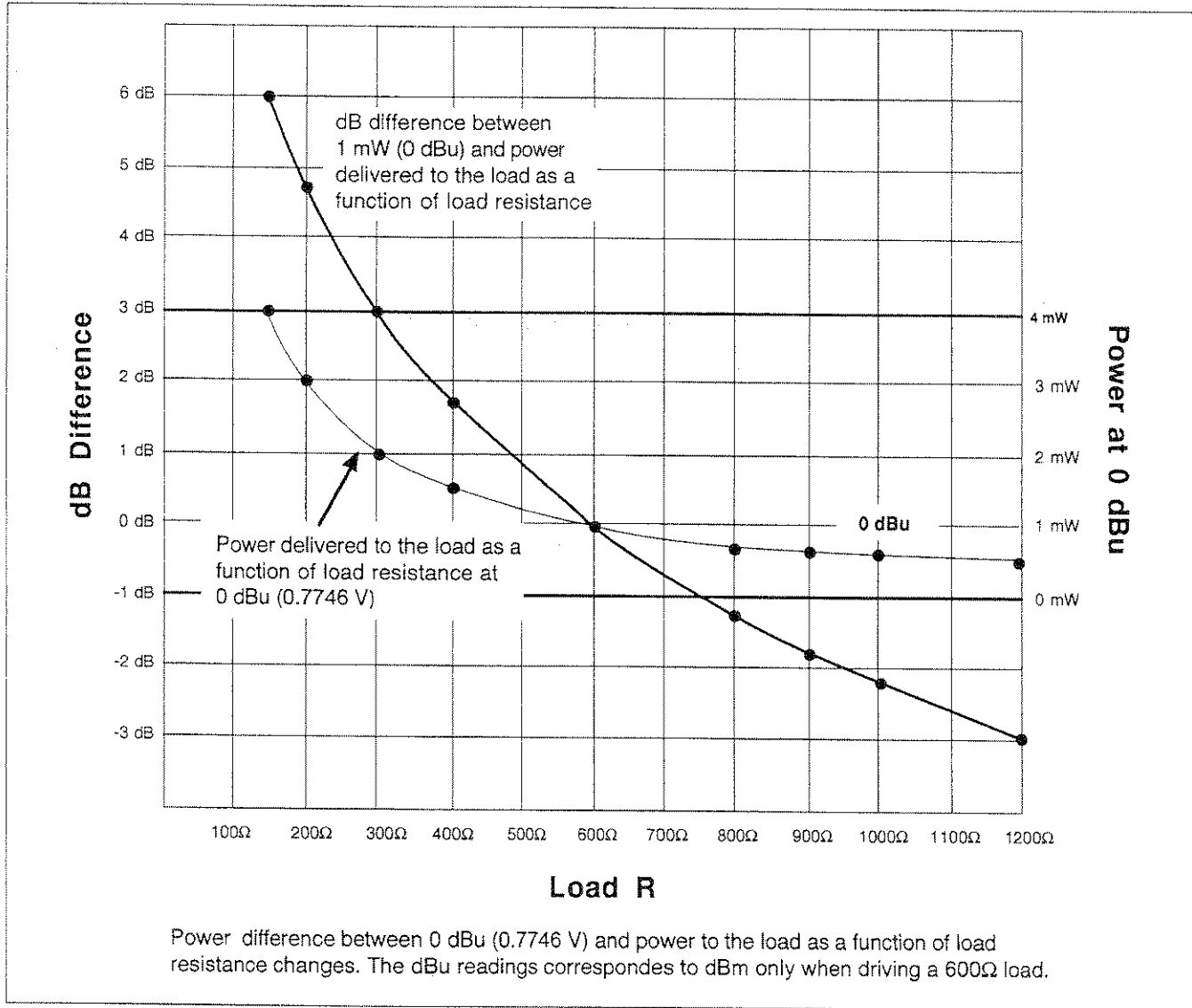

Figure 2-9. Effects of varying the load resistance on the actual power to the load with the ASG 140 output set at 0 dBu (0.7746 V). The effect of the internal drop is neglected for the graph.

# Section 3

## APPLICATIONS

### AT REMOTE LOCATIONS

Place an ASG 140 at each remote location, and use remote control via a modem to send the repeating voice ID to identify each line to the control operator. Initiate any of the ASG 140 test signals to test for path signal loss or frequency response.

#### NOTE

*The voice identifier has to be recorded from the front panel of the ASG 140.*

To document correct audio transmission, transmit an AUTO test sequence to a VM700A Option 40 or Option 41 at the control site. To further verify the identity of the source, program the four-character test sequence ID to include a site number or other unique designator. Full remote control of the ASG 140 via an RS-232C interface permits a control operator to ask for the full range of test signals available from the ASG 140.

### IN THE SHOP

To test the performance of recording equipment, record the output of the ASG 140 onto audio or video tape, then measure the output of the tape machines with a VM700A Option 40.

Monitoring the polarity signal makes it easy to check audio wiring polarity.

When troubleshooting equipment, you can step through the AUTO sequences using the PAUSE function, or you can send tones at levels and frequencies you specify using the MANUAL tone function.

The AUTO test sequences and the measurement report the VM700A Option 40 and Option 41 provides make it easy to keep a log of equipment performance and to verify repairs have been made.

### MULTITONE TEST SIGNAL

Most audio tests consist of measuring a sine-wave audio tone, then stepping the frequency and repeating the test. These type of checks for frequency response flatness take some time to complete even when done automatically using one of the ASG 140 AUTO test signals. When the time required to make these tests is a factor, a faster method for obtaining the needed measurements is needed. The time factor comes into play when the available time to perform the measurement is only a few seconds or when you are making circuit adjustments and need immediate feedback to determine the correct settings.

The multitone test signal is composed of a set of sine-wave signals across the audio spectrum. The frequencies are selected to provide predictable circuit responses. Four different multitone signals are available from the ASG 140. See Table 1-2 in Section 1 for a list of the frequencies contained in each set. When coupled with the VM700A Option 40 or Option 41 View Level measurement, the multitone signals provide rapid response curve measurements and continuous, near real-time updates for making circuit adjustments.

When processed by the measurement device, digital filtering can remove the known multitone test sequence frequency components. The remaining frequency components are then analyzed to determine the noise and distortion products produced by stimulating the circuit with the multitone test signal.

## POLARITY TEST SIGNAL

### Distortion Analyzer Check Signal

The ASG 140 polarity signal consists of the sum of a fundamental frequency (440 Hz) with equal amplitude and its second harmonic (880 Hz), with the relative phases chosen to produce the waveform shown in Figure 3-1. Inversion of this signal is easy to recognize with an oscilloscope.

The polarity signal is a source of a known amount of total harmonic distortion, so you can use it for a quick check of a distortion analyzer. Because the signal is composed of two frequencies, one twice the magnitude of the other, a distortion analyzer will interpret the higher frequency wave as a harmonic of the lower frequency wave. This correspond to a total harmonic distortion of 70.7%. Thus, if the distortion analyzer is calibrated correctly, it should indicate 70.7% when the TEK polarity signal is applied.

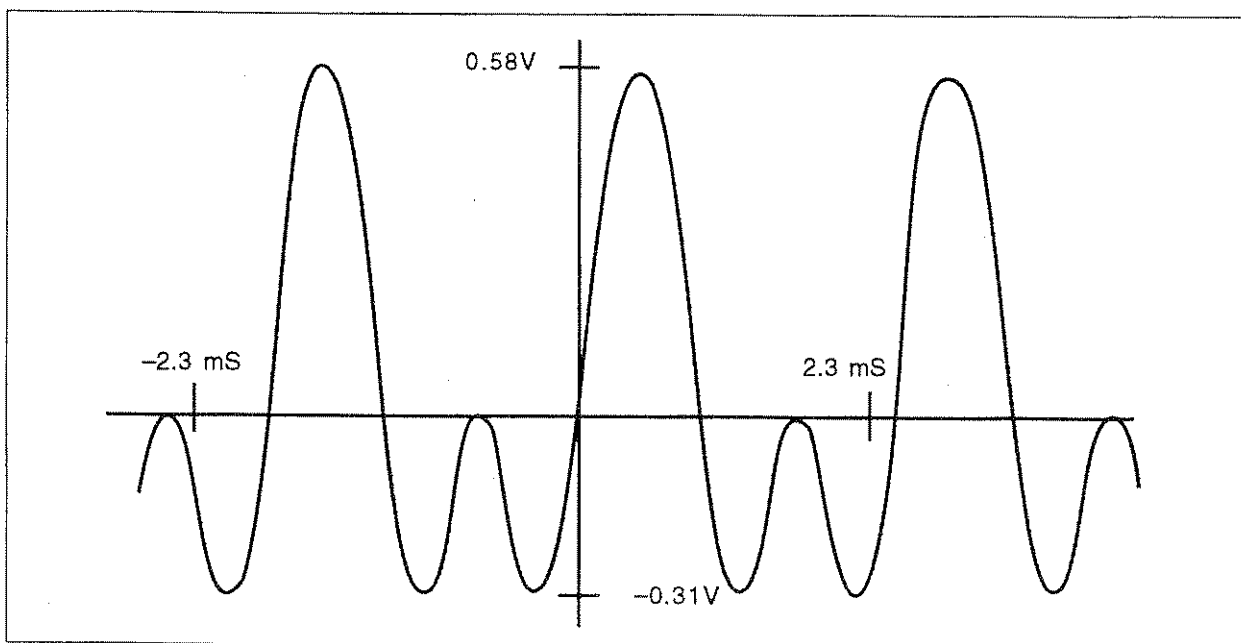

Figure 3-1. MANUAL polarity signal.

### Polarity Checks

Using the polarity signal, it is also easy to check for correct audio circuit polarity with a Lissajous pattern stereo monitor, such as the Tektronix 760. In fact, this method provides more information than an oscilloscope, simultaneously showing the status of polarity and phase in both channels.

Figure 3-2 illustrates the Lissajous pattern displayed by a Tektronix 760 stereo monitor for equal left and right channel signals with correct polarity preserved.

Notice that the upper part of the line (above the horizontal axis) is longer than the lower part, which indicates correct polarity. Alignment with the vertical (L=R) axis indicates equal amplitudes on left and right channels.

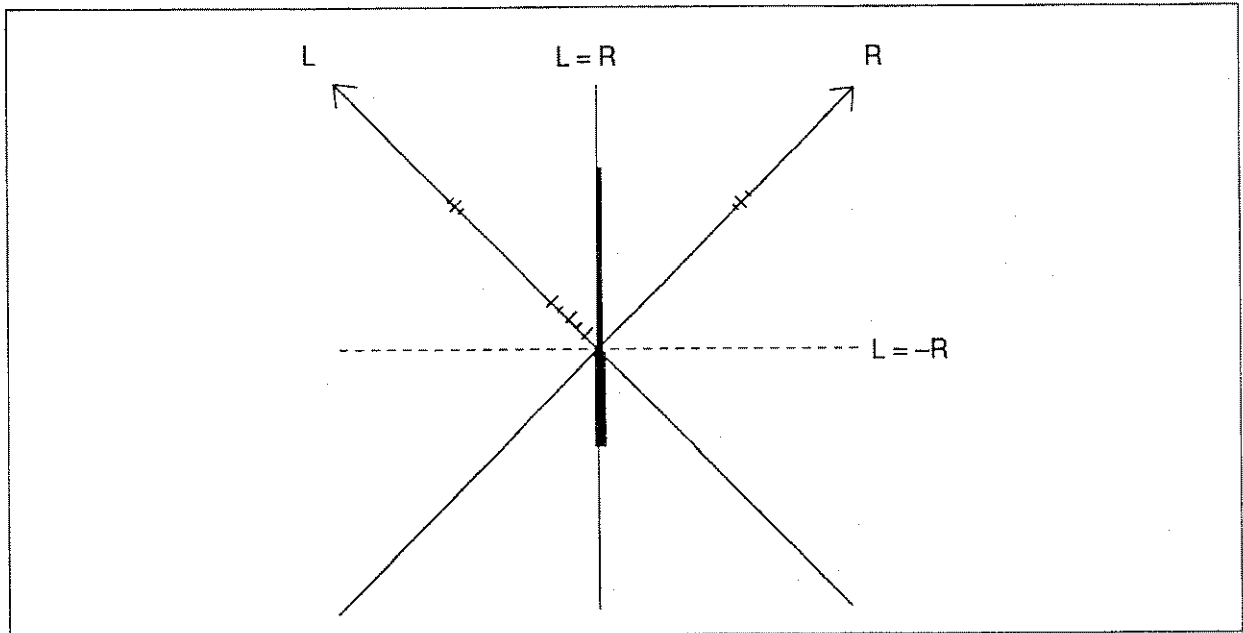

Figure 3-2. Lissajous pattern for correct polarity.

The Lissajous pattern shown in Figure 3-3 indicates reversed polarity on both channels.

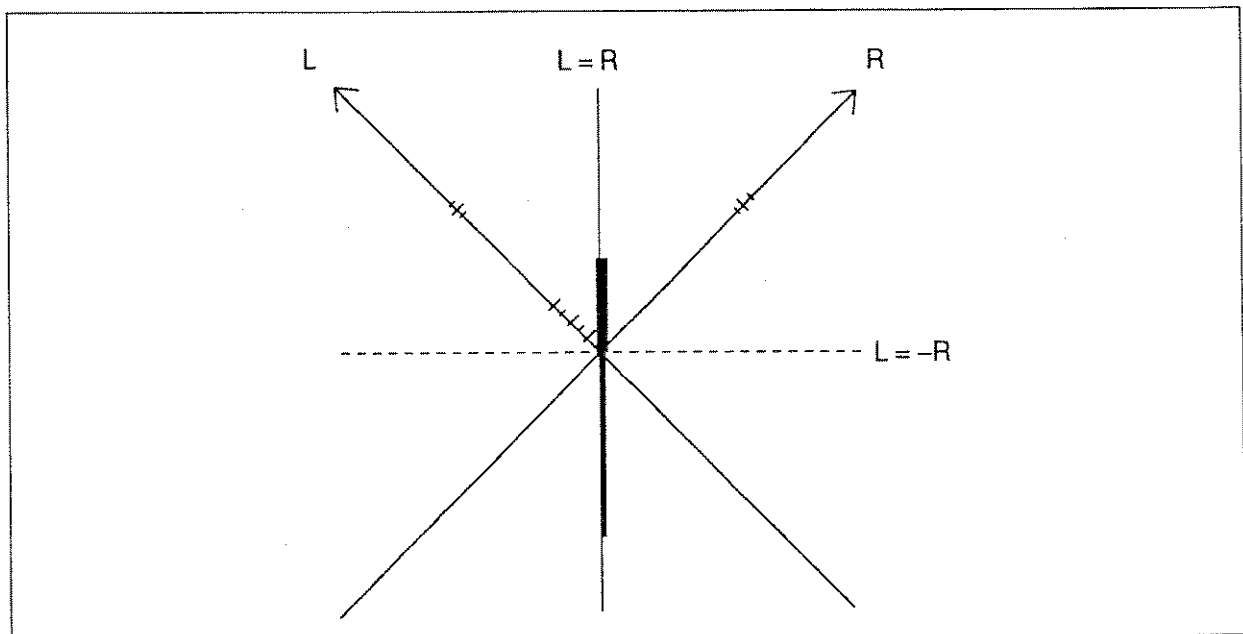

Figure 3-3. Lissajous pattern for left and right channel reversed polarity.

The Lissajous pattern shown in Figure 3-4 below indicates reversed polarity on the *left* channel only.

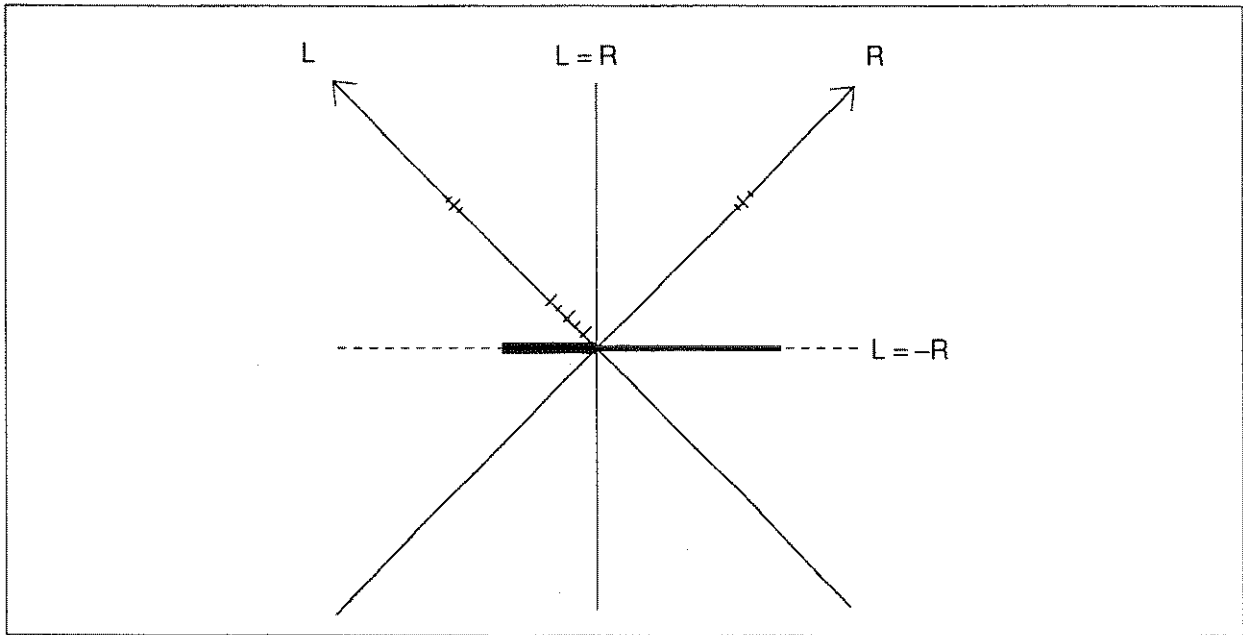

Figure 3-4. Lissajous pattern for left channel reversed polarity.

The horizontal line in Figure 3-4 indicates the signals on the two channels are out of phase ( $L = -R$ ). The shorter part of the line appearing to the left of the origin indicates that the left channel is inverted.

The Lissajous pattern shown in Figure 3-5 below indicates reversed polarity on the *right* channel only.

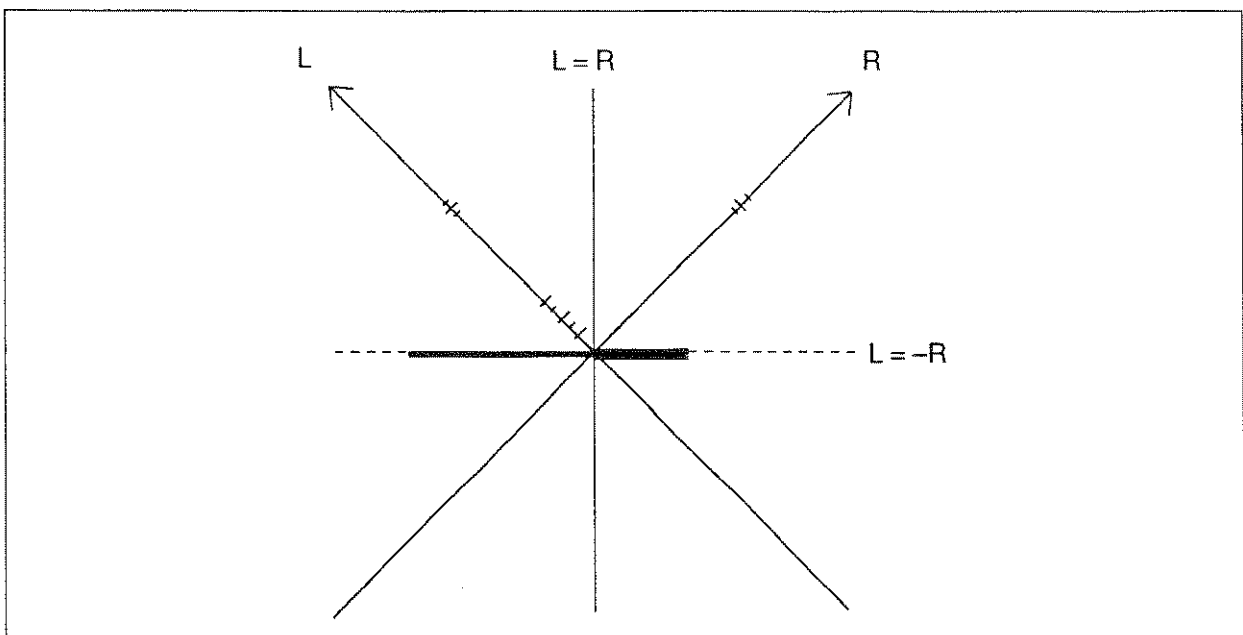

Figure 3-5. Lissajous pattern for right channel reversed polarity.



If the Lissajous pattern appears rotated between the vertical and horizontal axes as shown in Figure 3-6, it indicates unequal gains in the transmission path. An elliptical pattern as shown in Figure 3-7 indicates unequal phase shifts in the two channel signals. Combinations of unequal gain and phase shift plus noise can create many variations of the illustrations used here to show some possibilities.

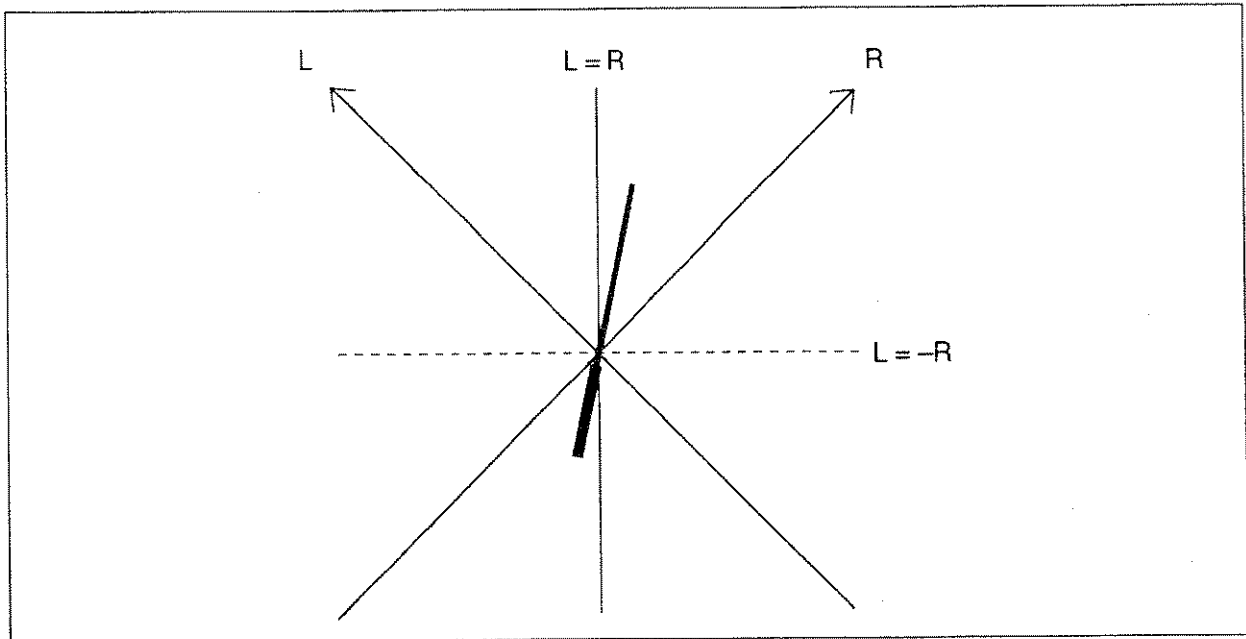

Figure 3-6. Lissajous pattern for unequal gain between right and left channels.

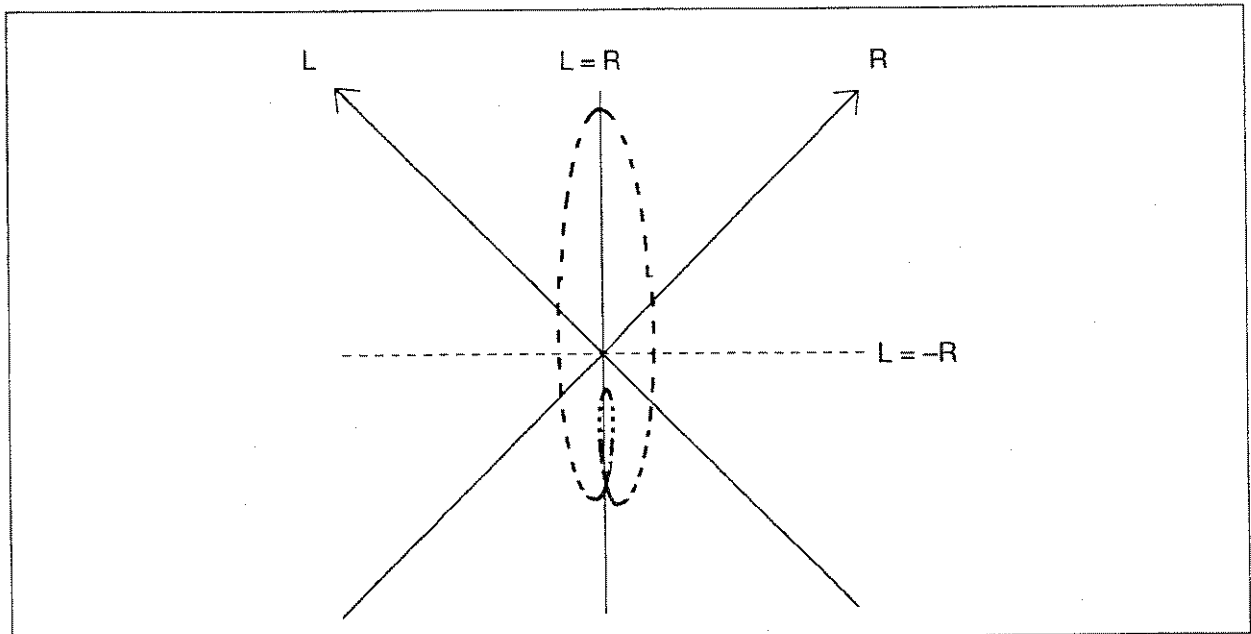

Figure 3-7. Lissajous pattern for unequal phase shift between right and left channels.

1  
2  
3  
4  
5  
6  
7  
8  
9  
10  
11  
12  
13  
14  
15  
16  
17  
18  
19  
20  
21  
22  
23  
24  
25  
26  
27  
28  
29  
30  
31  
32  
33  
34  
35  
36  
37  
38  
39  
40  
41  
42  
43  
44  
45  
46  
47  
48  
49  
50  
51  
52  
53  
54  
55  
56  
57  
58  
59  
60  
61  
62  
63  
64  
65  
66  
67  
68  
69  
70  
71  
72  
73  
74  
75  
76  
77  
78  
79  
80  
81  
82  
83  
84  
85  
86  
87  
88  
89  
90  
91  
92  
93  
94  
95  
96  
97  
98  
99  
100