



**PLEASE CHECK FOR CHANGE INFORMATION
AT THE REAR OF THIS MANUAL.**

576 CURVE-TRACER

INSTRUCTION MANUAL

Tektronix, Inc.
P.O. Box 500
Beaverton, Oregon 97077
070-0905-01
Product Group 48

Serial Number _____

First Printing NOV 1970
Revised JAN 1984

Copyright © 1969, 1970 Tektronix, Inc. All rights reserved.
Contents of this publication may not be reproduced in any
form without the written permission of Tektronix, Inc.

Products of Tektronix, Inc. and its subsidiaries are covered
by U.S. and foreign patents and/or pending patents.

TEKTRONIX, TEK, SCOPE-MOBILE, and  are
registered trademarks of Tektronix, Inc. TELEQUIPMENT
is a registered trademark of Tektronix U.K. Limited.

Printed in U.S.A. Specification and price change privileges
are reserved.

INSTRUMENT SERIAL NUMBERS

Each instrument has a serial number on a panel insert, tag,
or stamped on the chassis. The first number or letter
designates the country of manufacture. The last five digits
of the serial number are assigned sequentially and are
unique to each instrument. Those manufactured in the
United States have six unique digits. The country of
manufacture is identified as follows:

B000000	Tektronix, Inc., Beaverton, Oregon, USA
100000	Tektronix Guernsey, Ltd., Channel Islands
200000	Tektronix United Kingdom, Ltd., London
300000	Sony/Tektronix, Japan
700000	Tektronix Holland, NV, Heerenveen, The Netherlands

OPERATORS SAFETY SUMMARY

The general safety information in this part of the summary is for both operating and servicing personnel. Specific warnings and cautions will be found throughout the manual where they apply, but may not appear in this summary.

TERMS

In This Manual

CAUTION statements identify conditions or practices that could result in damage to the equipment or other property.

WARNING statements identify conditions or practices that could result in personal injury or loss of life.

As Marked on Equipment

CAUTION indicates a personal injury hazard not immediately accessible as one reads the marking, or a hazard to property including the equipment itself.

DANGER indicates a personal injury hazard immediately accessible as one reads the marking.

SYMBOLS

In This Manual



This symbol indicates where applicable cautionary or other information is to be found.

As Marked on Equipment



DANGER — High voltage.



Protective ground (earth) terminal.



ATTENTION — refer to manual.

Power Source

This product is intended to operate from a power module connected to a power source that will not apply more than 250 volts rms between the supply conductors or between either supply conductor and ground. A protective ground connection by way of the grounding conductor in the power cord is essential for safe operation.

Grounding the Product

This product is grounded through the grounding conductor of the power module power cord. To avoid electrical shock, plug the power cord into a properly wired receptacle before connecting to the product input or output terminals. A protective ground connection by way of the grounding conductor in the power module power cord is essential for safe operation.

Danger Arising From Loss of Ground

Upon loss of the protective-ground connection, all accessible conductive parts (including knobs and controls that may appear to be insulating) can render an electric shock.

Use the Proper Fuse

To avoid fire hazard, use only the fuse of correct type, voltage rating and current rating as specified in the parts list for your product.

Refer fuse replacement to qualified service personnel.

Do Not Operate in Explosive Atmospheres

To avoid explosion, do not operate this product in an explosive atmosphere unless it has been specifically certified for such operation.

Do Not Operate Without Covers

To avoid personal injury, do not operate this product without covers or panels installed. Do not apply power to the plug-in via a plug-in extender.

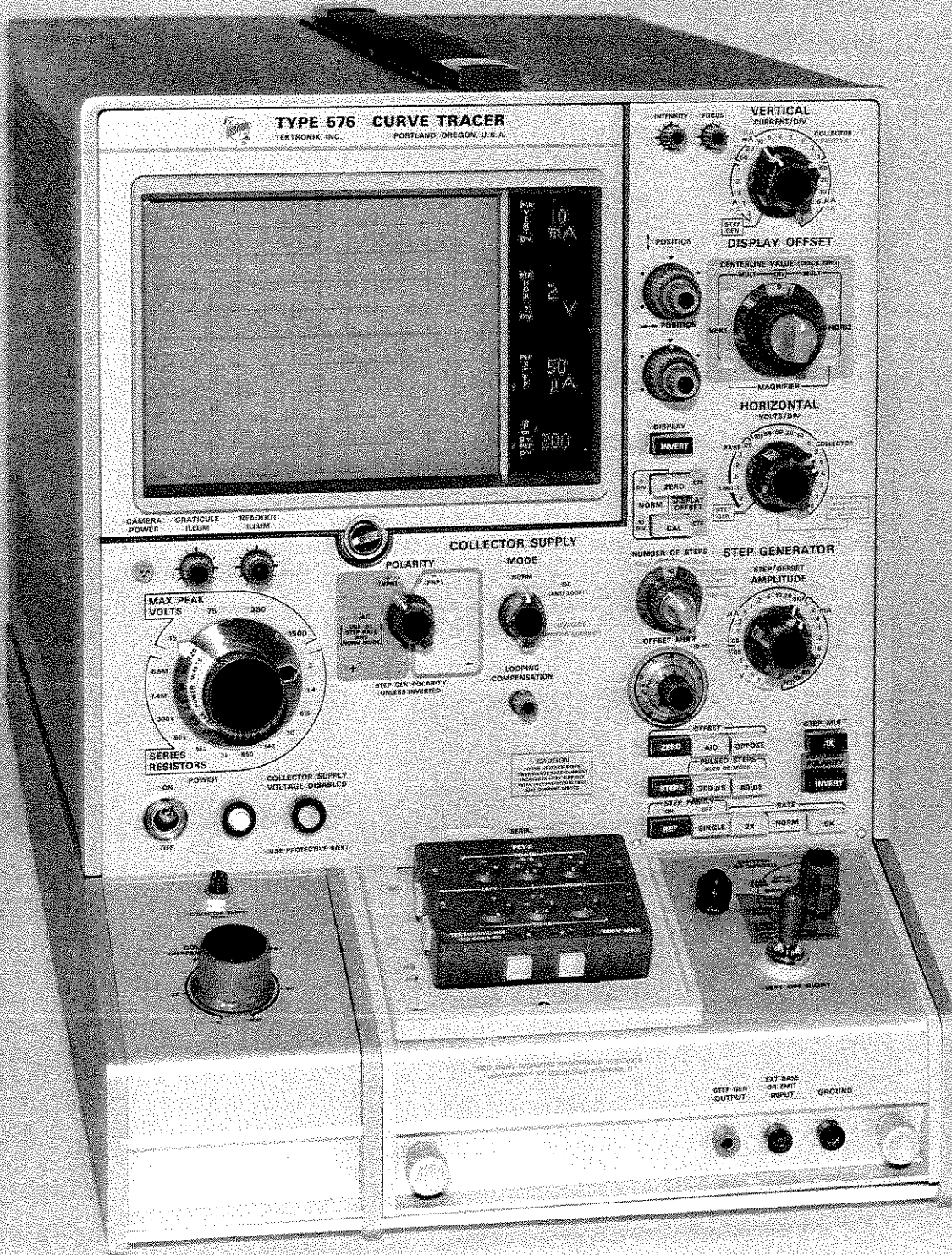

Fig. 1-1. Type 576 Curve Tracer.

SECTION 1

SPECIFICATION

The Type 576 Curve Tracer is a dynamic semiconductor tester which allows display and measurement of characteristic curves of a variety of two and three terminal devices including bipolar transistors, field effect transistors, MOS-FETs, silicon controlled rectifiers and unijunction transistors. A variety of possible measurements is available using either grounded emitter or grounded base configurations. The instrument has available either an AC or a DC collector supply voltage ranging from 0 to ± 1500 volts. The step generator produces either current or voltage steps, which may be applied to either the base terminal or the emitter terminal of the device under test. Step generator outputs range from 5 nA to 2 A in the current mode, and from 5 mV to 40 V in the voltage mode. The steps may also be produced as short duration pulses. Calibrated step offset allows offsetting the step generator output either positive or negative. The vertical display amplifier measures either collector current or leakage current with a maximum deflection factor of 1 nA/division when making a leakage

measurement. The horizontal display amplifier allows measurement of both collector and base voltage.

The following electrical and environmental characteristics are valid for instruments operated at an ambient temperature of from $+10^{\circ}\text{C}$ to $+40^{\circ}\text{C}$ after an initial warmup period of 5 minutes, when previously calibrated at a temperature of $+25^{\circ}\text{C} \pm 5^{\circ}\text{C}$. Section 5, Performance Check and Calibration Procedure, gives a procedure for checking and adjusting the Type 576 with respect to the following specification.

The Type 576 MOD 301W is a standard Type 576 without the Readout Assembly. All the information contained in this manual pertaining to the Readout Assembly and its operation should be disregarded when used in conjunction with a modified instrument.

TABLE 1-1
ELECTRICAL CHARACTERISTICS

Collector Supply	
Characteristic	Performance
Sweep Modes	Normal mode: AC (at line frequency); positive-or negative-going full wave rectified AC. DC mode: positive or negative DC.
DC Mode Ripple	No-load: 2% or less of voltage, or 0.1% or less of full range voltage.
Voltages Accuracy	Peak open circuit voltages on all ranges within +35% and -5%.

¹Collector Supply Maximum Continuous Peak Current Operating Time vs Duty Cycle and Ambient Temperature. With the PEAK POWER WATTS at 50 only, the following limitations apply: Maximum continuous operating time at rated current (100% duty cycle) into a short circuit is 20 minutes at 25°C ambient, or 10 minutes at 40°C ambient. Alternatively, duty cycle may be limited to 50% at 25°C ambient or 25% at 40°C ambient. (A normal family of curves for a transistor will produce a duty cycle effect to 50% or less even if operated continuously.) Over dissipation of the collector supply will temporarily shut it off and turn on the yellow COLLECTOR SUPPLY VOLTAGE DISABLED light. No damage will result.

Ranges	15 V	75 V	350 V	1500 V
Maximum Peak Current (Normal Mode) ¹	10 A	2 A	0.5 A	0.1 A
Peak Current (Step Generator in Pulsed Steps Mode)	At least 20 A	At least 4 A	At least 1 A	At least 0.2 A
Minimum Series Resistance	0.3 Ω	6.5 Ω	140 Ω	3 k Ω
Maximum Series Resistance	65 k Ω	1.4 M Ω	6.5 M Ω	6.5 M Ω
Series Resistance Available	0.3 Ω , 1.4 Ω , 6.5 Ω , 30 Ω , 140 Ω , 650 Ω , 3 k Ω , 14 k Ω , 65 k Ω , 300 k Ω , 1.4 M Ω and 6.5 M Ω , all within 5% or 0.1 Ω .			
Peak Power Watts Settings	0.1 W, 0.5 W, 2.2 W, 10 W, 50 W and 220 W. Derived from nominal peak open circuit collector voltages and nominal series resistance values at nominal line voltage.			
Safety Interlock	When MAX PEAK VOLTS switch is set to either 75, 350 or 1500, a protective box must be in place over test terminals and its lid closed be-			

Specification—Type 576

	fore voltage can be applied. Amber light on indicates interlock is open Red light on indicates voltage is being applied to test terminals.
Looping Compensation	Cancels stray capacitance between collector test terminal and ground in Standard Test Fixture and all Standard Test Fixture Accessories.

Step Generator

Accuracy (Current or Voltage Steps, Including Offset)	
Incremental Accuracy	Within 5% between any two steps, without .1X STEP MULT button pressed; within 10% with .1X STEP MULT button pressed.
Absolute Accuracy	Within 2% of total output, including any amount of offset, or 1% of AMPLITUDE switch setting, whichever is greater.
Step (Current or Voltage) Amplitudes	One times or 0.1 times (with .1X STEP MULT button pressed) the AMPLITUDE switch setting.
OFFSET MULT Control Range	Continuously variable from 0 to 10 times AMPLITUDE switch setting, either aiding or opposing the step generator polarity.
Current Mode	
AMPLITUDE Switch Range	200 mA to 50 nA, in 1-2-5 sequence.
Maximum Current (Steps and Aiding Offset) ²	20 times AMPLITUDE switch setting, except 10 times switch setting when switch is set to 200 mA, and 15 times switch setting when the switch is set to 100 mA.
Maximum Voltage (Steps and Aiding Offset)	At least 10 V.
Maximum Opposing Offset Current	Whichever is less: 10 times AMPLITUDE switch setting, or between 10 mA and 20 mA.
Maximum Opposing Voltage	Between 1 V and 3 V.

²Continuous DC Output vs Time, Temperature and Duty Cycle. 2A continuous DC output can be achieved for an unlimited period up to 30°C ambient. Between 30°C and 40°C ambient, 2A continuous DC operation should be limited to 15 minutes or limited to a 50% duty cycle or less. A family of steps (such as 10 steps at 200 mA per step) will automatically reduce the duty cycle to 50% even if generated continuously. Exceeding the rating will temporarily shut off power to the entire instrument but no damage will result.

Ripple Plus Noise	0.5% or less of AMPLITUDE switch setting or 1 nA, peak to peak.
Voltage Mode	
AMPLITUDE Switch Range	50 mV to 2 V, in 1-2-5 sequence.
Maximum Voltage (Steps and Aiding Offset)	20 times AMPLITUDE switch setting.
Maximum Current (Steps and Aiding Offset)	At least 2 A at 10 V or less, decreasing linearly to 10 mA at 40 V.
Short Circuit Current Limiting (Steps and Aiding Offset)	20 mA, 100 mA, 500 mA, +100%-0%; 2 A +50%-0%; as selected by CURRENT LIMIT switch.
Maximum Opposing Offset Voltage	10 times AMPLITUDE switch setting.
Maximum Opposing Current	Limited at between 5 mA and 20 mA
Ripple Plus Noise	0.5% or less of AMPLITUDE switch setting, or 2 mV, peak to peak.
Step Rates	(Front panel RATE button labels in parentheses.) 1 times (.5X), 2 times (NORM) and 4 times (2X) line frequency. Steps occur at zero collector voltage when .5X or NORM RATE buttons are pressed, and also at peak voltage when 2X RATE button is pressed. Steps occur at collector voltage peak and at normal rate when .5X and 2X RATE buttons are pressed together.
Pulsed Steps	Pulsed steps 80 μs wide within +20%, -5% or 300 μs wide within +5%, -15% produced whenever one of the PULSED STEPS buttons is pressed. Pulsed steps can be produced only at normal and .5 times normal rates. Collector Supply mode automatically becomes DC when either the 300 μs or 80 μs PULSED STEPS button is pressed unless POLARITY switch is set to AC. If the 300 μs and 80 μs PULSED STEPS buttons are pressed together, 300 μs pulsed steps are produced, but collector supply mode does not change.

Steps and Offset Polarity	Corresponds with collector supply polarity (positive going when POLARITY switch is set to AC) when the POLARITY INVERT button is released. Is opposite collector supply polarity (negative-going in AC) when either the POLARITY INVERT button is pressed or the Lead Selector switch is set to BASE GROUNDED. If Lead Selector switch is set to BASE GROUNDED, POLARITY INVERT button has no effect on steps and offset polarity.
Step Families	Repetitive families of characteristic curves generated with REP STEP FAMILY button pressed. Single family of characteristic curves generated each time SINGLE STEP FAMILY button is pressed.
Number of Steps	Ranges from 1 to 10 as selected by the NUMBER OF STEPS switch. For zero steps, press SINGLE STEP FAMILY button.

Display Amplifiers

Display Accuracies (% of Highest On-Screen Value)	Display magnified (DISPLAY OFFSET Selector switch set to either VERT X10 or HORIZ X10) and offset between			Display Unmagnified
	100 and 40 divisions	35 and 15 divisions	10 and 0 divisions	
Normal and DC Collector Supply Modes				
Vertical Collector Current	2%	3%	4%	3%
External Vertical (Through Interface)	2%	3%	4%	3%
Horizontal Collector Volts	2%	3%	4%	3%
Horizontal Base Volts	2%	3%	4%	3%

External Horizontal (Through Interface)	2%	3%	4%	3%
Leakage Collector Supply Mode				
Vertical Emitter Current (VERTICAL Switch set between 10 nA and 2 mA)	2% ±1 nA	3% ±1 nA	4% ±1 nA	3% ±1 nA
Vertical Emitter Current (VERTICAL Switch set to 5 nA, 2 nA or 1 nA)	Not Applicable			5% ±1 nA
Horizontal Collector or Base Volts VERTICAL switch set to:				
1 µA or more	2%	3%	4%	3%
100 nA, 10 nA or 1 nA	Not Applicable			3% plus 0.025 V for each vertical division of deflection on the CRT
500 nA, 50 nA or 5 nA	Not Applicable			3% plus 0.125 V for each vertical division of deflection on the CRT
200 nA, 20 nA or 2 nA	Not Applicable			3% plus 0.050 V for each vertical division of deflection of the CRT
Step Generator Display				

Specification—Type 576

Vertical Step Generator	3%	4%	5%	4%
Horizontal Step Generator	3%	4%	5%	4%
Deflection Factors				
Vertical Collector Current	1 μ A/division to 2 A/division in 1-2-5 sequence.			
Emitter Current	1 nA/division to 2 mA/division in 1-2-5 sequence.			
Step Generator	1 step/division.			
Horizontal Collector Volts	50 mV/division to 200 V/division in 1-2-5 sequence			
Base Volts	50 mV/division to 2 V/division in 1-2-5 sequence.			
Input Impedance	At least 100 M Ω with HORIZONTAL switch set to 50 mV, 100 mV and 200 mV BASE; 1 M Ω within 2% with switch set to .5 V, 1 V and 2 V.			
Step Generator	1 step/division			
Maximum Displayed Noise	1% or less, or the following depending on setting of MAX PEAK VOLTS switch:			
	15	75	350	1500
Vertical COLLECTOR	1 μ A	1 μ A	2 μ A	5 μ A
Vertical EMITTER	1 nA	1 nA	2 nA	5 nA
Horizontal COLLECTOR	5 mV	5 mV	20 mV	200 mV
Horizontal BASE	5 mV	5 mV	5 mV	5 mV
Calibration Check	<p>With DISPLAY OFFSET Selector switch set to NORM (OFF), spot is deflected 10 divisions both vertically and horizontally within 1.5% whenever the CAL button is pressed.</p> <p>With DISPLAY OFFSET Selector switch set to X10 MAGNIFIER (either axis) the calibration spot is within 0.5% of zero spot (previously set to CRT graticule center) when CAL button is pressed.</p>			

Vertical and Horizontal Position Controls	Coarse positioning in 5 division increments within 0.1 division; continuous fine positioning over at least 5 divisions for each coarse position.	
Display Offset	Vertical or Horizontal offset of display centerline value up to 10 divisions in 21 half division steps.	
Display Positioning Accuracy Using POLARITY Switch	Spot positioning with change in POLARITY switch setting (using AC position as reference), within 0.1 division of:	
	Vertically	Horizontally
AC	Centered	Centered
+(NPN)	-5 divisions	-5 divisions
-(PNP)	+5 divisions	+5 divisions

CRT and Readout

CRT Type	Electrostatic deflection.
Screen Size	Calibrated area of 10 divisions by 10 divisions; 12 usable divisions horizontally (1 division equals 1 cm).
Typical Accelerating Potential	4000 V
Readouts	Automatic digitally lighted display. Readout is automatically blanked if readings would be outside the available ranges or would give erroneous display.
PER VERT DIV	1 nA to 20 A calculated from VERTICAL switch setting, DISPLAY OFFSET Selector switch setting and MODE switch setting (or X10 Vertical Interface Input).
PER HORIZ DIV	5 mV to 200 V calculated from HORIZONTAL switch setting and DISPLAY OFFSET Selector switch setting.
PER STEPS	5 nA to 2A and 5 mV to 20 V calculated from AMPLITUDE switch setting and .1X STEP MULT button position (or X10 Step Interface Input).

β or g_m PER DIV	1 μ . to 500 k calculated from VERTICAL switch setting, DISPLAY OFFSET Selector switch setting, AMPLITUDE switch setting, .1X STEP MULT button position, X10 Vertical Interface Input and X10 Step Interface Input.
--------------------------	---

Power Requirements

Power Connection	<p>This instrument is designed for operation from power source with its neutral at or near ground (earth) potential. It is not intended for operation from two phases of multi-phase system, or across legs of single-phase, three wire system.</p> <p>It is provided with a three-wire power cord with three-terminal polarized plug for connection to the power source. Third wire is directly connected to instrument frame, and is intended to ground the instrument to protect operating personnel, as recommended by national and international safety codes.</p>	
------------------	---	--

Line Voltage Ranges	115 VAC		230 VAC	
	Low	90 V to 110 V	180 V to 220 V	
	Medium	104 V to 126 V	208 V to 252 V	
	High	112 V to 136 V	224 V to 272 V	
Line Frequency Range	48 to 66 Hz			
Maximum Power Consumption at 115 VAC, 60 Hz	305 W, 3.2 A			

**Table 1-2
ENVIRONMENTAL CHARACTERISTICS**

Characteristic	Information
Temperature Nonoperating	-40°C to +65°C

Useful Operation	0°C to +50°C
Specified Operation	+10°C to +40°C
Altitude Nonoperating	To 50,000 feet
Operating	To 10,000 feet
Vibration Operating	15 minutes along each axis at 0.015 inch with frequency varied from 10-50-10 c/s in 1-minute cycles. Three minutes at any resonant point or at 50 c/s.
Shock Nonoperating	30 g's, 1/2 sine, 11 ms duration, 1 shock per axis. Total of 6 shocks
Transportation	12 inch package drop. Qualified under the National Safe Transit Committee test procedure 1A.

**TABLE 1-3
MECHANICAL CHARACTERISTICS**

Characteristic	Description
Dimensions	
Height	≈15 inches
Width	≈11 3/4 inches
Depth	≈23 1/4 inches
Weight	≈69 lbs.
Finish	
Front Panel (Type 576 and Standard Test Fixture)	Anodized Aluminum
Cabinet	Blue vinyl painted aluminum
Trim and Rear Panel	Satin finished chrome

SECTION 2

OPERATING INSTRUCTIONS

Change information, if any, affecting this section will be found at the rear of the manual.

General

This section of the instruction manual provides information necessary for operating the Type 576 and for using it to test various semiconductor devices. Included are setup procedures, a description of the Type 576 controls and connectors, a discussion of the theory of the instrument, a first time operation procedure, and general operating information. Also included is a section describing the use of the Type 576 for measuring the characteristics of various semiconductor devices.

INITIAL CONSIDERATIONS

Cooling

The Type 576 maintains a safe operating temperature when operated in an ambient temperature between 0°C (32°F) and 50°C (122°F). Adequate clearance on all sides of the instrument should be provided to assure free air flow and dissipation of heat away from the instrument. A thermal cutout in the instrument provides thermal protection by disconnecting the power to the instrument if the internal temperature exceeds a safe operating level. Power is automatically restored when the temperature returns to a safe level. It should be noted that the instrument will turn off under certain conditions of high collector supply current output or high step generator current output even though the instrument is being operated in an ambient temperature which is within the specified range. See footnotes in the Specification section for further information.

Operating Voltage and Frequency

The Type 576 can be operated from either a 115-volt or a 230-volt line voltage source. The LINE VOLTAGE SELECTOR assembly, located on the rear panel, allows conversion of the instrument so that it may be operated from one line voltage or the other. In addition, this assembly changes the connections of the power transformer primary to allow selection of one of three regulating ranges (see Table 2-1). The assembly also includes the two line fuses. When the instrument is converted from 115-volt to 230-volt operation or vice versa, the assembly selects the proper fuse to provide the correct protection for the instrument.

The Type 576 may be operated from either a 50 Hz or a 60 Hz line frequency. In order to synchronize the step generator with the collector supply, the 60 Hz-50 Hz switch, located on the Type 576 rear panel below the LINE

VOLTAGE SELECTOR assembly, must be set to the position which corresponds to the line frequency being used.

Use the following procedure to convert this instrument between line voltages, regulating ranges or line frequencies:

1. Disconnect the instrument from the power source.

TABLE 2-1

Regulating Ranges

Range Selector Switch Position	Regulating Range	
	115 Volts Nominal	230 Volts Nominal
LO (switch bar in left holes)	90 to 110 volts	180 to 220 volts
M (switch bar in middle holes)	104 to 126 volts	208 to 252 volts
HI (switch bar in right holes)	112 to 136 volts	224 to 272 volts

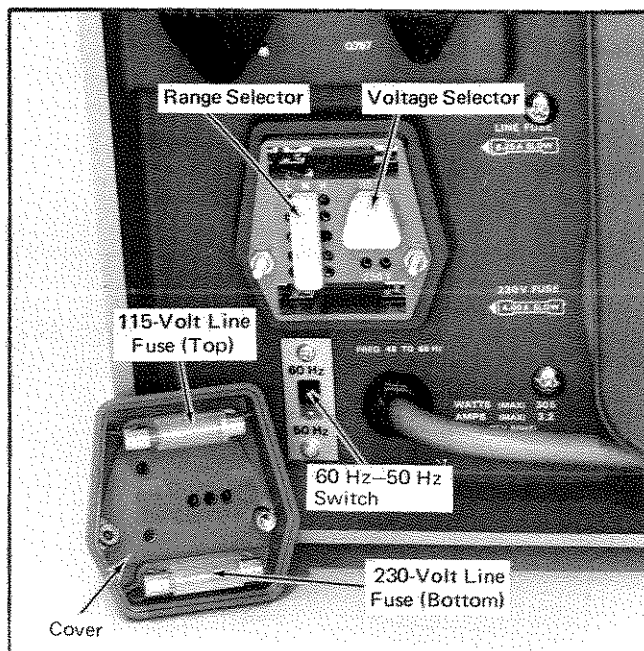

Fig. 2-1. Line Voltage Selector assembly and 60 Hz-50 Hz switch on the rear panel (shown with cover removed).

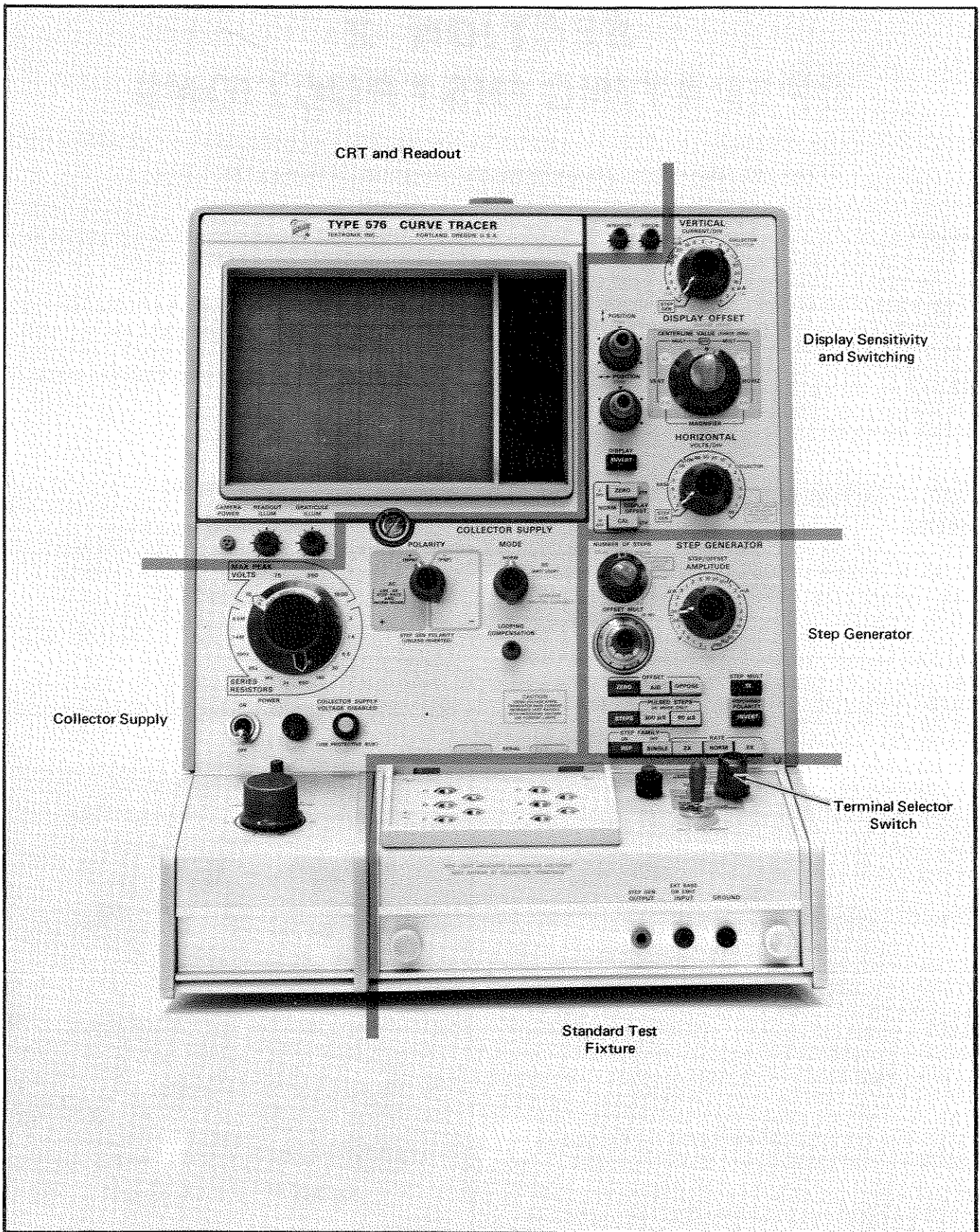

Fig. 2-2. Front-panel controls, connectors and readout.

2. Loosen the two captive screws which hold the cover onto the voltage selector assembly, then pull to remove the cover.

3. To convert from 115-volt to 230-volt line voltage or vice versa, pull out the Voltage Selector switch bar (see Fig. 2-1); turn it 180° and plug it back into the remaining holes. Change the line-cord power plug to match the power-source receptacle or use a 115-to-230-volt power plug adapter.

4. To change regulating ranges, pull out the Range Selector switch bar (see Fig. 2-1) slide it to the desired position and plug it back in. Select a range which is centered about the average line voltage to which the instrument is to be connected (see Table 2-1).

5. Re-install the cover and tighten the two captive screws.

6. To convert from operation with 60 Hz line frequency to operation with 50 Hz line frequency (or vice versa), slide the 60 Hz-50 Hz switch (see Fig. 2-1) to the position which coincides with the line frequency being used.

7. Before applying power to the instrument, check that the indicating tabs on the switch bars are protruding through the correct holes in the voltage selector assembly cover for the desired line voltage and regulating range.

CAUTION

The Type 576 should not be operated with the Voltage Selector switch or the Range Selector switch in the wrong position for the line voltage applied. Operation of the instrument with either of these switches in the wrong position will cause incorrect operation and may damage the instrument.

CONTROLS, CONNECTORS AND READOUT

All controls and connectors required for normal operation of the Type 576 are located on the front and rear panels of the instrument and on the front panel of the standard test fixture (see Figs. 2-2 and 2-3). In addition, readout of some of the instrument functions has been provided on the front panel. Familiarity with the function and use of each of these controls, connectors and the readout is necessary for effective operation of the instrument. The functions are described in the following table.

CRT and Readout

Controls

INTENSITY Control Controls brightness of display.

FOCUS Control Provides adjustment for optimum display definition.

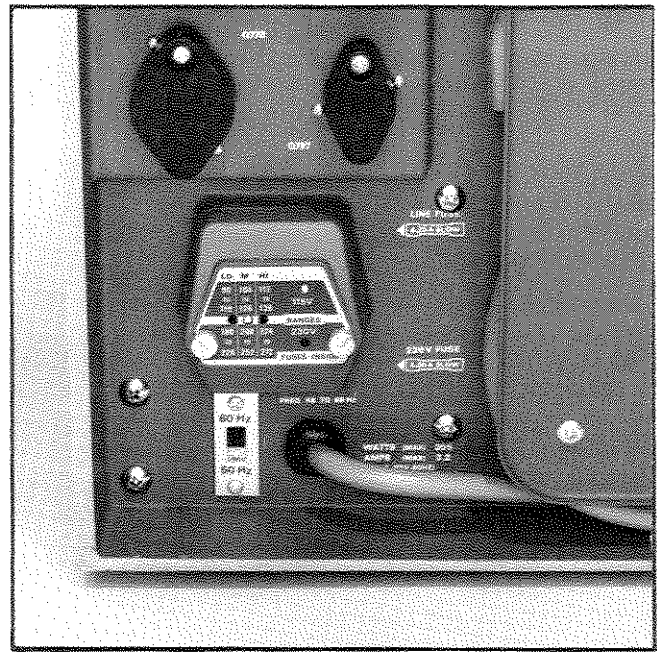

Fig. 2-3. Rear-panel controls.

READOUT ILLUM CONTROL Controls brightness of readout.

SCALE ILLUM Control Controls graticule illumination.

Connector

CAMERA POWER Connector Provides +15 volts for operation of camera.

Readouts

PER VERT DIV Readout Readout indicates deflection factor of vertical display as viewed on CRT.

PER HORIZ DIV Readout Readout indicates deflection factor of horizontal display as viewed on CRT.

PER STEP Readout Readout indicates amplitude per step of Step Generator output.

β OR gm PER DIV Readout Readout indicates beta or trans-conductance per division of CRT display.

Display Sensitivity and Positioning

VERTICAL CURRENT/DIV Switch Selects vertical deflection factor of display.

COLLECTOR—Normal operation of instrument. Vertical display represents collector current. Use black units to determine vertical deflection factor.

EMITTER—Operation of instrument with MODE switch set to LEAKAGE (EMITTER CURRENT). Vertical display represents emitter current. Use orange units to determine vertical deflection factor. STEP GEN—Steps indicating Step Generator output are displayed vertically. AMPLITUDE switch setting per division determines vertical deflection factor.

DISPLAY OFFSET Selector Switch Allows selection of display offset or display offset and magnification.

NORM (OFF)—Display offset is not operable.

HORIZ X1—Allows horizontal display to be offset using calibrated CENTERLINE VALUE switch.

VERT X1—Allows vertical display to be offset using calibrated CENTERLINE VALUE switch.

HORIZ X10—Horizontal display magnified by 10 times. Allows horizontal display to be offset using calibrated CENTERLINE VALUE switch.

VERT X10—Vertical display magnified by 10 times. Allows vertical display to be offset using calibrated CENTERLINE VALUE switch.

CENTERLINE VALUE Switch (Clear plastic flange with numbers on it) Provides calibrated offset of display.

X1 (VERT or HORIZ)—Number on CENTERLINE VALUE switch appearing in blue window represents number of divisions centerline of display is offset either vertically or horizontally from zero offset line.

X10 (VERT or HORIZ)—Number on CENTERLINE VALUE switch appearing in blue window multiplied by 10 represents number of divisions centerline of display is offset either vertically or horizontally from zero offset line.

HORIZONTAL VOLTS/DIV Switch Selects the horizontal deflection factor of display.

COLLECTOR—Horizontal display represents collector voltage to ground.

BASE—Horizontal display represents base voltage to ground.

STEP GEN—Steps indicating Step Generator output are displayed horizontally. AMPLITUDE switch setting per division determines hori-

zontal deflection factor.

ZERO Button Provides a zero reference for the display.

NORM—When DISPLAY OFFSET selector switch is set to NORM (OFF), ZERO button provides point on CRT of zero vertical and horizontal-deflection for adjusting position controls.

DISPLAY OFFSET—When DISPLAY OFFSET Selector switch is in one of four display offset positions, ZERO button provides reference point on CRT which must be positioned to vertical centerline (horizontal offset) or to horizontal centerline (vertical offset) to insure that the CENTERLINE VALUE switch setting applies to centerline. (Should always be checked with DISPLAY OFFSET Selector switch set to MAGNIFIER.)

CAL Button Provides signal which should cause 10 divisions of vertical and horizontal deflection for checking calibration of vertical and horizontal amplifiers.

NORM—When DISPLAY OFFSET selector switch is set to NORM (OFF), CAL button provides point on CRT of 10 divisions of vertical and horizontal deflection.

DISPLAY OFFSET—When DISPLAY OFFSET Selector switch is in one of four display offset positions, CAL button provides signal which should cause reference point on CRT to appear on vertical centerline (horizontal offset) or on horizontal centerline (vertical offset), assuming zero reference point was properly adjusted. (Check should be performed with DISPLAY OFFSET Selector switch set to MAGNIFIER.)

DISPLAY INVERT Button Inverts display vertically and horizontally about center of CRT.

POSITION Switch (Horizontal) Provides coarse positioning of horizontal display.

FINE POSITION Control (Horizontal) Provides fine positioning of horizontal display.

POSITION Switch (Vertical) Provides fine positioning of vertical display.

FINE POSITION Control (Vertical) Provides fine positioning of vertical display.

Collector Supply

Controls

MAX PEAK VOLTS Switch Selects range of VARIABLE COLLECTOR SUPPLY control. Switch is located below PEAK POWER WATTS switch and range is indicated by white arrow. When switch is set to 75, 350 and 1500, protective box must be used with Standard Test Fixtures (see section on interlock system).

PEAK POWER WATTS Switch Selects nominal peak power output of Collector Supply, by selecting resistance in series with Collector Supply output. PEAK POWER WATTS is indicated by number on transparent switch flange appearing above white MAX PEAK VOLTS indicator. SERIES RESISTORS are indicated by black indicator. PEAK POWER WATTS switch must be pulled out to set nominal peak power output. When PEAK POWER WATTS switch is set, series resistance is automatically changed to maintain desired nominal peak power output when MAX PEAK VOLTS switch setting is changed.

VARIABLE COLLECTOR SUPPLY Control Allows varying of collector supply voltage within range set by MAX PEAK VOLTS switch.

POLARITY Switch Selects polarity of Collector Supply voltage and Step Generator output.
 –(PNP)—Collector Supply voltage and Step Generator output are negative-going.
 +(NPN)—Collector Supply voltage and Step Generator output are positive-going.
 AC—Collector Supply voltage is both positive- and negative-going (sine wave); Step Generator output is positive-going. When switch is set to AC position, use .5X step rate and normal mode of operation.

MODE Switch Selects mode of operation of Collector Supply.
 NORM—Normal Collector Supply output is obtained.
 DC (ANTILOOP)—Collector Supply output is DC voltage equal to peak value set by VARIABLE COLLECTOR SUPPLY control.

LEAKAGE (EMITTER CURRENT)—Vertical sensitivity is increased 1000 times. Vertical amplifier measures emitter current. Collector Supply mode set for DC voltage output.

LOOPING COMPENSATION Control Allows adjustment of looping compensation. Allows compensation of internal and adapter stray capacitance. Does not compensate for device capacitance.

COLLECTOR SUPPLY RESET Button Resets Collector Supply if it has been disabled by internal circuit breaker. Collector Supply is turned off whenever maximum current rating of transformer primary of 1.2 Amperes is exceeded.

POWER ON-OFF Switch Controls input power to instrument.

Lights

POWER Light Lights when power is on.

COLLECTOR SUPPLY VOLTAGE DISABLED Light Indicates Collector Supply voltage has been disabled. Lights when Collector Supply may present a potentially dangerous voltage at its output. In such a case, use of protective box is required to enable Collector Supply. Also lights when high current generated by Collector Supply or Step Generator causes instrument to overheat.

Step Generator

Controls

NUMBER OF STEPS Switch Selects number of steps per family of Step Generator output.

CURRENT LIMIT Switch Provides current limit of the Step Generator output when voltage steps are being produced.

STEP/OFFSET AMPLITUDE Switch Selects amplitude per step of steps and offset of Step Generator output. Amplitudes within black arc represent current steps; within yellow arc, voltage steps. Note caution on front-panel when using voltage steps.

OFFSET Buttons Allows offsetting of Step Generator output using OFFSET MULT control.
 ZERO—No offset available.
 AID—Allows zero step of Step Generator output to be offset as many as 10 steps above its zero offset level.

Operating Instructions--Type 576

	OPPOSE—Allows zero step of Step Generator output to be offset as many as 10 steps below its zero offset level.	STEP/OFFSET POLARITY INVERT Button	Allows change of polarity of Step Generator output (from polarity set by POLARITY switch).
OFFSET MULT Control	Provides calibrated offset of step Generator output to ± 10 times AMPLITUDE setting when either OFFSET AID or OFFSET OPPOSE button is pressed.	STEP MULT .1X Button	Provides 0.1 times multiplication of step amplitude, but does not effect offset.
STEPS Button	Provides steps of normal duration (step lasts for entire period of rate cycle).		
PULSED STEPS Buttons	Allows Step Generator output to be applied to Device Under Test for only a portion of normal step duration. Pulsed steps occur at peak of Collector Supply output. 300 μ s—Selects pulsed steps with duration of 300 μ s. Collector Supply is automatically switched to DC mode. 80 μ s—Selects pulsed steps with duration of 80 μ s. Collector Supply is automatically switched to DC mode. 300 μ s and 80 μ s—When buttons are pressed together, selects pulsed steps with duration of 300 μ s; however, Collector Supply is not automatically switched to DC mode.		
STEP FAMILY Buttons	Allows steps to be generated in repetitive families or one family at a time. ON REP—Provides repetitive Step Generator output. OFF SINGLE—Provides one family of steps whenever button is pressed. Once button has been pressed, Step Generator is turned off until pressed again or until ON REP button is pressed.		
RATE Buttons	Selects rate at which steps are generated. NORM—Provides normal Step Generator rate of 1X normal Collector Supply rate (120 steps per second for 60 Hz line frequency). 2X—Provides rate of two times normal rate. .5X—Provides rate of one half normal rate. 2X and .5X—When buttons are pressed together, provides normal rate but with step transitions occurring at peak of Collector Supply sweep.		
		LEFT-OFF-RIGHT Switch	Selects which device (choice of 2) is to be tested, left or right.
		Interlock Switch	Enables Collector Supply when Protective Box is in place and lid is closed.
		Connectors	
		Adapter Connectors	Allows connection of various test adapters to Standard Test Fixture. Connectors will accept standard size

Standard Test Fixture

Controls

Terminal Selector Switch

Selects way in which Step Generator is applied to Device Under Test. In all positions Collector Supply output is connected to Collector terminal.

EMITTER GROUNDED—Emitter of Device Under Test is connected to ground.

STEP GEN—Step Generator is applied to base terminal of Device Under Test. Normal operating position.

OPEN (OR EXT)—Base terminal of Device Under Test open. External signal applied to EXT BASE OR EMIT INPUT connector, will be applied to base terminal.

SHORT—Base terminal of Device Under Test is shorted to emitter terminal.

BASE GROUNDED—Base terminal of Device Under Test is connected to ground. Step Generator polarity is inverted.

OPEN (OR EXT)—Emitter terminal of Device Under Test is open. External signal applied to EXT BASE OR EMIT INPUT connector, will be applied to emitter terminal.

STEP GEN—Inverted Step Generator output is applied to emitter of Device Under Test.

LEFT-OFF-RIGHT Switch

Interlock Switch

Connectors

Adapter Connectors

banana plugs if some other means of connecting Device Under Test to Standard Test Fixture is desired. C, B and E stand for collector, base and emitter, respectively. Unlabeled terminals allow Kelvin sensing of voltage for high current devices.

- STEP GEN OUT Connector Step Generator output signal appears at this connector.
- EXT BASE OR EMIT INPUT Connector Allows input of externally generated signal to either base terminal or emitter terminal of Device Under Test as determined by Terminal Selector Switch.
- GROUND Connector Provides external access to ground reference.
- Light**
Caution Light Red light on, indicates Collector Supply is enabled and dangerous voltage may appear at collector terminals.

Rear Panel

Controls

- Line Voltage Selector Switches Switch assembly selects operating voltage and line voltage range. Also includes line fuses.
Voltage Selector—Selects operating voltage (115 V or 230 V).
Range Selector—Selects line voltage range (low, medium, high).
- 60 Hz-50 Hz Switch Allows conversion of instrument for operation with either 60 Hz or 50 Hz line frequency.

FRONT PANEL COLORS

The various colors on the front-panel of the Type 576 and Standard Test Fixture indicate relationships between controls and control functions. Table 2-2 shows the relationship which each color indicates.

Table 2-2
Colors and Controls

Color	Relationship
Green	Indicates controls which affect the Step Generator polarity.
Blue	Indicates controls and statements associated with display offset.
Orange	Indicates relationship of LEAKAGE (EMITTER CURRENT) mode with the VERTICAL and HORIZONTAL switches.

Yellow	Indicates controls and statements associated with the voltage mode of operation of the Step Generator.
Black (Buttons)	Indicates function controlled by a single button, which is released for most common applications.
Dark Grey (Buttons)	Indicates function controlled by several buttons, and the dark grey button is pressed for most common applications.

PRECAUTIONS

A number of the Type 576 front-panel controls could, through improper use, cause damage to the device under test. Fig. 2-4 indicates the area of the Type 576 front panel where these controls are located. Care should be exercised when using controls located in this area.

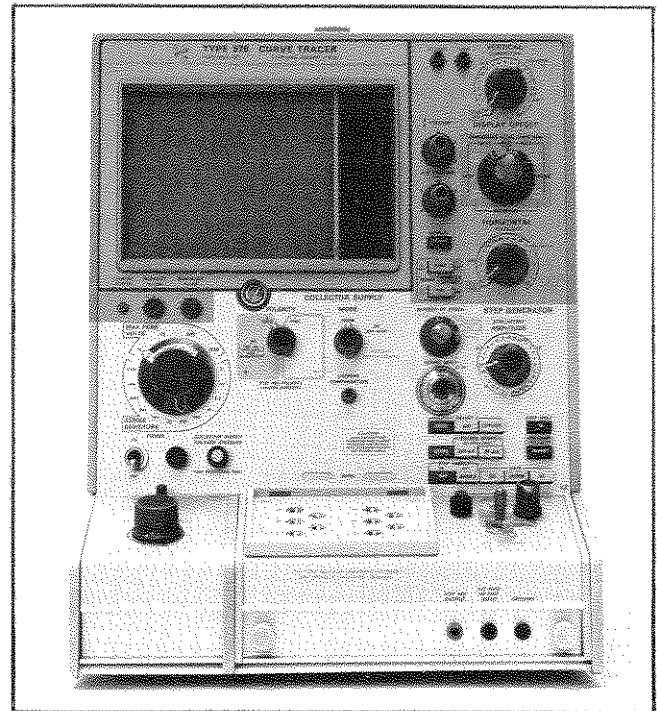

Fig. 2-4. Controls located in light area of Type 576 front-panel could cause damage to a device under test if used improperly.

GENERAL DESCRIPTION OF INSTRUMENT OPERATION

The Type 576 is a semiconductor tester which displays and allows measurement of both static and dynamic semiconductor characteristics obtained under simulated operating conditions. The Collector Supply and the Step Generator produces voltages and currents which are applied to the device under test. The display amplifiers measure the effects of these applied conditions on the device under test.

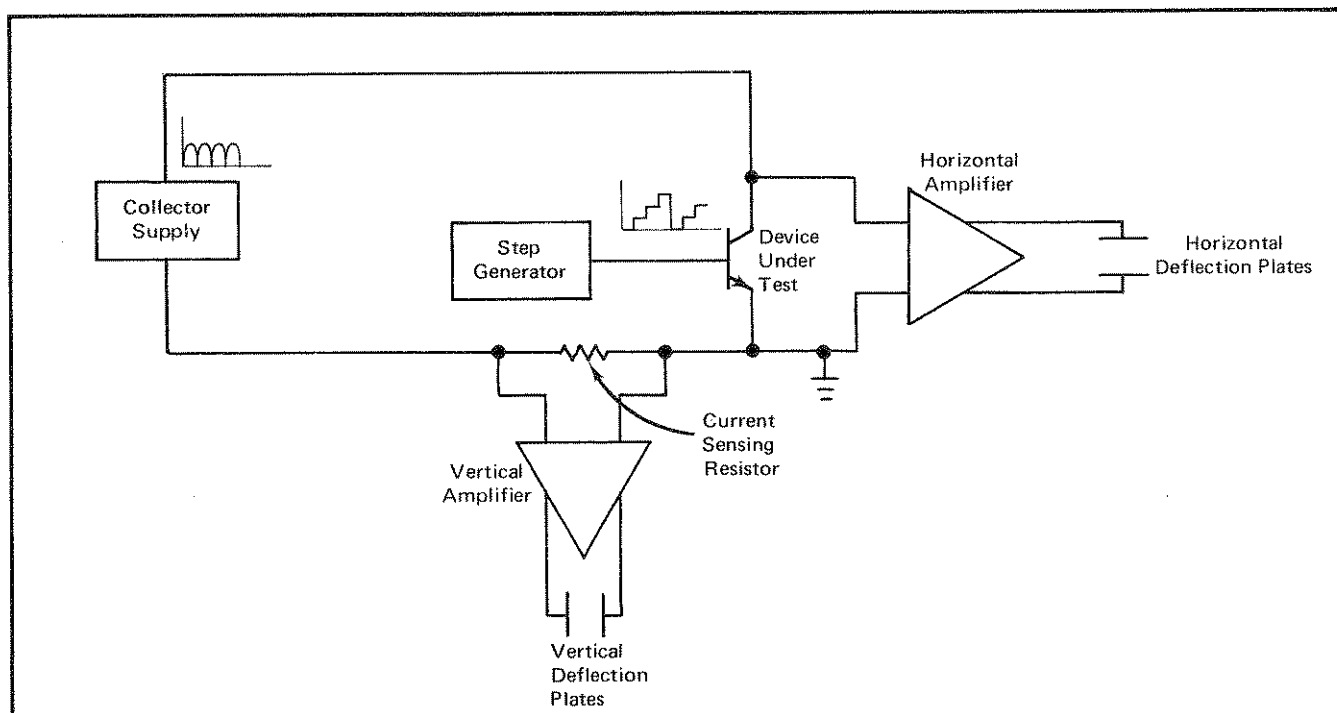

Fig. 2-5. Basic Block diagram showing typical connections of Collector Supply, Step Generator and Display Amplifiers to the device under test.

The result is families of characteristics curves traced on a CRT.

The Collector Supply circuit normally produces a full-wave rectified sine wave which may be either positive- or negative going. The amplitude of the signal can be varied from 0 to 1500 volts as determined by the MAX PEAK VOLTS switch and the VARIABLE COLLECTOR SUPPLY control. This Collector Supply output is applied to the collector (or equivalent) terminal of the device under test.

The Step Generator produces ascending steps of current or voltage at a normal rate of one step per cycle of the Collector Supply. The amount of current or voltage per step is controlled by the AMPLITUDE switch and the total number of steps is controlled by the NUMBER OF STEPS switch. This Step Generator output may be applied to either the base or the emitter (or equivalent) terminals of the device under test.

The display amplifiers are connected to the device under test. These amplifiers measure the effects of the Collector Supply and of the Step Generator on the device under test, amplify the measurements and apply the resulting voltages to the deflection plates of the CRT. The sensitivities of these amplifiers are controlled by the VERTICAL CURRENT/DIV switch and the HORIZONTAL VOLTS/DIV switch.

Fig. 2-5 is a block diagram showing the connection of these circuits to the device under test for a typical measurement.

FIRST TIME OPERATION

When the Type 576 is received, it is calibrated and should be performing within the specification shown in Section 1. The following procedure allows the operator to become familiar with the front panel controls and their functions as well as how they may be used to display transistor or diode characteristics. This procedure may also be used as a general check of the instrument's performance. For a check of the instrument's operation with respect to the specification given in Section 1, the Performance Check and Calibration Procedure in Section 5 must be used.

1. Apply power to the Type 576.
2. Allow the instrument to warm up for a few minutes. Instrument should operate within specified tolerances 5 minutes after it has been turned on.
3. Set the Type 576 and Standard Test Fixture front-panel controls as follows:

READOUT ILLUM	Fully counterclockwise
GRATICULE ILLUM	Fully counterclockwise
INTENSITY	Fully counterclockwise
FOCUS	Centered
VERTICAL	1 mA

DISPLAY OFFSET Selector	NORM (OFF)
CENTERLINE VALUE	0
HORIZONTAL	1 V COLLECTOR
Vertical POSITION	Centered
Vertical FINE POSITION	Centered
Horizontal POSITION	Centered
Horizontal FINE POSITION	Centered
ZERO	Released
CAL	Released
DISPLAY INVERT	Released
MAX PEAK VOLTS	15
PEAK POWER WATTS	0.1
VARIABLE COLLECTOR SUPPLY	Fully Counterclockwise
POLARITY	AC
MODE	NORM
LOOPING COMPENSATION	As is
NUMBER OF STEPS	1
CURRENT LIMIT	20 mA
AMPLITUDE	.05 μ A
OFFSET	ZERO
STEPS	Pressed
PULSED STEPS	Released
STEP FAMILY	REP ON
RATE	NORM
POLARITY INVERT	Released
STEP MULT .1X	Released
Terminal Selector	BASE TERM STEP GEN
LEFT-OFF-RIGHT	OFF

CRT and Readout Controls

4. Turn the GRATICULE ILLUM control throughout its range. Note that the graticule lines become illuminated as the control is turned clockwise. Set the control for desired illumination.

5. Turn the READOUT ILLUM control throughout its range. Note that the fiber-optic readouts and the readout titles become illuminated as the control is turned clockwise. Set the control for the desired readout illumination. The readout should read for these initial control settings; 1 mA per vertical division, 1 V per horizontal division, 50 nA per step and 20 k β or g_m per division.

6. Turn the INTENSITY control clockwise until a spot appears at the center of the CRT graticule. To avoid burning the CRT phosphor, adjust the INTENSITY control until the spot is easily visible, but not overly bright.

7. Turn the FOCUS control throughout its range. Adjust the FOCUS control for a sharp, well-defined spot.

Positioning Controls

8. Turn the vertical FINE POSITION control throughout its range. Note that the control has a range of at least ± 2.5 divisions about the center horizontal line. Set the control so that the spot is centered vertically on the CRT graticule.

9. Repeat step 8 using the horizontal FINE POSITION control.

10. Turn the vertical coarse POSITION switch. Note that the spot moves 5 divisions vertically each time the switch is moved one position. (The most extreme positions of the switch represent 10 divisions of deflection, which in this case causes the spot to be off the CRT graticule.) Set the POSITION-switch to the center position.

11. Repeat step 10 using the horizontal coarse POSITION switch.

12. Set the POLARITY switch to -(PNP). Note that the spot moves to the upper right corner of the CRT graticule.

13. Set the POLARITY switch to +(NPN). Note that the spot moves to the lower left corner of the CRT graticule.

Vertical and Horizontal Sensitivity

14. Install the diode adapter (Tektronix Part No.

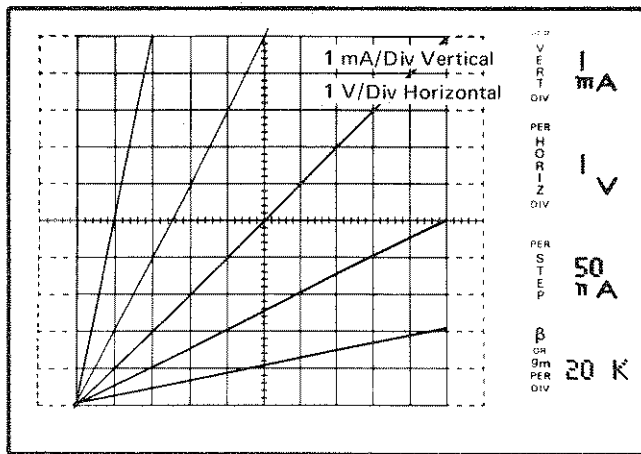

Fig. 2-6. Display of I vs. V for a 1 kΩ resistor using various settings of the VERTICAL and HORIZONTAL switches.

013-0072-00) into the right-hand set of accessory connectors located on the Standard Test Fixture.

15. Install a 1 kΩ, 1/2 watt resistor in the diode adapter.

16. Set the LEFT-OFF-RIGHT switch to RIGHT and turn the VARIABLE COLLECTOR SUPPLY control until a trace appears diagonally across the CRT.

17. Turn the VERTICAL switch clockwise and note that as the vertical deflection factor decreases the slope of the line increases (see Fig. 2-6). Turn the VERTICAL switch counterclockwise from the 1 mA position and note that the slope decreases. Also note that the PER VERT DIV readout changes in accordance with the position of the VERTICAL switch. Reset the VERTICAL switch to 1 mA.

18. Repeat step 17 using the HORIZONTAL switch within the COLLECTOR range of the switch. The change in slope of the trace will be the inverse of what it was for the VERTICAL switch. Reset the HORIZONTAL switch to 1 V COLLECTOR.

19. Press the ZERO button. Note that the diagonal trace reduces to a spot in the lower left corner of the CRT graticule. This spot denotes the point of zero deflection of the vertical and horizontal amplifiers. Release the ZERO button.

20. Press the CAL button. Note that the diagonal trace reduces to a spot in the upper right corner of the CRT graticule. The position of this spot indicates 10 divisions of deflection both vertically and horizontally. Release the CAL button.

21. Press the DISPLAY INVERT button and turn the VARIABLE COLLECTOR SUPPLY control counterclockwise. Note that the display has been inverted and is now originating from the upper right corner of the CRT graticule. Release the DISPLAY INVERT button.

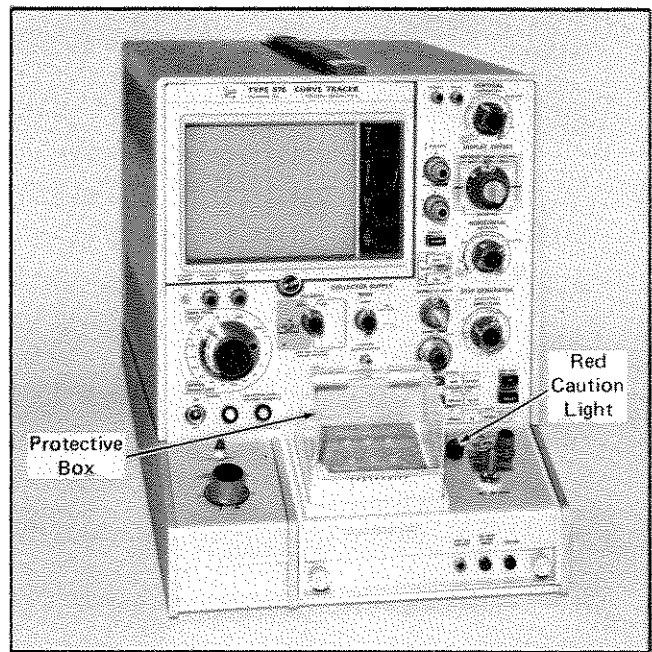

Fig. 2-7. Type 576 Standard Test Fixture with protective box installed for safe operation.

Collector Supply

22. Turn the MAX PEAK VOLTS switch throughout its range. Note that when the switch is in the 75, 350 and 1500 positions, the yellow light comes on.

23. While the yellow light is on, turn the VARIABLE COLLECTOR SUPPLY control fully clockwise. Note that the diagonal line obtained in step 16 does not appear. When the yellow light is on, the Collector Supply is disabled.

24. Set the following Type 576 controls:

MAX PEAK VOLTS	75
VARIABLE COLLECTOR SUPPLY	Fully counterclockwise
LEFT-OFF-RIGHT	OFF

25. Install the protective box on the Standard Test Fixture as shown in Fig. 2-7.

26. Close the lid of the protective box and note that the yellow light turns off and the red light turns on.

WARNING

The red light indicates that dangerous voltages may appear at the collector terminals of the Standard Test Fixture.

27. Set the LEFT-OFF-RIGHT switch to RIGHT and turn the VARIABLE COLLECTOR SUPPLY control clockwise. Note that the diagonal trace appears indicating that the Collector Supply has been enabled.

28. Set the following Type 576 controls to:

MAX PEAK VOLTS	15
VARIABLE COLLECTOR SUPPLY	Fully Counterclockwise

(The protective box may be removed if desired.)

29. Turn the VARIABLE COLLECTOR SUPPLY control until the diagonal trace reaches the center of the CRT graticule. Pull out on the PEAK POWER WATTS switch and set it to 220. Note that the diagonal trace lengthens as the switch is turned through its range. Also note that the SERIES RESISTORS decrease as the maximum peak power is increased.

30. Allow the MAX PEAK VOLTS switch and the PEAK POWER WATTS switch to become interlocked and switch to 75. Note that the maximum peak power value remains at 220 and that the SERIES RESISTORS values change.

31. Set the following Type 576 controls to:

HORIZONTAL	.1 V COLLECTOR
MAX PEAK VOLTS	15
VARIABLE COLLECTOR SUPPLY	Fully Counterclockwise
PEAK POWER WATTS	0.1
LEFT-OFF-RIGHT	OFF

32. Remove the resistor from the diode adapter and replace it with a silicon diode. Align the diode so that its cathode is connected to the emitter terminal.

33. Set the LEFT-OFF-RIGHT switch to RIGHT and turn the VARIABLE COLLECTOR SUPPLY control clockwise. Note the display of the forward voltage characteristic of the diode. (see Fig. 2-8).

34. Set the COLLECTOR SUPPLY POLARITY switch to -(PNP). Note the display of the reverse voltage characteristic of the diode (see Fig. 2-8).

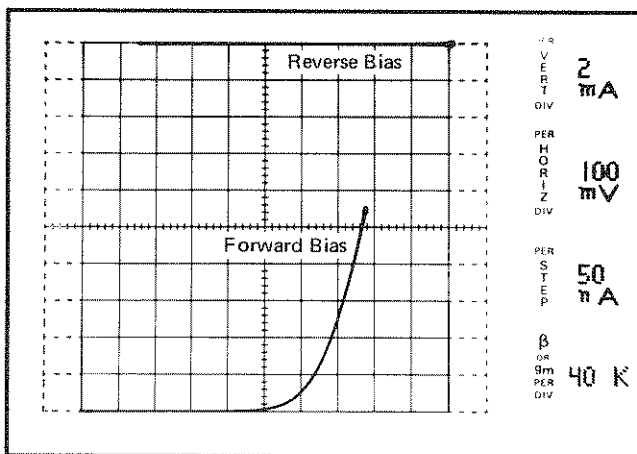

Fig. 2-8. Display of forward and reverse bias characteristics of a signal diode.

35. Set the following Type 576 controls to:

POLARITY	+ (NPN)
MODE	DC

Note that the display of the forward voltage diode characteristic has become a spot. The spot indicates the current conducted by the diode and the voltage across it.

36. Turn the VARIABLE COLLECTOR SUPPLY control counterclockwise. Note that the spot traces out the diode characteristic.

37. Set the following Type 576 controls to:

VERTICAL	1 μ A
HORIZONTAL	2 V COLLECTOR
Vertical POSITION	Display Centered
VARIABLE COLLECTOR SUPPLY	Fully Clockwise
MODE	NORM
LEFT-OFF-RIGHT	LEFT

38. Adjust the LOOPING COMPENSATION control for minimum trace width (see Fig. 2-9).

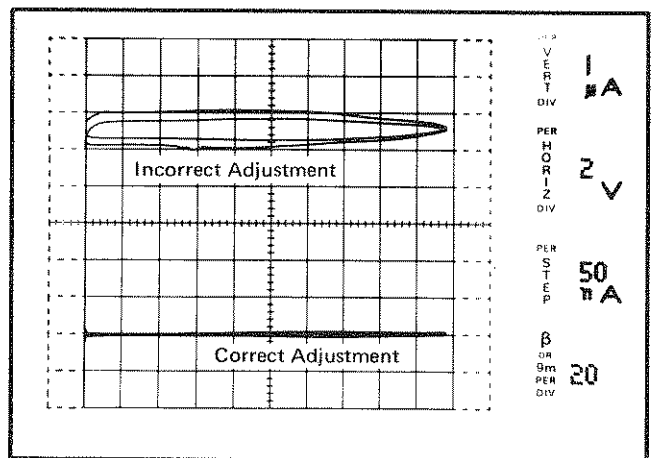

Fig. 2-9. Adjustment of LOOPING COMPENSATION control.

39. Set the following Type 576 controls to:

VERTICAL	5 mA
Vertical POSITION	Switch centered
VARIABLE COLLECTOR SUPPLY	Fully Counterclockwise
POLARITY	AC
LEFT-OFF-RIGHT	OFF

Operating Instructions—Type 576

40. Remove the diode from the diode adapter and replace it with an 8 volt Zener diode. Align the diode so that its cathode is connected to the emitter terminal.

41. Set the LEFT-OFF-RIGHT switch to RIGHT and turn the VARIABLE COLLECTOR SUPPLY control clockwise. Note that the display shows both the forward and reverse characteristics of the Zener diode (see Fig. 2-10).

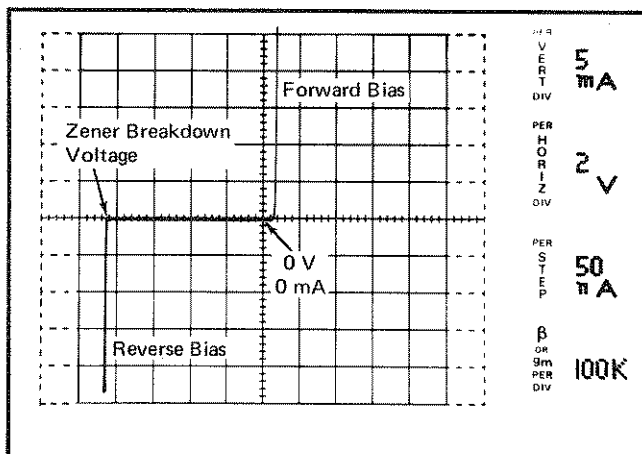

Fig. 2-10. Display of Zener diode I vs. V characteristic with POLARITY switch set to AC.

Display Offset and Magnifier

42. Set the Type 576 POLARITY switch to $-$ (PNP). Note the display of the reverse voltage characteristic of the Zener diode.

Note the display of the reverse voltage characteristic of the Zener diode.

43. Position the display to the center of the CRT graticule with the vertical POSITION switch (see Fig. 2-11A).

44. Set the DISPLAY OFFSET Selector switch to HORIZ X10. Press the ZERO button and, using the horizontal FINE POSITION control, adjust the spot so that it is on the center vertical line of the CRT graticule. This spot position represents the zero offset position. Release the ZERO button and set the DISPLAY OFFSET Selector switch to HORIZ X1.

45. Turn the CENTERLINE VALUE switch from the 0 position counterclockwise, until the Zener breakdown portion of the display is within ± 0.5 divisions of the center vertical line (see Fig. 2-11B). Note the number on the CENTERLINE VALUE switch which appears in the blue window below the word DIV. This number multiplied by the PER HORIZ DIV readout value gives the approximate value of the breakdown voltage of this Zener diode. For the diode in the example shown in Fig. 2-11, the approximate Zener breakdown voltage is 4 divisions times 2 V/division = 8 volts.

46. Set the DISPLAY OFFSET Selector switch to

HORIZ X10. Note that PER HORIZ DIV readout value has changed to indicate the 10 times multiplication. By expanding the scale, a measurement can be made of that part of the characteristic which was not quite offset to the center vertical line of the CRT graticule (see Fig. 2-11C). This value when added to the approximate value (or subtracted

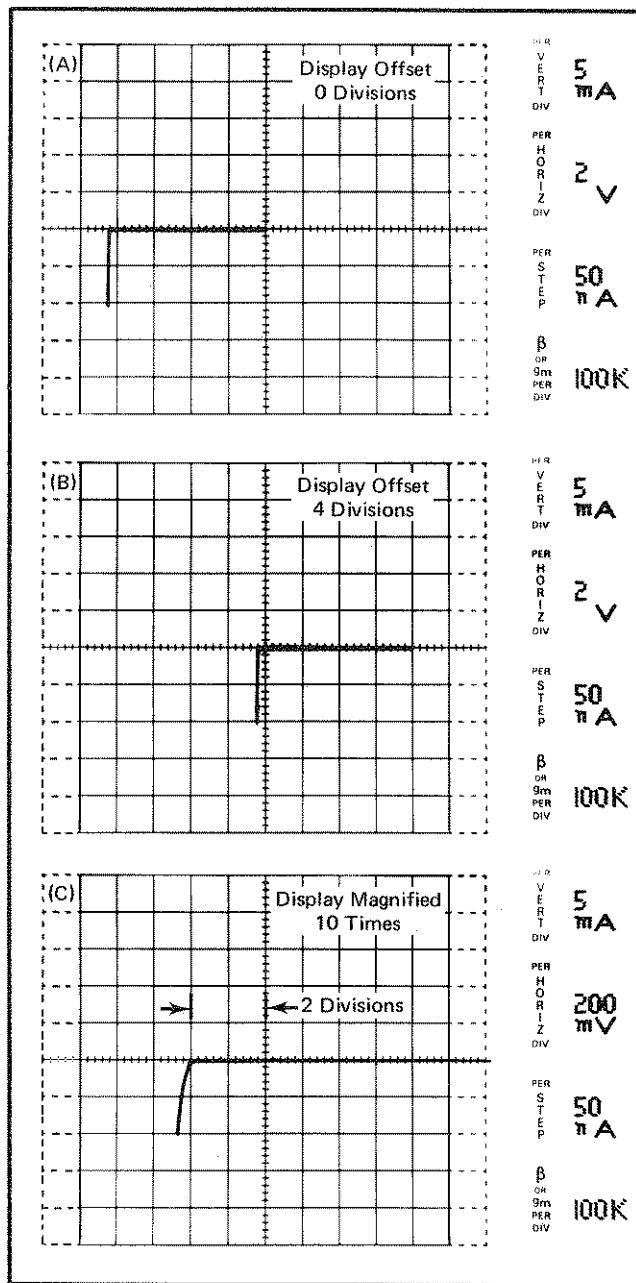

Fig. 2-11. Displays of measurement of Zener breakdown voltage using the DISPLAY OFFSET Selector and CENTERLINE VALUE switches. (A) DISPLAY OFFSET Selector switch set to HORIZ X1 and CENTERLINE VALUE switch set to 0; (B) CENTERLINE VALUE switch set to 4; (C) DISPLAY OFFSET Selector switch set to HORIZ X10.

if the approximate value was greater than the actual value) produces a more exact measurement of the breakdown voltage. In the example shown in Fig. 2-11, 400 mV should be

added to the approximate estimate, yielding a value of 8.4 for the Zener voltage of the diode. The same process can also be carried out using vertical display offset and magnification.

Step Generator

47. Set the following Type 576 controls to:
- | | |
|---------------------------|------------------------|
| DISPLAY OFFSET Selector | NORM (OFF) |
| CENTERLINE VALUE | 0 |
| HORIZONTAL | 1 V COLLECTOR |
| Vertical POSITION | Switch centered |
| POLARITY | +(NPN) |
| VARIABLE COLLECTOR SUPPLY | Fully Counterclockwise |
| LEFT-OFF-RIGHT | OFF |

48. Remove the diode adapter and replace it with a transistor adapter (Tektronix Part No. 013-0098-02).

49. Place an NPN silicon transistor into the right transistor test socket of the universal transistor adapter.

50. Set the LEFT-OFF-RIGHT switch to RIGHT and turn the VARIABLE COLLECTOR SUPPLY clockwise until the peak collector-emitter voltage is about 10 volts.

51. Turn the AMPLITUDE switch until a step appears on the CRT. Note that the greater the step amplitude, the greater the collector current (see Fig. 2-12). Set the AMPLITUDE for the minimum step amplitude which produces a noticeable step in the display.

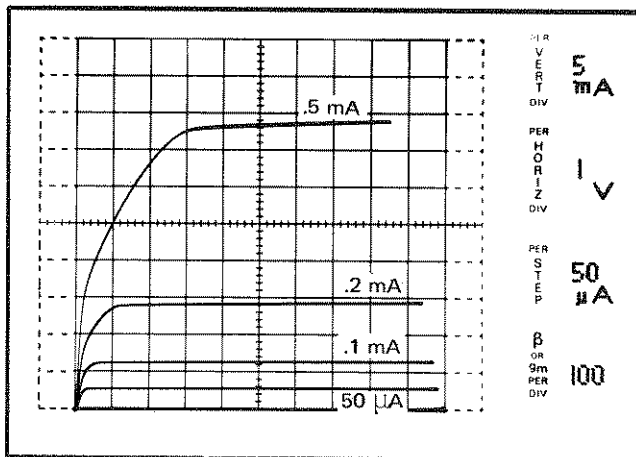

Fig. 2-12. Collector current vs. Collector-Emitter voltage for various settings of the AMPLITUDE switch.

52. Turn the NUMBER OF STEPS switch clockwise. Be sure the PEAK POWER WATTS switch is set within the power dissipation rating of the transistor being used. Note the display of collector current vs. collector-emitter voltage for ten different values of base current (see Fig. 2-13A).

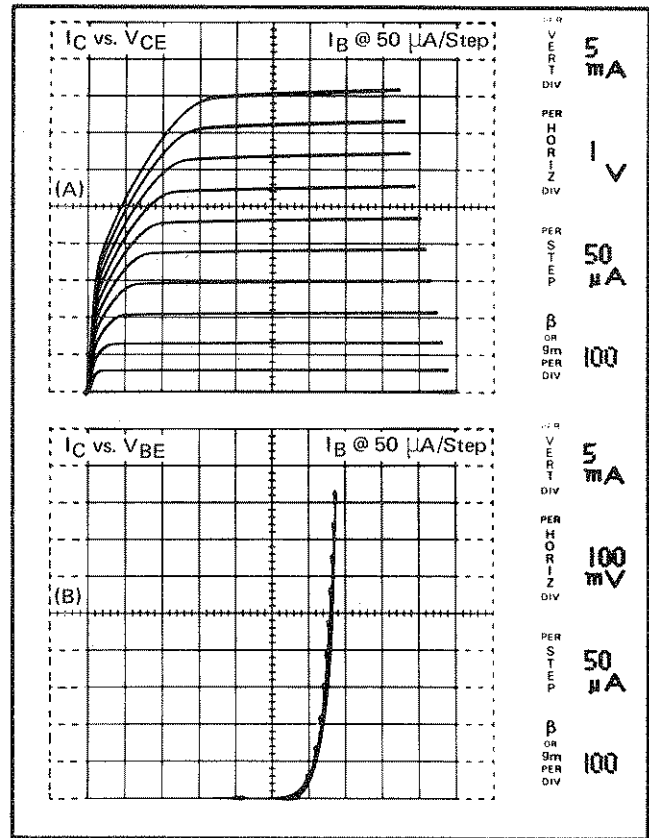

Fig. 2-13. (A) I_C vs. V_{CE} for 10 steps of base current at $50 \mu A$ per step; (B) I_C vs. V_{BE} for 10 steps of base current at $50 \mu A$ per step.

53. Set the HORIZONTAL switch to .1 V BASE. Note the display of the collector current vs. base-emitter voltage for ten different values of base current (see Fig. 2-13B).

54. Set the VERTICAL switch to STEP GEN and the HORIZONTAL switch to 1 V COLLECTOR. Note the display of the base current, one step per vertical division, vs. the collector-emitter voltage (see Fig. 2-14A).

55. Set the HORIZONTAL switch to .1 V Base. Note the display of base current, one step per vertical division, vs. base-emitter voltage (see Fig. 2-14B).

56. Set the VERTICAL switch to 5 mA and the HORIZONTAL switch to STEP GEN. Note the display of collector current vs. base-current, one step per horizontal division (see Fig. 2-15).

57. Set the following Type 576 controls to:

- | | |
|------------|---------------|
| HORIZONTAL | 1 V COLLECTOR |
| RATE | .5X |

Note that the step rate is slower than the normal rate.

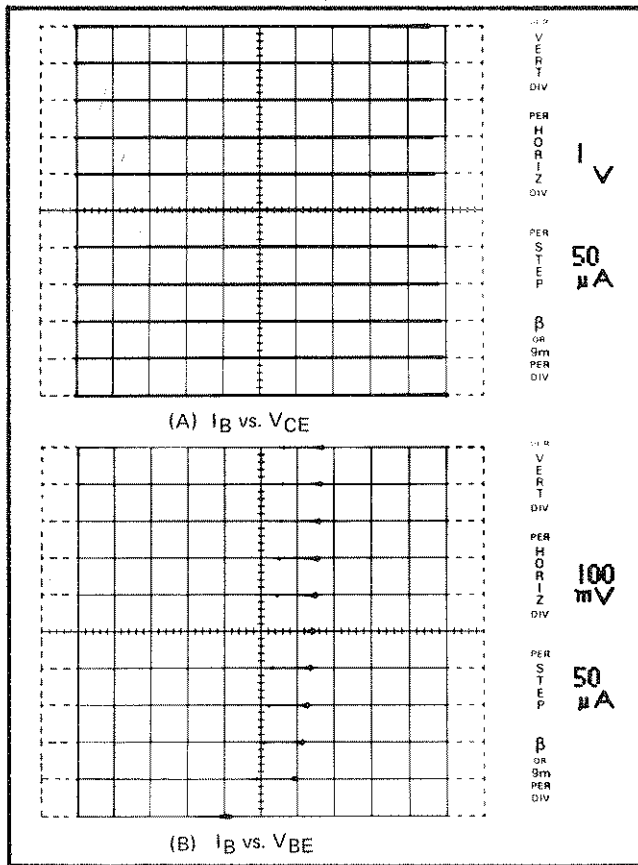

Fig. 2-14. (A) I_B vs. V_{CE} , I_b @ $50 \mu A$ per division; (B) I_B vs. V_{BE} , I_b @ $50 \mu A$ per division.

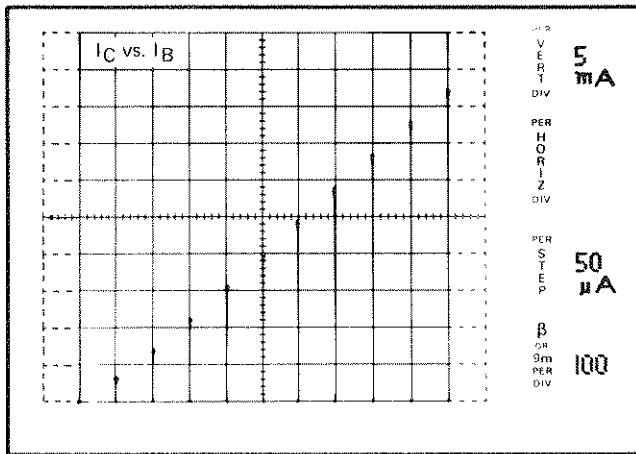

Fig. 2-15. I_C vs. I_B , I_b @ $50 \mu A$ per division.

58. Press the NORM RATE button and then the 2X RATE button. Note that the step rate is faster than the normal rate.

59. Press both the 2X RATE and .5X RATE buttons. Note that the step rate is normal, but that the steps occur

at the peak of each collector sweep, rather than at the beginning of each collector sweep, as when the NORM RATE button is pushed.

60. Press the SINGLE STEP FAMILY button. Press it again. Note that each time the SINGLE button is pressed, a single family of characteristic curves is displayed and then the Step Generator turns off.

61. Set the following Type 576 controls to:

STEP FAMILY REP ON

RATE NORM

PULSED STEPS 300 μs

Note that the collector supply is in the DC mode and that each step is in the form of a pulse. (See Fig. 2-16A.) (Readjustment of the INTENSITY control may be necessary.)

62. Press the 80 μs button. Note that the duration of each pulsed step is reduced.

63. Press both the 300 μs and the 80 μs buttons. Note that the Collector Supply is in the normal mode and the steps are occurring at the peak of the collector sweep, with a duration as observed in step 61 (see Fig. 2-16B).

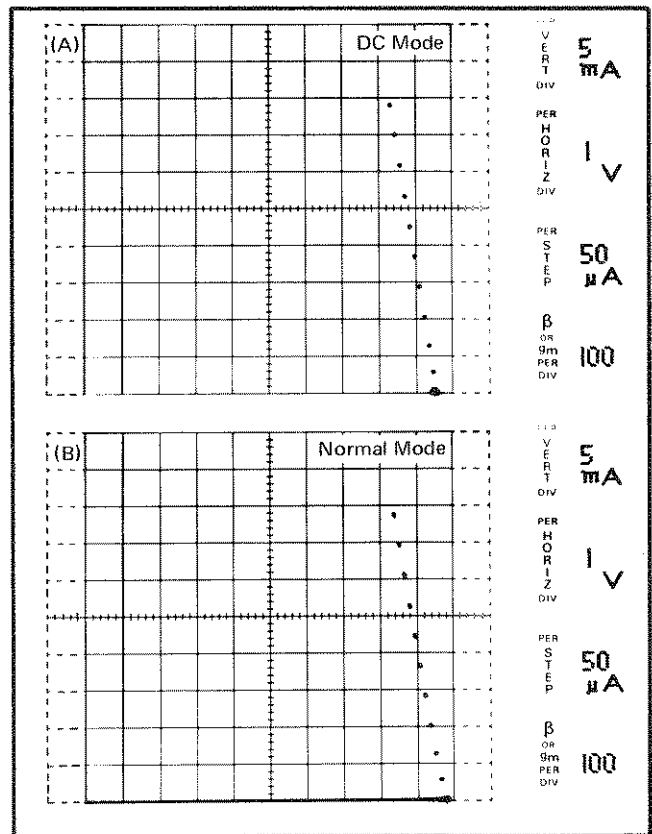

Fig. 2-16. 300 μs PULSED STEPS, (A) DC mode; (B) Normal mode.

64. Set the Type 576 LEFT-OFF-RIGHT switch to OFF and remove the universal transistor adapter from the Standard Test Fixture. (Leave the transistor in the adapter). Install the universal FET adapter (Tektronix Part No. 013-0099-02) on the Standard Test Fixture and place an N-channel junction FET into the right test socket of the adapter.

65. Set the following Type 576 controls to:

INTENSITY	Visible Display
VERTICAL	.5 mA
VARIABLE COLLECTOR SUPPLY	Fully Counterclockwise
AMPLITUDE	.1 V
STEPS	Pressed

66. Set the LEFT-OFF-RIGHT switch to RIGHT and turn the VARIABLE COLLECTOR SUPPLY control slowly clockwise. Note the display of drain current vs. drain-source voltage with voltage steps of 0.1 V/step

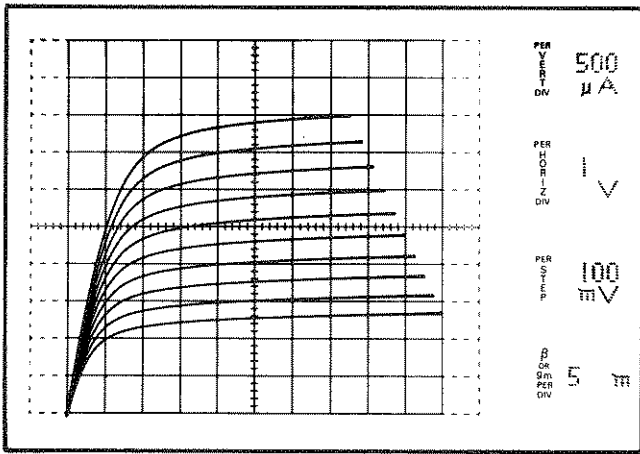

Fig. 2-17. Display of FET common-source characteristic curves: I_D vs. V_{DS} for 10 steps of gate voltage at 0.05 volts/step.

applied to the gate (see Fig. 2-17). Since the steps applied to the gate are positive-going, the curves displayed represent enhancement mode operation of the FET. (Press the SINGLE STEP FAMILY button to locate the curve obtained with zero volts on the gate.)

67. Press the POLARITY INVERT button and note the display of the depletion mode of operation of the FET (see Fig. 2-17). (Press SINGLE STEP FAMILY button for zero bias curve.)

68. Set the Type 576 LEFT-OFF-RIGHT switch to OFF. Remove the universal FET test adapter and replace it with the universal transistor test adapter (with the transistor still in it.)

69. Set the following Type 576 controls to:

VERTICAL	5 mA
AMPLITUDE	Current Steps
NUMBER OF STEPS	5
POLARITY INVERT	Released

Set the AMPLITUDE switch and the VARIABLE COLLECTOR SUPPLY control for a family of curves similar to Fig. 2-18A.

70. Note the β or g_m per division readout. By measuring the vertical divisions between two curves of the displayed family, the β of the device in that region can be determined. For example, there is approximately 0.9 division between the fourth and fifth steps shown in Fig. 2-18A. The β of the device when operated in this region is, therefore, approximately 0.9 (100) or (90). To make a more accurate measurement of β , the difference in both collector and base current between the fourth and fifth steps should be less.

71. Press the OFFSET AID button and set the OFFSET MULT control to 4. Note that the offset current has been added to the Step Generator output so that the zero step is now at the level of the fourth step displayed.

72. Press the STEP MULT .1X button. Note that the current per step is now 1/10 of the value set by the AMPLITUDE switch. Check the PER STEP readout for the new amplitude per step. (See Fig. 2-18B.)

73. Set the DISPLAY OFFSET Selector switch to VERT X1 and turn the CENTERLINE VALUE switch counterclockwise until the first step is within ± 0.5 division of the center horizontal line.

74. Set the DISPLAY OFFSET Selector switch to VERT X10. Note that though the β per division is still 100 as it was in step 70, the change in collector and base current (ΔI_C and ΔI_B) is less between the fourth and the fifth step. This allows for a more accurate measurement of β at the level of the fourth step (see Fig. 2-18C). The β of the device at the fourth step now measures at about 0.8 (100) = 80

75. Set the following Type 576 controls to:

VERTICAL	1 mA
DISPLAY OFFSET Selector	NORM (OFF)
AMPLITUDE	.1 V
NUMBER OF STEPS	1
OFFSET MULT	0
STEP MULT	Released

76. Turn the OFFSET MULT control until a step just begins to appear on the CRT. Note the multiplier value on the OFFSET MULT control. This number times the AMPLITUDE switch setting is the base-to-emitter turn on voltage of the transistor.

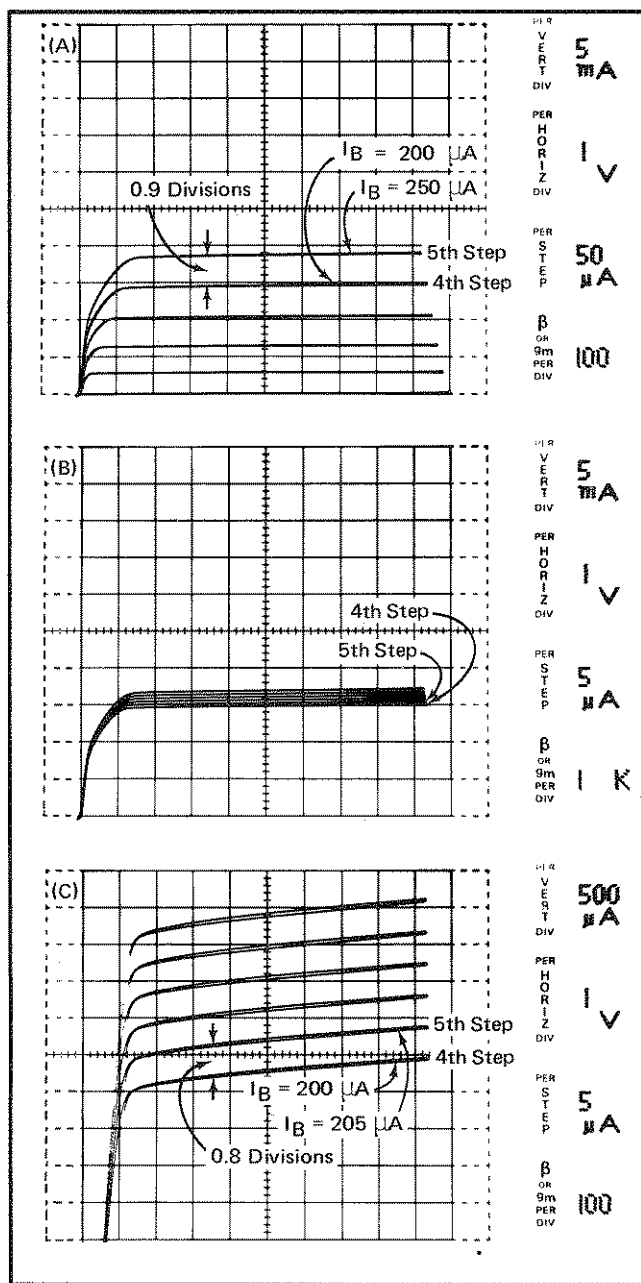

Fig. 2-18. Measurement of β of transistor, (A) Coarse measurement; (B) Offsetting of display and .1X multiplication of step amplitude; (C) 10X magnification of vertical display.

Standard Test Fixture

77. Set the following Type 576 controls to:

AMPLITUDE	1 μA
OFFSET	ZERO
NUMBER OF STEPS	10

78. Adjust the AMPLITUDE switch for a display of the characteristic curves with the emitter grounded and the current steps applied to the base (see Fig. 2-19A).

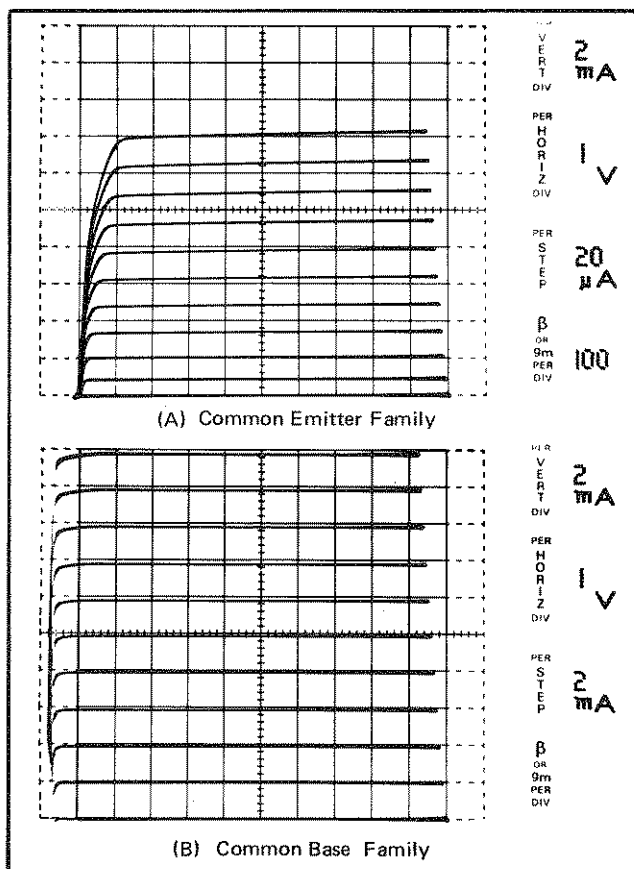

Fig. 2-19. (A) Terminal Selector switch set to BASE TERM STEP GEN (NORM); (B) Terminal Selector switch set to EMITTER TERM STEP GEN.

79. Set the LEFT-OFF-RIGHT switch to OFF and the STEP FAMILY button to OFF. Take a patch cord with banana plugs on each end and connect it between the STEP GEN OUTPUT connector and the EXT BASE OR EMIT INPUT connector.

80. Set the following Type 576 controls to:

STEP FAMILY	ON
LEFT-OFF-RIGHT	RIGHT
Terminal Selector	BASE TERM OPEN (OR EXT)

Note a display similar to that seen in step 78.

81. Set the following Type 576 controls to:

VERTICAL	1 nA EMITTER
MODE	LEAKAGE
VARIABLE COLLECTOR SUPPLY	Fully Counterclockwise
STEP FAMILY	OFF

Remove the patch cord.

82. Turn the VARIABLE COLLECTOR SUPPLY control clockwise and note the display of emitter leakage current with the base terminal open.

83. Set the Terminal Selector switch to SHORT and note the display of emitter leakage current with the base terminal shorted to ground.

84. Set the following Type 576 controls to:

VERTICAL	5 mA
AMPLITUDE	5 mA
MODE	NORM
Terminal Selector	EMITTER TERM STEP GEN
STEP FAMILY	ON

Turn the VARIABLE COLLECTOR SUPPLY control clockwise and note the display of collector current vs. collector-emitter voltage with current steps applied to the emitter of the transistor (see Fig. 2-19B).

85. Set the following Type 576 controls to:

STEP FAMILY	OFF
Terminal Selector	EMITTER TERM OPEN (OR EXT)

Reconnect the patch cord between the STEP GEN OUTPUT connector and the EXT BASE OR EMIT INPUT connector.

86. Set the STEP FAMILY button to ON and note a display similar to that seen in step 84.

This completes the first-time operation.

GENERAL OPERATING INFORMATION

CRT

The CRT in the Type 576 has a permanently etched internal graticule. The graticule is 10 divisions by 12 divisions, each division being 1 cm. Illumination of the graticule is controlled by the GRATICULE ILLUM control. Protective shields for the CRT and the fiber-optic readout display are fitted to the bezel. The bezel covers the CRT and the fiber-optic readout display. To remove, loosen the securing screw and pull out on the bottom of the bezel.

A blue filter has been provided to improve the contrast of the display when the ambient light is intense. This filter may be installed (or removed) by removing the bezel and sliding the filter from between the CRT protective shield and the bezel frame.

Readout

The readout located to the right of the CRT is made up of the fiber-optic displays and their titles. The fiber-optic displays show numbers and units (5 mA, 2 V, etc.) the

values of which are a function of front-panel control settings. The titles are words printed on the fiber-optic display shield attached to the bezel. These words indicate the characteristics of the CRT display to which each fiber-optic display is related (PER VERT DIV, PER STEP, etc.). Illumination of the titles and the fiber-optic displays is controlled by the READOUT ILLUM control. It should be noted that as the illumination of the readout is reduced, the fiber-optic display of β or g_m per division turns off before the other fiber-optic displays.

Intensity

The intensity of the display on the CRT is controlled by the INTENSITY control. This control should be adjusted so that the display is easily visible but not overly bright. It will probably require readjustment for different displays. Particular care should be exercised when a spot is being displayed. A high intensity spot may burn the CRT phosphor causing permanent damage to the CRT.

Focus

The focus of the CRT display is controlled by the FOCUS control. This control should be adjusted for optimum display definition.

Positioning

The position of the display on the CRT graticule, both vertically and horizontally, is controlled by four sets of controls: the vertical and horizontal POSITION controls, the POLARITY switch, the DISPLAY OFFSET controls and the DISPLAY INVERT, ZERO and CAL buttons.

The position controls provide coarse and fine positioning of the display both vertically and horizontally. Each coarse POSITION switch provides 5-division increments of display positioning. Each FINE POSITION control has a continuous range of greater than 5 divisions. The position controls should not be used to position the zero reference off the CRT. The DISPLAY OFFSET controls may be used for this purpose. If the display is magnified either vertically or horizontally using the DISPLAY OFFSET Selector switch, the ranges of the position controls are increased 10 times.

The POLARITY switch positions the zero signal point of a display (located by pressing the ZERO button) to a position convenient for making measurements on an NPN device, a PNP device or when making an AC measurement.

The DISPLAY OFFSET controls provide calibrated offset (or positioning) of the display either vertically or horizontally. These controls may be used either to make a measurement or to position particular portions of a display, which has been magnified, on the CRT graticule. The DISPLAY OFFSET Selector switch determines whether the display will be offset vertically or horizontally and the CENTERLINE VALUE switch provides the offset. Under unmagnified conditions, 10 divisions of offset are available. When the DISPLAY OFFSET Selector switch is set to one of its MAGNIFIER positions, 100 divisions of offset are available.

When making a measurement using the DISPLAY OFFSET controls, the CRT graticule becomes a window. When the CENTERLINE VALUE switch is set to 0, the vertical centerline (horizontal offset) or the horizontal centerline (vertical offset) of the window is at the zero signal portion of the display. As the CENTERLINE VALUE switch is turned counterclockwise, the window moves either vertically or horizontally along the display. For each position of the CENTERLINE VALUE switch, the number on the switch appearing in the blue window represents the number of divisions the vertical centerline or the horizontal centerline has been offset from the zero offset line. If the display has been magnified, the number in the blue window must be multiplied by 10.

The ZERO button provides a convenient means of positioning the zero reference point on the CRT graticule. Under normal operating conditions (DISPLAY OFFSET Selector switch set to NORM) when the ZERO button is pressed, a zero reference spot appears on the CRT graticule. This spot indicates the point on the CRT where zero signal is being measured by the vertical and horizontal display amplifiers. With the button pressed, the positioning controls may be used to position the spot to a point on the CRT graticule which makes measurements convenient. If the DISPLAY OFFSET Selector switch is set to VERT or HORIZ, the zero reference point indicates the horizontal or vertical graticule line, respectively, to which the CENTERLINE VALUE switch setting applies. To assure the accuracy of the CENTERLINE VALUE switch settings, the zero reference spot should be adjusted (using the positioning controls) to the appropriate centerline for the offset being used. For maximum accuracy of measurement, the position of this zero reference point should be adjusted with the DISPLAY OFFSET Selector switch in one of its MAGNIFIER positions.

The CAL button provides a means of checking the calibration of the display amplifiers. Under normal operating conditions (DISPLAY OFFSET Selector switch set to NORM) when the CAL button is pressed, a calibration reference spot appears on the CRT. This spot represents a signal applied to both the vertical and the horizontal display amplifiers which should cause 10 divisions deflection on the CRT graticule both vertically and horizontally. If the position of this spot is compared with the position of the spot obtained when the ZERO button is pressed, the accuracy of calibration of the display amplifiers can be determined. When the DISPLAY OFFSET Selector switch is set to either VERT or HORIZ, the calibration reference spot should appear on the vertical centerline (horizontal offset) or the horizontal centerline (vertical offset), assuming the zero reference point is properly adjusted. This calibration check should be made with the DISPLAY OFFSET Selector switch in either HORIZ X10 or VERT X10. Any departure of the calibration reference spot from the centerline, when this check is made, represents an error of 1% per division in the display offset.

The DISPLAY INVERT button provides a means of inverting the display on the CRT. When the DISPLAY INVERT button is pushed, the inputs to the display amplifiers are reversed, causing the display on the CRT to be inverted both vertically and horizontally about the center of the graticule.

If the position controls are centered, the zero and calibration reference spots should appear in particular positions on the graticule depending on the positions of the POLARITY switch and the DISPLAY OFFSET Selector switch. Fig. 2-20 shows these positions of the spot for the various settings of the two switches. To determine the spot positions when the INVERT button is pressed, assume the graticule shown is inverted both vertically and horizontally.

Vertical Measurement and Deflection Factor

In the vertical dimension, the display on the CRT measures either collector current (I_C), emitter current (I_E) or the output of the Step Generator. The MODE switch and the VERTICAL switch determine which of these measurements are made.

The Vertical deflection factor of the display on the CRT is controlled by the VERTICAL switch, the DISPLAY OFFSET Selector switch and the MODE switch. The PER VERT DIV readout to the right of the CRT indicates the vertical deflection factor due to the combined effects of these three controls.

Under normal operating conditions, with the MODE switch set to NORM and the DISPLAY OFFSET Selector switch set to NORM (OFF), collector current is measured vertically and the VERTICAL switch determines the vertical sensitivity of the display.

When measuring collector current, the VERTICAL switch provides deflection factors (unmagnified) ranging from 1 $\mu\text{A}/\text{division}$ to 2 $\text{A}/\text{division}$. The vertical deflection factor is indicated either by the PER VERT DIV readout or by the position of the VERTICAL switch, using the letters printed in black to determine units. The readout and the switch position should coincide.

When the MODE switch is set to LEAKAGE (EMITTER CURRENT) the CRT display measures emitter current vertically. In this case the vertical sensitivity of the display is increased by 1000 times for each position of the VERTICAL switch. The vertical deflection factor is indicated either by the PER VERT DIV readout or by the position of the VERTICAL switch, using the letters printed in orange to determine units. When the MODE switch is set to LEAKAGE the output of the Collector Supply is DC voltage, like that obtained when the MODE switch is set to DC (ANTI LOOP), rather than a voltage sweep. Also in the leakage mode a slight error (up to 1.25 V) is added to the horizontal display. The following Horizontal Measurement and Deflection Factor section shows how to determine the degree of this error.

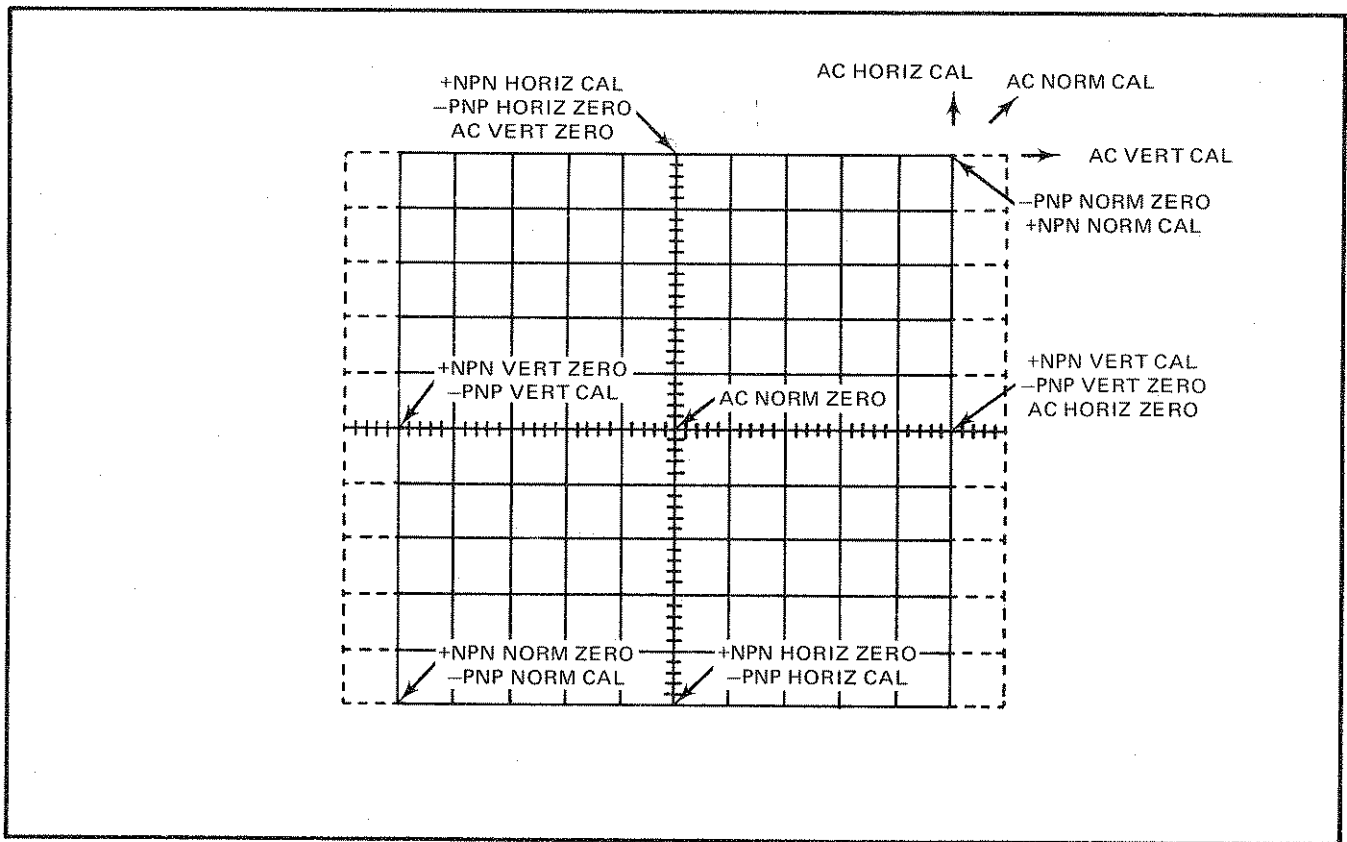

Fig. 2-20. Positions of spot on CRT graticule when ZERO or CAL buttons are pressed, for various positions of the POLARITY switch and the DISPLAY OFFSET Selection switch, assuming the position controls are centered.

In the leakage mode of operation, the current sensing resistor is between the emitter and ground. Assuming a constant collector supply output voltage, therefore, emitter current will change whenever the current sensing resistor is changed. The current sensing resistor is changed every decade on the VERTICAL switch. The resulting change in emitter is most evident when the VERTICAL switch is switched between its 5 nA and 10 nA positions or its 50 nA and 100 nA positions.

When the VERTICAL switch is set to STEP GEN, steps indicating the Step Generator output are displayed vertically. The vertical display shows one step per division and the amplitude of each step, as shown by the PER STEP readout, determines the vertical deflection factor. It should be noted that if the HORIZONTAL switch is set to STEP GEN, the Step Generator output signal is not available for display vertically. In this case, setting the VERTICAL switch to STEP GEN causes zero vertical signal to be displayed.

The vertical sensitivity can be increased by 10 times for any of the previously mentioned measurements by setting the DISPLAY OFFSET Selector switch to VERT X10. The magnified vertical deflection factor can be determined either from the PER VERT DIV readout¹ or by dividing the setting of the VERTICAL switch by 10.

¹The PER VERT DIV readout does not indicate deflection factors less than 1 nA/division.

Horizontal Measurement and Deflection Factor

In the horizontal dimension, the display on the CRT measures either collector to emitter voltage (V_{CE}), collector to base voltage (V_{CB}), base to emitter voltage (V_{BE}), emitter to base voltage (V_{EB}) or the Step Generator output. The HORIZONTAL switch, the Terminal Selector switch and the parameter being measured vertically determine what is measured horizontally.

The horizontal deflection factor of the display on the CRT is controlled by the HORIZONTAL switch and the DISPLAY OFFSET Selector switch. The PER HORIZ DIV readout to the right of the CRT indicates the horizontal deflection factor due to the combined effects of these two controls.

Under normal operating conditions with collector current being measured vertically, the Terminal Selector switch set to EMITTER GROUNDED and the DISPLAY OFFSET Selector switch set to NORM (OFF), the display will measure V_{CE} or V_{BE} horizontally. To measure V_{CE} , the HORIZONTAL switch must be set within the COLLECTOR range which has deflection factors between 50 mV/division and 200 V/division. To measure V_{BE} , the HORIZONTAL switch must be set within BASE range which has deflection factors between 50 mV/division and 2 V/division. In both cases, the horizontal deflection factors are indicated by both the PER HORIZ DIV readout and the position of the HORIZONTAL switch. The two values should coincide.

Operating Instructions—Type 576

When the Terminal Selector switch is set to BASE GROUNDED the horizontal display measures collector to base voltage (V_{CB}) with the HORIZONTAL switch in the COLLECTOR range, or emitter to base voltage (V_{EB}) with the HORIZONTAL switch in the BASE range. It should be noted that V_{EB} in this case does not indicate a measurement of the emitter-base voltage under a reverse biased condition. It is a measurement of the forward biased base-emitter voltage with the horizontal sensing leads reversed.

When emitter current is being measured by the vertical display, the only significant measurements made by the horizontal display are V_{CE} and V_{CB} . To make these measurements, the HORIZONTAL switch is set within the COLLECTOR range and the Terminal Selector switch is set to EMITTER GROUNDED or BASE GROUNDED.

With the VERTICAL switch set between 500 nA/division and 1 nA/division, an error occurs in the horizontal measurement. Table 2-3 indicates the degree of this error in voltage per division of vertical deflection for all the settings of the VERTICAL switch within this given range. Using this table and the following procedure, the actual V_{CE} or V_{CB} can be calculated.

TABLE 2-3

**Error in Horizontal Voltage Measurement
Per Division of Vertical Deflection**

VERTICAL Switch Setting ¹	Voltage Error Per Vertical Division
500 nA, 50 nA, 5 nA	125 mV
200 nA, 20 nA, 2 nA	50 mV
100 nA, 10 nA, 1 nA	25 mV

¹EMITTER current, DISPLAY OFFSET Selector switch set to NORM (OFF).

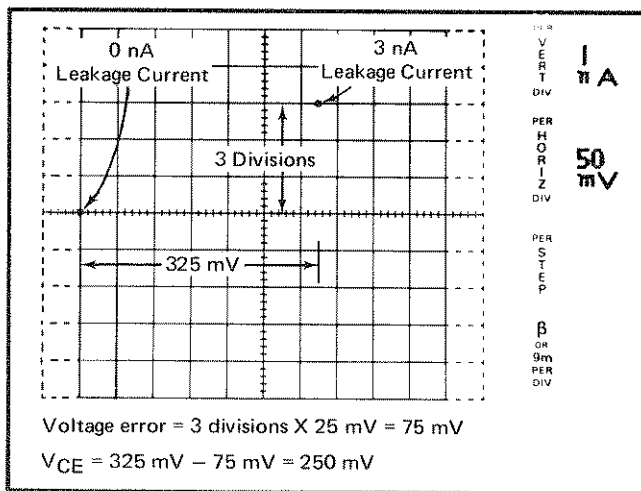

Fig. 2-21. Sample calculation of error in collector to emitter voltage incurred when measuring leakage of a transistor.

1. Measure the vertical deflection of the display in divisions (see Fig. 2-21).

2. Measure the horizontal deflection of the display in volts.

3. Using Table 2-3, find the error factor for the setting of the VERTICAL switch and multiply it by the value determined in step 1.

4. Subtract the voltage determined in step 3 from the voltage determined in step 2 to give the actual V_{CE} or V_{CB} .

When the HORIZONTAL switch is set to STEP GEN, steps indicating the Step Generator output are displayed horizontally. The horizontal display shows one step per division and the amplitude of each step, as shown by the PER STEP readout determines the horizontal deflection factor.

The horizontal deflection factor can be increased by 10 times for any of the previously mentioned measurements by setting the DISPLAY OFFSET Selector switch to HORIZ X10². The magnified horizontal deflection can be determined either from the PER HORIZ DIV readout or by dividing the setting of the HORIZONTAL switch by 10.

Measurements

Table 2-4 shows the measurements which are being made vertically and horizontally by the display for the various positions of the VERTICAL switch, the HORIZONTAL switch and the Terminal Selector switch. Those switch position combinations not covered by the table are not considered useful.

Display Offset and Magnifier

The DISPLAY OFFSET Selector switch and the CENTERLINE VALUE switch provides a calibrated display offset of from 0 to 10 divisions (0 to 100 divisions when the display is magnified) and a 10 times display magnifier. The display offset and the display magnifier, when in operation, effect the display either vertically or horizontally, but never the whole display. Use of the calibrate display offset is discussed in the Positioning section. Use of the magnifier is discussed in both the Vertical and Horizontal Measurement and Deflection Factor sections.

Collector Supply

The Collector Supply provides operating voltage for the device under test. It is a variable voltage in the form of either a sine wave, or a full-wave rectified sine wave (see Fig. 2-22). This voltage is applied to the collector terminals of the Standard Test Fixture.

The MAX PEAK VOLTS switch and the VARIABLE COLLECTOR SUPPLY control determine the peak voltage output of the Collector Supply, which may be varied from 0 volts to 1500 volts. The MAX PEAK VOLTS switch provides four peak voltage ranges: 15 volts, 75 volts, 350 volts and 1500 volts. The VARIABLE COLLECTOR SUPPLY

²The Horizontal display is not calibrated when the VERTICAL switch is set between 500 nA and 1 nA EMITTER.

TABLE 2-4

Measurements Made by the Type 576 Display

Switch Settings			Measured by Display	
VERTICAL	HORIZONTAL	Terminal Selector	Vertically	Horizontally
COLLECTOR	COLLECTOR	EMITTER GROUNDED	I_C	V_{CE}
COLLECTOR	BASE	EMITTER GROUNDED	I_C	V_{BE}
COLLECTOR	STEP GEN	EMITTER GROUNDED	I_C	I_B or V_{BE}
COLLECTOR	COLLECTOR	BASE GROUNDED	I_C	V_{CB}
COLLECTOR	BASE	BASE GROUNDED	I_C	V_{EB}^2
COLLECTOR	STEP GEN	BASE GROUNDED	I_C	I_B or V_{EB}^2
EMITTER	COLLECTOR	EMITTER GROUNDED	I_E	V_{CE}^1
EMITTER	COLLECTOR	BASE GROUNDED	I_B	V_{CB}^1
STEP GEN	COLLECTOR	EMITTER GROUNDED	I_B or V_{BE}	V_{CE}
STEP GEN	BASE	EMITTER GROUNDED	I_B or V_{BE}	V_{BE}
STEP GEN	COLLECTOR	BASE GROUNDED	I_B or V_{BE}	V_{CB}
STEP GEN	BASE	BASE GROUNDED	I_B or V_{EB}^2	V_{EB}^2

¹Error in voltage must be calculated. See Horizontal Measurements in Deflection Factor section.

² V_{EB} indicates a measurement of forward voltage base-emitter, with the horizontal voltage sensing leads reversed.

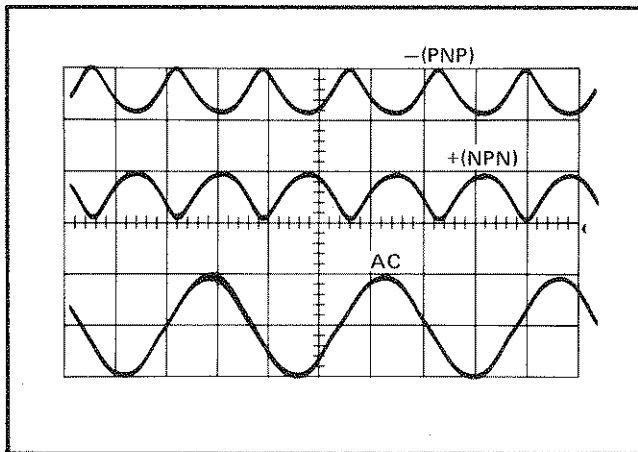

Fig. 2-22. Output of Collector Supply for three settings of POLARITY switch.

allows continuous voltage variation of the peak voltage within each peak voltage range.

The PEAK POWER WATTS switch, which interlocks with the MAX PEAK VOLTS switch, determines the maximum power output of the Collector Supply. Power output is controlled by placing a resistor, selected from the SERIES RESISTORS, in series with the Collector Supply output. The series resistance limits the amount of current which can be conducted by the Collector Supply. In setting

the peak power output using the PEAK POWER WATTS switch, the proper series resistor is automatically selected. If the peak voltage range is changed while the MAX PEAK VOLTS and the PEAK POWER WATTS switches are interlocked, a new series resistor is chosen which will provide the same peak power output.

The Collector Supply POLARITY switch determines the polarity of the Collector Supply output and the Step Generator output. It also provides an initial display position on the CRT graticule as discussed in the section on positioning. When the POLARITY switch is set to +(NPN) the Collector Supply output is a positive-going full wave rectified sine wave and the Step Generator output is positive-going. When the switch is set to -(PNP) the Collector Supply output is a negative-going full wave rectified sine wave and the Step Generator output is also negative-going. The AC position of the POLARITY switch provides a Collector Supply output which is an unrectified sine wave, and the Step Generator output is positive-going. A negative-going Step Generator output can be obtained in this case by pressing the STEP/OFFSET POLARITY INVERT button. As noted on the front panel, when the AC position is being used, the MODE switch should be set to NORM and the Step Generator rate to .5X.

The MODE switch determines whether the Collector Supply output voltage will be a voltage sweep or a DC voltage. When the MODE switch is set to NORM the output is a repetitive voltage sweep varying from 0 volts to the peak voltage set by the MAX PEAK VOLTS switch and the VARIABLE COLLECTOR SUPPLY control. When the MODE switch is set to DC (ANTILOOP) or LEAKAGE (EMITTER CURRENT) the Collector Supply output is a DC voltage equal to the peak voltage set by the MAX PEAK VOLTS switch and the VARIABLE COLLECTOR SUPPLY control. This DC voltage may be either positive or negative. The DC mode is very useful when the normal display is exhibiting excessive looping.

Occasionally some of the characteristic curves displayed on the CRT consist of loops rather than well defined lines (see Fig. 2-23). This effect is known as looping and is most noticeable at very low or very high values of current. Looping is generally caused by stray capacitance within the Type 576, and device capacitance. It may also be caused by heating of the device under test. The LOOPING COMPENSATION control provides complete compensation for non heat-related looping due to the Type 576 and any standard device adapter which may be used. In general it does not compensate for any added capacitance introduced by the device under test. (Control has some effect in reducing stray capacitance in small diodes, and voltage-driven three terminal devices.) If uncompensated looping is hindering measurements, the MODE switch should be set to DC (ANTILOOP). If the collector sweep mode of operation (MODE switch set to NORM) is desired, an imaginary line lying inside the loop and equidistant from each side of the loop is the best approximation of the actual characteristic curve (see Fig. 2-23). Looping due to heating may be reduced by using the pulsed steps operation of the Type 576.

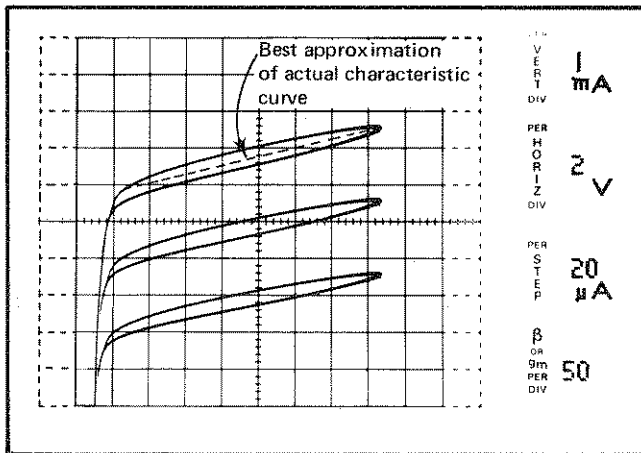

Fig. 2-23. Example of a display exhibiting looping.

Interlock System

Whenever the MAX PEAK VOLTS switch is in the 75, 350 or 1500 positions, the yellow COLLECTOR SUPPLY VOLTAGE DISABLED light comes on. This light indicates that the Collector Supply is disabled. In order to enable the

Collector Supply under these circumstances, the Type 576 uses an interlock system. When the yellow light is on, the protective box must be installed over the accessories connectors (see Fig. 2-7). When the protective box is in place and the lid closed, the yellow light turns off and the red light turns on. The red light indicates that the Collector Supply is enabled and that a dangerous voltage may appear at the Collector terminals. For further information about the interlock system, see the Circuit Description.

Step Generator

The Step Generator provides current or voltage which may be applied to the base or the emitter of the device under test. The output of the Step Generator is families of ascending steps of current or voltage (see Fig. 2-24). When these steps together with the Collector Supply output are applied to the device under test, families of characteristic curves of the device are displayed on the CRT.

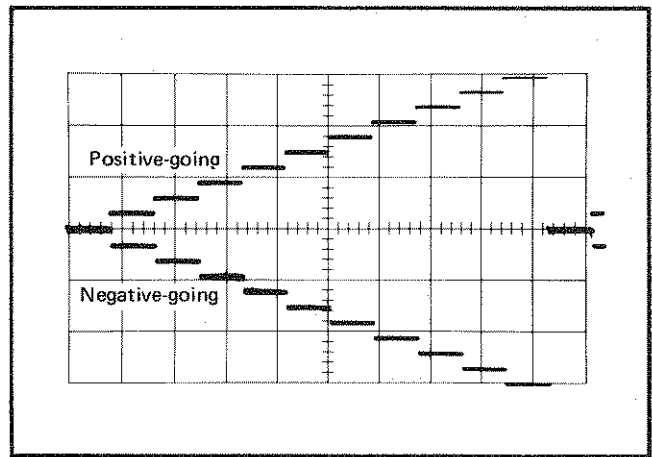

Fig. 2-24. Step Generator output in both polarities

The NUMBER OF STEPS switch determines the number of steps per family and has a range of from 1 step to 10 steps. The AMPLITUDE switch determines the amplitude of each step and provides both current steps and voltage steps. The range of step amplitudes available are from 50 nA/step to 200 mA/step for current steps and from 5 mV/step to 2 V/step for voltage steps. The STEP MULT .1X button, when pressed, divides the step amplitude by 10. When voltage steps are being applied to the base of a transistor, the base current increases very rapidly with increasing base voltage (note Caution on front-panel). To avoid damage to the transistor when using voltage steps, current limiting is provided through the CURRENT LIMIT switch.

The rate of generation of steps by the Step Generator is determined by the RATE buttons. When the NORM RATE button is pressed, steps are generated at a rate of 120 steps/second (assuming a 60 Hz line frequency), or one step per cycle of the Collector Supply, POLARITY switch set to +(NPN) or -(PNP). In this case each step occurs at the beginning of a Collector Supply cycle. When the .5X RATE button is pressed, the Step Generator rate is 60 steps/

second, or one step per 2 cycles of the Collector supply. Again, each step occurs at the beginning of a Collector Supply cycle. (This rate should be used when the POLARITY switch is set to AC.) Pressing the 2X RATE button produces a Step Generator rate of 240 steps/second, 2 steps per cycle of the Collector Supply. In this case steps occur at both the beginning and the peak of a Collector Supply cycle. If the 2X RATE and .5X RATE buttons are pressed together, the Step Generator rate is the normal rate of 120 steps/second except that the steps occur at the peak of each Collector Supply cycle rather than at the beginning as in normal rate operation.

The STEP FAMILY buttons determine whether step families are generated repetitively or one family at a time. Pressing the REP STEP FAMILY button turns the Step Generator on and provides repetitive families of steps. When the SINGLE STEP FAMILY button is pushed, one step family is generated and the Step Generator turns off. To get another step family, the SINGLE button must be pressed again.

The OFFSET buttons and the OFFSET MULT control allow current or voltage to be either added or subtracted from the Step Generator output. This causes the level at which the steps begin, to be shifted either in the direction of the ascending steps (aiding) offset, or in the opposite direction of the steps (opposing) offset. When the ZERO OFFSET button is pushed, the step family is generated at its normal level where the zero step level is either 0 mA or 0 V and the OFFSET MULT control is inhibited. When the AID OFFSET button is pressed, current or voltage may be added to the Step Generator output using the OFFSET MULT control. The amount of current or voltage added to the Step Generator output when the AID button is pressed is equal to the setting of the OFFSET MULT control times the setting of the AMPLITUDE switch. The OFFSET MULT control has a continuous range of 0 to 10 times the setting of the AMPLITUDE switch. Pressing the OPPOSE OFFSET button allows either current or voltage to be subtracted from the Step Generator output, the amount subtracted determined by the OFFSET MULT control. Table 2-5 shows the polarity of the offset current or voltage for the two polarities of the Step Generator output.

Opposing offset is most useful when generating voltage steps to test field effect transistors. When current steps are being generated, the maximum opposing voltage is limited to approximately 2 volts. This voltage limiting protects the base-emitter junction of a bi-polar transistor from reverse breakdown.

The STEP/OFFSET POLARITY INVERT button allows the Step Generator output (both steps and offset) to be inverted from the polarity at which it was set by the POLARITY switch. It has no effect when the Terminal Selector switch is set to BASE GROUNDED. Caution should be exercised when using this button to cause reverse current to flow between the base and emitter terminals. Voltage limit-

TABLE 2-5
Polarity of Offset for Polarity of Step Generator Output

Step Generator Polarity	OFFSET Buttons	Offset	
		Current	Voltage
Positive going	AID	Positive	Positive
Positive going	OPPOSE	Negative	Negative
Negative going	AID	Negative	Negative
Negative going	OPPOSE	Positive	Positive

ing occurs, when current steps are being generated, only when the OPPOSE OFFSET button is pressed.

When one of the PULSED STEPS buttons is pressed, steps are generated in pulses having durations of either 300 μ s or 80 μ s (offset is unaffected). Pulsed operation is useful when testing a device at power levels which might damage the device if applied for a sustained length of time. Pulsed steps of a 300 μ s duration occur when the 300 μ s PULSED STEPS button is pressed. When the 80 μ s PULSED STEPS button is pressed, the duration of the pulsed steps is 80 μ s. When either the 300 μ s button or the 80 μ s button is pressed, the Collector Supply mode is automatically set to DC. If the 300 μ s and 80 μ s buttons are pressed together, the Collector Supply remains in the normal mode and 300 μ s pulsed steps are produced. In all the previously mentioned cases, the pulses occur at the peak of the Collector Supply sweep and therefore only the normal and .5 times normal Step Generator rates are available for use.

Standard Test Fixture

The Standard Test Fixture, which slides into the front of the Type 576, provides a means of connecting the Collector Supply output, the Step Generator output and the display amplifiers to the device to be tested.

The Terminal Selector switch, located on the Standard Test Fixture, determines the state of the base and the emitter terminals of the device under test. The switch has two ranges: EMITTER GROUNDED and BASE GROUNDED. In the EMITTER GROUNDED range, the emitter terminal is connected to ground and the Terminal Selector switch determines the state of the base terminal. With the switch set to STEP GEN, the Step Generator output is applied to the base terminal. In the OPEN (OR EXT) position, the base terminal is left open. In this case measurements may be made with the base terminal left open or with an externally generated signal applied to it through the EXT BASE

TEST SET-UP CHART TYPE 576

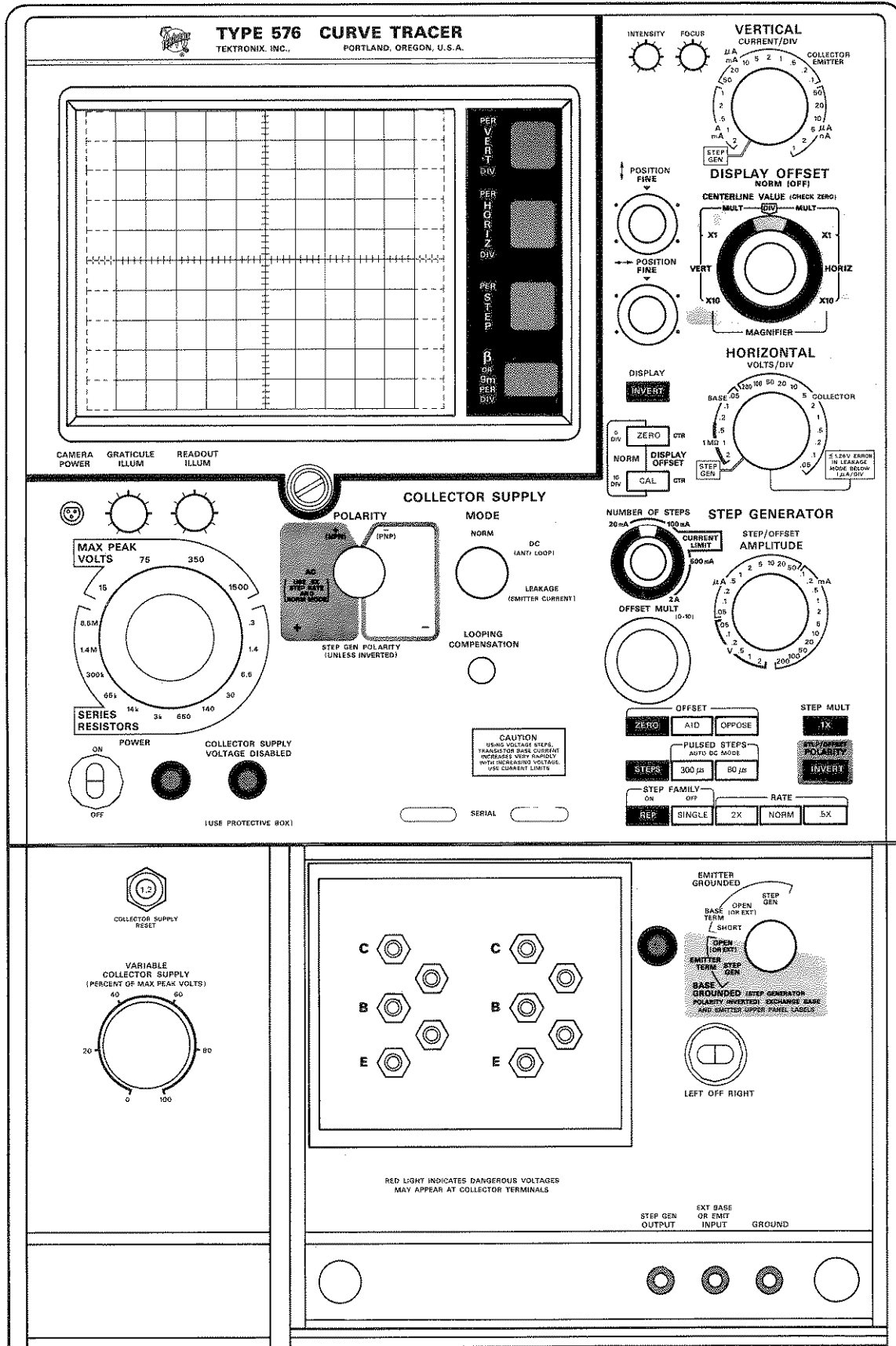

Fig. 2-25. Control setup chart for the Type 576 front-panel.

OR EMIT INPUT connector. When the Terminal Selector switch is set to BASE TERM SHORT, the base terminal is shorted to the emitter.

In the BASE GROUNDED range, the base terminal is connected to ground and the Terminal Selector switch determines the state of the emitter terminal. With the switch set to STEP GEN, the Step Generator output is inverted and applied to the emitter terminal. When the switch is set to OPEN (OR EXT) the emitter terminal is left open. In this case, measurements may be made with the emitter terminal left open or with an externally generated signal applied to it through the EXT BASE OR EMIT INPUT connector.

Devices to be tested are connected to the Type 576 through 10 accessories connectors provided on the Standard Test Fixture. These connectors allow two devices to be set up at a time for comparison testing. The LEFT-OFF-RIGHT switch determines which device is under test. Tektronix Type 576 test fixture adapters may be plugged into the 10 accessories connectors. These adapters provide sockets into which devices with various lead arrangements may be placed for testing. Table 2-7 lists the test fixture adapters available and their uses. The 10 accessories connectors also accept standard banana plugs so that a device may be connected to the Type 576 without using a specific device testing accessory.

The unlabeled accessories connectors allow Kelvin sensing of voltages measured under high current conditions. Kelvin sensing means that current is supplied to a device under test through one set of contacts and the voltage is measured through another set of contacts. This method of sensing voltage eliminates errors in voltage measurements due to contact resistance. The upper unlabeled accessories connectors on the Standard Test Fixture are used for sensing collector voltage and the lower connectors are for sensing emitter voltage.

CAUTION

Conduction of high current through a voltage sensing connector will damage the instrument. When using Kelvin sensing without a special test fixture adapter, separate leads are required for current carrying and for voltage sensing.

The STEP GEN OUTPUT connector allows the Step Generator output to be used externally. The EXT BASE OR EMIT INPUT connector allows application of an externally generated signal to either the base or the emitter of

the device under test. The external signal is applied to whichever terminal is chosen by the Terminal Selector switch. The GROUND connector provides a Type 576 ground reference for signals generated or used external in Type 576.

Polarities of the Collector Supply and Step Generator Output

Table 2-8 shows the polarities of the Collector Supply and the Step Generator output for various settings of the Collector Supply POLARITY switch and the Terminal Selector switch.

TABLE 2-7

Test Fixture Adapters¹

Tektronix Part Number	Devices tested	Case Types
013-0072-00	Diodes	Axial lead
013-0098-02	Transistors and P-Channel FET's	TO-18, TO-5 and related sizes
013-0099-02	N-Channel FET's	TO-18, TO-5 and related sizes
013-0100-01	Transistors and SCR's	TO-3; provides Kelvin sensing
013-0101-00	Transistors and SCR's	TO-66; provides Kelvin sensing
013-0102-00 ²	Transistors and P-Channel FET's	long lead devices
013-0103-00 ²	N-Channel FET's	long lead devices
013-0110-00 ²	Diodes	Stud leads; DO-4/DO-5; Kelvin sensing
013-0111-00 ²	Diodes	Axial leads; Kelvin sensing
013-0112-00 ²	Transistors and SCR's	TO-36; Kelvin sensing

¹Some of these accessories are made of plastic and are susceptible to damage from excessive heat. If a device is likely to heat excessively a heat sink for the device or the pulsed steps mode of operation should be used.

²Optional accessory.

TABLE 2-8
Polarities of the Collector Supply and
Step Generator Output

Switches		Polarities	
Collector Supply POLARITY	Terminal Selector	Collector Supply	Step Generator
-(PNP)	EMITTER GROUNDED	Negative going	Negative going ¹
-(PNP)	BASE GROUNDED	Negative going	Positive going
+(NPN)	EMITTER GROUNDED	Positive going	Positive going ¹
+(NPN)	BASE GROUNDED	Positive going	Negative going
AC	EMITTER GROUNDED	Positive and Negative going	Positive going ¹
AC	BASE GROUNDED	Positive and Negative going	Negative going

¹May be inverted by pressing the POLARITY INVERT button.

APPLICATIONS

This part of the Operating Instructions describes the use of the Type 576 to measure some basic parameters of bipolar transistors, field effect transistors, unijunction transistors, silicon controlled rectifiers, signal and rectifier diodes, Zener diodes, and tunnel and back diodes. For each of the devices discussed, this section includes tables of Type 576 control settings required to make an accurate measurement without damaging the device under test. Below each table is a block diagram showing the connections of the collector supply, the step generator and the display amplifiers to the device under test, and a picture of a typical characteristic for the semiconductor type being discussed. Also included is a list of common measurements which may be made on

the given devices with the Type 576 and a brief set of instructions on how to make each of these measurements.

This section has been written with the assumption that the reader is familiar with the operation of the Type 576 as described at the beginning of the Operating Instructions. It is also assumed that the reader is familiar with the parameters being discussed.

BIPOLAR TRANSISTORS Required Type 576 Control Settings

Control	Required Setting
HORIZONTAL	COLLECTOR
POLARITY	+(NPN) or -(PNP) depending on the transistor type
PEAK POWER WATTS	Less than maximum power rating of device
AMPLITUDE	Current steps
STEPS	Pressed when using low base current
PULSED STEPS	Pressed when using high base current
Terminal Selector	EMITTER GROUNDED BASE TERM STEP GEN for common-emitter family BASE GROUNDED EMITTER TERM STEP GEN for common-base family
OFFSET	AID pressed if more than 10 steps are desired

Common-Emitter Family

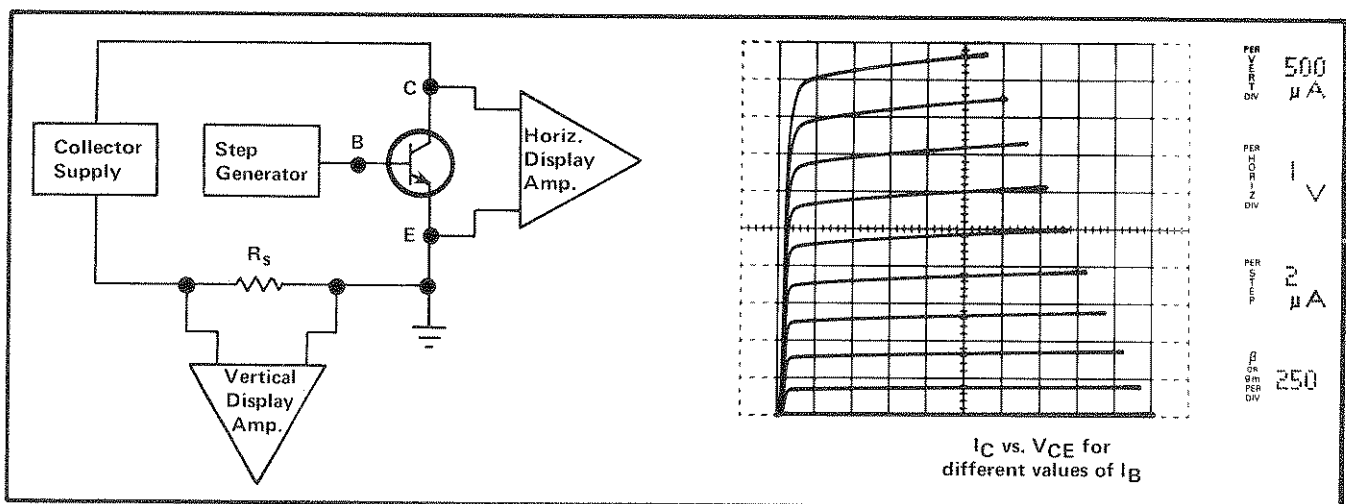

Some Common Measurements

- β (Static) The static forward current transfer ratio (emitter grounded), h_{FE} , is I_C/I_B .
- β (Small Signal) The small-signal short-circuit forward current transfer ratio (emitter grounded), h_{fe} , is $\Delta I_C/\Delta I_B$. To determine h_{fe} at various points in a family of curves, multiply the vertical separation of two adjacent curves by the β OR g_m PER DIV readout. To make a more accurate measurement, see steps 69 through 74 of the First Time Operation instructions.
- V_{CE} (Sat) Saturation current and voltage is measured by expanding the display of the saturation region of the device by decreasing the horizontal deflection factor with the HORIZONTAL switch or the DISPLAY OFFSET MAGNIFIER. Saturation current can be adjusted to the desired operating point with the AMPLITUDE switch.
- I_C vs. V_{BE} Base-emitter voltage can be measured by setting the HORIZONTAL switch to the BASE range.
- I_{CEO} and BV_{CEO} Collector-emitter leakage current and collector-emitter breakdown voltage (base open) are measured by setting the Terminal Selector switch to BASE TERM OPEN (OR EXT). For small leakage currents set the MODE switch to LEAKAGE (EMITTER CURRENT). To measure breakdown voltage, increase both the horizontal deflection factor and the collector supply voltage.
- I_{CES} and BV_{CES} Collector-emitter leakage current and collector-emitter breakdown voltage (base shorted to emitter) are measured the same as I_{CEO} and BV_{CEO} except that the Terminal Selector switch is set to BASE TERM SHORT.
- I_{CER} and BV_{CER} Collector-emitter leakage current and collector-emitter breakdown voltage (with a specified resistance between the base terminal and the emitter terminal) are measured the same as I_{CEO} and BV_{CEO} except that a specified resistance is connected between the base terminal and the emitter terminal.

Common-Base Family

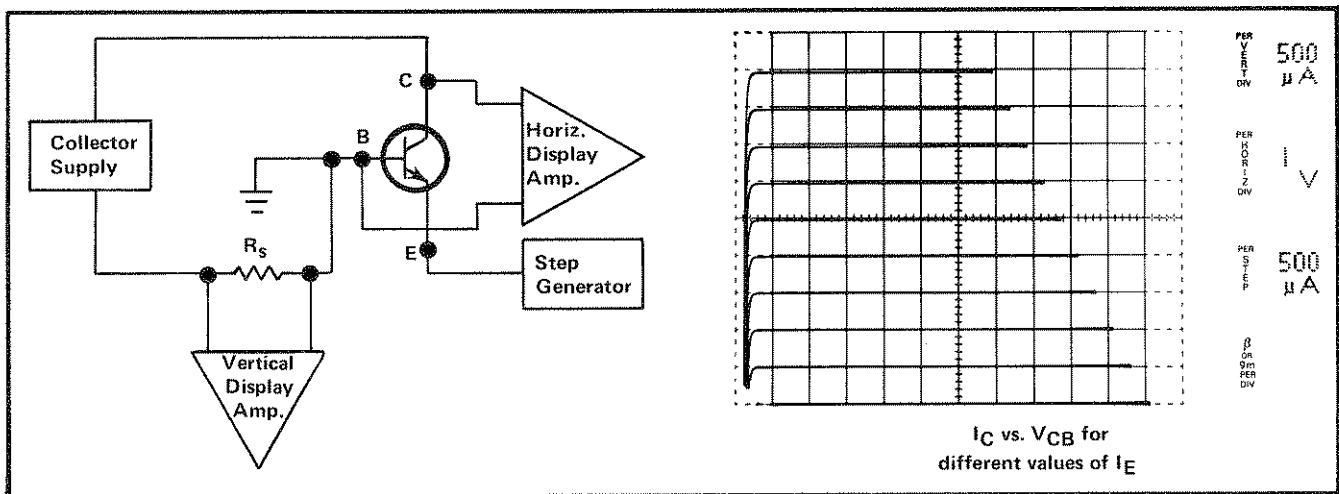

Some Common Measurements

- α (Small Signal) The small-signal short-circuit forward current transfer ratio (base grounded), h_{fb} , can be measured from the common-base family display but is determined most easily by calculating it from the equation $\alpha = \beta / (1 + \beta)$.

I_{CBO} and BV_{CBO}

Collector-base leakage current and collector-base breakdown voltage (emitter open) is measured the same as I_{CEO} and BV_{CEO} except that the Terminal Selector switch is set to EMITTER TERM OPEN (OR EXT).

I_{EBO} and BV_{EBO}

Emitter-base leakage current and emitter-base breakdown voltage (collector open) is measured the same as I_{CBO} and BV_{CBO} except that the device terminals are inverted in the device testing socket (collector lead in the emitter terminal of the socket and the emitter lead in the collector terminal).

FIELD EFFECT TRANSISTORS

Required Type 576 Control Settings

Control	Required Setting	
HORIZONTAL POLARITY	COLLECTOR	
PEAK POWER WATTS	Less than maximum power rating of device	
AMPLITUDE STEPS	Voltage Steps	
Terminal Selector	EMITTER GROUNDED BASE TERM STEP GEN	
POLARITY INVERT	Enhancement	Depletion
	Released	Pressed
OFFSET with POLARITY INVERT button pressed	OPPOSE	ZERO or AID

Common-Source Family

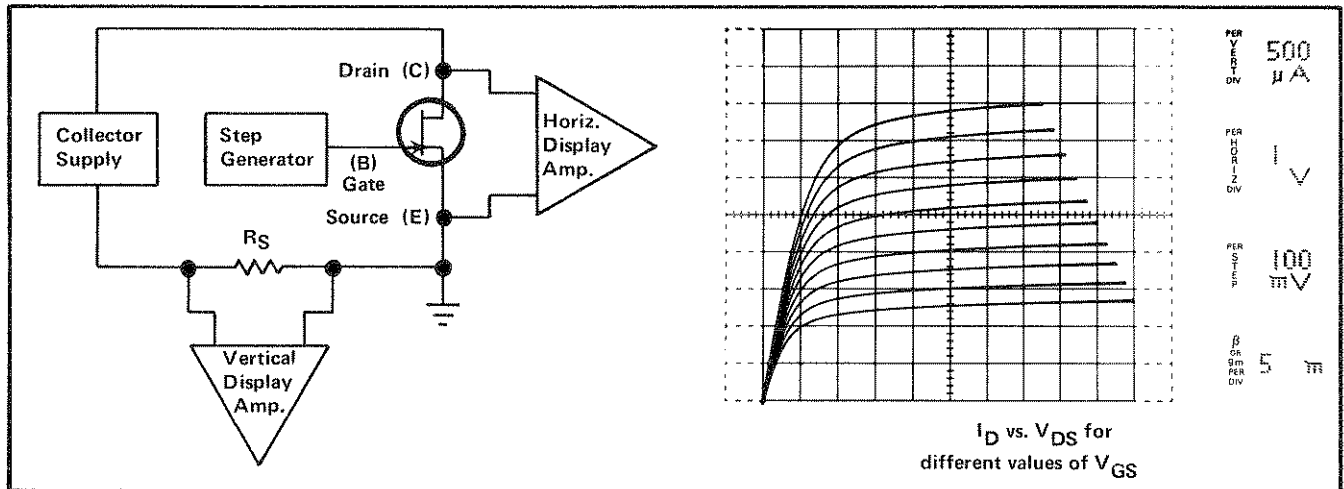

Some Common Measurements

g_m (Static)

The static transconductance (source grounded) is I_D/V_{GS} .

g_m (Small Signal)

The small-signal transconductance (source grounded) is $\Delta I_D/\Delta V_{GS}$. To determine g_m at various points in a family of curves, multiply the vertical separation of two adjacent curves by the β OR g_m PER DIV readout. To make a more accurate measurement, see steps 69 through 74 of the First Time Operation instructions.

Operating Instructions—Type 576

IDSS Drain-source current with zero V_{GS} is measured from the common-source family, with the Terminal Selector switch set to BASE TERM SHORT. It should be measured above the knee of the curve.

Pinch-Off Voltage (V_p) Pinch-off voltage (V_p) can be measured by increasing the depletion voltage with the OFFSET MULT control and the AMPLITUDE switch until the specified pinch-off current is reached by the zero step (zero step only is obtained by pressing SINGLE button). Thus the pinch-off voltage is the setting of the OFFSET MULT control times the setting of the AMPLITUDE switch, to which, for greatest accuracy in the LEAKAGE mode, must be added the error voltage developed between ground and source as per Table 2-3.

BV_{GSS} Gate-source breakdown voltage with the drain shorted to the source can be measured by putting the gate lead of the device in the drain terminal of the test socket, the source lead in the gate terminal and the drain lead in the source terminal. Set the Terminal Selector switch to BASE TERM SHORT and reverse the collector supply polarity. This measurement should not be made on an insulated-gate device.

**UNIJUNCTION TRANSISTORS
Required Type 576 Control Settings**

Control	Required Setting
HORIZONTAL	COLLECTOR
POLARITY	+(NPN)
PEAK POWER WATTS	Less than maximum power rating of device
AMPLITUDE	Voltage
OFFSET	AID
STEP FAMILY	OFF (SINGLE)
Terminal Selector	BASE TERM STEP GEN

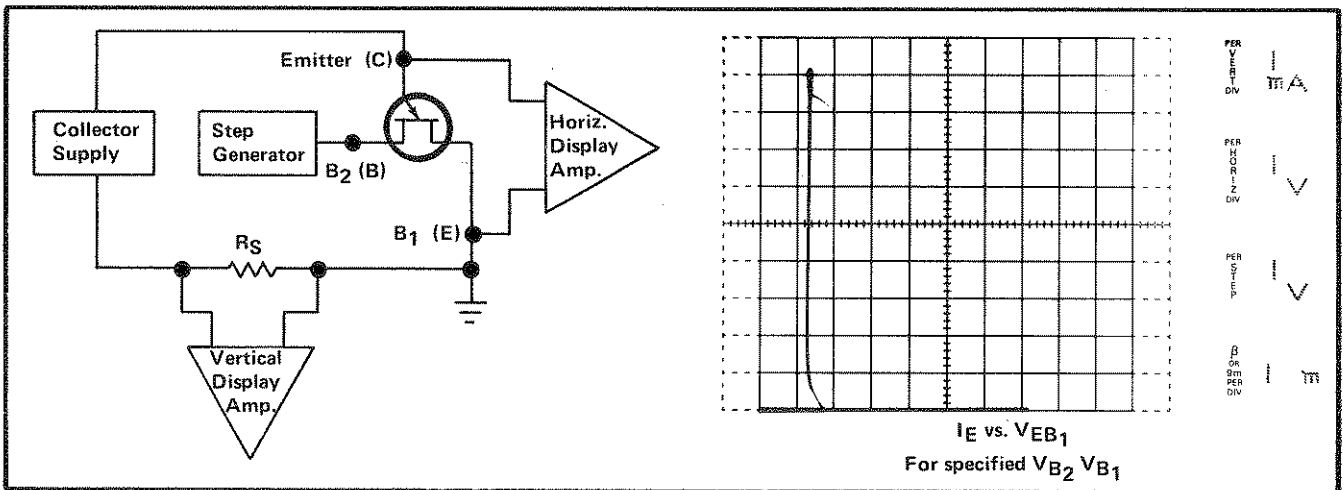

Some Common Measurements

η The intrinsic standoff ratio is $V_p - V_{EB1} / V_{B2} V_{B1}$. In measuring η , $V_{B2} V_{B1}$ is determined by the OFFSET MULT control and the AMPLITUDE switch. $V_{B2} V_{B1}$ may be measured by setting the HORIZONTAL switch to the BASE range. V_p is determined by applying voltage between the emitter and the base₁ terminals using the VARIABLE COLLECTOR SUPPLY control. V_p is the voltage at which the emitter-base₁ junction becomes forward biased. V_{EB1} , the turn on voltage of the emitter-base₁ junction is determined by setting the Terminal Selector switch to BASE TERM OPEN.

R_{B2}B₁

The interbase resistance can be measured by placing the base₂ lead in the collector terminal of the test socket and the base₁ lead in the emitter terminal. Leave the emitter lead at the device open and apply voltage across the two bases with the VARIABLE COLLECTOR SUPPLY control.

SILICON CONTROLLED RECTIFIERS (SCRs)

Required Type 576 Control Settings

Control	Required Setting
HORIZONTAL	COLLECTOR
PEAK POWER WATTS	Less than maximum power rating of device
POLARITY	+(NPN)
STEPS	Pressed when using low gate voltage or current
PULSED STEPS	Pressed when using high gate voltage or current
Terminal Selector	EMITTER GROUNDED BASE TERM STEP GEN

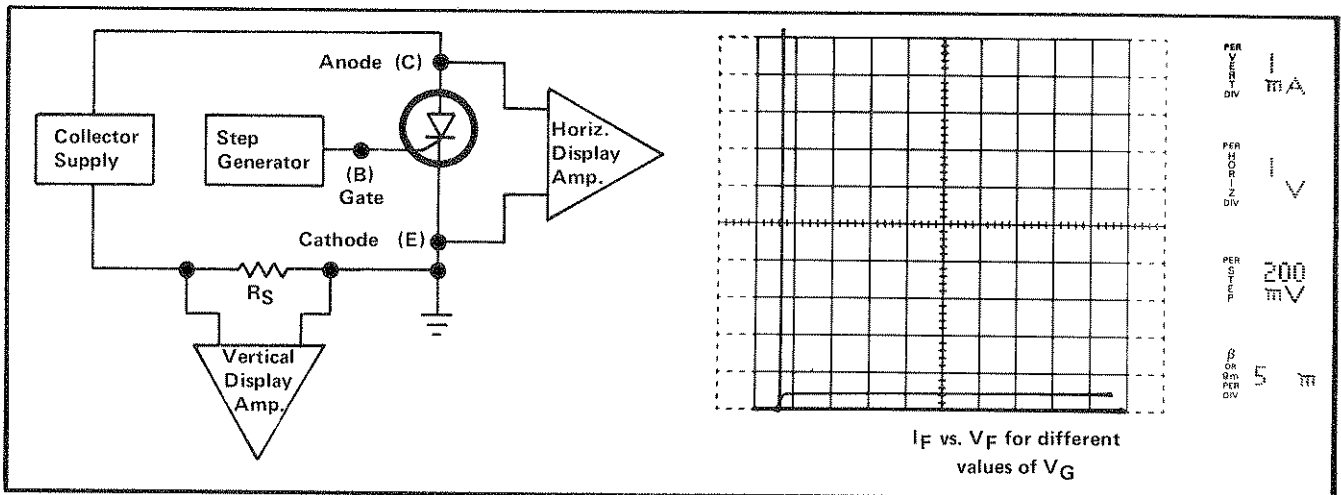

Some Common Measurements

- Turn-on** The gate voltage or current at which the device turns on can be measured by applying a specified voltage between the anode and cathode terminals using the VARIABLE COLLECTOR SUPPLY control and applying current or voltage steps in small increments to the gate with the AMPLITUDE switch.
- Forward Blocking Voltage** To measure the forward blocking voltage, set the Terminal Selector switch to BASE TERM OPEN (or SHORT depending on the specification) and turn the VARIABLE COLLECTOR SUPPLY control clockwise until the device switches to its low impedance state. The voltage at which switching occurs is the forward blocking voltage.
- Holding Current** Holding current is measured in the same manner as forward blocking voltage. Holding current is the minimum current conducted by the device, while operating in its low impedance state, without turning off.
- Reverse Blocking Voltage** The reverse blocking voltage is measured the same way as the forward blocking voltage except that the POLARITY switch is set to -(PNP).

SIGNAL DIODES AND RECTIFYING DIODES

Required Type 576 Control Settings

Control	Required Setting
HORIZONTAL	COLLECTOR
PEAK POWER WATTS	Less than maximum power rating of device
POLARITY	+(NPN)
Terminal Selector	EMITTER GROUNDED

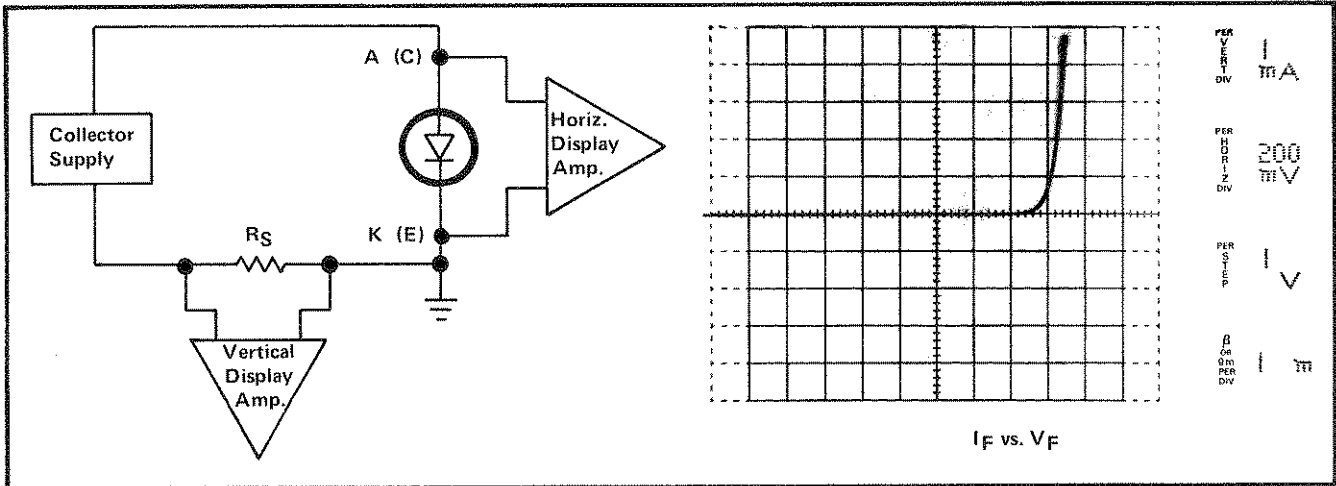

Some Common Measurements

I_F and V_F

To measure forward current and voltage, put the cathode of the diode in the emitter terminal of the test socket and the anode of the diode in the collector terminal. Apply voltage to the device with the VARIABLE COLLECTOR SUPPLY control.

I_R and V_R

Current and voltage in the reverse direction are measured in the same manner as in the forward direction except that the POLARITY switch is set to -(PNP). For measurements of small amounts of reverse current, set the MODE switch to LEAKAGE (EMITTER CURRENT).

ZENER DIODES

Required Type 576 Control Settings

Control	Required Setting
HORIZONTAL	COLLECTOR
PEAK POWER WATTS	Less than maximum power rating of device
POLARITY	-(PNP)
Terminal Selector	EMITTER GROUNDED

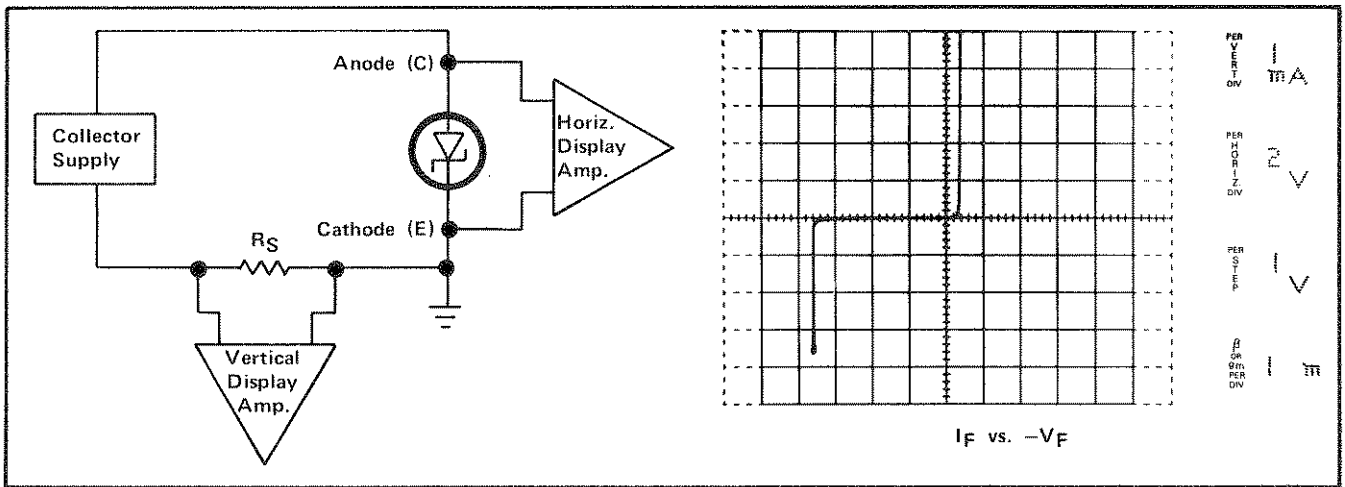

Some Common Measurements

V_Z and I_R

To measure Zener voltage or reverse current, put the cathode of the diode in the emitter terminal of the test socket and the anode of the diode in the collector terminal. Apply voltage to the device with the VARIABLE COLLECTOR SUPPLY control. For a more accurate measurement of Zener voltage, see steps 42 through 46 of the First Time Operation instructions. For measurements of small amounts of reverse current, set the MODE switch to LEAKAGE (EMITTER CURRENT).

I_F and V_F

Current and voltage in the forward direction are measured in the same manner as in the reverse direction except that the POLARITY switch is set to +(NPN). For a display of currents and voltages in both directions, set the POLARITY switch to AC.

TUNNEL DIODES AND BACK DIODES

Required Type 576 Control Settings

Control	Required Setting
HORIZONTAL	COLLECTOR
PEAK POWER WATTS	Less than maximum power rating of device
POLARITY	+(NPN)
Terminal Selector	EMITTER GROUNDED

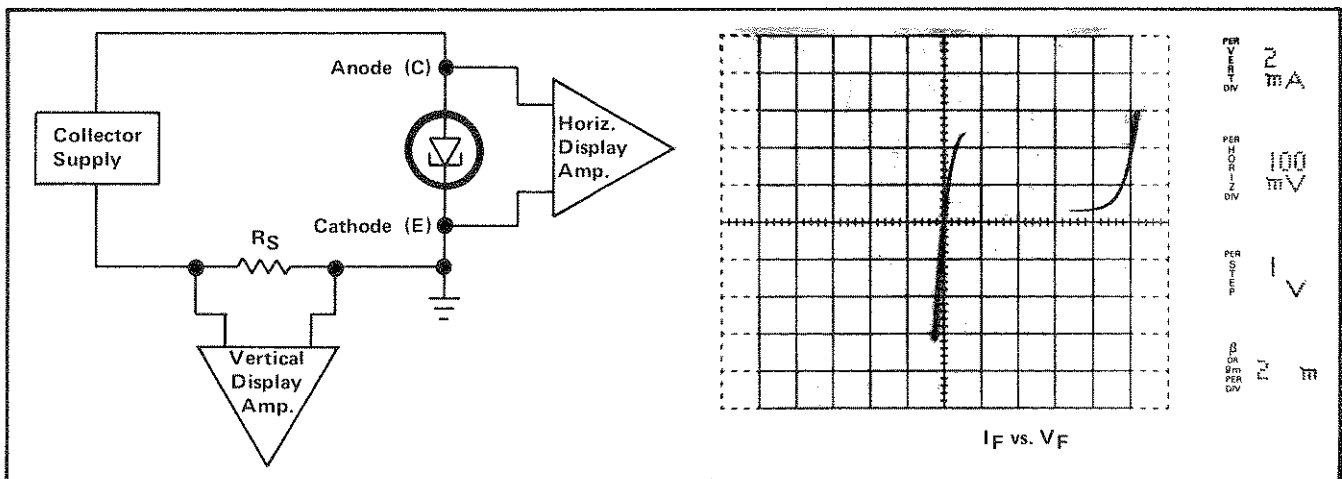

Some Common Measurements

I_F and V_F

To measure the forward current and voltage characteristics of a tunnel diode or a back diode, such as the peak point and valley point currents and voltages, put the cathode of the diode in the emitter terminal of the test socket and the anode of the diode in the collector terminal. Apply voltage to the device with the VARIABLE COLLECTOR SUPPLY control. For most accurate measurements of peak and valley points, use the magnified display offset as described in steps 42 through 46 of the First Time Operation instructions.

I_R and V_R

Current and voltage in the reverse direction are measured in the same manner as in the forward direction except that the POLARITY switch is set to -(PNP). For a display of currents and voltages in both directions, set the POLARITY switch to AC.

