

**Tektronix**

**492A/AP & 492B/BP  
Spectrum Analyzer  
Operator Manual**

**070-5562-01**

**Please check for change information at the rear  
of this manual.**

Second Edition: December 1987  
Last Revised: March 1988

Copyright © Tektronix, Inc. 1985, 1987. All rights reserved.

Tektronix products are covered by U.S. and foreign patents, issued and pending. Information in this publication supercedes that in all previously published material. Specifications and price change privileges reserved.

Printed in the U.S.A.

Tektronix, Inc., P.O. Box 1000, Wilsonville, OR 97070-1000

TEKTRONIX and TEK are registered trademarks of Tektronix, Inc.



## WARRANTY

Tektronix warrants that this product will be free from defects in materials and workmanship for a period of one (1) year from the date of shipment. If any such product proves defective during this warranty period, Tektronix, at its option, either will repair the defective product without charge for parts and labor, or will provide a replacement in exchange for the defective product.

In order to obtain service under this warranty, Customer must notify Tektronix of the defect before the expiration of the warranty period and make suitable arrangements for the performance of service. Customer shall be responsible for packaging and shipping the defective product to the service center designated by Tektronix, with shipping charges prepaid. Tektronix shall pay for the return of the product to Customer if the shipment is to a location within the country in which the Tektronix service center is located. Customer shall be responsible for paying all shipping charges, duties, taxes, and any other charges for products returned to any other locations.

This warranty shall not apply to any defect, failure or damage caused by improper use or improper or inadequate maintenance and care. Tektronix shall not be obligated to furnish service under this warranty a) to repair damage resulting from attempts by personnel other than Tektronix representatives to install, repair or service the product; b) to repair damage resulting from improper use or connection to incompatible equipment; or c) to service a product that has been modified or integrated with other products when the effect of such modification or integration increases the time or difficulty of servicing the product.

**THIS WARRANTY IS GIVEN BY TEKTRONIX WITH RESPECT TO THIS PRODUCT IN LIEU OF ANY OTHER WARRANTIES, EXPRESSED OR IMPLIED. TEKTRONIX AND ITS VENDORS DISCLAIM ANY IMPLIED WARRANTIES OF MERCHANTABILITY OR FITNESS FOR A PARTICULAR PURPOSE. TEKTRONIX' RESPONSIBILITY TO REPAIR OR REPLACE DEFECTIVE PRODUCTS IS THE SOLE AND EXCLUSIVE REMEDY PROVIDED TO THE CUSTOMER FOR BREACH OF THIS WARRANTY. TEKTRONIX AND ITS VENDORS WILL NOT BE LIABLE FOR ANY INDIRECT, SPECIAL, INCIDENTAL, OR CONSEQUENTIAL DAMAGES IRRESPECTIVE OF WHETHER TEKTRONIX OR THE VENDOR HAS ADVANCE NOTICE OF THE POSSIBILITY OF SUCH DAMAGES.**



# PREFACE

This manual is one of a set of product manuals for the TEKTRONIX 492A and programmable 492AP Spectrum Analyzer. The manual describes the instrument installation and operation. These instructions assume a thorough knowledge of frequency domain analysis. The purpose of this manual is to explain the operation of the 492A so that measurements will be meaningful whether made under adverse or laboratory conditions. The manual organization is shown in the Table of Contents. The manuals that are available now in addition to this Operators Manual are the

- 492A/492AP Service Manuals, Volume 1 and 2 (optional accessories),
- 492AP Programmers Manual (optional accessory for 492AP only),
- 492A/492AP Operators Handbook (standard accessory), and
- 490AP-Series Programmers Reference Guide (optional accessory).

For manual ordering information, contact your local Tektronix Field Office or representative or refer to the Accessories portion of the Replaceable Mechanical Parts list in the Service Manual, Volume 2.

## Standards and Conventions Used

Most terminology is consistent with standards adapted by IEEE and IEC. A glossary of terms is provided in Appendix A. Abbreviations in the documentation are consistent with ANSI Y1.1-1972. GPIB functions conform to the IEEE 488-1978 Standard. Copies of ANSI and IEEE standards can be ordered from the Institute of Electrical and Electronic Engineers Inc.

## Change/History Information

Any change information that involves manual corrections or additional information is located behind the tabbed Change Information page at the back of this manual.

History information, as well as the updated data, is combined within this manual when the page(s) is revised. A revised page is identified by a revision date located in the lower inside corner of the page.

## Unpacking and Initial Inspection

Instructions for unpacking and preparing the instrument for use are described in Section 5.

## Storage and Repackaging

Instructions for short- and long-term storage and instrument repackaging for shipment are described in Section 3.

# TABLE OF CONTENTS

	Page		Page
PREFACE.....	i	<b>Section 4 (continued)</b>	
TABLE OF CONTENTS.....	ii	Correcting Numerical Entry Errors .....	4-2
LIST OF ILLUSTRATIONS .....	iv	Instrument Power Control and	
LIST OF TABLES.....	v	Frequency.....	4-3
SAFETY SUMMARY .....	vi	Frequency Span and Resolution.....	4-5
<b>Section 1 GENERAL INFORMATION</b>		Marker Functions .....	4-7
Product Overview.....	1-1	Display Parameters .....	4-15
Firmware Version and Error Message		Sweep .....	4-18
Readout .....	1-1	Digital Storage.....	4-20
Accessories .....	1-1	Display and General Purpose .....	4-22
Options .....	1-2	Front-panel Input/Output and	
<b>Section 2 SPECIFICATION</b>		GPIB.....	4-25
Electrical Characteristics.....	2-1	Rear-panel Input/Output and	
Verification of Tolerance Values.....	2-1	GPIB.....	4-27
Frequency Related Characteristics .....	2-1	<b>Section 5 INSTRUMENT CHECK OUT</b>	
Amplitude Related Characteristics .....	2-7	Firmware Version and Error Message	
Input Signal Characteristics .....	2-12	Readout.....	5-1
Output Signal Characteristics.....	2-15	Firmware Version.....	5-1
General Characteristics.....	2-17	Error Message Readout.....	5-1
Power Requirements.....	2-17	Preparation for Use .....	5-1
Environmental Characteristics.....	2-18	1. Initial Turn On .....	5-1
Physical Characteristics.....	2-19	2. Calibrate Position, Center Fre-	
<b>Section 3 PREPARATION FOR USE</b>		quency, Reference Level, and Dynamic	
Unpacking and Initial		Range.....	5-2
Inspection.....	3-1	Functional or Operational Check .....	5-3
Installation.....	3-1	Equipment Required.....	5-3
Rackmount Instrument.....	3-1	Preliminary Preparation.....	5-3
Rack Adapter Kit.....	3-2	1. Check Operation of Front-Panel	
Power Source and Power		Pushbuttons and Controls.....	5-3
Requirements .....	3-2	2. Check Gain Variation Between	
Storage and Repackaging.....	3-2	Resolution Bandwidths .....	5-11
Storage .....	3-2	3. Check Span Accuracy and	
Repackaging for Shipment.....	3-2	Linearity .....	5-11
<b>Section 4 CONTROLS, CONNECTORS,</b>		4. Check Resolution Bandwidth and	
<b>AND INDICATORS</b>		Shape Factor.....	5-12
Operating Modes.....	4-1	5. Check Reference Level Gain and	
Initial Entry Functions (Black Labels) ..	4-1	RF Attenuator Steps .....	5-12
Multiple-Pushbutton Sequence		6. Check Sensitivity.....	5-13
Functions (SHIFT Pushbuttons).....	4-1	7. Check Residual FM.....	5-14
Terminating Multiple-Pushbutton		8. Check Frequency Drift or	
Sequences .....	4-1	Stability .....	5-15
DATA ENTRY Functions (Orange		9. GPIB Verification Program .....	5-15
Labels).....	4-1	<b>Section 6 OPERATION</b>	
<b>Section 4 CONTROLS, CONNECTORS,</b>		Instrument Operating Features.....	6-1
<b>AND INDICATORS</b>		Firmware Version and Error Message	
Operating Modes.....	4-1	Readout .....	6-1
Initial Entry Functions (Black Labels) ..	4-1	Crt Light Filters .....	6-1
Multiple-Pushbutton Sequence		Intensity Level and Beam Alignment ...	6-1
Functions (SHIFT Pushbuttons).....	4-1		
Terminating Multiple-Pushbutton			
Sequences .....	4-1		
DATA ENTRY Functions (Orange			
Labels).....	4-1		

	Page
<b>Section 6 (continued)</b>	
Signal Application .....	6-1
RF INPUT Connector .....	6-1
Resolution Bandwidth, Frequency Span, and Sweep Time .....	6-3
Using the HELP Feature.....	6-3
Using the MANUAL PEAK Control or Automatic Peaking.....	6-4
Using the Signal Identifier .....	6-4
Using the Video Filters .....	6-5
Using Time Domain Operation .....	6-5
Triggering the Display .....	6-6
Sweeping the Display.....	6-6
Manual Scan of the Spectrum.....	6-6
Reference Level, RF Attenuation, and Vertical Display .....	6-6
Alternate Reference Level Units Selection .....	6-6
Using the Delta A Mode .....	6-7
Using MIN NOISE or MIN DISTORTION.....	6-7
Using Digital Storage .....	6-7
Using the Store and Recall Features ..	6-8
Plotting the Display .....	6-8
Using the Markers Feature .....	6-9
Marker Terms .....	6-9
Marker Turn On.....	6-9
Marker Menu and Assign Menu .....	6-10
Assigning Markers .....	6-10
Tuning Markers .....	6-10
Error Detection.....	6-11
Using the Automatic Performance Testing Feature .....	6-11
Programming Features (492AP GPIB Operation).....	6-11
Setting GPIB Address Switches.....	6-11
TALK ONLY, LISTEN ONLY Switches.....	6-11
Connecting to a System.....	6-11
External Mixer Operation.....	6-12
External Mixers and Diplexer.....	6-12
Reference Level Readout and Conversion Loss for External Mixers .....	6-12
Handling .....	6-13
Installation.....	6-14
Operation .....	6-14
Operational Considerations/Precautions	6-15
1. RF INPUT Power Limit .....	6-15
2. Instrument Warm-up After Storage	6-15
3. Auto Resolution.....	6-15
4. Waveguide Mixer/Spectrum Analyzer System .....	6-15
5. Measurements Outside Specified Frequency and Tuning Range vs Display Span.....	6-15

	Page
<b>Section 6 (continued)</b>	
6. Level of Pulsed Signals.....	6-15
7. Level of Continuous Wave Signals	6-15
8. Excessive Input Signal Level.....	6-15
9. No Crt Trace .....	6-15
10. PEAK/AVERAGE.....	6-16
11. Digital Storage Effects on Signal Analyses.....	6-16
12. Stored Display Averaged in Wide Spans .....	6-16
13. Automatic Calibration of Relative Amplitudes of Resolution Bandwidth Filters .....	6-16
14. TRIGGERING .....	6-16
Service Information .....	6-16
Service Manual.....	6-16
Product Service.....	6-16
Emergency Repair.....	6-16
Maintenance Agreements.....	6-17
<b>Section 7 OPTIONS</b>	
Options A1–A5 (Power Cord Options)	7-1
Options M1–M3 (Extended Service and Warranty Options).....	7-2
Option 01 (Add Preselector).....	7-2
Option 07 (Provide 75 $\Omega$ Input).....	7-3
Option 08 (Delete External Mixer).....	7-5
Options 21 and 22 (Provide External Mixers).....	7-5
Options 30 and 31 (Provide Rackmount).....	7-5
Option 39 (Provide Silver Battery).....	7-7
Option 41 (Provide Digital Microwave Radio).....	7-7
Option 42 (Provide 110 MHz IF).....	7-7
Option 45 (Provide MATECO Capability) .....	7-7
Option 52 (Provide North American 220 V).....	7-7
<b>Appendix A GLOSSARY</b>	
General Terms .....	A-1
Terms Related to Frequency.....	A-1
Terms Related to Amplitude .....	A-2
Terms Related to Digital Storage .....	A-3
Terms Related to Markers .....	A-3

# LIST OF ILLUSTRATIONS

Figure Number	Page	Figure Number	Page
TEKTRONIX 492AP Programmable Spectrum Analyzer.....viii			
2-1	2-19	6-1	Circuit of a 75–50 $\Omega$ matching pad (ac coupled).....6-2
4-1	4-3	6-2	Graph illustrating the relationship between dBm, dBmV, and dB $\mu$ V (matching attenuator included where necessary).....6-2
4-2	4-5	6-3	Volts-dBm-Watts conversion chart for 50 $\Omega$ impedance.....6-3
4-3	4-7	6-4	A typical display generated by a signal into the waveguide mixer.....6-4
4-4	4-8	6-5	Typical example of Identifier mode displays.....6-5
4-5	4-11	6-6	Typical display mixed with the VIDEO FILTER.....6-5
4-6	4-12	6-7	Typical display using B–SAVE A to observe the difference between SAVE A and B displays.....6-8
4-7	4-13	6-8	Block diagram showing external waveguide mixer installation.....6-13
4-8	4-14	6-9	A typical display from an external mixer.....6-14
4-9	4-15	7-1	International power cord options for the spectrum analyzer.....7-1
4-10	4-18		
4-11	4-20		
4-12	4-22		
4-13	4-25		
4-14	4-27		
5-1	5-1		
5-2	5-2		
5-3	5-5		
5-4	5-6		
5-5	5-12		
5-6	5-14		



# LIST OF TABLES

Table Number	Page	Table Number	Page
1-1	Tektronix Waveguide Mixers .....1-2	6-1	50 $\Omega$ System Reference Level Conversion.....6-2
2-1	Frequency Related Characteristics.....2-1	6-2	Marker Trace Organization.....6-12
2-2	Amplitude Related Characteristics.....2-7		
2-3	Input Signal Characteristics .....2-12	7-1	Power Cord Options .....7-1
2-4	Output Signal Characteristics .....2-15	7-2	Extended Service and Warranty Options.....7-2
2-5	General Characteristics .....2-17	7-3	Option 01 Alternate Specifications.....7-2
2-6	Power Requirements .....2-17	7-4	Option 07 Alternate Specifications.....7-4
2-7	Environmental Characteristics .....2-18	7-5	Options 21 and 22 Alternate Specifications.....7-5
2-8	Physical Characteristics.....2-19	7-6	Options 30 and 31 Characteristics and Alternate Specifications.....7-6
5-1	Sensitivity .....5-13		

# SAFETY SUMMARY

(Refer all servicing to qualified servicing personnel)

The safety information in this summary is for both operating and servicing personnel. Specific warnings and cautions will be found throughout the manual where they apply, but may not appear in this summary.

## CONFORMANCE TO INDUSTRY STANDARDS

The 492A/492AP complies with the following Industry Safety Standards and Regulatory Requirements.

### Safety

**CSA:** Electrical Bulletin

**FM:** Electrical Utilization Standard Class 3820

**ANSI C39.5** — Safety Requirements for Electrical and Electronic Measuring and Controlling Instrumentation.

**IEC 348 (2nd edition)** — Safety Requirements for Electronic Measuring Apparatus.

### Regulatory Requirements

**VDE 0871 Class B** — Regulations for RFI Suppression of High Frequency Apparatus and Installations.

## TERMS

### In This Manual

**CAUTION** statements identify conditions or practices that could result in damage to the equipment or other property.

**WARNING** statements identify conditions or practices that could result in personal injury or loss of life.

### As Marked on Equipment

**CAUTION** indicates a personal injury hazard not immediately accessible as one reads the marking, or a hazard to property, including the equipment itself.

**DANGER** indicates a personal injury hazard immediately accessible as one reads the marking.

## SYMBOLS

### In This Manual



This symbol indicates where applicable cautionary or other information is to be found.

### As Marked on Equipment



**DANGER** — High voltage.



Protective ground (earth) terminal.



**ATTENTION** — refer to manual.



Refer to manual

## POWER

### Power Source

This product is intended to operate from a power source that will not apply more than 250 V rms between the supply conductors or between either supply conductor and ground. A protective ground connection by way of the grounding conductor in the power cord is essential for safe operation.

### Grounding the Product

This product is grounded through the grounding conductor of the power cord. To avoid electrical shock, plug the power cord into a properly wired receptacle before connecting it to the product input or output terminals. A protective ground connection by way of the grounding conductor in the power cord is essential for safe operation.

### Danger From Loss of Ground

Upon loss of the protective-ground connection, all accessible conductive parts (including knobs and controls that may appear to be insulating) can render an electric shock.

### Use the Proper Power Cord

Use only the power cord and connector specified for your product.

Use only a power cord that is in good condition.

Refer cord and connector changes to qualified service personnel.

For detailed information on power cords and connectors, see the Maintenance section in the Service Manual, Volume 1.

### Use the Proper Fuse

To avoid fire hazard or equipment damage, use only the fuse of correct type, voltage rating, and current rating for your product (as specified in the Replaceable Electrical Parts list in Volume 2 of the Service Manual). Refer fuse replacement to qualified service personnel.

## OPERATIONAL PRECAUTIONS

### Do Not Operate in Explosive Atmospheres

To avoid explosion, do not operate this product in an explosive atmosphere unless it has been specifically certified for such operation.

### Do Not Remove Covers or Panels

To avoid personal injury, do not remove the product covers or panels unless you are qualified to do so. Do not operate the product without the covers and panels properly installed.

Dangerous voltages exist at several points in this product. To avoid personal injury, do not touch exposed connections and components while power is on. REFER ALL SERVICING TO QUALIFIED SERVICE PERSONNEL.

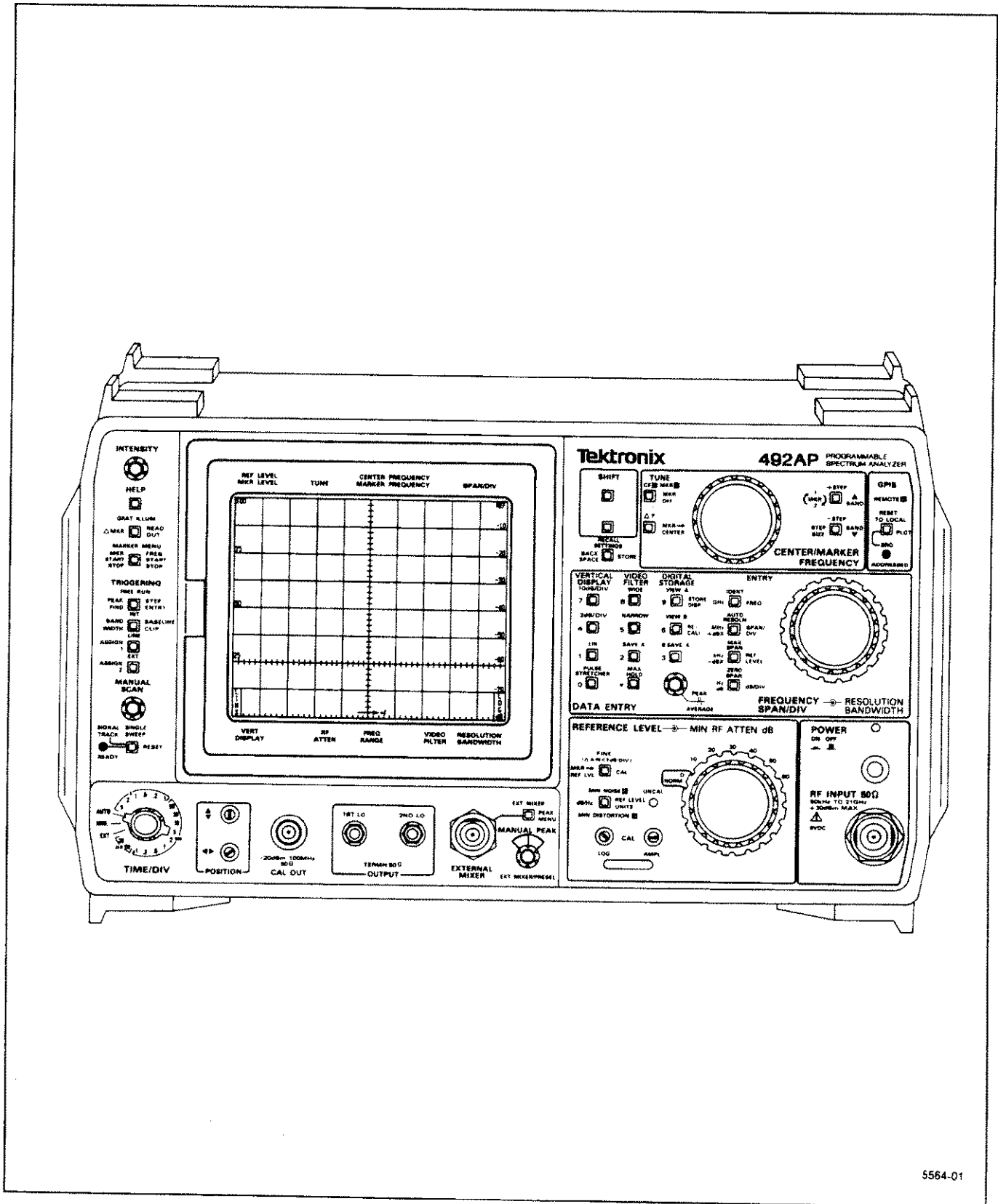

TEKTRONIX 492AP Programmable Spectrum Analyzer

# GENERAL INFORMATION

## PRODUCT OVERVIEW

The TEKTRONX 492A and programmable 492AP Spectrum Analyzer are high performance, compact, portable instruments. Microcomputer control of most functions simplifies and enhances operation.

The following is a list of the main instrument features.

- single and delta marker modes
- synthesizer frequency accuracy
- precise amplitude measurement capability
- digital storage display
- internal memory to retain front-panel settings and displays
- HELP message crt readout that describes the function of front-panel pushbuttons and controls as well as messages that explain operating errors
- front-panel Data Entry pushbuttons

The frequency range is 50 kHz to 21 GHz with the internal mixer, and up to 325 GHz when using external waveguide mixers. A minimum resolution bandwidth of 100 Hz, with a minimum span of 200 Hz/div, provides measurement resolution that is proportional to the frequency accuracy. Digital storage provides flicker-free displays plus SAVE A, B-SAVE A, and MAX HOLD to compare and subtract displays and save maximum values. In addition to conventional digital storage features, internal memory stores up to nine separate displays with their readouts and dot markers, which can be recalled later for additional analysis and comparison. It is also possible to store up to ten different front-panel control setups for future recall.

Select center frequency either by the front-panel CENTER/MARKER FREQUENCY knob or by the Data Entry pushbuttons. When using the Data Entry pushbuttons, it is not necessary to alter the Span/Div setting regardless of the frequency selected. Other parameters, such as vertical display and reference level, are pushbutton selectable with the flexibility previously available only under program control of the general purpose interface bus (GPIB).

The single and delta markers provide direct readout of frequency and amplitude information of any point along any displayed trace. Relative (delta) frequency and amplitude information between any two points along any displayed trace or between traces is also available. The CENTER/MARKER FREQUENCY control can move the markers, or it can move the display with a stationary frequency marker. For additional marker information refer to Using the Markers Feature in Section 6 of this Manual.

The programmable version of the instrument adds remote control capabilities to the manual instrument features.

The front-panel controls (except those intended exclusively for local use, such as INTENSITY) can be remotely operated through the GPIB port, which allows the spectrum analyzer to be used with a variety of systems and controllers. Refer to the Programmers Manual for additional information.

## Firmware Version and Error Message Readout

This feature of the spectrum analyzer provides readout that identifies the version of firmware installed. The readout is momentarily displayed when the power is turned on or when either the RESET TO LOCAL or <blue-SHIFT> RESET pushbuttons are pressed. All front-panel lights will temporarily flash on when the power is first turned on.

If the spectrum analyzer fails to complete any routine or function, an error message will flash on the screen explaining the failure.

## Accessories

The Replaceable Mechanical Parts list in the Service Manual, Volume 2, contains the part numbers, descriptions, and ordering information for all standard and optional accessories offered for the spectrum analyzer at this time.

The following list includes all standard accessories currently shipped with each instrument. Refer to Options 30 and 31 in the Options section of this manual for alternate information.

- 50 ohm coaxial cable; N to N connector, 72 inch
- 50 ohm coaxial cable; bnc to bnc connector, 18 inch
- Adapter; N male to bnc female
- 4A fast-blow fuses<sup>1</sup>; 2 each

<sup>1</sup> If the instrument is wired for 220-240 V operation (Options A1, A2, A3, A4, A5) or if Option 52 is installed (North American configuration for 220 V with standard power cord), 2A medium-blow fuses are used.

## General Information — 492A/492AP Operators

- Power cord
- Cord clamp
- Crt light filters; 2 – one each amber and grey
- Crt mesh filter
- Operators Manual
- Service Manual, Volume 1
- Service Manual, Volume 2
- Programmers Manual; 492AP Only

Table 1-1 lists the Tektronix waveguide mixers that are available as optional accessories.

**Table 1-1**  
**TEKTRONIX WAVEGUIDE MIXERS**

<b>Mixer</b>	<b>Frequency Range</b>
WM 490K	18 to 26.5 GHz
WM 490A	26.5 to 40 GHz
WM 490Q	33 to 50 GHz
WM 490U	40 to 60 GHz
WM 490V	50 to 75 GHz
WM 490E	60 to 90 GHz
WM 490W	75 to 110 GHz
WM 490F	90 to 140 GHz
WM 490D	110 to 170 GHz
WM 490G	140 to 220 GHz
WM 490G Option 01 Band Flange Transition	140 to 325 GHz

### Options

The Options section of this Manual contains detailed information on all of the options currently available for the spectrum analyzer.

# SPECIFICATION

This section includes the electrical, physical, and environmental characteristics of this instrument. Any instrument specification changes due to options are listed in the Options section of this manual.

## ELECTRICAL CHARACTERISTICS

The following tables of electrical characteristics and features apply to the spectrum analyzer after a 30-minute warm up and after doing the front-panel CAL adjustments, except as noted. The Performance Requirement column defines some characteristics in quantitative terms and in limit form. The Supplemental Information column explains performance requirements or provides performance information. Statements in this column are not considered to be guaranteed performance and are not ordinarily supported by a performance check procedure. Procedures to verify performance requirements are provided in the Performance Check portion of the Service Manual, Volume 1.

The instrument performs an internal calibration check each time power is turned on. This check verifies that the instrument frequency and amplitude performance is as specified. An Instrument Check Out procedure, which does not require external test equipment or technical expertise, is provided in Section 5 of this manual. This procedure will satisfy most incoming inspections and will help familiarize you with the instrument capabilities.

### Verification of Tolerance Values

Perform compliance tests of specified limits, listed in the Performance Requirement column, only after a 30-minute warm-up time (except as noted) and after a doing the front-panel CAL procedure. Use measurement instruments that do not affect the values measured. Measurement tolerance of test equipment should be negligible when compared to the specified tolerance. If the tolerance is not negligible, add the error of the measuring device to the specified tolerance.

Table 2-1  
FREQUENCY RELATED CHARACTERISTICS

Characteristic	Performance Requirement	Supplemental Information
Center Frequency Range Internal Mixer		50 kHz–21 GHz Tuned by the CENTER/MARKER FREQUENCY control or the DATA ENTRY pushbuttons
External Mixers (optional)		50 kHz–325 GHz (See Options Section)
Accuracy (after front-panel CAL has been performed)		Center Frequency Accuracy is specified by two characteristics: <ul style="list-style-type: none"> <li>● initial accuracy</li> <li>● center frequency drift during the sweep</li> </ul>
Initial (start of sweep) Bands 1 & 5–12 with SPAN/DIV >200 kHz, and Bands 2–4 with SPAN/DIV >100 kHz (1st LO unlocked)	$\pm \{20\%D + (CF \times 10^{-5})^a + 15N \text{ kHz}\}$ Where: D = SPAN/DIV or RESOLUTION BANDWIDTH, whichever is greater CF = Center Frequency N = Harmonic Number	Refer to IF, LO Range, and Harmonic Number specification later in this table for the N value  Allow a settling time of one second for each GHz change in CF within a band. In bands 4–12, divide the CF change by N.

<sup>a</sup>Over the operating temperature range this term is  $(CF \times 1.5 \times 10^{-5})$

Table 2-1 (Continued)  
 FREQUENCY RELATED CHARACTERISTICS

Characteristic	Performance Requirement	Supplemental Information
Initial Accuracy (Continued) Bands 1 & 5-12 with SPAN/DIV $\leq$ 200 kHz, and Bands 2-4 with SPAN/DIV $\leq$ 100 kHz (1st LO locked)	$\pm \{(20\%D) + (CF \times 10^{-5})^a \text{ Hz}\}$ Where: D = SPAN/DIV or RESOLUTION BANDWIDTH, whichever is greater CF = Center Frequency	
Drift  After 30 minute warm up Bands 1 & 5-12 with SPAN/DIV $>$ 200 kHz, and Bands 2-4 with SPAN/DIV $>$ 100 kHz (1st LO unlocked)		With constant ambient temperature and fixed center frequency (any error is observed during sweep time)  $\leq (25 \text{ kHz})N$ per minute of sweep time
Bands 1 & 5-12 with SPAN/DIV $\leq$ 200 kHz, and Bands 2-4 with SPAN/DIV $\leq$ 100 kHz (1st LO locked)		$\leq 150 \text{ Hz}$ per minute of sweep time
After 1 hour warm up Bands 1 & 5-12 with SPAN/DIV $>$ 200 kHz, and Bands 2-4 with SPAN/DIV $>$ 100 kHz (1st LO unlocked)		$\leq (5 \text{ kHz})N$ per minute of sweep time
Bands 1 & 5-12 with SPAN/DIV $\leq$ 200 kHz, and Bands 2-4 with SPAN/DIV $\leq$ 100 kHz (1st LO locked)	$\leq 50 \text{ Hz}$ per minute of sweep time	

<sup>a</sup>Over the operating temperature range this term is  $(CF \times 1.5 \times 10^{-5})$



**Table 2-1 (Continued)**  
**FREQUENCY RELATED CHARACTERISTICS**

Characteristic	Performance Requirement	Supplemental Information
Readout Resolution		At least 10% of SPAN/DIV to minimum of 1 kHz
Residual FM		Short term, after 1 hour warm up
Bands 1 & 5-12 with SPAN/DIV > 200 kHz, and Bands 2-4 with SPAN/DIV > 100 kHz (1st LO unlocked)	$\leq (7 \text{ kHz})N$ total excursion in 20 ms	
Bands 1 & 5-12 with SPAN/DIV $\leq$ 200 kHz, and bands 2-4 with SPAN/DIV $\leq$ 100 kHz (1st LO locked)	$\leq (10+2N)\text{Hz}$ total excursion in 20 ms	
Resolution Bandwidth (6 dB down)	Within 20% of selected bandwidth	100 Hz-1 MHz in decade steps
Shape Factor (60 dB/6 dB)	7.5:1 or less	
Noise Sidebands	At least -75 dBc at an offset of 30 $\times$ resolution bandwidth	
Video Filter Narrow		Reduces video bandwidth to approximately 1/300th of the selected resolution bandwidth.
Wide		Reduces video bandwidth to approximately 1/30th of the selected resolution bandwidth.
Pulse Stretcher Fall Time		30 $\mu$ s per vertical division ( $\pm$ 50%).

Table 2-1 (Continued)  
 FREQUENCY RELATED CHARACTERISTICS

Characteristic	Performance Requirement	Supplemental Information	
Frequency Span/Div			
Overall Range			
With SPAN/DIV control		200 Hz–10 GHz (in a 1-2-5 sequence)	
With the DATA ENTRY push-buttons		200 Hz–15 GHz (to two significant digits)	
Minimum Span/Div		200 Hz in all bands	
Maximum Span/Div		With SPAN/DIV Control	With DATA ENTRY Pushbuttons
Band 1 (50 kHz–4.2 GHz) <sup>a</sup>		200 MHz	410 MHz <sup>a</sup>
Band 2 (1.7–5.5 GHz)		200 MHz	370 MHz
Band 3 (3–7.1 GHz)		200 MHz	400 MHz
Band 4 (5.4–18 GHz)		1 GHz	1.2 GHz
Band 5 (15–21 GHz)		500 MHz	590 MHz
Band 6 (18–27 GHz)		500 MHz	790 MHz
Band 7 (26–40 GHz)		1 GHz	1.3 GHz
Band 8 (33–60 GHz)		2 GHz	2.6 GHz
Band 9 (50–90 GHz)		2 GHz	3.9 GHz
Band 10 (75–140 GHz)		5 GHz	6.4 GHz
Band 11 (110–220 GHz)		10 GHz	10 GHz
Band 12 (170–325 GHz)		10 GHz	15 GHz
		In addition, MAX SPAN sweeps across an entire band and ZERO SPAN provides a 0 Hz display.	
Accuracy/Linearity	Within 5% of the selected span/div	Measured over the center 8 divisions	

<sup>a</sup>For Option 01 instruments, band 1 is 50 kHz–1.8 GHz, and the Span/Div range with the SPAN/DIV control is 100 MHz and with the DATA ENTRY pushbuttons is 170 MHz.

**Table 2-1 (Continued)**  
**FREQUENCY RELATED CHARACTERISTICS**

Characteristic	Performance Requirement		Supplemental Information
Frequency Response			Measured with 10 dB RF attenuation and peaking optimized for each center frequency setting (when applicable)  Response is affected by: <ul style="list-style-type: none"> <li>● input VSWR</li> <li>● harmonic number (N)</li> <li>● gain variation</li> <li>● mixer</li> <li>● preselector (Opt 01)</li> </ul> Digital storage typically increases errors by $\pm 0.5\%$ .  Display flatness is typically 1 db greater than frequency response.
Coaxial (direct) Input  Band and Freq Range 1 (50 kHz–4.2 GHz) <sup>a</sup> 2 (1.7–5.5 GHz) 3 (3.0–7.1 GHz) 4 (5.4–18.0 GHz) 5 (15.0–21.0 GHz)	About the mid-point between two extremes	Referenced to 100 MHz	Refer to the Options section of this manual for variations in this specification.
With Tektronix External High Performance Waveguide Mixers  Band and Freq Range 6 (18.0–27 GHz) 7 (26.0–40.0 GHz) 8 (33.0–60.0 GHz) 9 (50.0–90.0 GHz)  10 (75.0–140.0 GHz)  11 (110.0–220.0 GHz)  12 (170.0–325.0 GHz)	$\pm 1.5$ dB $\pm 1.5$ dB $\pm 1.5$ dB $\pm 2.5$ dB $\pm 3.5$ dB  $\pm 2.0$ dB $\pm 2.0$ dB $\pm 2.5$ dB	$\pm 2.5$ dB $\pm 2.5$ dB $\pm 2.5$ dB $\pm 3.5$ dB $\pm 5.0$ dB  $\pm 6.0$ dB $\pm 6.0$ dB $\pm 6.0$ dB	Typically $\pm 3$ dB over any 5 GHz range Typically $\pm 3$ dB over any 5 GHz range Typically $\pm 3$ dB over any 5 GHz range Typically $\pm 3$ dB over any 5 GHz range

<sup>a</sup>For Option 01 instruments, band 1 is 50 kHz–1.8 GHz.

Table 2-1 (Continued)  
**FREQUENCY RELATED CHARACTERISTICS**

Characteristic	Performance Requirement	Supplemental Information		
IF Frequency, LO Range, and Harmonic Number (N)  <b>Band and Freq Range</b> 1 (50 kHz–4.2 GHz) <sup>a</sup> 2 (1.7–5.5 GHz) 3 (3.0–7.1 GHz) 4 (5.4–18 GHz) 5 (15–21 GHz) 6 (18–27 GHz) 7 (26–40 GHz) 8 (33–60 GHz) 9 (50–90 GHz) 10 (75–140 GHz) 11 (110–220 GHz) 12 (170–325 GHz)		1st IF (MHz)	(N)	LO Range (MHz)
		829	1 –	2529–6329
		829	1 +	2171–6271
		829	3 –	2072–6276
		2072	3 +	4309–6309
		2072	6 +	2655–4155
		2072	10 +	2443–3793
		2072	10 +	3092–5790
		2072	15 +	3195–5862
		2072	23 +	3170–6000
		2072	37 +	2917–5790
		2072	56 +	2998–5841
Marker(s)		When activated, the marker is a bright dot positioned by the CENTER/MARKER FREQUENCY control or the DATA ENTRY pushbuttons.		
Normal Accuracy	Identical to center frequency accuracy	For the live trace		
Δ MKR Accuracy	Differential frequency accuracy is twice the center frequency accuracy	For the live trace.  ΔMKR activates a second marker at the position of the single marker on the trace. Parenthesis appear on the marker display line indicating that the delta mode is active. The display shows the difference in frequency and amplitude. 1←MKR→2 selects which marker is tuned.		

<sup>a</sup>For Option 01 Instruments, band 1 is 50 kHz–1.8 GHz, and the LO Range is 2072–3872.

Table 2-2  
AMPLITUDE RELATED CHARACTERISTICS

Characteristic	Performance Requirement	Supplemental Information
Vertical Display Modes		10 dB/Div, 2 dB/Div, and Linear — any integer between 1–15 dB/Div can also be selected with the DATA ENTRY pushbuttons.
Display Dynamic Range		80 dB maximum (Log Mode) 8 divisions (Linear Mode)
Accuracy 10 dB/div Log Mode	$\pm 1.0$ dB/10 dB to a maximum cumulative error of $\pm 2.0$ dB over 80 dB range	
2 dB/div Log Mode	$\pm 0.4$ dB/2.0 dB to a maximum cumulative error of $\pm 1.0$ dB over 16 dB range	
Linear Mode	$\pm 5\%$ of full scale	
Reference Level Range Log Mode		Top of the graticule.  From $-117$ dBm to $+40$ dBm; $+40$ dBm includes 10 dB of IF gain reduction ( $+30$ dBm is the maximum safe input). Alternate reference levels are: <ul style="list-style-type: none"> <li>● dBV (<math>-130</math> dBV to <math>+27</math> dBV)</li> <li>● dBmV (<math>-70</math> dBmV to <math>+87</math> dBmV)</li> <li>● dB<math>\mu</math>V (<math>-10</math> dB<math>\mu</math>V to <math>+147</math> dB<math>\mu</math>V)</li> </ul>
Linear Mode		39.6 nV/Div–2.8 V/Div (1W maximum safe input)
Steps 10 dB/div Log Mode		10 dB for the Coarse Mode 1 dB for the Fine Mode
2 dB/div Log Mode		1 dB for the Coarse Mode 0.25 dB for the Fine Mode
Linear Mode		1-2-5 sequence for Coarse Mode 1 dB equivalent steps for Fine Mode
Set with DATA ENTRY push-buttons		Steps correspond to the display mode in coarse; except, for 2 dB when the steps are 1 dB.  In Fine Mode: <ul style="list-style-type: none"> <li>1 dB when the mode is 5 dB/div or more</li> <li>0.25 dB for display modes of 4 dB/div or less (referred to as Delta A Mode)</li> </ul>

Table 2-2 (Continued)  
AMPLITUDE RELATED CHARACTERISTICS

Characteristic	Performance Requirement	Supplemental Information
Reference Level (Continued) Accuracy		Dependent on the following characteristics: <ul style="list-style-type: none"> <li>●RF Attenuation Accuracy</li> <li>●IF Gain Accuracy</li> <li>●Resolution Bandwidth</li> <li>●Display Mode</li> <li>●Calibrator Accuracy</li> <li>●Frequency Band</li> <li>●Frequency Response</li> <li>●&lt;blue-SHIFT&gt; CAL routine reduces error between resolution bandwidths at -20 dBm REF LEVEL. Other reference levels may have larger errors.</li> <li>●Ambient Temperature Change (<math>\pm 0.15</math> dB/°C maximum)</li> </ul>
RF Attenuator Range		0-60 dB in 10 dB steps
Accuracy Dc-1.8 GHz	Within 0.5 dB/10 dB to a maximum of 1 dB over the 60 dB range	
1.8 GHz-18 GHz	Within 1.5 dB/10 dB to a maximum of 3 dB over the 60 dB range	
18 GHz-21 GHz	Within 3.0 dB/10 dB to a maximum of 6 dB over the 60 dB range	
Marker(s)		When activated, the marker is a bright dot positioned by the CENTER/MARKER FREQUENCY control.
Accuracy (Normal or Delta Mode)		Identical to REF LEVEL accuracy plus cumulative error of display scale (dependent on vertical position)  ΔMKR activates a second marker at the position of the single marker on the trace. Parenthesis appear on the marker display line indicating that the delta mode is active. The display shows the difference in frequency and amplitude. 1—MKR—2 selects which marker is tuned.

Table 2-2 (Continued)  
**AMPLITUDE RELATED CHARACTERISTICS**

Characteristic	Performance Requirement	Supplemental Information
Gain Variation Between Resolution Bandwidths		Measurement conditions: ●measured at -20 dBm ●Minimum Distortion Mode ●at 25°C ambient temperature ●after front-panel CAL adjustments
With respect to 1 MHz Filter	±0.4 dB	
Between Any Two Filters	0.8 dB	
IF Gain Range		87 dB of gain increase, 10 dB of gain decrease (MIN NOISE activated), in 10 dB and 1 dB steps
Accuracy 1 dB Step	At least 0.2 dB/dB step to 0.5 dB/9 dB steps except at the decade transitions	
Decade Transitions -19 to -20 dBm -29 to -30 dBm -39 to -40 dBm -49 to -50 dBm -59 to -60 dBm	0.5 dB or less	Maximum 1 dB cumulative error over 10 dB
Maximum Deviation over the 97 dB Range	±2 dB	

Table 2-2 (Continued)  
**AMPLITUDE RELATED CHARACTERISTICS**

Characteristic	Performance Requirement	Supplemental Information		
Differential Amplitude Measurement		Delta A Mode provides differential measurements in 0.25 dB increments.  (This is not related to the Delta Marker Mode.)		
Range		0 dB above to 48 dB below the reference level established when the Delta A Mode was activated.  DO NOT USE Delta A Mode outside the -117 dBm to +30 dBm reference level range.		
Accuracy		Difference	Steps	Error
		0.25 dB	1	0.15 dB
		2 dB	8	0.4 dB
		10 dB	40	1.0 dB
48 dB	192	2.0 dB		
Spurious Responses				
Residual	-100 dBm or less	No input signal, referenced to the EXTERNAL MIXER Input, and fundamental mixing for Bands 1-3. (See Options 30 and 31 in the Options section for alternate specifications.)		
3rd Order Intermodulation Products 50 kHz-21 GHz (Bands 1-5)	-70 dBc or less from any two on-screen signals within any frequency span.	Refer to Option 01 in the Options section for alternate specification. In Minimum Distortion Mode		
Harmonic Distortion 50 kHz-21 GHz (Bands 1-5)	-60 dBc or less	Measured at -40 dBm input level in Minimum Distortion Mode.		
LO Emission	Less than -10 dBm to 21 GHz	With 0 dB RF Attenuation		



Table 2-2 (Continued)  
AMPLITUDE RELATED CHARACTERISTICS

Characteristic	Performance Requirement						Supplemental Information	
Sensitivity	Equivalent Input Noise in dBm versus Resolution Bandwidth						Equivalent maximum input noise without internal preselection for each resolution bandwidth for frequency bands 1-5 (50 kHz-21 GHz), and Tektronix High Performance Waveguide Mixers for bands 6-12 (18-325 GHz). The NARROW Video Filter is activated for resolution bandwidths of 1 kHz or less and the WIDE Video Filter for resolution bandwidths above 1 kHz. (See Options 01 and 07 in the Options section for alternate specifications.)	
	Band and Frequency Range	100 Hz	1 kHz	10 kHz	100 kHz <sup>a</sup>	300 kHz <sup>a</sup>		1 MHz
1 <sup>b</sup> (50 kHz-4.2 GHz)	-125	-115	-105	-95	-90	-85	Typically -95 dBm for 1 kHz bandwidth at 50 GHz, degrading to -85 dBm at 90 GHz.	
2 & 3 (1.7-7.1 GHz)	-125	-115	-105	-95	-90	-85		
4 (lower part) (5.4-12.0 GHz)	-110	-100	-90	-80	-75	-70		
4 (upper part) (12.0-18.0 GHz)	-105	-95	-85	-75	-70	-65		
5 (15.0-21.0 GHz)	-105	-95	-85	-75	-70	-65		
6 <sup>c</sup> (18.0-27 GHz)	-108	-100	-90	-80		-70		
7 <sup>c</sup> (26.0-40.0 GHz)	-103	-95	-85	-75		-65		
8 <sup>c</sup> (33.0-60.0 GHz)	-103	-95	-85	-75		-65		
9 <sup>c</sup> (50.0-90.0 GHz)								Typically -90 dBm for 1 kHz bandwidth at 75 GHz, degrading to -75 dBm at 140 GHz.
10 <sup>c</sup> (75.0-140 GHz)								
11 <sup>c</sup> (110-220 GHz)								Typically -80 dBm for 1 kHz bandwidth at 110 GHz, degrading to -65 dBm at 220 GHz.
12 <sup>c</sup> (170-325 GHz)								

<sup>a</sup> Option 07 replaces the 100 kHz filter with a 300 kHz filter.

<sup>b</sup> For Option 01 instruments, band 1 is 50 kHz-1.8 GHz.

<sup>c</sup> Specified using external Tektronix High Performance Waveguide Mixers.

Table 2-3  
INPUT SIGNAL CHARACTERISTICS

Characteristic	Performance Requirement	Supplemental Information
RF INPUT		Type N female connector, specified to 21 GHz.  (See Option 07 in the Options section for supplemental specifications concerning an additional 75 $\Omega$ input.)
Impedance		50 $\Omega$
VSWR with 10 dB or more RF Attenuation 50 kHz–2.5 GHz		1.3:1 (typically 1.2:1)
2.5–6.0 GHz		1.7:1 (typically 1.5:1)
6.0–18 GHz		2.3:1 (typically 1.9:1)
18–21 GHz		3.5:1 (typically 2.7:1)
VSWR with 0 dB RF Attenuation		Standard measured within 3 MHz of center of preselector band for Option 01 (does not apply in Band 1). Typically 1.9:1
50 kHz–2.5 GHz		Typically 1.9:1
2.5–6.0 GHz		Typically 1.9:1
6.0–18 GHz		Typically 2.3:1
18–21 GHz		Typically 3.0:1
Maximum Safe Input (With 0 dB RF attenuation)		+13 dBm (Input Mixer Limit) 1 W with 20 dB attenuation
1 dB Compression Point (Minimum) Bands 1–5 (50 kHz–21 GHz)	–18 dBm	With no RF attenuation
Optimum RF Input Level for Linear Operation		–30 dBm, referenced to the input mixer  This is achieved with MIN DISTORTION active when not exceeding full screen display.
EXTERNAL MIXER		Input for an IF signal from an external waveguide mixer.  Provides dc bias for the external mixer. See Output Characteristics.

Table 2-3 (Continued)  
INPUT SIGNAL CHARACTERISTICS

Characteristic	Performance Requirement	Supplemental Information
HORIZ/TRIG (Rear Panel)		Dc coupled input for external horizontal drive (selected by the EXT position of the front-panel TIME/DIV control) and ac coupled input for external trigger signals (selected at other positions of the TIME/DIV control).
Sweep Input Voltage Range		0 to +10V (dc + peak ac) for full screen deflection
Trigger Input Voltage Range Minimum	At least 1.0V peak from 15 Hz–1 MHz	
Maximum dc + peak ac		50V
ac		30V <sub>rms</sub> –10 kHz, then derate linearly to 3.5V <sub>rms</sub> at 100 kHz and above.
Pulse Width		0.1 μs minimum
MARKER/VIDEO (Rear Panel)		External Video input or External Video Marker input, switched by pin 1 of the J104 ACCESSORIES connector.
Video Input Level		0 to +4V
Marker Input Level		0 to –10V Interfaces with Tektronix 1405 Sideband Adapter.
J104 ACCESSORY (Rear Panel)		25-pin connector (Not RS-232 compatible) Provides bi-directional access to the instrument bus. Also provides external Video select and external preselector drive. Except for the external preselector drive output, all lines are TTL compatible. Maximum voltage on all lines is ±15V.
Pin 1		External Video Select Low selects External Video Input. High (default) selects Video Marker Input.
Pin 2		External Preselector — Drive signal for an external preselector. Output voltage is proportional to frequency change (only Option 01 and in bands 2–5).
Pin 3		External Preselector Return — Ground return for the External Preselector signal.

Table 2-3 (Continued)  
INPUT SIGNAL CHARACTERISTICS

Characteristic	Performance Requirement	Supplemental Information
J104 ACCESSORY (Continued) Pin 4		Internal Control. High (default) selects internal control. Instrument bus lines are output at the J104 ACCESSORIES connector. Low selects External control. Instrument bus lines at the J104 ACCESSORIES connector accept input from an external controller.
Pin 5		Chassis Ground
Pins 6–13 <sup>a</sup>		Instrument Bus Address lines 7–0 <sup>a</sup>
Pin 14 <sup>a</sup>		Instrument Bus Data Valid signal <sup>a</sup>
Pin 15 <sup>a</sup>		Instrument Bus Service Request signal <sup>a</sup>
Pin 16 <sup>a</sup>		Instrument Bus Poll signal <sup>a</sup>
Pin 17		Data Bus Enable input signal for external controller. High (unasserted) disables external data bus. Low enables external data bus.
Pins 18–25		Instrument Bus Data lines 0–7 Active when external Data Bus Enable (pin 17) is low.

<sup>a</sup>Output when internally controlled (pin 4 high) and input when externally controlled (pin 4 low).

Table 2-4  
OUTPUT SIGNAL CHARACTERISTICS

Characteristic	Performance Requirement	Supplemental Information
Calibrator (CAL OUT)	-20 DBM $\pm$ 0.3 DB at 100 MHz $\pm$ 10 PPM*	100 MHz comb of markers provide amplitude calibration at 100 MHz and markers for frequency and span calibration to 1.0 GHz.
1st LO and 2nd LO OUTPUTs		Provide access to the output of the respective local oscillators. THESE PORTS MUST BE TERMINATED IN 50 $\Omega$ AT ALL TIMES.
1st LO OUTPUT Power		+7.5 dBm to +15 dBm
2nd LO OUTPUT Power		-22 dBm to 0 dBm.
EXTERNAL MIXER		When EXT MIXER is selected, provides bias from a 70 $\Omega$ source for an external mixer. Bias is set by the MANUAL PEAK control or internally set if AUTO PEAK is selected. Also see Input Characteristics. Replaced by 75 $\Omega$ RF Input for Option 07. See Options.
Bias Range		+1.0V to -2.0V (default) or, -1.0V to +2.0V (internally selectable)
VERT (OUTPUT) (Rear Panel)		Provides 0.5V $\pm$ 5% of signal per division of video that is above and below the centerline. Source impedance is approximately 1k $\Omega$ .
HORIZ (OUTPUT) (Rear Panel)		Provides 0.5V/Div either side of center. Full range -2.5V to +2.5V. Source impedance is approximately 1k $\Omega$ .
PEN LIFT (Rear Panel)		TTL compatible, nominal +5V to lift plotter pen.
10 MHz IF (OUTPUT) (Rear Panel)		Provides access to the 10 MHz IF signal. Output level is approximately -5 dBm for a full screen signal at -30 dBm reference level. Nominal impedance is approximately 50 $\Omega$ .
IEEE STD 488 PORT (Rear Panel) (Programmable (P) version only)		In accordance with IEEE 488-1978 standard and Tektronix GPIB Codes, Formats, Conventions, and Features standard, implemented as SH1, AH1, T5, L3, SR1, RL1, PP1, DC1, DT1, and C0. See Programmers Manual.

\* Over the operating temperature range this is +15 PPM.

Table 2-4 (Continued)  
**OUTPUT SIGNAL CHARACTERISTICS**

Characteristic	Performance Requirement	Supplemental Information
PROBE POWER (Rear Panel)		Provides operating voltages for active probes.
Outputs		
Pin 1		+5V at 100 mA maximum
Pin 2		Ground
Pin 3		-15V at 100 mA maximum
Pin 4		+15V at 100 mA maximum
J104 ACCESSORIES (Rear Panel)		All inputs and outputs are listed in Table 2-3 INPUT CHARACTERISTICS.

**Table 2-5  
GENERAL CHARACTERISTICS**

Characteristic	Performance Requirement	Supplemental Information
Sweep		Triggered, auto, manual, and external
Sweep Time	20 $\mu$ s/Div–5 s/Div in 1-2-5 sequence (10 s/Div available in AUTO)	
Accuracy	$\pm 5\%$ over center 8 divisions	
Triggering		INTERNAL, EXTERNAL, FREE RUN, and SINGLE SWEEP
Internal Trigger Level	2 divisions or more of signal	
External Trigger Input Level	1.0V peak, minimum	EXTERNAL is ac-coupled (15 Hz–1 MHz). Maximum external trigger input is 50V (dc + peak ac).
Crt Readout		Displays all parameters listed on the crt bezel, plus help and operating messages.
Battery-Powered Memory		Instrument settings, displays, calibration offsets, and peaking codes for each band are stored in battery-powered non-volatile RAM.  (See Option 39 in the Options section for alternate specification)
Battery Life		(See Option 39 in the Options section for alternate specification) 1 year
At +55°C Ambient Temperature		
At +25°C Ambient Temperature		At least 5 years
Temperature Range for Retaining Data Operating		–15°C to +55°C
Non-Operating		–30°C to +85°C

**Table 2-6  
POWER REQUIREMENTS**

Characteristic	Performance Requirement	Supplemental Information
Line Frequency Range	48–440 Hz	
Line Voltage Range	90 V <sub>ac</sub> to 132 V <sub>ac</sub> 180 V <sub>ac</sub> to 250 V <sub>ac</sub>	115 V nominal 230 V nominal
Line Fuse 115V Nominal	4A	
230V Nominal	2A Medium-Blow	
Input Power	210 W maximum (3.2A)	At 115V and 60 Hz
Leakage Current		5 mA maximum

**Table 2-7  
ENVIRONMENTAL CHARACTERISTICS**

Meets MIL T-28800C, type III class 3, style C specifications.																													
Characteristic	Description																												
Temperature																													
Operating and Humidity	-15°C to +55°C/95% (+5%, -0%) relative humidity.																												
Non-operating <sup>a</sup>	-62°C to +85°C																												
Altitude																													
Operating	15,000 feet (tested to 25,000 ft)																												
Non-operating	40,000 feet																												
Humidity (Non-operating)	Five cycles (120 hours) in accordance with MIL-Std-810																												
Vibration, Operating (instrument secured to a vibration platform during test)	MIL-Std-810, Method 514 Procedure X (modified). Resonant searches along all three axes at 0.020 inch displacement, frequency varied from 5 Hz-55 Hz for 15 minutes. All major resonances must be minimum/axis plus dwell at the resonant frequency, or 55 Hz if no resonance is found for 10 minutes minimum. Total vibration time is approximately 75 minutes.																												
Shock (Operating and Non-operating)	Three guillotine-type shocks of 30g, one-half sine, 11 ms duration each direction along each major axis; total of 18 shocks.																												
Transit drop (free fall)	8 inch, one per each of six faces and eight corners (instrument is tested and meets drop height of 12 inches).																												
Electromagnetic Interference (EMI)	Meets requirements described in MIL-Std-461B Part 4, except as noted.																												
	<table border="1"> <thead> <tr> <th>Test Method</th> <th>Remarks</th> </tr> </thead> <tbody> <tr> <td>CE01—60 Hz-15 kHz</td> <td>1 kHz-15 kHz only</td> </tr> <tr> <td>CE03—15 kHz-50 MHz power leads</td> <td>15 kHz-50 kHz, relaxed by 15 dB</td> </tr> <tr> <td>Conducted Susceptibility</td> <td></td> </tr> <tr> <td>  CS01—30 Hz-50 kHz power leads</td> <td>Full limits</td> </tr> <tr> <td>  CS02—50 kHz-400 MHz power leads</td> <td>Full limits</td> </tr> <tr> <td>  CS06—spike power leads</td> <td>Full limits</td> </tr> <tr> <td>Radiated Emissions</td> <td></td> </tr> <tr> <td>  RE01—30 Hz-50 kHz magnetic field (measured at 30 cm)</td> <td>Exceptioned, 30 kHz-36 kHz</td> </tr> <tr> <td>  RE02—14 kHz-10 GHz</td> <td>Full limit</td> </tr> <tr> <td>Radiated Susceptibility</td> <td></td> </tr> <tr> <td>  RS01—30 Hz-50 kHz</td> <td>Full limit</td> </tr> <tr> <td>  RS02—Magnetic Induction</td> <td>To 5A only</td> </tr> <tr> <td>  RS03—14 kHz-10 GHz</td> <td>Up to 1 GHz</td> </tr> </tbody> </table>	Test Method	Remarks	CE01—60 Hz-15 kHz	1 kHz-15 kHz only	CE03—15 kHz-50 MHz power leads	15 kHz-50 kHz, relaxed by 15 dB	Conducted Susceptibility		CS01—30 Hz-50 kHz power leads	Full limits	CS02—50 kHz-400 MHz power leads	Full limits	CS06—spike power leads	Full limits	Radiated Emissions		RE01—30 Hz-50 kHz magnetic field (measured at 30 cm)	Exceptioned, 30 kHz-36 kHz	RE02—14 kHz-10 GHz	Full limit	Radiated Susceptibility		RS01—30 Hz-50 kHz	Full limit	RS02—Magnetic Induction	To 5A only	RS03—14 kHz-10 GHz	Up to 1 GHz
Test Method	Remarks																												
CE01—60 Hz-15 kHz	1 kHz-15 kHz only																												
CE03—15 kHz-50 MHz power leads	15 kHz-50 kHz, relaxed by 15 dB																												
Conducted Susceptibility																													
CS01—30 Hz-50 kHz power leads	Full limits																												
CS02—50 kHz-400 MHz power leads	Full limits																												
CS06—spike power leads	Full limits																												
Radiated Emissions																													
RE01—30 Hz-50 kHz magnetic field (measured at 30 cm)	Exceptioned, 30 kHz-36 kHz																												
RE02—14 kHz-10 GHz	Full limit																												
Radiated Susceptibility																													
RS01—30 Hz-50 kHz	Full limit																												
RS02—Magnetic Induction	To 5A only																												
RS03—14 kHz-10 GHz	Up to 1 GHz																												

<sup>a</sup>After storage at temperatures below -15°C, the instrument may not reset when power is first turned on. If this happens, allow the instrument to warm up for at least 15 minutes, then turn POWER OFF for 5 seconds and back ON.



**Table 2-8  
PHYSICAL CHARACTERISTICS**

Characteristic	Description
Weight	44 lbs (20 kg) maximum (see Options 01, 30, and 31 in Options section for alternate specification) Including cover and standard accessories, except manuals.
Dimensions (See Figure 2-1)	
Without Front Cover, Handle, or Feet	6.9 × 12.87 × 19.65 inches (175 × 327 × 499 mm)
With Front Cover, Feet, and Handle Handle Folded Back Over the Instrument	9.15 × 15.05 × 23.1 inches (232 × 382 × 587 mm)
Handle Fully Extended	9.15 × 15.05 × 28.85 inches (232 × 382 × 732.8 mm)

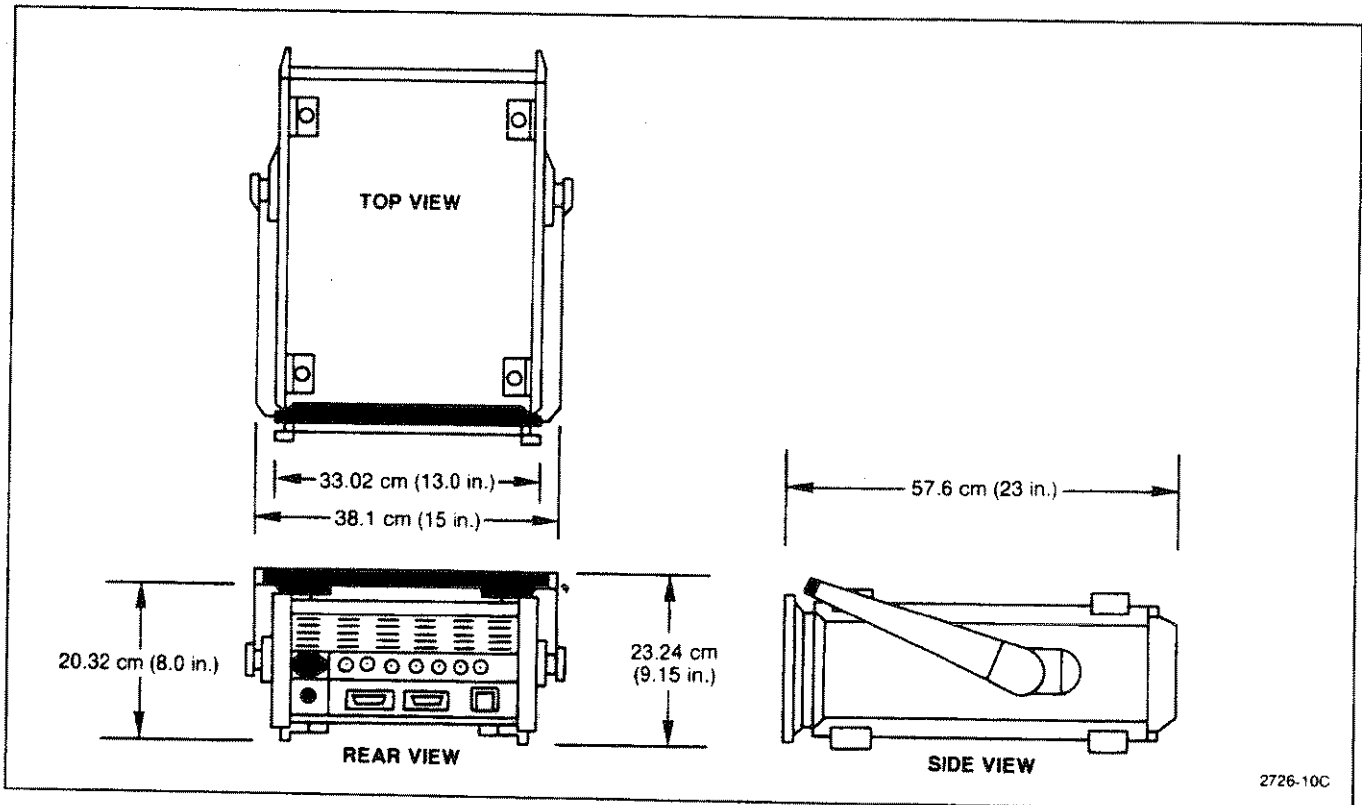

Figure 2-1. Dimensions.

www.valuetronics.com

# PREPARATION FOR USE

This section describes unpacking, installation, power requirements, storage information, and repackaging for the spectrum analyzer.

## UNPACKING AND INITIAL INSPECTION

Before unpacking the spectrum analyzer, inspect the shipping container for signs of external damage. If the container is damaged, notify the carrier as well as Tektronix, Inc. The shipping container contains the basic instrument and its standard accessories. For a list of the standard accessories, refer to Standard Accessories, in Section 1 of this Manual (or, for ordering information, refer to the list following the Replaceable Mechanical Parts list in the Service Manual, Volume 2).

If the contents of the shipping container are incomplete, if there is mechanical damage or defect, or if the instrument does not meet operational check requirements, contact your local Tektronix Field Office or representative.

Keep the shipping container if the instrument is to be stored or shipped to Tektronix for service or repair. Refer to Storage and Repackaging for Shipment later in this section.

The instrument was inspected both mechanically and electrically before shipment, and it should be free of mechanical damage and meet or exceed all electrical specifications. The Operation section of this Manual contains procedures to check functional or operational performance. Perform the functional check procedure to verify that the instrument is operating properly. This check is intended to satisfy the requirements for most receiving or incoming inspections. (A detailed electrical performance verification procedure in the Service Manual, Volume 1, provides a check of all specified performance requirements, as listed in the Specification section.)

The instrument can be operated in any position that allows air flow in the bottom and out the rear of the instrument. Feet on the four corners allow ample clearance even if the instrument is stacked with other instruments. The air is drawn in by a fan through the bottom and expelled out the back. Avoid locating the instrument where paper, plastic, or any other material might block the air intake.

## INSTALLATION

The front cover provides a dust-tight seal and a convenient place to store accessories and external waveguide mixers. Use the cover to protect the front panel when storing or transporting the instrument. To remove the cover, stand the instrument on the two back feet so the name on the handle is facing up and towards you, and pull slightly out and up on the sides of the cover. Attached to the inside of the cover is the accessories pouch. To open the accessories pouch, pull up evenly on the flap.

You can position the handle of the spectrum analyzer at several angles to serve as a tilt stand. To stack instruments, position the handle at the top rear of the instrument. To change the handle position, press in at both pivot points and rotate the handle to the desired position.

### WARNING

Removing or replacing the cabinet on the instrument can be hazardous. Only qualified service personnel should attempt to remove the instrument cabinet.

## Rackmount Instrument

Refer to the Service Manual, Volume 1, for installation instructions for the rackmount version of the instrument. Refer installation to qualified service personnel.

### CAUTION

If the rackmount instrument is extended out of the rack and tipped up to gain access to the bottom or back panels of the cabinet, securely hold the instrument so it cannot fall back into the rack. Use care when doing this to avoid damaging the instrument front panel or equipment that may be mounted above the instrument.

## Rack Adapter Kit

A field-installable kit is available to permit the spectrum analyzer to be rack mounted in a standard 19" wide rack on a non-tilting slide-out track. Fan-forced ventilation of the rack enclosure is highly recommended. If the rack-adapter assembly is installed in an enclosed rack, a minimum depth of 25" behind the front panel is recommended for proper air circulation. The rack adapter kit comes complete with the slide-out tracks and all mounting hardware. Contact your local Tektronix Field Office or representative for additional information and ordering instructions.

## POWER SOURCE AND POWER REQUIREMENTS

The spectrum analyzer is intended to be operated from a single-phase power source that has one of its current-carrying conductors (neutral) at ground (earth) potential. It is not recommended to operate the spectrum analyzer from power sources where both current-carrying conductors are isolated or above ground potential (such as phase-to-phase on a multi-phase system or across the legs of a 110-220 V single-phase, three-wire system). In this method of operation, only the line conductor has over-current (fuse) protection within the unit. Refer to the Safety Summary at the front of this Manual.

The ac power connector is a three-wire, polarized plug with the ground (earth) lead connected directly to the instrument frame to provide electrical shock protection. If the unit is connected to any other power source, connect the unit frame to an earth ground.

Operate the spectrum analyzer from either 115 Vac or 230 Vac nominal line voltage with a range of 90 to 132 or 180 to 250 Vac, at 48 to 440 Hz. Power and voltage requirements are printed on a back-panel plate mounted below the power input jack. Refer power input changes to qualified service personnel. The Service Manual, Volume 1, contains instructions to change the input voltage range.

The international power cord and plug configuration is shown in Figure 7-1 in Section 7 of this Manual.

### WARNING

Do not attempt to change the power input requirements. Unfamiliarity with safety procedures can result in personal injury. Refer all power input changes to qualified service personnel. Refer to the Safety Summary at the front of this Manual.

## STORAGE AND REPACKAGING

### Storage

**Short Term** (less than 90 days) — For short term storage, store the instrument in an environment that meets the non-operating environmental specifications in Table 2-9 in Section 2 of this Manual.

**Long Term** — For instrument storage of more than 90 days, use the original shipping container to repackage the instrument. In Option 39 instruments, we recommend removing the silver battery during long-term storage. Package the instrument in a vapor bag with a drying material and store in a location that meets the non-operating environmental specifications in Table 2-9 in Section 2 of this Manual.

If you have any questions, contact your local Tektronix Field Office or representative.

### Repackaging for Shipment

When the spectrum analyzer is to be shipped to a Tektronix Service Center for service or repair, attach a tag that shows the owner and address, the name of the individual at your location that can be contacted, the complete instrument serial number, and a description of the service required. If the original shipping container is unfit for use or not available, use the following repackaging information.

1. Use a container of corrugated cardboard with a test strength of 375 pounds (140 kilograms) and inside dimensions that are at least six inches more than the equipment dimensions (refer to Table 2-10 in Section 2), to allow for cushioning.

2. Install the instrument front cover, and surround the instrument with plastic sheeting to protect the finish.

3. Cushion the equipment on all sides with packing material or plastic foam.

4. Seal the container with shipping tape or an industrial, heavy-duty stapler.

**Transit Case** — A high-impact, ruggedized transit case is recommended if you require your spectrum analyzer to be frequently shipped between sites. A hard transit case that meets these requirements and has space to hold most of the instrument's standard accessories is provided as an optional accessory for the spectrum analyzer. The ordering number for this hard transit case is in the Optional Accessories information in the Service Manual, Volume 2. Refer to your local Tektronix Field Office or representative for additional information. The hard transit case is not available for rackmount (Options 30 and 31) instruments.



# CONTROLS, CONNECTORS, AND INDICATORS

This section includes the descriptions of the instrument's main operating modes. It also covers the functions of the controls, selectors, indicators, and connectors for the spectrum analyzer, which are shown and identified in Figures 4-1 through 4-3 and 4-9 through 4-14. Some of the functions are described in greater detail in Section 5.

Included with many of the descriptions are syntax diagrams that graphically display the function. The ovals and circles indicate a literal element that must be sent (i.e., pushbutton pressed) exactly as shown. Boxes contain a name for an element (i.e., DATA ENTRY represents numbered pushbuttons 0 through 9 and the units terminators). The arrows that connect the elements of the syntax diagrams show the possible paths through the diagram. Parallel paths mean that one, and only one, of the paths must be followed. A path around an element or group of elements indicates an optional skip. Arrows indicate the direction that must be followed (usually the flow is to the right; but, if an element may be repeated, an arrow returns from the right to the left of the element).

The following examples illustrate basic syntax diagram structure.

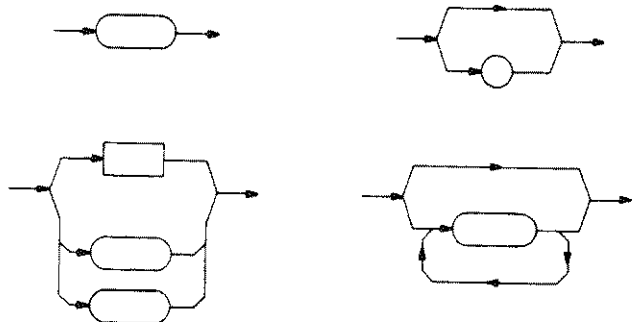

5562-34

When DATA ENTRY boxes are part of a command's syntax diagram, there are numbers shown with the boxes. These numbers represent the valid range available for that particular command.

## OPERATING MODES

### Initial Entry Functions (Black-Labels)

Most of the spectrum analyzer operating modes are selected by a single pushbutton press or control turn; i.e., FREE RUN, TIME/DIV, PULSE STRETCHER, MAX HOLD, PEAK/AVERAGE. Generally, these selections are the same with all Tektronix 49x-Series Spectrum Analyzers.

### Multiple-Pushbutton Sequence Functions (SHIFT Pushbuttons)

**<Blue-SHIFT> Functions** — There are many general operating modes and two marker operating modes selected with multiple-pushbutton presses. Press the <blue-SHIFT> pushbutton before selecting a blue-labeled function; i.e., PLOT, STORE DISP, CAL. For many of these functions, menu prompts appear on the screen to guide you.

**<Green-SHIFT> Functions** — Most of the operating modes selected with green-SHIFT multiple-pushbutton presses are marker related. Press the <green-SHIFT> pushbutton before selecting a green-labeled function; i.e., ASSIGN 1, PEAK FIND. For many of these functions, menu prompts appear on the crt readout to guide you.

There are also additional marker functions that can be assigned to either pushbutton ASSIGN 1 or ASSIGN 2 and then selected in the same manner as the labeled functions. MARKER MENU also has additional marker functions that can be selected directly from the menu.

### Terminating Multiple-Pushbutton Sequences

A SHIFT multiple-pushbutton sequence can be terminated at any time. Push either the <blue-SHIFT> or <green-SHIFT> pushbutton once to stop the sequence and return the spectrum analyzer to the previous activity.

### DATA ENTRY Functions (Orange Labels)

Some operations require the entry of numerical data; for example, to set frequency or enter a number to select a choice from a menu. This will be as part of a multiple-pushbutton sequence, and the crt will prompt you when a number is required. Enter the number with the orange-labeled DATA ENTRY pushbuttons. Numerical data is entered first, with a units terminator entered last; e.g., 100.00 MHz or 20 -dBx.

### Correcting Numerical Entry Errors

Use the BACKSPACE pushbutton to correct errors in numerical data that have been entered with the orange-labeled DATA ENTRY pushbuttons. Each pushbutton press backs the cursor up one space, erasing the number in that location. You can then enter the correct numerical data and end the sequence with a units pushbutton.



## INSTRUMENT POWER CONTROL AND FREQUENCY

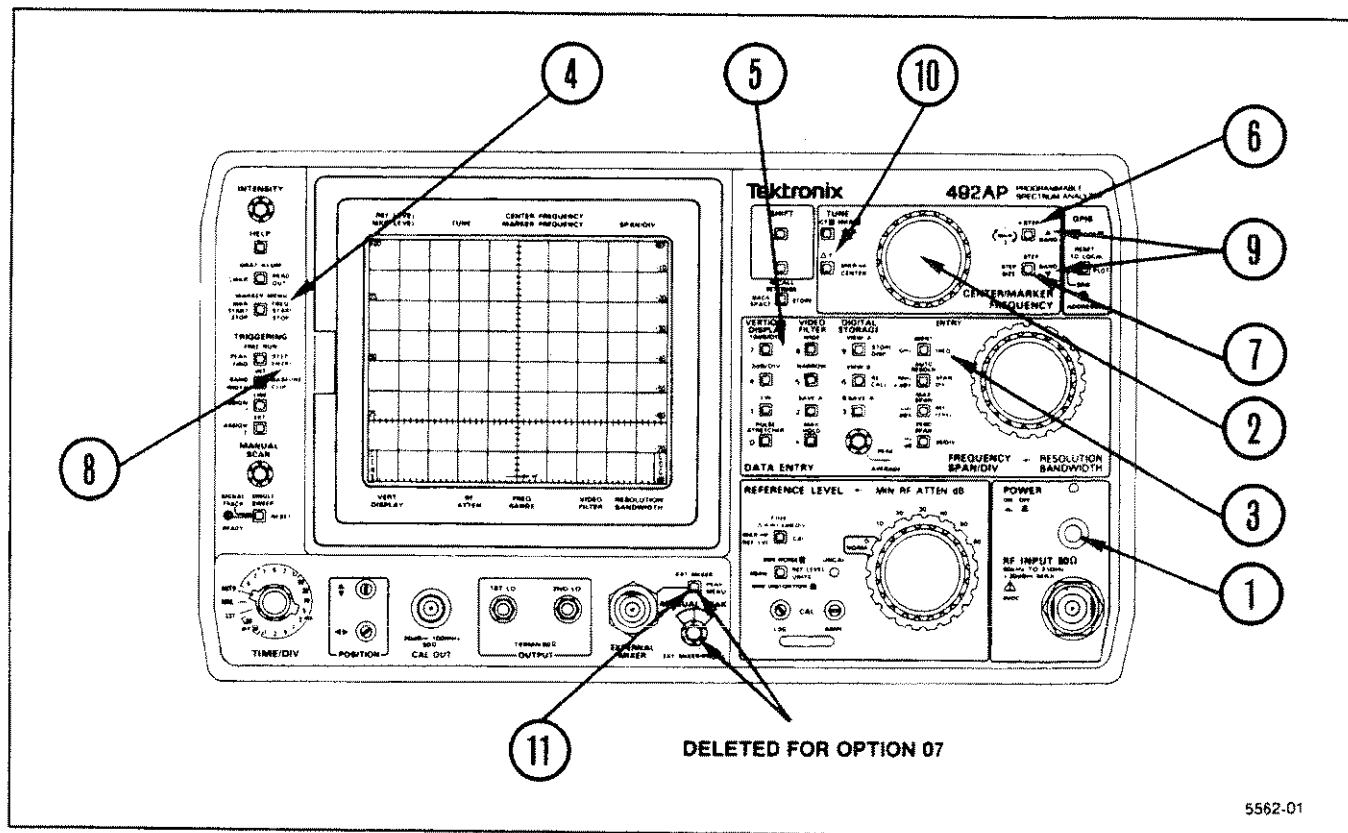
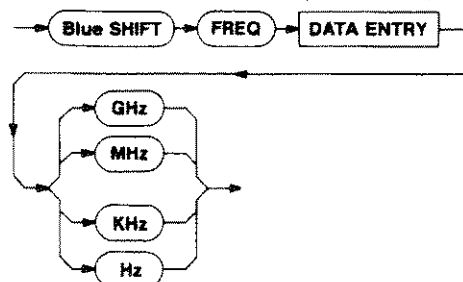

Figure 4-1. Instrument Power Control and Frequency.

- 1 **POWER** — This push-push switch turns the main power supply ON (green light on) and OFF (in=ON, out=OFF). When power is switched off, the current instrument front-panel set-up is stored in memory register 0 (see RECALL SETTINGS/STORE in Section 5) so this set-up can be easily recalled. Full RF attenuation is switched in when power is switched off to protect the 1st mixer from overload and damage.
- 2 **CENTER/MARKER FREQUENCY** — This control tunes the center frequency or marker, if selected (this function is limited to the edge of the screen). Tuning of center frequency is done in 0.1 division increments, regardless of the selected FREQUENCY SPAN/DIV. In MAX SPAN, the center frequency is fixed, and only the frequency dot is tuned. The tuning range in narrow spans is identical to wide spans; i.e., equal to the frequency range of the band selected.
- 3 **<Blue-SHIFT> FREQ** — This pushbutton sequence allows direct entry of center or marker frequency to 1 Hz resolution (it will be displayed to 1 kHz), from the DATA ENTRY pushbuttons. If the center frequency entered is not in the current frequency range, the nearest frequency range that contains the frequency will be automatically selected. The center frequency range that can be selected is 0 Hz to 325 GHz. Values that are entered outside this range will be ignored. Frequency digits that are entered from the DATA ENTRY pushbuttons are terminated with one of the four unit pushbuttons (GHz, MHz, kHz, or Hz).



- 4 **<Blue-SHIFT> FREQ START STOP** — This pushbutton sequence allows you to use the orange DATA ENTRY pushbuttons to enter a start frequency (at the left edge of the display) and a stop frequency (at the right edge of the display). The start-stop function is usable only in the selected band.
- 5 **<Blue-SHIFT> 10dB/DIV** (Disable Frequency Corrections; not identified on the front panel) — This pushbutton sequence disables the frequency correction for the local oscillator. This enables the instrument to be operated with reduced performance if the oscillator frequency cannot be corrected.
- 6 **+STEP** — When the instrument is in the Tune Center Frequency mode (TUNE CF/MKR pushbutton unlit), this pushbutton increases the center frequency by steps (this function is limited to the edge of the screen). The step size is determined by **<blue-SHIFT> STEP ENTRY** or **<green-SHIFT> STEP SIZE**. See +STEP later in this section under Marker Functions for alternate operation.
- 7 **-STEP** — When the instrument is in the Tune Center Frequency mode (TUNE CF/MKR pushbutton unlit), this pushbutton decreases the center or marker frequency by steps (this function is limited to the edge of the screen). The step size is determined by **<blue-SHIFT> STEP ENTRY** or **<green-SHIFT> STEP SIZE**. See -STEP later in this section under Marker Functions for alternate operation.
- 8 **<Blue-SHIFT> STEP ENTRY** — This pushbutton sequence allows you to enter a desired center or marker frequency step size with the orange DATA ENTRY pushbuttons (this function is limited to the edge of the screen).
- 9 **<Blue-SHIFT> ▲BAND/BAND▼** — These two pushbuttons step up or down through the frequency ranges. The frequency range of the current band is displayed by the crt readout. When the frequency range (band) is changed, an attempt is made to preserve the 1st and 2nd LO frequencies. If this is not possible, the nearest center frequency limit of the band is selected. When returning to a previous band, without changing center frequency, the original LO frequencies are always used, so the center frequency is preserved. External mixers are automatically selected in frequency ranges above 21 GHz.
- 10 **ΔF** — This pushbutton allows measurement of the frequency differences. When pressed (lit), the frequency readout goes to zero. The readout now shows only the offset, or deviation, from this refer-

ence as the center frequency is changed. The resolution of the readout will be the less accurate of either the current center frequency resolution or the center frequency resolution when  $\Delta F$  was activated. Do not confuse this pushbutton with **<green-SHIFT> Δ MKR**, which is described later in this section under Marker Functions.

- 11 **EXT MIXER** — (Not available on instruments with Option 07 or Option 08 installed) This pushbutton selects the External Mixer mode and disables the RF input. This is the bias source for external mixers, as well as the IF input to the analyzer. The External Mixer mode is indicated by EXT on the crt readout in place of RF ATTENUATION. Bias voltage is set by MANUAL PEAK when selected by the **<blue-SHIFT> PEAK MENU**. See External Mixers in Section 6 for connecting external mixers and mixer operation.

**CAUTION**

Do not exceed mixer input limits. Refer to External Mixers in Section 6.

## FREQUENCY SPAN AND RESOLUTION

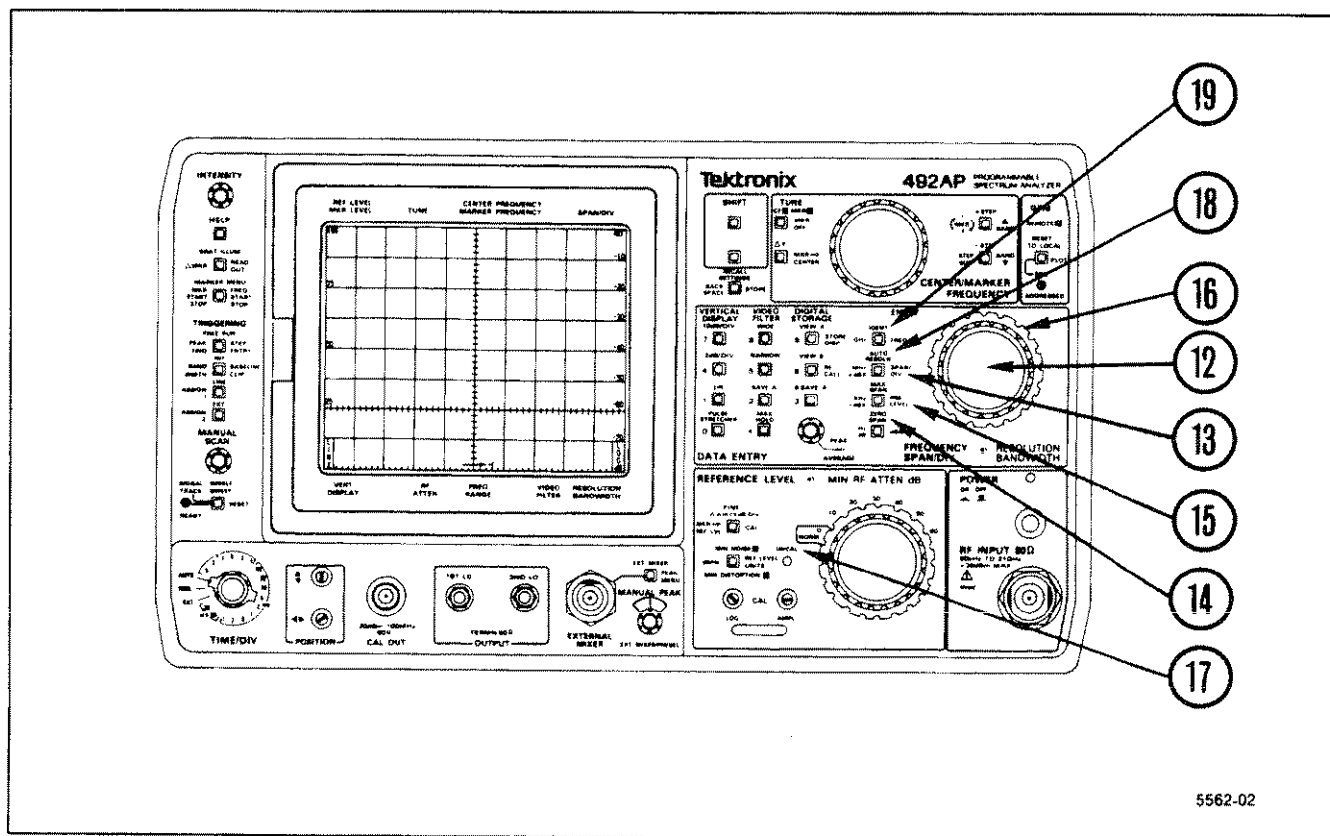

Figure 4-2. Frequency Span and Resolution.

**12 FREQUENCY SPAN/DIV** — This control selects the frequency span swept by the spectrum analyzer. The span/div is indicated by the crt readout. The range of this control depends on the frequency band. Selection is in a 1-2-5 sequence plus max span and zero, or time domain. FREQUENCY SPAN/DIV can also be entered with the <blue-SHIFT> SPAN/DIV pushbutton sequence and the DATA ENTRY pushbuttons. The spectrum analyzer will try to maintain a calibrated display if the TIME/DIV control is in the AUTO position or the AUTO RESOLN pushbutton is active (lit).

When the FREQUENCY SPAN/DIV is in the maximum span mode, the full band is displayed. A dot near the top of the screen indicates the center frequency readout position on the span. This dot and the center frequency position will be center screen when the FREQUENCY SPAN/DIV is reduced from the MAX span position. When the markers are on, they show the frequency position, and the dot

goes to center.

When the FREQUENCY SPAN/DIV is reduced to zero, the spectrum analyzer operates like a tunable receiver. The spectrum analyzer displays signals within the resolution bandwidth in the time domain, with the crt reading out time/div instead of frequency span/div.

- 13 **<Blue-SHIFT> SPAN/DIV** — This pushbutton sequence allows direct entry of FREQUENCY SPAN/DIV, with two significant digits of resolution. The span/div range that can be selected is 200 Hz/div to 10 GHz/div. The maximum range available is a function of frequency range. If a value outside the allowable range is entered, the Span/Div will switch to the lowest non-zero or maximum span. Spans entered from the DATA ENTRY pushbuttons are terminated with one of the four unit pushbuttons (GHz, MHz, kHz, or Hz).

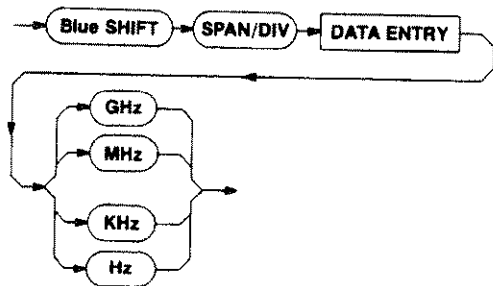

5562-26

- 14 **ZERO SPAN** — This pushbutton switches the span to zero for time domain display. When deactivated, the Span/Div returns to its previous value.
- 15 **MAX SPAN** — When activated, the spectrum analyzer sweeps the entire range of the current frequency band. The position of the spectrum analyzer's center frequency is shown with a dot near the top of the screen. When this function is turned off, the span returns to the previous Frequency Span/Div setting. When the markers are on, they show the frequency position, and the dot goes to center.
- 16 **RESOLUTION BANDWIDTH** — This control selects the bandwidth of the spectrum analyzer. Selected bandwidth is indicated on the crt readout. The bandwidth selections are 100 Hz, 1 kHz, 10 kHz, 100 kHz, and 1 MHz. Time/div is automatically selected when the TIME/DIV control is in the AUTO position.
- 17 **UNCAL** — This indicator lights when the display amplitude or frequency is no longer calibrated; e.g., the sweep rate is not compatible with the frequency span/div and resolution bandwidth. Select a slower sweep rate or larger resolution bandwidth to return to calibrated operation.
- 18 **AUTO RESOLN** — When this function is on, resolution bandwidth is automatically selected to maintain a calibrated display for the selected Freq Span/Div, Time/Div, Video Filter, and Vertical Display modes. When the TIME/DIV control is in the AUTO position, resolution bandwidth is selected as a function of Freq Span/Div only, and Time/Div is selected to maintain a calibrated display at the highest sweep rate. The RESOLUTION BANDWIDTH control will not operate when AUTO RESOLN is on (the message AUTO RESOLN MUST BE OFF TO CHANGE RESOLUTION will appear on the screen).
- 19 **IDENT** — IDENT separates real signals from spurious responses when using the spectrum analyzer without a pre-selected front end, as is generally the case when using external waveguide mixers or in instruments with no preselector. This pushbutton causes every other trace to be displaced vertically. The 1st and 2nd local oscillator frequencies shift so that real, or true, signals are not displaced horizontally on alternate sweeps (displaced less than 2 MHz in external waveguide bands, 1/2 division in internal bands), while spurious signals can be shifted to more than 100 MHz, or even off screen. The FREQ SPAN/DIV must be 50 kHz or less for the coaxial bands (0 to 21 GHz) or 50 MHz or less for the waveguide bands before the Identify mode can be used. When using IDENTify with waveguide mixers, the 1st LO frequency is shifted 2072/N MHz on alternate sweeps. Peaking should, therefore, be performed while using the Identify mode if the signal disappears, since a true conversion may not appear on alternate sweeps.

## MARKER FUNCTIONS

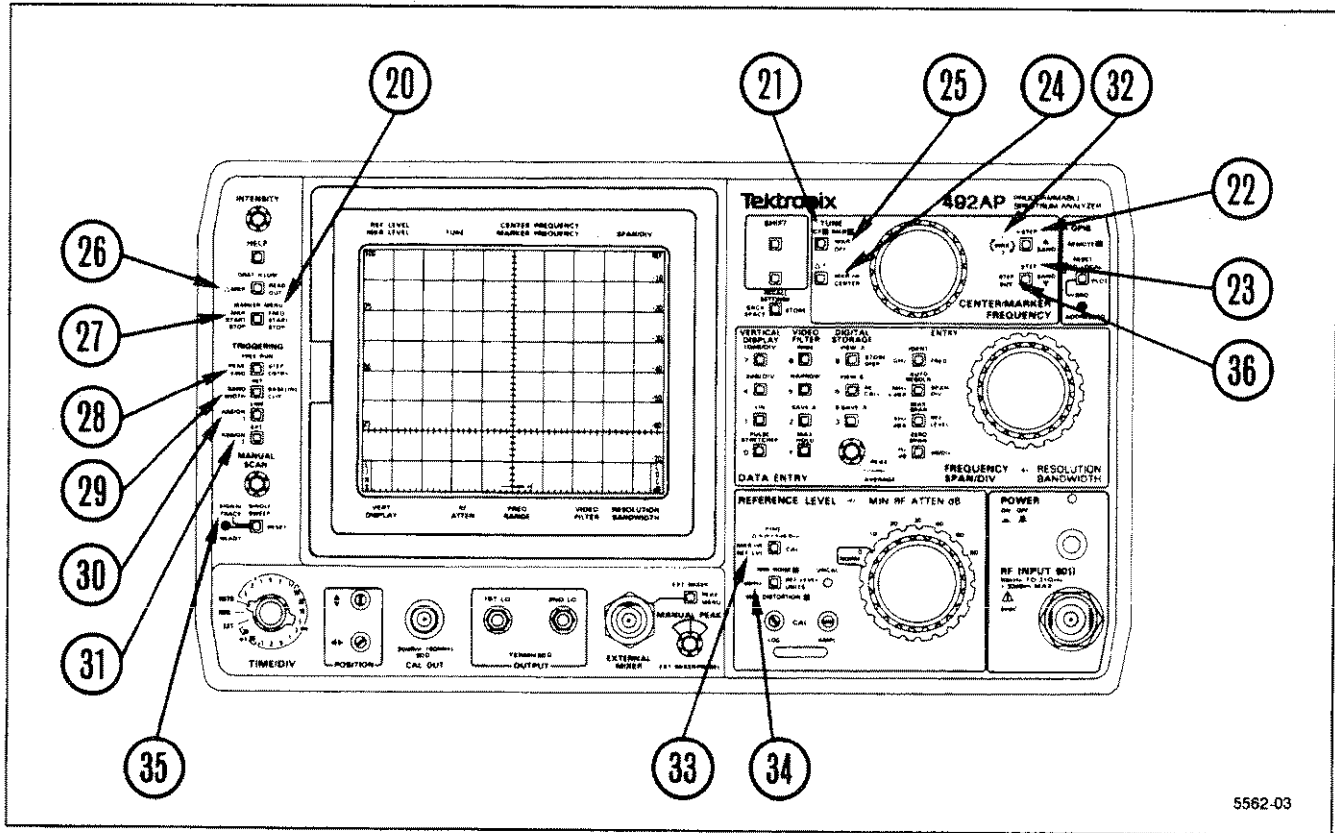

Figure 4-3. Marker Functions.

**20 MARKER MENU** — This pushbutton calls up a menu display on the crt that allows selection of one of the available marker commands that are not permanently assigned to a front-panel pushbutton.

**RIGHT NEXT** — This moves the Primary marker to the next visible signal higher than the present marker frequency. If there is no signal to the right of the Primary marker that meets threshold and signal type parameters, one of the following messages will be displayed on the screen (depending on whether CW, PULSE, or SPURS has been selected as the signal type) —

NO CW TO THE RIGHT ABOVE THRESHOLD

NO PULSE TO THE RIGHT ABOVE THRESHOLD

NO SPUR TO THE RIGHT ABOVE THRESHOLD

Select SET SIGNAL THRESHOLD and SET SIGNAL TYPE from the Marker Menu to set the parameters.

**LEFT NEXT** — This moves the Primary marker to the next visible signal lower than the present marker frequency. If there is no signal to the left of the Primary marker that meets threshold and signal type parameters, one of the following messages will be displayed on the screen (depending on whether CW, PULSE, or SPURS has been selected as the signal type) —

NO CW TO THE LEFT ABOVE THRESHOLD

NO PULSE TO THE LEFT ABOVE THRESHOLD

**NO SPUR TO THE LEFT ABOVE THRESHOLD**

Select **SET SIGNAL THRESHOLD** and **SET SIGNAL TYPE** from the **MARKER MENU** to set the parameters.

**NEXT LOWER PEAK** — This moves the Primary marker to the signal with the next lower amplitude, either left or right of the present marker position. If there is no signal lower than the Primary marker that meets threshold and signal type parameters, one of the following messages will be displayed on the screen (depending on whether **CW**, **PULSE**, or **SPURS** has been selected as the signal type) —

**NO LOWER CW SIGNAL ABOVE THRESHOLD**

**NO LOWER PULSE SIGNAL ABOVE THRESHOLD**

**NO LOWER SPUR ABOVE THRESHOLD**

Select **SET SIGNAL THRESHOLD** and **SET SIGNAL TYPE** from the **MARKER MENU** to set the parameters.

**NEXT HIGHER PEAK** — This moves the Primary marker to the signal with the next higher amplitude, either left or right of the present marker position. If there is no signal higher than the Primary marker that meets threshold and signal type parameters, one of the following messages will be displayed on the screen (depending on whether **CW**, **PULSE**, or **SPURS** has been selected as the signal type) —

**NO HIGHER CW SIGNAL ABOVE THRESHOLD**

**NO HIGHER PULSE SIGNAL ABOVE THRESHOLD**

**NO HIGHER SPUR ABOVE THRESHOLD**

Select **SET SIGNAL THRESHOLD** and **SET SIGNAL TYPE** from the **MARKER MENU** to set the parameters.

**SET SIGNAL TYPE** — This alters the marker functions to recognize one of three signal types above the threshold (select **SET SIGNAL THRESHOLD** from the **MARKER MENU** to set the threshold).

**CW** — Identifies continuous wave signals and ignores spurious signals and impulses.

**PULSE** — Identifies the peak of pulsed RF lobes for either line (lines must be <2 minimum divisions apart) or dense spectra.

**SPURS** — Identifies all signals.

Figure 4-4 is a signal enlarged to show how the spectrum analyzer locates the signal peak with one of the signal processing functions. The signal processing functions are **RIGHT NEXT**, **LEFT NEXT**, **NEXT LOWER PEAK**, **NEXT HIGHER PEAK**. The spectrum analyzer looks at both the individual left-most and right-most peaks of a signal. From this reading, the spectrum analyzer calculates the exact center of the signal. If this location is a digital storage point, the marker is positioned here. If, as in Figure 4-4, the calculated center of the signal is not equal to the maximum digital storage point, the marker is positioned on the closest point to the center. At the end of this Marker Functions portion are five illustrations showing the use of this signal finding command.

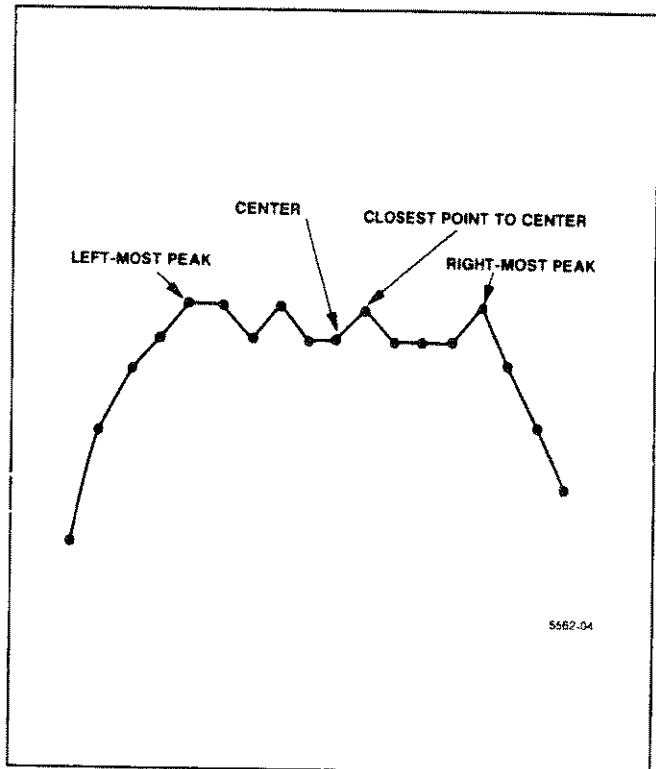

Figure 4-4. Locating the signal peak.

**SET SIGNAL THRESHOLD** — This changes the minimum visible signal level for the marker functions of **Right Next**, **Left Next**, **Next Lower Peak**, **Next Higher Peak**, **Peak Find**, **Bandwidth Mode**, and **Signal Track**. Select **AUTO** to automatically set the threshold above the noise floor.

**ASSIGN FUNCTION TO KEY** — This displays a menu (Assign Menu) of additional marker functions that can be assigned to either the <green-SHIFT> ASSIGN 1 or <green-SHIFT> ASSIGN 2 pushbutton. Call up HELP for the assigned pushbutton to get a description of the assigned function. The function will remain assigned to the pushbutton, even with power off, until another function is assigned. The ASSIGN MENU accesses the following functions.

**RIGHT NEXT** — This moves the Primary marker to the next visible signal higher than the present marker frequency. If there is no signal to the right of the Primary marker that meets threshold and signal type parameters, one of the following messages will be displayed on the screen (depending on whether CW, PULSE, or SPURS has been selected as the signal type) —

NO CW TO THE RIGHT ABOVE THRESHOLD

NO PULSE TO THE RIGHT ABOVE THRESHOLD

NO SPUR TO THE RIGHT ABOVE THRESHOLD

Select SET SIGNAL THRESHOLD and SET SIGNAL TYPE from the MARKER MENU to set the parameters.

**LEFT NEXT** — This moves the Primary marker to the next visible signal lower than the present marker frequency. If there is no signal to the left of the Primary marker that meets threshold and signal type parameters, one of the following messages will be displayed on the screen (depending on whether CW, PULSE, or SPURS has been selected as the signal type) —

NO CW TO THE LEFT ABOVE THRESHOLD

NO PULSE TO THE LEFT ABOVE THRESHOLD

NO SPUR TO THE LEFT ABOVE THRESHOLD

Select SET SIGNAL THRESHOLD and SET SIGNAL TYPE from the MARKER MENU to set the parameters.

**NEXT LOWER PEAK** — This moves the Primary marker to the signal with the next lower amplitude, either left or right of the present

marker position. If there is no signal lower than the Primary marker that meets threshold and signal type parameters, one of the following messages will be displayed on the screen (depending on whether CW, PULSE, or SPURS has been selected as the signal type) —

NO LOWER CW SIGNAL ABOVE THRESHOLD

NO LOWER PULSE SIGNAL ABOVE THRESHOLD

NO LOWER SPUR ABOVE THRESHOLD

Select SET SIGNAL THRESHOLD and SET SIGNAL TYPE from the MARKER MENU to set the parameters.

**NEXT HIGHER PEAK** — This moves the Primary marker to the signal with the next higher amplitude, either left or right of the present marker position. If there is no signal higher than the Primary marker that meets threshold and signal type parameters, one of the following messages will be displayed on the screen (depending on whether CW, PULSE, or SPURS has been selected as the signal type) —

NO HIGHER CW SIGNAL ABOVE THRESHOLD

NO HIGHER PULSE SIGNAL ABOVE THRESHOLD

NO HIGHER SPUR ABOVE THRESHOLD

Select SET SIGNAL THRESHOLD and SET SIGNAL TYPE from the MARKER MENU to set the parameters.

**MOVE RIGHT X dB** — This allows you to select the number of dB to move the Primary marker while staying on the trace (horizontal movement to the right). If there is no level to the right of the Primary marker that meets threshold and signal type parameters, the message NO POINT TO THE RIGHT TO MOVE TO will be displayed on the screen.

**MOVE LEFT X dB** — This allows you to select the number of dB to move the Primary marker while staying on the trace (horizontal movement to the left). If there is no level to the left of the Primary marker that meets threshold and signal type parameters, the message NO POINT TO THE LEFT TO MOVE TO will be displayed on the screen.

**FIND PEAK AND CENTER** — This places the active marker at the peak of the highest on-screen signal (refer to the <green-SHIFT> PEAK FIND description later in this section). If a signal is present, the center frequency is set equal to the marker frequency; this centers the signal of interest. If there is no signal above the threshold, the message NO POINT FOUND ABOVE THE THRESHOLD will be displayed on the screen, and the marker will not move, which is useful to center a signal just before reducing the span/div by several settings at once.

**ENTER BANDWIDTH NUMBER** — This sets the number of dB's below the signal peak at which bandwidth will be calculated when in the marker Bandwidth mode. The number is stored in memory.

**GREEN-SHIFT LOCK** — This locks <green-SHIFT> on so all green-labeled functions can be directly selected. When Green-Shift Lock is on, the black-labeled functions associated with green-labeled functions cannot be accessed. Blue-labeled functions operate normally. Press <green-SHIFT> to exit.

- 21 **TUNE CF/MKR** — When this pushbutton is lit, a single marker is turned on at the trace of highest priority, and you can move the marker with the CENTER/MARKER FREQUENCY control. When the pushbutton is pressed again, the marker stays on and does not change its horizontal positioning; the CENTER/MARKER FREQUENCY control now adjusts the center frequency.
- 22 **+STEP** — When the instrument is in the tune marker mode (the TUNE CF/MKR pushbutton is lit), this pushbutton increases the marker frequency by steps (this function is limited to the edge of the screen). The step size is determined by <green-SHIFT> STEP SIZE or <blue-SHIFT> STEP ENTRY. See +STEP earlier in this section under Frequency for alternate operation.
- 23 **-STEP** — When the instrument is in the tune marker mode (the TUNE CF/MKR pushbutton is lit), this pushbutton decreases the marker frequency by steps (this function is limited to the edge of the screen). The step size is determined by <green-SHIFT> STEP SIZE or <blue-SHIFT> STEP ENTRY. See -STEP earlier in this section under Frequency for alternate operation.
- 24 **<Blue-SHIFT> MKR → CENTER** — This pushbutton sequence centers the signal at the active marker by setting the center frequency equal to the marker frequency (this function is not available with a stored trace).
- 25 **<Blue-SHIFT> MKR OFF** — This pushbutton sequence turns the marker(s) off.
- 26 **<Green-SHIFT> Δ MKR** — This pushbutton sequence activates a second marker at the position of the single marker on the trace (or turns on the Delta Marker mode if markers are off). The symbols ( ) will appear on the screen on the marker frequency readout line to indicate delta frequency and delta amplitude.
- 27 **<Green-SHIFT> MKR START STOP** — This pushbutton sequence allows you to set the start and stop frequencies directly from the delta marker position (this function is not available with a stored trace). <Green-SHIFT> Δ MKR must be on for this function to operate.
- 28 **<Green-SHIFT> PEAK FIND** — This pushbutton sequence places the Primary marker at the peak of the highest on-screen signal. <Green-SHIFT> PEAK FIND locates the left-most peak (or the center peak of a cluster), but it is not a signal processing command with the built-in intelligence. Peak B would be selected from the cluster in Figure 4-5A; peak A would be selected in Figure 4-5B because the low point (B) would stop a search from continuing to the cluster (C).
- 29 **<Green-SHIFT> BANDWIDTH** — This pushbutton sequence places markers on a selected signal and displays the X dB bandwidth (select ENTER BANDWIDTH NUMBER from the marker menu to set X). The screen will display NO SIGNAL — BW IDLE when there is no signal at the marker that meets threshold and peak excursion parameters (select SET SIGNAL PARAMETERS in the MARKER MENU to set the parameters).
- 30 **<Green-SHIFT> ASSIGN 1** — This pushbutton sequence turns on the assigned function.
- 31 **<Green-SHIFT> ASSIGN 2** — This pushbutton sequence turns on the assigned function.
- 32 **<Green-SHIFT> 1—MKR→2** — This pushbutton sequence alternately selects which marker will be tuned when <green-SHIFT> Δ MKR is on.
- 33 **<Green-SHIFT> MKR → REF LVL** — This pushbutton sequence changes the reference level of the top graticule to the present marker amplitude (this function is not available with a stored trace).
- 34 **<Green-SHIFT> dB/Hz** — This pushbutton sequence mathematically figures the 1 Hz noise level at the current marker position.



- 35 <Green-SHIFT> SIGNAL TRACK — This pushbutton sequence automatically maintains tuning of a drifting signal within limits. While this mode is active SIGNAL TRACK will be displayed on the screen; SIGNAL TRACK IDLE will be displayed when there is no signal above the threshold. Select SET SIGNAL THRESHOLD from the MARKER MENU to set the threshold.
- 36 <Green-SHIFT> STEP SIZE — This pushbutton sequence defines the frequency step as the center frequency, marker frequency, or the delta marker frequency, whichever mode is active (this function is limited to the edge of the screen).

### Signal Finding

To the finding routine, a signal consists of a peak above threshold and two points (one on each side of the peak) that are 3 dB below the peak. The location of the signal is the highest amplitude point on the signal. Figures 4-6 through 4-8 illustrate the use of SET SIGNAL TYPE that can be selected from the MARKER MENU. All of the figures use the signal processing function RIGHT NEXT. Any of the other signal processing functions (LEFT NEXT, NEXT LOWER PEAK, NEXT HIGHER PEAK) work similarly, according to their specific function. The minimum bandwidth criteria is defined as the two 3 dB down points that must be <5 kHz (1/2 a resolution bandwidth) apart.

Figures 4-7 Top, 4-7 Bottom, and 4-6 Top— — If CW was selected, the spectrum analyzer would not identify any signal because none of the signals displayed meets the minimum bandwidth criteria. If PULSE was selected, the signals labeled D, E, and F would be identified because the other signals in the display are less than 2 minor divisions apart. If the signals were greater than 2 minor divisions apart, PULSE would have identified all labeled signals (A, B, C, etc.). If SPURS was selected, all signals would be identified (A, B, C, etc.).

Figure 4-8 — The NEXT RIGHT function begins at the left screen margin. With this display, CW, PULSE, and SPURS will each identify all of the signals because they all meet the minimum bandwidth criteria (i.e., the selections would be A, B, C, D, and E).

Figure 4-6 Bottom — The threshold is assumed to be -70 dBm. If CW was selected, signals B, E, F, and G would be identified. The other signals would not be identified because they do not meet the minimum bandwidth criteria. If PULSE was selected, signals A, B, D, E, F, and G would be identified. Signal C would be skipped, because it is within 2 minor divisions from signal B. The PULSE algorithm will think signal C is a part of signal B. If SPURS was selected, all signals would be identified.

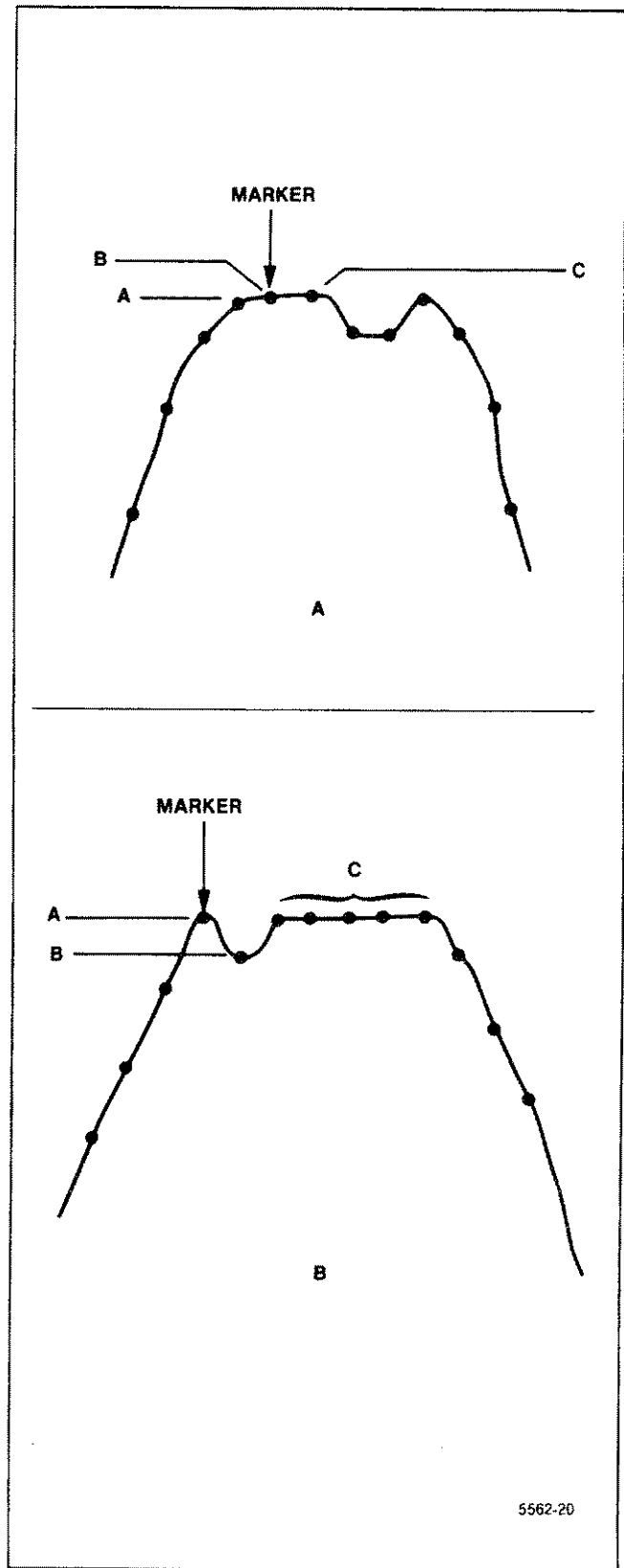

Figure 4-5. Using <green-SHIFT> PEAK FIND.

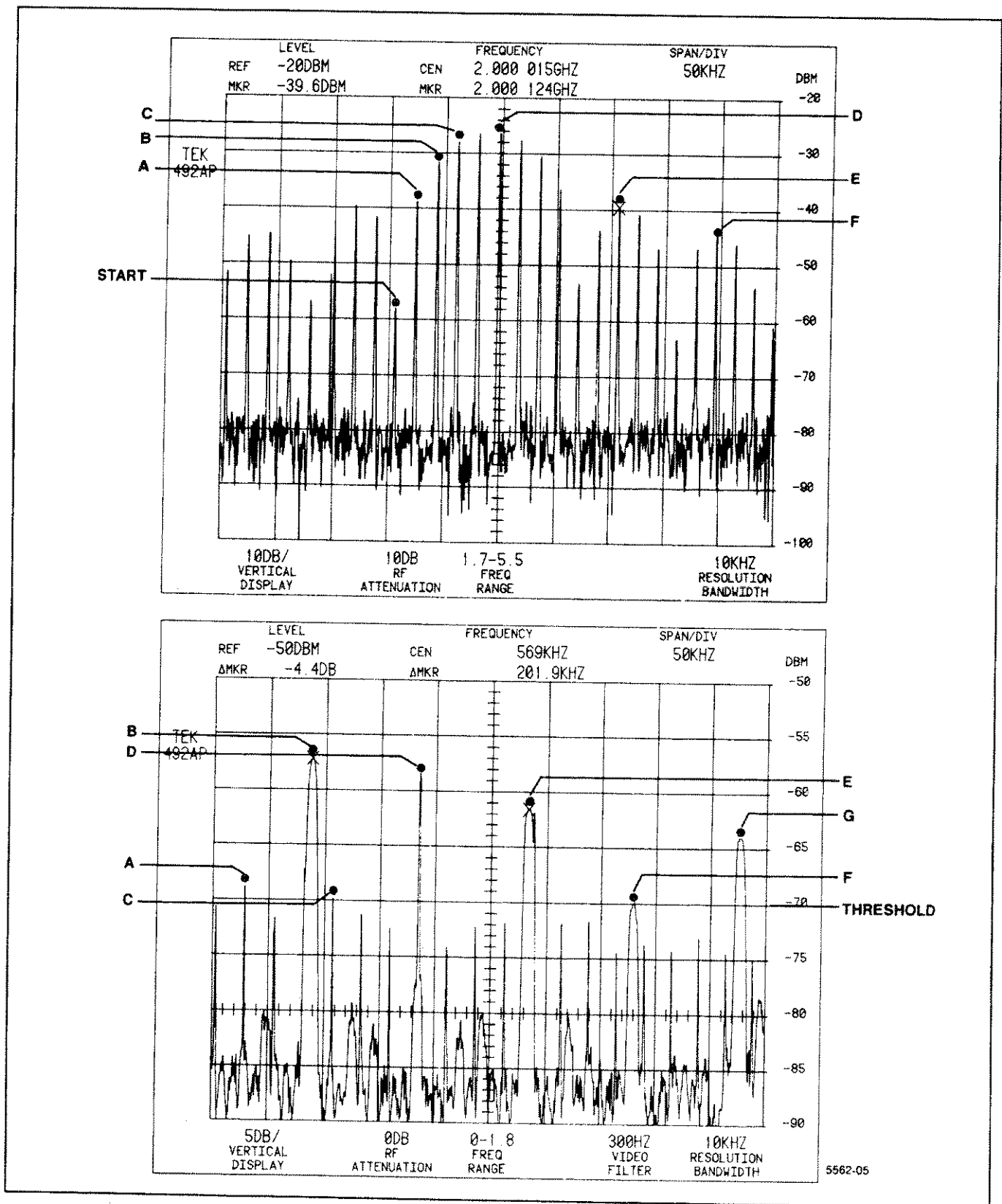

Figure 4-6. Signal finding examples.

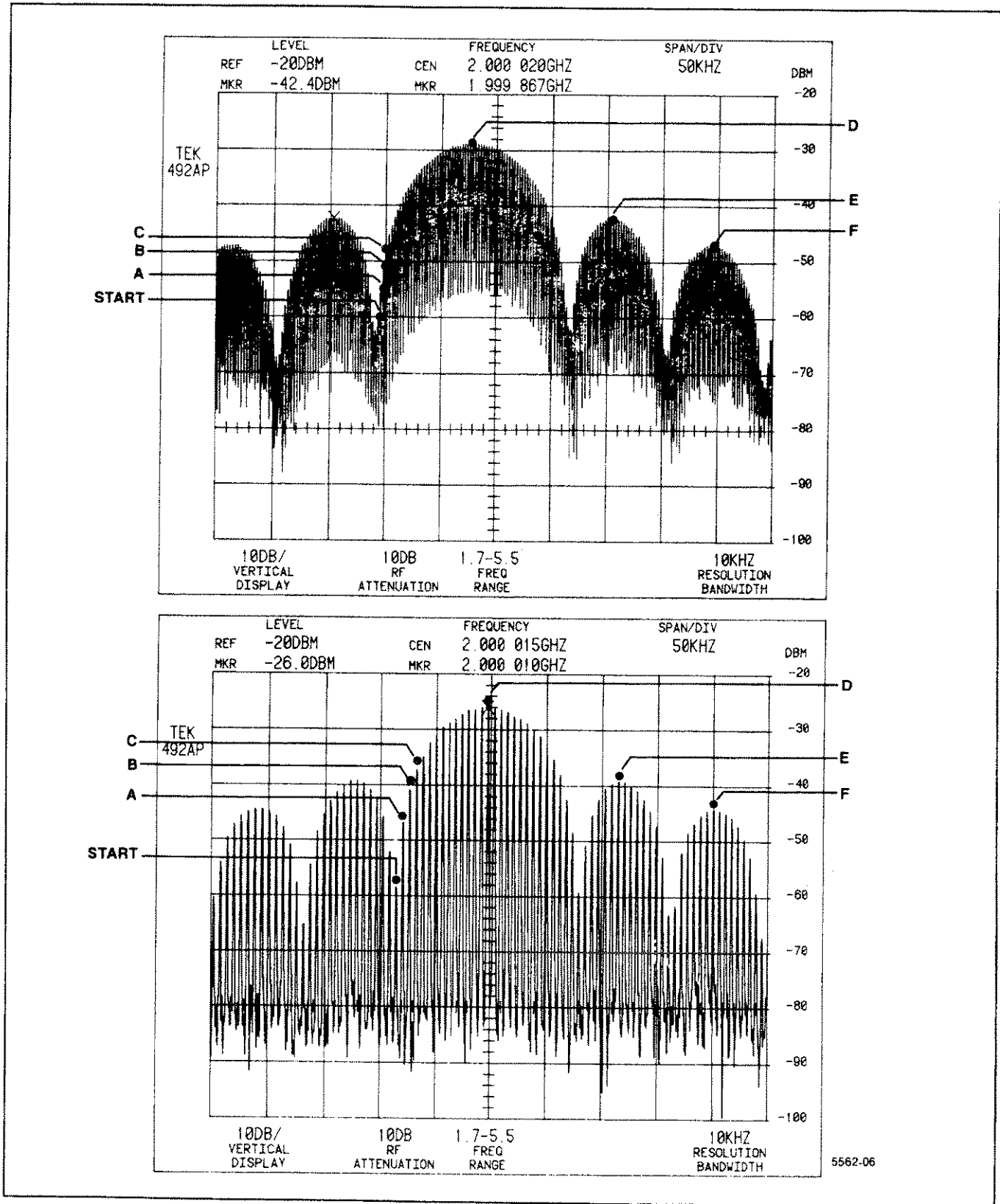

Figure 4-7. Signal finding examples.

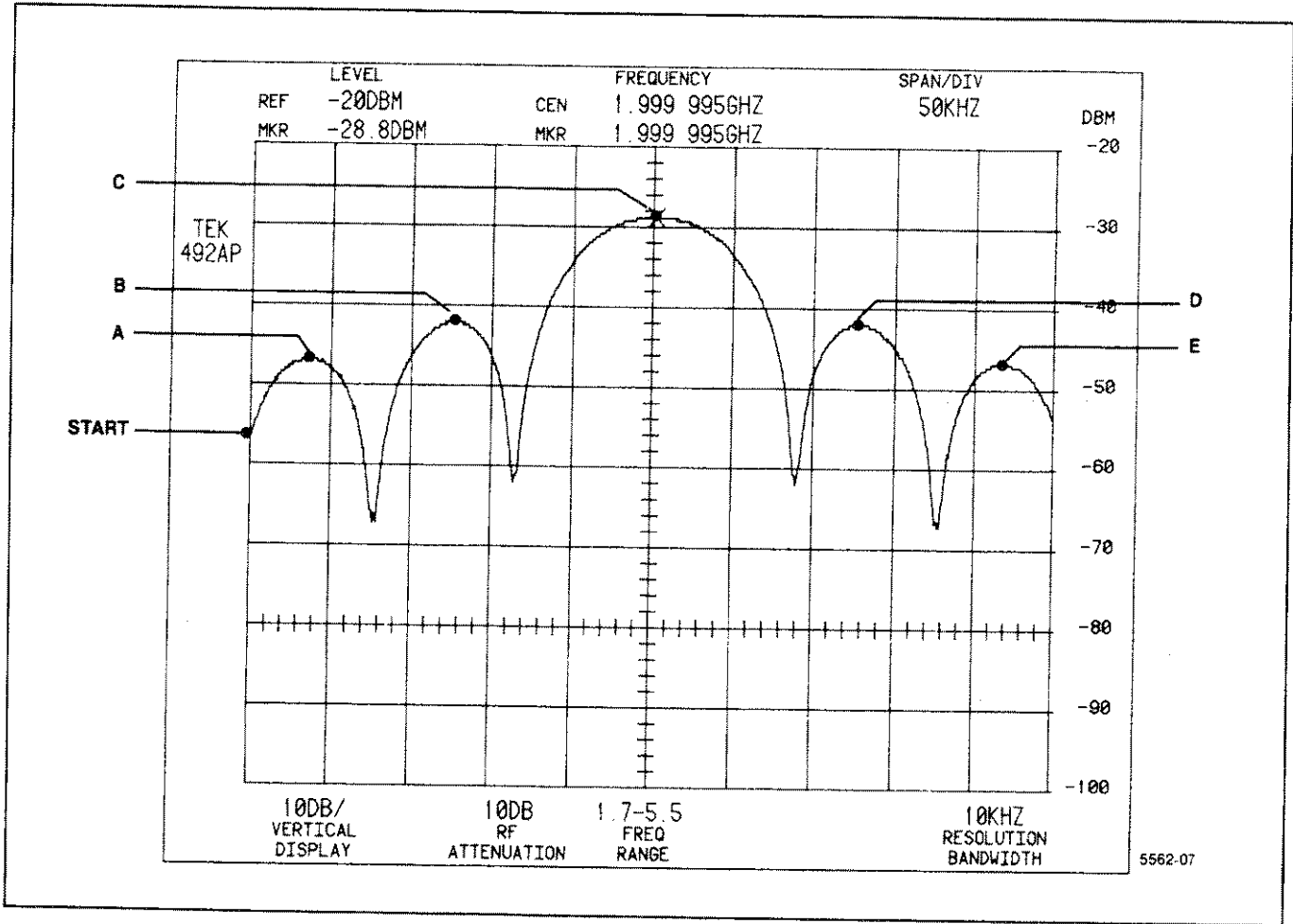
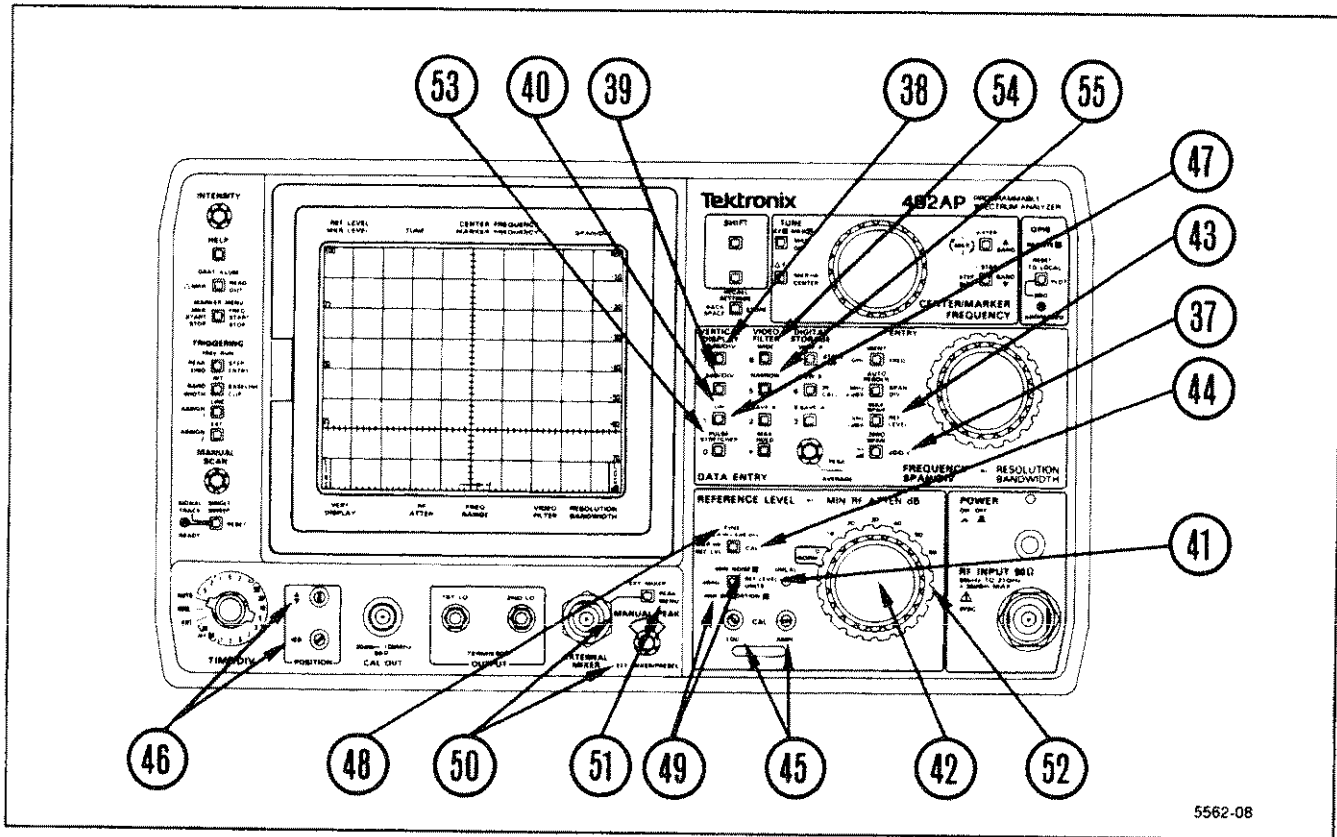

Figure 4-8. Signal finding example.

## DISPLAY PARAMETERS



5562-08

Figure 4-9. Display Parameters.

37 <Blue-SHIFT> dB/DIV — This pushbutton sequence allows direct entry of the desired amplitude display factor. The range is 1 to 15 dB/div in 1 dB increments. Although a display with greater than an 80 dB range can be selected, the actual measurement range will not exceed 80 dB. Numbers outside the allowable range will be ignored. Terminate the dB/div number entered with the dB pushbutton.



5562-27

**VERTICAL DISPLAY** — These three pushbuttons select the vertical display factors. The crt readout indicates the selection. The vertical display factor, in the Log mode, can also be entered with the DATA ENTRY pushbuttons.

38 10 dB/DIV — With this pushbutton activated, the dynamic range of the display is a calibrated 80 dB with each major graticule division representing 10 dB.

39 2 dB/DIV — This pushbutton increases resolution so that each major graticule division represents 2 dB. Display dynamic range is 16 dB.

40 LIN — With this pushbutton activated, a linear display between zero volts (bottom graticule line) and the reference level (top graticule line), scaled in volts/division, is selected (see the REFERENCE LEVEL description).

41 <Blue-SHIFT> REF LEVEL UNITS — This pushbutton sequence allows the selection of reference level units to be dBm, dBV, dBmV, or dBμV.

42 **REFERENCE LEVEL** — This control changes the reference level one step for each stop. Automatic selection of the IF gain and RF attenuation provide for the best overall noise and distortion performance. In the Log Vertical Display mode, when FINE is not activated, the step size equals the selected dB/div factor; except for 2 dB/div, where step size is 1 dB. When FINE is activated, the step size is 1 dB for dB/div factors of 5 or more and 0.25 dB for Vertical Display factors of <5 dB/div. When the display factor is <5 dB/div and FINE is activated, the Delta A mode is selected. Refer to Section 6 for a description of the Delta A mode.

43 **<Blue-SHIFT> REF LEVEL** — This pushbutton sequence allows direct entry of reference level, with 1 dB resolution. The range is +30 dBm to -117 dBm (+40 dBm if the Minimum Noise mode is selected). Values entered outside this range are ignored (values will be in the selected units; dBm, dBV, dBmV, or dBuV). Either the +dBx or -dBx pushbutton terminates the reference level numbers entered.

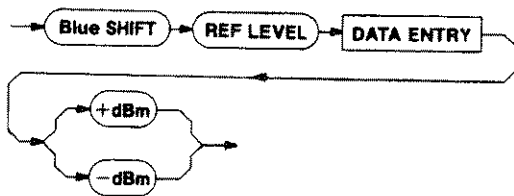

5562-28

44 **<Blue-SHIFT> CAL** — This pushbutton sequence starts a frequency and reference level measurement procedure that uses the spectrum analyzer calibrator. Messages on the crt screen will guide you through the adjustments of vertical and horizontal POSITION, and LOG and AMPL CAL. The spectrum analyzer then runs an automatic frequency, bandwidth, and relative amplitude measurement routine for the resolution bandwidth filters.

The frequency measuring routine adjusts center frequency by measuring the frequency of each resolution bandwidth filter to reduce center frequency variation when changing resolution bandwidth. The relative amplitude measuring routine reduces reference level variation when changing Resolution Bandwidth. To ensure that the instrument meets frequency and amplitude performance characteristics, run these routines whenever the instrument's surrounding temperature changes significantly. Cal factors that are used internally to correct for the errors measured by this function are retained in memory when the instrument power is off. To display these factors, press <blue-SHIFT> LIN.

45 **LOG and AMPL CAL** — These screwdriver adjustments calibrate the vertical portion of the display. LOG CAL adjusts the logarithmic gain in dB/div, and AMPL CAL adjusts the display amplitude. Press <blue-SHIFT> CAL to initiate a procedure that will guide you through these adjustments, as well as the vertical and horizontal POSITION adjustments. Refer to <blue-SHIFT> CAL for additional information.

46 **POSITION** — These screwdriver adjustments position the display along the horizontal and vertical axes. The <blue-SHIFT> CAL pushbutton sequence will guide you through the adjustment of these controls. Refer to <blue-SHIFT> CAL for additional information.

47 **<Blue-SHIFT> LIN** (Self-Measurement Results; not identified on the front panel) — The factors used to internally correct for frequency and amplitude errors are displayed. The factors shown are as measured with the last <blue-SHIFT> CAL operation. If one of the factors could not be measured at the last operation, the old value will be noted. This means that the previously measured value is used. If < or > appears next to the amplitude calibration factor, it means that this filter's amplitude related to the 1 MHz filter is outside the range of correction (correction is set to the limit). Press <blue-SHIFT> to exit the calibration factor display.

48 **FINE ( $\Delta$  A IN <5 dB/DIV)** — This pushbutton selects step size for the REFERENCE LEVEL control. When FINE is off, step size is equal to dB/div, except 2 dB/div where step size is 1 dB. When FINE is on, step size is 1 dB for display factors of 5 dB/div or more, and 0.25 dB for display factors of <5 dB/div. When step size is 0.25 dB, the Delta A mode is selected. The crt Ref Level readout goes to 0.00 dB, and the REFERENCE LEVEL control steps in 0.25 dB increments. These fine steps provide the means to make accurate relative amplitude measurements over a 48 dB measurement range. Refer to Delta A mode operation in Section 6 for more details.

49 **MIN NOISE/MIN DISTORTION**

**MIN NOISE** (pushbutton lit) — In this mode, the noise level is reduced by changing the RF attenuation and IF gain used for a particular reference level. Both are reduced 10 dB so noise generated in the IF stages is decreased; however, intermodulation distortion products will increase. RF attenuation must be at least 10 dB for this control to have any effect.

**MIN DISTORTION** (pushbutton not lit) — In this mode, intermodulation distortion products are minimized. This is the usual operating mode.

**50 MANUAL PEAK (EXT MIXER/PRESEL)** — This control varies the mixer bias for external mixers and peaks the internal preselector tracking in the 1.7 GHz to 21 GHz frequency range (bands 2 through 5). In Option 01 instruments, the peak code consists of numbers at 500 MHz intervals. The control is used to peak signal response. Refer to External Mixer Operation in Section 6 of this manual for more information.

**51 <Blue-SHIFT> PEAK MENU** — This pushbutton sequence calls up a menu that lists the available methods to adjust the preselector tracking or external mixer bias. The MANUAL PEAK control can be selected, peaking code can be stored in memory, and then used in the selected band; a number from 0 to 1023 can be run for electronic tuning; or an automatic repeak routine can be run that replaces the stored peak value for a particular band.

**52 MIN RF ATTEN dB** — This control specifies the lowest value of input attenuation that will be used when REF LEVEL is selected. This allows operator-control to protect the front end of the analyzer against overload and/or damage from excessive signal level into the 1st mixer. Actual attenuation is set according to the MIN RF ATTEN dB, REFERENCE LEVEL, and MIN NOISE/MIN DISTORTION selections and is displayed on the crt readout. If the MIN RF ATTEN dB setting is increased, the IF gain is automatically changed to maintain the current reference level, if possible.

**53 PULSE STRETCHER** — This pushbutton causes the fall-time of pulse signals to be increased so very narrow pulses can be seen. The effect is most apparent for pulsed RF signals where pulse width is small compared to one division of sweep time. Pulse stretcher operation may be necessary for a digital storage display of such signals, to ensure that the correct amplitude is displayed.

#### VIDEO FILTER

**54 WIDE** — This pushbutton reduces video bandwidth and high-frequency components for display noise averaging. The video bandwidth selected is approximately 1/30th of the selected resolution bandwidth. Selecting WIDE cancels NARROW. The filter value is displayed in the lower readout.

**55 NARROW** — This pushbutton reduces video bandwidth and high-frequency components for display noise averaging. The video bandwidth selected is approximately 1/300th of the selected resolution bandwidth. Selecting NARROW cancels WIDE. The filter value is displayed in the lower readout.

## SWEEP

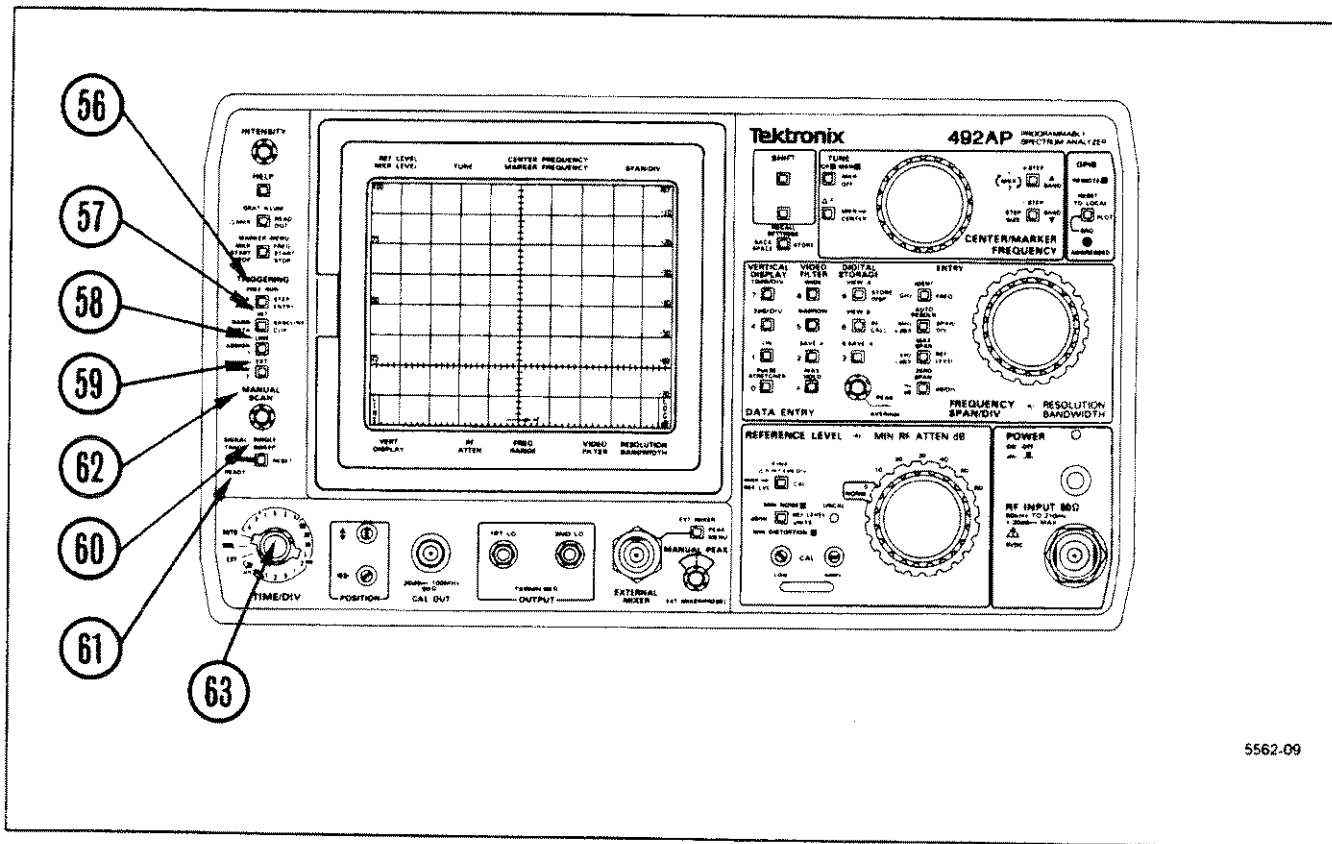

Figure 4-10. Sweep.

### TRIGGERING

- 56 **FREE RUN** — This pushbutton allows the sweep to free run without regard to trigger source. Other TRIGGERING selections are cancelled, including single-sweep.
- 57 **INT** — This pushbutton allows the sweep to be triggered by any signal at the left edge of the display that has an amplitude of 2.0 divisions or more. Other TRIGGERING selections are cancelled, including single-sweep.
- 58 **LINE** — This pushbutton allows a sample of the ac power line voltage to trigger the sweep. Other TRIGGERING selections are cancelled, including single-sweep.

- 59 **EXT** — This pushbutton allows the sweep to be triggered by signal between 1.0 V peak (minimum) to 50 V peak (maximum) that are applied through the rear-panel HORIZ|TRIG (EXT IN) connector. Other TRIGGERING selections are cancelled, including single-sweep.
- 60 **SINGLE SWEEP** When first pressed, this pushbutton activates the single-sweep mode and aborts the current sweep. When pressed again, the sweep trigger circuit is armed, the READY indicator is lit, and the center frequency is corrected. The sweep will run only after it receives a trigger signal. When SINGLE SWEEP is selected, the TRIGGERING selection (i.e., FREE RUN, INTERNAL, LINE, or EXTERNAL) is not changed. Select any TRIGGERING selection to cancel SINGLE SWEEP.



- 61 **READY** (only used in the Single Sweep mode) — This indicator lights when the trigger circuit is armed and ready for a trigger signal. It remains lit until the sweep ends.
- 62 **MANUAL SCAN** — With TIME/DIV in the MNL position, rotate this control to Manually scan the spectrum.
- 63 **TIME/DIV** — This control selects sweep rates from 5 s/div to 20 us/div, in a 1-2-5 sequence, in addition to AUTO, MaNuaL, and EXTernal sweeps.

**AUTO** (automatic) — This position allows the sweep rate to be selected automatically to maintain a calibrated display for most FREQUENCY SPAN/DIV, RESOLUTION BANDWIDTH, VIDEO FILTER, and Vertical Display selections.

**EXT** (external sweep) — This position allows the sweep circuit to be driven by a signal applied to the rear-panel HORIZ|TRIG (EXT IN) connector. A voltage ramp of 0 to +10 V will sweep 10 divisions of horizontal (X) axis.

**MNL** (Manual) — This position allows the spectrum or display to be manually swept with the MANUAL SCAN control.

## DIGITAL STORAGE

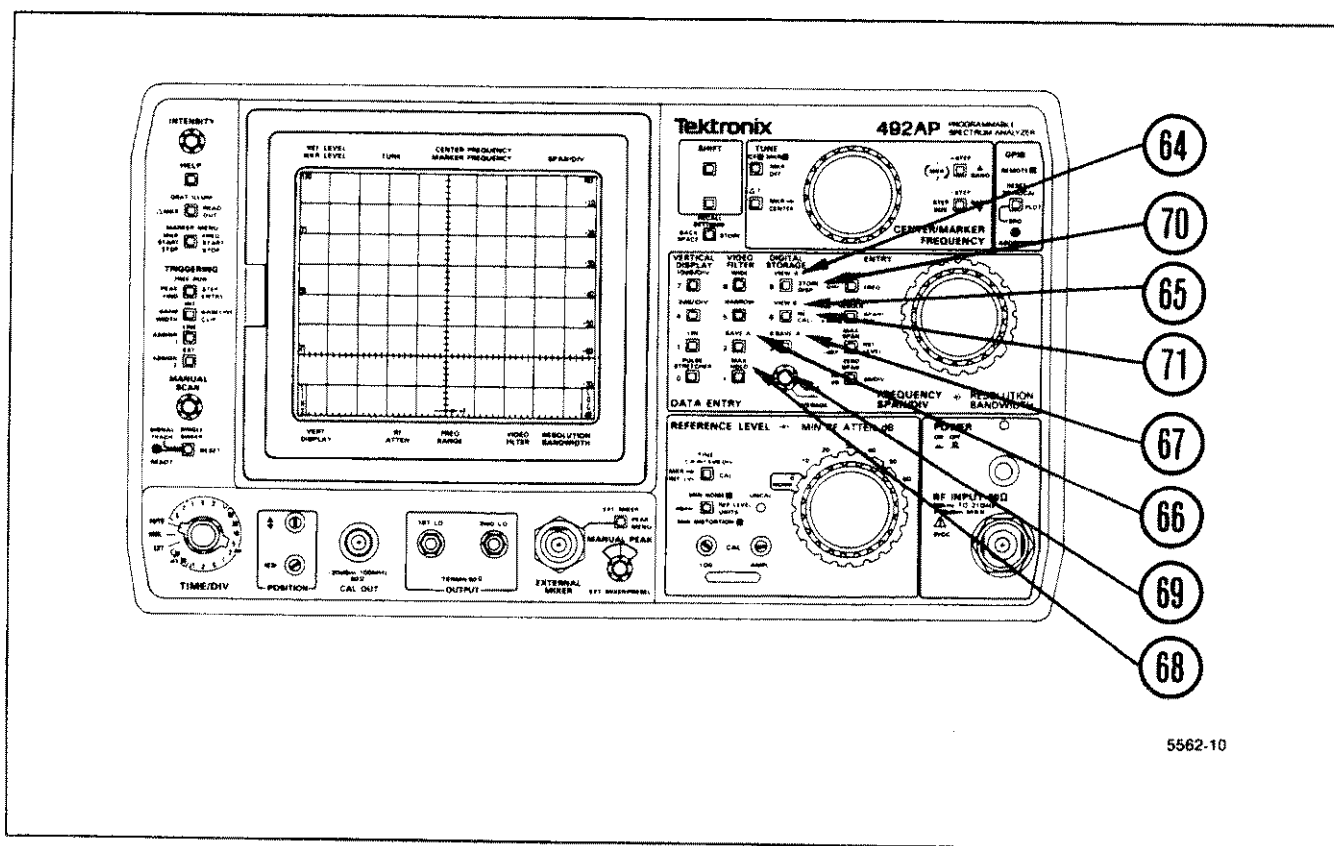

5562-10

Figure 4-11. Digital Storage.

**DIGITAL STORAGE** — These pushbuttons allow either or both sections of memory to be selected to provide digital storage. When VIEW A and VIEW B are activated, contents of both the A and B memories are displayed on the screen. Both sections are updated with each sweep.

- 64 **VIEW A** — This pushbutton causes the A waveform to be displayed. If SAVE A is on and only the A waveform is being viewed, the crt readout will show the settings when the A waveform was stored.
- 65 **VIEW B** — This pushbutton causes the B waveform to be displayed.
- 66 **SAVE A** — This pushbutton saves the A waveform and its readout. The readout stored with the waveform is displayed if both SAVE A and VIEW A are on and VIEW B and B-SAVE A are off; if either VIEW B or B-SAVE A is on, the readout reflects the current spectrum analyzer settings. Turning SAVE A off cancels B-SAVE A, if it is on. If SAVE A is off and either VIEW A

or VIEW B is on, both waveforms will be displayed. The A waveform is not updated by the sweep if SAVE A is on.

- 67 **B-SAVE A** — When activated, the spectrum analyzer displays the difference between the B waveform and the A waveform and automatically turns on SAVE A. The factory-set zero reference line is mid-screen, and positive differences are displayed above this line and negative differences below. Refer any change in the position of the zero reference line to authorized service personnel.
- 68 **MAX HOLD** — This pushbutton causes digital storage to retain the maximum signal amplitude at every storage location (500 locations; or 1000 locations if SAVE A is off). If SAVE A is on, the A waveform is not affected. Use MAX HOLD to measure frequency drift or peak amplitude excursions of a signal.

waveform is not affected. Use MAX HOLD to measure frequency drift or peak amplitude excursions of a signal.

- 69 **PEAK/AVERAGE** — This control selects the vertical position (shown on the screen by a horizontal line) at which digital storage switches from peak detection to signal averaging. Video signals above the cursor are peak detected; video signals below the cursor are digitally averaged.

**Store/Recall**

- 70 **<Blue-SHIFT> STORE DISP** — This pushbutton sequence starts a multiple-pushbutton sequence that stores either the A or B waveform and its associated readout and marker(s) in a numbered (0 through 8) memory register. Information is held in memory while instrument power is off. Messages displayed on the crt aid in completing the multiple-pushbutton sequence. After selecting <blue-SHIFT> STORE DISPlay, a list of the center frequencies of stored displays is shown. The number of digits in a center frequency in the menu list is an indication of the span/div of that stored display (a larger number of digits indicates a narrower span). This display includes a prompt asking for the register number (0–8) into which the display will be stored. Select the register from the DATA ENTRY pushbuttons. Press VIEW A to select the A waveform or VIEW B to select the B waveform. Selection of the waveform completes the sequence and returns the instrument to normal operation. To exit the store display sequence at any point, press SHIFT.

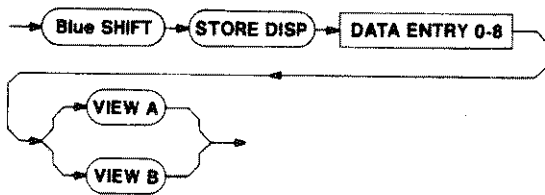

5562-29

- 71 **<Blue-SHIFT> RECALL** — This pushbutton sequence starts a multiple-pushbutton sequence that recalls a selected waveform, with its readout and marker(s) from one of the memory registers (0 through 8) and puts it in either the A or B display, for viewing. Information is held in memory while the instrument is off. After selecting <blue-SHIFT> RECALL, a list of center frequencies of stored displays is shown. This display includes a prompt asking for the register number (0–8) from which the display will be recalled. Select the register from the DATA ENTRY pushbuttons. The readout for a recalled A waveform will only be displayed if VIEW B and B–SAVE A are off and VIEW A is on. The readout for a recalled B waveform will only be displayed if both VIEW B or B–SAVE A are on and SINGLE SWEEP is selected. The marker(s) will only be displayed if markers are turned on.

SAVE A is activated to allow the separate display of the A or B waveform. Remember to turn on SINGLE SWEEP before recalling a waveform to B to prevent overwrite by the sweep. The waveform cannot be recalled into B when in Manual or External Sweep.

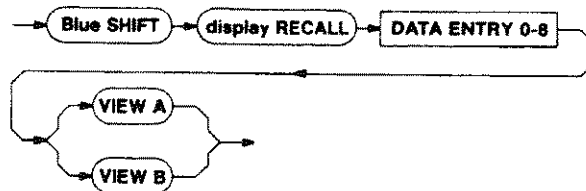

5562-30

## DISPLAY AND GENERAL PURPOSE

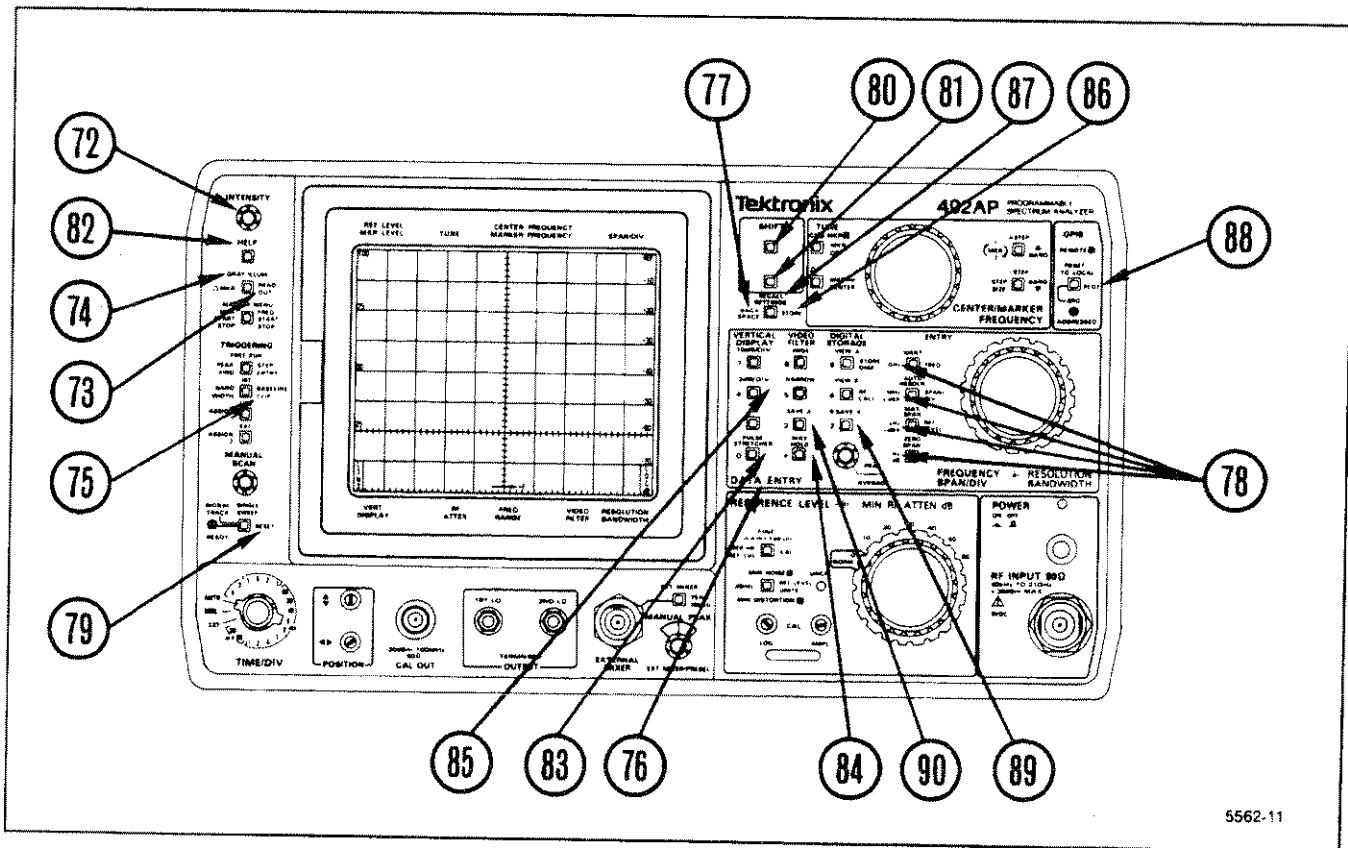

Figure 4-12. Display and General Purpose.

- 72 **INTENSITY** — This control adjusts the brightness of the crt trace, readout, and text. Beam focus is automatically controlled.
- 73 **<Blue-SHIFT> READOUT** — This pushbutton turns crt readout on and off. The brightness is proportional to the trace brightness. This pushbutton does not affect prompt or help messages.
- 74 **GRAT ILLUM** — This pushbutton switches the graticule lights from dim for low-light viewing to bright for photographing displays.
- 75 **<Blue-SHIFT> BASELINE CLIP** — This pushbutton clips, or blanks, about one graticule division of the spectrum trace at the baseline of the display. Use BASELINE CLIP to observe the readout at the bottom of the screen or to eliminate the bright baseline when photographing displays.
- 76 **DATA ENTRY** — These orange pushbuttons are used to enter data directly from the front panel when directed by a message on the crt.
- 77 **BACKSPACE** — This pushbutton backs the cursor up one space each time it is pressed, erasing the number in that location. This allows you to enter correct numerical data before finishing the sequence with a units pushbutton.
- 78 **Units** — The units GHz, MHz, kHz, Hz, +dBx, -dBx, and dB are available to complete a number-entry function from the front panel.

- 79 **<Blue-SHIFT> RESET** This pushbutton sequence resets all front-panel settings to their original condition as if power was just turned on.
- 80 **<Blue-SHIFT>** — This pushbutton allows selection of the blue-labeled front-panel pushbutton functions. Press **<blue-SHIFT>** each time before selecting a blue-lettered function. **<Blue-SHIFT>** also stops multiple-pushbutton sequence operations.
- 81 **<Green-SHIFT>** — This pushbutton allows selection of the green-labeled front-panel pushbutton functions. Press **<green-SHIFT>** each time before selecting a green-lettered function. **<Green-SHIFT>** also stops multiple-pushbutton sequence operations.
- 82 **HELP** — This pushbutton causes text to be displayed on the crt to explain the function of a selected front-panel control or pushbutton. Press the **HELP** pushbutton, then press any pushbutton or turn most controls for an explanation of their function. Explanations are not available for the **PEAK/AVERAGE**, **INTENSITY**, **MANUAL PEAK**, or **MANUAL SCAN** controls.

**<Blue-SHIFT> HELP** — This pushbutton sequence allows selection of all explanations for functions called out on the front panel in blue. **<Blue-SHIFT> HELP** only needs to be pressed once to begin the selection (i.e., **<blue-SHIFT> HELP**, **REF LEVEL**, **PLOT**, **READOUT**). Press **HELP** again to exit this mode.

**<Green-SHIFT> HELP** — This pushbutton sequence allows selection of all explanations for functions called out on the front panel in green. **<Green-SHIFT> HELP** only needs to be pressed once to begin the selection (i.e., **<green-SHIFT> HELP**, **SIGNAL TRACK**, **PEAK FIND**, **MKR START STOP**). Press **HELP** again to exit this mode.

For additional information on **HELP**, see Using the **HELP** Feature in Section 6.

- 83 **<Blue-SHIFT> PULSE STRETCHER** (Diagnostic Aids; not identified on the front panel) — This pushbutton sequence displays a menu on the crt of all the available diagnostic aids for use while troubleshooting.

**WARNING**

MOST OF THIS INFORMATION IS FOR QUALIFIED SERVICE PERSONNEL ONLY. UNFAMILIARITY WITH SAFETY PROCEDURES CAN RESULT IN PERSONAL INJURY. PERFORM ONLY THE OPERA-

TIONS THAT CAN BE COMPLETED FROM THE INSTRUMENT FRONT PANEL. DO NOT ATTEMPT TO REMOVE THE INSTRUMENT PANELS OR PERFORM ANY INTERNAL OPERATIONS; CONTACT QUALIFIED SERVICE PERSONNEL.

- 84 **<Blue-SHIFT> MAX HOLD** (Instrument Errors; not identified on the front panel) — This pushbutton sequence displays on the crt all the detected instrument errors; for use while troubleshooting.
- 85 **Item 85 has been deleted.**
- 86 **<Blue-SHIFT> STORE** — This pushbutton sequence allows a front-panel setup to be stored in memory. The crt displays a list of center frequencies of each setup as an aid in identifying the contents of each register. Select the desired register, and the setup is stored. The instrument settings are automatically stored in register 0 when the spectrum analyzer is turned off, overwriting the settings previously stored there.



5562-31

- 87 **RECALL SETTINGS** — This pushbutton recalls an instrument front-panel setup from memory. The crt displays a list of the center frequencies of each stored setup as an aid in identifying the contents of each register. To return to these settings, press **RECALL SETTINGS 0**; however, the time and minimum RF attenuation settings stay at the knob values. Select the desired register number, and the front-panel controls automatically switch to that setup. The instrument settings are automatically stored in register 0 when the spectrum analyzer is turned off, overwriting the settings previously stored there.
- 88 **<Blue-SHIFT> PLOT** — This pushbutton sequence causes display information to be sent over the GPIB to directly drive a plotter. The plotters that can be driven are a Tektronix 4662 Option 01, 4662 Option 31, or 4663 (emulating the 4662); a Hewlett Packard HP7470A, HP7475A, HP7580B, HP7585B, or HP7486B, or a Gould 6310 or 6320. The plotter type is selected by pressing the **<blue-SHIFT> SAVE A** pushbutton sequence. Refer to **Plotting The Display** in Section 6 for details. This pushbutton also causes the spectrum analyzer to update the GPIB address.

analyzer to update the GPIB address.

- 89 <Blue-SHIFT> B-SAVE A (Plot B-Save A Offset; not identified on the front panel) — The vertical position of the zero reference line for the B-SAVE A display is set with an internal switch selection. However, when using the PLOT function, the position of zero reference for the plot must be entered using this function. The range for the position is 0 to 225 with 125 representing center screen. Enter the position with the DATA ENTRY pushbuttons when prompted by the crt message, and terminate with the Hz pushbutton. The entered position is then stored in memory.

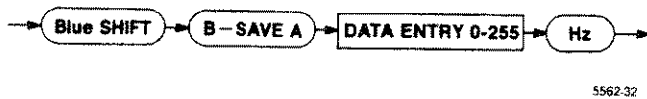

- 90 <Blue-SHIFT> SAVE A (Select Plotter Type; not identified on the front panel) — This pushbutton sequence displays the list of the plotter types available for use with the <blue-SHIFT> PLOT pushbutton sequence. Select the desired plotter type by choosing one of the menu items and entering the number on the DATA ENTRY push-buttons. The choices are 0=Tektronix 4662 Option 01 or the 4663 in a one-pen setup; 1=Tektronix 4662 Option 31 or the 4663 in a two-pen setup; 2=HP7470A or Gould 6310 or 6320; or 3=HP7475A, HP7580B, HP7585B, or HP7586B. Any plotter that is compatible with one of these can also be used. The selected plotter type is stored in memory.

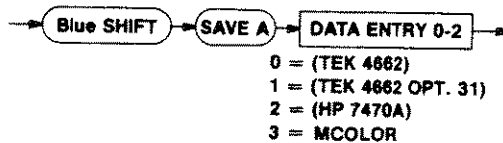

## FRONT-PANEL INPUT/OUTPUT AND GPIB

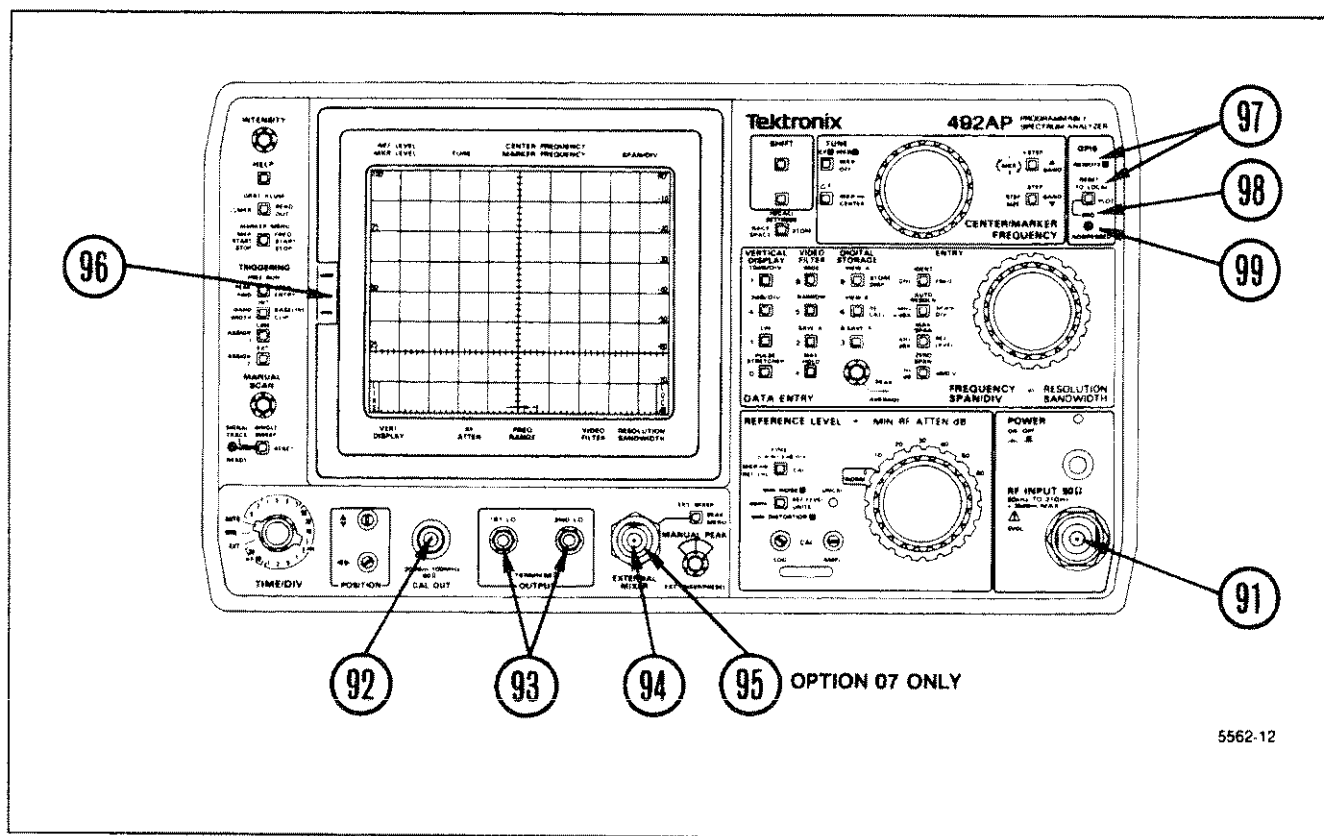

Figure 4-13. Front-panel input/output and GPIB.

**91 RF INPUT 50 Ω** — This 50 Ω coaxial input connector is for RF signals to 21 GHz. If the input signal has a dc component, use a blocking capacitor in line with the signal.

**CAUTION**

The maximum, non-destructive input signal level to the input mixer is +13 dBm or 20 mW. Signals above -18 dBm may cause compression.

The maximum rating of the RF attenuator is +30 dBm (1 W average, 75 W peak pulse width 1 ms or less, with a duty cycle that does not exceed 0.001). Burn-out occurs above 1 W. If MIN NOISE is activated and the RF ATTN is 60 dB, the +30 dBm rating will be exceeded if the signal level is increased to a full-screen display. Under these conditions the input level will be +40 dBm. Reduce the level of high-powered signals with external attenuators. Input signals

to the mixer must not contain any dc component. Refer to Signal Application in Section 6.

**92 CAL OUT (Calibrator output)** — This connector is the source of a calibrated -20 dBm ±0.3 dB, 100 MHz signal and a comb of frequency markers 100 MHz apart. This 100 MHz source is the instrument reference frequency. In Option 07 instruments using the 50 Ω input, the signal is the same as the standard instrument, and using the 75 Ω input, the signal is +20 dBmV, ±0.5 dB.

**93 OUTPUT (1ST LO/2ND LO)** — These connectors are the outputs of the respective local oscillators. The connectors must be terminated into 50 Ω when they are not connected to an external device.

**94 EXTERNAL MIXER** — When the EXT MIXER push-button is pushed, this connector is the bias source for external mixers, as well as the IF input to the spectrum analyzer. The External Mixer mode is

indicated by EXT on the crt readout in place of RF ATTENUATION. Bias voltage is set by the MANUAL PEAK control or set internally when another Auto-Peak Menu option is selected.

- 95 **RF INPUT 75  $\Omega$**  (Option 07 instruments only) — This connector provides calibrated 75  $\Omega$  measurement capability.
- 96 **Camera Power** — This connector is the source of power for the Tektronix C-50 Series Cameras that have electrically-actuated shutters (either the C-5 or the C-59 is recommended). Single-sweep reset is not provided.
- 97 **RESET TO LOCAL/REMOTE** — This pushbutton is lit when the spectrum analyzer is in the remote state. While the instrument is remote, the other front-panel controls are not active. Indicators still reflect the current state of front-panel functions. This pushbutton is not lit when the spectrum analyzer is in the local state. While the spectrum analyzer is under local control, no GPIB messages are executed that would conflict with front-panel controls or change the waveforms in digital storage. See Programming Features in Section 6 for additional information.
- 98 **<Green-SHIFT> SRQ** — This pushbutton sequence sends a service request over the GPIB bus to the controller.
- 99 **ADDRESSED** — This indicator lights when the spectrum analyzer is addressed to either talk or listen. The characters T, L, and/or S appear in the crt readout to indicate talk, listen, and/or SRQ, respectively.



## REAR-PANEL INPUT/OUTPUT AND GPIB

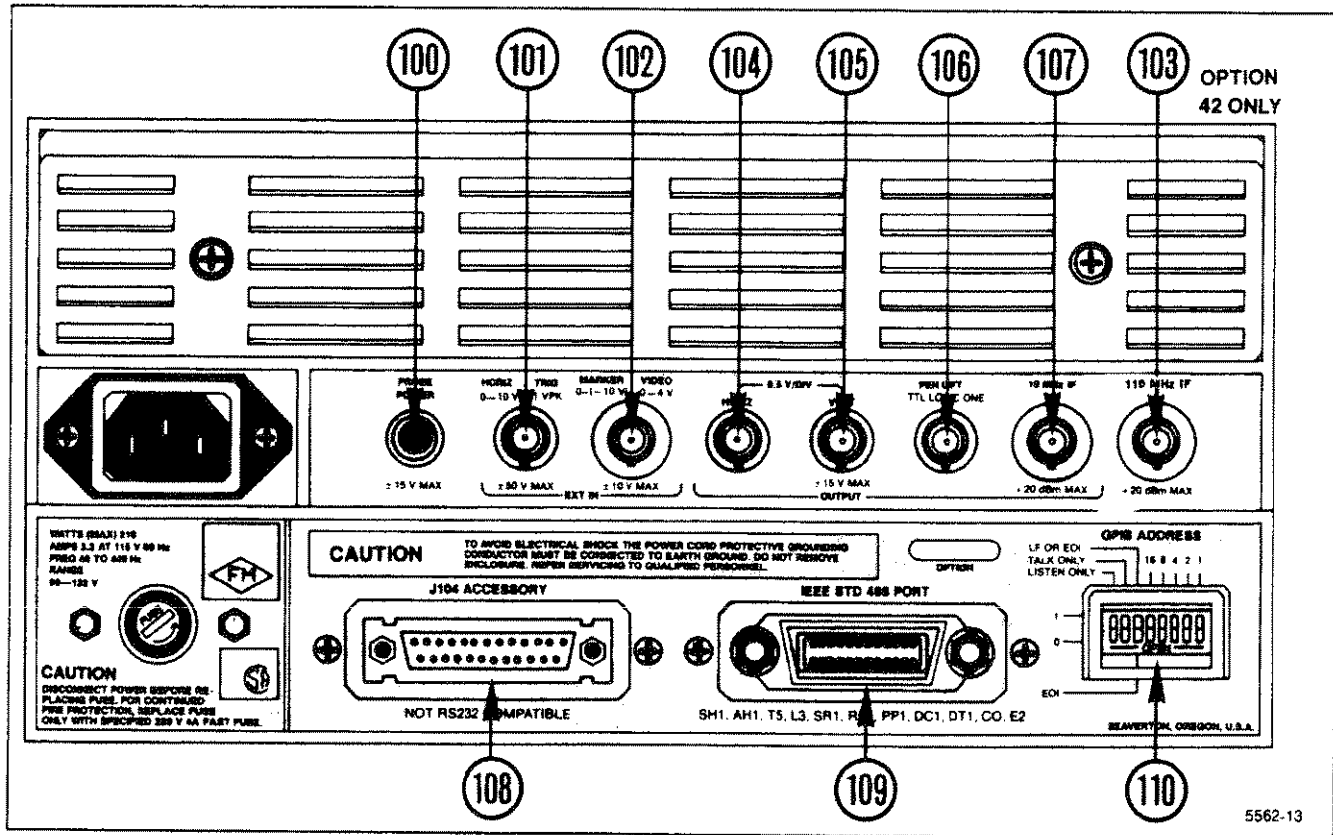

Figure 4-14. Rear-panel input/output and GPIB.

- 100 **PROBE POWER** — This connector provides operating power for active probe systems. This connector should be used only with compatible probes or accessories specifically designed for use with this power source.
- 101 **HORIZ/TRIG (EXT IN)** — Horizontal or triggering modes depend on the TRIGGERING and TIME/DIV selections. In the External Triggering mode, the connector is an ac coupled input for trigger signals. Trigger amplitudes from 1.0 V to 50 V peak, with a 0.1 ms minimum pulse width or within the frequency range of 15 Hz to 1 MHz, are required for triggering. When the TIME/DIV selection is EXT, the connector is a dc coupled input for horizontal sweep voltages. Deflection sensitivity is 1 V/div. A 0 to +10 voltage will deflect the beam across the screen from left to right.
- 102 **MARKER/VIDEO (EXT IN)** — (Available on instruments without Option 42 only. See 110 MHz IF for Option 42 instruments.) This connector interfaces the spectrum analyzer with a Tektronix 1405 TV Adapter to display an externally-generated marker.
- 103 **110 MHz IF** — (Available on Option 42 instruments only.) This connector provides 110 MHz IF output with a bandwidth greater than 5 MHz. Input external video signals used for calibration into the PEN LIFT connector.
- 104 **HORIZ (OUTPUT)** — This connector supplies a 0.5 V/div horizontal signal. Full range is -2.5 V to +2.5 V. Source impedance is approximately 1 k $\Omega$ .
- 105 **VERT (OUTPUT)** — This connector provides access to the video signal with 0.5 V for each division of displayed video that is above and below the center line. Source impedance is approximately 1 k $\Omega$ .

NOTE

Both HORIZ and VERT output signals are driven from digital storage if it is on. Both signals are driven from the analyzer sweep and video amplifier stage if digital storage is off.

- 106 PEN LIFT (OUTPUT)** — This connector provides access to a TTL compatible signal to lift the pen of a chart recorder during spectrum analyzer sweep retrace. This signal is always derived from the spectrum analyzer sweep, regardless of the selection of the digital storage.

In Option 42 instruments, use this connector to input external video signals if pin 1 of the ACCESSORIES connector is grounded (refer any questions about this connection to qualified service personnel).

- 107 10 MHz IF (OUTPUT)** — This connector provides access to the output of the 10 MHz IF. The output level is approximately  $-16$  dBm for a full-screen signal at  $-30$  dBm reference level.

- 108 J104 ACCESSORY** — This connector provides bi-directional access to the instrument bus. It is not RS 232 compatible. A TTL 0 applied to pin 1 selects External Video. Video signals, which are applied to rear-panel MARKERVIDEO, are connected to the video path ahead of the video filters. Pins 2 and 3 provide the output and return lines to drive an external preselector (used only in instruments with Option 01 installed).

- 109 IEEE STD 488 PORT (GPIB)** — This connector interfaces the spectrum analyzer to the GPIB bus. The interface functions provided are SH1, AH1, T5, L3, SR1, RL1, PP1, DC1, DT1, and C0.

- 110 GPIB ADDRESS** — These switches set the value of the lower five bits of the instrument GPIB address; this value is the instrument's primary address. These switches also select the Talk Only and Listen Only operating modes, and the message terminator for input and output. Address 31 (11111) logically disconnects the spectrum analyzer from the bus. Address 0 (00000) is reserved for Tektronix 4050-Series controllers. If these switches are changed after the instrument is already active, press RESET TO LOCAL or <blue-SHIFT> PLOT to cause the spectrum analyzer to re-read them.

Details of how the switches are used in remote control are in the Programmers Manual.

# INSTRUMENT CHECK OUT

This section includes the basic instrument check-out procedures and first-time preparation for use. An instrument operational check is included for the front-panel pushbuttons and controls and some of the operating functions. No extra equipment is required to perform these check-out procedures, and the instrument covers do not need to be removed. Refer any additional instrument check out to qualified service personnel.

## FIRMWARE VERSION AND ERROR MESSAGE READOUT

### Firmware Version

When the spectrum analyzer is first turned on, the front-panel processor firmware versions will be displayed on screen for approximately two seconds, and all the front-panel LEDs will light up.

### Error Message Readout

If the instrument detects an internal hardware failure, a failure report comes on screen and remains for approximately 2 seconds. A status message then appears and remains for as long as the failure exists. Press <blue-SHIFT> MAX HOLD to bring error messages to the screen that explain the impact of the failure on instrument operation.

If the oscillator frequency cannot be set due to a hardware failure, it will continue to try each sweep, and the sweep holdoff time will increase with each try. To disable attempted oscillator corrections, press <blue-SHIFT> 10dB/DIV; however, center frequency accuracy specifications will not be met in this mode. Press <blue-SHIFT> 10dB/DIV again to re-enable oscillator correction routines. Another failure message will appear if the failure has not been corrected.

There are other error messages to report a calibration failure, power supply failure, and battery-operated RAM checksum error. Promptly report any error messages to qualified service personnel.

## PREPARATION FOR USE

The following procedure creates a display and calibrates center frequency readout, display reference level, and bandwidth. Whenever the SHIFT pushbutton is required in this procedure to precede a multiple-pushbutton sequence, it is enclosed in arrows; i.e. <blue-SHIFT>.

### 1. Initial Turn On

a. Connect the spectrum analyzer power cord to an appropriate power source (see Power Source And Power Requirements in Section 3 of this manual) and push the POWER switch ON.

When POWER is switched ON (power-up), the processor runs a memory and I/O test. If no processor system problems are found, the power-up program will complete in approximately 7 seconds, and the instrument will be ready to operate. The crt readout is functioning properly if it is as shown in Figure 5-1 after the 7-second power-up period. If a problem does exist within the instrument, a message will appear on the screen. To bypass the failed test and attempt to use the instrument, press the pushbutton as directed in the error message. However, performance may not be as specified.

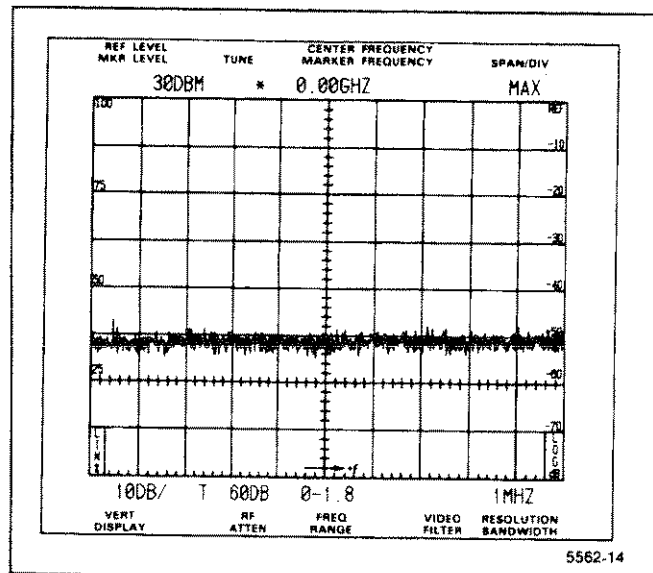

Figure 5-1. Crt display and readout at initial turn on.

## Instrument Check Out — 492A/492AP Operators

The spectrum analyzer operating functions and modes will initialize to the following power-up states.

REF LEVEL	30 dBm
FREQUENCY	
Center	2.10 GHz
Dot Marker	0.90 GHz (Option 01)
Dot Marker	0.00 GHz
SPAN/DIV	MAXimum
VERTICAL DISPLAY	10 dB/DIV
RF ATTENUATION	60 dB
FREQ RANGE	0-4.2
(FREQ RANGE OPTION 01)	0-1.8)
RESOLUTION BANDWIDTH	1 MHZ
TRIGGERING	FREE RUN
AUTO RESOLUTION	On
DIGITAL STORAGE	VIEW A/VIEW B On
All other pushbuttons	Inactive or Off

b. Set the MIN RF ATTEN dB control to 0 (NORM) and the PEAK/AVERAGE control fully counterclockwise. Set the TIME/DIV control to AUTO and the REF LEVEL to read -20 DBM, and adjust the INTENSITY control for the desired brightness. Note that the RF ATTENUATION readout is now 10 DB.

c. Connect a 50  $\Omega$  coaxial cable between the CAL OUT connector and RF INPUT to apply the CAL OUT signal to the RF INPUT connector.

d. A dot marker will appear in the upper portion of the screen in the MAX frequency mode. This marker indicates the location on the display to which the spectrum analyzer frequency is tuned. With a frequency readout of 0.00 GHz, the marker will be in the upper left portion of the screen. Rotate the CENTER/MARKER FREQUENCY control and watch the dot marker move across the display. Notice that the Center FREQUENCY readout (top line) remains at 0.90 GHz, and that the Marker FREQUENCY readout (second line) changes according to the position of the marker (dot).

e. A comb of 100 MHz markers will be displayed, as shown in Figure 5-2. To select 100 MHz center frequency, press the pushbutton sequence of <blue-SHIFT> FREQ 1 0 0 MHz.

f. To change the FREQ SPAN/DIV readout to 100 MHz, press the pushbutton sequence of <blue-SHIFT> SPAN/DIV 1 0 0 MHz. The dot marker is now horizontally centered, and the 100 MHz calibrator signal is at center screen.

## 2. Calibrate Position, Center Frequency, Reference Level, and Bandwidth

### NOTE

When the <blue-SHIFT> CAL sequence is pressed, the spectrum analyzer performs a center frequency, bandwidth, and reference

level calibration. Prompts appear on the screen to guide you step-by-step through the procedure. This calibration should be done at regular intervals. It must be done before the instrument will meet its center frequency and reference level accuracy performance specifications. It should also be done any time the instrument ambient temperature is substantially different from the last calibration. An explanation of reference level accuracy with respect to ambient temperature is described in the Specification section of this manual.

To see the results after the spectrum analyzer has completed a calibration routine, press the <blue-SHIFT> LIN sequence. A message will appear on the screen that shows the correction factors used by the spectrum analyzer to center the resolution bandwidth filters to produce a calibrated center frequency. It also shows the correction that was required to bring the amplitude level within 0.4 dB of the 1 MHz filter.

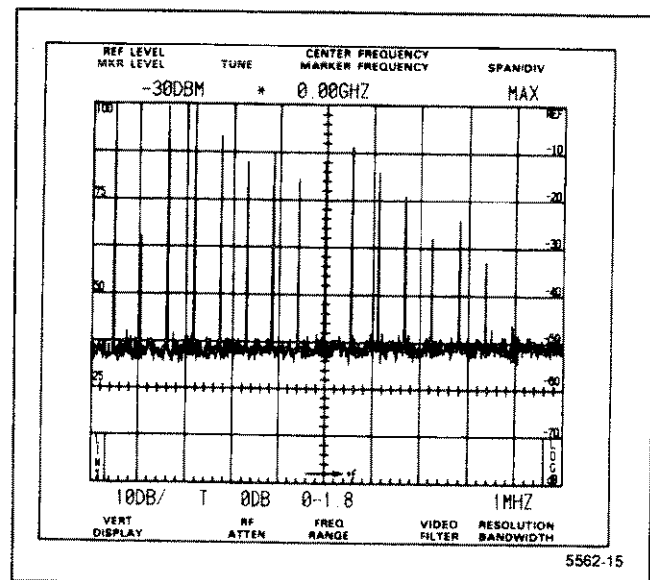

Figure 5-2. Typical display of calibration markers in the maximum span position.

Press the <blue-SHIFT> CAL sequence to start the calibration routine. Prompt messages on the screen will guide you through setting the four front-panel adjustments of vertical and horizontal POSITION, and AMPL and LOG CAL. This sets the absolute reference level for the 1 MHz resolution bandwidth filter. An automatic calibration is then done, which measures and corrects for absolute frequency and amplitude (relative to 1 MHz)

errors of the filters. This takes approximately 60 seconds. If a message appears on the screen, refer to Error Message Readout earlier in this section. The correction factors are held in memory. Press FINE to continue calibration as instructed or either SHIFT pushbutton to exit the routine.

## FUNCTIONAL OR OPERATIONAL CHECK

This procedure uses minimum test equipment to check instrument operating modes, functions, and basic performance. The procedure checks that the instrument is operating properly. The internal calibrator and attenuator are used as the source to check most of the operational characteristics. Since both are very accurate, this check should satisfy most incoming inspection or pre-operational check-out requirements. This check will also help familiarize you with the instrument operation. A detailed Performance Check that verifies all performance requirements in the Specification section is included in the Service Manual, Volume 1.

### Equipment Required

The only external equipment used is an N-male-to-bnc-female adapter and the 50  $\Omega$  coaxial cable, which are supplied as standard accessories.

### Preliminary Preparation

Perform the procedure described under Preparation for Use, then allow the instrument to warm up for at least 15 minutes before proceeding with this check.

### 1. Check Operation of Front-Panel Pushbuttons and Controls

This procedure checks the operation of all front-panel pushbuttons and controls and ensures that the buttons illuminate when the function is active.

The LEDs light on the pushbuttons when the function is active. Lighted LEDs also indicate the allowable selections for any of the multiple function pushbuttons. For example, all DATA ENTRY pushbuttons light after <blue-SHIFT> FREQ, <blue-SHIFT> SPAN/DIV, <blue-SHIFT> REF LEVEL, or <blue-SHIFT> dB/DIV shift functions have been selected. Any lighted pushbutton can enter data for that selection. Messages are displayed on the crt as guides to the entry sequence of these selections.

Connect the CAL OUT signal to the RF INPUT with the 50  $\Omega$  cable and bnc-to-N adapter. Tune the 100 MHz, -20 dBm signal to center screen. Reduce the FREQ SPAN/DIV readout to 20 kHz, and change the VERTICAL DISPLAY to 2 dB/DIV. Press or change the following pushbuttons and controls and note their affect on the operation.

**INTENSITY** — Rotate the control through its range and note the crt beam brightness change.

**HELP** — When this mode is activated, press or operate any pushbutton and most controls to produce a help message on the crt that explains the function of that pushbutton or control. Help messages also prompt action or explain any error message that may appear. Activate this mode, press various pushbuttons, and observe the crt message for each. Press the HELP pushbutton again to cancel. To get HELP messages for shifted functions, press either SHIFT pushbutton, press HELP, then press the desired pushbutton.

**GRAT ILLUM** — When activated, the graticule is illuminated.

**MARKER MENU** — Press this pushbutton to display a menu of available marker commands that are not permanently assigned to a front-panel pushbutton.

**TRIGGERING** — To activate the triggering mode, press one of four pushbuttons. The pushbutton illuminates when in the active state. Press any one of the pushbuttons to cancel or deactivate any other mode. Turn VIEW A and VIEW B off to better observe the triggering effect.

**FREE RUN** — In the active state, the trace free runs.

**INT** — When active, the sweep is triggered when the signal or noise level at the left edge is  $\geq 2.0$  division.

(a) Tune one of the 100 MHz calibrator signals to the center of the display and adjust the REFERENCE LEVEL control so the amplitude of the signal is 2 or more divisions.

(b) Activate INT TRIGGERING to trigger the sweep.

(c) Activate FREE RUN, and set the VERTICAL DISPLAY to 2 dB/DIV so the amplitude at the left edge is less than 1 division.

(d) Reactivate INT TRIGGERING. The sweep is no longer triggered.

**LINE** — When active, the trace is triggered at power line frequency. Switch to LINE and the sweep will be triggered.

**EXT** — When this function is active, the trace runs only when an external signal  $\geq 1.0$  V peak is applied to the back-panel EXT IN connector. Since external test equipment is required to check this function, a check cannot be made with this procedure.

**SINGLE SWEEP** — When this function is active, single sweep aborts the current sweep. Press the pushbutton again to arm the sweep generator and light the READY indicator. When triggering conditions are met after the circuit is armed, the analyzer makes only one sweep. The indicator will remain lit until the sweep has run. The single sweep mode is cancelled when any TRIGGERING pushbutton is pressed. The effect of SINGLE SWEEP is more apparent with VIEW A and VIEW B off.

(a) Press FREE RUN TRIGGERING, and set TIME/DIV to 0.5 s.

(b) Press SINGLE SWEEP to abort the sweep.

(c) Press SINGLE SWEEP again, and the READY indicator lights and the sweep runs.

(d) Press FREE RUN to cancel single sweep; return TIME/DIV to AUTO.

**TIME/DIV** — This control selects sweep rate, manual scan, and external sweep operation. In the MNL position, the MANUAL SCAN control should move the crt beam across the horizontal axis of the crt graticule. In the EXT position, a voltage of 0 to +10 V, applied to the rear-panel HORIZTRIG connector, should deflect the crt beam across the full 10 division screen.

**VERTICAL DISPLAY** — Display modes are activated by three pushbuttons. Press any of these pushbuttons to cancel any other mode. Turn VIEW A and VIEW B on.

**10 dB/DIV** — When this pushbutton is activated, the display is a calibrated 10 dB/division with an 80 dB dynamic range.

(a) With a REF LEVEL readout of -20 dBm, activate 10 dB/DIV. Set the FREQ SPAN/DIV to 20 kHz and tune the calibrator signal to center screen.

(b) Change REF LEVEL, and the display steps in 1 division increments, representing 10 dB/division. Return the REF LEVEL readout to -20 dBm.

**2 dB/DIV** — When this pushbutton is pressed, the display is a calibrated 2 dB/division with 16 dB of dynamic range.

(a) Activate 2 dB/DIV, and change the REF LEVEL readout to -6 dBm. The display now steps 1.0 division for each two steps of the REFERENCE LEVEL control.

(b) Return the REF LEVEL readout to -20 dBm.

**LIN** — When this pushbutton is pressed, the display is linear between the reference level (top of the graticule) and zero volts (bottom of the graticule), and the crt VERTICAL DISPLAY reads out in volts/division.

Activate LIN, and the Vertical Display readout changes to mV/division.

**PULSE STRETCHER** — When this pushbutton is pressed, the fall-time of video signals increases so narrow video pulses will show on the display.

(a) Increase the FREQ SPAN/DIV readout to 100 MHz, change the VERTICAL DISPLAY to 10 dB/DIV, increase TIME/DIV to 1 ms, and switch VIEW A and VIEW B both off.

(b) The markers should increase in brightness when PULSE STRETCHER is activated.

(c) Turn the PULSE STRETCHER off, return TIME/DIV to AUTO, and turn both VIEW A and VIEW B on.

**VIDEO FILTER** — Two filters can be independently selected to provide WIDE or NARROW (approximately 1/30th or 1/300th of the resolution bandwidth) filtering to reduce noise.

(a) Change the FREQ SPAN/DIV readout to 500 kHz, and tune the calibrator signal to center screen.

(b) Alternately activate WIDE and NARROW Video Filters. The noise in each filter is reduced as the filter is switched in (see Figure 5-3). The NARROW filter will have a more pronounced effect on noise reduction. Note the change in sweep rate when the TIME/DIV selector is in the AUTO position, when the Digital Storage is off.

(c) Turn both Video Filters off.

**DIGITAL STORAGE** — Select either one or both of the A and B waveforms from digital storage. The amplitude of a signal should remain constant when digital storage is turned on (VIEW A or VIEW B activated). The PEAK/AVERAGE control positions a cursor over the vertical window of the screen, with noise and signal level averaged below the cursor and peak-detected above the cursor.

**VIEW A** — When this pushbutton is pressed, the A waveform from digital storage is displayed. With SAVE A off, the A waveform is updated each sweep as the beam travels from left to right. With SAVE A on, the waveform is not updated.

**VIEW B** — When this pushbutton is pressed, the B waveform is displayed. When both VIEW A and

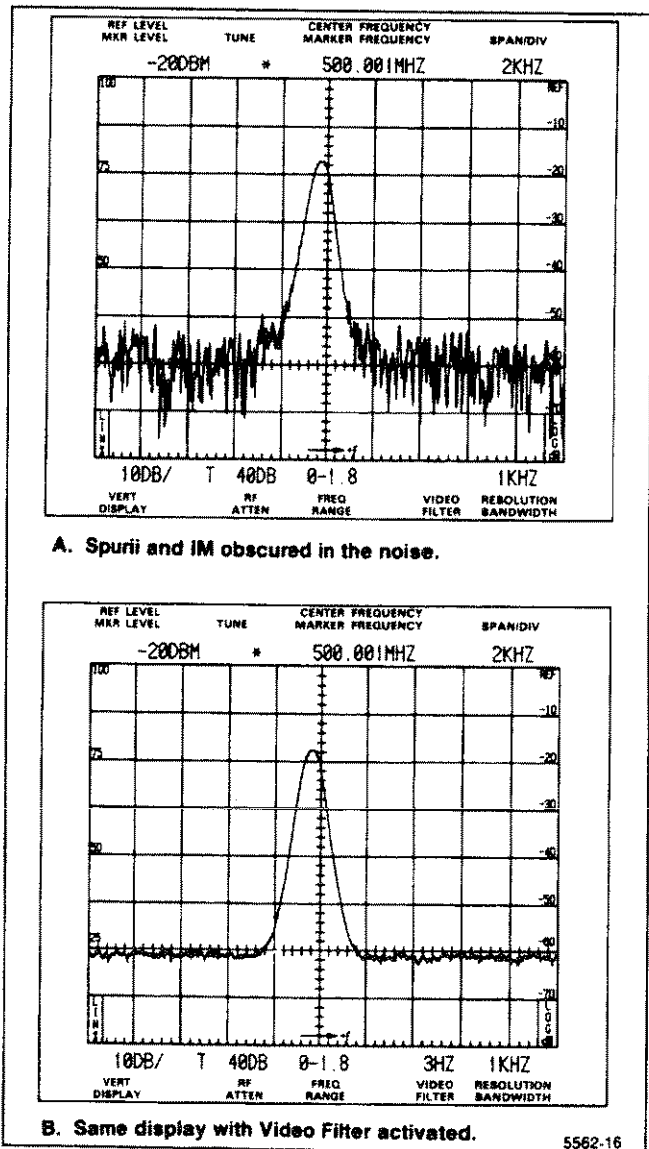

Figure 5-3. Integrating a display with the VIDEO FILTER.

VIEW B are active, the A and B waveforms are interlaced and displayed. Both waveforms are updated each sweep. Update of the A waveform depends on the state of SAVE A.

**SAVE A** — When SAVE A is activated, the A waveform with its readout is saved. In this mode, the data for the A waveform is not updated each sweep. Turn VIEW B off, and change the setting of the REFERENCE LEVEL control. The A display will not change. The readout for the saved waveform will be displayed any time SAVE A is on and VIEW B and B-SAVE A are off. If either VIEW B or B-SAVE A is on, the readout reflects the current analyzer setup.

**MAX HOLD** — When this pushbutton is pressed, the maximum signal amplitude at each memory location is stored. The waveform is updated only when signal data is greater than that previously stored. To verify operation, change the settings of the CENTER/MARKER FREQUENCY or REFERENCE LEVEL controls; the maximum level at each location will be retained.

**B-SAVE A** — Press this pushbutton to display the arithmetic difference between an updated B waveform and a SAVE A waveform. The SAVE A function is automatically activated when B-SAVE A is pressed.

Press B-SAVE A, and change the REFERENCE LEVEL setting so the difference between the B and SAVE A waveform is displayed with VIEW A and VIEW B off. The reference (zero difference) level is factory set at graticule center. The position of this reference level can be changed by qualified service personnel. Positive differences between the two displays appear above this line and negative differences below the line.

**PEAK/AVERAGE** — When digital storage is on, this control positions a horizontal line, or cursor, anywhere within the graticule window. Signals above the cursor are peak detected, signals below the cursor are averaged by the digital storage. To verify operation, move the cursor within the noise level; the noise amplitude will change as the cursor is positioned.

**IDENTify** — When the identify function is activated, every other sweep with its waveform is vertically displaced from the other. The frequencies of the 1st and 2nd local oscillators are moved so that true signals are not displaced horizontally on alternate sweeps while spurious signals are shifted significantly, or off screen. The FREQUENCY SPAN/DIV setting must be 50 kHz or less for the coaxial bands and 50 MHz or less for the waveguide bands (21 GHz or more) before the processor will activate the Identify mode. Refer to Using the Signal Identifier under General Operating Information, in Section 6 of this manual.

(a) With the 500 MHz calibrator harmonic tuned to center frequency, decrease the FREQUENCY SPAN/DIV setting to 50 kHz or less and press IDENT.

(b) There will be no horizontal displacement of the 500 MHz signal on alternate sweeps. To help determine if the signal is true or spurious (see Figure 5-4), decrease the sweep rate or push SAVE A with both VIEW A and VIEW B on, so a comparison can be made.

(c) Turn IDENT off.

**AUTO RESOLN** — When this pushbutton is pressed and FREQUENCY SPAN/DIV and TIME/DIV settings are changed, resolution bandwidth is automatically selected by the processor to maintain a calibrated display. To check operation, change FREQUENCY SPAN/DIV or TIME/DIV settings; the RESOLUTION BANDWIDTH will change. The UNCAL indicator should not light over the FREQUENCY SPAN/DIV range if the TIME/DIV selector is in the AUTO position.

**MAX SPAN** — When activated, the span switches to maximum and the analyzer sweeps the full band. When deactivated, the Span/Div returns to its previous setting.

**ZERO SPAN** — When activated, the span shifts to zero for a time-domain display. When deactivated, the span returns to its previous setting.

**FREQUENCY SPAN/DIV** — As this control is rotated, the Span/Div changes between 0 and Max, and the display indicates the change. The range of selections depends on the frequency band (see specifications in Section 2).

**RESOLUTION BANDWIDTH** — As this control is rotated from a full counterclockwise position, the resolution bandwidth changes in decade steps from 100 Hz to 1 MHz.

**REFERENCE LEVEL** — With 10 dB/DIV VERTICAL DISPLAY active and FINE off, the REF LEVEL readout steps in 10 dB increments as the control is rotated. When FINE is activated, the steps are 1 dB. In the 2 dB/DIV mode, the steps are 1 dB with FINE off and 0.25 dB with FINE active. When the Vertical Display factor is 4 dB/div or less with FINE on, the analyzer switches to the delta A mode. In the delta A mode, the REF LEVEL readout goes to 0.00 dB, then steps in 0.25 dB increments as the REFERENCE LEVEL control is rotated.

(a) Set the MIN RF ATTEN dB control to 0 dB and VERTICAL DISPLAY to 10 dB/DIV. Rotate the REFERENCE LEVEL control counterclockwise to 30 dBm, then clockwise to -110 dBm.

(b) The REF LEVEL readout changes in 10 dB increments.

(c) Press FINE, and change the setting of the REFERENCE LEVEL control. The REF LEVEL readout now steps in 1 dB increments.

(d) Press <blue-SHIFT> dB/DIV and 4 dB with the DATA ENTRY pushbuttons, and the REF LEVEL readout goes to 0.00 dB. Rotate the REFERENCE LEVEL control. The REF LEVEL now steps in 0.25 dB increments from the 0.00 dB reference.

(e) Return the REF LEVEL readout to -20 dBm, and 10 dB of RF ATTENUATION is switched in. This prevents signal compression of any signal with an amplitude within the graticule area.

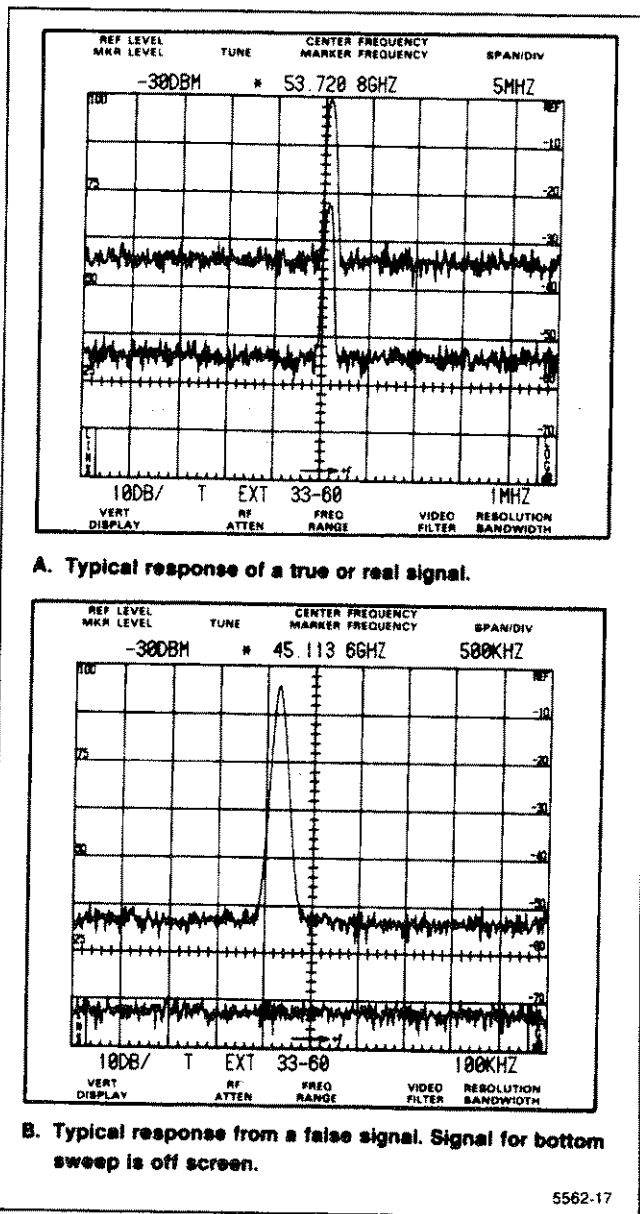

Figure 5-4. Using the IDENT feature to identify a real or true response.

**MIN RF ATTEN dB** — This control sets the minimum amount of RF attenuation in the signal path, regardless of the REFERENCE LEVEL control setting. To check operation, set the MIN RF ATTEN dB selector to 20 and change the REFERENCE LEVEL control settings. The RF ATTENUATION readout will not go below 20 dB.

**FINE** — When activated, the REFERENCE LEVEL control steps decrease to the Fine mode. (Refer to the REFERENCE LEVEL check earlier in this section).



**MIN NOISE/MIN DISTORTION** — This pushbutton selects one of two methods that select RF attenuator and IF gain. MIN NOISE (button illuminated) reduces the noise level by reducing attenuation 10 dB and decreasing IF gain 10 dB. MIN DISTORTION reduces IM distortion due to input mixer overload. The normal mode of operation is with minimum distortion. To observe any change, the amount of RF ATTENUATION displayed by the crt readout must be 10 dB higher than the MIN RF ATTEN dB selector setting.

(a) Set the FREQUENCY readout to 100 MHz, FREQ SPAN/DIV to 500 kHz, REF LEVEL readout to -20 dBm and MIN RF ATTEN dB to 0 dB. The RF ATTENUATION readout will indicate 10 dB.

(b) Activate MIN NOISE. The noise floor will drop approximately 10 dB, and the RF ATTENUATION readout will change to 0 dB.

(c) Deactivate MIN NOISE.

**UNCAL** — This indicator lights when the display is uncalibrated.

(a) Set the TIME/DIV control to 50 ms, deactivate AUTO RESOLUTION, and set RESOLUTION BANDWIDTH to 10 kHz.

(b) The UNCAL indicator should light and remain lit until the FREQ SPAN/DIV readout is reduced to 200 kHz or the RESOLUTION BANDWIDTH is increased to 100 kHz.

(c) Return TIME/DIV control to AUTO, press AUTO RESOLUTION, and set the FREQUENCY SPAN/DIV control to 100 MHz.

**SHIFT** — These pushbuttons shift multiple-function pushbuttons to their alternate function. The names of most of these alternate functions are printed in blue or green lettering next to the pushbutton. The shift mode deactivates after the function has been performed.

DATA ENTRY pushbuttons for the shift mode are labeled with orange lettering.

**RECALL SETTINGS/STORE** — When this pushbutton is pressed, the processor lists the settings, with their center frequency, that are stored in memory (registers 0-9). The 0 register holds the power-down settings so they can be recalled after power-up. Press <blue-SHIFT> STORE to store the existing front-panel setup in one of the available registers.

(a) Press <blue-SHIFT> STORE, and select register number 1 with the DATA ENTRY pushbuttons to store the current front-panel setup.

(b) Change front-panel pushbutton and control settings.

(c) Press RECALL SETTINGS, then DATA ENTRY 1 to recall the setup.

(d) The instrument front-panel set-up returns to that previously entered, with the exception of the Time/Div and RF Attenuation setting.

**Δ F** — When the delta F function is activated, FREQUENCY readout initializes to 0. The frequency difference, to a desired signal or point on the display, can be determined by tuning that point to center screen and noting the readout. Check by measuring the difference between calibrator harmonics. If the delta frequency is tuned below 0, the readout will include a minus sign.

**TUNE CF/MARKER** — When this pushbutton is lit, a Marker appears as a bright spot on the screen and the CENTER/MARKER FREQUENCY control tunes the Marker; the FREQUENCY readout remains constant. An asterisk (\*) between the FREQUENCY and REF LEVEL readout indicates that the CENTER/MARKER FREQUENCY control is tuning the Marker Frequency.

**+STEP/-STEP** — When these pushbuttons are pressed, the marker or center frequency is increased or decreased by steps. Perform the following steps while in the Tune CF mode.

(a) Reduce the SPAN/DIV readout to 50 MHz, set the FREQUENCY readout to 100 MHz. Press <blue-SHIFT> STEP ENTRY; enter 25 MHz with the DATA ENTRY pushbuttons. Press +STEP, the FREQUENCY readout will increase to 125 MHz. Press +STEP again, and the FREQUENCY readout will increase to 150 MHz.

(b) Push the -STEP pushbutton. The FREQUENCY readout will decrease to 125 MHz, and push -STEP again to return the FREQUENCY readout to 100 MHz.

**EXT MIXER/PEAK MENU** — This dual-function pushbutton selects External Mixer or when <blue-SHIFT> is activated, PEAK MENU.

If the spectrum analyzer is operating in the preselector bands (1.7-21 GHz), the preselector initiates a peaking routine on any signal within the center two divisions of the screen. In Option 01 instruments, the peak code consists of numbers at 500 MHz intervals. The algorithm will peak the preselector tuning for this center frequency setting, then store this peak setting in battery-operated memory. If a signal is not on screen, the algorithm will revert to the code that was previously stored in memory; or, if there is no setting, to the mid point of the peaking range. After a setting for a band has been stored, you can switch between preselector bands with the assurance that the preselector is peaked well enough to track the oscillator and provide reasonable sensitivity.

If the spectrum analyzer is operating in the External Mixer mode, the peaking routine sets the external mixer bias to peak the mixer response. If a signal is not present, the algorithm reverts to the previous bias setting stored in memory; or, if there is no previous setting, it sets the bias voltage mid range. In the External Mixer

mode the crt readout for RF ATTENUATION reads EXT. To exit this mode, press EXT MIXER again. The REF LEVEL automatically goes to +30 dBm and the RF ATTENUATION to 60 dB to protect the internal mixer from any high-level signals at the RF INPUT.

Press <blue-SHIFT> PEAK MENU to select one of four peaking options: KNOB, for manual operation using the MANUAL PEAK control, STORED VALUE, INPUT, for input via DATA ENTRY pushbuttons, and REPEAK. Only perform the following auto-peak routine (REPEAK) with Option 01 instruments.

(a) With the calibrator signal applied to the RF INPUT, select a FREQUENCY of 2.0 GHz by pressing <blue-SHIFT> FREQ 2.0 GHz with the DATA ENTRY pushbuttons. Select a REF LEVEL readout of -40 dBm SPAN/DIV readout of 10 kHz, and a RESOLUTION BANDWIDTH of 1 kHz.

(b) Press <blue-SHIFT> PEAK MENU, and select item 3 to peak the 2 GHz signal with the MANUAL PEAK control. The message PEAKING will appear on screen and the READY indicator for the SINGLE SWEEP mode will flash as the processor runs the auto-peak routine.

(c) When complete, the signal amplitude should equal or exceed that obtained with manual peaking.

(d) Change bands by pressing <blue-SHIFT> BAND Δ or BAND ∇, then return to band 2. Auto peak will maintain the setting stored in memory.

(e) Press EXT MIXER, and the analyzer should shift to the External Mixer mode (indicated by a readout of EXT above RF ATTENUATION).

(f) If you have a voltmeter available, connect it between the EXTERNAL MIXER port and ground. Measure the bias voltage. If in the Auto Peak mode, the bias should be a steady dc voltage. (If Auto Peak has not been run for this band, the bias voltage will read approximately mid range.)

(g) Switch to the manual peak mode by pressing <blue-SHIFT> PEAK MENU, item 0. The bias voltage at the EXTERNAL MIXER port should now vary between approximately -2.5 V to +1.0 V as the MANUAL PEAK control is rotated through its range.

Following is an alternate procedure.

Remote bias or peak operation can be checked by using a Tektronix 4041 controller connected to the spectrum analyzer with a general purpose interface bus (GPIB) cable. Set the GPIB ADDRESS switches on the back panel of the spectrum analyzer to a value of 1, then enter and run the following program.

```
80 Z=1 ! ADDRESS OF SPECTRUM
ANALYZER EQUALS 1
100 Print "ENTER VALUE ";
```

```
110 Input A$
120 Print #1:"PEAK ";A$
130 Go to 100
```

The program will wait until the value 0 to 1023 has been entered (the full range of the bias). If you have a problem, incorporate a SRQ handler.

```
80 Z=1 ! ADDRESS OF SPECTRUM
ANALYZER EQUALS 1
90 On SRQ Then 140
100 Print "ENTER VALUE ";
110 Input A$
120 Print #1:"PEAK";A$
130 Go to 100
140 Poll A,B;1
150 Print "SRQ ";B
160 Return
```

(h) Enter the value 0, then 1023. With a voltmeter, measure the mixer bias for each value at the EXTERNAL MIXER port. The bias should equal the two extremes of the bias range (+1 to -2.5 V). Turn off the EXT MIXER.

Enter AUTO instead of a number. The spectrum analyzer will run an auto peak routine, and the word PEAKING will appear on screen during the routine.

**RESET TO LOCAL** — The RESET TO LOCAL pushbutton is lighted when the spectrum analyzer is under control of the GPIB controller. While under remote control, the other front-panel controls are not active, but indicators will still reflect the current state of all front-panel functions, except Time/Div, Peak/Average and RF Attenuation.

This pushbutton is not lighted when the spectrum analyzer is under local operator control. While under local control, the spectrum analyzer does not execute GPIB messages that would conflict with front-panel controls or change the waveforms in digital storage.

When the pushbutton is pressed, local control is restored to the operator unless the controller prevents this with the local lockout message. Programmable functions do not change when switching from remote to local control, except as necessary to match the settings of front-panel controls for TIME/DIV, MIN RF ATTEN dB, PEAKING, and PEAK/AVERAGE.

The internal microcomputer flashes the instrument and front-panel firmware version numbers and the GPIB address on the crt when the pushbutton is pressed. The microcomputer also updates the GPIB primary address if the GPIB ADDRESS switches have been changed.

For another function of this pushbutton when in the talk-only mode, refer to Talk-Only/Listen-Only Operation in Section 6 of this manual.

**GPIB Function Readout —** A single character appears in the lower crt readout when the spectrum analyzer is talking (T), listening (L), or requesting service (S). Two characters will appear in this location if the spectrum analyzer is talking or listening and also requesting service, or is in the talk/listen mode.

**Blue-SHIFT Functions —** Press blue-SHIFT to change the pushbuttons that have more than one function. Some functions require a parameter or command to be entered that includes numerical data. This data is entered with the DATA ENTRY pushbuttons.

(a) Set the **FREQ SPAN/DIV** readout to 50 kHz and turn **AUTO RESOLution** on. Set the **FREQUENCY** readout to 2.0 GHz by pressing <blue-SHIFT> **FREQ 2 GHz** with the **DATA ENTRY** pushbuttons. This sets the **FREQUENCY** to 2.000 GHz. (The number of digits is a function of the span/div that was previously entered.)

(b) Enter frequencies of 200 MHz and 200 kHz by repeating the procedure in step a. The **FREQUENCY** readout will be set to the figures entered with the **DATA ENTRY** pushbuttons.

(c) With the **DATA ENTRY** pushbuttons, set the **SPAN/DIV** readout to any desired setting. The **SPAN/DIV** readout will be set to the figures entered with the **DATA ENTRY** pushbuttons.

(d) Enter a reference level with the **DATA ENTRY** pushbuttons. The **REF LEVEL** readout will be set to the figures entered with the **DATA ENTRY** pushbuttons.

(e) Enter a desired vertical display factor with the **DATA ENTRY** pushbuttons. The **VERTICAL DISPLAY** readout will be set to the figures entered with the **DATA ENTRY** pushbuttons.

**STORE DISPlay —** Press <blue-SHIFT> **STORE DISP**, the register number where you want to store the display, and the display you want stored (A or B).

**RECALL —** Press <blue-SHIFT> **RECALL**, the register number from the displayed menu, and the part of digital storage (A or B) where you want to have the recalled waveform placed.

If A is selected, **SAVE A** is automatically activated to prevent an overwrite. **VIEW A** must be on to observe the recalled waveform and **VIEW B** must be off to see the readout that applies to the recalled waveform. If **VIEW B** and **VIEW A** are on, both the recalled waveform in A and the current waveform in B will be displayed. Readout will apply to the current B waveform.

If B is selected, the next sweep will overwrite the display unless **SINGLE SWEEP** was activated before selecting B; a message will appear on the screen as a reminder of this. **VIEW B** must be on to observe the recalled waveform and its readout. Remember to deactivate **SINGLE SWEEP** when leaving this recalled mode.

(a) Establish a display on the screen. Press <blue-SHIFT> **STORE DISPlay**, the memory register number (0-8) to place the display, and the display (A or B) you wish stored.

(b) Change the characteristics of the current display with either **REFERENCE LEVEL** or **FREQUENCY SPAN/DIV** control.

(c) Press <blue-SHIFT> **RECALL**, the register number where the display was stored (note the center frequency listing of the stored displays in each register), then **VIEW A** so the recalled waveform is placed in the A part of digital storage.

(d) If **VIEW A** is on and **VIEW B** off, the recalled display with its readout will now become the A display. **SAVE A** will activate to prevent overwrite. If **VIEW A** and **VIEW B** are on, both the recalled display and the current B display will be on screen. Since the most current display is the B waveform, the readout will show the parameters for the B display. Switch **VIEW B** off to see the readout applicable to the recalled A waveform.

(e) Recall a stored display into the B section by repeating the process in step d. Before starting the process, press **SINGLE SWEEP** so the recalled waveform will not be overwritten by the next sweep; a message will appear when you select the B section to remind you of this.) Remember to deactivate **SINGLE SWEEP** when returning to normal operation.

#### NOTE

If an attempt is made to recall a display from an empty location, error message **NVRAM CHECKSUM ERROR** will be issued.

**MKR OFF —** Press <blue-SHIFT> **MKR OFF** to turn off the markers.

**MKR → CENTER —** Press <blue-SHIFT> **MKR → CENTER** to bring a marker signal to center screen.

(a) Set the **REF LEVEL** readout to -20 dBm, **FREQUENCY** readout to 100 MHz. Set **FREQ SPAN/DIV** to 200 kHz, and **VERTICAL DISPLAY** to 10 dB/DIV; set **RESOLUTION BANDWIDTH** to 100 kHz.

(b) Tune the signal off center, activate **TUNE MKR**. Tune the Marker to the top of the signal and press <blue-SHIFT> **MKR → CENTER**. The signal should move to center screen.

**BAND  $\Delta$ /BAND  $\nabla$**  — These <blue-SHIFTed> push-buttons shift the frequency range up or down from the current band. Press one and then the other and the frequency bands will change accordingly. If the frequency is selected from the DATA ENTRY pushbuttons, the spectrum analyzer automatically selects the appropriate frequency range.

**READOUT** — Press <blue-SHIFT> READOUT to turn off the crt readout of the markers, REF LEVEL, FREQUENCY, SPAN/DIV, VERTICAL DISPLAY, RF ATTENUATION, FREQ RANGE, RESOLUTION BANDWIDTH, and VIDEO FILTERS. Press <blue-SHIFT> READOUT to reactivate the readout on the display.

**FREQ START STOP** — Activating <blue-SHIFT> FREQ START STOP allows you to enter a start and stop frequency within the selected band with the DATA ENTRY pushbuttons.

(a) Enter a start frequency of FREQ 90 MHz with the DATA ENTRY pushbuttons. Enter stop frequency 210 MHz.

(b) The signals at the 1st and 9th graticule line should be 100 MHz apart. Set the VERTICAL DISPLAY to 10 dB/DIV, and observe that the SPAN/DIV readout is 12 MHz.

**STEP ENTRY** — Activate <blue-SHIFT> STEP ENTRY to increase the frequency setting a desired amount. Perform the following steps while in the Tune Marker mode.

Press <blue-SHIFT> STEP ENTRY and enter a step frequency of 10 MHz. Activate +STEP and note that the MARKER FREQUENCY readout is 160 MHz. Push -STEP to return the FREQUENCY setting to 150 MHz. Turn off the marker by pressing <blue-SHIFT> MKR OFF.

**BASELINE CLIP** — Press <blue-SHIFT> BASELINE CLIP to clip (blank) the baseline of the display up to about one graticule division.

**RESET** — Press <blue-SHIFT> RESET to return the instrument to the original power-up state.

**REF LEVEL UNITS** — Disconnect the calibrator signal from the RF INPUT, and change the REF LEVEL readout to 0 dBm. Press <blue-SHIFT> REF LEVEL UNITS. Select item 1, and note the REF LEVEL readout change to -13dBV. Select item 2, and note the REF LEVEL readout change to 47 dBmV. Select item 3, and note the REF LEVEL readout change to 107 dB $\mu$ V. Press 0 to return the readout to 0 dBm. Reconnect the calibrator signal to the RF INPUT.

**Green-SHIFT Functions** — Press green-SHIFT to change the pushbuttons that have more than one function. Some functions require a parameter or command to be entered that includes numerical data. This data is entered with the DATA ENTRY pushbuttons. Most green-shifted functions are marker related.

**Markers** — The markers provide direct readout of frequency and amplitude information of any point along any displayed trace or relative (delta frequency) and amplitude information between any two points along any displayed trace or traces (in delta only). In the delta mode, only the difference in frequency and amplitude will be displayed. Two independent marker frequencies and amplitudes cannot be displayed at the same time.

With the FREQUENCY readout at 100 MHz, a REF LEVEL readout of -10 dBm, and a FREQ SPAN/DIV of 5 MHz, press TUNE CF/MARKER. A bright dot, the marker, appears on screen, as well as a second line of readout with an asterisk between the REF LEVEL and FREQUENCY readout. Turn the CENTER/MARKER FREQUENCY knob, and note that the marker tunes.

Press TUNE CF/MARKER again, the indicator button will not be lit but the marker remains on screen. When the CENTER/MARKER FREQUENCY knob is rotated now, the marker does not move, but both the Center Frequency and the Marker Frequency change. Also, the asterisk has now moved to the first readout line to indicate that the center frequency is being tuned.

Return the FREQUENCY readout to 100 MHz, and press TUNE CF/MARKER to activate the marker.

**PEAK FIND** — Press <green-SHIFT> PEAK FIND to move the marker to the top of the signal.

$\Delta$  MKR, 1-MKR-2, MKR START STOP, MKR - REF LEVEL, ASSIGN 1, ASSIGN 2 — Press <green-SHIFT>  $\Delta$  MKR to activate a second marker at the position of the single marker on the trace. Parentheses will be added to the second line readout.

(a) Rotate the CENTER/MARKER FREQUENCY control; two markers will be on screen. Set the delta marker readout to 5 MHz.

(b) Press <green-SHIFT> 1-MKR-2. The left marker is now brighter as an indication that it is being tuned. Tune the marker until the readout shows -10 MHz, which is the difference in frequency between the two markers (the delta marker frequency).

(c) Press <green-SHIFT> MKR START STOP. The markers now appear at the left and right edge of the screen. The waveform will be "zoomed in".

(d) Press <green-SHIFT>  $\Delta$  MKR again, there will be just a single marker now, and the parentheses around the second line of readout will disappear.

(e) Press <green-SHIFT> PEAK FIND, then <blue-SHIFT> MKR-CENTER. The signal is now at center screen.

(f) Press <green-SHIFT> MKR-REF LEVEL, the signal and the marker will now be at the top of the screen.

(g) Reduce the **FREQ SPAN/DIV** readout to 500 kHz, and set the **RESOLUTION BANDWIDTH** to 1 MHz.

(h) Press **MARKER MENU**. Nine menu items are displayed. Press 7, and you will be prompted to enter the bandwidth number. Enter 10 +dB with the **DATA ENTRY** pushbuttons, press <green-SHIFT> **BANDWIDTH MODE**, and observe that the Delta MKRs have moved down 10 dB from the top of the signal. Delta frequency is a little over 1 MHz wide. Press <green-SHIFT> **BANDWIDTH MODE** again to turn it off.

(i) Press <blue-SHIFT> **MKR OFF**, and using the **DATA ENTRY** pushbuttons, set the **FREQUENCY** readout to 200 MHz and the **FREQ SPAN/DIV** readout to 25 MHz. Set the **Peak/Average** cursor to the bottom of the screen. Press **TUNE CF/MKR**.

(j) Press <green-SHIFT> **PEAK FIND**. The marker will now be positioned on the 100 MHz calibrator signal (the left-most tall signal of the three signals on screen).

(k) Press **MARKER MENU**. Nine menu items are displayed. Press 6 and the **Assign Menu** is displayed with seven menu items. Press 3 and note that both **ASSIGN** pushbuttons light. Press <green-SHIFT> **ASSIGN 1** to assign the **Next Lower Peak** function.

(l) Press **MARKER MENU** again. Press 6 to get the **Assign Menu**. Press 2. Press <green-SHIFT> **ASSIGN 2** to assign the **Next Higher Peak** function.

(m) Press <green-SHIFT> **ASSIGN 2**. The marker will move to the 300 MHz calibrator harmonic. Press the <green-SHIFT> **ASSIGN 2** pushbutton one more time; the marker will move to the 200 MHz calibrator harmonic. Press <green-SHIFT> **ASSIGN 1** twice to return the marker to the original 100 MHz signal. Press **TUNE CF/MKR** to turn the marker off.

**SIGNAL TRACK** — Press the <green-SHIFT> **SIGNAL TRACK** sequence to keep a drifting signal on screen.

(a) Set the **REF LEVEL** readout to -20 dBm, the **FREQUENCY** readout to 100.000 MHz, the **SPAN/DIV** readout to 5 kHz. Push the **VERTICAL DISPLAY 10 dB/DIV** pushbutton, and the **RESOLUTION BANDWIDTH** to 1 kHz. The signal should be on screen.

(b) Press the <green-SHIFT> **SIGNAL TRACK** sequence. The **TUNE MKR** lights and the signal will be moved back to center screen. **Signal Track** will be indicated in the marker readout on the crt.

(c) To deactivate the function, press <green-SHIFT> **SIGNAL TRACK** again.

## 2. Check Gain Variation Between Resolution Bandwidths

(less than 0.4 dB with respect to the 1 MHz filter and less than 0.8 dB between any two filters)

a. Calibrate the **Center/Marker Frequency**, **Reference Level**, and **Bandwidth** as described earlier in this section.

b. Set the **FREQUENCY** readout to 100 MHz by pressing <blue-SHIFT> **FREQ 1 0 0 MHz** with the **DATA ENTRY** pushbuttons. Set the **FREQUENCY SPAN/DIV** control to 1 MHz, the **RESOLUTION BANDWIDTH** to 1 MHz, the **REFERENCE LEVEL** control to -20dBm, **TIME/DIV** to **AUTO**, and activate **AUTO RESOLUTION**.

c. Apply 100 MHz markers from the **CAL OUT** connector to the **RF INPUT**. Set the **Vertical Display** factor to 1 dB/DIV by pressing <blue-SHIFT> **dB/DIV 1 dB**, and set the **RESOLUTION BANDWIDTH** readout to 1 MHz.

d. Verify that the amplitude of the 100 MHz signal is at the top graticule line. If not, repeat the front-panel calibration procedure by pressing <blue-SHIFT> **CAL**.

e. Change the **REF LEVEL** readout to -19 dBm, **RESOLUTION** to 1 MHz and activate **SAVE A**. This is the reference for checking the other filters.

f. Change the **RESOLUTION BANDWIDTH** and **FREQUENCY SPAN/DIV** controls to 100 kHz.

g. Check the amplitude of the 100 MHz signal. It should be within 0.4 dB of the 1 MHz reference established in part e.

h. Set the **RESOLUTION BANDWIDTH** control to each of the remaining positions and the **FREQ SPAN/DIV** readout for a readable display. The amplitude accuracy and frequency can now be checked with respect to the 1 MHz reference and between any two filters. Reference level error should not exceed 0.4 dB from the reference and 0.8 dB between any filter.

i. Turn **SAVE A** off.

## 3. Check Span Accuracy and Linearity

Span accuracy is the displacement error of calibrator markers from the center reference over  $\pm 4$  major divisions of span. Linearity accuracy is determined by the displacement of calibrator frequency markers from their specified positions over the center eight divisions of the display area, using the 1st graticule line as the reference.

a. Set the **FREQUENCY** readout to 500 MHz, the **FREQUENCY SPAN/DIV** control to 100 MHz, the **REF LEVEL** readout to -20 dBm, and activate **AUTO RESOLUTION**. Change the **VERTICAL DISPLAY** to 10 dB/DIV.

b. Span is accurate when the 100 MHz markers are within 5% of their reference graticule line over the center eight divisions. (It may be easier to observe the markers with DIGITAL STORAGE off.)

c. Tune CENTER/MARKER FREQUENCY to align one of the markers at the 1st graticule line from the left edge.

d. Linearity is accurate when the displacement of successive markers, over the center eight divisions, does not exceed 5% of 100 MHz (the FREQ SPAN/DIV setting) or 0.2 division.

#### 4. Check Resolution Bandwidth and Shape Factor

(bandwidth is within 20% of the selected 1 MHz to 100 Hz range, in decade steps to 100 Hz; shape factor is 7.5:1 or less)

a. With the Calibrator output applied to the RF INPUT and the FREQUENCY readout at 100 MHz, set the REFERENCE LEVEL control to -20 dBm, the FREQ SPAN/DIV control to 500 kHz, RESOLUTION BANDWIDTH to 1 MHz, TIME/DIV at AUTO, VERTICAL DISPLAY to 2 dB/DIV, and activate MIN NOISE.

b. Measure the 6 dB down bandwidth (see Figure 5-5A). Bandwidth should equal 1 MHz,  $\pm 200$  kHz.

c. Change VERTICAL DISPLAY to 10 dB/DIV, and measure the 60 dB down bandwidth (see Figure 5-5B).

d. Calculate the shape factor as the ratio of -60 dB/-6 dB bandwidths (see Figure 5-5). Shape factor should equal 7.5:1 or less.

e. Change the RESOLUTION BANDWIDTH setting to 100 kHz and the FREQ SPAN/DIV to 100 kHz.

f. Check the resolution bandwidth and shape factor of the 100 kHz filter by repeating the above process.

g. Repeat the process to check the resolution bandwidth and shape factor for the 10 kHz, 1 kHz, and 100 Hz filters. Shape factor should equal 7.5:1 for all.

#### 5. Check Reference Level Gain and RF Attenuator Steps

a. With the Calibrator signal applied to the RF INPUT and the FREQUENCY readout set to 100 MHz, set the FREQ SPAN/DIV and RESOLUTION BANDWIDTH controls to 100 kHz. Set VERTICAL DISPLAY to 10 dB/DIV, REF LEVEL readout to -20 dBm, and activate MIN NOISE and NARROW VIDEO FILTER.

b. To check the attenuator, increase REF LEVEL readout to +40 dBm; the signal peak will decrease 1 major division per 10 dB step of the RF ATTENUATION.

c. Set FREQUENCY readout to 200 MHz and the REFERENCE LEVEL control to -20 dBm.

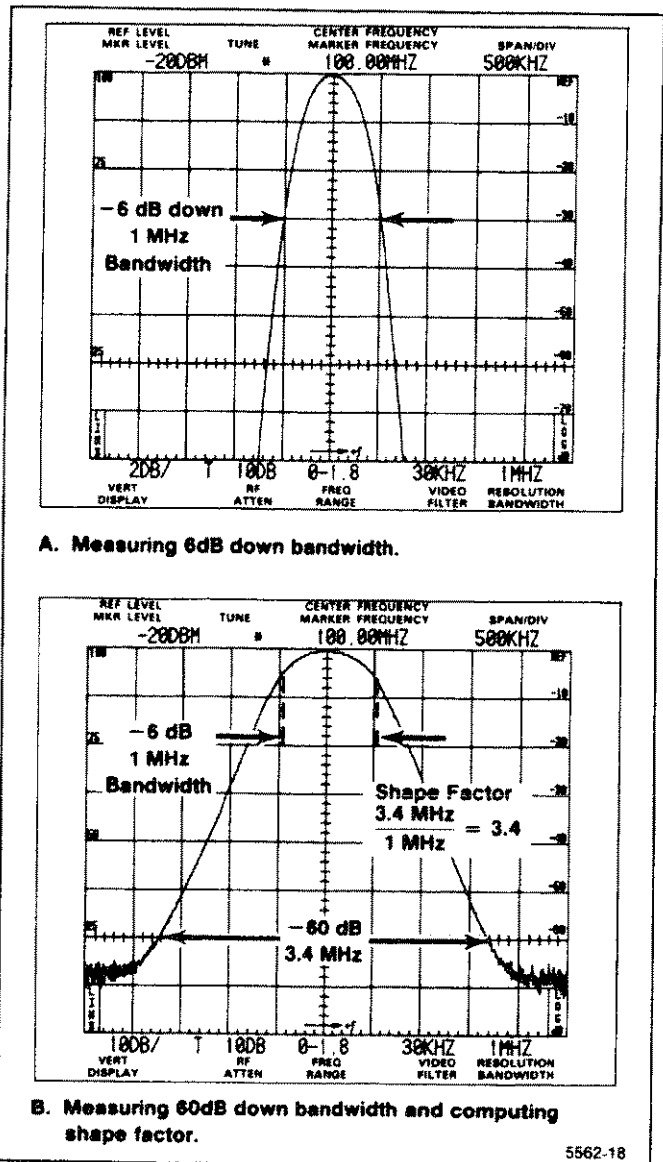

Figure 5-5. Displays that illustrate how bandwidth and shape factor are determined.

d. Increase the MIN RF ATTEN dB to 60 dB; the noise level will increase 1 division for each 10 dB step.

e. To check IF gain steps, switch REFERENCE LEVEL control between -20 dBm and +40 dBm. The noise level will decrease 1 division per step.

f. Activate FINE; then, check that the trace rises 1 dB/step of the reference level as it is changed to +30 dBm.

g. Switch FINE off, and reduce MIN RF ATTEN setting to 0.

h. Switch MIN NOISE off; the noise floor will rise about 1 division as the RF ATTENUATION increases 10 dB. REF LEVEL readout should not change.

i. Change REF LEVEL to -60 dBm, and switch VERTICAL DISPLAY to 2 dB/DIV. Adjust REF LEVEL so the signal level is near the top graticule line.

j. Change the REFERENCE LEVEL control; the signal amplitude will change in 1 dB increments (0.5 div).

k. Set VERTICAL DISPLAY readout to 1 dB/DIV with the <blue-SHIFT> dB/DIV 1 dB with the DATA ENTRY pushbuttons.

l. Change the REFERENCE LEVEL control positions; the REF LEVEL readout will change in 1 dB steps, and the display in 1 division steps.

m. Activate FINE (Delta A mode). The REF LEVEL now reads 0.00 dB, which denotes the Delta A mode.

n. Change the REFERENCE LEVEL control positions; the REF LEVEL readout will change in + or - 0.25 dB increments.

o. Deactivate FINE. Change the VERTICAL DISPLAY to 10 dB/DIV and the REF LEVEL readout to -20 dBm.

## 6. Check Sensitivity (refer to Table 5-1)

### NOTE

Sensitivity is specified according to the input mixer average noise level. The calibrator signal is the reference used to calibrate the display.

a. Remove the calibrator signal from the RF INPUT. Set VERTICAL DISPLAY to 10 dB/DIV, REF LEVEL readout to -30 dBm, FREQ SPAN/DIV readout to 5 MHz, the RESOLUTION BANDWIDTH control to 1 MHz, the TIME/DIV control at 1 second. Adjust the PEAK/AVERAGE cursor so it is off the top of the screen, and activate the WIDE VIDEO FILTER.

b. The noise floor (level) should be at least -80 dBm (as indicated in Table 5-1) or five divisions down from the REF LEVEL readout of -30 dBm.

c. Change the REFERENCE LEVEL control to -40 dBm, the FREQUENCY SPAN/DIV control to 1 MHz, and the RESOLUTION BANDWIDTH control to 100 KHz.

Table 5-1

### SENSITIVITY (OPTION 01 INSTRUMENT)

Equivalent Input Noise (dBm) versus Resolution Bandwidth						
Band	Frequency	1 MHz	100 kHz	10 kHz	1 kHz	100 Hz
Bands 1-3	50 kHz-7.1 GHz	-80	-90	-100	-110	-118
Band 4	5.4-12.0 GHz	-65	-75	-85	-95	-103
Band 5	15.0-21.0 GHz	-55	-64	-75	-85	-93
Band 6 <sup>a</sup>	18.0-26.5 GHz	-70	-80	-90	-100	-108
Band 7 <sup>a</sup>	26.5-40.0 GHz	-65	-75	-85	-95	-103
Band 8 <sup>a</sup>	33-60 GHz	-65	-75	-85	-95	-103
Band 9 <sup>a</sup>	50-90 GHz	Typically -95 dBm for 1 kHz resolution bandwidth at 50 GHz, degrading to -85 dBm at 90 GHz				
Band 10 <sup>a</sup>	75-140 GHz	Typically -90dBm for 1 kHz bandwidth at 75 GHz, degrading to -75 dBm at 140 GHz				
Band 11 <sup>a</sup>	110-220 GHz	Typically -80dBm for 1 kHz bandwidth at 110 GHz, degrading to -65 dBm at 220 GHz				
Band 12 <sup>a</sup>	170-325 GHz	External mixer dependent				

<sup>a</sup>Tektronix High Performance Waveguide Mixers.

d. The noise floor should be at least -90 dBm (refer to Table 5-1).

e. Change the REFERENCE LEVEL control to -60 dBm, the FREQUENCY SPAN/DIV to 10 kHz, the TIME/DIV control to AUTO and the RESOLUTION BANDWIDTH control to 1 kHz.

f. Check that the average noise level for the 1 kHz resolution bandwidth is as listed in Table 5-1.

g. Change REFERENCE LEVEL control to -70 dBm, the FREQUENCY SPAN/DIV control to 200 Hz, and RESOLUTION BANDWIDTH control to 100 HZ.

h. Check that the noise level for the 100 Hz resolution bandwidth is as listed in Table 5-1.

i. Repeat this procedure for the remaining coaxial input frequency range (0–21 GHz). If desired, the waveguide band sensitivity can be checked against the figures listed in Table 5-1. The 50 GHz to 140 GHz numbers are typical and should not be used as a performance requirement.

**NOTE**

Table 5-1 shows the equivalent maximum input noise (average noise) for each resolution bandwidth with internal mixer and Tektronix High Performance Waveguide Mixers.

**7. Check Residual FM**

(within 7 kHz over 20 ms, with FREQ SPAN/DIV readout greater than 200 kHz, and within 12 Hz, over 20 ms, with FREQ SPAN/DIV readout of 200 kHz or less)

a. With the calibrator signal applied to the RF INPUT, set the FREQUENCY readout to 100 MHz, the FREQ SPAN/DIV readout to 1 MHz, the RESOLUTION BANDWIDTH control to 100 kHz, VERTICAL DISPLAY to 2 dB/DIV, and the REFERENCE LEVEL readout to -23 dBm.

b. Press <blue-SHIFT> 10 dB/DIV. A message will appear on the screen to indicate that the 1st LO synthesis and phase lock are disabled. This is normal. It is now possible to switch the FREQUENCY SPAN/DIV control to narrower spans with the 1st LO phase lock disabled.

c. Decrease the FREQUENCY SPAN/DIV and RESOLUTION BANDWIDTH settings to 10 kHz. Keep the 100 MHz calibrator signal centered on the screen with the CENTER/MARKER FREQUENCY control.

d. Switch the VERTICAL DISPLAY to LIN. Position the signal so the slope (horizontal versus vertical excursion) of the response can be determined (see Figure 5-6A). It may help to determine slope by using SINGLE SWEEP and SAVE A to freeze the display at a convenient point on the graticule for measurement.

e. If SINGLE SWEEP and SAVE A were used in part d, deactivate SAVE A and SINGLE SWEEP. Push ZERO SPAN, set the TIME/DIV setting to 20 ms, and adjust the CENTER/MARKER FREQUENCY control to position the display near center screen as shown in Figure 5-6B. Use SINGLE SWEEP and SAVE A to freeze the display for ease in measuring the FM (frequency modulation). The peak-to-peak amplitude of the display per any horizontal division, scaled to the vertical deflections according to the slope estimated in part d, is the residual FM. Residual FM must not exceed 7 kHz for 20 ms (1 division).

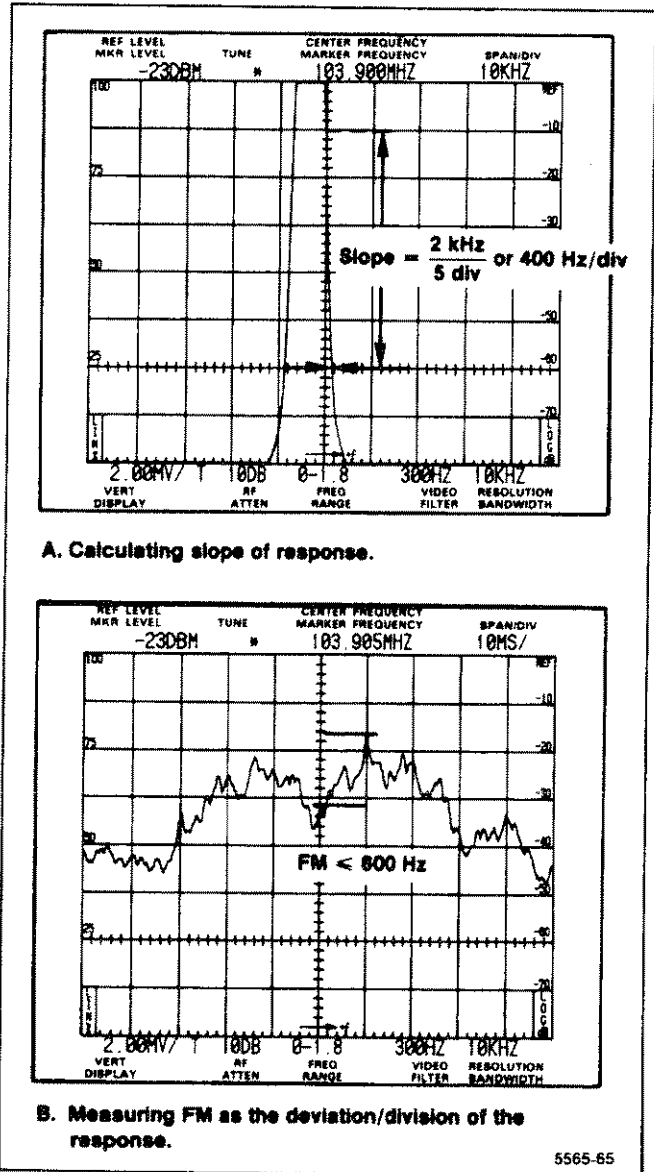

Figure 5-6. Typical display showing how to determine residual FM.

f. Press <blue-SHIFT> 10 dB/DIV to re-enable the phase lock, and set the FREQUENCY readout to 100 MHz. Switch the TIME/DIV setting to AUTO, and reduce the FREQUENCY SPAN/DIV to 200 Hz and RESOLUTION BANDWIDTH settings to 100 Hz.

g. Adjust the CENTER/MARKER FREQUENCY control to position the signal so its slope can be determined. It will be easier if you use SINGLE SWEEP and SAVE A to freeze the display at a convenient position on the graticule.



h. Deactivate SAVE A and SINGLE SWEEP, and switch the TIME/DIV control to 20 ms. Activate ZERO SPAN, and position the display near center screen so the vertical excursions per horizontal division (20 ms) can be measured. Residual FM must not exceed 12 Hz.

### 8. Check Frequency Drift or Stability

(50 Hz or less per minute of sweep time, when the FREQ SPAN/DIV is 200 kHz or less, after 1 hour of warmup, and within a stable ambient temperature)

a. With the Calibrator signal applied to the RF INPUT, set the FREQUENCY readout to 100 MHz, the TIME/DIV control to AUTO, the FREQUENCY SPAN/DIV control to 200 Hz, the RESOLUTION BANDWIDTH control to 100 HZ, VERTICAL DISPLAY to 2 dB/DIV, and the REFERENCE LEVEL control to -23 dBm. Switch VIEW A and VIEW B on.

b. Adjust the CENTER/MARKER FREQUENCY control so one side of the signal intersects the sixth division graticule line from the left edge. Press SINGLE SWEEP, and activate SAVE A to save the display.

c. Select the NARROW VIDEO FILTER, and press SINGLE SWEEP again to start the sweep. The sweep will now run at a 10 s/div rate.

d. Note the frequency difference between the two displays at the sixth graticule line. Label this difference  $\Delta f$ .

e. Check that the frequency drift rate in Hz/minute =  $300 \times \Delta f / (250 + \Delta f)$ . Drift rate must not exceed 50 Hz/minute.

### 9. GPIB Verification Program

The Service Manual, Volume 1, contains a GPIB verification program. If you wish to check the operation of the GPIB interface, request the program from service personnel.



# OPERATION

This section describes the normal operating features of the spectrum analyzer. Many instrument features and operating modes are described, and examples are included to show some typical applications.

## INSTRUMENT OPERATING FEATURES

### Firmware Version and Error Message Readout

Refer to Section 5 for information.

### Crt Light Filters

Two light filters, amber and grey, are supplied as standard accessories to the spectrum analyzer. Select the filter that best suits the surrounding light conditions, light reflections, and your viewing needs. To install the filter, pull the top of the plastic mask out and place the filter behind it. Remove the light filter when taking display photographs.

### Intensity Level and Beam Alignment

Operate the instrument with the intensity level no higher than that required to clearly see the display. Trace alignment and beam focus are internal adjustments that must be performed by qualified service personnel.

The required intensity level for some displays may be high enough to produce a bright and flared baseline. This bright baseline can be eliminated (clipped) with the <blue-SHIFT> BASELINE CLIP pushbutton sequence. <Blue-SHIFT> BASELINE CLIP is useful when photographing displays, and it also allows the lower readout characters to be more easily viewed. When the markers are turned on, set the intensity below the level where dot "blooming" or defocusing occurs.

### Signal Application

Signal frequencies to 21 GHz can be applied through a short, high-quality, 50  $\Omega$  coaxial cable to the RF INPUT connector. These signals pass through an internal RF attenuator to the 1st mixer. When Option 01 is installed, the instrument automatically selects either a low-pass filter or tuned preselector (depending on frequency range) between the RF attenuator and the 1st mixer.

An external mixer can be used (not applicable to instruments with Option 07 or Option 08 installed) by connecting it through the diplexer (optional accessory) to the EXTERNAL MIXER port. Signals from the external mixer by-pass the internal RF attenuator, preselector, and 1st mixer. External mixers above 21 GHz, and their applications, are described in detail later in this section.

### RF INPUT Connector

The nominal input impedance of the coaxial RF INPUT is 50  $\Omega$ , and 75  $\Omega$  on the optional 75  $\Omega$  INPUT (Option 07). Because cable losses can be significant at microwave frequencies, it is important to keep the cables as short as possible. Impedance mismatch between the signal source and the RF INPUT will produce reflections that degrade flatness, frequency response, and sensitivity and may increase spurious responses. Impedance mismatch can be caused by poor connections, incorrect signal source impedance, and long or low-quality coaxial cable. When optimum flatness or frequency response is desired and signal strength is adequate, set the MIN RF ATTEN dB control to 10 dB or more. The addition of the attenuator helps minimize reflections to improve the input characteristics.

### CAUTION

The front end of the spectrum analyzer is specified at +30 dBm maximum. It is possible to set the reference level to +40 dBm with MIN NOISE activated. If the signal level is increased for a full-screen display, the input level will exceed the power rating of the attenuator. Do not apply any dc potential to the RF INPUT. Use a dc block if a signal is riding on any dc potential. For dc block ordering information, see the Optional Accessories in the Service Manual, Volume 2, or contact your local Tektronix Field Office or representative.

Spurious responses can be minimized if the signal amplitude is kept within the graticule window. A recommended procedure is to select a reference level setting that limits stronger signals to the graticule window.

High-level signals can cause compression; if excessive (above +30 dBm or +20 dBm when MIN NOISE is on), the 1st mixer may be destroyed. Signals above +30 dBm must be reduced by external attenuators. Ensure that the frequency range of any external attenuator is

adequate for the input signal.

Line impedance stabilizing networks, used for conducting EMI/RF measurements, will often have several volts of 60 Hz signal at the output. To protect the input mixer, use a dc block (refer to the Service Manual, Volume 2, or your local Tektronix Field Office or representative for ordering information). It is important to be sure that all equipment being tested has power applied through the line stabilizing networks before any RF signal is connected to the spectrum analyzer input.

If your instrument has Option 01 installed, refer to the Option 01 information in Section 7 of this manual for additional information.

**Connecting to a 75 Ω Source** — Signals from a 75 Ω source, at the lower frequencies (1 MHz to 1 GHz), can be applied directly to the 75 Ω INPUT if Option 07 is installed or to the RF INPUT by using a 75 Ω-to-50 Ω minimum loss attenuator (refer to the Tektronix catalog or your local field office or representative for ordering information).

Sensitivity and power levels are often rated in dBm (dB with reference to 1 mW regardless of impedance). Sensitivity and power levels for 75 Ω systems are usually rated in dBmV (dB with reference to 1 mV across 75 Ω). A circuit diagram of a suitable matching pad for this purpose is shown in Figure 6-1. Figure 6-2 shows the relationship between 50 Ω and 75 Ω units with matching attenuators included. The conversion to alternate reference level units is listed below for 75 Ω and is shown in Table 6-1 for 50 Ω.

1. dBmV (75 Ω) = dBm (50 Ω) + 54.47 dB:  
e.g. -60 dBm (50 Ω) + 54.47 dB = -5.5 dBmV (75 Ω).
2. dBm (75 Ω) = dBm (50 Ω) + 5.72 dB:  
e.g. -60 dBm (50 Ω) + 5.72 dB = -54.3 dBm (75 Ω).

**Table 6-1**  
**50 Ω SYSTEM REFERENCE LEVEL**  
**CONVERSION**

To From	dBm	dBmV	dBμV
dBm	0	+47	+107
dBmV	-47	0	-60
dBμV	-107	+60	0

**Amplitude Conversion** — A conversion chart, as shown in Figure 6-3, can be used to convert input signal levels of voltage or power to dBm, dBV, dBmV, and dB.

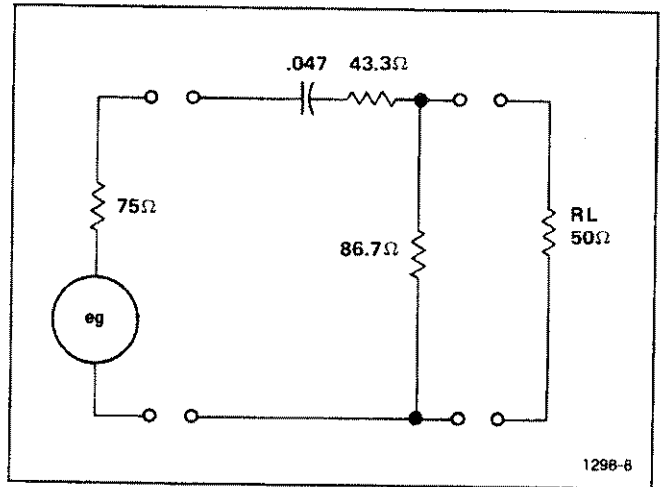

Figure 6-1. Circuit of a 75 to 50 Ω matching pad (ac coupled).

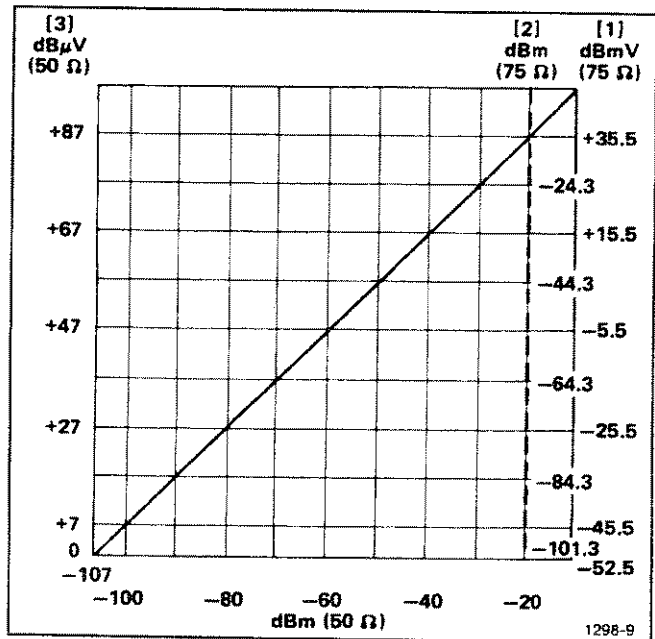

Figure 6-2. Graph illustrating the relationship between dBm, dBmV, and dBμV (matching attenuator included where necessary).

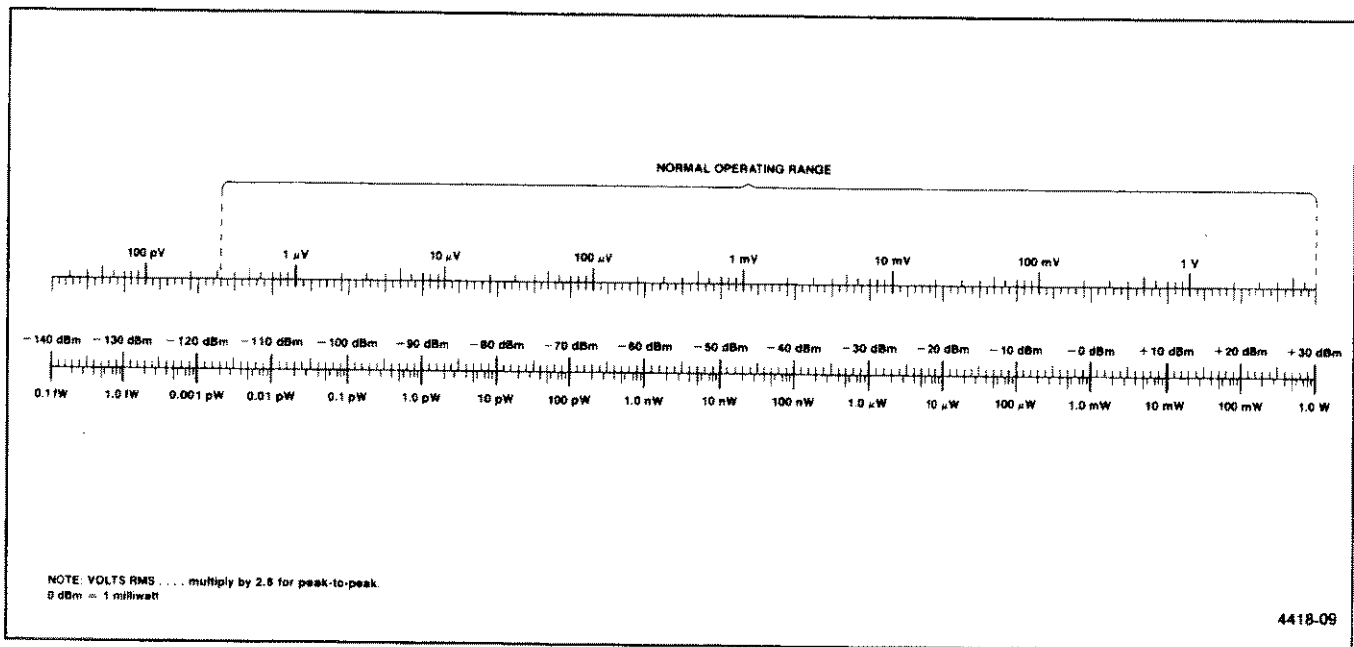

Figure 6-3. Volts-dBm-Watts conversion chart for 50 Ω impedance.

### Resolution Bandwidth, Frequency Span, and Sweep Time

Resolution is the ability of the spectrum analyzer to display discrete frequency components within a frequency span. This ability is a function of the instrument bandwidth, sweep time, frequency span, and incidental FM. Frequency span and sweep time are normally selected so the resolution bandwidth for a particular continuous wave (cw) signal is minimum. Bandwidth also has an effect on the noise level. As the bandwidth decreases, the signal-to-noise ratio, or sensitivity, increases so maximum sensitivity is attained with the narrow resolution bandwidths.

As the spectrum analyzer sweep rate is increased, a critical rate is reached where both sensitivity and resolution are degraded. Therefore, sweep time for a calibrated display is dependent on the resolution bandwidth and frequency span.

In MAX SPAN, the display represents the full frequency range of the selected band. The frequency readout on the crt is indicated on the display by a frequency dot if markers are off or by the primary marker if markers are turned on. This frequency point will shift to center screen when the FREQ SPAN/DIV is reduced to some setting other than MAX. The frequency span/division setting depends on the particular measurement application. Wide spans are usually used to monitor a frequency spectrum for spurious signals, or check harmonic content. When wide spans are used for non-digital store displays, the sweep rate is usually set for minimum flicker, which requires wider resolution bandwidths to

maintain a calibrated display. Narrow spans are used to analyze the characteristics about or near a particular signal, such as modulation side bands, bandwidth, or power line related distortion. Slow sweep rates are required when using narrow spans and high resolution to observe signal phenomena.

The spectrum analyzer will select the sweep rate and resolution bandwidth so the display remains calibrated for the selected frequency span/division, if TIME/DIV is in the AUTO position and AUTO RESOLN is on. AUTO RESOLN optimizes bandwidth for the selected FREQ SPAN/DIV and TIME/DIV settings unless either is outside the range of calibration. When this occurs, UNCAL lights and a > symbol prefixes the REF LEVEL readout on the crt display.

To analyze pulsed signals, a wider bandwidth than that provided by the automatic feature is usually required. Set RESOLUTION BANDWIDTH to approximately 1/10 the side lobe frequency width or the reciprocal of the pulse width, if known, in order to ensure adequate bandwidth. The resolution bandwidth is usually set for optimum main lobe detail after the sweep rate has been selected.

### Using the HELP Feature

When there is a question about the function of any front-panel pushbutton or control, press HELP then press the pushbutton or turn the control in question. A message displayed on the crt describes the function. The functions of all of the blue-labeled and green-labeled

pushbuttons can be called up without pushing the entire pushbutton-sequence each time; just push the appropriate SHIFT pushbutton, push HELP, then push all of the pushbuttons as desired. An example of this is <blue-SHIFT> HELP PLOT then REF LEVEL then READOUT and so on.

HELP will also provide explanations for the functions available from the marker menu. For detailed instructions, see Marker Menu and Assign Menu under Using the Markers Feature later in this section.

HELP is also useful in error detection (see Error Detection later in this section).

### Using the MANUAL PEAK Control or Automatic Peaking

The MANUAL PEAK control sets the bias voltage out the EXTERNAL MIXER port or the internal preselector (in instruments with Option 01 installed) tracking for the 1.7 to 21 GHz bands. It is adjusted for maximum signal amplitude or optimum conversion.

If REPEAK is activated from <blue-SHIFT> PEAK MENU, any signal within one division on either side of the marker is peaked (if the marker system is off, this will be one division on either side of the center). The peak code consists of numbers about the signal at 500 MHz intervals when using the preselector in Option 01 instruments. The resulting peaking code is stored in memory and peaking switches to the Stored Value mode. If there is no signal to be peaked, the previous value is used.

If INPUT is chosen from <blue-SHIFT> PEAK MENU, a menu allows input of a peaking code of the Primary marker frequency, or the center frequency if the marker system is off. After the value is input, the instrument switches to the Stored Value mode.

In the Stored Value mode, the instrument uses values from the automatic peaking routine or from user input to maintain peaking as the center frequency and frequency range are changed. In the 1.7—21 GHz bands, a peaking value is stored every 500 MHz. For external mixer peaking in the other bands, one value is stored per band. If no value was stored (either by REPEAK or INPUT), a mid-range value is used.

It is always good practice to re-adjust peaking before making amplitude or power measurements, especially if the measurement is to be made after a significant change in center frequency.

### Using the Signal Identifier

When external mixers are used or in non-option 01 instruments, there is no preselection ahead of the mixer, so many spurious responses are generated in the 1st mixer (see Figure 6-4). This is due to multiple harmonics of the local oscillator and incoming signals converting to

intermediate frequencies that are within the band-pass of the 1st IF. These responses pass through the IF band-pass and appear as signals on screen.

The spectrum analyzer features a Signal Identify mode to help identify true signals from false signals. When in this mode, the frequency of the local oscillators are shifted on alternate sweeps. At the same time, the sweeps are vertically displaced about two divisions. True signals shift only a small amount on alternate sweeps, while false signals or spurious responses will shift at least 1 division, especially in the millimeter wave bands where the N factor is large.

This mode can only be activated when the FREQ SPAN/DIV is 50 kHz or less for the coaxial bands (0 to 21 GHz) and 50 MHz or less for the waveguide bands (18 to 325 GHz).

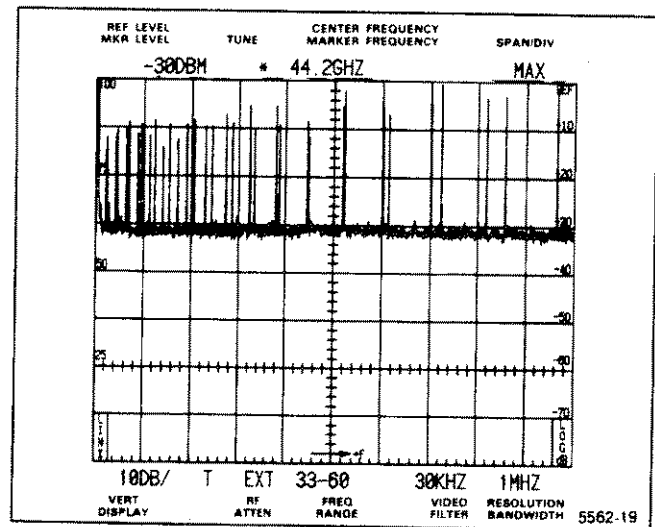

Figure 6-4. A typical display generated by a signal into the waveguide mixer.

The 1st LO is not phase locked when the FREQ SPAN/DIV is 500 kHz or more in the waveguide bands. Therefore, true or real signals can shift a slight amount between sweeps, due to limits of the oscillator setting accuracies. True signals can shift up to 2 MHz, but false signals will shift 70 MHz or more. If there is any question as to whether the signal is true or false, decrease the FREQ SPAN/DIV setting to 200 kHz or less so the oscillator is phase locked.

In the millimeter wave bands, the oscillator frequency is shifted far enough so that it is possible to lose the signal on alternate sweeps. If no signal is visible for the alternate sweep, re-adjust MANUAL PEAK so that the signal will appear on both sweeps if it is true.

Figure 6-5 illustrates two typical examples of signal identification. The amount of horizontal displacement depends on the band and the harmonic number of the signal or oscillator fundamental.

### Using the Video Filters

The video filters restrict the video bandwidth so noise is reduced (see Figure 6-6). When signals are closely spaced, the filter can reduce the modulation between two signals to make it easier to analyze the display. The filters can also be used to average the envelope of pulsed RF spectra that has a relatively high pulse repetition frequency (prf); however, because the filter is basically an integrating circuit, the video filter will not be very effective when measuring low prf spectra.

may require a reduction in the sweep rate to maintain a calibrated display. UNCAL lights if the sweep rate is not compatible with the other parameters to maintain a calibrated display. When either the WIDE or NARROW filter is selected, the filter bandwidth is displayed on the crt lower readout line.

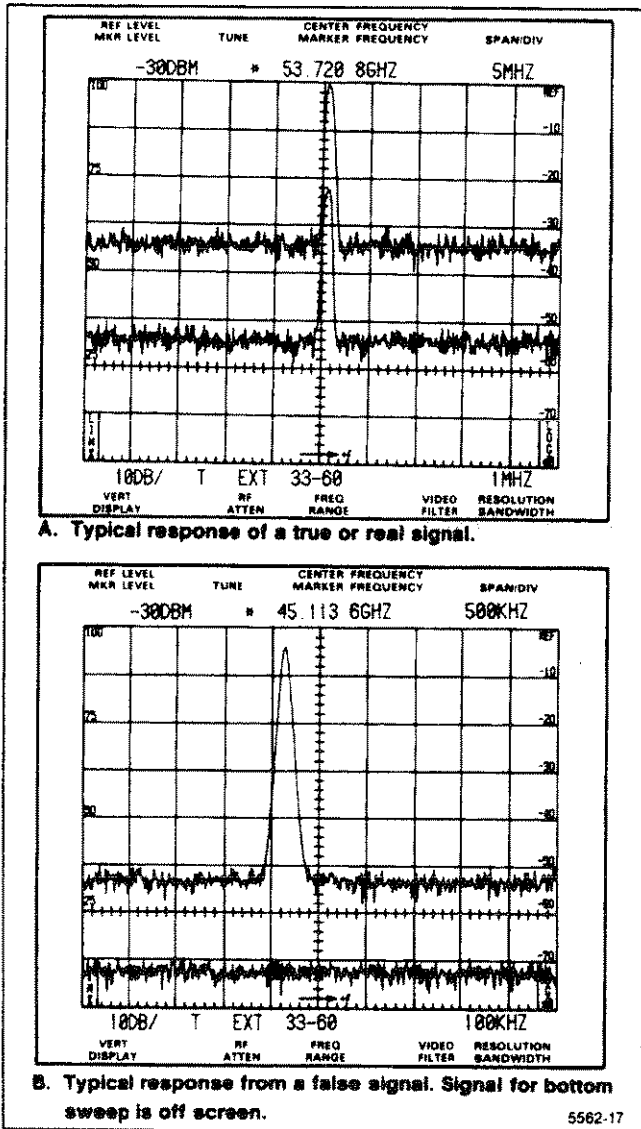

Figure 6-5. Typical example of Identifier mode displays.

The WIDE filter reduces the bandwidth to approximately 1/30th the selected resolution bandwidth; the NARROW filter to approximately 1/300th. Using the filter

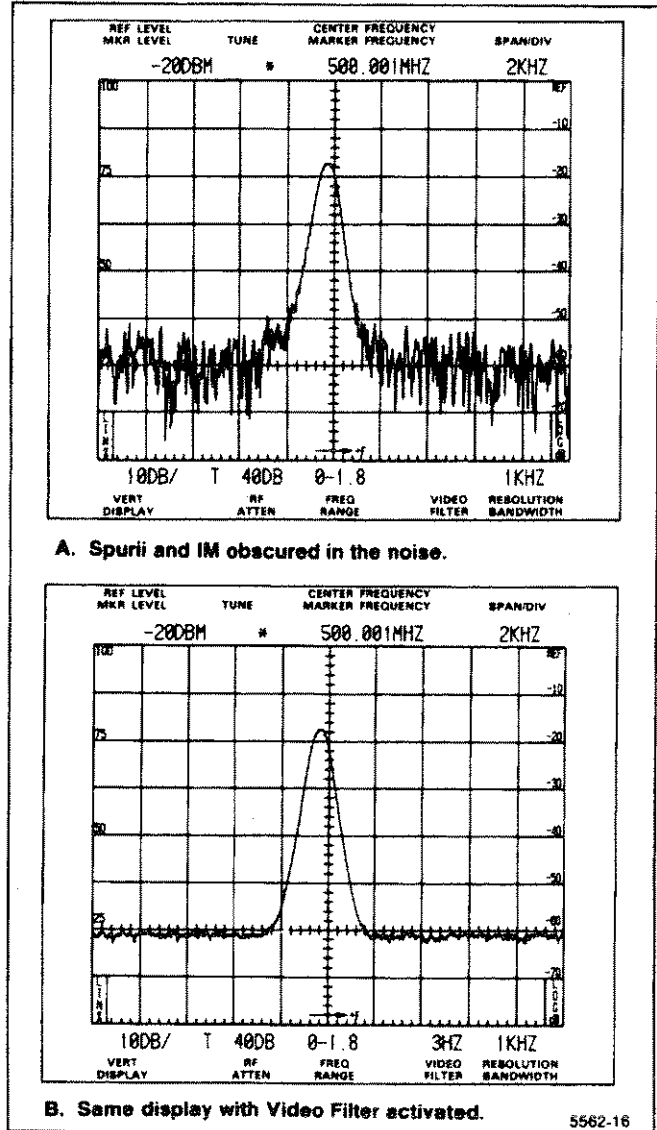

Figure 6-6. Typical display mixed with the VIDEO FILTER.

### Using Time Domain Operation

When the FREQ SPAN/DIV is zero, the spectrum analyzer functions as a tunable receiver to display time domain characteristics within the selected resolution bandwidth. Characteristics like modulation pattern and pulse repetition rates can now be analyzed with TIME/DIV selections. Resolution bandwidth is usually

maximum (1 MHz) for time domain analysis of the signal.

### Triggering the Display

The Triggering mode is usually FREE RUN for spectrum displays. However, it may be desirable or necessary to trigger the display when the event is time related to some source, or when the frequency span has been reduced to zero for time domain analysis. In FREE RUN, the sweep will not synchronize with any input signal.

In addition to FREE RUN, the sweep can be internally triggered (INT) by the video signal, at the line frequency rate of the power supply (LINE), or by an external signal (EXT) applied to the HORIZ|TRIG EXT IN connector on the rear panel. The required amplitude for triggering is 2.0 divisions or more for internal triggering and from 1.0 to 50 V maximum (dc + peak ac) for external triggering.

In addition to the Triggering source selections, SINGLE SWEEP is provided. In SINGLE SWEEP, the sweep will run once after the circuit has been armed and a trigger signal arrives. READY lights when the circuit is armed and waiting to be triggered and remains lit during sweep time. Push SINGLE SWEEP once to activate the Single Sweep mode and cancel the current sweep. Push SINGLE SWEEP again to arm the trigger circuit so it is ready for a trigger signal. This mode is useful for viewing single events.

### Sweeping the Display

Horizontal sweep voltage for the display can be internal or from an external source. Sweep rate and source are selected with the TIME/DIV control. When the TIME/DIV control is in the AUTO position, the sweep rate is automatically set to maintain a calibrated display.

When TIME/DIV is in the EXT position, a signal source of 0 to +10 V, applied to the HORIZ|TRIG EXT IN connector will sweep the crt beam across the 10 division span. The input is dc coupled and sensitivity is 1 V/div. External input impedance is approximately 10 k $\Omega$ .

The beam can be manually positioned by the MANUAL SCAN control when TIME/DIV is in the MNL position (see Manual Scan of the Spectrum that follows).

### Manual Scan of the Spectrum

The MANUAL SCAN control is usually used to examine a particular point or sector of a display. One example is looking at one of the null points of a frequency modulation spectrum. Another example is when it takes unnecessarily long to look at a small segment of the full span because of the slow sweep rate. With a wide span/div and/or a narrow resolution bandwidth, it is very possible to manually scan too fast to achieve an accurate display. Best results are obtained without digital

storage; digital storage can produce unpredictable results due to the sweep rate, and the digital storage display is only updated when scanning from left to right.

### Reference Level, RF Attenuation, and Vertical Display

When a change is made to REF LEVEL, the gain distribution is automatically selected (IF gain and input RF attenuation) for the new reference level. The selection is made according to the settings of VERTICAL DISPLAY, FINE, MIN RF ATTEN dB, and MIN NOISE/MIN DISTORTION.

The amount of input RF attenuation set is based on the reference level requested and the settings of MIN RF ATTEN dB and MIN NOISE/MIN DISTORTION. The spectrum analyzer assumes the MIN RF ATTEN dB selection is the minimum attenuation required for the expected signal levels, and will not reduce RF attenuation below this value. As MIN RF ATTEN dB is increased, the lowest reference level is raised an equal amount. At 0 dB minimum attenuation, the lowest reference level is -117 dBm; at 10 dB minimum attenuation, the lowest reference level is -107 dBm, and so on. The best ratio of RF attenuation IF gain is selected according to the Minimum Noise/Minimum Distortion mode (see the description later in this section).

The REFERENCE LEVEL control steps depend on the VERTICAL DISPLAY and FINE settings. With LOG selected, the REFERENCE LEVEL control steps in 1 dB to 15 dB increments with FINE off. With FINE on, it steps in 1 dB increments for display factors of 5 dB/div or more and 0.25 dB for display factors of 4 dB/DIV or less. The 0.25 dB increments apply to the Delta A mode (see the description later in this section). With LIN selected and FINE off, the bottom of the crt graticule is zero volts, and the top of the crt graticule is eight times the vertical display factor. The display factor changes in a 1-2-5 volts/division sequence from 500 mV to 50 nV with FINE off. With FINE on, the reference level changes in 1 dB steps and the scale factor/division is 1/8 the voltage equivalent of the REFERENCE LEVEL.

### Alternate Reference Level Units Selection

It is a simple procedure to select an alternate to dBm reference level units. Disconnect the calibrator signal from the RF INPUT, and change the REF LEVEL readout to 0 dBm. Press <blue-SHIFT> REF LEVEL UNITS to get the reference level units menu. To change to dBV, select 1 from the menu, and the REF LEVEL readout changes to -13 dBV. To change to dBmV, select 2 from the menu, and the REF LEVEL readout changes to 47 dBmV. To change to dB, select 3 from the menu, and the REF LEVEL readout changes to 107 dB. To change back to dBm, select 0 from the menu, and the REF LEVEL readout changes to 0 dBm.



## Using the Delta A Mode

To select the Delta A mode, push FINE while the vertical display factor is 4 dB/div or less. The REF LEVEL readout goes to 0.00 dB and the REFERENCE LEVEL control steps in 0.25 dB increments from this reference.

The Delta A mode accurately measures signal-relative amplitude difference. This is possible because the gain distribution (IF gain and RF attenuation) does not change in the Delta A mode. The REF LEVEL is changed by shifting the log amplifier offset. The total range of the Delta A mode is 58 dB. The measurement range depends on the REF LEVEL that is current at the time the Delta A mode is activated. It is typically at least 0 to 48 dB below the REF LEVEL that was current at the time the Delta A mode was activated. The overall instrument reference level range of -117 dBm to +30 dBm cannot be exceeded.

The Delta A mode is turned off when the vertical display factor is increased above 4 dB/div or FINE is turned off; by pushing the FINE pushbutton or changing the gain distribution with MIN RF ATTEN dB or MIN NOISE selections. The spectrum analyzer also turns off the Delta A mode when EXT MIXER is selected.

Signals with large amplitude differences that are within the Delta A range can be compared without the distortion usually introduced when signals are driven off-screen. Signals shifted off-screen by changes in the Delta A reference level are not overdriving the input. This is because the attenuator and IF gain do not change; so, the mixers do not see any change in signal levels even though the Delta A reference level changes.

Follow these five steps to measure the amplitude level differences of two signals.

1. Select the Delta A mode by pressing FINE. Select a vertical display of 4 dB/div or less with the dB/DIV DATA ENTRY pushbutton or push the 2 dB/DIV pushbutton.
2. Set the peak of the larger signal to a graticule line with the REFERENCE LEVEL control.
3. Press the FINE pushbutton twice to turn the Delta A mode off and on. The readout will return to 0.00 dB.
4. With the REFERENCE LEVEL control, set the peak of the lower amplitude signal to the same graticule line established in step 2.
5. The REF LEVEL readout will now indicate the amplitude difference between the two signals in dB.

### NOTE

Do not confuse the Delta A mode with the delta marker mode.

## Using MIN NOISE or MIN DISTORTION

One of two methods can be selected to control RF attenuator and IF gain settings. MIN NOISE minimizes noise level by decreasing input attenuation and IF gain by 10 dB. MIN DISTORTION minimizes input mixer overload by increasing input attenuation and IF gain 10 dB. MIN DISTORTION is the normal mode of operation.

### CAUTION

With MIN NOISE on and MIN RF ATTEN dB set to 60 dB, the REF LEVEL can be set to +40 dBm. The front end of the spectrum analyzer is specified at +30 dBm maximum if Option 01 is installed. Do not increase input signal level to full screen with a REF LEVEL of +40 dBm because this will exceed the attenuator rating. In instruments without Option 01 (no internal preselector), there is no limiter before the 1st mixer, so RF input power into the mixer (0 attenuation) should not exceed +13 dBm.

## Using Digital Storage

Digital storage provides a smooth, flicker-free display. Two complete displays can be digitized and stored. In addition, the instrument Store Display and Recall functions will store up to nine displays in memory (see Using the Store and Recall Features later in this section). One of the two digitized waveforms can be saved and then compared to later waveforms. The Max Hold feature updates digital storage data only when the input signal amplitude is greater than previous data. This allows monitoring and graphic plotting of display changes (amplitude and frequency) with time.

The display is divided by a horizontal line that is positioned with the PEAK/AVERAGE control. Above the line, video information is peak detected; below the line, signal averaging occurs. This feature subdues noise in the portion below the line and allows full peak detection above the line. An intensified spot on the line indicates the horizontal position where memory is being updated. The average (number of samples) is a function of the sweep rate; the slower the rate the more samples.

When digital storage is used, an error of 0.5% of full screen must be added to the amplitude performance characteristics (i.e., frequency response, sensitivity).

The digital storage display is divided into an A and B section. Data can be stored in either A or B or in both. There are 500 horizontal locations in A and 500 horizontal locations in B. When both are displayed, the origin of the B waveform is shifted so the A and B coordinates

are interlaced to provide 1000 display increments. Data in memory is continually updated with each sweep so the display is always current.

When SAVE A is turned on, data in the A section is saved and only the B section of storage is updated. This takes place whether the A waveform is displayed or not. This mode captures an event or waveform, with its readout, for comparison with a subsequent event displayed by the B display. If VIEW B is on, the readout applies to the current B waveform. If SAVE A and VIEW A are on and VIEW B and B-SAVE A are off, the readout applies to the saved A waveform.

When B-SAVE A is turned on, the arithmetic difference between the B waveform and the saved A waveform is displayed (see Figure 6-7). This convenient mode can be used to align filters or other devices. The reference waveform is stored in A and the unknown is displayed by B. If the device under test is active, the B waveform may be larger than the reference so that the difference is off the screen. The reference level is usually set mid-screen so positive and negative quantities can be observed. The position of the zero reference can be changed by an internal switch. Contact qualified service personnel to have the reference level repositioned.

MAX HOLD causes the memory to be updated only if the new input is of higher magnitude than the former (B memory only if SAVE A is active). This allows monitoring of signals that may change with time and provides a graphic record of amplitude/frequency excursions.

Signal averaging is useful for suppressing noise. The number of samples averaged per horizontal digitized slot is a function of the spectrum analyzer sweep rate. The slower the sweep speed, the more samples averaged per horizontal slot. Resolution bandwidth affects the amplitude difference between peak detected and average levels of cw signals. When the resolution bandwidth is less than 1/30th the span/division (e.g., 100 kHz or less with 5 MHz span/div) there will be significant error in the average amplitude levels of cw signals, especially if only A or B is displayed. The peak value will be the true value. When using narrow resolution bandwidth with wide frequency spans, it is best to run digital storage with both the A and B waveforms interlaced and the cursor (horizontal line) at the bottom of the display.

To measure signal amplitude level, set the cursor to the bottom of the screen. To average noise, set the horizontal line at least one division above the noise level.

### Using the Store and Recall Features

The spectrum analyzer features two functions to store up to nine waveforms, with marker(s) and readout, in memory to be recalled later for review or analyses. To save the display currently on the screen, press <blue-SHIFT> STORE DISPlay, the register number (0-8) where you want to store the display, and if SAVE A is on the identity of the display you want stored (A or B).

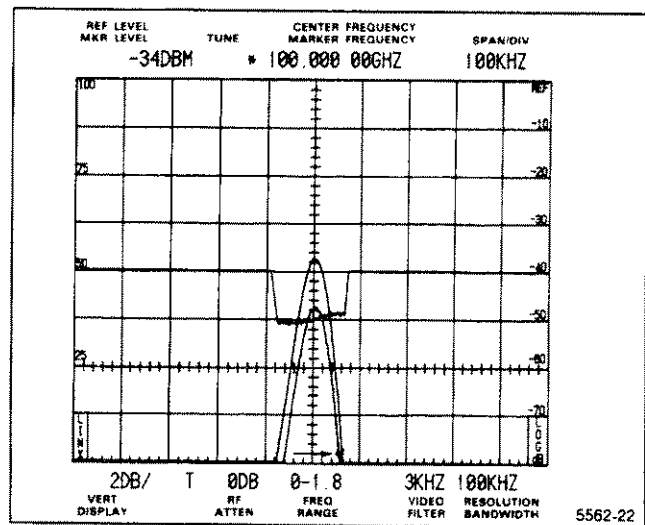

Figure 6-7. Typical display using B-SAVE A to observe the difference between SAVE A and B displays.

To later recall this same display, press <blue-SHIFT> RECALL, and the register menu showing the center frequency of each stored display will appear on the crt. Select the correct register number with a DATA ENTRY pushbutton, and then select the part of the digital storage (A or B) where you want to place the recalled display.

SAVE A is automatically activated to prevent an overwrite if location A is selected, VIEW A must be on to see the recalled display and VIEW B must be off to see the readout that applies to the recalled display. If VIEW B and VIEW A are on, both the display recalled in A and the current display in B will be visible on the screen. The readout shown applies to the current B display. Turn VIEW B off to see the readout that applies to the recalled A display.

If location B is selected, the next sweep will overwrite the display unless SINGLE SWEEP was activated before selecting B; a message will appear on the screen as a reminder of this. VIEW B must be on to observe the recalled display. Remember to deactivate SINGLE SWEEP when leaving this recalled mode. Ot.PP To plot waveforms and readout, see Plotting the Display under PROGRAMMING FEATURES later in this section.

### Plotting the Display

Press PLOT (standard instrument) or <blue-SHIFT> PLOT (programmable instrument) to drive many external plotters such as the

- Tektronix 4662 Option 01
- Tektronix 4662 Option 31

- Tektronix 4663 (emulating the 4662)
- Hewlett-Packard HP7470A
- Hewlett-Packard HP7475A
- Hewlett-Packard HP7580B
- Hewlett-Packard HP7585B
- Hewlett-Packard HP7486B
- Gould 6310
- Gould 6320

To use the plot feature, connect the plotter to the spectrum analyzer with a IEEE STD 488 (GPIB) cable, and complete the following steps.

1. Set the corners of the plot for a 3:2 aspect ratio for the Tektronix plotters, or 6:5 for the Hewlett Packard and Gould plotters. The plotter must be in the Listen Only mode. On programmable instruments, the TALK ONLY switch on the rear-panel GPIB ADDRESS switch bank must be closed or in the 1 position.

2. Set the plotter interface switches as follows:

Tektronix 4662 Option 01 or 4662 Option 31 (rear panel)

- A = 0, 1, 8, or 9
- B = C or D
- C = X (don't care)
- D = X (don't care)

Tektronix 4663

- Interface Select = 1 if Option 04 or 2 if Option 01
- Initial Command/Response Format = 5
- Interface Mode = Listen Only

Hewlett-Packard or Gould Plotters

Address = 31

3. Press <blue-SHIFT> SAVE A on the spectrum analyzer, and select the desired plotter type from the menu on the crt. The selection is stored in memory and does not need to be selected again unless the plotter type is changed.

4. Select the display and the information that you wish to plot. The Plot feature is similar to using a camera, in that a plot is made of everything that is turned on for the crt display. The information plotted depends on the setting of several front-panel pushbuttons and controls. If READOUT is on, the crt readout will be plotted with the display. If GRAT ILLUM is on, the bezel and graticule information will be included with the plot. If VIEW A, VIEW B, or B-SAVE A are on, these waveforms will be part of the plot. By the same token, if any of these functions are off, they will not be plotted.

The zero level for a B-SAVE A waveform is usually the graticule center line. (Switches within the instrument can set the level. Contact your service personnel for this change.) If you desire to shift the zero level for the plotting function only, press <blue-SHIFT> B-SAVE A, and enter the desired level in display units (25 is the bottom graticule line, 25 units/div). This zero level is retained in memory. It is not related to the display zero level, since the processor has no way of determining the internally-set zero level for the crt display or no way of changing it.

5. Press <blue-SHIFT> PLOT. During the plot operation, the front-panel controls are operational except <blue-SHIFT> STORE DISP, and <blue-SHIFT> RECALL. The instrument can be used for other measurements.

### Using the Markers Feature

The marker modes provide direct readout of frequency and amplitude information of any point along any displayed trace. Relative (delta) frequency and amplitude information between any two points along any displayed trace or between traces is also available. Two independent marker frequencies and amplitudes cannot be displayed at the same time.

**Marker Terms** — The following definitions of marker terms are used throughout this section.

- Live Trace — Any combination of the A trace when SAVE A is off and/or the B trace. A trace recalled into B is not an active trace.
- Active Trace — A Live Trace or the B-SAVE A trace (a trace recalled into B is not an active trace).
- Inactive Trace — A SAVE A trace or a trace recalled into the B display before the sweep is started.
- Primary Marker — The marker displayed in the Single Marker mode whose frequency and/or position is changed when tuning with the CENTER/MARKER FREQUENCY control. When two markers are displayed, the brightest marker is the Primary marker.
- Secondary Marker — The "second" marker; displayed only in the Delta Marker mode.

**Marker Turn On** — The Single Marker mode places one marker (Primary marker) on the spectrum to display marker frequency and amplitude. The Delta Marker mode places two markers (Primary marker and Secondary marker) that display the difference in frequency and amplitude between the two markers. When two markers are displayed, the Primary marker is brighter. The Primary marker position and frequency can be changed with the CENTER/MARKER FREQUENCY control or from the GPIB.

The marker(s) can be turned on by pushing many of the pushbuttons related to marker action.

- TUNE CF/MKR (pushbutton lit) turns on the Primary marker
- <Blue-SHIFT> MKR → CENTER turns on the Primary marker
- <Green-SHIFT> PEAK FIND turns on the Primary marker
- <Green-SHIFT> SIGNAL TRACK turns on the Primary marker
- <Green-SHIFT> MKR → REF LVL turns on the Primary marker
- <Green-SHIFT> 1←MKR→2 turns on both the Primary and Secondary markers
- <Green-SHIFT> Δ MKR turns on both the Primary and Secondary markers

There are three pushbutton sequences that turn the marker(s) off.

- <Blue-SHIFT> MKR OFF turns off all marker functions
- <Blue-SHIFT> INIT turns off all marker functions (the instrument is returned to the initial turn-on condition)
- <Green-SHIFT> Δ MKR (when both markers are on) turns off the Secondary marker and returns the instrument to the Single Marker mode

The markers are visible only when DIGITAL STORAGE functions are on; there can be no markers on a real-time trace.

When a trace with a marker or markers is stored, the marker positions and frequencies are also stored. When the trace is recalled and the marker system is on, the marker(s) first appears at the stored locations(s). Therefore, there is greater accuracy than is normally possible on an inactive trace. The increased accuracy is lost as soon as the marker is tuned.

In either the Single or Delta marker mode, a second line of readout appears on the crt. In the Single Marker mode, the marker frequency readout is displayed directly below the center frequency readout, and the marker amplitude is displayed directly below the reference level readout. In the Delta Marker mode, the frequency of the Primary marker with respect to that of the Secondary marker is displayed directly below the frequency readout, and the amplitude of the Primary marker with respect to that of the Secondary marker is displayed directly below the reference level readout. When in the Delta Marker mode, the relative amplitude and frequency readouts are enclosed on the screen in parentheses.

**Marker Menu and Assign Menu** — Most of the marker functions are available directly from front-panel pushbutton sequences. There are additional marker functions that are available either by direct selection from the Marker Menu, or after they have been assigned from the Assign Menu to either the ASSIGN 1 or ASSIGN 2 pushbutton. Press MARKER MENU to show a list of addi-

tional marker functions. These functions are all available simply by selecting them with the correct DATA ENTRY number pushbutton (see MARKER MENU under MARKER FUNCTIONS in Section 4 of this manual for the description of these functions).

Follow these steps to assign a function to the ASSIGN 1 or ASSIGN 2 pushbutton. (Once a function has been assigned, it will remain until the pushbutton is assigned a different function.)

1. Select 6=ASSIGN FUNCTION TO KEY. This will bring up the Assign Menu that contains the functions that can be assigned.
2. Push the correct DATA ENTRY number pushbutton.
3. For functions 0 through 3 or 6
  - a. The two ASSIGN pushbuttons will light.
  - b. A message will appear that asks you which pushbutton you want to use for that function.
  - c. Push the desired pushbutton.
  - d. The assignment has been made.
4. For functions 4 or 5
  - a. A message prompts you to enter the amount you want the marker to move.
  - b. Enter the amount and units selection.
  - c. The two ASSIGN pushbuttons will light.
  - d. A message will appear that asks you which pushbutton you want to use for that function.
  - e. Push the desired pushbutton.
  - f. The assignment has been made.

Once a function has been assigned, you can get a description of the function by pressing <green-SHIFT> HELP and the correct ASSIGN pushbutton.

**Assigning Markers** — When the marker mode is first turned on from the front panel, the trace(s) on which the marker(s) appears is determined by the traces that are currently displayed, as indicated in Table 6-2. When a trace is turned off, any marker(s) on it are re-located according to Table 6-2. When a trace is turned on, the previous marker locations do not change and the marker always jumps to the active trace in maximum span or when in the Signal Track mode.

**Tuning Markers** — Move the Primary marker with the front-panel CENTER/MARKER FREQUENCY control (when the TUNE CF/MKR pushbutton is lit). To make it possible to change the position of the Secondary marker, you must make the Secondary marker be the Primary marker. Push <green-SHIFT> 1←MKR→2 to swap the Primary and Secondary marker positions. Move the Primary marker (which used to be the Secondary marker), and then push <green-SHIFT> 1←MKR→2 again to swap the Primary marker back to its previous location.

The marker normally moves over the fixed display. Marker tuning (both frequency and position) stops when the screen edge is reached while using the CENTER/MARKER FREQUENCY control. If the marker is on a trace containing a band edge, the marker may be tuned over the in-band portion only. This is true for both active and inactive traces. However, if the marker is on the B—SAVE A trace and the A trace contains a band edge but the B trace does not, the tuning is not limited.

The marker tuning rate depends on the speed with which the TUNE CF/MKR control is turned. If the control is turned rapidly, the marker moves 1/10 of a division per increment. If the knob is turned quite slowly, the marker moves 1/100 of a division per increment. At intermediate turning speeds, the marker moves approximately 1/30 of a division per increment.

When two markers are displayed (delta-marker mode) and the marker frequency, center frequency, and span are changed, the Secondary marker remains fixed at its original frequency and is allowed to move off the screen. If the Primary and Secondary markers are swapped (with the <green-SHIFT> 1—MKR→2 pushbutton) while the Secondary marker is off the screen, the display is centered on the frequency of the old Secondary marker (now the new Primary marker). The old Primary marker (now the new Secondary marker) is placed off the screen.

### Error Detection

When an internal error is found in the spectrum analyzer, the words ERROR USE HELP will flash one after the other at the right end of the marker readout line (or just a steady ERROR will appear when under remote control). This message appears when the markers are on or the instrument is in MAX. Press HELP to read the definition of the problem and the probable effects of the problem. If the markers are off and the measurement is not in MAX, the error message will be steady and will specify the problem area. Additional information and servicing instructions are in the diagnostics information in the Maintenance section of the Service Manual, Volume 1. If you cannot solve the problem with the HELP information, report all problems or error information to qualified service personnel.

### Using the Automatic Performance Testing Feature

<Blue-SHIFT> CAL activates a routine that tests frequency and relative amplitude of the IF filters. This routine should be done any time the temperature changes. Settings are held in memory after the test routine has run. Refer to Display Parameter Controls in Section 4 for further information. <sup>a</sup>Not applicable. Since no digital storage traces are being viewed, there is no visible marker. The listed trace is that for which marker readouts are given.

## PROGRAMMING FEATURES (492AP GPIB OPERATION)

### Setting GPIB Address Switches

The general purpose interface bus (GPIB) ADDRESS switches on the rear panel set the value of the instrument's GPIB addresses. The Programmers manual contains details of how the switches are used in remote control operations.

The switches can be set as desired, except when using Tektronix 4050-Series controllers. They reserve address 0 for their own use. Selecting a primary address of 31 logically removes the instrument from the bus; it does not respond to any GPIB address, but remains both unlistened and untalked. If the switches are changed after power-up, the RESET TO LOCAL or <blue-SHIFT> PLOT pushbutton must be activated so the spectrum analyzer will update the primary address.

### TALK ONLY, LISTEN ONLY Switches

The spectrum analyzer switches for talk-only and listen-only operation are part of the GPIB ADDRESS switch bank. Set either or both switches (you can have talk only, listen only, or both talk only and listen only features). If the spectrum analyzer power is on, press RESET TO LOCAL or <blue-SHIFT> PLOT for a change in these switches to take effect. Both the TALK ONLY and LISTEN ONLY switches must be off (down) when the spectrum analyzer is used with any controller.

Set the LF OR EOI switch to EOI (down) for use with Tektronix equipment. The switches marked 1, 2, 4, 8, and 16 may be set to any combination except all ones (decimal 31), which logically disconnects the spectrum analyzer from the bus or all zeroes when using the instrument with a 4050-Series controller.

### Connecting to a System

Connect the programmable spectrum analyzer to a GPIB system through the GPIB cable supplied with the instrument. Connect the power cable after the power to the spectrum analyzer has been turned on or the controller is turned off to avoid generating interference on the bus.

Table 6-2  
MARKER TRACE ORGANIZATION

VIEW A	VIEW B	SAVE A	B-SAVE A	PRIMARY MARKER ON	SECONDARY MARKER ON
Off	Off	Off	Off	FULL <sup>a</sup>	FULL <sup>a</sup>
Off	Off	On	Off	A <sup>a</sup>	A <sup>a</sup>
Off	Off	On	On	B-SAVEA	B-SAVEA
Off	On	Off	Off	Full	Full
Off	On	On	Off	B	B
Off	On	On	On	B	B
On	Off	Off	Off	Full	Full
On	Off	On	Off	A	A
On	Off	On	On	B-SAVE A	B-SAVE A
On	On	Off	Off	Full	Full
On	On	On	Off	B	A
On	On	On	On	B	A

### EXTERNAL MIXER OPERATION

(Not Applicable When Option 07 or Option 08 is Installed)

External mixers are usually the waveguide type that extend the frequency range above that of the internal coaxial mixer. The WM 490-Series Tektronix Waveguide Mixers (18 to 325 GHz range) are two-port, broad-band mixers designed specifically for use with the Tektronix 49X-Series Spectrum Analyzers. The mixers cover both microwave and millimeter wave frequency bands. The 18 to 26.5 GHz and 26.5 to 40 GHz frequency ranges are considered microwave bands; frequencies above 40 GHz are considered millimeter wave bands.

The two microwave mixers that cover the 18 to 26.5 GHz and 26.5 to 40 GHz bands have standard rectangular flanges. Each uses a field replaceable diode and has a frequency response of  $\pm 2$  dB, when used with the spectrum analyzer. The millimeter wave mixers are NOT field repairable and must be returned to Tektronix, Inc. for repair.

Eight millimeter wave mixers cover the 33 to 220 GHz range in the standard Mil-spec band ranges. A mixer is designed specifically for the 140 to 220 GHz range, or a flange transition can be used to allow the 90 to 140 GHz mixer to cover this range. A flange transition is also available to allow the 140 to 220 GHz mixer to be used in the 220 to 325 GHz band. The mixers are optimized for flatness over each waveguide band. The 40 to 60 GHz mixer has a  $\pm 2.5$  dB frequency response. Typical performance characteristics for the mixers are listed in the Specification section of this manual.

### External Mixers and Diplexer

When an external mixer is used with the spectrum analyzer, the EXTERNAL MIXER port is the source for mixer bias and receives IF output from the mixer. A diplexer is used to couple the dc bias and the local oscillator signal to the mixer and couple the IF signal from the mixer to the EXTERNAL MIXER connector. (Refer to the Optional Accessories in the Service Manual, Volume 2, or your local Tektronix field office or representative for diplexer ordering information.) Connect the diplexer between the EXTERNAL MIXER port and the 1ST LO OUTPUT on the spectrum analyzer and then to the external mixer. Connect the 1ST LO OUTPUT to the LO port of the diplexer through a short semi-rigid 50  $\Omega$  coaxial cable. Connect the mixer to the diplexer through a standard 50  $\Omega$  coaxial cable (see Figure 6-8).

### Reference Level Readout and Conversion Loss for External Mixers

When EXT MIXER is on, the reference level initializes to  $-30$  dBm because the internal RF attenuation is no longer in the signal path. When switching to the 50 to 140 GHz waveguide bands, the reference level will increase 20 dB (initialize to  $-10$  dBm), and when switching to the 110 to 325 GHz bands, the reference level will increase another 10 dB (initialize to 0 dBm).

Conversion loss of the WM 490 Mixers for the 50 to 90 GHz and 75 to 140 GHz bands is approximately 20 dB more than the lower waveguide bands. Typical loss for mixers in the 110 to 220 GHz and 175 to 325 GHz bands is about 30 dB more than the lower waveguide bands.

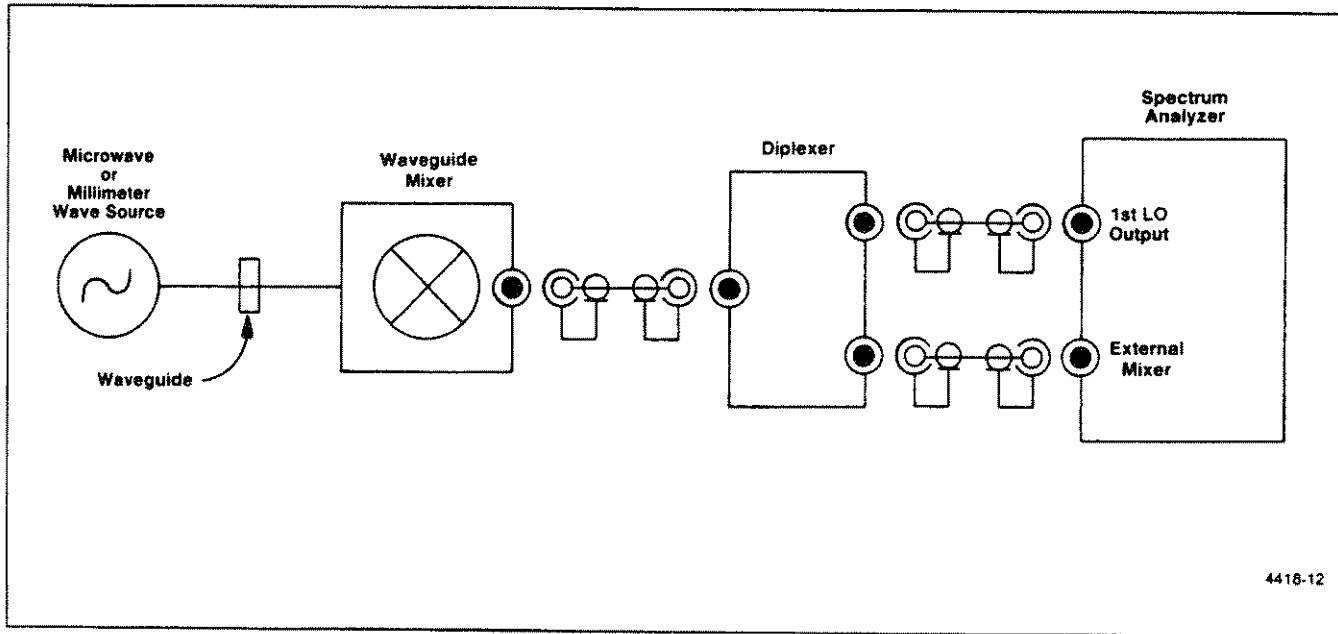

Figure 6-8. Block diagram showing external waveguide mixer installation.

This means the REF LEVEL readout is 20 dB and 30 dB higher for these bands; however, the display measurement dynamic range is not affected.

The reference level is calibrated to compensate for the nominal conversion loss of the waveguide mixers in each waveguide band. Slight variations between waveguide mixers result in an amplitude inaccuracy of approximately 6 dB, including the 3 dB frequency response of each mixer. The absolute power level accuracy of each waveguide mixer/spectrum analyzer system can be calibrated to within 3 dB. To do this, adjust AMPL CAL on the spectrum analyzer front-panel so the display amplitude is correct for the known level of an external input signal.

with 0.001 maximum duty factor and 1 ms pulse width for pulse signals. Bias for Tektronix waveguide mixers is a  $-2.0\text{ V}$  to  $+0.5\text{ V}$  with respect to the mixer body) voltage. Check bias requirements of non-Tektronix mixers before connecting them to the Tektronix spectrum analyzer.

NOTE

If your mixer requires positive-going bias, the spectrum analyzer bias polarity can be reversed. Contact your service personnel or a Tektronix Field Representative for this change.

Handling

**CAUTION**

The mixers can be damaged unless these instructions on handling and installing the mixers are followed.

Handle the waveguide mixers with care. The mixer diode is sensitive to static discharges and excessive RF energy. The maximum input level to all Tektronix waveguide mixers is  $+20\text{ dBm}$  (20 mW) cw and 1 W peak

Ensure that the shorting cap is installed when the mixer is not in use, and install the flange cover on the mixer before returning it to the storage box.

The mixer diode can also be destroyed by mechanical vibration or shock.

Do not use an ohmmeter to test or check the mixer diode. The voltage across the test leads of many ohmmeters is capable of destroying the diode.

Try to avoid scratching the flange surface. Scratches can degrade the performance.

## Installation

### CAUTION

The bias voltage out of the EXTERNAL MIXER port is negative-going. This is the bias requirement for Tektronix mixers. Your service personnel or a Tektronix Field Representative can change this bias to positive-going if desired. If changed, attach a label near the EXTERNAL MIXER port to reflect this change.

When EXT MIXER is turned on or the frequency range is in the external mixer bands, the internal RF attenuator is no longer in the signal path.

The waveguide mixer is connected to the diplexer and the analyzer as shown in Figure 6-8. The mixer is bolted to a waveguide flange at or near the RF signal source. When installing the mixer, make sure the flange surfaces are clean and free of scratches. Install and tighten all flange screws evenly. This care will minimize input vswr and provide optimum frequency response. Ball tipped 3/32-inch and 5/64-inch Allen screwdrivers are required to access the flange screws that are at an angle.

The diplexer assembly includes a sma-to-tnc adapter and a shaped semi-rigid coaxial cable to connect the diplexer to the 1ST LO OUTPUT and the EXTERNAL MIXER port. When installing, be sure that the connectors are not cross threaded. Use a flexible cable to connect the mixer to the External Mixer port on the diplexer. Connect the cable to the diplexer External Mixer port first to discharge any static build-up in the cable before connecting it to the waveguide mixer. Static can damage the mixer diode. Set the MANUAL PEAK control at the 9 o'clock position (0 volt bias position) before connecting the mixer to the diplexer. For best performance, use the cable supplied with the waveguide mixer set, and do not extend its length.

Never apply more than +20 dBm of continuous RF energy to the input of the waveguide mixer port. The waveguide mixers saturate at -20 dBm (typical); therefore, little is gained with inputs above this level. If the input level is unknown, use a general purpose mixer or appropriate waveguide attenuator and RF power meter to check the input level.

Tektronix mixers require +7 dBm (min) to +15 dBm (max), typically +10 dBm, of LO signal and a variable bias from -2.0 V to +0.5 V through a current limiting resistor to meet sensitivity and frequency response characteristics.

## Operation

When the frequency range is switched to the waveguide bands, the instrument automatically switches to the External Mixer mode. If there is no signal on screen, push <blue-SHIFT> PEAK MENU and select KNOB PEAKING, then set the MANUAL PEAK control mid-range. If in the Auto Peak mode, mixer bias will be set to the previous setting stored in memory or it will be set to mid-range if there is no stored setting. If a signal is present, tune to center screen and peak the response with the MANUAL PEAK control, or use automatic peaking. Adjusting the MANUAL PEAK control through its range produces several peaks. Select the maximum of these peaks as your setting.

Because there is no preselection or filters ahead of the mixer, many spurious signals will usually occur. A typical display, generated by a -30 dBm signal at 40 GHz, is shown in Figure 6-9. Before an analysis can be made of any signal, it must be determined if the signal is true or real. True or false signal identification is best accomplished with the IDENTify feature, which was covered earlier in this section.

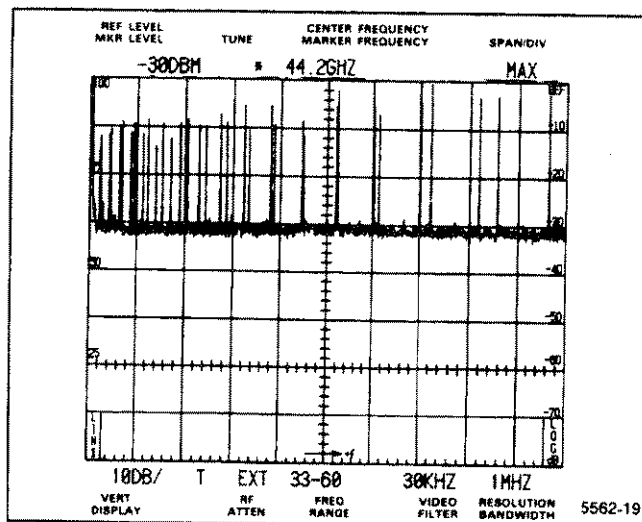

Figure 6-9. A typical display from an external mixer.

Because of the many spurious signals on screen, and the tedious task of operating the IDENTify feature on each signal, the approximate frequency of the signal should be known. A cavity wavemeter can be used to determine the signal frequency. The dip when the meter is tuned to the input frequency, is easily seen on a power meter if it is connected into the signal path. If not connected, use the 2 dB/div or less display mode to observe the dip.

Set the center frequency near the signal frequency, and peak the response with the MANUAL PEAK control or use automatic peaking. It may be desirable to increase the instrument sensitivity by reducing the



span/div and resolution bandwidth. Reduce the Freq Span/Div to 50 MHz or less so the IDENTify feature can be used. If there is a significant change in input signal frequency and the Frequency setting, it is best to read-just peaking to maintain sensitivity and frequency response characteristics.

## OPERATIONAL CONSIDERATIONS AND PRECAUTIONS

Following are some operational precautions to observe and traps that can occur when analyzing displays.

### 1. RF INPUT Power Limit

**CAUTION — DO NOT EXCEED THE RF INPUT POWER LIMIT OF +30 DBM. DO NOT APPLY DC VOLTAGE TO THE RF INPUT.**

### 2. Instrument Warm-up After Storage

After storage below  $-15^{\circ}\text{C}$ , allow 15 minutes instrument warm-up time, then turn the power off and back on.

### 3. Auto Resolution

Use AUTO RESOLN with care when measuring absolute amplitude level. Always use a bandwidth wider than the incidental FM level of the signal source.

### 4. Waveguide Mixer/Spectrum Analyzer System

The reference level is calibrated to compensate for the nominal conversion loss of the waveguide mixers in each waveguide band. Slight variations between mixers result in an amplitude accuracy of approximately  $\pm 6$  dB, including the  $\pm 3$  dB frequency response of each mixer. The absolute power level accuracy of each waveguide mixer/spectrum analyzer system can be calibrated to within 3 dB by adjusting front-panel AMPL CAL so the display amplitude is correct for the known level of an external input signal. Readjust the instrument with <blue-SHIFT> CAL when again using the bands below 21 GHz.

### 5. Measurements Outside Specified Frequency and Tuning Range vs Display Span

Signal level or frequency measurements outside the specified frequency range of the band are not reliable. In wide spans the total span of the display can exceed the frequency range; for example, the display extends below the 1.7 GHz lower limit of Band 2 and below the 15 GHz limit of Band 5 (15 to 21 GHz). The center frequency tuning range corresponds to the specified frequency range of the band. It can be confusing if a displayed signal, outside the frequency range of the band, will not tune to center screen.

The frequency range for external mixer bands is equal to the frequency range of the waveguide mixers.

### 6. Level of Pulsed Signals

The spectrum for a pulsed signal is spread out. Consequently, the height of the crt response is less for a pulsed signal than for a cw signal of the same peak amplitude. This loss in display height means, in effect, a loss in sensitivity. The amount of loss can be computed from the following formula.

$$\text{Voltage loss} = (t_p B)(1.5)$$

here  $t_p$  = pulse duty cycle  
 $B$  = resolution bandwidth

The power of the self-generated noise increase is proportional to bandwidth. Pulsed RF voltage level is also proportional. Since power is proportional to voltage squared, a wider bandwidth gives better sensitivity and greater dynamic range for pulsed RF inputs.

When in doubt about signal level overdrive problems, reduce the signal level by inserting RF attenuation; then, repeat the measurement. If the two agree, the measurement is correct; if not, the input mixer stage is probably overdriven.

An important consideration for pulsed RF measurements is the peak signal level at the mixer. The signal level is greater by  $(t_p B)(1.5)$  than the peak level displayed on the crt. Taking the sensitivity loss into account is the only way of being sure that the mixer peak power input for linear operation is not exceeded.

### 7. Level of Continuous Wave Signals

Problems similar to those described in 6 can occur when analyzing cw signals at relatively narrow span widths. The large cw signal may not appear on screen because its frequency is outside the set span width. The mixer, nevertheless, is saturated and will compress signals. This will occur only if within the preselected bandwidth from 20 MHz at 1.7 GHz to 60 MHz above 10 GHz in Option 01 instruments.

## 10. PEAK/AVERAGE

PEAK/AVERAGE should normally be fully counterclockwise so narrow signals in wide spans are not reduced in amplitude.

## 11. Digital Storage Effects on Signal Analyses

When using digital storage, the frequency base is divided into storage slots. For peak displays, above the cursor (horizontal line) the display point in each slot corresponds to the maximum sampled value of the signal. Samples are taken at about 9  $\mu$ s intervals. When sweeping at one second per division, this is about 1000 samples per slot. For average displays, below the cursor) the values of all samples per slot are added and divided by the number of samples to compute the display point for each slot. Each display point is connected to create a smooth display. When A or B memory are displayed independently, only half of the slots are connected. The following are a few pitfalls that can occur.

If the cursor set by PEAK/AVERAGE is above the signal level, the average value for each digital slot will be displayed. With narrow resolution bandwidths compared to the slot width, the average value of the resolution response shape will be displayed, which has nothing to do with signal amplitude.

To avoid the above pitfalls, run digital storage with A and B interlaced. Do not set the PEAK/AVERAGE cursor to average a cw signal. It is best if the cursor is about 1/4 division above the signal to be averaged and about 1/2 division below the signal to be analyzed.

None of these restrictions apply when the resolution bandwidth is wide compared to a digital storage slot (e.g., 5 MHz/div with 1 MHz resolution).

## 12. Stored Display Averaged in Wide Spans

When operating in wide spans with digital storage, low level signals will be averaged with the noise and lost if the PEAK/AVERAGE cursor is above the display. Turn the control fully counterclockwise for peak detection when operating with wide spans.

## 13. Automatic Calibration of Relative Amplitudes of Resolution Bandwidth Filters

If a calibration failed message appears when the automatic calibration completes, refer to the correction factors for an explanation. Press <blue-SHIFT> LIN to display the correction factors held in memory. Refer to Calibrate Center Frequency, Reference Level, and Dynamic Range in Section 5 for further information.

## 14. TRIGGERING

TRIGGERING is set to FREE RUN for most applications. In pulsed RF applications, a triggered display is required to measure between pulse repetition lines to determine the pulse repetition rate.

Internal triggering requires one or more divisions of signal amplitude. Tune the center frequency so a reasonably-sized signal is located at the sweep start before changing the trigger source from FREE RUN to INT.

## SERVICE INFORMATION

### Service Manual

The spectrum analyzer Service Manuals are separate publications. The Service Manual, Volume 1, includes circuit descriptions, troubleshooting information, calibration procedures, and maintenance procedures. The Service Manual, Volume 2, includes the electrical and mechanical parts lists, standard and optional accessories, and schematic diagrams. Service Manuals are intended for use by QUALIFIED SERVICE PERSONNEL ONLY. To avoid electrical shock, DO NOT perform any servicing unless qualified to do so. Service personnel should read the Safety information at the beginning of the Service Manuals before performing any servicing.

### Product Service

To assure adequate product service and maintenance for our instruments, Tektronix, Inc. has established Field Offices and Service Centers at strategic points throughout the United States and in all other countries where our products are sold. Contact your local Service Center, representative, or sales engineer for details regarding Warranty, Calibration, Emergency Repair, Repair Parts, Scheduled Maintenance, Maintenance Agreements, Pickup and Delivery, On-Site Service for fixed installations, and other services available through these centers.

### Emergency Repair

This service provides immediate attention to instrument malfunction if you are in an emergency situation. Contact any Tektronix Service center for assistance to get you on your way within a minimum of time.

## **Product Service**

To assure adequate product service and maintenance for our instruments, Tektronix, Inc. has established Field Offices and Service Centers at strategic points throughout the United States and in all other countries where our products are sold. Contact your local Service Center, representative, or sales engineer for details regarding Warranty, Calibration, Emergency Repair, Repair Parts, Scheduled Maintenance, Maintenance Agreements, Pickup and Delivery, On-Site Service for fixed installations, and other services available through these centers.

## **Emergency Repair**

This service provides immediate attention to instrument malfunction if you are in an emergency situation. Contact any Tektronix Service center for assistance to get you on your way within a minimum of time.

## **Maintenance Agreements**

Several types of maintenance or repair agreements are available. For example; for a fixed fee, a maintenance agreement program provides maintenance and recalibration on a regular basis. Tektronix, Inc. will remind you when a product is due for recalibration and perform the service within a specified time-frame. Refer to Options M1 through M5 in Section 7 for extended service and warranty options available. Any Service Center can furnish complete information on costs and types of maintenance programs.

Vertical text or artifacts along the right edge of the page, possibly from a scanning artifact or a page number.

# OPTIONS

This section describes the options available at this time for the spectrum analyzer. Changes in specifications, if any, are described in this section. Contact your local Tektronix Field Office or representative for additional information and ordering instructions (unless otherwise indicated).

Options are usually factory installed; however, field kits are available for some options. Contact your local Tektronix Field Office or representative for information on field kits and their installation.

## Options A1, A2, A3, A4, and A5 (Power Cord Options)

There are five international power cord options offered for the spectrum analyzer (see Table 7-1). The physical descriptions of the cord plugs are illustrated in Figure 7-1. For ordering purposes, refer to the Replaceable Mechanical Parts list in the Service Manual, Volume 2, for the Tektronix Part Number.

Table 7-1  
POWER CORD OPTIONS

Option	Description
A1	European, 220 V/50 Hz @ 16A
A2	United Kingdom, 240 V/50 Hz @ 13A
A3	Australian, 240 V/50 Hz, @ 10A
A4	North American, 240 V/60 Hz, @ 15A
A5	Swiss, 220 V/50 Hz, @ 10A

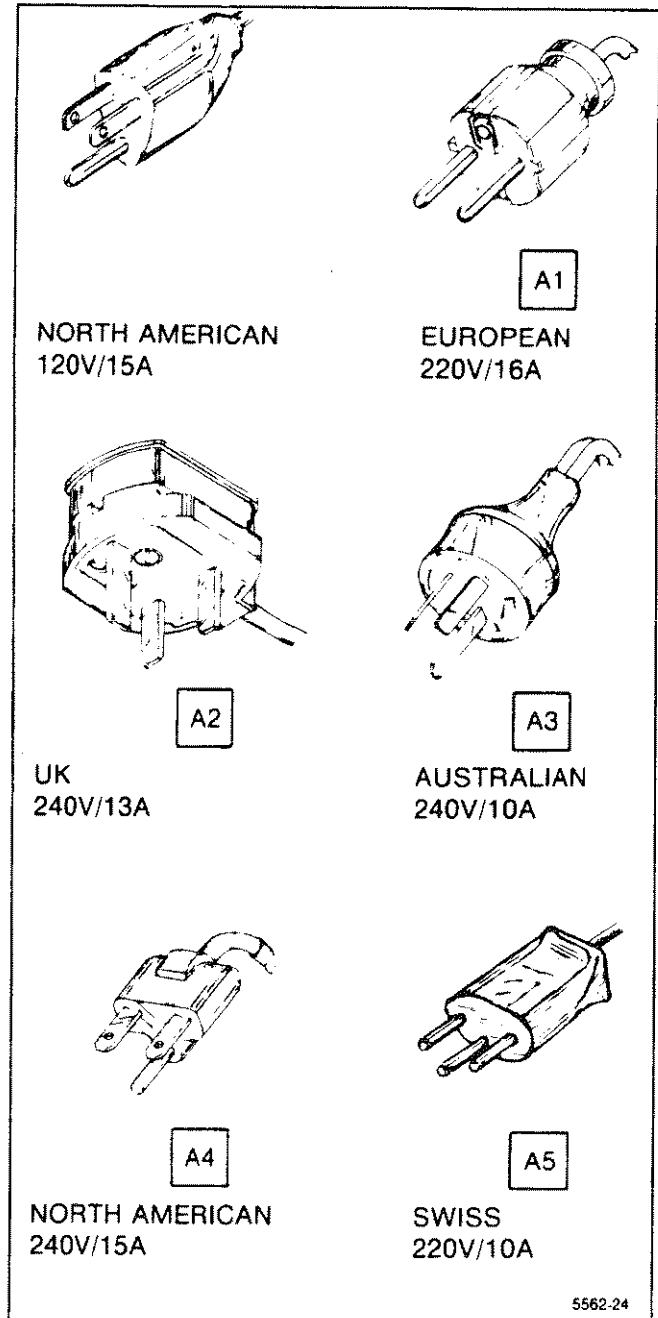

Figure 7-1. International power cord options for the spectrum analyzer.

**Options M1, M2, and M3 (Extended Service and Warranty Options)**

There are three extended service and warranty options offered for the spectrum analyzer (see Table 7-2) that go beyond the basic one-year coverage. Contact our local Tektronix Field Office or representative for additional information to satisfy your specific requirements.

**Option 01**

Option 01 adds an internal preselector and limiter. Band 1 input signals are routed through a limiter and low-pass filter. The band 1 frequency range becomes 50 kHz to 1.8 GHz. Band 2-5 input signals (1.7 GHz-21 GHz) are routed through the preselector. Table 7-3 lists the specification changes and additions to the standard instrument electrical characteristics.

Table 7-2  
EXTENDED SERVICE  
AND WARRANTY OPTIONS

Option	Description
M1	Two routine calibrations to published specifications; one each in years two and three of warranty coverage, plus two years remedial service
M2	Four years remedial service
M3	Four routine calibrations to published specifications; one each in years two, three, four, and five of product ownership, plus four years of remedial service

Table 7-3  
OPTION 01 ALTERNATE SPECIFICATIONS

Characteristic	Performance Requirement		Supplemental Information
<b>FREQUENCY</b>			
Response Coaxial (direct) Input			
<b>Band and Freq Range</b>	<b>About the mid-point between two extremes</b>	<b>Referenced to 100 MHz</b>	
1 (50 kHz-1.8 GHz)	±1.5 dB	±2.5 dB	
2 (1.7-5.5 GHz)	±2.5 dB	±3.5 dB	
3 (3.0-7.1 GHz)	±2.5 dB	±3.5 dB	
4 (5.4-18.0 GHz)	±3.5 dB	±4.5 dB	
5 (15.0-21.0 GHz)	±5.0 dB	±6.5 dB	
<b>AMPLITUDE</b>			
Spurious Responses 3rd Order Intermodulation Products			
50 kHz-21 GHz (Bands 1-5)	At least -70 dBc from any two on-screen signals within any frequency span		≥-100 dBc when signals are separated 100 MHz or more in preselected bands.

**Table 7-3 (Continued)**  
**OPTION 01 ALTERNATE SPECIFICATIONS**

Characteristic	Performance Requirement	Supplemental Information
<b>AMPLITUDE (Continued)</b>		
Harmonic Distortion		
50 kHz–1.8 GHz (Band 1)	–60 dBc or less	Measured at –40 dBm input level in Minimum Distortion Mode.
1.7–21 GHz	Not discernible	Typically –100 dBc
LO Emission	Less than –70-dBm–21 GHz	With 0 dB RF Attenuation
<b>INPUT</b>		
Maximum Safe Input Level (Attenuator Maximum Rating)		+30 dBm (1 W) continuous, 75 W peak, pulse width 1 $\mu$ s or less with a maximum duty factor of 0.001 (attenuator limit).  DO NOT APPLY DC VOLTAGE TO THE RF INPUT. (See Optional Accessories for DC Block)
<b>SENSITIVITY</b>		
	Equivalent Input Noise in dBm versus Resolution Bandwidth	
<b>Band and Frequency Range</b>	<b>100 Hz</b> <b>1 kHz</b> <b>10 kHz</b> <b>100 kHz<sup>a</sup></b> <b>300 kHz<sup>a</sup></b> <b>1 MHz</b>	Equivalent maximum input noise with internal preselection for each resolution bandwidth for frequency bands 1–5 (50 kHz–21 GHz), the NARROW Video filter is activated for resolution bandwidths of 1 kHz or less, and the WIDE filter for resolution bandwidths above 1 kHz.
1 (50 kHz–1.8 GHz)	–119 –110 –100 –90 –85 –80	
2 & 3 (1.7–7.1 GHz)	–120 –110 –100 –90 –85 –80	
4 (lower part) (5.4–12.0 GHz)	–105 –95 –85 –75 –70 –65	
4 (upper part) (12.0–18.0 GHz)	–100 –90 –80 –70 –65 –60	
5 (15.0–21.0 GHz)	–100 –90 –80 –70 –65 –60	
<b>PHYSICAL</b>		
Weight with standard accessories, except manuals	48 pounds 4 ounces, maximum	

**Option 07**

Option 07 provides an optional 75 $\Omega$  input, replacing the external mixer capability. Table 7-4 lists the changes and additions to the standard instrument electrical characteristics. These characteristics apply to the 75 $\Omega$  Input.

<sup>a</sup> Option 07 replaces the 100 kHz filter with a 300 kHz filter.

Table 7-4  
OPTION 07 ALTERNATE SPECIFICATIONS

Characteristic	Performance Requirement	Supplemental Information
<b>INPUT</b>		
Input Impedance		75 $\Omega$
Return Loss		17 dB (1.35:1 VSWR)
5 MHz–800 MHz		13 dB (1.6:1 VSWR) with $\geq 10$ dB attenuation
800 MHz–1000 MHz		
Maximum Input Level		+75 dBmV
With 0 dB Attenuation		
With 20 dB or More Attenuation		+78 dBmV, 100 $V_{dc}$ maximum (dc + peak)
<b>FREQUENCY</b>		
Center Frequency Operating Range		1 MHz–1000 MHz
Static Resolution Bandwidth	Within 20% of 300 kHz bandwidth (6 dB down)	300 kHz resolution filter replaces the standard instrument 100 kHz filter.
Frequency Response	$\pm 2.0$ dB about the midpoint between two extremes	Frequency response is measured with $\geq 10$ dB RF attenuation. The response figure includes the effects of: <ul style="list-style-type: none"> <li>• input vswr</li> <li>• mixer</li> <li>• gain variations</li> </ul> Variations in display flatness contribute about 1 dB to the response figure.
5 MHz–1000 MHz		
Coaxial Input		
1 MHz to 5 MHz		Typically <3 dB down from the 5 MHz response
<b>AMPLITUDE</b>		
Reference Level Range		–68 dBmV to +79 dBmV +89 dBmV is achievable in MIN NOISE mode
<b>SENSITIVITY</b>		
Equivalent Input Noise Sensitivity		See the main specifications and the Option 01 specifications for 300 kHz sensitivity with the 50 $\Omega$ RF INPUT.
5 MHz to 1000 MHz		
100 Hz	–74 dBmV	Typically –83 dBmV
1 kHz	–66 dBmV	Typically –73 dBmV
10 kHz	–56 dBmV	Typically –63 dBmV
300 kHz	–41 dBmV	Typically –48 dBmV
1 MHz	–36 dBmV	Typically –43 dBmV
<b>OUTPUT</b>		
Calibrator Output (CAL OUT) Level	+20 dBmV $\pm 0.5$ dB at 100 MHz $\pm 10$ PPM	100 MHz comb of markers provide amplitude calibration at 100 MHz and markers for frequency and span calibration to 1.0 GHz
Output Impedance		75 $\Omega$ nominal



**Option 08**

Option 08 deletes the external mixer capability. The frequency range is 50 kHz to 21 GHz.

**Options 21 and 22**

Option 21 includes a set of two high-performance waveguide mixers (18–40 GHz). Option 22 includes a set of three high-performance waveguide mixers (18 to 60 GHz). Both options also include an interface cable and a diplexer assembly. See Table 7-5 for characteristics. For ordering purposes, refer to the back of the Replaceable Mechanical Parts list in the Service Manual, Volume 2, for the Tektronix Part Number.

**NOTE****Options 21 and 22**

The characteristics in Table 7-5 for Options 21 and 22 assume that the waveguide mixer is connected to a continuous wave signal source and that PEAK/AVERAGE is adjusted for maximum signal amplitude. The signal must be stable (not frequency modulated more than the resolution bandwidth); otherwise, frequency response performance cannot be met.

**Table 7-5**

**OPTIONS 21 AND 22  
(WAVEGUIDE MIXERS) ALTERNATE  
SPECIFICATIONS**

<b>Frequency Range</b>	<b>Sensitivity: Equivalent Input Noise @ 1 kHz Bandwidth (Maximum)</b>
18.0–26.5 GHz (Options 21 and 22)	–100 dBm — frequency response, ±3.0 dB; referenced to 100 MHz, ±6.0 dB
26.5–40 GHz (Options 21 and 22)	–95 dBm — frequency response, ±3.0 dB; referenced to 100 Hz, ±6.0 dB
40.0 to 60 GHz (Option 22 only)	–95 dBm — frequency response, ±3.0 dB; referenced to 100 Hz, ±6.0 dB

**Options 30 and 31**

Option 30 provides the spectrum analyzer installed in a rackmount cabinet. Necessary extra cooling is provided by the addition of a larger fan. A front-panel

drawer provides storage for most accessories used with the spectrum analyzer. External vibrations, from rack cooling fans or surrounding equipment, may lower the FM-characteristic. Because of different rack frame types, this lowering cannot be specified; in a typical fan-cooled rack, lowering increases by a factor of two.

Option 31 provides the cabling necessary to access all the front-panel connectors at the cabinet rear panel. Because of the extra cabling, lowering may occur in response flatness and sensitivity at the high end of the frequency range; above 3.0 GHz this is typically about 2 dB.

Option 30 with Option 31 meets MIL-T-28800B, type III, class 5, style F specification. During verification tests, Option 30 alone and Option 30 with Option 31 are secured to the rack at the front and back (the semi-rigid cables between the front-panel connectors and the cabinet grill connectors (Option 31) are removed). Table 7-6 lists the similarities to and the changes from the standard instrument.

**Table 7-6**  
**OPTIONS 30 AND 31 (RACKMOUNT) CHARACTERISTICS**  
**AND ALTERNATE SPECIFICATIONS**

Characteristic	Description	
<b>AMPLITUDE</b>		
Spurious Responses	-90 dBm or less	
<b>ENVIRONMENTAL</b>	<b>Temperature</b>	<b>Relative Humidity</b>
Temperature Operating	0-25°C 25-40°C 40-50°C	95% +5, -0% 75% 45%
Non-operating	-55-+75°C	95% +5, -0%
Humidity Non-operating	Same as standard instrument.	
Altitude Operating	10,000 feet	
Non-operating	40,000 feet	
Vibration Operating	Method 514 Procedure X (modified)/MIL-STD-810C. Vibration limit is 1g. Resonance searches along all three axes at 0.0065 inch displacement, frequency varied from 10 Hz to 55 Hz, 15 minutes per axis, plus dwell at the resonant frequency or 33 Hz, if no resonance is found, for 10 minutes per axis. Total vibration time of 75 minutes. Instrument secured to vibration platform during test.	
Transportation Package Vibration	Meets National Safe Transit Association's pre-shipment test (project 1A-B-1) when correctly packaged. One hour vibration of 1g.	
Package Drop	Operable after a 24-inch drop on any corner or flat surface.	
Electromagnetic Interference (EMI)	Within limits described in MIL-STD-461B Part 4 (same as standard instrument).	
<b>PHYSICAL</b>		
Weight with standard accessories, except manuals	70 pounds, maximum	
Dimensions, without side rails	8.75 × 16.89 × 25.00 inches (222 × 429 × 635 mm)	
<b>SAFETY</b>	Same as the standard instrument.	
<b>ACCESSORIES</b>		
Standard	Same as the standard instrument, with the addition of rack slides.	
Optional	Same as the standard instrument, except the hard transit case is not available.	

### Option 39

Option 39 provides a silver battery for the instrument's battery-powered memory. The battery life at +55°C is 1–2 years and 2–5 years at +25°C.

### Option 41

Option 41 includes the following features to provide extra measurement capabilities for Digital Microwave Radio.

- A wider bandwidth preselector provides better signal symmetry in the digital radio bands.
- A narrow video filter (approximately 1/3000th of the resolution bandwidth) improves amplitude variation analysis at specific frequency spans that are unique to the digital radio measurements.
- Improved frequency span/div accuracy at 5 MHz/div span provides accurate signal bandwidth measurements.

### Option 42

Option 42 provides for a rear-panel 110 MHz IF signal with a bandwidth greater than 5 MHz, which makes the spectrum analyzer suitable for broadband swept-receiver applications.

### Option 45

This option provides the spectrum analyzer with the software/firmware necessary to meet Modular Automated Test Equipment Compatibility Options (MATECO). A MATECO Programmers Manual is included as an accessory with this option.

### Option 52

Option 52 provides a North American 220 V configuration with the standard power cord. The fuses are replaced with 2A slow blow.



# GLOSSARY

The following glossary will help you better understand terms as they are used in this document and with reference to spectrum analyzers.

## GENERAL TERMS

**Spectrum Analyzer** — An apparatus generally used to display the power distribution of an incoming signal as a function of frequency.

### NOTE

It is useful in analyzing the characteristics of repetitive electrical waveforms in general, since repetitively sweeping through the frequency range of interest will display all components of the signal.

**Center Frequency** — The frequency that corresponds to the center of a frequency span; expressed in hertz.

**dBc** — dB below carrier level.

**Effective Frequency Range** — The range of frequency over which the instrument performance is specified. The lower and upper limits are expressed in hertz.

**Frequency Band** — A part of effective frequency range over which the frequency can be adjusted; expressed in hertz.

**Full Span (Maximum Span)** — A mode of operation in which the spectrum analyzer scans an entire frequency band.

**Zero Span** — A mode of operation in which the frequency span is reduced to zero.

**Envelope Display** — The display produced on a spectrum analyzer when the resolution bandwidth is greater than the spacing of the individual frequency components.

**Line Display** — The display produced on a spectrum analyzer when the resolution bandwidth is less than the spacing of the individual frequency components.

**Line Spectrum** — A spectrum composed of signal amplitudes of the discrete frequency components.

**Maximum Safe Input Power** — WITHOUT DAMAGE. The maximum power applied at the input that will not cause degradation of the instrument characteristics.

—WITH DAMAGE. The minimum

power applied at the input which will damage the instrument.

**Intermodulation Spurious Response (Intermodulation Distortion)** — An unwanted spectrum analyzer response resulting from the mixing of the *n*th order frequencies, due to non-linear elements of the spectrum analyzer. The resultant unwanted response will be displayed.

**Baseline Clipper (Intensifier)** — Increasing the contrast between the signal and the baseline portion of the display.

**Pulse Stretcher** — A pulse shaper that produces an output pulse, whose duration is greater than that of the input pulse, and whose amplitude is proportional to that of the peak amplitude of the input pulse.

**Signal Identifier** — A means to identify the spectrum of the input signal when spurious responses are possible.

**Video Filter** — A post detection low-pass filter.

**Scanning Velocity** — Frequency span divided by sweep time and expressed in hertz per second.

## TERMS RELATED TO FREQUENCY

**Display Frequency** — The input frequency as indicated by the spectrum analyzer; expressed in hertz.

**Frequency Span (Dispersion)** — The magnitude of the frequency band displayed; expressed in hertz or hertz per division.

**Frequency Linearity Error** — The error of the relationship between the frequency of the input signal and the frequency displayed; expressed as a ratio.

**Frequency Drift** — Gradual shift or change in displayed frequency over the specified time due to internal changes in the spectrum analyzer; expressed in hertz per second, where other conditions remain constant.

**Residual FM (Incidental FM)** — Short term displayed frequency instability or jitter due to instability in the spectrum analyzer local oscillators, given in terms of peak-to-peak frequency deviation and expressed in hertz or percent of the displayed frequency.

**Impulse Bandwidth** — The displayed spectral level of an applied pulse divided by its spectral voltage density level assumed to be flat within the pass-band.

**Static (Amplifier) Resolution Bandwidth** — The specified bandwidth of the spectrum analyzer's response to a cw (continuous wave) signal, if sweep time is kept substantially long.

NOTE

This bandwidth is the frequency separation of two down points, usually 6 dB, on the response curve if it is measured either by manual scan (true static method) or by using a very low speed sweep (quasi-static method).

**Shape Factor (Skirt Selectivity)** — The ratio of the frequency separation of the two (60 dB/6 dB) down points on the response curve to the static resolution bandwidth.

**Zero Pip (Response)** — An output indication that corresponds to zero input frequency.

## TERMS RELATED TO AMPLITUDE

**Deflection Coefficient** — The ratio of the input signal magnitude to the resultant output indication.

NOTE

The ratio may be expressed in terms of volts (rms) per division, decibels per division, watts per division, or any other specified factor.

**Display Reference Level** — A designated vertical position representing a specified input level.

NOTE

The level may be expressed in dBm, volts, or any other units.

**Sensitivity** — Measure of a spectrum analyzer's ability to display minimum level signals, at a given IF bandwidth, display mode, and any other influencing factors; expressed in decibels.

**Equivalent Input Noise Sensitivity** — The average level of a spectrum analyzer's internally-generated noise referred to the input.

**Display Flatness** — The unwanted variation of the displayed amplitude over a specified frequency span, expressed in decibels.

**Relative Display Flatness** — The display flatness measured relative to the display amplitude at a fixed frequency within the frequency span; expressed in decibels.

NOTE

Display flatness is closely related to frequency response. The main difference is that the spectrum display is not recentered.

**Frequency Response** — The unwanted variation of the displayed amplitude over a specified center frequency range, measured at the center frequency; expressed in decibels.

**Display Law** — The mathematical law that defines the input-output function of the instrument.

The following cases apply.

- **Linear** — A display in which the scale divisions are a linear function of the input signal voltage.
- **Square law (power)** — A display in which the scale divisions are a linear function of the input signal power.
- **Logarithmic** — A display in which the scale divisions are a logarithmic function of the input signal voltage.

**Dynamic Range** — The maximum ratio of the levels of two signals simultaneously present at the input which can be measured to a specified accuracy.

**Display Dynamic Range** — The maximum ratio of the levels of two non-harmonically related sinusoidal signals; each of which can be simultaneously measured on the screen to a specified accuracy.

**Gain Compression** — Maximum input level where the scale linearity error is below that specified.

**Spurious Response** — A response of a spectrum analyzer where the displayed frequency does not conform to the input frequency.

**Hum Sidebands** — Undesired responses created within the spectrum analyzer, appearing on the display, that are separated from the desired response by the fundamental or harmonic of the power-line frequency.

**Noise Sidebands** — Undesired response caused by noise internal to the spectrum analyzer appearing on the display around a desired response.

**Residual Response** — A spurious response in the absence of an input signal. (Noise and zero pip are excluded.)

**Input Impedance** — The impedance at the desired input terminal, usually expressed in terms of vswr, return loss, or other related terms for low impedance devices and resistance-capacitance parameters for high-impedance devices.

## TERMS RELATED TO DIGITAL STORAGE

**Stored Display** — A display method whereby the displayed function is held in a digital memory. The display is generated by reading the data out of memory.

**Digitally Averaged Display** — A display of the average value of digitized data computed by combining serial samples in a defined manner.

**Multiple Display Memory** — A digitally-stored display with multiple memory sections that can be displayed separately or simultaneously.

**Clear (Erase)** — Presets memory to a prescribed state, usually that denoting zero.

**Save A** — A function that inhibits storage update, saving existing data in a section of a multiple memory (e.g., Save A).

**View (Display)** — Enables viewing of contents of the chosen memory section (e.g., View A displays the contents of memory A; View B displays the contents of memory B).

**Max Hold (Peak Mode)** — Digitally stored display mode that compares, at each frequency address, the incoming signal level to the stored level and retains the greater. In this mode, the display indicates the peak level at each frequency after several successive sweeps.

**Scan Address** — A number representing each horizontal data position increment on a directed beam type display. An address in a memory is associated with each scan address.

## TERMS RELATED TO MARKERS

**Live Trace** — Any combination of the A trace and/or the B trace when SAVE A is off.

**Active Trace** — Live Trace or the B—SAVE A trace (a trace recalled into B is not an active trace).

**Inactive Trace** — SAVE A trace or a trace recalled into the B display before the sweep is started.

**Primary Marker** — The marker displayed in the Single Marker mode whose frequency and/or position is changed when tuning with the CENTER/MARKER FREQUENCY control. When two markers are displayed, the brightest marker is the Primary marker.

**Secondary Marker** — The "second" marker; displayed only in the Delta Marker mode.





Manual Part No. 070-5562-01 First Printing DEC 1987

Product: 492A/AP & 492A/AP Operator Manual

Revised MAR 1988

### Manual Insert Status

<u>DATE</u>	<u>CHANGE REFERENCE</u>	<u>STATUS</u>
AUG 1987	C1/887	Effective
DEC 1987	C100/188	Effective
JUN 1988	M66071	Effective
SEP 1991	C1-991	Effective

www.valuetronics.com

Date: 8-27-87  
Product: See list

Change Reference: C1/887  
Manual Part No: See list

Product Group: 26

INSTRUMENT	PART NO.	S/N B010586 and up
492A/492AP Operators	070-5562-01	
492A/492AP Service 1	070-5565-01	

Replace Sensitivity table in the Option Section with the table below.

### OPTION 01 ALTERNATE SPECIFICATIONS

Characteristic	Performance Requirement	Supplemental Information
<b>AMPLITUDE (Continued)</b>		
Harmonic Distortion		
50 kHz to 1.8 GHz (Band 1)	-60 dBc or less	Measured at -40 dBm input level in Minimum Distortion Mode.
1.7 to 21 GHz	Not discernible	Typically -100 dBc
LO Emission	Less than -70 dBm to 21 GHz	With 0 dB RF Attenuation.
Input Level		+30 dBm (1 W) continuous, 75 W peak.
Maximum Safe Input (Attenuator Maximum Rating)		• Pulse Width = 1 $\mu$ s or less • Maximum duty factor of 0.001  (Attenuator limit)
		DO NOT APPLY DC VOLTAGE TO THE RF INPUT. (See Optional Accessories for DC Block)
Sensitivity	Equivalent Input Noise in dBm versus Resolution Bandwidth	Equivalent maximum input noise with internal preselection for each resolution bandwidth for frequency bands 1 — 5 (50 kHz — 21 GHz). The NARROW Video filter is activated for resolution bandwidths of 1 kHz or less, and the WIDE filter for resolution bandwidths above 1 kHz.
Band and Frequency Range	100 Hz   1 kHz   10 kHz   100 kHz   300 kHz*   1 MHz	
50 kHz—1.8 GHz (Band 1)	-120   -110   -100   -90   -85   -80	
1.7—5.5 GHz (Band 2)	-120   -110   -100   -90   -85   -80	
3.0—7.1 GHz (Band 3)	-119   -109   -99   -89   -84   -79	
5.4—12 GHz (Band 4)	-105   -95   -85   -75   -70   -65	
12—18 GHz (Band 4)	# -100   -90   -80   -70   -65   -60	
15—21 GHz (Band 5)	# -99   -89   -79   -69   -64   -59	
PHYSICAL		
Weight with standard accesso- ries, except manuals	48 pounds 4 ounces, maximum	

#### Option 07 (75 $\Omega$ Input)

Option 07 provides an optional 75 $\Omega$  input, replacing the external mixer capability.

- Option 07 replaces the 100 kHz filter with a 300 kHz filter.
- # Revised 8-27-87



Date: 12/21/87

Product: 492B/492BP Operators

Change Reference: C100/188

Manual Part No: 070-5562-01

Product Group: 26

---

*The 492B/492BP has the same features as the 492A/492AP Spectrum Analyzer with additional 3 MHz resolution bandwidth and precision counting ability. 492BP instruments also have macro instructions.*

## **Section 1 - GENERAL INFORMATION**

*The following features are added:*

- precision counting ability
- ability to plot the display, readout, and graticule
- ability to hold 8 personalized macros in memory (programmable instruments only)
- 100 Hz to 3 MHz resolution bandwidth
- multiband sweep capability.

*Change the **HELP feature** to read:*

- HELP message crt readout that describes the function of front-panel pushbuttons and controls as well as messages that explain operating errors.

*Replace the **2nd paragraph** with the following:*

The frequency range is 10 kHz to 21 GHz with the internal mixer, extending up to 325 GHz with external waveguide mixers. Resolution bandwidth is 100 Hz to 3 MHz. Digital storage provides flicker-free displays plus functions to compare and subtract displays, and save maximum values. In addition, up to nine separate displays with their readouts can be stored in battery-powered non-volatile memory, then later recalled for additional analysis and comparison. Up to ten different front-panel control setups can also be stored for future recall. The signal counting feature allows the spectrum analyzer to selectively count a particular signal out of several that may be present at its input.

*Insert the paragraph below in front of **Firmware Version and Error Message Readout**:*

The programmable instrument also adds the macro instructions (macros) feature. The instrument memory has 8K bytes set aside for the construction of made-to-order macros. The macro menu can hold the titles of eight macros for easy access. Specific macro information is located in the Programmers Manual.

*Add the following to the 1st paragraph under **Firmware Version and Error Message Readout**:*

In addition, the programmable instrument will flash the GPIB address and macro status when RESET TO LOCAL is pressed.

## Section 2 - SPECIFICATION

Replace the present Specifications Tables with the following:

**Table 2-1  
FREQUENCY RELATED CHARACTERISTICS**

Characteristic	Performance Requirement	Supplemental Informaiton
Center/Marker Frequency		
Operating Range		
Internal Mixer		10 kHz to 21 GHz  Tuned by the CENTER/MARKER FREQUENCY control or the DATA ENTRY keypad.
External Mixer		To 325 GHz (see Options Section)
Accuracy  (After front-panel CAL has been performed)		Center/Marker Frequency Accuracy is specified by three characteristics: <ul style="list-style-type: none"> <li>• reference frequency error</li> <li>• initial accuracy (Firmware corrected)</li> <li>• center frequency drift during the sweep</li> </ul>
Initial (start of sweep)		Refer to 'IF, LO Range and Harmonic Number' specification for the N value.  Allow a settling time of one second for each GHz change in CF within a band. In bands 4-12, divide the CF change by N.  See bandwidth centering, Page 6
Bands 1 & 5—12 with SPAN/DIV > 200 kHz, and Bands 2—4 with SPAN/DIV > 100 kHz  (1st LO unlocked)	$\pm[20\%D + (CF \times REF) + 15N \text{ kHz}]$ Where: D = SPAN/DIV or RESOLUTION BANDWIDTH, whichever is greater CF = Center/Marker Frequency REF = Reference Frequency Error N = Harmonic Number	
Bands 1 & 5—12 with SPAN/DIV ≤ 200 kHz and Bands 2—4 with SPAN/DIV ≤ 100 kHz  (1st LO locked)	$\pm[20\%D + (CF \times REF) + (2N + 25)\text{Hz}]$ Where: D = SPAN/DIV or RESOLUTION BANDWIDTH, whichever is greater CF = Center/Marker Frequency REF = Reference Frequency Error N = Harmonic Number	

**Table 2-1 (Continued)**  
**FREQUENCY RELATED CHARACTERISTICS**

Characteristic	Performance Requirement	Supplemental Information
Center Frequency Drift		With constant ambient temperature and fixed center frequency. Any error is observed during sweep time. Correction will occur at the end of sweep or as often as necessary to maintain specifications.
After 30 minute warmup		Typically $\leq(25 \text{ kHz})N$ per minute
Bands 1&5—12 with SPAN/DIV >200 kHz and Bands 2—4 with SPAN/DIV >100 kHz (1st LO unlocked)		
Bands 1&5—12 with SPAN/DIV $\leq$ 200 kHz and Bands 2—4 with SPAN/DIV $\leq$ 100 kHz (1st LO locked)		Typically $\leq$ 150 Hz per minute
After 1 hour warmup		Typically $\leq(5 \text{ kHz})N$ per minute
Bands 1&5—12 with SPAN/DIV >200 kHz and Bands 2—4 with SPAN/DIV >100 kHz (1st LO unlocked)		
Bands 1&5—12 with SPAN/DIV $\leq$ 200 kHz and Bands 2—4 with SPAN/DIV $\leq$ 100 kHz (1st LO locked)	$\leq$ 50 Hz per minute	
Readout resolution		$\leq$ 10% of Span/Div.
Reference Frequency Error (internal)		Warm-up time (after <24 Hrs. with power off) <72 Hrs. to meet aging rate specifications; otherwise (after power down indefinitely) 30 days to meet aging rate specifications.
Aging Rate		$\leq 2 \times 10^{-9}$ per day
Short Term		$\leq 1.4 \times 10^{-6}$ per week
First six months		$\leq 3.5 \times 10^{-7}$ in first six months
After the first six months		$\leq 5 \times 10^{-7}$ per year
Accuracy During Warmup at +25°C 30 Minutes After Power Up		Within $1 \times 10^{-6}$ of the frequency after 24 hours
Temperature Sensitivity		Within $1.5 \times 10^{-5}$ over the operating temperature range, referenced to +25° C.

**Table 2-1 (Continued)**  
**FREQUENCY RELATED CHARACTERISTICS**

Characteristic	Performance Requirement	Supplemental Information
Residual FM		Short term, after 1 hour warmup.
Bands 1 & 5—12 with SPAN/DIV >200 kHz and Bands 2—4 with SPAN/DIV >100 kHz (1st LO unlocked)	$\leq (7 \text{ kHz})N$ total excursion in 20 ms.	Refer to 'IF, LO Range, and Harmonic Number' specification for the N value.
Bands 1 & 5—12 with SPAN/DIV $\leq 200$ kHz and Bands 2—4 with SPAN/DIV $\leq 100$ kHz (1st LO locked)	$\leq (10+2N)$ Hz total excursion in 20 ms.	
Resolution Bandwidth (6 dB down)	Within 20% of selected bandwidth.	100 Hz to 1 MHz in decade steps, and 3 MHz
Shape Factor (60 dB/6 dB)	7.5:1 or less	
Noise Sidebands		Measured at an offset of 30 x the resolution bandwidth.
Resolution Bandwidth = 100 Hz	$\leq -70$ dBc	
Resolution Bandwidth $\leq 1$ kHz	$\leq -75$ dBc	
Signal Counter Accuracy With Span to Resolution Band width Ratios $\leq 10:1$	$\pm[(CF \times REF) + (10 + N)Hz + 1 \text{ LSD}]$  Where: CF = Center or Marker Frequency REF = Reference Frequency Error LSD = Least Significant Digit N = Harmonic Number	Refer to 'IF Frequency, LO Range, and Harmonic Number (N)' specification for the value of N. Count at center, marker, or delta markers
Sensitivity	Signal level, at center screen or at marker, must be 20 dB or more above the average noise level and within 60 dB of the reference level.	
Readout Resolution		Selectable from 1 Hz to 1 GHz in decade steps  Selected with <Blue-SHIFT> COUNT RESolution sequence
$\Delta F$ Accuracy	$\pm[(\Delta F \times REF) + (20 + 2N)Hz + 1 \text{ LSD}]$  Where: $\Delta F$ = Delta Frequency N = Harmonic Number REF = Reference Frequency Error LSD = Least Significant Digit	Refer to IF, LO Range, and Harmonic Number specification later in this table for the N value



**Table 2-1 (Continued)**  
**FREQUENCY RELATED CHARACTERISTICS**

Characteristic	Performance Requirement	Supplemental Information
Marker(s)		When activated, the marker is a bright dot positioned by the CENTER/MARKER FREQUENCY control or the DATA ENTRY pushbuttons.
Normal Accuracy	Identical to center frequency accuracy	For the active trace
$\Delta$ MKR Accuracy	$\pm 1\%$ of the total span	For the active trace.  5% on multiband and stored displays  Displays delta time or delta Frequency in Zero Span mode  $\Delta$ MKR activates a second marker at the position of the single marker on the trace. Parentheses appear on the marker display line indicating that the delta mode is active. The display shows the difference in frequency and amplitude. <Green-SHIFT> 1<-MKR->2 selects which marker is tuned.
$\Delta$ MKR Resolution		$\leq 10\%$ of Span/Div
Frequency Span/Div		
Overall Range		
With SPAN/DIV control		100 Hz to 10 GHz (in a 1-2-5 sequence)
With the DATA ENTRY Keypad.		100 Hz to 15 GHz (to one significant digit)
With Multiband Mode		In bands 1 through 5 (2—5 for Opt.01), <blue SHIFT> FREQ START/STOP permits entry of a start frequency in one band and the stop frequency in another band (Multiband Mode).  Maximum range is 0 to 21 GHz. (1.7 to 21 GHz for Option 01)  Start and Stop frequencies are limited to a single band in Band 1 (Opt.01 only) and bands 6 through 12.  The FREQ RANGE readout displays MULTIBD in Multiband mode.

**Table 2-1 (Continued)**  
**FREQUENCY RELATED CHARACTERISTICS**

Characteristic	Performance Requirement	Supplemental Information		
Frequency Span/Div (continued)		100 Hz all bands		
Minimum Span/Div				
Maximum Span/Div		With SPAN/DIV Control	With DATA ENTRY Keypad	
Band 1 (0—1.8 GHz Opt. 01)		100 MHz	170 MHz <sup>a</sup>	
Band 1 (0—4.2 GHz)		200 MHz	410 MHz	
Band 2 (1.7—5.5 GHz)		200 MHz	370 MHz	
Band 3 (3—7.1 GHz)		200 MHz	400 MHz	
Band 4 (5.4—18 GHz)		500 MHz	1.2 GHz	
Band 5 (15—21 GHz)		500 MHz	590 MHz	
Band 6 (18—27 GHz)		500 MHz	790 MHz	
Band 7 (26—40 GHz)		1 GHz	1.3 GHz	
Band 8 (33—60 GHz)		2 GHz	2.6 GHz	
Band 9 (50—90 GHz)		2 GHz	3.9 GHz	
Band 10 (75—140 GHz)		5 GHz	6.4 GHz	
Band 11 (110—220 GHz)		10 GHz	10 GHz	
Band 12 (170—325 GHz)		10 GHz	15 GHz	
		In addition, MAX SPAN sweeps across an entire band and ZERO SPAN provides a 0 Hz display. With ZERO SPAN the horizontal axis is calibrated in time/div instead of frequency/div		
Accuracy/Linearity	Within 5% of the selected Span/Div	Measured over center 8 divisions. Specification does not apply to multi-band mode.		
IF Frequency, LO Range, and Harmonic Number (N)				
Band and Freq. Range		1st IF (MHz)	LO Range (MHz)	(N)
1 (0—1.8 GHz Opt. 01)		2072	2072—3872	1-
1 (0—4.2 GHz)		2072	2072—6272	1-
2 (1.7—5.5 GHz)		829	2529—6329	1-
3 (3.0—7.1 GHz)		829	2171—6271	1+
4 (5.4—18 GHz)		829	2076—6276	3-
5 (15—21 GHz)		2072	4309—6309	3+
6 (18—27 GHz)		2072	2655—4155	6+
7 (26—40 GHz)		2072	2393—3793	10+
8 (33—60 GHz)		2072	3093—5793	10+
9 (50—90 GHz)		2072	3195—5862	15+
10 (75—140 GHz)		2072	3171—5997	23+
11 (110—220 GHz)		2072	2917—5890	37+
12 (170—325 GHz)		2072	2999—5767	56+
Bandwidth Filter Centering		The instrument filter centering routine defines the left most high point of the filter response curve in band one as the filter center. This point must be used for all measurements referencing filter center.		

<sup>a</sup>See Option Section

**Table 2-2**  
**AMPLITUDE RELATED CHARACTERISTICS**

Characteristic	Performance Requirement	Supplemental Information
Vertical Display Modes		10 dB/Div, 2 dB/Div, and Linear. Any integer between 1—15 dB/Div can also be selected via the DATA ENTRY keypad.
Display Dynamic Range		90 dB maximum for Log Mode $\geq$ 12 dB/Div.  8 divisions for Linear Mode.
Display Amplitude Accuracy 10 dB/DIV Mode	$\pm 1.0$ dB/10 dB to a maximum cumulative error of $\pm 2.0$ dB over 80 dB range	Maximum cumulative error of $\pm 4.0$ dB over 90 dB range
2 dB/DIV Mode	$\pm 0.4$ dB/2.0 dB to a maximum cumulative error of $\pm 1.0$ dB over 16 dB range	
LIN Mode	$\pm 5\%$ of full scale	
Reference Level		Top of the graticule
Range		From $-117$ dBm to $+50$ dBm; $+50$ dBm includes 20 dB of IF gain reduction ( $+30$ dBm is the maximum safe input). Alternate reference levels are: <ul style="list-style-type: none"> <li>•dBV (<math>-130</math> dBV to <math>+37</math> dBV)</li> <li>•dBmV (<math>-70</math> dBmV to <math>+97</math> dBmV)</li> <li>•dB<math>\mu</math>mV (<math>-10</math> dB<math>\mu</math>mV to <math>+157</math> dB<math>\mu</math>mV)</li> </ul>
LIN Mode		39.6 nV/Div to 2.8 V/Div (1W maximum safe input)
Steps		
10 dB/DIV Mode		10 dB for the coarse mode. 1 dB for the FINE mode.
2 dB/DIV Mode		1 dB for the coarse mode. 0.25 dB for the FINE mode.
LIN Mode		1-2-5 sequence for coarse mode. 1 dB equivalent steps for FINE mode.
Set via DATA ENTRY Keypad		Steps correspond to the display mode in coarse, except for 2 dB/DIV where steps are 1 dB.  In FINE mode:  1 dB when the mode is 5 dB/Div or more  0.25 dB for display modes of 4 dB/Div or less (referred to as $\Delta A$ mode)

**Table 2-2 (Continued)**  
**AMPLITUDE RELATED CHARACTERISTICS**

Characteristic	Performance Requirement	Supplemental Information
Reference Level (continued)		Dependent on the following characteristics:
Accuracy		<ul style="list-style-type: none"> <li>•RF Attenuation Accuracy</li> <li>•IF Gain Accuracy</li> <li>•Resolution Bandwidth</li> <li>•Frequency Response</li> <li>•Display Mode</li> <li>•Calibrator Accuracy</li> <li>•Frequency Band</li> <li>•&lt;Blue-SHIFT&gt; CAL routine reduces error between resolution bandwidths at -20 dBm REF LEVEL. Other REF LEVELs may have larger errors.</li> <li>•Temperature variation (<math>\pm 0.15</math> dB/°C maximum).</li> </ul> <p>The input RF attenuator steps 10dB for reference level changes above -30 dBm (-20 dBm when MIN NOISE is active) unless the MIN RF ATTEN setting is greater than zero.</p> <p>The IF gain increases 10 dB for each 10 dB reference level change below -30 dBm (-20 dBm when MIN NOISE is active).</p>
Marker/s Accuracy		Identical to REF LEVEL accuracy plus cumulative error of display scale (Dependent on vertical position)
RF Attenuator Range		0—60 dB in 10 dB steps
Accuracy		
Dc to 1.8 GHz	Within 0.5 dB/10 dB to a maximum of 1 dB over the 60 dB range	
1.8 GHz to 18 GHz	Within 1.5 dB/10 dB to a maximum of 3 dB over the 60 dB range	
18 GHz to 21 GHz	Within 3.0 dB/10 dB to a maximum of 6 dB over the 60 dB range	
IF Gain Range		87 dB of gain increase, 20 dB of gain decrease (MIN NOISE and reduced gain mode), in 10 dB and 1 dB steps.
Accuracy		
1 dB Step	$\leq 0.2$ dB/dB step to 0.5 dB/9 dB steps except at the decade transitions.	
Decade Transitions		
-29 to -30 dBm	0.5 dB or less	Maximum 1 dB cumulative error over 10 dB.
-39 to -40 dBm		
-49 to -50 dBm		
-59 to -60 dBm		
Maximum Deviation	$\pm 2$ dB	

**Table 2-2 (Continued)**  
**AMPLITUDE RELATED CHARACTERISTICS**

Characteristic	Performance Requirement		Supplemental Information
Gain Variation Between Resolution Bandwidths			Measurement conditions: • Measured at -20 dBm • MIN DISTORTION mode • After CAL routine @ Ambient Temp.
With respect to 3 MHz Filter	≤ ±0.4 dB		
Between Any Two Filters	≤ 0.8 dB		
Frequency Response			Measured with 10 dB RF Attenuation and Peaking optimized for each center frequency setting (when applicable).  Response is affected by: • input VSWR • harmonic number (N) • gain variation • mixer • preselector (Option 01)  Display flatness is typically 1 dB greater than frequency response.  Refer to the Options portion for variations in this specification.
Coaxial (direct) Input	About the mid-point between two extremes	Referenced to 100 MHz	
Band and Frequency Range			
1 (10 kHz—4.2 GHz)	±1.5 dB	±2.5 dB	
2 (1.7—5.5 GHz)	±1.5 dB	±2.5 dB	
3 (3.0—7.1 GHz)	±1.5 dB	±2.5 dB	
4 (5.4—18 GHz)	±2.5 dB	±3.5 dB	
5 (15—21 GHz)	±3.5 dB	±5.0 dB	

**Table 2-2 (Continued)**  
**AMPLITUDE RELATED CHARACTERISTIC**

Characteristic	Performance Requirement		Supplemental Information		
Frequency Response (continued)					
With TEKTRONIX Waveguide Mixers (WM 490 Series)					
Band and Frequency Range	About the midpoint between two extremes	Referenced to 100 MHz			
6 (18—26.5 GHz)	±2.0 dB	±6.0 dB			
7 (26.5—40 GHz)	±2.0 dB	±6.0 dB			
8 (33—50 GHz) (40—59 GHz)	±2.0 dB ±2.5 dB	±6.0 dB ±6.0 dB			
9 (50—90 GHz)					Typically ±3 dB over any 5 GHz range.
10 (75—140 GHz)					Typically ±3 dB over any 5 GHz range.
11 (110—220 GHz)					Typically ±3 dB over any 5 GHz range.
12 (170—325 GHz)					Typically ±3 dB over any 5 GHz range.
Differential Amplitude Measurement					ΔA mode provides differential measurements in 0.25 dB increments.  (This is not related to the ΔMKR mode.)
Range					Maximum range of 57.75 dB dependent on Reference Level when ΔA mode is activated.
Accuracy					
			Difference	Steps	Error
			0.25 dB	1	0.15 dB
			2 dB	8	0.4 dB
			10 dB	40	1.0 dB
			20–57.75 dB	80–231	2.0 dB

**Table 2-2 (Continued)**  
**AMPLITUDE RELATED CHARACTERISTICS**

Characteristic	Performance Requirement							Supplemental Information	
Sensitivity	Equivalent Input Noise in dBm vs. Resolution Bandwidth							Equivalent maximum input noise for each resolution bandwidth. Measured at 25° C with: • 0 dB attenuation (Min Atten 0 dB) • Narrow Video Filter on • Vertical Display 2dB/Div • Digital Storage on • Max Hold off • Peak/Average in Average • 1 sec Time/Div • Zero Span • Input terminated in 50Ω	
Frequency Range	100 Hz	1 kHz	10 kHz	100 kHz	300 kHz <sup>a</sup>	1 MHz	3 MHz		
Band 1 10 kHz—4.2 GHz	-125	-115	-105	-95	-90	-85	-80		
Band 2&3 1.7 GHz—5.5 GHz& 3.0 GHz—7.2 GHz	-125	-115	-105	-95	-90	-85	-80		
Band 4 5.4 GHz—12 GHz	-110	-100	-90	-80	-75	-70	-65		
Band 4 12 GHz—18 GHz	-105	-95	-85	-75	-70	-65	-60		
Band 5 15 GHz—21 GHz <sup>b</sup>	-105	-95	-85	-75	-70	-65	-60		
Band 6 18 GHz—27 GHz <sup>b</sup>	-108	-100	-90	-80		-70	-65		
Band 7&8 26 GHz—60 GHz <sup>b</sup>	-103	-95	-85	-75		-65	-60		
Band 9 50 GHz—90 GHz <sup>b</sup>									Typically -95 dBm at 50 GHz, degrading to -85 dBm at 90 GHz.
Band 10 75 GHz—140 GHz <sup>b</sup>									Typically -90 dBm at 75 GHz, degrading to -75 dBm at 140 GHz.
Band 11 110 GHz—220 GHz <sup>b</sup>									Typically -80 dBm at 110 GHz, degrading to -65 dBm at 220 GHz.
Band 12 170 GHz—325 GHz <sup>b</sup>									Typically -70 dBm at 170 GHz, degrading to -55 dBm at 325 GHz.
Characteristic	Performance Requirement							Supplemental Information	
Spurious Responses								No input signal, 0 dB RF Attenuation and fundamental mixing Bands 1—3. Terminate the input in 50 Ω  From any two on-screen signals within any frequency span. In MIN DISTORTION mode.  Measured at -40 dBm input level in MIN DISTORTION mode, and without reduced gain mode.  With 0 dB RF Attenuation.	
Residual	-100 dBm or less								
3rd Order Intermodulation Products									
10 kHz to 21 GHz (Bands 1—5)	-70 dBc or less								
Harmonic Distortion									
10 kHz to 21 GHz (Bands 1—5)	-60 dBc or less								
LO Emissions	Less than -10 dBm to 21 GHz								

<sup>a</sup> Option 07 replaces the 100 kHz filter with a 300 kHz filter.

<sup>b</sup> Specified using external TEKTRONIX High Performance Waveguide Mixers.

**Table 2-3  
INPUT SIGNAL CHARACTERISTICS**

Characteristic	Performance Requirement	Supplemental Information
RF INPUT		Type N female connector, specified to 21 GHz.  (See Option 07 for supplemental specifications concerning an additional 75 $\Omega$ input.)
Impedance		50 $\Omega$
VSWR With RF Attenuation $\geq 10$ dB		
10 kHz—2.5 GHz		1.3:1 (typically 1.2:1)
2.5—6 GHz		1.7:1 (typically 1.5:1)
6—18 GHz		2.3:1 (typically 1.9:1)
18—21 GHz		3.5:1 (typically 2.7:1)
VSWR With 0 dB RF Attenuation		Option 01 instruments measured within 3 MHz of the center of the preselector on Bands 2, 3, 4, and 5.
10 kHz—6 GHz		Typically 1.9:1
6—18 GHz		Typically 2.3:1
18—21 GHz		Typically 3.0:1
Maximum Safe Input		
With 0 dB RF Attenuation		+13 dBm (Input mixer limited)
With $\geq 20$ dBm Attenuation		+30 dBm (1W) continuous or 75 W peak pulse width of 1 $\mu$ s or less with a maximum duty factor of 0.001 (attenuator limit) <b>DO NOT APPLY DC VOLTAGE TO THE RF INPUT.</b>
1 dB Compression Point (Minimum) for Bands 1—5 (10 kHz—21 GHz)		With no RF attenuation. Measured at the 10 MHz IF output.
In Min Distortion mode	-23 dBm	
In Min Noise mode	-13 dBm	



Table 2-3 (Continued)  
INPUT SIGNAL CHARACTERISTICS

Characteristic	Performance Requirement	Supplemental Information
EXT REF IN		
Frequency	1 MHz, 2 MHz, 5 MHz, or 10 MHz ±5 PPM	
Power	-15 dBm to +15 dBm	
Waveshape		Sinewave, ECL or TTL, with a duty cycle of 40%—60%
Impedance		50Ω ac and 500Ω dc
HORIZ TRIG		
Sweep Input Voltage Range		0 to +10V (dc + peak ac) for full screen deflection
Trigger Input Voltage Range		
Minimum	At least 1.0 V peak from 15 Hz to 500 kHz	Typically 1.0 MHz at 1.5 V peak.
Maximum dc + peak ac		50V
ac		30Vrms to 10 kHz, then derate linearly to 3.5Vrms at 100 kHz and above.
Pulse Width		0.1 μs minimum
MARKER VIDEO		
MARKER Input Level		0 to -10V  Interfaces with TEKTRONIX 1405 Sideband Adapter.
VIDEO Input Level		0 to + 4 V for full screen display with pin 1 of the ACCESSORIES connector low

Table 2-3 (Continued)  
INPUT SIGNAL CHARACTERISTICS

Characteristic	Performance Requirement	Supplemental Information
ACCESSORY Connector (J104)		25-pin connector (Not RS-232 compatible)  Provides bi-directional access to the instrument bus. Also provides external Video select. All lines are TTL compatible, except 2 and 3.  Maximum voltage on all lines is $\pm 15V$ .
Pin 1		External Video Select  Low selects External VIDEO Input. High (default) selects Video MARKER Input.
Pin 2		External Preselector Drive — Drive signal for an external preselector. Output voltage is proportional to center frequency.
Pin 3		External Preselector Return — Ground return for the External Preselector signal.
Pin 4		Internal Control.  High (default) selects internal control. Instrument bus lines are output at the ACCESSORIES connector.  Low selects External control. Instrument bus lines at the ACCESSORIES connector accept input from an external controller.
Pin 5		Chassis Ground
Pins 6-13 <sup>a</sup>		Instrument Bus Address lines 7- 0 <sup>a</sup>
Pin 14 <sup>a</sup>		Instrument Bus Data Valid signal <sup>a</sup>
Pin 15 <sup>a</sup>		Instrument Bus Service Request signal <sup>a</sup>
Pin 16 <sup>a</sup>		Instrument Bus Poll signal <sup>a</sup>
Pin 17		Data Bus Enable input signal.  High (unasserted) disables external data bus. Low enables external data bus.
Pins 18-25		Instrument Bus Data lines 0-7 Active when External Data Bus Enable (pin 17) is low.

<sup>a</sup> Output when internally controlled (pin 4 high) and input when externally controlled (pin 4 low).

**Table 2-4  
OUTPUT SIGNAL CHARACTERISTICS**

Characteristic	Performance Requirement	Supplemental Information
Calibrator (CAL OUT)	-20 dBm $\pm$ 0.3 dB at 100 MHz	100 MHz comb of markers provide amplitude calibration at 100 MHz. Phase-locked to an External Reference in EXT mode.
1st LO and 2nd LO OUTPUTs		Provide access to the output of the respective local oscillators. THESE PORTS MUST BE TERMINATED IN 50 $\Omega$ AT ALL TIMES.
1st LO OUTPUT Power		+7.5 dBm to +20 dBm
2nd LO OUTPUT Power		-12 dBm $\pm$ 5 dB.
EXTERNAL MIXER		When EXT MIXER is selected, provides bias from a 70 $\Omega$ source for an external mixer. Bias is set by the MANUAL PEAK control or internally set if AUTO PEAK is selected.  Replaced by 75 $\Omega$ RF Input for Option 07. See Options.
Bias Range		+1.0 V to -2.0 V (default) or, -1.0 V to +2.0 V (internally selectable)
VERT Output		Provides 0.5V $\pm$ 5% (open circuit) of signal per division of video that is above and below the centerline. Full range -2.0V to +2.0V. Source impedance is approximately 1k $\Omega$ .
HORIZ Output		Provides 0.5V/Div (open circuit) either side of center. Full range -2.5V to +2.5V. 250 mV Max ripple. Source impedance is approximately 1k $\Omega$ .
PEN LIFT		TTL compatible, nominal +5V to lift plotter pen.
10 MHz IF Output		Output level is approximately -5 dBm for a full screen signal at -30 dBm reference level. Nominal impedance is approximately 50 $\Omega$ .
IEEE STD 488 PORT		In accordance with IEEE 488-78 standard and Tektronix Codes and Formats standard (version 81.1).
P Version		Implemented as SH1, AH1, T5, L3, SR1, RL1, PP1, DC1, DT1, and C0.
Non-P Version (Plotter Output)		Implemented as SH1, AH0, T3, L0, SR0, RL0, PP0, DC0, DT0, and C0.

**Table 2-4 (Continued)**  
**OUTPUT SIGNAL CHARACTERISTICS**

Characteristic	Performance Requirement	Supplemental Information
PROBE POWER		Provides operating voltages for active probes.
Outputs		
Pin 1		+5V at 100 mA maximum
Pin 2		Ground
Pin 3		-15V at 100 mA maximum
Pin 4		+15V at 100 mA maximum
ACCESSORIES (J104)		All inputs and outputs are listed in Input Signal Characteristics.

**Table 2-5  
DISPLAY CHARACTERISTICS**

Characteristic	Performance Requirement	Supplemental Information
Sweep		Triggered, auto, manual, external, and single sweep.
Sweep Time	20 $\mu$ s/Div to 5 s/Div in 1-2-5 sequence (10 s/Div available in AUTO)	
Accuracy	$\pm$ 5% over center 8 divisions	
MKR/Time Accuracy (in Zero Span mode)		
Single Marker		$\pm$ 10%
$\Delta$ Marker		$\pm$ 5%
Triggering		INTERNAL, EXTERNAL, FREE RUN, and LINE.
Internal Trigger Level	2 divisions or more of signal	
EXTERNAL Trigger Input Level	1.0V peak, minimum	EXTERNAL is ac-coupled (15 Hz—500 kHz). Maximum external trigger input is 50V (dc + peak ac).

**Table 2-6  
GENERAL CHARACTERISTICS**

Characteristic	Performance Requirement	Supplemental Information		
Video Bandwidth		Resolution Bandwidth	WIDE	NARROW
		3 MHz	30 kHz	3 kHz
		1 MHz	30 kHz	3 kHz
		100 kHz	3 kHz	300 Hz
		10 kHz	300 Hz	30 Hz
		1 kHz	30 Hz	3 Hz
		100 Hz	3 Hz	0.3 Hz
Pulse Stretcher Fall-Time		30 $\mu$ s/div of pulse amplitude.		
Crt Readout		Displays all parameters listed on the crt bezel, plus operating messages.		

**Table 2-6 (Continued)**  
**GENERAL CHARACTERISTICS**

Characteristic	Performance Requirement	Supplemental Information
Battery-Powered Memory		Instrument settings, macros ("P" instrument only), displays, calibration offsets, and preselector peaking codes (Opt.01 only) for each band are stored in battery powered non-volatile RAM.
Battery Life		
At +55°C Ambient Temperature		1—2 years
At +25°C Ambient Temperature		
Lithium (Standard)		At least 5 years
Silver (Option 39)		2 years
Temperature Range for Retaining Data		
Operating		-15°C to +55°C
Non-Operating		-30°C to +85°C

**Table 2-7**  
**POWER REQUIREMENTS**

Characteristics	Performance Requirement	Supplemental Information
Line Frequency Range		47—440 Hz
Line Voltage Range	90 V <sub>ac</sub> to 132 V <sub>ac</sub>	115 V nominal
	180 V <sub>ac</sub> to 250 V <sub>ac</sub>	230 V nominal
Line Fuse		
115V Nominal		4A
230V Nominal		2A Medium-Blow
Input Power	210 W maximum (3.2A)	At 115V and 60 Hz
Leakage Current		
47-63 Hz		3.5 mA maximum with the EMI filter at 250 V.
else		5 mA maximum

**Table 2-8  
ENVIRONMENTAL CHARACTERISTICS**

**Meets MIL T-28800C, type III class 3, style C specifications.**

Characteristic	Description																
Temperature																	
Operating	-15°C to +55°C																
Non-operating <sup>a</sup>	-62°C to +85°C																
Humidity																	
Operating	95% (±5%) relative humidity.																
Non-operating	Five cycles (120 hours) in accordance with MIL-Std-810D, Procedure III (modified)																
Altitude																	
Operating	15,000 feet, tested to 25,000 feet																
Non-operating	40,000 feet, tested to 50,000 feet																
Vibration, Operating (instrument secured to a vibration platform during test)	MIL-Std-810D, METHOD 514 Procedure I (modified). Resonant searches in all three axes from 5 Hz to 15 Hz at 0.060" displacement for 7 minutes, 15 Hz to 25 Hz at 0.040" displacement for 3 minutes, and 25 Hz to 55 Hz at 0.020" displacement for 5 minutes (tested to 0.025"). Dwell for an additional 10 minutes in each axis at the frequency of the major resonance or at 55 Hz if none was found. Resonance is defined as twice the input displacement. Total vibration time is 75 minutes.																
Shock (Operating and Non-operating)	Three guillotine-type shocks of 30g, one-half sine, 11 ms duration each direction along each major axis; total of 18 shocks. Tested to 50 G.																
Transit drop (free fall)	8 inch, one per each of six faces and eight corners (instrument is tested and meets drop height of 12 inches).																
Electromagnetic Interference (EMI)	Meets requirements described in MIL-Std-461B Part 4, except as noted.																
	<table border="1"> <thead> <tr> <th align="center">Test Method</th> <th align="center">Remarks</th> </tr> </thead> <tbody> <tr> <td>Conducted Emissions</td> <td></td> </tr> <tr> <td>    CE01-60 Hz to 15 kHz</td> <td>1 kHz to 15 kHz only</td> </tr> <tr> <td>    CE03-15 kHz to 50 MHz power leads</td> <td>15 kHz to 50 kHz, relaxed by 15 dB</td> </tr> <tr> <td>Conducted Susceptibility</td> <td></td> </tr> <tr> <td>    CS01-30 Hz to 50 kHz power leads</td> <td>Full limits</td> </tr> <tr> <td>    CS02-50 kHz to 400 MHz power leads</td> <td>Full limits</td> </tr> <tr> <td>    CS06-spike power leads</td> <td>Full limits</td> </tr> </tbody> </table>	Test Method	Remarks	Conducted Emissions		CE01-60 Hz to 15 kHz	1 kHz to 15 kHz only	CE03-15 kHz to 50 MHz power leads	15 kHz to 50 kHz, relaxed by 15 dB	Conducted Susceptibility		CS01-30 Hz to 50 kHz power leads	Full limits	CS02-50 kHz to 400 MHz power leads	Full limits	CS06-spike power leads	Full limits
Test Method	Remarks																
Conducted Emissions																	
CE01-60 Hz to 15 kHz	1 kHz to 15 kHz only																
CE03-15 kHz to 50 MHz power leads	15 kHz to 50 kHz, relaxed by 15 dB																
Conducted Susceptibility																	
CS01-30 Hz to 50 kHz power leads	Full limits																
CS02-50 kHz to 400 MHz power leads	Full limits																
CS06-spike power leads	Full limits																

<sup>a</sup> After storage at temperatures below -15°C, the instrument may not reset when power is first turned on. If this happens, allow the instrument to warm up for at least 15 minutes, then turn POWER OFF for 5 seconds and back ON.

**Table 2-8 (Continued)**  
**ENVIRONMENTAL CHARACTERISTICS**

Characteristic	Description	
Electromagnetic Interference (EMI) (Continued)	Test Method	Remarks
Radiated Emissions	RE01—30 Hz to 50 kHz magnetic field (measured at 30 cm).	Relaxed by 10 dB for fundamental to 10th harmonic of power line.  Exceptioned, 30 kHz to 36 kHz
	RE02—14 kHz to 10 GHz	Full limit
Radiated Susceptibility	RS01—30 Hz to 50 kHz	Full limit
	RS02—Magnetic Induction	To 5 A only, 60 Hz
	RS03—14 kHz to 10 GHz	Up to 1 GHz

**Table 2-9**  
**PHYSICAL CHARACTERISTICS**

Characteristic	Description
Weight	52 lbs. (24 kg) maximum for the standard instrument.  Including cover and standard accessories, except manuals.
Dimensions	
Without Front Cover, Handle, or Feet	6.9 X 12.87 X 19.65 inches (175 X 327 X 499 mm)
With Front Cover, Feet, and Handle Handle Folded Back Over the Instrument	9.15 X 15.05 X 23.1 inches (232 X 382 X 587 mm)
Handle Fully Extended	9.15 X 15.05 X 28.85 inches (232 X 382 X 732.8 mm)



## Section 4 - CONTROLS, CONNECTORS AND INDICATORS

Add the following descriptions after 9 <Blue-SHIFT> ▲BAND/BAND▼:

**COUNT** - (This pushbutton is located under the  $\Delta F$  pushbutton). When this pushbutton is pressed, the signal at the center or marker position is counted with up to 1 Hz resolution at any frequency span/division. The actual resolution is selected with <blue-SHIFT> COUNT RESOLN. The signal must be 20 dB or more above the noise level and within 60 dB of the reference level.

**<Blue-SHIFT> COUNT RESOLN** - (This pushbutton is located under the  $\Delta F$  pushbutton). This pushbutton sequence allows you to select the desired counter resolution with the DATA ENTRY pushbuttons. Terminate with one of the unit (GHz, MHz, kHz, or Hz) pushbuttons. The counter resolution will be truncated to the decade that is less than or equal to the selected resolution.

Replace the corresponding descriptions with those below:

**11 EXT MIXER** - (Not available on instruments with Option 07 installed). This pushbutton selects the External Mixer mode and disables the RF input. This is the bias source for external mixers, as well as the IF input to the analyzer. The External Mixer mode is indicated by EXT on the crt readout in place of RF ATTENUATION. Bias voltage is set by MANUAL PEAK when selected by the <Blue-SHIFT> PEAK MENU. See External Mixers in Section 6 for connecting external mixers and mixer operation.

**13 <Blue-SHIFT> SPAN/DIV** - This pushbutton sequence allows direct entry of FREQUENCY SPAN/DIV, with two significant digits of resolution. The span/div range that can be selected is 100 Hz/Div to 10 GHz/div. The maximum range available is a function of frequency range. If a value outside the allowable range is entered, the span/div will switch to the lowest non-zero or maximum span. Spans entered from the DATA ENTRY pushbuttons are terminated with one of the four unit pushbuttons (GHz, MHz, kHz, or Hz).

**16 RESOLUTION BANDWIDTH** - This control selects the bandwidth of the spectrum analyzer. Selected bandwidth is indicated on the crt readout. The bandwidth selections are 100 Hz, 1 kHz, 10 kHz, 100 kHz, 1 MHz, and 3 MHz. Time/div is automatically selected when the TIME/DIV control is in the AUTO position.

**24 <Blue-SHIFT> MKR→CENTER** - This pushbutton sequence centers the signal at the active marker by setting the center frequency equal to the marker frequency (this function is not available with a stored trace). When doing counted frequency, this moves the counted frequency to center).

**41 <Blue-SHIFT> REF LEVEL UNITS** - This pushbutton sequence calls up a menu that allows the selection of reference level units or offset as shown below.

- 0 - DBM
- 1 - DBV
- 2 - DBMV
- 3 - DBUV
- 4 - ENTER REFERENCE LEVEL OFFSET

**43 <Blue-SHIFT> REF LEVEL** - This pushbutton sequence allows direct entry of reference level, with 1 dB resolution. The range is +30 dBm to -117 dBm (+50 dBm if the Minimum Noise mode and Reduced Gain mode are selected). Values entered outside this range are ignored (values will be in the selected units; dBm, dBV, dBmV, or dB $\mu$ V). Either the +dBx or -dBx pushbutton terminates the reference level numbers entered.

**47 <Blue-SHIFT> LIN** (Self-Measurement Results; not identified on the front panel) - The factors used to internally correct for frequency and amplitude errors are displayed. The factors shown are as measured with the last <blue-SHIFT> CAL operation. If one of the factors could not be measured at the last operation, the old value will be noted. This means that the previously measured value is used. If < or > appears next to the amplitude calibration factor, it means that this filter's amplitude related to the 3 MHz filter is outside the range of correction (correction is set to the limit). Press <blue-SHIFT> to exit the calibration factor display.

**49 MIN NOISE** - Add: This is the usual operating mode.

**MIN DISTORTION** - In this mode, intermodulation distortion products are minimized.

**51 <Blue-SHIFT> PEAK MENU** - This pushbutton sequence calls up a menu that lists the available methods to adjust the preselector tracking or external mixer bias as shown below. In preselected bands, the peak code consists of numbers at 500 MHz intervals.

- 0 - KNOB Selects the MANUAL PEAK control
- 1 - STORED VALUE Selects a previously stored peaking value for the frequency
- 2 - INPUT Inputs a number from 0 to 1023 for electronic peaking
- 3 - REPEAK Executes an automatic peaking routine

**54 VIDEO FILTER WIDE** - This pushbutton reduces video bandwidth and high-frequency components for display noise averaging. The video bandwidth selected is approximately 1/30th of the selected resolution bandwidth. (1/10th for 3 MHz). Selecting WIDE cancels NARROW. The filter value is displayed in the lower readout.

**55 VIDEO FILTER NARROW** - This pushbutton reduces video bandwidth and high-frequency components for display noise averaging. The video bandwidth selected is approximately 1/300th of the selected resolution bandwidth. (1/100th for 3 MHz). Selecting NARROW cancels WIDE. The filter value is displayed in the lower readout.

**85 <Blue-SHIFT> 2 dB/DIV** - Options 12, 13, and 14 are no longer available.

*Add the following description after 87 RECALL SETTINGS:*

**PLOT** - (Non-programmable instruments only). This pushbutton causes display information to directly drive a plotter. The plotter type is selected by pressing the <blue-SHIFT> SAVE A pushbutton sequence. Refer to Plotting The Display in Section 6 for details. The plotters that can be driven are

- Tektronix 4662 Option 01
- Tektronix 4662 Option 31
- Tektronix 4663 (emulating the 4662)
- Hewlett-Packard HP7470A
- Hewlett-Packard HP7475A
- Hewlett-Packard HP7580B
- Hewlett-Packard HP7585B
- Hewlett-Packard HP7586B
- Gould 6310
- Gould 6320

*Replace the corresponding description with the one below:*

**88 <Blue-SHIFT> PLOT** - (Programmable instruments only). This pushbutton sequence causes display information to be sent over the GPIB to directly drive a plotter. The plotters that can be driven are the same as those listed previously for the non-programmable instrument. Select the plotter type by pressing the <blue-SHIFT>SAVE A pushbutton sequence. Refer to Plotting The Display in Section 6 for details. This pushbutton also causes the spectrum analyzer to update the GPIB address.

*Add the following descriptions after 90 <Blue-SHIFT> SAVE A:*

**<Blue-SHIFT> MACRO MENU** - (Programmable instruments only). (This pushbutton is located under the BASELINE CLIP pushbutton). This pushbutton sequence has three functions depending on the status of macros. The title of the macro is displayed next to the macro number. The functions are

- select a macro to be executed
- abort a macro
- return the readout to normal

**<Blue-SHIFT> RUN/STOP** - (Programmable instruments only). (This pushbutton is located under the MACRO MENU pushbutton). This pushbutton sequence has three functions, depending on the status of the macros.

- If a macro is running, press <blue-SHIFT> RUN/STOP to stop the macro.
- If a macro is stopped, press <blue-SHIFT> RUN/STOP to restart the macro.
- If no macro is running or stopped, press <blue-SHIFT> RUN/STOP to run the last macro that was executed.

**<Blue-SHIFT> VIDEO FILTER WIDE** - (Special Modes Menu; not identified on the front panel). This pushbutton sequence brings up a menu from which you can select the special modes (see below) available within the instrument. (Refer to Section 6 for additional information).

- 0 - TRACKING GENERATOR MODE
- 1 - SIDEBAND ANALYZER MODE
- 2 - REDUCED GAIN MODE
- 3 - EOS CORRECTIONS MODE
- 4 - ZERO-SPAN TIME MODE

*Replace the corresponding description with the one below:*

**97 RESET TO LOCAL/REMOTE** - (Programmable instruments only). This pushbutton is lit when the spectrum analyzer is in the remote state. While the instrument is remote, the other front-panel controls are not active except for PEAK/AVERAGE, INTENSITY, MANUAL SCAN, and MANUAL PEAK, if enabled. Indicators still reflect the current state of front-panel functions. This pushbutton is not lit when the spectrum analyzer is in the local state. If RESET TO LOCAL is pushed while a macro is executing or stopped, the current settings of TIME/DIV, MIN RF ATTEN dB, and PEAK/AVERAGE are held; otherwise, the controls revert back to their front-panel settings. While the spectrum analyzer is under local control, no GPIB messages are executed that would conflict with front-panel controls or change the waveforms in digital storage. See Programming Features in Section 6 for additional information.

Add the following description after **107 10 MHz IF (OUTPUT)**:

**EXT REF IN** - A 50  $\Omega$  input for a 1, 2, 5, or 10 MHz external reference signal, within -15 dBm to +15 dBm level. Phase noise should be no greater than -110 dBc in a 1 Hz bandwidth at 10 Hz offset, referenced to 10 MHz. Input signal must be a sinewave with a duty cycle symmetry of 40% to 60%, or ECL or TTL.

Replace the corresponding description with the one below:

**109 IEEE STD 488 PORT (GPIB)** - This connector interfaces the standard instrument to the selected plotter, and interfaces the programmable instrument to the GPIB. The interface functions provided in the spectrum analyzer are listed in the following table.

**INTERFACE FUNCTIONS**

Function	Instrument	
	Standard	Programmable
Source Handshake	SH1	SH1
Acceptor Handshake	AH0	AH1
Talker	T3	T5
Listener	L0	L3
Service Request	SR0	SR1
Remote/Local	RL0	RL1
Parallel Poll	PP0	PP1
Device Clear	DC0	DC1
Device Trigger	DT0	DT1
Controller	C0	C0

## Section 5 - INSTRUMENT CHECKOUT

Replace the **Error Message Readout** information with the following:

If the instrument detects an internal hardware failure, a failure report comes on screen and remains for approximately 2 seconds. A status message then appears and remains for as long as the failure exists. Press HELP to bring error messages to the screen that explain the impact of the failure on instrument operation.

There are error messages to report a calibration failure, power supply failure, and battery-operated RAM checksum error. Promptly report any error messages to qualified service personnel.

Replace the instrument initialization with the one below

### 1. Initial turn-on

The spectrum analyzer operating functions and modes will initialize to the following power-up states.

REF LEVEL	0 dBm
Center FREQUENCY	0.90 GHZ
Dot Marker FREQUENCY	0.00 GHZ
SPAN/DIV	MAXimum
VERTICAL DISPLAY	10 dB/DIV
RF ATTENUATION	Value of MIN RF ATTEN dB
FREQ RANGE	0.0 to 4.2 GHz
RESOLUTION BANDWIDTH	3 MHz (in AUTO TIME/DIV)
<Blue-SHIFT> READOUT	On
TRIGGERING	FREE RUN
AUTO RESOLutioN	On
DIGITAL STORAGE	VIEW A/VIEW B On
MIN NOISE/MIN DISTORTION	MIN NOISE
All other pushbuttons	Inactive or Off

b. Set the MIN RF ATTEN dB control to 0 (NORM) and the PEAK/AVERAGE control fully counterclockwise. Set the TIME/DIV control to AUTO and the REF LEVEL to read -20 dB m, and adjust the INTENSITY control for the desired brightness. Note that the RF ATTENUATION readout is now 0 dB.

### 2. Calibrate Position, Center Frequency, Reference Level, and Bandwidth

Replace the second and third paragraphs in this procedure with those below.

To see the results after the spectrum analyzer has completed this routine, press the <blue-SHIFT> LIN sequence. A message will appear on the screen that shows the correction factors used by the spectrum analyzer to center the resolution bandwidth filters to produce a calibrated center frequency. It also shows the correction that was required to bring the amplitude level within 0.4 dB of the 3 MHz filter.

Press the <blue-SHIFT> CAL sequence to start the routine. Prompt messages on the screen will guide you through setting the four front-panel adjustments of vertical and horizontal POSITION, and AMPL and LOG CAL. This sets the absolute reference level for the 3 MHz resolution bandwidth filter. An automatic procedure is then done, which measures and corrects for absolute frequency and amplitude (relative to 3 MHz) errors of the filters. This takes approximately 60 seconds. If a message appears on the screen, refer to Error Message Readout earlier in this section. The correction factors are held in memory. Press FINE to continue calibration as instructed or press either SHIFT pushbutton to exit the routine.

## FUNCTIONAL OR OPERATIONAL CHECK

### 1. Check the operation of front-panel pushbuttons and controls.

*Replace the corresponding paragraphs with those below.*

**VIDEO FILTER** - Two filters can be independently selected to provide WIDE or NARROW filtering to reduce noise.

**RESOLUTION BANDWIDTH** - As this control is rotated from a full counterclockwise position with Auto Resolution disabled, the resolution bandwidth changes in decade steps from 100 Hz to 1 MHz, then to 3 MHz.

#### REFERENCE LEVEL -

- (e) Return the REF LEVEL readout to -20 dBm, and 0 dB of RF ATTENUATION is switched in.

*Replace the check of the MIN NOISE/MIN DISTORTION pushbuttons with the following:*

**MIN NOISE/MIN DISTORTION** - This pushbutton selects one of two methods that select RF attenuator and IF gain. MIN NOISE (button illuminated) reduces the noise level by reducing attenuation 10 dB and decreasing IF gain 10 dB. MIN DISTORTION reduces IM distortion due to input mixer overload.

- a. Set the FREQUENCY readout to 100 MHz, FREQ SPAN/DIV to 500 kHz, REF LEVEL readout to -20 dBm and MIN RF ATTEN dB to 0 dB. The RF ATTENUATION readout will indicate 0 dB.

- b. Activate MIN DISTORTION. The noise floor will rise approximately 10dB, and the RF ATTENUATION readout will change to 10 dB.

- c. Deactivate MIN DISTORTION.

*Add the following description after EXT MIXER//PEAK MENU:*

**<blue-SHIFT> MACRO MENU** - (Programmable instruments only) This pushbutton sequence is used to select a macro to be run. The title of the macro is displayed next to the macro number (0-7). Perform the following steps to check the operation of the MACRO MENU pushbutton.

- (a) With the instrument under remote control, enter the following 4041 test program to enter a macro into menu location 5.

**CAUTION**

THIS PROGRAM WILL DELETE ANY PROGRAM STORED IN MACRO LOCATION 5.

```
80 Z=1! ADDRESS OF SPECTRUM ANALYZER
100 Print #z: KILL 5
110 Print #z:STMAC 5,"return test"
120 Print #z:FREQ 100M; GOSUB 1
130 Print #z:FREQ 200M; GOSUB 1
140 Print #z:FREQ 300M; GOSUB 1
150 Print #z:DONE
160 Print #z:LABEL 1;SWEEP;MFBIG;MCSTOP;RETURN
170 Print #z:EMAC
```

Line 80 defines z as the spectrum analyzer address. Line 100 clears out location 5, in case there was already a macro there. Line 110 gets the spectrum analyzer ready to store macro in location 5 with the title of "return test". Line 120 sets the center frequency to 100 MHz, then goes to line 160 to start a new sweep, move the primary marker to the peak of the largest on-screen signal, stop the macro to wait for you to press RUN/STOP on the instrument front panel to continue, and return to the next line. Lines 130 and 140 perform like line 120, only for 200 MHz and 300 MHz, respectively. Line 170 tells the spectrum analyzer that this is the end of the macro and to quit storing.

(b) Press RESET TO LOCAL to exit remote control and return the instrument to local control.

(c) Press <blue-SHIFT> MACRO MENU. The current macro menu will appear on the screen with the titles of all stored macros and the menu locations where they are stored.

(d) To select the test program just entered into location 5, press DATA ENTRY pushbutton 5. The macro will begin running.

(e) When the macro has moved the primary marker to the peak of the 100 MHz signal, the macro will wait (MCSTOP) for you to push RUN/STOP to run another sweep at 200 MHz.

(f) When the macro has moved the primary marker to the peak of the 200 MHz signal, the macro will wait (MCSTOP) for you to push RUN/STOP to run another sweep at 300 MHz.

(g) If you press RESET TO LOCAL at any time, the message MACRO=STOP (5), or MACRO=RUN, will appear on the right-center of the screen. This means that the macro in menu location 5 is now running, or stopped. This will have no effect on the performance of the macro.

(h) When the macro has moved the primary marker to the peak of the 300 MHz signal, the macro will know that it is done.

(i) If you press RESET TO LOCAL now, the message MACRO=OFF (5) will appear on the screen. This means that the last macro you were running was from menu location 5, and it is now off.

**<blue-SHIFT> RUN/STOP** - (Programmable instruments only) This pushbutton has three different functions, depending on the current status of the macros.

(a) If a macro is running, pressing RUN/STOP will stop the macro.

(b) If a macro is stopped (because RUN/STOP was pressed or because the MCSTOP command as in the MACRO MENU example), pressing RUN/STOP restarts the macro.

(c) If there is no macro running or stopped, pressing RUN/STOP will cause the last macro that was run to be run again.

*Change the NOTE in the RECALL checkout to read:*

If an attempt is made to recall a display from an empty location, error message RECALL ERROR - NO DATA AT SELECTION will be displayed.

## 2. Check Gain Variation between Resolution Bandwidths.

(less than 0.4 dB with respect to the 3 MHz filter and less than 0.8 dB between any two filters)

*Use the procedure below.*

- a. Calibrate the Center/Marker Frequency, Reference Level, and Bandwidth as described earlier in this section.
- b. Set the FREQUENCY readout to 100 MHz by pressing <blue-SHIFT> FREQ 1 0 0 MHz with the DATA ENTRY pushbuttons. Set the FREQUENCY SPAN/DIV control to 1 MHz, the RESOLUTION BANDWIDTH to 3 MHz, the REFERENCE LEVEL control to -20 dBm, TIME/DIV to AUTO, and deactivate AUTO RESOLUTION.
- c. Apply 100 MHz markers from the CAL OUT connector to the RF INPUT. Set the Vertical Display factor to 1 dB/DIV by pressing <blue-SHIFT> dB/DIV 1 dB.
- d. Verify that the amplitude of the 100 MHz signal is at the top graticule line. If not, repeat the front-panel calibration procedure by pressing <blue-SHIFT> CAL.
- e. Change the REF LEVEL readout to -19 dBm, and activate SAVE A. This is the reference for checking the other filters.
- f. Change the RESOLUTION BANDWIDTH control to 100 kHz.
- g. Check the amplitude of the 100 MHz signal. It should be within 0.4 dB of the 3 MHz reference established in part e.
- h. Set the RESOLUTION BANDWIDTH control to each of the remaining positions and the FREQ SPAN/DIV readout for a readable display. The amplitude accuracy and frequency can now be checked with respect to the 3 MHz reference and between any two filters. Reference level error should not exceed 0.4 dB from the reference and 0.8 dB between any filters.
- i. Turn SAVE A off.

*Add the following procedure*

### Check Counter Accuracy

{within (5+N) Hz + 1 LSD}

Press COUNT to activate a count for any signal at the center or marker, or below the dot marker. The signal to be counted must be 20 dB above the noise floor and within 60 dB of the reference level. The resolution of the counter is selected when in the Count Resolution mode.

- a. With the calibrator signal applied to the RF INPUT, set the crt readout for FREQUENCY to 100MHz, FREQ SPAN/DIV to 500 kHz, and REF LEVEL to 0 dBm, and set TIME/DIV to AUTO.
- b. To select 1 Hz counter resolution, press <blue-SHIFT> COUNT RESOLN, and enter 1 Hz with the DATA ENTRY pushbuttons.
- c. Press COUNT. The counter error over several counts should not exceed  $\pm 7$  Hz (100.000 007 to 99.999 993).
- d. Change the FREQ SPAN/DIV to 200 kHz and repeat part c.
- e. Select a counter resolution of 1 kHz and repeat the count accuracy check as described above. Counter error should not exceed  $\pm 1$  kHz.
- f. Press VIDEO FILTER NARROW and set CENTER FREQUENCY to one of the calibrator markers at 1.6 to 1.8 GHz. Signal amplitude must equal or exceed 20 dB above the noise floor.
- g. Repeat the count accuracy check as described above.



**5. Check Resolution Bandwidth and Shape Factor**

(within 20% of the selected bandwidth. Shape factor is 7.5:1 or less)

*Use the procedure below .*

- a. Apply the CAL OUT signal to the RF INPUT. Set the spectrum analyzer controls as follows:

CENTER FREQUENCY	100 MHz
SPAN/DIV	1 MHz
RESOLUTION BANDWIDTH	3 MHz
REF LEVEL	-20 dBm
VERTICAL DISPLAY	2 dB/DIV
MIN NOISE	Activated
PEAK/AVERAGE	Fully clockwise (Average)
TIME/DIV	AUTO
TRIGGERING	FREE RUN
AUTO RESOLN	Off

- b. Measure the 6 dB down bandwidth (see Figure 5-5A). Bandwidth should equal 3 MHz,  $\pm$  600 kHz.

- c. Change VERTICAL DISPLAY to 10 dB/DIV, and measure the 60 dB down bandwidth (see Figure 5-5B).

d. Check that the shape factor is 7.5:1 or less. The shape factor is the ratio of -60 dB/-6 dB bandwidths (see Figure 5-5).

- e. Reset the RESOLUTION BANDWIDTH to 1 MHz, SPAN/DIV to 500 kHz, and VERTICAL DISPLAY to 2 dB/DIV.

- f. Check the resolution bandwidth and shape factor of the 1 MHz filter by repeating parts b through d.

g. Check the resolution bandwidths and shape factors for the 100 kHz (300 kHz for Option 07), 10 kHz, 1kHz and 100 Hz filters. Shape factor should be 7.5:1 or less.

**6. Check Sensitivity (refer to Table 5-1)**

*Use the procedure below.*

a. Connect the CAL OUT signal to the RF INPUT, and perform the <blue-SHIFT> CAL routine. Remove the CAL OUT signal from the RF INPUT, and terminate the RF INPUT in its characteristic impedance. Set the spectrum analyzer controls as follows:

SPAN/DIV	MAX
RESOLUTION BANDWIDTH	3 MHz
VERTICAL DISPLAY	2 dB/DIV
NARROW VIDEO FILTER	On
REF LEVEL	Noise floor to mid-screen
MIN RF ATTEN dB	0
DIGITAL STORAGE	View A & B On
MAX HOLD	Off
PEAK/AVERAGE	Fully Clockwise ( Average)
AUTO RESOLN	Off
TIME/DIV	1 s
MARKER	On

b. Save the instrument settings by selecting <blue-SHIFT> STORE and enter the number 2 into memory ( select another number if 2 is being used).

c. Tune the marker to the highest point on the noise floor. Activate ZERO SPAN and adjust REFERENCE LEVEL so the noise floor is mid-screen.

**NOTE**

Very high noise spikes should not be considered as part of the noise floor.

d. Set TRIGGERING to SINGLE SWEEP and sweep once. Set marker to highest noise value and enable  $\Delta$ MARKER and set second marker to lowest noise value. Take the  $\Delta$ MARKER value and divide it by 2. Note the value. Push 1←MKR→2 button so highest marker is primary marker. Disable  $\Delta$ MARKER and take Marker Ref Level value and subtract the absolute value calculated and check this value to Table 5-1. Value should be less than or equal to the value in the table.

e. Reset the RESOLUTION BANDWIDTH to 1 MHz. Set TRIGGERING to FREERUN and adjust REF LEVEL so noise floor is mid-screen. Repeat step d.

f. Reset the RESOLUTION BANDWIDTH to 100 kHz (300 kHz in OPTION 07). Set TRIGGERING to FREERUN and adjust REF LEVEL so noise floor is mid-screen. Repeat step d.

g. Reset the RESOLUTION BANDWIDTH to 10 kHz. Set TRIGGERING to FREERUN and adjust REF LEVEL so noise floor is mid-screen. Repeat step d.

h. Reset the RESOLUTION BANDWIDTH to 1 kHz. Set TRIGGERING to FREERUN and adjust REF LEVEL so noise floor is mid-screen . Repeat step d.

i. Reset the RESOLUTION BANDWIDTH to 100 Hz and VERTICAL DISPLAY to 5 dB/DIV. Set TRIGGERING to FREERUN and adjust REF LEVEL so noise floor is mid-screen. Repeat step d.

**Table 5-1  
Sensitivity**

Equivalent Input Noise (dBm) versus Resolution Bandwidth							
Band	Frequency	100 Hz	1 kHz	10 kHz	100 kHz	1 MHz	3 MHz
Band 1	10 kHz-4.2 GHz	-125	-115	-105	-95	-85	-80
Bands 2 & 3	1.7-7.1 GHz	-119	-109	-99	-89	-79	-74
Band 4	5.4-12 GHz	-105	-95	-85	-75	-65	-60
Band 4	12-18 GHz	-100	-90	-80	-70	-60	-55
Band 5	15-21 GHz	-100	-90	-80	-70	-60	-55
Band 6	18-27 GHz	-108	-100	-90	-80	-70	-65
Band 7	26-40 GHz	-103	-95	-85	-75	-65	-60
Band 8	33-60 GHz	-103	-95	-85	-75	-65	-60
Band 9	50-90 GHz	Typically -95 dBm for 1 kHz resolution bandwidth at 50 GHz, degrading to -85 dBm at 90 GHz.					
Band 10	75-140 GHz	Typically -90 dBm for 1 kHz resolution bandwidth at 75 GHz, degrading to -75 dBm at 140 GHz					
Band 11	110-220 GHz	Typically -80 dBm for 1 kHz resolution bandwidth at 110 GHz, degrading to -65 dBm at 220 GHz					
Band 12	170-325 GHz	Typically -70 dBm for 1 kHz resolution bandwidth at 170 GHz, degrading to -55 dBm at 325 GHz.					

## Section 6 - OPERATION

*Add the following at the end of the Connecting to a 75Ω source under **RF INPUT Connector***

**Input Networks and Reference Level Offset** - If the measurement system includes any matching pads, attenuators, amplifiers, or other input networks, use the reference level offset feature of the spectrum analyzer to compensate for the network. If the gain or loss through the network is entered as an offset, the reference and marker levels will apply to the input of the network rather than to the input of the instrument. Enter attenuation as a positive offset, and enter gain as a negative offset. Some networks have a different offset in the linear (voltage) mode than in the log (power) mode. For example, the matching pad shown in Figure 6-1 has a power attenuation of 5.72 dB, but a voltage attenuation of 7.48 dB. (Strictly speaking, the voltage loss in dB is meaningless between points with different impedance. However, 7.48 dB (7.5 dB) is the offset value needed in the linear mode for the reference and marker levels to be those at the input to the pad.)

For more information, see Reference Level Offset later in this section.

*Change the sentence under Figure 6-5 to read:*

The WIDE filter reduces the bandwidth to approximately 1/30th the selected resolution bandwidth (1/10th in 3 MHz); the NARROW filter to approximately 1/300th (1/100th in 3 MHz).

*Change the last sentence in **Using Time Domain Operation** to read:*

Resolution bandwidth is usually maximum (3 MHz) for time domain analysis of the signal.

*Add the following after the description for **Reference Level, RF Attenuation, and Vertical Display***

### **Reference Level Offset**

Reference level offset will affect the readout of reference and marker levels. To set an offset to the reference level, press <blue-SHIFT> REF LEVEL UNITS, and choose selection 4 from the menu. An asterisk (\*) on the screen in front of the reference and marker levels indicates that a non-zero offset is in use. (If there currently is no reference level offset, but the marker is on a saved or stored trace taken with an offset, there will be an \* in front of the marker readout only.) If there is an uncalibrated condition while using a reference level offset, the uncal symbol (>) will not be displayed. However, UNCAL on the front-panel will still light whenever the instrument settings are uncalibrated.

Any offset alters the readouts without affecting instrument settings. For example, if the reference level is -30 dBm without offset and an offset of 30 dB is entered, the reference level will become 0 dBm; but, the RF attenuation, IF gain, an on-screen signal levels will not change.

Reference level and threshold entry must include the offset. For instance, to increase the reference level by 10 dB in the case just described, the value entered should be 10 dBm, not -20 dBm. Whenever the offset is non-zero, it is indicated in both the reference level menu (<blue-SHIFT> REF LEVEL UNITS) and threshold entry menu (MARKER MENU).

Use the following description for **MIN NOISE/MIN DISTORTION**

### Using **MIN NOISE**, **MIN DISTORTION**, or the **Reduced Gain Mode**

One of three methods can be selected to control RF attenuator and IF gain settings. **MIN NOISE** minimizes noise level by decreasing input attenuation and IF gain by 10 dB. **MIN DISTORTION** minimizes input mixer overload by increasing input attenuation and IF gain 10 dB.

The **Reduced Gain mode** uses the identify offset to reduce the effective gain of the spectrum analyzer, which lowers the displayed noise level. Because the identify offset is 1 division, and because the RF attenuator is controllable only in 10 dB steps, the **Reduced Gain mode** will have an effect only when the instrument is set for 10 dB/div. Even though the **Reduced Gain mode** can be selected when the instrument is set to other than 10 dB/div, the following discussion applies only when the instrument is in 10 dB/div.

The **Reduced Gain mode** reduces the IF gain and RF attenuation by 10 dB for any reference level for which the RF attenuation (in the non-reduced gain mode) is at least 10 dB greater than the **MIN RF ATTEN dB** control setting.

With **MIN NOISE** on and **MIN RF ATTEN dB** set to 60 dB, the **REF LEVEL** can be set to +40 dBm. Do not increase input signal level to full screen with a **REF LEVEL** of +40 dBm because this will exceed the attenuator rating.

In the **Reduced Gain mode**, the reference level may be set to +40 dBm (with **MIN DISTORTION** on) or +50 dBm (with **MIN NOISE** on). However, the maximum input level of the spectrum analyzer is still +30 dBm. NEVER apply more than +30 dBm to the input of the spectrum analyzer at any time, regardless of the indicated reference level.

Select the **Reduced Gain mode** from the **Special Modes Menu** (<blue-SHIFT> **VIDEO FILTER WIDE**). Item 2 in the menu toggles the **Reduced Gain mode** from off to on or vice versa each time it is selected. The **Reduced Gain mode** is indicated by an R on the right-hand-side of the second top readout line. (If an error message is using all or part of this readout line, the R will not be displayed.)

The **Reduced Gain mode** can be used with either **MIN DISTORTION** or **MIN NOISE** on. With **MIN DISTORTION** on, the **Reduced Gain mode** will have the same effect as if **MIN NOISE** is on. With **MIN NOISE** on, the **Reduced Gain mode** will further increase the distortion. Also, on-screen compression may occur. Because of this, any digital storage data over the top of the visible screen (that is, data values of 225 to 250) is likely to be inaccurate.

Replace **Plotting the Display** (presently under **Programming Features**) with the following, and insert it after **Using the Store and Recall Features**

### **Plotting the Display**

Press **PLOT** (standard instrument) or <blue-SHIFT> **PLOT** (programmable instrument) to drive many external plotters such as the

- Tektronix 4662 Option 01
- Tektronix 4662 Option 31
- Tektronix 4663 (emulating the 4662)
- Hewlett-Packard HP7470A
- Hewlett-Packard HP7475A
- Hewlett-Packard HP7580B
- Hewlett-Packard HP7585B
- Hewlett-Packard HP7586B
- Gould 6310
- Gould 6320

To use the plot feature, connect the plotter to the spectrum analyzer with a IEEE STD 488 (GPIB) cable, and complete the following steps.

1. Set the corners of the plot for a 3:2 aspect ratio for the Tektronix plotters, or 6:5 for the Hewlett Packard and Gould plotters. The plotter must be in the Listen Only mode. On programmable instruments, the spectrum analyzer must be in either the TALK ONLY or TALK/LISTEN ONLY mode, and the appropriate switches on the rear-panel GPIB ADDRESS switch must be closed or in the 1 position.

2. Set the plotter interface switches as follows:

Tektronix 4662 Option 01 or 4662 Option 31 (rear panel)

A = 0, 1, 8, or 9

B = C or D

C = X (don't care)

D = X (don't care)

Tektronix 4663

Interface Select = 1 if Option 04 or 2 if Option 01

Initial Command/Response Format = 5

Interface Mode = Listen Only

Hewlett-Packard or Gould Plotters

Address = 31

3. Press <blue-SHIFT> SAVE A on the spectrum analyzer, and select the desired plotter type from the menu on the crt. The selection is stored in memory and does not need to be selected again unless the plotter type is changed.

4. Select the display and the information that you wish to plot. The Plot feature is similar to using a camera, in that a plot is made of everything that is turned on for the crt display. The information plotted depends on the setting of several front-panel pushbuttons and controls. If READOUT is on, the crt readout will be plotted with the display. If GRAT ILLUM is on, the bezel and graticule information will be included with the plot. If VIEW A, VIEW B, or B-SAVE A are on, these waveforms will be part of the plot. Therefore, if any of these functions are off, they will not be plotted. (Refer to Using PLOT with Macros in the Helps and Hints section of the Programmers manual for additional information when using an instrument under program control.)

The zero level for a B-SAVE A waveform is usually the graticule center line. (Switches within the instrument can set the level. Contact your service personnel for this change.) If you want to shift the zero level for the plotting function only, press <blue-SHIFT> B-SAVE A, and enter the desired level in display units (25 is the bottom graticule line, 25 units/div). This zero level is retained in memory. It is not related to the display zero level, since the processor has no way of determining the internally set zero level for the crt display and no way of changing it.

*Add the following descriptions after **Using the Automatic Testing Feature***

#### **Using Signal Count**

The signal count function provides a way to exactly determine the frequency of an input signal. The advantage of the spectrum analyzer over a counter is that the spectrum analyzer will selectively count a particular signal out of several that may be present at its input.

**Front-panel Control** - The two front-panel controls associated with signal count are COUNT and <blue-SHIFT> COUNT RESOLN.

Press COUNT to turn the signal count on (the pushbutton will light). Press COUNT again to turn signal count off.

The <blue-SHIFT> COUNT RESOLN multiple-pushbutton sequence brings up a menu that allows entry of the resolution to which the signal count will be displayed. The range is 1 Hz to 1 GHz. If a non-decade resolution value is entered, the display resolution will be the next decade that is more accurate than the entry. (For example, if 23 kHz is entered, the resolution will be to 10 KHz.)

From 1 Hz to 1 kHz, selecting a less-accurate resolution will speed the count. Above 1 kHz, the resolution affects the display only.

In either the Delta F or Delta Marker mode, the displayed number may be the difference of counted and uncounted frequencies or of frequencies counted to different resolutions. In such cases, the display resolution is the less-accurate of the two resolutions.

When signal count is on, a C count indicator will appear in the appropriate top (center frequency or marker frequency readout line in the TUNE indicator position. When a counted frequency is tuned, the corresponding non-counted frequency is displayed from the time the frequency is changed until it is again counted (at the end of the sweep or after a short interval if in single sweep). While the non-counted frequency is displayed, the C indicator disappears and the displayed resolution changes to the non-counted value for the span in use.

**Counted Locations** - The spectrum analyzer counts at different locations depending upon the status of the marker system. If there is a marker, or markers, on a non-saved trace, signal count will occur at the marker(s). Otherwise, signal count will occur at center screen. (In MAX span, counting will occur at the dot marker position, rather than at center screen.) A C in the TUNE indicator position in the center frequency readout line indicates that the center frequency is being counted ( Likewise, a C in the TUNE indicator position in the marker frequency readout line indicates that the marker frequency is being counted. The count location is independent of the TUNE CF/MKR status. An asterisk (\*) will appear in the TUNE indicator location if the non-counted frequency is being tuned.

The frequency counted is that of the signal peak, even when the signal is not exactly centered (when counting at center), or the marker is not at the signal peak (when counting at the marker). The requirement is that the signal level at the center or marker be 20 dB greater than the average noise level and be within 60 dB of the reference level (top of screen). However, there may be an error between the true electrical location of the center or marker and its apparent on-screen location. This error should be less than 0.1 division, but it can become significant at large span/division to resolution bandwidth ratios. At ratios of over 10, the marker or center point should be placed at the signal peak. At ratios of over 50, it may be hard to get a good count.

**Signal Counting and Stored Traces** - Signals cannot be counted on a trace saved with SAVE A or stored and recalled with STORE DISP/RECALL. However, if there was a counted frequency on the display when it was saved or stored, that frequency is remembered.

If the frequency is a counted center frequency, it, along with the C count indicator, is displayed whenever the readout for the saved or stored trace is displayed. Any markers are scaled from the nominal center frequency, however.

If frequency is a counted marker frequency, the marker position, counted frequency, and C count indicator are displayed when the markers are first assigned to a trace or moved back to a trace after being re-assigned. When the marker is moved, the C indicator disappears and the marker frequency is scaled from center frequency and span and is displayed to the appropriate span-based resolution. If both Primary and Secondary markers were stored on the trace, the appropriate marker is used for any marker placed on the trace. If only one marker was stored, it is used when either marker is placed on the trace.

**Signal Count Familiarization** - The following procedure illustrates most of the features of signal count and requires only the instrument calibrator to perform.

Connect CAL OUT to the RF INPUT connector. Set Center Frequency to 100.0 MHz, Span to 5 MHz/div, Resolution Bandwidth to 1 MHz (Auto Resolution off), Vertical Display to 10 dB/div, and Reference Level to -20 dBm. Be sure that the marker system is off (i.e., no markers or marker readout line will be displayed).

Activate COUNT. Press <blue-SHIFT> COUNT RESOLN and enter 1 Hz. At the end of the sweep the tuning indicator will change to C, and the readout will expand to display the counted frequency to 1 Hz resolution.

Tune the signal approximately two divisions away from center. While tuning, the C disappears and the readout contracts until the end of the sweep. The counted frequency will vary as the counter counts the noise at the center frequency. Turn on the marker system with <green-SHIFT> PEAK FIND. The marker will appear at the peak of the calibrator signal. The C will disappear from the center frequency readout and the readout will change to the non-counted value and resolution. At the end of the sweep the C will appear in front of the marker frequency readout, and that readout will expand to the counted resolution.

Press TUNE CF/MKR to change to the center frequency tuning mode. The \* in the center frequency readout line indicates the center frequency is being tuned, while the C in the marker readout line indicates the marker is still being counted. Return to the marker tuning mode by again pressing TUNE CF/MKR.

Turn off VIEW A and VIEW B. The long delay between sweeps is caused by the time needed to move the oscillators and to count. Press <blue-SHIFT> COUNT RESOLN and enter 10 Hz. The delay between sweeps is now less. Enter 100 Hz count resolution. The delay is even less. Return the count resolution to 1 Hz.

Turn on VIEW A and SAVE A. The counted frequency is now remembered and the C will remain on the marker readout line. Tune the marker. The marker frequency readout will change to indicate a non-counted frequency and will not show the counted frequency, even if the marker is placed in the same position as it had before it was tuned. Turn off SAVE A and turn on VIEW B.

Tune the marker over the signal. The displayed count does not vary by more than the specified count accuracy as long as the marker remains at least 20 dB above the displayed noise level. Change the span to 20 MHz/div and again tune the marker over the calibrator signal. Now, a displayed marker position meeting the amplitude standards may give an incorrect count. Since there are now fewer digital storage locations representing the signal, the horizontal error in the marker may result in an actual marker location below the counting threshold. Turn on MAX SPAN. Tune the marker to the peak of the 100 MHz signal. The count may be incorrect even with the marker at the peak. (If the signals were of unknown frequency, it could be much harder to detect an incorrect count.)

Turn off MAX SPAN. Set the Center Frequency to 350 MHz and leave the span at 20 MHz/div. Press <green-SHIFT> PEAK FIND, <green-SHIFT> 1←MKR→2, and <green-SHIFT> PEAK FIND to place a marker at the peak of each signal. The frequency of each signal is now counted and the difference is displayed.

Press <blue-SHIFT> MKR→CENTER and reduce the span to 5 MHz/div. The counted delta is still accurate because the off-screen counted frequency is remembered.

Position the marker approximately two divisions below the signal peak. Turn the delta markers off and back on (push <green-SHIFT> ΔMKR twice) to reset the delta to zero. Turn on SAVE A. Because the counted frequency is used on the saved trace, the delta readout should be 0 Hz, within the count accuracy. Tune the Primary marker over the signal peak. As before, the displayed frequency does not change by more than the count accuracy. Note that although the display resolution changes as the marker is tuned, the C remains because the counted Secondary marker is used to form the delta even during tuning. Press <green-SHIFT> 1←MKR→2. This places the Primary marker on the saved trace. Tune the marker. As soon as the marker is moved, the saved counted marker frequency is forgotten, the Primary marker frequency is scaled from center frequency and span, and the resolution of the delta frequency readout changes appropriately. Because the counted marker frequency represents the signal peak and the non-counted marker frequency represents the actual marker frequency, the delta will not be zero when the markers are positioned together.

### Using the Tracking Generator Mode

In order to obtain higher frequency accuracy when using the tracking generator, the Tracking Generator mode disables use of the frequency correction factors for all resolution bandwidth filters wider than 1 kHz. These wide filters may be centered too far from 10 MHz for the difference to be corrected with the Tracking Adjust control on the tracking generator.

All amplitude correction factors are used.

For maximum frequency and amplitude accuracy, always adjust the Tracking Adjust control to peak the response in the resolution bandwidth filter you are using. Remaining amplitude errors can be corrected by using the B-SAVE A mode of digital storage.

Use the <blue-SHIFT> VIDEO FILTER WIDE pushbutton sequence to enter the Special Modes Menu to select 0 = TRACKING GENERATOR MODE (select the mode again to turn it off). When this mode is on, a T appears on the right side of the second top readout line, except when an error message is being displayed.

### Using the Sideband Analyzer Mode

Since the Tektronix 1405 sideband analyzer only uses the first local oscillator of the spectrum analyzer, it is only useful when the first local oscillator is sweeping (not phase locked). The Sideband Analyzer Mode extends the usefulness of the 1405 by causing the spectrum analyzer to phase lock in 50 kHz/div instead of the normal 200 kHz/div in band 1. Refer to the manual you received with the 1405 for additional information.

Use the <blue-SHIFT> VIDEO FILTER WIDE pushbutton sequence to enter the Special Modes Menu to select 1 = SIDEBAND ANALYZER MODE (select the mode again to turn it off). When this mode is on, an S appears on the right side of the second top readout line, except when an error message is being displayed.

### Using the EOS Correction Mode

The instrument normally measures the drift rate of its oscillators and corrects them when needed to maintain specified accuracy. When the EOS Correction mode is on, the oscillators are corrected at the end of every sweep.

Use the <blue-SHIFT> VIDEO FILTER WIDE pushbutton sequence to enter the Special Modes Menu to select 3 = EOS CORRECTION MODE (select the mode again to turn it off). When this mode is on, an E appears on the right side of the second top readout line, except when an error message is being displayed.

### Using the Multiband Sweep Mode

It is possible to sweep a frequency range that covers more than one band as long as the entire frequency range is within 0 GHz –21 GHz (1.7 –21 GHz for Option 01 instruments) when using the internal mixer. For Option 01 instruments, the low-pass filter/preselector boundary may not be crossed, as this would lead to excessive wear of the preselector switch. The multiband function is also available if the external mixer is in use, where the range that can be swept is 10 kHz –21 GHz. In the waveguide bands, the sweep range is restricted to a single band, since each band normally requires a different mixer.

**Entering the Multiband Sweep Mode** - Enter the Multiband Sweep mode with the front-panel <blue-SHIFT> FREQ START STOP pushbutton or when a setting using multiband sweep is recalled (refer to Using the Multiband Sweep Mode in the Programmers Manual for an alternate method for instruments under program control). Multiband sweep is started automatically when FREQ START STOP is used to enter a sweep that covers more than one band within the allowed multiband range. Follow these steps (for exiting methods, refer to Exiting the Multiband Sweep Mode later in this sequence).



1. Press <blue-SHIFT> **FREQ START STOP**.
2. A menu will come on the screen. The current starting frequency is shown at the top of the screen. You are prompted to enter a new starting frequency. Enter the desired left-edge start frequency with the **DATA ENTRY** pushbuttons and end with a units terminator pushbutton.
3. When the units terminator pushbutton is pressed, another menu comes on the screen showing the current stopping frequency. Enter the desired right-edge stopping frequency with the **DATA ENTRY** pushbuttons and end with a units terminator pushbutton.

**Multiband Sweep Operation** - To sweep a range that covers more than one band, the spectrum analyzer first determines the bands involved and calculates the center frequency and span needed in each band to cover the desired range. Then, the microcomputer successively sets the instrument and performs one sweep in each band. The digital data is collected in the B digital display. This data is then compressed to cover the appropriate portion of the screen and is displayed in the A storage display. During multiband sweep operation, **MULTIBD** is displayed at the bottom center of the screen.

If the start frequency is less than 3 GHz and the stop frequency is greater than 7.1 GHz, the 3 GHz - 7.1 GHz band is not used.

**Instrument Operating Differences When in the Multiband Sweep Mode** - Because of the method used to obtain a multiband sweep, certain instrument functions must be locked out and others will operate differently from normal. To remind you of these differences, the message **MULTIBAND SWEEP STARTED** is displayed at the center of the screen at entry to the mode, and **MULTIBAND SWEEP STOPPED** is displayed at the center of the screen when you exit from the mode.

Following are the functional operating differences that are present when in the Multiband Sweep mode.

- To allow data collection in the B display of digital storage while the A display is being viewed, the storage must be set with View A on and View B and B-**SAVED A** off. These settings are changed automatically when the Multiband Sweep mode is entered and cannot be changed while in the mode. The existing settings are restored when multiband sweep is exited. If there is a waveform saved in the A display, you are given the option to save it before multiband sweep is started (a warning message that requires a yes or no response comes on the screen). **SAVE A** and **MAX HOLD** operate normally. Since only the A waveform is displayed, **SAVE A** stops display updating.
- Displays may only be recalled into the A register. The display recall routine automatically places any recalled display into A, without a user prompt.
- If the multiband mode is exited using either the **MAX SPAN** or **ZERO SPAN** pushbuttons, the saved span will be the multiband span. The span will return to this value, or default to maximum, when either the Max or Zero Span Mode is cancelled (refer to the information under Changing the span in Exiting Multiband Sweep for additional information). The instrument will not return to the multiband mode.
- The multiband frequency range displayed can only be changed by entering new start and stop frequencies. Changing the span or directly entering a center frequency exits the Multiband Sweep mode. The center frequency knob is disabled in the Tune CF mode. Markers may be tuned over the displayed range only.
- The marker system treats the multiband display as if it were a saved or stored display; the tuning limits were mentioned previously.
- If **AUTO RESOLN** is selected, the resolution bandwidth used is the widest value required by the bands being swept. If any of the bands is uncalibrated, the **UNCAL** light will come on.
- If **TIME/DIV AUTO** is selected, the sweep speed may vary as each band is swept. Any time/division value refers to a division of the sweep that gathered the data, not to a division of the compressed display.

- If the sweep is not in TRIGGERING FREE RUN, the triggering conditions selected will be used for only the first (lowest-frequency) sweep of the sweep needed to do one complete multiband sweep. After this sweep is triggered, the remaining sweeps will be done in the Free Run mode. Similarly, once a single sweep is started, the number of sweeps needed to form a complete display will occur. If a multiband sweep is interrupted by the SINGLE SWEEP pushbutton being pressed, the next sweep will be the lowest-frequency sweep.
- TIME/DIV MaNuaL or EXTeRnal sweeps cannot be used when sweeping a multiband range. If either is chosen, a message that the frequency range cannot be swept in MNL or EXT sweep will appear on the screen and remain until the sweep mode is changed.
- Signal counting may not be done in the Multiband Sweep mode.
- Auto peaking will be done as usual in a 2-division window centered on the center or marker frequency. If this range covers more than one band, peaking will be done in all bands covered. If there is at least one signal within a band, or portion of a band, the peak value of the frequency window that contains the largest signal will be updated.

**Exiting Multiband Sweep** - Multiband sweep may be exited in several ways.

- Using the <blue-SHIFT> FREQ and DATA ENTRY pushbuttons to enter a frequency, or the +STEP or – STEP pushbuttons to enter a frequency while in the TUNE CF mode. Multiband sweep will be stopped even if the frequency is within the multiband range being swept.
- Recalling a setting with a sweep that falls within one band
- Using the FREQ START STOP or MKR START STOP pushbuttons to enter a sweep that falls within only one band
- Using the <blue-SHIFT> ▲BAND/BAND▼ pushbuttons
- Changing the span

If the marker is on when the multiband mode is exited, the center frequency is set to the Primary marker frequency. If the marker is not on, the center frequency remains at the center frequency of the multiband sweep. The span is set to the span of the multiband sweep, or is defaulted to maximum if the multiband sweep value is larger than the maximum span of the band containing the center frequency. The control change that caused the exit from multiband sweep will then change either the center frequency or span, or both.

### Using the Time Measurement Feature

This instrument employs a special time measurement feature that is available when the instrument is in the zero span mode, with either one or two markers on. Select the Zero-Span Time mode from the Special Modes Menu, which is called up by pressing <blue-SHIFT> VIDEO FILTER WIDE. (Refer to Using the Time Measurement Feature in the Programmers Manual for an alternate method for use with instruments under program control.)

In the Zero-Span Mode, the marker frequency readout or delta-marker frequency readout is replaced by a time or delta time readout, respectively. The time readout in the single-marker mode is the time to the marker position from the trigger point; this point is 1/2 division to the left of the screen. In the Delta Marker Mode, the delta time readout gives the time difference between the two markers. In both cases, the time value is scaled from the marker position(s) and the time/division. No actual time measurement is done.

The time measurement feature is available only during certain timing conditions. If the TIME/DIV setting is MNL or EXT or is faster than 1 ms/division, the message TIME UNAVAILABLE is displayed in the location of the normal readout.

When in the delta-time readout mode, both markers must be on the same trace for time measurement. If the markers are on different traces when zero span is entered, the secondary marker will move to the trace of the primary marker. (This marker will not move back when leaving zero span.) When either marker is assigned to a new trace, both markers (assuming delta markers are on) will move together.

In frequency-mode marker operation, the secondary marker remains at a constant frequency, while the primary marker remains at a constant horizontal location. However, in the time mode, both markers remain at constant horizontal positions as the sweep speed is changed.

Most of the frequency-related marker functions remain frequency related in zero span. The <green-SHIFT> STEP SIZE pushbutton still defines the frequency step size for the marker or delta-marker.

In the tune marker mode, <blue-SHIFT> FREQ and the DATA ENTRY pushbuttons will enter marker time. If the TIME UNAVAILABLE message is displayed, the entry functions will be disabled.

The <blue-SHIFT> MKR→CENTER pushbutton function is not available in zero span.

Bandwidth mode and signal track will go to idle in zero span. Since the idle message appears in the frequency/time readout location, these functions will have to be turned off in order to see the time display on the screen.

*Add the following after TALK ONLY, LISTEN ONLY switches*

### **Personalized Macros**

The programmable spectrum analyzer allows you to personalize your instrument to fill your specific needs. Eight programs compiled by you to your specifications can be stored in memory to be called up and run at any time. This feature makes it possible for you to perform complete tests with only the spectrum analyzer, without the need of a controller. These unique programs made up of existing, prepared commands are macroinstructions (macros).

There is 8K available memory originally set aside for personalized macros. When you create the macro, you have 22 characters available to you for the definitive name. Refer to the Programmers Manual for the available commands and their use, the amount of memory needed for each usable command, examples, and sample macros.

### Section 7 - OPTIONS

Replace Table 7-3 with the one below

**Table 7-3  
OPTION 01 ALTERNATE SPECIFICATIONS**

Characteristic	Performance Requirement		Supplemental Information
Option 01 (Adds Preselector)  Frequency Response			Measured with 10 dB RF Attenuation and Peaking optimized for each center frequency setting (when applicable).  Response is affected by: <ul style="list-style-type: none"> <li>• input VSWR</li> <li>• harmonic number (N)</li> <li>• gain variation</li> <li>• mixer</li> <li>• preselector</li> </ul> Display flatness is typically 1 dB greater than frequency response.
Coaxial (direct) Input  Frequency Range	About the mid-point (mean) between two extremes	Referenced to 100 MHz	
Band 1 (10 kHz—1.8 GHz)	±1.5 dB	±2.5 dB	
Band 2 (1.7—5.5 GHz)	±2.5 dB	±3.5 dB	
Band 3 (3.0—7.1 GHz)	±2.5 dB	±3.5 dB	
Band 4 (5.4—18.0 GHz)	±3.5 dB	±4.5 dB	
Band 5 (15.0—21.0 GHz)	±5.0 dB	±6.5 dB	
3rd Order Intermodulation Products  10 kHz to 21 GHz (Bands 1 — 5)	At least -70 dBc from any two on-screen signals within any frequency span.		≥-100 dBc when signals are separated 100 MHz or more in preselected bands.
Harmonic Distortion  10 kHz to 1.8 GHz (Bands 1)	-60 dBc or less		Measured at -40 dBm input level in MIN DISTORTION mode.
1.7 GHz through 21 GHz	Not discernible.		Typically -100 dBc
Maximum Span/Div Band 1 (0—1.8 GHz)			With Span/Div Control
			With Data Entry keypad
			100 MHz
			170 MHz

**Table 7-3 (Continued)**  
**OPTION 01 ALTERNATE SPECIFICATIONS**

Characteristic	Performance Requirement	Supplemental Information
IF Frequency, LO Range and Harmonic Number (N)		
Band and Frequency Range		1st IF (MHz)    LO Range (MHz)    (N)
1 (0—1.8 GHz)		2072    2072—3872    1—
2—12 (1.7—325 GHz)		Refer to table on page 6

Characteristic	Performance Requirement								Supplemental Information
Sensitivity	Equivalent Input Noise in dBm versus Resolution Bandwidth								Measured with: • 0 dB attenuation (Min Atten. 0 dB) • Narrow Video Filter • 2 dB/Div Log mode • Digital Storage on • Max Hold off • Peak Average in Average • 1 sec Time/Div • Zero Span • Input terminated in 50Ω
Frequency Range	100 Hz	1 kHz	10 kHz	100 kHz	300 kHz <sup>a</sup>	1 MHz	3 MHz		
Band 1 10 kHz—1.8 GHz	-120	-110	-100	-90	-85	-80	-75		
Band 2 1.7—5.5 GHz	-120	-110	-100	-90	-85	-80	-75		
Band 3 3.0—7.1 GHz )	-119	-109	-99	-89	-84	-79	-74		
Band 4 5.4—12 GHz	-105	-95	-85	-75	-70	-65	-60		
Band 4 12—18 GHz	-100	-90	-80	-70	-65	-60	-55		
Band 5 15—21 GHz	-99	-89	-79	-69	-64	-59	-54		
LO Emission	<-70 dBm to 21 GHz								With 0 dB RF Attenuation.
Input Level (0 dB attenuation)									+30 dBm (1 W) continuous, 75 W peak.
Maximum Safe Input  (Attenuator Maximum Rating)									• Pulse Width = 1 μs or less • Maximum duty factor of 0.001 (Attenuator limit) DO NOT APPLY DC VOLTAGE TO THE RF INPUT

<sup>a</sup> Option 07 replaces the 100 kHz filter with a 300 kHz filter.

Replace Table 7-4 with the one below

**Table 7-4  
OPTION 07 ALTERNATE SPECIFICATIONS**

Characteristic	Performance Requirement	Supplemental Information
<b>Option 07 (Adds 75Ω Input)</b>		
Center Frequency Range		0 to 1000 MHz on the readout
Resolution Bandwidth	Within 20% of 300 kHz bandwidth	Measured at 6 dB down.  The 300 kHz filter replaces the 100 kHz filter.
Frequency Response (75Ω Port)  5 MHz to 1000 MHz Coaxial input	±2.0 dB	Measured about the midpoint between the two extremes with ≥ 10 dB RF ATTEN.  The response figure includes the effects of input vswr, and gain variations.  Typical response for 1–5 MHz is < 3 dB down from the 5 MHz response.
Reference Level Range (with 0 Reference Level offset)		–68 dBmV to +89 dBmV  +99 dBmV is achievable in MIN NOISE mode.
Input Impedance (with 10 dB or more attenuation)		75Ω 17 dB Return Loss (1.35:1 vswr) 5 to 800 MHz 13 dB Return Loss (1.6:1 vswr) 800 to 1000 MHz
Maximum Input Level With 0 dB Attenuation		+78 dBmV
With 20 dB or more attenuation		+78 dBmV, 100 V <sub>rms</sub> maximum (dc + ac peak)
Calibrator (CAL OUT) Level	+20 dBmV, ±0.5 dB	100 MHz comb of markers provide amplitude calibration at 100 MHz. Phase-locked to an External Reference in EXT mode.

**Table 7-4 (Continued)**  
**OPTION 07 ALTERNATE SPECIFICATIONS**

Characteristic	Performance Requirement						Supplemental Information
75Ω INPUT Sensitivity 5—1000 MHz	Equivalent Input Noise in dBmV vs. Resolution Bandwidth						Equivalent maximum input noise for each resolution bandwidth. Measured at 25° C with: <ul style="list-style-type: none"> <li>• 0 dB attenuation (Min Atten 0 dB)</li> <li>• Narrow Video Filter on</li> <li>• Vertical Display 2dB/Div (5 dB/div in 10 Hz RBW)</li> <li>• Digital Storage on</li> <li>• Max Hold off</li> <li>• Peak/Average in Average</li> <li>• 1 sec Time/Div</li> <li>• Zero Span</li> <li>• Input terminated in characteristic input impedance</li> </ul>
	100 Hz	1 kHz	10 kHz	300 kHz	1 MHz	3 MHz	
	-74	-66	-56	-41	-36	-31	
50Ω INPUT Sensitivity for the 300 kHz Resolution Bandwidth	Equivalent Input Noise in dBm						
	Band 1	Band 2	Band 3	Band 4	Band 4	Band 5	
	-90	-90	-90	-75	-70	-70	
Option 01	Equivalent Input Noise in dBm						
	-85	-85	-84	-70	-65	-64	

**Supplementary Physical Characteristics**

Characteristics	Description
Weight Option 07	Adds 7 ounces (0.2 kg) to the standard instrument.

*Options 12, 13, 14 and 30 and 31 are no longer available for this instrument.*





Date: 6-01-88  
Product: See list

Change Reference: M66071  
Manual Part No: See list

Eff/SN B010100  
Product Group: 26

---

<b>INSTRUMENT</b>		<b>PART NO.</b>
494A/AP	Operators	070-5557-01
495/P	Operators	070-5082-00
2753P	Operators	070-6305-00
2754/P	Operators	070-6096-00
2756P	Operators	070-6317-00
492B/BP	Operators	070-5562-01
2755A/AP	Operators	070-6031-01
494A/AP	Service 1	070-5560-00
495/P	Service 1	070-5084-00
2753P	Service 1	070-6306-00
2754/P	Service 1	070-6097-00
2756P	Service 1	070-6318-00
492B/BP	Service 1	070-5565-01
2755A/AP	Service 1	070-6032-01

**ADD:**

**OPTION 43**

Option 43 provides a reduced graticule ray tube. This option also enables the main display readout characters to be positioned outside the graticule area.



Date: 11-Sep-91

Change Reference: C1-991

Product: See List

Manual Part No.: See List

DESCRIPTION	Product Group 2E
-------------	------------------

**Effective for All Serial Numbers:**

492A/AP & 492B/BP	070-5562-01, Operators Manual
494A/AP	070-5557-01, Operators Manual
495/P (B020100)	070-6888-00, Operators Manual
497P	070-7677-00, Operators Manual
2753/P	070-6306-00, Operators Manual
2754/P	070-6096-00, Operators Manual
2755/P & 2755A/AP	070-6031-01, Operators Manual
2756P	070-6317-00, Operators Manual

**Make the following change in your Operators manual:**

**Section 2 — Specification**

Change the 1 dB Compression specification as shown below.

1 dB Compression Point (Minimum) Coaxial Bands	0 dBm	Measured in Min Noise mode with no RF attenuation.
---	-------	---





