

Valuetronics International, Inc.
1-800-552-8258
MASTER COPY

2710 SPECTRUM ANALYZER

Please Check for CHANGE INFORMATION at the Rear of This Manual

First Printing JULY 1989
Revised May, 1990

Tektronix
COMMITTED TO EXCELLENCE

Copyright © 1987 Tektronix, Inc. All rights reserved.
Contents of this publication may not be reproduced in
any form without the written permission of Tektronix,
Inc.

Products of Tektronix, Inc. and its subsidiaries are
covered by U.S. and foreign patents and/or pending
patents.

TEKTRONIX, TEK, SCOPE-MOBILE, and  are
registered trademarks of Tektronix, Inc. TELEQUIP-
MENT is a registered trademark of Tektronix U.K.
Limited.

Printed in U.S.A. Specification and price change privi-
leges are reserved.

Tektronix, Inc.
P.O. Box 500
Beaverton, Oregon 97077

Serial Number _____

PREFACE

The OPERATORS manual is one of a set of manuals for the Tektronix 2710 Spectrum Analyzer. This manual contains the instrument's specifications, control descriptions, menu descriptions, operational check, and operating features. The manual organization and content is shown in the Table of Contents. These instructions assume the reader has a basic understanding of frequency domain analysis.

Other instruction manuals for this product are:

2710 Service Manual

For manual ordering information, refer to the Standard and Optional Accessories listing in Section 1 of this manual or contact your local Tektronix Field Office.

Standards and Conventions Used

Most terminology is consistent with standards adapted by IEEE and IEC. Appendix A provides a glossary of terms. Abbreviations used on the instrument and in the documentation are consistent with ANSI Y1.1-1972. Copies of ANSI and IEEE standards can be ordered from the Institute of Electrical and Electronic Engineers Inc.

Page Attributes

The manual pages follow a format using descriptive attributes to aid information retrieval. Figure i depicts the pages with the main features called out.

Note the location of the standard page features of the section or appendix number and name and the section and page number. These features help you keep track of where you are in the manual.

Change/History Information

Manual corrections or additional information is included when manual pages are revised. A revised page is identified by a revision date located in the lower inside corner of the page. The location on the manual page where the change was made is noted by a vertical black change bar (■) on the left or right margin of the page, depending on whether the change is in the left or right column. The change bar will appear only in the manual issue where the change first appears. Subsequent manual issues will not show the change bar, but the date will remain on the page.

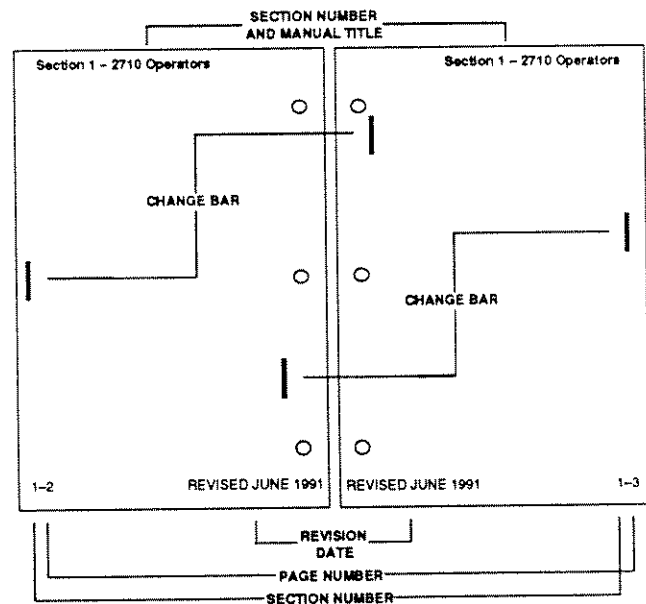

Figure i-1. 2710 Operators Manual page attributes.

TABLE OF CONTENTS

	PAGE		PAGE
PREFACE	i		
TABLE OF CONTENTS	ii		
SAFETY SUMMARY	v		
Section 1 GENERAL INFORMATION		Section 3 DISPLAY, CONTROLS, & CONNECTORS	
INSTRUMENT DESCRIPTION	1-1	Front Panel (layout)	3-1
Menu Operation	1-1	Rear Panel (layout)	3-1
Display	1-1	DISPLAY	3-2
Markers	1-1	Spectral Display	3-2
Precision Measurements	1-1	Menu Mode Display	3-2
Center Measure	1-1	CRT Nomenclature	3-3
Tracking	1-1	FRONT PANEL CONTROLS	3-4
OPTIONS	1-1	FREQ/MARKERS	3-5
UNPACKING	1-1	Frequency Span/Div	3-5
Storage	1-1	Resolution Bandwidth	3-5
REPACKING FOR SHIPMENT	1-2	Reference Level	3-6
Transit Case	1-2	VERTICAL SCALE	3-6
INITIAL INSPECTION	1-2	DISPLAY STORAGE	3-6
INSTALLATION	1-2	Sweep and Triggering	3-7
Colling	1-2	UTILITY	3-7
Cover	1-2	Miscellaneous Controls	3-7
Handle	1-2	REAR PANEL CONTROLS	3-8
RACKMOUNT	1-2	CONNECTORS	3-8
POWER REQUIREMENTS	1-2	Front Panel	3-8
SERVICE INFORMATION	1-2	Rear Panel	3-8
Service Manual	1-2	Rear Panel Connector Usage	3-8
Product Service	1-3		
STANDARD ACCESSORIES	1-3	Section 4 MENU OPERATION	
OPTIONAL ACCESSORIES	1-3	INTRODUCTION	4-1
		MENU DISPLAY	4-1
		KEYPAD AND ALPHA	
		CHARACTERS	4-4
		MENU SELECTIONS	4-4
		INVOKING A SELECTION	4-4
		MENU PATH	4-4
		DISPLAY RESPONSE	4-5
		MENU DESCRIPTIONS	4-5
		INPUT MENU	4-6
		MARKER/FREQ MENU	4-8
		SETUP TABLE	4-8
		PROGRAMMED TUNING	
		INCREMENT	4-8
		SWEEP/TRIGGER MENU	4-10
		SETUP TABLE	4-10
		DISPLAY MENU	4-12
		ENSEMBLE AVERAGING	4-14
		TITLE MODE	4-16
		DISPLAYLINE	4-18
		APPLICATIONS MENU	4-20
		SIGNAL SEARCH	4-20
		SETUP TABLE	4-20
		DETECTOR/GENERATOR MENU	4-22
Section 2 SPECIFICATIONS			
ELECTRICAL CHARACTERISTICS	2-1		
Frequency Related	2-2		
Frequency/Amplitude Related	2-3		
Amplitude Related	2-4		
Input/Output Signal	2-7		
Power Requirements	2-8		
General Characteristics	2-9		
Supplementary Due to Options	2-10		
ENVIRONMENTAL CHARACTER-			
ISTICS	2-13		
PHYSICAL CHARACTERISTICS	2-14		

TABLE OF CONTENTS (Cont)

	PAGE		PAGE
Section 4 MENU OPERATION (Continued)		Section 6 FEATURES, OPERATION, and MEASUREMENTS (Continued)	
UTILITY MENU	4-24	SIGNAL APPLICATION (Continued)	
STORED SETTINGS	4-26	Level of Pulsed Signals	6-2
KEYPAD ENTERED SETTINGS	4-26	Level of Continuous Wave Signals	6-3
INSTRUMENT		True vs Spurious Signals	6-3
NORMALIZATIONS	4-28	Preamplifier	6-3
SYSTEM CONFIGURATION	4-30	Measurements outside specified	
DIAGNOSTICS/ADJUSTMENT	4-32	Frequency and Tuning Range	6-3
SERVICE NORMALIZATIONS	4-32	Counter Feature	6-3
RESETS	4-34	Using the Center Measure	6-3
INTRODUCTION	4-34	Signal Tracking	6-3
TERMS USED IN THIS SECTION	4-34	Stored Settings	6-3
RESET CYCLES	4-34	Keyboard Entered Settings	6-4
RESET CATEGORIES	4-34	MARKERS	6-4
Non-Resettable Settings	4-34	Frequency Mode	6-4
Mode-Related Settings	4-34	Marker Mode	6-4
UTIL MENU Items	4-35	Delta Marker Mode	6-4
MKR/FREQ MENU Items	4-35	Amplitude Measurement	6-4
INPUT MENU Items	4-35	Control Selection	6-4
SWP/TRIG MENU Items	4-35	RESOLUTION BANDWIDTH,	
DSPL MENU Items	4-35	FREQUENCY SPAN, and	
APPL MENU Items	4-35	SWEEP TIME	6-4
Resettable Settings	4-35	Using the Video Filters	6-5
NORMALIZATION VALUES	4-36	Using Time Domain Operation	6-5
INITIALIZED/CORRUPTED NVRAM	4-36	Triggering the Display	6-5
		Single Sweep Feature	6-5
Section 5 OPERATIONAL CHECK		Sweeping the Display	6-5
Power-up Procedure	5-1	Manual Scan of the Spectrum	6-6
Instrument Use	5-2	Reference Level	6-6
Menu Selections	5-2	DISPLAY STORAGE	6-6
		Waterfall Feature	6-6
Section 6 FEATURES, OPERATION, and MEASUREMENTS		Maximum Hold Feature	6-6
FEATURES:		Acquisition Mode	6-6
Installed Options and		"B" minus "A" register &	
Firmware Version	6-1	"C" minus "A" register	6-6
Audio Alert Volume	6-1	MEASUREMENTS:	
Warning and Error Messages	6-1	Frequency Mode	6-7
Intensity Level	6-1	Marker Mode	6-7
Trace Alignment	6-1	Delta Markers Mode	6-7
Normalization Feature	6-1	Signal Level	6-8
OPERATION:		Measuring Bandwidth	6-8
SIGNAL APPLICATION	6-2	Carrier-to-Noise Measurement	6-8
Using the 2710 with a 75 /50		Frequency Corrections	6-8
Minimum Loss Attenuator	6-2	Signal Detecting	6-8
Mixer Input Considerations	6-2	FM Modulation Deviation	6-8
		Normalizing the Internal Reference	6-8
		Precision Measuring (Normalization)	6-9
		Considerations	6-9

TABLE OF CONTENTS (Cont)

	PAGE		PAGE
Section 7 OPTIONS		Section 8 NORMALIZATIONS (Continued)	
Introduction	7-1	BW FLTR AMPLTD (LIN)	8-11
Option A1 Through A5	7-1	BW FLTR AMPLTD (LOG)	8-12
Option B1	7-1	PREAMP GAIN	8-12
Option M1 Through M3	7-1	GAIN CORRECTION DAC	8-13
OPTION 01	7-1	LOG AMPLIFIER	8-14
OPTION 02	7-1	FULL SCREEN OFFSETS	8-15
OPTION 03	7-1	VR FILTER BW & CEN	8-15
OPTION 04	7-2	SENSITIVITY	8-17
OPTION 06	7-5	INTERNAL REF FREQ	8-17
OPTION 07	7-6	INTERNAL REF AMPLTD	8-18
OPTION 09	7-6	GAIN STEP REFERENCE (part 1)	8-19
OPTION 10	7-7	HI GAIN STEP REFERENCE	
OPTION 11	7-7	(part 2)	8-19
OPTION 14	7-8	NORMALIZATION SUBROUTINE	
OPTION 15	7-8	DESCRIPTION	8-20
OPTION 30	7-8	Vertical Adjustment	8-20
OPTION 33	7-12	LIN Mode Sensitivity Calculations	8-20
OPTION 34	7-12	YIG Frequency Counting	8-21
		APPENDIX I NORMALIZATION	
Section 8 NORMALIZATIONS		VALUES	8-22
INTRODUCTION	8-1	RF ATTEN AND PREAMP GAIN	8-22
GENERAL NORMALIZATION		VR GAIN STEPS	8-22
OVERVIEW	8-1	VR FINE GAIN	8-22
Types of Normalizations	8-1	FILTER AMPLITUDES	8-23
How the Normalization Values		FILTER SENSITIVITY	8-23
are Used	8-1	LOG NORMALIZATIONS	8-23
Acquiring, Defaulting, and		LOG NORMALIZATIONS	8-24
Recalling Values	8-2	LOG NORMALIZATIONS	8-24
Summary Messages	8-2	REFERENCES	8-24
Measurement Devices	8-2	CF NORMALIZATIONS	8-24
GENERAL OPERATIONS	8-3	VCO NORMALIZATIONS	8-25
User-Accessed Normalization		MISCELLANEOUS	8-25
Operation	8-3	VR 6DB BANDWIDTHS	8-25
Service Normalizations	8-3	VR NOISE BANDWIDTHS	8-26
Order of Normalizations	8-3	VR IMPULSE BANDWIDTHS	8-26
ADVANCED OPERATIONS ON		NORMALIZATION VALUES	8-26
NORMALIZATIONS	8-4	APPENDIX II NORMALIZATION	
Default, Recalling, and Executing	8-4	ERROR MESSAGES	8-30
Extracting Debug Information	8-4	Errors in MAIN DAC OFFSET	8-30
NORMALIZATION DESCRIPTIONS	8-4	Errors in MAIN DAC SENS	8-30
MAIN DAC OFFSET	8-5	Errors in FM DAC SENS	8-31
MAIN DAC SENS (B010001 and Up)	8-5	Errors in FREQUENCY DRIFT	8-31
MAIN DAC SENS	8-6	Errors in UPPER VCO SENS	8-31
FM DAC SENS	8-6	Errors in LOWER VCO SENS	8-32
FREQUENCY DRIFT	8-7	Errors in SPAN/DIV	8-32
UPPER VCO SENS	8-8	Errors in FREQUENCY ACCURACY	8-32
LOWER VCO SENS	8-8	Errors in GAIN AND ATTEN	8-32
SPAN/DIV	8-9	Errors in BW FLTR AMPLTD (LIN)	8-33
FREQUENCY ACCURACY	8-10	Errors in BW FLTR AMPLTD (LOG)	8-33
GAIN AND ATTEN	8-10	Errors in PREAMP GAIN	8-33

TABLE OF CONTENTS (Cont)

	PAGE		PAGE
Section 8 NORMALIZATIONS (Continued)		Section 10 FIELD STRENGTH MEASUREMENTS	
Errors in GAIN CORRECTION DAC ...	8-33	Key to Menu Selections	10-1
Errors in LOG AMPLIFIER	9-33	Reference Level Units Menu	10-2
Errors in FULL SCREEN OFFSETS ...	8-34	Setting up dB μ V/m	10-2
Errors in SENSITIVITY	8-34	Selecting Antenna Factor Tables	10-2
Errors in VR FILTER BW & CEN	8-34	Setting the Measurement Distance	10-3
Errors in INTERNAL REF FREQ	8-35	Specifying the Destination Waveform.....	10-3
Errors in INTERNAL REF AMPLTD	8-35	Setting the dB μ V/m	
Errors in GAIN STEP REFERENCE ...	8-36	Marker Display Mode	10-3
		Editing Antenna Factor Tables	10-3
		Beginning an Edit Session	10-4
		Free Memory Space Indicator	10-4
		Entering the Editing Session	10-4
		Entering and Editing Factor Values ...	10-5
		Ending the Edit Session	10-5
		Creating/Editing a Table	10-5
		Storing a Table	10-6
		Loading an Existing Table	10-6
		Deleting a Table	10-6
		Printing Out Tables	10-7
		Setting up Antenna Parameters	10-7
		Setting Start/Stop Frequencies	10-8
		Setting the Antenna	
		Reference Distance	10-8
		USING dB μ V/m UNIT TO	
		MAKE MEASUREMENTS	10-8
		MEASUREMENT APPEARANCE	
		TO THE USER	10-8
		IDLING THE dB μ V/m MEASUREMENT	10-9
		DISABLING dB μ V/m	10-9
Section 9 USER-DEFINED PROGRAMS		Section 11 TABULAR TUNING TABLES	
INTRODUCTION		INTRODUCTION.....	11-1
A GUIDE TO CREATING	9-1	Using Tabular Tuning Tables.....	11-1
USER-DEFINED PROGRAMS	9-1	Key to Menu Selections	11-1
Initial Conditions	9-1	MARKER/FREQUENCY MENU	
Potential Troublesome Settings	9-2	CHANGES	11-1
USER DEFINED PROGRAM MENU	9-3	Tabular Tuning Tables Menu	11-2
Key to Menu Selections	9-3	APPENDIX – Fixed Table Frequencies ..	11-3
User Defined Programs Menu	9-3	TV VHF AND UHF CHANNELS	11-3
User Defined Programs Utilities Menu ..	9-4	CATV STANDARD CHANNELS	11-4
Creating a Program	9-5	CATV HRC CHANNELS	11-5
Creating a Continuously		CATV IRC CHANNELS	11-6
Executing program	9-5	UHF STANDARD G AND	
Creating a Program Title	9-5	H CHANNELS	11-7
Wait for End of Sweep	9-6	UHF STANDARD I CHANNELS	11-7
Display Message	9-6	UHF STANDARD K AND	
Pause for 'USER DEF'Key	9-7	L CHANNELS	11-8
Storing the Program	9-7		
Deleting a Program	9-8		
Protecting a Program from Deletion ..	9-8		
EXECUTING A			
USER-DEFINED PROGRAM	9-8		
Display While the Program is Running ..	9-9		
APPENDIX.....	9-10		
FREQUENCY COMMANDS	9-10		
SPAN/DIV COMMANDS	9-10		
VERTICAL COMMANDS	9-11		
SWEEP SYSTEM COMMANDS	9-12		
WAVEFORM COMMANDS	9-13		
DISPLAY COMMANDS	9-13		
GENERAL PURPOSE COMMANDS ...	9-14		
INTERNAL CALIBRATION			
COMMANDS	9-14		
MARKER SYSTEM COMMANDS	9-15		
COMMUNICATIONS COMMANDS	9-16		
HUMAN INTERFACE COMMANDS	9-16		
RESOLUTION BANDWIDTH AND			
VIDEO COMMANDS	9-17		

TABLE OF CONTENTS (Cont)

PAGE

Section 11 TABULAR TUNING TABLES
(Continued)

UHF STANDARD M
(JAPAN) CHANNELS 11-8

Appendix A GLOSSARY

CHANGE INFORMATION

SAFETY SUMMARY

(Refer all servicing to qualified service personnel) **POWER**

The safety information in this summary is for both operating and servicing personnel. Specific warnings and cautions will be found throughout the manual where they apply, but may not appear in this summary.

TERMS

In This Manual

CAUTION statements identify conditions or practices that could result in damage to the equipment or other property.

WARNING statements identify conditions or practices that could result in personal injury or loss of life.

As Marked on Equipment

CAUTION indicates a personal injury hazard not immediately accessible as one reads the marking, or a hazard to property, including the equipment itself.

DANGER indicates a personal injury hazard immediately accessible as one reads the marking.

SYMBOLS

In This Manual

 This symbol indicates where applicable cautionary or other information is to be found.

As Marked on Equipment

 **DANGER--High voltage**

 Protective ground (earth) terminal.

 **ATTENTION--refer to manual**

 Refer to manual.

CAUTION

This instrument is not rated for outdoor use. Use in inclement weather conditions can result in an electrical shock.

Source Voltage

The power source for this instrument must not apply more than 250 V rms between the supply conductors or between either supply conductor and ground.

Grounding

This instrument is grounded through the grounding conductor of the power cord. To avoid electrical shock, ensure that the power source receptacle is properly wired before connecting it.

Danger From Loss of Ground

Upon loss of the protective-ground connection, all accessible conductive parts (including knobs and controls that may appear to be insulating) can render an electric shock.

Use the Proper Power Cord

See Section 1 for a list of Power Cord Options.

Use the Proper Fuse

For continued fire protection, observe the fuse specifications located on the rear panel.

Do not operate this product in an explosive atmosphere.

Do Not Remove Covers or Panels

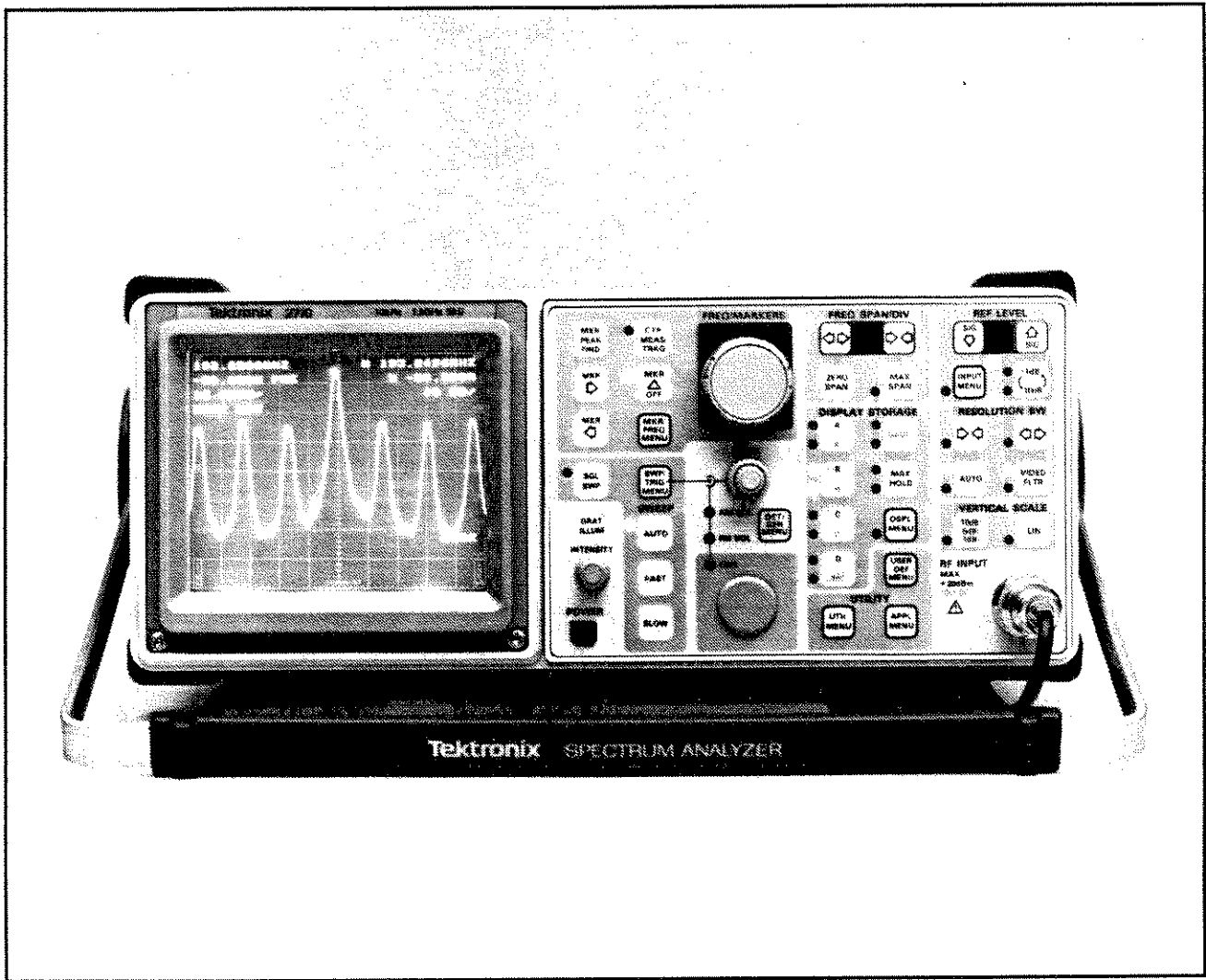

2710 SPECTRUM ANALYZER

GENERAL INFORMATION

This Section of the Manual includes a general description of the instrument, a list of Options, Unpacking and Repackaging instructions, Storage and Service information and a list of Standard and Optional accessories.

INSTRUMENT DESCRIPTION

The 2710 Spectrum Analyzer is a high performance, portable instrument for the 10 kHz to 1.8 GHz frequency range. Center Frequency accuracy is 1×10^{-5} . A minimum Resolution Bandwidth of 3 kHz, with a Span/Div down to 10 kHz provides measurement resolution commensurate with the frequency accuracy. Options are available for performance enhancements.

MENU OPERATION

Menu selected routines provide Diagnostics, Normalization, Adjustments, and set-up of basic parameters such as center frequency, frequency span, reference level, vertical scale factor, resolution bandwidth, etc. Each menu is described in Section 4.

DISPLAY

In the Spectral mode, the numerical values of signals and setup parameters are displayed. In the Menu mode, menus with their selections and prompts are displayed. Error, warning, or information messages are displayed in both modes.

MARKERS

A single marker can be enabled to show the frequency and amplitude of specific points on the display. Delta markers show the difference frequency and amplitude, between two points on the display.

PRECISION MEASUREMENTS

Menu selectable routines provide directions for normalizing the internal reference (calibrator signal) to external frequency and amplitude references. After the internal reference is normalized, other menu selections provide for normalizing all, or selected, instrument measurement parameters. It is recommended practice to invoke the normalization routines prior to a critical measurement.

CENTER MEASURE

When this function is activated, the instrument completes the sweep and centers the signal nearest to center-screen or with markers activated, the signal nearest to the marker. A readout of center frequency and amplitude is displayed.

TRACKING

Tracking locks drifting signals to center screen.

OPTIONS

See Section 7.

UNPACKING

The instrument and its standard accessories are packed in a shipping container. If the contents of the shipping container are incomplete, if there is mechanical damage or defect, or if the instrument does not meet operational check requirements, contact your local Tektronix Field Office or representative.

NOTE

Save the shipping container if the instrument is to be shipped or stored.

Storage

For **Short Term** (less than 90 days) store the instrument in an environment that meets the non-operating environmental specifications. See Specifications Section 2.

For **Long Term** (more than 90 days) use the original shipping container to repackage the instrument. Package the instrument in a vapor bag with a drying material and store in a location that meets the non-operating environmental specifications. If you have any questions, contact your local Tektronix Field Office or representative.

REPACKAGING FOR SHIPMENT

When the spectrum analyzer is to be shipped to a Tektronix Service Center for service or repair, attach a tag that shows:

- the owner and address
- the name of the individual at your location that may be contacted
- the complete instrument serial number
- a description of the service required.

Use the original shipping container or one of equivalent test strength and inside dimensions. Surround the instrument with plastic sheeting to protect the finish. Cushion the instrument on all sides with packing material or plastic foam.

Transit Case

A hard transit case that has space to hold most of the instrument's standard accessories is available as an optional accessory.

INITIAL INSPECTION

The instrument was inspected both mechanically and electrically before shipment. It should be free of mechanical damage and meet or exceed all electrical specifications.

NOTE

See Section 5 for a description of the procedures used to prepare the instrument for operation.

INSTALLATION

Cooling

The instrument may be operated in any position that allows the internal fan to draw adequate air into the intake areas at the front and expell it out the exhaust at the rear. To ensure proper cooling, maintain the clearance provided by the feet on the bottom and allow at least 2 inches clearance (more if possible) at the top, sides, and rear of the instrument.

Cover

The front cover provides protection from mechanical damage. Use the cover to protect the front panel when storing or

transporting the instrument. To remove the cover, stand the instrument on the back feet, then pull slightly out and up on the sides of the cover.

Handle

The handle of the spectrum analyzer can be positioned at several angles to serve as a tilt stand. To change the handle position, pull out at both pivot points and rotate the handle to the desired position.



WARNING

Only qualified service personnel should attempt to remove or replace the instrument's cabinet

RACKMOUNT

There are two Rackmount adapters available for this instrument. Option 30 is for a 19 inch width by 5.250 inch height application and Option 34 is for a 19 inch width by 6.970 height application.

Refer to the Service Manual for installation instructions.

POWER REQUIREMENTS

Power and voltage information is printed on the back panel near the power input jack.

Refer to Table 2-5 in Section 2 for input power requirements.

Do not connect the spectrum analyzer to a power source that will apply more than 250 V rms between the supply conductors or between either supply conductor and ground.

The ac power connector is a three-wire, polarized plug with the ground (earth) lead connected directly to the instrument frame. Completion of the grounding circuit, (usually via the power cord) is necessary to provide electrical shock protection.

SERVICE INFORMATION

Service Manual

In addition to all the information in this manual, the Service Manual includes circuit descriptions, troubleshooting information, calibration, and maintenance procedures. It also includes the electrical and mechanical parts lists, and sche-

matic diagrams. Service Manuals are intended for use by QUALIFIED SERVICE PERSONNEL ONLY. To avoid electrical shock, DO NOT perform any servicing unless qualified to do so. Service personnel should read the Safety information at the beginning of the Service Manual before performing any servicing.

Product Service

To assure adequate product service and maintenance for our instruments, Tektronix, Inc. has established Field Offices and Service Centers at strategic points throughout the United States and in all other countries where our products are sold. Contact your local Service Center, Representative, or Sales Engineer for details regarding warranty, calibration, emergency repair, repair parts, scheduled maintenance, maintenance agreements, pickup and delivery, on-site service for fixed installations, and other services available through these centers.

**TABLE 1-1
POWER CORDS**

Option A1	Universal Euro, 220 V/50 Hz at 16A
Option A2	United Kingdom, 240 V/50 Hz at 13A
Option A3	Australian, 240 V/50 Hz, at 10A
Option A4	North American, 240 V/60 Hz, at 12A
Option A5	Swiss, 250 V/50 Hz, at 6A

**TABLE 1-2
STANDARD ACCESSORIES**

Item	Tektronix P/N
Manual, Operator's	070-6022-01
Power Cord *	161-0104-00
Front Cover	200-2520-00
Adapter 50 , N Male to BNC Female	103-0045-00
75 to 50 Minimum Loss Attenuator, N Male to BNC Female	131-4199-00

* For Power Cord Options A1, A2, A3, A4, and A5, this power cord is replaced with an appropriate power cord.

**TABLE 1-3
OPTIONAL ACCESSORIES**

Item	Tektronix P/N
50 coaxial cable, BNC to BNC Conn, 18 in	012-0076-00
50 coaxial cable, BNC to BNC Conn, 42 in	012-0057-01
75 coaxial cable, BNC to BNC Conn, 42 in	012-0074-00
Rain Cover	016-0848-00
Accessory Pouch	016-0677-03
Viewing Hood	016-0566-00
Carrying Strap	346-0199-00
Service Kit	606-0110-00
Crt Light Filter (clear)	337-2775-01
Crt Light Filter (gray)	337-2775-02
Camera C-5C, (Option 02, 016-0359-01)	C-5C
K212 Portable Instrument Cart	K212
Manual, Service	070-6024-01
Transit Case	016-0792-01



SPECIFICATION

This section lists the electrical, physical, and environmental characteristics of the Spectrum Analyzer, specifies performance requirements, and provides supplementary information. Any changes to a characteristic's performance, due to the addition of an option, are integrated with the specific characteristic.

ELECTRICAL CHARACTERISTICS

The following tables of electrical characteristics and features apply to the 2710 Spectrum Analyzer after a 15 minute warm-

up period (within the environmental limits) and a Normalization function has been performed.

Information in the Performance Requirement column is guaranteed and verifiable, either through diagnostic routines or written performance check procedures.

Supplemental information is intended to further explain a characteristic, its performance requirement, or it may describe the performance of a characteristic that is impractical to verify. Supplemental information is not guaranteed and may not be supported by a performance check procedure.

**Table 2-1
FREQUENCY RELATED CHARACTERISTICS**

Characteristic	Performance Requirement	Supplemental Information
Frequency (Center)		
Range	10 kHz to 1.8 GHz	Tuned by the FREQ/MARKERS control or set via the MKR/FREQ MENU.
Accuracy	1×10^{-5} of center frequency ± 5 kHz	Assume zero drift since last normalization procedure.
Drift		
Long Term (One Year)		3×10^{-6} of Center Frequency
Short Term	≤ 20 kHz	Between correction cycles; typically ≤ 5 kHz.
Readout Resolution		$\leq 1\%$ of the selected Span/Div to 100 Hz
Span/Div		
Range		1.8 GHz in MAX SPAN and 0 Hz for ZERO SPAN, plus selections in a 1-2-5 sequence from 100 MHz/div to 10 kHz/div, selected with the FREQ SPAN/DIV pushbutton selectors, or to two significant digits via the MKR/FREQ MENU or Utility Menu.
Accuracy/Linearity	Within 3% of the selected span	Measured over the center 8 divisions.
Residual FM	≤ 2 kHz _{p-p} total excursion in 20 ms.	Short term, after 1 hr warm-up.
Resolution Bandwidth (6 dB down)		Resolution bandwidth selections are: 5 MHz, 300 kHz, 30 kHz, 3 kHz.
Shape Factor (60 dB/6 dB)	7:1 or less	Instrument noise floor prevents verification for RBWs > 1 MHz.
Noise Sidebands	≤ -70 dBc at 30X Resolution Bandwidth for all resolution bandwidths ≤ 100 kHz.	Instrument noise floor prevents verification in wide RBWs (≥ 300 kHz)
Video Filter		Reduces video bandwidth to approximately 1/100th of the selected resolution bandwidth, using one of eleven video filters (3 Hz, 10 Hz, 30 Hz, 100 Hz, 300 Hz, 1 kHz, 3 kHz, 10 kHz, 30 kHz, 100 kHz, 300 kHz, or WIDE). When not selected, the video filter is set to the same value as the selected Resolution Bandwidth filter. (Except that when the 5 MHz resolution bandwidth filter is selected, the video filter is set to WIDE).

**Table 2-2
FREQUENCY/AMPLITUDE RELATED CHARACTERISTICS**

Characteristics	Performance Requirement	Supplemental Information
Marker		<p>The Frequency and amplitude values of the marker position are preceded by the character "M" and are displayed.</p> <p>MKR "arrows" position the marker to the next right or left signal peak.</p>
Accuracy		
Frequency		Same as Span/Div
Amplitude		A function of the Reference Level and Vertical Scale factor. (See Display Dynamic Range.)
Delta Marker	When first activated, a second marker is displayed at the same frequency as the first marker, which is the "Reference Marker".	The FREQ/MARKERS control may be used to position the primary marker. The frequency and amplitude differences between markers are readouts preceded by a "D".
Accuracy		
Frequency		Same as Span/Div
Amplitude		Same as Marker
Center Measure		When activated, the signal nearest center screen (or with marker on, nearest the marker) and above a preset threshold level, is moved to center screen.
Readout Resolution	10% of Span/Div to 1 kHz	
Tracking		<p>When activated, the centered signal is held at center screen.</p> <p>Tracking requires a signal strength greater than the threshold level.</p> <p>If the strength of a signal being tracked decreases below the threshold level, the instrument moves to an idle mode.</p>

**Table 2-3
AMPLITUDE RELATED CHARACTERISTICS**

Characteristic	Performance Requirement	Supplemental Information
Vertical Display Mode		Log Mode (10 dB/Div, 5 dB/Div, 1 dB/Div) and Linear.
Reference Level (Top Graticule Line)		
Range		
Log Mode		-70 dBm to +20 dBm, -23 dBmV to +66.9 dBmV
Linear Mode		8.83 μ V to 280 mV (Bottom Graticule Line = 0 V)
Steps		
Log Mode		1 dB or 10 dB
Linear Mode		10 μ V/Div to 200 mV/Div in a 1-2-5 sequence, then 280 mV/Div
1dB Activated		≥ 0.2 dB per Increment
Accuracy		Dependent on the following: <ul style="list-style-type: none"> • Calibrator accuracy • Frequency response
Display Dynamic Range	80 dB maximum (Log mode) 8 divisions (Linear mode)	Select narrower resolution bandwidth and video filter than AUTO-selected for maximum range.
Accuracy		
10 dB/Div Mode	± 1.0 dB/10 dB to a maximum cumulative error of ± 2.0 dB over the 70 dB range ± 2.0 dB/10 dB from 70 dB to 80 dB In 5 MHz Resolution Bandwidth: ± 1.0 dB/10 dB to a maximum cumulative error of ± 3.0 dB	
5 dB/Div Mode	± 1.0 dB/10 dB to a maximum cumulative error of ± 2.0 dB over the 40 dB range.	
1 dB/Div Mode	± 1 dB maximum error over the 8 dB range.	
Linear Mode	$\pm 5\%$ of full scale	e.g. at 100 mV/div, accuracy is ± 40 mV.

Table 2–3 (continued)

Characteristic	Performance Requirement		Supplemental Information
RF Attenuator			
Range			0 to 50 dB in 2 dB steps
Display Flatness <i>(Frequency response with the Preamp enabled is not specified above 600MHz.)</i>	±1.5 dB		Measured with 10 dB of RF Attenuation. Frequency response is affected by: <ul style="list-style-type: none"> • Input VSWR (voltage standing-wave ratio) • Gain variation • Mixer conversion
Sensitivity (without preamp)			Equivalent maximum input noise for each resolution bandwidth. Sensitivity decreases linearly approximately 8 dB from low to high end of the frequency range.
Resolution Bandwidth	@ 100 MHz	@ 1.8 GHz	
5 MHz	-85 dBm	-77 dBm	
300 kHz ¹	-97 dBm	-89 dBm	
30 kHz	-107 dBm	-99 dBm	
3 kHz	-117 dBm	-109 dBm	
Sensitivity (With preamp)			<i>NOTE: Sensitivity with the Preamp enabled is not specified above 600MHz. (The UNCAL message is not displayed above 600 MHz.)</i>
5 MHz	-97 dBm		
300 kHz ¹	-109 dBm		
30 kHz	-119 dBm		
3 kHz	-129 dBm		

¹ In instruments from B010001 to B010318 this was a 500 kHz filter:

	@ 100 MHz	@ 1.8 GHz	
500 kHz Sensitivity without Preamp	-95 dBm	-87 dBm	
500 kHz Sensitivity with Preamp	-107 dBm	Not specified	

Table 2–3 (continued)

Characteristic	Performance Requirement	Supplemental Information
Spurious Responses		
Residual (no input signal)	≤ -100 dBm except at 1780 MHz where the spurious response is < -90 dBm.	With 0 dB RF attenuation
3rd Order Intermodulation Products	At least 70 dB down from any two on-screen signals within any frequency span.	Measured with 1st mixer input level of ≤ -30 dBm (INPUT MENU/#4).
Zero Frequency (0 Hz) Spur	≤ -10 dBm	Referenced to input with 0 dB RF Attenuation
2nd Harmonic Distortion	≤ -66 dBc	Measured with 1st mixer input level of ≤ -40 dBm (INPUT MENU/#4).
LO (Local Oscillator) Emission	≤ -70 dBm	With 0 dB RF Attenuation.

**Table 2-4
INPUT/OUTPUT SIGNAL CHARACTERISTICS**

Characteristic	Performance Requirement	Supplemental Information
RF INPUT		Type N female connector, 50 Ω
VSWR with RF Attenuation ≥10 dB		1.5:1 maximum
VSWR with 0 dB RF Attenuation		3.0:1 maximum
Maximum Safe Input (With 0 dB RF Attenuation)		20 dBm (0.1W) continuous peak. 100 V DC blocking capacitor. <div style="border: 1px solid black; padding: 5px; display: inline-block;">DO NOT APPLY >100 V DC TO THE RF INPUT</div>
1 dB Compression Point (Minimum)	≥-15 dBm	With no RF Attenuation and 1st mixer at -30 dBm.
EXT TRIG (J102)		BNC connector, 10 k Ω impedance
Voltage Range		
Minimum		Typically 100 mV peak, 15 Hz to 1 MHz
Maximum		35 V (DC + peak AC)
Pulse Width		0.1 μs minimum
ACCESSORY CONNECTOR (J103)		9-pin D-connector
Pin 1	External Video Input	DC coupled, 0–50 kHz, 0–1.6 V (200 mV/Div) signal input for vertical deflection of the crt beam. The signal is processed through the digital storage circuits and the 1 dB, 5 dB, and 10 dB scale factor circuits. Display storage may be bypassed.

Table 2-4 (continued)

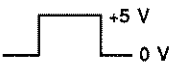
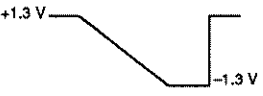
Characteristic	Performance Requirement	Supplemental Information
(J103) Pin 6	Sweep Gate 	TTL level signal that goes to +5 V while the crt beam is sweeping
Pin 2	Chassis and Signal Ground	
Pin 7	Sweep Output 	Provides a nominal +1.3 V to -1.3 V negative going ramp, proportional to the horizontal sweep.
Pin 3	Video Output	Provides 0 V to +1.6 V of video signal, proportional to the vertical display amplitude. 0 V is the top of the screen. Impedance is 1 k Ω.
Pins 4, 5, 8, and 9		Reserved for Future Options

**Table 2-5
POWER REQUIREMENTS**

Characteristic	Performance Requirement	Supplemental Information
Input Voltage		
Line Voltage Range	90 V AC to 250 V AC	
Line Frequency Range	48 Hz to 63 Hz	
Line Voltage Range	90 V AC to 132 V AC	
Line Frequency Range	48 Hz to 440 Hz	
Line Fuse	2 A Slow-Blow	
Input Power	90 W (1.2 A) standard instrument 105 W (1.3 A) maximum with options	At 115V and 60 Hz
Leakage Current		3.5 mA rms maximum or 5 mA peak maximum

**Table 2-6
GENERAL CHARACTERISTICS**

Characteristic	Performance Requirement	Supplemental Information
Sweep		Normal, Single Sweep, and Manual Scan.
Sweep Rate	1 μ s/Div to 2 sec/Div in a 1-2-5 sequence	
Accuracy	$\pm 10\%$ over the center 8 divisions	
Triggering		Free Run, Internal, External, Line, TV Line, and TV Field
Internal Trigger Level	1 division or more of signal	
External Trigger Level		See EXT TRIG (J102) in Table 2-4
Non-Volatile Memory (Battery-Backed Up Memory)		Instrument settings, waveforms, and Normalization results are stored in non-volatile RAM.
Battery		Lithium
Life Expectancy		
At +55° C Ambient Temperature		1 to 2 years
At + 25° C Ambient Temperature		At least 5 years
Temperature Range for Retaining Data		
Operating		-15° C to + 55° C
Non-Operating		-30° C to + 85° C
Internal Calibrator		Provides 100 MHz marker for amplitude calibration and comb of 100 MHz markers for frequency and span calibration.
Amplitude and Accuracy	-30 dBm ± 0.3 dB at 100 MHz ± 5 kHz	
Drift	± 10 PPM/Year	

**Table 2-7
SUPPLEMENTARY CHARACTERISTICS DUE TO OPTIONS**

Characteristic	Performance Requirement		Supplemental Information
Option 01			Adds phase-lock with span/div ≤ 20 kHz, 300 Hz resolution bandwidth filter, and spans/div of 5 kHz, 2 kHz, and 1 kHz.
Frequency			
Accuracy	5×10^{-7} of center frequency ± 700 Hz		Assume zero drift since last normalization procedure.
Long Term Drift (1 Year)			2 PPM/Year
Short Term Drift (with SPAN/DIV ≤ 20 kHz)	≤ 400 Hz		Between automatic frequency correction cycles
Readout Resolution			1% Span/Div to 10 Hz
Residual FM			Short term, after 1 hr warm-up
With SPAN/DIV ≤ 20 kHz	≤ 100 Hz _{p-p} total excursion in 20 ms.		
With SPAN/DIV > 20 kHz)	≤ 2 kHz peak to peak total excursion in 20 ms.		
300 Hz Resolution Bandwidth (6 dB Down)			
Shape Factor (60 dB/6 dB)	7:1 or less		
	At 100 MHz	At 1.8 GHz	
Sensitivity Without Preamp	-127 dBm	-119 dBm	
Sensitivity With Preamp	-139 dBm		Not Specified above 600 MHz
Internal Calibrator			
Amplitude and Accuracy	-30 dBm ± 0.3 dB at 100 MHz ± 2 kHz		
Drift	± 2 PPM/Year		
Option 02			Adds Frequency Counter
Frequency Accuracy (Counter) (Spans ≤ 10 MHz/Div)	1×10^{-5} of center frequency ± 10 Hz ± 1 least significant digit		Assume zero drift since last normalization procedure.
Readout Resolution			1 Hz or 1 kHz, Menu selectable
Drift			10 PPM/Year
Delta Marker Frequency Accuracy	Two times frequency counter accuracy		Both signals must be counted

Table 2–7 (Continued)

Characteristic	Performance Requirement	Supplemental Information
Option 01/02		
Frequency Accuracy (Counter)	5×10^{-7} of center frequency ± 10 Hz ± 1 LSB	Assume zero drift since last normalization procedure.
Option 04		Adds Tracking Generator
Frequency Range		
Nominal	100 kHz to 1.8 GHz, tracks the Spectrum Analyzer input	
TG TRACKING (Frequency Offset)	Sufficient to align Tracking Generator to Spectrum Analyzer window	Typically -5 kHz to $+60$ kHz. Auto Frequency correction for centering in Spectrum Analyzer window
Output Level		
Range	-48 dBm to 0 dBm	0.1 dB steps
Accuracy	± 1.5 dB	At 100 MHz
Output Impedance		50Ω nominal
VSWR	2:1 or better with output level ≤ -8 dBm	
Flatness		
Tracking Generator	± 1 dB from 100 kHz to 1.0 GHz and ± 1.5 dB to 1.8 GHz	Typically ± 1 dB to 1.8 GHz
System ^a	± 2.5 dB from 100 kHz to 1.0 GHz and ± 3 dB to 1.8 GHz	With 10 dB of attenuation in the Spectrum Analyzer
User-Corrected	± 0.2 dB	Using B C– Save A Flatness feature
System Dynamic Range	≥ 100 dB	Sensitivity ≥ -100 dBm
System Residual FM		
Option 01 Instruments		≤ 100 Hz _{pp} total excursion in 20 ms
Non-Option 01 Instruments		≤ 2 kHz _{pp} total excursion in 20 ms
Spurious Signals		
Harmonic	-20 dBc or better with respect to the fundamental	At frequencies ≥ 100 kHz
Non-Harmonic	-35 dBc or better with respect to the fundamental	

¹ System = Tracking Generator and Spectrum Analyzer combination.

Table 2-7 (Continued)

Characteristic	Performance Requirement		Supplemental Information
Option 14			Adds resolution bandwidths of: 1 MHz, 100 kHz, 10 kHz, and 1 kHz.
Shape Factor	7:1 or less		
Sensitivity Without Preamp			
	Resolution Bandwidth	At 100 MHz At 1.8 GHz	
	1 MHz	-92 dBm -84 dBm	
	100 kHz	-102 dBm -94 dBm	
	10 kHz	-112 dBm -104 dBm	
	1 kHz	-122 dBm -114 dBm	
Sensitivity With Preamp			<i>NOTE: Sensitivity with the Preamp enabled is not specified above 600MHz. (The UNCAL message is not displayed above 600 MHz.)</i>
	Resolution Bandwidth	At 100 MHz At 1.8 GHz	
	1 MHz	-104 dBm Not Specified	
	100 kHz	-114 dBm Not Specified	
	10 kHz	-124 dBm Not Specified	
	1 kHz	-134 dBm Not Specified	

**Table 2-8
ENVIRONMENTAL CHARACTERISTICS**

The Description column describes how most characteristics were derived and provides a description of the characteristic. This instrument meets MIL T-28800C, type III class 5, style C specifications.

Characteristic	Description
Temperature	
Operating and Humidity	0° C to +50° C MIL T-28800C 5 cycles (120 hours).
Non-operating ^a	-55° C to +75° C
Altitude	
Operating	15,000 ft
Non-operating	50,000 ft
Humidity (Non-operating)	Five cycles (120 hours) in accordance with MIL-Std-28800C, class 5
Vibration	
Operating (Instrument secured to a vibration platform during test)	MIL-Std-28800C, Method 514 Procedure X (modified). 15 minutes along each of 3 major axes at a total displacement of 0.015 inch peak-to-peak (2.4 g at 55 Hz), with frequency varied from 10 Hz to 55 Hz in 1-minute sweeps. Hold for 10 minutes at 55 Hz. All major resonances must be above 55 Hz.
Shock (Operating and Non-operating)	Three guillotine-type shocks of 30g, one-half sine, 11 ms duration each direction along each major axis; total of 18 shocks.
Transit Drop (free fall)	8 inch, one per each of six faces and eight corners (instrument is tested and meets drop height of 12 inches).
Electromagnetic Interference (EMI)	
Radiated and Conducted Emission	
FCC	FCC Part 15, sub-part J, Class A.
VDE	VDE 0871, Class B.

^a After storage at temperatures below -15° C, the instrument may not reset when power is first turned on. If this happens, allow the instrument to warm up for at least 15 minutes, then turn POWER OFF for 5 seconds and back ON. NV-RAM may lose data at temperatures below -30° C.

**Table 2-9
PHYSICAL CHARACTERISTICS**

Characteristic	Description
Weight	11.25 kg (<25 lb) maximum, includes Standard accessories. 9.5 kg (<21 lb) nominal for basic configuration.
Dimensions	
Height with feet and handle	137 mm (5.4 in)
Width	
With Handle	361 mm (14.2 in)
Without Handle	328 mm (12.9 in)
Depth	
With Front Panel Cover	445 mm (17.5 in)
Without Front Panel Cover	428 mm (16.85 in)
With Handle Extended	511 mm (20.1 in)

DISPLAY, CONTROLS, AND CONNECTORS

This section includes a description of the crt screen as a display for spectrum analysis and as a display for the menus.

The pin assignments or general use of each connector are listed in this section.

The specific use of each operating control and the three crt adjustments, located on the rear panel, are described in this section.

FRONT PANEL

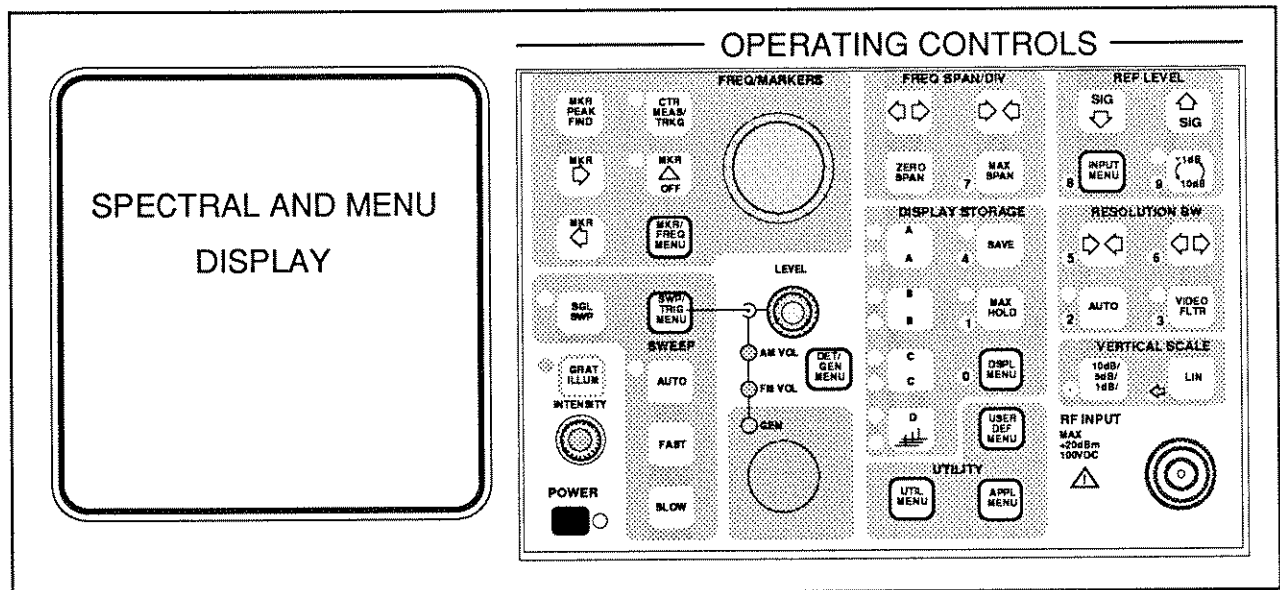

REAR PANEL

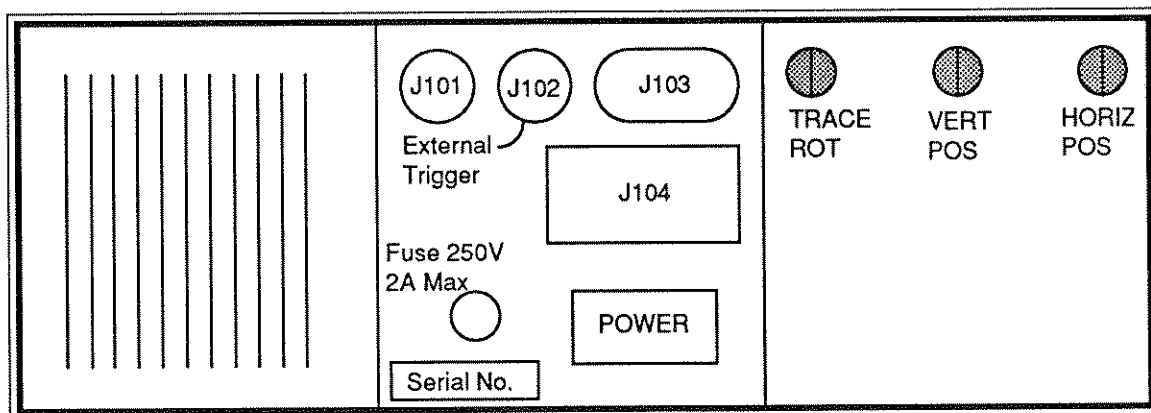

DISPLAY

The screen of the cathode ray tube (crt) is used in two modes of operation. In SPECTRAL mode, signals and the operating parameters are displayed simultaneously. In the MENU mode, the screen is used to display menu selections.

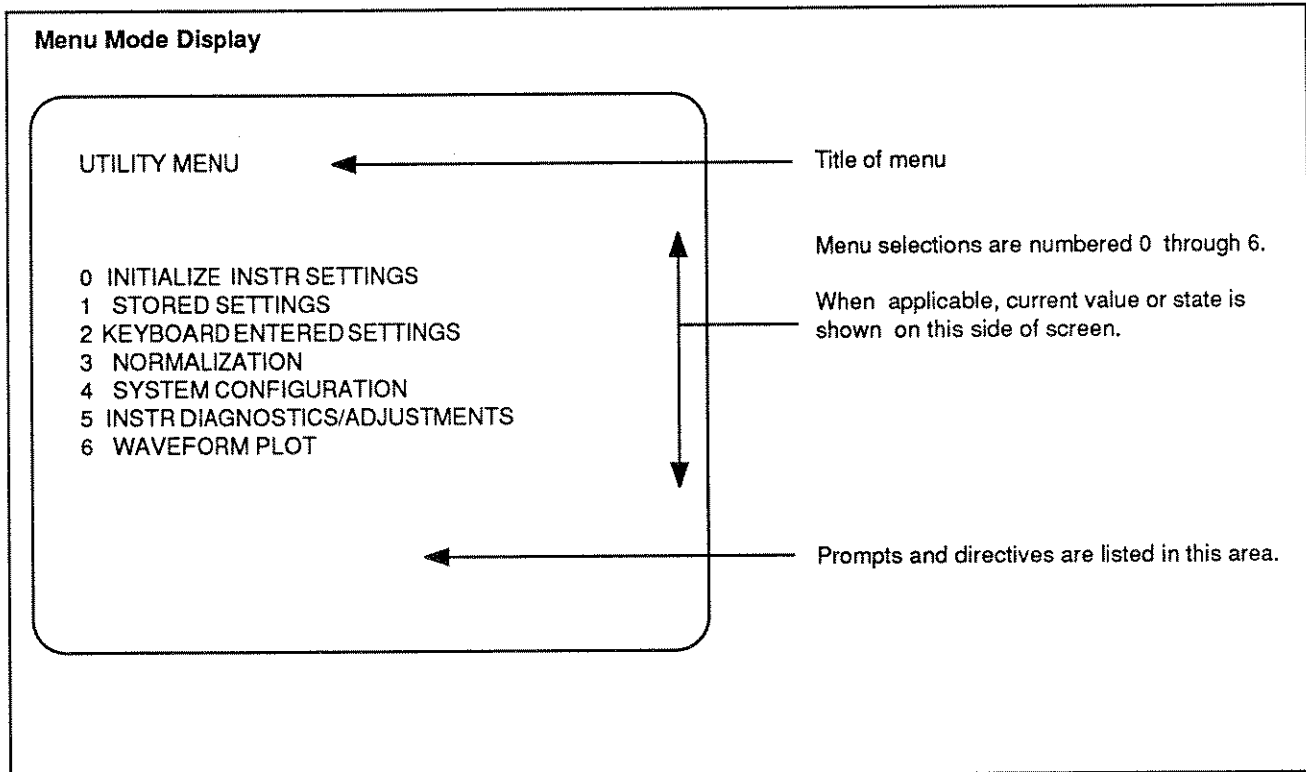
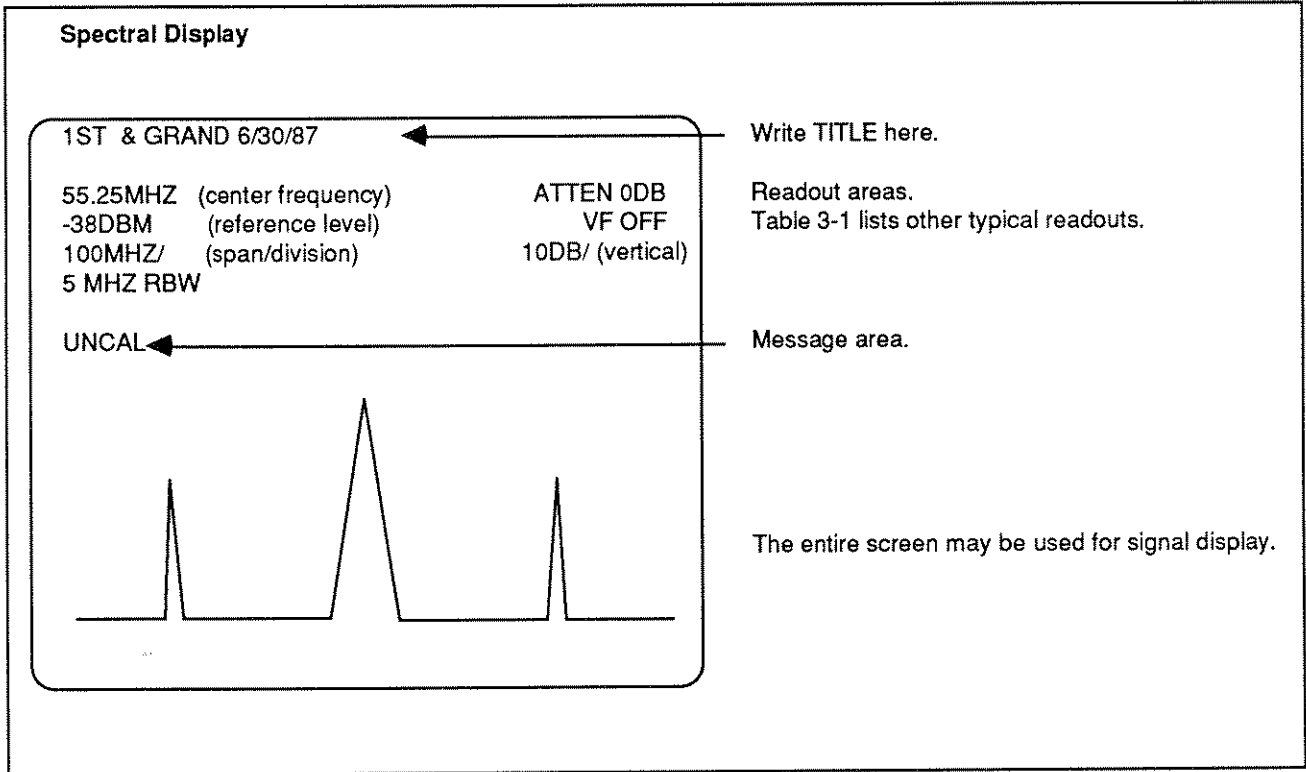

CRT Nomenclature

A typical readout item will appear as a letter designator preceding a numerical value. The letter is used to signify the meaning of the number. Table 3-1 lists some of the readouts that will appear on a spectral display.

Nomenclature	Readout	Typical Meaning	Supplemental Information
C	C 100.000MHz	Counter measurement frequency	Frequency readout resolution user defined to either 1 kHz or 1 Hz. Counter option required.
C	C -47DBM	Counter measurement amplitude	Counter Option required. Resolution is to the nearest 0.5 dB for 10 dB/, 0.25 dB for the 5 dB/, and 0.05 dB for the 1 dB/.
M	M 100MHZ	Dot marker frequency	
M	M -47DBM	Dot marker amplitude	
D	D 15.0KHZ	Delta marker frequency difference	
D	D -10.7DB	Delta marker amplitude difference	
DC	DC 15.0 kHz	Delta marker counter frequency difference	Mode enabled by executing Center/Measure on both Fixed Marker and Active Marker.
DC	DC -10.7 dB	Delta marker Amplitude difference with the counter enabled	
C/N	C/N 38DB @4.2MHZ BW	Carrier-to-noise measurement at 4.2 MHz bandwidth normalization (default is 1 Hz)	User enters Bandwidth via menu into non-volatile memory. C/N IDLE, indicates "no signal"
N	N -86DBM	Nominal noise at 1 Hz bandwidth	User enters Bandwidth via menu into non-volatile memory.
BW	BW 48KHZ	Bandwidth 6 dB down (default)	User enters Bandwidth via menu into non-volatile memory. BW IDLE, indicates "no signal"
PRE	-3DBM PRE	Preamp enabled	Sensitivity gain is approximately 12 dB.
MAX	180 MHZ/ MAX	Maximum Span	Maximum span is 180 MHz/division.
ZSPAN	10MS/ ZSPAN	Zero Span	X axis of the display is 10 milliseconds/division.
RBW	5MHZ RBW	Resolution Bandwidth	

FRONT PANEL CONTROLS

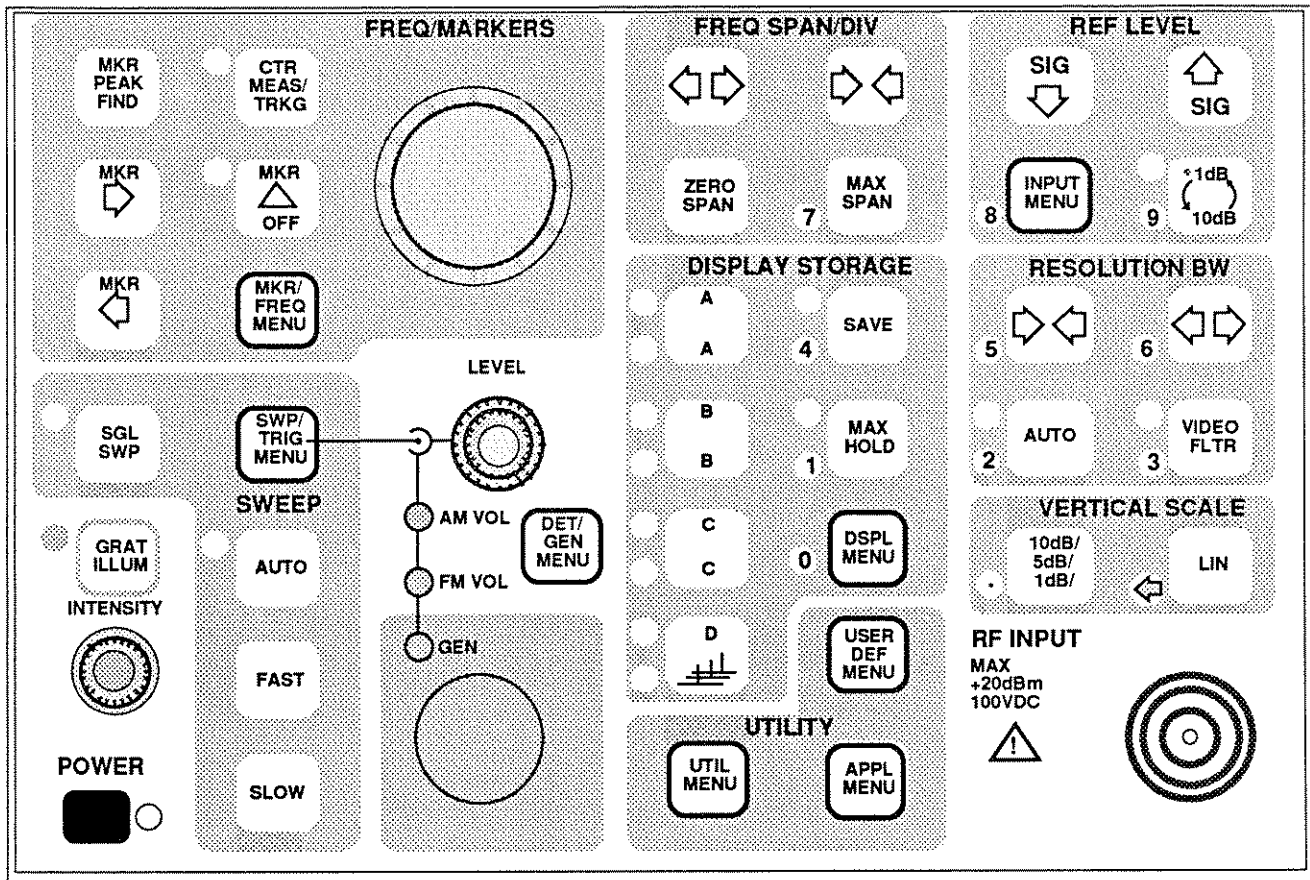

The front panel controls are grouped by function. Shaded areas define the groupings. In this section, the purpose of each control is described. The menu selections are listed and

described in Section 4. The operational use of the instrument is described in Sections 5 and 6.



NOTE

The "arrow" keys are screen oriented.

When the SPAN/DIV  is pressed, this display  changes to this. 

When the REF LEVEL  is pressed, this display  changes to this. 

FREQ/MARKERS

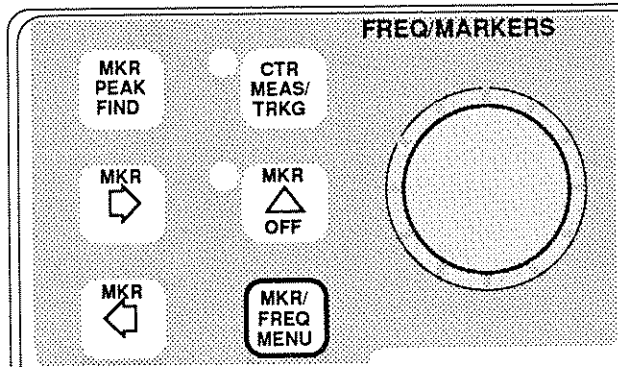

FREQ/MARKERS is a frequency or marker tuning control. The frequency tuning increment is 0.02 division, unless a different value is entered via this menu path.

MKR/FREQ MENU/#8-TUNING INCREMENT: Toggle to choose AUTO, PROGRMD, or TABULAR. If either PROGRMD or TABULAR are chosen, go to MKR/FREQ MENU/ #9-SETUP TABLE: choose #3 or #4.

In Zero Span, frequency is tuned at the rate of 0.1 times the selected Resolution Bandwidth for each click of the FREQ/MARKERS control.

When any of the marker-related pushbuttons in this group are activated, the MKR Δ OFF LED lights and this control positions the marker.

The left and right "arrow" MKR pushbuttons position the marker to the next left or right signal peak above the preset marker threshold.

MKR PEAK FIND moves the marker to the peak of the highest amplitude signal on screen.

CTR MEAS/TRKG is a selector for the Center Measure and Signal Tracking functions. When pushed and released in less than 0.4 seconds, Center Measure is selected. The signal nearest center screen (or with Markers activated, nearest the marker), and above a preset threshold level, is moved to center screen. (With Option 02, the frequency and amplitude of the centered signal are display readouts in the upper right, identified by the letter "C".)

To perform a Signal Tracking function, press and hold the pushbutton until two beeps are heard, at least 0.4 seconds, then release. After releasing the pushbutton, observe the display, the letters TRKG should appear as a center screen readout. Tracking is a continuously repeated center measure function, automatically invoked at the end of each sweep.

MKR - Δ - OFF is a three function toggle.

(1) The frequency dot is a marker that is controlled by the FREQ/MARKERS knob. Marker frequency and amplitude are displayed as readouts identified with an "M". The LED to the left of the pushbutton lights to indicate markers enabled.

(2) The delta function places a second marker at the position of the first. This second marker is the reference point. The first remains active and may be moved to any position on the trace. The amplitude and frequency differences between the two markers are displayed as readouts identified with a "D". The LED is illuminated.

(3) Markers are turned OFF and the dot becomes a center frequency indicator. The LED is extinguished.

MKR/FREQ MENU See Section 4, Menu Operation.

Frequency Span/Division

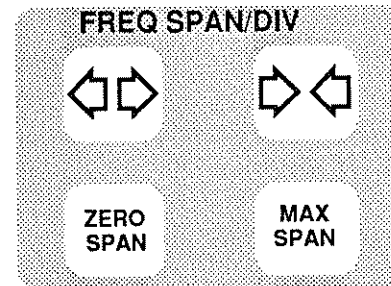

FREQ SPAN/DIV "arrow" push-buttons increase or decrease frequency span/div in a 1-2-5 sequence. ZERO SPAN and MAX SPAN are not an "arrow" selections.

MAX SPAN When activated, the analyzer sweeps and displays the full frequency range. When pressed a second time, the previous span is established.

ZERO SPAN pushbutton will configure the instrument with a Zero Hz span that is useful for time domain analyses. When pushed a second time, the previous span is established.

Any non-standard Span/Div may be set via the Utility Menu or MKR/FREQ MENU/ #1 - SPAN/DIV entry.

Resolution Bandwidth

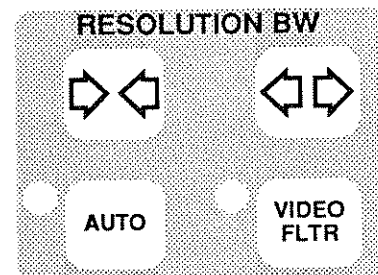

The Resolution Bandwidth is selected manually with the **RESOLUTION BW** "arrow" pushbuttons, by the microprocessor with AUTO, or via the Utility Menu. The value of the Resolution bandwidth is indicated on the crt.

AUTO In this mode of operation the display remains calibrated as the Span/Div, vertical display, and Video Filter settings are changed. When this mode is activated, the LED next to the pushbutton lights. Automatic Resolution Bandwidth is deactivated if the AUTO button is pressed again or the Resolution Bandwidth is changed with the "arrow" push-buttons.

VIDEO FLTR When this button is pressed the Video Filter mode is activated. The LED next to the button lights. The microprocessor selects a video filter that is approximately 1/100th the Resolution Bandwidth setting. Other Video Filter selections are available via the: UTILITY MENU/ #2- KEYBOARD SETTINGS/ #5-VIDEO FILTER/ #1-FIXED/ choose value.

Reference Level

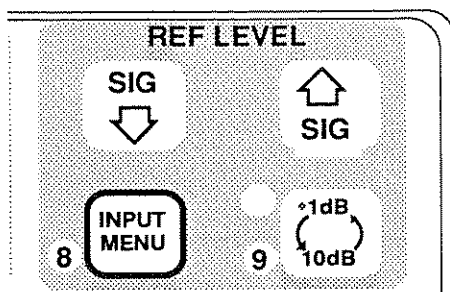

The Reference Level is the top of the screen. It represents a specified input level that may be expressed in dBm, dBmV, dBV, dBμV, or dBμW.

The Reference level may be moved up or down with the REF LEVEL "arrow" pushbuttons in either 1 dB or 10 dB steps (LED is lit when in the 1 dB mode).

With a Linear vertical scale factor and 10 dB steps selected, the increment size for the reference level (and readout) is volts/division (mV/Div.) in a 1-2-5 sequence. With 1 dB step size selected, the increment size is 0.2 division.

INPUT MENU See Section 4 , Menu Operation.

VERTICAL SCALE

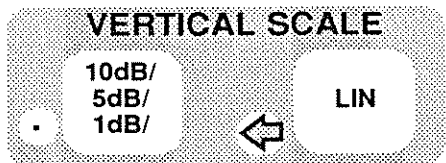

10 dB/ 5 dB/ 1 dB/ are the logarithmic scale factor selections. The default power-up selection is 10 dB. The crt readout indicates which scale factor is enabled.

LIN invokes a linear vertical scale. A direct conversion is made to volts/division and displayed in place of the log. readout.

Press LIN a second time to revert to the last selected logarithmic scale.

Vertical Scale factor is also a menu selection. See UTIL MENU in Section 4.

DISPLAY STORAGE

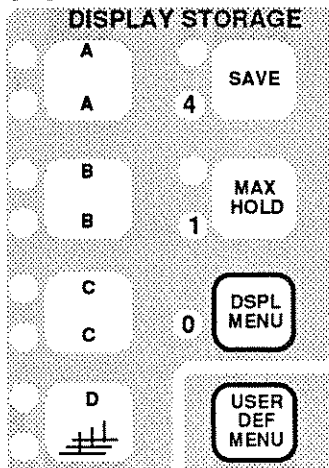

A,B,C, and D are the controls for the four display storage registers. Each button has a red and a green LED indicator. When a button is pressed, that register is activated and its contents are displayed and updated each sweep and the red LED lights. When a register is put in a saved mode, its contents are not updated and the green LED lights. A saved register may or may not be displayed.

SAVE is used with the A, B, C, and D buttons to modify the activity of the display registers. When SAVE is pressed and armed, its LED lights. To save the current contents of a register, press SAVE (light its LED), then press A, B, or C to light their green LEDs. By repeating this procedure for each register, all three can be saved in rapid succession.

When SAVE is used with the "D" register, the display is changed to the Waterfall mode. See Section 6, Display Storage for operating information and an explanation of the waterfall mode.

To remove a "saved" display, press SAVE, then the desired register pushbutton.

NOTE: If all four digital display storage registers are inactive (turned off), the display system will switch to the non-digitized (analog) display mode.

MAX HOLD When this pushbutton is pressed, the instrument compares the amplitude of each horizontal data point of the current sweep, with the amplitude of the same point in memory (maximum value from previous sweeps) and stores the larger value. Maximum Hold is applicable to the A and B registers only. If both registers are saved, Maximum Hold cannot be invoked.

NOTE: This instrument warns of invalid conditions by emitting a sound and displaying an error message.

DSPL MENU See Display Storage menu in Section 4.

Sweep and Triggering

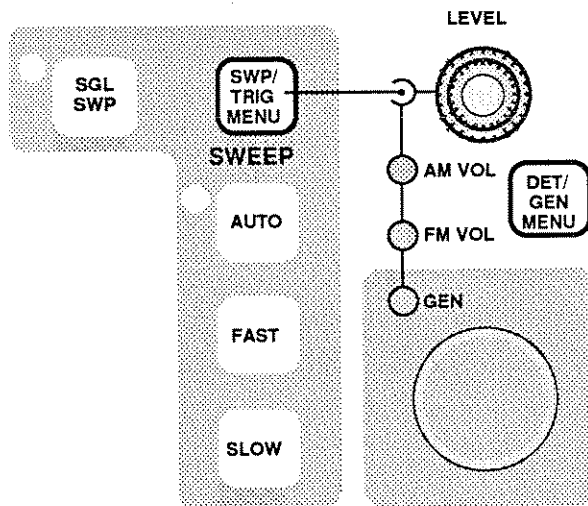

When the **SGL SWP** button is pressed, the Spectrum Analyzer aborts the current sweep and the LED next to the push-button lights. Press SGL SWP again to initiate a single sweep. When the sweep is triggered and completed, the LED remains lit. To turn the single sweep feature OFF, press and hold SGL SWP until two beeps are heard or follow this menu path: SWEEP TRIGGER MENU/press any # selection (0-5).

When the instrument is in Free Run mode and SGL SWP is pressed; at the end of the current sweep, the LED blinks, sweep action stops, and the last waveform is displayed. In Free Run, pressing SGL SWP again, causes an immediate single sweep function to occur (There is no wait for a trigger).

AUTO When automatic mode is activated the sweep rate is calculated and selected as a function of Frequency Span/Div, Resolution Bandwidth, Video Filter in use, and Vertical Display selections, to maintain a calibrated display .

FAST and SLOW These two pushbuttons increment the sweep rate to the next faster or slower sweep rate if available. Manual selection of the sweep rate can produce an uncalibrated display.

LEVEL The inner control is used to adjust the triggering level for Internal, External, and Line. The outer control is used to adjust receiver volume.

SWP/TRIG MENU See Section 4 Menu Operation

DET/GEN MENU See section 4 Menu Operation.

UTILITY

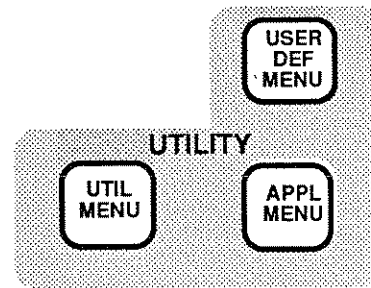

The push-buttons in this group are used in the operation of the Utility Menu. See Section 4.

Miscellaneous Controls

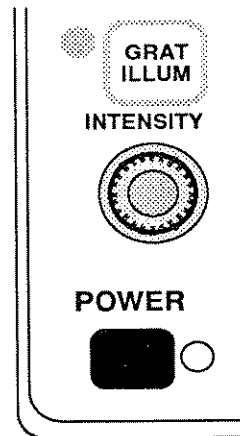

GRATICULE ILLUMINATION This pushbutton is the ON/OFF control for the graticule lights.

INTENSITY This control is used to adjust the brightness of the display and text.

POWER Push-push type switch that turns the instrument's power supply ON and OFF. Full RF attenuation is switched in when power is turned off. This will help protect the 1st mixer from input signal overloads when the Factory Default Power-up setting is used.

REAR PANEL CONTROLS

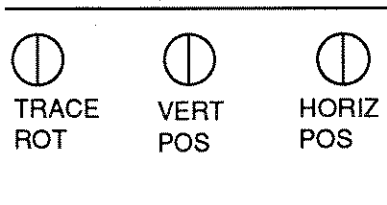

Rear Panel

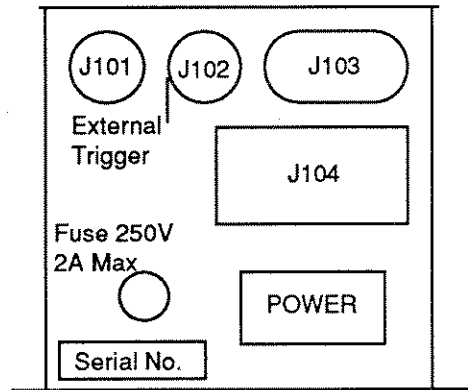

CONNECTORS

Front Panel

RF INPUT
MAX
+20dBm
100VDC

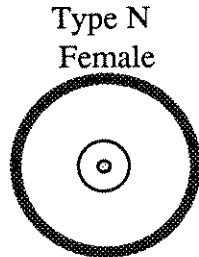

The receptacle for RF Input signals is a 50 Ω Type N female connector. Do not apply more than 100 volts DC to this input.

The maximum allowed input level applies to steady state. That is, connecting a high-level active line (≥ 10 V) to the **RF INPUT**, with less than 30 dB of attenuation enabled, can damage the Spectrum Analyzer.

For safe measurement practices, select substantial attenuation before connecting any signal source to the Spectrum Analyzer to prevent damage from unspecified high level voltage or rf power.

Select at least 30 dB of rf attenuation if a signal source exceeding 10 V dc or peak ac is to be connected to the **RF INPUT** to protect against damaging the Spectrum Analyzer front end. After the connection is made, the rf attenuation may be safely reduced in accordance with the rf signal levels present.

Rear Panel Connector Usage

J101 – This space is reserved for future applications.

J102 – This BNC connector is a DC coupled input for external trigger signals. The characteristic input impedance is 10 k Ω .

J103 – This is a 9 pin auxiliary connector .

The pin assignments for J103 are as follows:

- 1 External Video Input
- 2 Chassis and Signal Ground
- 3 Video Output
- 4, 5, 8, and 9 – These pins are reserved for future use.
- 6 Sweep Gate
- 7 Sweep Output

POWER_ This connector accepts the standard or any of the 5 optional power cords. See General Information Table 1-1 for a listing of the optional power cords.

MENU OPERATION

INTRODUCTION

There are seven menus of selections that are used to invoke most of the 2710 setups, operational modes, and applications. See Figures 4-1A, 4-1B, and 4-1C.

MENU DISPLAY

A menu of selections may be displayed by pressing its front panel pushbutton. MENU pushbuttons are outlined in black and are the on/off switch for their respective menu.

<p>INPUT MENU (page 4-6)</p> <ul style="list-style-type: none"> 0 REF LEVEL ENTRY 1 PREAMP 2 50 OHM DBM/75 OHM DBMV 3 REF LEVEL UNIT <ul style="list-style-type: none"> 0 DBM 1 DBMV 2 DBV 3 DBUV 4 DBUW 5 DBUV/M IN WFM C 9 DBUV/M SETUP <ul style="list-style-type: none"> 0 EDIT ANTENNA TABLE <ul style="list-style-type: none"> 1 2 3 4 5 6 MEASUREMENT DIST 7 SAVE RESULTS IN WFM 9 MARKER DISPLAY 4 1ST MIXER INPUT LVL 5 RF ATTENUATION 6 EXTERNAL ATTEN/AMPL <ul style="list-style-type: none"> 0 ON/OFF 1 ATTEN/AMPL ENTRY 9 CAL SIG @ 100MHZ -30DBM 	<p>MKR/FREQ MENU (Continued)</p> <ul style="list-style-type: none"> 9 SETUP TABLE <ul style="list-style-type: none"> 0 CENTER/START FREQ 1 THRESHOLD 2 COUNTER RESOLUTION <ul style="list-style-type: none"> 0 COUNTER OFF WHEN TRKG (1HZ) <ul style="list-style-type: none"> 1 1 HZ 2 1 KHZ 3 PROGRMD TUNING INC <ul style="list-style-type: none"> 0 CENTER FREQ 1 MARKER FREQ 2 KEYPAD ENTRD INC 3 KEYPAD ENTRY 4 RETURN TO AUTO 4 TABULAR TUNING TABLES <ul style="list-style-type: none"> 0 *TV VHF UHF <ul style="list-style-type: none"> 1 CATV STANDARD 2 CATV HRC 3 CATV IRC 4 UHF G AND H 5 UHF I 6 UHF K AND L 7 UHF M (JAPAN) 5 FREQ OFFSET 6 FREQ OFFSET MODE
<p>MKR/FREQ MENU (page 4-8)</p> <ul style="list-style-type: none"> 0 FREQUENCY ENTRY 1 SPAN/DIV ENTRY 2 KNOB FUNCTION <ul style="list-style-type: none"> 0 *FREQUENCY 1 MARKER 2 VIDEO LINE 3 TG TRACKING 3 MARKER TO REFERENCE LEVEL 4 MOVE MARKER TO NEXT PEAK 5 TRANSPOSE MARKERS 6 MARKER START/STOP 7 FREQUENCY START/STOP <ul style="list-style-type: none"> 0 FREQ START ENTRY 1 FREQ STOP ENTRY 8 TUNING INCREMENT 	<p>DET/GEN MENU (page 4-22)</p> <ul style="list-style-type: none"> 0 OFF 1 AM DETECTOR 2 FM DETECTOR 3 AM & FM DETECTOR 4 TRACKING GENERATOR 5 TG FIXED LEVEL 6 TG VARIABLE LEVEL 7 TG TRACKING 8 TG EXT ATTEN/AMPL <p>SWP/TRIG MENU (page 4-10)</p> <p>Trigger Menu</p> <ul style="list-style-type: none"> 0 FREE RUN 1 INTERNAL 2 EXTERNAL 3 LINE 4 TV LINE 5 TV FIELD <p>Sweep Menu</p> <ul style="list-style-type: none"> 6 SWEEP RATE 7 MANUAL SCAN 8 BROADCAST (AM) VIDEO

Figure 4-1A. Menu selections.

<p>SWP/TRIG MENU (Continued)</p> <p>9 SETUP TABLE Monitor 0 VIDEO DETECT MODE 1 SYNC POLARITY 2 VIDEO POLARITY Horizontal Line Triggering 3 CONTINUOUS 4 KNOB SELECTABLE 5 KEYPAD ENTERED LINE 6 KEYPAD ENTRY 7 TV LINE STANDARD</p>	<p>APPL MENU (page 4–20)</p> <p>0 BANDWIDTH MODE 1 CARRIER TO NOISE 2 NOISE NORM'D 3 SIGNAL SEARCH MENU 0 BEGIN FREQ 1 END FREQ 2 START TEST 3 DISPLAY RESULTS</p> <p>9 SETUP TABLE 0 DB DOWN FOR BW MODE 1 NORM BW FOR C/N 2 NOISE NORM'D BW</p>
<p>DSPL MENU (page 4–12)</p> <p>1 ENSEMBLE AVERAGING (page 4–14) 1 INITIATE AVERAGING 2 TERMINATE AVERAGING 3 MAX 4 MEAN 5 MIN 6 MAX/MIN 7 NUMBER OF AVERAGES 8 SAVE RESULTS IN DISPLAY</p> <p>2 B,C MINUS A 3 B,C MINUS A OFFSET TO 4 ACQUISITION MODE 5 TITLE MODE (page 4–16) 1 TITLE MODE ON/OFF 2 TITLE MODE EDIT 3 PLOT LABELING 4 PLOT LABELING EDIT</p> <p>6 READOUT 7 DISPLAY SOURCE (page 4–12) 1 AM DETECTOR 2 FM DETECTOR 3 EXTERNAL INPUT</p> <p>8 DISPLAY LINE 1 ON/OFF 2 VALUE ENTRY 3 DISPLAY LINE TO MARKER 4 LIMIT DETECTOR</p> <p>9 MIN HOLD IN WFM C</p>	<p>USER DEF MENU (User-Defined Programs: See Section 9)</p>

Figure 4-1B. More menu selections.

¹ These two menus are displayed only when HPGL-2 Pen or HPGL 4-Pen plotter language is selected.

UTIL MENU (page 4-24)	
<ul style="list-style-type: none"> 0 INITIALIZE INSTR SETTINGS 1 STORED SETTINGS/DISPLAYS <ul style="list-style-type: none"> 0 LAST POWER-DOWN 1 FACTORY DEFAULT POWER-UP 2 USER DEFINED POWER-UP 3 -9 User-Defined Settings 2 KEYPAD ENTERED SETTINGS <ul style="list-style-type: none"> 0 FREQUENCY 1 REFERENCE LEVEL 2 SPAN/DIV 3 RF ATTENUATION 4 RESOLUTION BW <ul style="list-style-type: none"> 0 AUTO 1 FIXED 5 VIDEO FILTER <ul style="list-style-type: none"> 0 AUTO 1 FIXED 6 VERTICAL SCALE <ul style="list-style-type: none"> 0 LOG 1 DB/DIV 1 LOG 5 DB/DIV 2 LOG 10 DB/DIV 3 LINEAR 7 SWEEP RATE 3 NORMALIZATIONS <ul style="list-style-type: none"> 0 ALL PARAMETERS 1 FREQUENCY ONLY 2 AMPLITUDE ONLY 4 SYSTEM CONFIGURATION <ul style="list-style-type: none"> 0 COMMUNICATION PORT CONFIG <ul style="list-style-type: none"> 1 CENTRONICS 1 SCREEN PLOT CONFIGURATION <ul style="list-style-type: none"> 0 COMM PORT 1 PLOTTER LANGUAGE 2 PLOT SPEED¹ 3 PLOTS PER PAGE¹ 4 PLOT POSITION¹ 2 PRINTER CONFIGURATION <ul style="list-style-type: none"> 0 PRINTER DEVICE 	<ul style="list-style-type: none"> 4 SYSTEM CONFIGURATION (Continued) <ul style="list-style-type: none"> 3 INSTRUMENT CONFIGURATION <ul style="list-style-type: none"> 0 AUDIO ALERT LEVEL 1 MINIMUM SIGNAL SIZE 2 WAVEFORM TO PRINTER 3 WAVEFORM OUTPUT FORMAT 4 PHASELOCK 5 FREQUENCY CORRECTIONS 6 SPECTRAL DISPLAY IN MENUS 7 SWEEP HOLDOFF 4 REAL-TIME CLOCK SETUP <ul style="list-style-type: none"> 0 YEAR 1 MONTH 2 DAY 3 HOUR 4 MINUTE 5 SECOND 5 STORED SETTINGS PROTECT 6 FILE SYSTEM DIRECTORY 7 PROTECT FILE 9 INSTALLED OPTIONS DISPLAY <ul style="list-style-type: none"> includes firmware version 5 INSTR DIAGNOSTICS/ADJUSTMENTS <p><i>UTIL MENU/#5 contains servicing and factory calibration information, with the exception of reference normalizations. Therefore, only reference normalizations are shown under this menu.</i></p> <ul style="list-style-type: none"> 5 SERVICE NORMALIZATIONS <ul style="list-style-type: none"> 1 REFERENCE NORMALIZATIONS <ul style="list-style-type: none"> 0 GAIN STEP REFERENCE 1 INTERNAL REF FREQ 2 INTERNAL REF AMPLTD 6 SCREEN PLOT¹ 9 MORE (Utility Menu Continued)² <ul style="list-style-type: none"> 0 PRINT READOUTS 9 MORE (Return to Previous Menu)

Figure 4-1C. More menu selections.

¹ These menus are operational only when Option 09 is installed.

KEYPAD and ALPHA CHARACTERS

When a menu is displayed, the front-panel keypad numbers 0 through 9, a decimal point, a back-space arrow, and alpha characters A, B, C, and D are lighted by green LED's. The numbers are used to invoke a selection or set values. The alpha characters are used as terminators. Appropriate directions for their use appear as prompts on the display. The back-space arrow may be used to "undo" an entry or selection.

MENU SELECTIONS

To choose a selection within a displayed menu, press the corresponding keypad number. Notice that in some menus, certain keypad numbers are not used for selections, i.e. the INPUT MENU does not have selections #7 and #8.

INVOKING A SELECTION

When the corresponding keypad number for a selection is pressed:

- Some selections invoke the choice and return the instrument to the spectral display.
- Some selections replace the displayed main-menu with a sub-menu that expands the field of choices (see Figure 4-1D).
- Other selections change or add a prompt to the current display (see Figure 4-1E). A prompt may provide directions for entry of a quantitative value with units, or it may be instructions for returning to a prior menu or to the spectral display.

MENU PATH

In this manual, a Menu Path is an abbreviated set of instructions for invoking the setup or operational choices within a menu or sub-menu.

This is an example of a menu path where a main menu selection invokes a sub-menu of operational choices.

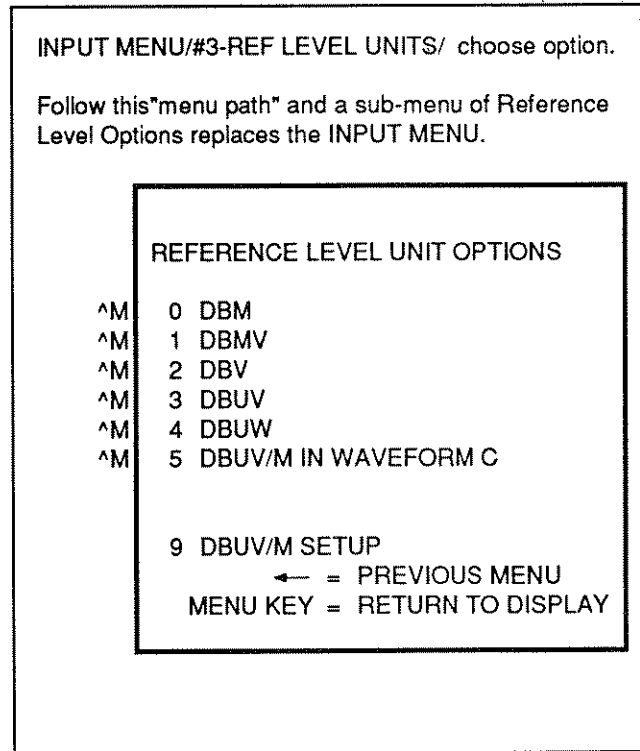

Figure 4-1D. Example of a selection that invokes a SUBMENU.

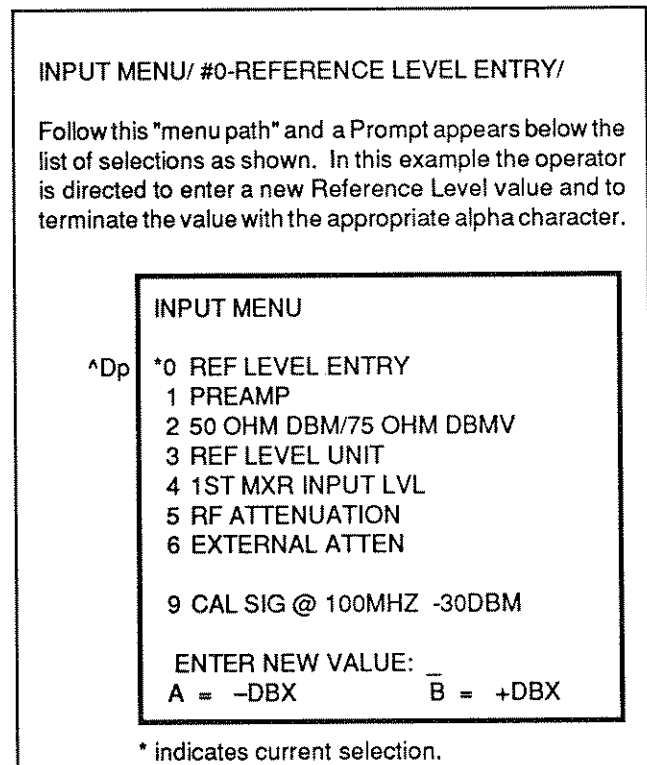
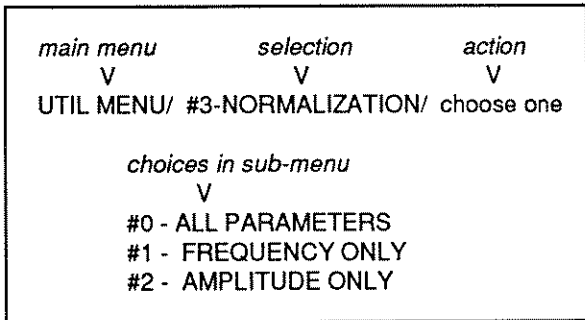

Figure 4-1E. Example of a selection that invokes a PROMPT.



To follow this menu path:

- Press the front panel UTIL MENU.
- The "/" indicates "next step".
- Press keypad #3 to choose NORMALIZATION.
- The UTILITY MENU display is replaced by a sub-menu of operational selections.
- The "next step" or action, is to choose one of the three entries using the keypad.

DISPLAY RESPONSE

There are six possible display responses for the menu selections. A key to these display responses is provided as follows:

- ^D = Exit to the Spectral Display.
- ^M = Exit to the prior (higher) menu.
- S = Stay in the current menu, returning to initial state.

vM = Move to a Sub Menu.

R = Perform a routine , then return to initial state of current menu.

^IS = Invalid Selection. Returns to initial menu and displays instructions.

Modifications to the Display Response keys are indicated with the following suffixes.

d = a momentary delay occurs prior execution. This delay is intended to allow the user time to confirm the choice.

p = a prompt must be responded to before the choice will be invoked.

NOTE

These display response keys are shown in the manual, they are not part of the display.

MENU DESCRIPTIONS

Each menu and its major sub-menus are described in the remaining pages of this section. The layout scheme is to use the left and right facing pages for a given menu. As shown in the diagram below, the left page contains directions for displaying the menu, a representation of the display, the display response to each selection, and supplementary information.

The right page contains a brief description of each menu selection.

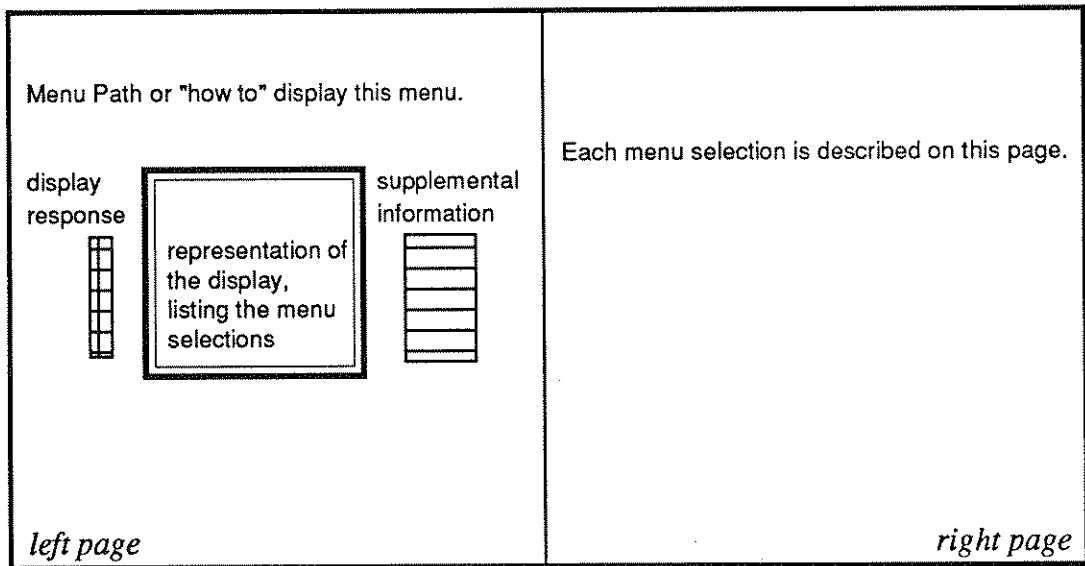

Menu Operation – 2710 Operators

Press **INPUT MENU** to display the menu selections shown in Figure 4-2.

NOTE: See facing page for menu selection details.

NOTE

In an actual display, only the CAPITAL letters within the boxed area are shown; the current value replaces the lower -case letters. The information outside the box is supplemental.

response key	INPUT MENU		
^Dp	0 REF LEVEL ENTRY	current	[10 DBX]
^D	1 PREAMP	ON	(OFF)
^D	2 50 OHM DBM/75 OHM DBMV	50	(75)
vM	3 REF LEVEL UNIT	current	[DBM, DBV, DBMV, DBUV, DBUW, DBUV/M]
^Dp	4 1ST MXR INPUT LVL	current	[-30 DBX]
^DP	5 RF ATTENUATION	FIXED	[(AUTO) 10 DB]
vM	6 EXTERNAL ATTEN/AMPL	current	[12.3 DB] (NONE)
^D	9 CAL SIG @ 100MHZ -30DBM	OFF	(ON)

← = PREVIOUS MENU
MENU KEY = RETURN TO DISPLAY

[] = example entry. () = alternate entry.

Figure 4-2. Input menu display and supplemental information.

INPUT MENU/ #3-REF LEVEL UNIT. This is a menu path that invokes the following sub-menu.

	REFERENCE LEVEL UNITS
^D	0 DBM
^D	1 DBMV
^D	2 DBV
^D	3 DBUV
^D	4 DBUW
^D	5 DBUV/M IN WFM C
vM	9 DBU/M SETUP

← = PREVIOUS MENU
MENU KEY = RETURN TO DISPLAY

Figure 4-2B. Reference level units menu.

INPUT MENU SELECTIONS

- 0 **REFERENCE LEVEL ENTRY:** Current level is displayed. This selection calls up a prompt for a new value. Enter value and terminate with appropriate unit.
- 1 **PREAMP (ON/OFF):** Current status is displayed. This selection toggles the mode to the other state and returns to the display. When PREAMP is ON, the front-end gain is increased approximately 18 dB and the IF/RF gain reduced a proportionate amount. The Pre-amplifier is used to increase sensitivity. The normal operating mode is OFF for minimum distortion.
- 2 **50 OHM DBM/75 OHM DBMV:** The current configuration is displayed. When invoked, the microprocessor calculates a calibrated reference level with respect to both the unit and impedance change, then exits to the spectral display.
- 3 **REF LEVEL UNIT*:** The current unit (DBM, DBMV, DBV, DBUV, DBUW, DBUV/M) is displayed. This selection calls up a REFERENCE LEVEL UNIT OPTIONS sub-menu for selecting the desired unit. When the unit is selected, the display returns to the INPUT MENU.
 - 0 **DBM:** Set reference level units to dBm.
 - 1 **DBMV:** Set reference level units to dBmV.
 - 2 **DBV:** Set reference level units to dBV.
 - 3 **DBUV:** Set reference level units to dB μ V.
 - 4 **DBUW:** Set reference level units to dB μ W.
 - 5 **DBUV/M IN WFM X:** This selection starts the field strength measurement and saves the measurement waveform in display storage register A, B, or C as selected via INPUT MENU/#3/#9/#7.
 - 9 **DBUV/M SETUP:** See Reference Level Units Menu on page 10-2.
- 4 **1st MXR INPUT LVL:** The current input level to the 1st mixer is displayed. When selected a prompt asks for the new value. Enter the new value, via the keyboard, and terminate with either A (-dBx), B (+dBx), or C (nominal current unit). Values are limited to -20 dB through -50 dB in 2 dB steps.
- 5 **RF ATTENUATION:** This selection calls up a prompt for the user to enter a new value (0 to 50 dB in 2 dB steps) or AUTO. Terminate the entry with the units pushbutton. When AUTO is selected, RF Attenuation is selected by the microcomputer as a function of the Reference Level, preamp status, 1st mixer input level and external Atten a fixed value is entered, the RF Attenuation remains fixed until changed to another fixed value or AUTO.
- 6 **EXTERNAL ATTEN/AMPL:** This selection calls up a sub-menu to enter the value of an external attenuator or amplifier. When "A" is pressed to terminate, the spectral display returns and the Ref Lvl readout now includes the added external value.
- 9 **CAL SIG:** This selection toggles the calibrator signal ON or OFF and returns to the spectral display. When ON the display will contain a comb of 100 MHz markers with a -30 dBm, 100 MHz fundamental.

* M in DBM, DBMV, and DBUV/M denotes milli (m).
 U in DBUV, DBUW, and DBUV/M denotes micro (μ).

Menu Operation – 2710 Operators

Press **MKR/FREQ MENU** to display the menu selections shown in Figure 4-3A.

response key	MARKER/FREQUENCY MENU		
^Dp	0 FREQUENCY ENTRY	current	[350KHZ]
^Dp	1 SPAN/DIV ENTRY	current	[150KHZ]
^D	2 KNOB FUNCTION	FREQ	(MARKER)
^D	3 MARKER TO REFERENCE LEVEL		
^D	4 MOVE MARKER TO NEXT PEAK		
^D	5 TRANSPOSE MARKERS		
^D	6 MARKER START/STOP		
vM	7 FREQUENCY START/STOP		
S	8 TUNING INCREMENT	AUTO	(PROGRMD) (TABULAR)
vM	9 SETUP TABLE		

← = PREVIOUS MENU
MENU KEY = RETURN TO DISPLAY

[] = example entry. () = alternate entry.

NOTE: See facing page for menu selection details.

Figure 4-3A. Marker and frequency menu selections.

MARKER-FREQUENCY MENU/ #9-SETUP TABLE. This is a menu path that invokes the following sub-menu.

MKR/FREQ MENU - SETUP TABLE			
^D	0 CENTER/START FREQ	CENTER	(START)
^Sp	1 THRESHOLD	current	[(AUTO) -30DBX]
vM	2 COUNTER RESOLUTION 1HZ		(1KHZ)
vM	3 PROGRMD TUNING INC		
vM	4 TABULAR TUNING TABLES		
Sp	5 FREQ OFFSET		
S	6 FREQ OFFSET MODE		

← = PREVIOUS MENU
MENU KEY = RETURN TO DISPLAY

Figure 4-3B. Marker-Frequency Setup Table.

MARKER-FREQUENCY MENU/ #9-SETUP TABLE/ #3-PROGRAMMED TUNING INCREMENT/

PROGRAMMED TUNING INCREMENT

(START FREQ)	^D	0 CENTER FREQUENCY	current	[500 KHZ]
(DELTA MKR FREQ)	^D	1 MARKER FREQUENCY	current	(OFF)
	^D	2 *KEYPAD ENTRD INC	current	[233KHZ]
	^Dp	3 KEYPAD ENTRY		
	^D	4 RETURN TO AUTO	current	[30KHZ]
		CURRENT TUNING INC	current	[30KHZ]
		ENTER NEW VALUE: A=HZ B=KHZ C=MHZ D=GHZ		

This keypad entered increment is the MKR/FREQ MENU/ #8 - TUNING INCREMENT/ PROGRMD value.

Figure 4-3C. Tuning increment programming.

MARKER, FREQUENCY- MENU SELECTIONS

- 0 **FREQUENCY ENTER:** This selection displays the current setting and calls up a prompt that allows user to enter a new value. After entry is terminated with units selection, the display returns to the spectral display.
- 1 **SPAN/DIV ENTRY:** This selection displays the current setting and calls up a prompt that allows the user to enter a different Span per division value. After entry is terminated with units selection, the display returns to the spectral display.
- 2 **KNOB FUNCTION:** This selection calls up a sub-menu that allows selection of one of the following four knob functions:
 - 0 **FREQUENCY:** Center frequency
 - 1 **MARKER:** Marker position (frequency)
 - 2 **VIDEO LINE:** Selected video line triggering
 - 3 **TG¹ TRACKING:** Tracking Generator Tracking (when enabled)

Thus, the **FREQ/MARKERS** knob may be selected to control center frequency, marker/s frequency, selected video line triggering, or TG Tracking.
- 3 **MARKER TO REFERENCE LEVEL:** This selection moves the marker, together with the marked signal, to the top of the graticule. The reference level changes to the level of the marked signal. If the marker system is not enabled prior to making the selection, the message "MARKERS ARE OFF" is displayed. If the marked signal is below a preset threshold, an error message "OUT OF RANGE" is displayed.
- 4 **MOVE MARKER TO NEXT PEAK:** This selection activates marker mode and moves the marker to the next higher or lower signal than the current signal, provided the signal is above threshold level. If no signal exists above the current peak when **NEXT HIGHER** is selected or below when **NEXT LOWER** is selected, the message "NO SIGNAL FOUND ABOVE THRESHOLD" is displayed.
- 5 **TRANSDUCE MARKERS:** In Delta mode, this selection switches the active function from one marker to the other.
- 6 **MARKER START/STOP:** This selection changes the current span to a span whose start and stop frequencies are those of the delta markers. The instrument must be in Delta Mode for this selection to be operative.
- 7 **FREQUENCY START/STOP:** This selection calls up a sub-menu to select frequency start/stop limits. As the Start/Stop selections are made, prompts ask for the new value and when the units key is pressed, the frequency value is updated to that entered.
- 8 **TUNING INCREMENT:** This selection cycles through the choices of tuning increments for the **FREQUENCY/MARKERS** control through **AUTO**, **PROGRAMMED**, and **TABULAR**. If either Programmed or Tabular increments are selected, the value of the increments may be read or changed by going to Selection #9 **SETUP TABLE** and choosing the appropriate sub-menu.
- 9 **SETUP TABLE:** This selection calls up a sub-menu that expands the selections.
 - 0 **CENTER/START FREQ:** When selected, the indicated frequency dot toggles between the center frequency and start frequency of the display.
 - 1 **THRESHOLD:** Threshold establishes the minimum amplitude level for marker related functions. When selected, a prompt asks for a new threshold value or selection of the **AUTO** threshold level (10 dB above the displayed noise floor). Enter new value or press "C" for Auto. When a new value is terminated with a units selection, the threshold readout is updated.
 - 2 **COUNTER RESOLUTION:** (applicable with Option 02 only). This selection invokes a sub-menu with choices of 1 Hz, 1 kHz, or **COUNTER OFF WHEN TRKG** (counter turned off in Signal Tracking mode).
 - 3 **PROGRMD TUNING INC:** See Figure 4-3C. The selections in this sub-menu are active only when **MKR/FREQ MENU/ #8 TUNING INCREMENT/PROGRMD** is active. To revert to normal increment, select **MKR/FREQ MENU/ #8-TUNING INCREMENT/AUTO**.
 - 4 **TABULAR TUNING TABLES:** Tabular tuning tables are used for changing the spectrum analyzer's center frequency in specified increments or channels. These channels may be television channels, radio channels or any other random or non-uniform frequency increments. A channel may be selected by tuning the **FREQ/MARKERS** knob. See Tabular Tuning Tables in Section 11.
 - 5 **FREQ OFFSET:** This selection allows entering a frequency offset to the center frequency readout. Example: when viewing a known signal through a down converter, a frequency offset can be entered so that the spectrum analyzer displays the frequency of the original signal and not the down-converted frequency. Also, start and stop frequencies entered via **MKR/FREQ MENU/#7**, are modified by the offset frequency.
 - 6 **FREQ OFFSET MODE:** This selection cycles through **ON PLUS** (positive offset), **ON MINUS** (negative offset), and **OFF**.

¹ Tracking Generator

Menu Operation – 2710 Operators

Press **SWP/TRIG MENU** to display the selections shown in Figure 4-4.

NOTE: See facing page for menu selection details.

response key	TRIGGER MENU	
^Dd	0 *FREE RUN	
^Dd	1 INTERNAL	
^Dd	2 EXTERNAL	
^Dd	3 LINE	
^Dd	4 TV LINE	
^Dd	5 TV FIELD	
	SWEEP MENU	
^Dp	6 SWEEP RATE	current [20 MS/DIV]
^D	7 MANUAL SCAN	OFF (ON)
^D	8 BROADCAST (AM) VIDEO	OFF (ON)
vM	9 SETUP TABLE	
	← = PREVIOUS MENU	
	MENU KEY = RETURN TO DISPLAY	

[] = example entry. () = alternate entry.

(SINGLE SWEEP)
 (SINGLE SWEEP)
 (SINGLE SWEEP)
 (SINGLE SWEEP)
 (SINGLE SWEEP)
 (SINGLE SWEEP)
 * See facing page.

Figure 4-4A. Trigger and Sweep menus.

SWEEP-TRIGGER MENU/ #9-SETUP TABLE. This is a menu path that invokes the following sub-menu.

SWEEP/TRIGGER MENU - SETUP TABLE			
MONITOR			
^Dd	0 VIDEO DETECT MODE	BROADCAST	(SATELLITE)
S	1 SYNC POLARITY	POSITIVE	(NEGATIVE)
S	2 VIDEO POLARITY	NEGATIVE	(POSITIVE)
HORIZONTAL LINE TRIGGERING			
^Dd	3 CONTINUOUS		
^Dd	4 KNOB SELECTABLE		
^Dd	5 KEYPAD ENTERED LINE		
^Dp	*6 KEYPAD ENTRY	current	[17]
^Dp	7 TV LINE STANDARD	current	[NTSC] (PAL) (SECAM) (OPEN)
	← = PREVIOUS MENU		
	MENU KEY = RETURN TO DISPLAY		

* When #6 - KEYPAD ENTRY is chosen, the following prompt appears;

ENTER NEW VALUE: (new value choices are 6 to 1023.)
 A = ENTER

Fig. 4-4B. Sweep/Trigger Menu/ #9-Setup Table

TRIGGER MENU SELECTIONS

- 0 **FREE RUN:** The sweep is free running without regard to trigger source. Other trigger modes are cancelled, including Single Sweep.
- 1 **INTERNAL:** This selection triggers the sweep with the demodulated signal from the instrument's detected video. The demodulated signal is a by-product of the RF carrier at the RF INPUT.
- 2 **EXTERNAL:** This selection triggers the sweep with a signal applied to the External Trigger connector.
- 3 **LINE:** The sweep is triggered by a sample of the ac power line voltage.
- 4 **TV LINE:** This selection triggers the sweep with the demodulated signal detected from the TV RF carrier; only the horizontal sync frequency portion (about 15 kHz) of the detected signal is passed through to the trigger circuit.
- 5 **TV FIELD:** This selection triggers the sweep with the demodulated signal from a TV carrier signal; only the vertical sync portion of the signal is passed through to the triggering circuit.
- ** **SINGLE SWEEP** is a frontpanel selection. When activated, SINGLE SWEEP, appears on the menu display next to the selected trigger source.

SWEEP MENU SELECTIONS

- 6 **SWEEP RATE:** This selection calls up a prompt to enter a new sweep rate value (time /div) and terminate with either "A" for second, "B" for millisecond, or "C" for microsecond.
- 7 **MANUAL SCAN:** This selection is an ON–OFF toggle. The crt beam position is controlled by turning the LEVEL control (small knob). No trigger is required.
- 8 **BROADCAST (AM) VIDEO:** ON - OFF toggle for the Video Monitor option. When activated, the Resolution Bandwidth changes to 5 MHz, Sweep Rate to 5 μ s/Div, a vertical generator is invoked to generate TV Field, the video filter and digital storage are deactivated. The display is a monitor for the AM or FM modulated video signal. When the MONITOR is switched off, the previous instrument setup is restored. The signal peak must be brought to within 5 dB of the reference level to produce a raster on the display.
- 9 **SETUP TABLE:** This selection invokes the sub-menu shown in Figure 4-4B.

MONITOR

- 0 **VIDEO DETECT MODE:** This is a BROADCAST or SATELLITE toggle. (SATELLITE not currently available.)
- 1 **SYNC POLARITY:** This is a POSITIVE or NEGATIVE toggle.
- 2 **VIDEO POLARITY:** This is a POSITIVE or NEGATIVE toggle.

HORIZONTAL LINE TRIGGERING

- 3 **CONTINUOUS:** Each horizontal line is used as a trigger.
- 4 **KNOB SELECTABLE:** The FREQ/MARKERS control is used to select one line (6 through 1023). The selected line number is displayed in the upper-right of the screen.
- 5 **KEYPAD ENTERED LINE:** The line entered using #6 below, is the trigger.
- 6 **KEYPAD ENTRY:** Invokes a prompt for entering a line number.
- 7 **TV LINE STANDARD:** Selects NTSC, PAL, or SECAM TV standard.

Menu Operation – 2710 Operators

Press **DSPL MENU** to display the menu selections shown in Figure 4-5A.

response key	DISPLAY MENU		
vM	1 ENSEMBLE AVERAGING		
^D	2 B, C MINUS A	OFF	(ON)
^D	3 B, C MINUS A OFFSET TO	CTR	(TOP)
^D	4 ACQUISITION MODE	PEAK	(MAX/MIN)
vM	5 TITLE MODE		
^D	6 READOUT	OFF	(ON)
vM	*7 DISPLAY SOURCE	FM	(AM , EXT)
vM	**8 DISPLAY LINE	off or current	
^D	9 MIN HOLD IN WFM C	OFF	(ON)

[] = example entry. () = alternate entry.

← = PREVIOUS MENU
MENU KEY = RETURN TO DISPLAY

NOTE: See facing page for menu selection details.

Figure 4-5A. Display Storage Menu selections.

* This sub-menu is displayed when #7- DISPLAY SOURCE is selected.

DISPLAY SOURCE	
1	* AM DETECTOR
2	FM DETECTOR
3	EXTERNAL INPUT

← = PREVIOUS MENU
MENU KEY = RETURN TO DISPLAY

**This prompt is displayed when #8-DISPLAY LINE is selected.

DISPLAY LINE	
1	ON/OFF
2	VALUE ENTRY
3	DISPLAY LINE TO MARKER
4	LIMIT DETECTOR

← = PREVIOUS MENU
MENU KEY = RETURN TO DISPLAY

The sub-menu "vM" for #1 - ENSEMBLE AVERAGING is shown on pages 16 and 17, for #5 - TITLE MODE on pages 18 and 19, and for #8 - DISPLAY LINE on pages 20 and 21.

DISPLAY MENU SELECTIONS

- 1 **ENSEMBLE AVERAGING FOR DISPLAYS A, B, C:** When selected, a sub-menu is displayed (see pages 4–14 & 4–15 for details). The selections provide routines for Ensemble Averaging "n" sweeps by partitioning the screen into 512 segments and finding the numerical average of each segment over successive sweeps.
- 2 **[B, C] MINUS A:** This selection is an On or Off toggle. In the ON state, values in the Saved A register are subtracted from B or C and the difference is displayed. This difference waveform may be saved. A waveform must be saved in A before a subtraction can occur. The "D" display is always the current display.
- 3 **[B, C] MINUS A OFFSET TO:** Top or center of screen. The results of menu selection #2 are offset either to the top or the center of the screen. Normal position is center screen so both positive and negative excursions can be observed. In some cases the active (B & C) waveforms may be larger than the reference so the difference could be off-screen. This is corrected by shifting the reference to the top of the screen.
- 4 **ACQUISITION MODE:** This selection toggles between MAX/MIN or PEAK acquisition modes, then returns to the spectral display. Data is acquired on the next sweep. In MAX/MIN mode, 256 digital horizontal locations acquire the maximum excursions and 256 the minimum excursions. This produces a 512 point horizontal display, showing both maximum and minimum values of the acquired event. PEAK mode is a 512 point display where only the positive peak excursions of the event are acquired and displayed.
- 5 **TITLE MODE:** This selection calls up a sub-menu (see pages 4–16 & 4–17 for details). NOTE: This feature not implemented in early 2710 instruments.
- 6 **READOUT:** This selection toggles the display readout ON or OFF.
- 7 **DISPLAY SOURCE:** This selection invokes a sub-menu for selecting demodulated AM or FM from the front panel input signal or an external (EXT) video signal applied to J103 pin 1 on the rear panel as the vertical signal source for the display. When selected, Display Source overrides any front panel source selections.

AM is the power-up Display Source selection, it is the choice for most spectral applications.

FM Display Source provides a means of measuring frequency deviation. In ZERO SPAN, the Reference Level is the top of the screen. Deviation calibration is displaced vertically as follows:

- 10 kHz/div
- 5 kHz/div
- 1 kHz/div

The 10 dB/ 5 dB/ 1dB/ control cycles through 10 kHz/div, 5 kHz/div, and 1 kHz/div.

EXT selects the rear panel External Video Input.

- 8 **DISPLAY LINE:** This horizontal line provides a reference for amplitude measurements.

DSPL MENU/ #1-ENSEMBLE AVERAGING/ choose selection. This menu path invokes the following sub-menu.

ENSEMBLE AVERAGING	
^D, ^Dp, or Sp	1 INITIATE AVERAGING
S	2 TERMINATE AVERAGING
S	3 MAX
S	4 MEAN
S	5 MIN
S	6 MAX/MIN
Sp	7 NUMBER OF AVERAGES current [16] (CONT)
S	8 SAVE RESULTS IN DISPLAY C (A, B)
	← = PREVIOUS MENU
	MENU KEY = RETURN TO DISPLAY

NOTE: See facing page for menu selection details.

Figure 4-5B. The Ensemble Averaging sub-menu of the Display Menu.

Ensemble Averaging requires the user to invoke this menu path, DISPLAY MENU/ #1-ENSEMBLE AVERAGING- choose selection: The averaging provides an improved signal-to-noise ratio. The choice of acquisition mode (selection 3,4,5,or 6) is dependent upon the application (type of signal, noise, etc.).The averaging function includes acquiring digital values for the vertical components, saving the values at horizontal data points, finding the numerical average over successive sweeps, and storing the specified data in a register (bin) for display.

An "acquisition" occurs every 400 nanoseconds, and the input signal strength is measured and converted to a digital value (A to D conversion). Each acquisition or conversion is compared with the last (previous) and the maximum and minimum values are retained. These values are referred to as Vertical units. The number of conversions that occur prior to a "save" function depends on the sweep rate.

A "save" function occurs when the sweep encounters the next Horizontal Data Point. At this time, the Vertical values are saved at that data point. This acquiring and saving continues to the end of the sweep.

When an acquisition mode is invoked, the specified Vertical values within each of the saved data points are acted on by a mathematical routine over successive sweeps and the result is stored in the selected display register.

ENSEMBLE AVERAGING OPTIONS – MENU SELECTIONS (Figure 4-5B)

- 1 **INITIATE AVERAGING:** This selection starts the ensemble routine unless the register chosen in #8 contains a saved waveform. If the selected register contains a waveform, a **WARNING** message is displayed. Screen prompts provide directions to override the saved display, abort the command, or select another register.
- 2 **TERMINATE AVERAGING:** This selection stops the averaging process, saves the average in the selected register and returns to the display.
- 3 **MAX:** Maximum positive excursions within each bin are averaged with previous sweeps and saved.
- 4 **MEAN:** Mean values within each bin are averaged with previous sweeps and saved.
- 5 **MIN:** Minimum values within each bin are averaged with previous sweeps and saved.
- 6 **MAX/MIN:** The maximum values within each bin are averaged with previous sweeps and saved, and the minimum values within each bin is averaged with previous sweeps and saved. The display is the vectors produced by alternating from the maximum to minimum values in each bin in turn.
- 7 **NUMBER OF AVERAGES:** Current number is displayed. When selected, a prompt asks for a new value. Enter value (default is 16, maximum is 1024). Terminate by pressing the "A" pushbutton. For continuous averaging press "C". In the continuous averaging mode the significance of the previous value for each point decreases with time.
- 8 **SAVE RESULTS IN DISPLAY (A, B, or C):** This selection will toggle between registers. At the completion of a #7 - NUMBER OF AVERAGES function. The result is saved in the selected register.

DISPL MENU/ #5-TITLE MODE/ choose selection. This menu path invokes the following sub-menu.

TITLE MODE				
S	1	TITLE MODE	OFF	(ON)
^Dp	2	TITLE MODE EDIT	WFM D	
S	3	PLOT LABELING	OFF	(ON)
Sp	4	PLOT LABELING EDIT		
← = PREVIOUS MENU				
MENU KEY = RETURN TO DISPLAY				

NOTE: See facing page for menu selection details.

Figure 4-5C. Title Mode sub-menu of the Display Menu.

TITLE MODE – MENU SELECTIONS (Figure 4-5C)

There are two title modes: TITLE MODE EDIT (for the display) and ON SCREEN INFO EDIT (for waveform anotation).

- 1 **TITLE MODE:** This selection toggles TITLE MODE on or off. When TITLE MODE is enabled, readout information is pushed one line down the screen, but the waveform display remains fixed.
- 2 **TITLE MODE EDIT:** This selection causes an instruction set to be displayed. An editing session can than be enabled by pressing "A". Pressing "A" again ends the edit session without saving the title. ("A" toggles the title and/or cursor on and off.) However, TITLE MODE EDIT can be exited only after pressing "B", "C", or "D". When the editing session is enabled, a cursor appears approximately two lines down from the menu title. The cursor is positioned horizontally with the MKR front-panel arrows. Characters and numbers for the title are selected by rotating the FREQ/MARKERS control. Numbers can also be selected with the front-panel keypad. A character selected via the keypad is automatically entered as it is selected, and a character selected via the FREQ/MARKERS control is entered by moving the cursor to another position. One line of title information, limited to 31 characters may be entered. If multipule registers (waveforms) are active at the same time, the title is associated with the highest order register at the time of its creation. Also, if multiple registers with different titles are displayed simultaneously, the title associated with the highest order register will be displayed ("D" over "C", "B", and "A" etc.) The printing (hard copy) program moves the Title information outside the plot window. The editing session is finalized and stored by pressing "B". An editing session is aborted without saving the recently entered characters by pressing "D". A previously existing title can be deleted by pressing "C".
- 3 **PLOT LABELING:** This selection toggles PLOT LABELING information on or off.
- 4 **PLOT LABELING EDIT:** This selection is identical to the TITLE MODE EDIT (selection #2), except that a full screen is made available for labeling waveforms (a blank page if no text has previously been written on the screen), and "A" toggles between the editing session and the instruction set. This selection is used for writing in the waveform display area (signal annotation). The cursor is positioned vertically with the REF LEVEL front-panel arrows, and horizontally with the MKR front-panel arrows. Character entry is the same as it is for TITLE MODE EDIT. All currently displayed waveforms (active and/or stored) are displayed on the (superimposed) on the blank page. Information written on screen can be viewed only when the edit page is called up, and will be plotted with whatever registers are being currently displayed. The printing program will maintain the on screen relationship between the information and the waveform.

Menu Operation – 2710 Operators

DISPL MENU/ #8-DISPLAY LINE/ choose selection. This menu path invokes the following sub-menu.

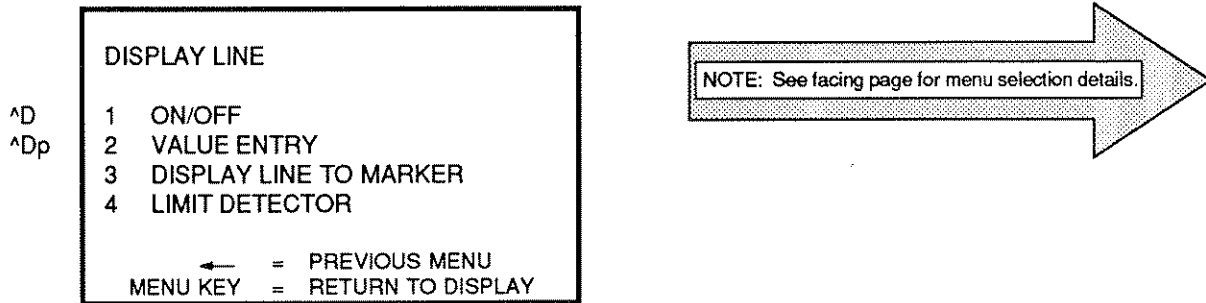

Figure 4-5D. Display Line sub-menu of the Display Menu.

DISPLAY LINE – MENU SELECTIONS (Figure 4-5D)

- 1 **ON/OFF:** This selection toggles between Display Line On and Display Line Off, then returns to the spectral display. When the display line is enabled (ON), a horizontal line is displayed according to the current setting. This horizontal line provides a reference for amplitude measurements.
 - 2 **VALUE ENTRY:** When the Display Line is enabled (ON), this selection calls up a prompt to enter a new value.
 - 3 **DISPLAY LINE TO MARKER:** When selected, this menu turns on the Display Line and places it at the marker level, and displays the current setting. If Delta Markers are enabled when the selection is made, the Display Line is placed at the position of the primary marker. If the marker is not enabled when the selection is made, the message "MARKERS ARE OFF".
 - 4 **LIMIT DETECTOR:** This selection cycles through OVER (SET THE DISPLAY LINE TO THE UPPER LIMIT), UNDER (SET THE DISPLAY LINE TO THE LOWER LIMIT), OVER-UNDER (SET THE DISPLAY LINE TO THE UPPER LIMIT, SET THE THRESHOLD TO THE LOWER LIMIT), and OFF.
-
-

Menu Operation – 2710 Operators

Press **APPL MENU** to display the menu selections shown in Figure 4-6A.

response key	APPLICATIONS MENU	[] = example entry.	() = alternate entry.
^D	0 BANDWIDTH MODE @ current	[-6HZ BW]	
^D	1 CARRIER TO NOISE @ current	[4.2 MHz]	
^D	2 NOISE NORM'D @ current	[1HZ BW]	
vM	3 SIGNAL SEARCH MENU		
vM	9 SETUP TABLE		

← = PREVIOUS MENU
MENU KEY = RETURN TO DISPLAY

NOTE: See facing page for menu selection details.

Figure 4-6A. Applications menu selections.

APPL MENU/ #3-SIGNAL SEARCH MENU/ choose selection and enter new value. This menu path invokes the sub-menu shown in Figure 4-6B.

	SIGNAL SEARCH MENU
Sp	0 BEGIN FREQ
Sp	1 END FREQ
Sp	2 START TEST
Sp	3 DISPLAY RESULTS
	DESTINATION DEVICE CENT

← = PREVIOUS MENU
MENU KEY = RETURN TO DISPLAY

Figure 4-6B. Setup table sub-menu for Applications Menu.

APPL MENU/ #9-SETUP TABLE/ choose selection and enter new value. This menu path invokes the sub-menu shown in Figure 4-6C.

	APPLICATIONS MENU - SETUP TABLE	
Sp	0 DB DOWN FOR BW MODE current	[-6DBC]
Sp	1 NORM BW FOR C/N current	[4.2MHZ BW]
Sp	2 NOISE NORM'D BW current	[1HZ BW]

← = PREVIOUS MENU
MENU KEY = RETURN TO DISPLAY

Figure 4-6C. Setup table sub-menu for Applications Menu.

APPLICATIONS MENU SELECTIONS

- 0 **BANDWIDTH MODE:** Selects an operational routine that measures the bandwidth (pre-defined in the Setup table) of a signal that is at center screen and above the threshold level. The **FREQ/MARKERS** knob is designated as the center frequency control so signals to be measured can be tuned to center screen. The bandwidth is measured and the read out is updated at the end of each sweep.
- 1 **CARRIER-TO-NOISE:** When selected, this routine performs a center measure for the signal nearest center screen, then turns Delta markers on. At this time, the fixed and active markers will appear at the center peak of the signal being measured. Use the **FREQ/MARKERS** control to move the active marker 30 times the Resolution Bandwidth to the right of the fixed marker. The routine will calculate the carrier-to-noise ratio after several sweeps, normalized to the bandwidth specified in the setup table. Readout is preceded with "C/N" to denote carrier-to-noise.

If **MARKERS** are activated prior to entering this mode. The routine will perform its operation on the signal nearest the marker.
- 2 **NOISE NORM'D (dB/Hz):** When this is selected, the absolute noise level per user selected bandwidth, at the marker position, is computed and the read out is updated at the end of each sweep.

3 SIGNAL SEARCH MENU

- 0 **BEGIN FREQ:** This selection allows entry of the start (lower limit) frequency for the signal search routine. The frequency value is updated to that entered after entry is finished.
- 1 **END FREQ:** This selection allows entry of the stop (upper limit) frequency for the signal search routine. The frequency value is updated to that entered after entry is finished
- 2 **START TEST:** This selection starts the signal search routine. While the Signal Search routine is in progress, the message "SIGNAL SEARCH IN PROCESS" is displayed. Current instrument settings are used, except that the D register is enabled if only saved displays are present (current settings for waveform D are used), **TUNING INCREMENT** is set to **AUTO**, **FREE RUN TRIGGERING** is enabled, **CENTER/START FREQUENCY** is set to **CENTER**, and **FREQUENCY OFFSET** is disabled but all reported frequencies reflect that offset. The routine is terminated and the message "SEARCH TERMINATED, MAX SIGNALS" is displayed if the number of signals found exceeds 50.
- 3 **DISPLAY RESULTS:** This selection is used in conjunction with the **DESTINATION DEVICE** to display a report of the signals found in the last search routine executed. The **DESTINATION DEVICE** is selected via **UTIL MENU/#4/#2/#0**.

When the selected **DESTINATION DEVICE** is the crt, the report will contain the signal frequency, the center frequency set when the signal was found and the signal amplitude.

When the selected **DESTINATION DEVICE** is a port, the report will contain the signal frequency, the center frequency set when the signal was found, the signal amplitude, and some additional information.

9 SETUP TABLE

- 0 **dB DOWN FOR BW MODE:** When selected, a prompt allows the user to enter bandwidth reference points for the **BANDWIDTH MODE** measurement routine.
- 1 **NORMALIZED BW FOR C/N:** When selected, a prompt allows the user to enter the desired normalized bandwidth for the **CARRIER-TO-NOISE** measurement routine.
- 2 **NOISE NORM'D BW:** This selection calls up a prompt for the user to enter the desired normalized bandwidth for the **NOISE NORM'D** measurement routine.

Menu Operation – 2710 Operators

Press **DET/GEN** to display the menu selections shown in Figure 4-7.

response key

DETECTOR/GENERATOR MENU	
^Dd	0 OFF
^Dd	1 AM DETECTOR
^Dd	2 FM DETECTOR
^Dd	3 AM AND FM DETECTOR
← = PREVIOUS MENU	
MENU KEY = RETURN TO DISPLAY	

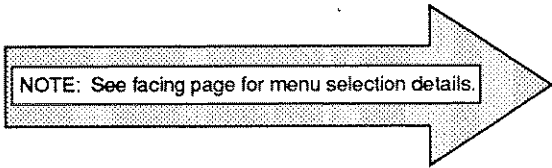

Figure 4-7. Detector- Generator menu display.

DETECTOR/GENERATOR MENU SELECTIONS

- 0 **OFF:** This selection disables any selected detector.
 - 1 **AM Detector:** Enables the AM Detector and sets the outer knob of the LEVEL control to its receiver volume function.
 - 2 **FM Detector:** Enables the FM Detector and sets the outer knob of the LEVEL control to its receiver volume function.
 - 3 **AM and FM:** Enables both detectors simultaneously.
-

Menu Operation – 2710 Operators

Press **UTIL MENU** to display the menu selections shown in Figure 4-8A.

response key	UTILITY MENU	[] = example entry. () = alternate entry.
^D	0 INITIALIZE INSTRUMENT SETTINGS	(user sel or factory)
vM	1 STORED SETTINGS	(optionally operative)
VM	2 KEYPAD ENTERED SETTINGS	
vM	3 NORMALIZATIONS	
vM	4 SYSTEM CONFIGURATION	
vM	5 INSTR DIAGNOSTICS/ADJUSTMENTS	
vM	6 SCREEN PLOT	
vM	9 MORE	

← = PREVIOUS MENU
MENU KEY = RETURN TO DISPLAY

NOTE: See facing page for menu selection details.

Figure 4-8A. Utility menu.

100
100
100

UTIL MENU SELECTIONS

- 0 **INITIALIZE INSTRSETTINGS:** This selection resets the instrument settings. The configuration is determined by the settings entered in:
 - UTIL MENU/ #1- STORED SETTING/ #2 USER DEFINED POWER-UP
 - Or, if sub-menu selection #2 is empty, then selection #1- FACTORYDEFAULT POWER-UP settings are used.
 - 1 **STORED SETTINGS:** Invokes a sub-menu (Figure 4-8B) that lists Last Power- Down, Factory Default Power-Up, User Defined Power- Up, and up to seven User Selected setups.
 - 2 **KEYPAD ENTERED SETTINGS:** Invokes a sub-menu (Figure 4-8C) which allows the user to directly enter basic operational parameters and functions.
 - 3 **NORMALIZATIONS:** Invokes a sub-menu of routines for setting measurement parameters to an internal reference to ensure performance in accord with specifications. Selections, #0-ALL PARAMETERS, #1-FREQUENCY ONLY, and #2-AMPLITUDE ONLY, are operator choices. When normalizations are invoked, the microprocessor performs amplitude measurements, frequency measurements, or both; determines the amount of correction necessary for a calibrated display; and stores those values for use when needed.
 - 4 **SYSTEM CONFIGURATION:** Invokes a sub-menu that shows the Communication Port (if installed), allows the user to set the Screen Plot Configurations, Printer Configuration, Instrument Configuration, and Real-Time Clock (if installed), provides protection for Stored Settings, and shows Installed Options (including the Firmware version).
 - 5 **INSTRUMENT DIAGNOSTICS/ADJUSTMENTS:** When selected, a sub-menu is called up that lists additional sub-menus with routines for conducting diagnostic tests, performing internal adjustments to re-calibrate the instrument, and normalizing the instruments measurement parameters. The diagnostics tests and adjustment procedures are for use by service personnel only. Operators may use this sub-menu to perform reference normalizations only via UTIL MENU/#5/#5/#1/#0, UTIL MENU #5/#5/#1/#1, and UTIL MENU/#5/#5/#1/#2.
 - 6 **SCREEN PLOT:** (Optional Centronics® Interface required.) This selection executes a plot of a display on an external plotter.
 - 9 **MORE:** Calls up a sub-menu for printing readouts.
-

UTIL MENU/ #1-STORED SETTINGS/ choose option. This menu path invokes the following sub-menu.

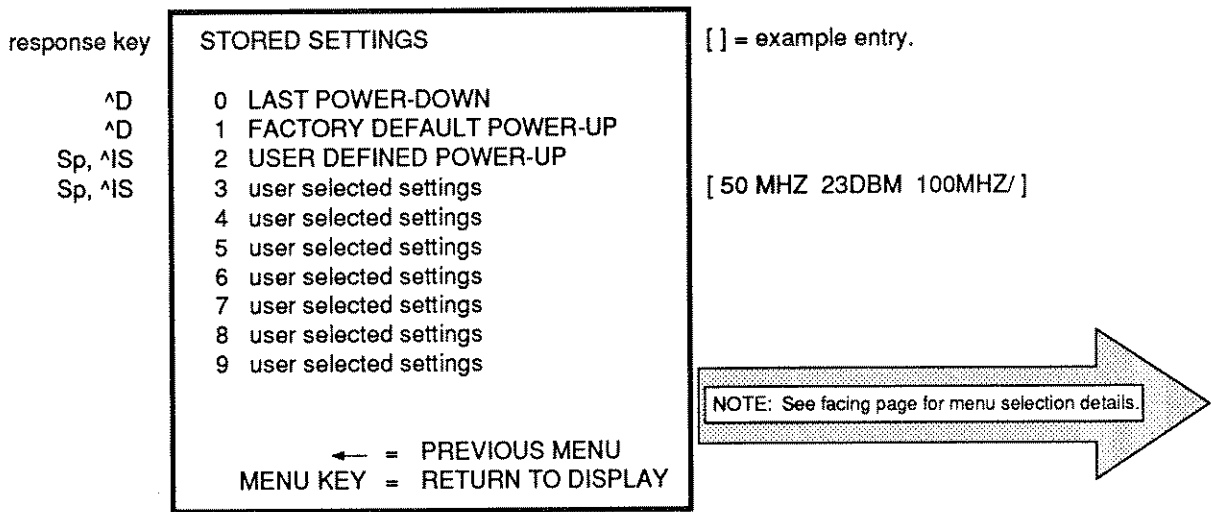

Figure 4-8B. Stored Settings sub-menu.

UTIL MENU/ #2-KEYPAD ENTERED SETTINGS/ choose selection.

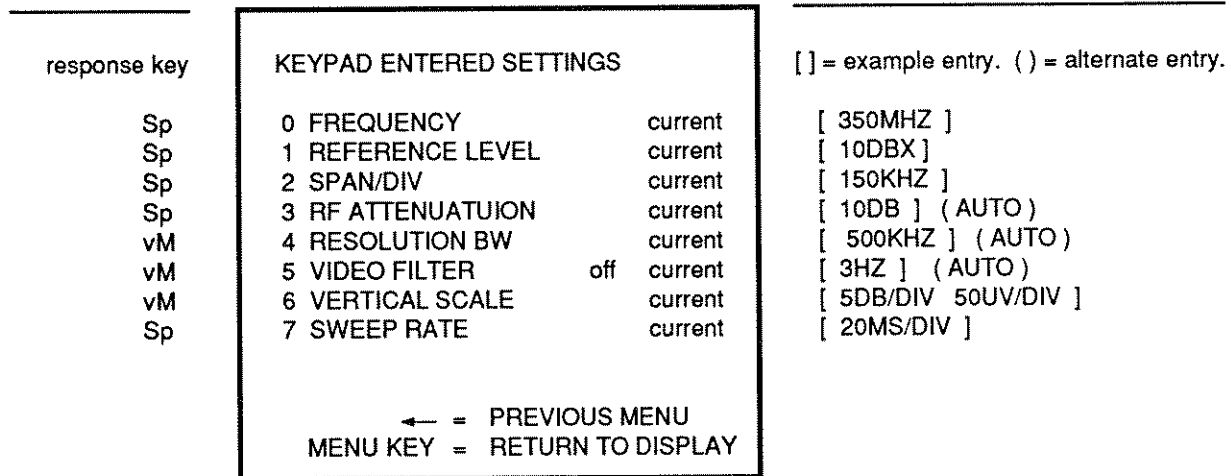

Figure 4-8C. Keyboard Entered Settings sub-menu.

#1- STORED SETTINGS SUB-MENU SELECTIONS

- 0 **LAST POWER-DOWN:** This selection resets instrument settings to those that existed when power was last interrupted or switched off.
- 1 **FACTORY DEFAULT POWER-UP:** This selection resets the instrument settings to factory default.
- 2 **USER DEFINED POWER-UP:** This selection resets the instrument to user designated settings. At power-up, the message WAITING FOR USER DEFINED POWERUP is displayed until the display defaults to the user-defined settings.
- 3 - 9 **User Selected Setups:** The current instrument setup or a "saved" waveform (saved display register) plus its setups can be stored, recalled, or deleted in any of these selections. An on-screen prompt provides the four choices: STORE the current instrument settings or a saved waveform plus its instrument settings. RECALL the Selected Setup and waveform to the display. DELETE removes the contents of the selection. ABORT returns to the STORED SETTINGS sub-menu.

#2-KEYBOARD ENTERED SETTINGS

- 0 **FREQUENCY:** Displays current setting. This selection calls up a prompt to enter a new value and terminate with units key.
- 1 **REFERENCE LEVEL:** Displays current setting. This selection calls up a prompt to enter new value and terminate with units key.
- 2 **SPAN/DIV:** Displays current setting. This selection calls up a prompt to enter a new value and terminate with the units key.
- 3 **RF ATTENUATION:** This selection toggles between AUTO and FIXED. In AUTO, attenuation is varied to maintain a -30 dBm level at the mixer input, or the level INPUT MENU/ #4-1st MIXER INPUT LEVEL. In FIXED, a prompt appears and the user can set attenuation values from 0 to 50 in 2 dB steps. This value remains fixed regardless of reference level setting and will limit the range of reference levels available.
- 4 **RESOLUTION BANDWIDTH:** Displays current setting. Switches to sub-menu when pressed, to allow the user to enter new value or Auto mode. In Auto, the bandwidth is a function of the Span/Div and Sweep Time.
- 5 **VIDEO FILTER:** When KEYBOARD ENTERED SETTINGS sub-menu is displayed, the state of this selection (AUTO, current FIXED value, or OFF) is also displayed. When #5 is selected, a sub-menu allows the user to select AUTO or FIXED. AUTO provides a filter that is 1/100th of the selected resolution bandwidth. FIXED provides for filter selection from 3Hz to 300 kHz in a 1, 3 sequence. To turn OFF the Video Filter, press the front panel VIDEO FLTR pushbutton.
- 6 **VERTICAL SCALE:** Displays current scale factor value. This selection calls up a sub-menu listing the Log (1 dB/Div, 5 dB/Div and 10 dB/Div) or Linear options. When Linear mode is selected a prompt asks for the new value.
- 7 **SWEEP RATE:** Displays current rate. This selection calls up a prompt to enter new sweep rate value (1-2-5-sequence) and terminate with a units selection.

UTIL MENU/ #3-NORMALIZATIONS/ choose option. This menu path invokes the following sub-menu.

response key

NORMALIZATIONS	
^D	0 ALL PARAMETERS
^D	1 FREQUENCY ONLY
^D	2 AMPLITUDE ONLY
FREQ NOT DONE, NRMLZD VALUES USED	
REF NOT DONE, DEFLT VALUES USED	
AMP NOT DONE, NRMLZD VALUES USED	
NORMALIZATION SUGGESTED	
← = PREVIOUS MENU	
MENU KEY = RETURN TO DISPLAY	

[] = example entry.

NOTE: See facing page for menu selection details.

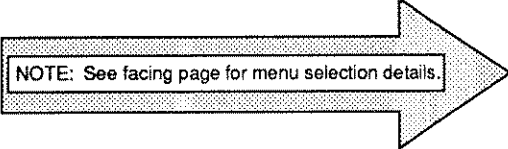

Figure 4-8D. Normalizations sub-menu.

#3-NORMALIZATIONS SUB-MENU SELECTIONS

- 0 **ALL PARAMETERS:** When ALL PARAMETERS (selection #0) is selected, the microprocessor performs both frequency and amplitude measurements; determines the amount of correction necessary for a calibrated display; and stores those values for use when needed.
- 1 **FREQUENCY ONLY:** When FREQUENCY ONLY (selection #1) is selected, the microprocessor performs frequency measurements; determines the amount of correction necessary for a calibrated frequency display; and stores those values for use when needed.
- 2 **AMPLITUDE ONLY:** When AMPLITUDE ONLY (selection #2) is selected, the microprocessor performs amplitude measurements; determines the amount of correction necessary for a calibrated amplitude display; and stores those values for use when needed.

Performing frequency and amplitude normalizations improves the accuracy of the Spectrum Analyzer. However, that does not ensure optimum performance accuracy (according to specifications) if any of the reference normalizations have not been done. To attain optimum accuracy, frequency and amplitude normalizations should be performed after reference normalizations have been performed. Also, frequency and amplitude normalizations should be performed each time reference normalizations are performed. If external references are not readily available, perform the frequency and amplitude normalizations to improve accuracy.

UTIL MENU/ #4-SYSTEM CONFIGURATION/ choose selection.

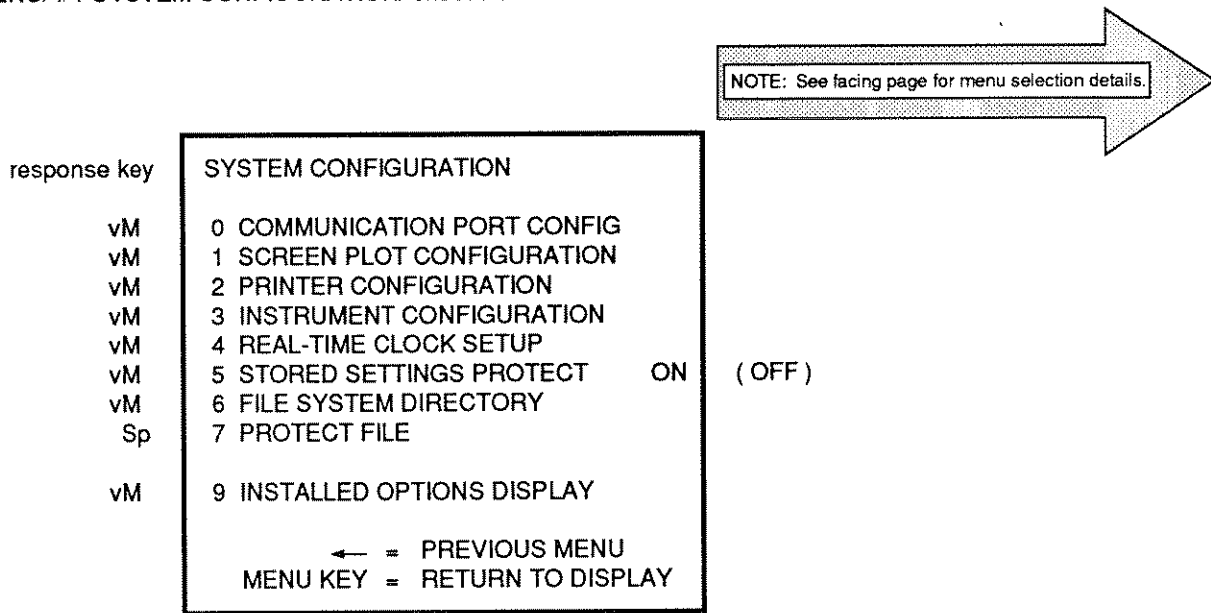
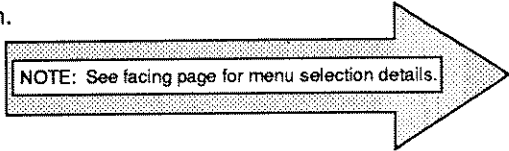

Figure 4-8E. System Configuration sub-menu.

UTIL MENU/ #4-SYSTEM CONFIGURATION

- 0 **COMMUNICATION PORT CONFIG:** This selection invokes a sub-menu that shows the communications port configuration.
 - 1 **SCREEN PLOT CONFIGURATION:** This selection invokes a sub-menu that permits selection of a Communications Port and Plotter Language.
 - 2 **PRINTER CONFIGURATION:** This selection invokes a sub-menu that permits selection of the Printer Device (CRT or Centronics Interface).
 - 3 **INSTRUMENT CONFIGURATION:** When selected, the following sub-menu is displayed:
 - 0 **AUDIO ALERT LEVEL:** Permits setting of the audio alert level to Low, High, CW, or Off.
 - 1 **MINIMUM SIGNAL SIZE:** Factory default is 20 vertical-digital-storage units. A signal difference less than the set value will not be recognized during a "next left" or "next right" operation.
 - 2 **WAVEFORM OUTPUT FORMAT:** This key toggles between ASCII and bin (binary).
 - 3 **WAVEFORM TO PRINTER:** This selection sends waveform data (ASCII or binary as selected via UTIL MENU/#4#3#3) to the printer port.
 - 4 **PHASELOCK:** This selection allows the user to enable and disable phaselock (it toggles between AUTO and OFF).
 - 5 **FREQUENCY CORRECTIONS:** This selection allows the user to enable and disable Frequency Corrections (it toggles between ON and OFF).
 - 6 **SPECTRAL DISPLAY IN MENUS:** This selection allows the user to enable and disable the Spectral Display while a menu is displayed (it toggles between ON and OFF).
 - 7 **SWEEP HOLDOFF:** This selection toggles between normal and short Sweep Holdoff. Short Sweep Holdoff yields faster display refresh times. However, most end-of-sweep processing such as frequency corrections are suspended.
 - 4 **REAL TIME CLOCK:** This selection invokes a sub-menu that allows the user to set the Real Time Clock.
 - 5 **STORED SETTINGS PROTECT:** This selection allows the user to effect or remove protection from erasure for Stored Settings.
 - 6 **FILE SYSTEM DIRECTORY:** This selection invokes a sub-menu that lists a directory of the file system (FID is the file number).
 - 7 **PROTECT FILE:** This selection allows the user to protect or remove protection from file. File protection is removed by initiating protection for a file that is already protected.
 - 9 **INSTALLED OPTIONS:** This selection invokes a sub-menu that shows Installed Options and firmware version.
-

UTIL MENU/ #5-INSTR DIAGNOSTICS-ADJUSTMENTS/ choose selection.



response key	INSTR DIAGNOSTICS/ADJUSTMENTS
vM	0 DIAGNOSTICS
vM	1 EXTENDED DIAGNOSTICS
vM	2 MANUAL ADJUSTMENTS
vM	3 DEBUG MENU
vM	4 INTERNAL PARAMETERS
vM	5 SERVICE NORMALIZATIONS
vM	6 DIGITAL OPTIONS DIAGNOSTICS
	← = PREVIOUS MENU
	MENU KEY = RETURN TO DISPLAY

Figure 4-8F. Instrument Diagnostics/Adjustments sub-menu.

UTIL MENU/ #5-INSTR DIAGNOSTICS & ADJUSTMENTS/ #5-SERVICE NORMALIZATIONS/ choose selection.

response key	SERVICE NORMALIZATIONS
vM	0 FREQUENCY NORMALIZATIONS
vM	1 REFERENCE NORMALIZATIONS
vM	2 AMPLITUDE NORMALIZATIONS
vM	3 NORMALIZATION VALUES
R	4 PRINT ALL NORM VALUES
S	5 NORM DEBUG TO PRINTER
	← = PREVIOUS MENU
	MENU KEY = RETURN TO DISPLAY

UTIL MENU #5-INSTRUMENT DIAGNOSTICS/ADJUSTMENTS

With the exception of reference normalizations, this menu is meant to be used by servicing personnel and for in-house diagnostics and calibration.

5 **SERVICE NORMALIZATIONS:** Even though this menu is meant to be used by servicing personnel and for in-house diagnostics and calibration, it may be used by operators to perform reference normalizations. For that reason, only reference normalizations are discussed. Frequency and amplitude normalizations can be readily performed via UTIL MENU/#3/#0 or individually via UTIL MENU/#3/#1 and UTIL MENU/#3/#2 respectively. When selected a sub-menu that includes item #1 below is displayed:

1 **REFERENCE NORMALIZATIONS:** When selected, it invokes a sub-menu that lists three reference parameters: Gain Step Reference, Internal Reference Frequency, and Internal Reference Amplitude. This selection is used to normalize the internal Reference Gain Step with respect to a known external step attenuator, the frequency of the internal Reference Frequency with respect to an external standard frequency reference, and the internal Reference Amplitude with respect to an external amplitude reference.

RESETS

INTRODUCTION

The settings of the 2710 Spectrum analyzer can be reset in many ways. Some of instrument settings are always reset, while others are never reset, and still others are reset during certain reset cycles only. This document includes a description of which settings are in each category, and when each category of settings are reset.

TERMS USED IN THIS SECTION

- **RESET** — To restore a setting to a previous state. For example, this is what happens to the center frequency when power is interrupted. The center frequency setting is RESET.
- **RESET CATEGORY** — Each setting belongs to one RESET CATEGORY. For example, Center Frequency belongs to the Resettable settings category. See Reset Categories in this section.
- **RESET CYCLE** — An operation which causes one of the reset categories to be operated upon.
- **RETAIN** — The opposite of RESET. A setting is RETAINED for a particular RESET CYCLE if its value can be set to any allowable value and remains at that value after the RESET CYCLE completes.

RESET CYCLES

The following sections describe each of the Reset Cycles possible in the Spectrum Analyzer.

- **POWER DOWN/UP Cycle** — This cycle is invoked by powering the instrument down and back up again.
- **INITIALIZE INSTRUMENT SETTINGS Cycle** — This cycle is invoked via UTIL MENU/#0.
- **RECALL LAST POWER DOWN Cycle** — This cycle is invoked via UTIL MENU/#1/#0.
- **RECALL FACTORY DEFAULT POWER-UP Cycle** — This cycle is invoked via UTIL MENU/#1/#1.
- **RECALL USER DEFINED POWER-UP Cycle** — This cycle is invoked via UTIL MENU/#1/#2/A.

- **RECALL NUMBERED SETTINGS Cycle** — This cycle is invoked via UTIL MENU/#1/#3-9/A.
- **POWER-UP DIAG AND REBOOT Cycle** — This cycle is invoked via UTIL MENU/#5/#0/#9.

RESET CATEGORIES

There are several distinct reset categories in the Spectrum Analyzer, viz:

Non-Resettable Settings

Non-resettable settings are not reset by any reset cycle. The settings in this class can only be changed by manually setting each to its desired value. Settings in this category are:

- Saved Waveforms
- RS232 Configuration (RS232 option only)
- Centronics Configuration (Centronics option only)
- Plot Configuration, including Comm Port, Plot Language, and Plot Speed (Plotter Option only).
- Real Time Clock Configuration (Current Time and Date is retained in the clock hardware, if present.)
- Audio Alert Level
- Settings Protect Mode
- Signal Search Parameters

Mode-Related Settings — These are settings which are reset for some reset cycles and retained for others. The Mode-Related settings are reset as follows:

- During a INITIALIZE INSTRUMENT SETTINGS cycle, reset to the values retained at the last physical power down.
- During a POWER DOWN/UP cycle, reset to the values retained at the last physical power down,

unless a User-Defined Power-up exists. In that case, reset to those stores in the User-Defined Power-up setting.

- A POWER-UP DIAG AND REBOOT cycle resets these the same as a POWER DOWN/UP cycle, but instead of the values resetting to those retained at the last physical power down, they reset as if a physical power down had just occurred.
- During all other cycles, do not reset.

UTIL MENU Items

- Spectral Display in Menus

MKR/FREQ MENU Items

- Frequency Reference Mode (CENTER/START)
- Counter Resolution
- Frequency Tuning Mode (AUTO and TABULAR only, others revert to AUTO)
- Entered Frequency Tuning Increment
- Tabular Tuning Table
- On-screen Signal Threshold
- Frequency Offset
- Frequency Offset Mode (ON/OFF)

INPUT MENU Items

- Input Impedance
- Reference Level Units
- External Gain/Attenuation
- External Gain/Attenuation Mode (ON/OFF)
- dB μ V/M Measurement Distance
- dB μ V/M Antenna Table
- dB μ V/M Target Waveform

SWP/TRIG MENU Items

- Video Monitor Mode (BROADCAST/SATEL-LITE)
- Video Monitor Sync Polarity
- Video Monitor Video Polarity
- Video Line Triggering Mode (CONTINUOUS/KNOB/ENTERED)
- Video Line Triggering Standard (NTSC/SECAM/PAL/OPEN)

DSPL MENU Items

- Ensemble Averaging Destination Waveform
- Ensemble Averaging Mode
- Ensemble Averaging Number-of-sweeps
- B,C Minus A Offset Mode
- Display Acquisition Mode (PEAK/MAX-MIN)
- Display Line Value

APPL MENU Items

- Bandwidth Display dBc Value
- Carrier-to-noise Reference Bandwidth
- Noise Normalized Display Reference Bandwidth

Resettable Settings

Resettable settings are those which are reset during ANY reset cycle. Any setting not covered by the previous categories are RESETTABLE. Resets occur as follows:

- During POWER DOWN/UP, INITIALIZE INSTRUMENT SETTINGS, and POWER-UP DIAG AND REBOOT cycles, reset to user-defined power-up (if it exists). Otherwise, reset to default values.
- During RECALL LAST POWER DOWN cycle, reset to last power-down settings.

Menu Operation – 2710 Operators

- During RECALL FACTORY DEFAULT POWER-UP, reset to the factory default settings.
- During RECALL USER DEFINED POWER-UP and RECALL NUMBERED SETTINGS cycles, reset to the specified settings storage register.

NORMALIZATION VALUES

The normalization values are modified by executing some or all of the normalizations. These values are only lost if certain NVRAM failures occur. The values being used by the instrument may be set to default values via the service normalization menus (UTIL MENU/#5/#5/#1 & #2). The actual (most recently passed) normalization values are always restored during the POWER DOWN/UP and the POWER-UP DIAG AND REBOOT cycles. The other cycles do not affect the normalization values.

INITIALIZED/CORRUPTED NVRAM

An occasion may arise where some or all of NVRAM is corrupted either intentionally, or by a hardware failure. The result of this corruption is that any one of the fore-mentioned reset cycles may require the information deleted from NVRAM, which would cause the reset cycle to fail. In this case, the reset action does not occur, and the previous settings are retained. For example, if a user-defined power-up has been defined, but that part of NVRAM is now corrupted, the POWER DOWN/UP cycle cannot recall the user-defined power-up, and acts as if the user-defined power-up settings never existed.

OPERATIONAL CHECK

The Power-up sequence for this instrument includes:

- Automatic selection of user-defined power-up settings.
- After the warm-up period, Normalization routines must be invoked to set measurement parameters, including frequency and amplitude, to an internal standard to ensure performance according to specifications.

Power-up Procedure

- Connect the Spectrum Analyzer power cord to an appropriate power source (see Section 2, Power Requirements).
- Push the frontpanel **POWER** switch ON.
- The instrument will configure itself to a set of User Defined Power-up settings. (This feature is not included with some of the early 2710 units.) If this set is empty (not defined) the instrument will configure itself to a set of Factory Default Power-up settings.

To enter or change User Defined Power-Up settings, set the instrument in the desired state and follow this menu path:

UTIL MENU/ #1-STORED SETTINGS/ #2-USER DEFINED POWER-UP/ press "B" (store)

- If the Factory Default Power-up settings are selected through default or via the menu, the instrument's configuration will be as follows:

Span/Div	= MAX SPAN
Center Frequency	= 900 MHz
Center Frequency Corrections	= ON
Signal Tracking	= OFF
Resolution Bandwidth	= AUTO (5 MHz)
Sweep Time	= AUTO (10 msec/div)
Tune Increment	= AUTO
Triggering	= FREE RUN
Reference level	= +20
Reference Level Units	= dBm
Input Impedance	= 50 Ω
Preamplifier	= OFF
Minimum RF Attenuation	= 0 dB
First Mixer input Level	= -30 dBm
RF Attenuation	= AUTO (50 dB)
External Attenuation	= OFF (0)
Vertical Display Mode	= log
Vertical Scale	= 10 dB/div
Video Filter	= OFF
Display Register	= D
Max Hold	= OFF
Max/Min mode	= ON
Video Sync	= Positive
Video Polarity	= Negative
Markers	= OFF
Graticule Illumination	= OFF

To select the Factory Default Power-up settings, follow this menu path:

UTIL MENU/ #1 STORED SETTINGS/ #1-FACTORY DEFAULT POWER-UP/ returns to display

- At this point in the power-up sequence, as the Spectrum Analyzer continues to warm-up, frequency and amplitude measurement parameters have not been normalized (set to the internal reference). The instrument is operational but is in an uncalibrated condition, and the decision to use it in this condition is discretionary. The instrument is useable for non-critical measurements.

- When the power-up routine is finished, the Frequency and Amplitude measurement parameters will have to be set to the internal reference (UTIL MENU/#3 NORMALIZATIONS/#0 ALL PARAMETERS) to bring the instrument's measurement performance within the specifications listed in Section 2.

Instrument Use

Most of the instrument's features, with examples of how to select them using the menus, and how to use them for basic measurements are described in Section 6.

Menu Selections

The menus and sub-menus are described in detail in Section 4.

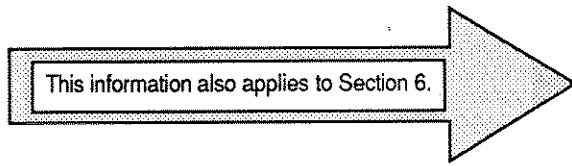

In this manual, a **Menu Path** is an abbreviated set of instructions for invoking setup or operational choices within a menu or sub-menu.

This is an example of a menu path where the main menu selection invokes a sub-menu that contains operational choices.

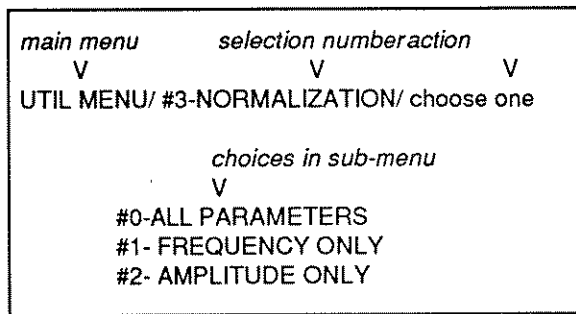

To normalize all parameters, using the example menu path:

- Press the front panel UTIL MENU pushbutton. The Utility Menu selections will be displayed.
- The "/" indicates "next step".
- Press frontpanel keypad #3 to choose the NORMALIZATION selection of the displayed menu. A sub-menu replaces the first menu of selections as the display.
- The "next step" is to choose the desired entry. In this case, press keypad #0 and the instruments microprocessor will conduct routines that normalize all parameters with respect to the internal reference.

FEATURES, OPERATION, AND MEASUREMENTS

This section describes the instrument's operating features, how to select them, and how they are applied in basic measurements.

FEATURES

Installed Options and Firmware Version

To find this information, follow this menu path.

UTIL MENU/#4-SYSTEM CONFIGURATION/#9-INSTALLED OPTIONS DISPLAY/ read information

The firmware version number is useful when requesting service or operational information.

Audio Alert Volume

Volume is a Menu selection. Follow this menu path.

UTIL MENU/#4-SYSTEM CONFIGURATION/#3-AUDIO ALERT LEVEL/ toggle - OFF, LOW, HIGH, CW

Warning and Error Messages

Two types of status messages inform the operator when either an operational error or a hardware failure exists. Warning messages, such as "OUT OF RANGE" tell the operator the instrument parameter is at a stop or limit. Error messages, such as "300 Hz FILTER NOT INSTALLED" tell the operator that the instrument cannot perform the requested measurement or operation. Both status messages print out on the crt screen and produce an audible beep from the speaker.

Intensity Level

Adjust the front panel INTENSITY control to set the display brightness for clear viewing but below marker blooming or defocusing.

Trace Alignment

Three rear panel screwdriver adjustments and a checkerboard display provide for trace alignment. The checker-board display is a menu selection.

UTIL MENU/ #5-INSTRUMENT DIAGNOSTICS-ADJUSTMENTS/#2-MANUAL ADJUSTMENTS/#2-MANUAL ADJUSTMENTS/#2-DISPLAY STORAGE CAL.

Adjust TRACE ROT – checkerboard tilt at center = graticule horizontal centerline.

Adjust VERT POS – checkerboard top line = graticule top line.

Adjust HORIZ POS – checkerboard vertical centerline = graticule vertical centerline.

Normalization Feature

Normalization routines set measurement parameters to an internal reference to ensure performance in accord with specifications. It is recommended practice to invoke normalization prior to a critical measurement. The display message during a routine identifies the parameter being normalized, and after normalizations are complete, the message is "NORMALIZATION COMPLETE" if everything passed, "AMPLITUDE NORMALIZATION FAILED" if any of the amplitude routines failed, or "FREQUENCY NORMALIZATION FAILED" if any of the frequency routines failed.

NOTE

A normalization failure usually results from drift as the instrument warms up if sufficient warm up time is not allowed before normalizations are invoked. Re-invoke normalizations after the instrument has warmed up. If the failure persists, then other problems exist.

To invoke any of three Normalization routines, follow this menu path.

UTIL MENU / #3- NORMALIZATION/ choose one

- #0-ALL PARAMETERS
- #1-FREQUENCY ONLY
- #2-AMPLITUDE ONLY

OPERATION

SIGNAL APPLICATION

The RF INPUT connector presents a 50 Ω impedance to the input source. Use a high quality 50 Ω coaxial cable to connect the signal source to the RF INPUT. Keep the input cable as short as possible to avoid cable loss at the higher frequencies. Impedance mismatch, caused by poor connections, incorrect signal source impedance, and long or low-quality coaxial cable, can produce reflections that degrade flatness, frequency response, sensitivity, and in some cases generate spurious responses. Adding RF ATTENUATION, via the Input Menu, when the signal strength is adequate will improve flatness and frequency response and will minimize reflections.

CAUTION

The RF INPUT of the spectrum analyzer is specified at +20 dBm maximum. The maximum dc level is 100 V.

However, connecting a high-level active line (≥10 V) to the RF INPUT has the potential of damaging the Spectrum Analyzer.

For safe measurement practices, select substantial attenuation before connecting any signal source to the Spectrum Analyzer to prevent damage from unspecified high level voltage or rf power.

Select at least 30 dB of rf attenuation if a signal source exceeding 10 V dc or peak ac is to be connected to the RF INPUT to protect against damaging the Spectrum Analyzer front end. After the connection is made, the rf attenuation may be safely reduced in accordance with the rf signal levels present.

Using The 2710 with a 75 Ω/50 Ω Minimum Loss Attenuator

The 2710 may be used in a 75 Ω system with a 75 Ω-to-50 Ω minimum loss attenuator. However, one should be aware that the conventional 5.76 dB loss usually associated with the minimum loss attenuator is the difference in power, not voltage, between the 75 Ω and the 50 Ω end of that attenuator. The voltage difference between the 75 Ω and 50 Ω ends of the attenuator is 7.54 dB.

Since the Spectrum Analyzer starts with the input signal being developed across its own 50 Ω input, the reference level is based on the voltage conversion through the attenuator. Figure 6-1 represents a 75 Ω system driving the Spectrum Analyzer through the minimum loss attenuator, and provides the derivation of the conversion.

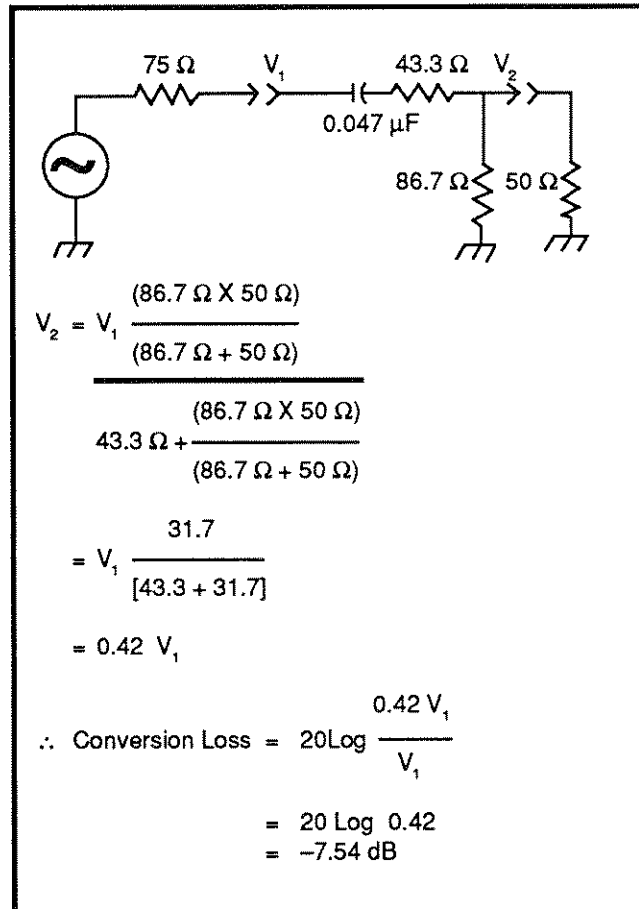

Figure 6-1. Conversion loss.

Mixer Input Considerations

Spurious responses can be generated by overdriving the mixer circuit. These spurious responses can be mistaken for true signals (see True vs Spurious below). The optimum signal level to the mixer is -30 dBm. Its 1 dB compression point is +6 dBm. Signal strength at the mixer input is a menu selection, follow this menu path:

INPUT MENU/#4-1ST MXR INPUT LVL/enter new value

The internal microprocessor will select the appropriate RF ATTENUATION for the given REF LEVEL to maintain proper operating conditions.

Level of Pulsed Signals

An important consideration for pulsed signal measurements is the peak signal level at the mixer. The display of a pulsed signal consists of a fundamental with harmonics. The signal

level at the mixer is greater, by the pulse duty cycle times 1.5, than the peak level of the fundamental that is displayed on the crt.

Level of Continuous Wave Signals

Measuring cw signals using frequency span widths that are relatively narrow or cw signals that exceed the display window, can also overdrive the mixer and generate spurious signals.

True vs Spurious signals

To determine whether a response is a true signal or one generated by the input circuit, decrease the RF level to the mixer input by adding 10 dB of attenuation. A true response will decrease approximately 10 dB, a spurious response will decrease about twice the amount.

Preamplifier

The Preamplifier is used to enhance measurements of low-level signals and improve the signal-to-noise ratio. Use the Input Menu to activate the Preamp.

INPUT MENU/ #1-PREAMP/ toggle ON-OFF

When the Preamplifier is activated, PRE appears adjacent to the REF LEVEL readout. Preamplifier gain is approximately 18 dB. This gain is taken into consideration by the microprocessor and the attenuation is adjusted to maintain the proper Reference Level.

Sensitivity with the Preamplifier activated begins to roll off above 600 MHz.

The actual value of the Preamplifier gain at 100 MHz, as determined during the NORMALIZATION cycle may be obtained via this menu path:

UTIL MENU/#5-INSTR DIAGNOSTICS/ADJUSTMENTS/#5 SERVICE NORMALIZATIONS/#3-NORMALIZATION VALUES/#0-RF ATTEN AND PREAMP GAIN

Measurements Outside Specified Frequency and Tuning Range

The displayed frequency scan of the instrument is slightly greater than the specified frequency range. The tuning range of the FREQ/MARKERS control is limited to the specified frequency range. With these conditions it is possible to observe signals outside the specified frequency range that cannot be tuned.

Counter Feature

Instruments with Counter Option 02, can count frequency to either 1 kHz or 1 Hz resolution. To activate and select the desired resolution, follow this menu path:

MKR/FREQ MENU/ #9-SETUP TABLE/ #2-COUNTER RESOLUTION/ choose #0-COUNTER OFF WHEN TRACKING, #1-1Hz or #2-1KHz

Counter resolution is not indicative of frequency accuracy. Option 01 provides improved frequency accuracy via a higher stability timebase.

Using the Center Measure

The Center Measure function is activated when the CTR MEAS/TRKG button is pressed and released in less than 0.4 seconds. The instrument completes the sweep and centers the signal nearest center-screen (or with markers activated, the signal nearest the marker is centered). It counts the center frequency and measures the amplitude, then displays both. Readout is preceded with the character "C" to denote center measure. The signal level must equal or exceed the threshold level (default is 10 dB above the average noise level).

Signal Tracking

To activate Signal Tracking, press and hold the CTR MEAS/TRKG button until two beeps are heard, at least 0.4 seconds, then release. In this mode, a Center Measure function is performed each sweep, i.e. the signal is centered, counted, and measured, and the readout is updated each sweep. The purpose of Signal Tracking is to hold a drifting signal at center screen. If the signal decreases below the threshold level, the tracking function goes to an idle state until the signal level returns to the threshold level.

Stored Settings

The total instrument configuration, this includes stored waveforms, Values for Frequency, Reference Level, Span/Div, Resolution Bandwidth, Video Filter, Vertical Scale, Sweep Rate, and any menu setup, may be stored and recalled as a group. To store or recall a group of settings, follow this menu path.

UTIL MENU/#1-STORED SETTINGS/sub-menu

Selections #0 and #1 of the sub-menu are reserved. Selections #2 through #9 may be used to store a "saved" Display Register and all its settings. Settings stored in #2 are used for the "Initialize" and "Power-up" set-ups. To define the "Initialize" and "Power-up" settings, set the instrument in the desired state and follow this menu path:

UTIL MENU/ #1-STORED SETTINGS/ #2-USER DEFINED POWER-UP/ press "B" (store)

In this sub-menu, display prompts provide directions for RECALL, STORE, DELETE, and ABORT functions. For a detailed description of the selections see page 4-23.

During instrument operation, to reset the instrument to "power-up" settings, follow this menu path.

UTIL MENU/ #0-INITIALIZE INSTRUMENT SETTINGS

Keyboard Entered Settings

To enter values via the keyboard, follow this menu path.

UTIL MENU/ #2-KEYBOARD ENTERED SETTINGS/

This invokes a sub-menu of basic parameters. Appropriate prompts appear with each selection as follows:

- #0 - FREQUENCY
- #1 - REFERENCE LEVEL
- #2 - SPAN/DIV
- #3 - RF ATTENUATION
- #4 - RESOLUTION BW
- #5 - VIDEO FILTER
- #6 - VERTICAL SCALE
- #7 - SWEEP RATE

MARKERS

For Frequency, Marker, and Delta Marker modes, the frequency mark is a bright dot(s) on the trace. The readout for Frequency mode is in the upper left portion of the display. The readout for Markers is in the upper-right. The amplitude of a marked position is added to the readout with the two Marker modes. The readout update for an amplitude change is noticeably delayed as compared to the update for a frequency change. Markers are visible only with a digitized trace. They are not displayed on an analog trace. When more than one trace is displayed, the markers will appear on the highest order trace, e.g. "D" has precedence over "C", etc.

Frequency Mode

On instrument power-up, the marker identifies the center or start frequency position. This is a Menu selection:

MKR FREQ MENU/ #9-SETUP TABLE/ toggle
#0-CENTER-START FREQ

In MAX SPAN, the marker can be moved along the trace with the FREQ/MARKERS control. When changing from MAX another SPAN/DIV selection, the marker moves to the center (or start) frequency of the span. This feature provides an effective means of marking a signal in MAX SPAN, then changing the SPAN/DIV sufficiently to view only (zoom-in) the marked signal.

Marker Mode

In Marker mode, FREQ/MARKERS control can move the marker to any point on the trace. Frequency and Amplitude readouts in the upper right portion of the display are preceded by the character "M".

Delta Marker Mode

In this mode, a second marker (reference) is placed on the first marker. The two markers appear as one. The reference marker is fixed relative to the display. The first marker is still moveable with the FREQ/MARKERS control. As the first marker is moved, the character "D" precedes the Frequency and Amplitude readouts to signify they are the difference between the markers.

Amplitude measurement

The marker amplitude readout is valid when the marker is between the threshold level and the top of the graticule. When the marker is above the top of the graticule or below the threshold level, "OUT OF RANGE" is displayed and a beep is sounded.

Control Selection

Frequency or Marker functions are selected with either the front panel controls or this menu path:

MKR FREQ MENU/ #2-KNOB FUNCTION/ toggle MARKER-FREQUENCY

RESOLUTION BANDWIDTH, FREQUENCY SPAN, AND SWEEP TIME

Resolution is the degree of ability to discretely display adjacent signals. This is a function of the instrument's IF filter bandwidth, sweep time, frequency span, and incidental FM. With substantially long sweep times, Resolution and Resolution Bandwidth are synonymous. Resolution Bandwidth affects sensitivity and signal-to-noise ratio. Maximum sensitivity and best signal-to-noise ratio is attained with the narrower resolution bandwidths. As the Resolution Bandwidth is decreased, the sweep time and/or the span/div must decrease to maintain a calibrated display. Wide resolution bandwidths are required when analyzing broadband signals or the modulation components of a signal, or when it is necessary to use the wider spans and faster sweep rates.

Pulsed signal analysis requires a resolution bandwidth that is about 1/10 the reciprocal of the pulse width and a sweep rate that is about 1/10 the pulse repetition rate. AUTO Resolution Bandwidth and AUTO sweep speed may not produce these conditions.

Wide spans provide the broad spectrum required to search for spurious signals or check harmonic content of a signal. When wide spans are used, with non-digitized displays, the sweep rate is usually set for minimum flicker. Wide spans require wide resolution bandwidths to maintain a calibrated display. Narrow frequency spans are used to zoom in on a signal and with narrow resolution bandwidth, analyze phenomena near a carrier, such as modulation sidebands, signal-to-noise ratio, intermodulation distortion or power-line related sidebands.

Sweep time, for a calibrated display, is inversely proportional to the square of the resolution bandwidth. As the bandwidth is decreased or the analyzer sweep rate is increased, a critical point is reached where the resolution and sensitivity are both degraded. Sweep rate for spectrum displays should be slow enough to maintain a calibrated display yet fast enough to minimize flicker or signal drift between sweeps.

With AUTO Sweep rate and Resolution Bandwidth, the microprocessor automatically selects a sweep rate and resolution bandwidth that is compatible for each Span/Div selection so the display remains calibrated. If only the Resolution Bandwidth is in the AUTO mode, the microprocessor selects a bandwidth that is compatible with the selected FREQ SPAN/DIV. When this occurs, an "UNCAL" (uncalibrated) message may be displayed to warn that the display is no longer calibrated if the selected sweep rate is inappropriate.

Using the Video Filters

Video filters can be invoked via the front panel VIDEO FLTR pushbutton or the Utility menu. A video filter restricts the video bandwidth, which reduces noise and high frequency components. When signals are closely spaced, a video filter can reduce the modulation between signals, making it easier to analyze the display. Filters can also be used to average the envelope of pulsed RF spectra that has a relatively high pulse repetition frequency (prf). A video filter is basically an integrating circuit, it is not effective when measuring low prf spectra. Using a filter may require a slower sweep rate to maintain a calibrated display. When the VIDEO FLTR button is pressed, the microprocessor automatically selects a filter that is approximately 1/100th of the resolution bandwidth. The Utility Menu may be used to select filters, from 3 Hz to 300 kHz, in a 1,3 sequence. Follow this menu path:

UTIL MENU/ #2-KEYPAD ENTERED SETTINGS/ #5-VIDEO FILTER/ #1-FIXED/ enter filter value

After a filter is menu selected, frontpanel VIDEO FLTR is the ON/OFF switch. To reinstate AUTO, use the same menu path.

Using Time Domain Operation

When ZERO SPAN is invoked, the spectrum analyzer functions as a tunable receiver. In this mode it displays time domain characteristics of signals within the resolution bandwidth of the instrument. Signal characteristics such as modulation pattern, video pattern, pulse repetition rates, etc., can now be analyzed with Sweep rate and sweep trigger selections. The signal bandwidth being displayed will be limited by the selected Resolution Bandwidth.

Triggering the Display

Normal trigger mode for spectrum analysis is Free Run. In this mode the sweep rate is asynchronous with the signal. If the event is time-related, such as power line frequency phenomena, pulse-related or modulating events, external or internal triggering by the source or signal, may be necessary to analyze the signals. TV Line and TV Field along with the SELECTIVE LINE TRIGGER and VIDEO MONITOR MODE (option 10) are logic type trigger signals and will trigger at preset levels. These triggers permit analysis or monitoring of TV related signals.

Triggering level (amplitude) for Internal, External, or Line (power line) is set by the LEVEL control (small knob). Internal triggering requires a signal amplitude of 1.0 division or more. External triggering will occur with any level from 100 mV to 50 V maximum (dc + peak ac). To prepare the instrument for internal triggering, use Free Run trigger mode. Tune to the signal, then activate ZERO SPAN and the Internal trigger mode. Adjust the LEVEL control for the desired trigger level. The analyzer will now trigger on the incoming signal at the level set by the control. To use Internal trigger for a spectrum display, the signal must be tuned to the start of the trace.

Single Sweep Feature

This feature is provided to analyze single event phenomena. When the SGL SWP button is pressed, the analyzer completes the current sweep. The LED next to the SGL SWP button. Press SGL SWP again to arm the sweep circuit for the next trigger signal. The LED remains lit until the sweep has been triggered and completed. It then blinks again. Single sweep mode may be turned off by pressing and holding SGL SWP until two beeps are heard or by using the menu as follows:

SWP TRIG MENU/ press any #- selection

Sweeping the Display

The sweep rate mode is usually AUTO. In this mode the rate changes with different Resolution Bandwidth and Freq Span/

Div settings to maintain a calibrated display. With some applications, such as time related events, it may be desirable to manually select a sweep rate that is commensurate with an event for example, looking at the pulse rate of a pulsed signal or a field of a TV signal. The sweep rate can be incremented over a seven decade range from 2s/Div to 1 us/Div by means of the FAST or SLOW pushbuttons or the sweep rate may be set via the Sweep Trigger menu.

Manual Scan of the Spectrum

This feature is a Menu selection.

SWP TRIG MENU/#7-MANUAL SCAN/ toggle ON-OFF

When selected, the crt beam is positioned with the LEVEL (small knob) control. Manual Scan allows the user to examine a particular point or sector of a spectrum, such as one of the null points of a frequency modulated spectrum. When manually scanning a wide Span/Div and/or a narrow Resolution Bandwidth, it is recommended practice to scan very slowly.

Reference Level

The REF LEVEL increments in 1 dB or 10 dB steps in the Log mode, and in a 1-2-5 sequence from 10 μ V to 280 mV/ div in the Lin mode. With Lin mode selected, the bottom of the screen is zero volts and the top of the graticule is eight times the vertical display factor. With the 1 dB step size activated, the Reference Level changes in 1 dB steps and the scale factor increment is approximately 1/20 the scale factor equivalent.

Reference Level units are Input Menu choices. Follow this menu path:

INPUT MENU/ #3-REF LEVEL UNITS/ choose #-(unit)

The selections in the sub-menu are DBM, DBMV, DBV, DBUV, DBUW, and DBUV/M. When units are changed, the readout is changed to the current units and the microprocessor calculates the equivalent value in new units from the previous units, i.e., a 0.0 dBV readout would change to a 60.0 dBmV readout.

DISPLAY STORAGE

Four display storage registers, "A", "B", "C" and "D", may be activated with front panel pushbuttons. Each pushbutton has two associated LED's. When a button is pressed, that register is activated (its contents are updated and displayed each sweep) and the red LED lights. To save and display the current contents of an active A, B, or C register, press SAVE then repress the button of the desired register. The green LED of the saved register lights.

Waterfall Feature

When SAVE and D are pressed, the display changes to produce a "waterfall" effect. This feature uses all four registers to provide a means of visually comparing the current sweep with the three previous sweeps. After at least four sweeps, the contents of the four registers are changed to produce waveforms as follows:

- The current sweep ("D" register) is the bottom waveform.
- The previous sweep ("D") is shifted up 1, and to the right 1/2 division. It is displayed as the "C" waveform.
- The previous "C" waveform is shifted another division upward and 1/2 division to the right and displayed as the "B" waveform.
- The previous "B" waveform is shifted up and to the right and displayed as the "A" waveform.

Maximum Hold Feature

This feature may be invoked for either the "A" or "B" registers. The maximum amplitude of each horizontal data point of the current sweep is compared with the same point in memory (maximum value from previous sweeps) and the larger value is retained (stored). This feature provides a means of finding the maximum amplitude and frequency excursions over a number of sweeps.

Acquisition Mode

The two selections of data acquisition for the registers are "store Peak value" or "store the Maximum and Minimum values". When PEAK is selected, only the peak value for each horizontal data point of a sweep is stored. With the other selection, the maximum values are stored in the odd numbered data points and the minimum values in even numbered data points. To select the acquisition mode, follow this menu path.

DSPL MENU/ #4-ACQUISITION MODE/ toggle PEAK-MAX/ MIN

"B" minus "A" register & "C" minus "A" register

This feature is a Menu selection.

DSPL MENU/ #2-B,C MINUS A/ toggle ON - OFF

Before selecting this feature, save the "A" register to establish a reference, then activate either or both "B" and "C" registers. The displayed waveform(s) is the difference between the current waveform ("B" and/or "C" register) and the stored reference ("A" register). This feature is useful for normalization of flatness.

MEASUREMENTS

Frequency mode

This procedure is an example of how to mark a signal in Maximum Span then zoom-in and make a more precise measurement using the Center Measure function.

- Configure the instrument to the Factory Default Power-up settings using this menu path:

UTIL MENU/#1-STORED SETTINGS/#1-FACTORY DEFAULT POWER-UP/ returns to spectral display.

- Change the Reference Level from +20 to -20 dBm, use the REF LEVEL frontpanel controls or use this menu path:

INPUT MENU/#0-REF LEVEL ENTRY/ enter new value

- To provide a signal for this example, activate the internal reference signal, use this menu path:

INPUT MENU/#9-CAL SIG @ 100MHZ -30DBM/ toggle ON

When the reference signal is activated, "CALIBRATOR" appears on the right side of the display.

- Turn the **FREQ/MARKERS** control to move the marker to a signal on the display. The frequency readout is a coarse indication of the signal frequency.
- To obtain a more precise measurement, use the **FREQ SPAN/DIV** "outward arrows" to change from MAX to a different SPAN/DIV. Do not select ZERO span.

Note that the signal marked in MAX SPAN is moved to the center of the new SPAN/DIV display.

- Turn the **FREQ/MARKERS** control.

Note the marker is fixed at center and the signal moves away.

- With the signal peak offset from the marker, press the **CTR MEAS/TRKG** button (press and release in less than 0.4 seconds).

The signal, is centered and measured.

Marker Mode

- To enable the Marker function, press the **MKR-Δ-OFF** button. The **FREQ/MARKERS** control now moves the marker with respect to the waveform in all SPAN/DIV selections.

- Set the **SPAN/DIV** to 50 MHz. Press **CTR MEAS/TRKG**.

Note that the signal nearest the marker and the marker are centered and measured. The frequency and amplitude values are preceded by the character "M" and appear in the upper right portion of the display.

Delta Markers mode

- Activate Delta Markers by pressing the **MKR-Δ-OFF** button a second time. A second marker (reference) is placed at the same position as the existing marker. The two markers appear as only one. The reference marker is fixed relative to the display.

- Move the reference marker with the **FREQ/MARKERS** control. The Frequency and Amplitude readouts are preceded with the character "D" and are the difference between the two markers.

- To turn OFF the Marker or Delta Marker mode, press the **MKR-Δ-OFF** button a third time.

Signal Level

- To measure amplitude, move the marker to the signal at the level you wish to measure. The marker amplitude in current units will be a read out in the upper right corner of the display.
- If differential amplitude is desired, use the Delta Marker mode and note the "D" amplitude readout.

The top of the graticule is the Reference Level. Its value and units of measure are a read out in the upper left part of the display. The Factory Default Power-up setting is +20 dBm.

- To enter a reference level value, follow this menu path.

INPUT MENU/#0-REF LEVEL ENTRY/ follow prompt

- To select units of amplitude, dBm, dBmV, dBV, dBuW, and dBuV/m follow this menu path.

INPUT MENU/ #3-REF LEVEL UNIT/ choose one

Measuring Bandwidth

To measure bandwidth, follow this menu path:

APPL MENU/#0-BANDWIDTH MODE

When Bandwidth Mode is selected from the menu a routine will automatically measure and readout the bandwidth and the dBc value (default is -3 dBc). Bandwidth is measured and the readout updated after each sweep.

The dBc value (dB below peak) may be set using this menu path:

APPL MENU/#9-SET-UP TABLE/#0-DB DOWN FOR BW MODE/ enter new value

Carrier-to-Noise Measurement

To perform this measurement, set the Span/Div to 1 MHz, adjust the signal to use full screen, set Marker to OFF, then follow this menu path.

APPL MENU/#1-CARRIER TO NOISE

When selected, a routine performs a center measure on the signal nearest center screen. Delta Marker mode is turned ON with the reference marking the center frequency (carrier frequency). Place the other marker a desired distance from the carrier frequency. The routine assumes a noise level that

is half way between the top and bottom of the displayed noise at the marked point. The routine compensates for the Resolution Bandwidth, the analyzer/system noise floor differential, the LOG and DETECTOR circuitry offsets, then calculates the carrier-to-noise ratio, normalized to the bandwidth specified in the Setup Table sub-menu. Readout is preceded with "C/N".

Frequency Corrections

This function is turned ON or OFF via this menu path:

UTIL MENU/#4-SYSTEM CONFIGURATION/#3-INSTRUMENT CONFIGURATION/#5-FREQUENCY CORRECTIONS/ toggle ON/OFF

When selected ON, the microprocessor periodically stops the sweep, calculates the correction factor, returns the signal to center frequency, and resumes the sweep.

If a continuous sweep condition has higher priority than frequency corrections with its attendant interruptions, turn this feature OFF.

Signal Detecting

Use AUTO sweep to locate and center a signal then switch to Zero Span. An alternate method is to Manually tune to the desired signal. Broadband FM signals are best detected with a 500 kHz resolution bandwidth filter.

FM Modulation Deviation

To measure the amount of frequency deviation caused by an FM modulating signal, follow this menu path:

DSPL MENU/#7-DISPLAY SOURCE/#2-FM DETECTOR

Deviation is displaced vertically dependent on the Vertical scale setting.

10 kHz/div = 10 dB/div
5 kHz/div = 5 dB/div
1 kHz/div = 1 dB/div

Normalizing the Internal Reference

- To normalize the frequency of the internal reference with respect to an external source, follow this menu path:

UTIL MENU/ #5-INST DIAGNOSTICS & ADJUSTMENTS/ #5-SERVICE NORMALIZATIONS/#1-REFERENCE NORMALIZATIONS/#1-INTERNAL REF FREQ/ follow sub-menu instructions

These instructions direct the operator to enter, via the keypad, the chosen frequency of the external source and to connect the generator to the analyzer. The higher the frequency used, the more accurate the normalization values. The calculated value is essentially the frequency difference between the internal and external references. When an instrument Normalization function is invoked this calculated value is accounted for.

- To normalize the amplitude of the internal reference to an external source, follow this menu path:

UTIL MENU/#5-INST DIAGNOSTICS & ADJUSTMENTS/
#5-SERVICE NORMALIZATIONS/#1-REFERENCE NOR-
MALIZATIONS/#2-INTERNAL REF AMPLTD/ follow sub-
menu instructions.

These directions do not allow a choice of amplitude values. Set and connect the generator to the analyzer. The routine calculates the amplitude normalization value.

Precision Measuring (Normalization)

Prior to a critical measurement it is recommended practice to invoke an appropriate Normalization routine. Follow this menu path:

UTIL MENU/ #3-NORMALIZATION/ choose one

- #0 ALL PARAMETERS
- #1 FREQUENCY ONLY
- #2 AMPLITUDE ONLY

These routines calculate normalized values for the concerned measurement parameters (circuits) with respect to the internal calibration signal (100 MHz, -30 dBm). The precision of a measurement immediately following a Normalization routine will exceed performance specifications.

Considerations

- Center Measure requires the Span/Div value to be at least six times the Resolution Bandwidth value.
- When demodulating video signals, use 5MHz Resolution Bandwidth and set the Video Filter to OFF.
- With Display Storage (A, B, C, or D) ON, 100 μ s/Div is fastest sweep speed available.
- LIN mode, 1 dB step size increments in 1/20 division increments.
- With EXT Display Source selected, menu path:
DSPL MENU/#7- DISPLAY SOURCE/#3-EXTER-
NAL INPUT

The LOG 10, 5, 1 dB/Div scale factors change to gain factors of 1X, 2X, and 10X.



OPTIONS

Introduction

This section describes the options available for the Spectrum Analyzer.

Options are usually factory installed; however, field kits are available for some options. Contact your local Tektronix Field Office or representative for information on field kits and their installation.

Options A1 Through A5 (Power Cord Options)

There are five international power cord options offered for the spectrum analyzer. The physical descriptions of the cord plugs are listed in Table 7-1. For replacement purposes, refer to the Replaceable Mechanical Parts list.

**Table 7-1
POWER CORD OPTIONS**

Option A1	Universal Euro, 220 V/50 Hz at 16A
Option A2	United Kingdom, 240 V/50 Hz at 13A
Option A3	Australian, 240 V/50 Hz, at 10A
Option A4	North American, 240 V/60 Hz, at 12A
Option A5	Swiss, 250 V/50 Hz, at 6A

Option B1 (Service Manual)

Option B1 includes a service manual with the instrument.

Options M1 Through M3 (Extended Service and Warranty Options)

There are three extended service and warranty options offered for the spectrum analyzer that go beyond the basic one-year coverage (see Table 7-2). Contact your local Tektronix Field Office or representative for additional information about your specific requirements.

**Table 7-2
EXTENDED SERVICE
AND WARRANTY OPTIONS**

Option	Description
M1	Two routine calibrations to published specifications; one each in years two and three of warranty coverage, plus two years remedial service.
M2	Four years remedial service
M3	Four routine calibrations to published specifications; one each in years two, three, four, and five of product ownership, plus four years of remedial service.

OPTION 01

Option 01 adds a 300 Hz resolution bandwidth filter and a minimum Span/Div of 1 kHz for enhanced measurement resolution that is commensurate with the improved frequency accuracy of 5×10^{-7} .

OPTION 02

Option 02 adds a frequency counter with readout resolution selectable between 1 Hz and 1 kHz. Also, a provision for turning off the counter when tracking is invoked has been provided.

OPTION 03

Option 03 adds the IEEE Standard 488 General Purpose Interface Bus (GPIB). The pertinent circuits are located on the Digital Option board. The GPIB port consists of mainly three components. They are the general purpose interface bus controller, an octal bus transceiver, and an eight channel transceiver. In addition there is circuitry included to drive two LEDs to display the status of the Not Ready For Data (NRFD) and Not Data Accepted (NDAC) handshake lines.

Options – 2710 Options

The general purpose interface bus controller, octal bus transceiver, and eight channel transceiver meet the IEEE-488 1975/78 standards along with the IEEE-488A 1980 supplement.

For programming see the 2710 GPIB Programmers Guide.

The rear-panel connection provides full GPIB printer compatibility.

J150 - GPIB Port Bus

Pin #	Description	Pin #	Description
1	GD1	2	GD5
3	GD2	4	GD6
5	GD3	6	GD7
7	GD4	8	GD8
9	EOI	10	REN
11	DAV	12	Ground
13	NRFD	14	Ground
15	NDAC	16	Ground
17	IFC	18	Ground
19	SRG	20	Ground
21	ATN	22	Ground
23	Ground	24	Ground

Using the Plot Feature

To use the plot feature, connect the plotter or printer to interface port J104 at the rear of the Spectrum Analyzer and perform the following:

NOTE

The communications port selection will default to the GPIB.

a. Press keypad #1 until the desired output device type (HPGL 2-PEN, HPGL 4-PEN, or EPSON FX-80) is displayed. If the EPSON FX-80 printer is selected, press UTIL MENU to exit or proceed to part c.

b. If HPGL 2-PEN or 4-PEN was selected in part a, press keypad #2 until the desired plotter speed is displayed. The best resolution is obtained at the slowest speed.

c. If HPGL 2-PEN or 4-PEN was selected in part a, press keypad #3 to select one or four plots per page.

d. If four plots per page was selected in part c, press keypad #4 to select the plot position for the first plot. Press UTIL MENU to exit.

e. Power-up the plotter/printer, ascertain that the paper is in position, and confirm that the desired display is on the screen.

f. Press UTIL MENU/#6 to start the plot.

When UTIL MENU/#6 (WAVEFORM PLOT) is pressed, display and graticule information is sent over the interface bus to drive an external plotter or printer. Graticule information is plotted only when the graticule is illuminated.

When more than one waveform is plotted using a 4-pen plotter, each waveform is plotted with a different color pen. A legend at the upper left hand corner of the plot identifies by color the register in which each waveform resides (A, B, C, or D). Also, each waveform may be given a title via TITLE MODE (DISPLAY MENU/#5). See Figure 7-1 for a typical plot.

NOTE

Plotter time may be reduced by selecting PEAK ACQUISITION MODE (DSPL MENU/#4) or enabling the VIDEO FILTER.

Baseline noise has negligible effect on display reproduction time when using matrix printing devices.

OPTION 04

Option 04 adds a Tracking Generator to the Spectrum Analyzer package. The Tracking Generator generates a sweep frequency which tracks the frequency window of the Spectrum Analyzer with the following features:

- A microprocessor-controlled frequency adjustment for correlating the generator frequency with the Spectrum Analyzer's window.
- Optimum flatness
- Microprocessor-controlled output levels
- Excellent harmonic and spur performance
- 50 Ω nominal output impedance

Controls, Indicators, And Connectors

Controls – The Tracking Generator mode is initiated by selecting "TRACKING GENERATOR" in the DET/GEN MENU. The front-panel GEN LED lights at this time to indicate that the Tracking Generator is enabled.

The Tracking Generator is incompatible with the calibrator mode. Consequently, the calibrator mode is automatically turned off by the firmware when the Tracking Generator is enabled.

The output level of the Tracking Generator may be set from 0.0 to -48.0 dBm in 0.1 dB increments via the DET/GEN MENU. This range is automatically converted to match the current reference level units when other than dBm is used.

The front-panel LEVEL control may be enabled if continuous adjustment over a small range (several dB) is required. When the level CONTROL is enabled, the Tracking Generator output level readout is suffixed by a "*" symbol, indicating that the level is not calibrated.

If output frequency tracking is not correct, for example, due to long external lines, the signal may be "peaked up" by invoking "TG TRACKING" and setting the FREQ/MARKERS control for maximum signal response. The offset frequency is set at a fixed rate (30 Hz/click of the knob) for all instrument settings.

The Tracking Generator mode is exited by pressing DET/GEN MENU/#4. The calibrator mode is not restored if it had been automatically disabled when the Tracking Generator was enabled.

All Tracking Generator settings are recalled during a Power-Down/Power-Up cycle, including output on/off, manual adjust on/off, output level setting, output level offset, and frequency offset setting.

The following are the factory default settings for the Tracking Generator parameters:

- TG Enable = OFF
- TG Output Level = -48.0 dBm (or equivalent)
- TG Manual Adjust = OFF
- TG Frequency Offset = 0.0
- TG Amplitude Offset = 0.0

The Tracking Generator is enabled and disabled via keypad sequence DET/GEN MENU/#4. The output level is automatically set at the last selected level when the Tracking Generator is enabled.

There are two ways of setting the output level.

1. The output level may be precisely set by pressing DET/GEN MENU/#5 (TG FIXED LEVEL) and entering the desired level via the keypad. This method yields a calibrated output level.
2. The output level may be set by pressing DET/GEN MENU/#5 and entering a level near the desired level, then pressing #6 (TG VARIABLE LEVEL) and varying the LEVEL control for the actual desired level. This method yields an uncalibrated output level. When enabled, the LEVEL control has a total range of ≈ 4 dB, and the level indicator readout is suffixed by a "*" symbol, indicating an uncalibrated output level.

In some Spectrum Analyzers the peak of the 5 MHz resolution bandwidth filter is not centered about its bandpass. This can result in some amplitude variation when switching from the 5 MHz resolution filter to a narrower filter. Relative responses using the 5 MHz filter are not affected. Determine the amount of error by first making a measurement using the 5 MHz resolution bandwidth filter then making another measurement using the 300 kHz resolution bandwidth filter (the peak of the 300 kHz resolution bandwidth filter is centered about its bandpass). Note the difference, and correct any measurements made with the 5 MHz resolution bandwidth filter by that amount.

The flatness of the Tracking Generator output may vary slightly with different output level settings. This output flatness variation can be removed by using the B,C MINUS A feature of the Spectrum Analyzer as follows:

- a. Prior to making a test measurement, set the measurement parameters such as center frequency, span, resolution bandwidth, reference level, and Tracking Generator output level.
- b. Connect the Tracking Generator output to RF INPUT, and save the resultant sweep in the A register.
- c. Insert the device to be tested.
- d. Enable the B,C MINUS A mode by pressing DSPL MENU/#2.

Make all measurements in the B,C MINUS A mode. This method cancels out the variations in Spectrum Analyzer/Tracking Generator system response leaving only the response of the device under test.

VARIABLE LEVEL Feature – Set the LEVEL control fully counterclockwise. Set the TG FIXED LEVEL to within a few tenths of a dB less than the desired output level. Enable the TG VARIABLE LEVEL and set the LEVEL control for the desired level as viewed on the display.

Options – 2710 Options

Setting the variable level above the fixed level may result in some degradation of the 2nd harmonic specification. Normally, this is not a problem with passive linear devices. However, it can result in some intermodulation products with non-linear devices, and spurious radiation from active devices such as modulators or transmitters. To avoid these problems, use the Tracking Generator fixed level and the Spectrum Analyzer reference level controls to move signals vertically on the screen, rather than using the variable level feature.

Output Frequency Tracking – Sometimes the Tracking Generator frequency may not track the Spectrum Analyzer frequency window due to long external lines being tested (group delay). The effect of group delay is readily apparent in narrow resolution bandwidth filters. To find out if group delay is present, select a narrow resolution bandwidth filter, e.g. 3 kHz, and check to see if the amplitude drops. If the amplitude does drop, invoke "TG TRACKING" (DET/GEN MENU/#7) and set the FREQ/MARKERS control for maximum amplitude (optimum tracking).

The Knob Function (MKR/FREQ MENU/#2) automatically defaults to TG TRACKING when TG TRACKING is invoked.

External Attenuator/Amplifier Compensation – In certain cases, the user may wish to attenuate or boost the output signal. In these cases, the readout may be made to display the signal amplitude after the external attenuator or amplifier. The DET/GEN MENU/#8 selection allows the user to enter offset values for an external attenuator or amplifier, such that the readouts indicate the true value of the signal at the output of the attenuator or amplifier.

To enter an external attenuator or amplifier gain, select DET/GEN MENU/#8/#1 and enter the desired value. The entered value is then applied to the TG level readouts.

Also, when DET/GEN MENU/#8/#0 is selected, the entered gain factor is applied to the output level readouts. In both cases, the menu reverts to the DETECTOR/GENERATOR MENU after the entry is made.

Indicators – The GEN LED is the only indicator for the tracking Generator. It is illuminated only when the Tracking Generator is enabled.

Connectors – The Tracking Generator output connector is an N-Type, 50 Ω connector at the front panel of the Spectrum Analyzer.

Normalizations

The term "normalization" describes any internal firmware routine that makes a parameter calibrated (normal) with respect to an internal reference.

There are three kinds of normalizations, viz:

Reference normalizations, amplitude normalizations, and frequency normalizations. For optimum results, normalizations should be performed in the following sequence.

1. Perform reference normalizations prior to frequency, amplitude, and Tracking Generator normalizations by pressing UTIL MENU/#5/#5/#1 and following screen prompts.
2. Perform frequency and amplitude normalizations by pressing UTIL MENU/#3/#0/C.
3. Perform Tracking Generator normalizations by pressing UTIL MENU/#3/#3/C/C.

NOTE

In the UTIL MENU/#3 sub-menu, item 0 (ALL PARAMETERS) does not affect the Tracking Generator parameters.

When #3 (TRACKING GENERATOR ONLY) in Figure 6 is selected, all of the Tracking Generator normalizations are executed.

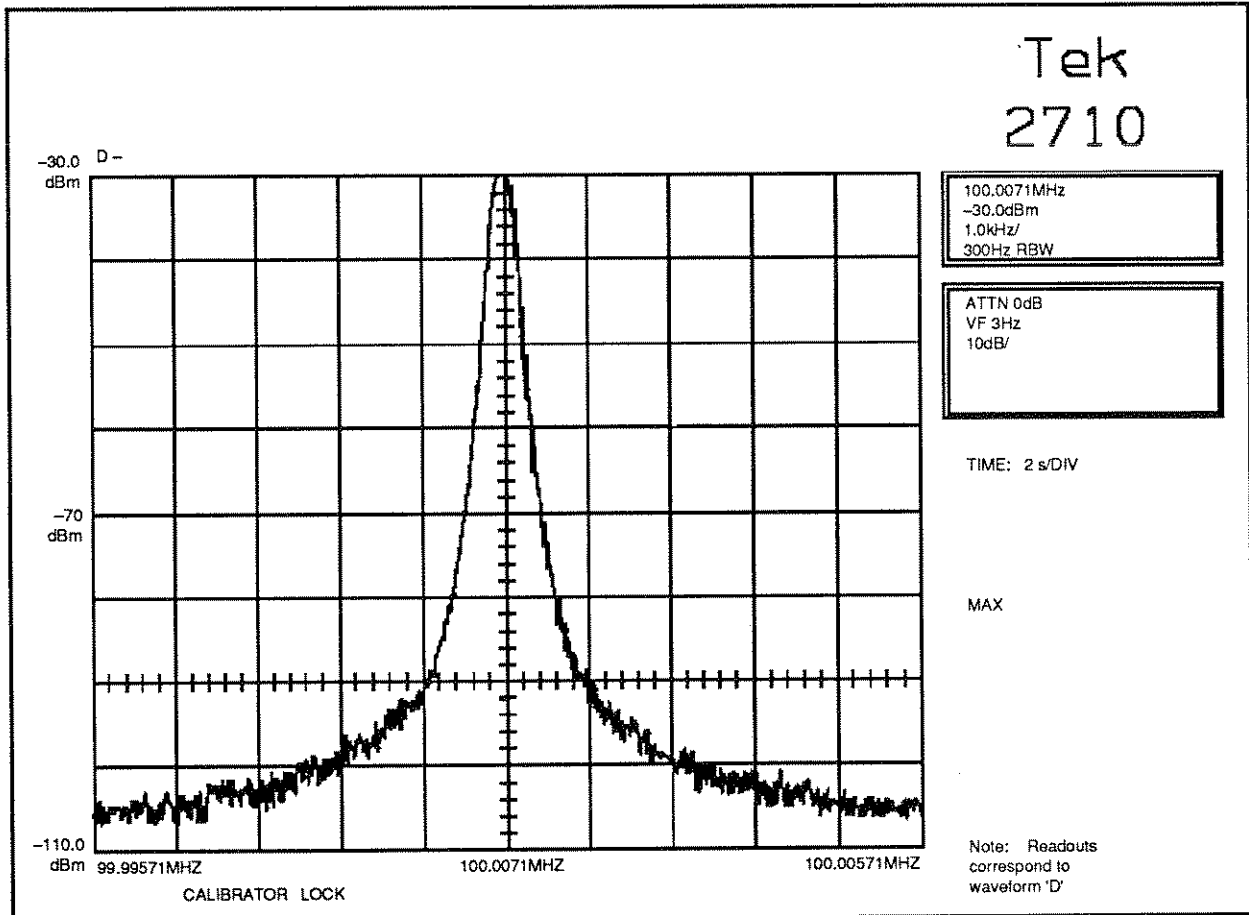

Figure 7-1. Typical plot.

OPTION 06¹

Introduction

Option 06 includes the Tektronix 1106 Battery Power Supply and the Tektronix 1107 DC Converter with adapter mounting kits and their respective instruction manuals. The following describes the installation of the Tektronix 1106 and 1107 Battery Power option.

Installation of 1106 Battery Power Supply

Two mounting straps, with slots at each end, are welded on the bottom of the Spectrum Analyzer. These mounting straps with the conversion kit supplied with the 1106 Battery Power

unit provide the means to attach the 1106 to the Spectrum Analyzer. The following procedure describes the process for installing the Battery Power Supply.

1. Lay the Spectrum Analyzer on its top so the underside is exposed. Note the two mounting straps, with slots at each end, welded to the bottom of the instrument.
2. Slide the four (4) studs, from the mounting kit, into the slots on the mounting strip and bolt them in place using the washers and the thick 8-32 nuts. See Figure 7-2. Tighten the four nuts finger tight so the studs will still move in the slot.
3. Now place the adapter plate assembly, with the slotted feet up, on the mounting studs and install the four (4) plain nuts to hold the plate assembly on the studs.

¹ Option 06 is discontinued as of August, 1990.

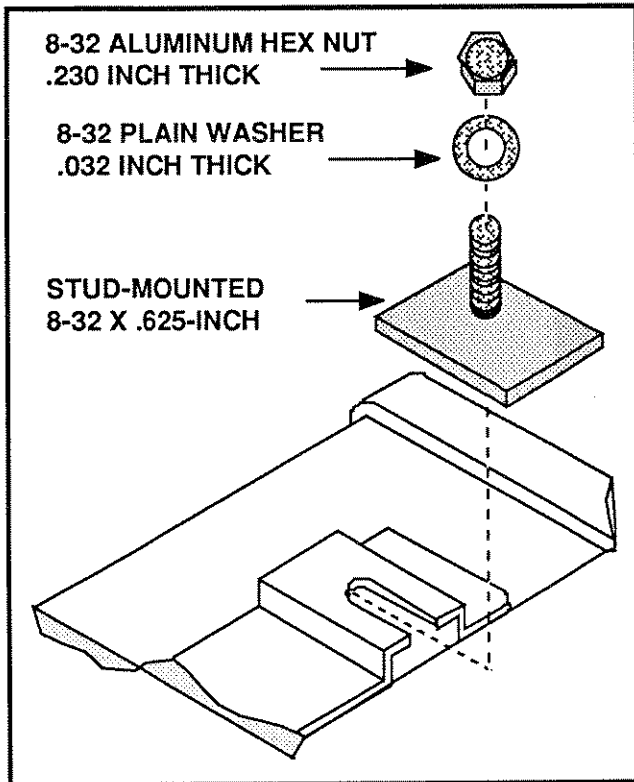

Figure 7-2. Installing a stud into the mounting strip.

4. Using a 5/16 inch wrench, tighten the nuts holding the adapter plate on the studs.
5. The analyzer, with its adapter plate will now mount on the 1106 Battery Power Supply. Set the slotted feet of the adapter plate into the recessed holes on the battery pack and close the retaining slide catch.

Installing 1107 DC Converter

The installation kit for this Tektronix DC Converter consists of an adapter plate and mounting hardware. The following describes how to install this DC converter.

1. Remove the two Spectrum Analyzer rear panel mounting screws and replace them with the two standoff studs, supplied with the adapter kit.
2. Tighten the studs with a 5/16 inch open-end wrench.
3. Install the adapter plate on the standoff studs, using the two 8-32, 5/16 inch flat-head screws.
4. The 1107 DC Converter can now be mounted on the four slotted feet of the rear panel adapter plate.

5. Plug the DC Converter power cord into the receptacle on the Battery Power Supply pack.

6. The Spectrum Analyzer is now ready for battery power operation.

OPTION 07

Option 07, a direct replacement for Option 06, comprises the Tektronix 2704 DC Inverter and 2705 Battery Pack. The Inverter and Battery Pack are designed to allow operation of the Spectrum Analyzer in locations where AC power is not available.

The Inverter and Battery Pack combination is capable of operating the Spectrum Analyzer for a minimum of one hour. Moreover, the Inverter contains a charger and an 18 VDC output to power external devices such as Low Noise Block Down Converters (LNB) used in satellite downlink applications. The Inverter also includes an additional 12 V input to allow use of external batteries without power interruption to the Spectrum Analyzer. The Inverter and Battery Pack form a matching unit and attach together to the Spectrum Analyzer. At least one Battery Pack is needed with each Inverter for normal operation and to add stability when mounting to the Spectrum Analyzer.

Refer to the 2704 DC-TO-AC INVERTER AND 2705 BATTERY PACK manual for specifications, installations instructions, and other pertinent information.

OPTION 09

Option 09 adds a Centronics®-compatible parallel printer interface. The pertinent circuits are located on the Digital Options board. The Centronics port consists of two 8-bit, tri-statable data latches and two 8-bit, tri-statable data buffers. The port can be used as a 12-bit read/4-bit write or 4-bit read/12-bit write port for diagnostics, or as a full specification Centronics communications port. The rear-panel connection provides full IBM-PC printer compatibility.

J104 - Centronics Port Bus

Pin #	Description	Pin #	Description
1	STROBE	2	D0
3	D1	4	D2
5	D3	6	D4
7	D5	8	D6
9	D7	10	ACKNLG
11	BUSY	12	PE
13	SLCT	14	FEED
15	ERROR	16	INIT
17	SLCT IN	18	Ground
19	Ground	20	Ground
21	Ground	22	Ground
23	Ground	24	Ground
25	Ground		

Compatible Plotters and Printers

The Centronics interface may be used with all EPSON FX-compatible printers and HPGL-compatible plotters, such as the TEKTRONIX HC100 COLOR PLOTTER.

Using the Plot Feature

When UTIL MENU/#6 (WAVEFORM PLOT) is pressed, display and graticule information is sent over the interface bus to drive an external plotter or printer. Graticule information is plotted only when the graticule is illuminated.

To use the plot feature, connect the plotter or printer to the Spectrum Analyzer interface port J104 and perform the following:

NOTE

The communications port selection will default to the installed option.

a. Press keypad #1 until the desired output device type (HPGL 2-PEN, HPGL 4-PEN, or EPSON FX-80) is displayed. If the EPSON FX-80 printer is selected, press UTIL MENU to exit or proceed to part c.

b. If HPGL 2-PEN or 4-PEN was selected in part a, press keypad #2 until the desired plotter speed is displayed. The best resolution is obtained at the slowest speed.

c. If HPGL 2-PEN or 4-PEN was selected in part a, press keypad #3 to select one or four plots per page.

d. If four plots per page was selected in part c, press keypad #4 to select the plot position for the first plot. Press UTIL MENU to exit.

e. Power-up the plotter/printer, ascertain that the paper is in position, and confirm that the desired display is on the screen.

f. Press UTIL MENU/#6 to start the plot.

When more than one waveform is plotted using a 4-pen plotter, each waveform is plotted with a different color pen. A legend at the upper left hand corner of the plot identifies by color the register in which each waveform resides (A, B, C, or D). Also, each waveform may be given a title via TITLE MODE (DISPLAY MENU/#5). See Figure 7-1 for a typical plot.

NOTE

Plotter time may be reduced by selecting PEAK ACQUISITION MODE (DSPL MENU/#4) or enabling the VIDEO FILTER.

Baseline noise has negligible effect on display reproduction time when using matrix printing devices.

NOTE

When using an EPSON FX-series or equivalent printer, there is a 30-second delay between initiation of the waveform plot session and the beginning of the printing action. The Spectrum Analyzer front panel is locked out until just before the plot/print action ends.

OPTION 10

Option 10 adds Video Monitor capabilities. The pertinent circuits are located on the Sweep board.

OPTION 11

Option 11 adds non-volatile memory.

OPTION 14

Option 14 provides the resolution bandwidths used as “fill in” resolution bandwidth filters to enhance the measurement capability of the overall instrument. The board consists of a high performance amplifier and bandpass filter combination whose bandwidth is variable over 4 decades in discrete steps. The bandwidth range is 1M Hz to 1KHz.

NOTE

The board is configurable as Option 14, or as Option 14 plus Option 1.

OPTION 15

Option 15 Provides an interface for a 1405 TV Sideband Analyzer. The 1st LO is routed to J101 at the rear panel and terminated in 50 Ω. See Figure 7-3.

OPTION 30

Introduction

Option 30 enables mounting of the Spectrum Analyzer in a standard 19-inch rack. The Spectrum Analyzer is guaran-

teed to meet all electrical and environmental characteristics, published in both the Operators and Service Manuals, when it is mounted according to the procedures given in this instruction sheet.

Temperature Requirements

Ambient temperature inside the rack with the Spectrum Analyzer power on must not exceed +50° C (122° F).

Clearance Requirements

Figure 7-4 is a dimensional drawing of the Rack Adapter and Spectrum Analyzer. At least 5 1/4 inches (133 mm) of vertical space are needed to mount the Spectrum Analyzer in an equipment rack. Minimum width of the opening between the left and the right front rails in the rack must be 17 5/8 inches (448 mm). Total depth of the rack must be at least 17 inches (432 mm). These clearances will allow sufficient space for air circulation and accomodation of the power cord and mounting hardware.

NOTICE

Installation is to be performed only by qualified service personnel.

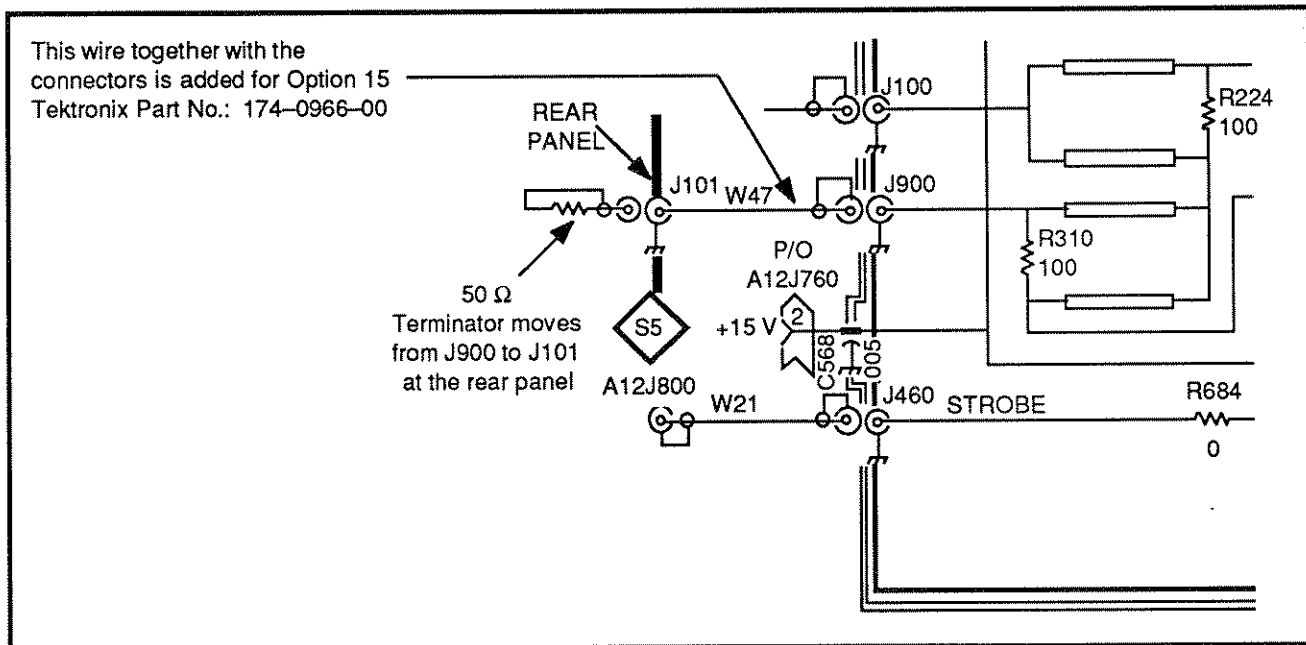

Figure 7-3. Partial 1st LO Buffer Amp schematic.

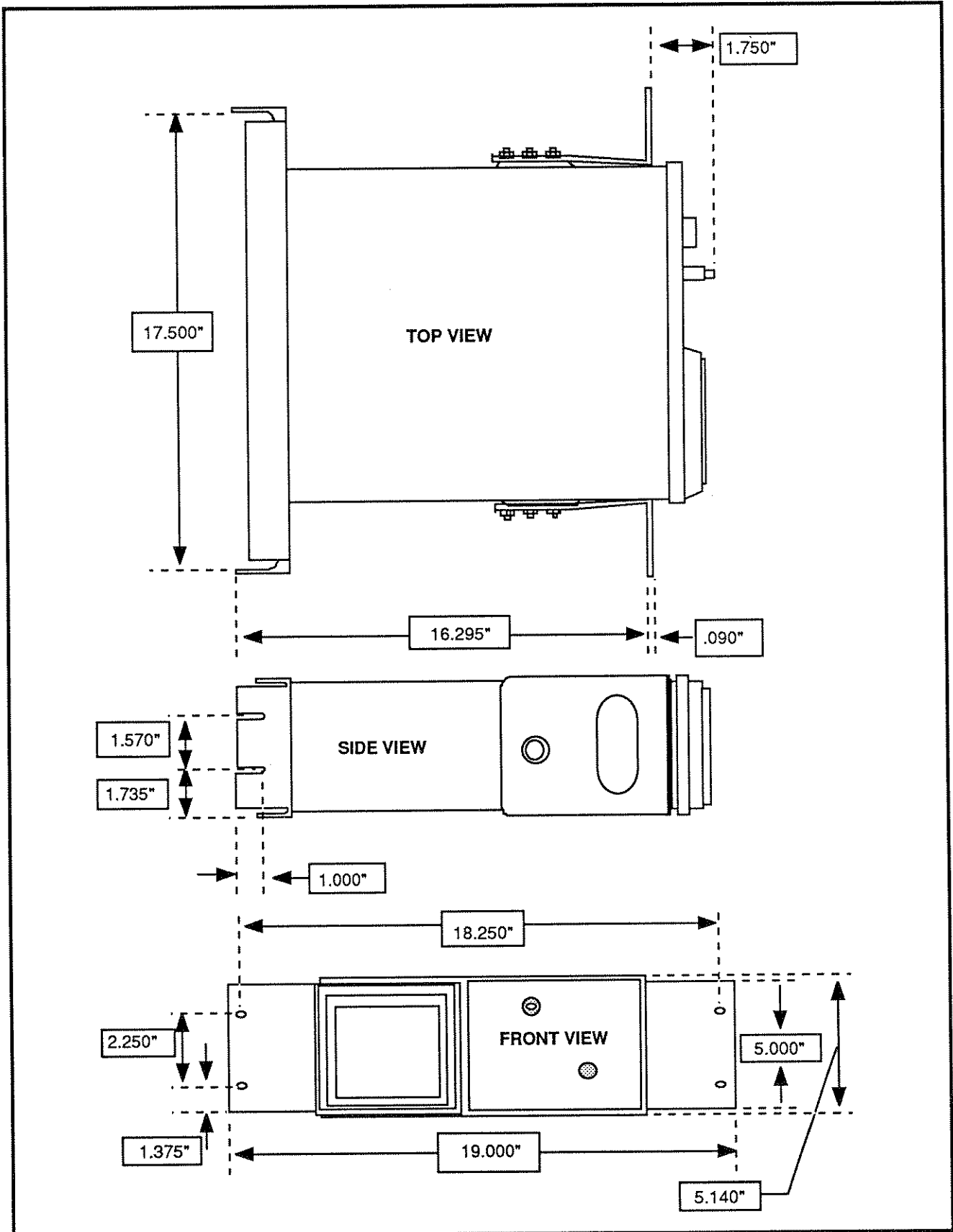

Figure 7-4. Dimensional drawing.

MOUNTING PROCEDURE

Assembling The Adapter

The following steps describe how to attach the Rack Adapter to the Spectrum Analyzer in preparation for installing it in a cabinet or rack.

1. Disconnect the power cord from the rear of the Spectrum Analyzer.
2. Use a #T15 Torx® tip to remove the two screws that retain the rear panel, and the four screws that retain the feet at the top and bottom front of the Spectrum Analyzer cabinet. Remove the four feet and the rear panel.
3. Remove two 4-40 X 5/16-inch screws from the top rear and three 4-40 X 5/16 screws from the bottom rear of the Spectrum Analyzer cabinet.
4. Pull the front panel and attached chassis forward and out of the Spectrum Analyzer cabinet.
5. Pry off the two rubber feet from the bottom front part of the instrument's cabinet.
6. Use a #T20 Torx tip to remove the two screws that retain the handle from the inside of the cabinet. Remove the handle.

NOTE

The following items (previously removed) can be set aside and saved, for reconvertng to a portable Spectrum Analyzer at some future time, if so desired: rear panel with two attaching screws, four feet with four attaching screws, two feet, handle with two retaining screws.

7. Install the front right frame onto the Spectrum Analyzer cabinet using four 10-32 x 7/16-inch flat-head screws and four 10-32 Keps nuts. Use a small torque wrench to tighten the nuts to 20 in-lb.
8. Install the front left frame onto the Spectrum Analyzer cabinet using four 10-32 x 7/16-inch flat-head screws and four 10-32 Keps nuts. Tighten the nuts to 20 in-lb.
9. Slide the Spectrum Analyzer chassis back into its cabinet until the front edge of the cabinet is fully engaged in the front-panel groove. The rear edge of the cabinet should be flush with the rear of the Spectrum Analyzer chassis.

NOTE

Should the flat-head screws (installed in steps 7 and 8) cause the chassis to bind in the cabinet, remove the cabinet and tighten the screws until there is sufficient clearance for the chassis to slide freely into the cabinet.

A slight amount of chassis deformation will occur when tightening the screws. Therefore, the rear support must seat firmly on the Spectrum Analyzer chassis to ensure proper vibration dampening.

10. Install the two 4-40 X 5/16-inch screws at the top rear and three 4-40 X 5/16 screws at the bottom rear of the Spectrum Analyzer cabinet.
11. Remove four 6-32 X 1/4-inch screws from the rear corners of the Spectrum Analyzer.
12. Install six snap-in fasteners to the rear support as shown in Figure 7-5.
13. Install the rear support using four 6-32 x 7/16 -inch pan-head screws. Use a small torque wrench to tighten the nuts to 7.5 in-lb.
14. The adapted Spectrum Analyzer is now ready to be installed in a standard equipment rack.

RACKMOUNTING THE ADAPTED SPECTRUM ANALYZER

Perform the following procedure to install the Spectrum Analyzer (with attached rack adapter) in a standard 19-in rack.

1. Select appropriate mounting holes in the front rails of the equipment rack, observing the clearance measurements shown in Figure 7-6.
2. Secure a bracket extension to each of the two rear rails on the equipment rack, using mounting holes in the rear rails that correspond to the same level as the front-rail holes selected in step 1. If the mounting holes in the rear rails are tapped, use Figure 7-7A as a guide to secure the bracket. If the rear mounting holes are not tapped, use Figure 7-7B.

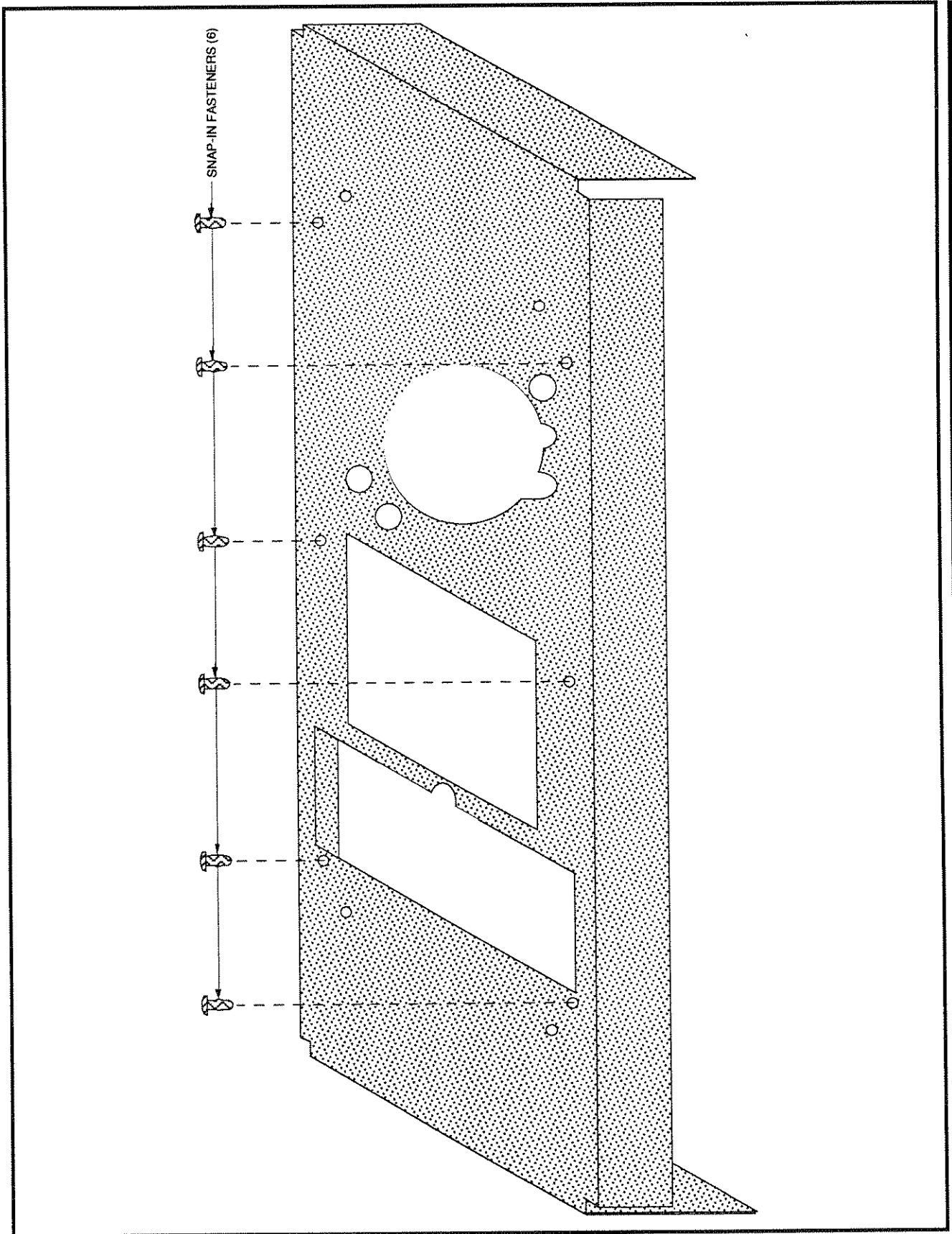

Figure 7-5. Installing the snap-in fasteners in the rear support.

NOTE

Two persons are needed to bolt the Spectrum Analyzer in the rack. One person is needed to hold the Spectrum Analyzer in place while the other secures it in the rack.

3. Set the Spectrum Analyzer in the rack and align the screw holes in the front frames of the rack adapter with the screw holes selected in step 1.
4. Secure the front frames of the rack adapter to the front rails of the equipment rack using four oval-head screws, four finishing washers, and four plastic washers, as shown in Figure 7-8.
5. Secure the bracket extensions to the rear support using four 10-32 x 1/2-in hex-head screws, four flat washers, and two bar nuts as shown in Figure 7-7.

OPTION 33

Option 33 Provides a Travel Line package including a rain cover, accessory pouch, gray crt filter, and carrying strap.

OPTION 34

Option 34 is a Portable to Rackmount adapter for 19 by 6.970 inch rack dimensions that enables mounting of the TEKTRONIX 2710 Spectrum Analyzer in a standard 19-inch rack. The adapter consists of a cradle (shelf) with slide-out assemblies and a mask to fit over the regular instrument panel.

Temperature Requirements

The ambient temperature inside the rack with the Spectrum Analyzer power on must not exceed +50° C (122° F).

Clearance Requirements

Figure 7-9 is a dimensional drawing of the Rack Adapter. At least 7 in (177.8 mm) of vertical space are needed to mount

the Spectrum Analyzer in an equipment rack. Minimum width of the opening between the left and the right front rails in the rack must be 17 5/8 inches (448 mm). Total depth of the rack must be at least 17 inches (432 mm). These clearances will allow sufficient space for air circulation and accomodation of the power cord and mounting hardware.

Mounting the Spectrum Analyzer in the Adapter

The following steps describe how to attach the Spectrum Analyzer to the Rack Adapter in preparation for installing it in a cabinet or rack.

1. Disconnect the power cord from the rear of the Spectrum Analyzer.
2. Swing the Spectrum Analyzer handle up so it ends up at approximately 90° with respect to the Spectrum Analyzer.
3. On the rack adapter, loosen the three screws shown in Figure 7-10, and slide the retaining bar back.
4. Move the tie-down strap on the rack adapter out of the way.
5. Place the Spectrum Analyzer in the rack adapter and push it forward until the crt bezel is flush with the rack adapter mask. See Figure 7-11.
6. Push the rack adapter retaining bar forward to hold the Spectrum Analyzer in the cradle, then tighten the three screws (Figure 7-10).
7. Drape the tie-down over the Spectrum Analyzer and latch it in the hole shown in Figure 7-12.
8. Take up some slack from the tie-down so that the nylon strap is just barely snug, then take up the final slack with the tie-down buckle. See Figure 7-11 for the final product.
9. Swing the Spectrum Analyzer handle back so it ends up resting on the Spectrum Analyzer.
10. The adapted Spectrum Analyzer is now ready to be installed in a standard equipment rack.
11. To install the adapted Spectrum Analyzer in the rack, refer to RACKMOUNTING THE ADAPTED SPECTRUM ANALYZER under Option 33.

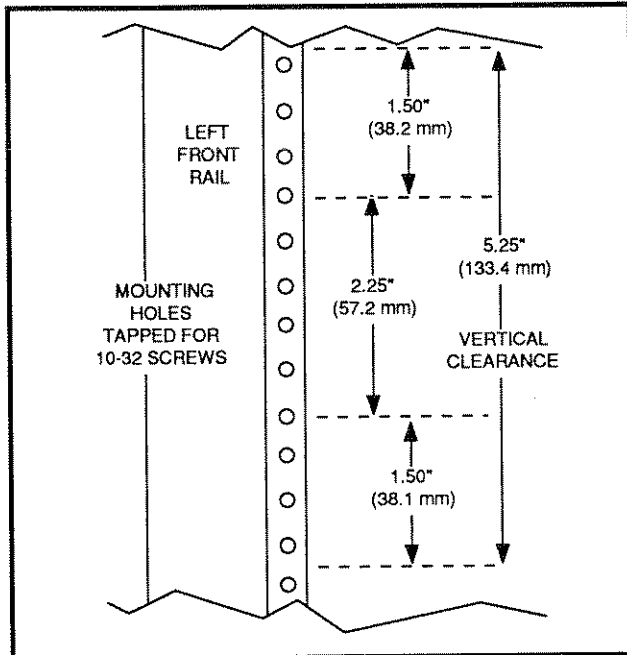

Figure 7-6. Locating mounting holes on rack front rails.

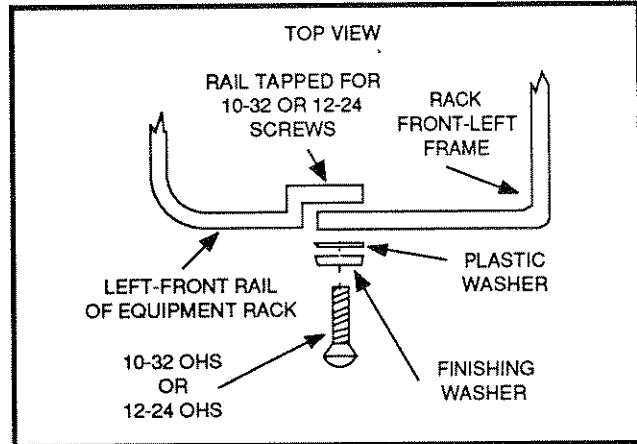

Figure 7-8. Securing rack-adapted Spectrum Analyzer to front rails of equipment rack.

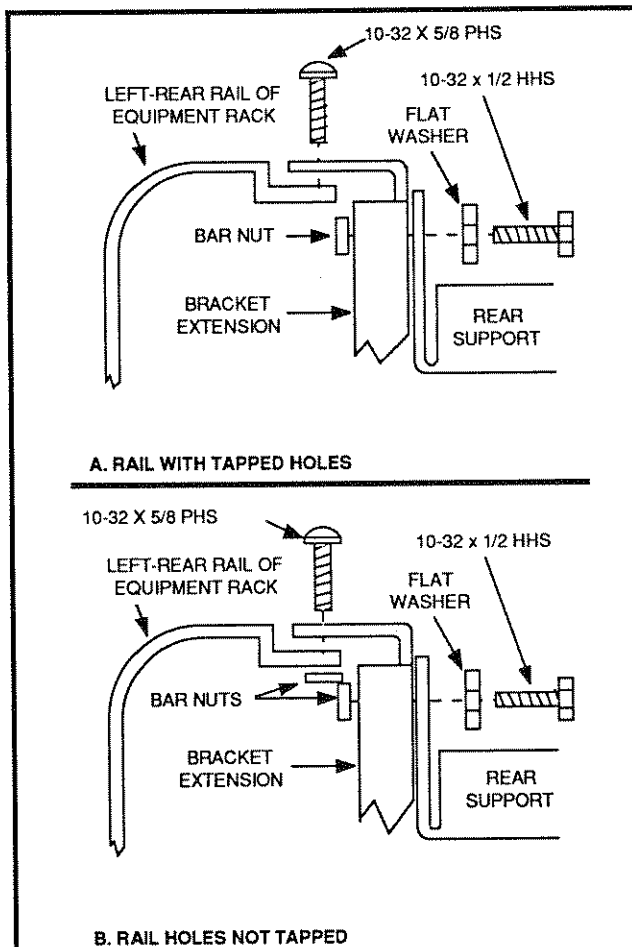

Figure 7-7. Installing bracket extensions.

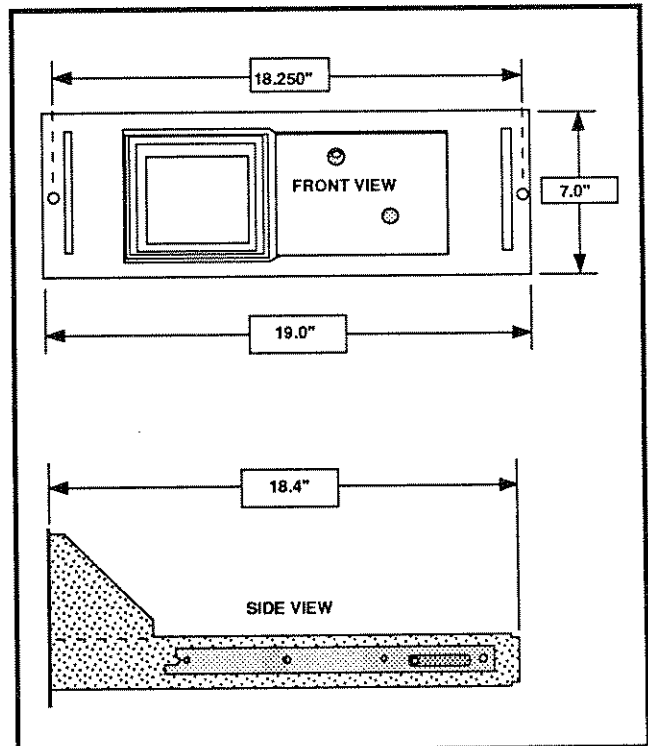

Figure 7-9. Rack Adapter dimensions.



NORMALIZATIONS

The 2710 uses a set of software functions called “normalizations” to insure that the instrument meets various controllable specifications at all operating conditions. This section describes the normalization functions and the exact operation of each normalization function as it is implemented. It applies to firmware version 4–6–89 and later.

INTRODUCTION

The purpose of these descriptions is to educate the user about the operation of these functions and to provide general information about the instrument firmware.

This section of the manual includes the following items:

- A general overview of normalizations
- Two operational guides, one for general use, one for using the normalizations as a troubleshooting tool.
- Specific descriptions of all normalizations
- An appendix which lists all normalization values, their location in the menu system and on screen, and their maximum and minimum allowable values
- An appendix which enumerates and details every debug-style message the normalizations can produce.

GENERAL NORMALIZATION OVERVIEW

The instrument contains a variety of adjustments which are designed to fine tune the instrument. This fine tuning allows the instrument to be built with lower cost, readily available components. The instrument, as adjusted at the factory, will satisfy all performance requirements within a certain degree over a variety of operating conditions.

The normalizations perform a similar function. The adjustment portion of the circuitry can be eliminated entirely in some cases, reducing the total instrument cost. All parameters are adjusted in the environment at which the instrument is used, eliminating drift due to temperature and time.

The term “normalization” derives from the intent of the functions to make a parameter normal with respect to an external reference, or with respect to a normalized internal reference.

Types of Normalizations

There are several kinds of normalizations:

- Reference Normalizations measure the instrument's internal reference sources against user-supplied reference sources. These include the calibrator frequency and amplitude, and a gain reference.
- Amplitude Normalizations measure all parameters related to the screen vertical axis.
- Frequency Normalizations measure all parameters related to the screen horizontal axis.

A specific normalization may also be placed into one of two categories.

The first is an Applied Result normalization, where the normalization result is used to set the hardware parameter differently than it would be if the instrument was perfectly aligned at all temperatures. For example:

When the preamp is turned on, the signals being viewed on screen should not vary in amplitude. Without normalizing, the firmware assumes the preamp gain to be +20 dBm. Since there is no adjustment for the preamp gain, and the preamp gain is not exactly +20 dBm, the VR gain must be set differently to compensate for the deviation. The preamp gain normalization tells the firmware how much to deviate.

The second category is a Measurement Only type of normalization, which only measures a particular parameter for use in future calculations. For example:

When a carrier-to-noise measurement is being made, the level of the spectrum analyzer's noise floor must be known. The sensitivity normalization produces this figure. Note that no hardware setting must be modified as a result of this normalization.

How the Normalization Values are Used

The normalization values are used by the regular operating firmware to set various portions of the instrument properly. The exact gain of the VR module, for example, is set to a more accurate gain setting by placing a different number into an adjusting Digital-to-Analog Converter (DAC) on the VR module.

Acquiring, Defaulting, and Recalling Values

When the instrument is powered up for the first time, all normalization values are in a default state. These default values are a "best guess" estimate of what the instrument should need. Most of the gain parameters are set to zero, indicating perfect alignment, and the frequency parameters are set to nominal values. Performing the normalizations installs new values into Non-Volatile Random Access Memory (NVRAM), which reflect all gain and frequency errors which the instrument must correct for.

When a normalization passes, the new values are installed in NVRAM. When a normalization fails, the previous values are retained, whether the old values were default values or previously passed normalization values.

The normalization values may be defaulted by accessing the appropriate service menu. All values for a specific normalization are defaulted at once, and may be recalled by the use of the same menu. This menu also allows execution of a specific normalization.

Summary Messages

When any normalization is executed, defaulted, or recalled, the firmware makes a determination as to the condition of the normalized values. This information is summarized in a few lines in the normalization menus. These messages are displayed in the normalization menu ([UTIL] [3]), and in the service normalization menu ([UTIL] [5] [5]).

Two pieces of information are displayed for each of the three types of normalization:

- **Pass/Fail/Not_Done** — This part of the message indicates whether or not the normalizations have been executed successfully.
- **Default** — This indicator appears when any of the normalizations in the category contain default values.

The following table shows the format of the messages:

Category	Result	Values
FREQ Result	Ultimate	VALUES USED
REF Result	Ultimate	VALUES USED
AMP Result	Ultimate	VALUES USED

Result = PASSED, FAILED, or NOT DONE
Ultimate = Either DEFLT or NRMLZD

The precedence of the pass/fail/not_done message is as follows:

- If any normalization/s in the category has failed, "FAILED" is displayed in the result column, even if some normalization/s in that category are not tested.
- If none have failed, but some are not done, "NOT DONE" is displayed in the result column.
- If all have been done and all pass, "PASSED" is displayed in the result column.

Measurement Devices

There are two major measurement devices which are used by the normalizations. These devices are used to acquire information about the hardware, such as the current beat note frequency or the amplitude of a signal. These major devices are the internal frequency counter and the digital storage accumulator.

Several minor devices are used in conjunction with the major devices. These are all parts of the instrument which have previously been measured, and are used as references for other measurements. For example, the gain steps are used to measure the VR filter levels, and the calibrator frequency is used as a time base for all frequency counting.

Internal Frequency Counter – The internal frequency counter is used by the processor system to monitor several internal frequencies. This counter has three inputs, one of which is used during the normalizations. This input is used to count the beat frequency or the VCO frequency (B020319 and up) while normalizing all of the frequency-related parameters.

Display Storage Accumulator – The Display Storage Accumulator is used exclusively for amplitude-related measurements. This device operates in one of two modes:

- The accumulator may be read directly if a fast measurement is required. This requires that the signal of interest is in the same position horizontally on screen as the sweep position. Usually the signal is identified and centered through other means, then the instrument is placed in zero span.
- The accumulator may also be read by simply sweeping the screen and reading the result from the proper location in display storage memory. This requires searching through memory for the highest (or other) point on a signal, but does not require that the signal be as stable as the direct accumulator reading method.

Normalization Values¹ – Many of the normalization values are used to aid in normalizing other parameters. The reference normalization values are always used, except when they themselves are normalized.

The detailed descriptions define which normalization values are dependent on which others.

GENERAL OPERATIONS

In most cases, the normalization values being used by the instrument will be correct for all measurements. The instrument must be re-normalized under the following conditions:

- After the instrument is built.
- After NVRAM is corrupted or erased.
- When the operating conditions (primarily temperature) change significantly.
- After an extended period of time since the last normalization.

In general, whenever the instrument's optimum accuracy is required, the appropriate normalization must be performed. For example, if highly accurate amplitude measurements are required, the amplitude normalizations should be performed prior to making measurements.

User-Accessed Normalization Operation

The normalizations are invoked by pressing [UTIL] [3] [#], where [#] may be 0 (for ALL NORMALIZATIONS), 1 (for FREQUENCY ONLY), or 2 (for AMPLITUDE ONLY). The normalizations may also be invoked individually through [UTIL] [5] [5] [#], where [#] is a sequence of keystrokes for selecting the specific normalization.

Service Normalizations

There are three normalizations which normalize the internal references with respect to externally applied reference signals. These normalizations are accessed by [UTIL] [5] [5] [#], where [#] represents the selection for the reference normalization in question.

Gain Step Normalization – A 100 MHz signal and an external attenuator are used for this normalization. The required level for the signal is stated in the on-screen instructions. If the signal is near the limit of the stated range, the normalization may still fail to operate. In this case, adjust the level of the signal source to bring it farther inside the required tolerances.

¹ If the normalizations are executed out of order, the resultant values cannot be guaranteed.

Reference Frequency Normalization – A Frequency reference which is easily countable by the instrument is used for this normalization. A signal of any countable frequency and level is connected to the RF input and brought to center screen in a reasonable span and resolution setting. It should be verified that the instrument can count the signal before proceeding. The exact frequency of the external reference used must be entered (This is NOT the frequency which the instrument has just counted, as that frequency is based on a reference that has not been normalized). The reference frequency normalization is then invoked, which measures the signal and applies a normalization value for the internal frequency reference.

Reference Amplitude Normalization – A monotonic, 100 MHz signal source is connected to the RF input for this test. The signal must be within 1 MHz of 100 MHz, and the level of the signal must be $-30 \text{ dBm} \pm 1 \text{ dB}$. When the signal is connected, the normalization is invoked and the firmware measures the internal reference amplitude based on the externally-applied reference.

Order of Normalizations

Since most normalizations are dependent on others, the normalizations must be executed in a specific order. The order of normalization follows for various instrument types and conditions:

- **Standard Instruments (without NVRAM):**
- For instruments from B010001 to B010318:
 1. [UTIL] [5] [5] [1] [0] ² (Gain step reference)
 2. [UTIL] [5] [5] [1] [1] ² (Reference Frequency)
 3. [UTIL] [5] [5] [1] [2] ² (Reference Amplitude)
 4. [UTIL] [3] [0] (All Normalizations)
- For B020319 and up:
 1. [UTIL] [3] [1] (Frequency Normalizations)
 2. [UTIL] [5] [5] [1] [0] ² (Gain step reference)
 3. [UTIL] [5] [5] [1] [1] ² (Reference Frequency)
 4. [UTIL] [5] [5] [1] [2] ² (Reference Amplitude)
 5. [UTIL] [3] [0] (All Normalizations)
- **First time after NVRAM corrupted** or with a new display storage board, option 11 installed:
- For instruments from B010001 to B010318:
 1. [UTIL] [5] [5] [1] [0] (Gain step reference)
 2. [UTIL] [5] [5] [1] [1] (Reference Frequency)
 3. [UTIL] [5] [5] [1] [2] (Reference Amplitude)
 4. [UTIL] [3] [0] (All Normalizations)

² For full specification compliance, the steps marked as such must be followed after EACH instrument power-up.

Normalizations – 2710 Operators

- For B020319 and up:
 1. [UTIL] [3] [1] (Frequency Normalizations)
 2. [UTIL] [5] [5] [1] [0] (Gain step reference)
 3. [UTIL] [5] [5] [1] [1] (Reference Frequency)
 4. [UTIL] [5] [5] [1] [2] (Reference Amplitude)
 5. [UTIL] [3] [0] (All Normalizations)
- **All other times :**
- For instruments from B010001 to B010318:
 1. [UTIL] [3] [0] (All Normalizations) or [UTIL] [3] [1] (Frequency Normalizations) or [UTIL] [3] [2] (Amplitude Normalizations)
- For B020319 and up:
 1. [UTIL] [3] [0] (All Normalizations) or [UTIL] [3] [1] (Frequency Normalizations) or [UTIL] [3] [2] (Amplitude Normalizations)

ADVANCED OPERATIONS ON NORMALIZATIONS

There are several advanced operations which can be performed on with normalizations. These operations are typically used only for troubleshooting the instrument itself, and are not a normal part of the 2710's operation. The normalizations can be individually set to default values, and conversely set back (recalled) to the most recent normalized values. Each normalization can also be executed by itself to help locate a specific failure in the instrument.

Defaulting, Recalling, and Executing

To perform an advanced operation on a normalization or group of normalizations, select [UTIL] [5] [5] [#] , where [#] is a sequence of keystrokes which selects the appropriate normalization to default, recall, or execute.

NOTE

The default and recall functions for the service normalizations ([UTIL MENU] [5][5][1][0], [UTIL MENU][5][5][1][1], and [UTIL MENU][5][5][1][2]) are accessed by selecting "CONNECTED, MEASURE" and then either [B] or [C].

When defaulting normalization values, it is important to remember that other normalizations are dependent on the defaulted values, and any new normalization may be somewhat invalid by the defaulting action. For Example:

Step 1: Normalize everything (no defaulted values)

Step 2: Default GAIN AND ATTENUATION normalization values.

Step 3: Execute VR FILTER AMPLITUDE normalization.

After step 3, the VR filters will have normalized values which, to some degree, may be incorrect since the VR gain steps are used to measure the VR filter amplitudes.

When executing normalizations individually, accuracy can only be achieved by performing the individual normalizations in the specified order. This order is described later in this section.

Extracting Debug Information

As the normalizations execute, several types of debug (troubleshooting) information can be extracted. Each message which can be printed by the normalizations is detailed in appendix 2. This information can be used to get a better insight as to why a particular normalization fails at given time.

"CAL DEBUG" Messages – To enable the calibration debug messages, use [UTIL] [5] [3] [6], then [8] as many times as necessary to select the device where the messages will be sent. If the debug display is selected, the messages can be viewed only after normalizations have completed. The printer and/or RS232 ports can only be selected when an option 09 (digital options) board is installed.

NORMALIZATION DESCRIPTIONS

The following descriptions contain the exact procedure the firmware follows when executing that particular normalization. Some general notes about the descriptions:

- The DEPENDENCIES part details which normalization(s) must be executed first to insure optimum accuracy. In some cases, failure to execute the dependent normalizations will cause the normalization in question to fail.
- The OPERATION part details the steps which the firmware follows when executing that particular normalization. Some of the steps cannot be followed by any manipulation from the front panel. These procedures are included for the person who is troubleshooting a normalization-related problem, and needs to know what operations the firmware uses.

- Any setting change made by the normalizations is the same as a direct entry from the front panel, except where noted.
- Some subroutines are called at various points in the normalizations, and are described under the section "Normalization Subroutines". These are referred to in the description in all capital letters, surrounded by an underscore, as in "_VERT_ADJ_".

MAIN DAC OFFSET

MAIN DAC OFFSET finds the value to place into the main DAC to get zero MHz Center Frequency. This value is used in conjunction with the *MAIN DAC SENS* to get the main DAC value for any center frequency:

$$DACVAL = OFFSET + CF/SENS$$

where DACVAL = Main DAC value
 OFFSET = MAIN DAC OFFSET
 CF = Desired Center Frequency
 SENS = MAIN DAC SENS

Values Updated

The single value Main DAC Offset is updated *DEPENDENCIES*.

Dependencies

Dependent upon:

- *INTERNAL REF FREQ*
- *UPPER VCO SENS*

Operation

INITIAL SETTINGS

5 MHz Resolution
 0 MHz Center Frequency
 100 MHz Span/div
 +20 dBm Reference Level
 Single Sweep ON
 50 dB RF Attenuation

Procedure

- Beginning with span set to 125 MHz/div, then 5 and 1 MHz/div, center the signal by changing the main DAC and sweeping the signal. Degauss the YIG at each new DAC setting, and set resolution to 500 KHz when the span is less than 5 MHz/div. This leaves the start spur set to near center screen in 1 MHz/div. If the signal cannot be centered with the Main DAC after 5 tries, message *EO1* is generated.

- Set the instrument to zero span by setting the span DAC to 0.
- Decide on a beat frequency to look for when the start spur is centered. For instruments from B020319 and up, this is 5 MHz when the strobe frequency is 2105 MHz. For instruments from B010001 to B010318, this is always 10 MHz.
- Count the beat frequency to get an initial count. If the signal cannot be counted, generate message *EO2*.
- Set the main DAC such that the desired beat frequency is counted. If the Main DAC cannot be set low enough, generate message *EO3*. If the frequency cannot be counted, generate message *EO4*.
- Main DAC Offset is equal to the last main DAC value used. If this value is outside of allowable limits, generate message *EO5*.

MAIN DAC SENS (B010001 and Up)

MAIN DAC SENS measures the sensitivity of the main DAC, in Hz/step. This value is used in conjunction with the *MAIN DAC OFFSET* to get the main DAC value for any center frequency.

Values Updated

The values Main DAC Sensitivity, Main DAC Offset, and a value representing the ratio of the FM DAC to the main DAC are updated.

Dependencies

Dependent upon:

- *INTERNAL REF FREQ*
- *MAIN DAC OFFSET*

Operation

INITIAL SETTINGS

Single Sweep ON
 Zero Span

Procedure

- Set the FM DAC to 2047 (Center Range).
- Degauss the YIG.
- Set the Main DAC to Main DAC Offset (Approx 0 MHz center frequency).

Normalizations – 2710 Operators

- Count the beat frequency. If an error occurs during counting, generate message **EO1**.
- Using only the main DAC, attempt to set the CF to the following frequencies: 5, 100, 200, 400, 600, 800, 1000, 1200, 1400, 1600, and 1800 MHz.
- For each of the above frequencies, count the beat frequency, calculate the center frequency change, and then calculate a better estimation of the main DAC sensitivity. If an error occurs during counting the beat frequency at any center frequency, generate message **EO2**. If the main DAC cannot be set high enough (required value is >4095), generate message **EO3**. If the main DAC cannot be set low enough (required value is <1), generate message **EO4**.
- The latest calculated sensitivity is the overall main DAC sensitivity. If this result is outside allowable limits, generate message **EO5**.
- Set the center frequency to 900 MHz. Since the YIG is not always linear, the main DAC offset value should be updated to help lower the maximum frequency error.
- Degauss the YIG.
- Count the beat frequency. If this cannot be done, generate message **EO6**.
- The difference between the beat frequency and 10 MHz is the error in center frequency at 900 MHz center frequency. Split this difference and adjust the main DAC offset to compensate for it.
- Since the main DAC sensitivity figure may have changed, calculate the ratio of the FM DAC to the main DAC.

MAIN DAC SENS

MAIN DAC SENS measures the sensitivity of the main DAC, in Hz/step. This value is used in conjunction with the *MAIN DAC OFFSET* to get the main DAC value for any center frequency.

Values Updated

The values Main DAC Sensitivity, Main DAC Offset, and a value representing the ratio of the FM DAC to the main DAC are updated.

Dependencies

Dependent upon:

- *INTERNAL REF FREQ*
- *UPPER VCO SENS*

MAIN DAC OFFSET

Operation

INITIAL SETTINGS

Single Sweep ON
Zero Span

Procedure

- Set the FM DAC to 2047 (Center Range).
- Set the main DAC to Main DAC Offset (0 MHz center frequency)
- Measure the YIG frequency (see *_MSR_YIG_FREQ_*). If this cannot be done, generate message **EO1**.
- Set the main DAC to 80% of its range.
- Measure the YIG frequency (see *_MSR_YIG_FREQ_*). If this cannot be done, generate message **EO2**.
- Calculate what DAC value will be required for a center frequency of 1800 MHz. If this value is greater than 4095, generate message **EO3**.
- Set the main DAC to produce what should be 1800 MHz center frequency.
- Measure the YIG frequency (see *_MSR_YIG_FREQ_*). If this cannot be done, generate message **EO4**.
- Calculate the main DAC sensitivity. If this value is outside allowable limits, generate message **EO5**.
- Set the center frequency to 900 MHz. Since the YIG is not always linear, the main DAC offset value should be updated to help lower the maximum frequency error.
- Degauss the YIG.
- Count the YIG frequency (see *_MSR_YIG_FREQ_*). If this cannot be done, generate message **EO6**.
- The difference between the YIG frequency and 3010 MHz is the error in center frequency at 900 MHz center frequency. Split this difference and adjust the main DAC offset to compensate for it.
- Since the main DAC sensitivity figure may have changed, calculate the ratio of the FM DAC to the main DAC.

FM DAC SENS

FM DAC SENS measures the sensitivity of the FM DAC, in Hz/step. This value is used to determine a new FM DAC value when the YIG's FM coil is being moved in small steps.

Values Updated

The value FM DAC Sensitivity is updated, as well as a value representing the ratio of the FM DAC to the main DAC.

Dependencies

Dependent upon:

- *INTERNAL REF FREQ*
- *UPPER VCO SENS (B020319 and up)*
- *MAIN DAC OFFSET*
- *MAIN DAC SENS*

Operation

INITIAL SETTINGS

100 MHz Center Frequency
 Single Sweep ON
 5 MHz Resolution Bandwidth
 Zero Span (By setting the span DAC to Zero)

Procedure

- For instruments from B020319 and up, set the strobe frequency such that the beat frequency is 5 MHz (2205 MHz strobe). If this cannot be done, generate message **EO1**. This 5 MHz will be the target beat frequency. The upper and lower limit frequencies are 7 and 3 MHz, respectively.
- For instruments from B010001 to B010318, the target frequency is 15 MHz, with the upper and lower limits being 8 and 25 MHz, respectively.
- Set the main DAC such that the beat frequency is within the two limit frequencies. If the count cannot be completed properly, generate message **EO2**. If the frequency cannot be set within 15 attempts, generate message **EO3**.
- Set the FM DAC to minimum (1) and count the beat frequency. If the count cannot be made, generate message **EO4**.
- Set the FM DAC to maximum (4095) and count the beat frequency. If the count cannot be made, generate message **EO5**.
- Calculate the FM DAC Sensitivity. If the result is outside allowable limits, generate message **EO6**.

- Since the FM DAC sensitivity figure may have changed, calculate the ratio of the FM DAC to the main DAC.

FREQUENCY DRIFT

FREQUENCY DRIFT measures the medium-term YIG drift parameter, and is used to determine how accurately the YIG's frequency can be predicted over a frequency counting period. This parameter is only measured on instruments from B010001 to B010318.

Values Updated

The single value Frequency Drift is updated.

Dependencies

Dependent upon:

- *INTERNAL REF FREQ*
- *MAIN DAC OFFSET*
- *MAIN DAC SENS*

Operation

INITIAL SETTINGS

5 MHz Resolution
 100 MHz Center Frequency
 Single Sweep ON
 Zero Span (by loading 0 into the span DAC)

Procedure

- For instruments from B020319 and up, set the strobe frequency such that the beat frequency is 5 MHz (2205 MHz strobe). This 5 MHz will be the target beat frequency. The upper and lower limit frequencies are 7 and 3 MHz, respectively.
- For instruments from B010001 to B010318, the target frequency is 15 MHz, with the upper and lower limits being 8 and 25 MHz, respectively.
- Set the main DAC such that the beat frequency is within the two limit frequencies. If the count cannot be completed properly, generate message **EO1**. If the frequency cannot be set within 5 attempts, generate message **EO2**.

Normalizations – 2710 Operators

- Wait 5 seconds to eliminate all post-tune drift.
- Count the beat frequency. This is the base frequency against which all subsequent frequencies are checked. If this count cannot be performed, generate message **EO3**.
- Count the beat frequency 10 More times, at intervals of 200 ms. If any one of these counts cannot be performed, generate message **EO4**.
- Note the maximum positive and negative differences between the base frequency and the 10 subsequent frequency counts. The difference between these two numbers is the frequency drift value. If this value is outside allowable limits, generate message **EO5**.

UPPER VCO SENS

UPPER VCO SENS is the sensitivity of the VCO's Upper-order DAC. This parameter takes the form of a table of coefficients. These coefficients are plugged into a polynomial equation, into which is sent the desired VCO frequency, and out of which is extracted the Upper VCO DAC value. **This parameter is only measured on instruments from B020319 and up.**

Values Updated

An array of coefficients for a sixth-order polynomial is updated, as well as the highest and lowest VCO frequencies and a value representing the sensitivity of the VCO when the VCO is at 13 MHz.

Dependencies

Dependent upon:

- *INTERNAL REF FREQ*

Operation

INITIAL SETTINGS

Zero span (Set the span DAC to 0)
Single Sweep ON

Procedure

- Center the lower VCO DAC.
- Set the Upper VCO DAC to 20 different settings, approximately 215 steps apart. This covers the entire range of the DAC.

- For each of the above steps, count the VCO. If any of these counts cannot be performed, generate message **EO1**.
- Check the highest and lowest VCO frequencies measured against allowable limits. If either value is out of range, generate message **EO2**.
- Using the 20 sample frequencies and their corresponding DAC values, calculate the coefficients for a sixth-order polynomial which best describes the sample points. If the polynomial cannot be calculated, generate message **EO3**.
- Save the highest and lowest VCO frequencies for future reference.
- Use the new coefficients to calculate the sensitivity of the upper VCO DAC when the VCO is at 13 MHz.

LOWER VCO SENS

LOWER VCO SENS measures the sensitivity of the lower VCO DAC, in terms of the number of steps on the lower DAC which equals one step on the upper DAC. Since the frequency change per step of the lower DAC will change depending on what the upper DAC's setting is, the polynomial which calculates the upper VCO DAC setting is used in conjunction with this value to determine the sensitivity of the lower DAC at the upper DAC setting.

Values Updated

The value Lower VCO Sensitivity is updated.

Dependencies

Dependent upon:

- *INTERNAL REF FREQ*
- *UPPER VCO SENS*

Operation

INITIAL SETTINGS

Zero span (Set span DAC to 0)
Single Sweep ON

Procedure

- Set the Lower VCO DAC to center (2047).

- Calculate where the upper VCO DAC should be set for a VCO frequency of 13.4 MHz, then set it to that value.
- Count the VCO 8 times, then average the result. If any count cannot be performed, generate message **EO1**.
- Calculate the sensitivity of the Upper VCO DAC at the measured average frequency. This value is the sensitivity of the Upper VCO DAC at the measured frequency, in Hz/step.
- Set the Lower VCO DAC to its upper limit (4095).
- Average 8 frequency counts of the the VCO. If any of the counts cannot be performed, generate message **EO2**.
- Calculate the number of lower VCO DAC steps which equals one upper VCO DAC step. If this value is outside allowable limits, generate message **EO3**.

SPAN/DIV

SPAN/DIV measures the sensitivity of the span DAC in terms of Hz/bit/div. These values allow the instrument firmware to calculate the proper DAC value for a desired span/div. The instrument uses more than one set of hardware to get all desired spans, such as Main Coil sweep, FM coil sweep, and various decade dividers. The normalizations must therefore provide a sensitivity value for each type of hardware setup.

The general method for measuring a span DAC range is to count a signal (YIG, beat, or VCO) at four points:

- When the beam is at center screen and the DAC is at some minimum value (*cent_min*).
- When the beam is at center screen and the DAC is at maximum (*cent_max*).
- When the beam is at the rightmost graticule line and the DAC is at some minimum value (*right_min*).
- When the beam is at the rightmost graticule line and the DAC is at maximum (*right_max*).

The span sensitivity for the range is then calculated as:

$$\frac{(right_max - right_min) - (cent_max - cent_min)}{(max_dac - min_dac)}$$

This parameter is only measured on instruments from B020319 and up.

This parameter is only measured on instruments from B020319 and up.

On Version 11-18-88 firmware and later, only *cent_max* and *right_max* are measured, changing the span calculation to:

$$\frac{right_max - cent_max}{max_dac}$$

Values Updated

A table of span sensitivities is updated, one for each range that the span operates in.

Dependencies

Dependent upon:

- *INTERNAL REF FREQ*
- *MAIN DAC OFFSET*
- *MAIN DAC SENS*

Operation

INITIAL SETTINGS

- 100 MHz Center Frequency
- 100 MHz Span/div
- Single Sweep ON

Procedure

- Select what to count for each range:
 - For the Main Coil Span ranges using the +1 and +10 attenuators, and the FM Coil Span using the +1 attenuator, count The YIG (see *_MSR_YIG_FREQ_*) when measuring spans (span ranges 0–2).
 - For the FM Coil Span ranges using any other divide-by attenuators, count the beat frequency when measuring spans (span ranges 3–6).
 - For any VCO Span ranges, count the VCO when determining spans (spans 7–8).
- If counting the YIG (ranges 0–2), degauss before measuring.
- If counting the beat frequency (ranges 3–6), first set the beat frequency to 10 MHz.
- If counting the VCO (ranges 7–8), first set the VCO to 13 MHz.
- Set the beam to center screen.
- Set the Span DAC to 100.

Normalizations – 2710 Operators

- Count the signal (cent_min). If the signal cannot be counted, generate message EO1.
- Set the Span DAC to maximum (3600).
- Count the signal (cent_max). If the signal cannot be counted, generate message EO2.
- Set the bean to the right-hand park position (right-most graticule line).
- Set the Span DAC to 100.
- Count the signal (cent_min). If the signal cannot be counted, generate message EO3.
- Set the Span DAC to maximum (3600).
- Count the signal (cent_max). If the signal cannot be counted, generate message EO4.
- Calculate the sensitivity for this span range. If this value is outside of allowable limits, generate message EO5.

FREQUENCY ACCURACY

FREQUENCY ACCURACY measures the frequency accuracy of the instrument with corrections off, and with normalization values applied. The value generated by this normalization is used by the frequency correction routine to determine how close the center frequency can be predicted after tuning. This parameter is only measured on instruments from B010001 to B010318.

Values Updated

The single value Frequency Accuracy is updated.

Dependencies

Dependent upon:

- *INTERNAL REF FREQ*
- *MAIN DAC OFFSET*
- *MAIN DAC SENS*

Operation

INITIAL SETTINGS

5 MHz Resolution
Single Sweep ON
Zero Span (Set the span DAC to 0)

Procedure

- Set the instrument to center frequencies 100 MHz apart, beginning with 0 MHz.
- For instruments from B020319 and up, count the YIG frequency (see *MSR_YIG_FREQ*) at each of the above frequencies. Calculate the deviation from the expected YIG frequency at each frequency. If any of the counts cannot be performed, generate message EO1.
- For instruments from B010001 to B010318, count the beat frequency at each of the above frequency. Calculate the deviation from 10 MHz at each frequency. If any of the counts cannot be performed, generate message EO2.
- Determine which center frequency has the greatest error from the expected value. This error is the Center Frequency Accuracy figure.
- If the Center Frequency Accuracy is outside of allowable limits, generate message EO3.

GAIN AND ATTEN

GAIN AND ATTEN measures the exact gain of each VR gain step and RF attenuator. These gains are used to determine which gain step to invoke for a desired reference level, and how much VR FINE GAIN to use.

Values Updated

Two arrays are updated, one for the actual VR step gains, the other for the actual RF attenuator gains.

Dependencies

Dependent upon:

- *INTERNAL REF AMPLTD*
- *GAIN STEP REFERENCE*
- *UPPER VCO SENS (B020319 and up)*
- *MAIN DAC OFFSET (B020319 and up)*
- *MAIN DAC SENS (B020319 and up)*

Operation

INITIAL SETTINGS

100 MHz Center Frequency
 5 MHz Resolution
 5 MHz Span/div
 -30 dBm Reference Level
 Calibrator ON
 LIN Vertical Display Mode
 Single Sweep ON

Procedure

- Span down gradually to zero span, keeping the calibrator signal centered. If the signal is lost, or cannot be centered properly before going to zero span, generate message EO1.
- Wait for 1 s and repeat the above step, as a precaution against signal drift. If an error occurs while spanning down, generate message EO2.
- Turn on the 300 Hz Video Filter
- Set VR gain to 0, RF attenuation to 0, and VR fine gain to center (127 on the PIN DAC). This simulates an uncorrected -30 dBm reference level.
- Calculate the LIN mode sensitivity, using the PIN DAC only to place the signal at full screen (see `_CALC_LIN_SENS_`). If the signal was lost or the sensitivity values are outside of allowable limits, generate message EO3.
- Beginning with -10 dB VR gain (all gain steps off) and 2 dB RF attenuation, measure all VR gain and RF attenuation steps, using the following method:
 - Measure the signal level.
 - If the signal is less than 1.5 dB below full screen, go to the next attenuator step and remeasure the signal. Use the difference in signal level to calculate the actual gain of the attenuator step. If the value is outside of allowable limits, generate message EO4.
 - If the signal level is more than 1.5 dB below full screen, go to the next gain step and remeasure the signal. Use the difference in signal level to calculate the actual gain of the gain step. If the value is outside of allowable limits, generate message EO5.

BW FLTR AMPLTD (LIN)

BWFLTRAMPLTD (LIN) measures the amplitude of each VR filter, using the 5 MHz filter as a reference. This allows gain

correction when switching between 2 resolution bandwidth settings. The filters are all normalized in LIN vertical display mode.

Values Updated

A table of corrections is updated, one correction for each VR filter installed.

Dependencies

Dependent upon:

- *INTERNAL REF AMPLTD*
- *GAIN STEP REFERENCE*
- *GAIN AND ATTEN*
- *GAIN CORRECTION DAC*
- *UPPER VCO SENS (B020319 and up)*
- *MAIN DAC OFFSET (B020319 and up)*
- *MAIN DAC SENS (B020319 and up)*

Operation

INITIAL SETTINGS

100 MHz Center Frequency
 -30 dBm Reference Level
 Calibrator ON
 5 MHz Resolution
 5 MHz Span/div
 Single Sweep ON
 LIN Vertical Display Mode
 Video Filter ON, AUTO

Procedure

- Turn Frequency Corrections ON.
- Set VR gain to 0, RF attenuation to 0, and VR fine gain to center (127 on the PIN DAC). This simulates an uncorrected -30 dBm reference level.
- Calculate the LIN mode sensitivity, using the PIN DAC and gain and attenuation steps to place the signal at full screen (see `_CALC_LIN_SENS_`). If the signal was lost or the sensitivity values are outside of allowable limits, generate message EO1.
- For each filter in the instrument, from narrowest to widest:

Normalizations – 2710 Operators

- Set the instrument to the resolution of interest.
- Set the span/div to be the same as the width of the filter of interest (approximately 1 division wide signal).
- If this is the first (narrowest) filter, run frequency corrections twice to get signal on screen.
- Sweeping the screen to get the signal peak, attenuate the signal until it is below full screen (if necessary). If this is not possible, generate message **EO2**.
- Keeping in mind any attenuation which was used, calculate the amplitude of the filter with respect to the 5 MHz filter. If this value is outside allowable limits, generate message **EO3**.

BW FLTR AMPLTD (LOG)

BW FLTR AMPLTD (LOG) measures the amplitude of each VR filter with a bandwidth equal to or greater than 300 KHz. The filters are normalized in LOG vertical display mode. The narrower bandwidth filters are extrapolated using the LIN filter measurements. filter.

Values Updated

A table of corrections is updated, one correction for each VR filter installed.

Dependencies

Dependent upon:

- INTERNAL REF AMPLTD
- GAIN STEP REFERENCE
- GAIN AND ATTEN
- GAIN CORRECTION DAC
- BW FLTR AMPLTD (LIN)
- UPPER VCO SENS (B020319 and up)
- MAIN DAC OFFSET (B020319 and up)
- MAIN DAC SENS (B020319 and up)

Operation

INITIAL SETTINGS

100 MHz Center Frequency
–30 dBm Reference Level

Calibrator ON
5 MHz Resolution
5 MHz Span/div
Single Sweep ON
LOG Vertical Display Mode
1 dB/div Vertical Scale
Video Filter ON, AUTO

Procedure

- Set VR gain to 0, RF attenuation to 0, and VR fine gain to center (127 on the PIN DAC). This simulates an uncorrected –30 dBm reference level.
- Set the 5 MHz filter to full screen, using the gain and attenuator steps and the VR PIN DAC. If the 5 MHz filter cannot be set to full screen, generate message **EO1**.
- For each filter in the instrument with a bandwidth equal to greater than 300 KHz (scanned from widest to narrowest):
 - Set the resolution to the bandwidth of interest.
 - Set the span/div to the same value as the bandwidth filter of interest.
 - Set the signal to full screen, using VR gain steps, RF attenuators, and the VR PIN DAC (see `_VERT_ADJ_`). If the signal cannot be set to full screen, generate message **EO2**.
 - Calculate the exact amount of gain (or attenuation) which was necessary to set the signal to full screen. This is the gain correction factor for the filter of interest.
- For all other filters:
 - Calculate the correction for the filter of interest by noting the difference between the next highest filter and the filter of interest in the LIN mode VR filter correction table, and extrapolating the correction for the filter of interest.
 - If this value is outside allowable limits, generate message **EO3**.

PREAMP GAIN

PREAMP GAIN measures the actual gain of the preamp at 100 MHz center frequency. This allows reference level corrections to occur when the preamp is being used.

Values Updated

The single value Preamp Gain is updated.

Dependencies

Dependent upon:

- *INTERNAL REF AMPLTD*
- *GAIN STEP REFERENCE*
- *GAIN AND ATTEN*
- *UPPER VCO SENS (B020319 and up)*
- *MAIN DAC OFFSET (B020319 and up)*
- *MAIN DAC SENS (B020319 and up) INTERNAL REF FREQ*

Operation

INITIAL SETTINGS

100 MHz Center Frequency
 5 MHz Resolution
 5 MHz Span/div
 LIN Vertical Display Mode
 Calibrator ON
 -30 dBm Reference Level
 Single Sweep ON

Procedure

- Sweep screen and center the calibrator signal.
- Turn on the video filter in AUTO mode.
- Span down gradually to zero span, keeping the calibrator signal centered. If the signal is lost, or cannot be centered properly before going to zero span, generate message EO1.
- Set VR gain to 0, RF attenuation to 0, and VR fine gain to center (127 on the PIN DAC). This simulates an uncorrected -30 dBm reference level.
- Calculate the LIN mode sensitivity, using the PIN DAC only to place the signal at full screen (see _CALC_LIN_SENS_). If the signal was lost or the sensitivity values are outside of allowable limits, generate message EO2.
- Turn on the preamp.

- Attenuate the signal back below full screen. If the signal cannot be brought back on screen, generate message EO3.
- Measure the new signal level.
- Calculate the gain of the preamp from the two measured levels and the amount of attenuation used to bring the signal on screen. If this value is outside allowable limits, generate message EO4.

GAIN CORRECTION DAC

GAIN CORRECTION DAC measures the exact gain of the VR PIN attenuator for each step on the VR PIN DAC. This table of gains is then used to produce a cross reference table from which the firmware selects a DAC value for a desired gain. For example, if +1.0 dB of gain is required:

Nominal gain/DAC step is 0.04 dB.
 The "center" of the DAC is step 127.
 Nominal DAC value desired:
 $127 + (1.0 \text{ dB} / 0.04 \text{ dB/step}) = \text{step } 153$
 Number 153 in the normalization-generated table may be 135 (for this example). Therefore, the value 135 is placed into the VR PIN DAC.

Values Updated

The fine gain cross-reference array is updated, along with values representing the highest and lowest gains attainable by the VR PIN DAC.

Dependencies

Dependent upon:

- *INTERNAL REF AMPLTD*
- *GAIN STEP REFERENCE*
- *GAIN AND ATTEN*
- *UPPER VCO SENS (B020319 and up)*
- *MAIN DAC OFFSET (B020319 and up)*
- *MAIN DAC SENS (B020319 and up)*

Operation

INITIAL SETTINGS

100 MHz Center Frequency
 -30 dBm Reference Level

Normalizations – 2710 Operators

Calibrator ON
5 MHz Resolution
5 MHz Span/div
Video Filter ON, AUTO
LIN Vertical Display Mode
Single Sweep ON

Procedure

- Span down gradually to zero span, keeping the calibrator signal centered. If the signal is lost, or cannot be centered properly before going to zero span, generate message **EO1**.
- Set VR gain to 0, RF attenuation to 0, and VR fine gain to center (127 on the PIN DAC). This simulates an uncorrected -30 dBm reference level.
- Calculate the LIN mode sensitivity, using the VR gain and RF attenuation to place the signal near full screen (see `_CALC_LIN_SENS_`). If the signal was lost or the sensitivity values are outside of allowable limits, generate message **EO2**.
- Beginning with step 127 on the PIN DAC, reduce the DAC value by 4 until the DAC value equals 0:
 - Measure the new signal level, and calculate the gain at the current PIN DAC setting.
 - Interpolate between the previous measurement and the current one to find the gain of the steps which were not measured.
- If the signal gets too low, add a gain step, noting the effect of the extra gain.
- Beginning with 127 on the PIN DAC, increase the DAC value by 4 until 255 is reached:
 - Measure the new signal level, and calculate the gain at the current PIN DAC setting.
 - Interpolate between the previous measurement and the current one to find the gain of the steps which were not measured.
- If the signal gets too low, add a gain step, noting the effect of the extra gain.
- If the highest gain measured and the lowest gain measured are not within allowable limits, generate message **EO3**.

LOG AMPLIFIER

LOG AMPLIFIER measures the logging error in all three log modes (1, 5, and 10 dB/div). This normalization produces a table of error values which are used to determine the level at a particular point below full screen.

Values Updated

Three tables are updated, one for each LOG vertical display scale.

Dependencies

Dependent upon:

- *INTERNAL REF AMPLTD*
- *GAIN STEP REFERENCE*
- *GAIN AND ATTEN*
- *GAIN CORRECTION DAC*
- *UPPER VCO SENS (B020319 and up)*
- *MAIN DAC OFFSET (B020319 and up)*
- *MAIN DAC SENS (B020319 and up)*

Operation

INITIAL SETTINGS

100 MHz Center Frequency
5 MHz Resolution
5 MHz Span/div
-30 dBm Reference Level
Calibrator ON
LIN vertical Display Mode
Single Sweep ON

Procedure

- Span down gradually to zero span, 500 KHz resolution bandwidth, keeping the calibrator signal centered. If the signal is lost, or cannot be centered properly before going to zero span, generate message **EO1**.
- Set Vertical Display Mode to LOG, Scale to 1 dB/div.
- Set VR gain to 0, RF attenuation to 0, and VR fine gain to center (127 on the PIN DAC). This simulates an uncorrected -30 dBm reference level.

- Set the Calibrator signal to full screen, using gain steps, attenuators, and the VR PIN DAC (see `_VERT_ADJ_`). If this cannot be done, generate message **EO2**.
- Turn on 300 Hz Video Filter
- For each Vertical LOG scale (1, 5, 10 dB/div):
 - Set the Calibrator signal to full screen, using gain steps, attenuators, and the VR PIN DAC. If this cannot be done, generate message **EO3**.
 - Place the signal at every 1/3 of a division from full screen (24 points), using the gain steps, RF attenuators, and VR PIN DAC (see `_VERT_ADJ_`).
 - For each point in the previous step, calculate the amount of attenuation necessary to place the signal at that point. The difference between that value and the expected value is the correction factor for that position.
 - If any result is outside allowable limits, generate message **EO4**.
 - If the signal could not be attenuated far enough (not enough attenuators, too much noise, etc), copy the last known good result through to the end of the table.

FULL SCREEN OFFSETS

FULL SCREEN OFFSETS measures the amount of gain which must be added to (or subtracted from) the current instrument gain to set the 5 MHz resolution bandwidth filter to full screen when the RF attenuators, VR gain steps, and VR fine gain are all set to a nominal zero value. This zero value is the same as the -30 dBm reference level that has not been normalized. This normalization is performed for each 1, 5, and 10 dB/div in LOG display mode, and also for LIN display mode.

Values Updated

One value is updated for each LOG mode vertical scale and one for LIN mode.

Dependencies

Dependent upon:

- *INTERNAL REF AMPLTD*
- *GAIN STEP REFERENCE*
- *GAIN AND ATTEN*
- *GAIN CORRECTION DAC*

- *UPPER VCO SENS (B020319 and up)*
- *MAIN DAC OFFSET (B020319 and up)*
- *MAIN DAC SENS (B020319 and up)*

Operation

INITIAL SETTINGS

100 MHz Center Frequency
 5 MHz Resolution
 5 MHz Span/div
 -30 dBm Reference Level
 Calibrator ON
 LIN Vertical Display Mode
 Single Sweep ON
 Video Filter ON

Procedure

- Span down gradually to 1 MHz span/div, 5 MHz resolution bandwidth, keeping the calibrator signal centered. If the signal is lost, or cannot be centered properly, generate message **EO1**.
- For each Vertical Scale Factor (including LIN):
 - Set the instrument to the Scale factor of interest.
 - Set the signal to full screen using VR gain steps, RF attenuators, and the VR PIN DAC (see `_VERT_ADJ_`). If this cannot be performed, generate message **EO2**.
 - Calculate the offset necessary to place the signal to full screen, in dB. This value is the correction factor for this scale factor. If this value is outside allowable limits, generate message **EO3**.

VR FILTER BW & CEN

VR FILTER BW & CEN measures the 6dB, noise, and impulse bandwidths of each VR filter.

Values Updated

Three tables of corrections are updated, one for each type of bandwidth, one correction for each VR filter installed.

Dependencies

Dependent upon:

- INTERNAL REF AMPLTD
- GAIN STEP REFERENCE
- GAIN AND ATTEN
- GAIN CORRECTION DAC
- LOG AMPLIFIER
- FULL SCREEN OFFSETS
- UPPER VCO SENS (B020319 and up)
- MAIN DAC OFFSET (B020319 and up)
- MAIN DAC SENS (B020319 and up)

Operation

INITIAL SETTINGS

100 MHz Center Frequency
 -30 dBm Reference Level
 Calibrator ON
 5 MHz Resolution
 5 MHz Span/div
 Single Sweep ON
 5 dB/div LOG Vertical Display Mode
 Video Filter OFF

Procedure

- Create a table to convert between log dB and lin volts. If this table cannot be created, generate message **EO1**.
- Turn Frequency Corrections ON.
- Set VR gain to 0, RF attenuation to 0, and VR fine gain to center (127 on the PIN DAC). This simulates an uncorrected -30 dBm reference level.
- For each filter in the instrument, from narrowest to widest:
 - Set the instrument to the resolution of interest.
 - Set the span/div to be the same as one half the width of the filter of interest (approx. 2 division wide signal).
 - If this is the first (narrowest) filter, run frequency corrections twice to get signal on screen.
 - At this point, if the signal is less than 1 division (35 dB too low), generate message **E02**.

- Sweeping the screen to get the signal peak, add attenuation or gain to the signal until it is between 2 and 5 dB from full screen (if necessary). If this is not possible, generate message **E03**. Remember this attenuation and gain as **ATTN** and **GAIN**.

- Measure the 6dB bandwidth of this filter in the following way:

- Find the a and y position of the signal peak. If this peak is less than half screen, generate message **E04**.

- Find the x and y position of the point 6dB down to the right of the signal peak (*right_x and right_y*). If this point cannot be found, generate message **E05**.

- Find the x and y position of the point 6dB down to the left of the signal peak (*left_x and left_y*). If this point cannot be found, generate message **E06**.

- Calculate the 6dB bandwidth as follows:

$$6\text{ dB_bw} = \frac{\text{right_x} - \text{left_x}}{\text{span_per_div}} \times \text{points_per_div}$$

- If this result is outside reasonable limits, generate the message **E07**.

- Measure the impulse and noise bandwidths of this filter in the following way:

- Find the a and y position of the signal peak. If this peak is less than half screen, generate message **E08**.

- Add up all of the points in the signal which are more than one division above the bottom of the screen (signal area).

- Add up the squares of all the points in the signal which are more than one division above the bottom of the screen (signal area squared).

- Calculate the impulse bandwidth as:

$$\frac{\left[\frac{\text{sig_area}}{\text{peak_volts}} \times \text{span_per_div} \right]}{\text{points_per_div}}$$

- If this result is outside reasonable limits, generate the message **E09**.

- Calculate the noise bandwidth as:

$$\frac{\left[\frac{\text{sig_area_squared}}{\text{peak_volts_squared}} \times \text{span_per_div} \right]}{\text{points_per_div}}$$

- If this result is outside reasonable limits, generate the message **E10**.

SENSITIVITY

SENSITIVITY measures the level of the noise floor for each resolution bandwidth filter at intervals of 100 MHz center frequency, starting at 90 MHz center frequency. The peak of the noise is also measured once for each filter at 100 MHz center frequency only. The first portion of this normalization is repeated with the preamp turned on.

Values Updated

Three Tables are updated: an average sensitivity figure is found for each resolution bandwidth filter installed with the Preamp OFF, at each 100 MHz; an average sensitivity is found for each resolution with the preamp ON, at each 100 MHz; A peak-minus-average sensitivity figure is found for each resolution at 100 MHz.

Dependencies

Dependent upon:

- *INTERNAL REF AMPLTD*
- *GAIN STEP REFERENCE*
- *GAIN AND ATTEN*
- *GAIN CORRECTION DAC*
- *BW FLTR AMPLTD (LOG)*
- *LOG AMPLIFIER*
- *FULL SCREEN OFFSETS*
- *UPPER VCO SENS (B020319 and up)*
- *MAIN DAC OFFSET (B020319 and up)*
- *MAIN DAC SENS (B020319 and up)*

Operation

INITIAL SETTINGS

Zero Span
 -65 dBm Reference Level
 Calibrator ON
 LOG Vertical Scale Mode
 3 Hz Video Filter
 Single Sweep ON
 50 dB RF Attenuation *
 * Set by directly writing to the RF Deck Driver.

Procedure

- With the Preamp OFF, Using the 5 MHz resolution filter, Set the instrument to every 100 MHz, beginning with 90 MHz (90, 190, 290, etc).
- Measure the noise level by reading the storage accumulator 12 times, then throwing out the highest and lowest measurement and averaging the rest. This is the sensitivity at this frequency in 5 MHz filter.
- Returning to 100 MHz CF, Measure the average sensitivity at 100 MHz in all filters. By cross-mapping the frequency-by-frequency results (collected in the previous step) with the filter-by-filter results, a sensitivity figure is calculated for all filters at each frequency.
- If the preamp is off, the peak sensitivity is also calculated in the previous step for all resolution filters. This is done by turning off the video filter, measuring the noise with the accumulator, and subtracting the average sensitivity figure.
- If any value calculated for the peak-minus-average table is outside of allowable limits, generate message **EO1**.
- If any value calculated for the filter-frequency table is outside of allowable limits with the preamp ON, generate message **EO2**.
- If any value calculated for the filter-frequency table is outside of allowable limits with the preamp OFF, generate message **EO3**.

INTERNAL REF FREQ

INTERNAL REF FREQ measures the frequency of the internal calibration signal.

Values Updated

The single value Reference Frequency is updated.

Dependencies

Dependent upon:

- *UPPER VCO SENS (B020319 and up)*
- *MAIN DAC OFFSET (B020319 and up)*
- *MAIN DAC SENS (B020319 and up)*

Operation

INITIAL SETTINGS

There are no initial settings. Much of the setup for this test depends upon the operator. The external reference signal must be near or at center screen, and must be at a countable level before this normalization is executable. The operator is also responsible for entering the EXACT frequency of their reference signal.

Procedure

- Count the externally-applied signal with the center-measure function. If the signal cannot be counted, generate message **EO1**.
- The internal reference frequency is used as a time base for the previous signal count. If this signal count is different from what the operator entered for the external reference frequency, the percentage error will be the same percentage that the internal reference frequency is in error. The internal reference frequency is calculated from this figure. If this value is outside allowable limits, generate message **EO2**.

INTERNAL REF AMPLTD

INTERNAL REF AMPLTD measures the frequency of the internal calibration signal.

Values Updated

The single value Reference Amplitude is updated.

Dependencies

Dependent upon:

- *GAIN STEP REFERENCE*
- *UPPER VCO SENS (B020319 and up)*
- *MAIN DAC OFFSET (B020319 and up)*
- *MAIN DAC SENS (B020319 and up)*

Operation

INITIAL SETTINGS

NOTE

Before this normalization is invoked the user must connect an external amplitude reference signal into the analyzer.

- 30 dBm Reference Level
- 100 MHz Center Frequency
- 5 MHz Resolution
- 5 MHz Span/div
- Calibrator OFF
- Single Sweep ON

Procedure

- Center the user-applied signal.
- Span down gradually to Zero Span, 5 MHz resolution bandwidth, keeping the calibrator signal centered. If the signal is lost, or cannot be centered properly, generate message **EO1**.
- Beginning with 10 dB gain in the VR and 10 dB RF attenuation (effectively -30 dBm reference level with 10 dB RF attenuation), set the signal to one division below full screen using the gain steps, attenuator steps, and the VR PIN DAC (see *_VERT_ADJ_*). If the signal cannot be set to this point, generate message **EO2**.
- Measure the signal level, then turn off the reference gain step, then remeasure the signal.
- If the two measurements are the same, the signal has probably been lost. Generate message **EO3**.
- Calculate the LIN mode sensitivity from the two measurements and the known gain of the reference gain step. If this value is outside allowable limits (see *_CALC_LIN_SENS_*), generate message **EO4**.
- Replace the reference gain step.
- Ask the operator to remove the externally-applied signal. When the signal drops by 1/2 screen, continue.
- The position of the external signal is known by this step. Now reset the instrument to measure the internal signal. Set the instrument to:
 - 100 MHz Center Frequency
 - 5 MHz Resolution
 - 5 MHz Span/div
 - Calibrator ON
 - Single Sweep ON
- Center the calibrator signal.
- Span down gradually to Zero Span, 5 MHz resolution bandwidth, keeping the calibrator signal centered. If the signal is lost, or cannot be centered properly, generate message **EO5**.
- Reset the instrument to the gain, attenuation, and PIN DAC value used when measuring the external signal.

- Measure the internal signal.
- Calculate the amplitude of the internal calibrator signal, using the difference between the internal and external signals. If this value is outside allowable limits, generate message **EO6**.

GAIN STEP REFERENCE (part 1)

GAIN STEP REFERENCE (part 1) is the first part of normalizing the reference gain step. This entails setting the user-supplied signal to full screen.

Values Updated

No values updated.

Dependencies

Dependent upon:

- *UPPER VCO SENS (B020319 and up)*
- *MAIN DAC OFFSET (B020319 and up)*
- *MAIN DAC SENS (B020319 and up)*

Operation

INITIAL SETTINGS

The operator connects a 100 MHz signal to the RF input. The level of this signal is between -20 and +20 dBm.

+20 dBm Reference Level
 100 MHz Center Frequency
 5 MHz Resolution
 5 MHz Span/div
 Calibrator OFF
 10 dB RF Attenuation
 Single Sweep ON
 LIN Vertical Display Mode

Procedure

- The Target Level for this test is 3/4 divisions below full screen.
- Set RF attenuation to 50 dB.
- Set VR gain to 0.
- Set the VR PIN DAC to center (127).

- Turn off the reference gain step.
- Decrease RF attenuation in 10 dB steps until the signal is over the Target Level.
- Increase RF attenuation in 2 dB steps until the signal is below the Target Level.
- If the RF attenuation is at or beyond limits, generate message **EO1**.
- Use only the VR PIN DAC to set the signal right at the target level (see *_VERT_ADJ_*). If this cannot be done, generate message **EO2**.
- Measure the signal level (should be the same as the target level).

HI GAIN STEP REFERENCE (part 2)

HI GAIN STEP REFERENCE (part 2) is the second part of normalizing the reference gain step. This entails measuring the new (reduced) level of the user-supplied signal, then using that difference to measure the internal gain step.

Values Updated

The single value Reference Gain Step is updated.

Dependencies

Dependent upon:

- *GAIN STEP REFERENCE (part 1)*
- *UPPER VCO SENS (B020319 and up)*
- *MAIN DAC OFFSET (B020319 and up)*
- *MAIN DAC SENS (B020319 and up)*

Operation

INITIAL SETTINGS

The operator reduces the external signal by approximately 10 dB. The exact amount by which the signal is reduced is entered by the operator. All instrument settings remain as they were during the first part of the reference gain step normalization.

Procedure

- The signal level is measured.
- If the level did not decrease by 70 vertical display locations, generate message **EO3**.
- From the level measured at the end of the first part of the reference gain step normalization and the previous signal level, calculate the LIN mode sensitivity. If this value is outside allowable limits, generate message **EO4**.
- Turn the reference gain step back on.
- The amount the external signal changed between the first and second parts of this normalization, added to the difference between the last step of the first part and the first step of this part, is the actual gain of the reference gain step. If this value is outside allowable limits, generate message **EO5**.

NORMALIZATION SUBROUTINE DESCRIPTION

This portion contains descriptions of the commonly used normalization subroutines. These subroutines are referred to in section V as `_VERT_ADJ_`, `_CALC_LIN_SENS_`, and `_MSR_YIG_FREQ_`.

These subroutines do not produce error messages themselves, but may cause a normalization to produce a message.

Vertical Adjustment

This routine is used to set a signal to full screen. The routine may use The gain and attenuator steps only, the VR fine gain DAC only, or both mechanisms to accomplish this task. The measurement method is selectable between direct-read and memory-read operation (see section II.D.2).

Procedure

- Calculate a reasonable accuracy of adjustment. If the instrument is in LIN or 1 dB/div LOG vertical display mode, adjust the signal within 2 steps of the desired vertical position. Adjust within 1 step for all other modes.
- If the VR fine gain DAC is to be adjusted, preset it to step 75. Measure the initial position of the signal.
- If the gain and attenuation are to be adjusted, increase gain or attenuation until the signal crosses the desired position. If gain was used (as opposed to attenuation), reduce the gain by 1 step, placing the signal just below the desired level. If the instrument ran out of attenuation or gain, return an error to the calling function.

- If the VR fine gain is to be adjusted, adjust it repeatedly until the signal is at the desired position, \pm the desired accuracy. If the DAC runs out of range, return an error to the calling function. If the signal "crossed over" the desired position more than 12 times, return an error message to the calling function indicating a "jumpy" signal.
- After all adjustments, if the signal is below a reasonable level, return an error to the calling function.

LIN Mode Sensitivity Calculations

This subroutine is used to calculate the sensitivity of LIN mode in V/step on screen. By using the values calculated in this subroutine, other routines can determine the number of dB from full screen for a specific vertical position.

Procedure

- Set the signal to the desired level, using the vertical adjustment subroutine. The reference gain step is guaranteed to be ON after this adjustment.
- Measure the signal with the gain step ON.
- Turn the reference gain step OFF.
- Measure the signal with the gain step OFF.
- Calculate where 0 V would be on screen.
- Since the following calculations require a division by the difference in the previously measured levels, an error is returned to the calling function if the signal level did not change (potential division by zero). This is classed as a "no signal" condition.
- Calculate the "range" of LIN mode by subtracting the 0 V position from the position used as a reference (the "desired position" in the vertical adjustment).
- Calculate the LIN mode sensitivity by dividing the voltage at the reference position by the LIN mode range.
- If either the zero position or the LIN range are outside allowable limits (see chart, below) return an error to the calling function. If these two parameters are within limits, the sensitivity will be within limits.
 1. Name: Zero Position
Upper Limit: 40
Lower Limit: -40
 2. Name: Lin Range
Upper Limit: 350
Lower Limit: 125

YIG Frequency Counting

In instruments from B020319 and up, the YIG oscillator frequency is determined by setting the LF VCO to various frequencies, measuring the resultant beat frequency, and analyzing all frequencies together. This method allows calculation of the YIG frequency without prior knowledge of the approximate frequency.

If the VCO is set to 2 different frequencies, a pair of beat frequencies will be produced which are related to the VCO frequencies by a factor of the strobe frequency N-number.

For many settings of the VCO and YIG, the beat frequency pairs will not correspond to a valid or correct YIG frequency. To validate the calculated frequency, a second pair is measured in an attempt to match to the first frequency calculation.

Procedure

- Set the VCO to several different frequencies.
- For each frequency, measure the resultant beat frequency.
- For each frequency, calculate the base strobe frequency. This is equal to the VCO frequency divided by four, added to 100 MHz, and divided by four again.
- For each pair of VCO frequencies and beat frequencies, calculate the apparent N-number by dividing the beat frequency difference by the base strobe frequency difference.
- Using the apparent N-number and strobe frequency, calculate the apparent YIG frequency.
- When two consecutive YIG frequencies have the same N-number and the same frequency (within limits), return that frequency as the actual YIG frequency. The Yig frequencies must be within 100 KHz of each other, and the N-numbers must be within 0.3 N-numbers.
- If two YIG frequency calculations do not match within 15 VCO-beat-frequency samples, an error is returned to the calling function.

APPENDIX I NORMALIZATION VALUES

Most normalization values can be viewed on the CRT by selecting [UTIL] [5] [5] [3] (Normalization Values). The following diagrams show where each normalization value can be found.

RF ATTEN AND PREAMP GAIN, [UTIL] [5] [5] [3] [0]

This menu contains the actual attenuations of the RF attenuators and the actual gain of the preamp. The attenuator figures are organized from lowest (0 dB) to highest (50 dB) attenuation, in 2 dB steps, read from left to right and top to bottom.

RF ATTEN AND PREAMP GAIN				
RF ATTENUATION				
0.0	2.0	4.0	6.0	8.0
10.0	12.0	14.0	16.0	18.0
20.0	22.0	24.0	26.0	28.0
30.0	32.0	34.0	36.0	38.0
40.0	42.0	44.0	46.0	48.0
50.0				
PREAMP GAIN				20.0
← = PREVIOUS MENU MENU KEY = RETURN TO DISPLAY				

VR GAIN STEPS				
-10.0	9.0	8.0	7.0	6.0
5.0	4.0	3.0	2.0	1.0
0.0	1.0	2.0	3.0	4.0
5.0	6.0	7.0	8.0	9.0
10.0	11.0	12.0	13.0	14.0
15.0	16.0	17.0	18.0	19.0
20.0	21.0	22.0	23.0	24.0
25.0	26.0	27.0	28.0	29.0
30.0	31.0	32.0	33.0	34.0
35.0	36.0	37.0	38.0	39.0
40.0				
← = PREVIOUS MENU MENU KEY = RETURN TO DISPLAY				

VR FINE GAIN, [UTIL] [5] [5] [3] [2]

This menu contains a section of the cross reference table which is used to select what step value to place into the VR fine gain DAC, as well as the lowest and highest achievable gain (attenuation). For the cross reference table, the star marks the step value which corresponds to zero dB (no correction). All other steps are the 40 DAC positions immediately surrounding the zero dB point.

VR FINE GAIN							
0	0	0	0	0	0	0	0
0	0	0	0	0	0	0	0
0	0	0	0	0	0	0	0
0	0	0	0	0	0	0	0*
0	0	0	0	0	0	0	0
0	0	0	0	0	0	0	0
0	0	0	0	0	0	0	0
0	0	0	0	0	0	0	0
0	0	0	0	0	0	0	0
LOW -11.3DB				HIGH 3.2DB			
← = PREVIOUS MENU MENU KEY = RETURN TO DISPLAY							

VR GAIN STEPS, [UTIL] [5] [5] [3] [1]

This menu contains the actual gain of each VR gain step. The values are organized from lowest (-10 dB) to highest (+40 dB), in 1 dB steps, read from left to right, top to bottom.

FILTER AMPLITUDES, [UTIL] [5] [5] [3] [3]

This menu displays the filter amplitude corrections for both LOG and LIN vertical scale modes. For each mode, the correction values shown relate to the relative amplitude of each filter with respect to the 5 MHz filter. The order of the results (read from left to right and top to bottom) is as follows: 300 Hz, 1 KHz, 3 KHz, 9 KHz, 30 KHz, 100 KHz, 500 KHz (300 KHz), 1 MHz, and 5 MHz.

FILTER AMPLITUDES					
LIN FILTER AMPLITUDES					
0.0	0.0	0.0	0.0	0.0	0.0
0.0	0.0	0.0	0.0	0.0	0.0
LOG FILTER AMPLITUDES					
0.0	0.0	0.0	0.0	0.0	0.0
0.0	0.0	0.0	0.0	0.0	0.0

← = PREVIOUS MENU
MENU KEY = RETURN TO DISPLAY

LOG NORMALIZATIONS, [UTIL] [5] [5] [3] [5]

This menu is the access to the logging error normalization values, and also displays the normalization values for the full screen (vertical) offsets.

LOG NORMALIZATIONS			
0	1 DB		
1	5 DB		
2	10 DB		
VERTICAL SCALE OFFSET			
1DB	-	0.0	5DB - 0.0
10DB	-	0.0	LIN - 0.0

← = PREVIOUS MENU
MENU KEY = RETURN TO DISPLAY

FILTER SENSITIVITY, [UTIL] [5] [5] [3] [4]

This menu displays some of the sensitivity measurements. For preamp on and preamp off, the sensitivity for each VR filter is displayed at 100 MHz and at the top of the usable range of the instrument (1.8 GHz for preamp off, 500 MHz for preamp on). The order of the results (read from left to right and top to bottom) is as follows: 300 Hz, 1 KHz, 3 KHz, 9 KHz, 30 KHz, 100 KHz, 500 KHz (300 KHz), 1 MHz, and 5 MHz.

FILTER SENSITIVITY					
SENSITIVITY @100MHZ (ALL NEG)					
PREAMP ON	0	0	0	0	0
	0	0	0	0	0
PREAMP OFF	0	0	0	0	0
	0	0	0	0	0
SENSITIVITY @500MHZ (ALL NEG)					
PREAMP ON	0	0	0	0	0
	0	0	0	0	0
SENSITIVITY @1800MHZ (ALL NEG)					
PREAMP OFF	0	0	0	0	0
	0	0	0	0	0

← = PREVIOUS MENU
MENU KEY = RETURN TO DISPLAY

LOG NORMALIZATIONS, [UTIL] [5] [5] [3] [5] [0]

This menu displays the logging error when in 1 dB/div vertical display scale. The values are organized such that the first value is for top of screen, the next for 1/3 div from top, the next for 2/3 from top, etc., as read from left to right and top to bottom.

LOG NORMALIZATIONS – 1DB					
0.0	0.0	0.0	0.0	0.0	0.0
0.0	0.0	0.0	0.0	0.0	0.0
0.0	0.0	0.0	0.0	0.0	0.0
0.0	0.0	0.0	0.0	0.0	0.0
0.0	0.0	0.0	0.0	0.0	0.0

← = PREVIOUS MENU
MENU KEY = RETURN TO DISPLAY

LOG NORMALIZATIONS, [UTIL] [5] [5] [3] [5] [1]

This menu displays the logging error when in 5 dB/div vertical display scale. The values are organized such that the first value is for top of screen, the next for 1/3 div from top, the next for 2/3 from top, etc., as read from left to right and top to bottom.

LOG NORMALIZATIONS – 5DB				
0.0	0.0	0.0	0.0	0.0
0.0	0.0	0.0	0.0	0.0
0.0	0.0	0.0	0.0	0.0
0.0	0.0	0.0	0.0	0.0
0.0	0.0	0.0	0.0	0.0

← = PREVIOUS MENU
MENU KEY = RETURN TO DISPLAY

REFERENCES, [UTIL] [5] [5] [3] [6]

This menu displays the normalization values for all references. The "CALIBRATOR FREQ" value is the normalized value for the internal calibrator frequency, while the "CF REFERENCE" is the frequency of the reference as read from the reference oscillator. The other two parameters are the internal calibrator amplitude and the VR gain step reference.

REFERENCES	
CALIBRATOR FREQ	100.109700MHZ
CF REFERENCE	100.109700MHZ
CALIBRATOR AMPLTD	30.00
GAIN STEP REFERENCE	10.40

← = PREVIOUS MENU
MENU KEY = RETURN TO DISPLAY

LOG NORMALIZATIONS, [UTIL] [5] [5] [3] [5] [2]

This menu displays the logging error when in 10 dB/div vertical display scale. The values are organized such that the first value is for top of screen, the next for 1/3 div from top, the next for 2/3 from top, etc., as read from left to right and top to bottom.

LOG NORMALIZATIONS – 10DB				
0.0	0.0	0.0	0.0	0.0
0.0	0.0	0.0	0.0	0.0
0.0	0.0	0.0	0.0	0.0
0.0	0.0	0.0	0.0	0.0
0.0	0.0	0.0	0.0	0.0

← = PREVIOUS MENU
MENU KEY = RETURN TO DISPLAY

CF NORMALIZATIONS, [UTIL] [5] [5] [3] [7]

This menu displays many of the center frequency-related parameters. The span DAC sensitivities are displayed in the following order (as read from left to right, top to bottom):

- Main coil spans using the +1 decade attenuator.
- Main coil spans using the +10 decade attenuator.
- FM coil spans using the +1 decade attenuator.
- FM coil spans using the +100 decade attenuator.
- FM coil spans using the +100 decade attenuator.
- FM coil spans using the +100 decade attenuator.

CF NORMALIZATIONS

MAIN DAC SENS		461.50KHZ
MAIN DAC OFFSET		100
FM DAC SENS		488.00HZ

SPAN DAC SENSITIVITY		
50.00KHZ	5.00KHZ	1.38KHZ
138.90HZ	13.89HZ	1.38HZ

← = PREVIOUS MENU
 MENU KEY = RETURN TO DISPLAY

MISCELLANEOUS, [UTIL] [5] [5] [3] [9]

This menu displays the difference between the peak and average of the noise floor, and provides access to the bandwidth and centering results. The order of the results (read from left to right and top to bottom) is as follows: 300 Hz, 1 KHz, 3 KHz, 9 KHz, 30 KHz, 100 KHz, 500 KHz (300 KHz), 1 MHz, and 5 MHz.

MISCELLANEOUS – NORM VALUES

0 VR 6DB BANDWIDTH
 1 VR NOISE BANDWIDTHS
 2 VR IMPULSE BANDWIDTHS
 3 VR FILTER CENTERING

PEAK AVERAGE

0.0	0.0	0.0	0.0	0.0
0.0	0.0	0.0	0.0	

← = PREVIOUS MENU
 MENU KEY = RETURN TO DISPLAY

VCO NORMALIZATIONS, [UTIL] [5] [5] [3] [8]

This menu displays all of the VCO-related normalization values. The VCO minimum and maximum values describe the range of the LF VCO. The 13 MHz sensitivity value is an internal-use parameter. The VCO span values are for the +1 and +10 decade attenuator, respectively.

VCO NORMALIZATIONS

VCO MAX FREQUENCY	17.59MHZ
VCO MIN FREQUENCY	10.79MHZ
VCO SENS @ 13 MHZ	0.0005301

VCO SPAN SENSITIVITY	
2.722HZ	0.273HZ

← = PREVIOUS MENU
 MENU KEY = RETURN TO DISPLAY

VR 6DB BANDWIDTHS, [UTIL] [5] [5] [3] [9] [0]

This menu displays the 6 dB-down VR filter bandwidths. The order of the results (read from left to right and top to bottom) is as follows: 300 Hz, 1 KHz, 3 KHz, 9 KHz, 30 KHz, 100 KHz, 500 KHz (300 KHz), 1 MHz, and 5 MHz.

VR 6DB BANDWIDTHS

300.00HZ	1.00KHZ	3.00KHZ
10.00KHZ	30.00KHZ	100.00KHZ
300.00KHZ	1.00MHZ	5.00MHZ

← = PREVIOUS MENU
 MENU KEY = RETURN TO DISPLAY

VR NOISE BANDWIDTHS, [UTIL] [5] [5] [3] [9] [1]

This menu displays the VR filter noise bandwidths. The order of the results (read from left to right and top to bottom) is as follows: 300 Hz, 1 KHz, 3 KHz, 9 KHz, 30 KHz, 100 KHz, 500 KHz (300 KHz), 1 MHz, and 5 MHz.

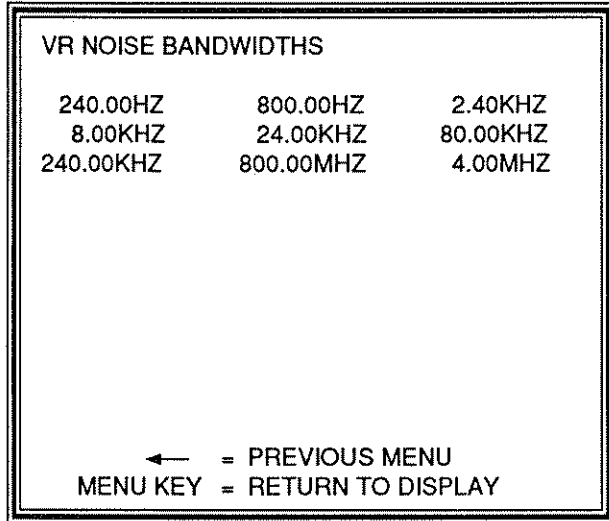

VR IMPULSE BANDWIDTHS, [UTIL] [5] [5] [3] [9] [2]

This menu displays the VR filter impulse bandwidths. The order of the results (read from left to right and top to bottom) is as follows: 300 Hz, 1 KHz, 3 KHz, 9 KHz, 30 KHz, 100 KHz, 500 KHz (300 KHz), 1 MHz, and 5 MHz.

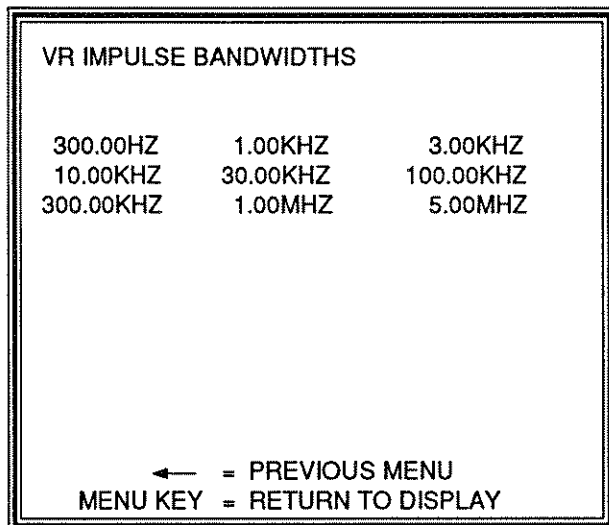

NORMALIZATION VALUES

The following is a list of all normalization values. Some values are listed for reference only (as noted), since they are not visible to the user through any menu. These values are listed in an order similar to their positions in the normalization value display (UTIL/5/5/7).

- Name:** RF Attenuation
Description: The actual gain of each 2 dB attenuation step, from 0 to -52 dB.
Default: 0.0 to -52.0 dB, in 2.0 dB steps
Upper Limit: +3.0 dB from the default values.
Lower Limit: -3.0 dB from the default values.
- Name:** Preamp Gain
Description: The actual gain of the Preamp.
Default: 20 dB
Upper Limit: 30 dB
Lower Limit: 10 dB
- Name:** VR Gain Steps
Description: The actual gain of each 1 dB gain step, from -10 dB to +40 dB.
Default: -10.0 dB to +40.0 dB, in 1.0 dB steps
Upper Limit: +3.0 dB from the default values.
Lower Limit: -3.0 dB from the default values.
- Name:** VR Fine Gain
Description: The actual gain of the VR PIN attenuator at each setting of the control DAC. The Upper and lower limits apply to the maximum and minimum DAC points, respectively.
Default: From -5.1 dB to +5.1 dB, in .04dB/DAC step. **Upper Limit:** The highest DAC step must give at least 2.0 dB gain.
Lower Limit: The lowest DAC step must give more than 2.0 dB attenuation.
- Name:** VR Filter Amplitude (LIN)
Description: The amplitude difference between each VR filter and the 5 MHz filter.
Default: 0.0 dB
Upper Limit: 5.0 dB
Lower Limit: -5.0 dB
- Name:** VR Filter Amplitude (LOG)
Description: The amplitude difference between each VR filter and the 5 MHz filter.
Default: 0.0 dB
Upper Limit: 5.0 dB
Lower Limit: -5.0 dB
Notes: Not on all firmware versions.

7. Name: 6dB VR Filter Bandwidths
 Desc: The bandwidth of each VR filter at the 6 dB-down points.
 Default: Same as the nominal filter bandwidth.
 Upper Limit: Nominal bandwidth + 80%
 Lower Limit: Nominal bandwidth - 80%
 Notes: Not on all firmware versions.
8. Name: VR Filter Noise Bandwidths
 Desc: The noise bandwidth of each VR filter.
 Default: 80% of the nominal filter bandwidth.
 Upper Limit: (80% of the nominal bandwidth) + 80%
 Lower Limit: (80% of the nominal bandwidth) - 80%
 Notes: Not on all firmware versions.
9. Name: VR Filter Impulse Bandwidth
 Desc: The impulse bandwidth of each VR filter.
 Default: Same as the nominal filter bandwidth.
 Upper Limit: Nominal bandwidth + 80%
 Lower Limit: Nominal bandwidth - 80%
 Notes: Not on all firmware versions.
10. Name: Filter Sensitivity
 Description: The level of the average noise, measured in 100 MHz increments beginning at 90 MHz, measured for each filter and with without the preamp. These figures are used in carrier to noise calculations.

Default:

Filter	Preamp	100 MHz	1800 MHz
5 MHz	Off	-85	-77
1.5 MHz ¹	Off	-90	-82
500 kHz	Off	-95	-87
120 kHz ¹	Off	-101	-93
30 kHz	Off	-107	-99
9 kHz ¹	Off	-112	-104
3 kHz	Off	-117	-109
1 kHz ¹	Off	-122	-114
300 Hz ²	Off	-127	-119
200 Hz ¹	Off	-127	-119
5 MHz	On	-97	
1.5 MHz ¹	On	-102	
500 kHz	On	-107	
120 kHz ¹	On	-113	
30 kHz	On	-119	
9 kHz ¹	On	-124	
3 kHz	On	-129	
1 kHz ¹	On	-134	
300 Hz ²	On	-139	
200 Hz ¹	On	-139	

¹ - RF options only.

² - Option 01 (Phase lock) only

Upper Limit:

Filter	Preamp	Llimit
5 MHz	Off	-68
1.5 MHz ¹	Off	-73
500 kHz	Off	-78
120 kHz ¹	Off	-84
30 kHz	Off	-90
9 kHz ¹	Off	-95
3 kHz	Off	-100
1 kHz ¹	Off	-105
300 Hz ²	Off	-110
200 Hz ¹	Off	-110
5 MHz	On	-88
1.5 MHz ¹	On	-93
500 kHz	On	-98
120 kHz ¹	On	-104
30 kHz	On	-110
9 kHz ¹	On	-115
3 kHz	On	-120
1 kHz ¹	On	-125
300 Hz ²	On	-130
200 Hz ¹	On	-130

¹ - RF options only.

² - Option 01 (Phase lock) only

Lower Limit: No Limit

11. Name: Logging Error
 Description: The logging error in each log scale factor, measured at every 10 vertical storage locations.

	1dB	5dB	10dB
Default:	0.0	0.0	0.0
Upper Limit:	3.0	5.0	5.0 (max dB error)
Lower Limit:	-3.0	-5.0	-5.0 (max dB error)

12. Name: Vertical Offset
 Description: The amount of gain to be added to bring the 5 MHz filter to full screen at -30 dBm reference level. There is one value for each scale factor (1dB, 5dB, 10dB, LIN).
 Default: 0.0 dB
 Upper Limit: 5.0 dB
 Lower Limit: -5.0 dB

Section 8 – 2710 Operators

13. Name: Reference Frequency
 Description: The measured frequency of the internal calibrator.
 Default: 100.000 MHz
 Upper Limit: 100.010 MHz
 Lower Limit: 99.990 MHz

14. Name: Reference Amplitude
 Description: The measured amplitude of the internal calibrator.
 Default: -30.0 dBm
 Upper Limit: -28.0 dBm
 Lower Limit: -32.0 dBm

15. Name: 10 dB Reference Gain Step
 Description: The gain of the internal 10 dB reference gain step.
 Default: 10.4 dB
 Upper Limit: 11.9 dB
 Lower Limit: 8.9 dB

16. Name: Main DAC Sensitivity
 Description: The CF change for each Main CF DAC step.
 Default: 461.5 kHz/step
 Upper Limit: 600.0 kHz/step
 Lower Limit: 200.0 kHz/step

17. Name: Main DAC Offset
 Description: The Main CF DAC value necessary to place the instrument at 0 MHz center frequency.
 Default: 100
 Upper Limit: 450
 Lower Limit: 40

18. Name: FM DAC Sensitivity
 Description: The CF change for each FM CF DAC step.
 Default: 488 Hz/step
 Upper Limit: 650 Hz/step
 Lower Limit: 200 Hz/step

19. Name: FM DAC to Main DAC ratio
 Description: The number of FM CF DAC steps which is equal to one Main CF DAC step. This value is used internally to reduce calculation time, and is not seen by any user.
 Default: 946
 Upper Limit: 3000
 Lower Limit: 307
 Note: Not on all firmware versions.

20. Name: Span DAC values
 Description: The non-phaselocked span DAC sensitivities. These are stored in terms of Hz/DAC_step/div. If range 3 was used to get a 100 kHz/div span, using default values from the table below, the span DAC would be set to 1000/138.9, or 719.

Default:

Range	Coil Swept	Divide By	Default Value (Hz/step/div)
0	Main	1	50000
1	Main	10	5000
2	FM	1	1389
3	FM	10	138.9
4	FM	100	13.89
5 ¹	FM	100	13.89
6 ¹	FM	100	13.89

¹ - Duplicate ranges, used to simplify firmware.

Upper Limit: 13% Over the default values.
 Lower Limit: 13% Under the default values.
 Note: Not normalized on instruments from B010001 to B010318

21. Name: VCO Polynomial Coefficients
 Description: These are the coefficients used to set the LF VCO upper DAC. The coefficients belong to the following equation:

$$DAC = X_0 \times f^0 + X_1 \times f^1 \dots + X_n \times f^n$$

where f is the desired frequency.

These coefficients are not seen by any user.

Default:

x0 (constant)	40323.5904
x1	-22427.1026
x2	4560.4199
x3	-467.7120
x4	26.4079
x5	-0.7858
x6	0.0097

Upper Limit: { Upper and lower limits are taken care of in }

Lower Limit: { the VCO Upper and VCO Lower normalization values. }

Note: Not normalized on instruments from B010001 to B010318.

22. Name: VCO Lower to Upper Ratio
 Description: The ratio between the Upper and lower LF VCO DACs. This value is used internally by the frequency setting software, and is not seen by the user.
 Default : 1024
 Upper Limit: 2000
 Lower Limit: 400
 Note: Not normalized on instruments from B010001 to B010318.

23. Name: VCO Lower Limit
 Description: The lowest frequency that the LF VCO can be set to.
 Default: 10.637 MHz
 Upper Limit: 12.7 MHz
 Lower Limit: 9.0 MHz
 Note: Not normalized on instruments from B010001 to B010318.

24. Name: VCO Upper Limit
 Description: The highest frequency that the LF VCO can be set to.
 Default: 17.508 MHz
 Upper Limit: 18.5 MHz
 Lower Limit: 16.0 MHz
 Note: Not normalized on instruments from B010001 to B010318.

25. Name: 13 MHz VCO Sensitivity
 Description: The Sensitivity of the VCO when the VCO is at 13 MHz. This is in terms of LSB's of the Upper LF VCO DAC / MHz change in the LF VCO.
 Default: .000526 LSB/MHz
 Upper Limit: .002000 LSB/MHz
 Lower Limit: .000400 LSB/MHz
 Note: Not normalized on instruments from B010001 to B010318.

26. Name: VCO Span values
 Description: The phaselocked span DAC sensitivities. These values are interpreted in terms of the LF VCO's frequency change as the sweep position changes. The actual span DAC value is calculated from these values, along with the VCO 13 MHz sen-

sitivity (Below), the strobe harmonic number, and the currently calculated VCO sensitivity.

Default:

Range	Divide By	Default Value (Hz/step/div)
0	1	2.710
1	10	.271

Upper Limit: 13% Over the default values.
 Lower Limit: 13% Under the default values.
 Note: Not normalized on instruments from B010001 to B010318.

27. Name: Peak to Average Sensitivity
 Description: The difference between the peak of the unfiltered noise floor and the average of the filtered noise. This is measured for each filter, and for Preamp on off conditions, at 90 MHz Center Frequency.

Default: 12 dB
 Upper Limit: 32 d
 Lower Limit: 5 dB

28. Name: YIG Drift
 Description: The largest center frequency change when measured 10 times over 2 seconds.

Default: 5 kHz
 Upper Limit: 50 kHz
 Lower Limit: 0 Hz
 Note: Not normalized on B020319 and up.

29. Name: Frequency Accuracy
 Description: The largest center frequency error when measured at every 100 MHz from 100 MHz to 1800 MHz. This value is a magnitude only.

Default: 2 MHz
 Upper Limit: 6 MHz
 Lower Limit: 0 Hz
 Note: Not normalized on B020319 and up.



USER-DEFINED PROGRAMS

USER DEF Key

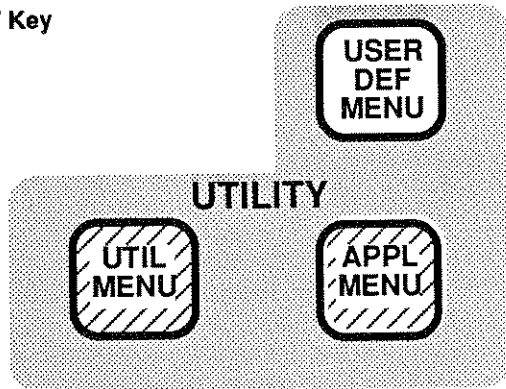

INTRODUCTION

The user-defined programs (UDP) is a group of key stroke sequences that are created by the user and stored in non-volatile, random-access memory (NVRAM). The **USER DEF MENU** key on the front panel permits the execution of each of these key stroke sequences (user-defined programs) with only two key strokes. This feature is useful when the user must make a repetitive sequence of measurements.

The user-defined programs menu is invoked by pressing the **USER DEF MENU** key. Double-pressing the **USER DEF MENU** key automatically repeats the last program executed.

A user-defined program may be stopped while it is executing by pressing the **USER DEF** key. All of the other front panel keys are locked out while a user-defined program is running.

A GUIDE TO CREATING USER-DEFINED PROGRAMS

A user who wishes to create a UDP must be aware of certain aspects of the instrument's operation, such as:

- which keystroke combinations form an instrument "operation" (see Section 4 in this manual)
- and how much NVRAM will be used by each operation (see the Appendix at the end of this section).

The user must also be aware of rules to be followed when entering a program.

There is no provision for editing a program which has already been stored. Therefore, it is suggested that more complex programs be written down and tested before they are entered and stored.

The following practices are recommended for use when entering a program.

Initial Conditions

The initial instrument settings may sometimes cause program execution that is perceived to be erroneous when in fact it is not. The instrument continues operations from whatever state the instrument is in when the program begins execution.

The following keystroke sequence will yield duplicate initial conditions for a program, provided the storage register (one of #3-9) is not modified (The initial conditions in the above example should be protected to prevent them from being modified):

[UTIL] [1] [Register No.] [B]	Store Initial Conditions
[USER DEF MENU] [9] [0]	Begin Acquiring Keystrokes
[UTIL] [1] [Register No.] [A]	Recall Initial Conditions
(Rest of Program)	

The **FACTORY DEFAULT** setting may always be used for initial conditions, since these settings are the same from instrument to instrument.

Sometimes it is not appropriate to restore all of the instrument settings, as in the above example. All reasonable instrument conditions must be kept in mind when selecting a keystroke sequence to use. Consider the following example:

↑ ↑ ↑
[SIG] [SIG] [SIG] Increment Reference Level (3X)

If the instrument is at -30 dBm reference level before this program is executed, the reference level will be at -60 dBm after the program terminates. If, however, the reference level is at $+20$ dBm, the final reference level is -10 dBm. In this

User-Defined Programs – 2710 Operators

case, the following direct entry may have been more appropriate if the program is intended for use when the initial reference level is unknown:

```
[INPUT MENU] [0] [60] [A] Set Reference Level to -60 dBm
```

Potential Troublesome Settings

When using certain commands, care must be taken to ensure that the instrument will respond to the commands as expected. The following paragraphs describe the commands which are known to be more troublesome than others.

Marker Commands – When the instrument is operated manually, the marker system commands are normally executed after the instrument has had time to update the display, such as after one or two sweep intervals. Under program control, the screen update functions (sweep, wait-for-end-of-sweep) must be programmed in along with the marker commands. For example:

```
[MKR/FREQ MENU][0][500][C] Set Center Frequency to 500 MHz
[MKR PEAK FIND]           Mark the Highest Signal On Screen
[MKR↔] [MKR↔]           Mark the second signal to the right
```

If a spectrum containing several signals (one dominant signal) is being input into the spectrum analyzer, this sequence will leave the marker on the second signal to the right of the dominant signal, if the display is allowed to update after the setting of the center frequency. The following example describes a more appropriate command sequence:

```
[MKR/FREQ MENU][0][500][C] Set Frequency to 500 MHz
[USER DEF] [9] [2]       Wait for the current sweep to end
[USER DEF] [9] [2]       Wait for one full sweep to end
[MKR PEAK FIND]         Mark the Highest Signal On Screen
[MKR↔] [MKR↔]           Mark the second signal to the right
```

Center Measure – The center measure problem is similar to the marker problem, with one difference. The center-measure function does not actually execute until the end of the pending sweep. This means that any command following a center-measure will probably execute before the center-measure has been accomplished. For example:

```
[MKR/FREQ MENU] [0] [500] [C] Set Frequency to 500 MHz
[USER DEF MENU] [9] [2] Wait for the current sweep to end
[USER DEF MENU] [9] [2] Wait for one full sweep to end
[CTR MEAS/TRKG] Center the signal closest to the marker
[USER DEF MENU] [9] [2] Wait for one full sweep to end
[USER DEF MENU] [9] [2] Wait for one full sweep to end
[SPAN↔↔] [SPAN↔↔] Decrement span/division
```

In this example, the first 2 triggered sweeps ensure that the display is updated before the center-measure function occurs. The third sweep ensures that the center-measure occurs before the span decrement operations, while the fourth sweep updates the screen after the signal centering was accomplished.

Single Sweep Mode – Some of the anomalies described under Marker Commands and Center Measure can be minimized by using the Single Sweep mode in conjunction with the Wait-for-end-of-sweep function. Once the instrument is in Single Sweep mode, several commands can be programmed followed by a Single Sweep Arm ([SGL SWP])/Wait-for-end-of-sweep ([USER DEF MENU] [9] [2]) combination to update the display. For example, the following program segment will initialize the instrument, and count and center the calibrator signal:

```
[UTIL MENU] [1] [1] Recall FACTORY DEFAULT settings
[SGL SWP] Enter Single Sweep mode
[INPUT MENU] [9] Turn on the calibrator signal
[MKR/FREQ MENU][0][100][C] Set Frequency at 100 MHz
[MKR/FREQ MENU] [1] [1] [C] Set Span to 1 MHz/div
[INPUT MENU] [0] [30] [A] Set Reference Level at -30 dBm
[CTR MEAS/TRKG] Count and center the signal
[SGL SWP] Update display and perform Center Measure
[USER DEF MENU] [9] [2] Wait for the sweep to end
[SGL SWP] Update display with the centered signal
[USER DEF MENU] [9] [2] Wait for the sweep to end
```

The preceding example completed a Center Measure operation using only two Wait-for-end-of-sweep functions, because the Single Sweep mode allows absolute control over sweep arming. The previous Center Measure example, which assumed Free Run triggering and non-Single Sweep mode, required four Wait-for-end-of-sweep functions.

FREQ/MARKERS Knob – The FREQ/MARKERS knob operates differently under program control than it does in manual mode. The knob has an “anti-rubberbanding” function when operated manually which minimizes tuning overshoot. This feature has the side effect of increasing the amount of center frequency change when under program control, making the knob an unreliable data entry device for user-defined programs. For this reason the anti-rubberband feature has been defeated when using the programming feature, and the tuning overshoot will be more pronounced when in acquisition mode.

Manual Scan – The Wait-for-end-of-sweep function will never terminate when the instrument is in manual scan mode. The program may still be terminated by pressing [USER DEF MENU].

USER DEFINED PROGRAMS MENU

Key to Menu Selections

There are seven possible responses for the menu selections. These responses are represented by special characters to the left of each possible menu selection. They define the action of the menu system when a particular menu entry has been selected. A key to these display responses is provided as follows:

- ^D = Exit to the active display.
- ^M = Exit to the prior (higher) menu level.
- S = Stay in the current menu, returning to initial state.
- vM = Move to a Sub Menu.
- R = Perform a routine, then return to the initial state of the current menu.
- R^D = Perform a routine, then return to the display.
- ^IS = An invalid selection has been made; returns to the initial menu after momentarily displaying a message.

Modifications to the Display Response keys are indicated with the following suffixes.

- d = A momentary delay occurs prior to execution, allowing the user to see confirmation of his choice.
- p = A prompt must be responded to before the choice is invoked.

NOTE

These display response keys are shown in the manual, they are not part of the display.

User Defined Programs Menu

Press the **USER DEF MENU** key to bring up the User Defined Programs Menu. See Figure 9-1.

This is the main menu for user-defined programs. Up to 9 programs may be stored in NVRAM. Storage registers 0 through 8 in this menu will contain titles of programs when filled. Initially, the storage registers are empty (no programs have been entered). See Figure 9-1.

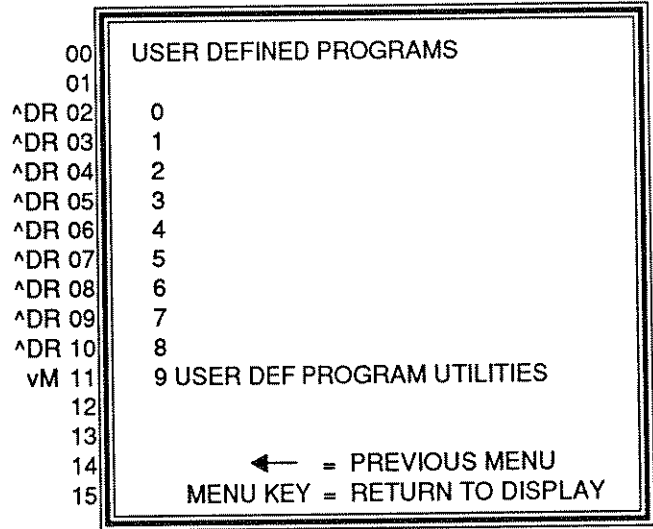

Figure 9-1. User-defined program main menu.

User-Defined Programs – 2710 Operators

User Defined Program Utilities Menu

Press USER DEF MENU/#9 to bring up the program utilities. See Figure 9-2.

```
00 USER DEF PROGRAM UTILITIES
01
^D 02 0 ACQUIRE KEY STROKES (EXIT ACQUIRE MODE)
vM 03 1 TITLE EDIT
^D 04 2 WAIT FOR END OF SWEEP
vM 05 3 DISPLAY MESSAGE
^D 06 4 PAUSE FOR "USER DEF" KEY
vM 07 5 CONTINUOUS EXECUTION (ON)
vM 08 6 STORE
vM 09 7 DELETE
10 8 PROTECT
11
12
13 AVAILABLE MEMORY 11220 BYTES
14 ← = PREVIOUS MENU
15 MENU KEY = RETURN TO DISPLAY
```

Figure 9-2. The USER DEFPROGRAM UTILITIES entered via selection 9 of the USER DEFINED PROGRAMS menu.

Creating a Program

1. Select ACQUIRE KEY STROKES in the USER DEFINED PROGRAMS menu by pressing **USER DEF MENU/#9/#0**.

The spectrum analyzer returns to the spectral display. The spectral display shows the title of the program being acquired (if one already exists), the message ACQUIRE KEY STROKES, and the number of bytes of memory used. See Figure 9-3.

NOTE

a. The program title should be created or edited prior to saving the program. See *Creating a Program Title* on this page.

b. Acquire mode may be aborted by pressing **USER DEF MENU/#9/#0** (EXIT ACQUIRE MODE). The program entered will reside in the editing buffer until it is replaced by another program or power is turned off.

2. Press the desired sequence of key strokes to create an operation/s.

The instrument functions normally except that key strokes are saved in an editing buffer as they are entered.

3. Save the key strokes sequence (program) permanently by pressing **USER DEF MENU/#9/#6/Desired Register (STORE)**.

The STORE menu allows the user to select the desired program storage register. Storing a program automatically exits the ACQUIRE KEY STROKES mode.

00	100.0MHZ	ATTN 10DB
01	-20DBM	VF OFF
02	10KHZ/	10DB/
03	3KHZ RBW	
04	UNCAL	
05	error line	
06	program title	
07		
08	ACQUIRE KEY STROKES	30 BYTES
09		
10		
11		
12		
13		
14		
15		

Figure 9-3. Example of the display while in the ACQUIRE mode. The title of the program may be seen on the display.

Creating a Continuously Executing Program [USER DEF MENU/#9/#5]

1. A newly created program may be enabled to execute continuously by pressing **USER DEF MENU/#9/#5 [CONTINUOUS EXECUTION (ON)]** prior to storing the program.

When continuous execution of a program is invoked, the instrument displays an instruction set. See Figure 9-4.

00	USER DEF PROGRAM UTILITIES
01	
02	THE CONTINUOUS EXECUTION
03	FEATURE OF USED DEFINED KEY
04	ALLOWS A PROGRAM, ONCE
05	STARTED, TO REPEATEDLY
06	EXECUTE UNTIL THE "USED DEF"
07	KEY IS PRESSED.
08	
09	
10	
11	ENABLE CONTINUOUS EXECUTION
12	FOR THIS PROGRAM?
13	
14	
15	A = YES B = NO

Figure 9-4. Instruction set for setting up continuous execution of a program.

Creating a Program Title

1. Invoke the TITLE EDIT menu by pressing **USER DEF MENU/#9/#1**.

The spectrum analyzer displays a title line (limited to 28 characters), available character set, and a set of instructions. See Figure 9-5.

```

00 TITLE EDIT
01
02 _title line of up to 28 char
03
04 @ ABCDEFGHIJKLMNOPQRSTUVWXYZ
05 0123456789 !"#%&'()*+,-./:;<=>?
06
07 PRESS "A" FOR EDITING/INSTRUCT
08 PRESS FOR CURSOR MOVEMENT:
09 SIG ^ V, MKR <>, SPAN <><<
10 TURN KNOB TO SELECT CHARACTER
11 OR SELECT DIGIT FROM KEYPAD
12
13 PRESS "B" TO STORE
14 PRESS "C" TO DELETE
15 PRESS "D" TO ABORT
    
```

Figure 9-5. This menu is used for editing a title for a user defined program.

2. Enable the edit session by pressing "A".

The cursor () in the display points to a character to be edited in the title line.

3. Scroll through the range of available characters by turning the **FREQ/MARKERS** knob.

The range of characters available include 0 to 9, A to Z, some punctuation characters, and a space. The space character is available between the 9 and the !, @ and the A, and the Z and the 0.

4. Select the desired character by scrolling to that character, then moving the cursor to the next position.

Pressing "B" (the STORE selection) stores the title in the editing buffer. Pressing "C" (the DELETE selection) erases the entered title from the editing buffer. (NOTE: Pressing "C" may also be used to erase a previously entered title). Pressing "D" (the ABORT selection) leaves the previous title in the editing buffer unchanged.

If a title is stored, it will reside in the editing buffer, which is temporary (the title will be lost if power is turned off).

Wait for End of Sweep

USER DEF MENU/#9/#2 – Wait-for-End-of-Sweep must be programmed along with some operations that require a sweep update before execution of the next operation in the program, such as when the display must be allowed to update after the setting of the center frequency before a marker operation occurs.

If the display must be updated before a subsequent operation in the program, it is recommended that two wait-for-end-of-sweeps be inserted in the program. See Potential Troubleshooting Settings on page 9-2.

This function causes the instrument to suspend execution of instructions until the end of sweep is reached. Program execution continues after end-of-sweep processing is complete.

The message **WAIT FOR END OF SWEEP** is displayed.

This command is **NOT** executed while in the acquire mode. It is executed only while the program is running.

Display Message

1. Press **USER DEF MENU/#9/#3** to start a crt display message edit.

The spectrum analyzer displays a message line (limited to 32 characters), available character set, and a set of instructions. See Figure 9-6.

2. Enable the message entry session by pressing "A".

The cursor () in the display points to a character to be edited in the title line.

The message is entered in a manner similar to **TITLE EDIT**. A subsequent **PRINT** will overwrite a previous print line. Line 8 is used on the crt display.

3. Select the desired character by scrolling to that character using the **FREQ/MARKERS** knob, then moving the cursor to the next character position.

The range of characters available include 0 to 9, A to Z, some punctuation characters, and a space. The space character is available between the 9 and the !, @ and the A, and the Z and the 0.

Pressing "B" (the STORE selection) stores the message in the editing buffer. Pressing "C" (the DELETE selection) erases the entered message from the editing buffer. (NOTE: Pressing "C" may also be used to erase a previously entered message). Pressing "D" (the ABORT selection) leaves the previous message in the editing buffer unchanged.

If a message is stored, it will reside in the editing buffer, which is temporary (the message will be lost if power is turned off).

```

00 DISPLAY MESSAGE
01
02 _line of up to 32 characters
03
04 @ ABCDEFGHIJKLMNOPQRSTUVWXYZ
05 0123456789 !"#%()*+,-./:;<=>?
06
07 PRESS "A" FOR EDITING/INSTRUCT
08 PRESS FOR CURSOR MOVEMENT:
09 SIG ^ V, MKR <>, SPAN <>><
10 TURN KNOB TO CHOOSE CHARACTER
11 OR SELECT DIGIT FROM KEYPAD
12
13 PRESS "B" TO STORE
14 PRESS "C" TO DELETE
15 PRESS "D" TO ABORT
    
```

Figure 9-6. This menu is used for editing a message to be printed onto the display.

```

00 STORE
01
^D 02 0 title of program
^D 03 1 title of program
^D 04 2* title of program
^M 05 3 title of program
^D 06 4 title of program
^D 07 5 title of program
^M 08 6 title of program
^D 09 7 title of program
^D 10 8 title of program
11 title of programor UNTITLED
12
13
14 ← = PREVIOUS MENU
15 MENU KEY = RETURN TO DISPLAY
    
```

Figure 9-7. This menu is displayed when the STORE program selection is invoked.

Pause for 'USER DEF' Key

USER DEF MENU/#9/#4 – This function causes the instrument to suspend execution of instructions until the **USER DEF MENU** key is pressed. This feature is useful for stopping program execution so that operational results up to that point can be recorded. The "pause" may be inserted anywhere in the program.

The following message is displayed if a **PAUSE FOR "USER DEF"** key is encountered during program execution:

PRESS "USER DEF" TO CONTINUE

This command is **NOT** executed while in the acquire mode. It is executed only while the program is running.

Storing The Program

1. Press **USER DEF MENU/#9/#6 (STORE)** to start the storage sequence for the currently selected program. A menu of all stored programs is displayed when the STORE selection is invoked. See Figure 9-7.

Registers 1 through 8 in Figure 4 will be blank if no programs have been previously entered.

2. Select a register to end the storage sequence.

The following error message is displayed if a program already exists in the desired selection.

DELETE EXISTING PROGRAM FIRST

The following error message is displayed if the local buffer is empty.

EDITING BUFFER IS EMPTY

The following error message is displayed if the NVRAM is full.

CANNOT STORE – NV MEMORY FULL

The program in the editing buffer along with the program title and file name information is stored in the currently selected user-defined program. The asterisk (*) moves to the stored selection.

If no title has been created, a default title is stored in the buffer in the format **PROGRAM n** where 'n' is a number 0 to 8 of the register in which the program is stored.

Deleting a Program

1. Press **USER DEF MENU/#9/#7 (DELETE)** to start the program deletion sequence. A menu of all stored programs is displayed when the DELETE selection is invoked. See Figure 9-8.

2. Select a program to end the deletion sequence.

The following message is displayed if there is no program stored for the selection:

SELECTED PROGRAM IS EMPTY

The following error message is displayed if the stored program is file-protected.

REMOVE PROTECTION FIRST

As a confirmation of the deletion, the following message is displayed.

PRESS "C" TO DELETE, OR
"D" TO ABORT

3. Press "C" to delete the selected program, or press "D" to abort.

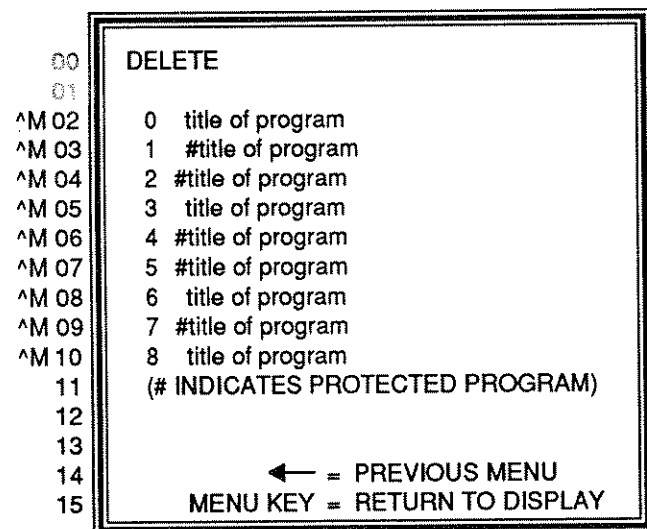

Figure 9-8. This menu is displayed when the DELETE program selection is invoked.

Protecting a Program From Deletion

1. Press **USER DEF MENU/#9/#8 (PROTECT)** to start the stored program protection sequence. A menu of all stored programs is displayed when the PROTECT selection is invoked. See Figure 9-9.

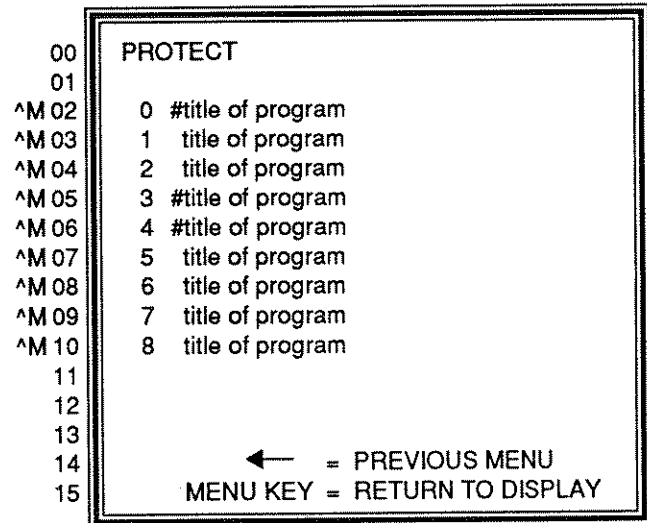

Figure 9-9. This menu is displayed when the PROTECT program selection is invoked.

2. Select a program to end the protection sequence.

The PROTECT selection enables or disables protection for the specified stored program.

Once the program selection has been made, the protection is toggled on ('#' preceding the title) or off (no '#').

EXECUTING A USER-DEFINED PROGRAM

Initiate a user-defined program by pressing USER DEF and selecting one of nine registers (programs). See Figure 9-10. Once a selection is made, the spectrum analyzer returns to the display and the user-defined program is executed. A program may be stopped while it is executing by pressing the "USER DEF" key.

The asterisk (*) moves to the program being executed.

If there is no program stored for the selection, the following message is displayed:

SELECTED PROGRAM IS EMPTY

The last program executed, as indicated by the asterisk, may be repeated by double-pressing the "USER DEF" key.

The pound (#) sign between the program number and the program name indicates that the program is protected from deletion.

```

00  DELETE
01
^M 02  0  title of program
^M 03  1  #title of program
^M 04  2  #title of program
^M 05  3  title of program
^M 06  4  #title of program
^M 07  5  #title of program
^M 08  6  title of program
^M 09  7  #title of program
^M 10  8  title of program
11  9  USER DEF PROGRAM UTILITIES
12
13
14  ← = PREVIOUS MENU
15  MENU KEY = RETURN TO DISPLAY
    
```

Figure 9-10. This menu is displayed when the DELETE program selection is invoked.

Display While the Program is Running

The title of the program is displayed on line 6 of the crt display while the program is running. If a "print to display" operation is encountered during execution, the respective message will be displayed on line 7 of the display.

Line 8 of the display is reserved for specific progress messages that are displayed during program execution.

- If a wait-for-end-of-sweep instrument operation is encountered, the message WAIT FOR END OF SWEEP is displayed.
- If a pause for "USER DEF" key is encountered, the message PRESS "USER DEF" TO CONTINUE is displayed.

```

00  100.0MHZ                ATTN 10DB
01  -20DBM                  VF OFF
02  10KHZ/                  10DB/
03  3KHZ RBW
04  UNCAL
05  error line
06  program title
07  print to display line
08  progress message line
09
10
11
12
13
14
15
    
```

Figure 9-11. The Program title, print to display, and the progress line message lines are displayed while program execution is in progress.

APPENDIX

The following information is broken up into categories to aid in locating the desired command. Since the large front panel knob is primarily a generic "increment-decrement" device, its description is located in the "Human Interface" section. The knob's function is changed by commands found in various other sections of this appendix.

FREQUENCY COMMANDS

Operation	Keystrokes	Memory Used
Center Frequency Value	[MKR/FREQ MENU] [0] [Value] [UTIL MENU] [2] [0] [Value]	10 Bytes
Frequency Increment Mode	[MKR/FREQ MENU] [9] [3] [0-2]	4 Bytes
Tabular Tuning Table for Frequency Increment	[MKR/FREQ MENU] [9] [4] [0-7]	4 Bytes
Turn off the Frequency Counter when in Tracking Mode	[MKR/FREQ MENU] [9] [2] [0]	3 Bytes
Counter Resolution	[MKR/FREQ MENU] [9] [2] [1-2]	6 Bytes
Start Frequency Value	[MKR/FREQ MENU] [7] [0] [Value]	10 Bytes
Stop Frequency Value	[MKR/FREQ MENU] [7] [1] [Value]	10 Bytes
Center Frequency Offset	[MKR/FREQ MENU] [9] [5] [Value]	10 Bytes
User-Defined Tuning Increment	[MKR/FREQ MENU] [9] [3] [3] [Value]	18 Bytes
Center Frequency Value: Toggle the tuning increment mode	[MKR/FREQ MENU] [8]	2 Bytes
Toggle frequency hinge point between Center and Start	[MKR/FREQ MENU] [9] [0]	2 Bytes
Execute one center-measure cycle	[CTR MEAS/TRKG]	2 Bytes
Enable Frequency Offset mode	[MKR/FREQ MENU] [9] [6]	3 Bytes
Toggle phaselock mode (Option 01 only)	[UTIL MENU] [4] [3] [4]	3 Bytes

SPAN/DIV COMMANDS

Operation	Keystrokes	Memory Used
Span/Division Value	[MKR/FREQ MENU] [1] [Value] [UTIL MENU] [2] [2] [Value]	6 Bytes
Increment or Decrement Span/Division in a 1-2-5 Sequence	[SPAN ↺] [SPAN ↻]	5 Bytes
Toggle MAX span mode on and off	[MAX SPAN]	3 Bytes
Toggle ZERO span mode on and off	[ZERO SPAN]	3 Bytes

VERTICAL COMMANDS

Operation	Keystrokes	Memory Used
LOG Vertical Mode	[10DB/5DB/1DB] [UTIL MENU] [2] [6] [0-2] [LIN] (if in LIN vertical display mode)	9 Bytes
LIN Vertical Mode	[LIN] (if in LOG vertical display mode) [UTIL MENU] [2] [6] [3] [Value]	9 Bytes
Toggle LIN vertical mode	[LIN]	3 Bytes
Set reference level units	[INPUT MENU] [3] [0-5]	3 Bytes
Set full-screen reference level value	[UTIL MENU] [2] [1] [Value] [INPUT MENU] [0] [Value]	6 Bytes
Increment or decrement the full-screen reference level	[REF LEVEL SIG] [REF LEVEL SIG]	5 Bytes
Toggle reference level fine step mode	[(1dB / 10dB)]	4 Bytes
Set external attenuation/amplification level	[INPUT MENU] [6] [1] [Value]	6 Bytes
Set RF attenuation value	[INPUT MENU] [5] [Value] [UTIL MENU] [2] [3] [Value]	6 Bytes
Set RF attenuation mode to auto	[INPUT MENU] [5] [C] [UTIL MENU] [2] [3] [C]	3 Bytes
Set the display acquisition mode	[DSPL MENU] [4]	3 Bytes
Toggle the vertical scale through a 1/5/10 sequence	[1DB/5DB/10DB] when in log mode	2 Bytes
Toggle the RF preamplifier on and off	[INPUT MENU] [1]	3 Bytes
Set the system input impedance	[INPUT MENU] [2]	2 Bytes
Set the first input mixer level	[INPUT MENU] [4] [Value]	4 Bytes
Toggle external attenuation and amplification offset mode	[INPUT MENU] [6] [0]	3 Bytes
Select dBuV/M Correction Table	[INPUT MENU] [3] [9] [1-5]	4 Bytes
Delete dBuV/M Correction Table	[INPUT MENU] [3] [9] [9] [0] [1-5,6]	4 Bytes
Print dBuV/M Correction Table	[INPUT MENU] [3] [9] [9] [0] [1-6,7]	4 Bytes
Select dBuV/M Measurement Distance	[INPUT MENU] [3] [9] [6] [Value]	10 Bytes
Toggle dBuV/M Marker Display Mode	[INPUT MENU] [3] [9] [9]	3 Bytes
Toggle dBuV/M Destination Waveform	[INPUT MENU] [3] [9] [7]	4 Bytes

SWEEP SYSTEM COMMANDS

Operation	Keystrokes	Memory Used
Set the sweep trigger source mode	[SWP/TRIG MENU] [0-5]	3 Bytes
Toggle single sweep mode	[SGL SWP] (if not in single sweep mode) [SGL SWP] [SGL SWP] (if already in single sweep mode)	3 Bytes
Arm single sweep once	[SGL SWP] (After single sweep mode has been entered)	3 Bytes
Set sweep mode	[SWEEP AUTO] [SWP/TRIG MENU] [7-8]	3 Bytes
Set sweep time/division	[SWP/TRIG MENU] [6] [Value] [UTIL MENU] [2] [7] [Value]	6 Bytes
Increment or decrement the sweep time/division	[FAST] [SLOW]	5 Bytes
Set the horizontal line triggering mode	[SWP/TRIG MENU] [9] [3-4]	3 Bytes
Set the horizontal line trigger mode line number	[SWP/TRIG MENU] [9] [6] [Value] [A]	4 Bytes
Toggle between horizontal line trigger TV line standards	[SWP/TRIG MENU] [9] [7]	3 Bytes

WAVEFORM COMMANDS

Operation	Keystrokes	Memory Used
Ensemble averaging mode	[DSPL MENU] [1] [1] (to enable) [DSPL MENU] [1] [2] (to disable)	3 Bytes
Toggle max hold mode	[MAX HOLD]	3 Bytes
Toggle viewing of the specified waveform	[A-D]	3 Bytes
Toggle difference display offset reference	[DSPL MENU] [3]	2 Bytes
Set the number of sweeps for ensemble averaging mode	[DSPL MENU] [1] [7] [C] (for continuous) [DSPL MENU] [1] [7] [Value] [A] (for a fixed number)	4 Bytes
Toggle saving of the specified waveform	[SAVE] [A-C]	3 Bytes
Toggle waterfall mode (save-D)	[SAVE] [D]	3 Bytes
Set the ensemble averaging mode	[DSPL MENU] [1] [3-6]	3 Bytes
Set the ensemble average destination waveform	[DSPL MENU] [1] [8]	3 Bytes
Toggle min hold display mode	[DSPL MENU] [9]	3 Bytes

DISPLAY COMMANDS

Operation	Keystrokes	Memory Used
Toggle readouts	[DSPL MENU] [6]	3 Bytes
Toggle graticule illumination	[GRAT ILLUM]	2 Bytes
Toggle video monitor mode	[SWP/TRIG MENU] [8]	3 Bytes
Toggle video monitor mode	[SWP/TRIG MENU] [9] [0]	3 Bytes
Toggle the video sync polarity	[SWP/TRIG MENU] [9] [1]	3 Bytes
Toggle the video polarity	[SWP/TRIG MENU] [9] [2]	3 Bytes
Print Readouts	UTIL MENU] [9] [0]	2 Bytes
Display text on screen	[USER DEF MENU] [9] [3] [A] [edit-message] [B]	38 Bytes

GENERAL PURPOSE COMMANDS

Operation	Keystrokes	Memory Used
Store the current settings in the specified register	[UTIL MENU] [1] [2-9] [B]	3 Bytes
Recall settings from the specified register	[UTIL MENU] [1] [0-2] [UTIL MENU] [1] [3-9] [A]	3 Bytes
Delete the settings stored in the specified register	[UTIL MENU] [1] [2-9] [C] [C]	3 Bytes

INTERNAL CALIBRATION COMMANDS

Operation	Keystrokes	Memory Used
Normalize internal parameters	[UTIL MENU] [3] [0-2] [UTIL MENU] [5] [5] [0] [0-5,8] [A] [UTIL MENU] [5] [5] [1] [0] [1] [A] [2] [2] [A] [UTIL MENU] [5] [5] [1] [1] [2] [A] [UTIL MENU] [5] [5] [1] [2] [1] [A] [UTIL MENU] [5] [5] [2] [0-9] [A]	4 Bytes
Toggle the internal calibrator signal	[INPUT MENU] [9]	3 Bytes
Toggle frequency corrections	[UTIL MENU] [4] [3] [5]	3 Bytes
Set the external pad value to be used in the reference gain normalization	[UTIL MENU] [5] [5] [1] [0] [2] [1] [Value]	6 Bytes
Set the external reference frequency value	[UTIL MENU] [5] [5] [1] [1] [1] [Value]	10 Bytes
Enable RF Mother board diagnostic function	[UTIL MENU] [5] [0] [0]	2 Bytes
Default normalized internal parameters	[UTIL MENU] [5] [5] [0] [0-5,8] [C] [UTIL MENU] [5] [5] [1] [0] [1] [C] [UTIL MENU] [5] [5] [1] [1] [2] [C] [UTIL MENU] [5] [5] [1] [2] [1] [C] [UTIL MENU] [5] [5] [2] [0-9] [C]	3 Bytes
Recall prior normalized parameters	[UTIL MENU] [5] [5] [0] [0-5,8] [B] [UTIL MENU] [5] [5] [1] [0] [1] [B] [UTIL MENU] [5] [5] [1] [1] [2] [B] [UTIL MENU] [5] [5] [1] [2] [1] [B] [UTIL MENU] [5] [5] [2] [0-9] [B]	3 Bytes

MARKER SYSTEM COMMANDS

Operation	Keystrokes	Memory Used
Toggle the marker system mode	[MKR Δ OFF]	3 Bytes
Toggle noise-normalized mode on and off	[APPL MENU] [2]	3 Bytes
Toggle signal tracking mode	[CTR MEAS/TRKG] (double press for on, single for off)	3 Bytes
Exchange primary and secondary marker positions	[MKR/FREQ MENU] [5]	2 Bytes
Set signal threshold to AUTO mode	[MKR/FREQ MENU] [9] [1] [C]	3 Bytes
Set signal threshold level	[MKR/FREQ MENU] [9] [1] [Value]	6 Bytes
Set reference level to place marker at full screen	[MKR/FREQ MENU] [3]	2 Bytes
Set marker to next highest signal	[MKR/FREQ MENU] [9] [7]	2 Bytes
Set marker next lower signal	[MKR/FREQ MENU] [9] [8]	2 Bytes
Set marker to next signal to the left	[MKR ←]	2 Bytes
Set marker to next signal to the right	[MKR →]	2 Bytes
Set Marker to peak of maximum signal	[MKR PEAK FIND]	2 Bytes
Toggle bandwidth mode	[APPL MENU] [0]	3 Bytes
Set frequency start/stop to marker positions	[MKR/FREQ MENU] [6]	2 Bytes
Set the DBC level for bandwidth mode	[APPL MENU] [9] [0] [Value]	6 Bytes
Set minimum signal size (in display points) for marker commands	[UTIL MENU] [4] [3] [1] [Value]	4 Bytes
Toggle carrier-to-noise mode	[APPL MENU] [1]	3 Bytes
Set carrier-to-noise bandwidth	[APPL MENU] [9] [1] [Value]	6 Bytes
Set noise normalized mode bandwidth	[APPL MENU] [9] [2] [Value]	6 Bytes
Enable the Signal Search (spur search) function	[APPL MENU] [3] [8]	42 Bytes
Display the spur search results	[APPL MENU] [3] [9]	2 Bytes

COMMUNICATIONS COMMANDS

Operation	Keystrokes	Memory Used
Toggle the plotter language (Option 09 only)	[UTIL MENU] [4] [1] [1]	3 Bytes
Begin a plot (Option 09 only)	[UTIL MENU] [6]	2 Bytes
Toggle the plot output port (Option 09 only)	[UTIL MENU] [4] [1] [0]	3 Bytes
Wait fir Event (Wait for end of sweep or display-line-limit)	[USER DEF] [9] [2]	2 Bytes
Toggle the Centronics port mode (Option 09 only)	[UTIL MENU] [4] [0] [1] [0]	3 Bytes
Toggle the plots-per-page (Option 09 only)	[UTIL MENU] [4] [1] [3]	3 Bytes
Toggle the plot speed (Option 09 only)	[UTIL MENU] [4] [1] [2]	3 Bytes
Toggle the plot position (Option 09 only)	[UTIL MENU] [4] [1] [4]	3 Bytes
Wait for user response	[USER DEF MENU] [9] [3]	2 Bytes

HUMAN INTERFACE COMMANDS

Operation	Keystrokes	Memory Used
Sets the knob function	[MKR/FREQ] [2]	5 Bytes
Set the display line level	[DSPL MENU] [8] [2] [Value]	6 Bytes
Set the display line mode	[DSPL MENU] [8] [1]	3 Bytes
Set detector/speaker mode	[DET/GEN MENU] [0-3]	3 Bytes
Toggle the audio alert level	[UTIL MENU] [4] [3] [0]	3 Bytes
Increment or decrement the front panel knob	[FREQ/MARKERS knob]	5 Bytes
Toggle title mode ON and OFF	[DSPL MENU] [5] [1]	3 Bytes
Toggle plot labeling ON and OFF	[DSPL MENU] [5] [3]	3 Bytes
Toggle display line audio beep mode	[DISPLAY MENU] [8] [4]	3 Bytes

RESOLUTION BANDWIDTH AND VIDEO COMMANDS

Operation	Keystrokes	Memory Used
Set resolution bandwidth value	[UTIL MENU] [2] [4] [1] [Value]	6 Bytes
Increase or decrease resolution bandwidth setting	[RESOLUTION BW ◀▶] [RESOLUTION BW ▶▶]	5 Bytes
Toggle auto resolution bandwidth	[RESOLUTION BW AUTO] [UTIL MENU] [2] [4] [0]	3 Bytes
Set the video detection mode	[DSPL MENU] [7] [1-3]	3 Bytes
Toggle video filter	[VIDEO FLTR]	3 Bytes
Set video filter value	[UTIL MENU] [2] [5] [1] [Value]	6 Bytes



FIELD STRENGTH MEASUREMENTS

Computing and certain other electronic equipment emit spurious rf energy in the immediate environment in which they are used. Government agencies such as the U.S. Federal Communications Commission (FCC) and the German Verband Deutscher Elektrotechniker (VDE) have set standards for the maximum amount of spurious rf energy that this equipment can emit.

Electromagnetic Interference (EMI) tests must measure the field strength of spurious emissions (measured in dB μ V/m) of electronic equipment. This is usually done by placing a calibrated antenna at a specified distance from the device under test, and connecting the antenna to a spectrum analyzer via a transmission line. The antenna develops a terminal voltage in response to the incident electromagnetic energy radiated by the device under test, and the spectrum analyzer measures the terminal voltage intensity in dB μ V.

In order to facilitate making these measurements, the voltage measured across the antenna must be converted to field strength units, dB μ V/m. This conversion is meaningful only when the following conditions are met:

- The antenna factor, provided with the test antenna, is used to normalize the measurement.
- A correction for distance is made to the measured field intensity if the antenna is placed at a distance other than the specified distance.

The 2710 Spectrum Analyzer provides a convenient vehicle for making these EMI measurements.

This section of the manual describes the field strength measurement software in the Spectrum Analyzer, dealing with the following:

- Measurement Invocation
- Measurement Appearance to the User
- Measurement Deactivation

Key to Menu Selections

There are seven possible responses for the menu selections. These responses are represented by special characters to the left of each possible menu selection. They define the action of the menu system when a particular menu entry has been selected. A key to these display responses is provided as follows:

- ^D = Exit to the active display.
- ^M = Exit to the prior (higher) menu level.
- S = Stay in the current menu, returning to initial state.
- vM = Move to a Sub Menu.
- R = Perform a routine, then return to the initial state of the current menu.
- R^D = Perform a routine, then return to the display.
- ^IS = An invalid selection has been made; returns to the initial menu after a momentary display of an instructive message.

Modifications to the Display Response keys are indicated with the following suffixes.

- d = a momentary delay occurs prior to execution, allowing the user to see confirmation of his choice
- p = a prompt must be responded to before the choice is invoked.

NOTE

These display response keys are shown in the manual, they are not part of the display.

Press INPUT MENU/#3 to display the menu selections shown in Figure 10-1.

NOTE

In an actual display, only the CAPITAL letters within the boxed area are shown; the current value replaces the lower-case letters. The information outside the box is supplemental.

Reference Level Units Menu

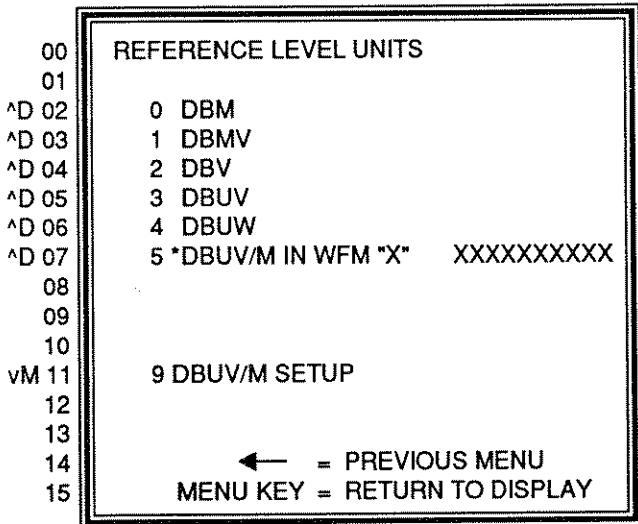
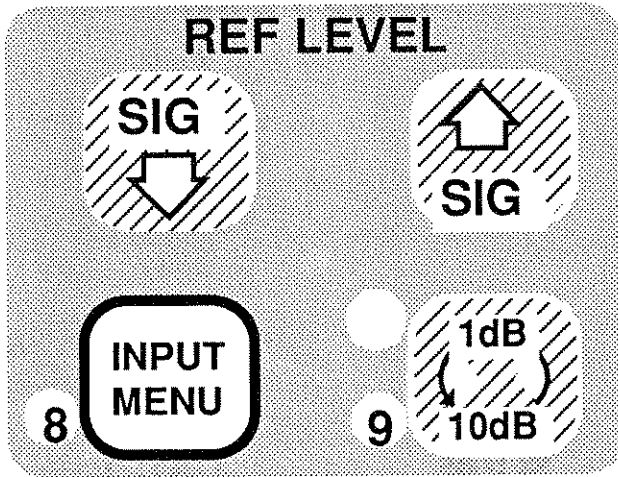

Figure 10-1. Reference level units selection menu.

The user may select which reference level units to use, or he may select 9 to setup the current dB μ V/m configuration.

NOTE

This menu has been changed from previous versions of firmware.

The user can enable dB μ V/m reference level unit by selecting (DBUV/M IN WFM "X"...) in the preceding menu.

The destination waveform buffer, either A, B, or C, is printed on line 5.

In Figure 10-1, XXXXXXXXXX is replaced with a title. The title will be one of the following:

1. ANTENNA N, where N is the antenna table entry number from the DBUV/M SETUP menu if the entry uses the default title.
2. ANT EMPTY if the currently selected antenna table entry has no antenna factor table associated with it.
3. The first 10 characters of the title of the antenna factor table selected.

The following warning message is displayed if dB μ V/m is enabled while the currently selected antenna table is empty.

WARNING: USING EMPTY ANT TABLE

Setting up dB μ V/m

Selection #9 (DBUV/M SETUP) in the REF LEVEL UNITS menu is used to select one of three things:

- To select which antenna factor table is to be used with the dB μ V/m measurement
- To set the current measurement distance and marker display mode.
- To edit/create an antenna factor table.

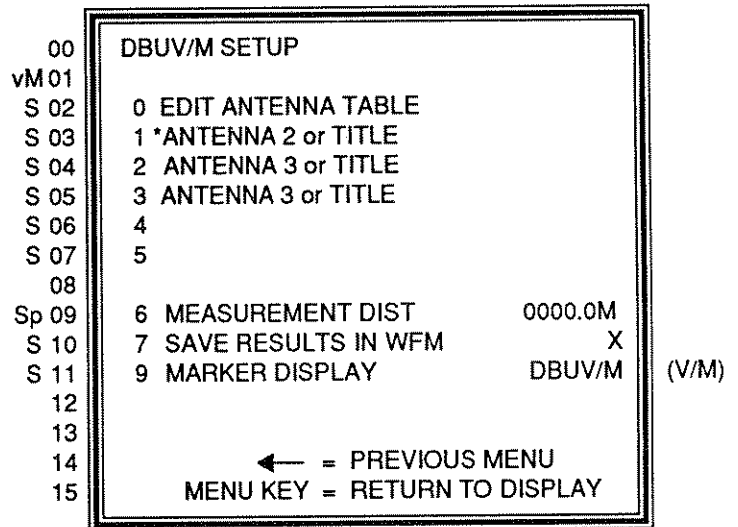

Figure 10-2. dB μ V/m setup menu.

Selecting Antenna Factor Tables

Menu selections 1 through 5 are used for making field strength measurements with a corresponding antenna. The entry marked with an asterisk (*) specifies the currently selected table. The default is 1.

There is a possible maximum of five antenna factor tables available to the user, subject to available NVRAM storage space.

The titles for antenna factor tables are displayed next to their index number. The lack of a title on a line implies that no antenna factor table has been associated with that entry. Entries with no antenna factor tables associated with them are considered empty, but may be selected for use in the measurement.

If a new antenna factor table is selected while a field strength measurement is in progress, the change occurs immediately and the destination waveform reflects corrections for the new antenna factor table.

Setting the Measurement Distance

Menu entry #6 (MEASUREMENT DISTANCE) is used to specify the measurement distance between the antenna and the device under test. When menu item #6 is selected, the user is prompted for a new measurement distance. Measurement distances are specified in meters, within the range of 0.1 through 214,748,364.0 meters, and with a resolution to the nearest tenth of a meter. The default is the same distance as the reference distance of the antenna currently selected.

The measurement distance may also be entered in feet, Km, or miles; however, the status of the measurement distance is always displayed in meters because the value is immediately converted to meters upon entry.

If a new measurement distance is selected while a field strength measurement is in progress, the change occurs immediately and the destination waveform reflects corrections for the new antenna factor table.

When the user is prompted for a measurement distance, lines 13, 14, and 15 appear as follows:

```
13  ENTER NEW VALUE: _  
14  
15  A = METERS B = KM C = FEET D = MILES
```

The following error message is displayed if the user specifies an out-of-range measurement distance, and the measurement distance value changes to its minimum(maximum) if the entered distance is under(over) the limit..

OUT OF RANGE

Specifying the Destination Waveform

Menu entry #7 (SAVE RESULTS IN WAVEFORM X) allows the user to select the waveform register in which the results of the measurement are placed. This menu item, when selected, cycles through the sequence A – B – C. The default waveform register is C.

The following error message is displayed if an attempt is made to change the destination waveform while the dB μ V/m mode is enabled [running(idle)].

FUNCTION NOT AVAIL IN DBUVM MODE

(NOT AVAILABLE WITH DBUV/M IDLE)

Setting The dB μ V/m Marker Display Mode

Menu entry #9 (MARKER DISPLAY) allows the user to select the readout display mode for markers placed on the dB μ V/m waveform. The marker amplitude will be displayed in the selected units (dB μ V/m or V/m) and the frequency in Hz.

Editing Antenna Factor Tables

Menu entry #0 (EDIT ANTENNA TABLE) allows the user to enter new and edit existing antenna factor tables.

The user can manipulate, print, and transfer antenna tables through selections in this menu.

Any changes made to the currently selected antenna factor table while a field strength measurement is in progress is NOT immediately reflected in the destination waveform. New and edited antenna factor tables may be enabled by selecting the new (edited) table by presing INPUT MENU/#3/#9/#1-5. This may entail having to reselect the currently selected table if it has been edited.

```

00  EDIT ANTENNA TABLE
01
vM02  0 BEGIN EDIT           {status}
vM03  1 TITLE EDIT
vM04  2 STORE
vM05  3 LOAD
vM06  4 DELETE
vM07  5 PRINT
vM08  6 ANTENNA SETUP
09
10
11
12  (FREE MEMORY  00000  BYTES)
13
14  ← = PREVIOUS MENU
15  MENU KEY = RETURN TO DISPLAY
    
```

Figure 10-3. Antenna table editing menu.

Beginning an Edit Session – Menu selection #0 (INPUT MENU/#3/#9/#9/#0 BEGIN EDIT) is used to enter the antenna factor table editing mode. The following message is displayed while the editing buffer is being created:

WORKING

The maximum size of the editing buffer is 999 entries. The following error message is displayed if the maximum number of entries is exceeded:

TABLE IS TOO LARGE TO EDIT

The user performs editing in a local buffer until requirements are met, then the contents of the editing buffer may be stored in NVRAM. A description of the editing scheme can be found under Entering the Editing Session.

The current status of the editing buffer is also displayed next to menu item #0 in Figure 10-3. Possible status messages are:

- **EMPTY** – indicating that the local buffer is currently empty.
- **NEW** – indicating that an editing session has been started on a new table in the local buffer.
- **MODIFIED** – indicating that an edit session on a previously existing table has occurred, and the contents have been modified.
- **ANTENNA N** – (where N is the number of the antenna table entry, see Figure 10-2), indicating that the contents of the corresponding table in NVRAM has been loaded into the local buffer for editing. This text is only printed if there is no title associated with the selected entry.

- The first 10 characters of the title of the table that has been loaded from NVRAM into the local buffer for editing.

The following error message is displayed if item #0 is selected while the antenna parameters have not been set.

USE "ANTENNA SETUP" MENU FIRST

The antenna parameters must be set correctly before a new table can be edited.

Free Memory Space Indicator – The amount of free NVRAM space available for storing antenna factor tables is displayed on line 12.

Entering the Editing Session

```

00  EDIT ANTENNA TABLE (CONT)
01
02  FREQUENCIES ARE IN MHZ
03
04  TURN KNOB TO SELECT LINE
05
06  [table title]
07  >BEGINNING
08  1 >0000.000000 : 00.0
09  2 *>0000.000000 : 00.0
10  3 >0000.000000 : 00.0
11  4 >0000.000000 : 00.0
12
13
14
15  A = ENTER/EDIT      D = EXIT
    
```

Figure 10-4. Antenna table editing menu.

A table entry (to be edited) is selected with the **FREQ/MARKERS** knob and correction factors are entered with the **A** key. The **D** key reverts to the previous menu.

The **FREQ/MARKERS** knob is used to move the cursor (**_**) to the character to be edited. An asterisk is placed next to the current entry. Select **A** to enter a new antenna factor, or **D** to end editing and return to the previous menu (Figure 10-3).

Entering and Editing Factor Values – Press **A** to invoke entry/edit mode. Menu lines 13, 14, and 15 change to:

```

13  ENTER NEW VALUE:  _
14  A = -DB          B = +DB
15  TO EXIT ENTER/EDIT MODE
    
```

Antenna factor values are entered in dB units. Antenna factor entries must be within the range of -80.0 dB to +80.0 dB, with optional resolution to one-tenth dB. The default antenna factor value is 0.0 dB. The following error message is displayed if the entered value is not within the specified range.

OUT OF RANGE

After an antenna factor value has been entered, the next entry in the list becomes the current entry, and the user is asked for a new value. The user may press the (backspace) **BACKSPACE ARROW** key to exit enter/edit mode. After the last entry in the table has been entered/modified, enter/edit mode is exited.

The user may change the current entry to be edited when being prompted for a factor value by turning the knob.

Ending the Edit Session – End the current editing session and return to the previous menu (Figure 10-3) by pressing **D**.

Creating/Editing a Table

```

00  TITLE EDIT
01
02  _TITLE OF UP TO 28 CHARS
03
04  @ ABCDEFGHIJKLMNOPQRSTUVWXYZ
05  0123456789 !"#$%()'*,.-/;<=>?
06
07  PRESS "A" FOR EDITING/INSTRUCT
08  PRESS FOR CURSOR MOVEMENT:
09  SIG ^ v, MKR < >, SPAN <> ><
10  TURN KNOB TO CHOOSE CHARACTER
11  OR SELECT DIGIT FROM KEYPAD
12
13  PRESS "B" TO STORE
14  PRESS "C" TO DELETE
15  PRESS "D" TO ABORT
    
```

Figure 10-5. Title editing menu.

Menu selection #1 (INPUT MENU/#3/#9/#9/#1 TITLE EDIT) allows the user to create/edit a title for the current editing buffer. Titles are limited to 28 characters.

Pressing **A** (EDITING/INSTRUCT) will begin the edit session. Once a title has been entered, it may be stored in the local buffer by pressing the **B** (STORE) selection. The **C** (DELETE) key will erase a previously entered title from the local buffer. The **D** (ABORT) key will leave the title in the local buffer unchanged.

The range of characters available include 0 to 9, A to Z, space, and most punctuation characters. Turning the knob scrolls through the range of characters available. The space character is available between the '9' and the '!', the '@' and the 'A', and the 'Z' and the '0'.

The cursor (**_**) in the display points to a character to be edited in the title.

Storing a Table

```

00 STORE
01
^M 02 1 [title of table]
^M 03 2 [title of table]
^M 04 3 [title of table]
^M 05 4 [title of table]
^M 06 5 [title of table]
07
08 [TITLE OF TABLE OR "NEW"]
09
10
11
12
13
14 ← = PREVIOUS MENU
15 MENU KEY = RETURN TO DISPLAY
    
```

Figure 10-6. Local buffer store menu.

Menu selection #2 (INPUT MENU/#3/#9/#9/#2 STORE) allows the user to store the contents of the current editing buffer in one of the five available antenna table entries. The title of the antenna table in the current buffer, or "NEW" is displayed on line 8 if a title has not been entered.

The following error message is displayed if a table already exists in a desired selection.

DELETE EXISTING TABLE FIRST

The following error message is displayed if the local editing buffer is empty.

EDITING BUFFER IS EMPTY

The following error message is displayed if there is insufficient storage space available in NVRAM.

FILE SYSTEM FULL

The table in the local buffer, along with the title of the table and antenna parameter information, is permanently stored in the currently selected table entry. Once the table has been stored, the local buffer is deleted.

If no title has been created, a default title is stored in the buffer in the format ANTENNA N, where N is the number of the register in which the table will be stored.

Loading an Existing Table

```

00 LOAD
01
^M 02 1 [title of table]
^M 03 2 [title of table]
^M 04 3 [title of table]
^M 05 4 [title of table]
^M 06 5 [title of table]
07
08
09
10
11
12
13
14 ← = PREVIOUS MENU
15 MENU KEY = RETURN TO DISPLAY
    
```

Figure 10-7. Antenna table load menu.

Menu selection #3 (INPUT MENU/#3/#9/#9/#3 LOAD) allows the user to load the contents of an existing table (specified antenna factor table and its respective title and antenna parameters) into the editing buffer. The table may now be edited and/or stored in one of the antenna factor table entries in NVRAM.

If a modified or edited table already exists in the local buffer, lines 14 and 15 will display the following text:

```

14 "C" = OVERWRITE LOCAL BUFFER
15 "D" = ABORT
    
```

Deleting a Table

```

00 DELETE
01
^M 02 1 [title of table]
^M 03 2 [title of table]
^M 04 3 [title of table]
^M 05 4 [title of table]
^M 06 5 [title of table]
^M 07 6 EDITING BUFFER
08
09
10
11
12
13
14 ← = PREVIOUS MENU
15 MENU KEY = RETURN TO DISPLAY
    
```

Figure 10-8. Delete antenna table entry menu.

Menu selection #4 (INPUT MENU/#3/#9/#9/#4 DELETE) allows the user to delete a selected table from the antenna factor table entries, or from the current editing buffer. The following message is displayed if there is no table stored in the selected table entry.

SELECTED TABLE IS EMPTY

where N is the entry selected

The following error message is displayed if the user attempts to delete an empty editing buffer.

EDITING BUFFER IS EMPTY

The following error message is displayed if the table to be deleted is currently in use.

TABLE CURRENTLY IN USE

The user may still delete the table if he wishes.

When the user selects a table to be deleted, lines 14 and 15 will display the following text:

```

14  |  PRESS  "C" TO DELETE, OR
15  |  |      "D" TO ABORT
    
```

Printing Out Tables

```

00  |  PRINT
01  |
^M 02 | 1 [title of table]
^M 03 | 2 [title of table]
^M 04 | 3 [title of table]
^M 05 | 4 [title of table]
^M 06 | 5 [title of table]
^M 08 | 6 ALL TABLES
^M 08 | 7 EDITING BUFFER
09  |
10  |
11  |
12  |
13  |
14  |  ← = PREVIOUS MENU
15  |  MENU KEY = RETURN TO DISPLAY
    
```

Figure 10-9. Print antenna factor table menu.

Menu selection #5 (INPUT MENU/#3/#9/#9/#5 PRINT) allows the user to print one or all of the existing antenna factor tables in NVRAM, or the table in the current buffer.

The following message is displayed if the user selects an entry with the printer not connected.

PRINTER NOT CONNECTED

The following message is displayed if there is no table stored in the selected entry.

ANTENNA TABLE #X: EMPTY

The following message is displayed if the local buffer is selected for printout and the buffer is empty.

LOCAL EDITING BUFFER IS EMPTY

The output is routed to the currently selected printer device (PRN).

EXAMPLE OF PRINTER OUTPUT

```

TEK 2710
[antenna factor table title]
Cal Distance =          3.0 Meters
Frequency              Factor (dB)
-----
100.0 MHz              12.3
125.0 MHz              13.7
.                      .
.                      .
.                      .
1000.0 MHz             22.3
    
```

Setting up Antenna Parameters

```

00  |  ANTENNA PARAMETERS
01  |
Sp 02 | 1 START FREQ          0000.000000MHZ
Sp 03 | 2 STOP FREQ           0000.000000MHZ
Sp 04 | 3 INC FREQ            0000.000000MHZ
05  |
Sp 06 | 4 REFERENCE DISTANCE  0000.0M
07  |
08  |
09  |
10  |
11  |
12  |
13  |
14  |  ← = PREVIOUS MENU
15  |  MENU KEY = RETURN TO DISPLAY
    
```

Figure 10-10. Antenna parameters menu.

Field Strength Measurements – 2710 Operators

Menu selection #6 (INPUT MENU/#3/#9/#9/#6 ANTENNA SETUP) is used to setup the antenna parameters (start frequency, stop frequency, etc.) for a new antenna factor table.

Setting Start/Stop/Inc Frequencies – The user must enter a new start, stop, increment frequency, and (optionally) an antenna reference distance before a new antenna factor table can be edited. When the user selects items 1 through 3, lines 13, 14, and 15 change to:

```
13  ENTER NEW VALUE: _  
14  
15  A=HZ   B=KHZ   C=MHZ   D=GHZ
```

The start and stop frequencies must lie within the frequency limits of the Spectrum Analyzer (10 kHz to 1.8 GHz). The stop frequency must be less than or equal to the start frequency. The increment frequency must be less than or equal to the difference between the start and stop frequencies.

The following error message is displayed if the user enters a frequency that is not within the above specified range.

OUT OF RANGE

Setting the Antenna Reference Distance – Menu selection #4 (INPUT MENU/#3/#9/#9/#6/#4 REFERENCE DISTANCE) allows the user to specify the antenna reference distance. Distances are entered in meters, optionally to the nearest one-tenth meter, within the range of 0.1 to 9999.9 meters. The default is 3.0 meters. When the user selects menu item 4, lines 13, 14, and 15 change to:

```
13  ENTER NEW VALUE: _  
14  
15  A = METERS
```

The following error message is displayed if the entered reference distance is not within the specified range.

OUT OF RANGE

Start/stop/increment parameters cannot be changed once the start/stop/increment frequencies have been set and editing of table entries has occurred. The user must delete the table in the current editing buffer must be deleted before these parameters can be changed. The reference distance may be set or changed at any time.

When BEGIN EDIT or STORE is selected, the validity of the start/stop/increment frequencies is checked. The following

error message is displayed if the entered values do not meet the specified requirements.

ILLEGAL START/STOP/INC VALUES

USING dB μ V/m UNIT TO MAKE MEASUREMENTS

Enable the field strength (dB μ V/m) measurement by selecting INPUT MENU/#3/#5 (REF LEVEL UNIT - DBUV/M - IN WAVEFORM X). The antenna factor table currently selected is used in the calculation.

The following message is displayed, and dB μ V/m mode is not enabled if the measurement destination waveform (as specified in the DBUV/M SETUP menu) currently has a waveform stored in it:

CANNOT OVERWRITE SAVED DISPLAY

MEASUREMENT APPEARANCE TO THE USER

- All waveforms except the destination waveform (A, B, or C) are turned off. The destination waveform is turned on.
- The destination waveform on-screen reference level is calculated by summing the current reference level for waveform D and the maximum antenna factor correction value amplitude for the table in use. This value is displayed on screen.
- The contents of waveform D summed with the antenna factor correction values are placed in the destination waveform.
- If the destination waveform is turned off, the on-screen reference level is set relative to the highest active waveform.
- The following error message is displayed if the user attempts to turn on LIN mode, enable FM DETECTOR or EXTERNAL INPUT display source, or unsave the destination waveform while dB μ V/m is enabled [(running)(idle)]:

FUNCTION NOT AVAIL IN DBUVM MODE

(NOT AVAILABLE WITH DBUV/M IDLE)

The same message is displayed if the user attempts to enable dB μ V/m mode while LIN mode, FM DETECTOR, or EXTERNAL INPUT are enabled.

IDLING THE dB μ V/m MEASUREMENT

The measurement enters the idle state if the selected destination waveform display is turned off while the dB μ V/m mode is enabled. The correction calculation is not performed until the destination display waveform is turned on again. The reference units are displayed in dB μ V, and the following message is displayed:

DBUV/M MEASUREMENT MODE IDLE

DISABLING dB μ V/m

The dB μ V/m measurement is disabled by selecting one of the other reference level units available (dBm, dBmV, etc.).

Field Strength Measurements – 2710 Operators

```

00 USER DEFINED PROGRAM MENU
01
^DR 02 0 title of program
^DR 03 1
^DR 04 2
^DR 05 3
^DR 06 4*#title of program
^DR 07 5 #title of program
^DR 08 6
^DR 09 7
^DR 10 8
vM 11 9 USER DEF PROGRAM UTILITIES
12
13
14
15 PRESS ← TO EXIT
    
```

Figure 1. User-defined program main menu. This menu appears when the USER DEF key is pressed."

```

00 100.0MHZ ATTN 10DB
01 -20DBM VF OFF
02 10KHZ/ 10DB/
03 3KHZ RBW
04 UNCAL
05 error line
06 program title
07 print to display line
08 progress message line
09
10
11
12
13
14
15
    
```

Figure 2. The Program title, print to display, and the progress line message lines are displayed while program execution is in progress.

```

00 USER DEF PROGRAM UTILITIES
01
^D 02 0 ACQUIRE KEY STROKES (EXIT ACQUIRE MODE)
vM 03 1 TITLE EDIT
^D 04 2 WAIT FOR END OF SWEEP
vM 05 3 DISPLAY MESSAGE
^D 06 4 PAUSE FOR "USER DEF" KEY
vM 07 5 STORE
vM 08 6 DELETE
vM 09 7 PROTECT
10
11
12 AVAILABLE MEMORY 11220 BYTES
13
14 PRESS ← TO EXIT
15
    
```

Figure 3. The USER DEFPROGRAM UTILITIES entered via selection 9 of the USER DEFINED PROGRAMS menu.

```

00 100.0MHZ ATTN 10DB
01 -20DBM VF OFF
02 10KHZ/ 10DB/
03 3KHZ RBW
04 UNCAL
05 error line
06 program title
07
08 ACQUIRE KEY STROKES 30 BYTES
09
10
11
12
13
14
15
    
```

Figure 4. Example of the display while in the ACQUIRE mode. The title of the program may be seen on the display.

```

00 TITLE EDIT
01
02 _title line of up to 28 char
03
04 @ ABCDEFGHIJKLMNOPQRSTUVWXYZ
05 0123456789 !"#%()*+,-./:;<=>?
06
07 PRESS "A" FOR EDITING/INSTRUCT
08 PRESS FOR CURSOR MOVEMENT:
09 SIG ^ V, MKR <>, SPAN <>><
10 TURN KNOB TO SELECT CHARACTER
11 OR SELECT DIGIT FROM KEYPAD
12
13 PRESS "B" TO STORE
14 PRESS "C" TO DELETE
15 PRESS "D" TO ABORT
    
```

Figure 5. This menu is used for editing a title for a user defined program.

```

00 STORE
01
^D 02 0 title of program
^D 03 1 title of program
^D 04 2* title of program
^M 05 3 title of program
^D 06 4 #title of program
^D 07 5 #title of program
^M 08 6 title of program
^D 09 7 title of program
^D 10 8 title of program
11
12
13 title of program or "NEW"
14
15 PRESS ← TO EXIT
    
```

Figure 6. This menu is displayed when the STORE program selection is invoked.

```

00 PROTECT
01
^M 02 0 #title of program
^M 03 1 title of program
^M 04 2 title of program
^M 05 3 #title of program
^M 06 4 #title of program
^M 07 5 title of program
^M 08 6 title of program
^M 09 7 title of program
^M 10 8 title of program
11
12
13
14
15 PRESS ← TO EXIT
    
```

Figure 7. This menu is displayed when the PROTECT program selection is invoked.

```

00 DELETE
01
^M 02 0 title of program
^M 03 1 #title of program
^M 04 2 #title of program
^M 05 3 title of program
^M 06 4 #title of program
^M 07 5 #title of program
^M 08 6 title of program
^M 09 7 #title of program
^M 10 8 title of program
11
12
13 (# INDICATES PROTECTED PROGRAM)
14
15 PRESS ← TO EXIT
    
```

Figure 8. This menu is displayed when the DELETE program selection is invoked.

```

00 DISPLAY MESSAGE
01
02 _line of up to 32 characters
03
04 @ ABCDEFGHIJKLMNOPQRSTUVWXYZ
05 0123456789 !"#%()'*,.-/;<=>?
06
07 PRESS "A" FOR EDITING/INSTRUCT
08 PRESS FOR CURSOR MOVEMENT:
09 SIG ^ V, MKR <>, SPAN <>><
10 TURN KNOB TO CHOOSE CHARACTER
11 OR SELECT DIGIT FROM KEYPAD
12
13 PRESS "B" TO STORE
14 PRESS "C" TO DELETE
15 PRESS "D" TO ABORT
    
```

Figure 9. This menu is used for editing a message to be printed onto the display.

```

00 UTILITY MENU (CONT)
01
^D 02 0 PRINT READOUTS TO PRINTER
03
04
05
06
07
08
09
10
11
12
13
14
15 PRESS ← TO EXIT
    
```

Figure 10. This menu is displayed when the UTILITY MENU (CONT) selection is invoked via selection #9 of the UTIL MENU menu.



TABULAR TUNING TABLES

INTRODUCTION

Tabular tuning tables are used for changing the spectrum analyzer's center frequency in specified increments or channels. These channels may be television channels, radio channels or any other random or non-uniform frequency increments. A channel may be selected either by tuning the **FREQ/MARKERS** knob.

The basic system may have up to 8 fixed tabular tuning tables.

Using Tabular Tuning Tables

Tabular tuning mode is invoked by selecting tabular tuning increment via **MKR/FREQ MENU/#8**.

Once tabular tuning increment has been invoked, the channel number may be selected by tuning the **FREQ/MARKERS** knob. While in the tabular tuning increment mode, the **MKR/FREQ MENU/#2 (KNOB FUNCTION)** selection can be changed to **MARKER** (knob controls the marker) or **FREQ** (knob changes the channel). If tv line triggering (**SWP/TRIG MENU/#4**) is enabled, the Knob Function has a third choice called **VIDLINE** where the knob controls the selected video line.

Key to Menu Selections

There are four possible display responses for the menu selections. These responses are represented by special characters to the left of each possible menu selection. They define the action of the menu system when a particular menu entry

has been selected. The following is a key to these display responses:

- ^D** = Exit to the active display.
- S** = Stay in the current menu, returning to initial state.
- vM** = Move to a Sub Menu.

Modifications to the Display Response keys are indicated with the following suffix:

- p** = a prompt must be responded to before the choice is invoked.

NOTE

These display response keys shown in the manual are not part of the display.

MARKER/FREQUENCY MENU CHANGES

The marker/frequency menu is invoked from the **MKR/FREQ MENU** key on the front panel.

The tabular tuning mode may be invoked by pressing **MKR/FREQ/#8** (Figure 11-1). The #8 key cycles through **AUTO**, **PRGRMD**¹, and **TABULAR**. The **TUNING INCREMENT** selection changes to **TABULAR**.

MARKER/FREQUENCY MENU			
^Dp	0	FREQUENCY ENTRY	current [0 to 1.8GHZ]
^Dp	1	SPAN/DIV ENTRY	current [150KHZ/]
S	2	KNOB FUNCTION	TABULAR (MARKER) (FREQ)
^D	3	MARKER TO REFERENCE LEVEL	
^D	4	NEXT LOWER AMPTD PEAK	
^D	5	TRANPOSE MARKERS	
^D	6	MARKER START/STOP	
vM	7	FREQUENCY START/STOP	
S	8	TUNING INCREMENT	TABULAR (PROGRMD) (AUTO)
vM	9	SETUP TABLE	

← = PREVIOUS MENU

MENU KEY = RETURN TO DISPLAY

Figure 11-1. Marker/Frequency menu.

¹ = PROGRAMMED

Tabular Tuning Tables – 2710 Operators

Press MKR/FREQ MENU/#8 to enable the tabular tuning mode. The #8 key cycles the tuning increment through AUTO, PROGRMD, and TABULAR.

A channel selection is made by tuning the FREQ/MARKERS knob. After a direct entry or knob selection of a channel, the MARKER TO REFERENCE LEVEL selection may be used to bring the signal level up to the top of the display, if desired.

The tabular tuning mode may be disabled by changing the TUNING INCREMENT function to either AUTO or PROGRMD.

After a channel entry, the MARKER TO REFERENCE LEVEL selection may be used to bring the signal level up to the top of the display, if desired.

Tabular Tuning Tables Menu

Press MKR/FREQ MENU/#9/#4 (TABULAR TUNING TABLES) to invoke the Tabular Tuning Tables. See Figure 11-2.

The (*) asterisk preceding the selection name indicates the currently selected table.

After selecting a frequency table, enter the desired carrier frequency by tuning the FREQ/MARKERS knob. The channel name will be displayed on the spectral display when in the tabular tuning mode. See Figure 11-3.

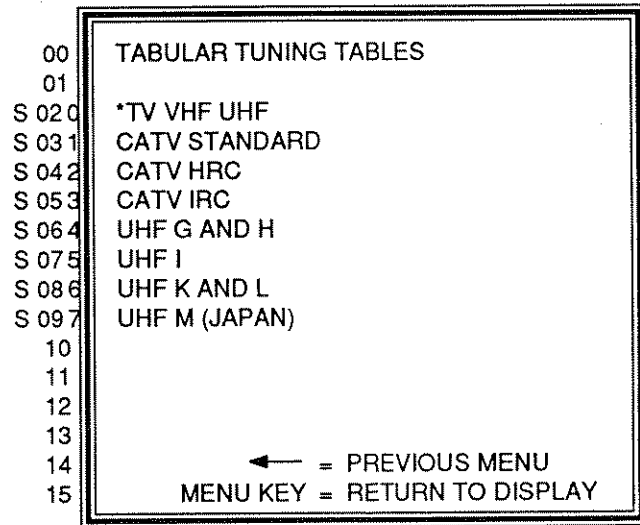

Figure 11-2. The tabular tuning table menu.

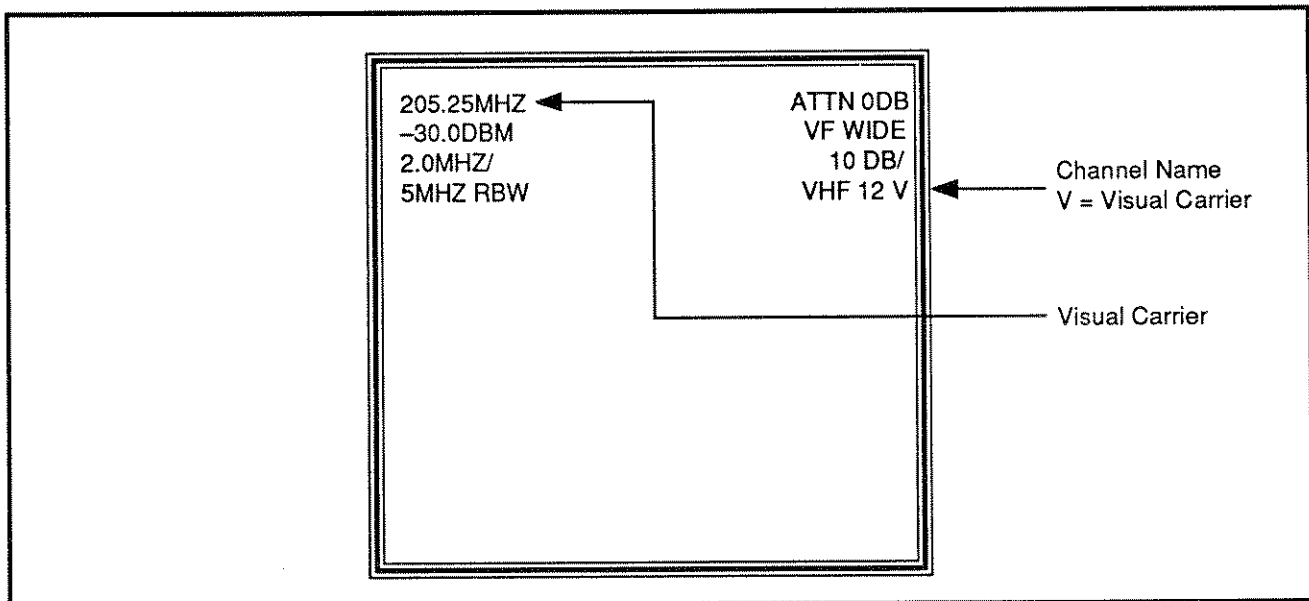

Figure 11-3. Cannel name in spectral display.

APPENDIX

Fixed Table Frequencies

The following tabular tuning tables are accessible to the user via MKR/FREQ/#9/#4/(#0 through #7).

TV VHF AND UHF CHANNELS

TV VHF AND UHF CHANNELS (Cont)

Channel	Visual Carrier	Channel	Aural Carrier
VHF 2 V	55.25	VHF 2 A	59.75
VHF 3 V	61.25	VHF 3 A	65.75
VHF 4 V	67.25	VHF 4 A	71.75
VHF 5 V	77.25	VHF 5 A	81.75
VHF 6 V	83.25	VHF 6 A	87.75
VHF 7 V	175.25	VHF 7 A	179.75
VHF 8 V	181.25	VHF 8 A	185.75
VHF 9 V	187.25	VHF 9 A	191.75
VHF 10V	193.25	VHF 10A	197.75
VHF 11V	199.25	VHF 11A	203.75
VHF 12V	205.25	VHF 12A	209.75
VHF 13V	211.25	VHF 13A	215.75
UHF 14V	471.25	UHF 14A	475.75
UHF 15V	477.25	UHF 15A	481.75
UHF 16V	483.25	UHF 16A	487.75
UHF 17V	489.25	UHF 17A	493.75
UHF 18V	495.25	UHF 18A	499.75
UHF 19V	501.25	UHF 19A	505.75
UHF 20V	507.25	UHF 20A	511.75
UHF 21V	513.25	UHF 21A	517.75
UHF 22V	519.25	UHF 22A	523.75
UHF 23V	525.25	UHF 23A	529.75
UHF 24V	531.25	UHF 24A	535.75
UHF 25V	537.25	UHF 25A	541.75
UHF 26V	543.25	UHF 26A	547.75
UHF 27V	549.25	UHF 27A	553.75
UHF 28V	555.25	UHF 28A	559.75
UHF 29V	561.25	UHF 29A	565.75
UHF 30V	567.25	UHF 30A	571.75
UHF 31V	573.25	UHF 31A	577.75
UHF 32V	579.25	UHF 32A	583.75
UHF 33V	585.25	UHF 33A	589.75
UHF 34V	591.25	UHF 34A	595.75
UHF 35V	597.25	UHF 35A	601.75
UHF 36V	603.25	UHF 36A	607.75
UHF 37V	609.25	UHF 37A	613.75
UHF 38V	615.25	UHF 38A	619.75
UHF 39V	621.25	UHF 39A	625.75
UHF 40V	627.25	UHF 40A	631.75
UHF 41V	633.25	UHF 41A	637.75
UHF 42V	639.25	UHF 42A	643.75
UHF 43V	645.25	UHF 43A	649.75
UHF 44V	651.25	UHF 44A	655.75
UHF 45V	657.25	UHF 45A	661.75

Channel	Visual Carrier	Channel	Aural Carrier
UHF 46V	663.25	UHF 46A	667.75
UHF 47V	669.25	UHF 47A	673.75
UHF 48V	675.25	UHF 48A	679.75
UHF 49V	681.25	UHF 49A	685.75
UHF 50V	687.25	UHF 50A	691.75
UHF 51V	693.25	UHF 51A	697.75
UHF 52V	699.25	UHF 52A	703.75
UHF 53V	705.25	UHF 53A	709.75
UHF 54V	711.25	UHF 54A	715.75
UHF 55V	717.25	UHF 55A	721.75
UHF 56V	723.25	UHF 56A	727.75
UHF 57V	729.25	UHF 57A	733.75
UHF 58V	735.25	UHF 58A	739.75
UHF 59V	741.25	UHF 59A	745.75
UHF 60V	747.25	UHF 60A	751.75
UHF 61V	753.25	UHF 61A	757.75
UHF 62V	759.25	UHF 62A	763.75
UHF 63V	765.25	UHF 63A	769.75
UHF 64V	771.25	UHF 64A	775.75
UHF 65V	777.25	UHF 65A	781.75
UHF 66V	783.25	UHF 66A	787.75
UHF 67V	789.25	UHF 67A	793.75
UHF 68V	795.25	UHF 68A	799.75
UHF 69V	801.25	UHF 69A	805.75
UHF 70V	807.25	UHF 70A	811.75
UHF 71V	813.25	UHF 71A	817.75
UHF 72V	819.25	UHF 72A	823.75
UHF 73V	825.25	UHF 73A	829.75
UHF 74V	831.25	UHF 74A	835.75
UHF 75V	837.25	UHF 75A	841.75
UHF 76V	843.25	UHF 76A	847.75
UHF 77V	849.25	UHF 77A	853.75
UHF 78V	855.25	UHF 78A	859.75
UHF 79V	861.25	UHF 79A	865.75
UHF 80V	867.25	UHF 80A	871.75
UHF 81V	873.25	UHF 81A	877.75
UHF 82V	879.25	UHF 82A	883.75
UHF 83V	885.25	UHF 83A	889.75

Tabular Tuning Tables – 2710 Operators

CATV STANDARD CHANNELS

Channel	Visual Carrier	Channel	Aural Carrier
CATV T7 V	7.00	CATV T7 A	11.50
CATV T8 V	13.00	CATV T8 A	17.50
CATV T9 V	19.00	CATV T9 A	23.50
CATV T10V	25.00	CATV T10A	29.50
CATV T11V	31.00	CATV T11A	35.50
CATV T12V	37.00	CATV T12A	41.50
CATV T13V	43.00	CATV T13A	47.50
CATV 2 V	55.25	CATV 2 A	59.75
CATV 3 V	61.25	CATV 3 A	65.75
CATV 4 V	67.25	CATV 4 A	71.75
CATV 5 V	77.25	CATV 5 A	81.75
CATV 6 V	83.25	CATV 6 A	87.75
CATV 95 V	91.25	CATV 95 A	95.75
CATV 96 V	97.25	CATV 96 A	101.75
CATV 97 V	103.25	CATV 97 A	107.75
CATV 98 V	109.25	CATV 98 A	113.75
CATV 99 V	115.25	CATV 99 A	119.75
CATV 14 V	121.25	CATV 14 A	125.75
CATV 15 V	127.25	CATV 15 A	131.75
CATV 16 V	133.25	CATV 16 A	137.75
CATV 17 V	139.25	CATV 17 A	143.75
CATV 18 V	145.25	CATV 18 A	149.75
CATV 19 V	151.25	CATV 19 A	155.75
CATV 20 V	157.25	CATV 20 A	161.75
CATV 21 V	163.25	CATV 21 A	167.75
CATV 22 V	169.25	CATV 22 A	173.75
CATV 7 V	175.25	CATV 7 A	179.75
CATV 8 V	181.25	CATV 8 A	185.75
CATV 9 V	187.25	CATV 9 A	191.75
CATV 10 V	193.25	CATV 10 A	197.75
CATV 11 V	199.25	CATV 11 A	203.75
CATV 12 V	205.25	CATV 12 A	209.75
CATV 13 V	211.25	CATV 13 A	215.75
CATV 23 V	217.25	CATV 23 A	221.75
CATV 24 V	223.25	CATV 24 A	227.75
CATV 25 V	229.25	CATV 25 A	233.75
CATV 26 V	235.25	CATV 26 A	239.75
CATV 27 V	241.25	CATV 27 A	245.75
CATV 28 V	247.25	CATV 28 A	251.75
CATV 29 V	253.25	CATV 29 A	257.75
CATV 30 V	259.25	CATV 30 A	263.75
CATV 31 V	265.25	CATV 31 A	269.75
CATV 32 V	271.25	CATV 32 A	275.75
CATV 33 V	277.25	CATV 33 A	281.75
CATV 34 V	283.25	CATV 34 A	287.75
CATV 35 V	289.25	CATV 35 A	293.75
CATV 36 V	295.25	CATV 36 A	299.75
CATV 37 V	301.25	CATV 37 A	305.75

CATV STANDARD CHANNELS (cont)

Channel	Visual Carrier	Channel	Aural Carrier
CATV 38 V	307.25	CATV 38 A	311.75
CATV 39 V	313.25	CATV 39 A	317.75
CATV 40 V	319.25	CATV 40 A	323.75
CATV 41 V	325.25	CATV 41 A	329.75
CATV 42 V	331.25	CATV 42 A	335.75
CATV 43 V	337.25	CATV 43 A	341.75
CATV 44 V	343.25	CATV 44 A	347.75
CATV 45 V	349.25	CATV 45 A	353.75
CATV 46 V	355.25	CATV 46 A	359.75
CATV 47 V	361.25	CATV 47 A	365.75
CATV 48 V	367.25	CATV 48 A	371.75
CATV 49 V	373.25	CATV 49 A	377.75
CATV 50 V	379.25	CATV 50 A	383.75
CATV 51 V	385.25	CATV 51 A	389.75
CATV 52 V	391.25	CATV 52 A	395.75
CATV 53 V	397.25	CATV 53 A	401.75
CATV 54 V	403.25	CATV 54 A	407.75
CATV 55 V	409.25	CATV 55 A	413.75
CATV 56 V	415.25	CATV 56 A	419.75
CATV 57 V	421.25	CATV 57 A	425.75
CATV 58 V	427.25	CATV 58 A	431.75
CATV 59 V	433.25	CATV 59 A	437.75
CATV 60 V	439.25	CATV 60 A	443.75
CATV 61 V	445.25	CATV 61 A	449.75
CATV 62 V	451.25	CATV 62 A	455.75
CATV 63 V	457.25	CATV 63 A	461.75
CATV 64 V	463.25	CATV 64 A	467.75
CATV 65 V	469.25	CATV 65 A	473.75
CATV 66 V	475.25	CATV 66 A	479.75
CATV 67 V	481.25	CATV 67 A	485.75
CATV 68 V	487.25	CATV 68 A	491.75
CATV 69 V	493.25	CATV 69 A	497.75
CATV 70 V	499.25	CATV 70 A	503.75

CATV HRC CHANNELS

Channel	Visual Carrier	Channel	Aural Carrier
HRC 2 V	54.00	HRC 2 A	58.50
HRC 3 V	60.00	HRC 3 A	64.50
HRC 4 V	66.00	HRC 4 A	70.50
HRC 1 V	72.00	HRC 1 A	76.50
HRC 5 V	78.00	HRC 5 A	82.50
HRC 6 V	84.00	HRC 6 A	88.50
HRC 95 V	90.00	HRC 95 A	94.50
HRC 96 V	96.00	HRC 96 A	100.50
HRC 97 V	102.00	HRC 97 A	106.50
HRC 98 V	108.00	HRC 98 A	112.50
HRC 99 V	114.00	HRC 99 A	118.50
HRC 14 V	120.00	HRC 14 A	124.50
HRC 15 V	126.00	HRC 15 A	130.50
HRC 16 V	132.00	HRC 16 A	136.50
HRC 17 V	138.00	HRC 17 A	142.50
HRC 18 V	144.00	HRC 18 A	148.50
HRC 19 V	150.00	HRC 19 A	154.50
HRC 20 V	156.00	HRC 20 A	160.50
HRC 21 V	162.00	HRC 21 A	166.50
HRC 22 V	168.00	HRC 22 A	172.50
HRC 7 V	174.00	HRC 7 A	178.50
HRC 8 V	180.00	HRC 8 A	184.50
HRC 9 V	186.00	HRC 9 A	190.50
HRC 10 V	192.00	HRC 10 A	196.50
HRC 11 V	198.00	HRC 11 A	202.50
HRC 12 V	204.00	HRC 12 A	208.50
HRC 13 V	210.00	HRC 13 A	214.50
HRC 23 V	216.00	HRC 23 A	220.50
HRC 24 V	222.00	HRC 24 A	226.50
HRC 25 V	228.00	HRC 25 A	232.50
HRC 26 V	234.00	HRC 26 A	238.50
HRC 27 V	240.00	HRC 27 A	244.50
HRC 28 V	246.00	HRC 28 A	250.50
HRC 29 V	252.00	HRC 29 A	256.50
HRC 30 V	258.00	HRC 30 A	262.50
HRC 31 V	264.00	HRC 31 A	268.50
HRC 32 V	270.00	HRC 32 A	274.50
HRC 33 V	276.00	HRC 33 A	280.50

CATV HRC CHANNELS (cont)

Channel	Visual Carrier	Channel	Aural Carrier
HRC 34 V	282.00	HRC 34 A	286.50
HRC 35 V	288.00	HRC 35 A	292.50
HRC 36 V	294.00	HRC 36 A	298.50
HRC 37 V	300.00	HRC 37 A	304.50
HRC 38 V	306.00	HRC 38 A	310.50
HRC 39 V	312.00	HRC 39 A	316.50
HRC 40 V	318.00	HRC 40 A	322.50
HRC 41 V	324.00	HRC 41 A	328.50
HRC 42 V	330.00	HRC 42 A	334.50
HRC 43 V	336.00	HRC 43 A	340.50
HRC 44 V	342.00	HRC 44 A	346.50
HRC 45 V	348.00	HRC 45 A	352.50
HRC 46 V	354.00	HRC 46 A	358.50
HRC 47 V	360.00	HRC 47 A	364.50
HRC 48 V	366.00	HRC 48 A	370.50
HRC 49 V	372.00	HRC 49 A	376.50
HRC 50 V	378.00	HRC 50 A	382.50
HRC 51 V	384.00	HRC 51 A	388.50
HRC 52 V	390.00	HRC 52 A	394.50
HRC 53 V	396.00	HRC 53 A	400.50
HRC 54 V	402.00	HRC 54 A	406.50
HRC 55 V	408.00	HRC 55 A	412.50
HRC 56 V	414.00	HRC 56 A	418.50
HRC 57 V	420.00	HRC 57 A	424.50
HRC 58 V	426.00	HRC 58 A	430.50
HRC 59 V	432.00	HRC 59 A	436.50
HRC 60 V	438.00	HRC 60 A	442.50
HRC 61 V	444.00	HRC 61 A	448.50
HRC 62 V	450.00	HRC 62 A	454.50
HRC 63 V	456.00	HRC 63 A	460.50
HRC 64 V	462.00	HRC 64 A	466.50
HRC 65 V	468.00	HRC 65 A	472.50
HRC 66 V	474.00	HRC 66 A	478.50
HRC 67 V	480.00	HRC 67 A	484.50
HRC 68 V	486.00	HRC 68 A	490.50
HRC 69 V	492.00	HRC 69 A	496.50
HRC 70 V	498.00	HRC 70 A	502.50

Tabular Tuning Tables – 2710 Operators

CATV IRC CHANNELS

Channel	Visual Carrier	Channel	Aural Carrier
IRC 2 V	55.25	IRC 2 A	59.75
IRC 3 V	61.25	IRC 3 A	65.75
IRC 4 V	67.25	IRC 4 A	71.75
IRC 1 V	73.25	IRC 1 A	77.75
IRC 5 V	79.25	IRC 5 A	83.75
IRC 6 V	85.25	IRC 6 A	89.75
IRC 95 V	91.25	IRC 95 A	95.75
IRC 96 V	97.25	IRC 96 A	101.75
IRC 97 V	103.25	IRC 97 A	107.75
IRC 98 V	109.25	IRC 98 A	113.75
IRC 99 V	115.25	IRC 99 A	119.75
IRC 14 V	121.25	IRC 14 A	125.75
IRC 15 V	127.25	IRC 15 A	131.75
IRC 16 V	133.25	IRC 16 A	137.75
IRC 17 V	139.25	IRC 17 A	143.75
IRC 18 V	145.25	IRC 18 A	149.75
IRC 19 V	151.25	IRC 19 A	155.75
IRC 20 V	157.25	IRC 20 A	161.75
IRC 21 V	163.25	IRC 21 A	167.75
IRC 22 V	169.25	IRC 22 A	173.75
IRC 7 V	175.25	IRC 7 A	179.75
IRC 8 V	181.25	IRC 8 A	185.75
IRC 9 V	187.25	IRC 9 A	191.75
IRC 10 V	193.25	IRC 10 A	197.75
IRC 11 V	199.25	IRC 11 A	203.75
IRC 12 V	205.25	IRC 12 A	209.75
IRC 13 V	211.25	IRC 13 A	215.75
IRC 23 V	217.25	IRC 23 A	221.75
IRC 24 V	223.25	IRC 24 A	227.75
IRC 25 V	229.25	IRC 25 A	233.75
IRC 26 V	235.25	IRC 26 A	239.75
IRC 27 V	241.25	IRC 27 A	245.75
IRC 28 V	247.25	IRC 28 A	251.75
IRC 29 V	253.25	IRC 29 A	257.75
IRC 30 V	259.25	IRC 30 A	263.75
IRC 31 V	265.25	IRC 31 A	269.75
IRC 32 V	271.25	IRC 32 A	275.75
IRC 33 V	277.25	IRC 33 A	281.75

CATV IRC CHANNELS (cont)

Channel	Visual Carrier	Channel	Aural Carrier
IRC 34 V	283.25	IRC 34 A	287.75
IRC 35 V	289.25	IRC 35 A	293.75
IRC 36 V	295.25	IRC 36 A	299.75
IRC 37 V	301.25	IRC 37 A	305.75
IRC 38 V	307.25	IRC 38 A	311.75
IRC 39 V	313.25	IRC 39 A	317.75
IRC 40 V	319.25	IRC 40 A	323.75
IRC 41 V	325.25	IRC 41 A	329.75
IRC 42 V	331.25	IRC 42 A	335.75
IRC 43 V	337.25	IRC 43 A	341.75
IRC 44 V	343.25	IRC 44 A	347.75
IRC 45 V	349.25	IRC 45 A	353.75
IRC 46 V	355.25	IRC 46 A	359.75
IRC 47 V	361.25	IRC 47 A	365.75
IRC 48 V	367.25	IRC 48 A	371.75
IRC 49 V	373.25	IRC 49 A	377.75
IRC 50 V	379.25	IRC 50 A	383.75
IRC 51 V	385.25	IRC 51 A	389.75
IRC 52 V	391.25	IRC 52 A	395.75
IRC 53 V	397.25	IRC 53 A	401.75
IRC 54 V	403.25	IRC 54 A	407.75
IRC 55 V	409.25	IRC 55 A	413.75
IRC 56 V	415.25	IRC 56 A	419.75
IRC 57 V	421.25	IRC 57 A	425.75
IRC 58 V	427.25	IRC 58 A	431.75
IRC 59 V	433.25	IRC 59 A	437.75
IRC 60 V	439.25	IRC 60 A	443.75
IRC 61 V	445.25	IRC 61 A	449.75
IRC 62 V	451.25	IRC 62 A	455.75
IRC 63 V	457.25	IRC 63 A	461.75
IRC 64 V	463.25	IRC 64 A	467.75
IRC 65 V	469.25	IRC 65 A	473.75
IRC 66 V	475.25	IRC 66 A	479.75
IRC 67 V	481.25	IRC 67 A	485.75
IRC 68 V	487.25	IRC 68 A	491.75
IRC 69 V	493.25	IRC 69 A	497.75
IRC 70 V	499.25	IRC 70 A	503.75

UHF STANDARD G AND H CHANNELS

Channel	Visual Carrier	Channel	Aural Carrier
GH 21 V	471.25	GH 21 A	476.75
GH 22 V	479.25	GH 22 A	484.75
GH 23 V	487.25	GH 23 A	492.75
GH 24 V	495.25	GH 24 A	500.75
GH 25 V	503.25	GH 25 A	508.75
GH 26 V	511.25	GH 26 A	516.75
GH 27 V	519.25	GH 27 A	524.75
GH 28 V	527.25	GH 28 A	532.75
GH 29 V	535.25	GH 29 A	540.75
GH 30 V	543.25	GH 30 A	548.75
GH 31 V	551.25	GH 31 A	556.75
GH 32 V	559.25	GH 32 A	564.75
GH 33 V	567.25	GH 33 A	572.75
GH 34 V	575.25	GH 34 A	580.75
GH 35 V	583.25	GH 35 A	588.75
GH 36 V	591.25	GH 36 A	596.75
GH 37 V	599.25	GH 37 A	604.75
GH 38 V	607.25	GH 38 A	612.75
GH 39 V	615.25	GH 39 A	620.75
GH 40 V	623.25	GH 40 A	628.75
GH 41 V	631.25	GH 41 A	636.75
GH 42 V	639.25	GH 42 A	644.75
GH 43 V	647.25	GH 43 A	652.75
GH 44 V	655.25	GH 44 A	660.75
GH 45 V	663.25	GH 45 A	668.75
GH 46 V	671.25	GH 46 A	676.75
GH 47 V	679.25	GH 47 A	684.75
GH 48 V	687.25	GH 48 A	692.75
GH 49 V	695.25	GH 49 A	700.75
GH 50 V	703.25	GH 50 A	708.75
GH 51 V	711.25	GH 51 A	716.75
GH 52 V	719.25	GH 52 A	724.75
GH 53 V	727.25	GH 53 A	732.75
GH 54 V	735.25	GH 54 A	740.75
GH 55 V	743.25	GH 55 A	748.75
GH 56 V	751.25	GH 56 A	756.75
GH 57 V	759.25	GH 57 A	764.75
GH 58 V	767.25	GH 58 A	772.75
GH 59 V	775.25	GH 59 A	780.75
GH 60 V	783.25	GH 60 A	788.75
GH 61 V	791.25	GH 61 A	796.75
GH 62 V	799.25	GH 62 A	804.75
GH 63 V	807.25	GH 63 A	812.75
GH 64 V	815.25	GH 64 A	820.75
GH 65 V	823.25	GH 65 A	828.75
GH 66 V	831.25	GH 66 A	836.75
GH 67 V	839.25	GH 67 A	844.75
GH 68 V	847.25	GH 68 A	852.75

UHF STANDARD I CHANNELS

Channel	Visual Carrier	Channel	Aural Carrier
I 21 V	471.25	I 21 A	477.25
I 22 V	479.25	I 22 A	485.25
I 23 V	487.25	I 23 A	493.25
I 24 V	495.25	I 24 A	501.25
I 25 V	503.25	I 25 A	509.25
I 26 V	511.25	I 26 A	517.25
I 27 V	519.25	I 27 A	525.25
I 28 V	527.25	I 28 A	533.25
I 29 V	535.25	I 29 A	541.25
I 30 V	543.25	I 30 A	549.25
I 31 V	551.25	I 31 A	557.25
I 32 V	559.25	I 32 A	565.25
I 33 V	567.25	I 33 A	573.25
I 34 V	575.25	I 34 A	581.25
I 35 V	583.25	I 35 A	589.25
I 36 V	591.25	I 36 A	597.25
I 37 V	599.25	I 37 A	605.25
I 38 V	607.25	I 38 A	613.25
I 39 V	615.25	I 39 A	621.25
I 40 V	623.25	I 40 A	629.25
I 41 V	631.25	I 41 A	637.25
I 42 V	639.25	I 42 A	645.25
I 43 V	647.25	I 43 A	653.25
I 44 V	655.25	I 44 A	661.25
I 45 V	663.25	I 45 A	669.25
I 46 V	671.25	I 46 A	677.25
I 47 V	679.25	I 47 A	685.25
I 48 V	687.25	I 48 A	693.25
I 49 V	695.25	I 49 A	701.25
I 50 V	703.25	I 50 A	709.25
I 51 V	711.25	I 51 A	717.25
I 52 V	719.25	I 52 A	725.25
I 53 V	727.25	I 53 A	733.25
I 54 V	735.25	I 54 A	741.25
I 55 V	743.25	I 55 A	749.25
I 56 V	751.25	I 56 A	757.25
I 57 V	759.25	I 57 A	765.25
I 58 V	767.25	I 58 A	773.25
I 59 V	775.25	I 59 A	781.25
I 50 V	783.25	I 50 A	789.25
I 51 V	791.25	I 51 A	797.25
I 52 V	799.25	I 52 A	805.25
I 53 V	807.25	I 53 A	813.25
I 54 V	815.25	I 54 A	821.25
I 55 V	823.25	I 55 A	829.25
I 56 V	831.25	I 56 A	837.25
I 67 V	839.25	I 67 A	845.25
I 68 V	847.25	I 68 A	853.25

Tabular Tuning Tables – 2710 Operators

UHF STANDARD K AND L CHANNELS

Channel	Visual Carrier	Channel	Aural Carrier
KL 21 V	471.25	KL 21 A	477.75
KL 22 V	479.25	KL 22 A	485.75
KL 23 V	487.25	KL 23 A	493.75
KL 24 V	495.25	KL 24 A	501.75
KL 25 V	503.25	KL 25 A	509.75
KL 26 V	511.25	KL 26 A	517.75
KL 27 V	519.25	KL 27 A	525.75
KL 28 V	527.25	KL 28 A	533.75
KL 29 V	535.25	KL 29 A	541.75
KL 30 V	543.25	KL 30 A	549.75
KL 31 V	551.25	KL 31 A	557.75
KL 32 V	559.25	KL 32 A	565.75
KL 33 V	567.25	KL 33 A	573.75
KL 34 V	575.25	KL 34 A	581.75
KL 35 V	583.25	KL 35 A	589.75
KL 36 V	591.25	KL 36 A	597.75
KL 37 V	599.25	KL 37 A	605.75
KL 38 V	607.25	KL 38 A	613.75
KL 39 V	615.25	KL 39 A	621.75
KL 40 V	623.25	KL 40 A	629.75
KL 41 V	631.25	KL 41 A	637.75
KL 42 V	639.25	KL 42 A	645.75
KL 43 V	647.25	KL 43 A	653.75
KL 44 V	655.25	KL 44 A	661.75
KL 45 V	663.25	KL 45 A	669.75
KL 46 V	671.25	KL 46 A	677.75
KL 47 V	679.25	KL 47 A	685.75
KL 48 V	687.25	KL 48 A	693.75
KL 49 V	695.25	KL 49 A	701.75
KL 50 V	703.25	KL 50 A	709.75
KL 51 V	711.25	KL 51 A	717.75
KL 52 V	719.25	KL 52 A	725.75
KL 53 V	727.25	KL 53 A	733.75
KL 54 V	735.25	KL 54 A	741.75
KL 55 V	743.25	KL 55 A	749.75
KL 56 V	751.25	KL 56 A	757.75
KL 57 V	759.25	KL 57 A	765.75
KL 58 V	767.25	KL 58 A	773.75
KL 59 V	775.25	KL 59 A	781.75
KL 50 V	783.25	KL 50 A	789.75
KL 51 V	791.25	KL 51 A	797.75
KL 52 V	799.25	KL 52 A	805.75
KL 53 V	807.25	KL 53 A	813.75
KL 54 V	815.25	KL 54 A	821.75
KL 55 V	823.25	KL 55 A	829.75
KL 56 V	831.25	KL 56 A	837.75
KL 67 V	839.25	KL 67 A	845.75
KL 68 V	847.25	KL 68 A	853.75

UHF STANDARD M (JAPAN) CHANNELS

Channel	Visual Carrier	Channel	Aural Carrier
M 13 V	471.25	M 13 A	475.75
M 14 V	477.25	M 14 A	481.75
M 15 V	483.25	M 15 A	487.75
M 16 V	489.25	M 16 A	493.75
M 17 V	495.25	M 17 A	499.75
M 18 V	501.25	M 18 A	505.75
M 19 V	507.25	M 19 A	511.75
M 20 V	513.25	M 20 A	517.75
M 21 V	519.25	M 21 A	523.75
M 22 V	525.25	M 22 A	529.75
M 23 V	531.25	M 23 A	535.75
M 24 V	537.25	M 24 A	541.75
M 25 V	543.25	M 25 A	547.75
M 26 V	549.25	M 26 A	553.75
M 27 V	555.25	M 27 A	559.75
M 28 V	561.25	M 28 A	565.75
M 29 V	567.25	M 29 A	571.75
M 30 V	573.25	M 30 A	577.75
M 31 V	579.25	M 31 A	583.75
M 32 V	585.25	M 32 A	589.75
M 33 V	591.25	M 33 A	595.75
M 34 V	597.25	M 34 A	601.75
M 35 V	603.25	M 35 A	607.75
M 36 V	609.25	M 36 A	613.75
M 37 V	615.25	M 37 A	619.75
M 38 V	621.25	M 38 A	625.75
M 39 V	627.25	M 39 A	631.75
M 40 V	633.25	M 40 A	637.75
M 41 V	639.25	M 41 A	643.75
M 42 V	645.25	M 42 A	649.75
M 43 V	651.25	M 43 A	655.75
M 44 V	657.25	M 44 A	661.75
M 45 V	663.25	M 45 A	667.75
M 46 V	669.25	M 46 A	673.75
M 47 V	675.25	M 47 A	679.75
M 48 V	681.25	M 48 A	685.75
M 49 V	687.25	M 49 A	691.75
M 50 V	693.25	M 50 A	697.75
M 51 V	699.25	M 51 A	703.75
M 52 V	705.25	M 52 A	709.75
M 53 V	711.25	M 53 A	715.75
M 54 V	717.25	M 54 A	721.75
M 55 V	723.25	M 55 A	727.75
M 56 V	729.25	M 56 A	733.75
M 57 V	735.25	M 57 A	739.75
M 58 V	741.25	M 58 A	745.75
M 59 V	747.25	M 59 A	751.75
M 60 V	753.25	M 60 A	757.75
M 61 V	759.25	M 61 A	763.75
M 62 V	765.25	M 62 A	769.75

GLOSSARY

GENERAL TERMS

Amplitude Modulation – A radio transmission process in which the carrier frequency is modulated by changing its amplitude.

Calibrator Signal – A signal generated for the purpose of providing a reference, either amplitude or frequency or both.

Carrier – The wave of constant amplitude, frequency, and phase which can be modulated, by changing amplitude frequency or phase.

dBc – Decibels below carrier level.

Distortion – An undesired change in waveform caused by signal processing in a non-linear device or system.

Envelope Display – The display produced on a spectrum analyzer when the resolution bandwidth is greater than the spacing of the individual frequency components.

Filter – A circuit for separating signals on the basis of their frequency.

Frequency Modulation – Modulation of a sine-wave carrier so that its instantaneous frequency differs from the nominal carrier frequency by an amount proportionate to the instantaneous amplitude of the modulating wave.

Harmonic – A sinusoidal component of a periodic wave or quantity having a frequency that is an integral multiple of the fundamental frequency.

Intercept Point – The theoretical points at which the fundamental (driving) signals and the distortion products have equal amplitudes.

Intermodulation Spurious Response – A response resulting from non-linear elements of the spectrum analyzer. The resultant unwanted response will be displayed.

Line Display – The display produced on a spectrum analyzer when the resolution bandwidth is less than the spacing of the individual frequency components.

Line Spectrum – A spectrum composed of signal amplitudes of the discrete frequency components.

Maximum Safe Input Power (Without Damage) – The maximum power applied at the input that will not cause degradation of the instrument characteristics.

Maximum Safe Input Power (With Damage) – The minimum power applied at the input which will damage the instrument.

Noise – Unwanted disturbances superimposed upon a useful signal that tend to obscure its information.

Normalization – An internal process that uses firmware-based, adjustment routines to optimize instrument parameters with respect to an external reference and/or characterized internal reference/s.

Optimum Input Level – Design parameter of the first mixer which allows for maximum dynamic range (largest carrier to noise ratio) and minimum distortion.

Products – the resultant frequencies produced through mixing of two or more signals.

Reference Level – A selected level or amplitude associated with the top graticule line of the crt. Any signal displayed whose amplitude reaches the top line is said to have an amplitude equal to the Reference Level quantity.

Refresh Rate – The rate or frequency at which a swept crt display is refreshed (updated). This rate is typically greater than 50 Hz to avoid flicker.

RF Attenuator – A device which reduces the amplitude of an input signal to a level required by the mixer. The term RF implies linear operation into the high frequencies.

RF Input – The input connector or circuitry directly following the input connector.

Single Sweep – Operating mode for a triggered sweep instrument in which the sweep must be armed for each operation. Single Sweep provides a means of analyzing single event phenomena.

Scanning Velocity – Frequency span divided by sweep time and expressed in Hertz per second.

Spectrum Analyzer – A device which is generally used to display the power distribution of an input signal as a function of frequency.

Spurious Response – A characteristic of a spectrum analyzer wherein the displayed frequency does not conform to the input frequency.

Standing Wave – The distribution of current and voltage on a transmission line formed by two sets of waves traveling in opposite directions, and characterized by the presence of a number of points of successive maxima and minima in the distribution curves. Also called the stationary wave. The impedance mismatch of the transmission line and the termination causes reflections of the forward signal to combine with the forward signal (both in and out of phase) to produce the peaks and nulls.

Standing Wave Ratio (SWR) – The ratio of the maximum current (or voltage) to the minimum value of a standing wave. It is equal to the ratio of the characteristic line impedance to the load impedance.

Sweep Time – The time required for the trace to move across the full graticule width (usually expressed as Time/Division in a linear system).

Tracking Generator – A signal source whose output frequency tracks in synchronism with the input frequency of a spectrum analyzer.

Trigger – A signal used to initiate a triggered sweep.

Ultimate Rejection – The ability of a filter to reject or suppress a frequency other than which it was designed to pass.

Vertical Display Factor – The y-axis scale factor for display on a crt.

Voltage Standing Wave Ratio (VSWR) – The ratio of the amplitude of the electric field or voltage at a voltage maximum to that at an adjacent voltage minimum.

Video Filter – A post detection low-pass filter.

TERMS RELATED TO FREQUENCY

Center Frequency – The frequency that corresponds to the center of a frequency span; expressed in Hertz.

Display Frequency – The input frequency as indicated by the spectrum analyzer; expressed in Hertz.

Effective Frequency Range – The range of frequency over which the instrument performance is specified. The lower and upper limits are expressed in Hertz.

Frequency Band – A part of effective frequency range over which the frequency can be adjusted; expressed in Hertz.

Frequency Drift – Gradual shift or change in displayed frequency over the specified time due to internal changes in the spectrum analyzer; expressed in Hertz per second, where other conditions remain constant.

Frequency Linearity Error – The error of the relationship between the frequency of the input signal and the frequency displayed; expressed as a ratio.

Frequency Span – The magnitude of the frequency band displayed; expressed in Hertz (for the full screen width) or Hertz per division.

Impulse Bandwidth – The displayed spectral level of an applied pulse divided by its spectral voltage density level assumed to be flat within the pass-band.

Maximum Span – A mode of operation in which the effective frequency range is scanned.

Residual FM – (Incidental FM) Short term displayed frequency instability or jitter due to instability in the spectrum analyzer local oscillators, given in terms of peak-to-peak frequency deviation and expressed in Hertz or percent of the displayed frequency.

Resolution – The degree of ability to discretely display adjacent signal frequencies. The measure of resolution is the frequency separation of two responses which merge with a 3-dB notch. At very long sweep times, Resolution and Resolution Bandwidth are synonymous.

Resolution Bandwidth – The width in Hz of the spectrum analyzer's response to a continuous wave signal. This width is defined as the frequency difference at specified points on the response curve, such as 3 or 6 dB down points. (Sweep time must be substantially long.)

Shape Factor (Skirt Selectivity) – The ratio of the frequency difference of the two (60 dB/6 dB) down points on the response curve of the resolution bandwidth.

Zero Hz Marker (Start Spur) – The response that appears when the frequency of the 1st local oscillator is equal to the intermediate frequency. It is sometimes deliberately not suppressed to provide a zero frequency marker.

Zero Span – A mode of operation in which the frequency span is reduced to zero.

TERMS RELATED TO AMPLITUDE

Deflection Coefficient – The ratio of the input signal magnitude to the resultant output indication.

NOTE

The ratio may be expressed in terms of volts (rms) per division, decibels per division, watts per division, or any other specified factor.

Display Flatness – The unwanted variation of the displayed amplitude over a specified frequency span, expressed in decibels.

Display Law – The mathematical law that defines the input-output function of the instrument.

- **Linear** – A display in which the scale divisions are a linear function of the input signal voltage.
- **Square law** – A display in which the scale divisions are a linear function of the input signal power.
- **Logarithmic** – A display in which the scale divisions are a logarithmic function of the input signal voltage.

Display Reference Level – A designated vertical position representing a specified input level.

NOTE

The level may be expressed in dBm, volts, or any other units.

Dynamic Range – The maximum ratio of the levels of two signals simultaneously present at the input which can be measured to a specified accuracy.

Equivalent Input Noise Sensitivity – The average level of a spectrum analyzer's internally-generated noise referenced to the input.

Frequency Response – The peak-to-peak variation of the displayed amplitude over a specified center frequency range, measured at the center frequency; expressed in decibels.

Gain Compression – Maximum input level where the scale linearity error is below that specified.

Hum Sidebands – Undesired responses created within the spectrum analyzer, appearing on the display, that are separated from the desired response by the fundamental or harmonic of the power-line frequency.

Input Impedance – The impedance at the desired input terminal, usually expressed in terms of vswr, return loss, or other related terms at a given impedance for low impedance devices and resistance-capacitance parameters for high-impedance devices.

Noise Sidebands – Undesired response caused by noise internal to the spectrum analyzer appearing on the display around a desired response.

Relative Display Flatness – The display flatness measured relative to the display amplitude at a fixed frequency within the frequency span; expressed in decibels.

Residual Response – A spurious response in the absence of an input signal. (Noise and start spur are excluded.)

Sensitivity – Measure of a spectrum analyzer's ability to display minimum level signals, at a given IF bandwidth, display mode, and any other influencing factors; expressed in decibels.

Spurious Response – A response of a spectrum analyzer where the displayed frequency does not conform to the input frequency.

TERMS RELATED TO DIGITAL STORAGE

Digitally Averaged Display – A display of the average value of digitized data computed by combining serial samples in a defined manner.

Display – Enables viewing of contents of a display register.

Ensemble Averaging – Finding and saving the numerical average of specified data (max, min, etc.) within each horizontal data point (field) over successive sweeps.

Horizontal Data Point – One of 512 reference points along the Horizontal axis.

Max Hold (Peak Mode) – Digital storage mode that compares, at each horizontal data point, the incoming signal level to the stored level and retains the greater. In this mode, the display indicates the peak level that occurred at each data point after several successive sweeps.

Multiple Display Memory – A digitally-stored display with multiple memory sections that can be displayed separately or simultaneously.

Save – A function that inhibits display register update.

Stored Display – A display method whereby the displayed function is held in a digital memory. The display is generated by reading the data out of memory.

TERMS RELATED TO MARKERS

Active Marker – The dot displayed in the Marker mode whose position is moveable with the FREQUENCY/MARKERS control.

Reference Marker – A second marker that appears at the position of the active marker when Delta Marker Mode is invoked. The Reference Marker position is fixed on the display.

MANUAL CHANGE INFORMATION

At Tektronix, we continually strive to keep up with latest electronic developments by adding circuit and component improvements to our instruments as soon as they are developed and tested.

Sometimes, due to printing and shipping requirements, we can't get these changes immediately into printed manuals. Hence, your manual may contain new change information on following pages.

A single change may affect several sections. Since the change information sheets are carried in the manual until all changes are permanently entered, some duplication may occur. If no such change pages appear following this page, your manual is correct as printed.



DESCRIPTION

This information applies to all 2710 Spectrum Analyzers with Option 04 installed.

GENERAL INFORMATION

DESCRIPTION

2710 Tracking Generator generates a sweep frequency which tracks the frequency window of the 2710 Spectrum Analyzer with the following features:

- A microprocessor-controlled frequency adjustment for correlating the generator frequency with the Spectrum Analyzer's window.
- Optimum flatness
- Microprocessor-controlled output levels
- Excellent harmonic and spur performance
- 50 Ω nominal output impedance

Output Level Control

There are two methods of controlling the output level: first, by keyboard entry via the DET/GEN MENU and second, via the Spectrum Analyzer LEVEL control. The LEVEL control allows some dynamic level control, uncalibrated, while the instrument is sweeping. When using the LEVEL control, the Tracking Generator level readout is suffixed with an asterisk to indicate that the level is not calibrated. The keyboard entry method produces a calibrated output level.

ACCESSORIES

Standard Accessories

Item	Tektronix/No.
Adapter 50 Ω N Male to BNC Female	103-0045-00
75 Ω -to-50 Ω Minimum Loss Attenuator, N Male to BNC Female	131-4199-00

**Table 1
ELECTRICAL CHARACTERISTICS**

Characteristics	Performance Requirement	Supplemental Information
Frequency Range		
Nominal	100kHz to 1.8GHz, tracks the 2710 input	
TG TRACKING (Frequency Offset)	Sufficient to align Tracking Generator to Spectrum Analyzer window, typically -5 kHz to + 60 kHz	Auto Frequency correction for centering into Spectrum Analyzer window
Output Level		
Range	-48 dBm to 0 dBm	0.1 dB steps
Accuracy	±1.5 dB	At 100 MHz
Output Impedance		50Ω nominal
VSWR	2:1 or better with output level ≤ -8 dBm	
Flatness		
Tracking Generator	±1 dB from 100 kHz to 1.0 GHz and ±1.5 dB to 1.8 GHz	Typically ±1 dB to 1.8 GHz
System ^a	±2.5 dB from 100 kHz to 1.0 GHz and ±3 dB to 1.8 GHz	With 10 dB of attenuation in the Spectrum Analyzer
User-Corrected	±0.2 dB	Using B,C- Save A Flatness feature
System Dynamic Range	≥100 dB	Sensitivity ≥ -100 dBm
System Residual FM		
Option 01 Instruments		≤100 Hz _{p-p} total excursion in 20 ms
Non-Option 01 Instruments		≤ 2 kHz _{p-p} total excursion in 20 ms
Spurious Signals		
Harmonic	-20 dBc or better with respect to the fundamental	At frequencies ≥100 kHz
Non-Harmonic	-35 dBc or better with respect to the fundamental	

^a System = Tracking Generator and Spectrum Analyzer combination.

CONTROLS, INDICATORS, AND CONNECTORS

CONTROLS

The Tracking Generator mode is initiated by selecting "TRACKING GENERATOR" in the DET/GEN MENU. The front-panel GEN LED lights at this time to indicate that the Tracking Generator is enabled.

The Tracking Generator is incompatible with the calibrator mode. Consequently, the calibrator mode is automatically turned off by the firmware when the Tracking Generator is enabled.

The output level of the Tracking Generator may be set from 0.0 to -48.0 dBm in 0.1 dB increments via the DET/GEN menu. This range is converted to match the current reference level units.

The front-panel LEVEL control may be enabled if continuous adjustment over a small range (several dB) is required. If the level CONTROL is enabled, the Tracking Generator level will be marked with a "*" symbol and the level cannot be guaranteed.

If the Tracking Generator frequency offset is not correct, due to long external lines, the signal may be "peaked up" by invoking "TG OFFSET" and setting the FREQ/MARKERS control for maximum signal response. The offset frequency has is set at a fixed rate for all instrument settings.

The Tracking Generator mode is exited by pressing DET/GEN MENU/#4. The calibrator mode is not restored if it had been automatically disabled when the Tracking Generator was enabled.

All Tracking Generator settings are recalled during a Power-Down/Power-Up cycle, including output on/off, manual adjust on/off, output level setting, output level offset, and frequency offset setting.

The following are the factory default settings for the Tracking Generator parameters:

- TG Enable = OFF
- TG Output Level = -48.0 dBm (or equivalent)
- TG Manual Adjust = OFF
- TG Frequency Offset = 0.0
- TG Amplitude Offset = 0.0

Tracking Generator on/off

The Tracking Generator is enabled and disabled via keypad sequence DET/GEN MENU/#4. The output level is automatically set at the last selected level when the Tracking Generator is enabled. The menu in Figure 1 exits to the spectral display after the Tracking Generator is enabled.

Output Level

There are two ways of setting the output level.

1. The output level may be precisely set by pressing DET/GEN MENU/#5 (GENERATOR LEVEL) and entering the desired level via the keypad. This method yields a calibrated output level.
2. The output level may be set by pressing DET/GEN MENU/#5 and entering a level near the desired level, then pressing #6 (TG VARIABLE LEVEL) and varying the LEVEL control for the actual desired level. This method yields an uncalibrated output level. When enabled, the LEVEL control has a total range of about 4dB, and the level indicator readout is suffixed by a "*" symbol, indicating an uncalibrated output level. See Figure 2.

In some Spectrum Analyzers the peak of the 5 MHz resolution bandwidth filter is not centered about its bandpass. This can result in some amplitude variation when switching from the 5 MHz resolution filter to a narrower filter. Relative responses using the 5 MHz filter are not affected. Determine the amount of error by first making a measurement using the 5 MHz resolution bandwidth filter then making another measurement using the 300 kHz resolution bandwidth filter (the peak of the 300 kHz resolution bandwidth filter is centered about its bandpass). Note the difference, and correct any measurements made with the 5 MHz resolution bandwidth filter by that amount.

The flatness of the Tracking Generator output may vary slightly with different output level settings. This output flatness variation can be removed by using the B,C MINUS A feature of the Spectrum Analyzer as follows:

- a. Prior to making a test measurement, set the measurement parameters such as center frequency, span, resolution bandwidth, reference level, and Tracking Generator output level.

- b. Connect the Tracking Generator output to RF INPUT, and save the resultant sweep in the A register.
- c. Insert the device to be tested.
- d. Enable the B,C MINUS A mode by pressing DSPL MENU/#2.

devices such as modulators or transmitters. To avoid these problems, use the Tracking Generator fixed level and the Spectrum Analyzer reference level controls to move signals vertically on the screen, rather than using the variable level feature.

Make all measurements in the B,C MINUS A mode. This method cancels out the variations in Spectrum Analyzer/Tracking Generator system response leaving only the response of the device under test.

VARIABLE LEVEL Feature - Set the LEVEL control fully counterclockwise. Set the TG FIXED LEVEL to within a few tenths of a dB less than the desired output level. Enable the TG VARIABLE LEVEL and set the LEVEL control for the desired level as viewed on the display.

Setting the variable level above the fixed level may result in some degradation of the 2nd harmonic specification. Normally, this is not a problem with passive linear devices. However, it can result in some intermodulation products with non-linear devices, and spurious radiation from active

Output Frequency Tracking

Sometimes the Tracking Generator frequency may not track the Spectrum Analyzer frequency window due to long external lines (group delay). The effect of group delay is readily apparent in narrow resolution bandwidth filters. To find out if group delay is present, select a narrow resolution bandwidth filter, e.g. 3 kHz, and check to see if the amplitude drops. If the amplitude does drop, invoke "TG TRACKING" (DET/GEN MENU/#7) and set the FREQ/MARKERS control for maximum amplitude (optimum tracking).

The Knob Function (MKR/FREQ MENU/#2) automatically defaults to TG TRACKING when TG TRACKING is invoked (via the DET/GEN MENU).

DETECTOR/GENERATOR MENU

0	*OFF		
1	AM DETECTOR		
2	FM DETECTOR		
3	AM & FM DETECTOR		
4	TRACKING GENERATOR	OFF	(ON)
5	TG FIXED LEVEL	current	[-45.5 DBM, *-45.5 DBM]
6	TG VARIABLE LEVEL	OFF	(ON)
7	TG TRACKING	OFF	(ON)
8	TG EXT ATTEN/AMPL	NONE	[-10.5DB]

= PREVIOUS MENU
 MENU KEY = RETURN TO DISPLAY

Figure 1. This menu is displayed when the DETECTOR/GENERATOR MENU is invoked.

PERFORMANCE CHECK

Introduction

The performance check procedures verify that the instrument is performing according to the characteristics specified under the Performance Requirement column in the Specification.

History Information

The instrument and manual are periodically evaluated and updated. If modifications require changes in the procedures, information applicable to earlier instruments will be included within a step or as a sub-part to a step.

Verification of Tolerance Values

Tests shall be performed only after the normalizations have occurred. If a test should fail, normalize the instrument by pressing UTIL MENU/#3/#0, then press UTIL MENU/#3/#3 and follow screen prompts. The normalization will correct for any changes in the operating environment due to time or temperature.

Measurement tolerance of test equipment should be negligible in comparison to the specification being tested. If not, the error of the measuring apparatus must be added to the specification tolerance.

Tracking Generator Settings

Tracking Generator parameters are set via DET/GEN MENU.

Equipment Required

Table 2 lists the test equipment recommended for the Performance Check. The characteristics specified are the minimum. If equipment is substituted, it must meet or exceed these specifications.

Table 2
RECOMMENDED TEST EQUIPMENT

Test Equipment	Characteristics	Recommendation
Spectrum Analyzer	Frequency range at least 2 GHz to 4 GHz	TEKTRONIX 492PGM
Tracking Generator	Frequency Range : 100 kHz to at least 1.8 GHz	TEKTRONIX TR503
Test Oscilloscope	Deflection Factor: 2 mV/Div to 5 V/Div; Bandwidth: DC to 100 Mhz, and X-Y display capability	TEKTRONIX 2236A-Series Oscilloscope and P6108A X10 Probes
10 dB and 1 dB Step Attenuators	Range : 132 dB in combination 10 dB and 1 dB steps Accuracy: ± 0.1 dB. Frequency Range: 0 to at 1 GHz	Hewlett Packard 355C and 355D, calibrated using precision standard attenuators such as Weinchel Model AS-6
Power Meter with Power Sensors	-30 dBm to +20 dBm full scale; 100 kHz to 4.2 GHz	Hewlett Packard Model 436A with 8482A and 8484A Sensors
Frequency Counter	0 to 200 MHz, 1 Hz resolution, 25 mV sensitivity	TEKTRONIX DC 510 with TM500-Series Power Module
VSWR Bridge	10 MHz to 1 GHz	Wiltron VSWR Bridge 62BF50

PERFORMANCE CHECK PROCEDURE

Power Up Procedure

- a. Apply power to the Spectrum Analyzer.
- b. The instrument will initialize itself according to the configuration stored in the USR DEF (User Defined) Power Up settings. If this register is empty it will initialize to the configuration stored in the Factory Default Power Up settings.
- c. Allow a 30 minute warm up period before continuing this procedure.
- d. The Spectrum Analyzer/Tracking Generator system must be normalized before any measurements can be made. Invoke Spectrum Analyzer normalizations by pressing UTIL MENU/#3/#0. The instrument will begin normalizations and print progress messages on the CRT. After Spectrum Analyzer normalizations are complete, invoke Tracking Generator normalizations by pressing UTIL MENU/#3/#3 and follow screen prompts.
- e. After the instrument has completed normalization, press UTIL MENU/#5/#5/#0 to display frequency normalization results. Verify that all frequency related tests have passed.
- g. Press the backspace arrow (LIN) and #2 to display amplitude normalization results. Verify that all amplitude related tests have passed.
- h. Press UTIL MENU to exit.

1. Check Frequency Range

(100 kHz to 1.8 GHz)

- a. Connect the Tracking Generator output to the RF INPUT.
- b. Select the following settings on the Spectrum Analyzer:

FREQUENCY	1 GHz
REFERENCE LEVEL	+10 dBm
FREQ SPAN/DIV	MAX SPAN
RESOLUTION BW	Auto
VERTICAL SCALE	10 dB/div

- c. Set the Tracking Generator output at 0 dBm by pressing DET/GEN MENU/#5 and entering 0 dBm. Press keypad #4 to enable the Tracking Generator.
- d. Check that the Spectrum Analyzer displays a sweep signal from 100 kHz to at least 1.8 GHz with a level of approximately 0 dBm.
- e. Recall default power-up settings by pressing UTIL MENU/#1/#1.

2. Check Tracking (Frequency Offset)

(typically -5 kHz to +60 kHz)

Test equipment required:

- Test Spectrum Analyzer

- a. Monitor the Tracking Generator output with the test spectrum analyzer.

- b. Set the test spectrum analyzer as follows:

Center Frequency	900 MHz
Reference Level	0 dBm
Span/Div	20 kHz
Resolution Bandwidth	1 kHz

- c. Select the following Spectrum Analyzer /Tracking Generator system parameters:

FREQUENCY	900 MHz
FREQ SPAN/DIV	1 kHz
RESOLUTION BW	Auto

- d. Enable the Tracking Generator by pressing DET/GEN MENU/#4. Set the Tracking Generator output level at 0 dBm, then enable TG TRACKING by pressing DET/GEN MENU/#7. Press DET/GEN to exit the menu.

- e. Tune the FREQ/MARKERS knob such that the tracking readout (lower right corner of system display) reads 0 Hz.

- f. Press SGL SWP on the Spectrum Analyzer. Center the display on the test spectrum analyzer with the center frequency control knob then save the display (in the test spectrum analyzer).

- g. Vary the FREQ/MARKERS control clockwise until the system beeps and indicates "OUT OF RANGE."

- h. Check that the signal on the test spectrum analyzer has moved three divisions to the right of the center position.

- i. Reset the test spectrum analyzer Span/Div to 5 kHz, and repeat parts e and f.

- j. Vary the FREQ/MARKERS control counter-clockwise until the system beeps and indicates "OUT OF RANGE."

- k. Check that the signal on the test spectrum analyzer has moved one division to the left of the center position.

Figure 1 Legend

- (XX) = Values within parentheses indicate alternate choices
- [kk] = Values within square brackets indicate setting examples
- * = An asterisk before any one of the first four items in the menu indicates a selection, and an asterisk before the generator's output amplitude indicates that the variable level (TG VARIABLE LEVEL) has been enabled.

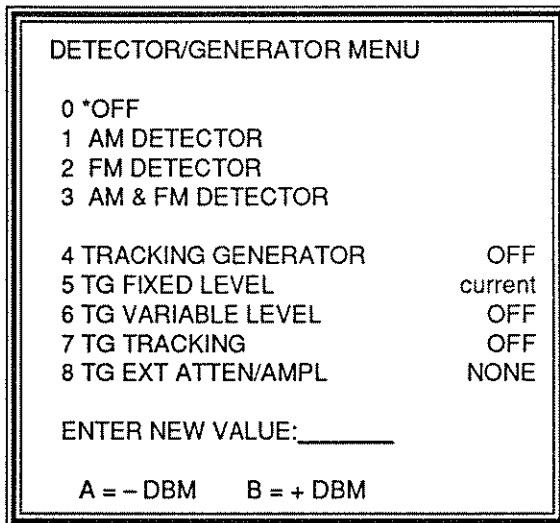

Figure 2. Menu displayed when keypad entered level adjustment (#5 GENERATOR LEVEL) is invoked.

External Attenuator/Amplifier Compensation – In certain cases, the user may wish to attenuate or boost the output signal. In these cases, the readout may be made to display the signal amplitude after the external attenuator or amplifier. The DET/GEN MENU/#8 selection allows the user to enter offset values for an external attenuator or amplifier, such that the readouts indicate the true value of the signal at the output of the attenuator or amplifier. The menu in Figure 3 is displayed when selection 8 is invoked.

To enter an external attenuator or amplifier gain, select #1 (ATTEN/AMPL ENTRY) in Figure 3. The following submenu will be displayed. The difference between this menu and that of Figure 3 is the prompt to enter a new value.

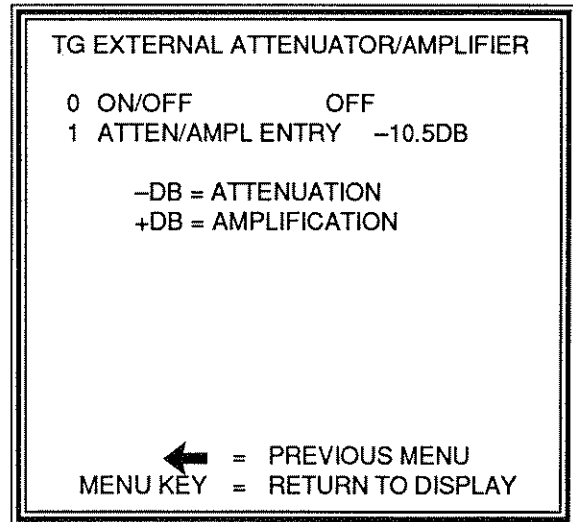

Figure 3. Menu displayed when TG EXT ATTEN/AMPL (DET/GEN MENU/#8) is invoked.

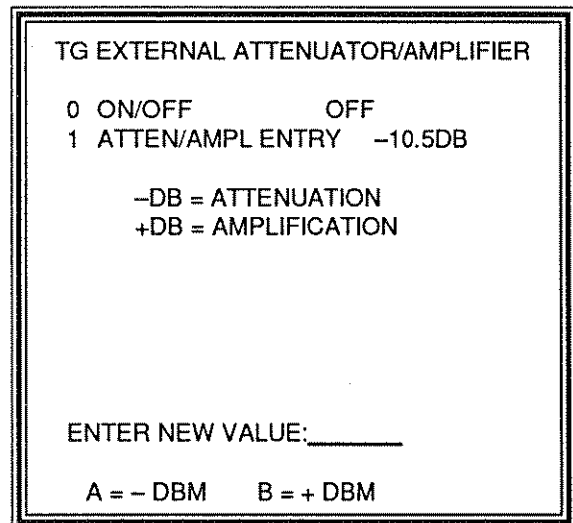

Figure 4. External attenuator/gain value entry Menu.

After the new value is entered, it is applied to the TG level readouts, and the menu reverts to the DETECTOR /GENERATOR MENU.

When #0 is selected in the preceding menu (Figure 3), the entered gain factor is applied to the output level readouts, and the menu reverts to the DETECTOR /GENERATOR MENU.

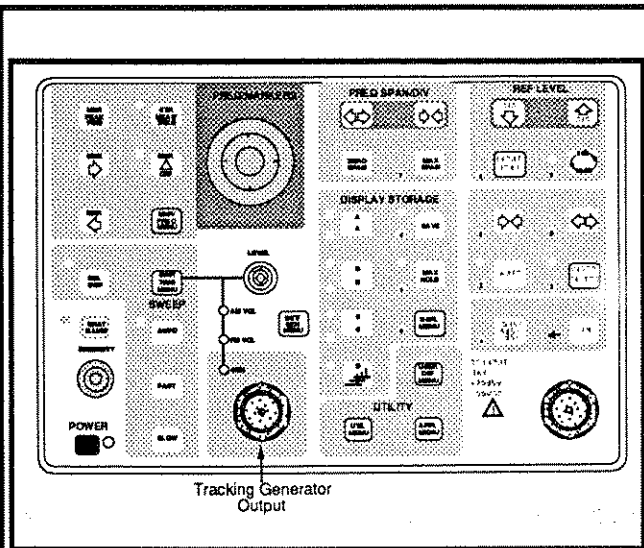

Figure 5. Spectrum Analyzer front panel.

INDICATORS

The GEN LED is the only indicator for the tracking Generator. It is illuminated only when the Tracking Generator is enabled.

CONNECTORS

The Tracking Generator output connector is an N-Type, 50 Ω connector at the front panel of the Spectrum Analyzer. See Figure 5.

NORMALIZATIONS

The term "normalization" describes any internal firmware routine that makes a parameter calibrated (normal) with respect to an internal reference.

here are three kinds of normalizations, viz:

Reference normalizations, amplitude normalizations, and frequency normalizations. For optimum results, normalizations should be performed in the following sequence.

1. Perform reference normalizations prior to frequency, amplitude, and Tracking Generator normalizations by pressing UTIL MENU/#5/#5/#1 and following screen prompts.
2. Perform frequency and amplitude normalizations by pressing UTIL MENU/#3/#0/C (Figure 6).
3. Perform Tracking Generator normalizations by pressing UTIL MENU/#3/#3/C/C.

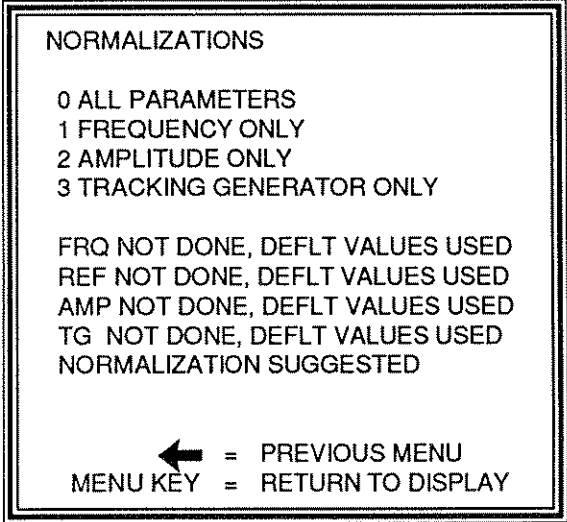

Figure 6. Menu displayed when UTIL MENU/#3 is pressed.

NOTE

In the UTIL MENU /#3 sub-menu, item 0 (ALL PARAMETERS) does not affect the Tracking Generator parameters.

When #3 (TRACKING GENERATOR ONLY) in Figure 6 is selected, all of the Tracking Generator normalizations are executed.

3. Check Output Level Range and Accuracy

(Range: -48 dBm to 0 dBm)
 (Accuracy: ± 1.5 dB at 100 MHz)

Test equipment required:

- Power Meter

NOTE

This check step requires two power sensors; one to measure a level approximately -48 dBm and the other to measure a level approximately 0 dBm. The low power sensor must be calibrated using a precision 30 dB attenuator such as a Weinschell Model 50 - 30.

WARNING

Be sure to turn the power meter off before removing or connecting a power sensor.

- a. Set the following Spectrum Analyzer /Tracking Generator system parameters:

FREQUENCY	100 MHz
REFERENCE LEVEL	-30 dBm
FREQ SPAN/DIV	ZERO
SWEEP RATE	AUTO
TG FIXED LEVEL	-48 dBm
TG VARIABLE LEVEL	OFF
TG TRACKING	OFF
TRACKING GENERATOR	ON

- b. Connect the output of the Tracking Generator to the power meter using the low power sensor.

- c. Check that the power meter indicates -48 dBm ± 1.5 dB.

- d. Turn off the power meter and replace the low power sensor with the high power sensor, then turn the power meter back on.

- e. Reset the Tracking Generator output level to 0 dBm by pressing DET/GEN MENU/#5 and entering 0 dBm.

- f. Check that the power meter reads 0 dBm ± 1.5 dB.

- g. Recall default power-up settings by pressing UTIL MENU/#1/#1.

4. Check Return Loss

(10 dB or better with output Level -8 dBm)

Test equipment required:

- VSWR Bridge
- Test Spectrum Analyzer with Tracking Generator (Tektronix 492A and TR503)

- a. Connect the test equipment as shown in Figure 7.

- b. On the 2710 front panel, press DET/GEN MENU/#5 and enter -8 dBm (enables 8 dB of attenuation at the Tracking Generator output).

- c. Set the following parameters on the test spectrum analyzer:

Span/Div	Max Span
Reference Level	0 dBm
Vertical Scale	10 dB/div

- d. Set the TR503 output level at 0 dBm.

- e. Disconnect the cable from the 2710 Tracking Generator output connector, and press [B-SAVE A] on the test spectrum analyzer. The resultant display is the measurement reference.

- f. Reconnect the cable to the 2710 Tracking Generator output.

- g. Check that the displayed response on the test spectrum analyzer is ≥ 1 division down from the reference established in part e. Ignore the spur that appears at the center frequency of the Spectrum Analyzer.

- h. Recall default power-up settings by pressing UTIL MENU/#1/#1.

5. Check Tracking Generator Flatness

(± 1 dB from 100 kHz to 1.0 GHz and ± 1.5 dB to 1.8 GHz)

Test equipment required:

- Power Meter
- Test Oscilloscope

- a. Connect the test equipment as shown in Figure 8.

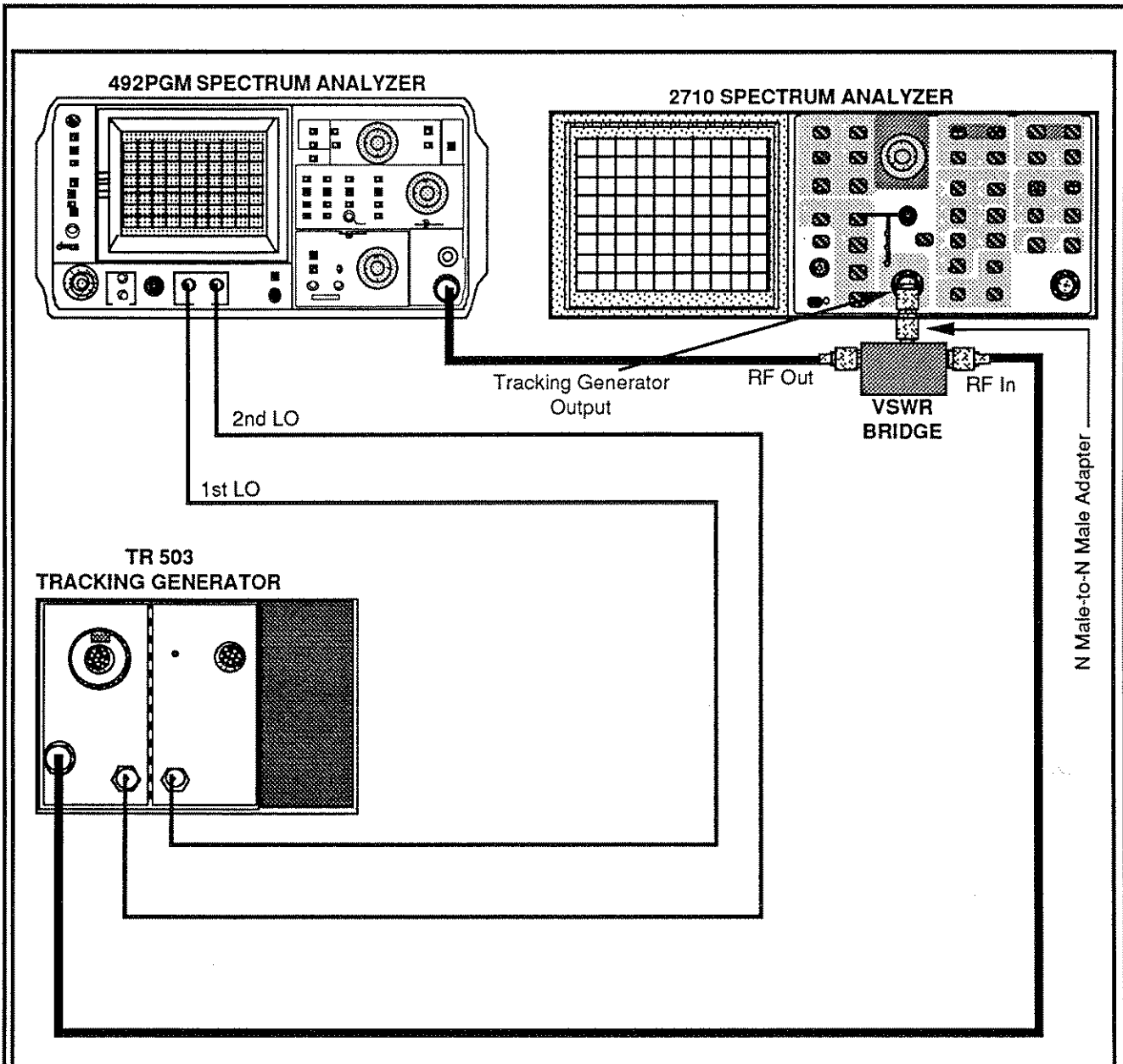

Figure 7. Test setup for measuring return loss.

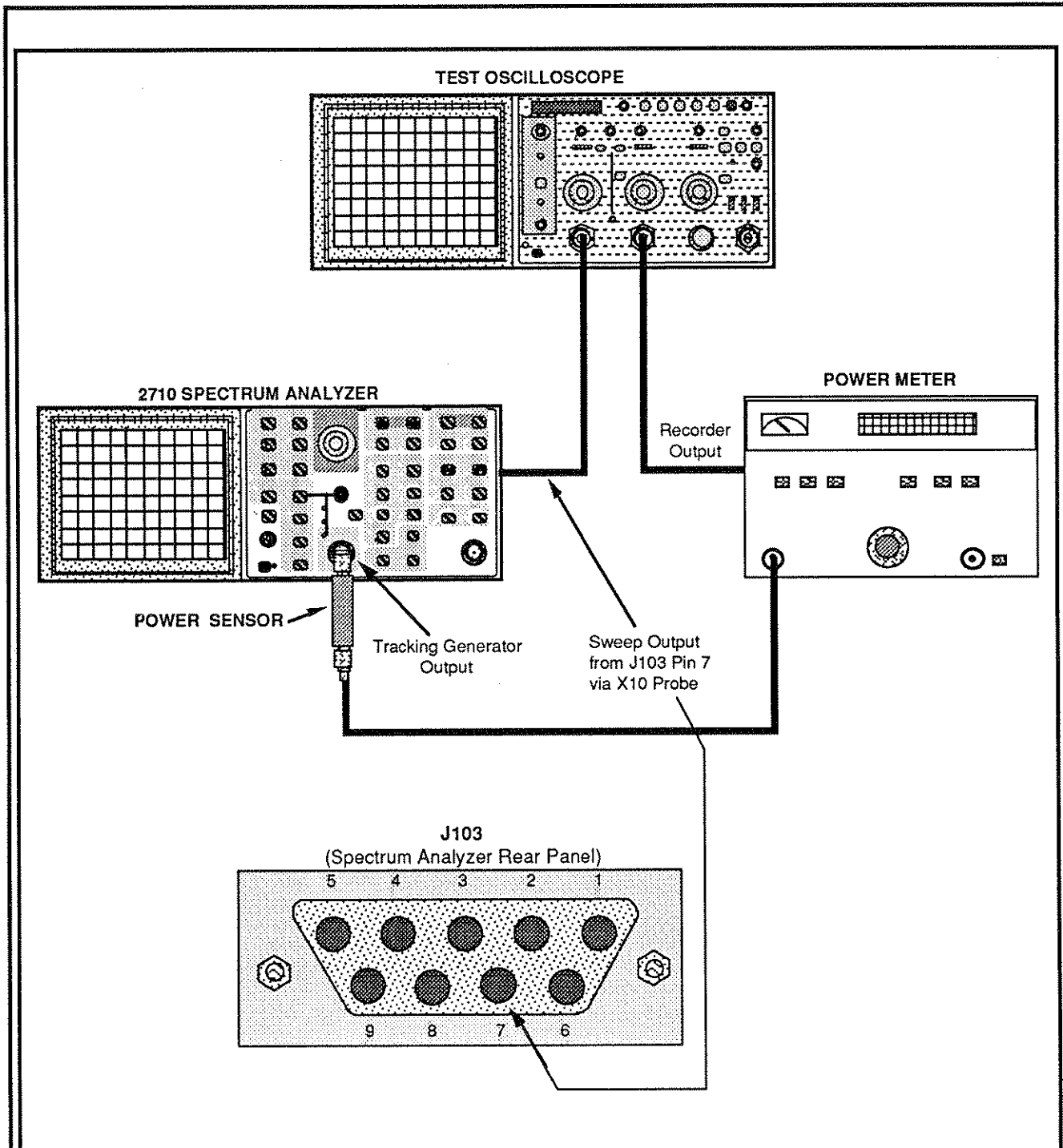

Figure 8. Test setup for measuring Tracking Generator flatness.

b. Set the following Spectrum Analyzer/Tracking Generator system parameters:

FREQUENCY	500 MHz
REFERENCE LEVEL	0 dBm
FREQ SPAN/DIV	100 MHz
RESOLUTION BW	AUTO
VERTICAL SCALE	1 dB/div
TG FIXED LEVEL	0 dBm
TG VARIABLE LEVEL	OFF
TG TRACKING	OFF
TRACKING GENERATOR	ON

c. Set up the test oscilloscope for X-Y operation. The sweep signal from pin 7 of J103 drives the X-axis and the power meter output (Recorder Output) drives the Y-axis. Set the Y-axis deflection factor (V/Div and Variable) for a full horizontal deflection.

d. Enable manual sweep on the Spectrum Analyzer/Tracking Generator system by pressing SWP/TRIG MENU/#7.

e. Manually sweep the Spectrum Analyzer slowly from 100 kHz to 1 GHz while viewing the flatness trace on the test oscilloscope. Make a note of the highest and lowest points on the flatness trace as read on the power meter.

f. Check that the difference in amplitude between the highest and lowest points on the flatness trace excluding the start spur is ≤ 2 dB.

g. Manually sweep the Spectrum Analyzer slowly from 100 kHz to 1.8 GHz while viewing the flatness trace on the test oscilloscope. Make a note of the highest and lowest points on the flatness trace.

h. Check that the difference in amplitude between the highest and lowest points on the flatness trace is ≤ 3 dB from 1 GHz to 1.8 GHz.

i. Recall default power-up settings by pressing UTIL MENU/#1/#1.

6. Check System Flatness

(± 2.5 dB from 100 kHz to 1.0 GHz and 3 dB to 1.8 GHz)

a. Select the following settings on the Spectrum Analyzer:

FREQUENCY	500 MHz
REFERENCE LEVEL	2 dBm
FREQ SPAN/DIV	100 MHz
RESOLUTION BW	AUTO
VERTICAL SCALE	1 dB/div
SWEEP	AUTO
TG FIXED LEVEL	0 dBm
TG VARIABLE LEVEL	OFF
TG TRACKING	OFF
TRACKING GENERATOR	ON

b. Connect the output of the Tracking Generator to the RF INPUT.

c. Make a note of the highest and lowest points on the flatness trace from 100 kHz to 1 GHz. Ignore the start spur.

d. Check that the difference in amplitude between the highest and lowest points on the flatness trace excluding the start spur is ≤ 5 dB.

e. Make a note of the highest and lowest points on the flatness trace from 100 kHz to 1.8 GHz.

f. Check that the difference in amplitude between the highest and lowest points on the flatness trace is ≤ 6 dB.

g. Recall default power-up settings by pressing UTIL MENU/#1/#1.

7. Check Characterized Flatness

(± 0.2 dB)

a. Connect the output of the Tracking Generator to the RF INPUT.

b. Select the following settings on the Spectrum Analyzer:

FREQ SPAN/DIV	MAX SPAN
RESOLUTION BW	AUTO
VERTICAL SCALE	1 dB/div
TG FIXED LEVEL	0 dBm
TG VARIABLE LEVEL	OFF
TG TRACKING	OFF
TRACKING GENERATOR	ON

c. Set the reference for a visible display (≈ 2 dBm).

d. Enable single sweep on the Spectrum Analyzer by pressing SGL SWP. Press SGL SWP again to initiate a sweep.

e. Store the single sweep waveform in Register A by pressing SAVE and then A.

f. Enable the B display and ensure that all other displays are disabled.

g. Enable B, C MINUS A by pressing DISPLAY MENU/#2.

h. Initiate a single sweep on the Spectrum Analyzer by pressing SGL SWP.

i. Check for a flat trace across the screen. The Trace flatness must be within a minor division (± 0.2 dB). Ignore the start spur and switching transients.

j. Recall default power-up settings by pressing UTIL MENU/#1/#1.

8. Check Spurious Signals

(Harmonic: -20 dBc or better)
(Non-Harmonic: -35 dBc or better)

Test equipment required:

- Test Spectrum Analyzer (Tektronix 492PGM)

a. Set the following Spectrum Analyzer/Tracking Generator system parameters:

FREQUENCY	100 kHz
FREQ SPAN/DIV	ZERO SPAN
TG FIXED LEVEL	0 dBm
TG VARIABLE LEVEL	OFF
TG TRACKING	OFF
TRACKING GENERATOR	ON

b. Monitor the output of the Tracking Generator with the test spectrum analyzer.

c. Set the test spectrum analyzer parameters as follows:

Frequency	500 kHz
Reference Level	0 dBm
Freq Span/Div	100 kHz
Resolution BW	Auto
Vertical Scale	10 dB/Div
Min Noise	On
Peak Average	Fully counter-clockwise
Sweep Rate	Auto

d. The test spectrum analyzer will display harmonic spurs approximately one division apart. The signal at the left graticule line is the start spur (0 Hz), the signal to the right of the start spur is the fundamental, and all signals to the right of the fundamental signal are harmonic spurs. See Figure 9.

e. Check that the harmonic spurs are at least 20 dB down from the fundamental.

f. Reset the test spectrum analyzer span/div to Max Span, and enable MAX SPAN on the Spectrum Analyzer/Tracking Generator.

g. On the Spectrum Analyzer/Tracking Generator system, enable MANUAL SCAN by pressing SWP/TRIG MENU/#7.

h. Manually sweep the Spectrum Analyzer/Tracking Generator system slowly from 100 kHz to 1.8 GHz while observing the test spectrum analyzer display. The high signal moving from left to right as the system is manually swept is the fundamental. Other signals that move from left to right are harmonic spurs and signals that move from right to left are non-harmonic spurs.

i. Check that all harmonic spurs are at least 20 dB down from the fundamental.

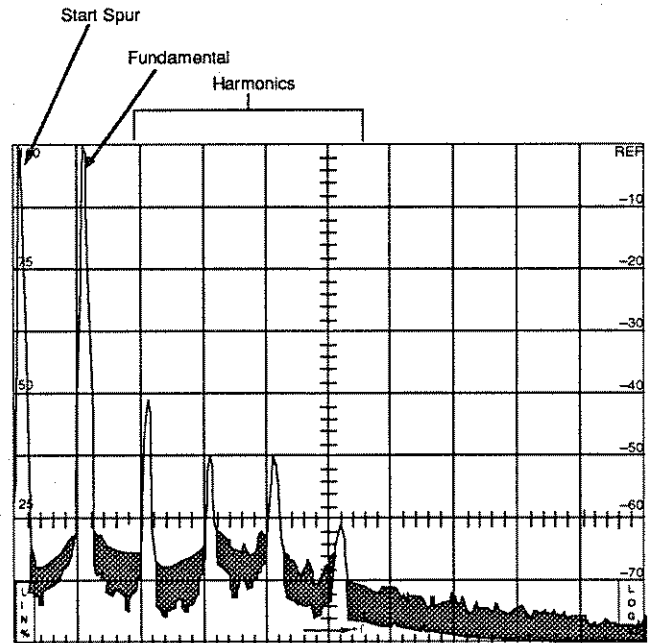

Figure 9. Harmonic spur distribution near the 100 kHz fundamental (10 dB/div display).

j. Check that all non-harmonic spurs are at least 35 dB down from the fundamental.

k. Recall default power-up settings by pressing UTIL MENU/#1/#1.

9. Check 1st LO Output Level

(+5 dBm to +10 dBm)

NOTE

This check applies only to those Spectrum Analyzers that have Option 15 installed.

Test equipment required:

- Power Meter

a. Remove the 50Ω terminator from J101 at the rear panel of the Spectrum Analyzer.

b. Monitor J101 with the power meter.

c. Select the following settings on the Spectrum Analyzer:

FREQ SPAN/DIV	MAX SPAN
RESOLUTION BW	Auto

d. Enable MANUAL SCAN by pressing SWP/TRIG MENU/
#7.

e. Manually sweep the Spectrum Analyzer/Tracking Gen-
erator system slowly from 100 kHz to 1.8 GHz while observ-
ing the power meter.

f. Check that the power meter indicates a power level of at
least + 5 dBm and not greater than +10 dBm over the full
span.

g. Disconnect the power meter from J101 and replace the
50 Ω terminator.

h. Recall default power-up settings by pressing UTIL MENU/
#1/#1.

