

**2246
PORTABLE
OSCILLOSCOPE
OPERATORS**

*Please Check for
CHANGE INFORMATION
at the Rear of This Manual*

First Printing SEP 1986
Revised MAR 1988

Tektronix
COMMITTED TO EXCELLENCE

Copyright © 1986 Tektronix, Inc. All rights reserved.
Contents of this publication may not be reproduced in any
form without the written permission of Tektronix, Inc.

Products of Tektronix, Inc. and its subsidiaries are covered
by U.S. and foreign patents and/or pending patents.

TEKTRONIX, TEK, SCOPE-MOBILE, and  are
registered trademarks of Tektronix, Inc.

Printed in U.S.A. Specification and price change privileges
are reserved.

INSTRUMENT SERIAL NUMBERS

Each instrument has a serial number on a panel insert, tag,
or stamped on the chassis. The first number or letter
designates the country of manufacture. The last five digits
of the serial number are assigned sequentially and are
unique to each instrument. Those manufactured in the
United States have six unique digits. The country of
manufacture is identified as follows:

B000000	Tektronix, Inc., Beaverton, Oregon, USA
100000	Tektronix Guernsey, Ltd., Channel Islands
200000	Tektronix United Kingdom, Ltd., London
300000	Sony/Tektronix, Japan
700000	Tektronix Holland, NV, Heerenveen, The Netherlands

Certificate of the Manufacturer/Importer

We hereby certify that the 2246 PORTABLE OSCILLOSCOPE

AND ALL INSTALLED OPTIONS

complies with the RF Interference Suppression requirements of Amtsbl.-Vfg 1046/1984.

The German Postal Service was notified that the equipment is being marketed.

The German Postal Service has the right to re-test the series and to verify that it complies.

TEKTRONIX

Bescheinigung des Herstellers/Importeurs

Hiermit wird bescheinigt, daß der/die/das 2246 PORTABLE OSCILLOSCOPE

AND ALL INSTALLED OPTIONS

in Übereinstimmung mit den Bestimmungen der Amtsblatt-Verfügung 1046/1984 funktentstört ist.

Der Deutschen Bundespost wurde das Inverkehrbringen dieses Gerätes angezeigt und die Berechtigung zur Überprüfung der Serie auf Einhalten der Bestimmungen eingeräumt.

TEKTRONIX

NOTICE to the user/operator:

The German Postal Service requires that Systems assembled by the operator/user of this instrument must also comply with Postal Regulation, Vfg. 1046/1984, Par. 2, Sect. 1.

HINWEIS für den Benutzer/Betreiber:

Die vom Betreiber zusammengestellte Anlage, innerhalb derer dies Gerät eingesetzt wird, muß ebenfalls den Voraussetzungen nach Par. 2, Ziff. 1 der Vfg. 1046/1984 genügen.

NOTICE to the user/operator:

The German Postal Service requires that this equipment, when used in a test setup, may only be operated if the requirements of Postal Regulation, Vfg. 1046/1984, Par. 2, Sect. 1.7.1 are complied with.

HINWEIS für den Benutzer/Betreiber:

Dies Gerät darf in Meßaufbauten nur betrieben werden, wenn die Voraussetzungen des Par. 2, Ziff. 1.7.1 der Vfg. 1046/1984 eingehalten werden.

OPERATORS SAFETY SUMMARY

The general safety information in this part of the summary is for both operating and servicing personnel. Specific warnings and cautions will be found throughout the manual where they apply and do not appear in this summary.

Terms in This Manual

CAUTION statements identify conditions or practices that could result in damage to the equipment or other property.

WARNING statements identify conditions or practices that could result in personal injury or loss of life.

Terms as Marked on Equipment

CAUTION indicates a personal injury hazard not immediately accessible as one reads the markings, or a hazard to property, including the equipment itself.

DANGER indicates a personal injury hazard immediately accessible as one reads the marking.

Symbols in This Manual



This symbol indicates where applicable cautionary or other information is to be found. For maximum input voltage see Table 1-2.

Symbols as Marked on Equipment



DANGER — High voltage.



Protective ground (earth) terminal.



ATTENTION — Refer to manual.

Power Source

This product is intended to operate from a power source that will not apply more than 250 volts rms between the supply conductors or between either supply conductor and ground. A protective ground connection by way of the grounding conductor in the power cord is essential for safe operation.

Grounding the Product

This product is grounded through the grounding conductor of the power cord. To avoid electrical shock, plug the power cord into a properly wired receptacle before making any connections to the product input or output terminals. A protective ground connection by way of the grounding conductor in the power cord is essential for safe operation.

Danger Arising from Loss of Ground

Upon loss of the protective-ground connection, all accessible conductive parts (including knobs and controls that may appear to be insulated) can render an electric shock.

Use the Proper Power Cord

Use only the power cord and connector specified for your product.

Use only a power cord that is in good condition.

For detailed information on power cords and connectors, see Figure 2-1.

Use the Proper Fuse

To avoid fire hazard, use only a fuse of the correct type, voltage rating and current rating as specified in the parts list for your product.

Do Not Operate in Explosive Atmospheres

To avoid explosion, do not operate this instrument in an explosive atmosphere.

Do Not Remove Covers or Panels

To avoid personal injury, do not remove the product covers or panels. Do not operate the instrument without the covers and panels properly installed.

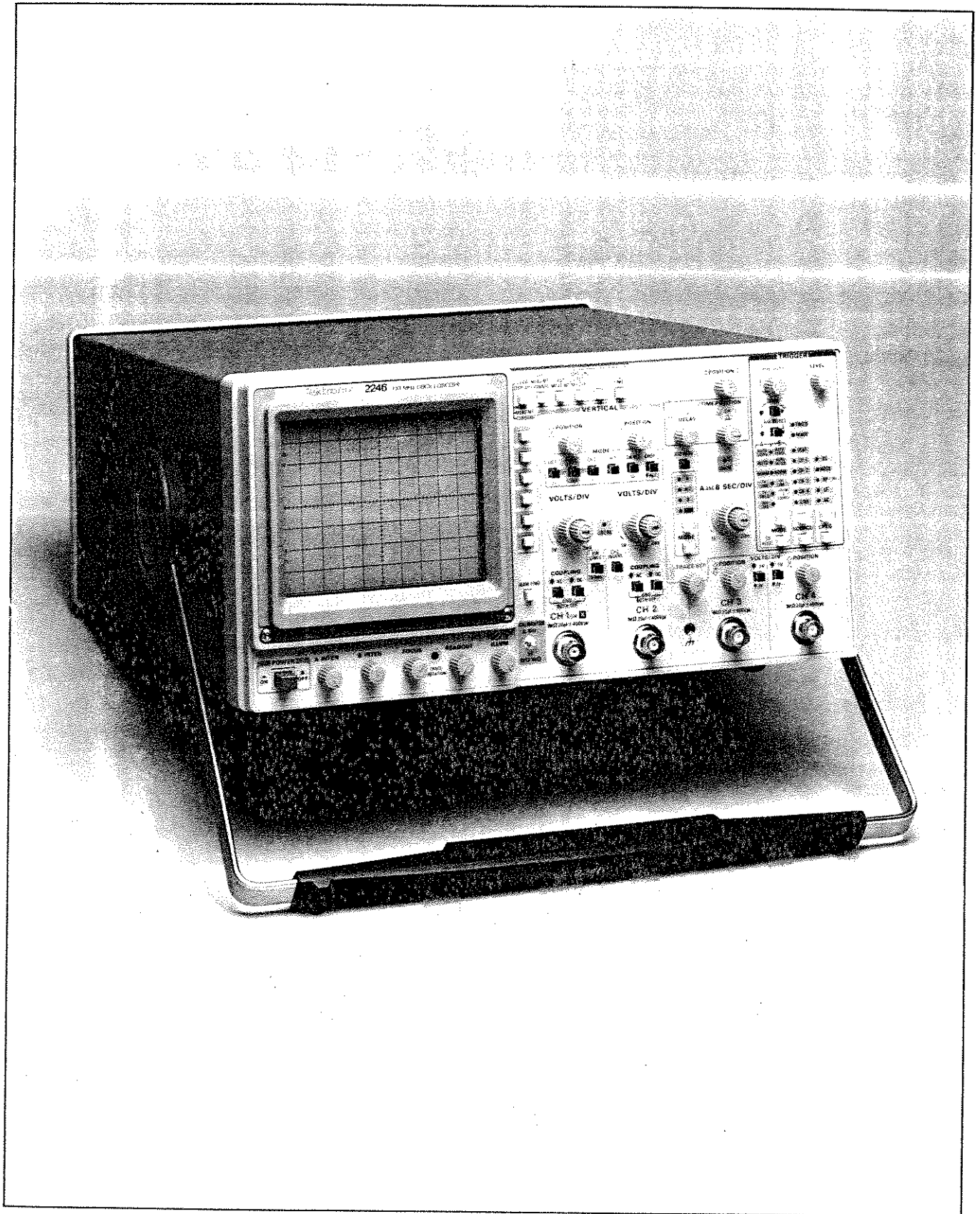

6083-01

The 2246 Portable Oscilloscope.

SPECIFICATION

INTRODUCTION

The TEKTRONIX 2246 Oscilloscope is a portable 100 MHz bandwidth instrument having a four-channel vertical deflection system. The horizontal deflection system provides calibrated sweep speeds from 0.5 s to 20 ns per division and delayed sweep features. The trigger system provides stable triggering over the full bandwidth of the vertical deflection system. Alphanumeric crt readouts of the vertical and horizontal scale factors are displayed at the bottom of the screen. On-screen vertical and horizontal cursors provide accurate voltage, time, frequency, and phase measurements with measurement value readouts displayed at the top of the crt.

The 2246 is microprocessor controlled and features menu-driven waveform measurement processes. The flexible measurement features of the oscilloscope include a choice of either voltmeter measurements for +Peak, -Peak, Peak-to-Peak, and average DC values of the signal applied to a selected measurement channel or positionable cursors for measuring voltage difference, time difference, frequency and phase. Measurement-tracking, trigger-level tracking, and ground-tracking SmartCursors[®] that provide visual feedback to the user may be placed on the displayed waveforms. Menus called up to make the measurement mode choices are displayed at the right side of the crt next to the menu selection buttons. Delay-time and delta-delay measurements for time, frequency, and phase are available in ALT and B Horizontal Modes.

The vertical deflection system consists of two channels with calibrated deflection factors from 2 mV to 5 V per division in a 1-2-5 sequence of 11 steps and two channels with two basic deflection factors of 0.1 V and 0.5 V. Use of coded probes having attenuation factors of 1X, 10X, and 100X extends the minimum sensitivity to 500 V per division.

VOLTS/DIV readouts are switched to display the correct vertical scale factor when properly coded probes are attached to the vertical input connectors.

STANDARD ACCESSORIES

The following items are standard accessories shipped with the 2246 instrument:

- 2 Probes, 10X, 1.5 meter, with accessories
- 1 Power cord
- 1 Power cord clamp
- 1 Operators manual
- 1 Operators guide
- 1 Crt filter, blue plastic (installed)
- 1 Fuse, 2 A, 250 V, slow-blow
- 1 Accessory pouch, Ziploc

For part numbers and further information about standard accessories and a list of the recommended optional accessories, refer to "Options and Accessories" (Section 7) in this manual. For additional information on accessories and ordering assistance, contact your Tektronix representative or local Tektronix Field Office.

PERFORMANCE CONDITIONS

The electrical characteristics of Table 1-1 apply when the 2246 has been calibrated at an ambient temperature between +20°C and +30°C, has had a warmup period of at least 20 minutes, and is operating at an ambient temperature between -10°C and +55°C (unless otherwise noted).

Items listed in the "Performance Requirements" column are verifiable qualitative or quantitative limits that define the measurement capabilities of the instrument.

Mechanical Specifications of the 2246 are given in Table 1-2, and Environmental Specifications are given in Table 1-3.

RECOMMENDED CALIBRATION SCHEDULE

To ensure accurate measurements, check the performance of this instrument every 2000 hours of operation or, if used infrequently, once each year. Replacement of components in the instrument may also necessitate readjustment of the affected circuits.

Table 1-1
Electrical Characteristics

Characteristics	Performance Requirements				
VERTICAL DEFLECTION SYSTEM—CH 1 AND CH 2					
Deflection Factor					
Range	2 mV/div to 5 V/div in 1-2-5 sequence.				
Accuracy (includes ADD MODE and CH 2 INVERT)					
15 to 35°C	Within ±2%.				
-10°C to 15°C and 35°C to 55°C	Within ±3%.				
Variable Range	Increases deflection factor by at least 2.5:1.				
Frequency Response (-3 dB bandwidth)					
-10°C to 35°C	DC to 100 MHz (at the probe tip).				
35°C to 55°C	DC to 90 MHz (at the probe tip).				
AC Coupled Lower -3 dB Point					
1X Probe	10 Hz or less.				
10X Probe	1 Hz or less.				
Step Response (5-division step)					
Rise Time					
-10°C to 35°C	3.5 ns or less.				
35°C to 55°C	3.9 ns or less.				
Delay Match (CH 1 to CH 2)	Less than 200 ps difference.				
Common Mode Rejection Ratio (CMRR)	At least 10:1 at 50 MHz for signals of eight divisions or less with VOLTS/DIV VAR adjusted for best CMRR at 50 kHz.				
Channel Isolation (Attenuation of deselected channel)					
2 mV/Div to 0.5 V/Div	<table style="display: inline-table; vertical-align: top;"> <tr> <td style="text-align: center;">10 MHz</td> <td style="text-align: center;">100 MHz</td> </tr> <tr> <td>50 dB or more.</td> <td>34 dB or more.</td> </tr> </table> Channel isolation tested with eight-division input signal.	10 MHz	100 MHz	50 dB or more.	34 dB or more.
10 MHz	100 MHz				
50 dB or more.	34 dB or more.				
Trace Shift as VAR VOLTS/DIV is Turned	1 division or less.				
Invert Trace Shift	1 division or less.				
Trace Shift Between VOLTS/DIV Switch Positions	0.2 division or less.				
Trace Shift Between GND and DC Input Coupling					
-10°C to 35°C	Less than 0.5 mV.				
35°C to 55°C	Less than 2 mV.				
Position Range	At least ±11 divisions from graticule center.				
Input Characteristics					
Resistance	1 MΩ ±0.5%.				
Capacitance	20 pF ±1.0 pF.				
Capacitance Match Between Any Two VOLTS/DIV Settings in Each Channel	Within ±0.5 pF.				
Max Input Volts 	400 V (dc + peak ac); 800 V p-p ac at 10 kHz or less.				

Table 1-1 (cont)

Characteristics	Performance Requirements
VERTICAL DEFLECTION SYSTEM—CH 3 AND CH 4	
Deflection Factors	0.1 V per division and 0.5 V per division.
Accuracy	
15°C to 35°C	Within $\pm 2\%$.
-10°C to 55°C	Within $\pm 3\%$.
Frequency Response (-3 dB bandwidth)	
-10°C to 35°C	DC to 100 MHz (at the probe tip).
35°C to 55°C	DC to 90 MHz (at the probe tip).
Step Response (5-division step)	
Rise Time	
-10°C to 35°C	3.5 ns or less.
35°C to 55°C	3.9 ns or less.
Delay Match (CH 3 to CH 4)	Less than 800 ps difference.
Trace Shift Between VOLTS/DIV Settings	1 division or less.
Position Range	At least ± 11 divisions from graticule center.
Channel Isolation (attenuation of deselected channel)	34 dB or more at 100 MHz. Channel isolation tested with eight-division input signal.
Input Characteristics	
Resistance	1 M Ω $\pm 1.0\%$.
Capacitance	20 pF ± 1.0 pF.
Max Input Volts 	400 V (dc + peak ac); 800 V p-p ac at 10 kHz or less.
VERTICAL DEFLECTION SYSTEM—ALL CHANNELS	
Bandwidth Limit (-3 dB bandwidth)	20 MHz $\pm 15\%$.
Low Frequency Linearity (Relative to center screen)	Within $\pm 5\%$. Linearity is measured by positioning a two-division test signal anywhere on screen and noting the amplitude change.
TRACE SEP Control Position Range	At least ± 4 divisions.
CHOP Mode Clock Rate	625 kHz $\pm 10\%$.
Delay Match (CH 1 or CH 2 to CH 3 or CH 4)	Less than 200 ps difference.

Table 1-1 (cont)

Characteristics	Performance Requirements	
HORIZONTAL DEFLECTION SYSTEM		
Sweep Range		
A Sweep	0.5 s/div to 20 ns/div in a 1-2-5 sequence. X10 magnifier extends maximum sweep speed to 2 ns/div.	
B Sweep	5.0 ms/div to 20 ns/div in a 1-2-5 sequence. X10 magnifier extends maximum sweep speed to 2 ns/div.	
Accuracy	Unmagnified	Magnified
15°C to 35°C	±2%	±3%
-10°C to 15°C and 35°C to 55°C	±3%	±4%
	Sweep Accuracy applies over the center eight divisions. Excludes the greater of the first 1/4 division or 25 ns from the sweep start of the magnified sweep and anything beyond the 100th magnified division.	
Sweep Linearity (relative to center two displayed divisions)	±5%.	
POSITION Control Range		
Normal Displays	Able to move the start of the sweep to the right of the center vertical graticule; able to move a time mark corresponding to the end of the tenth division of an unmagnified sweep to the left of the center graticule.	
X-Y Displays	At least ±13 divisions.	
X10 Magnifier		
Registration	Expands the normal sweep by ten times around that portion of the sweep positioned at the center vertical graticule line.	
X10 to X1	0.5 division or less shift.	
Variable Control Range	Continuously variable between calibrated SEC/DIV switch settings. Extends both the A and B sweep time per division by at least a factor of 2.5.	
Sweep Length	Greater than 10 divisions.	
Delay Time		
Delay Control Range	Less than 0.1 division to 10 times the A SEC/DIV switch setting. Maximum value does not exceed end of the A Sweep.	
Jitter	1 part in 20,000, or less, peak-to-peak, during a two-second time interval.	
Delta Time		
Delta Control Range	0 to greater than 9.9 divisions to the right of setting of DELAY control, but maximum value does not exceed end of the A Sweep.	

Table 1-1 (cont)

Characteristics	Performance Requirements
A AND B TRIGGER	
Sensitivity—CH 1 through CH 4: AUTO LEVEL, NORM, AND SINGLE SEQUENCE	Trigger sensitivity is defined as the minimum peak-to-peak sine-wave trigger signal amplitude required to show the test signal with horizontal jitter of less than 3.0% of one period (p-p viewed over two seconds).
COUPLING	
DC	0.35 division from DC to 25 MHz, increasing to 1.0 division at 150 MHz.
NOISE REJECT	1.4 division from DC to 50 MHz; increasing to 2.2 division at 100 MHz. 0.5 division or less will not trigger.
HF REJECT	0.35 division from DC to 50 kHz; attenuates signals above the upper -3 dB cutoff frequency of 70 kHz.
LF REJECT	0.35 division from 100 kHz to 25 MHz, increasing to 1.0 division at 150 MHz; attenuates signals below the lower -3 dB cutoff frequency of 50 kHz.
AC	0.35 division from 50 Hz to 25 MHz, increasing to 1.0 division at 150 MHz; attenuates signals below the lower -3 dB cutoff frequency of 20 Hz.
TV LINE, TV FIELD	0.5 division of composite sync will achieve a stable display.
AUTO LEVEL Lowest Usable Frequency	10 Hz.
LEVEL Control Range	±20 divisions referred to the appropriate vertical input. This range is sufficient to allow triggering at any point on a displayed waveform for all modes except "ADD." In ADD, the combined range of the two position controls exceeds the trigger level range, making it possible (though unlikely) to pull a signal on screen for display but fail to trigger on it due to insufficient trigger level range.
TRIGGER LEVEL READOUT Accuracy	±(0.3% of reading + 10% of one vertical division).
HOLDOFF Control Range	Increases A Sweep holdoff time by at least a factor of 10.

Table 1-1 (cont)

Characteristics	Performance Requirements
FUNCTIONS WITH DIGITAL READOUT	
Specifications for functions with digital readout are valid only when the ambient temperature is within $\pm 10^{\circ}\text{C}$ of the temperature at the time of the last SELF CAL. For maximum performance, a recent SELF CAL is recommended.	
VOLTMETER FUNCTIONS	
DC VOLTS	
Accuracy	$\pm(0.5\% \text{ of reading} + 2\% \text{ of one vertical division} + 250 \mu\text{V})$.
Normal Mode Rejection Ratio	Greater than 50 dB at 50 or 60 Hz.
PLUS or MINUS PEAK	
Accuracy—Full Bandwidth	$\pm(2\% \text{ of reading} + 10\% \text{ of one vertical division} + 1 \text{ mV})$.
25 Hz to 25 MHz	
Greater Than 25 MHz to 100 MHz	+0.5 dB/-3 dB $\pm 1 \text{ mV}$. Follows the trigger system frequency response curve.
Accuracy—Bandwidth Limited	$\pm(2.0\% \text{ of reading} + 10\% \text{ of one vertical division} + 0.3 \text{ mV})$.
25 Hz to 10 MHz	
Gated Region Minimum Width (when gated)	(0.2 division + 50 ns) or less.
PK-PK VOLTS	
Accuracy—Full Bandwidth	$\pm(2.0\% \text{ of reading} + 10\% \text{ of one vertical division} + 1.5 \text{ mV})$.
25 Hz to 25 MHz	
Greater Than 25 MHz to 100 MHz	+0.5 dB/-3 dB $\pm 1.5 \text{ mV}$. Follows the trigger system frequency response curve.
Accuracy—Bandwidth Limited	$\pm(2.0\% \text{ of reading} + 10\% \text{ of one vertical division} + 0.5 \text{ mV})$.
25 Hz to 10 MHz	
Gated Region Minimum Width (when gated)	(0.2 division + 50 ns) or less.
CURSOR FUNCTIONS	
I- SEC -I (manually positioned cursors)	
Accuracy	$\pm(0.5\% \text{ of reading} + 2\% \text{ of the SEC/DIV setting})$.
I- 1/SEC -I (manually positioned cursors)	
Accuracy	Readout calculated from I- SEC -I cursor positions.
VOLTS -I (manually positioned cursor)	
Accuracy	$\pm(0.5\% \text{ of reading} + 2\% \text{ of the VOLTS/DIV setting} + \text{high-frequency display errors})$.
I- VOLTS -I (manually positioned cursors)	
Accuracy	$\pm(0.5\% \text{ of reading} + 2\% \text{ of the VOLTS/DIV setting} + \text{high-frequency display errors})$.
I- PHASE -I (manually positioned cursors)	
Accuracy	Readout calculated from I- SEC -I cursor positions.

Table 1-1 (cont)

Characteristics	Performance Requirements
FUNCTIONS WITH DIGITAL READOUT (cont)	
CURSOR FUNCTIONS (cont)	
TRACK MEASUREMENT Position Accuracy (Cursor position on waveform versus digitally displayed measurement value)	± 0.05 vertical division.
TRACK TRIG LEVEL Position Accuracy (Cursor position on waveform versus digitally displayed trigger level value)	± 0.05 vertical division.
TRACK GROUND Position Accuracy (Cursor position on waveform versus baseline displayed with grounded input)	± 0.05 vertical division.
DELTA TIME FUNCTIONS	
DELTA TIME Accuracy	± (0.5% of reading + 1.0% of one division of the A Sweep).
Delay Accuracy, A Sweep Trigger Point to Start of B Sweep	± (0.5% of reading + 5% of one division of the A Sweep + 25 ns).

Table 1-1 (cont)

Characteristics	Performance Requirements
X-Y OPERATION	
Deflection Factors	Same as Vertical deflection system with the VOLTS/DIV variable controls in calibrated detent position.
Accuracy	
Y-Axis	
15°C to 35°C	Within ±2%.
-10°C to 15°C, 35°C to 55°C	Within ±3%.
X-Axis	
15°C to 35°C	Within ±3%.
-10°C to 15°C, 35°C to 55°C	Within ±4%.
Horizontal (X-Axis) -3 dB Bandwidth	3 MHz or more.
Phase Match (DC Coupled)	±3 degrees from DC to 50 kHz.
EXTERNAL Z-AXIS INPUT	
Active Region Lower Threshold (intensity decreases above this voltage)	+1.8 volts or less.
Signal Required to Modulate an A or B Trace	+3.8 volts or less at maximum intensity. External Z-Axis signal does not affect the readout or the intensified zone intensity.
Max Input Voltage 	30 V (dc + peak ac); 30 V p-p ac at 1 kHz or less.
Input Loading	Represents less than one LSTTL load.
CALIBRATOR OUTPUT	
Overshoot (rising and falling edge)	0.1% or less.
Output Voltage on CALIBRATOR Jack	0.5 V ±2% into 1MΩ load.
Repetition Rate	1 kHz ±25%.
FRONT PANEL SETUP MEMORY	
Data Retention Time	At least three years.

Table 1-1 (cont)

Characteristics	Performance Requirements
POWER SOURCE	
Line Voltage Range	90 Vac to 250 Vac.
Line Frequency	48 Hz to 445 Hz.
Line Fuse	2 A, 250 V, fast blow.
Max Power Consumption	80 Watts (110 VA).
CRT DISPLAY	
Display Area	8 by 10 cm.
Geometry	
Vertical	$\pm 1/2$ minor (0.1 div) at 8 by 8 cm centered area.
Horizontal	$\pm 1/2$ minor (0.1 div) at 8 by 10 cm centered area.
Trace Rotation Range	Adequate to align trace with center horizontal graticule line.
Standard Phosphor	P31.
Y-Axis Orthogonality	0.1 division or less, over eight vertical divisions. No adjustment.
Nominal Accelerating Voltage	16.5 kV.

Table 1-2
Mechanical Characteristics

Characteristics	Description
STANDARD INSTRUMENT	
Weight	
Instrument Alone	7.6 kg (16.8 lb).
Instrument with Probes, Power Cord, and Manual	8.3 kg (18.2 lb).
Shipping Weight	
Domestic	11.7 kg (25.8 lb).
Overall Dimensions :	See Figure 1-1 for a dimensional drawing.
Height	
With Feet and Accessories Pouch (empty)	177 mm (7 in).
Without Accessories Pouch	164 mm (6.44 in).
Width	
With Handle	362 mm (14.25in).
Depth	
With Front Cover	446 mm (17.6 in).
With Handle Extended	521 mm (20.53 in).
Cooling	Forced air circulation; no air filter.
Finish	Tek Blue, pebble-grain finish painted on aluminum cabinet.
Construction	Aluminum alloy chassis. Plastic-laminate front panel.

Table 1-3
Environmental Characteristics

Characteristics	Description
STANDARD INSTRUMENT	
Environmental Requirements	Instrument meets or exceeds the environmental requirements of MIL-T-28800D for Type III, Class 3, Style D equipment.
Temperature	
Operating	–10°C to +55°C (+14°F to +131°F).
Non-operating	–51°C to +71°C (–60 to 160°F). Tested to MIL-T-28800D paragraphs 4.5.5.1.3 and 4.5.5.1.4, except in 4.5.5.1.3, steps 4 and 5 (–10°C operating test) are performed ahead of step 2 (–51°C non-operating test). Equipment shall remain off upon return to room ambient during step 6. Excessive condensation shall be removed before operating during step 7.
Altitude	
Operating	To 4,570 m (15,000 ft). Maximum operating temperature decreases 1°C/1000 ft above 5000 ft.
Non-operating	To 15,240 m (50,000 ft).
Humidity (Operating and Non-operating)	Five cycles (120 hours) referenced to MIL-T-28800D paragraph 4.5.5.1.2.2, for type III, class 3 instruments. Non-operating and operating at 95%, 0% to +2% relative humidity. Operating at +30°C and +55°C for all modes of operation. Non-operating at +30°C to +60°C.
Radiated and Conducted Emission Required per VDE 0871	Meets Category B.
Electrostatic Discharge	Conforms to Tektronix Standard 062-2862-00.
Vibration (operating)	15 minutes along each of 3 major axis at a total displacement of 0.025 inch p-p (4 g at 55 Hz) with frequency varied from 10 Hz to 55 Hz in 1-minute sweeps. Hold for 10 minutes at 55 Hz in each of the three major axis. All major resonances must be above 55 Hz.
Bench Handling Test	Four-inch drop per Tektronix standard 062-2858-00.
Shock (Operating and Non-operating)	30 g, half-sine, 11 ms duration, 3 shocks per axis each direction, for a total of 18 shocks.
Transportation	
Packaged Vibration Test	Meets the limits of Tektronix Standard 062-2858-00.
Package Drop Test	Meets the limits of Tektronix Standard 062-2858-00.

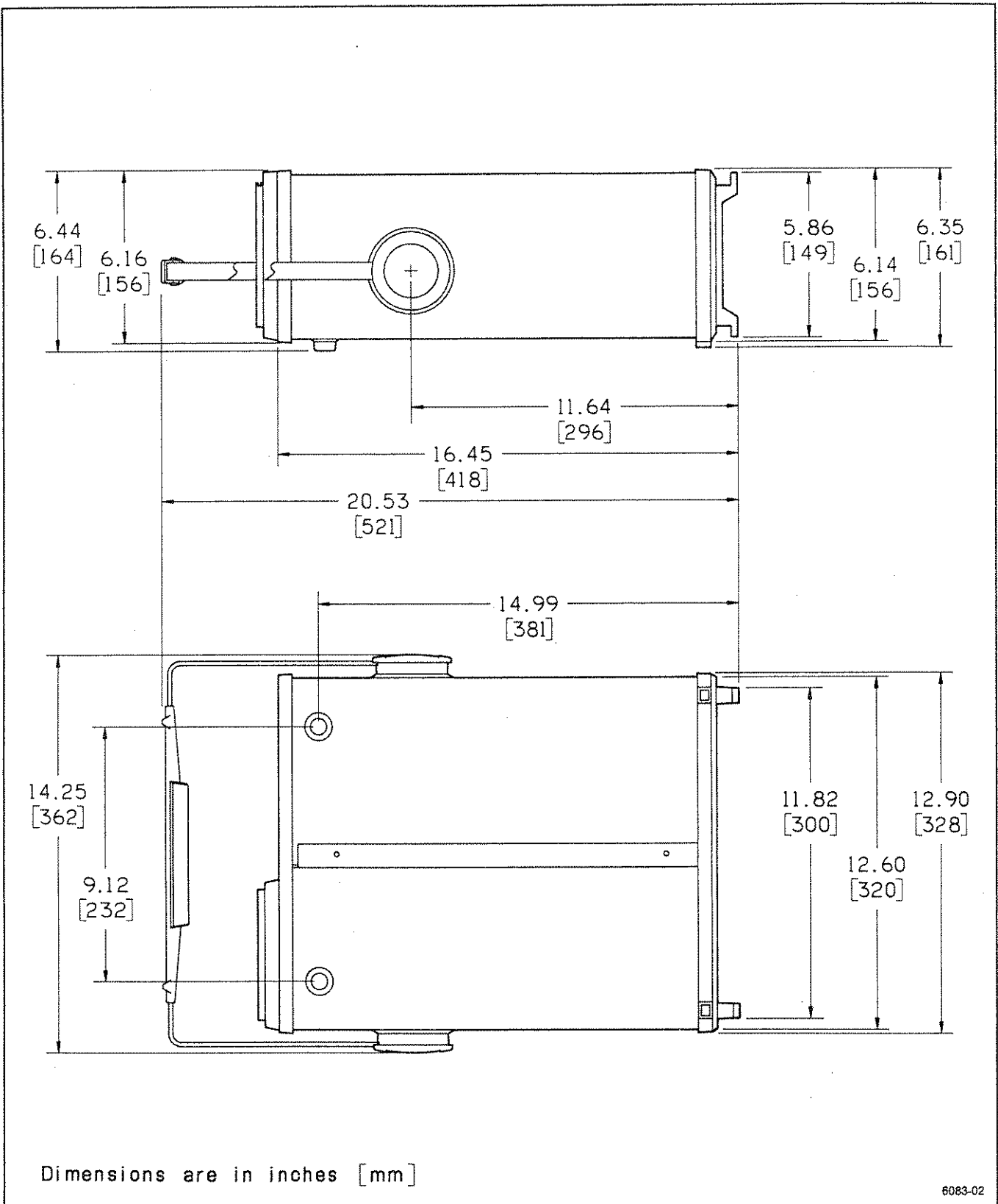

Figure 1-1. Dimensional drawing.

PREPARATION FOR USE

SAFETY

This section tells how to prepare for and to proceed with the initial start-up of the TEKTRONIX 2246 Oscilloscope.

Refer to the Operator's Safety Summary at the front of this manual for power source, grounding, and other safety considerations pertaining to the use of the instrument. Before connecting the oscilloscope to a power source, read both this section and the Safety Summary.



This instrument may be damaged if the wrong line fuse is installed.

LINE FUSE

To verify the proper value of the instrument's power-input fuse, perform the following procedure.

1. Press in the fuse-holder cap and release it with a slight counterclockwise rotation.
2. Pull the cap (with the attached fuse inside) out of the fuse holder.
3. Verify proper fuse value.
4. Install the proper fuse and reinstall the fuse-holder cap.

POWER CORD

This instrument has a detachable three-wire power cord with a three-contact plug for connection to both the power source and protective ground. The power cord is secured to the rear panel by a cord-set securing clamp. The protective ground contact on the plug connects (through the

power cord protective grounding conductor) to the accessible metal parts of the instrument. For electrical shock protection, insert this plug into a power-source outlet that has a properly grounded protective-ground contact.

Instruments are shipped with the power-cord option ordered by the customer (see Figure 2-1). Contact your Tektronix representative or local Tektronix Field Office for additional power-cord information.

INSTRUMENT COOLING

To prevent instrument damage from overheated components, adequate internal airflow must be maintained.

Plug Configuration	Usage	Line Voltage	Reference Standards	Option Number
	North American 120V/ 15A	120V	ANSI C73.11 NEMA 5-15-P IEC 83	A0
	Universal Euro 240V/ 10-16A	240V	CEE (7),II,IV,VII IEC 83	A1
	UK 240V/ 13A	240V	BS 1363 IEC 83	A2
	Australian 240V/ 10A	240V	AS C112	A3
	North American 240V/ 15A	240V	ANSI C73.20 NEMA 6-15-P IEC 83	A4
	Switzerland 220V/ 6A	220V	SEV	A5

Abbreviations:
 ANSI — American National Standards Institute
 AS — Standards Association of Australia
 BS — British Standards Institution
 CEE — International Commission on Rules for the Approval of Electrical Equipment
 IEC — International Electrotechnical Commission
 NEMA — National Electrical Manufacturer's Association
 SEV — Schweizerischer Elektrotechnischer Verein

(2931-21)6083-35

Figure 2-1. Optional power cords.

Preparation for Use—2246 Operators

Before turning on the power, first verify that ventilation holes on the bottom and sides of the cabinet are free of any obstruction to airflow.

START-UP

On the initial power-up of the instrument, characterizations of the vertical and horizontal systems to calibrate portions of the measurement system are done. After the initial 20-minute warmup period, the self-characterization procedure is done automatically to adjust the gains and offsets to account for the operating temperature of the instrument, and the calibration constants are stored in memory.

These start-up procedures will not be repeated again unless the calibration constants have been lost from memory. A possible reason for this to happen is that the keep-alive battery is dead and in need of replacement. Refer the instrument to a qualified service person if the battery needs replacement.

REPACKAGING FOR SHIPMENT

It is recommended that the original carton and packing material be saved in the event it is necessary for the instrument to be reshipped using a commercial transport carrier. If the original materials are unfit or not available, then repackage the instrument using the following procedure.

1. Use a corrugated cardboard shipping carton having a test strength of at least 275 pounds and with an inside dimension at least six inches greater than the instrument dimensions.

2. If the instrument is being shipped to a Tektronix Service Center, enclose the following information; show the owner's address, name and phone number of a contact person, type and serial number of the instrument, reason for returning, and a complete description of the service required.

3. Completely wrap the instrument with polyethylene sheeting or equivalent to protect the outside finish and prevent entry of harmful substances into the instrument.

4. Cushion instrument on all sides using three inches of padding material or urethane foam, tightly packed between the carton and the instrument.

5. Seal the shipping carton with an industrial stapler or strapping tape.

6. Now mark the address of the Tektronix Service Center and also your own return address on the shipping carton in two prominent locations.

CONTROLS, CONNECTORS, AND INDICATORS

CRT, POWER, and DISPLAY

See Figure 3-1 for items 1 through 9.

- ① **POWER Switch**—Turns instrument power on and off. Press in for ON; press again for OFF.

Power-on is indicated by the front-panel control buttons. At least one of the back-lighted buttons will be lit at any time the instrument is on. Front-panel switch settings present at power-off will be returned when power is reapplied to the instrument (except for the menus and the B SEC/DIV switch setting if different than the A SEC/DIV switch setting). The A AND B SEC/DIV settings are locked together at power up. Potentiometer settings are not retained in memory.

- ② **A INTEN Control**—Adjusts brightness of the A trace. Brightness is increased when the control is rotated clockwise.

- ③ **B INTEN Control**—Adjusts brightness of the B Delayed Sweep trace and the intensified zone on the A trace. Brightness is increased when the control is rotated clockwise.

- ④ **FOCUS Control**—Adjusts the traces, readout, and cursors for optimum display definition.

- ⑤ **TRACE ROTATION Control**—Aligns the crt trace with the horizontal graticule lines.

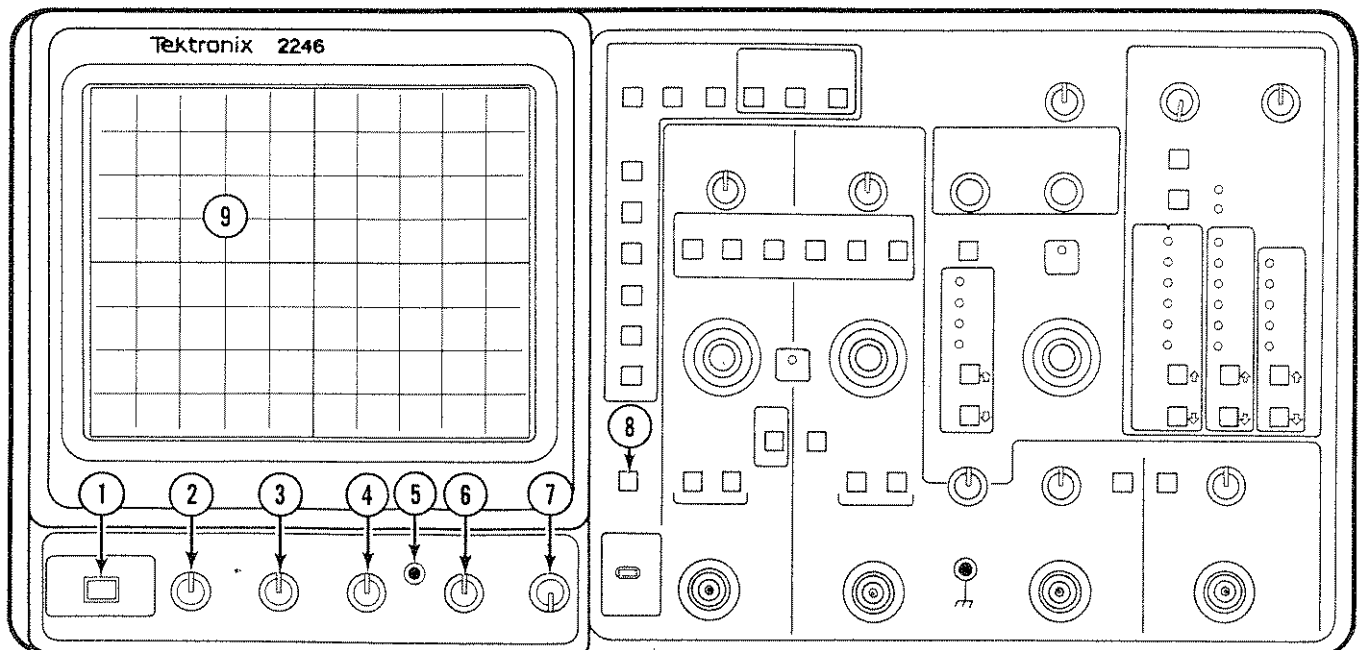

6083-03

Figure 3-1. CRT, Power, and Display controls.

Controls, Connectors, and Indicators—2246 Operators

6 **READOUT Control**—Adjusts brightness of the crt readout display. Brightness is increased when the control is rotated clockwise. Full counterclockwise rotation of the READOUT control turns off the readout circuitry operation.

7 **SCALE ILLUM Control**—Adjusts the light level of the graticule illumination.

NOTE

Maximum life of the graticule illumination lamps is gained by setting the SCALE ILLUM control for the minimum intensity needed for viewing. Turning the scale illumination lamps down, or off when not needed, extends the life many times over using maximum intensity.

8 **BEAM FIND Button**—Restricts the vertical and horizontal display size to within the graticule area and unblanks the crt to aid the user in locating off-screen or overscanned displays.

9 **CRT**—Displays the waveform and readout displays in an 80 mm vertical by 100 mm horizontal graticule area.

Internal graticule lines eliminate parallax-viewing error between the trace and graticule lines. 0%, 10%, 90% and 100% points are marked at the left edge of the graticule as a convenience to the user for making rise- and fall-time measurements.

VERTICAL

See Figure 3-2 for items 10 through 17.

10 **Channel 1 and Channel 2 POSITION Controls**—Set the vertical position of the Channel 1 and Channel 2 signal displays.

Clockwise rotation of a control knob moves the associated trace up; counterclockwise rotation moves the trace down. In X-Y mode, the associated POSITION control moves the display vertically.

11 **MODE Buttons**—Select the vertical channels for display and CHOP or ALT and ADD Mode for display of the selected channels.

The buttons will light to indicate the selection made (except that for ALT Mode the CHOP/ALT button light is off). One channel will always be displayed.

When only one channel is selected for display, that channel cannot be turned off.

CH 1, CH 2, CH 3, and CH 4 Buttons—Select any combination of the vertical channels for display by pressing in the appropriate MODE buttons. Pressing the button of a displayed channel (button lighted) removes that channel's trace from the display.

CHOP/ALT Button—Chops between the selected input channels at a chopping frequency of approximately 625 kHz when the button is lighted (CHOP Mode); displays each selected channel in sequence when the button light is off (ALT Mode).

ADD Button—Displays the algebraic sum of the Channel 1 and Channel 2 input signals when the ADD button light is on. The ADD display is in addition to any other selected channel displays. A plus sign (+) appears on the readout between the Channel 1 and Channel 2 VOLTS/DIV switch settings when ADD mode is on. Press the ADD button a second time to turn off the ADD button light and remove the ADD trace from the display.

NOTE

In ADD mode, the algebraic sum of Channel 1 and Channel 2 display is the only signal source for the trigger system when either AUTO LEVEL TRIGGER MODE or CHOP VERTICAL MODE is selected.

12 **Channel 1 and Channel 2 VOLTS/DIV Switches**—Select the calibrated deflection settings for Channel 1 and Channel 2 from 2 mV per division to 5 V per division in a 1-2-5 sequence of 11 steps.

The switches are detented, continuous-rotation controls with no end stops. The VOLTS/DIV switch setting displayed in the crt readout reflects the attenuation factor of coded attenuator probes that are connected to the vertical inputs.

13 **VOLTS/DIV VAR Controls**—Provide for adjustable vertical deflection between the calibrated settings of the Channel 1 and Channel 2 VOLTS/DIV switches.

The controls vary the deflection factors from calibrated (fully clockwise detent position) to at least 2.5 times the calibrated deflection factor (fully counterclockwise position). When a VAR control is out of its detent position, a greater than (>) sign appears on the left side of the associated VOLTS/DIV readout display to indicate a deflection factor greater than the VOLTS/DIV switch setting.

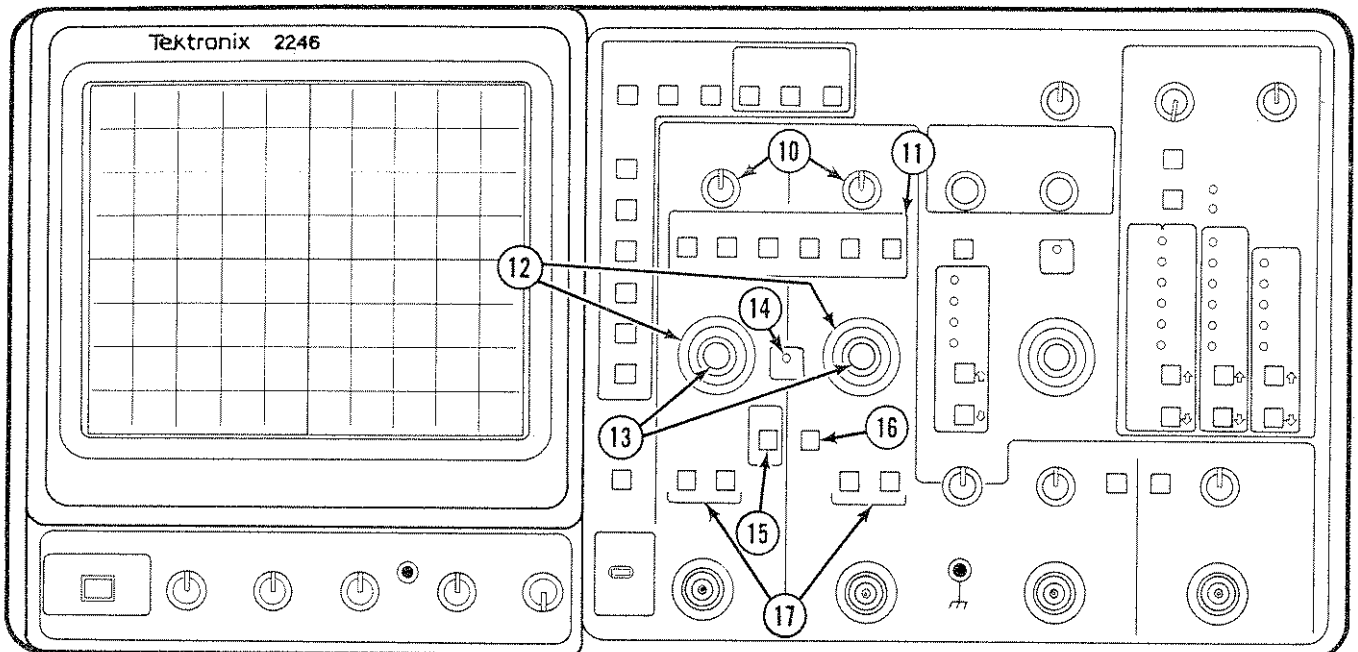

6083-04

Figure 3-2. CH 1 and CH 2 Vertical Controls and Indicators.

- 14 **UNCAL Indicator**—Indicates that either or both VOLTS/DIV VAR controls are out of their calibrated detent position.
- 15 **BW LIMIT Button**—Reduces the bandwidth of the vertical deflection system to between 17 MHz to 23 MHz when the button light is on. Full vertical deflection bandwidth is available when the BW LIMIT button light is off.
- 16 **INVERT Button**—Inverts the Channel 2 input signal when the INVERT button light is on.
Both the Channel 2 input signal in ADD mode and the Channel 2 trigger signal pickoff are also inverted. A down-arrow symbol appears on the readout between the Channel 1 and Channel 2 VOLTS/DIV switch settings to indicate INVERT mode is on.
- 17 **COUPLING Buttons**—Select the method of coupling input signals to the Channel 1 and Channel 2 vertical attenuators and indicate the selection made.

GND—Disconnects the input signal and grounds

the input of the associated vertical attenuator to provide a zero (ground) reference voltage display.

The input to the vertical attenuator is grounded when the AC and the DC button lights are both off. A ground symbol (\perp) appears on the right side of the associated VOLTS/DIV readout display. The ground symbol also appears after the value readout of any of the CH1/CH2 VOLTME-TER measurements.

AC—Capacitively couples the input signal to the vertical attenuator when the AC button light is on.

Turning AC coupling on turns DC coupling off. With AC coupling, the dc component of the input signal is blocked. The lower -3 dB frequency limit is 10 Hz or less when using either a 1X probe or properly terminated coaxial cable; it is 1 Hz or less using a compensated 10X probe. With AC Coupling selected, an AC symbol (\sim) appears on the right side of the associated VOLTS/DIV readout display. Selecting the DC measurement of the CH1/CH2 VOLTME-TER choices when AC Input Coupling is in effect for the measurement source channel, causes the

Controls, Connectors, and Indicators—2246 Operators

error message "CH 1 (or CH 2) — SELECT DC COUPLING" to appear.

DC—Couples dc and all frequency components of the input signal to the vertical attenuator when the DC button light is on.

Turning on DC coupling turns off AC coupling. With DC Coupling selected, a DC symbol (---) appears on the right side of the associated VOLTS/DIV readout display. Input resistance is 1 M Ω to ground.

See Figure 3-3 for items 18 through 23.

- 18 CH 1 OR X and CH 2 Input Connectors**—Connect external signals to the inputs of Channel 1 and Channel 2 vertical attenuators.

The input connectors are BNC type with an outer contact ring for the probe-code recognition circuit. In X-Y mode, the signal applied to CH 1 OR X Input Connector produces the horizontal deflection (X-Axis). Any of the vertical signal channels or ADD

may be selected to provide the vertical deflection (Y-Axis) for an X-Y display.

- 19 CALIBRATOR Connector**—Outputs a 0.5 V square-wave signal at a frequency of approximately 1 kHz for use in compensating voltage probes and checking the vertical deflection accuracy.

- 20 Auxiliary Ground Jack**—Provides an auxiliary signal ground connection between the equipment under test and the oscilloscope. Hookup is made via a banana-tip connector on the front panel.

- 21 Channel 3 and Channel 4 POSITION Controls**—Set the vertical position of the Channel 3 and Channel 4 signal displays.

Clockwise rotation of a control moves the associated trace upward; counterclockwise rotation moves the trace downward. When in X-Y mode, the associated Vertical POSITION control moves the display vertically.

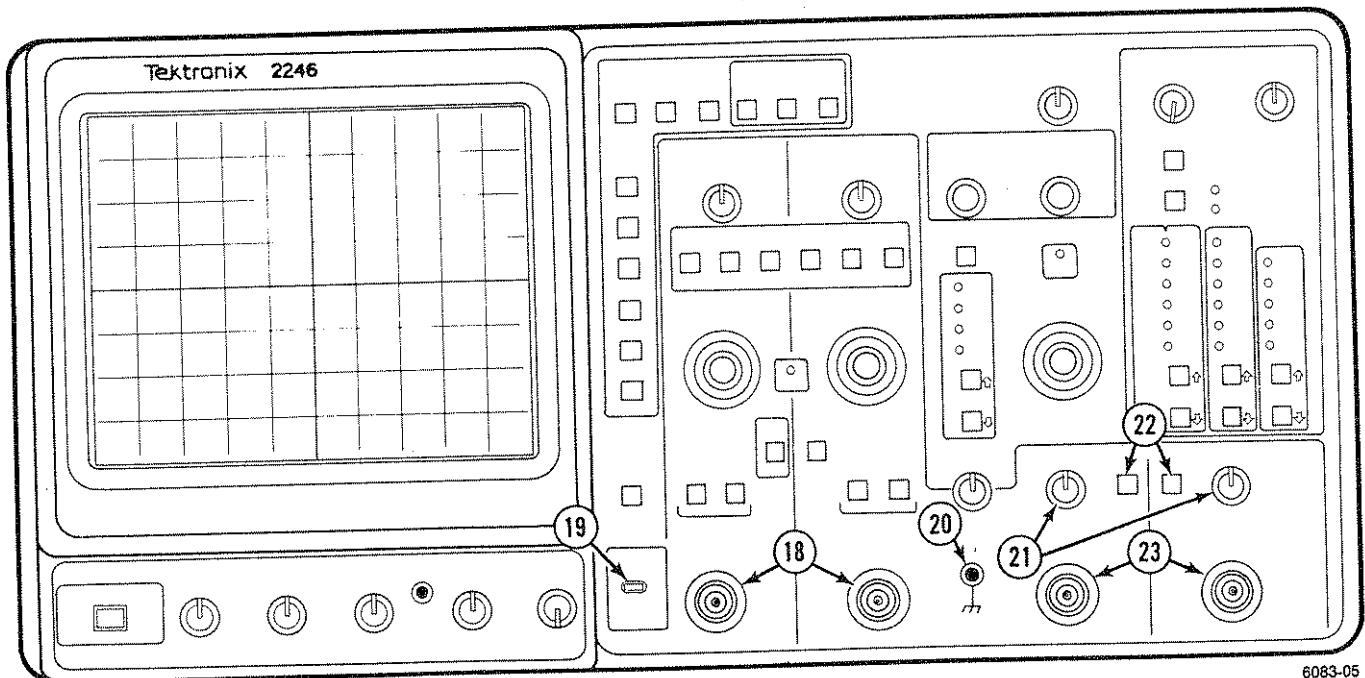

Figure 3-3. Vertical connectors and CH 3 and CH 4 Controls and indicators.

22 **Channel 3 and Channel 4 VOLTS/DIV Switches**—Select either of two basic deflection factors for Channel 3 and Channel 4. When the VOLTS/DIV button light is off, the deflection factor is 0.1 V per division (using a X1 probe or a coaxial cable input connection); when it is on, the deflection factor is 0.5 V per division.

23 **CH 3 and CH 4 Input Connectors**—Connect external signals to the inputs of Channel 3 and Channel 4 vertical attenuators via DC input coupling only.

The input connectors are BNC with probe-coding ring contacts (the same as the Channel 1 and Channel 2 connectors). The limited choice of deflection factors for the Channel 3 and Channel 4 inputs makes them most useful for the application of digital signal levels and trigger-signal-input channels. In X-Y mode, signals applied to either or both input connectors may be selected to provide a vertical deflection (Y-Axis) signal.

HORIZONTAL

See Figure 3-4 for items 24 through 32.

24 **POSITION Control**—Sets the horizontal position of the waveform displays on the crt. Clockwise rotation of the POSITION control will move the display to the right.

25 **X10 MAG Switch**—Horizontally magnifies the portion of all the normal sweep displays positioned at the center vertical graticule line by a factor of 10 when the X10 MAG button light is on. No action occurs in X-Y mode.

A X10 symbol appears in the readout on the right side of the A SEC/DIV display in A and ALT Horizontal MODE and on the left side of the B SEC/DIV display in B Horizontal MODE when X10 MAG is on. In X10 MAG mode, the fastest display sweep speed is extended to 2 ns per division. The crt SEC/DIV readout reflects the correct display sweep speed for the X10 MAG displays and the unmagnified displays.

26 **MODE Buttons (Up-Arrow and Down-Arrow) and Indicators**—Select and indicate the operating mode of the horizontal deflection system.

The Up/Down MODE buttons are used to select the desired mode of operation; the Horizontal MODE indicator lights show the selected horizontal

deflection mode. (Not all Menu Measurement modes are compatible with all horizontal deflection modes. See Section 6 for Menu Measurement operation.)

A—Horizontal deflection occurs at a sweep speed determined by the A SEC/DIV switch setting displayed in the crt readout. The A/B SELECT setting initializes to the A Trigger whenever the A MODE is selected.

ALT—Alternates between the A Sweep (with an intensified zone) and the B Delayed Sweep. Both the A and the B SEC/DIV switch settings are displayed in the crt readout. The A/B SELECT setting initializes to the B Trigger whenever ALT MODE is selected.

The B SEC/DIV switch setting is selectable in ALT Mode, but it cannot be set slower than the A SEC/DIV switch setting. Attempting to do so will switch both the A and the B SEC/DIV switch settings to a slower sweep speed. A faster A SEC/DIV setting must be set by the A and B SEC/DIV switch in the A Horizontal MODE before switching to ALT MODE. The B Sweep speed and the length of the intensified zone are both determined by the B SEC/DIV switch setting. When the A SEC/DIV and the B SEC/DIV are both set to the same sweep speed, an intensified zone 1/100 of the A SEC/DIV setting appears on the A Sweep and no alternate B Delayed Sweeps are displayed. To display the B Delayed Sweep in ALT Mode, set the B SEC/DIV setting to a faster sweep speed than the A SEC/DIV setting.

B—Horizontal deflection occurs at a sweep speed determined by the B SEC/DIV switch setting. The A/B SELECT setting initializes to the B Trigger whenever the B MODE is selected.

The start of the B Sweep in RUNS AFTER mode (or the arming of the B Trigger in any triggered mode) is delayed from start of the A Sweep by a time determined by the setting of the I- or DELAY control. The B SEC/DIV switch setting and the Delay Time Position setting are displayed in the crt readout. A question mark is displayed in front of the Delay Time readout if the B Trigger MODE is not RUNS AFTER. When a time CURSOR measurement mode is selected (I- SEC -I, I- 1/SEC -I, or I- PHASE -I) is selected, the B Trigger MODE switches to RUNS AFTER so that timing measurements may be made.

X-Y—The signal applied to CH 1 OR X input connector produces the horizontal (X-Axis) deflection. Signals applied to any vertical input

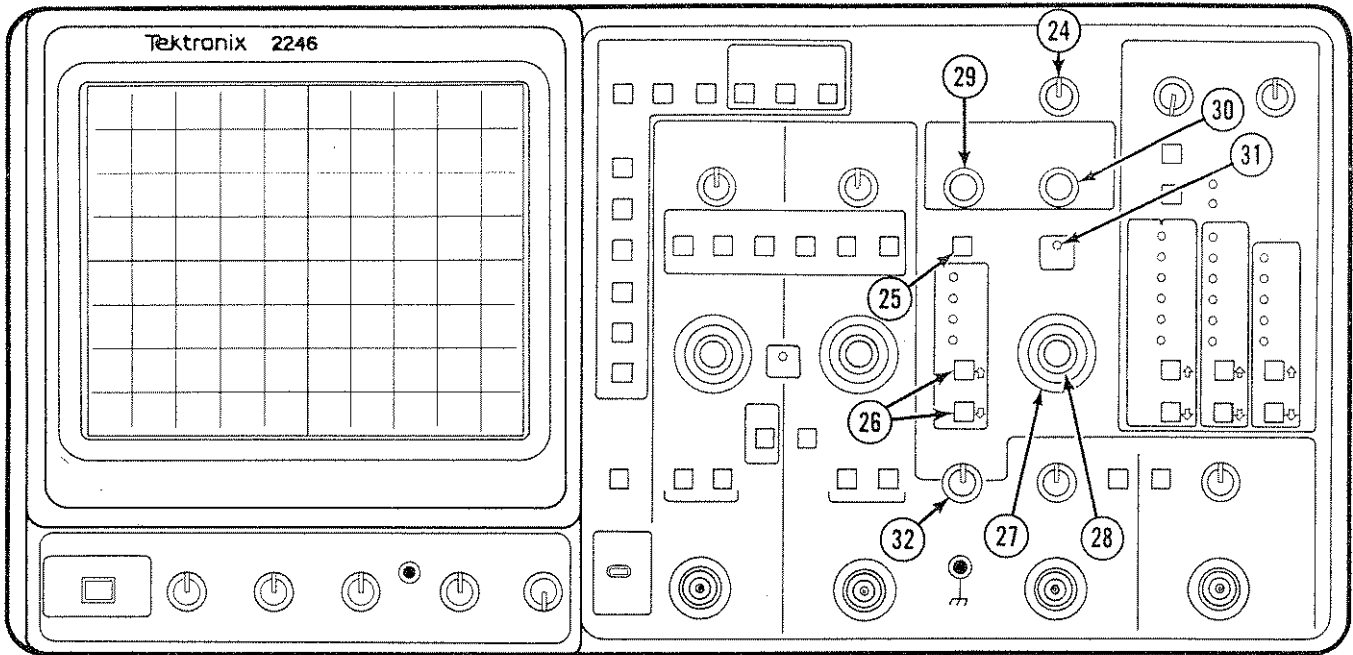

6083-06

Figure 3-4. Horizontal Controls and Indicators.

connector and/or ADD may be selected to supply the vertical (Y-Axis).

The X-Y displays are horizontally positioned by the Horizontal POSITION control and vertically positioned by the associated vertical channel POSITION control.

speeds to at least 2.5 times slower than the calibrated SEC/DIV setting.

The VAR control extends the slowest A Sweep speed to at least 1.25 sec per division. A greater-than sign (>) will appear before each displayed SEC/DIV setting when the VAR control is out of its detent position.

27) A AND B SEC/DIV Switch—Selects the horizontal deflection rate (sweep speed) for both the A Sweep and the B Sweep in a 1-2-5 sequence. Calibrated sweep speeds are obtained with the A and B SEC/DIV VAR control in the calibrated detent (fully clockwise) position.

A SEC/DIV—The calibrated A Sweep speed is selected only in A Horizontal MODE from 0.5 s per division to 20 ns per division (X10 MAG off).

B SEC/DIV—The calibrated B Sweep speed is selected either in ALT or B Horizontal MODE from 5 ms per division to 20 ns per division (X10 MAG off).

28) A and B SEC/DIV VAR Control—Provides continuously variable, uncalibrated A Sweep and B Sweep

29) CURSORS/TIME POSITION I- OR DELAY Control—Positions both the reference cursor and the delta cursor together when one of the cursor measurement modes is selected (volts or time in the A Horizontal MODE); positions the reference delay and the delta delay together when in ALT or B Horizontal MODE with ΔTIME measurements active. The control sets the B Sweep delay time in ALT or B Horizontal Mode in DELAY measurement mode and positions the intensified zone for GATED CH1/CH2 VOLTMETER measurements.

30) CURSORS/TIME POSITION →I OR Δ Control—Positions the delta cursor when one of the cursor measurement modes is selected; sets the B Sweep delta delay in ALT or B Horizontal Mode when the

Δ TIME measurement mode is active. Sets the width of the intensified zone for GATED CH1/CH2 VOLTMETER measurements.

NOTE

The delta cursor may be positioned to the end of the A trace; however, the delta delay time has a range of only ten times the A SEC/DIV setting (10 divisions). When maximum delta delay has been reached, increasing the main delay time reduces the spacing between the two delays and they do not track together (delta delay cannot be increased).

- 31 **UNCAL**—Indicates that the A AND B SEC/DIV VAR control is out of the calibrated detent position when lighted.
- 32 **TRACE SEP Control**—Positions the B Sweep trace vertically with respect to the A Sweep trace when ALT Horizontal MODE is selected.

TRIGGER

See Figure 3-5 for items 33 through 39.

- 33 **A/B SELECT Button**—Directs the MODE, SOURCE, CPLG, SLOPE, and LEVEL controls and Trigger LED indicators (TRIG'D and READY) to either the A Trigger system or the B Trigger system. The A/B SELECT button light is on for the A Trigger and off for the B Trigger. When switching Horizontal MODES, the A/B SELECT choice is initialized for the MODE switched to: A Trigger when selecting A Horizontal MODE and B Trigger when selecting ALT or B Horizontal MODE. No change occurs when switching to X-Y Horizontal MODE.
- 34 **SLOPE Button**—Selects the slope of the trigger source signal that triggers either the A Sweep or the B Sweep.

The sweep to which the trigger controls are directed by the A/B SELECT switch is triggered from the positive-going slope of the trigger signal when the SLOPE button light is on. When the SLOPE button light is off, the sweep is triggered from the negative-going slope of the trigger signal.

- 35 **HOLDOFF Control**—Varies the amount of holdoff time between the end of one A Sweep and the start of the next A Sweep.

Full clockwise rotation of the HOLDOFF control increases the holdoff time by at least a factor of ten; full counterclockwise rotation produces minimum holdoff time. Use this control as an aid in obtaining stable triggering on aperiodic signals (such as complex digital waveforms).

- 36 **LEVEL Control**—Sets the amplitude point on the trigger signal at which either the A Sweep or the B Sweep (as directed by the A/B SELECT button) is triggered.

When the TRIGGER MODE is set to AUTO LEVEL, adjusting the trigger level setting to either end of the control range causes the auto level trigger to be recalculated so that the LEVEL control range is limited to the peak-to-peak amplitude of the trigger source signal.

- 37 **MODE Buttons (Up-Arrow and Down-Arrow) and Indicators**—Select and indicate the operating mode of the A and B trigger systems.

The Up/Down MODE buttons are used to select the trigger system operating mode from the choices of AUTO LEVEL, AUTO, NORM, TV LINE, TV FIELD, and SGL SEQ for the A Trigger system and AUTO LEVEL, RUNS AFTER, NORM, TV LINE FROM A SOURCE for the B Trigger system as directed by the A/B SELECT button. The TRIGGER MODE front-panel lights indicate the selected mode of operation for the A and the B trigger system.

A TRIGGER MODES

AUTO LEVEL—Automatically sets the range of the Trigger LEVEL control to the peak-to-peak limits of the signal selected as the A Trigger source if that signal's amplitude and repetition rate are adequate. This mode is very useful for quickly locating the Trigger LEVEL setting for stable triggering.

The A Sweep free runs if the trigger source signal amplitude is too low or if the repetition rate of the applied signal is too slow. An amplitude change of the triggering signal does not cause a reacquisition of the peak-to-peak signal limits unless triggering is lost at the set level. See VERT Trigger MODE for related information regarding the Trigger Signal SOURCE selection.

The signal trigger level is reacquired in the following conditions: whenever triggering is lost, when the TRIGGER LEVEL control is rotated to either end stop, and if the AUTO LEVEL mode is

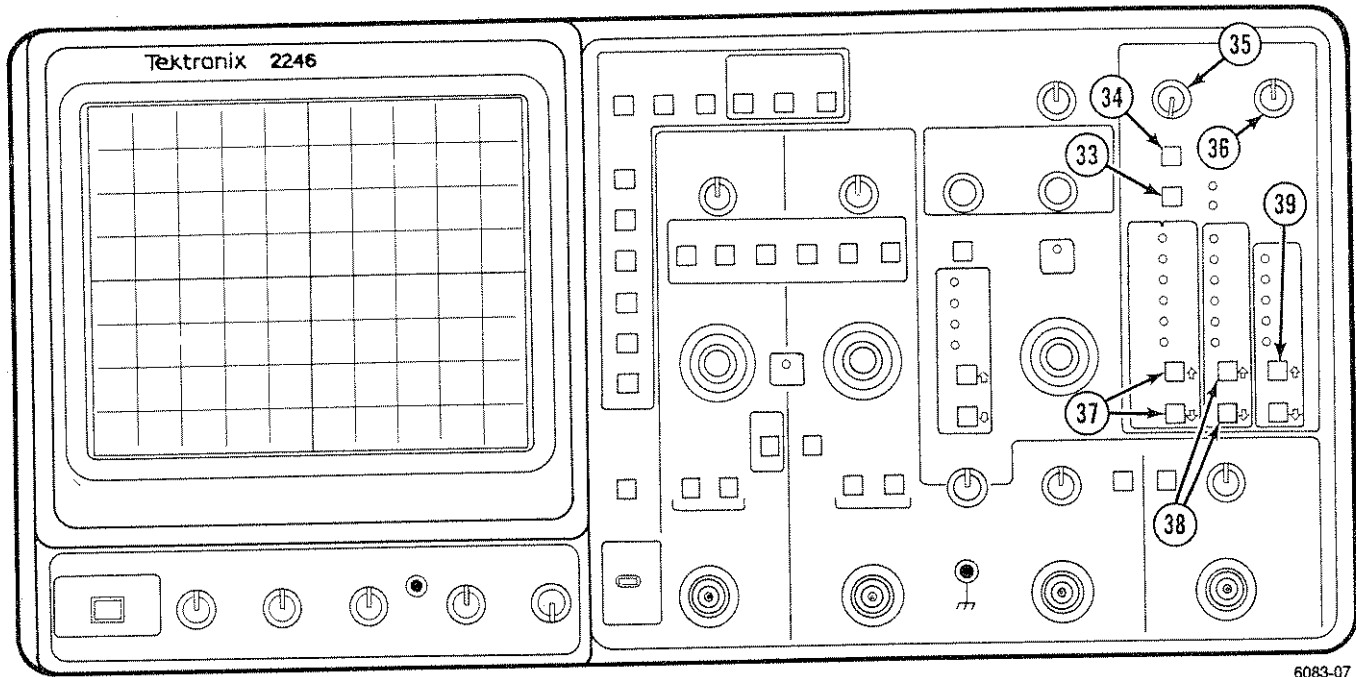

Figure 3-5. Trigger Controls and indicators.

reselected. The trigger selected by the A/B SELECT button is the trigger signal that is reacquired, except when triggering is lost. In that case, reacquiring the A Trigger has priority over the B Trigger. The trigger level remains as set when switching to AUTO or NORM TRIGGER MODE until the TRIGGER LEVEL control is rotated.

AUTO—Triggers as in NORM Trigger MODE when an adequate trigger signal is applied.

The A Sweep begins free-running for an auto baseline in the absence of a triggering signal or when the repetition rate of the trigger signal is too low (see Table 3-1 for critical triggering intervals). The set triggering level changes only when the TRIGGER LEVEL control is adjusted to a new level setting.

NORM—Initiates the A Sweep when an adequate trigger signal is applied. In the absence of a trigger signal, a sweep is not generated (no baseline trace is displayed).

TV LINE—Starts the A Sweep at the beginning of a video signal line. SLOPE polarity must match

Table 3-1
Auto Triggering Intervals

SEC/DIV Setting	Critical Trigger Interval
5 ms/div and faster	20 ms
10 ms/div	40 ms
20 ms/div	160 ms
50 ms/div and slower	400 ms

the composite sync polarity to obtain TV LINE triggering on the horizontal sync pulse.

TV FIELD—Starts the A Sweep at the beginning of a video signal field. SLOPE polarity must match the composite sync polarity to obtain TV FIELD triggering.

SGL SEQ (Single Sequence)—Arms the A Sweep for single-sequence operation when

selected and with each additional press of the down-arrow MODE button after selection.

When triggered, the sweep runs to produce a single sweep of each of the traces as required by the setting of the VERTICAL MODE and TRIGGER MODE switches, but each displayed sweep in the sequence requires a distinct A Sweep triggering event. The READY front panel light remains on until the final trace in the sequence is completed. The readout and cursors may be turned on for only a short period of time at the end of sequence for use with a camera, or they may be set to remain on by changing the instrument configuration from the CONFIGURE menu (see SERVICE MENU in Section 6).

B TRIGGER MODES

AUTO LEVEL—Sets the range of the Trigger LEVEL control to the peak-to-peak limits of the signal selected as the B Trigger source if the signal amplitude and repetition rate are adequate. This mode is very useful for quickly setting the Trigger Level to obtain stable triggering.

The B Sweep is triggered as for NORM triggering after all the trigger signal conditions and the delay time set by the I- or DELAY control have been met. If a trigger is not found (trigger source signal amplitude is not sufficient or if the repetition rate of the applied signal is too slow), the B TRIGGER MODE operation reverts to RUNS AFTER to produce an untriggered baseline display. (See Table 3-1 for critical triggering intervals that will result in a free running B Sweep.) The resulting trace will appear to be triggered if the A Sweep is triggered, but the TRIG'D LED will not be on and the DELAY control will move the displayed B trace signal smoothly rather than from trigger point to trigger point as would be expected for a triggered B Sweep.

Peak signal levels will be measured from the start of the delay time to the end of the A Sweep if the measurement time interval does not exceed 500 ms. If the measurement time exceeds 500 ms, the peak signal limits will be measured over the entire A Sweep. The signal trigger level is reacquired for the same conditions described in A TRIGGER MODES for AUTO LEVEL. The B Trigger signal AUTO LEVEL peak measurements will not be done if the A Trigger MODE is SGL SEQ.

RUNS AFTER—Starts the B Sweep immediately after the delay time selected by the I- OR DELAY control.

RUNS AFTER Trigger MODE is forced on if timing measurements other than Delay are selected when the Horizontal Mode is ALT or B Delayed.

NORM—The B Sweep is initiated when an adequate trigger signal is received after the delay time condition has been met. In the absence of a trigger signal, no B Sweep trace occurs.

TV LINE FROM A SOURCE—Starts the B Sweep at the beginning of a the video signal line received after the delay time has been met.

SLOPE polarity must match the composite sync polarity (same as A Trigger SLOPE) to obtain correct triggering on the horizontal sync pulse.

38 SOURCE (Up-Arrow and Down-Arrow) Buttons and Indicators—Select the trigger source for either the A or the B Trigger system and indicate the selected source as directed by the A/B SELECT button.

The Up/Down SOURCE buttons are used to select the trigger source, and the Trigger SOURCE front-panel lights indicate the selected trigger signal source for the trigger system selected by the A/B SELECT button.

VERT—Selects the trigger signal from the displayed waveforms.

The selection of the trigger signal source is determined by the TRIGGER MODE and VERTICAL MODE switch settings. With VERT selected, one or more of the SOURCE front-panel lights will be on to indicate the trigger signal source. See Table 3-2 for VERT Trigger SOURCE selections.

Table 3-2
VERT Trigger SOURCE

Trigger and Vertical Modes	ADD Mode	Trigger SOURCE Selected
AUTO LEVEL or CHOP	On	Algebraic sum of CH 1 and Ch 2 input signals.
	Off	Lowest numbered vertical channel displayed.
NON-AUTO LEVEL and ALT	On or Off	Alternates between displayed vertical channels in the following order: CH 1, CH 2, CH 3, CH 4, and ADD.

Controls, Connectors, and Indicators—2246 Operators

CH 1—The signal applied to the CH 1 OR X input connector is the source of the trigger signal.

CH 2—The signal applied to the CH 2 input connector is the source of the trigger signal.

CH 3—The signal applied to the CH 3 input connector is the source of the trigger signal.

CH 4—The signal applied to the CH 4 input connector is the source of the trigger signal.

LINE—The triggering signal is obtained from a sample of the ac power-source waveform. This trigger source is useful when the displayed waveform frequency is time related to the ac power-source frequency.

39 CPLG (Up-Arrow and Down-Arrow) Buttons and Indicators—Select the type of coupling of the input trigger signal to the trigger signal amplifier and indicate the coupling selected as directed by the A/B SELECT button.

DC—Couples dc and all frequency components of a triggering signal to the trigger circuitry.

DC coupling is useful for most signals, but it is especially useful for providing a stable display of low-frequency or low-repetition-rate signals.

NOISE REJ (Noise Reject)—Couples all frequency components of the input signal to the trigger circuitry but increases the peak-to-peak signal amplitude required to produce a trigger event.

NOISE REJ coupling is useful for improving stability when the trigger signal is accompanied by low-level noise.

HF REJ (High Frequency Reject)—Attenuates high-frequency triggering signal components above 50 kHz.

HF REJ coupling is useful for providing a stable display of low-frequency components of complex waveforms and eliminates high-frequency interference from the trigger signal.

LF REJ (Low Frequency Reject)—Attenuates low-frequency triggering signal components below 100 kHz and blocks the dc component of the trigger signal.

LF REJ coupling is useful for producing stable triggering on the high-frequency components of complex waveforms and rejecting low-frequency interference or power supply hum from the trigger signal.

AC—Attenuates trigger signal frequency components below 50 Hz and blocks the dc component of the signal.

AC coupling is useful for triggering on ac waveforms that have a large dc offset.

REAR PANEL

See Figure 3-6 for items 40 through 42.

40 EXT Z-AXIS INPUT Connector—Connects external signals to the Z-Axis amplifier for the purpose of intensity modulating the crt display.

Signals applied to the EXT Z-AXIS INPUT do not affect display waveshape. Signals with fast rise times and fall times provide the most abrupt intensity change. The active region threshold level is 1.8 V. Z-Axis voltage above the threshold voltage decreases the intensity, and 3.8 V or more produces blanking. The Z-Axis signals must be time related to the displayed signal to obtain a fixed intensity-modulation presentation on the crt.

41 Fuse Holder—Contains the primary power fuse.

42 Power Cord Receptacle—Connects the ac power source to the instrument power supply.

The power cord safety-ground connection is connected to the exposed metal parts of the instrument. The power cord must be connected to a properly grounded source for electrical shock protection.

MENU CONTROLS

See Figure 3-7 for items 43 and 44. See Section 6 "Measurement Processes" for detailed use of the menus for making cursor measurements.

43 Menu Select Buttons—Used to make a menu selection from the list that is displayed on the right side of the crt.

A menu-driven function is activated by pressing the Menu Select button next to the menu label, and the

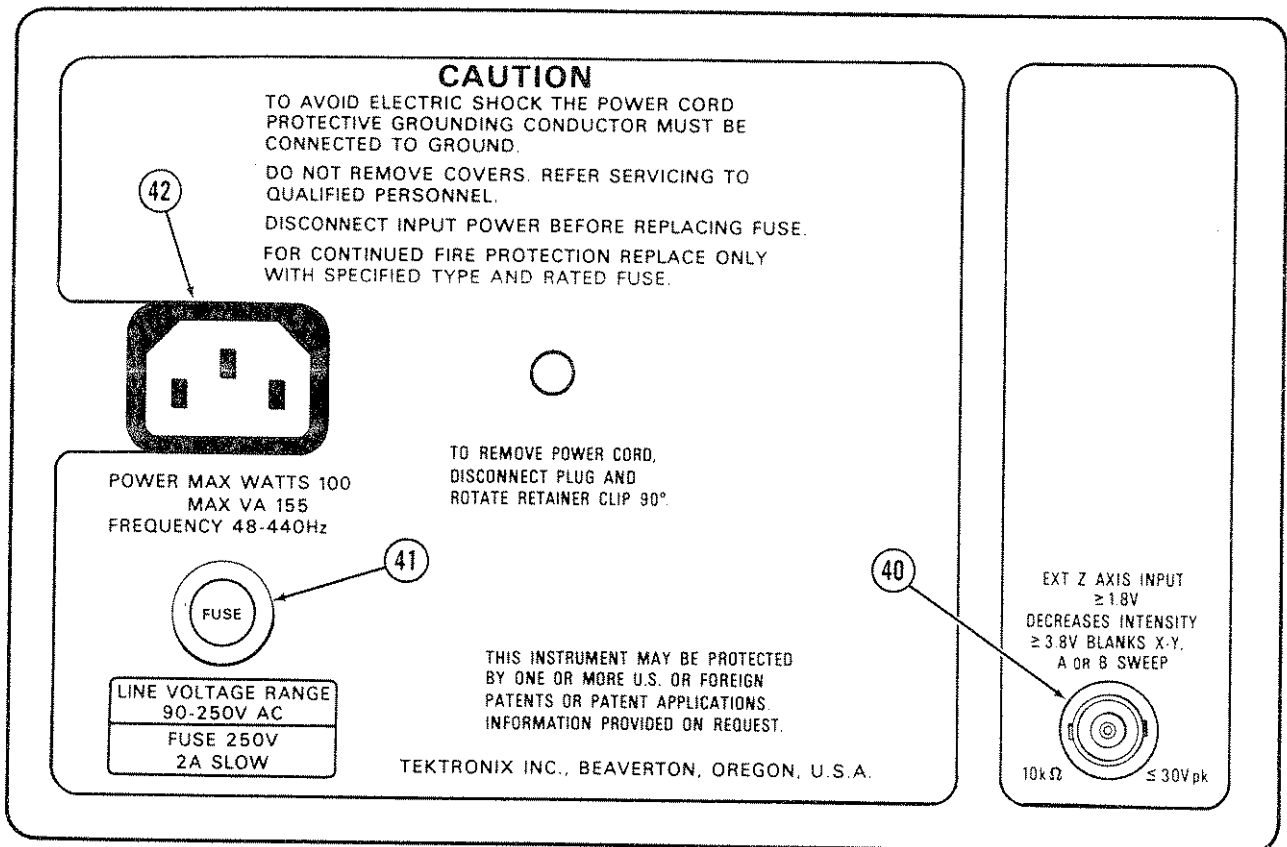

Figure 3-6. Rear Panel Connectors and Fuse.

6083-08

menu display is cleared. (The menu displays may be configured to remain on from the CONFIGURE menu, see Section 6.) When a menu is recalled to make a new selection, the label of the active function is shown underlined. A function is turned off either by pressing the active function menu button a second time or by selecting another menu choice when only one choice may be active. If there is no label next to a Menu Select button, that button is ignored if pressed.

Some menus have more than six choices available. For menus that are longer than one page, press the Menu Select button opposite the menu choice directing the user "TO" the next page for the additional choices. The first page of the menu is returned either by pressing the Menu Select button for that menu list a second time or by selecting the menu choice in the second menu page that directs the user "BACK TO" to the first page.

44 **Menu Display Control Buttons**—Control the menu display and call up Measurement selection menus that are displayed on the right side of the crt screen.

CLEAR DISPLAY—Turns off a displayed menu, turns off a measurement function (and TRACK MEASMT cursors if displayed), or turns off the TRACK TRIG LVL and TRACK \uparrow functions in three levels.

If a menu is on, the first press clears it from the display; active measurement functions are turned off as the second priority; and finally the TRACK TRIG LVL and TRACK \uparrow cursors are canceled as the third priority.

SET MEAS'MT CHANNEL—Calls up the source channel menu for the selected measurement.

The menu lists the possible input signal sources (channels) for the selected measurement mode (see Table 6-1 in Section 6 for choices). Pressing one of the Menu Select buttons designates that channel as the signal source for the measurement and clears the menu from the display.

If no measurement mode is in effect when the button is pressed, the message "SELECT A MEASUREMENT" is displayed for two seconds

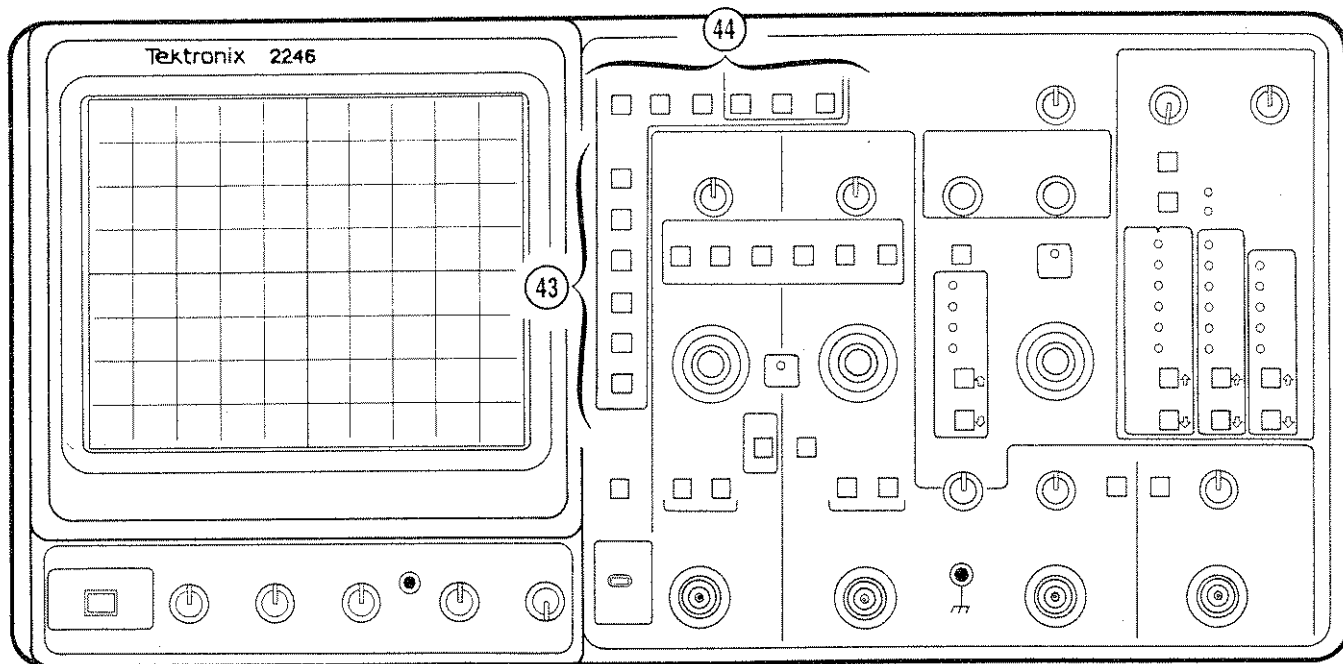

6083-09

Figure 3-7. Menu Controls.

then cleared. If a measurement mode not requiring a measurement channel to be selected is active (such as a Cursor Time Measurement mode), the message "NO MEAS CHANNEL NEEDED" is displayed for two seconds.

Changing the Horizontal MODE (A to ALT or B to X-Y or vice versa) while the SET MEAS'MT CHANNEL menu is being displayed, turns off the measurement mode in effect and clears the channel select menu from the display.

LAST MEAS'MT—Recalls and initializes the last active measurement mode if none is active or reinitializes an active measurement mode.

The measurement mode and measurement value are displayed at the top of the screen. LAST MEAS'MT initializes in the following manner:

↳ VOLTS ↳ and $\overline{\text{H}}$ VOLTS ↳ cursors and CH1/CH2 VOLTMETER measurements are initialized to Channel 1 if Channel 1 is displayed; otherwise to Channel 2.

Δ TIME measurements in ALT and B Horizontal mode initialize to the lowest number displayed channel for the reference delay time and the next lowest number displayed channel for the delta delay if more than one channel is displayed; otherwise, both delays are on the same channel. ADD is considered the highest numbered channel for initialization purposes.

NOTE

If the stored front panel data ever becomes invalid, the last measurement is initialized to ↳ SEC ↳ at power on. This initialization occurs if the memory-backup battery is dead, and the first time the instrument is turned on after replacing the battery. Refer the instrument to a qualified service person for battery replacement.

CH1/CH2 VOLTMETER—Calls up the voltage measurement menu. A selected measurement mode is indicated by an underscored menu label. Measurement-tracking and ground-tracking

SmartCursors® may be displayed to provide visual feedback to the user about the measurement points on the displayed signal (see CURSORS).

Only one active measurement at a time is allowed. The name of the active measurement and readout of the measurement value are displayed at the top of the screen. Available voltmeter menu choices are given in Figure 3-8. If the Horizontal Mode is changed to a mode that cannot be used for the selected measurement, the measurement will be canceled, and no messages to that effect will be displayed. See Section 6 for compatible modes.

GATED VOLTMETER measurements are made within the gated (intensified) region on the displayed waveform. The position of the gated zone is set using the ← OR DELAY control, and the width is set using the → OR Δ position control. Gated measurements are not allowed in SGL SEQ Trigger MODE, and any active gated measurements will be canceled if SGL SEQ Trigger MODE is selected. If a gated measurement is selected after switching to SGL SEQ Trigger MODE, the message "NOT ALLOWED IN SSEQ" will be visible for two seconds, if a trigger occurs.

CURSORS—Calls up the Page 1 menus used to select a positionable-cursor measurement mode. Page 2 menus are used to enable the auto-tracking SmartCursors® that may be displayed (see Figure 3-9).

Only two cursors of any type, tracking or positionable, may be displayed at the same time. Which enabled cursors are displayed is based on a prescribed priority system, with positionable cursors and measurement-tracking cursors taking priority over the trigger-level and ground-tracking cursors. Pressing CLEAR DISPLAY turns off the TRACK TRIG LVL and TRACK ⇄ functions and removes the TRACK MEASUREMENT cursors from the waveform display (see the CLEAR DISPLAY description for the way the button operates).

Selecting a positionable-cursor measurement mode from Page 1 prevents any of the tracking cursors from being displayed, but does not disable the selection in Page 2 of the menu. Enabled tracking cursors will be returned to the display as their priority permits. Displayed cursors are labeled to distinguish one type from another (see Figure 3-10).

In addition to being enabled in the Page 2 menu, the appropriate settings of VERTICAL MODE,

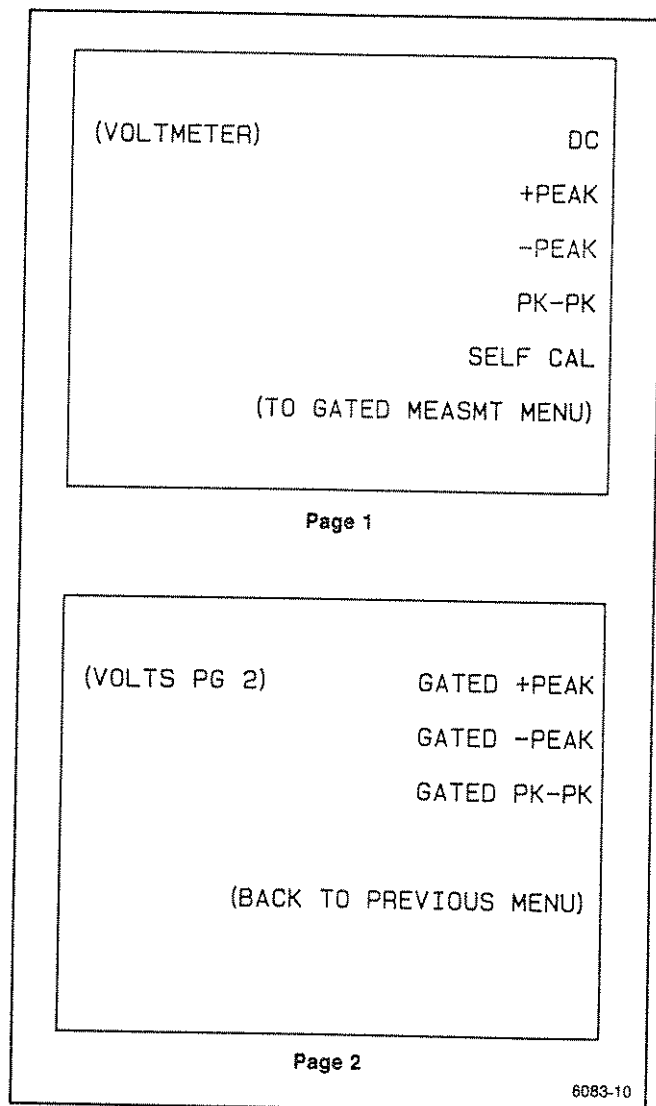

Figure 3-8. CH1/CH2 VOLTMETER Measurement Menus.

Trigger SOURCE, Trigger MODE, Trigger CPLG, and Horizontal MODE must be made for the TRACK TRIG LVL cursor to appear in the display. TRACK ⇄ cursors must only be enabled and have either CH 1 or CH 2 VERTICAL MODE on.

When a ← VOLTS → or a ⇄ VOLTS → measurement mode is first selected (either by direct selection or as a result of pressing the LAST MEAS'MT button), the voltage measurement cursor positions are initialized. For ← VOLTS →, the SmartCursors® are set at the plus-peak and minus-peak values of the lowest number displayed waveform of CH 1 or CH 2. For ⇄ VOLTS →, the active cursor is set to the plus peak. The ← VOLTS → cursors may be used to

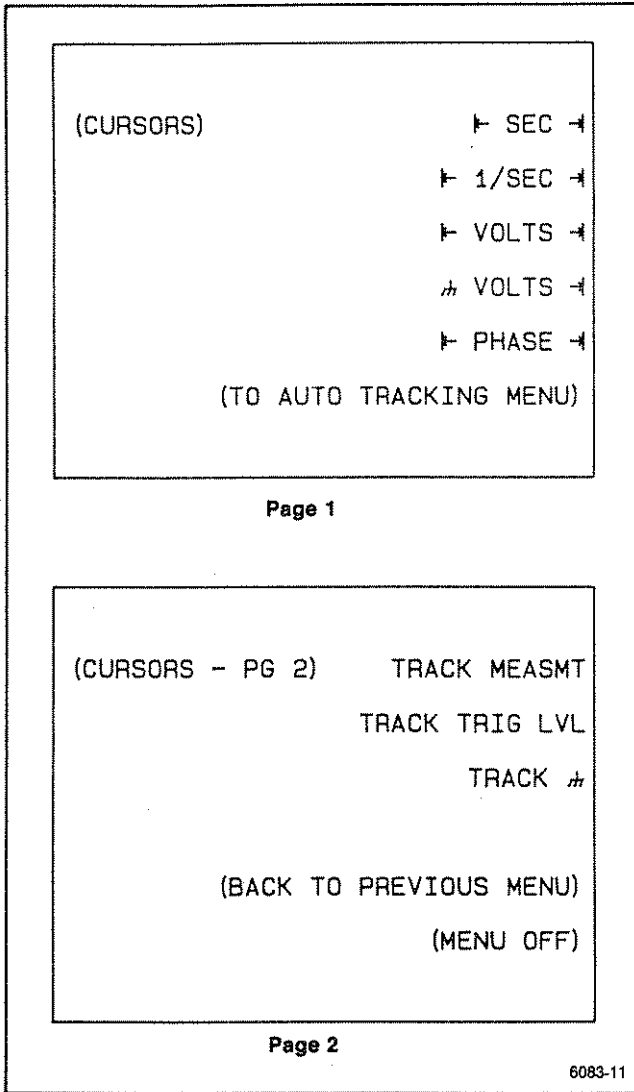

Figure 3-9. CURSOR Measurement Menus.

make measurements on the CH 3 or CH 4 waveforms (with less accuracy than possible on the CH 1 or CH 2 waveforms) by setting the VOLTS/DIV setting of the measurement source channel to the same VOLTS/DIV setting as the channel the signal to be measured is on. For example, if the signal to be measured is on CH 4 at 0.5 VOLTS/DIV, set the measurement source to CH 1 and CH 1 VOLTS/DIV to 0.5 V.

ΔTIME Button—Calls up the menu used to select the type of timing measurement to be made. Menu choices are listed on the right side of the screen.

A selected ΔTIME measurement mode is underscored when the menu is displayed. Only one

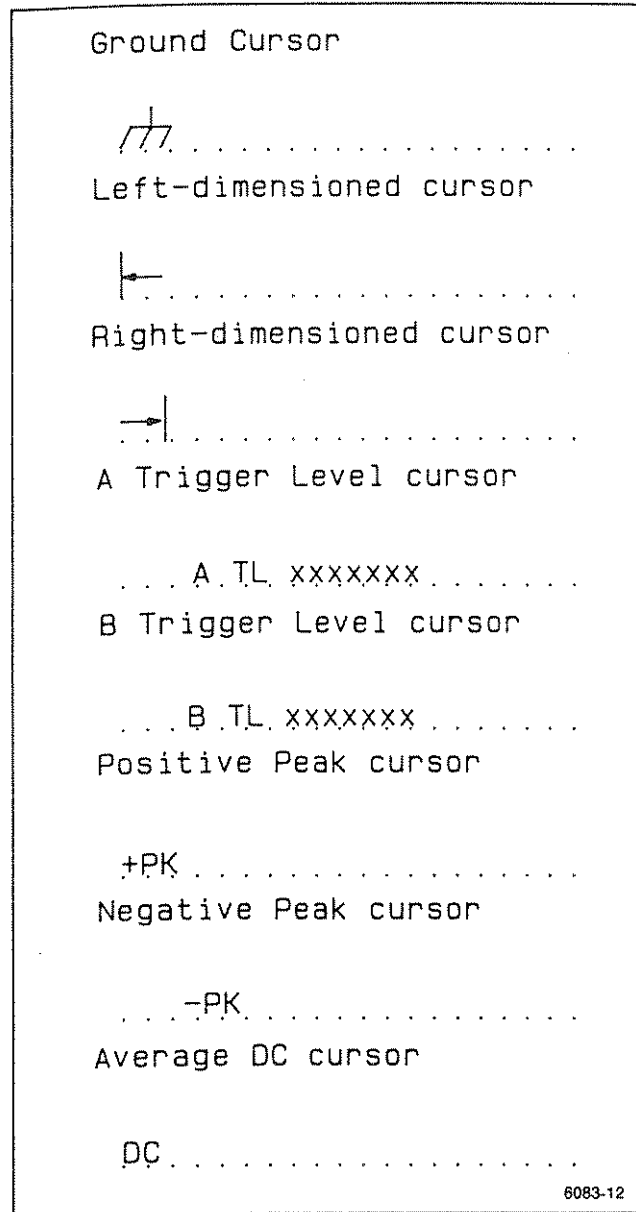

Figure 3-10. Cursor identifiers.

active measurement at a time is allowed. Upon making a selection, the menu is removed, and the name of the selected measurement type and readout of the measurement value are displayed at the top of the screen. Menu selections for ΔTIME measurements are shown in Figure 3-11.

In the A Horizontal MODE, cursors are used to make the time measurements; in ALT or B Horizontal MODE, the timing measurements are made using either the intensified zones that appear in the A Sweep trace in ALT Horizontal MODE or the B delayed waveforms in either ALT

or B Horizontal MODE. The I- OR DELAY control positions both cursors or delay times (reference and delta) together, and the →I OR Δ control positions the independent delta cursor or delay when ΔTIME measurements are selected.

When selecting I- PHASE →I measurement, a second menu is displayed to permit the user to set the 360 degree phase measurement reference. The two choices displayed are:

I- PHASE →I and I- SET 360° →I.

If the current reference setting is correct, select I- PHASE →I to continue with the phase measurement. To set a new reference, press I- SET 360° →I and position the cursors to the new reference value using the I- OR DELAY and →I OR Δ control knobs. After setting the new reference, press I- PHASE →I to continue the phase measurement.

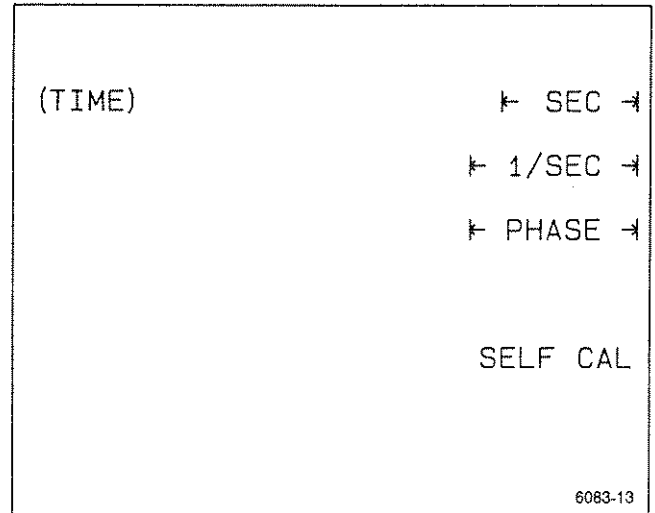

Figure 3-11. ΔTIME Menu Selections.

OPERATING INFORMATION

GRATICULE

The graticule is internally marked on the faceplate of the crt to eliminate parallax-viewing error and to enable accurate measurements (see Figure 4-1). The graticule is marked with eight vertical and ten horizontal major divisions. Major divisions are further divided into five subdivisions of 0.2 division each, marked along the center vertical and horizontal graticule lines. Percentage marks for rise-time and fall-time measurements are located on the left side of the graticule. The vertical deflection factors and horizontal timing are calibrated to the graticule so that accurate measurements may be made directly from the crt.

The waveform displays are calibrated to the crt graticule markings for making quick and very accurate esti-

mates of waveform parameters. Voltage measurements are done by counting the vertical graticule divisions and partial divisions occupied by the portion of the display being measured and then multiplying by the VOLTS/DIV setting. Time measurements using the graticule markings are done in a similar manner. Count the number of horizontal graticule divisions and partial divisions occupied by the portion of the waveform being measured and multiply by the SEC/DIV setting.

To improve the accuracy of the estimate, position the display to take advantage of the 0.2 division minor graticule markings on the center graticule lines. Also position one of the measurement points of the waveform as precisely as possible on one of the major graticule marks to be used as a measurement reference point.

CRT READOUTS

The crt readout display is the user's guide to how the instrument controls are set up. No physical markings are on the rotating switches and control knobs to indicate the control setting. A key to the location and type of readout information displayed is illustrated in Figure 4-2.

GROUNDING

The most reliable signal measurements are made when the 2246 and the unit under test are connected by a common reference (ground lead) in addition to the single lead or probe. The ground lead of the probe provides the best grounding method for signal interconnection and ensures the maximum amount of signal-lead shielding in the probe cable. A separate ground lead can also be connected from the unit under test to the oscilloscope ground jack on the front panel using a banana-tip connector.

SIGNAL CONNECTIONS

Probes

Generally, probes offer the most convenient means of connecting an input signal to the instrument and are shielded to prevent pickup of electromagnetic interference.

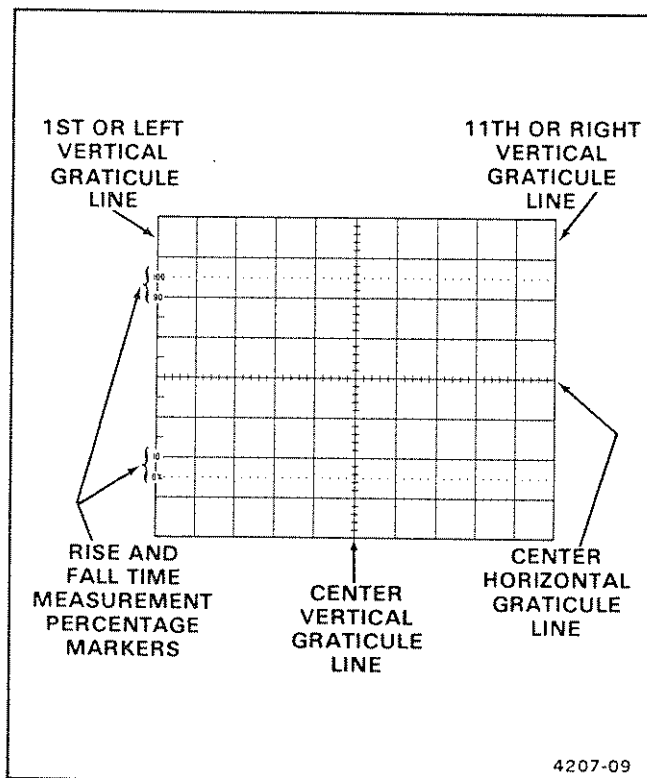

Figure 4-1. Graticule measurement markings.

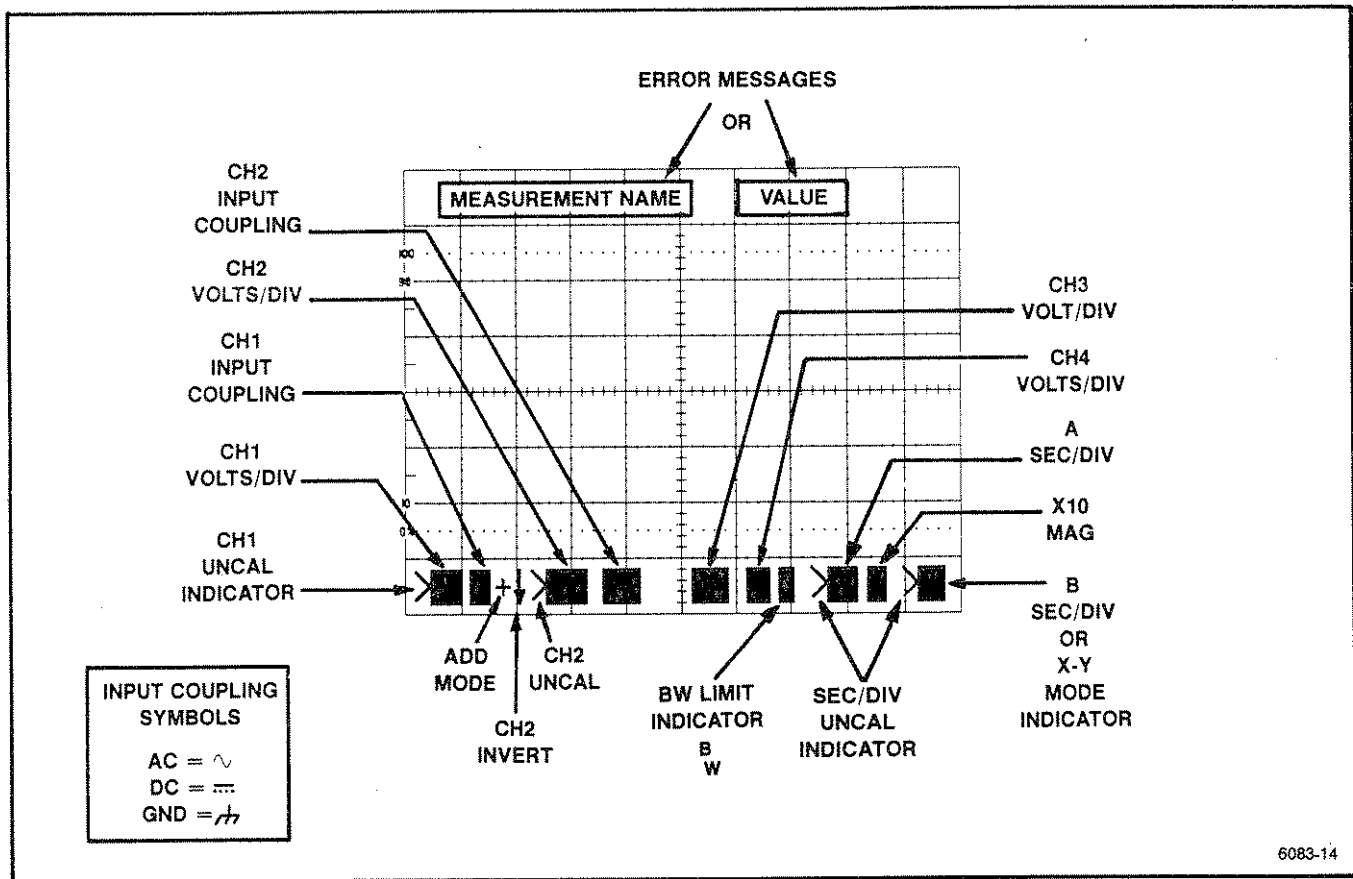

Figure 4-2. 2246 Readout display locations.

The standard 10X probes supplied with this instrument offer a high input impedance that minimizes circuit loading. This allows the circuit under test to operate with a minimum of change from the normal, unloaded condition. Also, the subminiature body of these probes has been designed for ease of use when probing circuitry containing close lead spacing.

The probe itself and the probe accessories should be handled carefully at all times to prevent damage. Striking a hard surface or dropping the probe body can cause damage to both the body and the probe tip. Use care to prevent the cable from being crushed or kinked, and do not place excessive strain on the cable by pulling it.

The standard-accessory probe is a compensated 10X voltage divider. It is a resistive voltage divider for low frequencies and a capacitive voltage divider for high-frequency signal components. Inductance introduced by long signal or ground leads may form a series-resonant circuit. This resonant circuit will affect system bandwidth and will oscillate (ring) if driven by a signal containing

significant frequency components at or near its resonant frequency. Ringing can then appear on the scope display and distort the true signal waveform. Always keep both the ground lead and the probe signal-input connections as short as possible to maintain the best waveform fidelity.

Misadjustment of probe compensation is a common source of measurement error. Because of variations in oscilloscope input characteristics, probe compensation should be checked and adjusted, if necessary, whenever a probe is moved from one oscilloscope to another or between channels of a multichannel oscilloscope. The probe compensation adjustment procedure is found in "Operator's Checks and Adjustments," Section 5 of this manual and in the instructions supplied with the probe.

SCALE FACTOR SWITCHING. The VOLTS/DIV scale factors are displayed on the CRT. The VOLTS/DIV readout always reflects the correct scale factor in response to a control change or as a result of change in

the probe attenuation factor (when Tektronix coded probes are used).

Coaxial Cables

Cables used to connect signals to the input connectors may have considerable effect on the accuracy of a displayed waveform. To maintain the original frequency characteristics of an applied signal, only high-quality, low-loss coaxial cables should be used. Coaxial cables must be terminated at both ends in their characteristic impedance to prevent signal reflections within the cable. Use suitable impedance-matching devices.

EXTERNAL TRIGGERING

The A and the B trigger signals are independently obtainable from a variety of sources. When viewing signals that require a trigger source different than one of the displayed signals, a free vertical input channel may be used to input the trigger signal. The CH 1 and CH 2 vertical input channels may be used to condition a wide range of signals to produce triggers over the full vertical deflection range from millivolts to hundreds of volts in amplitude. The CH 3 and CH 4 vertical input channels have a choice of two attenuation factors (either divided by 1 or by 5 without the use of external attenuation) and are especially useful for triggering on and viewing digital signal levels.

OPERATOR'S CHECKS AND ADJUSTMENTS

INTRODUCTION

If adjustments are required beyond the level of these operator's checks and adjustments, refer the instrument to a qualified service person.

For new equipment checks, before proceeding with these instructions, refer to "Preparation for Use," Section 2 of this manual to prepare the instrument for the initial start-up before applying power.

Verify that the POWER switch is OFF (out position), then plug the power cord into an appropriate ac-power-source outlet supplying a voltage within the operating range of the instrument's power supply.

During the performance of these procedures, if an improper indication or instrument malfunction is noted refer the instrument to a qualified service person.

INITIAL SETUP

1. Press in the POWER switch button (ON) and allow the instrument to warm up (20 minutes is recommended for maximum accuracy).

2. Set the instrument front-panel controls to obtain a baseline trace:

Vertical Controls

POSITION	Midrange
VERTICAL MODE	CH 1
VOLTS/DIV	1 V
Channel 1 COUPLING	GND

Horizontal Controls

POSITION	Midrange
MODE	A
X10 MAG	Off
A SEC/DIV	0.1 ms
SEC/DIV VAR	Cal detent

Trigger Controls

A/B SELECT	A
MODE	AUTO
SOURCE	VERT
CPLG	DC

3. Adjust the A INTEN, READOUT, and FOCUS controls for desired brightness and best trace and readout definition.

4. Adjust the Vertical and Horizontal POSITION controls to center the trace within the graticule area.

TRACE ROTATION ADJUSTMENT

1. Preset instrument controls and obtain a baseline trace as described in "Initial Setup." Position the trace vertically to align it with the center horizontal graticule line and check that the trace is parallel with the graticule line.

NOTE

Normally, the resulting baseline trace will be parallel to the center horizontal graticule line, and the TRACE ROTATION adjustment will not be needed.

2. If the baseline trace is not parallel to the center horizontal graticule line, use a small straight-blade screwdriver or alignment tool to adjust the TRACE ROTATION pot for proper alignment of the trace.

PROBE LOW-FREQUENCY COMPENSATION

Misadjustment of probe compensation is a possible source of measurement error. The attenuator probes are equipped with compensation adjustments. To ensure the best measurement accuracy, always check probe compensation before making measurements.

Operator's Checks and Adjustments—2246 Operators

1. Preset instrument controls and obtain a baseline trace as described in "Initial Setup." Set the CH 1 VOLTS/DIV setting to 100 mV.
2. Connect the two supplied 10X probes to the CH 1 and CH 2 BNC input connectors.
3. Connect the probe tips to the CALIBRATOR loop and connect the probe ground leads to scope ground.
4. Use the CH 1 Vertical POSITION control to center the five-division CALIBRATOR square wave in the graticule area.
5. Check the square-wave signal for overshoot and rolloff (see Figure 5-1). If necessary, use the special adjustment tool supplied in the probe accessory package to adjust the low-frequency compensation for a square front corner on the square wave.
6. Press the CH 2 VERTICAL MODE button to turn CH 2 on in the display, and press the CH 1 Mode button to remove the CH 1 trace from the display.
7. Set the CH 2 VOLTS/DIV setting to 100 mV and vertically center the CALIBRATOR signal.
8. Repeat Step 5 for the second probe on the CH 2 BNC input connector.

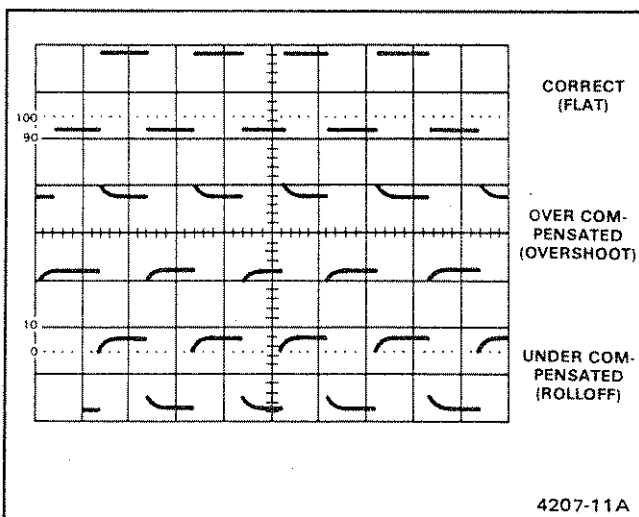

Figure 5-1. Probe Compensation.

NOTE

Refer to the instruction manual supplied with the probe for more detailed information about the probes and adjustment procedure.

VERTICAL DEFLECTION CHECK

The CALIBRATOR output signal may be used to check the Channel 1 and Channel 2 vertical deflection system in the following procedure:

1. Set the instrument controls to obtain a baseline trace as described in "Initial Setup."
2. Connect the two 10X probes supplied with the instrument to the CH 1 OR X and CH 2 input connectors (scale factor readout switches to 0.1 VOLTS/DIV for the attached 10X probes).
3. Connect both probe hook tips to the CALIBRATOR output connector.
4. Set the bottom of the trace of the CALIBRATOR square-wave signal to a convenient horizontal graticule line with the Vertical POSITION control.
5. Check for a five-division display of the CALIBRATOR square-wave signal.

TIMING CHECKS

The time measurement cursors may be used to check the accuracy of the horizontal deflection system.

1. Preset instrument controls and obtain a baseline trace as described in "Initial Setup." Vertically center the baseline trace.
2. Press the CURSORS button to call up the Cursor Measurement Mode menu on the crt and select I- SEC -I function for measuring time difference by pressing the Menu Select button opposite the menu label.
3. Align the reference cursor to the second vertical graticule line using the I- OR DELAY control (both cursors are positioned together).

4. Align the independent Δ cursor to the 10th vertical graticule line using the \rightarrow OR Δ control (for an eight-division cursor position difference).

5. Check that the time difference between the two cursors on the readout is between $794 \mu\text{s}$ and $806 \mu\text{s}$. To verify other A SEC/DIV switch settings, check the timing for each A SEC/DIV setting given the Table 5-1.

Table 5-1
Horizontal Timing Check

A SEC/DIV Setting	Readout Display
10 ms	79.4 ms to 80.6 ms
1 ms	7.94 ms to 8.06 ms
0.1 ms	$794 \mu\text{s}$ to $806 \mu\text{s}$
$10 \mu\text{s}$	$79.4 \mu\text{s}$ to $80.6 \mu\text{s}$
$1 \mu\text{s}$	$7.94 \mu\text{s}$ to $8.06 \mu\text{s}$

MEASUREMENT PROCESSES AND APPLICATIONS

This section is divided into three subsections: MENU SYSTEM OPERATION, MAKING MEASUREMENTS, and OTHER OPERATING FEATURES. The first subsection details the ways in which the measurement menus operate. The second subsection provides some general applications for using the measurement menus to make measurements on signal waveforms. The third subsection discusses use of other oscilloscope features that may aid the user in general measurement applications.

MENU SYSTEM OPERATION

The menu system is used to activate the measurement features of the 2246 and modify the ways in which those features operate. The control menus comprise the measurement menu call-up buttons (SET MEAS'MT CHANNEL, LAST MEAS'MT, CH1/CH2 VOLTMETER, CURSORS, and Δ TIME), the menu-item selection buttons beside the crt, the crt menu display, and the CLEAR DISPLAY button.

Pressing one of the measurement menu call-up buttons causes a list of menu items to be displayed on the right-hand side of the crt beside a group of six menu selection buttons. Pressing the menu button next to a menu item on the display selects that function (i.e., to another menu page, a measurement selection, a measurement source channel, or menu off). When an measurement mode or measurement source channel in the menu list is selected, that label is underlined.

Normally, the menu display turns off after a measurement function is selected (if not configured to remain on), and the name and value of a selected measurement function appears in the top line of the crt readout. However, when it is possible to make more than one selection from the menu list (or if the menu is configured to remain on), the menu will remain displayed for making further choices until either MENU OFF is selected or the CLEAR DISPLAY button is pressed.

CLEAR DISPLAY—Turns off a displayed menu, turns off a measurement function (and CH1/CH2 TRACK

MEASMT cursors), and turns off the TRACK TRIG LVL and TRACK $\uparrow\downarrow$ cursors in three levels depending on what is on that can be turned off. If a menu is on, the first press clears it from the display; measurement functions are turned off with the second press (or the first press if no menu is displayed); and finally the TRACK TRIG LVL and TRACK $\uparrow\downarrow$ cursors are canceled with a third press (or the first press if no menu is displayed and no measurement functions are active).

SET MEASUREMENT CHANNEL

The menu called up by pressing SET MEAS'MT CHANNEL depends on the measurement type, either CH1/CH2 VOLTMETER or Δ TIME (see Table 6-1). An error message of "NO MEAS CHANNEL NEEDED" is displayed for two seconds if attempting to select a measurement channel when a CURSORS time-measurement mode is active.

Pressing a menu button next to a channel number selects that choice as the source channel for the measurement. For CH1/CH2 VOLTMETER measurements, the selected source channel need not be displayed and is not automatically turned on when selected. It is possible therefore to view a CH 1 display and have the CH 2 voltage measurement value displayed by the readout (and vice versa).

When setting the measurement channel for the I- VOLTS \rightarrow I or $\uparrow\downarrow$ VOLTS \rightarrow I SmartCursors[®] or when set-

Table 6-1
Measurement Signal Source Selection Menu

CH1/CH2 VOLTMETER	ΔTIME	
	Set DELAY Time Channel	Set Δ DELAY Time Channel
CH1	CH1	CH1
CH2	CH2	CH2
	CH3	CH3
	CH4	CH4
	ADD	ADD
	(TO Δ CHANNEL MENU)	(BACK TO DELAY CHANNEL MENU)

ting delay-time channels, a channel that is selected in the menu is turned on if not previously selected, and it remains displayed when deselected as the measurement source channel. Any channel traces turned on that are not wanted in the display must be turned off using the VERTICAL MODE buttons.

If no measurement is active, pressing the SET MEAS'MT CHANNEL button causes the message "SELECT A MEASUREMENT" to appear in the top line of the display for two seconds.

RECALLING THE LAST MEASUREMENT MODE

Press LAST MEAS'MT to recall the last selected measurement mode if no measurement mode is active. The LAST MEAS'MT button may also be used to reinitialize an active measurement mode. A press of the button cancels the active measurement, and then recalls it in its initialized state. This feature is quite useful for returning VOLTS cursors to their initialized positions after they have been adjusted away.

CH1/CH2 VOLTMETER

Press CH1/CH2 VOLTMETER to display the choices of menu 1 shown in Figure 6-1.

NOTE

If a single channel is selected for display, that is the default measurement source channel. If both CH 1 and CH 2 are being displayed, the default measurement source channel upon each initialization is CH 1. Use the SET MEAS'MT CHANNEL function to assign CH 2 as the measurement channel. Turn off the CH 1 display if CH 2 is the desired default measurement source channel.

Voltmeter Measurements Page 1

DC—Press to measure the average DC level of the measurement channel waveform.

+PEAK—Measures the most positive (screen-relative) voltage in the applied waveform.

−PEAK—Measures the most negative (screen-relative) voltage in the applied waveform.

PK-PK—Measures the peak-to-peak voltage of the applied waveform.

SELF CAL—Self characterizes the vertical system. SELF CAL may be performed at any time. Suggested times are: after a warmup period, whenever the ambient operating temperature changes by $\pm 15^{\circ}\text{C}$, and just prior to making any voltmeter measurements requiring the best possible accuracy.

(TO GATED MEASMT MENU)—Selects the gated-measurement menu.

Voltmeter Measurements Page 2, GATED Measurements

The oscilloscope must be properly triggered for gated measurements. If there is no trigger signal in NORM Trigger MODE, the message "LO REP RATE — STILL TRYING" will be displayed. If there is no trigger signal in AUTO LEVEL or AUTO Trigger MODE, the readout value will be unstable and meaningless.

GATED +PEAK—Press to measure the most positive (screen-relative) voltage in the gated (intensified) portion of the waveform.

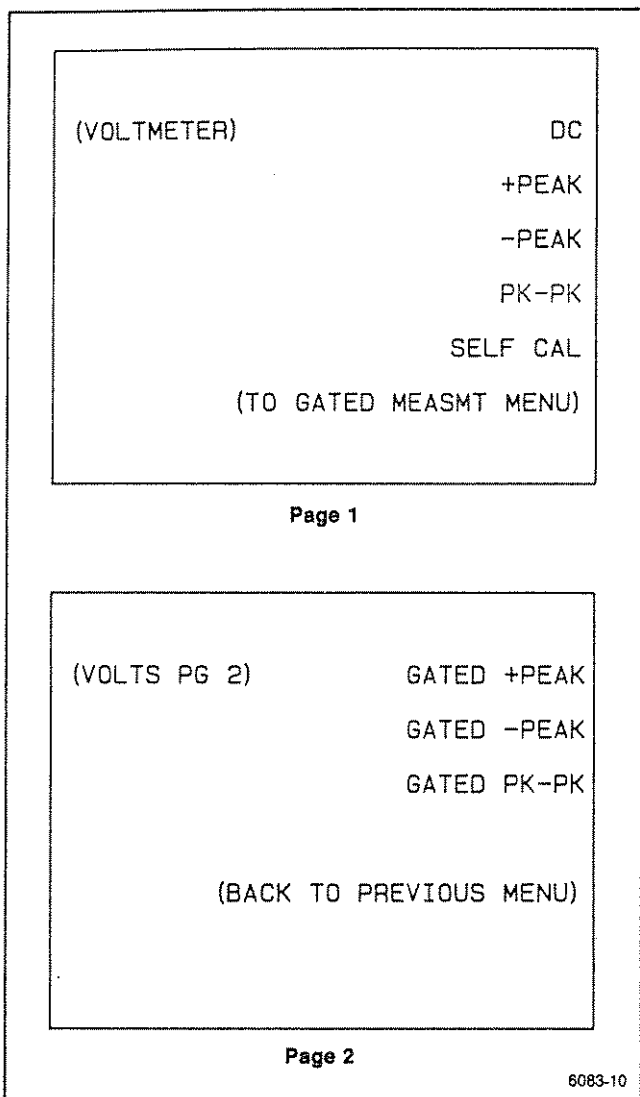

Figure 6-1. CH1/CH2 VOLTMETER Menu.

GATED -PEAK—Press to measure the most negative (screen-relative) voltage in the gated (intensified) portion of the waveform.

GATED PK-PK—Press to measure the peak-to-peak voltage in the gated (intensified) portion of the waveform.

(BACK TO PREVIOUS MENU)—Returns the first page of the Voltmeter menu.

CURSORS MEASUREMENTS

Press CURSORS to display the measurement choices of menu 1 shown in Figure 6-2.

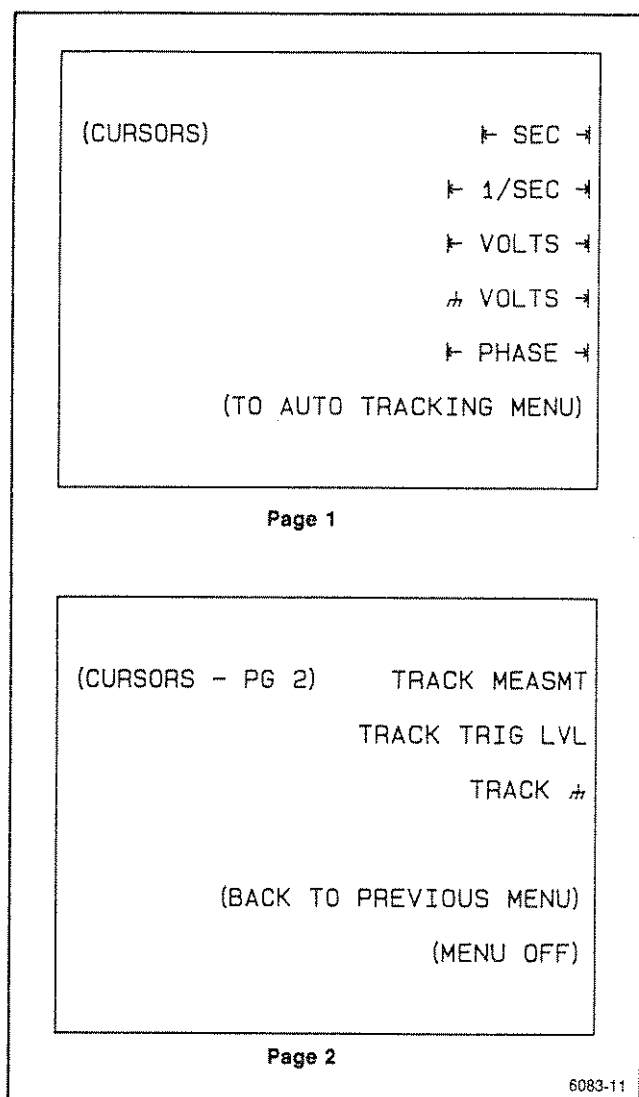

Figure 6-2. CURSOR Measurement Menus.

The action of the I- SEC -I, I- 1/SEC -I, and I- PHASE -I SmartCursors® is exactly the same as the ΔTIME measurement choices. See the "ΔTIME MENU" description for their operation.

I- VOLTS -I—Measures the equivalent voltage difference between two horizontal cursors in either A Horizontal MODE or X-Y Horizontal MODE. Both cursors are positioned by the I- OR DELAY control and the delta cursor is positioned by the -I OR Δ control. When the VOLTS cursors measurement is first turned on (or recalled as a last measurement mode), the peak voltages of the source channel signal are measured and one cursor is placed at the most positive peak and the other is placed at the most negative peak.

⇄ VOLTS ⇄—Calls up a cursor to mark the ground position of the selected waveform display in either A Horizontal MODE or X-Y Horizontal MODE. The ground cursor follows the ground level of the source channel waveform as it is positioned vertically.

(TO AUTO TRACKING MENU)—Selects CURSOR measurement menu 2 choices.

Cursor Menu 2

All of the tracking cursor selections may be underlined, but only two cursors (of either type—tracking or measurement) may be displayed at a time. If TRACK MEASMT is selected and a CH1/CH2 VOLTMETER measurement is active, the TRACK ⇄ cursor is not displayed when TRACK TRIG LVL is also active. If the MEASUREMENT is turned off, the ground tracking cursor will return to the display.

CLEAR DISPLAY may be used to turn off the MENU, MEASUREMENT, and TRACK TRIG LVL and TRACK ⇄ cursors in a priority scheme of three levels. MENU first, MEASUREMENT (and TRACK MEASMT cursors) second, and TRACK TRIG LVL and TRACK ⇄ cursor last. The highest level being displayed is turned off each time the CLEAR DISPLAY button is pressed.

TRACK MEASMT—Press to enable or disable the CH1/CH2 VOLTMETER measurement-tracking cursors (SmartCursors® that attach to the waveform-measurement points). The state of the TRACK MEASMT feature does not affect the positionable, ⇄ VOLTS ⇄ cursor operation. The CLEAR MENU button will not turn off the TRACK MEASMT feature, it only turns off the present display of the TRACK MEASMT cursor when it turns off the active measurement mode. The next time a CH1/CH2 VOLTMETER measurement mode is selected, the TRACK MEASMT cursor or cursors will again be displayed.

TRACK TRIG LVL—Press to enable or disable the Trigger Level tracking cursor. See "USING THE TRACK TRIG LEVEL CURSORS" in this section for conditions required to display the Trigger Level tracking cursors.

TRACK GND—Press to enable or disable the ground level tracking cursor.

(BACK TO PREVIOUS MENU)—Selects menu 1 choices.

(MENU OFF)—Clears the menu from the display.

ΔTIME MENUS

Press the ΔTIME button to call up the time measurement choices shown in Figure 6-3.

Vertical cursors are displayed for use in setting the time-measurement points in A Horizontal MODE. In ALT Horizontal MODE, the delay measurement is made using either the intensified zones as the measurement points or the alternate B delayed sweeps. For B Delayed Horizontal MODE, the delayed sweeps only are available for making timing measurement.

When the Horizontal MODE is either ALT or B, the B Trigger MODE is forced to RUNS AFTER. If the B Trigger MODE is switched away from RUNS AFTER using the front panel Trigger MODE buttons, a selected ΔTIME measurement will be canceled. Pressing LAST MEAS'MT will return the B Trigger MODE to RUNS AFTER and restart the last selected ΔTIME measurement (if no other measurement type has been selected first).

⇄ SEC ⇄—Press to measure the equivalent time difference between the two vertical cursors displayed in the A Horizontal MODE or the two time delays in ALT or B Horizontal mode. The position of the both cursors or both delays is controlled by the ⇄ or DELAY control; the position of the Δ cursor or the Δ delay is controlled by the ⇄ or Δ control. The measured time difference between the two cursors or delays is displayed in the crt readout.

If the Horizontal MODE is X-Y, pressing the ⇄ SEC ⇄ button causes the message "USE A ALT OR B

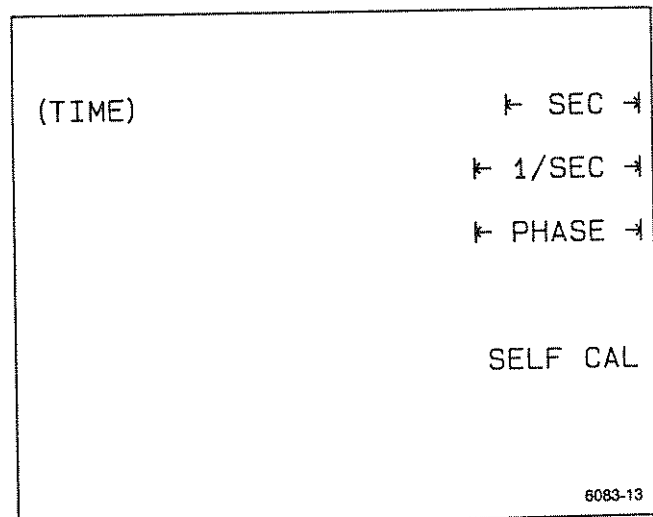

Figure 6-3. ΔTIME Measurement Menus.

MODE" to be displayed for two seconds. Changing the Horizontal MODE to X-Y after I- SEC -I has been activated, will cancel the measurement with no message.

I- 1/SEC -I—Measures the time difference in frequency units (hertz) between the cursor positions in A Horizontal MODE or between the delay-time setting and the delta-delay time setting in either ALT or B Horizontal MODE. Measurement points are the left ends of the two intensified zones in ALT Horizontal MODE.

I- PHASE -I—Calls up a lower level menu for phase measurement operation.

I- PHASE -I—Cursor positioning or delay and delta time setting is identical to the I- SEC -I mode. The value displayed for the phase-measurement readout has units of degrees and is calculated by the following formula:

$$\frac{(\text{time difference})}{(\text{reference time})} \times (360)$$

The reference time is the number of divisions set as the reference for 360 degrees using the I- SET 360° -I menu selection that appears along with the I- PHASE -I choice when phase measurements are selected. If the reference is already set to the desired reference value, pressing the I- PHASE -I menu selection exits the menu and activates the phase-measurement mode.

I- SET 360° -I—Permits resetting of the 360° reference for the I- PHASE -I measurements. Cursor difference or DELAY TIME to ΔTIME difference is taken as the reference value when exiting the SET 360° reference function. Set the desired time that represents the complete 360 degrees of a reference waveform using the I- or DELAY and -I or Δ controls then select I- PHASE -I to exit the menu and continue the phase measurement. Recalling the LAST MEAS'MT when I- PHASE -I was the last selected measurement mode recalls the 360 degree reference as well.

SELF CAL—Self characterizes the horizontal system. SELF CAL may be performed at any time. Suggested times are: after a warmup period, whenever the ambient operating temperature changes by ±15°C, and just prior to making any time measurements requiring the best possible accuracy.

BEHAVIOR FOR HORIZONTAL MODE CHANGES

If the Horizontal MODE is changed to a mode that cannot be used for the active measurement, that measure-

ment will be canceled without a message being displayed. Returning to a mode that may be used and pressing the LAST MEAS'MT button will restore the canceled measurement mode (if no other measurement selection is made first). See Table 6-2 for compatible and incompatible modes.

The only Trigger MODE restriction is that gated-voltage measurements will not run in SGL SEQ Trigger MODE. Any gated measurement that is active will be canceled if SGL SEQ Trigger MODE is selected. If a gated-voltage measurement is selected while SGL SEQ is also selected, the message "NOT ALLOWED IN SSEQ" is displayed for two seconds (only if the menu is configured to remain on after the selection is made).

MEASUREMENT COMPATIBILITY AND ERROR MESSAGES

The CH1/CH2 VOLTMETER measurements cannot be made when the signal is larger than the range of the B trigger level. The displayed error message is "OUCH—TURN VOLTS/DIV CCW."

The CH1/CH2 VOLTMETER measurement of DC cannot be made with the Input COUPLING set to AC; the displayed error message is "CH 1 (or CH 2) — SELECT DC COUPLING." If GND Input COUPLING is in use, a ground symbol is displayed after the readout value.

For +PEAK, -PEAK, and PK-PK measurements, the ac symbol (~) will be displayed in AC Input COUPLING, and the ground symbol will be displayed in GND Input COUPLING. The symbols will be displayed after the readout units.

The following measurements cannot occur when the VARIABLE VOLTS/DIV knob for the channel being measured is not in the detent position: +PEAK, -PEAK, PK-PK, DC, GATED +PEAK, GATED -PEAK, GATED PK-PK, I- VOLTS -I, and $\overline{\text{I}}$ VOLTS -I. The displayed error message is "VAR VOLTS/DIV OUT OF DETENT."

The following measurements cannot occur when the VARIABLE SEC/DIV knob for the channel being measured is out of the detent position: I- SEC -I, I- 1/SEC -I, I- PHASE -I, and I- SET 360° -I. The displayed error message is "VAR SEC/DIV OUT OF DETENT."

When in ALT or B Horizontal MODE, and the B Trigger MODE is not RUNS AFTER, a question mark will appear

Table 6-2
Behavior for Horizontal MODE Changes

Measurement Mode	Compatible Horizontal Modes	Incompatible Horizontal Modes
I- VOLTS -I, \square VOLTS -I	A, X-Y	ALT, B
I- SEC -I, I- 1/SEC -I, I- PHASE -I	A, ALT, B	X-Y
DC, +PEAK, -PEAK, PK-PK	A, X-Y	ALT, B
GATED +PEAK, GATED -PEAK, GATED PK-PK	A	ALT, B, X-Y

before the delay-time readout. The readout value displayed is the delay time between the A trigger and the time a B trigger can be accepted by the trigger system. A question mark (?) will also appear in front of the delay time readout for delay measurements when the DELAY time is set to 0.25 division or less from the beginning of the sweep.

If the oscilloscope is not triggered when a gated voltage measurement mode is selected, the following error message is displayed: "LO REP RATE — STILL TRYING."

This can happen if the selected trigger channel has no trigger signal applied in NORM Trigger MODE or if the Trigger LEVEL control is not set to obtain a triggered display. An improperly triggered display in either AUTO LEVEL or AUTO Trigger MODE will cause the measurement readout value to be unstable, but no error message will be displayed.

MEASUREMENT BEHAVIOR IN SINGLE SEQUENCE MODE

The following measurements run continuously during SGL SEQ Trigger MODE: DC, +PEAK, -PEAK, PK-PK, I- VOLTS -I, \square VOLTS -I, I- SEC -I, I- 1/SEC -I, and I- PHASE -I.

The readout and/or cursors are displayed briefly during single sequence mode for making a photographic record (or they may be configured to remain on—see the "SERVICE MENU" discussion). The displayed readout is the value of the measurement at the instant it is displayed.

GATED +PEAK, GATED -PEAK, and GATED PK-PK measurements are not available during single sequence mode and will be canceled if active when SGL SEQ is selected.

B Trigger AUTO LEVEL acquisitions do not occur when the A Trigger MODE is SGL SEQ.

SERVICE MENU

The SERVICE menu contains operating choices not normally accessed by the operator. Most of the choices are for diagnostics, troubleshooting, and calibration. Explanation of those choices are left to the servicing documentation. One of the INTERNAL SETTINGS menu choices and the CONFIGURE menu choices, however, are useful to the operator and are explained here.

Pressing the top and bottom menu selection buttons brings up the SERVICE menu with the selections shown in Figure 6-4.

The up and down arrow buttons move the underline (seen under SERVICE MENU when first called up) through

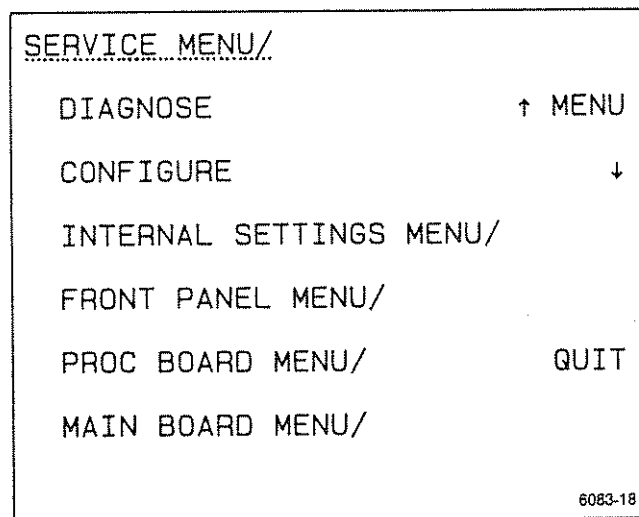

6083-18

Figure 6-4. Service Menu.

the menu choices. Press the down arrow twice to underline CONFIGURE. When the desired choice is underlined, press RUN to start the CONFIGURE process. Pressing QUIT exits the SERVICE MENU and returns to the oscilloscope operation mode.

Configure Menu

The CONFIGURE menu contains oscilloscope operating mode features that require infrequent change. In the menu, a typical screen display is shown in Figure 6-5.

Press YES or NO as needed for your method of operation.

The CONFIGURE menu provides an expandable mode selection menu for possible future changes. At this time, the operating mode choices to be made are:

KEEP MENU ON WHEN ITEM SELECTED?
and
KEEP READOUT ON IN SGL SEQ?

KEEP MENU ON. Normally, once a final choice in a measurement menu is selected, the menu is removed from the display to eliminate clutter when making a measurement. In that case, to obtain a new menu selection it is necessary to recall the menu using the Menu Display Con-

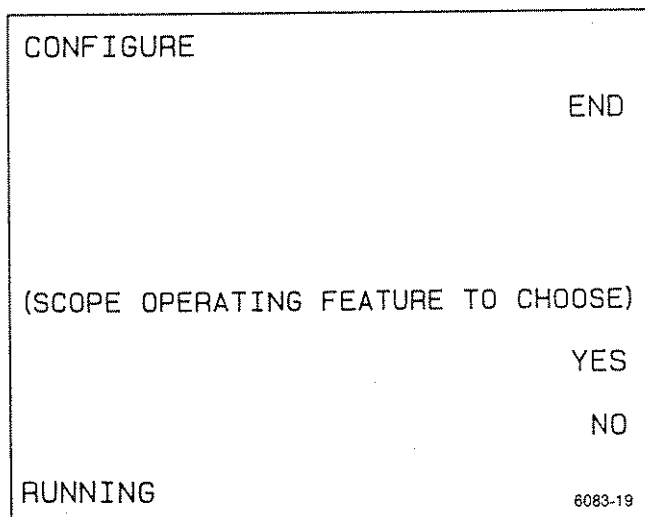

Figure 6-5. Configure Menu.

trol buttons. Selecting NO in the CONFIGURE menu retains the normal menu removal operation.

A choice of YES in the CONFIGURE menu causes the measurement menus to remain displayed during the measurement after a selection has been made. The feature may be used to permit quick selection of a series of measurements on a waveform or to switch measurement channels back and forth without recalling the active menu each time. Operating in this manner, once a user is finished with a particular menu, it may be removed by simply pressing the CLEAR DISPLAY button once.

After the YES/NO choice is made, the next configuration choice is displayed.

KEEP READOUT ON. Normal operation for this operating mode is decided in favor of possible camera use to record the resulting single sequence display. The readout is displayed briefly after the sequence has completed to get it on film and then removed to prevent overexposure. That is the NO choice.

The YES choice for the feature permits the user to view any of the measurements that continue to be made during SGL SEQ trigger mode even if no waveform is being displayed. The front panel control settings may also be made in SGL SEQ without the need to change the Trigger MODE from SGL SEQ to view the readouts as the controls are changed. The measurement readout is especially useful for the CH1/CH2 VOLTMETER measurements because the signal on the selected input channel is continually monitored. (GATED Voltmeter measurements are not permitted in SGL SEQ Trigger MODE.)

Once the final YES/NO choice is made, the CONFIGURE process is stopped, and the SERVICE menu is again displayed. Pressing END at any time also stops the CONFIGURE process and returns to the SERVICE menu. Press QUIT in the SERVICE menu to get back to operating the oscilloscope.

Internal Settings Menu

SELF CAL MEASUREMENTS. The 2246 has a self-characterization feature in the INTERNAL SETTINGS MENU that optimizes accuracy of the CH 1 and CH 2 vertical channels and the horizontal timing as a single routine. A SELF CAL choice is also available in both the CH1/CH2 VOLTMETER menu and the ΔTIME menu.

NOTE

Calibration constants are stored for use in maintaining the instrument calibration, especially the CH1/CH2 VOLTMETER measurements and the tracking cursor placement on the displayed waveforms. Performing the SELF CAL readjusts the calibration constants for the present operating temperature of the instrument. If a SELF CAL is done when the instrument is cold, the calibration constants acquired will not be correct when the operating temperature is reached. The SELF CAL must then be done again after the warm-up to achieve the accuracy stated in the Specification section of this manual.

The SELF CAL choice found in either the CH1/CH2 VOLTMETER menu or the Δ TIME menu calibrates the associated circuitry (either vertical for voltage measurements or horizontal for timing measurements). Any time the user requires the highest degree of measurement accuracy possible of the 2246, especially the CH1/CH2 VOLTMETER measurements, the SELF CAL routine may be run. Both vertical and horizontal calibration will be done when using the SELF CAL MEASUREMENTS choice in the INTERNAL SETTINGS MENU.

Pressing the down arrow three times from the entry level to the SERVICE menu underlines the INTERNAL SETTINGS MENU label and displays the SELECT label. Press SELECT to display the menu shown in Figure 6-6.

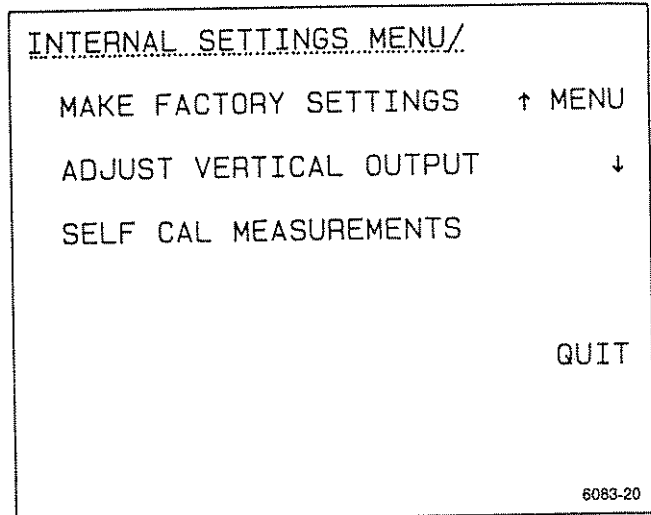

Figure 6-6. Internal Settings Menu.

Press the down arrow three times again to underline the SELF CAL MEASUREMENTS choice, then press the RUN button that appears in the menu. At this point, the instrument automatically does a self-characterization of the CH 1 and CH 2 Vertical channels first and then the horizontal timing. Upon completion of the procedure, the INTERNAL SETTINGS MENU choices are again displayed. Press QUIT to return to the oscilloscope operation mode.

MAKE FACTORY SETTINGS. This menu selection sets up the front panel controls in predefined settings as shipped from the factory.

MAKING MEASUREMENTS

The TEKTRONIX 2246 Oscilloscope provides an accurate and flexible measurement system. After becoming familiar with the controls, indicators, menus, and capabilities of the instrument, an operator can develop convenient methods for making special measurements required by his or her own applications. The measurements given in this subsection are examples of typical applications that may assist in developing efficient techniques for your specific measurements. A brief description of how the graticule markings are used in making measurements is given in Section 4 of this manual.

CH1/CH2 VOLTMETER MEASUREMENTS

The CH1/CH2 VOLTMETER measurements are continuous measurement of the DC, +PEAK, -PEAK, or PK-PK values of an applied signal. The readout of the measurement value is given in the crt readout. Measurement tracking and/or ground tracking cursors may be displayed to give the user instant feedback about where on the applied signal the measurement is being made and the location of ground level.

GATED modes of +PEAK, -PEAK, and PK-PK measurements may be used to define the area of the measurement on the displayed waveform. The position and width of the gated region is displayed as an intensified zone on the A trace of the waveform display. Position of the gated region on the waveform is controlled by the \leftarrow or DELAY control and width of the gated region is controlled by the \rightarrow or Δ control.

Some features of the CH1/CH2 VOLTMETER function are:

- a. Measures either CH 1 or CH 2 while viewing any channel. (Select the measurement source channel using the SET MEAS'MT CHANNEL menu.)
- b. Measures signal levels (DC values and peaks) in SGL SEQ (single-sequence) Trigger MODE continuously. (Use CONFIGURE to get menus and readouts to remain on between single sequence triggers.)
- c. Finds peaks of signal applied, not only just the displayed portions of the waveform.

d. Defines a portion of the waveform (GATED measurements—especially useful for making measurements on a multi-level signal) on which to make the selected measurement. (Use page 2 of the CH1/CH2 VOLTMETER menu to select a GATED-measurement mode.)

NOTE

Very narrow-gated measurements at 20 ns per div sweep speed are impractical due to imprecise definition of the intensified zone at that sweep speed.

+ PEAK VOLTAGE MEASUREMENT

Setup for Front Panel Controls

The following procedure is a general front-panel setup for making any type of CH1/CH2 VOLTMETER or CURSORS measurement on an unknown signal. Use it as a guideline to set up for your specific measurement applications. The control settings used in the procedure should produce a triggered, viewable display for most input signal types. Certain signals such as video or aperiodic signals (non-repeating) and signals containing many unrelated frequency components may require more trigger signal conditioning and/or holdoff to obtain the best display.

1. Apply the test signal to be measured to either the CH 1 or the CH 2 input connector. If using coaxial cable to make the signal connections, remember to correctly terminate them at the input to the 2246. If using the supplied 10X probes, no further matching devices are needed. The choice of using coaxial cables or a probe to connect the input signal depends on the signal's source. Generally, for an active circuit under test, probes are used; signals from test generators usually are connected via terminated coaxial cables.

2. Set the front-panel controls as follows:

A INTEN and READOUT	For good viewing intensity.
SCALE ILLUM	As needed.
VERTICAL MODE	To display the test signal.
VERTICAL POSITION	Center the display vertically.

Measurement Processes and Applications—2246 Operators

Input Channel VOLTS/DIV Setting VAR VOLTS/DIV	To display about 3 to 5 divisions of signal. Calibrated (fully clockwise in detent).
Input Channel COUPLING	DC
BW LIMIT	OFF (button light off).
CH 2 INVERT	OFF (button light off).
Horizontal MODE	A
X10 MAG	Off (button light off).
SEC/DIV	Suitable sweep speed for the applied signal.
Horizontal POSITION	Start of trace at left graticule edge.
A/B SELECT	Set to select the A Trigger control settings (button light on).
TRIGGER MODE	AUTO LEVEL
TRIGGER SOURCE	VERT
TRIGGER COUPLING	DC
HOLDOFF	MIN (fully counterclockwise)
MEASUREMENT MODES, TRACKING CURSORS and MENUS	All off (press CLEAR DISPLAY three times to ensure all off).

3. Press the CH1/CH2 VOLTMETER button to call up the selection menu and select the +PEAK choice. Any of the page one choices may be selected as required for the waveform measurement wanted.

NOTE

Depending on the way the CONFIGURE choices of the SERVICE menu have been made, the menu will either go off when the measurement selection is made or it will stay on. If the menu remains on, press the CLEAR DISPLAY button once to remove it from the display. See the "SERVICE MENU" discussion in this section for further details.

4. The TRACK MEASMT cursor may be displayed with the waveform. Pressing CLEAR DISPLAY in the initial setup removes the measurement tracking cursor from the display but does not disable the feature once it has been enabled; and the next time a CH1/CH2 VOLTMETER measurement mode is called for, the measurement tracking cursor is again displayed.

5. Press the CURSORS button and display page 2 of the menu by selecting the (TO AUTO TRACKING MENU)

choice. Of the three features available in page 2, select both TRACK MEASMT and TRACK \uparrow . Menu labels are UNDERLINED when the function is enabled. The TRACK \uparrow cursor is especially useful for providing feedback to the user about dc offset of the signal from ground level.

NOTE

In this menu, the select buttons toggle the choices on and off with each press, and all three choices may be selected (but not all displayed together because only two cursors are allowed). Also, pressing CLEAR DISPLAY (as many as three times may be necessary) does turn off the TRACK TRIG LVL and TRACK \uparrow choices.

6. Press either MENU OFF (in the menu selection list) or CLEAR DISPLAY (once) to remove the AUTO TRACKING menu from the display.

NOTE

If CH1/CH2 VOLTMETER PK-PK measurement is selected, two TRACK MEASMT cursors are required; therefore, the TRACK \uparrow cursor will not be displayed.

7. See Figure 6-7. The test signal used for the example has a dc offset (as shown by the position of the TRACK \uparrow cursor), and +PEAK value (peak ac + dc) as indicated by the voltage readout.

GATED VOLTAGE MEASUREMENT

If you need to track the +PEAK, -PEAK, or PK-PK voltage of a selected portion of a waveform, that portion can be defined using the GATED MEASUREMENTS available in page 2 of the CH1/CH2 VOLTMETER menu. The general steps given in the previous +PEAK Voltage Measurement procedure are used for this function also. Set up all the controls and apply the signal to be measured in the same way; but, after pressing the CH1/CH2 VOLTMETER button, select the (TO GATED MEASMT MENU) choice. After that, follow these additional steps to make the gated measurement.

1. Select GATED +PEAK measurement mode. The menu will be removed (if configured to do so), and any enabled tracking cursors will be displayed. If none are enabled in page 2 of the CURSORS menu, none will be displayed.

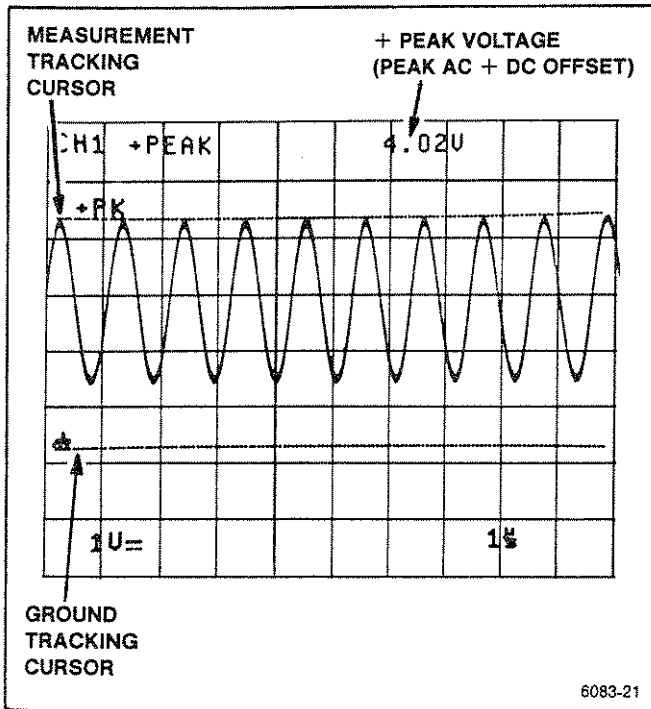

Figure 6-7. +PEAK voltage measurement and tracking cursors.

NOTE

Only a choice of two of the possible three available selections may be displayed (on a priority basis). TRACK MEASMT has the highest priority, followed by TRACK TRIG LVL and TRACK gnd in that order. Also the TRACK TRIG LVL and TRACK gnd cursors may only be displayed on the Trigger SOURCE signal. The TRACK MEASMT cursor may be directed to either CH 1 or CH 2 input signal without regard as to what the trigger signal SOURCE is.

2. Adjust the B INTEN and A INTEN controls to provide a good viewing contrast of the intensified zone that appears on the A Sweep trace.

NOTE

If the zone does not appear, it may be positioned out of the viewing area (but not past the end of the A Sweep trace). Turn the I- OR DELAY control counterclockwise to move the gate zone closer to the beginning of sweep.

3. Use the I- OR DELAY control to position the intensified zone to the area of interest on the waveform to be tracked. (See Figure 6-8.)

4. The width of the gated zone is controlled by the I- OR Δ control. Adjust the width to define the gated measurement zone.

5. The voltage value that appears in the readout is the +PEAK voltage that occurs within the zone.

CURSOR MEASUREMENTS

Time and voltage measurements may be made using cursors to identify the measurement points on the waveform. Time measurement cursors may be used on any of the input waveforms only in the A Horizontal MODE. The units of the time cursors may be selected to provide some automatic calculations for the user. The units of the I- SEC I- cursors are time (s, ms, μs, and ns), the I- 1/SEC I- cursors have units of frequency (Hz, kHz, and MHz), and the I- PHASE I- cursor units are in degrees and scaled to a 360 degree reference set by the user. The time cursors that appear in the CURSORS measurement mode and the time cursors that appear in the ΔTIME measurement mode in the A Horizontal MODE are exactly the same.

Voltage cursors are attached to a measurement channel (either CH 1 or CH 2) to obtain their scaling. Voltage measurements using cursors may be done on the CH 3, the CH 4, or the ADD waveform by setting the VOLTS/DIV setting of the selected measurement channel to the same scale factor as the signal to be measured. However, the

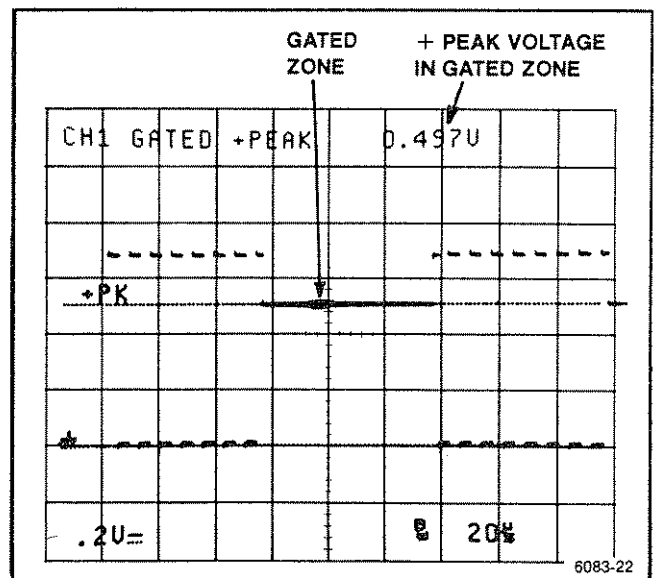

Figure 6-8. Gated voltage measurement.

measurement accuracy on the CH 3 or CH 4 input signals will be less accurate than available on the CH 1 or CH 2 input signals. Volts cursors are also available for making measurements in the both the A Horizontal MODE and the X-Y Horizontal MODE.

Voltage Measurements Using Cursors

VOLTAGE DIFFERENCE. Use the following procedure steps as a guideline in making voltage difference measurements using the positionable cursors.

1. Set up the signal to be measured and the front panel controls as indicated in steps 1 and 2 of the +PEAK VOLTAGE MEASUREMENT procedure.

2. Press the CURSORS button to display the measurement selection menu and select the $\left| \right|$ VOLTS \rightarrow cursors. The Voltage cursors are initialized to the peak-to-peak levels of the lowest numbered displayed channel of either CH 1 or CH 2 (see Figure 6-9).

NOTE

Voltage cursors are initialized to levels seen by the peak detector circuitry. Noise and other signals riding on the signal to be measured will cause a slight displacement of the cursors from the displayed waveform peaks, and above 50 MHz, the bandwidth rolloff of the trigger circuit will affect the initial cursor positions on the waveform.

3. For a peak-to-peak voltage measurement, slightly reposition the cursors as necessary to precisely align them with the peak amplitudes of the waveform, and the work is done. The $\left| \right|$ OR DELAY control positions both cursors together (keeping the original spacing), and the \rightarrow OR Δ control positions the independent cursor. Then, simply read the measurement value displayed in the top line of the readout.

4. To make voltage difference measurements between any other locations on the waveform, simply move the $\left| \right|$ cursor to the new point of interest, then position the independent \rightarrow cursor to second point on the waveform and read the voltage difference.

DC VOLTAGE. Plus and minus dc voltage measurements using ground as a reference are made using the $\left| \right|$ VOLTS \rightarrow cursors. The ground tracking cursor is fixed at the dc ground level of the applied signal and the

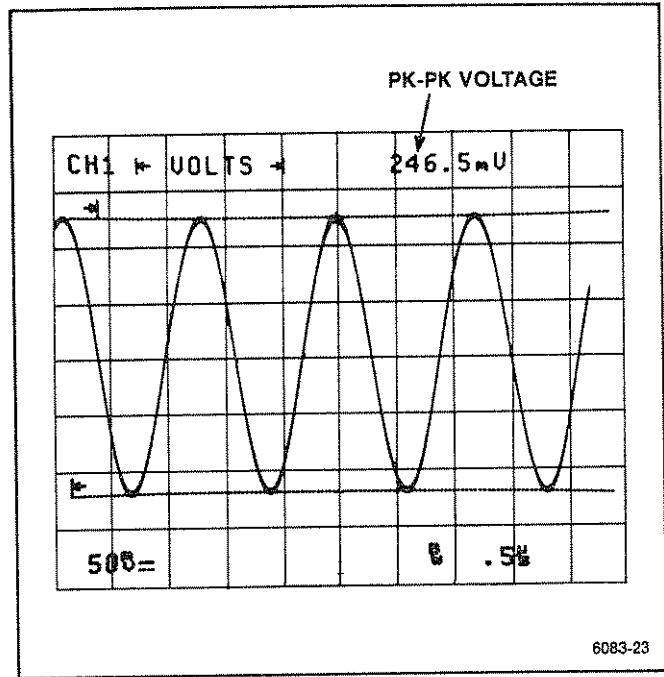

Figure 6-9. Voltage difference measurement using cursors.

independent cursor above or below ground as necessary to measure the instantaneous dc voltage at the cursor position. Use the following procedure steps to set up to measure ground-referenced dc voltages.

1. Set up the signal to be measured and the front panel controls as indicated in steps 1 and 2 of the +PEAK VOLTAGE MEASUREMENT procedure.

NOTE

An important point to remember here is to have the Input COUPLING set to DC. A question mark will appear in front of the measurement value readout if the coupling is not DC because any dc offset present with the applied waveform will be removed when AC Input COUPLING is used.

2. Press the CURSORS button to display the measurement selection menu and select the $\left| \right|$ VOLTS \rightarrow cursors. The independent cursor is initialized to the +PEAK of the input waveform.

3. Position the independent cursor using the \rightarrow or Δ control to the measurement point on the waveform and read out the dc value of the cursor position (shown in Figure 6-10). (The $\left| \right|$ or DELAY control has no effect.)

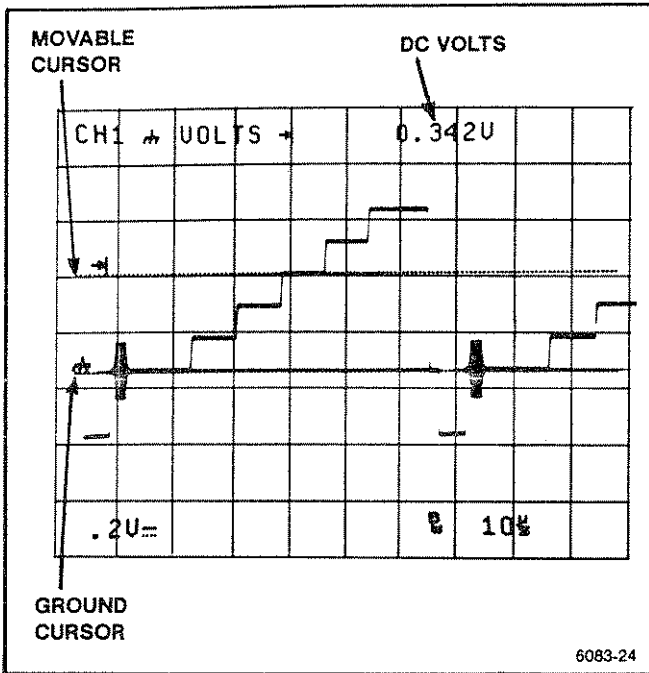

Figure 6-10. Instantaneous dc voltage measurement.

NOTE

The test signal used for illustration purposes shown in Figure 6-10 is a video test signal. For triggering on video waveforms, select TV LINE Trigger COUPLING and negative Trigger SLOPE; for other signal types, no change of COUPLING or SLOPE is required.

Time Difference

Use the following procedure steps as a guideline in making time difference measurements using the |- SEC -| cursors. As with the |- VOLTS -| cursors, the |- OR DELAY control positions both cursors together, and the |- OR Δ control positions the independent cursor.

1. Set up the signal to be measured and the front panel controls as indicated in steps 1 and 2 of the +PEAK VOLTAGE MEASUREMENT procedure.

2. Select a SEC/DIV setting that provided no more cycles of the applied waveform than necessary to display the measurement points of interest. This is to improve the accuracy of cursor placement for the measurement.

NOTE

The independent Δ cursor cannot be positioned in front of the reference cursor.

3. Use the |- OR DELAY control to position the reference cursor to the point on the waveform to be measured from. Use the |- OR Δ control to position the independent cursor to the second point of interest. Then, read the time difference value in the top line of crt readout.

Pulse Period Measurement

This measurement is basically a time-difference measurement. The |- SEC -| cursors are positioned to define a full period of the input waveform and the time difference value displayed is the pulse period. Use the setup for making time-difference measurements as a guideline for making pulse period measurements (see Figure 6-11).

Frequency Measurement

A frequency measurement is made the same as the pulse period measurement; the difference being that the |- 1/SEC -| cursors are selected from the CURSORS menu. The measurement value displayed with units of frequency. When the exact pulse period is defined by positioning the cursors, the frequency of the signal is displayed. Use the same front panel setup as for making a time-difference measurement as a guideline for making frequency measurements with cursors (see Figure 6-12).

Rise-Time Measurements

Making rise-time or fall-time measurement requires some additional signal scaling to use the graticule rise-time

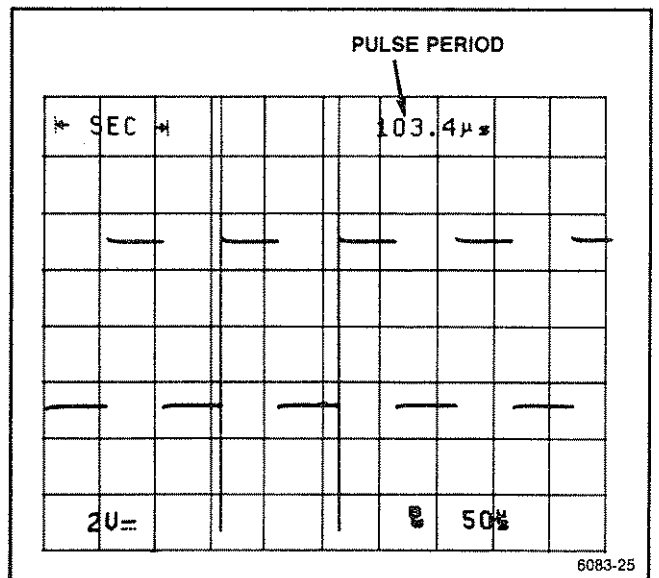

Figure 6-11. Pulse period measurement.

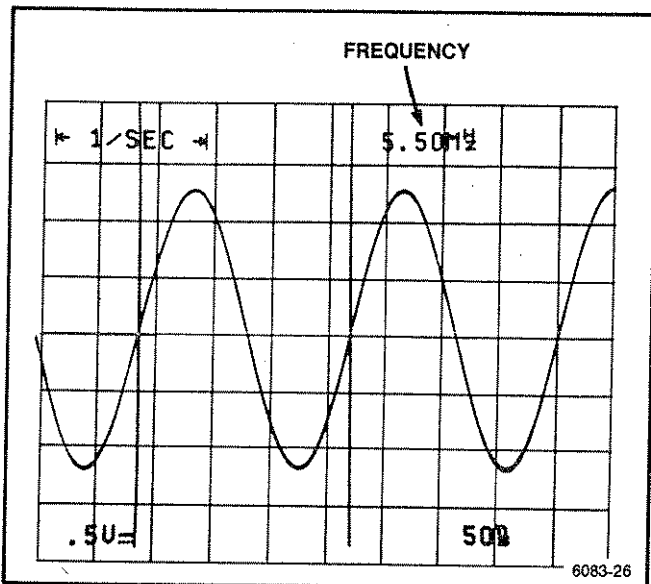

Figure 6-12. Frequency measurement.

5. Increase the A INTEN control if necessary to brighten the beginning of the trace, and use the Horizontal POSITION control to place the rising edge of the waveform at the center vertical graticule line.

6. Press CURSORS and select the \leftarrow SEC \rightarrow menu choice.

7. Use the \leftarrow OR DELAY control to align the first cursor to the rising edge at the point it crosses the 10% reference graticule line. Then use the \rightarrow OR Δ control to align the second cursor to the point that the rising edge crosses the 90% graticule line and read the rise time displayed in the top line of the crt readout (see Figure 6-13).

Phase Measurements

Making a phase measurement is done by first setting a reference for the full 360 degree waveform period. Use the following procedure as a guide.

1. Apply the reference waveform to the CH 1 input connector (any channel may be used, but CH 1 and CH 2 provide the most signal scaling possibilities). Use the standard 10X attenuator probe supplied with the instrument to make the signal connections as they produce very little signal loading to a circuit under test and produce matched delays. For phase measurements, external loading of a circuit and different delays in the signal connection paths will produce incorrect results.

measurement aids. Notice that on the left edge of the graticule the number 0%, 10, 90, and 100 are etched. These marks provide convenient reference points when the signal to be measured is properly set up. Use the following procedure steps as a guideline in making rise-time measurements.

1. Set up the signal to be measured and the front panel controls as indicated in steps 1 and 2 of the +PEAK VOLTAGE MEASUREMENT procedure.

2. Set the VOLTS/DIV and VOLTS/DIV VAR controls to provide an exact five-division vertical display.

3. Use the Vertical POSITION control to place the negative amplitude of the signal on the 0% reference line and the positive amplitude on the 100% reference line.

4. Advance the SEC/DIV setting to stretch out the rising edge of the waveform as much as possible to improve the cursor placement accuracy (see Figure 6-13).

NOTE

If measuring fall time, use negative SLOPE. This places the trigger point at the beginning of the sweep so that when the SEC/DIV setting is advanced, the slope of interest remains within the viewing area.

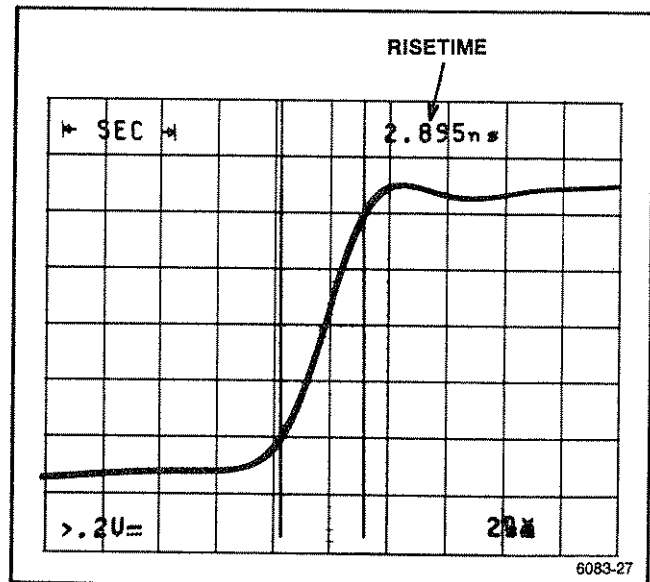

Figure 6-13. Rise time measurement.

2. Select CH 1 for display using the VERTICAL MODE buttons, and set the Input COUPLING for CH 1 and CH 2 to DC. AC may be used if the signals to be measured are riding on a dc voltage, but set both inputs to the same coupling. AC coupling produces some signal phase shift, especially at lower frequencies.
3. Set the CH 1 VOLTS/DIV control to display the reference waveform with about five divisions of amplitude. Vertically center the waveform.
4. Set the A SEC/DIV setting (in A Horizontal MODE) to display at least one complete reference waveform period and no more than two (if possible). An excessive number of cycles of the reference waveform in the display reduces the user's ability to make an accurate reference setting. (Triggering on the negative slope of the sine wave may position the waveform correctly within the graticule area for ease in measurement when viewing a single cycle of the reference signal.)
5. Press the CURSORS front panel button to display the Cursor measurement choices.
6. Select \leftarrow PHASE \rightarrow . A second-level phase-measurement menu is then displayed with two choices: one to continue the phase measurement and one to set the 360 degree reference. Assume the present reference setting is not correct (if it were, selecting \leftarrow PHASE \rightarrow again continues the measurement using the present reference value).
7. Press \leftarrow SET 360° \rightarrow to activate the reference setting function. The position of the displayed cursors when \leftarrow PHASE \rightarrow is again selected defines the full waveform period (360 degrees).
8. Position the first vertical cursor to the point that the reference waveform crosses the center horizontal graticule line in the positive direction (see Figure 6-14A). The Horizontal POSITION control may be used as necessary to center the waveform period in the viewing area.
9. Position the Δ cursor to the second positive crossing of the center horizontal graticule line by the reference waveform as shown in Figure 6-14A.
10. Select \leftarrow PHASE \rightarrow to set the new reference value and continue the phase measurement.
11. Apply the phase-shifted, sine-wave signal to be measured to the CH 2 input connector using a 10X attenuator probe, and turn CH 2 VERTICAL MODE on to display the signal.
12. Set the VOLTS/DIV and VOLTS/DIV VAR controls to match the amplitude of the phase-shifted signal to that of the reference waveform as shown in Figure 6-14B. Use the VERTICAL POSITION control as necessary to align the two waveforms vertically.
13. Reposition the second cursor to the first positive crossing of the phase-shifted signal and read the phase difference.

NOTE

For increased resolution of the phase measurement, the sweep may be increased and both cursors repositioned to the measurement points (see Figure 6-14C). The X10 MAG feature may also be used in a similar manner by placing the measurement points at the center vertical graticule line before pressing the X10 MAG button (you may want to reduce the A SEC/DIV setting prior to turning on the X10 MAG feature).

DELAY TIME MEASUREMENTS

The delay-time readout (DELAY) is displayed when the Horizontal MODE is ALT or B and no menu-selectable measurement mode is active. (Push CLEAR DISPLAY to turn off menu-selected measurements.)

Delay time is set using the \leftarrow OR DELAY control. In RUNS AFTER B Trigger MODE, the delay time from the start of the A Sweep to the start of the B Sweep is set, and the top line of the readout displays the time delay between the start of the A sweep and the start of the B sweep. For triggered B Sweep modes (AUTO LEVEL, NORM, and TV LINE) the delay time to the arming of the B trigger is set, not the displayed delay, and a question mark (?) is displayed in front of the delay-time readout value.

In ALT Horizontal MODE with the A and B SEC/DIV settings set to the same sweep speed, there is no Alternate B trace, and the length of the intensified zone appearing on the A Sweep trace is 1/100 of the SEC/DIV setting. The position of the dot on the A trace indicates the position of the DELAY setting. The dot may be used to

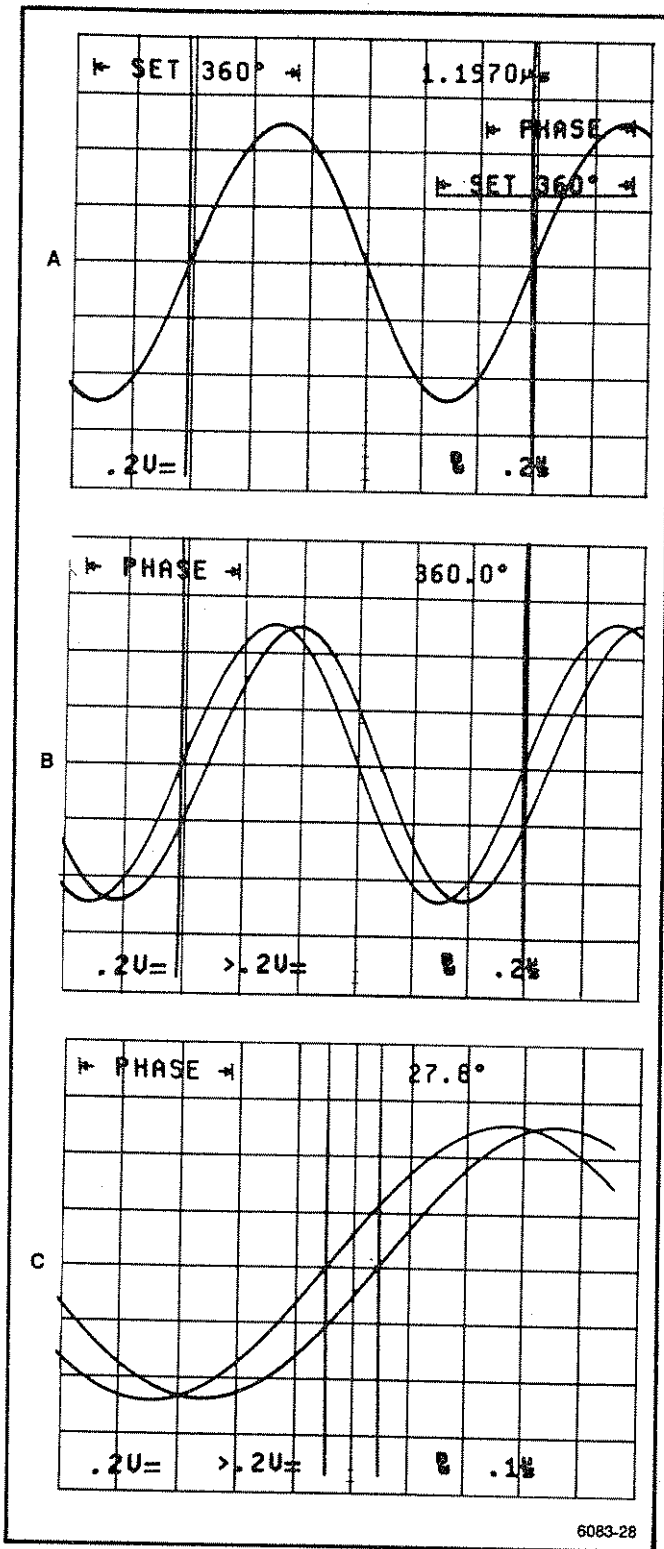

Figure 6-14. Making a phase difference measurement.

The small dot size is also a convenient marker for making quick, but not the most accurate, time measurements. Simply position the dot to the first point of interest to be measured from, and note the delay time setting shown in the crt readout. Then, position the dot to the second point of interest, and again note the delay-time setting. The time difference is calculated by subtracting the first number from the second (or the smaller from the larger).

Using the B delayed traces in ALT Horizontal MODE permits the most accurate measurement of time difference to be made. The method described uses the center vertical graticule line as a measurement reference point. Use the following procedure as a guideline for making delay-time measurements.

1. Set up the signal to be measured and the front panel controls as indicated in steps 1 and 2 of the +PEAK VOLTAGE MEASUREMENT procedure.

2. Select an A SEC/DIV setting that produces an A trace long enough to display both measurement points of interest on the waveform.

3. Switch to ALT Horizontal MODE, and advance the B SEC/DIV setting three positions faster than the A SEC/DIV setting (if possible). You may set the B SEC/DIV setting faster than three positions if you wish, in which case, the intensified zone on the A trace becomes even more necessary as an aid in identifying the measurement points.

4. Set the input channel VOLTS/DIV setting to produce a two-to-three division vertical display. Position the display in the upper half of the graticule area (above the center horizontal graticule line).

NOTE

If more than one vertical channel is being displayed, a more viewable display is obtained by reducing the vertical display amplitude to about one division in amplitude. Then, use the Vertical POSITION control and TRACE SEP controls to organize the displayed traces in an order that permits the traces to be identified. Up to ten traces may be displayed at a time; however, extra channel traces not involved in making a measurement should be turned off to eliminate possible confusion.

5. Use the TRACE SEP control to position the alternate B delayed trace in the lower half of the graticule area

set the delay time to a point of interest on the displayed waveform for expansion using the faster B Sweep speeds.

(or directly below the A trace display if more than one channel is being displayed).

6. Position the intensified zone to the first measurement point in the waveform using the I- OR DELAY control. (The -I OR Δ control has no effect.)

7. Align the measurement point as displayed by the B delayed trace with the center vertical graticule line. The center line then becomes the measurement reference point for making the time difference measurement.

8. Note the delay-time setting in the upper line of crt readout.

9. Now position the intensified zone to the second measurement point, and again align the point displayed on the B delayed trace with the center horizontal graticule line.

10. Note the second delay-time setting. Subtract the first setting from the second setting to determine the time difference.

Δ TIME DELAY MEASUREMENT

In the A Horizontal MODE, the time cursors that appear when the measurement mode is enabled are exactly the same as those that are seen for the CURSORS measurement mode, and the measurement choices are the same. Refer to CURSORS MEASUREMENT for their use. When in ALT or B Horizontal MODE, the Δ TIME measurement mode provides two intensified zones on the A Intensified trace. There are also two associated B delayed traces matching the intensified zones. A direct readout of the delay difference between the two zones is displayed in the top line of crt readout. Use the following procedure steps as a guideline for making Δ TIME delay-time measurements.

1. Apply the signals that measurements are to be made on to the vertical input connectors. Turn on the VERTICAL MODEs needed to display the signals.

NOTE

Probes are the most convenient for in-circuit testing, and coaxial cables are the most convenient when using signal generators as the source of the test signals. Use correct terminations to match the output impedance of any signal generator used. The CH 1 and CH 2 vertical channels provide the widest range of signal conditioning, and the CH 3 and CH 4 vertical channels are most useful for digital signal levels.

2. Use a VOLTS/DIV setting that produces a usable vertical display amplitude for viewing ease; use an A SEC/DIV setting that produces two to five repetitions or cycles of the signal across the graticule area.

NOTE

When viewing multiple traces, it is best to limit the vertical amplitude to about two divisions so that good trace separation may be obtained in the display.

3. Switch the Horizontal MODE to ALT. Advance the SEC/DIV setting at least one position to obtain a faster B SEC/DIV setting. This activates the B Sweep and expands the intensified portion of the A Sweep trace.

4. Press the Δ TIME button, then select the I- SEC -I menu choice. This produces two intensified zones on the A Sweep trace and two alternate B Delay Sweeps. Use the TRACE SEP and VERTICAL POSITION controls to position the B Delay Sweeps vertically in the graticule area for ease of viewing the separate traces.

5. Use the SET MEAS'MT CHANNEL menu choices to select the desired channels to make the time measurements on.

NOTE

When making delay measurements between two different signals for time or phase difference, the SET MEAS'MT CHANNEL choices must be set to the correct measurement source channel to obtain the desired measurement results. BOTH delays must be set to the same channel source for making period, pulse width, or rise-time and fall-time measurements. If only a single channel is selected for display, both delays will default to that channel. If a channel is selected as a measurement source, it will be turned on if not already on; but it will not be turned off when deselected as a measurement source. Extra display channels must be turned off using the VERTICAL MODE buttons. If a channel is displayed but not selected as a measurement source, that waveform trace will not be intensified, and no alternate B Delayed trace will be displayed for that channel.

6. Using the center horizontal graticule line as a reference point, set the reference delay to align the point of interest to be measured (point A in Figure 6-15) from to that reference point with the I- OR DELAY control. Set the Δ delay to align the second point of interest, displayed in the second B Sweep (point B in Figure 6-15), to the reference point using the -I OR Δ control. The measured

difference between the two delays is displayed at the top of the screen.

Once the measurement points are identified, the A Intensified Sweep traces may be removed from the display for ease in viewing the B Sweep traces by switching to B Delayed Horizontal MODE. In B Horizontal MODE, exact placement of the two delays may be obtained by positioning one trace over the other and then aligning the measurement point using the \rightarrow OR Δ control. Additional resolution may be obtained by advancing the B SEC/DIV switch setting to further expand the B Sweep traces.

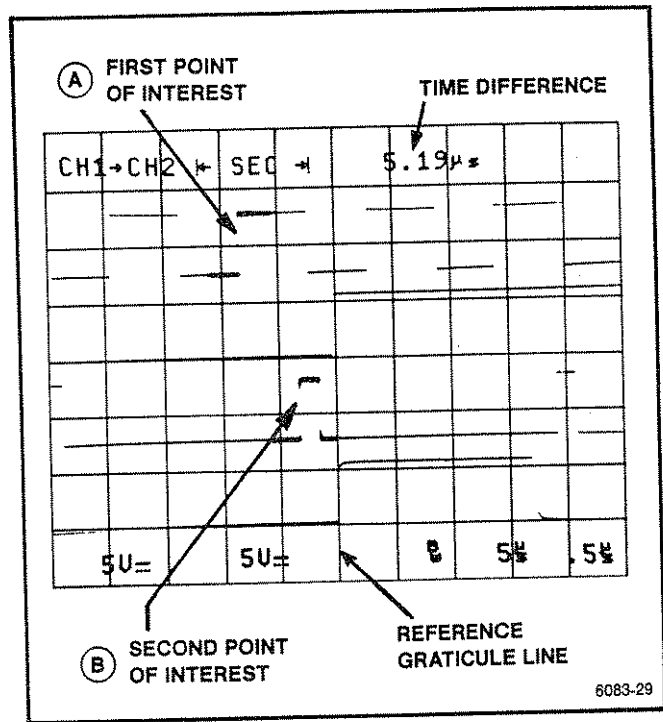

Figure 6-15. Time difference using Δ TIME with two delays.

OTHER OPERATING FEATURES

USING THE TRACK TRIG LEVEL CURSORS

For most general purpose applications, the AUTO LEVEL Trigger MODE provides the user with the easiest method to obtain stable waveform triggering. When information regarding the actual trigger level setting is needed to set special triggering levels for NORM or SGL SEQ triggering, the user may use the TRACKING CURSORS features of the oscilloscope. The TRACK TRIG LVL cursors provide both a visual indication of location and a numeric readout of the Trigger LEVEL control setting. In ALT Horizontal MODE (with the A Intensified and the B Delayed traces both displayed) the A and the B TRACK TRIG LVL cursors will be displayed (see Figure 6-16). The A Trigger LEVEL may be set when the trigger controls are directed to the A Trigger system (by the A/B SELECT switch), and the B Trigger LEVEL may be set when the trigger controls are directed to the B Trigger system.

The Trigger LEVEL cursor will be displayed when enabled if the following conditions exist:

1. The Trigger SOURCE is either CH 1 or CH 2 (selected directly or VERT SOURCE), and
2. The Trigger SOURCE channel is displayed, and
3. The Trigger CPLG is DC, NOISE REJ, or HF REJ, and
4. The Trigger mode is AUTO LEVEL, AUTO, NORM, RUNS AFTER or SGL SEG.

Additionally, the A Trigger LEVEL cursor is displayed in A and ALT Horizontal MODE, and the B Trigger LEVEL cursor is displayed in ALT or B Horizontal MODE (both displayed in ALT if conditions are met).

NOTE

If the TRACK \uparrow auto-tracking measurement is on, only one of the TRIGGER LVL cursors will be on in ALT Horizontal MODE. The A TRIGGER LVL cursor will be the default display if the the conditions are met to display an A TRIGGER LVL cursor. Otherwise, it will be the B TRIGGER LVL cursor that is displayed when all the listed conditions have been met to display a B TRIGGER LVL cursor.

The labels for the Trigger Level cursors are:

- A TL A trigger level
- B TL B trigger level

The A and B Trigger LEVEL readouts include the sign, the integer and decimal fractional value of the level, and the units when a cursor is displayed. For example:

A TL +3.25 mV.....

The A and B Trigger Level Cursors are not guaranteed to reach the waveform if the Horizontal POSITION control is set fully cw. Also, since the Trigger LEVEL cursor may be located anywhere within the viewing area (and beyond), the labels for those cursors may overlap each other or the +PK, -PK, and DC or TRACK \uparrow cursor labels in the displays.

The trigger cursor channel is determined from the Trigger source as indicated in Table 6-3.

Table 6-3
Trigger Cursor Channel

A Trigger Source	A Cursor Channel
VERT	Lowest numbered channel displayed (CH 1 or CH 2)
CH 1	CH 1
CH 2	CH 2
CH 3	Not used
CH 4	Not used
Line	Not used
B Trigger Source	B Cursor Channel
VERT	Lowest numbered channel displayed (CH 1 or CH 2)
CH 1	CH 1
CH 2	CH 2
CH 3	Not used
CH 4	Not used
Line	Not used

To enable the TRACK TRIG LVL cursors, press the CURSORS button to call up page one of the menu. The last selection in the menu is "TO AUTO TRACKING MENU." Press the menu select button for that choice to display page 2 with the tracking cursor choices. All of the choices, TRACK MEASMT, TRACK TRIG LVL, and TRACK \uparrow , may be underlined, but they cannot all be displayed at the same time. Only two cursors at a time are permitted. If enabled, but not displayed in a particular waveform, omitted cursors will be displayed when a higher priority cursor is turned off. TRACK MEASMT cursors take priority over the TRACK \uparrow cursor when TRACK TRIG LVL is also enabled. In ALT Horizontal MODE the TRACK \uparrow cursor for the A Trigger signal is higher in priority than the B Trigger Level cursor. The cursors displayed when a CURSORS measurement is called take priority over all the Auto Tracking Cursors.

NOTE

The CLEAR DISPLAY button will turn off the TRACK TRIG LVL and TRACK \uparrow cursors if pressed the appropriate number of times. To enable either or both of these, it is necessary to re-enter the CURSORS menu and reselect them.

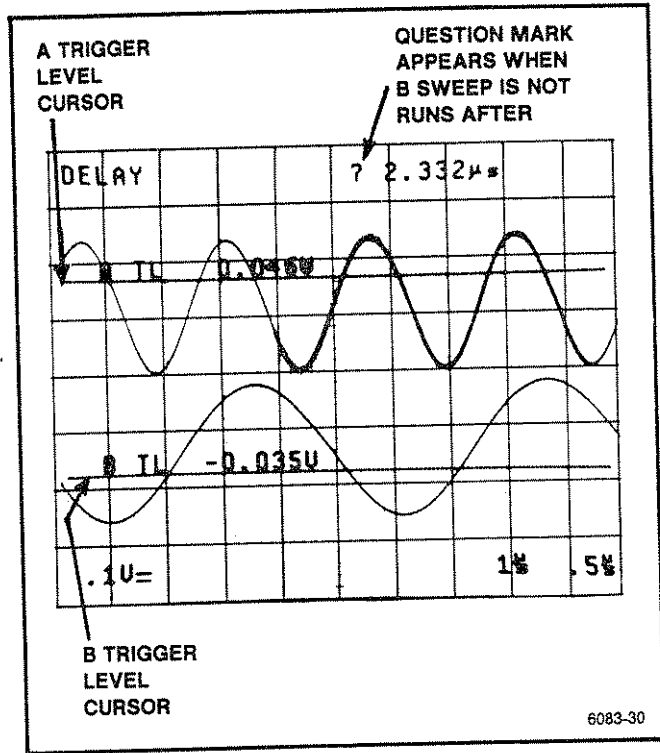

Figure 6-16. A and B TRACK TRIG LVL cursors.

The TRACK MEASMT cursors are also turned off by the CLEAR DISPLAY button, but the function is not turned off; the TRACK MEASMT cursor(s) will be displayed again when a CH1/CH2 VOLTMETER measurement is call up.

Setting Trigger Level

The trigger level readout supplied by the TRACK TRIG LVL cursor may be used to set a specific trigger level for triggering on a displayed waveform. As an example, assume the following conditions:

1. The signal to be examined is a mix of two different signal levels (see Figure 6-17).
2. We want to trigger on the larger amplitude signals to make a closer examination of their waveshape and take pulse width and/or rise time measurements.

To set the Trigger LEVEL to the appropriate level with no signal applied (or with GND input coupling) use the TRACK \uparrow cursor feature. (The TRACK \uparrow cursor menu choice is reached through the same menu path as the TRACK TRIG LVL cursor.) The ground cursor provides feedback to the user so that the ground level may be positioned without the need for a ground baseline trace.

Set the VOLTS/DIV control so that the displayed signal will have a good viewing amplitude. For the assumed signal shown in Figure 6-17, a setting of 1 V/div will produce a four to five division display amplitude. Position the ground cursor (using the VERTICAL POSITION control) at about two graticule divisions below the center graticule line. (For negative-going signals, two divisions above the center graticule would about center the display; and for bipolar signals, centering the ground trace is appropriate.)

Zeroing the Trigger LEVEL control may be useful if the cursor is positioned out of the viewing area. Simply switch the Input COUPLING of the selected channel to GND and switch the Trigger MODE to AUTO LEVEL. Once zeroed, set the Trigger MODE to NORM so that the Trigger LEVEL you set will be maintained. (If AUTO LEVEL is left on, the Trigger LEVEL will continue to follow the applied signal; ground in this case.) Use the Trigger LEVEL control to position the trigger level cursor to about 3 V (measured from the ground cursor). For the assumed signal, this level is ample to avoid triggering on the lower amplitude signals in the display. For other waveforms, the user must determine what trigger level is needed to obtain triggering on a specific waveform amplitude.

Apply the signal to the appropriate input channel connector, and set the Input COUPLING to DC. The

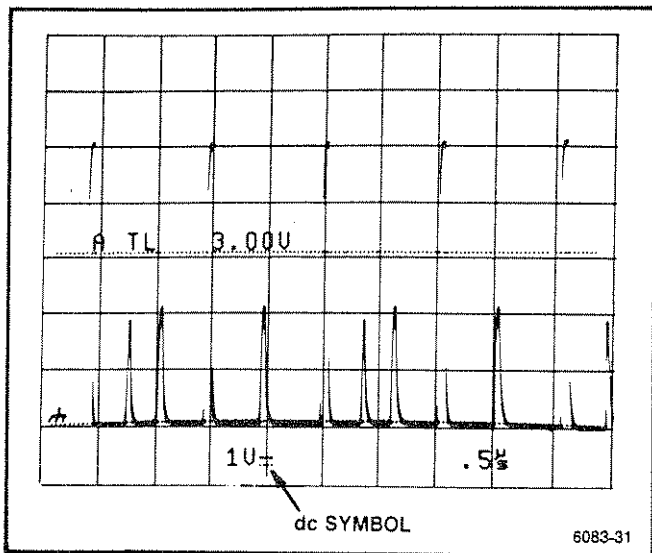

Figure 6-17. Setting a specific Trigger LEVEL.

waveform display will now appear (assuming the A INTENSITY is set to a viewing level), and it will be triggered on the larger amplitude pulses of the signal.

Once triggering is obtained, the A SEC/DIV setting may be set to a faster sweep speed to expand the triggering pulse for making any measurements wanted.

USE OF THE ADD MODE

With the VERTICAL MODE set to ADD, the resulting waveform is the algebraic sum of the signals applied to the Channel 1 and Channel 2 inputs (CH 1 + CH 2). A plus symbol (+) appears in the readout between the CH 1 and CH 2 VOLTS/DIV setting readout to indicate that ADD is active. If the CH 2 INVERT feature is turned on (INVERT button light on), the waveform displayed is the difference between the signals applied to the Channel 1 and Channel 2 inputs. Neither CH 1 nor CH 2 waveform needs to be displayed to obtain the ADD trace, but any or ALL vertical input channels may be displayed at the same time if wanted by the user.

When the VOLTS/DIV switches of CH 1 and CH 2 are both set to the same setting, the total deflection factor in the ADD mode is equal to the deflection factor indicated by either VOLTS/DIV readout. The \leftarrow VOLTS \rightarrow cursors may be used to make voltage measurements on the ADD trace if either CH 1 or CH 2 is displayed along with the ADD trace (and, of course, both CH 1 and CH 2 at the same VOLTS/DIV setting). If any voltage measurement function is active, turning off CH 1 and CH 2 to display the

ADD trace by itself causes the message "INVALID MEASUREMENT SOURCE" to appear, and cancels the measurement. If calling for a voltage measurement with ADD displayed and neither CH 1 nor CH 2 displayed, the CH 1 VERTICAL MODE is turned on, and the measurement is initialized to the signal applied to the CH 1 input.

Two common uses for ADD mode are: (1) providing a dc offset to bring an ac signal riding on top of a large dc voltage within the graticule viewing area and (2) canceling out a large line-frequency signal component to view some small feature riding on the waveform in greater detail using common-mode rejection.

NOTE

The following general precautions should be observed when using ADD mode:

1. Do not exceed the input-voltage rating of the oscilloscope or probe.
2. Do not apply signals that exceed the equivalent of about eight times the VOLTS/DIV switch settings, since large voltages may distort the display. For example, with a VOLTS/DIV setting of 0.5 V, the voltage applied to that channel should not exceed 4 V.
3. Use CH 1 and CH 2 POSITION control settings which most nearly position the signal on each channel to mid-screen, when viewed separately. This ensures the greatest dynamic range for ADD mode signal displays.
4. To have similar responses for both channels, use the same Input COUPLING for both CH 1 and CH 2.

The following procedure shows how to eliminate an unwanted ac input-power frequency signal component from the displayed signal.

1. Set the front panel controls to obtain a baseline trace. Use the settings given for making a +PEAK voltage measurement, but do not apply any signals and center the baseline trace vertically.
2. Apply the signal of interest containing the unwanted line-frequency component to the CH 1 input connector.
3. Apply a line-frequency signal to the CH 2 input connector. To maximize cancellation, the signal applied to the

CH 2 input must be in phase with the frequency component to be canceled from the CH 1 signal.

4. Turn on CH 1 and CH 2 VERTICAL MODE.
5. Set both VOLTS/DIV switches to produce displays of about four to five divisions in amplitude.
6. Adjust the CH 2 VOLTS/DIV switch and VAR control so that the CH 2 display is about the same amplitude as the component to be canceled in the CH 1 waveform (see Figure 6-18A).
7. Select both ADD and CH 2 INVERT. Turn off the CH 1 and CH 2 displays and slightly readjust the CH 2 VOLTS/DIV VAR control for maximum cancellation of the line-frequency component (see Figure 6-18B).
8. The SEC/DIV setting may be set to a faster sweep speed to expand the waveform, and the display amplitude may be increased by advancing both VOLTS/DIV switches and readjusting the VOLTS/DIV VAR controls as necessary to maintain cancellation of the undesired signal component.

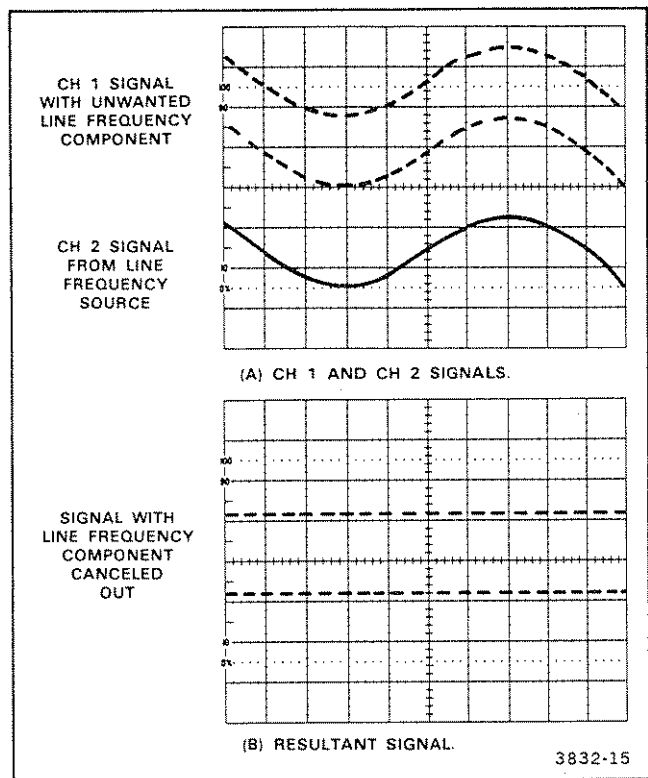

Figure 6-18. Eliminating common-mode signals.

OPTIONS AND ACCESSORIES

INTRODUCTION

This section contains a general description of instrument options and accessories available at the time of publication of this manual. To obtain additional information about instrument options and accessories, consult the current Tektronix Product Catalog or contact your local Tektronix Field Office or representative.

OPTIONS A0-A5 INTERNATIONAL POWER CORDS

Instruments are shipped with the detachable power-cord option ordered by the customer. Descriptive information about the international power-cord options is provided in Section 2, "Preparation for Use." The following list identifies the Tektronix part numbers for the available power cords.

Option A0	(North American, 115 V) Power cord (74 inches)	161-0230-01
Option A1	(Universal Euro) Power cord (2.5 m)	161-0104-06
Option A2	(UK) Power cord (2.5 m)	161-0104-07
Option A3	(Australian) Power cord (2.5 m)	161-0104-05
Option A4	(North American, 240 V) Power cord (2.5 m)	161-0104-08
Option A5	(Switzerland) Power cord (2.5 m)	161-0167-00

STANDARD ACCESSORIES

The following standard accessories are provided with each instrument:

	Part Number
2 Probes, 10X, 1.5 meter, with accessories	P6109
1 Power cord (Option A0-A5)	As ordered
1 Power cord clamp	343-1213-00
1 Operators Manual	070-6083-00
1 Operators Guide	070-6082-00
1 Crt implosion shield, blue plastic (installed)	337-2775-00
1 Fuse, 2 A, 250 V, slow-blow	159-0023-00
1 Accessory pouch, ziploc	004-0130-00

OPTIONAL ACCESSORIES

The following optional accessories are recommended for use with the 2246 Oscilloscope:

Instrument Enhancements	Part Number
Protective front-panel cover	200-3232-00
Attaching accessories pouch	016-0857-00
Protective waterproof vinyl cover	016-0848-00
Clear implosion shield	337-2775-01
Rackmounting kit	2240F1R
DC Inverter power supply	1105
2246 Service Manual	070-6081-01

Options and Accessories—2246 Operators

	Part Number		Part Number
Transportation Aids		Current probes	P6021 (1.52 m); P6022 (1.52 m); A6302/AM503; A6303/AM503
Carrying strap	346-0199-00	Environmental probe	P6008 (1.83 m)
Portable instrument cart	K212	High voltage probe	P6009 (2.74 m)
Instrument shuttle	K117	1X/10X Passive probe	P6063B (1.83 m)
		Subminiature 10X probe	P6130 (2 m)
Cameras		Ground isolation monitor	A6901
Low-cost scope camera	C5 Option 02	Isolator (for floating measurements)	A6902B
Motorized camera	C7 Options 03 and 30		
High-performance camera	C30B Option 01	Viewing Hoods	
		Collapsible viewing hood	016-0592-00
Probes		Binocular viewing hood	016-0566-00
Active probe	P6202A	Polarized collapsible viewing hood	016-0180-00
Power supply for active probe	1101A		