

**2245  
PORTABLE  
OSCILLOSCOPE  
OPERATORS**

*Please Check for  
CHANGE INFORMATION  
at the Rear of This Manual*

---

First Printing OCT 1986  
Revised MAR 1987

**Tektronix**<sup>®</sup>  
COMMITTED TO EXCELLENCE

Copyright © 1986 Tektronix, Inc. All rights reserved.  
Contents of this publication may not be reproduced in any  
form without the written permission of Tektronix, Inc.

Products of Tektronix, Inc. and its subsidiaries are  
covered by U.S. and foreign patents and/or pending  
patents.

TEKTRONIX, TEK, SCOPE-MOBILE, and  are  
registered trademarks of Tektronix, Inc.

Printed in U.S.A. Specification and price change privileges  
are reserved.

#### **INSTRUMENT SERIAL NUMBERS**

Each instrument has a serial number on a panel insert,  
tag, or stamped on the chassis. The first number or letter  
designates the country of manufacture. The last five digits  
of the serial number are assigned sequentially and are  
unique to each instrument. Those manufactured in the  
United States have six unique digits. The country of  
manufacture is identified as follows:

B000000	Tektronix, Inc., Beaverton, Oregon, USA
100000	Tektronix Guernsey, Ltd., Channel Islands
200000	Tektronix United Kingdom, Ltd., London
300000	Sony/Tektronix, Japan
700000	Tektronix Holland, NV, Heerenveen, The Netherlands

**WIND POWER CORD TIGHT, THEN  
POSITION MALE RECEPTICAL IN  
RECESSED AREA OF REAR PANEL**

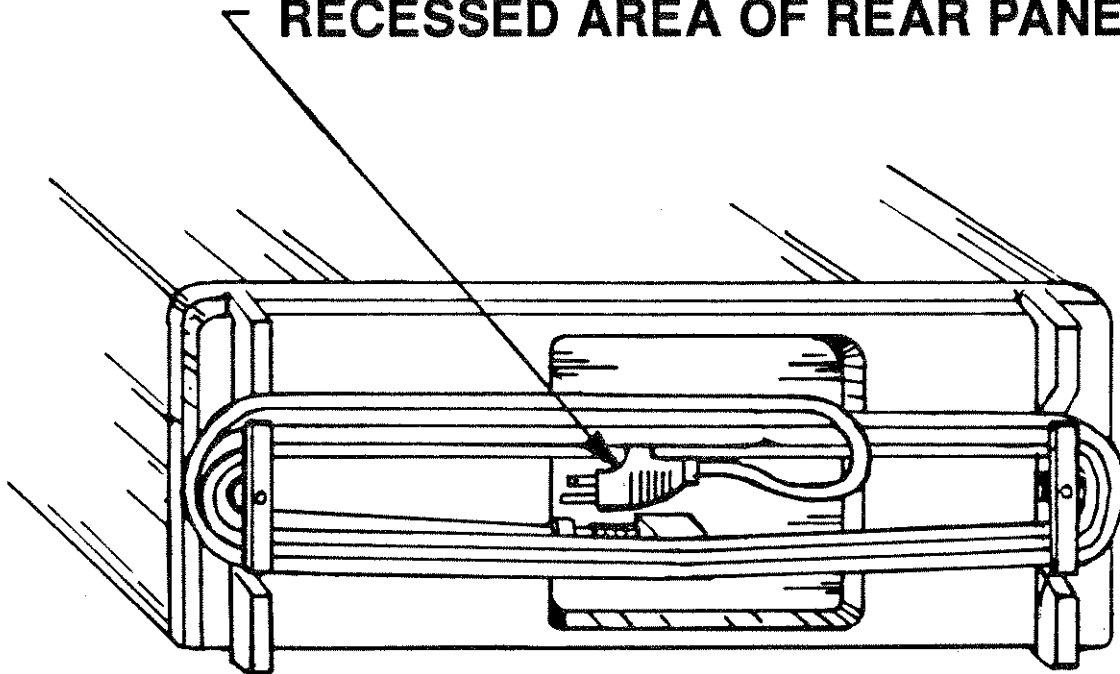

**2200 SERIES POWER CORD WRAP**



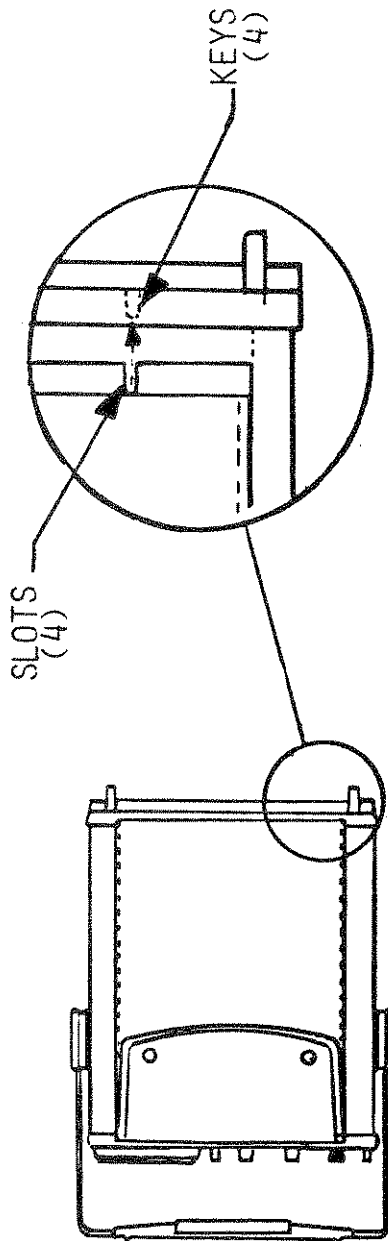
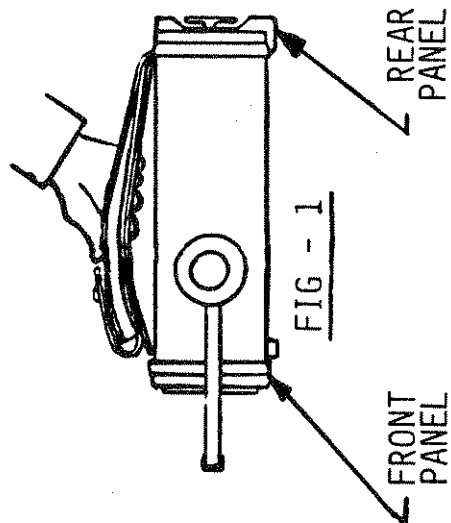

FIG - 2

FIG - 3

POUCH MOUNTING - (2200 INST)

1. POUCH IS MOUNTED ON TOP, SECURED BY THE TWO END PANELS
2. POUCH CAN BE MOUNTED BY ARCHING THE POUCH & SLIDING THE TWO ENDS UNDER THE REAR & FRONT PANELS. (SEE FIG - 1)
3. WHEN POUCH IS SECURED PROPERLY THE (4) SLOTS IN THE METAL POUCH PLATE WILL MATE WITH THE (4) KEYS INSIDE THE FRONT & REAR PANELS (SEE FIG - 3)





Certificate of the Manufacturer/Importer

We hereby certify that the 2245 PORTABLE OSCILLOSCOPE

AND ALL INSTALLED OPTIONS

complies with the RF Interference Suppression requirements of Amtsbl.-Vfg 1046/1984.

The German Postal Service was notified that the equipment is being marketed.

The German Postal Service has the right to re-test the series and to verify that it complies.

TEKTRONIX

Bescheinigung des Herstellers/Importeurs

Hiermit wird bescheinigt, daß der/die/das 2245 PORTABLE OSCILLOSCOPE

AND ALL INSTALLED OPTIONS

in Übereinstimmung mit den Bestimmungen der Amtsblatt-Verfügung 1046/1984 funkentstört ist.

Der Deutschen Bundespost wurde das Inverkehrbringen dieses Gerätes angezeigt und die Berechtigung zur Überprüfung der Serie auf Einhalten der Bestimmungen eingeräumt.

TEKTRONIX

NOTICE to the user/operator:

The German Postal Service requires that Systems assembled by the operator/user of this instrument must also comply with Postal Regulation, Vfg. 1046/1984, Par. 2, Sect. 1.

HINWEIS für den Benutzer/Betreiber:

Die vom Betreiber zusammengestellte Anlage, innerhalb derer dies Gerät eingesetzt wird, muß ebenfalls den Voraussetzungen nach Par. 2, Ziff. 1 der Vfg. 1046/1984 genügen.

NOTICE to the user/operator:

The German Postal Service requires that this equipment, when used in a test setup, may only be operated if the requirements of Postal Regulation, Vfg. 1046/1984, Par. 2, Sect. 1.7.1 are complied with.

HINWEIS für den Benutzer/Betreiber:

Dies Gerät darf in Meßaufbauten nur betrieben werden, wenn die Voraussetzungen des Par. 2, Ziff. 1.7.1 der Vfg. 1046/1984 eingehalten werden.





# TABLE OF CONTENTS

	Page		Page
LIST OF ILLUSTRATIONS .....	iii	<b>Section 5 OPERATOR'S CHECKS AND ADJUSTMENTS</b>	
LIST OF TABLES .....	iv	INTRODUCTION.....	5-1
OPERATORS SAFETY SUMMARY .....	v	INITIAL SETUP.....	5-1
		TRACE ROTATION	
<b>Section 1 SPECIFICATION</b>		ADJUSTMENT.....	5-1
INTRODUCTION.....	1-1	PROBE LOW-FREQUENCY	
PERFORMANCE CONDITIONS .....	1-1	COMPENSATION.....	5-1
RECOMMENDED CALIBRATION		VERTICAL DEFLECTION CHECK.....	5-2
SCHEDULE.....	1-1		
		<b>Section 6 BASIC APPLICATIONS</b>	
<b>Section 2 PREPARATION FOR USE</b>		INITIAL SETUP.....	6-1
SAFETY .....	2-1	NONDELAYED MEASUREMENTS .....	6-1
LINE FUSE .....	2-1	AC Peak-to-Peak Voltage .....	6-1
POWER CORD.....	2-1	Ground-Referenced Dc Voltage .....	6-2
INSTRUMENT COOLING.....	2-1	Algebraic Addition.....	6-3
START-UP .....	2-2	Common-Mode Rejection.....	6-3
REPACKAGING FOR		Amplitude Comparison .....	6-5
SHIPMENT .....	2-2	Time Duration .....	6-5
		Frequency .....	6-6
<b>Section 3 CONTROLS, CONNECTORS, AND INDICATORS</b>		Rise Time.....	6-6
CRT, POWER AND DISPLAY.....	3-1	Time Difference Between	
VERTICAL .....	3-2	Two Time-Related Pulses .....	6-7
HORIZONTAL.....	3-4	Time Comparison .....	6-8
TRIGGER.....	3-6	Phase Difference.....	6-8
REAR PANEL.....	3-9	Slope.....	6-9
		TV Line Signal .....	6-10
<b>Section 4 OPERATING INFORMATION</b>		TV Field Signal.....	6-10
GRATICULE .....	4-1	DELAYED-SWEEP	
CRT READOUTS .....	4-1	MAGNIFICATION .....	6-12
GROUNDING .....	4-1	Magnified Sweep Runs	
SIGNAL CONNECTIONS .....	4-1	After Delay .....	6-12
EXTERNAL TRIGGERING .....	4-3	Pulse Jitter Time.....	6-12
SERVICE MENU .....	4-3	Triggered Magnified Sweep.....	6-12
		DELAYED-SWEEP TIME	
		MEASUREMENTS .....	6-12
		Time Duration .....	6-12
		Rise Time .....	6-13
		Time Difference Between	
		Repetitive Pulses .....	6-14
		Time Difference Between Two	
		Time-Related Pulses.....	6-14

## TABLE OF CONTENTS (cont)

	Page		Page
<b>Section 7 OPTIONS AND ACCESSORIES</b>		<b>PERFORMANCE CHECK</b>	
INTRODUCTION.....	7-1	INTERVAL .....	A-1
OPTIONS A0-A5		PREPARATION .....	A-1
INTERNATIONAL POWER CORDS ....	7-1	INDEX TO PERFORMANCE	
STANDARD ACCESSORIES.....	7-1	CHECK PROCEDURE.....	A-3
OPTIONAL ACCESSORIES.....	7-1	DISPLAY.....	A-4
		VERTICAL .....	A-5
		TRIGGERING .....	A-14
		HORIZONTAL.....	A-18
		EXTERNAL Z-AXIS AND	
<b>Appendix PERFORMANCE CHECK PROCEDURE</b>		CALIBRATOR.....	A-22
INTRODUCTION.....	A-1		
TEST EQUIPMENT REQUIRED .....	A-1	<b>CHANGE INFORMATION</b>	

# LIST OF ILLUSTRATIONS

Figure		Page
	The 2245 Portable Oscilloscope .....	vi
1-1	Dimensional drawing .....	1-10
2-1	Optional power cords .....	2-1
3-1	CRT, Power, and Display controls.....	3-1
3-2	CH 1 and CH 2 vertical controls and indicators.....	3-2
3-3	Vertical connectors and CH 3 and CH 4 controls and indicators .....	3-4
3-4	Horizontal controls and indicators .....	3-5
3-5	Trigger controls and indicators .....	3-6
3-6	Rear-panel connectors and fuse.....	3-10
4-1	Graticule measurement markings .....	4-1
4-2	2245 Readout display locations.....	4-2
4-3	Service menu.....	4-4
4-4	Internal settings menu.....	4-4
5-1	Probe compensation.....	5-2
6-1	Peak-to-peak waveform voltage .....	6-2
6-2	Ground-referenced voltage.....	6-3
6-3	Algebraic addition .....	6-4
6-4	Common-mode rejection .....	6-6
6-5	Time duration.....	6-6
6-6	Rise time.....	6-7
6-7	Time difference between two time-related pulses .....	6-7
6-8	Phase difference .....	6-9
6-9	High-resolution phase difference.....	6-9
6-10	Slope.....	6-10
6-11	Delayed-sweep magnification.....	6-11
6-12	Pulse jitter.....	6-12
6-13	Time duration.....	6-13
6-14	Rise time, differential method.....	6-13
6-15	Time difference between repetitive pulses.....	6-14
6-16	Time between two time-related pulses .....	6-15

# LIST OF TABLES

Table		Page
1-1	Electrical Characteristics .....	1-2
1-2	Environmental Characteristics .....	1-8
1-3	Mechanical Characteristics .....	1-9
3-1	Auto Triggering Intervals .....	3-7
3-2	VERT Trigger SOURCE .....	3-8
A-1	Test Equipment Required.....	A-2
A-2	Signal-to-Graticule Accuracy .....	A-8
A-3	Settings for Timing Accuracy Checks .....	A-19
A-4	Delay Time Accuracy.....	A-21

# OPERATORS SAFETY SUMMARY

*The general safety information in this part of the summary is for both operating and servicing personnel. Specific warnings and cautions will be found throughout the manual where they apply and do not appear in this summary.*

## Terms in This Manual

CAUTION statements identify conditions or practices that could result in damage to the equipment or other property.

WARNING statements identify conditions or practices that could result in personal injury or loss of life.

## Terms as Marked on Equipment

CAUTION indicates a personal injury hazard not immediately accessible as one reads the markings, or a hazard to property, including the equipment itself.

DANGER indicates a personal injury hazard immediately accessible as one reads the marking.

## Symbols in This Manual



This symbol indicates where applicable cautionary or other information is to be found. For maximum input voltage see Table 1-1.

## Symbols as Marked on Equipment



DANGER — High voltage.



Protective ground (earth) terminal.



ATTENTION — Refer to manual.

## Power Source

This product is intended to operate from a power source that will not apply more than 250 volts rms between the supply conductors or between either supply conductor and ground. A protective ground connection by way of the grounding conductor in the power cord is essential for safe operation.

## Grounding the Product

This product is grounded through the grounding conductor of the power cord. To avoid electrical shock, plug the power cord into a properly wired receptacle before making any connections to the product input or output terminals. A protective ground connection by way of the grounding conductor in the power cord is essential for safe operation.

## Danger Arising from Loss of Ground

Upon loss of the protective-ground connection, all accessible conductive parts (including knobs and controls that may appear to be insulated) can render an electric shock.

## Use the Proper Power Cord

Use only the power cord and connector specified for your product.

Use only a power cord that is in good condition.

For detailed information on power cords and connectors, see Figure 2-1.

## Use the Proper Fuse

To avoid fire hazard, use only a fuse of the correct type, voltage rating and current rating as specified in the parts list for your product.

## Do Not Operate in Explosive Atmospheres

To avoid explosion, do not operate this instrument in an explosive atmosphere.

## Do Not Remove Covers or Panels

To avoid personal injury, do not remove the product covers or panels. Do not operate the instrument without the covers and panels properly installed.

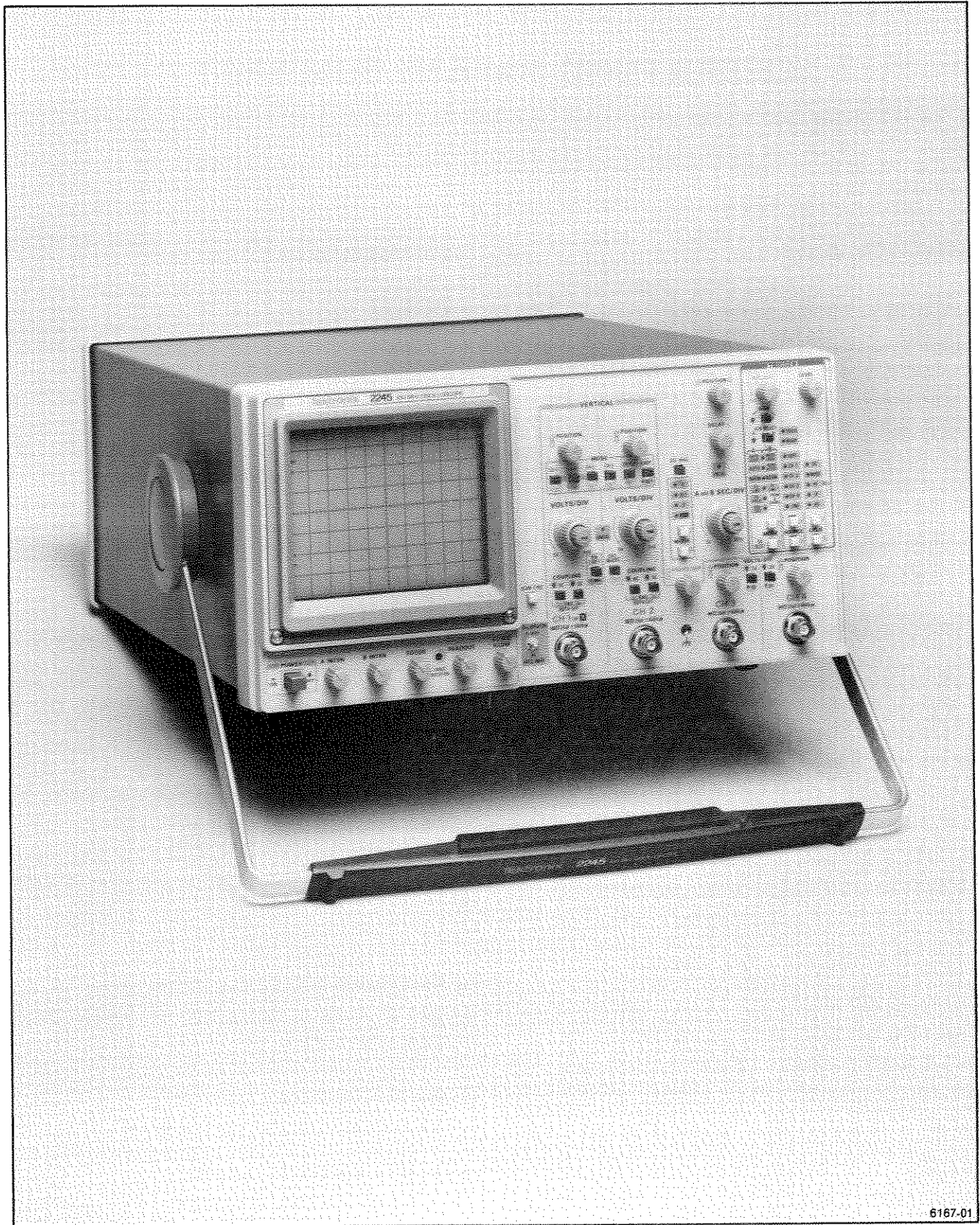

6167-01

The 2245 Portable Oscilloscope.

# SPECIFICATION

## INTRODUCTION

The TEKTRONIX 2245 Oscilloscope is a portable 100 MHz bandwidth instrument with a four-channel vertical deflection system. The horizontal deflection system provides single, dual, or delayed sweeps from 0.5 s to 20 ns per division. The trigger system provides stable triggering over the full bandwidth of the vertical deflection system. The instrument displays alphanumeric crt readouts of the vertical and horizontal scale factors.

The vertical deflection system consists of two channels with calibrated deflection factors from 2 mV to 5 V per division in a 1-2-5 sequence of 11 steps and two channels with two basic deflection factors of 0.1 V and 0.5 V per division. When using attenuator probes, the minimum sensitivity can be extended to 500 V per division. VOLTS/DIV readouts are automatically switched to display a correct scale factor when properly coded probes are attached to the vertical input connectors.

The 2245 Oscilloscope is shipped with the following standard accessories:

- 2 Probes, 10X, 1.5 meter, with accessories
- 1 Power cord
- 1 Operators manual
- 1 Crt filter, blue plastic (installed)
- 1 Fuse
- 1 Accessory pouch, snap
- 1 Accessory pouch, Ziploc

For part numbers and further information about both standard and optional accessories, refer to "Options and Accessories" (Section 7) in this manual.

## PERFORMANCE CONDITIONS

The electrical characteristics of Table 1-1 apply when the 2245 has been calibrated at an ambient temperature between +20°C and +30°C, has had a warmup period of at least 20 minutes, and is operating at an ambient temperature between -10°C and +55°C (unless otherwise noted).

Items listed in the "Performance Requirements" column are verifiable qualitative or quantitative limits that define the measurement capabilities of the instrument.

Environmental Specifications of the 2245 are given in Table 1-2, and Mechanical Specifications are given in Table 1-3.

## RECOMMENDED CALIBRATION SCHEDULE

To ensure accurate measurements, check the performance of this instrument every 2000 hours of operation or, if used infrequently, once each year. Replacement of components in the instrument may also necessitate readjustment of the affected circuits.

**Table 1-1**  
**Electrical Characteristics**

Characteristics	Performance Requirements						
<b>VERTICAL DEFLECTION SYSTEM—CH 1 AND CH 2</b>							
Deflection Factor							
Range	2 mV/div to 5 V/div in 1-2-5 sequence.						
Accuracy (includes ADD and CH2 INVERT)							
+15°C to +35°C	Within ±2%.						
-10°C to +15°C and +35°C to +55°C	Within ±3%.						
Variable Range	Increases deflection factor by at least 2.5:1.						
Frequency Response (-3 dB bandwidth)							
-10°C to +35°C	DC to 100 MHz (at the probe tip).						
+35°C to +55°C	DC to 90 MHz (at the probe tip).						
AC Coupled Lower -3 dB Point							
1X Probe	10 Hz or less.						
10X Probe	1 Hz or less.						
Step Response (5-division step)							
Rise Time							
-10°C to +35°C	3.5 ns or less.						
+35°C to +55°C	3.9 ns or less.						
Delay Match (CH 1 to CH 2)	Less than 200 ps difference.						
Common Mode Rejection Ratio (CMRR)	At least 10:1 at 50 MHz for signals of eight divisions or less with VOLTS/DIV VAR adjusted for best CMRR at 50 kHz.						
Channel Isolation (Attenuation of deselected channel)							
2 mV/Div to 0.5 V/Div	<table style="width: 100%; border: none;"> <tr> <td style="width: 50%;"><b>10 MHz</b></td> <td style="width: 50%;"><b>100 MHz</b></td> </tr> <tr> <td>50 dB or more.</td> <td>34 dB or more.</td> </tr> <tr> <td colspan="2">Channel isolation tested with eight-division input signal.</td> </tr> </table>	<b>10 MHz</b>	<b>100 MHz</b>	50 dB or more.	34 dB or more.	Channel isolation tested with eight-division input signal.	
<b>10 MHz</b>	<b>100 MHz</b>						
50 dB or more.	34 dB or more.						
Channel isolation tested with eight-division input signal.							
Trace Shift as VAR VOLTS/DIV is Turned	1 division or less.						
Invert Trace Shift	1 division or less.						
Trace Shift Between VOLTS/DIV Switch Positions	0.2 division or less.						
Trace Shift Between GND and DC Input Coupling							
-10°C to +35°C	Less than 0.5 mV.						
+35°C to +55°C	Less than 2 mV.						
Position Range	At least ±11 divisions from graticule center.						



Table 1-1 (cont)



Characteristics	Performance Requirements
<b>VERTICAL DEFLECTION SYSTEM—CH 1 AND CH 2 (cont)</b>	
Input Characteristics	
Resistance	1 M $\Omega$ $\pm$ 0.15%.
Capacitance	20 pF $\pm$ 1 pF.
Capacitance Match Between Any Two VOLTS/DIV Settings in Each Channel	Within $\pm$ 0.5 pF.
Max Input Volts 	400 V (dc + peak ac); 800 V p-p ac at 10 kHz or less.
<b>VERTICAL DEFLECTION SYSTEM—CH 3 AND CH 4</b>	
Deflection Factors	
Range	0.1 V per division and 0.5 V per division.
Accuracy	
+15°C to +35°C	Within $\pm$ 2%.
-10°C to +55°C	Within $\pm$ 3%.
Frequency Response (-3 dB bandwidth)	
-10°C to +35°C	DC to 100 MHz (at the probe tip).
+35°C to +55°C	DC to 90 MHz (at the probe tip).
Step Response (5-division step)	
Rise Time	
-10°C to +35°C	3.5 ns or less.
+35°C to +55°C	3.9 ns or less.
Delay Match (CH 3 to CH 4)	Less than 200 ps difference.
Trace Shift Between VOLTS/DIV Settings	1 division or less.
Position Range	At least $\pm$ 11 divisions from graticule center.
Channel Isolation (attenuation of deselected channel)	34 dB or more at 100 MHz. Channel isolation tested with eight-division input signal.
Input Characteristics	
Resistance	1 M $\Omega$ $\pm$ 1.0%.
Capacitance	20 pF $\pm$ 1.0 pF.
Max Input Volts 	400 V (dc + peak ac); 800 V p-p ac at 10 kHz or less.

Table 1-1 (cont)

Characteristics	Performance Requirements
<b>VERTICAL DEFLECTION SYSTEM—ALL CHANNELS</b>	
Bandwidth Limit (−3 dB bandwidth)	20 MHz ± 15%.
Low Frequency Linearity (Relative to center screen)	Within ± 5%. Linearity is measured by positioning a two-division test signal anywhere on screen and noting the amplitude change.
TRACE SEP Control Position Range	At least ± 4 divisions.
CHOP Mode Clock Rate	625 kHz ± 10%.
Delay Match (CH 1 or CH 2 to CH 3 or CH 4)	Less than 200 ps difference.
<b>HORIZONTAL DEFLECTION SYSTEM</b>	
Sweep Range A Sweep	0.5 s/div to 20 ns/div in a 1-2-5 sequence. X10 magnifier extends maximum sweep speed to 2 ns/div.
B Sweep	5.0 ms/div to 20 ns/div in a 1-2-5 sequence. X10 magnifier extends maximum sweep speed to 2 ns/div.
Accuracy	<b>Unmagnified</b> <b>Magnified</b>
+15°C to +35°C	± 2%                  ± 3%
−10°C to +15°C and +35°C to +55°C	± 3%                  ± 4%
	Sweep Accuracy applies over the center eight divisions. Excludes the first 1/4 division or 25 ns from the sweep start of the magnified sweep and anything beyond the 100th magnified division.
Sweep Linearity (relative to center two displayed divisions)	± 5%.
POSITION Control Range Normal Displays	Able to move the start of the sweep to the right of the center vertical graticule; able to move a time mark corresponding to the end of the tenth division of an unmagnified sweep to the left of the center graticule.
X-Y Displays	At least ± 13 divisions.
X10 Magnifier Registration X10 to X1	Expands the normal sweep by ten times around that portion of the sweep positioned at the center vertical graticule line.  0.5 division or less shift.
Variable Control Range	Continuously variable between calibrated SEC/DIV switch settings. Extends both the A and B sweep time per division by at least a factor of 2.5.
Sweep Length	Greater than 10 divisions.

Table 1-1 (cont)

Characteristics	Performance Requirements
<b>HORIZONTAL DEFLECTION SYSTEM (cont)</b>	
Delay Time	
Delay Control Range	Continuously variable between calibrated SEC/DIV settings. Maximum value does not exceed end of the A Sweep.
Delay Accuracy, A Sweep Trigger Point to Start of B Sweep	$\pm$ (0.5% of reading +5% of 1 division of the A Sweep +25 ns).
Jitter	1 part in 20,000, or less, peak-to-peak, during a two-second time interval.
<b>A AND B TRIGGER</b>	
Sensitivity—CH 1 through CH 4: AUTO LEVEL, NORM, AND SINGLE SEQUENCE	Trigger sensitivity is defined as the peak-to-peak sine-wave trigger signal amplitude required to display the test signal with horizontal jitter of less than 1.0% of one period (p-p viewed over two seconds).
COUPLING	
DC	0.35 division from DC to 25 MHz, increasing to 1.0 division at 150 MHz.
NOISE REJECT	1.4 division from DC to 25 MHz; increasing to 2.2 division at 150 MHz. 0.5 division or less will not trigger.
HF REJECT	0.35 division from DC to 50 kHz; attenuates signals above the upper $-3$ dB cutoff frequency of 70 kHz.
LF REJECT	0.35 division from 100 kHz to 25 MHz, increasing to 1.0 division at 150 MHz; attenuates signals below the lower $-3$ dB cutoff frequency of 50 kHz.
AC	0.35 division from 50 Hz to 25 MHz, increasing to 1.0 division at 150 MHz; attenuates signals below the lower $-3$ dB cutoff frequency of 20 Hz.
TV LINE, TV FIELD	Less than 0.5 division of composite sync to achieve a stable display.
AUTO LEVEL Lowest Usable Frequency	10 Hz.
LEVEL Control Range	$\pm$ 20 divisions referred to the appropriate vertical input.  This range is sufficient to allow triggering at any point on a displayed waveform for all modes except ADD. In ADD, the combined range of the two position controls exceeds the trigger level range, making it possible (though unlikely) to pull a signal on screen for display but fail to trigger on it due to insufficient trigger level range.
HOLDOFF Control Range	Increases A Sweep holdoff time by at least a factor of 10.

Table 1-1 (cont)

Characteristics	Performance Requirements
<b>X-Y OPERATION</b>	
Deflection Factors	Same as Vertical deflection system with the VOLTS/DIV variable controls in calibrated detent position.
Accuracy	
Y-Axis	
+15°C to +35°C	Within ±2%.
-10°C to +15°C, +35°C to +55°C	Within ±3%.
X-Axis	
+15°C to +35°C	Within ±3%.
-10°C to +15°C, +35°C to +55°C	Within ±4%.
Horizontal (X-Axis) -3 dB Bandwidth	3 MHz or more.
Phase Match (DC Coupled)	±3 degrees from DC to 50 kHz.
<b>EXTERNAL Z-AXIS INPUT</b>	
Active Region Lower Threshold (intensity decreases above this voltage)	+1.8 volts or less.
Signal Required to Blank an A or B Trace	+3.8 volts or less at maximum intensity. External Z-Axis signal does not affect the readout or the intensified zone intensity.
Max Input Voltage 	30 V (dc + peak ac); 30 V p-p ac at 1 kHz or less.
Input Loading	Represents less than one LSTTL load.
<b>CALIBRATOR OUTPUT</b>	
Overshoot (rising and falling edge)	0.1% or less.
Output Voltage on CALIBRATOR Jack	0.5 V ±2% into 1MΩ load.
Repetition Rate	1 kHz ±25%.
<b>FRONT PANEL SETUP MEMORY</b>	
Data Retention Time	At least three years.

Table 1-1 (cont)

Characteristics	Performance Requirements
<b>POWER SOURCE</b>	
Line Voltage Range	90 Vac to 250 Vac.
Line Frequency	48 Hz to 445 Hz.
Fuse	2 A, 250 V, slow-blow.
Max Power Consumption	80 Watts (110 VA).
<b>CRT DISPLAY</b>	
Display Area	8 by 10 cm.
Geometry	
Vertical	$\pm 1/2$ minor (0.1 div) at 8 by 8 cm centered area.
Horizontal	$\pm 1/2$ minor (0.1 div) at 8 by 10 cm centered area.
Trace Rotation Range	Adequate to align trace with center horizontal graticule line.
Standard Phosphor	P31.
Y-Axis Orthogonality	0.1 division or less, over eight vertical divisions. No adjustment.
Nominal Accelerating Voltage	16.5 kV.

**Table 1-2**  
**Environmental Characteristics**

Characteristics	Description
<b>STANDARD INSTRUMENT</b>	
Environmental Requirements	Instrument meets or exceeds the environmental requirements of MIL-T-28800D for Type III, Class 3, Style D equipment.
Temperature	
Operating	−10°C to +55°C (+14°F to +131°F).
Non-operating	−51°C to +71°C (−60 to 160°F). Tested to MIL-T-28800D paragraphs 4.5.5.1.3 and 4.5.5.1.4, except in 4.5.5.1.3, steps 4 and 5 (−10°C operating test) are performed ahead of step 2 (−51°C non-operating test). Equipment shall remain off upon return to room ambient during step 6. Excessive condensation shall be removed before operating during step 7.
Altitude	
Operating	To 4,570 m (15,000 ft). Maximum operating temperature decreases 1 C/1000 ft above 5000 ft.
Non-operating	To 15,240 m (50,000 ft).
Humidity (Operating and Non-operating)	Five cycles (120 hours) referenced to MIL-T-28800D paragraph 4.5.5.1.2.2, for type III, class 3 instruments. Non-operating and operating at 95%, −0% to +2% relative humidity. Operating at +30°C and +55°C for all modes of operation. Non-operating at +30°C to +60°C.
Radiated and Conducted Emission Required per VDE 0871	Meets Category B.
Electrostatic Discharge	Conforms to Tektronix Standard 062-2862-00.
Vibration (operating)	15 minutes along each of 3 major axis at a total displacement of 0.025 inch p-p (4.0 g at 55 Hz) with frequency varied from 10 Hz to 55 Hz in 1-minute sweeps. Hold for 10 minutes at 55 Hz in each of the three major axis. All major resonances must be above 55 Hz.
Bench Handling Test	Four-inch drop per Tektronix standard 062-2858-00.
Shock (Operating and Non-operating)	30 g, half-sine, 11 ms duration, 3 shocks per axis each direction, for a total of 18 shocks.
Transportation	
Packaged Vibration Test	Meets the limits of Tektronix Standard 062-2858-00.
Package Drop Test	Meets the limits of Tektronix Standard 062-2858-00.

**Table 1-3**  
**Mechanical Characteristics**

Characteristics	Description
<b>STANDARD INSTRUMENT</b>	
Weight	
Instrument Alone	7.6 kg (16.8 lb).
Instrument with Probes, Power Cord, and Manual	8.3 kg (18.2 lb).
Shipping Weight	
Domestic	11.7 kg (25.8 lb).
Overall Dimensions	See Figure 1-1 for a dimensional drawing.
Height	
With Feet and Accessories Pouch (empty)	177 mm (7 in).
Without Accessories Pouch	164 mm (6.44 in).
Width	
With Handle	362 mm (14.25 in).
Depth	
With Front Cover	446 mm (17.6 in).
With Handle Extended	521 mm (20.53 in).
Cooling	Forced air circulation; no air filter.
Finish	Tek Blue, pebble-grain finish painted on aluminum cabinet.
Construction	Aluminum alloy chassis. Plastic-laminate front panel.

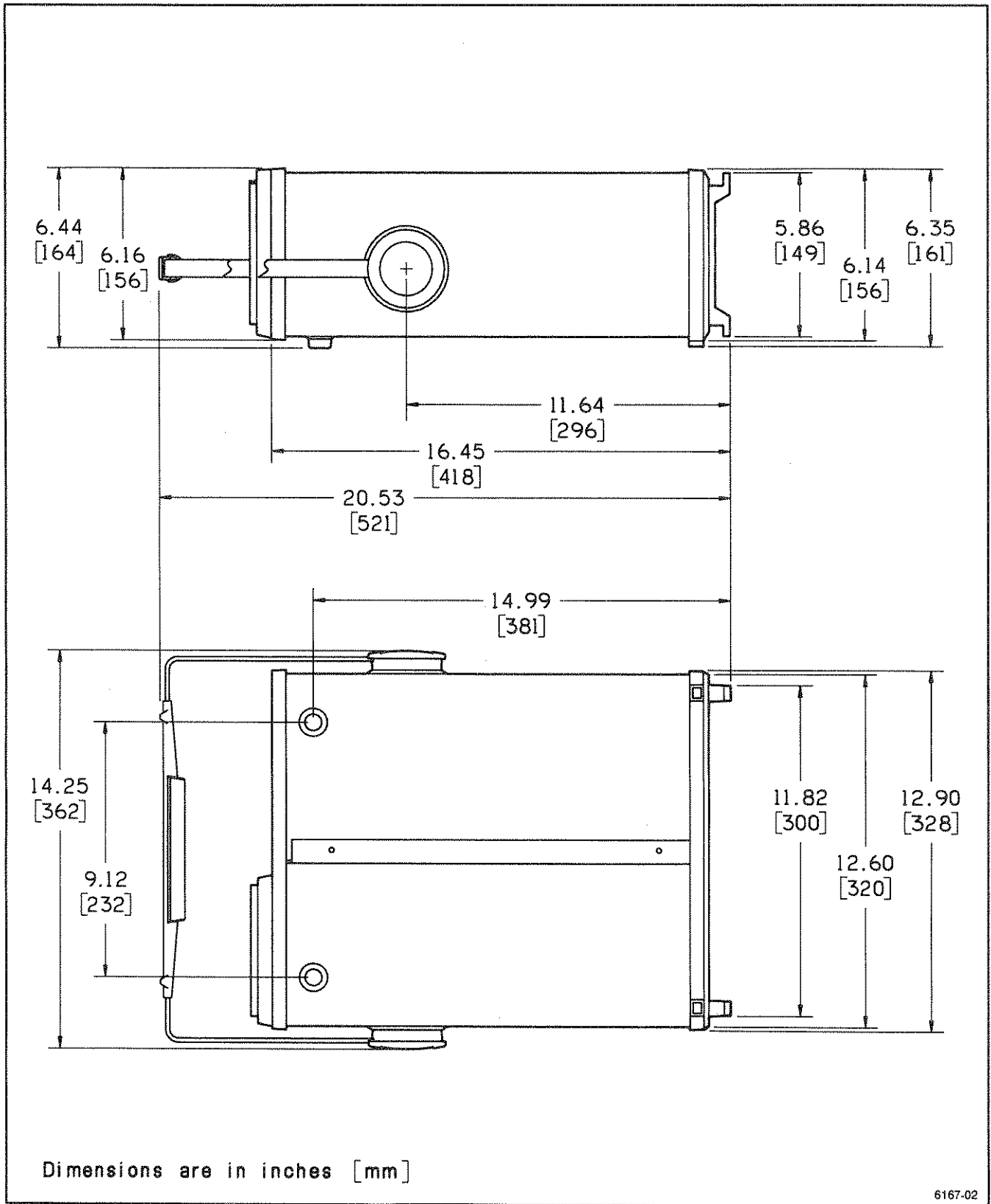

Figure 1-1. Dimensional drawing.



# PREPARATION FOR USE

## SAFETY

This section tells how to prepare for and to proceed with the initial start-up of the TEKTRONIX 2245 Oscilloscope.

Refer to the Operator's Safety Summary at the front of this manual for power source, grounding, and other safety considerations pertaining to the use of the instrument. Before connecting the oscilloscope to a power source, read both this section and the Safety Summary.

### CAUTION

*This instrument may be damaged if the wrong line fuse is installed.*

## LINE FUSE

To verify the proper value of the instrument's power-input fuse, perform the following procedure.

1. Press in the fuse-holder cap and release it with a slight counterclockwise rotation.
2. Pull the cap (with the attached fuse inside) out of the fuse holder.
3. Verify proper fuse value.
4. Install the proper fuse and reinstall the fuse-holder cap.

## POWER CORD





This instrument has a detachable three-wire power cord with a three-contact plug for connection to both the power source and protective ground. The power cord is secured to the rear panel by a cord-set securing clamp. The protective ground contact on the plug connects (through the

power cord protective grounding conductor) to the accessible metal parts of the instrument. For electrical shock protection, insert this plug into a power-source outlet that has a properly grounded protective-ground contact.

Instruments are shipped with the power-cord option ordered by the customer (see Figure 2-1). Contact your Tektronix representative or local Tektronix Field Office for additional power-cord information.

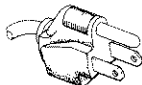
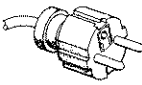
## INSTRUMENT COOLING

To prevent instrument damage from overheated components, adequate internal airflow must be maintained.

Plug Configuration	Usage	Line Voltage	Reference Standards	Option Number
	North American 120V / 15A	120V	ANSI C73.11 NEMA 5-15-P IEC 83	A0
	Universal Euro 240V / 10-16A	240V	CEE (7),II,IV,VII IEC 83	A1
	UK 240V / 13A	240V	BS 1363 IEC 83	A2
	Australian 240V / 10A	240V	AS C112	A3
	North American 240V / 15A	240V	ANSI C73.20 NEMA 6-15-P IEC 83	A4
	Switzerland 220V / 6A	220V	SEV	A5
Abbreviations: ANSI — American National Standards Institute AS — Standards Association of Australia BS — British Standards Institution CEE — International Commission on Rules for the Approval of Electrical Equipment IEC — International Electrotechnical Commission NEMA — National Electrical Manufacturer's Association SEV — Schweizerischer Elektrotechnischer Verein				

2931-21

Figure 2-1. Optional power cords.

## Preparation for Use—2245 Operators

Before turning on the power, first verify that ventilation holes on the bottom and sides of the cabinet are free of any obstruction to airflow.

### START-UP

At power-on, the instrument automatically performs a self-diagnostic routine. If an error message is displayed, refer the instrument to a qualified service technician.

### REPACKAGING FOR SHIPMENT

It is recommended that the original carton and packing material be saved in the event it is necessary for the instrument to be reshipped using a commercial transport carrier. If the original materials are unfit or not available, then repackage the instrument using the following procedure.

1. Use a corrugated cardboard shipping carton having a test strength of at least 275 pounds and with an inside dimension at least six inches greater than the instrument dimensions.

2. If the instrument is being shipped to a Tektronix Service Center, enclose the following information; show the owner's address, name and phone number of a contact person, type and serial number of the instrument, reason for returning, and a complete description of the service required.

3. Completely wrap the instrument with polyethylene sheeting or equivalent to protect the outside finish and prevent entry of harmful substances into the instrument.

4. Cushion instrument on all sides using three inches of padding material or urethane foam, tightly packed between the carton and the instrument.

5. Seal the shipping carton with an industrial stapler or strapping tape.

6. Now mark the address of the Tektronix Service Center and also your own return address on the shipping carton in two prominent locations.

# CONTROLS, CONNECTORS, AND INDICATORS

## CRT, POWER, and DISPLAY

See Figure 3-1 for items 1 through 9.

- ① **POWER Switch**—Turns instrument power on and off. Press in for ON; press again for OFF.

Power-on is indicated by the front-panel control buttons. At least one of the back-lighted buttons will be lit at any time the instrument is on. Front-panel control settings (except B SEC/DIV) present at power-off will be the same when power is again turned on. The B SEC/DIV setting is set to the A SEC/DIV setting at power-up. Potentiometer settings remain the same only if not moved when instrument is off.

- ② **A INTEN Control**—Adjusts brightness of the A trace.
- ③ **B INTEN Control**—Adjusts brightness of the B Delayed Sweep trace and the intensified zone on the A trace.

- ④ **FOCUS Control**—Adjusts the traces and readout for optimum display definition.

- ⑤ **TRACE ROTATION Control**—Aligns the crt trace with the horizontal graticule lines.

- ⑥ **READOUT Control**—Adjusts brightness of the crt readout display.

- ⑦ **SCALE ILLUM Control**—Adjusts the level of the graticule illumination.

### NOTE

Maximum life of the graticule illumination lamps is gained by setting the SCALE/ILLUM control for the minimum intensity needed for viewing. Turning the scale illumination lamps down, or off when not needed, extends the life many times over using maximum intensity.

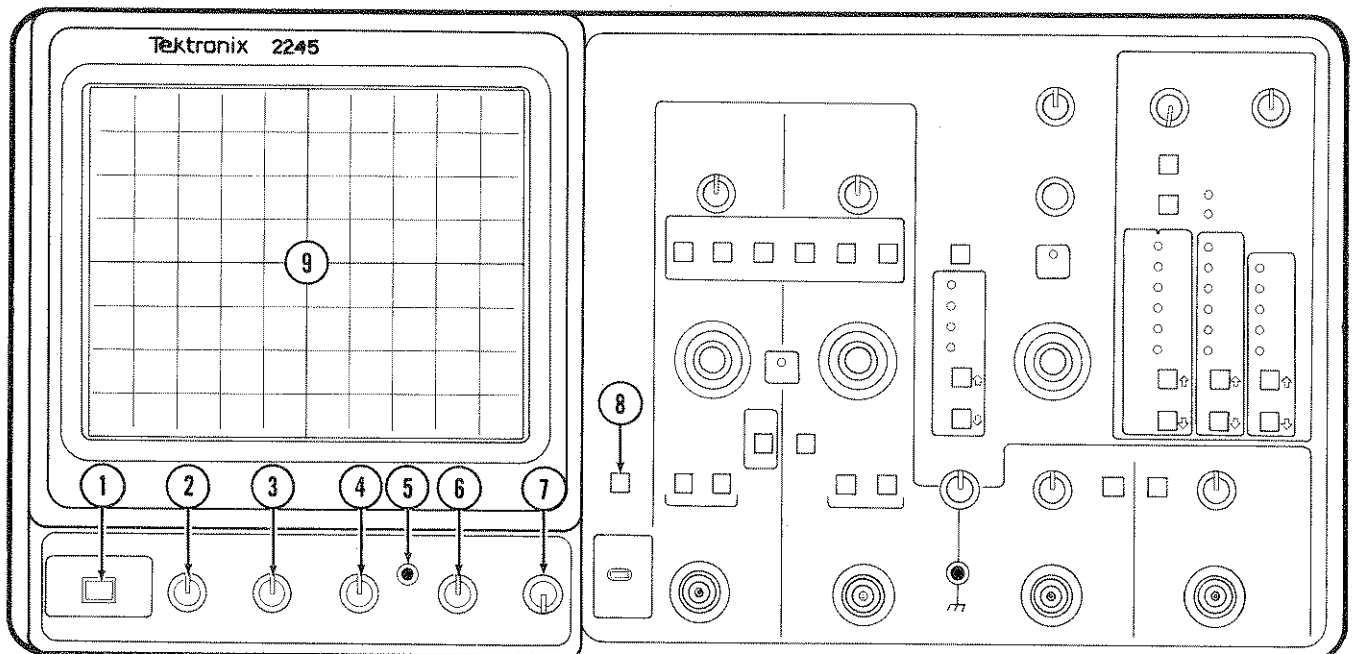

6167-03

Figure 3-1. CRT, Power, and Display controls.

8 **BEAM FIND Button**—Restricts the vertical and horizontal display size to within the graticule area and unblanks the crt to aid the user in locating off-screen or overscanned displays.

9 **CRT**—Displays the waveform and readout displays in an 80 mm vertical by 100 mm horizontal graticule area.

Internal graticule lines eliminate parallax-viewing error between the trace and graticule lines. 0%, 10%, 90% and 100% points are marked at the left edge of the graticule as an aid to the user for making rise- and fall-time measurements.

### VERTICAL

See Figure 3-2 for items 10 through 17.

10 **CH 1 and CH 2 POSITION Controls**—Set the vertical position of the Channel 1 and Channel 2 waveform displays.

Clockwise rotation of a control knob moves the associated trace up; counterclockwise rotation moves the trace down. In X-Y mode, the associated POSITION control moves the display vertically.

11 **MODE Buttons**—Select the vertical channels for display and CHOP or ALT and ADD Mode for display of the selected channels.

The buttons will light to indicate the selection made (except that for ALT Mode the CHOP/ALT button light is off). One channel will always be displayed. When only one channel is selected for display, that channel cannot be turned off.

**CH 1, CH 2, CH 3, and CH 4 Buttons**—Select any combination of the vertical channels for display. Pressing the button of a displayed channel (button lit) removes that channel's trace from the display.

**CHOP/ALT Button**—Chops between the selected input channels at a chopping frequency of approximately 625 kHz when the button is lit (CHOP Mode); displays each selected channel in sequence when the button light is off (ALT Mode).

**ADD Button**—Displays the algebraic sum of the Channel 1 and Channel 2 input signals. The ADD display is in addition to any other selected channel displays. A plus sign (+) appears on the readout between the Channel 1 and Channel 2 VOLTS/DIV switch settings when ADD mode is on. Press the ADD button a second time to turn off the ADD button light and remove the ADD trace from the display.

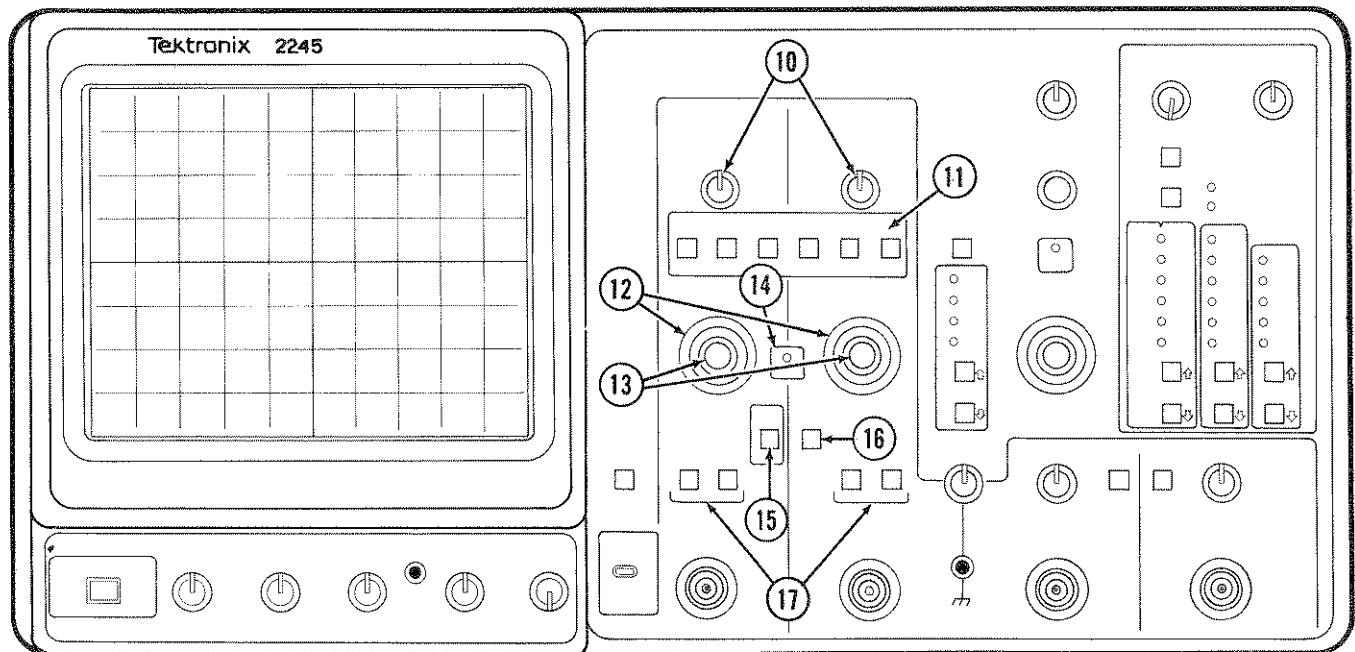

6167-04

Figure 3-2. CH 1 and CH 2 vertical controls and indicators.

## NOTE

*In ADD mode, the algebraic sum of Channel 1 and Channel 2 display is the only signal source for the trigger system when either AUTO LEVEL TRIGGER MODE or CHOP VERTICAL MODE is selected.*

- ⑫ **Channel 1 and Channel 2 VOLTS/DIV Switches**—Select the calibrated deflection settings for Channel 1 and Channel 2 from 2 mV per division to 5 V per division in a 1-2-5 sequence of 11 steps.

The switches are detented, continuous-rotation controls with no end stops. The VOLTS/DIV switch setting displayed in the crt readout reflects the attenuation factor of coded attenuator probes that are connected to the vertical inputs.

- ⑬ **VOLTS/DIV VAR Controls**—Provide for adjustable vertical deflection between the calibrated settings of the Channel 1 and Channel 2 VOLTS/DIV switches.

The controls vary the deflection factors from calibrated (fully clockwise detent position) to at least 2.5 times the calibrated deflection factor (fully counter-clockwise position). When a VAR control is out of its detent position, a greater than (>) sign appears on the left side of the associated VOLTS/DIV readout display to indicate a deflection factor greater than the VOLTS/DIV switch setting.

- ⑭ **UNCAL Indicator**—Indicates that either or both VOLTS/DIV VAR controls are out of their calibrated detent position.

- ⑮ **BW LIMIT Button**—Reduces the bandwidth of the vertical deflection system to between 17 MHz to 23 MHz when the button light is on. Full vertical deflection bandwidth is available when the BW LIMIT button light is off.

- ⑯ **INVERT Button**—Inverts the Channel 2 input signal when the INVERT button light is on.

Both the Channel 2 input signal in ADD mode and the Channel 2 trigger signal pickoff are also inverted. A down-arrow symbol appears on the readout between the Channel 1 and Channel 2 VOLTS/DIV switch settings to indicate INVERT mode is on.

- ⑰ **COUPLING Buttons**—Select the method of coupling input signals to the Channel 1 and Channel 2 vertical attenuators and indicate the selection made.

**GND**—Disconnects the input signal and grounds the input of the associated vertical attenuator to provide a zero (ground) reference voltage display.

The input to the vertical attenuator is grounded when the AC and the DC button lights are both off. A ground symbol ( $\perp$ ) appears on the right side of the associated VOLTS/DIV readout display.

**AC**—Capacitively couples the input signal to the vertical attenuator when the AC button light is on.

Turning AC coupling on turns DC coupling off. With AC coupling, the dc component of the input signal is blocked. The lower  $-3$  dB frequency limit is 10 Hz or less when using either a 1X probe or properly terminated coaxial cable; it is 1 Hz or less using a compensated 10X probe. With AC Coupling selected, an AC symbol ( $\sim$ ) appears on the right side of the associated VOLTS/DIV readout display.

**DC**—Couples dc and all frequency components of the input signal to the vertical attenuator when the DC button light is on.

Turning on DC coupling turns off AC coupling. With DC Coupling selected, a DC symbol ( $\text{---}$ ) appears on the right side of the associated VOLTS/DIV readout display. Input resistance is 1 M $\Omega$  to ground.

See Figure 3-3 for items 18 through 23.

- ⑱ **CH 1 OR X and CH 2 Input Connectors**—Connect external signals to the inputs of Channel 1 and Channel 2 vertical attenuators.

The input connectors are BNC type with an outer contact ring for the probe-code recognition circuit. In X-Y mode, the signal applied to CH 1 OR X Input Connector produces the horizontal deflection (X-Axis). Any of the vertical signal channels or ADD may be selected to provide the vertical deflection (Y-Axis) for an X-Y display.

- ⑲ **CALIBRATOR Connector**—Outputs a 0.5 V square-wave signal at a frequency of approximately 1 kHz for use in compensating voltage probes and checking the vertical deflection accuracy.

- ⑳ **Auxiliary Ground Jack**—Provides an auxiliary signal ground connection between the equipment under test and the oscilloscope. Hookup is made via a banana-tip connector.

- 21 **Channel 3 and Channel 4 POSITION Controls**—Set the vertical position of the Channel 3 and Channel 4 signal displays.

Clockwise rotation of a control moves the associated trace upward; counterclockwise rotation moves the trace downward. When in X-Y mode, the associated Vertical POSITION control moves the display vertically.

- 22 **Channel 3 and Channel 4 VOLTS/DIV Switches**—Select either of two basic deflection factors for Channel 3 and Channel 4. When the VOLTS/DIV button light is off, the deflection factor is 0.1 V per division (using a X1 probe or a coaxial cable input connection); when it is on, the deflection factor is 0.5 V per division.

- 23 **CH 3 and CH 4 Input Connectors**—Connect external signals to the inputs of Channel 3 and Channel 4 vertical attenuators via DC input coupling only.

The input connectors are BNC with probe-coding ring contacts (the same as the Channel 1 and Channel 2 connectors). The limited choice of deflection factors for the Channel 3 and Channel 4 inputs makes them most useful for digital signals and trigger signals. In X-Y mode, signals applied to either or both input connectors may be selected to provide a vertical deflection (Y-Axis) signal.

## HORIZONTAL

See Figure 3-4 for items 24 through 31.

- 24 **POSITION Control**—Sets the horizontal position of the waveform displays on the crt. Clockwise rotation moves the display to the right.

- 25 **X10 MAG Switch**—Horizontally magnifies the portion of all the normal sweep displays positioned at the center vertical graticule line by a factor of 10 when the X10 MAG button light is on. No action occurs in X-Y mode.

A X10 symbol appears in the readout on the right side of the A SEC/DIV display in A and ALT Horizontal MODE and on the left side of the B SEC/DIV display in B Horizontal MODE when X10 MAG is on. In X10 MAG mode, the fastest display sweep speed is extended to 2 ns per division. The crt SEC/DIV readout reflects the correct display sweep speed for the X10 MAG displays and the unmagnified displays.

- 26 **MODE Buttons (Up-Arrow and Down-Arrow) and Indicators**—Select and indicate the operating mode of the horizontal deflection system.

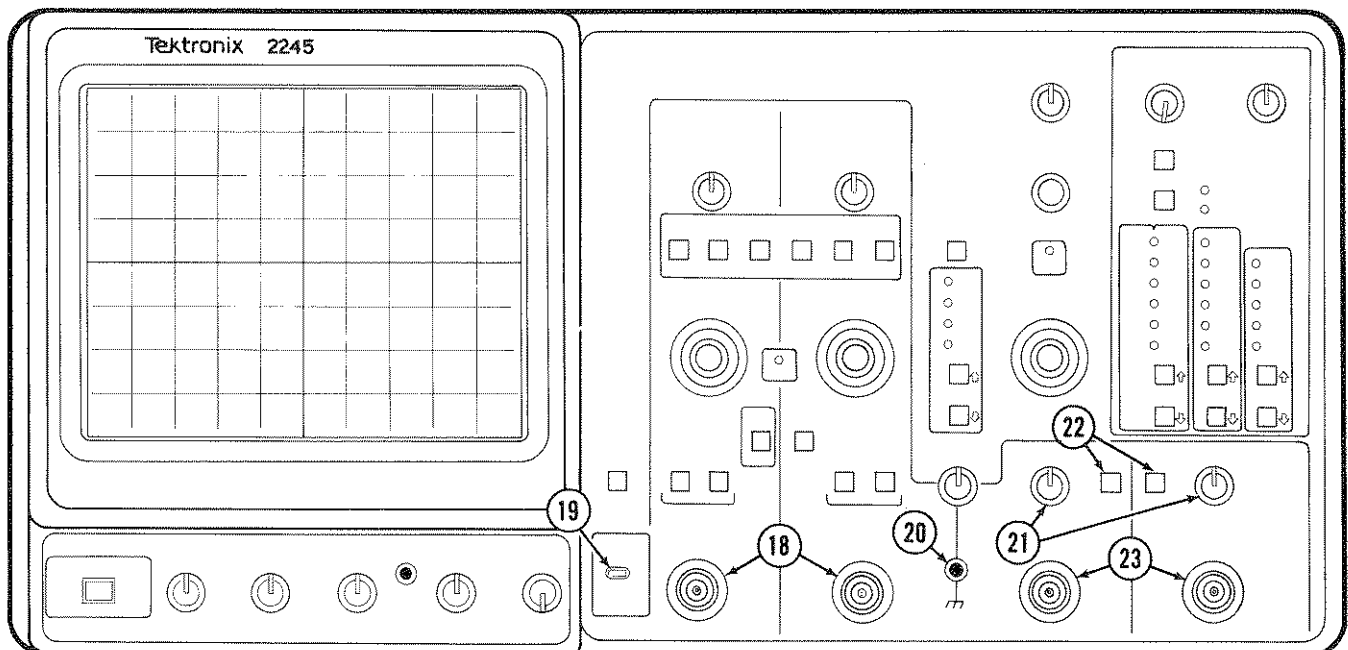

Figure 3-3. Vertical connectors and CH 3 and CH 4 controls and indicators.

6167-05

The Up/Down MODE buttons are used to select the desired mode of operation; the Horizontal MODE indicator lights show the selected horizontal deflection mode.

**A**—Horizontal deflection occurs at a sweep speed determined by the A SEC/DIV switch setting displayed in the crt readout.

**ALT**—Alternates between the A Sweep (with an intensified zone) and the B Delayed Sweep. Both the A and the B SEC/DIV switch settings are displayed in the crt readout.

The B SEC/DIV switch setting is selectable in ALT Mode, but it cannot be set slower than the A SEC/DIV switch setting. Attempting to do so will switch both the A and the B SEC/DIV switch settings to a slower sweep speed. A faster A SEC/DIV setting must be set by the A and B SEC/DIV switch in the A Horizontal MODE before switching to ALT. The B Sweep speed and the length of the intensified zone are both determined by the B SEC/DIV switch setting. When the A SEC/DIV and the B SEC/DIV are both set to the same sweep speed, an intensified zone 1/100 of the A SEC/DIV setting appears on the A Sweep and no alternate B Delayed Sweeps are displayed. To display the B Delayed Sweeps in ALT Mode, set the B SEC/DIV setting to a faster sweep speed than the A SEC/DIV setting.

**B**—Horizontal deflection occurs at a sweep speed determined by the B SEC/DIV switch setting.

The start of the B Sweep in RUNS AFTER mode (or the arming of the B Trigger in any triggered mode) is delayed from start the of the A Sweep by a time determined by the setting of the DELAY control. The B SEC/DIV switch setting and the Delay Time Position setting are displayed in the crt readout.

**X-Y**—The signal applied to CH 1 OR X input connector produces the horizontal (X-Axis) deflection. Signals applied to any vertical input connector and/or ADD may be selected to supply the vertical deflection (Y-Axis).

The display is horizontally positioned by the Horizontal POSITION control and vertically positioned by the associated vertical channel POSITION control.

**27 A AND B SEC/DIV Switch**—Selects the horizontal deflection rate (sweep speed) for both the A Sweep and the B Sweep in a 1-2-5 sequence. Calibrated sweep speeds are obtained with the A and B SEC/DIV VAR control in the calibrated detent (fully clockwise) position.

**A SEC/DIV**—The calibrated A Sweep speed is selected only in A Horizontal MODE from 0.5 s per division to 20 ns per division (X10 MAG off).

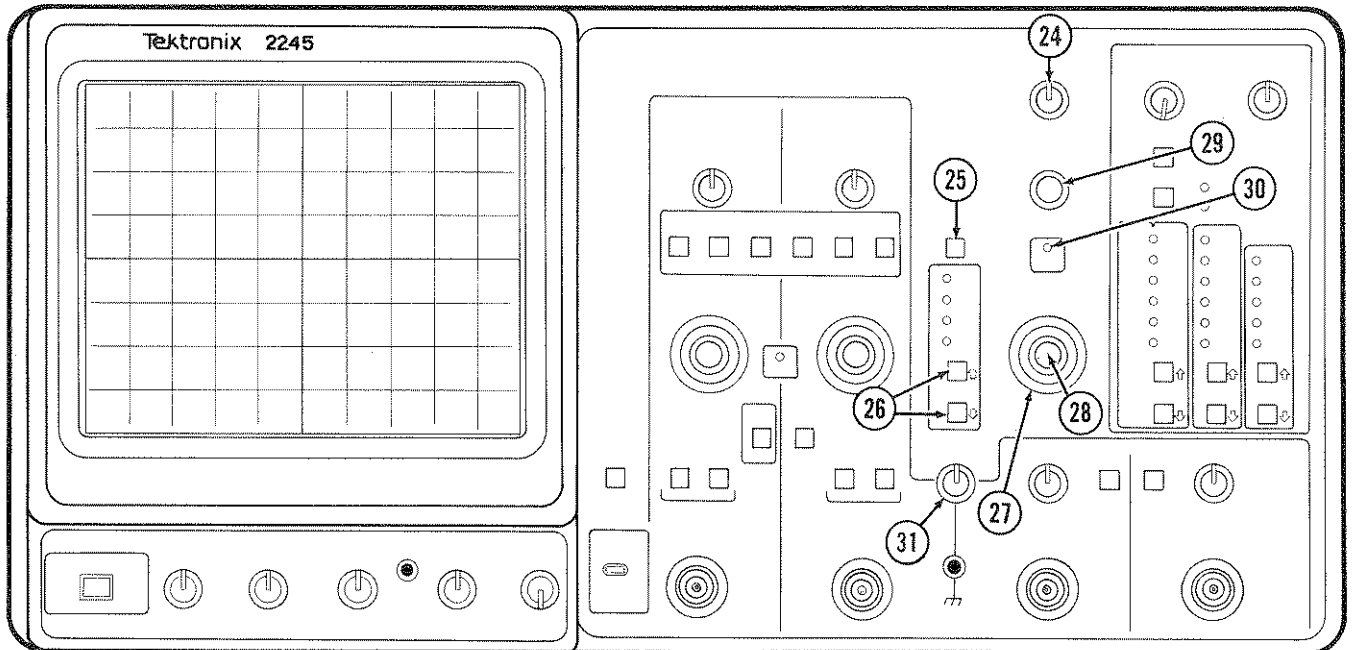

6167-06

Figure 3-4. Horizontal controls and indicators.

**B SEC/DIV**—The calibrated B Sweep speed is selected either in ALT or B Horizontal MODE from 5 ms per division to 20 ns per division (X10 MAG off).

- 28 **A and B SEC/DIV VAR Control**—Provides continuously variable, uncalibrated A Sweep and B Sweep speeds to at least 2.5 times slower than the calibrated SEC/DIV setting.

The VAR control extends the slowest A Sweep speed to at least 1.25 sec per division. A greater-than sign (>) will appear before each displayed SEC/DIV setting when the VAR control is out of its detent position.

- 29 **DELAY Control**—Sets the B Sweep delay time in ALT or B Horizontal Modes. Positions the intensified zone that appears on the A Sweep trace in ALT Horizontal Display Mode.

- 30 **UNCAL**—Indicates that the A AND B SEC/DIV VAR control is out of the calibrated detent position when lighted.

- 31 **TRACE SEP Control**—Positions the B Sweep trace vertically with respect to the A Sweep trace when ALT Horizontal MODE is selected.

## TRIGGER

See Figure 3-5 for items 32 through 39.

- 32 **A/B SELECT Button**—Directs the MODE, SOURCE, CPLG, SLOPE, and LEVEL controls and Trigger LED indicators (TRIG'D and READY) to either the A Trigger system or the B Trigger system. The A/B SELECT button light is on for the A Trigger and off for the B Trigger.

- 33 **SLOPE Button**—Selects the slope of the trigger source signal that triggers either the A Sweep or the B Sweep.

The sweep to which the trigger controls are directed by the A/B SELECT switch is triggered from the positive-going slope of the trigger signal when the SLOPE button light is on. When the SLOPE button light is off, the sweep is triggered from the negative-going slope of the trigger signal.

- 34 **HOLDOFF Control**—Varies the amount of holdoff time between the end of one A Sweep and the start of the next A Sweep.

Full clockwise rotation of the HOLDOFF control increases the holdoff time by at least a factor of ten;

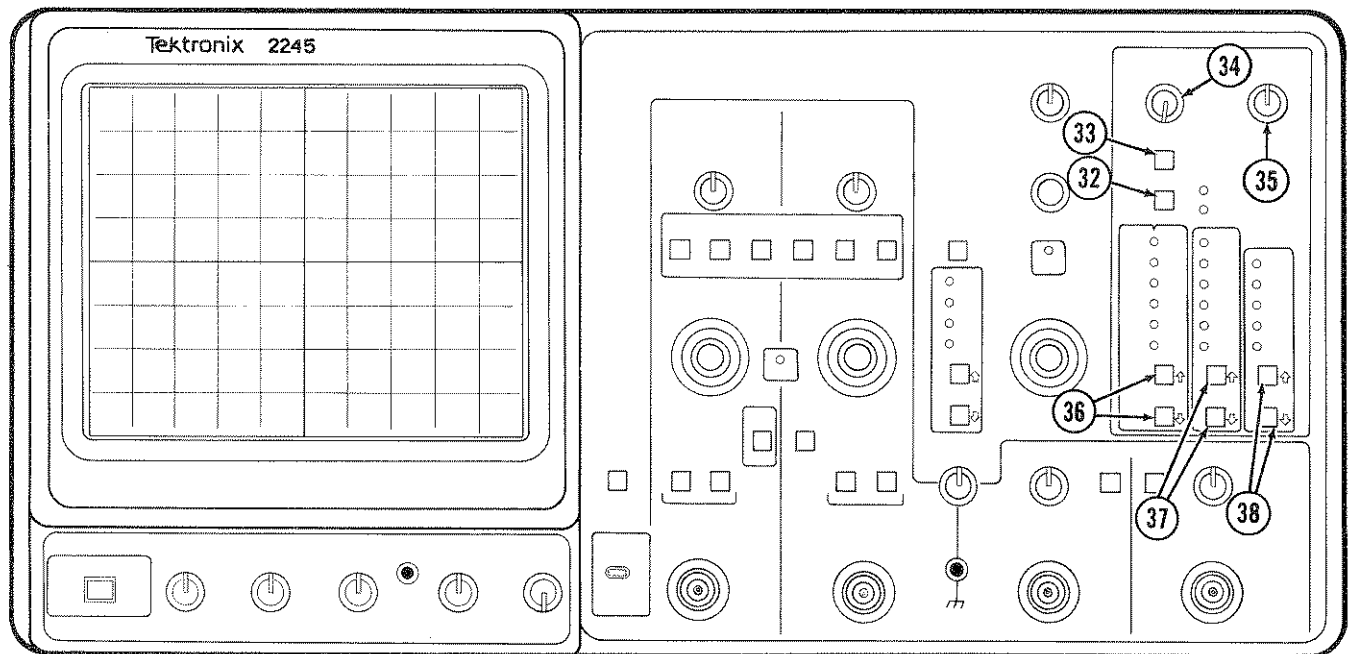

6167-07

Figure 3-5. Trigger controls and indicators.



full counterclockwise rotation produces minimum holdoff time. Use this control as an aid in obtaining stable triggering on aperiodic signals (such as complex digital waveforms).

- 35 **LEVEL Control**—Sets the amplitude point on the trigger signal at which either the A Sweep or the B Sweep is triggered.

When the TRIGGER MODE is set to AUTO LEVEL, adjusting the trigger level setting to either end of the control range causes the auto level trigger to be recalculated so that the LEVEL control range is limited to the peak-to-peak amplitude of the trigger source signal.

- 36 **MODE Buttons (Up-Arrow and Down-Arrow) and Indicators**—Select and indicate the operating mode of the A and B trigger systems.

The Up/Down MODE buttons are used to select the trigger system operating mode from the choices of AUTO LEVEL, AUTO, NORM, TV LINE, TV FIELD, and SGL SEQ for the A Trigger system and AUTO LEVEL, RUNS AFTER, NORM, TV LINE FROM A SOURCE for the B Trigger system as directed by the A/B SELECT button. The TRIGGER MODE front-panel lights indicate the selected mode of operation for the A and the B trigger system.

**A TRIGGER MODES**

**AUTO LEVEL**—Sets the range of the Trigger LEVEL control to the peak-to-peak limits of an adequate A trigger-source signal and triggers the A Sweep.

**NOTE**

*The A Sweep free runs to produce a baseline trace when the A trigger-source signal is too low or the repetition rate of the applied signal is too slow to autolevel. See Table 3-1 for critical triggering intervals that may result in a free-running A Sweep. Switch to NORM triggering if the repetition rate is too slow for autoleveling.*

Once set, autoleveling is repeated only if triggering is lost, if the TRIGGER LEVEL control is rotated to either end stop, or if the AUTO LEVEL Trigger MODE is reselected. AUTO LEVEL mode is useful for quickly locating an appropriate triggering level.

**AUTO**—Triggers as in NORMAL Mode when an adequate trigger signal is applied.

The A Sweep begins free-running for an auto baseline in the absence of a triggering signal or when the repetition rate of the trigger signal is too low (see Table 3-1 for auto triggering repetition rates). The set triggering level changes only when the TRIGGER LEVEL control is adjusted to a new level setting.

**Table 3-1**  
**Auto Triggering Intervals**

SEC/DIV Setting	Critical Trigger Interval
5 ms/div and faster	20 ms
10 ms/div	40 ms
20 ms/div	160 ms
50 ms/div and slower	400 ms

**NORM**—Initiates the A Sweep when an adequate trigger signal is applied. In the absence of a trigger signal, a sweep is not generated (no baseline trace is displayed).

**TV LINE**—Starts the A Sweep at the beginning of a video signal line. SLOPE polarity must match the composite sync polarity to obtain TV LINE triggering on the horizontal sync pulse.

**TV FIELD**—Starts the A Sweep at the beginning of a video signal field. SLOPE polarity must match the composite sync polarity to obtain TV FIELD triggering.

**SGL SEQ (Single Sequence)**—Arms the A Sweep for single-sequence operation when selected and with each additional press of the Down Arrow MODE button after selection.

When triggered, the sweep runs to produce a single sweep of each of the traces as required by the setting of the VERTICAL MODE and TRIGGER MODE switches, but each displayed sweep in the sequence requires a distinct A Sweep triggering event. The READY front panel light remains on until the final trace in the sequence is completed. The readout may be turned on for only a short period of time at the end of sequence for use with a camera

**B TRIGGER MODES**

**AUTO LEVEL**—Sets the range of the Trigger LEVEL control to the peak-to-peak limits of an adequate B trigger-source signal and triggers the B Sweep.

**NOTE**

*The B Sweep operates in RUNS AFTER mode when the trigger-source signal amplitude is too low or the repetition rate of the applied signal is too slow to autolevel. See Table 3-1 for critical triggering intervals. Switch to NORM triggering if the repetition rate is too slow for auto leveling. The A Sweep must be running (free-running or triggered) for B Sweep to trigger.*

Once set, autoleveling is repeated only if triggering is lost, if TRIGGER LEVEL control is rotated to either end stop, or if AUTO LEVEL Trigger MODE is reselected. AUTO LEVEL mode is useful for quickly locating an appropriate triggering level.

**RUNS AFTER**—Starts the B Sweep immediately after the delay time selected by the DELAY control.

RUNS AFTER Trigger MODE is forced on if timing measurements other than Delay are selected when the Horizontal Mode is ALT or B Delayed.

**NORM**—The B Sweep is initiated when an adequate trigger signal is received after the delay time condition has been met. No B Sweep display occurs without a trigger signal.

**TV LINE FROM A SOURCE**—Starts the B Sweep at the beginning of a the video signal line received after the delay time has been met.

SLOPE polarity must match the composite sync polarity (same as A Trigger SLOPE) to obtain correct triggering on the horizontal sync pulse.

**37 SOURCE (Up-Arrow and Down-Arrow) Buttons and Indicators**—Select the trigger source for either the A or the B Trigger system and indicate the selected source as directed by the A/B SELECT button.

The Up/Down SOURCE buttons select the trigger source, and the Trigger SOURCE front-panel lights indicate the selected trigger signal source for the trigger system selected by the A/B SELECT button.

**VERT**—Selects the trigger signal from the displayed waveforms.

The selection of the trigger signal source is determined by the TRIGGER MODE and VERTICAL MODE switch settings. With VERT selected, one or more of the SOURCE front-panel lights will be on to indicate the trigger signal source. See Table 3-2 for VERT Trigger SOURCE selections.

**Table 3-2**  
**VERT Trigger SOURCE**

Trigger and Vertical Modes	ADD Mode	Trigger SOURCE Selected
AUTO LEVEL or CHOP	On	Algebraic sum of CH 1 and Ch 2 input signals.
	Off	Lowest numbered vertical channel displayed.
NON-AUTO LEVEL and ALT	On or Off	Alternates between displayed vertical channels in the following order: CH 1, CH 2, CH 3, CH 4, and ADD.

**CH 1**—The signal applied to the CH 1 OR X input connector is the source of the trigger signal.

**CH 2**—The signal applied to the CH 2 input connector is the source of the trigger signal.

**CH 3**—The signal applied to the CH 3 input connector is the source of the trigger signal.

**CH 4**—The signal applied to the CH 4 input connector is the source of the trigger signal.

**LINE**—The triggering signal is obtained from a sample of the ac power-source waveform. This trigger source is useful when the displayed waveform frequency is time related to the ac power-source frequency.

- 38 **CPLG (Up-Arrow and Down-Arrow) Buttons and Indicators**—Select the type of coupling of the input trigger signal to the trigger signal amplifier and indicate the coupling selected as directed by the A/B SELECT button.

**DC**—Couples dc and all frequency components of a triggering signal to the trigger circuitry.

DC coupling is useful for most signals, but it is especially useful for providing a stable display of low-frequency or low-repetition-rate signals.

**NOISE REJ (Noise Reject)**—Couples all frequency components of the input signal to the trigger circuitry but increases the peak-to-peak signal amplitude required to produce a trigger event.

NOISE REJ coupling is useful for improving stability when the trigger signal is accompanied by low-level noise.

**HF REJ (High Frequency Reject)**—Attenuates high-frequency triggering signal components above 50 kHz.

HF REJ coupling is useful for providing a stable display of low-frequency components of complex waveforms and eliminates high-frequency interference from the trigger signal.

**LF REJ (Low Frequency Reject)**—Attenuates low-frequency triggering signal components below 100 kHz and blocks the dc component of the trigger signal.

LF REJ coupling is useful for producing stable triggering on the high-frequency components of complex waveforms and rejecting low-frequency interference or power supply hum from the trigger signal.

**AC**—Attenuates trigger signal frequency components below 50 Hz and blocks the dc component of the signal.

AC coupling is useful for triggering on ac waveforms that have a large dc offset.

## REAR PANEL

See Figure 3-6 for items 39 through 41.

- 39 **EXT Z-AXIS INPUT Connector**—Connects external signals to the Z-Axis amplifier to intensity modulate the crt display.

Signals applied to the EXT Z-AXIS INPUT do not affect display waveshape. Signals with fast rise times and fall times provide the most abrupt intensity change. The active region threshold level is 1.8 V. Z-Axis voltage above the threshold voltage decreases the intensity, and 3.8 V or more produces blanking. The Z-Axis signals must be time related to the displayed signal to obtain a fixed intensity-modulation display.

- 40 **Fuse Holder**—Contains the primary power fuse for the instrument.

- 41 **Power Cord Receptacle**—Connects the ac power source to the power supply of the instrument.

The power cord safety-ground connection is connected to the exposed metal parts of the instrument. The power cord must be connected to a properly grounded source for electrical shock protection.

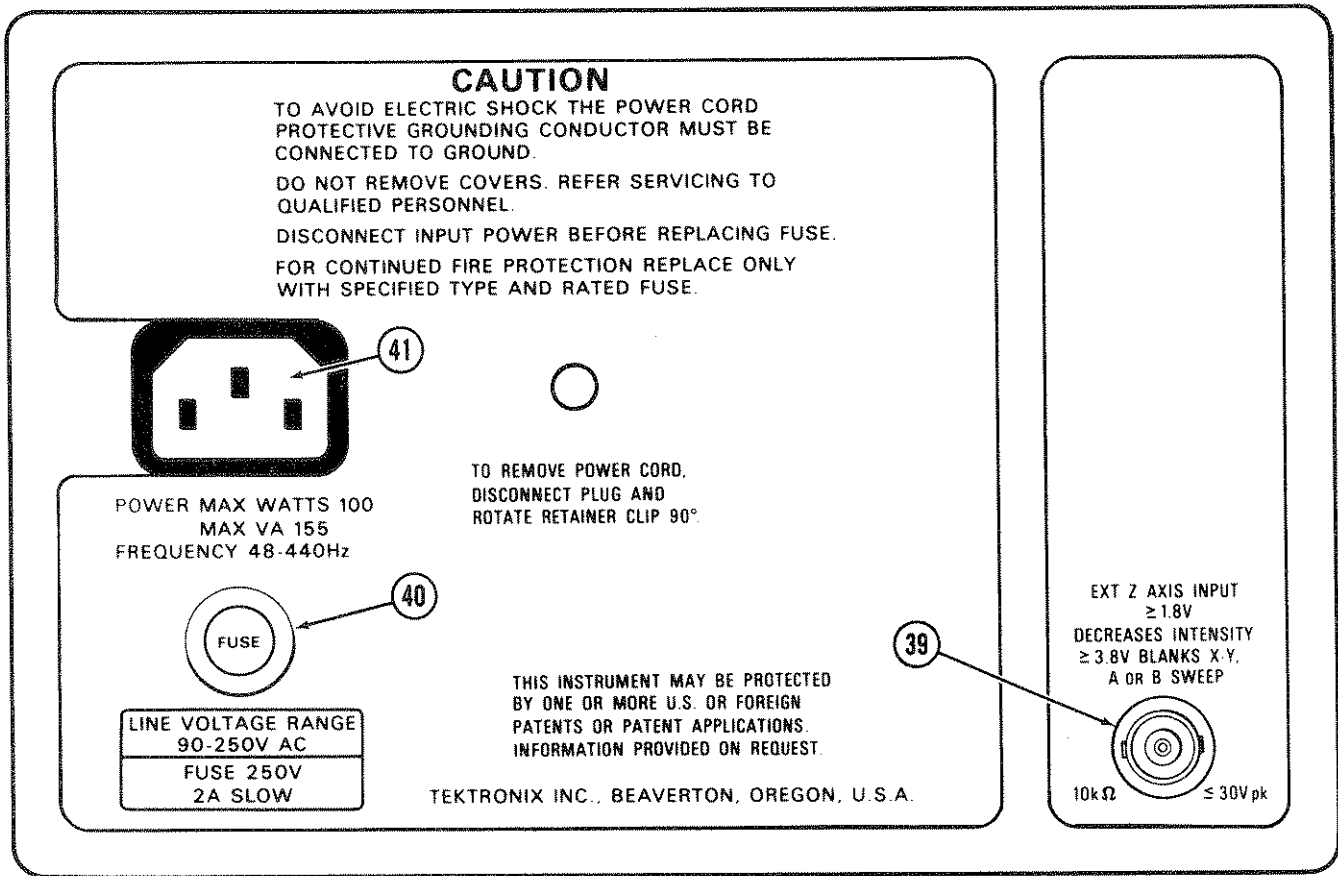

6167-08

Figure 3-6. Rear-panel connectors and fuse.

# OPERATING INFORMATION

## GRATICULE

The graticule is internally marked on the faceplate of the crt to eliminate parallax-viewing error and to enable accurate measurements (see Figure 4-1). The graticule is marked with eight vertical and ten horizontal major divisions. Major divisions are further divided into five subdivisions of 0.2 division each, marked along the center vertical and horizontal graticule lines. Percentage marks for rise-time and fall-time measurements are located on the left side of the graticule. The vertical deflection factors and horizontal timing are calibrated to the graticule so that accurate measurements may be made directly from the crt.

The waveform displays are calibrated to the crt graticule markings for making quick and very accurate estimates of waveform parameters. Voltage measurements

are done by counting the vertical graticule divisions and partial divisions occupied by the portion of the display being measured and then multiplying by the VOLTS/DIV setting. Time measurements using the graticule markings are done in a similar manner. Count the number of horizontal graticule divisions and partial divisions occupied by the portion of the waveform being measured and multiply by the SEC/DIV setting.

To improve the accuracy of the estimate, position the display to take advantage of the 0.2 division minor graticule markings on the center graticule lines. Also position one of the measurement points of the waveform as precisely as possible on one of the major graticule marks to be used as a measurement reference point.

## CRT READOUTS

The crt readout display is the user's guide to how the instrument controls are set up. No physical markings are on the rotating switches and control knobs to indicate the control setting. A key to the location and type of readout information displayed is illustrated in Figure 4-2.

## GROUNDING

The most reliable signal measurements are made when the 2245 and the unit under test are connected by a common reference (ground lead) in addition to the single lead or probe. The ground lead of the probe provides the best grounding method for signal interconnection and ensures the maximum amount of signal-lead shielding in the probe cable. A separate ground lead can also be connected from the unit under test to the oscilloscope ground jack on the front panel using a banana-tip connector.

## SIGNAL CONNECTIONS

### Probes

Generally, probes offer the most convenient means of connecting an input signal to the instrument and are shielded to prevent pickup of electromagnetic interference.

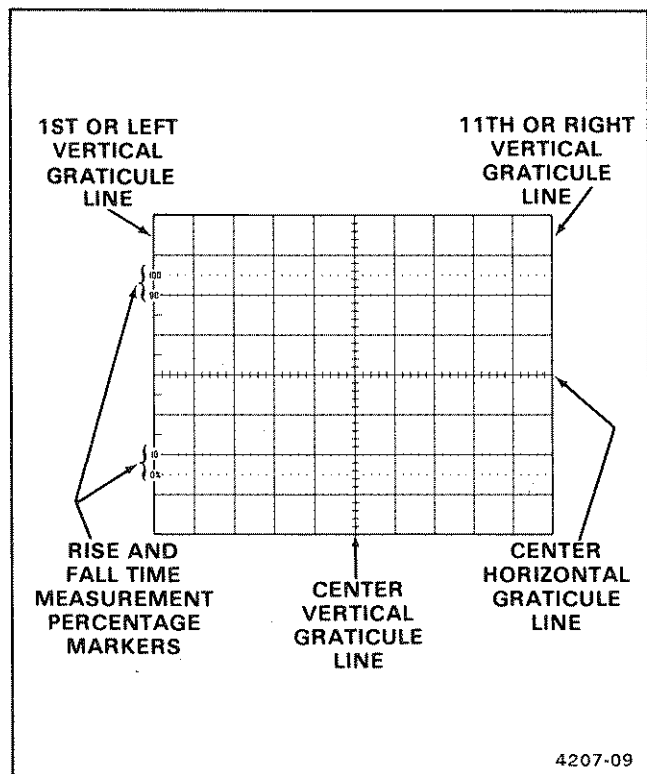

Figure 4-1. Graticule measurement markings.

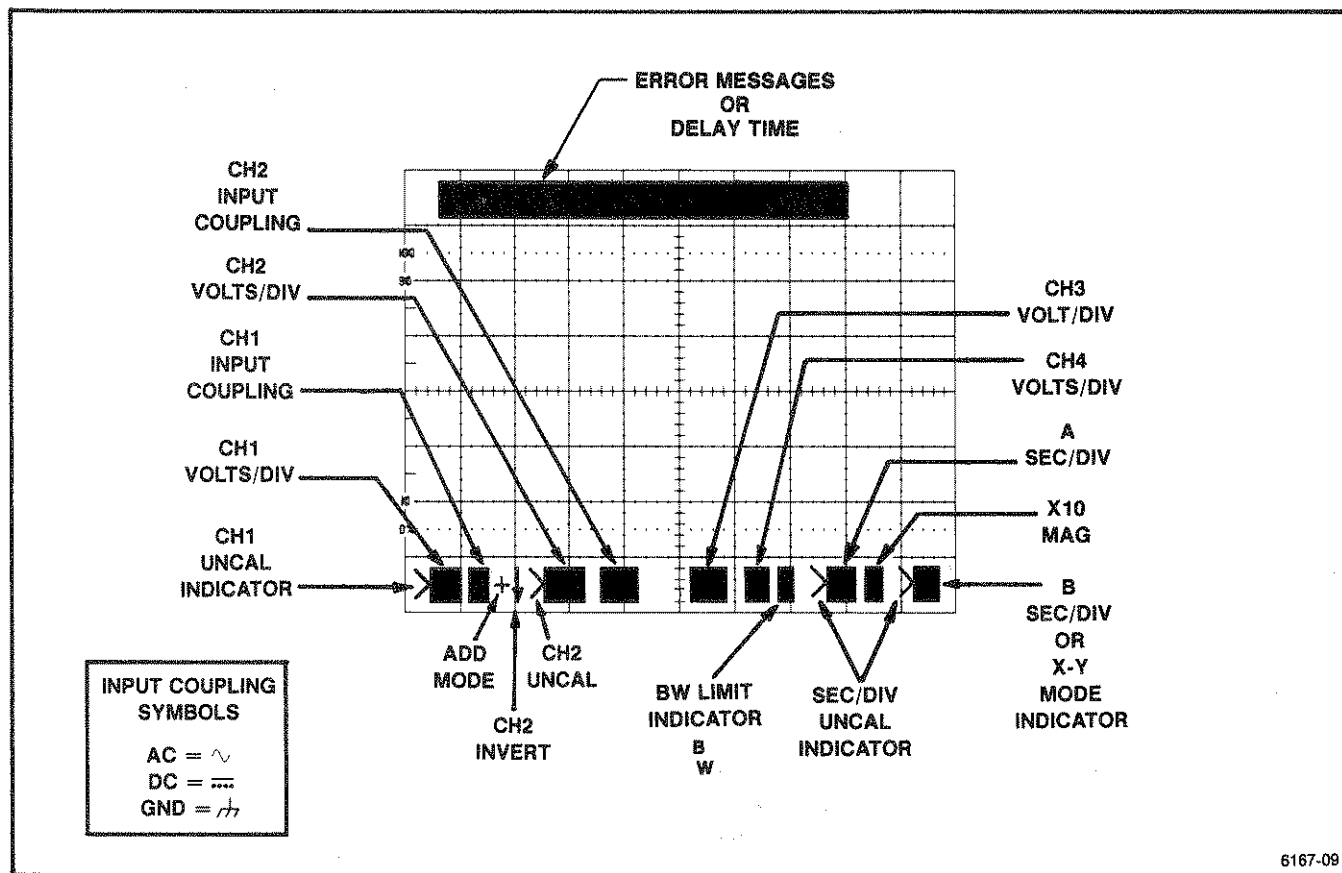

Figure 4-2. 2245 Readout display locations.

The standard 10X probes supplied with this instrument offer a high input impedance that minimizes circuit loading. This allows the circuit under test to operate with a minimum of change from the normal, unloaded condition. Also, the subminiature body of these probes has been designed for ease of use when probing circuitry containing close lead spacing.

The probe itself and the probe accessories should be handled carefully at all times to prevent damage. Striking a hard surface or dropping the probe body can cause damage to both the body and the probe tip. Use care to prevent the cable from being crushed or kinked, and do not place excessive strain on the cable by pulling it.

The standard-accessory probe is a compensated 10X voltage divider. It is a resistive voltage divider for low frequencies and a capacitive voltage divider for high-frequency signal components. Inductance introduced by long signal or ground leads may form a series-resonant circuit. This resonant circuit will affect system bandwidth and will oscillate (ring) if driven by a signal containing

significant frequency components at or near its resonant frequency. Ringing can then appear on the scope display and distort the true signal waveform. Always keep both the ground lead and the probe signal-input connections as short as possible to maintain the best waveform fidelity.

Misadjustment of probe compensation is a common source of measurement error. Because of variations in oscilloscope input characteristics, probe compensation should be checked and adjusted, if necessary, whenever a probe is moved from one oscilloscope to another or between channels of a multichannel oscilloscope. The probe compensation adjustment procedure is found in "Operator's Checks and Adjustments," Section 5 of this manual and in the instructions supplied with the probe.

**SCALE FACTOR SWITCHING.** The VOLTS/DIV scale factors are displayed on the crt. The VOLTS/DIV readout always reflects the correct scale factor in response to a control change or as a result of change in the probe attenuation factor (when Tektronix coded probes are used).

## Coaxial Cables

Cables used to connect signals to the input connectors may have considerable effect on the accuracy of a displayed waveform. To maintain the original frequency characteristics of an applied signal, only high-quality, low-loss coaxial cables should be used. Coaxial cables must be terminated at both ends in their characteristic impedance to prevent signal reflections within the cable. Use suitable impedance-matching devices.

## EXTERNAL TRIGGERING

The A and the B trigger signals are independently obtainable from a variety of sources. When viewing signals that require a trigger source different than one of the displayed signals, a free vertical input channel may be used to input the trigger signal. The CH 1 and CH 2 vertical input channels may be used to condition a wide range of signals to produce triggers over the full vertical deflection range from millivolts to thousands of volts in amplitude. The CH 3 and CH 4 vertical input channels have a choice of two attenuation factors (either divided by 1 or by 5 without the use of external attenuation) and are especially useful for triggering on and viewing digital signal levels.

## SERVICE MENU

A SERVICE MENU can be accessed on the 2245 screen that is intended primarily for performing servicing procedures. However, there are a couple of operational selections under the INTERNAL SETTINGS MENU that can be useful to the operator and are discussed below. Detailed explanations for the complete SERVICE MENU are given in the servicing documentation for the 2245.

### NOTE

*SERVICE MENU routines other than those given here are for servicing only. Running SERVICE MENU selections other than for normal operation may cause the front panel controls to lock up. To restore normal operation if this happens, turn the power off and on. If normal operation does not return, the problem is not due to SERVICE MENU features; refer the instrument to a qualified service person.*

## Accessing the INTERNAL SETTINGS MENU

Press the CH 1 and CHOP/ALT VERTICAL MODE buttons simultaneously to display the SERVICE MENU with the selections shown in Figure 4-3. Menu selections are made using VERTICAL MODE buttons that correspond to the menu prompts appearing at the right side of the crt display.

A menu-selection underline appears under the SERVICE MENU heading. Pressing the ADD button (down arrow) moves the underline down; the CH 2 button (up arrow) moves the underline up.

Once the desired item is underlined, select RUN (CH 2 button) to start the selected process. Select QUIT (CH 4 button) to exit the SERVICE MENU and return to the normal oscilloscope operation.

**INTERNAL SETTINGS MENU.** The 2245 has a self-calibration feature in the Internal Settings Menu that calibrates the SEC/DIV timing.

### NOTE

*Warm up instrument for 20 minutes before running SELF CAL to ensure SEC/DIV timing accuracy as stated in the Specification section.*

Pressing the down arrow three times from the entry level to the SERVICE MENU underlines the INTERNAL SETTINGS MENU label and displays the SELECT label. Press SELECT to display the menu shown in Figure 4-4.

**SELF CAL MEASUREMENTS.** Press the down arrow three times again to underline the SELF CAL MEASUREMENTS choice, then select the RUN (CH 2) that appears in the menu. At this point, the instrument automatically does a self-characterization of the SEC/DIV timing. Upon completion of the procedure, the INTERNAL SETTINGS MENU choices are again displayed. Press QUIT to return to normal scope operation.

**MAKE FACTORY SETTINGS.** This menu selection sets up the front panel controls as shipped from the factory.

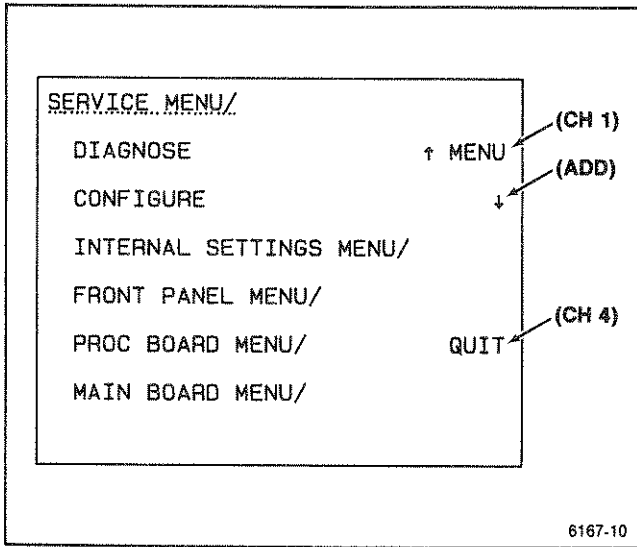

Figure 4-3. Service menu.

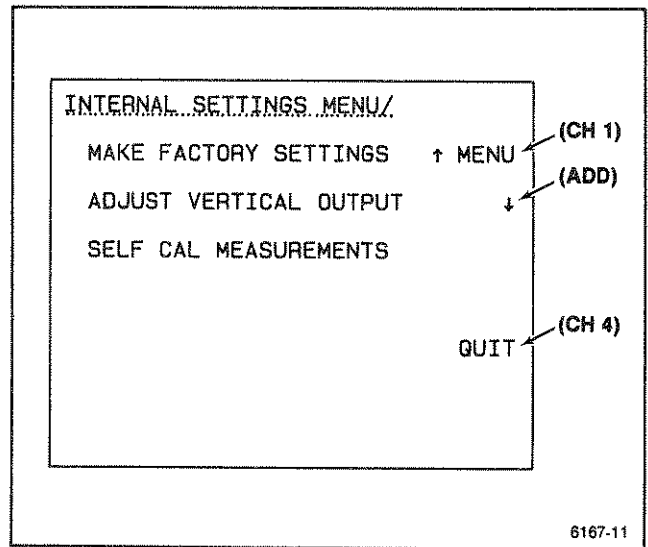

Figure 4-4. Internal settings menu.



# OPERATOR'S CHECKS AND ADJUSTMENTS

## INTRODUCTION

If adjustments are required beyond the level of these operator's checks and adjustments, refer the instrument to a qualified service person.

For new equipment checks, before proceeding with these instructions, refer to "Preparation for Use," Section 2 of this manual to prepare the instrument for the initial start-up before applying power.

Verify that the POWER switch is OFF (out position), then plug the power cord into an appropriate ac-power-source outlet supplying a voltage within the specified operating range of the instrument.

If an improper indication or other malfunction is noted, refer the instrument to a qualified service person.

## INITIAL SETUP

1. Press in the POWER switch button (ON) and allow the instrument to warm up (20 minutes is recommended for maximum accuracy).

2. Set the instrument front-panel controls to obtain a baseline trace:

### Vertical Controls

POSITION	Midrange
VERTICAL MODE	CH 1
VOLTS/DIV	1 V
Channel 1 COUPLING	GND

### Horizontal Controls

POSITION	Midrange
MODE	A
X10 MAG	Off
A SEC/DIV	0.1 ms
SEC/DIV VAR	Cal detent

### Trigger Controls

A/B SELECT	A
MODE	AUTO
SOURCE	VERT
CPLG	DC

3. Adjust the A INTEN, READOUT, and FOCUS controls for desired brightness and best trace and readout definition.

4. Adjust the Vertical and Horizontal POSITION controls to center the trace within the graticule area.

## TRACE ROTATION ADJUSTMENT

1. Preset instrument controls and obtain a baseline trace as described in Initial Setup. Position the trace vertically to align it with the center horizontal graticule line and check that the trace is parallel with the graticule line.

### NOTE

*Normally, the resulting baseline trace will be parallel to the center horizontal graticule line, and the TRACE ROTATION adjustment will not be needed.*

2. If the baseline trace is not parallel to the center horizontal graticule line, use a small straight-blade screwdriver or alignment tool to adjust the TRACE ROTATION pot for proper alignment of the trace.

## PROBE LOW-FREQUENCY COMPENSATION

Misadjustment of probe compensation is a possible source of measurement error. The attenuator probes are equipped with compensation adjustments. To ensure the best measurement accuracy, always check probe compensation before making measurements.

## Operator's Checks and Adjustments—2245 Operators

1. Preset instrument controls and obtain a baseline trace as described in "Initial Setup." Set the CH 1 VOLTS/DIV setting to 100 mV.

2. Connect the two supplied 10X probes to the CH 1 and CH 2 BNC input connectors.

3. Connect the probe tips to the CALIBRATOR loop and connect the probe ground leads to scope ground.

4. Use the CH 1 Vertical POSITION control to center the five-division CALIBRATOR square wave in the graticule area.

5. Check the square-wave signal for overshoot and rolloff (see Figure 5-1). If necessary, use the special adjustment tool supplied in the probe accessory package to adjust the low-frequency compensation for a square front corner on the square wave.

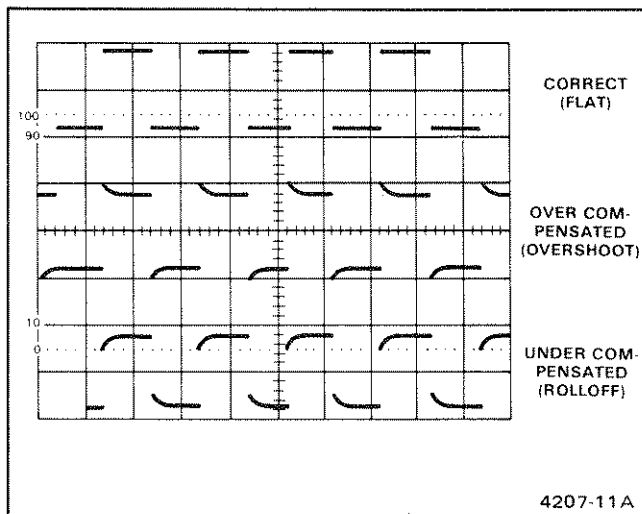

Figure 5-1. Probe compensation.

6. Press the CH 2 VERTICAL MODE button to turn CH 2 on in the display, and press the CH 1 Mode button to remove the CH 1 trace from the display.

7. Set the CH 2 VOLTS/DIV setting to 100 mV and vertically center the CALIBRATOR signal.

8. Repeat Step 5 for the second probe on the CH 2 BNC input connector.

### NOTE

*Refer to the instruction manual supplied with the probe for more detailed information about the probes and adjustment procedure.*

## VERTICAL DEFLECTION CHECK

The CALIBRATOR output signal may be used to check the Channel 1 and Channel 2 vertical deflection system in the following procedure:

1. Set the instrument controls to obtain a baseline trace as described in Initial Setup.

2. Connect the two 10X probes supplied with the instrument to the CH 1 OR X and CH 2 input connectors (scale factor readout switches to 0.1 VOLTS/DIV for the attached 10X probes).

3. Connect both probe hook tips to the CALIBRATOR output connector.

4. Set the bottom of the trace of the CALIBRATOR square-wave signal to a convenient horizontal graticule line with the Vertical POSITION control.

5. Check for a five-division display of the CALIBRATOR square-wave signal.

# BASIC APPLICATIONS

This section contains basic measurement procedures that can be performed with the 2245 oscilloscope. Before using these procedures, you should become familiar with the basic functions of this instrument by reading the other sections of this manual.

The measurements in this section are based on first obtaining a baseline display as given in the following Initial Setup.

## INITIAL SETUP

1. Press in the POWER switch button (ON) and allow the instrument to warm up (20 minutes is recommended for maximum accuracy).

2. Set the instrument front-panel controls to obtain a baseline display:

### Vertical Controls

POSITION	Midrange
VERTICAL MODE	CH 1
VOLTS/DIV	1 V
CH 1 COUPLING	DC

### Horizontal Control

POSITION	Midrange
MODE	A
X10 MAG	Off
A SEC/DIV	0.1 ms
SEC/DIV VAR	Cal detent

### Trigger Controls

A/B SELECT	A
MODE	AUTO
SOURCE	VERT
CPLG	DC

## NONDELAYED MEASUREMENTS

### AC Peak-to-Peak Voltage

To perform a peak-to-peak voltage measurement, use the following procedure:

#### NOTE

*This procedure may also be used to make voltage measurements between any two points on the waveform.*

1. Preset instrument controls and obtain a baseline display.

2. Apply the ac signal to either CH 1 or CH 2 input and select the appropriate VERTICAL MODE channel.

3. Set the appropriate VOLTS/DIV switch to display about five divisions of the waveform, ensuring that the VOLTS/DIV VAR control is in the calibrated detent.

4. Adjust the TRIGGER LEVEL control for a stable display.

5. Set the SEC/DIV switch to a position that displays several cycles of the waveform.

6. Vertically position the display so that the negative peak of the waveform coincides with one of the horizontal graticule lines (see Figure 6-1, Point A).

7. Horizontally position the display so that one of the positive peaks coincides with the center vertical graticule line (see Figure 6-1, Point B).

8. Measure the vertical deflection from peak to peak (see Figure 6-1 Point A to Point B).

**NOTE**

*A more accurate value can be obtained by measuring from the top of a peak to the top of a valley. This eliminates trace thickness from the measurement.*

9. Calculate the peak-to-peak voltage, using the following formula:

$$\text{Volts (p-p)} = \text{vertical deflection (divisions)} \times \text{VOLTS/DIV switch setting}$$

Also include the attenuation factor or the probe being used, if it is not a 10X or 100X scale-factor-switching probe.

**EXAMPLE:** The measured peak-to-peak vertical deflection is 4.9 divisions (see Figure 6-1) with a VOLTS/DIV switch setting of 5 V.

Substituting the given values:

$$\text{Volts (p-p)} = 4.9 \text{ div} \times 5 \text{ V/div} = 24.5 \text{ V.}$$

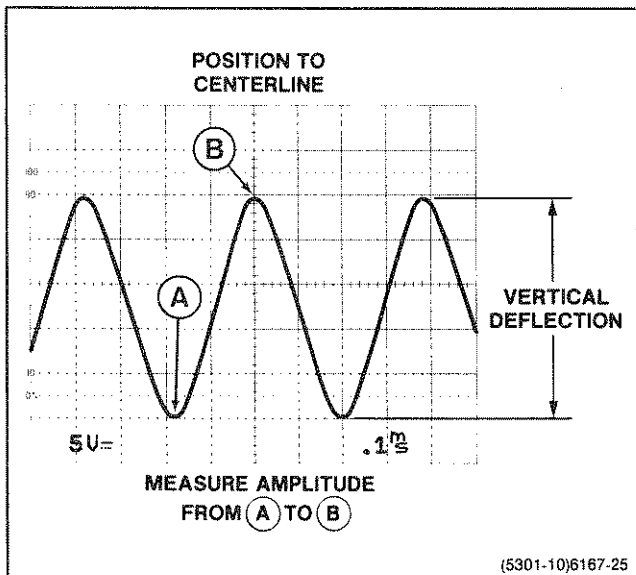

Figure 6-1. Peak-to-peak waveform voltage.

**Ground-Referenced Dc Voltage**

To measure the dc level at a given point on a waveform, use the following procedure:

1. Preset instrument controls and obtain a baseline display.
2. Apply the signal to either the CH 1 or CH 2 input and select the appropriate VERTICAL MODE channel. If using CH 2, make sure CH 2 INVERT button is not lit.
3. Verify that the VOLTS/DIV VAR control is in the calibrated detent and set both COUPLING buttons off to select GND.
4. Vertically position the baseline trace to the center horizontal graticule line.
5. Select DC COUPLING. If the waveform moves above the centerline of the crt, the voltage is positive. If the waveform moves below the centerline, the voltage is negative.

6. Set both COUPLING buttons off to select GND and position the baseline trace to a convenient reference line, using the VERTICAL POSITION control. For example, if the voltage to be measured is positive, position the baseline trace to the bottom graticule line. If a negative voltage is to be measured, position baseline trace to top graticule line.

**NOTE**

*Do not move the POSITION control after this reference line has been established. The ground reference line can be checked at any later time by setting the COUPLING buttons for GND.*

7. Select DC Coupling and adjust the TRIGGER LEVEL control to obtain a stable display.
8. Set the SEC/DIV switch to a position that displays several cycles of the signal.
9. Measure the divisions of vertical deflection between the reference line and the desired point on the waveform at which the dc level is to be determined (see Figure 6-2).

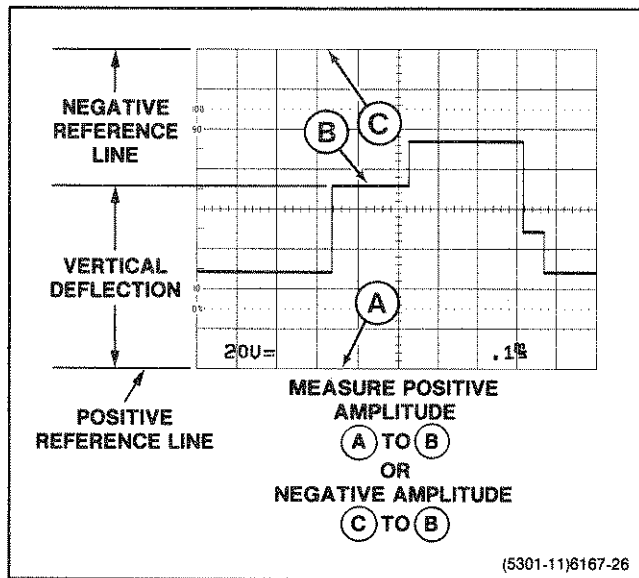

Figure 6-2. Ground-referenced voltage.

10. Calculate the voltage, using the following formula:

$$\text{Voltage} = \frac{\text{vertical distance (divisions)}}{\text{VOLTS/DIV switch setting}} \times \text{polarity (+ or -)}$$

Also include the attenuation factor of the probe being used, if it is not a 10X or 100X scale-factor-switching probe.

EXAMPLE: The vertical distance measured is 4.6 divisions (see Figure 6-2). The waveform is above the reference line and the VOLTS/DIV switch is set to 20 V (includes attenuator probe scale factor).

Substituting the given values:

$$\text{Voltage} = 4.6 \text{ div} \times (+1) \times 20 \text{ V/div} = +92 \text{ V.}$$

### Algebraic Addition

With VERTICAL MODE ADD button lit, waveform displayed is algebraic sum of signals applied to CH 1 and CH 2 inputs (CH 1 + CH 2). If CH 2 INVERT button is lit, waveform displayed is the difference between signals applied to CH 1 and CH 2 inputs (CH 1 - CH 2). The total deflection factor in ADD mode is equal to the deflection factor indicated by either VOLTS/DIV switch (when both

VOLTS/DIV switches are at the same setting). A common use for ADD mode is to provide a dc offset for a signal riding on top of a high dc level.

The following general precautions should be observed when using the ADD mode:

a. Do not exceed the input voltage rating of the oscilloscope.

b. Input signals should not exceed about 8 times the VOLTS/DIV switch setting (e.g., about 4 V maximum for setting of 0.5 V). Large voltages may distort the display.

c. Use CH 1 and CH 2 POSITION control settings which most nearly position the signal on each channel to midscreen, when viewed separately. This ensures the greatest dynamic range for ADD mode operation.

d. To obtain similar response on each channel, set both the CH 1 and CH 2 COUPLING buttons to the same position.

EXAMPLE: Using graticule center line as 0 V, the CH 1 signal is at a 3-division, positive dc level (see Figure 6-3A).

1. Multiply 3 divisions by the VOLTS/DIV switch setting to determine the dc-level value.

2. To the CH 2 input connector, apply a negative dc level (or positive level, using the CH 2 INVERT switch whose value was determined in step 1 (see Figure 6-3B).

3. Select ADD VERTICAL MODE to place the resultant display within the operating range of the vertical POSITION controls (see Figure 6-3C).

### Common-Mode Rejection

ADD mode can also be used to display signals with undesirable frequency components. These components can be eliminated through common-mode rejection. The precautions given under the preceding Algebraic Addition procedure should be observed.

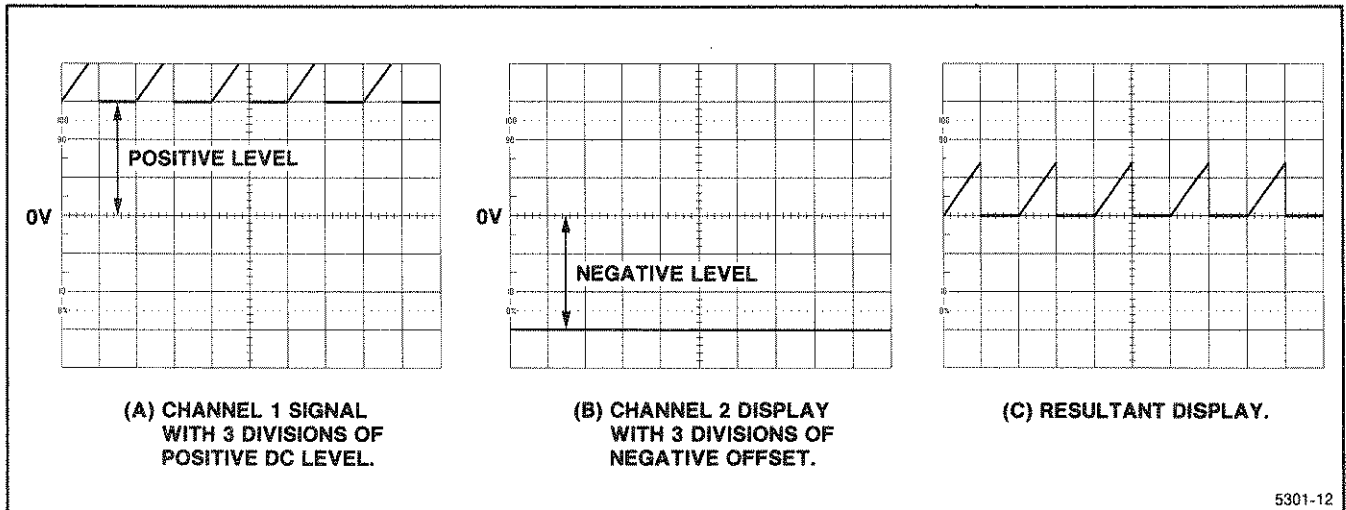

Figure 6-3. Algebraic addition.

EXAMPLE: The signal applied to CH 1 input connector contains unwanted ac-input-power-source frequency components (see Figure 6-4A). To remove these components, use the following procedure:

1. Preset instrument controls for a baseline display.
2. Apply signal containing unwanted line-frequency components to CH 1 input.
3. Apply a line-frequency signal to CH 2 input.
4. Select ALT VERTICAL MODE and press CH2 INVERT button.
5. Adjust the CH 2 VOLTS/DIV switch and VAR control so that CH 2 display is approximately the same amplitude as the undesired portion of the CH 1 display (see Figure 6-4A).
6. Select ADD VERTICAL MODE and slightly readjust the CH 2 VOLTS/DIV VAR control for maximum cancellation of the undesired signal component (see Figure 6-4B).

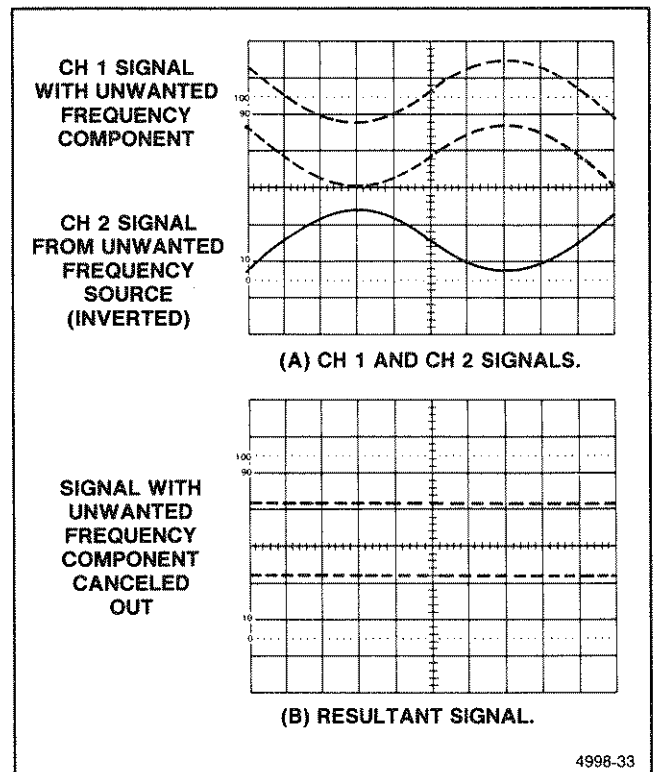

Figure 6-4. Common-mode rejection.

### Amplitude Comparison

In some applications it may be necessary to establish a set of deflection factors other than those indicated by the VOLTS/DIV switch settings. This is useful for comparing unknown signals to a reference signal of known amplitude. To accomplish this, a reference signal of known amplitude is first set to an exact number of vertical divisions by adjusting the VOLTS/DIV switch and VAR control. Unknown signals can then be quickly and accurately compared with the reference signal without disturbing the setting of the VOLTS/DIV VAR control. The procedure is as follows:

1. Preset instrument controls and obtain a baseline trace.
2. Apply the reference signal to either CH 1 or CH 2 input and select the appropriate VERTICAL MODE channel.
3. Set the amplitude of the reference signal to an exact number of vertical divisions by adjusting the VOLTS/DIV switch and VOLTS/DIV VAR control.
4. Establish a vertical conversion factor, using the following formula (reference signal amplitude must be known):

$$\text{Vertical Conversion Factor} = \frac{\text{Reference Signal Amplitude (volts)}}{\text{Vertical Deflection (divisions)} \times \text{VOLTS/DIV Switch Setting}}$$

5. Disconnect the reference signal and apply the unknown signal to be measured to the same channel input. Adjust the VOLTS/DIV switch to a setting that provides sufficient vertical deflection to make an accurate measurement. Do not readjust the VOLTS/DIV VAR Control.

6. Establish an arbitrary deflection factor, using the following formula:

$$\text{Arbitrary Deflection Factor} = \text{Vertical Conversion Factor} \times \text{VOLTS/DIV Switch Setting}$$

7. Measure the vertical deflection of the unknown signal in divisions and calculate its amplitude using the following formula:

$$\text{Unknown Signal Amplitude} = \text{Arbitrary Deflection Factor} \times \text{Vertical Deflection (divisions)}$$

EXAMPLE: The reference signal amplitude is 30 V, with a VOLTS/DIV VAR control adjusted to provide a vertical deflection of exactly 4 divisions.

Substituting these values in the Vertical Conversion Factor formula:

$$\text{Vertical Conversion Factor} = \frac{30 \text{ V}}{4 \text{ div} \times 5 \text{ V/div}} = 1.5$$

Continuing, for the unknown signal the VOLTS/DIV switch setting is 1, and the peak-to-peak amplitude spans five vertical divisions. The Arbitrary Deflection Factor is then determined by substituting values in the formula:

$$\text{Arbitrary Deflection} = 1.5 \times 1 \text{ V/div} = 1.5 \text{ V/div Factor}$$

The amplitude of the unknown signal can then be determined by substituting values in the unknown signal amplitude formula:

$$\text{Amplitude} = 1.5 \text{ V/div} \times 5 \text{ div} = 7.5 \text{ V}$$

### Time Duration

To measure time between two points on a waveform use the following procedure:

1. Preset instrument controls and obtain a baseline display.
2. Apply the signal to either CH 1 or CH 2 input connector and select the appropriate VERTICAL MODE channel.
3. Adjust the TRIGGER LEVEL control to obtain a stable display.
4. Set the SEC/DIV switch to display one complete period of the waveform. Make sure that the SEC/DIV VAR control is in the calibrated detent.
5. Position the display to place the time-measurement points on the center horizontal graticule line (see Figure 6-5).

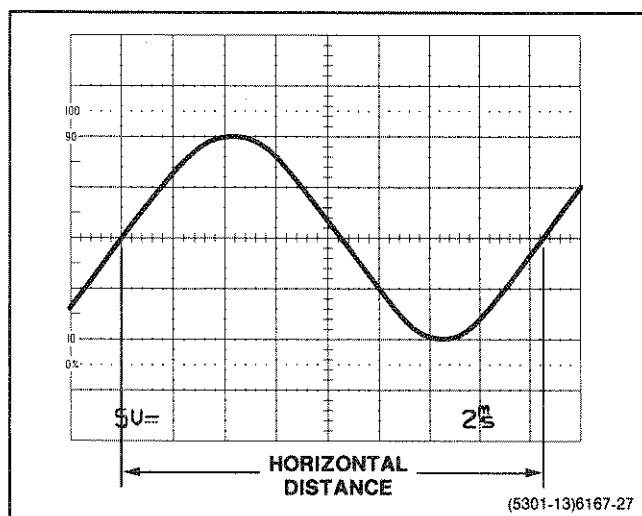

Figure 6-5. Time duration.

6. Measure the horizontal distance between the time-measurement points.

7. Calculate time duration, using this formula:

$$\text{Time Duration} = \text{horizontal distance (divisions)} \times \text{SEC/DIV switch setting}$$

EXAMPLE: The distance between the time-measurement points is 8.3 divisions (see Figure 6-5), and the SEC/DIV switch is set to 2 ms. A magnification factor of 1 is used.

Substituting the given values:

$$\text{Time Duration} = 8.3 \text{ div} \times 2 \text{ ms/div} = 16.6 \text{ ms}$$

### Frequency

The frequency of a recurrent signal can be determined from its time-duration measurement as follows:

1. Measure the time duration of one waveform cycle using the preceding Time Duration measurement procedure.

2. Calculate the reciprocal of the time-duration value to determine the frequency of the waveform.

EXAMPLE: The signal in Figure 6-5 has a time duration of 16.6 ms.

Calculating the reciprocal of time duration:

$$\text{Frequency} = \frac{1}{\text{time duration}} = \frac{1}{16.6 \text{ ms}} = 60 \text{ Hz}$$

### Rise Time

1. Preset instrument controls and obtain a baseline display.

2. Apply the signal to either CH 1 or CH 2 input and select the appropriate VERTICAL MODE channel.

3. Set TRIGGER SLOPE button on (positive-going). Use a sweep-speed setting that displays several complete cycles or events (if possible).

4. Set the VOLTS/DIV switch and VAR control for an exact 5-division display.

5. Adjust vertical positioning so that the zero reference of the waveform touches the 0% graticule line and the top of the waveform touches the 100% graticule line (see Figure 6-6).

6. Set the SEC/DIV switch for a signal-waveform display, with the rise time spread horizontally as much as possible.

7. Horizontally position the display so the 10% point on the waveform intersects the second vertical graticule line (see Figure 6-6, point A).

8. Measure the horizontal distance between the 10% and 90% points and calculate the time duration using the following formula:

$$\text{Rise Time} = \text{horizontal distance (divisions)} \times \text{SEC/DIV switch setting}$$

EXAMPLE: The horizontal distance between the 10% and 90% points is 5 divisions (see Figure 6-6), and the SEC/DIV switch is set to 1  $\mu$ s. A magnification factor of 1 is used.



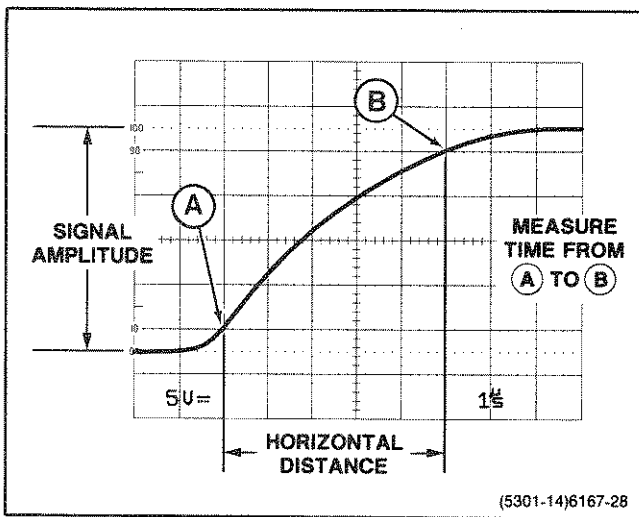

Figure 6-6. Rise time.

Substituting the given values in the formula:

$$\text{Rise Time} = \frac{5 \text{ div} \times 1 \mu\text{s/div}}{1} = 5 \mu\text{s}$$

### Time Difference Between Two Time-Related Pulses

To measure the time difference between two separate events, use the following procedure:

1. Preset instrument controls and obtain a baseline display.
2. Set the TRIGGER SOURCE to CH 1.
3. Select the same COUPLING (AC or DC) for both channels.
4. Using either probes or cables with equal time delays, connect a known reference signal to the CH 1 input and comparison signal to the CH 2 input.
5. Set both VOLTS/DIV switches for 4- or 5-division displays.
6. Select either ALT or CHOP VERTICAL MODE, depending on the frequency of input between two time-related pulses.

7. If the two signals are of opposite polarity, press in the CH 2 INVERT button to invert the CH 2 display (signals may be of opposite polarity due to 180° phase difference; if so, note this for use later in the final calculation).

8. Adjust the TRIGGER LEVEL control for a stable display.

9. Set the SEC/DIV switch to a sweep speed which provides three or more divisions of horizontal separation between the reference points on the two displays. Center each of the displays vertically (see Figure 6-7).

10. Measure the horizontal difference between the two signal reference points and calculate the time difference using the following formula:

$$\text{Time Difference} = \text{SEC/DIV switch setting} \times \text{horizontal difference (divisions)}$$

EXAMPLE: The X10 MAG switch is on and the SEC/DIV switch is set to read out 5 μs X10 and the horizontal difference between waveform measurement points is 4.5 divisions.

Substituting the given values in the formula:

$$\text{Time Difference} = 5 \mu\text{s/div} \times 4.5 \text{ div} = 22.5 \mu\text{s}$$

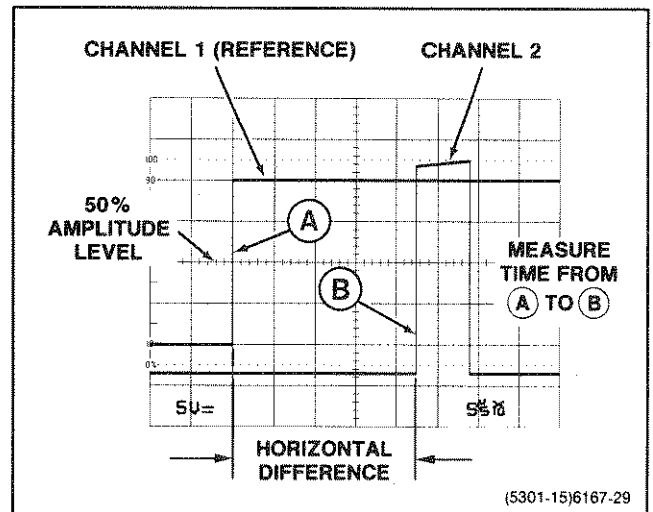

Figure 6-7. Time difference between two time-related pulses.

### Time Comparison

In a similar manner to Amplitude Comparison, repeated time comparisons between unknown signals and a reference signal (e.g., on assembly line test) may be easily and accurately measured with this oscilloscope. To accomplish this, a reference signal of known time duration is first set to an exact number of horizontal divisions by adjusting the SEC/DIV switch and the VAR control. Unknown signals can then be compared with the reference signal without disturbing the setting of the VAR control. The procedure is as follows:

1. Set the time duration of the reference signal to an exact number of horizontal divisions by adjusting the SEC/DIV switch and VAR control.

2. Establish a horizontal conversion factor, using the following formula (reference signal time duration must be known):

$$\text{Horizontal Conversion Factor} = \frac{\text{reference signal time duration (seconds)}}{\text{horizontal distance (divisions)} \times \text{SEC/DIV switch setting}}$$

3. For the unknown signal, adjust the SEC/DIV switch to a setting that provides sufficient horizontal deflection to make an accurate measurement. Do not readjust the VAR control.

4. Establish an arbitrary deflection factor using the following formula:

$$\text{Arbitrary Deflection Factor} = \text{horizontal conversion factor} \times \text{SEC/DIV switch setting}$$

5. Measure the horizontal distance of the unknown signal in divisions and calculate its time duration using the following formula:

$$\text{Time Duration} = \text{arbitrary deflection factor} \times \text{horizontal distance (divisions)}$$

6. Frequency of the unknown signal can then be determined by calculating the reciprocal of its time duration.

**EXAMPLE:** The reference signal time duration is 2.19 ms, the SEC/DIV switch setting is 0.2 ms, and the VAR control is adjusted to provide a horizontal distance of exactly 8 divisions.

Substituting the given values in the horizontal conversion factor formula:

$$\text{Horizontal Conversion Factor} = \frac{2.19 \text{ ms}}{8 \text{ div} \times 0.2 \text{ ms/div}} = 1.37$$

Continuing, for the unknown signal the SEC/DIV switch setting is 50  $\mu\text{s}$ , and on complete cycle spans 7 horizontal divisions. The arbitrary deflection factor is then determined by substituting values in the formula:

$$\text{Arbitrary Deflection Factor} = 1.37 \times 50 \mu\text{s/div} = 68.5 \mu\text{s/div}$$

The time duration of the unknown signal can then be computed by substituting values in the formula:

$$\text{Time Duration} = 68.5 \mu\text{s/div} \times 7 \text{ div} = 480 \mu\text{s/div}$$

The frequency of the unknown signal is then calculated:

$$\text{Frequency} = \frac{1}{480 \mu\text{s}} = 2.083 \text{ kHz}$$

### Phase Difference

Phase comparison between two signals of the same frequency can be made in a manner similar to Time Difference measurements. This method of phase-difference measurement can be used up to the frequency limit of the vertical system. To make a phase comparison, use the following procedure:

1. Preset instrument controls and obtain a baseline display, then set the TRIGGER SOURCE switch to CH 1.

2. Select the same COUPLING (AC or DC) for both channels. Connect a known reference signal to the CH 1 input and the unknown signal to the CH 2 input.

4. Select either ALT or CHOP VERTICAL MODE, depending on the frequency of the input signals. The reference signal should precede the comparison signal in time.

5. If the two signals are of opposite polarity, press the CH 2 INVERT pushbutton to invert the CH 2 display.

6. Set both CH 1 and CH 2 VOLTS/DIV switches and VAR controls for displays of equal amplitude.

7. Adjust the TRIGGER LEVEL control for a stable display.

8. Set the SEC/DIV switch to a sweep speed which displays about one full cycle of the waveforms.

9. Position the displays and adjust the SEC/DIV VAR control so that one reference-signal cycle occupies exactly 8 horizontal graticule divisions at the 50% rise-time points (see Figure 6-8). Each division of the graticule now represents 45° of the cycle (360°/8 div), and the horizontal graticule calibration can be stated as 45° per division.

10. Measure the horizontal difference between corresponding points on the waveforms at a common horizontal graticule line (50% of rise time) and calculate the phase difference using the following formula:

$$\text{Phase Difference} = \text{horizontal difference (divisions)} \times \text{graticule calibration (°/div)}$$

EXAMPLE: The horizontal difference is 0.6 division with a graticule calibration of 45° per division as shown in Figure 6-8.

$$\text{Phase Difference} = 0.6 \text{ div} \times 45^\circ/\text{div} = 27^\circ$$

More accurate phase measurements can be made by using the X10 MAG function.

EXAMPLE: If the sweep rate were increased 10 times with the magnifier (X10 MAG push button in), the magnified horizontal graticule calibration would be 45° per division divided by 10 (or 4.5° per division).

Figure 6-9 shows the same signals illustrated in Figure 6-8, but magnifying the displays results in a horizontal difference of 6 divisions between the two signals.

Substituting the given values in the phase difference formula:

$$\text{Phase Difference} = 6 \text{ div} \times 4.5^\circ/\text{div} = 27^\circ$$

**Slope**

The slope of a particular portion of a waveform is the rate of change of voltage with respect to time. The following procedure is useful for making the measurements required to determine the slope.

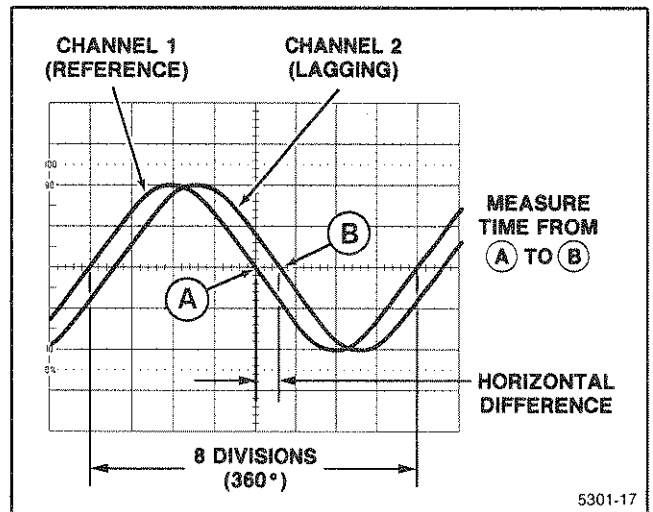

Figure 6-8. Phase difference.

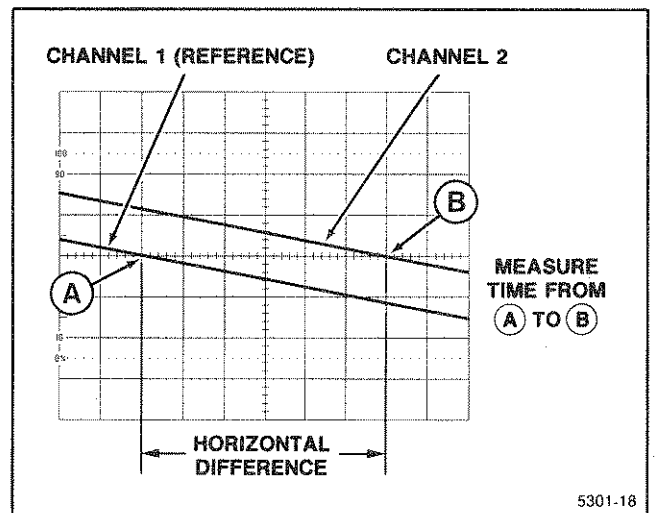

Figure 6-9. High-resolution phase difference.

1. Preset instrument controls and obtain a baseline display.
2. Set the VOLTS/DIV switch to obtain about 5 divisions of vertical amplitude.
3. Set the SEC/DIV switch to horizontally spread the portion of the waveform to be measured across the width of the graticule area (see Figure 6-10).
4. Read voltage difference between waveform points of interest.

5. Read time difference between two waveform points of interest.

6. Slope is determined by using the measured voltage and time to calculate the rate of change using the following formula:

$$\text{Slope (rate of change)} = \frac{\text{Change in voltage}}{\text{Change in time}}$$

EXAMPLE: In Figure 6-10, the voltage difference between measurement points is 1.74 V, and time difference is 2.71 s.

Substituting these values into the formula:

$$\text{Slope} = \frac{1.74}{2.71 \text{ s}} = 0.32 \text{ V/s}$$

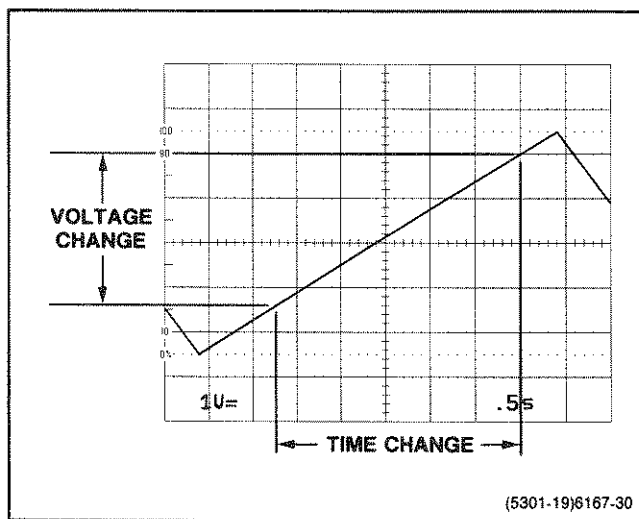

Figure 6-10. Slope.

### TV Line Signal

1. Preset instrument controls and obtain a baseline display. Select TV LINE TRIGGER MODE.

2. Apply the TV signal to either vertical-channel input connector and select the appropriate VERTICAL MODE channel.

3. Set the appropriate VOLTS/DIV switch to display 0.3 division or more of composite video signal.

4. Set the SEC/DIV switch to 10  $\mu$ s. Set the TRIGGER SLOPE button on for positive-going TV signal sync pulses or off for negative-going.

### NOTE

To examine TV Line signal in more detail, turn on the X10 MAG button.

### TV Field Signal

The television feature of the instrument can also be used to display TV Field signal.

1. Preset instrument controls and obtain a baseline display. Select TV FIELD TRIGGER MODE.

2. To display a single field, connect the TV signal to either vertical input; select the appropriate VERTICAL MODE channel.

3. Set the appropriate VOLTS/DIV switch to display 2.5 divisions or more of composite video signal.

4. Set the TRIGGER SLOPE button on for positive-going TV signal sync pulses or off for negative-going.

5. To change the field that is displayed, momentarily interrupt the trigger signal by setting both COUPLING buttons off (GND) and then back to AC on until the desired field is displayed.

### NOTE

To examine a TV Field signal in more detail, turn on the X10 MAG button.

6. To display either Field 1 or Field 2 individually, connect the TV signal to both CH 1 and CH 2 input connectors. Select the appropriate VERTICAL MODE channels and ALT mode.

7. Set the SEC/DIV switch to a faster speed (displays of less than one full field). This will synchronize the CH 1 display to one field and the Channel 2 display to the other field.

## DELAYED-SWEEP MAGNIFICATION

The delayed sweep provides a higher apparent magnification than is provided by the X10 MAG function. Apparent magnification occurs as a result of displaying a selected portion of the A trace at a faster sweep speed (B sweep speed). The A sweep SEC/DIV setting determines how often the B trace will be displayed. Since the B sweep can occur only once for each A sweep, the A sweep time duration sets the amount of time elapsed between succeeding B sweeps.

The intensified zone is an indication of both the location and length of the B sweep interval within the A sweep interval. Positioning of the intensified zone (i.e., setting the amount of time between start of the A sweep and start of the B sweep) is accomplished with the DELAY control. With either the A or B horizontal MODE selected and with B RUNS AFTER TRIGGER MODE selected, the DELAY control provides continuously variable positioning of the start of the B sweep. The range of this control is sufficient to place the B sweep interval at any location within the A sweep interval. When the B horizontal MODE is selected, the SEC/DIV switch setting determines the B Sweep speed and sets the length of the intensified zone on the A trace.

Using delayed-sweep magnification may produce a display with some slight horizontal movement (pulse jitter). Pulse jitter includes not only the inherent uncertainty of triggering the delayed sweep at exactly the same trigger point each time, but also jitter that may be present in the input signal. If pulse jitter needs to be measured, use the Pulse Jitter Time Measurement procedure which follows the discussion of Magnified Sweep Runs After Delay.

When looking at a signal having pulse jitter, it is often useful to be able to hold that signal stationary on the screen. Operating the B sweep in a triggered mode will produce a more stable display, since the delayed display is triggered at the same level each time. This capability is provided by the 2245 and is explained in the Triggered Magnified Sweep discussion.

### Magnified Sweep Runs After Delay

The following explains how to operate the B sweep in a non-triggered mode and to determine apparent magnification factor.

1. Preset instrument controls and obtain a baseline display. Set the B TRIGGER MODE for RUNS AFTER.

2. Apply the signal to either CH 1 or CH 2 input.

3. Set the appropriate VOLTS/DIV switch to produce a display about two divisions in amplitude.

4. Set the SEC/DIV switch to a sweep speed which displays at least one complete waveform cycle.

5. Select ALT horizontal MODE.

6. Rotate the SEC/DIV switch clockwise so that the B sweep speed is less than the A sweep speed. If necessary adjust the POSITION and TRACE SEP controls to display A and B sweeps one above the other.

### NOTE

*The B SEC/DIV setting cannot be set lower than the A SEC/DIV setting. If you attempt to set it lower, the A SEC/DIV setting will follow. In the ALT mode the B trace will not be displayed when both A and B sweep speeds are the same. To set the A SEC/DIV setting faster, set the horizontal MODE to A, readjust the SEC/DIV switch, then return the horizontal MODE to ALT.*

8. Adjust the DELAY control to position the intensified zone on the A trace to the portion of the display to be magnified (see Figure 6-11).

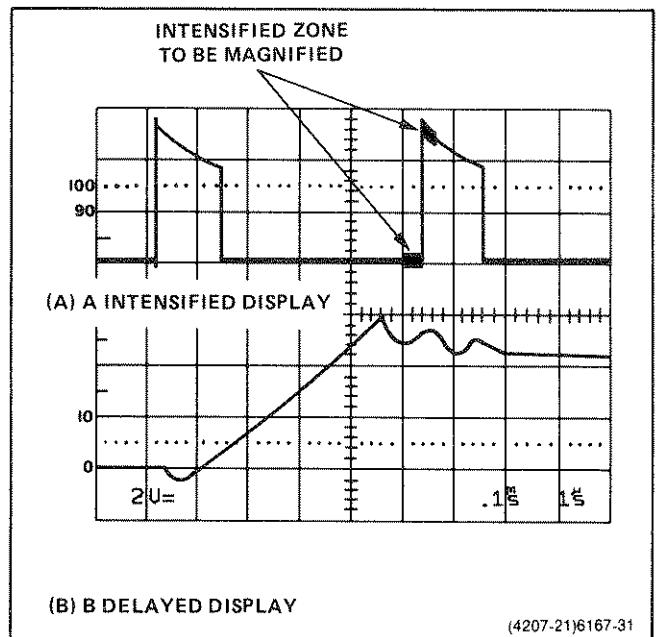

Figure 6-11. Delayed-sweep magnification.

9. Set the B SEC/DIV switch to a setting that intensifies the full portion of the A trace to be magnified. The intensified zone will be displayed as the B trace. The start of the intensified zone remains as previously positioned in step 8.

10. The apparent sweep magnification can be calculated from the following formula:

$$\text{Apparent Delayed Sweep Magnification} = \frac{\text{A SEC/DIV switch setting}}{\text{B SEC/DIV switch setting}}$$

EXAMPLE: Determine the apparent magnification of a display with an A SEC/DIV switch setting of 0.1 ms and a B SEC/DIV switch setting of 1  $\mu$ s.

Substituting the given values:

$$\text{Apparent Delayed Sweep Magnification} = \frac{0.1 \text{ ms}}{1 \mu\text{s}} = 100$$

### Pulse Jitter Time

1. Perform steps 1 through 9 of the preceding Magnified Sweep Runs After Delay procedure.

2. Referring to Figure 6-12, measure the difference between Point A and Point B in divisions and calculate the pulse jitter time using the following formula:

$$\text{Pulse Jitter Time} = \text{horizontal difference (divisions)} \times \text{B SEC/DIV switch setting}$$

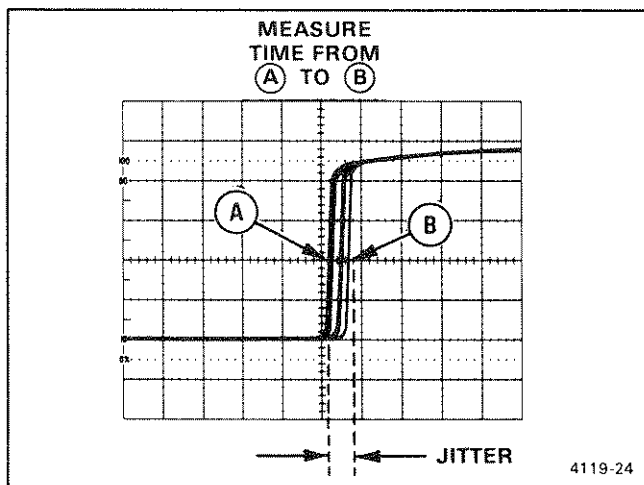

Figure 6-12. Pulse jitter.

### Triggered Magnified Sweep

The following procedure explains how to operate the B sweep in a triggered mode and to determine the resulting apparent magnification factor.

1. Perform steps 1 through 9 of the preceding Magnified Sweep Runs After Delay procedure.

2. Set the TRIGGER A/B SELECT button to B (off) and the TRIGGER MODE to AUTO LEVEL or NORM.

3. Adjust the TRIGGER LEVEL control so that the intensified zone on the A trace is stable.

### NOTE

*Inability to intensify the desired portion of the trace indicates that the signal does not meet the triggering requirements. Increasing the display amplitude should allow proper triggering to occur, unless delay is such that no edge of the correct polarity for B triggering is present.*

4. Measurements are made and magnification factors are calculated in the same manner described in the Magnified Sweep Starts After Delay procedure.

### DELAYED-SWEEP TIME MEASUREMENTS

Operating the 2245 oscilloscope in the horizontal ALT mode allows you to make time measurements with a greater degree of accuracy than can be attained with the A sweep mode only.

### Time Duration

1. Preset instrument controls and obtain a baseline trace.

2. Apply the signal to either CH 1 or CH 2 input and select the appropriate VERTICAL MODE channel.

3. Set the appropriate VOLTS/DIV switch to produce a display of approximately 5 divisions in amplitude and center the display.

4. Set the A SEC/DIV switch to a sweep speed that displays the entire portion of the waveform for which time duration is to be measured.

5. Select ALT horizontal mode. A small intensified zone will appear on the A sweep to indicate the start of the B sweep.

6. Adjust the DELAY control to move the start of the intensified zone so that it just touches the intersection of the waveform and the center horizontal graticule line (see Figure 6-13, Point A). Record the DELAY readout value.

7. With the DELAY control move the start of the intensified zone to the second time measurement point (see Figure 6-13, Point B). Record the DELAY readout value.

8. Determine time difference using the following formula:

$$\text{Time Difference} = \text{2nd readout value} - \text{1st readout value}$$

EXAMPLE: The first DELAY readout value is 2.000  $\mu\text{s}$  and the second is 18.420  $\mu\text{s}$  (see Figure 6-13).

Substituting the given values:

$$\text{Time Duration} = 18.420 \mu\text{s} - 2.000 \mu\text{s} = 16.420 \mu\text{s}$$

### Rise Time

Rise time measurements are similar to time duration, except that measurements are made between 10% and 90% points on the leading edge of a waveform. Fall time is measured between 90% and 10% points on the trailing edge of the waveform.

1. Preset instrument controls and obtain a baseline trace.

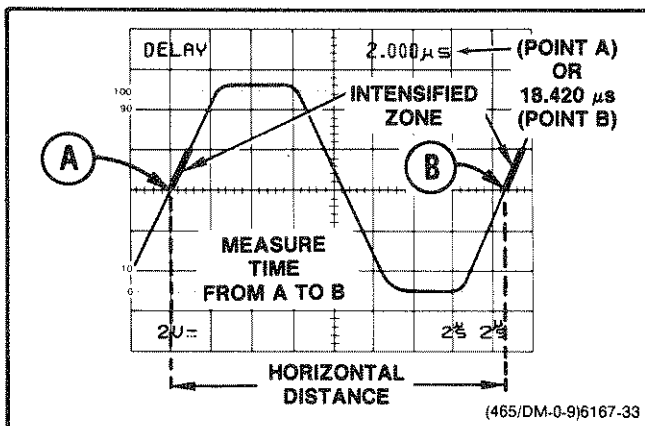

Figure 6-13. Time duration.

2. Apply the signal to either CH 1 or CH 2 input and select the appropriate VERTICAL MODE channel.

3. Set the VOLTS/DIV switch and VAR control to obtain an exact five-division display.

4. Vertically position trace so that zero reference of waveform touches the 0% graticule line and the top of the waveform touches the 100% graticule line (see Figure 6-14).

5. Set the SEC/DIV switch for a single-waveform display, with the rise time spread horizontally as much as possible. Ensure that the SEC/DIV VAR control is in the calibrated detent.

6. Horizontally position the display so that the 10% point on the waveform intersects the third vertical graticule line.

7. Select the ALT horizontal mode.

8. With the DELAY control, move the start of intensified zone (left-hand edge) until it just touches the intersection of the signal and the 10% graticule line (see Figure 6-14, Point A). Record the DELAY readout value.

9. With the DELAY control, move the start of the intensified zone until it just touches the intersection of the signal and the 90% graticule line (see Figure 6-14, Point B). Record the DELAY readout value.

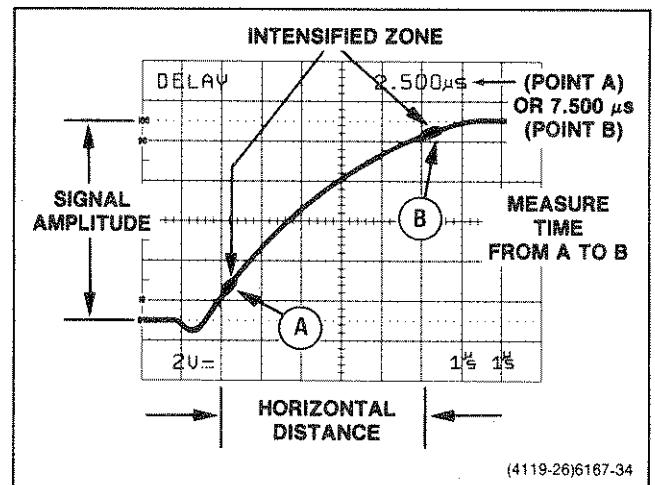

Figure 6-14. Rise time, differential method.

## Basic Applications—2245 Operators

10. Determine time difference (rise time) using this formula:

$$\text{Time Difference} = \text{Rise Time} = \frac{2\text{nd}}{\text{Readout Value}} - \frac{1\text{st}}{\text{Readout Value}}$$

Substituting the given values:

$$\text{Rise Time} = 7.500 \mu\text{s} - 2.500 \mu\text{s} = 5 \mu\text{s}$$

### Time Difference Between Repetitive Pulses

1. Preset instrument controls and obtain a baseline trace.

2. Apply the signal to either CH 1 or CH 2 input and set the appropriate VERTICAL MODE channel.

3. Set the appropriate VOLTS/DIV switch for a display of approximately 3 divisions. Vertically center the display around the 90% horizontal graticule line.

4. Set the A SEC/DIV switch to display the measurement points of interest within the graticule area.

5. Select the ALT horizontal mode and set the SEC/DIV switch to the fastest B sweep that provides a usable (visible) intensified zone. Adjust the TRACE SEP control to center the B sweep display around the 10% horizontal graticule line. With the DELAY control, move the intensified zone to the first pulse (see Figure 6-15, Point A).

6. While viewing the B sweep display, adjust the DELAY control to move rising portion of the magnified pulse to a vertical reference point. Record DELAY readout value. Do not change setting of horizontal POSITION control.

7. Turn DELAY control clockwise to move the rising portion of the second pulse to the same reference point. Observe A sweep display to position the intensified zone to the correct pulse. Record DELAY readout value.

8. Determine time difference using the following formula:

$$\text{Time Difference} = 2\text{nd readout value} - 1\text{st readout value}$$

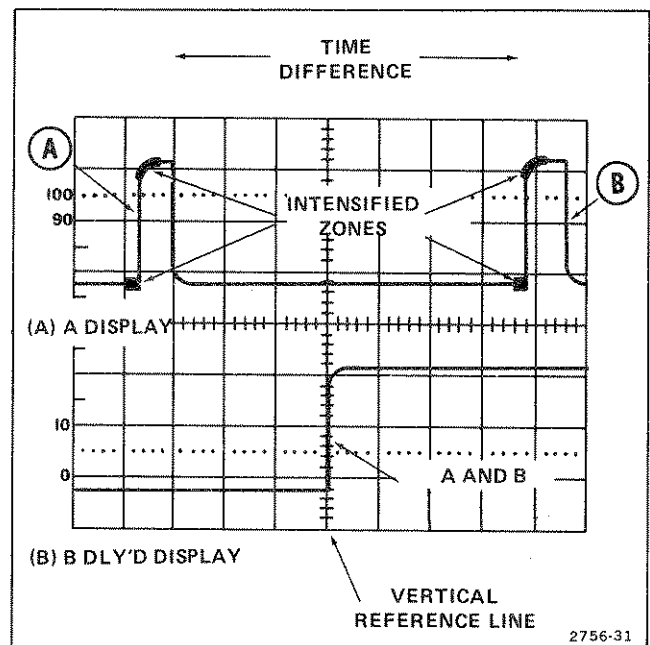

Figure 6-15. Time difference between repetitive pulses.

EXAMPLE: The first DELAY readout value is  $1.310 \mu\text{s}$  and the second is  $8.810 \mu\text{s}$  (see Figure 6-15).

Substituting the given values:

$$\text{Time Difference} = 8.810 \mu\text{s} - 1.310 \mu\text{s} = 7.500 \mu\text{s}$$

### Time Difference Between Two Time-Related Pulses

1. Preset instrument controls and obtain a baseline trace. Set the TRIGGER SOURCE to CH 1.

2. Connect the reference signal to CH 1 and the comparison signal to CH 2. Use probes or cables having equal time delays.

3. Turn on CH 1 and CH 2 VERTICAL MODE buttons. Use CHOP or ALT vertical mode, depending on the frequency of input signals. In general, CHOP is more suitable for low-frequency signals, and ALT for high-frequency. Set CH 1 and CH 2 VOLTS/DIV switches for display amplitude of about 3 divisions. Position the displays above the graticule center line.

4. Select ALT horizontal mode and select B trigger mode RUNS AFTER. Observe intensified zones on the display.



5. Turn off CH 2. Set the B SEC/DIV switch about 20 times faster than the A SEC/DIV setting. Adjust the TRACE SEP control so that the B sweep is centered below the graticule center line. With the DELAY control, move the intensified zone to the rising edge of a pulse and adjust until the rising portion (Figure 6-16, point A) is centered at a graticule reference point. Record the DELAY readout value.

7. Turn on CH 2 and turn off CH 1. With the DELAY control, move CH 2 pulse (rising portion) to the same vertical reference point. Adjust TRACE SEP control as necessary to center the B sweep display. Record the DELAY readout value.

8. Determine time difference using the following formula:

$$\text{Time Difference} = 2\text{nd readout value} - 1\text{st readout value}$$

EXAMPLE: The A SEC/DIV switch is set to  $50 \mu\text{s}$ , and the B SEC/DIV switch is set to  $2 \mu\text{s}$ . The DELAY readout value is  $130.0 \mu\text{s}$  for CH 1 and  $355.0 \mu\text{s}$  for CH 2.

Substituting the given values:

$$\text{Time Difference} = 355.0 \mu\text{s} - 130.0 \mu\text{s} = 225 \mu\text{s}$$

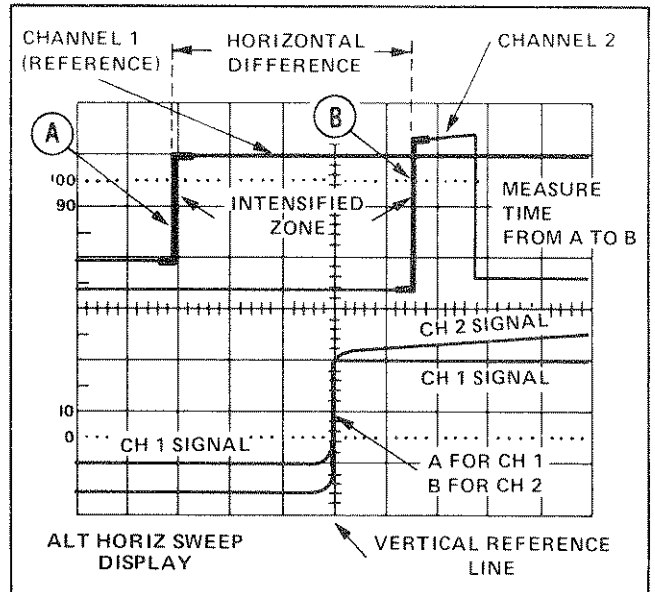

(4207-26)6167-32

Figure 6-16. Time between two time-related pulses.



# OPTIONS AND ACCESSORIES

## INTRODUCTION

The section contains a general description of instrument options and accessories available at the time of publication of this manual. Additional information about instrument options and other accessories can be obtained either by consulting the current Tektronix Product Catalog or by contacting your local Tektronix Field Office or representative.

### OPTIONS A0-A5 INTERNATIONAL POWER CORDS

Instruments are shipped with the detachable power-cord option ordered by the customer. Descriptive information about the international power-cord options is provided in Section 2, "Preparation for Use." The following list identifies the Tektronix part numbers for the available power cords.

Option A0 (North American, 120 V) Power cord (74 inches)	161-0230-00
Option A1 (Universal Euro) Power cord (2.5 m)	161-0104-06
Option A2 (UK) Power cord (2.5 m)	161-0104-07
Option A3 (Australian) Power cord (2.5 m)	161-0104-05
Option A4 (North American, 240 V) Power cord (2.5 m)	161-0104-08
Option A5 (Switzerland) Power cord (2.5 m)	161-0167-00

## STANDARD ACCESSORIES

The following standard accessories are provided with each instrument:

	Part Number
2 Probes, 10X, 1.5 meter, with accessories	P6109 Opt. 01
1 Power cord (Option A0-A5)	As ordered
1 Power cord clamp	343-1213-00
1 Operators Manual	070-6167-00
1 Crt implosion shield, blue plastic (installed)	337-2775-00
1 Fuse, 2 A, 250 V, slow-blow	159-0023-00
1 Accessory pouch, ziploc	004-0130-00

## OPTIONAL ACCESSORIES

The following optional accessories are recommended for use with the 2245 Oscilloscope:

Instrument Enhancements	Part Number
Protective front-panel cover	200-3232-00
Attaching accessories pouch	016-0857-00
Protective waterproof vinyl cover	016-0848-00
Clear implosion shield	337-2275-01
Rackmounting kit	2240F1R
DC Inverter power supply	1105
2245 Service Manual	070-6276-00

## Options and Accessories—2245 Operators

### Transportation Aids

Carrying strap	346-0199-00
Portable instrument cart	K212
Instrument shuttle	K117

### Cameras

Low-cost scope camera	C5 Option 02
Motorized camera	C7 Options 03 and 30
High-performance camera	C30B Option 01

### Probes

Active probe	P6202A
Power supply for active probe	1101A

### Current probes

P6021 (1.52 m);  
P6022 (1.52 m);  
A6302/AM503;  
A6303/AM503

### Environmental probe

P6008 (1.83 m)

### High voltage probe

P6009 (2.74 m)

### 1X/10X Passive probe

P6063B (1.83 m)

### Subminiature 10X probe

P6130 (2 m)

### Ground isolation monitor

A6901

### Isolator (for floating measurements)

A6902B

### Viewing Hoods

#### Collapsible viewing hood

016-0592-00

#### Binocular viewing hood

016-0566-00

#### Polarized collapsible viewing hood

016-0180-00

# PERFORMANCE CHECK PROCEDURE

## INTRODUCTION

The Performance Check Procedure in this Appendix is used to verify the instrument's Performance Requirements as listed in the Specification (Section 1) and to determine the need for readjustment. These checks may also be used as an acceptance test or as a preliminary troubleshooting aid.

It is not necessary to remove the wrap-around cabinet from the instrument to perform this procedure. All checks are made using the operator-accessible controls and connectors.

## TEST EQUIPMENT REQUIRED

The test equipment listed in Table A-1 is a complete list of the equipment required to accomplish the Performance Check Procedure. Test equipment specifications described in Table A-1 are the minimum necessary to provide accurate results. Therefore, equipment used must meet or exceed the listed specifications. Detailed operating instructions for test equipment are not given in this procedure. If more operating information is required, refer to the appropriate test equipment instruction manual.

When equipment other than that recommended is used, control settings of the test setup may need to be altered. If the exact item of equipment given as an example in Table A-1 is not available, check the Minimum Specification column to determine if any other available test equipment might work.

## PERFORMANCE CHECK INTERVAL

To ensure instrument accuracy, check its performance after every 2000 hours of operation, or once each year if used infrequently. If the checks made indicate a need for readjustment or repair, refer the instrument to a qualified service person.

## PREPARATION

This procedure is structured in subsections to permit checking individual sections of the instrument whenever a complete Performance Check is not required. At the beginning of each subsection there is a list showing only the test equipment required to perform the checks of that subsection. The equipment name in the Equipment Required block at the beginning of each subsection refers to the test equipment listed in Table A-1.

The initial front-panel control settings required to prepare the instrument for performing Step 1 are given at the beginning of each subsection. Each succeeding step within a subsection should then be performed both in the sequence presented and in its entirety to ensure that control settings will be correct for subsequent steps. The instrument must be warmed up for 20 minutes to meet the accuracies stated in the Specifications (Section 1). After warmup and before starting this procedure, run the SELF CAL MEASUREMENTS routine in the SERVICE MENU (see Section 4 of this manual).

**Table A-1**  
**Test Equipment Required**

Item and Description	Minimum Specification	Purpose	Example of Suitable Test Equipment
1. Leveled Sine-Wave Generator	Frequency: 250 kHz to above 70 MHz. Output amplitude: variable from 10 mV to 5 V p-p. Output impedance: 50 $\Omega$ . Reference frequency: 50 kHz. Amplitude accuracy: constant within 1.5% of reference frequency up to 100 MHz; within 3% above 100 MHz.	Vertical, horizontal, and triggering checks and adjustments. Display adjustments and Z-Axis check.	TEKTRONIX SG 503 Leveled Sine-Wave Generator. <sup>a</sup>
2. Calibration Generator	Standard-amplitude signal levels: 5 mV to 50 V. Accuracy: $\pm 0.25\%$ . High-amplitude signal levels: 1 V to 60 V. Repetition rate: 1 kHz. Fast-rise signal level: 1 V. Repetition rate: 1 MHz. Rise time: 1 ns or less. Flatness: $\pm 0.5\%$ .	Signal source for gain and transient response.	TEKTRONIX PG 506 Calibration Generator. <sup>a</sup>
3. Time-Mark Generator	Marker outputs: 10 ns to 0.5 s. Marker accuracy: $\pm 0.1\%$ . Trigger output: 1 ms to 0.1 $\mu$ s, time-coincident with markers.	Horizontal checks and adjustments. Display adjustment.	TEKTRONIX TG 501 Time-Mark Generator. <sup>a</sup>
4. Function Generator	Range: less than 1 Hz to 1 kHz; sinusoidal output; amplitude variable up to greater than 10 V p-p open circuit with dc offset adjust.	Low-frequency checks.	TEKTRONIX FG 502 Function Generator. <sup>a</sup>
5. Coaxial Cable (2 required)	Impedance: 50 $\Omega$ . Length: 42 in. Connectors: BNC.	Signal interconnection.	Tektronix Part Number 012-0057-01.
6. Precision Coaxial Cable	Impedance: 50 $\Omega$ . Length: 36 in. Connectors: BNC.	Used with PG 506 Calibration Generator.	Tektronix Part Number 012-0482-00.
7. Termination (2 required)	Impedance: 50 $\Omega$ . Connectors: BNC.	Signal termination.	Tektronix Part Number 011-0049-01.
8. 10X Attenuator	Ratio: 10X. Impedance: 50 $\Omega$ . Connectors: BNC.	Triggering checks.	Tektronix Part Number 011-0059-02.
9. 2X Attenuator	Ratio: 2X. Impedance: 50 $\Omega$ . Connectors: BNC.	Triggering checks.	Tektronix Part Number 011-0069-02.
10. Adapter	Connectors: BNC male-to-miniature-probe tip.	Signal interconnection.	Tektronix Part Number 013-0084-02.
11. Alignment Tool	Length: 1-in shaft. Bit size: 3/32 in. Low capacitance; insulated.	Adjust TRACE ROTATION pot.	Tektronix Part Number 003-0675-00.
12. Test Oscilloscope with 10X Probe	Bandwidth: 60 MHz with Counter/Timer for frequency measurement.	CALIBRATOR signal check.	TEKTRONIX 2236.

<sup>a</sup>Requires a TM500-Series Power Module.

Table A-1 (cont)

Item and Description	Minimum Specification	Purpose	Example of Suitable Test Equipment
13. Dual-Input Coupler	Connectors BNC female-to-dual-BNC male.	Signal interconnection.	Tektronix Part Number 067-0525-01.
14. T-Connector	Connectors, BNC.	Signal interconnection.	Tektronix Part Number 103-0030-00.
15. TV Signal Generator	Provide Composite TV Video and Line Sync signals.	Check TV Trigger circuit.	TEKTRONIX 067-0601-00. Calibration Fixture with 067-5002-00 (525/60) and 067-5010-00 (1201/60) plug-ins.

## INDEX TO PERFORMANCE CHECK PROCEDURE

Display	Page
1. Trace Rotation.....	A-4
2. Geometry .....	A-4
<b>Vertical</b>	
1. Input COUPLING Functional Check.....	A-5
2. CH 1 and CH 2 VOLTS/DIV Trace Shift .....	A-5
3. CH 3 and CH 4 VOLTS/DIV Trace Shift .....	A-6
4. CH 1 and CH 2 VAR VOLTS/DIV Trace Shift.....	A-6
5. CH 1 and CH 2 Input COUPLING Trace Shift .....	A-6
6. CH 2 INVERT Trace Shift .....	A-7
7. CH 1 and CH 2 VAR VOLTS/DIV Range .....	A-7
8. Low Frequency Linearity Check.....	A-7
9. CH 1 and CH 2 Vertical Deflection Accuracy .....	A-7
10. CH 3 and CH 4 Vertical Deflection Accuracy .....	A-8
11. ADD Mode and CH 2 INVERT Deflection Accuracy .....	A-8
12. Vertical POSITION Range (all channels).....	A-9
13. CH 1 to CH 2 Signal Delay Match.....	A-10
14. CH 1 to CH 4 Signal Delay Match.....	A-10
15. CH 3 to CH 4 Signal Delay Match.....	A-10
16. CH 1 and CH 2 Vertical Bandwidth .....	A-10
17. CH 3 and CH 4 Vertical Bandwidth .....	A-11
18. Bandwidth Limit.....	A-11
19. Common-mode Rejection Ratio .....	A-11
20. Channel Isolation .....	A-12
21. Check AC Coupled Lower -3 dB Point.....	A-12
22. Vertical ALT and CHOP Modes .....	A-13
23. BEAM FIND .....	A-13
24. A and B Trace Separation .....	A-13

Triggering	Page
1. A and B Trigger Sensitivity .....	A-14
2. Single Sweep Mode .....	A-16
3. Trigger LEVEL Control Range .....	A-16
4. TV Trigger Sensitivity .....	A-17
5. LINE Trigger .....	A-17

Horizontal	Page
1. A and B Sweep Length .....	A-18
2. Horizontal Position Range.....	A-18
3. Horizontal VAR Range .....	A-18
4. Mag Registration .....	A-19
5. A and B Timing Accuracy and Linearity .....	A-19
6. A and B Magnified Timing Accuracy and Linearity .....	A-19
7. Delay Time Jitter .....	A-20
8. Delay Time Accuracy.....	A-20
9. Delay Time Position Range .....	A-21
10. X-Axis Gain Accuracy.....	A-21
11. Y-Axis Gain Accuracy.....	A-21
12. X-Y Phase Difference .....	A-21
13. X-Axis Bandwidth .....	A-21

### External Z-Axis and CALIBRATOR

1. Check External Z-Axis Input .....	A-22
2. Check Calibrator Output .....	A-22

# DISPLAY

**Equipment Required (see Table A-1):**

Time Mark Generator	50 $\Omega$ BNC coaxial cable
50 $\Omega$ BNC termination	

## 1. Trace Rotation

SET:

READOUT (Intensity)	12 o'clock
A INTEN	10 o'clock
VERTICAL MODE	CH 1
CH 1 VOLTS/DIV	0.1 V
CH 1 Input COUPLING	AC
A/B SELECT	A Trigger
TRIGGER MODE	AUTO LEVEL
TRIGGER SOURCE	VERT
TRIGGER CPLG	DC
TRIGGER SLOPE	 (positive-going)
TRIGGER HOLDOFF	Min
TRIGGER LEVEL	12 o'clock
Horizontal MODE	A
Horizontal POSITION	12 o'clock
A SEC/DIV	2 $\mu$ s
FOCUS	For best defined display
BW LIMIT	Off

POSITION: Trace to center graticule.

CHECK: Trace rotation control range is adequate to align trace with center graticule line using a small straight-bladed alignment tool.

ADJUST: Trace parallel to center horizontal graticule line.

## 2. Geometry

CONNECT: Time Mark Generator (TG 501) to CH 1 via a 50  $\Omega$  BNC coaxial cable and a 50  $\Omega$  BNC termination.

SET: Time Marks 0.2  $\mu$ s

POSITION: The bottom of the CH 1 signal below the bottom graticule line.

CHECK: Deviation of any vertical line within the center eight horizontal divisions does not exceed 0.1 division (half a minor division).

SET: CH 1 COUPLING GND

POSITION: Trace slowly from the bottom graticule line to the top graticule line while making the following check.

CHECK: Bowing or tilt of baseline trace doesn't exceed 0.1 division (half a minor division) within the eight vertical divisions.

DISCONNECT: Test signal from the 2245.



# VERTICAL

## Equipment Required (see Table A-1):

Leveled Sine-Wave Generator	50 $\Omega$ Precision BNC coaxial cable
Calibration Generator	50 $\Omega$ Termination
Function Generator	Adapter, BNC-male-to-miniature-probe tip
50 $\Omega$ BNC coaxial cable	Dual-input Coupler

### 1. Input COUPLING Functional Check

SET:

READOUT (Intensity)	12 o'clock
A INTEN	10 o'clock
VERTICAL MODE	CH 1 and CH 2
CH 1 and CH 2	
VOLTS/DIV	1 V
CH 1 and CH 2	
Input COUPLING	DC
A/B SELECT	A TRIGGER
TRIGGER MODE	AUTO LEVEL
TRIGGER SOURCE	VERT
TRIGGER CPLG	DC
TRIGGER SLOPE	 (positive-going)
TRIGGER LEVEL	12 o'clock
TRIGGER HOLDOFF	Min
Horizontal POSITION	12 o'clock
Horizontal MODE	A
SEC/DIV	0.1 ms
FOCUS	For best defined display
BW LIMIT	Off
CH 2 INVERT	Off

CONNECT: Function Generator (FG 502) sine-wave output to the CH 1 input via a 50  $\Omega$  BNC coaxial cable and a 50  $\Omega$  BNC termination.

SET: Function Generator output for 1 kHz sine-wave signal of five divisions peak-to-peak with maximum positive dc offset.

POSITION: The bottom of the signal to the center horizontal graticule line.

SET: CH 1 Input COUPLING AC

CHECK: Display is centered about the center horizontal graticule line.

MOVE: The test signal to the CH 2 input.

SET: CH 1 VERTICAL MODE Off

REPEAT: The procedure for CH 2.

DISCONNECT: The test signal from the 2245.

### 2. CH 1 and CH 2 VOLTS/DIV Trace Shift

SET:

A SEC/DIV	0.5 ms
CH 1 and CH 2	
VERTICAL MODE	On
CH 1 and CH 2	
VOLTS/DIV	2 mV
CH 1 and CH 2	
Input COUPLING	DC

SET: VERTICAL MODE CH 1 (CH 2 off)

POSITION: Trace to center horizontal graticule line.

## Appendix—2245 Operators

SWITCH: CH 1 VOLTS/DIV through all positions from 2 mV to 5 V.

CHECK: Trace shift does not exceed 0.2 division between steps.

SET: VERTICAL MODE CH 2 (CH 1 off)

POSITION: CH 2 trace to the center horizontal graticule line.

SWITCH: CH 2 VOLTS/DIV through all positions from 2 mV to 5 V.

CHECK: Trace shift does not exceed 0.2 division between steps.

### 3. CH 3 and CH 4 VOLTS/DIV Trace Shift

SET: VERTICAL MODE CH 3 (CH 2 off)

POSITION: Trace to the center horizontal graticule line.

SWITCH: CH 3 VOLTS/DIV between 0.1 V and 0.5 V.

CHECK: Trace shift does not exceed one division.

SET: VERTICAL MODE CH 4 (CH 3 off)

POSITION: Trace to the center horizontal graticule line.

SWITCH: CH 4 VOLTS/DIV between 0.1 V and 0.5 V.

CHECK: Trace shift does not exceed one division.

### 4. CH 1 and CH 2 VAR VOLTS/DIV Trace Shift

SET:

VERTICAL MODE CH 1 (CH 4 off)  
CH 1 VOLTS/DIV 2 mV

POSITION: Trace to center graticule line.

SET: CH 1 VAR VOLTS/DIV Full CCW

CHECK: Trace shift does not exceed one division.

SET:

CH 1 VAR VOLTS/DIV Detent (calibrated)  
VERTICAL MODE CH 2 (CH 1 off)  
CH 2 VOLTS/DIV 2 mV

POSITION: Trace to center graticule line.

SET: CH 2 VAR VOLTS/DIV Full CCW

CHECK: Trace shift does not exceed one division.

SET: CH 2 VAR VOLTS/DIV Detent (calibrated)

### 5. CH 1 and CH 2 Input COUPLING Trace Shift

SET: CH 2 Input COUPLING GND

POSITION: Trace to center graticule line.

SET: CH 2 Input COUPLING DC

CHECK: Trace shift does not exceed 0.25 division.

SET:

VERTICAL MODE CH 1 (CH 2 off)  
CH 1 Input COUPLING GND

POSITION: Trace to center graticule line.

SET: CH 1 Input COUPLING DC

CHECK: Trace shift does not exceed 0.25 division.

**6. CH 2 INVERT Trace Shift**

SET: VERTICAL MODE CH 2 (CH 1 off)

POSITION: Trace to center horizontal graticule line.

SET: CH 2 INVERT On

CHECK: Trace shift does not exceed one division.

SET: CH 2 INVERT Off

**7. CH 1 and CH 2 VAR VOLTS/DIV Range**

SET: VERTICAL MODE CH 1 and CH 2

POSITION: CH 1 and CH 2 traces to the center horizontal graticule line.

CONNECT: Calibration Generator (PG 506) Std Ampl output to the CH 1 input via 50  $\Omega$  coaxial cable.

SET:

Std Ampl output	50 mV
CH 1 and CH 2	
VOLTS/DIV	10 mV
CH 1 VAR VOLTS/DIV	Full CCW

CHECK: The signal amplitude is two divisions or less.

SET:

CH 1 VAR VOLTS/DIV	Detent (calibrated)
CH 1 VERTICAL MODE	Off

MOVE: The test signal to the CH 2 input.

SET: CH 2 VAR VOLTS/DIV Full CCW

REPEAT: The CHECK procedure for CH 2.

SET: CH 2 VAR VOLTS/DIV Detent (calibrated)

**8. Low Frequency Linearity Check**

SET:

VERTICAL MODE	CH 1
CH 1 VOLTS/DIV	10 mV
BW LIMIT	ON

SET:

Std Ampl output	20 mV
-----------------	-------

MOVE: The test signal to the CH 1 input.

POSITION: Top of the signal to top graticule line.

CHECK: The signal amplitude is between 1.9 and 2.1 divisions.

SET: Bottom of the signal to bottom graticule line.

CHECK: The signal amplitude is between 1.9 and 2.1 divisions.

REPEAT: The procedure for CH 2.

**9. CH 1 and CH 2 Vertical Deflection Accuracy**

SET:

A SEC/DIV	0.5 ms
CH 2 VOLTS/DIV	2 mV
Std Ampl output	10 mV

CHECK: All positions of the VOLTS/DIV settings for correct signal-to-graticule accuracy, using the settings in Table A-2, Signal-to-Graticule Accuracy, for the checks.

SET: Std Ampl output 10 mV

MOVE: The test signal to the CH 1 input.

SET:

VERTICAL MODE	CH 1 (CH 2 off)
CH 1 VOLTS/DIV	2 mV

REPEAT: CHECK procedure for CH 1.

**Table A-2**  
**Signal-to-Graticule Accuracy**

VOLTS/DIV Setting	Std Ampl Setting	Deflection Accy. (in divisions)
2 mV	10 mV	4.90 to 5.10
5 mV	20 mV	3.92 to 4.08
10 mV	50 mV	4.90 to 5.10
20 mV	100 mV	4.90 to 5.10
50 mV	200 mV	3.92 to 4.08
0.1 V	500 mV	4.90 to 5.10
0.2 V	1 V	4.90 to 5.10
0.5 V	2 V	3.92 to 4.08
1 V	5 V	4.90 to 5.10
2 V	10 V	4.90 to 5.10
5 V	20 V	3.92 to 4.08

**10. CH 3 and CH 4 Vertical Deflection Accuracy**

SET:

VERTICAL MODE      CH 3 and CH 4 on;  
                                 CH 1 off

CH 3 and CH 4  
VOLTS/DIV              0.1 V

POSITION: CH 3 and CH 4 traces to the second graticule line down from the center horizontal graticule line.

MOVE: CH 1 test setup to the CH 3 input.

SET: Std Ampl output    0.5 V

CHECK: The signal amplitude is between 4.90 and 5.10 divisions.

MOVE: The test signal to the CH 4 input.

SET: CH 3 VERTICAL MODE    Off

REPEAT: CHECK for CH 4.

SET:

CH 3 and CH 4  
VOLTS/DIV              0.5 V

Std Ampl output        2 V

CHECK: The signal amplitude is between 3.92 and 4.08 divisions.

SET: CH 3 VERTICAL MODE    On (CH 4 off)

MOVE: The test signal to the CH 3 input.

REPEAT: CHECK procedure for CH 3.

DISCONNECT: The test setup from the 2245.

**11. ADD Mode and CH 2 INVERT Deflection Accuracy**

SET:

VERTICAL MODE        CH 1 and CH 2 on;  
                                 CH 3 off

CH 1 and CH 2  
VOLTS/DIV              0.1 V

CH 1 and CH 2  
Input COUPLING        GND

CONNECT: Calibration Generator Std Ampl output to the CH 1 and CH 2 inputs via 50 Ω coaxial cable and a dual-input coupler.

SET: Std Ampl output    0.2 V

POSITION: CH 1 trace to second horizontal graticule line from the top of the graticule area and position the CH 2 trace to second horizontal graticule line from the bottom.

SET:

CH 1 and CH 2  
Input COUPLING        AC

VERTICAL MODE        ADD, CH 1, and CH 2

CHECK: A third trace (the ADD signal) is located in between CH 1 and CH 2 signals, and that the ADD signal amplitude is between 3.92 and 4.08 divisions.

SET: CH 2 INVERT On

CHECK: The ADD signal amplitude is 0.08 division (less than half a minor graticule division) or less excluding trace width (sweep will free run).

DISCONNECT: The test setup from the 2245.

## 12. Vertical POSITION Range (all channels)

SET:

A SEC/DIV	0.1 ms
CH 1 VERTICAL MODE	On (ADD and CH 2 off)
CH 1 VOLTS/DIV	1 V
CH 2 INVERT	Off
BW LIMIT	Off
CH 1 and CH 2 Input COUPLING	AC

CONNECT: Leveled Sine-Wave Generator (SG 503) output to the CH 1 and CH 2 inputs via a 50  $\Omega$  cable, a 50  $\Omega$  BNC termination, and a dual-input coupler.

POSITION: Trace to center horizontal graticule line.

SET: Leveled Sine-Wave Generator output for two-division signal at 50 kHz.

SET:

CH 1 VOLTS/DIV	0.1 V
CH 1 POSITION	Full CW

CHECK: That the bottom of the waveform is at least one division above the center horizontal graticule line.

SET: CH 1 POSITION Full CCW

CHECK: That the top of the waveform is at least one division below the center horizontal graticule line.

SET:

CH 1 POSITION	12 o'clock
VERTICAL MODE	CH 2 (CH 1 off)
CH 2 POSITION	Full CW

CHECK: That the bottom of the waveform is at least one division above the center horizontal graticule line.

SET: CH 2 POSITION Full CCW

CHECK: That the top of the waveform is at least one division below the center horizontal graticule line.

SET: CH 2 POSITION 12 o'clock

MOVE: The BNC dual-input coupler from the CH 1 and CH 2 inputs to the CH 3 and CH 4 inputs.

SET:

VERTICAL MODE	CH 3 (CH 2 off)
CH 3 and CH 4 VOLTS/DIV	0.1 V
CH 3 POSITION	Full CW

CHECK: That the bottom of the waveform is at least one division above the center graticule line.

SET: CH 3 POSITION Full CCW

CHECK: That the top of the waveform is at least one division below the center graticule line.

SET:

CH 3 POSITION	12 o'clock
VERTICAL MODE	CH 4 (CH 3 off)

REPEAT: The procedure for CH 4.

SET: CH 4 POSITION 12 o'clock

DISCONNECT: The test setup from the 2245.

### 13. CH 1 to CH 2 Signal Delay Match

SET:

VERTICAL MODE	CH 1 and CH 2
CH 1 and CH 2	
Input COUPLING	DC
CH 1 and CH 2	
VOLTS/DIV	0.1 V
SEC/DIV	20 ns
TRIGGER SOURCE	CH 3

SUPERIMPOSE: The CH 1 and CH 2 traces at the 100% graticule marking.

CONNECT: Calibration Generator (PG 506) FAST RISE, rising-edge signal to the CH 1 and CH 2 inputs via a 50  $\Omega$  coaxial cable, a 50  $\Omega$  BNC termination, and a BNC dual-input coupler.

CONNECT: Calibration Generator TRIG OUT signal to the CH 3 input via a 50  $\Omega$  coaxial cable and a 50  $\Omega$  BNC termination.

SET: The Calibration Generator output for five divisions of signal amplitude at 1 MHz.

POSITION: The rising edges of the superimposed waveforms horizontally to the center vertical graticule line.

SET: X10 MAG On (for 2 ns/div sweep speed)

CHECK: That the leading edges of the two waveforms have less than 0.1 horizontal division separation at the center graticule line excluding trace width.

### 14. CH 1 to CH 4 Signal Delay Match

SET: VERTICAL MODE CH 1 and CH 4 (CH 2 off)

MOVE: The CH 2 signal to the CH 4 input connector.

SUPERIMPOSE: The CH 4 waveform on the CH 1 waveform.

CHECK: That the leading edges of the two waveforms have less than 0.1 horizontal division separation at the center graticule line excluding trace width.

### 15. CH 3 to CH 4 Signal Delay Match

SET:

VERTICAL MODE	CH 3 and CH 4 (CH 1 off)
TRIGGER SOURCE	CH 2

MOVE: The CH 1 signal to the CH 3 input and the CH 3 trigger signal to the CH 2 input.

SUPERIMPOSE: CH 3 and CH 4 waveforms at the center graticule line.

CHECK: That the leading edges of the two waveforms have less than 0.1 horizontal division separation at the center graticule line.

DISCONNECT: The test setup.

### 16. CH 1 and CH 2 Vertical Bandwidth

SET:

X10 MAG	Off
VERTICAL MODE	CH 1 (CH 3 and CH 4 off)
SEC/DIV	0.1 ms
CH 1 VOLTS/DIV	2 mV
CH 1 and CH 2	
Input COUPLING	DC
TRIGGER SOURCE	VERT
Horizontal POSITION	12 o'clock

CONNECT: Leveled Sine-Wave Generator (SG 503) output to the CH 1 input via a 50  $\Omega$  precision coaxial cable and a 50  $\Omega$  BNC termination.

SET: The Leveled Sine-Wave Generator output for a six-division signal amplitude at 50 kHz.

SET: The generator Frequency Range and Frequency Variable controls for a 100 MHz output signal.

CHECK: The displayed signal amplitude is 4.2 divisions or more.

REPEAT: The frequency setup and CHECK procedure for VOLTS/DIV settings of 5 mV through 1 V.

MOVE: The test signal to the CH 2 input.

SET:

VERTICAL MODE	CH 2 (CH 1 off)
CH 2 VOLTS/DIV	2 mV

REPEAT: The complete Bandwidth check procedure for Channel 2.

### 17. CH 3 and CH 4 Vertical Bandwidth

SET:

VERTICAL MODE	CH 3 (CH 2 off)
CH 3 and CH 4 VOLTS/DIV	0.1 V

CONNECT: Leveled Sine-Wave Generator (SG 503) output to the CH 3 input via a 50  $\Omega$  precision coaxial cable and a 50  $\Omega$  BNC termination.

SET: The generator output for a six-division signal display at 50 kHz.

SET: The generator Frequency Range and Frequency Variable controls for a 100 MHz output frequency.

CHECK: That the signal display amplitude is 4.2 divisions or more.

REPEAT: The Procedure for 0.5 VOLTS/DIV setting.

MOVE: The test signal to the CH 4 input.

SET: VERTICAL MODE CH 4

REPEAT: The procedure for CH 4.

### 18. Bandwidth Limit

SET:

VERTICAL MODE	CH 1 (CH 4 off)
CH 1 VOLTS/DIV	10 mV

MOVE: Test signal from the CH 4 input to the CH 1 input.

SET: Leveled Sine-Wave Generator (SG 503) output for a six-division signal amplitude at 50 kHz.

SET: BW LIMIT On

SET: The Leveled Sine-Wave generator Frequency Range and Frequency Variable controls to produce a signal display amplitude of 4.2 divisions.

CHECK: That the Sine-Wave generator output frequency is between 17 MHz and 23 MHz.

DISCONNECT: The test setup.

### 19. Common-mode Rejection Ratio

CONNECT: Leveled Sine-Wave Generator (SG 503) output to the CH 1 and CH 2 input connectors via a 50  $\Omega$  precision coaxial cable, a 50  $\Omega$  BNC termination, and a dual-input coupler.

SET: The Leveled Sine-Wave Generator output for an eight-division signal-display amplitude at 50 kHz.

SET:

ADD MODE	On
CH 2 VOLTS/DIV	10 mV
CH 2 INVERT	On
CH 1 VERTICAL MODE	Off

ADJUST: CH 1 OR CH 2 VAR VOLTS/DIV for smallest signal amplitude (as needed).

SET: The Leveled Sine-Wave output frequency to 50 MHz.

SET:

CH 1 VERTICAL MODE	On
ADD MODE	Off
CH 2 INVERT	Off

## Appendix—2245 Operators

SET: The Leveled Sine-Wave output amplitude for an eight-division display.

SET:

ADD MODE	On
CH 2 INVERT	On
CH 1	Off

CHECK: The signal is less than 0.8 division in amplitude.

DISCONNECT: The test setup.

### 20. Channel Isolation

SET:

CH 1 and CH 2	
VERTICAL MODE	On (ADD off)
CH 2 INVERT	Off
CH 1, CH 2, CH 3, and CH 4 VOLTS/DIV	0.1 V
TRIGGER SOURCE	CH 1

#### CH 1 Isolation

CONNECT: The Leveled Sine-Wave Generator (SG 503) output to the CH 1 input via a 50  $\Omega$  coaxial cable and a 50  $\Omega$  BNC termination.

SET: The Leveled Sine-Wave Generator (SG 503) output for a five-division signal display amplitude at 100 MHz.

SET:

CH 2, CH 3, and CH 4	
VERTICAL MODE	On (CH 1 off)

CHECK: Display amplitude is 0.1 division or less, excluding trace width, on the CH 2, CH 3, and CH 4 traces.

MOVE: Sine-Wave Generator signal to the CH 2 input.

SET:

CH 1, CH 3, and CH 4	
VERTICAL MODE	On (CH 2 off)
TRIGGER SOURCE	CH 2

CHECK: Display amplitude is 0.1 division or less, excluding trace width, on the CH 1, CH 3, and CH 4 traces.

#### CH 3 Isolation

MOVE: Sine-Wave Generator signal to the CH 3 input.

SET:

CH 1, CH 2, and CH 4	
VERTICAL MODE	On (CH 3 off)
TRIGGER SOURCE	CH 3

CHECK: Display amplitude is 0.1 division or less, excluding trace width, on the CH 1, CH 2, and CH 4 traces.

#### CH 4 Isolation

MOVE: Sine-Wave Generator signal to the CH 4 input.

SET:

CH 1, CH 2, and CH 3	
VERTICAL MODE	On (CH 4 off)
TRIGGER SOURCE	CH 4

CHECK: Display amplitude is 0.1 division or less, excluding trace width, on the CH 1, CH 2, and CH 3 traces.

DISCONNECT: The test setup.

### 21. Check AC Coupled Lower —3 dB Point

SET:

A SEC/DIV	10 ms
VERTICAL MODE	CH 1 (all others off)
TRIGGER SOURCE	VERT
TRIGGER MODE	NORM
TRIGGER HOLDOFF	Full CW

CONNECT: Function generator (FG 502) output to the CH 1 input via a 50  $\Omega$  coaxial cable and a 50  $\Omega$  BNC termination.

SET: The function generator output controls to produce a six-division sine-wave display at 10 Hz (with no dc offset).



SET: CH 1 Input COUPLING AC

CHECK: Display amplitude is 4.2 division or more.

SET: VERTICAL MODE CH 2 (CH 1 off)

REPEAT: The procedure for CH 2.

DISCONNECT: The test equipment from the 2245.

## 22. Vertical ALT and CHOP Modes

SET:

VERTICAL MODE	CH 1, CH 2 CH 3, and CH 4 on
CHOP VERTICAL MODE	Off (ALT mode)
CH 1 and CH 2 VOLTS/DIV	10 mV
CH 3 and CH 4 VOLTS/DIV	0.1 V
CH 1 and CH 2 Input COUPLING	DC
Horizontal MODE	A
SEC/DIV	1 ms
TRIGGER MODE	AUTO LEVEL

POSITION: All traces for two divisions of separation with the CH 1 trace near the top; then in order down the graticule area with the CH 4 trace near the bottom.

SET: SEC/DIV 10 ms

CHECK: That four traces are sweeping across the screen alternately.

SET: CHOP VERTICAL MODE On

CHECK: That four traces are sweeping across the screen simultaneously.

## 23. BEAM FIND

PUSH: BEAM FIND IN and HOLD

CHECK: The signal is visible and compressed fully within the graticule area as the horizontal and vertical position controls are rotated through their ranges.

RELEASE: The BEAM FIND button.

SET: All Vertical and Horizontal POSITION controls at the 12 o'clock position.

## 24. A and B Trace Separation

SET:

A SEC/DIV	1 ms
VERTICAL MODE	CH 1 (others off)
Horizontal MODE	ALT
B SEC/DIV	0.5 ms
A/B SELECT	B
B Trigger MODE	RUNS AFTER
TRACE SEP	Full CW

POSITION: The CH 1 trace below the center horizontal graticule line to display the separated B trace.

CHECK: For at least four divisions of upward trace separation between the B trace and the A trace.

SET: TRACE SEP Full CCW

POSITION: The CH 1 trace above the center horizontal graticule line to display the separated B trace.

CHECK: For at least four divisions downward trace separation of the B trace from the A trace.

# TRIGGERING

**Equipment Required (see Table A-1):**

Leveled Sine-Wave Generator	Function Generator
50 Ω Coaxial Cable	10X Attenuator
2X Attenuator	50 Ω BNC Termination
Dual-Input Coupler	TV Signal Generator

**1. A and B Trigger Sensitivity**

**NOTE**

**500 Hz Sensitivity**

*The TRIGGER LEVEL control may be used to obtain a stable display.*

**SET:**

READOUT (Intensity)	For a viewable readout
A INTEN	For a viewable trace
VERTICAL MODE	CH 1
CH 1 and CH 2	
Input COUPLING	DC
CH 1 VOLTS/DIV	0.1 V
Horizontal MODE	A
A SEC/DIV	20 ms
A/B SELECT	A Trigger
TRIGGER MODE	AUTO LEVEL
TRIGGER SOURCE	VERT
TRIGGER CPLG	AC
TRIGGER SLOPE	 (positive-going)
TRIGGER HOLDOFF	Min
FOCUS	For best defined display

**CHECK:** That the display is stably triggered with DC, HF REJ, and AC Trigger CPLG; and that the display will not trigger on NOISE REJ or LF REJ Trigger CPLG.

**SET:**

TRIGGER CPLG	DC
A/B SELECT	B Trigger
TRIGGER MODE	NORM
TRIGGER SOURCE	VERT
TRIGGER CPLG	DC
TRIGGER SLOPE	 (positive-going)
Horizontal MODE	B
B SEC/DIV	0.5 ms
B INTEN	For viewable display
DELAY	?0.000 (minimum delay time)

**CHECK:** That, using the Trigger LEVEL control the display can be stably triggered in DC, HF REJ, and AC Trigger CPLG; and that the display can not be triggered in NOISE REJ or LF REJ Trigger CPLG.

**CONNECT:** Function generator (FG 502) output to the CH 1 input via a 50 Ω coaxial cable, and a 50 Ω BNC termination.

**DISCONNECT:** The test setup from the CH 1 input.

**SET:** Function Generator (FG 502) output to produce a 7.0 division sine-wave display at 500 Hz.

**500 kHz Sensitivity**

**SET:**

Horizontal MODE	A
A/B SELECT	A Trigger
A SEC/DIV	2 μs

**ADD:** A 10X and a 2X BNC attenuator before the 50 Ω BNC termination (for a 0.35 division display).

CONNECT: Leveled Sine-Wave Generator (SG 503) output to the CH 1 input via a 50  $\Omega$  coaxial cable and a 50  $\Omega$  BNC termination.

SET: Leveled Sine-Wave Generator output to produce a 7.0 division sine-wave display amplitude at 500 kHz.

ADD: A 10X and a 2X attenuator before the 50  $\Omega$  BNC termination (for a 0.35 division display amplitude).

CHECK: That the display cannot be triggered in either HF REJ or NOISE REJ CPLG.

SET:

Horizontal MODE	B
A/B SELECT	B Trigger
B SEC/DIV	1 $\mu$ s

CHECK: That the display cannot be triggered in HF REJ or NOISE REJ CPLG by adjusting the Trigger LEVEL control.

#### 25 MHz Sensitivity

SET:

Horizontal MODE	A
A/B SELECT	A Trigger
TRIGGER CPLG	DC
A SEC/DIV	50 ns

REMOVE: The 10X and 2X attenuators from the signal path.

SET: Leveled Sine-Wave Generator output to produce a 7.0 division display amplitude at 25 MHz.

ADD: A 10X and a 2X attenuator before the 50  $\Omega$  BNC termination.

CHECK: That the display is stably triggered in DC, LF REJ, and AC Trigger CPLG; the display is not triggered in NOISE REJ and HF REJ Trigger CPLG settings.

SET:

TRIGGER CPLG	AC
Horizontal MODE	B
A/B SELECT	B Trigger
B SEC/DIV	20 ns

CHECK: That, using the Trigger LEVEL control the display can be stably triggered in DC, LF REJ, and AC Trigger CPLG; the display cannot be triggered in NOISE REJ and HF REJ Trigger CPLG settings.

SET: Leveled Sine-Wave Generator (SG 503) to produce a 1.4 division display at 25 MHz.

CHECK: That the display can be stably triggered with NOISE REJ Trigger CPLG but does not trigger with HF REJ CPLG.

SET:

Horizontal MODE	A
A/B SELECT	A Trigger

CHECK: That the display is stably triggered with NOISE REJ Trigger CPLG but does not trigger with HF REJ CPLG. (The Trigger LEVEL control may be adjusted to improve display stability in NOISE REJ CPLG.)

#### 150 MHz Sensitivity

SET: TRIGGER CPLG DC

SET: Leveled Sine-Wave Generator to produce a 1.0 division display at 150 MHz.

CHECK: That the display is stably triggered in DC, LF REJ, and AC Trigger CPLG; the display is not triggered in NOISE REJ and HF REJ Trigger CPLG.

SET:

Horizontal MODE	B
A/B SELECT	B Trigger

CHECK: That, using the Trigger LEVEL control the display can be stably triggered in DC, LF REJ, and AC Trigger CPLG; the display cannot be triggered in NOISE REJ and HF REJ Trigger CPLG.

## Appendix—2245 Operators

SET:

VERTICAL MODE	CH 2 (CH 1 off)
CH 2, CH 3, and CH 4	
VOLTS/DIV	0.1 V
A/B SELECT	A Trigger
TRIGGER CPLG	DC

MOVE: Test signal from CH 1 to the CH 2 input.

SET: Leveled Sine-Wave Generator output to produce a 1.0 division display amplitude at 150 MHz.

CHECK: That a stable display can be obtained. (The Trigger LEVEL control may be adjusted to improve the display stability.)

REPEAT: Procedure for the CH 3 and CH 4 (turn on the appropriate VERTICAL MODE and move the test signal as required).

MOVE: Test signal to the CH 1 input.

SET: VERTICAL MODE CH 1 (others off)

REMOVE: The 2X attenuator from the test signal path.

SET: Leveled Sine-Wave Generator output for a 2.2 division display amplitude at 100 MHz.

CHECK: That the display is stably triggered with NOISE REJ Trigger CPLG but is not triggered with HF REJ Trigger CPLG.

SET:

TRIGGER CPLG	DC
Horizontal MODE	B
A/B SELECT	B Trigger

REPEAT: 100 MHz NOISE REJ Trigger CPLG procedure for the B Trigger.

## 2. Single Sweep Mode

SET:

Horizontal MODE	A
A SEC/DIV	10 $\mu$ s
A/B SELECT	A Trigger

REMOVE: The 10X attenuator from the test signal path.

SET: Leveled Sine Wave Generator output to produce a 7.0 division display amplitude at 50 kHz.

ADD: A 10X and a 2X attenuator before the 50  $\Omega$  BNC termination. (Display should stably trigger with AUTO LEVEL finding the correct trigger level setting.)

SET:

A TRIGGER MODE	NORM
CH 1 Input COUPLING	GND
TRIGGER MODE	SGL SEQ

CHECK: That the Trigger READY LED turns on and remains on.

SET:

A INTEN	3/4 full CS
CH 1 Input COUPLING	DC (see CHECK below)

CHECK: That the TRIG'D LED flashes, and the READY LED turns off after a single sweep and readout display occurs when the Input COUPLING switches to DC.

## 3. Trigger LEVEL Control Range

SET:

TRIGGER MODE	AUTO
TRIGGER LEVEL	Full CCW
A INTEN	For a good viewing intensity

REMOVE: 10X and 2X attenuators from the test signal path.

REDUCE: Leveled Sine-Wave Generator output level until a stably triggered display is just obtainable.

SET: TRIGGER LEVEL Full CW

SET: Leveled Sine-Wave Generator output for a stable display (if necessary).

SET: CH 1 VOLTS/DIV 1 V

CHECK: That the CH 1 signal display amplitude is four divisions or more (peak-to-peak).

DISCONNECT: The test setup from the 2245.

#### 4. TV Trigger Sensitivity

##### TV FIELD

SET:

VERTICAL MODE	CH 2 (CH 1 off)
CH 2 VOLTS/DIV	2 V
SEC/DIV	0.2 ms
TRIGGER SLOPE	 (negative-going)
TRIGGER MODE	TV FIELD

CONNECT: TV SIGNAL GENERATOR negative-going sync pulse output to the CH 1 input via a 50 Ω BNC cable.

SET: CH 2 VAR VOLTS/DIV control for a 0.5 division composite sync signal.

CHECK: That a stable display is obtained.

SET:

CH 2 INVERT	On
TRIGGER SLOPE	 (positive-going)

CHECK: That a stable display is obtained.

##### TV LINE

SET:

SEC/DIV	20 μs
TRIGGER MODE	TV LINE
TRIGGER HOLDOFF	For a single triggered display

CHECK: That a stable display is obtained.

SET:

CH 2 INVERT	Off
TRIGGER SLOPE	 (negative-going)

CHECK: That a stable display is obtained.

SET:

CH 2 VAR VOLTS/DIV	Detent Position (calibrated)
--------------------	------------------------------

DISCONNECT: The TV signal generator from the 2245.



#### 5. LINE Trigger

SET:

CH 2 VOLTS/DIV	0.1 V (without a 10X probe attached)
CH 2 Input COUPLING	DC
A SEC/DIV	5 ms
TRIGGER MODE	AUTO LEVEL
TRIGGER SOURCE	LINE
TRIGGER CPLG	DC

CONNECT: A 10X probe to the CH 2 input connector.

CONNECT: The probe tip to a 12-inch jumper wire that has been wrapped around the ac power cord to the oscilloscope.

CHECK: That the display can be triggered in both  (positive-going) and  (negative-going) slopes.

DISCONNECT: The test setup.

# HORIZONTAL

**Equipment Required (see Table A-1):**

Time Mark Generator	50 $\Omega$ BNC Coaxial Cable
50 $\Omega$ BNC Termination	

## 1. A and B Sweep Length

SET:	
READOUT (Intensity)	For a viewable readout
A INTEN	For a viewable trace
VERTICAL MODE	CH 1
CH 1 and CH 2	
Input COUPLING	DC
CH 1 VOLTS/DIV	0.5 V
Horizontal MODE	A
A SEC/DIV	2 ms
A/B SELECT	A Trigger
TRIGGER MODE	AUTO LEVEL
TRIGGER SOURCE	VERT
TRIGGER CPLG	AC
TRIGGER SLOPE	 (positive-going)
TRIGGER HOLDOFF	Min
TRIGGER LEVEL	12 o'clock
FOCUS	For best defined display

CONNECT: Time Mark Generator (TG 501) to the CH 1 input via a 50  $\Omega$  coaxial cable and a 50  $\Omega$  BNC termination.

SET: Time Marks 2 ms

CHECK: Sweep length of the A trace is greater than 10 divisions.

SET:

Horizontal MODE	B
B SEC/DIV	1 ms
A/B SELECT	B Trigger
TRIGGER MODE	RUNS AFTER
DELAY Control	Full CCW (?0.000)
B INTEN	For a visible display

CHECK: The Delay Time readout is ?0.000 ms, and the B Sweep length is greater than 10 divisions.

## 2. Horizontal Position Range

SET:

Horizontal MODE	A
Horizontal POSITION	Full CW

CHECK: That the start of trace positions past the center vertical graticule line.

SET: Horizontal POSITION Full CCW

CHECK: That the time marker is positioned to the left of the center vertical graticule line.

## 3. Horizontal VAR Range

SET:

SEC/DIV	1 ms
SEC/DIV VAR	Full CCW
Time Marks	5 ms
Horizontal POSITION	12 o'clock

CHECK: The time marker spacing is equal to or less than two divisions.

SET:  
SEC/DIV VAR Full CW (calibrated detent)

**4. Mag Registration**

SET: X10 MAG On

POSITION: Center a time marker to the center vertical graticule line.

SET: X10 MAG Off

CHECK: For less than 0.5 division horizontal trace shift.

**5. A and B Timing Accuracy and Linearity**

SET:  
A SEC/DIV 20 ns  
Time Marks 20 ns

POSITION: The time marker peaks vertically to the center horizontal graticule line (allows use of the minor division graticule markings as an aid in making the accuracy checks).

POSITION: The second time marker to the second vertical graticule line.

CHECK: That the tenth marker is within 0.16 division to the left or right of the tenth graticule line, and the linearity accuracy is within 0.1 division over any two or the center eight divisions.

REPEAT: The procedure for all other SEC/DIV settings. Use Table A-3, Settings for Timing Accuracy Checks, for the SEC/DIV and Time Mark Generator settings.

SET:  
SEC/DIV 20 ns  
Time Marks 20 ns  
Horizontal MODE B  
B INTEN For a viewable display

REPEAT: The CHECK procedure for all the B SEC/DIV settings.

**Table A-3**  
**Settings for Timing Accuracy Checks**

SEC/DIV Setting		Time-Mark Setting	
Normal	X10 MAG	Normal	X10 MAG
20 ns	2 ns	20 ns	5 ns
50 ns	5 ns	50 ns	5 ns
0.1 μs	10 ns	0.1 ns	10 ns
0.2 μs	20 ns	0.2 μs	20 ns
0.5 μs	50 ns	0.5 μs	50 ns
1 μs	0.1 μs	1 μs	0.1 μs
2 μs	0.2 μs	2 μs	0.2 μs
5 μs	0.5 μs	5 μs	0.5 μs
10 μs	1 μs	10 μs	1 μs
20 μs	2 μs	20 μs	2 μs
50 μs	5 μs	50 μs	5 μs
0.1 ms	10 μs	0.1 ms	10 μs
0.2 ms	20 μs	0.2 ms	20 μs
0.5 ms	50 μs	0.5 ms	50 μs
1 ms	0.1 ms	1 ms	0.1 ms
2 ms	0.2 ms	2 ms	0.2 ms
5 ms	0.5 ms	5 ms	0.5 ms

**A Sweep only**

10 ms	1 ms	10 ms	1 ms
20 ms	2 ms	20 ms	2 ms
50 ms	5 ms	50 ms	5 ms
0.1 s	10 ms	0.1 s	10 ms
0.2 s	20 ms	0.2 s	20 ms
0.5 s	50 ms	0.5 s	50 ms

**6. A and B Magnified Timing Accuracy and Linearity**

SET:  
B SEC/DIV 20 ns  
Time Marks 5 ns  
X10 MAG On (for 2 ns/div sweep speed)  
CH 1 VOLTS/DIV 0.5 V (use 0.2 V for the 5 ns time markers if necessary)

**NOTE**

*In the following checks, for magnified SEC/DIV settings between 2 ns and 20 ns, set the first time marker that is 25 ns after the start of the sweep to the second vertical graticule line. For the SEC/DIV settings between 50 ns and 50 ms (0.5 ms for B Sweep), position the leading edge of the second time marker to the second graticule line.*

**ALIGN:** The rising edge of the first time marker past 25 ns from the start of the sweep with the second vertical graticule line (center the display vertically).

**CHECK:** That the rising edge of the fourth displayed time marker crosses the center horizontal graticule line at between 8.27 divisions to 8.73 divisions.

**CHECK:** The linearity is within 0.1 division over any 2.5 divisions of the center eight divisions. Exclude any portion of the sweep past the 100th magnified division.

SET: SEC/DIV 5 ns

**ALIGN:** The correct time marker to the second vertical graticule line (see NOTE above).

**CHECK:** That the tenth time marker is within 0.24 division (left or right) of the tenth graticule line.

**CHECK:** That the linearity accuracy is 0.1 division over any two of the center eight divisions. (Excluding any portion of the sweep past the 100th magnified division for SEC/DIV settings of 5 ns through 20 ns.)

**REPEAT:** The timing and linearity checks for all SEC/DIV settings between 10 ns and 0.5 s. Use the SEC/DIV and Time Mark Generator X10 MAG settings given in Table A-3.

SET:

Horizontal MODE	A
SEC/DIV	2 ns (with X10 MAG on)
Time Marks	5 ns

**REPEAT:** The magnified accuracy and linearity for the A Sweep at all SEC/DIV settings.

**7. Delay Time Jitter**

SET:

X10 MAG	Off
Time Marks	1 ms
A SEC/DIV	1 ms
Horizontal MODE	ALT
SEC/DIV	0.5 $\mu$ s

**POSITION:** The intensified dot to the leading edge of the 10th time marker to display the rising edge on the B Trace (using the DELAY control).

SET:

Horizontal MODE	B
B INTEN	Full CW (maximum intensity)

**CHECK:** That the jitter on the leading edge does not exceed one division over a two-second interval. Disregard slow drift.

**8. Delay Time Accuracy**

SET:

Horizontal MODE	ALT
B SEC/DIV	10 $\mu$ s
TRACE SEP	Full CCW (maximum downward position)
CH 1 VERTICAL POSITION	To display both the ALT and the B Delayed Traces

**POSITION:** The first time marker on the ALT trace to first vertical graticule line (left-most edge).

**POSITION:** The intensified dot to full left position (counterclockwise rotation of the DELAY control).

**CHECK:** That the readout is ?0.000 ms.

**POSITION:** The intensified zone to the second time marker and align the leading edge of the time marker displayed on the B Trace to the left-most (first) graticule line. Using the Readout Accuracy Limits given in Table A-4, check the delay time accuracy.

**REPEAT:** The procedure for the third through 10th time markers.



**Table A-4**  
**Delay Time Accuracy**

Time Marker	Readout Accuracy Limits
1st	? 0.000 ms
2nd	0.975 ms to 1.025 ms
3rd	1.970 ms to 2.030 ms
4th	2.965 ms to 3.035 ms
5th	3.960 ms to 4.040 ms
6th	4.955 ms to 5.045 ms
7th	5.950 ms to 6.050 ms
8th	6.945 ms to 7.055 ms
9th	7.940 ms to 8.060 ms
10th	8.935 ms to 9.065 ms

**9. Delay Time Position Range**

SET:

Time Marks            0.1 ms  
 A SEC/DIV            1 ms  
 B SEC/DIV            5  $\mu$ s  
 DELAY Control        Full CCW

CHECK: That the intensified dot is positioned at or before the second time mark.

SET: DELAY control    Full CW

CHECK: That the intensified dot is positioned at or after the 99th time marker (located at a Delay Time of 9.9 ms).

DISCONNECT: The Time Mark Generator from the 2245.

**10. X-Axis Gain Accuracy**

SET:

Horizontal MODE        X-Y  
 VERTICAL MODE        CH 2 (CH 1 off)  
 CH 1 and CH 2 VOLTS/DIV    10 mV  
 CH 1 Input COUPLING    DC  
 CH 2 Input COUPLING    GND

CONNECT: Calibration Generator Std Ampl output to the CH 1 and CH 2 inputs via a 50  $\Omega$  coaxial cable and a dual-input coupler.

SET: Std Ampl output    50 mV

CHECK: X-Axis amplitude is between 4.85 and 5.15 horizontal divisions.

**11. Y-Axis Gain Accuracy**

SET:

CH 1 Input COUPLING    GND  
 CH 2 Input COUPLING    DC

CHECK: Y-Axis amplitude is between 4.90 and 5.10 vertical divisions.

**12. X-Y Phase Difference**

SET:

VERTICAL MODE        CH 1 (CH 2 off)  
 CH 1 Input COUPLING    DC

CONNECT: Leveled Sine-Wave Generator output to the CH 1 input via a 50  $\Omega$  coaxial cable and a 50  $\Omega$  termination.

SET: Leveled Sine-Wave Generator output for six divisions of signal display amplitude at 50 kHz.

SET:

Horizontal MODE        X-Y  
 CH 1 Input COUPLING    GND

POSITION: Dot to graticule center.

SET: CH 1 Input COUPLING    DC

CHECK: Ellipse opening at the center is 0.3 division or less, measured horizontally.

**13. X-Axis Bandwidth**

SET:

VERTICAL MODE        CH 2 (CH 1 off)  
 Leveled Sine Wave output    3 MHz

CHECK: X-Axis display is 4.2 horizontal divisions or more.

DISCONNECT: The test equipment from the 2245.

## EXTERNAL Z-AXIS AND CALIBRATOR

**Equipment Required (see Table A-1):**

Calibration Generator	BNC T-Connector
Two 50 $\Omega$ BNC Coaxial Cables	Test Oscilloscope with 10X Probe

### 1. Check External Z-Axis Input

SET:

READOUT (Intensity)	For a viewable readout
A INTEN	For a viewable trace
VERTICAL MODE	CH 1
CH 1 VOLTS/DIV	1 V
CH 2 INVERT	Off
BW LIMIT	Off
CH 1 Input COUPLING	DC
Horizontal MODE	A
A SEC/DIV	0.5 ms
A/B SELECT	A Trigger
TRIGGER MODE	AUTO LEVEL
TRIGGER CPLG	DC
TRIGGER SOURCE	VERT
TRIGGER SLOPE	(positive-going)
TRIGGER HOLDOFF	Min
FOCUS	For best defined display
Horizontal POSITION	12 o'clock

CONNECT: Calibration Generator (PG 506) Std Ampl output to the CH 1 and the EXT Z-AXIS inputs via a 50  $\Omega$  BNC T-connector, and two 50  $\Omega$  coaxial cables.

SET:

Std Ampl output	5V
A INTEN	Full CW (maximum intensity)

CHECK: Waveform display intensity starts decreasing at 1.8 V or less; above 3.8 V, the waveform display is completely blanked out.

DISCONNECT: The test equipment from the EXT Z-AXIS Input.

SET: A INTEN for a viewable trace.

### 2. CHECK Calibrator Output

SET Test Scope controls:

Volts/Div	0.1 V
Sec/Div	0.2 ms
Vert Mode	CH 1
CH 1 Input Coupling	DC
Measurement Mode	Frequency

CONNECT: A 10X probe to the test scope CH 1 input connector and connect the probe tip to the 2245 CALIBRATOR output.

CHECK: The display is between 4.90 divisions and 5.10 divisions, the negative amplitude of the signal is at ground, and the frequency is between 750 Hz and 1.25 kHz.

DISCONNECT: The test scope probe from the 2245.

This completes the Performance Check Procedure.

## **MANUAL CHANGE INFORMATION**

At Tektronix, we continually strive to keep up with latest electronic developments by adding circuit and component improvements to our instruments as soon as they are developed and tested.

Sometimes, due to printing and shipping requirements, we can't get these changes immediately into printed manuals. Hence, your manual may contain new change information on following pages.

A single change may affect several sections. Since the change information sheets are carried in the manual until all changes are permanently entered, some duplication may occur. If no such change pages appear following this page, your manual is correct as printed.

