



1910
Digital Generator
Operator Manual
070-4466-01

Please check for change information at the rear
of this manual.

Copyright © Tektronix, Inc. All rights reserved.

Tektronix products are covered by U.S. and foreign patents, issued and pending. Information in this publication supercedes that in all previously published material. Specifications and price change privileges reserved.

Printed in the U.S.A.

Tektronix, Inc., P.O. Box 1000, Wilsonville, OR 97070-1000

TEKTRONIX and TEK are registered trademarks of Tektronix, Inc.

WARRANTY

Tektronix warrants that the products that it manufactures and sells will be free from defects in materials and workmanship for a period of one (1) year from the date of shipment. If a product proves defective during this warranty period, Tektronix, at its option, either will repair the defective product without charge for parts and labor, or will provide a replacement in exchange for the defective product.

In order to obtain service under this warranty, Customer must notify Tektronix of the defect before the expiration of the warranty period and make suitable arrangements for the performance of service. Customer shall be responsible for packaging and shipping the defective product to the service center designated by Tektronix, with shipping charges prepaid. Tektronix shall pay for the return of the product to Customer if the shipment is to a location within the country in which the Tektronix service center is located. Customer shall be responsible for paying all shipping charges, duties, taxes, and any other charges for products returned to any other locations.

This warranty shall not apply to any defect, failure or damage caused by improper use or improper or inadequate maintenance and care. Tektronix shall not be obligated to furnish service under this warranty a) to repair damage resulting from attempts by personnel other than Tektronix representatives to install, repair or service the product; b) to repair damage resulting from improper use or connection to incompatible equipment; c) to repair any damage or malfunction caused by the use of non-Tektronix supplies; or d) to service a product that has been modified or integrated with other products when the effect of such modification or integration increases the time or difficulty of servicing the product.

THIS WARRANTY IS GIVEN BY TEKTRONIX IN LIEU OF ANY OTHER WARRANTIES, EXPRESS OR IMPLIED. TEKTRONIX AND ITS VENDORS DISCLAIM ANY IMPLIED WARRANTIES OF MERCHANTABILITY OR FITNESS FOR A PARTICULAR PURPOSE. TEKTRONIX' RESPONSIBILITY TO REPAIR OR REPLACE DEFECTIVE PRODUCTS IS THE SOLE AND EXCLUSIVE REMEDY PROVIDED TO THE CUSTOMER FOR BREACH OF THIS WARRANTY. TEKTRONIX AND ITS VENDORS WILL NOT BE LIABLE FOR ANY INDIRECT, SPECIAL, INCIDENTAL, OR CONSEQUENTIAL DAMAGES IRRESPECTIVE OF WHETHER TEKTRONIX OR THE VENDOR HAS ADVANCE NOTICE OF THE POSSIBILITY OF SUCH DAMAGES.

PREFACE

This Preface describes the contents of the 1910 Operators Manual, with a brief description of each section within the manual.

Section 1 (Specification) includes a reference documentation list, a product description, and the specification of the instrument. Specification includes the parameter specifications for the 1910 and the signals it generates, including the optional test set signals.

Section 2 (Installation) includes unpacking instructions, a list of the selectable jumper option modes, electrical and mechanical information, cabling precautions, and an accessories list.

Section 3 (Operator's Instructions) describes the functions of the controls, connectors, and indicators on the front and rear panels. A functional block diagram with a description of each block is also provided.

Section 4 (Operator Checkout Procedure) includes information for the operator to functionally check the operation of the 1910 Digital Generator.

Section 5 (Remote Operation) includes information necessary to operate the 1910 remotely using the RS-232 CONTROL or REMOTE CONTROL port.

Section 6 (Test Signal Applications) includes a description of each test signal generated by the 1910 and the distortions which are detected by these signals. A glossary of distortion terms is also included.

Appendix A (Application Notes) includes specific applications of several test signals.

Change and correction information after the manual has been printed is located behind a tabbed page at the rear of the manual.

TABLE OF CONTENTS

	Page		Page
PREFACE	i	Section 3 OPERATING INSTRUCTIONS (cont).	
LIST OF ILLUSTRATIONS	iv	APL (Average Picture Level)	3-3
LIST OF TABLES	v	Shift	3-3
OPERATORS SAFETY SUMMARY	vi	Full Field Signal	3-3
SERVICE SAFETY SUMMARY	vii	Control LED	3-4
Section 1 SPECIFICATION		Reset	3-4
Reference Documentation	1-1	APL Bounce	3-4
Product Description	1-1	APL Bounce Rate	3-4
SPECIFICATION	1-2	VITS Insertion	3-4
Program Signal Path/VITS Inserter ..	1-2	VIR Signal Programming	3-5
Genlock Function	1-5	Rear-Panel Connectors	3-5
External VITS Input	1-6	Digital Input	3-5
Test Signals—Full Field & VITS	1-7	Digital Output	3-5
Test Signals—Full Field Output		Subcarrier Out	3-5
(Sync & Burst)	1-29	Comp Sync Out	3-5
Sync & Subcarrier	1-33	Full Field Out	3-5
RS-232 Control Port Interface	1-35	VITS Input	3-5
Digital Input Interface	1-36	Black Burst In	3-5
Digital Output Interface	1-37	Prgm Monitor Out	3-5
Power Supply	1-39	Program	3-7
Physical Characteristics	1-40	Remote Control	3-7
Environmental Characteristics	1-40	RS-232 Control	3-7
Section 2 INSTALLATION		Pulse Output Option (H Drive,	
Unpacking and Initial Inspection	2-1	V Drive, Comp Blanking,	
Repackaging for Shipment	2-1	Burst Flag)	3-7
Preparation for Installation	2-1	Power Input	3-7
Mains Voltage and Frequency		Generator Functions	3-7
Requirements	2-1	Program Sync and Burst	
Power Connections	2-3	Regeneration	3-7
Operating Mode Selections	2-3	Transmitter Protection	3-7
Jumper Connector Index	2-3	VITS/VIRS Insertion	3-7
Operating Mode Description	2-4	External VIRS Insertion	3-8
Mechanical Installation (Rackmounting)	2-7	Digital Input and Digital Output	3-8
Latching	2-7	Functional Characteristics	3-10
Rackmounting	2-7	Introduction	3-10
Rackmount-to-Cabinet Conversion ..	2-10	Block Diagram Description	3-10
Cabinet-to-Rackmount Conversion ..	2-10	Section 4 OPERATOR'S CHECKOUT	
Accessories	2-11	PROCEDURE	
Standard Accessories	2-11	Equipment Required	4-1
Optional Accessories	2-11	Checkout Procedure	4-1
Section 3 OPERATING INSTRUCTIONS		1. Setup	4-1
Front-Panel Controls, Connectors, and		2. Initialized State of 1910	4-1
Indicators	3-1	3. Genlock and VITS Insertion	
Power	3-1	Operations	4-1
Operating Range	3-1	4. Test Points (Input & Output)	
Fuse Current Rating	3-1	Pin Jacks	4-3
Fuse	3-1	5. VIR Signal Programming	
Insert Subcarrier Phase Adjust	3-1	Operation	4-3
Program Line	3-1	6. Insert Subcarrier Phase	
Outputs	3-3	Adjustment	4-3
		7. Full Field Signal Operation	4-3
		8. Comp Sync Output	4-4

TABLE OF CONTENTS (cont)

	Page		Page
Section 4		Appendix A APPLICATION NOTES	
OPERATOR'S CHECKOUT PROCEDURE (cont).		The Multipulse Waveform	A-1
9. Subcarrier Output	4-4	Frequency Response Testing Using the $\frac{\sin x}{x}$ Test Signal	A-7
10. Remote Control Operations	4-4		
Section 5		Appendix B 1910 Option 03	
REMOTE OPERATION		Description	B-1
Marker Sets	5-1	Hardware Changes	B-1
Definition of Terms	5-1	Full Field Sync and Burst Insertion	B-1
PART I RS-232 CONTROL PORT COMMUNICATION		Test Signal Mnemonic Changes	B-1
Introduction	5-5	Front Panel and VITS Assignment Changes	B-1
Description	5-6		
Memory Description	5-7		
Special Character Definitions	5-8		
Initial Operation Using the RS-232 Control Port	5-8		
COMMANDS	5-11		
PART II REMOTE CONTROL PORT	5-32	Appendix C 1910 Option 01	
Description	5-32	Description	C-1
Controlling the 1910 Functions Using an Owner-Constructed Remote		Hardware Changes	C-1
Control Panel	5-32	Signal Changes	C-1
Functions of the Tektronix Remote Control Unit Front-Panel		Test Signal Mnemonics Changes	C-1
Controls	5-36	Front Panel and VITS Assignment Changes	C-1
Section 6		Appendix D 1910 Option 02 and Option 04	
TEST SIGNAL APPLICATIONS		Description	D-1
Introduction	6-1	Hardware Changes	D-1
Video System Testing	6-1	Signal Changes	D-1
Choice of a Test Signal	6-1	Test Signal Mnemonics Changes	D-1
Signal Discussions	6-3	Front Panel and VITS Assignment Changes	D-1
Signal Discussion Outline	6-3		
Full Field Signals	6-3		
Glossary of Distortion Terms	6-19		
		Appendix E 1910 Option 1K	
		Description	E-1
		Hardware Changes	E-1
		Signal Changes	E-1
		Test Signal Mnemonics	E-1
		Front Panel and VITS Assignment Changes	E-1

LIST OF ILLUSTRATIONS

Fig. No.	Page	Fig. No.	Page
1-1		5-10	Martix Configuration Work Sheet 5-30
1-2		5-11	Full Field Sequence Work Sheet 5-31
	1-24	5-12	REMOTE CONTROL Port Pin Configuration 5-33
1-3		5-13	TEKTRONIX Remote Control Unit Front-Panel Controls 5-37
	1-25		
1-4		6-1	Signal/Distortion Matrix 6-2
	1-26	6-2	Black Burst and Pedestals 6-3
1-5		6-3	Color Bars 6-3
	1-27	6-4	Color Multipulse 6-4
1-6		6-5	EIA Color Bar 6-4
	1-28	6-6	Eye Test Pattern 6-5
1-7		6-7	FCC Composite 6-6
1-8		6-8	FCC Multiburst 6-6
1-9		6-9	FCC Multiburst Exhibiting Gain/Frequency Distortion 6-6
1-10		6-10	Field Bar 6-7
2-1	2-2	6-11	5-Step Staircase 6-7
2-2	2-7	6-12	Inverted Pulse & Bar 6-7
2-3		6-13	2T Pulse Exhibiting Gain/Frequency and/or Group-Delay Distortion 6-8
	2-7		
2-4	2-8	6-14	IYQB 6-8
2-5	2-8	6-15	Modulated Bar 6-8
2-6	2-9	6-16	Modulated 5-Step 6-9
2-7	2-10	6-17	Modulated Pedestal 6-9
		6-18	The Filtered Luminance Components of a Modulated Pedestal Exhibiting Chrominance-to-Luminance Intermodulation 6-9
3-1	3-2	6-19	Modulated Ramp 80 IRE 6-10
3-2	3-6	6-20	Modulated 10-Step 6-10
3-3		6-21	Chrominance Components of a Modulated 10-Step Exhibiting Differential Gain 6-10
	3-9		
3-4	3-10	6-22	Multipulse 70 6-11
		6-23	NTC 7 Composite 6-11
4-1	4-2	6-24	NTC 7 Combination 6-12
4-2	4-4	6-25	Red Field 6-12
		6-26	Reverse Blue Bars 6-13
5-1		6-27	$\frac{\sin x}{x}$ 6-13
	5-1		
5-2	5-2	6-28	Special Multipulse 6-14
5-3		6-29	10-Step Staircase 6-15
	5-3	6-30	Differentiated 10-Step Staircase exhibiting Luminance Non-Linearity 6-15
5-4	5-7	6-31	VICR (Vertical Interval Color Reference) 6-15
5-5	5-9	6-32	VIRS (Vertical Interval Reference Signal) 6-15
5-6	5-10	6-33	Y Color Bar 6-16
5-7		6-34	Y Ramp 100 IRE 6-16
	5-17	6-35	Distorted Y Ramp 100 6-17
	5-18	6-36	Adjusting hue and chroma with SMPTE Bars, with red and green monitor screens turned off 6-18
5-8	5-18		
5-9	5-29		

LIST OF TABLES

Table No.		Page
1-1	Program Signal Path/VITS Inserter	1-2
1-2	Genlock Function	1-5
1-3	External VITS Input	1-6
1-4	Test Signals—Full Field & VITS	1-7
1-5	Test Signals—Full Field Output (Sync & Burst)	1-29
1-6	Sync & Subcarrier	1-33
1-7	RS-232 Control Port Interface	1-35
1-8	Digital Input Interface	1-36
1-9	Digital Output Interface	1-37
1-10	Power Supply	1-39
1-11	Physical Characteristics	1-40
1-12	Environmental Characteristics	1-40
2-1	Jumper Connectors	2-3
3-1	Full Field Signal Selection	3-4
5-1	Special Character Definitions	5-8
5-2	1910 Commands	5-26
5-3	1910 Mnemonics	5-28
5-4	Full Field Signal Selection as Shipped from the Factory	5-34
5-5	Program VITS Line Selection	5-34
5-6	Program VIT Signal Selection as Shipped from the Factory	5-35
B-1	Option 03 Test Signal Changes	B-2
B-2	Option 03 Factory VITS Programming	B-2
C-1	Option 01 Test Signal Changes	C-1
C-2	Option 01 Factory VITS Signal Programming (Line-18)	C-3
D-1	Option 02 and Option 04 Test Signal Changes	D-1
D-2	Factory VITS Sequence Programming for Ghost Cancellation Reference (Mnemonic GCR) on Line 18	D-2

OPERATORS SAFETY SUMMARY

The general safety information in this part of the summary is for both operating and servicing personnel. Specific warnings and cautions will be found throughout the manual where they apply, but may not appear in this summary.

TERMS

In This Manual

CAUTION statements identify conditions or practices that could result in damage to the equipment or other property.

WARNING statements identify conditions or practices that could result in personal injury or loss of life.

As Marked on Equipment

CAUTION indicates a personal injury hazard not immediately accessible as one reads the marking, or a hazard to property including the equipment itself.

DANGER indicates a personal injury hazard not immediately accessible as one reads the marking.

SYMBOLS

In This Manual



This symbol indicates where applicable cautionary or other information is to be found.

As Marked on Equipment



DANGER—High voltage.



Protective ground (earth) terminal.



ATTENTION—refer to manual.

Power Source

This product is intended to operate from a power source that will not apply more than 250 V rms between the supply conductors or between either supply conductor and ground. A protective ground connection by way of the grounding conductor in the power cord is essential for safe operation.

Grounding the Product

This product is grounded through the grounding conductor of the power cord. To avoid electrical shock, plug the power cord into a properly wired receptacle before connecting to the product input or output terminals. A protective ground connection by way of the grounding conductor in the power cord is essential for safe operation.

Danger Arising From Loss of Ground

Upon loss of the protective-ground connection, all accessible conductive parts can render an electrical shock.

Use the Proper Fuse

To avoid fire hazard, use only the fuse of correct type, voltage rating, and current rating as specified in the parts list for your product.

Refer fuse replacement to qualified service personnel.

Do Not Operate in Explosive Atmospheres

To avoid explosion, do not operate this product in an explosive atmosphere unless it has been specifically certified for such operation.

Do Not Operate Without Covers

To avoid personal injury, do not operate this product without covers or panels installed.

SERVICE SAFETY SUMMARY

FOR QUALIFIED SERVICE PERSONNEL ONLY

Refer also to the preceding Operators Safety Summary.

Do Not Service Alone

Do not perform internal service or adjustment of this product unless another person capable of rendering first aid and resuscitation is present.

Disconnect power before removing protective panels, soldering, or replacing components.

Use Care When Servicing With Power On

Dangerous voltages exist at several points in this product. To avoid personal injury, do not touch exposed connections and components while power is on.

Power Source

This product is intended to operate from a power source that will not apply more than 250 V rms between the supply conductors or between either supply conductor and ground. A protective ground connection by way of the grounding conductor in the power cord is essential for safe operation.

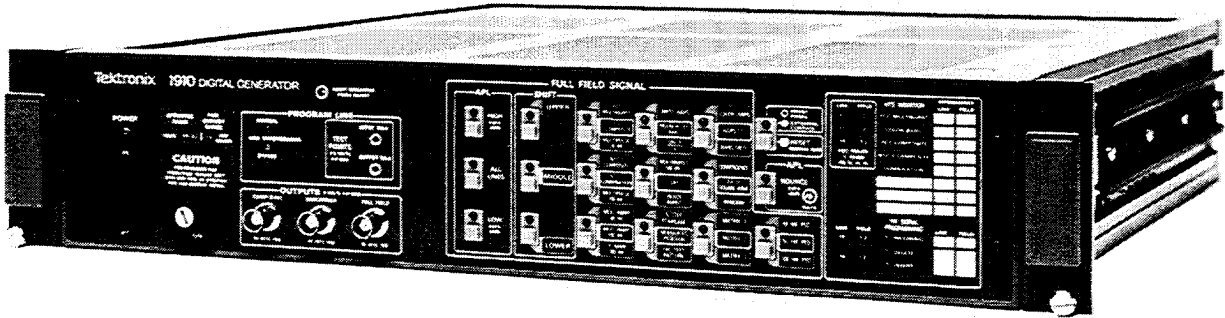

(A) Rackmount Version.

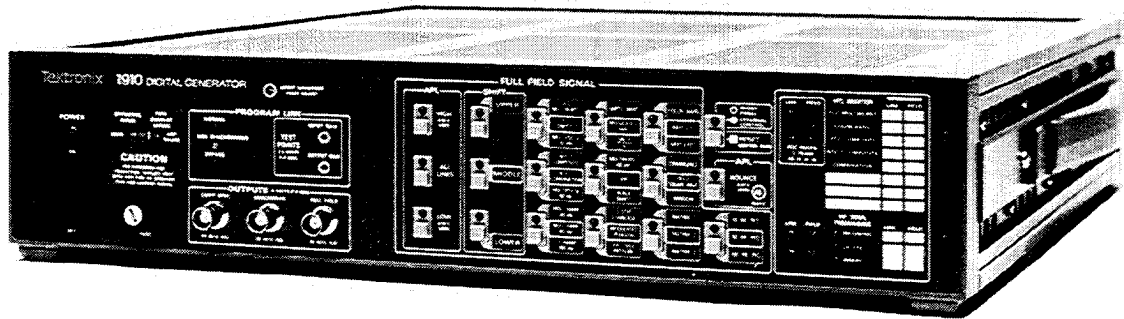

(B) Cabinet Version.

4523-00

Fig. 1-1. The 1910 Digital Generator.

SPECIFICATION

INTRODUCTION

Reference Documentation

The following documents were used as references in the preparation of this Operators Manual.

UL 1244—Standard for Electrical and Electronics Measuring and Testing Equipment.

FCC Rules and Regulations, Section 73.676(f) and Figures 13, 14, and 15 of Section 73.699 for Remote Control Monitoring of Television Broadcast Transmitters.

RS-170A—Color Television Studio Picture Line Amplifier Output.

RS-189 EIA STANDARD—Encoded Color Bar Signals.

RS-232-C EIA STANDARD—Interface Between Data Terminal Equipment and Data Communications Equipment Employing Serial Binary Data Interchange.

Proposed SMPTE Standard for a Composite Parallel Digital Video Interface.

ANSI Y1.1—1972, Abbreviations.

Product Description

The TEKTRONIX 1910 DIGITAL GENERATOR (see Fig. 1-1) is a high quality test instrument capable of providing a variety of test signals useful for testing NTSC video systems or discrete parts of the systems. The test signals generated are available from the FULL FIELD OUTPUT as field information. Also, most of the test signals are available as Vertical Interval Test Signals (VITS) inserted on the incoming Program Line Signal.

A non-volatile memory maintains selected VITS and Full Field Signals after a power-line interruption. There is a provision for insertion of up to four external VITS for such services as Teletext and closed captioning. If external VITS is not needed, this provision can be replaced with a Pulse Output board that provides four signals: H Drive, V Drive, Comp Blanking, and Burst Flag.

The test signals generated by the 1910 are derived from information stored in sets of PROMs. This provides several advantages. Test signal format changes are accomplished by replacing the appropriate test signal memory. No recalibration is required and changing industry test signal standards will not cause obsolescence. The other advantage is the exceptional stability of the test signals. This stability means that very little maintenance and recalibration is required.

The 1910 test signals may be genlocked¹ to the incoming Program Signal or to a Black Burst master generator, thus assuring accurate timing and phasing of the output signal. In the absence of burst, the 1910 locks to the leading edge of sync. A front-panel light will illuminate upon loss of sync, indicating a free-running state of the instrument's oscillator. In the free-running state the 1910 oscillator is controlled by a crystal in a constant-temperature oven.

The signals generated by the 1910 are programmed to be SCH (subcarrier-to-horizontal sync) phase referenced. Because of this it is not recommended to genlock the 1910 with a signal where sync and burst are non-synchronous.

The 1910 Digital Generator has remote-control capabilities for some of its functions. The remote-control capabilities may be utilized by either the REMOTE CONTROL interface or the RS-232 CONTROL interface on the rear panel. The 1910 is compatible with other instruments that have RS-232 interface; some examples are: TEKTRONIX 4006 Computer Display Terminal, TEKTRONIX 4010 Computer Display Terminal, TEKTRONIX 4052 Desktop Computer, and TEKTRONIX 1980 ANSWER. (Some hand-held computers and personal or home computers may be compatible with the 1910 RS-232 CONTROL port.)

The 1910 will also accept digital information from an external source through the DIGITAL INPUT connector to generate test signals. A DIGITAL OUTPUT connector provides access to the 10-bit words that are being used to generate the Full Field Signals.

¹Synchronization of signal in both frequency and phase.

SPECIFICATION

The performance requirements listed here apply over an ambient temperature range of 0°C to +50°C after a warm-up time of 20 minutes. The rated accuracies are valid when this instrument is calibrated at +20°C to +30°C after a warm-up time of ten minutes minimum.

Test equipment used in verifying performance requirements must be calibrated and working within the limits specified under Table 3-1, Recommended Test Equipment, provided in Section 3, Performance Check Procedure, of the Service Manual.

Items listed in the Performance Requirements column of the Electrical Characteristics tables are verified by completing the Performance Check in Section 3 of the Service Manual, unless specifically stated otherwise. Items listed in the Supplemental Information column may not be verified in either manual; they are either explanatory notes or performance characteristics for which no limits are specified.

The Performance Check Step No. column lists the specific step number of the Performance Check procedure in Section 3 of the Service Manual that checks the appropriate Performance Requirement items.

**Table 1-1
PROGRAM SIGNAL PATH/VITS INSERTER**

Characteristics	Performance Requirements	Supplemental Information	Perf. Ck. Step. No.
Program Line Input			
Input Level		1 V (0.7 to 1.4 V)	
Input Impedance	75 Ω nominal		53
Return Loss			
Power On	At least 46 dB to 5 MHz		53
Power Off/Bypass	At least 40 dB to 5 MHz		53
Program Line Out Program Monitor Out			
Impedance	75 Ω nominal		53
Return Loss	At least 36 dB to 5 MHz		53
Hum Rejection	At least 10 dB. Referenced to 1 V hum.	Jumper selectable to 20 dB. Requires unique test equipment capable of inserting 1 V hum on the program line.	15
Keyboard (no noise)	Less than 0.25 IRE		9
Video Gain	Unity Gain ±0.5%		1
DC Blanking Output Level	0 V ±100 mV		8
VITS Pedestal Offset from Blanking			
0 V Hum	2 mV or less		10
1 V Hum	10 mV or less	Requires unique test equipment capable of inserting 1 V hum on the program line.	

Table 1-1 (cont)

Characteristics	Performance Requirements	Supplemental Information	Perf. Ck. Step. No.
Isolation Program Line to Program Monitor	At least 40 dB to 5 MHz	Referenced to 1 V	2
Pulse-to-Bar Ratio			
T/2	100% \pm 2%		3
T	100% \pm 0.5%		3
2T	100% \pm 0.25%		3
Pulse and Bar Aberrations			
T/2	2% or less		4
T	0.5% or less		4
2T	0.25% or less		4
Waveform Tilt			
Field Tilt (Field Rate Square Wave)	0.5% or less		5
Bar Tilt (25 μ s Bar)	0.5% or less		5
Differential Phase (10—90 APL)	0.15° or less		22
Differential Gain (10—90 APL)	0.2% or less		23
Inserted VITS			
Differential Phase	0.4° or less		
Differential Gain	0.7% or less		
Amplitude Nonlinearity	0.25% or less		6
Frequency Response	\pm 0.5% to 5 MHz \pm 1% to 10 MHz \pm 3% to 15 MHz		11
Random Noise Output	At least 75 dB (rms) down	Referenced to 1 V. 5 MHz low-pass filter and a noise weighting filter into a rms meter.	18
Residual Subcarrier	At least 60 dB down	Referenced to 1 V. 5 MHz low-pass filter into an oscilloscope.	12
Hum	At least 60 dB down	Referenced to 1 V. 5 MHz low-pass filter into an oscilloscope.	16

Table 1-1 (cont)

Characteristics	Performance Requirements	Supplemental Information	Perf. Ck. Step. No.
Spurious Signals During Blanking			
Up to 5 MHz	At least 40 dB down (10 mV or less)	Insertion transient	17
Above 5 MHz	At least 46 dB down (5 mV or less)	Clock noise	17
Delete Mode Signal Attenuation			
2T Pulse	At least 70 dB down	Referenced to 0.714 V	14
Subcarrier	At least 60 dB down	Referenced to 0.714 V	14
Crosstalk (Internal to Program Line)			
2T	At least 70 dB down	Referenced to 0.714 V	13
Subcarrier	At least 60 dB down	Referenced to 0.714 V	13
Insert Delay Range	$\pm 8 \mu\text{s}$, (16 μs total)	In 70 ns increments (internal DIP switch)	19
INSERT SUBCARRIER PHASE ADJUST RANGE	Minimum 10° total	Continuously adjustable over 70 ns (internally)	21
Instrument Delay		25 ns typical. Input to output delay.	
Insertion Width	$9.8 \mu\text{s} \pm 100 \text{ ns}$ to $10.9 \mu\text{s} \pm 100 \text{ ns}$	Front Porch (jumper selectable): 1.6 μs to 1.32 μs nominal. Back Porch (jumper selectable): 8.46 μs , 8.74 μs , 9.02 μs , or 9.3 μs nominal.	20

Table 1-2
GENLOCK FUNCTION

Characteristics	Performance Requirements	Supplemental Information	Perf. Ck. Step No.
Genlock Input (via PROGRAM IN or BLACK BURST IN)			
Burst Amplitude	40 IRE \pm 6 dB		25
Phase Change with APL		For 1° or less phase change over 10% to 90% APL.	
Sync Amplitude	40 IRE \pm 6 dB		25
Return Loss			
BLACK BURST IN	At least 46 dB to 5 MHz		53
Genlock Performance			
Burst Lock	3.579545 MHz \pm 20 Hz	0.00056%	
If Burst Not Present	Clock is referenced to leading edge of sync.		
Sync Lock	15.73426 kHz \pm 0.079 Hz	Requires unique test equipment capable of measuring 0.079 Hz sync frequency offset.	
If Sync and Burst Not Present		Clock is referenced to temperature-controlled crystal oscillator.	
Oscillator (Free Running)			
Subcarrier Frequency	3.579545 MHz \pm 10 Hz	Digitally derived from 14.3 MHz clock.	26
Sync Frequency	15.73426 kHz \pm 0.04 Hz	Digitally derived from 14.3 MHz clock. Locked to subcarrier by 455/2 ratio.	
Jitter	5 ns or less		27

**Table 1-3
EXTERNAL VITS INPUT**

Characteristics	Performance Requirements	Supplemental Information	Perf. Ck. Step No.
Maximum Input	± 1 V peak	Ac plus dc.	
Input Impedance	75 Ω nominal		
Return Loss	At least 40 dB to 5 MHz	Power on and off.	53
Insertion Level	± 5 mV	Referenced to External VITS In blanking level.	42
Insertion Gain	Unity ± 1%		43
Frequency Response	Flat within 1% to 5 MHz	-3 dB at 8 MHz	44
Pulse-to-Bar Ratio			
2T	100% ± 1%		45
T	100 ± 2%		45
Pulse and Bar Aberrations			
2T	Less than 0.5%		45
T	Less than 1%		45
Differential Phase	0.5° or less	10 to 90% APL. Blanking at 0 Vdc.	48
Differential Gain	0.5% or less	10 to 90% APL. Blanking at 0 Vdc.	49
Amplitude Non-linearity	0.5% or less		47
Line-Time Tilt	1% or less		46
External Input Isolation	Greater than 60 dB to 5 MHz		50
Switching Transients	Less than 10 mV p-p to 5 MHz	(Switching transient at insertion time.)	51
	Less than 5 mV above 5 MHz	(Generator clock noise.)	51

Table 1-4
TEST SIGNALS—FULL FIELD & VITS

Characteristics	Performance Requirements	Supplemental Information	Perf. Ck. Step. No.
AC BOUNCE	0 to 100 IRE on 4 out of 5 lines	Refer to FIELD SQ WAVE Amplitude specification.	7
Bounce Frequency	Adjustable from approximately 1 Hz to greater than 1/30 Hz.		7
BOUNCE & APL		Selected full-field signal on one line with the Bounce or APL signal on the next four lines.	
Amplitude	100 IRE \pm 0.7 IRE		28
Rise Time	250 ns \pm 25 ns		
Line Timing	See Fig. 1-2A.		
FIELD SQ WAVE			
Field Timing			
Lines (White)	Lines 72 to 202		
Lines at Blanking		All remaining active lines.	
Field Tilt	0.5% maximum		34
Line Tilt	0.5% maximum		33
Amplitude	100 IRE \pm 0.7 IRE		28
Rise Time	250 ns \pm 25 ns		
Line Timing	See Fig. 1-2A.		
WINDOW/FIELD BAR			
White Bar Amplitude	100 IRE \pm 0.7 IRE		
Rise Time	250 ns \pm 25 ns		
Field Tilt	0.5% maximum		
Line Tilt	0.5% maximum		
Field Timing	Lines 72 to 202	Window only	
Line Timing	See Fig. 1-2B.		
FCC MULTIBURST/ MULTIBURST 100			
White Reference Bar Amplitude	100 IRE \pm 0.7 IRE		
Rise Time	250 ns \pm 25 ns		
Multiburst Packets	FCC MB	MB 100	
Amplitude	60 IRE, \pm 1 IRE, p-p	100 IRE \pm 2 IRE, p-p	
Average Level	40 IRE \pm 1 IRE	50 IRE \pm 1 IRE	

Table 1-4 (cont)

Characteristics	Performance Requirements		Supplemental Information	Perf. Ck. Step. No.
Frequencies	500 kHz 1.25 MHz 2.0 MHz 3.0 MHz 3.58 MHz 4.1 MHz		Digitally derived from 14.3 MHz clock.	
Packet Rise Time			The packets are envelope shaped.	
500 kHz	140 ns ± 14 ns			
The Remaining	400 ns ± 40 ns			
Harmonic Content	At least 40 dB down			
Line Timing	See Fig. 1-2C.			
MULTIPULSE 70/100				
70	70 IRE ± 0.7 IRE white reference bar. 10 IRE ± 0.5 IRE pedestal level.			
100	100 IRE ± 0.7 IRE white reference bar. No pedestal.			
70 and 100				
Rise Time	250 ns ± 25 ns			
Pulse-to-Bar Ratio	100% ± 1%			
Pulse Half Amplitude Duration				
2T HAD	250 ns ± 25 ns			
25T HAD	3.14 μs ± 0.3 μs			
12.5T HAD	1.57 μs ± 150 ns			
Modulated Pulse Frequencies	MP 70	MP 100	The first pulse HAD is 25T, and the remaining pulse HADs are 12.5T. All pulses are digitally derived from 14.3 MHz clock.	
1st Pulse	1.25 MHz	1.0 MHz		
2nd Pulse	2 MHz	2 MHz		
3rd Pulse	3 MHz	3 MHz		
4th Pulse	3.58 MHz	3.58 MHz		
5th Pulse	4.1 MHz	4.2 MHz		
Group Delay	10 ns or less			31
Other Perturbations on Baseline	0.5 IRE or less.			
Line Timing	See Figs. 1-2D and 1-2E.			

Table 1-4 (cont)

Characteristics	Performance Requirements	Supplemental Information	Perf. Ck. Step. No.
COLOR MULTIPULSE			
White Reference Bar			
Amplitude	100 IRE \pm 0.7 IRE		
Rise Time	250 ns \pm 25 ns		
Pulse-to-Bar Ratio	1:1 \pm 1%		
Pulse Half Amplitude Duration			
2T HAD	250 ns \pm 25 ns		
12.5T HAD	1.57 μ s \pm 150 ns		
Modulated Pulse Frequencies			
1st	2.379545 MHz	HAD for all modulated pulses is 12.5T. All pulses digitally derived from 14.3 MHz clock. Phase of the 5th pulse is 327°.	
2nd	2.679545 MHz		
3rd	2.979545 MHz		
4th	3.279545 MHz		
5th	3.579545 MHz		
6th	3.879545 MHz		
7th	4.179545 MHz		
8th	4.479545 MHz		
9th	4.779545 MHz		
Group Delay	10 ns or less		31
Other Baseline Perturbations	0.5 IRE or less		
Line Timing	See Fig. 1-2F.		
SPECIAL MULTIPULSE			
White Reference Bar			
Amplitude	100 IRE \pm 0.7 IRE	This signal occupies two adjacent television lines.	
Rise Time	250 ns \pm 25 ns		
Pulse-to-Bar Ratio	1:1 \pm 1% for pulses to 5 MHz		
			30

Table 1-4 (cont)

Characteristics	Performance Requirements	Supplemental Information	Perf. Ck. Step. No.
5.5 MHz		Typically -3%.	
6.0 MHz		Typically -7.5%.	
Pulse Half Amplitude Duration			
2T HAD	250 ns ± 25 ns		
12.5T HAD	1.5 μs ± 150 ns		
25T HAD	3.14 μs ± 0.3 μs		
Modulated Pulse Frequencies			
First Line			
1st Pulse	1.0 MHz	First two pulses are 25T HAD. Last three pulses are 12.5T HAD. All pulses are digitally derived from 14.3 MHz clock.	
2nd Pulse	1.5 MHz		
3rd Pulse	2.0 MHz		
4th Pulse	2.5 MHz		
5th Pulse	3.0 MHz		
Second Line			
1st Pulse	3.5 MHz	All pulses are 12.5T HAD and digitally derived.	
2nd Pulse	4.0 MHz		
3rd Pulse	4.5 MHz		
4th Pulse	5.0 MHz		
5th Pulse	5.5 MHz		
6th Pulse	6.0 MHz		
Group Delay	10 ns or less for pulses of 5 MHz or less.		31
5.5 MHz Pulse		20 ns typical.	
6.0 MHz Pulse		100 ns typical.	
Line Timing	See Fig. 1-3A.		

Table 1-4 (cont)

Characteristics	Performance Requirements			Supplemental Information	Perf. Ck. Step. No.
COLOR BARS Luminance and Chrominance	Absolute amplitudes of luminance signal, setup, and sync are within 1% or 1.5 mV, whichever is greater, with respect to blanking. Chrominance amplitudes are within 1% of their given value.				
75% Amplitude, 7.5% Setup	LUM (mV)	CHROMA P-P (mV)	Phase (degrees)		
Full Field & SMPTE BARS					
White	714.3	1.0 or less			
Gray	549.1	1.0 or less			
Yellow	494.6	444.2	167.1		
Cyan	400.4	630.1	283.4		
Green	345.9	588.5	240.8		
Magenta	256.7	588.5	60.8		
Red	202.2	630.1	103.4		
Blue	108.1	444.2	347.1		
Full Field Black	53.6	1.0 or less			
IYQB -I	53.6	285.7	303.0		
IYQB White Ref	714.3	1.0 or less			
IYQB Q	53.6	285.7	33.0		
IYQB + Pluge	82.1				
IYQB - Pluge	25.0				
Luminance Rise Time					
Full Field	250 ns \pm 25 ns				
SMPTE	140 ns \pm 15 ns				

Table 1-4 (cont)

Characteristics	Performance Requirements	Supplemental Information	Perf. Ck. Step. No.
Chrominance Rise Time			
-I	250 ns ± 25 ns		
Q	833 ns ± 80 ns		
All Others	400 ns ± 40 ns		
Bar Duration			
Full Field		6.5 μs/bar (8 bars).	
SMPTE		7.5 μs/bar (7 bars).	
Time Difference Between Luminance and Chrominance	20 ns or less		
Residual Subcarrier	At least 52 dB below 1 V White, Black		40
Spurious Subcarrier	At least 52 dB below 1 V		
Other Spurious Outputs	At least 52 dB below 1 V, except 40 dB for 2nd harmonic		41
Field Timing			
FULL FIELD COLOR BARS		241 lines per field.	
BARS/Y (Full Field Color Bars)		Modulated bars first 181 active lines per field; unmodulated bars last 60 lines of the field.	
BARS/RED (Full Field Color Bars)		Same as for BARS/Y except last 60 lines of the field are red.	
SMPTE BARS		EIA Color Bars first 161 active lines per field; Reverse Blue Bars for 20 lines; and IYQB with Pluge for the last 60 lines of field.	
Line Timing			
FULL FIELD COLOR BARS	See Fig. 1-3B.		

Table 1-4 (cont)

Characteristics	Performance Requirements	Supplemental Information	Perf. Ck. Step. No.
Color Bars for SMPTE BARS or EIA COLOR BARS	See Fig. 1-3C.		
IYQB	See Fig. 1-3D.		
REVERSE BLUE BARS	See Fig. 1-3E.		
RED FIELD			
Luminance		NOTE: These electrical characteristics are the same as for red color bar.	
Amplitude	202.2 mV, $\pm 1\%$ or 1.5 mV, whichever is greater, with respect to blanking.		
Rise Time	250 ns ± 25 ns		
Chrominance			
Amplitude	630.1 mV $\pm 1\%$		
Phase	103.4° $\pm 0.3^\circ$		
Rise Time	400 ns ± 40 ns		
Duration	51.9 μ s		
Line Timing	See Fig. 1-4A.		
FCC/NTC 7 COMPOSITE			
Modulated 5-step Staircase			
Luminance			
Amplitude			
FCC	80.4 IRE ± 0.7 IRE		
NTC 7	90.2 IRE ± 0.7 IRE		
Riser Amplitude	1/5 of 5-step amplitude $\pm 0.5\%$		
Rise Time	250 ns ± 25 ns		

Table 1-4 (cont)

Characteristics	Performance Requirements	Supplemental Information	Perf. Ck. Step. No.
Chrominance			
Phase	Same as burst $\pm 0.3^\circ$		
Amplitude	40 IRE ± 0.5 IRE (3.6 mV)		
Inherent Diff Gain	0.6% or less		38
Inherent Diff Phase	0.3° or less		37
Envelope Rise Time			
FCC	375 ns ± 37.5 ns		
NTC 7	400 ns ± 40 ns		
2T Pulse			
Pulse-to-Bar Ratio	100% $\pm 0.5\%$		30
Half Amplitude Duration (HAD)	250 ns ± 25 ns		
Ringing	1.0 IRE or less		36
Modulated Sine-Squared Pulse			
Pulse-to-Bar Peak Amplitude	100% $\pm 0.5\%$		
Half Amplitude Duration (HAD)	1.563 μ s ± 150 ns		
Chrominance-to-Luminance Delay	10 ns or less		
Chrominance-to-Luminance Gain Inequality (RCL)	± 0.5 IRE ($\pm 1\%$)		
Other Perturbations on Baseline	0.5 IRE or less		
Harmonic Distortion of Subcarrier	At least 40 dB down		41
Phase	$60.8^\circ \pm 1^\circ$		

Table 1-4 (cont)

Characteristics	Performance Requirements	Supplemental Information	Perf. Ck. Step. No.
Bar			
Amplitude	100 IRE \pm 0.7 IRE		
Rise Time			
FCC	250 ns \pm 25 ns		
NTC 7	125 ns \pm 15 ns		
Line Timing			
FCC	See Fig. 1-4B.		
NTC 7	See Fig. 1-4C.		
MODULATED BAR			
White Reference Bar			
Amplitude	100 IRE \pm 0.7 IRE		
Rise Time	250 ns \pm 25 ns		
Pulse-to-Bar	1:1 \pm 1%		
Pulse Half Amplitude Duration			
12.5 HAD	1.57 μ s \pm 180 ns		
2T HAD	250 ns \pm 25 ns		
12.5 Modulated Pulse			
Frequency	3.579545 MHz	Digitally derived from 14.3 MHz clock.	
Phase	327° \pm 1°		
Modulated Bar Chrominance			
Amplitude	100 IRE \pm 1 IRE		
Rise Time	1.56 μ s \pm 100 ns		
Frequency	3.579545 MHz	Digitally derived from 14.3 MHz clock.	

Table 1-4 (cont)

Characteristics	Performance Requirements	Supplemental Information	Perf. Ck. Step. No.
Phase	$33^\circ \pm 1^\circ$		
Luminance Amplitude	50 IRE \pm 0.5 IRE		
Group Delay	Equal to or less than 10 ns		
Baseline Perturbations	0.5 IRE or less		
Line Timing	See Fig. 1-4D.		
INVERTED PULSE & BAR			
Reference Bar			
Amplitude	100 IRE \pm 0.7 IRE		
Rise Time	250 ns \pm 25 ns		
Pulse-to-Bar Ratio	1:1 \pm 1%		
2T Pulse HAD	250 ns \pm 25 ns		
Baseline Perturbations	0.5 IRE or less		
Timing	See Fig. 1-4E.		
VIRS (Vertical Interval Reference Signal)			
Chrominance Reference			
Amplitude	40 IRE \pm 0.4 IRE		
Phase	Same as burst \pm 0.3°		
Envelope Rise Time Time (Sine-squared shaped)	1 μ s \pm 100 ns		
Average Level of Chrominance Signal	70 IRE \pm 0.7 IRE		
Luminance Reference			
50 IRE Level	50 IRE \pm 0.5 IRE		
Black Reference	7.5 IRE \pm 0.5 IRE		
Line Timing	See Fig. 1-4F.		

Table 1-4 (cont)

Characteristics	Performance Requirements	Supplemental Information	Perf. Ck. Step. No.
VICR (Vertical Internal Color Reference)		Removed S/N B023197.	
Chrominance Reference			
Amplitude	100 IRE \pm 1 IRE		
Phase	Same as burst within \pm 0.3°		
Envelope Rise Time	1 μ s \pm 100 ns	Sine-squared shape	
Average Level Chrominance Signal	50 IRE \pm 0.5 IRE		
Luminance Reference			
100 IRE Level	100 IRE \pm 0.7 IRE		
Black Reference	7.5 IRE \pm 0.5 IRE		
Line Timing	See Fig. 1-5A.		
BLACK BURST, 10/25/ 50/100 IRE PED Pedestal			
Amplitudes			
BLACK	7.5 IRE \pm 0.5 IRE		
10 IRE	10 IRE \pm 0.5 IRE		
25 IRE	25 IRE \pm 0.5 IRE	Removed S/N B023197.	
50 IRE	50 IRE \pm 0.5 IRE		
100 IRE	100 IRE \pm 0.5 IRE		
Rise Time	250 ns \pm 25 ns		
Tilt	0.5% or less		
Line Timing	See Fig. 1-5B.		
GCR Positive (Ghost Cancellation Reference, Positive)		Added S/N B023197.	
Pedestal Amplitude	30 IRE \pm 0.5 IRE		
Chrominance Amplitude	80 IRE \pm 1 IRE		
Spectrum	Flat to 4.1 MHz. -3 dB at 4.3 MHz		
Line Timing	See Fig. 1-6D.		
GCR Negative (Ghost Cancellation Reference, Negative)		Added S/N B023197.	
Pedestal Amplitude	30 IRE \pm 0.5 IRE		
Chrominance Amplitude	80 IRE \pm 1 IRE		
Spectrum	Flat to 4.1 MHz. -3 dB at 4.3 MHz		
Line Timing	See Fig. 1-6E.		
GCR (Ghost Cancellation Reference) for Options	See individual Appendix sections.		

Table 1-4 (cont)

Characteristics	Performance Requirements	Supplemental Information	Perf. Ck. Step. No.
MOD PED (Modulated Pedestal)			
Pedestal			
Amplitude	50 IRE \pm 0.5 IRE		
Rise Time	250 ns \pm 25 ns		
Tilt	0.5% or less		
Chrominance			
Amplitudes			
20 IRE	20.01 IRE p-p, \pm 0.5 IRE		
40 IRE	40.02 IRE p-p, \pm 0.5 IRE		
80 IRE	80.04 IRE p-p, \pm 0.5 IRE		
Phase			
Relative to Burst	90° within 0.3°		
Relative to the Other Two	0° within 0.5°		
Harmonic Distortion	At least 40 dB down		
Rise Time	400 ns \pm 40 ns		
Line Timing	See Fig. 1-5C.		
5-STEP STAIRCASE, MODULATED 5 STEP			
Luminance			
Amplitude	100 IRE \pm 0.7 IRE		
Linearity	\pm 0.5% of total amplitude	Any step amplitude will match any other by 0.5 IRE.	29
Rise Time	250 ns \pm 25 ns		
Chrominance			
5-STEP STAIRCASE	No modulation		

Table 1-4 (cont)

Characteristics	Performance Requirements	Supplemental Information	Perf. Ck. Step. No.
MODULATED 5 STEP (each step)			
Amplitude	40 IRE \pm 0.5 IRE		
Rise Time	400 ns \pm 40 ns		
Phase	180°		
Line Timing	See Fig. 1-5D.		
10-STEP STAIRCASE, MODULATED 10 STEP			
Luminance			
Amplitude	100 IRE \pm 0.7 IRE		
Linearity	1/10 of 10-step amplitude \pm 0.5%		
Rise Time	250 ns \pm 25 ns		
Chrominance			
10-STEP STAIRCASE	No modulation		
MODULATED 10 STEP (Each Step)			
Amplitude	40 IRE \pm 0.5 IRE		
Rise Time	400 ns \pm 40 ns		
Phase	Same as burst		
Line Timing	See Fig. 1-5E.		
$\frac{\sin x}{x}$ Spectrum			
	Flat within \pm 0.2 dB to 4.5 MHz. –3 dB at 4.75 MHz.		
Main Pulse Zero Crossing	210 ns \pm 21 ns		
Small Lobe Zero Crossing	105 ns \pm 15 ns		
Bar Rise Time	250 ns \pm 25 ns		
Line Timing	See Fig. 1-5F.		

Table 1-4 (cont)

Characteristics	Performance Requirements	Supplemental Information	Perf. Ck. Step. No.
MOD RAMP 80/100, Y RAMP 100			
Luminance Amplitudes			
MOD RAMP 80	0 to 80 IRE \pm 0.7 IRE		
MOD RAMP 100, Y RAMP 100	0 to 100 IRE \pm 0.7 IRE		
Slope	1:1	LSB:Sample	
Linearity	Within 1%		
Chrominance			
Amplitude	40 IRE \pm 0.5 IRE		
Inherent Diff Gain	0.6% or less		38
Inherent Diff Phase	0.3° or less		37
Envelope Rise Time	400 ns \pm 40 ns		
Phase	Same as burst within \pm 0.3°		
Line Timing	See Figs. 1-6A & 1-6B.		
NTC 7 COMBINATION			
Multiburst White Reference Bar			
Amplitude	100 IRE \pm 0.7 IRE		
Rise Time	250 ns \pm 25 ns		
Overshoot	1% or less		
Tilt	0.5% or less		
Multiburst Packets			
Amplitude	50 IRE \pm 0.5 IRE p-p		
Average Level	50 IRE \pm 0.5 IRE		

Table 1-4 (cont)

Characteristics	Performance Requirements	Supplemental Information	Perf. Ck. Step. No.
Frequencies	500 kHz 1.0 MHz 2.0 MHz 3.0 MHz 3.58 MHz 4.2 MHz	Digitally determined from 14.3 MHz.	
Packets Rise Time		The packets are envelope shaped as indicated.	
500 kHz, 1 MHz	140 ns \pm 14 ns		
Remaining Packets	400 ns \pm 40 ns		
Harmonic Content	40 dB down		
Modulated Pedestal			
Pedestal			
Amplitude	50 IRE \pm 0.5 IRE		
Rise Time	250 ns \pm 25 ns		
Tilt	0.5% or less		
Chrominance			
Amplitude			
20 IRE	20.01 IRE \pm 0.5 IRE		
40 IRE	40.02 IRE \pm 0.5 IRE		
80 IRE	80.04 IRE \pm 0.6 IRE		
Phase			
Relative to Burst	90° \pm 0.5°		
Relative to the Other Two Levels	0° \pm 0.3°		
Harmonic Distortion	At least 40 dB down		
Rise Time	400 ns \pm 40 ns		
Line Timing	See Fig. 1-6C.		

Table 1-4 (cont)

Characteristics	Performance Requirements	Supplemental Information	Perf. Ck. Step. No.
CONVERGENCE			
Peak Level	77.0 IRE \pm 1 IRE		
Crosshatch Vertical Lines			
Number of Un-blanked Pulses	17 per active line		
Pulse Polarity	Positive		
Line Pulse HAD	225 ns \pm 25 ns		
Dot Pulse HAD	350 ns \pm 35 ns		
Crosshatch Horizontal Lines			
Number of Un-blanked Pulses	14 per frame		
Pulse Polarity	Positive		
Line Pulse Rise Time	140 ns \pm 15 ns		
Line Pulse Duration	2 lines (1 line on each field)		
Dot Pulse	3 lines (1 line on one field and 2 lines on the other field)		
EYE TEST PATTERN			
Amplitude	68 IRE	This signal occupies two adjacent television lines. The second line is of opposite phase. High = 70 IRE, Low = 2 IRE	
Rise & Fall Times	100 ns \pm 25 ns	Sine-squared shape.	
Bit Period	174.6 ns/bit	5.727272 MHz bit rate.	
Bit Sequence	16 cycles at 2.86 MHz 8 cycles at 1.43 MHz 5 cycles at 954 kHz 4 cycles at 716 kHz 4 cycles at 573 kHz 3 cycles at 477 kHz 2 cycles at 409 kHz 2 cycles at 358 kHz 1 cycle at 716 kHz 1 cycle at 954 kHz 2 cycles at 1.43 MHz 2 cycles at 2.86 MHz		

Table 1-4 (cont)

Characteristics	Performance Requirements		Supplemental Information	Perf. Ck. Step. No.
EYE PATTERN REFERENCE SIGNAL			This signal occupies two adjacent TV lines. The second line is of opposite phase.	
Amplitude	68 IRE		High = 70 IRE, Low = 2 IRE	
Rise & Fall Times	100 ns \pm 25 ns		Sine-squared shape.	
Bit Period	174.6 ns/bit		5.727272 MHz bit rate.	
Bit Sequence	144 cycles at 2.86 MHz			
MATRIX 1	Signal	Lines	Customer definable.	
	MOD 10 STEP	21-103		
	COLOR BARS	104-182		
	RED FIELD	183-262		
MATRIX 2	MOD RAMP 100	21-87	Customer definable.	
	EIA BAR	88-151		
	REV. BLUE BAR	152-202		
	MULTIPULSE 100	203-262		
MATRIX 3	CONVERGENCE	21-54	Customer definable.	
	EIA BAR	55-87		
	REV. BLUE BAR	88-103		
	CONVERGENCE	104-151		
	IYQB	152-214		
	CONVERGENCE	215-262		

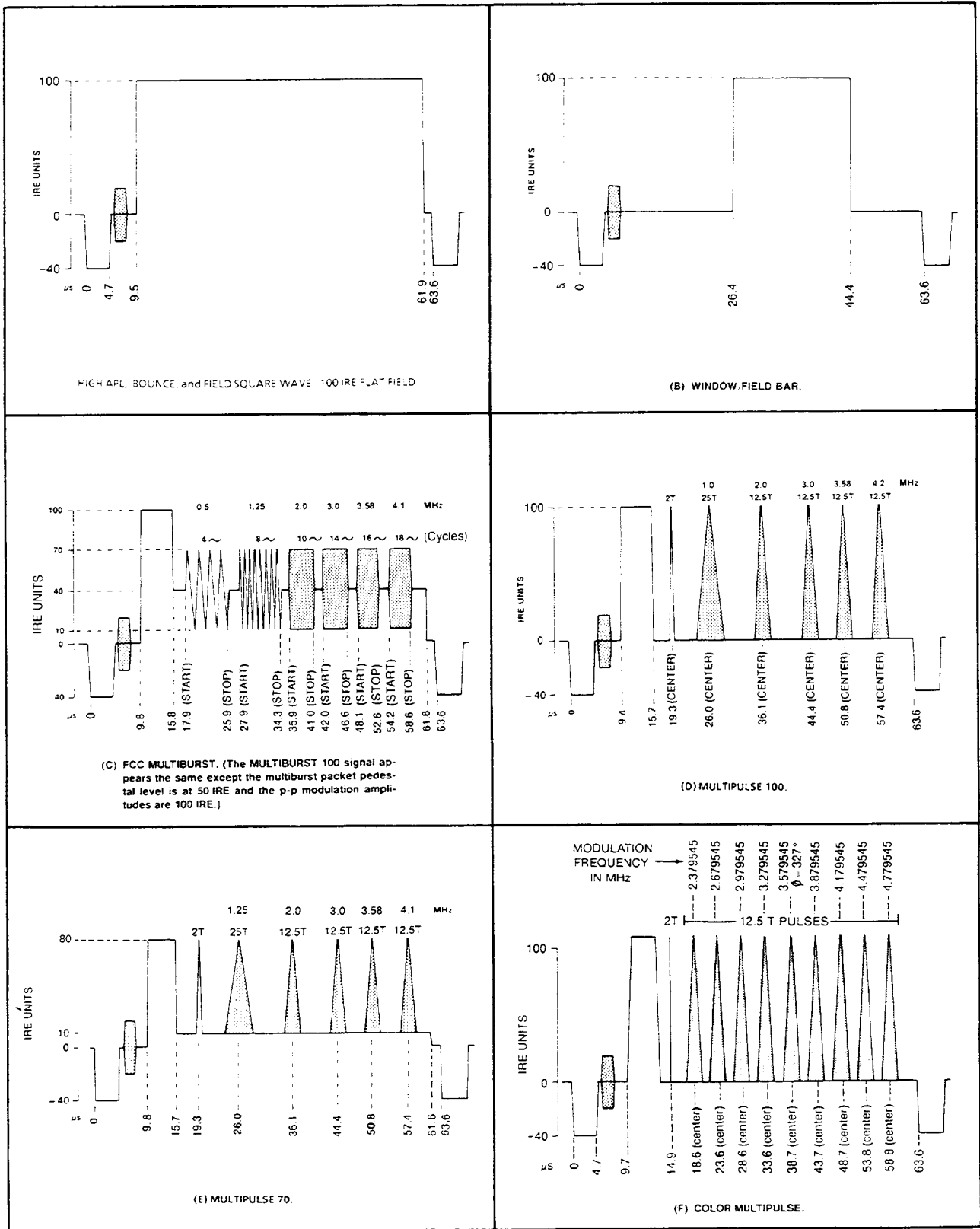

Fig. 1-2. Test Signals With Amplitude and Timing Details.

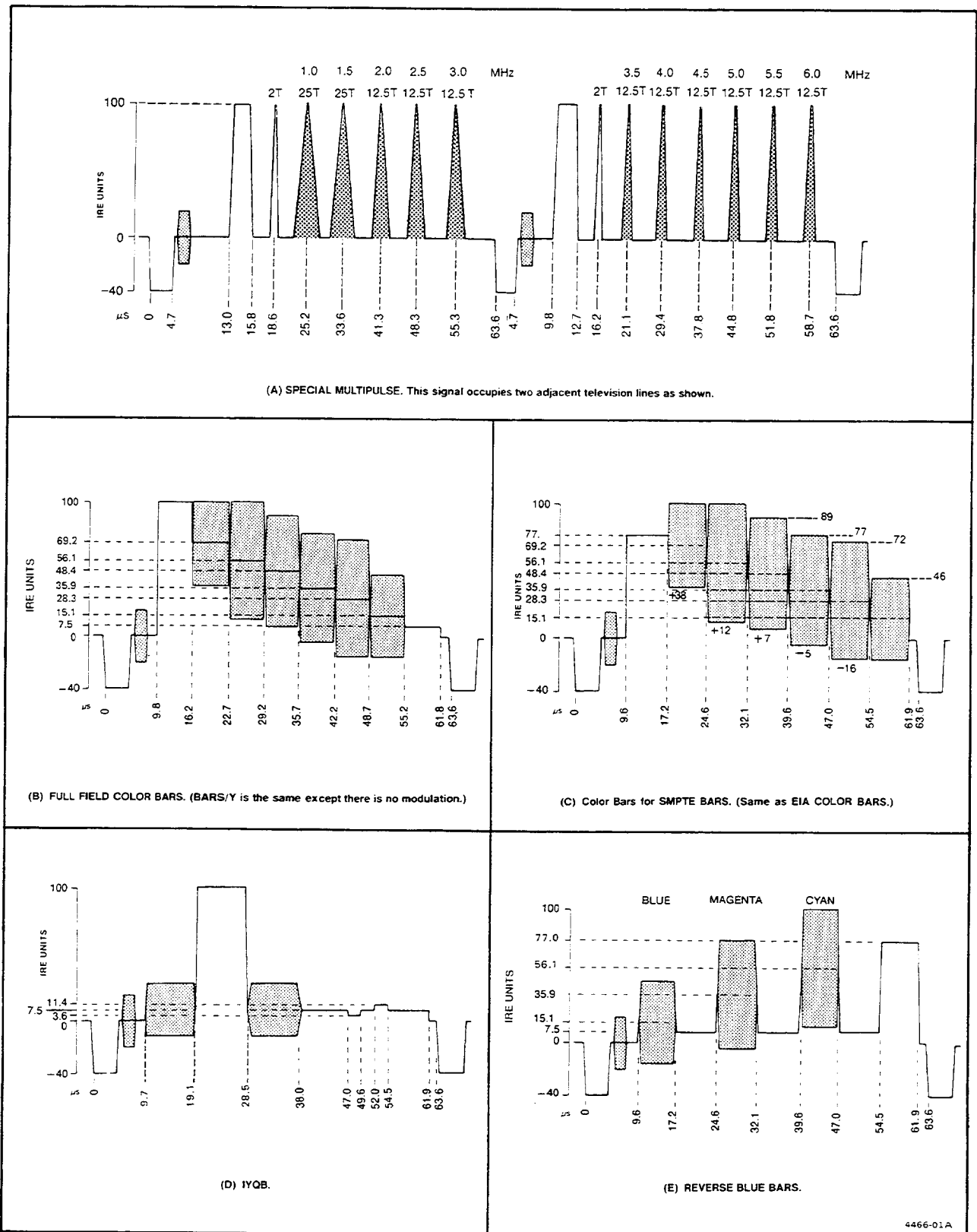

Fig. 1-3. Test Signals With Amplitude and Timing Details.

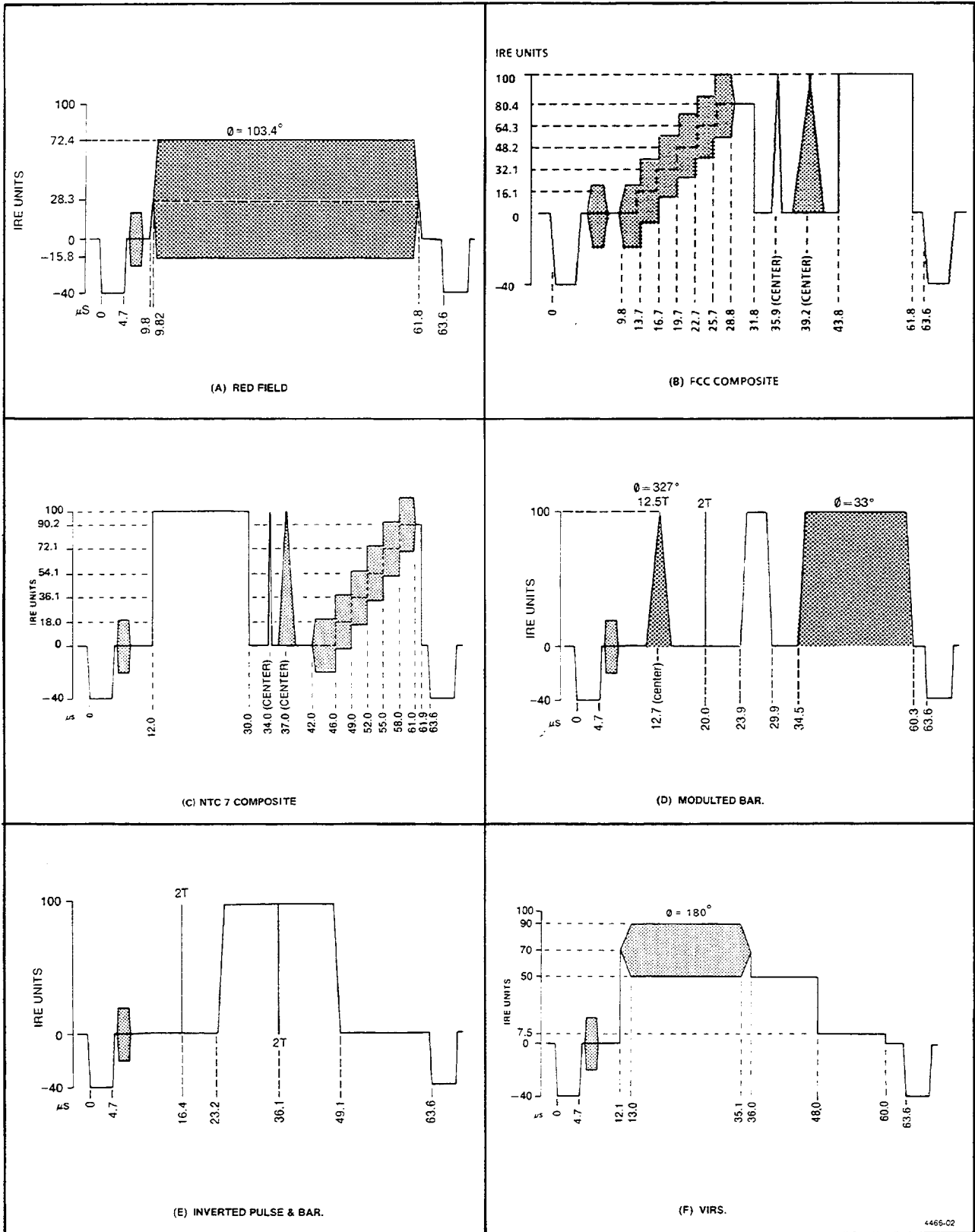

Fig. 1-4. Test Signals With Amplitude and Timing Details.

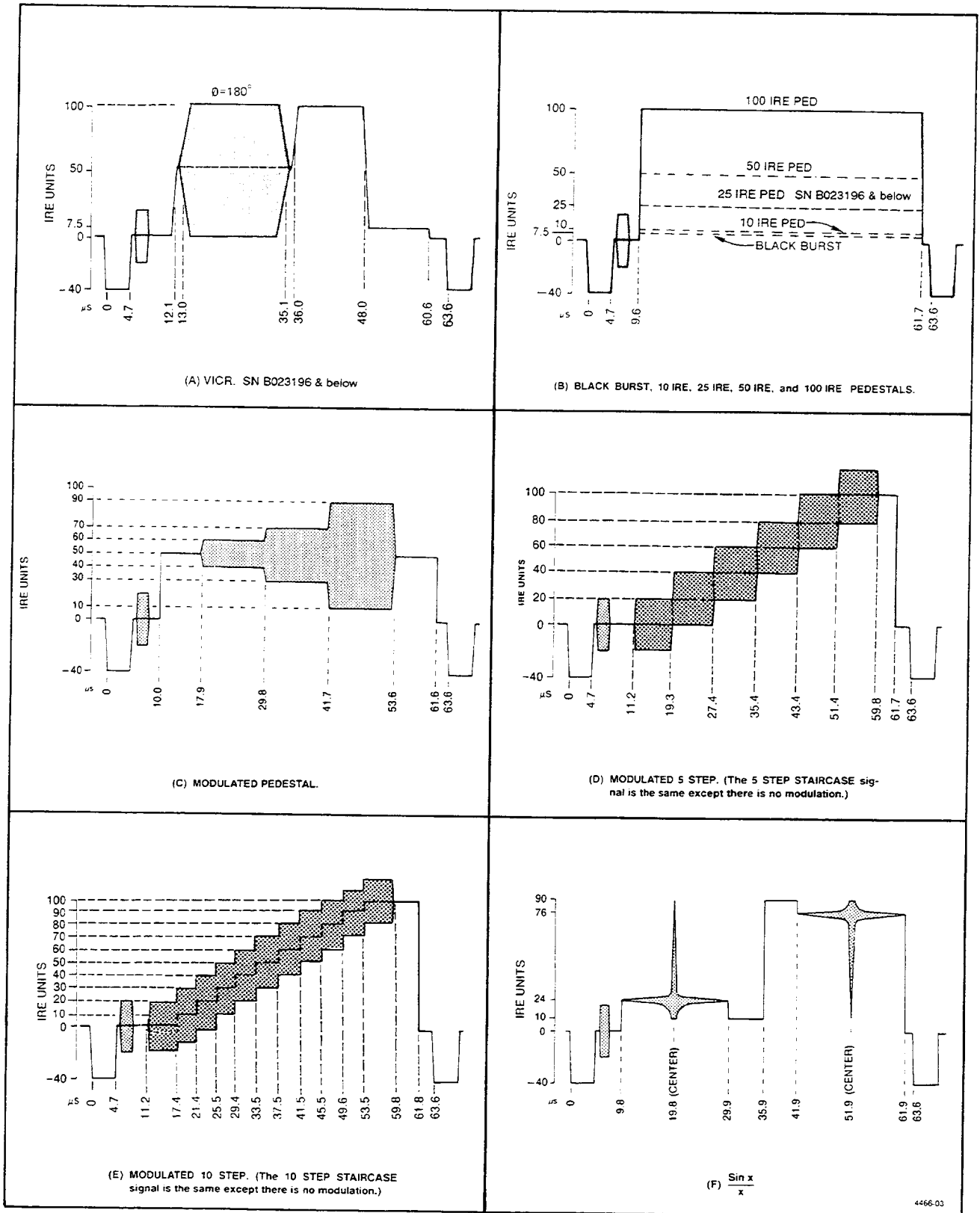

Fig. 1-5. Test Signals With Amplitude and Timing Details.

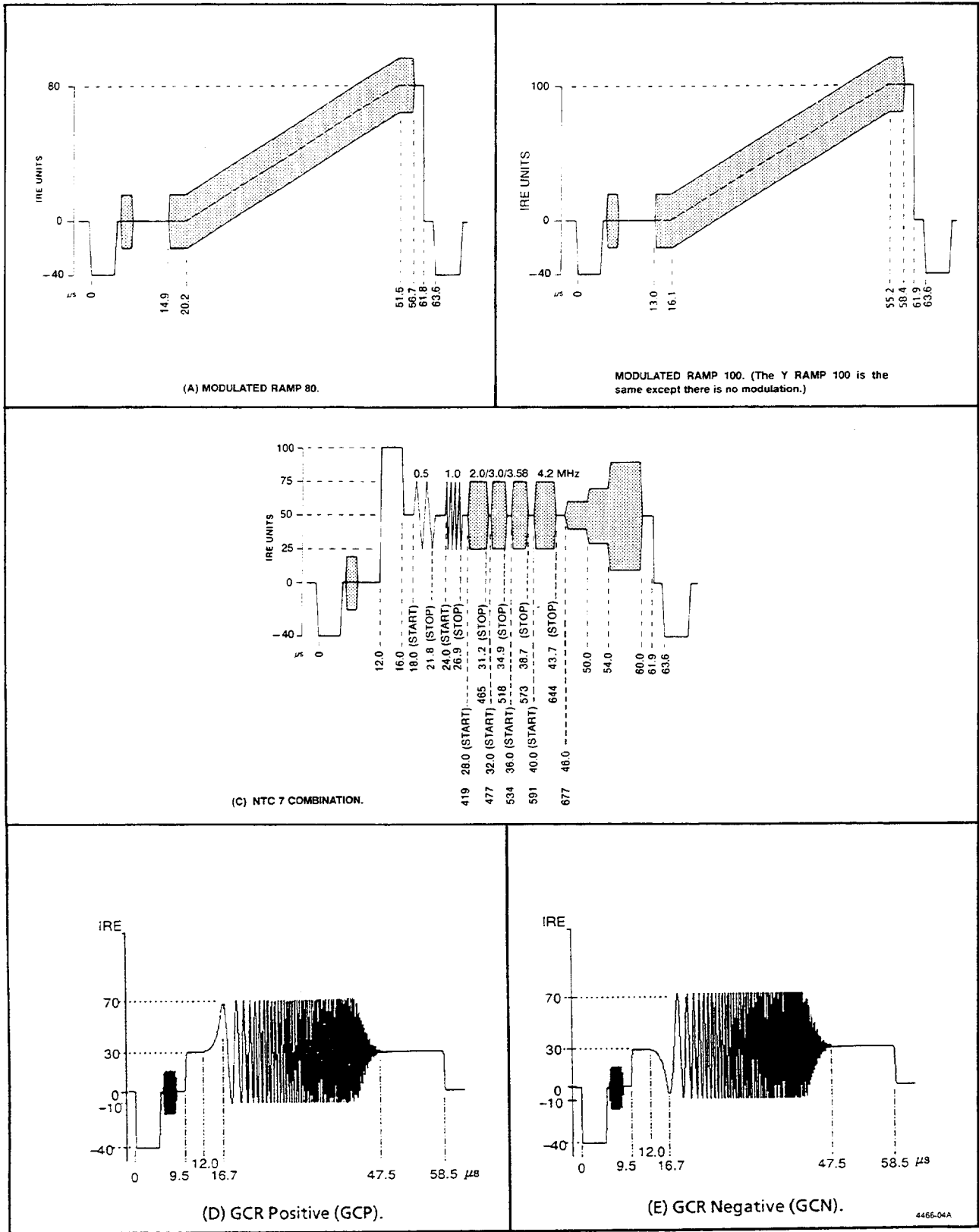

Fig. 1-6. Test Signals With Amplitude and Timing Details.

Table 1-5
TEST SIGNALS—FULL FIELD OUTPUT
(Sync & Burst)

Characteristics	Performance Requirements	Supplemental Information	Perf. Ck. Step. No.
Amplitude	1.2 V maximum p-p into 75 Ω		
Sync	285.7 mV \pm 2 mV		
Peak Level	714.3 mV \pm 5 mV		28
Blanking Level			
DAC DC Restorer On	0 V \pm 2 mV		40
DAC DC Restorer Off	0 V \pm 50 mV		40
Field Period	16.68 ms	Digitally determined from 14.3 MHz.	
Line Period	63.56 μ s		
Sync Rise & Fall Time	140 ns \pm 15 ns	10% to 90% amplitude.	
Sync Timing	See Fig. 1-7.		
Front Porch	1.7 μ s \pm 100 ns using a 100 IRE pedestal	Digitally determined from 14.3 MHz.	
Line Blanking Interval	11.28 μ s \pm 100 ns at 20 IRE points using a 100 IRE Pedestal		
Breezeway	0.6 μ s, \pm 50 ns, at 50% of sync to 50% of burst amplitude		
Back Porch Duration	4.83 μ s, \pm 50 ns, at 50% of sync to 20 IRE using a 100 IRE pedestal		
Line Sync	4.7 μ s, \pm 50 ns, at 50% amplitude point		
Vertical Serration	See Fig. 1-8.		

Table 1-5 (cont)

Characteristics	Performance Requirements	Supplemental Information	Perf. Ck. Step. No.
Duration	4.7 μ s, \pm 50 ns, at 50% amplitude point		
Sequence		Three lines.	
Period	262.5 lines	Digitally determined from 14.3 MHz.	
Equalizing Pulse			
Duration	2.33 μ s, \pm 50 ns, at 50% amplitude point		
Sequence		Three lines.	
Burst			
Rise & Fall Time	400 ns \pm 40 ns		
Delay from Line	5.308 μ s \pm 35 ns	19 cycles of subcarrier.	
Half-Amplitude Duration of Envelope	2.51 μ s \pm 100 ns	9 cycles of subcarrier.	
Amplitude	285.7 mV \pm 8.57 mV		
Residual Subcarrier (Luminance & Blanking)	At least 52 dB below 1 V (2.5 mV)	As viewed on a 1480 Waveform Monitor	40
Spurious Subcarrier on Outputs	At least 52 dB below 1 V (2.5 mV)		40
Chrominance Subcarrier Frequency			
Free Running	3.579545 MHz \pm 10 Hz		26
Locked Mode		Locked to incoming burst; locked to the leading edge of sync if burst is not present.	
Output Impedance	75 Ω nominal		
Return Loss	At least -36 dB to 5 MHz		53
Isolation (Front- & Rear-Panel Outputs)	At least -40 dB		35

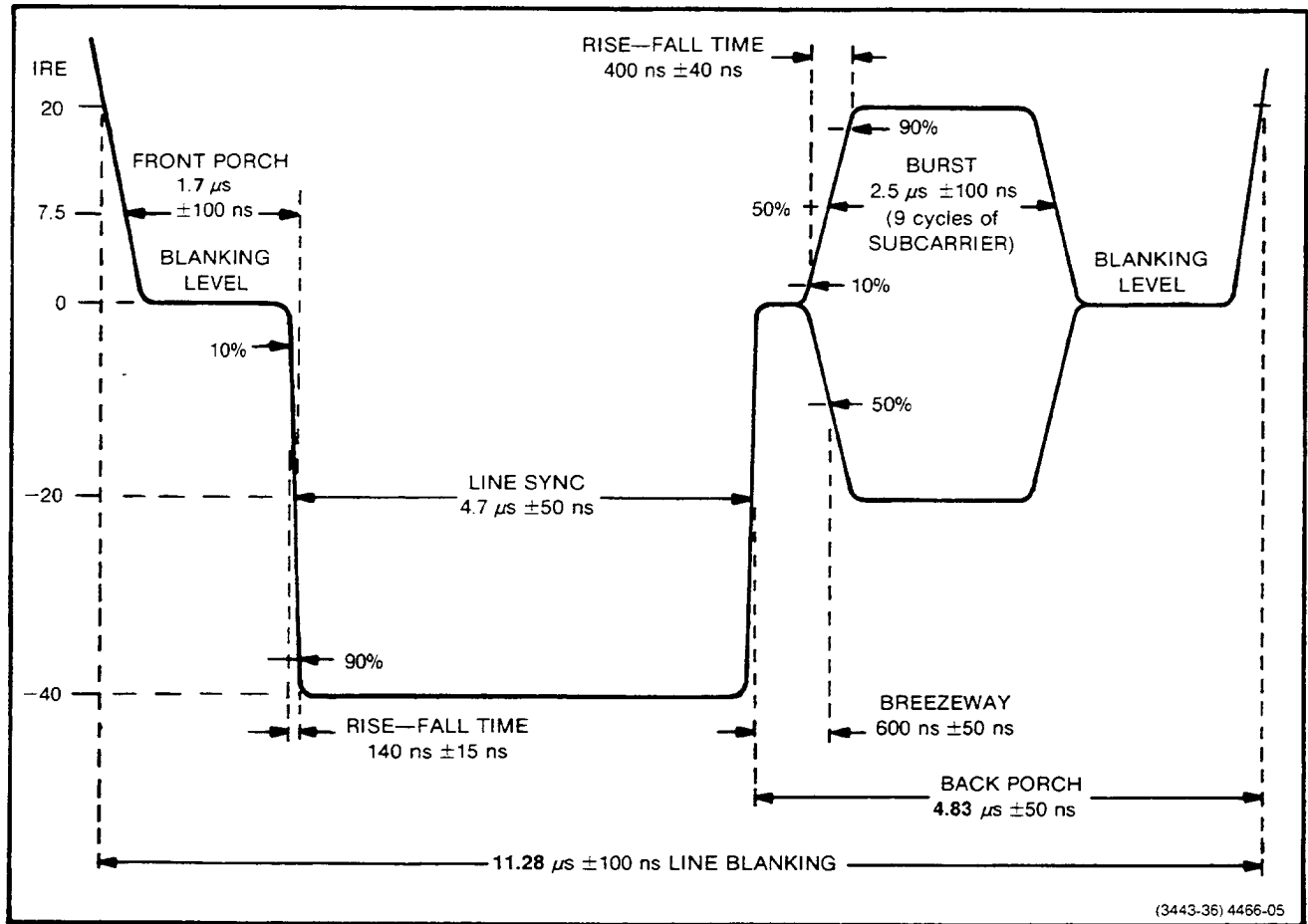

(3443-36) 4466-05

Fig. 1-7. Horizontal Blanking Details.

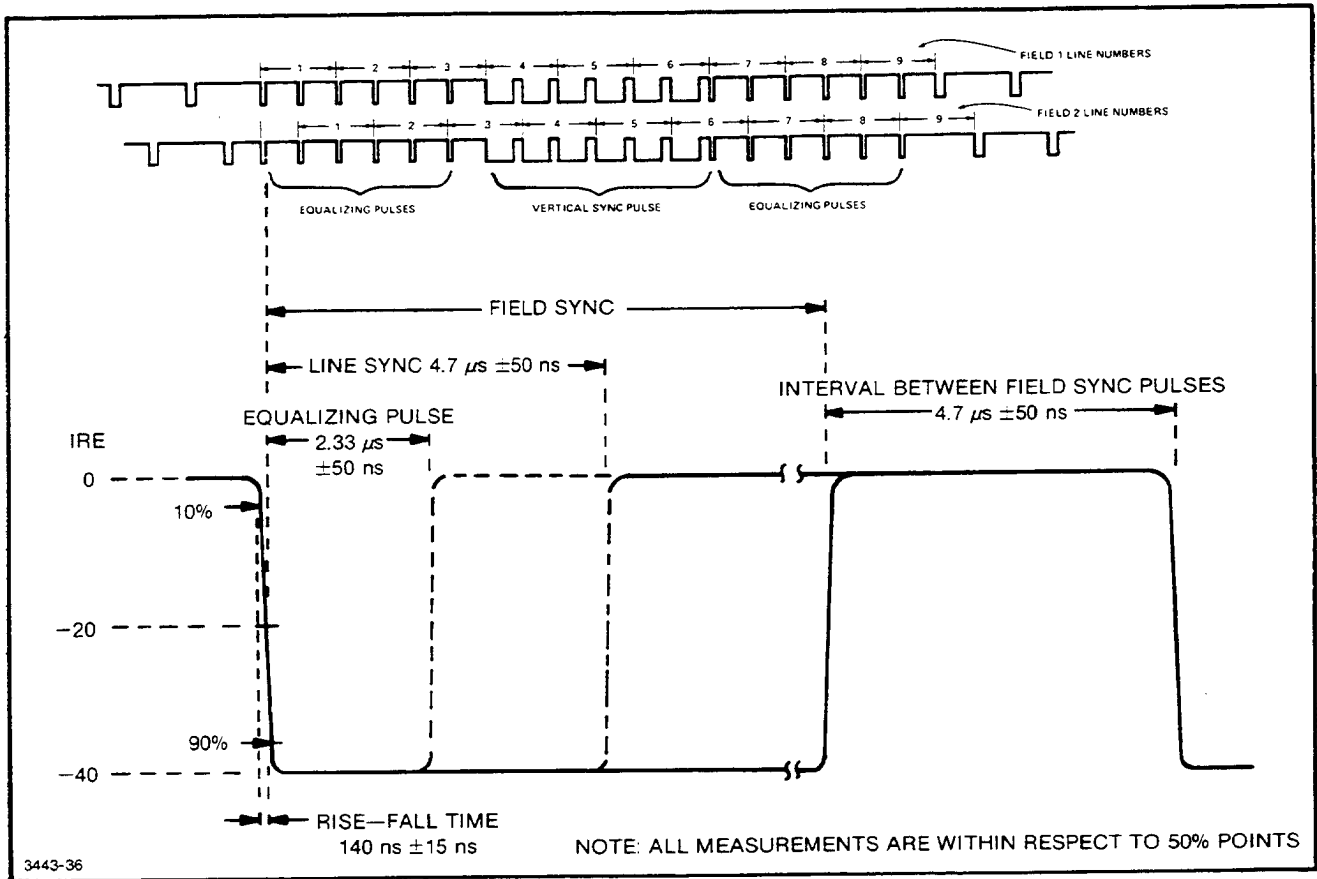

Fig. 1-8. Composite Sync Details.

Table 1-6
SYNC & SUBCARRIER

Characteristics	Performance Requirements	Supplemental Information	Perf. Ck. Step. No.
COMPOSITE SYNC			
Amplitude	4 V \pm 10% p-p, negative going, into 75 Ω		
Rise & Fall Times	140 ns \pm 20 ns	Measured from 10% to 90% amplitude points.	
Return Loss	At least 30 dB to 3.58 MHz		53
Line Period		Nominal (H) = $\frac{63.556 \mu\text{s}}{\frac{1}{\text{Subcarrier X 2}}}$ 455	
Line Sync Duration	4.7 μs \pm 50 ns	Measured at 50% amplitude point.	
Equalizer Pulse			
Duration	2.3 μs \pm 50 ns	Measured at 50% amplitude point.	
Sequence Duration		Three lines each.	
Vertical Sync Pulse			
Serration	4.7 μs \pm 50 ns		
Sequence Duration		Three lines.	
Field Period	262.5 H Lines	16.6835 ms nominal.	
SUBCARRIER			
Amplitude	2 V p-p \pm 10%	Into 75 Ω .	
Return Loss	At least 30 dB into 5 MHz		53
Frequency		Locked to incoming burst. If burst is not present, locked to leading edge of incoming sync. If sync is not present, determined by an internal oven-controlled oscillator.	25

Table 1-6 (cont)

Characteristics	Performance Requirements	Supplemental Information	Perf. Ck. Step. No.
Pulse Outputs ^a	H DRIVE, V DRIVE, BURST FLAG, & COMP BLANKING		
Amplitude	4 V ± 10% p-p, negative going, into 75 Ω		
Rise & Fall Times	140 ns ± 20 ns	Measured from 10% to 90% amplitude points.	
Return Loss	At least 30 dB to 5 MHz		
Timing			
H DRIVE Duration	Start of line blanking to end of line sync ± 100 ns		52
V DRIVE Duration	Nine lines	Coincident with beginning of field. Blanking extends nine lines.	52
BURST FLAG			
Delay from Line Sync	5.3 μs ± 100 ns		52
Duration	2.5 μs	9 cycles of subcarrier.	52
COMP BLANKING			
Line Blanking Duration	11.1 μs ± 100 ns		52
Front Porch	1.5 μs ± 100 ns	Leading edge of comp sync to end of line blanking is 9.6 μs ± 100 ns.	52
Field Blanking Duration		Field 1 = 21 lines Field 2 = 21 lines Start: 1.5 μs ± 100 ns before leading edge of first equalizing pulse.	52

^aAvailable when the Pulse Output board, A15 (a standard accessory), is installed in place of the External VITS board, A17.

Table 1-7
RS-232 CONTROL PORT INTERFACE

Characteristics	Performance Requirements	Supplemental Information	
Interface ^a		Supports EIA Standard RS-232-C format to the extent shown below.	
Baud	300, 1200, 2400, and 4800 bits/sec	Selectable through the RS-232 port.	
Input	Serial Asynchronous Data	Full duplex input and output.	
Output	Serial Asynchronous Data		
Data Code	ASCII		
Character Length	Eleven bits per character, including a start and two stop bits.		
Parity		No parity is required; and, if present, it is ignored.	
Input			
Output	No parity is sent.		
Keyboard Syntax		See Section 5 of this manual.	

^aThe control lines used in the 1910 are listed below:

Pin	Function	Input or Output
1	Protective Ground	
2	Receive Data	Input
3	Transmit Data	Output
4	Request to Send	Input
5	Clear to Send	Output
6	Data Set Ready	Output
7	Signal Ground	
8	Received Line Signal Detector (Data Carrier Detect)	Output
20	Data Terminal Ready	Input

Table 1-8
DIGITAL INPUT INTERFACE

Characteristics	Performance Requirements	Supplemental Information	Perf. Ck. Step. No.
Digital Format		Parallel, 12 balanced signal pairs consisting of 10 data bits per sample, a clock, and a timing reference signal.	
Encoding Format		Positive binary	
Sampling Frequency	4 times color subcarrier. Nominally 14.31818 MHz		
Sampling Phase Angle		Referenced to I and Q axis.	
Input Logic Levels Terminated in 100 Ω	High: -1.10 to -0.81 V Low: -1.85 to -1.48 V	At 25°C. 10K ECL compatible.	
Dynamic Range 10 bits/sample	Blanking level (0 IRE) is at digital word 240. Reference white (100 IRE) is at digital word 800 (5.6 LSB/IRE).		
Setup Time	Data needs to be valid at least 10 ns before the 50% point of the negative transition of the clock pulse.		
Hold Time	Data needs to be valid for at least 10 ns after the 50% point of the negative transition of the clock pulse.		

Table 1-9
DIGITAL OUTPUT INTERFACE

Characteristics	Performance Requirements	Supplemental Information	Perf. Ck. Step. No.
Digital Format		Parallel, 12 balanced signal pairs consisting of 10 data bits per sample, a clock, and a timing reference signal.	
Timing Reference Signal		See Fig. 1-9.	
Encoding Format	Positive Binary		
Sampling Frequency	4 times color subcarrier nominal (14.31818 MHz)		
Sampling Phase Angle		Referenced to I and Q axis.	
Output Logic Levels	10K ECL compatible. High: -0.96 to -0.81 V Low: -1.85 to -1.65 V	At 25°C.	
Dynamic Range 10 bits/sample	Blanking level (0 IRE) is at digital word 240. Reference white (100 IRE) is at digital word 800 (5.6 LSB/IRE).		
Clock Timing	The 50% point of the leading edge of the clock pulse precedes the data by 5 ns \pm 5 ns.		

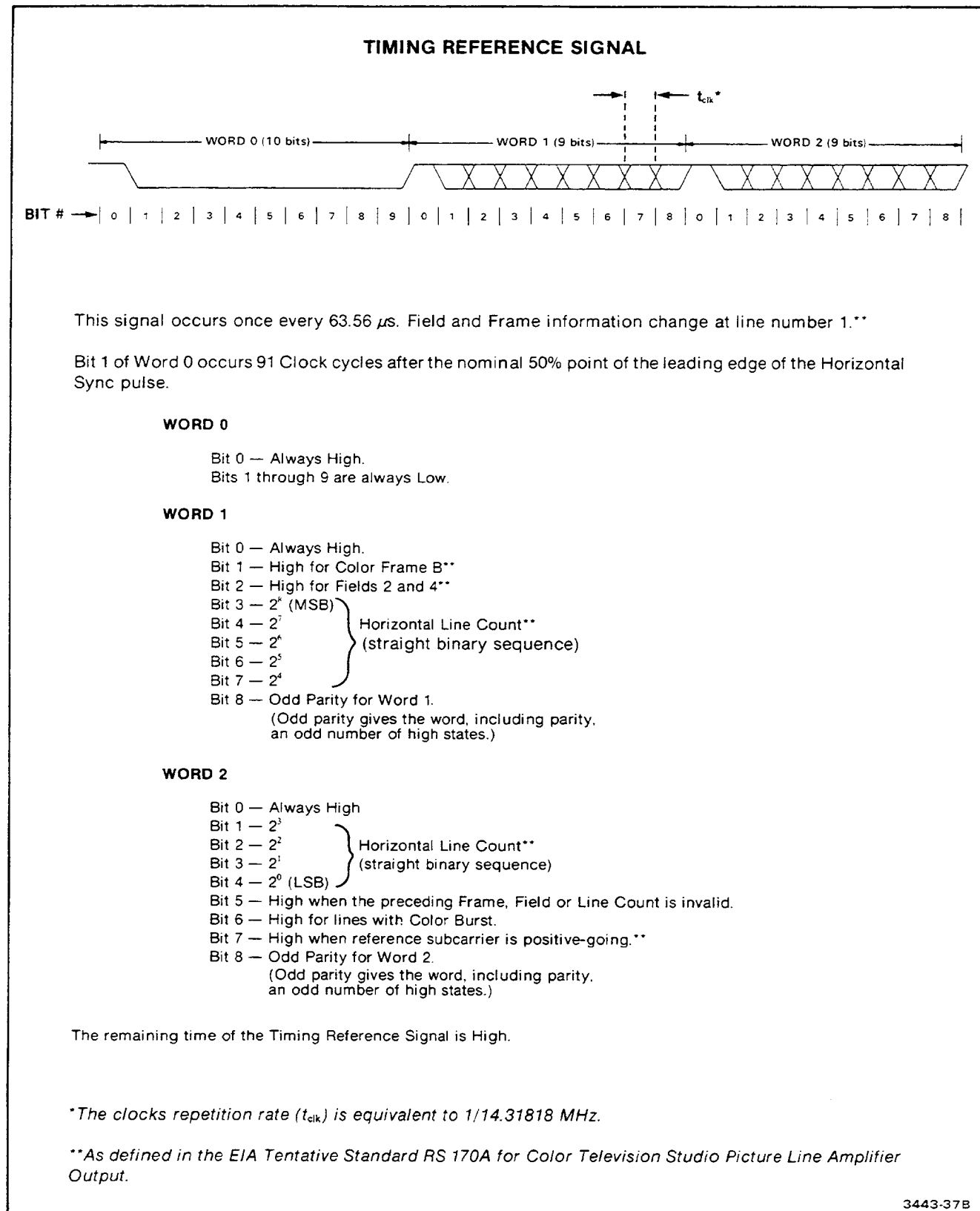

Fig. 1-9. Timing Reference Signal Details.

Table 1-10
POWER SUPPLY

Characteristics	Performance Requirements	Supplemental Information	Perf. Ck. Step. No.
Supply Accuracy			
+15 V		15 V \pm 50 mV	
+5 V Analog		5 V \pm 50 mV	
+5 V Digital		5 V \pm 50 mV	
-5.2 V ECL		-5.2 V \pm 50 mV	
-15 V		-15 V \pm 25 mV	
Current Limit		Nominal	
+15 V		0.7 A	
+5 V Analog		0.5 A	
+5 V Digital		6.5 A	
-5.2 V ECL		2 A	
-15 V		0.8 A	
Supply Ripple		Typical	
+15 V		5 mV	
+5 V Analog		5 mV	
+5 V Digital		5 mV	
-5.2 V ECL		5 mV	
-15 V		5 mV	
Line Voltage Range			
100 Vac	90 Vac to 110 Vac		
110 Vac	99 Vac to 121 Vac		
120 Vac	108 Vac to 132 Vac		
200 Vac	180 Vac to 220 Vac		
220 Vac	198 Vac to 242 Vac		
240 Vac	216 Vac to 250 Vac		
Crest Factor		At least 1.35	
Fuse Data			
100/120 Vac		1.6 A Slow-Blow	
200/240 Vac		0.8 A Slow-Blow	
Maximum Power Consumption		130 W	
Maximum Current at 120 Vac, 60 Hz		1.08 A	
Line Frequency		47 Hz to 63 Hz	

**Table 1-11
PHYSICAL CHARACTERISTICS**

Characteristics	Information
Dimensions	See Fig. 1-10.
Rackmount	
Height	88 mm (3.470 inches)
Width	486 mm (19.134 inches)
Length	525 mm (20.650 inches)
Cabinet	
Height	96 mm (3.770 inches)
Width	442 mm (17.399 inches)
Length	525 mm (20.650 inches)
Net Weight	
Rackmount	12.2 kg (27 lbs)
Cabinet	11.6 kg (25.5 lbs)
Shipping Weight	16.7 kg (37 lbs)

**Table 1-12
ENVIRONMENTAL CHARACTERISTICS**

Characteristics	Information
Temperature	
Non-Operating	-40°C to +65°C.
Operating	0°C to +50°C.
Altitude	
Non-Operating	To 50,000 feet.
Operating	To 15,000 feet.
Vibration	
Operating	15 minutes each axis at 0.015 inch, frequency varied from 10-50-10 c/s in 1-minute cycles with instrument secured to vibration platform. Three minutes each axis at any resonant point or at 50 c/s.
Shock	
Non-Operating	30 g's, 1/2 sine, 11 ms duration, 2 guillotine-type shocks per axis.
Transportation	Qualified under NTSC Test Procedure 1A, Category II (24-inch drop).

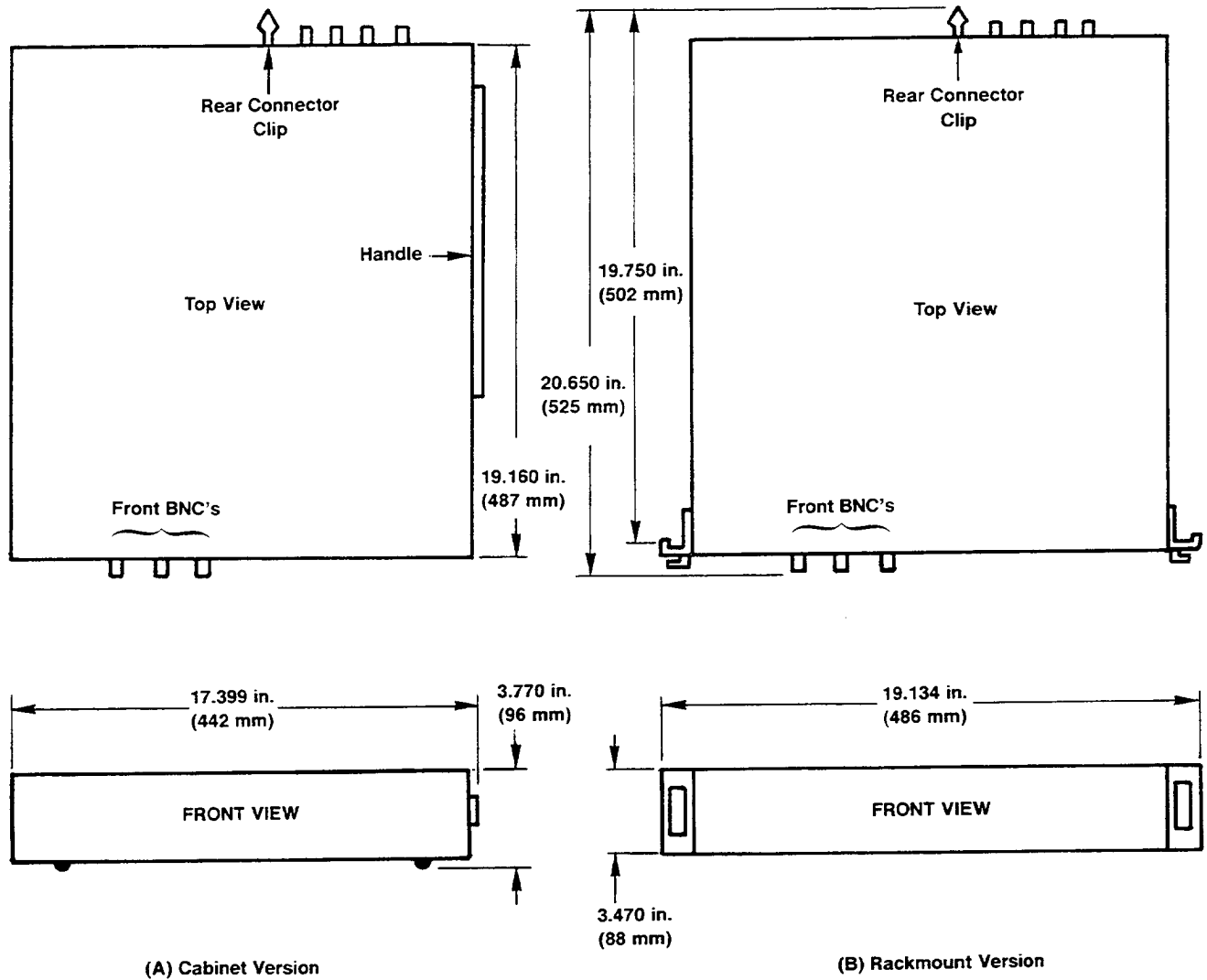

4466-06

Fig. 1-10. Dimensional Illustrations for the 1910.

INSTALLATION

This section describes unpacking, electrical and mechanical installation, power requirements, and repackaging information for the 1910 Digital Generator. The rackmount and cabinet versions of the 1910 are shown in Fig. 1-1 of Section 1.

UNPACKING AND INITIAL INSPECTION

Before unpacking the 1910 from its shipping container or carton, inspect for signs of external damage. If the carton is damaged, notify the carrier. The shipping carton contains the basic instrument and its standard accessories. Optional (non-standard) accessories are shipped in separate containers. Refer to the Accessories listing near the end of this section for more information.

If the contents of the shipping container are incomplete, if there is mechanical damage or defect, or if the instrument does not meet operational check requirements, contact your local Tektronix field office or representative. If the shipping container is damaged, notify the carrier as well as Tektronix, Inc.

The instrument was inspected both mechanically and electrically before shipment. It should be free of mechanical defects and should meet or exceed all electrical specifications. The Operator's Checkout Procedure, Section 4 of this manual, provides information to functionally check for correct operation of the several modes and signal outputs and inputs of the 1910. This check should satisfy the requirements for most receiving and incoming inspections. A detailed electrical performance check procedure is part of the Service Manual instructions.

NOTE

At installation time, save the shipping carton and packing material for repackaging in case reshipment becomes necessary.

REPACKAGING FOR SHIPMENT

If the instrument is to be shipped to a Tektronix Service Center for service or repair, attach a tag to the instrument showing:

1. Owner (with complete address) and the name of an individual at your firm that can be contacted.

2. Instrument serial number and a description of the service required.

Save and reuse the package in which your instrument was shipped. Repackage the instrument in the original manner for maximum protection (see Fig. 2-1). If the original packaging is unfit for use or not available, repackage the instrument as follows:

1. Obtain a carton of corrugated cardboard having inside dimensions of six inches or more than the dimensions of the instrument. This will allow for cushioning. Use a shipping carton that has a test strength of 375 pounds.

2. Surround the instrument with polyethylene sheeting to protect the finish of the instrument.

3. Cushion the instrument on all sides by tightly packing dunnage or urethane foam between carton and instrument. Allow three inches on all sides for cushioning.

4. Seal the carton with shipping tape or industrial stapler.

PREPARATION FOR INSTALLATION

WARNING

Removing or replacing the dust covers on the instrument can be hazardous. They should only be removed by qualified service personnel. Also, if internal jumpers need to be changed, refer such changes to qualified service personnel.

Mains Voltage and Frequency Requirements

The 1910 can be operated from either 110 Vac or 220 Vac nominal mains voltage with a range of 90 to 132 or 180 to 250 Vac, at 47 to 63 Hz. The 1910 is factory set for a range of 108 to 132 Vac; if the mains voltage range needs to be changed, refer to qualified service personnel. The qualified service personnel can find the necessary information in Section 1 of the Service Manual.

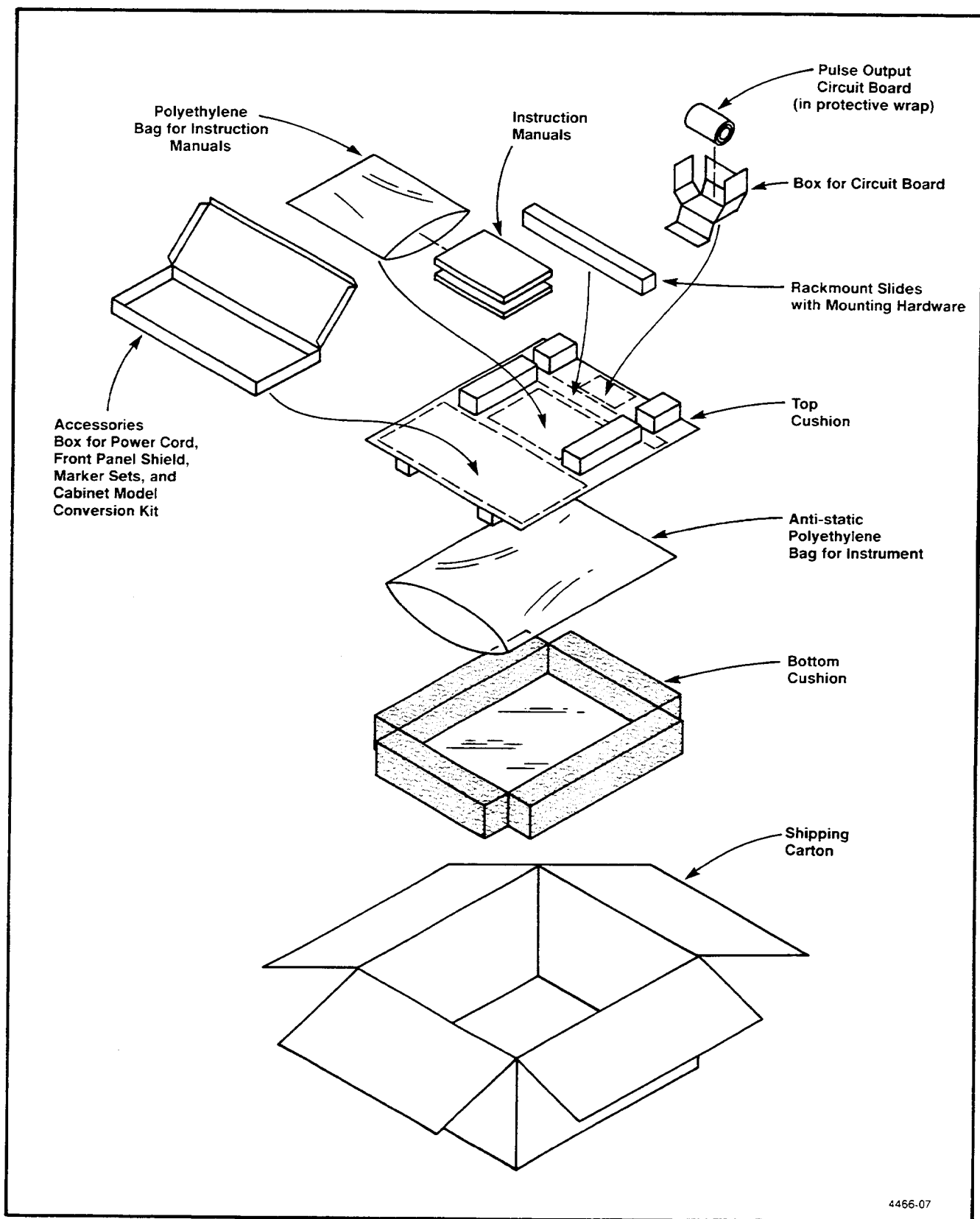

4466-07

Fig. 2-1. Repacking the Instrument and Accessories for Shipment

Power Connections

Check that the 1910 front-panel POWER switch is set to OFF. Connect the appropriate three-wire power-supply cord to the power-cord receptacle. Plug the power cord into the outlet.

Operating Mode Selections

There are a number of operating modes the user can choose to obtain optimum performance from the 1910 in the user's specific system. All operating modes covered in this section are internally set by means of jumpers. Therefore, the changes need to be made by qualified personnel.



If the internal jumpers need to be changed, refer all changes to qualified service personnel.

Jumper Connector Index

Table 2-1 is an index of the jumper connections arranged by board assembly number. Use the table to see at a glance all the selections that are available.

NOTE

Calibration jumpers are also included in Table 2-1 to complete the list. Insertion Delay switch S250 on the Sync & Memory board, A9, is not listed in the table. Its settings are determined during calibration. The service technician can refer to step 15 in Section 4 of the Long-Form Adjustment Procedure in the Service Manual for more information.

Circuit board illustrations, Figs. 8-2, 8-4, 8-5, 8-7, and 8-8, provided on foldout pages in Section 8 of the Service Manual, show the location of the jumper connectors and Insertion Delay switch S250.

**Table 2-1
JUMPER CONNECTORS**

Name of Jumper Connectors	Jumper Positions	Factory Setting & Pins Jumpered		Circuit No.	Circuit Board Name & Assy No.
VITS Offset	Enable-Disable	Enable	1 & 2	P631	VITS/VIRS Inserter Board A6
Clamp Speed	Slow-Fast	Slow	1 & 2	P732	
H Blanking Stop	8.46 μ s, 8.74 μ s, 9.02 μ s, or 9.3 μ s	8.46 μ s	1 & 1	P450	Sync & Memory Board A9
H Blanking Start	1.6 μ s or 1.32 μ s	1.32 μ s	2 & 2	P460	
Burst	μ P Controlled or On	μ P Controlled	1 & 2	P530	
Bounce Trigger	Random, Selected Line, or Vertical Interval	Random	1 & 1	P635	
Transmitter Protect Mode	Regenerated Sync & Burst or Full Field	Full Field	2 & 3	P660	
Memory Option	Normal or RAM	Normal	1 & 2	P760	
Transmitter Protect	μ P Controlled, Disabled, or Enabled	μ P Controlled	1 & 2	P850	
Memory Option Enable	Enable or Normal	Normal	2 & 3	P851	
Sync & Burst Insertion (Proc Amp)	μ P Controlled, Disabled, or Enabled	μ P Controlled	1 & 2	P860	

Table 2-1 (cont)

Name of Jumper Connectors	Jumper Positions	Factory Setting & Pins Jumpered	Circuit No.	Circuit Board Name & Assy No.	
Digital Data Source Control	Internal (TTL) or Remote (ECL/TTL)	Remote (ECL/TTL)	1 & 2	P206	DAC Board A10
External Digital In LSBs	Enable-Disable	Disable	1 & 2	P224	
	Enable-Disable	Disable	1 & 2	P324	
Temp Comp Polarity	(1 & 2) (4 & 5) or (2 & 3) (5 & 6)	See Footnote ^a		P359	
Temp Comp Source	External (1 & 2), Internal	Internal 2 & 3), or Off (2 & 4)	2 & 3	P461	
TRS Source	Switch or Internal Only	Switch	1 & 2	P530	
Clock Source	Switch or Internal Only	Internal Only	2 & 3	P532	
			2 & 3	P534	
			2 & 3	P536	
Digital Output	Enable-Disable	Enable	1 & 2	P607 through P627	
DAC Data Input	Enable-Disable	Enable	1 & 2	P705 through P723	
DC Restorer	Enable-Disable	Enable	1 & 2	P815	
DAC Output	Test-Operate	Operate	2 & 3	P820	
RS-232 Calibrate	Test-Operate	Operate	2 & 3	P115	Microprocessor Board A12
External VITS Disable	Disable-Enable	Disable	1 & 2	P502	External VITS Board A17

^aTest selected. Final position is determined when performing step 34 in Section 4, Adjustment Procedure of the Service Manual.

Operating Mode Description

The following is a description of each jumper connector listed in Table 2-1. The information that follows is arranged by board assembly and circuit number sequence.

A6 VITS/VIRS Inserter Board

P631 VITS Offset—When enabled (pins 1 & 2 connected), the inserted VITS blanking level follows the PROGRAM IN blanking level. When disabled (pins 2 & 3 connected), the inserted VITS blanking level will stay nominally at 0 volts as determined by the Program Output Amplifier.

This jumper should be used in conjunction with the Clamp Speed jumper. When the Clamp Speed is in the fast clamp mode, unwanted offsets may occur at the VITS insertion time. Therefore, the Insertion Offset should be disabled. P631 is factory set in the enabled mode (pins 1 & 2 connected).

P732 Clamp Speed—P732 has a slow (pins 1 & 2 connected) and fast (pins 2 & 3 connected) position for the clamping of the incoming Program Signal. P732 is factory set in the slow clamp position (pins 1 & 2 connected).

A9 Sync & Memory Board

P450 H Blanking Stop—This jumper enables the horizontal blanking width to be changed when sync and burst is inserted on the program line. P450 changes the blanking width by changing the time that horizontal blanking **stops after** the leading edge of sync. There are four positions: 8.46 μs (pins 1 & 1 connected), 8.74 μs (pins 2 & 2 connected), 9.02 μs (pins 3 & 3 connected), or 9.3 μs (pins 4 & 4 connected). P450 is factory set so horizontal blanking **stops** 8.46 μs (pins 1 & 1 connected) **after** the leading edge of sync.

P460 H Blanking Start—This jumper is the same as P450, except the horizontal blanking width can be changed by changing the time that horizontal blanking **starts before** the leading edge of sync. P460 has two positions: 1.6 μs (pins 1 & 1 connected) or 1.32 μs (pins 2 & 2 connected). P460 is factory set so horizontal blanking **starts** 1.32 μs (pins 2 & 2 connected) before the leading edge of sync.

P530 Burst—This jumper has two positions: μP Controlled or On. In the μP Controlled position (pins 1 & 2 connected), burst presence or absence on the full field signal is controlled by the μP (microprocessor) through the RS-232 port. If P530 is set to On (pins 2 & 3 connected) and the 1910 is properly genlocked, burst will always be present on the full field signal. P530 is factory set to the μP Controlled position (pins 1 & 2 connected).

P635 Bounce Trigger—The location at which bounce occurs within the field may be selected from one of the following three alternatives; (a) during the vertical interval (pins 3 & 3 connected), (b) on a selected line within the active portion of the field (pins 2 & 2 connected), or (c) at random locations (pins 1 & 1 connected). P635 is factory set in the random mode (pins 1 & 1 connected).

P660 Transmitter Protect Mode & P850 Transmitter Protect—To prevent overdriving a transmitter, a video signal should always be present at the transmitter input. Often one piece of equipment will be designated to detect the loss of the program signal and insert a new signal in its place. The Transmitter Protect jumper, P850 in the 1910, can be set to automatically bypass the PROGRAM IN to the PROGRAM OUT connector (pins 2 & 3 connected) when the incoming signal loses sync. This allows other equipment to detect the signal loss and to do the appropriate switching of signals. If desired, P850 can be set to the Enabled position (pins 3 & 4 connected) to insert either a full field test signal (pins 2 & 3 connected on P660) or regenerate sync and burst (pins 1 & 2 connected on P660) at the PROGRAM OUT connector if the signal at the PROGRAM IN connector loses sync. Also, if desired, P850 can be set to the μP Controlled position (pins 1 & 2 of P850 connected). In this mode, transmitter protection is controlled through the RS-232 port.

The 1910 is factory set with P850 Transmitter Protect jumper set to the μP Controlled position (pins 1 & 2 connected) and P660 Transmitter Protect Mode jumper set for a full field test signal (pins 2 & 3 connected).

P760 Memory Option—P760 is factory set to the Normal position (pins 1 & 2 connected). The RAM position (pins 2 & 3 connected) is used only when the RAM is inserted at U890, U885, U880, U872, U870, and setup to operate with the Tektronix 1980 Automatic Video Measurement Set.

P851 Memory Option Enable—P851 is factory set to the Normal position (pins 2 & 3 connected). The Enable position (pins 1 & 2 connected) is reserved for future expansion.

P860 Sync & Burst Insertion (Proc Amp)—Internally-processed sync and burst (genlocked to the PROGRAM IN signal) can be inserted in place of the PROGRAM LINE IN sync and burst; this is the Enabled position (pins 3 & 4 connected). Sync and burst insertion can be turned off (pins 2 & 3 connected) or controlled by the μP (pins 1 & 2 connected). P860 is factory set to the μP Controlled position (pins 1 & 2 connected) so that sync and burst can be controlled through the RS-232 port.

A10 DAC Board

P206 Digital Data Source Control—Synthesized signal data applied to the DAC (Digital-to-Analog Converted) board and the rear-panel DIGITAL OUT connector can be internally generated by the 1910 or generated by an external source which is applied to the DIGITAL IN connector of the 1910. Using the P206 jumper positions, two modes of control can be implemented. One mode allows pin 16 of the rear-panel REMOTE CONTROL connector to select the signal data source while the other mode allows the Microprocessor board in the 1910 to control the switching.

Pin 16 on the REMOTE CONTROL connector is capable of using TTL or ECL logic to switch the signal data source. When this mode is enabled, no matter which logic is used, the signal data source can be switched at any time, whether it be for a full field signal or selected VITS or VIRS. When TTL logic is used (pins 1 & 2 connected), a high is present at the input of pin 16. This high causes the 1910 to switch to the internal signal data. If a low is externally applied to pin 16, the 1910 switches to the external signal data. When ECL logic is used (pins 4 & 5 connected), a low (nominally -1.8 V) is present at the input of pin 16. This low causes the 1910 to switch to the internal signal data. If a high (nominally -0.85 V) is externally applied to pin 16, the 1910 will switch to the external signal data.

Installation—1910 Operators

With the microprocessor in control of the switching (pins 2 & 3 connected), the 1910 can be programmed to insert external signal data as VITS or VIRS on Lines 15 through 20 during the active portion of the VITS lines. If the Sync and Burst Insertion Mode is enabled (discussed earlier in this section), then the sync, burst, and inserted VITS or VIRS on Lines 15 through 20 are selected from the externally-applied data. The remaining signals or all information other than the VITS or VIRS on Lines 15 through 20 are internally generated by the 1910.

Pins 5 & 6 on P206 have no function at this time and should always be left disconnected.

P206 is factory set with pin 16 of the REMOTE CONTROL connector controlling the signal data source using TTL logic (pins 1 & 2 connected).

P224 & P324 External Digital In—The External Digital In is compatible with 8-, 9-, or 10-bit data. Disable the 9th (pins 2 & 3 connected on P324) and/or 10th (pins 2 & 3 connected on P224) bit inputs to eliminate possible undefined data from passing through in the case of an 8- or 9-bit data source.

The 1910 is factory set with the 8 MSBs (Most Significant Bits) connected and the 2 LSBs (Least Significant Bits) disabled (pins 1 & 2 connected on P224 & P324).

P359 Temperature Compensation Polarity—This is a test selected dual jumper. The final setting for the jumper is determined when performing step 34 in Section 4, Adjustment Procedure, of the Service Manual.

P461 Temperature Compensation Source—This jumper has three positions. When P461 is set to Off (pins 2 & 4 connected) during calibration, temperature compensation to the DAC clock is eliminated. When set to Internal (pins 2 & 3 connected), temperature compensation is enabled to ensure that the phase of the Full Field Out signal matches that of the program line as temperature varies. The External position (pins 1 & 2 connected) is not used. P461 is factory set to the Internal position (pins 2 & 3 connected).

P530 TRS (Timing Reference Signal) Source—The TRS applied to the DAC and the DIGITAL OUTPUT connector can be internally generated or externally supplied through the DIGITAL INPUT connector. Jumper option allows internal generation only (pins 2 & 3 connected) or switching between internal and external as the Digital Data Source is switched (pins 1 & 2 connected). P530 is factory set for the switching mode (pins 1 & 2 connected).

P532, P534, P536 Clock Source—The clock information to the DAC and the DIGITAL OUTPUT may be selected to be internally-generated information only (pins 2 & 3 connected) or to switch between internal and external clock information as the Digital Data Source is switched (pins 1 & 2 connected). P532, P534, and P536 are factory set for internally-generated clock information (pins 1 & 2 connected).

P607 through P627 are factory set with all 10 bits connected (pins 2 & 3 connected).

P705 through P723 DAC Data Input—Any of the 10 data bits to the DAC board may be disconnected internally with jumpers (pins 2 & 3 connected). P705 through P723 are factory set with all 10 bits connected (pins 1 & 2 connected).

P815 DC Restorer—A clamp on the DAC output amplifier referencing the horizontal blanking to zero volts may be enabled (pins 1 & 2 connected). The clamp can be disabled (pins 2 & 3 connected) when using external data that is not genlocked to the 1910. P815 is factory set with the DC Restorer enabled (pins 1 & 2 connected).

P820 DAC Output—This jumper has two positions. When set to Test (pins 1 & 2 connected), the output of the DAC is disabled for testing. This position prevents the DAC output from being applied to the output amplifier. When set to Operate (pins 2 & 3 connected), the DAC output is applied to the output amplifier for normal operation. P820 is factory set to the Operate position (pins 2 & 3 connected).

A12 Microprocessor Board

P115 RS-232 Calibrate—This jumper has a Test position (pins 1 & 2 connected) for calibration and diagnostics purposes, and an Operate position (pins 2 & 3 connected). P115 is factory set to the Operate position (pins 2 & 3 connected).

A17 External VITS Board

P502 External VITS Disable—Allows external VITS to be enabled (pins 2 & 3 connected) or disabled (pins 1 & 2 connected). P502 is factory set to the Disabled position (pins 1 & 2 connected).

Remote Control

The 1910 can be controlled from two remote-control connectors (REMOTE CONTROL and RS-232 CONTROL) on the rear panel. For more information utilizing these connectors, refer to Section 5 on remote operations in this manual.

CAUTION

Cabling Precaution

When connecting the RS-232 cable to the RS-232 CONTROL receptacle on the rear panel of the 1910, be extremely cautious not to connect it to the DIGITAL OUTPUT receptacle. This error may result in permanent damage to the DIGITAL OUTPUT circuitry.

Operating Options for Remote Control Unit (Internal Jumper)

The optional Tektronix Remote Control Unit 015-0374-00 has an internal jumper to override its Enable/Disable front-panel switch. The Enable/Disable switch is used to disable the VITS insertion and control transfer over the 1910 functions.

The Remote Control Unit is factory set with the Enable/Disable switch functioning. For more information on the Remote Control Unit, refer to Section 5, REMOTE OPERATION, in this manual.

MECHANICAL INSTALLATION (RACKMOUNTING)

Latching

The 1910 incorporates a spring-latch design built into the rack handle. To release, grasp the rackmount latch releases (see Fig. 2-2) and pull outward until they stop, then pull the 1910 forward. After the instrument has been slid out of the rack, press the rackmount latch releases back in. To re-latch, push the 1910 in until the spring-latches catch.

For those applications where additional racking security is needed, the rackmounting ears of the 1910 have thumb-screw hold-downs.

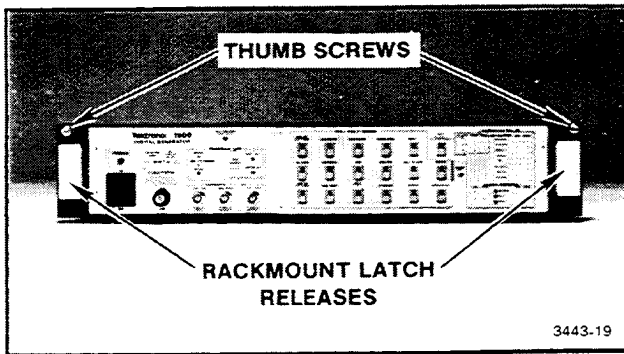

Fig. 2-2. Location of the Rackmount Latch Releases.

NOTE

Because of the spring-latch feature and new rack handle requirements, the 1910 **cannot** be racked in already-installed stationary slide sections. The slide tracks supplied with the 1910 are equipped to accommodate the spring latches and rack handles. See Fig. 2-3.

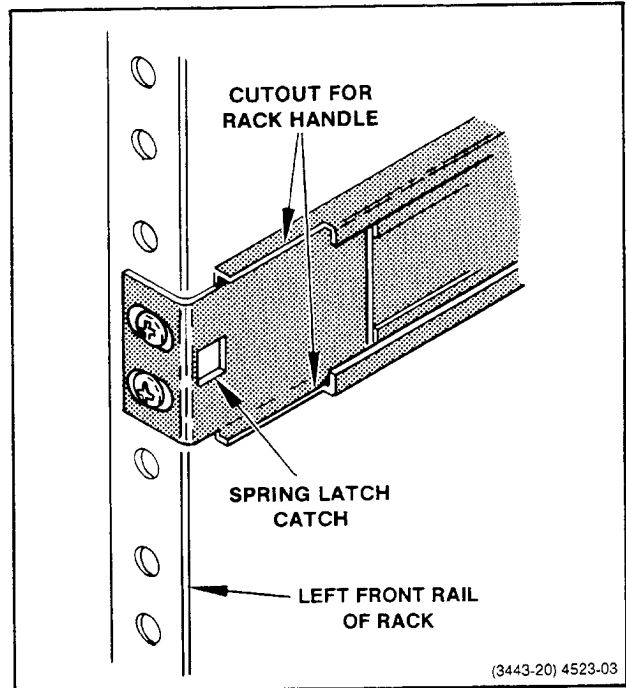

Fig. 2-3. Spring Latch Catch and Cutout for Rack Handle.

Rackmounting

The 1910 will fit most commercial consoles and 19-inch wide racks whose rail holes conform to universal spacing. See Fig. 2-4 for hole spacing details.

Allow one inch clearance above, below, left, and right sides of the 1910 for air circulation. Also, allow at least three inches of clearance between the 1910 rear panel and the rack enclosure to ensure an adequate supply of cooling air and provide room for the cables that connect to the connectors. The depth of the 1910 from behind the rack ears to the rear panel is 19.160 inches; the distance to the furthest point is 19.750 inches. The rack depth should be at least 22 inches (see Fig. 2-5) to meet the rear clearance requirement.

The slide-out tracks mount easily to the rack front and rear vertical mounting rails if the inside distance between the rails is within 13 to 26 inches. If the tracks are going to be installed in a rack whose distance between the mounting rails is not within 13 and 26 inches, some means of support

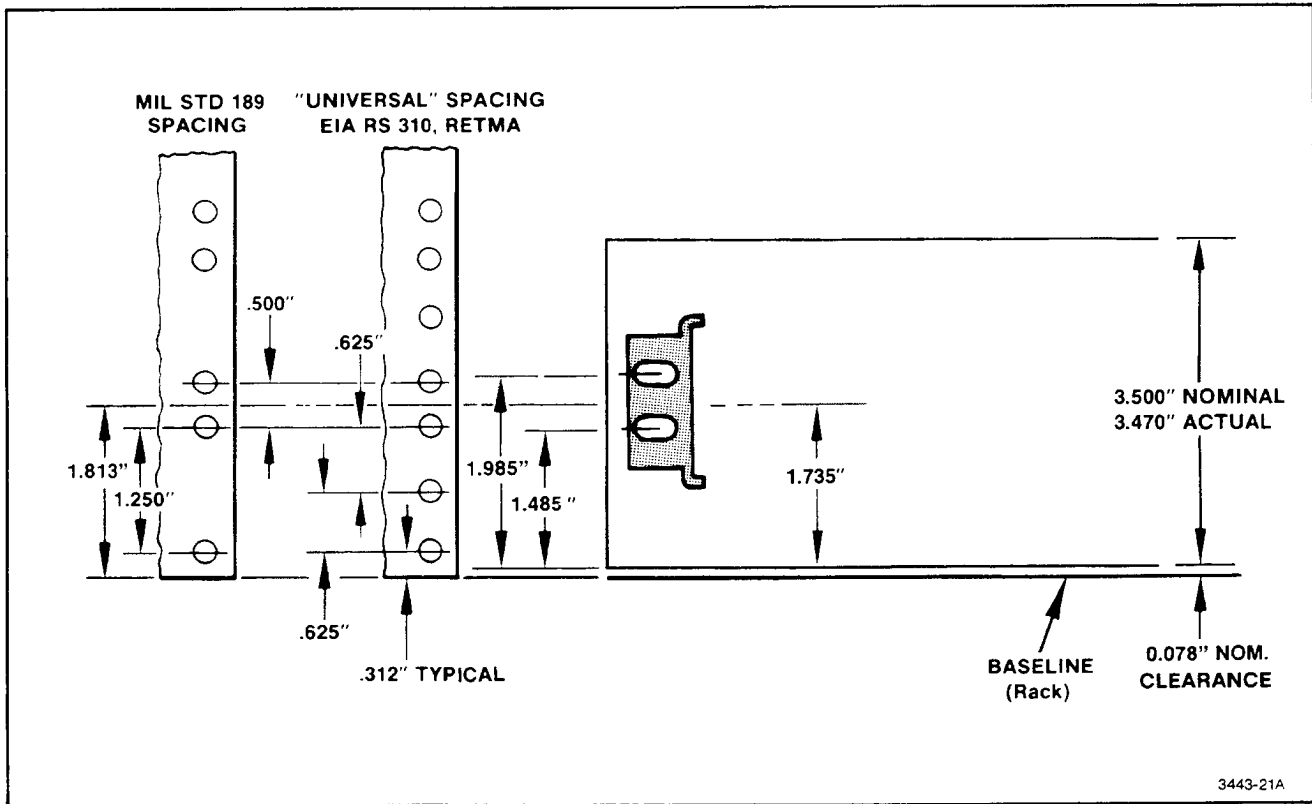

Fig. 2-4. Rackmount Hole Spacing.

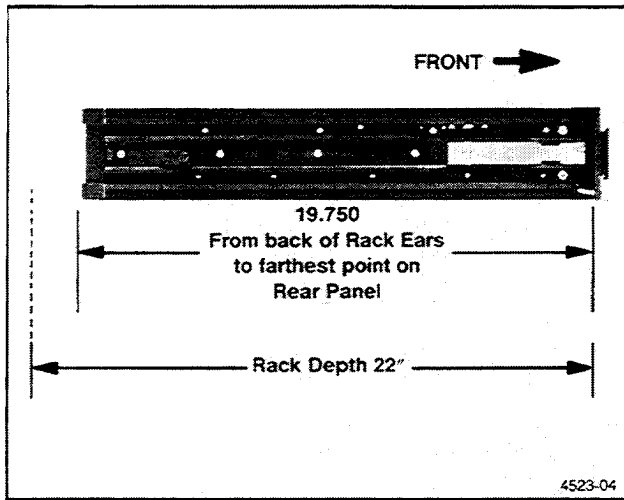

Fig. 2-5. 1910 Rackmounting Length and Clearance.

(for example, extensions to the rear mounting brackets) is needed for the rear ends of the slide-out tracks.

The 1910 is 3 1/2 inches high. This height is a multiple of 1.75 inches (the standard rack spacing). As long as the

1910 is positioned in a conventional rack, some multiple of 1.75 inches from the bottom or top, all holes should line up and no drilling will be necessary.

The dimension of the opening between front rack rails must be at least 17 5/8 inches in width. The front lip of the stationary-track section mounts in front of the rail. Use the bar nuts behind untapped front rails. The front lip of the stationary-track section must mount in front of the front rail to allow the 1910 spring-latch to function properly.

The slide-out tracks consist of two assemblies, one for each side of the instrument. Each assembly consists of three sections. See Fig. 2-6. The stationary section of each track attaches to rack rails as illustrated in Fig. 2-7. The chassis section mounts on the instrument and is installed at the factory. The intermediate section fits between the other two sections, allowing the instrument to be fully extended out of the rack.

The stationary and intermediate sections for both sides are shipped as a matched set and should not be separated. The package includes matched sets for both sides and mounting hardware. To identify the assemblies, note that

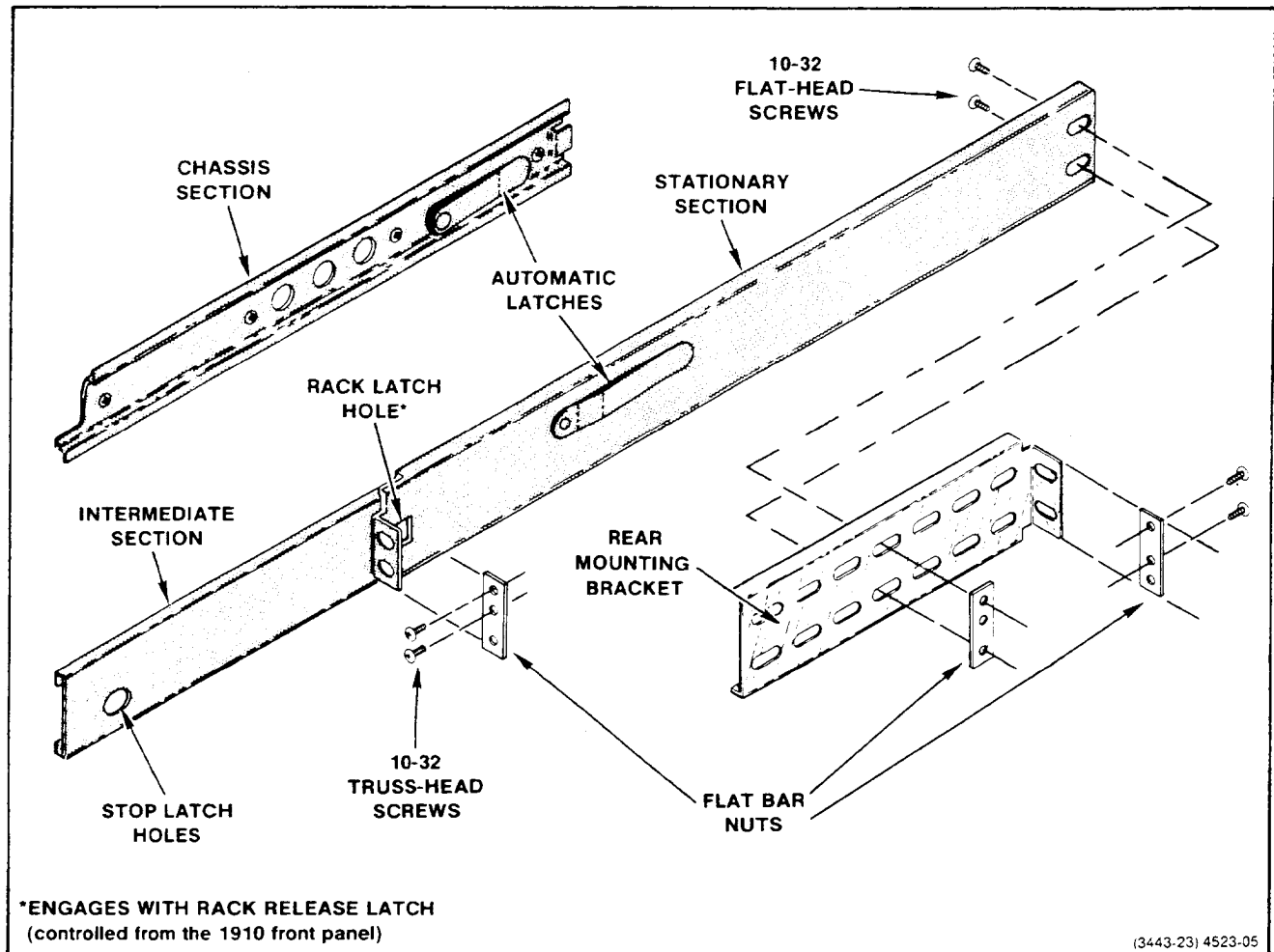

Fig. 2-6. Rackmounting Hardware.

the automatic latch and intermediate section latch stop holes are located near the top when the matched sets are properly mated to the chassis sections.

To mount the instrument in a rack, select the appropriate holes in the rack rail, using Fig. 2-4 as a guide.

Mount the stationary-track sections to the front rack rails with truss head screws (and bar nuts).

Mount the stationary-track sections to the rear rails, using one of the methods in Fig. 2-7. Note that the rear mounting bracket can be installed to fit either deep or shallow cabinet rack.

After mounting the instrument in the slide-out tracks, adjust for proper width by loosening the front and rear screws and allowing the slides to seek the proper width. Be sure that the instrument is centered, and then re-tighten with screws.

When the instrument is pushed into the rack, an automatic spring latch engages the spring latch catch to hold the instrument in place. To extend the instrument out of the rack, just pull the rackmount latch releases on the front panel (see Fig. 2-2) out to disengage the spring latches. Then, pull instrument out. After the instrument is out of the rack, press the latch releases back in.

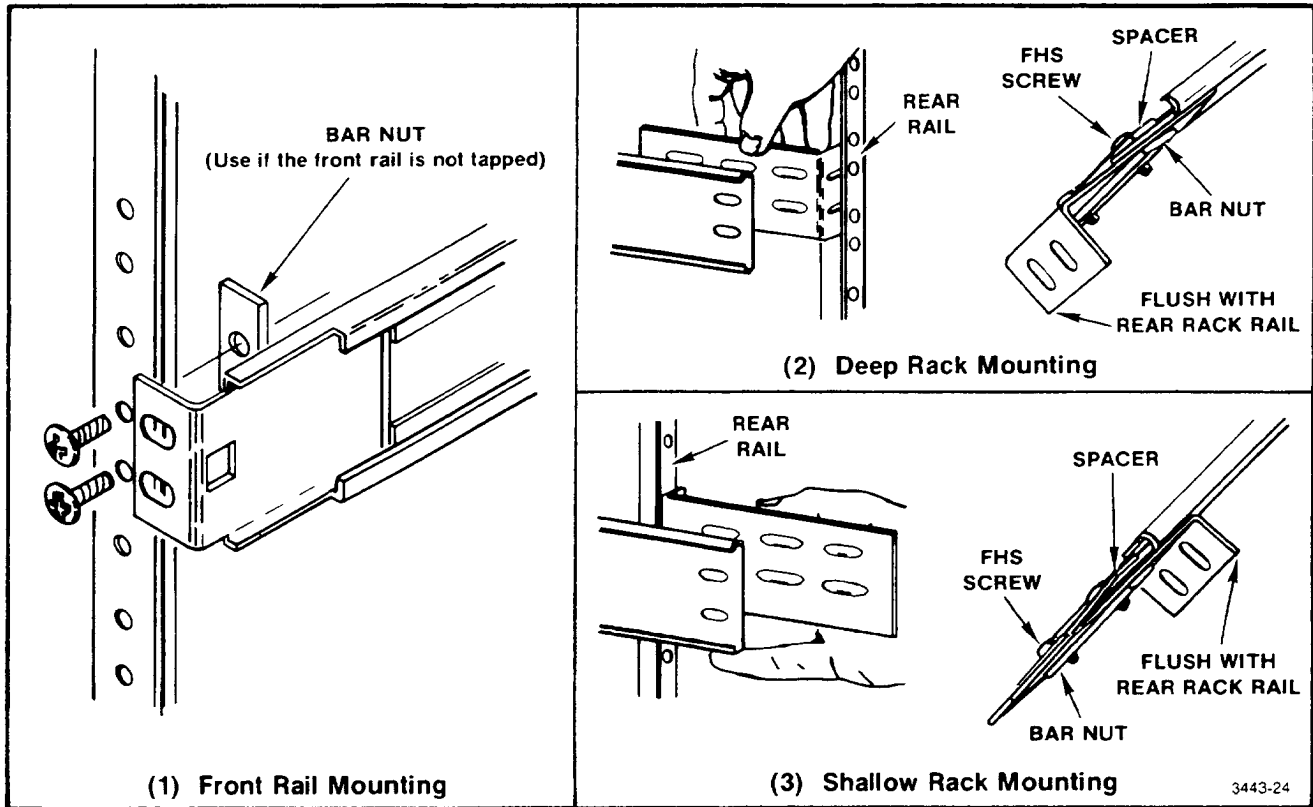

Fig. 2-7. Mounting Stationary Rackmount Sections.

RACKMOUNT-TO-CABINET CONVERSION

To convert the 1910 rackmount version to a cabinet model, proceed as follows:

1. Remove the left and right handles with latch releases from the instrument.
2. Remove the left and right chassis sections.
3. Mount the carrying handle assembly to the right side of the instrument as shown in the exploded view on the ACCESSORIES foldout page in Section 9, REPLACEABLE MECHANICAL PARTS, of the Service Manual. Note that the handle is off center, since the balancing point of the instrument is toward the rear.
4. Remove the protective backing from each foot. Place a foot at each corner on the bottom of the front and rear frames of the instrument. (The feet are placed here to support the weight of the instrument and to allow removal of the bottom cover.)

CABINET-TO-RACKMOUNT CONVERSION

To convert the 1910 cabinet model to a rackmount version, use the following procedure:

1. Remove the carrying handle as follows:
 - a) Remove the plastic retainer caps that cover the screws located at each end of the handles.
 - b) Remove the two screws, lock washers, and flat washers to remove the handle.
2. Mount the chassis slide sections to each side of the 1910 instrument. Before tightening the screws, check that the chassis slides are parallel to the bottom of the instrument.
3. Mount the handles and latch release hardware to the left- and right-front sides of the instrument. Use Fig. 1, CHASSIS, exploded view, in Section 9, REPLACEABLE MECHANICAL PARTS, of the Service Manual for a guide.
4. Rackmount the instrument by following the rack-mounting instructions given earlier.

ACCESSORIES

The 1910 has a number of accessory items, some of which are supplied with the instrument (Standard Accessories), while the others (called Optional Accessories) can be ordered from Tektronix, Inc. For ordering information, contact a Tektronix, Inc., field office or distributor.

Standard Accessories

The following items are shipped with the 1910. If you need more of them, they can be purchased from Tektronix, Inc. The part numbers for these items are listed on the last tabbed page (ACCESSORIES) in Section 9, REPLACEABLE MECHANICAL PARTS, of the Service Manual.

1. Operator's Manual
2. Service Manual
3. Command Language Reference Card
4. Power Cord, 3-wire
5. One pair Rackmount Slides, with mounting hardware
6. Right Front Panel Shield for 1910
7. 1910 Front-Panel Marker Set
8. Remote Control Unit Marker Set

9. A15 Pulse Output Board (Replaces A17 External VITS board, if H Drive, V Drive, Comp Blanking, and Burst Flag signals are needed)
10. Cabinet Model Conversion Kit

Optional Accessories

Optional or not-included accessories are listed here. These items can also be ordered from Tektronix, Inc., through your local field office or distributor.

1. Remote Control Unit (RCU) (Tektronix Part No. 015-0374-00)
2. Six-foot Interconnecting Cable (1910 to RCU) (Tektronix Part No. 012-0108-00)
3. 22-foot Interconnecting Cable (1910 to RCU) (Tektronix Part No. 012-0251-00)

OPERATING INSTRUCTIONS

This section describes the functions of the various front- and rear-panel controls, connectors, and indicators. A block diagram description is also included in this section.

FRONT-PANEL CONTROLS, CONNECTORS, AND INDICATORS (See Fig. 3-1)

1 POWER

ON/OFF rocker switch to connect or interrupt the mains voltage to the power transformer primary circuit. The green light illuminates when the POWER switch is set to ON, the instrument is connected to a line voltage source, and the fuse is good.

When the 1910 is powered up, it automatically pre-sets to a preselected mode of operation.

2 OPERATING RANGE

Indicates that the transformer primary is wired to operate within one of the following ranges of the mains input voltage: 90-110, 99-121, 108-132, 180-220, 198-240, or 216-250 Vac.

3 FUSE CURRENT RATING

Indicates value of the fuse located in the front-panel fuseholder; 1.6 A slow blow for the operating voltages from 90 to 132 Vac, or 0.8 A slow blow for the operating voltages from 180 to 250 Vac.

4 FUSE

Fuseholder that contains the mains input fuse.

WARNING

Turn the instrument off and disconnect the power cord from the receptacle on the rear-panel before removing the fuse.

5 INSERT SUBCARRIER PHASE ADJUST

A screwdriver adjustment that permits setting the phase of the color subcarrier on internally-generated

signals with respect to the incoming color burst signal. Since the signals generated by the 1910 are SCH phase referenced, this adjustment shifts the entire Full Field Signal, not just the subcarrier.

6 PROGRAM LINE

NORMAL—A green LED (light emitting diode) that illuminates when the generator is genlocked to the incoming sync information.

NON-SYNCHRONOUS—An amber LED that illuminates during absence of incoming sync information.

BYPASS—A red LED that illuminates when the incoming program signal bypasses the active circuits in the generator. The rear-panel PROGRAM IN and OUT connectors are connected to each other through the relay contacts in the Bypass mode.

The Bypass mode is activated by one of three conditions:

(a) When sync is not present. (Exception: Bypass is not activated when in Transmitter Protection mode and sync is not present.)

(b) 1910 is locked to the BLACK BURST input.

(c) 1910 is remotely programmed for Bypass.

TEST POINTS (INPUT, OUTPUT)—Front-panel pin jacks to provide isolated (15 k Ω) video test points. These connectors enable the incoming program signal to be checked. The INPUT test point is electrically located at the input to the Input Amplifier circuit in the generator, and can be used to determine if the video signal is applied via the rear-panel PROGRAM IN connector to this point. The OUTPUT test point is electrically located at the output of the Output Amplifier stage and can be used to check the signal after it is processed. If the bypass relay is de-energized, the Program Line signal will not be present at either of these test points.

7 **OUTPUTS**

COMP SYNC—Regenerated composite sync signal, approximately 4 V negative going into 75 Ω.

SUBCARRIER—Regenerated subcarrier signal, approximately 2 V peak-to-peak into 75 Ω.

FULL FIELD—Output connector for the selected Full Field test signals with inserted VITS. Amplitude is 1 V peak-to-peak into 75 Ω.

8 **APL (AVERAGE PICTURE LEVEL)**

APL refers to the HIGH APL (4 of 5 lines), LOW APL (4 of 5 lines), and APL BOUNCE buttons.

HIGH APL (4 of 5 lines)—Push-button switch that enables a 100 IRE flat field signal to be generated on four out of five active lines. The selected Full Field Signal to be generated is present on the remaining one out of five active lines.

ALL LINES—Push-button switch that enables the selected Full Field Signal to appear on all active lines. Used in conjunction with all the Full Field Signal buttons.

LOW APL (4 of 5 lines)—Push-button switch that enables a 0 IRE flat field signal to be generated on four out of five active lines. The selected Full Field Signal appears on the remaining one out of five lines.

APL BOUNCE—Refer to **13** APL BOUNCE.

NOTES

1. Full Field Signal is the signal selected by the SHIFT and FULL FIELD SIGNAL push-button switches.
2. APL can be selected without pressing a SHIFT or FULL FIELD SIGNAL button.
3. APL does not modify a pending SHIFT or FULL FIELD SIGNAL selection.
4. APL is available for all Full Field Signals, including Convergence.
5. The LED adjacent to the APL button that was pressed will illuminate to indicate the selection that was made.

9 **SHIFT**

The UPPER, MIDDLE, and LOWER SHIFT push-button switches correspond to and select the upper, middle, and lower Full Field Signals (see Fig. 3-1 and Table 3-1).

For example, to select the MULTIPULSE 70 IRE signal, press the FULL FIELD SIGNAL button for this group of three signals: FCC MULTIBURST, FCC COMPOSITE, and MULTIPULSE 70 IRE. Then, to select the lower signal (MULTIPULSE 70 IRE) of this group, press the SHIFT-LOWER button. The LEDs for these buttons, when pressed, will illuminate to indicate the selection.

10 **FULL FIELD SIGNAL**

This nomenclature, as used in the manual, applies to the ten push buttons located to the right of the SHIFT buttons (see Fig. 3-1).

Each FULL FIELD SIGNAL button has an LED that illuminates when the button is pressed.

Each FULL FIELD SIGNAL button, as previously defined, selects a three-signal group. For example, FCC MULTIBURST, FCC COMPOSITE, and MULTIPULSE 70 IRE comprise a three-signal group. To select one signal—the lower signal (MULTIPULSE 70 IRE)—in this group, press the SHIFT-LOWER button. The LEDs for these buttons will illuminate to indicate the selection.

Use Table 3-1 as an aid for selecting Full Field Signals.

NOTES

1. 1910 front-panel selection does not alter the EEPROM. If a power loss occurs, the power-up sequence reverts to that stored in the EEPROM, and not necessarily the last button pressed.
2. The FULL FIELD SIGNAL button for MATRIX 1, 2, and 3 is programmable so that, under RS-232 control, these three matrixes can be defined for up to 16 test signals each in any combination. Any signal may occupy any or all of the 16 matrix windows. Each window of the matrix spans approximately 16 video lines. Refer to the topic, MODIFY MATRIX CONFIGURATION, in Section 5 of this manual for more information.
3. Refer to Section 6, TEST SIGNAL APPLICATIONS, and Appendix A, APPLICATION NOTES, for information about using the full field test signals.

**Table 3-1
FULL FIELD SIGNAL SELECTION**

SHIFT	FULL FIELD SIGNAL			
UPPER Push Button	FCC MULTIBURST	SMPTE BARS	COLOR BARS	
	NTC 7 COMPOSITE	MULTIBURST 100 IRE	CONVERGENCE	
	MOD RAMP 80 IRE	5 STEP STAIRCASE	MATRIX 1	10 IRE PED
MIDDLE Push Button	FCC COMPOSITE	MODULATED BAR	BARS/Y	
	NTC 7 COMBINATION	VIR	FIELD SQUARE WAVE	
	MOD RAMP 100 IRE	MODULATED PEDESTAL	MATRIX 2	50 IRE PED
LOWER Push Button	MULTIPULSE 70 IRE	$\frac{\text{SIN } X}{X}$	BARS/RED	
	MULTIPULSE 100 IRE	BLACK BURST	WINDOW	
	Y RAMP 100 IRE	EYE TEST PATTERN	MATRIX 3	100 IRE PED

11 CONTROL LED

The CONTROL LED, when off, indicates that the front-panel push buttons have control of signal selection. The CONTROL LED, when on, indicates that an external input (via the RS-232 CONTROL or REMOTE CONTROL connector) has control of signal selection.

12 RESET

The RESET button, when pressed, resets the FULL FIELD OUTPUT test signal and VITS and VIRS operation to the status that was saved in the EEPROM. This is the normal factory-shipped configuration unless specifically modified by the user through the RS-232 CONTROL input.

13 APL BOUNCE

A bouncing flat-field signal that is generated on four out of five active lines. The selected Full Field Signal appears on the remaining one out of five active lines. The bouncing flat-field signal changes the dc level of the active portion of the line (excluding sync) from 0 IRE to 100 IRE.

The position at which the bounce occurs within the field may be internally selected from three alternatives; (a) during the vertical interval, (b) on a selected line of the latter active portion of the field, and (c) at a random location. This signal is used to test clamping circuitry and APL-dependent distortion.

To cancel the APL Bounce mode of operation, press one of the other APL buttons (ALL LINES, HIGH, or LOW).

14 APL BOUNCE RATE

Screwdriver adjustment to vary the bounce rate from approximately 1 Hz to greater than 1/30 Hz.

15 VITS INSERTION

Front-panel chart that lists Fig. 13 (MULTIBURST), Fig. 14 (COLOR BARS), and Fig. 15 (COMPOSITE) signals of FCC Rules and Regulations 73.699. These signals are automatically inserted on television lines 17 and 18, Fields 1 and 2. The rear-panel interface connectors (REMOTE CONTROL or

RS-232 CONTROL) are used to program VIT signals on lines 14 to 21 for the REMOTE CONTROL and lines 10 to 21 for the RS-232 CONTROL in both fields of the incoming Program Signal.

16 VIR SIGNAL PROGRAMMING

Three red LEDs that indicate the status of the VIR Signal as follows:

INCOMING: Red LED that illuminates when VIRS is present on the incoming composite video signal.

DELETE: Red LED that illuminates when an incoming signal on the line programmed for VIRS is being deleted by the 1910.

INSERT: Red LED that illuminates when an internally-generated VIRS is being inserted by the 1910 on the line programmed for VIRS.

**REAR-PANEL CONNECTORS
(See Fig. 3-2)**

17 DIGITAL INPUT

A digital input interface to allow external digital video information to be connected to the 1910's Digital-to-Analog Converter, which converts the digital information into analog video information. The data input accepts 10 bits of parallel differential ECL in a straight binary format. The input also requires a differential clock and a system ground. The connector is a 25-pin, male, D-type, subminiature connector.

18 DIGITAL OUTPUT

An output connector allowing composite, digital-encoded, video-signal information to interface with other video, digital instruments. The digital output information is derived from the 1910 or from external information at the DIGITAL INPUT connector. The output format consists of parallel 10-bit, differential-data signal pairs. Also included in the format is a differential timing-reference signal and a differential clock. A system ground is available on one pin. The output connector is a 25-pin, female, D-type, subminiature connector.

19 SUBCARRIER OUT

Regenerated subcarrier output signal, approximately 2 V p-p into 75 Ω.

20 COMP SYNC OUT

Regenerated composite sync output signal, approximately 4 V into 75 Ω.

21 FULL FIELD OUT

Output connector for the Full Field Output test signal selected by the front-panel FULL FIELD SIGNAL push buttons or by remote control.

22 VITS INPUT

Four internally-terminated, 75 Ω, bnc inputs. Externally generated VITS from another source can be connected to these four connectors and switched in via the RS-232 CONTROL port. Also, after redefining a front panel push button as external VITS (via the RS-232 CONTROL port), it can be switched in with the REMOTE CONTROL. The selected VITS can be inserted on any of lines 10 through 21, Field 1 or 2, of the Program Line, appearing at the PROGRAM OUT connector. An internal jumper located on the External VITS input board, A17, may be set to pins 1 and 2 to disable the external VIT Signals if they are not needed.

The signal path for the externally-generated VITS into and through the 1910 is dc coupled. Therefore, any dc offset on the external VITS generator output will appear as a pedestal offset on the selected lines of the PROGRAM OUT signal.

An internal adjustment (Ext VITS Offset) is normally adjusted for zero at the factory, and may be used to compensate for minor offset variations on the VITS INPUT signal.

23 BLACK BURST IN

A single, high-impedance input connection for an incoming composite video signal (black burst) from a master generator. This signal can be switched in by using the remote control. When switched in, the 1910 will genlock to the incoming composite video signal at the BLACK BURST IN connector rather than the composite video signal applied to the PROGRAM IN connector. Also, the PROGRAM IN connector will be connected to the PROGRAM OUT connector through the Bypass Relay.

24 PRGM MONITOR OUT

During Normal Program Line mode of operation, this output connector has the same signal as the PROGRAM OUT connector. When the 1910 is in the Bypass mode, only the inserted VIT Signals and inserted sync and burst will be present at the output if the Sync & Burst Insertion mode is selected.

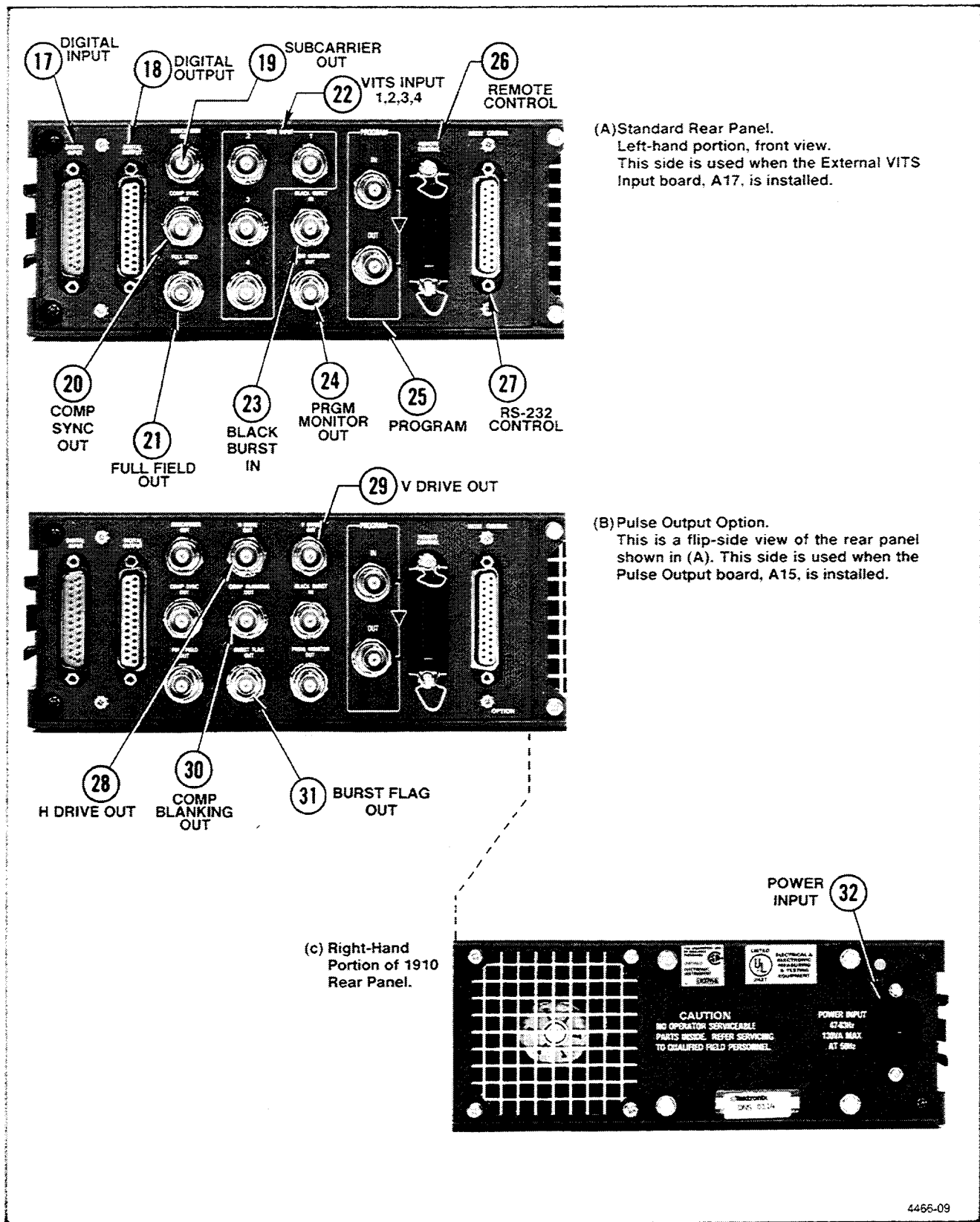

Fig. 3-2. 1910 Rear Panel.

25 PROGRAM
IN—Normal input via a bnc connector for an incoming program signal or composite video to which VITS is to be inserted. This connector is internally terminated into 75 Ω.

OUT—Output via a bnc connector for the normal program input signal with selected VITS insertion controlled by the 1910. The PROGRAM OUT connector is connected internally to the PROGRAM IN connector through the relay contacts in the BY-PASS or POWER OFF conditions.

26 REMOTE CONTROL
 This port allows remote control operation of the 1910 by ground closures on the appropriate pins. The following functions can be remotely controlled: ¹selection of 1910 control source (Front Panel, Remote, RS-232), selection of Full Field Signals, ¹Program Line routed through the 1910 or bypassed, ¹Genlock referenced to Program signal or Black Burst signal, program VITS insertion or deletion on lines 14 through 20 for Field 1, Field 2, or both, Detect VIRS, and VIRS Insert-Delete-Auto-Pass switching. Refer to Section 5, REMOTE OPERATION, for information about an optional Remote Control Unit accessory. The REMOTE CONTROL connector is a 24-pin, female, 57-Series, rectangular connector.

27 RS-232 CONTROL
 This port allows remote control operation of the 1910 with data information that complies with the Electronic Industries Association Standard RS-232-C. The functions controlled by the RS-232 port are the same as listed under REMOTE CONTROL, except for Remote Control and Genlock selection. This connector is a 25-pin, female, D-type.

28 H DRIVE OUT²
 A connector that provides a 4 V negative-going pulse. Its leading edge is coincident with the start of line blanking.

29 V DRIVE OUT²
 This connector provides a 4 V negative-going pulse. Its leading edge is coincident with the start of vertical blanking.

30 COMP BLANKING OUT²
 This connector provides a 4 V negative-going composite blanking pulse per EIA specifications.

31 BURST FLAG OUT²
 A connector that provides 4 V negative-going pulses coincident with burst.

32 POWER INPUT
 Contains the power cord receptacle and RFI filter.

¹These functions operate in remote control mode of the 1910 only.

²These signals are available when the Pulse Output board, A15, is installed in place of the External VITS board, A17. Then, the rear-panel is flipped over to provide the necessary nomenclature for the four, pulse-output signals as shown in Fig. 3-2B. NOTE: After installing the Pulse Output board, A15, External VITS does not exist. (If External VITS is selected using the Remote Control Unit, external VITS will not be obtained. If the RS-232 CONTROL port is used to select External VITS, the prompt "DELETE" will appear.)

GENERATOR FUNCTIONS

Program Sync and Burst Regeneration

Degradation of video signals occurs at times due to microwave-signal fadeout. The sync and blanking areas of the signal may become excessively noisy or fade to a point where monitors and receivers cannot synchronize to the signals. The 1910 has a mode of operation (internal jumper selectable or μP controlled) where internally-processed sync and burst (genlocked to the PROGRAM IN signal) can be substituted for the PROGRAM IN sync and burst. If burst is not present on the incoming PROGRAM IN signal, only sync information is substituted.

Transmitter Protection

To prevent overdriving a transmitter, a video signal should always be present at the transmitter input. Often, one piece of equipment in the video chain will be designated to detect the loss of the Program Signal, and insert a new signal in its place. The 1910 is factory-connected to automatically bypass the PROGRAM IN to the PROGRAM OUT connector when the incoming signal loses sync. This allows other equipment to detect the signal loss, and to do the appropriate switching of signals.

If desired, the 1910 can be internally programmed by internal jumpers or μP controlled to insert Sync and Burst or Full Field Signals at the PROGRAM OUT connector if the incoming signal at the PROGRAM IN connector loses sync.

VITS/VIRS Insertion

One of the basic functions of the 1910 is to allow the operator to delete and re-insert locally-generated Vertical Interval Test Signals (VITS) and Vertical Interval Reference Signals (VIRS) on the incoming Program Signal. When the

Operating Instructions—1910 Operators

1910 is genlocked to the incoming signal at the PROGRAM IN connector, VITS and VIRS are inserted and deleted as determined by the programming.

VITS. The programming for the VITS insertion of the 1910, when the front panel is in control, is determined by a factory-programmed PROM. The 1910 is programmed to automatically delete and re-insert VITS in compliance with FCC Rules and Regulations 73.676(f) for remote control monitoring of transmitters. The signals are reduced FCC Multiburst on Line 17, Field 1; Color Bars on Line 17, Field 2; and FCC Composite on Line 18, Fields 1 and 2. An internal jumper is available that moves all inserted VIT and VIR signals ahead by one line to compensate for studio delay of the Program Signal. This jumper operates only after a reset or Power Up is done.

The VITS insertion program may be changed to the user's desires by use of the REMOTE CONTROL and RS-232 CONTROL ports. VITS may be deleted and/or inserted on Lines 14-21 by the REMOTE CONTROL port and Lines 10-21 by using the RS-232 CONTROL port. VITS programmed from the Remote Control Unit are permanently saved. The locally-generated Full Field test signals that are available for VITS insertion are indicated in Section 5 of this manual.

The Remote Control Unit (Tektronix Remote Control Unit 015-0374-00, with optional cables) is an optional accessory that is available to interface to the REMOTE CONTROL port on the rear panel of the 1910. The operation of the Remote Control Unit is discussed in Section 5.

The RS-232 CONTROL port will interface to peripheral communication data devices complying to and using the Electronics Industries Association standard RS-232-C. The terminal keyboard syntax is discussed in Section 5.

VIRS. The 1910 has four different modes of operation for VIRS Programming (Automatic, Delete, Insert, and Pass). The Automatic mode checks for the presence of VIRS on the line(s) and field(s) programmed for detection. If VIRS is detected as being present in the proper location, the signal is unaltered. However, if VIRS is not detected on the line(s) and field(s) programmed for VIRS detection, then the lines programmed for VIRS are deleted to remove any VITS or noise present and the locally-generated VIR signal is inserted. In the Delete mode, the incoming VIRS is deleted from the line(s) and field(s) programmed for VIRS. The Insert mode first deletes the line(s) and then re-inserts the local VIRS on the line(s) programmed for VIRS. The Pass mode passes the vertical interval line(s) programmed for VIRS.

The programming of the VIRS on Power Up and after RESET is determined by a factory-programmed PROM. The

1910 is programmed for function in the Automatic mode, looking for VIRS on Line 19 of both fields. The VIRS signal may be moved ahead one line by an internal jumper to compensate for studio delay of the Program Signal.

Although VIRS is factory programmed for detection in the Automatic mode on Line 19 of both fields, VIRS programming may be changed to the operator's preference by the use of the REMOTE CONTROL or RS-232 CONTROL connectors. Any of the four different modes of operation discussed above for VIRS may be selected. VIRS can be programmed on vertical interval Lines 14-20 with the REMOTE CONTROL or Lines 10-20 with the RS-232 CONTROL for either or both fields.

External VIRS Insertion

Another of the basic functions of the 1910 is to allow the operator to insert up to four externally-generated VITS on the incoming Program Video when an external VITS generator and 1910 are both genlocked to the incoming signal. The external VITS is inserted as determined by the 1910 programming.

Control of the external VITS insertion is accomplished by use of the REMOTE CONTROL and RS-232 CONTROL ports. External VITS may be inserted on Lines 14-21 by the REMOTE CONTROL and Lines 10-21 by the RS-232 CONTROL ports.

Digital Input and Digital Output

The DIGITAL INPUT and OUTPUT connectors provide digital interfacing between the 1910 and other System M (525/60) NTSC digital television instruments. The DIGITAL INPUT connector allows the operator to apply externally-generated digital video information to the 1910 DAC (Digital-to-Analog Converter). The DIGITAL OUTPUT connector allows the operator to obtain the digital information that is being applied to the DAC in the 1910.

The Digital Input and Output format consists of 12 parallel, balanced signal pairs and a ground. This allows for 10 bits of differential data signal pairs, a differential clock, and a differential timing-reference signal. All the differential lines are ECL-compatible. The data lines are encoded in a straight binary code (BIN) format. The pin out assignment for the DIGITAL INPUT and OUTPUT connectors is shown in Figs. 3-3A and 3-3B, respectively.

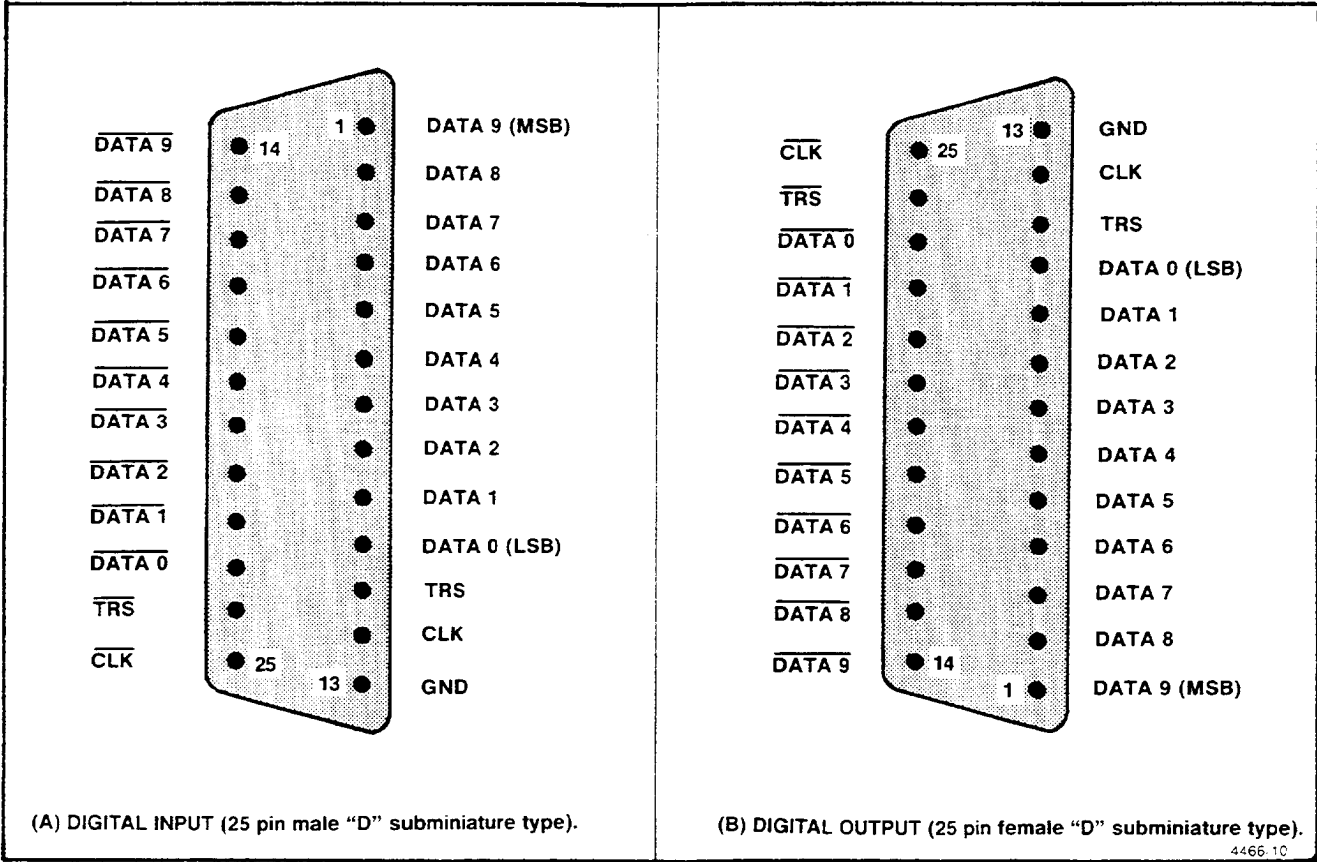

Fig. 3-3. Pin Configuration for the 1910 Rear-Panel DIGITAL INPUT and DIGITAL OUTPUT Connectors.

FUNCTIONAL CHARACTERISTICS

INTRODUCTION

This portion of the Operator's Manual contains a simplified block diagram and a brief description of each block. The intention is to give the reader a basic understanding of the 1910 function.

BLOCK DIAGRAM DESCRIPTION

The main function of the 1910 is to insert Vertical Interval Test Signals (VITS) and a Vertical Interval Reference Signal (VIRS) on the Program In signal. Also, the 1910 generates Full Field test signals. The basic functions of the 1910 are illustrated in the simplified block diagram shown in Fig. 3-4.

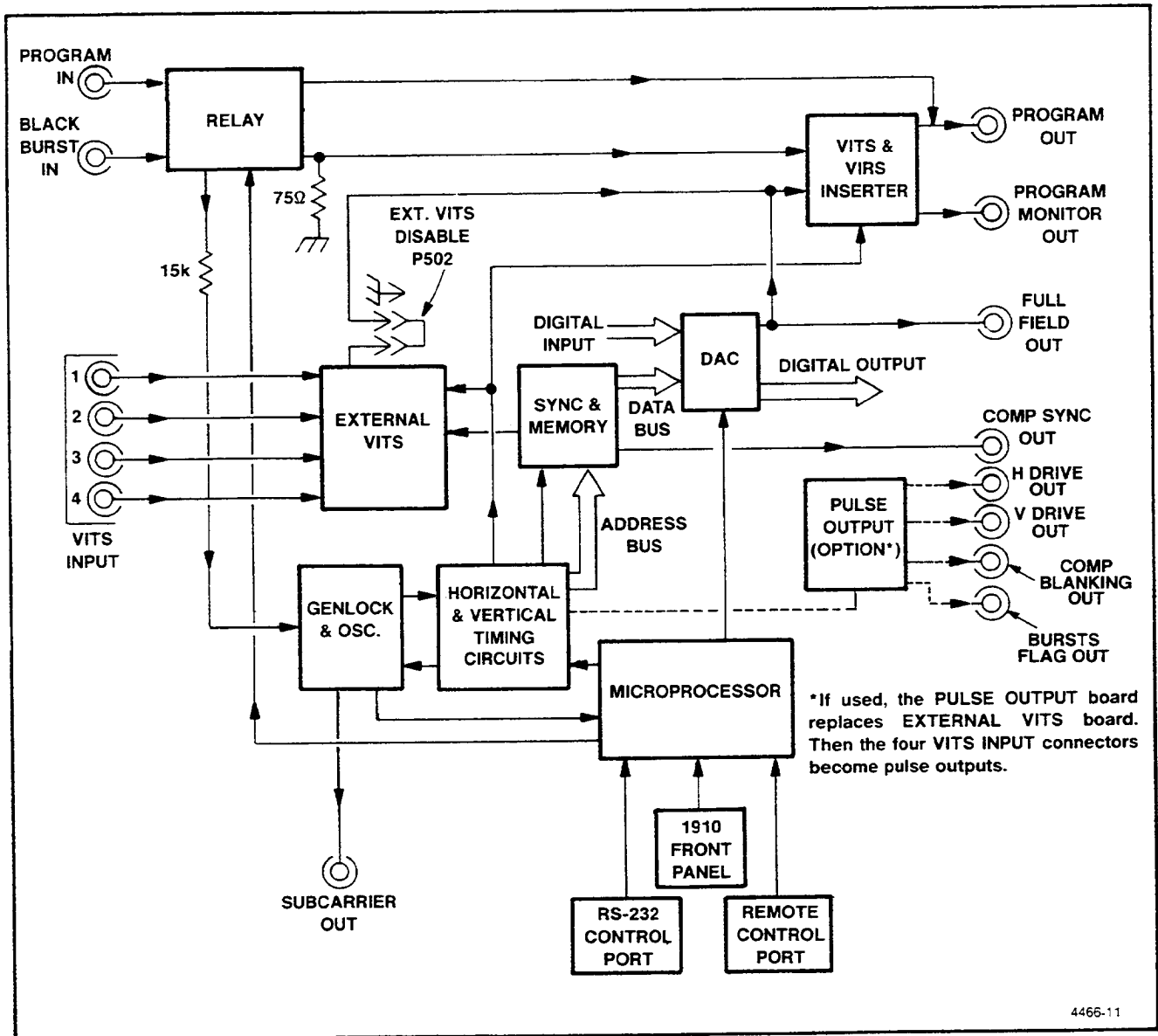

Fig. 3-4. Simplified Block Diagram.

The Relay block consists of a relay that directs the route of the Program In signal. For normal operation where the 1910 is genlocked to the incoming signal, the relay routes the Program In signal to the VITS & VIRS Inserter. In the event of loss of sync, instrument malfunction, or the Bypass mode is selected from the Remote Control Unit, the relay is switched to route the Program In signal directly to the PROGRAM OUT connector.

The VITS & VIRS Inserter is basically an electronic switch that selects between the Program In signal (externally applied to the PROGRAM IN connector) and the Full Field Signal (internally-generated) during selected intervals so that a composite of both is available at the PROGRAM OUT and PROGRAM MONITOR OUT connectors. Externally-generated VITS may be added to a blank line of the Full Field Signal that is applied to the VITS & VIRS Inserter when instructed via the Remote Control or RS-232 ports. The Inserter is instructed to select the Program In signal, except during certain vertical interval lines, and then VIT and VIR Signals are selected off the Full Field Signal. This results in VIT and VIR Signals being inserted on the Program Line signal.

The Sync & Memory and DAC blocks in Fig. 3-4 are the essential components for generating the Full Field test signals and VIT Signals. The different test signals are stored in digital form in the PROMs (Programmable Read Only Memory) in the Sync & Memory block. The signals are selected by enabling the portion of the memory block that contains the signal information desired. As the PROMs are addressed, the digital information stored in them is transferred to the DAC (Digital-to-Analog Converter) block via the Data Bus.

The DAC converts the digital information from the Data Bus into analog signal information. This analog signal is filtered and amplified before driving the FULL FIELD OUT

connectors and VITS & VIRS Inserter. By external control, the DAC can be made to accept external data information from the DIGITAL INPUT connector. The DIGITAL OUTPUT connector provides an output of the digital data information that the DAC is using to generate test signals.

The Horizontal & Vertical Timing Circuits are used to control the operation of the 1910. It contains a horizontal counter, a vertical counter, and the appropriate circuitry to generate gate signals. The Address Bus information is derived from the horizontal counter.

The Genlock & Oscillator block has sync and subcarrier processing circuits to detect synchronization information. This information is used in generating test signals, VITS, and VIRS in the 1910 so they will be synchronized to the Program In signal. The oscillator frequency that drives the Controller Timing Circuit is derived from the Program In subcarrier frequency.

The operator's control over the instrument can be exercised through the 1910 front panel, a remote control unit connected to the REMOTE CONTROL port, or a terminal interfaced to the 1910 via the RS-232 CONTROL port. As the operator enters information through one of these interfaces, the Microprocessor circuitry analyzes this information and directs the change of operation to the appropriate circuit within the instrument.

When the Pulse Output board (a standard accessory) is installed in place of the External VITS board and the rear panel is flipped over to change the nomenclature, the four VITS INPUT connectors become the following output connectors for the Pulse Output option: H DRIVE OUT, V DRIVE OUT, COMP BLANKING OUT, and BURST FLAG OUT.

OPERATOR'S CHECKOUT PROCEDURE

This Checkout Procedure may be used for operator familiarization and as a check of the basic instrument operation. Only instrument functions, not measurement quantities of specification, are checked in this procedure. Therefore, a minimum amount of test equipment is required. If performing the Operator's Checkout Procedure reveals improper operation or instrument malfunction, first check the operation of associated equipment, then refer to qualified personnel for repair or adjustment of the instrument.

Equipment Required

1. Waveform Monitor. A TEKTRONIX 1480 Waveform Monitor or equivalent.
2. NTSC Vectorscope. A TEKTRONIX 520A NTSC Vectorscope or equivalent.
3. NTSC Video Signal Source. A TEKTRONIX 1410 Mainframe with the SPG2 Sync Generator, TSG1 Color Bars, and TSP1 Switcher modules or equivalent.
4. Test Oscilloscope. A TEKTRONIX 7603 Oscilloscope with a 7A18 Vertical Amplifier and a 7B53A Time Base plug-in unit or equivalent.

CHECKOUT PROCEDURE

1. Setup

NOTE

Check the line voltage information indicated on the left-hand side of the front panel of the 1910 under OPERATING RANGE. If the power source voltage to be used is not within the factory-set range, have a qualified service person change the voltage operating range. He will find the necessary information in Section 1, INSTALLATION, of the Service Manual.

- a. Connect and set up the instruments together as indicated in Fig. 4-1.
- b. Set the 1910 POWER switch ON.
- c. CHECK—that the POWER indicator light is on.

2. Initialized State of 1910

a. CHECK—for the correct APL, SHIFT, and FULL FIELD SIGNAL indicator lights to be illuminated. The correct LEDs to be turned on at the Initialized State (when the 1910 POWER switch is set to ON and the RESET button is pressed) is as follows:

APL	ALL LINES
SHIFT	UPPER
FULL FIELD SIGNAL	COLOR BARS

b. CHECK—The 1910 (VIR SIGNAL PROGRAMMING) INSERT indicator light should be lit.

3. Genlock and VITS Insertion Operations

a. In the PROGRAM LINE section on the left-hand side of the 1910 front panel, check that only the NORMAL indicator is lit. This indicates the 1910 is genlocked to and inserting VITS on the incoming Program Signal.

b. Observe the waveform monitor and adjust the Vertical and Horizontal positioning to display Lines 17 and 18 of Fields 1 & 3. Check for the correct VIT signals on the appropriate lines as indicated in the left-hand VITS INSERTION list on the right side of the 1910 front panel. Press the waveform monitor Fields 2 & 4 buttons and check for the correct VIT signals as listed on the 1910 front panel.

c. Press the Burst button on the TSG1 module of the 1410 Generator. This deletes the burst off the incoming Program Signal. Check that no changes occurred in the 1910 operations as described in parts a and b of this step.

d. Release the Burst button to the out position on the TSG1 module and press the Sync button in. This Sync button position removes the sync information from the incoming Program Signal.

e. CHECK—the front-panel PROGRAM LINE indicators. The NONSYNCHRONOUS and BYPASS indicators should be lit; the NORMAL and (VIR SIGNAL PROGRAMMING) INSERT indicators should be off.

f. Observe the waveform monitor display. The PROGRAM OUT signal should appear the same as the PROGRAM IN signal, no VITS or VIRS added by the 1910.

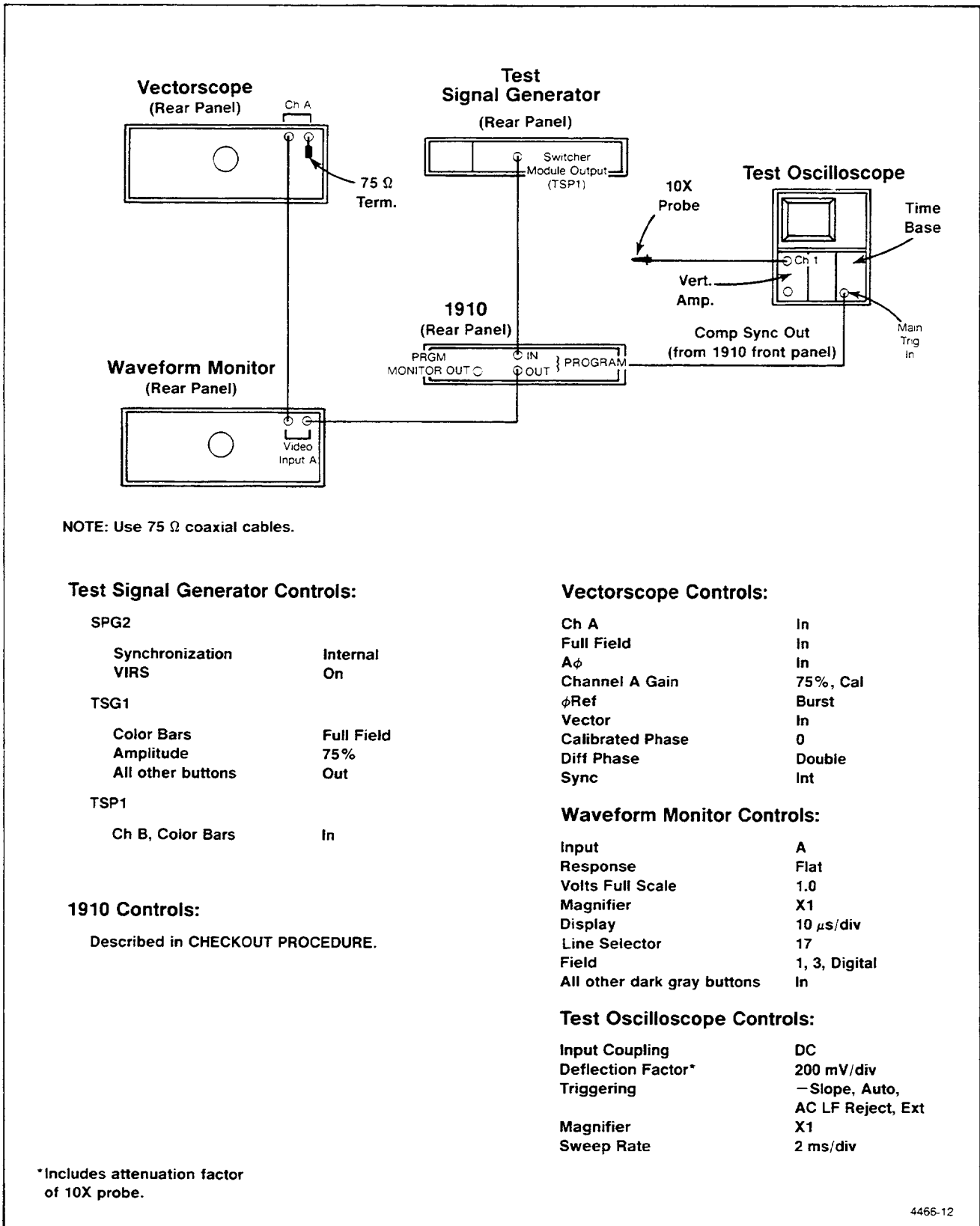

Fig. 4-1. Initial Setup Conditions.

NOTE: The display will be unstable because the TSG1 has deleted sync.

g. Move the 75 Ω cable from the PROGRAM OUT connector on the rear panel of the 1910 to the PRGM MONITOR OUT connector. Check that the TSG1 Sync button is pressed in (Off).

h. Set the waveform monitor Display switch to 2 Field.

i. Observing the waveform monitor display, only the VIT and VIR signals should be present. No full field signals will be present on the active television lines. If the (Proc Amp) Sync & Burst Insertion On (Enabled) mode has been selected, sync information will also be present.

j. Release the Sync button to the out position on the TSG1 in the 1410.

k. Observing the waveform monitor display, the signal should be the same as the PROGRAM OUT connector as observed in part b of step 3.

l. Move the 75 Ω cable from the PRGM MONITOR OUT connector back to the PROGRAM OUT connector. Check that this cable is connected from the 1910 PROGRAM OUT connector to the waveform monitor Video Input A connector as shown in Fig. 4-1.

4. TEST POINTS (INPUT & OUTPUT) Pin Jacks

a. Connect the oscilloscope 10X probe to the (PROGRAM) INPUT pin jack on the left front panel of the 1910.

b. Adjust the controls of the oscilloscope to observe the signal. The PROGRAM IN signal should be displayed. The signal will be lacking high-frequency information since the pin jack is isolated by 15 k Ω .

c. Connect the oscilloscope probe to the 1910 (PROGRAM) OUTPUT pin jack.

d. The PROGRAM OUT signal should be displayed with the same deterioration as described in part b of this step.

e. Disconnect the 10X probe from the pin jack.

5. VIR SIGNAL PROGRAMMING Operation

a. The 1410 Test Signal Generator must be set up with VIRS on Line 19 of both fields.

b. Set the waveform monitor Line Selector switch to 19. Check that the VIR signal is displayed.

c. CHECK—Only the INCOMING indicator should be lit in the VIR SIGNAL PROGRAMMING section of the 1910 front panel.

d. Release the VIRS button to the out position on the SPG2 of the 1410. This removes VIRS off the incoming Program Signals.

e. CHECK—Only the INSERT indicator should be lit in the VIR SIGNAL PROGRAMMING section of the 1910 front panel.

f. CHECK—on the waveform monitor for VIRS on Line 19 of both fields.

6. Insert Subcarrier Phase Adjustment

a. Observe the burst vector and the 1910-inserted VIRS subcarrier vector on the vectorscope.

b. Set the vectorscope Channel A Phase control so the burst vector is at 180 degrees.

NOTE

To identify the vectors, the burst vector is bright and the VIRS vector is dim.

c. Vary the INSERT SUBCARRIER PHASE ADJUST; note if the VIRS vector can be varied to either side of the burst vector.

d. Adjust the INSERT SUBCARRIER PHASE ADJUST so the VIRS vector overlays the burst vector.

7. FULL FIELD SIGNAL Operation

a. Disconnect the cable from the PROGRAM OUT connector. Connect this cable to the FULL FIELD OUT on the 1910 rear panel.

Operators Checkout Procedure—1910 Operators

b. Set the waveform monitor Field buttons to 1, 3, and Line Selector button to Off.

c. CHECK—for the correct Full Field Signal on the waveform monitor and that the corresponding LED is lit as the APL, SHIFT, and FULL FIELD SIGNAL buttons are pressed sequentially.

Information concerning these Full Field Signals can be found in Sections 1, 3, and 6 of this manual.

d. Disconnect the 75 Ω cable from the FULL FIELD OUT connector on the 1910 rear panel. Connect this cable to the FULL FIELD connector on the front panel of the 1910.

e. CHECK—for the same signal as observed from the rear-panel FULL FIELD OUT connector.

f. Select the APL BOUNCE signal.

g. CHECK—the bounce rate should vary as the BOUNCE RATE adjustment is varied. Adjust to operator's preference.

h. Press the 1910 APL-ALL LINES button.

i. Disconnect all the equipment from the 1910.

8. COMP SYNC OUTPUT

a. Set up the instruments as illustrated in Fig. 4-2.

b. CHECK—Composite Sync amplitude should be approximately 4 V peak-to-peak terminated into 75 Ω . The sync pulse should be negative going.

c. Move the cable from the COMP SYNC OUT connector on the rear panel of the 1910 to the COMP SYNC OUTPUT connector on the front panel.

d. CHECK—Repeat part b of this step.

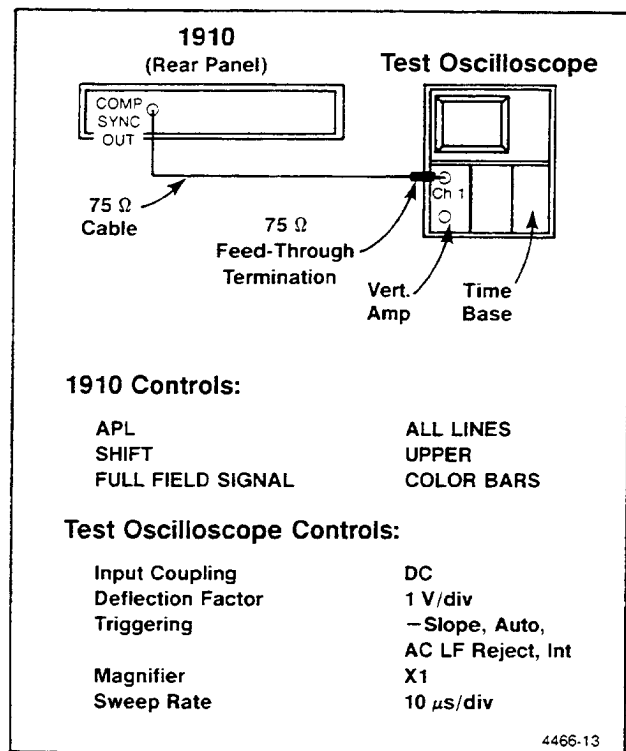

Fig. 4-2. Setup Conditions for Checking the 1910 Composite Sync Signal.

9. SUBCARRIER OUTPUT

a. Disconnect the cable from the COMP SYNC OUTPUT connector. Reconnect this cable to the SUBCARRIER OUTPUT connector on the 1910 front panel.

b. CHECK—Subcarrier signal information should be approximately 2 V peak-to-peak terminated into 75 Ω .

c. Move the cable from the SUBCARRIER OUTPUT connector on the 1910 front panel to the SUBCARRIER OUTPUT connector on the rear panel.

d. CHECK—Repeat part b of this step.

10. Remote Control Operations

The operation of the REMOTE CONTROL and RS-232 CONTROL ports may be checked out using the information provided in Section 5 of this manual.

REMOTE OPERATION

Introduction

This section covers information pertaining to the remote-control operations of the 1910. The contents are divided into two parts, one dealing with the RS-232 CONTROL port communication and the other with the REMOTE CONTROL port. Both of these ports can be connected to the 1910 at the same time and used together in certain functions. See Fig. 5-1 for a typical setup configuration using these ports.



When connecting the RS-232 interface cable to the RS-232 CONTROL receptacle on the rear panel of the 1910, **be extremely cautious** not to connect it to the DIGITAL OUTPUT receptacle. This error may result in permanent damage to the DIGITAL OUTPUT circuitry.

Marker Sets

Two marker sets are provided in the 1910 accessories kit. They are as follows:

- (1) Tektronix 1910 FRONT PANEL MARKER SET (see Fig. 5-2)—Used for changing the 1910 Digital Generator front-panel nomenclature.
- (2) Tektronix 1910 REMOTE CONTROL UNIT MARKER SET (see Fig. 5-3)—Used for changing the front-panel nomenclature on the Tektronix Remote Control Unit (RCU).

The sticky-back labels on the marker sets are utilized when the commands from the RS-232 port have redefined the switches for the full Field and VIT Signals. The desired labels can then be peeled from the backing and placed on the front panels of the 1910 and RCU to agree with the newly modified control configuration.

If none of the signal labels are suitable, there are some blank labels provided on the marker sets for the user to print the desired nomenclature on them.

As shown in Fig. 5-3, there is one label that reads: Tektronix 1910 REMOTE CONTROL UNIT. This label can be used to change the name of the RCU from 1900 to 1910.

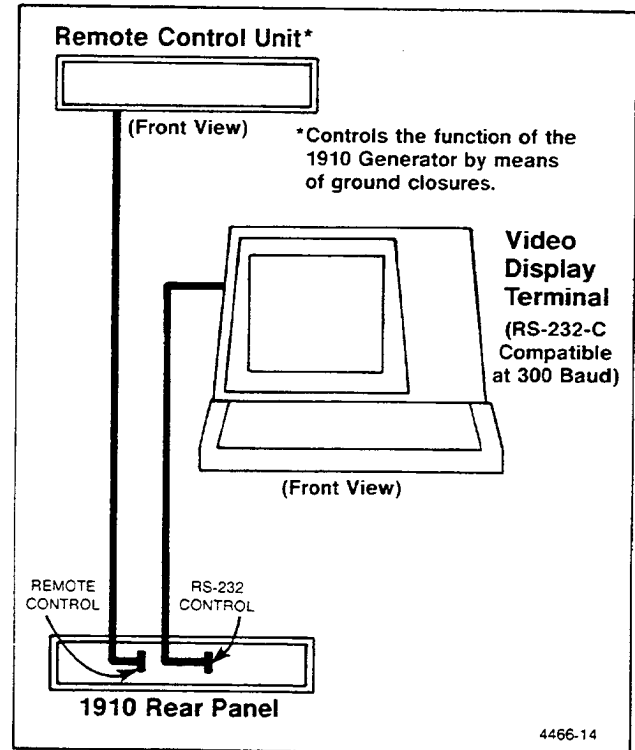

Fig. 5-1. Typical Setup Configuration Using the 1910 REMOTE CONTROL and RS-232 CONTROL Ports.

When applying this label to the RCU front panel, do not cover the part number.

Definition of Terms

The following terms appear in this portion of the manual. Some of these terms also appear in other sections of this manual. The definitions listed here are provided to help in understanding their meaning.

Acronym—A word formed from the first letter or letters of words in a name, term, or phrase; for example, VITS from Vertical Interval Test Signal.

ASCII—American Standard Code for Information Interchange. Coded character set used for the general interchange of information among information-processing systems, communications systems, and associated equipment.

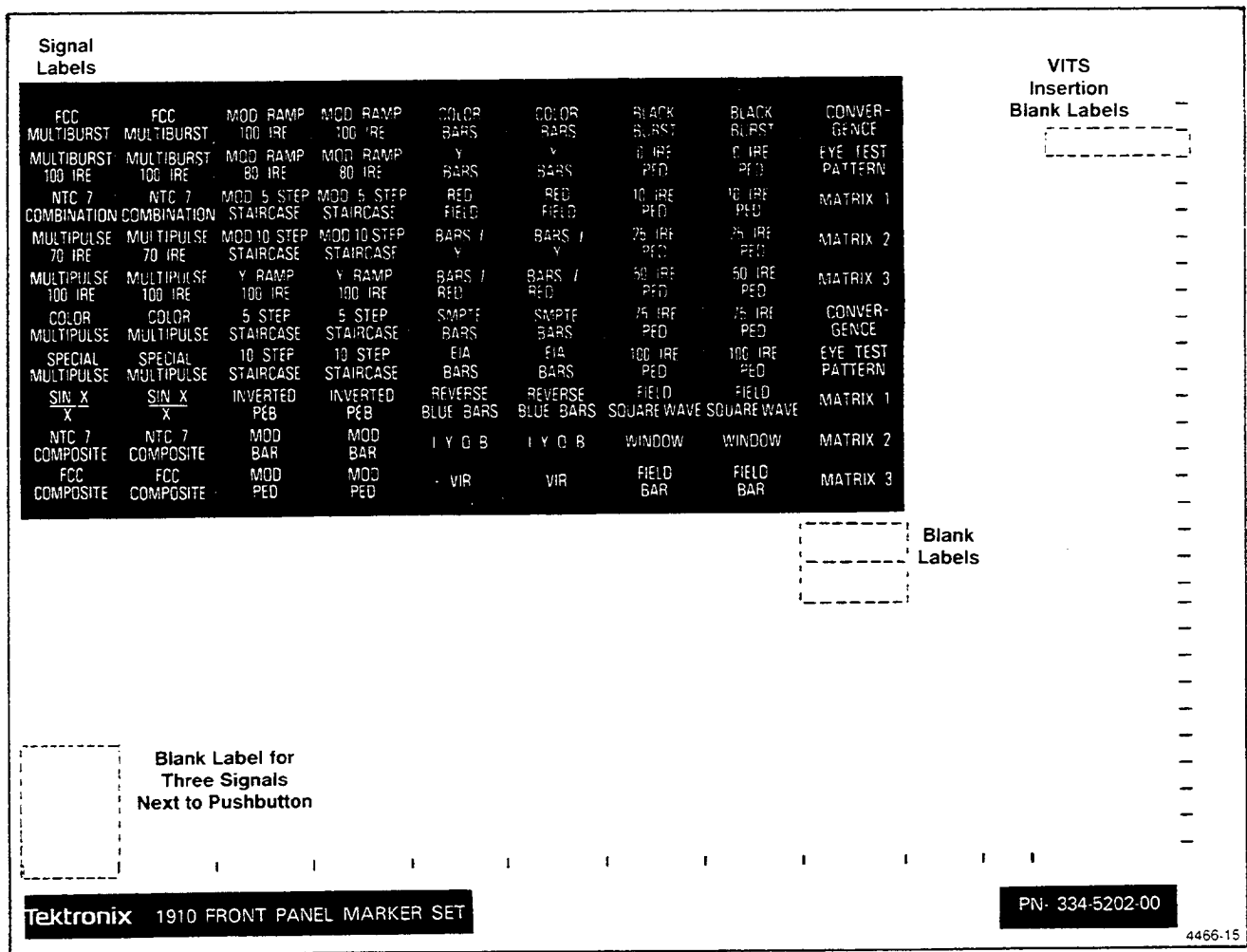

Fig. 5-2. TEKTRONIX 1910 Front-Panel Marker Set.

Baud—A unit of telegraph signalling speed equal to the number of code elements (pulses and spaces) transmitted per second. For practical purposes, it is now used interchangeably with "bits per second" as the unit of measure of serial data flow.

Bit—An abbreviation of binary digit. A single character in a binary number.

EPROM—Ultraviolet Erasable and Electrically Programmable Read Only Memory.

EEPROM—Electrically Erasable and Programmable Read Only Memory.

Interface—The specification of interconnection between two pieces of equipment that allows them to communicate via a predetermined interface protocol.

Keyboard—A device for the encoding of data by key depression, which causes the generation of the selected code element; for example the keyboard of a computer display terminal that produces the ASCII codes according to the keys depressed.

LSB—Least Significant Bit. The 'zero' bit position in a binary word.

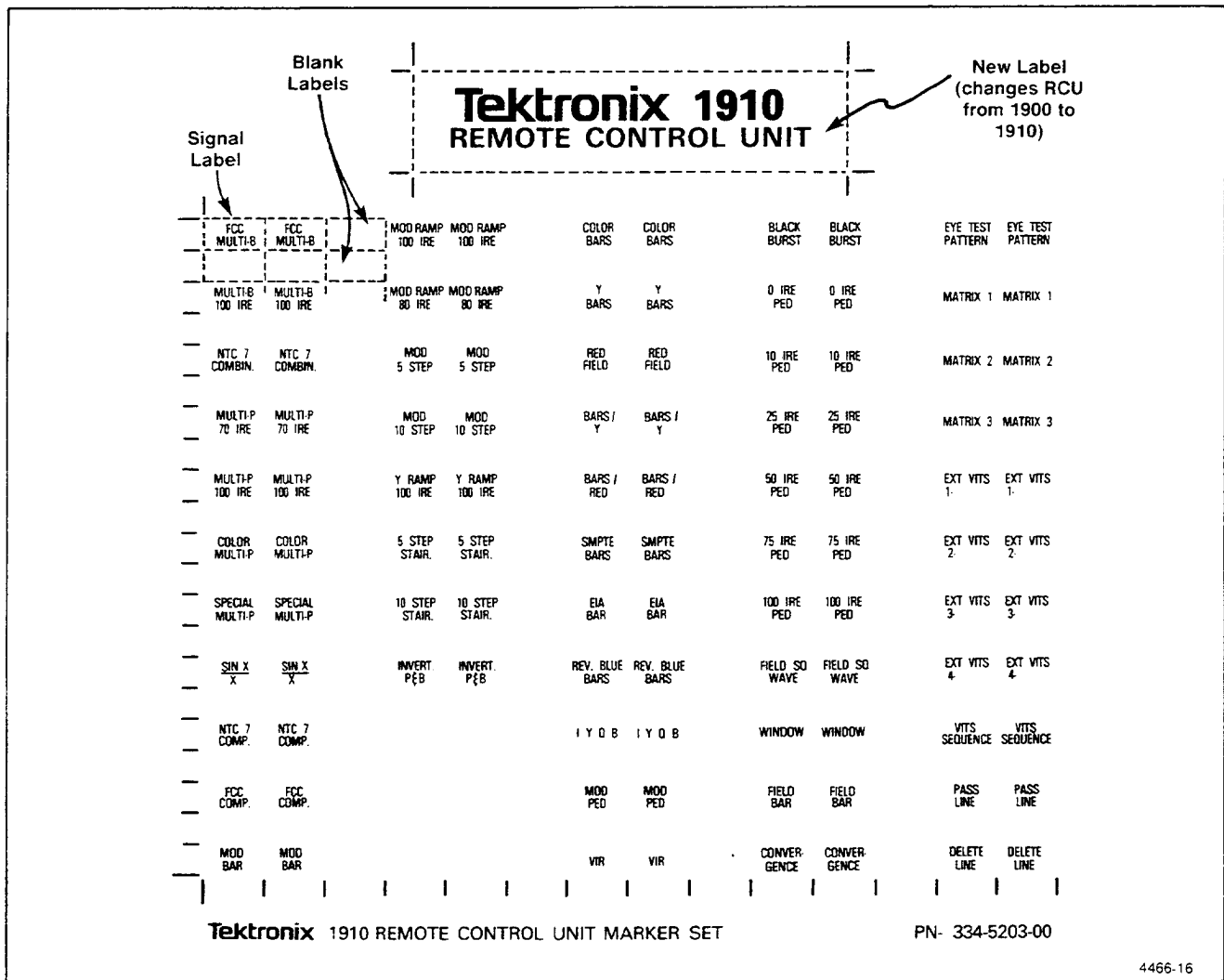

Fig. 5-3. TEKTRONIX 1910 Remote Control Unit Marker Set.

Mnemonic—A long string of characters is abbreviated to form a shortened string that the 1910 will recognize; for example, CBR is the abbreviation for Color Bars. The abbreviation is also more convenient for the operator to use.

MSB—Most Significant Bit. The 'Nth' bit position in a N bit binary word.

Object—The keyword in a command line that specifies the object on which the command (verb) is to perform the desired operation. An object is similar to the object of a verb in a sentence.

Parity—Pertaining to the use of a self-checking code employing binary digits in which the total number of ONEs (or ZEROS) in each permissible code expression is always even

or always odd. A check may be made for either even parity or odd parity.

Port—An interface through which information may be transmitted or received by some predetermined interface standard.

PROM—Programmable Read Only Memory.

RAM—Random-Access Memory.

RS-232-C—An Electronic Industries Association (EIA) standard titled, "Interface Between Data Terminal Equipment and Data Communication Equipment Employing Serial Binary Data Interchange". This standard is applicable to the

Remote Operation—1910 Operators

interconnection of data terminal equipment (DTE) and data communication equipment (DCE) employing serial binary data interchange.

Syntax—The structure or rules of grammar used to group keywords to form a valid command line.

Terminal—Hardware communication device, with a typewriter-like keyboard, that transmits and receives ASCII-encoded information via the RS-232-C standard.

Terminal Keyboard—See: Keyboard.

VITS Sequence—A sequence of VIT signals that can appear on a given line in a field. For example, Line 16 may have a sequence of these signals: F1=Color Bars, F2=Multiburst, F3=Composite, and F4=Sin X/X. Up to eight color frames can be sequenced. Time duration is a multiple of color frames up to a maximum of 65,536 color frames.

Volatile Memory—A storage medium in which information is destroyed when power is removed from the system.

PART I

RS-232 CONTROL PORT COMMUNICATION

Introduction

This portion of the manual contains information needed to control the 1910 from the keyboard of a terminal that is connected to the RS-232 CONTROL port.

The RS-232 CONTROL port allows the operator to obtain status reports and control the functions of the 1910 Generator. This port is compatible to the EIA Specification RS-232-C as defined in Table 1-7 in Section 1 of this manual. The following is a list of functions that are controllable from the RS-232 CONTROL port of the 1910:

1. Modify the RS-232 names and their descriptions.
2. Redefine the 1910 front panel to change the signal selected by any of the signal buttons.
3. Redefine any of the Full Field and VIT Signal buttons on the Remote Control so any of the signals existing in the 1910 may be selected.
4. Enable or disable sync and burst insertion and transmitter protect.
5. Define three Matrix signals with up to 16 signals per field.
6. Program VITS sequencing.
7. The command SAVE XXXX is available for operators who wish to try several VITS/Full Field combinations before committing the selections to the EEPROM.
8. Select the 1910 PROGRAM IN signal route, either through the 1910 VITS/VIRS Inserter board or bypassed directly from the PROGRAM IN to the PROGRAM OUT connector. This function is controllable only when the Remote Control Unit is in the Program Insert mode or pin 20 on the REMOTE CONTROL port is high (default condition).
9. Select the FULL FIELD OUTPUT signal.
10. Program VITS and VIRS on Lines 10 through 21 in Field 1, 2, or both.
11. Select the VIRS mode of operation.

Description

The command language with which the 1910 is controlled contains three elements; verbs, objects, and modifiers. The verbs communicate the action to be performed. The action of the verb is carried out on the object. The modifier changes or modifies the action of the verb. For example, the verb DISPLAY will cause the 1910 to print a message to the terminal device telling about the object which was specified in the

Remote Operation—1910 Operators

RS-232 Control Port Communication

command. The DISPLAY command accepts modifiers that determine the location in memory of the object. For example, the P modifier on the DISPLAY VITS command will display the VITS from the non-volatile memory (the P stands for permanent memory). The user communicates to the 1910 by entering a command line composed of a verb, which will tell the 1910 what action is to be performed, an object, which tells the 1910 what to perform the action on, and a modifier, which modifies the action (not all commands accept modifiers).

VERBS:

MODIFY: MAKE OR INITIATE CHANGES TO THE OBJECT.
DISPLAY: PRINTS THE STATE OF THE OBJECT.
COMPARE: COMPARES LIKE OBJECTS STORED IN DIFFERENT MEMORY DEVICES.
SAVE: SAVE AN OBJECT IN NON-VOLATILE MEMORY.
LOAD: LOAD AN OBJECT INTO VOLATILE MEMORY FROM NON-VOLATILE MEMORY.
RESET: LOAD AN OBJECT INTO VOLATILE MEMORY FROM FACTORY MEMORY.
?: DISPLAYS THE ACCEPTED COMMANDS.

OBJECTS:

ALL: INCLUDES ALL OBJECTS KNOWN TO A VERB.
VITS: INSERT VITS SIGNALS.
STATUS: INSTRUMENT SIGNAL OUTPUT/PROCESSING STATE.
MATRIX: PROGRAMMABLE MATRIX SIGNALS.
VSEQUENCE: VITS SEQUENCE SIGNALS.
FSEQUENCE: FULL FIELD SEQUENCE SIGNALS.
SSEQUENCE: SCH SEQUENCE SIGNAL.
NAME: SIGNAL MNEMONIC AND DESCRIPTION.
FRPA: FRONT PANEL SIGNAL ASSIGNMENTS.
RCUN: REMOTE CONTROL UNIT SIGNAL ASSIGNMENTS.
TABLE: INCLUDES NAME, FRPA, AND RCUN IN UNDER ONE OBJECT.
VIRM: VIR MODE PROCESSING STATE.
FULL: FULL FIELD SIGNAL.
COMMAND: COMMAND NAMES.
BAUD: BAUD RATE.

The 1910 accepts a rather large set of commands. The question mark command can be a help in reminding the user what the commands are. The user need only enter a question mark after any prompt, and the 1910 will give a list or a description of the command(s).

Command Language Notes:

The following should be observed when programming the 1910 from a terminal or other device connected to the RS-232 CONTROL port.

1. Prior to SN B021411, vertical interval line 21 (all fields) can not be configured to insert a signal generated by the 1910. It can only be programmed to pass the program input on line 21, delete incoming line 21 programming, or insert one of the Four externally input VITS. If 1910 signal insertion is attempted on line 21, the 1910 will allow the command input, but a 0 IRE Pedestal will be inserted in place of the chosen signal.

2. If a matrix is selected as the full field output signal, modifications to the matrix (including changes using the commands LOAD MATRIX and RESET MATRIX, and MODIFY MATRIX) will not be actively displayed in the full field output. In order to display the modified matrix, it must be selected again as a full field signal by pressing the appropriate front panel buttons, or by selecting the matrix through the RS-232 CONTROL port or the REMOTE CONTROL port.

3. The "Transmitter Protect" and "Proc Amp" status indicators are presented in the DISP STATUS report only when they are "on".

4. In Table 5-1, the key "ESC" input should be added. This key performs the function of returning the user to the command (1910>) mode.

5. A signal choice of NSL (no select) causes a sequence (either Full Field or VITS Sequence) to return to the first signal of the sequence, in order to continue sequence repetition. If NSL is chosen as the first signal of the Full Field Sequence, or as one of first color frame inputs of a VITS Sequence, an error will occur which causes the sequence to deprogram itself, and the 1910 will return to a (default condition for a Full Field Sequence is a full field Color Bars display, default for VITS Sequence is PASS).

Memory Description

The 1910 has three separate memory devices, STANDARD, TEMPORARY, and PERMANENT. The STANDARD memory is the EPROM that stores the control program and the factory constants. This memory cannot be changed by the user, but can be used as a source for the objects. The TEMPORARY memory is the RAM, and it is used to store the objects that determine the operation of the 1910. The objects stored in the TEMPORARY memory are lost when the instrument is powered down. The PERMANENT memory is the EEPROM and is also referred to as NON-VOLATILE memory. This memory will retain the information in it when the power is turned off like the factory memory, however, the non-volatile memory is user programmable. The non-volatile memory allows the user to store objects permanently; the objects stored in the non-volatile memory are transferred into TEMPORARY memory at power-up.

Fig. 5-4 shows the relationship between the memory devices and the action of the commands on objects stored in the memory devices. The TEMPORARY MEMORY is shown in the center with the standard (or factory) and PERMANENT memories on either side. The command names are the arrows and are shown outside of the MEMORY blocks to indicate the movement of data or the data upon which the action is performed.

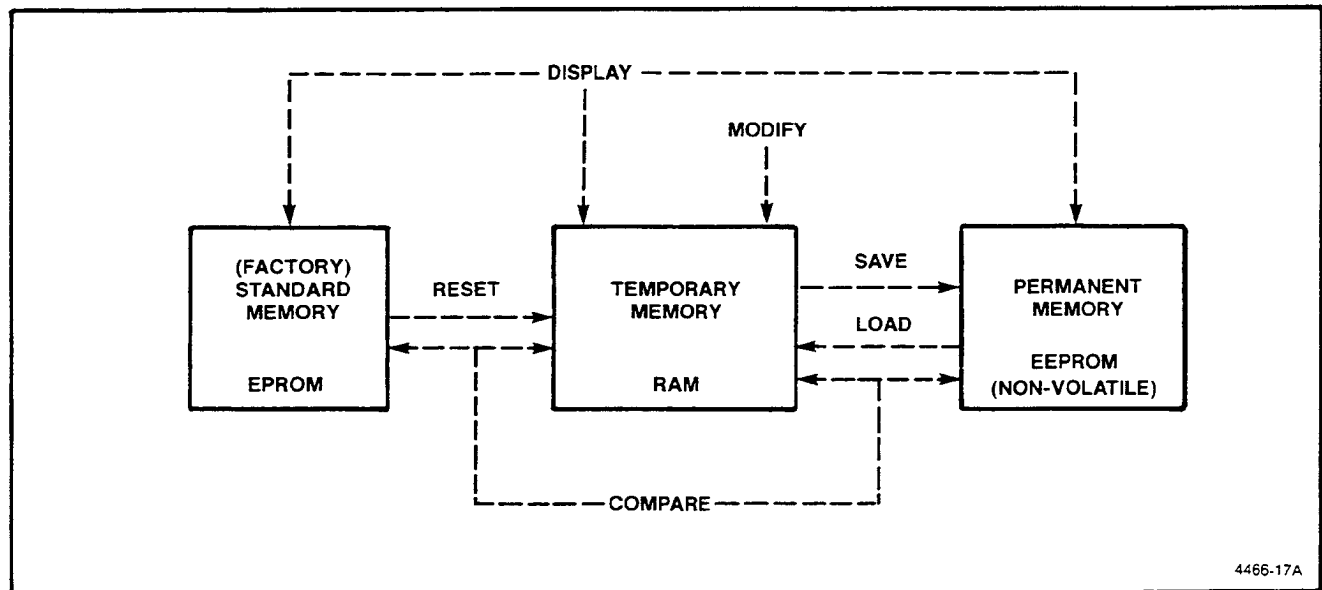

Fig. 5-4. Relationship Between Memory Devices.

Special Character Definitions

Table 5-1 lists the special characters and their meanings.

Table 5-1
SPECIAL CHARACTER DEFINITIONS

CHARACTER(S)	Action or Effect
Control-S	Suspends all output until a Control-Q is received. Wait for Control-Q.
Control-Q	Restarts output from the point that a Control-S was received.
Control-R	Prints the contents of the line buffer (Control-R is not entered, line buffer is unaltered).
<CR> or <LF> or <CR> <LF>	End of Line-Input
<CR> <LF>	End of Line-Output
Control-C or Control-T	Aborts all jobs or command processing and transfers control to the mode selected on the Remote Control Unit.
Control-U	Deletes the contents of the line buffer.
Control-H	Backspace - decrements line buffer.
Rubout	Sends underscore, type character, and backspace line buffer.

Initial Operation Using the RS-232 Control Port

Use the following first-time procedure to become familiar with RS-232 CONTROL port communication.

1. Check the interface cable. Fig. 5-5 shows three ways to make connections between the 1910 RS-232 CONTROL port and the terminal or computer. Use the connection diagram that is appropriate for your system. Fig. 5-6 shows the 1910 rear-panel RS-232 CONTROL port pin configuration. Fig. 5-1 shows a typical setup configuration.

2. Connect the RS-232 interface cable from the terminal to the 1910 rear-panel RS-232 control port.



When connecting the RS-232 interface cable to the 1910 rear-panel RS-232 CONTROL port, do not inadvertently connect the cable connector to the 1910 rear-panel DIGITAL OUTPUT connector.

3. Set the Power switch for the 1910 and terminal or computer to On.

Remote Operation—1910 Operators
RS-232 Control Port Communication

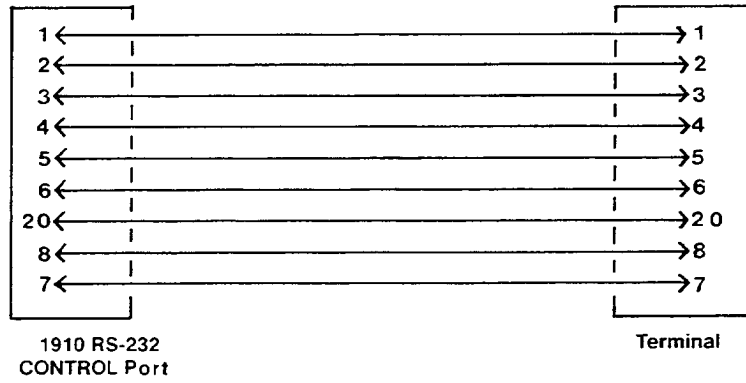

(A) 1910-to-Terminal Connections.

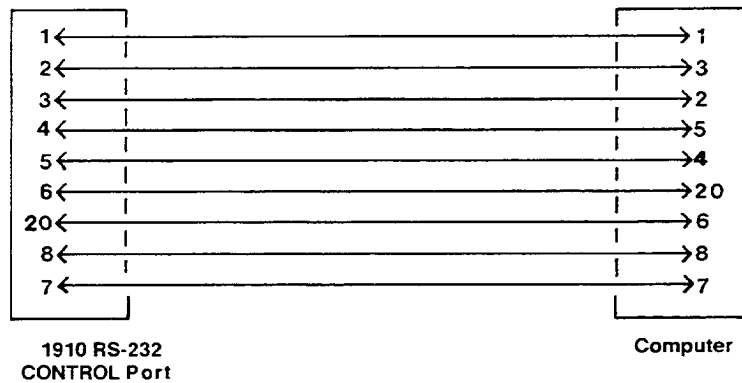

(B) 1910-to-Computer Connections.

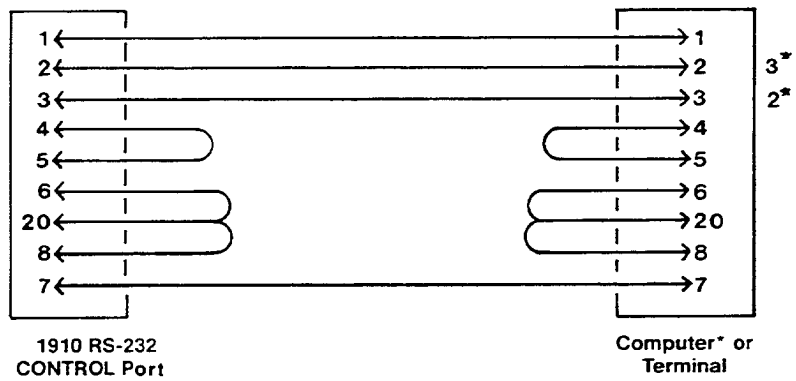

*Interchange the wires to pins 2 and 3 for the computer (not the terminal).

(C) 1910-to-Four Wire Interface.

4466-18

Fig. 5-5. Connection Diagrams for the RS-232 Port.

Remote Operation—1910 Operators
RS-232 Control Port Communication

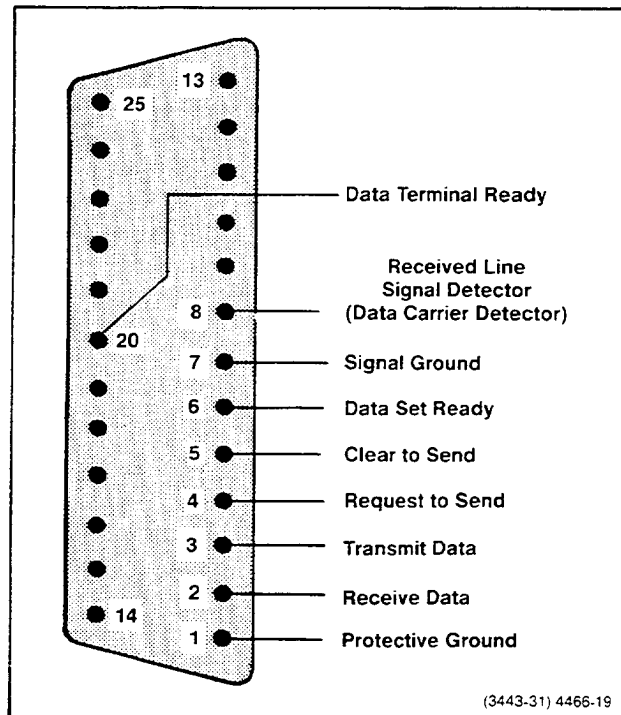

Fig. 5-6. RS-232 CONTROL Port Pin Configuration.

4. Check that the setup conditions for the terminal or computer are as follows:

Line	On
Parity	Odd, Disable
Bits per Character	8
Half Duplex (Local Echo)	Full Duplex
Handshake	Enable
Line (On-Off)	On
Baud	300

5. Check that the baud rate of the terminal or computer is set to the same transmit and receive rate as the 1910. The 1910 is factory set to 300 baud.

6. Press <CTRL> C. The following prompt will appear:

1910>

7. Read the remaining portion of the RS-232 CONTROL port communication information to learn the command language. A summary of the 1910 commands and mnemonics, Tables 5-2 and 5-3, is provided later on. Refer to the topic entitled, "Reproducible Tables and Worksheets".

COMMANDS

COMPARE

COMPare { ALL
VITS
NAME
FRPA
RCUN
MATRix
VSEquence
FSEquence
SSEquence
NAME } [P or (S)]

The compare command compares the object currently stored in temporary memory to the object stored in the memory device specified by the modifier. The default memory device is the factory memory or EPROM. The command will produce a table that specifies the differences between the two copies of the object. The command will print only the elements of the objects that are found to be different from one another. The elements that are found to be different are listed in two columns. The first column tells the user the current definition (contained in temporary memory) of the element. The second column tells the user the definition contained in the modifier-selected memory source. At the top of the compare output is a message that reminds the user which memory source was selected. At the conclusion of the compare command, the number of differences that were found by the compare command is printed. The following sample output shows a typical compare command execution.

```

USER PROGRAMMED:
SIGNAL NAMES:
PERMANENT          CURRENT
COL-COLORFUL BARS  CBR-COLOR BARS
CMP-COLOR MULTI-P  CLP-COLOR MULTIPULS

2 DIFFERENCES FOUND.

```

**Remote Operation—1910 Operators
RS-232 Control Port Communication**

DISPLAY

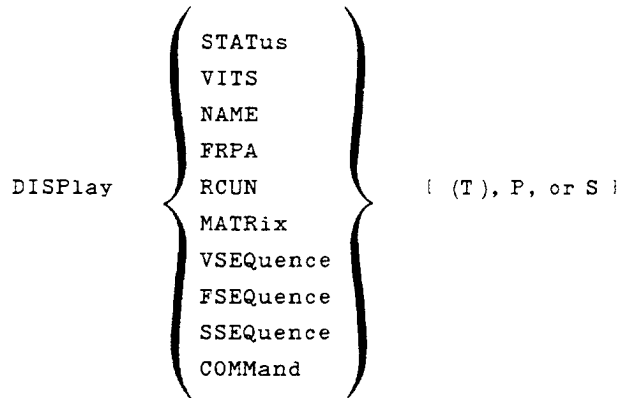

The display command prints the information about the object contained in the memory device specified by the modifier (T, P, or S) to the terminal. The display command does not modify or change the operation of the 1910, it only displays the current state of the specified object. The format of the message printed by the command is unique to each display command. The following example shows the DISPLAY VITS command. The user enters the command and the 1910 responds with the table showing the user the current state of the VITS.

```
1910>DISPLAY VITS
LINE  FIELD 1/3                FIELD 2/4
10    PAS-PASS PROGRAM          PAS-PASS PROGRAM
11    PAS-PASS PROGRAM          PAS-PASS PROGRAM
12    PAS-PASS PROGRAM          PAS-PASS PROGRAM
13    PAS-PASS PROGRAM          PAS-PASS PROGRAM
14    PAS-PASS PROGRAM          PAS-PASS PROGRAM
15    PAS-PASS PROGRAM          PAS-PASS PROGRAM
16    PAS-PASS PROGRAM          PAS-PASS PROGRAM
17    FRM-FCC MULTIBURST       CBR-COLOR BARS
18    FCP-FCC COMPOSIT         FCP-FCC COMPOSITE
19    VRD-VIR DETECT           VRD-VIR DETECT
20    PAS-PASS PROGRAM          PAS-PASS PROGRAM
21    PAS-PASS PROGRAM          PAS-PASS PROGRAM
1910 >
```

LOAD

LOAD { ALL
TABLE
MATRix
VIRMode
FULLfield [NO MODIFIERS]
VITS
VSEquence
FSEquence
SSEquence }

The load command moves the object contained in the non-volatile memory into the temporary memory. The 1910 will immediately reflect the new values by modifying its operation, except in the case of the matrix signals. Any matrix currently being output will be unmodified by this command. However, the next time a matrix is selected, the matrix will be the one loaded from the non-volatile memory. This command gives the user the capability of loading the permanent objects. For example, to load the VITS from the non-volatile memory, the user would enter: LOAD VITS.

Remote Operation—1910 Operators
RS-232 Control Port Communication

MODIFY

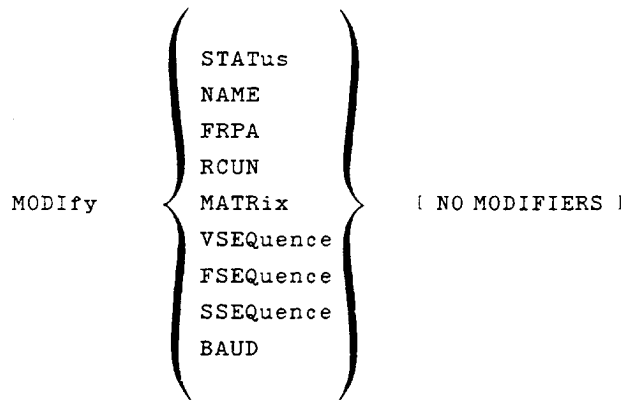

This command opens the modify command mode which allows the user to change the operation of the 1910. The command mode invoked by each object is unique to that object, and the command mode is explained in the object descriptions under the header MODIFY "OBJECT." Once the modify command is entered, the 1910 will respond with the command mode prompt for the particular object selected. Each object command mode accepts commands that modify the object contained in temporary memory. The format of these commands can be seen by inputting a question mark (?). The object command mode is exited by inputting an escape (ESC or control-shift-[]). For the specifics about the modify command mode, refer to the object command mode descriptions that follow.

```

1910 >
MS >?
MODIFY STATUS COMMANDS:
FYLXX=MNM-PROGRAM VITS LINE XX (10-21 ) FIELD Y (1 OR 2 )
FU=MNM-PROGRAMS FULL FIELD SIGNAL
VI=AUT,PAS,DEL, or INS PROGRAMS VIR MODE
OP or BY-PROGRAM OPERATE or BYPASS
PR ON or OFF-PROC. AMP
TR ON or OFF-TRANSMITTER PROTECT
AP=ALL,LOW,HIG, or BNC-SET APL
BU=ON or OFF-BURST
MS ><ESC >
1910 >

```

MODIFY BAUD

```
SELECT BAUD RATE:  
1-300  
2-1200  
3-2400  
4-4800  
? >
```

The modify baud command mode allows the user to select one of the four software-programmable baud rates. The command mode presents the user with a menu of the allowed baud rates from which the user can select the desired rate. The command will immediately reset the baud rate to the selected value. The user must, therefore, be prepared to change the baud rate of the communicating device, be it a terminal or a computer, to the selected baud rate. The following example shows the user changing the baud rate from the factory-standard 300 baud to 4800 baud.

```
1910 >MODIFY BAUD  
SELECT BAUD RATE:  
1-300  
2-1200  
3-2400  
4-4800  
? >4
```

THE USER THEN CHANGES THE BAUD RATE OF THE TERMINAL FROM 300 TO 4800,
AND ENTERS A CARRIAGE RETURN.

```
1910 >
```

MODIFY NAME

```
SPA >  
[ OLD SIGNAL MNEMONIC ] = [ NEW SIGNAL MNEMONIC ]  
INPUT DESCRIPTION > [ USER DEFINED SIGNAL DESCRIPTION ]
```

This object command mode is invoked to change the signal mnemonic names. The format of the command is given above. The present signal mnemonic is entered first, followed by an equal sign, and the new mnemonic to which it will be changed. The mnemonic is a three-character/number name that is used to specify the signal. Non-character/number inputs will result in an error message. If more than three characters are entered, the first three are used and the rest ignored. If the new mnemonic is already used to refer to a signal, an error message is printed and the input is ignored. After a rename command is accepted, the user will be prompted to input a signal description. This description will accompany the signal mnemonic in all reports of signal names in the display, compare commands. The description is limited to no more than 15 letters/numbers. If the description contains other than a letter or a number, an error message is printed and the input is ignored. It will continue to ask for a description until the user enters a valid description or enters an escape. The escape will retain the current description. The input description is truncated to the first 15 characters input by the user. The following example shows the renaming of CBR to COL.

```
1910 >MODIFY NAME  
SPA >?  
OLD MNM =NEW MNM  
SPA >CBR =COL  
INPUT DESCRIPTION >COLORFUL BARS  
SPA > -ESC >  
1910 >DISPLAY VITS
```

LINE	FIELD 1/3	FIELD 2/4
10	PAS-PASS PROGRAM	PAS-PASS PROGRAM
11	PAS-PASS PROGRAM	PAS-PASS PROGRAM
12	PAS-PASS PROGRAM	PAS-PASS PROGRAM
13	PAS-PASS PROGRAM	PAS-PASS PROGRAM
14	PAS-PASS PROGRAM	PAS-PASS PROGRAM
15	PAS-PASS PROGRAM	PAS-PASS PROGRAM
16	PAS-PASS PROGRAM	PAS-PASS PROGRAM
17	FRM-FCC MULTIBURST	COL-COLORFUL BARS
18	FCP-FCC COMPOSITE	FCP-FCC COMPOSITE
19	VRD-VIR DETECT	VRD-VIR DETECT
20	PAS-PASS PROGRAM	PAS-PASS PROGRAM
21	PAS-PASS PROGRAM	PAS-PASS PROGRAM

1910 >

MODIFY FRPA

```
FPA >
FPA > {U, M or L} XX = { SIGNAL MNEMONIC }
      XX = FRONT PANEL SWITCH NUMBER
```

This object command mode accepts commands that allow the user to change the signals that are assigned to the buttons on the front panel. To change a signal on the front panel, the user specifies the button by entering the shift-level designator U-upper, M-middle, or L-lower followed by the number of the button (1-10). The button numbers can be found in the front-panel shown in Fig. 5-7. This button number is then set equal to a signal mnemonic. This command will cause the signal to be selected by the specified front-panel button. An error will result if an invalid switch number is entered or if an invalid signal is specified (nonexistent or VITS only). To put color bars on button number 8 at the middle-shift level the user would enter the following command: M8=CBR.

Use the sticky-back labels from the 1910 Front-Panel Marker Set to change the name of the signal that was redefined.

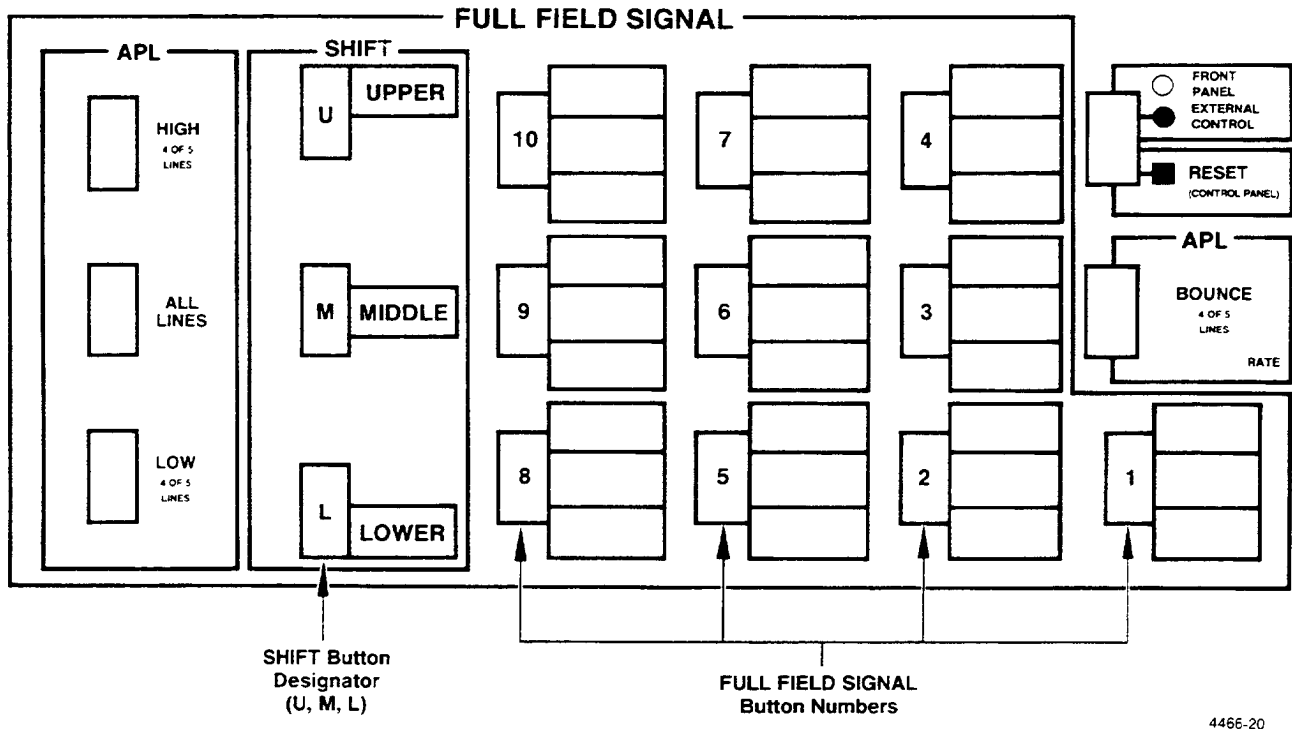

Fig. 5-7. Partial 1910 Front Panel that has been Altered to illustrate the SHIFT Button Designators and FULL FIELD SIGNAL Button Number Assignments.

**Remote Operation—1910 Operators
RS-232 Control Port Communication**

MODIFY RCUN

```
RMA >
RMA >[F or V]XX=[SIGNAL MNEMONIC] XX=NUMBER:0-15
```

This object command mode allows the user to change the signals that are assigned to the buttons on the Remote Control Unit. The remote has two groups of buttons: Full Field Signal and VITS. The user specifies the desired button by entering the button group identifier and the number of the button. The button numbers can be determined from the remote control panel diagram shown in Fig. 5-8. The button number designation is set equal to a signal mnemonic. From then on that button will call the signal specified by the signal mnemonic. The command mode issues two types of errors: switch number and mnemonic. The switch number error is issued if the switch number specification is not in the format previously described. The mnemonic error is issued if the signal mnemonic is non-existent or the signal is the wrong type (VITS for full field, etc.). To change the VIRS position on the Remote Control Unit, the user would issue the following command: F11=CBR. This would change the VIR signal, factory set to this position, to the color bars signal.

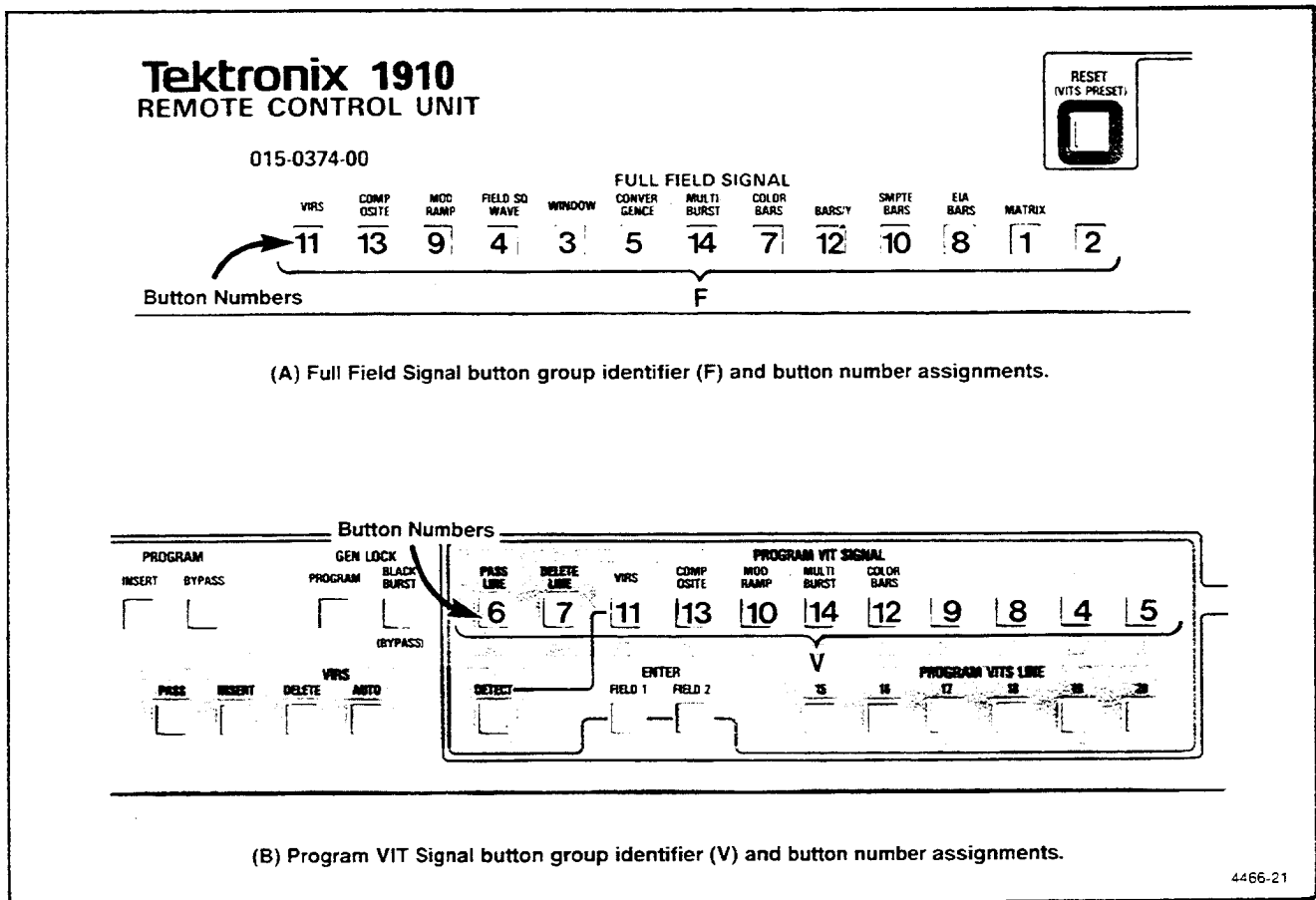

Fig. 5-8. Remote Control Unit Front Panel.

Redefining the Remote Control Unit Switches

The following information describes how to modify the Remote Control Unit (RCU) switches for the Full Field Signal and Program VIT Signal functions in more detail. This information is a supplement to the preceding description for MODIFY RCUN.

As an example, supposing the user wants to change the (Full Field Signal) Mod Ramp button to Modulated 5 Step. Also, the user would like to change the (Program VIT Signal) Composite button to External VITS 1. To make these changes, use the following procedure:

1. Find the group identifier and button number of the (Full Field Signal) Mod Ramp on the RCU by referring to Fig. 5-8. This is F9.
2. Find the group identifier and button number of the (Program VIT Signal) Composite button. See Fig. 5-8. This is V13.
3. Check that the equipment is connected the same as shown in Fig. 5-1.
4. Using F9 and V13 as examples, enter the following:

```
<CTRL>C
1910>MODI RCUN <CR>
RMA>F9=M5S <CR>
RMA>V13=EX1 <CR>
RMA><ESC>
1910>SAVE TABLE <CR>
```

NOTE

The prompts are 1910> and RMA>.

5. After making the changes, peel the labels from the RCU Marker Set backing (see Fig. 5-3). Using the example given in step 4, the labels would be MOD 5 STEP and EXT VITS 1. Place these labels over the (Full Field Signal) Mod Ramp and (Program VIT Signal) Composite nomenclature, respectively, on the RCU front panel.

6. To verify that the changes in this example have taken place, type the following command:

```
1910>COMP RCUN S
FACTORY STANDARD:
REMOTE SIGNAL ASSIGNMENTS:
      SELECTED          CURRENT
F9 MRO-MOD RAMP 100    M5S-MOD 5 STP STAIR
V13 FCP-FCC COMPOSITE  EX1-EXT INPUT NO. 1
2 DIFFERENCES FOUND
1910>
```

This display shows the current changes made to F9 and V13 buttons on the RCU.

MODIFY MATRIX

```
SELECT MATRIX (1, 2, or 3) > [NUMBER OF THE DESIRED MATRIX]

MTX (Y) =MNM >      { SIGNAL MNEMONIC }      Y =ELEMENT NUMBER
                    {   +             }      MTX =MATRIX NAME
                    {   -             }
```

This command allows the user to modify one of the three user-definable matrix signals. The command mode will first ask the user which of the three matrix signals is to be modified. It then will prompt the user with the name of the matrix selected, the matrix element number, and the signal that is currently assigned to that matrix element number. The user can then enter either the mnemonic of the signal desired in that position, or a plus sign to move to the next matrix position, or a minus sign to move to the last position. If the user enters a signal mnemonic, the prompt will automatically move to the next matrix position. A move command at either end of the matrix will cause the position to roll to the location at the other end of the sequence. The following example shows a MODIFY MATRIX session in which MT2(3) is changed to color multipulse, CLP.

```
1910>MODIFY MATRIX
SELECT MATRIX (1, 2, OR 3)>2
MT2 (1) =MRO >?

INPUT:
+ :ADVANCE ONE POSITION
- :BACK UP ONE POSITION
MNM:CHANGE SIGNAL TO MNM
MT2 (1) =MRO >+
MT2 (2) =MRO >+
MTS (3) =MRO >CLP
MT2 (4) =MRO >-
MT2 (3) =CLP ><ESC >
1910 >
```

MODIFY VSEQUENCE

INPUT SEQUENCE PERIOD (1-65535) (Color Frames) >[XX]

VSQ (X, Y) =MNM:	$\left\{ \begin{array}{l} \text{SIGNAL NMEMONIC} \\ +:\text{FORWARD} \\ -:\text{BACKWARD} \end{array} \right\}$	X-FIELD DESIGNATION
		Y-ELEMENT NUMBER

This object command mode allows the user to modify the VITS sequence. The VSEQ command mode prompts the user with the VITS sequence mnemonic, the field designation, and the number of the element in the sequence followed by the mnemonic of the signal currently assigned to that position. The user can move to the preceding element by entering a minus sign, or to the next element by entering a plus sign. If a move command is issued at either end of the sequence to move out of the sequence, it will roll around. For example, if the current position is 4,8 and the user enters a plus sign, then the 1,1 element will be displayed next. To change the signal, the user enters the mnemonic of the signal desired for that location. For example, to change the first field of fourth element from VIRS to color bars the user would enter the following command: VSQ(1,4)=VIR:CBR. The following example shows the modification of VSQ(1,2) to color multipulse.

```

1910 >MODIFY VSEQ
INPUT SEQUENCE PERIOD (1-65535 COLOR FRAMES) >15
VSQ (1,1) =SXX >?
INPUT:
+ :ADVANCE ONE POSITION
- :BACK UP ONE POSITION
MNM:CHANGE SIGNAL TO MNM
VSQ (1,1) =SXX >+
VSQ (2,1) =SXX >+
VSQ (3,1) =SCC >+
VSQ (4,1) =SXX >+
VSQ (1,2) =MR8 >CLP
VSQ (2,2) =CLP ><ESC >
1910 >

```

**Remote Operation—1910 Operators
RS-232 Control Port Communication**

**MODIFY FSEQUENCE
MODIFY SSEQUENCE**

```

FSQ (X )=MNM:  SIGNAL MNEMONIC
                +: FORWARD
                -: BACKWARD

SCH (X )=MNM:  SIGNAL MNEMONIC
                +: FORWARD
                -: BACKWARD

X =ELEMENT NUMBER
MNM =CURRENT SIGNAL MNEMONIC

```

This object command mode allows the user to modify the full field sequence or the SCH sequence (they are very similar so they are discussed together). The FSEQ command mode prompts the user with full field sequence mnemonic, the field designation, and the number of the element in the sequence followed by the mnemonic of the signal currently assigned to that position. The user can move to the preceding element by entering a minus sign, or to the next element by entering a plus sign. If a move command is issued at either end of the sequence to move out of the sequence, it will roll around to the beginning or the end. To change the signal, the user enters the mnemonic of the signal desired for that location. For example, to change the sixth element in the full field sequence from color bars to multiburst, the user would enter the following command: FSQ(6)=CBR:FMR. Likewise, to change the second element of the SCH sequence from VIRS to color bars, the user would enter the modify SCH command mode and issue this command: SCH(2)=VIR:CBR. The dialogues below show example modify FSEQ and SSEQ sessions.

```

1910 >MODIFY FSEQ
INPUT SEQUENCE PERIOD (1-65535 COLOR FRAMES )>15
FSQ (1 )=COL >?
INPUT:
+ :ADVANCE ONE POSITION
- :BACK UP ONE POSITION
MNM:CHANGE SIGNAL TO MNM
FSQ (1 )=COL >+
FSQ (2 )=FRM >+
FSQ (3 )=MT1 >+
FSQ (4 )=SCH >SXX
FSQ (5 )=VIR >-
FSQ (4 )=SXX >L <ESC >
1910 >

```

```

1910 >MODIFY SSEQ
SCH (1 )=FMS >+
SCH (2 )=BBR >+
SCH (3 )=BBR >+
SCH (4 )=BBR >+ SXX
SCH (1 )=FMR >CLP
SCH (1 )=CLP > <ESC >
1910 >

```

MODIFY STATUS

```
Full field=(SIGNAL MNEMONIC)
APL=(HIGH, LOW, ALL, OR BNC (BOUNCE))
Burst (ON or OFF)
TRansmitter protect (ON or OFF)
PRocamp (ON or OFF)
FXLYY=(SIGNAL MNEMONIC) X=1 or 2 Y=10 through 21
VIRmode=(AUTO, PASs, DElete, or INSert)
BYpass OPerate
```

This modify object command mode accepts the commands that change the signal output/conditioning functions of the 1910. The format of these commands is given above, and a further explanation of the commands are given below.

FU=[SIGNAL MNEMONIC]: The full field signal is modified by entering the command "FU=" followed by the mnemonic of the desired full field signal. For example, color bars is programmed by entering the command: FU=CBR.

FXLYY=[SIGNAL MNEMONIC]: The VITS signals can be programmed by entering the command F1 or F2 followed by the line number specification, equals, and the signal mnemonic. For example, to put color bars on Field 1, Line 17, the user would enter the following command: F1L17=CBR.

APL=[HIGH, LOW, ALL, or BNC]: The APL of the full field signal can be programmed by entering "AP=" followed by the mnemonic of the desired level. For example, the APL can be set to bounce by enter the command: AP=BNC.

PR, TR, or BU[ON or OFF]: There are several ON or OFF commands; these are: Transmitter Protect, Procamp, and Burst. To enable these functions, the function name (at least the first two letters) is entered followed by on. To disable these functions, enter the function name followed by OFF.

VIRmode=[AUTO, PASs, DElete, or INSert]: The VIRMODE is programmed by setting it equal to the desired value. For example, to set the VIR mode to insert the user would enter the following command: VI=INS.

BYpass or OPerate: The 1910 can be put in the bypassed mode by simply entering the BYPASS command: BY. Likewise, it can be put in the operate mode by entering the OPERATE command: OP. These commands complete the modify status command mode.

**Remote Operation—1910 Operators
RS-232 Control Port Communication**

RESET

RESET { ALL
TABLE
MATRix
VIRMode
FULLfield
VITS
VSEquence
FSEquence
SSEquence } [NO MODIFIERS]

This command moves the object configuration from the factory standard storage area to the temporary memory. The effect of this operation is to reset the operation of the 1910 to the factory standard. The operation of the 1910 will immediately reflect this change, except for the matrix signals. Any matrix signal being output when this command is executed will remain unchanged. However, the next time the matrix signal is selected the factory matrix signals will be used. This command provides the user with a quick and easy way of getting to a "known" set of conditions. For example, to Reset VITS to factory conditions, the user would enter: RESET VITS.

SAVE

SAVE { ALL
TABLE
VIRMode
MATRix
FULLfield
VITS
VSEquence
FSEquence
SSEquence } [NO MODIFIERS]

This command moves the specified object from temporary memory to the non-volatile memory. This action "saves" the object so that subsequent resets and power-ups will use this configuration. This command does not modify the current operation of the 1910, only the operation after a reset or power-on. The command can take quite some time to complete. Any character (except ^C or ^T) will cause a busy message to be printed to the terminal to inform the user that the 1910 is busy completing this command. It is not recommended that the user abort this command with a ^C, a ^T, or a reset; the results left in the non-volatile memory will not be guaranteed. This command provides the user the capability of permanently storing an object. For example, to save the currently-programmed VITS in non-volatile memory, the user would enter: SAVE VITS.

Reproducible Tables and Worksheets

Tables 5-2 and 5-3 summarize the 1910 commands and mnemonics previously described. These tables may be reproduced to serve as a handy reference.

Figures 5-8 through 5-11 may be reproduced for use as worksheets when redefining the 1910 front panel or reconfiguring a new matrix signal.

Table 5-2
1910 COMMANDS

COMPARE	Compare Data in RAM to Data in EPROM
ALL	Compare All Tables
VITS	Compare VITS Tables
NAME	Compare Mnemonic Table
FRPA	Compare Front Panel
RCUN	Compare Remote Control Panel
MATRIX	Compare Matrix Table
VSEQUENCE	Compare VITS Sequence Table
FSEQUENCE	Compare Full Field Sequence Table
SSEQUENCE	Compare SCH Field Sequence Table
Modifier to COMPARE Command:	S (EPROM), P (EEPROM); Default is S
DISPLAY	Display Data in RAM
STATUS	Display Status
VITS	Display Inserted VITS
NAME	Display Mnemonic Table
FRPA	Display Front Panel
RCUN	Display Remote Control Panel
MATRIX	Display Matrix Table
VSEQUENCE	Display VITS Sequence Table
FSEQUENCE	Display Full Field Sequence Table
SSEQUENCE	Display SCH Field Sequence Table
COMMAND	Display Commands Available
Modifier to the DISPLAY Commands:	T (RAM), S (EPROM), P (EEPROM); Default is T
LOAD	Moves Data from EEPROM to RAM
ALL	Load All Tables
TABLE	Load Mnemonic Table (NAME, FRPA, RCUN)
VIRMODE	Load VIRS Mode Table (BYPASS, OPERATE)
FULLFIELD	Load Full Field Table (APL, BURST, TR, and PR)
VITS	Load VITS Table
MATRIX	Load Matrix Table
VSEQUENCE	Load VITS Sequence Table
FSEQUENCE	Load Full Field Sequence Table
SSEQUENCE	Load Field SCH Sequence Table

Table 5-2 (cont)

MODIFY	Modifies Data in RAM
NAME	Modify Mnemonic Table SPA>
FRPA	Modify Front Panel FPA>
RCUN	Modify Remote Control Panel RMA>
MATRIX	Modify Matrix Table MTM>
VSEQUENCE	Modify VITS Sequence Table VSQ(__, __)>
FSEQUENCE	Modify Full Field Sequence Table FSQ(__)>
SSEQUENCE	Modify SCH Field Sequence Table SCH (__, __)>
BAUD	Modify RS232 Baud Rate
STATUS	Modify the following
FU=	Full Field Signal
API=	Full Field APL (LOW, HIGH, ALL, BNCA)
BURST	Burst Enable/Disable (On, Off)
TR	Transmitter Protect (On, Off)
PR	Proc Amp Mode (On, Off)
F__ L __ __ =	VIT Signals
VIRMODE=	VIRS Mode (AUT, DEL, PAS, INS)
BYPASS	Bypass Program Line
OPERATE	Not Bypassed
RESET	Moves Data from EPROM to RAM
ALL	Load All Tables
TABLE	Load Mnemonic Table (NAME, FRPA, RCUN)
VIRMODE	Load VIRS Mode Table (BYPASS, OPERATE)
FULLFIELD	Load Full Field Table (APL, BURST, TR, and PR)
VITS	Load VITS Table
MATRIX	Load Matrix Table
VSEQUENCE	Load VITS Sequence Table
FSEQUENCE	Load Full Field Sequence Table
SSEQUENCE	Load Field SCH Sequence Table
SAVE	Save Data in RAM to EEPROM
ALL	Save All Tables
TABLE	Save Mnemonic Tables (NAME, FRPA, RCUN)
VIRMODE	Save VIRS Mode Table (BYPASS, OPERATE)
FULLFIELD	Save Full Field Table (APL, BURST, TR, and PR)
VITS	Save VITS Table
MATRIX	Save Matrix Table
VSEQUENCE	Save VITS Sequence Table
FSEQUENCE	Save Full Field Sequence Table
SSEQUENCE	Save Field SCH Sequence Table

Any place where a prompt for an input appears, a <?><CR> will cause a menu to be displayed.

Table 5-3
1910 MNEMONICS

RS-232 MNEMONIC	DESCRIPTION
FMR	FCC MULTIBURST
MB0	MULTIBURST 100 IRE
CMB	NTC 7 COMBINATION
MP7	MULTIPULSE 70 IRE
MP0	MULTIPULSE 100 IRE
CLP	COLOR MULTIPULSE
SPP	SPECIAL MULTIPULSE
SXX	SIN X/X
FCP	FCC COMPOSITE
NCP	NTC 7 COMPOSITE
MR0	MOD RAMP 100
MR8	MOD RAMP 80
M5S	MOD 5 STEP
M0S	MOD 10 STEP
YR0	Y RAMP 100
YS0	5 STEP STAIR
SS1	10 STEP STAIR
CBR	COLOR BARS
YCB	Y COLOR BARS
RFL	RED FIELD
BRY	BARS/Y
BRR	BARS/RED
EIA	EIA COLOR BARS
RBB	REV BLUE BARS
IYQ	IYQB + PLUGE
SMP	SMPTE BARS
MPD	MODULATED PED
VIR	VIR

Table 5-3 (cont)

RS-232 MNEMONIC	DESCRIPTION
VIC	VICR (Removed at B023197)
MDB	MODULATED BAR
IPB	INVERTED P & B
BBR	BLACK BURST
P00	0 IRE PED
PD1	10 IRE PED
25P	25 IRE PED (Removed at B023197)
PD5	50 IRE PED
PD0	100 IRE PED
BAR	FIELD BAR
FSW	FIELD SQ WAVE
WIN	WINDOW
CNV	CONVERGENCE
ETR	EYE TEST REFERENCE
ETP	EYE TEST PATTERN
MT1	MATRIX 1
MT2	MATRIX 2
MT3	MATRIX 3
PAS	PASS PROGRAM
VRD	VIR DETECT
EX1	EXTERNAL INPUT NO. 1
EX2	EXTERNAL INPUT NO. 2
EX3	EXTERNAL INPUT NO. 3
EX4	EXTERNAL INPUT NO. 4
VSQ	VITS SEQUENCE
FSQ	FULL FIELD SEQUENCE
SCH	SCH SEQUENCE
NSL	NOT SELECTED
GCP	GCR Positive
GCN	GCR Negative

FACTORY SET FRONT PANEL

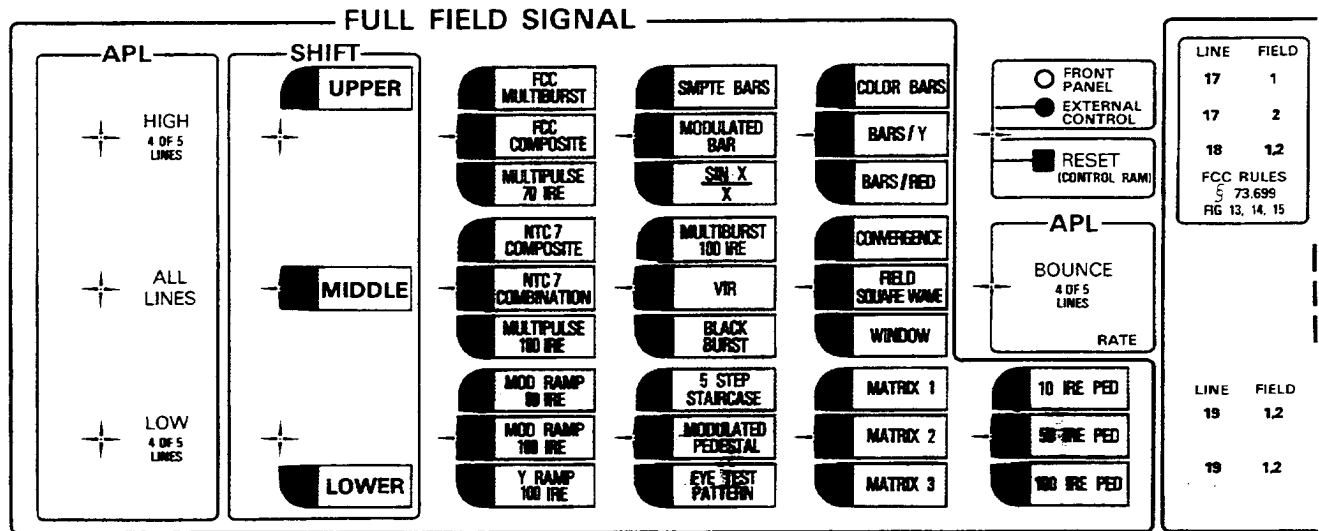

CUSTOM RECONFIGURING

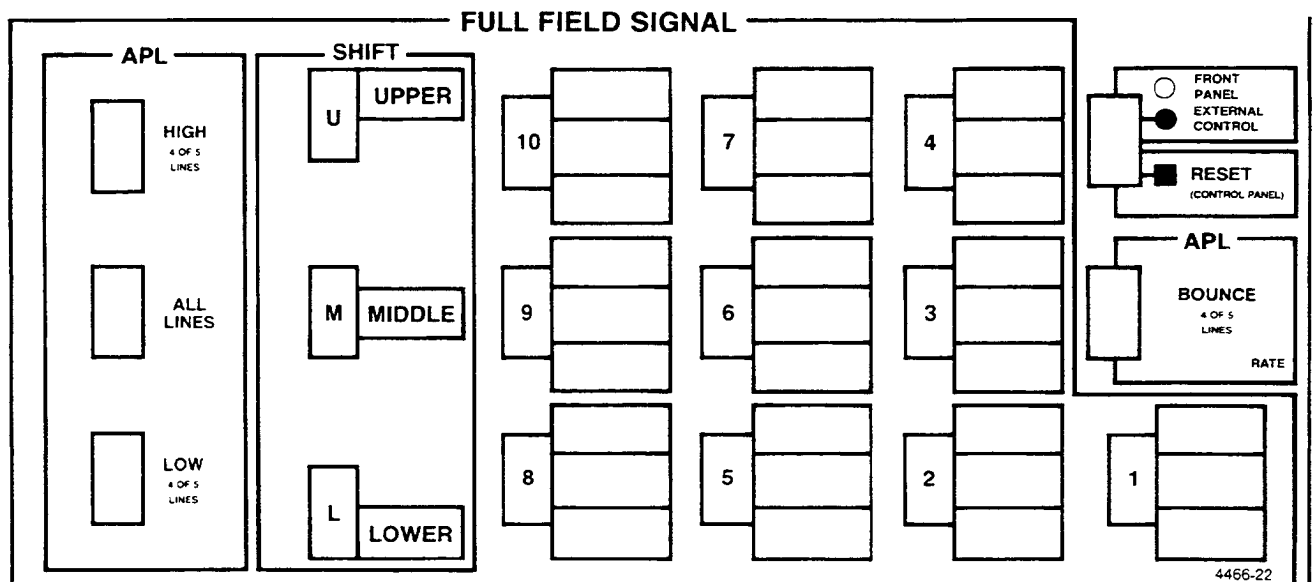

Fig. 5-9. Work Sheet for Reconfiguring the 1910 Front Panel.

MATRIX CONFIGURATION

Line Group MT#()	Actual Lines	Number of Lines in the Group	Desired Signal
(1) =	22 to 37	16	
(2) =	38 to 54	17	
(3) =	55 to 71	17	
(4) =	72 to 87	16	
(5) =	88 to 103	16	
(6) =	104 to 119	16	
(7) =	120 to 135	16	
(8) =	136 to 151	16	
(9) =	152 to 167	16	
(10) =	168 to 182	15	
(11) =	183 to 198	16	
(12) =	199 to 202	4	
(13) =	203 to 214	12	
(14) =	215 to 230	16	
(15) =	231 to 247	17	
(16) =	248 to 262	15	

Notes:

Fig. 5-10. Matrix Configuration Work Sheet.

FULL FIELD SEQUENCE

TIME THAT EACH SIGNAL WILL BE DISPLAYED IN COLOR FRAMES: _____ 1910 PROMPT:

COLOR FRAME = 4 FIELDS OR 1/15 SEC.

Element*	Signal Desired	Color Frames or Seconds
1		
2		
3		
4		
5		
6		
7		
8		
9		
10		
11		
12		
13		
14		
15		
16		
17		
18		
19		
20		
21		
22		
23		
24		
TOTAL SEQUENCE PERIOD		_____

* Sequence can be truncated. It is not necessary to allocate all the available sequence slots.

Fig. 5-11. Full Field Sequence Work Sheet.

PART II REMOTE CONTROL PORT

Description

The REMOTE CONTROL port on the rear panel of the 1910 allows the operator to control the function of the 1910 Generator by means of ground closures from a remote location. Below is a list of functions controllable from the REMOTE CONTROL port. (A number of these functions are not controllable from the front panel of the 1910.)

1. Transferring control of the 1910 to the front panel of the 1910, REMOTE CONTROL port, or RS-232 CONTROL port. Control is not stored in the EEPROM but is continually scanned in all three control modes.

2. Resetting the 1910 to default (factory-programmed or user-programmed) operation. (This function is also controllable from the front panel of the 1910.)

3. Selecting the 1910 Program Signal route, either through the 1910 VITS/VIRS Inserter board or bypassed directly from the PROGRAM IN to the PROGRAM OUT connector.

4. Selecting the genlock source, either the PROGRAM IN signal or BLACK BURST input signal.

5. Selecting the Full Field Output signal. (This function is also controllable from the front panel of the 1910.) Up to 13 Full Field Signals may be selected from the REMOTE CONTROL port. The signal selection may be changed through the RS-232 CONTROL port. Sticky-back labels are provided to reflect these changes to the Remote Control Unit switches.

6. Programming VITS and VIRS on Lines 14 through 21 in Fields 1, 2, or both. VITS programming is saved in the EEPROM.

7. Selecting the VIRS mode of operation.

8. Selecting the data source for the 1910 DAC.

Of the functions mentioned above, the REMOTE CONTROL port needs to be in control of the 1910 only for the selection of the FULL FIELD OUTPUT signal, selection of

the VIRS mode of operation, and the programming of the VIT and VIR Signals. The remainder of the functions do not require the REMOTE CONTROL port to be in control. The Tektronix Remote Control Unit 015-0374-00 is available as an optional accessory to interface with the 1910 through the REMOTE CONTROL port. It is described later in this section after the discussion on the functions of the REMOTE CONTROL port. The Remote Control Unit can be ordered from the factory or the user may construct a control panel.

CONTROLLING THE 1910 FUNCTIONS USING AN OWNER-CONSTRUCTED REMOTE CONTROL PANEL

Introduction

NOTE

Due to the many possible combinations of cable lengths and configurations, it may be necessary to compensate for the resistance added to the 1910 circuitry by the remote cabling. Cabling with wire of 26 or greater may extend over 1000 feet without excessive voltage drop. If lines of very long lengths are used, an intermediate incorrect signal selection may occur as the lines are changing voltage levels. However, after the lines have settled, the signal selection will be correct.

The following discussion deals with 'how to control' functions of the 1910 through the REMOTE CONTROL port using an owner-constructed unit. Therefore, any reference to pin numbers are those belonging to the REMOTE CONTROL port. The pin-out configuration of the REMOTE CONTROL port is illustrated in Fig. 5-12 so the operator can design an interface for a control panel.

Transfer of Control

Transfers control of the 1910 to any of the following locations:

1. 1910 front panel (default condition), accomplished by leaving pins 17 and 18 high.

2. REMOTE CONTROL port, accomplished by grounding pin 18 only.

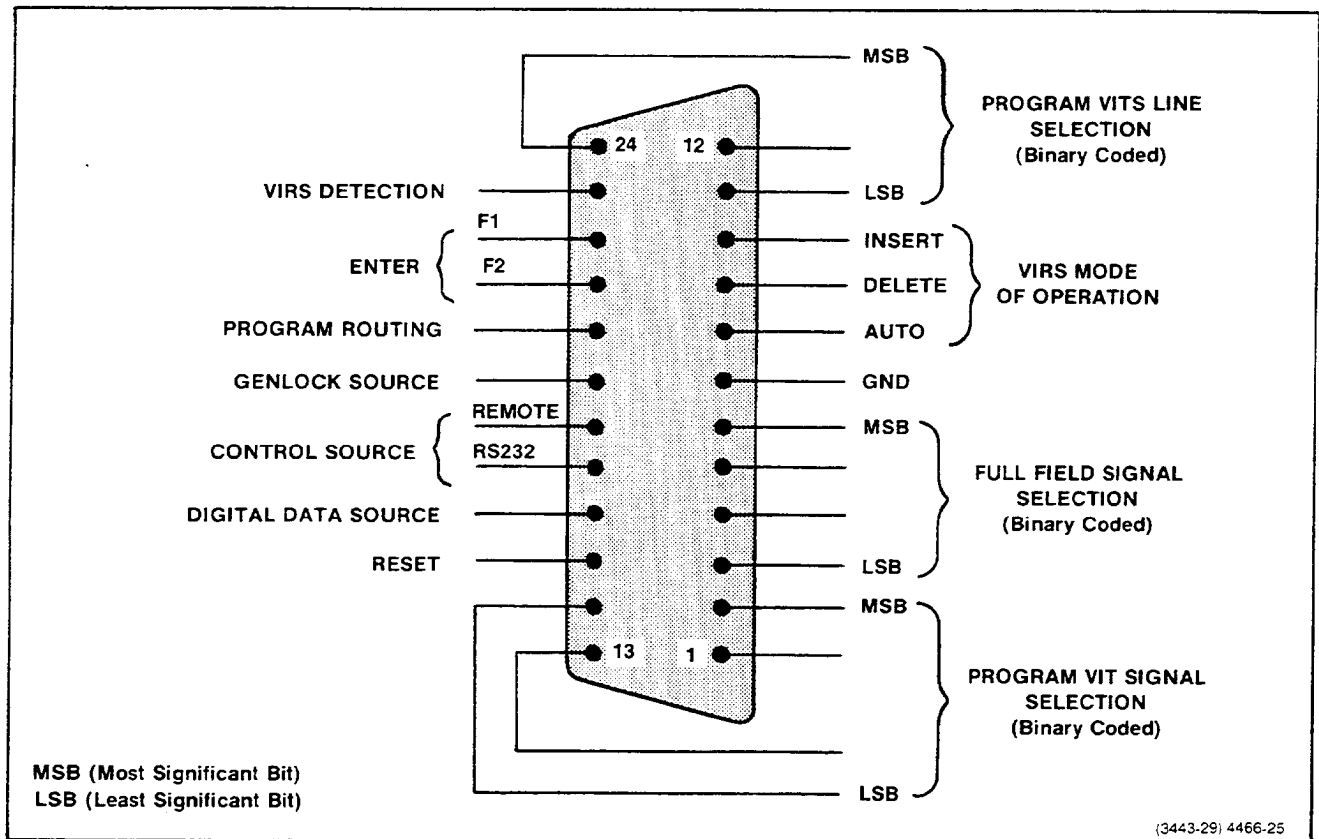

Fig. 5-12. REMOTE CONTROL Port Pin Configuration.

3. RS-232 CONTROL port, accomplished by grounding pin 17 only. Refer to Table 5-1, Control-C or Control-T, to transfer control away from the RS-232 mode.

Reset

Momentarily pressing the Reset button causes the CPU to be reset. This programs the 1910 for the initialized VITS and VIRS programming set by either the operator or the factory. However, if control of the 1910 belongs to the REMOTE CONTROL port (Control Remote button pressed in) when the Reset button is pressed, the full field signal selected will depend on the Full Field Signal button pressed in. The same result is accomplished by setting the 1910 POWER switch to OFF and then back to ON, except the Program Signal is disturbed by the switching of the bypass relay.

Full Field Signal Selection

Selecting the Full Field Signals when control of the 1910 belongs to the REMOTE CONTROL port is accomplished through four pins. Thirteen Full Field Signals have been assigned a binary number or digital code (see Table 5-4).

When the digital code is applied to the assigned pins, the corresponding signal is outputted by the 1910. Example: Grounding pin 6 and leaving pins 5, 4, and 3 high will select the COLOR BARS signal. The digital code is 0111. The signal selected by the digital code may be changed as described under MODIFY CONTROL CONFIGURATION in this section.

Program Routing

This function selects the route of the Program Signal through the 1910 by means of pin 20 at the REMOTE CONTROL port. When pin 20 is high (normal condition), the incoming Program Signal is routed through the 1910 VITS/VIRS Insertion board. Grounding pin 20 causes a relay to directly connect the PROGRAM IN and PROGRAM OUT together, thus bypassing the 1910 VITS/VIRS Insertion board.

Genlock Source Selection

The selection of the genlock source for the 1910 is accomplished with pin 19 of the REMOTE CONTROL port. When pin 19 is high (normal condition), the signal used to

Remote Operation—1910 Operators
Remote Control Port

Table 5-4
Full Field Signal Selection as Shipped from the Factory
(Through the REMOTE CONTROL Port)

Program VIT Signal	Digital Code ^a	Pins
No change	1111	6-5-4-3 M L S S B B
FCC Multiburst	1110	
FCC Composite	1101	
Bars/Y	1100	
VIRS	1011	
SMPTE Bars	1010	
Modulated Ramp 100	1001	
EIA Color Bars	1000	
Color Bars	0111	
No change	0111	
Convergence	0101	
Field Square Wave	0100	
Window	0011	
(Sin X)/X	0010	
Matrix 1	0001	
No change	0000	

^aA zero indicates that the corresponding pin must be grounded.

genlock the 1910 is selected from the PROGRAM IN connector. When pin 19 is grounded, the signal at the BLACK BURST IN connector is selected as the genlock source. When the the 1910 is genlocked to the BLACK BURST input signal, the PROGRAM IN signal is automatically bypassed to the PROGRAM OUT connector.

Program VITS Line Selection

Selection of a vertical interval line from Lines 14 through 21 of the PROGRAM IN signal for VITS and VIRS insertion programming is accomplished with pins 11, 12, and 24 at the REMOTE CONTROL port. Each vertical interval line is assigned a digital code that, when applied to these pins, will select the corresponding VITS line. The digital code assigned to each is shown in Table 5-5.

Examples:

To select Line 14, ground pins 24, 12, and 11.
 Digital Code: 000.

To select Line 17, ground pin 24 and leave pins 12 and 11 high.
 Digital Code: 011.

To select Line 21, leave pins 24, 12, and 11 high.

Table 5-5
Program VITS Line Selection
(Through the REMOTE CONTROL Port)

Program VITS Line	Digital Code ^a	Pins
Line 14	000	24-12-11 M L S S B B
Line 15	001	
Line 16	010	
Line 17	011	
Line 18	100	
Line 19	101	
Line 20	110	
Line 21	111	

^aA zero indicates that the corresponding pin must be grounded.

Program VIT Signal Selection

Four pins at the REMOTE CONTROL port are used to select the desired VIT Signal to be inserted on the incoming Program Signal. Eleven VIT Signals are assigned a binary code that, when applied to the four pins, results in that selection (refer to Table 5-6). The different VITS insertion signals are described as follows:

1. **Pass Line.** Allows the incoming Program VIT Signal on the lines selected to pass unaltered, and inserts blanking level on the Full Field Signal VITS line.

2. **Delete Line.** Deletes incoming Program VIT Signal on the line and field selected by inserting blanking level on the Program Signal and Full Field Signal VITS line.

3. **Insertion of VITS.** All other choices delete the incoming signal and insert the designated VIT Signal on the selected line of the incoming Program Signal. The Full Field Signal will contain the same VITS as inserted on the Program Signal.

The Program VIT Signal selection works in conjunction with the Program VITS Line, Enter Field 1, and Enter Field 2 functions.

**Table 5-6
Program VIT Signal Selection as Shipped from the
Factory
(Through the REMOTE CONTROL Port)**

Program VIT Signal	Digital Code ^a	Pins
No change	1111	
FCC Multiburst	1110	
FCC Composite	1101	
Color Bars	1100	
VIRS	1011	2-1-13-14
Modulated Ramp 100	1010	M L
No change	1001	S S
No change	1000	B B
Delete Line	0111	
Pass Line	0110	
No change	0101	
No change	0100	

^aA zero indicates that the corresponding pin must be grounded.

Enter Field 1 and Field 2 (Field Selection)

The Enter Field 1 and Field 2 function is used to enter the VITS information selected by the Program VIT Signal and Program VITS Line functions on the desired field (1 or 2) of the Program Signal. The Enter Field 1 and Field 2 function is interfaced to the 1910 through pins 21 and 22 of the REMOTE CONTROL port. Momentarily grounding pin 22 enters the Program VITS information on Field 1; momentarily grounding pin 21 enters the Program VITS information on Field 2.

The procedure for entering new Program VITS information is as follows:

1. Select the desired VITS insertion signal using the Program VIT Signal Selection described previously.
2. Select the desired line using the Program VITS Line Selection described previously.
3. Enter step 1 and 2 information on the desired field by momentarily grounding pin 22 for Field 1 and/or pin 21 for Field 2.

However, the VIR Signal will not be inserted on the incoming Program Signal if the 1910 is in the Auto VIRS mode and the incoming VIRS is detected. (Refer to the VIRS Detection information that follows.) A VIT Signal programmed to be inserted on the incoming Program Signal will also be inserted on the Full Field Out signal.

VIRS Detection

The VIRS Detection function is used to program the line(s) on which VIRS is to be detected. VIRS Detection is selected by grounding pin 23 of the REMOTE CONTROL port. This function is used in conjunction with the Program VITS Line, Program VIT Signal (VIRS), Enter Field 1, and Enter Field 2 functions. These functions were described previously in this portion of the manual.

Example:

To change the VIRS detection from Line 19, Fields 1 and 2 (default condition), to Line 20, Fields 1 and 2, perform the following steps:

1. Select Line 20
 - a. Leave pins 24 and 12 high (default condition).
 - b. Ground pin 11.
2. Select VIR Signal
 - a. Leave pins 2, 13, and 14 high.
 - b. Ground pin 1.
3. Select VIRS Detection
 - a. Ground pin 23.
4. Select the Field and Enter the Information
 - a. Momentarily ground pin 22 for Field 1.
 - b. Momentarily ground pin 21 for Field 2.

At this point, VIRS is being detected on Lines 19 and 20 of both fields. To disable the detection on Line 19 of both fields, continue with the following steps:

Remote Operation—1910 Operators Remote Control Port

5. Select Line 19
 - a. Leave pins 11 and 24 high.
 - b. Ground pin 12.
6. Select the desired Program VIT Signal insertion condition. Refer to Table 5-6.
7. Select the Field and Enter the Information.
 - a. Momentarily ground pin 22 for Field 1.
 - b. Momentarily ground pin 21 for Field 2.

After completing steps 1 through 7 of the preceding procedure, VIRS Detection will be occurring on Line 20, Fields 1 and 2 only.

VIRS Function

The VIRS function has four different modes of operation. These modes of operation are selected by three of the pins at the REMOTE CONTROL port. The following is a list of the four modes of VIRS operation for the 1910.

1. **Pass.** Passes the PROGRAM IN signal unaltered for all the lines programmed for VIRS.
2. **Insert.** Inserts VIRS on all the lines programmed for VIRS.
3. **Delete.** Deletes all lines on the incoming PROGRAM IN signal that are programmed for VIRS by inserting a blanking level during the active line time.
4. **Auto.** Automatically determines if VIRS is present on all lines programmed for VIRS detection on the PROGRAM IN signal. If VIRS is present on all lines, no VIRS is inserted. If VIRS is absent on any line, all lines programmed for VIRS have VIRS inserted.

Selecting the VIRS Modes

Pins 8, 9, and 10 of the REMOTE CONTROL port are used to interface the VIRS information to the 1910. Use the following information to select the four modes of VIRS operation.

1. **Pass.** Leave pins 8, 9, and 10 high (default condition).
2. **Insert.** Leave pins 8 and 9 high; ground pin 10.
3. **Delete.** Leave pins 8 and 10 high; ground pin 9.

4. **Auto.** Leave pins 9 and 10 high; ground pin 8.

DAC Input Selection

The DAC (Digital-to-Analog Converter) Input Selection is used to control the data source that drives the 1910 internal DAC and the DIGITAL OUTPUT connector. When pin 16 of the REMOTE CONTROL port is high, the data from the 1910 memory PROM is applied to the DAC and the DIGITAL OUTPUT connector. Grounding pin 16 allows the DIGITAL INPUT data to be applied to the DAC and the DIGITAL OUTPUT connector. If desired, an internal jumper in the 1910 can be set to allow DAC Input Selection using ECL levels; see P206 Digital Data Source Control in Section 2 of this manual.

FUNCTIONS OF THE TEKTRONIX REMOTE CONTROL UNIT FRONT-PANEL CONTROLS

The following information describes how to implement the functions of the 1910 REMOTE CONTROL port using the Tektronix Remote Control Unit 015-0374-00. The front panel of the Remote Control Unit is shown in Fig. 5-13. In the functions-of-controls description that follows, the names of the Remote Control Unit controls have only the first letter capitalized; the names of the 1910 Digital Generator controls have all letters capitalized.

- ① **Control.** Allows transfer of control of the 1910 Generator to the following locations:
 - a. Front Panel of the 1910 Generator.
 - b. REMOTE CONTROL port of the 1910.
 - c. RS-232 CONTROL port of the 1910.
- ② **Full Field Signal.** The Full Field Signal buttons select the different full field test signals available at the 1910 FULL FIELD OUTPUT connector when the 1910 is controlled via the REMOTE CONTROL port.
- ③ **Reset.** Momentarily pressing the Reset button causes the CPU to be reset. This programs the 1910 for the initialized VITS and VIRS programming set by either the operator or the factory. However, if control of the 1910 belongs to the REMOTE CONTROL port (Control-Remote button pressed in) when the Reset button is pressed, the full field signal selected will depend on the Full Field Signal button pressed in. The same result is accomplished by setting the 1910 POWER switch to OFF and then back to ON, except the Program Signal is disturbed by the switching of the bypass relay.

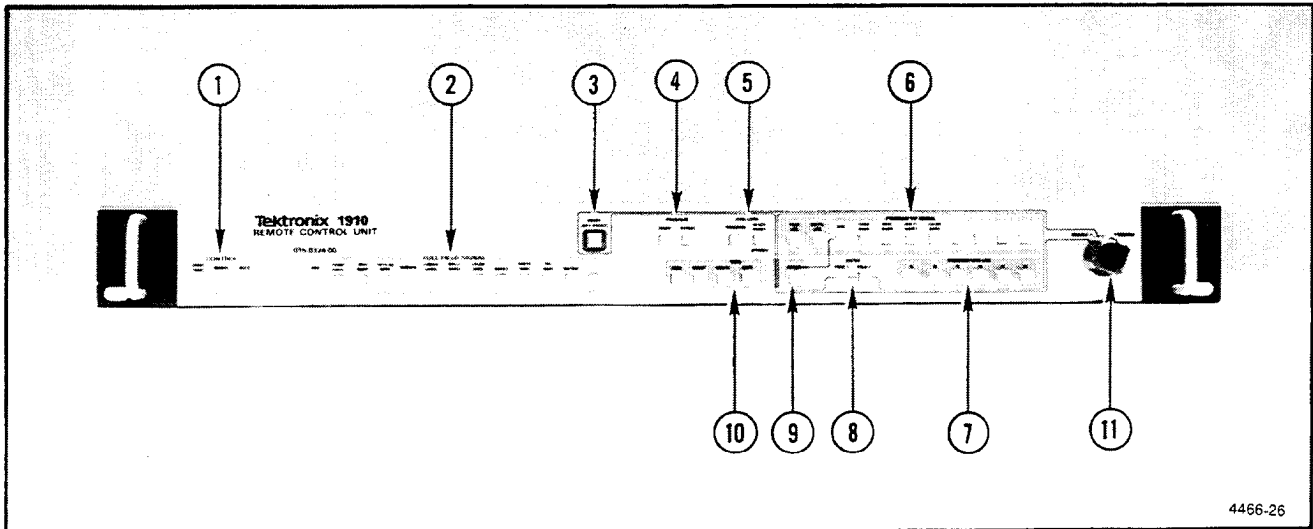

Fig. 5-13. TEKTRONIX Remote Control Unit Front-Panel Controls.

- 4 **Program.** The Program function is used when selecting the route of the incoming Program Signal through the 1910. Two buttons (Insert and Bypass) are used to determine the route. The Insert button, when pressed in, routes the PROGRAM IN signal through the 1910 so that VIT Signals may be inserted during the vertical interval. The Bypass button, when pressed in, connects the PROGRAM IN signal directly to the PROGRAM OUT connector via the relay.
- 5 **GenLock.** The genlock source for the 1910 may be selected from the PROGRAM IN signal (Program button) or the BLACK BURST IN signal (Black Burst button). When the 1910 is genlocked to the BLACK BURST IN signal, the PROGRAM IN signal is automatically bypassed to the PROGRAM OUT connector.
- 6 **Program VIT Signal.** The Program VIT Signal buttons select the desired VITS insertion mode of operation as follows:
- a. **Pass Line.** This button allows the incoming Program VIT Signal on the lines selected to pass unaltered, and inserts a blanking level on the Full Field Signal.
 - b. **Delete Line.** This button deletes the incoming Program VIT Signal on the line and field selected by inserting a blanking level on the Program Signal and Full Field Signal VITS line.
 - c. **Insertion of VITS.** All of the remaining buttons within the Program VIT Signal functional block are used to insert the selected test signal on the selected line (Program VITS Line buttons) of the incoming Program Signal and Full Field Signal.
- NOTE*
The Program VIT Signal buttons operate in conjunction with the Program VITS Line and Enter (Field 1, Field 2) buttons.
- 7 **Program VITS Line.** The Program VITS Line buttons allow selection of a vertical interval line from Lines 14 through 21 of the PROGRAM IN signal for VITS and VIRS programming. The Program VITS Line button operates in conjunction with the Program VIT Signal and Enter (Field 1, Field 2) buttons.
- To select Line 14, both 15 and 16 of the Program VITS Line buttons must be pressed in (Digital Code: 000).
- To select Line 21, all Program VITS Line buttons must be released by partially pressing in any of the 'out' buttons.
- 8 **Enter.** The Enter function consists of two buttons, Field 1 and Field 2. Momentarily pressing the Enter Field 1 and/or the Enter Field 2 buttons places the selected Program VITS information in that field.

Remote Operation—1910 Operators

Remote Control Port

The procedure for entering new Program VITS information is as follows:

- a. Select the desired line using the Program VITS Line buttons.
- b. Select the desired VIT Signal using the Program VIT Signal buttons.
- c. Enter all of the above information on the desired field by pressing the Enter Field 1 and/or Enter Field 2 buttons.

NOTE

After pressing the Enter Field 1 and/or Enter Field 2 buttons, wait at least two seconds before pressing any other push buttons. This gives the 1910 time to update the EEPROM with the new information.

A VIT Signal programmed to be inserted on the incoming Program Signal will also be inserted on the Full Field Out signal.

- 9 **VIRS Detect.** The VIRS Detect button is used to program the line(s) on which VIRS is to be detected. This button is used in conjunction with the Program VIT Signal (VIRS), Program VITS Line, and Enter (Field 1, Field 2) buttons.

To change VIRS detection from Line 19, Fields 1 and 2 (default condition), to Line 20, Fields 1 and 2, perform the following steps.

- a. Press the Program VITS Line 20 button.
- b. Press the Program VIT Signal VIRS button.
- c. Hold down the VIRS Detect button while sequentially pressing the Enter Field 1 and Enter Field 2 buttons. Release the VIRS Detect button.

At this point VIRS is being detected on Lines 19 and 20 of both fields. To disable the detection on Line 19 of both fields, use the following procedure.

- d. Press the Program VITS Line 20 button.
- e. Select the desired Program VIT Signal to be inserted.

- f. Sequentially press the Enter Field 1 and Enter Field 2 buttons.

After completing parts a through f of the VIRS Detect procedure, VIRS detection will be occurring on Line 20 only.

- 10 **VIRS.** The VIRS buttons are used to select different modes of VIRS operation for the 1910. These modes are as follows:

- a. **Pass.** Passes the PROGRAM IN signal unaltered for all the lines programmed for VIRS.

- b. **Insert.** Inserts VIRS on all the lines programmed for VIRS.

- c. **Delete.** Deletes all lines on the incoming PROGRAM IN signal that are programmed for VIRS by inserting a blanking level during the active line time.

- d. **Auto.** Automatically determines if VIRS is present on all lines programmed for VIRS detection on the PROGRAM IN signal. If VIRS is present on all lines, no VIRS is inserted. If VIRS is absent on any line, all lines programmed for VIRS have VIRS inserted.

- 11 **Enable/Disable.** The Enable/Disable switch in the Enable position allows the VITS and VIRS programming and Reset modes to function. In the Disable position, the VIT and VIR Signal programming cannot be modified and the Reset function is inhibited. This switch can be overridden by an internal jumper, P435, in the Remote Control Unit.

NOTE

For more information concerning P435 and two other jumpers (P535, P635), refer to the REMOTE CONTROL UNIT 015-0374-00 Instruction Sheet.

TEST SIGNAL APPLICATIONS

Introduction

The Test Signal Applications section is a reference guide for the use of test signals generated by the 1910. This section outlines some basic procedures for distortion measurement and picture monitor adjustment using these test signals, and provides basic background information outlining the intended purpose of the numerous test signals generated by the 1910.

The first part of the Test Signal Applications section, Signal Discussions, describes each of the fundamental signals generated by the 1910, and indicates their capabilities for distortion measurement or picture monitor adjustment. The second part, Split Field and Special Purpose Signals, describes a set of split-field signals (made up of two or more of the fundamental signals), and special APL functions, generated by the 1910. The third part of the Test Signal Applications section is a glossary of distortion terms, defining a basic set of television signal distortions, their causes and effects on a TV picture, and the test signal best suited to detect or measure the distortion.

Video System Testing

A basic distortion measurement setup starts with the 1910 signal generator used as a signal source, either full field or in the VITS insertion mode, injecting a test signal into the video system to be analyzed. At the end of the video system, a waveform monitor and vectorscope with distortion measuring capabilities are present in the signal line to analyze distortions caused in processing the signal.

The video system under test can consist of any video processing equipment, ranging from a single piece of closed-circuit gear (or multiple pieces, cascaded), to the transmission/reception sequence of an active program line.

Choice of a Test Signal

Figure 6-1 is a signal/distortion matrix. Use it to quickly identify which basic 1910 signals measure (M) or detect (D) a distortion (defined in the Distortion Glossary). The matrix may also be used to determine which distortions can be detected and measured by a given test signal. Test signals which are optimized for measurement of particular distortions are mentioned along with the distortion definitions in the glossary.

D - Detect
M - Measure

	CHROM./LUM. DELAY INEQUALITY	CHROM./LUM. GAIN INEQUALITY	CHROM. NON-LINEAR GAIN	CHROM. NON-LINEAR PHASE	CHROM. TO LUM. INTERMODULATION	DIFFERENTIAL GAIN	DIFFERENTIAL PHASE	FIELD TIME LINEAR DISTORTION	GAIN/FREQUENCY DISTORTION	GROUP DELAY	LINE TIME LINEAR DISTORTION	LOW FREQUENCY CHROM. RESPONSE	LUM. NON-LINEARITY	PICTURE MONITOR ADJUSTMENT	SHORT TIME LINEAR DISTORTION
BLACK BURST; PEDESTALS								M	D	D	M			D	D
COLOR BARS														D	
COLOR MULTIPULSE	M	M							M	M					
EIA COLOR BAR														D	
EYE TEST PAT., EYE TEST REF.									D	D					
FCC COMPOSITE	M	M				M	M		D	D	D				D
FCC MULTIBURST, MULTIBURST 100				D					M						
FIELD BAR									D	D	D				D
5-STEP STAIRCASE									D	D			M		D
INVERTED PULSE & BAR									D	D					D
IYQB														D	
MODULATED BAR	M	M							D	D		D			
MODULATED 5-STEP						M	M								
MODULATED PEDESTAL			M	M	M							D			
MODULATED RAMP 80; 100						M	M								
MODULATED 10-STEP						M	M								
MULTIPULSE 70,100	M	M							M	M					
NTC 7 COMPOSITE	M	M				M	M	D	D	D	D				D
NTC 7 COMBINATION			M	M	M				M						
RED FIELD												D		D	
REVERSE BLUE BARS														D	
$\frac{\sin x}{x}$									M	D					D
SPECIAL MULTIPULSE									M	M					
10-STEP STAIRCASE									D	D			M		D
VICR									D	D	D	D			
VIRS									D	D	D	D			
Y COLOR BAR									D	D			D	D	
Y RAMP 100													D	D	

4466-61

Fig. 6-1. Signal/Distortion Matrix.

SIGNAL DISCUSSIONS

Signal Discussion Outline

Signal discussions are arranged alphabetically according to the signal name. Although there are numerous deviations from the exact form of this outline, the basic form observed in Signal Discussion writing is as follows:

- 1) Signal name and equivalent 1910 mnemonic.
- 2) Brief technical description of signal makeup (first paragraph).
- 3) Distortions primarily detected (or measured) using signal, including any basic techniques for measurement (second to third paragraph).
- 4) Secondary distortions detected or measured, including basic measurement techniques, if applicable (third to fourth paragraph).
- 5) Miscellaneous notes about signal, including warnings about possible misuse (last paragraph).

Full Field Signals

BLACK BURST; 0,10,25,50,100 IRE PEDESTALS (BBR, P00, PD1, 25P, PD5, PD0)

All six of these signals are composed of a pedestal maintained for the duration of the active video line. See Fig. 6-2.

Use the Black Burst for both black signal level reference and monitor adjustment. Use the 0 IRE Pedestal for signal blanking level setup. The 10, 25, and 50 IRE Pedestals provide differing levels of APL for picture monitor adjustment. Use the 100 IRE Pedestal as signal white reference, for both signal level setup and monitor adjustment. All six signals, when displayed alternately on a waveform monitor, can be used to detect line time nonlinearity, both APL-dependent and independent, by observing whether any tilt is present on the normally flat pedestals. Line tilt is measured using the center of the pedestal as an amplitude reference. Gain/frequency and group delay distortions will cause ringing or overshoot of pedestal edges.

COLOR BARS (CBR)

The Color Bars signal, as specified in FCC §73.699, consists of eight luminance pedestals, with the center six chrominance-modulated. The outside two (unmodulated) bars represent reference white (immediately following burst) and reference black (the last bar of the field). The remaining six bars are modulated with chrominance amplitude and phase so that they appear as the three primary and three secondary colors arranged in descending order of their relative luminance amplitudes. See Fig. 6-3.

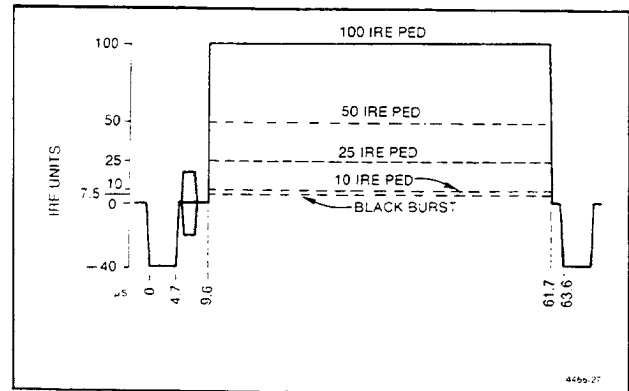

Fig. 6-2. Black Burst and Pedestals.

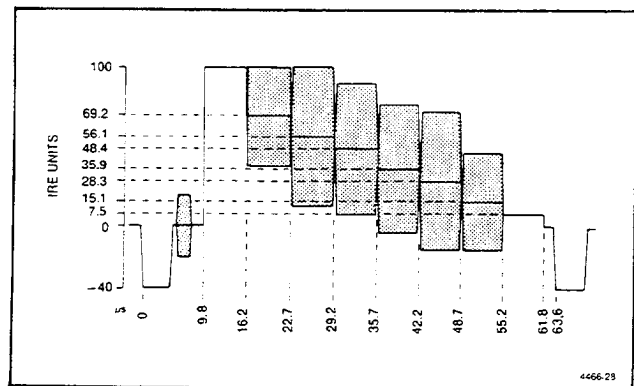

Fig. 6-3. Color Bars.

When displayed full field on a color monitor, this signal is used to make subjective adjustments of the monitor's hue and chroma controls. When displayed on a waveform monitor, the white and black bars can be used as signal set-up references.

COLOR MULTIPULSE (CLP)

The Color Multipulse signal consists of a 100 IRE white reference flag immediately following burst, a 100-IRE 2T pulse, and nine 100 IRE amplitude pulse packets of increasing frequency from 2.38 to 4.78 MHz. See Fig. 6-4.

The advantage in using the Color Multipulse over the standard multipulse signals (Multipulse 70 or 100) is its ability to better identify chrominance/luminance gain and delay errors in the chrominance band where color information is transmitted. Distortions in the band of frequencies near the

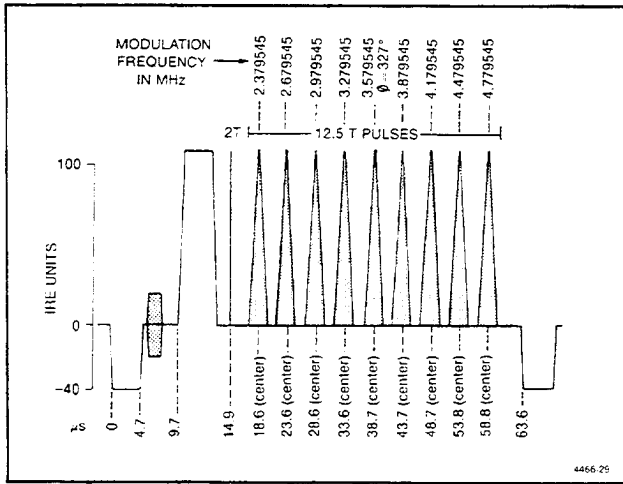

Fig. 6-4. Color Multipulse.

chrominance subcarrier frequency (3.58 MHz) can have a decided effect in distorting video color. The Color Multipulse signal allows careful analysis of selected frequencies in this bandwidth, and the corresponding chrominance/luminance distortions at these frequencies can be precisely measured.

The waveform monitor photographs in Appendix A, Figs. 3, 4 and 5, demonstrate the effects that gain/frequency and group delay distortions have on a multipulse waveform. Distortions at the discrete pulse frequencies can be evaluated by reading the magnitude of a baseline error from a waveform monitor, and relating this error to the nomograph, also found in Appendix A, Fig. 6. From the nomograph, the group delay (in ns) and gain/frequency distortion (in dB gain) can be read directly.

EIA COLOR BAR (EIA)

EIA Color Bar is the signal which comprises the color bar portion of the RS-189-A standard. The seven bars displayed in the signal are a 77 IRE grey reference flag, and the six primary and complimentary colors arranged in descending order of their relative luminance amplitudes. The amplitudes correspond to 75% of each color's fully saturated luminance level. See Fig. 6-5.

The EIA Color Bar signal facilitates adjustment of hue and chroma on color picture monitors. One method of doing this is to turn off the red and green picture monitor screens and adjust hue for brightness uniformity between the center two blue bars, and then adjust chroma for brightness uniformity between the outside two bars. This technique has since been improved with the advent of the Reverse Blue Bars signal which, when used in a split-field arrangement with EIA Color Bar, is better suited for these adjustments (see the SMPTE Bars signal discussion).

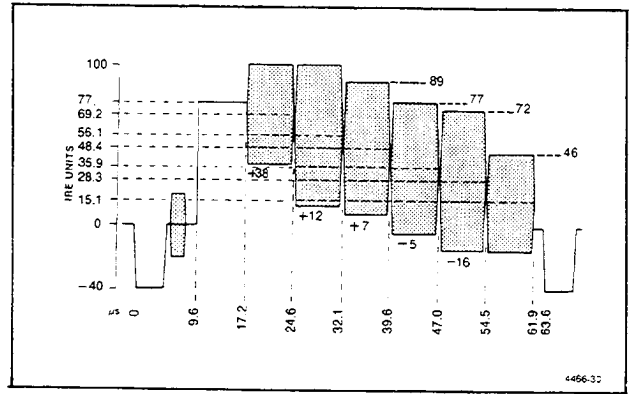

Fig. 6-5. EIA Color Bar.

EYE TEST PATTERN, EYE TEST REFERENCE (ETP, ETR)

The Eye Test Pattern signal is composed of a test string of digitally-encoded data at a data rate of 5.72 Megabits per second. The data sample is encoded with an amplitude-modulated 2.86 MHz sine wave, each full cycle representing two bits of data. The entire active video line of the Eye Test Reference signal is modulated with the 2.86 MHz sine wave. Both signals have their information encoded on a 34-IRE pedestal, with 68 IRE p-p modulation.

The Eye Test Pattern and Reference signals are used together to provide an indication of how much distortion digitally-encoded information (teletext, for example) experiences when processed through a video system. Consecutive lines of a full-field transmission of either signal (or alternate lines of a VITS insertion of either signal) have one line's data inverted as compared to the other. The alternating lines, when overlapped using a multiple field display mode on a waveform monitor, form an "eye" pattern, which will change its shape and size in the presence of distortions such as gain/frequency and group delay (see Fig. 6-6). Such distortions will also cause pulse delays, which can be measured by overlapping the Eye Test Pattern signal with the Eye Test Reference signal and noting the delay of crossing points between the two signals.

Evaluating parameters of the eye shape (its narrowed width and height, and the delay of a received signal compared to the reference) can lead to a quantitative method of determining the integrity of transmitted digitally-encoded data.

FCC COMPOSITE (FCP)

This multi-purpose test signal, as specified in FCC §73.699, is composed of a 5-Step linearity staircase immediately following burst, a 100-IRE 2T sine-squared pulse, a

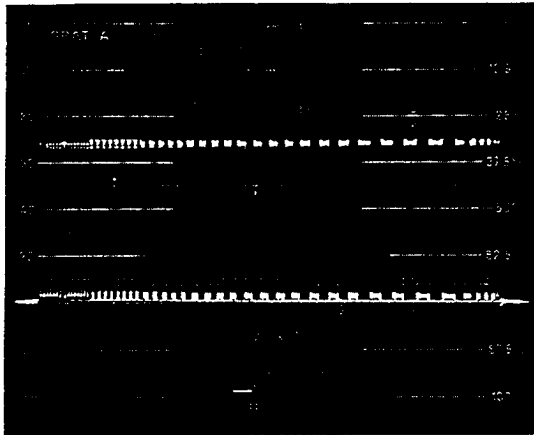

A. Full active line of Eye Test Pattern.

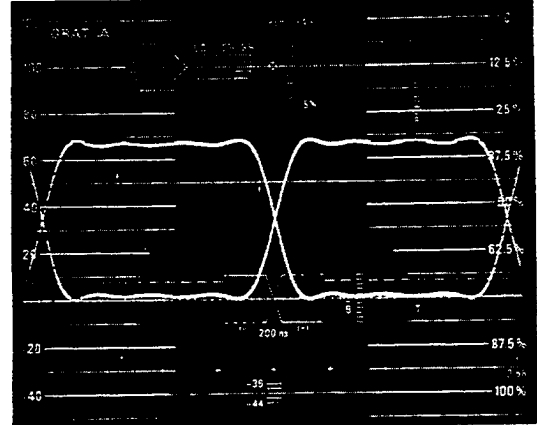

B. 4 high-bit/4 low-bit portion of Signal (Fields 1 and 3 displayed simultaneously causes interleaving).

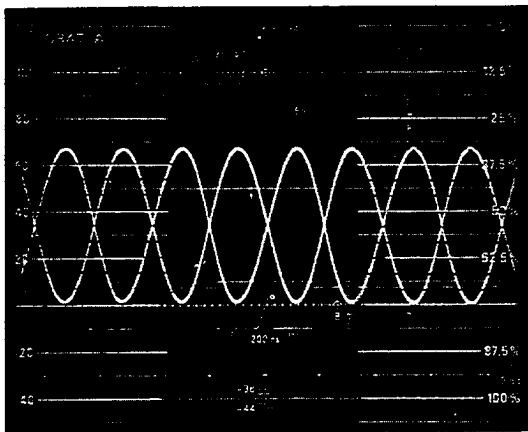

C. Eye Test Reference, at same horizontal sweep rate as (B).

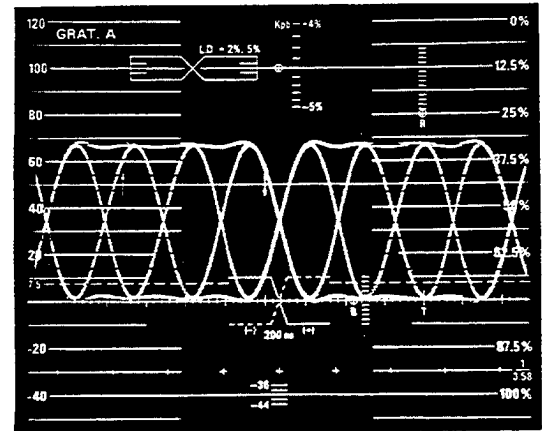

D. Undistorted interleaving of reference and pattern. Note zero crossings and peak amplitudes coincide.

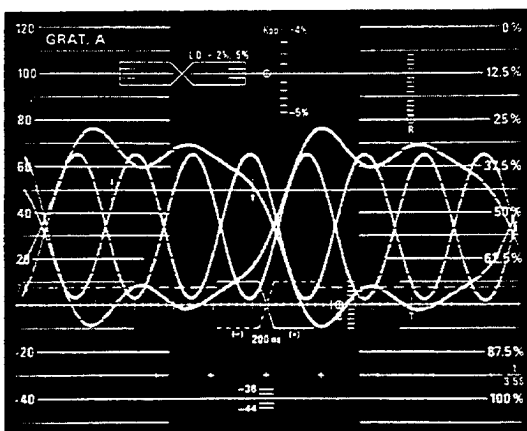

E. Signal of (D) when band limited to 4 MHz. Note gain distortions of 4 high-bit signal, while 2.86 MHz reference remains undistorted.

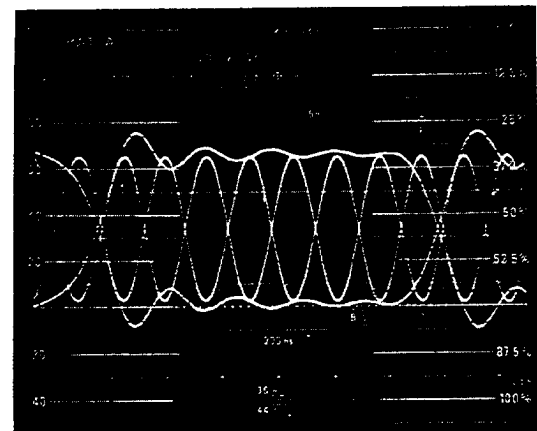

F. 8 high-bit/8 low-bit portion of pattern, interleaved with reference and band limited to 4 MHz.

4466-31

Fig. 6-6. Eye Test Pattern.

Test Signal Applications—1910 Operators

100-IRE 12.5T sine-squared modulated pulse (modulated at 3.58 MHz), and a 100-IRE pedestal. See Fig. 6-7.

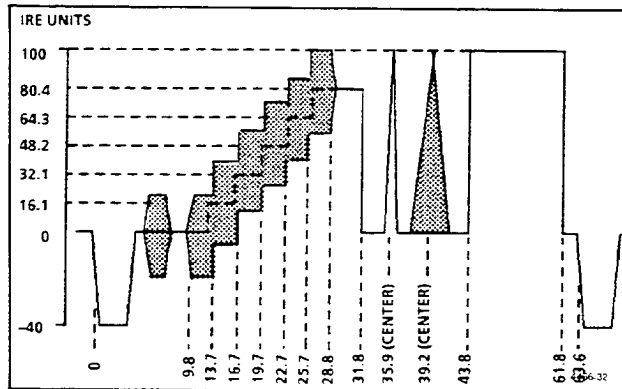

Fig. 6-7. FCC Composite.

Intended specifically for use as a VIT Signal, the FCC Composite can be used to identify and measure several video signal distortions. The 5-Step portion of the signal, when measured on a waveform monitor and vectorscope, can be used to measure differential gain and phase. (see the discussion of the Modulated 5-Step signal). The 2T pulse-to-bar ratio, as described in the Inverted Pulse and Bar test signal discussion, is used to detect gain/frequency and group delay distortions. The 12.5T sine-squared pulse allows measurement of chrominance/luminance gain and delay inequalities, described in detail in Appendix A. Finally, the reference bar (100 IRE pedestal) can provide an indication of line time linear distortions, as well as gain/frequency and group delay distortions (see discussion on Black Burst and Pedestal signals).

FCC MULTIBURST, MULTIBURST 100 (FMR, MB0)

The FCC Multiburst signal, as specified in FCC §73.699, consists of a 100 IRE pedestal immediately following burst, and six discrete packets of 60 IRE peak-to-peak bursts of increasing frequency based on a 40 IRE pedestal. Frequencies of the packets range from 0.5 to 4.1 MHz. See Fig. 6-8. The Multiburst 100 signal is similar, but has a 50 IRE pedestal with bursts of 100 IRE p-p.

Use the Multiburst to quickly make an approximation of a video system's frequency response. This is done simply by viewing the multiburst signal on a waveform monitor after it has passed through a video system, and noting the attenuation present at the packet frequencies. The frequencies which most often experience attenuation when passed through a video system are those which range from the chrominance subcarrier frequency, 3.58 MHz, to the upper video limit frequency, 4.1 MHz (see Fig. 6-9). These two fre-

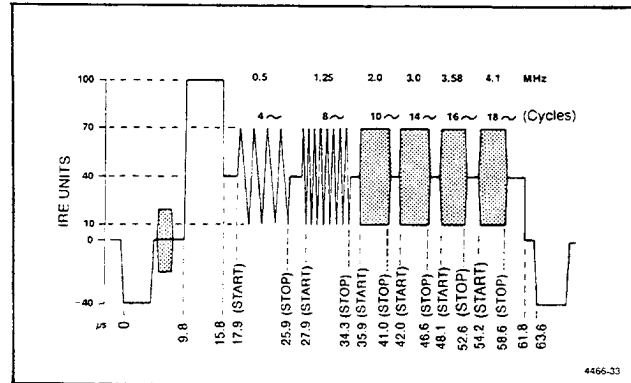

Fig. 6-8. FCC Multiburst.

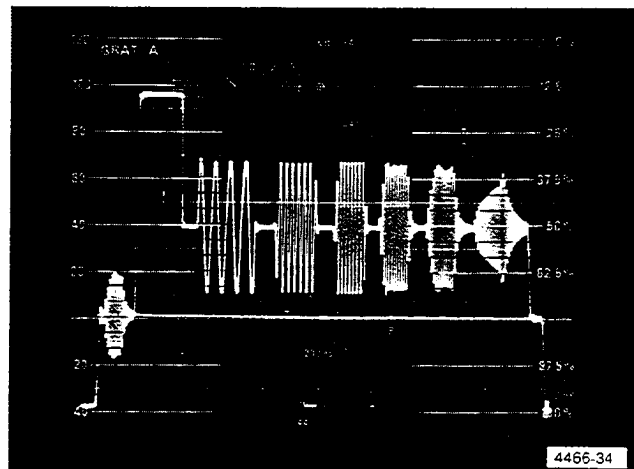

Fig. 6-9. FCC Multiburst Exhibiting Gain/Frequency Distortion.

quencies are the last two modulating frequencies of the FCC Multiburst. The Multiburst 100 has a last-packet modulating frequency of 4.2 MHz in place of the FCC Multiburst's 4.1 MHz for a more stringent standard of in-studio system performance. The low-frequency packet (0.5 MHz) is used as an amplitude reference by which the upper frequency packets can be quickly evaluated.

If a packet were at a luminance level other than 40 IRE for FCC Multiburst or 50 IRE for Multiburst 100, luminance nonlinearity or chrominance-to-luminance intermodulation would be present. If the packet modulation amplitude was other than 60 IRE p-p for FCC Multiburst or 100 IRE p-p for Multiburst 100, a frequency dependent distortion, such as gain/frequency distortion, would be present.

The two signal amplitudes offered by the FCC Multiburst and Multiburst 100 signals are used to measure two stan-

dards of video system performance. Average amplitudes of composite video lie in the range covered by the FCC Multiburst signal, and it will experience frequency-dependent distortions similar to typical program material. It is therefore well suited for transmitter testing. The Multiburst 100 signal is designed to cover the entire normal amplitude range for useful composite video, and it will be subject to not only gain/frequency distortion, but amplitude-dependent, nonlinear distortions (such as differential gain and phase) as well. It is therefore used as an in-studio test signal (ideally inserted at the program source and detected immediately prior to transmission for an indication of the entire studio system performance).

FIELD BAR (BAR)

The Field Bar signal consists of a single 100 IRE (peak white) pedestal for approximately one-half the line duration, centered in the video line. See Fig. 6-10.

Display this signal on a waveform monitor to detect line-time linear distortion (line tilt), gain/frequency distortion (ringing or overshoot in pedestal edges), and chrominance/luminance gain or delay distortion (overshoot or pre-shoot of pedestal edges, ringing near pedestal edges).

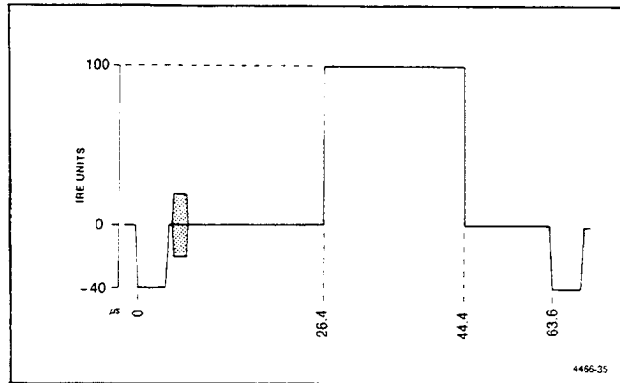

Fig. 6-10. Field Bar.

5-STEP STAIRCASE (YS0)

The 5-Step Staircase consists of five unmodulated luminance steps of 20 IRE each, ranging from 20 IRE to 100 IRE. See Fig. 6-11.

Use this test signal to measure the luminance nonlinearity of a video system. The procedure for measuring luminance nonlinearity using this type of test signal is described in the discussion of the 10-Step Staircase.

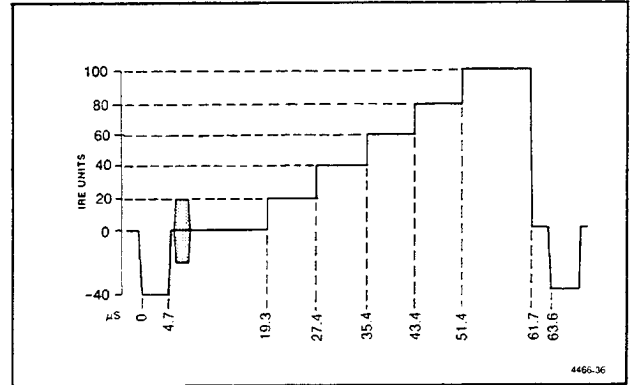

Fig. 6-11. 5-Step Staircase.

INVERTED PULSE & BAR (IPB)

This test signal is composed of a 100-IRE 2T pulse, followed by a 100 IRE pedestal split by a negative-going 100-IRE 2T pulse. See Fig. 6-12.

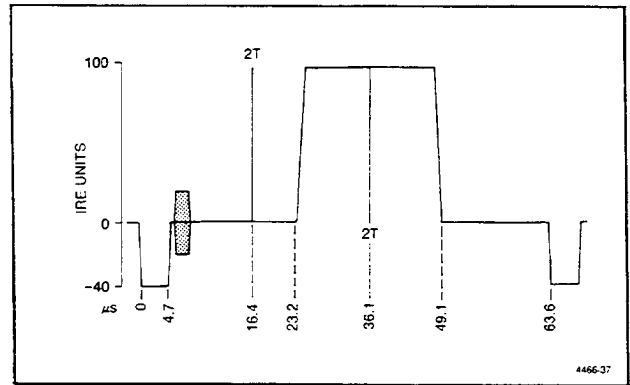

Fig. 6-12. Inverted Pulse & Bar.

Use the Inverted Pulse & Bar signal primarily for the pulse-to-bar ratio test. Perform the test by first normalizing the pedestal to 100 IRE on a waveform monitor, and then compare the amplitude of the positive-going 2T pulse with the pedestal level. Attenuated pulse amplitude implies a lack of high-frequency phase or gain response, caused by group delay and (or) gain/frequency distortion (see Fig. 6-13). The same test can be performed on the negative-going pulse, comparing it to the video blanking level 0 IRE. Often, overshoot, pre-shoot, or an overall widening of the pulse width will accompany the pulse amplitude attenuation.

Another useful test employing both the positive- and negative-going 2T pulses involves overlapping the pulses using the overlay mode of a Tektronix 1480-Series Waveform

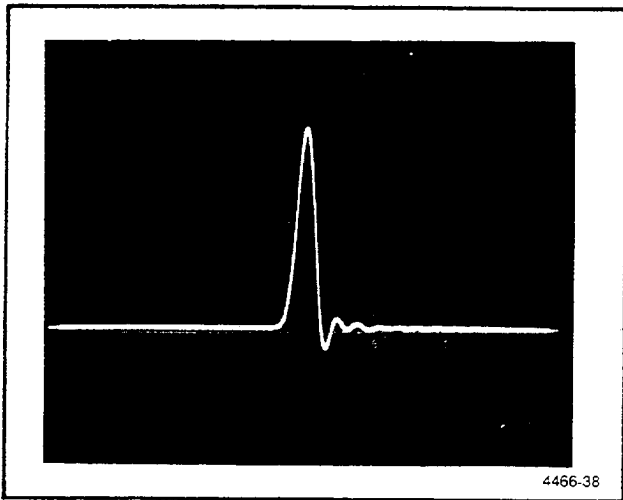

Fig. 6-13. 2T Pulse Exhibiting Gain/Frequency and/or Group-Delay Distortion.

Monitor. Ideally, the crossover points of the two waveforms would be at half either pulse's amplitude, or 50 IRE. If one pulse had rise or fall times which were different than the other, the crossover points would move up or down. This distorting effect could arise from transmitter power supply inadequacies if the transmitter power available does not meet the demand of a sudden positive transition. Negative step transitions could be less affected because they do not require the sudden power surge that the positive step transition does.

IYQB (IYQ)

The IYQB test signal is composed of a 7.5 IRE (black level) pedestal with 40 IRE "–I" phase modulation immediately following burst, a 100 IRE (peak white) pedestal, a 7.5 IRE pedestal with 40 IRE "Q" phase modulation, and a 7.5 IRE pedestal with PLUGE (3.5 IRE, 7.5 IRE, and 11.5 IRE pedestals, 2 μs each). See Fig. 6-14.

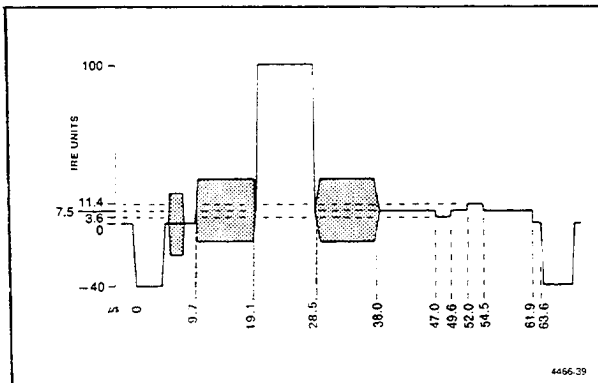

Fig. 6-14. IYQB.

Use this test signal, normally a split-field companion to EIA Color Bar signal, for adjusting brightness (using PLUGE) on a color picture monitor. PLUGE is a visual black level reference, with one region blacker-than-black (3.5 IRE), one region at black level (7.5 IRE), and one just slightly lighter-than-black (11.5 IRE). The picture monitor brightness is adjusted so that the black and blacker-than-black bars are indistinguishable from one another, but the lighter-than-black bar is marginally lighter. Monitor contrast level should be at its normal setting.

Use the "–I" and "Q" reference modulations found in IYQB for signal decoder and encoder adjustments.

MODULATED BAR (MDB)

This combination signal is composed of a 100-IRE 12.5T sine-squared modulated pulse (3.58 MHz modulation) immediately after burst, a 100 IRE 2T pulse, a 100 IRE pedestal, and a 50 IRE pedestal with 100 IRE p-p chrominance modulation. See Fig. 6-15.

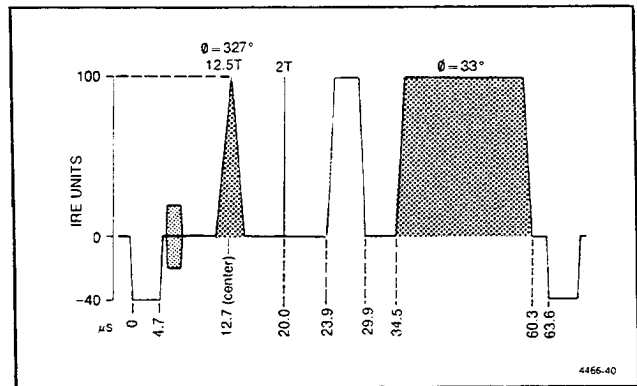

Fig. 6-15. Modulated Bar.

Use the individual components of the Modulated Bar test signal both together and separately for detecting and measuring several video signal distortions. Use the 12.5T modulated pulse to measure chrominance/luminance gain and delay inequalities with a procedure outlined in Appendix A. The 2T pulse-to-bar ratio, as described in the discussion of the Inverted Pulse & Bar signal, indicates high-frequency gain and (or) delay problems. The 50 IRE pedestal with modulation will indicate low frequency chrominance response errors, which are manifested as chrominance information before or after the 50 IRE luminance step, or a low-frequency modulation of the chrominance envelope.

MODULATED 5-STEP (M5S)

The Modulated 5-Step test signal consists of five 20 IRE luminance steps, modulated with 40 IRE p-p chrominance. Chrominance phase is 180° (burst phase). See Fig. 6-16.

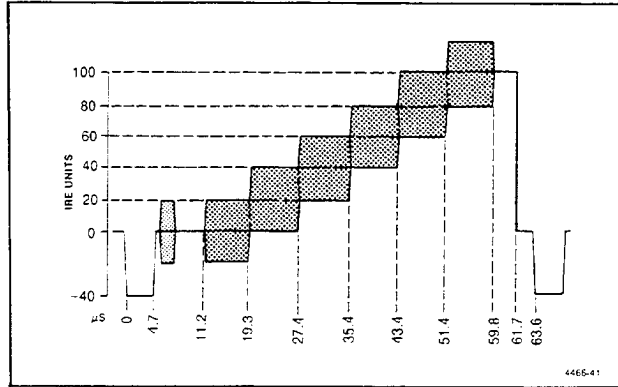

Fig. 6-16. Modulated 5-Step.

Measure differential gain with the Modulated 5-Step signal by filtering out the luminance components and observing the remaining chrominance components on a waveform monitor. See the discussion on the Modulated 10-Step signal for this method of measuring differential gain.

Differential gain and phase measurements can also be made with the Modulated 5-Step signal by using a vector-scope such as a TEKTRONIX 520A. Please refer to the vectorscope instruction manual for measurement information.

MODULATED PEDESTAL (MDP)

The Modulated Pedestal is composed of a 50 IRE luminance pedestal immediately after burst, and three amplitudes of chrominance modulation on this pedestal: 20, 40, and 80 IRE peak-to-peak respectively. All chrominance has a phase of 90° (see Fig. 6-17).

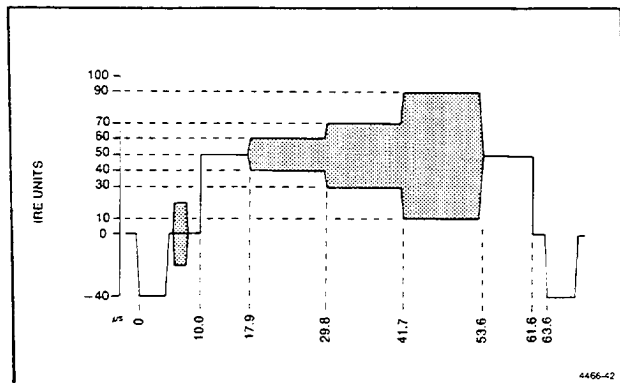

Fig. 6-17. Modulated Pedestal.

The Modulated Pedestal is ideally suited to measure chrominance-to-luminance intermodulation. When a video signal is affected by this distortion, luminance levels experience a shift due to varying chrominance amplitudes in a single line of video. If all chrominance in the Modulated Pedestal is filtered out using a waveform monitor with response set to "Low Pass," all that remains is the signal's original luminance information. What should ideally remain on the waveform monitor screen is a flat 50 IRE pedestal across the entire video line. However, when chrominance/luminance intermodulation is present, deviations in the linearity of the pedestal will appear (see Fig. 6-18). This distortion can be measured as suggested in NTC Report No. 7, by adjusting the waveform monitor so that the low-pass filtered signal has its original pedestal normalized to 50 IRE. The chrominance-to-luminance intermodulation of the signal is then the difference from the maximum to minimum pedestal amplitudes.

Use the Modulated Pedestal to measure chrominance nonlinear gain and phase distortions. Measure chrominance nonlinear gain with a waveform monitor adjusted so the center modulation of the pedestal is normalized to a 40 IRE display. Chrominance nonlinear gain is then defined as the differences in amplitudes of the first and last modulations of the pedestal, as compared to the standard shown in Fig. 6-18. Measure chrominance nonlinear phase with a vectorscope and note the number of degrees deviation from 90° (the phase of Modulated Pedestal chrominance) that is present in the waveform.

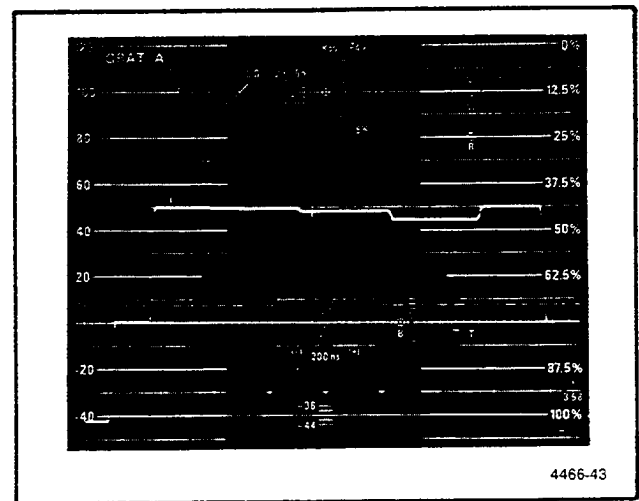

Fig. 6-18. The Filtered Luminance Components of a Modulated Pedestal Exhibiting Chrominance-to-Luminance Intermodulation.

MODULATED RAMP 80; 100 IRE (MR8,MR0)

The Modulated Ramp consists of a luminance ramp immediately following burst, extending from 0 IRE (blanking level) to either 80 (see Fig. 6-19) or 100 IRE, with 40 IRE p-p chrominance imposed on the ramp.

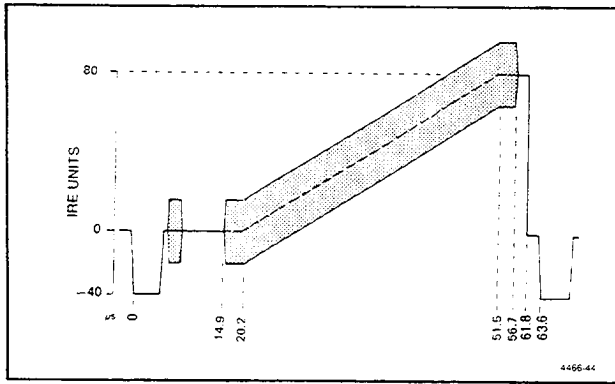

Fig. 6-19. Modulated Ramp 80 IRE.

A principle use of the Modulated Ramp test signal is to detect differential gain. Use a waveform monitor to filter out all components of the composite video signal, except the 3.58 MHz chrominance subcarrier. Ideally, only a 40 IRE p-p subcarrier component should remain in place of the Modulated Ramp. If the signal is distorted by differential gain, the amplitude of the remaining sine wave will vary from 40 IRE p-p. The procedure for calculating the magnitude of differential gain present is described in the Modulated 10-Step discussion. The Modulated Ramp test is better than the Modulated 10-Step test for measuring differential gain, since the Modulated Ramp gives a continuous indication of differential gain throughout the luminance amplitude range.

Differential gain and phase can be precisely measured with a vectorscope such as the Tektronix 520A using the Modulated Ramp in place of the Modulated 10-Step, again due to the continuity of the luminance ramp. For measurement methods, please refer to the vectorscope instruction manual.

The 80 and 100 IRE Modulated Ramps are provided as separate test signals because each tests a different performance standard of a video system. If only the normal operating range of composite video is to be tested, the 80 IRE ramp should be used. Differential gain and phase above this luminance level would not seriously affect the average TV picture quality. If the entire operating region of a composite signal is to be tested, the 100 IRE Modulated Ramp is needed. This signal forces the chrominance peaks to 120 IRE, the maximum allowable amplitude in a composite signal.

MODULATED 10-STEP (MOS)

The Modulated 10-Step test signal is composed of 40 IRE p-p chrominance (phase of 180°) subcarrier imposed upon 10 luminance steps of 10 IRE each, in ascending order of luminance amplitude. The luminance steps range from 10

IRE to 100 IRE (40 IRE p-p chrominance is also imposed on the blanking level pedestal immediately following burst). See Fig. 6-20.

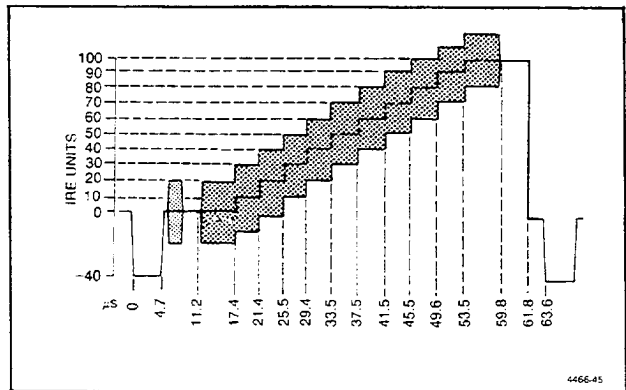

Fig. 6-20. Modulated 10-Step.

Differential gain can be measured and calculated using the Modulated 10-Step by filtering out the luminance components in the signal and observing the remaining chrominance components on a waveform monitor (see Fig. 6-21). Composite signal chrominance is band passed using a 3.58 MHz bandpass filter, either internal or external to the waveform monitor. After adjusting the gain on a waveform monitor so that the remaining chrominance has a maximum peak amplitude display of 100 IRE, calculate differential gain using a variation of the equation recommended by IEEE Method C,

$$\text{diff gain} = (100 - a) \%$$

where 'a' is the minimum chrominance amplitude (in IRE units peak). An ideal video system would yield differential gain of 0.0%.

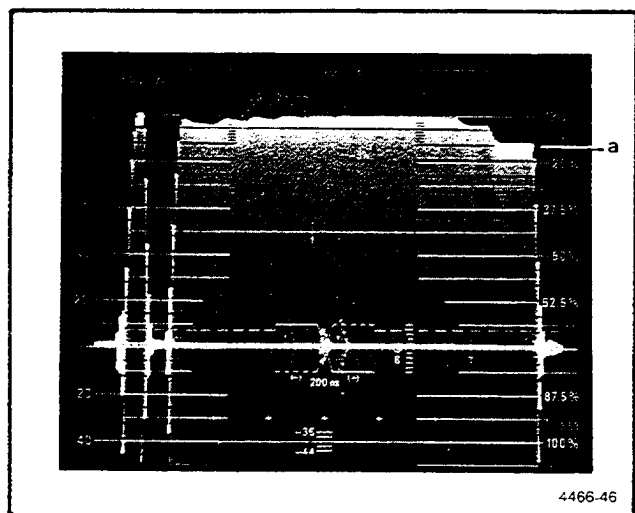

Fig. 6-21. Chrominance Components of a Modulated 10-Step Exhibiting Differential Gain.

Differential gain and phase can also be measured with the Modulated 10-Step signal by using a vectorscope such as a TEKTRONIX 520A. Please refer to the vectorscope instruction manual for measurement information.

MULTIPULSE 70,100 (MP7,MP0)

The Multipulse 70 (100) signal is composed of the following, superimposed on a 10 IRE (0 IRE) pedestal; a 70 IRE (100 IRE) amplitude reference flag immediately following burst, a 2T pulse of 70 IRE (100 IRE) peak amplitude, and six modulated sine-squared pulses of discrete, increasing frequency at 70 IRE (100 IRE) peak amplitude.

The pulse-packet frequencies are the same as the five highest packet frequencies used in the FCC Multiburst signal, i.e., 1.25, 2.0, 3.0, 3.58, and 4.1 MHz. See Fig. 6-22. These frequencies cover the chrominance and high frequency luminance bandwidths of the video frequency spectrum, with a low frequency luminance pulse as a gain and phase reference.

Use the Multipulse 70 and 100 signals primarily to measure gain/frequency and group delay distortions. Measure these distortions by viewing the signal on a waveform monitor and noting if distortions are present in the baselines of the pulse packets. Ideally, the frequency response of a video system would be flat with linear phase response across the entire bandwidth of the video signal frequency spectrum. The Multipulse signal would indicate this as perfectly flat pulse-packet baselines and equal peak amplitudes on all six pulses (including the 2T pulse). When dealing with practical video systems, however, frequency-dependent distortions commonly occur in the chrominance-to-high frequency luminance bandwidth of the video spectrum. The Multipulse test signal gives the opportunity to test for gain and delay distortions at five discrete frequencies in this range.

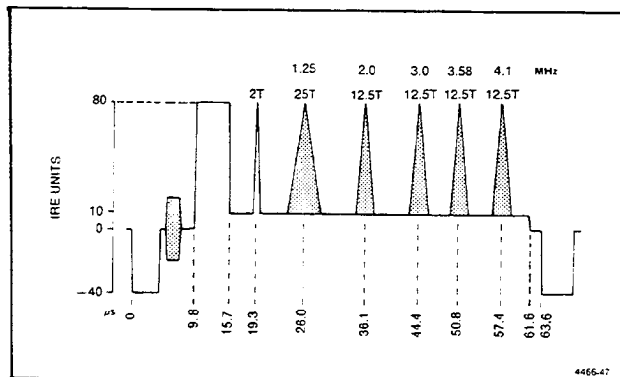

Fig. 6-22. Multipulse 70.

Two ranges of pulse amplitudes are offered in the Multipulse 70 and 100 signals (10 to 80 IRE and 0 to 100 IRE) to evaluate two levels of video system performance with regards to gain/frequency and group delay distortions. The lower amplitude Multipulse 70 signal is used to test the average signal amplitude performance of the video system. The higher amplitude Multipulse 100 signal tests the system over a greater range to see if gain or delay distortions would be encountered at high signal levels.

Note that, when taking measurements using the Multipulse test signals, the system must be reasonably free of amplitude-dependent, nonlinear distortions, such as differential gain and phase. These distortions will cause erroneous readings of gain/frequency and group delay.

The waveform monitor photographs in Appendix A, Figs. 3, 4 and 5, demonstrate the effects that gain/frequency and group delay distortions have on a multipulse waveform. Distortions at the discrete pulse frequencies can be evaluated by reading the magnitude of a baseline error from the monitor, and relating this error to the nomograph, also found in Appendix A, Fig. 6. From the nomograph, the group delay (in ns) and gain/frequency distortion (in dB gain) can be read directly.

NTC 7 COMPOSITE (NCP)

This combination test signal is specified in Section 3 of NTC Report No. 7, and is composed of a 100-IRE pedestal immediately following burst, a 100 IRE 2T pulse, a 100-IRE 12.5T modulated pulse (burst frequency and phase of 60.8°), and a narrow, Modulated 5-Step, with 40 IRE p-p chrominance. See Fig. 6-23.

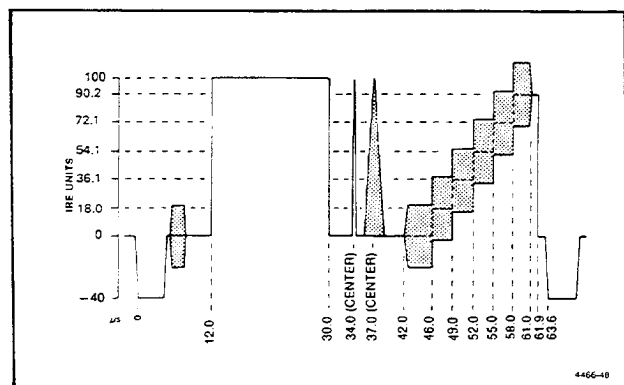

Fig. 6-23. NTC 7 Composite.

This is one of two test signals specified by the Network Transmission Committee. As noted in NTC Report No. 7, this signal is used for measuring field time nonlinearity (field

Test Signal Applications—1910 Operators

tilt, detected with the full field viewed on a waveform monitor), line time nonlinearity (line tilt, seen as droop in the 100 IRE pedestal), short time nonlinearity (2T pulse-to-bar ratio, overshoot or pre-shoot of 100 IRE pedestal corners), gain/frequency distortion (2T pulse height, see the Inverted Pulse & Bar test signal), chrominance/luminance gain and delay inequalities (using the 12.5T, 3.58 MHz modulated pulse; see Appendix A), and differential gain and phase (using narrowed Modulated 5-Step; see discussion on the Modulated 5-Step test signal).

Because of the numerous distortions which can be measured with the NTC 7 Composite, it is well suited for VITS insertion. Although this signal can be used to measure several distortions, it is not optimized for measuring any one of them. If precise measurements are needed, other signals available from the 1910 should be used, as they are optimally designed for measuring these signal distortions. Consult the signal/distortion matrix (Fig. 6-1) for such signals.

NTC 7 COMBINATION (CMB)

This combination test signal is specified in Section 3 of NTC Report No. 7, and is composed of a 100 IRE (peak white) luminance pedestal immediately following burst, six different frequency burst packets on a 50 IRE pedestal, and a three-level chrominance signal on a 50 IRE pedestal. See Fig. 6-24.

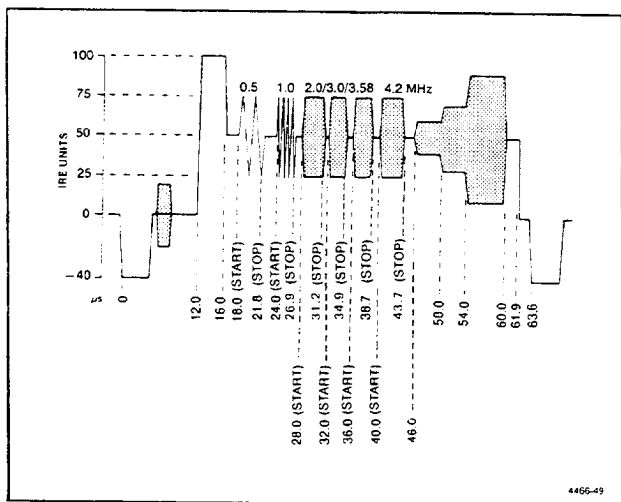

Fig. 6-24. NTC 7 Combination.

Use the NTC 7 Combination for measuring gain/frequency distortion (multiburst), chrominance-to-luminance intermodulation (using three-level chrominance), and chrominance nonlinear gain and phase (using three-level chrominance; see Modulated Pedestal signal description for distortion measurements).

Note that the multiburst frequencies of the NTC 7 Combination do not correspond to the FCC Multiburst frequencies, the difference being the highest frequency packet. In the FCC Multiburst, the highest frequency packet is 4.1 MHz, whereas with the NTC 7 Combination, the highest frequency packet is 4.2 MHz. Since the stated high cutoff frequency for video information is at 4.2 MHz, 3 dB attenuation (about 9 IRE down from the 30 IRE peak) would be expected. Much less attenuation should be present in the 4.1 MHz packet of the FCC Combination.

The NTC 7 Combination test signal is well suited for transmission as a VIT Signal by virtue of its distortion measurement capabilities. However, when precise measurements of the above mentioned distortions must be made, other signals generated by the 1910 should be used, as they are designed specifically for measuring these distortions. See the signal/distortion matrix (Fig. 6-1) for signal types.

RED FIELD (RFL)

The Red Field signal consists of a 28.3 IRE pedestal modulated with 88.2 IRE p-p red chrominance. See Fig. 6-25.

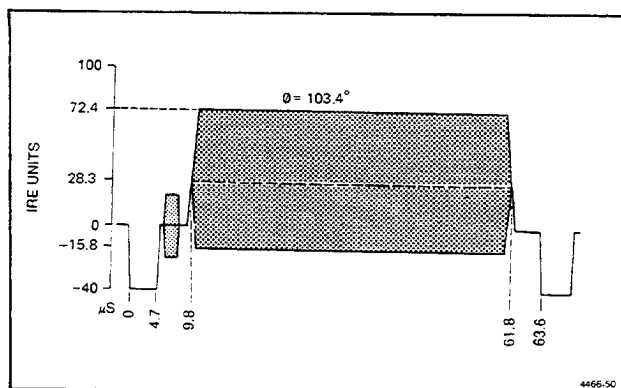

Fig. 6-25. Red Field.

The human eye is sensitive to static noise intermixed in a red field and displayed on a color picture monitor. When Red Field is displayed, video system distortions which cause small inconsistencies in picture quality, can be visually gauged for the effect they have on the final picture. This requires that the Red Field signal occupy at least 10 percent of a full-field signal. Also, color purity on the picture monitor can be gauged visually when Red Field is displayed.

REVERSE BLUE BARS (RBB)

This test signal is composed of blue chrominance on a 15.1 IRE pedestal immediately following burst, a 7.5 IRE (black level) pedestal, 63 IRE p-p magenta chrominance on a 35.9 IRE pedestal, a 7.5 IRE unmodulated pedestal, 88.2 IRE p-p cyan chrominance on a 56.1 IRE pedestal, a 7.5 IRE unmodulated pedestal, and a 77 IRE pedestal for the remainder of the line. See Fig. 6-26.

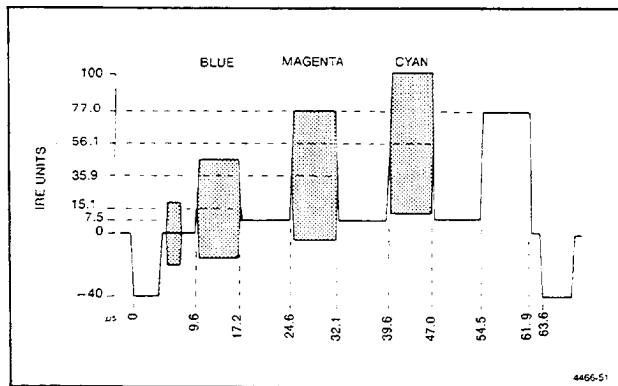

Fig. 6-26. Reverse Blue Bars.

Normally used adjacent to the EIA Color Bar signal in a split-field arrangement, the Reverse Blue Bars signal facilitates the adjustment of chroma and hue controls on a color picture monitor (see the discussion of the SMPTE Bars signal).

The EIA Color Bar signal contains blue chrominance in four of its seven bars; i.e., blue, magenta, cyan, and white. These bars are the same colors and amplitudes as the non-black bars in Reverse Blue Bars, but are arranged in opposite order of the EIA Color Bar signal. The black level bars of Reverse Blue Bars are opposite of the bars in EIA Color Bars which contain no blue chrominance.

$\frac{\text{Sin } x}{x}$ (SXX)

This unique signal is composed of a 24 IRE pedestal with positive $\text{Sin } x/x$ modulation, a 10 IRE pedestal, a 90 IRE pedestal, and a 76 IRE pedestal with negative $\frac{\text{Sin } x}{x}$ modulation for the remainder of the line, see Fig. 6-27.

$\frac{\text{Sin } x}{x}$ is unlike any other test signal available on the 1910 because it is intended to be used with a spectrum analyzer for frequency domain analysis. The $\frac{\text{Sin } x}{x}$ waveform packet included in this test signal has even density and equal mag-

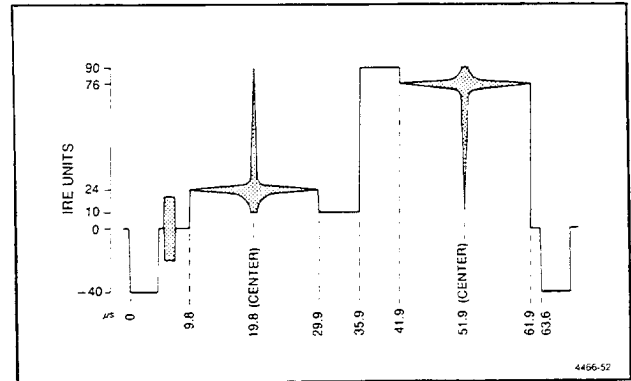

Fig. 6-27. $\frac{\text{Sin } x}{x}$.

nitude spectral components confined to the bandwidth of 15 kHz to 4.75 MHz. This is greater than the bandwidth of composite video information. So, when this signal is passed through a video system and viewed on a spectrum analyzer, the actual frequency response curve of the video system can be viewed on the analyzer screen.

Since all spectral components across the video bandwidth are present, and of equal magnitude, the spectrum analyzer should display a flat line to 4.1 MHz (the upper video band limit) and then taper off with increasing frequency. If the system were lacking in high-frequency response, the curve would begin tapering off at an earlier point. If the system responded to negative transitions differently than it responded to positive transitions, the curve would diverge into two different curves; one representing the negative-going $\frac{\text{Sin } x}{x}$ response, and the other representing the positive-going $\frac{\text{Sin } x}{x}$ response. Virtually every gain-related video waveform distortion will have an adverse effect on the flatness of the $\frac{\text{Sin } x}{x}$ spectrum analyzer curve.

A more complete description of the $\frac{\text{Sin } x}{x}$ signal, including typical equipment hook-up procedures and waveform photos, is given in Appendix A.

SPECIAL MULTIPULSE (SPP)

The Special Multipulse test signal contains two separate lines of video information which occur as consecutive lines of the same field when the Special Multipulse is displayed as a full-field signal.

When used in VITS insertion, the two lines are displayed on alternate fields (if inserted in odd fields, the first line is displayed in field 1 and the second is displayed in field 3).

Test Signal Applications—1910 Operators

The first line is composed of a 100 IRE pedestal, a 100-IRE 2T pulse, a 25T pulse modulated at 1.0 MHz, and four 12.5T pulses modulated at 1.5, 2.0, 2.5, and 3.0 MHz. The second line is composed of a 100 IRE pedestal immediately following burst, and six sine-squared pulses modulated at 3.5, 4.0, 4.5, 5.0, 5.5, and 6.0 MHz. See Fig. 6-28.

As with the Multipulse 70 and 100 test signals, use the Special Multipulse with a waveform monitor to measure gain frequency and group delay distortions. The Special Multipulse has extended capabilities for this measurement, and is normally used as a full-field, out-of-service test for a video system. Eleven discrete frequencies, equally spaced in 0.5 MHz increments from 1 to 6 MHz, are available for measurement on the two video lines. The 1.0 and 1.5 MHz pulses are of 25T time duration; all others are of 12.5T time duration. The procedures for measuring gain/frequency and group delay distortions are outlined in the Multipulse 70, 100 signal discussion.

Note that the two highest frequency pulses, 5.5 and 6.0 MHz, have inherent gain/frequency and group delay errors at the output of the 1910. Allow for these errors when making measurements with the Special Multipulse signal.

The 2T pulse in the Special Multipulse is used to view the 2T pulse-to-bar ratio. If the 2T pulse amplitude is lower than the 100 IRE bar, gain/frequency distortion and (or) group delay is present in the signal (see the discussion of the Inverted Pulse & Bar signal).

When used as a full-field test signal, the Special Multipulse is best displayed on a waveform monitor (such as a Tektronix 1480-Series) set to 10 μ s horizontal sweep (2 lines displayed) and X5 or X10 horizontal magnification for measurement ease.

10-STEP STAIRCASE (SS1)

The 10-Step Staircase consists of ten unmodulated luminance steps of 10 IRE each, ranging from 10 IRE to 100 IRE. See Fig. 6-29.

When differentiated, use this test signal to measure luminance nonlinear distortion. Differentiation is done using either a waveform monitor internal "Diff'd Step" function, or an external network (Tektronix 015-0154-00) in-line with the input to the waveform monitor. Once differentiated, the waveform monitor gain should be adjusted so that the highest amplitude peak displayed (corresponding to the shortest risetime/highest amplitude staircase step) is at 100 IRE, and the vertical position should be adjusted so that the baseline is at 0 IRE (see Fig. 6-30). Luminance nonlinear distortion is then calculated using the amplitude of the lowest riser, and the equation

$$DnI = (100 - a) \%$$

where "a" is the amplitude of the lowest riser.

An ideal video system would yield luminance nonlinear distortion of 0.0%.

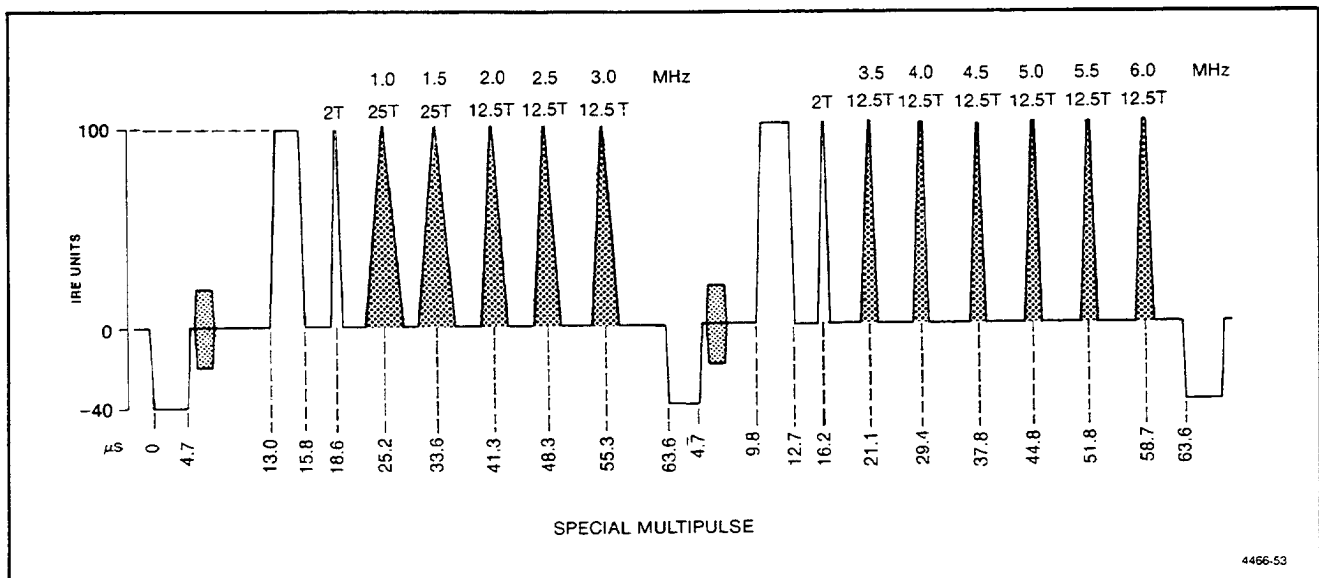

Fig. 6-28. Special Multipulse.

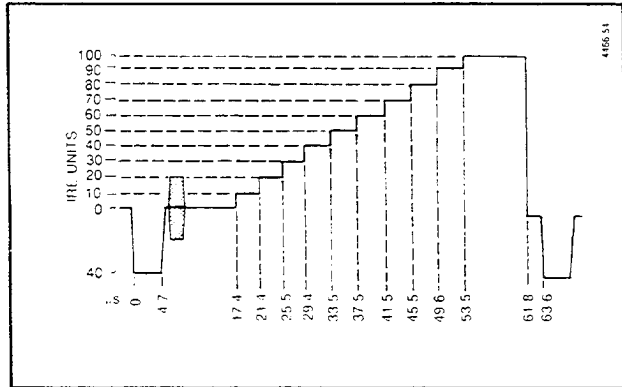

Fig. 6-29. 10-Step Staircase.

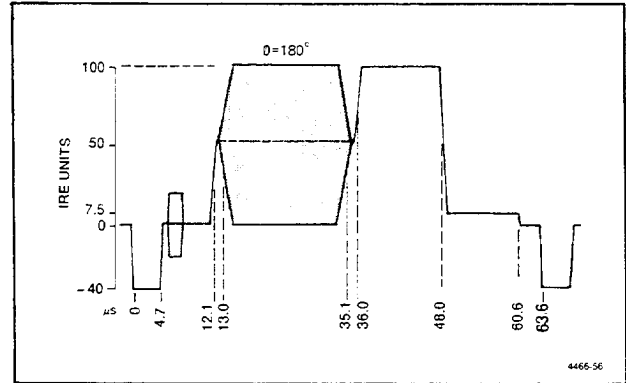

Fig. 6-31. VICR (Vertical Interval Color Reference).

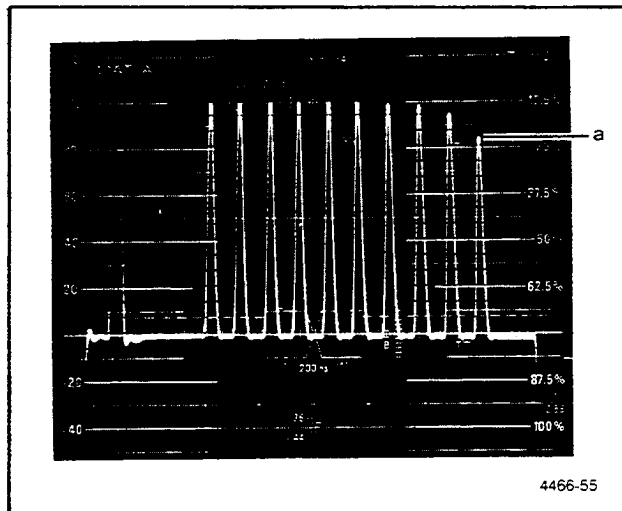

Fig. 6-30. Differentiated 10-Step Staircase exhibiting Luminance Non-Linearity.

VICR (VIC)

The Vertical Interval Color Reference signal is composed of a 50 IRE pedestal modulated with 100 IRE p-p chrominance (burst phase), a 100 IRE luminance pedestal, and a 7.5 IRE (black level) luminance pedestal. See Fig. 6-31.

VICR is normally inserted in the vertical interval as a chrominance phase and luminance level reference. When VICR is viewed on a vectorscope, the 100 IRE p-p chrominance on the first pedestal will cause a burst phase vector to extend to the perimeter (far left edge) of the graticule circle. This allows accurate evaluation of signal color phases from the vectorscope display.

Use the 100 IRE pedestal and the 7.5 IRE pedestal as setup references.

The pedestals also indicate gain/frequency distortion or chrominance/luminance gain (pedestal edge overshoot, pre-shoot, or ringing), or line time linear distortion in the form of line tilt (pedestal drop in amplitude). The 100 IRE p-p chrominance may also indicate low frequency chrominance response distortion, indicated on a waveform monitor by chrominance amplitude variances.

Although similar in make-up to VIRS (the FCC standard color reference and setup signal (see FCC 73.682 (21) and 73.699 (Fig. 16)), VICR may not be used in its place on vertical interval line 19 in any field. Automatic color referencing equipment designed for monitoring VIRS will not function properly with VICR.

VIRS (VIR)

The Vertical Interval Reference Signal, as specified in FCC 73.699, is composed of a 70 IRE modulated pedestal with 40 IRE p-p chrominance (burst phase), a 50 IRE unmodulated pedestal, and a 7.5 IRE (black level) pedestal. See Fig. 6-32.

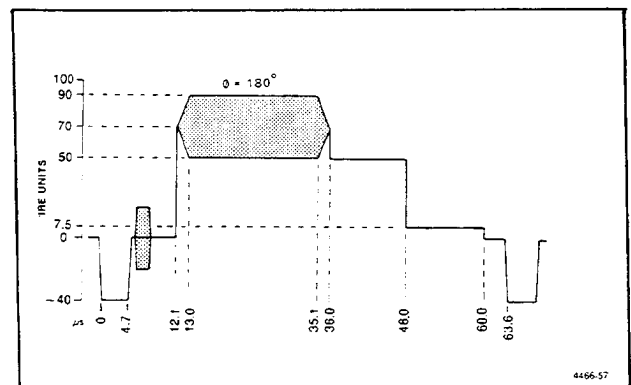

Fig. 6-32. VIRS (Vertical Interval Reference Signal).

Test Signal Applications—1910 Operators

VIRS is normally used in the vertical interval to provide a reference for either manual or automatic adjustment of signal chrominance gain and phase, luminance, and setup parameters of a video signal. The modulated pedestal approximates average chrominance phase, at average skin-tone luminance. The 50 IRE pedestal represents an average picture luminance level, and also indicates line-time linear distortion (tilt of pedestal). The 7.5 IRE pedestal is used for picture black level setup. Pre-shoot or ringing of the pedestal edges indicates gain/frequency or group delay distortions.

Y COLOR BAR (YCB)

The Y Color Bar signal is composed of a luminance reverse staircase, corresponding to the luminance pedestals of the Color Bars test signal. The staircase has luminance levels of 100, 69.2, 56.1, 48.4, 36.0, 28.3, 15.1, and 7.5 IRE. See Fig. 6-33.

This test signal is used with Color Bars in a split-field arrangement for color monitor adjustment and detection of chrominance to luminance intermodulation distortion. Alone, it can be viewed on a waveform monitor for detection of gain/frequency and group delay distortions, which will appear as overshoot and ringing of the luminance transitions. Also, luminance nonlinearity could be seen as luminance levels which differ from the original levels in Fig. 6-33.

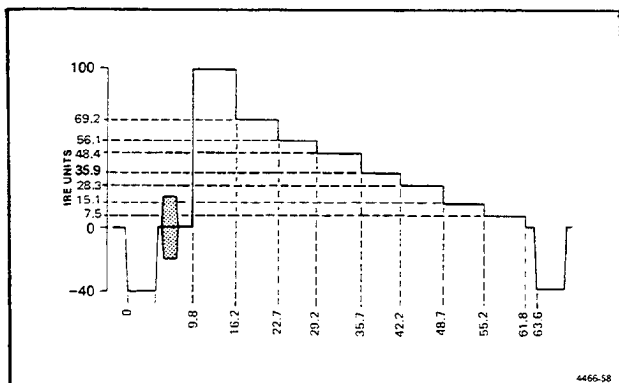

Fig. 6-33. Y Color Bar.

The Y Color Bar signal should not be differentiated to measure luminance nonlinearity. The luminance transitions that form the staircase are not all the same amplitude, which is necessary for an accurate measurement using staircase differentiation.

Y RAMP 100 (YR0)

This test signal is composed of a single unmodulated luminance ramp with constant slope, beginning at 0 IRE im-

mediately following burst and ending at 100 IRE. See Fig. 6-34.

The Y Ramp 100 is used with a waveform monitor to detect luminance nonlinearity. This is done by differentiating the signal (with the "Diff'd Step" function on a 1480-Series Tektronix Waveform Monitor), and noting any variation in the resulting flat line on the monitor screen. Deviations from the flat line indicate luminance nonlinearity (Fig. 6-35b). This can also be seen as nonlinear curvature in the ramp itself (Fig. 6-35a).

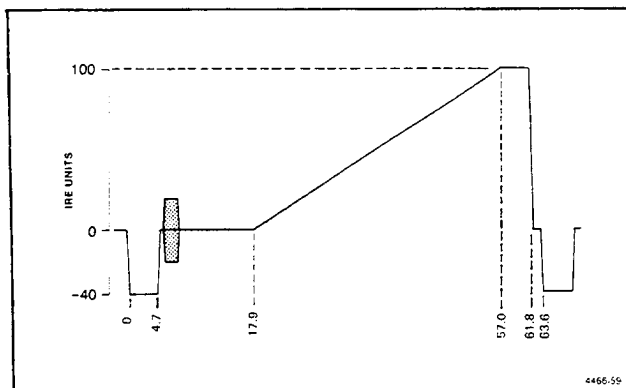

Fig. 6-34. Y Ramp 100 IRE.

SPLIT-FIELD AND SPECIAL PURPOSE SIGNALS

BARS/RED (BRR)

Bars/Red is a split-field signal, composed of the Color Bars test signal for the first three-fourths of the field, and Red Field for the remainder of the field.

This signal not only provides a reference for color picture monitor adjustment (see the discussion of the Color Bars signal), but it also provides a visual indication of destructive signal noise. The human eye is sensitive to irregularities (caused by white noise or high-frequency periodic noise) which appear in a red field.

BARS/Y (BRY)

This split-field test signal is composed of the Color Bars test signal for the first three-fourths of the field, and Y Color Bars for the remainder of the field.

Use Bars/Y to detect grey-scale tracking errors in color picture monitors, as well as a monitor color reference. Se-

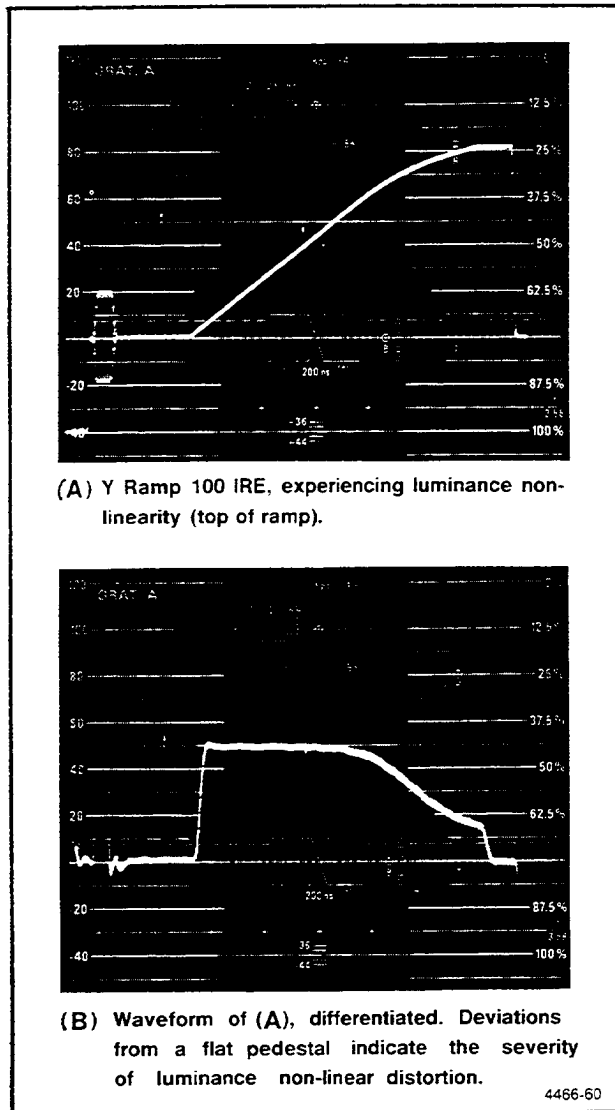

Fig. 6-35. Distorted Y Ramp 100.

lect the “monochrome” mode on the picture monitor while displaying Bars/Y, and note if the remaining bars are vertically consistent across the entire field. This test assumes the Bars/Y signal is experiencing no chrominance-to-luminance intermodulation or quadrature distortion, which would inherently cause this effect. Therefore, this test should be performed in-studio, before transmission and reception of the signal (or at least after the signal’s integrity has been checked with a waveform monitor).

Bars/Y can be used to detect chrominance-to-luminance intermodulation or quadrature distortion by displaying the signal on a waveform monitor in a line mode, with the vertical response set to luminance filter. This will cause Color Bars’ and Y Color Bars’ luminance levels to be superimposed. If quadrature distortion or chrominance-to-luminance

intermodulation is present, the luminance levels of the respective signal staircases will differ.

CONVERGENCE (CNV)

This signal produces a crosshatch and dot pattern, white on a black background, on a monitor screen. Use it as a full-field signal for checking and adjusting a color picture monitor’s convergence (alignment of the three color electron guns) and linearity.

FIELD SQUARE WAVE, WINDOW (FSW, WIN)

Field Square Wave is a split-field signal composed of the 0 IRE pedestal (blanking level) for the first one-fourth of the field, the 100 IRE pedestal for the next one-half of the field, and the 0 IRE pedestal for the remainder of the field.

Window is a split-field signal composed of the 0 IRE pedestal for the first one-fourth of the field, the Field Bar signal for the next one-half of the field, and the 0 IRE pedestal for the remainder of the field.

Three time-related linear distortions (short, line, and field time) can be detected with either of these signals. When displayed on a waveform monitor set to a 2-field mode, detect field time linear distortion by noting any slope in either the baseline or the 100 IRE line. This test essentially analyzes a video system’s low frequency response, since the Field Square Wave or Window approximates a 50% duty cycle, 60 Hz square wave input to the system.

Detect line time linear distortion by displaying either signal in the line mode and noting if the 100 IRE pedestal remains level. Measurement of this effect, known as line tilt, is usually done with the Window signal, using the bar center as an amplitude reference.

This test is similar to the test described in the Black Burst and Pedestals discussion, with the exception that the video system is experiencing more stress due to the square-wave effect. Because of this effect, each line should be inspected, because this stress can affect lines close to the 0 IRE-to-100 IRE pedestal field transitions (and vice-versa) more than lines in the center of the 100 IRE pedestal portion of the field.

Short time linear distortion can be seen as overshoot or ringing of pedestal edges on either side of the pedestal edge.

HIGH APL, LOW APL, BOUNCE

Although these 1910 functions are not test signals per se, they are used in conjunction with other full-field test signals to detect video system distortions which are APL-dependent. The High APL function inserts a 100 IRE pedestal on 4 out of every 5 lines of any full-field test signal. The Low APL function similarly inserts a 0 IRE pedestal on 4 out of every 5 lines. The Bounce function causes alternation between High and Low APL at a front panel selectable rate of 1 to 30 seconds/cycle.

Changing APL (Average Picture Level, the average luminance amplitude over several lines duration) in a full-field signal can cause varying effects of video signal distortions. By forcing high and low average picture levels, these variations in APL-dependent distortions can be measured, using any test signal in the full-field mode.

Sudden changes in APL, such as those created by Bounce, can be used to detect problems in clamp speed (i.e., the system does not react quickly enough to sudden APL transitions), faulty ac coupling of system components (the system exhibits ringing on APL transitions), and poor

regulation of a picture monitor's high voltage supply (this will cause apparent blooming of a bounced Window signal).

SMPTE BARS (SMP)

This split-field signal is composed of the EIA Color Bar signal for the first two-thirds of the field, the Reverse Blue Bars signal for the next one-twelfth of the field, and the IYQB signal for the remaining one-fourth of the field.

SMPTE Bars is used to set hue, chroma, and brightness levels on a color picture monitor. Perform chroma and hue adjustments by first turning off the red and green guns of the monitor, and observing the boundary between the EIA Color Bar signal and the Reverse Blue Bars signal. Adjust the hue control for vertical uniformity in the center two blue bars, and the chroma control for uniformity between the outside two blue bars (see Fig. 6-36). The red and green guns must be turned back on for monitor brightness adjustment (see the IYQB signal discussion).

Use SMPTE Bars to make adjustments of a video signal encoder or decoder, with the IYQB portion of the signal.

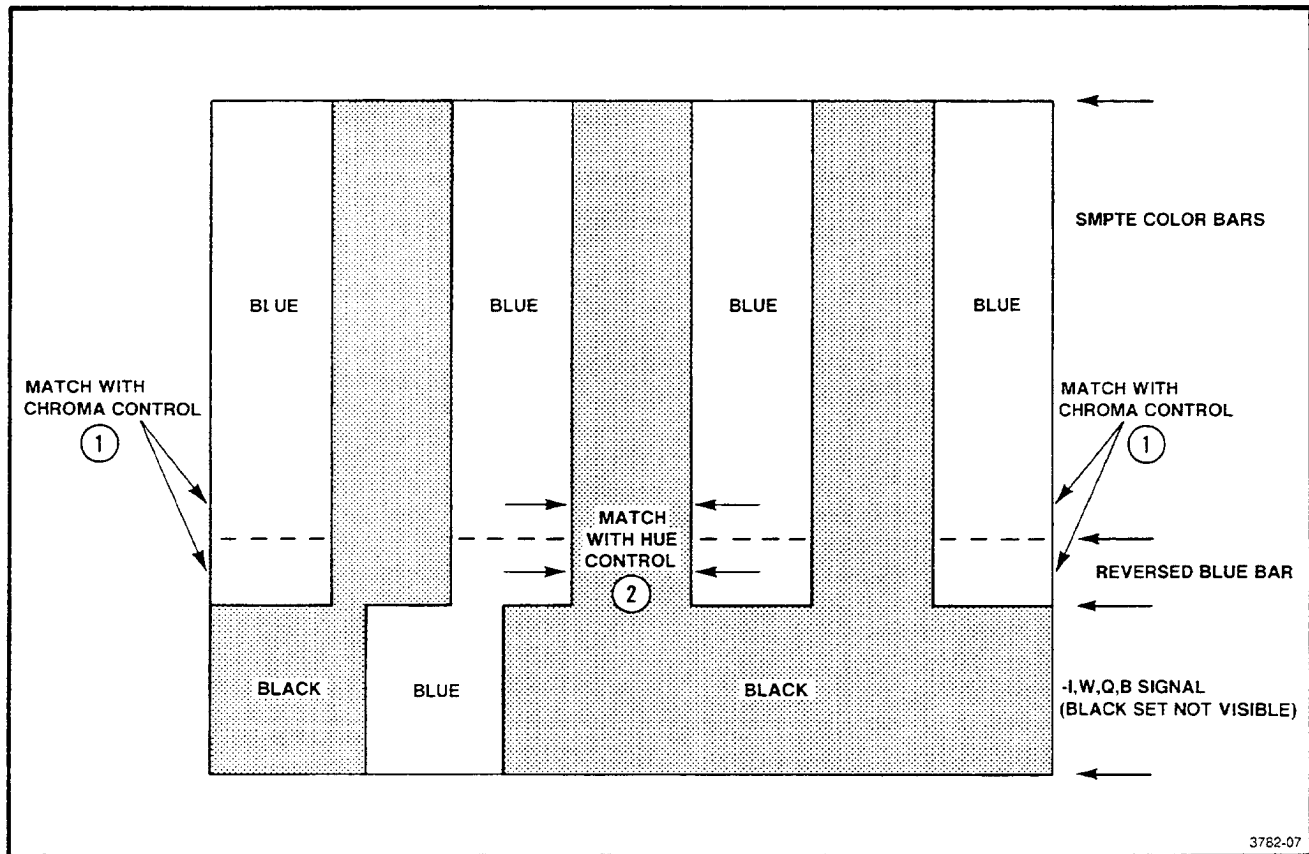

Fig. 6-36. Adjusting hue and chroma with SMPTE Bars, with red and green monitor screens turned off.

GHOST CANCELLATION REFERENCE SIGNALS (GCP and GCN)

The Ghost Cancellation Reference Signals, GCR Positive (GCP) and GCR Negative (GCN), were added to the 1910 signal set at S/N B023197. These signals, adopted by the United States Advanced Television Systems Committee, will reduce or eliminate ghosts from television broadcasts, when used with equipment incorporating ghost-cancelling circuitry.

The standard calls for these signals to be inserted on Line 19, previously reserved for VIRS, in the order:

Field 1 – GCR Positive	Field 5 – GCR Negative
Field 2 – GCR Negative	Field 6 – GCR Positive
Field 3 – GCR Positive	Field 7 – GCR Negative
Field 4 – GCR Negative	Field 8 – GCR Positive

After issuing a RESET ALL and a SAVE ALL command, through the 1910 RS-232 port, the VIT sequence will recall the Ghost Cancellation Reference signals in the specified order. It is still necessary to issue a Modify Status command to assign them to line 19, or any other line:

```
MODI STAT
F1L19=VSQ
^C^C
SAVE ALL
^C
```

GLOSSARY OF DISTORTION TERMS

Chrominance Nonlinear Gain

A change in chrominance amplitude causes a change in chrominance gain.

This distortion is often seen as attenuation of relatively high amplitude chrominance signals, and will appear in the TV picture as incorrect color saturation.

The Modulated Pedestal is used to measure chrominance nonlinear gain.

Chrominance Nonlinear Phase

A change in chrominance amplitude causes a change in chrominance phase.

Often seen as a phase shift of relatively high amplitude chrominance signals, this distortion will appear in the picture as a shift in hue as the color saturation level increases.

The Modulated Pedestal is used to measure chrominance nonlinear phase.

Chrominance/luminance Delay Inequality

Chrominance phase experiences a nonlinear shift from luminance phase.

This is a special case of delay/frequency distortion, and is caused by nonlinear phase response across the video bandwidth (a linear phase response is necessary to retain the phase relationship between chrominance and luminance). This distortion usually accompanies chrominance/luminance gain inequality. It will cause color smearing or bleeding in the resulting picture, particularly in areas adjacent to the border of a sharp luminance transition. It will also cause poor resolution of sharp luminance transitions (which form vertical lines on the picture).

Any signal containing the 12.5T sine-squared pulse with 3.58 MHz (chrominance frequency) modulation can be used to measure chrominance/luminance delay inequality.

Chrominance/luminance Gain Inequality

Chrominance gain differs from Luminance gain, when originally equal.

This is a specific case of gain/frequency distortion, and is caused by a system frequency response which is not flat across the video bandwidth (one range of video frequencies are amplified more than others). This distortion causes low-frequency luminance information to be amplified disproportionately from the high-frequency chrominance information,

and is commonly seen as attenuation of chrominance information. It will appear in the TV picture as a loss (or, possibly, gain) of color saturation.

Any signal containing the 12.5T sine-squared pulse with 3.58 MHz modulation can be used to measure chrominance/luminance gain inequality.

Chrominance-To-Luminance Intermodulation (Cross-Modulation, Crosstalk)

A change in chrominance amplitude causes a change in luminance amplitude.

This distortion appears as a shift (either positive or negative) in luminance amplitude caused by simultaneous change in the corresponding chrominance amplitude. The luminance shift may also be caused by the clipping of high-amplitude chrominance peaks (this is also known as quadrature distortion). In the resulting picture, it will appear as unwarranted brightness (luminance) variations caused by changes in color saturation levels.

The Modulated Pedestal is used to measure chrominance-to-luminance intermodulation.

Differential Gain

A change in luminance amplitude causes a change in chrominance amplitude.

This distortion is caused by nonlinear video amplifier characteristics, and often appears as decreasing chrominance amplitudes due to high luminance levels. The resulting picture will show a change in color saturation caused by a simultaneous change in picture brightness.

The Modulated Ramp is used to measure differential gain.

Differential Phase

A change in luminance amplitude causes a change in chrominance phase.

Nonlinear video amplifier characteristics can cause differing chrominance phase as a result of a change in luminance level, commonly at high luminance levels. As a result of this distortion, the TV picture will experience a change in hue due to a simultaneous change in picture brightness.

The Modulated Ramp is used to measure differential phase.

Group Delay

A change in frequency causes a nonlinear phase response.

This distortion is the result of a nonlinear phase/frequency response across the video bandwidth, and usually results in nonlinear phase shifts of frequencies near or above the chrominance subcarrier frequency (3.58 MHz). As the phase response falls off at these frequencies, the gain/frequency response will usually fall off also. In the resulting TV picture this can cause a lack of vertical-line sharpness due to luminance pulse ringing and overshoot, and color smearing due to chrominance envelope shift.

The Multipulse test signals are used to measure group delay.

Gain/frequency Distortion

A change in frequency causes a change in signal amplitude.

This distortion is the result of a non-flat gain/frequency response across the video bandwidth in a composite video signal, and usually results in the attenuation of frequencies near or above the chrominance subcarrier frequency (3.58 MHz). As the gain response falls off at these frequencies, the phase response will usually also fall off (resulting group delay distortion). In the resulting TV picture this can cause serious distortions in color saturation, as well as a lack of vertical line resolution due to luminance pulse ringing.

The Multiburst signals are used to measure gain/frequency distortion.

Luminance Nonlinearity (Differential Luminance)

A change in luminance amplitude causes a change in luminance gain.

Nonlinear operation of a video amplifier can cause the luminance gain in a composite video signal to vary with luminance amplitude. In most cases, luminance nonlinearity will reduce luminance gain at high luminance levels, where a video amplifier can be driven out of its linear operating range. As a result of this, the picture will display poor resolution between brightness levels in the nonlinear range.

The 10-Step Staircase and Y Ramp 100 are used to measure luminance nonlinearity.

Short Time Linear Distortion

An unwarranted change in amplitude or phase occurs in a short time frame (0.1 to 1 μ s).

Commonly the result of a decrease in the bandwidth of a composite video signal, these effects are most noticeable in sharp transitions (2T sine-squared pulse, luminance step) which occur within 0.1 to 1 μ s. The distortions appear as step or pulse ringing, and shortened 2T pulse height. When a video signal experiences short time distortions, the resulting TV picture will have dulled luminance transitions (fuzzy vertical lines), and ringing can be interpreted as chrominance information, causing color bleeding or smearing of areas adjacent to the vertical lines.

The Inverted Pulse & Bar is used to measure short time linear distortion.

Line Time Linear Distortion

An unwarranted change in signal amplitude occurs in a time frame between 1 μ s and 20 μ s.

Otherwise known as line tilt or droop, this gradual decline in luminance level can be caused by video amplifier power supply inadequacies. The linear loss of luminance amplitude in the time of one video line will result in a gradual left-to-right shading of the TV picture.

An 18 μ s pedestal, as found in several 1910 test signals, is used to measure line time linear distortion.

Field Time Linear Distortion

An unwarranted change in signal amplitude occurs in a time frame between 16 ms and one second.

Also known as field tilt, the gradual loss of luminance over the period of one field can be the result of video amplifier power supply inadequacies. Field time linear distortion will cause top-to-bottom shading of the resulting TV picture.

The Field Square Wave is used to measure field time linear distortion.

Low Frequency Chrominance Response

A change in time (1 μ s to 60 μ s) causes a change in chrominance amplitude.

Amplifier distortions such as group delay can cause low-frequency oscillation or attenuation in a composite signal's chrominance subcarrier envelope. In a resulting picture, this will appear as unwarranted saturation variations from left to right, similar in effect to line-time linear distortion, in which luminance experiences unwanted left-to-right variations.

The Modulated Bar, or Red Field, is used to measure low frequency chrominance response.

APPENDIX A

APPLICATION NOTES

THE MULTIPULSE WAVEFORM

By L. E. Weaver

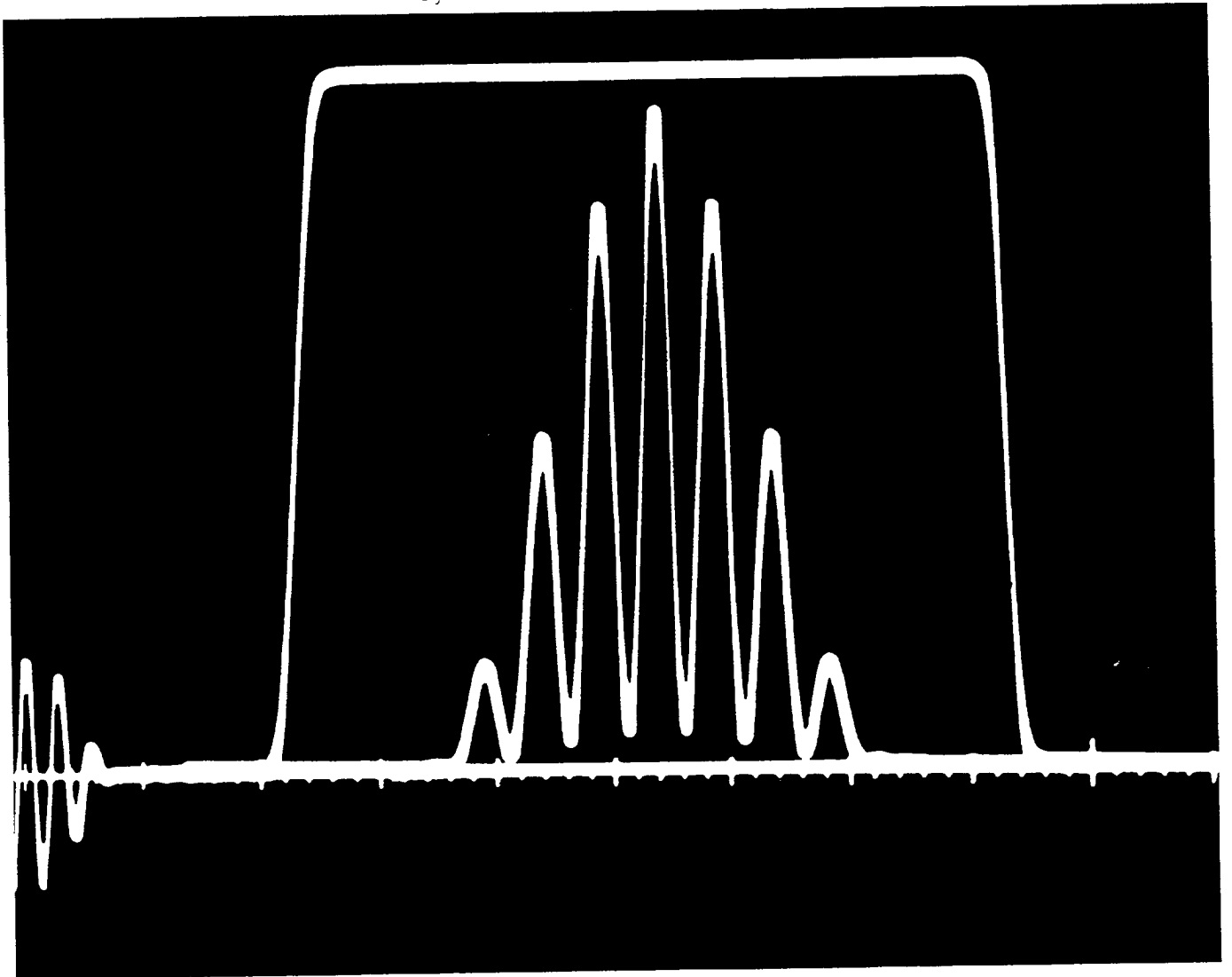

Tektronix[®]
COMMITTED TO EXCELLENCE

A very important addition to the range of test waveforms provided by the Tektronix 1900 Series Generators is the multipulse. This powerful and versatile test signal is new to the U.S.A., although it has been in operational use for some years in Europe by one of the world's leading broadcasters¹. Digital generation of the waveform ensures an extremely high degree of accuracy and long-term stability.

WHAT IS THE MULTIPULSE?

In simplest terms, the multipulse is a development from the familiar multi-burst, but is much superior in that it can be used to measure group delay errors over the video band as well as amplitude errors. Up to now the former have required the use of specialized and expensive equipment, so the importance of this new technique, especially for transmitter testing, can hardly be exaggerated.

The essential element of the multipulse is a waveform resembling the standard 12.5T composite chrominance pulse. As is well known, this pulse has the property by which the deviations from flatness of its base provide a means for determining amplitude and group delay errors in the chrominance region. An excellent discussion of these measurements is given by Rhodes².

The multipulse originated from the realization that the high frequency component of the composite pulse does not necessarily have to be chrominance subcarrier, but can be made any frequency one wishes within reason. It follows that a sequence of such pulses spaced along a single TV line can provide measurements of both amplitude and group delay variations when referenced to the lower video frequencies.

THE PRACTICAL WAVEFORM.

Figs. 1 (a) and 1 (b) illustrate the Tektronix versions of the multipulse for 525-line system testing. In Fig. 1 (b), the waveform dynamic range is limited to between 10 and 80 IRE units. This has applications in transmitter testing and where nonlinearity may be present.

The two waveforms at the start of the line are, in order, a 6 μ s 2T bar and a 2T sine-squared pulse, which allow conventional waveform testing to be carried out to supplement the frequency-domain measurements provided by the multipulse. In addition, the bar is available as a useful amplitude reference for the pulse height as will be seen below. Next follows a sequence of composite pulses with frequencies of 1.0, 2.0, 3.0, 3.579545, and finally 4.2 MHz. (The first and last pulse frequencies are 1.25 and 4.1 MHz on the reduced amplitude multipulse.) Each has a 12.5T shaping

Undistorted Multipulse waveform.

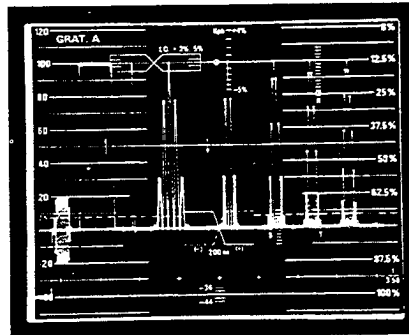

Figure 1 (a) Full amplitude.

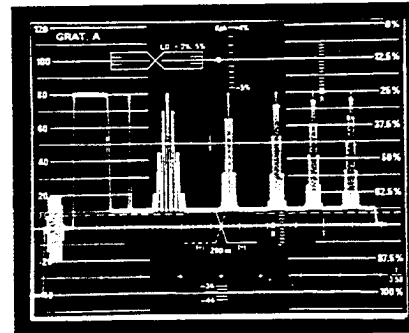

Figure 1 (b) Reduced amplitude.

with the exception of the 1.0 MHz pulse, which has been made 25T in order to accommodate a sufficient number of cycles within the pulse envelope. Exactly the same device has been employed in the standard multiburst. This dimensioning offers the advantage that the methods developed for the analysis of the composite chrominance pulse can be taken over for use with the multipulse. Incidentally, the 3.579545 MHz pulse is obviously identical with the normal composite chrominance pulse.

The detailed structure of the individual pulses is shown in Figs. 2 (a) through 2 (e). Since the frequencies are all locked to horizontal rate, the displays are stationary, and when the bar is overlaid, as in the photographs, the accuracy of the

generated waveforms is very conclusively demonstrated. The use of digital techniques for generating these waveforms guarantees not only their accuracy, but also their long-term stability.

Detail of undistorted multipulse.

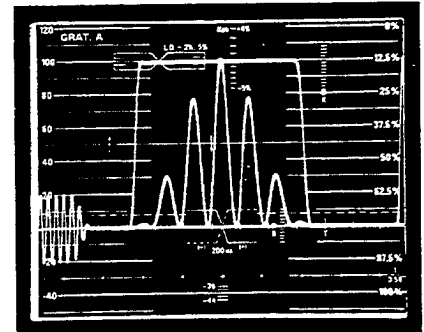

Figure 2 (a) 1.0 MHz

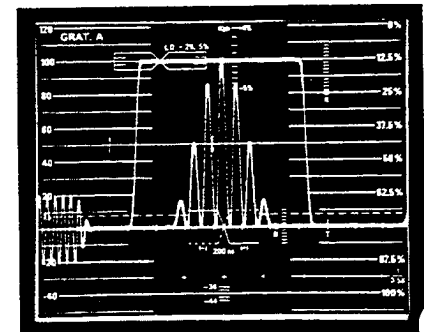

Figure 2 (b) 2.0 MHz

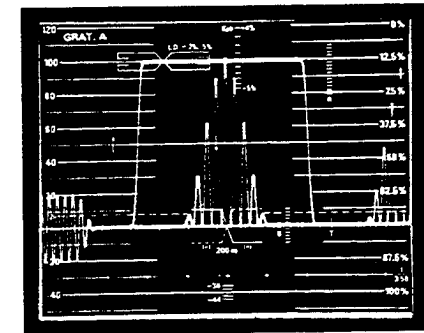

Figure 2 (c) 3.0 MHz

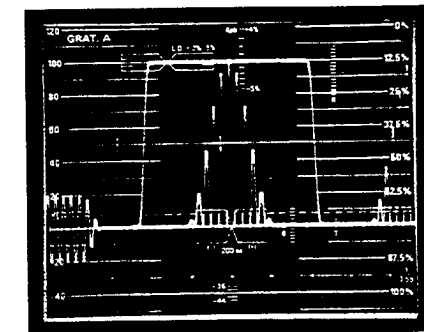

Figure 2 (d) 3.58 MHz

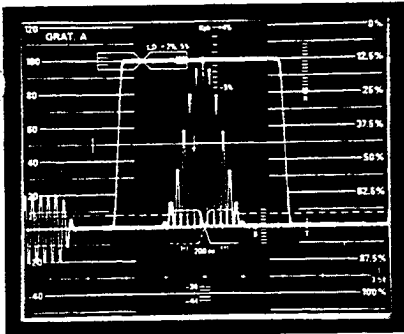

Figure 2 (e) 4.2 MHz

HOW THE MULTIPULSE IS USED.

To clarify the explanation, amplitude and group delay distortions will first of all be considered separately, after which the more common situation of combined amplitude and delay errors will be discussed.

Amplitude Errors Only:

Consider the multipulse of Fig. 3 (a), individual pulses of which are shown in detail in Figs. 3 (b) through 3 (e). Above 1.0 MHz the pulses exhibit a "bowing" of the base of the pulse which increases with frequency. When this is perfectly symmetrical so that it is in fact a complete half-period of a sine wave, then amplitude distortion alone is present. Analysis of the pulse² leads to the following relevant statements:

- (a) A bowing of the pulse base, which is symmetrical about the center line of the pulse, indicates an amplitude error only.
- (b) If the bowing is in the upward direction, the amplitude at the pulse modulation frequency is decreased. An amplitude increase is denoted by the bowing being downwards.
- (c) The maximum shift of the base of the pulse from the display baseline is a measure of the amount of the error. This is exactly equal to the displacement of the peak of the pulse from the top of the bar when the distortion is purely linear.

Taking these into consideration, it is obvious that Fig. 3 (a) corresponds to a high frequency loss which increases with frequency. At 4.2 MHz it is in fact about 1.7 dB (-18%).

Multipulse with amplitude errors only.

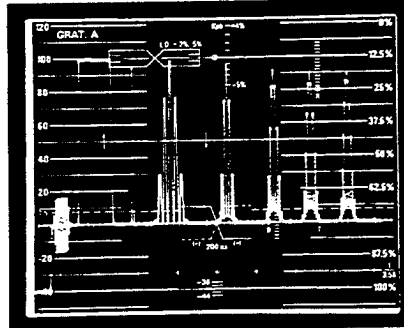

Figure 3 (a) Complete multipulse.

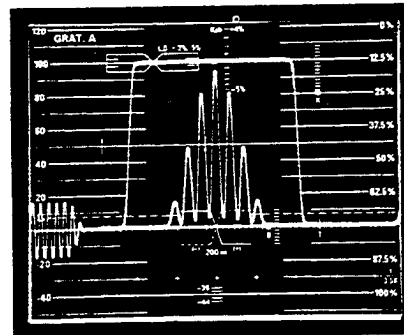

Figure 3 (b) 2.0 MHz

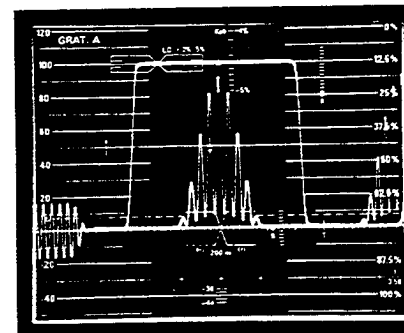

Figure 3 (c) 3.0 MHz

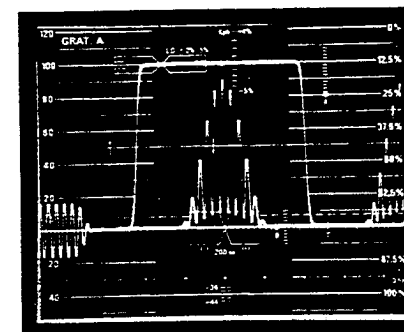

Figure 3 (d) 3.58 MHz

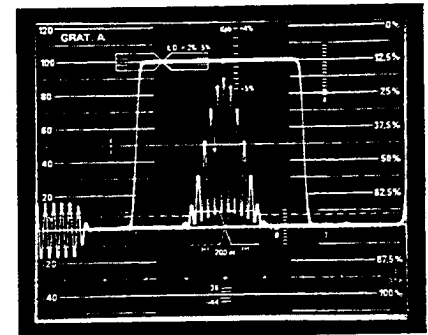

Figure 3 (e) 4.2 MHz

Delay Errors Only:

These lead to a quite different and characteristic deformation of the base of the pulse.

- (a) A difference in group delay between the low video frequencies and the pulse modulation frequency results in the base of the pulse having the perfectly skew symmetrical shape of a single complete period of a sine wave (see Figs. 4a, 4b, 4c, and 4d).
- (b) If the pulse modulation frequency is delayed with respect to the low video frequencies, the upper lobe is on the left-hand side of the display. Conversely, an advance will transfer the upper lobe to the right-hand side of the display.
- (c) The amplitude of the sinusoidal pulse baseline is a measure of the delay error.
- (d) With delay distortion only, the height of the pulse remains unchanged.

In the photograph of Fig. 4 (a) there is obviously a delay which increases steadily with frequency. The maximum value at 4.2 MHz is around 200 nanoseconds. Incidentally, a time advance at the upper frequencies is not impracticable, but an everyday occurrence, since it will be found whenever one measures the FCC envelope delay characteristic (Fig. 4e). This characteristic is described in 73.687(a)(5) of the FCC Rules and Regulations.

Multipulse with delay distortions only.

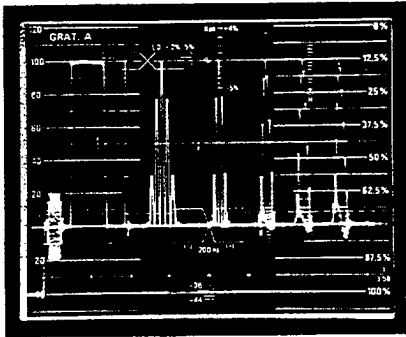

Figure 4 (a) Complete multipulse.

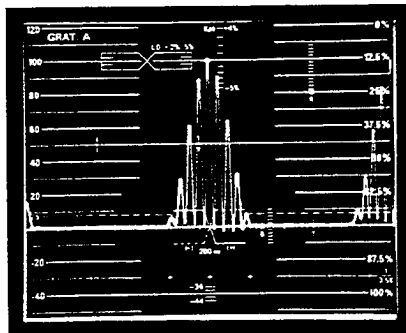

Figure 4 (b) 3.0 MHz

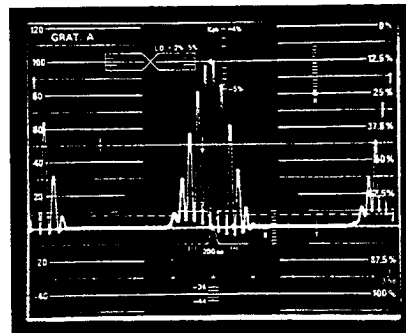

Figure 4 (c) 3.58 MHz

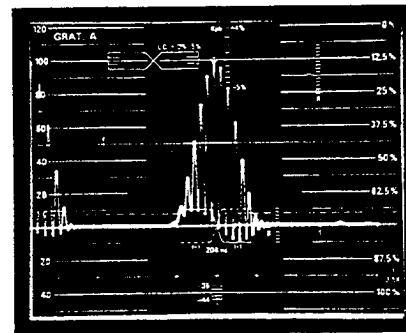

Figure 4 (d) 4.2 MHz

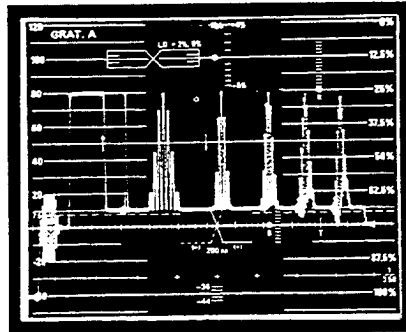

Figure 5 (a)

Combined Amplitude and Delay Errors:

From what has been said above, it should be clear that a combination of amplitude and delay errors will result in the base of the pulse having two lobes which are unequal in amplitude, as well as a pulse height which is no longer equal to that of the top of the bar. A typical example is given in Fig. 5 (a), whose 3.0, 3.58 and 4.2 MHz pulses are shown in detail in Figs. 5 (b), (c), and (d), respectively. This last illustrates the difference in the lobe amplitudes very clearly.

Multipulse with amplitude and delay errors.

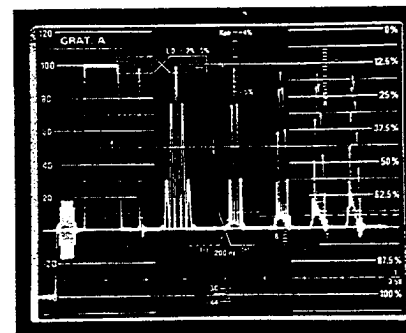

Figure 5 (a) Complete multipulse waveform.

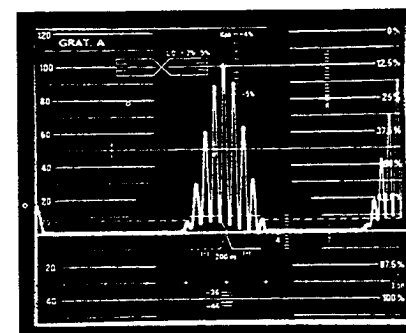

Figure 5 (b) 3.0 MHz

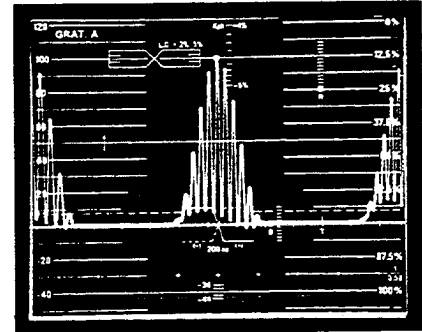

Figure 5 (c) 3.58 MHz

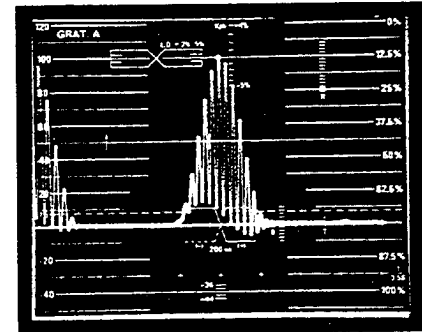

Figure 5 (d) 4.2 MHz

An interesting case which could be deceptive if one were not careful appears in Fig. 5 (a). The 3.58 MHz pulse at first sight seems to have only one lobe, but on closer examination (see Figure 5(c)), it can be seen that its maximum is not in the center of the pulse. It must, therefore, correspond to a combination of amplitude and delay errors such that the lower lobe is almost suppressed.

DERIVATION OF THE MEASUREMENTS.

By far the most generally applicable method is to measure the maximum amplitudes of the two lobes in the base of the distorted pulse, from which the values of the amplitude and delay errors can be found by the use of the nomograph of Fig. 6.

However, the following remarks must be borne in mind:

- (a) The measurement of the lobe amplitudes must be carried out with the pulse height normalized to 100 IRE as in Figs. 5 (b) through 5 (d).
- (b) The nomograph is directly valid for all pulses with the exception of the 1.0 MHz pulse, which is 25T and not 12.5T.

- (c) The nomograph is also valid for 1.0 MHz amplitude errors, but in this instance, the delay errors read off must be multiplied by a factor of two to obtain the correct values. In practice, of course, delay errors only very rarely occur at this frequency, so there is no real inconvenience.

Two additional points are worth noting. If one only requires the amplitude error, it can be measured directly in terms of the pulse height against the bar even when delay errors are also present. This property also means that if there is a significant lack of agreement between the nomograph reading and the amplitude error derived from the pulse

height, then one must suspect non-linearity distortion.

The other point concerns the measurement of delay which, as can be seen from Fig. 6, is more accurately determined when the amplitude error is low. If a variable amplitude equalizer is available which has no phase distortion of its own, and this is used to cancel whatever the amplitude error of the pulse is, then the delay can be measured with optimum sensitivity. In fact, the value can be read directly from a simple graticule. This is a well-known technique with the composite chrominance pulse².

Multipulse Application Nomograph for 12.5T Pulses for 525/60 Standards
 Note: To apply to 25T pulse, actual delay is twice value indicated by nomograph.
 PULSE PEAK \approx 100%

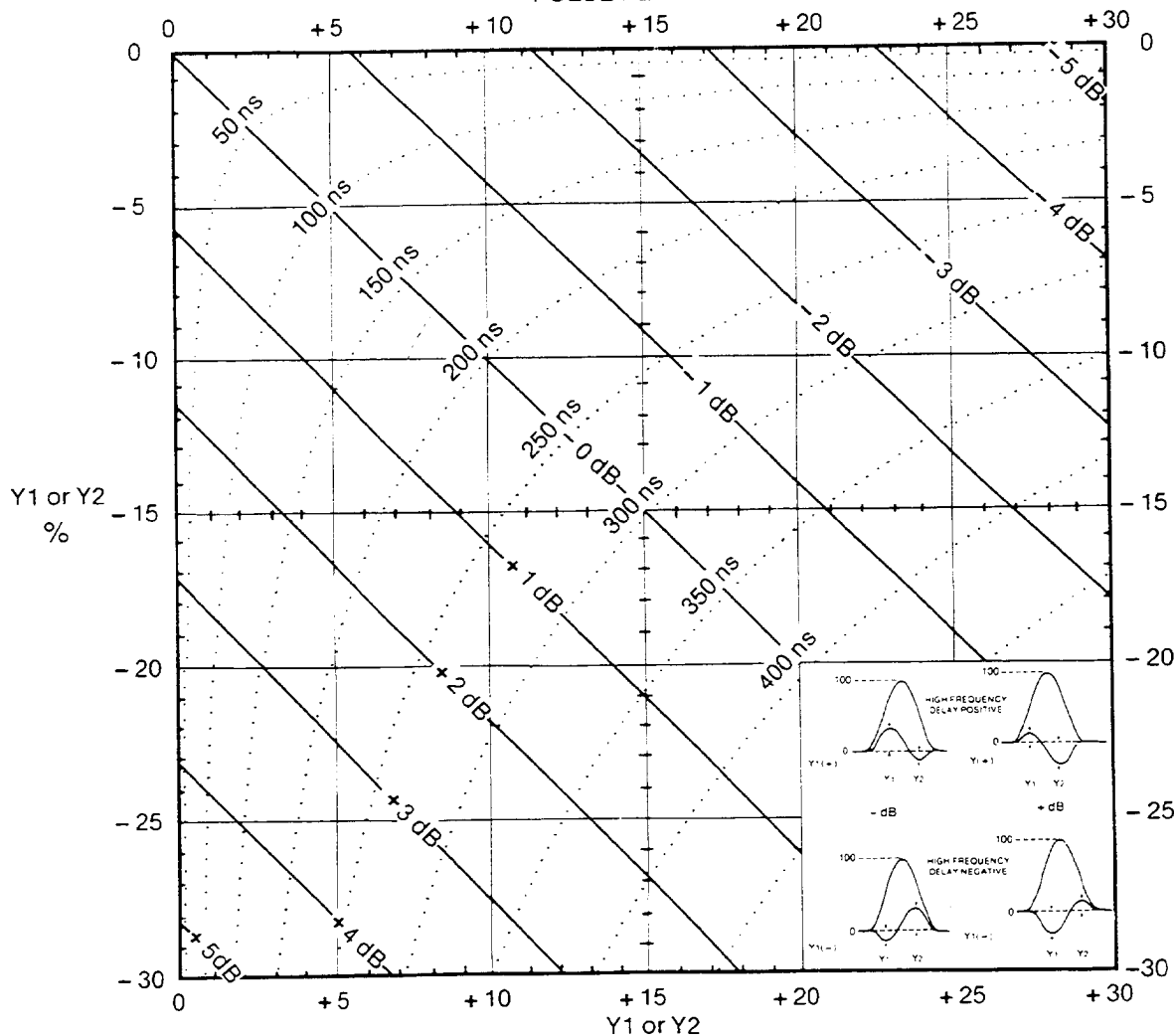

Figure 6. Nomograph for determination of amplitude and delay errors from the multipulse.

WHY PREFER THE MULTIPULSE?

The overwhelming benefit of the multipulse is its utility in group delay measurements. This would mean a great deal in itself, but the fact that the measurement is made within the duration of a single TV line ensures that the waveform can also be employed for in-service testing of transmitters, as well as for VTR machines and so on.

It can be objected that it should be possible to measure group delay with the multiburst as well. In principle, this is true, but it turns out not to be feasible in practice. Group delay distortion only modifies the regions immediately around the burst transitions. These are not only difficult to deal with, but they are also the locations where imperfections in the generator are likely to occur. Even if this were not the case, it can be shown theoretically that the sensitivity, and hence the accuracy, of delay measurement with the burst is less by a factor of three compared with the pulse³.

Even amplitude distortion is more satisfactorily measured with the multipulse, since the pulses are so much less affected by waveform tilt resulting from low-frequency phase errors, which tend to impair multiburst measurements.

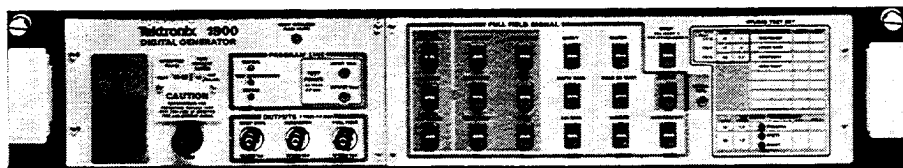

The Tektronix 1900 is an NTSC test signal generator/VITS inserter which, in addition to the multipulse signal, and depending on the version, generates SMPTE Color Bars for color picture monitor adjustment and the Sin X/X signal for in-service measurement of frequency response.

L. E. Weaver, B.Sc., C.Eng., M.I.E.E.

Les Weaver is an international TV engineering consultant, primarily for Tektronix, Inc. His prior experience included work on the design of multi-channel communication systems. Mr. Weaver has published two books and numerous papers on the techniques of television measurements.

References.

- ¹J. E. Holder, "New Television Test Waveform," *Electronics Letters*, vol. 13, no. 9, April 1977.
- ²C. W. Rhodes, "The 12.5T Modulated Sine-Squared Pulse for NTSC," *IEEE Trans. on Broadcasting*, vol. BC-18, no. 1, 1972.
- ³L. E. Weaver, "Sine-Squared Pulse and Bar Testing in Color Television," *BBC Engineering Monograph* no. 58, 1965.

For further information, contact:

U.S.A., Asia, Australia, Central & South America, Japan
Tektronix, Inc.
P.O. Box 1700
Beaverton, OR 97075
Phone: 800/547-1512
Oregon only 800/644-9051
Telex: 910-467-8708
Cable: TEKTRONIX

Europe, Africa, Middle East
Tektronix International, Inc.
European Marketing Centre
Postbox 827
1180 AV Amstelveen
The Netherlands
Telex: 18312

Canada
Tektronix Canada Inc.
P.O. Box 6500
Barrie, Ontario L4M 4V3
Phone: 705/737-2700

Tektronix sales and service offices around the world:
Argentina, Australia, Austria, Belgium, Bolivia, Brazil, Canada, Chile, Colombia, Costa Rica, Denmark, East Africa, Ecuador, Egypt, El Salvador, Federal Republic of Germany, Finland, France, Greece, Hong Kong, Iceland, India, Indonesia, Iraq, Israel, Italy, Ivory Coast, Japan, Jordan, Korea, Kuwait, Lebanon, Malaysia, Mexico, Morocco, The Netherlands, New Zealand, Norway, Pakistan, Panama, Peru, Philippines, Portugal, Republic of South Africa, Saudi Arabia, Singapore, Spain, Sri Lanka, Sudan, Surinam, Sweden, Switzerland, Syria, Taiwan, Thailand, Turkey, Tunisia, United Kingdom, Uruguay, Venezuela, Zambia.

Copyright © 1981, Tektronix, Inc. All rights reserved. Printed in U.S.A. Tektronix products are covered by U.S. and foreign patents, issued and pending. Information in this publication supersedes that in all previously published material. Specification and price change privileges reserved. TEKTRONIX, TEK, SCOPE-MOBILE, and  are registered trademarks of Tektronix, Inc. TELEQUIPMENT is a registered trademark of Tektronix U.K. Limited

Tektronix
COMMITTED TO EXCELLENCE

FREQUENCY RESPONSE TESTING USING THE SIN X/X TEST SIGNAL

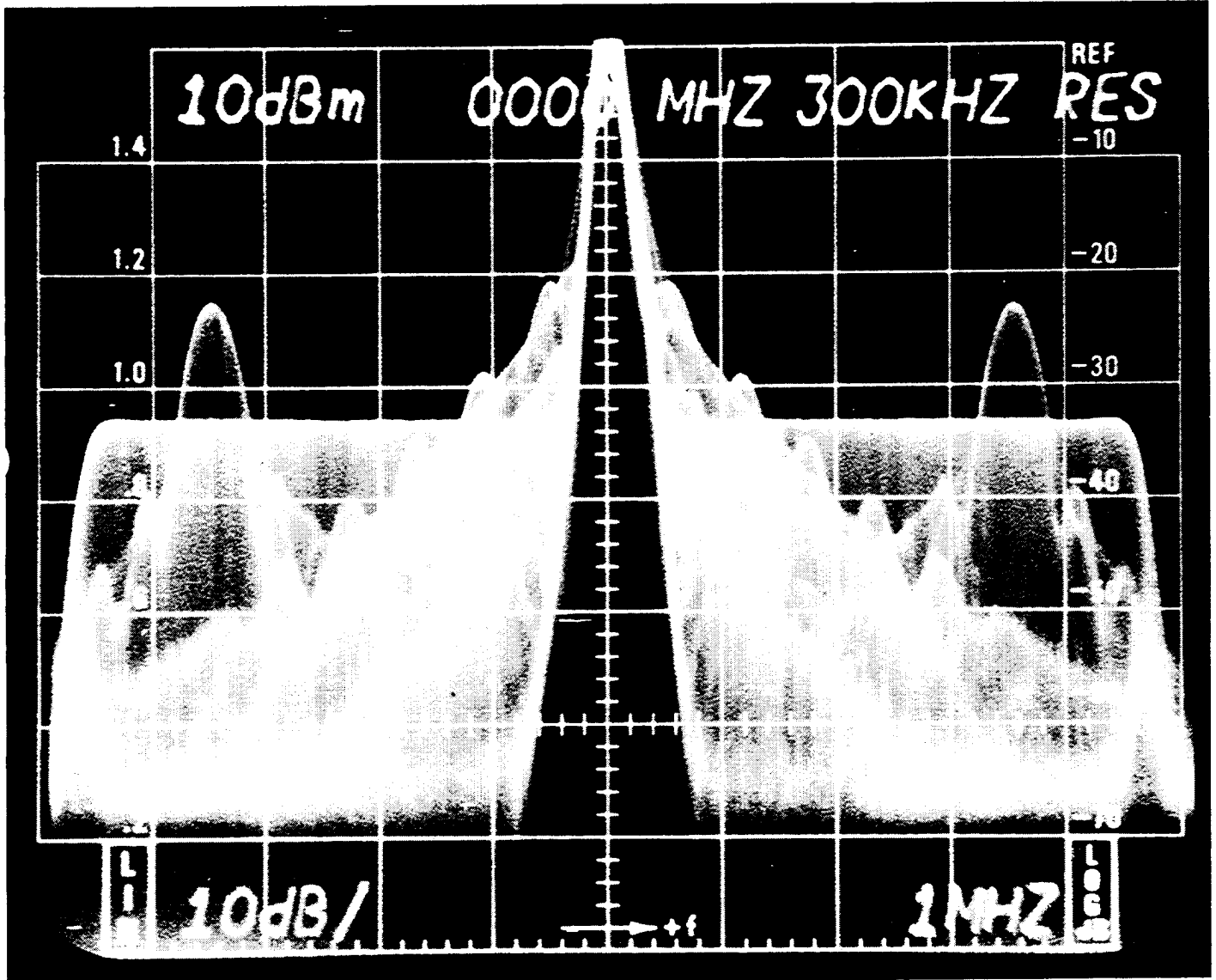

Tektronix
COMMITTED TO EXCELLENCE

Introduction

A new test signal for frequency response testing is now available in the Tektronix 1900 Digital Generator. This test signal is called the sin x/x and is shown in both the time and frequency domain in Figures 1 and 2 respectively.

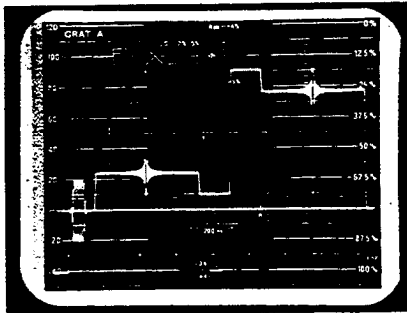

Figure 1. Sin x/x test signal displayed in the time domain.

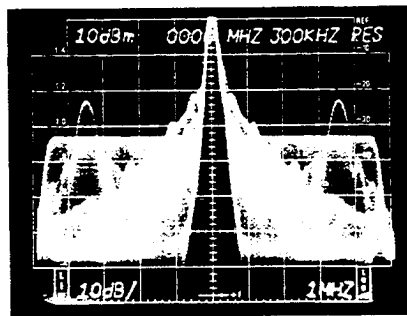

Figure 2. Sin x/x test signal displayed in the frequency domain.

The sin x/x, as generated by the 1900 Digital Generator, is a pulse whose spectrum contains all the harmonics of the horizontal scanning frequency up to 4.75 MHz. These harmonics are all of equal amplitude and energy with negligible energy above 4.75 MHz (See Figure 3).

As the sin x/x contains all the horizontal scanning frequency harmonics, it has much more video band information than the multiburst which has useful information at only six frequencies within the band. These properties, plus the fact that the sin x/x signal may be used as VIT signal, make this signal ideal for checking fre-

quency response in television transmitters and other limited bandwidth devices and systems.

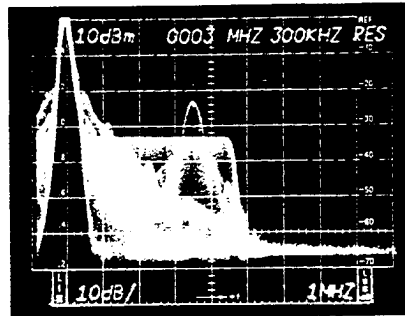

Figure 3. Sin x/x frequency domain display. Note the very steep roll off characteristic and absence of out-of-band energy (above 4.75 MHz).

Testing Methodology

Frequency response testing with the sin x/x signal is carried out with a spectrum analyzer. If the sin x/x is employed as a VIT signal, such as for in-service trans-

mitter testing, a storage display will be required. The spectrum analyzer/mainframe combination used for this application note is a Tektronix 7L14/7613. Other suitable spectrum analyzers include the Tektronix 7L12 and 7L13 models.

Either of two testing methods may be employed: out-of-service testing where the sin x/x is used as a full field test signal or in-service testing where the sin x/x is used as a VIT signal. The equipment setup for each method is shown in Figures 4 and 5 respectively.

In figure 5, the Remote Control Unit is used to program the sin x/x VIT signal on the desired line and field. The 1480R Waveform Monitor is set to display the sin x/x VIT signal at 5 microseconds per division. The line strobe pulse from the 1480R is used to unblank the spectrum analyzer display for the sin x/x signal only.

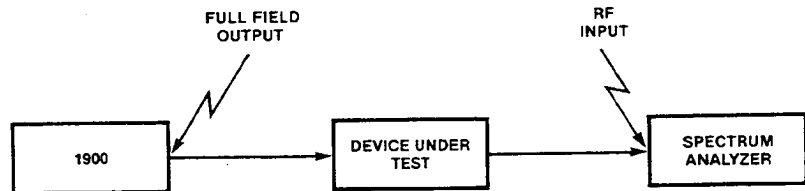

Figure 4. Setup for out-of-service testing.

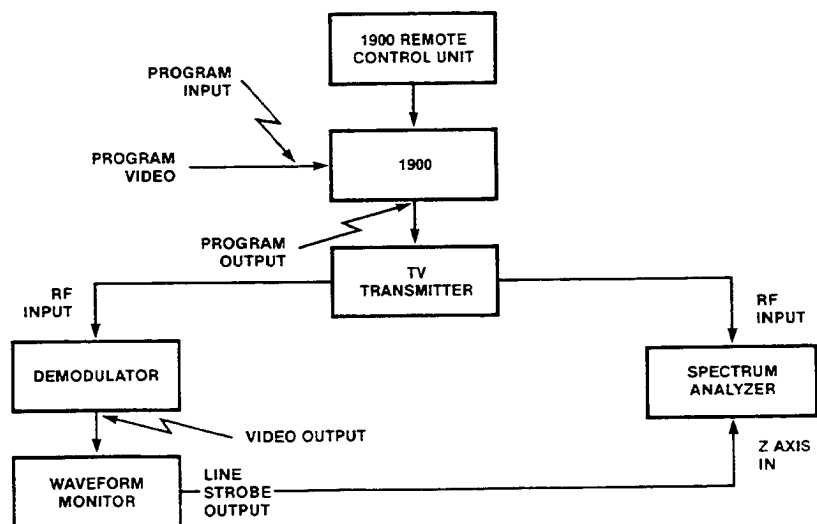

Figure 5. Setup for in-service testing at a television transmitter.

Correlation of the Sin x/x and the Multiburst

To further familiarize the user with the sin x/x signal, a frequency domain amplitude correlation with the more familiar multiburst is shown in Figures 6 through 15. Figures 6 and 7 are time domain displays of the multiburst and sin x/x signals respectively. Note that the multiburst signal contains equal amplitude and equal width frequency packets.* It is only when the multiburst signal meets these two criteria that the packets will be of equal energy content and give a flat amplitude response in the frequency domain.

NOTE: Do not attempt to correlate the sin x/x and multiburst signals in the frequency domain when the multiburst packets are not generated at equal amplitude and duration.

Figures 8 and 9 are frequency domain displays of the multiburst and sin x/x respectively. Note the flat amplitude response of both signals and the sweep-like display of the sin x/x signal. In Figure 9, the ruler flat portion of the display is the sin x/x signal. The steeply falling portion of the display between the 0 Hz marker (graticule center) and 1.25 MHz away from the 0 Hz marker is the luminance bar element of the sin x/x signal and the synchronizing signal information. The energy peak at 3.58 MHz is the color burst signal. Figures 10 and 11 are higher vertical resolution (2 dB per division) displays of Figures 8 and 9. Notice that the two signals correlate nearly perfectly across the entire video band.

* This multiburst signal was generated with a 1410 Series TSG6 Multiburst Generator with special PROMS installed. Tektronix part number for the PROMS is 160-0220-00 and 160-0222-00.

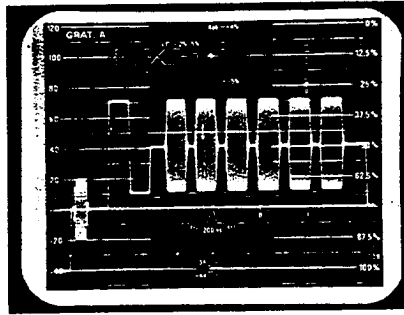

Figure 6. Multiburst signal displayed in the time domain.

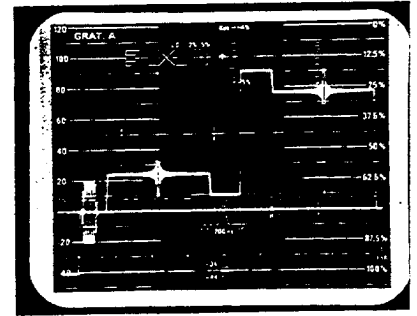

Figure 7. Sin x/x signal displayed in the time domain.

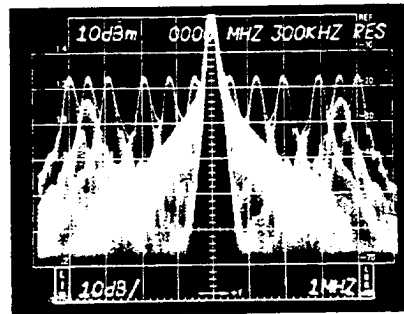

Figure 8. Multiburst signal displayed in the frequency domain.

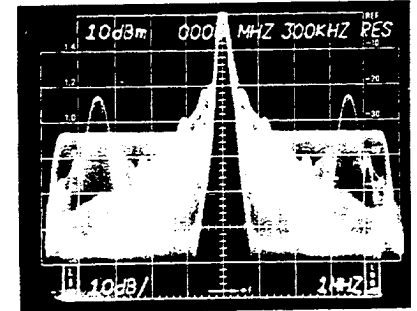

Figure 9. Sin x/x signal displayed in the frequency domain.

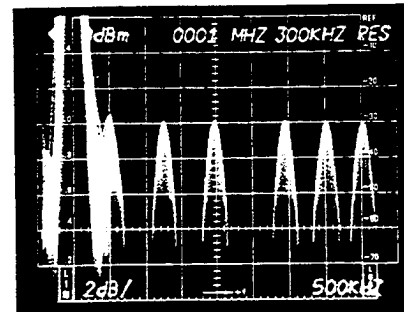

Figure 10. Multiburst signal displayed in the frequency domain at 2 dB per division.

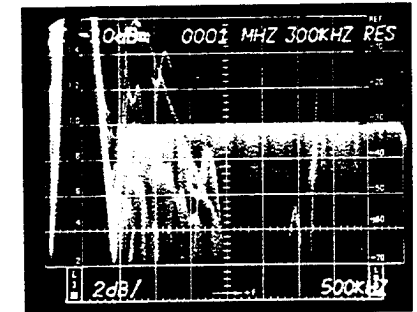

Figure 11. Sin x/x signal displayed in the frequency domain at 2 dB per division.

Figures 12 and 13 are the multi-burst and sin x/x respectively after passing through a circuit with high frequency roll off. Notice the sin x/x pulse amplitude has been reduced by about 8 IRE at its peak and that the lobe amplitudes at the bottom of the positive going pulse and at the top of the negative going pulse are also reduced.

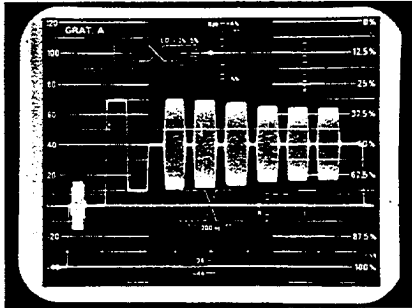

Figure 12. Time domain display of the multi-burst signal exhibiting high frequency roll off.

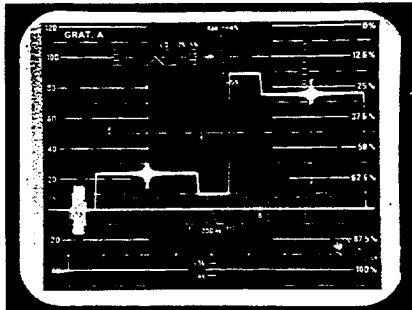

Figure 13. Time domain display of the sin x/x signal exhibiting high frequency roll off.

Figures 14 and 15 are high resolution frequency domain displays of 12 and 13. Note that the correlation between multi-burst and sin x/x is excellent. This will always be the case in linear systems where frequency response does not vary as a function of signal amplitude.

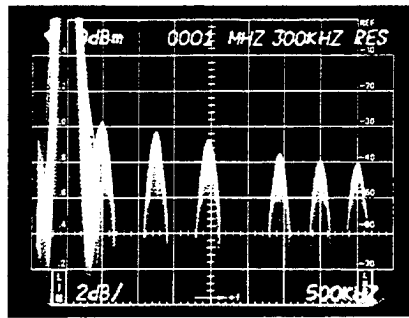

Figure 14. Frequency domain 2 dB per division display of the multi-burst signal exhibiting high frequency roll off.

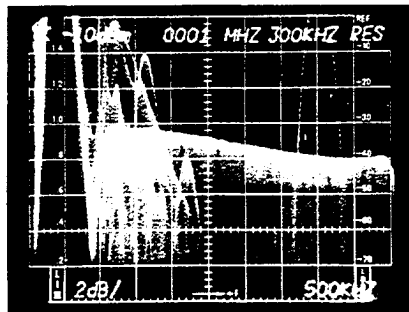

Figure 15. Frequency domain 2 dB per division display of the sin x/x signal exhibiting high frequency roll off.

Transmitter Frequency Response Testing

One application of the sin x/x signal is in-service frequency response testing of television transmitters. The advantages of this method of testing where the measurements are made at the designated channel frequencies are:

1. The shape of the vestigial sideband may be determined while the transmitter is in-service.
2. Amplitude errors introduced by a less than measurement grade demodulator are eliminated. The signal is not subjected to errors introduced in the RF to baseband conversion process when using a spectrum analyzer.

For this particular test, the sin x/x signal was inserted on line 18 of field 2 in place of the usual composite signal (see section 73.676 of the FCC rules for details on substitution of VIT signals on line 18 of field 2).

The equipment setup is that of Figure 5 with the demodulator video output fed to the waveform monitor input. The waveform monitor is set to view line 18 of field 2 at 5 microseconds per division. The spectrum analyzer RF input is taken from the point of interest within the transmitter system. A storage oscilloscope display is required.

Figures 16 and 17 show the sin x/x signal at 1 MHz and 500 kHz per division respectively. Figures 18 and 19 are higher vertical resolution displays of Figures 16 and 17.

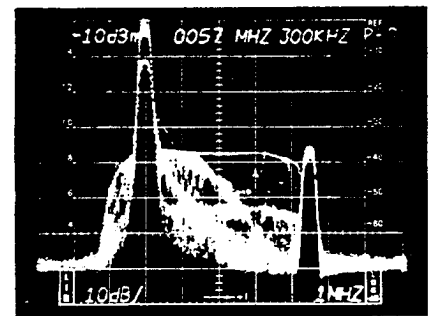

Figure 16. Sin x/x signal modulated on to the vision carrier (10 dB per division and 1 MHz per division).

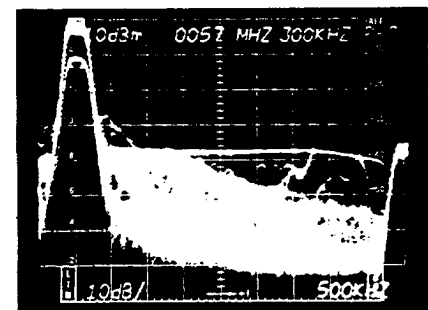

Figure 17. Sin x/x signal modulated on to the vision carrier (10 dB per division and 500 kHz per division).

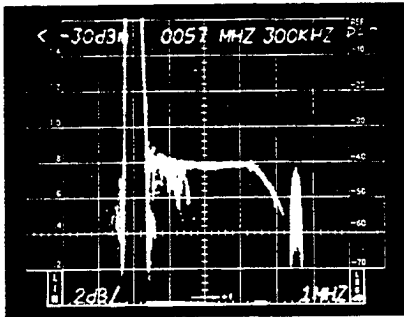

Figure 18. A 2 dB per division display of Figure 16.

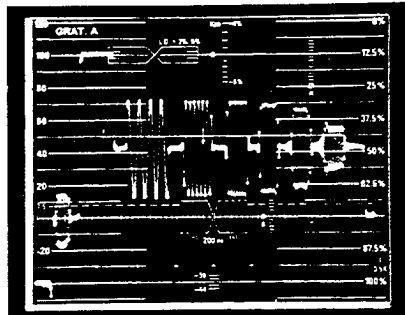

Figure 20. Demodulated multiburst test signal.

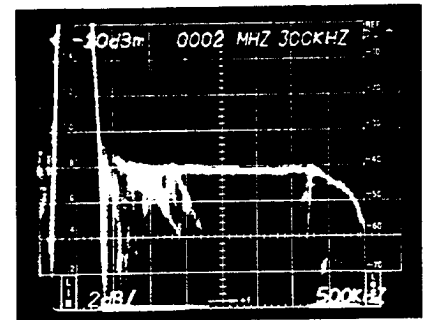

Figure 22. Demodulated sin x/x signal displayed at 2 dB per division.

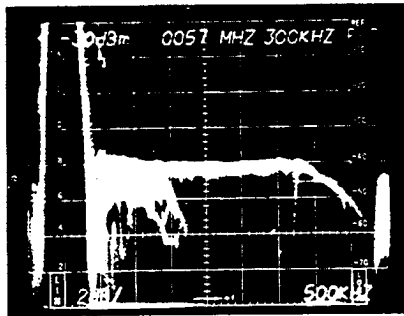

Figure 19. A 2 dB per division display of Figure 17.

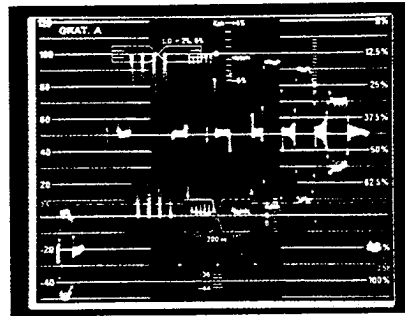

Figure 21. Demodulated multiburst test signal expanded to fill the 0 to 100 IRE range.

The demodulated multiburst is shown in Figures 20 and 21. When compared with the demodulated sin x/x signal in Figure 22, there is amplitude correlation within 0.2 dB (referenced to 500 kHz) across the video band. The slight response differences between the sin x/x signal at the designated channel frequency (Figure 19) and the demodulated sin x/x signal (Figure 22) are due to the frequency response characteristics of the television demodulator.

Amplitude Non-Linearity

When amplitude non-linearity exists in the device under test, the positive and negative going sin x/x pulse will suffer different kinds of distortion. The result of this will be a divergence of the two spectra as shown in Figure 23.



Figure 23. Sin x/x signal after passing through a non-linear system.

This indicates that the frequency response of the device under test is different at different signal levels. When this occurs, determination of the actual frequency response characteristic can become difficult and the results subject to question.

If possible, the device under test should be adjusted to minimize non-linearity before using the sin x/x signal. Where this is not practical, the user should attempt to correlate results obtained with the sin x/x signal by employing alternate methods of frequency response testing. Two such methods of testing would be swept frequency and multiburst testing.

A requirement to do in-service testing would likely dictate use of the multiburst test signal. If testing is out-of-service, either a multiburst or swept frequency signal would be appropriate. In either case, the frequency response characteristic of the device under test should be noted for both full and reduced amplitude test signals to allow determination of the effects of non-linearity on the results. Full and reduced amplitude multiburst and sweep signals as provided by Tektronix 1410 Series Generators are shown in Figures 24 through 27.

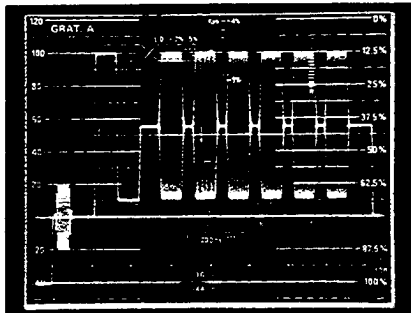

Figure 24. Full amplitude multiburst test signal.

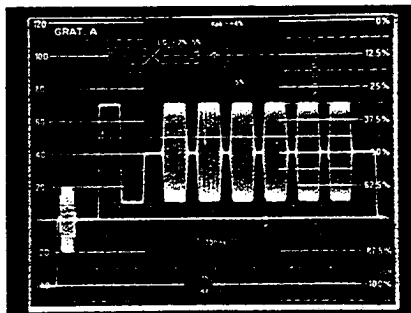

Figure 25. Reduced amplitude multiburst test signal.

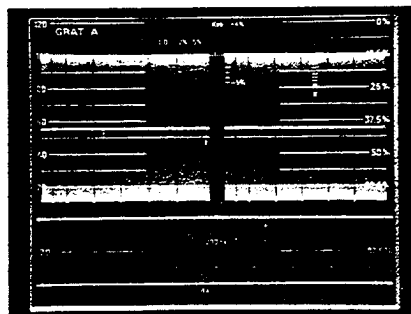

Figure 26. Full amplitude sweep signal with markers.

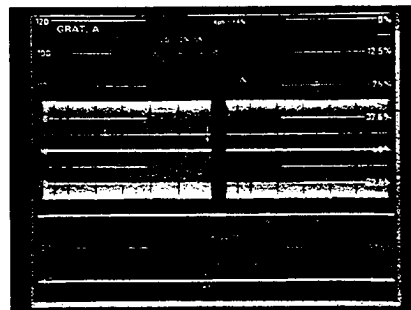

Figure 27. Reduced amplitude sweep signal with markers.

Summary

This application note has attempted to illustrate an easy means for doing frequency response testing using the $\sin x/x$ signal and a spectrum analyzer. The advantages of this method of testing are:

1. Continuous frequency coverage from 15 kHz to 4.75 MHz.
2. $\sin x/x$ signal may be used as a VIT signal.
3. Elimination of the demodulator as a source of amplitude response error when testing TV transmitters.
4. Provision of an easily recognizable indication of amplitude non-linearity, thus alerting the user to verify results with alternate testing methods.

For further information, contact:

U.S.A., Asia, Australia, Central & South America, Japan
Tektronix, Inc.

P.O. Box 4828
Portland, OR 97208

For additional literature, or the address and phone number of the Tektronix Sales Office nearest you, contact:

Phone: 800/547-1512

Oregon only 800/452-1877

Telex: 910-467-8708

TLX: 15-1754

Cable: TEKTRONIX

Europe, Africa,
Middle East

Tektronix Europe B.V.
European Headquarters

Postbox 827

1180 AV Amstelveen

The Netherlands

Phone: (20) 471146

Telex: 18312 - 18328

Canada

Tektronix Canada Inc.

P.O. Box 6500

Barrie, Ontario L4M 4V3

Phone: 705/737-2700

Tektronix sales and service offices around the world:

Argentina, Australia, Austria, Belgium, Bolivia, Brazil, Canada, Chile, Colombia, Costa Rica, Denmark, East Africa, Ecuador, Egypt, El Salvador, Federal Republic of Germany, Finland, France, Greece, Hong Kong, Iceland, India, Indonesia, Ireland, Israel, Italy, Ivory Coast, Japan, Jordan, Korea, Kuwait, Lebanon, Malaysia, Mexico, Morocco, The Netherlands, New Zealand, Norway, Pakistan, Panama, Peru, Philippines, Portugal, Republic of South Africa, Saudi Arabia, Singapore, Spain, Sri Lanka, Sudan, Surinam, Sweden, Switzerland, Syria, Taiwan, Thailand, Turkey, Tunisia, United Kingdom, Uruguay, Venezuela, Zambia, Zimbabwe.

Copyright © 1982, Tektronix, Inc. All rights reserved. Printed in U.S.A. Tektronix products are covered by U.S. and foreign patents, issued and pending. Information in this publication supersedes that in all previously published material. Specification and price change privileges reserved. TEKTRONIX, TEK, SCOPE-MOBILE, TELEQUIPMENT, and  are registered trademarks. For further information, contact: Tektronix, Inc., P.O. Box 500, Beaverton, OR 97077. Phone: (503) 627-7111; TWX 910-467-8708; TLX: 15-1754; Cable: TEKTRONIX. Subsidiaries and distributors worldwide.

Tektronix[®]
COMMITTED TO EXCELLENCE

APPENDIX B

1910 OPTION 03

Description

Option 03 to the 1910 NTSC Test Signal Generator/Inserter consists of changes to 7 of the test signals, and is designed to meet the needs of the Canadian market. Customers in Canada will now be able to choose between the standard 1910 and the Option 03 which includes test signals modified to Canadian Broadcasting Company specifications.

Hardware Changes

Option 03 replaces the microprocessor instruction PROMS (U320 and U335) on the Microprocessor Kernel Board, altering some of the factory programmed front-panel button/signal assignments and the test-signal/vertical-interval line configuration. It also replaces five test signal PROMS (U970, U872, U880, U885, and U890) on the Sync and Memory board, changing some of the test signals listed in Table 1-4. These changes are shown in Table B-1.

Full Field Sync and Burst Insertion

It is recommended that the Color Bars, Y Color Bars, and Modulated 10-Step 100 IRE signals should not be used as full field signals when the 1910 Option 03 is set to insert Sync & Burst (PROC AMP ON) and wide insertion blanking width is selected (via an internal jumper). Use of these signals in a full field output will cause a small spike to appear either immediately before sync or after burst in each line of the program active video output.

Test Signal Mnemonic Changes

The RS-232 Port mnemonic references to VICR (VIC) and FCC Multiburst (FMR) test signals have been replaced by signal mnemonics identifying Modulated 10-Step 90 IRE (MS9) and Multiburst 50 (MB5) respectively. VICR and FCC Multiburst do not exist for the Option 03.

Starting with S/N B023197 the Option 3 also provides the new Ghost Cancellation Reference signals. In the Option 3, the RS-232 Port mnemonic reference of Inverted Pulse and Bar (IPB) is removed and GCR Positive (GCP) is added. GCR Negative takes the place of the 25 IRE Pedestal, as in the standard instrument.

Although not explicitly covered in the test signal applications (Section 5) of the 1910 Operators manual, general descriptions of applications for the Modulated 10-Step 90 IRE and Multiburst 50 can be gathered from the Section 5 discussions of the Modulated 10-Step (100 IRE) and FCC Multiburst test signals, respectively.

Front Panel and VITS Assignment Changes

The front panel upper shift level of button 10 has, for Option 03, the test signal assignment of 50 IRE Multiburst (RS232 mnemonic MB5). This signal, mnemonic, and front panel assignment replaces the FCC Multiburst test signal for Option 03 (see Table 5-3 and Fig. 5-9, pages 5-28 and 5-29 in the 1910 Operators manual for reference). The upper shift level of button number 1 has the assignment of 0 IRE Pedestal for Option 03, replacing the 10 IRE Pedestal (this is a front panel reconfiguration only; the 10 IRE Pedestal still exists for Option 03).

Option 03 factory programming of VITS line/signal assignments and new front panel VITS nomenclature are shown in Table B-2.

Table B-1
Option 03 Test Signal Changes

Signal(s)	Changed Specification(s)	1910 Standard Specification	Option 03 Specification
Color Bars and Y Color Bars	Time from leading edge of sync to leading edge of active video	9.75 microseconds	9.4 microseconds
Modulated 10-Step 100 IRE	Time from trailing edge of video to leading edge of sync	1.84 microseconds	1.6 microseconds
Multiburst 100	First packet frequency	0.5 MHz	0.75 MHz
(FCC Multiburst)* Multiburst 50	First and last packet frequencies, amplitude	First: 0.5 MHz Last: 4.1 MHz 60 IRE p-p on a 40 IRE pedestal	First: 0.75 MHz Last: 4.2 MHz 50 IRE p-p on a 50 IRE pedestal
Modulated 5-step	Luminance pedestal amplitudes.	20 IRE each; 100 IRE max. luminance	18 IRE each; 90 IRE max. luminance
(VICR)* Modulated 10-Step	Replacement of VICR with Modulated 10-Step 90 IRE	No modulated 10-Step 90 IRE	Modulated 10-Step 90 IRE replaces VICR in signal EPROMS
(IPB)* GCR Positive	Replacement of IPB with GCR Positive	Standard inst has both IPB and GCR Positive	Option 3 does not have Inverted Pulse and Bar signal

*Standard 1910 test signal, replaced for Option 03.

Table B-2
Option 03 Factory VITS Programming

Line	Field(s)	Test Signal Assignment	Mnemonic
17	1,3	NTC 7 Composite	NCP
17	2,4	NTC 7 Combination	CMB
19	All Fields	VIRS	VIR
All Other Lines	All Fields	PASS Incoming VITS	PAS

APPENDIX C

1910 OPTION 01

Description

Option 01 for the 1910 NTSC Test Signal Generator/Inserter consists of changes to five of the test signals, to provide a Ghost Cancellation Reference test signal set. In addition, option 01 provides full line insertion on field 2 line 21, similar to the 1910 Mod AA.

Hardware Changes

Option 01 replaces one of the microprocessor instruction PROMs (U320) on the Microprocessor Kernel Board, altering one of the factory programmed front-panel button/signal assignments and the test signal/vertical-interval line configuration. In addition, it replaces all of the signal memory PROMs (U471, U472, U484, U485, U491, U670, U672, U684, U685, U690, U870, U872, U880, U885, and U890) on the Sync and Memory board. This changes all of the test signal setup levels to 0 V, and completely replaces five of the test signals shown in Table 1-4. Specifications for the new signals are shown in Table C-1.

Signal Changes

Option 01 replaces five of the standard test signals with Ghost Cancellation Reference test signals. All but one of these new signals are the integrated product of a SIN X/X waveform, such as the one shown in Fig. 1-5f. The bandwidth of the SIN X/X signal to be integrated is 4.177447 MHz, and the waveform slope width (start to center) is 10 μ s.

Test Signal Mnemonic Changes

The RS-232 Port mnemonic references to 25 IRE Pedestal (25P), Inverted Pulse & Bar (IPB), VICR (VIC), Modulated 5 Step (M5S), and Modulated Bar (MDB) have been replaced with signal mnemonics identifying 70 IRE Wide Reverse SIN X/X Bar (WRB), 70 IRE Wide Reverse SIN X/X Bar 1 (WR1), 80 IRE SIN X/X Bar (BE8), 70 IRE Wide Reverse SIN X/X Bar 7 (WR7), and H Sweep (HSW) respectively. See Table C-1.

Table C-1. Option 01 Test Signal Changes

Standard 1910 Signal	Replaced by Option 01 Signal	Option 01 Specification	Supplemental Information
Mod Bar (MDB)	H Sweep (HSW) Bar Amplitude Rise Time Fall Time SIN Sweep Chroma Sweep Frequency Amplitude (p-p) Rise Time Fall Time Luminance Amplitude Rise Time Fall Time	70 IRE. 250 ns 250 ns 500 kHz to 4.2 MHz. 50 IRE. 400 ns. 400 ns. 20 IRE. 250 ns. 250 ns.	See Fig. C-1.

Table C-1. (cont.)

Standard 1910 Signal	Replaced by Option 01 Signal	Option 01 Specification	Supplemental Information
Inverted Pulse & Bar (IPB)	70 IRE Wide Reverse SIN X/X Bar 1 (WR1) Bar Amplitude Positive Peak Negative Peak Fall Time	70 IRE. 77.3 IRE. -3.9 IRE. 250 ns.	See Fig. C-2.
VICR (VIC)	80 IRE SIN X/X Bar (BE8) Bar Amplitude Positive Peak Negative Peak Rise Time	80 IRE. 84.5 IRE. -4.5 IRE. 250 ns.	See Fig. C-3.
25 IRE Pedestal (25P)	70 IRE Wide Reverse SIN X/X Bar (WRB) Bar Amplitude Positive Peak Negative Peak Fall Time	70 IRE. 77.3 IRE. -3.9 IRE. 250 ns.	See Fig. C-4.
Mod 5 Step (M5S)	70 IRE Wide Reverse SIN X/X Bar 7 (WR7) Bar Amplitude Positive Peak Negative Peak Fall Time	70 IRE. 77.3 IRE. -3.9 IRE. 250 ns.	See Fig. C-5.

Front Panel & VITS Assignment Changes

The front panel middle shift level of button 7 has, for Option 01, the test signal assignment of H Sweep (RS-232 mnemonic HSW). This signal, mnemonic, and front panel assignment replace the Modulated Bar test signal for Option 01 (see Table 5-3 and Fig. 5-9 for reference). The other four added test signals are not available from the front panel, as factory programmed, but are available through the RS-232 Control Port (see Section 5 REMOTE OPERATION).

Option 01 factory programming of the line 18 VITS Sequence is shown in Table C-2.

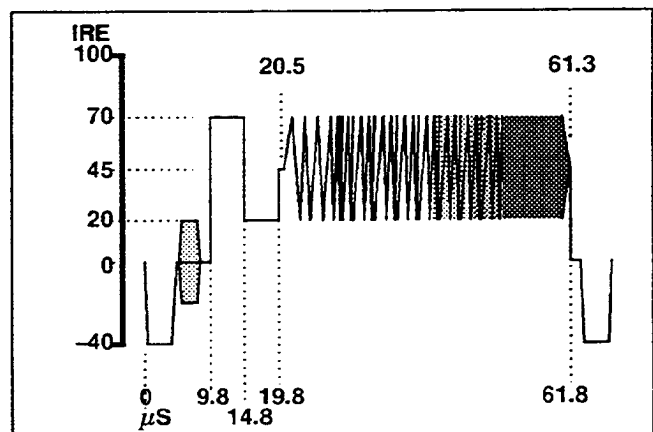

FIG. C-1. Horizontal Sweep (HSW).

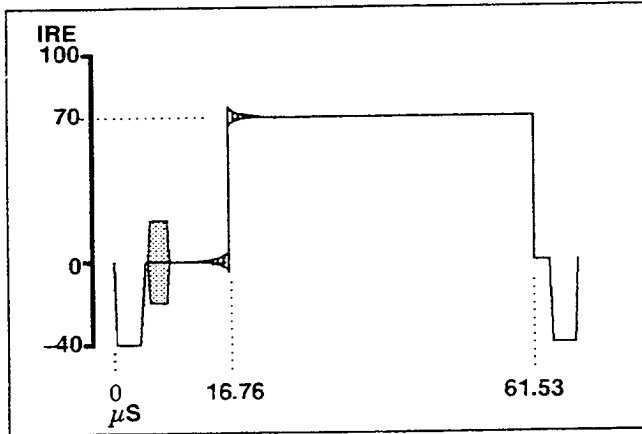

FIG. C-2. 70 IRE Wide Reverse SIN X/X Bar 1 (WR1).

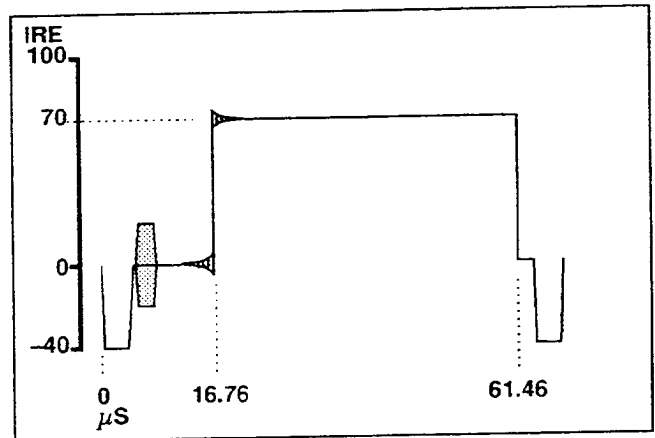

FIG. C-4. 70 IRE Wide Reverse SIN X/X Bar (WRB).

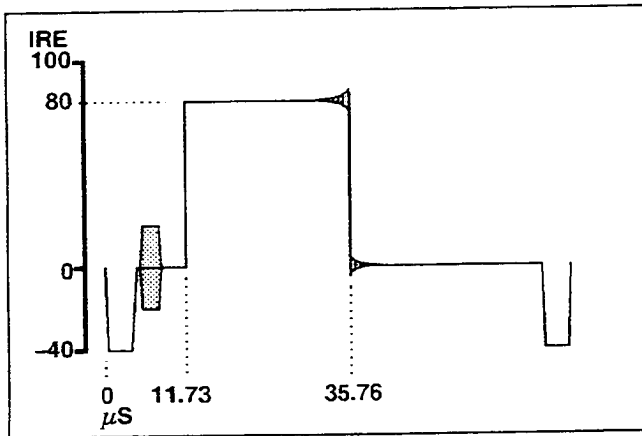

FIG. C-3. 80 IRE SIN X/X Bar (BE8).

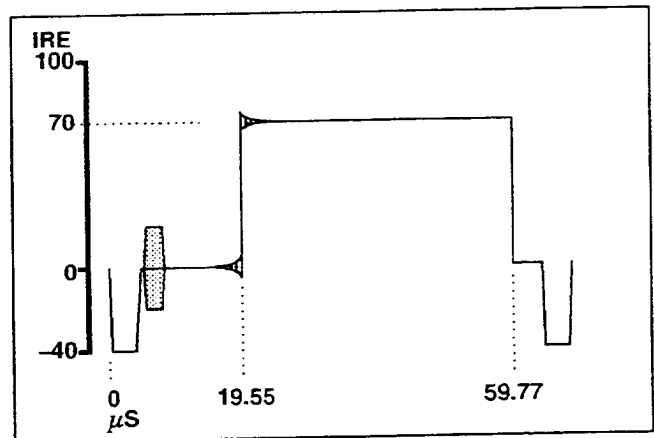

FIG. C-5. 70 IRE Wide Reverse SIN X/X Bar 7 (WR7).

Table C-2
Option 01 Factory VITS Sequence Programming (Line 18)

Frame	Field	Test Signal Assignment	Mnemonic
1	1	70 IRE Wide Reverse SIN X/X Bar	WRB
1	2	0 IRE Pedestal	POO
1	3	70 IRE Wide Reverse SIN X/X Bar	WRB
1	4	0 IRE Pedestal	POO
2	1	0 IRE Pedestal	POO
2	2	70 IRE Wide Reverse SIN X/X Bar	WRB
2	3	0 IRE Pedestal	POO
2	4	70 IRE Wide Reverse SIN X/X Bar	WRB

APPENDIX D

1910 Options 02 and 04

Description

Option 02 for the 1910 NTSC Digital Generator consists of changes to two of the test signals, to provide a Ghost Cancellation Reference test signal set. Option 04 adds the test signal, mnemonic, and front-panel changes of Option 02 to the the changes for the Option 03 Canadian Broadcasting signal set. The information presented in this Appendix must be used in conjunction with Appendix B for complete Option 04 signal information.

Hardware Changes

Both of these Options replace one of the micro-processor instruction PROMs (U320) on the Micro-processor Kernel board. This changes one of the

front-panel button/signal assignments and the test signal/vertical-interval line configuration. Five of the signal memory PROMs (U870, U872, U880, U885, and U890) on the Sync and Memory board are also changed, to provide the two GCR signals.

Signal Changes

The GCR signals replace two of the standard 1910 signals, making a total of nine signal changes for the Option 04. One of these GCR signals, the 70 IRE Wide Reverse $SIN X/X$ Bar is the integrated product of a $SIN X/X$ waveform, such as the one shown in Fig. 1-5f. The $SIN X/X$ signal bandwidth was 4.177447 MHz, and the waveform slope width (start to center) was 10 μ s. Specifications for the GCR signals are shown in Table D-1.

Table D-1
Option 02 and Option 04 Test Signal Changes.

Standard 1910 Signal	Replaced by GCR Signal	Option 02 Specification	Supplemental Information
Mod Bar (MDB)	H Sweep (HSW) Bar Amplitude Rise Time Fall Time SIN Sweep Chroma Sweep Frequency Amplitude (p-p) Rise Time Fall Time Luminance Amplitude Rise Time Fall Time	70 IRE. 250 ns. 250 ns. 500 kHz to 4.2 MHz. 50 IRE. 400 ns. 400 ns. 20 IRE. 250 ns. 250 ns.	See Fig. D-1.
25 IRE Pedestal (25P)	70 IRE Wide Reverse $SIN X/X$ Bar (WRB) Bar Amplitude Positive Peak Negative Peak Fall Time	70 IRE. 77.3 IRE. -3.9 IRE. 250 ns.	See Fig. D-2.

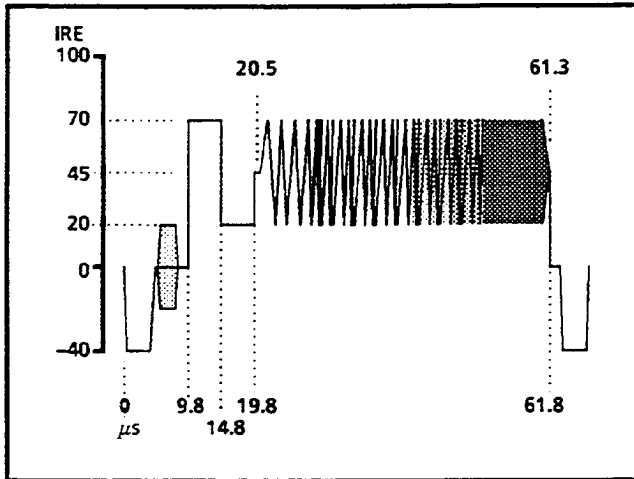

Fig. D-1. Horizontal Sweep (HSW),

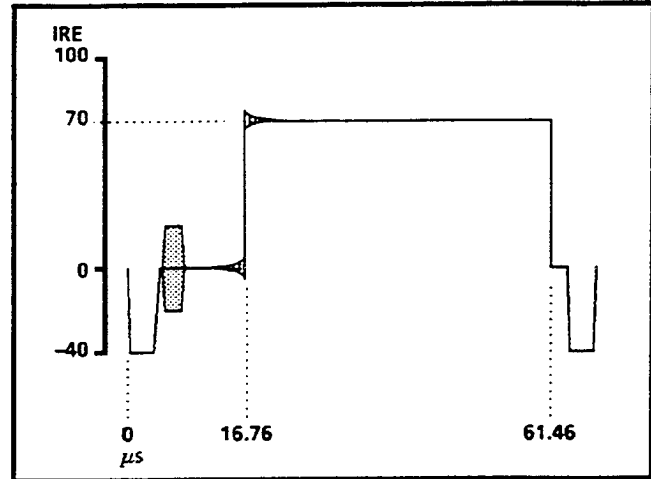

Fig. D-2. 70 IRE Wide Reverse $SIN X/X$ Bar (WRB),

Test Signal Mnemonic Changes

The RS-232 Port mnemonic references to 25 IRE Pedestal (25P) and Modulated Bar (MDB) have been replaced with signal mnemonics identifying the 70 IRE Wide Reverse $SIN X/X$ Bar (WRB), and H Sweep (HSW) respectively. The mnemonic for VITS Sequence (VSQ) has been replaced with one identifying Ghost Cancellation Reference (GCR).

Front Panel & VITS Assignment Changes

The front panel middle shift level of button 7 has the test signal assignment of H Sweep (RS-232 mnemonic HSW). This signal, mnemonic, and front panel assignment replace the Modulated Bar test signal (see Table 5-3 and Fig. 5-9 for reference). The other added test signal, 70 IRE Wide Reverse $SIN X/X$ Bar (WRB), is not available from the front panel, as factory programmed, but is available through the RS-232 Control Port (see Section 5 REMOTE OPERATION).

Factory programming of the line 18 VITS Sequence is shown in Table D-2.

Table D-2
Factory VITS Sequence Programming for Ghost Cancellation Reference (Mnemonic GCR) on Line 18.

Frame	Field	Test Signal Assignment	Mnemonic
1	1	70 IRE Wide Reverse $SIN X/X$ Bar	WRB
1	2	0 IRE Pedestal	POO
1	3	70 IRE Wide Reverse $SIN X/X$ Bar	WRB
1	4	0 IRE Pedestal	POO
2	1	0 IRE Pedestal	POO
2	2	70 IRE Wide Reverse $SIN X/X$ Bar	WRB
2	3	0 IRE Pedestal	POO
2	4	70 IRE Wide Reverse $SIN X/X$ Bar	WRB

Appendix E

1910 Option 1K

Description

Option 1K adds Korean ghost cancellation reference (GCR) signals to the 1910 NTSC Digital Test Signal Generator and Inserter. The new GCR signals replace the VICR and 25 IRE Pedestal signals in the base 1910 instrument.

Hardware Changes

Option 1K replaces two of the instruction PROMs on the Microprocessor circuit board and five of the signal memory PROMs on the Sync and Memory circuit board. The new configuration alters the test signal vertical-interval line configuration.

Installing this option deletes any previously installed custom signals.

Signal Changes

Option 1K replaces two of the standard test signals with Korean ghost cancellation reference signals. Changes to the standard specifications are noted in Table E-1. Figures E-1 and E-2 show details of the replacement test signals.

Table E-1: Option 1K test signal changes

Characteristic	Description
GCR Positive	
Pedestal amplitude	30 IRE \pm 0.5 IRE
Chrominance amplitude	80 IRE \pm 1 IRE ¹
Line timing	See Figure 1 on page E-2
GCR Negative	
Pedestal amplitude	30 IRE \pm 0.5 IRE
Chrominance amplitude	80 IRE \pm 1 IRE ¹
Line timing	See Figure 2 on page E-2

¹ (+70 to -10 IRE).

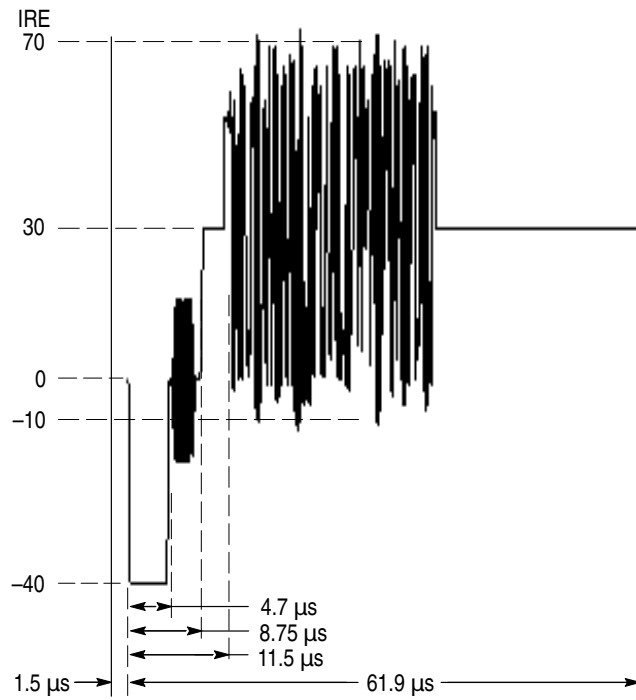

Figure E-1: GCR positive test signal with amplitude and timing details

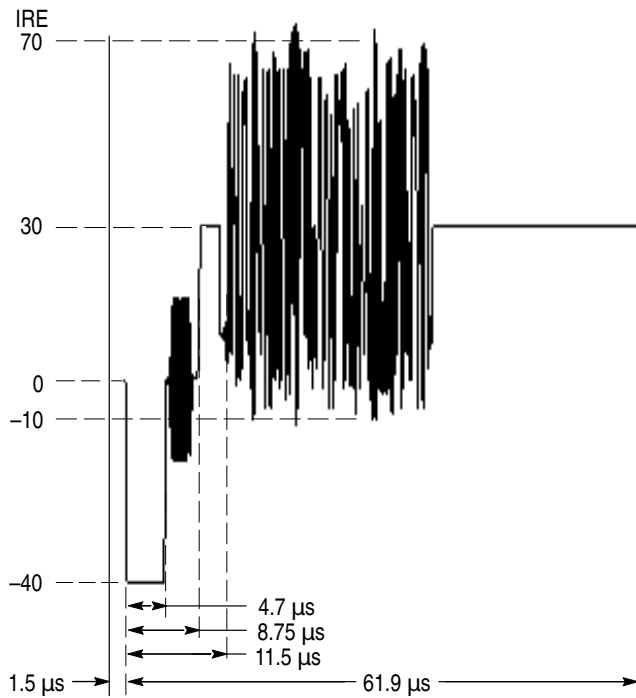

Figure E-2: GCR negative test signal with amplitude and timing details

Test Signal Mnemonics

Option 1K uses standard 1910 mnemonics.

Front Panel and VITS Assignment Changes

Option 1K uses the standard 1910 front panel assignments. Table E-2 shows the factory VITS sequence programming for line 20.

Table E-2: Ghost Cancellation Reference VITS sequence programming (Mnemonic GCP and GCN)

F1 = GCP	F2 = GCN	F3 = GCP	F4 = GCN
F5 = GCP	F6 = GCN	F7 = GCP	F8 = GCN

