

User Manual

Tektronix

11801B
Digital Sampling Oscilloscope
070-8783-00

Please check for change information at the rear
of this manual.

First Printing: March 1993
Revised Printing: November 1993

Instrument Serial Numbers

Each instrument manufactured by Tektronix has a serial number on a panel insert or tag, or stamped on the chassis. The first letter in the serial number designates the country of manufacture. The last five digits of the serial number are assigned sequentially and are unique to each instrument. Those manufactured in the United States have six unique digits. The country of manufacture is identified as follows:

B010000	Tektronix, Inc., Beaverton, Oregon, USA
E200000	Tektronix United Kingdom, Ltd., London
J300000	Sony/Tektronix, Japan
H700000	Tektronix Holland, NV, Heerenveen, The Netherlands

Instruments manufactured for Tektronix by external vendors outside the United States are assigned a two digit alpha code to identify the country of manufacture (e.g., JP for Japan, HK for Hong Kong, IL for Israel, etc.).

Tektronix, Inc., P.O. Box 500, Beaverton, OR 97077

Printed in U.S.A.

Copyright © Tektronix, Inc., 1993. All rights reserved. Tektronix products are covered by U.S. and foreign patents, issued and pending. The following are registered trademarks: TEKTRONIX, TEK, TEKPROBE, and SCOPE-MOBILE.

About This Manual

This is the user reference manual for the 11801B Digital Sampling Oscilloscope. This manual has three sections. The *Getting Started* section provides an introduction to the 11801B, the *Operating Basics* section provides several examples on using the instrument, and the *Reference* section provides complete reference information.

The first section of this manual, *Getting Started*, presents quick get-acquainted information and a map of the menu system. Each menu is accompanied by pointers into the *Operating Basics* and *Reference* sections.

Other manuals that complete the documentation set for the 11801B Digital Sampling Oscilloscope:

- The *CSA 803A and 11801B Programmer Reference* describes using a computer to control the 11801B through GPIB or RS-232-C interfaces.
- The *11801B Service Reference* provides module-level repair and replacement information about the 11801B.

This manual applies to the 11801A and the 11801B Digital Sampling Oscilloscopes that are equipped with firmware Version 4 or later for the Executive Processor, Display, and Timebase Controller. See *System Identification* in the *Reference* section of this manual for information about obtaining the firmware version number.

Note that the following features described in this manual do *not* apply to the 11801A Digital Sampling Oscilloscope.

- High Frequency On/Off selection (see *Triggering* in the *Reference* section of this manual)
- Enhanced Triggering On/Off selection (see *Triggering* in the *Reference* section of this manual)
- User-adjustable Trigger Holdoff (see *Triggering* in the *Reference* section of this manual)

Refer to Appendix B for specifications for the 11801A Digital Sampling Oscilloscope.

Introduction	1
Getting Started	2
Basic Operation	3
Advanced Operation	4
Specifications	5
Appendix A	6
Appendix B	7
Appendix C	8
Appendix D	9
Appendix E	10
Appendix F	11
Appendix G	12
Appendix H	13
Appendix I	14
Appendix J	15
Appendix K	16
Appendix L	17
Appendix M	18
Appendix N	19
Appendix O	20
Appendix P	21
Appendix Q	22
Appendix R	23
Appendix S	24
Appendix T	25
Appendix U	26
Appendix V	27
Appendix W	28
Appendix X	29
Appendix Y	30
Appendix Z	31

List of Tables

Table 2-1: Measurement Mode Comparison	2-61
Table 3-1: A Sample Assignment of Colors to Hit Density	3-45
Table 3-2: Time Base Cal Mode Comparison	3-50
Table 3-3: Delay Compensate Comparison	3-50
Table 3-4: Repetition Encodings	3-93
Table 3-5: Hardcopy Defaults	3-96
Table 3-6: CCITT G.703 Electrical Standards Masks	3-131
Table 3-7: ANSI SONET / CCITT SDH Optical Standards Masks	3-132
Table 3-8: ANSI T1.102 Electrical Standard Masks	3-133
Table 3-9: Miscellaneous Standards Masks	3-133
Table 3-10: Measurements	3-136
Table 3-11: Measurement Mode Comparison	3-143
Table 3-12: Measurement Parameters	3-149
Table 3-13: Trace Functions	3-208
Table B-1: 11801B Vertical System Specifications	B-1
Table B-2: 11801B Time Base Specifications	B-2
Table B-3: 11801B Input and Output Specifications	B-3
Table B-4: 11801B Trigger Specifications	B-4
Table B-5: 11801B Display Specifications	B-5
Table B-6: 11801B AC Line Power Specifications	B-5
Table B-7: 11801B Environmental Specifications	B-6
Table B-8: 11801A Vertical System Specifications	B-7
Table B-9: 11801A Time Base Specifications	B-8
Table B-10: 11801A Input and Output Specifications	B-8
Table B-11: 11801A Trigger Specifications	B-9
Table B-12: 11801A Display Specifications	B-10
Table B-13: 11801A AC Line Power Specifications	B-10
Table B-14: 11801A Environmental Specifications	B-11
Table D-1: Filter Characteristics of FFT Windowing Functions	D-5
Table D-2: Values of icoeff for FFT Windowing Functions	D-16
Table D-3: Values of wcoeff and m for FFT Windowing Functions ...	D-22



Figure 3-103: The Remove Selector in the Remove/Clr Pop-Up Menu	3-212
Figure 3-104: The Instrument Options Pop-up Menu	3-214
Figure 3-105: The Trigger Major Menu and Source Pop-up Menu ..	3-216
Figure 3-106: The Trigger Major Menu and the External Option Pop-up Menu	3-217
Figure 3-107: The Trigger Major Menu and the Trigger Holdoff Pop-up Menu	3-218
Figure 3-108: Identical 512-Point Traces without Trace Vectoring (top) and with Trace Vectoring (bottom)	3-219
Figure 3-109: The Instrument Options Pop-up Menu	3-220
Figure 3-110: Vertical Controls	3-221
Figure 3-111: A Window Trace Display	3-225
Figure 3-112: The Window Mode Pop-up Menu	3-227
Figure 3-113: An XY Trace	3-231
Figure 3-114: The Horizontal Desc Pop-up Menu	3-232



Figure 3-20: The Persist/Histograms Pop-up Menu	3-43
Figure 3-21: The Color Grad Scale Pop-up Menu	3-46
Figure 3-22: The Enhanced Accuracy Major Menu	3-49
Figure 3-23: The Calibrate All Pop-up Menu	3-51
Figure 3-24: A Typical Calibration Pop-up Menu	3-55
Figure 3-25: Loop Gain Calibration (in Vektored Trace Mode)	3-57
Figure 3-26: An Eye Diagram Display	3-62
Figure 3-27: The DefTra Pop-Up Menu	3-66
Figure 3-28: Location of the FFTmag Icon on the Display	3-67
Figure 3-29: Equations for Frequency Interval and Frequency Range	3-68
Figure 3-30: The Instrument Options Pop-Up Menu	3-70
Figure 3-31: Paired Dots Cursors on an FFT Magnitude Display	3-72
Figure 3-32: Using Split Dots Cursors to Measure FFT Phase	3-73
Figure 3-33: FFT Magnitude Displayed Using Rectangular Window .	3-75
Figure 3-34: FFT Magnitude Displayed Using Triangular Window ..	3-75
Figure 3-35: FFT Magnitude Displayed Using Blackman Window ..	3-76
Figure 3-36: FFT Magnitude Displayed Using Blackman-Harris Window	3-77
Figure 3-37: FFT Magnitude Displayed Using Hanning Window	3-77
Figure 3-38: FFT Magnitude Displayed Using Hamming Window ...	3-78
Figure 3-39: GPIB Rear-Panel Connector and Lights	3-79
Figure 3-40: The GPIB/RS232C Pop-up Menu	3-80
Figure 3-41: Graticule with Trace	3-83
Figure 3-42: Dual Graticules with Multiple Traces	3-84
Figure 3-43: The Graticules Pop-up Menu	3-85
Figure 3-44: Printer Connectors on Rear Panel	3-89
Figure 3-45: The Hardcopy Pop-up Menu	3-90
Figure 3-46: Front Panel Hardcopy Button	3-95
Figure 3-47: A Histogram Displayed on an Eye Diagram	3-97
Figure 3-48: The Persist/Histograms Pop-up Menu	3-98
Figure 3-49: Using Stop N Wfms	3-102
Figure 3-50: Histogram Readout Appears Below the Trace Display	3-104
Figure 3-51: Horizontal Controls	3-105
Figure 3-52: Horizontal Magnification with Pan/Zoom	3-108
Figure 3-53: The Horizontal Desc Pop-up Menu	3-110
Figure 3-54: The Initialize Verification Pop-up Menu	3-111
Figure 3-55: Labels Displayed with Active Traces	3-113
Figure 3-56: The Labeling Pop-up Menu	3-115
Figure 3-57: Mask Testing on an Eye Diagram	3-117
Figure 3-58: The Standard Masks Pop-up Menu	3-119
Figure 3-59: Pages 2 and 3 of the CCITT Electrical Standards	3-120
Figure 3-60: The Mask Testing Pop-up Menu	3-122
Figure 3-61: Editing a Mask	3-123

Figure 3-62: Creating a User Mask	3-124
Figure 3-63: How Points are Connected in a User Mask	3-125
Figure 3-64: Mask Count Readout	3-129
Figure 3-65: Using Stop N Wfms	3-130
Figure 3-66: Measure Major Menu	3-138
Figure 3-67: Measurements Pop-up Menu with Frequency and RMS Selected	3-139
Figure 3-68: Compare & References Pop-up Menu	3-146
Figure 3-69: A Typical Individual Measurement Pop-up Menu	3-148
Figure 3-70: Statistics in an Individual Measurement Pop-up Menu .	3-154
Figure 3-71: Measurements Pop-up Menu with Software Defaults ..	3-156
Figure 3-72: Power Connector, Fuse, and Switches	3-157
Figure 3-73: Front Panel ON/STANDBY Switch	3-157
Figure 3-74: Traces with Record Lengths of 512 (top) and 5120 (bottom)	3-161
Figure 3-75: The Horizontal Desc Pop-up Menu	3-162
Figure 3-76: Location of RS-232-C Connector	3-163
Figure 3-77: The GPIB/RS232C Pop-up Menu	3-164
Figure 3-78: Location of Sampling Head Compartments	3-167
Figure 3-79: Sampling Head Control Panel (SD-24 shown)	3-168
Figure 3-80: The Sampling Head Fnc's Pop-up Menu	3-171
Figure 3-81: The Save Trace Desc Pop-up Menu	3-174
Figure 3-82: The Store Setting Pop-up Menu	3-178
Figure 3-83: The Recall Setting Pop-up Menu	3-179
Figure 3-84: The Delete Setting Pop-up Menu	3-180
Figure 3-85: Front Panel SEQUENCE SETTING Button	3-181
Figure 3-86: The Store Trace Pop-up Menu	3-184
Figure 3-87: The Recall Trace Pop-up Menu	3-185
Figure 3-88: The Delete Trace Pop-up Menu	3-186
Figure 3-89: The Identify Pop-up Menu	3-189
Figure 3-90: Step Generator Simplified Schematic Diagram	3-191
Figure 3-91: Step Generator with a Shorted Output	3-192
Figure 3-92: Step Generation with a 50 Ω Load	3-192
Figure 3-93: Step Generation with a 50 Ω Load	3-193
Figure 3-94: Connections for Example	3-194
Figure 3-95: TDR Step and Reflection	3-195
Figure 3-96: The Graticules Pop-up Menu	3-196
Figure 3-97: Single Channel TDR	3-199
Figure 3-98: Channels 1 and 2 TDR	3-200
Figure 3-99: Ensuring Pulses Arrive at the Reference Plane at the Same Time	3-202
Figure 3-100: The Instrument Options Pop-up Menu	3-203
Figure 3-101: The DefTra Pop-up Menu	3-207
Figure 3-102: The Trace Status Menu	3-211

List of Figures

Figure 1-1: Front Panel Connectors	1-6
Figure 1-2: Rear Panel Power Connectors and Switches	1-7
Figure 1-3: Rear Panel Printer and Data Connectors	1-8
Figure 2-1: Utility1 Major Menu	2-4
Figure 2-2: Initialize Selector in Utility1 Major Menu	2-5
Figure 2-3: Cable from the CALIBRATOR Output to a Sampling Head Input	2-6
Figure 2-4: Sampling Head Control Panel (SD-24 shown)	2-7
Figure 2-5: The Trigger Major Menu and Source Pop-Up Menu	2-8
Figure 2-6: AUTOSET Button Location	2-9
Figure 2-7: The Instrument Options Pop-Up Menu	2-11
Figure 2-8: The Calibrator Signal After Pressing AUTOSET in Period Mode	2-12
Figure 2-9: The Knobs and the Knob Menu	2-13
Figure 2-10: Icons	2-15
Figure 2-11: The Knob Menu and Keypad Pop-Up Menu	2-17
Figure 2-12: Connections for Example 2	2-19
Figure 2-13: The Acquired Calibrator Signal	2-20
Figure 2-14: Graticule with Two Traces	2-21
Figure 2-15: The Waveform Major Menu with the Knob Menu	2-22
Figure 2-16: The Trace Status Menu	2-23
Figure 2-17: The Labeling Pop-Up Menu	2-25
Figure 2-18: The Graticules Pop-Up Menu	2-26
Figure 2-19: A Dual-Graticule Display	2-27
Figure 2-20: Connections for Example 3	2-29
Figure 2-21: The DefTra Pop-Up Menu	2-32
Figure 2-22: Complex Trace Aberration Caused by Off-Graticule Component	2-34
Figure 2-23: The Chan Sel Selector in the Knob Menu	2-34
Figure 2-24: A Window Trace Display	2-37
Figure 2-25: The Chan Sel Selector in the Knob Menu	2-38
Figure 2-26: Connections for Example 4	2-41
Figure 2-27: A Horizontally and Vertically Expanded Portion of the Calibrator Signal	2-42
Figure 2-28: The Acquire Desc Pop-Up Menu	2-44
Figure 2-29: Averaged and Normal Traces	2-44
Figure 2-30: The Persist/Histograms Pop-Up Menu	2-46
Figure 2-31: The Sampling Head Fnc's Pop-Up Menu	2-48
Figure 2-32: Connections for Example 5	2-51
Figure 2-33: The Measure Major Menu	2-53
Figure 2-34: The Measurements Pop-Up Menu	2-54

Figure 2-35: Measurements of a Trace	2-55
Figure 2-36: The RMS Pop-Up Menu and Annotation Lines	2-57
Figure 2-37: The Default Parameters Pop-Up Menu	2-59
Figure 2-38: The Hardware Measurements Pop-Up Menu	2-62
Figure 2-39: A Jitter Measurement on the Calibrator Signal	2-63
Figure 2-40: Connections for Example 6	2-65
Figure 2-41: The Cursors Major Menu and Cursor Type Pop-Up Menu	2-67
Figure 2-42: Horizontal Bar Cursors Placed Over a Trace	2-68
Figure 2-43: The Cursor Type Pop-Up Menu in Split Dots Mode	2-69
Figure 2-44: Connections for Example 7	2-73
Figure 2-45: The Graticules Pop-Up Menu	2-74
Figure 2-46: The Compare & References Pop-Up Menu	2-76
Figure 2-47: Connections for Example 8	2-80
Figure 2-48: The Save Trace Desc Pop-Up Menu	2-81
Figure 2-49: Connections for Example 9	2-83
Figure 2-50: The Store/Recall Major Menu and Store Trace Pop-Up Menu	2-84
Figure 2-51: Connections for Example 10	2-87
Figure 2-52: A Vertical Histogram Display	2-89
Figure 2-53: Connections for Example 11	2-91
Figure 2-54: The Sampling Head Fnc's Pop-Up Menu	2-92
Figure 2-55: TDR Step and Reflection	2-93
Figure 3-1: Acquisition of a Trace	3-1
Figure 3-2: Front Panel Acquisition Lights	3-3
Figure 3-3: The Acquire Desc Pop-up Menu	3-4
Figure 3-4: The Clear Trace Pop-up Menu	3-5
Figure 3-5: The Instrument Options Pop-up Menu	3-7
Figure 3-6: Front Panel Autoset Button	3-9
Figure 3-7: The Instrument Options Pop-up Menu	3-10
Figure 3-8: The Acquire Desc Pop-up Menu	3-15
Figure 3-9: Location of the CALIBRATOR and INTERNAL CLOCK Outputs	3-19
Figure 3-10: The Color Pop-up Menu	3-22
Figure 3-11: Adjusting the Main Position	3-26
Figure 3-12: How the Expanded Waveforms Should Appear	3-27
Figure 3-13: The Display After Selecting the XY Display Mode	3-28
Figure 3-14: The Cursors Major Menu and Cursor Type Pop-up Menu	3-30
Figure 3-15: The Set Zero Pop-up Menu	3-31
Figure 3-16: The Self Test Pop-up Menu in the Utility2 Major Menu	3-37
Figure 3-17: The Extended Diagnostic Pop-up Menu in the Utility2 Major Menu	3-38
Figure 3-18: The Top Portion of the Extended Diagnostics Menu ...	3-38
Figure 3-19: The Instrument Options Pop-up Menu	3-41

Hardware Measurements	D-25
Color Grading	D-27
Appendix E: Messages	E-1
Selected Message Descriptions	E-1

Glossary

Glossary	G-1
----------------	-----

Index

Index	I-1
-------------	-----

Sampling Head Front Panel	3-168
Controlling TDR and Smoothing Functions	3-170
Time-Domain Reflectometry (TDR) and Time-Domain Transmission (TDT)	3-170
Smoothing	3-172
Channel Δ Delay	3-172
Saved Trace Descriptions	3-173
Saving a Trace Description	3-175
Recalling a Saved Trace Description	3-175
Saving All Displayed Traces as Saved Trace Descriptions ...	3-176
Deleting a Saved Trace Description	3-176
Deleting All Saved Trace Descriptions	3-176
Stored Settings	3-177
Storing Settings	3-178
Recalling Stored Settings	3-179
Deleting Stored Settings	3-180
Sequencing Through Stored Settings	3-181
Stored Traces	3-183
Storing Traces	3-184
Recalling Stored Traces	3-185
Deleting Stored Traces	3-186
Displaying Time and Date with Stored Traces	3-187
System Identification	3-189
TDR	3-191
TDR Step Generation	3-191
Operation Into a Short Circuit	3-192
Operation Into a 50 Ω Load	3-192
Operation Into an Open Circuit	3-192
Baseline Correction	3-193
Example: Taking TDR Measurements	3-194
Changing Graticule Units for TDR	3-195
Example: Differential and Common Mode TDR	3-198
TDT Measurements	3-201
More About TDR Measurements	3-202
Time and Date	3-203
Displaying Time and Date with Stored Traces	3-204
Trace Definition and Management	3-205
Defining New Traces	3-206
Defining Traces Using the DefTra Icon	3-206
Using Trace Functions in Trace Expressions	3-208
Defining Traces Using the Sampling Head Channel Button	3-209
Trace Numbers	3-209

Selecting Traces	3-210
Selecting Traces by Touch	3-210
Selecting Traces Using the Trace Status Menu	3-210
Selecting Traces Using the Sampling Head Channel Button	3-211
Modifying Traces	3-211
Removing Traces	3-212
Removing Traces Using the Remove Selector	3-212
Removing Traces Using the Sampling Head Channel Button	3-212
Removing Traces Using the Store/Recall Delete Trace Selector	3-212
Trace Scaling	3-214
Triggering	3-215
Vectored Traces	3-219
Vertical Controls	3-221
Setting Vertical Size and Offset	3-222
Adjusting Channels and Adjusting Traces	3-222
Adjusting High Precision Traces	3-222
Trace Separation	3-223
Windows	3-225
Changing Window Size and Position	3-226
Trace Separation	3-226
Positioning Window Traces Automatically	3-227
XY Traces	3-231

Appendices

Appendix A: Accessories	A-1
Standard Accessories	A-1
Optional Accessories	A-1
Power Cord Options	A-2
Appendix B: Specifications	B-1
Appendix C: Safety	C-1
Symbols and Terms	C-1
Specific Precautions	C-2
Electrical Connections	C-3
Packaging for Shipment	C-4
Appendix D: Algorithms	D-1
Trace Functions	D-1
Software Measurements	D-12
Statistical Measurements	D-23

FFT Scaling	3-70
Aliasing	3-71
Using Cursors to Make Measurements	3-72
FFT Windowing Functions	3-74
The Rectangular Window	3-74
The Triangular Window	3-75
The Blackman Window	3-76
The Blackman-Harris Window	3-76
The Hanning Window	3-77
The Hamming Window	3-78
GPIB Parameters	3-79
GPIB Connection	3-79
Setting GPIB Parameters	3-80
Graticules	3-83
Managing Graticules and Traces	3-86
Changing Axis Units	3-87
Vertical Axis Units	3-87
Horizontal Axis Units	3-88
Hardcopy	3-89
Installing the Printer	3-89
Hardcopy Parameters	3-90
Printer Selections	3-90
Color Map	3-92
Screen Format	3-92
Direction	3-92
Data Format	3-93
Output Port	3-94
Making a Hardcopy	3-95
Terminating A Hardcopy In Progress	3-96
Hardcopy Defaults	3-96
Histograms	3-97
Displaying a Histogram	3-99
Histogram Controls	3-100
Changing the Size of the Histogram Box	3-100
Limiting Acquisition	3-100
Changing the Display Update Rate	3-102
Changing Scaling	3-103
Clearing the Histogram Data	3-103
The Histogram Readout	3-104
Horizontal Controls	3-105
Setting Horizontal Size and Position	3-106
Interactions With Other Traces	3-106
Pan/Zoom	3-107
Changing the Horizontal Reference Point	3-109

Initialization	3-111
Initializing and Erasing Nonvolatile RAM	3-112
Labeling	3-113
Creating Labels	3-114
Displaying Labels with Traces	3-116
Mask Testing	3-117
Using Predefined Telecommunication Masks	3-119
Selecting a Predefined Mask	3-120
Creating Masks	3-122
Deleting User Masks	3-123
Hints for Creating User Masks	3-124
Storing Mask Definitions	3-125
Modifying a User Mask	3-126
Creating a New Mask From a Standard Mask	3-126
Creating a User Eye Mask	3-126
Starting Mask Testing	3-128
Clearing the Hit Count	3-129
Limiting Acquisition	3-129
Standard Mask Definitions and Requirements	3-131
CCITT G.703 Electrical Standards Masks	3-131
ANSI SONET / CCITT SDH Optical Standards Masks	3-132
ANSI T1.102 Electrical Standard Masks	3-133
Measurements	3-135
Setting Up Measurements	3-138
Deleting Measurements	3-140
Topline/Baseline Calculation	3-140
Measurement Mode	3-141
Frequency Domain Measurements	3-141
Statistical Measurement Considerations	3-142
Comparing Measurements to References	3-145
Changing Measurement Parameters	3-147
Measurement Statistics	3-154
Changing Default Parameters	3-155
Power-On	3-157
Installation	3-157
Power-On Sequence	3-159
Warm-Up Period	3-159
Record Length	3-161
RS-232-C Parameters	3-163
RS-232-C Connection	3-163
Setting RS-232-C Parameters	3-164
Sampling Heads	3-167
Installing Sampling Heads	3-168

Example 7: Taking Comparison Measurements Using a Reference Trace	2-73
Setting X Axis Units to Meters, Feet, or Inches	2-74
Using the Reference Value	2-76
Example 8: Using Saved Trace Descriptions	2-79
Example 9: Comparing Traces to Stored Traces	2-83
Example 10: Creating a Histogram Display	2-87
Example 11: Taking TDR Measurements	2-91
Changing Graticule Units for TDR	2-94
Measuring Distance with TDR	2-95

Reference

Acquisition	3-1
How Traces are Acquired	3-1
Determining the Sample Interval	3-2
Controlling Acquisition	3-3
Clearing Traces	3-5
Audio Feedback	3-7
Autoset	3-9
Undoing an Autoset	3-10
Autoset Options	3-10
Standard Mask Autoset	3-11
Averaging and Enveloping	3-13
Defining an Averaged or Enveloped Trace	3-14
Terminating Averaging or Enveloping	3-15
Record Count	3-15
Limiting Acquisition	3-16
Side Effects of Averaging and Enveloping	3-16
Baseline Correction	3-17
Example	3-17
Calibrator	3-19
Color Display	3-21
Color Selection	3-21
Restoring Colors	3-22
Reassigning Trace Colors	3-23
Setting the Display Intensity	3-23
Constellation Diagrams	3-25
Displaying a Constellation Diagram	3-25

Cursors	3-29
Cursor Operation	3-30
Selecting Cursor Types	3-31
Cursor Calibration	3-31
Removing Cursors	3-32
Additional Cursor Facts	3-32
Cursor Examples	3-33
Measuring Trace Amplitude	3-33
Measuring Time Between Points On Different Traces	3-33
Diagnostics	3-35
Power-On Diagnostics	3-36
Self-Test Diagnostics	3-37
Extended Diagnostics	3-38
Display Intensity	3-41
Display Persistence	3-43
Setting the Persistence Mode	3-44
Normal	3-44
Variable	3-44
Infinite	3-44
Color Grading	3-44
Interpreting the Color Graded Display	3-45
Changing Colors	3-46
Limiting Acquisition	3-47
Enhanced Accuracy	3-49
Control of Automated Calibration	3-50
Calibration Assistance	3-51
Sampling Head Calibrations	3-53
Typical Calibration Method	3-54
Calibrating Gain Manually	3-56
Calibrating Blowby Compensation Manually	3-57
Calibrating Offset Manually	3-57
Calibrating TDR Amplitude Manually	3-58
Adjusting Delay Adjust Manually	3-58
Offset for Sampling Probes	3-60
Eye Diagrams	3-61
Displaying an Eye Diagram	3-61
Fast Fourier Transforms	3-65
Defining an FFT Trace	3-66
Defining an FFT Display Using the DefTra Pop-up Menu	3-66
Defining an FFT Display Using the FFTmag and FFTpha Icons	3-67
Amplitude Resolution	3-68
Frequency Range and Resolution	3-68
Changing Horizontal and Vertical Size	3-69

Table of Contents

List of Figures	xiii
List of Tables	xix

Getting Started

Introduction	1-1
11801B Description	1-1
Description of Sampling	1-3
Safety	1-3
Terms in Manuals	1-3
Terms on Equipment	1-3
Symbols in Manuals	1-3
Symbols on Equipment	1-4
Power Source	1-4
Grounding the 11801B	1-4
Use the Proper Fuse	1-4
Do Not Operate in Explosive Atmospheres	1-4
Do Not Remove Covers or Panels	1-4
Electrical Connections	1-5
SMA-Compatible and Other Precision Connectors	1-5
Electrostatic Discharge	1-5
Front Panel	1-6
Rear Panel	1-7
Installation	1-9
At a Glance	1-11
Front Panel and Sampling Heads	1-11
Rear Panel	1-12
Display and Touch Panel	1-13
Icons	1-14
Knobs, Knob Menu, and Keypad Menu	1-15
Major Menu Buttons	1-16
Waveform Major Menu	1-18
Trigger Major Menu	1-21
Measure Major Menu	1-22
Display Modes Major Menu	1-23
Store/Recall Major Menu	1-24
Utility1 Major Menu	1-26
Enhanced Accuracy Major Menu	1-28
Utility2 Major Menu	1-30

Operating Basics

Overview	2-1
Example 1: Displaying a Trace	2-3
Major Menu Buttons	2-3
The Touch Panel	2-5
Menu Selectors	2-5
Connecting Cables	2-6
Pop-Up Menus	2-8
Autoset	2-9
Autoset Options	2-10
The Knobs	2-13
Icons	2-14
Keypad Pop-Up Menu and Knob Resolution	2-16
Major Menu Knob Assignments	2-18
Example 2: Managing Multiple Traces	2-19
Adding Another Trace	2-21
Selecting Traces by Touch	2-22
Selecting Traces Using the Trace Status Menu	2-23
Labeling Traces	2-24
Displaying Dual Graticules	2-26
Removing Traces	2-28
Example 3: Defining Complex Traces	2-29
Trace Expressions	2-31
Vertical Adjustment of Complex Traces	2-33
High Precision Traces	2-36
Windows	2-37
Horizontal Reference Point	2-39
Example 4: Using Signal Processing	2-41
Averaging and Enveloping	2-43
Variable Persistence	2-46
Smoothing	2-48
Record Length	2-49
Example 5: Taking Automated Measurements	2-51
Specifying Measurements	2-53
Measurement Parameters and Annotations	2-56
Default Measurement Parameters	2-58
Measurement Modes	2-60
Example 6: Taking Delay Measurements Using Cursors	2-65
The Cursors Major Menu	2-66
Using Split Dot Cursors	2-69
Cursor Accuracy Considerations	2-71

WARRANTY

Tektronix warrants that this product will be free from defects in materials and workmanship for a period of one (1) year from the date of shipment. If any such product proves defective during this warranty period, Tektronix, at its option, either will repair the defective product without charge for parts and labor, or will provide a replacement in exchange for the defective product.

In order to obtain service under this warranty, Customer must notify Tektronix of the defect before the expiration of the warranty period and make suitable arrangements for the performance of service. Customer shall be responsible for packaging and shipping the defective product to the service center designated by Tektronix, with shipping charges prepaid. Tektronix shall pay for the return of the product to Customer if the shipment is to a location within the country in which the Tektronix service center is located. Customer shall be responsible for paying all shipping charges, duties, taxes, and any other charges for products returned to any other locations.

This warranty shall not apply to any defect, failure or damage caused by improper use or improper or inadequate maintenance and care. Tektronix shall not be obligated to furnish service under this warranty a) to repair damage resulting from attempts by personnel other than Tektronix representatives to install, repair or service the product; b) to repair damage resulting from improper use or connection to incompatible equipment; or c) to service a product that has been modified or integrated with other products when the effect of such modification or integration increases the time or difficulty of servicing the product.

THIS WARRANTY IS GIVEN BY TEKTRONIX WITH RESPECT TO THIS PRODUCT IN LIEU OF ANY OTHER WARRANTIES, EXPRESSED OR IMPLIED. TEKTRONIX AND ITS VENDORS DISCLAIM ANY IMPLIED WARRANTIES OF MERCHANTABILITY OR FITNESS FOR A PARTICULAR PURPOSE. TEKTRONIX' RESPONSIBILITY TO REPAIR OR REPLACE DEFECTIVE PRODUCTS IS THE SOLE AND EXCLUSIVE REMEDY PROVIDED TO THE CUSTOMER FOR BREACH OF THIS WARRANTY. TEKTRONIX AND ITS VENDORS WILL NOT BE LIABLE FOR ANY INDIRECT, SPECIAL, INCIDENTAL, OR CONSEQUENTIAL DAMAGES IRRESPECTIVE OF WHETHER TEKTRONIX OR THE VENDOR HAS ADVANCE NOTICE OF THE POSSIBILITY OF SUCH DAMAGES.

1801

(see text)

1802

1803

Introduction

This section describes the safety precautions, power and signal connections, and procedures you should follow when you install the 11801B. It then provides a high-level view of the 11801B Digital Sampling Oscilloscope and its features.

11801B Description

The 11801B Digital Sampling Oscilloscope provides unprecedented capabilities in capturing and accurately measuring high-speed electrical events. Some of the main features of the 11801B are:

- Fast rise time and wide bandwidth, as determined by sampling head.
- Sweep speeds from 1 picosecond per division to 5 milliseconds per division, adjustable in calibrated 1 picosecond per division steps.
- 200 kHz sampling rate for high system throughput and real-time display.
- Digital trace capture, display, and storage. Provides a bright stable display even with signals of low repetition rate.
- Traces are captured with 8-bit vertical resolution, and can have from 512 to 5120 points each.
- Simultaneous display of up to eight traces. Each trace can represent a single input channel, or a complex expression that mathematically combines multiple input channels, or an expanded window of another trace.
- Time or voltage histograms displayed on-screen and updated continuously as trace data are collected.
- Mask testing for easy “go/no-go” testing and error rate measurements.
- Standard mask testing using a library of 38 predefined telecommunication masks (Option 1T).
- Color grading provides a third dimension, sample density, to displayed data and allows histogram and mask analysis after collecting data.
- Full-function trigger up to 3.0 GHz with selectable $1 \times / 10 \times$ attenuation and AC/DC coupling.
- Single-ended and differential TDR measurements are available on all channels using SD-24 sampling heads.

- Automatic measurement capability that allows a wide variety of complex measurements on a signal and gives real time updating. Twenty-eight measurements are available, including rise time, fall time, rms voltage, delay, width, duty cycle, and frequency. Measurement statistics provide the mean and standard deviation of your measurements. Measurements can be based on data in the color grading database, for example, fully automatic noise and jitter measurements.
- Fast fourier transform capability that allows you to obtain a frequency domain display of a given trace. You can display the FFT magnitude and FFT phase of the trace.
- A unique statistical measurement mode that allows pulse parameter measurements on random data (for example, eye diagrams) as well as accurate timing measurements in the presence of jitter.

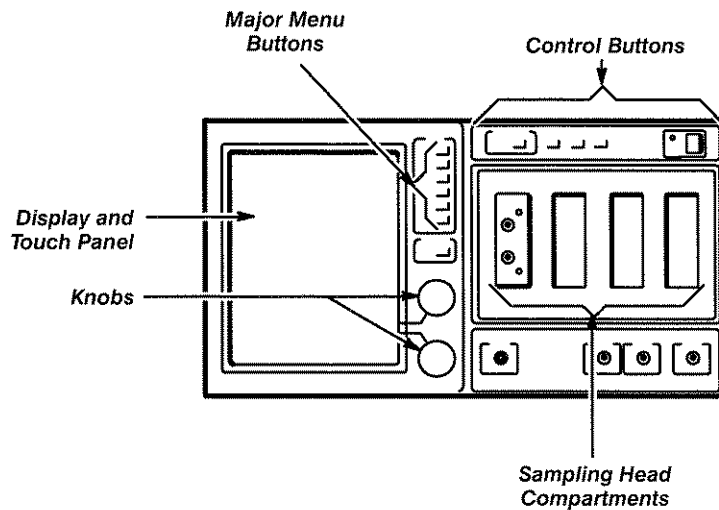

- An Autoset function that allows quick adjustment of settings by pressing a single button.
- Menu driven touch-screen operation that simplifies operator control of the 11801B. It disables invalid selections and indicates to the operator which choices are logical at any time.
- Programmable control of the 11801B that allows it to be run from an attached computer or instrument controller via the RS-232-C or GPIB interfaces.
- Continuous self-calibration system that ensures accurate, stable trace data and measurement results.

Description of Sampling

A traditional analog oscilloscope displays a trace dynamically as a beam is swept across the display horizontally. The 11801B Digital Sampling Oscilloscope separates a trace into discrete digital samples. The 11801B captures a sample before any amplification or attenuation is used to manipulate the signal. This technique provides very high bandwidth for repetitive signals and makes bandwidth a function solely of the sampling head. Thus, as higher bandwidth sampling heads are introduced, you can increase the capability of the 11801B just by adding a new sampling head.

The 11801B Digital Sampling Oscilloscope uses sequential sampling to sample one data point of the trace each time a trigger event occurs (up to 200K samples per second). Each successive trigger event samples the next point to the right of (occurring later than) the previous points sampled. Once the entire trace has been sampled and all data points are accumulated, the display shows the entire trace result. For very slow trigger rates, a partial trace is shown, even before all data points have been sampled.

Safety

The following safety information is provided for your protection and to prevent damage to the 11801B. This safety information applies to all operators and service personnel. See Appendix C for additional safety information.

Terms in Manuals

CAUTION statements identify conditions or practices that could result in damage to the equipment or other property.

WARNING statements identify conditions or practices that could result in personal injury or loss of life.

Terms on Equipment

CAUTION indicates a personal injury hazard not immediately accessible as one reads the marking, or a hazard to property including the equipment itself.

DANGER indicates a personal injury hazard immediately accessible as one reads the marking.

Symbols in Manuals



Static Sensitive Devices

Symbols on Equipment



DANGER
High Voltage



Protective
ground (earth)
terminal



ATTENTION
Refer to
manual

Power Source

This product is intended to operate from a power source that will not apply more than 250 V_{RMS} between the supply conductors or between either supply conductor and ground.

Grounding the 11801B

The 11801B is grounded through the power cord. To avoid electric shock, plug the power cord into a properly wired receptacle where earth ground has been verified by a qualified service person. Do this before making connections to the input or output terminals of the 11801B.

Without the protective ground, all parts of the 11801B are shock hazards. This includes knobs and controls that may appear to be insulators.

Use the Proper Fuse

Using an improper fuse can create a fire hazard. Always use fuses that exactly meet the specifications in the 11801B parts list. Match fuse type, voltage rating, and current rating.

Do Not Operate in Explosive Atmospheres

The 11801B provides no explosion protection from static discharges or arcing components. Do not operate the 11801B in an atmosphere of explosive gases.

Do Not Remove Covers or Panels

To avoid personal injury, do not operate the 11801B without the panels or covers.



Operating the 11801B without the covers in place may cause overheating and damage.

Electrical Connections

SMA-Compatible and Other Precision Connectors

You must attach cables to SMA-compatible and other precision connectors carefully to prevent damage to the cable or the instrument connector.



Do not over-tighten SMA-compatible connectors.

When attaching a cable to or removing a cable from an SMA-compatible connector, do not turn the cable, turn only the nut. Align the two connectors carefully and engage the connector nut over the exposed threads on the other connector. Use only finger pressure to make this initial connection. Then use a torque wrench *only* to tighten the connection to the range of 7–10 lb-in (79–112 N-cm).

There are two types of SMA-compatible connectors on the 11801B:

- Standard SMA connectors with plastic insulating material between the center lead and the outer shield. An example is the **INTERNAL CLOCK** output connector on the front panel.
- High-precision APC 3.5 connectors, which have air insulation between the center lead and outer shield. Examples include the input connectors on some of the sampling heads.

The APC 3.5 connectors are of closer mechanical tolerance than the standard SMA connector. Attaching a worn or damaged SMA cable to an APC 3.5 connector may damage the APC 3.5 connector.

Higher bandwidth sampling heads may use other connectors that are not SMA-compatible. Consult your sampling head manual for more information.

Electrostatic Discharge



Applying a voltage outside the range printed on the sampling head can result in damage. Static electricity is also a hazard.

The input diodes used in the sampling heads are very susceptible to damage from overdrive signal or DC voltages, and from electrostatic discharge. Never apply a voltage outside the range printed on the front of the sampling head. Operate the 11801B only in a static-controlled environment.

Connect the wrist strap provided with the 11801B to the **ANTISTATIC CONNECTION**, as shown in Figure 1-1.

Front Panel



Never install or remove a sampling head with the 11801B power on.

The front panel has four compartments for sampling heads. At least one sampling head must be installed in a 11801B configuration to allow the 11801B to sample signals.

The **TRIGGER INPUT**, the **INTERNAL CLOCK** output, and the **CALIBRATOR** output connector are located below the sampling heads. The tutorial procedures in this manual describe the use of these connectors. See Figure 1-1.

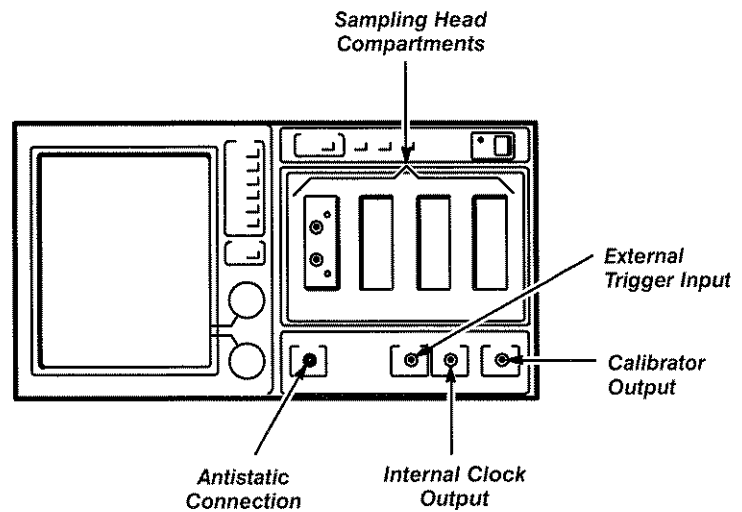

Figure 1-1: Front Panel Connectors

Rear Panel

The **POWER** plug provides AC power to the 11801B. The plug is an IEC-style connector; the separate power cord supplied with the 11801B should match the physical configuration of electrical outlets in your country.



*Set the **LINE VOLTAGE SELECTOR** switch before connecting the 11801B to power.*

Before connecting the power cord between your electrical outlet and the 11801B **POWER** plug, make sure that the adjacent **LINE VOLTAGE SELECTOR** switch is set to match the voltage range of the electrical system of your country. The main fuse is near these controls, as is the **PRINCIPAL POWER SWITCH**. See Figure 1-2.

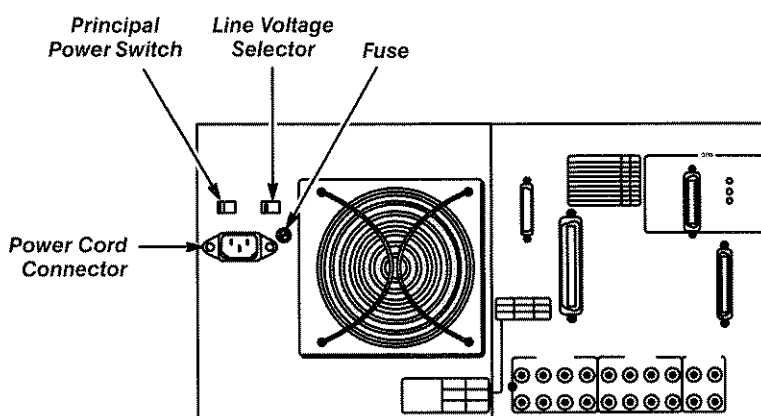

Figure 1-2: Rear Panel Power Connectors and Switches

The **PRINTER** connector provides a Centronics-style interface, so you can connect a printer to the 11801B. This lets you make a paper copy of the display by pressing the **HARDCOPY** button on the front panel.

The **RS-232-C (DCE)** connector lets you connect a computer, terminal, or modem to the 11801B. The GPIB section similarly has an **IEEE STD 488 PORT** connector. Both of these connectors let you make the 11801B part of an automated test and measurement system. Hardcopy information can also be routed through either the **RS-232-C** or the **IEEE STD 488 PORT** connector. See Figure 1-3.

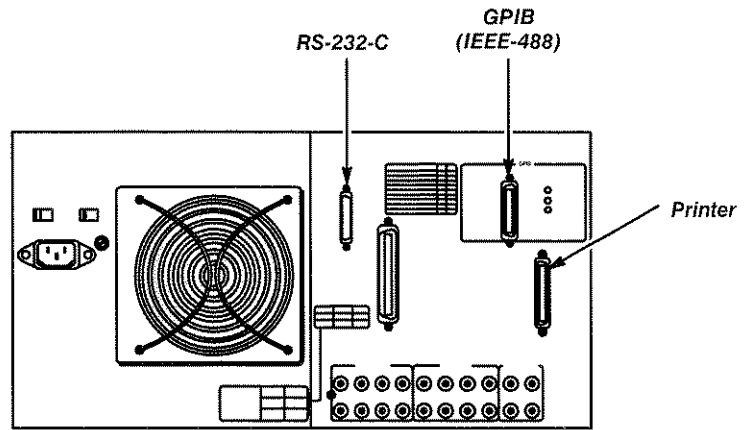
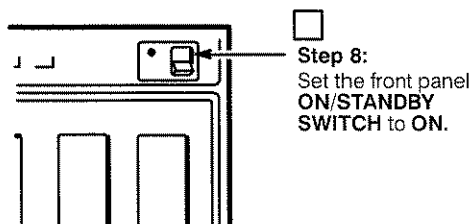
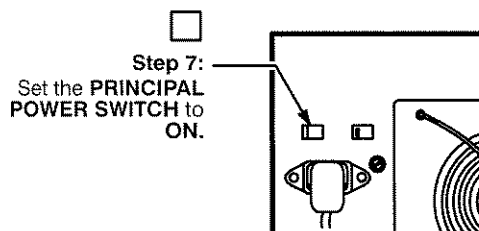
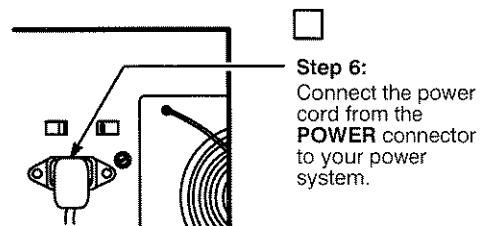
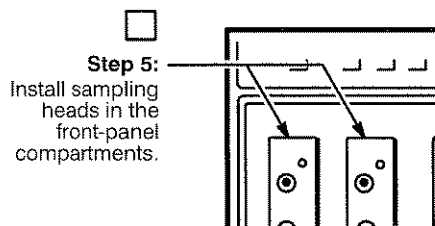
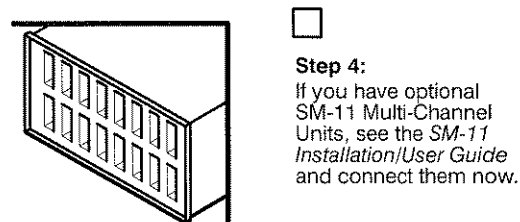
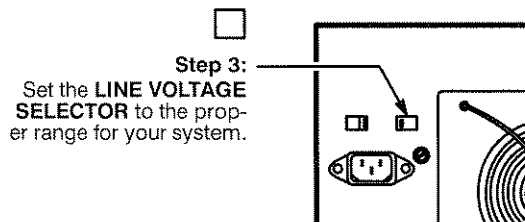
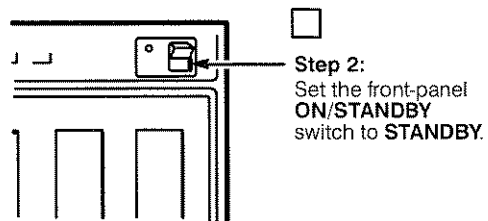
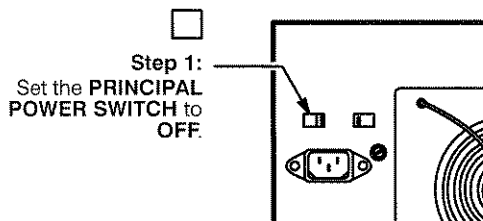

Figure 1-3: Rear Panel Printer and Data Connectors

Installation

Follow this sequence when you install the 11801B:



Once the 11801B is installed, use the **ON/STANDBY** switch as a power switch.



At a Glance

This part of the manual presents general operating instructions and a road-map of the menu system. All menus are shown in this section. Once you find a menu of interest, you will be directed to the page in the *Reference* section that discusses that feature. The *Operating Basics* section provides several examples on using the instrument. Complete reference information is contained in the *Reference* section.

Front Panel and Sampling Heads

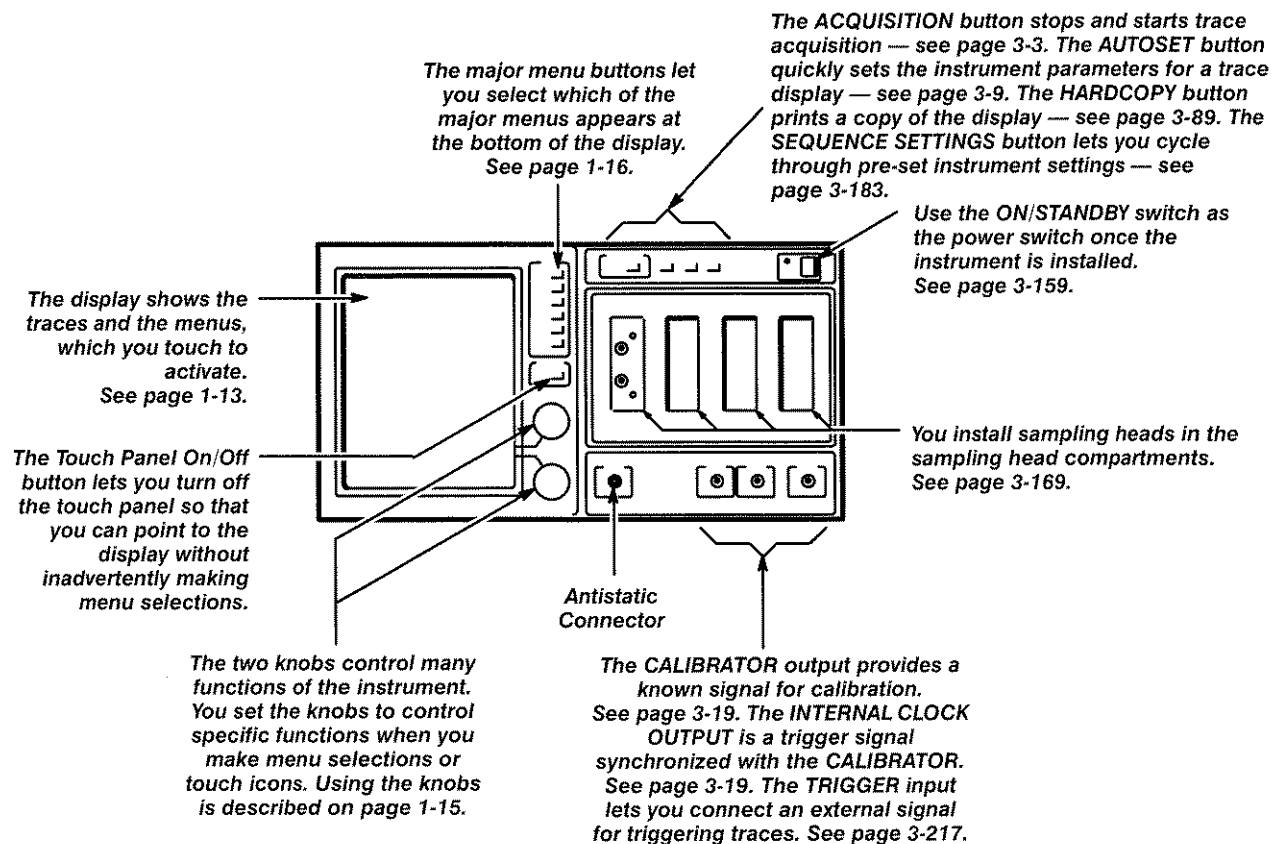

Rear Panel

Power line controls include the **LINE VOLTAGE SELECTOR SWITCH**, the fuse, the power connector, and the **PRINCIPAL POWER SWITCH**. See page 3-159.

The **RS-232-C** connector allows a remote computer to control the instrument through a serial interface. It can also be used to drive serial output devices. See page 3-165.

The **GPIB** connector allows a remote computer to control the instrument through an **IEEE Std 488** parallel interface. It can also be used to drive compatible plotters. Three lights show the status of the parallel bus. See page 3-79.

The **PRINTER** connector lets you attach several kinds of printers using a **Centronics** interface. See page 3-89.

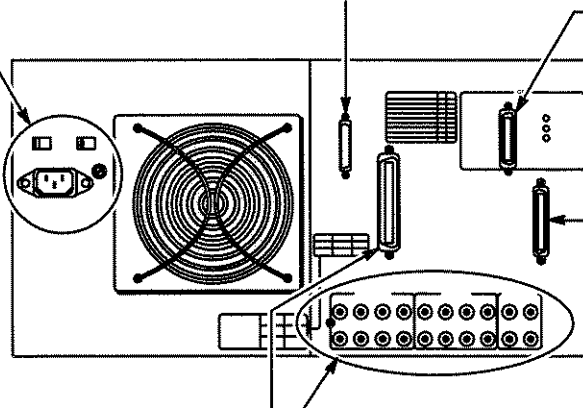

If your 11801B is equipped with **Option 1M**, the **SM-11** connectors let you attach up to four **SM-11 Multi-Channel Units**, which provide more sampling head compartments. See the **SM-11 Manual**.

Display and Touch Panel

The display shows the output of the instrument, such as traces and measurement information. The display is combined with the touch panel to provide a touch menu system. Touch the selectors that are displayed in the various menus to execute those items. Each menu selector has a shaded top portion that names the selector and a lower portion that shows the current status of the parameter that the selector controls.

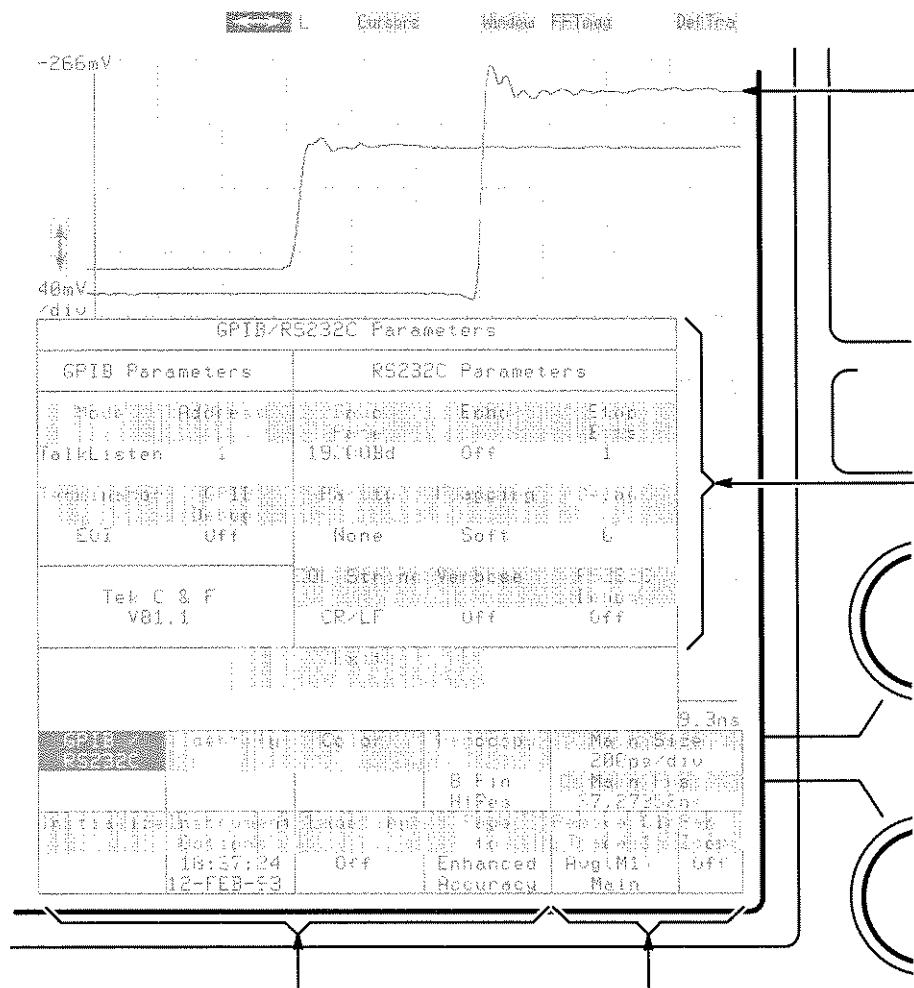

Selected trace (highlighted) and unselected trace. Axis labels and readouts apply to the selected trace. Traces can be selected by touching them. See page 3-212.

A pop-up menu provides a temporary dialog to let you set specific parameters. This is the GPIB/RS232C pop-up menu, which is accessed by touching the GPIB/RS232C selector in the Utility1 major menu.

Several different major menus are available. You display and use the major menus by pressing the major menu buttons. This is the Utility1 major menu. Touch the GPIB/RS232C selector to display that pop-up menu. See page 1-16 for a description of the various major menus.

The Knob Menu always shows the parameters the knobs are currently assigned to control (top two selectors). You can also use the knob menu to remove traces from the display. You can touch the knob labels to see the Keypad Menu, which lets you enter a numeric value for any knob-controlled parameter. See page 1-15.

Icons

Touch the horizontal icon to assign the knobs to adjust the trace horizontal size and position. See page 3-107.

Def Tra
Touch the Define Trace icon to display a pop-up menu that lets you define a new trace to be displayed. See page 3-207.

FFTmag
Touch this icon to display the magnitude of the frequency spectrum of the selected trace. This icon is then replaced by FFTpha. See page 3-65.

Window
Touch the window icon to create a new trace that represents an enlarged portion of another trace. See page 3-227.

Cursors
Touch the cursors icon to display bar or dot cursors for measurements of trace values. See page 3-29.

Touch the trigger icon to assign the knobs to adjust the trigger level and holdoff. If the instrument is not triggered, !not! appears above the word trig'd. See page 3-217.

Touch the vertical icon to assign the knobs to adjust the trace vertical size and position. See page 3-223.

-369mV		50.68ns	
675.7ns		50.68ns	
Vertical	Horizontal	Trigger	Main
Wave	Main	Cont	Single
M1	Main	Continuous	Single
Fast	512 pts	1.0V	50.68ns
Setup	Window	Trace	M1
Auto	Mode	Status	Main
			off

Icons are always available, regardless of the major menu that is displayed.

Knobs, Knob Menu, and Keypad Menu

If you touch the wrong knob label by accident, the top two selectors let you choose the other knob parameter for Keypad Menu manipulation.

You can use the Keypad Menu to enter a numeric value for your parameter instead of turning the knob until the parameter is set. Touch number selectors as if you were typing the number, and end your entry by touching the Enter selector. CHS changes the sign of your number, Back Space lets you correct errors. The p (pico), n (nano), μ (micro), and m (milli) selectors let you scale your number.



The Coarse, Medium, and Fine selectors affect the knob resolution. When set to coarse, each knob click represents a greater change than when set to medium or fine.

The Set to Min and Set to Max selectors let you quickly set a parameter to either extreme of its range of adjustment.

Touch either knob label to display the Keypad Menu for that parameter.

The knob labels always show the knob assignments, the parameters that the knobs will control. The bottom half of each knob label shows the current value of the parameter. When you turn a knob, you will see the current value change, and you will see the change on the display and on any displayed menus that show the parameter. Any time knob labels change they will change color. When you turn a knob, the labels return to normal.

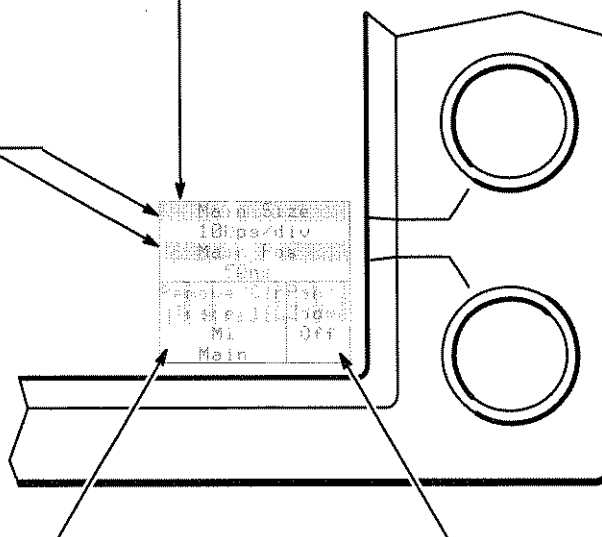

This selector lets you remove a trace from the display. First select (highlight) the trace you want removed by touching it, then touch this selector. A pop-up menu will ask you to select remove or clear. See page 3-214.

The Pan/Zoom selector lets you expand any part of a trace using horizontal magnification. See page 3-109. When the knobs are assigned to vertical size and offset, this selector may change to provide more vertical control. See page 3-223.

Major Menu Buttons

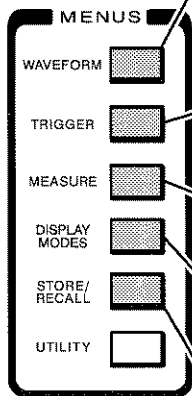

Waveform	Main	Continuous	Single
File	Window	512 pts	Trace
More...	Mode		Status

The Waveform major menu controls trace definition, acquisition, and the sampling heads. See page 1-18.

10mV	50mV		
200ps	200ps		Single Trace

An alternate form of the Waveform major menu, the Trace Status menu, can be displayed using the More... selector in the Waveform major menu. See page 1-18.

External	EV		Off
Report			
Auto	+	Enhanced	Auto
		Triggering	SAS

The Trigger major menu controls triggering. See page 1-21.

25	304.000		
25	mV		

The Measure major menu controls the automatic measurement system. See page 1-22.

Persistence	Mask	Color Grad	Background
Normal	Count Off	Scale	Mask
Continuous			User Mask

The Display Modes major menu controls display persistence, histograms and mask testing. See page 1-23.

Store/Recall			
			Off

The Store/Recall major menu controls storage and recall of trace data and instrument settings. See page 1-24.

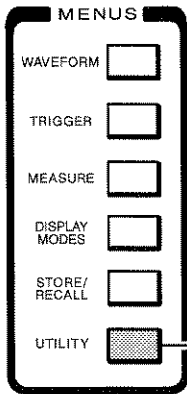

Utility1	Utility2	Color	Hardcopy
Utility1	Utility2	Color	Hardcopy
Utility1	Utility2	Color	Hardcopy
Utility1	Utility2	Color	Hardcopy
Utility1	Utility2	Color	Hardcopy
Utility1	Utility2	Color	Hardcopy

The Utility1 major menu controls general instrument parameters such as display colors, GPIB and RS-232-C settings, and hardcopy parameters. See page 1-26.

Enhanced Accuracy	Utility2	Utility2	Utility2
Enhanced Accuracy	Utility2	Utility2	Utility2
Enhanced Accuracy	Utility2	Utility2	Utility2
Enhanced Accuracy	Utility2	Utility2	Utility2
Enhanced Accuracy	Utility2	Utility2	Utility2
Enhanced Accuracy	Utility2	Utility2	Utility2

The Enhanced Accuracy menu controls the calibration system. See page 1-28.

Utility2	Utility2	Utility2	Utility2
Utility2	Utility2	Utility2	Utility2
Utility2	Utility2	Utility2	Utility2
Utility2	Utility2	Utility2	Utility2
Utility2	Utility2	Utility2	Utility2
Utility2	Utility2	Utility2	Utility2

The Utility2 major menu provides access to the diagnostic system. See page 1-30.

V1	-161.25mV		
V2	750.02mV		
Paired	162.00mV		
Dots			
t1	60.900ns	t1/2	30.190ns
t2	62.424ns	t2/2	31.212ns
Δt	2.0440ns	Δt/2	1.0220ns
f/Δt	489.24MHz		

The Cursors major menu controls the cursors, markers that you position on your trace to make measurements. Use the Cursors icon to display the Cursors major menu. See page 3-29.

Waveform Major Menu

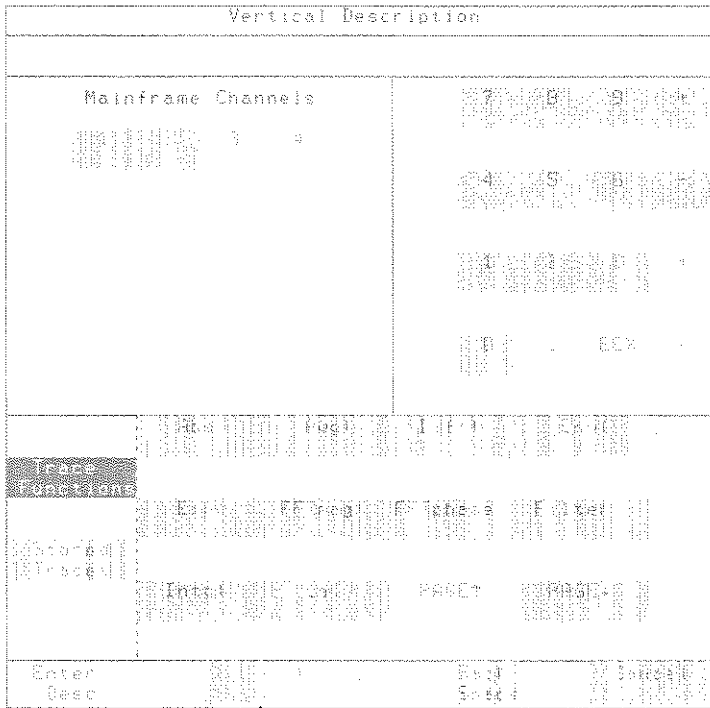

This pop-up menu lets you modify the trace expression of the selected trace. See page 3-213.

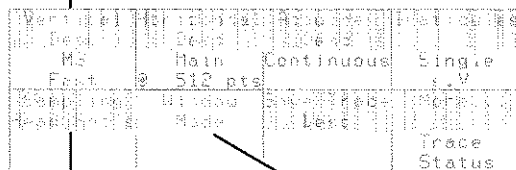
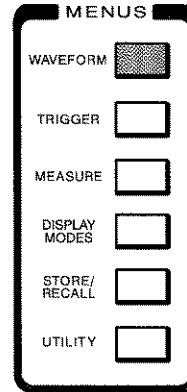

The More... selector displays the alternate Trace Status major menu. This displays the status of all traces on the display. See page 3-212.

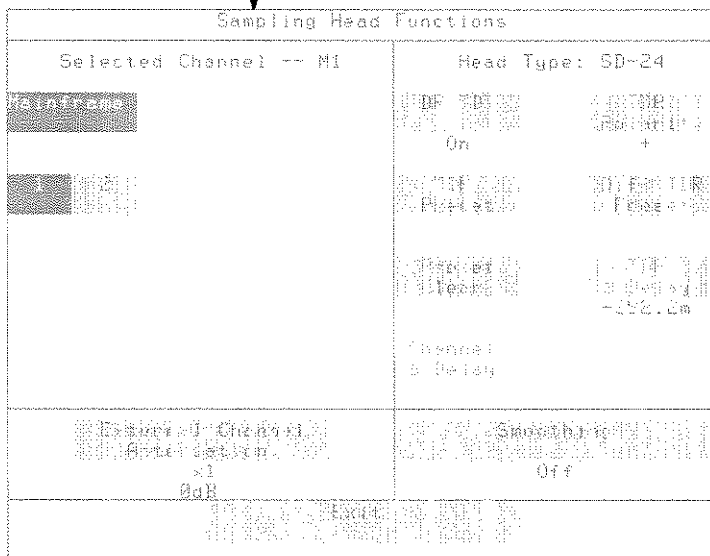

Sampling head controls. See page 3-169.

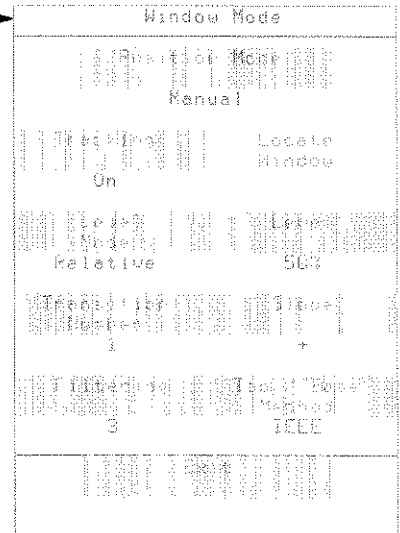

This pop-up menu controls the position of window traces. See page 3-229.

Horizontal Description

Acquiring Timebase: Main
 Main Sample Interval: 2ps/point
 Window Sample Interval: 200fs/point
 512 points 512 points

Horizontal Reference Point

XY Display Mode: X=Acquired Trace

Normal: Y1

XY Display Mode: X=Stored Trace

Record length controls. See page 3-163.

Horizontal reference point controls. See page 3-111.

XY trace controls. See page 3-233.

Acquire Description

Stop Acquisition On

Average Complete

Envelope Both Complete Avg 3 Cnt

Run Acquisition

Averaging and enveloping. Acquisition control. See page 3-3. See page 3-13.

Ms	Main	Continuous	Single
Fact	512 pts		s.v
Window Mode		Trace	Trace Status

Graticules

Reduce to One Graticule

Move Trace to Other Graticule

Y Units

Volts

21mV

X Units

Seconds

Propagation Velocity 0.7

Graticule and axis unit controls. See page 3-83.

MENUS

- WAVEFORM
- TRIGGER
- MEASURE
- DISPLAY MODES
- STORE/RECALL
- UTILITY

At a Glance

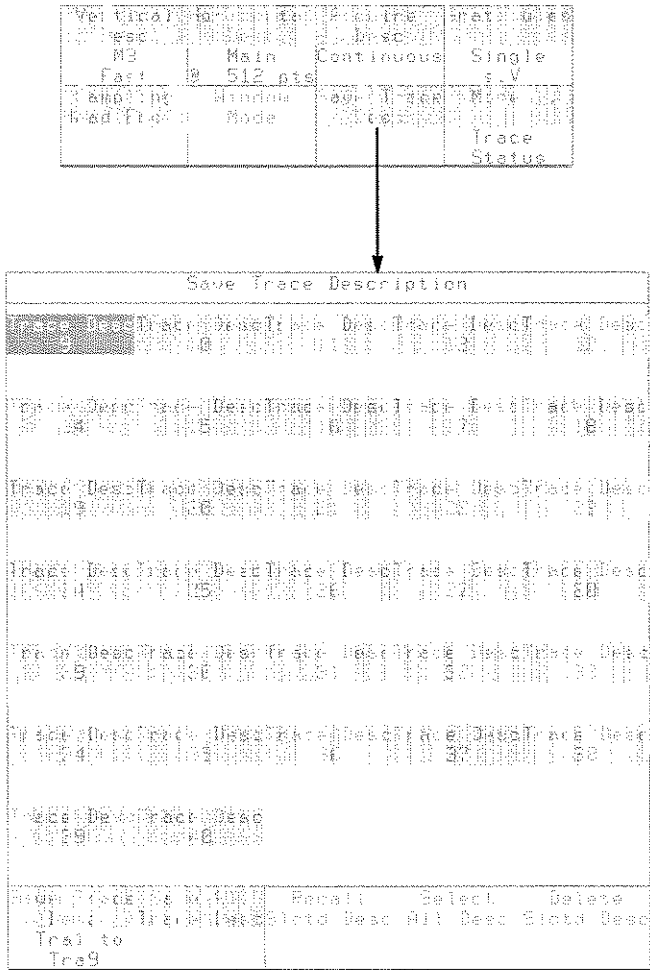
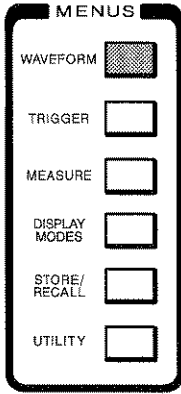

Saved trace description controls. See page 3-175.

Trigger Major Menu

Select the trigger source using this pop-up menu. See page 3-217.

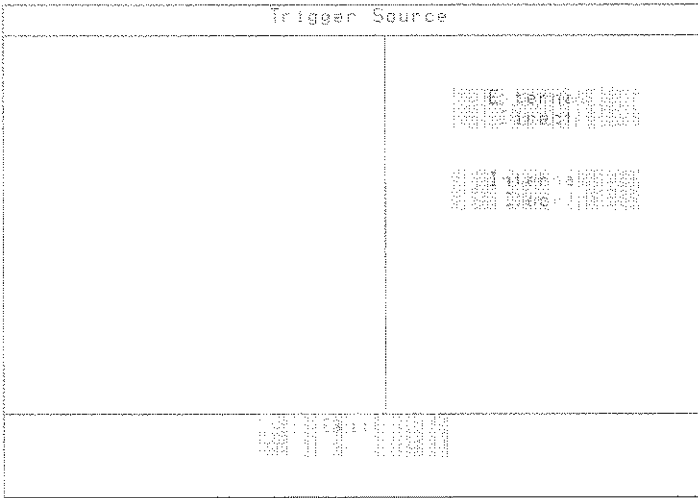

Use this pop-up to with external triggering to select AC or DC coupling and trigger attenuation. See page 3-217.

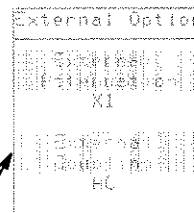

Touch this selector to assign the knobs to control trigger level. See page 3-217.

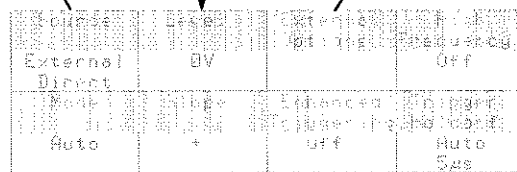
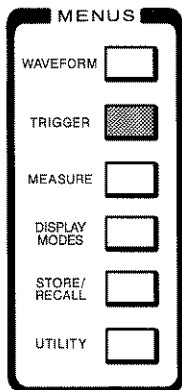

Touch this selector to enable/disable high frequency holdoff. See page 3-217.

Set trigger holdoff parameters with this pop-up. See page 3-217.

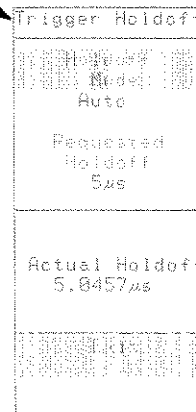

Select Normal or Auto Trigger with this selector. See page 3-217.

Touch this selector to enable/disable enhanced triggering. See page 3-217.

Touch this selector to change the trigger slope. See page 3-217.

Measure Major Menu

Use this pop-up menu to specify which measurements you want to take. As you select measurements, the readouts appear immediately in the unused selectors of the major menu. See page 3-141.

Touch a measurement readout to display a pop-up menu that lets you control the way the measurement is taken. See page 3-149.

Min

Measurement Mode:
Software

45.6483ns 47.0923ns

32

Cur N: 32
Mean: -253.74999mV
StDev: 0.0000000V

Measurements

Amplitude	Timing	AreaEnergy
Phase	Filter	Spectral
Noise	SNR	Spectral Mag
		THD

MENUS

- WAVEFORM
- TRIGGER
- MEASURE
- DISPLAY MODES
- STORE/RECALL
- UTILITY

11.641%	-174.000	-348.000
4.94572	9.99999	1.00000
μ s	μ s	%

These six selectors are reserved for the readouts of measurements that you select. This sample menu shows that the measurement system is set up to take six measurements on the selected trace. See page 3-137.

Compare and Reference Values

Compare

Adjust References

3V 1V 5V

1s 1s 0

Use this pop-up menu to make your measurement relative to a reference value. See page 3-147.

Store/Recall Major Menu

These pop-up menus let you store and recall displayed traces. See page 3-185.

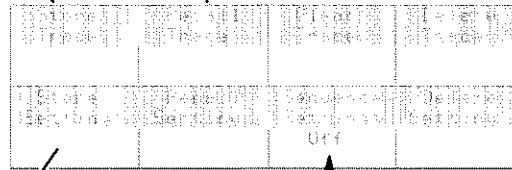
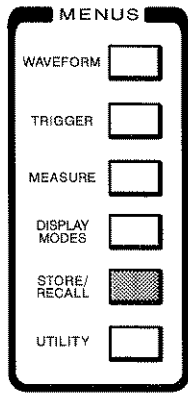
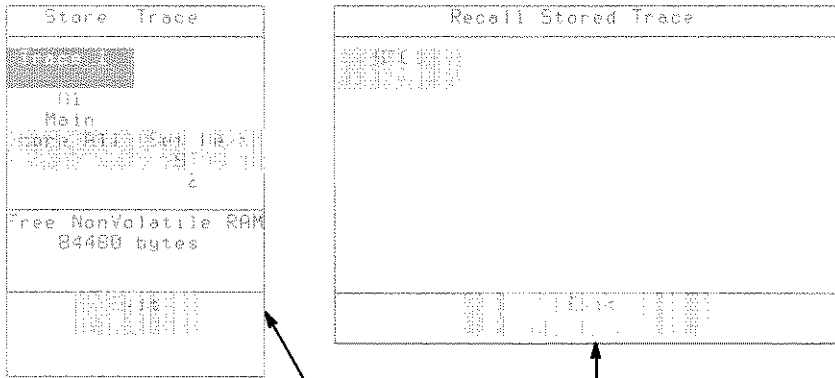

This selector activates or disables the SEQUENCE SETTINGS button on the front panel. You can use that button to change from one instrument setting to the next. See page 3-183.

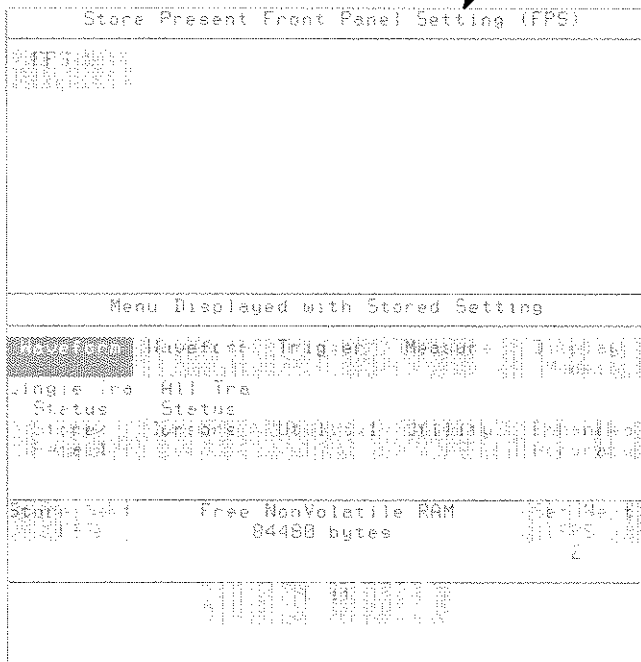

This pop-up menu lets you store an instrument setting. See page 3-180.

Clear displayed traces using this pop-up menu. See page 3-5.

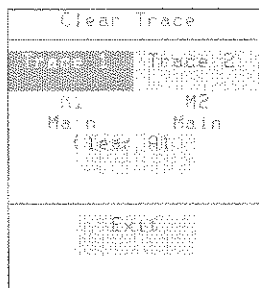

Delete stored traces using this pop-up menu. See page 3-188.

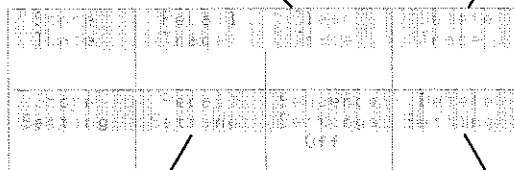
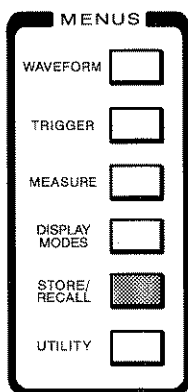
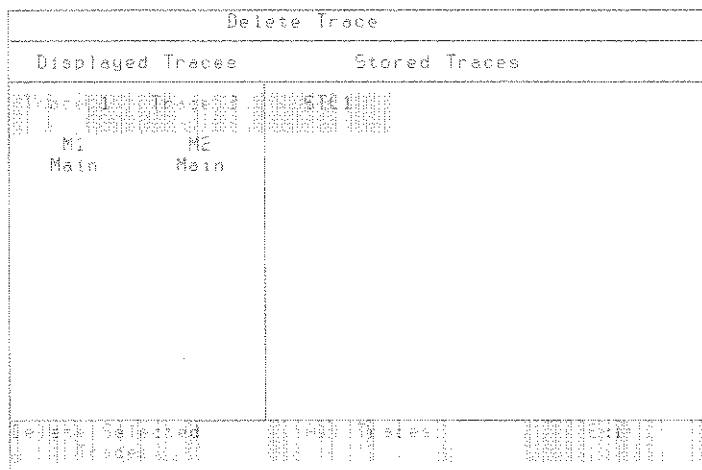

These pop-up menus let you recall or delete settings. See page 3-181.

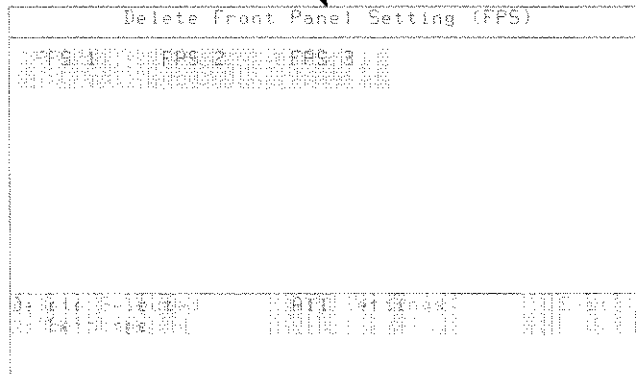
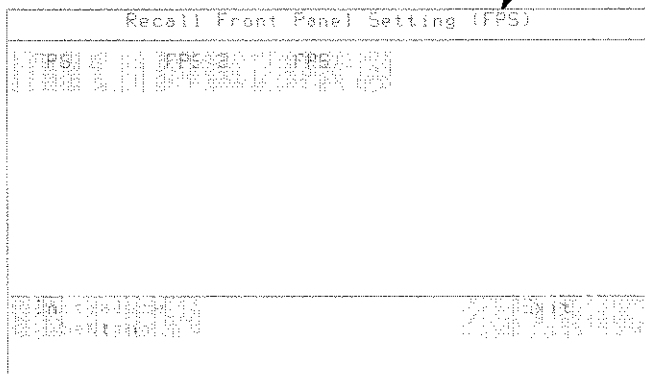

Utility1 Major Menu

This pop-up menu shows instrument and sampling head identification and firmware version numbers. See page 3-191.

Use this pop-up menu to set GPIB and RS-232-C parameters. See page 3-80 for GPIB, and page 3-166 for RS-232-C.

GPIB/RS232C Parameters			
GPIB Parameters		RS232C Parameters	
Mode:	Force	Sup:	Auto
TalkListen	7	9600Bd	On
Rel. Addr:	0000	None	Soft
ECI	Off	CR/LF	On
Tek C & F V81.1		CR/LF	Off

System Identification			
Unit Select			
11881B Mainframe ID# B010391			
Executive Processor :	3.13	Display :	3.13
Time Base/Controller :	3.26	Acquisition #1 :	9.02
Acquisition #2 :	9.02		
Mainframe Sampling Heads			
Chan M1 :	1X	Chan M2 :	1X SD-24
Chan M3 :	0X	Chan M4 :	0X
Chan M5 :	0X	Chan M6 :	0X
Chan M7 :	0X	Chan M8 :	0X
Options			
IT - Telecomm Standard Masks	Installed		
IM - SM-11 Competability	Not Installed		
Identify	Off	Bitmap Screen	Off
Enhanced Accuracy	Off	Page 1	Trace 1
12-FEB-93		Accuracy	Main

Identify	Bitmap Screen	Page 1	Trace 1
Off	Off	Trace 1	Trace 1
Enhanced Accuracy	Off	Accuracy	Main

MENUS

WAVEFORM

TRIGGER

MEASURE

DISPLAY MODES

STORE/RECALL

UTILITY

Labeling			
Displayed	Labels	Trace 1	Main
Trace 1	Manual	Off	
<p>Back Numbers Increase Back Exit</p> <p>Space Space Space Space</p>			

Verify Initialize

Use this selector to initialize the instrument to a known state. See page 3-113.

Use this pop-up menu to label traces and settings. See page 3-115.

Color and Intensity

H 0	L 65, 0 40
P 0 0	H 100
H 100	L 60, 0 55
H 200	L 55, 0 45
H 300	H 0
L 40, 5 100	L 60, 5 30

Hue Lightness Saturation

This pop-up menu enables you to set the colors of various elements of the display. See page 3-21.

Use this pop-up menu to set Hardcopy parameters. See page 3-91.

Hardcopy Parameters

Printer	Color Map
Background	Trace Color 1
Trace Selectors	Trace Color 2
Window Trace	Trace Color 3
Cursors	Trace Meas Zones Color 4
Default	Default
Screen Horizontal	BinHex
	Compacted
Hardcopy Abort	

MENUS

- WAVEFORM
- TRIGGER
- MEASURE
- DISPLAY MODES
- STORE/RECALL
- UTILITY

Enhanced Accuracy

3-FEB-93 Off

Use this selector to access the Enhanced Accuracy major menu. See page 1-28.

Touch this selector to turn the audible beep on or off. See page 3-7.

Touch this selector to assign the knobs to control display brightness. See page 3-41.

These selectors control FFT windowing and scaling parameters. See page 3-65.

Use these controls to set the instrument clock. See page 3-205.

Instrument Options

Autoset Options

Horizontal Vertical In Autoset

On On On Period

Undo Last Autoset

60% On Off Optional

dBm 5-Harris Off Centered

Time: 19:27:32
Date: 3-FEB-93
OnTime: 523.0hrs
Powerups: 197 times

Autoset controls are described on page 3-9.

Turn on or off vectored traces with this selector. See page 3-221.

Control trace scaling, a property of traces, with this selector. See page 3-216.

Select shifted or centered filter mode. See page D-6.

Touch this selector to turn on or off time and date stamps for stored traces. See page 3-185.

Enhanced Accuracy Major Menu

Calibrate blowby compensation of the sampling heads that use this calibration. See page 3-49.

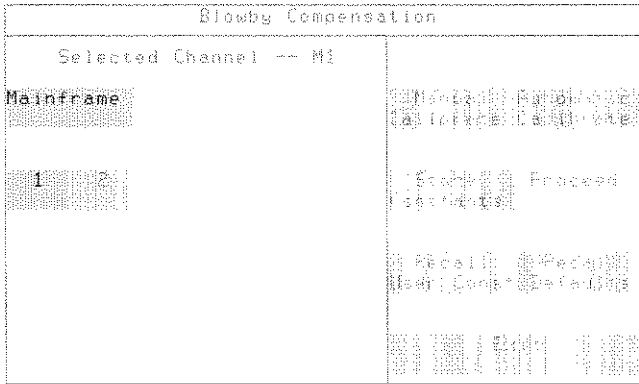

Calibrate gain of sampling heads. See page 3-49.

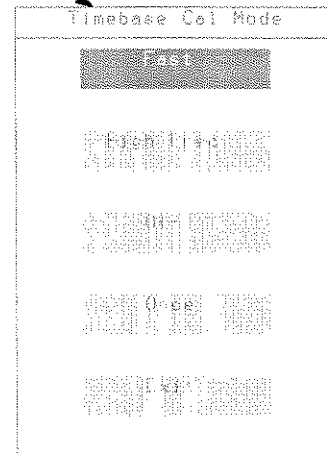
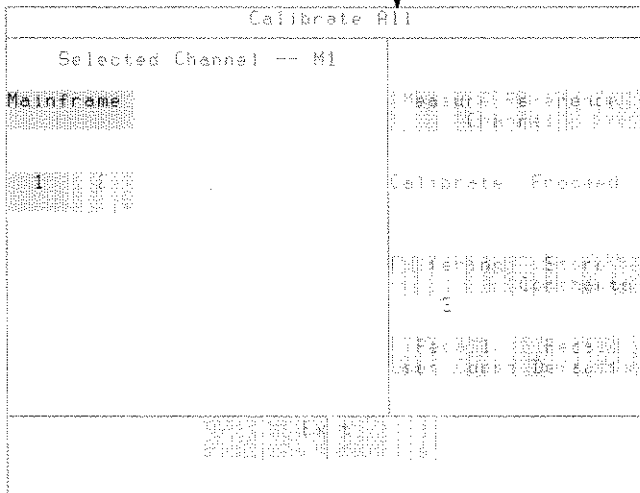
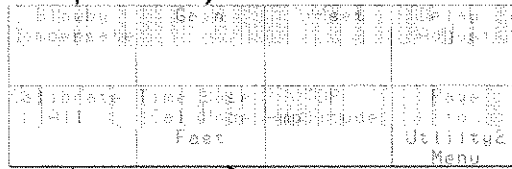
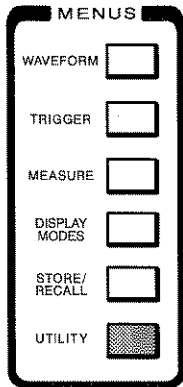
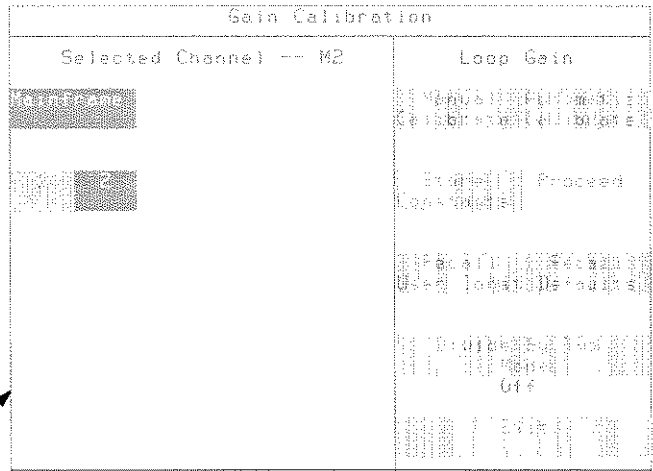

This pop-up menu provides assistance in making all calibrations of a sampling head quickly. See page 3-49.

This pop-up menu controls the automatic self-calibration system. See page 3-49.

Calibrate offset of sampling heads. See page 3-49.

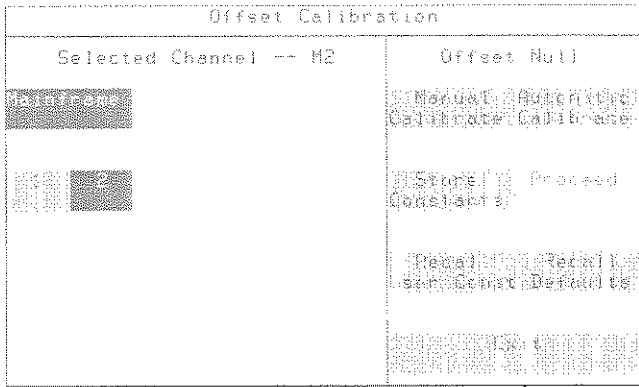

Use this pop-up menu to compensate for minor timing variations between sampling heads. See page 3-49.

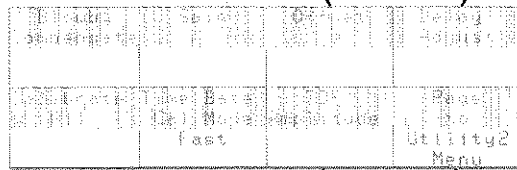
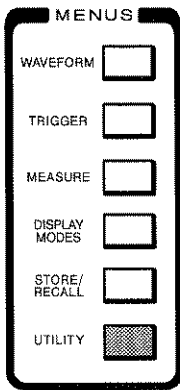
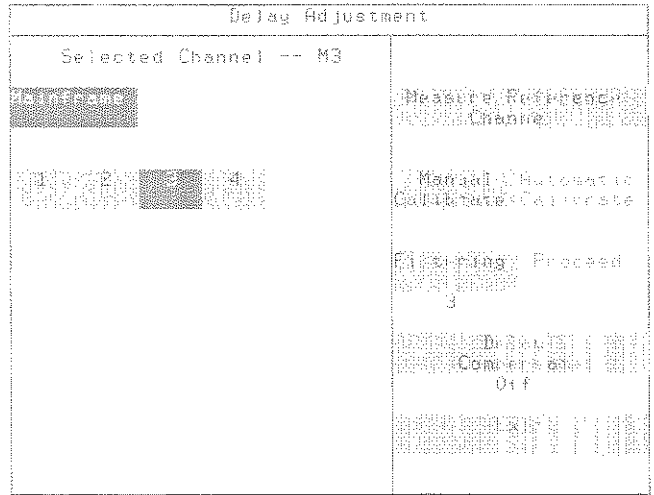

Use this selector to access the Utility2 major menu. See page 1-30.

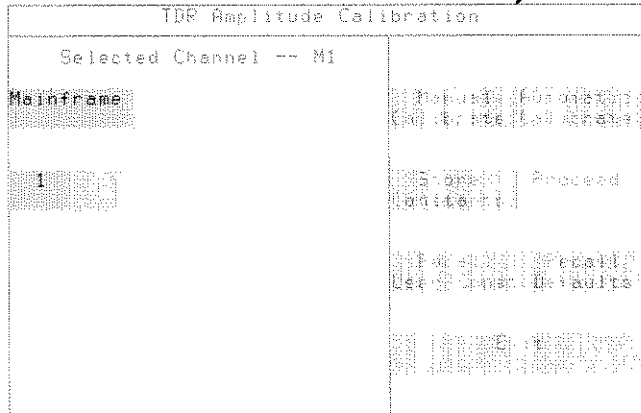

Calibrate the TDR amplitude of those sampling heads that support TDR. See page 3-49.

Utility2 Major Menu

Use this selector to initiate a self-test and verify that the instrument is operating properly. See page 3-38.

Use this selector to enter the extended diagnostics system. See page 3-38.

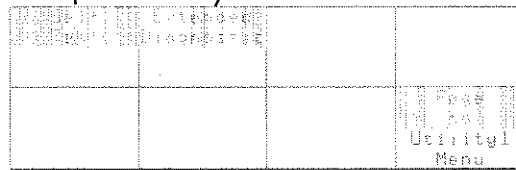
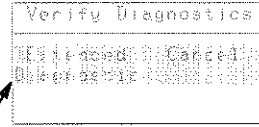
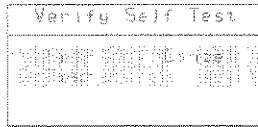
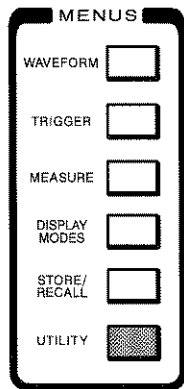

Use this selector to return to the Utility1 major menu. See page 1-26.

Overview

This section presents eleven examples that illustrate how to use the 11801B Digital Sampling Oscilloscope. Examples 1 through 4 describe how to define and display single and multiple traces and how to perform signal processing.

Examples 5 through 7 describe how to take automated measurements, how to use measurement annotations to control the measured portion of the trace, how to select from the three types of measurements (software, statistical or hardware), and how to use a reference trace for comparison measurements.

Examples 8 through 11 discuss advanced features of your 11801B Digital Sampling Oscilloscope that are beyond the standard set of oscilloscope features. These examples cover using a stored trace as a reference, saving trace descriptions for later use, taking histograms of displayed trace data, and taking Time Domain Reflectometry (TDR) measurements.

- Example 1: Displaying a Trace
- Example 2: Managing Multiple Traces
- Example 3: Defining Multiple Traces
- Example 4: Using Signal Processing
- Example 5: Taking Automated Measurements
- Example 6: Taking Delay Measurements
- Example 7: Taking Comparison Measurements Using a Reference Trace
- Example 8: Using Saved Trace Descriptions
- Example 9: Comparing Traces to Stored Traces
- Example 10: Creating a Histogram Display
- Example 11: Taking TDR Measurements

Each example demonstrates features and capabilities of the instrument. The *Reference* section later in this manual also provides detailed information about instrument capabilities.



Example 1: Displaying a Trace

This example shows how quickly you can display a meaningful trace on the display. You will also become familiar with the basic front-panel controls.

For this example you will need an 11801B with at least one sampling head installed, one SMA connecting cable, and a static protection wrist strap.

Major Menu Buttons

You will begin by initializing the 11801B to its default settings. Each example in this manual begins with this step.

CAUTION

Read the Operator Overview section for information on installing your 11801B.

To the right of the display is a column of six buttons grouped under the title **MENUS**. Each button has an indicator light that shows which button was pressed last. Associated with each button is a major menu at the bottom of the display.

You may wish to press different major menu buttons and observe the changes on the display. Each major menu presents a group of controls that are related to each other.

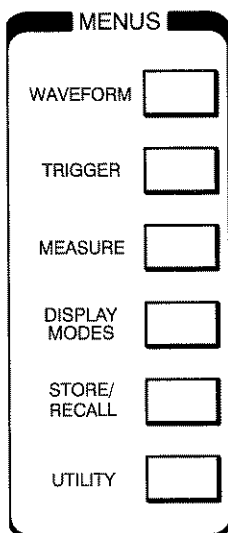

- **WAVEFORM** controls trace definition, sampling head control and acquisition control.
- **TRIGGER** controls triggering.
- **MEASURE** controls the automatic measurement system.
- **DISPLAY MODES** controls histograms, mask testing and editing, and other display features.
- **STORE/RECALL** controls storage and recall of trace data and 11801B settings.
- **UTILITY** controls general 11801B parameters such as display colors, GPIB and RS-232-C settings, and the clock. You can access the enhanced accuracy system, which performs internal calibrations of the 11801B and installed sampling heads, through the Utility major menus.

Example 1: Displaying a Trace

The Waveform major menu has two pages and the Utility major menu has three pages. Press the appropriate menu button to display the first page of the major menu. Press the same button a second time to display the second page of the menu.

Initialize the 11801B to default settings using the **Initialize** selector, which appears in the Utility1 major menu.

- Step 1:** Press the major menu **UTILITY** button, located in the **MENUS** column. If you see a different major menu than that shown on the opposite page, press the **UTILITY** button again to change the page.

This illuminates the **UTILITY** button's light and displays the Utility1 major menu, as shown in Figure 2-1.

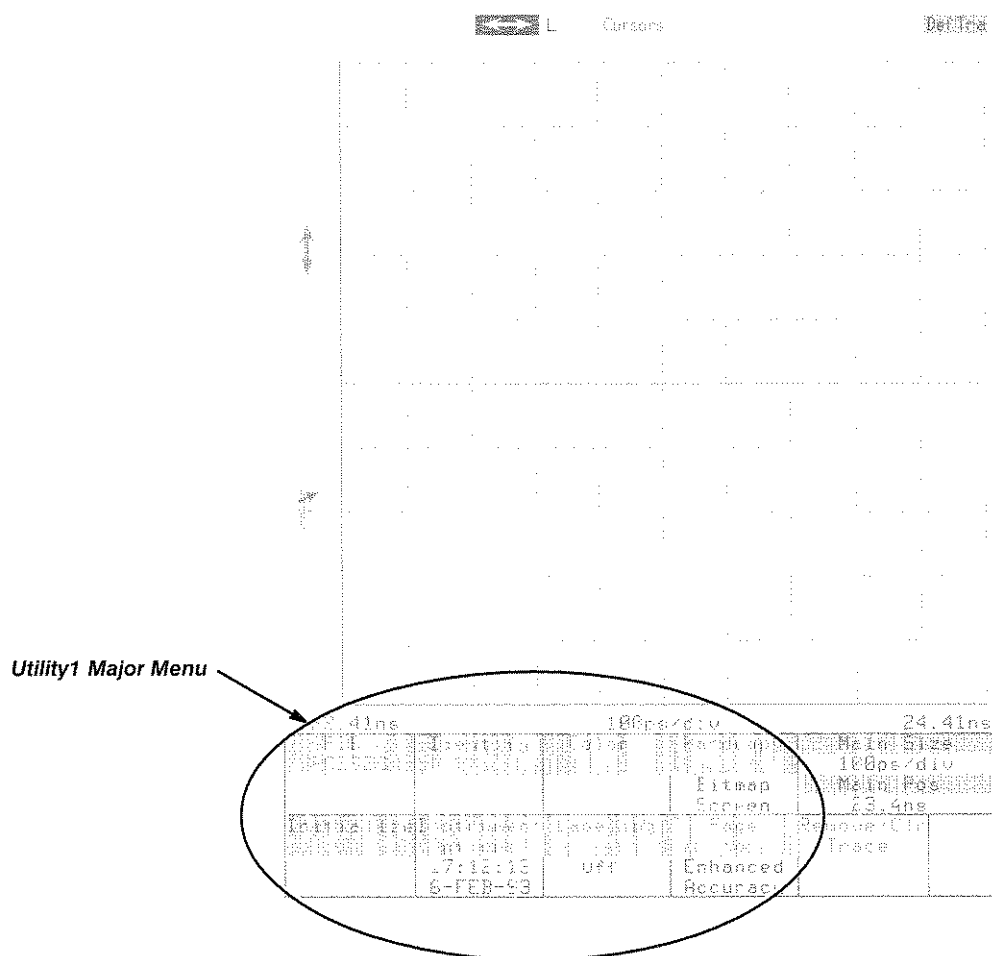

Figure 2-1: Utility1 Major Menu

The Touch Panel

You make selections from menus by touching the appropriate area. Until you remove your finger from the display, the 11801B indicates your potential selection by outlining that selector. You can change your potential selection by dragging your finger to the desired selector before withdrawing it.

NOTE

The 11801B does not perform any operation until you remove your finger from the display.

Menu Selectors

The Utility1 major menu has eight selectors in ruled boxes. The top half of each selector shows the name of the selector with a shaded background, while the bottom displays the current status on a black background.

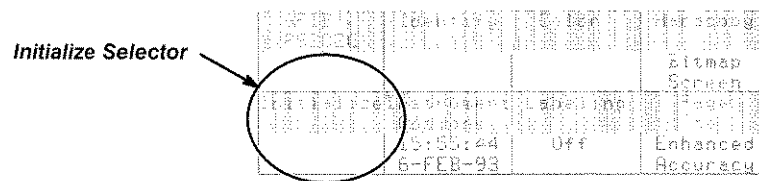

Figure 2-2: Initialize Selector in Utility1 Major Menu

Selectors can be normal brightness, like the ones you see in the Utility1 major menu. A selector appears very dim if it cannot be selected in the current state. Bright appearance indicates a selector is already selected or being used.

The **Initialize** selector operates when you touch it and withdraw your finger.

NOTE

*Be sure that the light beside the **TOUCH PANEL** button says **ON**. This button is below the major menu buttons.*

- Step 2:** Touch the **Initialize** selector in the major menu area (see Figure 2-2). Then touch the **Initialize** selector that is displayed in the pop-up menu.

This sequence, pressing the **UTILITY** button and then touching the **Initialize** selector, will always set the 11801B to a default state.

- Step 3:** Put on the wrist strap and ensure that it is connected to the antistatic connector on the front panel of the 11801B.

Connecting Cables

To view the calibrator signal, you must connect a cable from the **CALIBRATOR** output to any sampling head input connector.

- Step 4:** Connect an SMA cable from the **CALIBRATOR** output to either input connector of any installed sampling head (see Figures 2-3 and 2-4).



Read the Operator Overview section for information about SMA-compatible connectors.

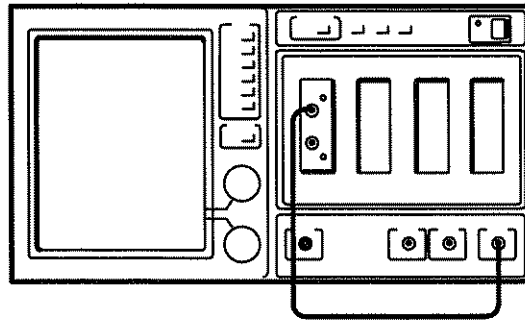

Figure 2-3: Cable from the CALIBRATOR Output to a Sampling Head Input

Beside each sampling head input is a small **SELECT CHANNEL** button. Pressing it is a quick way to display that channel. The resulting yellow light near the button tells you that the channel is being displayed.

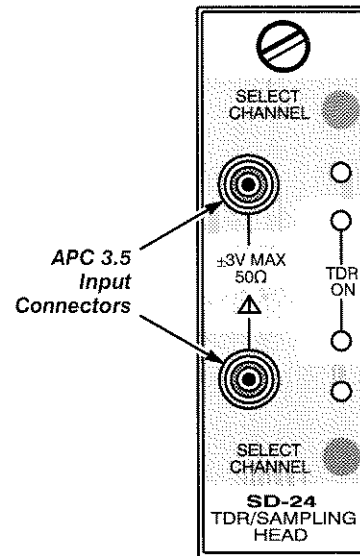



Figure 2-4: Sampling Head Control Panel (SD-24 shown)

- Step 5:** Press the **SELECT CHANNEL** button nearest the sampling head input you have connected to the calibrator.

The yellow light on the sampling head blinks, indicating that the channel is being displayed.

You don't see a trace on the display because the trace is not triggered. The trigger icon () at the left of the graticule shows **Inot!** above it meaning the 11801B is not triggered. This icon always shows you the trigger status.

The 11801B has an internal clock, which is synchronized with the calibrator output. You will use this clock to trigger the trace. To set triggering, you need to use the Trigger major menu.

- Step 6:** Press the **TRIGGER** major menu button in the **MENUS** column.

This displays the Trigger major menu. The **Source** selector indicates that the current trigger source is the External Direct. You need to change the source to Internal Clock.

Pop-Up Menus

Touching the **Source** selector demonstrates a common operation of selectors: they display pop-up menus. These menus are a temporary dialog with you; they cover a portion of the graticule. Most pop-up menus disappear automatically when you make a selection. Most pop-up menus also provide an **Exit** or **Cancel** selector so you can remove them.

If you inadvertently display a pop-up menu and wish to remove it, you can also remove it by touching the selector that displayed the pop-up menu. This selector is highlighted during the time that the pop-up menu is displayed. Or, you can touch a part of the graticule that has no traces on it.

Step 7: Touch the **Source** selector in the major menu.

The Trigger Source pop-up menu appears and the **Source** selector itself is highlighted (see Figure 2-5).

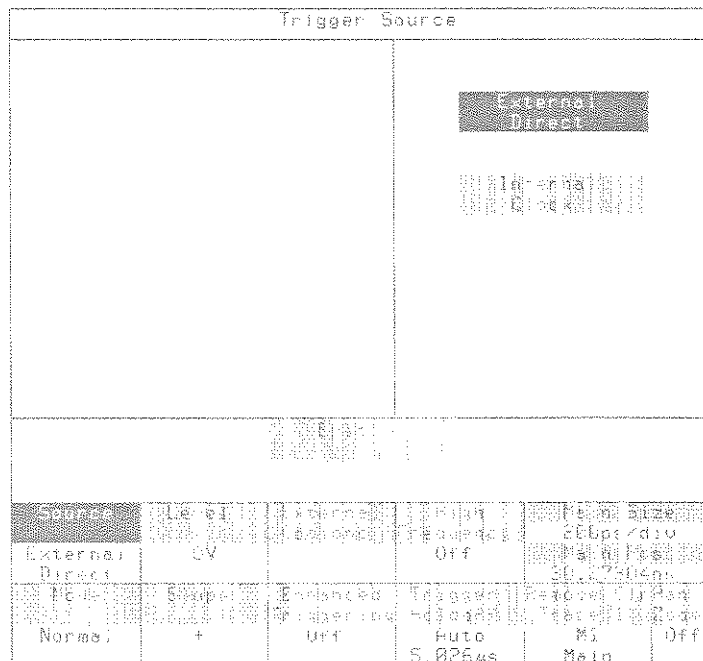

Figure 2-5: The Trigger Major Menu and Source Pop-Up Menu

Now that the **Source** pop-up menu is displayed, you can specify the internal clock trigger source:

Step 8: Touch the **Internal Clock** selector in the pop-up menu.

This selects **Internal Clock** as the trigger source. Notice that the **Source** selector in the major menu now indicates **Internal Clock**.

Step 9: Touch **Exit** to remove the pop-up menu.

Autoset

You now see a flat trace on the display. However, it does not show the “interesting” part of the trace. To quickly show the desired data, use the autoset feature. The **AUTOSET** button, located above the sampling heads just to the right of the major menu buttons (see Figure 2-6), automatically sets the horizontal, vertical, and trigger parameters to display the desired portion of the trace.

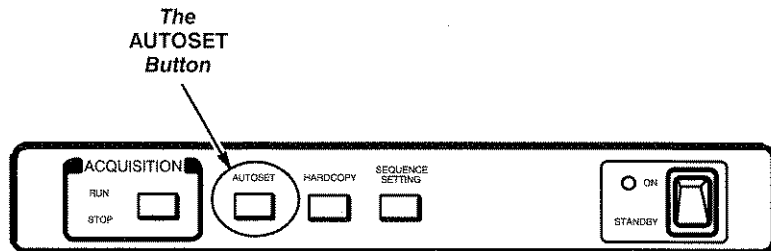

Figure 2-6: AUTOSET Button Location

Step 10: Press the **AUTOSET** button above the sampling heads.

You will see rising edge of the calibrator signal on the display.

Autoset Options

You have used autoset to show the rising edge of the calibrator signal. The **Instrument Options** pop-up menu of the Utility1 major menu controls auto-set operation (see Figure 2-7).

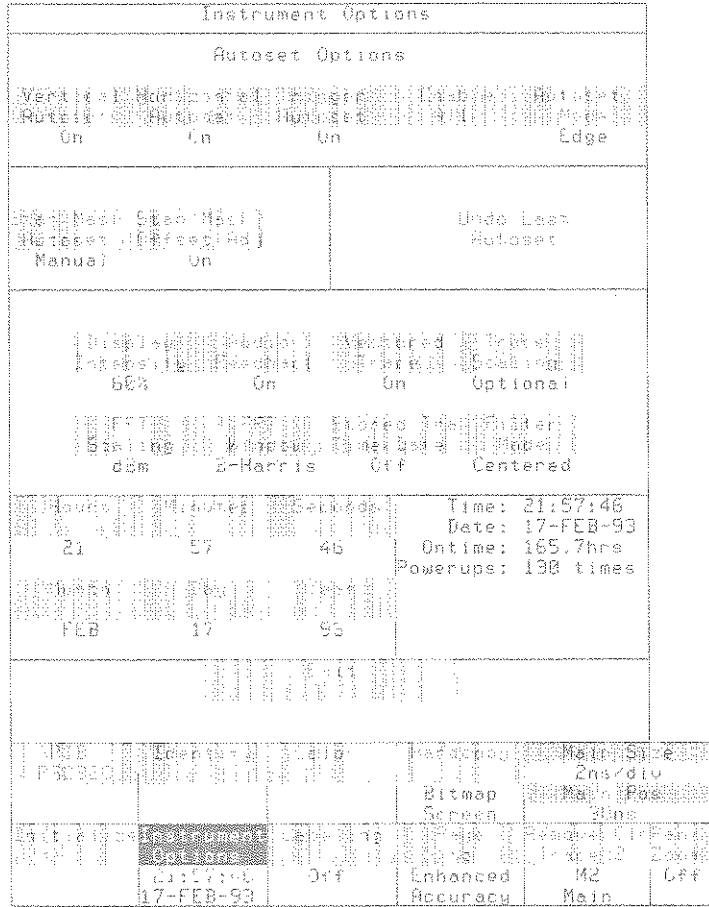

Figure 2-7: The Instrument Options Pop-Up Menu

- Step 11:** Press the **UTILITY** major menu button in the **MENUS** column and touch the **Instrument Options** selector in the major menu. (If you see a different major menu than the Utility1 menu, press the **UTILITY** button again.)

The **Instrument Options** pop-up menu controls autoset with the following groups of selectors:

- Under **Autoset Options** you can turn on or off **Vertical Autoset**, **Horizontal Autoset** and **Trigger Autoset**, which determine whether performing an autoset will alter those types of parameters. If you want to set all three parameters to On, use the **Enable All** selector.
- Under **Autoset Mode** you can select **Period Mode** or **Edge Mode**. Edge mode is the initialized default and displays a single rising edge of the signal. Period mode displays several cycles of the trace.

- The **Stan Mask Autoset** and **Stan Mask Offset Adj** selectors are used in performing autoset to the selected standard mask, during mask testing. Standard mask autoset is discussed in the *Mask Testing* section, beginning on page 3-119.
- The **Undo Last Autoset** selector restores the 11801B to the settings that existed before you pressed the **AUTOSET** button.

You want to display several cycles of the calibrator signal.

- Step 12:** Touch the **Autoset Mode** selector in the pop-up menu (to set autoset to period mode) and press the **AUTOSET** button above the sampling heads.

A display should appear similar to the illustration in Figure 2-8.

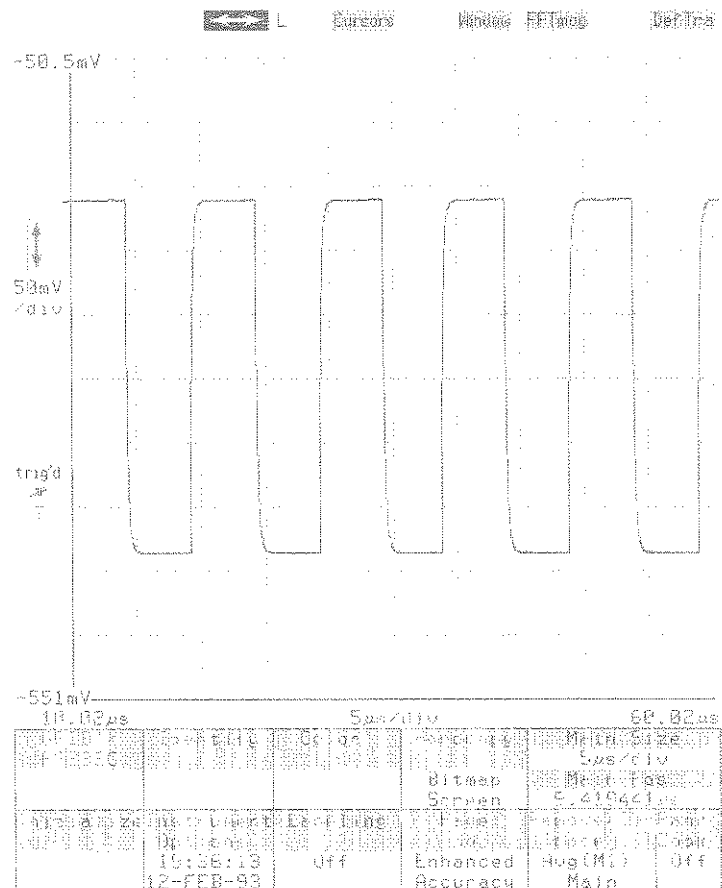

Figure 2-8: The Calibrator Signal After Pressing AUTOSET in Period Mode

The Knobs

There are two control knobs to the right of the display and below the major menu buttons. They adjust different things at different times. You can always look at the Knob menu to see what the knobs will adjust. This is called the current *knob assignment*. The Knob menu appears on the display to the right of the major menu (see Figure 2-9).

The top two selectors of the Knob menu are half-height and always show the current knob assignment. At present they show that the top knob controls the **Main Size** (time per division) parameter, and the bottom knob **Main Pos** (main time base position). The bottom half of each selector shows the current value of that parameter.

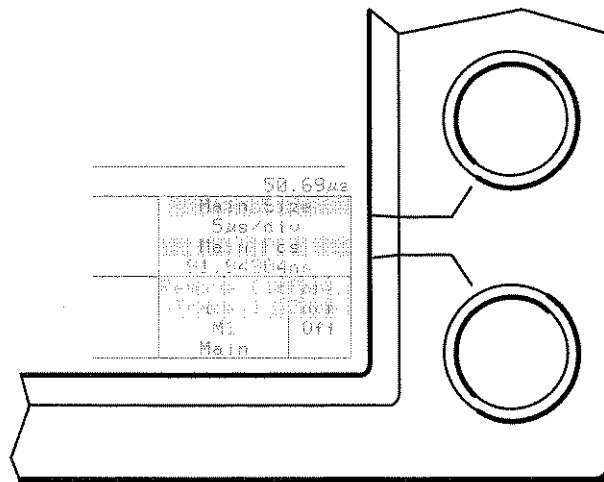

Figure 2-9: The Knobs and the Knob Menu

Selectors may perform specific tasks, or assign the knobs, or do both. Each knob assignment remains in effect until you change it with another selector or a major menu button. Each major menu button “remembers” its current knob assignment, meaning that if you change from one major menu to another, and then return to the previous major menu, the knob assignments will be the assignments that were in effect when the major menu was active last.

NOTE

Always glance at the knob labels before using the knobs.

When you turn the knobs, you will feel clicks instead of smooth motion. Each click represents a minimum change; the 11801B “counts clicks” to measure knob motion. Depending on the value the knobs are assigned to, each click changes the value by some linear increment, a multiplicative factor, or the next number in a 1-2-5 sequence.

- Step 13:** Turn each knob left and right, observing the trace changes. When you are done, restore the trace to its original appearance by turning the knobs or by pressing the **AUTOSET** button above the sampling heads.

Icons

To control the vertical size and offset of a trace, you need to reassign the knobs. You will use an icon to do this.

Above and to the left of the graticule are several icons as shown in Figure 2-10. These icons are always available on the display regardless of which major menu is being shown. The trigger icon (↕), the vertical icon (↕), and the horizontal icon (↔) assign the knobs. Since the current knob assignment is horizontal (main) size and position, the horizontal icon (↔) is highlighted.

NOTE

The trigger icon is presently unselectable because you cannot adjust the internal trigger level.

Touching the vertical icon (↕) changes the knob assignments, as shown in the Knob menu labels. Turning the knobs shows that the vertical characteristics of the trace are altered.

- Step 14:** Touch the ↕ icon and turn each knob left and right. Observe the changes in the trace.

Example 1: Displaying a Trace

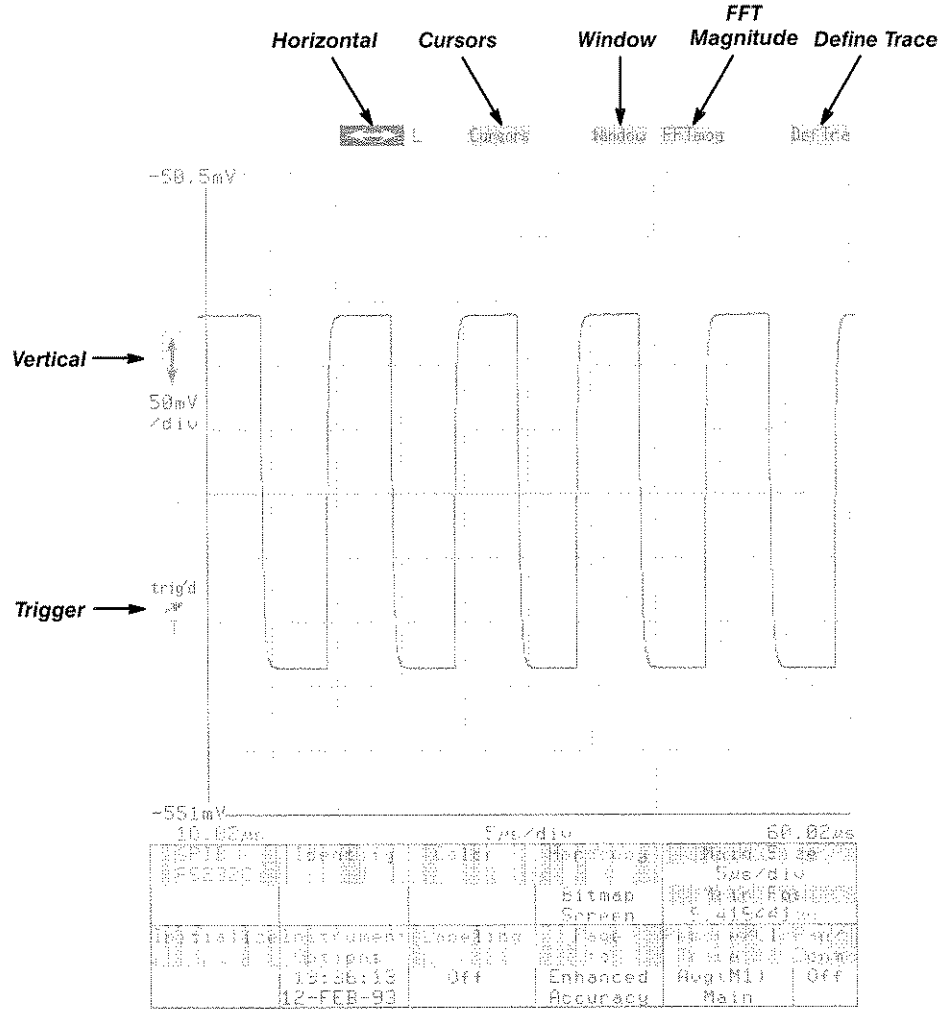

Figure 2-10: Icons

Keypad Pop-Up Menu and Knob Resolution

The knobs can be adjusted to finer or coarser resolution with the Keypad pop-up menu. This menu also allows numeric entry of a parameter assigned to a knob. The Keypad pop-up menu is displayed by touching either knob label selector in the Knob menu (see Figure 2-11).

- Step 15:** Touch the **Vert Offset: M1** knob label selector. (If you connected your signal to a different channel, you may see a different channel number.)

The two selectors across the top of the Keypad pop-up menu allow you to change the knob parameter.

The **Knob Res** section has selectors for **Coarse**, **Medium**, and **Fine** resolution. Vertical offset does not support medium resolution, so that selector is dimmed. The other two selectors show the knob click increment: coarse will set the knob to add or subtract 5 mV for each knob click, while fine sets the knob increment to 500 μ V. The **Coarse** selector is highlighted to show that it is the current selection.

- Step 16:** Touch the **Fine** selector in the pop-up menu, and turn the bottom knob.

Observe that the trace movement is now finer than it was before.

The Keypad pop-up menu can also set a parameter to its minimum or maximum, using the **Set to Min** or **Set to Max** selectors.

NOTE

*Look at the **Set to Min** and **Set to Max** selectors to see the valid range of any parameter.*

- Step 17:** Touch the **Vert Size: M1** knob label. Then touch the **Set to Max** selector in the Keypad pop-up menu.

Vertical size is now the maximum volts per division, producing the smallest height trace possible.

You can directly enter any value you wish using the Keypad pop-up menu.

- Step 18:** Touch the **Vert Size: M1** knob label. Then touch the following selectors: **5 0 m**. Notice the entry line being formed above the **Numeric Entry** label in the pop-up menu. Use **Back Space** to remove incorrect entries. Touch **Enter** to complete entry.

Vertical size is now set to 50 mV per division.

Example 1: Displaying a Trace

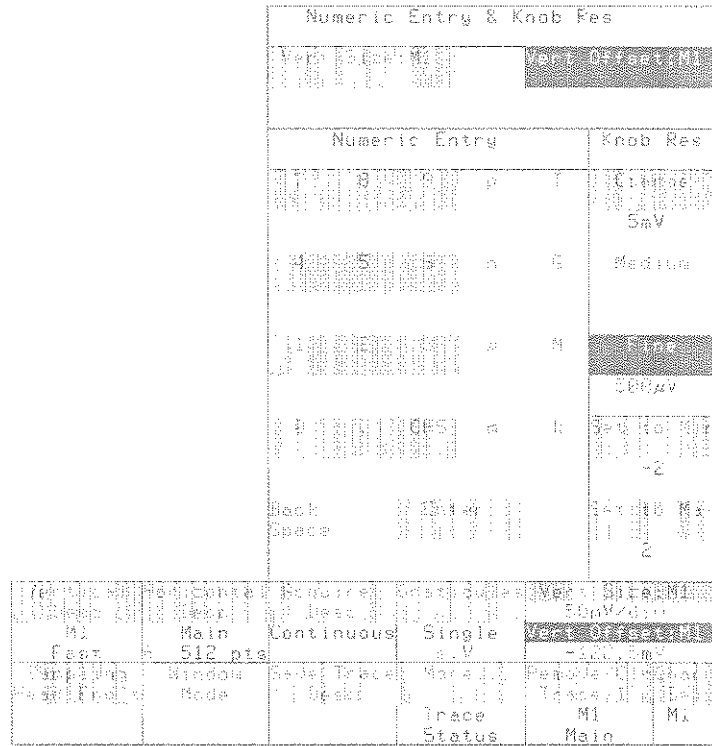

Figure 2-11: The Knob Menu and Keypad Pop-Up Menu

Major Menu Knob Assignments

Each major menu assigns the knobs to different parameters. Whenever you select a major menu, the knob assignments will be the assignments that were in effect when that major menu was active last.

For example, you have the Trigger major menu selected. The current knob assignments are **Vert Size: M1** and **Vert Offset: M1** (you may be using a different channel number).

NOTE

Major menu buttons perform knob assignments.

- Step 19:** Press the **WAVEFORM** major menu button in the **MENUS** column.

The knob assignment changes to **Main Size** and **Main Pos**, because that was the last assignment made using the Waveform major menu.

Example 1: Displaying a Trace



Example 2: Managing Multiple Traces

This example demonstrates multiple traces and graticules on the display. It also shows how to select and manage multiple traces.

For this example you will need an 11801B with at least one sampling head installed, two SMA cables, and a static protection wrist strap.

- Step 1:** Press the **UTILITY** major menu button in the **MENUS** column, touch the **Initialize** selector in the major menu, and touch **Initialize** in the pop-up menu.
- Step 2:** Put on the wrist strap and ensure that it is connected to the antistatic connector on the front panel of the 11801B.
- Step 3:** Connect the **CALIBRATOR** output to any sampling head input.
- Step 4:** Connect the **INTERNAL CLOCK** output to any available sampling head input.

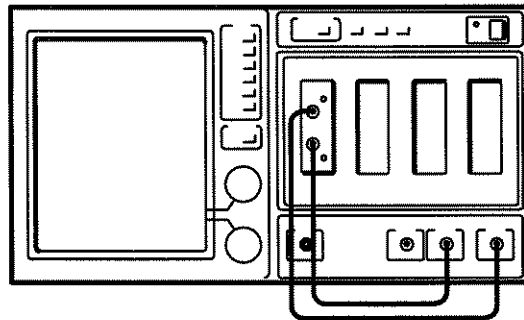

Figure 2-12: Connections for Example 2

Display the trace coming from the calibrator.

- Step 5:** Press the **SELECT CHANNEL** button of the channel you have the **CALIBRATOR** output connected to.

You will need to set the trigger source to Internal in order to display the calibrator signal.

- Step 6:** Press the **TRIGGER** button to display the Trigger major menu.
- Step 7:** Touch the **Source** selector in the major menu area, and select **Internal Clock** in the **Source** pop-up menu. Select **Exit** to remove the pop-up menu.

Example 2: Managing Multiple Traces

Step 8: Press the **UTILITY** button to display the Utility major menu. Touch the **Instrument Options** selector in the major menu area, and select **Autoset Mode** in the pop-up menu to select **Period** as the auto-set mode. Touch **Exit** to remove the pop-up menu.

Step 9: Press the **AUTOSET** button (above the sampling heads).

You should see several cycles of the calibrator signal on the display, as shown in Figure 2-13.

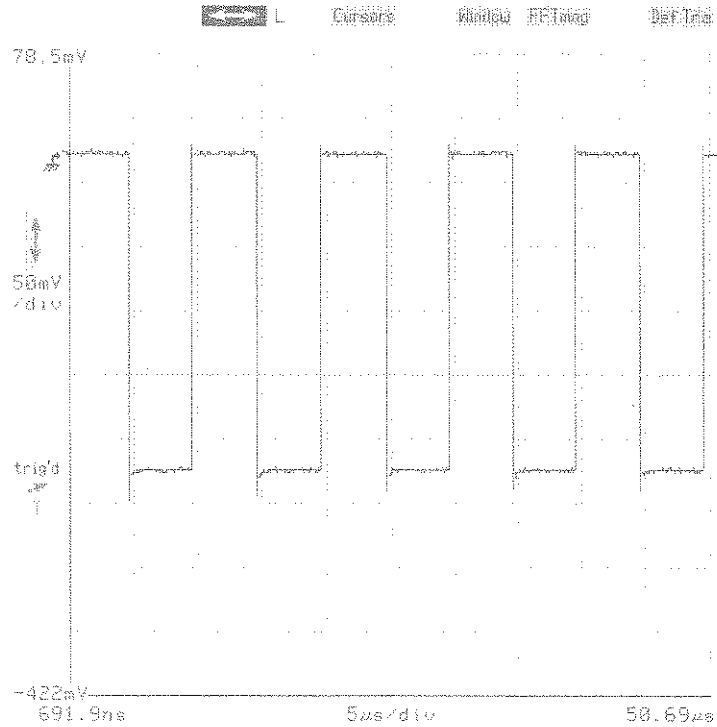

Figure 2-13: The Acquired Calibrator Signal

Adding Another Trace

Adding another trace to an existing display is easy: press the **SELECT CHANNEL** button of the sampling head channel you wish to add.

- Step 10:** Press the sampling head channel button of the signal from the **INTERNAL CLOCK** output.

You should be aware of several important points about this display (see Figure 2-14).

- Both traces share the same time base, and so both traces display the same span of time. The horizontal axis labels apply to both traces. This may not hold true for the vertical axis.
- While the 11801B can display up to 8 traces at once, there is always one *selected* trace. The selected appears brighter than other traces. Most menu selectors, the knobs, the status displays, and autoset all operate on the selected trace. The 11801B can display four different colors, so that when up to four traces are displayed, each trace is displayed in a different color. If greater than four traces are displayed, additional traces are displayed in the same colors used for the first four traces.
- The graticule axes and the axis labels are the same color as the selected trace.
- The channel lights on the sampling head are lighted to show that both channels are being displayed. The light for the selected trace blinks.

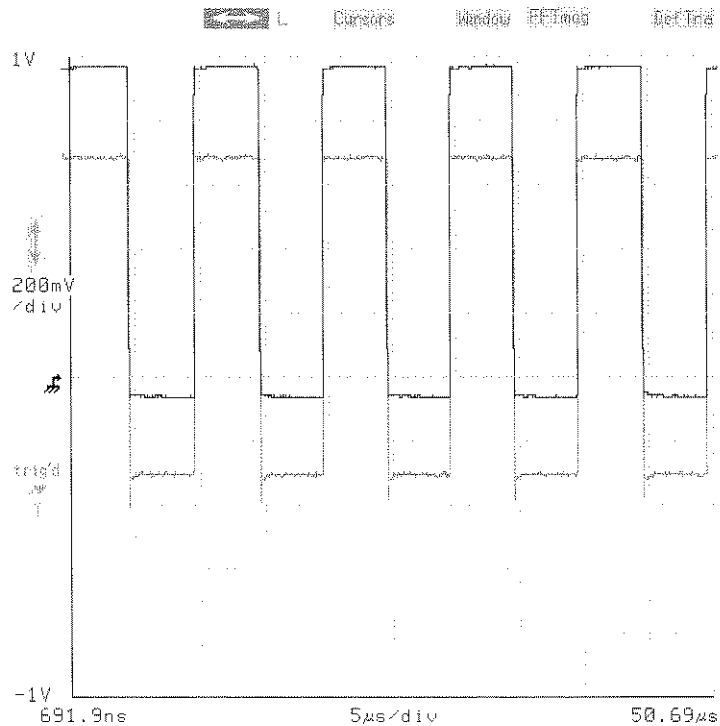

Figure 2-14: Graticule with Two Traces

Selecting Traces by Touch

To select a different trace simply touch the desired trace. An outline box indicates your potential selection. If only one trace passes through that outlined area when you withdraw your finger, it will become the selected trace. If several traces pass through the outlined area, repeatedly touching the same area will select successive traces.

- Step 11:** Touch the traces to change selections. Try touching an area with one trace, and an area where both appear together.

The Waveform major menu shows status of the selected trace (see Figure 2-15). The **Vertical Desc** selector shows the trace expression of the selected trace.

- Step 12:** Press the **WAVEFORM** major menu button in the **MENUS** column and observe (don't touch) the **Vertical Desc** selector.

If the selected trace displays mainframe channel 1 then the **Vertical Desc** selector will show **M1**. (**Fast** is a trace parameter that is described in Example 3.) Channels can be combined in a single trace, for example M1+M3, as you will see in Example 3.

The **Remove/Clr Trace n** selector of the Knob menu also shows the expression of the selected trace. (It also indicates that the Main time base is used.)

M1	Main	Continuous	Single	M1
Fast	@ 512 pts			
Window	Mode			
			Trace Status	M1 Off

Figure 2-15: The Waveform Major Menu with the Knob Menu

The number **n** in the **Remove/Clr Trace n** selector is the trace number assigned by the 11801B when the trace is created. It should not be confused with the trace expression. Trace numbers range from 1 through 8. This selector always shows the number of the selected trace.

- Step 13:** Select each trace by touch, and observe the **Vertical Desc** and **Remove/Clr Trace n** selectors and the sampling head lights.

Selecting Traces Using the Trace Status Menu

Another method of selecting traces presents information about all displayed traces simultaneously. The Waveform major menu has an alternate “Trace Status” menu as shown in Figure 2-16. The **WAVEFORM** button is lit when either alternative is displayed. The **More...** selector of the standard Waveform major menu displays this alternate.

- Step 14:** Touch the **More...** selector in the major menu to see the Trace Status menu.



Figure 2-16: The Trace Status Menu

The Trace Status menu has a **Return to Single Trace** selector to return you to the normal Waveform major menu — or just press the **WAVEFORM** major menu button.

The Trace Status menu presents one selector for each displayed trace. These selectors show status information about the trace they represent. The selector for the selected trace is highlighted. You can make any trace the selected trace by touching its selector. This highlights the new trace and the representative selector in the Trace Status Menu.

- Step 15:** Touch the trace selector that is not highlighted. Notice that it becomes highlighted and that its trace is brightened on the graticule.
- Step 16:** Return to the normal Waveform major menu, either by touching the **Return to Single Trace** selector in the major menu or by pressing the **WAVEFORM** major menu button in the **MENUS** column.

Labeling Traces

You can label traces to help you keep track of them. You can specify a label of up to 10 characters for each trace, and you can have these labels displayed with the traces on the graticule. You can use letters of the alphabet (upper or lower case), Greek symbols, graphic symbols or numbers in your label. The trace label moves with the trace as the signal changes. You can change the position of the label relative to the trace. Use the **Labeling** pop-up menu in the Utility1 major menu to control labels (see Figure 2-17).

Step 17: Press the **UTILITY** button to display the Utility1 major menu.

Step 18: Touch the **Labeling** selector in the Utility1 major menu.

The **Display** selector in the **Labeling** pop-up menu turns on or off the display of all trace labels. Display is currently turned off.

Step 19: Touch the **Display** selector to turn display of trace labels on.

Step 20: If it is not already highlighted, touch the **Displayed Traces** selector.

There is a selector for each displayed trace. Each selector shows a trace number, the trace expression, and the time base for that trace.

Step 21: Touch the selector for **Trace 1**.

The lower portion of this pop-up menu displays selectors that let you type the label. The selectors along the very bottom let you select the set of characters from: **Upper Case**, **Lower Case**, **Numbers** (which includes most punctuation), **Graphics** (mathematical symbols and more), **Greek** (the Greek alphabet), and **Other** (characters from non-English alphabets). **Back Space** lets you correct errors. **Exit** removes the pop-up menu.

Step 22: Use the keyboard selectors to type in your own label, for example **CAL**.

Step 23: Touch the selector for **Trace 2**. Type in a label as you did for the first trace. Finish by touching the **Exit** selector.

Once a label is established, it moves with the trace. You can control the position of the label relative to the trace. The **Position** selector in the **Labeling** pop-up menu to assigns the knobs to set the position of the label.

Trace labels will always stay on the graticule. If the position or the movement of the trace would take a label off the display, the edge of the graticule limits the movement of the label.

Step 24: Touch the **Labeling** selector in the major menu area, and touch the **Position** selector in the pop-up menu.

Step 25: Use the knobs to position the labels horizontally and vertically. To select the label to move, simply touch it as you would touch a trace to select it.

Note that each label is the color of its associated trace. When you touch a label, you select that trace.

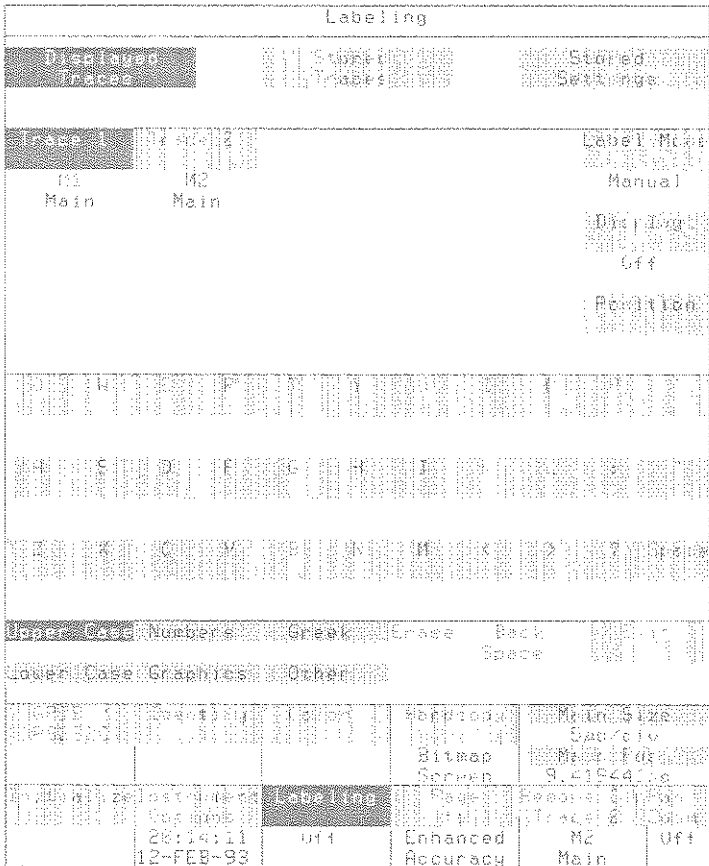

Figure 2-17: The Labeling Pop-Up Menu

Displaying Dual Graticules

The **Graticules** selector can create a dual-graticule display (see Figure 2-19). You can place traces on either graticule.

- Step 26:** Press the **WAVEFORM** button to display the Waveform major menu.
- Step 27:** Touch the **Graticules** selector in the major menu, and touch **Create Second Graticule** in the pop-up menu (see Figure 2-18).

The selected trace appears on the graticule with the horizontal (↔) and vertical (↑↓) icons; this is called the active graticule. If you select a trace on the other graticule, it will make that graticule the active graticule.

- Step 28:** Touch the **Lower Graticule** selector of the major menu (it was **Graticules**). Touch **Move Trace to Other Graticule**, and observe the selected trace move to the other graticule.
- Step 29:** Touch the **Upper Graticule** selector of the major menu (it was **Lower Graticule**). Touch **Reduce to One Graticule**.

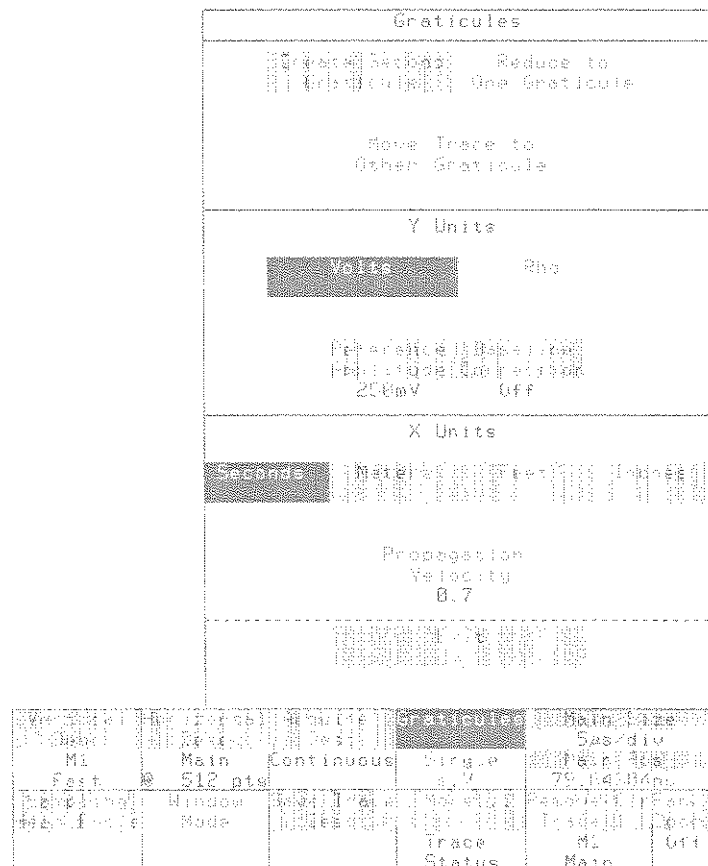

Figure 2-18: The Graticules Pop-Up Menu

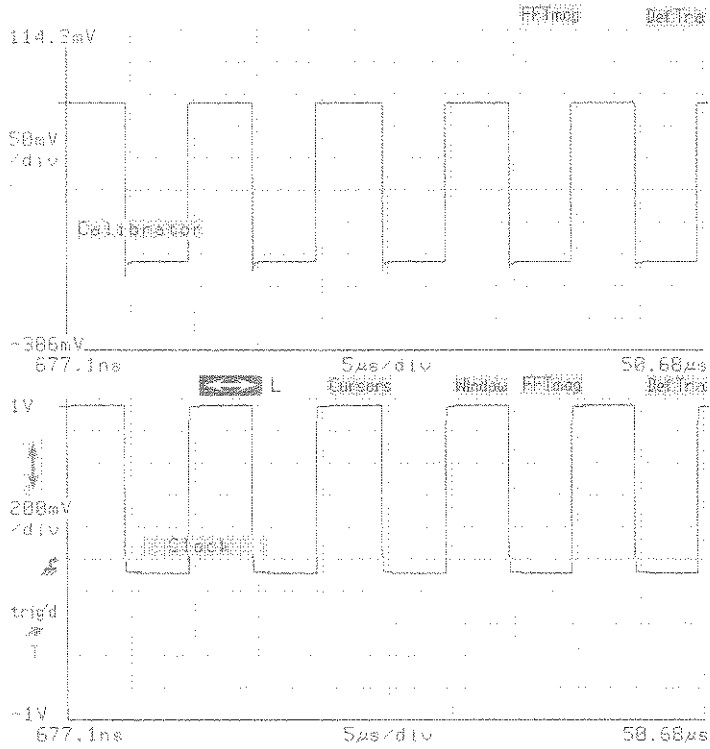

Figure 2-19: A Dual-Graticule Display

Removing Traces

- Step 30:** Below the knob labels, touch the **Remove/Clr Trace n** selector, and then **Remove Trace n** in the pop-up menu.

This will remove one of your traces, leaving one on the display. You could remove the remaining trace with **Remove/Clr Trace n** again. Since the trace is already selected, it can also be removed by pressing the **SELECT CHANNEL** button on the sampling head.

The sampling head channel light can have three states: off (channel not displayed), on steady (channel displayed only on non-selected traces), or blinking (the selected trace displays this channel). The operation of the channel button depends on the light:

- If the yellow light is off (channel not displayed), pressing the button creates a trace of that channel.
 - If the yellow light is on steady (channel displayed but not part of the selected trace) then pressing the button selects that trace, causing the light to blink.
 - If the yellow light is blinking (channel is part of the selected trace), pressing the button will entirely remove *all* traces displaying that channel.
- Step 31:** Press the sampling head **SELECT CHANNEL** button beside the blinking light to remove the remaining trace.

Example 3: Defining Complex Traces

This example shows how you can create traces that combine signals from more than one channel.

For this example you will need a 11801B with at least one dual-channel sampling head installed. Also, a power divider and two SMA cables of different length will be used (2 ns and 5 ns cables are recommended). You may substitute a signal-splitting T adapter for the power divider. You will also need a static protection wrist strap.

- Step 1:** Initialize the 11801B (press the **UTILITY** button in the **MENUS** column, touch **Initialize** in the major menu, and touch **Initialize** in the verification pop-up menu).
- Step 2:** Put on the wrist strap and ensure that it is connected to the antistatic connector on the front panel of the 11801B.
- Step 3:** Attach the power divider to the **CALIBRATOR** output connector of the 11801B.
- Step 4:** Connect cables from each branch of the power divider to sampling head input connectors.

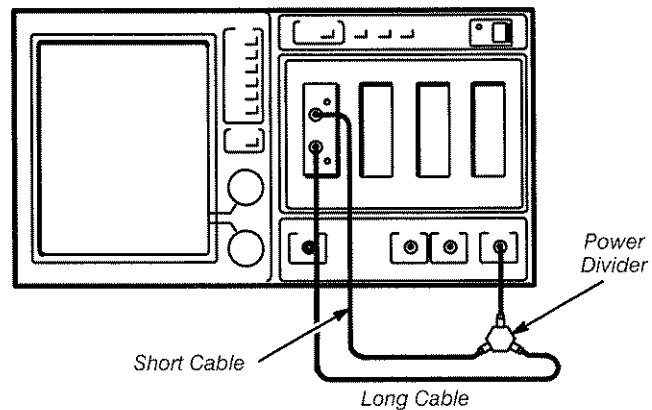

Figure 2-20: Connections for Example 3

- Step 5:** Press the **TRIGGER** button in the **MENUS** column, and touch **Source** in the major menu and **Internal Clock** in the pop-up menu. Touch **Exit** to remove the menu.
- Step 6:** Press the **SELECT CHANNEL** button on each channel that you have connected the calibrator signal to.

Example 3: Defining Complex Traces

- Step 7:** Turn the top knob to the left until the horizontal scale is 5 ns/div.
*Don't use the **AUTOSET** button!*

You should see the calibrator trace on the display twice. Because of the different lengths of the cables you are using, the edges of these traces will be separated by 3 ns.

Trace Expressions

You can display a trace that represents the difference between the two signals. Up to now, you have pressed the sampling head channel button to display a trace. This is a short-cut method limited to single-channel traces.

The **DefTra** icon creates new traces. It is located above each graticule's upper right corner. Touching the icon displays a pop-up menu that covers the full display. The same pop-up menu is presented by the **Vertical Desc** selector of the Waveform major menu. The menu selector allows you to view and change the expression of an existing trace, while the **DefTra** icon creates a new trace.

NOTE

*The **Vertical Desc** selector and the **DefTra** icon operate differently, though they both display the same pop-up menu.*

Step 8: Touch the **DefTra** icon.

The selectors in this pop-up menu are keystrokes that you use to build a trace expression (see Figure 2-21). As you enter keystrokes, the expression is shown at the top of the menu. These selectors are available:

- **Channel Selectors** specify an input channel.

NOTE

You don't need to display the source traces to create a complex trace.

- **Numeric Keypad** allows entry of numeric constants and arithmetic operators of addition, subtraction, multiplication, and division.
- **Trace Functions** specify functions such as logarithms, differentiation, and averaging.
- **Stored Traces** specify a previously stored trace.
- **Syntax** includes parentheses, **Back Space** (which can be used for successive entries), and **Enter Desc** (which enters your completed expression, removes the pop-up menu, and creates the trace). **Cancel** removes the pop-up without defining a trace.

Now you can enter a difference expression **M1 – M2**. (If you are using different channels you will use different numbers. This example uses M1 for the channel the short cable is connected to.)

- #### Step 9: Touch **Mainframe**, then **1** (under **Mainframe** in the numeric keypad area), **– Mainframe**, **2** (under **Mainframe** in the numeric keypad area), and **Enter Desc**, all in the pop-up menu.

Example 3: Defining Complex Traces

The difference trace is created. Notice that on the sampling heads, both of the yellow lights for the source channels are blinking, indicating that both channels are represented in the selected trace.

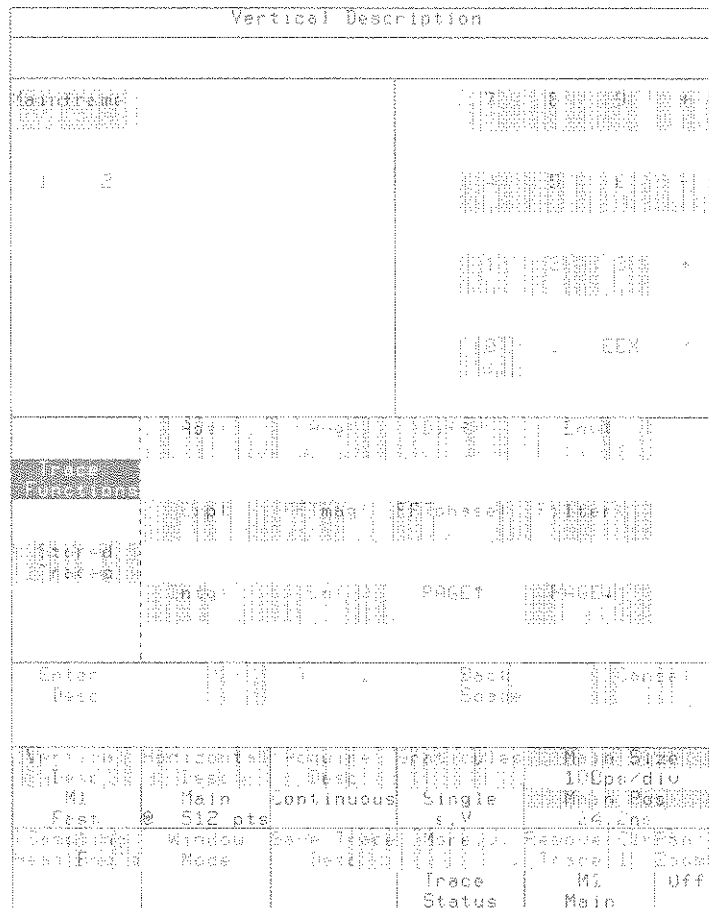

Figure 2-21: The DefTra Pop-Up Menu

Vertical Adjustment of Complex Traces

You can change the vertical size and offset of only one input channel at a time, even if the selected trace represents several inputs.

- Step 10:** Make the selected trace the single-source trace from the short cable. Select this trace by touching it. Check the **Vertical Desc** selector to see that **M1** is the trace description. If necessary, touch the same area again to select the right trace.
- Step 11:** Touch the vertical icon (↓). The knobs are set to Vertical Size and Offset of the channel indicated in the knob labels, which is also the channel of the selected trace.
- Step 12:** Turn the top knob right to set the vertical scale to 100 mV/div. Turn the bottom knob to the left to move a *part* of the trace off the graticule.

The selected trace will change to be twice as high. The difference trace will also change, becoming quite ragged (see Figure 2-22).

This aberration is caused by a component signal being off the graticule. The selected trace is off the bottom edge of the display, and this means that the complex trace that depends on it is affected as well.

- Step 13:** Turn the bottom knob to the right until the selected trace is completely on the graticule. You will see the “noise” disappear from the difference trace.
- Step 14:** Continue to move the trace up to the top half of the display and observe that as it moves, the difference trace moves up as well.

NOTE

Unless all component traces have the same vertical size, a “Fast” complex trace will have undefined vertical units. (High Precision traces don't have this limitation.)

- Step 15:** Turn the top knob to the left to return the selected trace to its original size of 200 mV/div.

Example 3: Defining Complex Traces

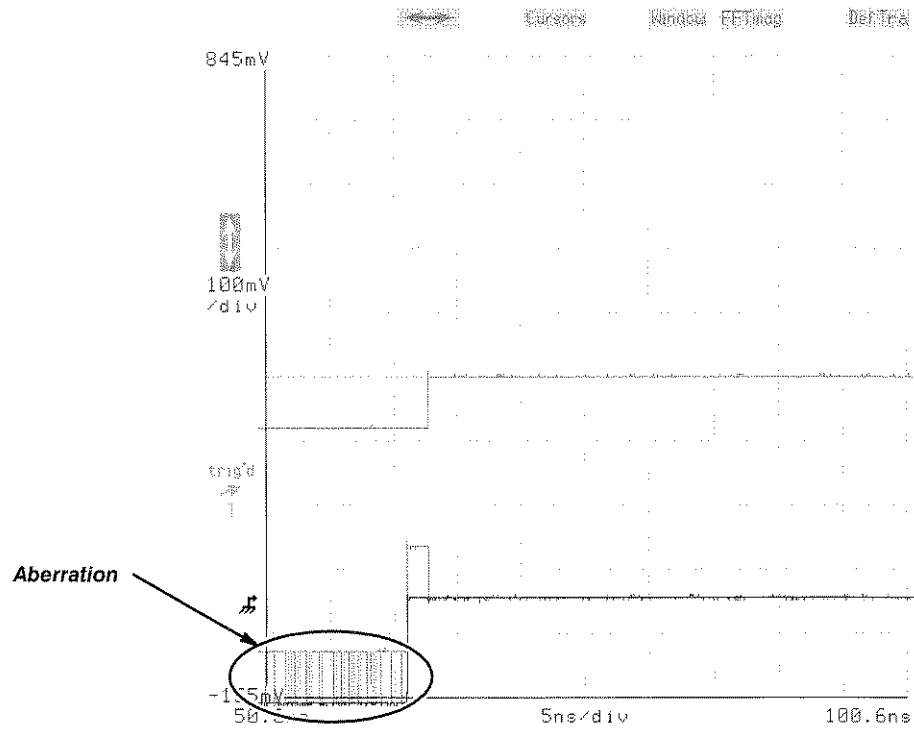

Figure 2-22: Complex Trace Aberration Caused by Off-Graticule Component

In the last few steps, you have moved the complex trace by selecting and moving one of the component traces. Since you have the component traces on the display this is easy to do. Usually, when you display a complex trace, you will not be displaying all the traces that represent the individual channel signals.

You can select this complex trace and move it with the knobs. However, when you do this you are actually moving only one component input channel of the complex trace.

Whenever the knobs are set to vertical size and offset, the Knob menu selector at the lower right corner of the display becomes a **Chan Sel** selector (see Figure 2-23). Touch this selector to choose which channel you wish to move. Repeatedly touching the selector lets you choose from all of the input channels that make up the complex trace.

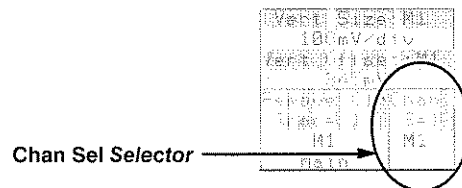

Figure 2-23: The Chan Sel Selector in the Knob Menu

- Step 16:** Touch the difference trace to make it the selected trace.
- Step 17:** Observe the **Chan Sel** selector in the Knob menu, and then turn the top knob to the right to set the vertical size to 100 mV/div. You may need to turn the bottom knob to position the trace completely on the graticule.
- Step 18:** Touch **Chan Sel** in the Knob menu to select the other input channel. Observe that the knob labels reflect the channel change.
- Step 19:** Turn the top knob to the right to set the vertical size to 100 mV/div. You may need to turn the bottom knob to position the trace completely on the graticule.

Now the input channel traces and the complex difference trace are double their original size.

High Precision Traces

If your complex trace is a *high precision* trace, you can move it vertically using the knobs without changing the offset of any component channel. High precision traces are calculated using floating-point arithmetic. The complex trace you have created and moved in this example is not a high precision trace; this is indicated by the notation of **Fast** in the **Vertical Desc** selector. High precision traces will show **High Prec** in the **Vertical Desc** selector.

You can specify that all traces you create in the future will be high precision traces: Press the **UTILITY** button, and touch the **Instrument Options** selector. In the pop-up menu, touch the **Trace Scaling** selector until it shows **Forced**. This does not affect any trace already on the screen, but will cause all traces you create in the future to be high precision traces. For this example, leave **Trace Scaling** set to **Optional**.

The remainder of this example will be clearer without multiple traces on the display.

- Step 20:** Select and remove each of the simple traces that represent a single input channel. Use the **Remove/Clr Trace n** selector of the Knob menu.

Windows

A window is a trace that represents a horizontally magnified portion of another trace. A window trace is sampled separately from the main trace it is magnifying. Windows are created by touching the **Window** icon above the graticule.

Step 21: Touch the **Window** icon.

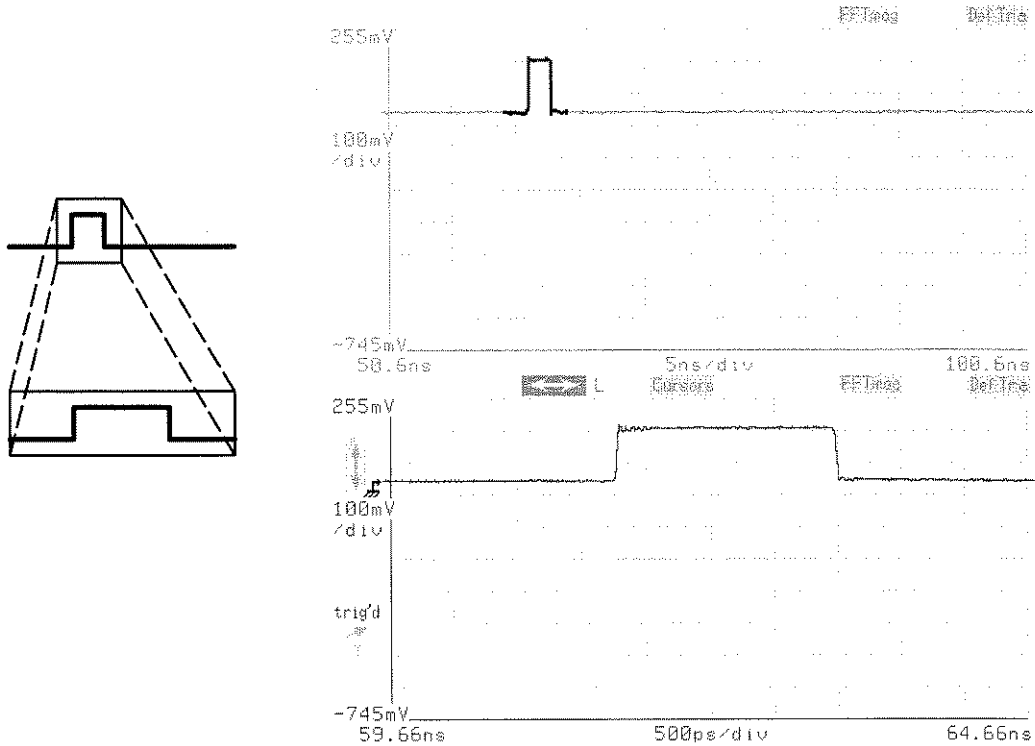

Figure 2-24: A Window Trace Display

The 11801B automatically added a second graticule with the window trace. The main trace was placed on the top graticule, and its highlighted portion shows what the window trace is displaying (see Figure 2-24).

NOTE

Window traces can be moved from one graticule to another, or combined into a single graticule display.

In Example 2, when you created a dual-graticule display, both traces shared the same time base. Here the two traces have different horizontal measures because they represent different views of time. This can be seen in the graticule labels and the trace descriptions presented in the alternate Trace Status major menu.

Example 3: Defining Complex Traces

- Step 22:** Touch the **WAVEFORM** button and then touch the **More...** selector in the major menu.

The original trace is on the Main time base, while the currently selected window trace is on a window time base.

- Step 23:** Touch the horizontal icon (↔), and turn the bottom **Window Pos** knob left and right. The highlighted portion of the main trace moves and the window trace tracks it.
- Step 24:** Turn the top **Window Size** knob left and right one click at a time. The size of the highlighted area changes and the window trace reflects that change.

You can add another window trace that is based on the original main trace, but you cannot take a window of a window. Since the window trace is the selected one there is no **Window** icon above the lower graticule.

- Step 25:** Touch the main trace to select it, and then touch the **Window** icon on that graticule.

A second window trace is created, and shares the lower graticule with the original window trace. Two highlighted segments appear on the main trace. This new window is on its own window time base.

- Step 26:** Turn the bottom **Window Pos** knob. The second window trace moves.
- Step 27:** Turn the top **Window Size** knob. This knob changes the size of both windows.

The two window traces are placed on top of each other. You can separate them vertically. Normally, the **Chan Sel** selector of the Knob menu (see Figure 2-25), on successive touching, shows all the channels that are represented in the trace. For window traces, this selector also includes a **Trace Sep** setting, which causes the knobs to move the selected window trace vertically. This moves only the selected trace.

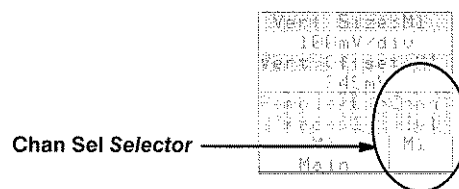

Figure 2-25: The Chan Sel Selector in the Knob Menu

- Step 28:** Touch the vertical icon (↑↓), and the **Chan Sel** selector in the Knob menu until it displays **Trace Sep**.
- Step 29:** Turn either knob and observe the selected window trace move up or down.

Horizontal Reference Point

Up to now, whenever you have changed the horizontal size of a trace, the left edge remained in place, and magnification occurred around it. You can change the anchor point of a trace to either the center or the right edge by using the **Horizontal Desc** pop-up menu.

- Step 30:** Select the main trace (top graticule) by touching it. Touch the horizontal icon (↔), and use the bottom knob to position a critical portion of your trace at the center of the graticule. Turn the top knob left and right one click at a time, and observe that the critical part moves. End by re-establishing the original position with the critical portion of the trace centered.
- Step 31:** Press the **WAVEFORM** button in the **MENUS** column, touch **Horizontal Desc** in the major menu and **Center** in the pop-up menu. Turn the top knob left one click at a time. Observe that the critical center part of the trace remains stationary.

Note that the **L** next to the horizontal icon changes to **C** to remind you that the reference point is the center of the screen.

Example 3: Defining Complex Traces



Example 4: Using Signal Processing

This example shows how you can process your signals to get the most information from the available data.

You will simulate a noisy signal by examining part of the calibrator signal at very fine horizontal (time per division) and vertical (volts per division) settings.

NOTE

The amount of noise you see in this example will depend on the sampling head you have installed.

For this example you will need an 11801B with at least one sampling head installed, one SMA cable, and one static protection wrist strap.

- Step 1:** Initialize the 11801B (press the **UTILITY** button in the **MENUS** column, touch **Initialize** in the major menu, and touch **Initialize** in the verification pop-up menu).
- Step 2:** Put on the wrist strap and ensure that it is connected to the antistatic connector on the front panel of the 11801B.
- Step 3:** Connect the **CALIBRATOR** output to any sampling head input.

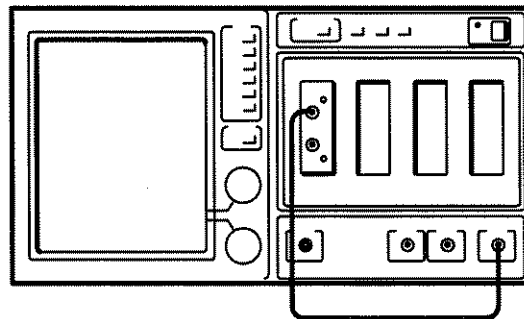

Figure 2-26: Connections for Example 4

- Step 4:** Press the **SELECT CHANNEL** button nearest the sampling head input you have connected to the calibrator.
- Step 5:** Press the **TRIGGER** button in the **MENUS** column, touch **Source** in the major menu and **Internal Clock** in the pop-up menu. Touch **Exit** to remove the pop-up menu.

Example 4: Using Signal Processing

- Step 6:** Turn the top knob to the right until the horizontal scale is 1 ps/div.

By turning off horizontal autoset, you can use the **AUTOSET** button to display a portion of the trace at this horizontal setting.

- Step 7:** Press **UTILITY** and touch **Instrument Options**. Touch **Horizontal AutoSet** until the selector shows Off and touch **Exit**.
- Step 8:** Press the **AUTOSET** button. The display should appear as shown in Figure 2-27.

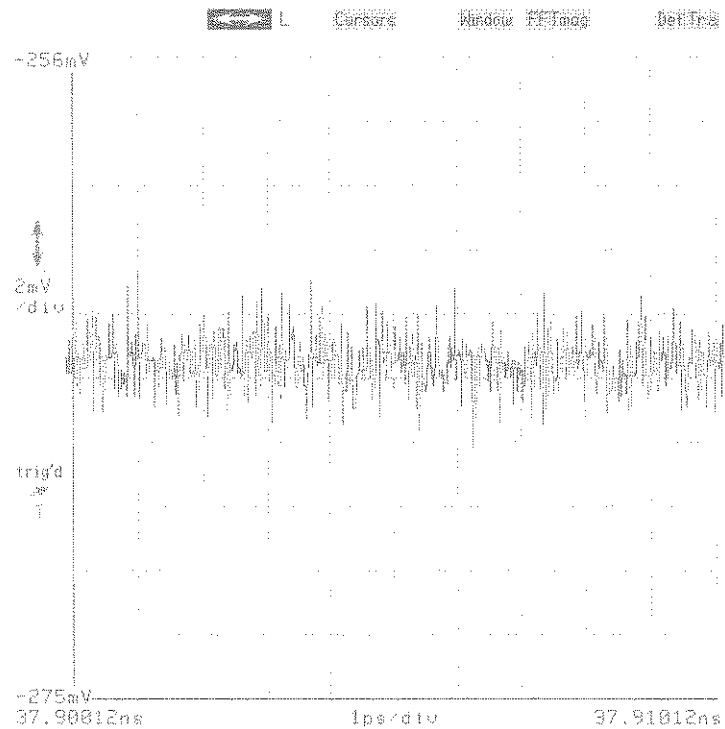

Figure 2-27: A Horizontally and Vertically Expanded Portion of the Calibrator Signal

Averaging and Enveloping

An averaged trace is one where several trace records (successive trace acquisitions) are combined. Each displayed point of the resulting trace is an average of all the same points in the individual records. This can reduce the noise of the trace and increase vertical resolution.

Enveloping is similar in that several trace records are collected. Instead of a single-point average, the envelope displays the maximum and minimum excursion of the samples. This shows the accumulated variation of the signal.

The **DefTra** pop-up menu has **Avg(** and **Env(** selectors. Typically, an averaged trace expression:

Avg(M1)

would be entered with the selectors:

DefTra Avg(Mainframe 1)
Enter Desc

A short-cut is available to apply averaging or enveloping to an existing trace expression. The Waveform major menu's **Acquire Desc** pop-up menu provides **Average N** and **Envelope N** selectors to set these functions on and off (see Figure 2-28).

- Step 9:** Press the **WAVEFORM** major menu button in the **MENUS** column and touch **Acquire Desc** in the major menu.
- Step 10:** Touch the **Average N** selector in the pop-up menu, then touch **Exit** to remove the pop-up menu.

The averaged trace appears less noisy. While the individual traces are being acquired, the current record number is displayed in the **Acquire Desc** selector. The trace expression, shown in the **Vertical Desc** selector, is **Avg(M1)**, showing that averaging has been added to your earlier expression.

You can change the number of records in an average from the default of 32 that was set by the initialization.

- Step 11:** Touch **Acquire Desc** in the major menu and **Set AvgN** in the pop-up menu. Adjust the top knob to change the average count.

Each time you click the knob, a new average begins. If you wish the 11801B to stop acquiring data after the required number of samples, you can use the **Average Complete** selector in the section **Stop Acquisition On**.

- Step 12:** Touch **Acquire Desc** in the major menu and select **Average Complete** in the pop-up menu.

The 11801B stops acquiring data when the average is complete, leaving a stable display (see Figure 2-29).

Example 4: Using Signal Processing

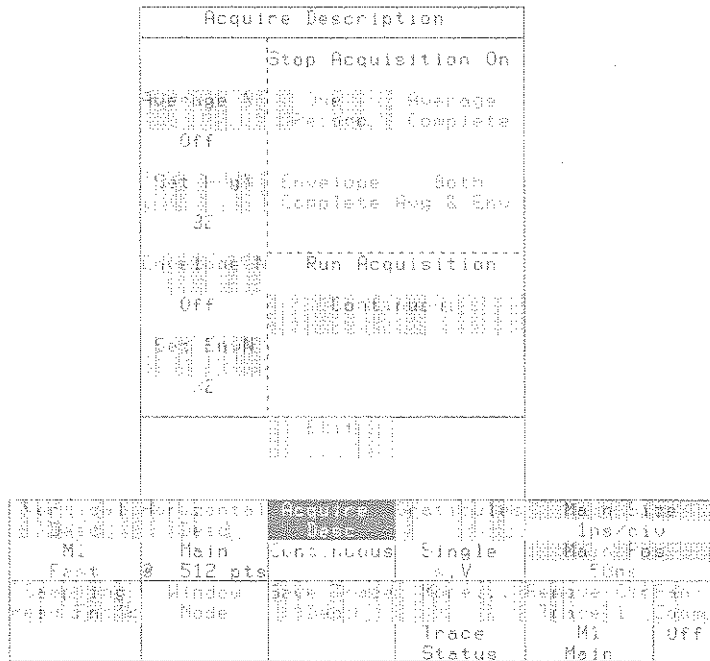

Figure 2-28: The Acquire Desc Pop-Up Menu

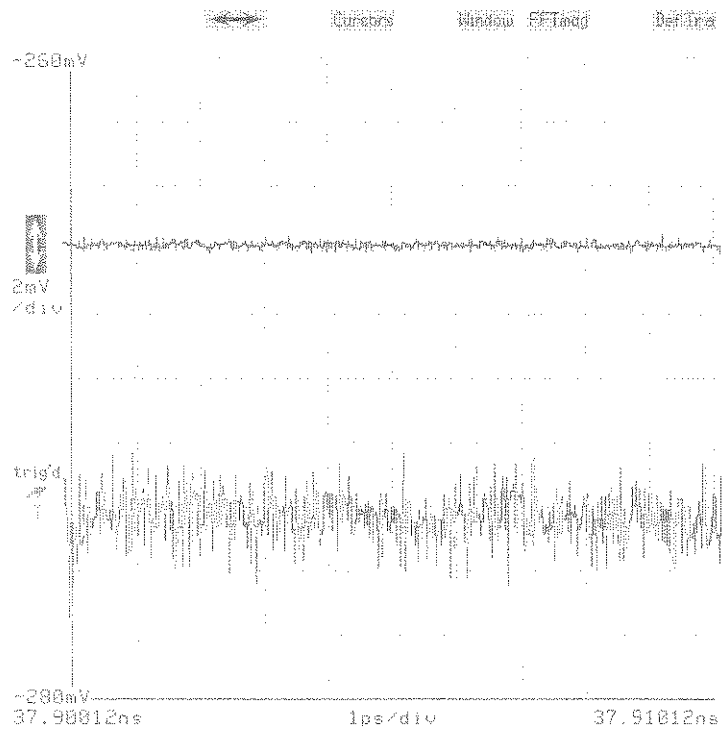

Figure 2-29: Averaged and Normal Traces

- **Step 13:** Touch **Acquire Desc** in the major menu and **Average N** in the pop-up menu, to turn off averaging. Notice that the trace expression in the **Vertical Desc** selector has removed the average function specification.

This is an example of averaging. Enveloping is done similarly, using **Envelope N**, **Set EnvN**, and **Envelope Complete** selectors.

Both averaging and enveloping can be done simultaneously. To do both, you must enter the trace expression from the **DefTra** or **Vertical Desc** pop-up menus. No shortcut is available from the **Acquire Desc** pop-up menu.

Variable Persistence

Another method of observing trace noise is using variable persistence, available through the Display Modes major menu. This leaves earlier trace data on the display for a specified period of time as new data values are added, building a recent history of displayed trace points.

- Step 14:** Press the **DISPLAY MODES** button in the **MENUS** column to display the Display Modes major menu. Select **Persist/Histograms** in the major menu area (see Figure 2-30).
- Step 15:** Select **Variable** in the pop-up menu and select **Exit** to remove the pop-up menu.

The **Infinite** selector in the **Persist/Histograms** pop-up menu selects infinite persistence, a display mode in which trace data remains on the display as new values are added, building a history of all displayed trace points.

Color grading enables you to visually distinguish the relative density of trace data on the display. As trace data values are accumulated, areas where more trace record points fall are displayed in a different color from areas where fewer points occur.

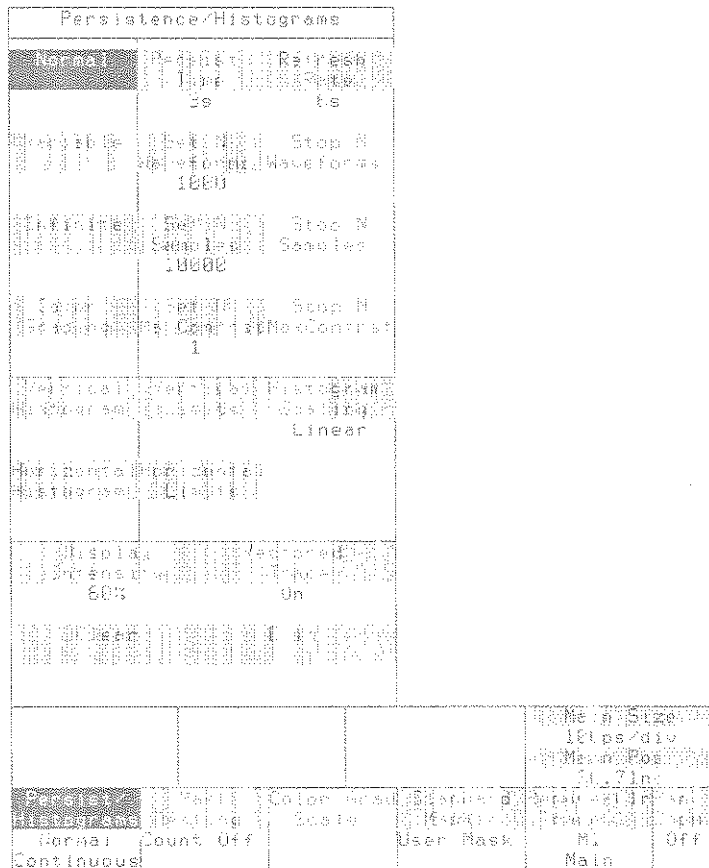

Figure 2-30: The Persist/Histograms Pop-Up Menu

- Step 16:** Select **Persist/Histograms** in the major menu and select **Color Grading** in the pop-up menu. Select **Exit** to remove the pop-up menu. After waiting a few seconds for a sufficient amount of data to be acquired, observe the colored regions of the trace. On the major menu, you can select **Color Grad Scale** to see how colors are assigned to regions of the histogram. Select **Exit** to remove the pop-up menu.
- Step 17:** Select **Persist/Histograms** again and select **Normal** to return to the normal trace display. Select **Exit** to remove the pop-up menu.

Smoothing

Some sampling heads, including the SD-24, provide another way to reduce apparent noise. To access it, you use the **Sampling Head Fnc's** selector in the Waveform major menu.

- Step 18:** Press the **WAVEFORM** button in the **MENUS** column and touch **Sampling Head Fnc's** in the major menu. In the pop-up menu touch **1** (or whichever channel your trace is using) and **Smoothing**. Touch the **Exit** selector in the pop-up menu.

NOTE

If you turn on smoothing for one sampling head channel, both channels are smoothed.

Observe the smoother trace.

- Step 19:** Touch **Sampling Head Fnc's** in the major menu. In the pop-up menu touch **1** (or whichever channel your trace is using) and **Smoothing** to turn smoothing off. Touch the **Exit** selector in the pop-up menu (see Figure 2-31).

Note that neither smoothing nor averaging can be applied to random data displays, such as eye patterns.

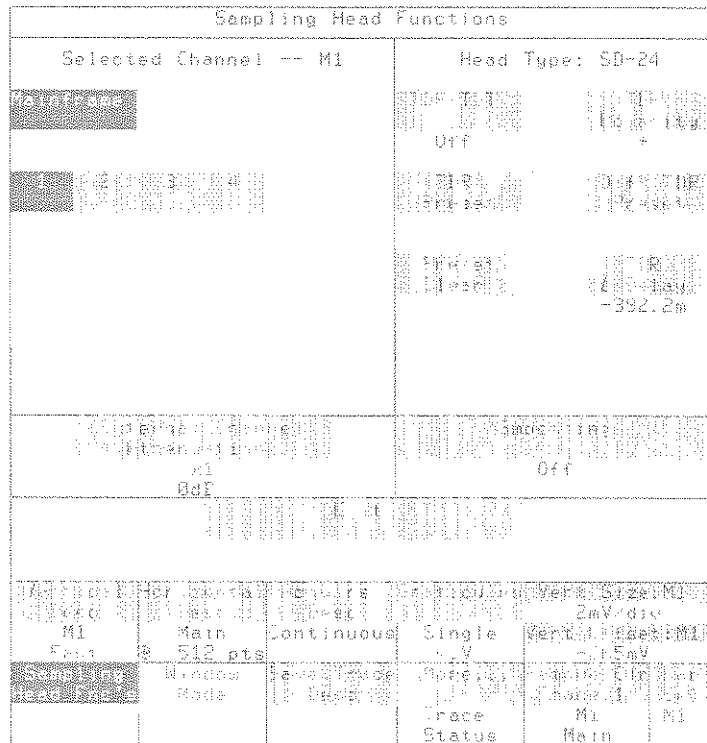

Figure 2-31: The Sampling Head Fnc's Pop-Up Menu

Record Length

You can specify the resolution of traces by setting the number of sample points in a trace. This is most important if you are using a remote interface to transfer trace data to a computer, but the effects are visible on the display. The **Horizontal Desc** selector always shows the point count of the selected trace.

- Step 20:** Touch **Horizontal Desc** in the major menu. In the pop-up menu touch either **Main Record Length** or **Window Record Length** (both selectors assign the knobs identically).
- Step 21:** Turn the top **Main Record Len** knob one click at a time to the left and right, and observe the difference in the main trace.

NOTE

*If the channel loop gain is not correctly calibrated, changing record lengths can also change the trace appearance. See **Enhanced Accuracy** in the Reference section of this manual.*

The bottom knob similarly controls the window record lengths.

You should be aware of the following attributes of record lengths:

- All main time base traces share the same record length.
- All window traces share the same record length.
- Initialize sets both record lengths to 512.
- Variable persistence, infinite persistence, and color grading are available only for traces with a 512-point record length. Selecting one of these modes automatically sets the record length to 512.
- The 4096 record length has the same resolution as a 5120 record length, but appears as a shorter trace. Some FFT and other signal processing algorithms running on external computers require record lengths that are exponential multiples of 2. The 4096 record length is provided for these applications. The visual truncation is the result of a shorter record using the same resolution as the 5120 record length.



Example 5: Taking Automated Measurements

This example demonstrates how quickly you can display a dynamic measurement from a displayed trace.

For this example you will need a 11801B with at least one sampling head installed, one SMA cable, and a static protection wrist strap.

The first step in taking a trace measurement is to achieve a good display of the trace.

- Step 1:** Initialize the 11801B (press the **UTILITY** button in the **MENUS** column, touch **Initialize** in the major menu, and touch **Initialize** in the verification pop-up menu).
- Step 2:** Put on the wrist strap and ensure that it is connected to the antistatic connector on the front panel of the 11801B.
- Step 3:** Connect the **CALIBRATOR** output to any sampling head input.

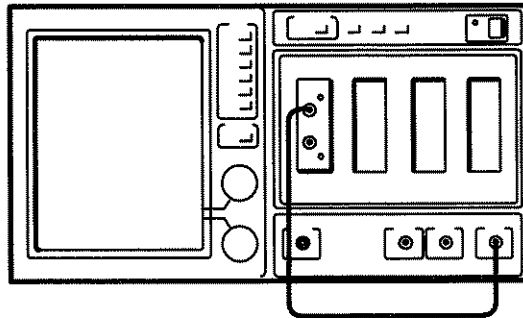

Figure 2-32: Connections for Example 5

- Step 4:** Press the **SELECT CHANNEL** button on the sampling head channel you have connected to the calibrator signal.
- Step 5:** Press the **TRIGGER** button and touch **Source** in the major menu. Select **Internal Clock** in the pop-up menu and touch **Exit** to remove the pop-up menu.
- Step 6:** Press the **UTILITY** button and touch **Instrument Options** in the major menu. Touch **Autoset Mode** in the pop-up menu until **Period** mode is selected, and touch **Exit** to remove the pop-up menu.

Example 5: Taking Automated Measurements

Step 7: Press the **AUTOSET** button.

You should have a stable display of the calibrator signal showing several cycles. It is important that all of the signal is on the display and that there are no places where the trace extends above or below the graticule area.

NOTE

Get a stable signal display before using the automated measurement system.

Specifying Measurements

The automated measurement system lets you specify a set of measurements for every trace on the display. The readouts of these measurements are continually updated to track changes in the signal. Up to twenty-eight different measurements are available, as listed in the pop-up menu shown on the next page. You may specify up to six measurements to be taken simultaneously on the selected trace.

Step 8: Press the **MEASURE** button.

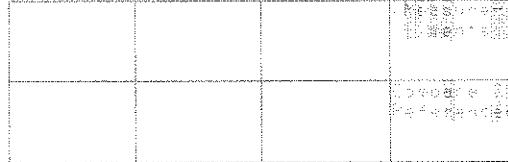

Figure 2-33: The Measure Major Menu

The Measure major menu is displayed (see Figure 2-33). Initially, this menu will appear mostly blank. Six of the selectors are reserved for your measurement readouts. The **Measurements** selector brings up a pop-up menu to let you choose which measurements you want (see Figure 2-34).

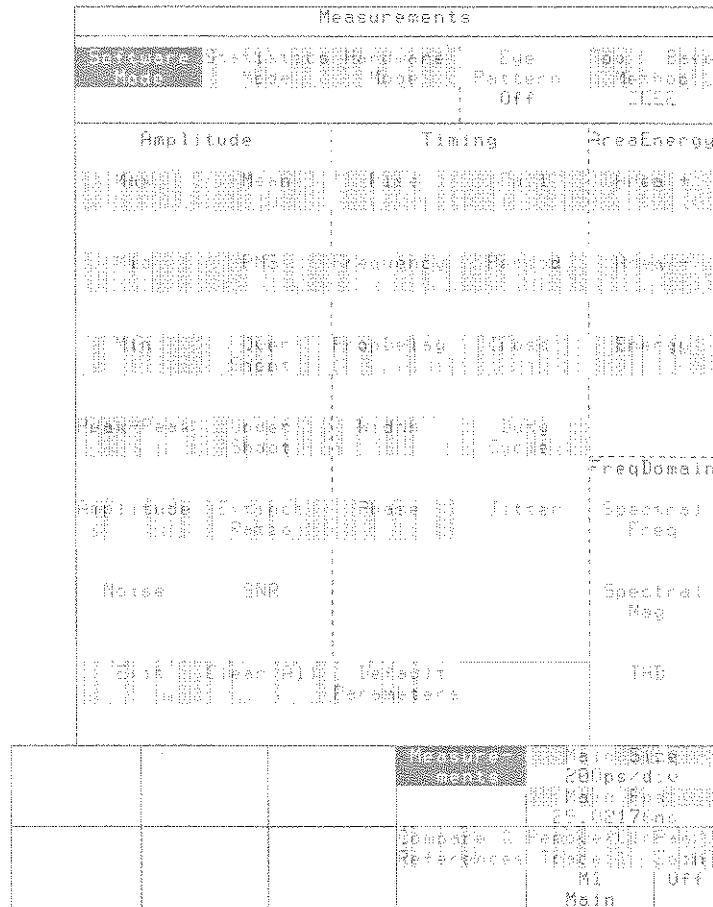

Figure 2-34: The Measurements Pop-Up Menu

- Step 9:** Touch the **Measurements** selector.

The **Amplitude**, **Timing**, and **AreaEnergy** sections of this pop-up menu show all the various measurements that you may specify. Touch the selectors in these areas to turn each measurement on and off. When a measurement is turned on, that selector is highlighted in the menu. Also, one of the selectors in the major menu area displays that measurement value.

- Step 10:** Touch the **RMS** and **Frequency** selectors.

This pop-up menu does not disappear as soon as you select a measurement, so that several measurements may be turned on at one time. The measurements are displayed, but you may want to view the trace while watching the measured values.

- Step 11:** Touch the **Exit** selector at the bottom of the pop-up menu.

The readout areas of two of the selectors in the major menu area are no longer empty, but show the measured values you have specified (see Figure 2-35). These values are updated continually.

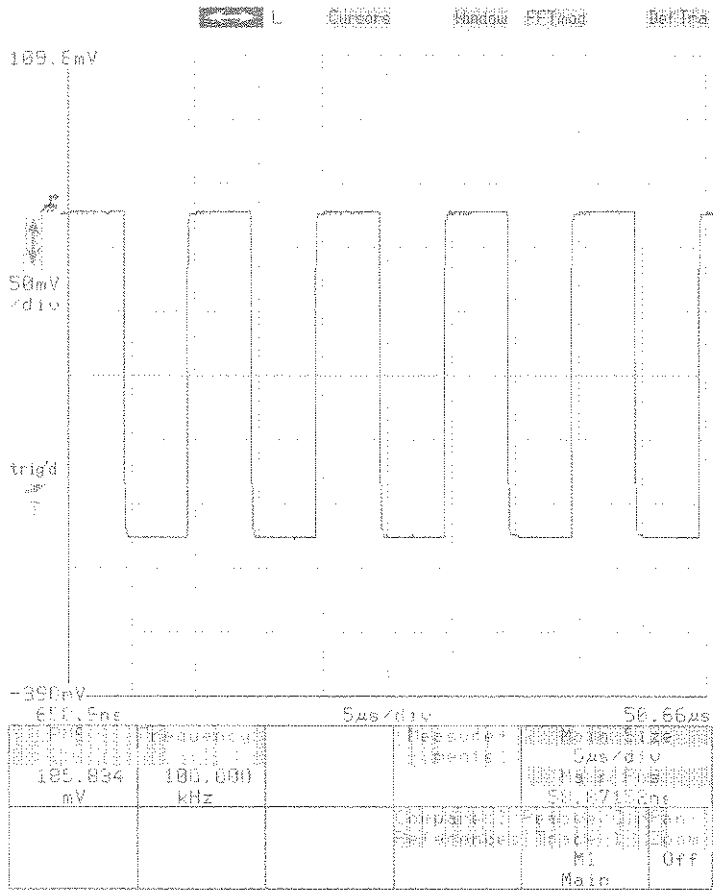

Figure 2-35: Measurements of a Trace

Measurement Parameters and Annotations

For each measurement, more information is available and more control is provided. Touching the measurement selector in the major menu area does the following:

- Displays annotation lines on the graticule. These annotation lines graphically show the portions of the trace that the measurement readout value is based on.
- Highlights the portion of the trace that the measurement is based on.
- Displays a pop-up menu that documents the annotation lines, shows accumulated measurement statistics, and allows you to assign the knobs to various measurement parameters.

Step 12: Touch the **RMS** selector in the major menu area.

Often you will want to observe the annotation lines without the pop-up menu hiding a portion of the trace. For this reason, annotation lines remain on the display even after a measurement pop-up menu has been removed.

Step 13: Touch the **RMS** selector again in the major menu area.

The annotation lines remain and you can see all of the display. (If you wish to remove these annotation lines, push a different major menu button or select a different trace by touch.) For now, closely examine the **RMS** pop-up menu (see Figure 2-36).

Step 14: Touch the **RMS** selector a third time to redisplay the menu.

At the bottom of the menu, non-selectable readouts show the Mean, Standard Deviation, and Current N (the number of samples the statistics are based on). A **Set N** selector lets you assign the knobs to control the N value. This N value is shared by all measurements on the selected trace, so if you change the N value of the **RMS** measurement, it will change the frequency measurement N value as well.

NOTE

Changing a parameter affects all measurements, that use that parameter, on the selected trace.

Step 15: Touch the **Set N** selector and turn either knob, observing the change in N.

You can change measurement parameters without the pop-up menu in the way. An example is the measurement limits: when the pop-up menu is present, you can't see these vertical lines. The measurement limits define the portion of the trace that the measurement system is limited to examining.

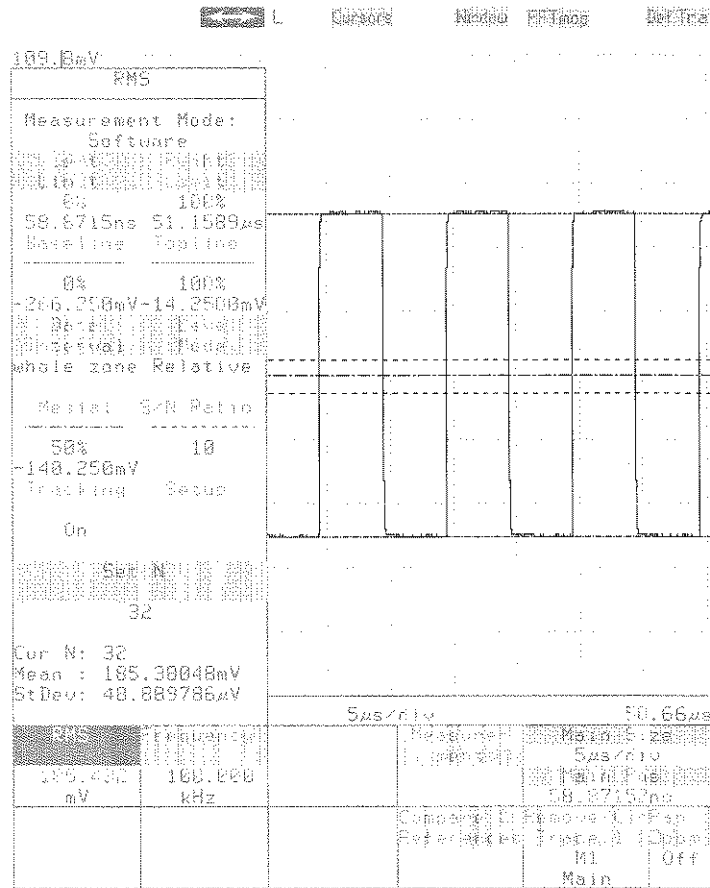

Figure 2-36: The RMS Pop-Up Menu and Annotation Lines

- Step 16:** Touch either the **Left Limit** or **Right Limit** selector, to assign the two knobs to these parameters.
- Step 17:** Touch the **RMS** selector in the major menu, to remove the pop-up menu.

The knob assignments remain after the pop-up menu is removed, so that you can set the limits without a menu covering part of the display.

- Step 18:** Turn the top knob clockwise, so that the left limit bar moves into the area of the trace previously highlighted.

When you used the limit bar to exclude the portion of the trace where the measurement was being taken, the 11801B took the measurement at the next opportunity on the trace. This is shown by the highlighted portion of the trace moving to the right. This new left limit is effective for all measurements on this trace, including the frequency measurement.

Default Measurement Parameters

Left and right limits are examples of measurement parameters. Measurement parameters are settings that you change to control the measurement system. Most parameters are shared by all the measurements being taken on any one trace. This means that each trace has an associated set of measurement parameters.

If you are taking measurements on several traces and want them all to have the same parameters, you can set the default parameters *before* creating any of the traces. Each time a trace is created, its measurement parameters are copied from the default parameter set. In addition, you can set the parameters for any trace to the complete set of defaults at any time. You can access the default parameters through the **Measurements** pop-up menu using the **Default Parameters** selector.

- Step 19:** Touch the **Measurements** selector in the major menu, and then touch the **Default Parameters** selector in the pop-up menu.

The pop-up menu changes to show measurement defaults (see Figure 2-37). Touching the **Measurement Functions** selector redisplay the original **Measurements** pop-up menu.

The new pop-up menu shows the various parameters that the measurements use. No one measurement uses all of these parameters, but each parameter is used for one or more measurements.

You can touch the various parameter selectors to assign the knobs to one or two of the parameters. After setting the parameters as desired, all traces created in the future will default to these measurement parameters.

NOTE

Changing a default parameter does not affect any existing trace or measurement.

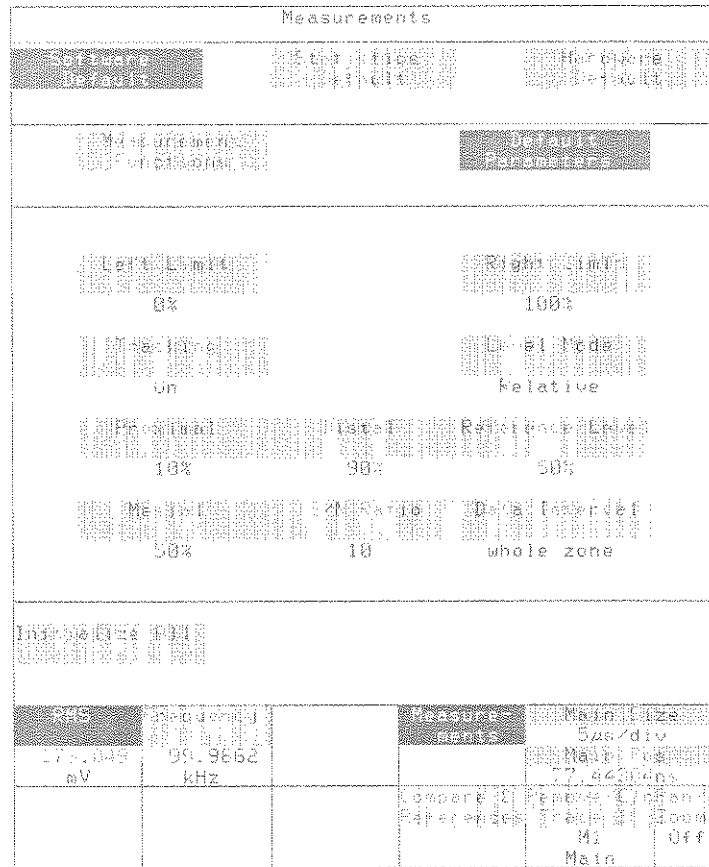

Figure 2-37: The Default Parameters Pop-Up Menu

- Step 20:** Touch the **Left Limit** or **Right Limit** selector, and turn the bottom knob counter-clockwise to set the *default* right limit to 80%.

In addition, all the parameters of the selected trace can be set to default values by using the **Initialize All** selector.

- Step 21:** Touch the **Initialize All** selector, and then the **RMS** selector on the major menu.

NOTE

Initialize All affects only the selected trace.

The right limit of the measurement is now set to 80%. This change did not occur until you touched the **Initialize All** selector. Had you been displaying other traces, their parameters would have been unaffected by either the change to the defaults or by the **Initialize All**.

Measurement Modes

Up to now, the measurements you have been using have been software measurements. However, there are actually three measurement modes: software mode, hardware mode, and statistics mode. In software mode, measurements are taken from the digitized trace data record, the same data that forms the trace on the display. In hardware mode, measurements are taken from the analog signal output from the sampling head before it is digitized and assembled into a trace record. The 11801B uses special timer circuits to take hardware measurements. The advantage of hardware measurements is that they are performed faster than software measurements. In statistics mode, measurements are taken from color graded waveform data and are based on histograms computed at the crossing levels. You can use statistical measurements to measure “random” data such as eye diagrams.

You cannot take measurements in different modes on the same trace. If you create two identical traces, you can take hardware measurements on one and software measurements on the other. You can display only the measurements for the selected trace, however.

Table 2-1 compares the three types of measurements. It will help you determine the best measurement type for your application.

Hardware measurements are specified using another alternate menu from the **Measurements** pop-up menu.

- Step 22:** Touch the **Measurements** selector in the major menu; then touch **Hardware Mode** in the pop-up menu.

Table 2-1: Measurement Mode Comparison

	Software	Hardware	Statistics
Functions	All measurements <i>except</i> Noise, Jitter, and SNR available.	Limited to 7 timing measurements.	Full range of measurements available, <i>except</i> frequency domain measurements.
Trace Complexity	All trace expressions supported. Not for random data, such as eye patterns.	Only traces without arithmetic operators or functions are allowed. Averaging and enveloping are allowed, but the measurement is taken from unaveraged samples. Not for random data, such as eye patterns.	All trace expressions, that include an active trace, are supported. For all types of traces, including random data such as eye patterns.
Display Restrictions	Any display mode.	Any display mode.	Color graded mode only. One trace per graticule.
Resolution	Affected by displayed vertical size and trace functions (e.g., averaging) and smoothing.	Unaffected by display or functions. Sampling head smoothing will affect hardware measurements.	Affected by displayed vertical size and trace functions (e.g., averaging), smoothing, and the use of dual graticules.
Speed	Slower	Faster	Updated when color graded database is updated (selectable between 5 and 100 seconds) or when a measurement parameter changes, such as mesial level.

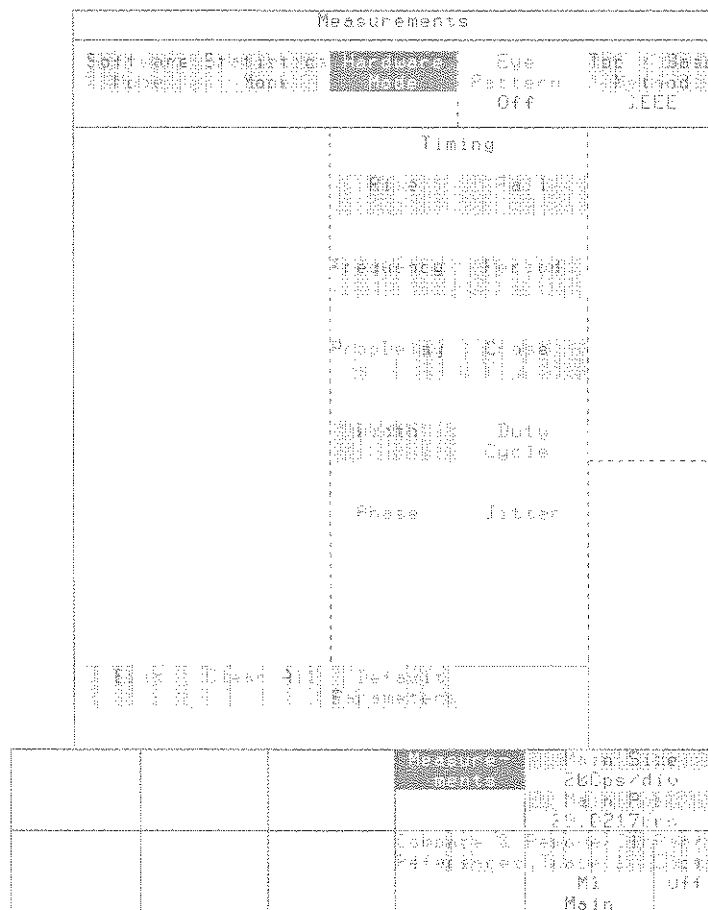

Figure 2-38: The Hardware Measurements Pop-Up Menu

You have now converted all your measurements on this trace to hardware measurements. Since hardware measurements cannot support amplitude or area energy measurements, these do not appear in the pop-up menu, and the **RMS** measurement has been removed from the major menu area. See Figure 2-38.

The third measurement mode is **Statistics Mode**. Statistics measurements can be selected only when the color grading display mode is enabled. All measurements are selectable in Statistics Mode except for the three frequency domain measurements: spectral frequency, spectral magnitude, and THD. Noise, Jitter, and SNR measurements, which cannot be selected in software or hardware measurement mode, are selectable in statistics mode.

- Step 23:** Press the **UTILITY** button to display the Utility1 major menu. Touch the **Instruments Options** selector in the major menu, then touch the **Autoset Mode** selector in the pop-up menu. Select **Edge** mode if it is not already selected. Touch **Exit** to remove the pop-up menu.
- Step 24:** Press **AUTOSSET**. You should now see the rising edge of the calibrator signal.

- Step 25:** Press the **DISPLAY MODES** button. Touch the **Persist/Histograms** selector in the major menu, then touch the **Color Grading** selector in the pop-up menu. Touch **Exit** to remove the menu.
- Step 26:** Press the **MEASURE** button. Touch the **Measurements** selector. To enable statistics mode measurements, touch **Statistics Mode** at the top of the pop-up menu. Touch **Jitter** and then touch **Exit** to remove the menu.

The data used for the statistics mode measurements are taken from the statistical database created when Color Grading is enabled. This capability enables you to make automatic pulse parametric measurements directly on random data such as eye diagrams. See Figure 2-39.

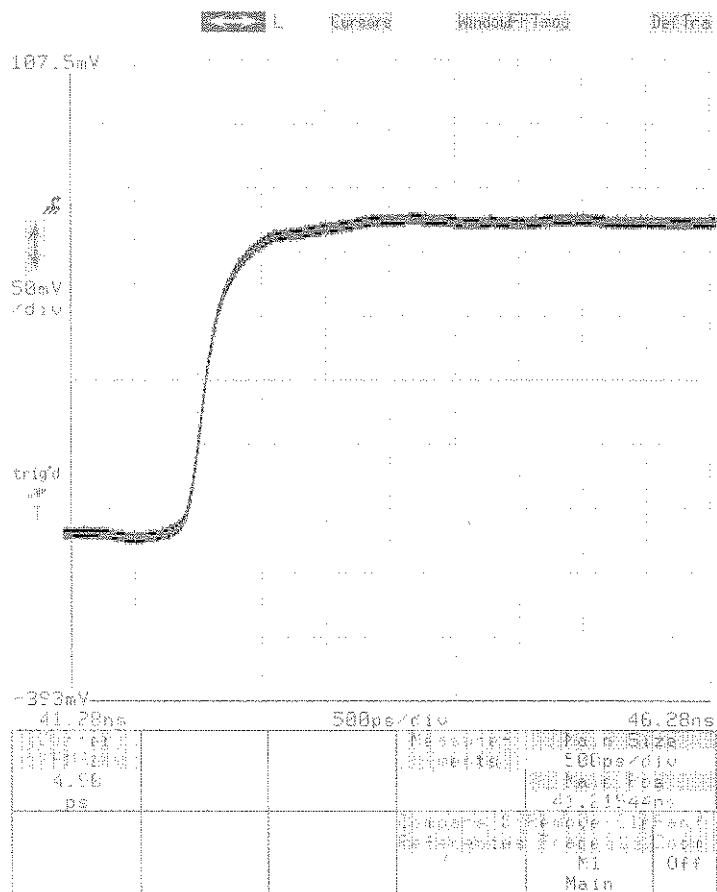

Figure 2-39: A Jitter Measurement on the Calibrator Signal

Example 5: Taking Automated Measurements

Example 6: Taking Delay Measurements Using Cursors

This example shows another way to measure trace parameters, using cursors. When the measurement you want to make is not included in the list of automated measurements, you can use cursors.

You will use the cursors to take two common measurements, trace amplitude and delay between traces. The 11801B can do both of these as automated measurements, so you can compare the method of using automated measurements to using cursors.

For this example you will need a 11801B with at least one dual-channel sampling head installed two SMA cables of equal length, and a static protection wrist strap.

- Step 1:** Initialize the 11801B (press the **UTILITY** button in the **MENUS** column, touch **Initialize** in the major menu, and touch **Initialize** in the verification pop-up menu).
- Step 2:** Put on the wrist strap and ensure that it is connected to the antistatic connector on the front panel of the 11801B.
- Step 3:** Connect the **CALIBRATOR** output to a sampling head input.
- Step 4:** Connect the **INTERNAL CLOCK** output to any available sampling head input.

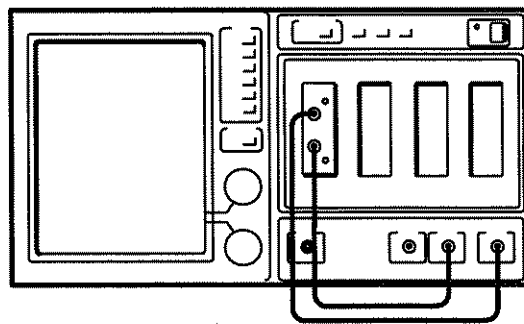

Figure 2-40: Connections for Example 6

- Step 5:** Press the **TRIGGER** button. Touch **Source** in the major menu area and select **Internal Clock**, then touch **Exit**.
- Step 6:** Press the **SELECT CHANNEL** button on the sampling head input channel you have connected to the calibrator signal.

- Step 7:** Turn the top knob to the left to set the horizontal scale to 10 ns/div.

You should see the calibrator signal on the display.

The Cursors Major Menu

First you will use the cursors to determine the amplitude of the calibrator signal. This introduces the use of cursors on a single trace. You will then use cursors to measure the delay between two different traces.

The recommended way of using cursors is to first display the trace(s), and then invoke the cursors to take the measurement.

NOTE

Always display the traces before invoking the cursors.

You invoke the cursors by touching the **Cursors** icon, located above the graticule.

This icon acts like most icons in that it assigns the knobs, in this case to control the cursor positions. However, the **Cursors** icon is unique in that it behaves much like a major menu button. It replaces the major menu with the special Cursors major menu and highlights the **Cursors** icon instead of lighting any major menu button. See Figure 2-41.

The Cursors major menu has selectors for **Cursor Type**, **Set Zero**, and **Exit**. The remainder of the major menu area displays the cursor positions and distance between cursors. You can select four types of cursors:

- **Vertical Bars**, which you move with the knobs to the desired horizontal position. The major menu shows the positions of the cursors and the distance between them in X units. Also, if the X units are seconds, the inverse of the distance between the cursors is shown. When the cursors are positioned at the beginning and end of a period, this represents frequency.
- **Horizontal Bars**, which you move with the knobs to the desired vertical position. The major menu shows the positions of the cursors and the distance between them in Y units.
- **Paired Dots**, which you move with the knobs to the desired horizontal position. The dots “float” vertically on the trace; you cannot control the vertical position. The major menu shows both vertical and horizontal positions of the cursors, in graticule units. Also, if the X units are seconds, the inverse of the distance between the cursors is shown.
- **Split Dots**, which operate like paired dots, but on two different traces of your choice. The same information is shown as for paired dots.

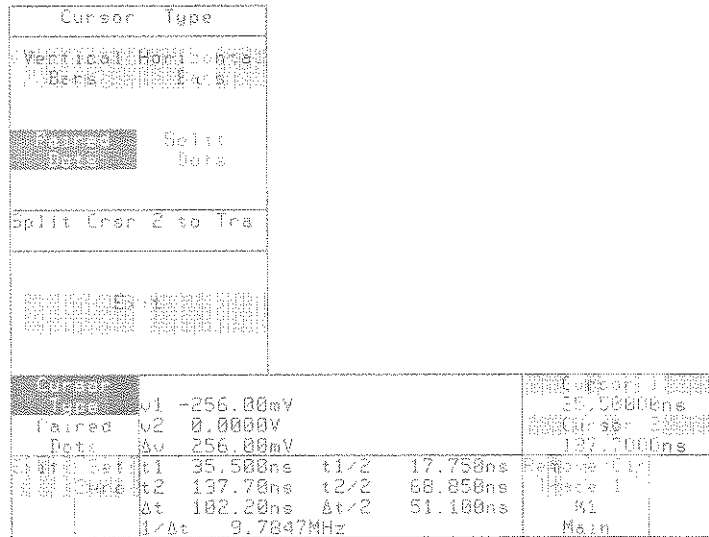

Figure 2-41: The Cursors Major Menu and Cursor Type Pop-Up Menu

The horizontal bar cursors are used to take amplitude measurements. You move them up and down with the knobs to the position you desire. See Figure 2-42.

- Step 8:** Touch the **Cursors** icon, and then the **Cursor Type** selector.
- Step 9:** Touch the **Horizontal Bars** selector. Select **Exit** to remove the pop-up menu.
- Step 10:** Use the upper and lower knobs to move the bars over the upper and lower levels of the trace.

NOTE

To precisely position the cursors, set the knobs to fine resolution by using the Keypad pop-up menu. Setting the resolution of one knob changes the resolution of both.

The major menu area shows the voltage values of each cursor, and ΔV shows the distance between the cursors in volts. This is the amplitude of the calibrator signal.

Example 6: Taking Delay Measurements Using Cursors

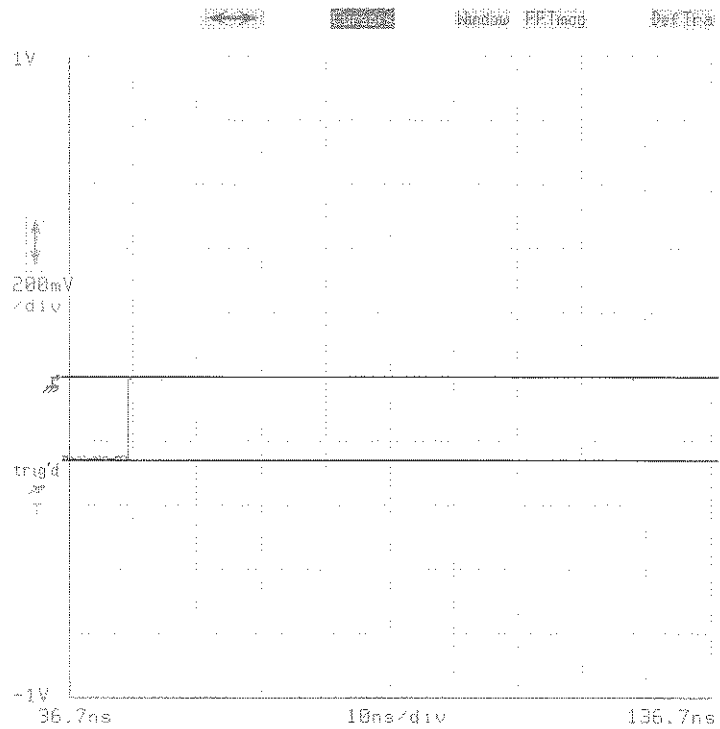

Figure 2-42: Horizontal Bar Cursors Placed Over a Trace

The same value can be determined using the automated measurement system. The sequence to do this is: press the **MEASURE** button, touch **Measurements** in the major menu area and then the **Peak-Peak** selector in the pop-up menu. The measurement value is visible in the **Peak-Peak** selector in the major menu area. **Exit** will allow you to observe the trace as the measurement readout is updated.

NOTE

*The **Peak-Peak** automated measurement value will include any signal noise.*

Using Split Dot Cursors

Dot cursors are small dots that “float” on the trace. You position them horizontally using the knobs, but their vertical height is determined by the trace on which they are placed.

Split dot cursors operate the same way, but they are placed on two different traces of your choice. In this example, you will have one trace on each of two graticules, but this is not required to use split dot cursors. You will follow the convention of displaying the traces before invoking the cursors.

- Step 11:** Establish a dual graticule display (press the **WAVEFORM** button, and touch the **Graticules** and **Create Second Graticule** selectors).
- Step 12:** Press the **SELECT CHANNEL** button of the sampling head channel to which you have connected the **INTERNAL CLOCK** output.
- Step 13:** If both traces are on a single graticule, move one to the other graticule by touching either **Lower Graticule** or **Upper Graticule** and **Move Trace to Other Graticule**.

You should now see a trace on each graticule. You will use split dot cursors to measure the delay time between these traces.

- Step 14:** Touch either trace on which you want to place a cursor. (In this case, since there are only two traces on the display, this step is already done.)
- Step 15:** Touch the **Cursors** icon and the **Cursor Type** selector. Touch the **Split Dots** selector.

Cursor Type																																									
Vertical	Horizontal																																								
Dots:	Split Dots																																								
Split Csr 2 to Tra																																									
Trace:	Trace 2																																								
M1:	Main																																								
M2:	Main																																								
<table border="1"> <thead> <tr> <th>Trace</th> <th>V1</th> <th>V2</th> <th>V</th> <th>Cursor</th> </tr> </thead> <tbody> <tr> <td>Split</td> <td>M1</td> <td>-96.000mV</td> <td></td> <td>35.500ns</td> </tr> <tr> <td>Dots</td> <td>M2</td> <td>944.000mV</td> <td></td> <td>137.700ns</td> </tr> <tr> <td></td> <td>Δv</td> <td>1.0400V</td> <td></td> <td>177.700ns</td> </tr> <tr> <td>t1</td> <td>t1</td> <td>35.500ns</td> <td>t1/2</td> <td>17.750ns</td> </tr> <tr> <td>t2</td> <td>t2</td> <td>137.70ns</td> <td>t2/2</td> <td>68.850ns</td> </tr> <tr> <td>Δt</td> <td>Δt</td> <td>102.20ns</td> <td>Δt/2</td> <td>51.100ns</td> </tr> <tr> <td>1/Δt</td> <td></td> <td>9.7847MHz</td> <td></td> <td></td> </tr> </tbody> </table>		Trace	V1	V2	V	Cursor	Split	M1	-96.000mV		35.500ns	Dots	M2	944.000mV		137.700ns		Δv	1.0400V		177.700ns	t1	t1	35.500ns	t1/2	17.750ns	t2	t2	137.70ns	t2/2	68.850ns	Δt	Δt	102.20ns	Δt/2	51.100ns	1/Δt		9.7847MHz		
Trace	V1	V2	V	Cursor																																					
Split	M1	-96.000mV		35.500ns																																					
Dots	M2	944.000mV		137.700ns																																					
	Δv	1.0400V		177.700ns																																					
t1	t1	35.500ns	t1/2	17.750ns																																					
t2	t2	137.70ns	t2/2	68.850ns																																					
Δt	Δt	102.20ns	Δt/2	51.100ns																																					
1/Δt		9.7847MHz																																							

Figure 2-43: The Cursor Type Pop-Up Menu in Split Dots Mode

Example 6: Taking Delay Measurements Using Cursors

When you first select split dots cursors, both dots are on the selected trace. The **Cursor Type** pop-up menu remains on the display until you select the trace you want to move the other cursor to. See Figure 2-43.

Beneath the selectors that allow cursor choice, a second set of selectors lists all of the traces currently on the display. The highlighted selector always shows which trace the second cursor is assigned to.

NOTE

Each trace selector for the second cursor shows the trace description.

Initially, both dots are placed on the selected trace, so the highlighted selector shows the selected trace. Touching the only other trace selector in this case will assign the second cursor to that trace and remove the menu.

- Step 16:** Touch the selector in the pop-up menu for the other trace on the display.
- Step 17:** Move each cursor on its respective trace to a point halfway up the rising edge. Use the fine knob control for precise positioning. Some vertical noise is to be expected.

The major menu area shows the vertical and horizontal positions of both cursors. It also shows the distance between the cursors along both axes. The **Δt** readout shows the time between the leading edges, which is the delay time you want to measure.

The automated measurement system can take the same delay measurement. If you want to see how this is done, select the trace with the earliest transition, and then press the **MEASURE** button. Touch **Measurements**, **Hardware Mode**, **PropDelay**, and **Exit**.

The measurement value will be displayed in the **PropDelay** selector in the major menu area, but will show zero because only one trace is being examined. To assign the second trace, touch **PropDelay** and, under the heading **Second Trace** (at the bottom of the pop-up menu), touch the **Trace n** selector of the other trace. Touch **Prop Delay** again to remove the pop-up menu.

Cursor Accuracy Considerations

Cursor measurements are limited to the resolution of the display. Tips to help you get the most accuracy from measurements are:

- Use the automated measurement system whenever you can, both for convenience and for accuracy.
- Use dot cursors to take a more precise measurement (when record length is greater than 512 points). Bar cursors are best for visual comparison and are positioned with display resolution (when record length is 512 points). Dot cursors follow the trace vertically as you position them horizontally, and provide readouts of actual trace data values.
- Always use the fine knob resolution to perform the final cursor positioning. Setting one cursor knob to fine will also set the other.
- When using cursors or software measurements, always make the area to be measured as large as possible, and cover as much of the graticule area as you can. This will give the finest resolution.

Example 6: Taking Delay Measurements Using Cursors



Example 7: Taking Comparison Measurements Using a Reference Trace

This example demonstrates the compare and reference features of the automated measurement system. This is particularly useful when you need to check a series of components or circuits to see if a particular measurement falls within an acceptable range.

For this example you will need a 11801B with at least one sampling head installed, two SMA cables of different length (2 ns and 5 ns cables are recommended), and a static protection wrist strap.

- Step 1:** Initialize the 11801B (press the **UTILITY** button in the **MENUS** column, touch **Initialize** in the major menu, and touch **Initialize** in the verification pop-up menu).
- Step 2:** Put on the wrist strap and ensure that it is connected to the antistatic connector on the front panel of the 11801B.
- Step 3:** Connect the short cable from the **CALIBRATOR** output of the 11801B to a sampling head input.

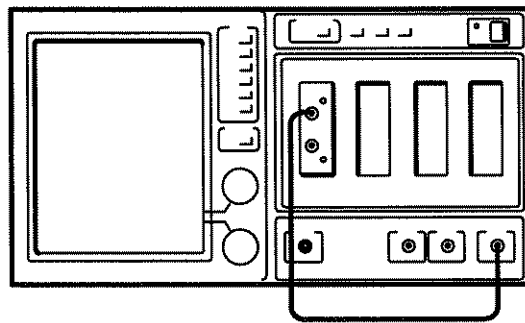

Figure 2-44: Connections for Example 7

- Step 4:** Press the **TRIGGER** button, and touch **Source** and **Internal Clock**. Touch **Exit** to remove the pop-up menu.
- Step 5:** Press the **SELECT CHANNEL** button on the sampling head input that the calibrator signal is connected to.
- Step 6:** Turn the top knob to the left to set the horizontal scale to 10 ns/div.

You will see the calibrator signal on the display.

Example 7: Taking Comparison Measurements Using a Reference Trace

You will measure the difference in propagation time down the two cables which are different lengths. The cross measurement, which shows the time delay from the trigger to the rising edge of a signal, will be the basis of your comparison.

- Step 7:** Press the **MEASURE** button.
- Step 8:** Touch **Measurements** and **Hardware Mode**.
- Step 9:** Touch **Cross**, and touch **Exit** if you want to observe the trace.

Setting X-Axis Units to Meters, Feet, or Inches

The measurement will be more useful to you if it is expressed in distance rather than time: how much longer is the second cable? The **Graticules** selector on the Waveform major menu lets you choose feet, meters, or inches for the horizontal axis. See Figure 2-45.

- Step 10:** Press the **WAVEFORM** button and touch the **Graticules** selector.

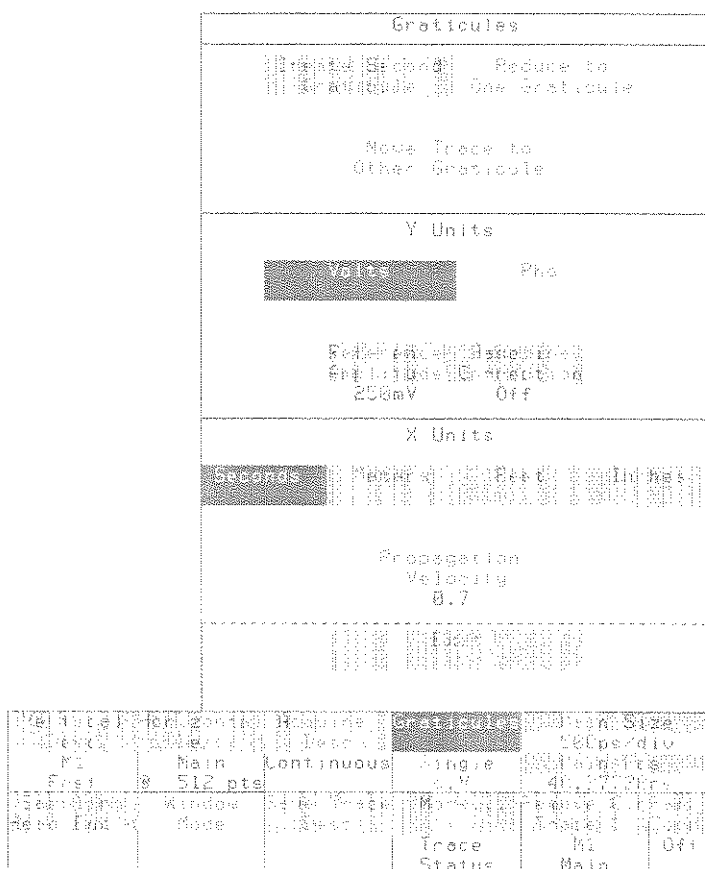

Figure 2-45: The Graticules Pop-Up Menu

Example 7: Taking Comparison Measurements Using a Reference Trace

The pop-up menu shows an **X Units** section near the bottom. You can select seconds, meters, feet, or inches. In addition, the **Propagation Velocity** selector, can be used to assign the knobs to let you indicate the signal speed of your cable. The default **0.7** indicates that the horizontal axis labels, if inches, feet or meters, will be based on a cable that passes signals at 0.7 times the speed of a cable having free air insulation.

Step 11: Touch **Inches, Feet, or Meters** in the pop-up menu. If you know that the propagation velocity of your cable differs from the default, touch the **Propagation Velocity** selector and adjust this parameter. If you don't know the velocity or are using Tektronix polyethylene dielectric SMA cables, accept the 0.7 default.

Step 12: Press the **MEASURE** button to redisplay the Cross measurement.

The measurement readout is in the units of distance that you selected. Also, the horizontal axis is labeled in the units chosen.

Using the Reference Value

You will use this measurement value as a reference value. The **Compare & References** pop-up menu allows you to save this value and cause all measurements to be displayed as a difference from this value. See Figure 2-46.

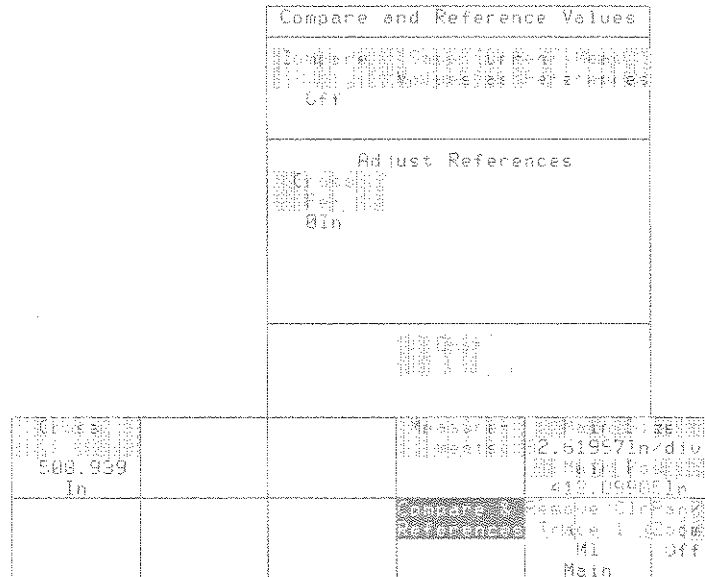

Figure 2-46: The Compare & References Pop-Up Menu

- Step 13:** Touch **Compare & References**, and then touch **Save Current Meas Values as References**.

You will see that this reference value for the cross measurement is now very close to the cross measurement value in the major menu area (they may not match exactly because of noise or horizontal jitter).

The **Cross** selector in the major menu area displays the measurement parameters pop-up menu. The **Cross Ref** selector in the **Compare & References** pop-up menu assigns the knobs to adjust the reference value; this is useful when you want to establish your own standard reference value.

The **Compare** selector in the **Compare & References** pop-up menu changes the entire measurement system. This makes the measurement system display the measured deviation from the references, rather than the direct measurement.

- Step 14:** Touch the **Compare** selector to set compare on, and touch the **Exit** selector to remove the pop-up menu.

The **Cross** measurement selector in the major menu area has changed to **ΔCross**, and the value being displayed is at or near zero. The zero value shows that this cable deviates very little from its own signal propagation characteristics.

Example 7: Taking Comparison Measurements Using a Reference Trace

Once the 11801B has been set up with a comparison measurement, no further adjustment is necessary to make a series of deviation measurements. To compare the longer cable to the reference you have established:

- Step 15:** Remove the short cable from the calibrator and sampling head, and replace it with the longer cable connected in the same way.

The **Δ Cross** measurement readout shows the difference in length of the cables by showing how much longer it takes a signal to travel through the second cable. In a testing environment, this method of measuring can be used to test a collection of cables to a specific tolerance, without altering the setup on the 11801B.

Example 7: Taking Comparison Measurements Using a Reference Trace



Example 8: Using Saved Trace Descriptions

This example demonstrates how saved trace descriptions can extend the capabilities of the 11801B. When you save a trace description, you save the parameters that control acquisition for a trace, but you do not save any data points. With saved trace descriptions, you can effectively control up to 40 traces at a time (450 traces with four SM-11 Multi-Channel Units attached). Saved trace descriptions can be used while they are not being displayed.

In Example 7 you compared a trace to a stored reference measurement value, and in Example 9 you will compare a trace to a stored static trace. In this example, you will compare a trace on the display to a trace being acquired in the background. You could do this using two traces on the display, but in this example you will use a saved trace description and display only the trace that is to be measured.

For this example you will need an 11801B with at least one dual-channel sampling head installed. Also, a power divider and two SMA cables of different length will be used (2 ns and 5 ns cables are recommended). A signal splitting T adapter may be substituted for the power divider. You will also need a static protection wrist strap.

- Step 1:** Initialize the 11801B (press the **UTILITY** button in the **MENUS** column, touch **Initialize** in the major menu, and touch **Initialize** in the verification pop-up menu).
- Step 2:** Put on the wrist strap and ensure that it is connected to the antistatic connector on the front panel of the 11801B.
- Step 3:** Attach the power divider to the **CALIBRATOR** output of the 11801B.
- Step 4:** Connect each cable from the power divider to a sampling head input connector.

Figure 2-47 shows these connections.

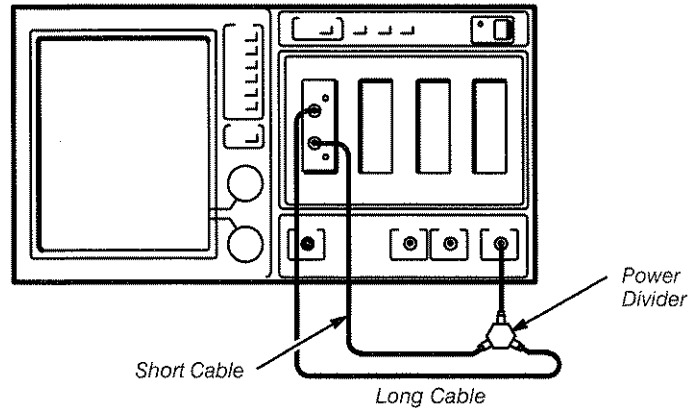

Figure 2-47: Connections for Example 8

- Step 5:** Press the **TRIGGER** button, touch **Source** and **Internal Clock**.
- Step 6:** Press the **SELECT CHANNEL** button on the sampling head input channel to which you have connected the long cable.
- Step 7:** Turn the top knob to set Main Size to 10 ns/div.

You should see the calibrator signal displayed.

You will now save this trace description using the Waveform major menu's **Save Trace Desc** selector. See Figure 2-48.

- Step 8:** Press the **WAVEFORM** button, and touch the **Save Trace Desc** selector.

Selectors **Trace Desc 9** through **Trace Desc 40** (or higher) are locations for saved trace descriptions. They start with 9 because the active visible traces are numbered 1 through 8. If a trace description is already saved in a location, the selector will indicate its channel and time base.

The selectors at the bottom of the pop-up menu allow you to copy the description of the selected trace into a storage location, recall a saved trace description into the next available visible trace, or to delete a trace description. Touching the **Select All Desc** selector will highlight all the locations that are not empty.

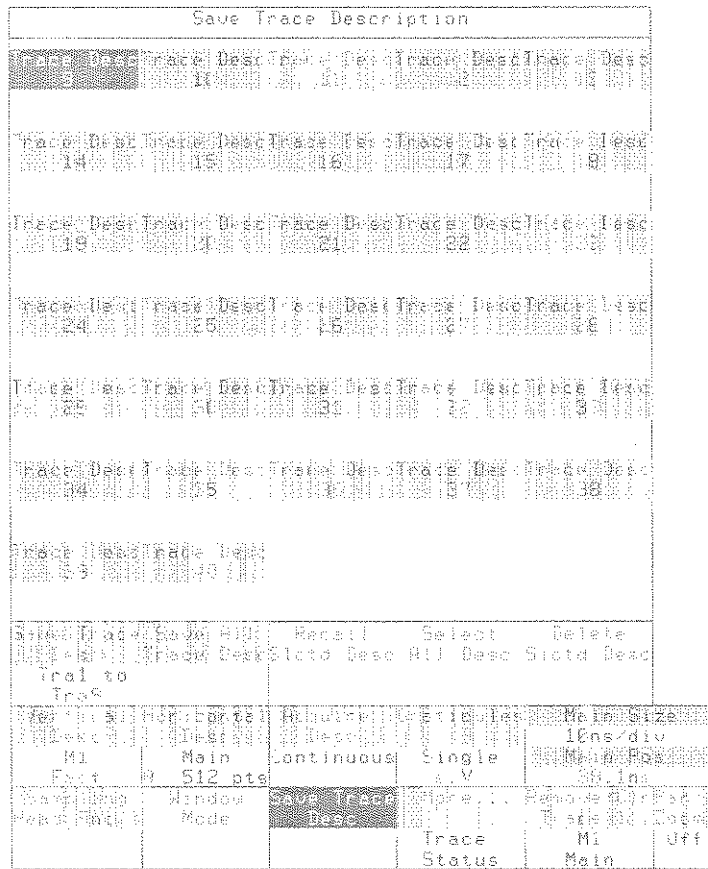

Figure 2-48: The Save Trace Desc Pop-Up Menu

- Step 9:** If it is not already highlighted, touch **Trace Desc 9** (or any other number of your choice) to highlight it. Then touch **Save Trace Desc** in the pop-up menu. This selector will show **Tra1 to Tra9** (or whichever location you used).

When you save the trace description, you are not saving data points as when you store a trace. Instead the 11801B saves all the parameters to create that trace when needed. Just as with a visible trace on the display, the data of a saved trace description will change with the input signal. The parameters saved are:

- Trace definition, including the input channel used and averaging.
- The window information, if it is a window trace.
- The measurements associated with the trace (hardware measurement mode only).

NOTE

Saved trace descriptions are not cleared by initializing the 11801B.

Example 8: Using Saved Trace Descriptions

Saved trace descriptions do not save the size and position of traces on the main time base, or window size of traces on a window time base. When the saved trace description is recalled, these parameters are set to match the current time bases.

Saved trace descriptions must be of simple one-channel traces, and cannot be of traces that use any arithmetic operator such as subtraction or multiplication. Averaging is the only trace function that can be applied to a saved trace description.

NOTE

The limitations on saved trace description complexity are identical to hardware measurements.

- Step 10:** Delete the visible trace by touching **Remove/Clr Trace 1** and verifying that you want it removed in the query pop-up menu.
- Step 11:** Press the **SELECT CHANNEL** button of the sampling head input channel to which you have connected the short cable.

The propagation delay measurement allows you to make a measurement to a second trace. *In hardware mode only*, that second trace may be a saved trace description.

- Step 12:** Press the **MEASURE** button and touch **Measurements, Hardware Mode, Prop Delay**, and **Exit Menu**.
- Step 13:** Touch **Prop Delay**, and at the bottom of the pop-up touch **Trace 9** (or whichever location you used).

You can read the propagation delay from **Prop Delay** selector in the major menu area. If you touch this selector to remove the pop-up menu, you will see that only one trace is on the display, and seven more can still be displayed.

Example 9: Comparing Traces to Stored Traces

This example demonstrates how to store a trace that is a “snapshot” of a particular moment, and how to use the stored trace as a basis for comparing other traces. This is similar to Example 7, where you used a reference measurement as a basis of comparison. This time, the entire trace will be saved as a reference.

For this example you will need a 11801B with at least one sampling head installed and one SMA connecting cable.

- Step 1:** Initialize the 11801B (press the **UTILITY** button in the **MENUS** column, touch **Initialize** in the major menu, and touch **Initialize** in the verification pop-up menu).
- Step 2:** Put on the wrist strap and ensure that it is connected to the antistatic connector on the front panel of the 11801B.
- Step 3:** Connect the **CALIBRATOR** output to any sampling head input.

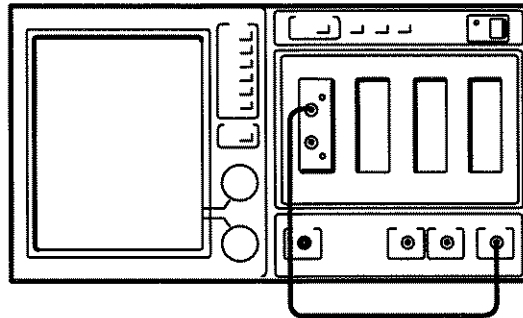

Figure 2-49: Connections for Example 9

- Step 4:** Press the **TRIGGER** button and select **Source** in the Trigger major menu. Select **Internal Clock** and touch **Exit** to remove the pop-up menu.
- Step 5:** Press the **SELECT CHANNEL** button on the sampling head input you have connected to the **CALIBRATOR** signal.
- Step 6:** Press **UTILITY**, **Instrument Options**, and **Autoset Mode**. Select Period mode.

Example 9: Comparing Traces to Stored Traces

- Step 7:** Press the **AUTOSET** button.

You should have a stable display of the calibrator signal showing several cycles. Make sure that all of the signal is on the display and that there are no places where the trace extends above or below the graticule area.

You will store this trace and then define a new trace that shows the difference between a signal and the stored trace.

Storing a trace means storing a copy of each data point that forms the trace on the display. A limited amount of memory is available for storing traces and for storing front panel settings. As you store traces and front panel settings, the instrument keeps a running total of the available memory. In the pop-menu below, available memory is shown under **Free NonVolatile RAM**.

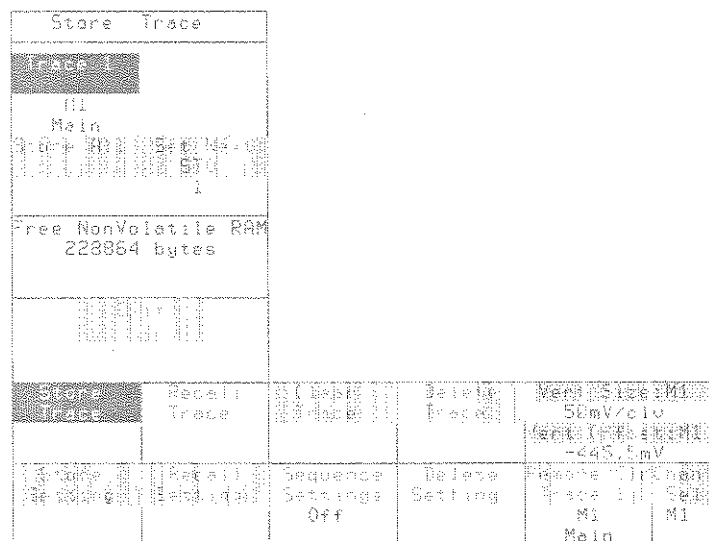

Figure 2-50: The Store/Recall Major Menu and Store Trace Pop-Up Menu

The **STORE/RECALL** button lets you store and recall traces and front-panel settings. In addition, you can clear traces (discard accumulated data and force re-acquisition) and delete traces. See Figure 2-50.

- Step 8:** Press the **STORE/RECALL** button, then touch **Store Trace** and select **Trace 1** in the **Store Trace** pop-up menu.

The 11801B has stored a trace in memory, named “STO 1”. Once the trace is stored, there is no reason to leave its source on the display.

- Step 9:** Touch **Remove/Clr Trace 1** and then touch **Remove Trace 1** in the pop-up menu.
- Step 10:** This step is optional. If you wish to see the stored trace with which the comparison will be made, touch the **Recall Trace** selector and select **STO1** in the pop-up menu.

- Step 11:** Create a difference trace by touching the **DefTra** icon, then touch **Mainframe**, then **1** (or whatever channel number you are using), under **Trace Functions** –, **Stored Traces**, **STO1**, and **Enter Desc**.
- Step 12:** Touch the vertical icon (↓) and adjust the top knob to set the vertical size of the trace to 50 mV/div (the vertical size of the stored trace).

The difference trace should be close to a flat trace, because the signal you are comparing is identical to the source of the saved trace, except for noise.

This setup is useful in cases where you are tuning a circuit to a known standard of performance. First, you save the desired signal trace from a circuit of known performance; then you use the difference trace to observe other circuit samples. These circuits can then be dynamically tuned to the same performance.

To accurately quantify the signal variation from a straight line, you can use the **RMS** measurement:

- Step 13:** Press the **MEASURE** button and touch **Measurements**, **RMS**, and **Exit**.

To tune a circuit, you could make adjustments to get the smallest RMS measurement instead of simply trying for the “flattest” trace.

Example 9: Comparing Traces to Stored Traces



Example 10: Creating a Histogram Display

This example demonstrates how you can create a histogram of a displayed trace. As in Example 4, you will display the calibrator signal at very fine horizontal (time per division) and vertical (volts per division) settings to simulate a noisy signal.

For this example you will need a 11801B with at least one dual-channel sampling head installed, one SMA cable, and a static protection wrist strap.

- Step 1:** Initialize the 11801B (press the **UTILITY** button in the **MENUS** column, touch **Initialize** in the major menu, and touch **Initialize** in the verification pop-up menu).
- Step 2:** Put on the wrist strap and ensure that it is connected to the antistatic connector on the front panel of the 11801B.
- Step 3:** Connect the **CALIBRATOR** output to any sampling head input.

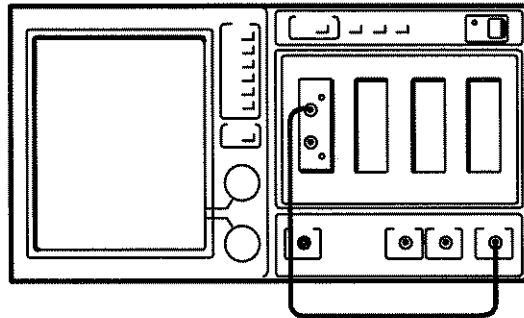

Figure 2-51: Connections for Example 10

- Step 4:** Press the **TRIGGER** button, and touch **Source** and **Internal Clock**, then touch **Exit**.
- Step 5:** Press the **SELECT CHANNEL** button on the sampling head input channel to which you have connected the calibrator.
- Step 6:** Turn the top knob to the right until the horizontal scale is 1 ps/div.
- Step 7:** Press **UTILITY** and touch **Instrument Options**. Touch **Horizontal Autoset** until the selector shows **Off** and touch **Exit**.
- Step 8:** Press the **AUTOSET** button.

Example 10: Creating a Histogram Display

In Example 4, you used color grading to view the relative density of trace points in a display of this signal. A histogram will provide additional statistical information about the distribution of points in the trace.

- Step 9:** Press the **DISPLAY MODES** button and select **Persist/Histograms** in the major menu area.
- Step 10:** Select **Vertical Histogram** in the pop-up menu, and then select **Exit**.

When you selected **Vertical Histogram**, the display persistence automatically changed from **Normal** to **Infinite**. Histograms can be displayed on traces in the infinite persistence and color grading display modes, but not in normal or variable persistence modes.

The histogram display appears in red along the right side of the graticule. A red box on the graticule outlines the limits of the histogram data; trace data that fall outside these limits are ignored.

The amount of noise you see in the displayed signal will depend on the sampling head you have installed. The illustration in Figure 2-52 shows the calibrator signal as acquired using an SD-24 sampling head. If you are using a lower-noise sampling head, such as the SD-22, you will see less noise on the display.

The major menu area shows readouts for the histogram parameters and results:

- **Top, Btm, Lft, and Rgt** are the limits of the histogram data (displayed as a red box).
- **Mean** is the mean vertical value of the trace data within the histogram limits.
- **RMSΔ** is the root mean square deviation, or standard deviation, of trace data points from the **Mean** value.
- **PkPk** is the peak-to-peak measurement of the trace within the histogram limits.
- **Hits** is the number of trace data points that fall within the histogram limits.
- **Wfms** is the number of traces (waveforms) acquired for the histogram.
- **$\mu \pm 1\sigma$** is the percentage of points that are within one standard deviation (σ) of the mean (μ). **$\mu \pm 2\sigma$** and **$\mu \pm 3\sigma$** are the percentages of points that fall within two standard deviations and three standard deviations, respectively, of the mean.

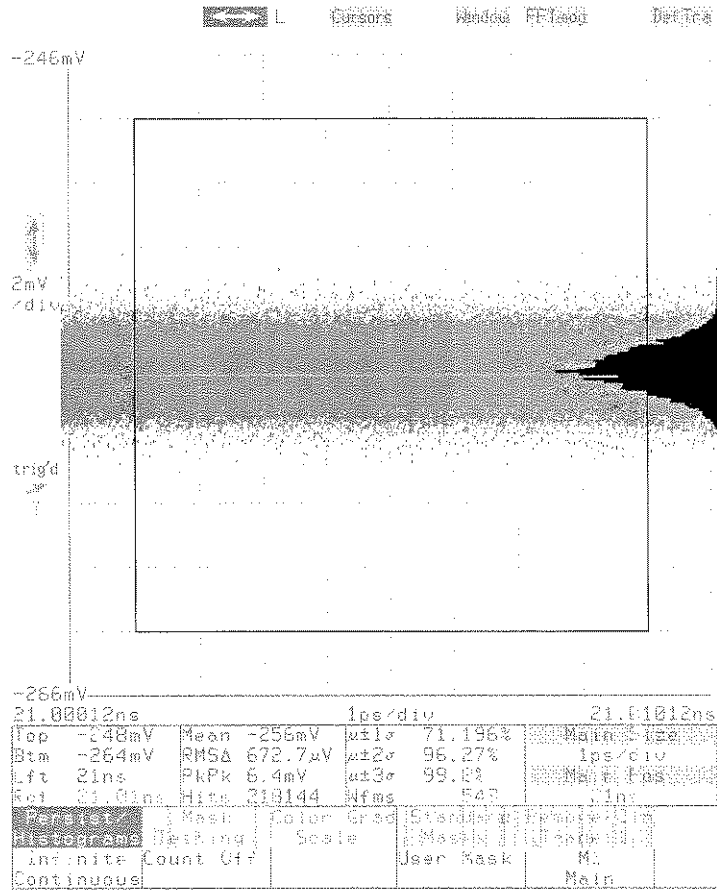

Figure 2-52: A Vertical Histogram Display

You can adjust the histogram limits to restrict the range of trace record points that the 11801B will recognize as valid data points.

- Step 11:** Touch **Persist/Histograms** to redisplay the pop-up menu.
- Step 12:** Select **Vertical Limits** in the pop-up menu.

The knobs are now assigned to **Top** and **Bottom**.

- Step 13:** Use the knobs to adjust the top and bottom limits of the histogram, and observe the changes in the distribution displayed. Note that in Infinite Persist mode, changing a limit causes all trace data to be cleared and new data to be acquired. You can save time using Color Graded mode because the trace data doesn't need to be cleared.

Example 10: Creating a Histogram Display

You can also control the number of samples the 11801B uses to develop the histogram. Using the **Persist/Histograms** pop-up menu, you can set a number of waveforms (traces) or a number of samples (individual trace record points, or “hits”) to acquire for the histogram before stopping acquisition.

- Step 14:** Touch the **Persist/Histograms** selector to redisplay the pop-up menu.
- Step 15:** Touch **Set N Samples** to assign the knobs to control the number of samples for the histogram.
- Step 16:** Turn either knob to set the **Sample N** value.
- Step 17:** Select **Stop N Samples** in the **Persist/Histograms** pop-up menu.

Trace acquisition stops when the number of **Hits** listed in the major menu area is equal to the number of samples you set.

Example 11: Taking TDR Measurements

This example demonstrates the TDR (Time Domain Reflectometry) feature of the SD-24 sampling heads when they are used in combination with the 11801B. TDR is a method of examining and measuring a network or transmission line by sending a step into the network and monitoring the reflections.

For this example you will need a 11801B with at least one SD-24 sampling head installed. You will also need one SMA cable, preferably of 5 ns length, and a static protection wrist strap.

- Step 1:** Initialize the 11801B (press the **UTILITY** button in the **MENUS** column, touch **Initialize** in the major menu, and touch **Initialize** in the verification pop-up menu).
- Step 2:** Put on the wrist strap and ensure that it is connected to the antistatic connector on the front panel of the 11801B.
- Step 3:** Attach one end of the cable to any SD-24 sampling head input. Leave the other end unattached.

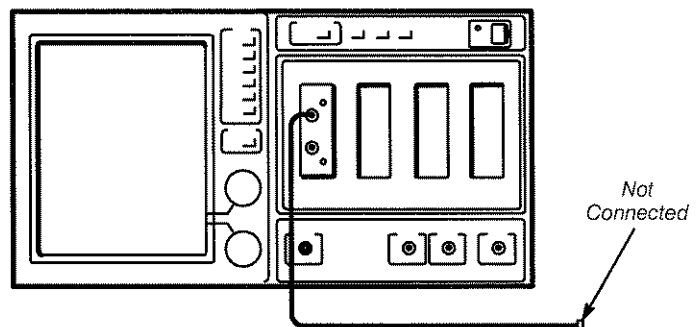

Figure 2-53: Connections for Example 11

- Step 4:** Press the **WAVEFORM** button, and touch the **Sampling Head Fnc's** selector. See Figure 2-54.
- Step 5:** Touch **Mainframe, 1** (or whichever channel you are using) and then **TDR Preset** to define a trace and turn on TDR.

The sampling head will turn on a red light next to the channel input connector, indicating that TDR is activated for that channel. TDR can be used on each channel independently.

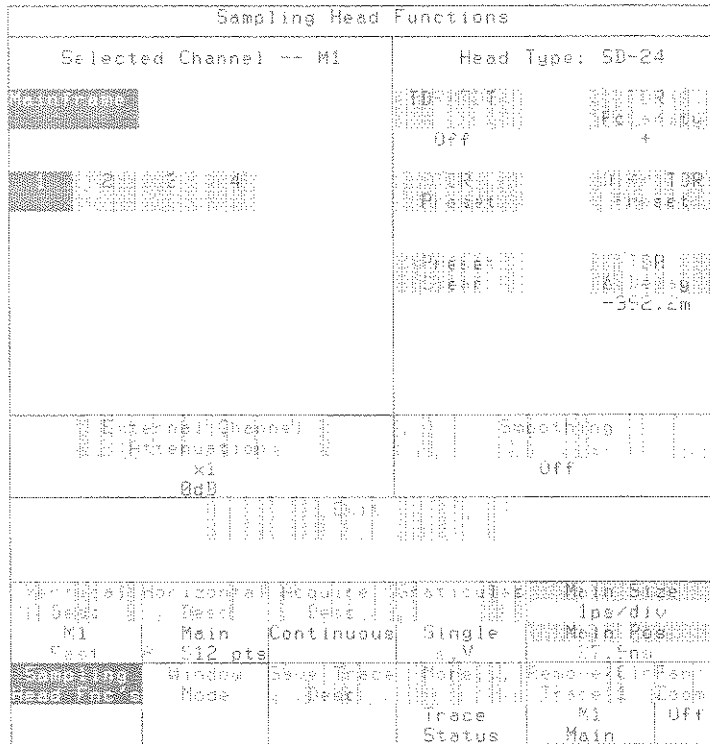

Figure 2-54: The Sampling Head Fnc's Pop-Up Menu

- Step 6:** Adjust the display sizes and positions to show a trace similar to that shown in Figure 2-55. The vertical (↓) and horizontal (↔) icons will let you make fine adjustments.

The first rise of this trace is the TDR pulse leaving the sampling head; the second rise is the reflection of the pulse returning from the end of the cable.

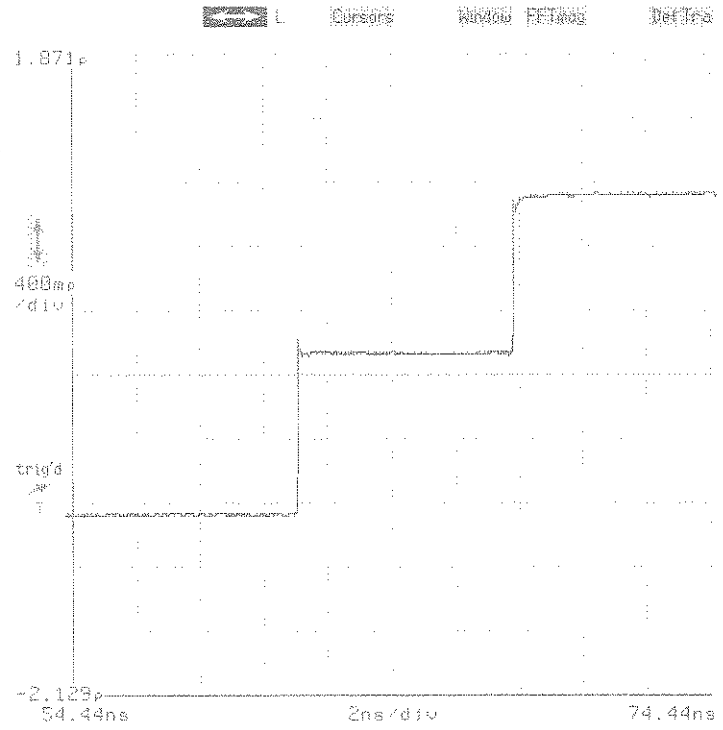

Figure 2-55: TDR Step and Reflection

Changing Graticule Units for TDR

Under normal operation, the graticule units of measurement are volts for the vertical axis and seconds for the horizontal axis. These are not the units of measurement commonly used in TDR.

When you selected **TDR Preset**, the 11801B automatically changed the units of the vertical axis to units of rho (ρ). You can change the measurement units for both graticule axes by using the **Graticules** selector in the Waveform major menu.

- Step 7:** Touch **Graticules** in the major menu and **Feet, Meters**, or **Inches** in the pop-up menu. If you know that the propagation velocity of your cable differs from the default, touch the **Propagation Velocity** selector and adjust this parameter. If you don't know the velocity or are using Tektronix SMA cables, accept the 0.7 default. This unitless number represents the fraction of the speed of light that signals pass through your network or transmission line.

The horizontal axis is now calibrated in your chosen units of measurement.

NOTE

Cursor readouts, and measurements when appropriate, are expressed in the same units as the graticule axes.

Observe the **Y Units** section of the **Graticules** pop-up menu. The vertical axis units are set to rho, so **Rho** is selected. In addition, the **Reference Amplitude** selector shows a reference amplitude of **250 mV**. This is the amplitude of the step that the SD-24 sampling head sends through the cable.

Readouts are displayed in units of impedance (Ω), as well as in units of rho, in the Cursors major menu.

Measuring Distance with TDR

One of the common uses of TDR is measuring distance. The 11801B makes it easy to measure the length of a cable or circuit board run by using the Cursors major menu. Distance is determined by the measuring the time required for a pulse to travel down a transmission line (for example, a cable or circuit board run) and for its reflection to return. The measured distance is dependent on the propagation velocity of the transmission line.

- Step 8:** Touch the **Cursors** icon to display the Cursors major menu.
- Step 9:** Touch **Cursor Type**, touch **Vertical Bars** in the pop-up menu and then touch **Exit**.
- Step 10:** Use the knobs to position Cursor 1 at the first rising edge and position Cursor 2 at the second rising edge.

You are now measuring the distance between the rising edge of the step leaving the head and the rising edge of the reflection. If you select Feet for the Y Units in the Graticules pop-up menu, you can read the length of the cable, in feet, at the $\Delta f/2$ readout. The Δf readout shows you the total distance traveled by the step and its reflection. Divide that value in half, $\Delta f/2$, and you have the length of the cable.

Example 11: Taking TDR Measurements



Acquisition

Acquisition is the process of digitizing data points from a signal and assembling them into a trace record that is shown on the oscilloscope display. Once you create a trace, acquisition of the signal is continuous and you see a live trace on the display.

How Traces are Acquired

When the 11801B acquires trace records, it bases the sampling process on a trigger event, an electrical event that occurs on the trigger signal. The trigger signal is independent of the signal being acquired. See Figure 3-1.

When the trigger event is detected, the 11801B waits a specified period of time before sampling and digitizing the first trace point. This time period is the *horizontal position* of the trace, which is set using the knobs. After the first point is digitized, the 11801B waits for another trigger event before sampling and digitizing the second point of the trace record. For the second point, the waiting time between the trigger event and the sampling and digitizing of the point is increased by the *sample interval*.

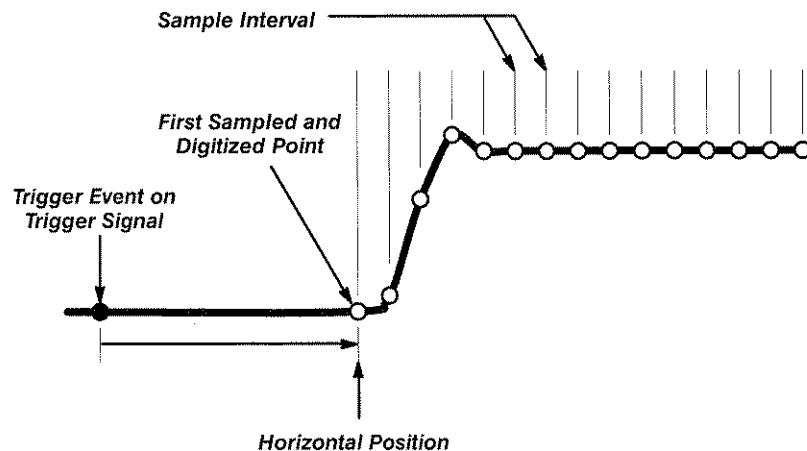

Figure 3-1: Acquisition of a Trace

The acquisition process continues until all the points in the trace are sampled and digitized. Points are acquired in order from left to right, and each point is sampled from a separate trigger event. When all the points in the trace record have been sampled and digitized, the trace is displayed. Note that for very slow trigger rates with traces that do not involve math functions or operations, a partial trace will be displayed even before all data points are accumulated.

A trace remains on the display until it is replaced by a more recent acquisition or until you clear the trace. The process of clearing traces is described on page 3-5.

You can set the number of points in a trace record, called the *record length*, to be 512, 1024, 2048, 4096, or 5120 points. Setting the record length is described in more detail on page 3-163.

Determining the Sample Interval

The sample interval is the time difference represented between successive points on the trace record. This is different from the *sampling rate*, which is the actual time that it takes to sample and digitize the successive points in the trace record. Since only one point is sampled and digitized after a trigger event, the sampling rate is much slower than the sample interval.

To compute the sample interval, divide the time period that the trace record displays by the number of points in the trace record. For example, if you are display a trace at 20 ns per division, the trace displays a little more than 200 ns of time. (There are a few points outside the 10-division graticule on either side.) If the trace has 2048 points, the sample interval is 200 ns divided by 2048, or 100 ps.

All traces on the main time base have the same record length and horizontal size. Similarly, all traces on window time bases share the same record length and horizontal size. This means that the 11801B uses one sample interval for main traces and a different sample interval for window traces. You can see what the current sample intervals are by looking at the top of the **Horizontal Desc** pop-up menu in the Waveform major menu.

Controlling Acquisition

You can freeze the traces on the display at any time by pressing the **ACQUISITION** button. This button is found above the sampling heads, near the column of major menu buttons. This technique lets you stop live traces to examine them more closely.

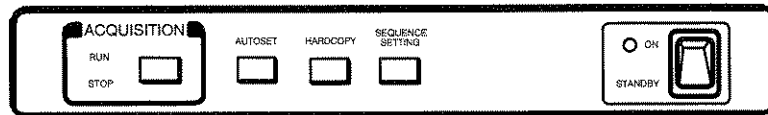

Figure 3-2: Front Panel Acquisition Lights

Next to the **ACQUISITION** button are **RUN** and **STOP** lights. One or the other of these lights is always on, telling you whether acquisition is occurring.

The **Acquire Desc** pop-up menu in the Waveform major menu also controls acquisition. You can specify that acquisition stop after all the data points are sampled for a single record. If you use the averaging or enveloping features, you can specify that acquisition stop after enough records have been acquired to provide a complete average and/or envelope.

NOTE

See Averaging and Enveloping on page 3-13 for details of how to use this pop-up menu to specify averaging or enveloping modes.

You can also stop acquisition based on the number of samples or waveforms acquired for a color-graded display, the number of samples or waveforms acquired for a histogram, or the number of “hits” acquired in mask testing. See the sections on *Display Persistence*, page 3-43; *Histograms*, page 3-99; and *Mask Testing*, page 3-119, for more information about these acquisition conditions.

You use the selectors in the **Stop Acquisition On** section of the pop-up menu to specify that acquisition stop on these various conditions. You can specify **One Record**, **Average Complete**, **Envelope Complete**, or **Both Avg and Env**. If you select **One Record**, all waveforms will be reacquired and acquisition will stop after a new, complete acquisition has been made for each waveform.

When you wish to resume normal, continuous acquisition, touch the **Continuous** selector under the heading **Run Acquisition**.

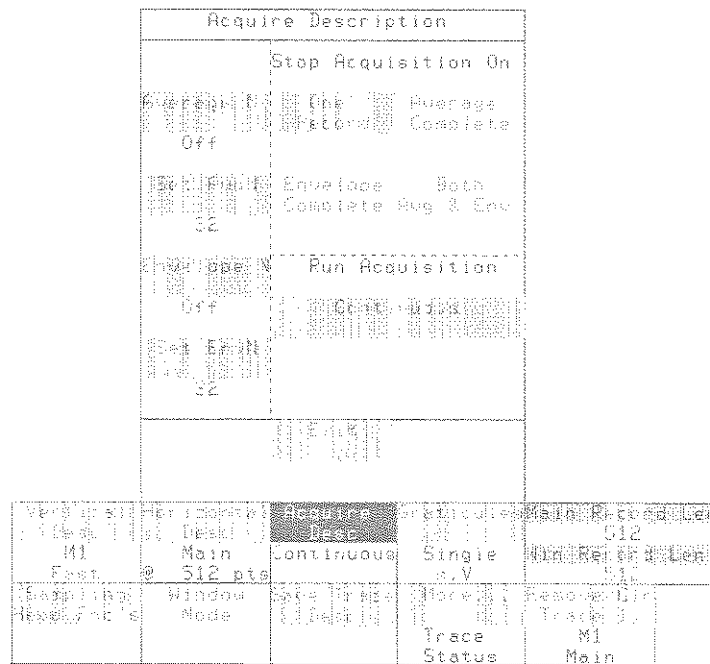

Figure 3-3: The Acquire Desc Pop-up Menu

Clearing Traces

A trace may be displayed, but not currently acquiring new trace data. This happens if a trace is not triggered, or if you use the **ACQUISITION** button to stop acquisition.

When the trace is displayed but is not acquiring data, the trace record from the last acquisition remains on the display. This is why traces appear frozen on the display when you turn **ACQUISITION** off.

You can clear the frozen trace data from the screen, using the **Clear Trace** pop-up menu in the Store/Recall major menu. This pop-up menu is illustrated on the next page. To clear a trace, touch the selector in the pop-up menu that represents the trace you want to clear. Traces are identified both by trace number and by trace expression and time base.

The **Clear All** selector lets you clear all traces at once.

You cannot clear a trace that displays only stored trace data. For example, if you have a trace that is defined to be **STO1+STO2**, then that trace will not be listed in the **Clear Trace** pop-up menu.

If you clear traces that are being acquired (live traces on the display), they will be cleared and replaced with new trace data. You may notice that the trace blinks as it is cleared and replaced. The **Remove/Clr** pop-up menu can also be used to clear the selected trace.

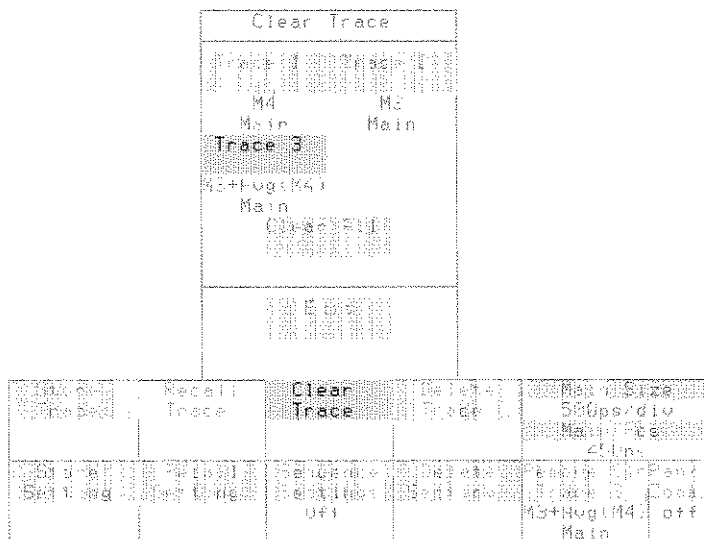

Figure 3-4: The Clear Trace Pop-up Menu



Audio Feedback

When you select a function on the touch screen, a beep indicates that your selection has been noted and is being acted on. This beep can be turned on or off.

To turn the audio feedback on or off use the **Instrument Options** pop-up menu from the Utility1 major menu. Touch the **Audio Feedback** selector in this pop-up menu to turn the beep off or on. See Figure 3-5.

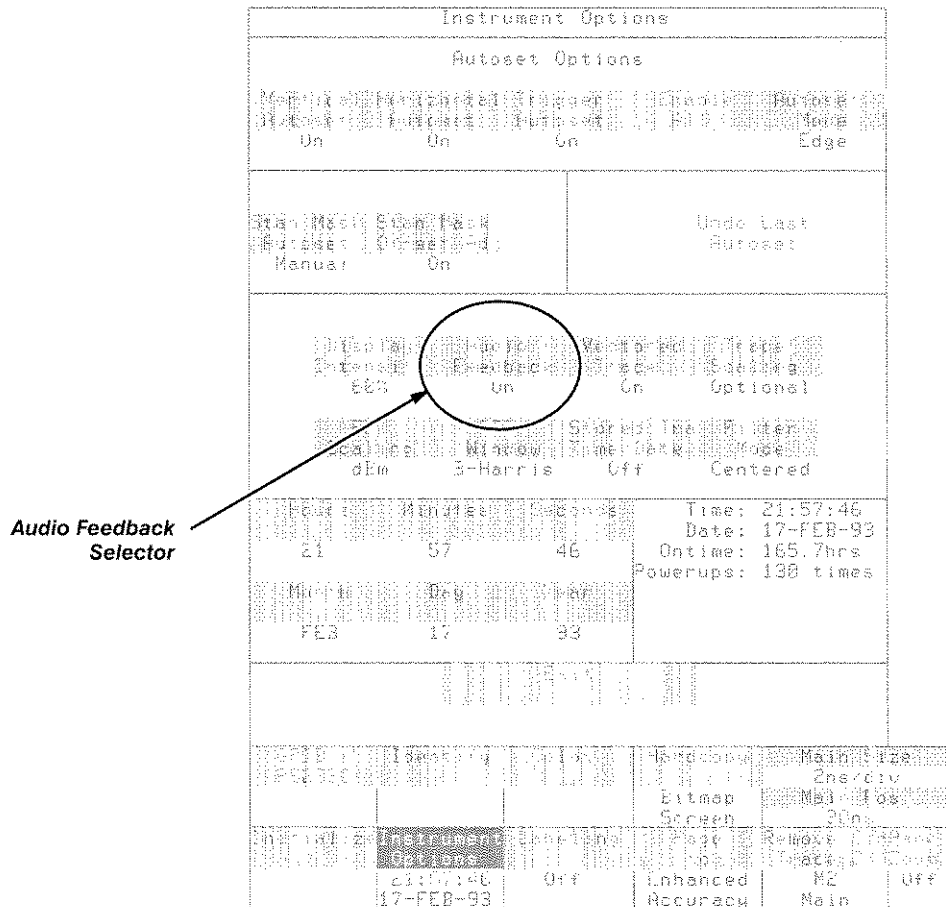

Figure 3-5: The Instrument Options Pop-up Menu



Autoset

Adjusting an oscilloscope to display a stable trace of usable size and amplitude can be a time-consuming process. The Autoset feature of the 11801B can quickly give you a stable, meaningful trace display.

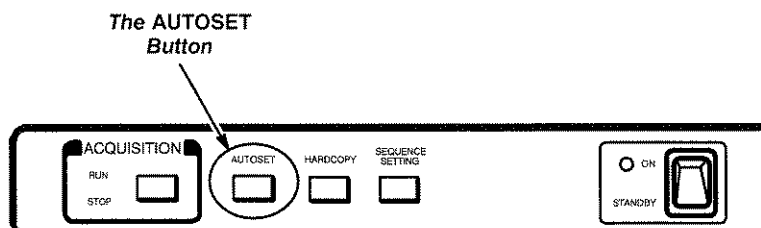

Figure 3-6: Front Panel Autoset Button

NOTE

The sampling head channels must be calibrated for autoset to work properly. See Enhanced Accuracy, on page 3-49, for more information on sampling head calibration.

When you press the **AUTOSSET** button, located above the sampling heads, you tell the 11801B to examine the signal and adjust the following controls for optimum display:

- **Vertical** gain and offset; and for calculated traces, vertical size and position
- **Horizontal** size and position
- **Trigger** level, if appropriate to that trigger source

Undoing an Autoset

If you don't like the results of an autoset, you can restore the status of the 11801B by touching the **Undo Last Autoset** selector in the **Instrument Options** pop-up menu of the Utility1 major menu. See Figure 3-7.

Autoset Options

The **Instrument Options** pop-up menu lets you set several autoset parameters, so that you can tailor the autoset operation to your needs.

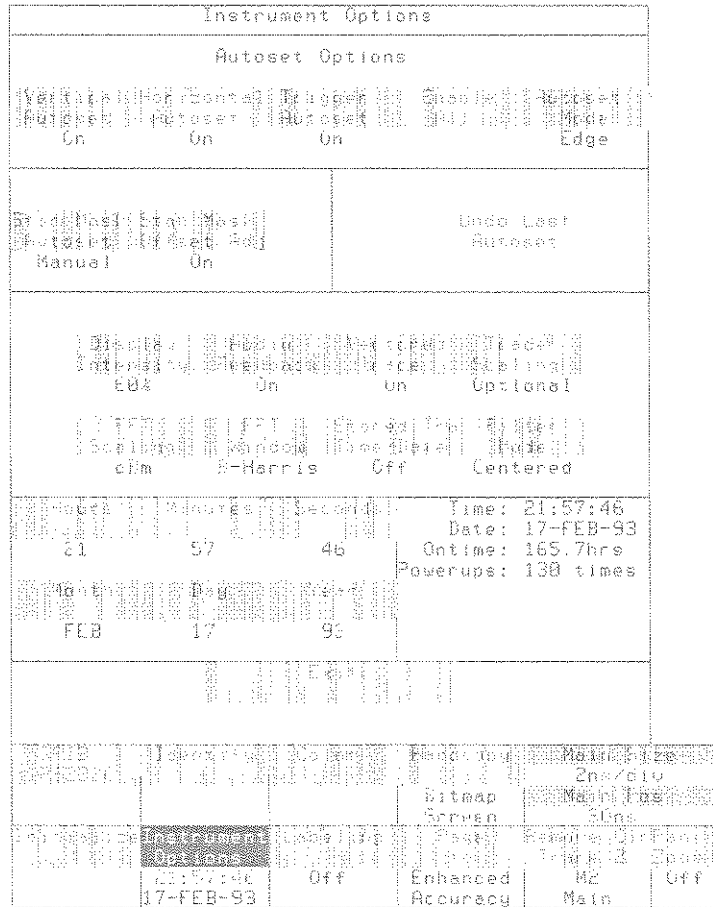

Figure 3-7: The Instrument Options Pop-up Menu

The **Autoset Options** section has five selectors to let you turn off or toggle certain autoset operations. When you set the **Vertical Autoset**, **Horizontal Autoset**, or **Trigger Autoset** to **Off**, those settings are not affected when you press the **AUTOSSET** button. For example, if you set **Horizontal Autoset** to **Off**, then the **Horizontal Size** or time-per-division setting is not changed when you next press **AUTOSSET**. The **Enable All** selector sets the other three selectors to their normal **On** state. The exception to this is Standard Mask Autoset. See Standard Mask Autoset on page 3-11.

The **Autoset Mode** selector lets you choose between **Edge** mode, which shows a single rising or falling edge of signal across 20% or less of the display, or **Period**, mode which shows three or more complete cycles of a signal. Note that for Standard Mask Autoset, the **Autoset Mode** does not apply. See Standard Mask Autoset on page 3-11.

Standard Mask Autoset

The 11801B can be configured to perform an autoset automatically whenever a standard mask is selected from the Standard Mask pop-up menu, which is available in the Display Modes major menu. A standard mask autoset sets the horizontal, vertical and trigger parameters to the signal characteristics of the selected standard mask. By setting **Stan Mask Autoset** to **Auto**, the instrument performs the autoset when a standard mask is selected. If **Stan Mask Autoset** is set to **Manual**, the standard mask autoset occurs only when you press **AUTOSET** at the front panel. Note that after initialization, the instrument defaults to **Manual**. You can turn off the trigger parameter adjustments during standard mask autoset from the Instrument Options pop-up menu. Setting **Trigger Autoset** to **Off** causes the 11801B to leave trigger parameters unchanged during a standard mask autoset.

Also, when **Stan Mask Autoset** is set to **Auto**, then whenever you perform a standard mask autoset, either by first selecting the standard mask or by pressing the **AUTOSET** button, the instrument immediately begins counting mask hits and also enables **Stop N Waveforms** on the Mask Testing pop-up menu. This feature helps simplify your testing sequence, because you can select a particular standard mask and the instrument will immediately perform standard mask autoset and begin mask testing. You can change the signal source, press **AUTOSET** at the front panel, and the instrument will perform standard mask autoset and begin mask testing on the new signal source. See *Mask Testing*, page 3-119, in this manual for more information.

When performing a standard mask autoset for pulse masks (not eye pattern masks), the instrument turns on waveform averaging and acquires the number of waveforms indicated or selected in the Acquire Description pop-up menu before performing autoset. In this way, the autoset is more accurately performed to an average. For this autoset, you can set the number waveforms averaged to between 8 and 128. (You can select greater or fewer waveforms for the average, however the instrument limits the selection to this range for this autoset.) You can use this feature to control the speed and accuracy of autoset for pulse masks.

Many of the standards specify voltage levels for the signal. For these standards, be sure to enter any external attenuation that may be in the signal. You can do this from the **Sampling Head Fncs** pop-up menu, in the Waveform major menu.

For bipolar signals, you may want to compare the negative pulse to the standard mask. To do this, define the trace as **-M1** (not **-1 x M1**). You can use the **Vertical Description** pop-up menu. Standard mask autoset will work for inverted negative pulses, but only if **Time Base Cal Mode** is set to **Fast** and not **High Prec**. Standard mask autoset will produce errors for more complicated trace expressions.

Setting the **Stan Mask Offset Adj** selector to **On** causes the instrument to adjust the vertical offset during a standard mask autoset to make the waveform match the selected standard mask more closely. Setting this selector to **Off** turns off vertical offset adjustments during a standard mask autoset. This feature only applies to 19 of the standard masks. They are:

- CCITT G.703 Standard Masks

- Single Pulse 64 kb/s
- Double Pulse 64 kb/s
- Data Pulse 64 kb/s
- Timing Pulse 64 kb/s
- Pulse 1.544 Mb/s
- Sym Pair 2.048 Mb/s
- Coax Pair 2.048 Mb/s
- Sym Pair 6.312 Mb/s
- Coax Pair 6.312 Mb/s
- Pulse 8.448 Mb/s
- Pulse 32.064 Mb/s
- Pulse 34.368 Mb/s
- Pulse 44.736 Mb/s
- Pulse 97.728 Mb/s

- ANSI T1.102 Standard Masks

- Digital Signal 1 (DS1) 1.544 Mb/s
- Digital Signal 1 (DS1 old) 1.544 Mb/s
- Digital Signal 1C (DS1C) 3.152 Mb/s
- Digital Signal 2 (DS2) 6.312 Mb/s
- Digital Signal 3 (DS3) 44.736 Mb/s

For all other standard masks, vertical offset is always adjusted by the standard mask autoset, regardless of how this option is set in the Instrument Options pop-up menu.

Averaging and Enveloping

The averaging and enveloping functions allow you to examine and manage noisy signals.

- Averaging reduces the apparent noise of a displayed trace and provides a cleaner display. The 11801B presents a trace that is an average of several accumulated trace records. Each sample in a record is numerically averaged with the same sample in all the other records. The resulting trace is displayed.
- Enveloping shows the cumulative effect of noise over a period of time. It is similar to averaging in that several trace records are accumulated and a combined result is displayed. An enveloped trace shows the maximum excursions of the individual trace records. This often results in a “thicker” trace that shows the limits of variation of the signal.

Defining an Averaged or Enveloped Trace

There are two ways of establishing an averaged or enveloped trace.

1. If you are establishing a new trace, you can use the **AVG(** or **ENV(** trace functions as you define your trace. These can be selected from the **Def Tra** menu. For more information on this method, see Trace Definition and Management on page 3-207.
2. The easiest method is to establish the trace first without averaging or enveloping. Then, after you have the trace adjusted, you can invoke averaging or enveloping.

The following procedure describes averaging and enveloping using the second method described above.

- Step 1:** Create the trace you want using any method.

NOTE

If you aren't sure how to define a trace, see Trace Definition and Management on page 3-207.

- Step 2:** If the trace isn't selected, touch the trace to select it.
- Step 3:** To average the trace, press the **WAVEFORM** button, touch the **Acquire Desc** selector in the major menu, and then touch the **Average N** selector in the pop-up menu. See Figure 3-8.
- Step 4:** To envelope the trace, press the **WAVEFORM** button, touch the **Acquire Desc** selector in the major menu, and then touch the **Envelope N** selector in the pop-up menu.

The **Vertical Desc** selector status, shows that the average or envelope function is part of the trace expression.

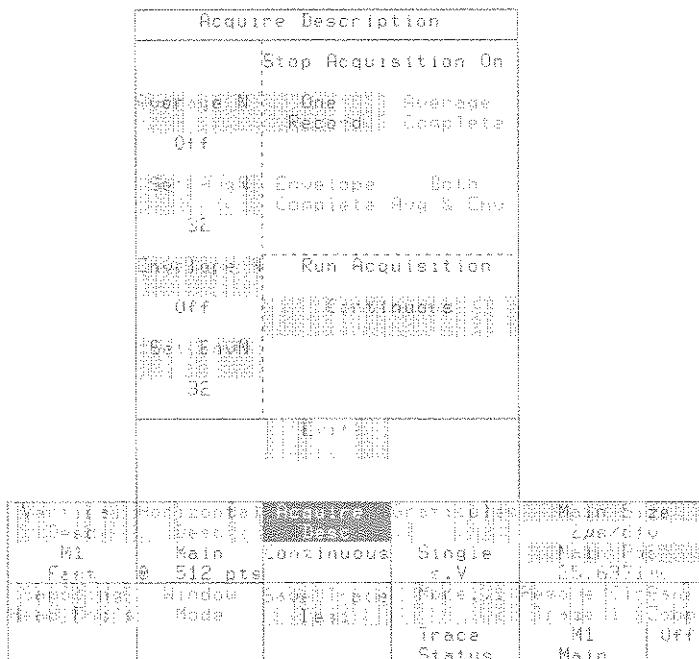

Figure 3-8: The Acquire Desc Pop-up Menu

Terminating Averaging or Enveloping

When you want to return to normal trace display, touch the **Average N** or **Envelope N** selector in the Acquire Description pop-up menu.

Record Count

Several complete trace records are combined to form an averaged or enveloped trace. You can set the number of records that the 11801B accumulates and combines.

Use the **Set Avg N** and **Set Env N** selectors in the **Acquire Desc** pop-up menu to assign the knobs to set the number of records. The top knob sets the number of records to accumulate for an average, and the bottom knob does the same for enveloping when you also limit acquisitions. You can set the instrument to limit acquisitions for enveloping or averaging. See *Limiting Acquisition* in this section.

Each knob click changes the current value by a multiple of two in the coarse setting. You can use the numeric keypad to enter specific values or change the knob resolution.

Limiting Acquisition

You can have the 11801B stop acquiring trace data when enough data is accumulated to determine a complete average or envelope. This has the effect of freezing the trace. The selectors in the **Stop Acquisition On** section of the Acquire Description pop-up menu let you specify **One Record**, **Average Complete**, **Envelope Complete**, or **Both Avg & Env**. When you want to resume normal continuous acquisition, touch the **Continuous** selector.

Side Effects of Averaging and Enveloping

Averaging improves the accuracy of some software measurements because the measurements are taken from averaged data. However, some measurements can be adversely affected by averaging or enveloping. For example, if you take a rise time measurement of a signal with horizontal jitter, the averaged trace will indicate an inaccurately slow reading. Be cautious when taking software measurements of averaged or enveloped traces. One way to take an accurate rise time measurement on a signal with jitter is to use statistical measurements on the unaveraged signal.

Hardware measurements are unaffected by averaging or enveloping because these measurements are taken directly from the signal.

Baseline Correction

Baseline correction holds the vertical position of a trace on the display while the signal is changing. This feature is most useful in TDR measurements because changes in transmission line impedance affect the vertical placement of the trace.

When baseline correction is first turned on, the left-most region of the selected trace is examined and the vertical screen placement of this trace segment is determined. The left-most region is the region of samples soonest after the trigger, and may or may not be shown on the trace display. Thereafter, the baseline correction feature periodically examines this left-most region of the trace and automatically adjusts the vertical position to move that portion of the trace to its established vertical placement.

Select the Waveform major menu to access the **Graticules** pop-up menu. Touch the **Baseline Correction** selector in the **Graticules** pop-up menu to turn baseline correction on or off.

Baseline correction works on all channels (up to 12) in all defined traces. Baseline Correction is automatically turned on when Rho is selected for Y Units and turned off when Volts are selected for Y Units.

Example

The following example shows the value of Baseline Correction.

- Step 1:** Turn baseline correction off.
- Step 2:** Put on the wrist strap and ensure that it is connected to the antistatic connector on the front panel of the 11801B.
- Step 3:** Using an SD-24 sampling head, establish a TDR display of a short, unterminated cable. Position the trace horizontally so that the first rise does not occur to the left of the first graticule division.
- Step 4:** Terminate the cable using a 50 Ω terminator. Observe that the impedance change moves the entire trace vertically on the display.
- Step 5:** Remove the 50 Ω terminator.
- Step 6:** Turn baseline correction on.
- Step 7:** Replace the 50 Ω terminator on the cable. Observe that this time, the baseline of the signal has not moved vertically on the display. Instead, the vertical axis coordinates have adjusted to the new trace values being displayed.



Calibrator

The **CALIBRATOR** output connector provides a known signal output for your use in calibrating sampling heads. This connector is found at the bottom right of the front panel. See Figure 3-9.

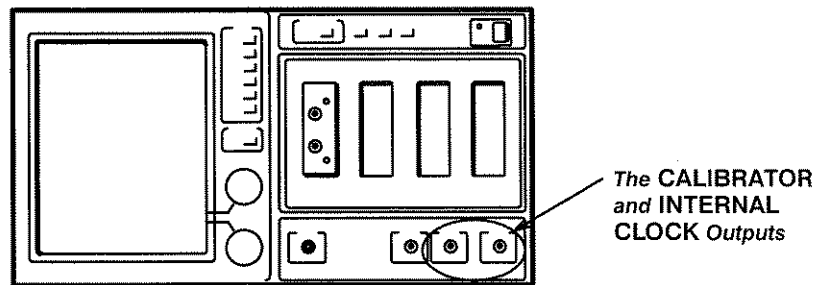

Figure 3-9: Location of the CALIBRATOR and INTERNAL CLOCK Outputs

The signal from the calibrator output is a fast risetime, 250 mV square wave with a period of approximately 10 μ s.

The internal clock trigger source is synchronized with the calibrator output, and provides a trigger event approximately 23 ns prior to the rising edge of the calibrator signal (45.5 ns for option 1M). This synchronized trigger signal is available at the **INTERNAL CLOCK** connector, located below the sampling heads.

To see the calibrator signal on the screen, follow these steps.

- Step 1:** Initialize the instrument (press the **UTILITY** button, touch **Initialize**, then touch **Initialize** again).
- Step 2:** Connect the **CALIBRATOR** output to any sampling head input, using an SMA cable.
- Step 3:** Press the sampling head **SELECT CHANNEL** button for the channel you are using.
- Step 4:** Select the internal clock trigger source (press the **TRIGGER** button, touch the **Source** selector in the major menu, and touch the **Internal Clock** selector in the pop-up menu).
- Step 5:** Press the **AUTOSET** button.



Color Display

Specific colors are assigned to the items on the display. The background, graticule and selectors, and cursors and measurement annotations are displayed in distinct colors for easy identification. In addition, there are up to four colors for traces and an additional color for window traces.

The four trace colors are assigned automatically to traces as the traces are defined. When a window trace is defined, it is displayed in the window trace color. When you select a trace, its color brightens.

Color Selection

You can modify the display colors to suit your preferences using the **Color** pop-up menu in the Utility1 major menu. See Figure 3-10. You can change the colors displayed and the overall intensity of the display. You can also reassign the color of the selected trace to any of the four trace colors or window trace color.

The upper section of the **Color** pop-up menu has a selector for each display color. Next to each selector is a box the color of that display element, and beneath the selector is a readout of the hue, lightness, and saturation values of that color.

- **Hue** is the characteristic associated with a color name, such as red. It is expressed in degrees on a range of 0° to 360°.
- **Lightness** is the intensity of the color, or the amount of light it transmits. Lightness is expressed from 0% (black) to 100% (white).
- **Saturation** is the vividness of the color, or the extent that it differs from gray. Saturation is expressed from 0% (maximum white content) to 100% (fully saturated).

To change the color of a display element, select the element in the **Color** pop-up menu. The knobs are automatically assigned to control **Lightness** and **Saturation**; select **Hue** if you want to adjust the hue of the color. Adjust the color using the control knobs.

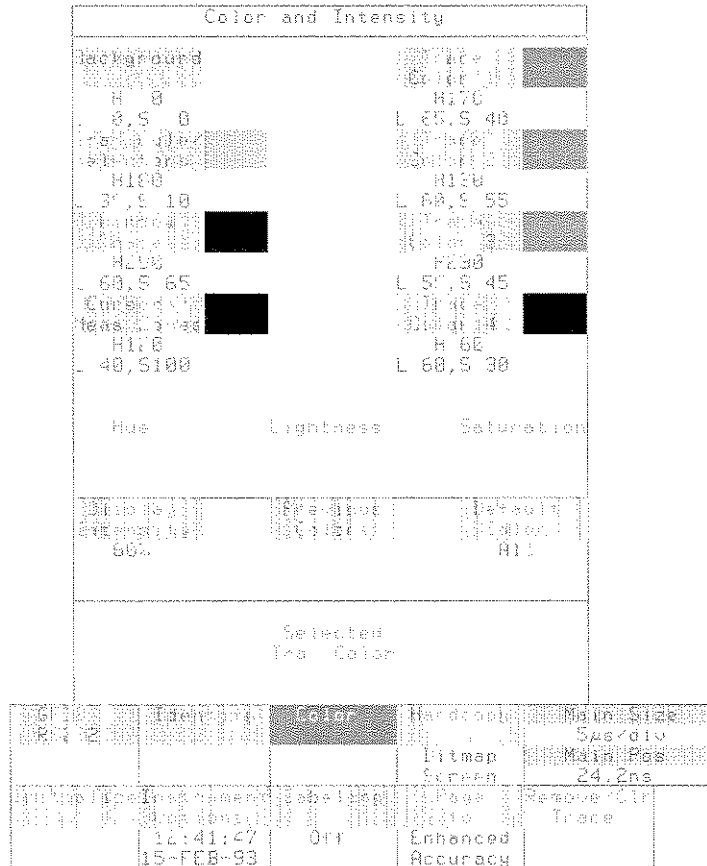

Figure 3-10: The Color Pop-up Menu

Restoring Colors

Two selectors in the **Color** pop-up menu let you restore colors to their default settings or to the colors previously defined.

- **Previous Colors** restores all eight display elements to the colors they had when you displayed the **Color** pop-up menu.
- **Default Color** sets the selected display element to the factory default color.

When no display elements are selected, the **All** label is displayed below the **Default Color** selector, and touching **Default Color** sets all eight display elements to the factory default colors.

Reassigning Trace Colors

Although the four trace colors are assigned to traces in order as they are created, you can change a trace's color assignment using the **Selected Tra Color** selector at the bottom of the **Color** pop-up menu.

The status area below the **Selected Tra Color** shows the trace number of the selected trace and the number of the color assigned to that trace, for example **Trace Color 1**. The box next to the selector displays the color of the trace.

Touch the **Selected Tra Color** selector to change the color assignment of the selected trace. As you touch the **Selected Tra Color** selector, it cycles through the four trace colors and window trace color. Touch the **Window Trace** selector to change the color assignment of the window trace.

Setting the Display Intensity

You can adjust the overall intensity, or brightness, of the display. Touch the **Display Intensity** selector in the **Color** pop-up menu to assign the knobs to control the intensity of the display. Display intensity can be from 0% to 100%.



Constellation Diagrams

A constellation diagram is the result of displaying one data signal against another in an XY format, resulting in a matrix display of the various signal levels. This section provides general instructions to help you display a constellation diagram on the 11801B.

Displaying a Constellation Diagram

You will need the following equipment:

- A two-channel sampling head or two single-channel sampling heads
- 3 SMA cables
- A static protection wrist strap

To display a constellation diagram perform the following steps:

- Step 1:** Press the **UTILITY** button, touch **Initialize** in the Utility1 major menu, and then touch **Initialize** in the **Verify Initialize** pop-up menu.
- Step 2:** Put on the wrist strap and ensure that it is connected to the antistatic connector on the front panel of the 11801B.
- Step 3:** Connect a cable from signal source 1 (often called the “I” signal) to Channel 1 (for simplicity, we assume you are using a two channel sampling head).
- Step 4:** Connect another cable, of the same length, from signal source 2 (often called the “Q” signal) to Channel 2.
- Step 5:** Connect the third cable from your trigger source to the **TRIGGER INPUT** connector on the front panel. Be sure not to exceed the maximum input voltage shown below each of the trigger inputs.
- Step 6:** Press the **TRIGGER** button. Touch the **Source** selector in the Trigger major menu. Touch **External Direct**. Touch **Exit** to remove the pop-up menu.
- Step 7:** Turn on Channel 2 by pressing the select channel button next to the input connector.
- Step 8:** Turn on Channel 1 by pressing the select channel button next to the input connector.
- Step 9:** To acquire a constellation diagram, you need to sample the data on both channels at a point where it is stable (this is, not transitioning between states). See Figure 3-11.

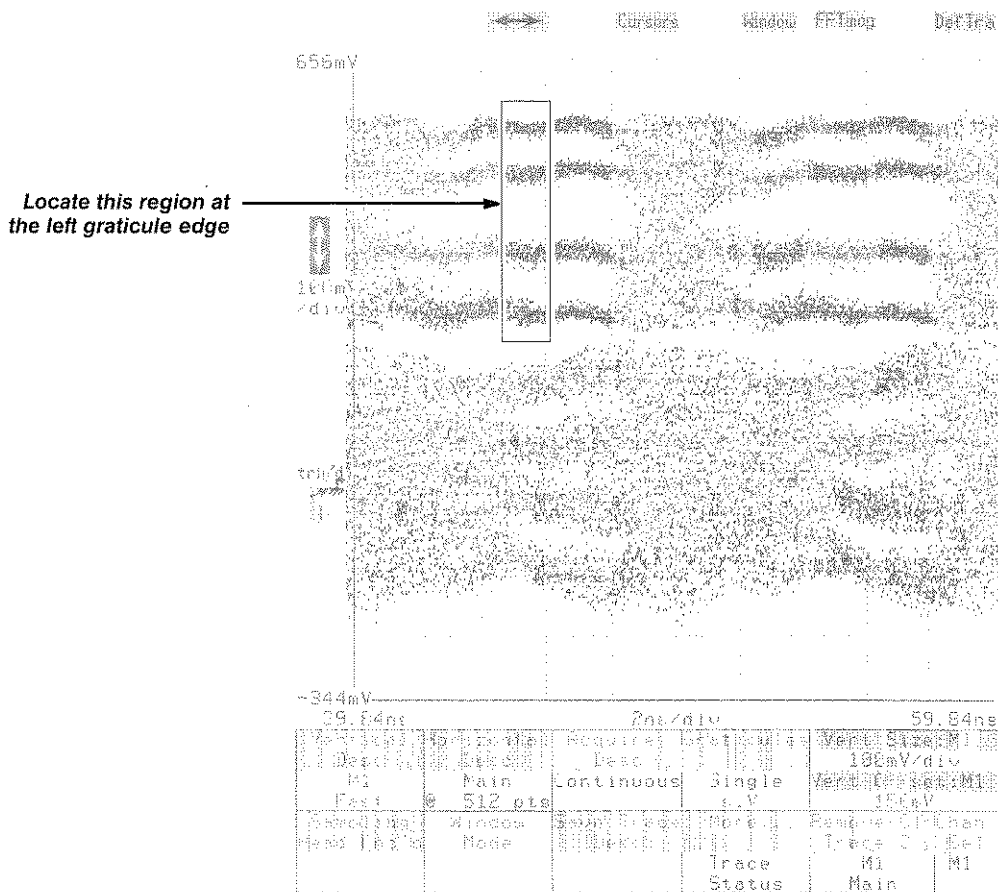

Figure 3-11: Adjusting the Main Position

- Step 10:** To set the 11801B for this condition, create a normal YT waveform on each of the two channels. Adjust the horizontal size and position to expand a small section of the waveform horizontally and to fill most of the screen vertically. The exact settings required to achieve this result will depend on your signal. For fast signals, you can even set the horizontal size to zero ps/div by keying in 0 on the knob pop-up keypad. Repeat this process for both channels until you have two waveforms that look something like Figure 3-12.

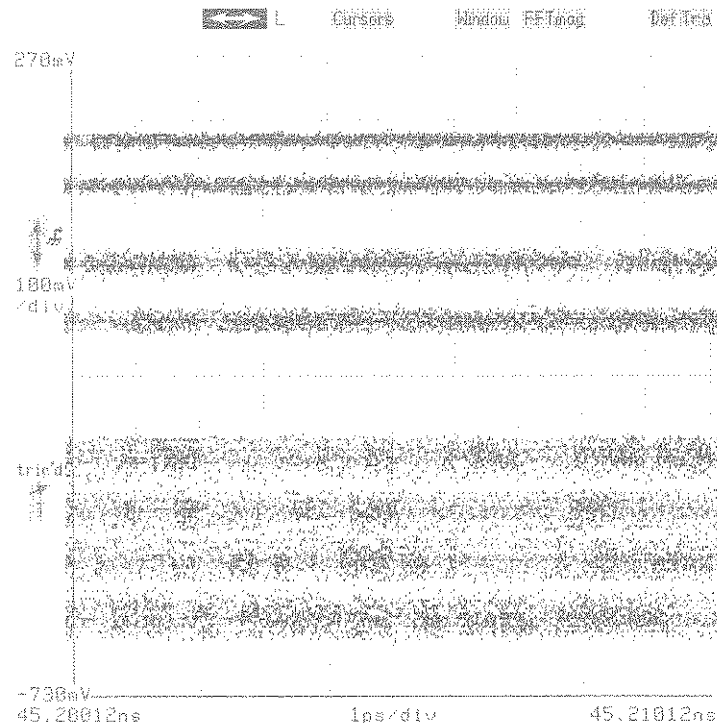

Figure 3-12: How the Expanded Waveforms Should Appear

- Step 11:** Adjust the Main size to 0 ps/div. You should see two or more distinct voltage levels (depending on the signal) across the full screen. If not, go back to 1 ns/div and reposition the four states on the left graticule edge.
- Step 12:** Select channel 2 by touching it. You can determine which channel is selected by the yellow blinking light next to the input connector.
- Step 13:** Press the **WAVEFORM** button.
- Step 14:** Select **Horizontal Desc** from the major menu.
- Step 15:** Touch the **Trace 2** selector in the XY Display Mode section of the pop-up menu.

If a 45° line appears instead of a constellation diagram, you have selected the wrong trace as the “X” component. This results in plotting one channel against itself, which produces a diagonal line instead of a constellation diagram. To select the correct channel, go back to the **Horizontal Desc** pop-up menu and select the other (non-highlighted) channel in the XY display mode section of the pop-up menu. See Figure 3-13.

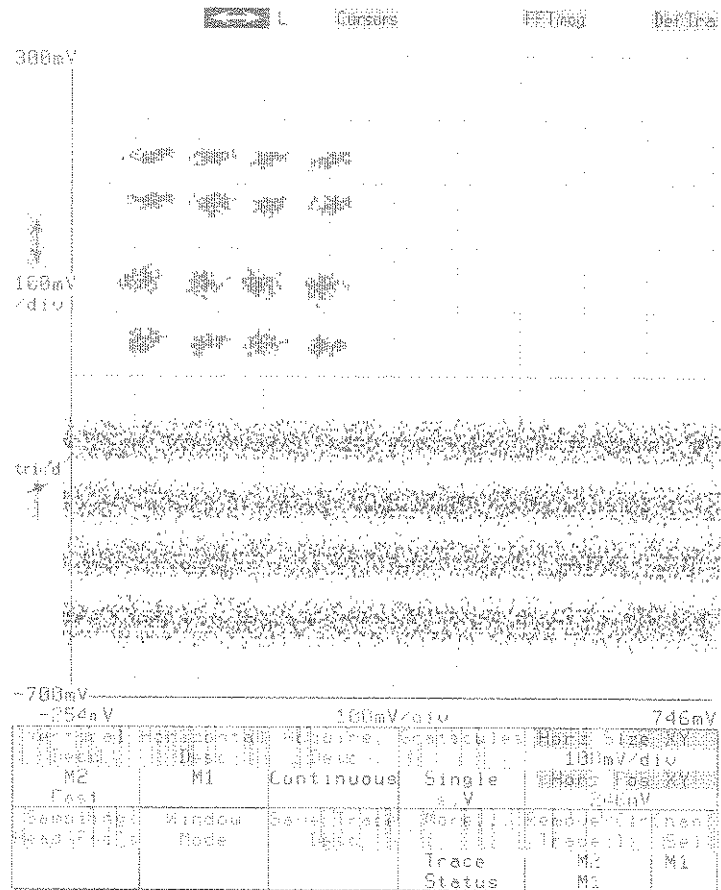

Figure 3-13: The Display After Selecting the XY Display Mode

- Step 16:** The channel 2 trace should now appear as a constellation diagram and the channel 1 trace should remain unchanged. Now, delete the channel 1 trace (touch the other signal display and use the **Remove/Clr** pop-up menu) and adjust the constellation diagram to fill the screen. To enlarge the constellation diagram, adjust the size and position controls as necessary.

You should now have a constellation diagram in the center of the screen. You can now use histograms, mask testing, variable persistence, and color grading to evaluate the constellation diagram.

Cursors

Cursors provide a way to measure the difference between two trace locations that you specify. Cursors are markers that you position using the knobs. Once the cursors are positioned, readouts in the Cursors major menu show the absolute locations of the two cursors, and the difference (Δ) between them.

- **Vertical cursors** are a pair of vertical bars. The position of the cursors and the horizontal distance between them is shown in horizontal axis units.
- **Horizontal cursors** are a pair of horizontal bars. The position of the cursors and the vertical distance between them is shown in vertical axis units.
- **Paired-Dots cursors** are a pair of small, diamond-shaped dots resting on the trace. As you move a dot cursor using the knob, it follows the trace to the left or right. The cursor readout shows both the vertical and horizontal positions, in the respective axis units.
- **Split-Dots cursors** appear similar to paired dots, except the dots may be on different traces. The readout indicates both the vertical and horizontal measurements, in the respective axis units.

NOTE

Consider using the automated measurement system to take measurements before using cursors.

You can use cursors to take several measurements. However, the automated measurement system is easier, faster, and more accurate. You can take many common measurements using the Measure major menu. See Measurements on page 3-137 for more information.

Cursor Operation

Before you use cursors, display the trace(s) that you want to measure. The trace should be selected (highlighted). For split-dot cursors, either trace may be the selected one.

To invoke the Cursor major menu, touch the **Cursors** icon, located above the graticule with the selected trace. This icon operates like one of the menu buttons at the right of the screen: it has its own major menu. When the Cursor menu is displayed, none of the lights of the major menu buttons are lighted.

NOTE

*Establish all trace displays **before** turning on the cursors.*

When you touch the **Cursors** icon, the 11801B displays the cursors and their readouts. Whenever you touch the **Cursors** icon, the knobs are assigned to adjust cursor positions.

The Cursors major menu has three selectors, **Cursor Type**, **Set Zero**, and **Exit**. The rest of the major menu area shows the data readouts associated with the displayed cursors. See Figure 3-14.

NOTE

*The **Cursors** icon functions much like a major menu button.*

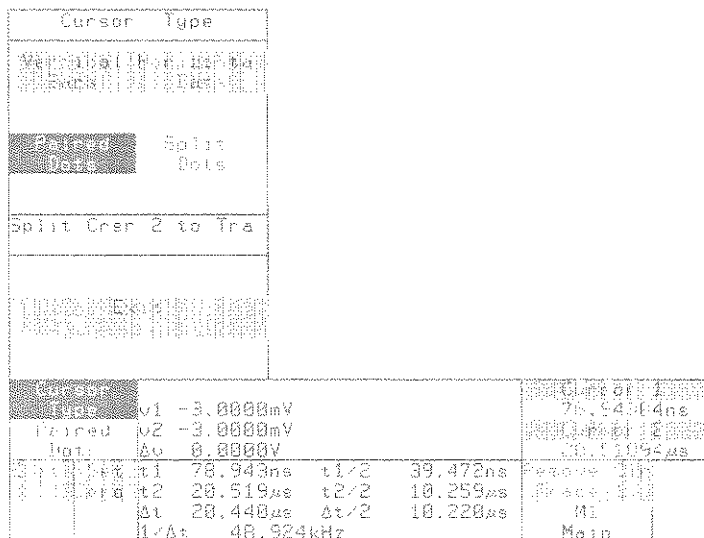

Figure 3-14: The Cursors Major Menu and Cursor Type Pop-up Menu

Selecting Cursor Types

At the top of the **Cursor Type** pop-up menu, you can select from four cursor types. If you select **Vertical Bars**, **Horizontal Bars**, or **Paired Dots**, the 11801B removes the pop-up menu and shows the selected cursors. The knobs control the cursor positions.

If you select **Split Dots**, the pop-up menu stays on the display, and the lower half of the pop-up menu is active. The lower menu shows a selector for each displayed trace (for example **Trace 1**, **Trace 2**). The selector for the displayed trace is highlighted.

At this point, both split-dot cursors are assigned to the selected (highlighted) trace. To assign the second (right-most) cursor to a different trace, touch the selector for that trace. This action removes the pop-up menu and moves the second cursor to the selected trace.

Cursor Calibration

Cursor readout can be referenced to a user-set horizontal point. This is useful for making distance or time measurements using TDR or TDT. To specify cursor readout based on cursor position, press the **Set Zero** selector. The **Set Zero** pop-up menu is displayed. See Figure 3-15.

Set to Zero					
Set Cur1 Zero	0	0x2	0	0	0
Paired	p1 -998.00ms	50.04mΩ	100.1mΩ	40.20376ns	
	p2 985.00ms	7.093kΩ	6.567kΩ	0.00000ns	
Delta	Δp 1.9840e	0.0000	0.0000	0.00000ns	
	t1 40.224ns	t1/2	20.112ns		
	t2 50.444ns	t2/2	25.222ns		
	Δt 10.220ns	Δt/2	5.1100ns		
	1/Δt	97.847MHz			

Figure 3-15: The Set Zero Pop-up Menu

To set the current horizontal value of Cursor 1 to zero, touch the **Set Cur1 Zero** selector. A Δ (delta) is displayed in the status area of the **Cursor Type** selector, indicating that cursor measurements are made by subtracting that value. This is useful in TDR and TDT measurements. Touch **Clear Cursors** to return to normal mode. Touching **Set Zero Rho** enables you to position the cursors on a portion of the trace that you wish to be used as the “zero rho” (or 50 Ω) position. (**Set Zero Rho** is not selectable unless Y Units is set to **Rho** in the **Graticules** pop-up menu.)

- To undo the effect of setting zero rho, the selected trace must be removed and redefined. However, you can also recalibrate the zero rho point for better results.

Once you have positioned the cursors, select **Proceed**. The 11801B will calculate a constant (RHOZERO) to be saved with the selected trace. The RHOZERO constant is added to the rho position (RHOPOS) for the selected trace. Every time RHOPOS is recalculated for the selected trace (for example, by baseline correction) RHOZERO will be added to RHOPOS again. This makes the cursor readout (and the automated measurement system) more accurate for the selected trace.

Removing Cursors

You can remove cursors by touching the **Exit** selector in the status area. The front panel will return to the previously selected major menu.

Additional Cursor Facts

- Once cursors are established on a trace or trace pair, touching another trace selects that trace and moves both cursors to it.
- Split Dots cursors cannot be used on X-Y traces. Other cursor types operate normally on X-Y traces.
- If the horizontal axis displays time (the normal case), then the horizontal cursor readout shows the inverse of the delta ($1/\Delta t$), which can be used to show frequency. The cursor readout also shows the absolute values of the cursor locations and the distance between them.
- A dot cursor is displayed as a vertical bar if it is placed on a trace where trace data cannot be displayed. For example, if your trace is not triggered and therefore is not showing on the display, placing dot cursors on it will show vertical bars. This is because without trace data, there is no known vertical position for the dot.
- When a trace is scaled in rho, and the cursor type is dots or Horizontal Bars, ohms (Ω) and ohms $\times 2$ ($\Omega \times 2$) values will also be displayed for the cursor.

Cursor Examples

Measuring Trace Amplitude

The following procedure shows how to use cursors to measure trace amplitude.

- Step 1:** Acquire and display a trace you want to measure. Make sure all of the trace is within the graticule area, but make the trace as tall as possible for best vertical resolution (use the vertical icon if necessary).
- Step 2:** Select the trace you want to measure.
- Step 3:** Touch **Cursors**, **Cursor Type** and **Horizontal Bars**.
- Step 4:** Use the knobs to move the cursor positions to the top and bottom of the trace. Use the **Cursor 1** or **Cursor 2** selectors in the Knob menu to increase the resolution of the knobs. This lets you position the cursors more precisely. The Δv readout at the display bottom indicates the trace amplitude.

Measuring Time Between Points On Different Traces

The following procedure shows how to use cursors to measure time between points on different traces.

- Step 1:** Create a display of the two traces you want to measure. Make sure that the point you want to measure on each trace is visible on the display. For the most accurate results, use the shortest time per division that shows the points to be measured. (Window traces can be used to get a much shorter time-per-division and still have both cursor points on the display)
- Step 2:** Leave either of these traces as the selected trace, and note the number of the other trace.
- Step 3:** Touch **Cursors**, **Cursor Type** and **Split Dots**.
- Step 4:** Touch the trace selector of the other trace that you want to place a cursor on. If you've forgotten its number, the trace description appears in each selector.
- Step 5:** The cursors are now placed, one on each trace. Use the knobs to move the cursors to the two locations from which you want to measure time difference. Then read the time difference (Δt) at the bottom of the display.



Diagnostics

The 11801B features a diagnostic system that performs comprehensive tests of the instrument. This ensures you that your instrument is operating correctly. A set of tests is automatically performed whenever the 11801B is powered on. You can execute additional diagnostic tests at any time.

There are three categories of tests:

- **Power-On Diagnostics** are basic functional tests. These ensure that the various microprocessors are running and communicating with each other. The power-on diagnostics take about 5 seconds to execute and are run only at power-on.

NOTE

The 11801B executes the power-on and self-test diagnostics whenever the power is turned on.

- **Self-Test Diagnostics** are a subset of the extended diagnostics and are executed as a group at power-on. You can also execute this group at any time. This group of tests takes about 15 seconds to execute.
- **Extended Diagnostics** are a complete set of tests which you can execute either individually or as a group at any time. A separate menu system controls the extended diagnostics. Any time the self-test diagnostics encounter a failure, the extended diagnostics menu remains on the screen so that you are notified of the failure.

The extended diagnostics menu is primarily intended as an aid for those servicing the instrument. This manual introduces the menu but does not discuss the extended diagnostics completely. For complete information, see the *11801B Service Manual*.

NOTE

Do not touch the touch screen or press the front panel buttons during any diagnostic tests. You may cause the diagnostics to report spurious failures.

Power-On Diagnostics

The 11801B executes the power-on diagnostics whenever you turn the power on; this is the only time these tests are executed. The power-on diagnostics test the most fundamental operations of the microprocessors and the communication paths between microprocessors.

Power-on diagnostics take about 5 seconds to execute. During this time the front panel lights will blink and the display will show the following message. (If the display is not yet warmed up, you may not be able to see the message.)

Diagnostics in Progress

Comm Test in Progress

If the power-on diagnostics are completed successfully, the self-test diagnostics are executed immediately and you will see the message **Self Test in Progress** on the display.

If the power-on diagnostics fail, one or more of the following indications will notify you.

- The instrument emits a high-low beep.
- The instrument freezes and a message appears on the display. For example:

Dsy Kernel Failure RAM Data Bit

- The instrument freezes and some of the front panel lights are turned on.

Self-Test Diagnostics

The 11801B automatically executes the self-test diagnostics after the power-on diagnostics are completed successfully.

The self-test diagnostics can also be initiated by touching the **Self Test** selector, located in the Utility2 major menu (press the **UTILITY** button until the Utility2 menu appears), and then touching **Self Test** in the verification pop-up menu. See Figure 3-16.

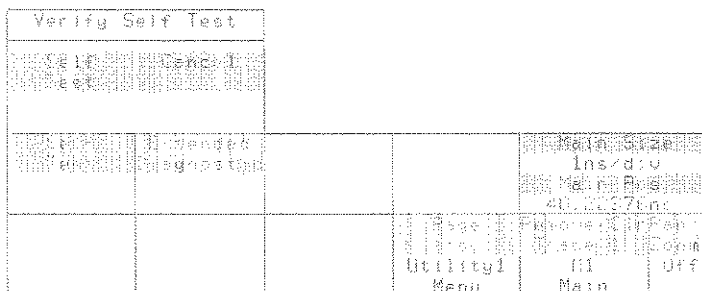

Figure 3-16: The Self Test Pop-up Menu in the Utility2 Major Menu

The self-test diagnostics take about 15 seconds to execute. During this time you will see the message **Self Test in Progress** on the display. You will also see the front panel lights blink on and off, and you will see several test patterns on the display.

If the self-test diagnostics are completed successfully, the instrument will return to the state it was in before the self-test ran. In the case where the self-test diagnostics were executed after power-on, the instrument will return to the state it was in when last powered off.

If the self-test diagnostics fail, the **Extended Diagnostic** menu is displayed and the failure is noted on the display. You can exit the extended diagnostic system and try to use the instrument, but until the failure is repaired you should not rely on any measurements taken. Call your service person to repair the cause of any failures.

Extended Diagnostics

You can enter the extended diagnostic system by touching the **Extended Diagnostic** selector, located in the Utility2 major menu (press the **UTILITY** button until the Utility2 menu appears), and then touching **Extended Diagnostic** in the verification pop-up menu. When self-test diagnostics fail, the extended diagnostic system is entered automatically. See Figure 3-17.

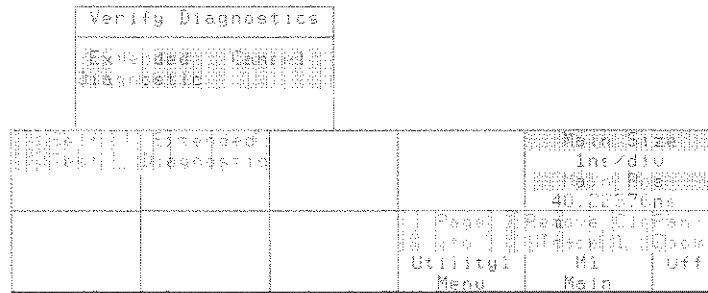

Figure 3-17: The Extended Diagnostic Pop-up Menu in the Utility2 Major Menu

The extended diagnostic system is an independent subsystem of the instrument. While in this system, few of the front panel buttons operate and the Extended Diagnostics menu covers the entire display.

To leave the extended diagnostic system and return to normal instrument operation, touch the **(E) Exit** selector in the extended diagnostic menu twice. The instrument will return to the state it was in before the extended diagnostics were entered. In the case where extended diagnostics were entered after power-on, the instrument will return to the state it was in when last powered off.

The top portion of the Extended Diagnostics menu shows three columns with the status of the diagnostic tests.

<u>SUBSYSTEM</u>	<u>INDEX</u>	<u>FAULTS</u>
a) Executive	****	
b) Display	****	
c) Time Base	****	
d) Main Acq	****	

Figure 3-18: The Top Portion of the Extended Diagnostics Menu

If the extended diagnostic system has been entered because of a test failure, the asterisks in the **INDEX** column will be replaced with test results. The three columns of this display have the following meanings:

- **SUBSYSTEM** lists the names of the subsystem tests.
- **INDEX** shows the test status for each subsystem. Four asterisks (****) indicate the subsystem tests have yet to be executed. The word **pass** indicates all tests in this subsystem have executed successfully. Any other number or letter sequence indicates a diagnostic failure.

NOTE

Do not rely on any measurements taken from an instrument that does not pass all extended diagnostics. Call your service person for repair.

- **FAULTS** shows the number of tests in the subsystem that failed.

Running all of the extended diagnostics takes about 40+ seconds depending on system configuration. You may execute all the tests from the extended diagnostics menu by touching the **(x) All** selector to set the all parameter **On**, and then touching the **(r) Run** selector.

While the diagnostic tests are running, the **(r) Run** selector changes to a **(q) Quit** selector. You can touch this selector, anyplace else on the screen or a button to stop execution of diagnostic tests.

When the extended diagnostic tests are complete, the **(r) Run** selector is displayed again, and the test status appears in the **INDEX** and **FAULT** columns.

When you are done with the extended diagnostic tests, touch the **(e) Exit** selector twice in succession.



Display Intensity

To change the brightness of the display, use the **Instrument Options** pop-up menu from the Utility1 major menu. Touch the **Display Intensity** selector in this pop-up menu. This assigns the knobs to control the intensity of the display. You can then use either knob to adjust the intensity. See Figure 3-19.

Display intensity can also be changed in the **Color** pop-up menu, or in the **Persist/Histograms** pop-up menu in the Display Modes major menu.

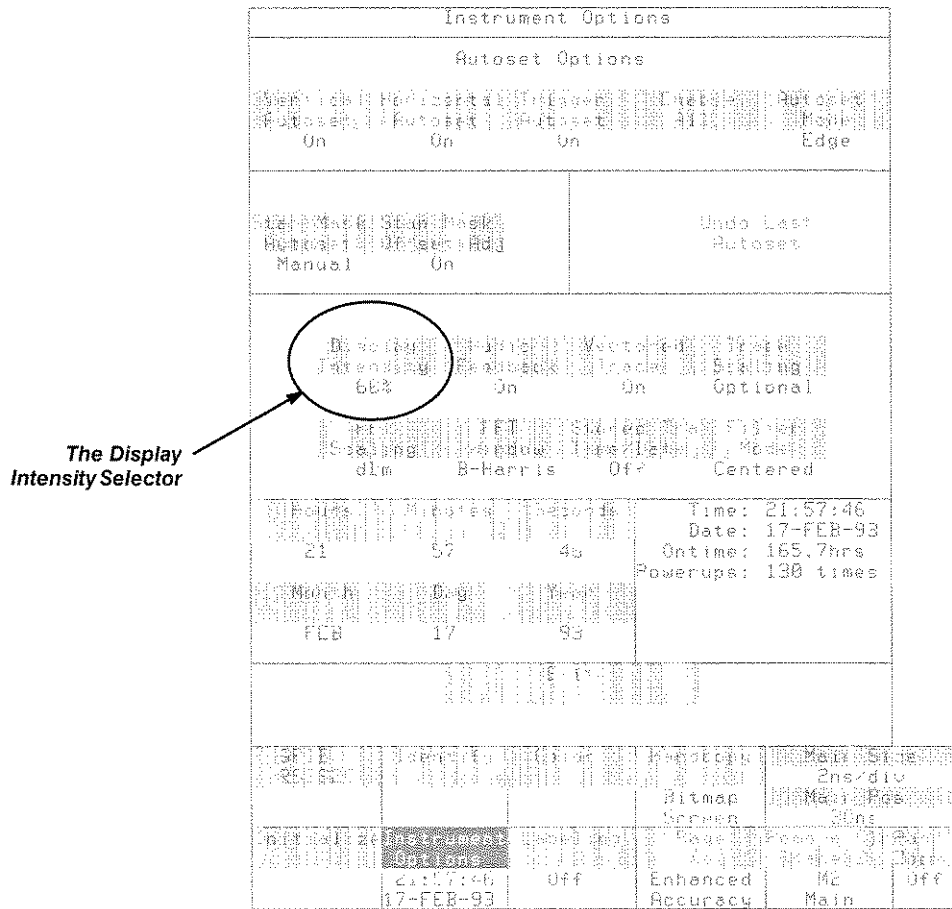

Figure 3-19: The Instrument Options Pop-up Menu



Display Persistence

Persistence is a measure of how long a data point remains displayed. Traces can be displayed in four different persistence modes: Normal, Variable, Infinite, and Color Grading.

The persistence mode is selected from the **Persist/Histograms** pop-up menu. To display the **Persist/Histograms** menu, press the **DISPLAY MODES** button and then touch **Persist/Histograms**. See Figure 3-20.

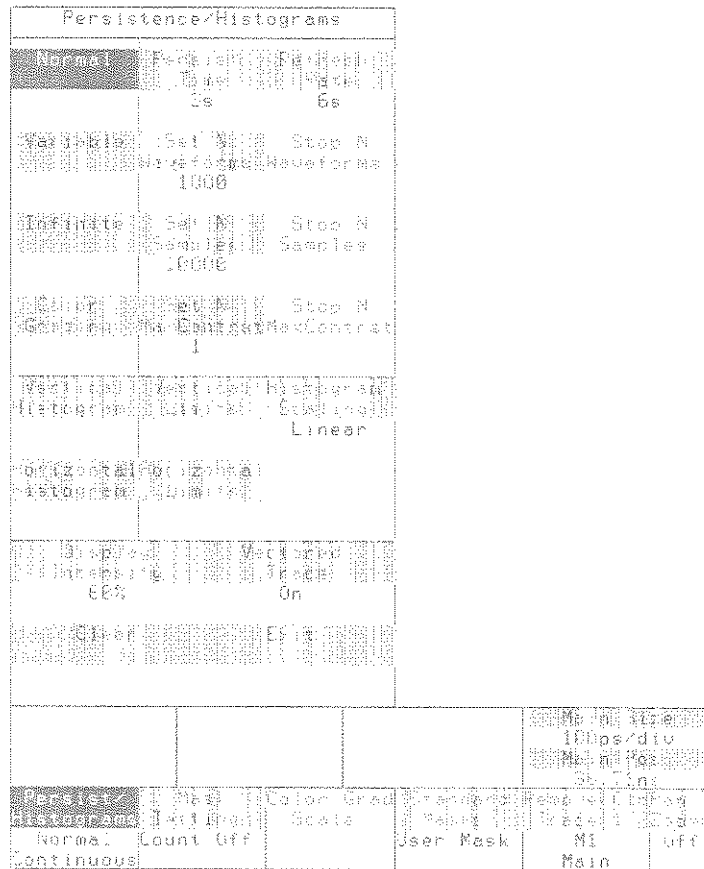

Figure 3-20: The Persist/Histograms Pop-up Menu

Setting the Persistence Mode

There are four persistence modes in the **Persist/Histograms** pop-up menu. To select the mode, touch the appropriate selector.

Normal

In normal mode, each record replaces its predecessor record by erasing it from the screen.

Variable

In variable persistence mode, the 11801B accumulates waveform data on the screen for a user-specified period and then automatically removes them from the screen after the time has expired or aged.

The duration over which the waveform is displayed on the screen before the data is removed is user selectable. The range for persistence is 200 ms to 20 s. To set the duration, select **Persist Time** and use the knobs or the keypad pop-up menu to set the time.

Variable persistence mode cannot be selected when histograms are displayed or mask testing is occurring. Histograms and mask testing can be displayed only in infinite persistence and color grading modes. If any displayed waveform has a record length longer than 512 points when **Variable Persistence** is selected, the record length is set to 512 points and a message is displayed informing you of the change in record length.

Infinite

In infinite persistence mode, accumulated waveform data points remain on the screen indefinitely until some instrument set-up change occurs which causes the process to start over. For example, infinite persistence is used in mask testing and if **Clear Hits** is selected during testing, the waveform data is cleared and the mask count begins accumulating all over.

If any displayed waveform has a record length longer than 512 points, when **Infinite Persistence** is selected, the record length is set to 512 points and a message is displayed informing you of the change in record length.

Color Grading

This mode is similar to infinite persistence mode. The only difference is that the accumulated points are color graded (shaded with different colors) to indicate the density of the points, and a color graded database is built. You can use the color graded database with histograms, mask testing, and statistical measurements. You can also use color grading to provide more visual information about the trace.

Because the data at any point on the screen can change in this mode, there is an additional control available in color grading mode that is not available for infinite persistence mode. This is the **Refresh Rate**. The screen is not refreshed after every acquisition; instead, the screen is refreshed at a specific, user-selectable rate. The **Refresh Rate** controls how often the screen is

updated with new data (this also applies to histogram displays). The range for refresh rate is 5 s to 180 s. To change the refresh rate, display the **Persist/Histograms** pop-up menu and touch **Refresh Rate**. Both of the knobs are now assigned to control the refresh rate.

You can also set the refresh rate to 0 using the keypad pop-up menu, which means the display is never updated. The color graded database is not affected by the refresh rate (only the display is), so setting the refresh rate to 0 may speed some computations, such as measurements.

If any displayed waveform has a record length longer than 512 points when **Color Grading** is selected, the record length is set to 512 points and a message is displayed informing you of the change in record length.

Interpreting the Color Graded Display

Colors in the color graded display are based on the number of hits that have fallen in a “bin”, with a bin assigned to each pixel of the display. A bin can represent a maximum of 65,535 hits. In a single-graticule display, the bins are arranged in a 512 (horizontal) by 256 (vertical) matrix. In a dual-graticule display, there are 512 (horizontal) by 128 (vertical) bins on each graticule.

There are three algorithms used to assign colors to the display. The algorithm used depends on the maximum number of hits for any pixel in the display. These algorithms are detailed in Appendix D, Algorithms. An example of the assignment of colors is shown in the table below. Max in the table represents the maximum number of hits in any bin, which for this algorithm must be at least 16.

Table 3-1: A Sample Assignment of Colors to Hit Density

Hit Density	Default Color	Maps To
1/2 Max to Max	Pale Yellow	Trace Color 1
1/4 Max to 1/2 Max – 1	Rose	Trace Color 2
1/8 Max to 1/4 Max – 1	Purple	Trace Color 4
1/16 Max to 1/8 Max – 1	Light Blue	Window Trace
1 to 1/16 Max	Green	Trace Color 3

To see the actual range of values represented by each color, press **Color Grad Scale** in the Display Modes major menu. The **Color Grad Scale** pop-up menu shows the hit density for each of the five waveform colors. The hit density readouts are updated when the 11801B updates the color graded display.

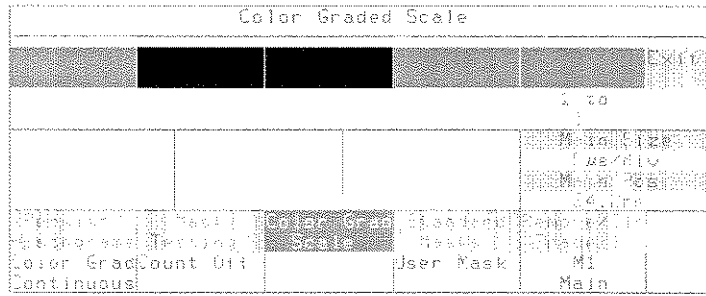

Figure 3-21: The Color Grad Scale Pop-up Menu

Changing Colors

There are five colors used in the color graded display. The colors can be changed, from the **Color** pop-up menu in the Utility1 major menu. The colors are mapped to the four trace colors and the window trace color. To change the colors of the color graded display, press the **UTILITY** button, touch **Color** and change the appropriate trace color.

NOTE

Changing display colors is described in more detail in Color Display, on page 3-21.

Although the four trace colors are assigned to traces in order as they are created, you can change a trace's color assignment, and thus the color used in the color graded display, using the **Trace Color N** selectors at the right side of the **Color** pop-up menu.

The selectors at the right side of the pop-up menu show the number of the color (HLS: hue, lightness and saturation) assigned to that trace, for example **Trace Color 3**. The box next to the selector displays the color of the trace. To change the color of trace 3, touch **Trace Color 3**. Notice that **Lightness** and **Saturation** are highlighted and the knobs are assigned to **Lightness** and **Saturation**. Turn the knobs to change the color attributes. If you touch **Color**, the menu will be removed and you can see the color graded display better. The knobs are assigned to **Lightness** and **Saturation** as long as you are in the Utility major menu. You can now change the color and see how the new color works with the other colors in the color graded display. Changing the **Selected Tra Color** has no effect on the Color Grading colors. To return to the Display Modes major menu, press the **DISPLAY MODES** button.

Limiting Acquisition

In color grading mode, every pixel on the screen is assigned a “bin” which counts the number of samples that fall on that pixel. Each bin can hold a maximum count of 65,535. If a sample falls into a bin which is full, an overflow is generated. You can limit the number of acquisitions performed based on the number of times overflows occur. The **Set N MaxContrast** selector controls the number of overflows allowed before acquisition is stopped. The stop condition can be satisfied by N overflows in one bin and/or one overflow in N bins (that is, the total number of overflows in all bins). To stop acquisition after a set number of overflows, touch **Set N MaxContrast**. This assigns the knobs to limit the number of overflows allowed before the digitizer is stopped. The range for the number of overflows is 1 to 65,535. To begin acquisition, touch **Stop N MaxContrast**. Touching this selector starts acquisition, which then continues until the specified number of overflows have occurred. When the number of overflows have occurred, acquisition stops. Thus, there are two steps to stop acquisition based on the number of overflows:

- Step 1:** Set the number of overflows used to limit acquisition by touching **Set N MaxContrast** and using the knobs
- Step 2:** Begin the acquisition by touching **Stop N MaxContrast**

If you want to stop the acquisition while still acquiring data, press **RUN/STOP**.

Enhanced Accuracy

The Enhanced Accuracy menu allows you to control the continuous self-calibration features of the 11801B. It also allows you to perform some user-assisted calibration procedures on the sampling heads. You do not need tools to make these calibrations; you use the front panel of the 11801B. You can choose to have the 11801B calibrate the sampling heads automatically, or, for most sampling heads, you can use the knobs to calibrate manually. See Figure 3-22.

NOTE

Use enhanced accuracy only when the instrument temperature has stabilized. It takes 20 minutes for the 11801B to completely warm up.

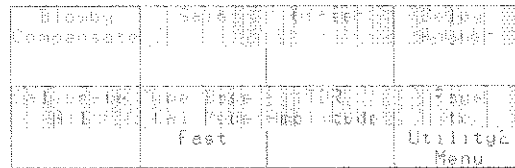

Figure 3-22: The Enhanced Accuracy Major Menu

The Enhanced Accuracy menu is selected from the Utility1 major menu by selecting **Page to Enhanced Accuracy**. The eight selectors in this menu fall into these categories:

- **Control of Automated Calibration** — the **Time Base Cal Mode** selector controls the internal time base automated calibration system. You can select among Fast, High Precision, Off or Once. The **Delay Compensate** selector, in the **Delay Adjust** pop-up menu, controls operation of the automated delay adjustment.
- **Calibration Assistance** — the **Calibrate All** selector helps you quickly calibrate a sampling head channel, as well as deskew sampling head delays.
- **Sampling Head Calibration** — the **Blowby Compensate**, **Gain**, **Offset**, **TDR Amplitude**, and **Delay Adjust** selectors let you calibrate sampling head parameters. You can make each of these calibration adjustments automatically with instrument assistance, or you can make each calibration manually using the knobs.

Control of Automated Calibration

The 11801B automatically calibrates the internal time base and vertical amplifiers, without your intervention. You can specify whether you want the calibration optimized for accuracy or for system speed. Touch the **Time Base Cal Mode** selector of the Enhanced Accuracy major menu to display the pop-up menu. Note that **Off** and **Once** turn off automatic calibration, thus, if the instrument is left in either mode, it can drift out of specification. The instrument should be left in **Fast** or **High Prec** mode for normal operation.

Table 3-2: Time Base Cal Mode Comparison

Setting	Benefit	Side Effects
Fast	Increases system throughput slightly.	Reduces accuracy slightly.
High Prec	Increases accuracy slightly.	Slows system throughput slightly.
Off	Increases system throughput.	System can drift out of specification if left in this mode.
Once	Forces the instrument to perform one complete pass of the time base and vertical calibration, then return to the OFF state. This single calibration will be a Fast calibration if the previous Time Base Cal Mode setting was Fast ; High Precision if the previous setting was High Prec .	Generally used in OFF state to force calibration.

The 11801B periodically compensates the sampling head delay adjustments without your intervention. This maintains the accuracy of the delay adjustment calibrations you have performed earlier. You can specify whether or not you want the 11801B to perform this automatic compensation. Touch the **Delay Compensate** selector in the **Delay Adjust** pop-up menu to set this parameter to either **On** or **Off**.

Table 3-3: Delay Compensate Comparison

Setting	Benefit	Side Effect
Off	Increases system throughput slightly.	May allow time coincidence of different sampling heads to drift over time and temperature.
On	Compensates for drift in deskew adjustment between sampling heads.	Slows system throughput slightly.

Calibration Assistance

The easiest way to calibrate the sampling heads is to use the **Calibrate All** selector to perform all the calibration adjustments for a single sampling head channel at once. The 11801B prompts you to make the signal connections that are needed to calibrate automatically. See Figure 3-23.

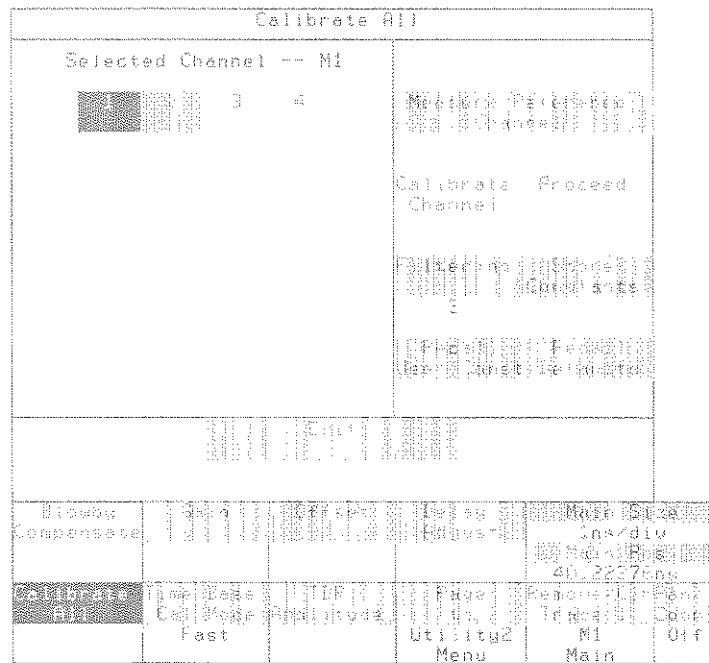

Figure 3-23: The Calibrate All Pop-up Menu

You should first decide which sampling head channel you want to use as the reference channel for delay adjust. The delay adjustment of the other heads will be calibrated to match the time position of this head. Select the reference channel using the selectors in the **Selected Channel** section of the **Calibrate All** pop-up menu. Then touch the **Measure Reference Channel** selector, and follow the displayed directions to connect the calibrator output to the selected channel. Touch the **Proceed** selector to measure that channel.

NOTE

*With the **Calibrate All** pop-up menu, you must first establish the reference channel before you can calibrate any channels.*

Once the reference channel is calibrated, you can calibrate all the channels, including the reference channel. You select the channel you want to calibrate using the selectors in the **Selected Channel** section of the **Calibrate All** pop-up menu. Then you touch the **Calibrate** selector to begin calibrating that channel. The sequence for calibrating the sampling head channel is:

1. A message prompts you to connect the calibrator output to the selected channel and touch the **Proceed** selector. The 11801B automatically calibrates blowby, gain, and delay adjust.
2. Another message prompts you to connect a 50 Ω terminator to the selected channel and touch the **Proceed** selector. The 11801B automatically calibrates offset.
3. If the sampling head supports TDR, a final message prompts you to connect a 50 Ω terminator to the selected channel and touch the **Proceed** selector. The 11801B automatically calibrates TDR amplitude.

Once a channel is calibrated, you can select a different channel using the selectors in the **Selected Channel** section of the **Calibrate All** pop-up menu and calibrate that new channel.

When you have calibrated a channel, it is good practice to store its calibration values using the **Store Constants** selector. This stores the current calibration values into sampling head non-volatile memory. When the system is powered on, it calibrates the sampling heads to the values that were stored as constants. If you later change the calibration values but do not store them, the **Recall User Const** selector of the **Calibrate All** pop-up menu will recall and use all the calibration values for the selected sampling head channel.

You can also recall the calibration values that were set at the factory, by touching the **Recall Defaults** selector of the **Calibrate All** pop-up menu. Since temperature and humidity variations affect calibration, these factory defaults may only approximate ideal performance of your sampling heads.

Sampling Head Calibrations

You can perform individual calibrations on the sampling heads. If you have used the **Calibrate All** pop-up menu to calibrate the sampling head channel, you have already performed all the calibrations and there is no need to repeat them individually. Note that for a dual-channel sampling head, calibrating one channel on a sampling head does not affect the other channel; you need to calibrate both channels separately.

You should refer to the User/Installation Manual for the sampling head or heads that you are using. This will tell you which calibrations are appropriate to that particular head. Some sampling heads do not require or allow certain calibrations. Some calibrations are rarely needed on certain types of sampling heads.

You can make five individual calibrations on the sampling heads.

- **Blowby Compensate** adjusts the sampling head to minimize DC level trace aberrations near the point of a large voltage change. Calibrate blowby compensation only if you notice that the displayed trace is not flat near the point of a large voltage change.

NOTE

Some sampling heads do not require blowby compensation. The blowby selector is not selectable (dim) for this type of head.

- **Gain** (loop gain) adjusts the dot transient response of a sampling head channel. A channel that is out of adjustment will change the shape of the displayed trace as you change the horizontal size, particularly at very high sweep speeds. Trace noise can be increased when gain is greater than unity (1). This calibration is temperature sensitive. If any of these conditions occur, check the gain calibration. Note that some sampling heads are not equipped to perform this calibration.
- **Offset** adjusts the DC voltage accuracy by setting the reference level to zero. This calibration is temperature sensitive, and can also be affected by gain calibration. If the temperature of your environment changes, if the sampling rate changes significantly, or if you calibrate gain, also calibrate offset.
- **TDR Amplitude** adjusts the DC voltage levels of the TDR pulse. TDR Amplitude is thermally stable, and should rarely need to be calibrated. If you notice the amplitude of the TDR pulse is not to specification, you should calibrate the TDR amplitude. The Reference Amplitude (in the Graticules pop-up menu) is used in rho mode and should be set to match the voltage calibrated here (nominally 250 mV). Note that some sampling heads are not equipped to perform this calibration.

- **Delay Adjust** lets you deskew different sampling heads to any one sampling head. The reference head you choose is measured, and the delay of the other sampling heads is adjusted to match that reference head. Calibrate delay adjust only when you need to measure delays between two sampling heads to close tolerance. When the **Delay Compensate** selector is set to **Off**, compensation of the sampling head delays is not done automatically and the deskew calibration is not maintained automatically by the system. This calibration parameter is unique in that the delay adjust does not apply to individual channels but to the sampling head as a whole. The delay adjust value is not stored in the sampling head, but in the instrument mainframe, and there is no factory default value.

Typical Calibration Method

The five available sampling head calibrations are made in a similar way. The following description is of the options used when making a typical calibration. Further discussion of the manual method of making each individual calibration follows the description of the typical method.

To make a sampling head calibration, touch the selector in the Enhanced Accuracy major menu that names the parameter you want to calibrate. These include **Blowby Compensate**, **Gain**, **Offset**, **Delay Adjust**, and **TDR Amplitude**. Each of these displays a pop-up menu. All of these pop-up menus are similar, and the illustration on the next page of the **Offset** pop-up menu is typical of these menus.

When you use these pop-up menus, you first select the sampling head channel you want to calibrate. The left side of the pop-up menu is reserved for this. The **Selected Channel** line at the top of this section shows which channel is currently selected. You can use the selectors in this section to change the selected channel. See Figure 3-24.

Many of the calibration controls on the right of the pop-up menu are common to all five of the pop-up menus. All these common selectors operate similarly, and give you the same options for each calibration.

Each of the calibrations can be made manually or automatically. In addition, you can set the calibration to the factory default or to be the same as a calibration you made earlier.

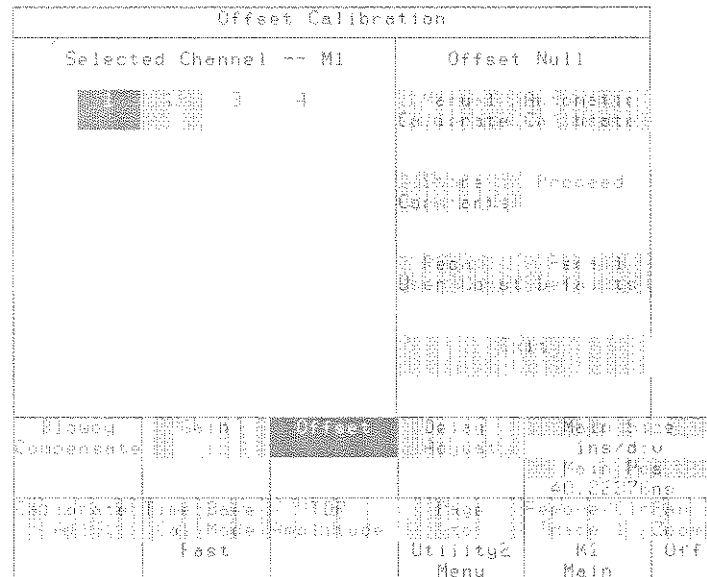

Figure 3-24: A Typical Calibration Pop-up Menu

- To calibrate automatically, touch the **Automatic Calibrate** selector. A message will tell you to either connect the **CALIBRATOR** output to the sampling head channel you are calibrating, or to attach a terminator to the sampling head channel you are calibrating. (For most sampling heads, a 50 Ω terminator is appropriate. Refer to the Installation/User manual for the sampling head.) When you have done as directed, touch the **Proceed** selector. The instrument will calibrate automatically.

NOTE

Some calibrations, such as Offset, have more than one calibration value. Automatic calibration adjusts all the calibrations associated with that parameter.

- To save the current calibration values, touch the **Store Constants** selector in the pop-up menu. Any time you want to restore the calibration to the stored value, touch the **Recall User Const** selector in the pop-up menu.
- When the 11801B is powered on, the sampling head calibration values are taken from the stored user constants. It is a good idea to store calibration values immediately after you finish each calibration.
- To reset the calibration value to the factory default, touch the **Recall Defaults** selector in the calibration pop-up menu.

- To calibrate manually, you will need to establish a specific trace display before beginning to calibrate. Once the proper trace display is established, press the **UTILITY** major menu button, touch **Page to Enhanced Accuracy** and touch the desired calibration selector in the major menu area. Select the sampling head channel you want to calibrate. Then touch the **Manual Calibrate** selector in the pop-up menu. This assigns the knobs to that calibration. You adjust the knobs to see the effect on the trace. If the pop-up menu is in the way, touch the **Exit** selector to remove it.

NOTE

Once you assign the knobs to calibrate manually, the knob assignment remains until you change it or go to another major menu. Be careful not to inadvertently change an earlier calibration.

Calibrating Gain Manually

The **Gain** pop-up menu is used to calibrate loop gain. See Figure 3-25. This menu has one selector in addition to the standard ones for calibration pop-up menus. The **Divide By Two Mode** selector turns the trigger divide by two mode on or off. Normal operation of the 11801B internal clock requires that this selector be set to **Off**. Set it to **On** only when calibrating loop gain. This calibration does not apply to the SD-14 sampling head.

To calibrate loop gain manually, first establish a display of the calibrator signal on the sampling head channel you want to calibrate. Adjust the vertical size to 50 mV/div and the horizontal size to 500 ps/div. Center the rising edge of the calibrator trace on the graticule. See the illustration on the next page. Touch the **Divide By Two Mode** selector to turn this mode **On**.

Adjust the calibration value to the display that aligns the single line portion of the trace with the bottom of the high-amplitude portion. If several settings qualify, select the setting that gives the highest amplitude.

Remember to turn off the **Divide By Two Mode** after the loop gain has been calibrated.

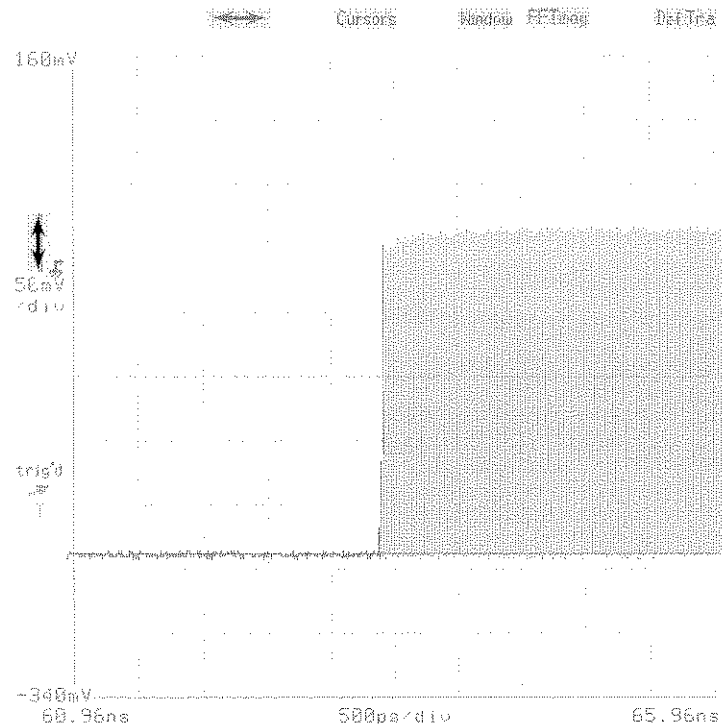

Figure 3-25: Loop Gain Calibration (in Vektored Trace Mode)

Calibrating Blowby Compensation Manually

To calibrate blowby compensation manually, first establish a display of the calibrator signal on the sampling head channel you want to calibrate. Adjust the vertical size to 50 mV/div and the horizontal size to 500 ps/div. Center the rising edge of the calibrator trace on the graticule.

Adjust the calibration value to the display that gives the flattest horizontal trace segments.

Calibrating Offset Manually

To calibrate offset manually, first attach a 50 Ω terminator to the sampling head channel you want to calibrate. Establish a trace showing this channel, with a vertical size of 50 mV/div. For the most accurate results, you should provide the trigger for this calibration that will be used to perform measurement and testing of the input signal. If possible, you should also set the trigger hold-off to the same value that will be used in test. If you do not provide a trigger, the 11801B will automatically use the internal clock as a trigger.

At the Acquire Description pop-up menu (selected at the Waveform major menu), set **Average N** to **On**. Touch the vertical icon (\downarrow) and the **Vert Offset** knob label selector to show the Numeric Keypad pop-up menu. On the

pop-up menu, touch **0** and **Enter**. This sets the vertical offset to zero, positioning 0 V at the center height of the graticule. This calibration does not apply to the SD-14 sampling head.

NOTE

You should calibrate gain before calibrating offset.

Adjust the calibration value to set the trace exactly on the centerline of the graticule. Repeat the process using a vertical size of 2 mV/div. You can set the knob resolution to fine adjust the calibration value more accurately. You can also use waveform averaging or the mean measurement to calibrate offset null.

There are two offset values to calibrate manually: normal sampling mode and smoothing mode. Calibrate both separately by setting the sampling head in the desired mode before making the calibration. **Smoothing** is selected from the **Sampling Head Fnc's** pop-up menu of the Waveform major menu.

Calibrating TDR Amplitude Manually

To calibrate TDR amplitude manually, first attach a 50 Ω terminator to the sampling head channel you want to calibrate. Establish a TDR trace showing this channel, with a vertical size of 50 mV/div and a horizontal size of 1 ns/div. Touch the vertical icon (\updownarrow) and the **Vert Offset:##** knob label selector to show the Numeric Keypad pop-up menu. On the pop-up menu, touch **0** and **Enter**. This sets the vertical offset to zero, positioning 0 V at the center height of the graticule. Center the rising edge of the pulse horizontally on the graticule.

Adjust the calibration value to set the height of the first part of the trace exactly at the bottom (+ TDR Polarity) or top (– TDR Polarity) of the graticule.

There are two TDR Amplitude values to calibrate manually; one for each polarity of TDR pulse. Calibrate both separately by setting the TDR polarity of the sampling head before making the calibration. **TDR Polarity** is selected from the **Sampling Head Fnc's** pop-up menu of the Waveform major menu.

After calibrating TDR amplitude, check to see that the Reference Amplitude (in the **Graticules** pop-up menu) is set to match the voltage calibrated here.

Adjusting Delay Adjust Manually

The delay adjust calibration corrects for minor deviations in time coincidence between sampling heads. You select which head you want to use as a reference, and then calibrate the other heads to that standard.

This calibration is not an attribute of any one sampling head, so the values for this calibration cannot be stored in the heads. There are no **Store Constants** or **Recall User Const** selectors in the **Delay Adjust** pop-up menu.

To establish the reference channel, you select the desired channel in the **Delay Adjust** pop-up menu, and then touch the **Measure Reference Channel** selector. The display will show a message for you to connect the calibrator output signal to the specified channel. When you have done so, touch the **Proceed** selector and the system will measure the delay automatically.

NOTE

The two channels of dual-channel sampling heads are locked in time coincidence. When you have calibrated one channel, there is no need to calibrate delay adjust on the other.

There is no need to calibrate the reference channel manually.

Once you have determined the reference value, you can calibrate the other heads to this value, either manually or automatically.

To manually calibrate delay adjust on other heads, first display the calibrator signal on the *reference* channel, and note the horizontal position of the rising edge. Then, using the same signal, cables and settings, display the signal on either channel of the sampling head that you want to calibrate.

The top knob is assigned to the calibration value. Adjust the calibration value so that the signal event is placed at the same horizontal position as on the reference channel.

You can specify whether or not the 11801B should automatically maintain the results of delay adjust. Touch the **Delay Compensate** selector of the **Delay Adjust** pop-up menu to set the delay adjust parameter to either **On** (maintain delay adjustment) or **Off** (do not maintain the delay adjustment automatically).

Offset for Sampling Probes

Sampling probes such as the SD-14 use an automated offset adjustment that sets both both offset null and offset gain.

The offset null adjustment removes unwanted DC offset that may be present in the sampling probe. This adjustment effectively zeroes the offset circuitry in the sampling probe so that a 0 V input signal delivers a 0 V output.

The offset gain adjustment matches the requested offset from the user to the sensitivity of the probe offset circuit.

If offset null and offset gain are not both adjusted correctly, measurements taken will be incorrect. The absolute voltage values for any cursors displayed in the trace will also be incorrect.

Eye Diagrams

An eye diagram is typically the display of a random digital data signal versus time, with the display triggered by the data clock. This section provides general instructions to help you display a constellation or eye diagram on the 11801B.

Displaying an Eye Diagram

You will need the following equipment:

- At least a single-channel sampling head
- Two SMA cables
- A static protection wrist strap

To display an eye diagram perform the following steps:

- Step 1:** Press the **UTILITY** button, touch **Initialize** in the Utility1 major menu, and then touch **Initialize** in the **Verify Initialize** pop-up menu.
- Step 2:** Select **Instrument Options** and touch **Vectored Trace** to turn vectored traces off.
- Step 3:** Put on the wrist strap and ensure that it is connected to the antistatic connector on the front panel of the 11801B.
- Step 4:** Connect a cable from your data line to channel 1.
- Step 5:** Connect a cable from your clock to the **TRIGGER INPUT** on the front panel. Be sure not to exceed the maximum input voltage for the external attenuation you have selected.
- Step 6:** Press the **TRIGGER** button. Touch the **Source** selector in the Trigger major menu. Touch **External Direct**; then touch **Exit** to remove the pop-up menu.
- Step 7:** Select channel 1 by pressing the select channel button next to the input connector on the sampling head.
- Step 8:** Press the **AUTOSET** button. The signal may not be recognizable at this point.
- Step 9:** Because the signal is a random pulse train, the horizontal size cannot be properly autoset. Adjust the horizontal size to display a useful eye diagram. See Figure 3-26.

NOTE

Correct gain calibration is critical to see an eye pattern properly.

Eye Diagram Analysis can be reliably performed on signals up to 400 mV peak to peak in amplitude. Signals larger than 400 mV in amplitude should be attenuated to achieve reliable results in Eye Diagram Analysis.

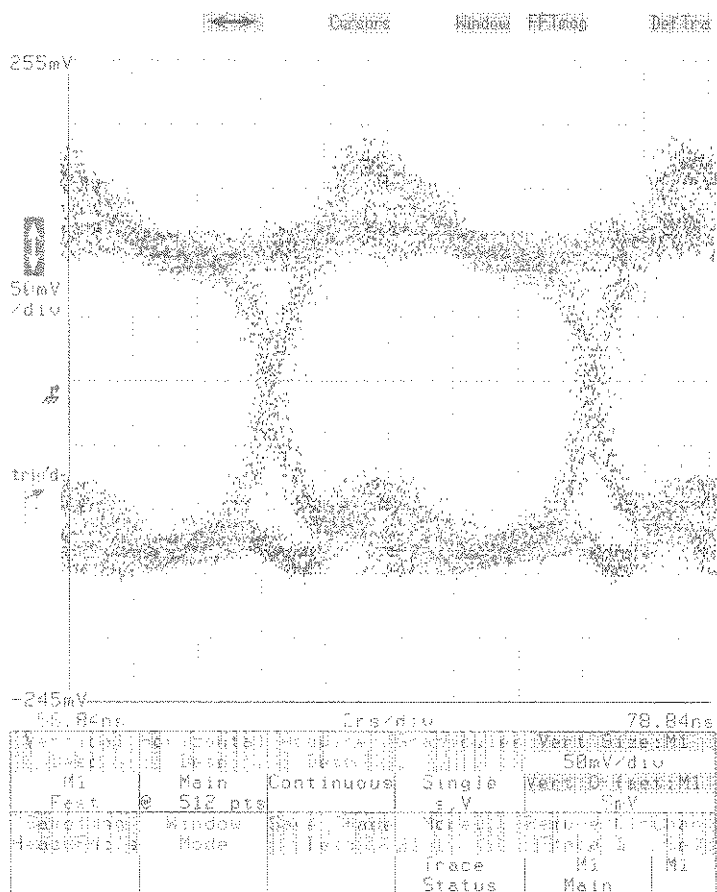

Figure 3-26: An Eye Diagram Display

- Step 10:** One way to enhance the display of the eye diagram is to use Variable Persistence. To do this, press the **DISPLAY MODES** button, touch the **Persist/Histograms** selector, touch the **Variable** selector in the pop-up menu, and then touch **Exit** to remove the pop-up menu. For additional information on variable persistence, see Setting the Persistence Mode on page 3-44.

- Step 11:** One of the most powerful display modes in the 11801B is color grading. Color grading adds statistical information to the display by varying the color according to the number of “hits” for a given pixel. Color grading adds a third dimension to the persistence display and allows accumulating data in a statistical database for later analysis with histograms or masks. To turn on color grading, touch the **Persist/Histograms** selector, touch the **Color Grading** selector in the pop-up menu, and touch the **Exit** selector to remove the menu. For more information on color grading, see Setting the Persistence Mode on page 3-44.
- Step 12:** After enabling color grading, measure eye pattern characteristics such as risetime, jitter, and noise in the Statistical Measurement Mode. To turn on Statistical measurement, press the **MEASURE** button, touch the **Measurements** selector, touch the **Statistics Mode** selector, and then touch the desired measurement, for example risetime. For more information on statistics mode, see Measurement on page 3-137.



Fast Fourier Transforms

You can use the Fast Fourier Transform (FFT) capability of the 11801B to obtain a frequency domain display of a trace. You can display both the magnitude and the phase of the frequency components of the signal, using a linear or decibel vertical scale.

You can perform Fast Fourier Transforms on any arbitrary trace. The record length of the trace must be a power of two, up to a maximum of 4096 points. Because the 11801B performs FFT calculations on a complete trace record, you should use the shortest record length that provides adequate resolution; FFT traces update slowly at long record lengths.

The 11801B offers a choice of six FFT windowing functions which modify the time domain data to minimize "leakage" of energy across frequency components.

The three automated measurements spectral frequency, spectral magnitude, and total harmonic distortion are intended for FFT traces. See *Measurements*, on page 3-137, for more information on these measurements. You can also use the cursors to take magnitude and phase measurements on frequency domain traces.

Defining an FFT Trace

You can define an FFT display of a trace using the **DefTra** pop-up menu or you can use the **FFTmag** and **FFTpha** icons.

Defining an FFT Display Using the DefTra Pop-up Menu

You can define a trace that displays the FFT magnitude or FFT phase using the **DefTra** pop-up menu, which is displayed when you select the **DefTra** icon. The **FFTmag**(and **FFTphase**(selectors can be used to define a display of the magnitude or the phase of the frequency spectrum of a trace. See Figure 3-27.

The part of the trace description that is within the **FFTmag**(or **FFTphase**(function may be any arbitrary trace.

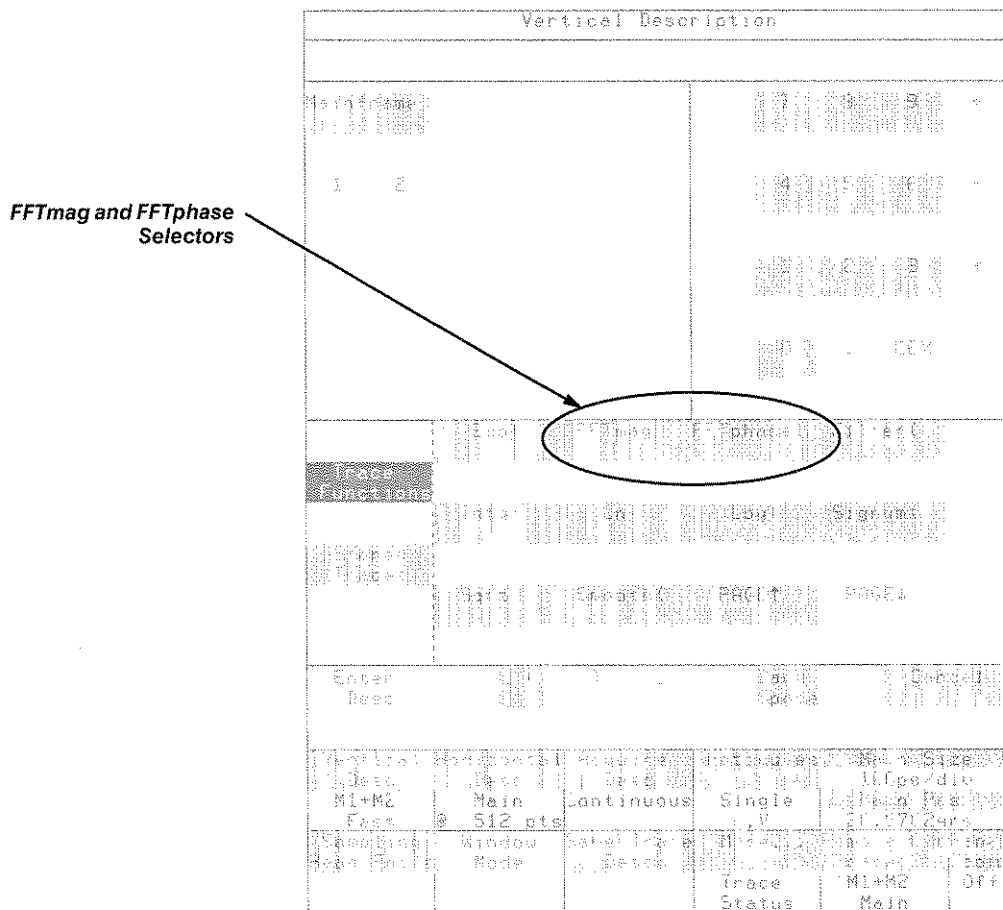

Figure 3-27: The DefTra Pop-Up Menu

Defining an FFT Display Using the FFTmag and FFTpha Icons

You can display the magnitude of the frequency spectrum of a displayed trace by selecting the trace and touching the **FFTmag** icon. The 11801B creates a second graticule to display the FFT magnitude of the trace. If the display already shows two graticules, the FFT magnitude is displayed on the lower graticule.

Once you have created a display of the magnitude of the frequency spectrum, the **FFTpha** icon appears above the lower graticule. See Figure 3-28. Touch this icon to display the phase of the frequency components of the trace. The FFT phase trace appears on the lower graticule.

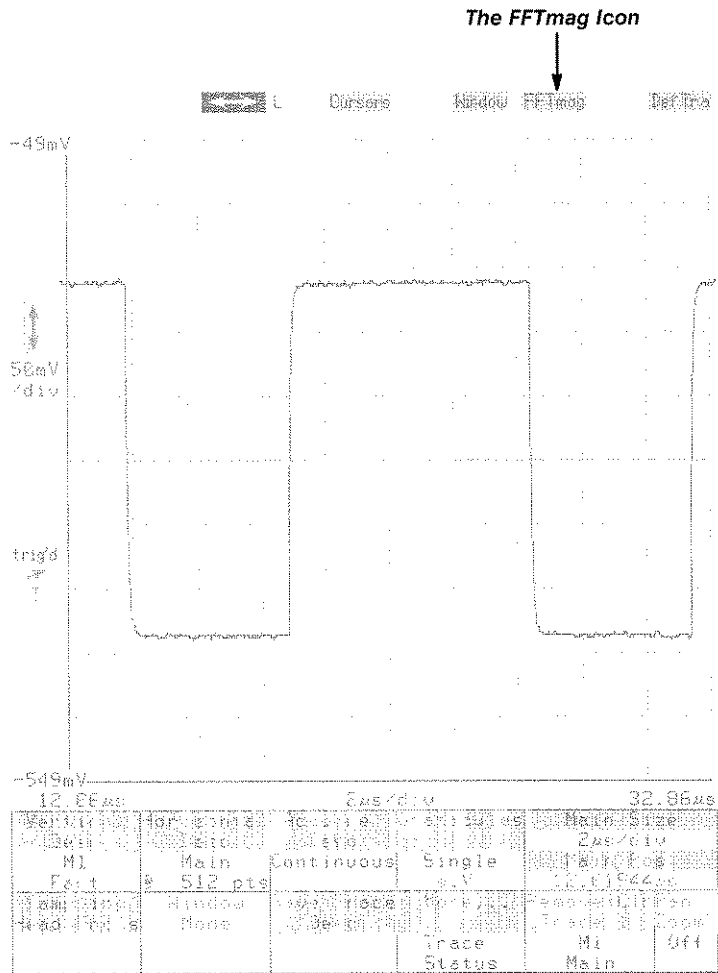

Figure 3-28: Location of the FFTmag Icon on the Display

Amplitude Resolution

Amplitude resolution is influenced by the windowing function used and by the vertical adjustment of the time domain trace. For maximum amplitude resolution, the time domain trace should be adjusted so that it is centered vertically on the graticule and is as tall as possible without going beyond the graticule, above or below.

Frequency Range and Resolution

The range and resolution of the frequency spectrum displayed by the 11801B are determined by the *sample interval* and *record length* of the time domain trace. The sample interval is displayed in the **Horizontal Desc** pop-up menu (in the Waveform major menu) and is determined by the time base and record length.

A trace record of N points in the time domain corresponds to a record of the same number of points in the frequency domain. However, for any real signal, the frequency domain data will be symmetrical about DC, so only the positive part of the spectrum is displayed. Of the displayed points of the FFT trace, the N/2 even-numbered points are the *frequency lines* computed by the FFT; the N/2 odd-numbered points are added by linear interpolation.

The maximum frequency that can be determined by a Fast Fourier Transform is the *Nyquist frequency*, which is equal to one-half the effective sample rate. In fact, the maximum frequency displayed by the 11801B, F_{max} , is slightly lower than the Nyquist frequency; it is equal to the Nyquist frequency minus the *frequency interval*, δF , the interval between frequency lines. The *frequency range* displayed is from DC (0 Hz) to F_{max} .

The frequency interval, δF , is equal to the Nyquist frequency (the maximum possible recognizable frequency) divided by the number of frequency lines in the FFT display (half the record length of the time domain trace). Since the Nyquist frequency is half the effective sample rate, this works out to the effective sample rate divided by the record length.

$$\text{effective sample rate} = \frac{1}{\text{sample interval}}$$

$$\delta F = \frac{\text{effective sample rate}}{\text{record length}}$$

$$F_{max} = \frac{\text{effective sample rate}}{2} - \delta F$$

Figure 3-29: Equations for Frequency Interval and Frequency Range

Changing Horizontal and Vertical Size

You can change the horizontal and vertical size and position of the FFT trace display by selecting the vertical and horizontal icons and using the knobs to adjust size and position.

When you touch the horizontal icon (↔), the knobs are assigned to control **Frequency Span/div** and **Frequency Resolution**. The Span/div function changes the **Main Size** (time base) setting (or, for windows, the **Window Size** setting). The resolution function changes the record length. When you adjust **Frequency Span/div** and **Frequency Resolution**, you are changing the time base of the source trace, so you will see a change in the display of all traces on that time base.

You can also use Pan/Zoom to horizontally expand the display of the FFT trace without affecting the time base. Changing the horizontal magnification and position of an FFT trace using Pan/Zoom changes the appearance of the trace, but does not increase the horizontal (frequency) resolution. For more details about Pan/Zoom, including changing the pivot point and using multitrace Pan/Zoom, see page 3-109.

You can also change the frequency interval and frequency range by changing the record length and horizontal size of the time domain trace. If the record length increases, frequency resolution improves (δF decreases). When the effective sample rate increases (due to a faster horizontal size setting), F_{max} and δF both increase, giving the FFT trace a broader frequency range with less frequency resolution.

When you touch the vertical icon (↑↓), the knobs are assigned to control **Vertical Mag: Tra** and **Vertical Pos: Tra**, the vertical magnitude and position of the trace. As with other calculated traces, the vertical controls of the FFT trace affect only the appearance of the trace.

FFT Scaling

The FFT magnitude display may be scaled in either a linear or decibel format. To set the vertical scaling of the FFT magnitude display, select the **FFT Scaling** selector in the **Instrument Options** pop-up menu, in the Utility major menu. See Figure 3-30. This selector toggles between **Linear** and **dBm**. When FFT Scaling is set to dBm, the display is in decibels relative to a 0.316 V peak sine wave (0 dBm) into 50 Ω.

If you want to display the FFT magnitude of a trace in dB relative to a specific reference, you can subtract your reference value from the FFT magnitude of the trace when you enter the FFT trace description. For example, enter **FFTmag(M1) - 10** to display the FFT magnitude of the signal at channel one relative to a 10 dB reference.

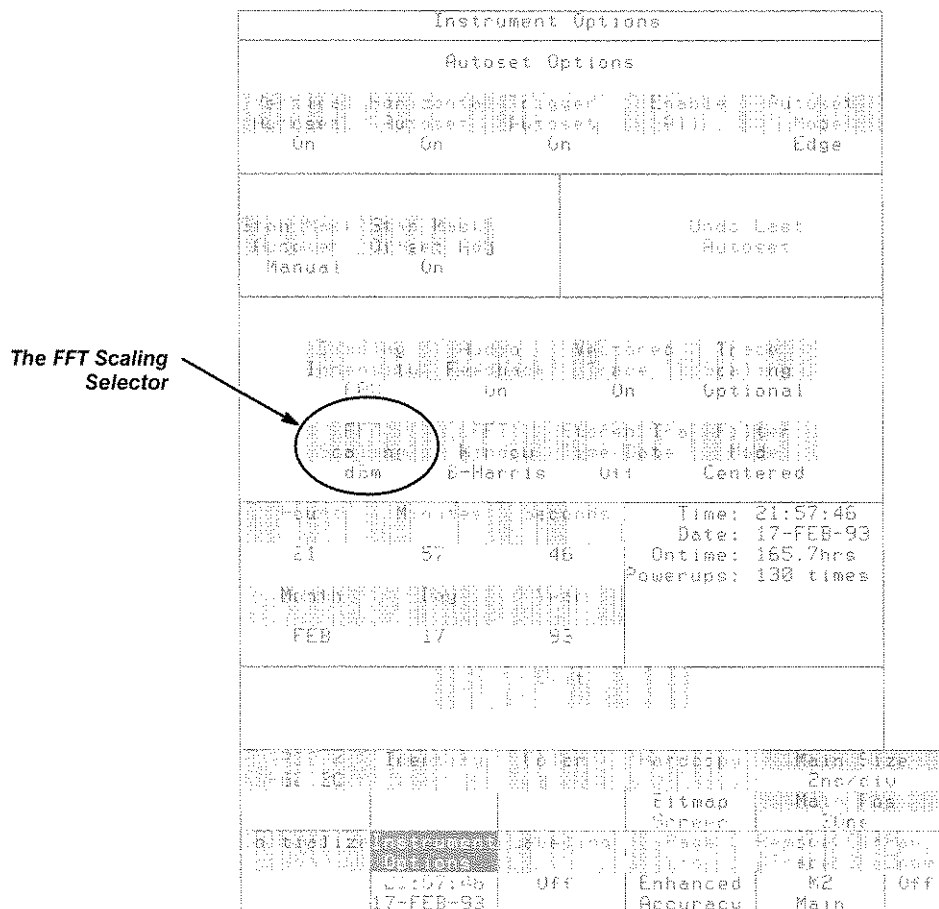

Figure 3-30: The Instrument Options Pop-Up Menu

Aliasing

Aliasing occurs when the input signal includes components at frequencies higher than the Nyquist frequency. These frequency components appear in the FFT trace display as peaks at lower frequencies. The higher-frequency components are reflected around the Nyquist frequency. For example, a frequency component 5 MHz above the Nyquist frequency will appear as a peak 5 MHz below the Nyquist frequency in the FFT trace display.

You can eliminate aliasing by setting the effective sample rate to be at least twice the highest frequency in the input signal. Increasing the record length or decreasing the horizontal size will increase the effective sample rate.

The best way to avoid aliasing is to either apply an external filter to the signal to cut out high-frequency components, or use the filter function with a specified risetime limit. For example, to create a filter to reduce aliasing, touch the following selectors: **defTra, FFTmag(, Filter(, Mainframe, 1, , , 1, EEX, -, 9,))** This filter will limit signal risetime to 1 ns, or limit bandwidth to 350 MHz.

You can apply averaging to the source trace to reduce random noise and prevent aliasing of high-frequency noise in repetitive traces. Define your trace as an averaged trace before selecting the **FFTmag** icon, or make averaging part of the trace description when you define the FFT trace in the **DefTra** pop-up menu, for example, **FFTmag(, Avg(, Mainframe, 1,))**.

You can also average the FFT trace, for example, **Avg(, FFTmag(, Mainframe, 1,))**.

Another way to decrease aliasing is to select an appropriate FFT windowing function. The 11801B provides six common FFT windowing functions, which are accessible from the **Instrument Options** pop-up menu. Touch the **FFT Window** selector to sequence through the six functions.

Using Cursors to Make Measurements

You can use the cursors to make measurements of an FFT trace display. Select the FFT trace and touch the **Cursors** icon to display the Cursors major menu. See Cursors on page 3-29 for more information on using cursors.

When making measurements on an FFT trace, recall that the odd-numbered points in the trace record are derived by interpolation. The even-numbered record points are the frequency lines; peaks in the FFT magnitude always occur on the even-numbered points. You can see the peaks more clearly by using Pan/Zoom to horizontally magnify the FFT trace.

NOTE

The automated frequency domain measurements are described in Measurements, on page 3-137.

When you first display cursors on an FFT trace, paired dots cursors are automatically selected, with one dot cursor placed at DC and the other at F_{max} . You can use the paired dots cursors to make relative measurements of the peaks of an FFT trace. See Figure 3-31.

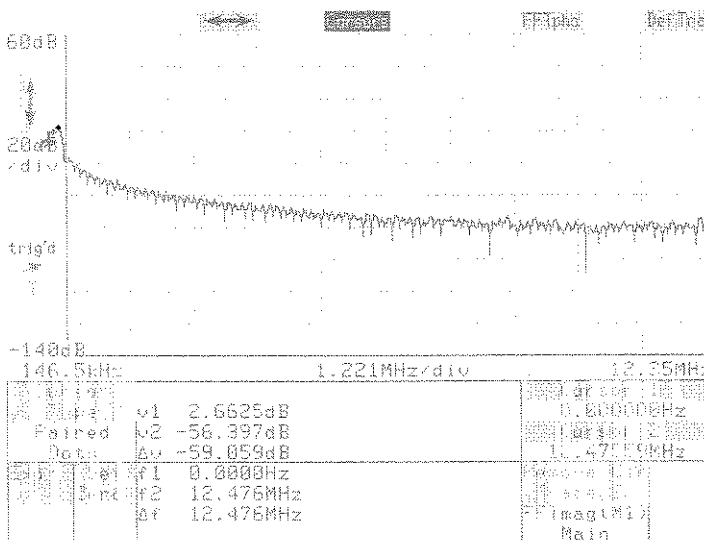

Figure 3-31: Paired Dots Cursors on an FFT Magnitude Display

The DC value displayed with the FFT magnitude is twice the actual DC amplitude. This value does not include any vertical offset of the sampling heads. When making measurements near DC, use the rectangular window function.

Split dots cursors can be used to make phase measurements. With both the magnitude and the phase of trace in the frequency domain displayed, you can place one cursor on the FFT magnitude display and the other on the FFT phase display. By adjusting the cursors horizontally so that the Δf readout is 0.000 Hz, you can easily match the phase readout to the corresponding peak in frequency magnitude. See Figure 3-32.

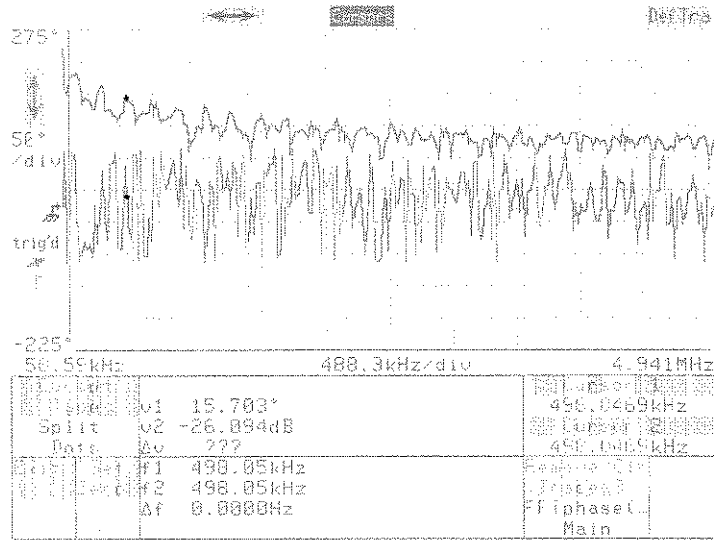

Figure 3-32: Using Split Dots Cursors to Measure FFT Phase

FFT Windowing Functions

The Fast Fourier Transform operates on the time-domain trace record acquired by the 11801B. The FFT algorithm assumes that the signal is composed of an infinite repetition of this trace record.

Since the time domain trace record rarely matches an actual periodicity in the signal, the frequency spectrum displayed will reflect extra frequencies due to discontinuities at the time-domain trace record edges. These additional frequencies are known as *leakage error*.

The effect of discontinuities at the ends of the time domain trace record can be limited by choosing an FFT windowing function that tapers near the trace record ends. The 11801B provides a rectangular FFT window, which does not taper the time domain data, and five tapering FFT windows of different shapes.

Each time domain FFT windowing function corresponds to a filter in the frequency domain. Each frequency domain filter has a high central lobe, or passband. The width of this lobe determines how well adjacent frequency components can be resolved. The height of the side lobes surrounding the central lobe determines how much leakage can occur. Leakage is the spreading of energy from one frequency component across the displayed frequency spectrum; low amplitude frequency components can be entirely masked by leakage.

To select an FFT windowing function, repeatedly touch the **FFT Window** selector in the **Instrument Options** pop-up menu, in the Utility major menu. This selector cycles through the available windowing functions. The selected FFT windowing function, shown in the selector's status area, applies to all FFT trace displays. The shapes of the FFT windowing functions and their effects on a signal composed of two sine waves are shown in the following discussion.

The Rectangular Window

The rectangular window does not taper the time domain data. In the frequency domain, the filter shape is $\sin(x)/x$. This is the best window to use when you want to examine the frequency spectrum of a non-repetitive signal. The rectangular window should also be used when you want to measure frequency components near DC.

Set the **FFT Window** selector in the **Instrument Options** pop-up menu to **Rectangle** to select this windowing function. See Figure 3-33.

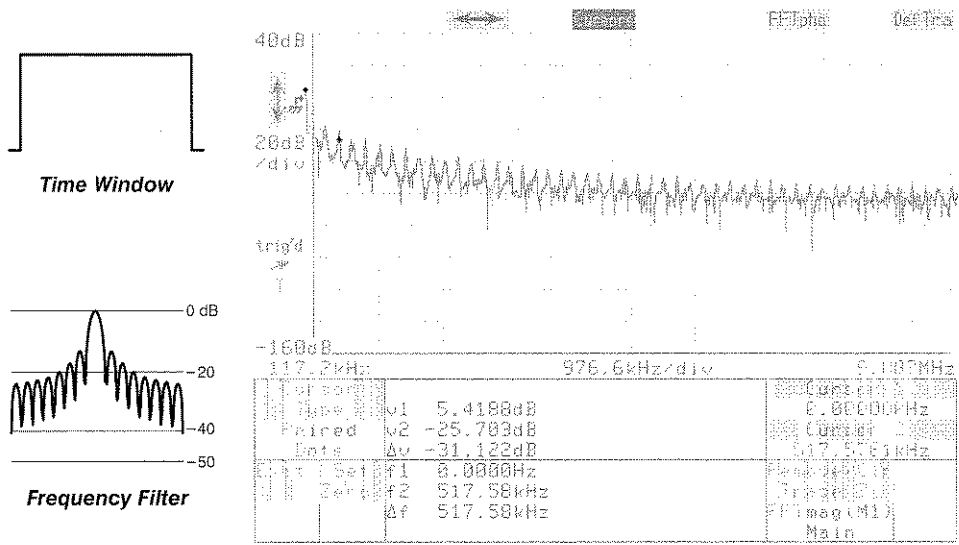

Figure 3-33: FFT Magnitude Displayed Using Rectangular Window

The Triangular Window

The triangular (or Bartlett) window is the convolution of two rectangles half the width of the window, so the frequency spectrum of the triangular window is the product of the rectangular window’s spectrum with itself.

Set the **FFT Window** selector in the **Instrument Options** pop-up menu to **Triangle** to select this windowing function. See Figure 3-34.

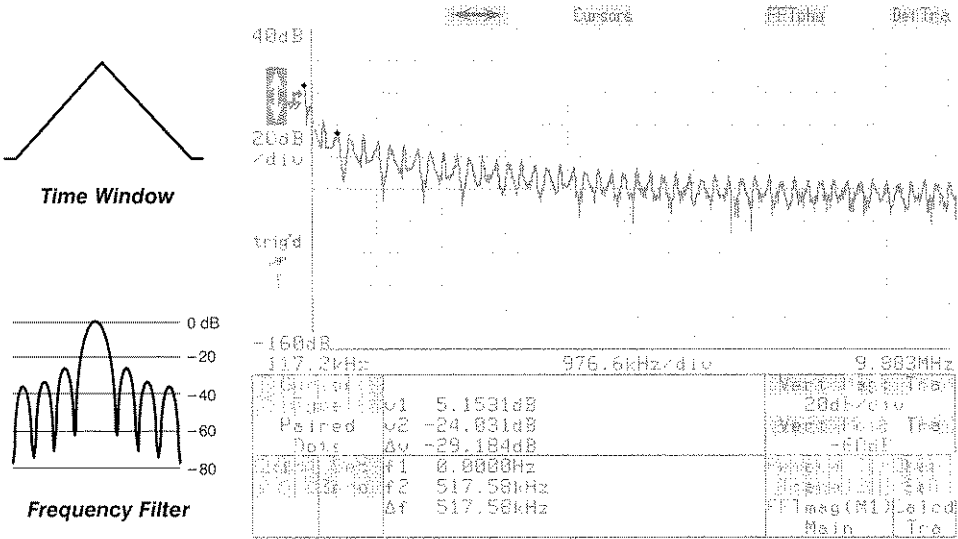

Figure 3-34: FFT Magnitude Displayed Using Triangular Window

The Blackman Window

The Blackman window reduces leakage better than the Hamming window because of the lower side lobes in the frequency domain, but the resolution of nearby frequencies is diminished.

Set the **FFT Window** selector in the **Instrument Options** pop-up menu to **Blackman** to select this windowing function. See Figure 3-35.

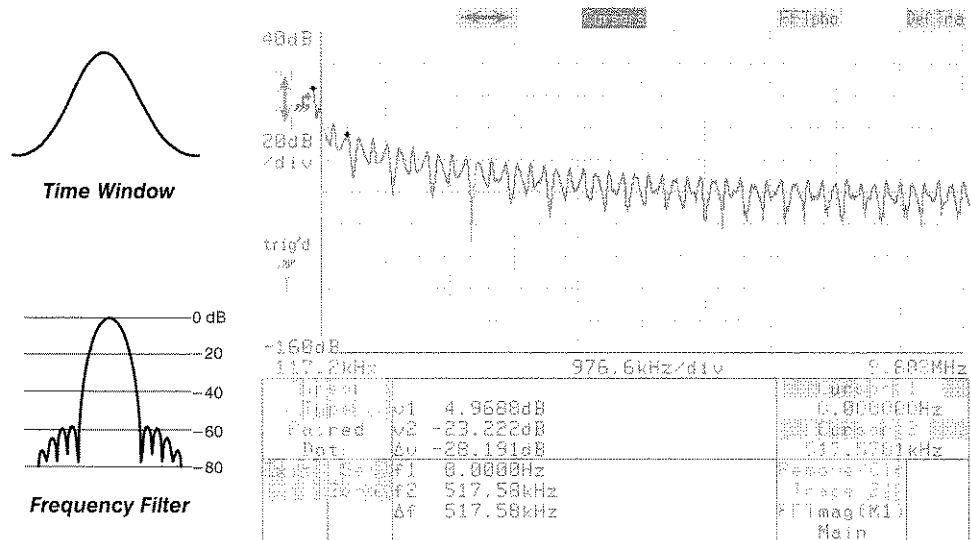

Figure 3-35: FFT Magnitude Displayed Using Blackman Window

The Blackman-Harris Window

The Blackman-Harris window has the widest pass band (lowest frequency resolution) and lowest side lobes (best elimination of leakage) of the six window functions. This window is especially good for viewing a broad spectrum.

Set the **FFT Window** selector in the **Instrument Options** pop-up menu to **B-Harris** to select this windowing function. See Figure 3-36.

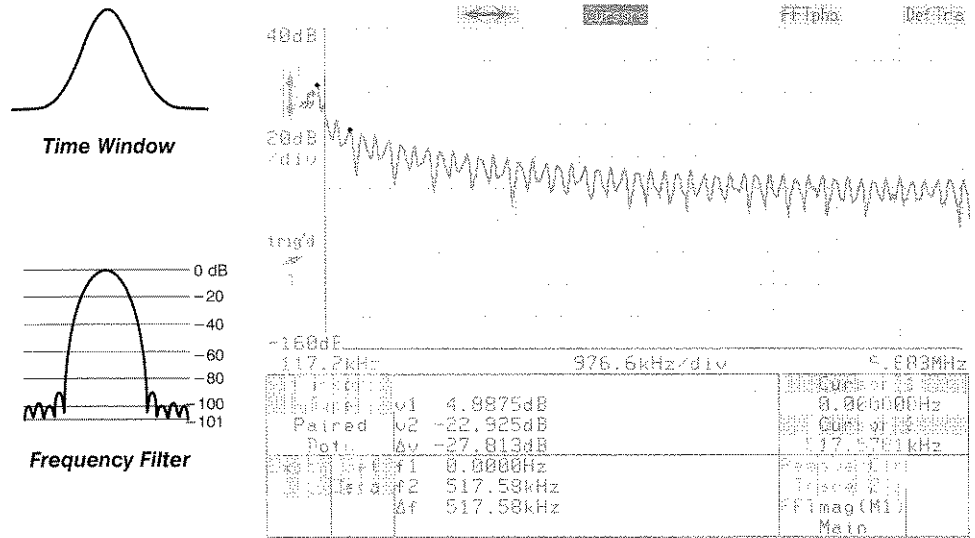

Figure 3-36: FFT Magnitude Displayed Using Blackman-Harris Window

The Hanning Window

The Hanning (or Hann, or cosine) window is derived from a cosine. This window provides reasonably good amplitude accuracy and leakage rejection.

Set the **FFT Window** selector in the **Instrument Options** pop-up menu to **Hanning** to select this windowing function. See Figure 3-37.

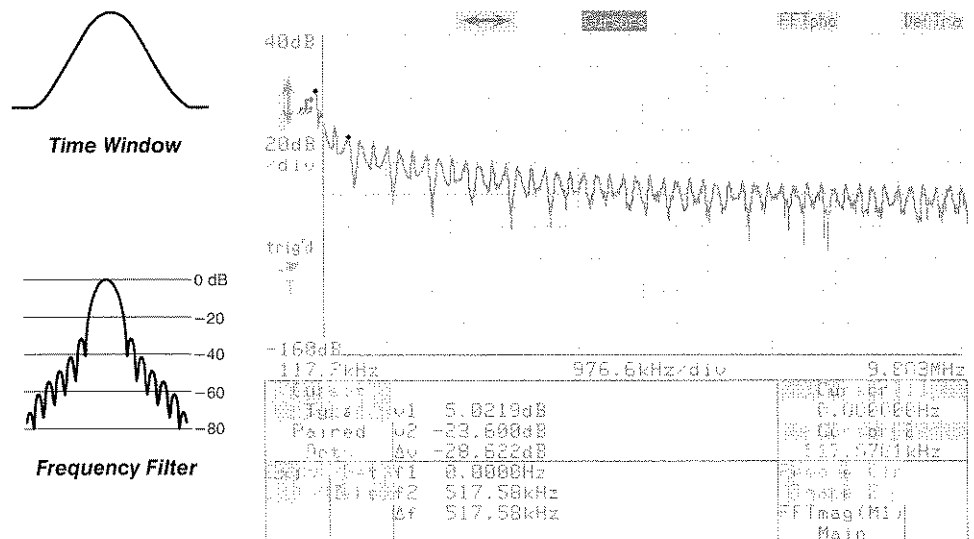

Figure 3-37: FFT Magnitude Displayed Using Hanning Window

The Hamming Window

The Hamming window is similar to the Hanning window, but is optimized to lower the first side lobe, which is why the separation between the two spikes in the illustration below is greater than in the illustration on the previous page. This window is especially useful for resolution of frequencies that are very close together.

Set the **FFT Window** selector in the **Instrument Options** pop-up menu to **Hamming** to select this windowing function. See Figure 3-38.

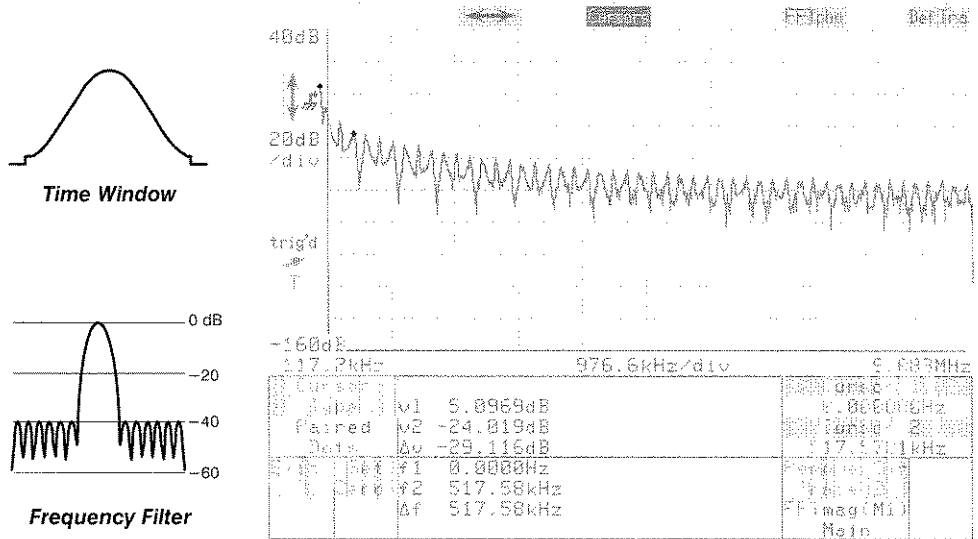

Figure 3-38: FFT Magnitude Displayed Using Hamming Window

GPIB Parameters

The 11801B can be controlled by a remote computer, through one of two interfaces. These interfaces are industry standards IEEE Std 488 and RS-232-C. IEEE Std 488 is also known as the General Purpose Interface Bus or GPIB.

This manual does not discuss the details of connecting a remote computer to the 11801B or the syntax and capabilities of remote commands. That information is found in the *CSA 803A and 11801B Programmer Manual*.

GPIB Connection

Connect the cable from your GPIB controller (computer) to the **IEEE STD 488 PORT** connector on the 11801B rear panel. See Figure 3-39. Three red lights show the internal GPIB status of the 11801B:

- **SRQ** (Service Request) is lighted whenever the 11801B activates the Service Request line. This indicates to the controller that the 11801B has requested service.
- **NRFD** (Not Ready For Data) is lighted whenever the 11801B is not yet ready for the next data byte.
- **NDAC** (Not Data Accepted) is lighted whenever a data byte is on the bus but has not yet been captured by any listener device.

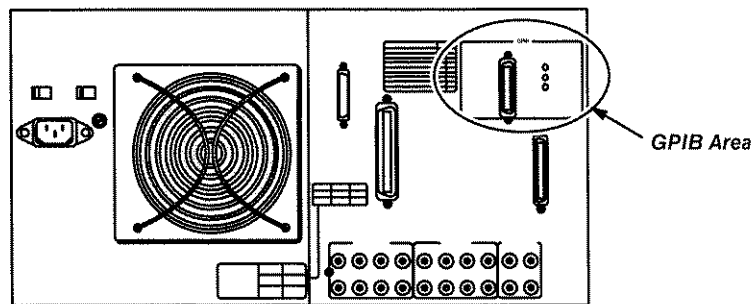

Figure 3-39: GPIB Rear-Panel Connector and Lights

Setting GPIB Parameters

Communication between the devices on a GPIB bus can occur only if all bus devices are configured in a compatible manner. For example, each device on the bus must have a unique identifying address.

Use the **GPIB/RS232C** pop-up menu in the Utility1 major menu to set these GPIB parameters directly, before you attempt to communicate with other devices on the bus. See Figure 3-40.

GPIB/RS232C Parameters			
GPIB Parameters		RS232C Parameters	
Mode	Talk/Listen	Baud Rate	15200Bd
Address	1	Parity	None
LOI	Off	Stop Bits	Soft
Tek C & F	V81.1	Flow Control	CR/LF
Hard Copy	Bitmap	Memo Size	100ps/div
Page Setup	Screen	Main Page	24.2ps
Page	Enhanced	Trace	Trace
Accuracy			

Figure 3-40: The GPIB/RS232C Pop-up Menu

The following list describes each selector in the **GPIB Parameters** section of this pop-up menu:

- Mode** — lets you set the mode to either **Talk/Listen**, **Talk Only** or **Off Bus**. Off bus effectively disconnects the 11801B from the bus. The 11801B must be in talk/listen mode to communicate with a controller using the GPIB. Talk only can be used to drive a printer or plotter over the GPIB.

NOTE

GPIB parameters are not changed when you initialize the 11801B.

- Address** — assigns the knobs to the GPIB address of the 11801B. The GPIB address can be from 0 to 30. No other device on the bus can use the address that you assign to the 11801B.

- **Terminator** — lets you select between two types of message terminations. All message terminations assert the EOI (End Or Identify) signal in the interface. You can choose to have the 11801B recognize a Line Feed (LF) character as a message terminator in addition to EOI, by setting the **Terminator** selector to **EOI/LF**. The 11801B will then append a Line Feed character to the end of all messages. Set the **Terminator** selector to **EOI** to have only the EOI line recognized as a message terminator.
- **GPIB Debug** — lets you turn the debugging feature **On** or **Off**. When you turn debug on, the 11801B displays each command from the GPIB controller as it is executed. The messages appear at the top of the display. Debug off is the normal mode of operation. Set debug on if you need to watch the result of each 11801B command of a controlling program running in the GPIB controller. When debug mode is on, it slows the GPIB interface throughput significantly.



Graticules

The grid on the display where traces appear is called a graticule. The graticule axis labels show you the horizontal and vertical scale factors of the selected trace, most often expressed in time per division and voltage per division. See Figure 3-41.

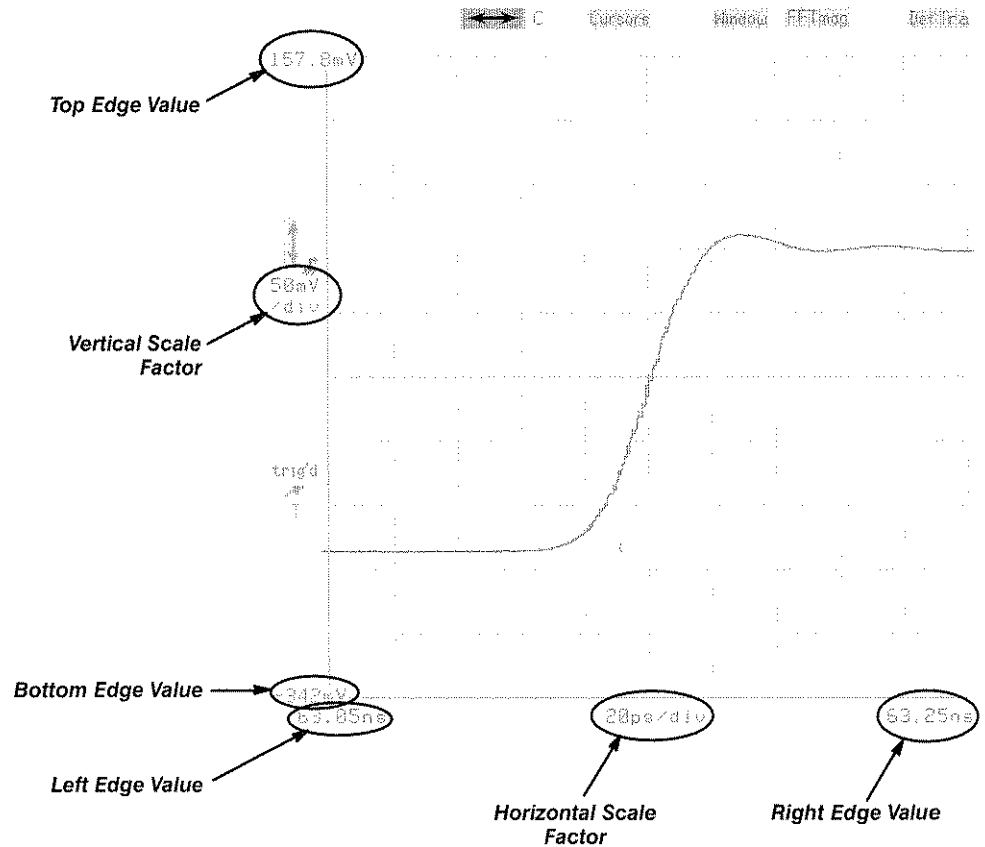

Figure 3-41: Graticule with Trace

If a graticule shows two or more traces, one trace is brighter because it is the trace for which the axis labels are correct. The axis labels are displayed in the same color as this trace. The other traces may or may not share the same axis labels.

NOTE

Traces extend outside the graticule area slightly. The axis labels represent the graticule edge, not the trace edge.

You can display two different graticules, each being half the height of a single-graticule display. In this case, each graticule shows one trace brighter than any others on that graticule. In addition, the graticule with the selected trace has the vertical (\updownarrow) and horizontal (\leftrightarrow) icons. The bright trace on the graticule with icons is the selected trace. See Figure 3-42.

The menu selectors act on and report the status of the selected trace.

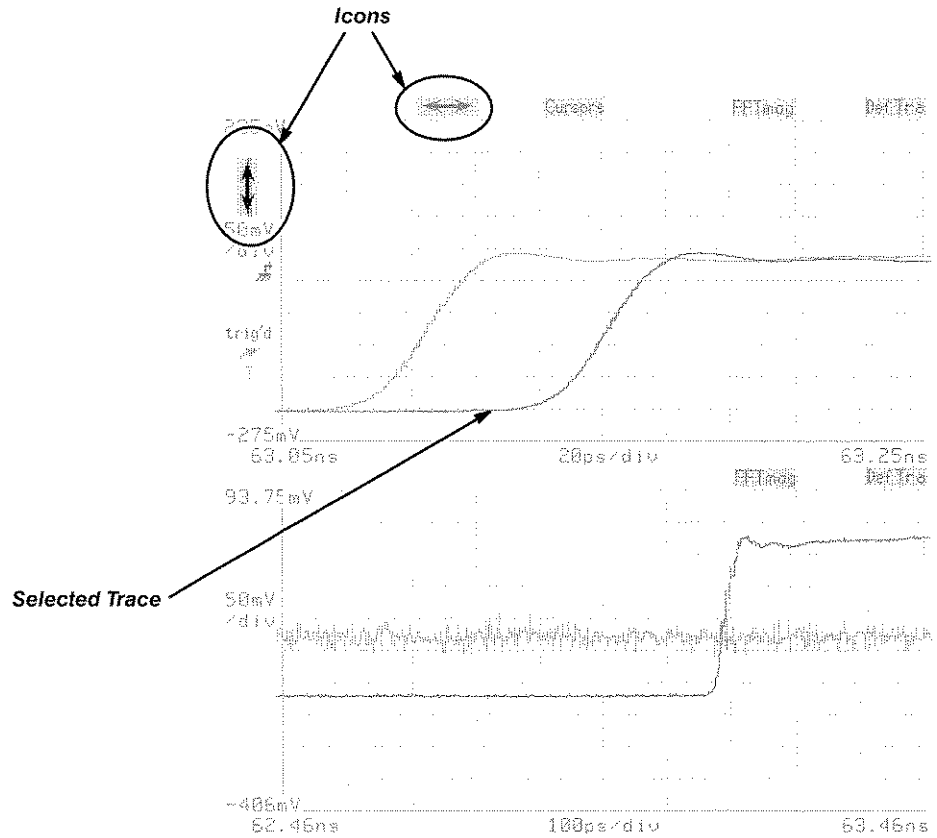

Figure 3-42: Dual Graticules with Multiple Traces

You can make any trace the selected trace by touching it. If you select the wrong one because the traces are close together, touch again until the desired trace is selected and becomes brightened. Other methods of selecting traces are discussed in Trace Definition and Management on page 3-207.

You can control the number of graticules, the placement of traces on the graticules, and the graticule axis units by using the **Graticules** pop-up menu in the Waveform major menu. See Figure 3-43. When dual graticules are displayed, the **Graticules** selector is renamed **Upper Graticule** or **Lower Graticule**, depending on which graticule has the icons and the selected trace.

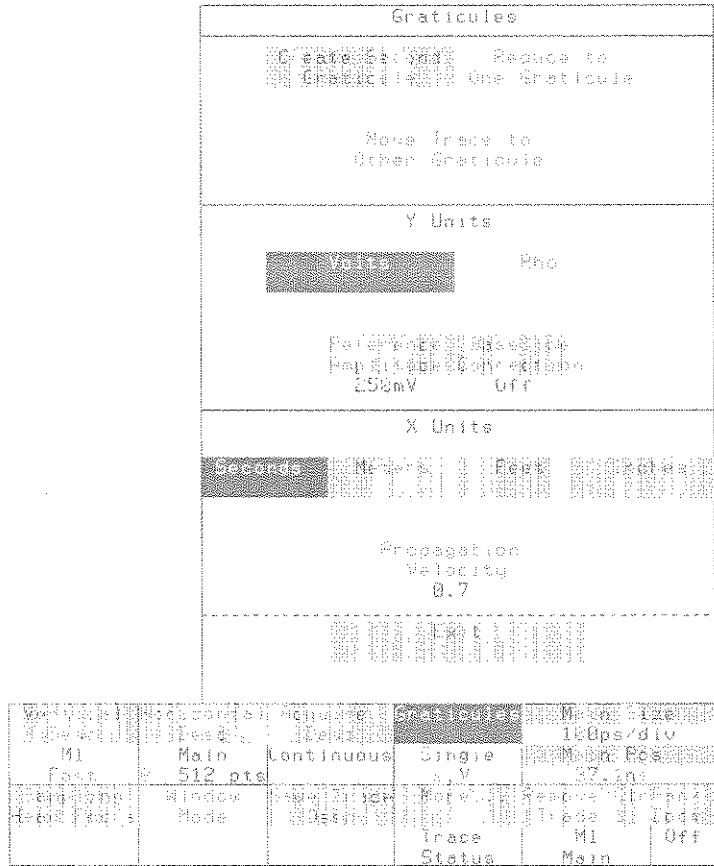

Figure 3-43: The Graticules Pop-up Menu

Managing Graticules and Traces

When only one graticule is being displayed, you can create a dual-graticule display using the **Graticules** pop-up menu from the Waveform major menu. Touch the **Create Second Graticule** selector in this pop-up menu. The selected trace and all traces from window time bases will be placed on the lower graticule. The upper graticule will show all other traces.

When two graticules are being displayed, you can move the selected trace from the graticule it is on to the other. Touch the **Move Trace to Other Graticule** selector to move the trace. After the trace is moved, it remains the selected trace. The horizontal icon (↔) and vertical icon (↕) move to the new graticule.

When two graticules are being displayed, you can combine the traces from both graticules into a single-graticule display. Touch the **Reduce to One Graticule** selector to combine the traces onto one large graticule. The trace that was selected before the operation remains the selected trace on the new single graticule.

When the last trace is removed from the second graticule, the second graticule is automatically removed, leaving a single graticule.

Changing Axis Units

Usually, the graticule axis labels are units of time on the horizontal axis and units of voltage on the vertical axis. For some tasks these axis labels are more meaningful if expressed in other units. Horizontal units of distance are appropriate for TDR and TDT measurements. The 11801B allows you to specify the horizontal axis units to be feet, meters or inches. You can also specify the propagation delay, which is the fraction of the speed of light at which signals travel through your transmission line.

The vertical axis units most appropriate to TDR measurements are either units of rho (ρ) or of impedance (Z). The 11801B lets you specify units of rho for the vertical axis. Rho values can be converted to impedance values by using the following equation (where Z_0 is usually 50Ω):

$$Z = Z_0 \frac{1 + \rho}{1 - \rho}$$

NOTE

Changing axis units on one graticule also changes the axis units of all graticules displayed.

However, readout of impedance is available from the Cursors menu whenever the vertical axis is scaled in rho units.

The status area of the **Graticules** selector in the Waveform major menu always shows the number of graticules and the axis units of measure.

Rho is not selectable for vertical axis units unless the selected trace is displayed in Volts units and TDR is turned on.

Vertical Axis Units

To change the vertical axis units, use the **Graticules** pop-up menu in the Waveform major menu. The section of this pop-up menu labeled **Y Units** governs the vertical axis units.

You can touch either the **Volts** or **Rho** selectors to set the vertical axis labels to those units. The current setting is highlighted.

Rho is not selectable unless the following are true:

- The selected trace can be displayed in Volts units, as opposed to U or N units. Traces such as "Log (M1)" or "M1/M2" are not scaled in Volts and therefore cannot be scaled in Rho. Any linear combination of channels and stored traces can be displayed in Volts or Rho.
- TDR must be on in all channels in the selected trace.

The **Reference Amplitude** selector assigns the knobs to control the rho reference amplitude. This has meaning only when the vertical axis units are rho. For TDR measurements, the rho reference amplitude should be set to the absolute amplitude of the TDR pulse sent by the sampling head. A voltage change equal to the reference amplitude corresponds to a change in rho of 1.

The **Baseline Correction** selector is discussed in Baseline Correction, page 3-17, in this manual. The baseline correction feature of the 11801B is used to hold the vertical position of a trace on the display when the TDR pulse level shifts due to a change in termination impedance. This selector appears in the **Y Units** section of the **Graticules** pop-up menu because the feature is most useful when TDR pulses are being started or stopped, causing the trace to shift vertically. Baseline Correction automatically turns on when **TDR Preset** or **Differential TDR Preset** is selected in the **Sampling Head Fnc's** menu. In the **Graticules** pop-up menu, Baseline Correction also turns on when **Rho** is selected; it turns off when **Volts** is selected.

Horizontal Axis Units

To change the horizontal axis units, use the **Graticules** pop-up menu in the Waveform major menu. The section of this pop-up menu labeled **X Units** governs the horizontal axis units.

You can touch the **Seconds, Meters, Feet** or **Inches** selectors to set the horizontal axis labels to those units. The current setting is highlighted.

The **Propagation Velocity** selector assigns the knobs to let you specify the fraction of the speed of light at which the signal passes through your transmission line or network. Propagation velocity only applies to axis units of distance, and does not apply if your horizontal axis units are seconds.

Propagation velocity is relative to an air-line transmission cable, so a setting of 1.0 indicates that your transmission line or network passes signals at the same speed as an air-insulated cable. The default value of 0.7 applies to most 50 Ω SMA coaxial cables with plastic dielectric.

Hardcopy

A variety of printers and plotters are supported for producing a paper copy of the display. This section will cover how to configure your system for most printers. Also, refer to your printer manual for the proper printer settings.

Installing the Printer

Connect the printer to the 11801B. Depending on the printer, you will want to use the **PRINTER** connector, the **GPIB** connector, or the **RS-232-C** connector. See Figure 3-44.

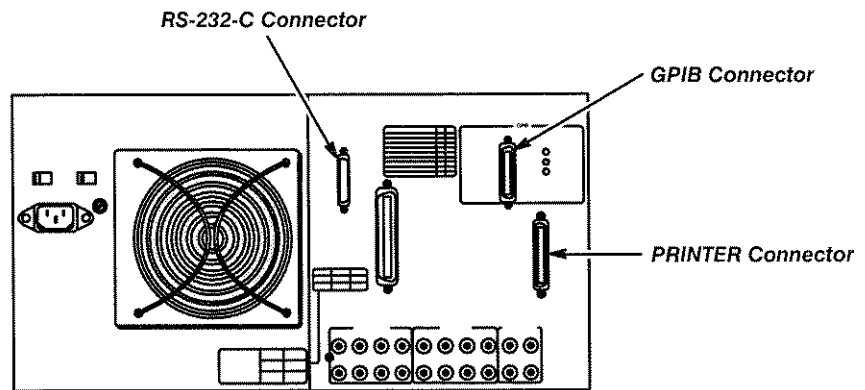

Figure 3-44: Printer Connectors on Rear Panel

- **PRINTER** is the appropriate connector for Centronics®-compatible printers. This is the standard interface for the 11801B and no special configuration of the 11801B is required.
- **GPIB** is the General Purpose Interface Bus parallel interface connector. Use a standard cable fifteen meters or less in length. If you are not using a controller to initiate the hardcopy, set the GPIB Mode parameter of the 11801B to Talk Only and set the printer to Listen Only or Listen Always mode (address 31). Setting GPIB parameters is explained on page 3-80.
- **RS-232-C** is a serial interface connector. Use a standard, straight-wired cable with male connectors on both ends. Hard flagging is used, so all lines must be connected. Do not use a null modem cable. The 11801B acts as a DCE device. Connecting the 11801B to a computer also requires a straight-wired cable, but soft flagging may be used.

The RS-232-C parameters baud rate, parity, and number of stop bits, of the 11801B should be set to match those of the printer or computer. When you connect a printer to the RS-232-C connector, you may also need to set the RS-232-C flagging to **Hard**. Setting RS-232-C parameters is explained on page 3-164.

Hardcopy Parameters

Set the printing properties of the 11801B using the **Hardcopy** pop-up menu in the Utility1 major menu. See Figure 3-45. This menu includes selectors for seven types of printers and for specific options available with some printers.

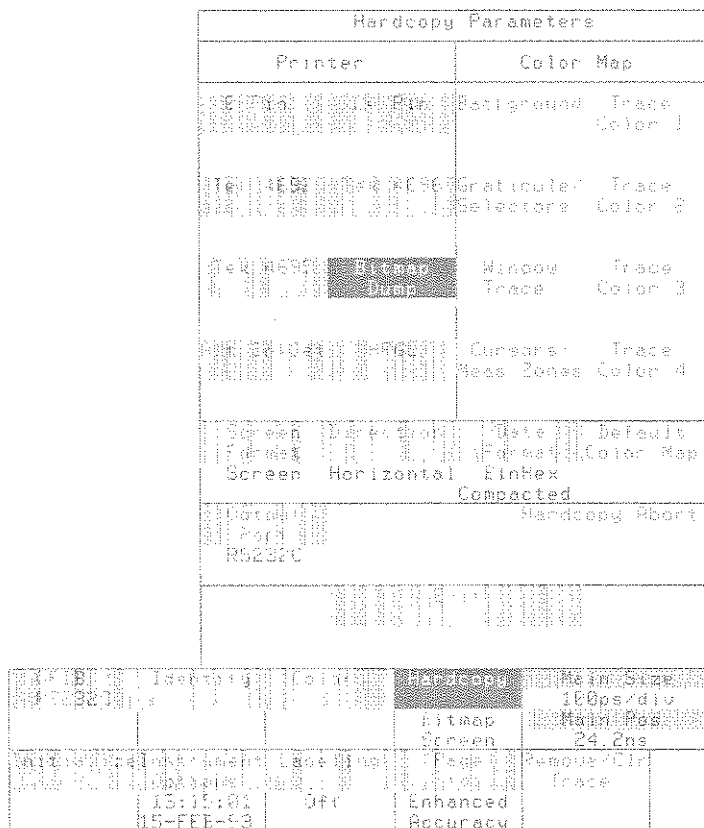

Figure 3-45: The Hardcopy Pop-up Menu

Printer Selections

The selectors in the Printer section of the **Hardcopy** pop-up menu determine the printing configuration of the 11801B. The settings of the other hardcopy parameters will vary according to the printer that is selected. When you change one of these parameters, you are setting its default value for the selected printer type. These settings are not changed when you initialize the 11801B.

NOTE

Printer selection and the associated parameters are not affected by initialization.

- **8 Pin** supports several eight-pin dot-matrix printers, including the Tektronix 4644, Epson® FX80 and Epson EX800. The IBM® ProPrinter™ and Epson RX80 may also be used, but only the **HiRes** screen format provides useful output for these printers. All the supported printers typically use the **PRINTER** (Centronics) connector.

Set the configuration switches on your printer as recommended in its manual except set No Auto Line Feed, No Perf Skip, and Inbuf On.

- **24 Pin** supports the Extended Epson command set for 24-pin dot-matrix printers, including the Epson LQ500, Epson LQ1000, NEC® P6, and NEC P7. These printers typically use the **PRINTER** (Centronics) connector.

Set the configuration switches on your printer as recommended in its manual except set No Auto Line Feed, No Auto-Carriage Return, No Perf Skip, and Inbuf On.

- **Tek 4692** supports the Tektronix 4692 color graphics copier. The Tek 4693D may also be used when set to 4692 emulation, Full Color, Maximized by Interpolation, and Portrait Mode. These printers typically use the **PRINTER** (Centronics) connector.
- **Tek 4696** supports the Tektronix 4696 and 4695 color inkjet plotters. These printers typically use the **PRINTER** (Centronics) connector.
- **Tek 4697** supports the Tektronix 4697 ColorQuick™ Ink-Jet printer. This printer typically uses the **PRINTER** connector.
- **Bitmap Dump** provides the ability to acquire the screen data for external processing. For example, you can use this option to send the display data to a computer. The format of this information is determined by the **Data Format** selector. (Data format is discussed on page 3-93.) You will typically want to use the **GPIB** or **RS-232-C** connector for this type of transfer.
- **Alt Inkjet** supports the HP ThinkJet and HP LaserJet printers. The ThinkJet should be used in HP graphics mode, not Epson emulation mode. For the HP ThinkJet, either **Draft** or **HiRes** screen mode may be used, but **HiRes** mode will be very slow. Only **Draft** screen mode will produce usable output with the HP LaserJet. Either the **PRINTER** (Centronics) connector, **RS-232-C** connector or the **GPIB** connector may be used.
- **HPGL** supports the HPGL color plotter command set. When **HiRes** is selected under **Screen Format**, an HPGL hardcopy will show graticules, axis labels, all waveforms and the major menus at the bottom of the screen. You can suppress the plotting of the major menus by selecting **Draft** under **Screen Format**. Color graded displays are not plotted with HPGL. Supported plotters include the Tek HC100, HP-7475, and HP-7550. These printers can be connected to the **PRINTER** (Centronics) connector. The HP-7474 and HP-7550 may be connected to the **GPIB** or **RS-232-C** connector.

Color Map

The selections in the **Color Map** section of the menu become available whenever a color printer or plotter is selected. A color selector is available for selected elements of the display. To change a color, simply select the element in the menu, then use the control knobs or keypad pop-up menu to adjust the setting. To restore the color map to its factory default settings, touch the **Default Color Map** selector.

The color selections are expressed in terms appropriate to the selected printer. When **Tek 4692** is selected, the colors are expressed as hexadecimal RGB values. For the **Tek 4696** selection, thirteen color name selections are available. **HPGL** supports pen numbers 0 to 8.

Screen Format

The **Screen Format** selector provides several qualities of hard-copy output. Different format selections are available for different printer types.

- **HiRes** produces an enhanced contrast display on printers with limited gray-scale capability. Selected items, including windows, are highlighted for easy identification.
- **Draft** produces hardcopies faster than **HiRes** mode, but sacrifices some gray-scale capability.
- **Reduced** produces low-resolution hardcopies a quarter of the size of **Draft** hardcopies. Advantages are quicker printing and use of less memory.
- **Screen** produces an exact color replica of the screen without reformatting to enhance features. Available for color printers and plotters only.
- **Dithered** reduces saturation and increases contrast by dithering icons and selector backgrounds. May be used with **Tek 4692**, **Tek 4696**, **Tek 4697**, and **Bitmap Dump**.

Direction

The **Direction** selector controls whether information is sent to a printer as horizontal rows or as vertical columns. For most printers, this has the effect of rotating the image by 90°. Some printers will produce an image more quickly in one direction than in the other. When **Direction** is set to **Horizontal**, screen information is sent to the printer by horizontal rows starting at the top left corner of the display. When it is set to **Vertical**, the information is sent by vertical columns starting at the bottom left corner of the display.

Data Format

When **Bitmap Dump** is selected, the screen data is transferred as an ASCII title block followed by a pixel data block. The format of the pixel data is determined by the **Data Format** setting. Touch this selector to cycle through the six available formats.

- **TIFF** sends a TIFF image. This format conforms to Rev. 6.0 of the TIFF specification. Screen and Dithered screen formats generate Palette Color (Class P) prints; Hires, Draft, and Reduced formats create Bilevel (Class B) prints.
- **TIFF Compacted** sends a compressed TIFF image using PackBits compression. Note that some application software will not accept Rev. 6.0 compressed TIFF Class P images. Screen formats are the same as for **TIFF**.
- **Binary** mode bytes of pixel data are sent as a stream of binary values without delimiters.
- **Binary Compacted** mode pixel data are compressed before being sent. See the discussion of compression, below.
- **BinHex** mode converts every four bits into a hexadecimal character. Each line is terminated by a new-line character.
- **BinHex Compacted** mode pixel data are compressed and then converted into BinHex characters.

Title Block — consists of three character strings terminated by new-line characters. The first line contains the firmware version numbers, time and date, and the 11801B ID number. The second and third lines give the number of pixels per display line and the number of display lines, respectively. In **Binary** mode, the title block is terminated by a NULL character.

Pixel Data Compression — significantly reduces the size of the pixel data block. Without compression, each data byte contains a single three-bit pixel. With compression, two pixels are stored in the six low-order bits of the data byte, and the two high-order bits are a repetition encoding with the following meaning:

Table 3-4: Repetition Encodings

Bit 7	Bit 6	Meaning
0	1	Pattern repeats once
1	0	Pattern repeats twice
1	1	Pattern repeats three times
0	0	Following byte(s) contain repetition count

Hardcopy

If the second byte of the pixel block has a value in the range 4–225, it is the pattern repetition count. If the value is 1-3 decimal, it is the high order bits of a 10-bit repetition count, and the third byte of the pixel block contains the eight lower-order bits.

Output Port

The **Output Port** selector allows you to choose **GPIB**, **RS232C**, or **Centronics** (the **PRINTER** connector). The selection must match the rear panel connection.

Making a Hardcopy

Once you have installed a printer and configured the 11801B properly, you can make a hardcopy of the screen by pressing the **HARDCOPY** button on the front panel.

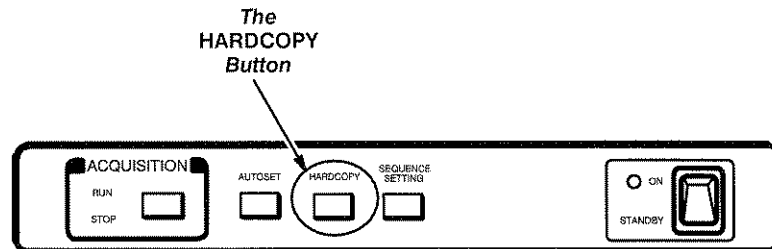

Figure 3-46: Front Panel Hardcopy Button

When you press the **HARDCOPY** button, the display freezes for a short time. The shades of intensity on the display may be altered. The printer starts printing immediately.

The length of time that the display is frozen depends on the hardcopy mode, complexity of the display, and memory available for hardcopies. During this pause the 11801B formats and buffers the print commands.

After the pause, the 11801B returns to normal operation and continues to print the hardcopy. When the display becomes active again, you may operate the 11801B without affecting the hardcopy being printed.

You can also initiate a new hardcopy at this point. The 11801B will automatically queue multiple screen displays for hardcopy output. The number of hardcopies that can be queued is subject to the amount of available memory.

When the hardcopy is printed, a message is displayed. The hardcopy is not complete until this message appears. You should not turn off the 11801B, perform self-test diagnostics, or use the Extended Diagnostics menu until the hardcopy is complete, or the hardcopy will be terminated before it is finished.

NOTE

Do not turn off the 11801B or perform diagnostics until the hardcopy is complete.

Terminating A Hardcopy In Progress

You can terminate a hardcopy by selecting **Hardcopy Abort**, in the **Hardcopy** pop-up menu. A message will appear stating that the hardcopy has been cancelled.

You can also terminate the hardcopy while the screen is still frozen by pressing the **HARDCOPY** button a second time.

Hardcopy Defaults

The following table summarizes the factory default settings associated with each printer selection in the **Hardcopy** pop-up menu. These settings are not affected by initialization.

Table 3-5: Hardcopy Defaults

Printer	Screen Format	Direction	Data Format	Output Port
8 pin	HiRes	N/A	N/A	Centronics
24 pin	HiRes	N/A	N/A	Centronics
Tek 4692	Screen	Vertical	N/A	Centronics
Tek 4696	Dithered	Vertical	N/A	Centronics
Tek 4697	Dithered	Horizontal	N/A	Centronics
Alt Inkjet	Draft	Horizontal	N/A	Centronics
HPGL	HiRes	N/A	N/A	Centronics

The default settings for the color map associated with a color printer setting may be recovered by selecting **Default Color Map** in the **Hardcopy** pop-up menu.

Histograms

The 11801B can display histograms constructed from the selected trace's waveform data. You can display either a vertical (voltage) or horizontal (time) histogram. Only one type of histogram can be displayed at a time. See Figure 3-47.

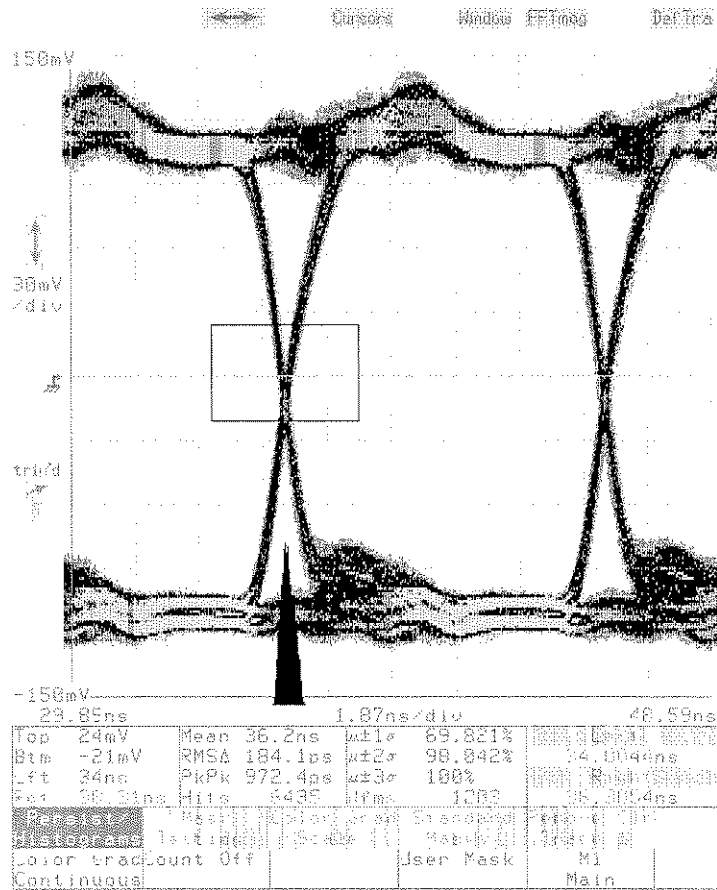

Figure 3-47: A Histogram Displayed on an Eye Diagram

To create a histogram, use the **Persist/Histograms** pop-up menu. You can specify the section of the selected trace used to determine the histogram and set histogram scaling to either linear or logarithmic. You can specify that acquisition stop after a set number of trace acquisitions or after a set number of samples have been acquired. See Figure 3-48.

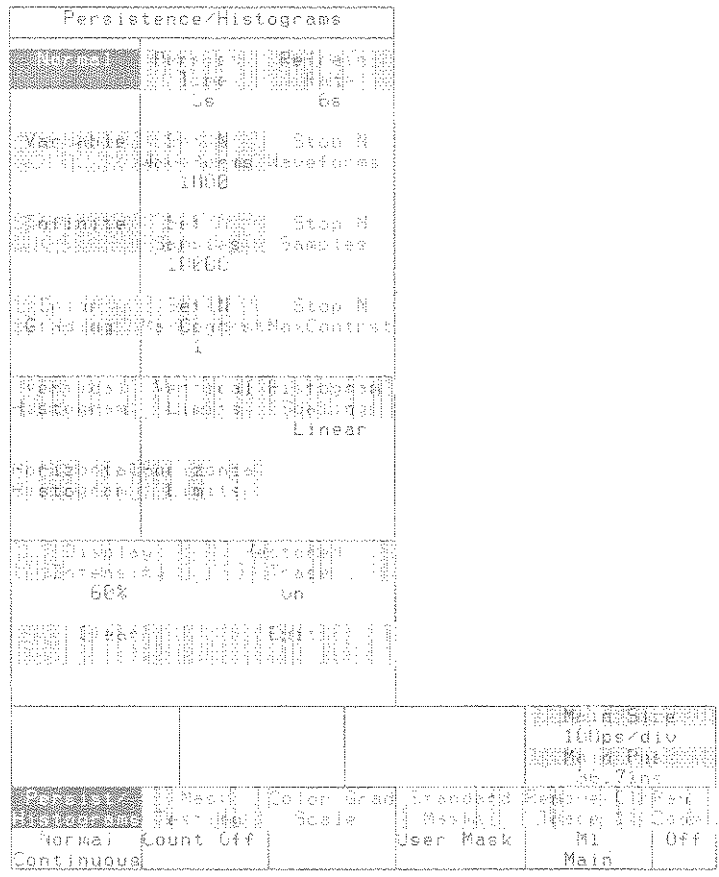

Figure 3-48: The Persist/Histograms Pop-up Menu

Displaying a Histogram

To turn on the histogram display, press the **DISPLAY MODES** button, touch **Persist/Histogram** and then touch either the **Vertical Histogram** or **Horizontal Histogram** selector. This changes the display mode to infinite persistence if the current mode is normal or variable. If the current display mode is color-graded, it won't change. When the histogram display is turned on, the waveform record length is set to 512 points. If the record length was greater than 512, you will see a message informing you of the change in record length.

A rectangular box, used to specify the section of the selected trace used to generate the histogram, is displayed when histograms are turned on. If the display is in color-graded mode when the histogram display is turned on, the histogram is initialized with data from the color-graded display.

Note that the color-graded display does not make a distinction between the selected trace and non-selected traces when the histogram is initialized with data from the color-graded display. Thus it is possible to get samples from non-selected traces in the histogram data (if the histogram box encompasses any non-selected trace). Therefore, when using the color-graded mode, display only one trace or maintain enough vertical separation between traces so they don't overlap. Also, histograms can be displayed (calculated) after waveforms have been accumulated in color-graded mode (even if acquisition has been stopped), whereas they cannot in infinite persistence mode.

By using dual graticules, you can acquire color-graded information on two traces simultaneously. Display one trace on each graticule, and set up a histogram for each trace. Both histograms are acquired, but only the histogram for the selected axis is displayed. Since the color-graded database is used, the second histogram can be seen later.

Histogram Controls

The histogram display can be affected by several controls. You can specify which part of the selected trace is used to calculate the histogram. You can stop acquisition based on the number of waveforms acquired or the number of histogram samples acquired. You can set how often the histogram display is updated with new data and you can set scaling to logarithmic or linear. All the histogram controls are located in the **Persist/Histograms** pop-up menu.

Changing the Size of the Histogram Box

To change the section of the selected trace used for the histogram, touch either **Vertical Limits** or **Horizontal Limits**. Touching the **Vertical Limits** selector assigns the top knob to **Upper Limit** and the bottom knob to **Lower Limit**. Touching **Horizontal Limits** assigns the top knob to **Left Limit** and the bottom knob to **Right Limit**. Turning either knob will change the position of the assigned edge of the histogram box, thus limiting the part of the selected trace used for the histogram.

The vertical and horizontal limits of the histogram box can be set without turning on the histogram display. To set the size and location of the histogram box without turning on the histogram display, touch either **Vertical Limits** or **Horizontal Limits** first without touching either the **Vertical Histogram** or **Horizontal Histogram** selector. This way, you can set up your histogram limits before you begin acquiring your data.

Histogram limits are set separately for each displayed trace. And because a histogram applies only to the selected trace, if you select a different trace, the histogram display will disappear. If you then reselect the original trace, the histogram display will reappear. This enables you to display several traces, each with a different histogram display. (Remember that only one histogram, that of the selected trace, can be displayed at a time.)

Histogram limits are expressed in axis units (usually volts and seconds), but are actually determined by screen position. The histogram limits will remain fixed on the screen regardless of changes in vertical or horizontal size and position.

In color-graded mode, the histogram is initialized from the color-graded database when the box limits change. This will occur even when in Acquisition **STOP** mode.

Limiting Acquisition

You can limit acquisition based on either the number of waveforms or the number of samples, or "hits," acquired in the histogram. These functions are controlled by the **Set N** and **Stop N** selectors in the **Persist/Histograms** pop-up menu. See Figure 3-49.

To limit acquisition based on the number of waveforms acquired, display the **Persist/Histograms** menu and touch **Set N Waveforms**. This assigns the knobs to limit the number of waveforms acquired. The range for the number of waveforms acquired is 1 to $2^{32}-1$ (approximately four billion). To begin conditional acquisition, touch **Stop N Waveforms**. Acquisition will stop when N waveforms have been acquired.

The number of waveforms left to acquire is shown in the lower-left corner of the display.

To limit acquisition based on the number of histogram hits, first touch **Set N Samples**. This assigns the knobs to limit the number of samples acquired. Using the knobs, set the number of samples you wish to acquire. The range for the number of samples acquired is 1 to $2^{32}-1$ (approximately four billion). To begin acquisition, touch **Stop N Samples**. Touching this selector starts acquisition, which then continues until N samples have been acquired.

The number of samples left to acquire is shown in the lower-left corner of the display.

Thus, there are two steps to stop acquisition based on the number of samples acquired:

- Step 1:** Set the number of waveforms or samples using **Set N Wfms** or **Set N Samples**.
- Step 2:** Begin the acquisition by selecting **Stop N Wfms** or **Stop N Samples**.

If you want to stop the acquisition before the conditional acquisition completes, press **RUN/STOP**.

The data that appears in the histogram readout is calculated as waveforms are acquired. The histogram display is updated based on the Refresh Rate.

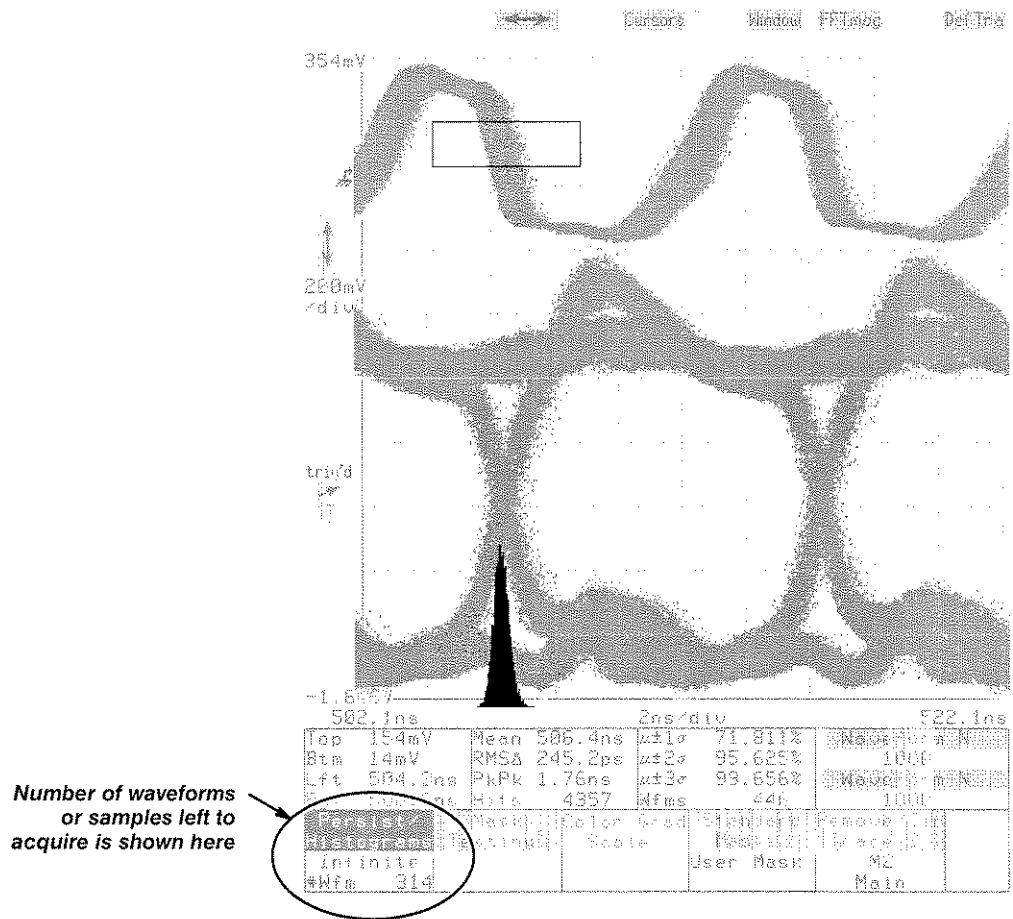

Figure 3-49: Using Stop N Wfms

Changing the Display Update Rate

The rate the histogram display is updated can be varied from zero seconds to three minutes (180 seconds). To change how often the histogram display is updated, touch **Refresh Rate**. You can now turn either of the control knobs to change the time between updates or you can use the knob pop-up menu to enter the time directly. With the knobs, you can vary the update rate from 5 to 180 seconds.

With the knob pop-up menu, you can enter zero seconds. Setting the display update rate to zero seconds allows the instrument to build the histogram more rapidly, until the number of waveform samples equals the number set by **Set N Samples**, or the number of waveforms acquired equals the number set by **Set N Wfms**. The instrument then displays the acquired histogram.

Changing Scaling

You can set the histogram scaling to either linear or logarithmic. To change the histogram scaling, touch **Histogram Scaling**. Linear scaling better illustrates the relative quantity of various data, while logarithmic scaling provides better detail at the edges of the histogram. Histogram scaling is a display feature; it does not affect the histogram data.

Clearing the Histogram Data

To clear the data in the histogram display, touch the **Clear** selector in the **Persist/Histogram** pop-up menu or touch the Clear Trace selector in the **Remove/Clr** pop-up menu

Histograms cannot be displayed for stored traces. Histograms can be displayed for calculated traces if the calculated trace contains at least one active channel, even if the calculated trace contains a stored trace.

The Histogram Readout

In the major menu area of the display is a readout of histogram characteristics. Included in the display are the values for the position of each of the sides of the histogram box, statistical values and measurements. See Figure 3-50.

Top	24mV	Mean	36.2ns	$\mu\pm 1\sigma$	59.821%
Btm	-21mV	RMSΔ	184.1ps	$\mu\pm 2\sigma$	98.842%
Lft	24ns	PkPk	972.4ns	$\mu\pm 3\sigma$	100%
Rgt	38.21ns	Hits	6025	Wfms	1280
		Test	Pass	Fail	Stop
		Lower Grad	Count Off	User Mask	
		Continuous			

Figure 3-50: Histogram Readout Appears Below the Trace Display

- Top, Btm, Lft, and Rgt represent the position of each of the sides of the histogram box, in appropriate axis units. That is, Top and Btm values are given in volts; Lft and Rgt are given in seconds.
- Mean is the average value of all the acquired points within the histogram box. Pk-Pk is the difference between the most positive acquired point and the least positive acquired point, when Vertical Histogram is selected. When horizontal Histogram is selected, Pk-Pk is the difference between the left-most data point and the right-most data point within the histogram box.
- RMSΔ is the RMS deviation (also known as standard deviation). $\mu\pm 1\sigma$ represents the percentage of waveform points which fell within one standard deviation of the mean. $\mu\pm 2\sigma$ and $\mu\pm 3\sigma$ represent the percentage of waveform points which fell within two and three standard deviations of the mean, respectively.
- Wfms is the number of waveforms that have been acquired since the histogram display was turned on. Hits is the number of waveform data points that have fallen inside the histogram box.

Horizontal Controls

The horizontal controls let you set the horizontal size and placement of your traces. Touch the horizontal icon (↔) to access these controls.

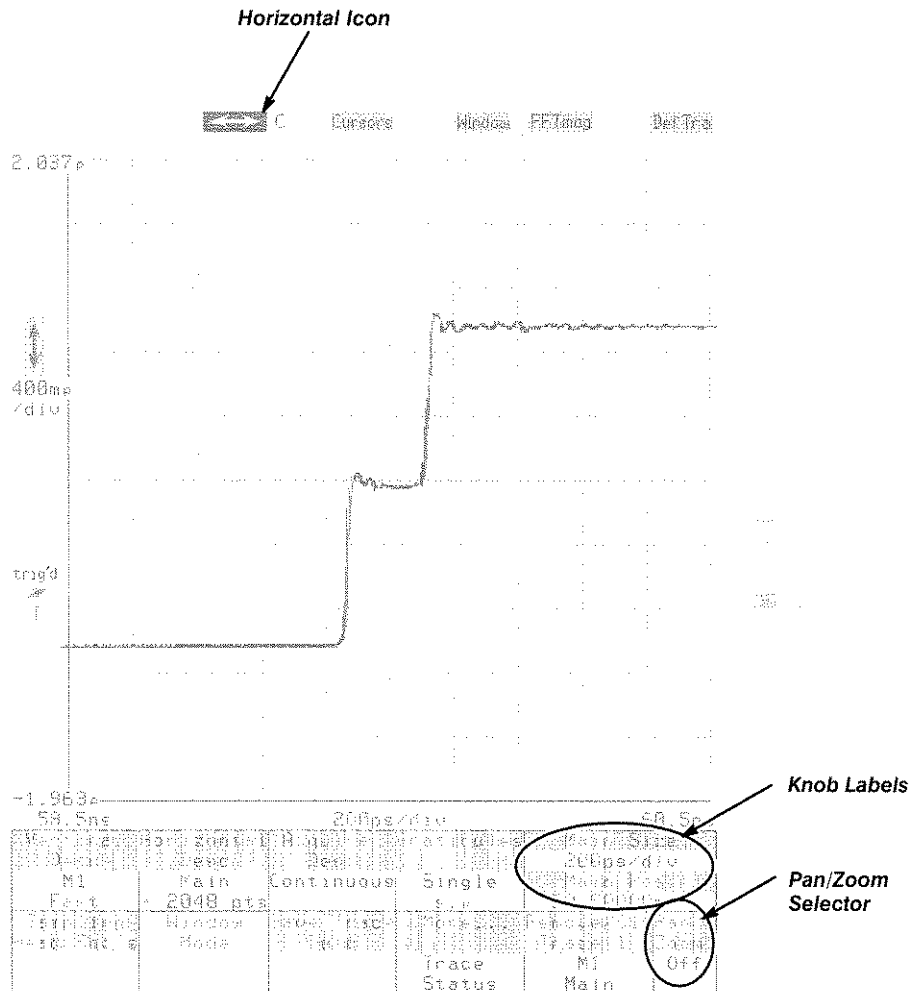

Figure 3-51: Horizontal Controls

Setting Horizontal Size and Position

You can change the horizontal magnification, or *size*, of a trace. You can also move the trace left or right to see different portions of the trace. This is called adjusting the horizontal *position*. To do either of these, touch the horizontal (↔) icon. This assigns the knobs to adjust the horizontal size (top knob) and position (bottom knob) of the selected trace.

The axis label for the left edge of the graticule is slightly different than the horizontal position of a trace. This is because traces extend slightly beyond the edges of the graticule. The illustration on the previous page shows the main position (the knob label) is 59.5 ns, and the left edge of the graticule is 58.5 ns.

If you want to change the size or position of a different trace, touch the desired trace to select it. Then you can use the knobs to adjust horizontal size and position.

NOTE

Touch a knob label to display the Keypad pop-up menu. This lets you set horizontal size and position numerically, or quickly set them to maximum or minimum limits. It also lets you set the knob resolution.

Interactions With Other Traces

The knob labels tell you whether the selected trace is from the main time base or a window time base.

All traces from the main time base share the same size and position. If you change the size or position of one main trace, you will change the size or position of all of main traces.

All traces from window time bases have the same horizontal size. If you change the horizontal size of one window trace, you will change the horizontal size of all window traces. Each window trace can have a unique horizontal position.

Pan/Zoom

Pan/Zoom allows you to magnify any portion of the selected trace to examine it more closely. You can magnify (zoom) the selected trace to the point where each digitized sample appears on the display, and you can move the magnified trace left and right (pan) to examine any part of the trace.

The maximum magnification is determined by the trace record length, which is described in the Record Length section, page 3-161. The trace display area is 512 pixels wide, so you can magnify a 5120-point trace up to 10 times. A 512-point trace already displays only one digitized sample per pixel and cannot be magnified.

NOTE

Pan/Zoom does not change the way trace data is sampled and recorded. It only changes the way the trace data is displayed.

Whenever the  icon is highlighted, the lower right corner of the display shows the **Pan/Zoom** selector. Normally, Pan/Zoom is **off**, and the knobs are assigned to horizontal size and position. When you touch the **Pan/Zoom** selector to set it **on**, the knobs are assigned to **Horz Mag** (Zoom) and **Horz Pos Gr** (Pan).

You use the top knob, **Horz Mag**, to specify how much magnification you want on the selected trace. You use the bottom knob, **Horz Pos Gr**, to position the segment of the trace that you want to view onto the display. The knob label status area shows how many trace data points are not shown because they are off the left end of the screen. When you set **Horz Pos Gr** to zero, you display the leftmost portion of the trace.

You can use horizontal magnification to see the exact data points of a trace record. Set horizontal magnification to the maximum and turn off trace vectoring. Trace Vectoring is discussed in the Vectored Traces section, page 3-219. The display will show each sampled data point of the trace. See Figure 3-52.

Horizontal Controls

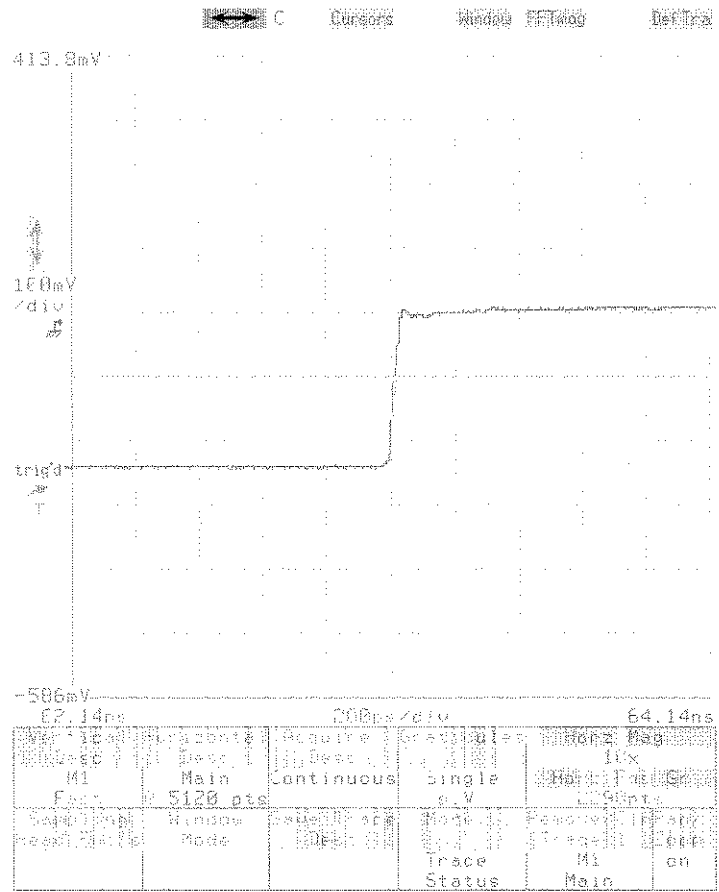

Figure 3-52: Horizontal Magnification with Pan/Zoom

Changing the Horizontal Reference Point

When you change the horizontal size of a trace, you magnify or compress the horizontal scale. Normally, the same point of the trace shows at the left edge of the display after the horizontal size is changed. The point about which the expansion or contraction of the trace occurs is called the horizontal reference point.

You may find that having the horizontal reference point at the left edge of the display is not appropriate for your task. For example: you have a trace that shows a rising edge of a pulse near the center of the display. When you increase the horizontal size of the trace, the rising edge moves off the right edge of the display. You must move the trace to the left with horizontal position in order to view the rising edge of the pulse at its new size.

You can change the horizontal reference point to keep the interesting portion of the trace on the display whenever you change horizontal size. In the example above, before you changed the horizontal size, you could change the horizontal reference point to the center of the display. Then, the part of the trace that was in the center of the display remains in the center of the display after the the horizontal size changes. The current setting for horizontal reference point is indicated by a letter next to the horizontal icon (↔) L indicates the horizontal reference point is set to Left, C indicates Center and R indicates Right.

The horizontal reference point applies only to horizontal size. In Pan/Zoom mode, the **Horz Pos Gr** setting serves a similar purpose.

Use the **Horizontal Desc** pop-up menu of the Waveform major menu to control the horizontal reference point (see Figure 3-53.) The pop-up menu has three selectors in the section labeled **Horizontal Reference Point: Left, Center, and Right**. The selector for the current setting is highlighted. Touch the selector that corresponds to the setting you want.

In some cases, changing the horizontal size control (time per division) may force the horizontal position to change. For example, with the reference point set to Center, small main position settings may cause the first point of the record to reach the minimum delay for the trigger point. Further increases in the main size will cause the horizontal position to be moved to maintain the minimum delay for the first sample of the record. However, the oscilloscope remembers any forced horizontal position changes and restores the position to its original location when the main size is set to smaller values. If the user adjusts the main position, when the setting has been forced to change, the 11801B *does not* restore the old position when main size is decreased.

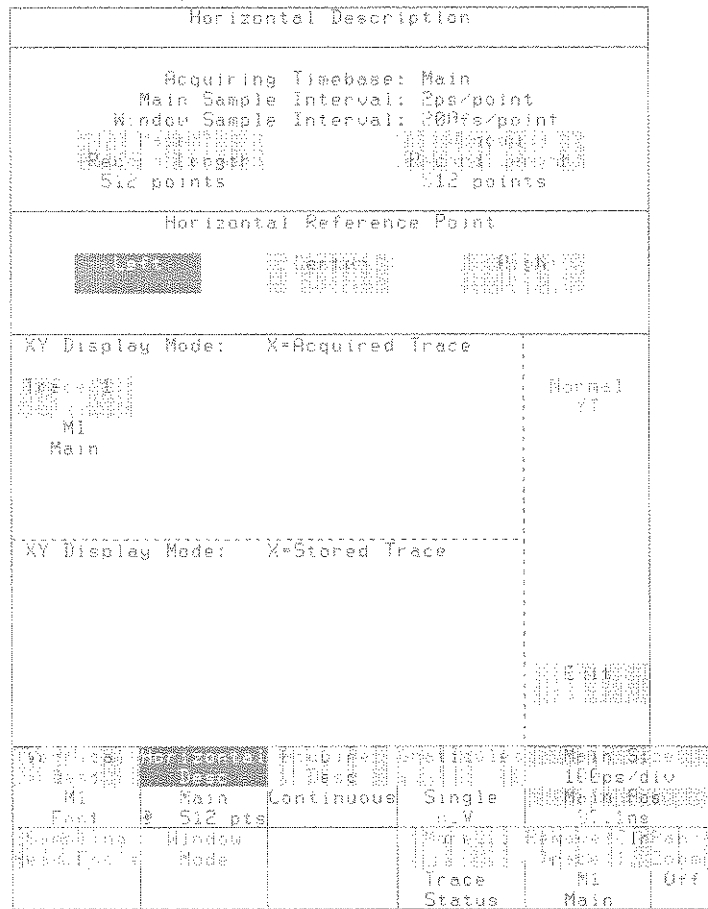

Figure 3-53: The Horizontal Desc Pop-up Menu

Initialization

Whenever you begin a new task using the 11801B, you should initialize the system so that all settings are at “factory default.” That way you do not get unexpected results because of settings remaining from the last use of the 11801B.

To initialize the system settings to default, touch the **Initialize** selector in the Utility1 major menu, then touch Initialize in the Verify Initialize pop-up menu, as shown in Figure 3-54.

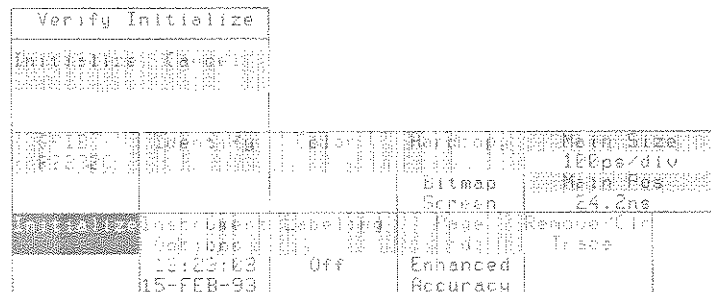

Figure 3-54: The Initialize Verification Pop-up Menu

An alternate method to initialize is to select **Initialize Setting** in the **Recall Setting** pop-up menu in the Store/Recall major menu.

The following settings are *not* affected when you initialize:

- Stored traces, stored settings, and saved trace descriptions
- Sampling head calibration values
- Time and Date
- The following GPIB parameters: Address, Mode, and Terminator
- The following RS-232-C parameters: Baud Rate, Echo, Stop Bits, Parity, Flagging, Delay, and EOL String
- Hardcopy parameters

Initializing and Erasing Nonvolatile RAM

You can erase all information stored in nonvolatile RAM by holding down both the **WAVEFORM** and **TRIGGER** major menu buttons when you turn on the 11801B. Release the buttons when the lights next to the major menu buttons stop flickering. When the power-on sequence is complete, the message “Teksecure Erase Memory Status: Erased, Instrument ID, on-time, and number of power-ups retained” will appear on the display.

When nonvolatile RAM is erased in this manner, the 11801B writes the hexadecimal value DEAD over all nonvolatile RAM locations for settings, traces, and saved-trace descriptions.

The following information is *not* lost when nonvolatile RAM is erased:

- Serial number of the 11801B
- Accumulated time the 11801B has been on
- Number of times the 11801B has been powered on
- Factory calibration constants, which are established at the factory and cannot be changed by the user or by the 11801B
- Enhanced Accuracy calibration constants, which are periodically calculated and updated
- Time and Date

Labeling

You can label active traces, stored traces, and stored settings for easier identification.

A label is a string of up to ten letters, numbers, or spaces that appears next to a displayed trace or as part of a trace or stored setting selector in menus. See Figure 3-55.

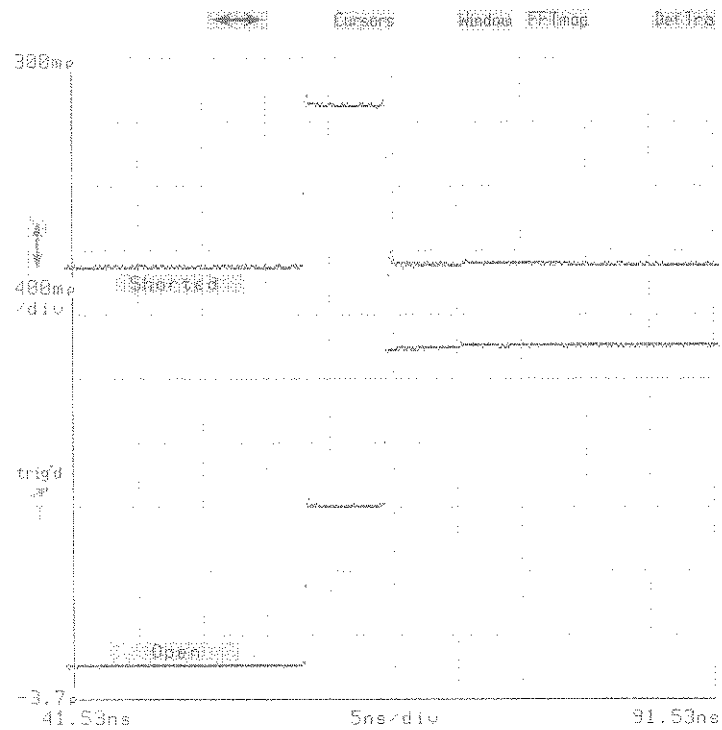

Figure 3-55: Labels Displayed with Active Traces

Creating Labels

You can create and edit labels by using the **Labeling** pop-up menu, shown on the next page. Select **Labeling** in the Utility1 major menu to display the pop-up menu. The uppermost section of this menu contains selectors for **Displayed Traces**, **Stored Traces**, and **Stored Settings**. Beneath these selectors, the selectors for individual active traces, stored traces, or stored settings appear. If there are more stored traces or stored settings than can be displayed at once, use the **Page**↑ and **Page**↓ selectors to scroll through the menu.

To create or change a label, select the item you want to label from the **Labeling** pop-up menu, shown in Figure 3-56. For example, select **Stored Trace**. Then select the stored trace you want to label. You can then type the label by touching the character selectors in the lower half of the menu. (Letters are laid out as if they were on a standard keyboard.) The selectors beneath the characters allow you to choose **Upper Case** letters, **Lower Case** letters, **Numbers** (which include some punctuation and symbols), **Graphics**, **Greek** letters, or **Other** characters. You can mix character types within a label. As you type, the label appears in the selector, just below the trace or setting number. A maximum of 10 characters can be used for a label.

Use the **Back Space** selector to correct errors as you type a label. Touch **Erase** to completely erase the selected label. Use the **Exit** selector to leave the pop-up menu. When you leave the pop-up menu, new labels are entered automatically. If you want to enter a label without leaving the **Labeling** menu, touch the selector for the labeled item in the menu.

You cannot use the same label for two items of the same type (for example, two active traces or two stored traces). If you attempt to enter a duplicate label, the error message “Duplicate label – label not changed” appears on the display and the previous label is restored.

NOTE

You cannot enter the same label for two items of the same type.

You can use automatic labeling if you don't want to enter labels yourself. Automatic labeling labels the trace with its trace description. For example, if you turn on channel 2, the label attached to the trace will be M2. If you define a trace using the **Def Tra** pop-up menu, the label will be the trace description, up to 10 characters. To enable automatic labeling, touch the **Label Mode** selector to set it to automatic.

When you store a labeled trace, or create an active trace that displays a stored trace, the label will be copied to the new trace, unless this would duplicate a label on another trace in the same class.

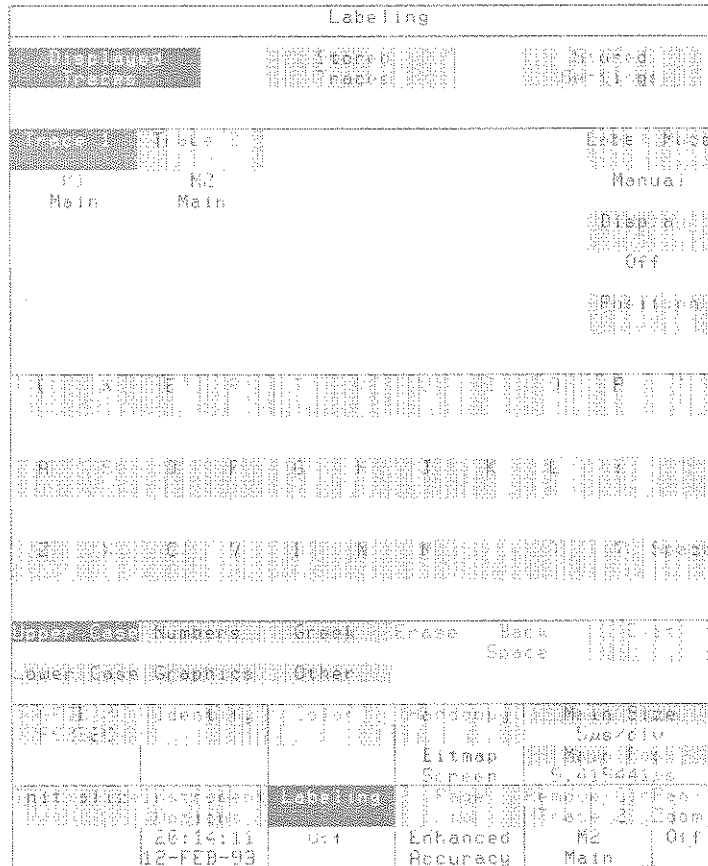

Figure 3-56: The Labeling Pop-up Menu

Changing the trace description of an active trace will not change the label of the trace.

Displaying Labels with Traces

Labels of displayed traces may be displayed on the screen with the traces. When **Displayed Traces** is selected, **Display** and **Position** selectors appear to the right of the trace selectors in the **Labeling** pop-up menu. Turning on **Display** will cause the labels to appear with the traces. Labels will appear in the selectors for all traces whether **Display** is turned on or off.

Labels that are displayed on the screen move with the traces. You can position each label relative to its trace. Select **Position** to assign the knobs to set the vertical (top knob) and horizontal (bottom knob) position of the label. The label position is relative to a specific point on the trace. By changing the horizontal position of the label, you are changing the point the label will follow. By changing the vertical label position, you can specify the vertical offset of the label from the point. If the trace record point is out of the range of the graticule, the label will remain at the top or bottom of the graticule.

You can select a trace by touching its displayed label.

Mask Testing

The 11801B enables you to perform mask testing (see Figure 3-57) using the **Standard Masks** and **Mask Testing** pop-up menus. The **Standard Masks** pop-up menu lets you select a mask from a collection of 38 predefined telecommunication masks. These permanent masks include 18 CCITT standard masks, 8 ANSI/SONET standard masks, 10 ANSI T1.102 standard masks, and 2 miscellaneous standard masks. The **Standard Masks** pop-up menu is accessed from the Display Modes major menu.

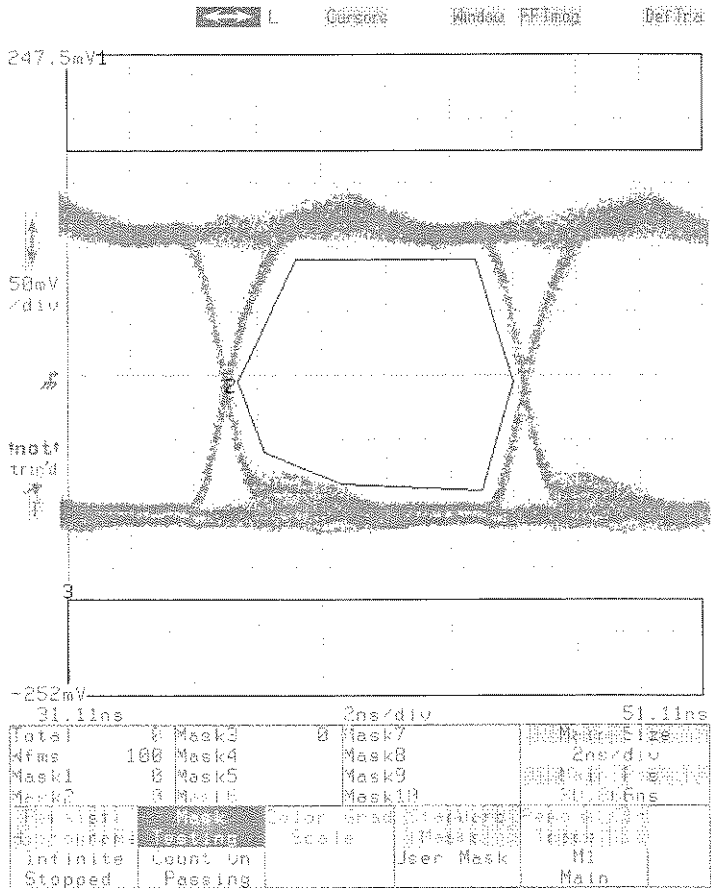

Figure 3-57: Mask Testing on an Eye Diagram

Mask Testing

Masks are selected and created using the **Mask Testing** pop-up menu. The **Mask Testing** menu lets you perform mask testing using the standard masks, or create a custom mask for testing. The **Mask Testing** pop-up menu is accessed from the Display Modes major menu. You can create up to 10 custom masks, of up to 50 points each. The **Mask Testing** menu also lets you specify that acquisition stop after a set number of trace acquisitions or after a set number of mask hits have been acquired. To remove the **Mask Testing** menu, touch **Exit**.

Using Predefined Telecommunication Masks

The predefined telecommunication masks are available as Option 1T. To view the standard masks that are available (assuming that this option is installed), you first need to have a trace acquired. With a trace acquired, press the **DISPLAY MODES** button, and then touch **Standard Masks**. This brings up the **Standard Masks** pop-up menu (see Figures 3-58 and 3-59). This menu lists the masks available in four categories: ANSI SONET / CCITT optical standards, CCITT G.703 electrical standards, ANSI T1.102 electrical standards, and Miscellaneous standards. On the menu, eight masks are available under ANSI SONET / CCITT optical standards. The CCIT G.703 electrical standards masks total 18 and are contained on three pages. Touch **PAGE↑** and **PAGE↓** to view the remaining CCIT G.703 masks available. Ten ANSI T1.102 electrical standards are also available. Lastly, two masks are selectable under Miscellaneous standards: the FDDI Halt mask and a User Eye mask.

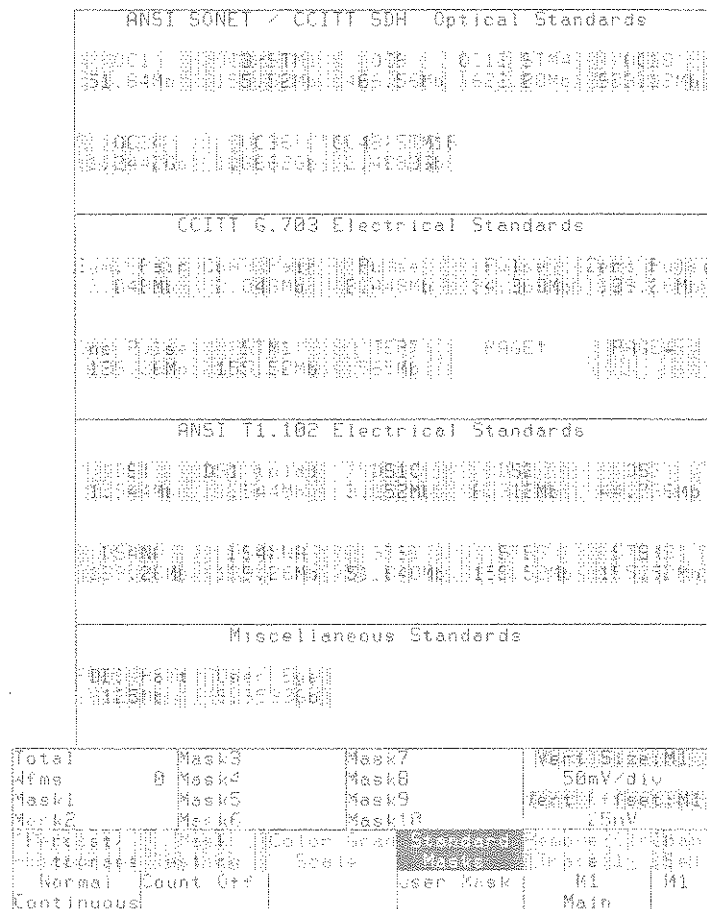

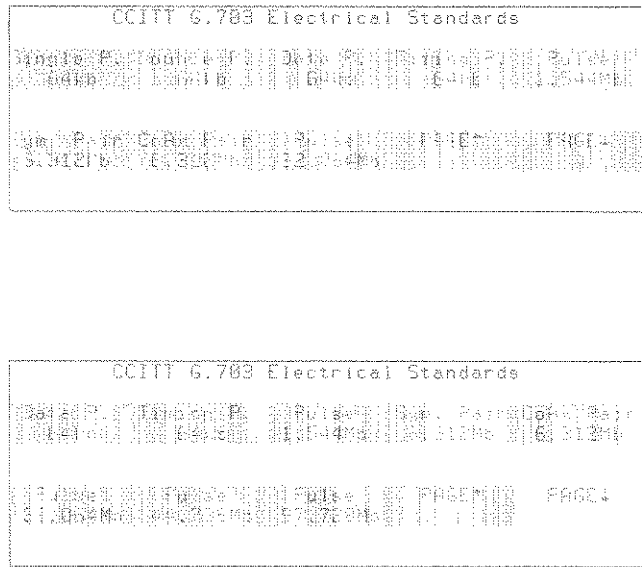

Figure 3-59: Pages 2 and 3 of the CCITT Electrical Standards

As shown in Figure 3-59, the CCITT G.703 Electrical Standards masks are contained on three pages. These pages overlap, meaning that some masks are shown on more than one page.

Selecting a Predefined Mask

To select a particular predefined, standard mask, first acquire a trace. Standard masks cannot be selected if a user trace is not present. With a trace displayed, press the **DISPLAY MODES** button, and then touch **Standard Masks**. Then touch the desired mask label for the signal displayed. After selecting a standard mask the 11801B performs the following.

- If a user mask (not predefined) is currently displayed, the instrument will ask you to store the mask in a setting. If you choose not to store the mask, it is removed. If a standard mask is currently displayed, it is removed without asking you to store it (because any standard mask can easily be selected again).
- The 11801B displays the mask you selected.
- The 11801B resets the time-per-division setting appropriate for the selected mask. Note however that you are free to change the time-per-division setting without altering the mask.
- The instrument updates the two-line **Standard Masks** label on the Display Modes major menu to indicate which mask is displayed.

- The instrument displays the message **A front panel AutoSet will now use a mask-specific algorithm while in the Display major menu.** This means that the autoset function is now modified to perform an autoset to the signal characteristics of the selected standard mask. You can choose to have the instrument perform this AutoSet to Standard automatically whenever you select a standard mask from the Standard Mask pop-up, or to perform AutoSet to Standard only when you push the **AutoSet** button. This feature is controlled from the **Instrument Options** pop-up menu, under the Utility major menu. Note that the AutoSet to Standard feature is only available for standard masks and is not available for masks that you create or modify, except for the User Eye. See AutoSet on page 3-9 and AutoSet Options on page 3-10 for more information.

You can also create a new mask that uses a standard mask as a base. See *Creating a New Mask from a Standard Mask*, page 3-126.

Note that for all standard masks except eye pattern masks, if you press the AUTOSET button or configure for automatic autoset, the instrument automatically turns on waveform averaging. See *Averaging and Enveloping*, page 3-13, and *AutoSet*, page 3-9.

To perform testing using standard masks, see *Starting Mask Testing* on page 3-128.

Creating Masks

A user mask is created by moving a cross-hair cursor on the display and adding or deleting points as required. You can edit or use the masks at any time by selecting the **Mask Testing** pop-up menu from the Display Modes major menu. See Figure 3-60.

To create a mask, press the **DISPLAY MODES** button, and then touch **Mask Testing**. This brings up the **Mask Testing** pop-up menu. To create a new mask, select any one of the “MaskN” labels, for example, **Mask1**. Next, touch **Edit Mask Definition**. This displays the mask editing screen. A cross-hair cursor is located at the center of the display. The cursor is moved by turning the knobs. The upper knob is assigned to **Mask Cursor X** and the bottom knob is assigned to **Mask Cursor Y**.

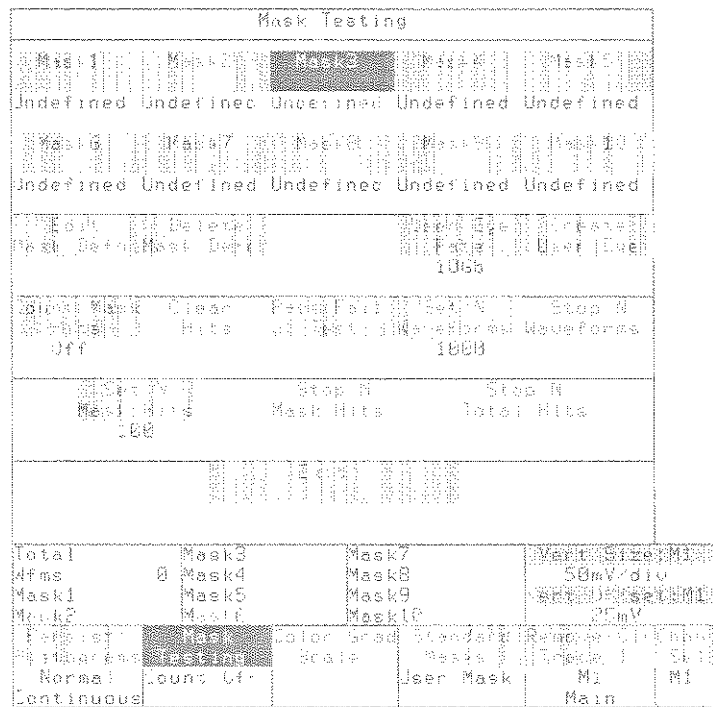

Figure 3-60: The Mask Testing Pop-up Menu

To add a point to a mask, use the cursors to locate the cross-hair cursor over the location where you want to add a point. Touch **Add Point**. To delete a point from a mask, locate the cursor over the point to be deleted. Touch **Delete Point**. When you are finished creating the mask, touch **Exit Mask Editing**. See Figure 3-61.

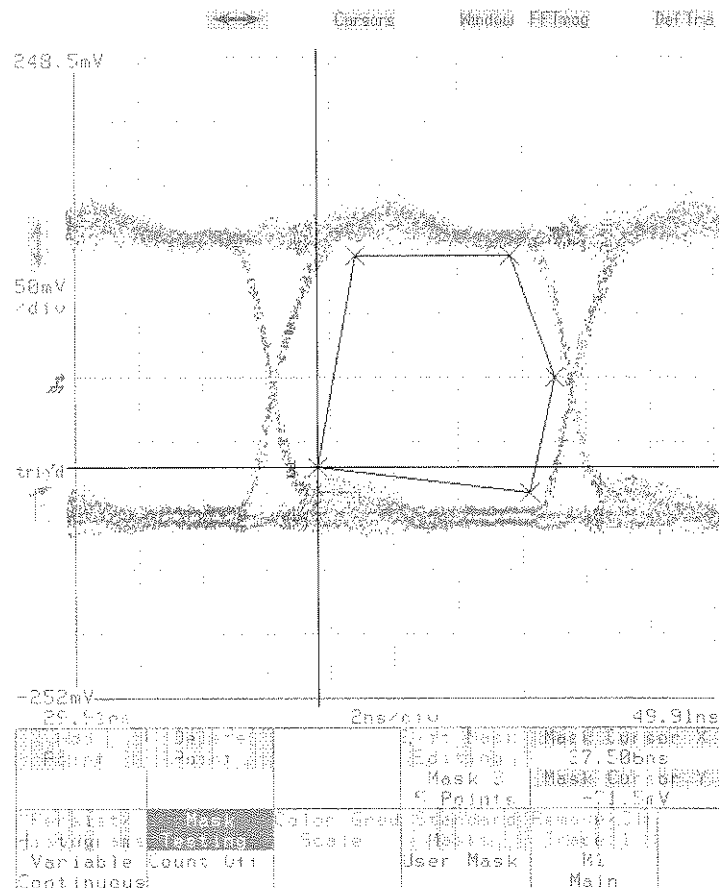

Figure 3-61: Editing a Mask

Masks are created by connecting the points independent of the order they are entered. Points are connected by sorting the points into left-to-right order and grouping them across a diagonal from the left-most point to the right-most point. If two points share the same horizontal position along either the left or right edge of the mask, then the diagonal runs from the top left-most point to the bottom right-most point. Points below the diagonal form the bottom boundary of the mask; points above it form the top boundary. Thus, it is difficult to make masks that have concave sides. (See Hints for Creating Masks, below.)

The illustrations on the following pages show how mask points are connected when you edit a mask.

Deleting User Masks

To delete a mask, first display the **Mask Testing** menu. Select the mask to delete by touching the **MaskN** selector and then touch **Delete Mask Definition**.

Hints for Creating User Masks

To ensure the best results when creating masks, remember the following and refer to Figures 3-62 and 3-63:

- Locate one point along the left edge or right edge of the mask further left or further right than any other. You can still create straight lines along the edge; just place one point further left or right than the others on the edge.
- Points are connected left to right.
- All points above the imaginary line between the left-most point and the right-most point are grouped together as the “top.” All points below the imaginary line between the left-most and right-most point are grouped together as the “bottom.” Thus, an added point that falls below the imaginary line will be added, in left-to-right order, to the bottom group of points. And an added point which falls above the imaginary line will be added to the top group of points.

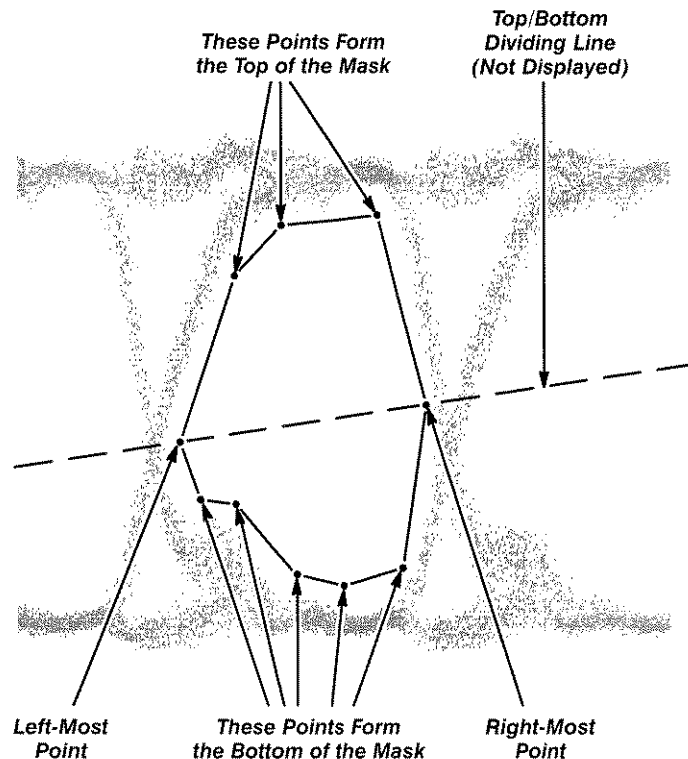

Figure 3-62: Creating a User Mask

- If you wish to create a mask with a concave area, create several masks to cover the same area. Data falling into two overlapping masks is counted only once as part of **Total**.

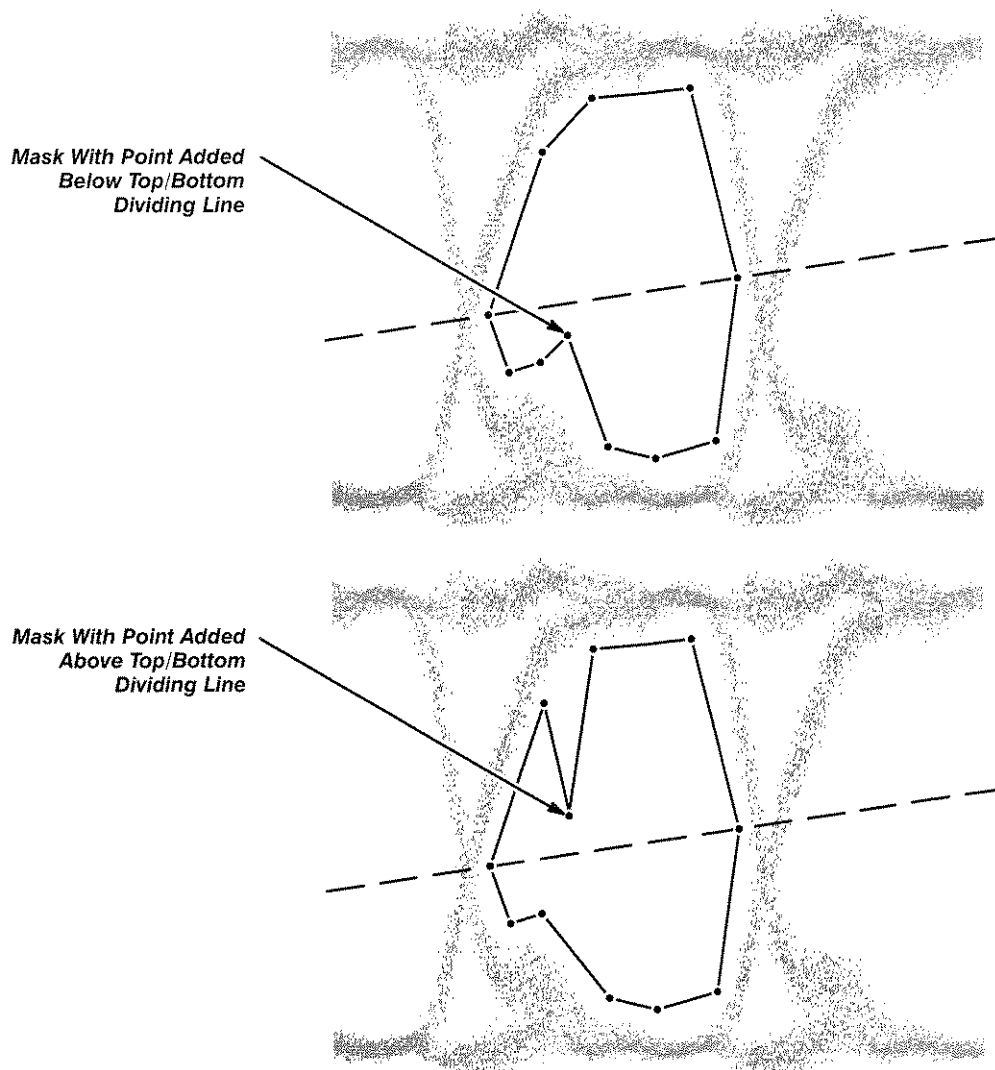

Figure 3-63: How Points are Connected in a User Mask

Storing Mask Definitions

Masks are saved with stored settings, so you can save sets of masks by defining them, then storing the instrument setting. For the same reason, any defined masks displayed on the screen will be overwritten whenever you recall a stored setting or initialize the 11801B.

NOTE

For more details on Stored Settings, see page 3-177.

Modifying a User Mask

To modify an existing user mask, touch **Mask Testing** in the Display Modes major menu. Select the mask you want to edit by touching the appropriate **MaskN Definition** selector and then touch **Edit Mask Definition**. You can now add or delete points as described previously.

Creating a New Mask From a Standard Mask

You can use one of the many standard masks as a basis for creating a new user mask. To do this, first select the desired standard mask from the **Standard Masks** pop-up menu, as described previously. Then touch **Mask Testing** in the Display Modes major menu. Each standard mask is composed of two, three, or four mask components, numbered Mask1, Mask2, Mask3, and Mask4, which you edit separately. The Mask1 component is always at the top of the screen, Mask2 is the second from the top, and so on. To edit the top mask component, touch the **Mask1** selector. Then touch **Edit Mask Defn**. The **Mask Testing** pop-up menu disappears and the standard mask is displayed, with the top mask component, Mask1, highlighted with a blue x at each of its vertices.

To add a point to the Mask1 component, use the knobs to locate the cross-hair cursor over the location where you want to add a point. Touch **Add Point**. To delete a point from a mask, locate the cursor over the point to be deleted. Touch **Delete Point**.

When you are finished editing Mask1 and want to edit Mask2, touch **Mask Testing** again. Now touch **Mask2** to select it for editing. Then touch **Edit Mask Defn**. Now Mask2 is highlighted with a blue x at each of its vertices. You can now edit Mask2 as you did Mask1, and so on for the Mask3 and Mask4 components, if present.

When you are finished creating the new user mask, touch **Exit Mask Editing**. Note that modifying a standard mask creates a user mask and has no effect on the standard mask. Also, **Standard Mask AutoSet** is not available on a user mask, even though the user mask may have been created from a standard mask. The only exception is the user eye mask.

Creating a User Eye Mask

The Create User Eye selector in the Mask Testing pop-up menu lets you create one custom eye mask per setting from an existing standard eye mask. This User Eye Mask is similar to standard eye masks, because the instrument can perform Standard Mask AutoSet for user eye masks that you create.

To create a custom user eye mask, first acquire a trace and then select the **Standard Masks** pop-up menu. The default user eye mask is a 9.9533 Gb mask that is similar in appearance to the OC48/STM16 mask available from this menu. To use the default mask as a base, touch **User Eye 9.9533Gb**. However, you can select any eye mask that has exactly three components or use **Edit Mask Defu** to create masks 1, 2, and 3. Standard masks with more or less components cannot be used. After selecting the desired eye mask,

you need to set the rate for the mask. Touch **Mask Testing**, touch the **User Eye Rate** selector, and use the knob to set the desired rate. Now proceed to edit the mask as described previously. After editing the mask, touch **Create User Eye** from the **Mask Testing** pop-up menu. The new user eye mask becomes a standard mask selectable from the **Standard Masks** pop-up menu, as **User Eye**, and the instrument is able to perform standard mask autoreset to your user eye mask. You can define and store many separate user eye masks with the Store Setting feature. See Store Settings, page 3-177, for more information. The following conditions apply to user eye masks:

- There must be three component masks.
- The three component masks are numbered 1 through 3, from the top to the bottom of the screen. Masks 1 and 3 must extend from the extreme left to the extreme right of the display.
- There cannot be more than 24 vertices in all three component masks.
- Each component mask must have at least three vertices.

Starting Mask Testing

After you have a user mask or standard mask selected, the mask remains on the display. However, mask testing does not begin automatically. To initiate mask testing, display the **Mask Testing** menu. Then select either **Pass/Fail Test** or **Count Mask Hits**. If you select **Pass/Fail Test**, the instrument acquires a set number of waveforms and then looks for any sample that falls inside the mask (a mask hit). One or more mask hits is a failure, and **Failure** is indicated in red beneath the **Mask Testing** selector. If there are no mask hits, the instrument indicates **Passing** in green beneath the **Mask Testing** selector.

When you select **Pass/Fail Test**, the **Set N Waveforms** parameter defaults to 20 if the number of waveforms to be acquired (**N**) for the test is less than 10 or greater than 100. The instrument then turns on **Count Mask Hits** and also turns on **Stop on N Waveforms**.

If you select **Count Mask Hits**, the instrument begins counting mask hits, but does not indicate passing or failure. Mask hit counts are allowed only in Infinite or Color Grading display modes. If the display mode is either Normal or Variable when mask testing is initiated, the display mode is switched to Infinite Persistence. If the display mode is Color Grading, then the display mode isn't changed. If the display mode is Color Grading when mask testing is turned on, the mask count data is initialized with data from the color graded display.

Note that the color graded display mode makes no distinction between selected and non-selected traces. Thus, if your mask overlaps a non-selected trace in Color Grading mode, the mask will contain samples from the non-selected trace. To avoid this, maintain enough vertical separation between traces to prevent overlap. Masks are not allowed on stored traces, though masks can be applied to calculated traces with stored components (for example, M1 – STO1).

In both **Pass/Fail** and **Count Mask Hits** mode, the mask count readout, just above the **Mask Testing** selector, begins displaying results. There are three boxes located on the Display major menu which contain the mask count readout. See Figure 3-64.

The numbers in the three boxes are:

- Total number of hits (data points within all masks)
- Total number of waveforms acquired
- Number of hits in each mask

Total is the sum of data points that fall inside *all* of the defined masks. This number takes into account the overlap between masks. That is, if a sample falls into two overlapping masks, the sample will be counted only once.

Wfms is the number of waveforms which have been acquired.

To turn on mask counting, select **Count Mask Hits** in the **Mask Testing** pop-up menu.

Total	1416	Mask3	2	Mask7		Mask10	07
Wave	764	Mask4		Mask8		Mask9	07
Mask1	1116	Mask5		Mask9		Mask10	07
Mask2	205	Mask6		Mask10			
Mask3		Mask7					
Mask4		Mask8					
Mask5		Mask9					
Mask6		Mask10					
Mask7							
Mask8							
Mask9							
Mask10							
Infinite							
Continuous							

Figure 3-64: Mask Count Readout

Mask1 through Mask10 show the number of data points that have fallen inside the named mask.

When mask testing is initiated, the readouts are active as long as **Mask Testing** is selected (**Mask Testing** is highlighted). Like the histogram display, the counting is continued in the background as long as the Display Modes major menu is displayed even if you select the **Persist/Histograms** pop-up menu. If you select another major menu, the mask is removed and counting is cancelled. However, the last displayed masks is redisplayed if you again select the Display major menu.

Masks are global. That is, all traces share the same masks. However, only data from the selected trace is counted when mask testing is on, even if other traces fall within the mask boundaries. (As described earlier, mask testing in Color Grading mode is an exception; samples from all traces are counted in Color Grading mode.) When you select another trace, all mask counts are cleared.

Clearing the Hit Count

To clear the counters in the mask readout, display the **Mask Testing** menu and select **Clear Hits**. This sets the counters for the various masks, the total hits and waveform counters to zero, in addition to clearing the waveform data for the selected trace. Like histograms, these counters are cleared by any implicit or explicit clearing of the waveform data such as selecting **Clear Trace** from the **Remove/Clr** pop-up menu.

Limiting Acquisition

You can limit acquisition under mask testing based on either the number of waveforms acquired or the number of mask hits detected. These functions are controlled by the **Set N** and **Stop N** selectors in the **Mask Testing** pop-up menu.

To limit acquisition based on the number of waveforms acquired, display the **Mask Testing** pop-up menu and touch **Set N Wfms** (see Figure 3-65). This assigns the knobs to limit the number of waveforms acquired, in the same fashion that Pass/Fail testing works. The range for the number of waveforms acquired is 1 to 2^{32} (approximately four billion). To begin conditional acquisition, touch **Stop N Wfms**. Acquisition will stop when N waveform records have been acquired. The number of waveforms left to acquire is shown in the lower-left corner of the display.

Thus, without using Pass/Fail testing, there are two steps to stop acquisition based on the number of waveforms acquired:

- Step 1:** Set the number of waveforms using **Set N Wfms**.
- Step 2:** Begin the acquisition by selecting **Stop N Wfms**.

If you want to stop the acquisition before the conditional acquisition completes, press **RUN/STOP**

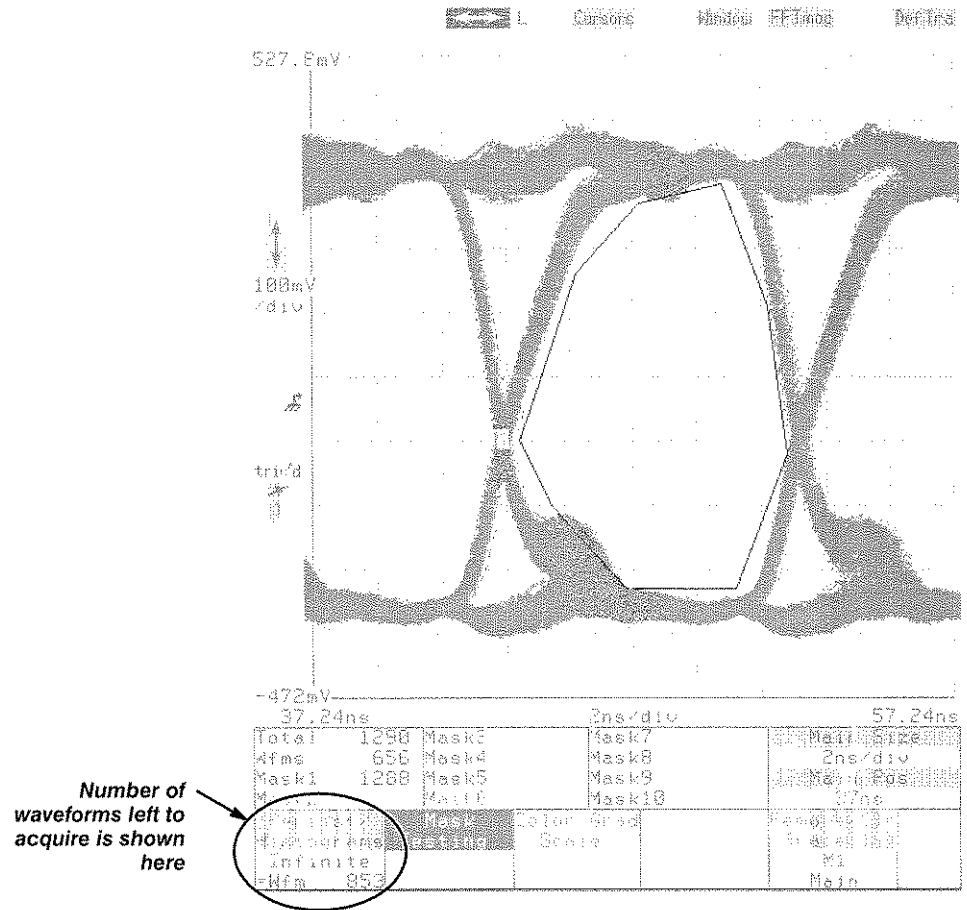

Figure 3-65: Using Stop N Wfms

Standard Mask Definitions and Requirements

The following three tables define the 38 standard telecommunication masks that are stored in the 11801B.

CCITT G.703 Electrical Standards Masks

Signal Requirements: 75 Ω signals require a 75-to-50 Ω converter with signal attenuation entered.

Table 3-6: CCITT G.703 Electrical Standards Masks

Mask Name	Data Rate	Trigger Signal	Data Signal
Symmetrical Pair	2.048 Mb/s	Same as data	120 Ω , AIS, all ones
Coaxial Pair	2.048 Mb/s	Same as data	75 Ω , AIS, all ones
Pulse	8.448 Mb/s	Same as data	75 Ω , AIS, all ones
Pulse	34.368 Mb/s	Same as data	75 Ω , AIS, all ones
Zero Pulse	139.26 Mb/s	Same as data	75 Ω , CMI all zeroes
One Pulse	139.26 Mb/s	Same as data	75 Ω , CMI all ones
STM1	155.52 Mb/s	Clock or data	75 Ω , CMI PRBS or live Data
CEPT	565 Mb/s	Clock or data	50 Ω , PRBS or live data
Single Pulse	64 kb/s	Same as data	110 Ω , AIS, all ones
Double Pulse	64 kb/s	Same as data	110 Ω , AIS, all ones
Data Pulse	64 kb/s	Same as data	110 Ω , AIS, all ones
Timing Pulse	64 kb/s	Same as data	110 Ω , AIS, all ones
Pulse	1.544 Mb/s	Same as data	100 Ω , B8ZS, 10000000100000001000 0000...
Symmetrical Pair	6.312 Mb/s	Same as data	110 Ω , B6ZS, 100000100000100000...
Coaxial Pair	6.312 Mb/s	Same as data	75 Ω , B8ZS, 10000000100000001000 0000...
Pulse	32.064 Mb/s	Same as data	75 Ω , B3ZS, 100100100...
Pulse	44.736 Mb/s	Same as data	75 Ω , B3ZS, 100100100...
Pulse	97.728 Mb/s	Same as data	75 Ω , AIS, All ones

ANSI SONET / CCITT SDH Optical Standards Masks

Signal Requirements: O/E converter should comply with ANSI/CCITT specifications.

Data Type: NRZ, PRBS, SDH/SONET Frame or live data.

Trigger Signal: Clock, recovered clock, or data signal.

Table 3-7: ANSI SONET / CCITT SDH Optical Standards Masks

Mask Name	Data Rate
OC1	51.84 Mb/s
OC3/STM1	155.52 Mb/s
OC9	466.56 Mb/s
OC12/STM4	622.08 Mb/s
OC18	933.12 Mb/s
OC24	1.2442 Gb/s
OC36	1.8662 Gb/s
OC48/STM16	2.4883 Gb/s

ANSI T1.102 Electrical Standard Masks

Signal Requirements: 75 Ω signals require 75-50 converter with signal attenuation entered.

Table 3-8: ANSI T1.102 Electrical Standard Masks

Mask Name	Data Rate	Trigger Signal	Data Signal
DS1	1.544 Mb/s	Same as data	100 Ω , B8ZS, 10000000100000001000 0000...
DS1 old	1.544 Mb/s	Same as data	100 Ω , B8ZS, 10000000100000001000 0000...
DS1C	3.152 Mb/s	Same as data	100 Ω , B8ZS, 10000000100000001000 0000...
DS2	6.312 Mb/s	Same as data	110 Ω , B6ZS, 100000100000100000...
DS3	44.736 Mb/s	Same as data	75 Ω , B3ZS, 100100100...
DS4NA	139.26 Mb/s	Same as data	75 Ω , CMI PRBS or live data
DS4XNA	139.26 Mb/s	Same as data	75 Ω , CMI PRBS or live data
STS1	51.84 Mb/s	Clock or data	75 Ω , PRBS or live data
STS3	155.52 Mb/s	Clock or data	75 Ω , PRBS or live data
STSX3	155.52 Mb/s	Clock or data	75 Ω , PRBS or live data

Table 3-9: Miscellaneous Standards Masks

Mask Name	Data Rate	Trigger Signal	Data Signal
FDDI Halt	125 Mb/s	Clock or data	11111000001111100000 1111100000...
User Eye	Programmable	Clock or data	NRZ, PRBS or live data



Measurements

Measurements are numeric readouts of properties of a trace. Measurements are updated continuously so that as the signal changes the numeric readouts change also. You can select up to six measurements for each of your traces. The readouts of the measurements of the selected trace appear in the Measure major menu. The measurements are listed in the table below and on the next page. Refer to Appendix D for a detailed discussion of each of these measurements.

Table 3-10: Measurements

Selector	Measures
Amplitude Measurements:	
Max	Maximum amplitude, the most positive peak voltage/rho value.
Min	Minimum amplitude, the most negative peak voltage/rho value.
Mid	Middle amplitude, halfway between maximum amplitude and minimum amplitude.
Mean	Arithmetic mean of all signal points.
RMS	True Root Mean Square voltage.
Peak-Peak	The voltage difference between maximum amplitude and minimum amplitude.
Overshoot	The difference between the maximum amplitude and the topline value, expressed as a percentage of the difference between the topline and baseline values.
Undershoot	The difference between the baseline value and the minimum amplitude, expressed as a percentage of the difference between the topline and baseline values.
Amplitude	The difference between the topline and baseline values.
Extinct Ratio	Extinction ratio can be measured using three methods. The default method is for extinct equal to be the topline value divided by the baseline value. Using the Measurements pop-up, you can set this measurement equal to FDDI (100(baseline/topline)) or SONET (10x (log10(topline/baseline))).
Noise	The vertical dispersion of a trace. (Available in Statistics mode only.) The noise measurement can be taken at the topline or baseline.
Signal to Noise Ratio	The amplitude divided by the noise. (Noise is always calculated as RMS for this measurement, regardless of how the Dispersion parameter is set.) The amplitude is equal to the baseline subtracted from the topline. Noise is measured at the topline or baseline, depending on how the noise location parameter is set. This measurement is only available in Statistical Measurement mode.

Table 3-10: Measurements (Cont.)

Selector	Measures
Timing Measurements:	
Rise	The transition time of a rising pulse edge.
Fall	The transition time of a falling pulse edge.
Frequency	The reciprocal of the period.
Period	The time taken for one complete signal cycle.
PropDelay	The time between mesial crossings of two different traces or two points on the same trace.
Cross	The time from the trigger point to a specified level crossing.
Width	The time the signal takes to go from a voltage level crossing to the next crossing of the opposite slope.
Duty Cycle	The percentage of a period that a waveform spends above the mesial.
Phase	The phase angle from the selected waveform to the reference waveform.
Jitter	The horizontal dispersion of the trace. (Available in Statistics mode only.) When measuring jitter for a trace that is an eye pattern, set the Eye Pattern selector in the Measurements pop-up menu to On . This ensures a more accurate measurement.
Area and Energy Measurements:	
Area +	The area under the curve of a trace.
Area —	The difference between the area under the curve above a reference level, and the area under the curve below that reference level.
Energy	The energy represented under the curve of a trace. This integral of the squared voltages can be divided by the resistance of the circuit to yield power measurements.
Frequency Domain Measurements:	
Spectral Frequency	This provides frequency tracking for the fundamental and user-specific harmonic as well as spectral peak frequency measurements.
Spectral Magnitude	This provides amplitude tracking for the fundamental and user-specific harmonic as well as spectral peak amplitude measurements.
THD	Total harmonic distortion.

Setting Up Measurements

Measurements are taken from displayed traces. The trace on which measurements are based must be adjusted so that all areas that are needed to take the measurements are visible on the display. No part of the trace should extend above or below the graticule display area. If a measurement requires a full cycle, as in frequency or period measurements, then adjust the horizontal size to show at least one complete cycle of the signal. If a measurement requires a rising or falling edge, as in rise or cross measurements, then adjust the horizontal size and position to show the complete rising or falling edge.

Hardware measurements, described on page 3-141, are an exception. Hardware measurements are not taken from the displayed data, and are not affected by the vertical size settings. (Hardware measurements are, however, affected by horizontal settings.)

Once the trace display is established, press the **MEASURE** button to display the Measure major menu. Initially, this menu is mostly blank. The six empty selectors are reserved as places where measurement readouts will appear when you select your measurements. See Figure 3-66.

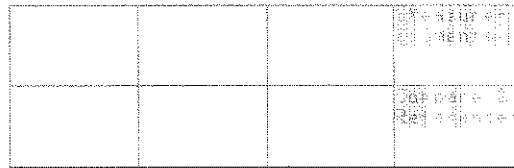

Figure 3-66: Measure Major Menu

Touch the **Measurements** selector to display a pop-up menu with all the measurement selectors available. Touch the individual measurement selectors to take measurements of your trace. As you select each measurement, the result of the measurement is immediately displayed in one of the selector areas of the Measure major menu.

The illustration below shows the **Measurements** pop-up menu with two measurements, Frequency and RMS, selected. The numeric readouts for these two measurements are in the major menu area. See Figure 3-67.

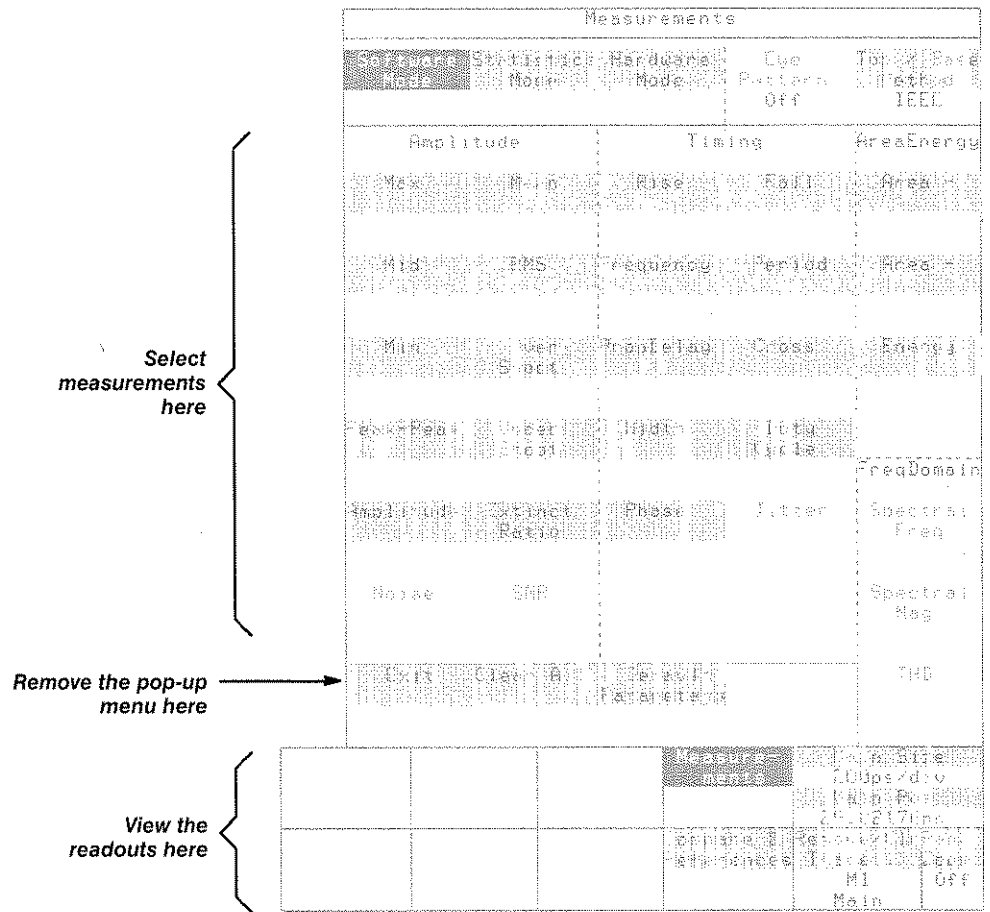

Figure 3-67: Measurements Pop-up Menu with Frequency and RMS Selected

When the measurements you want are selected, you can remove the pop-up menu by touching either the **Exit** selector in the pop-up menu or the **Measurements** selector in the major menu area. This lets you see the trace as the measurements are taken.

NOTE

*If your **Measurements** pop-up menu shows only timing measurements, touch the **Software Mode** selector at the top of the menu.*

Measurements are part of the definition of a trace. When the Measure major menu is displayed, the measurements of the selected trace are also displayed.

Deleting Measurements

To delete a measurement that is established on a trace, touch the **Measurements** selector in the Measure major menu. In the pop-up menu, touch the selectors for the measurements you want to remove. As you touch the measurement selectors, they will turn off highlighting and the measurement readouts will be removed from the major menu area. **Clear All** deletes all measurements. When you are finished removing measurements, touch the **Exit** selector to remove the pop-up menu.

Topline/Baseline Calculation

The **Top/Base Method** selector allows you to select the method of determining the topline and baseline. You can choose between the standard IEEE method (histograms) or an alternate method that smooths and differentiates the waveform data before calculating topline and baseline. The alternate method is particularly suited to pulse waveforms with ringing or other anomalies. Try this method whenever the IEEE method produces unstable topline and baseline results. This choice also affects Automatic Windows; see page 3-227 for more information.

The IEEE method is always used for statistics mode measurements.

Measurement Mode

Measurements may be taken in software mode, hardware mode, or statistics mode. In software mode, measurements are taken from the digitized trace data record, the same data that forms the trace on the display. Software mode is the default.

In hardware mode, measurements are taken from the analog signal output from the sampling head before it is digitized and assembled into a trace record. The 11801B uses special timer circuits to take hardware measurements. The advantage of hardware measurements is that they are performed faster than software measurements.

In statistics mode, measurements are taken from color graded waveform data and are based on histograms computed at the crossing levels. You can use statistical measurements to measure “random” data such as eye diagrams. Statistics mode also provides jitter and noise measurements, and can be more accurate for other measurements on waveforms with significant jitter or noise.

Statistics mode can be selected only in color graded display mode. Because the color graded database does not distinguish between traces, statistical measurements are limited to one trace per graticule. (Stored traces may be left on the display; they are ignored by the statistical measurement algorithm.) Whenever making Statistics Mode measurements of an eye pattern trace, set the **Eye Pattern** selector in the **Measurements** pop-up menu to **On**.

All measurements, except the three Frequency Domain measurements, in the **Measurements** pop-up menu can be taken as statistical measurements. In software mode, all measurements except Noise, SNR, and Jitter are available. Only seven timing measurements (Rise, Fall, Frequency, Period, Prop Delay, Cross, and Width) can be taken as hardware measurements. Duty Cycle and Phase are software measurements; Jitter, Signal to Noise Ratio, and Noise are statistical measurements. For example, the Rise measurement can be taken as a software measurement, a hardware measurement, or a statistical measurement. The RMS measurement is not a timing measurement and cannot be taken as a hardware measurement.

You cannot take measurements in different modes on the same trace. You can, however, create two or three identical traces and take measurements in different modes on each. You can display only the measurements for the selected trace at any one time.

Frequency Domain Measurements

The frequency domain measurements **Spectral Freq**, **Spectral Mag**, and **THD** may be taken on FFT magnitude waveforms only. These selectors are available on the **Measurements** pop-up menu only when an FFT magnitude waveform is selected and only in the Software Mode.

Statistical Measurement Considerations

A number of factors can affect measurements in statistics mode. Most of these limitations result from the need to collect histograms to determine the topline, baseline, and crossings of the trace. Note that you must be in color graded mode to use statistics mode.

- Measurements may be incorrect if not enough trace records have been acquired. Eye diagrams and signals with significant noise or jitter are examples of signals that will require many trace records for accurate measurements.
- If a rising or falling edge is nearly instantaneous (relative to the horizontal size), no data may be acquired on that edge, and timing measurements will be incorrect or will report an error.
- The 11801B may not be able to recognize an eye diagram if the the areas above and below the eye crossings are closed, or if the proximal and distal levels do not pass through the open areas. You may need to adjust the proximal and distal parameters so that they pass through these areas, and adjust the mesial so that it does not. (Refer to the Eye Pattern discussion, page 3-61, for additional information.)
- If the measurement zone left limit passes through the crossing of an eye diagram, the statistics mode algorithm will automatically move the left limit for timing measurements. To reset the left limit, use the default parameters or the parameters of another measurement, such as **Rise**, to move the left limit to the left of the first eye crossing.)
- If you use dual graticules, each graticule has only 128 vertical values (compared to 256 for a single graticule), so set the vertical size as large as possible for better precision.
- The time required to take statistical measurements can vary from a few hundred milliseconds to over a second, depending on which measurements are selected and what the measurement parameters are.
- Whenever making Statistics Mode measurements of an eye pattern trace, set the **Eye Pattern** selector in the **Measurements** pop-up menu to **On**.

Refer to the table on the next page to determine the best measurement type for your application.

Table 3-11: Measurement Mode Comparison

	Software	Hardware	Statistics
Functions	All measurements <i>except</i> Noise, Jitter, and SNR available.	Limited to 7 timing measurements.	Full range of measurements available, <i>except</i> frequency domain measurements
Trace Complexity	All trace expressions supported. Not for random data, such as eye patterns.	Only traces without arithmetic operators or functions are allowed. Averaging and enveloping are allowed, but the measurement is taken from unaveraged samples. Not for random data, such as eye patterns.	All trace expressions that include an active channel are supported. For random data such as eye patterns.
Display Restrictions	Any display mode. Measurements are taken from a single trace record, regardless of display mode.	Any display mode. Measurements are taken from a single trace record, regardless of display mode.	Color graded mode only. One active trace per graticule.
Resolution	Affected by displayed vertical size and trace functions (e.g., averaging) and smoothing.	Unaffected by display or functions. Only sampling head smoothing will affect hardware measurements.	Affected by displayed vertical size and trace functions (e.g., averaging), smoothing, and dual graticules Limited to 512-point record length.
Speed	Slower	Faster	Updated when color graded database is updated (selectable between 5 and 100 seconds) or when a measurement parameter changes, such as mesial level.

Use the **Measurements** pop-up menu of the Measure major menu to select the measurement mode. At the top of this pop-up menu are three selectors: **Software Mode**, **Statistics Mode**, and **Hardware Mode**. The selector for the current mode is always highlighted. Touch the selector for the mode you want.

When you select **Hardware Mode**, the Amplitude, Area/Energy, Duty Cycle, Phase, and Jitter measurement selectors do not appear. If any of these measurements were established when you selected hardware measurements, they are removed from the trace measurements, and a message appears on the display to warn you that some measurements have been removed. Any timing measurements that were established are kept and changed to hardware mode measurements.

When you select **Software Mode**, all existing timing measurements are kept and converted to software measurements. If the Jitter or Noise measurements were established in statistics mode, they will be removed when you switch to software mode.

When you select **Statistics Mode**, all existing measurements, except for the Frequency Domain measurements, are converted to statistical measurements. You must be in the color graded display mode in order to use statistics mode.

Frequency domain measurements (**FreqDomain**) are only available if the selected waveform is an FFT magnitude waveform and you select the Software Mode.

Comparing Measurements to References

You can establish reference values for your measurements and have the 11801B display the measurement readouts as the amount of variance from the reference value. For example, you can store the propagation delay through the cables that connect to your device under test. Then, by turning on compare mode, you can measure the delay through the device under test with the cable delay automatically removed from the measurement result. You can also use this feature to compare measurements on several different tests or parts.

You can also tell the 11801B to save the current measurement readouts as the reference values for those measurements. If you then turn on the compare feature, you can observe how much the signal deviates from those references as you tune the circuit under test.

NOTE

If you change the axis units on a trace, for example from volts to rho, the reference values are not changed to match the new units. Be sure the reference value is stored with appropriate units.

When the compare mode is on and measurement readouts show difference values, the measurement readouts show a delta (Δ) in the selector label to remind you that difference values are being displayed. For example, the **RMS** measurement readout in the major menu area becomes the **Δ RMS** readout when compare mode is turned on.

Measurement reference values are stored separately for each trace. The reference values you establish for one trace will not affect the reference values for other traces.

The compare feature affects all measurements on all traces. When you turn on compare mode, all measurement readouts show Δ comparison values, even if you select a different trace.

Compare mode is turned on or off using the **Compare & References** pop-up menu in the Measure major menu.

You set the reference values to the current measurement values by touching the **Save Current Meas Values as References** selector. See Figure 3-68. When you touch this selector, all the reference values for the measurements established on the selected trace are copied from the current measurement readouts.

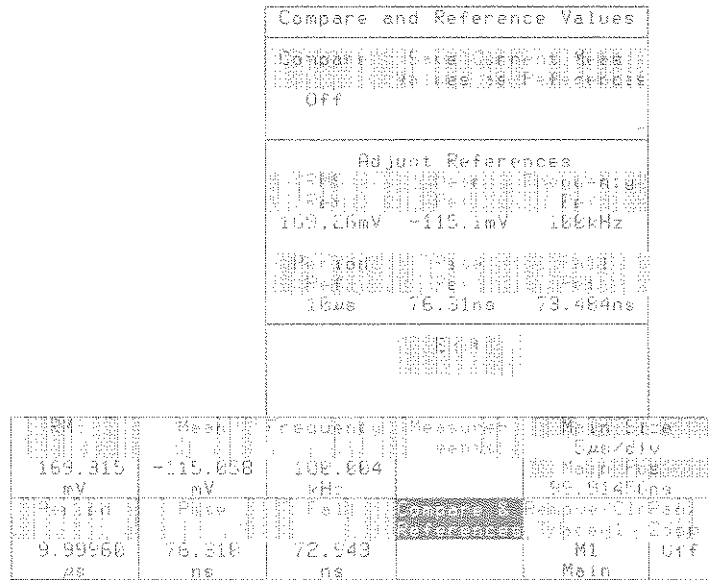

Figure 3-68: Compare & References Pop-up Menu

When compare mode is off, you can use the knobs or keypad menu to set the reference values. A selector appears in the **Adjust References** section of the **Compare & References** pop-up menu for each measurement currently established on the selected trace. Each of these has the word **Ref** after the measurement name, for example, the **RMS Ref** selector. Touch the reference selector for the measurement reference you want to adjust, and both knobs are set to adjust that reference value. Turn either knob, or touch either knob label to display the keypad pop-up menu, to enter the numeric reference value.

Changing Measurement Parameters

Once you have established a measurement on a trace, you can find out more information about the measurement and you can control the way the 11801B takes the measurement by changing the measurement parameters.

Touch the measurement readout selector in the major menu area to see the additional information. This displays a pop-up menu for the individual measurement. It also displays *annotation lines* that overlay the selected trace displayed on the graticule. These lines show the value of the *measurement parameters* that pertain to that particular measurement.

In addition to the annotation lines, the portion of the trace that is used by the 11801B to determine the measurement value is highlighted when in Normal display mode, or marked by dashed vertical lines in other display modes.

Figure 3-69 shows a typical pop-up menu for an individual measurement, along with the annotation lines and the highlighted portion of the trace.

Many of the selectors in the measurement pop-up menu set the knobs to adjust the measurement parameters. As you turn the knob, the annotation lines move to reflect the new value of the measurement parameter. For example, in the software **Frequency** pop-up menu, the **Left Limit**, **Right Limit**, **Mesial**, and **S/N Ratio** selectors set the knobs to those measurement parameters.

The dotted line style of the annotation lines is repeated in the relevant parameter selector in the pop-up menu for the individual measurement.

When you remove the measurement pop-up menu by touching its selector in the major menu area, the annotation lines remain on the display. The knob settings remain also; so you can set the knobs in the pop-up menu, remove the pop-up menu from the display, and adjust the measurement parameter with the annotation lines on the trace.

NOTE

*You can remove the annotation lines completely by pressing the **MEASURE** major menu button.*

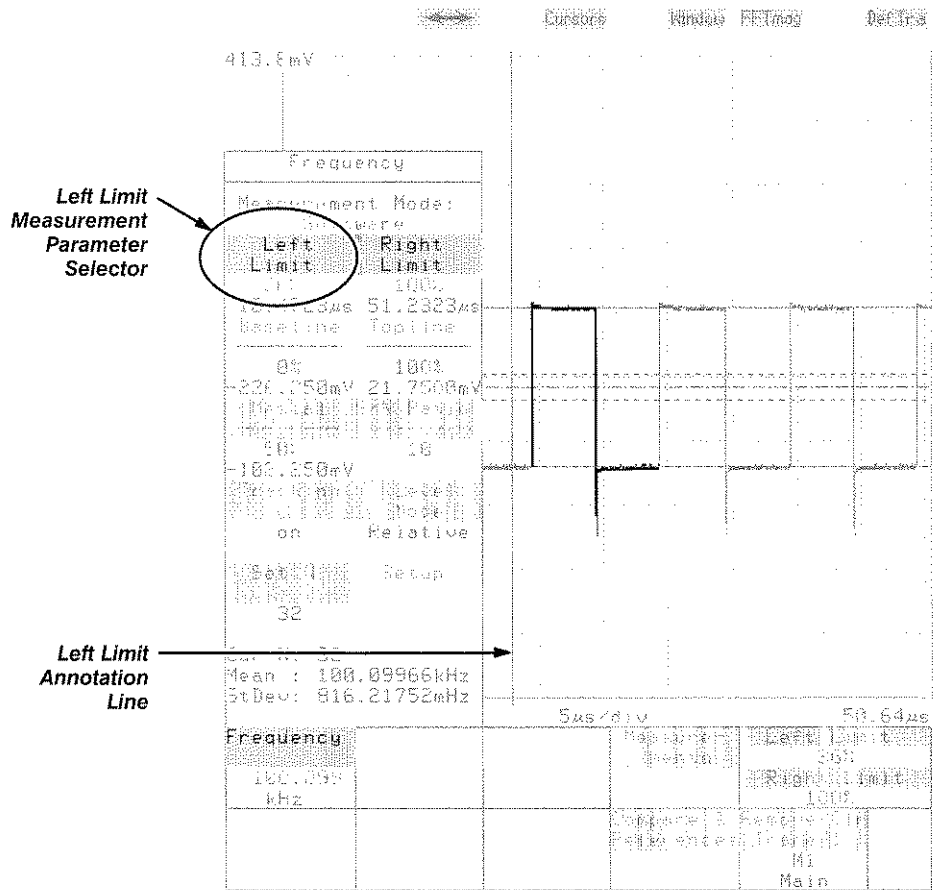

Figure 3-69: A Typical Individual Measurement Pop-up Menu

In Figure 3-69, the Left Limit measurement parameter is set to 36%. The left limit vertical line is positioned 36% of the way across the graticule, and the 11801B measures the frequency from the first complete cycle to the right of the left limit. The highlighted portion of the trace shows the area being measured.

The following table shows the measurement parameters. Some apply only to hardware measurements, some only to software measurements, some only to statistical measurements, and some apply to all three. No pop-up menu for an individual measurement uses all these parameters; only the ones that apply to that particular measurement are shown in the pop-up menu.

Changing a measurement parameter in one measurement changes it in all measurements of the selected trace that use that parameter.

Table 3-12: Measurement Parameters

SW	HW	Stat	Name	Definition
✓	✓	✓	Baseline	The 0% level on which proximal, mesial, reference level, and distal levels are based. When tracking mode is Both or Baseline, the 11801B repeatedly determines the baseline and you cannot adjust it. When tracking mode is Off or Topline, you can set baseline or you can have the 11801B set it once by touching the Setup selector.
✓		✓	Data Interval	Determines whether the measurement will be taken from one cycle of the trace or the entire measurement zone.
		✓	Dispersion	Selects the peak-to-peak or RMSΔ (standard deviation) statistic for the Noise and Jitter measurements. The Dispersion parameter does not affect the Signal to Noise Ratio measurement.
✓	✓	✓	Distal	The distal (most distant from the origin) voltage level. Rise and fall times are measured between the proximal and distal voltage levels, which are typically 10% and 90% of the baseline to topline voltages. May be set as a relative (percent), an absolute (volts) value, or a delta voltage from the baseline or topline.
	✓		Filtering	The number of successive samples that must cross a threshold level before the transition is considered valid. Noisy signals will be most affected by filtering.
✓			Harmonic Number	For frequency domain measurements; used with the harmonic search mode. (See Search Mode, below.)
		✓	Histogram Points	The number of points in the histograms taken for Jitter and Noise measurements. This parameter cannot be adjusted, but appears in the Jitter and Noise pop-up menus as Hist Pts .
		✓	Jitter Level	The level at which the Jitter measurement is taken, in volts. This parameter cannot be adjusted, but appears in the Jitter pop-up menu as Jitt Lvl . This parameter will be affected by the Jitter Location setting.

Table 3-12: Measurement Parameters (Cont.)

SW	HW	Stat	Name	Definition
		✓	Jitter Location	The location of the histogram for the Jitter measurement. May be Mesial or Eye Cross. If the 11801B does not recognize the signal as an eye diagram, only Mesial is available.
✓		✓	Left Limit	The beginning of the trace measurement zone.
✓	✓	✓	Level Mode	In <i>absolute</i> level mode, you set proximal, distal, mesial, and reference level in absolute voltage values. In <i>relative</i> level mode, you set these parameters in terms of percentages of the baseline to topline distance. In <i>delta</i> level mode, you set a delta voltage with from the baseline or topline.
✓	✓	✓	Mesial	The middle voltage level, expressed as a percentage of baseline to topline distance. May be set as a relative (percent) value, an absolute (volts) value, or a delta voltage from the baseline or topline.
		✓	Noise Location	The location of the histogram for the Noise measurement. May be Baseline or Topline.
✓			Peak Index	For frequency domain measurements; used with the Peak search mode. (See Search Mode, below.)
✓	✓	✓	Proximal	The proximal (closest from origin) voltage level. Rise and fall times are measured between the proximal and distal voltage levels, which are typically 10% and 90% of the baseline to topline voltages. May be set as a relative (percent), an absolute (volts) value, or a delta voltage from the baseline or topline.
✓	✓	✓	Reference Baseline	The reference baseline value is the 0% level on which the reference tracking level is based. When reference tracking mode is set to Both or Baseline, the 11801B repeatedly determines the reference baseline and you cannot adjust it. When reference tracking mode is set to Topline or Off, you can set the reference baseline or you can have the 11801B set it once by touching the Setup selector in the Prop Delay or Pulse measurement pop-up menu.

Table 3-12: Measurement Parameters (Cont.)

SW	HW	Stat	Name	Definition
	✓		Reference Filtering	The filtering constant on the reference trace used for propagation delay and phase measurements.
✓	✓	✓	Reference Level	The transition crossing voltage level. May be set as a relative (percent) value, an absolute (volts) value, or a delta voltage from the baseline or topline. The reference level affects the Cross measurement and can also affect the Spectral Frequency and Spectral Magnitude measurements. (See the Search Mode parameter.)
✓	✓	✓	Reference Level Mode	The level mode on the reference trace for propagation delay and phase measurements.
✓		✓	Reference LM Zone	The left limit of the measurement zone used in propagation delay and phase measurements on the reference trace.
✓	✓	✓	Reference Mesial	The voltage level used in propagation delay and phase measurements on the reference trace. May be set as a relative (percent) value, an absolute (volts) value, or a delta voltage from the reference baseline or reference topline.
✓		✓	Reference RM Zone	The right limit of the measurement zone used in propagation delay and phase measurements on the reference trace.
✓	✓	✓	Reference Slope	The direction the waveform must pass through a reference level for the Prop Delay measurement.
✓			Reference SN Ratio	The amplitude of a noise rejection band centered on the reference mesial level. Transitions through the reference mesial level are qualified by S/N ratio by the requirement that the signal enter the noise rejection band and leave the noise rejection band at the opposite limit with the same slope and with no intermediate values outside the noise rejection band. S/N ratio may be set to any value from 1 to 99. The reciprocal of the number is the fraction of the peak-to-peak signal value that the noise rejection band extends above and below the reference mesial line. For a 1 V peak-to-peak signal, S/N ratio of 20 creates a noise rejection band 0.05 V above and 0.05 V below the reference mesial level.

Table 3-12: Measurement Parameters (Cont.)

SW	HW	Stat	Name	Definition
✓	✓	✓	Reference Topline	The 100% level on which the reference mesial level is based. When reference tracking is set to Both or Topline, the 11801B repeatedly determines the reference topline for itself and you cannot adjust it. When reference tracking is set to Baseline or Off, you can set the topline or you can have the 11801B set it once by touching the Setup selector.
✓	✓	✓	Reference Tracking	The track mode on the reference trace for propagation delay and phase measurements.
	✓		Reference Transition Number	The transition number on the reference trace used in propagation delay and phase measurements.
✓		✓	Right Limit	The end of the trace measurement zone.
✓			Search Mode	<p>For frequency domain measurements. When search mode is set to Harmonic, the instrument determines the fundamental frequency, f_0, by searching for the highest peak of the FFT magnitude in the measurement zone. The harmonic components are computed as $n \times f_0$, where n is the user-defined harmonic number.</p> <p>When search mode is set to Peak, a spectral peak is defined as a peak of the FFT magnitude greater than the reference level. Using the pop-up menu, you can specify the index of the peak to be measured and the reference level.</p>

Table 3-12: Measurement Parameters (Cont.)

SW	HW	Stat	Name	Definition
✓			S/N Ratio	The amplitude of a noise rejection band centered on the mesial level. Transitions through the mesial level are qualified by S/N ratio by the requirement that the signal enter the noise rejection band and leave the band at the opposite limit with the same slope and with no intermediate values outside the noise rejection band. S/N ratio may be set to any value from 1 to 99. The reciprocal of the number is the fraction of the topline to baseline distance that the noise rejection band extends above and below the mesial line. For a 1 V peak-to-peak signal, S/N ratio of 20 creates a noise rejection band 0.05 V above and 0.05 V below the mesial level.
✓	✓	✓	Second Trace	The Prop Delay and phase measurements shows the timing difference between two traces. One of the traces is always the selected trace. Second Trace lets you select to which trace the selected trace is compared. For Hardware Mode, this can be a Saved Trace Description.
✓	✓	✓	Slope	The direction the trace must pass through a reference level.
✓	✓	✓	Topline	The 100% level on which proximal, mesial, distal, and reference levels are based. When tracking mode is Both or Topline, the 11801B repeatedly determines the topline for itself and you cannot adjust it. When tracking mode is Off or Baseline, you can set topline or you can have the 11801B set it once by touching the Setup selector, and then adjust the values with the knobs.
✓	✓	✓	Tracking	With tracking set to Both, the topline and baseline are repeatedly determined by the 11801B. Tracking Off allows you to set topline and baseline. When tracking is set to Baseline (or Topline), just the baseline (or just the topline) is tracked, but not the other. Tracking is only available if level mode is not absolute.
	✓		Transition Number	The number of times the signal must pass through a specified voltage level before the measurement zone begins.

Measurement Statistics

The 11801B collects measurement statistics automatically when in either software or hardware mode. (Statistics are not collected in statistics mode.) You can set the N parameter to determine the number of individual measurements on which the statistics are based.

Each measurement readout selector in the Measure major menu can be touched to bring up the pop-up menu for the individual measurement. This menu shows the number of measurement samples taken so far, the mean, and the standard deviation (see Figure 3-70). The **Set N** selector sets the knobs to control the N parameter.

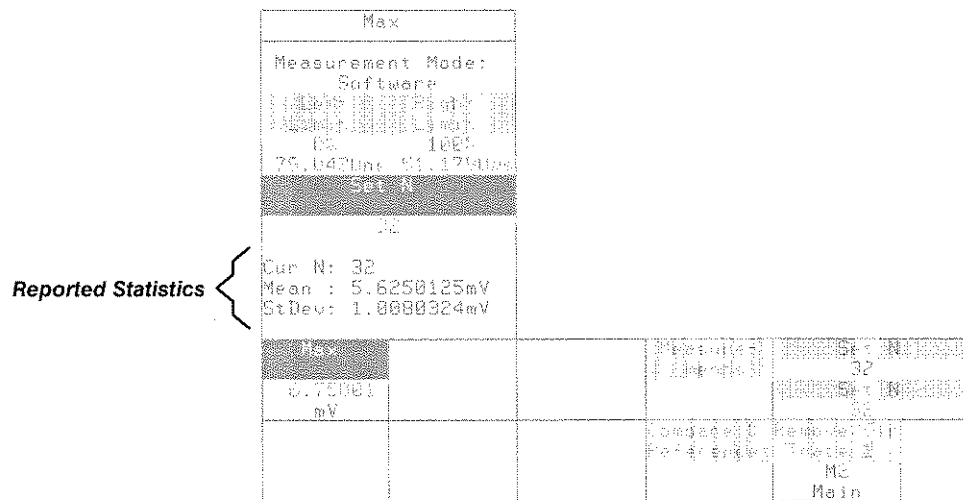

Figure 3-70: Statistics in an Individual Measurement Pop-up Menu

Changing Default Parameters

Whenever you define a new trace, the measurement parameters for that trace are initialized by copying them from a set of default parameters. There is one set of default parameters for the 11801B. You can set the default parameters to the values you want. This does not change the measurement parameters of any existing traces, but will set the initialized state of all new traces that you define.

You might want to change the default parameters if you are about to create a number of traces and take measurements from them, knowing that they will all need the same measurement parameters. Setting the default parameters before creating the traces saves time over the process of changing the measurement parameters of each trace individually.

You access the default parameters through the **Measurements** pop-up menu in the Measure major menu. When this pop-up menu is first displayed, it shows a list of measurements, and the **Measurement Functions** selector is highlighted. If you touch the **Default Parameters** selector, the menu changes to show the default parameters.

Defaults for either software, hardware, or statistics mode are shown, depending on whether **Software Default**, **Hardware Default**, or **Statistics Default** is highlighted at the top of the menu (see Figure 3-71). You can change to another set of defaults by touching the appropriate selector. Changing the default does not affect the current measurement mode.

Once the appropriate set of defaults is displayed, touch the selector that names the default you want to set. A knob will be assigned to set the value of that default parameter.

Once you have the defaults set the way you want them, you can change all the measurement parameters of the selected trace to the default settings by touching the **Initialize All** selector. This selector changes all the measurement parameters of the selected trace only; other traces are not affected.

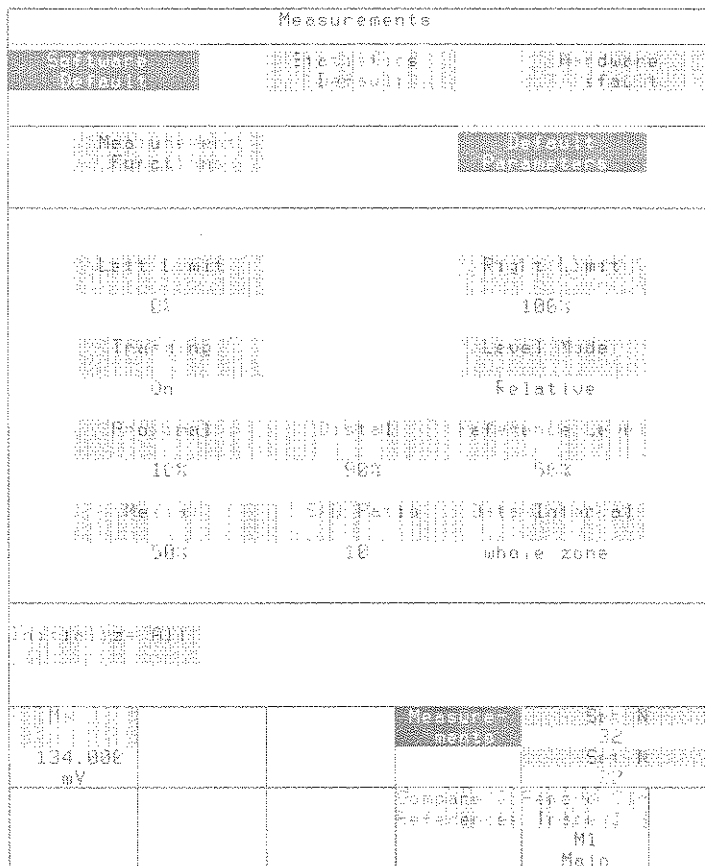

Figure 3-71: Measurements Pop-up Menu with Software Defaults

Installation

Before you first power on your 11801B, you should make certain it is correctly installed. The installation sequence involves the following controls, connectors and switches on the rear panel (see Figure 3-72):

- **POWER** Connector
- **FUSE**
- **LINE VOLTAGE SELECTOR** switch
- **PRINCIPAL POWER SWITCH**

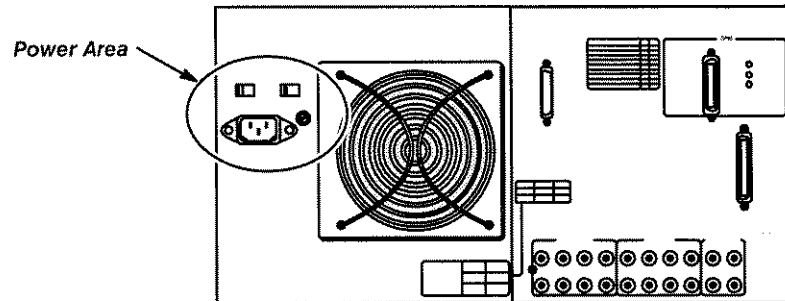

Figure 3-72: Power Connector, Fuse, and Switches

In addition, you will need to know the location of the **ON/STANDBY** switch on the front panel (see Figure 3-73).

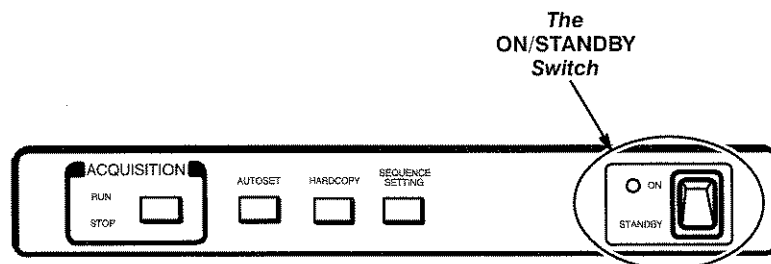

Figure 3-73: Front Panel ON/STANDBY Switch

The following steps describe the installation procedure for the 11801B.

- Step 1:** Set the **PRINCIPAL POWER SWITCH** to **OFF**.
- Step 2:** Set the front panel **ON/STANDBY** switch to **STANDBY**.
- Step 3:** Set the **LINE VOLTAGE SELECTOR** to the proper range for your power system.
- Step 4:** Check the **FUSE** to be sure it is of the proper type and rating, as printed on the rear panel.
- Step 5:** If you have optional SM-11 Multi-Channel Units, see the SM-11 User Manual for installation instructions and connect them now.
- Step 6:** With a grounding wrist strap properly attached to your wrist and connected to the antistatic connector on the front panel of your instrument, install one or more sampling heads in the front panel compartments.



Never install or remove a sampling head with the 11801B power on.

To install a sampling head, place it into a compartment and push it in with firm pressure. Once it is seated, turn the screw shaft on the sampling head to tighten the head into place. Sampling heads are described on page 3-167.

- Step 7:** Connect the power cord from the **POWER** connector to your power system.
- Step 8:** Set the **PRINCIPAL POWER SWITCH** to **ON**.

The **PRINCIPAL POWER SWITCH** controls all AC power to the instrument. The **ON/STANDBY** switch controls power to most of the instrument's circuits, but continues to supply power to certain circuits even when set to **STANDBY**.

- Step 9:** To operate the instrument, set the front panel **ON/STANDBY** switch to **ON**.

Once the 11801B is installed, use the **ON/STANDBY** switch as the power switch.

Power-On Sequence

Each time you power on the 11801B, the instrument performs a sequence of internal checks, and then restores the settings that were in effect when the instrument was last powered off. The sequence is:

1. The power-on diagnostics are performed and take about five seconds to execute. If these diagnostics fail, the instrument will freeze and you will not be able to operate it.

NOTE

Complete descriptions of the diagnostics are on page 3-35.

2. The self-test diagnostics are performed, and take about 15 seconds to execute. If these diagnostics fail, the extended diagnostic system is entered, and the extended diagnostic menu is displayed.
3. The system restores all the settings and traces that it can. If the configuration of mainframe, SM-11 units, and sampling heads has not changed since the last power-off, then the instrument will completely restore to the state it was in when powered off.

Warm-Up Period

It takes about 20 minutes for the 11801B to warm up after power-on. You should perform any enhanced accuracy calibrations only when the instrument has warmed up and achieved thermal stability. The enhanced accuracy calibrations are described on page 3-49.

Power-On

Record Length

The number of samples that form a trace is called the record length. You can select record lengths of 512, 1024, 2048, 4096, and 5120 samples (see Figure 3-74). For FFT traces, the 5120 sample size is not selectable. If the display mode is infinite, variable, or color graded, the 1024, 2048, 4096, and 5120 sample sizes are not selectable.

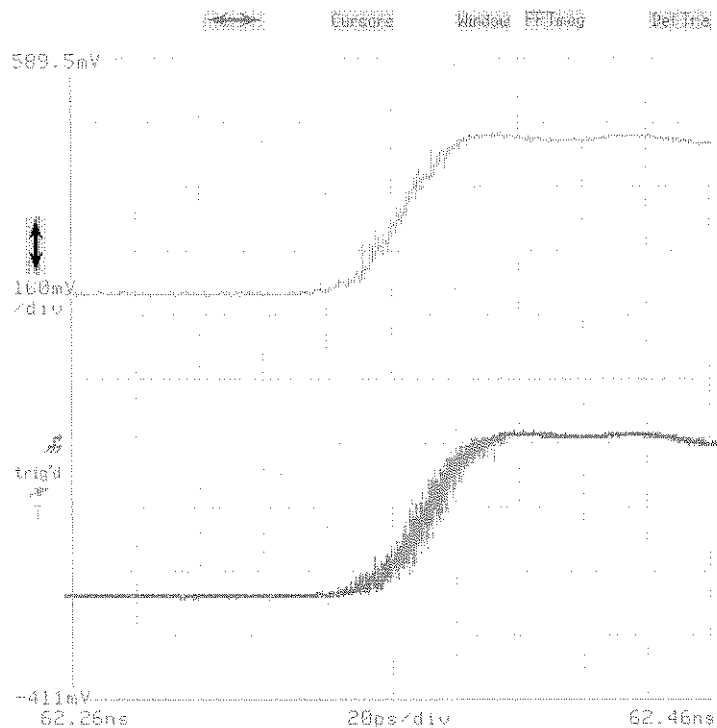

Figure 3-74: Traces with Record Lengths of 512 (top) and 5120 (bottom)

You can set the main record length and the window record length using the knobs. All traces on the main time base have the same record length. Window traces similarly share identical record length.

Variable, Infinite and Color Grading persistence displays will work only with the 512-point record length. If the record length is longer when one of these display modes is selected, the record length is automatically shortened to 512 points. Returning to Normal persistence does not reset the record length; it remains at 512 points.

The 4096-point record length has the same sample interval (the time between successive trace samples) as 5120-point records. The 4096-point trace appears shorter on the display than 5120-point traces. Many Fast

Record Length

Fourier transform algorithms require record lengths that are a power of two. The 4096-point record length is provided as a convenience, and the visual truncation is a natural result.

You control the record length by using the **Horizontal Desc** pop-up menu in the Waveform major menu. The **Main Record Length** and **Window Record Length** selectors assign the knobs to set the record lengths. The **Horizontal Desc** pop-up menu shows the sample intervals for the current settings. See Figure 3-75.

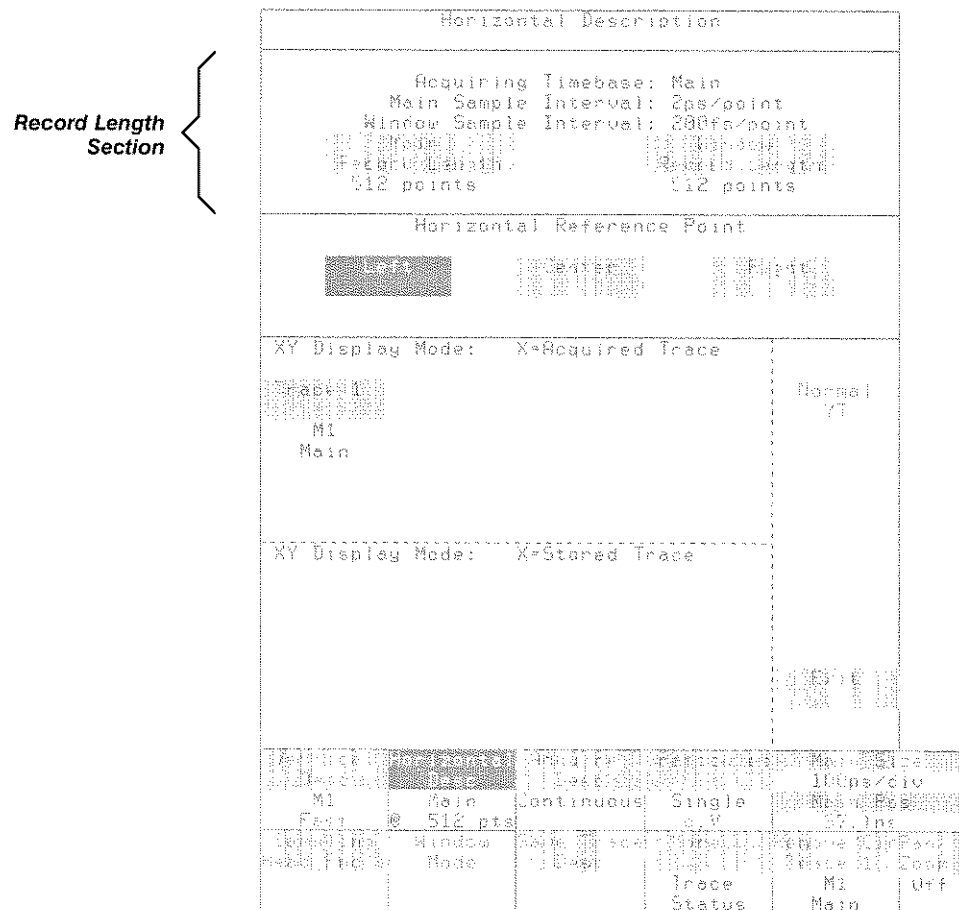

Figure 3-75: The Horizontal Desc Pop-up Menu

RS-232-C Parameters

The 11801B can be controlled by a remote computer, through one of two interfaces. These interfaces are industry standards IEEE Std 488 (GPIB) and RS-232-C.

This manual does not discuss the details of connecting a remote computer to the 11801B or the syntax and capabilities of remote commands. That information is found in the *CSA 803A and 11801B Programmer Manual*.

RS-232-C Connection

Connect the cable from your computer to the **RS-232-C** connector on the 11801B rear panel (see Figure 3-76). The 11801B is configured as data communications equipment (DCE), and the computer must be configured as data terminal equipment (DTE).

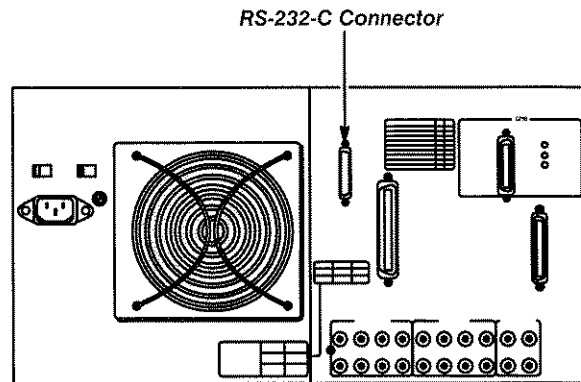

Figure 3-76: Location of RS-232-C Connector

- **Stop Bits** — lets you select among **1**, **1.5**, or **2** stop bits. Touch the selector repeatedly until the appropriate number is shown in the selector. You should set the number of stop bits to match the computer you are using.
- **Parity** — lets you select among **Even** parity, **Odd** parity, or **None**. Touch the selector repeatedly until the appropriate setting is displayed in the selector. Parity is an error detection scheme. You should set parity to match that of the computer you are using.
- **Flagging** — lets you select among **Hard** flagging, **Soft** flagging, or **None**. Touch the selector repeatedly until the appropriate setting is displayed in the selector. Flagging is used by the 11801B or the computer to signal that its input buffer is full, and that the other device should stop transmitting until further notice.

When soft flagging is selected, the 11801B sends a Ctrl-S (decimal 13) to signal the other device to stop transmission, and recognizes Ctrl-S as a signal to stop transmitting. Ctrl-Q restarts transmission. When hard flagging is selected, the 11801B uses the RS-232-C DSR/DTR signal to control data transmission. You should set the type of flagging to match the computer you are using.

- **Delay** — assigns the knobs to baud rate and delay. Delay is the minimum time that the 11801B will wait before responding to a command sent from the computer. The delay setting can be 0 to 60 seconds.
- **EOL String** — lets you select the end-of-line query terminator to one of the following: **LF** (Line Feed), **CR** (Carriage Return), **CR/LF**, or **LF/CR**. Touch the selector repeatedly until the appropriate setting is displayed in the selector.
- **Verbose** — lets you set verbose **ON** or **OFF**. When verbose is on, the 11801B posts to the computer a message indicating the success or failure of each command sent to the 11801B. When verbose is off, the computer can specifically query the 11801B about the success or failure of each command if so programmed.
- **RS232C Debug** — lets you set debug **ON** or **OFF**. When debug is on, the 11801B displays each command from the computer as it is executed. The messages appear at the top of the display. Debug off is the normal mode of operation. Set debug on if you need to watch the result of each 11801B command of a program that is running in the computer. When debug mode is on it slows performance significantly.



Sampling Heads

A sampling head is a small plug-in device that samples electrical signals and converts them to a much lower speed analog output signal. At least one sampling head must be installed in the 11801B or in an attached SM-11 Multi-Channel Unit to acquire signals.

Several types of sampling heads are available. The type and number of sampling heads you will use depends on the tasks you are performing with the 11801B.

The 11801B mainframe provides four compartments for sampling heads, as shown in Figure 3-78. You can attach SM-11 Multi-Channel Units to expand this capability to a limit of 68 sampling heads. Some sampling heads have two separate channels; others have only one.

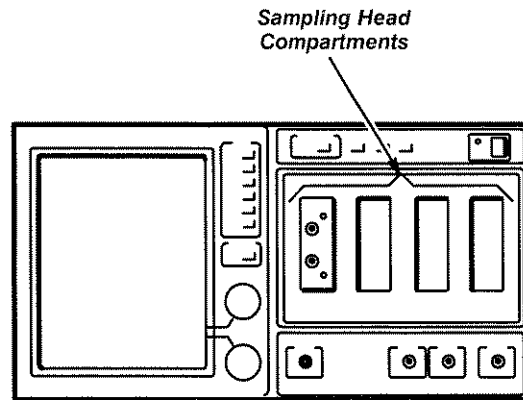

Figure 3-78: Location of Sampling Head Compartments

Installing Sampling Heads

Power off the instrument before installing or removing sampling heads. To install a sampling head, place the head in the compartment and slowly push it in with firm pressure. Once the head is seated, turn the screw shaft on the sampling head to tighten the head into place.



Never install or remove a sampling head with the 11801B power on.

Sampling Head Front Panel

The front panel of a typical sampling head is shown in Figure 3-79. The sampling head illustrated, the SD-24 TDR/Sampling Head, has two channels.

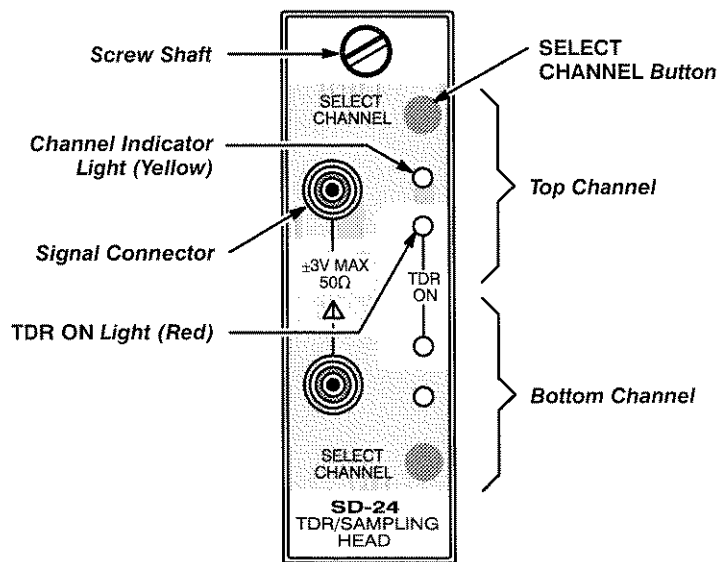

Figure 3-79: Sampling Head Control Panel (SD-24 shown)

Each channel has a signal connector for signal input and for TDR step output. Each channel also has a **SELECT CHANNEL** button and an associated yellow channel indicator light, and a red **TDR ON** indicator light.



Applying a voltage outside the range printed on the sampling head can result in damage. Static electricity is a hazard.

The input diodes in sampling heads are susceptible to damage from electrostatic discharge and from voltage levels that are outside the range printed on the face of the sampling head. Always wear an antistatic wrist strap connected to the **ANTISTATIC CONNECTION** on the 11801B when you are making connections to a sampling head or handling the device under test.

The channel indicator light can have three states: off, on steady, or blinking. The operation of the **SELECT CHANNEL** button depends on the light:

- If the yellow light is off, the channel is not displayed. Pressing the button creates a trace of that channel.
- If the yellow light is on steady, the channel is displayed but is not part of the selected trace. Pressing the button selects that trace, causing the light to blink.
- If the yellow light is blinking, the channel is part of the selected trace. Pressing the button will remove *all* traces displaying that channel.

The red **TDR ON** light indicates whether or not the sampling head is sending out a TDR (Time Domain Reflectometry) step through the signal connector. You cannot control the TDR function from the sampling head front panel; a menu in the mainframe is used to turn this feature on and off.

Controlling TDR and Smoothing Functions

The time domain reflectometry (TDR) and smoothing functions cannot be controlled from the sampling head front panel. These functions are controlled using the **Sampling Head Fnc's** pop-up menu in the Waveform major menu.

The left part of the **Sampling Head Fnc's** pop-up menu lets you select the sampling head channel on which to set TDR or smoothing. The selectors in the right part of the pop-up menu always reflect the status of the TDR or smoothing for the sampling head channel selected in the left part.

Time-Domain Reflectometry (TDR) and Time-Domain Transmission (TDT)

Time Domain Reflectometry, or TDR, is a method of characterizing a transmission line or network by sending a signal into one end and monitoring the electrical reflections. Some sampling heads have a TDR feature.

A TDR step can also be used to make Time Domain Transmission (TDT) measurements. TDT is a technique that allows you to measure the response of a system by sending steps through a device and monitoring the output of the device on another channel. The measurements are made on signals transmitted through the device, rather than reflections from the device (as in TDR).

The selectors in the **Head Type** section of the **Sampling Head Fnc's** pop-up menu (see Figure 3-80) let you control the TDR functions of a sampling head that has the TDR feature. The **TDR/TDT** selector turns the feature **On** or **Off**. The **TDR Polarity** selector sets the polarity of the TDR step to + or -. **TDR Δ Delay** assigns the knobs to set the delay between the TDR steps generated by the two channels of the sampling head.

TDR Preset turns on the TDR step generator, selects Internal Clock trigger, creates a waveform on the selected channel, turns on rho scaling, turns on baseline correction, and autosets (in edge mode) the TDR step. **Diff TDR Preset** performs the same actions as **TDR Preset** except it creates two channels of TDR, with opposite polarities. **Preset Clear** partially undoes TDR and Diff TDR settings by turning off TDR generators (waveforms are not deleted), and if no channels have TDR on, trigger source is set to external, trigger mode is set to Auto, baseline correction is turned off and vertical scaling is set to Volts (instead of rho).

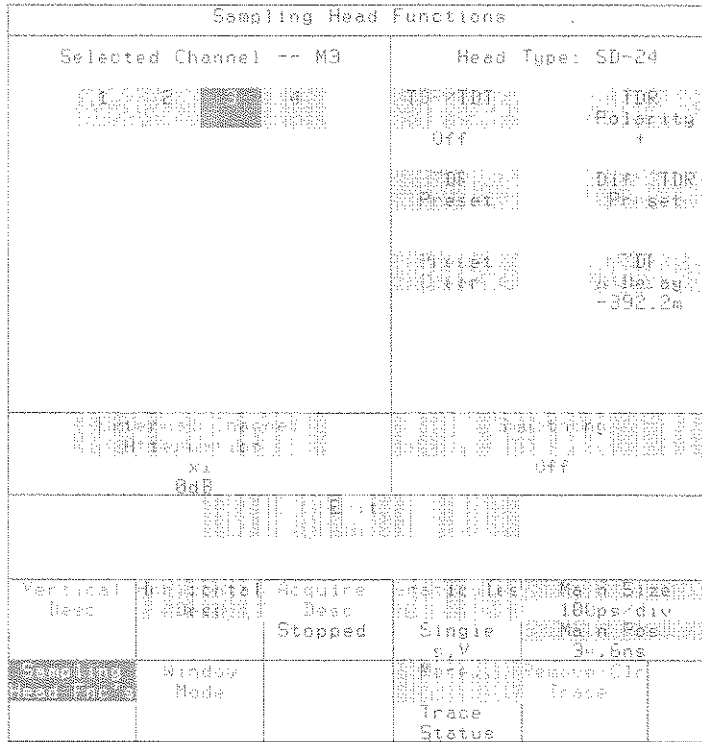

Figure 3-80: The Sampling Head Fnc's Pop-up Menu

External Channel Attenuation enables you to enter a number representing the external attenuation of a channel. Once the number has been entered (1 is the default), the instrument then uses the total attenuation factor in scaling measurement results. Note that the attenuation factor is also applied to Vertical Size.

Total attenuation is the product of the external attenuation times the hardware attenuation of the probe or sampling head. The hardware attenuation factor is displayed in the **Identify** pop-up menu of the Utility1 major menu.

External attenuation can be specified either as a scaling factor (2, 5, 10 etc.) or in decibels (dB). Decibels (dB) is related to the attenuation factor by the formula:

$$dB = 20 \times \log_{10} (\text{attenuation factor})$$

The range for dB is -120 to +120.

Negative dB values or fractional attenuation factors indicate gain, rather than attenuation.

External channel attenuation is a feature of the mainframe, not of the sampling head. Thus, this feature applies to all sampling heads.

Smoothing

Smoothing is processing applied by the sampling head prior to the digitization of a trace, to reduce noise. When smoothing is on, the sampling head samples each trace sample, or dot, eight times before going on to the next dot. The average of the eight samples is digitized as the dot value in the trace record.

NOTE

If you turn on smoothing for one channel of a dual-channel sampling head, both channels are smoothed.

You turn smoothing on or off with the **Smoothing** selector in the **Sampling Head Fnc's** pop-up menu. Not all sampling heads provide smoothing, so **Smoothing** may not be selectable in some cases.

Channel Δ Delay

Channel Δ Delay adjusts the time delay of the channel 2 acquisition (the lower channel) with respect to the channel 1 acquisition (the upper channel) on sampling heads equipped with this feature.

If you change Channel Δ Delay, you should also adjust offset. Refer to Adjusting Parameters in your sampling head manual.

To adjust Channel Δ Delay, press the **WAVEFORM** menu button on your mainframe instrument and select **Sampling Head Fnc's** from the Waveform major menu. Touch the **Channel Δ Delay** selector to set the knobs to control that parameter.

NOTE

*Be aware that not all sampling heads provide the **Channel Δ Delay** selector.*

Saved Trace Descriptions

The 11801B can display eight traces at any one time. However, the instrument is capable of handling many more traces than it can display. A trace that is defined but not displayed is called a saved trace description.

Saved trace descriptions are useful when you are working with many traces and many channels. If you have more traces than can be displayed, you can save a trace as a saved trace description and remove the displayed version of the trace. This lets you display another trace, while keeping the original trace in a form that can be easily retrieved.

NOTE

Saved trace descriptions are saved when you power off the instrument. They will be available when you power on.

Another use for saved trace descriptions is measuring between two traces using prop delay. Hardware prop delay measurements permit the comparison trace to be a saved trace description. Only one trace must be displayed to take measurements between two traces, which lets seven other traces be displayed.

An additional use for saved trace descriptions is to perform measurements or curve queries on them via the GPIB or RS-232-C interface(s).

A saved trace description does not store any digitized samples and is not a record of a trace at some specific time. A saved trace description consists of parameters that define how a trace is to be acquired once it is displayed or used in taking a measurement. A saved trace description stores the following:

NOTE

A saved trace description is different than a stored trace. Stored traces are described on page 3-183.

- The trace expression.
- The window information, if it is a window trace.
- The hardware measurements and measurement parameters associated with the trace (but only when in the Hardware Mode).

Saved trace descriptions do not save the size and position of traces on the main time base or the window size of traces on a window time base. When the saved trace description is recalled or used in a measurement, these parameters are set to match the current time bases.

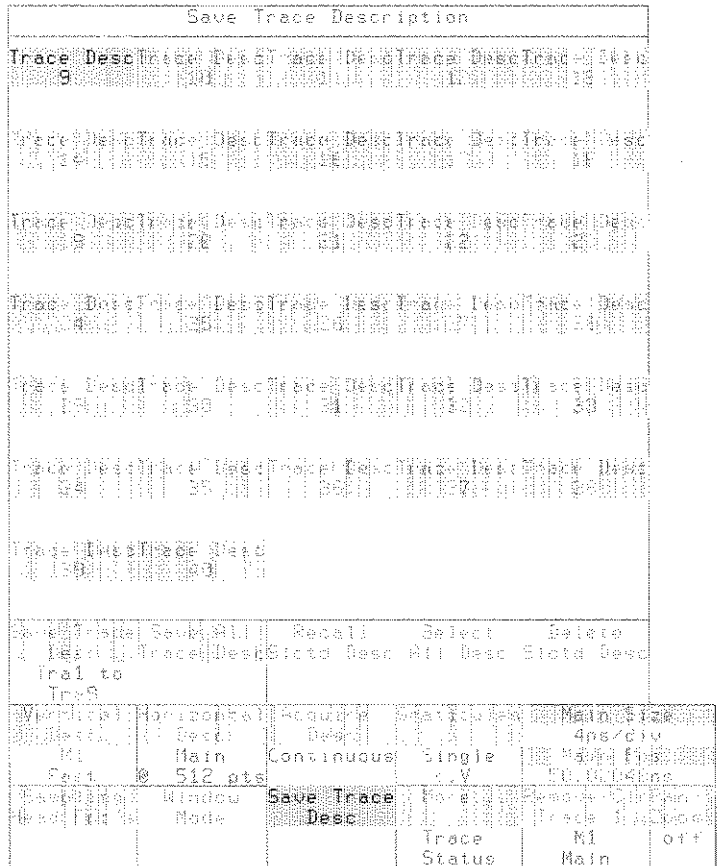

Figure 3-81: The Save Trace Desc Pop-up Menu

Saved trace descriptions must be of simple one-channel traces and cannot be of traces that use any arithmetic operation such as subtraction or multiplication. Averaging is the only trace function that can be applied to a saved trace description.

NOTE

The limitations on saved trace description complexity are similar to the limitations for hardware measurements.

The **Save Trace Desc** pop-up menu in the Waveform major menu is used to save and recall trace descriptions. See Figure 3-81.

The largest section of the **Save Trace Desc** pop-up menu is a list of trace description selectors. These represent the storage "cells" where a saved trace descriptions may be stored. In the illustration above, a trace description has been saved in cell number 9, and this is displayed as the trace expression (**M1**) and time base designation (**Main**).

The numbers of saved trace descriptions begin with 9 because traces 1 through 8 are the displayed traces.

The number of saved trace description cells that are available depends on the configuration of your 11801B system. If no SM-11 Multi-Channel Units are connected, 32 cells are provided, numbered 9 through 40. If one or more SM-11 Multi-Channel Units are connected, then more saved trace description cells are provided. The additional cells can be shown using the **Page** ↓ and **Page** ↑ selectors to scroll through the list.

The five selectors at the bottom of the **Save Trace Desc** pop-up menu are used to save, recall, and delete saved trace descriptions.

Saving a Trace Description

You can copy the parameters of the selected trace on the display into a saved trace description cell. Any saved trace description in that cell will be replaced by the new trace description.

- Step 1:** Select a displayed trace.
- Step 2:** Press the **WAVEFORM** button and touch the **Save Trace Desc** selector in the major menu area.
- Step 3:** In the pop-up menu, touch the selector for the cell where you want to save the trace description.
- Step 4:** Verify that the **Save Trace Desc** selector at the bottom of the pop-up menu shows the two trace numbers you want: the number of the displayed trace and the number of the saved trace description cell. Touch the **Save Trace Desc** selector. The selector for the saved trace description cell will show the new trace expression and time base.

Recalling a Saved Trace Description

You can display a saved trace description by touching the **Save Trace Desc** selector in the Waveform major menu. In the pop-up menu, touch the selector for the saved trace description cell you want to display. Touch the **Recall Slected Desc** selector.

Saving All Displayed Traces as Saved Trace Descriptions

You can quickly save all displayed traces as a group of saved trace descriptions. The procedure is similar to saving a single trace description.

- Step 1:** Press the **WAVEFORM** button and touch the **Save Trace Desc** selector in the major menu area.
- Step 2:** In the pop-up menu, touch the selector for the first cell of a group of consecutive cells that will hold the trace descriptions. One cell will be used for each trace currently displayed. Any trace descriptions saved in these cells will be replaced by the new trace descriptions of the displayed traces.
- Step 3:** Touch the **Save All Trace Desc** selector. The selectors for the saved trace description cells will show the new trace expressions and time bases.

Deleting a Saved Trace Description

You can delete a saved trace description. Touch the **Save Trace Desc** selector in the Waveform major menu. In the pop-up menu, touch the selector for the saved trace description cell you want to delete. Touch the **Delete Slctd Desc** selector.

Deleting All Saved Trace Descriptions

You can quickly delete all saved trace descriptions. Touch the **Save Trace Desc** selector in the Waveform major menu. In the pop-up menu, touch the **Select All Desc** selector, and then touch the **Delete Slctd Desc** selector.

Stored Settings

When you initialize the 11801B, you recall a stored front panel setting that was established at the factory. You can save your own front panel settings for quick recall.

If you establish a test setup, you might want to store the setting and go to another task. After the setting has been changed because of the intervening work, you could recall the test setting that you saved. Masks are saved with stored settings, so you can use stored settings to store sets of masks for different tests.

The instrument has a set amount of memory available for saving stored settings and stored traces. The number of front panel settings you can save depends on how much memory is being used to store traces. Assuming that no traces are stored, you can store approximately 50 front panel settings. You can recall a stored front panel setting anytime. You can also use the **SEQUENCE SETTINGS** button to recall stored settings in a specific order. This is useful if your work requires several instrument setups for standardized tests.

Stored settings are saved when you power off the instrument. They will be available when you power on.

The following instrument controls are not saved with stored settings, and are not changed when settings are recalled:

- Stored traces
- Saved trace descriptions
- GPIB and RS-232-C parameters, except GPIB address is saved
- Enhanced accuracy calibrations, except **Delay Compensate** and **Time Base Cal Mode** are saved
- Display colors and intensity, audio feedback, vectored trace mode, and hardcopy mode
- Sequence settings mode

Storing Settings

Use the **Store Setting** pop-up menu in the Store/Recall major menu to store a setting. After you setup the instrument, touch the **Store Setting** selector to display the pop-up menu. See Figure 3-82.

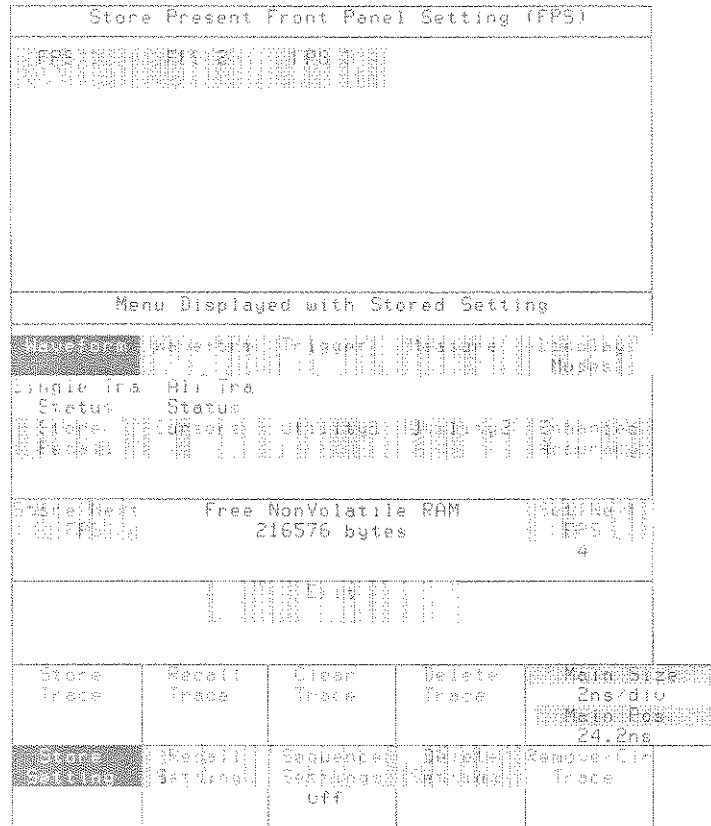

Figure 3-82: The Store Setting Pop-up Menu

You can choose which major menu you want to be displayed when the stored setting is recalled. Touch the selector of the desired major menu in the section of the pop-up menu titled **Menu Displayed with Stored Setting**. Both Waveform major menus are listed as options.

After you choose the major menu you want recalled with the stored setting, touch **Store Next FPS** to store the setting. The FPS (Front Panel Setting) number that will be assigned to that setting appears under the label **Set Next FPS**. If you want to specify a number other than the default, you can assign the knobs to set the number by touching **Set Next FPS**. You can choose any number from 1 to 9999. If you choose a number that is already in use, the word “Exists!” appears under the **Store Next FPS** label. If you store the setting under that number, the previously stored setting using that number will be deleted. You can also replace an existing stored setting with the current setting by touching one of the selectors in the top half of the **Stored Setting** pop-up menu.

The **Store Setting** pop-up menu keeps track of the amount of non-volatile RAM available to store both settings and traces. This information is listed under “Free NonVolatile RAM”. This number will decrease after you store settings or traces, and increase after you delete settings or traces.

Recalling Stored Settings

You can recall a stored setting using the **Recall Setting** pop-up menu in the Store/Recall major menu (see Figure 3-83). Touch the **FPS n** selector, where n is the setting number you want to recall.

The **Recall Setting** pop-up menu also provides a way to initialize the 11801B. The **Initialize Setting** selector operates the same as the Utility1 major menu **Initialize** selector. Initialization is described completely on page 3-111.

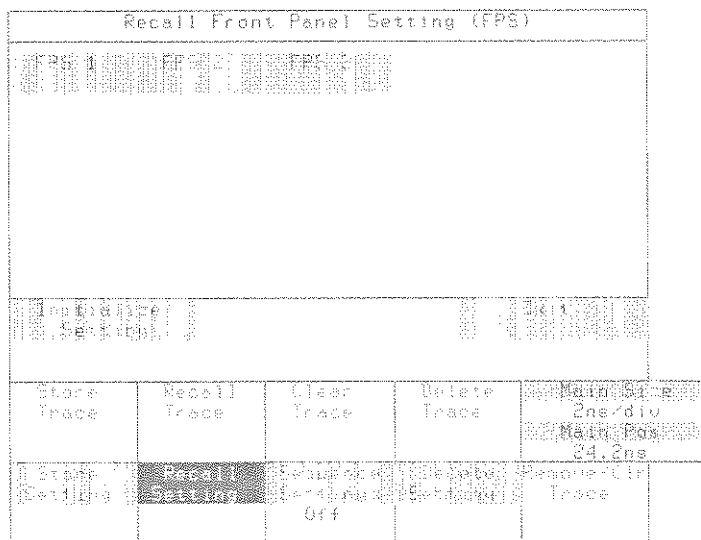

Figure 3-83: The Recall Setting Pop-up Menu

Deleting Stored Settings

Use the **Delete Setting** pop-up menu in the Store/Recall major menu to delete a stored setting. Select the setting or settings to delete by touching the selectors in the top part of the pop-up menu (see Figure 3-84). If more than 15 settings are stored, touch **Page↑** and **Page↓** to scroll through the menu. As you touch these selectors, they highlight to show that they will be deleted when you touch the **Delete Selected Settings** selector. Touch a highlighted selector a second time to remove it from the list of settings to delete. The **All Settings** selector is a quick way to select all the stored settings.

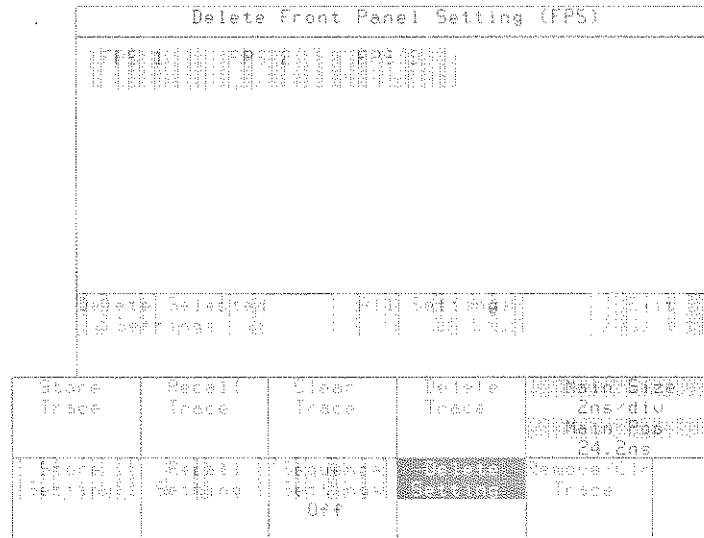

Figure 3-84: The Delete Setting Pop-up Menu

Sequencing Through Stored Settings

If you have several settings saved, you can quickly cycle through the settings. This is useful if you have a series of test set-ups that you want to use repeatedly.

The sequencing order of stored settings is the same as the order in which they appear in the Store Setting pop-menu. That is, settings will recall or sequence in ascending numerical order. Therefore, you must set the sequencing order of stored settings by choosing the appropriate numbers for those stored settings.

Enable sequencing of settings by touching the **Sequence Settings** selector in the Store/Recall major menu. This selector can set sequencing to **On** or **Off**. When this selector is set to **Off**, the **SEQUENCE SETTING** button on the front panel (see Figure 3-85) does not operate. When it is set to **On**, the **Sequence Settings** selector displays the next setting to be recalled.

When you have stored all the settings you want to sequence through and have enabled sequencing, use the **SEQUENCE SETTING** button to recall the next setting of the sequence. This button is located above the sampling head compartments, near the **ON/STANDBY** switch.

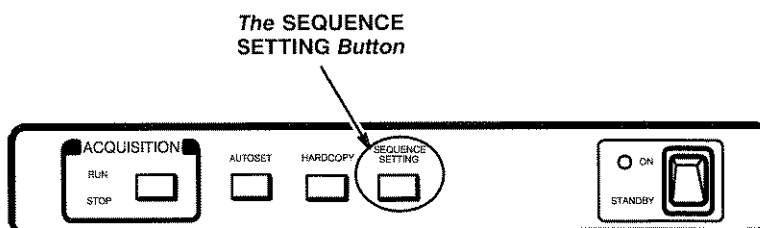

Figure 3-85: Front Panel SEQUENCE SETTING Button



Stored Traces

A stored trace is a trace record of a single acquisition cycle. You can think of it as a “snapshot” of a trace. In normal acquisition mode, the stored trace is the same as the trace record on the display. For traces acquired in variable persistence, infinite persistence, or color grading modes, only the current 512-point trace record is saved (not the entire history of displayed points).

NOTE

A stored trace is different from a saved trace description. Saved trace descriptions are described on page 3-173.

Once you have stored a trace, you can use it as an element of trace expressions in other traces. For example, you could define a trace to be **M1 –STO3**. This trace acquires data from sampling head channel M1 and subtracts from each sample the data recorded in stored trace number 3.

Stored traces are saved when you power off the instrument and are available when you power it on again.

Storing Traces

When you store a trace, the instrument takes a copy of the trace record of the selected trace. The trace record is always copied into the stored trace location with the lowest available number, unless you select otherwise.

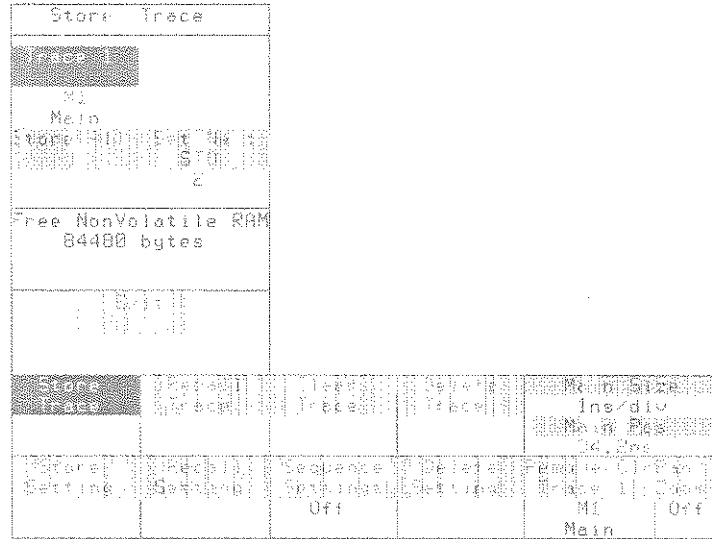

Figure 3-86: The Store Trace Pop-up Menu

Use the following steps to store a trace:

- Step 1:** Create a stable trace on the display.
- Step 2:** Press the **Store/Recall** major menu button, and touch the **Store Trace** selector in the major menu. See Figure 3-86.
- Step 3:** Observe the **Set Next Sto:** selector on the pop-up menu. The trace you store will be assigned this number. If you want to set this number to one other than the next available, touch the **Set Next Sto** selector and adjust the knobs to select a number. You can choose any number between 1 (if no trace is currently stored) and 9999. You cannot store a trace where another trace is already stored.
- Step 4:** All displayed traces are listed in the pop-up menu. Touch the selector that represents the trace you want to store.

The **Store Trace** pop-up menu keeps track of the amount of non-volatile RAM available to store both traces and settings. This information is listed under "Free NonVolatile RAM". This number will decrease after you store traces or settings, and increase after you delete traces or settings.

You can also use the **Store All** selector to store all the displayed traces as separate stored traces. In this case, the **Next Storage:** notation tells you the first storage number that will be used.

Recalling Stored Traces

Once a trace is stored, you can use it when creating a trace expression. To create a trace that displays a stored trace, touch the **Def Tra** icon, then in the pop-up menu touch the **Stored Traces** selector, the selector for the stored trace you want to display, and the **Enter Desc** selector.

The **Recall Trace** pop-up menu provides a simpler way to do the same thing. Press the **Store/Recall** major menu button and touch the **Recall Trace** selector to display the pop-up menu. In the pop-up menu, touch the selector for the stored trace you want to display. See Figure 3-87.

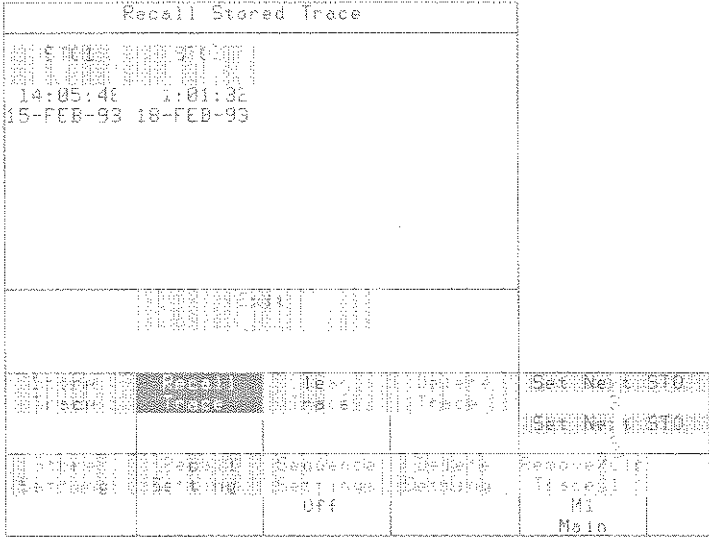

Figure 3-87: The Recall Trace Pop-up Menu

Deleting Stored Traces

You can delete stored traces by using the **Delete Traces** pop-up menu in the Store/Recall major menu. This pop-up menu may also be used to delete displayed traces. See Figure 3-88.

In the **Delete Traces** pop-up menu, touch the selectors for the displayed and stored traces you want to delete. The traces are not deleted until you touch the **Delete Selected Traces** selector. You may select several traces to be deleted before touching the **Delete Selected Traces** selector. As you select traces to delete, their selectors highlight to tell you they will be deleted. If you touch a trace selector by accident, touch it again to remove the highlighting. If you want to delete all the displayed and stored traces, touch the **All Traces** selector.

You cannot delete a stored trace if it is being used as part of a displayed trace. In Figure 3-88, stored trace 1 is used in the trace definition of displayed trace 3. The selector for stored trace 1 cannot be selected.

Delete Trace				
Displayed Traces			Stored Traces	
M1	M2		14:05:40	1:01:32
Main	Main		15-FEB-93	18-FEB-93
M1+M2				
Main				
<input type="checkbox"/> All Traces <input type="checkbox"/> M1 <input type="checkbox"/> M2 <input type="checkbox"/> M1+M2 <input type="checkbox"/> Main				
<input type="checkbox"/> Delete Selected Traces <input type="checkbox"/> Cancel				
<input type="checkbox"/> Delete <input type="checkbox"/> Cancel			<input type="checkbox"/> Delete <input type="checkbox"/> Cancel	
<input type="checkbox"/> Off			<input type="checkbox"/> M1+M2 <input type="checkbox"/> Main	

Figure 3-88: The Delete Trace Pop-up Menu

Displaying Time and Date with Stored Traces

You can display the time and date that a trace was stored by selecting **Stored Tra Time/Date**, in the **Instrument Options** pop-up menu of the Utility1 major menu. The time and date for each stored trace appears in the stored trace selectors. Time and date can be displayed with stored traces regardless of whether **Stored Tra Time/Date** was on when the traces were stored.

When the **Stored Tra Time/Date** display is on, the time and date stamp appear underneath any stored trace selector in all appropriate pop-up menus, including the Recall Trace and Delete Trace pop-up menus in the Store/Recall major menu, the Vertical Desc and Horizontal Desc pop-up menus in the Waveform major menu, and the Labeling pop-up menu in the Utility 1 major menu.

System Identification

You can determine the configuration of your system by looking at the **Identify** pop-up menu in the Utility1 major menu. See Figure 3-89.

System Identification					
Unit Select					
Mainframe					

11801B Mainframe ID# 0010391					
Executive Processor : 3.13					
Display : 3.13					
Time Base/Controller: 3.26					
Acquisition #1 : 9.02					
Acquisition #2 : 9.02					

Mainframe Sampling Heads					
Chan M1 :	1X	Chan M2 :	1X	SD-24	
Chan M3 :	0X	Chan M4 :	0X		
Chan M5 :	0X	Chan M6 :	0X		
Chan M7 :	0X	Chan M8 :	0X		

Options					
IT - Telecomm Standard Masks Installed					
IM - SM-11 Compatibility Not Installed					

Model	Acquisition	Time Base	Enhanced Accuracy	Main Size	Ins/dtu
11801B	3.13	3.26	Enhanced Accuracy	Ins/dtu	Ins/dtu
Version	Time Base	Time Base	Enhanced Accuracy	Ins/dtu	Ins/dtu
17:05:40	3.13	3.26	Enhanced Accuracy	Ins/dtu	Ins/dtu
12-FEB-93	3.13	3.26	Enhanced Accuracy	Ins/dtu	Ins/dtu

Figure 3-89: The Identify Pop-up Menu

The top section of the **Identify** pop-up menu shows the devices; you can see the status of the 11801B mainframe or any attached SM-11 Multi-Channel Unit by touching its selector.

The second section of the **Identify** pop-up menu shows the instrument serial number, and the version numbers of the firmware (programming) for the various internal microprocessors.

System Identification

The third section of the **Identify** pop-up menu shows which channels have sampling heads installed (**1X**, **10X**, etc.) and which channels are not available (**0X**). For those channels that have sampling heads, the sampling head type and serial number are shown.

The bottom section of the **Identify** pop-up menu shows instrument options and their respective states, such as whether or not the option is installed.

This section describes how to perform time domain reflectometry (TDR) measurements. TDR measurements can be made only with an SD-24 TDR/Sampling Head or an SD-20 Loop-Thru Sampling Head; none of the other SD Series sampling heads provide TDR capabilities.

TDR Step Generation

Both channels in the SD-24 TDR/Sampling Head have a step generator, which gives both channels TDR measurement capabilities. You can use the outputs of both generators to perform differential and common mode TDR measurements.

The SD-20 Loop-Thru Sampling Head is capable of performing single-ended TDR when used with an external signal generator. This discussion pertains mainly to the SD-24 TDR/Sampling Head.

The step generator circuitry consists fundamentally of an adjustable current source and a diode switch. Initially, before the step, the diode switch is biased to conduct current to the output. When the diode switch opens, the step occurs. Figure 3-90, a simplified diagram, shows the switch and the current source.

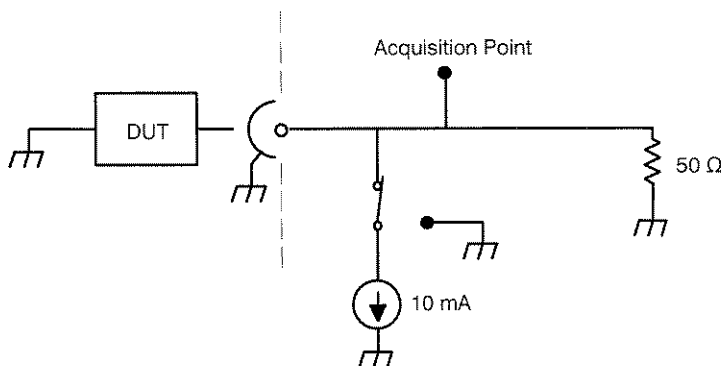

Figure 3-90: Step Generator Simplified Schematic Diagram

Because of the architecture of the step generator, the output voltage of the step depends on the DC resistance to ground of the device under test. The following sections describe the operation with a short circuit, an open circuit, and a 50 Ω load.

Operation Into a Short Circuit

Initially, the diode switch is conducting -10 mA. Since the step generator output is initially shorted, the resistance to ground is $0\ \Omega$ and the output voltage is 0 V.

When the diode switch opens (reverse-biased), apparent resistance to ground at the acquisition point (and at the channel connector) is $25\ \Omega$, because the internal termination resistance is $50\ \Omega$ and the connector impedance is $50\ \Omega$. The voltage at the acquisition point rises to $+250$ mV.

The transition propagates to the short in the device under test and is negatively reflected back to the acquisition point; cancelling the transition. The time displayed from the first transition to the second transition is the propagation time from the acquisition point to the short in the device under test and back. See Figure 3-91.

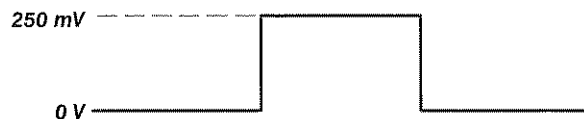

Figure 3-91: Step Generator with a Shorted Output

Operation Into a $50\ \Omega$ Load

Initially, the diode switch is conducting. Since the step generator output is connected to a $50\ \Omega$ load, the resistance to ground at the acquisition point is $25\ \Omega$ (because of the internal $50\ \Omega$ impedance). The 10 mA current source places -250 mV at the acquisition point.

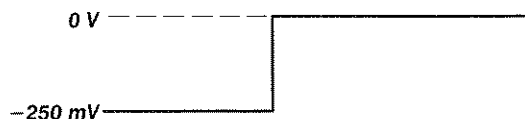

Figure 3-92: Step Generation with a $50\ \Omega$ Load

When the diode switch opens (reverse-biased), the return path to ground is broken and the acquisition point rises to 0 V. The matched impedance allows the acquisition point to remain at 0 V. See Figure 3-92.

Operation Into an Open Circuit

Initially, the diode switch is conducting. Since the step generator output is open, the resistance to ground at the acquisition point is $50\ \Omega$ (because of the internal $50\ \Omega$ impedance). The -10 mA current source places -500 mV at the acquisition point, as a starting condition.

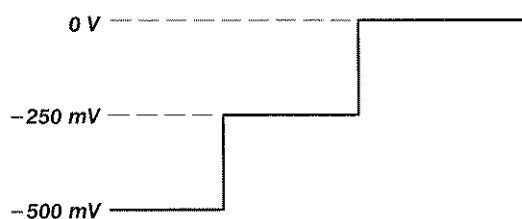

Figure 3-93: Step Generation with a 50 Ω Load

When the diode switch opens (reverse-biased), apparent resistance to ground at the acquisition point (and at the channel connector) is 25 Ω , because the internal circuit impedance is 50 Ω and the connector impedance is 50 Ω . This causes the acquisition point to rise to -250 mV.

The transition propagates to the open in the device under test and is reflected back to the acquisition point, causing the voltage at the acquisition point to rise to 0 mV. At the acquisition point, the time displayed from the first step to the second step is the propagation time from the acquisition point to the open in the device under test and back. See Figure 3-93.

Baseline Correction

Baseline correction is a feature of the 11801B instrument. This feature holds the displayed baseline of a trace in one location despite variations of the offset in the sampling head. These offset variations are caused by changes in impedance at the device under test as just described.

Baseline correction is especially useful with TDR/TDT measurements. Without baseline correction, changes in the DC resistance to ground for the cable or device under test would cause the entire step to move vertically on the display.

Baseline correction keeps the baseline in one location vertically. For the 11801B, you can enable baseline correction from the Graticules pop-up menu. However, if you use the **TDR Preset** selector to set up for TDR measurements, baseline correction is automatically turned on. For more information on baseline correction, see page 3-17.

Example: Taking TDR Measurements

This example demonstrates the TDR (Time Domain Reflectometry) feature of the SD-24 sampling head. TDR is a method of examining and measuring a network or transmission line by sending a step into the network and monitoring the reflections.

For this example you will need an 11801B with at least one SD-24 installed. Also, you will need one SMA cable, preferably of 5 ns length.

- Step 1:** Initialize the 11801B (press **UTILITY**, touch **Initialize** and touch **Initialize** again).
- Step 2:** Attach one end of the cable to any SD-24 sampling head input. Leave the other end unattached.

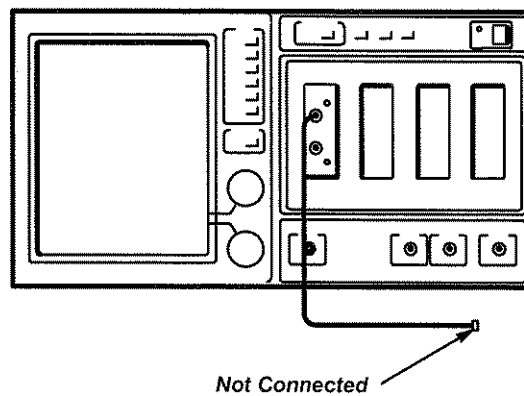

Figure 3-94: Connections for Example

- Step 3:** Press the **SELECT CHANNEL** button on the sampling head input channel to which you have connected the cable.

You see only a flat trace on the display because there is no signal on the channel. But, when the TDR feature is used, the sampling head supplies the signal for you. As with the calibrator signal, the TDR step is synchronized with the internal clock.

- Step 4:** Press the **WAVEFORM** button, and touch the **Sampling Head Fnc's** selector.
- Step 5:** To turn on TDR, touch **TDR Preset**. The TDR Preset function acts to turn on the step generator for the selected channel, creates a trace from that channel, sets the graticule to rho scaling, turns on baseline correction, and autosets the TDR waveform.

The sampling head will turn on a red light next to the channel input connector, indicating that TDR is activated for that channel. TDR can be used on each channel independently.

- Step 6:** Adjust the display sizes and positions to show a trace similar to that shown in Figure 3-95. **AUTOSET** may make this job easier, and the vertical (\updownarrow) and horizontal (\leftrightarrow) icons will let you make fine adjustments.

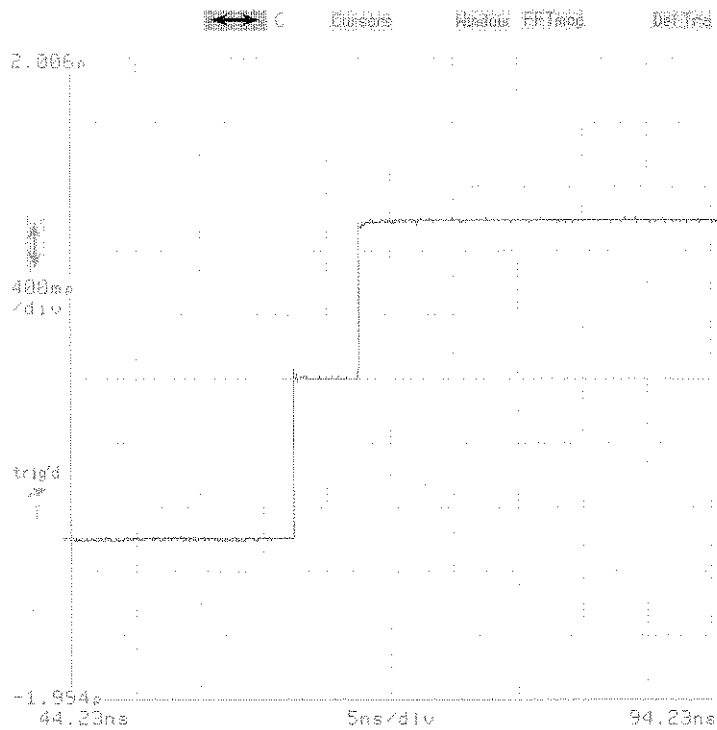

Figure 3-95: TDR Step and Reflection

The first rise of this trace is the incident TDR step leaving the sampling head; the second rise is the reflection of the step returning from the end of the cable.

Changing Graticule Units for TDR

The units of measure commonly used in TDR are units of rho (ρ), measured on the vertical axis, and time on the horizontal axis. You can change the measurements by using the **Graticules** selector on the Waveform major menu.

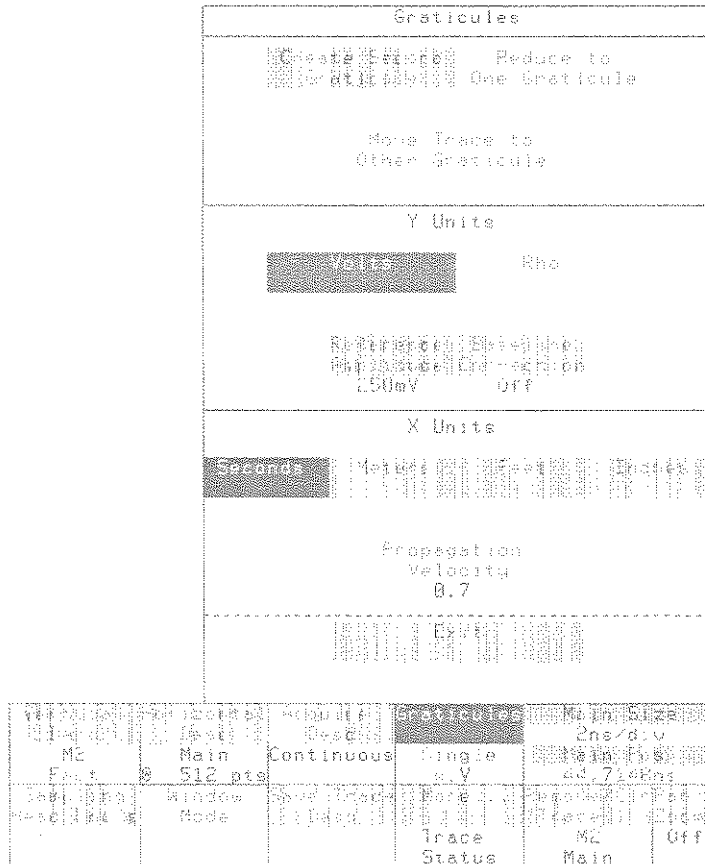

Figure 3-96: The Graticules Pop-up Menu

- Step 7:** Touch **Graticules** in the major menu and **Feet, Meters,** or **Inches** in the pop-up menu (see Figure 3-96). If you know that the propagation velocity of your cable differs from the default, touch the **Propagation Velocity** selector and adjust this parameter. If you don't know the velocity or are using Tektronix SMA cables, accept the 0.7 default. This unitless number represents the fraction of the speed of light that signals pass through your network or transmission line. If you don't know the propagation velocity but you know the dielectric constant of the transmission medium, you can convert their dielectric constant to a propagation velocity using the following equation:

$$Prop\ velocity = \frac{1}{\sqrt{dielectric\ constant}}$$

The horizontal axis is now calibrated in your chosen units of measurement.

NOTE

Measurements and cursor readouts are always expressed in the same units as the graticule axes.

To set the vertical axis to rho, you need to specify the amplitude, in volts, of the incident step that the sampling head sends through the cable. Touching the **Reference Amplitude** selector assigns both knobs to this parameter.

For the SD-24, this step amplitude is 250 mV. This amplitude is also the default setting of this parameter, so you don't need to change this parameter when using the SD-24.

For the SD-20, the step amplitude depends on the external signal source used.

Note that when using the TDR Preset function, the vertical axis scaling is automatically set to Rho.

- Step 8:** Touch **Exit** to remove the pop-up menu and view the trace and graticule.

Example: Differential and Common Mode TDR

The 11801B can perform differential and common mode TDR measurements with the SD-24 sampling head. As described earlier, the sampling head has two sampling input channels and two independent step generators.

The step generator output for each channel is selectable for positive or negative polarity and amplitude. This example will show you how to use the two channels and step generators of an SD-24 to perform differential and common mode TDR measurements.

For this example you need at least one SD-24 installed in the left-most slot of the 11801B. You also need one SMA cable, preferably of 5 ns length.

- Step 1:** Initialize the 11801B (press **UTILITY**, touch **Initialize** and touch **Initialize** again).
- Step 2:** Attach one end of the cable to any SD-24 sampling head input. Leave the other end unattached.
- Step 3:** Press the **SELECT CHANNEL** button on the sampling head input channel to which you have connected the cable.
- Step 4:** Touch the **Sampling Head Fnc's** selector.
- Step 5:** Touch **TDR Preset**.
- Step 6:** Attach the loose end of the cable to the lower channel connector on the same sampling head.
- Step 7:** Adjust the display size and position to show a trace similar to that shown in Figure 3-97.

In Figure 3-97, notice that there is only one rising edge, that of the incident TDR step. There is very little or no reflection, because the impedance of the termination in the receiving channel connector matches the impedance of the cable.

- Step 8:** Press the **SELECT CHANNEL** button for the lower channel on the sampling head. Adjust the vertical and horizontal settings to display the TDR step generated by the upper channel.

The horizontal distance separating the leading edges on the two traces is the time it takes the step transmitted by channel 1 (upper channel) to be sampled by channel 2 (lower channel).

- Step 9:** Touch **Sampling Head Fnc's** and touch **Mainframe 2** under Selected Channel. Touch **TDR/TDT** to turn on the step generator for that channel. The lower channel on each sampling head has an internal delay adjustment. This lets you set the time at which the step generator for the lower channel asserts the TDR step. Touch the **TDR Head Δ Delay** selector. Then touch **Exit** to remove the pop-up menu.

In step 9, you turned on TDR for the lower channel, and you also assigned the knobs to adjust delay for the TDR step generator. With some adjustments, the mainframe displays the two traces in Figure 3-98.

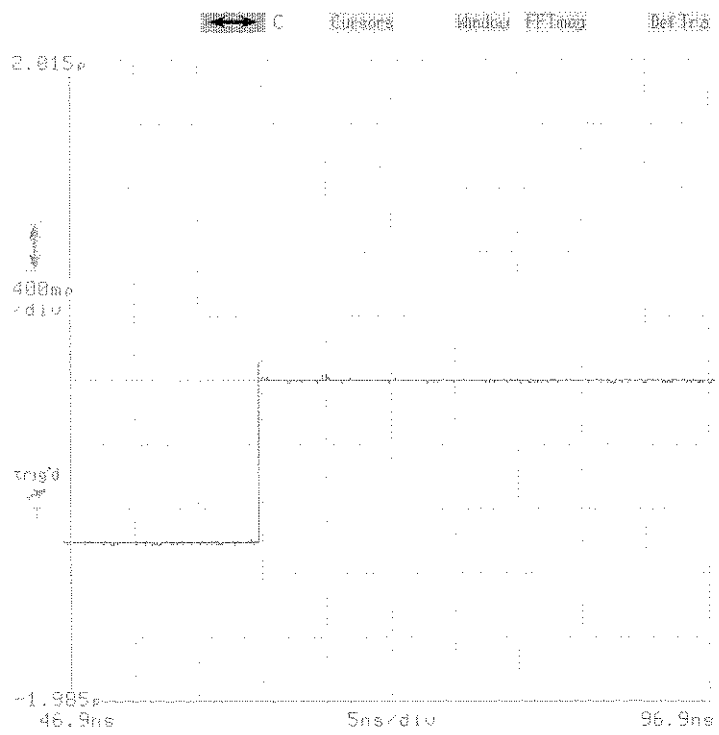

Figure 3-97: Single Channel TDR

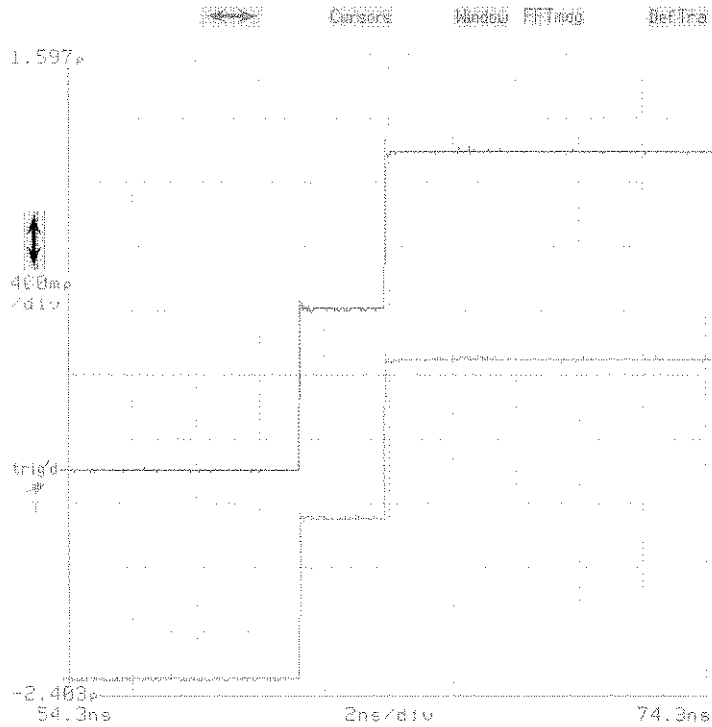

Figure 3-98: Channels 1 and 2 TDR

Notice that there are two rising edges on each trace. On the upper trace, the left-most edge is the step transmitted by the step generator of the upper channel, M1. The second rising edge is the step transmitted by the step generator of lower channel, M2.

On the lower trace, the left-most edge is the step transmitted by the step generator of the lower channel, M2. The second rising edge is the step transmitted by the step generator of the upper channel, M1.

Note that both steps are positive. This is equivalent to common mode transmission. For both traces, common mode operation appears as though the cable is open at the middle (since the two steps meet and are cumulative).

- Step 10:** Turn either knob on the mainframe to adjust the delay for channel 2. This varies the time when channel 2 asserts the TDR step.

Notice that on the upper trace the second edge moves horizontally, and on the lower trace the first edge moves horizontally. They are actually the same step, seen at different times by the two channels.

- Step 11:** Press the **WAVEFORM** button. On the display, touch **Sampling Head Fnc's**. Touch **1** and the **TDR Polarity** selector. This causes channel 1 to assert a negative TDR step. Touch **Exit**.

Notice that the upper channel is asserting a negative TDR step. This is equivalent to differential TDR. Note that in both traces, the step appears as though the cable is shorted at the center of the cable (since the two steps meet and cancel to zero volts).

When the TDR steps on the two channels are opposite (one positive and one negative), you can now define a trace that represents the true differential signal by touching the **DefTra** icon and touching **Mainframe 1, - , Mainframe 2, Enter Desc.**

When the TDR steps on the two channels are the same polarity (both positive or negative), you can define a trace that represents the true common mode signal by touching the **DefTra** icon and touching **Mainframe 1, +, Mainframe 2, Enter Desc.**

This example has been designed to show how the instrument acquires common-mode and differential TDR traces, and how they relate to each other.

Differential TDR is quickly set up by using the **Diff TDR Preset** selector on the **Sampling Head Fnc's** pop-up menu. This preset automates the setup for differential TDR by:

- Turning on both channels of the SD-24
- Turning on both step generators
- Inverting the polarity on one step generator
- Autosetting both traces
- Turning on Baseline Correction
- Changing the vertical scaling from volts to rho

TDT Measurements

You can make forward and reverse Time Domain Transmission (TDT) measurements using the SD-24. To perform a TDT measurement, connect one sampling head channel to the input of the device under test and the other sampling head channel to the output of the device under test. You can then alternately enable the step generators on both channels and sample the transmitted signal on the other channel to perform forward and reverse TDT measurements.

More About TDR Measurements

When making differential or common mode TDR measurements, it is important that the two steps arrive at the same time at the reference plane (usually the connection point to the device under test). To check and adjust this condition, disconnect the transmission cables from device under test *at the point where the cables connect to the device*. If the cables aren't matched perfectly, matching either the incident or the reflected edges will not match the steps at the end of the cable, since the reflections had to travel back through unmatched cables as well. As shown in Figure 3-99, to match the steps at the open end, make the delay between the incident steps, T_1 , equal but opposite in sign to the delay between the reflected steps, T_2 .

- Step 1:** Press the **WAVEFORM** button and touch the **Sampling Head Fnc's** selector.
- Step 2:** Touch **TDR Δ Delay** and then adjust the knob.

For some measurements and comparisons, you may want to visually line up the leading edges of both TDR steps, even though you've delayed the step assertion time for one channel. To do this, create a window of each trace, and place each window trace in the lower graticule. Then select one of the window traces and, using the \updownarrow icon and the lower knob, position the leading edge of the trace. This does not affect the arrival of the TDR steps at the reference plane.

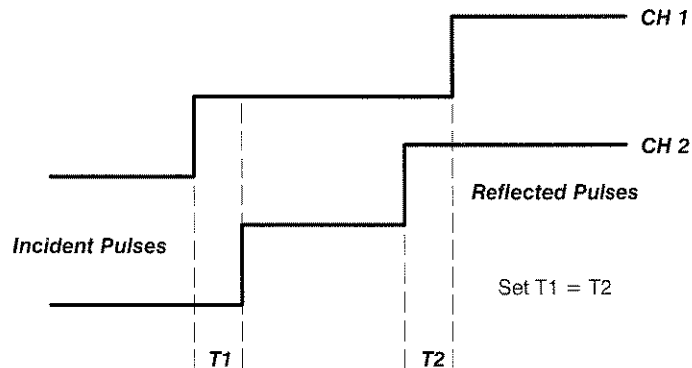

Figure 3-99: Ensuring Pulses Arrive at the Reference Plane at the Same Time

Time and Date

The 11801B has an internal clock, with battery back-up, that keeps track of the time and date. You can set the clock using the **Instrument Options** pop-up menu in the Utility1 major menu. When you touch the **Hours, Minutes, Seconds, Month, Day, or Year** selector, one of the knobs is assigned to set that clock parameter. See Figure 3-100.

Next to the time and date selectors is a readout showing how many times the 11801B has been powered on, and how many hours it has been on.

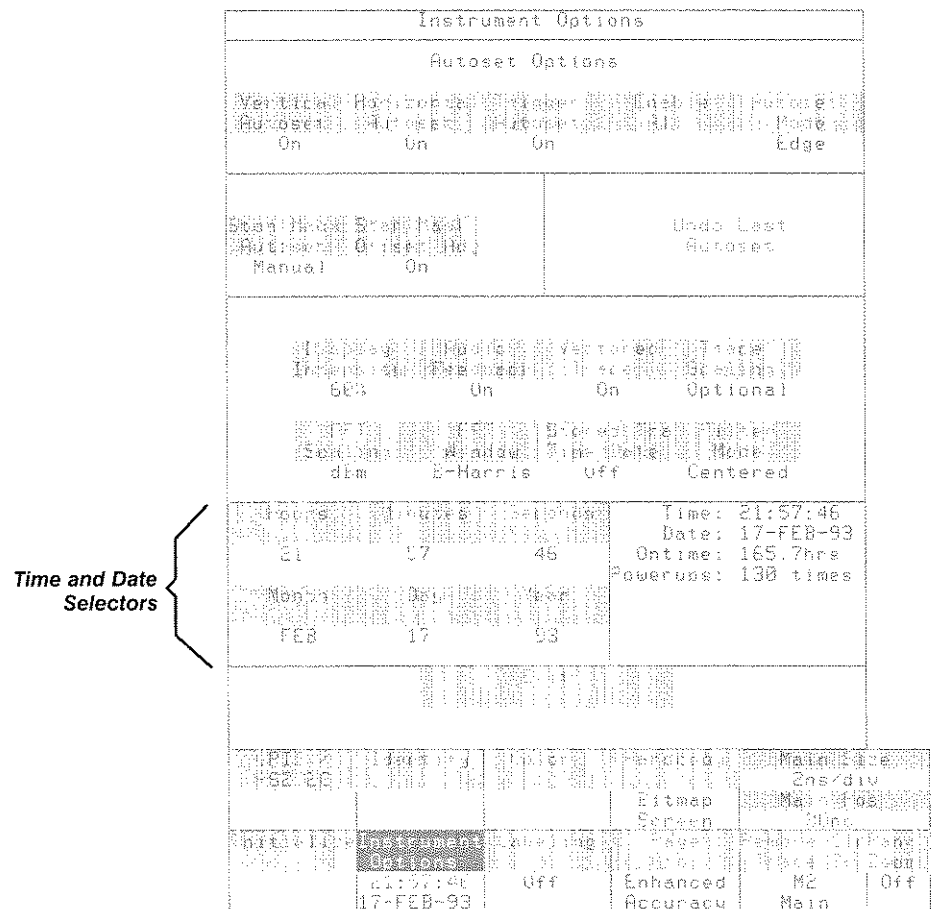

Figure 3-100: The Instrument Options Pop-up Menu

Displaying Time and Date with Stored Traces

You can display the time and date that a trace was stored by selecting **Stored Tra Time/Date**, in the **Instrument Options** pop-up menu of the Utility1 major menu. The time and date for each stored trace appears in the stored trace selectors. Time and date can be displayed with stored traces regardless of whether **Stored Tra Time/Date** was on when the traces were stored.

When the **Stored Tra Time/Date** display is on, the time and date stamp appear underneath any stored trace selector in all appropriate pop-up menus, including the Recall Trace and Delete Trace pop-up menus in the Store/Recall major menu, the Vertical Desc and Horizontal Desc pop-up menus in the Waveform major menu, and the Labeling pop-up menu in the Utility 1 major menu.

Trace Definition and Management

Traces are the visible representation on the display of the electrical signal, or combination of signals, that the 11801B samples and digitizes. You can define and display up to eight traces simultaneously.

You define a new trace on the main time base by entering a *trace expression*. A trace expression is a description of the signal sources and mathematical computation that determines the trace display. An example of a simple trace expression is **M1**, which specifies that a trace should show the signal source of mainframe channel 1, with no mathematical computation. The trace defined by this trace expression displays the signal that the 11801B samples and digitizes from the specified sampling head input channel.

An example of a complex trace expression is **Log(M1+M2)**, which specifies that the signals from mainframe channels 1 and 2 are to be algebraically added, and the base 10 log of the sum is to be shown as the final trace.

Defining New Traces

NOTE

*You define traces on a window time base using the **Window** icon, described on page 3-225.*

Defining Traces Using the DefTra Icon

You enter trace expressions using the **DefTra** icon. A **DefTra** icon appears above the top right corner of the graticule or graticules on the display. Touch the **DefTra** icon above the graticule on which you want to define a new trace. When you touch the icon, a blank **DefTra** pop-up menu is displayed. This pop-up menu covers the entire display, as shown in Figure 3-101.

You use the selectors of the **DefTra** pop-up menu to “type” your trace expression. As you type, the trace expression you are building appears at the top of the pop-up menu. The **Back Space** selector lets you correct errors as you type. When your trace expression is complete, touch the **Enter Desc** selector to remove the pop-up menu and create the new trace.

For example, to enter the expression **Log(M1+M2)**, touch the following selectors in sequence: **Log(, Mainframe, 1, +, Mainframe, 2,), Enter Desc**.

Another example of a trace expression, **M1-(2*Smooth(STO1,5))**, is entered as **Mainframe, 1, -, (, Mainframe, 2, *, Smooth(, Stored Traces, STO1, ,, 5,),), Enter Desc**.

The selectors presented in the **DefTra** pop-up menu are grouped into the following categories:

- **Channel Selectors** — let you specify a sampling head channel. The 11801B presents only those channel numbers where a sampling head is installed.
- **Numeric Keypad** — lets you enter a numeric value as part of your trace expression, or one of the four arithmetic operators +, -, *, and /.
- **Trace Functions** — let you specify a function, which are listed on the next page. This area of the menu is shared with the stored traces selectors described below. If the **Trace Functions** selector is highlighted, the trace function selectors are shown. Touch the **Trace Functions** selector to highlight it if the stored traces list is shown.

NOTE

Trace Functions and Stored Traces can both be included in a single trace expression.

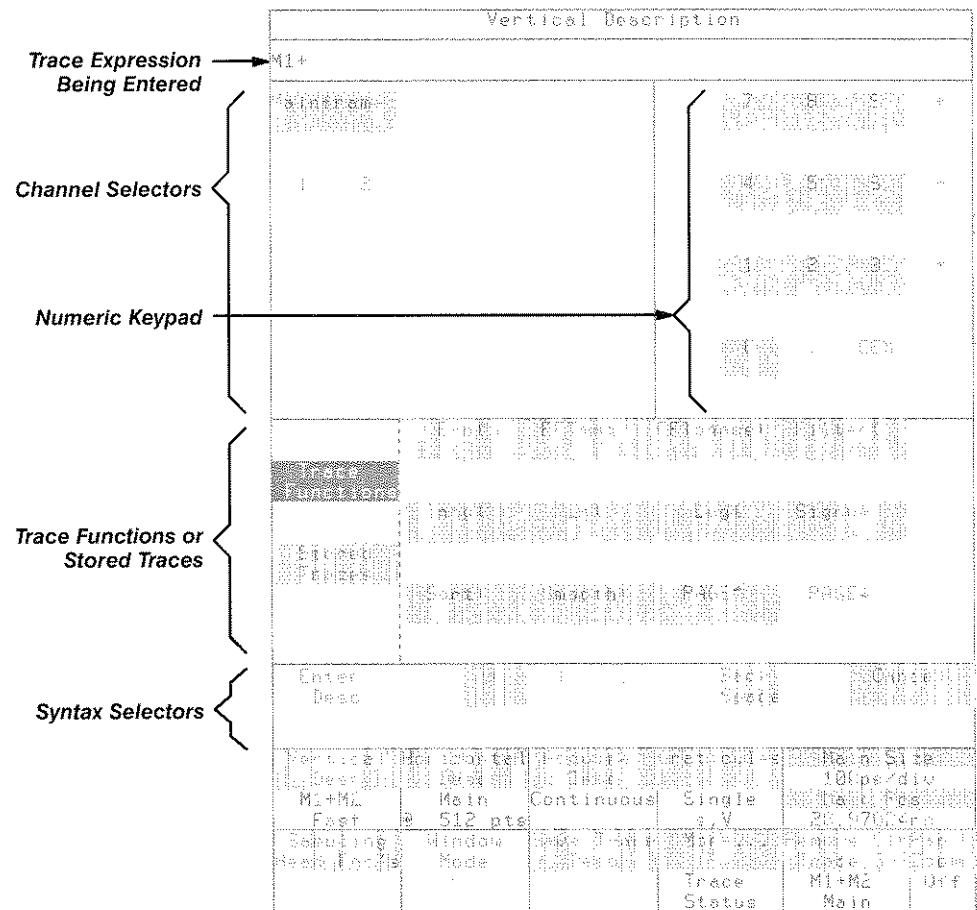

Figure 3-101: The DefTra Pop-up Menu

- **Stored Traces** — list all the traces that have been stored in the 11801B. For a discussion of stored traces, see Stored Traces on page 3-183. This area of the menu is shared with the trace functions selectors described above. If the **Stored Traces** selector is highlighted, the stored trace selectors are shown. Touch the **Stored Traces** selector to highlight it if the trace functions list is shown.
- **Syntax Selectors** — (and) let you specify the order of mathematical operations. Each opening parenthesis must be matched with a closing parenthesis. Use the , selector to separate arguments to functions that require more than one argument, as does **Smooth**(. Use **Back Space** to correct errors as you enter the trace expression. Always finish your trace expression by touching the **Enter Desc** selector. **Cancel** allows you to leave the **DefTra** pop-up menu without implementing the trace expression entered. **Cancel** can be selected at any time.

NOTE

All trace functions have an opening parenthesis. You must use a closing parenthesis to enclose the function arguments.

Using Trace Functions in Trace Expressions

Trace functions operate on arguments which are usually channels or trace expressions. The function is applied to each individual sample of the trace. The trace that is displayed is built from the function being applied to each sample.

Table 3-13: Trace Functions

Function	Trace Functions
Abs(...)	The absolute value of the argument trace.
Avg(...)	The average of several trace record acquisitions of the argument. The number of records acquired is controlled by the knobs after touching the Avg N selector in the Acquire Desc pop-up menu.
NOTE	
<i>Average and envelope can be applied to a trace that is already defined and being displayed. See Averaging and Enveloping, on page 3-13</i>	
Diff(...)	The differential of the argument.
Env(...)	The limit of excursion of several trace record acquisitions of the argument. The number of records acquired is controlled by the knobs after touching the Env N selector in the Acquire Desc pop-up menu.
Exp(...)	The natural antilog of the argument.
FFTmag (...)	The magnitude of the frequency spectrum of the selected trace.
FFTphase (...)	The phase of the frequency spectrum of the selected trace.
Filter(...)	Applies the Smooth function to a trace two times. Like Smooth , Filter has two arguments. The first argument is the trace to be filtered; the second argument is a rise time. Each time Filter is evaluated, the record length, time per division, and the specified rise time are used to calculate the number of dots to be used in the smoothing algorithm. Filtering may be centered or shifted. A centered filter is non-causal and uses an average that is centered on each point. A shifted filter causal and forms the average for each point based only on preceding points. The filter mode is set in the Instrument Options pop-up menu.
Intg(...)	The integral of the argument.
Ln(...)	The natural logarithm of the argument.
Log(...)	The base 10 logarithm of the argument.
Signum(...)	The sign of the argument. Signum returns 1 if an argument is greater than zero and -1 if less than zero.

Table 3-13: Trace Functions (Cont.)

Function	Trace Functions
Sqrt(...)	The square root of the argument.
Smooth(...)	A moving average of a trace. This function has two arguments, separated by a comma (,). The first argument is the trace to be smoothed; the second argument is the number of samples in the moving average. If the second argument is 9, then 4 samples before each point and 4 samples after each point are averaged with the point value. If the second argument is an even number, one is added to it to make it odd. Smooth(can be applied to stored traces or a single channel live trace.

NOTE

Stored traces are described on page 3-183.

Defining Traces Using the Sampling Head Channel Button

A short-cut method of defining traces is available. When you want to define a trace that represents a single sampling head channel, you can press the **SELECT CHANNEL** button on the sampling head. There are two limitations to this method:

- The channel must not be displayed as part of any other trace being displayed. If the yellow channel light is on, either steady or blinking, this method of defining a trace cannot be used.
- The trace expression will consist only of this channel. You cannot use this method to enter complex trace expressions.

Trace Numbers

When you define a new trace, the 11801B assigns it a trace number. Trace numbers range from 1 through 8. New traces are assigned the lowest available number. Once a number is assigned to a trace, the number does not change.

Selecting Traces

When you define a new trace, it is highlighted (bright intensity) on the display. This indicates that it is the selected trace. When multiple traces are displayed, there is always one selected trace. The graticule labels and axes match the color of the selected trace.

The selectors, knobs, and buttons operate on the selected trace. The graticule axis labels show the vertical and horizontal size and position of the selected trace. Selectors that show trace status, such as the **Vertical Desc** and **Horizontal Desc** selectors in the Waveform major menu, show the status of the selected trace. When you use the ↔ and ↓ icons to assign the knobs to horizontal or vertical size and position, the knobs affect the selected trace.

When you have more than one trace on the display, you can select and highlight any trace. There are three methods that you can use to select a trace; touch the trace on the display or on its displayed label, use the All Trace Status major menu, or use the sampling head **SELECT CHANNEL** button.

Selecting Traces by Touch

The fastest way to select a trace is to touch it on the display or on its displayed label. When you touch the graticule area of the display, a box is displayed that shows the boundaries of your touch. If a single trace passes through the boxed area when you remove your finger, that trace will become the selected trace. The touch box disappears when you withdraw your finger and select a trace.

You can drag your finger across the display to change the position of the box before you remove your finger to select the trace.

If several traces pass through the area indicated by the touch box, one becomes the selected trace when you remove your finger. Touching the same area repeatedly will select different traces. You can select traces by touching the same spot on the display repeatedly, until the trace you want is selected.

Selecting Traces Using the Trace Status Menu

You can see the status of all displayed traces at once by using the Trace Status menu. You are shown the trace number, the first part of the trace expression, the time base, and the vertical and horizontal size per division.

To view this information, touch the **More...** selector in the Waveform major menu. The entire Waveform major menu is replaced by the Trace Status major menu, though the light beside the **WAVEFORM** button remains lighted.

This menu shows one selector for each displayed trace. You can select any trace by touching its selector. The selector for the selected trace is always highlighted. The **Return to Single Trace** selector restores the regular Waveform major menu. See Figure 3-102.

1: M1	200mV	500ns	
Main	200mV	500ns	
			Single Trace

Figure 3-102: The Trace Status Menu

Selecting Traces Using the Sampling Head Channel Button

You may want to select a trace that displays a specific sampling head channel. If that sampling head channel is not already part of the selected trace, you can press the **Select Channel** button on the sampling head.

You can look at the channel light on the sampling head to determine if that channel is part of the selected trace. If the light is on and blinking, then the channel is part of the selected trace, and pressing the channel button will remove the selected trace. If the light is on and not blinking, that indicates that the channel is displayed but is not part of the selected trace. Pressing the channel button will select a trace that contains that channel.

Modifying Traces

You can change the trace expression of the selected trace. When you touch the **Vertical Desc** selector in the Waveform major menu, the **Vertical Desc** pop-up menu is displayed.

This menu is identical to the pop-up menu that is displayed when you touch the **DefTra** icon. When you display the **Vertical Desc** pop-up menu, the trace expression of the selected trace appears at the top of the pop-up menu. You can use the **Back Space** selector to alter the trace, or you can extend the trace expression. When you touch the **Enter Desc** selector, the new trace expression is applied to the selected trace.

Removing Traces

You can remove traces from the display in three different ways: using the **Remove** selector in the **Remove/Clr** pop-up menu, using the **Select Channel** button on the sampling head, or using the **Delete Trace** selector in the Store/Recall menu.

Removing Traces Using the Remove Selector

The **Remove** selector in the **Remove/Clr** pop-up menu always shows the number, the trace expression, and the time base of the selected trace. The **Remove/Clr** selector menu is displayed at all times, and so the **Remove** selector is available regardless of which major menu is displayed.

As shown in Figure 3-103, when you touch the **Remove/Clr** selector, a small pop-up menu appears allowing you to remove or clear the selected trace. Removing a trace turns off the selected channel and causes the trace to disappear. Clearing a trace affects averaged, enveloped, color graded, variable persistence and infinite persistence waveforms. Touching Clear causes the selected function to start over, removing all current waveform data. The selected waveform remains on-screen; its description is unaltered.

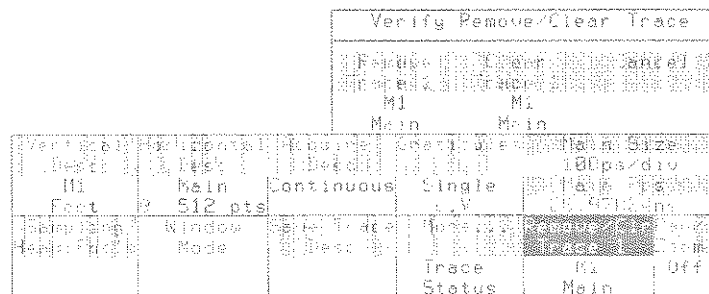

Figure 3-103: The Remove Selector in the Remove/Clr Pop-Up Menu

Removing Traces Using the Sampling Head Channel Button

You can use the **Select Channel** button on the sampling head to remove all traces displaying that channel as part of their trace expression.

When a sampling head channel is incorporated as part of the selected trace, the yellow channel light on the sampling head is on and blinking. If you press the channel button on the sampling head when the light is blinking, *all* traces displaying that channel are removed.

Removing Traces Using the Store/Recall Delete Trace Selector

You can delete displayed traces by using the **Delete Traces** pop-up menu in the Store/Recall major menu. This pop-up menu may also be used to delete displayed traces.

In the **Delete Traces** pop-up menu, touch the selectors for the displayed and stored traces you want to delete. The traces are not deleted until you touch the **Delete Selected Traces** selector. You may select several traces to be deleted before touching the **Delete Selected Traces** selector. As you select traces to delete, their selectors highlight to tell you they will be deleted. If you touch a trace selector by accident, touch it again to remove the highlighting. If you want to delete all the displayed and stored traces, touch the **All Traces** selector.

Trace Scaling

When you define a new trace, it is defined as either a fast trace or a high precision trace. Fast traces are computed with integer arithmetic, and operate significantly faster than high precision traces. High precision traces use floating-point arithmetic to provide highest precision.

Normally, the trace is defined to be fast unless some part of the trace expression forces high precision. Floating-point functions such as **Diff** and **Log** will force the trace to be defined as high precision.

You can force complex traces to be defined as high precision traces by using the **Instrument Options** pop-up menu in the Utility1 major menu. In this pop-up menu, the **Trace Scaling** selector can be set to **Optional** or **Forced**. When set to optional, new traces are defined as fast traces if they can be implemented as fast traces. When set to forced, new complex traces are defined as high precision traces. Single-channel traces without waveform math are always acquired in Fast mode. See Figure 3-104.

Once a trace is defined, its trace scaling cannot be changed. The setting of the **Trace Scaling** selector affects only the definition of new traces.

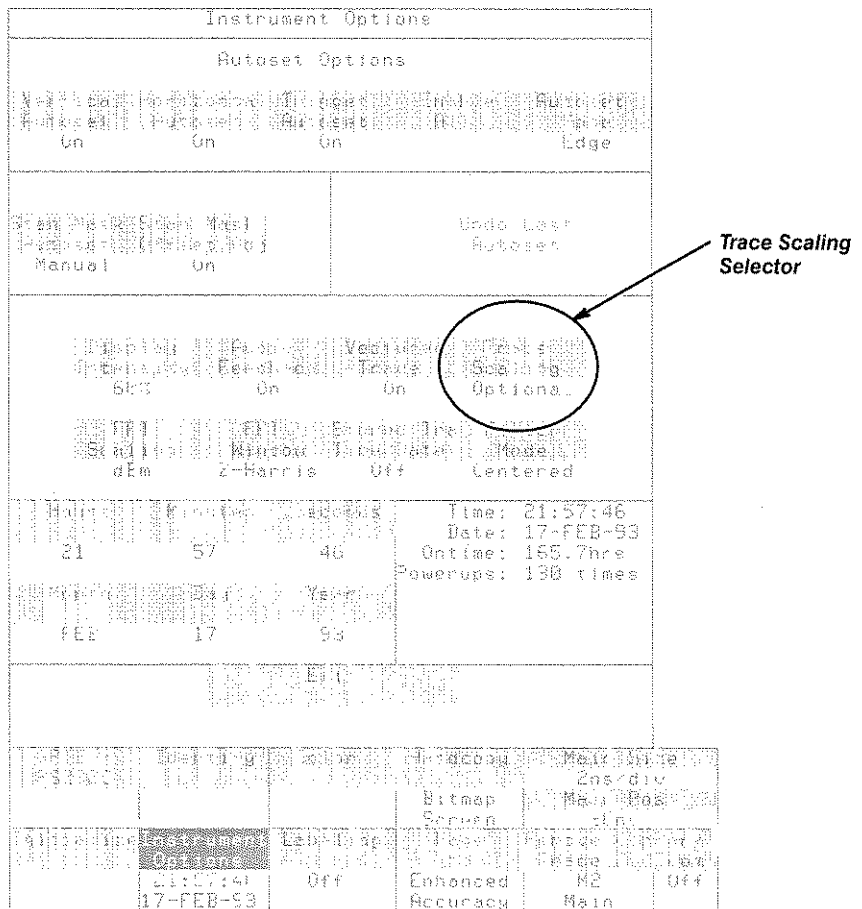

Figure 3-104: The Instrument Options Pop-up Menu

Triggering

A trigger is an electrical event that initiates acquisition of a trace. The event that triggers acquisition is when the trigger *source*, the signal being monitored by the trigger circuits, passes through a specified voltage *level* in the specified direction (the trigger *slope*).

Until a trigger event takes place, a newly defined trace will not appear on the display. If triggering of an acquired trace stops, the last trace record is left “frozen” on the display. The trigger status is shown to the left of the graticule as either **trig’d** or **!not! trig’d**.

The trigger source can be the internal clock or a signal that you apply to the **TRIGGER INPUT** connector on the 11801B front panel. The trigger input can be up to 3.0 GHz. You can connect the signal being sampled to the **TRIGGER INPUT** connector using a signal splitter or power divider, so that the sampled signal is also the trigger signal. Whatever signal you use as the trigger source, it should be synchronized with the signal you are sampling and displaying. However, you can only view the trigger event if it precedes the observed event by at least 23 ns (45.5 ns for Option 1M).

NOTE

*When you use an external trigger source, the 11801B may not be supplied with triggers. To restore operation, supply a trigger signal to the external **TRIGGER INPUT**, or select the Auto mode.*

You can also set the coupling of the external trigger to DC, which passes the unaltered trigger signal to the trigger circuits, or AC, which removes the DC component of the trigger signal. AC coupling is useful when the signal you want to trigger on is a small AC signal with a large DC bias. This is helpful in cases where the DC bias is large enough to cause the trigger signal to be out of range.

You can set the trigger mode to auto mode, which will produce an internal trigger in the absence of other trigger events on the trigger signal.

You can assign the knobs to set the trigger level of the selected trace by touching the ∇ icon to the left of each graticule. Use the Trigger major menu to access all other trigger controls. See Figure 3-105. The selectors in this menu are:

NOTE

Use the trigger icon (∇) to assign the knobs to set the trigger level.

- **Source** — displays a pop-up menu that lets you select the signal that the 11801B monitors for the trigger event. The **External Direct** source is the **TRIGGER INPUT** connector on the 11801B front panel. The **Internal Clock** source is synchronized with the **CALIBRATOR** output on the 11801B front panel.

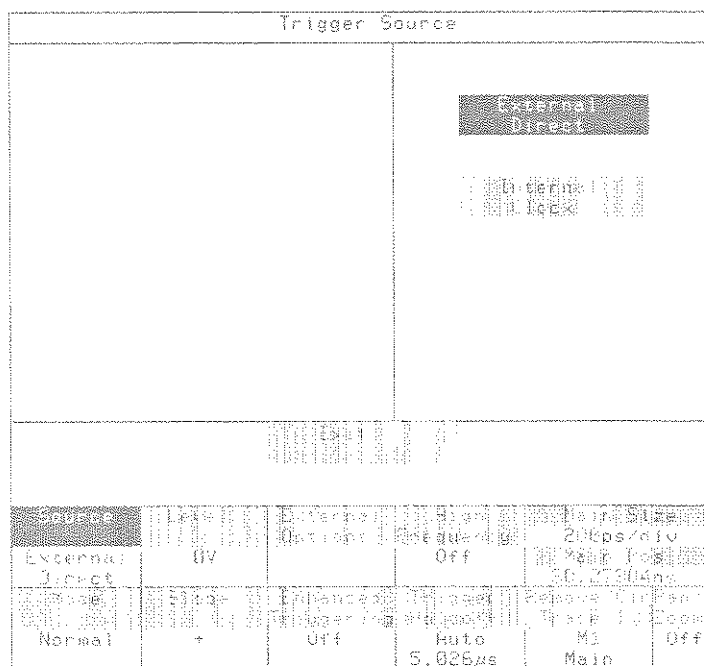

Figure 3-105: The Trigger Major Menu and Source Pop-up Menu

- **Level** — assigns the knobs to set the trigger level. Touching this selector is the same as touching the ∇ icon to the left of the graticule.
- **Mode** — selects between **Normal** mode and **Auto** mode. Auto mode supplies unsynchronized trigger events in the absence of trigger events on the trigger signal.
- **Slope** — selects between + (a rising slope trigger event) and - (a falling slope trigger event).

- External Options** — displays a pop-up menu that allows you to select the external attenuation and external coupling. See Figure 3-106. **External Attenuation** changes the external trigger source range. When set to **X1**, the trigger level range is from -1 V to $+1$ V. When set to **X10**, the trigger level range is from -10 V to $+10$ V. **External Coupling** selects between **AC** or **DC** coupling of the external trigger signal. AC coupling removes any DC component from the trigger signal.

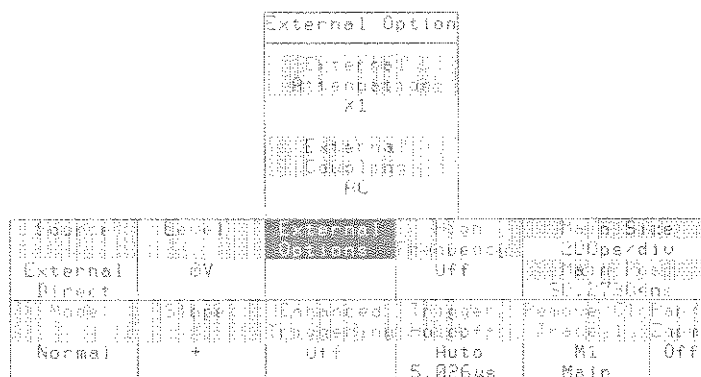

Figure 3-106: The Trigger Major Menu and the External Option Pop-up Menu

- Enhanced Triggering** — controls the state of the metastable trigger reject in the **Trigger Input** trigger path. **Enhanced Triggering On** causes the timebase to detect trigger events that are metastable and to reject the acquired data. The point is re-acquired on the next trigger event. **Enhanced Triggering Off** allows metastable trigger events to be displayed. Touching the **Enhanced Triggering** icon toggles the setting between **On** and **Off**.
- High Frequency** — controls the state of the trigger hysteresis in the **Direct** trigger paths. **High Frequency On** removes trigger hysteresis and improves sensitivity, but should be used only when the trigger signal edge has a slew rate of 1 V/ns or greater. This corresponds to a 320 mV_{p-p} sinusoid at 1 GHz. **High Frequency Off** retains trigger hysteresis and improves noise rejection at low frequency. Generally, it should always be used below 1 V/ns slew rate, or a 320 mV_{p-p} sinusoid at 1 GHz. It can be used at all frequencies if there is sufficient trigger signal amplitude to reliably trigger the oscilloscope. Touching the **High Frequency** icon toggles the setting between **On** and **Off**.

- Trigger Holdoff** — displays a pop-up menu that allows you to select auto or manual holdoff mode. See Figure 3-107. For **Auto** mode, the trigger holdoff is automatically programmed to the minimum possible holdoff value, shown under **Actual Holdoff**. This value is slightly beyond the rightmost point acquired in the Main record. For **Manual** mode, you can select a trigger holdoff under **Requested Holdoff** to extend the trigger holdoff to periods longer than the auto mode minimum value, up to 2.5 seconds. Touching the Holdoff Mode toggles the setting between Auto and Manual modes.

In **Auto** holdoff mode, the **Actual Holdoff** setting for the trigger ignores **Requested Holdoff** and depends only on the timebase settings. **Actual Holdoff** is updated when the assigned values for **Main Size** and **Main Position** change, in order to hold off retriggering to a point beyond the rightmost point acquired in the Main record. The minimum value for **Actual Holdoff** is 5 μ s.

In **Manual** holdoff mode, the **Actual Holdoff** setting for the trigger takes into account the value of **Requested Holdoff** in addition to the timebase settings. The result is always a longer **Actual Holdoff** in manual mode than in auto mode. The value of **Requested Holdoff** must be between 5 μ s and 2.5 seconds. Touching **Requested Holdoff** allows you to enter a new value for requested holdoff.

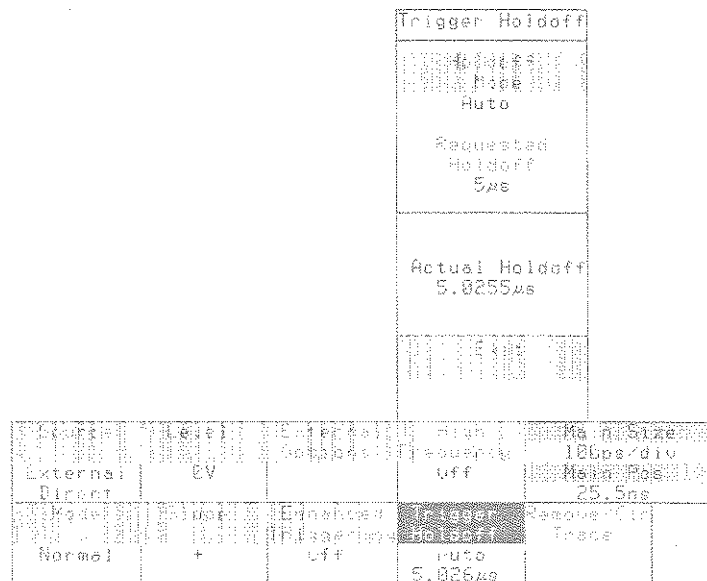

Figure 3-107: The Trigger Major Menu and the Trigger Holdoff Pop-up Menu

Vectored Traces

Vectored traces is a display mode that enhances the appearance of displayed traces by eliminating any gaps or discontinuities. See Figure 3-108.

The trace display area is 512 pixels (dots) wide. When a trace with a record length of 512 samples is displayed, each sample has its own unique horizontal position on the display. When traces with record lengths longer than 512 samples are displayed, two or more samples must share the same horizontal location. For a trace of 5120 samples, each horizontal place shows the results of ten samples.

When more than one sample shares the same horizontal location, the resulting display is always a series of vertical lines, called columns, that extend from the top sample to the bottom sample.

The 11801B normally extends the columns to “touch” adjacent columns, so that no gaps are shown in the trace. You can turn off this trace vectoring so that no intermediate data is assumed for display purposes.

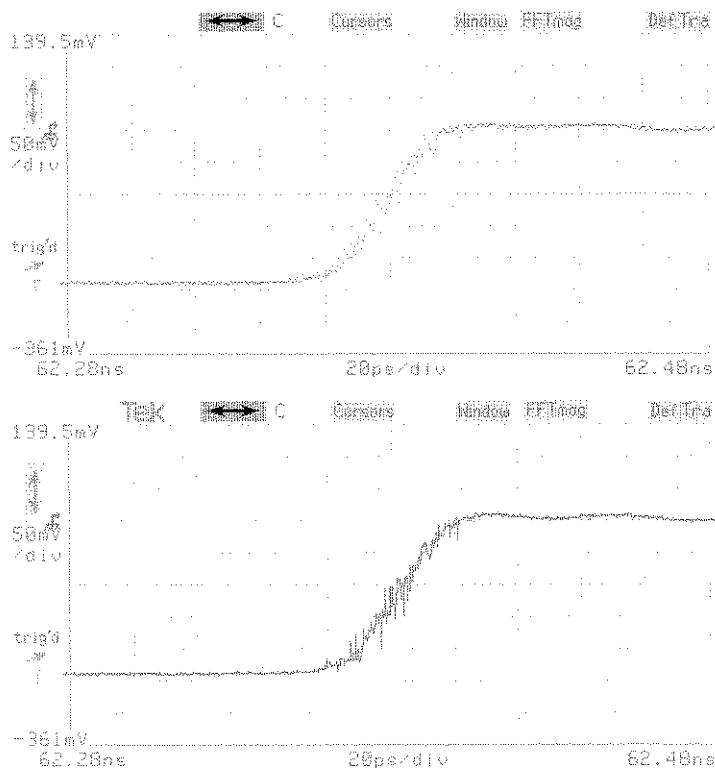

Figure 3-108: Identical 512-Point Traces without Trace Vectoring (top) and with Trace Vectoring (bottom)

Trace vectoring makes the biggest difference in the appearance of a trace with 512 samples. As the record length of a trace increases, the visual enhancement of trace vectoring becomes less evident.

When you display a 512-sample trace, with trace vectoring turned off, the individual samples of the trace show as dots. When you display a trace of more than 512 samples, you can use horizontal magnification to achieve the same effect by displaying any 512-sample portion of the trace. For information about horizontal magnification, see Pan/Zoom on page 3-107.

You turn trace vectoring on or off using the **Instrument Options** pop-up menu in the Utility1 major menu. Touch the **Vectored Trace** selector to set it to **Off** or **On**. See Figure 3-109.

Trace vectoring can also be turned on or off in the **Persist/Histograms** pop-up menu in the Display Modes major menu.

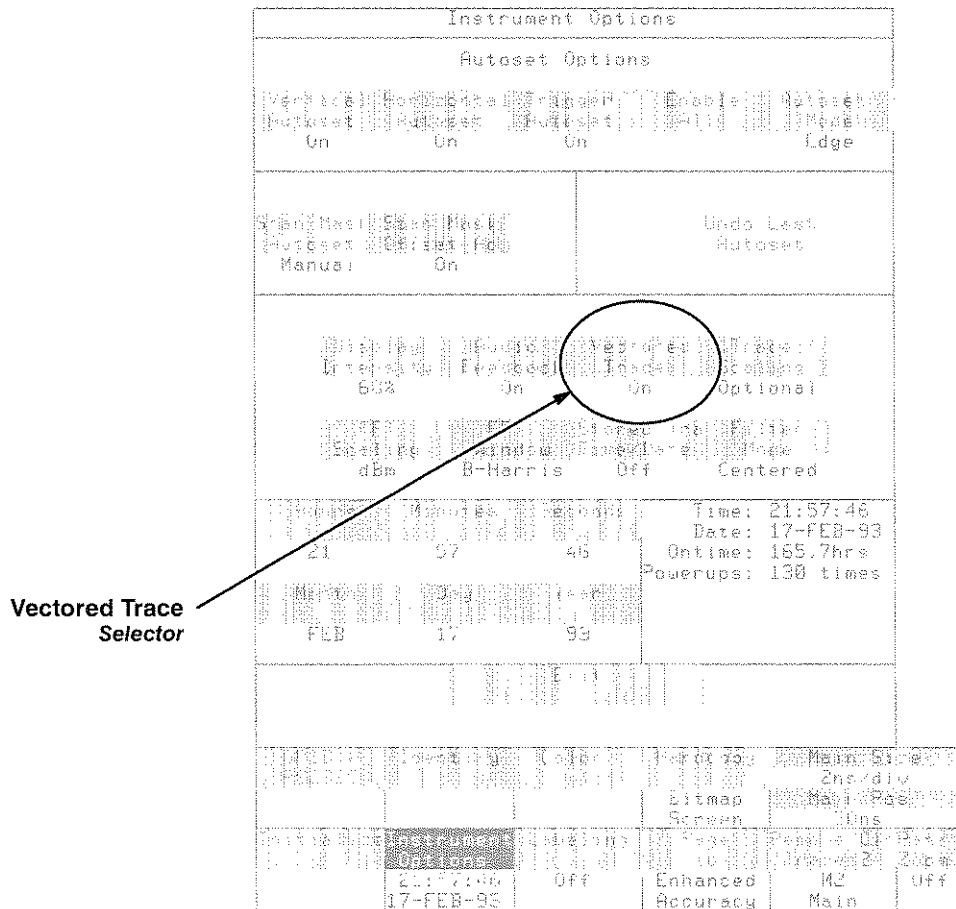

Figure 3-109: The Instrument Options Pop-up Menu

Setting Vertical Size and Offset

You can change the vertical magnification, or size, of a trace. You can also move the trace up or down on the display. This is called adjusting the vertical *offset*. To do either, touch the vertical (\updownarrow) icon; this assigns the knobs to adjust the vertical size (top knob) and offset (bottom knob) of a channel of the selected trace.

If you want to change the size or offset of a different trace, touch the desired trace to select it. Then use the knobs to adjust vertical size and offset.

NOTE

Touch a knob label to display the keypad pop-up menu. This lets you set vertical size and offset numerically, or quickly set them to maximum or minimum limits. It also lets you set the knob resolution.

Adjusting Channels and Adjusting Traces

When you adjust the vertical size or offset of a trace acquired in Fast mode, you are adjusting the size or offset of one of the channels that is in the trace expression. If the trace you are adjusting has the trace expression **M1+M2**, you can adjust the vertical size of only one channel at a time. This has the following side effects:

- Changing the channel size or offset for this trace changes the channel size or offset for all the other traces that display that channel.
- If the trace you are adjusting has more than one channel in its trace expression, changing the vertical size of one channel does not change the size of the other channels. If the vertical scale factors of all the channels in a trace do not match, the vertical size of the trace is undefined.

For example, in the case of the trace **M1+M2**, if M1 has a vertical size of 50 mV/div and M2 has a vertical size of 100 mV/div, the trace will have undefined vertical units.

You can select which channel of the trace you want to adjust with the knobs. Whenever the \updownarrow icon is highlighted, the lower right corner of the display shows the **Chan Sel** selector. This selector always shows which channel the knobs are set to adjust. You can touch this selector until it shows the channel you want to adjust with the knobs.

Adjusting High Precision Traces

High precision traces use floating-point arithmetic in their calculation. When the selected trace is a high precision trace, you will see **High Prec** in the bottom line of the **Vertical Desc** selector in the Waveform major menu.

You can adjust the vertical size and offset of high precision traces, without adjusting a channel.

NOTE

See Trace Scaling on page 3-214 for a description of high precision traces.

When you adjust the vertical controls of a high precision trace, the **Chan Sel** selector at the lower right of the display can be used to specify the individual channel to adjust, and to specify the **Calcd Tra**, or calculated trace. When you specify that you want to adjust the calculated trace, the knobs adjust the size and offset of the trace without changing the vertical size and offset of other traces displaying that channel.

Trace Separation

When you adjust the vertical size and offset of a trace on a window time base, the **Chan Sel** selector at the lower right of the display can be used to specify the individual channel to adjust, and to specify **Trace Sep**, or trace separation. This vertical offset control lets you move a window trace up or down, to visually separate it from other window traces or the main time base trace.



Windows

A window trace is a trace that represents a portion of another trace that is magnified horizontally. A window trace is sampled separately from the main trace it is magnifying.

Windows are created by touching the **Window** icon above the graticule. When you touch the **Window** icon, the 11801B creates a second graticule to show the window trace. The portion of the main trace that is windowed is highlighted. The display in Figure 3-111 is the result of touching the **Window** icon when the top trace was displayed alone on a single-graticule display.

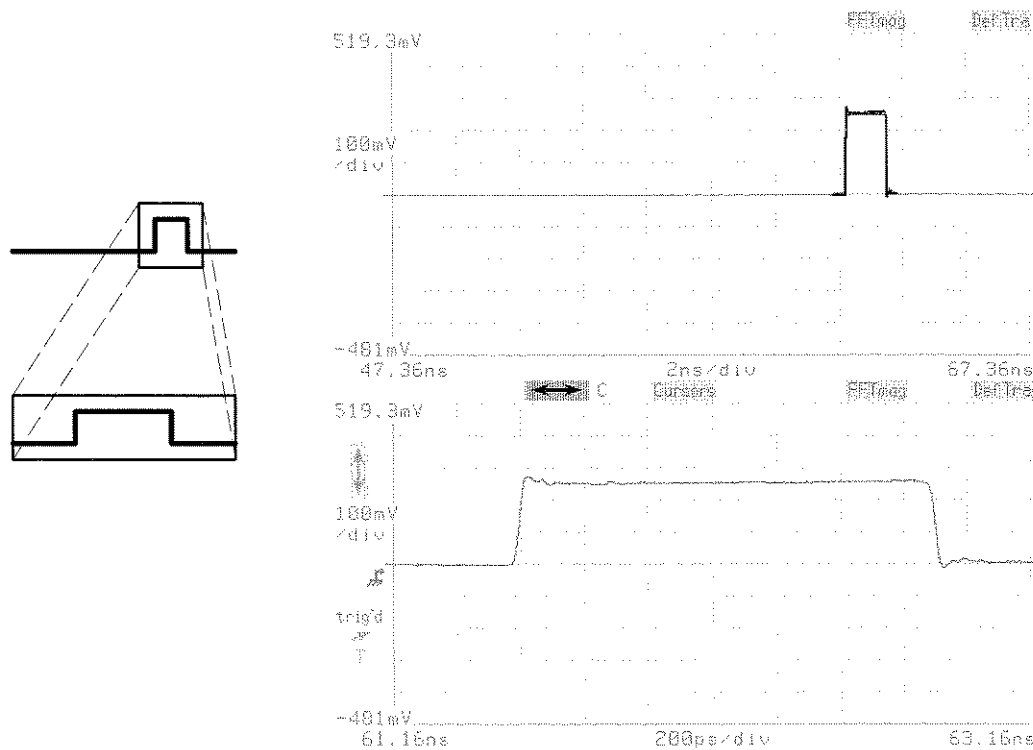

Figure 3-111: A Window Trace Display

The window trace has the same trace expression as the main trace. The difference between the two is the time base that each uses; the main trace uses the main time base, while the window traces uses a window time base. The **Horizontal Desc** selector in the Waveform major menu always shows the time base of the selected trace.

A window trace is independent of the main trace. Once a window trace is established, you can remove the main trace or move the window trace from graticule to graticule.

You can create more than one window trace from a single main trace. You cannot create a window trace of a window trace.

If you remove all windows, the display automatically returns to a single graticule display.

Changing Window Size and Position

You can change the size and position of a window trace just as you do with any main trace. Touch the \leftrightarrow or \updownarrow icons to assign the knobs to horizontal size and position or vertical size and offset. Complete information about horizontal size and position is on page 3-105 and vertical size and offset is on page 3-221.

NOTE

All window traces are the same horizontal size. If you change horizontal size on one window trace, you change horizontal size on all window traces.

All main traces share the same time base, and so all have the same horizontal size and position. Each window trace has its own time base, and so each can have a different horizontal position. However, all window time bases have the same horizontal size.

As you change the horizontal size or position of a window trace, the highlighted portion of the main trace changes size and position. This allows you to always see the portion of the main trace that the window trace is magnifying. (In display modes other than Normal, the main trace will not show a highlighted region).

Trace Separation

When you use the \updownarrow icon to offset any trace, the **Chan Sel** selector in the lower right corner of the screen can be used to select which channel you want to size or offset. Touch the **Chan Sel** selector until it shows the channel you want.

When you use the \updownarrow icon to offset a window trace, the **Chan Sel** selector can be used to select **Trace Sep**. When you set the **Chan Sel** selector to **Trace Sep**, the vertical offset knob moves the selected trace up or down without moving other traces that show the same channels as the selected trace. This lets you visually separate the selected window trace from other window or main traces that may overlap it.

Positioning Window Traces Automatically

The 11801B can position your window traces automatically based on an electrical event that occurs on the main trace. This triggers the window trace in a manner similar to triggering of the main trace. Automatic window positioning can only be used on traces that do not use arithmetic operators or trace functions.

NOTE

The limitations on window complexity when automatic positioning is used are identical to the complexity limitations on hardware measurements.

You initiate and control automatic window positioning using the **Window Mode** pop-up menu in the Waveform major menu. Touch the **Position Mode** selector in this pop-up menu to set the positioning mode to **Automatic** or to **Manual**. See Figure 3-112.

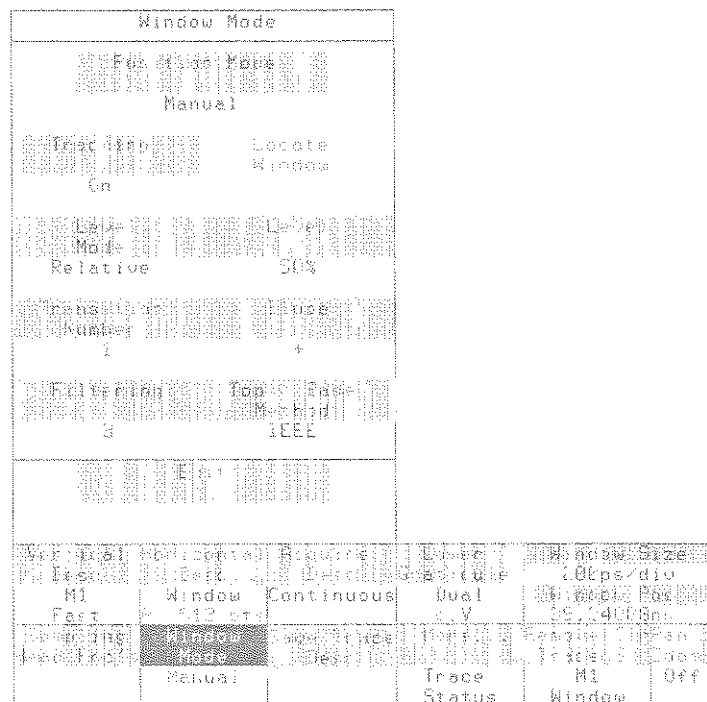

Figure 3-112: The Window Mode Pop-up Menu

The electrical event that triggers the automatic window position is the point at which the main trace passes through a specified voltage *level* in the specified direction (the *slope*) the specified number of times (the *transition number*).

You can specify the voltage level in volts (absolute) or as a percentage of the baseline-to-topline voltage of the trace (relative).

The selectors of the **Window Mode** pop-up menu let you control the window positioning in the following ways:

- **Position Mode** — can be set to **Manual** (you position the window with the knobs) or **Automatic** (the 11801B positions the window based on an electrical event on the main trace).

Automatic window positioning has a resolution equal to one Main record sample interval. If the Main record sample interval is large compared to the window size, the position may appear to “jump.” In most cases, this will not affect the accuracy of measurements because the 11801B automatically compensates for the change in position.

- **Transition Number** — assigns a knob to specify the number of times the electrical event must occur before the window trace is positioned. This affects only an automatic window with tracking on, or an automatic window when locate window is performed.
- **Slope** — selects between + (a rising slope transition event) or – (a falling slope transition event).
- **Filtering** — assigns a knob to set the number of successive trace samples that must cross the transition level before the transition is counted as valid. Noisy signals will be affected most by filtering. This affects only an automatic window with tracking on, or an automatic window when locate window is performed.
- **Level Mode** — selects between **Absolute** (you specify the transition level in terms of volts) or **Relative** (you specify the transition level in terms of percentage of baseline-to-topline height of the trace).
- **Level** — assigns a knob to set the transition voltage level in the mode determined by the **Level Mode** selector.
- **Tracking** — This affects only an automatic window with tracking on, or an automatic window when locate window is performed. Three types of tracking are available:
 - Relative tracking** — Baseline and topline are recalculated and used to calculate an absolute level. Window position is then found using that absolute level.
 - Absolute tracking** — Absolute level used to find window position.
 - No tracking (either)** — No position change until **Locate Window** is selected. A Relative tracking or Absolute tracking measurement is performed once each time **Locate Window** is selected.
- **Locate Window** — meaningful only when **Position Mode** is **Automatic** and **Tracking** is **Off**, tells the 11801B to position the window trace.

- **Top/Base Method** — allows you to select the method of determining the topline and baseline. You can choose between the standard IEEE method (histograms) or an alternate method that smooths and differentiates the waveform data before calculating topline and baseline. The alternate method works better than the IEEE method for ramps, triangular or irregular square waves.

The **Top/Base Method** parameter affects all window traces. It also affects how automatic measurements are performed on all traces. You can also change this parameter from the **Measurements** pop-up menu in the Measure major menu.



XY Traces

Most traces show a signal voltage (the vertical axis) as it varies over time (the horizontal axis). You can display a trace that shows how two traces compare with each other, independent of time. Such an XY trace shows the signal voltage of one trace on one axis against the signal voltage of the other trace on the other axis. See Figure 3-113.

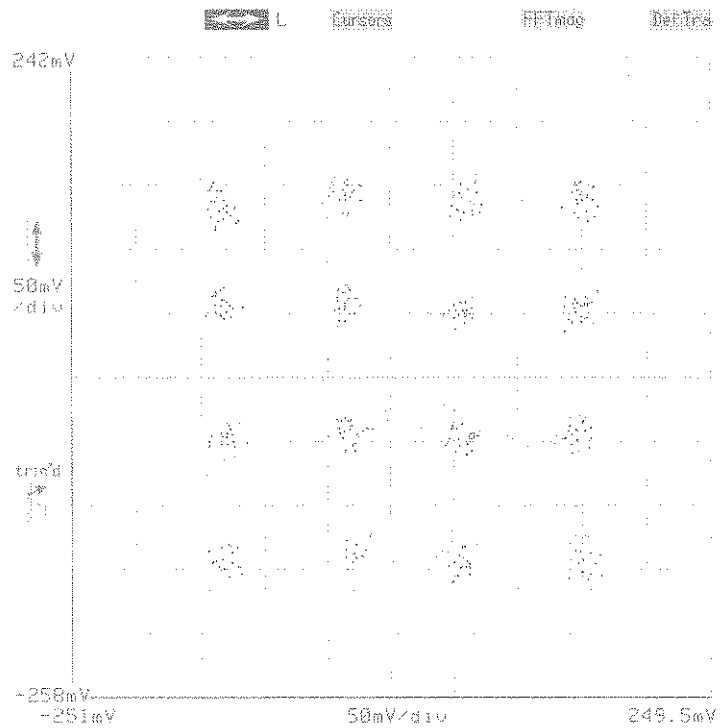

Figure 3-113: An XY Trace

NOTE

You can have only one XY trace. You cannot take measurements of XY traces. This XY trace is a constellation diagram. Constellation diagrams are discussed on page 3-25.

When an XY trace is displayed, the axis units cannot be changed from volts on either axis.

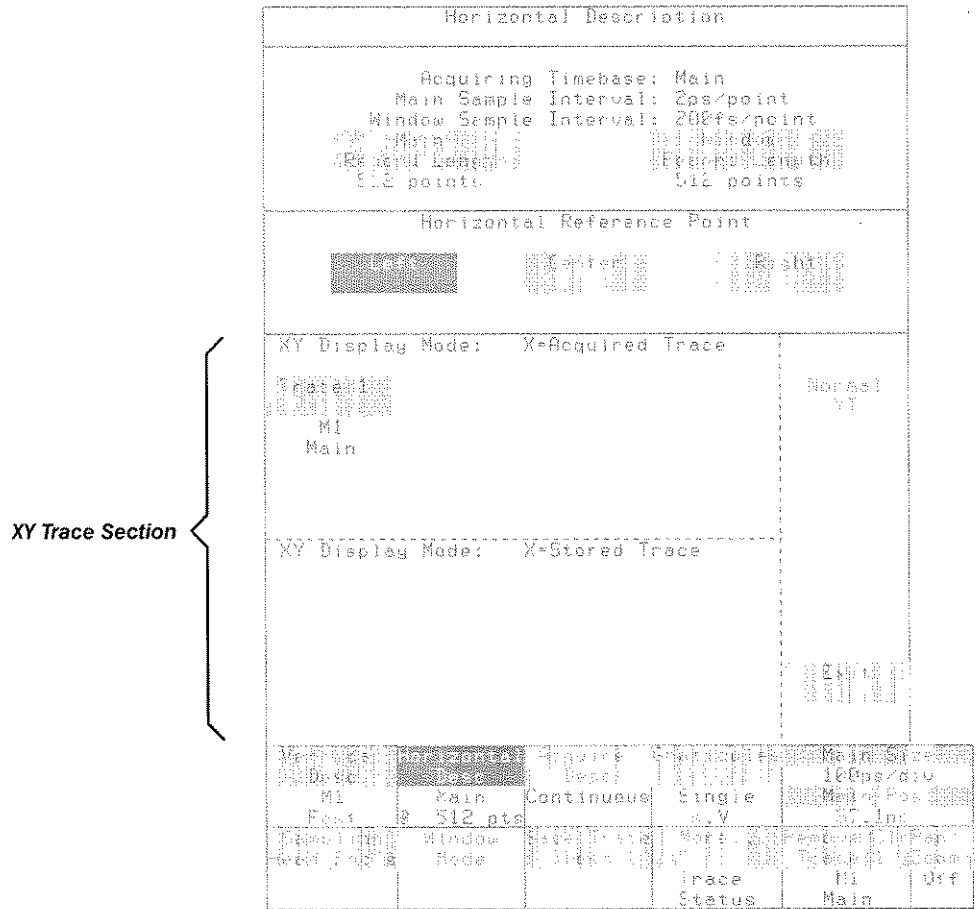

Figure 3-114: The Horizontal Desc Pop-up Menu

You initiate and control XY traces using the **Horizontal Desc** pop-up menu in the Waveform major menu. See Figure 3-114. Two sections of the menu are titled **XY Display Mode**, one for displayed traces and one for stored traces.

Use the following sequence to create XY traces:

- Step 1:** Define a trace that shows the information you want on the X axis (the horizontal axis). This trace may be a displayed trace or a stored trace.
- Step 2:** Define and display a trace with the information you want on the Y axis (the vertical axis).
- Step 3:** Select the trace that displays the Y-axis information.
- Step 4:** Press the **WAVEFORM** major menu button, and touch the **Horizontal Desc** selector to display the pop-up menu.

- **Step 5:** Touch the selector in the **Horizontal Desc** pop-up menu that represents the trace showing the X-axis information. If the X-axis trace is a displayed trace, it will appear in the section titled **XY Display Mode: X=Acquired Trace**. If the X-axis trace is a stored trace, it will appear in the section titled **XY Display Mode: X=Stored Trace**.

When you touch the X-axis trace selector in the **Horizontal Desc** pop-up menu, the trace is immediately converted into an XY trace on the display.

If the trace defining the X-axis information is a displayed trace, this process will leave two traces on the display; the XY trace and the X-axis information trace. Once the XY trace is established, you can remove the trace displaying the X-axis information.

To restore an XY trace to normal YT mode, select the XY trace and touch the **Normal YT** selector in the **Horizontal Desc** pop-up menu.

Constellation diagrams are a common application of XY traces. See Constellation Diagrams, on page 3-25, for more details.



Appendix A: Accessories

Standard Accessories

The 11801B instrument package includes the following standard accessories:

- *11801B User Manual* (this manual).
- *CSA 803A and 11801B Programmer Manual*, Tektronix part number 070–8784–01.
- *11801B Service Manual*, Tektronix part number 070–8781–00.
- Power Cord (North American 120 V), Tektronix part number 161–0066–00.
- One-foot SMA interconnecting cable, Tektronix part number 174–1364–00.
- Antistatic wrist strap, Tektronix part number 006–3415–04.

To obtain replacements, refer to a Tektronix products catalog or contact your local Tektronix field representative.

Optional Accessories

The following optional accessories have been selected from our catalog specifically for the 11801B. For detailed information and prices, see a Tektronix products catalog or contact your local Tektronix field representative.

- Option 1M, provides interface to SM-11 Multi-Channel Units.
- Option 1R Rack Mount, converts the 11801B for rack mounting.
- Option 1T, provides 38 predefined telecommunication masks conforming to ANSI SONET/CCITT Optical Standards, CCITT G.703 Electrical Standards, and ANSI T1.102 Electrical Standards.
- GPIB cable, two meter, Tektronix part number 012–0991–00.
- RS-232-C cable, ten foot, Tektronix part number 012–0911–00.
- Ten-foot Centronics printer cable, Tektronix part number 012–0555–00.
- Sampling head extender cable, one-meter, Tektronix part number 012–1220–00.
- Sampling head extender cable, two-meter, Tektronix part number 012–1221–00.
- Sampling head panel, blank, Tektronix part number 200–3395–00.

- Acquisition extender, Tektronix part number 067–1323–00.
- Acquisition System extender, Tektronix part number 067–1324–00.
- Calibration pulser, Tektronix part number 067–1338–00.
- Hardcopy unit: Epson-compatible Dot Matrix Printer, Tektronix 4697.
- Tektronix SCOPE-MOBILE cart, Model 205.
- Calibration Head, Tektronix part number 067–1413–00.

Power Cord Options

The following power cords are available for the 11801B.

- Option A1 Universal European 220 V/6A, 50 Hz, Tektronix part number 161–0066–09.
- Option A2 United Kingdom 240 V/6A, 50 Hz, Tektronix part number 161–0066–10.
- Option A3 Australian, 240V/6A, 50 Hz, Tektronix part number 161–0066–11.
- Option A4 North American 250 V/10A, 60 Hz, Tektronix part number 161–0066–12.
- Option A5 Switzerland, 240 V/6A, 50 Hz, Tektronix part number 161–0154–00.

Appendix B: Specifications

The 11801B electrical characteristics apply to the following conditions:

- The instrument has had a 20-minute warm-up period.
- The instrument is operating in an environment that meets the limits described in Environmental Specifications in this section.

The specifications in Tables B-1 through B-7 apply to the 11801B Digital Sampling Oscilloscope, only. See Tables B-8 through B-14 for specifications for the 11801A.

Table B-1: 11801B Vertical System Specifications

Characteristic	Specification
Input sources	
Mainframe	4 sampling heads, 8 channels
Option 1M, with 4 SM-11 Multi-Channel Units	68 sampling heads, 136 channels
Bandwidth	Dependent on sampling head
Risetime	Dependent on sampling head
Amplifier gain accuracy	$\pm 1\%$ of full-scale range
Vertical resolution	
Trace data	8 bits
Hardware measurements	14 bits
Input sensitivity	2 mV/div to 255 mV/div in 1 mV/div steps
Offset accuracy	± 2 mV
Offset range	± 2 V
Offset resolution	0.25 mV
Measurement level accuracy	± 2 mV
Vertical acquisition resolution	
Single graticule	25 points/div
Dual graticule	25 points/div

Table B-1: 11801B Vertical System Specifications (Cont.)

Characteristic	Specification
Vertical display resolution	
Single graticule	50 pixels/div
Dual graticule	25 pixels/div

Table B-2: 11801B Time Base Specifications

Characteristic	Specification
Internal reference clock	Crystal-controlled oscillator
Sample rate	200 kHz maximum
Record length	User selectable, 512, 1024, 2048, 4096, or 5120 points.
Sweep rate resolution	1–2–5 steps or 1 ps/div increments
Record duration	10 ps to 50 ms
Maximum sweep rate	
512-point record	1 ps/div
1024-point record	1 ps/div
2048-point record	2 ps/div
4096-point record	5 ps/div
5120-point record	5 ps/div
Time interval measurement accuracy	$8 \text{ ps} + 0.01\% \times (\text{interval}) + 0.001\% \times (\text{position})$, guaranteed; $4 \text{ ps} + 0.004\% \times (\text{interval}) + 0.0004\% \times (\text{position})$, typical, where interval $\geq 1 \text{ ns}$; $2.5 \text{ ps} + 0.0004\% \times (\text{position})$, typical, where interval = 100 ps; $1 \text{ ps} + 0.0004\% \times (\text{position})$, typical, where interval $\leq 10 \text{ ps}$. Notes: 1) For intervals $< 100 \text{ ps}$, the above holds for time/div $\leq 20 \text{ ps/div}$. 2) For other intervals not listed above, linearity interpolate the cardinal points.

Table B-3: 11801B Input and Output Specifications

Characteristic	Specification
Touch panel	Infrared beam touchable array, 22 rows of 11 columns
Knobs	2 general-purpose knobs, set by user to desired function
Calibrator output step	
Voltage	500 mV open circuit or 250 mV into 50 Ω
Frequency	Approximately 100 kHz (50 kHz if divide-by-two mode selected)
Risetime	Approximately 250 ps into 50 Ω
Internal clock output	
Voltage	Positive pulse from 0 to 2.0 V
Source impedance	50 Ω
Repetition rate	Approximately 100 kHz (50 kHz if divide-by-two mode selected)

Table B-4: 11801B Trigger Specifications

Characteristic	Specification
Jitter	1.3 ps RMS + 4 ppm of position typical 2.0 ps RMS + 5 ppm of position max. Freq = 2.5 GHz, DC/ $\times 1$, $V_{in} = 200 \text{ mV}_{p-p}$, HF = Off, Enhanced = On May require trigger level adjustment to avoid 250 ps pulse width when triggering on trailing edge
Trigger source	External trigger or internally generated clock signal
Trigger mode	
Auto	Free runs after 20 ms timeout
Normal	Acquisition only after trigger event
Maximum p-p trigger input	1 V_{p-p} ($\times 1$) 10 V_{p-p} ($\times 10$)
Maximum safe trigger input voltage	$\pm 1.5 \text{ V}$ ($\times 1$) $\pm 15 \text{ V}$, $\leq 5 V_{RMS}$ ($\times 10$)
External trigger attenuation	$\times 1$ and $\times 10$
Trigger level	-1 V to $+1 \text{ V}$, $\times 1$ attenuation, -10 V to $+10 \text{ V}$, $\times 10$ attenuation
Trigger level resolution	1 mV, $\times 1$ attenuation 10 mV, $\times 10$ attenuation
Trigger accuracy	10% of full scale
Trigger sensitivity	
DC coupled	$\times 1$: 100 mV, DC to 3 GHz $\times 10$: 1 V, DC to 3 GHz (Auto, Enhanced Off, Auto holdoff, HF Off) May require trigger level adjustment to avoid 250 ps pulse width when triggering on trailing edge for stable triggering.
AC coupled	$\times 1$: 100 mV, 30 kHz to 3 GHz $\times 10$: 1 V, 30 kHz to 3 GHz (Auto, Enhanced Off, Auto holdoff, HF Off) May require trigger level adjustment to avoid 250 ps pulse width when triggering on trailing edge for stable triggering.

Table B-4: 11801B Trigger Specifications (Cont.)

Characteristic	Specification
Metastability	Typically 0 ppm (tested with 250 K trigger events) at 2.5 GHz, 100 mV _{p-p} trigger, Enhanced = On
Main and window position	Minimum 25 ns pre-trigger required (48 ns, Option 1M)
Initial window delay	25 ns to 50 ms in steps of 1% of main record size (48 ns, Option 1M)
Strobe skew adjustment	±1.5 ns

Table B-5: 11801B Display Specifications

Characteristic	Specification
CRT	8½ inch diagonal, color, magnetic deflection. Vertical raster orientation. Nominal screen size: 6.087 inches vertical by 4.496 inches horizontal
Character display	
Character height	0.10 in (upper case)
Character cell	16 pixel vertical by 10 pixel horizontal

Table B-6: 11801B AC Line Power Specifications

Characteristic	Specification
Voltage ranges	90 to 132 V _{RMS} or 180 to 250 V _{RMS} Voltage ranges apply to trace distortion, which reduces peak line voltage 5%
Frequency	48 Hz to 440 Hz
Power	320 W
Current	4.6 A _{RMS} at 50 Hz, 90 V line with 5% clipping
Fuse	6 A, 250 V normal blow

Table B-7: 11801B Environmental Specifications

Characteristic	Specification
Temperature	Meets MIL-T-28800E, Type III, Class 5
Operating	0° C to 50° C
Non-operating	-40° C to 75° C
Humidity	Up to 95% relative humidity, at up to 50° C
Altitude	Meets MIL-T-28800E, Type III, Class 5
Operating	Up to 4.5 km (15,000 ft)
Non-operating	Up to 15 km (50,000 ft)
Vibration	Operating, sampling heads not installed: meets MIL-T-28800E, Type III, Class 5 (section 4.5.5.3.1)
Shock	Non-operating, sampling heads not installed: meets MIL-T-28800E, Type III, Class 5 (section 4.5.5.4.1)
Bench handling	Operating: meets MIL-T-28800E, Type III, Class 5 (section 4.5.5.4.3)
Packaged product vibration and bounce	Packaged product, sampling heads not installed: meets NSTA Proj. 1A
Drop of packaged product	Packaged product, sampling heads not installed: meets NSTA Proj. 1A
Electrostatic immunity	No disruption or degradation of performance: up to 10 kV. No damage to instrument: up to 20 kV

The specifications in Tables B-8 through B-14 apply to the 11801A Digital Sampling Oscilloscope, only. See Tables B-1 through B-7 for specifications for the 11801B Digital Sampling Oscilloscope.

Table B-8: 11801A Vertical System Specifications

Characteristic	Specification
Input sources	
Mainframe	4 sampling heads, 8 channels
Option 1M, with 4 SM-11 Multi-Channel Units	68 sampling heads, 136 channels
Bandwidth	Dependent on sampling head
Risetime	Dependent on sampling head
Amplifier gain accuracy	$\pm 1\%$ of full-scale range
Vertical resolution	
Trace data	8 bits
Hardware measurements	14 bits
Input sensitivity	2 mV/div to 255 mV/div in 1 mV/div steps
Offset accuracy	± 2 mV
Offset range	± 2 V
Offset resolution	0.25 mV
Measurement level accuracy	± 2 mV
Vertical acquisition resolution	
Single graticule	25 points/div
Dual graticule	25 points/div
Vertical display resolution	
Single graticule	50 pixels/div
Dual graticule	25 pixels/div

Table B-9: 11801A Time Base Specifications

Characteristic	Specification
Internal reference clock	Crystal-controlled oscillator, voltage-controlled oscillator for timebase
Sample rate	200 kHz maximum
Record length	User selectable, 512, 1024, 2048, 4096, or 5120 points.
Sweep rate resolution	1–2–5 steps or 1 ps/div increments
Record duration	10 ps to 50 ms
Maximum sweep rate	
512-point record	1 ps/div
1024-point record	1 ps/div
2048-point record	2 ps/div
4096-point record	5 ps/div
5120-point record	5 ps/div
Time interval measurement accuracy	10 ps +0.01% of selected delay

Table B-10: 11801A Input and Output Specifications

Characteristic	Specification
Touch panel	Infrared beam touchable array, 22 rows of 11 columns
Knobs	2 general-purpose knobs, set by user to desired function
Calibrator output step	
Voltage	500 mV open circuit or 250 mV into 50 Ω
Frequency	Approximately 100 kHz (50 kHz if divide-by-two mode selected)
Risetime	Approximately 250 ps into 50 Ω
Internal clock output	Synchronized with TDR and calibrator output
Voltage	Positive pulse from 0 to 2.0 V
Source impedance	50 Ω
Repetition rate	Approximately 100 kHz (50 kHz if divide-by-two mode selected)

Table B-11: 11801A Trigger Specifications

Characteristic	Specification
Trigger source	External trigger or internally generated clock signal
Trigger mode	
Auto	Free runs after 20 ms timeout
Normal	Acquisition only after trigger event
Maximum trigger input	×1: ±1.5 VDC or 1.5 V _{RMS} ×10: ±5 VDC or 5 V _{RMS}
External trigger attenuation	×1 and ×10
Trigger level	−1 V to +1 V, ×1 attenuation, −10 V to +10 V, ×10 attenuation
Trigger level resolution	10 mV, ×1 attenuation
Trigger accuracy	10% of full scale
Trigger sensitivity	
DC coupled	40 mV peak-peak from DC to 200 MHz, increasing to 150 mV at 800 MHz, increasing to 250 mV at 2.0 GHz
AC coupled	40 mV peak-peak from 30 kHz to 200 MHz, increasing to 150 mV peak- peak at 2.0 GHz Attenuates signals below 30 kHz
Main and window position	Minimum 40 ns pre-trigger required
Initial window delay	40 ns to 50 ms in 1 ps steps
Strobe skew adjustment	±1.5 ns

Table B-12: 11801A Display Specifications

Characteristic	Specification
CRT	8½ inch diagonal, color, magnetic deflection. Vertical raster orientation. Nominal screen size: 6.087 inches vertical by 4.496 inches horizontal
Character display	
Character height	0.10 in (upper case)
Character cell	16 pixel vertical by 10 pixel horizontal

Table B-13: 11801A AC Line Power Specifications

Characteristic	Specification
Voltage ranges	90 to 132 V _{RMS} or 180 to 250 V _{RMS} Voltage ranges apply to trace distortion, which reduces peak line voltage 5%
Frequency	48 Hz to 440 Hz
Power	320 W
Current	4.6 A _{RMS} at 50 Hz, 90 V line with 5% clipping
Fuse	6 A, 250 V normal blow

Table B-14: 11801A Environmental Specifications

Characteristic	Specification
Temperature	Meets MIL-T-28800E, Type III, Class 5
Operating	0° C to 50° C
Non-operating	-40° C to 75° C
Humidity	Up to 95% relative humidity, at up to 50° C
Altitude	Meets MIL-T-28800E, Type III, Class 5
Operating	Up to 4.5 km (15,000 ft)
Non-operating	Up to 15 km (50,000 ft)
Vibration	Operating, sampling heads not installed: meets MIL-T-28800E, Type III, Class 5 (section 4.5.5.3.1)
Shock	Non-operating, sampling heads not installed: meets MIL-T-28800E, Type III, Class 5 (section 4.5.5.4.1)
Bench handling	Operating: meets MIL-T-28800E, Type III, Class 5 (section 4.5.5.4.3)
Packaged product vibration and bounce	Packaged product, sampling heads not installed: meets NSTA Proj. 1A
Drop of packaged product	Packaged product, sampling heads not installed: meets NSTA Proj. 1A
Electrostatic immunity	No disruption or degradation of performance: up to 10 kV. No damage to instrument: up to 20 kV





Appendix C: Safety

Please take a moment to review these safety precautions. They are provided for your protection and to prevent damage to the 11801B. This safety information applies to all operators and service personnel.

Symbols and Terms

These two terms appear in manuals:

-  statements identify conditions or practices that could result in damage to the equipment or other property.
-  statements identify conditions or practices that could result in personal injury or loss of life.

These two terms appear on equipment:

- *CAUTION* indicates a personal injury hazard not immediately accessible as one reads the marking, or a hazard to property including the equipment itself.
- *DANGER* indicates a personal injury hazard immediately accessible as one reads the marking.

This symbol appears in manuals:



Static-Sensitive Devices

These symbols appear on equipment:



DANGER
High Voltage



Protective
ground (earth)
terminal



ATTENTION
Refer to
manual

Specific Precautions

Observe all of the following precautions to ensure your personal safety and to prevent damage to either the 11801B or equipment connected to it.

Power Source

The 11801B is intended to operate from a power source that will not apply more than 250 V_{RMS} between the supply conductors or between either supply conductor and ground. A protective ground connection, through the grounding conductor in the power cord, is essential for safe system operation.

Grounding the Instrument

The 11801B is grounded through the power cord. To avoid electric shock, plug the power cord into a properly wired receptacle where earth ground has been verified by a qualified service person. Do this before making connections to the input or output terminals of the 11801B.

Without the protective ground connection, all parts of the 11801B are potential shock hazards. This includes knobs and controls that may appear to be insulators.

Use the Proper Fuse

To avoid fire hazard, use only the fuse specified in the parts list for your product, and which is identical in type, voltage rating, and current rating.

Do Not Operate in Explosive Atmospheres

The 11801B provides no explosion protection from static discharges or arcing components. Do not operate the 11801B in an atmosphere of explosive gasses.

Do Not Remove Covers or Panels

To avoid personal injury, do not operate the 11801B without the panels or covers.



Operating the instrument without the covers in place may cause overheating and harm the instrument.

Electrical Connections

SMA-Compatible and Other Precision Connectors

You must attach cables to SMA-compatible connectors carefully to prevent damage to the cable or the instrument connector.



Do not overtighten SMA-compatible connectors.

When attaching a cable to or removing a cable from an SMA-compatible connector, do not turn the cable, turn only the nut. Align the two connectors carefully and engage the connector nut over the exposed threads on the other connector. Use only finger pressure to make this initial connection. Then use a torque wrench *only* to tighten the connection to the range of 7–10 lb-in (79–112 N-cm).

There are two types of SMA-compatible connectors on the 11801B:

- Standard SMA connectors with plastic insulating material between the center lead and the outer shield. An example is the trigger **INPUT** connector.
- High-precision APC 3.5 connectors, which have air insulation between the center lead and outer shield. Examples include the input connectors on some of the sampling heads.

The APC 3.5 connectors are of closer mechanical tolerance than the standard SMA connector. Attaching a worn or damaged SMA cable to an APC 3.5 connector may damage the APC 3.5 connector.

Higher bandwidth sampling heads may use other connectors that are not SMA-compatible. Consult your sampling head manual for more information.

Electrostatic Discharge

The input diodes used in the sampling heads are susceptible to damage from overdrive signal or DC voltages, and from electrostatic discharge. Never apply a voltage outside the range printed on the front of the sampling head. Operate the instrument only in a static-controlled environment.



Applying a voltage outside the range printed on the sampling head can result in damage. Static electricity is also a hazard.

Packaging for Shipment

If you ship the 11801B, pack it in the original shipping carton and packing material. If the original packing material is unavailable, package the instrument as follows:

- Step 1:** Obtain a corrugated cardboard shipping carton with inside dimensions at least 15 cm (6 in) taller, wider, and deeper than the instrument. The shipping carton must be constructed of cardboard with 375 pound test strength.
- Step 2:** If you are shipping the 11801B to a Tektronix field office for repair, attach a tag to the instrument showing the instrument owner and address, the name of the person to contact about the instrument, the instrument type, and the serial number.
- Step 3:** Wrap the instrument with polyethelene sheeting or equivalent material to protect the finish.
- Step 4:** Cushion the instrument on all sides by tightly packing dunnage or urethane foam between the carton and and the instrument, allowing 7.5 cm (3 in) on each side.
- Step 5:** Seal the carton with shipping tape or an industrial stapler.

Appendix D: Algorithms

Digitized traces are a sequence of samples stored as 16-bit signed integers. The samples are numbered from 0 through the record length less one; a 512-point record numbers samples from 0 through 511.

Three sample values represent invalid data points.

- The value $-32,768$ (hexadecimal 8000) represents *null*, an unacquired data point. A trace that is defined but has never been acquired contains null values. Clearing a trace fills it with null values. A trace is either completely filled with null values or it contains no null values; null values and non-null values cannot coexist in the same trace record.
- The value $-32,767$ (hexadecimal 8001) represents a data value below the dynamic range of the digitizer. This is called *underrange*. Under-range values do not appear on a displayed trace.
- The value $+32,767$ (hexadecimal 7FFF) represents a data value above the dynamic range of the digitizer. This is called *overrange*. Overrange values do not appear on a displayed trace.

When a trace function encounters one of these three data values, it passes the invalid data value as its output. When a measurement encounters one of these three data values, the measurement is noted as an error. There are exceptions to these rules, as noted below. All trace functions assume that the trace record contains data other than these three values, unless specifically noted.

Trace Functions

Absolute Value

$$\begin{aligned} \text{Abs}(n) &= W(n) \\ &\text{for } W(n) \geq 0 \\ \text{Abs}(n) &= -W(n) \\ &\text{for } W(n) < 0 \end{aligned}$$

where:

n = index into the record of data points

$W(n)$ = input sampled data point

Average

$$Avg_p(n) = W(n)$$

$$\text{for } p = 1$$

$$Avg_p(n) = Avg_{p-1}(n) + \frac{[W(n) - Avg_{p-1}(n)]}{2^{INT(\log_2(p/\log_e 2))}}$$

$$\text{for } 1 < p < P$$

$$Avg_p(n) = Avg_{p-1}(n) + \frac{[W(n) - Avg_{p-1}(n)]}{P}$$

$$\text{for } p \geq P$$

where:

n = index into record of data points

$W(n)$ = input sampled data point

p = record number

P = total number of records specified for average

INT = integer part of

Differentiate

$$Diff(n) = [W(1) - W(0)]/T$$

$$\text{for } n = 0$$

$$Diff(n) = [W(n + 1) - W(n - 1)]/(2T)$$

$$\text{for } 1 \leq n \leq (R - 1)$$

$$Diff(R - 1) = [W(R - 1) - W(R - 2)]/T$$

$$\text{for } n = R - 1$$

where:

n = index into the record of data points

$W(n)$ = input sampled data point

T = time interval between successive samples

R = record length

Envelope

$$Env_p(n) = W(n)$$

for $p = 1$

$$Env_p(n) = \text{Minimum of } [Env_{p-1}(n), W(n), W(n + 1)]$$

for $p > 1$ and n even(2, 4, 6, ..., $R - 1$)

$$Env_p(n) = \text{Maximum of } [Env_{p-1}(n), W(n - 1), W(n)]$$

for $p > 1$ and n odd(1, 3, 5, ..., $R - 2$)

where:

n = index into record of data points

$W(n)$ = input sampled data point

p = record number

R = record length

P , the total number of records specified for enveloping, is used only to determine completion for conditional acquisition, when acquisition is stopped on envelope complete.

Exponential

$$Exp(n) = e^{W(n)}$$

where:

n = index into record of data points

$W(n)$ = input sampled data point

This function is implemented by the 80287 math coprocessor and supporting routines.

Fast Fourier Transform

The instrument computes an integer radix-2 FFT of a complex sequence:

$$x(n) = W(n) + jb(n)$$

where;

$W(n)$ = the time-domain waveform point

$b(n) = 0$

$X(k)$, the complex sequence representing the Discrete Fourier Transform of the sequence $x(n)$, is computed as:

$$X(k) = \sum_{n=0}^{R-1} x(n) \times W_R^{k \times n}$$

for $k = [0 \cdots R - 1]$

where

R , the record length, is a power of 2

$$W_R = e^{-j\frac{2\pi}{R}}$$

The linear magnitude (FFT_{mag}) and the phase (FFT_{phase}) of the FFT are computed as:

$$FFT_{mag}(k) = \sqrt{A(k)^2 + B(k)^2}$$

$$FFT_{phase}(k) = \arctan\left(\frac{B(k)}{A(k)}\right)$$

where

$A(k)$ = real part of $X(k)$

$B(k)$ = imaginary part of $X(k)$

The magnitude and phase for negative frequencies are discarded and linear interpolation is used to expand the positive frequencies to fill the entire record length.

The magnitude of the frequency spectrum in decibels is given as:

$$FFT_{magdB}(k) = 20\log(FFT_{mag}(k))$$

where the 0 dB point is defined as the sine wave of 0.316 V peak (0.224 V_{RMS}), which gives 1.0 mW into 50 Ω.

FFT Windowing Functions

The selected FFT windowing function is applied to the time-domain waveform before the FFT is computed. The FFT windowing functions are as follows:

- Rectangular

$$x(n) = \begin{cases} 1 & n = 0 \\ \dots & \dots \\ 1 & n = R - 1 \end{cases}$$

- Triangular

$$x(n) = \begin{cases} \frac{R}{2} \left(2 - 2\frac{n}{R}\right) & n = 0 \\ \dots & \dots \\ \frac{R}{2} \left(2 - 2\frac{n}{R}\right) & n = \frac{R}{2} \\ \dots & \dots \\ \frac{R}{2} \left(2 - 2\frac{n}{R}\right) & n = R - 1 \end{cases}$$

- Hanning

$$x(n) = \begin{cases} 0.5 \left(1 - \cos\left(2\pi\frac{n}{R}\right)\right) & n = 0 \\ \dots & \dots \\ 0.5 \left(1 - \cos\left(2\pi\frac{n}{R}\right)\right) & n = R - 1 \end{cases}$$

- Hamming

$$x(n) = \begin{cases} 0.54 - 0.46 \cos\left(2\pi\frac{n}{R}\right) & n = 0 \\ \dots & \dots \\ 0.54 - 0.46 \cos\left(2\pi\frac{n}{R}\right) & n = R - 1 \end{cases}$$

- Blackman

$$x(n) = \sum_{n=0}^{R-1} 0.42 - 0.5 \cos(2\pi \frac{n}{R}) + 0.08 \cos(4\pi \frac{n}{R})$$

- Blackman-Harris

$$x(n) = \sum_{n=0}^{R-1} 0.35875 - 0.48829 \cos(2\pi \frac{n}{R}) + 0.14128 \cos(4\pi \frac{n}{R}) - 0.01168 \cos(6\pi \frac{n}{R})$$

where

R = the record length, which must be a power of 2.

The filter characteristics of the FFT windowing functions are summarized in Table D-1. These numbers are taken from a table in Frederic J. Harris: *Handbook of Digital Signal Processing*, edited by Douglas F. Elliot, Academic Press, San Diego, 1987, pp. 254–255.

Table D-1: Filter Characteristics of FFT Windowing Functions

Windowing Function	Highest Side-lobe (dB)	Noise Band-width (bins)	3 dB Band-width (bins)	6 dB Band-width (bins)	Scallop Loss (dB)	Worst Loss (dB)
Rectangular	-13	1.00	0.89	1.21	3.92	3.92
Triangular	-27	1.33	1.28	1.78	1.82	3.07
Hanning	-32	1.50	1.44	2.00	1.42	3.18
Hamming	-43	1.36	1.30	1.81	1.78	3.30
Blackman	-58	1.73	1.68	2.35	1.10	3.47
Blackman-Harris	-92	2.00	1.90	2.72	0.83	3.85

where

bins refers to the frequency bins, the even numbered points in the FFT waveform.

highest sidelobe is the minimum stopband attenuation, which indicates how well leakage is blocked.

noise bandwidth is the equivalent noise bandwidth (the width of an equivalent rectangular spectral response that would pass the same noise power as this windowing function).

3 dB bandwidth and **6 dB bandwidth** apply to the major lobe. These affect the frequency resolution.

scallop loss is the attenuation of the windowing function at the odd-numbered (interpolated) points in the FFT waveform.

worst loss is the worst-case processing loss (the sum of the scallop loss and the equivalent noise bandwidth, in dB).

Filter

$$Filter(n) = Smooth(Smooth(n))$$

Centered Mode (Non-Causal) Filter Algorithm —

$$Smooth(n) = (1/s) \left[\sum_{m=0}^{n+h} W(m) + (h-n) \times W(0) \right]$$

for $n < h$

$$Smooth(n) = (1/s) \left[\sum_{m=n-h}^{n+h} W(m) \right]$$

for $h \leq n \leq R-1-h$

$$Smooth(n) = (1/s) \left[\sum_{m=n-h}^{R-1} W(m) + (M-1-n) \times W(M-1) \right]$$

for $n > M-1-h$

where:

n = index into record of data points

$W(n)$ = input sampled data point

s = smoothing interval = Round (sf)

$$sf = \frac{risetime}{(time\ per\ dot) \times 1.10557}$$

$risetime$ = the second argument to Filter

where:

$risetime > 10$ ps and < 50 ms

h = half interval: $(s-1)/2$ rounded up

R = record length in points

The centered-mode, smoothed trace is derived by computing the average value of the corresponding point of the original trace and some number of points of the original trace on either side of the corresponding point. The number of points on either side is derived from the smoothing interval, the second argument of the Smooth function. Near the ends of the trace, nonexistent points beyond the ends of the trace are required for averaging. The nonexistent points are assumed to be the value of the corresponding end points. This method of extending the trace is arbitrary, so the results within a smoothing interval of the ends of the trace must be interpreted accordingly.

Shifted Mode (Causal) Filter Algorithm —

$$Smooth(n) = \frac{1}{s} \left[\sum_{m=0}^n W(m) + (s - n - 1)W(0) \right]$$

for $n < s$

$$Smooth(n) = \frac{1}{s} \left[\sum_{m=n-s+1}^n W(m) \right]$$

for $n \geq s$

The shifted mode trace only uses points that occur before the corresponding point. Thus, the only points that are assumed occur before the trace, not after.

Integrate

$$Intg(n) = 0$$

for $n = 0$

$$Intg(n) = \left[1/2W(0) + \sum_{m=1}^{n-1} W(m) + 1/2W(n) \right] \times T$$

for $1 \leq n \leq R$

where:

n = index into record of data points

$W(n)$ = input sampled data point

T = time interval between successive samples

R = record length in points

Logarithm

$$Log(n) = \log_{10} W(n)$$

where:

n = index into record of data points

$W(n)$ = input sampled data point

This function is implemented by the 80287 math coprocessor and supporting routines.

Natural Logarithm

$$\text{Ln}(n) = \log_e W(n)$$

where:

n = index into record of data points

$W(n)$ = input sampled data point

This function is implemented by the 80287 math coprocessor and supporting routines.

Rho

Rho is normally calculated to be between +1 and -1 by:

For trace M1:

$$\rho = \frac{\text{volts}}{(RA \times \text{pol})} - \rho_{\text{pos}}$$

$$\rho_{\text{pos}} = \frac{(\text{Ref Voltage})}{(RA \times \text{pol})} + 1 + \rho_{\text{zero}}$$

where:

RA = Reference Amplitude (normally 250 mV); where the reference amplitude is equivalent to the change in volts that corresponds to a change of 1 in rho

pol = +1 if M1 has positive polarity, -1 if M1 has negative polarity

volts = the voltage at any point in M1

Ref Voltage = the voltage of M1 measured as early in time as possible. Baseline correction keeps remeasuring the reference voltage, and will force a recalculation of ρ_{pos} any time it changes by more than a few millivolts

ρ_{zero} = 0 by default. The cursor feature **Set Zero Rho** sets this value.

For trace "M1-M2," where M1 has positive polarity and M2 has negative polarity:

$$\rho = \frac{\text{volts}}{(RA \times rf)} - \rho_{\text{pos}}$$

$$\rho_{\text{pos}} = \frac{(\text{RhoPos of M1})}{rf} + \frac{(\text{RhoPos of M2})}{rf} + \rho_{\text{zero}}$$

$$\text{RhoPos of } M_j = \frac{(\text{Ref Voltage } M_j)}{(RA \times (\text{pol of } M_j))} + 1$$

where:

volts = voltage at any point in M1-M2

rf = rhofactor; 2 for this trace

M_j = M1 or M2

For trace "M1 – STO1," where STO1 was created from M1:

$$\rho = \frac{\text{volts}}{(RA \times rf)} - \rho_{pos}$$

$$\rho = \frac{(\text{RhoPos of M1})}{rf} - \frac{(\text{RhoPos of STO1})}{rf} + \rho_{zero}$$

$$\text{RhoPos of } M_j = \frac{(\text{Ref Voltage } M_j)}{(RA \times (\text{pol of } M_j))} + 1$$

where:

RhoPos of STO1 = RhoPos of STO1 at the time STO1 was created

rf = rhofactor; 2 for this trace

M_j = M1 or M2

For trace "*C₁ × T₁ + ... + C_n × T_n*:"

$$\rho = \frac{\text{volts}}{(RA \times rf)} - \rho_{pos}$$

$$\rho_{pos} = \frac{C_1 \times (\text{pol1}) \times (\text{RhoPos of } T_1)}{rf} + \dots +$$

$$\frac{C_n \times (\text{poln}) \times (\text{RhoPos of } T_n)}{rf} + \rho_{zero}$$

where:

C_i = a numeric constant (for example, 1.0 or 0.5)

T_j = a channel or stored trace

pol_j = +1 or –1 polarity if *T_j* is a channel, or

= rhofactor of a stored trace which equals the rhofactor of the live trace when the stored trace was created

rf = rhofactor = *C₁ × (pol1) + ... + C_n × (poln)*

however, if this is 0, then:

$$= \frac{ABS(C_1 \times (\text{pol1})) + \dots + ABS(C_n \times (\text{poln}))}{2}$$

Trace functions Smooth, Filter, and Avg have no effect on the formulas used for rho.

For trace "*C₀ + C₁ × T₁ + ... + C_n × T_n*" the rho values produced are the same as if *C₀* was 0.

Signum

$$\text{Signum}(n) = 1.0$$

for $W(n) > 0$

$$\text{Signum}(n) = 0$$

for $W(n) = 0$

$$\text{Signum}(n) = -1$$

for $W(n) < 0$

where:

n = index into record of data points

$W(n)$ = input sampled data point

Square Root

$$\text{Sqrt}(n) = W(n)^{1/2}$$

where:

n = index into record of data points

$W(n)$ = input sampled data point

This function is implemented by the 80287 math coprocessor and supporting routines.

Smooth

Centered Mode (Non-Causal) Algorithm —

$$\text{Smooth}(n) = (1/s) \left[\sum_{m=0}^{n+h} W(m) + (h - n) \times W(0) \right]$$

for $n < h$

$$\text{Smooth}(n) = (1/s) \left[\sum_{m=n-h}^{n+h} W(m) \right]$$

for $h \leq n \leq R - 1 - h$

$$\text{Smooth}(n) = (1/s) \left[\sum_{m=n-h}^{R-1} W(m) + (M - 1 - n) \times W(M - 1) \right]$$

for $n > M - 1 - h$

where:

n = index into record of data points

$W(n)$ = input sampled data point

s = smoothing interval in samples; the second argument

h = half interval: $(s - 1)/2$, rounded up

R = record length in points

The centered-mode, smoothed trace is derived by computing the average value of the corresponding point of the original trace and some number of points of the original trace on either side of the corresponding point. The number of points on either side is derived from the smoothing interval, which is the second argument of the Smooth function.

Near the ends of the trace, nonexistent points beyond the ends of the trace are required for averaging. The nonexistent points are assumed to be the value of the corresponding end points. This method of extending the trace is arbitrary, so the results within a smoothing interval of the ends of the trace must be interpreted accordingly.

Shifted Mode (Causal) Algorithm —

$$\text{Smooth}(n) = \frac{1}{s} \left[\sum_{m=0}^n W(m) + (s - n - 1)W(0) \right]$$

for $n < s$

$$\text{Smooth}(n) = \frac{1}{s} \left[\sum_{m=n-s+1}^n W(m) \right]$$

for $n \geq s$

The shifted mode trace only uses points that occur before the corresponding point. Thus, the only points that are assumed occur before the trace, not after.

Software Measurements

Measurements are taken using the measurement parameters. You can directly set many the measurement parameters, or you can specify that some are to be determined automatically by the 11801B. It is common to have the 11801B dynamically measure topline and baseline.

You specify automatic topline and baseline positioning by turning tracking on in the individual measurement pop-up menus. The mesial level, when topline and baseline are automatically positioned by tracking, is calculated:

$$\text{mesial} = [(m\%/100) \times (\text{topline} - \text{baseline})] + \text{baseline}$$

where $m\%$ is the percentage of topline to baseline height to use for mesial level. Proximal, distal, and reference levels are calculated similarly from percentage levels. These percentage levels are set using the knobs.

When you use tracking, the topline and baseline are determined either from the IEEE histogram method or from an alternate method. The IEEE method of determining topline and baseline, is as follows:

1. Create a histogram of the trace data points. For each possible vertical value, count the number of data points having that value.
2. The largest value that has a non-zero point count is the maximum value.
3. The smallest value that has a non-zero point count is the minimum value.
4. Determine the median value, halfway between the maximum and minimum values.
5. Examine the point counts between the median value and the maximum value, to find the largest point count. If this point count is greater than or equal to twice the second-largest point count, the value associated with the point count is the topline. If the largest point count is not twice the second-largest point count, then the maximum value is used as the topline.
6. Examine the point counts between the median value and the minimum value, to find the largest point count. If this point count is greater than or equal to twice the second-largest point count, the value associated with the point count is the baseline. If the largest point count is not twice the second-largest point count, then the minimum value is used as the baseline.

The Alternate method of determining topline and baseline, is as follows:

1. Smooth the raw waveform data.
2. Differentiate the smoothed waveform data.
3. Smooth the differentiated data.
4. Search the smoothed, differentiated data for the largest negative and positive peaks. The peaks must be equal to at least 30% of the peak-to-peak amplitude to qualify as valid.

5. Determine the 30% value of the largest valid topline and largest valid baseline peak.
6. Search the smoothed, differentiated data for crossings of the -30% and +30% levels, and build a table of these crossings.
7. Using the table built in step 6, qualify the original waveform data into topline, baseline, and ignore points.
8. The topline value is the average of all the points in the topline group.
9. The baseline value is the average of all the points in the baseline group.

Amplitude

$$\text{Amplitude} = \text{topline} - \text{baseline}$$

Area+

$$\text{Area+} = \sum_{j=m}^{n-1} \frac{\text{ABS}[W(j+1) - R] + \text{ABS}[w(j) - R]}{2} \times T$$

where:

- m = index of left-most measurement zone sample
- n = index of right-most measurement zone sample
- $W(j)$ = input sampled data point
- R = reference level measurement parameter
- T = time interval between successive samples
- ABS = the absolute value function

Area-

$$\text{Area-} = \sum_{j=m}^{n-1} \frac{[W(j+1) - R] + [w(j) - R]}{2} \times T$$

where:

- m = index of left-most measurement zone sample
- n = index of right-most measurement zone sample
- $W(j)$ = input sampled data point
- R = reference level measurement parameter
- T = time interval between successive samples

Cross

The cross measurement finds the left-most crossing of the reference level of the proper slope that is within the measurement zone. The horizontal position of the crossing point is displayed.

Linear interpolation between vertical points and between time intervals is necessary to determine the crossing time, when the reference level value does not correspond to acquired data.

Duty Cycle

1. Calculate the Period of the selected waveform (perform a period measurement).
2. Calculate the pulse width of the selected waveform (perform a width measurement).
3. If the positive portion of the part of the waveform measured for the Period measurement lies between the first two mesial crossings in the measurement zone, then:

$$\text{Duty Cycle} = \frac{100 \times \text{Width}}{\text{Period}}$$

If the positive portion of the part of the waveform measured for the Period measurement lies between the second and third mesial crossings in the measurement zone, then:

$$\text{Duty Cycle} = 100 - \frac{100 \times \text{Width}}{\text{Period}}$$

Energy

$$\text{Energy} = \sum_{j=m}^{n-1} \frac{W(j+1)^2 + w(j)^2}{2} \times T$$

where:

- m = index of left-most measurement zone sample
- n = index of right-most measurement zone sample
- $W(j)$ = input sampled data point
- T = time interval between successive samples

Extinction Ratio

$$\text{Standard Extinction Ratio} = \frac{\text{topline}}{\text{baseline}} \text{ (no units)}$$

$$\text{FDDI Extinction Ratio} = 100 \times \frac{\text{baseline}}{\text{topline}} \text{ (% units)}$$

$$\text{SONET Extinction Ratio} = 10 \times \log_{10} \left(\frac{\text{topline}}{\text{baseline}} \right) \text{ (dB units)}$$

Fall

1. Find the first point in the measurement zone that is greater than the distal value, searching from left to right.
2. From this point, find the first distal crossing and note the time, t_d .
3. From the distal crossing, examine points to the right, looking for the proximal crossing t_p . Update t_d if subsequent distal crossings are found.
4. Calculate the fall time:

$$Fall = t_p - t_d$$

Linear interpolation between vertical points and between time intervals is necessary to determine the crossing times, when the proximal and distal values do not correspond to acquired data.

Frequency

1. Search the measurement zone for the left-most mesial crossing of positive slope. Continue the search to the right to find the first upper signal/noise ratio level crossing to the right of the first mesial crossing. The horizontal coordinate of this crossing is $Cross_p$.
2. Search the measurement zone for the left-most mesial crossing of negative slope. Continue the search to the right to find the first lower signal/noise ratio level crossing to the right of the second mesial crossing. The horizontal coordinate of this crossing is $Cross_n$.
3. If $Cross_p < Cross_n$, set $Cross_1 = Cross_p$, $Cross_2 = Cross_n$, and $Slope = positive$. If $Cross_p > Cross_n$, set $Cross_1 = Cross_n$, $Cross_2 = Cross_p$, and $Slope = negative$.
4. If $Slope = positive$, search for the third left-most mesial crossing, and continue the search to find the next upper signal/noise ratio level crossing to the right. If $Slope = negative$, use the next lower signal/noise ratio level crossing to the right. The horizontal coordinate of this crossing is $Cross_3$.
5. Calculate the frequency:

$$Frequency = \frac{1}{Cross_3 - Cross_1}$$

Linear interpolation between vertical points and between time intervals is necessary to determine the crossing time, when the mesial value does not correspond to acquired data.

Frequency Domain Measurements

There are two modes of operation, harmonic and peak search. If Search Mode is set to harmonic, the instrument will determine the fundamental frequency, f_0 , by searching for the highest peak of the FFT magnitude in the measurement zone. The harmonic components are computed as $n \times f_0$ where n is the user-defined harmonic number.

In peak search mode, no harmonic relations are assumed between the spectral components. A spectral peak is defined as a peak of the FFT magnitude waveform greater than a user-adjustable reference level. The user can specify the index of the spectral peak to be measured.

In order to improve the frequency measurement resolution beyond the sampling resolution, the frequency of a peak (in either harmonic or peak search mode) is determined by using an FFT interpolation algorithm.

Table D-2: Values of lcoeff for FFT Windowing Functions

FFT Window	lcoeff(0)	lcoeff(1)	lcoeff(2)
Blackman	2.5486667398	1.5170635356	1.0632064084
Blackman-Harris	3.2326135798	2.1999343343	1.0653584909
Hamming	1.8732586725	0.7978694346	1.1507784758
Hanning	2.0	1.0	1.0
Rectangular	1.0	0	1.0
Triangular	1.7708896670	0.7177145486	1.1063502367

NOTE

All even points of the frequency magnitude waveform are results of FFT calculation, and all odd points are linearly interpolated results. Thus, the algorithm ignores all odd points. The real frequency resolution is twice the frequency per point of the waveform.

Peak Search Mode —

1. Scan the FFT Magnitude waveform to find the n th spectral peak. A spectral peak is defined as a waveform peak above a user adjusted reference level.
2. Apply the FFT interpolation algorithm described above to find the spectral frequency.

Max

The maximum digitized or calculated data point in the measurement zone of the trace record. An overrange value in the trace record will qualify the measurement readout with “≥”. If the trace is null, the measurement value will show “error”.

Mean

$$Mean = \sum_{j=m}^{n-1} \frac{W(j+1) + W(j)}{2(n-m)}$$

where:

- m = index of left-most measurement zone sample
- n = index of right-most measurement zone sample
- $W(j)$ = sampled data point

The summation extends over the interval of time corresponding to one period when Data Interval is set to one period, or the entire measurement zone when Data Interval is set to the entire zone.

Mid

$$Mid = \frac{Max + Min}{2}$$

An overrange value in the trace record will qualify the measurement with “≥”, and an underrange value in the trace record will qualify the measurement with “≤”. If the trace record has both underrange and overrange values, the measurement readout will be “0.0000 ?V”. If the trace is null, the measurement value will show “error”.

Min

The minimum digitized or calculated data point in the measurement zone of the trace record. An underrange value in the trace record will qualify the measurement readout with “≤”. If the trace is null, the measurement value will show “error”.

Over Shoot

$$OverShoot = 100 \times \frac{Max - topline}{topline - baseline}$$

If the values of *topline* and *baseline* are equal, the measurement value will show “error”.

Peak-Peak

$$PeakPeak = Max - Min$$

An overrange value in the trace record will qualify the measurement with “≥”, and an underrange value in the trace record will qualify the measurement with “≤”. If the trace record has both underrange and overrange values, the measurement readout will be qualified with “?”. If the trace is null, the measurement value will show “error”.

Period

1. Search the measurement zone for the left-most mesial crossing of positive slope. Continue the search to the right to find the first upper signal/noise ratio level crossing to the right of the first mesial crossing. The horizontal coordinate of this crossing is $Cross_p$.
2. Search the measurement zone for the left-most mesial crossing of negative slope. Continue the search to the right to find the first lower signal/noise ratio level crossing to the right of the second mesial crossing. The horizontal coordinate of this crossing is $Cross_n$.
3. If $Cross_p < Cross_n$, set $Cross_1 = Cross_p$, $Cross_2 = Cross_n$, and $Slope = positive$. If $Cross_p > Cross_n$, set $Cross_1 = Cross_n$, $Cross_2 = Cross_p$, and $Slope = negative$.
4. If $Slope = positive$, search for the third left-most mesial crossing, and continue the search to find the next upper signal/noise ratio level crossing to the right. If $Slope = negative$, use the next lower signal/noise ratio level crossing to the right. The horizontal coordinate of this crossing is $Cross_3$.
5. Calculate the period:

$$Period = Cross_3 - Cross_1$$

Linear interpolation between vertical points and between time intervals is necessary to determine the crossing time, when the mesial value does not correspond to acquired data.

Phase

1. On the selected waveform, search the measurement zone for the left-most mesial crossing. The horizontal position is $Cross_{sel}$.
2. On the reference waveform, search the measurement zone for the left-most mesial crossing of the same slope. The horizontal position is $Cross_{ref}$.

- Calculate the skew:

$$Skew = Cross_{ref} - Cross_{sel}$$

Linear interpolation between vertical points and between time intervals is necessary to determine the crossing time when the mesial value does not correspond to acquired data.

- Calculate the period value of the selected waveform. (Perform a Period measurement.)
- Calculate the phase shift:

$$Phase = \frac{Skew}{360 \times Period} \text{ mod } 360$$

If the measurement of either *Period* or *Skew* results in an error, the Phase measurement will show "error".

Prop Delay

- On the selected trace, search the measurement zone for the left-most mesial crossing of the specified slope. The horizontal position is $Cross_1$.
- On the second trace, search the measurement zone for the left-most mesial crossing of the specified slope. The horizontal position is $Cross_2$.
- Calculate the delay:

$$Delay = Cross_2 - Cross_1$$

Linear interpolation between vertical points and between time intervals is necessary to determine the crossing time, when the mesial value does not correspond to acquired data.

Rise

- Find the first point in the measurement zone that is less than the proximal value, searching from left to right.
- From this point, find the first proximal crossing and note the time, t_p .
- From the proximal crossing, examine points to the right, looking for the distal crossing t_d . Update t_p if subsequent proximal crossings are found.
- Calculate the rise time:

$$Rise = t_d - t_p$$

Linear interpolation between vertical points and between time intervals is necessary to determine the crossing times, when the proximal and distal values do not correspond to acquired data.

RMS

$$RMS = \sum_{j=m}^{n-1} \frac{[W(j+1)^2 + W(j)^2]^{1/2}}{[2(n-m)]^{1/2}}$$

where:

- m = index of left-most measurement zone sample
- n = index of right-most measurement zone sample
- $W(j)$ = sampled data point

The summation extends over the interval of time corresponding to one period when Data Interval is set to one period, or the entire measurement zone when Data Interval is set to the entire zone.

Spectral Frequency

See Frequency Domain Measurements on page D-16.

See also Table D-2 on page D-16.

Harmonic Mode —

1. Scan measurement zone on FFT magnitude waveform to find the highest peak.
2. Determine the largest adjacent spectral component.
3. Using FFT window characteristics, find the fundamental components, $S(\ell)$ and $S(\ell + 1)$.
4. The n th frequency harmonic of the waveform is determined by multiplying the harmonic number by fundamental frequency, and then searching the waveform for the nearest spectral peak. The interpolation algorithm is applied again in order to prevent the increase of the error rate by the harmonic number.

where:

$$\sigma = \frac{|s(\ell + 1)|}{|s(\ell)|}, \text{ is the ratio of the two highest peaks}$$

$$\Delta = \frac{icoeff(0) \times \sigma - icoeff(1)}{icoeff(2) \times \sigma + 1}, \text{ is the interpolation value.}$$

where $icoeff(i)$ is an array of interpolation coefficients which depend on the type of FFT windowing function (refer to the table on the next page).

$$\text{fundamental frequency} = (\ell + \Delta) \times \text{fresolution}$$

where fresolution is the frequency resolution.

NOTE

All even points of the frequency magnitude waveform are results of FFT calculation, and all odd points are linearly interpolated points. Thus, the algorithm ignores all odd points. The real frequency resolution is twice the frequency per point of the waveform.

Peak Search Mode —

1. Scan the FFT Magnitude waveform to find the nth spectral peak. A spectral peak is defined as a waveform peak above a user adjusted reference level.
2. Apply the FFT interpolation algorithm described above to find the spectral frequency.

Spectral Magnitude — The 11801B computes the magnitude of a harmonic frequency by interpolating the FFT magnitude waveform and compensating for the FFT windowing function effect.

1. Given the frequency of the spectral component, the routine identifies the two consecutive bins between when the harmonic component lies. By using the interpolation factor determined for the fundamental frequency, and the FFT window equations, the amplitude of the harmonic peak is determined.
2. For the amplitude of the fundamental, given the two highest spectral components, $S(\ell)$ and $S(\ell + 1)$, (See Spectral Frequency), the amplitude of the fundamental is:

$$\text{if } S(\ell) > S(\ell + 1), \max = S(\ell)$$

$$\text{if } S(\ell + 1) > S(\ell), \max = S(\ell + 1) \text{ and } \Delta \leq 1 - \Delta$$

$$AI = \frac{\max}{\text{Sin}(\pi \times \Delta) / (\pi \times \Delta)} \times w_{\text{correct}}$$

where:

$$w_{\text{correct}} = \frac{w_{\text{coeff}}(1)}{w_{\text{coeff}}(0)} + \sum_{i=1}^m \frac{w_{\text{coeff}}(i) \times \Delta^2}{\Delta^2 - i^2}$$

where i is the FFT window order.

For the triangular window, the computation is different:

$$AI = \frac{\max}{[\text{Sin}(\pi \times \frac{\Delta}{2})]^2 / (\pi \times \frac{\Delta}{2})^2} \times w_{\text{correct}}$$

where

w_{correct} is the window correction,
 w_{coeff} are FFT window coefficients,
 m is the window order.

Table D-3: Values of wcoeff and m for FFT Windowing Functions

FFT Window	wcoeff(0)	wcoeff(1)	wcoeff(2)	wcoeff(3)	m
Blackman	0.42	-0.5	0.08	0	2
Blackman-Harris	0.35875	-0.48829	0.14128	-0.01168	3
Hamming	0.54	-0.46	0	0	1
Hanning	10.5	-0.5	0	0	1
Rectangular	1.0	0	0	0	0
Triangular	0.5	0	0	0	1

- For the n th harmonic magnitude, compute the harmonic frequency and apply the previous algorithm.

In Peak Search Mode — apply the FFT interpolation algorithm and magnitude correction to the spectral component which is the n th peak of the FFT magnitude waveform.

Total Harmonic Distortion (THD)

See also Frequency Domain Measurements on page D-16.

- Determine the fundamental frequency.
- Find the magnitude of the spectral peak and of adjacent values: $S(\ell - 1)$, $S(\ell)$, $S(\ell + 1)$ in the FFT magnitude waveform,

$$A_1 = S(\ell) + \frac{(S(\ell - 1))^2 + (S(\ell + 1))^2}{S(\ell - 1) + S(\ell) + S(\ell + 1)}$$

- Find the first n harmonic components and determine the three highest waveform points in the FFT magnitude waveform, $S(\ell - 1)$, $S(\ell)$, $S(\ell + 1)$ compute:

$$A_n = S(\ell) + \frac{S(\ell - 1) + (S(\ell + 1))}{S(\ell - 1) + S(\ell) + S(\ell + 1)}$$

$$n = 2, \dots, 10$$

- Compute Total Harmonic Distortion

$$THD = \frac{\sqrt{A_2^2 + A_3^2 + \dots + A_{10}^2}}{A_1}$$

Under Shoot

$$\text{UnderShoot} = 100 \times \frac{\text{baseline} - \text{Min}}{\text{topline} - \text{baseline}}$$

If the values of *topline* and *baseline* are equal, the measurement value will show "error".

Width

1. Search the measurement zone for the leftmost mesial crossing of positive slope. Continue the search to the right to find the first upper signal/noise ratio level crossing to the right of the first mesial crossing. The horizontal coordinate of this crossing is $Cross_p$.
2. Search the measurement zone for the leftmost mesial crossing of negative slope. Continue the search to the right to find the first lower signal/noise ratio level crossing to the right of the second mesial crossing. The horizontal coordinate of this crossing is $Cross_n$.
3. If $Cross_p < Cross_n$, set $Cross_1 = Cross_p$, $Cross_2 = Cross_n$, and $Slope = \text{positive}$. If $Cross_p > Cross_n$, set $Cross_1 = Cross_n$, $Cross_2 = Cross_p$, and $Slope = \text{negative}$.
4. Calculate the width:

$$\text{Width} = Cross_2 - Cross_1$$

Linear interpolation between vertical points and between time intervals is necessary to determine the crossing time, when the mesial value does not correspond to acquired data.

Statistical Measurements

The algorithms for statistical measurements are identical to those for software measurements, except as noted below. A statistical measurement represents all the data in the color graded database, representing many acquisitions of the selected trace.

The IEEE histogram method is always used to determine topline and baseline when tracking is on. See page D-12 for a description of this method. The proximal, mesial, distal, and reference values are then determined as percentages of the topline and baseline.

In statistical measurement mode, the 11801B creates a voltage histogram in order to calculate Amplitude, Area+, Area-, or Energy.

The 11801B uses timing (horizontal) histograms to determine the crossing values for timing measurements. The timing histograms have a height of 1% of the amplitude (topline – baseline) of the waveform, and are computed at the proximal, mesial, distal, and reference levels. Peaks in the histogram indicate crossings. A peak must be at least 1/8 the height of the maximum peak to be recognized.

Jitter

The Jitter measurement is available only in statistical measurement mode.

1. Find the leftmost mesial crossing, using timing histograms. This horizontal value is $Cross_1$.
2. Find the second mesial crossing, using the same method. If a second crossing is found, its horizontal value is $Cross_2$.
 - a. If a second crossing was found, center the histogram horizontal limits about the first crossing, with a width equal to $Cross_1 - Cross_2$. That is:

$$RightLimit = Cross_1 + \frac{Cross_2 - Cross_1}{2}$$

$$LeftLimit = Cross_1 - \frac{Cross_2 - Cross_1}{2}$$

- b. If no second crossing was found, the histogram limits are the Left Limit and Right Limit of the measurement zone.
3. Set the top and bottom limits of the histogram at the mesial level.
4. If the Jitter Location is set to Eye Cross and the trace was recognized as an eye diagram, measure the jitter above and below the mesial to find the minimum jitter. Otherwise, calculate the jitter at the mesial.

Noise

The Noise measurement is available only in statistical measurement mode.

1. Find the leftmost mesial crossing, using timing histograms. This horizontal value is $Cross_1$. If no mesial crossing is found, set $hcenter$ midway between the measurement zone Left and Right limits.
2. If a first mesial crossing was found, find the second mesial crossing, using timing histograms. This horizontal value is $Cross_2$. If no second mesial crossing is found, set $hcenter$ midway between $Cross_1$ and the measurement zone Right Limit.
3. If a second crossing was found, center $hcenter$ between $Cross_1$ and $Cross_2$ (for an eye diagram, the center of the "eye").
4. Set the left and right limits of the histogram at $hcenter$.
5. If Noise Location is Baseline, then center the top limit of the histogram midway between the topline and the baseline and set the bottom limit at the bottom of the graticule.
6. If Noise Location is Topline, then center the bottom limit of the histogram midway between the topline and the baseline and set the top limit at the top of the graticule.

7. Collect a vertical histogram within these limits. If the histogram is empty and the trace is not recognized as an eye diagram, then set *hcenter* midway between the first crossing and the Left limit of the measurement zone, and measure the Noise from a vertical histogram within the limits determined.

Phase

If the reference trace is not the selected trace, the Phase measurement must be taken using a dual-graticule display, with the selected trace on one graticule, and the reference trace on the other. No other traces may be displayed on either graticule.

If either trace is an eye diagram, the Phase measurement will use the first crossing on the trace, regardless of slope. The Left Limit measurement parameter may be adjusted to control which crossings are used.

Prop Delay

If the reference trace is not the selected trace, the Prop Delay measurement must be taken using a dual-graticule display, with the selected trace on one graticule and the reference trace on the other. No other traces can be displayed on either graticule.

SNR (Signal to Noise Ratio)

$$SNR = \frac{Amplitude}{NoiseR}$$

where

NoiseR = *Noise*, measured in RMS Dispersion mode.

Hardware Measurements

For all hardware measurements, the 11801B determines the voltage levels that are used for the measurement. These are the mesial, distal, proximal, and reference voltage levels. If Level mode is set to absolute, then these levels are set to absolute voltages using the knobs.

If Level mode is set to Relative, then the 11801B performs the following steps to determine the baseline and topline voltages:

1. If Tracking is off, the 11801B uses the baseline and topline values that were last set using the knobs or those left from the most recent use of tracking.
2. If Tracking is on, the 11801B acquires a 2,048-point trace record and builds a histogram. The 11801B determines the baseline and topline voltages from the histogram. The histogram algorithm is identical to that used for software measurements.

3. Using the baseline and topline voltages, 11801B calculates the mesial, proximal, distal, and reference levels from the percentage levels set using the knobs.
4. The 11801B acquires a new trace record of the current record length. The measurement hardware determines the dot number(s) on the trace(s) where the signal crosses the level(s) required for the measurement. The dot number is affected by the user settings for the transition number and filtering, and, if appropriate, slope.

The determination of which dot represents a level crossing is not performed on the digitized trace data, but on the analog signal, using comparators in the measurement circuitry.

Cross

$$Cross = Dly + (T \times M)$$

where:

Dly = delay time from trigger to left edge of selected trace

T = time between successive dots of selected trace

M = selected trace dot number from comparators

Fall

$$Fall = T \times (M_p - M_d)$$

where:

M_d = distal dot number from comparators

M_p = proximal dot number from comparators

T = time between successive dots of trace

Frequency

$$Frequency = \frac{1}{T \times (M_{m1} - M_{m2})}$$

where:

M_{m1} = first mesial dot number from comparators

M_{m2} = second mesial dot number from comparators

T = time between successive dots of trace

Period

$$Period = T \times (M_{m1} - M_{m2})$$

where:

M_{m1} = first mesial dot number from comparators

M_{m2} = second mesial dot number from comparators

T = time between successive dots of trace

Prop Delay

$$\text{PropDelay} = [Dly_2 + (T_2 \times M_2)] - [Dly_1 + (T_1 \times M_1)]$$

where:

Dly_1 = delay time from trigger to left edge of selected trace

T_1 = time between successive dots of selected trace

M_1 = selected trace dot number from comparators

Dly_2 = delay time from trigger to left edge of second trace

T_2 = time between successive dots of second trace

M_2 = second trace dot number from comparators

Rise

$$\text{Rise} = T \times (M_d - M_p)$$

where:

M_d = distal dot number from comparators

M_p = proximal dot number from comparators

T = time between successive dots of trace

Width

$$\text{Width} = T \times (M_{m1} - M_{m2})$$

where:

M_{m1} = first mesial dot number from comparators

M_{m2} = opposite slope second mesial dot number

T = time between successive dots of trace

Color Grading

Three algorithms are used to assign colors to the Color Grading display. A statistical database is used to track the number of times a waveform point falls on each pixel of the display, where each time a data point "falls" on a pixel it is counted as a hit. The algorithms are based on the maximum number of hits that have occurred on any pixel in the display. In the following algorithms Max is the maximum number of hits.

For Max > 15:

Hit Density	Default Color	Maps To
[Max/2 + 1] to Max	Pale Yellow	Trace Color 1
[Max/4 + 1] to Max/2	Rose	Trace Color 2
[Max/8 + 1] to Max/4	Purple	Trace Color 4
[Max/16 + 1] to Max/8	Light Blue	Window Trace
1 to Max/16	Green	Trace Color 3

For $Max \geq 6$ and $Max \leq 15$:

$$sf = \text{Scale Factor} = \sqrt[4]{Max}$$

Hit Density	Default Color	Maps To
$[Max/sf + 1]$ to Max	Pale Yellow	Trace Color 1
$[Max/sf^2 + 1]$ to Max/sf	Rose	Trace Color 2
$[Max/sf^3 + 1]$ to Max/sf^2	Purple	Trace Color 4
$[Max/sf^4 + 1]$ to Max/sf^3	Light Blue	Window Trace
1 to Max/sf^4	Green	Trace Color 3

For $Max < 6$:

Hit Density	Default Color	Maps To
Max	Pale Yellow	Trace Color 1
$Max-1$	Rose	Trace Color 2
$Max-2$	Purple	Trace Color 4
$Max-3$	Light Blue	Window Trace
$Max-4$	Green	Trace Color 3

For all points where Hit Density ≤ 0 , no color is assigned. Note that if Max is less than 5, not all colors will be represented on the display.

Appendix E: Messages

The 11801B displays a message at the top of the display whenever one of the following events occurs:

- Errors — The 11801B cannot perform a requested operation.
- Warnings — The instrument performs the requested operation, but warns you that the results may be corrupted or meaningless.
- Ready Messages — The 11801B is waiting for your response to complete the task.
- Operation Complete Messages — An operation is complete.

When a message appears on the display, you can remove it by performing any operation: touching the graticule area, making a menu selection, or pressing a button.

When a hardcopy is made, any message on the display is removed immediately before making the copy.

Selected Message Descriptions

The meaning of most messages is self-evident. The listing below shows some of the messages that might be unclear, and gives more information about the cause of the message.

Autoset failed, bad trigger level.

Autoset failed due to a unacceptable trigger signal. Autoset will not change trigger coupling, slope, or external attenuation. Make certain these are appropriate for your trigger source before using autoset.

Baseline correction failed to find – 1 p point.

If the trace is not triggered, or if the portion of the trace immediately to the left of the display (earlier in time) is not a flat trace, the voltage reference cannot be determined.

Blowby calibration failed — can't find reference step.

The required signal is not connected to the channel being calibrated. Be certain to follow the instruction message on the display before touching the **Proceed** selector.

Calculated waveforms cannot be measured in hardware mode.

Hardware measurements can only be taken from traces without arithmetic operators or trace functions.

Change in channel (#, Unit) configuration.

Do not change sampling heads with the power on. Doing so may damage the mainframe, the sampling head, or both.

Channel (#, Unit) powered down during mainframe operation — Cycle power to continue.

Do not change sampling heads with the power on. Doing so may damage the mainframe, the sampling head, or both.

Channel (#, Unit) powered-up during mainframe operation — Cycle power to utilize.

Do not change sampling heads with the power on. Doing so may damage the mainframe, the sampling head, or both.

Channel (#, Unit) was not maintained at desired calibration delay value.

Indicates that the automated calibration system attempted to adjust the delay of the named sampling head channel. If you are not using the delay adjust feature of the Enhanced Accuracy major menu, you can turn off the **Delay Compensate** selector to stop the 11801B from making the delay adjust calibration.

Connect a 50-Ω terminator to the selected channel and press Proceed when ready.

The 11801B is waiting for you to put a terminator on the signal connector of the sampling head channel you are calibrating, and touch the **Proceed** selector. If you touch the **Proceed** selector without attaching the terminator, the calibration will fail or the results will be inaccurate.

Delay adjust calibration failed, can't find transition.

The required signal is not connected to the channel being calibrated. Be certain to follow the instruction message on the display before touching the **Proceed** selector.

Delay adjust measurement on reference channel failed — Can't find transition.

The required signal is not connected to the channel being calibrated. Be certain to follow the instruction message on the display before touching the **Proceed** selector.

Error detected in acquisition system: (channel #).

The time base controller detected an acquisition system error. You should contact your service person. The message is accompanied by six groups of four characters. You should note the accompanying information for your service person.

Front panel locked out.

A command from a computer on a remote interface (GPIB or RS-232-C) has disabled the touch panel. Touches are ignored until the remote computer restores touch panel operation.

Hardcopy absent or off-line.

Either no printer is connected to the 11801B, or the printer that is connected is not on-line. Until the condition is remedied, hardcopies cannot be taken.

Minor time base calibration problem: (channel #).

The time base calibration is no longer accurate to enhanced accuracy specifications. Be sure you wait 20 minutes for the 11801B system to warm up before performing enhanced accuracy calibrations. If this error message occurs repeatedly after warm-up, contact your service person.

Non-volatile RAM completely reset-probable battery failure.

Due to a battery failure, all instrument data in non-volatile RAM was lost at power-on. Lost data includes the number of power-on cycles, the uptime count, all stored settings, all stored traces, and the instrument serial number.

Non-volatile RAM settings, stored traces, and store trace descriptions lost-instrument ID data retained.

Part of the non-volatile RAM was reset to default at power-on because the non-volatile RAM was corrupted. This can reflect an internal problem, or the settings can be corrupted by improper commands from a remote computer connected to the GPIB or RS-232-C interfaces.

Reference trace defaulted to selected trace.

The reference trace for a prop delay measurement is no longer a valid trace, so the reference is now the same trace as the trace being measured. For example, assume you defined a prop delay measurement on trace 2, using trace 1 as a reference trace. If you delete trace 1, then the next time you display the measurements on trace 2, you will see this message.

Rho scaling failed to find -1 p point. Cannot calibrate rho scales.

If the trace is not triggered, or if the portion of the trace to the immediately to the left of the display (earlier in time) is not a flat trace, the voltage reference cannot be determined.

Time base calibration failed.

The time base controller detected an acquisition system error. You should contact your service person.

Time base system error.

The time base controller detected an acquisition system error. You should contact your service person. The message is accompanied by six groups of four characters. You should note the accompanying information for your service person.

Glossary

Acquisition

The process of repeatedly sampling the signals coming through input channels and accumulating the samples into traces.

Active Graticule

The graticule in a dual-graticule display that shows the selected trace.

Annotation

Lines that show the current measurement parameter settings in a visual way.

Autoset

A means of letting the 11801B set itself to provide a stable and meaningful display of a given trace.

Averaging

Displaying a trace that is the combined result of several acquisitions, thereby reducing apparent noise.

Axis Label

There are three notations on each axis. The first and last notation on each axis show the numeric value of the graticule edge (*not* the edge of the displayed points, which are slightly outside the graticule). The center notation is the scale factor expressed in units per division.

Baseline Correction

The process of maintaining the displayed vertical placement of a trace, correcting for changes in the signal levels that would ordinarily move the trace up or down.

Channel

A place to connect a signal or attach a network or transmission line to sampling heads. Also, the smallest component of a trace expression.

Channel Number

The number assigned to a specific signal input connector. The top channel of the left-most sampling head compartment of the 11801B mainframe is always mainframe channel 1, regardless of any repositioning or omission of sampling heads.

Complex Trace

A trace with a trace expression beyond a single channel specification. Any trace using a numeric value, a function, a reference to a stored trace, or an arithmetic operator is a complex trace.

Control Knob

see Knob

Cursor

Any of four styles of paired markers that you position with the knobs. The 11801B displays the positions of the cursors and the distance between them in axis units.

Default Measurement Parameter

A value from the default set of measurement parameters. The operator can change the default values. Whenever a trace is created, the measurement parameters are copied from the default set.

Distal

The most distant point from a reference point. As used in the 11801B, the ending measurement point for timing measurements.

Dragging

The act of changing your touch panel selection by moving your finger without removing it from the screen. The selection that is activated is the last one that you were touching before removing your finger.

Dual Graticule

A display with two graticules. Each one is half the height of the single graticule.

Entry Line

A text line that shows your input as you enter selections in a pop-up menu.

Enveloping

Displaying a trace that shows the extremes of variation of several acquisitions.

GPIB (General Purpose Interface Bus)

An interface that allows remote computer control of, and data capture from, an 11801B.

Graticule

The grid where traces are displayed.

Hardcopy

A paper print or plot of the display.

Hardware Measurement

An automated measurement that is captured by special circuitry that monitors signals directly, as opposed to software measurements that are derived from acquired trace samples.

Highlighted Trace

The selected trace in a single-graticule or dual-graticule display. Also, in a dual-graticule display, the last selected trace on the non-active graticule (the graticule without icons).

Horizontal Reference Point

The point about which the trace is expanded or contracted when horizontal size adjustments are made. The horizontal reference point remains anchored as the rest of the trace grows or shrinks around it.

Icon

A marker on the edge of the graticule that performs a specific function when touched.

Initialize

Setting the 11801B to a completely known, default condition.

Internal Clock

A trigger source that is synchronized with the Calibrator signal.

Keypad Menu

A pop-up menu that controls knob resolution and lets you enter specific numeric values for any control to which a knob is assigned.

Knob

One of the two large rotary controls to the right of the 11801B screen.

Knob Assignment

The value that a knob will adjust at a given time.

Knob Menu

The on-screen menu that always displays the current knob assignment. The knob menu also lets you display the Keypad menu.

Knob Resolution

The amount of change caused by each click of a knob.

Major Menu

The menu that is displayed at the bottom of the screen alongside the Knob menu. One of the several major menus is always displayed.

Major Menu Button

A labeled button above the knobs that determines which major menu is displayed.

Measurement

An automated numeric readout that the 11801B provides directly from the displayed trace in real time, without operator intervention.

Measurement Parameter

One of several controls that the 11801B operator can exercise over the automated measurement process.

Measurement Statistics

The accumulation of a history of individual measurement readouts, showing the mean and standard deviation of a selected number of samples.

Measurement Tracking

The process of automatically adjusting the measurement parameters to reflect changes in the trace.

Mesial

The middle point of a range of points. As used in the 11801B, the middle measurement point between proximal and distal points for timing measurements, and the intermediate height between baseline and topline for amplitude measurements.

Outline Box

A visual feedback mechanism of the touch panel. Your potential selection is always indicated by a box while you have your finger touching the screen.

Persistence

The amount of time a data point remains displayed. There are four persistence modes available in the 11801B: Normal, Variable, Infinite and Color Grading.

Pixel

A visible point on the display. The 11801B display is 551 pixels wide and 704 pixels high. Each pixel may be set to any of the display colors.

Pop-up Menu

A temporary menu that provides an interactive dialog for a specific purpose. A sub-menu of a major menu.

Principal Power Switch

The master power switch located on the rear panel of the 11801B.

Proximal

The point closest to a reference point. As used in the 11801B, the beginning measurement point for timing measurements.

Record Length

The number of samples (data points) that make up a trace.

RS-232-C

An interface that allows remote computer control of, and data capture from, an 11801B.

Sample Interval

The time interval between successive samples in a trace record.

Sampling Head

A high-performance amplifier that captures the incoming signal of a channel and reports the sampled data to the 11801B.

Saved Trace Description

A specification of a trace that is not displayed.

Selected Trace

The highlighted (brightest) trace of a multi-trace display. The selected trace is the trace that is acted on by the knobs and menu selectors.

Selector

An area of a menu that performs some action when you touch it.

Setting

The state of the front panel and system at a given time.

Software Measurement

An automated measurement that is derived from acquired trace samples, as opposed to hardware measurements that are captured by special circuitry that monitors the signals directly.

Smoothing

Processing applied by the sampling head prior to the digitization of a trace, to reduce apparent noise. With smoothing, the sampling head samples the signal 8 times instead of once, and the average of the samples is then used by hardware measurements and the digitizing circuitry.

Statistical Measurement

An automated measurement that is derived from color graded waveform data and is based on histograms computed at the crossing levels. A statistical measurement can be selected only in color graded display mode.

Stored Trace

A collection of sampled points that constitute a single trace acquisition that is saved in memory.

Time Base

The time-dependent specifications that control the acquisition of a trace. The time base determines when and how long to acquire and digitize signal data points.

Time-Domain Reflectometry (TDR)

A method of characterising a transmission line or network by sending a signal from one end and monitoring the electrical reflections.

Trace

The visible representation of an input signal or combination of signals. Identical to waveform.

Trace Expression

The definition of what the trace displays. It can include one or more channels combined arithmetically and modified by functions.

Trace Number

A number assigned by the 11801B to identify a trace. Displayed traces are numbered 1 through 8. A new trace is always given the lowest available number.

Tracking

The process of automatically adjusting the measurement parameters or window position to reflect changes in the trace.

Trigger

An electrical event that initiates acquisition of a trace as specified by the time base.

Uptime

The number of hours the instrument has been powered on.

Vertical Description

see Trace Expression

Waveform

The visible representation of an input signal or combination of signals. Identical to trace.

Window

A trace that represents a horizontally expanded portion of another trace.

XY Trace

A trace where both horizontal and vertical position of the data points reflect signal data.

YT Trace

A trace where the vertical position of the trace data points reflects signal data, and the horizontal position of the trace data points reflects time.

A

Accessories, A-1–A-2

Acquire Desc pop-up menu, 3-3, 3-14–3-16

Acquisition, 3-1–3-6
conditional, 3-3
stopping and starting, 3-3

ACQUISITION button, 3-3

Algorithms
measurement, D-1, D-12–D-28
trace function, D-1–D-11

Aliasing, 3-71

All trace status menu, 3-210–3-211

ANSI Standard Masks, 3-119–3-134

APC 3.5. *See* **Connectors**

Audio feedback, 3-7

Autoset, 3-9–3-12
Options, 2-10
using, 2-9

AUTOSET button, 3-9

Averaging, 2-43, 3-13–3-16

Axis labels, 3-83

Axis units, 2-74, 2-94, 2-95
rho, 3-87–3-88
seconds, meters, and feet, 3-87, 3-88

B

Baseline, 3-149, D-12–D-28

Baseline correction, 3-17, 3-193–3-202

Beep. *See* **Audio feedback**

Blowby Compensate pop-up menu, 3-53, 3-57

Brightness. *See* **Display intensity**

Buttons, 1-11–1-30

ACQUISITION, 3-3

AUTOSET, 2-9, 3-9

HARDCOPY, 1-7, 3-95–3-96

MENUS, 2-3

sampling head **SELECT CHANNEL**, 3-168–3-169
SEQUENCE SETTING, 3-181–3-182

C

Calibration. *See* **Enhanced accuracy**

Calibrator, 1-6

Calibrator output, 3-19

Calipers. *See* **Cursors**

Cancel, 1-14

CCITT Standard Masks, 3-119–3-134

Chan Sel, 2-34–2-40

Clear (Histograms), 3-103

Clear Cursors selector, 3-31

Clear Trace pop-up menu, 3-5–3-6

Clearing traces, 3-5–3-6

Clock. *See* **Time and date**

Color, 3-21, 3-22, 3-23

Color Grading mode, 3-44

Color pop-up menu, 3-21, 3-22, 3-23

Common mode TDR measurements, 3-191, 3-198–3-201

Compare & References pop-up menu, 3-145–3-146

Connectors, 1-11–1-30

APC 3.5, 1-5, C-3

GPIB, 3-79–3-82, 3-89

GPIB, 1-7

INTERNAL CLOCK, 3-19

POWER, 3-157

power, 1-7

PRINTER, 3-89

printer, 1-7

RS-232-C, 3-89, 3-163

RS-232-C, 1-7

SMA, 1-5, C-3

trigger **INPUT**, 3-215

Constellation Diagrams, 3-25–3-28

Cursor Type pop-up menu, 3-29–3-31

Cursors, 3-29–3-34
accuracy, 2-71
types, 2-66
using, 2-66

Cursors icon, 3-30

D

DefTra icon, 3-206–3-209

DefTra pop-up menu, 3-66, 3-206–3-209

Delay Adjust pop-up menu, 3-54, 3-58–3-60

Delayed sweep. *See* **Windows**

Delete Setting pop-up menu, 3-180

Delete Trace pop-up menu, 3-186, 3-212, 3-213

Diagnostics, 3-35–3-40
extended, 3-35, 3-38–3-40
power-on, 3-35–3-36
self-test, 3-35, 3-37

Diff TDR Preset, Sampling Head Fnc's, 3-170

Differential TDR measurements, 3-191, 3-198, 3-200–3-201

Display, 1-11–1-30

Display intensity, 3-23, 3-41

Display modes, 2-46

Display persistence, 3-43–3-48

Displaying labels, 3-116

Distal, 3-149

E

- Electrostatic discharge, C-3
- Enhanced accuracy, 3-49-3-60
 - automatic calibration, 3-51-3-52, 3-54, 3-55
 - manual calibration, 3-56-3-60
 - sampling heads, 3-49-3-60
- Enveloping, 2-43, 3-13-3-16
- Error messages, E-1-E-4
- Extended Diagnostic** selector, 3-38
- External Channel Attenuation, Sampling Head Fnc's**, 3-171
- Eye Diagrams, 3-61-3-63

F

- Fast, 2-36
 - See also *Trace scaling*
- Fast Fourier Transforms, 3-65-3-78
 - measurements, 3-72
 - record length, 3-65
 - windowing functions, 3-75, 3-76, 3-77, 3-78
- FFT, 3-69, 3-72, 3-74, 3-75, 3-76, 3-77, 3-78
 - See also *Fast Fourier Transforms*
 - aliasing, 3-71
 - amplitude resolution, 3-68
 - Bartlett window, 3-75
 - Blackman window, 3-76
 - Blackman-Harris window, 3-76
 - cosine window, 3-77
 - defining an FFT display, 3-67
 - frequency range, 3-68
 - frequency resolution, 3-68
 - Hamming window, 3-78
 - Hanning window, 3-77
 - horizontal and vertical size, 3-69
 - measurements, 3-72-3-73
 - rectangular window, 3-74
 - triangular window, 3-75
 - using the **FFTmag** and **FFTpha** icons, 3-67
 - vertical scaling, 3-70
 - windowing functions, 3-74-3-78
- FFTmag** icon, 3-67-3-78
- FFTpha** icon, 3-67

- Filtering, 3-149
- Fuse, 1-12-1-30, 3-157, B-5, B-10

G

- Gain** pop-up menu, 3-53, 3-56-3-57
- GPIB, 1-2, 1-7, 2-49-2-50, 3-79-3-81
- GPIB** connector, 3-79-3-82, 3-89
- GPIB/RS232C** pop-up menu, 3-80-3-82, 3-164-3-166
- Graticules, 3-83-3-88, 3-231
 - active, 2-26
 - multiple, 2-26
 - units, 2-74, 2-94
- Graticules** pop-up menu, 3-17, 3-84-3-88

H

- Hardcopy, 1-7, 3-89-3-96
 - color map, 3-92
 - defaults, 3-96
- HARDCOPY** button, 3-95-3-96
- Hardcopy Options** pop-up menu, 3-90-3-96
- High Prec, 2-36
- High precision. See *Trace scaling*
- High Precision Traces, 2-36
- Histograms, 2-87-2-90, 3-97-3-104
 - clear, 3-103
 - hits, 3-104
 - mean, 3-104
 - $\mu \pm 2\sigma$, 3-104
 - parameters, 2-88
 - pk-pk, 3-104
 - record length, 3-99
 - refresh rate, 3-102
 - RMSΔ, 3-104
 - Set N Samples, 3-101
 - Set N Wfms, 3-101
 - Stop N Samples, 3-101
 - Stop N Wfms, 3-101
 - vertical, 2-88-2-90
 - Wfms, 3-104

- Hits (histogram display), 3-104
- Horizontal
 - controls, 3-105-3-110
 - icon (↔), 3-105, 3-226
 - pan/zoom, 3-107-3-108
 - reference point, 3-109-3-110
 - size and position, 3-1, 3-105-3-110, 3-226
- Horizontal adjustment, 2-14, 2-38
- Horizontal Bars** selector, 3-31
- Horizontal Desc** pop-up menu, 3-109-3-110, 3-162, 3-232-3-234
- Horizontal histogram, 3-99
- Horizontal Reference Point, 2-39

I

- Icons, 1-14-1-30, 2-14
 - Cursors**, 2-66, 3-30
 - Def Tra**, 2-31
 - DefTra**, 3-206-3-209
 - FFTmag**, 3-67-3-78
 - FFTpha**, 3-67
 - horizontal, 2-14, 2-38
 - horizontal (↔), 3-105, 3-226
 - trigger, 2-14
 - trigger (↕), 3-216
 - vertical, 2-14, 2-33, 2-36, 2-38
 - vertical (↓), 3-221-3-224, 3-226
 - Window**, 2-37, 2-38, 3-225-3-226
- Identify** pop-up menu, 3-189-3-190
- Infinite persistence, 3-44
- Initialization, 3-111-3-112
- Initialize, 2-4-2-18
- Installation, 1-9
- Instrument Options** pop-up menu, 3-7, 3-10-3-12, 3-41, 3-203, 3-214, 3-220
- Intensity, display, 3-23
- Internal clock, connector, 1-6
- INTERNAL CLOCK** connector, 3-19

K

- Keypad Menu
 - Knob Resolution, 2-16-2-18
 - Numeric Entry, 2-16-2-18
- Keypad pop-up menu, 1-15-1-30
- Knob menu, 1-15-1-30
- Knobs, 1-11-1-30
 - assignment, 2-13, 2-14
 - assignment by major menu, 2-18
 - clicks, 2-13
 - labels, 2-13-2-18
 - resolution, 2-16-2-18

L

- Label mode, 3-114
- Labeling** pop-up menu, 3-114, 3-115
- Labels, 2-24, 3-113, 3-114, 3-115, 3-116
 - displayed on graticule, 3-116
 - positioning, 3-116
- Level mode, 3-149
- LINE VOLTAGE SELECTOR** switch, 3-157
- Lower Graticule** pop-up menu, 3-84-3-88

M

- Mask Cursor X, 3-122
- Mask Testing** pop-up menu, 3-118
- Mask Testing** pop-menu, Set N Wfms, 3-129
- Mask Testing** pop-up menu, 3-117-3-134
 - Clear Hits, 3-129
 - Edit Mask definition, 3-122
 - Mask1 - Mask10, 3-129
 - Stop N Wfms, 3-129
 - Total, 3-128
 - Wfm, 3-128
- Masks
 - creating a user mask from a standard mask, 3-126
 - creating user, 3-122, 3-123, 3-124

- deleting user, 3-123
- editing user, 3-123, 3-124, 3-126
- standard, 3-120
 - defined, 3-131
- storing user, 3-125
- testing, 3-128
- user eye, 3-126
- Mean (histogram display), 3-104
- Measurements, 3-135-3-156
 - algorithms, D-1, D-12- D-28
 - annotations, 2-56
 - automated, 2-52-2-63, 2-68, 2-70, 2-76
 - comparing to references, 2-76, 3-145-3-146
 - default parameters, 2-58, 3-155-3-156
 - defining, 3-138-3-139
 - factors affecting accuracy, 3-16
 - hardware, 2-60
 - hardware and software, 3-141-3-144
 - individual measurement pop-up menus, 3-147
 - parameters, 2-56, 3-147-3-153
 - software, 2-60
 - specifying, 2-53, 2-68, 2-70
 - spectral magnitude, D-21- D-28
 - statistical, 2-60
 - statistics, 3-154
 - statistics mode, 3-141-3-144
 - THD, D-22- D-28
 - Topline/Baseline calculation, 3-140

- Measurements** pop-up menu, 3-138-3-144, 3-155-3-156

- Measuring distance, 2-95

- Menus, 1-17-1-30
 - Major Menu buttons, 2-3
 - Pop-Up, 2-8
 - Selectors, 2-5

- Mesial, 3-149

- Messages, E-1-E-4

- More...** menu, 3-210-3-211

- $\mu \pm 2\sigma$ (histogram display), 3-104

N

- Normal persistence, 3-44

O

- Offset** pop-up menu, 3-53, 3-57
- ON/STANDBY** switch, 3-157
- Options, A-1-A-2
- Overall intensity, 3-23

P

- Packaging, C-4
- Paired Dots** selector, 3-31
- Pan/zoom, 3-107-3-108
- Persist/Histograms** pop-up menu, 3-43-3-48, 3-97
 - Color Grading, 3-44
 - Infinite, 3-44
 - Normal, 3-44
 - Refresh Rate, 3-44-3-45
 - Set N MaxContrast, 3-47
 - Stop N MaxContrast, 3-47
 - Variable, 3-44
- Pk-Pk (histogram display), 3-104
- Points per Trace, 2-49
- Pop-up menus, 1-13-1-30
 - Acquire Desc**, 3-3, 3-14-3-16
 - Blowby Compensate**, 3-53, 3-57
 - Clear Trace**, 3-5-3-6
 - Color**, 3-21, 3-22, 3-23
 - Compare & References**, 3-145-3-146
 - Cursor Type**, 3-29-3-31
 - DefTra**, 3-66, 3-206-3-209
 - Delay Adjust**, 3-54, 3-58-3-60
 - Delete Setting**, 3-180
 - Delete Trace**, 3-186, 3-212, 3-213
 - Gain**, 3-53, 3-56-3-57
 - GPIO/RS232C**, 3-80-3-82, 3-164-3-166
 - Graticules**, 3-17, 3-87, 3-88
 - Hardcopy Options**, 3-90-3-96
 - Horizontal Desc**, 3-109-3-110, 3-162, 3-232-3-234
 - Identify**, 3-189-3-190
 - individual measurement, 3-147
 - Instrument Options**, 3-10-3-12, 3-41, 3-203, 3-214, 3-220

keypad, 1-15-1-30
Labeling, 3-114, 3-115
Lower Graticule, 3-84-3-88
Mask Testing, 3-117-3-134
Measurements, 3-138-3-144,
 3-155-3-156
Offset, 3-53, 3-57
Recall Setting, 3-179
Recall Trace, 3-185
Sampling Head Fnc's,
 3-170-3-172
Saved Trace Desc, 3-174-3-176
Set Zero, 3-31
Source, 3-217-3-218
Standard Masks, 3-119-3-134
Store Setting, 3-178-3-179
Store Trace, 3-184
TDR Amplitude, 3-53, 3-58
Upper Graticule, 3-84-3-88
Vertical Desc, 3-211
Window Mode, 3-227-3-230

Power

line voltage selector, 1-7
 ON/STANDBY switch, 1-9
 plug, 1-7
 power-on, 1-9
PRINCIPAL POWER SWITCH, 1-9

POWER connector, 3-157

Power-on, 3-157-3-160

Predefined telecommunication masks,
 3-119, 3-120

Preset Clear, Sampling Head Fnc's,
 3-170

PRINCIPAL POWER SWITCH, 3-157

Printer, 1-7

PRINTER connector, 3-89

Proceed selector, 3-32

Propagation velocity, 3-88

PR

Recall Setting pop-up menu, 3-179

Recall Trace pop-up menu, 3-185

Record length, 2-49, 3-99,
 3-161-3-162

Reference amplitude, 3-88

Reference plane, 3-202

Refresh rate, 3-102

Remove/Clr, 3-5

Rho, 3-87-3-88

Rho units, selecting, 3-195-3-197

RMSΔ (histogram display), 3-104

RS-232-C, 1-2, 1-7, 2-49-2-50

RS-232-C connector, 3-89, 3-163

RS-232-C parameters, 3-163-3-166

S

Safety, 1-3-1-10, C-1-C-4

Sampling

Definition, 1-3

Rate, 1-1

Setting Points per Trace, 2-49

Sampling Head Fnc's pop-up menu,
 3-170-3-172

Sampling heads, 3-167-3-172
 button, 2-28

compartments, 1-6, 1-11-1-30,
 3-167

installation, 1-6

red light, 2-91, 3-168-3-169

SELECT CHANNEL button,
 3-168-3-169

smoothing, 3-171-3-172

Time Domain Reflectometry (TDR),
 2-91-2-96

yellow light, 2-28, 3-168-3-169

Saved Trace Desc pop-up menu,
 3-174-3-176

Saved trace descriptions, 2-80-2-82,
 3-173-3-176

Scaling, trace, 3-214

SELECT CHANNEL button, 3-194,
 3-198

Self Test selector, 3-37

SEQUENCE SETTING button,
 3-181-3-182

Set Cur1 Zero selector, 3-31

Set N Samples, 3-101

Set N Wfms, 3-101, 3-129

Set Zero Rho selector, 3-31

Set Zero selector, 3-31

Settings

default, 3-111-3-112

initialize, 3-111-3-112

stored, 3-177-3-182

Shipping, C-4

Signal Processing

Averaging, 2-43

Enveloping, 2-43

Persistence, 2-46

Smoothing, 2-48

SMA. *See Connectors*

Smooth function, 3-209

Smoothing, 2-48, 3-171-3-172

Source pop-up menu, 3-217-3-218

Specifications, 1-1, B-1-B-6

Split Dots selector, 3-31

Standard Deviation (histogram dis-
 play), 3-104

Standard Masks pop-up menu,
 3-119-3-134

Statistical measurements, 3-141-3-144

Step generator, operation,
 3-191-3-193

Stop N Samples, 3-101

Stop N Wfms, 3-101, 3-129

Store Setting pop-up menu,
 3-178-3-179

Store Trace pop-up menu, 3-184

Stored settings, 3-177-3-182
 sequencing, 3-181-3-182

Stored traces, 2-84-2-85, 3-183,
 3-184, 3-185, 3-186, 3-212, 3-213

Stored waveforms, 3-187, 3-204
 time and date, 3-187, 3-204

Switches, 1-11-1-30

LINE VOLTAGE SELECTOR, 3-157

ON/STANDBY, 3-157

PRINCIPAL POWER SWITCH,
 3-157

System identification, 3-189-3-190

T

TDR, 3-170, 3-191-3-202

differential and common mode
 measurements, 3-198

plus alignment, 3-202

taking measurements, 3-194-3-202

TDR Amplitude pop-up menu, 3-53, 3-58

TDR Head Delta Delay, Sampling Head Fnc's, 3-170

TDR Polarity, Sampling Head Fnc's, 3-170

TDR Preset, Sampling Head Fnc's, 3-170

TDR/TDT, Sampling Head Fnc's, 3-170

TDT, 3-201

Time and date, 3-203
stored waveforms, 3-187, 3-204

Time Base Cal Mode selector, 3-50

Time bases, 2-21, 3-106

Time Domain Reflectometry (TDR), 2-91-2-96, 3-191-3-202

Time Domain Transmission (TDT), 3-170, 3-201

Topline, *D-12- D-28*

Touch panel, 1-13-1-30
touch screen, 2-5

Touching
selectors, 2-5
traces, 2-22

Trace Status menu, 2-23

Traces, 3-205-3-214
additional, 2-21
clearing, 3-5-3-6, 3-212-3-213
complex, 2-31, 2-82
creating, 2-7, 2-31
defining, 3-205-3-209
deleting, 2-28
expression, 2-22-2-28, 2-31
functions, 3-14
high precision, 2-36
labeling, 2-24
modifying, 3-211

numbers, 2-22
removing, 3-212-3-213
saved trace descriptions, 2-80-2-82, 3-173-3-176
scaling, 3-214
selected, 2-21, 2-22
selecting, 3-84-3-88, 3-210-3-211
selecting by touch, 2-22
separation, 2-38
status, 2-22-2-28
stored, 2-84-2-85, 3-183, 3-184, 3-185, 3-186, 3-212, 3-213
trace expressions, 3-205-3-209
trace function algorithms, *D-1-D-11*
trace functions, 3-208-3-209
trace numbers, 3-209
trace scaling, 3-214
trace separation, 3-223
vectoring, 3-219-3-220
XY, 3-231-3-234

Tracking, 3-153

Trigger

connectors, 1-6
icon, 2-14
INPUT connector, 3-215

Trigger icon (↖), 3-216

Triggering, 3-215-3-218

channel, 3-216
external direct, 3-216
internal clock, 3-216

U

Upper Graticule pop-up menu, 3-84-3-88

User Eye Mask, 3-126

V

Variable persistence, 2-46, 3-44

Vectored traces, 3-219-3-220

Vertical

icon (↕), 3-221-3-224, 3-226
size and offset, 3-221-3-224, 3-226

Vertical adjustment, 2-14, 2-33, 2-36, 2-38

Vertical Bars selector, 3-37

Vertical Desc pop-up menu, 3-211

Vertical description, 2-22-2-28, 2-31

Vertical histogram, 3-99

W

Waveforms, stored, 3-187, 3-204

Wfms (histogram display), 3-104

Window icon, 3-225-3-226

Window Mode pop-up menu, 3-227-3-230

Windows, 2-37, 2-58, 3-225-3-230

X

XY traces, 3-231-3-234

AA





.....

