

DCS-E 1kW Series & DCS-E 1.2kW Series DC Power Supplies

Operation Manual

This manual covers models:

DCS8-125E	DCS33-33E	DCS60-18E	DCS150-7E
DCS8-140E	DCS33-36E	DCS60-20E	DCS150-8E
DCS10-100E	DCS40-25E	DCS80-13E	DCS300-3.5E
DCS10-120E	DCS40-30E	DCS80-15E	DCS300-4E
DCS20-50E	DCS50-20E	DCS100-10E	DCS600-1.7E
DCS20-60E	DCS50-24E	DCS100-12E	DCS600-2E

SORENSEN
Elgar Electronics Corporation
9250 Brown Deer Road
San Diego, CA 92121-2294
1-800-733-5427
Tel: (858) 450-0085
Fax: (858) 458-0267
Email: sales@elgar.com
www.elgar.com

©2003 by Sorensen, Division of Elgar Electronics Corporation
This document contains information proprietary to Sorensen, Elgar Electronics Corporation. The information contained herein is not to be duplicated or transferred in any manner without prior written permission from Sorensen.

SAFETY NOTICE

Before applying power to the system, verify that the DCS Series unit is configured properly for the user's particular application.



WARNING!

HAZARDOUS VOLTAGES IN EXCESS OF 280 VRMS, 600V PEAK MAY BE PRESENT WHEN COVERS ARE REMOVED. QUALIFIED PERSONNEL MUST USE EXTREME CAUTION WHEN SERVICING THIS EQUIPMENT. CIRCUIT BOARDS, TEST POINTS, AND OUTPUT VOLTAGES MAY BE FLOATING ABOVE (BELOW) CHASSIS GROUND.

Installation and service must be performed by qualified personnel who are aware of dealing with attendant hazards. This includes such simple tasks as fuse verification.

Ensure that the AC power line ground is connected properly to the DCS Series unit input connector or chassis. Similarly, other power ground lines including those to application and maintenance equipment must be grounded properly for both personnel and equipment safety.

Always ensure that facility AC input power is de-energized prior to connecting or disconnecting the input/output power cables.



During normal operation, the operator does not have access to hazardous voltages within the chassis. However, depending on the user's application configuration, HIGH VOLTAGES HAZARDOUS TO HUMAN SAFETY may be generated normally on the output terminals.

Ensure that the output power lines are labeled properly as to the safety hazards and that any inadvertent contact with hazardous voltages is eliminated. To guard against risk of electrical shock during open cover checks, do not touch any portion of the electrical circuits. Even when the power is off, capacitors can retain an electrical charge. Use safety glasses during open cover checks to avoid personal injury by any sudden failure of a component.

Due to filtering, the unit has high leakage current to the chassis. Therefore, it is essential to operate this unit with a safety ground.

Some circuits are live even with the front panel switch turned off. Service, fuse verification, and connection of wiring to the chassis must be accomplished at least five minutes after power has been removed via external means; all circuits and/or terminals to be touched must be safety grounded to the chassis.

After the unit has been operating for some time, the metal near the rear of the unit may be hot enough to cause injury. Let the unit cool before handling.

Qualified service personnel need to be aware that some heat sinks are not at ground, but at high potential.

These operating instructions form an integral part of the equipment and must be available to the operating personnel at all times. All the safety instructions and advice notes are to be followed.

Neither Sorensen, San Diego, California, USA, nor any of the subsidiary sales organizations can accept any responsibility for personal, material or consequential injury, loss or damage that results from improper use of the equipment and accessories.

SAFETY SYMBOLS



CAUTION
Risk of Electrical Shock



CAUTION
Refer to Accompanying Documents



Off (Supply)



Direct Current (DC)

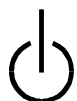

Standby (Supply)



Alternating Current (AC)



On (Supply)



Three-Phase Alternating Current



Protective Conductor Terminal



Earth (Ground) Terminal



Fuse



Chassis Ground

SORENSEN FIVE-YEAR WARRANTY

Sorensen, a division of Elgar Electronics Corporation, warrants its products to be free from defects in material and workmanship. This warranty is effective for five years from the date of shipment of the product to the original purchaser. Liability of Sorensen under this warranty shall exist provided that:

- the Buyer exposes the product to normal use and service and provides normal maintenance on the product;
- Sorensen is promptly notified of defects by the Buyer and that notification occurs within the warranty period;
- the Buyer receives a Return Material Authorization (RMA) number from Sorensen's Repair Department prior to the return of the product to Sorensen for repair, phone 800-458-4258;
- the Buyer returns the defective product in the original, or equivalent, shipping container;
- if, upon examination of such product by Sorensen it is disclosed that, in fact, a defect in materials and/or workmanship does exist, that the defect in the product was not caused by improper conditions, misuse, or negligence; and,
- that Sorensen QA seal and nameplates have not been altered or removed and the equipment has not been repaired or modified by anyone other than Sorensen authorized personnel.

This warranty is exclusive and in lieu of all other warranties, expressed or implied, including, but not limited to, implied warranties of merchantability and fitness of the product to a particular purpose. Sorensen, its agents, or representatives shall in no circumstance be liable for any direct, indirect, special, penal, or consequential loss or damage of any nature resulting from the malfunction of the product. Remedies under this warranty are expressly limited to repair or replacement of the product.

CONDITIONS OF WARRANTY

- To return a defective product, contact a Sorensen representative or the Sorensen factory for an RMA number. Unauthorized returns will not be accepted and will be returned at the shipper's expense.
- For Sorensen products found to be defective within thirty days of receipt by the original purchaser, Sorensen will absorb all ground freight charges for the repair. Products found defective within the warranty period, but beyond the initial thirty-day period, should be returned prepaid to Sorensen for repair. Sorensen will repair the unit and return it by ground freight pre-paid.
- Normal warranty service is performed at Sorensen during the weekday hours of 7:30 am to 4:30 pm Pacific time. Warranty repair work requested to be accomplished outside of normal working hours will be subject to Sorensen non-warranty service rates.
- Warranty field service is available on an emergency basis. Travel expenses (travel time, per diem expense, and related air fare) are the responsibility of the Buyer. A Buyer purchase order is required by Sorensen prior to scheduling.
- A returned product found, upon inspection by Sorensen, to be in specification is subject to an inspection fee and applicable freight charges.
- Equipment purchased in the United States carries only a United States warranty for which repair must be accomplished at the Sorensen factory.

Sorensen

Committed to Quality...Striving for Excellence

This page intentionally left blank.

CONTENTS

SECTION 1 FEATURES AND SPECIFICATIONS	1-1
1.1 Description.....	1-1
1.2 Operating Modes	1-1
1.3 Power Supply Features	1-1
1.4 Specifications.....	1-3
1.4.1 Electrical Specifications for 1kW Models	1-3
1.4.2 Electrical Specifications for 1.2kW Models	1-4
1.4.3 Physical Specifications	1-5
1.4.4 Mechanical Specifications	1-6
SECTION 2 INSTALLATION AND OPERATION.....	2-1
2.1 General	2-1
2.2 Initial Inspection	2-1
2.3 Installation.....	2-1
2.3.1 Input Voltage Selection.....	2-1
2.3.2 Input Line Impedance	2-2
2.3.3 Ventilation Requirements.....	2-2
2.3.4 Output Voltage Biasing	2-2
2.3.5 Rack Mounting	2-2
2.4 Controls, Connectors, and Indicators	2-4
2.4.1 Front Panel	2-4
2.4.2 Rear Panel.....	2-4
2.4.3 J3 Program, Sense and Monitor Connector Description	2-5

2.5	Initial Functional Tests	2-6
2.6	Standard Operation.....	2-7
2.6.1	Load Conductor Ratings	2-7
2.6.2	Load Connection and Grounding	2-7
2.6.3	Inductive Loads	2-8
2.6.4	Remote Sensing.....	2-8
2.6.5	Negative Output Operation	2-9
2.7	Single Supply Operation (Local Mode)	2-9
2.8	Multiple Supplies.....	2-10
2.8.1	Series Operation	2-10
2.8.2	Parallel Operation	2-10
2.8.3	Split Supply Operation	2-11
2.9	Over Voltage Protection (OVP)	2-11
2.9.1	Front Panel OVP Operation	2-11
2.9.2	Remote Programming of OVP With External Voltage Sources.....	2-12
2.9.3	Remote Programming of OVP with an External Resistance	2-13
2.9.4	Remote Programming of OVP with External Current Sources.....	2-14
2.9.5	Remote OVP Sensing	2-15
2.10	Remote ON/OFF	2-15
2.10.1	Remote ON/OFF by Contact Closure.....	2-16
2.11	Remote Programming of Output Voltage and Current Limit	2-16
2.11.1	Programming With External Voltage Sources	2-17
2.11.2	Programming With an External Resistance	2-18
2.11.3	Programming With an External Current Source	2-19
2.12	Remote Monitoring and Status Indicators	2-21

SECTION 3 THEORY OF OPERATION

3.1	Power Circuit (A2 Assembly)	3-1
3.1.1	Basic Off-Line Switching Regulator Theory	3-1
3.1.2	Simplified Full Bridge Converter Theory	3-3
3.1.3	Detailed Circuit Description.....	3-3
3.2	Meter Circuit (A1 Assembly)	3-9
3.2.1	Voltmeter.....	3-10
3.2.2	Current Meter	3-10

SECTION 4 MAINTENANCE, TROUBLESHOOTING, AND CALIBRATION

4.1	General	4-1
4.2	Periodic Service	4-1
4.3	Troubleshooting	4-1
4.3.1	Preliminary Checks	4-2
4.3.2	Troubleshooting at the Operation Level	4-2
4.4	Calibration	4-3

SECTION 5 PARTS LISTS

5.1	General	5-1
5.2	Parts Ordering	5-1
5.3	Parts Lists	5-2

SECTION 6 DRAWINGS AND SCHEMATICS

LIST OF FIGURES

Figure 2-1 DCS Series Power Supply.....	2-3
Figure 3-1 Simplified Full Bridge Converter	3-2
Figure 4-1 Trimpot Locations	4-4

LIST OF TABLES

Table 2-1 Wire Size and Length.....	2-7
Table 4-1 Troubleshooting Guide.....	4-2
Table 5-1 DCS 1kW and 1.2kW Fuse Ratings.....	5-2
Table 5-2 DCS 1kW Parts Lists by Model Number	5-2
Table 5-3 DCS 1kW Parts Lists	5-3
Table 5-4 DCS 1.2kW Parts Lists by Model Number	5-4
Table 5-5 DCS 1.2kW Parts Lists	5-5

SECTION 1

FEATURES AND SPECIFICATIONS

1.1 Description

DCS Series power supplies are 1000W and 1200W supplies designed to provide highly stable, continuously variable output voltage and current for a broad range of development, system, and burn-in applications. The DCS Series employs high frequency switching regulator technology to achieve high power density and small package size.

The series consists of twelve 1000W models and twelve 1200W models. The model numbers are designated by the DCS prefix, followed by the output voltage and current ratings. For example, the model number DCS 60-18E indicates that the unit is rated at 0-60 Vdc and 0-18 Amps while a model DCS 20-50E is rated at 0-20 Vdc and 0-50 Amps.

1.2 Operating Modes

The DCS Series supply has two basic operating modes: Constant Voltage and Constant Current. In constant voltage mode the output voltage is regulated at the selected value while the output current varies with the load requirements. In constant current mode the output current is regulated at the selected value while output the voltage varies with the load requirements.

An automatic crossover system enables the unit to switch operating modes in response to varying load requirements. If, for example, the unit is operating in voltage mode and the load current attempts to increase above the setting of the current control, the unit will switch automatically from voltage mode to current mode. If the load current is subsequently reduced below the setting of the current control the unit will return to voltage mode automatically.

1.3 Power Supply Features

- Twelve 1kW models with voltage ranges from 0-8 Vdc to 0-600 Vdc and current outputs from 1.7A to 125A.
- Twelve 1.2kW models with voltage ranges from 0-8 Vdc to 0-600 Vdc and current outputs from 2A to 140A.
- 115/230 Vac selectable input voltage, 50-60 Hz single phase, Installation Category II. For Indoor Use.
- Simultaneous digital display of both voltage and current.

- Automatic mode crossover into current or voltage mode.
- Ten turn potentiometer voltage and current controls permit high resolution setting of the output voltage and current from zero to the rated output.
- Flexible output configuration: multiple units can be connected in parallel or series to provide increased current or voltage.
- High frequency switching technology allows high power density, providing increased power output in a small, light package.
- Remote sensing to compensate for losses in power leads.
- Adjustable Over-Voltage Protection (OVP)
- External TTL, AC or DC shutdown
- Remote voltage, resistive, current limit and OVP programming with selectable programming constants.
- External indicator signals for remote monitoring of OVP status, local/remote programming status, thermal shutdown, and output voltage and current.
- Optional IEEE-488 interface for complete remote programming and readback capability.

1.4 Specifications

1.4.1 Electrical Specifications for 1kW Models

Specifications are warranted over a temperature range of 0-50°C with default local sensing. From temperatures of 50-70°C, derate output 2% per °C.

Models	8-125	10-100	20-50	33-33	40-25	50-20	60-18	80-13	100-10	150-7	300-3.5	600-1.7
Output Ratings:												
Output Voltage	0-8V	0-10V	0-20V	0-33V	0-40V	0-50V	0-60V	0-80V	0-100V	0-150V	0-300V	0-600V
Output Current	0-125A	0-100A	0-50A	0-33A	0-25A	0-20A	0-18A	0-13A	0-10A	0-7A	0-3.5A	0-1.7A
Output Power	1000W	1000W	1000W	1089W	1000W	1000W	1080W	1040W	1000W	1050W	1050W	1020W
Line Regulation: ¹												
Voltage	8 mV	10 mV	20 mV	33 mV	40 mV	50 mV	60 mV	80 mV	100 mV	150 mV	300 mV	600 mV
Current	125 mA	100 mA	50 mA	33 mA	25 mA	20 mA	18 mA	13 mA	10 mA	7 mA	3.5 mA	1.7 mA
Load Regulation: ²												
Voltage	8 mV	10 mV	20 mV	33 mV	40 mV	50 mV	60 mV	80 mV	100 mV	150 mV	300 mV	600mV
Current	125 mA	100 mA	50 mA	33 mA	25 mA	20 mA	18 mA	13 mA	10 mA	7 mA	3.5 mA	1.7 mA
Meter Accuracy:												
Voltage	0.09V	0.11V	0.3V	0.43V	0.5V	0.6V	0.7V	0.9V	1.1V	1.6V	4.0V	7.0V
Current	1.35A	1.1A	0.6A	0.43A	0.35A	0.30A	0.28A	0.23A	0.11A	0.08A	0.045A	0.018A
OVP Adjustment Range	0.4-8.8V	0.5-11V	1.0-22V	1.65-36.3V	2-44V	2.5-55V	3-66V	4-88V	5-110V	7.5-165V	15-330V	30-660V
Output Noise/Ripple(V) ³												
Rms	4 mV	4 mV	4 mV	4 mV	4 mV	4 mV	4 mV	4 mV	6 mV	12 mV	20 mV	TBD mV
p-p (20Hz-20MHz)	60 mV	60 mV	60 mV	60 mV	60 mV	60 mV	60 mV	60 mV	60 mV	160 mV	200 mV	TBD mV
Stability: ⁴												
Voltage	4 mV	5 mV	10 mV	16.5 mV	20 mV	25 mV	30 mV	40 mV	50 mV	75 mV	150 mV	300 mV
Current	62.5 mA	50 mA	25 mA	16.5 mA	12.5 mA	10 mV	9 mA	6.5 mA	5 mA	3.5 mA	1.75 mA	0.85 mA
Temperature Coefficient: ⁵												
Voltage	1.6 mV	2 mV	4 mV	6.6 mV	8 mV	10 mV	12 mV	16 mV	20 mV	30 mV	60 mV	120 mV
Current	37.5 mA	30 mA	15 mA	9.9 mA	7.5 mA	6 mA	5.4 mA	3.9 mA	3 mA	2.1 mA	1.05 mA	0.51 mA
Maximum Remote Sense Line Drop ⁶ Compensation/line	4V	4V	4V	4V	4V	4V	4V	4V	4V	4V	4V	4V

¹ For input voltage variation over the AC input voltage range, with constant rated load

² For 0-100% load variation, with constant nominal line voltage

³ Typical P-P noise and ripple

⁴ Maximum drift over 8 hours with constant line, load, and temperature, after 20-minute warm-up

⁵ Change in output per °C change in ambient temperature, with constant line and load

⁶ Line drop subtracts from the maximum available output voltage at full rated power

AC Input: 200-250 Vac at 9A rms or 100-130 Vac at 18A rms, 47-63 Hz

Maximum Voltage Differential from output to safety ground: 150 Vdc

1.4.2 Electrical Specifications for 1.2kW Models

Specifications are warranted over a temperature range of 0-50°C with default local sensing. From temperatures of 50-70°C, derate output 2% per °C.

Models	8-140	10-120	20-60	33-36	40-30	50-24	60-20	80-15	100-12	150-8	300-4	600-2
Output Ratings:												
Output Voltage	0-8V	0-10V	0-20V	0-33V	0-40V	0-50V	0-60V	0-80V	0-100V	0-150V	0-300V	0-600V
Output Current	0-140A	0-120A	0-60A	0-36A	0-30A	0-24A	0-20A	0-15A	0-12A	0-8A	0-4A	0-2A
Output Power	1200W	1200W	1200W	1200W	1200W	1200W	1200W	1200W	1200W	1200W	1200W	1020W
Line Regulation: ⁷												
Voltage	8 mV	10 mV	20 mV	33 mV	40 mV	50 mV	60 mV	80 mV	100 mV	150 mV	300 mV	600 mV
Current	140 mA	120 mA	60 mA	36 mA	30 mA	24 mA	20 mA	15 mA	12 mA	8 mA	4 mA	2 mA
Load Regulation: ⁸												
Voltage	8 mV	10 mV	20 mV	33 mV	40 mV	50 mV	60 mV	80 mV	100 mV	150 mV	300 mV	600 mV
Current	140 mA	120 mA	60 mA	36 mA	30 mA	24 mA	20 mA	15 mA	12 mA	8 mA	4 mA	2 mA
Meter Accuracy:												
Voltage	0.09V	0.11V	0.3V	0.43V	0.5V	0.6V	0.7V	0.9V	1.1V	1.6V	4.0V	7.0V
Current	1.55A	1.3A	0.7A	0.46A	0.40A	0.34A	0.3A	0.25A	0.13A	0.09A	0.05A	0.021A
OVP Adjustment Range	0.4-8.8V	0.5-11V	1.0-22V	1.65-36.3V	2-44V	2.5-55V	3-66V	4-88V	5-110V	7.5-165V	15-330V	30-660V
Output Noise/Ripple(V) ⁹												
Rms	5 mV	5 mV	5 mV	5 mV	5 mV	5 mV	5 mV	5 mV	10 mV	15 mV	25 mV	TBD mV
p-p (20Hz-20MHz)	60 mV	60 mV	60 mV	60 mV	60 mV	60 mV	60 mV	60 mV	60 mV	160 mV	200 mV	TBD mV
Stability: ¹⁰												
Voltage	4 mV	5 mV	10 mV	16.5 mV	20 mV	25 mV	30 mV	40 mV	50 mV	75 mV	150 mV	300 mV
Current	70 mA	60 mA	30 mA	18 mA	15 mA	12 mV	10 mA	7.5 mA	6 mA	4 mA	2 mA	1 mA
Temperature Coefficient: ¹¹												
Voltage	1.6 mV	2 mV	4 mV	6.6 mV	8 mV	10 mV	12 mV	16 mV	20 mV	30 mV	60 mV	120 mV
Current	42 mA	36 mA	18 mA	10.8 mA	9 mA	7.2 mA	6 mA	4.5 mA	3.6 mA	2.4 mA	1.2 mA	0.6 mA
Maximum Remote Sense Line Drop ¹² Compensation/line	2V	2V	4V	4V	4V	4V	4V	4V	4V	4V	4V	4V

⁷ For input voltage variation over the AC input voltage range, with constant rated load

⁸ For 0-100% load variation, with constant nominal line voltage

⁹ Typical P-P noise and ripple

¹⁰ Maximum drift over 8 hours with constant line, load, and temperature, after 20-minute warm-up

¹¹ Change in output per °C change in ambient temperature, with constant line and load

¹² Line drop subtracts from the maximum available output voltage at full rated power

AC Input: 200-250 Vac at 10A rms or 100-130 Vac at 20A rms, 47-63 Hz

Maximum Voltage Differential from output to safety ground: 150 Vdc

1.4.3 Physical Specifications

Altitude: 2000M (6562 ft.)

Storage Temperature Range: -55 to +85°C

Humidity Range: 0 to 80% Non-condensing

Time Delay from power on until output stable: 3 seconds maximum

Voltage Mode Transient Response Time: 500 μ S recovery to 1% band for 30% step load change from 70% to 100% or 100% to 70%

Remote Start/Stop and Interlock: TTL compatible input, Contact Closure, 12-250 Vac or 12-130 Vdc

Switching Frequency: Nominal 70 kHz typical (140 kHz output ripple)

Analog Programming Linearity: Typical error is less than 0.5% setting. Maximum error is 1% of rated output.

Agency Approvals: CE Pollution Degree 2 (UL pending)

Remote Analog Programming (Full Scale Input)

Scales are selectable via an internally-mounted switch.

Parameter	Resistance	Voltage	Current
Voltage	5 k Ω	5V, 10V	1 mA
Current	5 k Ω	5V, 10V	1 mA
OVP	5 k Ω	5V, 10V	1 mA

1.4.4 Mechanical Specifications

Size: 44mm H x 482.6mm W x 508mm D (1.75" H x 19" W x 20" D)

Weight: 8.2 kg (18 lbs)

Output Connector

Models DCS-E 8V through DCS 100V

Connector type: Nickel plated copper bus bars.

Approximate dimensions: 1.365" x 0.8" x 0.125"

Distance between positive and negative bus bar centers: 2.2"

Load wiring mounting holes: Two 0.257" diameter holes on 0.5" centers (1/4" hardware)
Two 0.191" diameter holes on 0.4" centers (#10 hardware)

Models DCS-E 150V through DCS 600V

Connector type: Six-pin Amp Universal Mate-N-Lok connector

Chassis mounted parts: Housing: Amp part number 1-480705-0
Pins: Amp part number 350547-1

Mating connector parts: Housing: Amp part number 1-480704-0
Socket pins: Amp part number 350550-1

Note: Six Socket pins and one mating connector housing are supplied with each 150V through 600V unit.

Input Connector

2 position terminal block plus safety ground screw.

Note: Input power cord not supplied.

SPECIFICATIONS SUBJECT TO CHANGE WITHOUT NOTICE

SECTION 2

INSTALLATION AND OPERATION

2.1 General

After unpacking, perform an initial inspection and function test to ensure that the unit is in good working order. If the unit was damaged in shipment, notify the carrier immediately. Direct repair problems to the Sorensen Customer Service Department at 1-800-458-4258.

2.2 Initial Inspection

The equipment should be inspected for damage as follows:

- Inspect for obvious signs of physical damage.
- Turn front panel controls from stop to stop. Rotation should be smooth.
- Test the action of the power switch. Switching action should be positive.
- If internal damage is suspected, remove the cover and check for printed circuit board and/or component damage. Reinstall cover.

2.3 Installation

2.3.1 Input Voltage Selection

Before using the DCS power supply, the correct AC input voltage must be selected and an appropriate line cord and plug attached, or hook up wire sized for input current based on NEC or local electrical code. The frequency of the AC input voltage must be maintained between 47 and 63 Hz.

All units are shipped in a configuration requiring a 200-250 Vac input. The unit can be converted for use with a 100-130 Vac input or purchased preset for 115 Vac with the M1 Option.



CAUTION

Attempted operation of the DCS power supply with the incorrect input voltage may result in internal damage to the unit.

For use with a **200-250 Vac input**, connect a 250 Vac 10 Amp plug and cord to the rear panel AC connector and the safety ground screw. (Note that the NEUT. and LINE designations above the AC connector do not apply to 200-250V operation.)

To convert the unit for use with a **100-130 Vac input**, perform the following steps:

1. Ensure that the unit is switched off and disconnected from any power source.
2. Remove the Phillips head screws that secure the cover and then remove the cover.
3. Remove the 230 Vac voltage selector jumper located at the front center of the PCB from its mating header (P1 on the PCB) and install the attached 115 Vac jumper in its place.
4. Remove the adhesive backed 115 Vac 20A label from fan and cover the 230 Vac 10A input specification above the rear panel AC connector.
5. Reinstall the cover and replace screws.
6. Install a 125 Vac 20A plug and cord ensuring that the neutral (white) wire and line (black) wire are connected in the correct positions and that the safety ground wire is connected to the ground screw.

Note that both the 1kW and 1.2kW models can exceed the 15A standard wall outlet capacity at full load.



NOTE: To provide protection for personnel in the case of unit failure and to ensure proper power supply operation, the safety ground wire of the AC input line cord must **always** be connected to the ground screw provided.

2.3.2 Input Line Impedance

The maximum input line impedance for operation at full rated output is 0.5 ohm. Higher source impedances can be tolerated by raising the input line voltage or by reducing the output voltage and/or current.

2.3.3 Ventilation Requirements

The DCS power supply may be used in rack mounted or benchtop applications. In either case sufficient space must be allowed for cooling air to reach the ventilation inputs on each side of the unit and for the fan exhaust air to exit from the rear of the unit.

2.3.4 Output Voltage Biasing



WARNING

If the output voltage is to be biased relative to safety ground, the power supply outputs may be biased up to a maximum of 150 Vdc with respect to the chassis.

2.3.5 Rack Mounting

The DCS power supply is designed to fit in a standard 19" equipment rack. When installing the unit in a rack, be sure to provide adequate support for the rear of the unit while not obstructing the ventilation inlet on the sides of the unit. Use adjustable support angles such as Hammond RASA22WH2, or a support bar such as Hammond RASB19WH2.

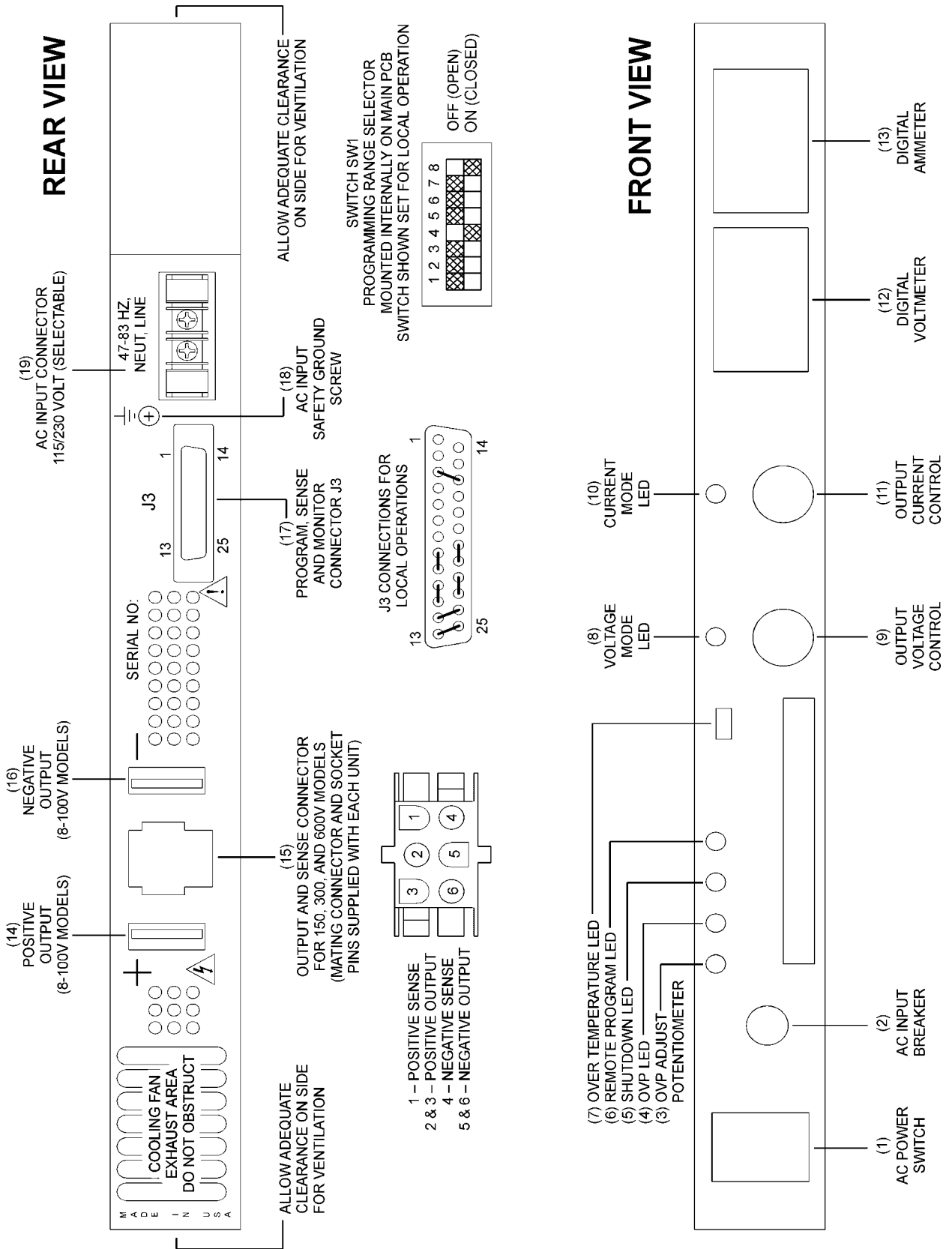

Figure 2-1 DCS Series Power Supply

2.4 Controls, Connectors, and Indicators

Refer to **Figure 2-1** and the descriptions below.

2.4.1 Front Panel

- (1) AC Power Switch
- (2) AC Input Circuit Breaker
- (3) OVP Adjust Potentiometer: Manual adjustment for OVP trip level
- (4) OVP LED: Indicates that the OVP circuit has been activated when illuminated
- (5) Shutdown LED: Indicates activation of the remote shutdown circuit when illuminated
- (6) Remote Programming LED: Indicates operation by remote programming when illuminated
- (7) Over-Temperature LED: Indicates that the power supply is shut down due to an internal over-temperature condition when illuminated
- (8) Voltage Mode LED: Indicates operation in voltage mode when illuminated
- (9) Output Voltage Control: Multi-turn potentiometer used to adjust the output voltage in local mode
- (10) Current Mode LED: Indicates operation in current mode when illuminated
- (11) Output Current Control: Multi-turn potentiometer used to adjust the output current limit in local mode
- (12) Digital Voltmeter
- (13) Digital Ammeter

2.4.2 Rear Panel

- (14) Positive Output for 8, 10, 20, 33, 40, 50, 60, 80, and 100 volt models
- (15) Output and Sense Connector for 150, 300 and 600 volt models
- (16) Negative Output for 8, 10, 20, 33, 40, 50, 60, 80, and 100 volt models
- (17) Programming, Sense and Monitor Connector J3: Input connector for programming signals. Also provides access to sense connections and monitoring points. See Section 2.4.3 for individual pin descriptions. **Note:** *The positive output and positive sense are not available at connector J3 on 150, 300, and 600 volt models.*
- (18) AC Input Safety Ground Screw
- (19) AC Input Connector

2.4.3 J3 Program, Sense and Monitor Connector Description

D-subminiature 25-pin female; mating connector: 25-pin Male ITT Cannon DB25P or equivalent

Pin #	Function
1	AC/DC Shutdown Input (12-250 Vac or 12-130 Vdc)
2	Return for Shutdown Input Signals
3	OVP Programming Input (0-5V, 0-10V, or 0-1mA) Jumpered to pin 16 for local mode operation
4	Remote Programming Indicator (high=remote programming, low=local control)
5	Operating Mode Indicator (high=voltage mode, low=current mode)
6	Ground
7	Output Current Monitor (calibrated) 0-5V=0-100%
8	Front Panel Voltage Control (remote programming) Input for 0-1mA remote programming signal Jumpered to pin 9 for local operation and remote current source programming
9	Remote Voltage Programming Input (0-5V or 0-10V) Jumpered to pin 8 for local operation and remote current source programming
10	Remote Current Programming Input (0-100mV, 0-5V, or 0-10V) Jumpered to pin 11 for local operation and remote current source programming
11	Front Panel Current Control (remote programming) Input for 0-1mA external programming signal Jumpered to pin 10 for local operation and remote current source programming
12	Return Sense (return for remote programming inputs)
13	Positive Sense
14	TTL Shutdown Input
15	+12 Vdc Output (1k ohm source impedance)
16	1mA Current Source for Local OVP Control or Remote Resistive OVP Programming
17	OVP Status (high=OVP circuit activated)
18	Thermal Shutdown Indicator (high=shutdown)
19	Output Voltage Monitor (uncalibrated) 0-5V=0-100%
20	Front Panel Voltage Control (local mode); jumpered to pin 21 for local operation
21	1mA Current Source for Local Operation or Remote Resistive Programming of Output Voltage; jumpered to pin 20 for local operation
22	1mA Current Source for Local Operation or Remote Resistive Programming of Output Current Limit; jumpered to pin 23 for local operation
23	Front Panel Current Control (local mode); jumpered to pin 22 for local operation
24	Return (for local sense connections only)
25	Positive Output (for local sense connections only)

Note: Pins 25 and 13 not connected on 150, 300, and 600V models.

2.5 Initial Functional Tests

Before connecting the unit to an AC outlet, make sure that the power switch is in the OFF position and that the voltage and current controls are turned fully counter clockwise. Check that the J3 mating connector on the rear of the unit is in place with jumpers connected for local operation as shown below. (This is the default configuration as shipped from the factory). Connect the unit to a 230 Vac grounded outlet (115 Vac outlet if previously configured for 115 Vac operation as per instructions in section 2.3.1) and switch the unit on. After a short power on delay the front panel meters should light up with both displays reading zero.

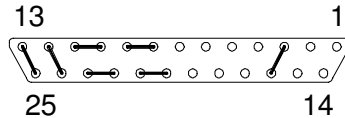

Connector J3 Configuration for Local Operation

To check **voltage mode operation**, proceed as follows:

- Connect a DVM, rated better than 0.5% accuracy, to the rear output terminals, observing correct polarity.
- Rotate the CURRENT control 1/2 turn clockwise. Slowly rotate the VOLTAGE control clockwise and observe both the internal and external meters. Minimum control range should be from zero to the maximum rated output. Compare the test meter reading with the front panel voltmeter reading. Check that the green voltage mode indicator led is ON.
- Set the POWER switch to OFF.

To check **current mode operation**, proceed as follows:

- Rotate the VOLTAGE and CURRENT controls fully counterclockwise.
- Rotate the VOLTAGE control 1/2 turn clockwise.
- Connect a high current DC ammeter across the rear output terminals, observing correct polarity. Select leads of sufficient current carrying capacity and an ammeter range compatible with the unit's rated current output. The ammeter should have an accuracy of better than 0.5%.
- Set the POWER switch to ON.
- Rotate the CURRENT control slowly clockwise. The control range should be from zero to the maximum rated output. Compare the test meter reading with the reading on the front panel ammeter. Check that the red current mode indicator led is ON.
- Set the POWER switch to OFF.

2.6 Standard Operation

Reliable performance of the DCS power supply can be obtained if certain basic precautions are taken when connecting it for use on the lab bench or installing it in a system.

To obtain a stable, low noise output, careful attention should be paid to factors such as conductor ratings, system grounding techniques and the way in which the load and remote sensing connections are made.

2.6.1 Load Conductor Ratings

Table 2–1 lists the maximum allowable load wiring length (in feet) for a specified wire gauge and power supply model operating at full rated output. The lengths indicated are based on PVC insulated wire with a maximum operating temperature of 105°C. To overcome impedance and coupling effects, which can degrade the power supply performance, use leads of the largest gauge and shortest length possible.

Model	Wire Size (AWG)								
	2	4	6	8	10	12	14	16	18
8V	19	12	–	–	–	–	–	–	–
10V	19	12	–	–	–	–	–	–	–
20V	30	30	30	23	–	–	–	–	–
33V	30	30	30	30	22	14	–	–	–
40V	30	30	30	30	30	18	–	–	–
50V	30	30	30	30	30	23	13	–	–
60V	30	30	30	30	30	26	16	10	–
80V	30	30	30	30	30	30	22	20	–
100V	30	30	30	30	30	30	22	20	–
150V	30	30	30	30	30	30	28	26	–
300V	30	30	30	30	30	30	30	30	–
600V	30	30	30	30	30	30	30	30	30

Table 2–1 Wire Size and Length

2.6.2 Load Connection and Grounding

Proper connection of distributed loads is an important aspect of power supply application. A common mistake is to connect leads from the power supply to one load, from that load to the next load, and so on for each load in the system. In this **parallel power distribution** method, the voltage at each load depends on the current drawn by the other loads and DC ground loops are developed. Except for low current applications, this method should not be used.

The preferred way to distribute power is by the **radial distribution** method in which power is connected to each load individually from a single pair of terminals designated as the positive and negative distribution terminals. The pair of terminals may be the power supply output terminals, the terminals of one of the loads or a distinct set of terminals specially established for distribution. Connecting the sense leads to these terminals will compensate for losses and minimize the effect of one load upon another.

2.6.3 Inductive Loads

To prevent damage to the power supply from inductive kickback, connect a diode rated at greater than or equal to the supply's output voltage and current across the output. Connect the cathode to the positive output and the anode to return. Where positive load transients such as back EMF from a motor may occur, connect a transorb or a varistor across the output to protect the power supply.

2.6.4 Remote Sensing

The use of remote sensing permits the regulation point of the power supply to be shifted from the output terminals to the load or other distribution terminals thereby automatically compensating for the voltage losses in the leads supplying the load (provided these losses do not exceed 1V/line [0.5V/line for the DCS 8-125 and DCS 10-100 models]). For example, with the voltmeter reading 10.0 volts and the sense lines connected directly to the load, the load voltage will remain regulated at 10.0 volts regardless of the voltage drops in the power leads and variations in the load current.

On 8V, 10V, 20V, 33V, 40V, 50V, 60V, 80V, and 100V models, the positive sense connection is available at pin 13 of connector J3 and the return sense connection is available at pin 12. For local sensing (regulation at the power supply output terminals) the sense pins are connected to pins 25 (positive output) and 24 (return) of connector J3. For remote sensing the local operation jumpers are removed and pins 13 and 12 are connected directly to the positive and negative terminals of the load.

On 150, 300 and 600V models, the sense connections are available through the output connector (see **Figure 2-1** for the exact pin out). On these models, no sense line jumpers are required for local operation.

Sense wires can be any size (24AWG or larger) but in high noise environments or when the lowest possible power supply ripple is required, sense wires must be twisted and/or shielded.



NOTE

On 8V–100V models, the sense leads must always be connected, either for remote or local sensing. Operation of the supply with the sense leads disconnected will cause the output to fall to zero or to be unregulated.



CAUTION

Never use the sense connections without the normal power lead connections to the output terminals. Avoid reversing positive and negative sense lead connections, this could result in damage to the load.

2.6.5 Negative Output Operation

Operation of the unit as a negative output supply may be accomplished by referencing the positive output terminal to the power supply chassis or some other common system ground. This mode of operation is limited to 8V–150V models only due to the metal shell 25-pin “D” connector supplied with the unit which mates to J3.



WARNING

Operation of the 300V or 600V models in the negative output mode is in violation of the European Community’s Low Voltage Directive.

Note: If a -300V or -600V supply is required, please contact the Sorensen Sales Department or Customer Service for availability.

2.7 Single Supply Operation (Local Mode)

To operate the DCS power supply in local mode, first install the unit and connect the load following the instructions in **Sections 2.1 to 2.6**. Check that switch SW1 (mounted internally on the main printed circuit board) is set for local operation, and that the J3 mating connector on the rear of the unit is in place with jumpers connected for local operation. Note that this is the default configuration as shipped from the factory; see the diagram below. Set both the current and voltage controls fully counterclockwise.

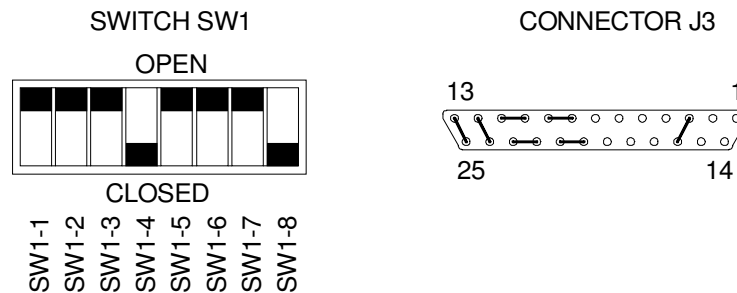

Switch SW1

SW1-1 Off (Open)
 SW1-2 Off (Open)
 SW1-3 Off (Open)
 SW1-4 On (Closed)
 SW1-5 Off (Open)
 SW1-6 Off (Open)
 SW1-7 Off (Open)
 SW1-8 On (Closed)

**Switch SW1 and Connector J3 Configuration for Local Operation
 (Default factory settings)**

For **voltage mode operation**, turn the current control fully clockwise and then adjust the voltage control to obtain the desired output voltage. For **current mode operation**, turn the voltage control 1/2 turn clockwise, the current control fully counterclockwise and connect an appropriately sized shorting jumper across the output terminals. Turn the current control clockwise until the desired output current is obtained. Turn the power supply off, remove the shorting jumper, turn the voltage control fully clockwise and turn the power supply on.

Note that for a short period (less than 2 seconds) after power on, the power supply output is disabled and the current mode LED is illuminated while the main filter capacitors charge through the inrush limiter.

2.8 Multiple Supplies

DCS Series power supplies of the SAME MODEL may be operated with outputs in series or parallel to obtain increased load voltage or current. Split supply operation allows two positive or a positive and negative output to be obtained.

2.8.1 Series Operation

Series operation is used to obtain a higher voltage single output supply using two or more single units. Connect the negative terminal (–) of one supply to the positive terminal (+) of the next supply of the same model. The total voltage available is the sum of the maximum voltages of each supply (add voltmeter readings).

Notes:

1. The maximum allowable sum of the output voltages is 300V. This is limited by the creepage/clearance distances internal to the construction of the metal shell 25-pin 'D' connector mated to J3. If a higher output voltage range is required, contact the Sorensen Sales Department or Customer Service for availability.
2. The maximum allowable current for a series string of power supplies is the rated output current of a single supply in the string.
3. Remote sensing should not be used during series operation.

2.8.2 Parallel Operation

Parallel operation is used to obtain a higher current single output supply using two or more single units. Set all of the outputs to the same voltage before connecting the positive terminals (+) and negative terminals (–) in parallel. The total current available is the sum of the maximum currents of each supply.



CAUTION

To prevent internal damage, ensure that the OVP trip level of all supplies is set to maximum.

2.8.3 Split Supply Operation

Split supply operation is used to obtain two positive voltages with a common ground, or a positive-negative supply.

To obtain **two positive voltages**, connect the negative terminals of both supplies together. The positive terminals will supply the required voltages with respect to the common connection.

To obtain a **positive-negative supply**, connect the negative terminal of one supply to the positive terminal of the second supply. The positive terminal of the first supply then provides a positive voltage relative to the common connection while the negative terminal of the second supply provides a negative voltage. The current limits can be set independently. The maximum current available in split operation is equal to the rated output of the supplies used.



CAUTION

Refer to Section 2.6.5 for additional information pertaining to negative output configured supplies.

2.9 Over Voltage Protection (OVP)

The OVP circuit allows for protection of the load in the event of a remote programming error, incorrect voltage control adjustment, or power supply failure. The protection circuit monitors the output and reduces the output voltage and current to zero whenever a preset voltage limit is exceeded. A red LED on the front panel indicates when the OVP circuit has been activated. Resetting the OVP circuit after activation requires removal of the over-voltage condition and powering the unit OFF and back ON or momentarily activating the remote shut down circuit (See **Section 2.10** for information on shut down circuit operation). The OVP trip level can be set using either the front panel potentiometer or by using one of three remote programming methods (voltage, resistance or current) through the J3 connector at the rear of the unit.

2.9.1 Front Panel OVP Operation

To set the trip level from the front panel, use the following procedure:

1. With the unit off and disconnected from its AC source remove the cover and check that switches SW1-4 and SW1-8 are closed (factory default setting). Also check that the jumper between pins 3 and 16 of connector J3 is in place.
2. Using a small flat bladed screwdriver through the OVP ADJUST hole in the front panel, turn the adjusting screw fully clockwise (until audible clicking is heard or 20 turns maximum).
3. Turn the unit on and adjust the output to the desired trip voltage.
4. Slowly turn the adjusting screw counterclockwise until the red OVP indicator lights and the power supply output shuts off.
5. Turn the POWER switch to OFF.
6. Turn the voltage control knob to minimum.
7. Turn the POWER switch back ON and increase the voltage to check that the power supply shuts off the output at the desired voltage.

2.9.2 Remote Programming of OVP With External Voltage Sources

To remotely program the OVP trip level using a 0-5V or 0-10V DC voltage source, use the following procedure:

1. With the unit off and disconnected from its AC source, remove the cover and set switch SW1-4 closed (default factory setting) for 0-5V programming or open for 0-10V programming. Also check that switch SW1-8 is closed (default factory setting). Set the front panel OVP adjusting potentiometer fully clockwise (until audible clicking is heard or 20 turns maximum).
2. Remove the default jumper connecting pins 16 and 3 of connector J3 and connect the voltage source between pins 3 (positive) and 12 (negative). Set the programming source voltage to maximum.
3. Turn the unit on and adjust the output to the desired trip voltage.
4. Slowly reduce the programming voltage until the red OVP indicator lights and the power supply shuts down.
5. Turn the POWER switch to OFF.
6. Turn the voltage control knob to minimum.
7. Turn the POWER switch back ON and increase the voltage to check that the power supply shuts off the output at the desired voltage.

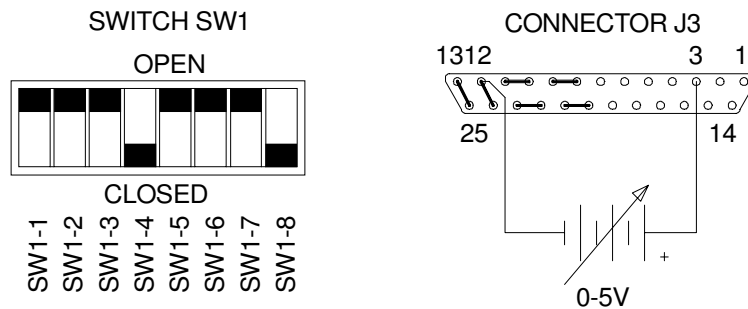

Switch SW1

- SW1-1 Off (Open)
- SW1-2 Off (Open)
- SW1-3 Off (Open)
- SW1-4 On (Closed)
- SW1-5 Off (Open)
- SW1-6 Off (Open)
- SW1-7 Off (Open)
- SW1-8 On (Closed)

Switch SW1 and Connector J3 Configuration for 0-5 Vdc OVP Programming

(J3 sense line, voltage control and current control jumpers shown set for local operation)

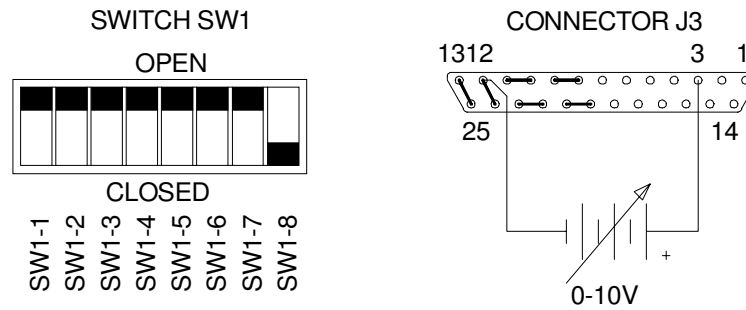

Switch SW1

SW1-1 Off (Open)
 SW1-2 Off (Open)
 SW1-3 Off (Open)
 SW1-4 Off (Open)
 SW1-5 Off (Open)
 SW1-6 Off (Open)
 SW1-7 Off (Open)
 SW1-8 On (Closed)

Switch SW1 and Connector J3 Configuration for 0-10 Vdc OVP Programming

(J3 sense line, voltage control and current control jumpers shown set for local operation)

2.9.3 Remote Programming of OVP with an External Resistance

To remotely program the OVP trip level using a 5k ohm external potentiometer, use the following procedure.

1. With the unit off and disconnected from its AC source remove the cover, set switch SW1-8 open and check that switch SW1-4 is closed (default factory setting for switch SW1-4).
2. Connect the counterclockwise end of the 5k potentiometer to pins 3 and 16 of connector J3. Connect the tap and the clockwise end of the potentiometer to pin 12. Set the potentiometer fully clockwise.
3. Turn the unit on and adjust the output to the desired trip voltage.
4. Slowly turn the potentiometer counterclockwise until the red OVP indicator lights and the power supply shuts down.
5. Turn the POWER switch to OFF.
6. Turn the voltage control knob to minimum.
7. Turn the POWER switch back ON and increase the voltage to check that the power supply shuts off the output at the desired voltage.

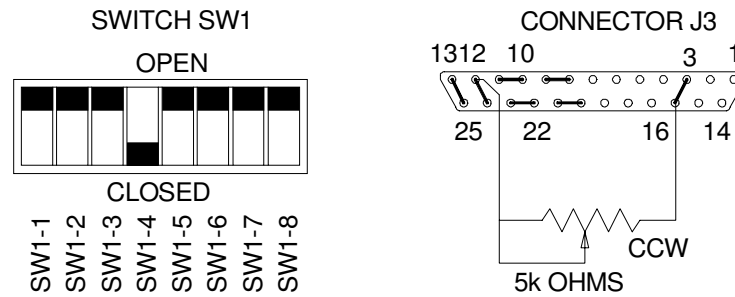

Switch SW1

- SW1-1 Off (Open)
- SW1-2 Off (Open)
- SW1-3 Off (Open)
- SW1-4 On (Closed)
- SW1-5 Off (Open)
- SW1-6 Off (Open)
- SW1-7 Off (Open)
- SW1-8 Off (Open)

Switch SW1 and Connector J3 Configuration for 0-5k OVP Programming

(J3 sense line, voltage control and current control jumpers shown set for local operation)

2.9.4 Remote Programming of OVP with External Current Sources

To remotely program the OVP trip level using a 0-1mA current source use the following procedure.

1. With the unit off and disconnected from its AC source remove the cover and set switches SW1-4 and SW1-8 closed (default factory setting).
2. Using a small flat bladed screwdriver through the OVP ADJUST hole in the front panel, turn the adjusting screw fully clockwise (until audible clicking is heard or 20 turns maximum).
3. Remove the default jumper connecting pins 16 and 3 of connector J3 and connect the current source between pins 3 (positive) and 12 (negative). Set the programming source to 1mA.
4. Turn the unit on and adjust the output to the desired trip voltage.
5. Slowly reduce the programming current until the red OVP indicator lights and the power supply shuts down.
6. Turn the POWER switch to OFF.
7. Turn the voltage control knob to minimum.
8. Turn the POWER switch back ON and increase the voltage to check that the power supply shuts off the output at the desired voltage.

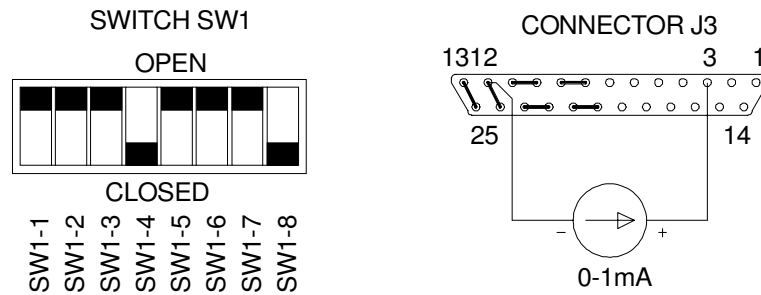

Switch SW1

- SW1-1 Off (Open)
- SW1-2 Off (Open)
- SW1-3 Off (Open)
- SW1-4 On (Closed)
- SW1-5 Off (Open)
- SW1-6 Off (Open)
- SW1-7 Off (Open)
- SW1-8 On (Closed)

Switch SW1 and Connector J3 Configuration for 0-1mA Current Source OVP Programming

(J3 sense line, voltage control and current control jumpers shown set for local operation)

2.9.5 Remote OVP Sensing

The default configuration for the OVP circuit senses the output voltage at the power supply output terminals. For applications using remote sensing where there is a need to accurately monitor the actual load voltage, the following procedure allows the OVP sense point to be shifted from the power supply output to the sense line connection points.

1. Shut the unit off and disconnect it from its power source. Remove the cover from the unit.
2. Unsolder or clip out R412, the zero ohm OVP sense link located next to the output filter capacitor C53.
3. Install a piece of insulated #22 AWG wire from the via marked C (near R412) to the via marked C1 (near capacitor C51).
4. Reinstall the cover and reconnect the unit to its power source.

To return to local OVP sensing, remove the jumper installed in step 3 above and install a jumper across R412 removed in step 2.

2.10 Remote ON/OFF

This feature is useful in test applications requiring remote ON-OFF control of the output. The remote ON-OFF control circuit uses either a TTL compatible or a 12-250 Vac (or 12-130 Vdc) input to remotely control (disable or enable) the power supply output. For TTL operation, a logic

level signal between pins 14 (positive) and 2 (return) of connector J3 determines the output conditions:

TTL LOW = OUTPUT ON
 TTL HIGH = OUTPUT OFF

For AC or DC operation, an input of 12-250 Vac (or 12-130 Vdc) between pins 1 (positive for DC input) and 2 (return) of connector J3 will disable the output of the supply.

A red LED on the front panel indicates when the shutdown circuit is activated. The input lines are optically isolated and can therefore be accessed by circuits with a voltage differential of up to 600 Vdc.

2.10.1 Remote ON/OFF by Contact Closure

An external relay may be used to operate the ON/OFF control circuit as follows. Connect one side of a normally open relay to pin 15 of connector J3 (+12V). Connect the other side of the relay to pin 14 (TTL Shutdown). Also connect J3 pin 2 (Shutdown return) to pin 6 (Ground). Using this configuration, the power supply will be OFF when the relay coil is energized and ON when the relay is de-energized.

If a normally closed relay is substituted for the normally open relay in the configuration described above, the power supply will be ON when the relay coil is energized and OFF when the relay is de-energized.

2.11 Remote Programming of Output Voltage and Current Limit

The output voltage and current limit of the power supply can be remotely programmed through the rear panel J3 connector using **external voltage sources, current sources and resistances**. Switch SW1 on the A2 printed circuit board controls the programming as diagrammed below. When the supply is controlled by remote programming, the green REMOTE led on the front panel is illuminated.

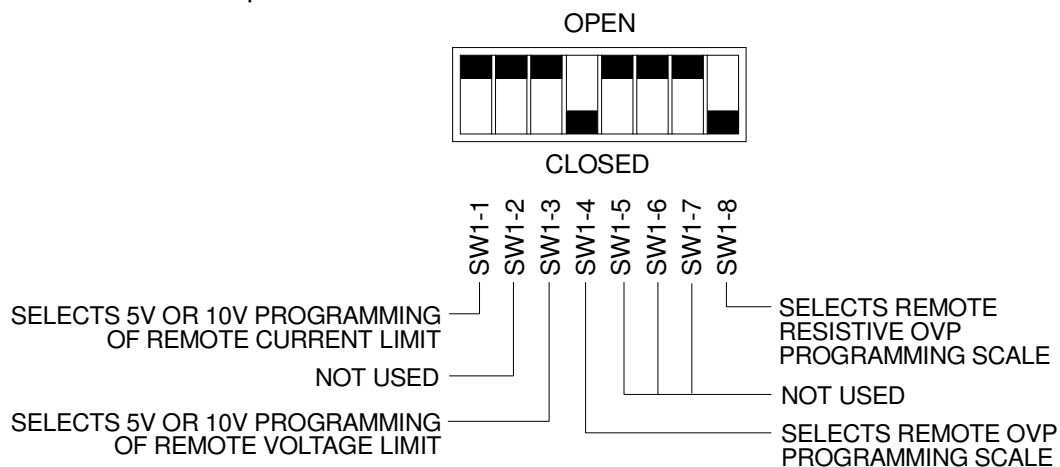

Switch SW1 and Functions

Note: To set SW1, shut the unit off, disconnect the AC source, and remove the cover. Make the desired switch settings, reinstall the cover, and reconnect the unit to its AC source.

2.11.1 Programming With External Voltage Sources

The **output voltage** can be programmed using either a 0-5 Vdc or 0-10 Vdc external voltage source. To program the output voltage with a 0-5 Vdc source, set switch SW1-3 open (default factory setting) and remove the jumpers connecting pins 8 to 9 and 20 to 21 on connector J3. Connect the external source between pins 9 (positive) and 12 (return). Varying the external voltage from 0-5V will cause the output to vary from 0-100% of rated output.

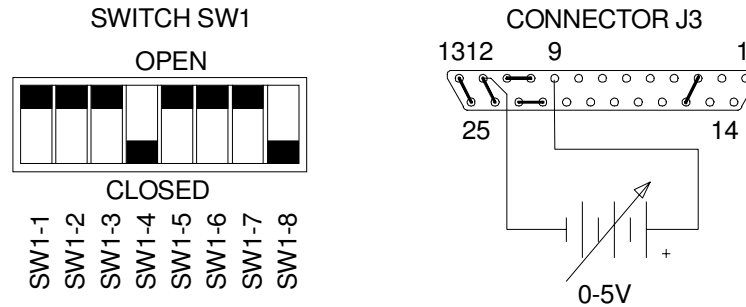

Switch SW1

SW1-1 Off (Open)	SW1-5 Off (Open)
SW1-2 Off (Open)	SW1-6 Off (Open)
SW1-3 Off (Open)	SW1-7 Off (Open)
SW1-4 On (Closed)	SW1-8 On (Closed)

Switch SW1 and Connector J3 Configuration for 0-5V Programming of the Output Voltage

(J3 sense line, OVP and current control jumpers shown set for local operation)

For programming with a 0-10 Vdc source, close switch SW1-3 and replace the 0-5V source with a 0-10V source.

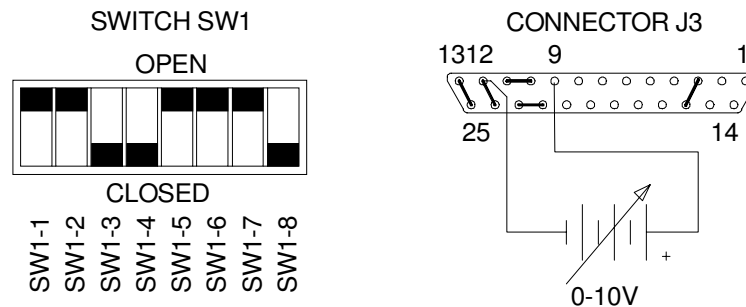

Switch SW1

SW1-1 Off (Open)	SW1-5 Off (Open)
SW1-2 Off (Open)	SW1-6 Off (Open)
SW1-3 On (Closed)	SW1-7 Off (Open)
SW1-4 On (Closed)	SW1-8 On (Closed)

Switch SW1 and Connector J3 Configuration for 0-10V Programming of the Output Voltage

(J3 sense line, OVP and current control jumpers shown set for local operation)

The **output current limit** can be programmed using a 0-5 Vdc or 0-10 Vdc external voltage source. Selection of the programming voltage is done using switches SW1-1 and SW1-2 as indicated below:

SW1-1	SW1-2	PROGRAMMING VOLTAGE
OPEN	OPEN	0-5 Vdc and Local Mode
CLOSED	CLOSED	Not Used
CLOSED	OPEN	0-10 Vdc
OPEN	CLOSED	Not Used

To remotely program the output current limit, set switches SW1-1 and SW1-2 as shown above, remove the jumpers connecting pins 10 to 11 and 22 to 23 of connector J3 and connect the external voltage source between pins 10 (positive) and 12 (return). Varying the voltage source from 0-100% causes the current limit to vary from 0-100% of the rated maximum.

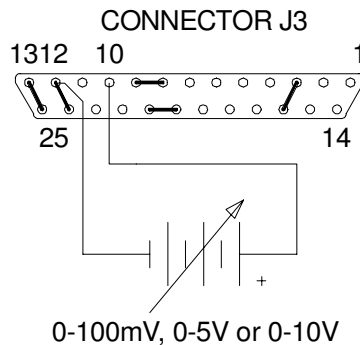

**Connector J3 Configuration
for Remote Programming of the Output Current Limit**

(J3 sense line, OVP and voltage control jumpers shown set for local operation)

2.11.2 Programming With an External Resistance

The output voltage and current limit can be programmed using a 5k ohm external potentiometer.

To program the **output voltage**, set switch SW1-3 open (default factory setting) and remove the jumpers connecting pins 8 to 9 and 20 to 21 on connector J3. Connect pins 9 and 21 to the counterclockwise end of the 5k potentiometer and connect the tap and clockwise end of the potentiometer to pin 12. Adjusting the tapped resistance from 0-5k will vary the output voltage from 0-100% of the rated output.

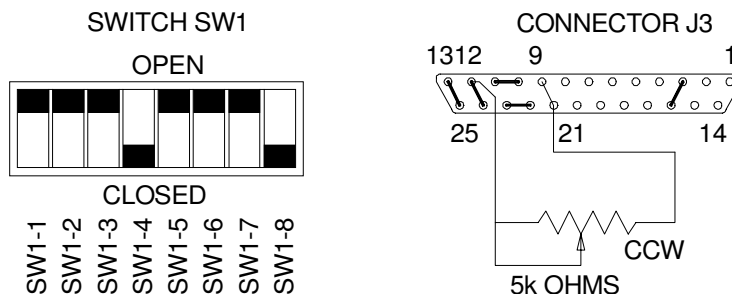

Switch SW1

SW1-1 Off (Open)
 SW1-2 Off (Open)
 SW1-3 Off (Open)
 SW1-4 On (Closed)
 SW1-5 Off (Open)
 SW1-6 Off (Open)
 SW1-7 Off (Open)
 SW1-8 On (Closed)

**Switch SW1 and Connector J3 Configuration
 for Resistive Programming of the Output Voltage**

(J3 sense line, OVP and current control jumpers shown set for local operation)

To program the **output current limit**, set switches SW1-1 and SW1-2 open (default factory setting) and remove the jumpers connecting pins 10 to 11 and 22 to 23 on connector J3. Connect pins 10 and 22 to the counterclockwise end of the 5k potentiometer and connect the tap and clockwise end of the potentiometer to pin 12. Adjusting the tapped resistance from 0-5k will vary the current limit from 0-100% of the rated output.

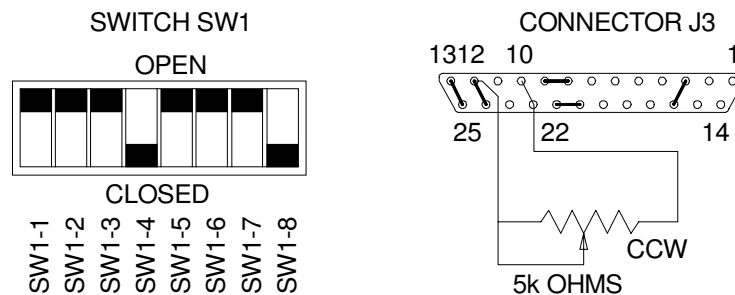
**Switch SW1**

SW1-1 Off (Open)
 SW1-2 Off (Open)
 SW1-3 Off (Open)
 SW1-4 On (Closed)
 SW1-5 Off (Open)
 SW1-6 Off (Open)
 SW1-7 Off (Open)
 SW1-8 On (Closed)

**Switch SW1 and Connector J3 Configuration
 for Resistive Programming of the Output Current Limit**

(J3 sense line, OVP and voltage control jumpers shown set for local operation)

2.11.3 Programming With an External Current Source

The output voltage and current limit can be programmed using an external 0-1mA current source.

To program the **output voltage**, set the front panel voltage control to maximum, set switch SW1-3 open (default factory setting) and remove the jumper between pins 20 and 21 of

connector J3. Connect the external current source between pins 8 (positive) and 12 (return) of connector J3. Varying the current source from 0-1mA will vary the output voltage from 0-100% of the rated output.

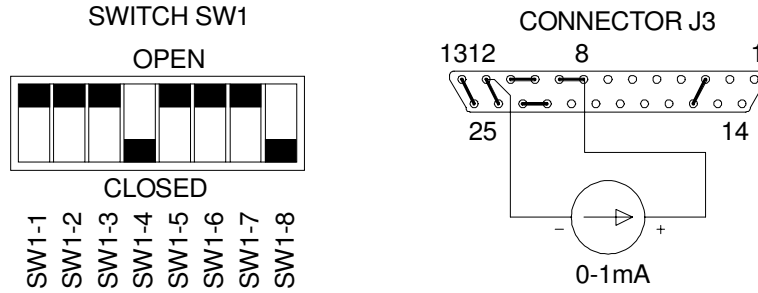

Switch SW1 and Connector J3 Configuration for 0-1mA Current Programming of the Output Voltage

(J3 sense line, OVP and current control jumpers shown set for local operation)

To program the **output current limit**, set the current control to maximum, set switches SW1-1 and SW1-2 open (factory setting) and remove the jumper between pins 22 and 23 of connector J3. Connect the external current source between pins 11 (positive) and 12 (return). Varying the current source from 0-1mA causes the current limit to vary from 0-100% of rated maximum.

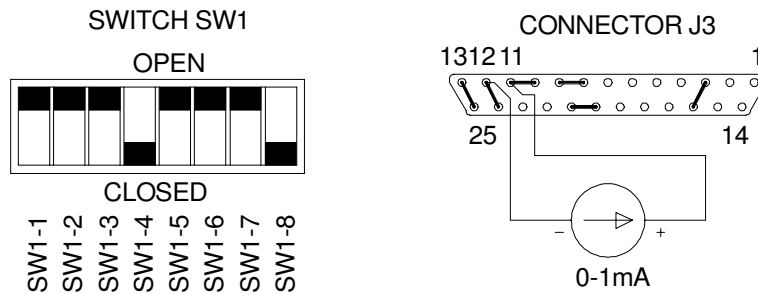

Switch SW1 and Connector J3 Configuration for 0-1mA Current Programming of the Output Current Limit

(J3 sense line, OVP and voltage control jumpers shown set for local operation)

2.12 Remote Monitoring and Status Indicators

Readback signals for remote monitoring of the output voltage and current are available at connector J3 on the rear of the unit. A 0-5V (uncalibrated) signal between pins 19 (positive) and 12 (negative) represents 0-100% of the rated output voltage. A 0-5V (calibrated) signal between pins 7 (positive) and 12 (negative) represents 0-100% of the rated output current. The offset and gain of the current readback signal may be adjusted through holes in the cover of the unit (see **Section 4.4 Calibration** for location of adjusting holes).

Status indicators for thermal shutdown, OVP operation, remote programming and operating mode are also available through the J3 connector. The table below lists the various signals, the J3 connector pins where they are available, the approximate magnitude of the signal (measured with respect to pin 6 of connector J3) and the source impedance through which the signal is fed.

Indicator Signal	J3 Connector Pin	Signal Voltage	Source Impedance
Thermal Shutdown	18	+10V	750Ω
OVP Circuit Activated	17	+9V	750Ω
Remote Programming	4	+10V	750Ω
Voltage Mode Operation	5	+10V	750Ω
Current Mode Operation	5	-3V	750Ω

Monitor Signal	J3 Connector Pin	Jumper Selection	Output Signal Range	Source Impedance
Output Voltage	19 (+) 6 (RTN)	JP1 OUT IN	0–5V 0–10V	100Ω
Output Current	7 (+) 6 (RTN)	JP2 OUT IN	0–5V 0–10V	100Ω

This page intentionally left blank.

SECTION 3

THEORY OF OPERATION

3.1 Power Circuit (A2 Assembly)

This section describes the operation of the A2 assembly switching regulator power circuit. Three subsections cover basic switching regulator theory, a simplified description of the Sorensen full bridge converter, and a more detailed circuit description intended for troubleshooting purposes.

3.1.1 Basic Off-Line Switching Regulator Theory

An off-line switching power supply first converts the AC input line voltage to high voltage DC by diode rectification and then chops the DC at a high frequency. This high frequency waveform is applied to the primary of a power transformer that provides a step-up or step-down in voltage and electrical isolation on its secondary. The secondary waveform is rectified and filtered, giving a smooth DC output voltage. Feedback from the secondary circuit is applied to a pulse width modulator (PWM) control circuit which controls the on-time of the primary circuit switching waveform. This increases or decreases the voltage on the secondary of the power transformer so that output regulation is obtained.

The use of high frequency transformers in switching power supplies has the advantage of requiring less volume, less weight, and dissipating less heat than the lower frequency transformers in conventional linear power supplies.



CAUTION

Potentially LETHAL VOLTAGES exist on the A2 circuit board on the primary side of the isolation barrier. Troubleshoot with care, preferably with power off and recognizing that filter capacitors store potentially LETHAL and DESTRUCTIVE ENERGY even for some time AFTER POWER is REMOVED. Always use an isolation transformer connected ONLY to the power supply input when making test measurements on the primary side circuits.

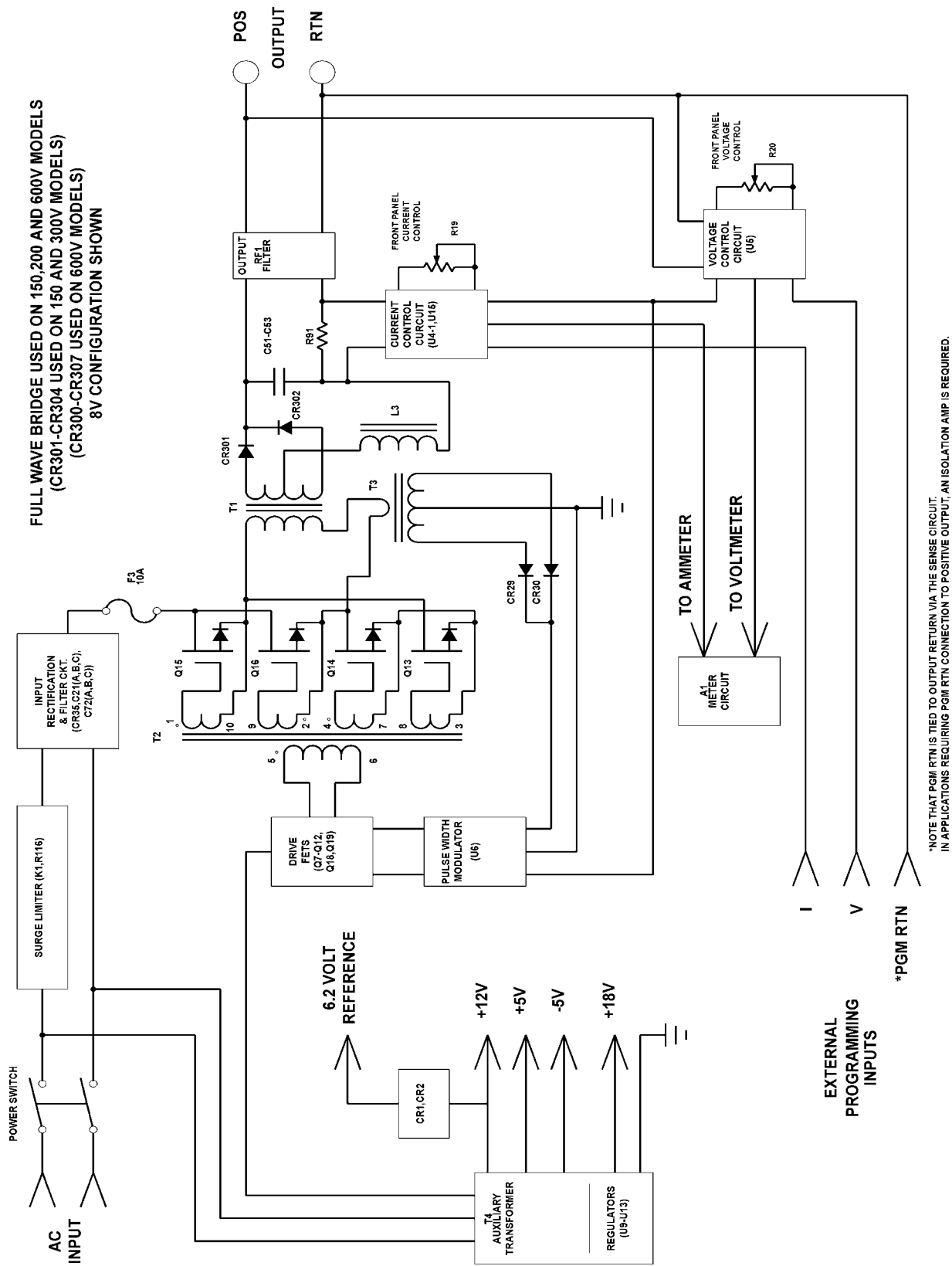

Figure 3-1 Simplified Full Bridge Converter

3.1.2 Simplified Full Bridge Converter Theory

See **Figure 3-1**.

The input AC line voltage is rectified and filtered by CR35, C32(A,B,C), and C72(A,B,C) to a raw DC voltage which is supplied to the power FETs, Q13-Q16, on the primary of power transformer T1. Resistor R116, R116A and relay K1 form an input surge current limiter which reduces the inrush current to the filter capacitors C32(A,B,C), and C72(A,B,C) during power-up. The power FETs and the primary winding of T1 form a bridge which is driven at 70 kHz by pulse width modulator (PWM) U6 through FETs Q7-Q12, Q18 and Q19 and drive transformer T2. A current sense transformer, T3, in the primary of the power transformer provides a feedback signal to the PWM which is compared to a limited error signal derived from the output current and voltage control circuits. The output of the comparator controls the on-time of the PWM output drive waveforms on a cycle by cycle basis thereby controlling the primary current and the output of the power transformer. Diodes CR301 and CR302 on 8V thru 20V models (D1 and D2 on 33-100V models, CR301-CR304 on the 150V and 300V models and CR300-CR307 on the 600V model) rectify the output of power transformer T1 and inductor L3 and capacitors C51, C52 and C53 (C153 with series connected C106, C107 on the 600V model) filter the rectified signal to provide the DC output.

A current shunt (R91) in the output return line develops a voltage proportional to the output current. This current information is amplified by U15 and compared to the setting of the current limit control in the current control error amplifier U4-1. The output voltage is also monitored and compared to the voltage control setting in the voltage error amplifier U5. The outputs of the voltage and current error amps are OR'd through CR18 and R26 and this signal is fed into the PWM error amplifier inverting input providing the negative feedback required to produce a regulated output. The output voltage and current information from the current and voltage control circuits is also fed to the front panel A1 assembly where it is displayed on the digital voltage and current readouts.

Transformer T4, rectifier CR42 and regulators U9-U13 provide the necessary auxiliary supply voltages for the PWM circuit, voltage and current control circuits, the A1 display board and the raw DC supply for drive transformer T2. A 6.2V reference is also derived from the 12V supply for use in display circuits by temperature compensated reference diode CR1 and resistor R2.

Transformers T1, T2, T3 and T4 provide output isolation from the line potentials in the primary circuit, the PWM circuit and the auxiliary supply circuits respectively.

3.1.3 Detailed Circuit Description

This section provides further detail for troubleshooting purposes. Please read the previous section as an overview and then refer to the detailed assembly schematic in **Section 6**.



CAUTION

Potentially LETHAL VOLTAGES exist on the A2 circuit board on the primary side of the isolation barrier. Troubleshoot with care, preferably with power off and recognizing that filter capacitors store potentially LETHAL and DESTRUCTIVE ENERGY even for some time AFTER POWER is REMOVED. Always use an isolation transformer connected ONLY to the power supply input when making test measurements on the primary side circuits.

Input Rectifier and Inrush Limiting

Input AC power passes from the rear panel AC connector (TB1) through an RFI filter consisting of C1-6, R122, and common mode filter inductors L1, and L2 to the front panel power switch. Both input lines are switched with one line (the neutral line of a 115Vac input) returning to the A2 PCB and the input bridge rectifier CR35 via fuse F1. The other input line (the hot line of a 115Vac input) is connected to the remaining input of rectifier CR35 via front panel circuit breaker CB1, relay K1 and the inrush limiter formed by parallel resistors R116, R116A and fuse F2. Resistors R116, R116A limit the power-on inrush current to the main filter capacitors C32(A,B,C) and C72(A,B,C) until it is shorted by K1 relay contacts. The time delay for K1 contact closure is determined by the time constant formed by capacitor C12, resistor R118 and the gate threshold of FET Q6. Diode CR33 keeps the PWM shutdown input high until the relay closes. Diode CR38 discharges C12 when the 12V auxiliary supply collapses and CR39 provides an inductive kickback path for the relay coil. During the inrush period, diode CR33 holds the PWM shutdown line high, disabling the power supply output until Q6 turns on. Resistors R114 and R115 are bleeder resistors for the main filter capacitors. The rectified high voltage dc from CR35 is supplied to the main switching FETs Q13-Q16 on the primary of the power transformer T1 via fuse F3.

For 230Vac operation, rectifier CR35 and filter capacitors C32(A,B,C) and C72(A,B,C) are configured as a full wave bridge. For 115Vac operation the input voltage selector P1 is configured so that CR35, C32(A,B,C) and C72(A,B,C) form a voltage doubler. In this manner, the rectified DC voltage is always within the range of 225-350VDC with either a 115 or 230Vac input voltage. In addition to determining the input rectifier configuration, P1 also configures the connections to the primary of auxiliary transformer T4 for series or parallel operation.

Pulse Width Modulator

Pulse width modulator U6 is a current mode controller that drives the main switching FETs Q13-Q16 through a driver circuit consisting of FETs Q7-Q12, Q18 and Q19 and FET gate drive transformer T2. Capacitor C69 and resistors R111-R113 form a snubber on the primary of transformer T1 limiting switching transients. Transformer T3 is used to monitor the primary current in T1 and provide a feedback signal for the peak current sense amplifier of U6. Diodes CR29 and CR30 rectify T3 output while resistor R95 and C64A provide a burden impedance to T3 and filter the switching spikes. Resistors R96, R97 and capacitors C60-C62 and C97 scale and condition the signal before it is applied to the input of the PWM IC at U6-4. Transistor Q20 is connected to the ramp generator at U6-8 through R66 to provide slope compensation to the current feedback signal to allow for stable operation at light loads. An internal comparator compares the output of the current sense amplifier with a limited error signal derived from the output voltage and current control circuits. The output of the PWM comparator controls the pulse duration of the drive signals from pins 11 and 14 of the PWM thereby controlling the primary current in T1 and the output power. Resistor R100 and capacitor C63 set the internal oscillator of U6 to approximately 140kHz, resulting in an approximate 70kHz output switching frequency. A 5.1V reference developed at pin 2 of U6 is divided down by resistors R64 and R67 to provide a reference at the non-inverting input of the error amplifier at U6-5. The 5.1V reference voltage is also divided by resistors R65 and R68 to provide a reference at pin 1 of the PWM which limits the swing of the error amplifier output placing an upper limit on the primary current in transformer T1. Resistors R413 and R102 form a divider to limit the voltage to shutdown pin 16 of U6 to turn the PWM off during startup, shutdown or OVP or over temperature conditions.

Output Rectifier Circuit and Output Filter

The DCS series uses two different configurations for the output rectifier. The 8V to 100V models use a full wave center tap configuration while the 150 to 600V models employ a full wave bridge. On 8V to 20V models, the output rectifiers are one piece power tap units mounted on the rectifier heatsink with the secondary snubber components connected directly to the rectifier terminals. The 33V to 600V models have their rectifier and snubber components on a separate printed circuit board that is mounted on a rectifier heatsink. Capacitors C51-C53, power inductor L3 and common mode inductor L4 form the main output filter on all models. On 8V to 100V models the secondary filter capacitors C401-C406 are on a separate PCB that is mounted on the output bus bar assembly. On 150V to 600V models the secondary filter capacitors C50, C50A, C50B, C50C, C48, C48B, C49, and C49B are mounted directly on the A2 PCB. Resistor R145 is an output pre-load which allows the unit to operate under no load or light load conditions (resistor R144A is a zero ohm jumper to short out R144 and connect R145 to the positive output on models from 8-300V). Resistor R144 is used in series with R145 only on the 600V model as the output filter capacitors C106, C107 are used in series at this higher voltage. Following is a description of the differences between models that describe the rectifier arrangements for the models at differing voltages

- **Models 8V through 20V**

On these models diodes CR301 and CR302 rectify the output of power transformer T1. Resistors R301, R303 and R304 and capacitors C301 and C302 form snubbers on the secondary of T1 to limit switching transients while capacitors C305 and C306 are used to provide bypassing on the positive output of the rectifier to chassis.

- **Models 33V through 100V**

On these models diodes D1 and D2 rectify the output of power transformer T1. Resistors R2 and R3 and capacitors C3 and C4 form snubbers on the secondary of T1 to limit switching transients. Resistors R1 and R4 and capacitors C2 and C5 are used to provide additional rectifier snubbing. C1 and C6 provide bypassing on the positive output of the rectifier to chassis.

- **Models 150V through 300V**

On these models diodes CR301-CR304 form the rectifier bridge with resistors R301-R304 and capacitors C301-C304 providing snubbing for the diodes. Resistor R305 and capacitor C305 form the snubber on the secondary of T1. Capacitor C306 provides bypassing on the positive output of the bridge to chassis.

- **Model 600V**

On this model, series connected diodes CR300-CR307 form the rectifier bridge with resistors R300-R307 and capacitors C300-C307 providing snubbing for the diodes. Resistor R308 and R309 and capacitor C308 form the snubber on the secondary of transformer T1. Capacitor C309 provides bypassing on the positive output of the bridge to chassis.

Voltage Control Circuit

The output voltage feedback is monitored by the voltage control op amp U5 pin 3 via the positive sense line (pin 13 of connector J3 on 8V to 100V models and on pin 1 of the Amp high voltage connector) and the resistor divider formed by R21, R22, R53, R85 and R147. This feedback voltage is compared with a 0-5V reference voltage generated by the front panel voltage control pot to U5 pin 2 through the normally closed CMOS switch U7-2 to provide an error signal for the PWM. If the output voltage tries to rise above the selected level the voltage at U5 pin 3 rises and the output of U5 becomes more positive. This increase is applied to the inverting input of the PWM error amplifier through diode CR18 and resistor R69 causing the amplifier output to decrease. This reduces the PWM output drive waveform pulse width, lowering the output voltage and regulating the output at the desired level. Similarly, if the output voltage tries to fall below the selected level the voltage at U5 pin 3 decreases, U5 output decreases, the output from the PWM error amplifier increases and the drive waveform pulse width increases which raises the output voltage to the desired level. During voltage mode operation the output of the current control circuit at U4-1 pin 1 remains low. Resistor R70 and capacitor C54 provide frequency compensation for the op amp and diode CR21A limits saturation. Capacitor C20, resistor R54 and FET Q22 provide a soft start for the power supply during initial startup and recovery from shut down conditions by ramping the voltage rise at pin 2 of U5. Q22 acts as a voltage-controlled resistor whose resistance increases as C20 is discharged by R54. Buffer amplifier U2 pin 1 provides for remote monitoring of the output voltage at pin 19 of connector J3. The output voltage monitor default connection provides a 0-5Vdc proportional to the full-scale output voltage. With the addition of a jumper added to the pins of JP1, U2 along with resistors R419 and R420 allow the voltage monitor to provide 0-10Vdc proportional to the full-scale output voltage. Potentiometer R53 is used to adjust the full-scale output of the power supply and potentiometer R52 is used to adjust the offset on op amp U5. Resistor R21 supplies the front panel voltmeter with a voltage proportional to the output voltage through pin 6 of the J1 connector.

Current Control Circuit

The output current is monitored by current shunt resistor R91 which develops a voltage across it proportional to the output current. This voltage is amplified and conditioned by the differential op amp U15 and associated components to provide a control ground referenced 0-2V signal at pin 3 of the current control op amp U4-1. This signal is compared to a reference level generated from the front panel current control pot to pin 2 of U4-1 through the normally closed CMOS switch U7-1. As the output current increases, the voltage at pin 3 rises until it reaches the reference level set at U4 pin 2. At this time, the output of U4-1 goes high and the unit switches from voltage mode to current mode operation. The output current is maintained at the desired level by providing negative feedback to the PWM error amplifier as described in the voltage control circuit description above. Resistor R27 and capacitor C27 provide frequency compensation for U4-1 and diode CR26A limits saturation. Capacitor C20, resistor R54, and FET Q23 provide a soft start for the power supply during initial startup and recovery from shut down conditions by ramping the voltage rise at pin 2 of U4. Q23 acts as a voltage-controlled resistor whose resistance increases as C20 is discharged by R54. Op amp U4-2 and related components scale the current feedback signal to provide a calibrated 0-5V proportional to the full scale output current to buffer amplifier U2-2. U2-2 provides a low impedance output at pin 7 of connector J3 for external monitoring of the output current. With the addition of a jumper added to the pins of JP2, U2-2 along with resistors R422 and R423 allow the current monitor to provide 0-10V proportional to the full scale output current. The shunt voltage is also fed to the front panel ammeter via pins 8 and 9 of connector J1 in order to display the output current.

Operating Mode Indicator Circuit

Op amp U8-2 monitors the polarity of the voltage across diode CR18. CR18 is forward biased during voltage mode and reverse biased during current mode to provide a mode indication signal at U8 pin 7. This output is used to drive the back to back mode indicator LEDs CR1 and CR2 on the front panel through pin 1 of connector J1. In voltage mode U8 pin 7 is high and the green voltage mode led is illuminated. In current mode U8 pin 7 is low and the red current mode led is illuminated.

Auxiliary Supply and 6.2V Reference Circuit

Transformer T4, rectifier CR42 and capacitors C9 and C10 provide the raw dc supply voltages from which three terminal regulators U10 and U11 derive the +12V and +5V auxiliary supplies respectively. Two additional regulators (U12 and U13) provide the regulated +12V to drive FETs Q7-Q12, Q18 and Q19 on the primary of T2, and the +12V feed to PWM U6. Diodes CR40 and CR41 with capacitors C7 and C11 provide the negative voltage input to regulator U9 which supplies the -5V auxiliary output. Resistor R2 and temperature compensated reference zener diode CR1 are used to derive a stable 6.2V reference from the +12V auxiliary supply for use on the front panel voltage and current meters (via pin 5 of connector J1) and the Remote indicator circuitry on the A2 PCB. Transistor Q5, diode CR32, resistors R60-62 and zener diode CR20 form a low voltage lock out which disables the power supply output by shutting down the PWM should the auxiliary raw supply fall below the threshold set by CR20.

Voltage and Current Control Current Sources

Op amp U3-1 and transistors Q1, Q2 and Q4, and related components are used to provide three separate 1mA current sources for the front panel voltage and current control pots. These current sources are also used for remote resistive programming of the output voltage and current limit. The circuit operates by comparing the voltage generated by 2.5V reference CR60 to the voltage drop across Q4 emitter resistor R31. The current is regulated at 1mA by maintaining the drop across R31 at 2.5V. Q1 and Q2 act as current mirrors by having their bases in common and using identical emitter resistors. The 1mA current source from the transistor collectors goes to J3 pins 16, 21 and 22 for OVP, voltage and current control functions.

Over Voltage Protection Circuit

The OVP 1mA current source is fed to the front panel OVP adjusting pot via the external jumper connecting pins 3 and 16 of connector J3, switch SW1-8 and pin 17 of connector J1. This current source and the OVP adjusting pot provide a 0-5V reference at pin 6 of U3-2, the OVP control op amp. The power supply output voltage is monitored at pin 5 of U3-2 through the resistor divider formed by R80, R89, R148 and OVP sense link R412. When the output voltage increases such that the voltage at pin 5 becomes higher than that at pin 6, the output of U3-2 goes high activating MOSFET Q17 (via drive FET Q2A) which discharges the power supply output through resistor R93. Diode CR25 latches U3-2 on while diodes CR23 and CR24 gate the high signal to the shutdown pin of the PWM. The OVP indicator on the front panel is biased on via pin 15 of connector J1 when the OVP is activated. The OVP may be reset by cycling the power switch off and then back on to release the latch provided by CR25 or by momentarily activating the remote shutdown circuit which causes pin 6 to be pulled high through diode CR10 and Q3.

During remote voltage programming of the OVP trip level the internal 1mA current source is disconnected by removing the jumper that connects pin 3 and 16 of J3. The reference voltage at pin 6 of U3-2 is then provided directly by the external voltage source. Switch SW1-4 is used to select the programming range; 0-5V (with the switch closed) or 0-10V (with the switch open) by utilizing R1 as a voltage divider. For current programming the internal 1mA current source is replaced with a 0-1mA external source to provide the required 0-5V reference signal. For resistive programming switch SW1-8 is opened to disconnect the front panel adjusting potentiometer and the internal 1mA current source is connected to the external 0-5k ohm potentiometer to provide a 0-5V reference.

Over Temperature Circuit

U8-3 and associated circuitry consisting of R57-59 and thermister RT1 provide overtemperature protection by monitoring the main FET heatsink temperature. When negative temperature coefficient device RT1 is heated, the value of resistance decreases until the voltage on U8 pin 9 equals the voltage on U8 pin 10 at which time U8 pin 8 will provide a high signal to the U6 PWM shutdown input through CR27.

Remote ON/OFF Circuit

A TTL high signal applied between pins 14 (positive) and 2 (negative) of connector J3 activates optocoupler U1 which turns on transistor switch Q3 by pulling its base low. This applies 12V through diode CR11 to the shutdown pin of the PWM thereby shutting down the power supply output. A 12-250Vac or 12-130Vdc signal applied between pins 1 (positive) and 2 (negative) of connector J3 will also activate U1 and disable the power supply output. Diode CR14 rectifies ac inputs while resistors R37 and R38 limit the current through the optocoupler. Diode CR13 provides protection against reverse polarity signals.

Remote Programming of the Output Voltage

During remote programming of the output voltage with an external voltage source (0-5V or 0-10V) the local operation jumpers connecting J3 pins 8 to 9 and 20 to 21 are removed and the external source is connected between pins 9 (positive) and 12 (negative) of connector J3. The input signal at J3 pin 9 is clamped by CR7 and CR8 and filtered by R409 and C104 to protect the input buffer amplifier U14-2 which provides the 0-5V programming signal for the output voltage. When using a 0-10V programming source, switch SW1-3 is closed to provide the necessary voltage divider to scale the reference voltage back to 0-5V.

For remote programming with an external 5k resistance the jumpers connecting J3 pins 8 to 9 and 20 to 21 are removed, pins 9 and 21 are connected to the counterclockwise end of the external 5k ohm potentiometer and the tap and clockwise end are connected to pin 12. The internal 1mA current source at pin 21 develops a 0-5V potential across the potentiometer, depending on the potentiometer setting, which is fed to pin 2 of U5 through buffer amp U14-2.

During remote programming of the output voltage with an external 0-1mA current source, the jumper connecting J3 pins 20 and 21 is removed, the front panel voltage control is set fully clockwise and the external current source is connected between pins 8 (positive) and 12 (return). Varying the current source from 0-1mA causes 0-5V to be developed at the reference pin of the voltage control circuit.

The front panel remote programming indicator is controlled by op amp U8-4. Resistors R55 and R56 form a voltage divider with the 6.2V reference which develops a nominal 0.3V at pin 12 (the non-inverting input) of the op amp. During local operation, current flow through diode CR15 and the front panel voltage control provides a higher voltage at pin 13 (the inverting input) keeping U8-4 output low. During remote programming there is no current flow through diode CR15 and the output of U8-4 goes high illuminating the remote programming indicator through diode CR4, resistor R13 and pin 13 of connector J1. The high signal is also provided at pin 4 of connector J3 for remote monitoring purposes.

Remote Programming of the Output Current Limit

During remote programming of the output current limit with an external voltage source the local operation jumpers connecting J3 pins 10 to 11 and 22 to 23 are removed and the external source (0-5V or 0-10V) is connected between pins 10 (positive) and 12 (negative). The input signal at J3 pin 10 is clamped by CR5 and CR6 and filtered by R411 and C103 to protect the input buffer amplifier U14-1 which provides a 0-5V programming signal for the output current. This signal is further reduced to a 0-2V signal with a voltage divider consisting of R20 and R146. When using a 0-10V programming source, switch SW1-1 is closed to provide the necessary voltage divider to scale the reference voltage back to appropriate 0-5V level.

For remote programming with an external 5k resistance the jumpers connecting J3 pins 10 to 11 and 22 to 23 are removed, pins 10 and 22 are connected to the counterclockwise end of the external 5k ohm potentiometer and the tap and clockwise end are connected to pin 12. The internal 1mA current source at pin 22 develops a 0-5V potential across the potentiometer, depending on the potentiometer setting, which is fed to pin 3 of U4-1.

During remote programming of the output current with an external 0-1mA current source, the jumper connecting J3 pins 22 and 23 is removed, the front panel voltage control is set fully clockwise and the external current source is connected between pins 11 (positive) and 12 (return). Varying the current source from 0-1mA causes 0-5V to be developed at the reference pin of the current control circuit.

The front panel remote programming indicator is controlled by op amp U8-1. Resistors R55 and R56 form a voltage divider with the 6.2V reference which develops a nominal 0.3V at pin 3 (the non-inverting input) of the op amp. During local operation, current flow through diode CR16 and the front panel voltage control provides a higher voltage at pin 2 (the inverting input) keeping U8-1 output low. During remote programming there is no current flow through diode CR16 and the output of U8-1 goes high illuminating the remote programming indicator through diode CR2, resistor R13 and pin 13 of connector J1. The high signal is also provided at pin 4 of connector J3 for remote monitoring purposes.

3.2 Meter Circuit (A1 Assembly)

The A1 assembly is comprised of the voltmeter and ammeter displays, the output voltage and current limit controls, the local operation OVP adjusting potentiometer and the indicator LEDs. The operation of the voltage and current controls, the OVP potentiometer and the indicator LEDs is covered in the A2 description in Section 3.1. Refer to the schematic diagram in Section 6 for the following discussion.

3.2.1 Voltmeter

U2 is a 3 1/2 digit analog to digital converter which converts the analog input from the A2 board voltage control circuit to a digital display on seven segment displays DS5-DS8 (maximum display is 1999). The 6.2V reference from pin 5 of connector J1 is divided down by resistors R16 and R17 and potentiometer R18 to provide the reference for the converter. The analog input from the voltage control circuit (via pin 6 of connector J1) is filtered by resistor R9 and capacitor C14 before it is input to pin 31 of the converter. Capacitor C12 and resistor R7 set the conversion frequency to approximately 3 times per second. Resistors R8, R11 and R12 are used to select the appropriate decimal point position depending on the model of the power supply.

3.2.2 Current Meter

The current meter circuit operates in the same manner as the voltage meter circuit with U1 performing the conversion for display on DS1-DS4. Capacitors C4 and C6 provide additional filtering on the meter analog input. Resistors R2, R5 and R6 are used to select the appropriate decimal point.

SECTION 4 MAINTENANCE, TROUBLESHOOTING, AND CALIBRATION

4.1 General

This section provides periodic maintenance, calibration and troubleshooting information.

4.2 Periodic Service

Routine service consists only of annual calibration and periodic cleaning. Whenever a unit is removed from service, it should be cleaned, using denatured or isopropyl alcohol or an equivalent solvent on the metal surfaces and a weak solution of soap and water for the front panel. Low pressure compressed air may be used to blow dust from in and around components on the printed circuit boards.

4.3 Troubleshooting

Units requiring repair during their warranty period should be returned to Sorensen for service. Unauthorized repairs performed by anyone other than Sorensen Company during the warranty period may void the warranty. Any questions regarding repair should be directed to the Service Department, Sorensen Company, Division of Elgar Company.



CAUTION

POTENTIALLY LETHAL VOLTAGES EXIST IN THE POWER CIRCUIT AND THE OUTPUT OF HIGH VOLTAGE MODELS. Filter capacitors store potentially dangerous energy for some time after power is removed. Repairs should be attempted by experienced technical personnel only. Be sure to isolate the power supply from the input line with an isolation transformer when using grounded test equipment such as an oscilloscope in the power circuit.

4.3.1 Preliminary Checks

If the power supply displays any unusual or erratic operation shut the power supply off immediately and disconnect it from the AC power source. Check all load, programming and monitoring connections and circuits. Check the AC input for correct voltage and frequency. Correct any problems found and retest the system. If no problems are found or the unit fails to operate correctly upon retesting proceed with internal troubleshooting as described below.

4.3.2 Troubleshooting at the Operation Level

Use the guidelines in Table 4–1 to ensure the DCS series supply is configured and connected for default operation at the front panel. If you need further troubleshooting, please call Sorensen Customer Service.

Table 4–1 Troubleshooting Guide

Symptom	Check	Further Checks and Corrections
No output and the display is blank	Is power switch on?	Turn on power.
	Is power applied to AC input?	Measure voltage on input terminals.
	Is input voltage within specified range?	Measure voltage on input terminals. See Section 1.4.
	Internal circuit?	Call Sorensen Customer Service.
No output but the display lights	Is J3 mating connector installed with proper jumpers?	Ensure that J3 mating connector is installed. See Section 2.5.
	Is voltage control set to zero?	Turn Voltage knob clockwise. Measure output with a DVM. See Section 2.5.
	Is OVP LED lit?	See Section 2.9.
	Is S/D LED lit?	See Section 2.10.
	Is REM LED lit?	See Section 2.11.
Output not adjustable	Is unit in current limit mode? (Red Current Mode LED lit)	Turn current knob clockwise to increase current limit. Reduce load if current is at maximum.
	Is unit in remote mode? (Green REM LED lit)	See Section 2.11.
	Is unit at maximum voltage or current limit?	Reduce load for lower voltage or current requirement.

Symptom	Check	Further Checks and Corrections
Output voltage fluctuating or regulation poor	Is unit at current limit?	See Section 2.5.
	Is input voltage within specified range?	Measure voltage on input terminals. See Section 1.4.
	Are sense lines connected?	See Section 2.6.4.
	Is unit under remote analog control?	See Section 2.11.
	Internal circuit?	Call Sorensen Customer Service.
Output oscillating	Long sense leads?	See Section 2.6.4.
	Inductance in load cables with capacitive load?	See Section 2.6.3.
	Internal circuit?	Call Sorensen Customer Service.

4.4 Calibration

Calibration is performed at the factory during testing. Recalibration should be performed annually and following major repairs. Calibration should be done with the cover on, through the access holes in the cover. See **Figure 4-1** below. Calibration on both the A1 and A2 assemblies is accomplished using multiturn trimpots. The list below gives the circuit designation of the trimpot and the parameter affected by that part.

Circuit Designation	Assembly	Parameter Affected
R7	A2	Output Current Monitor Calibration
R46	A2	Output Current Monitor Offset
R47	A2	Current Control Circuit Offset
R48	A2	Output Current Range
R52	A2	Voltage Control Circuit Offset
R53	A2	Output Voltage Range
R18	A1	Front Panel Voltmeter Calibration
R15	A1	Front Panel Ammeter Calibration

Note: Consult the factory for full calibration requirements.

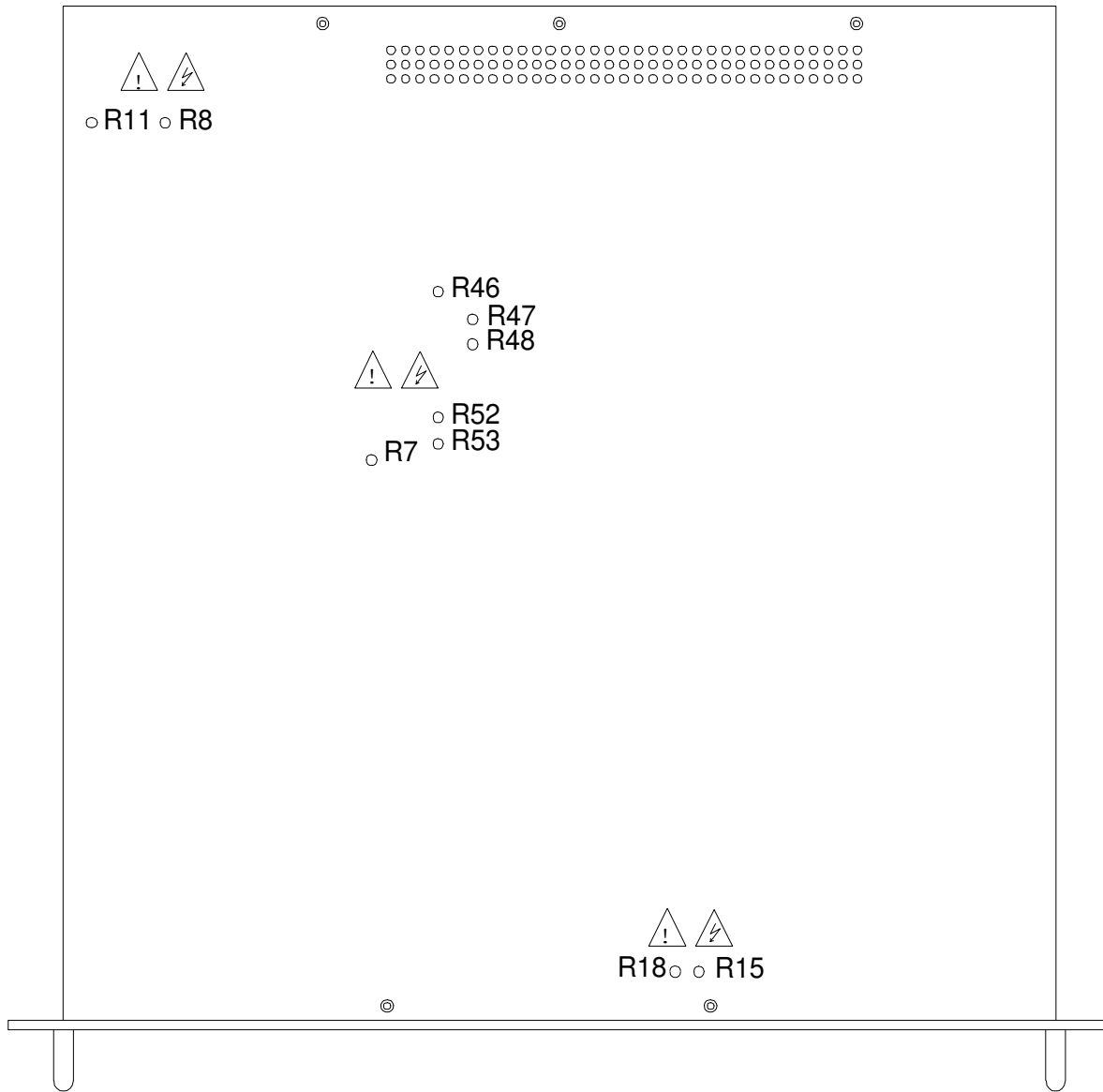

Figure 4-1 Trimpot Locations



Refer to the Safety Notice at the beginning of this manual for an explanation of these symbols.

SECTION 5 PARTS LISTS

5.1 General

This section provides parts lists for the following assemblies:

Front panel assembly (A1)

Power assembly (A2)

Chassis and cover

Most assemblies consist of parts common to all series models as well as parts that are model-specific, or differential.

5.2 Parts Ordering

Do not substitute parts without first checking with Sorensen's Service Department. Parts may be ordered from the factory with the information in the following sections. Order parts from:

SORENSEN
Division of **ELGAR**
9250 Brown Deer Road
San Diego, CA 92121-2294

Sales
Tel: 1-800-525-2024
Fax: (858) 458-0267

Customer Service
Tel: 1-800-458-4258
Fax: (858) 677-9453

When ordering parts, please include the model number and serial number of the unit with your order.

5.3 Parts Lists

Table 5–1 provides fuse ratings for the DCS 1kW and DCS 1.2kW power supplies.

Table 5–2 provides a matrix of parts lists according to model numbers for the DCS 1kW power supplies, and Table 5–3 provides a listing of the parts lists.

Table 5–4 provides a matrix of parts lists according to model numbers for the DCS 1.2 kW power supplies, and Table 5–5 provides a listing of the parts lists.

Reference Designator	Fuse Type	Rating	Size
F1	Fast Acting, GBB	25A, 250V	1/4" x 1-1/4"
F2	Time Lag, 3AG	0.5A, 250V	1/4" x 1-1/4"
F3	Fast Acting	10A, 250V	13/32" x 1-1/2"

Table 5–1 DCS 1kW and 1.2kW Fuse Ratings

Model	Final Assembly	Mother PCB Assembly	Front Panel PCB Assembly	Output PCB Assembly	Rectifier PCB Assembly
DCS8-125E	5360800-01	5362100-008	5360801-01	1066830-008	N/A
DCS10-100E	5360800-12	5362100-010	5360801-01	1066830-008	N/A
DCS20-50E	5360800-02	5362100-020	5360801-02	1066830-020	N/A
DCS33-33E	5360800-03	5362100-033	5360801-02	1066830-01	5360726-01
DCS40-25E	5360800-04	5362100-040	5360801-02	1066830-01	5360726-02
DCS50-20E	5360800-10	5362100-050	5360801-02	1066830-01	5360726-02
DCS60-18E	5360800-05	5362100-060	5360801-02	1066830-01	5360726-03
DCS80-13E	5360800-06	5362100-080	5360801-02	1066830-080	5360726-04
DCS100-10E	5360800-13	5362100-100	5360801-02	1066830-100	5360726-04
DCS150-7E	5360800-07	5362100-150	5360801-01	N/A	N/A
DCS300-3.5E	5360800-08	5362100-300	5360801-01	N/A	N/A
DCS600-1.7E	5360800-09	5362100-600	5360801-01	N/A	N/A

Table 5–2 DCS 1kW Parts Lists by Model Number

Number	Assembly
1066830-008	Output PCB Assembly
1066830-01	Output PCB Assembly
1066830-020	Output PCB Assembly
1066830-080	Output PCB Assembly
1066830-100	Output PCB Assembly
5360726-01	Rectifier PCB Assembly
5360726-02	Rectifier PCB Assembly
5360726-03	Rectifier PCB Assembly
5360726-04	Rectifier PCB Assembly
5360800-01	Final Assembly
5360800-02	Final Assembly
5360800-03	Final Assembly
5360800-04	Final Assembly
5360800-05	Final Assembly
5360800-06	Final Assembly
5360800-07	Final Assembly
5360800-08	Final Assembly
5360800-09	Final Assembly
5360800-10	Final Assembly
5360800-12	Final Assembly
5360800-13	Final Assembly
5360801-01	Front Panel PCB Assembly
5360801-02	Front Panel PCB Assembly
5362100-008	Mother PCB Assembly
5362100-010	Mother PCB Assembly
5362100-020	Mother PCB Assembly
5362100-033	Mother PCB Assembly
5362100-040	Mother PCB Assembly
5362100-050	Mother PCB Assembly
5362100-060	Mother PCB Assembly
5362100-080	Mother PCB Assembly
5362100-150	Mother PCB Assembly
5362100-100	Mother PCB Assembly
5362100-300	Mother PCB Assembly
5362100-600	Mother PCB Assembly

Table 5-3 DCS 1kW Parts Lists

Model	Final Assembly	Mother PCB Assembly	Front Panel PCB Assembly	Output PCB Assembly	Rectifier PCB Assembly
DCS8-140E	5362500-008	5362462-008	5360801-01	1066830-008	N/A
DCS10-120E	5362500-010	5362462-010	5360801-01	1066830-008	N/A
DCS20-60E	5362500-020	5362462-020	5360801-02	1066830-020	N/A
DCS33-36E	5362500-033	5362462-033	5360801-02	1066830-01	5360726-01
DCS40-30E	5362500-040	5362462-040	5360801-02	1066830-01	5360726-02
DCS50-24E	5362500-050	5362462-050	5360801-02	1066830-01	5360726-02
DCS60-20E	5362500-060	5362462-060	5360801-02	1066830-01	5360726-03
DCS80-15E	5362500-080	5362462-080	5360801-02	1066830-080	5360726-04
DCS100-12E	5362500-100	5362462-100	5360801-02	1066830-100	5360726-04
DCS150-8E	5362500-150	5362462-150	5360801-01	N/A	N/A
DCS300-4E	5362500-300	5362462-300	5360801-01	N/A	N/A
DCS600-2E	5362500-600	5362462-600	5360801-01	N/A	N/A

Table 5-4 DCS 1.2kW Parts Lists by Model Number

Number	Assembly
1066830-008	Output PCB Assembly
1066830-01	Output PCB Assembly
1066830-020	Output PCB Assembly
1066830-080	Output PCB Assembly
1066830-100	Output PCB Assembly
5360726-01	Rectifier PCB Assembly
5360726-02	Rectifier PCB Assembly
5360726-03	Rectifier PCB Assembly
5360726-04	Rectifier PCB Assembly
5362500-008	Final Assembly
5362500-010	Final Assembly
5362500-020	Final Assembly
5362500-033	Final Assembly
5362500-040	Final Assembly
5362500-050	Final Assembly
5362500-060	Final Assembly
5362500-080	Final Assembly
5362500-100	Final Assembly
5362500-150	Final Assembly
5362500-300	Final Assembly
5362500-600	Final Assembly
5360801-01	Front Panel PCB Assembly
5360801-02	Front Panel PCB Assembly
5362462-008	Mother PCB Assembly
5362462-010	Mother PCB Assembly
5362462-020	Mother PCB Assembly
5362462-033	Mother PCB Assembly
5362462-040	Mother PCB Assembly
5362462-050	Mother PCB Assembly
5362462-060	Mother PCB Assembly
5362462-080	Mother PCB Assembly
5362462-150	Mother PCB Assembly
5362462-100	Mother PCB Assembly
5362462-300	Mother PCB Assembly
5362462-600	Mother PCB Assembly

Table 5-5 DCS 1.2kW Parts Lists

This page intentionally left blank.

SECTION 6 DRAWINGS AND SCHEMATICS

Please click on the link below to access assembly drawings, schematics, bills of materials, and latest updates to this manual.

To view these documents, you must be connected to the Internet, and you must have a valid password. To obtain a password, please call **800-525-2024** or **858-458-0253** and ask to speak to an Applications Engineer. Please have the serial number of your product when you call.

[DRAWINGS](#)

This page intentionally left blank.