

1250

FREQUENCY RESPONSE ANALYSER

OPERATING MANUAL

Issue 6: October 1985

Part No 12502021



Solartron Instruments, Victoria Road, Farnborough
Hampshire, England GU14 7PW Telephone: Farnborough (0252) 544433
Telex: 858245 Solfar G Cables: Solartron Farnborough
A division of Schlumberger Electronics (UK) Ltd

www.valuetronics.com

Contents

Chapter 1	General Information	<i>Page No.</i>
1	Introduction	1.2
2	Basic Measuring Set-Up	1.2
3	The Instrument Essentials	1.3
4	Additional Facilities	1.4
5	Options	1.6
Chapter 2	Installation	<i>Page No.</i>
1	Safety	2.2
2	General Safety Precautions	2.2
3	Connecting the ac Mains	2.3
3.1	Safety Precautions: Earthing	2.3
3.2	Procedure	2.3
4	Accessories	2.4
5	Rack Mounting	2.4
5.1	Rack Dimensions	2.5
5.2	Ventilation	2.5
5.3	Fitting Telescopic Slide Mounting Kit 12505B (Accuride)	2.5
5.4	Fitting Telescopic Slide Mounting Kit 12505C (Jonathan)	2.10
Chapter 3	Switching On and Initialising	<i>Page No.</i>
1	Switch On	3.2
2	Initialising	3.3
3	Resetting	3.4
Chapter 4	Making Measurements: The Generator	<i>Page No.</i>
1	Simple Measurements	4.2
2	Setting the Generator	4.2
2.1	Introduction	4.2
2.2	Setting the Generator Menu	4.2
2.3	Waveform	4.2
2.4	Frequency	4.3
2.5	Clear	4.4
2.6	Amplitude	4.4
2.7	Bias	4.4
2.8	Modulated Carrier	4.4
3	Checking Generator Settings: Using the Status Displays	4.4
4	Starting the Generator	4.5
4.1	Generator Start Key	4.5
4.2	Generator Waveform Starting Point	4.5
5	Stopping the Generator	4.5
5.1	Introduction	4.5
5.2	Generator Stop Key	4.5
5.3	Generator Stop @ Key	4.6
5.4	Applications of the Stop @ Key	4.6

Chapter 5	Making Measurements: The Analysers	<i>Page No.</i>
1	Introduction	5.2
2	Setting the [ANALYSER COMMON] Menu	5.2
2.1	f Time	5.2
2.2	Delay	5.3
2.3	Harmonic	5.3
2.4	Order	5.4
2.5	Auto f	5.4
2.6	Applications of Auto Integration	5.4
3	Setting Individual Analysers	5.6
3.1	Range	5.6
3.2	Demod	5.6
3.3	Coupling	5.6
3.4	Input	5.6
4	Measurement Start	5.7
5	Stopping the Analyser; Stop and Break Keys	5.8
6	Changing Menus during Recycle	5.8
7	Measurement Start Point	5.8
7.1	Implementation of Delay	5.8
Chapter 6	The Sweep Facility	<i>Page No.</i>
1	Introduction	6.2
2	Logarithmic Sweep	6.2
3	Linear Sweep	6.2
4	Setting Up a Logarithmic or Linear Sweep	6.3
5	Executing the Sweep	6.3
6	Automatic Sweep Time	6.3
7	End of Sweep Conditions	6.4
8	Further Sweeps	6.4
9	Stopping and Re-starting the Sweep	6.4
9.1	Introduction	6.4
9.2	Commands Which Produce "Sweep Stop" Status	6.4
9.3	Commands Which Produce "Sweep Idle" or "Hold" Status	6.5
10	Changing Parameters in Mid-Sweep	6.5
11	Harmonic Sweep	6.5
11.1	Introduction	6.5
11.2	Performing a Harmonic Sweep	6.6
11.3	Error 21	6.6
11.4	Sweep Termination Conditions	6.6
Chapter 7	The Display Menu and Mini Status	<i>Page No.</i>
1	Introduction	7.2
2	Sources	7.3
3	Co-Ordinates	7.3
4	Mini Status Display	7.4
Chapter 8	Menu Summary	<i>Page No.</i>
1	Menu Summary	8.2

Chapter 9	Additional Generator Controls	<i>Page No.</i>
1	The Variable Key	9.2
1.1	Introduction	9.2
1.2	Methods of Use	9.2
1.3	Method 1, With Analysers Stopped	9.2
1.4	Method 2, With Analysers Running	9.3
1.5	Using Variable with the Generator STOP @ Key.	9.4
2	Amplitude Compression	9.5
2.1	Introduction	9.5
2.2	Principle of Operation	9.5
2.3	Generator Output Limit	9.7
2.4	Setting the Menu	9.8
2.5	Error 84	9.8
2.6	Use of the File	9.8
Chapter 10	Facilities For More Complex Measurements	<i>Page No.</i>
1	The Function Key	10.2
1.1	Introduction	10.2
1.2	Angle Information	10.3
1.3	Multiplication Factors: $\times \omega^n$	10.4
1.4	Scaling	10.5
1.5	Limits	10.6
1.6	Function Key Summary	10.7
2	Data Flow Schematic	10.8
Chapter 11	Additional Displayed Information	<i>Page No.</i>
1	The Status Key	11.2
1.1	Introduction	11.2
1.2	Using the Key	11.2
1.3	Main Status	11.3
1.4	Other Status	11.5
1.5	Printed Record	11.8
2	Error Codes	11.9
2.1	Introduction	11.9
2.2	Error Codes: Summary	11.9
3	Error Codes: Details	11.11
3.1	Introduction	11.11
3.2	Group 0. Errors Pertaining to Command Structure	11.11
3.3	Group 1. Errors Pertaining to the Learnt Program	11.12
3.4	Group 2. Parametric Interaction Errors	11.12
3.5	Group 3. Generator Warnings and Errors	11.12
3.6	Group 4. Learnt Program, File, and Variable	11.13
3.7	Group 5. Missing Boards	11.13
3.8	Group 6. Illegal I/O Manipulation	11.14
3.9	Group 7. System Errors	11.14
3.10	Group 8. Measurement Validity is Suspect	11.14

Chapter 12 Recording, Learning and Storing Facilities

		<i>Page No.</i>
1	The Data Output Key	12.2
1.1	Introduction	12.2
1.2	[DATA OUTPUT]	12.2
1.3	[FORMAT]: Heading and Reformat	12.3
1.4	Heading	12.3
1.5	Reformat	12.4
1.6	Menu Changes Activating the Heading and Reformat Functions	12.5
1.7	Channel & Range Column Conventions	12.5
1.8	[GPIB CONFIGURE]	12.6
1.9	Parallel Poll and Poll Sense	12.6
1.10	Serial Poll	12.6
1.11	Terminator and Separator	12.6
2	The File	12.7
2.1	Introduction	12.7
2.2	Maximum File Size	12.7
2.3	Selecting File Size	12.7
2.4	Overwriting of Results in the File	12.7
2.5	Starting a File	12.8
2.6	Reading from the File	12.8
3	Learnt Programs	12.9
3.1	Introduction	12.9
3.2	Learning a Program: From the Front Panel	12.9
3.3	Learning a Program: From an External Device	12.10
3.4	Executing a Program	12.11
3.5	Editing a Program: From the Front Panel	12.11
3.6	Editing a Program: From an External Device	12.12
3.7	Program Pause/Continue Key	12.12
3.8	Example Programs: Looping and Calling	12.12
3.9	Error Messages Displayed during Program Running	12.13
4	X-Y Plotter	12.14
4.1	Introduction	12.14
4.2	Setting up a Plot: Non-Plotter Menus	12.14
4.3	The [PLOTTER COMMON] Menu	12.15
4.4	The [PLOTTER X-AXIS] and [PLOTTER Y-AXIS] Menus	12.16
4.5	The [PLOTTER SCALING] Menu	12.17
4.6	Performing a Plot	12.18
4.7	Bode and Nyquist Plots	12.19
4.8	Adjusting the Plotting Field to suit Preprinted Chart Paper	12.20
4.9	Pen Selection with Two-Pen Plotters	12.21
4.10	Plotting Data from the File	12.21

Chapter 13 The RS423 and GPIB Ports. Remote Control

		<i>Page No.</i>
1	Introduction	13.3
1.1	GPIB Capability Code	13.3
2	Connections	13.4
3	RS423 Baud Rate	13.4
4	RS423 Input Command Terminator Character; RS423 Character Frame	13.4
5	GPIB Switches	13.5
5.1	Address Switches	13.6
5.2	Input Command Terminator Character Switches	13.6
5.3	Talk Only Switch	13.6
5.4	GPIB Switch Example	13.6
6	REMOTE/LOCAL Facility	13.7
6.1	Local Lock-Out	13.8

Chapter 13	The RS423 and GPIB Ports. Remote Control (Continued)	<i>Page No.</i>
7	1250 Command Codes	13.9
7.1	Introduction	13.9
7.2	Command Code Format	13.9
7.3	Generator Commands	13.10
7.4	Synchroniser Commands	13.10
7.5	Amplitude Compression Commands	13.11
7.6	Auxiliary Generator Commands	13.11
7.7	Analyser Commands	13.11
7.8	Sweep Commands	13.12
7.9	Display Commands	13.12
7.10	Plotter Commands	13.12
7.11	Status Commands	13.13
7.12	Variable Commands	13.13
7.13	File Commands	13.13
7.14	Program Commands	13.14
7.15	Data Output Commands	13.14
7.16	RS423/GPIB Commands	13.14
7.17	Function Commands	13.15
7.18	Miscellaneous Commands	13.15
7.19	Self Test Commands	13.16
7.20	Commands in Alphabetical Order	13.16
8	GPIB Controller: Language Used in Program Examples	13.19
9	Command Query	13.19
10	Measurement Output Selection	13.20
10.1	Via RS423 Port	13.20
10.2	Via GPIB Interface	13.20
11	Measurement Output Rate	13.21
11.1	Via RS423 Port	13.21
11.2	Via GPIB Interface	13.21
12	Measurement Output Format	13.21
12.1	RS423 Port	13.21
12.2	GPIB Talk Only Mode	13.21
12.3	GPIB Normal Mode	13.22
12.4	Dump Mode	13.23
12.5	Floating Point Format	13.23
12.6	Output Terminators and Separators	13.24
13	Serial Poll/Parallel Poll	13.25
13.1	Serial Poll	13.25
13.2	Parallel Poll	13.26
14	Learnt Programs. External Storing and Reloading	13.27
14.1	RS423 Port, Device Control Characters	13.27
14.2	Procedure for Storing a Learnt Program Externally, Via RS423 Port	13.28
14.3	Procedure for Loading a Learnt Program into the 1250, Via RS423 Port	13.28
14.4	Procedure for Loading a Learnt Program into the 1250, Via GPIB Port	13.28
14.5	Example of Controller Program for Transferring Learnt Program 1 from 1250 Via GPIB Port, Without Handshake	13.29
14.6	Example of Controller Program for Transferring Learnt Program 1 from 1250 Via GPIB Port, With Handshake	13.29
14.7	Reloading a Learnt Program to 1250 Via GPIB	13.29
15	File Output	13.30
15.1	Procedure to Output the File Via RS423 Port, by External Command	13.30
15.2	Procedure to Output the File Via GPIB Port	13.30
15.3	Example of Controller Program for Copying the File to the GPIB, Without Handshake	13.31
15.4	Example of Controller Program for Copying the File to the GPIB, With Handshake	13.31

Chapter 13	The RS423 and GPIB Ports. Remote Control (Continued)	<i>Page No.</i>
16	GPIB Plotting	13.31
16.1	Operating Sequence for GPIB Plotter. Using a Controller	13.32
17	Combinations of RS423 and GPIB Devices	13.32
Chapter 14	Break, Self Test, Time Display and Power Fail	<i>Page No.</i>
1	The Break Key	14.2
2	Self Test	14.2
3	Time Display	14.4
4	Power Fail	14.5
Chapter 15	Options	<i>Page No.</i>
1	Synchroniser Unit 12501	15.2
1.1	Introduction	15.2
1.2	Description	15.2
1.3	Installation	15.2
1.4	Connecting Up	15.2
1.5	Modes of Operation	15.3
1.6	The Synchroniser Menu	15.5
1.7	Procedure for Establishing the Sync. Locked State	15.8
1.8	Synchroniser Status	15.9
1.9	Measuring Harmonics: Use of Order Analysis	15.11
2	Modulator/Demodulator Unit 12502	15.12
2.1	Introduction	15.12
2.2	Installation	15.12
2.3	Connections	15.12
2.4	Setting Up	15.12
3	Analog Plotter Interface 12503	15.13
3.1	Introduction	15.13
3.2	Installation	15.13
3.3	Preset Controls	15.14
3.4	Setting Up and Performing a Plot	15.14
4	Auxiliary Generator Unit 12506	15.15
4.1	Introduction	15.15
4.2	Description	15.15
4.3	Installation	15.15
4.4	Setting Up	15.16

Chapter 16	The 1251 Multichannel Analyser System	<i>Page No.</i>
1	Introduction	16.2
2	Description	16.2
3	System Configuration	16.2
3.1	1250-1251 Interface Bus	16.2
3.2	IEEE 488 Interface Bus	16.2
3.3	1250 Series Options	16.2
4	Connecting up	16.4
4.1	Safety: Connecting the ac Mains	16.4
4.2	Connecting up the 1250-1251 Interface Bus	16.4
5	1251 Unit Identification Switches	16.5
5.1	Analyser Channel Numbering	16.5
6	Manual Operation of the System	16.5
6.1	Introduction	16.5
6.2	Manual Setting up of the 1251 System	16.5
6.3	Setting up the 1251 Analysers	16.6
6.4	Displaying and Plotting data from the 1251 Analysers	16.6
6.5	Checking the Analyser and Display/Plotter Menu Settings	16.7
7	Remote Operation of the System	16.7
7.1	Introduction	16.7
7.2	GPIB Capability Code	16.7
7.3	Setting up the GPIB Configure Menu	16.8
7.4	Data Transfer Speeds	16.8
7.5	GPIB Output Buffers	16.8
7.6	GPIB Addresses	16.9
7.7	1251 Multichannel Analyser Output: Complete Block Format	16.9
7.8	ASCII Format	16.9
7.9	Dump Mode Format	16.10
8	1251 Multichannel Analyser Specification	16.11

Chapter 17 Specification

Index

www.valuetronics.com

Chapter 1

General Information

Contents

		<i>Page No.</i>
1	Introduction	1.2
2	Basic Measuring Set-Up	1.2
3	The Instrument Essentials	1.3
4	Additional Facilities	1.4
5	Options	1.6

1 INTRODUCTION

The 1250 Frequency Response Analyser measures the gain and phase characteristics of the system under test, when stimulated by a known sinusoid. Ease of use is provided by the touch-sensitive front panel keys. Many advanced features are incorporated, making full use of microprocessor technology.

Standard interfaces allow full remote control. Readings can be stored for future processing or fed to external recording devices. The instrument can be either free-standing or rack-mounted.



Fig. 1.1 1250 Frequency Response Analyser

2 BASIC MEASURING SET-UP

Measurements are made with the 1250 as shown in Fig. 1.2.

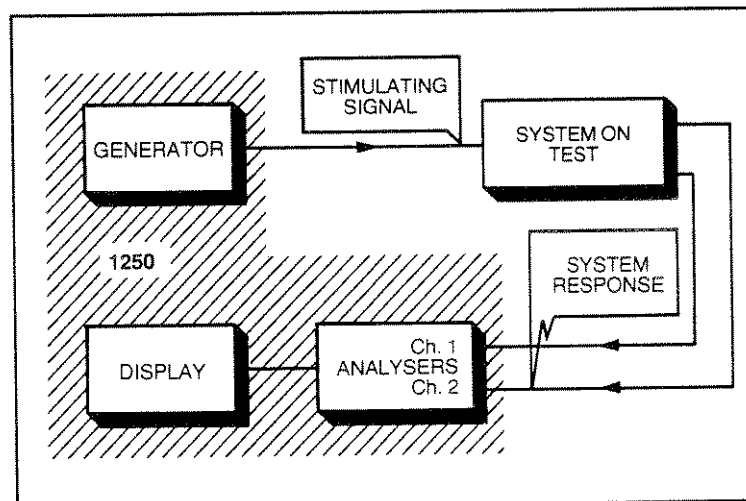

Fig. 1.2 Basic Measuring Set-Up

3 THE INSTRUMENT ESSENTIALS

The three main sections of the 1250 are:

1. A Generator which produces a sinusoidal, square, or triangular-wave electrical stimulus for the system on test.
2. Two Analysers which measure the response to the stimulus at two points in the system, enabling either of the following to be calculated and displayed:
 - a. Single Point measurements (i.e. the absolute voltage of either Channel, and its phase with respect to the Generator) as shown in Fig. 1.3:

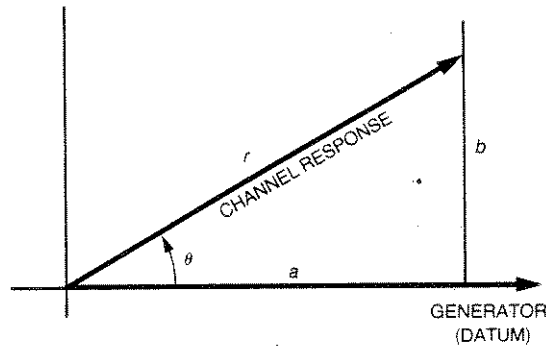

Fig. 1.3 Single Point Measurements

- b. Point-to-Point measurements (e.g. the response of Ch.2 with respect to Ch.1, in terms of gain and phase shift) as shown in Fig. 1.4:

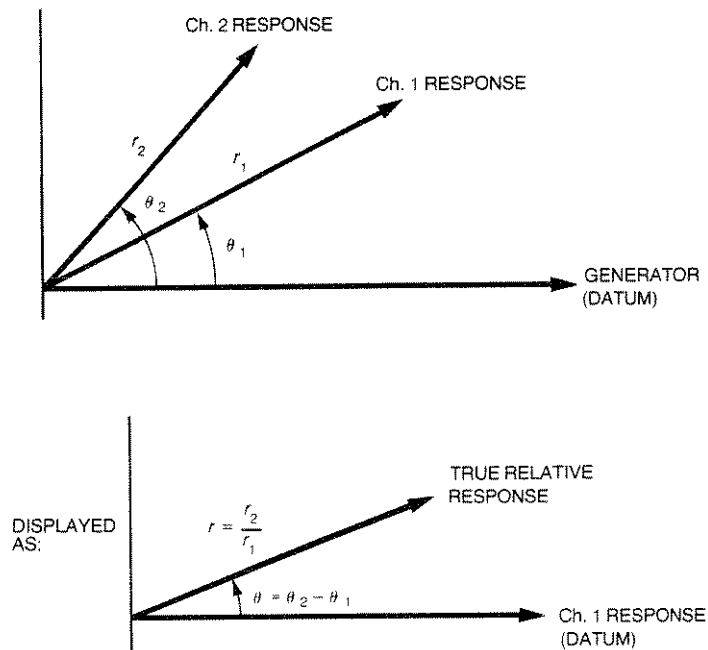

Fig. 1.4 Point-to-Point Measurements

3. The Display, which shows the results of the measurements in any one of the following co-ordinate systems:

- a. Cartesian (a, jb)
- b. Polar (r, θ)
- c. Log Polar ($\log r, \theta$)

The results may also be stored within the instrument for further processing. Additionally, results may be passed to a plotter or a computer.

4. ADDITIONAL FACILITIES

These are shown in Fig. 1.5:

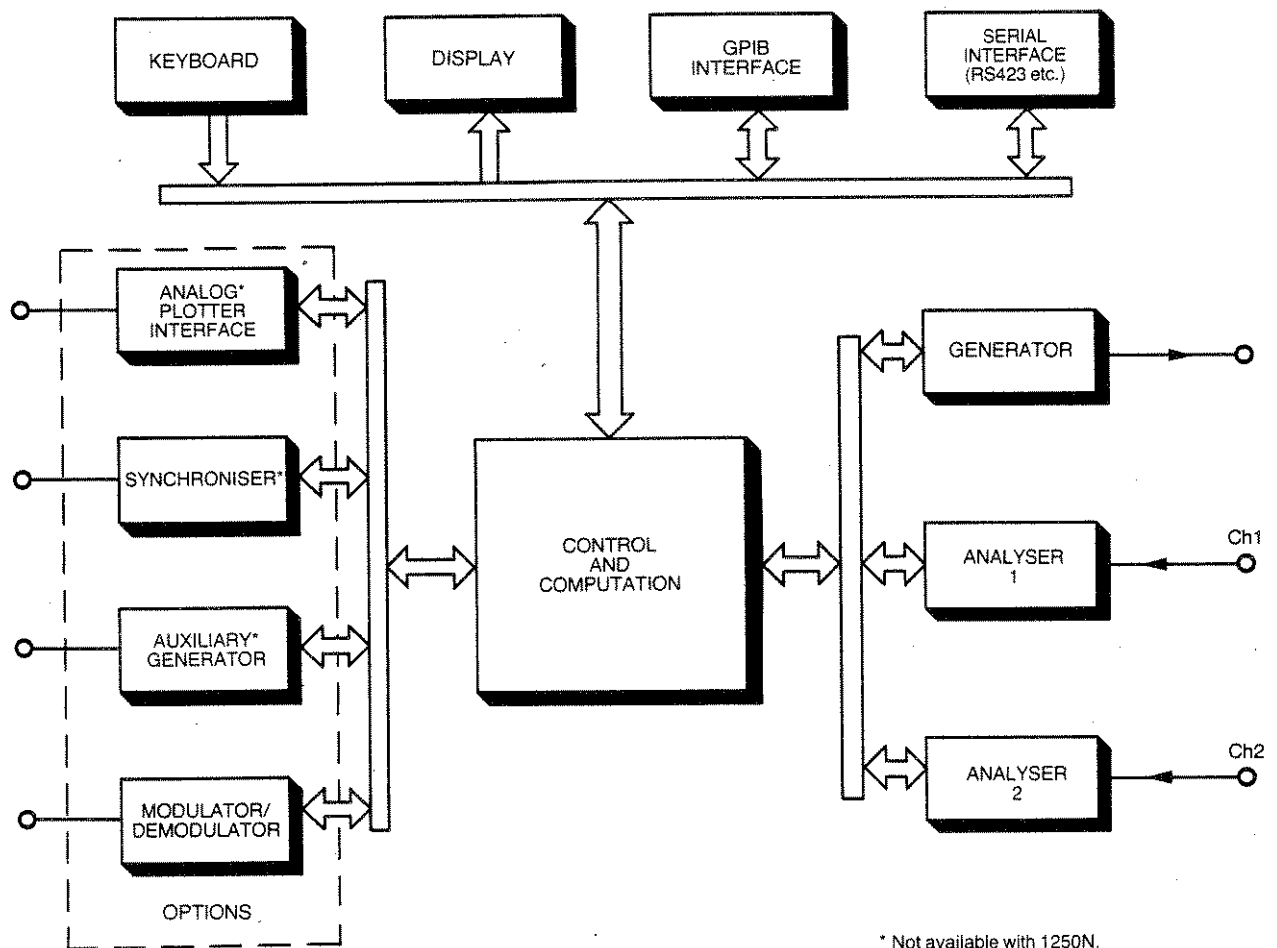

Fig. 1.5 1250 Block Schematic

5 OPTIONS

All these are controllable from the 1250 keyboard, as are the GPIB and Serial Interface:

1. **Plotter Interface:*** enables the 1250 to plot the measured results on an analog plotter. A digital plotter may be driven from the GPIB.
2. **Synchroniser:*** enables the 1250 to be synchronised to an external source.
3. **Auxiliary Generator:*** an additional generator, synchronised to the main generator but producing a signal in quadrature with it. If required, however, the two generators can be in-phase.
4. **Modulator/Demodulator:** enables the 1250 to be directly interfaced with systems that require ac carrier inputs, or which produce ac carrier outputs.

* Not available with 1250N. In this manual, references to these options are not applicable to 1250N.

Chapter 2

Installation

Contents

	<i>Page No.</i>
1 Safety	2.2
2 General Safety Precautions	2.2
3 Connecting the ac Mains	2.3
3.1 Safety Precautions: Earthing	2.3
3.2 Procedure	2.3
4 Accessories	2.4
5 Rack Mounting	2.4
5.1 Rack Dimensions	2.5
5.2 Ventilation	2.5
5.3 Fitting Telescopic Slide Mounting Kit 12505B (Accuride)	2.5
5.4 Fitting Telescopic Slide Mounting Kit 12505C (Jonathan)	2.10

1 SAFETY

The 1250 has been designed in accordance with IEC publication 348 (Class 1), Safety Requirement for Electronic Measuring Apparatus, and has been supplied in a safe condition. This operating manual contains information and warnings which must be followed by the user to ensure safe operation and to retain the equipment in a safe condition.

The operating instructions include safety precautions where appropriate, but the principal ones are also listed below.

2 GENERAL SAFETY PRECAUTIONS

1. Before switching on, ensure that the mains lead is connected to the ac supply in accordance with the colour code.
2. Ensure that the mains voltage selector is correctly set.
3. Ensure that the mains plug is connected only to a mains outlet which has a protective earth contact. This applies equally if an extension lead is used; the lead must contain an earth conductor.
4. To effect earthing, the mains plug must be inserted before connections are made to measuring and control circuits. The mains plug or external earth (as appropriate) must remain connected until all measuring and control circuits have been disconnected.
5. Any interruption of the earth connection (inside or outside the 1250) is prohibited.
6. When the 1250 is connected to its supply the opening of covers or removal of parts could expose live conductors. The 1250 should be disconnected from all voltage sources before it is opened for any adjustment, replacement, maintenance or repair. Adjustments, maintenance or repair of the 1250 when it is powered should not be attempted by the user. Consult a Solartron Service Centre if repairs are necessary.
7. Ensure that only fuses of the correct rating and of the specified type are fitted. Makeshift fuses, and short-circuiting of fuse holders is prohibited.
8. Whenever it is likely that the protection of the 1250 has been impaired, it should be made inoperative and secured against any unintended operation. Protection could be impaired if the 1250:
 - i) shows visible damage
 - ii) fails to perform the intended measurements
 - iii) has been subjected to prolonged storage under unfavourable conditions.
 - iv) has been subjected to severe transport stress.
9. The  symbol on the 1250 means 'Refer to Operating Manual' for detailed instructions or safety precautions.

3 CONNECTING THE AC MAINS

3.1 SAFETY PRECAUTIONS: EARTHING

For reasons of safety an earth connection is essential whenever measurement and control circuits are connected, even if the 1250 is switched off. Earthing is achieved by connecting the 1250 to a mains outlet, or other suitable earthing point. This earth should be capable of carrying 25A and conform to the regulations in 'British Standard Code of Practice CP1013 1965, Earthing'.

3.2 PROCEDURE

The 1250 is powered from 115V or 230V ac mains. Before connecting the supply:

1. Ensure that the mains voltage selector switch on the rear panel is set at 115V or 230V as appropriate. Also on the rear panel, check that the mains fuse rating is correct: 2A SLO BLO for 115V, 1A SLO BLO for 230V.
2. Ensure that the Power On/Off switch in the bottom left-hand corner of the Front Panel is Off.
3. Connect the mains lead.

An ac supply cable, complete with a mating connector socket for the IEC plug on the 1250, is supplied. This cable should be connected to the user's ac supply in accordance with the following colour code:

BROWN	:	LINE
BLUE	:	NEUTRAL
GREEN/YELLOW	:	EARTH

If the user already has available a supply cable terminated with an IEC socket, then this can be plugged directly into the ac supply plug on the 1250. It should be ensured, however, that the socket is correctly wired, as shown in Fig. 2.1.

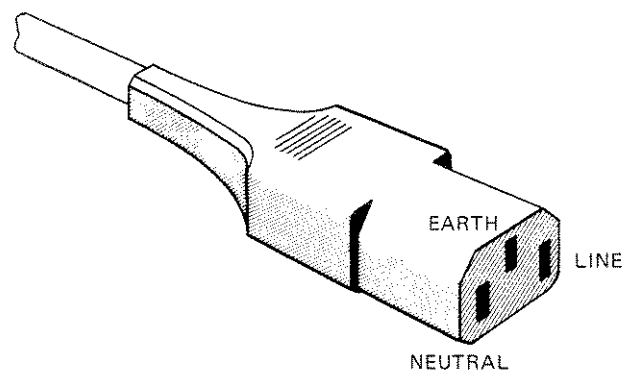

Fig. 2.1 IEC power socket connections

4. Press the Power switch to On.

4 ACCESSORIES

The 1250 accessories are supplied in a polythene bag packed with the instrument. The accessory bag should contain:

- a. 1 fuse, 1A SLO BLO, for 240V ac supply
- b. 1 fuse, 2A SLO BLO, for 115V ac supply
- c. 2 rack mounting brackets ("ears")
- d. 1 slide mounting bar, part no. 12502024B, for telescopic slide rack mounting
- e. 4 screws, M4×12 countersunk, to fix item d
- f. 3 cable assemblies, terminated for front panel connections

An appropriate ac mains cable is packed with the instrument. If ordered with the 1250, a telescopic rack slide mounting kit (Option 12505B, or 12505C for U.S.A.) is also packed.

5 RACK MOUNTING

The 1250 can be rack mounted in two ways: either by using fixed rails in the rack to support the underside of the case, or by using telescopic slides to support the 1250 and allow easy withdrawal for servicing.

With either method, the pair of rack mounting ears included in the accessory kit is substituted for the finisher trims on the 1250; screws inserted through the ears and into the rack keep the unit in place.

Note 1: The rack mounting ears must be used only to prevent the 1250 sliding out of the rack. They are not designed to support the whole weight of the instrument.

Note 2: When the 1250 is rack mounted on telescopic slides, ensure that the rack will not tip over when the slides are fully extended.

Two slide mounting kits are available as optional accessories:

1. kit 12505B (Accuride; UK), containing:
 - a. 1 telescopic slide kit, plus fixings
 - b. 14 screws, M4×6 panhead, to fix slide inner members to the mounting bars
 - c. 14 washers, M4 crinkle
 - d. 4 screws, M6 satin chrome, to fix front panel to rack
 - e. 4 washers, M6 plain
 - f. 4 caged nuts, M6, to fix front panel to rack

This kit is suitable only for 30 ins deep IMHOF IMRAK Series 80 or dimensionally similar cabinets.

2. kit 12505C (Jonathan; USA), containing:
 - a. 1 replacement case top, part no. 12500241A
 - b. 1 replacement case bottom, part no. 12500242A
 - c. 4 feet, self-adhesive, to support pcb's inside item b

Jonathan slides and fixings are not supplied by Solartron

5.1 RACK DIMENSIONS

The internal rack dimensions required for fitting the 1250 are:

610mm (24 ins) deep × 485mm (19 ins) wide for fixed rail mounting, and

760mm (30 ins) deep × 485mm (19 ins) wide for telescopic slide mounting (using either kit)

5.2 VENTILATION

Ensure that the rack in which a 1250 is mounted has adequate ventilation, either by an extractor fan or by having the rear of the rack open.

5.3 FITTING TELESCOPIC SLIDE MOUNTING KIT 12505B (ACCURIDE)

1. Remove the following items from the unit, as shown in Fig. 2.2:
 - a. **Finisher Trim** (two off)
Retain the four M4×16 panhead screws and M4 crinkle washers for securing the rack ears.
 - b. **Handle and Handle Trim**
 - c. **Side Trim**
Located on the opposite side to the handle, it is normally secured by a pip on the finisher trim, and slides out backwards.
 - d. **Feet (four off) and Tilt Bar**
The tilt bar is secured by the two front feet.

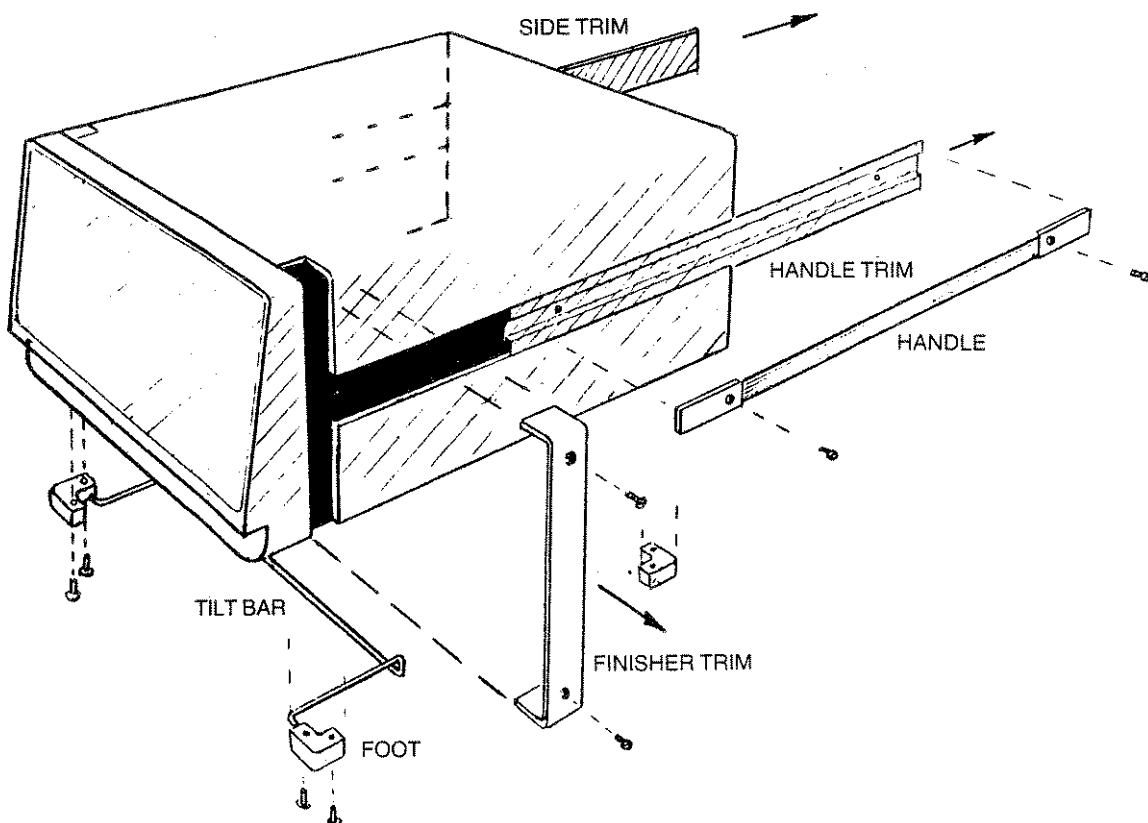

Fig. 2.2 Removal of trims, handle, feet, and tilt bar

2. Fit the following items to the unit, as shown in Fig. 2.3:

a. **Rack Ears** (two off)

Fit the rack ears in place of the finisher trim, using the same fixings.

The ears may be fitted as illustrated, or with their flanges facing the rear of the 1250, which causes the unit to stand out further in the rack, allowing use of racks too shallow for normal mounting.

b. **Slide Mounting Bar**

Screw the bar to the chassis in the former position of the handle, using the four M4×12 csk screws provided. The bar fits correctly only one way round, with threaded holes nearest the front.

The corresponding mounting bar on the left-hand side of the unit is supplied already fitted behind the side trim (part no. 12502019B); it is slightly narrower than the right-hand bar.

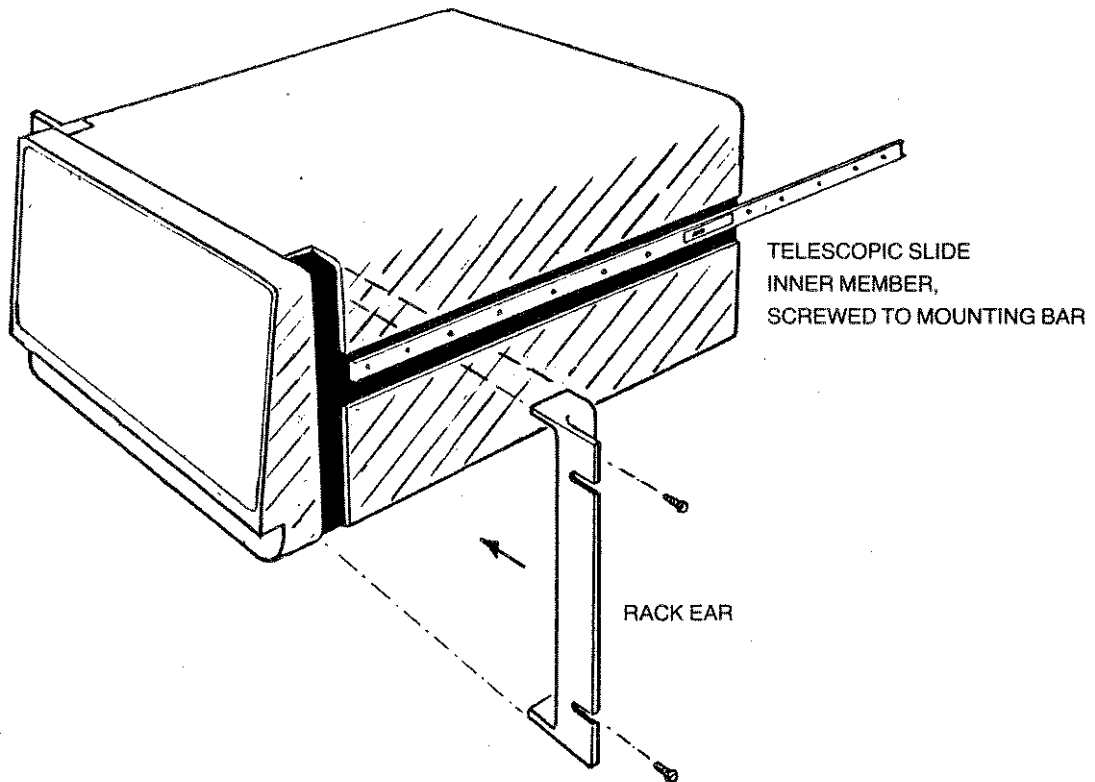

Fig. 2.3 Fitting rack ears and telescopic slide inner members

c. **Telescopic Slide Inner Members** (two off)

The telescopic slides are supplied with inner and outer members slotted together. Slide out the inner member as shown in Fig. 2.4, depressing the locking catch at the halfway point.

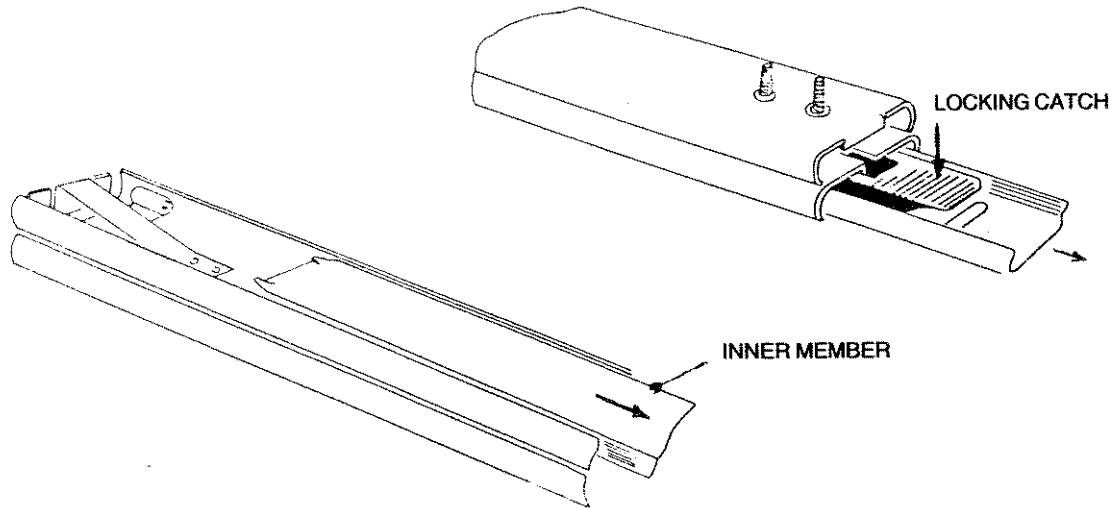

Fig. 2.4 Separating the inner and outer slide members, prior to fixing

Screw the slide inner members to the mounting bars, using the fourteen M4×6 panhead screws supplied, seven each side.

3. Fit the following items to the telescopic slide outer members, as shown in Figs. 2.5 and 2.6:

a. **Adjustable Rear Brackets** (two off)

Fit one rear bracket to each outer member, but do not fully tighten the screws until the 1250 is fitted into the rack (step 6).

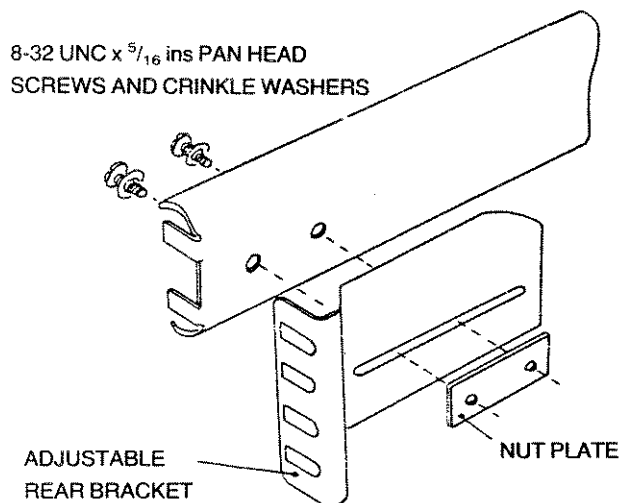

Fig. 2.5 Fitting a rear bracket

b. **Fixed Front Brackets together with Support Brackets** (two off each)

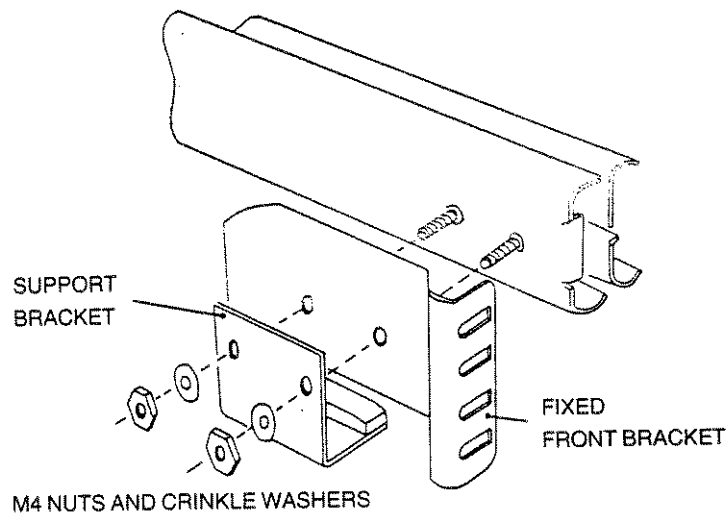

Fig. 2.6 Fitting a front bracket and support bracket

4. Fit the **M6 caged nuts** for outer slide member and rack ear fixing into the rack, in the positions shown in Fig. 2.7. How to insert and remove caged nuts is shown in the figure detail.

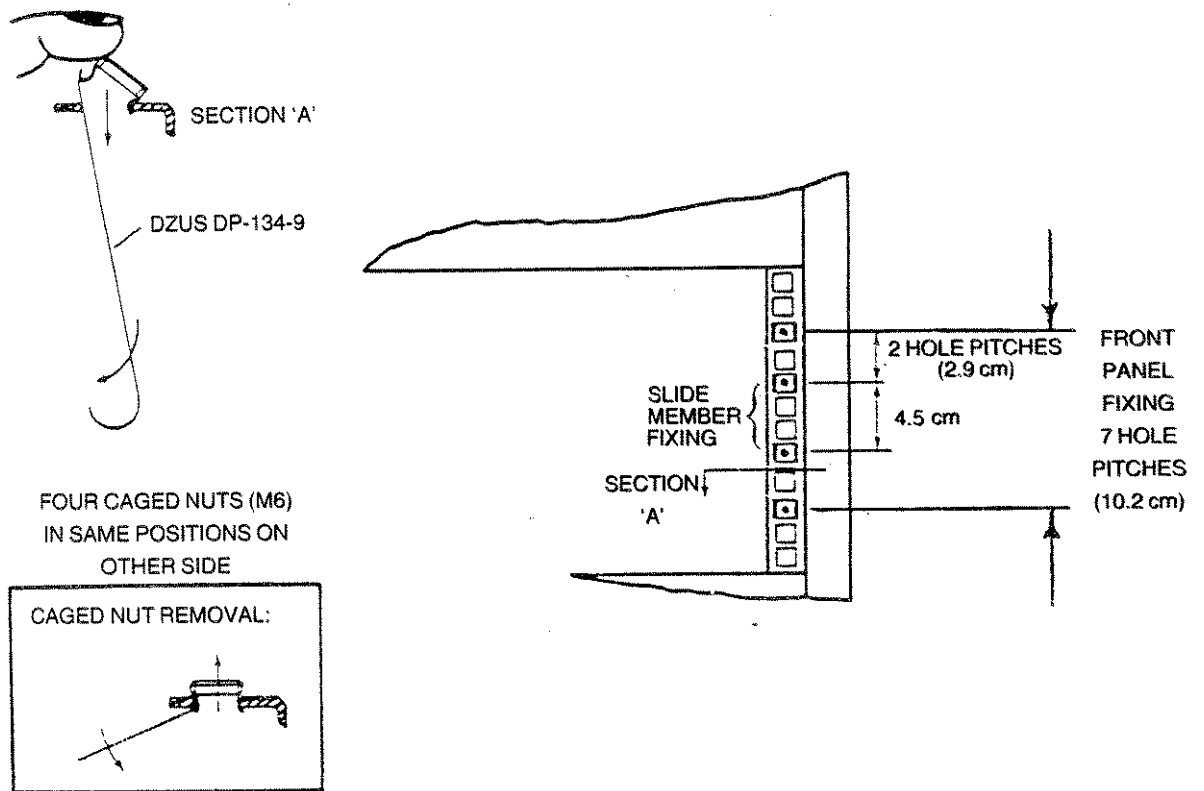

Fig. 2.7 Cage nut insertion in Imrak Series 80 (and similar) cabinets

5. Fit the **Outer Slide Members** (two off) to the rack as shown in Fig. 2.8

Note that the tapped holes in the nut plate are off centre to provide maximum lateral adjustment. Fit the plates, as shown, with the holes offset towards the rack exterior.

Fitting one end of an outer member is facilitated if the other end is supported, by hooking the bracket at the other end over an M5 screw pushed into the top caged nut.

Tighten the M5 screws securing each member until it is held moderately firmly in the rack, approximately in the centre of its travel. The members must, however, be free enough to take up any adjustment when the 1250 is first fitted into the rack.

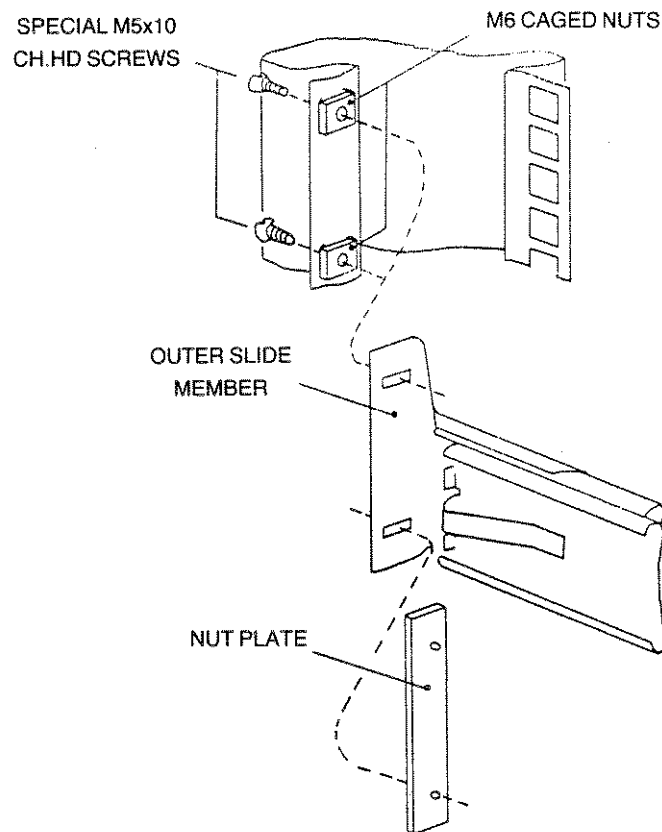

Fig. 2.8 Fitting the outer slide members into the rack

6. Finally, fit the 1250 into the rack, as follows:
 - a. Offer the 1250 up to the rack and feed the inner telescopic slide members into the outer members, pushing the unit into the rack until the locking catches engage and lock.
 - b. Depress both catches and push the unit fully into the rack, ensuring that no cables are trapped.
 - c. Tighten the screws on the outer slide members in the following order:
 1. The M5 screws securing the rear bracket to the rack.
 2. The M5 screws securing the front bracket to the rack.
 3. The 8-32 UNC screws securing the rear bracket to the outer slide member.

5.4 FITTING TELESCOPIC SLIDE MOUNTING KIT 12505C (JONATHAN)

1. Remove the following items from the unit, as shown in Fig. 2.9:
 - a. **Finisher Trim** (two off)
Retain the four M4×16 panhead screws and M4 crinkle washers for securing the rack ears.
 - b. **Handle and Handle Trim**

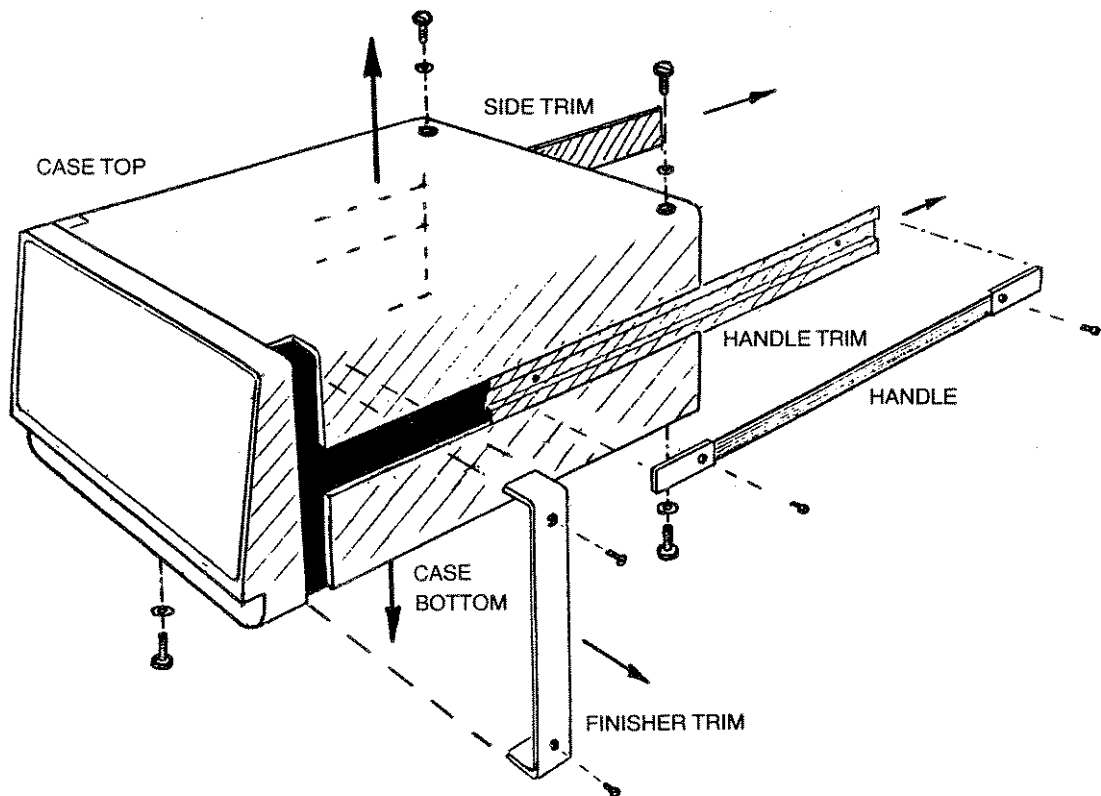

Fig. 2.9 Removal of trims, handle, top and bottom cases

c. **Side Trim**

Located on the opposite side to the handle, it is normally secured by a pip on the finisher trim, and slides out backwards.

Check that the threaded bar supplied already fitted behind the side trim is part no. 12502019B.

d. **Case Top and Case Bottom**

Retain the five screws and washers for securing the replacement cases.

2. Remove the **Board Support Plate** from the original case top and refit it in the corresponding position inside the Replacement Case Top using the same screws and washers. See Fig. 2.10.

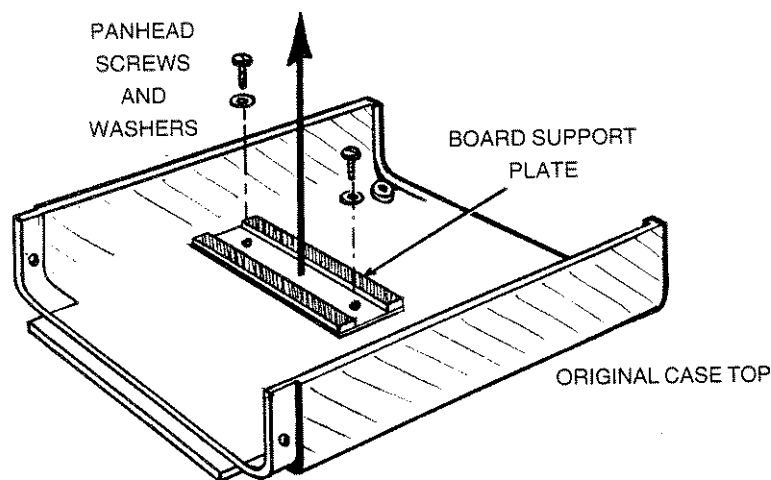

Fig. 2.10 Removing the board support plate from the original case top

3. Fit the **Self-adhesive Feet** (four off) to the inside of the Replacement Case Bottom in the positions corresponding to those in the original case bottom.
4. Fit the following items to the unit, as shown in Fig. 2.11 overleaf:
- a. **Rack Ears** (two off)
Fit the rack ears in place of the finisher trim, using the same fixings. The flanges must face the rear of the 1250.
 - b. **Slide Mounting Bar**
Screw the bar to the chassis in the former position of the handle, using the four M4×12 countersunk screws provided. The bar fits correctly only one way round, with the threaded holes nearest the front.
 - c. **Replacement Case Top and Case Bottom**
Use the original five screws and washers.
5. Fit the Jonathan Telescopic Slide (not supplied), e.g. Tru-Glide 110QD-2, and mounting brackets to the unit and fit it into the rack. See the Manufacturer's slide specification sheets for details of fixings, brackets and mounting accessories.

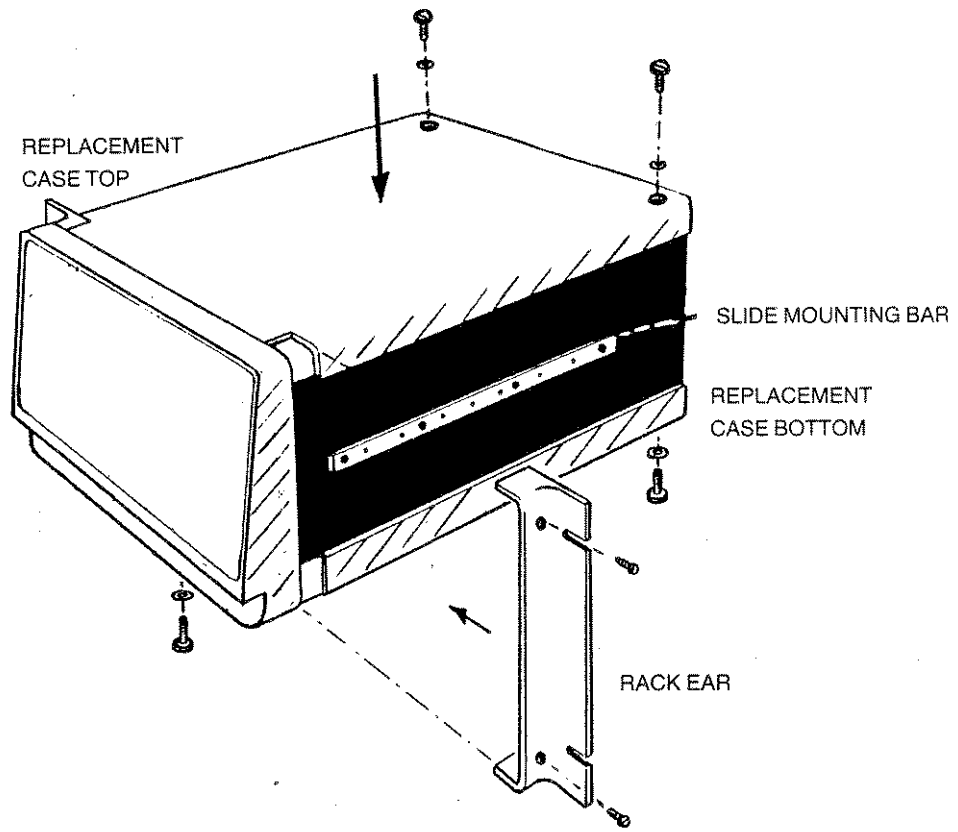

Fig. 2.11 Fitting rack ears, slide mounting bar, and replacement cases

Chapter 3

Switching On and Initialising

Contents

		<i>Page No.</i>
1	Switch On	3.2
2	Initialising	3.3
3	Resetting	3.4

1 SWITCH ON

The mains on/off switch is under the bottom left-hand corner of the front panel. Press in to switch on, press again to switch off.

When the instrument is switched on, one of the following two messages will be displayed:

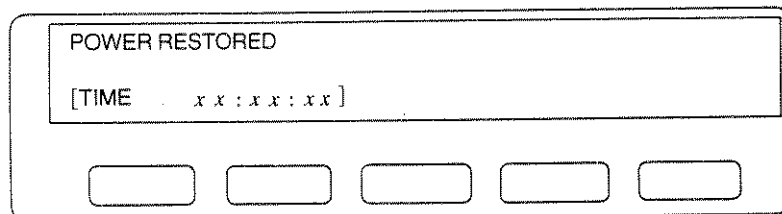

Fig. 3.1 Power-Up Message a.

This signifies that the 1250 has correctly remembered the settings for the Generator etc., from the last time that it was used. Also, any Learnt Programs are still available, and readings stored in the File have not been corrupted. Therefore the instrument may continue to be used as if it had not been switched off. (A fuller explanation of this feature is given in Chapter 14 Section 4 **Power Fail**).

The **Time** display, in hours, minutes and seconds, shows time elapsed since the instrument was switched on, starting from zero. The time-of-day can be entered in this display from the Front Panel or externally, see Chapter 14 Section 3 **Time Display**.

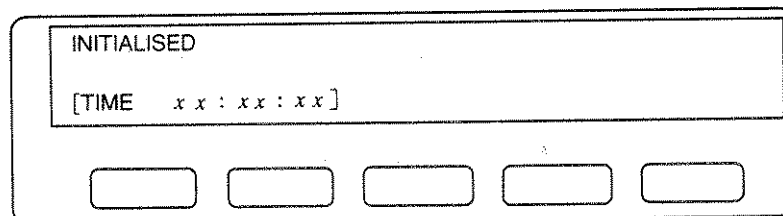

Fig. 3.2 Power-Up Message b.

This signifies that errors have been detected in the previous 1250 settings. Therefore the control circuitry has erased the contents of the parameter store and returned all settings to their default state. The contents of the File and the Learnt Program store have also been erased.

The configuration of the printed circuit boards (pcbs) present is also checked and the "Initialised" message displayed if:

- a. Any of the **essential** pcbs is missing;
- b. Any pcbs have been fitted or removed during the "power-off" period, e.g. option boards.

The TIME display is reset to zero, as in "POWER RESTORED"

2 INITIALISING

The 1250 can remember its previous settings for at least 100 hours whilst switched off. Therefore it is most likely that POWER RESTORED will be displayed when the instrument is switched on again. If the next measurement to be made is similar to the one preceding switch-off, the 1250 is already virtually set up, and will need only slight adjustment.

However, if a markedly different type of measurement is to be made, it is advisable to "erase" all existing settings to ensure that no unwanted facilities, e.g. Bias, are inadvertently left active. This is achieved by **initialising**, which returns all controls to the default state, and also erases the File plus all Learnt Programs. The default states are given in Chapter 8, **Menu Summary**.

To initialise, press "self test" on the front panel. Five soft keys will be assigned as shown in Fig. 3.3.

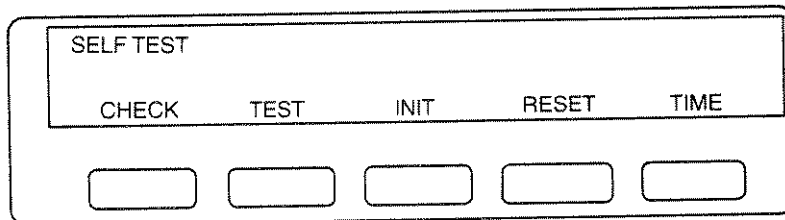

Fig. 3.3

Press INIT. When initialisation is complete, the Display will be as shown in Fig. 3.4.

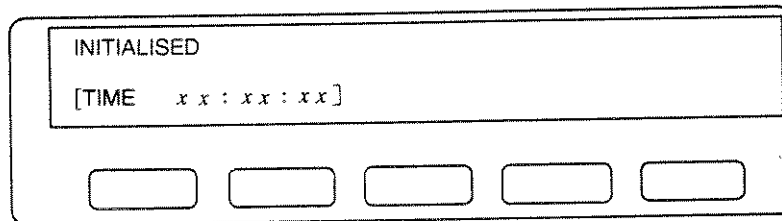

Fig. 3.4

The 1250 is now in an identical state to that shown in Fig. 3.2. Numerical values, e.g. Generator Amplitude, will read "not entered" on the Display when interrogated, but are actually set to their default values. The TIME display is set to zero.

3 RESETTING

To return all settings to the default state, **without** erasing the File and Learnt Programs, press the RESET soft key instead of INIT.

When resetting is complete, the Display will be as shown in Fig. 3.5.

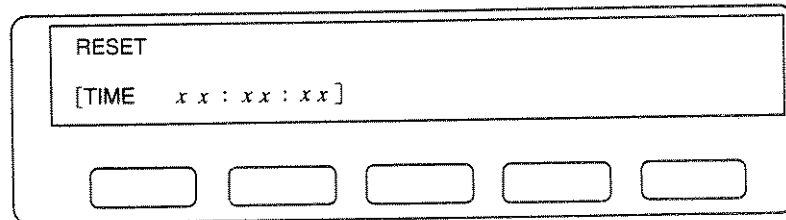

Fig. 3.5

For details of other "self test" functions, see Chapter 14 Section 2 **Self Test**.

Chapter 4

Making Measurements: The Generator

Contents

		<i>Page No.</i>
1	Simple Measurements	4.2
2	Setting the Generator	4.2
2.1	Introduction	4.2
2.2	Setting the Generator Menu	4.2
2.3	Waveform	4.2
2.4	Frequency	4.3
2.5	Clear	4.4
2.6	Amplitude	4.4
2.7	Bias	4.4
2.8	Modulated Carrier	4.4
3	Checking Generator Settings: Using the Status Displays	4.4
4	Starting the Generator	4.5
4.1	Generator Start Key	4.5
4.2	Generator Waveform Starting Point	4.5
5	Stopping the Generator	4.5
5.1	Introduction	4.5
5.2	Generator Stop Key	4.5
5.3	Generator Stop @ Key	4.6
5.4	Applications of the Stop @ Key	4.6
5.5	Generator Overload Protection	4.7

1 SIMPLE MEASUREMENTS

As the 1250 is so versatile, very comprehensive measuring sequences can be set up. Before attempting these however, it is recommended that the user acquire familiarity with the basic controls by making a few simple measurements first. Refinements such as Sweep, Recording of Data, Scaling of readings etc. can then be added as experience is gained.

The simplest way to start is to initialise, then couple the Generator output directly to the Analyser Channel 1 input. The Generator and Analyser Menus can now be set up for a single-frequency measurement, and the resulting readings will be shown on the Display in Cartesian form.

A summary of all menus is given in Chapter 8.

2 SETTING THE GENERATOR

2.1 INTRODUCTION

Setting up the Generator Menu is explained in detail in the following section. The other Menus are set in similar fashion, the salient points being explained under the relevant headings. For quick reference, all the Menus are listed together in Chapter 8.

The following sections describe the making of measurements by using only the Front Panel controls. Remote programming is described in Chapter 13.

2.2 SETTING THE GENERATOR MENU

Press GENERATOR MENU. The five soft keys will be assigned functions as per Fig. 4.1:

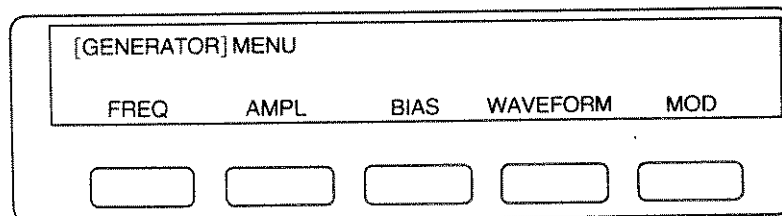

Fig. 4.1

2.3 WAVEFORM

For simplicity, start by establishing the required waveform. Press WAVEFORM: the Display will change to the form shown in Fig. 4.2.

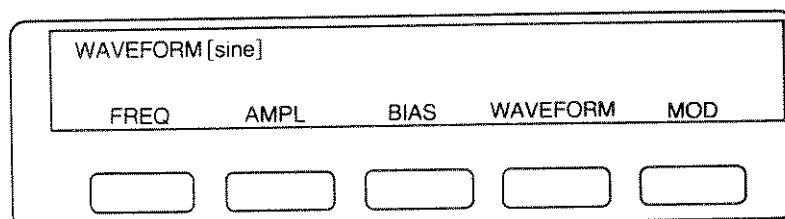

Fig. 4.2

The word in the square brackets identifies the waveform currently commanded from the Generator; [sine] is the default state, [square] and [triangle] are the alternatives. The

square brackets signify that the user has a choice as to which word or symbol shall appear between them. Successively operate the SELECT key until the chosen word appears in the square brackets.

Press ENTER; the new command will **not** be accepted by the 1250 until ENTER is pressed. The Display will revert to that shown in Fig. 4.1.

To verify that the new command has been accepted, simply press WAVEFORM again. If [square] has been entered the Display should now be as shown in Fig. 4.3.

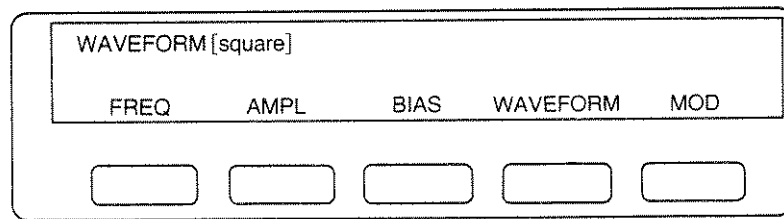

Fig. 4.3

2.4 FREQUENCY

Press FREQ. The Display should now resemble Fig. 4.4.

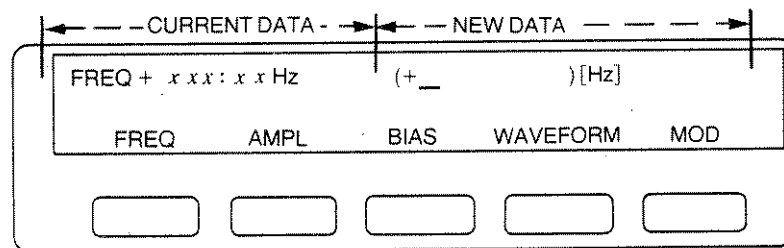

Fig. 4.4

The top left-hand section, here labelled "Current Data", displays the current frequency, represented by FREQ + xxx.xx Hz. If no frequency has been entered since an initialisation, the Current Data section will show "not entered" although the value will in fact have defaulted to 100Hz.

Key in the new frequency from the numeric key pad. The figures will appear after the "+" sign between the round brackets, in the section labelled "New Data" in Fig. 4.4. The flashing cursor indicates where the next character typed will be placed.

The maximum number of characters that can be displayed between the round brackets, excluding any exponent entry (described later), is six, or five digits plus decimal point. If further digits are typed, they do not displace those already displayed, and will usually be ignored by the 1250 if they exceed the specified resolution.

The units of frequency, Hz in Fig. 4.4, appear in square brackets and can therefore be altered by operating the SELECT key, the choices being mHz, Hz and kHz. Alternatively, range may be expressed in exponent notation, by using the EXP key. The 1250 accepts exponents in the range 10^{-9} to 10^{+9} , these being keyed in as E-9 to E+9, the sign of the exponent being changed by the +/- key.

The exponent must always be expressed with respect to the units in the square brackets.

Having set the required value plus units and/or exponent in the New Data section, ENTER must be pressed for the change to be actioned. The Display will again revert to that shown in Fig. 4.1. If FREQ is pressed again, the new frequency will now appear in the Current Data section.

Note that the format may have been altered by the transition from New to Current Data status, e.g. if 0.25 kHz is entered, this will appear as 250 Hz in the Current Data section.

2.5 CLEAR

If an error is made whilst keying information into the New Data section, pressing CLEAR erases the contents of the round brackets. As with "Setting the Waveform", the contents of the New Data section has no effect on the 1250 settings until ENTER has been pressed.

2.6 AMPLITUDE

Press AMPL. The Display will be similar to Fig. 4.4 for frequency, but show AMPL, with units of rms voltage. Key in the new amplitude as described for frequency and ENTER.

Note. The 1250N Generator source impedance is low, at approximately 1.5 Ω. So, for low impedance loads, multiply the amplitude required by a scale factor to get the amplitude you must program.

$$\text{The scale factor} = \frac{\text{load impedance} + 1.5}{\text{load impedance}}$$

2.7 BIAS

Press BIAS. The Display will be similar to Fig. 4.4 for frequency, but show BIAS, with units of dc voltage. As bias can be of either polarity, select the one required by the +/- key, set the required voltage and ENTER.

2.8 MODULATED CARRIER

This is available only when the optional Modulator/Demodulator Unit is fitted in the 1250. Connecting the Unit and the use of the MOD key are described in Chapter 15 "Options". The default state is "off", so if no unit is fitted, the MOD key is not used.

If an attempt is made to enter any state other than "off" via the MOD key, when no Unit is present, an Error Code Number will appear in the Display, accompanied by a warning "beep". The Error Codes are listed in Chapter 11.

This completes the setting up of the basic Generator menu. The remaining facilities accessible via the GENERATOR MENU key do not need setting up for simple measurements and are described in later sections.

3 CHECKING GENERATOR SETTINGS: USING THE STATUS DISPLAYS

To check that the Generator, or any other section of the 1250, has been set up correctly, the user could step through all the Menus again. However, a better method is to use the STATUS key, as described in Chapter 11.

Attention is also drawn to the Mini-Status Display, described in Chapter 7.

4 STARTING THE GENERATOR

4.1 GENERATOR START KEY

As a general rule, when setting up a new measurement after initialisation, the Generator should be the last item in the sequence to be started. The GENERATOR START key thus becomes the Measurement Start control. By this means, all output devices such as plotter, printer and computer can be enabled in advance; any scaling etc. can be set up and sweep details entered. All these facilities are then held waiting, so that when the Generator is finally started, everything begins at the same time, and no readings are lost.

Bearing this in mind, the Generator can, in fact, be started at any time, by simply pressing GENERATOR START. For simple measurements, it does not usually matter which is 'started' first, the Generator or the Analyser, but both must be running for readings to be taken.

4.2 GENERATOR WAVEFORM STARTING POINT

For most applications of single sinewave measuring techniques, the Generator waveform starting point is not critical. The power-up reset that occurs when the 1250 is switched on, and the initialising routine both ensure that the Generator waveform commences at 0° the next time that START is pressed.

However, if the Generator has been left halted as the result of a 'stop' command of any kind, the waveform may not start again from 0°. See Section 5 'Stopping the Generator' for details.

5 STOPPING THE GENERATOR

5.1 INTRODUCTION

Apart from using a remote controller, the Generator can be stopped by:

1. Pressing GENERATOR STOP.
2. Connecting the HI and LO GENERATOR STOP INPUT sockets on the rear panel to each other; or connecting the HI socket to 0V.
3. Using the STOP @ key, as explained in Section 5.3.

If methods 1 or 2 are used, the Generator waveform will remain at the level reached when the command was actioned. If not initialised, or switched off then on again in the interim, the next START command will cause the waveform to continue from wherever it had stopped.

5.2 GENERATOR STOP KEY

Because of its immediate action, the GENERATOR STOP key can be used as a 'Panic Switch' to stop the measurement if things seem to be getting out of control!

If it is essential to know the exact start point, and re-setting in any form is inconvenient, use the STOP @ key, as explained in Section 5.3.

There is no need to stop the Generator before changing the settings of frequency, amplitude etc.

5.3 GENERATOR STOP @ KEY

This control enables the Generator to be stopped at any of the four cardinal points shown in Fig 4.5. When the key is pressed, four soft keys will be assigned, one to each Stop point.

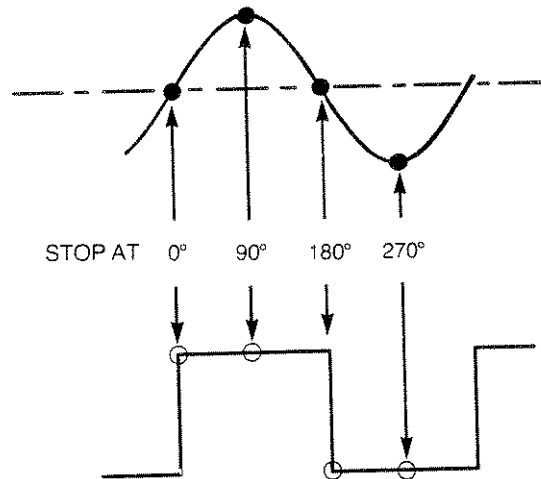

Fig. 4.5 Generator Stop Points

When the required soft key is pressed, the next time that the Generator waveform reaches the selected Stop point, it will halt there and stay until START is pressed again (unless the 1250 is initialised, or switched on and off again in the meantime).

When START is operated again, the STOP @ command is cancelled, and the Generator will continue running from the cardinal point at which it had been instructed to stop.

5.4 APPLICATIONS OF THE STOP @ KEY

Apart from enabling the user to ensure that the Generator waveform always starts from a known point, this control has several other applications in sine wave mode:

1. STOP @ 0° enables any offsets in the system under test to be adjusted to zero, before testing commences.
2. If a large piece of machinery is being controlled by the Generator, e.g. a hydraulic jack, this can be brought gently to rest by using STOP @ 0°, instead of being stopped in some arbitrary position from which it abruptly returns to zero, as could occur if GENERATOR STOP were used and then the equipment switched off.
3. STOP @ 90° or 270° enable maximum amplitudes to be determined empirically, see Chapter 9 'VARIABLE' Section 1.5 for a typical procedure.

5.5 GENERATOR OVERLOAD PROTECTION

Accidental Short-Circuit

The Generator is protected against accidental short-circuiting of its HI and LO terminals.

The 1250N (low source impedance) uses feedback within the power amplifier to limit the current to $\sim 300\text{mA}$ into a short-circuit. The 1250 relies on its higher source impedance ($50\ \Omega$) to limit the current to a similar value. No error message is displayed.

Excessive External Voltage at Generator Terminals

If an external voltage of between $\sim \pm 18\text{V}$ ($\sim \pm 22\text{V}$ for 1250N) and $\sim \pm 30\text{V}$ is applied across the Generator HI and LO terminals, Error 31 'Generator Overload' is displayed and the output is held open-circuit until the overload is removed.

For overloads greater than $\sim \pm 30\text{V}$ the 1250 and 1250N behave differently.

1250. An S.C.R. clamp is triggered which short-circuits the Generator terminals via $33\ \Omega$ for $\sim 5\text{ms}$ before open-circuiting them and displaying Error 31. Remove the overload to restore normal operation.

1250N. An S.C.R. clamp is triggered which short-circuits the Generator terminals. Then:

a) If the overloading source can supply more than $\sim 800\text{mA}$, an internal protection fuse blows which open-circuits the Generator output. Error 31 is displayed. Replace the fuse to restore normal operation.

The fuse is an 800mA anti-surge, $20\text{mm} \times 5\text{mm}$ cartridge type, Part No. 360106110 and is located on Option 12506D (Board 16). To access, remove the heat sink (4 screws).

b) If the overloading source cannot supply more than $\sim 800\text{mA}$, the fuse does not blow and the Generator output remains short-circuited even after the overload is removed. Error 31 is not displayed. Switch the 1250N 'off' then 'on' to restore normal operation.

During the short-circuit, the Generator output is fully protected.

Chapter 5

Making Measurements: The Analysers

Contents

	<i>Page No.</i>
1 Introduction	5.2
2 Setting the [ANALYSER COMMON] Menu	5.2
2.1 f Time	5.2
2.2 Delay	5.3
2.3 Harmonic	5.3
2.4 Order	5.4
2.5 Auto f	5.4
2.6 Applications of Auto Integration	5.4
3 Setting Individual Analysers	5.6
3.1 Range	5.6
3.2 Demod	5.6
3.3 Coupling	5.6
3.4 Input	5.6
4 Measurement Start	5.7
5 Stopping the Analyser; Stop and Break Keys	5.8
6 Changing Menus during Recycle	5.8
7 Measurement Start Point	5.8
7.1 Implementation of Delay	5.8

1 INTRODUCTION

Having completed the Generator Menu, the Analysers may now be set up. Channels 1 and 2 are connected to Analysers 1 and 2 respectively. The numbering of any additional Analysers is explained in Chapter 16, The 1251 Multichannel Analyser System.

2 SETTING THE [ANALYSER COMMON] MENU

Press ANALYSER MENU. The Display will show [ANALYSER COMMON]. The term 'COMMON' indicates that the values entered here will apply to **all** the Analysers in the system. Five soft keys are assigned as described below.

2.1 \int TIME (where \int is the symbol for integration).

Enter the required numerical value here, plus the chosen units, i.e. time [sec] or cycles [cyc]. If the signal to be analysed is noisy, the rms error in the readings due to the noise tends to zero as the integration time is increased. Hence the longer the integration time that can be tolerated, the closer the final reading will approach to the true value of the wanted signal.

The integration time chosen usually has to be a compromise between speed of measurement and acceptably small errors in the reading.

The ability of the Analysers to reject unwanted frequencies, especially harmonics is illustrated in Fig. 5.1

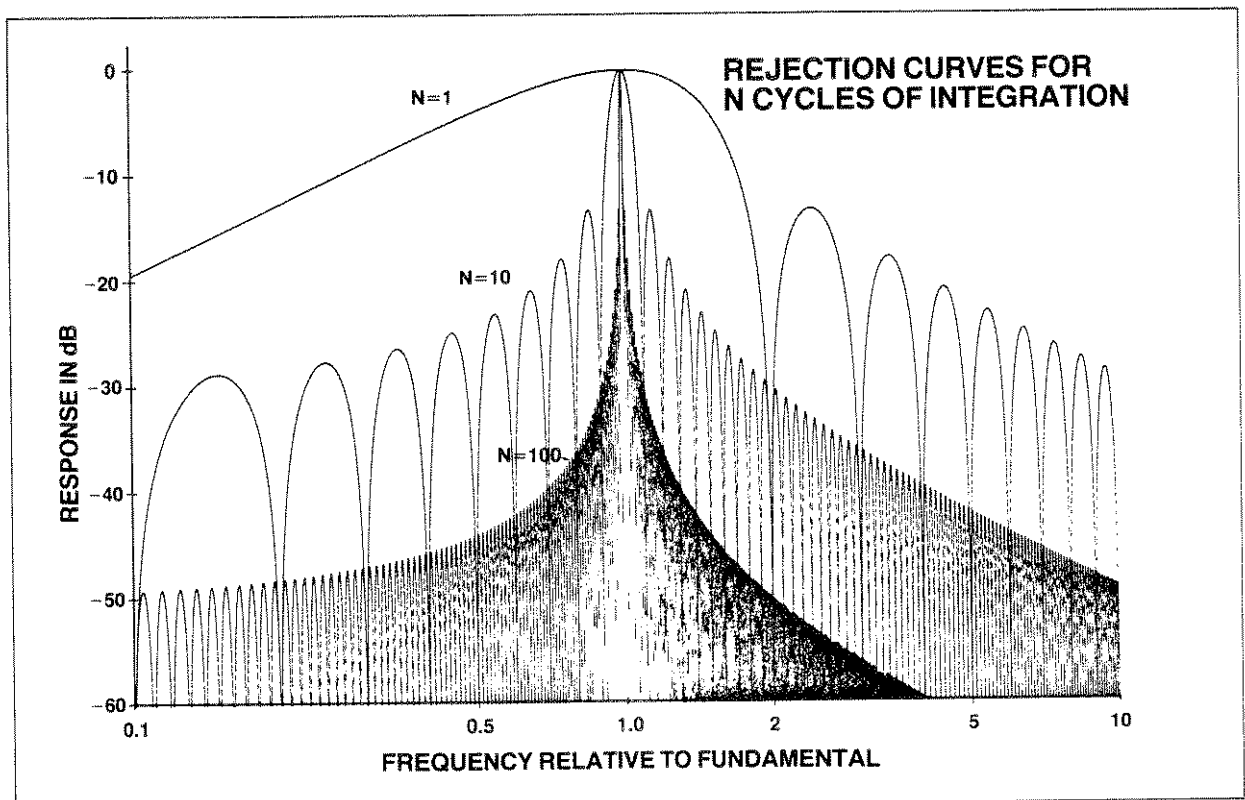

Fig. 5.1

The curves indicate that one cycle of integration will give a reasonable reading where the signal contains little random noise, but may have some harmonic distortion.

For measurements where the random noise level is high, however, the number of cycles of integration needs to be increased to improve the signal to noise ratio.

The minimum values that can be set are 10 ms or 1 cycle of the fundamental frequency, whichever is the longer, up to 655 Hz. Above this, the values are 10 ms or 61 cycles of the fundamental frequency, whichever is the longer (61 periods at 655 Hz = 93 ms).

If a time value is entered, the 1250 automatically rounds this up to give an exact number of cycles, or blocks of 61 cycles, according to frequency. Hence the user would normally enter a time value only as an approximate setting.

If no entry is made after initialising, a default value will be assigned automatically, depending upon the frequency of the Generator. This value will be as per the minima specified above.

If the user enters an integration time of less than the period of 1 cycle of the Generator frequency, the 1250 will not reject it, but will automatically set the relevant minimum integration time for the frequency concerned.

When the Analyser is set to measure the n th harmonic, over x cycles of integration, the 1250 always interprets this as meaning x cycles of the fundamental frequency, and not the harmonic.

One technique for evaluating the effect of different integration times, once measurements are being made, is to observe the scatter on the displayed readings, with the Analyser on RECYCLE. If the current integration time is too short to allow observation of the readings, add in a delay, as explained under Section 2.2 'DELAY'. If the scatter is due to noise, or other spurious components, increasing the f TIME value should cause a decrease in the scatter.

2.2 DELAY

This facility enables a time delay to be interposed between applying the Generator waveform to the system under test and taking a reading.

Two applications of this are:

1. To allow the system under test to 'settle' after a change to the input stimulus, e.g. after each change of frequency when performing a sweep.
2. To enable scatter on readings to be observed on the Display, when using only a short f TIME value.

Note: The 1250 itself does not require any delay to allow it to settle. However, on receipt of a command to start, either from the front panel or by remote control, it takes approximately 10 ms to action the command.

As with f TIME, the required delay is entered as a number, plus units of time or cycles, but the 1250 converts all delays into time values. See Section 4 'Measurement Start' for the implications of this. There is no minimum delay, and the default value is zero.

2.3 HARMONIC

The 1250 can be set to analyse the response of the system under test at any harmonic of the fundamental up to the 16th, provided that the frequency of the harmonic does not exceed 65.535 kHz. Enter the required harmonic number, between 1 and 16, in the round brackets in the Display. The default value is 1, i.e. the fundamental frequency.

2.4 ORDER

Using Order Analysis, the 1250 computes the response of the system under test at the first 16 harmonics of the analysis frequency, all within a single measurement period.

This is effectively a 'fast' harmonic analysis, since in the normal harmonic mode only the selected harmonic response is computed within one measurement period. However, Order Analysis does not work with AUTO f , and cannot be used when the analysis frequency is greater than 650 Hz (or 400 Hz when Synchronising).

If Harmonic Analysis has also been set up, Order Analysis computes the 16 harmonics of the chosen **harmonic**, rather than of the fundamental (generator) frequency.

For example, if HARMONIC (10) has been selected, then Order Analysis computes the 10th, 20th, 30th 150th, and 160th harmonics of the measurement frequency, provided that HARMONIC (10) is less than 650 Hz (or 400 Hz when Synchronising). Setting up ORDER (2), for example, then displays the second of the 16 values viz: the 20th harmonic.

The Order Analysis facility is particularly useful in conjunction with the Synchroniser Unit, Option 12501 (see Chapter 15, Section 1 for further explanation).

Note: REFORMAT (accessed via the DATA OUTPUT menu) must be 'on' when the ORDER facility is in use.

2.5 AUTO f

When a signal contains random noise or other spurious components, it may be difficult to decide how long an integration is required in order to give a result with acceptably small error. The crude approach of providing plenty of time may entail a test sequence that is unnecessarily lengthy, particularly if a succession of signals cover a wide dynamic range and thus require different integration times.

With auto-integration the measurement is continued until either the variation in the running average result becomes sufficiently small or the maximum time allowed has expired. Two levels of acceptable variation are available, chosen by integrating for a 'short' or 'long' time, the readings being averaged until the Standard Deviation falls below the limits:

short: = $\pm 10\%$ of reading $\pm 0.01\%$ of full scale.

long: = $\pm 1.0\%$ of reading $\pm 0.001\%$ of full scale.

Students 't' test is applied to the Standard Deviation to ensure a 90% confidence level.

The maximum time that the user is prepared to allow should be entered using the \int TIME key. If the 1250 has just been initialised, and no new value is entered here, the default value is automatically increased when AUTO f is enabled, to the longer of 3 cycles or 1 second. This is now the minimum time that can be set, i.e. auto-integration relies on at least 3 readings.

If the maximum integration time is reached before the measured deviation has fallen below the selected limit, a reading will still be displayed, but with ERROR 82 flagged as a warning that the specified confidence level has not necessarily been achieved.

2.6 APPLICATIONS OF AUTO INTEGRATION

Where more than one Analyser is being used, auto-integration could usefully be assigned to the channel with the worst signal-to-noise ratio. Once the chosen Standard Deviation limit has been achieved on this channel, the measurement will terminate. It is now probable that the readings on the less noisy channels will have even smaller Standard Deviations.

Auto-integration can also be used to reduce sweep time when the signal-to-noise ratio varies widely across the swept spectrum. Consider the points plotted in Fig. 5.2.

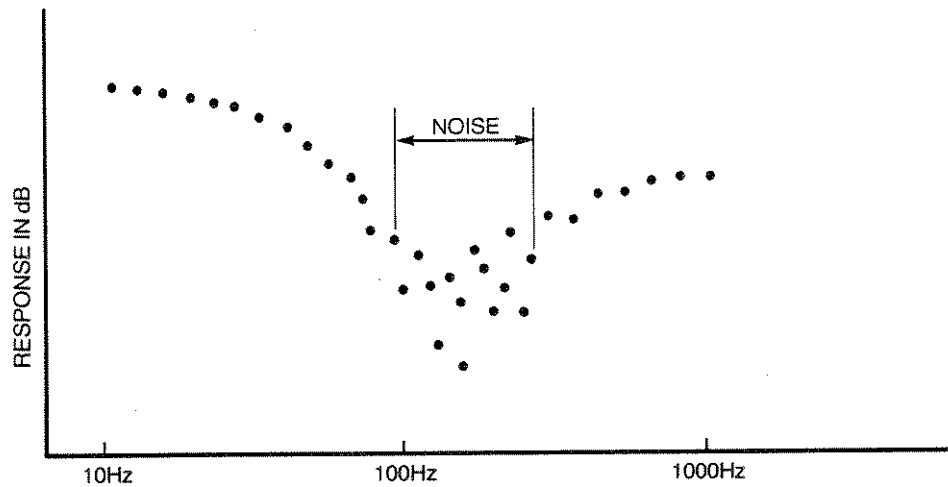

Fig. 5.2. Plot of readings from a sweep measurement

Either side of the band marked "noise", a fairly clear curve is indicated, as represented in Fig. 5.3. A short integration time will suffice here.

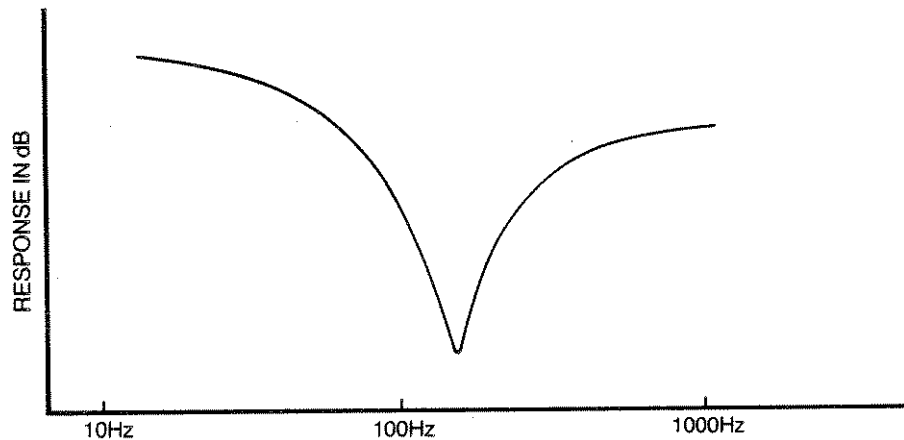

Fig. 5.3. Idealised curve from Fig. 5.2.

As the scatter on the readings increases as shown towards the centre of Fig. 5.2, the integration time must be lengthened until it is at a maximum where the wanted signal is completely obscured by noise. This process will yield a plot which approaches the idealised curve of Fig. 5.3.

If a fixed integration time is chosen, this must be long enough to cope with the noisiest part of the signal. Hence it will be unnecessarily long where the signal is relatively clean. Auto-integration solves this problem as illustrated by the following example.

Example

With fixed integration time. Suppose that this must be 10 seconds in the noisiest region. If the sweep consists of 60 steps, the sweep time would therefore be $60 \times 10 = 600$ seconds = **10 minutes**

With auto-integration. Not all the steps in the sweep will need the full 10 seconds.
A typical simplified allocation could be:

20 points at 10 seconds each = 200 seconds
15 points at 5 seconds each = 75 seconds
25 points at 1 second each = 25 seconds

TOTAL 300 seconds = **5 minutes**

i.e. half the previous time.

3 SETTING INDIVIDUAL ANALYSERS

Having completed the setting up of the common features of the Analysers, the last operation of the ENTER key should have left the Display showing [ANALYSER COMMON]. Successive operations of the SELECT key will call up the specific Analyser menus, each of which will assign four soft keys as follows:

3.1 RANGE

Pressing this key offers the user a choice of several fixed ranges from 30mV to 300V. See the full Specification, Chapter 17 for details of these.

There is also an auto-ranging feature whereby the 1250 itself selects the range which will produce an accurate result with the best possible resolution. Measurements start on the most sensitive range and as soon as an overload is detected, the measurement is terminated, the range is changed and the measurement restarted. This process continues until the correct range has been found.

On termination of the measurement, the Analyser automatically resets to the most sensitive range, so if on Recycle, the auto-ranging process is repeated for every measurement. The default state is auto-range.

3.2 DEMOD

This key is used only when the optional Modulator/Demodulator Unit is fitted. Instructions for its use will be found in Chapter 15, Options. The default state is **off**. The Unit is not required for simple measurements.

If an attempt is made to enter any state other than **off** via the DEMOD key, when no Unit is present, an Error Code Number will appear in the Display, accompanied by a warning "beep". The Error Codes are listed in Chapter 11.

3.3 COUPLING

The default state gives direct [dc] coupling of the signal to the Analyser input. This mode should be used wherever possible, as it introduces minimum phase shift, particularly at low frequencies.

On the other hand, if the incoming signal has an unwanted direct component, such as dc bias, this could necessitate using the Analyser on a relatively insensitive range, which would impair the resolution of the ac component. In this case, ac coupling may be used to block the dc component.

3.4 INPUT

The Analyser input can be routed via the 4 mm sockets on either the front or the rear panel. The default state selects front panel.

4 MEASUREMENT START

The Generator and Analyser are assumed to have been fully set up for making simple measurements, as described in the previous sections.

As explained under 'Starting the Generator', it is recommended that the Analyser be enabled now, before the Generator is started. However, the user may choose either of the following methods:

1. With the Generator stopped

- a. Enable the Analyser by pressing either SINGLE if only one reading is to be taken, or RECYCLE if a continuous series of readings is required. The Analyser Status will change from ANALYSER STOP to ANALYSER IDLE, i.e. the Analyser is now ready to make a measurement, but cannot do so until the Generator has started.
- b. Press GENERATOR START. The Display will now be updated to show the latest reading, and the Generator Status will change from STOP to RUN.
- c. If the Analyser is on RECYCLE, its Status will change to RUN, but if a Delay has been entered, the Status will alternate between DELAY and RUN.

If the Analyser is on SINGLE with a Delay, the Status will first show DELAY, change to RUN whilst the measurement is being made, then revert to STOP on completion.

2. With the Generator already running

- a. Enable the Analyser by pressing either SINGLE if only one reading is to be taken, or RECYCLE if a continuous series of readings is required. The Display will be updated to show the latest reading.
- b. The Status information will follow the sequence given in 1c.

The Running Display

When the 1250 has completed a measurement, the Display will resemble Fig. 5.4.

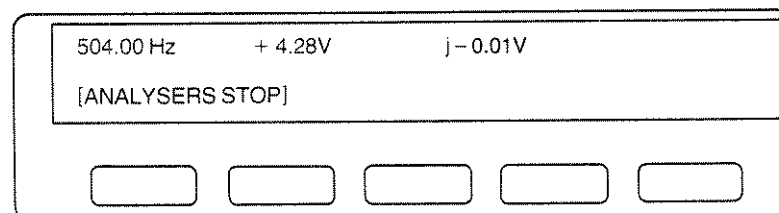

Fig. 5.4 The Running Display

The top left-hand number shows the frequency at which the measurement was made, in this case 504 Hz. The remaining two numbers show the result of the measurement, in Cartesian convention. Changing the Display to show readings in Polar or Log Polar form is explained in Chapter 7.

If taking single measurements, the Running Display will be updated once for each operation of the ANALYSER SINGLE key. With ANALYSER RECYCLE commanded, the Display is automatically updated as each measurement is completed.

The message in square brackets is the Mini Status Display and is explained in Chapter 7, Section 4.

5 STOPPING THE ANALYSER; STOP AND BREAK KEYS

When the Analyser is on RECYCLE, it is normally stopped by pressing the ANALYSER STOP key. The measurement then terminates when the current integration is complete. This may take an unacceptably long time at very low frequencies, so if an immediate stop is required, irrespective of validity of reading, press the BREAK key.

Also, if the Analyser Status shows WAIT, this means that the Analyser is waiting for another section of the 1250 to complete its task. Pressing BREAK over-rides this and returns control of the Analyser to the Front Panel immediately. (Additional functions of the BREAK key, which affect other sections of the instrument, are described in Chapter 14 Section 1 'The BREAK key').

6 CHANGING MENUS DURING RECYCLE

The Generator and Analyser do not have to be stopped in order to change the Menus. Any change that is entered will be held until the 1250 has completed the current measurement. The alteration will then be implemented and the next measurement made according to the new setting.

7 MEASUREMENT START POINT

The Analyser must make its measurement with respect to some reference point on the Generator waveform, known as the measurement start point. This start point varies according to Generator frequency. At mid-frequencies, start will occur at the next 0° crossing. At 4 Hz and below this could take an excessive time, so the period of one cycle is divided into 104 equal parts, start occurring at the next 104th point. For frequencies of approximately 655 Hz and above, integration occurs over blocks of 61 cycles, so start coincides with the beginning of the next 61-cycle block.

7.1 IMPLEMENTATION OF DELAY

As mentioned in Section 2.2, any Delay value entered is converted into a time period. After this Delay time has elapsed, measurement commences at the next start point, as defined above.

Chapter 6

The Sweep Facility

Contents

	<i>Page No.</i>
1 Introduction	6.2
2 Logarithmic Sweep	6.2
3 Linear Sweep	6.2
4 Setting Up a Logarithmic or Linear Sweep	6.3
5 Executing the Sweep	6.3
6 Automatic Sweep Time	6.3
7 End of Sweep Conditions	6.4
8 Further Sweeps	6.4
9 Stopping and Re-starting the Sweep	6.4
9.1 Introduction	6.4
9.2 Commands Which Produce "Sweep Stop" Status	6.4
9.3 Commands Which Produce "Sweep Idle" or "Hold" Status	6.5
10 Changing Parameters in Mid-Sweep	6.5
11 Harmonic Sweep	6.5
11.1 Introduction	6.5
11.2 Performing a Harmonic Sweep	6.6
11.3 Error 21	6.6
11.4 Sweep Termination Conditions	6.6

1 INTRODUCTION

The setting up of single frequencies has already been described in the Generator Menu Section. However, the 1250 can also carry out an automatic sweep from one preselected frequency to another. This can be performed in either direction, using logarithmic or linear increments.

The sweep can be selected to cover the entire frequency range from 10 μ Hz to 65.5 kHz, or any part of it.

A special form of Harmonic Sweep can also be performed, as described separately.

2 LOGARITHMIC SWEEP

The 1250 offers four ways of setting a logarithmic sweep, selected by soft keys. In each case, the successive steps in Generator frequency are related by constant ratios, defined as follows.

1. By n steps per decade. The ratio is the n th root of 10. Hence the frequencies appear spaced at equal intervals if plotted along a logarithmic base line. See example, Fig. 6.1.

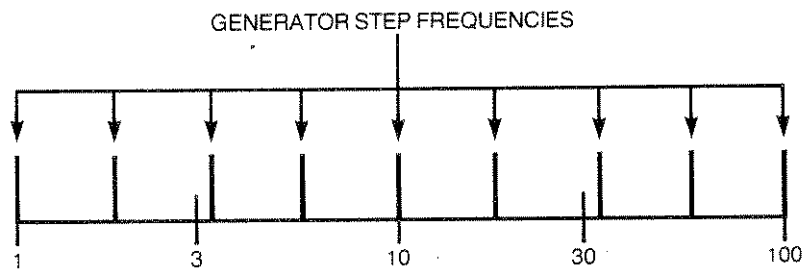

Fig. 6.1 Example of Logarithmic Sweep at 4 Steps per Decade

2. By n steps per octave. The ratio is the n th root of 2.
3. By n steps in the whole sweep. The ratio of f_{MAX} to f_{MIN} is calculated, let this be R . The step ratio is then the n th root of R .
4. By the ratio of the new frequency to the previous one. Here the user can enter the actual ratio required as a number, e.g. if each frequency is to be $\sqrt{2}$ times the previous one, enter 1.414 under ratio.

3 LINEAR SWEEP

There are two ways of setting a linear sweep:

1. By n Hz per step, where the Generator frequency is altered by a constant number of Hz per step throughout the sweep.
2. By n steps in the whole sweep. Here f_{MIN} is subtracted from f_{MAX} , the difference is divided by n , and the result added to, or subtracted from, the previous frequency for each step.

4 SETTING UP A LOGARITHMIC OR LINEAR SWEEP

1. Press the Generator, Analyser and Sweep STOP keys.
2. Use the Generator Menu to set the required amplitude, bias, waveform etc. The Generator frequency need not be altered, as the Sweep controls will over-ride any existing setting.
3. Set up the Analyser Menus.
4. Press SWEEP MENU; four soft keys will be allocated as follows:

FR MIN	Enter the required minimum frequency here.
FR MAX	Enter the required maximum frequency here.
Δ LOG	Enter the required number of steps, followed by the chosen log sweep.
Δ LIN	Enter the required number of steps, followed by the chosen linear sweep.
5. Press the START/CONTINUE key. Five soft keys will be allocated. The first soft key, HARMONIC is explained in Section 11. The remaining four keys act in pairs, one pair for log sweeps and one pair for linear. Each pair controls the direction of its associated sweep, either upwards or downwards as indicated by the arrows.

Press the key which shows the required direction for the type of sweep selected.

The Sweep Status will change from STOP to IDLE, and also show the type of Sweep selected, e.g. log up.

6. Press ANALYSER SINGLE if the steps of the sweep are to be executed manually, or ANALYSER RECYCLE if it is desired to carry out the whole sweep automatically. The Analyser Status will change to IDLE.

5 EXECUTING THE SWEEP

Press GENERATOR START. The sweep will now commence. If an \uparrow key has been selected, the Generator will first be set to FR MIN and the Analyser will take a reading at this frequency. Conversely, if a \downarrow key is operative, the first reading will be at FR MAX.

On ANALYSER SINGLE, only this one reading will be taken. To continue the sweep, successively operate the SINGLE key to step the Generator through the defined range, with a reading taken at each frequency until the opposite limit is reached.

On ANALYSER RECYCLE, readings are taken automatically, one per step of the Generator frequency, until the sweep is complete.

6 AUTOMATIC SWEEP TIME

With automatic sweeps, only one measurement is made at each frequency. As each measurement finishes, an "integration complete" signal allows the Generator to step on to the next frequency. Account is also taken of any Delay that has been entered.

Hence, the time taken to complete an automatic sweep is dependent not only upon the start and finish frequencies and the number of steps in between, but also on any Delays programmed and the Integration Time chosen.

7 END OF SWEEP CONDITIONS

On the completion of a sweep, the Status of the Analysers and Sweep controls will have reverted to STOP, but the Generator will keep running at the last frequency commanded.

8 FURTHER SWEEPS

To repeat the sweep described in Sections 4 and 5 above, the same procedure could be repeated. A simpler way to repeat, or reverse, an already set-up sweep is to:

- a. Press SWEEP START/CONTINUE, followed by the relevant soft key, as explained in Section 4 step 5.
- b. Press ANALYSER SINGLE or RECYCLE as before, but in this case, as the Generator is already running, the Analyser key now acts as the Sweep Start Control.

To carry out further sweeps, using markedly different settings, it is advisable to repeat Sections 4 and 5 sequence entirely.

9 STOPPING AND RE-STARTING THE SWEEP

9.1 INTRODUCTION

There are several ways of stopping a sweep, which can be grouped in two main categories:

- a. Those which produce the SWEEP STOP status. The sweep cannot now be continued from the frequency at which it stopped but reverts to the relevant start frequency and begins again from there. The START/CONTINUE key is used to re-start the sweep.
- b. Those which produce the SWEEP IDLE or HOLD status. The sweep can be continued from the frequency at which it stopped. The sweep parameters can also be changed before continuing.

9.2 COMMANDS WHICH PRODUCE "SWEEP STOP" STATUS

- a. SWEEP STOP. The Analysers will complete the reading at the current Generator frequency, then continue to take readings at this frequency on RECYCLE.
- b. BREAK. The Generator continues running at the current frequency, but the Analysers and Sweep stop immediately. The Display will continue to show the last reading taken before BREAK was pressed.
- c. INIT. Whilst this command produces the SWEEP STOP condition, it also returns all other settings to their default values, as described in Chapter 3.
- d. RESET. As for INIT, but Learnt Programs and Files are not cleared.
- e. Note that a normal continuous sweep, i.e. one where the Analysers are set to RECYCLE, stops automatically after taking a reading at the terminating frequency. This also sets the SWEEP STOP status.

9.3 COMMANDS WHICH PRODUCE "SWEEP IDLE" OR "HOLD" STATUS

- a. **ANALYSER SINGLE.** The Analysers will complete the current measurement, display a valid reading and stop. If **SINGLE** is pressed again, the Generator will step on to the next frequency in the sweep, and a new measurement will be made. This process may be continued until the sweep is complete.
Alternatively, if **ANALYSER RECYCLE** is pressed again, the sweep will continue automatically. An application of this technique is given in Section 10.
- b. **SWEEP HOLD.** The Analysers will complete the current measurement, and display a valid reading. Unlike method "a", however, the Analysers will continue measuring the signal, and the reading is continuously updated. This enables the user to make fine adjustments to the Generator settings, whilst observing their effect on the reading. See also Section 10 for other applications.
- c. **ANALYSER STOP.** This command would not normally be used if all the sweep readings are required. When given, the Analysers complete the current cycle of integration and display a reading, which may be accompanied by the message **ERROR 89**. This implies that the reading is not valid.
The sweep can be restarted by pressing either **ANALYSER RECYCLE** or **SINGLE**.
- d. **GENERATOR STOP.** This command will stop the sweep, but the current measurement will not give a reading. To restart the sweep, press **GENERATOR START**. The Analysers will attempt to complete the measurement which was interrupted by the **STOP** command, but the reading will be invalid. All further measurements will be made correctly.

10 CHANGING PARAMETERS IN MID-SWEEP

When the sweep has been halted, preferably by either pressing **SWEEP HOLD** or **ANALYSER SINGLE**, the user can change the settings and then continue. For example, if the steps of the sweep are too coarse to permit detailed observation of a steep-sided response curve, the sweep can be temporarily stopped somewhere near the area of interest. The frequency increments can now be made smaller, logarithmic sweep changed to linear, direction of sweep reversed etc., then the sweep continued.

If **SWEEP HOLD** is used, so that the Analysers are continuously updating the displayed reading, the **VARIABLE** key can be pressed, thus permitting extremely fine adjustments to be made to the Generator settings, as described in Chapter 9.

11 HARMONIC SWEEP

11.1 INTRODUCTION

For this type of sweep, the Generator is left set to the required fundamental frequency. The Analysers then sweep through to measure the response at all the harmonics up to the 16th (provided that this does not exceed the maximum frequency of the instrument). The **SWEEP MENU** soft key settings are ignored in this mode.

11.2 PERFORMING A HARMONIC SWEEP

1. STOP the Generator, Analyser and Sweep.
2. Use the GENERATOR MENU keys to set the required fundamental frequency.
3. Set up the Analyser Menu. Any Harmonic number entered, other than 1, will be over-ridden by the Harmonic Sweep command.
4. Press SWEEP START/CONTINUE to obtain the soft key titles. The Sweep Status will remain at STOP.
5. Press the HARMONIC soft key. The Sweep Status will change to IDLE, i.e. ready to start.
6. Press ANALYSER RECYCLE if all 16 harmonics are to be scanned as the result of one command, or ANALYSER SINGLE if the measurement at each harmonic is to be initiated manually.
7. Press GENERATOR START. If RECYCLE has been enabled, the complete sweep will now be carried out.

If SINGLE has been enabled, the Display will now change to show the result of the measurement at the fundamental frequency.

Each time the SINGLE key is pressed, a new reading will be displayed, showing the response at each successive harmonic frequency.

11.3 ERROR 21

If ERROR 21 is displayed, the limit of 65 kHz has been reached before completion of sweep.

11.4 SWEEP TERMINATION CONDITIONS

If, on ANALYSER RECYCLE, the sweep is completed normally, or is terminated due to the Error 21 condition, the Analysers will be left set to Harmonic 1, i.e. the fundamental frequency. However, if the sweep is not completed, e.g. is stopped by pressing SWEEP STOP or SWEEP HOLD, or is only stepped part way through by using ANALYSER SINGLE, the Analysers will be left set to the **last harmonic measured**.

If the latter condition is not required, the Analysers can be returned to the Harmonic 1 state by entering a "1" in the [ANALYSER COMMON] Menu in the HARMONIC position. INITIALising and RESETing have the same effect, but also return **all** the other parameters to their default values.

Chapter 7

The Display Menu and Mini Status

Contents

		<i>Page No.</i>
1	Introduction	7.2
2	Sources	7.3
3	Co-Ordinates	7.3
4	Mini Status Display	7.4

1 INTRODUCTION

In the default state, the Display uses Channel 1 Analyser as its source, and presents the readings in Cartesian ($a + jb$) form. By using the DISPLAY/PLOTTER MENU key, in conjunction with its associated soft keys, different sources and co-ordinates can be selected.

Display Areas

Specific areas of the Display are allocated to particular types of message, as shown in Fig. 7.1.

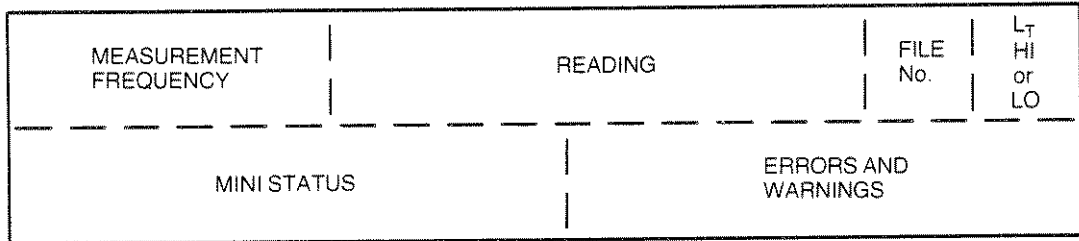

Fig. 7.1 Allocation of Display Areas

Measurement Frequency. This is the frequency at which the measurement was made, which, in the case of a harmonic or order measurement, is not necessarily the same as the Generator frequency.

Reading. This is the result of the measurement; the user may choose the co-ordinates as listed in Section 3.

File Number. This area is blank unless data is being viewed from the File, in which case a number from 1 to 450 will be displayed. This number indicates the relevant line in the File, as explained in Chapter 12.

Limit High or Low. This area is blank unless limits have been applied to the readings by using the FUNCTION key as described in Chapter 10.

Mini Status. This is explained in Section 4.

Errors and Warnings. A list of these, with explanations, is given in Chapter 11, Section 2.

2 SOURCES

With two Analysers in use, they may be employed as two separate measuring systems, called Channel 1 and Channel 2. Establish the required Channel [Ch 1] or [Ch 2] as source, by using the SELECT and ENTER keys in the usual way.

These two Channels can also be used together for point-to-point measurements, by selecting [Ch 2/Ch 1]. In this case, Channel 1 would be connected to monitor the input to the system under test, and Channel 2 to the output.

If more than two Analysers are available, the other Channels are established by selecting [Ch ()] and entering the required Channel number in the round brackets. To avoid confusion, the user should not enter a 1 or a 2 here. If the 1250 sees a 1 or a 2 in the round brackets, it automatically selects Channel 1 or Channel 2 respectively, and the STATUS display will show Ch 01 or Ch 02 as the chosen Source.

However, if [Ch ()] is selected again, the round brackets will be empty, whereas if, for example, Channel 11 had been established, the Display would show [Ch (11)].

The remaining mode is [Ch ()/Ch *m*]. Using this, the ratio of **any** two Channels can be displayed, for example by setting Channel 1/Channel 2, the reciprocal of the point-to-point measurement described above can be calculated.

To set this up, type 1 on the key pad and enter it. The Display will now show [Ch 1/Ch ()]. Now enter 2; the Display will revert to [DISPLAY] MENU but if the SOURCE soft key is pressed again, the Display will show [Ch (1)/Ch 2]. STATUS will show Ch 01/02.

To avoid confusion, the user is advised not to enter the specially-allocated Ch 2/Ch 1 mode here. If this is done, the 1250 will correctly establish the required sources, and STATUS will show Ch 02/01. However, the originally selected source title will be un-numbered, i.e. show [Ch ()/Ch *m*].

Either of the dual-channel modes can be used for measuring the forward gain of a closed loop system, which might become unstable if the feedback loop were broken. It is a straightforward matter to measure the error signal at the same time as the output.

3 CO-ORDINATES

In addition to Cartesian, the other co-ordinate presentations available are:

1. Polar, which is displayed as r, θ
where $r = \sqrt{a^2 + b^2}$ and $\theta = \arctan b/a$.
2. log Polar, which is displayed as $\log r, \theta$.
Where $\theta = \arctan b/a$ as before, and $\log r$ is defined as follows:
 - a. For Single Channel measurements, $\log r$ represents:
 $20 \log_{10} \sqrt{a^2 + b^2}$ in dB relative to 1V.
By using an appropriate scaling factor, the units can be changed to dB relative to any reference voltage.
 - b. For Dual Channel measurements, $\log r$ represents the ratio of the two readings in dB, e.g. for Ch 2/Ch 1:

$$\log r \text{ represents } 20 \log_{10} \frac{\sqrt{a_2^2 + b_2^2}}{\sqrt{a_1^2 + b_1^2}} \text{ dB}$$

4 MINI STATUS DISPLAY

When the bottom line of the Display appears in square brackets, as Fig. 7.2 below, the SELECT key can be used to call up the following status messages. Where one of several different messages may follow a title, they are shown in the form: /IDLE/RUN/NONE.

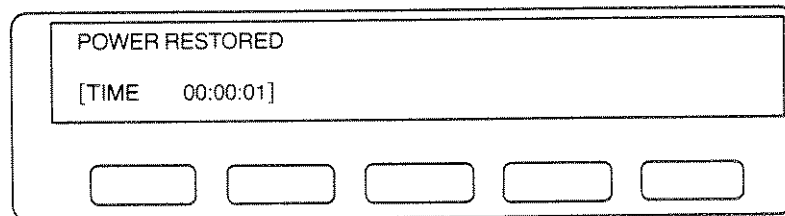

Fig. 7.2 Example of Mini Status Display showing TIME

[FRA READY]/BUSY/PROGRAM/remote/pause

[TIME xx:xx:xx]

[GENERATOR RUN]/STOP/FAULT

[ANALYSERS STOP]/RUN/IDLE/DELAY/WAIT

[SWEEP STOP]/IDLE/HOLD/RUN

[PLOTTER STOP]/IDLE/RUN/NONE

[SYNC. NONE]/IDLE/WAIT/STABLE/LOCKED/FAULT (but without the fault identification number which appears when the STATUS key is used).

[GPIB IDLE]/majTACS/majLACS/min LACS.

[STATUS xxxxxxxx] The significance of the 8-digit number is explained in Chapter 13, Section 13.1.

Chapter 8

Menu Summary

Contents

		<i>Page No.</i>
1	Menu Summary	8.2

1 MENU SUMMARY

The table below is a summary of all 1250 menus.

Notes: a. Italics denote default values.

- b. Round brackets denote that a numerical entry is required, which may be up to 5 digits plus decimal point, and exponent, unless an integer is indicated in the table.
- c. Limits are shown for each numerical entry, e.g. the range of frequency that can be entered via the **FREQ** soft key is $1\text{E}-5$ to 65535 Hz, as shown in the table.
- d. If just initialised, the 1250 displays “not entered” in front of the round brackets; otherwise the last **ENTERed** value is displayed. When “not entered” appears, the default value is operative.
- e. Square brackets denote choice via the **SELECT** key.
- f. All voltages are expressed as rms values.

1250 MENU SUMMARY

MENU	SELECTION	SOFT KEYS				
GENERATOR	[GENERATOR]	FREQ (100 Hz) 1E-5 to 65535 Hz	AMPL (0 V) 0 to 10.23V*†	BIAS (0 V) -10.23 to +10.23 V	WAVEFORM [sine] [square] [triangle]	MOD [off] [carrier 1 on] [carrier 2 on]
	[SYNCHRONISER]	LEVEL (0 V) -5.1 to +5.1 V	COUPLING [DC] [AC]	SLOPE [+] [-]	RATIO (0 = off) 0 to 100	SYNC [off] [tight lock] [loose lock]
	[AMPL. COMPRESS]	SOURCE [Ch 1] [Ch 2]	VALUE (0 V) 1E-4 to 300V	ERROR (0 %) 1 to 50%	LIMIT (0 V = off) 10mV to 10.23V †	COMPRESS [off] [on]
	[AUX. GENERATOR]	AMPL	BIAS	WAVEFORM	(Values as for [GENERATOR])	
GENERATOR STOP @	—	0°	90°	180°	270°	
ANALYSER	[ANALYSER COMMON]	∫ TIME ()** 0.01 to 1E5s	DELAY (0 s) 0 to 1E5s	HARMONIC (1) 1 to 16 integer	ORDER (1) 1 to 16 integer	AUTO ∫ [off] [long ∫ on Ch 1] [long ∫ on Ch 2] [short ∫ on Ch 1] [short ∫ on Ch 2]
	[ANALYSER 1] or [ANALYSER 2]	RANGE [auto] 30mV to 300V in decades	DEMOD [off] [carrier 1 on] [carrier 2 on]	COUPLING [DC] [AC]	INPUT [front] [rear]	
	[ANALYSER ()]**	RANGE	DEMOD	COUPLING	(Values as for [ANALYSER 1])	
SWEEP	—	FR MIN (0 Hz) 1E-5 to 65535 Hz	FR MAX (0 Hz) 1E-5 to 65535 Hz	Δ LOG (0 st/dec) 0.33 to 1E5 st/dec 0.1 to 33333 st/oct 1 to 1E5 st/swp 1.00001 to 1E3 ratio	Δ LIN (0 Hz) 1E-5 to 65535 Hz 1 to 1E5 st/swp	
START/CONTINUE	—	HARMONIC	LOG ↑	LOG ↓	LIN ↑	LIN ↓
DISPLAY/PLOTTER	[DISPLAY]	SOURCE [Ch 1] [Ch 2] [Ch 2/Ch 1] [Ch ()] [Ch ()/Ch m]	CO-ORDS [a, b] [r, θ] [log r, θ]	ERROR — [on] [off]		
	[PLOTTER COMMON]	MODE [point] [vector]	SIZE [A3] [A4]	TEXT [on] [off]	GRID [off] [on]	DEVICE [analog] [GPIB-HPGL] [GPIB-ESGL]
	[PLOTTER X-AXIS]	ITEM [a] [b] [r] [θ] [log r in dB] [f in Hz] [log f in Hz]	MINIMUM (0)	MAXIMUM (0)	ORIGIN (0)	—1E18 to 1E18

* 5.11V for triangle waveform

*** Not applicable to 1250N

MENU	SELECTION	SOFT KEYS				
DISPLAY/PLOTTER (contd.)	[PLOTTER Y-AXIS]	(Soft keys and values as for [PLOTTER X-AXIS])				
	[PLOTTER SCALING]	SCALE [fixed] [variable]	X-MIN (0)	Y-MIN (0)	X-MAX (0)	Y-MAX (0)
0 to 32,000 (x 0.025 mm) integer						
PLOT	—	GRAPH	AXES	MINIMUM	MAXIMUM	ZERO
FUNCTION	—	ANGLE <i>degree</i> [-180 to +180 ant.clk] [0 to 360 ant.clk] [-360 to 0 ant.clk] [0 to 360 clkwise] [radian] [-π to +π ant.clk] [0 to 2 π ant.clk] [-2 π to 0 ant.clk] [0 to 2 π clkwise]	$\times \omega^n$ [unity] [$j\omega$] [$1/j\omega$] [$j\omega^2$] [$1/j\omega^2$]	SCALE [unity] [a, b] [r, θ] [last result] (0)	LIMIT [off] [on a] [on b] [on r] [on θ] [on logr] (0)	
a, b, r: -1E18 to 1E18 θ: -180 to +180 log r: -380 to +380						
DATA OUTPUT	[DATA OUTPUT]	DISPLAY [all] [fail] [pass] [off]	RS-423 [off] [all] [fail] [pass] [dump]	GPIB [off] [all] [fail] [pass] [dump]	FILE [off] [all] [fail] [pass] Size (99) 1 to 450 integer	
	[FORMAT]	HEADING [on] [off]	REFORMAT [on] [off]			
	[GPIB CONFIGURE]	PAR.POL (0) 0 to 8 integer	P. SENSE [true] [false]	SER. POL (0) 0 to 255 integer	TERM. [cr lf] [cr lf + EO I] [cr] [cr + EO I]	SEP. [comma] [terminator]
VIEW FILE	[display] FILE	BOF	EOF	↓	↑	SUMMARY
	[list] FILE [clear] FILE	No soft keys				
PROGRAM LEARN	() [learn]	QUIT				
	() [1 to 9 integer] [edit]	INSERT	DELETE	↓	↑	QUIT
	() [clear]	No soft keys				
STATUS	[MAIN]	GEN	ANALYSER	SWEEP	DISPLAY	PLOTTER
	[OTHER]	SYNC	FN/PROG	μP	GPIB	
VARIABLE:	[freq] [ampli] [bias] [X-min] [Y-min] [X-max] [Y-max]	DIR ↑ ↓	SLOW	>	⇒	FAST
SELF TEST	—	CHECK	TEST	INIT	RESET	TIME

Chapter 9

Additional Generator Controls

Contents

	<i>Page No.</i>
1 The Variable Key	9.2
1.1 Introduction	9.2
1.2 Methods of Use	9.2
1.3 Method 1, With Analysers Stopped	9.2
1.4 Method 2, With Analysers Running	9.3
1.5 Using Variable with the Generator STOP @ Key.	9.4
2 Amplitude Compression	9.5
2.1 Introduction	9.5
2.2 Principle of Operation	9.5
2.3 Generator Output Limit	9.7
2.4 Setting the Menu	9.8
2.5 Error 84	9.8
2.6 Use of the File	9.8

1 THE VARIABLE KEY

1.1 INTRODUCTION

This mode of control enables the user to vary the Generator settings, whilst observing the effect on the object-under-test. By this means, for example, the optimum position of a mechanical device may be determined empirically, or an electrical resonance identified by observing the changing Display readings.

Three Generator parameters are controllable via the Variable key. These are:

Frequency (freq)
Amplitude (ampl)
Bias (bias)

The required choice is established by using the SELECT and ENTER keys as usual.

Another use of the VARIABLE key, when an X-Y plotter is connected, is to adjust precisely the size and position of the plotting field, e.g. to suit pre-printed chart paper. This use is explained fully in Chapter 12, Section 4 'X-Y Plotter'.

1.2 METHODS OF USE

There are basically two ways of using the VARIABLE key:

1. With the Generator running but the Analysers stopped. In this case the relevant Generator parameter is varied whilst observing the effect on a driven mechanical device. Having ascertained the required value for the Generator setting by this means, measurements can continue in the normal way by starting the Analysers, i.e. pressing SINGLE or RECYCLE.
2. With the Generator and Analysers running. Here the Generator parameter is varied whilst observing the effect on the reading in the Display. This method can be used for detailed investigation of small sections of the response curve of resonant circuits and filters.

1.3 METHOD 1, WITH ANALYSERS STOPPED

Press VARIABLE, the Display will show VARIABLE: [freq].

Establish the required parameter in the square brackets by operating the SELECT key, and ENTER. As an example, if **freq** is entered, the Display will be as in Fig. 9.1

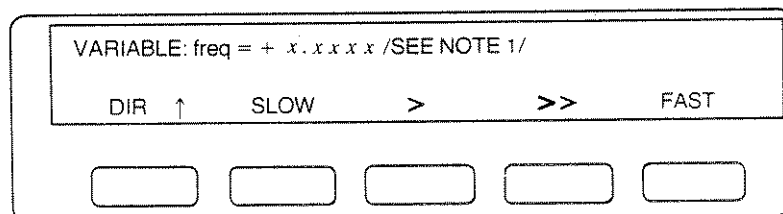

Fig. 9.1 Typical Display with VARIABLE pressed and Analysers stopped.

Varying the Frequency. The five soft keys now operate on the displayed frequency "x.xxxx" as follows:

The left-hand DIR key controls the **direction** of variation. It has only two settings, "DIR ↑" for **increasing** the frequency and "DIR ↓" for **reducing** it.

The other four keys control the **rate** at which the frequency is altered. They are graded from "SLOW" through to "FAST" and respectively change the frequency in larger and larger increments. These keys may be either pressed and released successively, in which case the frequency will alter by one increment per press, or a key may be held in, in which case the frequency will keep changing by the relevant increment until the maximum or minimum value is reached, depending upon direction of change.

A warning "beep" indicates that the limit has been reached, and ERROR 43 will be displayed briefly. As the FAST (coarse) key changes the frequency in relatively large increments, a maximum or minimum limit will be reached which is inside the 1250's capabilities. However, by then operating the slower (fine control) keys, the absolute frequency limits can be obtained.

Note 1. The frequency shown here as "x.xxxx" is the last frequency entered. This will be zero if the 1250 has just been initialised. To enter a new initial frequency upon which the VARIABLE controls can operate, use the Generator Menu keys as described in Chapter 4.

Note 2. When "varying" frequency, the increments are linear below 1.0 Hz then logarithmic from 1 Hz upwards.

Varying the Amplitude and Bias. These can be varied in a similar manner to that described above for "Frequency".

Amplitude increments are linear from 0 to 1.0 V rms, then logarithmic thereafter.

Bias can go below 0 V, i.e. negative. The increments are linear between -1.0 V and $+1.0$ V but logarithmic outside these values.

1.4 METHOD 2, WITH ANALYSERS RUNNING

When RECYCLE is pressed, the Display will resemble Fig. 9.2, assuming that the chosen presentation of results is the $a + j b$ form.

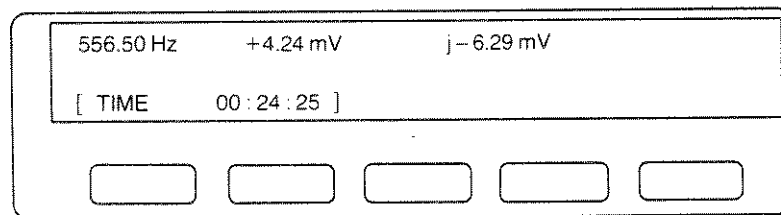

Fig. 9.2 Typical Display with Analysers Running.

The three entries in the top half of the Display show respectively Generator frequency, the in-phase part of the reading ($+4.24$ mV) and the quadrature component ($j-6.29$ mV).

When VARIABLE is pressed, the Display will change to just show: VARIABLE : [freq] as before. When the required Generator parameter has been entered, the Display will resemble Fig. 9.3

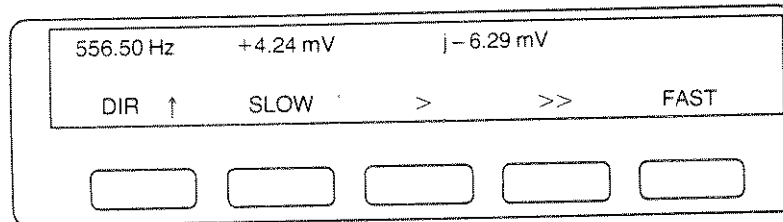

Fig. 9.3 Typical Display with VARIABLE pressed and Analysers running.

The soft keys can now be manipulated as in Method 1, but this time their effect can be observed on the displayed reading. If the Generator frequency is being varied, the current value is shown at the top left-hand end of the Display. If amplitude or bias are being varied, the current value can be found by interrogating the STATUS facility.

1.5 USING VARIABLE WITH THE GENERATOR STOP @ KEY

The VARIABLE key can be used in conjunction with the GENERATOR STOP @ key. For example, if it is required to set a hydraulic ram to a particular maximum extension, but it is not known how this relates to the Generator peak amplitude, proceed as follows:

1. Set the Generator to the required frequency and waveform, but set the amplitude to zero volts.
2. Press GENERATOR START. The Generator output will still be zero, so the ram should not move.
3. Press STOP @ 90°. The Generator will stop at peak amplitude, albeit this is still zero at the output terminals.
4. Press VARIABLE. By using the five soft keys as described previously, the peak amplitude, and hence ram extension, can be varied until the required value is found.
5. Press GENERATOR START. A continuous waveform, having the required maximum value, will now appear at the output terminals.

2 AMPLITUDE COMPRESSION

2.1 INTRODUCTION

It is sometimes desirable to control the amplitude of the signal at an intermediate point in the measuring circuit, rather than at the Generator output. For example, the input to an amplifier may need to be kept within close limits either side of the nominal value, to avoid non-linear operation. With Amplitude Compression, the Generator output is varied automatically to satisfy this condition, by using one of the Analyser Channels as part of a feedback control loop.

A safety feature is included in the control loop which limits the Generator output amplitude to a 'safe' level selected by the user; this is explained in Section 2.3.

Fig. 9.4 shows the Amplitude Compression facility schematically.

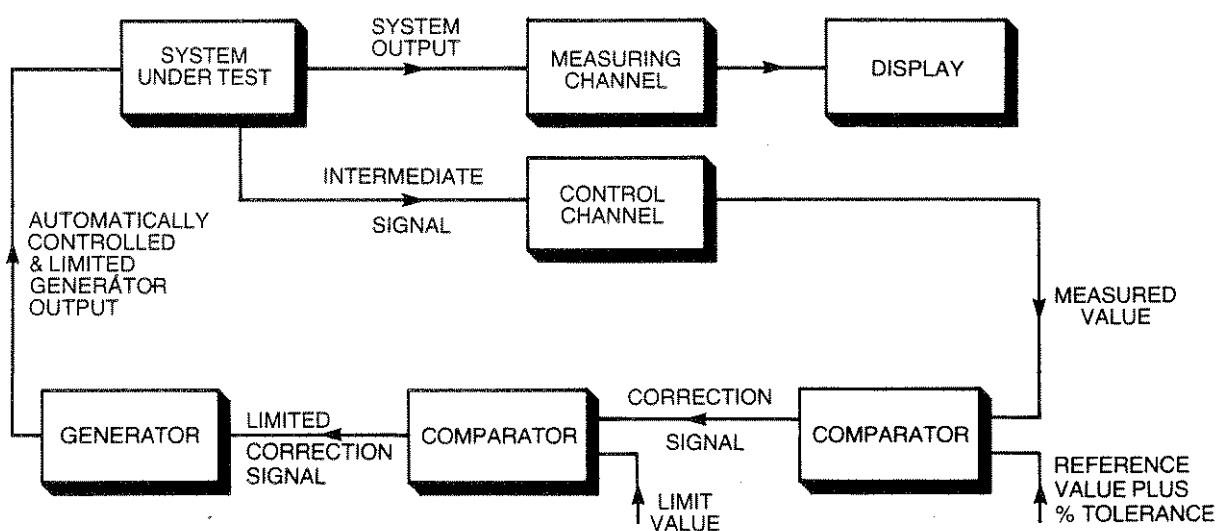

Fig. 9.4 Amplitude Compression Schematic.

2.2 PRINCIPLE OF OPERATION

In the arrangement shown in Fig. 9.4, an intermediate signal is monitored at some point within the system under test. The user defines the nominal voltage which is to be maintained at this point and the percentage error that can be tolerated. For example, if 1 volt \pm 25% is specified, the 1250 will attempt to hold the monitored voltage between the levels 0.75 and 1.25 volts.

One of the Analyser Channels is connected to the monitored point to form part of the control circuit. The other Analyser measures the output of the system under test. Both Analysers measure their respective signals simultaneously.

The Display is shown using the measuring Channel as its source, but it can use either or both, as explained in Chapter 7.

If the Intermediate Signal is outside the tolerance band during a measurement, the 1250 does not display the invalid reading but attempts to correct the Generator output appropriately before making a second measurement. The resulting reading is displayed, valid or not, but "Error 84" is indicated with the reading if it is still invalid.

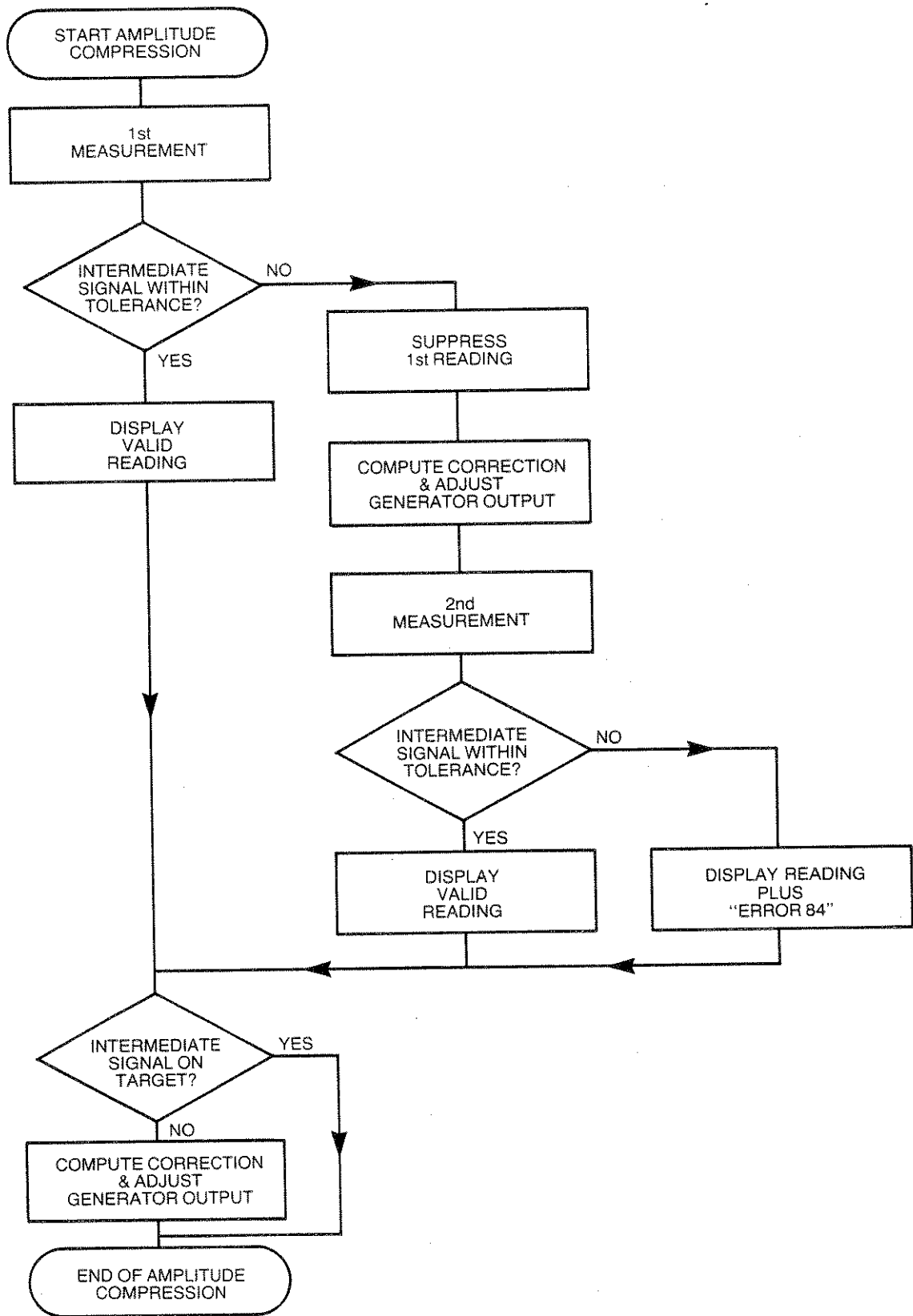

Fig. 9.5 Amplitude Compression flow diagram.

In order to hold the Intermediate Signal as closely as possible to its target value, and not merely within the tolerance band, the 1250 computes and applies any correction necessary to the Generator Output after displaying each reading.

The sequence of events is shown in the flow diagram, Fig. 9.5.

A typical sequence, when using Amplitude Compression with a Sweep, is shown graphically in Fig. 9.6. The ERROR 84 condition does not occur in this example.

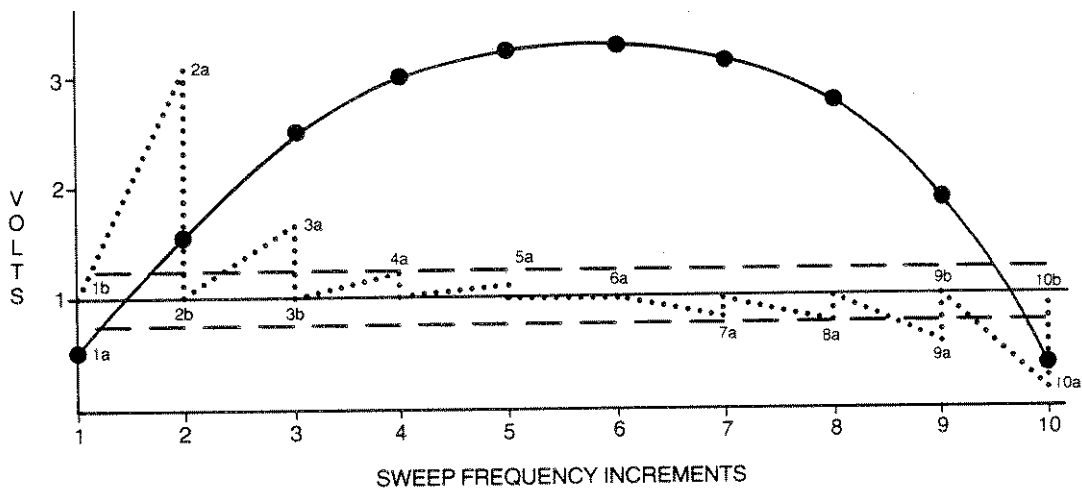

Fig. 9.6 Graphical Example of Amplitude Compression.

The solid curve represents the frequency response of the system under test, as it would appear at the monitored point **without** Amplitude Compression. The sweep steps are numbered from 1 to 10 along the base line.

Superimposed on this curve is the example quoted earlier of a nominal 1 volt level of Amplitude Compression $\pm 25\%$ error.

The dotted line shows the actual signal levels which appear at the monitored point as a result of the Amplitude Compression. The numbers 1a, 1b, 2a, 2b etc. represent the measurements made at each new frequency. Note that where the first measurement shows the signal to be between the permitted levels, only one measurement is made, e.g. at step 4.

2.3 GENERATOR OUTPUT LIMIT

If the Amplitude Compression feedback loop fails to gain control then the Generator output steadily increases to the maximum value achievable, which could exceed some prescribed 'safe' level for driving the system under test.

The LIMIT facility in the Amplitude Compression menu allows a maximum safe operating amplitude to be specified which cannot be exceeded even if the compression loop fails.

2.4 SETTING THE MENU

To set up the Amplitude Compression facility, press GENERATOR MENU, then operate the SELECT key until the Display shows [AMPL. COMPRESS] MENU. Five soft keys will be assigned as follows:

SOURCE. The SELECT key allows either Channel 1 or Channel 2 to be allocated as the control Channel, whichever is the most convenient to the user. The default state selects Channel 1, which is useful if a point to point measurement is to be made. Connect the input of the selected Channel to the point to be monitored.

VALUE. Enter the nominal value of the voltage that it is desired to maintain at the monitored point.

ERROR %. Enter the percentage error that can be tolerated on the nominal voltage. This figure often has to be a compromise. Whilst it is usually desirable to keep the error as small as possible, it may be necessary to accept a wider tolerance, for reasons discussed in Section 2.5.

LIMIT. Enter the safe operating Generator output voltage limit required.

COMPRESS. This key acts as the on/off control, the default state being "off". Enter "on" if the Amplitude Compression facility is required.

2.5 ERROR 84

Section 2.2 describes how ERROR 84 will be displayed if the corrected Generator output still yields a wrong signal level at the monitored point. This can occur if the 1250 bases its correction ratio calculation on unsuitable data, and may necessitate increasing the % ERROR value. There are three main reasons why the data may be unsuitable:

1. Excessive noise on the signal. The effect of this can be reduced by increasing the f TIME value.
2. The system under test parameters are not stable, e.g. the gain changes with time.
3. The amplitude response of the system under test is non-linear.

When ERROR 84 appears in the Display during a Sweep with Amplitude Compression on, a warning "beep" will sound. The Sweep is continued but ERROR 84 remains displayed as a warning at there has been at least one non-valid reading. Any further non-valid readings will also generate a "beep".

2.6 USE OF THE FILE

If a Sweep is left to run unattended, and the user wishes to know which, if any, readings produced ERROR 84, all the readings should be stored in the File, as explained in Chapter 12. These readings can then be replayed at a later date, as many times as necessary, for analysis.

Chapter 10

Facilities For More Complex Measurements

Contents

		<i>Page No.</i>
1	The Function Key	10.2
1.1	Introduction	10.2
1.2	Angle Information	10.3
1.3	Multiplication Factors: $\times \omega^n$	10.4
1.4	Scaling	10.5
1.5	Limits	10.6
1.6	Function Key Summary	10.7
2	Data Flow Schematic	10.8

1 THE FUNCTION KEY

1.1 INTRODUCTION

The FUNCTION key enables the result of a measurement to be processed in a variety of ways, before it appears as a reading:

1. The user may choose from several angle conventions, based on degrees or radians
2. As the measured values are sinusoidal, they can be integrated or differentiated by multiplying by $(j\omega)^n$, where $n = \pm 1$ or ± 2 .
3. The measured values can be scaled by suitable factors.
4. The measured values can be checked against high and low limits.

All the available functions are summarised in Section 1.6

The File. If the measured results are stored in the File, as described in Chapter 12, they can be processed prior to storing, then replayed from the File with a second set of Limits applied, as indicated in the Data Flow schematic of Section 2.

1.2 ANGLE INFORMATION

Having pressed FUNCTION, followed by the ANGLE soft key, SELECT and ENTER either "degree" or "radian". Each of these offers four choices of presentation, as illustrated in Fig 10.1. ENTER the required choice.

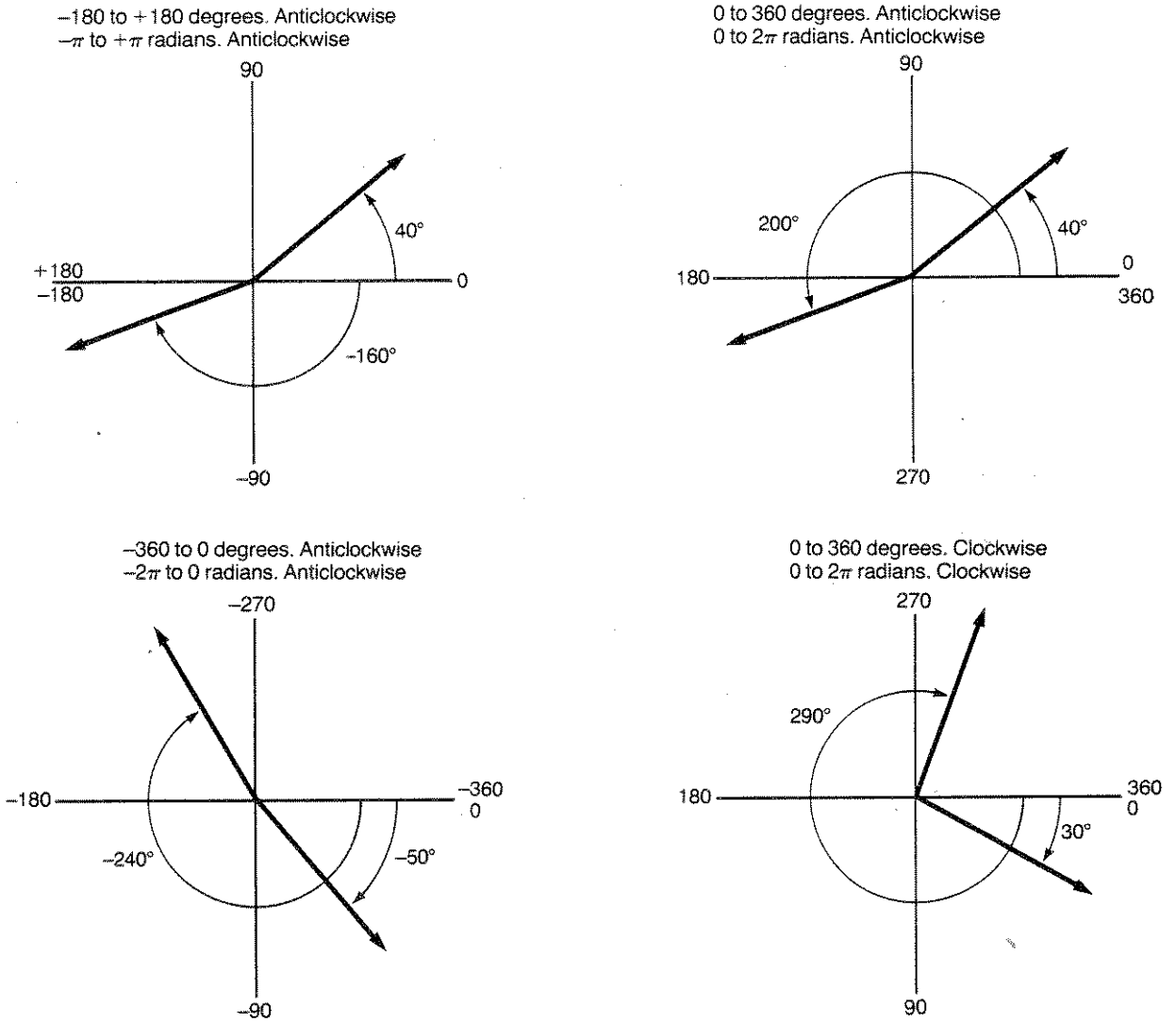

Fig. 10.1 Angle Conventions

1.3 MULTIPLICATION FACTORS: $\times \omega^n$

Pressing the $\times \omega^n$ soft key gives the user a choice of four multiplication factors, plus the default state of “ \times unity” which is the “off” condition. The four choices are:

1. $\times(j\omega)$, which differentiates the value
2. $\times(1/j\omega)$, which integrates the value
3. $\times(j\omega)^2$, which double differentiates the value.
4. $\times(1/j\omega)^2$, which double integrates the value.

Theory. A quantity which varies sinusoidally can be represented as a vector y rotating at a constant angular velocity ω , as shown in Fig 10.2

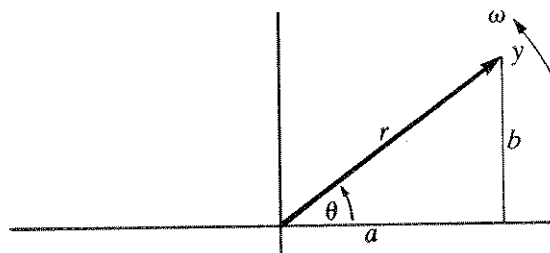

Fig. 10.2 Representation of Vector Quantity

The peak value is indicated by the length r , and the phase angle with respect to the 0° reference axis at any given moment, is θ . The vector can also be represented by a complex number, in the form $a + jb$.

As can be seen from Fig 10.2:

$$y = a + jb = r(\cos \theta + j \sin \theta)$$

and, by Euler's Formula:

$$r(\cos \theta + j \sin \theta) = re^{j\theta}$$

For uniformly rotating vectors, the phase angle θ is a linearly varying function of time i.e.:

$$\theta = \omega t$$

$$\text{thus } y = re^{j\omega t}$$

$$\text{and } \frac{dy}{dt} = j\omega re^{j\omega t}$$

Hence the original quantity has been differentiated by multiplying by $j\omega$.

The other three multiplying factors act in a similar fashion. Note that this method only applies to sinusoidal functions.

Applications. Where a required parameter cannot be measured directly, it is often possible, by using a suitable transducer, to measure a related function. One of the multiplying factors can then be applied to the results to derive the required data. For example, Fig. 10.3 illustrates how various mechanical parameters can be derived from one another by using the $\times \omega^n$ factors.

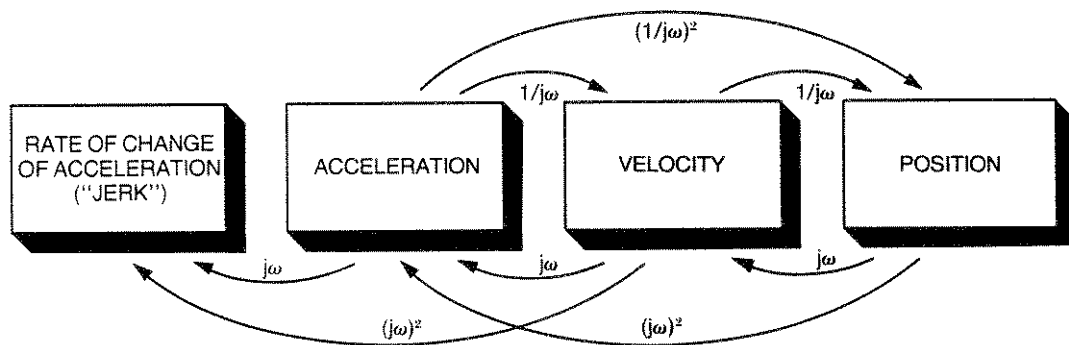

Fig. 10.3 Use of Multiplication Factors

1.4 SCALING

Pressing the SCALE soft key gives the user a choice of three scaling factors whereby the result of a measurement can be *divided* by a vector. There is also a default state of “divide by unity”, which is the “off” condition.

The next two choices are:

1. DIVIDE BY [*a*, *b*]
2. DIVIDE BY [*r*, θ]

If either of these is entered, the Display will request further information. For example, if [*a*, *b*] is entered, following an initialisation, the Display will show:

a not entered (+) V

Enter the required value for “*a*” in the round brackets; all numerical scaling values can be up to five digits plus decimal point and exponent. The Display will now show:

b not entered (+) V.

Enter the required value for “*b*”. The Display will revert to show FUNCTION plus the soft keys.

If [*a*, *b*] is now entered again, the current value will have replaced the “not entered” message e.g.:

a “*current value*” (+) V

Similarly, if scaling values had already been entered for a previous measurement, with no subsequent initialisation, these would have appeared instead of “not entered”.

The setting up of [*r*, θ] is similar, except that θ is given in degrees.

The third choice is:

DIVIDE BY [last result]. This mode can be used where relative, rather than absolute, measurements are to be made. A series of results is divided by a selected reference value which is measured at some point in the sequence, usually at the beginning.

The reference measurement is first completed, and then DIVIDE BY [last result] is entered. This causes the result of the measurement to be stored, and all subsequent results will be divided by this value.

1.5 LIMITS

The LIMIT soft key enables the user to assign a pair of values, called Upper and Lower Limits, to any one of five parameters. The measured results can then be compared to these values, results between the Limits being defined as Passes, those outside as Fails.

Press the FUNCTION key, followed by the LIMIT soft key. The default state is “off”, followed by the five parameter choices obtained by operating the SELECT key, as follows:

LIMIT CHECK [on a], [on b], [on r], [on θ] and [on $\log r$].

Enter the required parameter. For any choice other than “off”, the Display will request further information.

For example, if [on a] is entered, following an initialisation, the Display will show:

UPPER LIMIT not entered (+) V

Enter the required value for the Upper Limit in the round brackets; all Limit values can be up to five digits plus decimal point and exponent. The Display will now show:

LOWER LIMIT not entered (+) V

Enter the required Lower Limit. The Display will revert to show FUNCTION plus the soft keys.

If [on a] is now accessed again, the current value will have replaced the “not entered” message e.g.:

UPPER LIMIT “*current value*” (+) V

Similarly, if Limits had already been entered for a previous measurement, with no subsequent initialisation, these would have appeared instead of “not entered”.

The setting up of Limits on the other parameters is similar, except that θ is in degrees and $\log r$ in dB.

Limits can be set on only a single parameter at a time, namely the parameter last SELECTed, which appears in square brackets.:

LIMIT CHECK [on “parameter”].

If the measurement results have been stored in the File, new limits may be applied to the original or to another parameter, when the results are read back from the File.

1.6 FUNCTION KEY SUMMARY

Soft Key	Display	Displayed Choices	
ANGLE	ANGLE [degree] ↑ (SELECT and ENTER either) ↓	CONVENTION [-180 to +180 ant. clk] CONVENTION [0 to 360 ant. clk] CONVENTION [-360 to 0 ant. clk] CONVENTION [0 to 360 clkwise]	} (Default State) SELECT and ENTER
	ANGLE [radian]	CONVENTION [- π to + π ant. clk] CONVENTION [0 to 2π ant. clk] CONVENTION [- 2π to 0 ant. clk] CONVENTION [0 to 2π clkwise]	
$\times \omega^n$	MULTIPLY BY	[unity] [$j\omega$] [$1/j\omega$] [$j\omega^2$] [$1/j\omega^2$]	} (Default State) SELECT and ENTER
SCALE	DIVIDE BY	[unity] [a, b] [r, θ] [last result]	} (Default State) SELECT and ENTER See Note 1
LIMIT	LIMIT CHECK	[off] [on a] [on b] [on r] [on θ] [on log r]	} (Default State) SELECT and ENTER See Note 2.

Note 1. If [a, b] or [r, θ] is selected, values for a and b , or r and θ respectively must also be entered.

Note 2. For any choice other than "off", Upper and Lower Limit values must also be entered.

2 DATA FLOW SCHEMATIC

Each stage is represented by a box. Where the box has two sections, the upper contains the title of the facility and the lower shows the relevant Front Panel key.

Boxes shown shaded, such as LIMIT CHECK, are optional facilities which may be placed in the data path by the relevant key. If not switched in, they have no effect on the data.

The main data path is shown in heavy line.

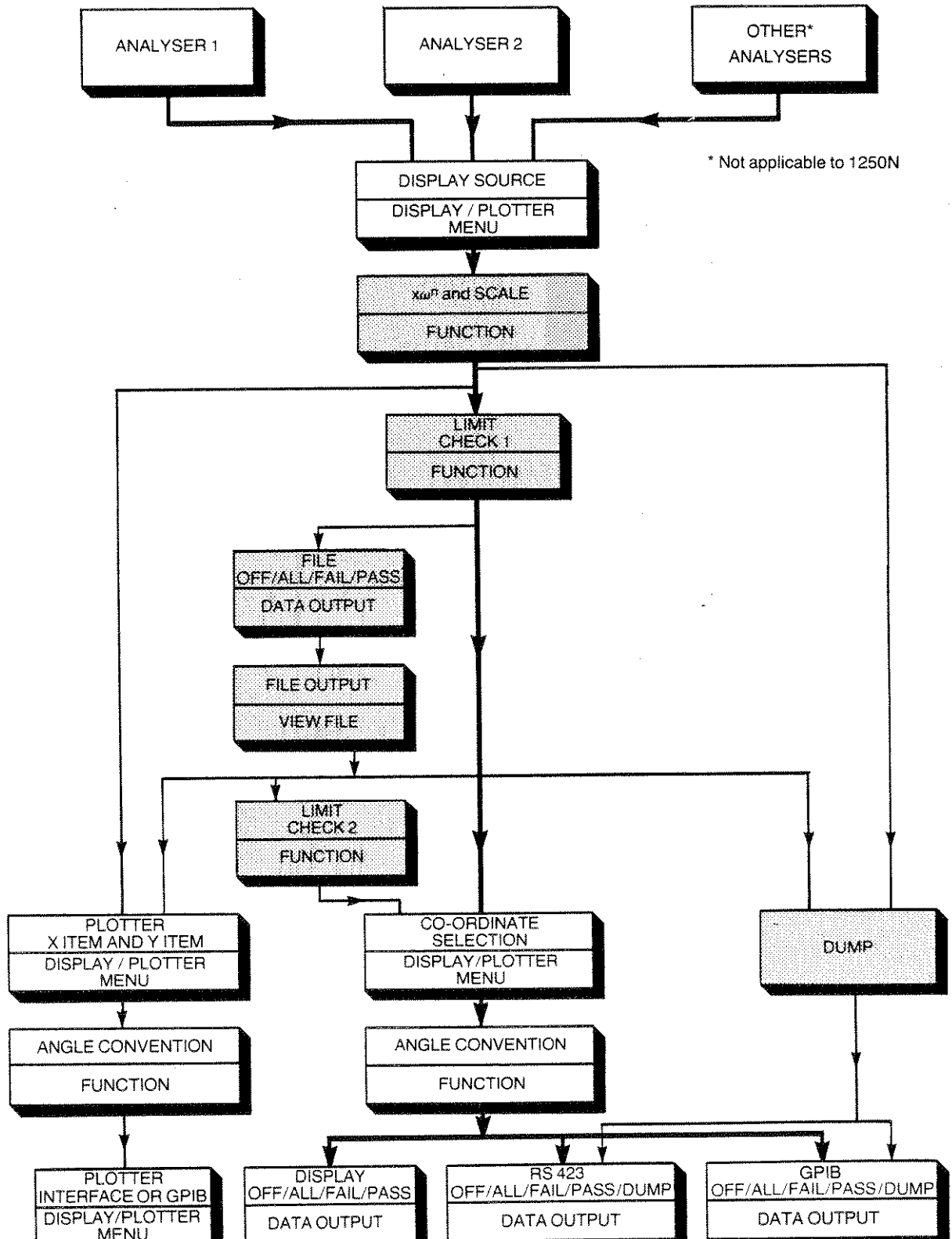

Chapter 11

Additional Displayed Information

Contents

	<i>Page No.</i>
1 The Status Key	11.2
1.1 Introduction	11.2
1.2 Using the Key	11.2
1.3 Main Status	11.3
1.4 Other Status	11.5
1.5 Printed Record	11.8
2 Error Codes	11.9
2.1 Introduction	11.9
2.2 Error Codes: Summary	11.9
3 Error Codes: Details	11.11
3.1 Introduction	11.11
3.2 Group 0. Errors Pertaining to Command Structure	11.11
3.3 Group 1. Errors Pertaining to the Learnt Program	11.12
3.4 Group 2. Parametric Interaction Errors	11.12
3.5 Group 3. Generator Warnings and Errors	11.12
3.6 Group 4. Learnt Program, File, and Variable	11.13
3.7 Group 5. Missing Boards	11.13
3.8 Group 6. Illegal I/O Manipulation	11.14
3.9 Group 7. System Errors	11.14
3.10 Group 8. Measurement Validity is Suspect	11.14

1 THE STATUS KEY

1.1 INTRODUCTION

The STATUS key, in conjunction with the SELECT key, enables the user to examine, but not alter, the current state of the controls and the existing parameter values in the 1250. Quantities displayed in lower case are usually those which the user has entered, whereas those in upper case indicate the state of the instrument. In the details that follow, where one of several different states may appear after a particular heading, all the possible states are listed in the form: RUN/STOP/IDLE/etc.

The Status information is available under two headings, [MAIN] STATUS which includes the Menus, and [OTHER] STATUS which covers the rest of the instrument. Nine soft key titles are allocated, details of which are given in Sections 1.3 and 1.4. The soft key titled “ μ P” gives information on the 1250 Central Processing Unit, as described in Section 1.4.

1.2 USING THE KEY

To view the STATUS information, press the STATUS key. The Display will show:

[MAIN] STATUS with soft keys: GEN (i.e. Generator)
 ANALYSER
 SWEEP
 DISPLAY
 PLOTTER

If SELECT is pressed, the Display will change to:

[OTHER] STATUS SYNC (i.e. Synchroniser)
 FN/PROG (i.e. Function/Program)
 μ P (i.e. the 1250 Central Processor Unit)
 GPIB

Having selected the required STATUS group, press the relevant soft key. The format of the information which now appears in the Display is referred to as a “page”. Several pages are available for each soft key. To step through the pages, successively operate the SELECT key, (although in this case no square-bracket prompt is given).

Having obtained the required page, and verified the status of the parameter concerned, press ENTER to retrieve the soft key display. Alternatively, to exit from the STATUS mode completely, press the key for the next operation that is to be performed.

1.3 MAIN STATUS

Soft Key	Page	Display		
GEN	1	GENERATOR RUN/STOP/FAULT		WAVEFORM sine/square/triangle
		CARRIER	NONE/LO/on	MOD off/1 on/2 on
		Notes: GENERATOR FAULT indicates that the Generator board is missing. CARRIER NONE indicates that no Modulator/Demodulator board is fitted. CARRIER LO indicates that a carrier is present, but at insufficient amplitude.		
	2	FREQ (Hz)	AMP (V)	BIAS (V)
		<i>value</i>	<i>value</i>	<i>value</i>
	Note: The units of frequency and voltage remain constant; exponent notation is used to cover the full range.			
	3	AMP. COMPRESS	VALUE (V)	ERROR (%)
		off/on Ch01/on Ch02.	<i>value</i>	<i>value</i>
	4	AUX. GEN	NONE	
		unless the optional Auxiliary Generator is fitted, in which case the Display reads:		
		AUX. GEN	RUN/STOP	WAVEFORM sine/square/triangle
	Note: CARRIER and MOD are not displayed; these will be as for Main Generator. A further page is available for the Auxiliary Generator.			
	5	AUX. GEN	AMP (V)	BIAS (V)
			<i>value</i>	<i>value</i>
ANALYSER	1	ANALYSERS STOP/RUN/IDLE/DELAY/WAIT*		RUN TIME(sec)
		AUTO-INT: off/short on Ch01/short on Ch02/		<i>value</i> †
		/long on Ch01/long on Ch02		
	*WAIT signifies that the Analyser is ready, but waiting for another section of the 1250			
	†This value shows the time taken for the last measurement completed.			
	2	INT. TIME (sec)/(cyc)	M. DELAY (sec/cyc)	HARMONIC
		<i>value</i>	<i>value</i>	01
	Note: HARMONIC will show a number from 1 to 16.			
	3	Ch	RANGE	DEMOM
		01	auto/30mV/	off/1 on/2 on
			300mV/3V/	front/rear
			30V/300V	COUPLING
				DC/AC
	4	Ch	as for Ch 01	
		02		
	Note: The Display will show only the Channel numbers of Analysers which are fitted. If additional Analysers are present, the status of these will be shown on subsequent pages, in the sequence Ch11 to Ch18, Ch21 to Ch28, Ch31 to Ch38, and Ch41 to Ch48.			

MAIN STATUS (cont)

Soft Key	Page	Display		
SWEEP	1	SWEEP	STOP/IDLE/HOLD/RUN	TYPE harm up/lin up/ lin down/log up/log down
	2	F. MIN (Hz) <i>value</i>	F. MAX (Hz) <i>value</i>	*

* For LOG: st/dec or st/oct or st/swp or ratio
 For LIN: st/swp or step (Hz)
 where st = step, dec = decade, oct = octave, swp = sweep.

For HARMONIC there is no entry.

DISPLAY	1	DISPLAY Ch01 to 48 or Ch <i>n/m</i> IN <i>a,b/r, theta/log r, theta</i> RANGE <i>value</i> *		
---------	---	---	--	--

* e.g. 3V. This figure shows the range used on the last completed measurement, even where the Analyser is on Auto-Range. If a ratio measurement was made, both ranges will be shown e.g. 3V/30mV.

PLOTTER	1	PLOTTER A3/A4	STOP/IDLE/RUN/NONE point/vector	X-Ch * Y-Ch
	2	X-MIN <i>value</i>	X-MAX <i>value</i>	X-ORIGIN <i>value</i>
	3	Y-MIN <i>value</i>	Y-MAX <i>value</i>	Y-ORIGIN <i>value</i>

* The Channel number will be given as for DISPLAY, followed by *a/b/r/theta deg/ theta rad/log r dB/f Hz/log f Hz*.

1.4 OTHER STATUS

Soft Key	Page	Display
SYNC	1	SYNC. NONE/IDLE/WAIT/STABLE/LOCKED/FAULT followed by a single-digit fault identifier. Further pages appear only if Synchroniser option fitted.
	2	TRIG LEVEL RATIO SLOPE COUPLING <i>value</i> <i>value</i> +/- AC/DC
	3	INPUT FREQ MIN FREQ MAX FREQ <i>value</i> <i>value</i> <i>value</i>
	4	START FREQ STOP FREQ AVGE FREQ <i>value</i> <i>value</i> <i>value</i>
FN/PROG	1	PROGRAM 1 2 3 4 5 6 7 8 9 LEARNT L* *L appears under every learnt program.
	2	FUNCTION ANGLES deg/rad - to + ant. clk or: 0 to + ant. clk or: - to 0 ant. clk or: 0 to + clkwise
		Note: “-to+” signifies -180° to $+180^\circ$ for degrees or $-\pi$ to $+\pi$ for radians “0 to +” signifies 0 to 360° for degrees or 0 to 2π for radians “- to 0” signifies -360° to 0 for degrees or -2π to 0 for radians
	3	FUNCTION LIMIT CHECK off/on a/on b/on r/on theta/on log r SCALE BY unity/a, b/r, theta/last result *
		NOTE: If $\times \omega^n$ has been selected, the area of the Display marked * above will show one of the following: and $j\omega$, and $1/(j\omega)$, and $(j\omega) \uparrow 2$, and $1/(j\omega) \uparrow 2$. Where “ $\uparrow 2$ ” indicates “squared”.

OTHER STATUS (cont).

FN/PROG (cont).

Soft Keys	Page		Display	
	4	SCALING FACTORS	<i>a</i> <i>value</i>	<i>b</i> <i>value</i>
	5	SCALING FACTORS	<i>r</i> <i>value</i>	<i>theta</i> <i>value</i>
	6	LIMIT VALUES	<i>a</i> LO <i>value</i>	<i>a</i> HI <i>value</i>
	7	LIMIT VALUES	<i>b</i> LO <i>value</i>	<i>b</i> HI <i>value</i>
	8	LIMIT VALUES	<i>r</i> LO <i>value</i>	<i>r</i> HI <i>value</i>
	9	LIMIT VALUES	<i>theta</i> LO <i>value</i>	<i>theta</i> HI <i>value</i>
	10	LIMIT VALUES	<i>logr</i> LO <i>value</i>	<i>logr</i> HI <i>value</i>

μ P	1	PROCESSOR READY/BUSY/ PROGRAM*/pause	FREE MEM See Note 1	LAST ERROR See Note 2
---------	---	--	------------------------	--------------------------

* PROGRAM indicates that the microprocessor is occupied in working through a program; BUSY indicates that it is engaged on some other activity; Pause indicates that it is waiting for a user input.

Note 1: Memory in the 1250 is of two types:

- a. **Assigned** memory, allocated for File storage and currently learnt Program lines.
- b. **Free** memory, available to the user for further storage.

The amount of free memory available appears here in the form "n BLOCKS". One Block of memory can hold one File result or one Program statement, e.g. Generator Frequency setting, or Analyser SINGLE instruction. The total amount of memory available in the 1250 is approximately 450 Blocks. Chapter 12 gives full details.

Note 2: The Error Codes for the last three errors noted are displayed here. For example, the Display could show: 01 21 59. The latest error appears on the left, in this case 01.

As new errors are detected, the existing numbers shift to the right, such that if the next error is code 70, the Display changes to:
70 01 21.

OTHER STATUS (cont).

μP (cont).

Soft Keys	Page	Display		
	2	LAST LIMIT	UPPER <i>value</i>	LOWER <i>value</i>

This page can be used to determine the limits which apply to the current parameter being entered, as an alternative to looking it up in the full specification. For example, if the maximum Generator output voltage is not known, enter an arbitrary value in the Generator menu. This can be either a known permissible value, e.g. 1 volt, or an excessive value such as 90 volts.

Now call up page 2 of the microprocessor status, and the available limits for the Generator output voltage will be displayed.

3	DATA O/P	GPIB off/ all/ fail/ pass/ dump	RS423 off/ all/ fail/ pass/ dump	DISPLAY off/ all/ fail/ pass	FILE off/ all/ fail/ pass
---	-------------	--	---	--	---------------------------------------

Note: see Chapter 12, DATA OUTPUT key, Section 1.2 for explanation of above messages.

4	REFORMAT on/off	HEADING on/off
---	--------------------	-------------------

Note: see Chapter 12, DATA OUTPUT key, Section 1.3 for explanation of above messages.

GPIB	1	GPIB	MODE t. only/ normal	STATE IDLE/ maj TACS/ min TACS/ maj LACS/ min LACS	ADDRESS e.g. 00/01
-------------	---	------	----------------------------	---	-----------------------

Notes: where t. = talk, normal = bi-directional, maj = major, min = minor

TACS = Talker Active State LACS = Listener Active State

The pair of numbers appearing under "ADDRESS" are the major and minor addresses respectively, as explained in Chapter 13, Section 5.1

OTHER STATUS (cont).

GPIB (cont).

Soft Keys	Page	Display			
	2	GPIB	SER. POLL 8 digits, consisting of a set of "flags" and a "service" bit.	PAR. POLL A number from 0 to 8 0 = disabled followed by sense: T = True F = False	CONTROL local/ remote/ loc + llo/ rem + llo

Note: SER = Serial PAR = Parallel llo = Local lock-out

For further explanation of these messages, see the GPIB section,
Chapter 13, Section 7.

3	GPIB	I/P TERM lf/cr/s-colon/EOI	O/P TERM crlf/crlf+EOI/ cr/cr+EOI	O/P SEP comma/term
---	------	-----------------------------------	---	---------------------------

Notes: TERM = Terminator, SEP = Separator

cr = carriage return, lf = line feed, EOI = End or Identify.

Where "term" appears under O/P SEP, it means that the Output Separator is the same as the Output Terminator. Further information appears in the GPIB section, Chapter 13.

1.5 PRINTED RECORD

If a printed record is required of the STATUS information, enable the relevant output device as described under DATA OUTPUT. Any state other than **off** will cause the data to be printed; the **pass/fail** conditions do not apply here. Note that STATUS information is not available via the GPIB.

Press STATUS, then the relevant soft key. It is only necessary to use SELECT to change from [MAIN] to [OTHER] STATUS; the pages will be "scrolled" automatically to the output device when the soft key is pressed. Note, however, that only the first page for each soft key will appear in the Display.

2 ERROR CODES

2.1 INTRODUCTION

The Error Codes fall into two main categories:

- a. Those which explain why the instrument has stopped; some of these are warnings, rather than errors.
- b. Those which explain why the instrument will not respond to a new command.

Some of the Code Numbers appear only briefly in the Display, accompanied by a warning "beep". However, they can always be recalled as described under STATUS, μ P, 1st page.

If a Code Number appears in the Display, but is not in the following list, it is intended for Service Engineer's use only.

2.2 ERROR CODES : SUMMARY

The Error Codes are assigned in groups as follows:

Group 0 = Errors Pertaining to Command Structure

01	Unknown command
02	Argument mismatch
03	Argument out of range
04	Floating Point format error
05	Illegal request for value

Group 1 = Programming Errors

11	Illegal edit command
12	Command cannot be learnt
13	Program does not exist
14	Recursion attempted
15	Attempt to edit whilst program running
16	Program Check Sum error

Group 2 = Parametric Interaction Errors

21	The combination of Frequency and Harmonic is $> 65\text{kHz}$
22	The combination of some or all of Generator Amplitude, Bias, Waveform and Modulation gives $> 15\text{V}^*$ peak
23	The combination of some or all of Auxiliary Generator Amplitude, Bias, Waveform and Modulation gives $> 15\text{V}^*$ peak
24	The combination of Frequency, Harmonic and Integration Time is out of range
25	Plotter MINIMUM $>$ MAXIMUM
26	Order Analysis incompatibility

* 21V for 1250N

Group 3 = Generator Warnings and Errors

30	Generator stopped by command
31	Generator overload or Generator power fail
32	(Spare code)
33	Auxiliary Generator overload or Auxiliary Generator power fail
34	Modulation Channel 1 overload
35	Modulation Channel 2 overload

ERROR CODES : SUMMARY (cont).

Group 4 = Learnt Program, File and Variable

41	Line number not found
42	Jump outside Program mode
43	Attempt to step Variable out of range
44	File empty
45	Illegal File access
46	Illegal File size entry

Group 5 = Missing Boards

50	Analyser not present
51	(Spare code)
52	(Spare code)
53	Generator not present
54	Control not present
55	Synthesizer not present
56	Mod/Demod not present
57	Synchroniser not present
58	Auxiliary Generator not present
59	Plotter not present

Group 6 = Illegal I/O Manipulation

60	Changing I/O device during Learn sequence
61	Attempt to change operating conditions from a non-enabled I/O device

Group 7 = System Errors

70	Out of Memory
----	---------------

Group 8 = Measurement Validity is Suspect

81	Overload
82	Auto-Integration terminated before valid completion
83	A combination of 81 and 82
84	Amplitude Compression failure
85	A combination of 81 and 84
86	A combination of 82 and 84
87	A combination of 81, 82 and 84
88	Internal hardware error
89	Analysis terminated early, by ANALYSER STOP key

Group 9 = Synchroniser and Slave Analyser Errors

91	}	(Spare codes)
92		
93		
94	Synchroniser not ready	
95	No results available from Slave Analyser(s)	
96	}	(Spare codes)
97		
98		

3 ERROR CODES : DETAILS

3.1 INTRODUCTION

Where the Error Code appears only in the Summary, the Code title is deemed to be self-explanatory.

Some of the Codes which refer to faulty modules are primarily intended to give information to Service Engineers.

3.2 Group 0. ERRORS PERTAINING TO COMMAND STRUCTURE.

01 Unknown command: is caused when a peripheral device sends a command which the 1250 does not recognise.

02 Argument mismatch. The instructions to the 1250 usually consist of two parts: the "command" e.g. FR for frequency, and the numerical part or "argument" e.g. 45 plus exponent. Hence a typical simple instruction would be FR 2E3, meaning "set the Frequency to 2 kHz".

Where there is more than one device, e.g. two Analysers, the Argument must specify not only the numerical value, but also the device. For example: RA 1, 3 means set the Analyser voltage range (RA), of Analyser 1, to Range 3. When the 1250 sees RA, it expects to see *two* other pieces of numeric information following. If it only sees *one*, this is detected and flagged as an Argument mismatch.

Conversely, if the instruction should contain only *one* piece of numeric information, but owing to an error contains *two*, this is also flagged as an Argument mismatch.

03 Argument out of range, i.e. outside the range of the 1250. This error can be caused by incorrect use of front panel keys, as well as by invalid instructions from a peripheral device. An example is trying to programme a frequency of 1 MHz, which is above the maximum frequency of 65 kHz.

04 Floating Point format error. Usually caused by a typing error, e.g. FR 1·25 E2 typed as FR 1·2·5 E2.

05 Illegal request for value, of a parameter or mode which does not possess a value. For example, if the peripheral device sends ?SG to the 1250, meaning "what value is Stop Generator", 05 will be flagged.

ERROR CODES: DETAILS (cont.)

3.3 GROUP 1. ERRORS PERTAINING TO THE LEARNT PROGRAM

11 Illegal edit command. The four Edit commands are listed in the Program Learn section. Once the Edit mode has been established, the only valid commands from a peripheral are these four plus the Edit Complete signal * Q. Any other command will produce ERROR 11.

If editing from the Front Panel, the correct way to exit from the Edit mode is to press the QUIT soft key.

12 Command cannot be learnt. In the Program Learn mode, there are certain commands which cannot be learnt, such as Edit Command, when given from a peripheral device.

13 Program does not exist. The STATUS display, soft key FN/PROG, page 1 shows the nine available Learnt Program numbers, with an L beneath those which have been learnt. Any attempt to e.g. Execute or Clear a Program whose number has no L allocated will produce ERROR 13.

14 Recursion attempted. Recursion in this case is defined as: "a program A, which, whilst being executed, either calls itself or calls a program B, which in turn calls program A". This is only allowed under special circumstances, as described in Chapter 12.

16 Program Check Sum error. Learnt Programs are stored in the 1250 Memory; a check sum is calculated and stored with the program data. Before a stored program can be operated upon, a new check sum is calculated, and compared with the original. If the two disagree, the stored data is presumed to have been corrupted. The operation will not be performed and ERROR 16 will be displayed.

Learnt Program operations are described in Chapter 12.

3.4 GROUP 2. PARAMETRIC INTERACTION ERRORS

26 Order Analysis incompatibility. Order Analysis selected with Auto Integration or with frequency > 650 Hz (400 Hz when Synchronising); or Order Analysis attempted on an incomplete measurement (e.g. if BREAK pressed during a measurement).

3.5 GROUP 3. GENERATOR WARNINGS AND ERRORS

30 is a warning that the Generator has stopped. For example, operating the GENERATOR STOP key will call up ERROR 30.

31 and 33 mean that an excessive external voltage has been applied across the Generator terminals.

34 and 35 indicate that an excessive modulating signal is being applied.

These five Error Code numbers only appear when page 1 of the μ P Status is displayed. The "Errors and Warnings" field of the Display will show one of the following messages, but no number.

Message	Error Code Number
GEN. STOPPED	30
GEN. O/LOAD	31
AUX. GEN O/L	33
MOD. Ch 1. O/L	34
MOD. Ch 2. O/L	35

3.6 GROUP 4. LEARNT PROGRAM, FILE, AND VARIABLE

41 Line number not found, in Learnt Program. This only applies when the Learnt Program has been compiled using a peripheral device, in which case each line of the program may be allocated a number. Jump instructions can then be used for program looping etc., using the line numbers as addresses.

If a command is given to jump to a line number which does not exist in the current program, ERROR 41 will be displayed.

42 Jump outside Program mode: refers to Learnt Program, but only when using a peripheral device. The 1250 will obey a Jump instruction when it forms part of a program which is being run from the Memory, but not when it is sent directly from an external keyboard.

For example, the stored program may contain:

Line 06 JP20 CR, meaning jump from Line 6 to Line 20. This jump will be executed when running the program from Memory. However, if the program is loaded into Memory, and the command JP20 is sent from the keyboard to try and start the program from Line 20, ERROR 42 will be displayed.

43 Attempt to step Variable out of range. Also applies to an attempt to use Variable on a parameter whose value has not been entered.

44 File empty, will be displayed in response to the [LIST]FILE command or the [DISPLAY]FILE command if the File is empty. However [CLEAR]FILE may still be used.

45 Illegal File Access. It is illegal to try to Display, List or Clear the File whilst the Analysers are running, or if they have been stopped in mid-measurement (by means of the Generator Stop key).

46 Illegal File size entry. Attempt to change File size during a measurement; or to reduce File size without first clearing; or to enter a File size greater than the number of free Blocks available.

3.7 GROUP 5. MISSING BOARDS

An Error Code number in this Group will be displayed only if the 1250 is commanded to perform an operation requiring a board or boards which are not fitted, e.g. if Modulation is programmed but no Mod/Demod board is present.

ERROR CODES: DETAILS (cont.)

3.8 GROUP 6. ILLEGAL I/O MANIPULATION

60 Changing I/O Device during Learn sequence.

This Error indicates that the 1250 was in the Learn mode, prior to the command which attempted to change the I/O device. As a result of this command, not only has the I/O device been changed, but the Learnt Program has also been terminated automatically. However, the program prior to the change of I/O device will have been learnt correctly and is therefore usable up to that point.

61 Attempt to change operating conditions from a non-enabled I/O device.

There are three Input/Output (I/O) routes to the 1250's Central Processor Unit (CPU):

- a. Via the Front Panel.
- b. Via the RS423 port.
- c. Via the GPIB.

ERROR 61 will be displayed when:

1. The GPIB is controlling the CPU *with Local Lock-Out asserted*, and an attempt is made to send commands via the Front Panel or the RS423 port. The GPIB must remove the Local Lock-Out first.
2. The GPIB is controlling the CPU *with no Local Lock-Out*, and an attempt is made to send commands via the Front Panel or the RS423 port without first asserting "Local".
3. The CPU is being controlled via the RS423 port or the Front Panel, and an attempt is made to send commands via the GPIB without first asserting "Remote".
4. The CPU is being controlled via the RS423 port and an attempt is made to send commands via the Front Panel, without first pressing LOCAL.

3.9 GROUP 7. SYSTEM ERRORS

70 Out of memory. There is a finite amount of unassigned Memory available for learning programs and storing readings on the File. Once all this Memory has been filled, any further demand will produce ERROR 70.

3.10 GROUP 8. MEASUREMENT VALIDITY IS SUSPECT

Mainly covers conditions under which a valid measurement may not have been achieved. The 1250 will display a reading accompanied by the appropriate warning Code number.

Chapter 12

Recording, Learning and Storing Facilities

Contents

		<i>Page No.</i>
1	The Data Output Key	12.2
1.1	Introduction	12.2
1.2	[DATA OUTPUT]	12.2
1.3	[FORMAT]: Heading and Reformat	12.3
1.4	Heading	12.3
1.5	Reformat	12.4
1.6	Menu Changes Activating the Heading and Reformat Functions	12.5
1.7	Channel & Range Column Conventions	12.5
1.8	[GPIB CONFIGURE]	12.6
1.9	Parallel Poll and Poll Sense	12.6
1.10	Serial Poll	12.6
1.11	Terminator and Separator	12.6
2	The File	12.7
2.1	Introduction	12.7
2.2	Maximum File Size	12.7
2.3	Selecting File Size	12.7
2.4	Overwriting of Results in the File	12.7
2.5	Starting a File	12.8
2.6	Reading from the File	12.8
3	Learnt Programs	12.9
3.1	Introduction	12.9
3.2	Learning a Program: From the Front Panel	12.9
3.3	Learning a Program: From an External Device	12.10
3.4	Executing a Program	12.11
3.5	Editing a Program: From the Front Panel	12.11
3.6	Editing a Program: From an External Device	12.12
3.7	Program Pause/Continue Key	12.12
3.8	Example Programs: Looping and Calling	12.12
3.9	Error Messages Displayed during Program Running	12.13
4	X-Y Plotter	12.14
4.1	Introduction	12.14
4.2	Setting up a Plot: Non-Plotter Menus	12.14
4.3	The [PLOTTER COMMON] Menu	12.15
4.4	The [PLOTTER X-AXIS] and [PLOTTER Y-AXIS] Menus	12.16
4.5	The [PLOTTER SCALING] Menu	12.17
4.6	Performing a Plot	12.18
4.7	Bode and Nyquist Plots	12.19
4.8	Adjusting the Plotting Field to suit Preprinted Chart Paper	12.20
4.9	Pen Selection with Two-Pen Plotters	12.21
4.10	Plotting Data from the File	12.21

1 THE DATA OUTPUT KEY

1.1 INTRODUCTION

The DATA OUTPUT key accesses three menu pages, which appear in the order: [DATA OUTPUT], [FORMAT], and [GPIB CONFIGURE]. These are described in the following sections, and summarised for quick reference in Chapter 8.

1.2 [DATA OUTPUT]

This page of the menu allows the user to enable or disable any or all of the possible output devices, including the Front Panel. The types of reading that are to be accepted can also be selected. The four soft keys act independently, e.g. all readings can be passed to the Display, but only those which fail the Limits Test are stored in the File. For details on setting Limits, see Chapter 10, Section 1.5.

The following roles are assigned to the soft keys, each one offering choices as shown:

	Soft Keys	
OUTPUT TO	DISPLAY	[all]
		[fail]
		[pass]
		[off]
	RS423	[off]
		[all]
		[fail]
		[pass]
		[dump]
	GPIB	[off]
		[all]
		[fail]
		[pass]
		[dump]
	FILE	[off]
		[all]
[fail]		
[pass]		

Note: Entering the FILE soft key selection causes the Display to show FILE SIZE (99).
This menu allows choice of File size to be input, as explained in Section 2, 'The File'.

When a choice has been selected and entered for a particular output device, the result is as follows:

[all]: all readings are passed to the output device, irrespective of any Limits that may have been imposed via the FUNCTION key. If Limits have been set, any readings outside them will be accompanied by the message HI or LO as appropriate.

[fail]: only readings which are outside the Limits set via the FUNCTION key will be passed to the output device.

[pass]: only readings which are within the Limits set via the FUNCTION key will be passed to the output device.

[off]: no readings will be passed to the output device. Note that the default state is [all] for the Display but [off] for all the others. The Display can be switched off when using the 1250 as part of a system, so that data may be transferred more rapidly.

[dump]: this choice is only available for the two output ports, and enables data to be transferred at maximum speed to some external device such as a computer.

Dump mode is explained in Chapter 13, Section 12.4.

1.3 [FORMAT]: HEADING AND REFORMAT

Two soft keys are assigned to this page, giving the selections shown:

HEADING	REFORMAT
[on]	[on]
[off]	[off]

1.4 HEADING

HEADING controls the output of headings above the columns of measurements sent to the RS423 port, and to the GPIB when it is in Talk Only mode.

With HEADING switched 'on' (the default state after INITIALising, or RESETing the 1250), the first heading is output only after the next measurement when SINGLE or RECYCLE is pressed.

Fig. 12.1 exemplifies some printer output from the 1250 via the RS423 port. Line 1) appeared after INITIALising; lines 2) and 3) appeared after menu selection, followed by pressing SINGLE.

1)*	INITIALISED					
2)	FREQUENCY (Hz)	REAL	IMAGINARY	CHANNEL & RANGE	TIME	STATUS
3)	+1.0000E+02	+6.2007E-07	+8.4455E-07	02/01 (R1/3)	00: 03: 33	BUSY
4)	+1.0000E+02	-1.0267E-06	-3.3775E-06	02/01 (R1/3)	00: 03: 56	BUSY
5)	FREQUENCY (Hz)	MAGNITUDE	PHASE (deg)	CHANNEL & RANGE	TIME	STATUS
6)	+1.0000E+02	+3.5301E-06	-1.0690E+02	02/01 (R1/3)	00: 04: 37	BUSY
7)	FREQUENCY (Hz)	MAGNITUDE (V)	PHASE (deg)	CHANNEL & RANGE	TIME	STATUS
8)	+1.0000E+02	+4.4962E+00	-3.1962E-02	01/00 (R3/0)	00: 05: 07	BUSY

(*Line numbers refer to text)

Fig. 12.1 Example of printer output with HEADING switched 'on'

After the initial output of headings, pressing SINGLE or RECYCLE no longer has this effect, but outputs only further measurements. Line 4) in Fig. 12.1 appeared after pressing SINGLE again.

New headings and a measurement now appear automatically whenever any change is made to the data being output which invalidates the existing column headings, e.g. changing from a,b to r, θ coordinates. The changes triggering new headings are listed in Section 1.6 below.

Lines 5) and 6) in Fig 12.1 were output when the DISPLAY/PLOTTER menu was altered by selecting r, θ coordinates instead of a,b, coordinates. SINGLE was not pressed. Lines 7) and 8) appeared because the SOURCE was altered from [Ch 2/Ch 1] to [Ch 1] only (with REFORMAT 'on', see Section 1.5). The 'Channel & Range' column conventions are explained in Section 1.7 below.

New headings may be generated at any time, without changing data type, by turning HEADING 'on', even if it is already 'on', followed by SINGLE or RECYCLE. As usual, the headings are followed by at least one line of measurements. This facility could be used at the start of each new page of printer output, for example, for clearer presentation of results.

With HEADING switched 'off', all headings are suppressed.

1.5 REFORMAT

REFORMAT controls the output of both headings and measurements. It affects all data output ports and devices (Display, RS423, File, GPIB).

With REFORMAT 'on' (the default state), results are output to all selected devices when any of the changes listed in Section 1.6 are made, or if the SINGLE or RECYCLE keys are pressed. The appearance of headings with these measurements is determined by the HEADING state, as explained in Section 1.4 above.

With REFORMAT 'off', results are output **only** when SINGLE or RECYCLE are pressed.

This suppression of automatic output after menu changes may be used when the operator wishes to alter limits or coordinates, for example, and does not want measurements to be output before the changes have been fully set up. Switching REFORMAT 'on' again, or pressing SINGLE or RECYCLE, causes results to be output (with headings if HEADING is also 'on').

The following table summarises what output is produced with all combinations of HEADING and REFORMAT states, when one of the menu changes listed in Section 1.6 is made.

Note: After SINGLE or RECYCLE, or REFORMAT 'on', a result without headings is output in all cases (apart from the initial set of headings and results output by the 1250).

DATA OUTPUT		MENU CHANGE	
HEADING	REFORMAT	to make existing headings: INVALID	STILL VALID
ON	ON	heading & result	result
ON	OFF	NIL until SINGLE or RECYCLE, or REFORMAT 'on', then: heading & result result	
OFF	ON	result	result
OFF	OFF	NIL	NIL

1.6 MENU CHANGES ACTIVATING THE HEADING AND REFORMAT FUNCTIONS

HEADING and REFORMAT may be initiated by changes to any of the following menus:

- a. Any FUNCTION menu
- b. The [DATA OUTPUT] menu
- c. The [DISPLAY], SOURCE and CO-ORDS menus
- d. The [ANALYSER COMMON], ORDER menu

Note: Making any of these changes, with either HEADING or REFORMAT 'on', causes a result to be sent to the File if it is also 'on'. This could happen, for example, when switching on the RS423 port in order to print out the filed results of a Sweep measurement.

To prevent this inadvertent filing of results, which could be confusing or cause overwriting and loss of data, it is advisable to switch off the File once the required results have been filed.

1.7 CHANNEL & RANGE COLUMN CONVENTIONS

In the 'Channel & Range' column (See Fig. 12.1), the first two pairs of digits separated by an oblique give the SOURCE channel(s), and the bracketed figures prefixed by "R" and separated by an oblique give the Analyser RANGE(s) operative for that measurement.

The ranges are coded as follows:

Code	Range
1	30 mV
2	300 mV
3	3 V
4	30 V
5	300 V

So, for example, the following entries have the meanings shown:

CHANNEL & RANGE ENTRY	MEANING	
	SOURCE	RANGE
02/01(R1/3)	Ch 2/Ch 1	Ch 2:30 mV Ch 1: 3 V
01/00(R3/0)	Ch 1 only	3 V

1.8 [GPIB CONFIGURE]

This page of the DATA OUTPUT menu accesses five soft keys, concerned with the remote control of the 1250. The soft keys and selections are as follows:

PAR. POL	P. SENSE	SER. POL	TERM.	SEP.
(0)	[true]	(0)	[cr lf]	[comma]
	[false]		[cr lf+EOI]	[terminator]
			[cr]	
			[cr + EOI]	

Chapter 13 gives details of the use of these functions for remote control; the following sections are a summary.

1.9 PARALLEL POLL AND POLL SENSE

Pressing the 'PAR. POL' soft key produces the display:

PAR. POL (0)

An integer from 1 to 8 is input (between the round brackets) to define which of the eight GPIB data lines is to be used by the 1250 to give a Parallel Poll response, indicating whether it is requesting service or not.

The 'P. SENSE' (POLL SENSE) soft key can be set up as [true] or [false] using the SELECT key; [true] is the default state.

Chapter 13, Section 13.2, explains the significance of these selections.

1.10 SERIAL POLL

Pressing the 'SER. POL' soft key produces the display:

SER. POL (0)

An integer from 1 to 255 is input, which configures the 1250 to interrupt the GPIB Controller when a particular event occurs. This is explained in detail in Chapter 13, Section 13.1.

1.11 TERMINATOR AND SEPARATOR

The 'TERM.' and 'SEP.' soft keys are used to select the Output Terminator character (terminating each line of data), and the Output Separator character (separating the line into fields), respectively.

The default characters generated by the 1250 are 'cr lf' as Terminator, and 'comma' as Separator. If [terminator] is selected for the Separator, this sets the Separator character to be the same as the Terminator.

Chapter 13, Section 12.6 gives further details.

2 THE FILE

2.1 INTRODUCTION

The File is a section of memory in the 1250 which can be used to store results from measurement sequences, for later recall and further processing if required. The 1250 retains this File for at least 100 hours after power is switched off.

If required, the results sent to the File can be only those which have passed (or failed) the Limit check. When the stored results are read back from the File, further, different Limits can be applied.

2.2 MAXIMUM FILE SIZE

The total amount of memory available in the 1250 is approximately 450 Blocks, each Block capable of holding one File result (or one Program statement).

On INITIALISATION, all memory is cleared, and 99 Blocks are allocated by default to the File. This leaves the maximum number of Blocks (less 99) free for either enlarging the File, or storing Learnt Program lines.

The number of free memory Blocks can be found at any time by interrogating the second page of the STATUS menu, via the 'μP' soft key (Chapter 11, Section 1.4).

2.3 SELECTING FILE SIZE

The number of memory Blocks allocated to the File may be selected to be other than the default value of 99, if required. Limiting the File size may be necessary if Learnt Programs are to occupy much of the 1250's memory.

The first page of the DATA OUTPUT menu, [DATA OUTPUT], accesses the FILE soft key, as described in Section 1.2 above. On ENTERING the File soft key selection, the Display shows:

FILE SIZE (99)

indicating that the default File size is 99 Blocks.

To alter the File size, ENTER the number of Blocks required via the numeric keypad; the new number replaces 99 inside the round brackets. Error 46 is flagged if the File size entered exceeds the number of memory Blocks free, or if an attempt is made to reduce the File size to less than the number of results already filed. Error 45 is flagged if the 1250 is measuring when ENTER is pressed.

2.4 OVERWRITING OF RESULTS IN THE FILE

If more results are sent to the File than the number of Blocks allocated to it, the earliest results in the File are discarded to make room for the latest results, which add to the end of the File. That is, only the last 'n' results are retained, where 'n' is the File size.

2.5 STARTING A FILE

Readings can be stored in the File as follows:

1. Press DATA OUTPUT
2. Press soft key FILE
3. SELECT and ENTER the required mode, e.g. FILE [pass]
4. If not already done for other purposes, define what is a "pass", i.e. set Limits as described in Chapter 10
5. Press VIEW FILE
6. SELECT and ENTER [clear] FILE
7. Start taking measurements
8. Stop taking measurements when it is judged that the File is full
9. Replay readings from the File.

2.6 READING FROM THE FILE

To replay from the File, press VIEW FILE. Three choices are available via the SELECT key, as follows:

[display] FILE: enables contents of the File to be examined in detail on the Display. When this mode is entered, the first reading stored in the File will appear in the form:

200.00 Hz + 0.99 V + 0.20 deg 1 HI

The first term shows the frequency at which the measurement was made. The next two terms are the result of the measurement, in this case in Polar form. '1' indicates that this is the first reading in the File. HI indicates that Limits have been set, and that this reading is above the upper value.

Five soft keys are also assigned, which act as follows:

BOF This stands for Beginning Of File, and when pressed, causes the Display to show the first reading stored. This reading is automatically displayed when [display] FILE is pressed, so BOF is usually used to return to the beginning after other readings have been displayed.

EOF This stands for End Of File, and when pressed, causes the last reading stored to be displayed. The number 1 shown in the example above will change to show the number of the EOF reading, which will be equal to the File size if the File is full. The Limit indication may change to LO, or disappear altogether if the reading is within limits.

↑ Enables the user to step through the File towards the beginning, one reading at a time. If the key is held pressed, further readings will continue to appear from the File.

↓ Enables the user to step on through the File towards the end, otherwise as for ↑.

SUMMARY A typical format produced in the Display by pressing this key would be:

READINGS 181 ACCEPTED 168 FILED 99

plus soft keys as before.

READING FROM THE FILE (cont.)

This indicates that the 1250 has taken 181 readings, of which 168 were of the specified type to be filed, e.g. FILE [fail]. Only 99 readings have been filed in this example, as this was the current maximum capacity of the File.

Note that READINGS and ACCEPTED can both count up to 99999, but no higher. In the unlikely event of more than this number of readings being taken or accepted, the figures displayed in SUMMARY remain at 99999.

[list] FILE: causes all the readings in the File to be fed to whichever output devices have been enabled via the DATA OUTPUT key. This mode is usually too fast for the eye to follow on the Display and is primarily intended for transferring the contents of the File to an output device, such as a printer. The 1250 settings used to obtain these filed readings may also be listed to the printer by means of the STATUS key. Chapter 11, Section 1.5 'Printed Record', explains how this is done.

[clear] FILE: when entered, the complete File is erased. It is a wise precaution to clear the File before starting a new one, as previously mentioned in Section 2.5 "Starting a File".

3 LEARNT PROGRAMS

3.1 INTRODUCTION

The 1250 can learn a sequence of measurement instructions for recall when required. Thus, for repetitive work, such as production tests, the identical tests can be applied time and time again by merely commanding the instrument to execute one of the stored programs.

One 'instruction' is formed by all the menu selections required for a given parameter together with its numerical value. A typical comprehensive routine uses less than 50 instructions.

The maximum number of instructions that can be learnt is equal to the number of free memory Blocks; this can be up to approximately 450 if the File size has been set to 1, the minimum possible. The total learnt instruction capacity can be split into 9 separate programs.

To determine how many memory Blocks are free at any time, interrogate the ' μ P' soft key in the STATUS menu. Sections 2.2 and 2.3 above give details of the 1250's storage capacity.

The program memory, together with other memory locations, is battery maintained for at least 100 hours after the mains supply is switched off.

3.2 LEARNING A PROGRAM: FROM THE FRONT PANEL

To learn a program, press PROGRAM LEARN.

The Display will show:

PROGRAM () [learn] or [edit] or [clear]

ENTER the required program number, from 1 to 9, in the round brackets. If a program already exists under this number, but is to be erased, SELECT [clear] and ENTER. Now SELECT [learn] and ENTER. The Display will show e.g.: 'PROGRAM 1 learn mode' with one soft key assigned the title QUIT.

Caution: If [learn] is SELECTed and ENTERed for an already existing program, that program is effectively erased (although the STATUS menu still shows it as a Learnt Program).

Set up the menus etc. in the usual way. Note that no current value is shown, neither is "not entered". This signifies that the menus are only being learnt; they are **not** setting up the 1250.

When the final instruction has been entered, press ENTER again to retrieve the Display:

PROGRAM 1 learn mode

and press the QUIT soft key which correctly terminates the program.

To check which program numbers, if any, have been allocated, interrogate the STATUS [OTHER] : FN/PROG menu (detailed in Chapter 11, Sections 1.2 and 1.4).

3.3 LEARNING A PROGRAM: FROM AN EXTERNAL DEVICE

A program may be learnt from an external device connected to the RS423 Serial Interface port, for example a printer and keyboard:

1. Enter Program Learn Mode by sending the command:

*Ln

from the external keyboard, where 'n' is the required program number.

2. Input the program line by line, using the command codes and arguments listed in Chapter 13, Section 7.20. Examples of two programs are given below in Section 3.8.

Line numbers may be included, but they are optional and do not affect the order in which the program instructions are executed. An exception to this is when the Jump to Line n (JPn) command is used, in which case line 'n' must be numbered. Any line numbers entered should be followed by a 'space' before the program command, otherwise Error 01 ('unknown command') may be flagged when the line is entered.

3. To terminate the program enter the command:

*Q

The Learnt Program is now in the 1250's memory and may be executed or edited from either the front panel or from the external device.

4. To obtain a listing of the nth program at the printer, send the command:

*Pn

from the keyboard.

3.4 EXECUTING A PROGRAM

To execute a Learnt Program from the front panel, press the PROGRAM EXECUTE key. The Display will show:

EXECUTE PROGRAM ()

Key in the required program number between the round brackets and press ENTER; the program will be run.

If an external device is being used, sending the command

EPn

causes the nth program to be executed.

Whilst a program is running, no remote commands or front panel controls should be used, except during a programmed 'PAUSE' when PAUSE/CONTINUE may be used to continue the program.

BREAK halts the program and transfers control back to the front panel or remote device.

3.5 EDITING A PROGRAM : FROM THE FRONT PANEL

From the 1250 front panel, program lines may be displayed singly, completely deleted, or new lines inserted. Editing is also possible via a peripheral device connected to the GPIB or RS423 ports.

To edit from the front panel;

1. Press PROGRAM LEARN
2. Key in the program number in the round brackets, e.g. 1
3. SELECT and ENTER: PROGRAM (1) [edit]
4. With Program 1 chosen to be edited, the Display will resemble:

PROGRAM 1 edit mode 00 FR + 1.0000 E + 02

with five soft keys.

The top line of the Display shows the program number and the selected mode. A line number other than 00 cannot be input when editing or programming from the front panel, but if an external device has been used for programming a program line number may appear here. The final entry, "FR + 1.0000 E + 02" represents a Generator Frequency of 100 Hz which has been programmed.

The five soft keys act as follows:

INSERT : allows any number of extra lines to be inserted **prior** to the one currently displayed.

When INSERT is pressed the Display becomes:

PROGRAM 1 insert mode
EDIT (soft key)

This Display may be retrieved after inserting lines by pressing ENTER. To return from insert mode to edit mode, press the EDIT soft key.

DELETE : allows the line currently displayed to be deleted.

↓ and ↑ : allow the user to step through the program in either direction, a line at a time. Alternatively, if the key is held pressed, an auto-repeat feature keeps presenting new lines until the key released.

QUIT : is pressed to indicate that editing is complete.

The final entry in a correctly terminated program is always '99*Q'.

3.6 EDITING A PROGRAM: FROM AN EXTERNAL DEVICE

a. To enter **Edit Mode** for program number 'n', send the command

*En

from the external device. The message: EDIT MODE, and the first program line are sent by the 1250 to the device (e.g. printer).

b. To **step** to the next line of the program, send the command *F. To step backwards to the previous line, send *B.

c. The current line may be **deleted** using the *D command.

d. To insert a line or lines before the current line, enter **Insert Mode** by sending the command *I, and then input the required line(s).

e. To **exit** from any of the modes, send the command:

*Q

After this command it is necessary to re-enter Edit Mode to perform further edits.

The full list of Edit commands available is given in Chapter 13, at the end of Section 7.20.

3.7 PROGRAM PAUSE/CONTINUE KEY

Pressing this key during a PROGRAM LEARN sequence causes the 1250 to pause indefinitely on reaching this command when the program is subsequently run. During this pause, control is returned to the front panel; pressing the PAUSE/CONTINUE key causes the program to continue.

During a programmed pause, adjustments may be made to the unit under test or to the 1250 settings and intermediate results noted down if necessary.

3.8 EXAMPLE PROGRAMS: LOOPING AND CALLING

The following two example programs show how one program may call another, and also how looping is achieved.

The programs could be used as a production test of a unit at three spot amplitudes and three spot frequencies.

The main program (1) sets up the required Generator amplitude, calling Program 2 to measure at the three frequencies. Program 2 pauses after each measurement to allow the result to be written down. After each complete set of nine measurements, Program 1 stops the Generator (at 0°) and pauses to allow the unit under test to be changed, before looping back to the start again.

In the listings following, each program line is explained briefly. A complete alphabetical list of commands and their meanings is given in Chapter 13, Section 7.20.

Program 1

00 AM +1.0000E-01	Set Generator amplitude to 0.1V
00 RG	Start Generator
00 EP 02	Execute (i.e. Call) Program 2
00 AM +1.0000E+00	Set Generator amplitude to 1V
00 EP 02	Call Program 2
00 AM +1.0000E+01	Set Generator amplitude to 10V
00 EP 02	Call Program 2
00 SQ 00	Stop Generator at 0°
00 CP	Pause (to allow unit to be changed)
00 EP 01	Execute Program 1 (i.e. loop)
99 *Q	Terminating Line

Program 2

00 FR +1.0000E+02	Set Generator frequency to 100Hz
00 SI	Perform single measurement
00 CP	Pause (to allow result to be noted)
00 FR +3.0000E+02	Set Generator frequency to 300Hz
00 SI	
00 CP	
00 FR +1.2300E+03	Set Generator frequency to 1230Hz
00 SI	
00 CP	
99 *Q	Terminating line

Note: A program may call **itself** (i.e. loop) only if the 'EP' command is the last one before the terminating line 99 *Q. Otherwise Error 14 ('recursion attempted') is flagged.

3.9 ERROR MESSAGES DISPLAYED DURING PROGRAM RUNNING

If an error occurs (e.g. Error 14) whilst a program is running, the error message and dummy line number are displayed as

ERROR 14 @ 00

for programs which have been learnt via the 1250 front panel. Specific line numbers (up to 98 maximum) may be displayed with the error message if the program was input via the GPIB or RS423 ports.

4 X-Y PLOTTER

4.1 INTRODUCTION

The results of measurements made by the 1250 can be plotted to provide a permanent record. Any of the accepted formats (Bode, Nyquist, co-quad) is easily set up using the front panel menus or by computer control. Axes and scales can be specified to give precisely the plot that is needed; plot size is adjustable to suit pre-printed chart paper; grid lines and axis legends are optional.

Suitable digital plotters can be driven by the 1250 without additional modules.

If an analog plotter is to be used, however, the 1250 must include the optional Plotter Interface (12503). The use of analog plotters is described in Chapter 15 "Options".

The 1250 drives a digital plotter directly on the GPIB. To do this the GPIB plotter must be switched to Listen Only mode (or addressed to Listen by using a suitable Controller), and the 1250 must be switched to TALK ONLY using the switch on the rear panel (or be addressed to Talk by using a suitable Controller).

The GPIB plotter section of the 1250 is compatible only with plotters using Hewlett-Packard Graphics Language (HPGL), for example the HP 7470 Digital Plotter, or Enertec Schlumberger Graphics Language (ESGL), for example the Enertec 8500 TNP Digital Plotter.

It could be convenient to put the 1250 results into its history file from which the data is read for plotting. This permits a sequence of measurements to be run at maximum speed, uninterrupted by the Controller needing to service other devices which may be on the bus. The history file may also be used to view the results in order to decide the best scales for the axes.

Another way of seeing graphical results is to pass the data to a computer from which a VDU can display a plot. By this means the effect of adjustments to the system (of phase margin, for example) can be observed, prior to obtaining a hard copy graph.

4.2 SETTING UP A PLOT: NON-PLOTTER MENUS

Set up the required Generator, Analyser, Sweep (etc.) menus. It is convenient to enable all functions except the Generator, which then acts as the 'on' switch when the plot is ready to be performed.

Note: Ensure that the GPIB section of the DATA OUTPUT menu is switched 'off' (the default state) so that only plotter commands will be passed to the GPIB.

As an example, the following settings produce a plot showing the amplitude of the first 16 harmonics of the square wave generated by the 1250 (Fig. 12.2). For this measurement no external unit is required; connect the Generator output terminals on the front panel directly to the Channel 1 terminals.

Set the Generator frequency to 1Hz, square wave, 10V amplitude, and switch 'off'.

Press the Analyser RECYCLE key.

Enable the Sweep function by pressing START/CONTINUE followed by the HARMONIC soft key.

All the remaining menus are left at their default states for this example plot, unless

4.3 THE [PLOTTER COMMON] MENU

Set up the [PLOTTER COMMON] page of the DISPLAY/PLOTTER menu.

The five soft keys and their selections are:

MODE	SIZE	TEXT	GRID	DEVICE
[point]	[A3]	[on]	[off]	[analog]
[vector]	[A4]	[off]	[on]	[GPIB-HPGL]
				[GPIB-ESGL]

a. **MODE**

In [point] mode (the default state) plotted points are left unconnected, as required for this example. If [vector] is SELECTed and ENTERed, the points are joined by straight lines.

b. **SIZE**

Select the appropriate size depending on the plotter and paper being used. The default size is A3.

c. **TEXT**

With TEXT 'on' (the default state) during axes plotting, the X- and Y-axes are annotated with their minimum and maximum values, channels, items, and units if appropriate. See Fig. 12.2 for an example.

With TEXT 'off', the plotted axes appear without any annotation.

Leave TEXT at its default state for this example plot.

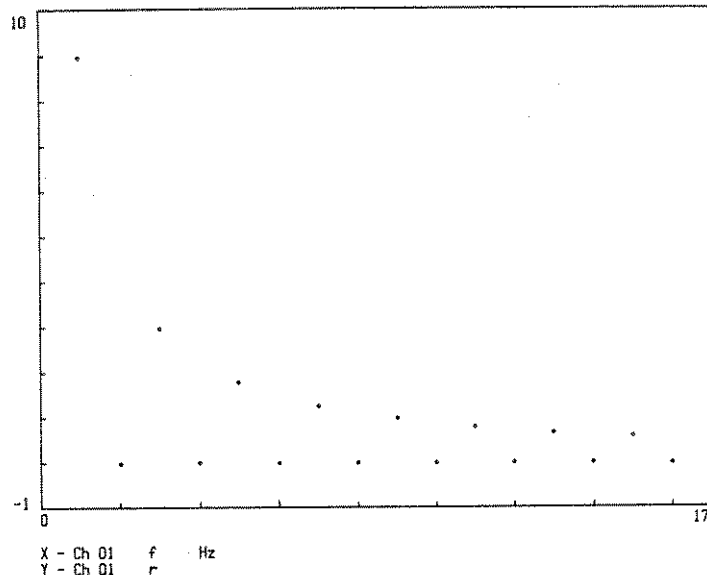

Fig. 12.2 Example plot: 1250 square wave harmonics

d. **GRID**

With GRID 'off' (the default state) during axes plotting, the divisions along the X and Y directions of the graph borders are marked by short lines only.

With GRID 'on', the division marks are extended completely across the graph in both dimensions to form a grid superimposed on the plot.

Leave GRID at its default state for this example plot.

e. **DEVICE**

Enter the appropriate plotter type connected (see Section 4.1 above). The default device is [analog]; see Chapter 15 "Options" if an analog plotter is being used.

4.4 THE [PLOTTER X-AXIS] AND [PLOTTER Y-AXIS] MENUS

Set up the [PLOTTER X-AXIS] and [PLOTTER Y-AXIS] pages of the DISPLAY/PLOTTER menu.

The four soft keys and their selections are identical for both pages:

ITEM	MINIMUM	MAXIMUM	ORIGIN
[a]	()	()	()
[b]			
[r]			
[θ]			
[log r in dB]			
[f in Hz]			
[log f in Hz]			

a. ITEM

The item to be plotted on each axis is entered via this soft key, the default item being [a], the real component of amplitude.

There are over 40 different possible combinations of X- and Y-items selectable via the ITEM soft key, but two commonly required types of plot, Bode and Nyquist, are detailed in Section 4.7 below.

With SCALE selected to be [fixed] (see Section 4.5 below) the shape of the plot is **rectangular** if the X-axis ITEM is set to [f in Hz] or [log f in Hz], but **square** in all other cases.

For this example plot, set the X-axis ITEM to [f in Hz] and the Y-axis ITEM to [r].

Note: The choice of items plotted is not affected by the display coordinates selected. The source channel(s) for the items plotted is that set for the Display.

b. MINIMUM and MAXIMUM

These soft keys enable the user to set the full-scale range of items to be plotted in the X- and Y-directions.

When the MINIMUM soft key, for example, is pressed the Display becomes:

MINIMUM not entered (+)

Key in the required value, which appears between the round brackets, and press ENTER. Subsequent pressing of MINIMUM will display the selected value in place of 'not entered'.

For the present example plot, set the X-axis MINIMUM to 0 and the MAXIMUM to 17. Set the Y-axis MINIMUM to -1 and the MAXIMUM to 10. These settings allow a small margin outside the expected ranges of values to be plotted, and avoid plotted points coinciding with the graph borders.

c. ORIGIN

The values entered via the ORIGIN soft key for the X-axis and Y-axis menus determine the point of intersection of the two axes i.e. the origin of the graph. This may be set anywhere within the plotting area. Choice of origin position does not affect the positions of plotted points, or the division markings at the graph borders.

Key in and ENTER the required X-axis and Y-axis origin values between the round brackets.

For this example plot enter the X-axis ORIGIN as 0, and the Y-axis ORIGIN as -1, which avoids points being plotted on the axes.

4.5 THE [PLOTTER SCALING] MENU

Set up the [PLOTTER SCALING] page of the DISPLAY/PLOTTER menu.

This section of the menu is concerned with the size and aspect ratio of the plotting field, and its position on the paper.

There are five soft keys:

SCALE	X-MIN	Y-MIN	X-MAX	Y-MAX
[fixed]	()	()	()	()
[variable]				

a. **SCALE [fixed]**

With SCALE set to [fixed], the default state, the size of the plotting field is matched by the 1250 to the paper size selected (A3 or A4); the shape (square or rectangular) is determined solely by the ITEM choice (see Section 4.4a above).

b. **SCALE [variable]**

With SCALE set to [variable] the user may freely adjust the size, aspect ratio, and position on the paper of the plot. The size and proportions of any annotations are automatically adjusted by the 1250 to suit those of the chosen plotting field.

Press the SCALE soft key then SELECT and ENTER [variable]. Then press the X-MIN soft key. The display becomes:

X-MIN not entered (+)

Key in and ENTER the value of the X-coordinate of the lower left-hand corner of the required plotting field, if this is known. This value of X-MIN is an integer from 0 to 32000. It is equivalent to 0.025 mm per unit, measured in the X-direction from a reference origin which is approximately at the lower left-hand limit of the plotting area (see Fig. 12.3).

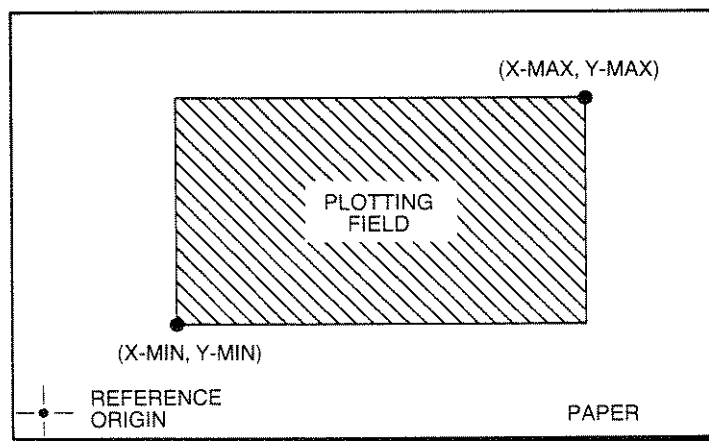

Fig. 12.3 Coordinates of the plotting field

Using the remaining soft keys, ENTER the other three coordinates needed to define the chosen plotting field.

If the numerical values of the required plotting field coordinates are not known, or if it is necessary to adjust the plotting field to coincide with pre-printed chart paper, the SCALE [variable] menu may still be used, in conjunction with the VARIABLE key. Section 4.8 below explains this method.

For the present example plot, leave SCALE at its default state i.e. [fixed].

4.6 PERFORMING A PLOT

Connect a suitable plotter to the appropriate port of the 1250, and set mode switches to their correct positions (Section 4.1 above explains this).

The plotter's activities are controlled via the PLOT key on the front panel. The five soft keys accessed via the PLOT key are:

GRAPH AXES MINIMUM MAXIMUM ZERO

There are no selections associated with these soft keys. Pressing each key initiates a plotting action directly (except for the GRAPH key: see a. below).

a. GRAPH

Pressing this soft key causes measurement results to be plotted, according to the PLOTTER menus set up previously (see Sections 4.2 to 4.5 above).

If no results are being output to the plotter, for example because the Generator is switched 'off', then pressing the GRAPH soft key merely enables the plotter by putting it into the IDLE state. Plotting starts as soon as results become available, e.g. when the Generator is switched 'on'.

Only the graph itself is drawn by means of this soft key; plot borders, axes, grid and annotations are not output.

b. AXES

Pressing this soft key causes the borders, division marks (or grid if GRID is 'on'), annotations (if TEXT is 'on'), and axes, to be plotted.

If the ORIGIN has been set to coincide with a corner of the plotting field, the axes will not be separately visible in the plot.

c. MINIMUM and MAXIMUM

Pressing MINIMUM or MAXIMUM causes the plotting pen to move (in the 'up' position) to the lower left-hand corner, or to the upper right-hand corner respectively, of the plotting field defined in the [PLOTTER SCALING] menu (see Section 4.5 above).

These two soft keys can be used to check the size and position of the plotting field before a plot is run.

d. ZERO

Pressing this soft key causes the plotter pen currently in use to be 'parked' in its home position.

4.7 BODE AND NYQUIST PLOTS

Different plot types may be obtained by selecting appropriate items via the ITEM soft keys in the [PLOTTER X-AXIS] and [PLOTTER Y-AXIS] menus. See Section 4.4 above.

A **Bode** plot is obtained if the X-axis item is selected as [log f in Hz], and the Y-axis item is selected as [log r in dB]. The Bode plot has a rectangular format (see Section 4.4 above). A typical Bode plot is shown in Fig. 12.4.

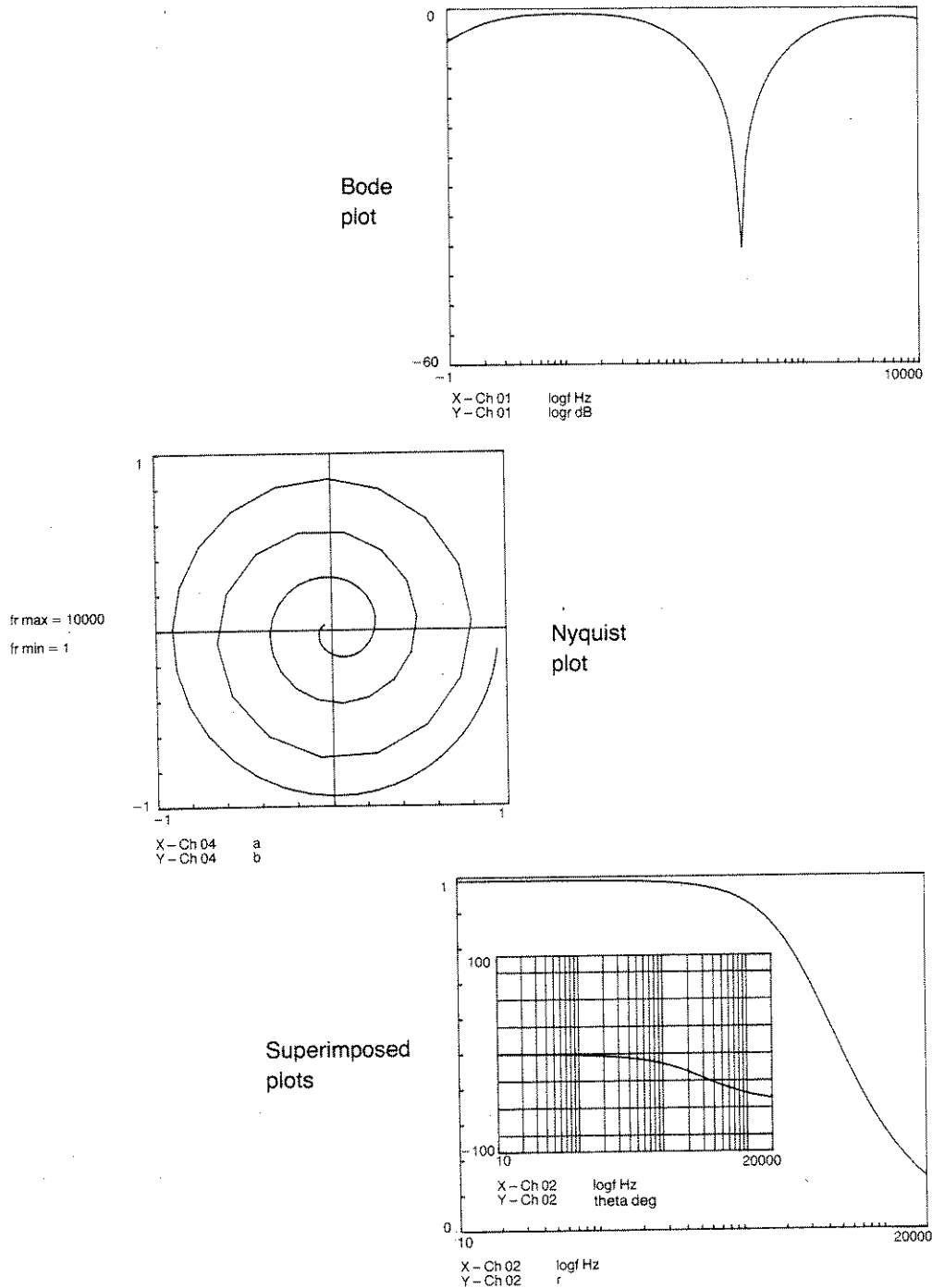

Fig. 12.4 Example plots: Bode, Nyquist, and Superimposed.

A **Nyquist** plot is obtained if the X-axis item is selected as [a], the real component, and the Y-axis item is selected as [b], the imaginary component. In this case the X-axis choice causes the plot format to be square. A typical Nyquist plot is shown in Fig. 12.4.

4.8 ADJUSTING THE PLOTTING FIELD TO SUIT PREPRINTED CHART PAPER

It may be necessary to adjust the size and position of the plotting field without knowing in advance the exact coordinates required. See Fig. 12.3 above for a definition of these coordinates. An example is when attempting to align a plot to the grid lines on preprinted chart paper.

In this case the [PLOTTER SCALING] page of the DISPLAY/PLOTTER menu can be used, in conjunction with the VARIABLE key.

Assuming a suitable plotter has been set up and connected to the 1250, and the DEVICE soft key of the [PLOTTER COMMON] menu has been correctly set, proceed as follows:

1. SELECT the [PLOTTER SCALING] page of the DISPLAY/PLOTTER menu.
2. Press the SCALE soft key; SELECT and ENTER the [variable] mode. In SCALE [variable] mode, the paper size selection (A3 or A4) is ignored.
3. Press the VARIABLE key on the front panel; SELECT and ENTER the [X-min] mode.

The Display becomes:

```
VARIABLE: X-min = +0.000
DIR ↑ SLOW > >> FAST
```

and the pen moves to the MINIMUM position of the plotting field automatically.

4. Use the VARIABLE soft keys in the usual way (see Chapter 9, Section 1 “The Variable Key”) to vary the value of X-MIN until the plotter pen is in or near the required position over the chart paper’s left-hand border (the Y-axis).
5. Retrieve the VARIABLE menu by pressing VARIABLE, and SELECT and ENTER the next page i.e. [Y-min].
6. Adjust the value of Y-MIN until the pen is exactly above the lower left-hand corner of the required plotting field. It may be necessary to readjust X-MIN, and activate ‘pen down’, to ensure accurate alignment with the required point on the chart paper.
7. Adjust the values of X-MAX and Y-MAX in a similar way (Steps 3 to 6 above) to complete the alignment.

Finally check all settings by pressing MINIMUM and MAXIMUM, via the PLOT key.

Note: The numerical values of the four plotting field coordinates arrived at above can be found by pressing the appropriate soft key in the [PLOTTER SCALING] menu. They may be noted down for future use, to avoid having to repeat the alignment procedure. In any case they remain in the 1250’s memory until INIT or RESET are activated.

4.9 PEN SELECTION WITH TWO-PEN PLOTTERS

With two-pen plotters, pen 1 is automatically selected by the 1250 if the X-axis ORIGIN is set to be the same as the X-axis MINIMUM, or nearer to it than to the X-axis MAXIMUM.

Pen 2 is selected if the X-axis ORIGIN is set to be the same as the X-axis MAXIMUM, or nearer to it than to the X-axis MINIMUM. If the ORIGIN is exactly midway between the MAXIMUM and MINIMUM X-axis values, pen 2 is selected.

4.10 PLOTTING DATA FROM THE FILE

To plot a sequence of measurements stored in the 1250's File, proceed as follows:

1. Switch the Generator 'off' if necessary to prevent measurement results being produced.
2. Set up the [PLOTTER COMMON], [PLOTTER X-AXIS], [PLOTTER Y-AXIS], and [PLOTTER SCALING] pages of the DISPLAY/PLOTTER menu (see Sections 4.3 to 4.5 above).
3. Press the PLOT key and plot the axes (plus text and grid if set up) by pressing the AXES soft key.
4. Press the PLOT key and then enable the plotter by pressing the GRAPH soft key.
5. Press the VIEW FILE key.

Two options are possible:

- a. If the **complete File** contents are to be plotted, SELECT and ENTER [list]. The data in File is now plotted in full, according to the plotter menu selections made previously.
- b. If **individual points** are to be plotted, under the user's control, SELECT and ENTER [display].

The first filed result appears on the Display and is plotted at the same time.

As each filed result is displayed (by means of the stepping soft keys, explained in Section 2 "The File") it is simultaneously plotted. This is useful when the precise coordinates of a point of interest on the plot need to be known.

If the last reading in the File is accessed, the plotter switches to STOP mode after plotting the last point.

Chapter 13

The RS423 and GPIB Ports. Remote Control

Contents

	<i>Page No.</i>
1 Introduction	13.3
1.1 GPIB Capability Code	13.3
2 Connections	13.4
3 RS423 Baud Rate	13.4
4 RS423 Input Command Terminator Character; RS423 Character Frame	13.4
5 GPIB Switches	13.5
5.1 Address Switches	13.6
5.2 Input Command Terminator Character Switches	13.6
5.3 Talk Only Switch	13.6
5.4 GPIB Switch Example	13.6
6 REMOTE/LOCAL Facility	13.7
6.1 Local Lock-Out	13.8
7 1250 Command Codes	13.9
7.1 Introduction	13.9
7.2 Command Code Format	13.9
7.3 Generator Commands	13.10
7.4 Synchroniser Commands	13.10
7.5 Amplitude Compression Commands	13.11
7.6 Auxiliary Generator Commands	13.11
7.7 Analyser Commands	13.11
7.8 Sweep Commands	13.12
7.9 Display Commands	13.12
7.10 Plotter Commands	13.12
7.11 Status Commands	13.13
7.12 Variable Commands	13.13
7.13 File Commands	13.13
7.14 Program Commands	13.14
7.15 Data Output Commands	13.14
7.16 RS423/GPIB Commands	13.14
7.17 Function Commands	13.15
7.18 Miscellaneous Commands	13.15
7.19 Self Test Commands	13.16
7.20 Commands in Alphabetical Order	13.16
8 GPIB Controller: Language Used in Program Examples	13.19
9 Command Query	13.19
10 Measurement Output Selection	13.20
10.1 Via RS423 Port	13.20
10.2 Via GPIB Interface	13.20
11 Measurement Output Rate	13.21
11.1 Via RS423 Port	13.21
11.2 Via GPIB Interface	13.21

Contents

Page No.

12	Measurement Output Format	13.21
12.1	RS423 Port	13.21
12.2	GPIB Talk Only Mode	13.21
12.3	GPIB Normal Mode	13.22
12.4	Dump Mode	13.23
12.5	Floating Point Format	13.23
12.6	Output Terminators and Separators	13.24
13	Serial Poll/Parallel Poll	13.25
13.1	Serial Poll	13.25
13.2	Parallel Poll	13.26
14	Learnt Programs. External Storing and Reloading	13.27
14.1	RS423 Port, Device Control Characters	13.27
14.2	Procedure for Storing a Learnt Program Externally, Via RS423 Port	13.28
14.3	Procedure for Loading a Learnt Program into the 1250, Via RS423 Port	13.28
14.4	Procedure for Loading a Learnt Program into the 1250, Via GPIB Port	13.28
14.5	Example of Controller Program for Transferring Learnt Program 1 from 1250 Via GPIB Port, Without Handshake	13.29
14.6	Example of Controller Program for Transferring Learnt Program 1 from 1250 Via GPIB Port, With Handshake	13.29
14.7	Reloading a Learnt Program to 1250 Via GPIB	13.29
15	File Output	13.30
15.1	Procedure to Output the File Via RS423 Port, by External Command	13.30
15.2	Procedure to Output the File Via GPIB Port	13.30
15.3	Example of Controller Program for Copying the File to the GPIB, Without Handshake	13.31
15.4	Example of Controller Program for Copying the File to the GPIB, With Handshake	13.31
16	GPIB Plotting	13.31
16.1	Operating Sequence for GPIB Plotter, Using a Controller	13.32
17	Combinations of RS423 and GPIB Devices	13.32

1 INTRODUCTION

Remote control of the 1250 can be achieved via either the General Purpose Interface Bus (GPIB) Interface, or the RS423 Serial Interface, both of which are fitted as standard. The 1250 can also be used in a system containing both GPIB and RS423 compatible devices.

The user will require the following documents in order to obtain a full understanding of remote control of the 1250:

1. The external device's Operating Manual.
2. The 1250 Operating Manual.
3. The relevant standard, as described below:

a. **GPIB.** The GPIB Interface conforms to the IEEE 488-1978 standard. The complete standard is published by the IEEE under the title: "IEEE Standard Digital Interface for Programmable Instrumentation". A useful introduction to the theory of the GPIB is given in the Solartron monograph: "Plus Bus – the Solartron GP-IB".

b. **RS423.** The RS423 Serial Interface is also compatible with RS232. Both these are Electronic Industries Association (EIA) standards, published by the Engineering Department under the titles:

EIA Standard RS232C. Interface Between Data Terminal Equipment and Data Communications Equipment Employing Serial Binary Data Interchange. August 1969.

EIA Standard RS423. Electrical Characteristics of Unbalanced Voltage Digital Interface Circuits. April 1975.

1.1 GPIB CAPABILITY CODE

The GPIB Interface in the 1250 conforms to the following sub-functions within the standard, as listed on the rear panel:

SH1	Source Handshake
AH1	Acceptor Handshake
T5	Basic Talker, Serial Poll, Talk Only Selectable, unaddressed if MLA (My Listener Address)
TE0	No Extended Talker capability
L4	Basic Listener, no Listen Only mode, unaddressed if MTA (My Talker Address)
LE0	No Extended Listener capability
SR1	Complete Service Request capability
RL1	Complete Remote/Local capability, with Local Lock-Out
PP2	Parallel Poll with Local Configuration
DC1	Complete Device Clear Capability, including Selective Device Clear
C0	No Controller capability
DT0	No Device Trigger capability
E1	Open Collector Drivers

2 CONNECTIONS

Connection to the GPIB is made via the 24-way connector on the rear panel of the 1250; see Fig 13.2. The pin connections conform to the IEEE 488-1978 standard.

Connection to the RS423 Serial Interface port is made via the 25-way sub-miniature D-type connector on the rear panel, see Fig 13.2. The pin connections are shown in Fig 13.1.

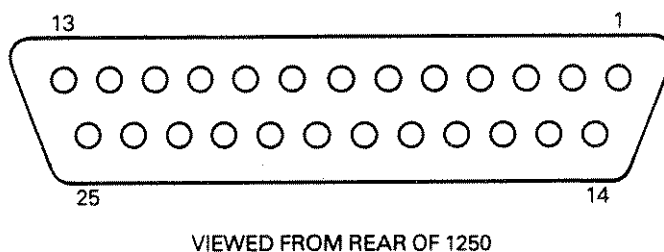

Fig. 13.1 RS423 Serial Interface Connector

Pin 1 = Ground
Pin 2 = Serial Data to 1250
Pin 3 = Serial Data from 1250
Pin 7 = Ground

The following additional facilities are also available:

Pin 4 = RTS (Request To Send)
Pin 5 = CTS (Clear to Send)
Pin 6 = DSR (Data Set Ready)
Pin 8 = DCD (Data Carrier Detect)
Pin 20 = DTR (Data Terminal Ready)

These facilities are all fully defined in the standards quoted in Section 1.

3 RS423 BAUD RATE

The RS423 baud rate is internally selectable on the Processor pcb 22, next to the Power Supply.

A jumper located next to the light emitting diodes enables selection of baud rates between a minimum of 110 and a maximum of 9600 baud. The factory setting is 300 baud.

CAUTION: The General Safety Precautions listed in Section 2 of Chapter 2, "Installation", must be observed; in particular Precaution 6 relating to the opening of covers and removal of parts.

4 RS423 INPUT COMMAND TERMINATOR CHARACTER; RS423 CHARACTER FRAME

The RS423 Command Code terminator character is fixed as CR (Carriage Return).

The RS423 Character Frame is always:

8 bit + no parity + stop bit.

5 GPIB SWITCHES

There are eight switches on the rear panel of the 1250, as shown in Fig. 13.2. These switches must be set before the instrument can be used in a GPIB system.

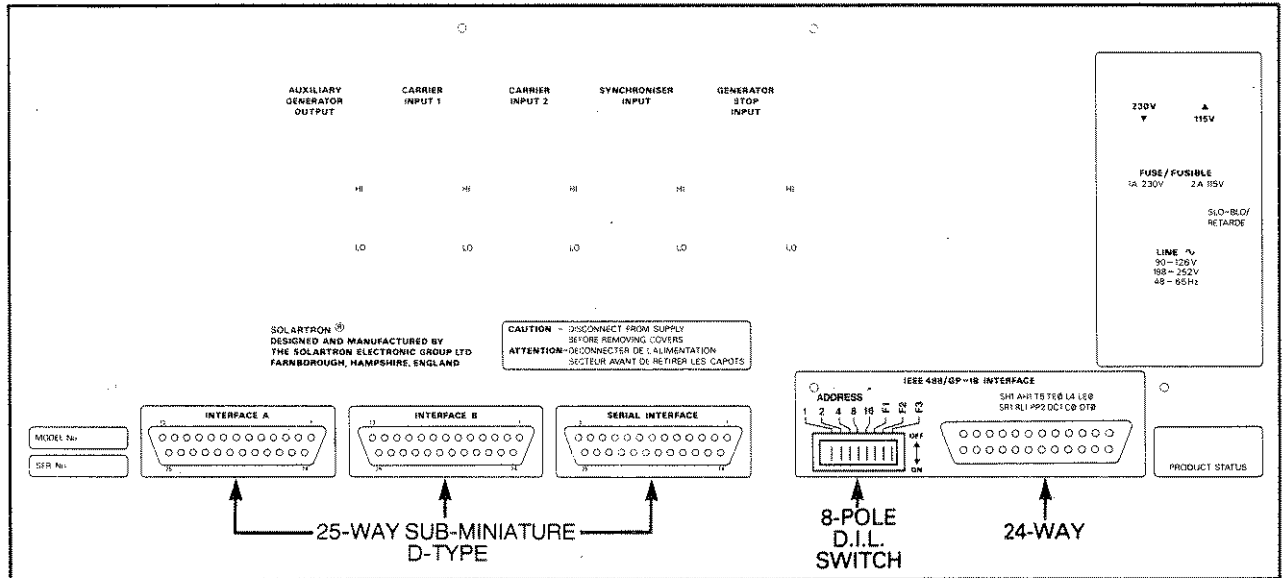
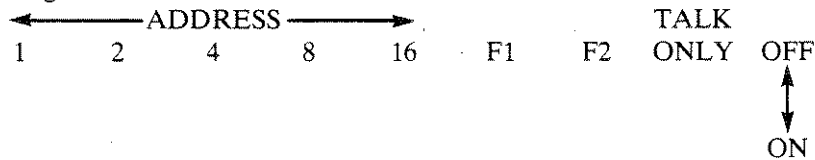

Fig. 13.2 1250 Rear panel

The eight switches are allocated as follows:



The first five switches select the GPIB address of the 1250. Switches F1 and F2 set up the Command Terminator characters. The last switch sets the mode of GPIB operation to Talk Only or normal Talker/Listener.

Once the switches have been set, the 1250 must "read" them, so that their settings can be implemented. The switches are read automatically on "power on" or when INITIALISE or BREAK is pressed. If the switches have to be altered after the 1250 has been set up, pressing BREAK will enable the new configuration to be read, without disturbing any other data within the instrument, apart from the Serial Poll STATUS BYTE, as explained in Section 13.1.

5.1 ADDRESS SWITCHES

Two GPIB ports are provided, one for ASCII commands and data, and the other for high speed binary (DUMP) output. This eliminates many of the problems that can occur when ASCII and binary information are mixed. The same connector pins are used but two different software addresses are assigned.

The address of the ASCII input/output port is set up on the five address switches and is called the MAJOR address. It must always be an even number, so the left-hand "1" switch should always be in the up position for "off". The address immediately following a MAJOR address is, of course, always on odd number, and is called the MINOR address. It is automatically assigned to the binary port, which is for data output only.

Example: if the MAJOR address is chosen to be 16, the MINOR address will automatically be 17.

5.2 INPUT COMMAND TERMINATOR CHARACTER SWITCHES

Switches F1 and F2 select the Terminating Character for the GPIB Input Commands to the 1250 as follows:

F1	F2	Meaning
0	0	= LF (Line Feed)
1	0	= CR (Carriage Return)
0	1	= ; (Semicolon)
1	1	= EOI (End Or Identify)

Any Command Terminator other than the one selected will be ignored by the Interface.

The choice of Command Terminator is usually determined by the type of Controller used, and should be defined in the relevant Controller handbook.

EOI is the title of one of the five GPIB Management Lines. Some Controllers automatically assert EOI accompanied by a Command Terminator. In this case, set the 1250 switches to EOI and if the Controller also offers a choice of Command Terminator, set this to CR, LF or semicolon, to prevent the possibility of Command Data being lost or corrupted.

5.3 TALK ONLY SWITCH

The 1250 GPIB Interface is put into Talk Only mode when the Talk Only switch is in the down (ON) position. The Talk Only mode is used for GPIB plotting (described in Section 16) and outputting data to a GPIB printer (described in Section 12.2).

5.4 GPIB SWITCH EXAMPLE

If the switches are set to 00110010 (read from left to right as viewed from the rear of the 1250):

The MAJOR address is 12
The MINOR address is therefore 13
The Command Terminator is semicolon
The GPIB mode is normal Talker/Listener.

6 REMOTE/LOCAL FACILITY

The REMOTE/LOCAL facility enables the 1250 to receive commands from either a REMOTE or a LOCAL source. The REMOTE facility is provided via the GPIB Interface and has priority over other devices.

The 1250 offers two forms of control under the heading LOCAL:

a. From the 1250 Front Panel and/or via the RS423 port. Both have equal priority. This mode is referred to as LOCAL 1.

b. Via the RS423 port only. No settings can be changed from the Front Panel, but the LOCAL key and the Main ON/OFF switch are still operative. The Menu keys can be used to verify, but not alter, the state of the controls. The STATUS key itself is inoperative, but the MINI-STATUS display is still available. This mode is referred to as LOCAL 2.

Note that the MINI-STATUS display will show "remote" when the 1250 is in LOCAL 2 mode.

The 1250 powers up in LOCAL 1 mode. Fig. 13.3 indicates how control can be transferred from LOCAL 1 to LOCAL 2 to REMOTE and back again.

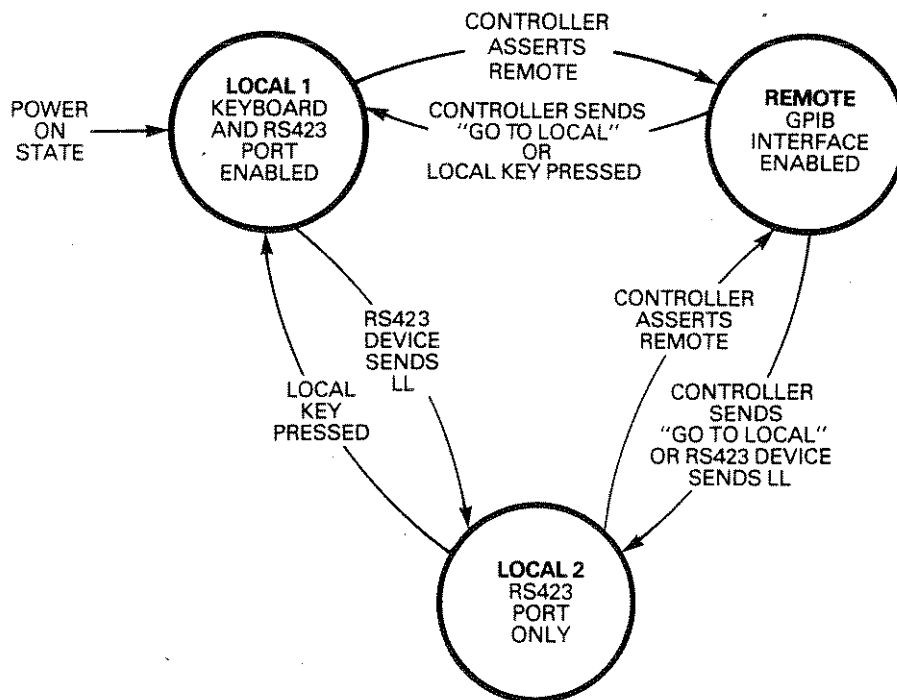

Fig. 13.3 REMOTE/LOCAL State Diagram

Note that whichever LOCAL mode was in force prior to a REMOTE command will resume control when the REMOTE mode is relinquished.

The full set of instructions for transfer from LOCAL to REMOTE and vice-versa is given in the IEEE Standard, where LOCAL 1 and LOCAL 2 are simply referred to as LOCAL.

7 1250 COMMAND CODES

7.1 INTRODUCTION

The Command language is based on the 1250 Front Panel operations. Each Command consists of a simple string of ASCII alpha-numeric characters whose significance parallels the hardkey-softkey arrangement. The numeric part of a Command can be in fixed point or floating point (exponential) format. The Command Codes are identical for RS423 or GPIB operation.

7.2 COMMAND CODE FORMAT

The Command Codes usually take the form of a two-letter prefix, followed by a numerical argument, i.e. a number.

Prefix. Where possible, the two letters abbreviate the name of the parameter to be commanded, e.g. FR for Frequency. Some of the Learnt Program Codes use asterisk plus letter rather than two letters, and certain Codes which are used only for queries are themselves prefixed by a question mark. Further use of the question mark with other Command Codes is described in Section 9 "Command Query".

Argument. The argument, abbreviated to ARG in the following lists (Sections 7.3 to 7.19), can take several forms:

1. F i.e. Floating Point, where, for example $1E5 = 1 \times 10^5$
2. I i.e. an Integer of up to 2 digits
3. I, I i.e. two Integers of up to 2 digits each. An example is Analyser Range, which requires that the Channel Number be specified as the first Integer, followed by the second Integer indicating the required Range for that Channel. The comma separator must be included between the two Integers.

A special form of double Integer Argument is used where several Command Codes have a common prefix, e.g. FN for Function can be followed by I, I etc. In this case the fixed Integer 1 selects the specific parameter, e.g. Angle Range and the variable Integer selects the required Range e.g. "-to +".

4. D i.e. an Integer of up to 4 digits. One application of this is in Point-to-Point measurements where it is necessary to specify two sources e.g. SO 0102 means "use Channel 1 divided by Channel 2 as the Display Source".
5. n i.e. a number as specified in the adjacent "Meaning" column.
6. none e.g. Stop Codes, which have no Argument.

Separators. No separators are required between individual characters in a Command, unless a double Integer is involved, in which case the two Integers must be separated by a comma.

Max and Min. These two columns give, where applicable, the upper and lower values that can be entered as the Argument part of the Code.

Init. This column shows the Initialised, or default state for each Command. The Argument usually has a default value of zero but the Display shows "not entered", abbreviated to "n.e." in the Code list. Where "none" appears, this indicates that there is no meaningful default state.

Self Test Codes, ?TS. The Self Test Results Code will produce a zero if the test passes but a number as given in Section 7.19 if it fails. The meaning of fail numbers is given in the Maintenance Manual.

To use the Self Test Commands:

1. Send TT1, and pause 2 seconds whilst the 1250 performs a Self Test.
2. Send ?TS0 to determine whether the overall test has been passed or failed. A number is returned: 0 = pass, 1 = fail.
3. If the Self Test has failed, determine which section of the 1250 has failed by sending successively ?TS1 (processor RAM), ?TS2 (processor ROM), etc., until a non-zero response is elicited, signifying a test failure.

7.3 GENERATOR COMMANDS

Facility	Parameter	Code	Arg	Meaning	Max	Min	Init
	Frequency	FR	F		65535	1E-5	ne
	Amplitude	AM	F		10.23*	0	ne
	Bias	BI	F		10.23	-10.23	ne
	Waveform	WF	I	0 = sine 1 = square 2 = triangle	2	0	sine
	Modulation	MO	I	0 = off 1 = on 1 2 = on 2	2	0	off
STOP AT		SQ	I	0 = 0° 1 = 90° 2 = 180° 3 = 270°	3	0	0°
STOP GENERATOR		SG	none				
START GENERATOR		RG	none				

* 11.00V for 1250N

7.4 SYNCHRONISER COMMANDS

Facility	Parameter	Code	Arg	Meaning	Max	Min	Init
	On/Off	SY	I	0 = off 1 = tight lock 2 = loose lock	2	0	off
	Level	LE	F		5.1	-5.1	ne
	Ratio	SR	F	0 = off	100	0	ne
	Slope	SL	I	0 = + 1 = -	1	0	+
	Coupling	AC	I	0 = dc 1 = ac	1	0	dc
	Status	?SN	none	0 = ready 1 = idle 2 = wait 3 = stable 4 = locked	4	0	ready
	Frequencies	?SF	n	0 = input 1 = max 2 = min 3 = start 4 = stop 5 = average	65535	1E-5	0

7.5 AMPLITUDE COMPRESSION COMMANDS

Facility	Parameter	Code	Arg	Meaning	Max	Min	Init
	Source	AS	D	100 = Ch1 200 = Ch2	200	100	Ch1
	Value	AV	F		300	1E-4	ne
	Error	AE	F	% error	50	1	ne
	Limit	AL	F	0 = off, otherwise Limit is on	10.23*	0	off
	On/Off	AP	I	0 = off 1 = on	1	0	off

* 11.00V for 1250V

7.6 AUXILIARY GENERATOR COMMANDS

Facility	Parameter	Code	Arg	Meaning	Max	Min	Init
	Amplitude	QA	F		10.23	0	ne
	Bias	QB	F		10.23	-10.23	ne
	Waveform	QW	I	0 = sine 1 = square 2 = triangle	2	0	sine

7.7 ANALYSER COMMANDS

Facility	Parameter	Code	Arg	Meaning	Max	Min	Init	
ANALYSER COMMON	Integration Time	IS	F	seconds	1E5	.01	ne	
	Integration Time	IC	F	cycles	1E6	1	ne	
	Measurement Delay	MS	F	seconds	1E5	0	ne	
	Measurement Delay	MC	F	cycles	1E6	0	ne	
	Harmonic Order	HA	I		16	1	1	
	Auto Order	OR	I		16	1	1	
	Integration	AU	I	0 = off 1 = Ch1 Long 2 = Ch2 Long 3 = Ch1 Short 4 = Ch2 Short	4	0	off	
	ANALYSERS	Range	RA	I,I	Channel Number, Range: 0 = auto 1 = 30mV 2 = 300mV 3 = 3V 4 = 30V 5 = 300V	48 5	1 0	1 auto
		Demod	DE	I,I	Channel Number, Demod: 0 = off 1 = on Ch1 2 = on Ch2	48 2	1 0	1 off
		Coupling	DC	I,I	Channel Number, Coupling: 0 = dc 1 = ac	48 1	1 0	1 dc
Input		IP	I,I	Channel Number, Input: 0 = front 1 = rear	2 1	1 0	1 front	

Facility	Parameter	Code	Arg	Meaning	Max	Min	Init
AUTO INTEGRATION TIME		?AI	none		1E5	01	none
LAST RANGE USED		?AR	0	numerator	5	0	0
		?AR	1	channel range			
		?AR	1	denominator	5	0	0
STOP ANALYSERS		SA	none			none	
SINGLE		SI	none			none	
RECYCLE		RE	none			none	

7.8 SWEEP COMMANDS

Facility	Parameter	Code	Arg	Meaning	Max	Min	Init
SWEEP	Maximum Freq	MA	F		65535	1E-5	ne
	Minimum Freq	MI	F		65535	1E-5	ne
	Log Increment	GD	F	steps/decade	1E5	0.33	ne
	Log Increment	GO	F	steps/octave	33333	0.1	ne
	Log Increment	GS	F	steps/sweep	1E5	1	ne
	Log Increment	GR	F	ratio	1E3	1.00001	ne
	Lin Increment	NH	F	Hz	65535	1E-5	ne
	Lin Increment	NS	F	steps/sweep	1E5	1	ne
STOP SWEEP		SS	none			none	
HOLD SWEEP		HS	none			none	
START/CONTINUE SWEEP		SC	1	0 = harmonic	4	0	harm.
				1 = log up			
				2 = log down			
				3 = lin up			
				4 = lin down			

7.9 DISPLAY COMMANDS

Facility	Parameter	Code	Arg	Meaning	Max	Min	Init
DISPLAY	Source	SO	D	nnmm = Chn/Chm	4847	0100	Ch1
	Co-ordinates	CO	I	0 = a, b 1 = r, θ 2 = log r, θ	2	0	a, b
	Error beep	BP	I	0 = on 1 = off	1	0	on

7.10 PLOTTER COMMANDS

Facility	Parameter	Code	Arg	Meaning	Max	Min	Init
PLOTTER COMMON	Mode	VE	I	0 = point 1 = vector	1	0	point
	Size	AA	I	0 = A3 1 = A4	1	0	A3
	Text	PT	I	0 = off 1 = on	1	0	on
	Grid	GT	I	0 = off 1 = on	1	0	off
	Device	PD	I	0 = analog 1 = GPIB-HPGL 2 = GPIB-ESGL	2	0	analog
	PLOTTER X-AXIS	X Item	XI	I	0 = a 1 = b 2 = r 3 = θ 4 = log r 5 = f 6 = log f	6	0
X Maximum		XH	F		1E18	-1E18	ne
X Minimum		XL	F		1E18	-1E18	ne
X Origin		XO	F		1E18	-1E18	ne

PLOTTER Y-AXIS	Y Item	YI	I	as X Item	6	0	a
	Y Maximum	YH	F		1E18	-1E18	ne
	Y Minimum	YL	F		1E18	-1E18	ne
	Y Origin	YO	F		1E18	-1E18	ne
PLOTTER SCALING	Scale	PZ	I	0 = fixed 1 = variable	1	0	fixed
	X-Minimum	XB	F		32000	0	ne
	Y-Minimum	YB	F		32000	0	ne
	X-Maximum	XT	F		32000	0	ne
	Y-Maximum	YT	F		32000	0	ne
STOP PLOT PLOT	SP		none				none
	PL	I		0 = graph 1 = axes 2 = minimum 3 = maximum 4 = zero	4	0	none

7.11 STATUS COMMANDS

Facility	Parameter	Code	Arg	Meaning	Max	Min	Init
SCROLL MINI STATUS		SM	none				none
INTERROGATE MAIN STATUS (Note: these codes only apply when using RS423 port)		ST	I	0 = generator 1 = analysers 2 = sweep 3 = display 4 = plot 5 = sync 6 = program 7 = μ P 8 = GPIB	8	0	gen

7.12 VARIABLE COMMANDS

Facility	Parameter	Code	Arg	Meaning	Max	Min	Init
SET VARIABLE		VA	I	0 = frequency 1 = amplitude 2 = bias 3 = X-min 4 = Y-min 5 = X-max 6 = Y-max	6	0	freq.
STEP VARIABLE	↑ (UP)	UP	I	1 = slowest 2 = slow 3 = fast 4 = fastest	4	1	none
STEP VARIABLE	↓ (DOWN)	DN	I	as for ↑	4	1	none

7.13 FILE COMMANDS

Facility	Parameter	Code	Arg	Meaning	Max	Min	Init
DISPLAY FILE		FD	I	0 = bof 1 = eof 2 = stepdown 3 = step up 4 = summary (from RS423 only)	4	0	none

Facility	Parameter	Code	Arg	Meaning	Max	Min	Init
LIST FILE		FO	none				none
CLEAR FILE		FC	none				none
FILE POPULATION		?FP	0	number of results in file	file size	0	none
			1	file pointer	~450	0	none
NUMBER OF READINGS TAKEN		?NR	none		99999	0	none
NUMBER OF READINGS ACCEPTED		?NA	none		99999	0	none
FILE SIZE		FS	D		~450	1	99

7.14 PROGRAM COMMANDS

Facility	Parameter	Code	Arg	Meaning	Max	Min	Init
ENTER LEARN MODE		*L	I	program no.	9	1	none
ENTER EDIT MODE		*E	I	program no.	9	1	none
CLEAR PROGRAM		*C	I	program no.	9	1	none
EDIT NEXT LINE		*F	none				none
EDIT PREVIOUS LINE		*B	none				none
EDIT DELETE LINE		*D	none				none
EDIT INSERT MODE		*I	none				none
EXIT LEARN/EDIT MODE		*Q	none				none
LIST PROGRAM		*P	I	program no.	9	1	none
EXECUTE PROGRAM		EP	I	program no.	9	1	none
JUMP		JP	I	jump to line no.			none
PAUSE/CONTINUE		CP	none	pause in program execution			none
PROGRAM LENGTH		?PN	n	n = prog. no. 1 to 9 Gives number of lines in program			none

7.15 DATA OUTPUT COMMANDS

Facility	Parameter	Code	Arg	Meaning	Max	Min	Init
DATA OUTPUT		OP	I, I	Device, Output: Device: 0 = display 1 = RS423 2 = GPIB 3 = file Output: 0 = off 1 = all 2 = fail 3 = pass 4 = dump	3	0	display
					4	0	all
					Available on all devices (RS 423 and GPIB only)		

7.16 RS423/GPIB COMMANDS

Facility	Parameter	Code	Arg	Meaning	Max	Min	Init
GPIB SRQ CONFIGURE		SV	I	0 = unconfigure	255	0	0
GPIB PARALLEL POLL CONFIGURE		PP	I	0 = unconfigure 1 = lsb ⋮ 8 = msb	8	0	0
GPIB PARALLEL POLL SENSE		PS	I	0 = false 1 = true	1	0	true

Facility	Parameter	Code	Arg	Meaning	Max	Min	Init
GPIB OUTPUT FORMAT SEPARATOR		OS	1	0 = comma 1 = terminator	1	0	comma
GPIB OUTPUT FORMAT TERMINATOR		OT	1	0 = crlf 1 = crlf + EOI 2 = cr 3 = cr + EOI	3	0	crlf
RS423/GPIB REFORMAT ENABLE		RR	1	0 = on 1 = off	1	0	on
RS423/GPIB HEADING ENABLE		RH	1	0 = on 1 = off	1	0	on

7.17 FUNCTION COMMANDS

Facility	Parameter	Code	Arg	Meaning	Max	Min	Init
ANGLE RANGE		FN	1, 1	0 = - to + 1 = 0 to 2 2 = -2 to 0 3 = 0 to 2 (Clk)	3	0	- to +
ANGLE UNITS		FN	2, 1	0 = deg 1 = rad	1	0	deg
OMEGA SCALE		FN	3, 1	0 = off 1 = $\times j\omega$ 2 = $\div j\omega$ 3 = $\times (j\omega)^2$ 4 = $\div (j\omega)^2$	4	0	off
VECTOR SCALE		FN	4, 1	0 = off 1 = a, jb 2 = r, θ 3 = last result	3	0	off
LIMIT CHECK		FN	5, 1	0 = off 1 = a 2 = b 3 = r 4 = θ 5 = $\log r$	5	0	off
SCALE FACTOR	a	AF	F		1E18	-1E18	ne
SCALE FACTOR	b	BF	F		1E18	-1E18	ne
SCALE FACTOR	r	RF	F		1E18	-1E18	ne
SCALE FACTOR	θ	TF	F		+180	-180	ne
UPPER LIMIT	a	UA	F		1E18	-1E18	ne
UPPER LIMIT	b	UB	F		1E18	-1E18	ne
UPPER LIMIT	r	UR	F		1E18	-1E18	ne
UPPER LIMIT	θ	UT	F		+180	-180	ne
UPPER LIMIT	$\log r$	UG	F		+380	-380	ne
LOWER LIMIT	a	LA	F		1E18	-1E18	ne
LOWER LIMIT	b	LB	F		1E18	-1E18	ne
LOWER LIMIT	r	LR	F		1E18	-1E18	ne
LOWER LIMIT	θ	LT	F		+180	-180	ne
LOWER LIMIT	$\log r$	LG	F		+380	-380	ne

7.18 MISCELLANEOUS COMMANDS

Facility	Parameter	Code	Arg	Meaning	Max	Min	Init
LOCAL		LL	none	(Allowed from RS423 only)			none

Facility	Parameter	Code	Arg	Meaning	Max	Min	Init
BREAK		BK	none				none
LAST ERROR		?ER	none	returns error number	99	0	none
SET TIME		TM	l,l	hours, minutes	99 59	0 0	none none

7.19 SELF TEST COMMANDS

Facility	Parameter	Code	Arg	Meaning	Max	Min	Init
		TT	l	0 = check 1 = test 2 = init 3 = reset	3	0	none

SELF TEST RESULTS

Facility	Parameter	Code	Arg	n	Meaning	Fail	Pass	Init
		?TS	n		0 = check or test pass/fail	1	0	0
					1 = processor RAM	1	0	0
					2 = processor ROM	1 to 5	0	0
					3 = timer	1	0	0
					4 = GPIB	1	0	0
					5 = generator	1 to 5	0	0
					6 = synthesiser	1 to 3	0	0
					7 = analyser 1 RAM	1	0	0
					8 = analyser 2 RAM	1	0	0
					9 = analyser control	1 to 6	0	0
					10 = front panel	1	0	0
					11 = front panel RAM	1 to 2	0	0
					12 = front panel ROM	1 to 3	0	0
					13 = (spare)	0	0	0
					14 = synchroniser	1 to 4	0	0
					15 = slave 1	1 to 14	0	0
					16 = slave 2	1 to 14	0	0
					17 = slave 3	1 to 14	0	0
					18 = slave 4	1 to 14	0	0

7.20 COMMANDS IN ALPHABETICAL ORDER

Code	Meaning
AA	Plot Size. 0 = A3, 1 = A4
AC	Synchroniser Coupling. 0 = DC, 1 = AC
AE	Amplitude Compression. Error %
AF	Scale Factor <i>a</i>
AL	Amplitude Compression Limit. 0 = off, otherwise Limit is on
AM	Generator Amplitude
AP	Amplitude Compression On/Off. 0 = Off, 1 = On
AS	Amplitude Compression Source. 100 = Ch1, 200 = Ch2
AU	Auto Integration. 0 = Off, 1 = Long on Ch1, 2 = Long on Ch2, 3 = Short on Ch1, 4 = Short on Ch2.
AV	Amplitude Compression Value
BF	Scale Factor <i>b</i>
BI	Generator Bias
BK	Break
BP	Error beep. 0 = on, 1 = off
CO	Display Co-ordinates. 0 = <i>a, b</i> 1 = <i>r, θ</i> 2 = log <i>r, θ</i>
CP	Pause/Continue
DC	Analyser Coupling. 0 = DC, 1 = AC
DE	Analyser Demod. 0 = Off, 1 = On 1, 2 = On 2

7.20 COMMANDS IN ALPHABETICAL ORDER (Continued)

Code	Meaning
DN	Step Variable Down. 1 = Slowest ----- 4 = Fastest
EP	Execute Program (n)
FC	Clear File
FD	Display File. 0 = bof, 1 = eof, 2 = Step Down, 3 = Step Up 4 = Summary
FN 1	Angle Range. 0 = - to +, 1 = 0 to 2, 2 = -2 to 0, 3 = 0 to 2 (CLK)
FN 2	Angle Units. 0 = degrees, 1 = radians
FN 3	Omega Scale. 0 = off, 1 = $\times j\omega$, 2 = $\div j\omega$, 3 = $\times (j\omega)^2$, 4 = $\div (j\omega)^2$
FN 4	Vector Scale. 0 = off, 1 = a , jb , 2 = r , θ , 3 = last result
FN 5	Limit Check. 0 = off, 1 = a , 2 = b , 3 = r , 4 = θ , 5 = $\log r$
FO	List File
FR	Generator Frequency
FS	File size in Blocks
GD	Sweep. Log Increment. Steps per decade
GO	Sweep. Log Increment. Steps per octave
GR	Sweep. Log Increment. Ratio
GS	Sweep. Log Increment. Steps per sweep
GT	Grid. 0 = off, 1 = on
HA	Analyser Harmonic
HS	Hold Sweep
IC	Analyser Integration Time in Cycles
IP	Analyser Input. 0 = front, 1 = rear
IS	Analyser Integration Time in Seconds
JPN	Jump to Line n
LA	Lower Limit a
LB	Lower Limit b
LE	Synchroniser Level
LG	Lower Limit $\log r$
LL	Local
LR	Lower Limit r
LT	Lower Limit θ
MA	Sweep f_{\max}
MC	Analyser Measurement Delay in Cycles
MI	Sweep f_{\min}
MO	Generator Modulation. 0 = off, 1 = on 1, 2 = on 2.
MS	Analyser Measurement Delay in Seconds
NH	Sweep Linear Increment in Hz
NS	Sweep Linear Increment in Steps per Sweep
OP	Data Output. 0 = display, 1 = RS423, 2 = GPIB, 3 = file Data Output. 0 = off, 1 = all, 2 = fail, 3 = pass, 4 = dump
OR	Analyser Common Order
OS	GPIB Output Format Separator. 0 = comma, 1 = terminator
OT	GPIB Output Format Terminator. 0 = crlf, 1 = crlf + EOI, 2 = cr, 3 = cr + EOI
PD	Plotter Device. 0 = analog, 1 = GPIB-HPGL, 2 = GPIB-ESGL
PL	Plot. 0 = graph, 1 = axes, 2 = min, 3 = max, 4 = zero
PP	GPIB Parallel Poll Configure. 0 = unconfigure, 1 = lsb ----- 8 = msb
PS	GPIB Parallel Poll Sense. 0 = false, 1 = true
PT	Plotter Common Text. 0 = off, 1 = on
PZ	Plotter Scaling Scale. 0 = fixed, 1 = variable
QA	Auxiliary Generator Amplitude
QB	Auxiliary Generator Bias
QW	Auxiliary Generator Waveform. 0 = sine, 1 = square, 2 = triangle
RA	Analyser Range. 0 = auto, 1 = 30mV, 2 = 300mV, 3 = 3V, 4 = 30V, 5 = 300V
RE	Recycle
RF	Scale Factor r
RG	Start Generator

7.20 COMMANDS IN ALPHABETICAL ORDER (Continued)

Code	Meaning
RH	Heading Enable. 0 = on, 1 = off
RR	Reformat Enable. 0 = on, 1 = off
SA	Stop Analysers
SC	Start/Continue Sweep. 0 = harmonic, 1 = log up, 2 = log down, 3 = lin up, 4 = lin down
SG	Stop Generator
SI	Single Measurement
SL	Synchroniser Slope. 0 = +, 1 = -
SM	Scroll Mini-Status
SO	Display Source
SP	Stop Plot
SQ	Stop At. 0 = 0°, 1 = 90°, 2 = 180°, 3 = 270°
SR	Sync Ratio. 0 = off
SS	Stop Sweep
ST	Interrogate Main Status. 0 = generator, 1 = analysers, 2 = sweep, 3 = display 4 = plot, 5 = synchroniser, 6 = program, 7 = μ Processor, 8 = GPIB
SV	GPIB SRQ Configure. 0 = unconfigure
SY	Synchroniser on/off. 0 = off, 1 = tight, 2 = loose
TF	Scale Factor θ
TM	Set Time. hours, minutes
TT	Self Test, 0 = check, 1 = test, 2 = init. 3 = reset
UA	Upper Limit a
UB	Upper Limit b
UG	Upper Limit log r
UP	Step Variable Up. 1 = slow ----- 4 = fast
UR	Upper Limit r
UT	Upper Limit θ
VA	Set Variable. 0 = frequency, 1 = amplitude, 2 = bias, 3 = X-min, 4 = Y-min, 5 = X-max, 6 = Y-max
VE	Plotter Mode. 0 = point, 1 = vector
WF	Generator Waveform. 0 = sine, 1 = square, 2 = triangle
XB	Plotter Scaling X-Minimum
XH	Plotter X max
XI	Plotter X item. 0 = a , 1 = b , 2 = r , 3 = θ , 4 = log r , 5 = f , 6 = log f
XL	Plotter X min
XO	Plotter X origin
XT	Plotter Scaling X-Maximum
YB	Plotter Scaling Y-Minimum
YH	Plotter Y max
YI	Plotter Y item. 0 = a , 1 = b , 2 = r , 3 = θ , 4 = log r , 5 = f , 6 = log f .
YL	Plotter Y min
YO	Plotter Y origin
YT	Plotter Scaling Y-Maximum
?AI	Query Auto Integration Time
?AR	Query Last Range Used
?ER	Query Last Error
?FP 0	Query Number of Results in File
?FP 1	Query File Pointer
?NA	Query Number of Readings Accepted
?NR	Query Number of Readings Taken
?PN	Query Program Length
?SF	Query Synchroniser Frequency
?SN	Query Synchroniser Status
?TS	Query Self Test Results
*B	Edit Previous Line
*C	Clear Program
*D	Edit by Deleting Line

7.20 COMMANDS IN ALPHABETICAL ORDER (Continued)

Code	Meaning
*E	Enter Program Edit Mode
*F	Edit Next Line
*I	Edit Insert Mode
*L	Enter Program Learn Mode
*P	List Program
*Q	Exit from Learn/Edit Mode

8 GPIB CONTROLLER: LANGUAGE USED IN PROGRAM EXAMPLES

To clarify the use of the GPIB port for remote control of the 1250, several examples are given of GPIB Controller programs. Each example is written as a series of abbreviated commands, including some BASIC programming language instructions. The programs are representational only and are not suitable for directly programming a Controller.

The examples are intended to show the required sequence of events, as they affect the controls of the 1250. Other GPIB commands, such as Enable Signals and Addressing, are omitted. The most commonly used instructions are listed below, with a full explanation of their meaning.

Instruction	Meaning
OUTPUT " "	Send to the 1250 the string of characters within inverted commas, plus a Command Terminator.
INPUT	Receive data from the 1250
INPUT A	Receive data from the 1250 and store it in Location A.
PRINT "FREQUENCY =", A	Print the statement: Frequency = "the value stored in location A"
DIM A\$(100)	The Controller is instructed to allocate sufficient temporary store space to accommodate a maximum of 100 strings of characters. A string could consist of a Learnt Program Command, a stored reading from the File etc. The store area is given the name A\$.
FOR I = 1 to N } INPUT A\$(I) } NEXT I }	This is a loop instruction telling the Controller to store each line of the 1250's output in area A\$, from Line 1 to the final Line N. The loop instruction terminates when I = N.

9 COMMAND QUERY

This feature may be used to examine the state or value of any parameter in the 1250.

The format of the Command is:

?XYn

where XY is the two-letter Command Code, e.g. FR for frequency, and n is a number specifying which parameter is required in Commands having more than one Argument, e.g. ?TM0 will give the "hours" value of Time, and ?TM1 will give the "minutes" value.

Note: if not specified, n defaults to zero.

Example: Command Query via GPIB, to ascertain Generator frequency. Using program statements given in Section 8.

```
OUTPUT "?FR"  
INPUT A  
PRINT "FREQUENCY = ", A
```

Note that the information sent from the 1250 to the Controller will include an Output Terminator, as explained in Section 12.6.

10 MEASUREMENT OUTPUT SELECTION:

10.1 VIA RS423 PORT

To enable measurement results to be sent to the RS423 port, using Front Panel controls:

1. Press DATA OUTPUT key
2. Select [DATA OUTPUT]
3. Press RS423 soft key
4. Select the required type of results from: [all], [fail], [pass], or [dump]. These terms are defined in Chapter 12 Section 1.2, "[DATA OUTPUT]".

The results of the above sequence can also be accomplished by remote control, using the Commands given in Section 7.15 "Data Output Commands".

Each measurement result is automatically accompanied by cr (carriage return) as an Output Terminator.

10.2 VIA GPIB INTERFACE

a. ASCII Port. To enable measurement results to be sent to the GPIB ASCII port, using Front Panel controls:

1. Press DATA OUTPUT key.
2. Select [DATA OUTPUT].
3. Press GPIB soft key.
4. Select the required type of results from: [all], [fail], or [pass]. These terms are explained in Chapter 12 Section 1.2, "[DATA OUTPUT]".
5. Select the Output Terminator and Separator as described in Section 12.6.

The above operations can also be commanded remotely by using the Codes given in Section 7.15 "Data Output Commands".

b. Binary Output Port. To enable measurement results to be sent to the GPIB Binary output port, using Front Panel controls:

1. Follow steps 1 to 3 inclusive in "a" above for ASCII port.
2. Select [dump]. This term is explained in Chapter 12 Section 1.2, "[DATA OUTPUT]".
3. The Output Terminator will be as described in Section 12.4 "Dump Mode".

The above operations can also be commanded remotely by using the Codes given in Section 7.15 "Data Output Commands".

11 MEASUREMENT OUTPUT RATE

11.1 VIA RS423 PORT

When using this port, the 1250 baud rate must be adjusted to suit the output device, as explained in Section 3 of this Chapter.

11.2 VIA GPIB INTERFACE

When the 1250 is running in RECYCLE mode, some measurement results may be lost if the Controller is not fast enough to assimilate all the data. The 1250 is capable of sending approximately 10 readings per second to the ASCII port. The actual data transmission is at approximately 1 byte per millisecond and each reading may occupy up to 40 bytes. The remainder is measurement time.

There are two ways of ensuring that data is not lost:

1. Use RECYCLE mode, but with a Measurement Delay selected if necessary to allow the Controller to keep pace with the data.
2. Use SINGLE mode to take a measurement, and pass the result to the GPIB. The Controller then reads the data and, when ready, commands the 1250 to make the next SINGLE measurement.

12 MEASUREMENT OUTPUT FORMAT

12.1 RS423 PORT

The results are presented in a tabulated format suitable for use with an RS423-compatible printer, having a line width of 80 characters or more. Carriage Return is automatically added as the Output Terminator.

Column headings may be either printed or suppressed as explained in Chapter 12, Section 1.4 "Heading". The column sequence is of the form:

FREQUENCY (Hz)	REAL (V)	IMAGINARY (V)	LIMIT CHECK	CHANNEL & RANGE	TIME	STATUS
Note: this is the measurement frequency	or MAGNITUDE (V) or (dBV)	or PHASE (DEG)		or HISTORY FILE NO		
	no units for point-to-point					

12.2 GPIB TALK ONLY MODE

This mode of presenting measurement results to the GPIB is selected by setting the TALK ONLY switch on the rear panel of the 1250 to ON. The 1250 then sends data to the GPIB ASCII port in a format suitable for GPIB-compatible printers. The format is the same as for the RS423 port, but the Output Terminator must be selected as described in Section 12.6.

12.3 GPIB NORMAL MODE

This mode of presenting measurement results is selected by setting the TALK ONLY switch on the rear panel of the 1250 to OFF. The data output is in compressed form, suitable for interpretation by a Controller. The 1250 automatically allocates to each parameter a constant field width of 11 characters, containing a 5-digit fixed point part and a 2-digit exponent. For example, the frequency field is of the form:

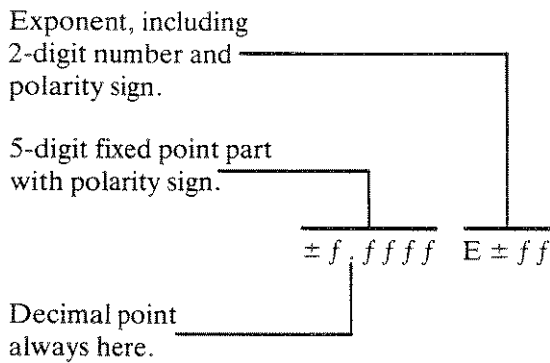

A complete reading takes the form:

$\pm f . ffff E \pm ff$	$\pm a . aaaa E \pm aa$	$\pm b . bbbb E \pm bb$	$e c r$
frequency	<i>a</i>	<i>b</i>	error code
frequency	<i>r</i>	<i>theta</i>	error code
frequency	$\log r$	<i>theta</i>	error code

where *e* represents a 1-digit Error Code, as listed in Chapter 11, Section 2. Only the last digit of Group 8 Error Codes is reported. The Output Separator character is shown as a comma, and the Output Terminator is cr, i.e. Carriage Return.

To select different Separator and Terminator characters see Section 12.6.

An example of a Controller program to output readings to the GPIB is given below. The programming statements defined in Section 8 are used, and the use of comma as Separator and crlf as Terminator is assumed.

Instruction	Meaning
OUTPUT "CO0"	Select co-ordinates <i>a</i> , <i>b</i> .
OUTPUT "OP 2, 1"	Send all readings to the GPIB
OUTPUT "SI"	Make a Single measurement
INPUT F, A, B, E	Store the results of the measurement.
PRINT "FREQ =", F	} means: print the results of the measurement
PRINT "a =", A	
PRINT "b =", B	
PRINT "error =", E	

Note that the results sent to the GPIB ASCII port are from the same Source Channel and are in the same co-ordinates as the results displayed on the Front Panel.

12.4 DUMP MODE

This mode provides the fastest means outputting data from the 1250. As the data is in binary form, however, it is suitable only for processing by a computer or for storage pending subsequent processing. Each reading is compressed into 12 bytes of binary information.

The format is:

a a a a b b b b f f f f

which represents 3×4 -byte floating point numbers, where:

a a a a = in phase data
b b b b = quadrature data
f f f f = frequency

If the Output Terminator, selected as described in Section 12.6, is either cr + EOI or crlf + EOI, then EOI is automatically asserted simultaneously with the 12th byte. The cr or crlf are *not* sent, neither is any Output Separator.

The output rate is approximately 1 byte per millisecond, as for the ASCII port, but the data is compressed into only 12 bytes compared with up to 40 bytes for ASCII. Also, in Dump mode, the 1250's internal computation time is much less.

12.5 FLOATING POINT FORMAT

To analyse the form of the Dump data in detail, consider, for example, the in-phase component of the reading "a a a a". This consists of a 4-byte floating point number, each byte containing 8 bits, as shown below:

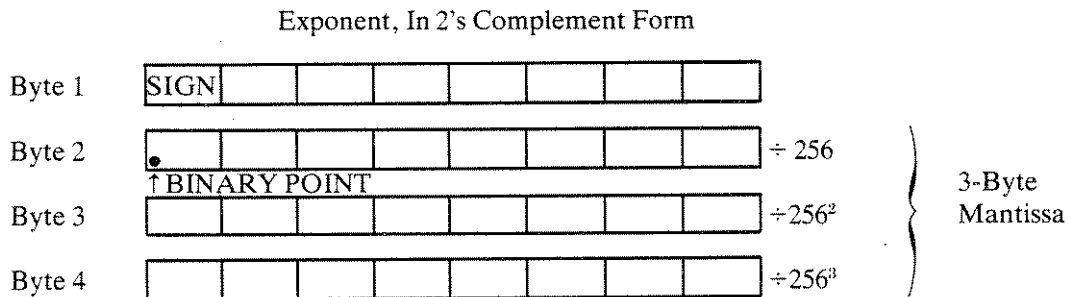

The sign bit in Byte 1 indicates the sign of the in-phase component. 0 indicates a positive number and 1 a negative number.

The remaining seven bits of Byte 1 indicate the binary exponent, in 2's complement format:

$$\begin{aligned}
 011\ 1111_2 &\equiv 2^{63} \approx 9.2 \times 10^{18} \\
 &\vdots \\
 000\ 0010_2 &\equiv 2^2 = 4 \\
 000\ 0001_2 &\equiv 2^1 = 2 \\
 000\ 0000_2 &\equiv 2^0 = 1 \\
 111\ 1111_2 &\equiv 2^{-1} = 0.5 \\
 111\ 1110_2 &\equiv 2^{-2} = 0.25 \\
 &\vdots \\
 100\ 0000_2 &\equiv 2^{-64} \approx 5.4 \times 10^{-20}
 \end{aligned}$$

12.5 FLOATING POINT FORMAT (Continued)

Bytes 2, 3 and 4 contain the mantissa part of the floating point number. The mantissa must always be less than unity, so the “binary point” is shown preceding the first bit of Byte 2. The maximum decimal number that Byte 2 can contain is $255 \div 256$; for Byte 3 it is $255 \div 256^2$ etc.

Example. To convert a 4-byte binary number to decimal:
Suppose that Byte 1 contains $11111110_2 = 254$
Byte 2 contains $10000000_2 = 128$
Byte 3 contains $00000000_2 = 0$
Byte 4 contains $00000000_2 = 0$

The sign bit of Byte 1 is “1”, therefore the number is **negative**. The exponent, from the table above, is numerically equal to 2^{-2} , i.e. $\frac{1}{2^2} =$ a multiplying factor of **0.25**. Therefore the number represented is:

$$(-1) \times 0.25 \times \left(\frac{128}{256} + \frac{0}{256^2} + \frac{0}{256^3} \right) = -0.125$$

12.6 OUTPUT TERMINATORS AND SEPARATORS

RS423 OUTPUT TERMINATOR

Each line of data that is sent from the 1250 via the RS423 port is automatically terminated with cr (carriage return).

GPIB OUTPUT TERMINATORS AND SEPARATORS

Output Terminators. When the 1250 sends a line of data to the GPIB, the line must be terminated by an Output Terminator character. The choice of character is determined by the requirements of the external device. The 1250 automatically generates crlf (carriage return line feed) as the default character, but others are available. To select one of these from the Front Panel:

1. Press DATA OUTPUT key
2. Select [GPIB CONFIGURE]
3. Press soft key TERM (for Output Terminator)
4. Select from [crlf], [crlf + EOI], [cr], or [cr + EOI].

where EOI = End or Identify.

Output Separators. Each line of data may consist of several “fields”, which require Output Separator characters between them. The 1250 automatically generates “comma”, but to change this:

1. Press DATA OUTPUT key
2. Select [GPIB CONFIGURE]
3. Press soft key SEP (for Output Separator)
4. Select from [comma], or [terminator]

where “terminator” means that the same character is used for the Output Terminator and Output Separator.

Remote Control. The Output Terminator and Separator characters can also be selected remotely by using the Commands given in Section 7.16.

13 SERIAL POLL/PARALLEL POLL

The 1250 can be configured to interrupt other GPIB activities by asserting a Service Request (SRQ) when a particular event has occurred, e.g. End of Sweep or Data Ready. When the Controller detects that SRQ has been asserted, it may “poll” the bus to find out which device requires service. Polling can be either “Parallel”, where all the devices on the bus are interrogated simultaneously, or “Serial”, where each device is interrogated in turn.

Parallel Poll is faster than Serial for identification purposes, but provides less information. However, choice of mode may be determined by the Controller as, whereas some Controllers offer both forms of Poll, some offer only one, and some do not offer either. Where both forms of Poll are available, and there are many devices connected to the bus, it may be faster to perform a Parallel Poll to identify the device requesting service, followed by a Serial Poll to ascertain the cause of the request.

13.1 SERIAL POLL

The GPIB Interface includes an 8-bit register which holds the STATUS BYTE (STB). The STB is interrogated when the Controller initiates a Serial Poll, and contains the following status data:

128 DATA READY	64 RQS	32 END OF PROGRAM	16 END OF FILE	8 END OF PLOT	4 END OF SWEEP	2 END OF MEASURE	1 ERROR
----------------------	-----------	-------------------------	----------------------	---------------------	----------------------	------------------------	------------

When the relevant condition exists, e.g. “End of Sweep”, that bit will be set to “1”.

Note that the status of all the bits, except “1” and “64”, will continue to follow data changes, e.g. if the 1250 is on RECYCLE, bit 2 will be set to “1” as each Measurement is completed, then revert to “0” as a new Measurement commences.

The RQS (Request Service) bit 64 is set when the 1250 Interface generates an SRQ (Service Request). A “1” in the RQS bit tells the Controller that this device generated the SRQ. All 8 bits of the STB appear on the DI/O lines when the 1250 is interrogated.

The STB bits can be configured so that any one of several events can set the RQS bit, as explained later in this section. However, to avoid possible ambiguities, it is preferable to configure for one event only. To monitor several of the STB bits simultaneously, the Controller can be instructed to Serial Poll continuously without using SRQ.

The remaining seven bits identify which event or events caused the SRQ. They are:

Bit 128, Data Ready, which is set when data is available for ASCII or Binary output to the GPIB.

Bits 32, 16, 8, 4 and 2, which indicate respectively the status of the Program, the File, the Plotter (GPIB and Analog), the Sweep and the current Measurement. The “End of File” bit 16 is set when either:

- a. The *n*th reading is stored in the File, where ‘*n*’ is the specified File size in Blocks (99 if default value).
- or
- b. The final reading, whatever number this may be, is read from the File. For example, if the File contains only six entries, then bit 16 will be set to “1” when the 6th entry has been read.

Bit 1, the Error bit, which will be set when an error affecting the other bits in the STB is detected. It does **not** register all possible errors in the 1250.

13.1 SERIAL POLL (Continued)

Configure. The code to configure the 1250 to interrupt on an event is:

SVn

where n = a number between 1 and 255, conforming to the bit numbers of the STB. For example SV8 will cause the 1250 to generate SRQ at the next End of Plot, and SV25 will generate SRQ from whichever event occurs first of "Error", "End of Plot" or "End of File" i.e. bits 1 + 8 + 16.

Once the 1250 has generated an interrupt, it must be reconfigured before it will generate another.

Unconfigure and Clear

Code SV0 unconfigures an existing interrupt, and also clears bit "1".

Pressing the BREAK key unconfigures an existing interrupt and also clears the whole STB. If the BREAK key is used to enable the 1250 to read the GPIB switches, as described in Section 5, the STB must be reconfigured afterwards.

The RQS and Error bits are automatically cleared by any SV command, by pressing the BREAK key, by Initialising, by Resetting, and by Power Off.

Mini Status. The status of the STB bits can be observed on the 1250 Display by selecting the Mini – Status line: [STATUS x x x x x x x x]

The eight x's correspond to the 8 bits of the STB, and will show a "1" or a "0", according to the bit status, updated every second.

13.2 PARALLEL POLL

The 1250 can also be configured to give a Parallel Poll, True/False response, on a particular GPIB data line, to indicate whether the 1250 is requesting service or not. As explained in "Serial Poll", the 1250 must first be configured by an SV command, to define which event shall assert SRQ.

This is followed by a PP command, to set up Parallel Poll configuration:

PPn means "configure Parallel Poll on a particular GPIB data line, where n = a data line number between 1 and 8 inclusive.

PP0 unconfigures Parallel Poll.

The sense of the Parallel Poll line may be configured by a PS command:

PS1 means "when the line is True, i.e. carries a "1", the 1250 is requesting service". PS1 is the default state.

PS0 means "when the line is False, i.e. carries a "0", the 1250 is requesting service".

The Parallel Poll response is cleared, in a similar fashion to Serial Poll, by any SV command, by PP0 command, pressing BREAK key, Initialising, Resetting, or Power Off.

Unlike Serial Poll, Parallel Poll does not have to be reconfigured after each interrupt.

14 LEARNT PROGRAMS. EXTERNAL STORING AND RELOADING

Learnt Programs may be transferred from the 1250 to an external device, via the RS423 port or the GPIB Interface. These Programs, if stored externally, can then be loaded back into the 1250 at a later date. This greatly increases the number of Programs that can be learnt, although the 1250 can still only hold up to 9 of them at a time.

The transfer is achieved by external command only; it cannot be commanded from the Front Panel.

The setting of the DATA OUTPUT key is immaterial.

By using the relevant Commands listed in Section 7, Learnt Programs can be compiled entirely on an external device and then transferred complete to the 1250.

All external Learnt Program manipulations can be performed whilst the 1250 is making measurements, but Commands to Execute Program will not be implemented until the measurement is complete.

In the following examples, n = the Learnt Program number, from 1 to 9.

14.1 RS423 PORT, DEVICE CONTROL CHARACTERS

When Learnt Programs are transferred via the RS423 port, the 1250 automatically generates four ASCII Device Control Characters. The user must ensure that any external device used for recording and replaying Learnt Programs is compatible with these Characters. The four Characters are:

Character	Assigned Meaning
DC 1	Turn Replay On
DC 2	Turn Record On
DC 3	Turn Replay Off
DC 4	Turn Record Off

The original definition of the Device Control Characters is in: USA Standard Code for Information Interchange (ASCII) X 3.4 1968. It is further explained in:

British Standard 4730 : 1974 Section 5.3

and: CCITT Volume VIII. 1 Recommendation V3 "International Alphabet No. 5".

Example. The four characters are used with a cassette recorder as follows:

When the Command *Pn (List Program) is sent from the external device via the RS423 port, the 1250 replies with DC2 (Turn Record On), followed by the Learnt Program contents which are then stored on the tape. When the final Program instruction *Q (Quit) is detected, the 1250 first generates DC3 (Turn Replay Off), which is recorded on the tape, then finally DC4 (Turn Record Off) which terminates the recording.

To load the Learnt Program back into the 1250, the Command *Ln is first sent from the external device. The 1250 will respond with DC1 (Turn Replay On). The Program will then be transferred from the cassette up to the final *Q instruction followed by the pre-recorded DC3 (Turn Replay Off), which terminates the replay.

14.2 PROCEDURE FOR STORING A LEARNT PROGRAM EXTERNALLY, VIA RS423 PORT

1. Ensure that the 1250 is in LOCAL 1 or LOCAL 2 mode.
2. Set up the relevant external device, connected to the RS423 port.
3. Instruct the 1250 to list the required Learnt Program by sending the Command:
$$*Pn$$
from the external device.
4. The contents of Program n will now be copied to the external device via the RS423 port.

14.3 PROCEDURE FOR LOADING A LEARNT PROGRAM INTO THE 1250, VIA RS423 PORT

To re-load a Learnt Program into the 1250:

1. Follow steps 1 and 2 of Section 14.2.
2. Send the Command:
$$*Ln$$
from the external device.
3. The Program will be sent to the 1250 and stored under the Learnt Program number n.
4. The Program can now be executed from the Front Panel in the normal way, or via the RS423 port by sending the Command:
$$EPn$$

14.4 PROCEDURE FOR STORING A LEARNT PROGRAM EXTERNALLY, VIA GPIB PORT

There are two methods of transferring Learnt Programs to an external device via the GPIB port, depending upon the rate at which the Controller can handle data.

- a. Fast Method. The 1250 transmits the Learnt Program at the rate of approximately 1 byte (i.e. one ASCII character) per millisecond. Provided that the Controller rate is faster than this, the 1250 merely has to "list" the required Program at its maximum speed. A typical Controller program for this method is shown in Section 14.5.
- b. Slower Method. This method includes a "handshake" routine to ensure that no data is lost. A typical Controller program is shown in Section 14.6.

Controller Programs. The most commonly used Controller program statements are defined in Section 8; the others are explained as they occur in the examples.

Note that the Learnt Program data fed to the GPIB will include an Output Terminator, as explained in Section 12.2

14.5 EXAMPLE OF CONTROLLER PROGRAM FOR TRANSFERRING LEARNT PROGRAM 1 FROM 1250 VIA GPIB PORT, WITHOUT HANDSHAKE

Instruction	Meaning
DIM A\$ (100)	Allocate temporary store space
OUTPUT "?PN1"	How many lines in Learnt Program 1?
INPUT N	N = number of lines in Learnt Program 1
OUTPUT "*P1"	List Learnt Program 1 to the GPIB
FOR I = 1 to N	Store all lines of Learnt Program until I = N
INPUT A\$ (I)	
NEXT I	

14.6 EXAMPLE OF CONTROLLER PROGRAM FOR TRANSFERRING LEARNT PROGRAM 1 FROM 1250 VIA GPIB PORT, WITH HANDSHAKE

Instruction	Meaning
DIM A\$ (100)	Allocate temporary store space
OUTPUT "?PN1"	How many lines in Learnt Program 1?
INPUT N	N = number of lines in Learnt Program 1
OUTPUT "*E1"	The command "Edit Learnt Program 1" sends Line 1 of the Program to the GPIB.
INPUT A\$ (1)	Store Line 1
FOR I = 2 to N	Keep sending *F (Edit Next Line) to the 1250 and store all until I = N
OUTPUT "*F"	
INPUT A\$ (I)	
NEXT I	Note the "handshake" effect of putting *F inside the loop, compared with the example in Section 14.5, where *P is outside the loop.
OUTPUT "*Q"	Send the Command: "end of Program Edit".

14.7 RELOADING A LEARNT PROGRAM TO 1250 VIA GPIB

Learnt Programs which have been saved or compiled on an external device can be reloaded to the 1250 by using the Learn Program Command *Ln, as shown in the following example for loading Program 1.

Instruction	Meaning
OUTPUT "*L1"	Instructs the 1250 to Learn Program 1
FOR I = 1 to N	Send all lines of Learnt Program 1 to the 1250 until I = N
OUTPUT A\$ (I)	
NEXT I	

Note: the last line of the Learnt Program should be *Q. There is therefore no need to send a separate *Q instruction from the Controller to quit the Learnt Program mode.

15 FILE OUTPUT

A description of the File is given in Chapter 12, Section 2, which includes the procedures for operating from the Front Panel. The File can also be controlled by external Commands via the RS423 and GPIB ports, but readings can only be placed in the File by the 1250 itself, not from outside.

Remote control of the File is achieved by using a combination of Commands from Section 7.13 "File Commands" and 7.15 "Data Output Commands". By using the appropriate Command, any of the relevant DATA OUTPUT key facilities are available, for example the readings can be transferred via either port in Dump mode, as described in Section 12.4. Also, new Limits can be applied to the readings as they are read from the File, by using the Function Commands given in Section 7.17.

Before storing data in a new File, it is advisable to send an FC (Clear File) Command.

The 1250 must be placed in ANALYSER STOP mode, before the File is read.

Unlike remote control of the Learnt Program, no Device Control characters are generated when using the RS423 port.

15.1 PROCEDURE TO OUTPUT THE FILE VIA RS423 PORT, BY EXTERNAL COMMAND

1. Ensure that the 1250 is in LOCAL 1 or LOCAL 2 mode.
2. Set up the relevant external device, connected to the RS423 port.
3. Instruct the 1250 to switch the RS423 section of the DATA OUTPUT switch to "all" by sending the Command:

OP 1,1

from the external device.

4. Instruct the 1250 to list the File by sending the Command:

FO

from the external device.

5. The contents of the File will now be copied to the external device via the RS423 port.

15.2 PROCEDURE TO OUTPUT THE FILE VIA GPIB PORT

There are two methods of transferring the contents of the File to an external device via the GPIB port, depending upon the rate at which the Controller can handle data.

a. Fast Method. The 1250 transmits the File contents at the rate of approximately one reading every 40 milliseconds (12 milliseconds in Dump Mode). Provided that the Controller rate is faster than this, the 1250 merely has to "list" the File at its maximum speed. A typical Controller program for this method is shown in Section 15.3.

b. Slower Method. This method includes a "handshake" routine to ensure that no data is lost. A typical Controller program is shown in Section 15.4.

Both examples use the Controller program statements defined in Section 8.

For any mode other than Dump, the readings will be transferred from the File in the form shown in Section 12.3, including the Separators and Terminator, which can be selected as described.

15.3 EXAMPLE OF CONTROLLER PROGRAM FOR COPYING THE FILE TO THE GPIB, WITHOUT HANDSHAKE

Instruction	Meaning
DIM A\$ (99)	Allocate temporary store space
OUTPUT "?FP0"	Query number of lines in File
INPUT N	N = number of lines in File
OUTPUT "OP2, 1"	Output all readings to GPIB
OUTPUT "FO"	List File
FOR I = 1 to N } INPUT A\$ (I) } NEXT I	Store all readings from File until I = N

15.4 EXAMPLE OF CONTROLLER PROGRAM FOR COPYING THE FILE TO THE GPIB, WITH HANDSHAKE

Instruction	Meaning
DIM A\$ (99)	Allocate temporary store space
OUTPUT "?FP0"	Query number of lines in File
INPUT N	N = number of lines in File
OUTPUT "OP2, 1"	Output all readings to GPIB
OUTPUT "FD0"	Output first reading from File.
INPUT A\$ (1)	Store the first reading, in the sequence: Measurement Frequency, Data 1 (e.g. <i>r</i>), Data 2 (e.g. <i>θ</i>), and Error Code
FOR I = 2 to N } OUTPUT "FD2" } INPUT A\$ (I) } NEXT I	Keep sending FD2 (Step Down File) to the 1250 and store each reading until I = N. Note the "handshake" effect of putting FD2 inside the loop, compared with the previous example where FO is outside the loop.

16 GPIB PLOTTING

The 1250 can drive a GPIB plotter via the standard GPIB without additional modules being required. When operating in this mode, ensure that the GPIB section of the DATA OUTPUT key is switched off, so that only plotter commands are passed to the GPIB. The default state of the GPIB DATA OUTPUT control is "off".

The GPIB plotter section of the 1250 is compatible only with plotters using Hewlett Packard Graphics Language (HPGL), or Enertec Schlumberger Graphics Language (ESGL). The 1250 plotter commands must be formatted with commas as Separators and crlf as Terminator, as explained in Section 12.6.

If the GPIB plotter can be put into Listen Only mode, it can be driven directly from the 1250 without requiring a Controller. However, if the plotter has no Listen Only mode, a Controller is necessary to instruct the plotter to "listen" to the 1250. When directly driving a plotter possessing Listen Only facility, the 1250 must have the switch on its rear panel set to TALK ONLY.

Serial Poll can be used to indicate completion of plotting, as described in Section 13.1. In this case, the STATUS BYTE should be configured so that bit 8 is set at End of Plot.

16.1 OPERATING SEQUENCE FOR GPIB PLOTTER, USING A CONTROLLER

To perform a GPIB plot using a Controller, first set up the 1250 for the desired type of sweep and set the plotter controls. This preliminary setting up can either be performed using the Front Panel keys, as described in previous Chapters, or remotely from the Controller using the Commands given in Section 7 of this Chapter.

The Controller program should now continue, using the instructions defined in Section 8:

Instruction	Meaning
OUTPUT "SV8"	Configure SRQ for end of plot
OUTPUT "PL0"	Plot graph
OUTPUT "SC3"	Start linear sweep up (for example)
OUTPUT "RE"	Recycle
OUTPUT "RG"	Start Generator

The Controller must now instruct the 1250 to "talk" and the plotter to "listen". Plotting will commence, and continue until an interrupt is asserted by the 1250, signalling End of Plot. Alternatively, the controller can continuously interrogate the STATUS BYTE by Serial Polling until it detects that the End of Plot bit has been set.

17 COMBINATIONS OF RS423 AND GPIB DEVICES

The 1250 can be used in a system containing both GPIB and RS423 compatible devices. For example, the GPIB Controller could be a Calculator with no recording capability whilst the RS423 port is connected to a tape cassette unit or a printer which has no keyboard. In this case, whatever data the GPIB Controller requests from the 1250, i.e. Measurement Results, Learnt Programs or File contents, will also be available at the Serial port, provided that the RS423 section of the DATA OUTPUT key facility is set to any mode other than "off".

Conversely, if the 1250 GPIB port is set to TALK ONLY, and connected to a printer or plotter set to LISTEN ONLY, data requested by a Command sent via the RS423 port will also be sent to the GPIB, provided that the GPIB section of the DATA OUTPUT key facility is set to any position other than "off".

However, if the 1250 GPIB port is set to TALKER/LISTENER, data requested via the RS423 port does **not** appear on the GPIB.

Chapter 14

Break, Self Test, Time Display and Power Fail

Contents

		<i>Page No.</i>
1	The Break Key	14.2
2	Self Test	14.2
3	Time Display	14.4
4	Power Fail	14.5

1 THE BREAK KEY

Note that this key operates only when the 1250 is in the Local mode. When pressed, it instantly stops any activity upon which the 1250 is engaged, and the message BREAK IN is displayed. Its main functions are:

1. To terminate a measurement prematurely, which would otherwise continue to the end of the integration cycle, even although ANALYSER STOP has been pressed.
2. To return control of the Analyser to the Front Panel, when the Analyser is in the Wait mode.
3. To stop the contents of the File being listed, i.e. if the user wishes to abort the List File command part way through the listing.
4. To abandon the Learnt Program mode and restore Front Panel control.
5. To enable the 1250 to learn new settings of the GPIB switches on the rear panel, without having to initialise. See GPIB section for details.
6. To clear, and unconfigure, the Serial Poll STATUS BYTE.

2 SELF TEST

There are two self test programs available for checking the functional state of the 1250. To gain access to these, press "self test" on the Front Panel. Five soft keys will be assigned as shown in Fig. 14.1.

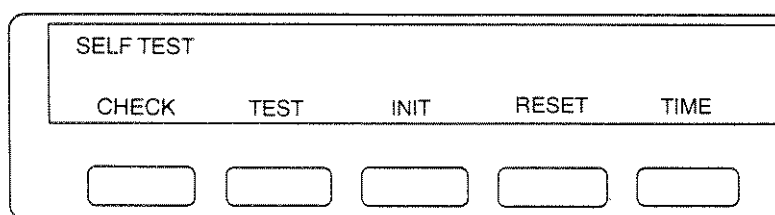

Fig. 14.1 Self Test Display

The INIT and RESET keys have already been described in Chapter 3, Sections 2 and 3. The other facilities are:

CHECK. Pressing this key initiates a relatively simple self test. It is useful for checking that the 1250 has no obvious faults, without disturbing any of the stored data. Check sums are performed on all the memories and basic circuit functions verified.

The user is not required to operate any other Front Panel keys. The TIME display is not reset and continues running. A satisfactory CHECK produces the following message:

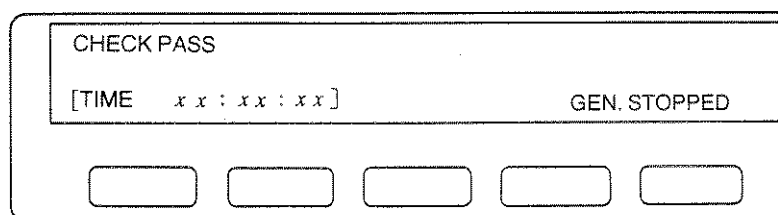

Fig. 14.2 Check Pass Message

If a fault is detected, the Display will show a message indicating the faulty area, e.g.:

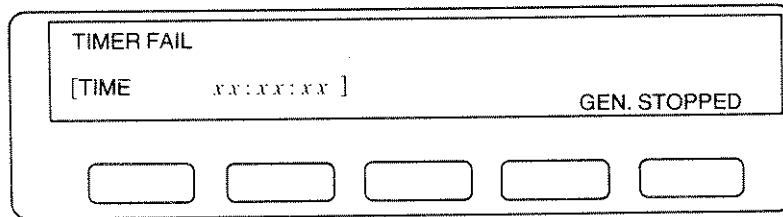

Fig. 14.3 Check Fail Display

In this case, the 1250 should be switched off until the fault can be rectified. It is unlikely that the instrument will be damaged if left switched on, but the readings are suspect.

TEST. Pressing this key implements a much more rigorous self test than that carried out by CHECK. It verifies that all boards write and read correctly. The Measure Delay and Watchdog timers are checked, and limited tests are performed on the communications interfaces. The Display will request some user interaction via the keyboard, as follows:

Press TEST. One horizontal line of dots will light in the Display, this line rolling downwards automatically until all dots have been lit. This checks for short circuits and open circuits. The pattern will repeat indefinitely to allow a thorough visual inspection. Once the user is satisfied that the Display is correct, press ENTER.

A vertical line will now light and move across the Display from left to right, to check for short and open circuits in that plane. Again press ENTER when satisfied.

A test pattern consisting of alphanumeric and other symbols will now appear on the Display:

A B C D E F G H I J K L M N O P Q R S T U V W X Y Z ? ! @ % & ' () * + - = []
 + - * / 0 1 2 3 4 5 6 7 8 9 a b c d e f g h i j k l m n o p q r s t u v w x y z

Press ENTER when satisfied.

A message will now appear on the screen:

press all keys ending with the enter key
 number of keys pressed =

As each key is pressed, a number following the "=" sign is incremented by one, and an abbreviated note of the key name is displayed. On pressing ENTER at the end of the sequence, one of two messages will be displayed,

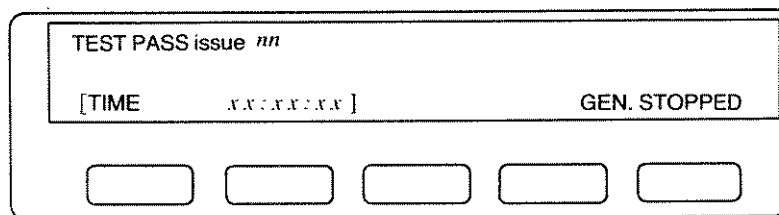

Fig. 14.4 Test Pass Display

Note: "nn" corresponds to the issue number of the software currently installed in the 1250.

This signifies that the performance of the 1250 has been verified to a deeper level than by using CHECK.

If a fault is detected, the Display will show a message indicating the faulty area, e.g.:

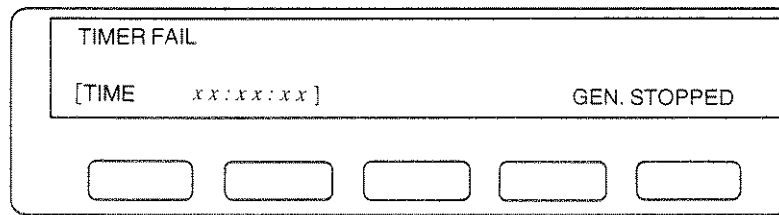

Fig. 14.5 Test Fail Display

The 1250 should be switched off until the fault can be rectified. It is unlikely that the instrument will be damaged if left switched on, but the readings are suspect.

3 TIME DISPLAY

To enter a time into the Display, press “self test”, followed by the TIME soft key. The Display will show:

TIME : HOURS = ()

Key the required hours value into the round brackets and ENTER. The Display will now show:

TIME : HOURS = “value entered” MINUTES = ()

Key the required minutes value into the round brackets and ENTER. The Display will revert to the “self test” format.

When displayed, the Mini Status will now show the entered time, updated every minute.

Time can also be entered from a peripheral device via the GPIB or RS423 ports.

4 POWER FAIL

The 1250 contains a circuit which detects any interruption to the mains supply, whether deliberate or accidental. When a mains failure is detected, the control circuitry adds up the “bits” of data in selected parts of the memory, and stores the result as a number, called the “check sum”. The memory circuits are switched to battery operation, so that all the data in them, plus the check sum, are preserved for at least 100 hours.

When the mains supply is restored, a new check sum calculation is made, and the result compared with the original check sum. If the two agree, the Display will be as in Fig. 14.6:

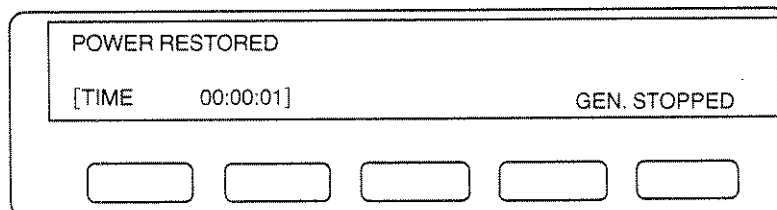

Fig. 14.6 Power Restored Display

This signifies that the 1250 has correctly remembered all the menu settings from the last time it was used. Therefore, after the Generator, Analysers, etc. have been restarted, the instrument may continue to be used as if it had not been switched off.

The TIME display, in hours, minutes and seconds, shows time elapsed since the instrument was switched on, starting from zero. The time-of-day can be entered in this display from the Front Panel, as described in Section 3, or from a peripheral device.

If the check sums do not agree, the Display will be as in Fig. 14.7:

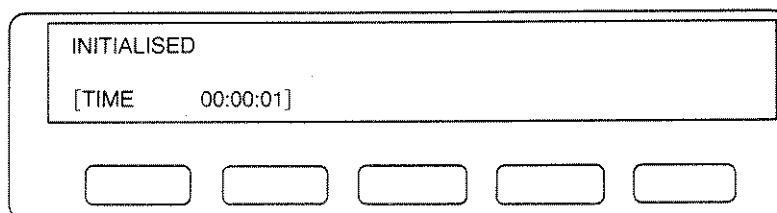

Fig. 14.7 Initialised Display

This signifies that errors have been detected in the previous 1250 settings. Therefore the control circuitry has erased the contents of the parameter store and returned all settings to their default state. The contents of the File and the Learnt Program store have also been erased.

The TIME display is reset to zero, as in “POWER RESTORED”. If the mains is interrupted whilst a measurement, or any other operation, is in progress, that operation stops at once and will not be automatically completed when power is restored. The 1250 recognises loss of mains for greater than 10 milliseconds as a mains failure; shorter interruptions are ignored.

Chapter 15

Options

Contents

	<i>Page No.</i>
1 Synchroniser Unit 12501	15.2
1.1 Introduction	15.2
1.2 Description	15.2
1.3 Installation	15.2
1.4 Connecting Up	15.2
1.5 Modes of Operation	15.3
1.6 The Synchroniser Menu	15.5
1.7 Procedure for Establishing the Sync. Locked State	15.8
1.8 Synchroniser Status	15.9
1.9 Measuring Harmonics: Use of Order Analysis	15.11
2 Modulator/Demodulator Unit 12502	15.12
2.1 Introduction	15.12
2.2 Installation	15.12
2.3 Connections	15.12
2.4 Setting Up	15.12
3 Analog Plotter Interface 12503	15.13
3.1 Introduction	15.13
3.2 Installation	15.13
3.3 Preset Controls	15.14
3.4 Setting Up and Performing a Plot	15.14
4 Auxiliary Generator Unit 12506	15.15
4.1 Introduction	15.15
4.2 Description	15.15
4.3 Installation	15.15
4.4 Setting Up	15.16

1 SYNCHRONISER UNIT 12501*

1.1 INTRODUCTION

Measurements may have to be made on devices which cannot be stimulated from the 1250 Generator, for example, the rotating shaft of a gearbox. In this case, the 12501 Synchroniser Unit can be used to lock the 1250 measurement frequency to that of the system under test. The 12501 must be connected to some point on the system under test from which a synchronising signal can be taken.

To enable the 12501 to be operated, the 1250 must contain at least Issue 4 software. The Issue may be determined from the Front Panel by using Self Test (see Chapter 14, Section 2 "Self Test") or by looking at the ROMs, IC22 to IC29 inclusive, on Processor Board 22, which should be Issue DA or higher.

1.2 DESCRIPTION

The 12501 consists of:

- a. A single printed circuit board, bearing on the component side the Type Number in silk-screened notation, and the Serial Number on a label.
- b. A metal panel carrying two sockets, connected to a lead with a polarised 4-pin plug on the other end. The sockets may be either 4mm or BNC type.
- c. A length of ribbon cable with DIL plugs at each end.

1.3 INSTALLATION

A 12501 ordered with a new 1250 will be installed and tested at the factory. When the 12501 is to be added to an existing 1250, installation must be performed by a Solartron engineer.

1.4 CONNECTING UP

Connect a screened lead from the HI and LO sockets to the take-off point for the trigger signal on the system under test.

* Not available for 1250N

1.5 MODES OF OPERATION

There are four modes of synchroniser operation:

Off. In this mode, the 1250 behaves as though the 12501 is not present. Synchroniser parameters can be entered but the measurements are unaffected by them. The “off” state is selected via the SYNC soft key described in Section 1.6

Loose Lock. This mode is intended for use in conditions where the trigger signal is too noisy for Tight Lock (see below) to be employed. The following sequence occurs before measurement commences:

- a. The frequency of the trigger signal is measured.
- b. The 1250 Synthesizer is synchronised to this trigger frequency.
- c. The Analysers are set to zero phase angle.
- d. Finally a phase-locked loop is activated, which attempts to track changes in the incoming trigger signal frequency.

This sequence is repeated before each measurement; consequently the 1250 measurement times will be longer than in non-synchroniser modes.

Once started, the measurement will proceed, and a reading will be displayed, even though the trigger signal frequency may be varying. However, in extreme cases, where dramatic changes occur in the trigger signal frequency during measurement, the measurement time may become indeterminately long, and any readings may appear as *.***, indicating invalid results. The input trigger frequency should not be allowed to change by more than 5% during a measurement.

If it is suspected that the measurement is not proceeding satisfactorily, control can be restored to the Front Panel by pressing BREAK. The SYNC. LOCKED state can then be re-established and a new measurement commenced.

Note that point to point measurements are particularly suitable in these conditions, as any variations affect both channels simultaneously and hence errors are minimised.

Tight Lock. This mode is similar to Loose Lock, except that if the trigger signal frequency changes by more than 0.5% in either 130 milliseconds or 1 cycle, whichever is the longer, the measurement will not be started. This ensures, in most cases, that any readings displayed are within the specified accuracy.

Ratio. In this mode, the input trigger frequency is computed as before, but the Analysers are set to measure at some multiple or sub-multiple of it, as programmed by the user. There are two main applications:

- a. Where a harmonic other than “1” has been selected, in which case Ratio mode is entered automatically (unless Synchronisation is “off”).

- b. Where no direct connection to the desired trigger signal source is possible. An example of this is shown in fig. 15.1, where the rotational speed of the main shaft can only be measured indirectly via a tachometer connected to a geared secondary shaft.

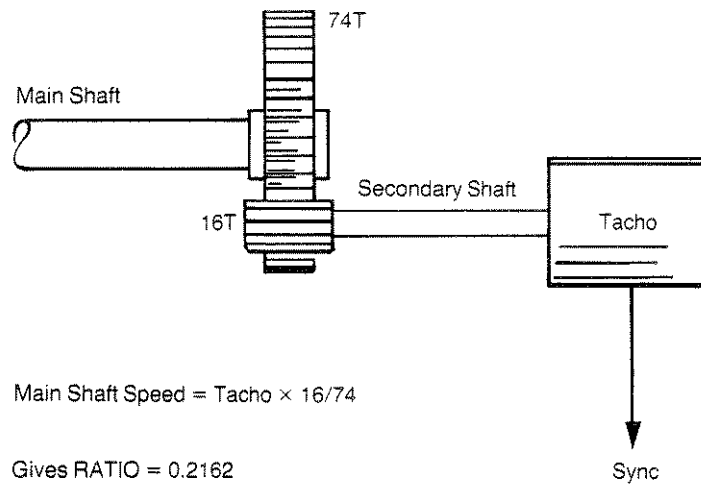

Fig. 15.1 Use of RATIO Mode for Indirect Synchronising

When the decimal value of the gear ratio is entered into the 1250, the instrument computes the rotational frequency of the **main** shaft, and synchronises the measurements to **this** frequency rather than that of the secondary shaft.

As it is not possible to phase lock the Analysers to the fundamental trigger source, absolute phase readings are meaningless in this mode. However, single-channel amplitude measurements can be made, preferably using Polar (r, θ) co-ordinates, and ignoring the θ value. Point-to-point measurements permit meaningful phase readings to be taken and, as before, will yield lower errors for amplitude readings.

As the phase locked loop is not used in Ratio mode, the measurement frequency cannot be controlled as tightly as in other modes. The effect of this is illustrated in Fig. 15.2, which expands part of the graph shown in Chapter 5, Section 2.1.

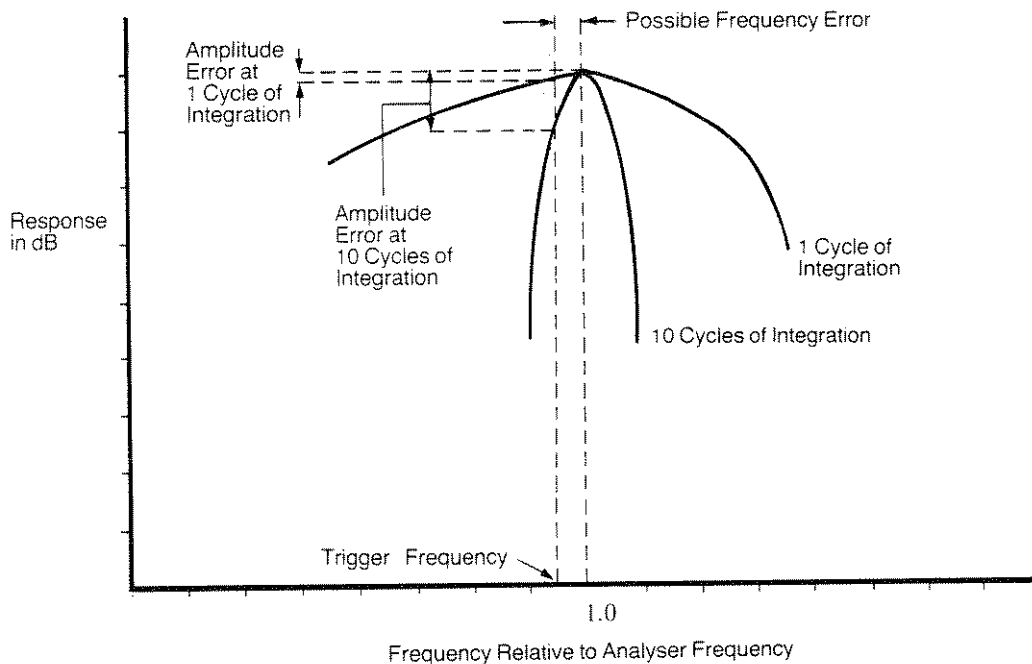

Fig. 15.2 Possible Amplitude Errors in Ratio Mode

Any difference between the trigger frequency and the frequency to which the Analysers have been set will prevent the measured signal coinciding with the peak of the Analyser response characteristic. The errors so produced become much worse as the number of cycles of integration is increased. It is therefore inadvisable to exceed 10 cycles of integration.

By using Order Analysis it is possible to measure at harmonics of the triggering frequency without the disadvantages of Ratio mode mentioned in this section. See Section 1.9 below, "Measuring Harmonics: Use of Order Analysis".

IMPORTANT NOTE

The user must define the point on the incoming waveform at which triggering is to occur. This is achieved by means of the LEVEL and SLOPE controls, as explained in Section 1.6. These controls must be set **before** the 1250 is instructed to start measuring, and must **not** be altered during a measurement.

Ensure that the Mini Status Display (Chapter 7 Section 4) is showing the message [SYNC LOCKED] before measurement commences.

1.6 THE SYNCHRONISER MENU

Access is gained to the Synchroniser Menu soft keys by pressing GENERATOR MENU followed by SELECT [].

The five soft keys are:

LEVEL. This control is used in conjunction with the SLOPE key to select the point on the incoming synchronising waveform at which triggering is to occur. Choice of trigger point is illustrated in Fig. 15.3 below. Enter a voltage value between the limits $\pm 5.1V$. If no value is entered after Initialisation, the 1250 will use the default value of zero, i.e. synchronise to the zero-crossing point of the waveform.

COUPLING. May be DC or AC, the former being the default state. AC coupling should not be used at low frequencies, as defined in the Specification, Chapter 17.

SLOPE. May be +ve or -ve, as illustrated in Fig. 15.3 below. Select and enter the slope which produces the best defined trigger point. The default state selects +ve slope.

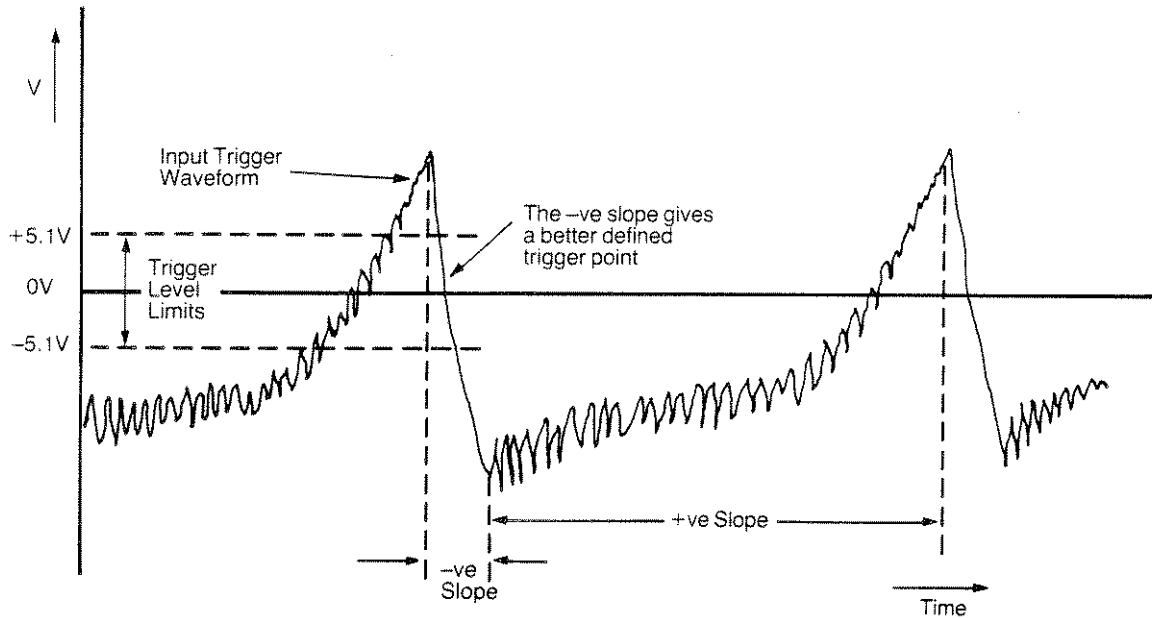

Fig. 15.3 Choice of Trigger Point

The minimum useable trigger signal amplitude is 250mV peak to peak.

To allow for hysteresis, when triggering from the positive slope the selected trigger point must be at least 75mV below the positive peak of the signal and at least 175mV above the negative peak. When triggering from the negative slope, the selected trigger point must be at least 175mV below the positive peak of the signal and at least 75mV above the negative peak.

RATIO. The Ratio mode is explained in Section 1.5 "Modes of Operation". Having pressed the RATIO key, enter the decimal value of the required multiple or sub-multiple of the incoming trigger signal frequency. The RATIO and SYNC keys interact as shown in Fig. 15.4 below.

SYNC. This key acts as the Synchroniser on/off control. There are two "on" modes, [loose lock] and [tight lock], both explained in Section 1.5 "Modes of Operation". The SYNC and RATIO keys interact with the [ANALYSER COMMON] HARMONIC key, as shown in the table below.

SYNC SOFT KEY: SELECT AND ENTER:	RATIO NUMBER ENTERED:	HARMONIC SELECTED:	RESULTING SYNCHRONISER MODE:
[off]	X	X	off
[loose]	0	1	loose lock
[tight]	0	1	tight lock
[loose] or ** [tight]	>0*	2 to 16*	ratio

Fig. 15.4 Interaction of RATIO, SYNC and HARMONIC Controls

Notes re Fig. 15.4

X = "don't care"

** In the Ratio and Harmonic modes, the terms "loose" and "tight" have no meaning other than that of indicating the "on" condition.

* Ratio \neq 0 and/or Harmonic \neq 1. When using the Synchroniser, if a Harmonic number other than "1" is entered in the Analyser Menu, the 1250 will automatically select the Ratio mode. The Harmonic number is then treated as the ratio by which the input frequency is multiplied before being used to synchronise the Analysers.

If numbers are entered for both Ratio and Harmonic, the 1250 will use the product of the numbers: e.g. enter 3 in Ratio and 3 in Harmonic, and the 1250 will measure the response at the 9th Harmonic. Entries under Harmonic do not affect the Synchroniser Status Display.

Note that BREAK, CHECK, TEST, RESET and Power-Up reset all turn the Synchroniser off.

1.7 PROCEDURE FOR ESTABLISHING THE SYNC. LOCKED STATE

1. Initialise
2. Ensure that the input trigger signal is connected to the 12501.
3. Select "SYNC" in the Mini Status Display. The state indicated may be IDLE, WAIT or STABLE, depending upon:
 - a. The compatibility of the trigger signal with the default state of the LEVEL, COUPLING and SLOPE controls.
 - b. The input trigger signal frequency.
(The Status messages are defined in Section 1.8).
4. Press GENERATOR START. (Although the Generator is not used as such in Synchroniser operations, the key must be pressed to enable measurement to proceed).
5. Press GENERATOR MENU.
6. Select [SYNCHRONISER] MENU.
7. Select and enter the required LEVEL, COUPLING and SLOPE settings.
8. Observe the Mini Status Display; lock cannot be achieved until the Display shows either WAIT or STABLE. If further adjustments of the LEVEL and SLOPE settings still fail to advance the displayed Status past IDLE, the definitions given in Section 1.8 may suggest reasons for this.
9. The next step depends upon the mode required; for Ratio, continue with step 10, for tight or loose lock go to step 13.
10. The Ratio mode can be entered when the Synchroniser is in either the WAIT or the STABLE STATE. Press the RATIO soft key, then enter the required number.
11. Press the SYNC soft key, select and enter [tight lock]. (As explained under Fig. 15.4, this merely acts as the "on" switch).
12. The Mini Status Display should change to SYNC LOCKED. Now proceed to step 15.
13. Whilst it is preferable to use tight lock whenever possible, the quality of the input trigger signal, as indicated by the Mini Status Display, may preclude this. If the Display consistently shows WAIT or fluctuates between WAIT and STABLE, loose lock is the best that can be achieved. However, if the Display consistently reads STABLE, tight lock can be used.

In either case, press the SYNC soft key, then select and enter either [tight lock] or [loose lock].
14. Watch the Mini Status Display for a consistent SYNC LOCKED message.
15. Set up the Analysers, Display etc. as normal.
16. Make the measurement by pressing SINGLE or RECYCLE.

Remember that the LEVEL, COUPLING and SLOPE settings must not be altered during a measurement.

1.8 SYNCHRONISER STATUS

The Synchroniser Status Display messages are shown in Chapter 11, Section 1.4. The first page of these messages is also available as the Mini Status Display, Chapter 7, Section 4. Status information is available externally by using the Commands given in Chapter 13, Section 7.4

Status Display Page 1, and Mini Status

The state of the Synchroniser at any given moment is defined by one of the six messages listed below:

Message	Meaning
NONE	No Synchroniser fitted. This message can appear even when SYNC is switched off.
IDLE	The Synchroniser is fitted but has not yet received at least the first two input trigger pulses. Hence the input trigger frequency cannot be measured.
WAIT	At least two input trigger pulses have been received, thus enabling the input frequency to be measured. If an attempt is made to establish a LOCKED condition before the WAIT state has been achieved, for example on very low trigger frequencies, ERROR 94 will be flagged.
STABLE	At least two frequency readings have been taken and compared, and the times between consecutive pairs of trigger pulses have been found to be identical; i.e. the input frequency is stable.
LOCKED	Lock has been achieved, and the 1250's Analysers will now measure at the correct frequency.
FAULT	The Synchroniser cannot achieve, or retain, the LOCKED stated. When Page 1 of the Status Display shows FAULT, this will be followed by one of the numbers defined below: <ol style="list-style-type: none">1. Frequency Overflow, i.e. the input trigger frequency exceeds 65535Hz.2. Time Overflow, i.e. the time interval between consecutive trigger pulses exceeds $2^{40}\mu\text{s}$ (≈ 12.5 days!).3. Event Overflow. This fault number indicates that an irrational occurrence has been detected. The user should try again, but if the fault persists, there is probably a hardware fault.9. Lock Lost. This fault indicates that the input trigger frequency has become unstable.

Remote Control Messages

Page 1 of the Status information can be interrogated externally by sending the Code “?SN”. The 1250 will reply with a number, as shown in Chapter 13, Section 7.4. The meanings assigned to the numbers are as defined for the messages in the Display. The additional message “0”, i.e. “ready”, means that the Synchroniser is ready for, but has not yet received, the first input trigger pulse.

The fault numbers are not available externally.

Status Display Page 2

Each of the four titles on Page 2 refers to a specific soft key in the Synchroniser Menu. All the parameters can also be set by remote control.

Status Display Pages 3 and 4

These pages contain data on the incoming trigger signal frequency, under the six headings given below. The data is also available externally by means of the “?SF” Command. The maximum frequency that can be displayed in 65535Hz.

Heading	Meaning
INPUT FREQ	The value of the current input frequency.
MAX FREQ	The maximum frequency measured since lock was achieved.
MIN FREQ	The minimum frequency measured since lock was achieved.
START FREQ	The first frequency measured since lock was achieved.
STOP FREQ	The last frequency measured.
AVGE FREQ	The average of all the frequencies that have been measured, updated four times per second.

All these parameters are updated eight times per second for input trigger frequencies greater than 8 Hz. For trigger frequencies below 8 Hz they are updated once for every trigger pulse.

The information available from the Status registers is only valid whilst the Synchroniser is “on”, as the last readings will be retained even when the “off” state is asserted. The registers are automatically cleared when SYNC is turned off then on again; also by INITIALISE, RESET, and by Power-Up reset.

Note that although the data in the Status registers is automatically updated, the Status Display only changes when the Page is re-called; it does not provide a continuous monitor.

1.9 MEASURING HARMONICS: USE OF ORDER ANALYSIS

Section 1.5 above details the use of Ratio mode to measure at a harmonic of the input trigger frequency. The disadvantages of this mode, arising from its inability to phase lock to the trigger source, can be overcome by using Order Analysis instead of Harmonic Analysis:

1. Follow the procedure given in Section 1.7 above for establishing the Sync. Locked state, leaving RATIO set to 0 (i.e. 'off', its default state).
2. Set the HARMONIC soft key in the [ANALYSER COMMON] menu to 1 (its default state), and the ORDER soft key to the required harmonic (2 to 16).

The measurements obtained using Order Analysis benefit from the following advantages, compared to the Ratio mode/Harmonic Analysis method:

- a) Results are far more accurate because the 1250-works in phase locked mode. Hence, even long integration times may be selected to give accurate results.
- b) Phase information is meaningful because each measurement is made in phase locked mode.
- c) The full range of results can be obtained very much more rapidly, because in Order Analysis all sixteen harmonics are computed from a single measurement (see Chapter 5, Section 2.4 "Order").

Order Analysis cannot be used, however, at the same time as Autointegration, or when the trigger frequency exceeds 400Hz.

2 MODULATOR/DEMODULATOR UNIT 12502

2.1 INTRODUCTION

This optional unit must be fitted if the 1250 is to make measurements on ac carrier systems. The 1250 must contain Issue 04, or higher, software; the Issue may be determined by using Self Test (see Chapter 14, Section 2 "Self Test").

2.2 INSTALLATION

A 12502 ordered with a new 1250 will be installed and tested at the factory. When the 12502 is to be added to an existing 1250, installation and calibration must be carried out by a Solartron engineer.

2.3 CONNECTIONS

Two separate carriers can be employed, by using the Carrier 1 and 2 sockets on the rear panel.

2.4 SETTING UP

The schematic in Fig. 15.5 shows how the carrier signals can be switched within the 1250.

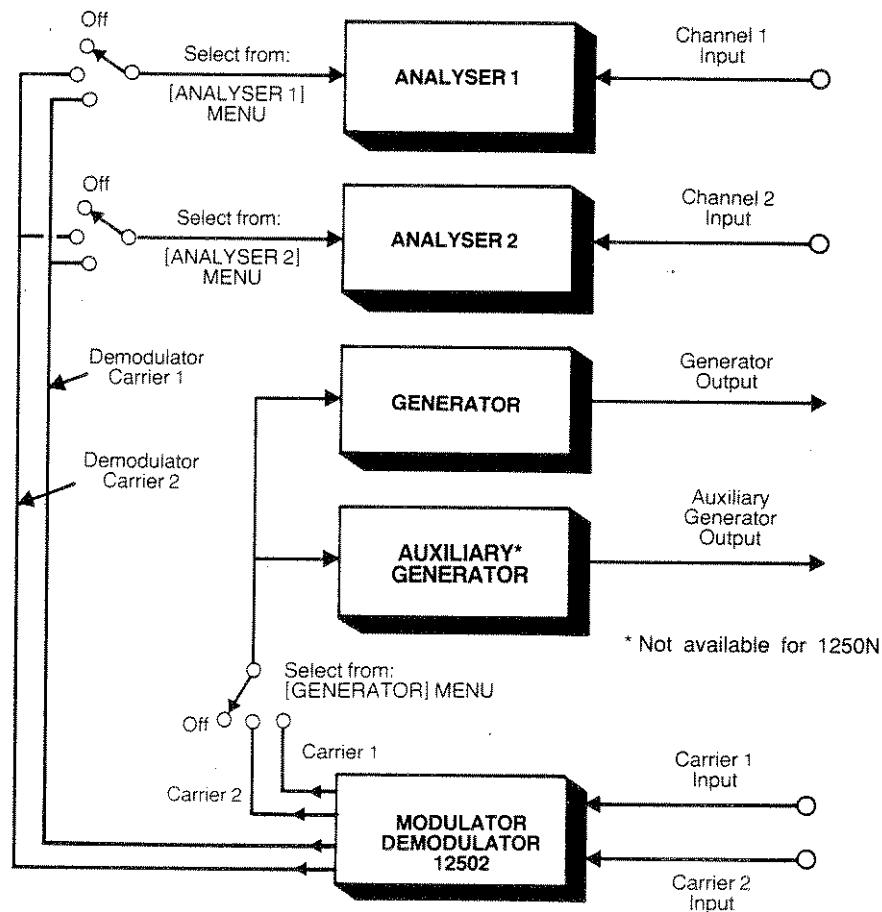

Fig. 15.5 Block Schematic of 1250 with 12502

The Generator and Auxiliary Generator are controlled together by the MOD soft key of the [GENERATOR]MENU, as shown in Chapter 8 "Menu Summary".

Analysers demodulation is controlled by the DEMOD soft key of [ANALYSER 1] or [ANALYSER 2]MENU, as shown in Chapter 8.

3 ANALOG PLOTTER INTERFACE 12503*

3.1 INTRODUCTION

An analog plotter is driven from the optional Plotter Interface 12503. With the 12503 installed a plotter is controlled using the menu and front panel keys as described in Chapter 12, Section 4 "X-Y Plotter". It is necessary that the 1250 has at least Issue 03 software; this may be determined by using Self Test (See Chapter 14, Section 2).

3.2 INSTALLATION

A 12503 ordered with a new 1250 is installed and tested at the factory. When the 12503 is to be added to an existing 1250 it is recommended that installation is done by a Solartron engineer. If this is not possible carry out the following procedure:

CAUTION: The General Safety Precautions listed in Section 2 of Chapter 2, "Installation", must be observed; in particular Precaution 6 relating to the opening of covers and removal of parts.

1. The 12503 module is a single printed circuit board bearing the number 12509524. Insert the module into the 1250 frame to occupy the 3rd slot from the power supply end. This slot is identified by socket SKE on the mother board. If the 3rd slot is already occupied it must be cleared by moving the existing occupant to the 4th slot.
2. With the 12503 in the 3rd slot the plotter output is obtained from Interface A plug at the rear panel. The corresponding sub-miniature D-type socket, supplied with 12503, should be wired as follows:

	Interface A Pin
X signal LOW	9
X signal HIGH	12
Y signal LOW	10
Y signal HIGH	11
Ground	4
Ground	5
Ground	13
Pen contact 2	24
Pen contact 1	25

The following three connections are provided specifically for Solartron 8700 Plotters:

Cart Y	2
<u>Cart X</u>	3
Mute servo	6

Note: The Gould Bryans 60020 Analog X-Y (A3) Recorder, part no. 8700D, is available from Solartron, together with an interface cable, part no. 12500239A suitable for connecting it to the 1250's rear panel Interface A.

* Not available for 1250N

3.3 PRESET CONTROLS

12503 carries two sets of 4 switches, close to the top edge, which may be accessed when the board is in the frame. The 'on' and 'off' positions of the switches are as shown:

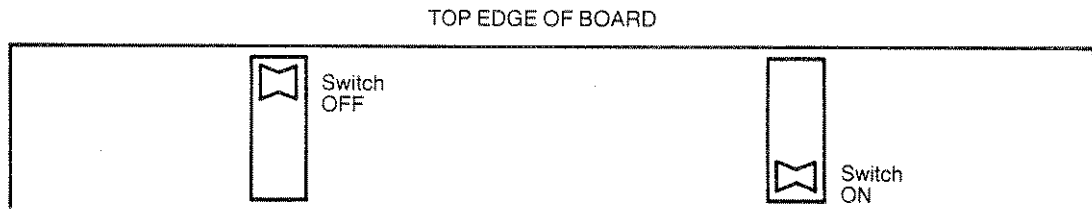

Fig. 15.6 Module 12503 switch positions

- a. **Point Mode.** Set switches S1A and S1B as shown for the different plotter speeds:

	Plotter Speed			
	>150cm/s	>100cm/s	>80cm/s	>30cm/s
S1A	on	on	off	off
S1B	off	on	off	on

- b. **Vector Mode.** Set switches S1C and S1D as shown for the different plotter accelerations:

	Plotter acceleration			
	>5000cm/s ²	>2000cm/s ²	>1000cm/s ²	>500cm/s ²
S1C	on	off	on	off
S1D	off	off	on	on

- c. **Pen Up/Down Delay.** Set switches S2C and S2D as shown for the different plotter pen delays:

	Delay			
	<40ms	<70ms	<170ms	<300ms
S2C	on	off	on	off
S2D	off	off	on	on

- d. **Pen Down Actuation**

If the plotter requires contact closure to give Pen Down, use pins 24 and 25 on Interface A connector.

If the plotter requires a line to be grounded to give Pen Down, set S2B to 'on' and use only pin 25 on Interface A connector.

3.4 SETTING UP AND PERFORMING A PLOT

The procedures to be followed are as given in Chapter 12, Section 4.2 onwards.

4 AUXILIARY GENERATOR UNIT 12506*

4.1 INTRODUCTION

There are three versions of the Auxiliary Generator, each synchronised to the main Generator:

- a. 12506A, which produces a cosine wave with respect to the main Generator's sine wave, and hence leads it by 90 degrees.
- b. 12506B, which produces a sine wave, in phase with the main Generator.
- c. 12506C, which produces a sine wave, 180 degrees out of phase with respect to the main Generator's sine wave. All three versions work with any issue of 1250 software.

4.2 DESCRIPTION

The 12506 consists of:

- a. A single printed circuit board, bearing a label on the component side showing the type number, e.g. 12506A and the serial number.
- b. A metal screening plate, with two M3 screws.
- c. A metal panel carrying two terminals, either 4 mm or BNC type, connected to a lead with a polarised two-pin plug on the other end.

4.3 INSTALLATION

A 12506 ordered with a new 1250 will be installed and tested at the factory. When the 12506 is to be added to an existing 1250, it is recommended that installation be performed by a Solartron engineer. If this is not possible, follow the procedure given below:

CAUTION: The General Safety Precautions listed in Section 2 of Chapter 2, "Installation", must be observed; in particular Precaution 6 relating to the opening of covers and removal of parts.

- a. Plug the 12506 pcb into sockets A4 and B4 of the 1250 Mother Board.
- b. Fix the metal screening plate alongside the pcb by means of the two M3 screws inserted into the tapped holes in the metal bars. The screening plate should now be covering sockets A5 and B5.
- c. Looking at the rear panel of the instrument, remove the first blanking panel on the left. This will reveal the title "AUXILIARY GENERATOR OUTPUT" and the words "HIGH" and "LOW".
- d. Fit the 12506 panel in place of the blanking panel such that, if 4mm sockets are present, the red socket aligns with the "HIGH" mark; or if BNC sockets are fitted, the one whose lead bears a red sleeve aligns with the "HIGH" mark.
- e. Plug the 12506 lead into the rear-most socket of the pair on the top edge of the 12506 pcb.
- f. As the unit has been calibrated at the factory, the pre-set controls on the pcb do not require adjustment.

* Not available for 1250N

4.4 SETTING UP

As the frequency of the 12506 is synchronised to the main Generator, there are only three soft keys to set, viz: AMPLITUDE, BIAS and WAVEFORM. These keys operate in a similar manner to the main Generator keys described in Chapter 4. There is no separate modulation facility; the main Generator MOD key controls both Generators.

NOTE: When modulating the output of the Auxiliary Generator, it is necessary to switch the modulation on with amplitude and bias both at zero. The amplitude and bias can then be set to the desired values.

Chapter 16

The 1251 Multichannel Analyser System

Contents

	<i>Page No.</i>	
1	Introduction	16.2
2	Description	16.2
3	System Configuration	16.2
3.1	1250-1251 Interface Bus	16.2
3.2	IEEE 488 Interface Bus	16.2
3.3	1250 Series Options	16.2
4	Connecting up	16.4
4.1	Safety: Connecting the ac Mains	16.4
4.2	Connecting up the 1250-1251 Interface Bus	16.4
5	1251 Unit Identification Switches	16.5
5.1	Analyser Channel Numbering	16.5
6	Manual Operation of the System	16.5
6.1	Introduction	16.5
6.2	Manual Setting up of the 1251 System	16.5
6.3	Setting up the 1251 Analysers	16.6
6.4	Displaying and Plotting data from the 1251 Analysers	16.6
6.5	Checking the Analyser and Display/Plotter Menu Settings	16.7
7	Remote Operation of the System	16.7
7.1	Introduction	16.7
7.2	GPIB Capability Code	16.7
7.3	Setting up the GPIB Configure Menu	16.8
7.4	Data Transfer Speeds	16.8
7.5	GPIB Output Buffers	16.8
7.6	GPIB Addresses	16.9
7.7	1251 Multichannel Analyser Output: Complete Block Format	16.9
7.8	ASCII Format	16.9
7.9	Dump Mode Format	16.10
8	1251 Multichannel Analyser Specification	16.11

1 INTRODUCTION

Used with the 1250 Frequency Response Analyser, the 1251 Multichannel Analyser System allows the number of analyser channels to be incremented to a maximum of 34 parallel channel. The 1251 system is not available with 1250N.

2 DESCRIPTION

The 1251 system consists of:

- a. Up to four individual free-standing 1251 Multichannel Analyser Units, each Unit accommodating a maximum of eight analyser channels. Inputs to the channels are via eight pairs of BNC sockets, marked HI and LO, mounted on the rear panel.
- b. Up to four lengths of ribbon cable with 25-way sub-miniature D-type connectors at each end, one cable per 1251 Unit. These cables together form the 1250-1251 Interface Bus, which connects the individual 1251 Units to each other and to the host 1250.

3 SYSTEM CONFIGURATION

The configuration of a complete multichannel frequency response measurement system is illustrated schematically in Fig. 16.1. The full system comprises four 1251 Units and a host 1250, providing a total of thirty-four input channels if required. The number of channels additional to the two in the 1250 can be varied anywhere between one and thirty-two, each group or part-group of eight extra analyser channels requiring an individual 1251 Unit.

3.1 1250-1251 INTERFACE BUS

The 1251 Units and the host 1250 are interconnected via the 1250-1251 Interface Bus as shown in Fig. 16.1. This bus is used to route all control commands from the 1250 to the 1251 Units; it can also route measured data from each 1251 Unit back to the 1250 for display or other processing or for onward transmission to the IEEE 488 Interface Bus via the IEEE 488 port of the 1250.

3.2 IEEE 488 INTERFACE BUS

In addition to the 1250-1251 Interface, each 1251 Unit contains its own IEEE 488 Interface port. This allows direct connection of the 1251 Unit to the IEEE 488 Interface Bus for the rapid transfer of measured data to a Controller. Details of data transfer speeds are given in Section 7.4.

3.3 1250 SERIES OPTIONS

Connecting the 1251 Units to a 1250 FRA does not affect the operation of any of the Options fitted in the 1250. In particular, each analyser channel of the 1251 System contains the demodulation facilities necessary for operation with a 1250 incorporating the 12502A Modulator/Demodulator Option Unit.

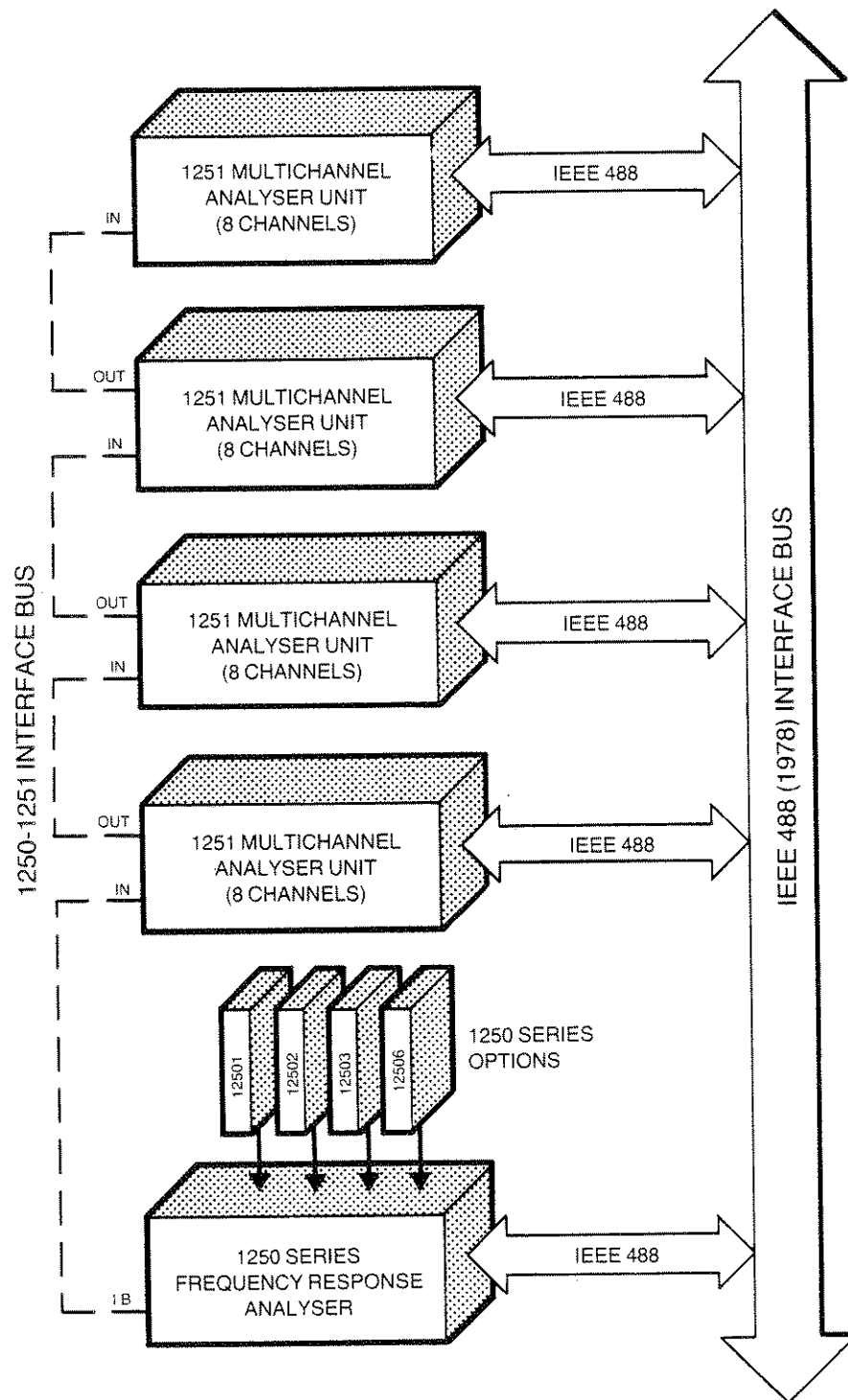

Fig. 16.1 1250/1251 Multichannel System Configuration

4 CONNECTING UP

4.1 SAFETY: CONNECTING THE AC MAINS

The safety precautions and connecting procedures given in Chapter 2 for the 1250 FRA apply equally to each of the 1251 Units.

Note: Setting the Unit Identification Switches. Before the system is switched on, the Unit Identification switches on the rear panel of each 1251 Unit in the system must be correctly set. Otherwise, measurements will be lost and circuits in the instruments may be overloaded. Section 5 describes how to set these switches.

4.2 CONNECTING UP THE 1250-1251 INTERFACE BUS

1. Plug the female connector on the ribbon cable into the **Interface B** connector on the rear panel of the 1250 FRA.
2. Plug the other end of the ribbon cable into the first of the 1251 Units, via the connector labelled **Control Interface In** mounted on the rear panel of each 1251 Unit, as shown in Fig. 16.2.
3. If a second 1251 Unit is to be used, plug the 25-way connector of another ribbon cable into the connector labelled **Control Interface Out** on the rear panel of the first 1251 Unit. Then connect the other end of this cable to the second 1251 Unit via its **Control Interface In** socket, as in step 2.
4. Connect up further 1251 Units in the same way.

Fig. 16.1 above shows which connections are used in the 1250-1251 Interface Bus. The host 1250 Interface B connector is labelled "IB"; the 1251 Control Interface In connectors are labelled "IN", and the Control Interface Out connectors are labelled "OUT".

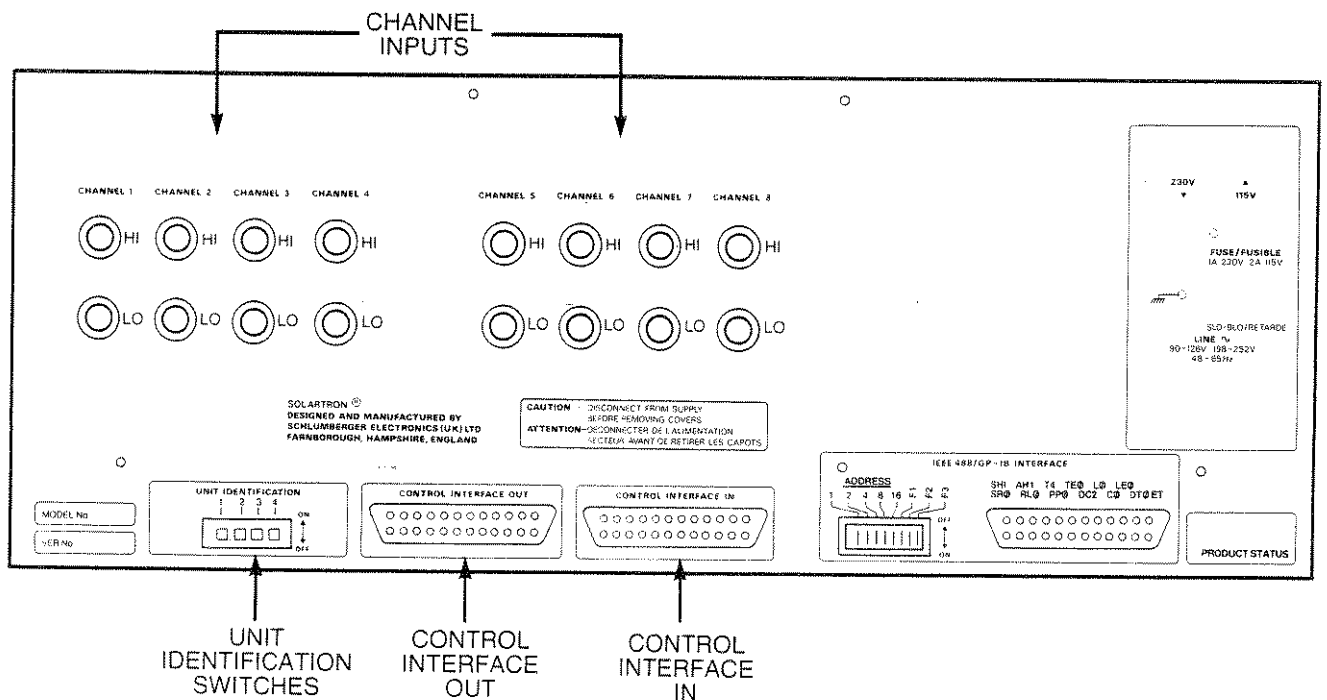

Fig. 16.2 1251 Rear panel

5 1251 UNIT IDENTIFICATION SWITCHES

There is a set of four switches (numbered 1 to 4) on the rear panel of each 1251 Unit, labelled **Unit Identification**, as shown in Fig. 16.2. Each 1251 Unit must have one of the four switches, and one only, in the ON (up) position. The number of the switch selected becomes the **Unit number**; this number must be different for each 1251 Unit, to enable the 1250 to distinguish between Units in the 1250-1251 Interface Bus and route data correctly to and from them.

The number chosen for each Unit need not be related to its position in the 1250-1251 Interface Bus, nor to the number of Units connected. So, for example, the sole 1251 Unit in an incomplete Multichannel Analyser System could be set at Unit number 4 if wished, even though Units 1, 2, and 3 are absent.

5.1 ANALYSER CHANNEL NUMBERING

Individual channels within each 1251 Unit are allocated numbers 1, 2, 3, 4, 5, 6, 7, and 8, by factory settings. If less than eight channels are fitted in a 1251 Unit, the channel numbering is sequential and starts at 1. When extra channels are required to be fitted, 1251 Units should be returned to Solartron.

The 'system number' of a channel has two digits: the first digit is the appropriate 1251 Unit number (1 to 4) and the second digit is the channel number within that Unit (1 to 8).

So, for example, channel number 7 in the 1251 Unit with Identification Switch set to number 2 has the system number:

ANALYSER (27)

6 MANUAL OPERATION OF THE SYSTEM

6.1 INTRODUCTION

The 1251 Multichannel Analyser System may be set up manually via the front panel keys of the host 1250 as described below.

Alternatively, the system operation may be commanded through a remote Controller connected to the IEEE 488 or RS 423 interface port of the 1250, as described in Section 7.

To operate the 1251 System manually the Analyser and Display/Plotter menus must be set up specifically for multichannel use, in addition to the setting up of the 1250 for conventional two-channel use.

6.2 MANUAL SETTING UP OF THE 1251 SYSTEM

Any menus already set up in the host 1250 are not affected by connecting it into the multichannel configuration.

Assuming that the system has been connected up and all Identification Switches set, proceed as follows:

1. Switch on all Units in the system, wait for at least one second, then press the BREAK key. Alternatively, press the Self Test key followed by any one of: CHECK, TEST, INIT, or RESET, if appropriate. This ensures that the 1250 has identified each 1251 Unit present in the system.

2. To check that all the 1251 Units present have been recognised correctly, press the STATUS key on the 1250, and then the ANALYSER soft key. Use the SELECT key to step through the pages of Analyser status information; only correctly recognised channel numbers will be displayed, and appear in the order Ch1, Ch2, Ch11 to Ch18, Ch21 to Ch28, Ch31 to Ch38, Ch41 to Ch48.

Missing channel numbers might be due to failure to press BREAK, incorrectly set Unit Identification Switches, improperly connected or faulty Interface Bus Cables, or to missing analyser boards.

3. Set up the 1250 for conventional two-channel operation, as described elsewhere in this manual.
4. Perform a Self Test to check that the system is functioning correctly. Chapter 14, Section 2, gives details.

6.3 SETTING UP THE 1251 ANALYSERS

1. Press the ANALYSER MENU key on the front panel of the 1250. The [ANALYSER COMMON] menu appears on the display.
2. Press the SELECT key repeatedly until the display shows:

```
[ANALYSER ( )] MENU
RANGE    DEMOD    COUPLING
```

3. Key in the appropriate two-digit channel number using the numeric keypad on the 1250 front panel and press ENTER. (Channel numbering is explained in Section 5.1).
4. Set up the RANGE, DEMOD, and COUPLING for the channel, using the normal keyboard entry procedures detailed in Chapter 5.

If nothing is entered, each analyser of the 1251 System adopts the default state:

```
RANGE      auto
DEMOM      off
COUPLING   dc
```

6.4 DISPLAYING AND PLOTTING DATA FROM THE 1251 ANALYSERS

To display or plot measured data from the Multichannel System, the DISPLAY/PLOTTER SOURCE must be set to the required channel(s).

1. Press the DISPLAY/PLOTTER MENU key on the front panel of the 1250. The [DISPLAY] menu appears, with soft keys SOURCE, CO-ORDS, and ERROR.
2. Press the SOURCE soft key, which results in the display:

```
SOURCE [Ch 1]
```

3. For display of data from a **single channel** of the Multichannel System, press the SELECT key until SOURCE [Ch ()] is reached.

Enter the appropriate two-digit channel number via the numeric keypad, and press ENTER.

4. To display data derived from any **two channels** of the measurement system, as a point-to-point (ratio) measurement, use the SELECT key until the display becomes:

SOURCE [Ch ()/Ch m]

5. Key in the numerator channel number, e.g. 47, and press ENTER. The display becomes:

SOURCE [Ch 47/Ch ()]

6. Now key in the denominator channel number, e.g. 32. The display shows the pair of channels selected as:

SOURCE [Ch 47/Ch (32)]

Press ENTER to input the selected channels.

6.5 CHECKING THE ANALYSER AND DISPLAY/PLOTTER MENU SETTINGS

After the ANALYSER and DISPLAY/PLOTTER menus have been set up, the STATUS key on the 1250 may be used to check the settings.

Chapter 11, Section 1, details the procedure and lists the order in which the pages of status information are displayed.

7 REMOTE OPERATION OF THE SYSTEM

7.1 INTRODUCTION

The command structure for operating the 1251 Multichannel Analyser System using an external Controller is identical to that used for 1250 remote operation. Details of the remote operating commands are given in Chapter 13

This section covers features peculiar to the remote operation of the 1251 System.

7.2 GPIB CAPABILITY CODE

The GPIB Interface in each 1251 'slave' Unit conforms to the following sub-functions within the IEEE 488-1978 standard, as listed on the rear panel:

SH1	Source Handshake, complete capability
AH1	Acceptor Handshake, complete capability
T4	Basic Talker
TE0	No Extended Talker capability
L0	No Listener capability
LE0	No Extended Listener capability
SR0	No Service Request capability (No Serial Poll)
RL0	No Remote/Local capability
PP0	No Parallel Poll capability
DC2	Device Clear capability, excluding Selective Device Clear
C0	No Controller capability
DT0	No Device Trigger capability
E1	Open Collector Drivers

7.3 SETTING UP THE GPIB CONFIGURE MENU

The GPIB is set up for remote operation from the GPIB CONFIGURE menu of the host 1250, accessed via the DATA OUTPUT key. Use of this key is fully explained in Chapter 12, Section 1. Configuring the 1250 for Service Request generation, Serial and Parallel Poll, is covered in Chapter 13, Sections 12 and 13; the 1251 Units do not affect this setting up process.

The selection of Output Separator and Terminator characters made on the 1250 reflects through all 1251 Units. The data output type on the 1251 is selected as follows:

1250 SELECTION	1251 OUTPUT
off	off
all	all
pass	all
fail	all
dump	dump

i.e. limit checks cannot be carried out on the 1251. To apply a limit check to data from a 1251 channel, the data must be output via the 1250.

Important: When the required GPIB configuration has been set up on the 1250, press the BREAK key on the front panel, or send the BREAK command via the GPIB Interface. Allow one second's delay before the next action, because BREAK resets the GPIB hardware in the 1250 and 1251 Units. This transfers the GPIB configuration settings to all 1251 Units, via the 1250-1251 Interface Bus.

7.4 DATA TRANSFER SPEEDS

The maximum data transfer rate across the GPIB port of the 1250 is approximately 1000 characters (bytes) per second, whereas a 1251 Unit achieves a rate of approximately 100,000 characters per second.

For the sake of speed, readings are always automatically output in blocks of eight channels even if not all eight channels are fitted. Missing channels output results of 'zero'. The software in the external Controller must select the required data from the standard fixed-format blocks presented to it by the 1251 Unit.

7.5 GPIB OUTPUT BUFFERS

The operation of reading data from the GPIB output buffer is also different in the 1251 compared to the 1250 Unit.

In the 1250, once data has been read from the GPIB output buffer, it is not possible to access the buffer again until new data is available. This allows the Controller to wait for new data by holding on a READ statement.

In the 1251 Unit, however, data in the GPIB output buffer can be accessed repeatedly, which could cause old data to be read into the Controller. To ensure that this does not happen, the 1250 may be configured to generate a Service Request when new data is available. The Controller then waits for Service Request before reading data from the 1251 Units. The 1251 data changes only when a new measurement is taken (i.e. via Single) or when the "order" is changed.

7.6 GPIB ADDRESSES

Viewed from a Controller, the host 1250 and the 1251 'slave' Units all appear as separate instruments in that they have different GPIB addresses. However, whilst the GPIB address of the 1250 can be either of two values (the Major and Minor addresses) depending on the output mode adopted, a 1251 Unit has only one address whether operating in ASCII or DUMP Output (binary) mode. Section 5.1, Chapter 13, explains the dual address system.

7.7 1251 MULTICHANNEL ANALYSER OUTPUT: COMPLETE BLOCK FORMAT

Like the 1250, the 1251 Unit outputs its measurements via the GPIB in two forms: ASCII format, or DUMP mode (fast binary) format. The 1250 and 1251 formats are very similar, but differ slightly because the 1251 format corresponds to a block of eight readings, whereas each 1250 output is a single reading.

The general format of a complete eight-channel block of 1251 readings, whether in ASCII or DUMP mode is:

frequency $\underbrace{\quad a \quad b \quad \text{error code} \quad}_{\text{channel 1}} \quad \underbrace{\quad a \quad b \quad \text{error code} \quad}_{\text{channel 2}} \quad \dots \quad \underbrace{\quad a \quad b \quad \text{error code} \quad}_{\text{channel 8}}$

Data from the 1251 GPIB ports are always represented in the Cartesian coordinate system (a = real component, b = imaginary component). However they may be displayed on the 1250 front panel, or output through its ports, in any of the three available coordinate systems.

7.8 ASCII FORMAT

In the ASCII format each measurement parameter is output as 11 characters (bytes), comprising a 5-digit fixed point part and polarity sign, and a 2-digit exponent with polarity sign; this is exactly as for the 1250 ASCII format (see Chapter 13, Section 12.3).

i.e. $\pm n . n n n n E \pm n n$

The error code format is always a single character, which takes the value of ASCII "1" when the Analyser is overloaded, and ASCII "0" otherwise. Other Analyser error codes to do with Autointegration and Amplitude Compression are signalled by the 1250.

In the complete eight-channel data block each parameter is marked off by an Output Separator (e.g. comma), and the complete block is terminated with an Output Terminator (e.g. cr). A complete block of output takes the form:

$\pm f . f f f f E \pm f f , \pm a_1 . a_1 a_1 a_1 a_1 E \pm a_1 a_1 , \pm b_1 . b_1 b_1 b_1 b_1 E \pm b_1 b_1 , e_1 , \dots \dots$
 $\pm a_8 . a_8 a_8 a_8 a_8 E \pm a_8 a_8 , \pm b_8 . b_8 b_8 b_8 b_8 E \pm b_8 b_8 , e_8 \text{ cr}$

where f represents the measurement frequency digits, and a_n, b_n, e_n represent the nth channel's measurement coordinates and error code respectively.

As with the 1250, the Output Terminator (e.g. cr) may be sent after each parameter if required by setting the Output Terminator to be the Output Separator.

7.9 DUMP MODE FORMAT

DUMP mode, in which results have been compressed into a binary form to occupy fewer bytes, is the fastest way to output data from a 1251 Unit.

Each measurement parameter consists of 4 bytes, compared to the 11 needed for ASCII format. The error code format is, like the ASCII format, a single character which in DUMP mode takes the value 1 to signify the overload condition, and 0 otherwise.

Chapter 13, Section 12.5, explains in detail how to decode the four parameter bytes from binary into decimal notation. This decoding yields seven significant figures for each parameter compared to the five given by the ASCII format; so DUMP mode is also more precise.

The complete eight-channel data block output by the 1251 in DUMP mode takes the form:

f f f f a₁ a₁ a₁ a₁ b₁ b₁ b₁ b₁ e₁ a₂ a₂ a₂ a₂ b₂ b₂ b₂ b₂ e₂ a₈ a₈ a₈ a₈ b₈ b₈ b₈ b₈ e₈

using the usual notation.

Output Separators and Output Terminators are not sent, although EOI (End or Identify) is automatically asserted simultaneously with the last byte if the appropriate Output Terminator has been selected (Chapter 12, Section 1). Appropriate Output Terminators are either cr+EOI, or crlf+EOI, chosen during the setting up of the 1250 GPIB CONFIGURE Menu (Section 7.3).

8 1251 MULTICHANNEL ANALYSER SPECIFICATION

Slave analyser system, operating in conjunction with 1250 Frequency Response Analyser. Up to four 1251 units may be used with each FRA, with each 1251 containing between one and eight analyser channels, operating in parallel.

ANALYSER

Specifications as for 1250 FRA except as shown below.

Input configuration

Connection: differential, rear input

INTERFACE

GPIB port IEEE 488 (1978)

Addressable talker to output results in $a + jb$ format.

1250 interface used to select analysis parameters.

Functions implemented: SH1, AH1, T4, TE0, L0, LE0, SR0, RL0, PP0, DC2, C0, DT0, E1

GENERAL

Power supply: switch selected, 90 to 126V or 198 to 252V
 consumption, with 8 analysers: 100VA
 with 1 analyser: 50VA

Environment: as 1250

Dimensions: height: 176mm (6.93 ins)
 width: 432mm (17.00 ins)
 depth: 526mm (20.71 ins)
 weight, with 8 analysers: 18kg
 weight, analyser channel only: 0.4 kg

RESULTS

Specification as for 1250 FRA except as shown below.
 Single point from any 1251 channels fitted:

unit 1	11 to 18	unit 3	31 to 38
unit 2	21 to 28	unit 4	41 to 48

Point-to-point from:

<u>any 1251</u>	or	<u>any 1250</u>	or	<u>any 1251</u>
any 1251		any 1251		any 1250

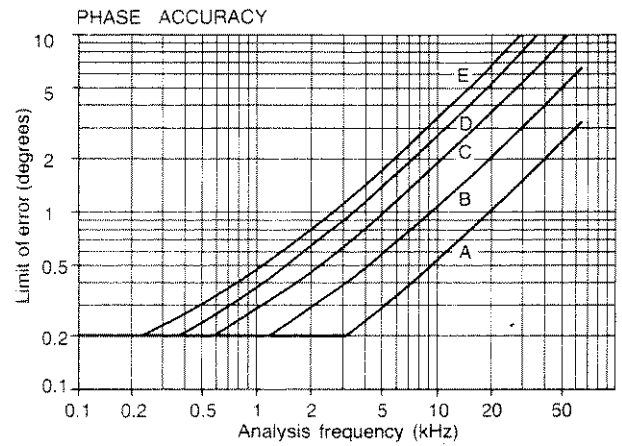

Phase accuracy curve	A	B	C	D	E
No. of inter-unit links in 1250/1251 interface bus	0	1	2	3	4

Chapter 17

Specification

www.valuetronics.com

ANALYSER

1250: Two independent channels operating in parallel

Nominal Range	Sensitivity		Full-scale peak input	Com. Mode rejected
	Integration <100ms	Integration ≥100ms		
30mV	10μV	1μV	50mV	30V
300mV	100μV	10μV	500mV	30V
3V	1mV	100μV	5V	30V
30V	10mV	1mV	50V	500V
300V	100mV	10mV	500V	500V

Maximum input, Hi or Lo to ground: 500V peak
300V rms

Input configuration

Connection: differential, front or rear
Coupling: dc or ac (<1dB at 2.5Hz)
Impedance: Hi or Lo to ground: 1MΩ
front sockets: <70 pF
rear sockets: <100 pF
Common mode rejection, dc coupling, up to 100Hz:
up to 50V peak: >65dB
over 50V peak: >60dB
Cross channel isolation,
1kΩ across inputs, up to 10kHz: >100dB

Integration time:

minimum: the longer of 1 cycle or 10ms
maximum: 10⁶ cycles or 10⁵s

Auto-integration:

minimum: the longer of 3 cycles or 1.5s
maximum: the programmed integration time

Variance in results, at 90% confidence:

long integration (signal >0.02% range): <1%
short integration (signal >0.2% range): <10%

Measurement delay

Variable from zero to 10⁶ cycles or 10⁵s.

RESULTS

Single channel or point-to-point

Processing, applicable to any of above:

Multiplication by $(j\omega)^n$ where $n = \pm 1$ or ± 2 .
Division by a vector, specified as $a + jb$ or r, θ
or as last displayed result

Limit check: high and low on a or b or r or $\log r$ or θ
pass or fail accepted

History file: stores up to 450 results after processing and limit check.
outputs result with further limit check.

Forms of results: $a + jb$ or r, θ or $\log r, \theta$

Resolution: a, b and r : *5 digits + exponent
 $\log r$: 0.01 dB
 θ (degrees): 0.01°
 θ (radians): 0.1 mrad

*Single channel, unprocessed, results are displayed as volts or millivolts. When integration is <100ms these are resolved to 4 digits.

Accuracy, ambient temperature $20 \pm 10^\circ\text{C}$.

All ranges, integration >200ms, input >10% full scale.

Data valid for 1 year after calibration.

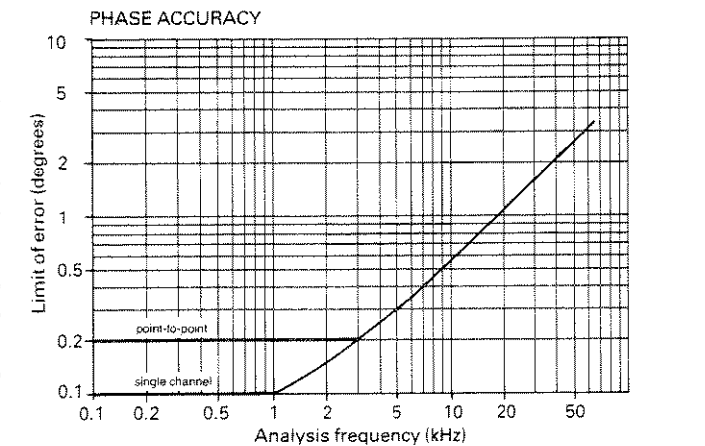
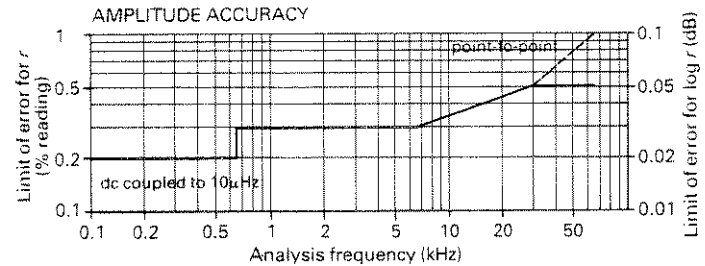

1250 converts from one co-ordinate form to another with negligible arithmetic error.

GENERATOR

Identical specifications apply to the optional additional sine (12506B and C) and cosine (12506A) generators. These options not available with 1250N.

	Range	Max Resolution	Error
Frequency	10μHz to 65.535kHz	1 in 65536	<0.01%
Amplitude	10mV to 1.023V	1 in 1024	<1% ± 1mV
	(10mV to 1.100V)	1 in 2048	<1% ± 0.5mV)†
	1.023V to 10.23V	1 in 1024	<1% ± 10mV
	(1.100V to 11.00V)	1 in 2048	<1% ± 5mV)†
Bias	- 10.23V to + 10.23V	1 in 1024	<1% ± 10mV

Output is short-circuit proof.

Maximum output (bias + signal): 15V (21V†) peak
Output impedance: 50Ω (<2Ω†) + 2%
Maximum voltage, Lo to ground: 150V
Impedance, Lo to ground: 100kΩ, <100pF

Waveform: sine, square, or triangle
Distortion, for sinewave: <1%
Stop control: immediate, or at 0°, 90°, 180° or 270°
Stop input: contact closure or TTL logic 0

Sweep: logarithmic, up or down
linear, up or down
harmonic

Maximum load capacitance†: 1nF
Maximum load inductance†: 10μH

† For 1250N

PLOTTING

General

Data source:	single channel or point-to-point
Parameters, X or Y axis:	a, b or r log r (dB) θ (degrees) f (linear scale) f (log scale)
Type of Plotter:	analog* or digital (GPIB)
Type of plot	point (separate points) vector (joined points)
Plot size:	A3 or A4 or adjustable in 0.025mm steps

Digital plotting

Compatible with Enertec-Schlumberger and Hewlett-Packard plotters.	
Interface:	built-in IEEE 488

Analog plotting*

Interface:	option 12503
Connector:	D-type, 25 way
X, Y drives, bottom left:	0V, 0V
top right:	10V, 10V
Pen drop delay selectable:	0.4, 0.6, 0.8 or 1.2s

SYNCHRONISER*

Input configuration

Connection:	differential, rear terminals
Coupling:	dc or ac (<3dB at 3Hz)
Impedance, Hi or Lo to ground:	>200k Ω , <100 pF
Common mode rejection, dc coupling, up to 100Hz:	>50dB
maximum rejected:	20V
Maximum input, Hi or Lo to ground:	350V peak, 250V rms

Synchronisation

Frequency range:	1mHz to 65kHz
Sensitivity:	0.25V
Level adjustment:	\pm 5V in steps of 0.02V
Time to synchronise:	the longer of 4 cycles or 500ms

MODULATOR-DEMODULATOR

Input configuration

Two independent carrier inputs.	
Connections:	differential, rear terminals
Coupling:	ac
Impedance, Hi or Lo ground:	>100k Ω , <100 pF
Common mode rejection, up to 100Hz:	>50dB
Maximum common mode:	300V
Maximum input, Hi or Lo to ground:	350V peak, 250V rms

Carriers 1 and 2

Frequency range:	48Hz to 20kHz
Voltage range:	6V to 250V rms

Generator output

May modulate either Carrier 1 or Carrier 2.	
Carrier phase shift, 50Hz to 300Hz:	<3°
300Hz to 3kHz:	<1°
3kHz to 20kHz:	<6°

Analysers

Either carrier may demodulate any analyser.	
Quadrature rejection, 1250:	>26dB
1251:	>14dB

Limits of error, when demodulating:

Mod frequency = 0.05 \times carrier. Input > 10% full scale, integration 200ms.	
r (% reading):	<0.5
log r (dB):	<0.05
θ , single channel (degrees):	<0.5
θ , point-to-point (degrees):	<1

INTERFACES

Serial port	standard fittings compatible with RS423 and RS232
Selectable data rates:	110, 150, 300, 600, 1200 2400, 4800, 9600 baud

GPIB port

Fully programmable talker/listener.	
Switch selected talk only.	
Maximum data rate:	1000 bytes/s
Functions implemented:	SH1, AH1, T5, TE0, L4, LE0, SR1, RL1, PP2, DC1, C0, DT0

GENERAL

Power supply:	switch selected, 90 to 126V or 198 to 252V 48 to 65Hz
consumption, with no options:	120VA
with all options:	200VA

Memory battery, charged when mains is on:	
discharge time:	>100 hr
charge, from fully discharged:	<12 hr

Environment: temperature, operating:	0 to 50°C
storage:	-30 to 70°C
temp for specified limits:	20 \pm 10°C
humidity, non-condensing:	95%

Dimensions: height:	176mm (6.93ins)
width:	432mm (17 ins)
depth:	573mm (22.56 ins)
weight:	18 kg (40 lbs)

* Not available with 1250N

Subject

- 1250 Command Codes, 13.8
- 1250 Series Option, 16.2
- 1250-1251 Interface Bus, 16.2
- 1251 ASCII Format, 16.9
- 1251 Analyser, Setting up, 16.6
- 1251 Connecting up, 16.4
- 1251 Data Transfer Speeds, 16.8
- 1251 Dump Mode Format, 16.10
- 1251 GPIB Addresses, 16.9
- 1251 GPIB Capability Code, 16.7
- 1251 GPIB Output Buffers, 16.8
- 1251 Manual Operation of the System, 16.5
- 1251 Multichannel Analyser Output: Complete Block Format, 16.9
- 1251 Multichannel Analyser System, 16.2
- 1251 Multichannel Analyser Specification, 16.11
- 1251 Remote Operation of the System, 16.7
- 1251 Safety: Connecting the ac Mains, 16.4
- 1251 Setting up the GPIB Configure Menu, 16.8
- 1251 Unit Identification Switches, 16.5

- Accessories, 2.4
- Address Switches, 13.6
- Amplitude, 4.4
- Amplitude Compression, 9.5
- Amplitude Compression Commands, 13.11
- Analog Plotter Interface 12503, 15.13
- Analog Plotter: Setting Up and Performing a Plot, 15.14
- Analyser Channel Numbering, 16.5
- Analyser Commands, 13.11
- Analyser Common Menu, setting, 5.2
- Analyser; Stop and Break Keys, 5.8
- Analysers, individual setting, 5.6
- Angle Information, 10.3
- Auto Integration, 5.4
- Auxiliary Generator Commands, 13.11
- Auxiliary Generator Unit 12506, 15.15

- Bias, 4.4
- Bode and Nyquist Plots, 12.19
- Break Key, 14.2

- Changing Menus during Recycle, 5.8
- Channel and Range Column Conventions, 12.6
- Clear Key, 4.4
- Co-ordinates, 7.3
- Command Code Format, 13.9
- Command Query, 13.19
- Commands in Alphabetical Order, 13.16

Commands, Miscellaneous, 13.15
Controller Program for Copying the File to the GPIB, 13.31
Controller Program for Transferring Learnt Programs, 13.29
Coupling, 5.6

Data Flow Schematic, 10.8
Data Output Commands, 13.14
Data Output Key, 12.2
Delay, 5.3
Delay, implementation, 5.8
Demod, 5.6
Display Commands, 13.12
Display menu: Introduction, 7.2
Dump Mode, 13.23

Earthing Safety Precautions, 2.3
End of Sweep Conditions, 6.4
Error 21, 6.6
Error 84, 9.8
Error Codes, 11.9
Error Codes: Details, 11.11
Error Codes: Group 0. Errors Pertaining to Command Structure, 11.11
Error Codes: Group 1. Errors Pertaining to the Learnt Program, 11.12
Error Codes: Group 2. Parametric Interaction Errors, 11.12
Error Codes: Group 3. Generator Warnings and Errors, 11.12
Error Codes: Group 4. Learnt Program, File, and Variable, 11.13
Error Codes: Group 5. Missing Boards, 11.13
Error Codes: Group 6. Illegal I/O Manipulation, 11.14
Error Codes: Group 7. System Errors, 11.14
Error Codes: Group 8. Measuring Validity is Suspect, 11.14
Error Messages Displayed during Program Running, 12.13

Facilities, 1.4
File, 12.7
File Commands, 13.13
File Output, 13.30
File Size, Maximum, 12.7
File Size, Selecting, 12.7
File output via GPIB Port, 13.30
File output via RS423 Port, by External Command, 13.30
File, Overwriting results in, 12.7
File, Starting, 12.8
File, Use of, 9.8
Fitting Telescopic Slide Mounting Kit 12505B (Accuride), 2.5
Fitting Telescopic Slide Mounting Kit 12505C (Jonathan), 2.10
Floating Point Format, 13.23
Frequency, 4.3
Function Commands, 13.15
Function Key, 10.2
Function Key Summary, 10.7

GPIB Capability Code, 13.3
GPIB Configure, 12.6
GPIB Connections, 13.4
GPIB Controller: Language Used in Program Examples, 13.19
GPIB Normal Mode, 13.22
GPIB Plotter operation, using a Controller, 13.32
GPIB Plotting, 13.31

GPIB Switch Example, 13.6
GPIB Switches, 13.5
GPIB Talk Only Mode, 13.21
General Information, Introduction, 1.2
Generator Commands, 13.10
Generator Menu setting, 4.2
Generator Output Limit, 9.7
Generator Overload Protection, 4.7
Generator Start Key, 4.5
Generator Stop @ Key, 4.6
Generator Stop Key, 4.5
Generator Stopping, 4.5
Generator Waveform Starting Point, 4.5

Harmonic, 5.3
Harmonic Sweep, 6.5
Harmonics: Use of Order Analysis, 15.11
Heading, 12.3

IEEE 488 Interface Bus, 16.2
Initialising, 3.3
Input, 5.6
Input Command Terminator Character Switches, 13.6
Instrument Essentials, 1.3
Integral Time, 5.2

Learnt Programs: External Storing and Reloading, 13.27
Limits, 10.6
Linear Sweep, 6.2
Loading a Learnt Program into the 1250, via RS423 Port, 13.28
Loading a Learnt Program into the 1250, via GPIB Port, 13.28
Local Lock-Out, 13.7
Logarithmic Sweep, 6.2
Logarithmic or Linear Sweep, setting up, 6.3
Looping and Calling, 12.12

Mains Connecting, 2.3
Measurement Output Format, 13.21
Measurement Output Rate, 13.21
Measurement Output Selection, 13.20
Measurement Start, 5.7
Measurement Start Point, 5.8
Measuring Set-Up, Basic, 1.2
Menu Changes Activating the Heading and Reformat Functions, 12.5
Menu Summary, 8.2
Mini Status Display, 7.4
Modulated Carrier, 4.4
Modulator/Demodulator Unit 12052, 15.12
Multichannel Analyser System, 1251, 16.2
Multiplication Factors: $\times \omega^n$, 10.4

Options: General Information, 1.6
Order, 5.4
Output Terminators and Separators, 13.24
Overload Protection, Generator, 4.7

Parallel Poll, 13.26
Parallel Poll and Poll Sense, 12.6

- Pen Selection with Two-Pen Plotters, 12.21
- Plot Scaling Menu, 12.17
- Plotter, 12.14
- Plotter Commands, 13.12
- Plotter Common Menu, 12.15
- Plotter X-axis and Plotter Y-axis Menus, 12.16
- Plotting, 12.18
- Plotting Data from the File, 12.21
- Plotting Field, adjusting to suit Preprinted Chart Paper, 12.20
- Power Fail, 14.5
- Program Commands, 13.14
- Program Pause/Continue Key, 12.12
- Program, Editing from an External Device, 12.12
- Program, Editing from the Front Panel, 12.12
- Program, Executing, 12.11
- Program, Learning from an External Device, 12.10
- Program, Learning from the Front Panel, 12.9
- Programs, Learnt, 12.9

- REMOTE/LOCAL Facility, 13.6
- RS423 Baud Rate, 13.4
- RS423 Input Command Terminator Character, 13.4
- RS423 Port, Character Device Control/s, 13.27
- RS423 and GPIB Devices, Combinations, 13.32
- RS423/GPIB Commands, 13.14
- Rack Dimensions, 2.5
- Rack Mounting, 2.4
- Range, 5.6
- Reformat, 12.4
- Reloading a Learnt Program to 1250 via GPIB, 13.29
- Resetting, 3.4

- Safety Precautions: Installation, 2.2
- Scaling, 10.5
- Self Test, 14.2
- Self Test Commands, 13.16
- Serial Poll, 12.6
- Serial Poll/Parallel Poll, 13.25
- Sources, 7.3
- Status Commands, 13.13
- Status Display: Generator, 4.4
- Status Key, 11.2
- Status, Main, 11.3
- Status, Other, 11.5
- Status: Printed Record, 11.8
- Stop @ Key, Application, 4.6
- Storing a Learnt Program Externally, via RS423 Port, 13.28
- Sweep Commands, 13.12
- Sweep Idle or Hold Status, Commands producing, 6.5
- Sweep Stop Status, Commands producing, 6.4
- Sweep Termination Conditions, 6.6
- Sweep Time, Automatic, 6.3
- Sweep, Stopping and Re-starting, 6.4
- Sweep: Changing Parameters in Mid-Sweep, 6.5
- Switch On, 3.2
- Sync. Locked State, Establishing, 15.8
- Synchroniser Commands, 13.10

Synchroniser Menu, 15.5
Synchroniser Status, 15.9
Synchroniser Unit 12501, 15.2
Synchroniser: Modes of Operation, 15.3

Talk Only Switch, 13.6
Terminator and Separator, 12.6
Time Display, 14.4

Variable Commands, 13.13
Variable Key, 9.2
Variable with the Generator STOP @ Key, 9.4
Variable: Method 1, With Analysers Stopped, 9.2
Variable: Method 2, With Analysers Running, 9.3
Ventilation, 2.5

Waveform, 4.2

X-Y Plotter, 12.14

1.520