

Digital Oscilloscope
Waveform Generator
DC Power Supply
DC Electronic Load
Digital Multimeter
RF Signal Generator
Spectrum Analyzer
Real-Time Spectrum Analyzer
Spectrum & Vector Network Analyzer
Handheld Oscilloscope
Probes & Accessories

SIGLENT TECHNOLOGIES PRODUCT CATALOG



CATALOG

Company Profile	2
SDS5000X Super Phosphor Oscilloscope	3
SDS2000X Plus Super Phosphor Oscilloscope	8
SDS2000X Super Phosphor Oscilloscope	13
SDS2000X-E Super Phosphor Oscilloscope	18
SDS1000X / SDS1000X+ Super Phosphor Oscilloscope	23
SDS1000X-E Super Phosphor Oscilloscope	27
SDS1000DL+/CML+ Digital Storage Oscilloscope	31
SDG6000X Pulse/Arbitrary Waveform Generator	33
SDG2000X Function/Arbitrary Waveform Generator	40
SDG1000X Function/Arbitrary Waveform Generator	45
SDG800 Function/Arbitrary Waveform Generator	49
SPD3303 Programmable Linear DC Power Supply	51
SPD1000X Programmable Linear DC Power Supply	53
SDL1000X DC Electronic Load	56
SDM3065X Digital Multimeter	60
SDM3055 Digital Multimeter	63
SDM3045X Digital Multimeter	66
SSG5000X RF Signal Generator	69
SSG3000X RF Signal Generator	73
SSA3000X Spectrum Analyzer	77
SSA3000X Plus Spectrum Analyzer	80
SSA3000X-R Real-Time Spectrum Analyzer	84
SVA1000X Spectrum & Vector Network Analyzer	88
SHS1000 Handheld Digital Oscilloscope	92
SHS800 Handheld Digital Oscilloscope	95
Probes & Accessories	97
Service	102

SIGLENT TECHNOLOGIES Co., Ltd.

The Best Value in Electronic Test & Measurement.

SIGLENT has been providing test & measurement solutions for almost 18 years from its headquarter in Shenzhen, China. There are more than 300 employees, one third of whom are high-educated R&D engineers.

SIGLENT has many patent technologies. We are dedicated to develop sophisticated and high quality digital oscilloscopes, waveform generators, RF signal generators, handheld digital oscilloscopes, spectrum analyzers, vector network analyzers and DC power supplies, DC Electronic Loads, digital multimeters. We strive to deliver the highest quality of customer service and satisfaction to our customers.



SIGLENT provides the following instruments:

- Digital Oscilloscope
- Waveform Generator
- DC Power Supply
- DC Electronic Load
- Digital Multimeter
- RF Signal Generator
- Spectrum Analyzer
- Spectrum & Vector Network Analyzer
- Handheld Oscilloscope
- Probes & Accessories

SIGLENT sincerely invite you to join

Please email :

sales@siglent.com





SDS5000X Super Phosphor Oscilloscope

Key Features

- 1 GHz, 500 MHz, 350 MHz models with real-time sampling rate up to 5 GSa/s
- SPO technology
 - Waveform capture rate up to 110,000 wfm/s (normal mode), and 500,000 wfm/s (sequence mode)
 - Supports 256-level intensity grading and color temperature display modes
 - Record length up to 250 Mpts
 - Digital trigger system
- Intelligent trigger: Edge, Slope, Pulse Window, Runt, Interval, Dropout, Pattern, Qualified and Video (HDTV supported)
- Serial bus triggering and decoder, supports protocols I²C, SPI, UART, CAN, LIN, CAN FD, FlexRay, I²S and MIL-STD-1553B
- Low background noise, supports 0.5 mV/div to 10 V/div voltage scales
- Segmented acquisition (Sequence) mode, dividing the maximum record length into multiple segments (up to 100,000), according to trigger conditions set by the user, with a very small dead time segments to capture the qualifying event
- History waveform record (History) function, the maximum recorded waveform length is 100,000 frames
- Automatic measurement function on more than 70 kinds of parameters, supports statistics, Gating measurement, Math measurement, History measurement and Ref measurement
- Math function (2 Mpts FFT, addition, subtraction, multiplication, division, integration, differential, square root)
- Search and Navigate
- Digital Voltmeter
- High Speed hardware-based Average, ERES (Enhanced Resolution)
- 16 digital channels (optional) with maximum waveform capture rate up to 1.25 GSa/s, record length up to 62.5 Mpts
- 25 MHz function / arbitrary waveform generator, built-in multiple predefined waveforms
- Large 10.1" TFT-LCD display with 1024 * 600 resolution; Capacitive touch screen supports multi-touch gestures
- Supports external mouse and keyboard
- 10 types of one-button shortcuts
- Multiple interfaces: USB Host, USB Device (USBTMC), LAN (VXI-11, telnet, socket, web), Pass / Fail, Trigger Out, 10 MHz In, 10 MHz Out, VGA output
- Built-in web server supports remote control by the LAN port using a web browser
- Supports SCPI remote control commands

Characteristics

- 10.1" TFT-LCD display with capacitive touch screen



- 10.1" display with 1024*600 resolution
- Capacitive touch screen, supporting multi-touch gestures, can move or scale the waveform traces quickly by finger-touch movements, which greatly improves the operation efficiency.

- Record Length of up to 250 Mpts/ch

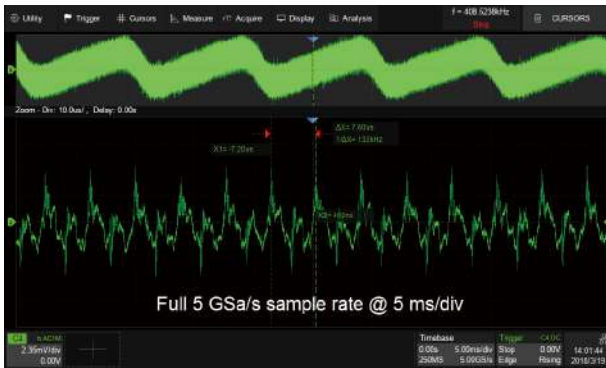

Using hardware-based Zoom technique and record length of up to 250 Mpts, users are able to select a slower timebase without compromising the sampling rate, and then quickly zoom in to focus on the area of interest

- Serial Bus Decode

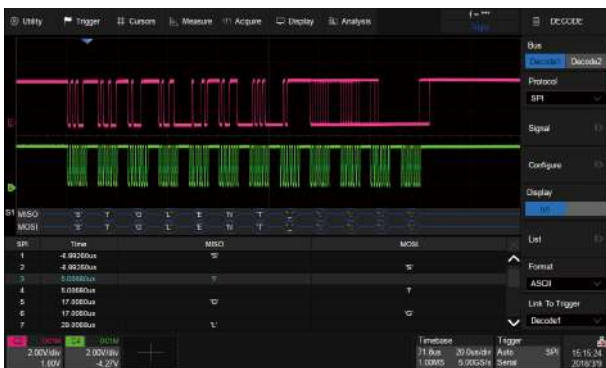

Display the decoded characters through the events list. Bus protocol information can be quickly and intuitively displayed in tabular form. I2C, SPI, UART, CAN, LIN, CAN FD, FlexRay and I2S and MIL-STD-1553B are supported

- Zone Trigger

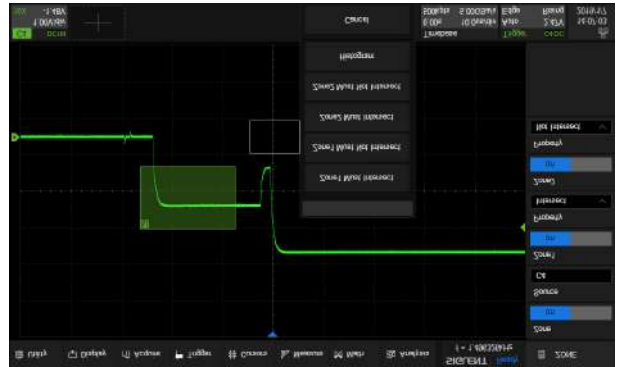

Zone Trigger is available for advanced triggering

- Multiple Trigger Functions

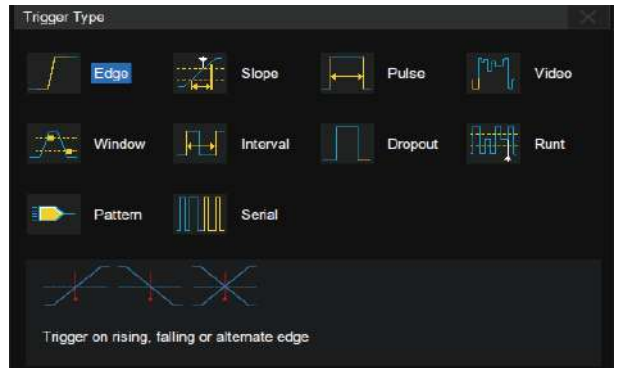

Edge, Slope, Pulse, Video, Windows, Runt, Interval, Dropout, Pattern, Qualified, Nth edge, Setup/hold, Delay and serial trigger

- Measurements of a Variety of Parameters

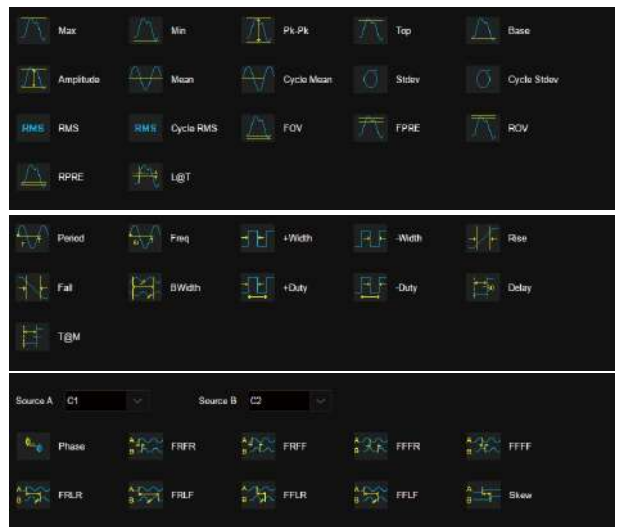

Parameter measurements includes 3 categories: horizontal, vertical and CH delay providing more than 70 different types of measurements. Measurements can be performed within a specified gate period. Measurements on Math, Reference and History frames are supported

• Advanced Math Function



In addition to the traditional (+, -, X, /) operations, FFT, integration, differential, square root and so on are supported. Formula Editor is available for more complex operations. 2 math traces are available.



Hardware accelerated FFT supports up to 2 Mpts operation. This provides high frequency resolution with a fast refresh rate. The FFT function also supports a variety of window functions so that it can adapt to different spectrum measurement needs. Three modes (Normal, Average and Max hold) can satisfy different requirements for observing the power spectrum

• Sequence Mode

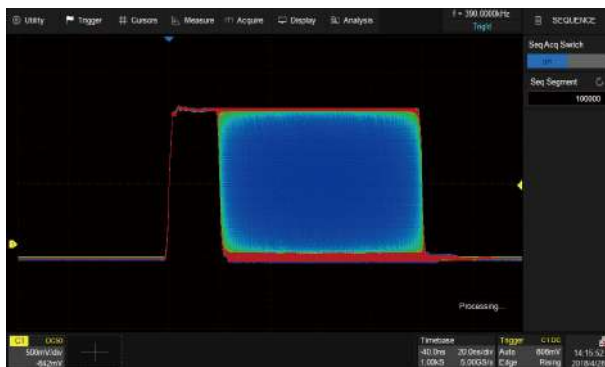

Segmented memory collection will store the waveform into multiple memory segments (up to 100,000) and each segment will store a triggered waveform as well the dead time information. The dead time between segments can be as small as 2 μs. All of the segments can be played back using the History function

• History Mode



History function can record up to 100,000 frames of waveforms. The recording is executed automatically, so that the customer can play back the history waveforms at any time in order to observe unusual events and quickly locate the area of interest using the cursors or measurements

• Parameter statistics function

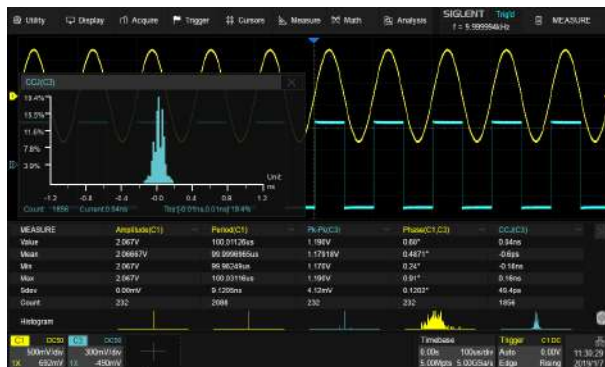

Statistics shows the current value, maximum value, minimum value, standard deviation and mean value of up to 5 parameters. Histogram is available to show the probability distribution of a parameter

• Search and Navigate



The SDS5000X can search events specified by the user in a frame. Events flagged by the Search can be recalled automatically using Navigate. It can also navigate by time (delay position) and history frames

• Digital Voltmeter Function



4-digit voltmeter and 7-digit frequency counter. Any analog channel can be selected as a source. Bar, Histogram and Trend diagrams are supported

• Bode Plot

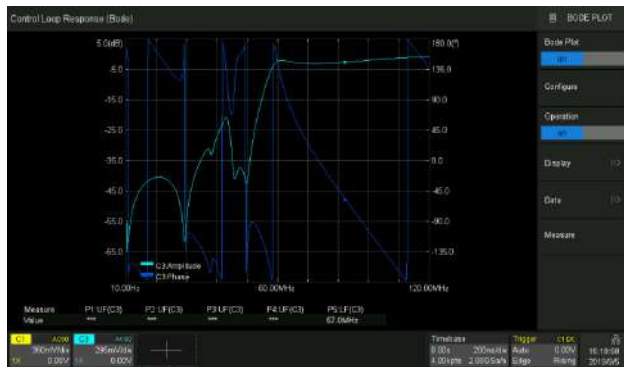

The SDS5000X can control the USB AWG module or a stand-alone SIGLENT SDG generator, to scan the amplitude and phase frequency response of the DUT, and display the data as a Bode Plot. This makes it possible to replace expensive network analyzer in some applications.

• Digital Channels / MSO (Optional)



Four analog channels plus 16 digital channels enable users to acquire and trigger on the waveforms then analyze the pattern, simultaneously with one instrument

• Web control



With the new embedded web server, users can control the oscilloscope from a simple web page. This provides wonderful remote troubleshooting and monitoring capabilities.

• Power Analysis (Optional)



The Power Analysis option provides a full suite of power measurements and analysis, which greatly improve the measurement efficiency in switching power supplies and power devices design.

• Built-in 25 MHz Function / Arbitrary Waveform Generator (Optional)



the SDS5000X can control the SAG1021I USB Function / Arbitrary waveform generator to output waveform with up to 25 MHz frequency and ± 3 V amplitude. Six basic waveforms plus multiple types of arbitrary waveforms are built-in.

• Hardware-based Average and ERES Acquisition

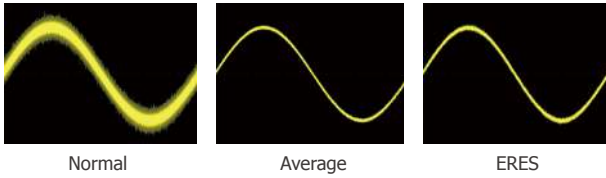

Average and ERES (Enhanced Resolution) acquisition modes are hardware-based, allowing the waveforms to be captured at a faster rate

• Complete Connectivity



USB Host, USB Device (USBTMC), LAN (VXI-11, telnet, socket, web), Pass / Fail, Trigger Out, 10 MHz In / Out and VGA output

Specifications

Model	SDS5034X SDS5032X	SDS5054X SDS5052X	SDS5104X SDS5102X
Bandwidth	350 MHz	500 MHz	1 GHz
Sampling rate (Max.)	5 GSa/s (interleaving mode), 2.5 GSa/s (non-interleaving mode)		
Analog channels	2 / 4 + EXT		
Memory depth (Max.)	250 Mpts (interleaving mode), 125 Mpts (non-interleaving mode)		
Waveform capture rate(Max.)	110,000 wfm/s (normal mode), 500,000 wfm/s (sequence mode)		
Trigger type	Edge, Slope, Pulse width, Window, Runt, Interval, Dropout, Pattern, Video, Qualified		
Serial trigger and decode	I ² C, SPI, UART, CAN, LIN, CAN FD, FlexRay, I ² S, MIL-STD-1553B		
Digital channel (optional)	16-channel; maximum waveform capture rate up to 1.25 GSa/s; record length up to 62.5 Mpts		
Waveform generator (optional)	Single channel, frequency up to 25 MHz, 125 MSa/s sample rate, 16 kpts waveform memory		
I / O	USB Host, USB Device, LAN, Pass / Fail, Trigger Out, 10 MHz In, 10 MHz Out, VGA Output		
Probe (standard)	1 probe supplied for each channel		
Display	10.1" TFT-LCD with capacitive touch screen (1024*600)		

Ordering Information

Description	Model
1 GHz, 4 CH, 5 GSa/s (Max.)	SDS5104X
1 GHz, 2 CH, 5 GSa/s (Max.)	SDS5102X
500 MHz, 4 CH, 5 GSa/s (Max.)	SDS5054X
500 MHz, 2 CH, 5 GSa/s (Max.)	SDS5052X
350 MHz, 4 CH, 5 GSa/s (Max.)	SDS5034X
350 MHz, 2 CH, 5 GSa/s (Max.)	SDS5032X

Standard Accessories

USB cable x1	Quick start x1	Certificate of calibration x1	Power cord x1
Passive probe x2 (2-ch model); x4 (4-ch model), SP2035A for 350 MHz models and SP3050A for 500 MHz / 1 GHz models			

Optional Accessories

SDS-5000X-4BW05	350 MHz to 500 MHz bandwidth upgrade(4-ch model)
SDS-5000X-2BW05	350 MHz to 500 MHz bandwidth upgrade (2-ch model)
SDS-5000X-4BW10	500 MHz to 1 GHz bandwidth upgrade (4-ch model)
SDS-5000X-2BW10	500 MHz to 1 GHz bandwidth upgrade (2-ch model)
SDS-5000X-FG	Waveform generator software
SAG1021I	25 MHz USB function / arbitrary waveform generator
SDS-5000X-16LA	16 digital channels (software)
SPL2016	16-channel logic probe
SDS-5000X-I2S	I2S trigger & decode
SDS-5000X-CANFD	CAN FD trigger & decode
SDS-5000X-FlexRay	FlexRay trigger & decode
SDS-5000X-1553B	MIL-STD-1553B trigger & decode
STB3	STB3 demo signal source
SAP1000	1 GHz active probe
HPB4010	High voltage probe
CP4020 / CP4050 / CP4070 / CP4070A / CP5030 / CP5030A / CP5150 / CP5500	Current probe
DPB4080 / DPB5150 / DPB5150A / DPB5700 / DPB5700A	High voltage differential probe



SDS2000X Plus Super Phosphor Oscilloscope

Key Features

- 350 MHz, 200 MHz, 100 MHz models with real-time sample rate up to 2 GSa/s. A 500 MHz bandwidth upgrade option is available for 350 MHz models.
- SPO technology
Waveform capture rates up to 120,000 wfm/s (normal mode) and 500,000 wfm/s (sequence mode)
Supports 256-level intensity grading and color temperature display modes
Record length up to 200 Mpts/ch, 400 Mpts in total for all 4 channels
Digital trigger system
- 10-bit mode provides higher resolution and lower noise
- Segmented acquisition (Sequence) mode, dividing the maximum record length into multiple segments (up to 90,000), according to trigger conditions set by the user, with a very small dead time between segments to capture the qualifying event
- History waveform record (History) function for up to 90,000 triggered waveforms (frames)
- Automatic measurement function on 50+ parameters, supports statistics with histogram and trend
- Two Math traces, support 2 Mpts FFT, +, -, x, ÷, d/dt, ∫dt, √, average, ERES, and formula editor
- Abundant data processing and analysis functions such as Search, Navigate, Mask Test, Bode plot, Power Analysis (optional) and Counter
- 16 digital channels (optional)
- Built-in 50 MHz waveform generator (optional)
- Large 10.1" TFT-LCD display with 1024x600 resolution; Capacitive touch screen supports multi-touch gestures
- Multiple interfaces: USB Host, USB Device (USBTMC), LAN (VXI-11/Telnet/Socket), Pass/Fail, Trigger Out
- Built-in web server supports remote control by the LAN port using a web browser; Supports SCPI remote control commands

Characteristics

• Competitive Front End Performance

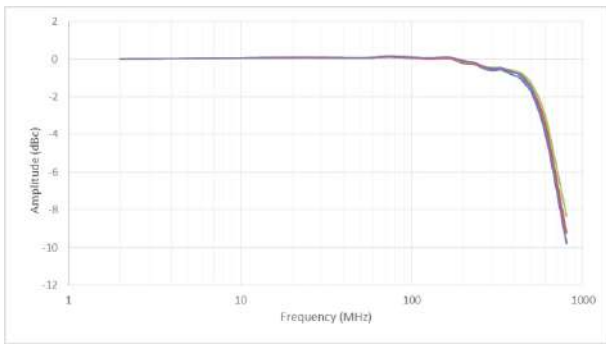

500 MHz bandwidth (at 2 GSa/s sample rate with 500 MHz bandwidth option).

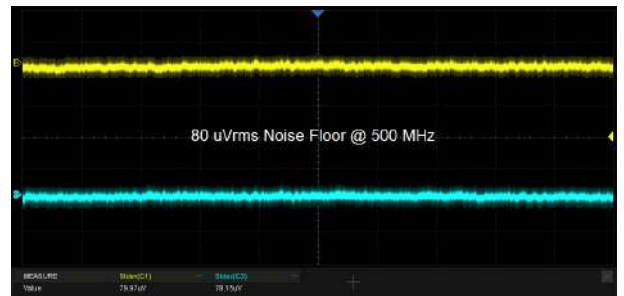

Low noise floor: Only 80 μ V rms at 500 MHz bandwidth.

• 10-bit Mode



10-bit mode combined with Zoom shows you more details and less noise on the waveform.

• Trigger Zone

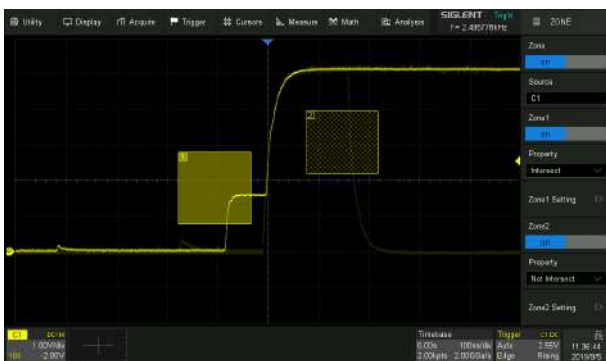

Trigger Zone is available for advanced triggering.

• Serial Bus Decode

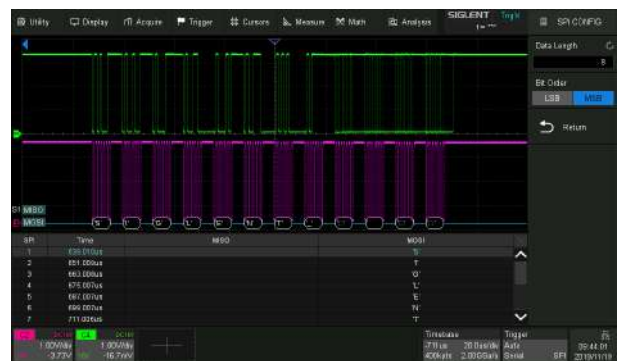

In addition to the decoder lanes correlated to the waveform, bus protocol information can be displayed in tabular form. I2C, SPI, UART, CAN, LIN, CAN FD, FlexRay, I2S and MIL-STD-1553B are supported.

• Measurements for All relevant Parameters and Parameter Statistics

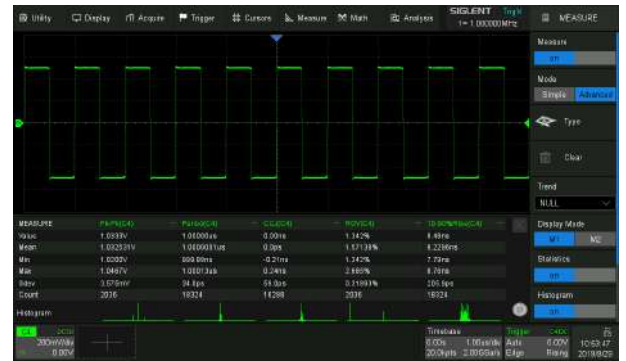

Parameter measurements includes 4 categories: Vertical, Horizontal, Miscellaneous and Channel Delay providing a total of 50+ different types of measurements. Measurements can be performed within a specified gate period. Measurements on Math, Reference and History frames are supported.

Statistics shows the current value, maximum value, minimum value, standard deviation and mean value of up to 12 parameters simultaneously. Histogram is available to show the probability distribution of a parameter. Trend is available to show the parameter value vs. time. In addition, horizontal measurements can process up to 1000 signal edges within one single frame, thus greatly improving the test efficiency.

• Advanced Math Function

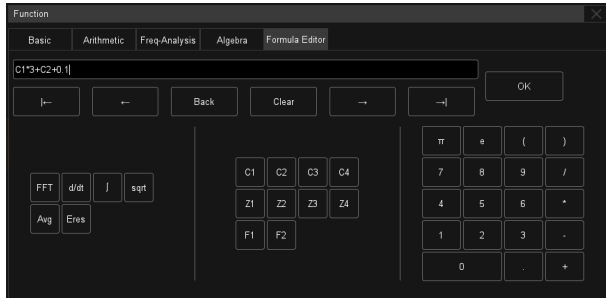

Two Math traces, support FFT, +, -, x, ÷, d/dt, ∫dt, √, average, ERES, and formula editor.

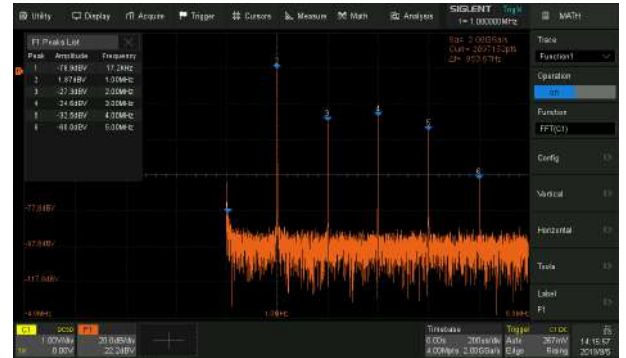

Hardware accelerated FFT up to 2 Mpts. This provides high frequency resolution with fast refresh rate. The FFT function also supports a variety of window functions so that it can adapt to different spectrum measurement needs. Three modes (Normal, Average and Max hold) can satisfy different requirements for observing the power spectrum. Auto peak detection and markers are supported.

• Bode Plot



The SDS2000X Plus can control the built-in waveform generator or any stand-alone SIGLENT SDG device to scan the amplitude and phase response over frequency of passive or active circuits. The data is presented as Bode Plot. This makes it possible to replace expensive network analyzers in less demanding applications.

• Digital Channels / MSO (Optional)



Four analog channels plus 16 digital channels allow the acquisition and triggering of mixed waveforms with one instrument.

• Power Analysis (Optional)



The Power Analysis option provides a full suite of power measurements and analysis, thus improving the efficiency of measurement in switching power supplies and power device designs.

• 50 MHz Built-in Waveform Generator (Optional)

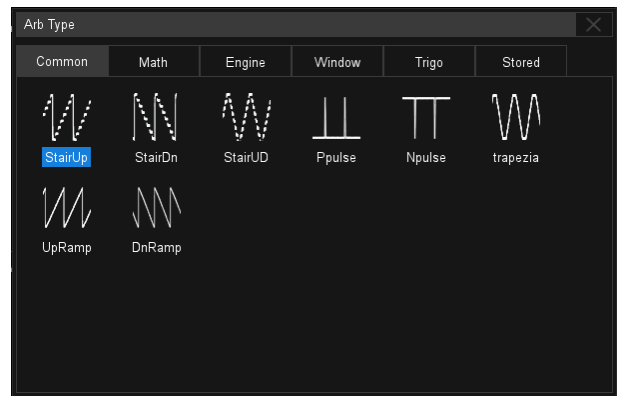

The built-in waveform generator can output waveforms with up to 50 MHz frequency and ± 3 V amplitude. Six basic waveforms together with multiple types of predefined waveforms and as user defined arbitrary waveforms are supported.

Specifications

Model	SDS2354X Plus	SDS2204X Plus	SDS2104X Plus SDS2102X Plus
Analog channels	4 + EXT		2/4 + EXT
Bandwidth	350 MHz, (upgradable to 500 MHz)	200 MHz	100 MHz
Sample rate (Max.)	2 GSa/s (interleaving mode), 1 GSa/s (non-interleaving mode)		
Memory depth (Max.)	200 Mpts/ch (interleaving mode), 100 Mpts/ch (non-interleaving mode)		
Waveform capture rate (Max.)	Normal mode: 120,000 wfm/s; Sequence mode: 500,000 wfm/s		
Vertical resolution	8-bit. 10-bit mode (with typical 100 MHz bandwidth)		
Trigger type	Edge, Slope, Pulse, Window, Runt, Interval, Dropout, Pattern, Video and Serial		
Serial trigger and decode	Standard: I2C, SPI, UART, CAN, LIN Optional: CAN FD, FlexRay, I2S, MIL-STD-1553B		
Measurement	More than 50 parameters, supports statistics with histogram and trend		
Math	2 traces		
Math	2 Mpts FFT, +, -, x, ÷, d/dt, ∫dt, √, average, ERES, and formula editor		
Data processing and analysis tools	Search, Navigate, History, Mask test, Bode plot, Power Analysis (optional) and Counter		

Digital Oscilloscope

Digital channel (optional)	16-channel; maximum sample rate up to 500 MSa/s; record length up to 50 Mpts/ch	
Waveform generator (optional)	Single channel, frequency up to 50 MHz, 125 MSa/s sample rate, 16 kpts waveform memory	
Interface	USB 2.0 Host x2, USB 2.0 Device, LAN, External trigger, Auxiliary output (TRIG OUT, PASS/FAIL)	
Probe (standard)	SP2035A, 350 MHz, 1 probe supplied for each channel	PP215, 200 MHz, 1 probe supplied for each channel
Display	10.1" TFT-LCD with capacitive touch screen (1024x600)	

Ordering Information

Model	Description
SDS2354X Plus	350 MHz, 4-ch, 2 GSa/s (Max.), 200 Mpts, 10.1"touch screen
SDS2204X Plus	200 MHz, 4-ch, 2 GSa/s (Max.), 200 Mpts, 10.1"touch screen
SDS2104X Plus	100 MHz, 4-ch, 2 GSa/s (Max.), 200 Mpts, 10.1"touch screen
SDS2102X Plus	100 MHz, 2-ch, 2 GSa/s (Max.), 200 Mpts, 10.1"touch screen

Standard Accessories	Quantity
USB cable	1
Quick start	1
Passive probe	x2 (2-ch model); x4 (4-ch model)
Certificate of calibration	1
Power cord	1

Optional Accessories	Part Number
Waveform generator option (software)	SDS2000XP-FG
16 digital channels (software)	SDS2000XP-16LA
16-channel logic probe	SPL2016
Power Analysis (software)	SDS2000XP-PA
Power Analysis deskew fixture	DF2001A
I2S trigger & decode (software)	SDS2000XP-I2S
MIL-STD-1553B trigger & decode (software)	SDS2000XP-1553B
FlexRay trigger & decode (software)	SDS2000XP-FlexRay
CAN FD trigger & decode (software)	SDS2000XP-CANFD
100 MHz to 200 MHz bandwidth upgrade (4-ch model) (software)	SDS2000XP-4BW02
200 MHz to 350 MHz bandwidth upgrade (4-ch model) (software)	SDS2000XP-4BW03
350 MHz to 500 MHz bandwidth upgrade (4-ch model) (software)	SDS2000XP-4BW05
100 MHz to 350 MHz bandwidth upgrade (2-ch model) (software)	SDS2000XP-2BW03
ISFE isolated front end	ISFE
STB3 demo signal source	STB3
High voltage probe	HPB4010
High voltage differential probe	DPB1300/DPB4080/DPB5150/DPB5150A/DPB5700/DPB5700A
Current probe	CPL5100/CP4020/CP4050/CP4070/CP4070A/CP5030/CP5030A/CP5150/CP5500
Bag	BAG-S2



SDS2000X Super Phosphor Oscilloscope

Key Features

- 70 MHz, 100 MHz, 200 MHz, 300 MHz models
- Real-time sampling rate up to 2 GSa/s
- New generation of SPO technology
- Waveform capture rate up to 140,000 wfm/s (normal mode), and 500,000 wfm/s (sequence mode)
- Supports 256-level intensity grading and color temperature display
- Record length up to 140 Mpts
- Digital trigger system
- Intelligent trigger: Edge, Slope, Pulse, Window, Runt, Interval, Dropout, Pattern and Video (HDTV supported)
- Serial bus trigger and decoder, supports protocols I²C, SPI, UART, RS232, CAN and LIN
- Low background noise, supports 1 mV/div to 10 V/div voltage scales
- 10 types of one-button shortcuts, including Auto Setup, Default, Cursors, Measure, Roll, History, Display/Persist, Clear Sweeps, Zoom and Print
- Segmented acquisition (Sequence) mode, dividing the maximum record length into multiple segments (up to 80,000), according to trigger conditions set by the user, with a very small dead time segment to capture the qualifying event
- History waveform record (History) function, the maximum recorded waveform length is 80,000 frames
- Automatic measurement function on 37 parameters, supports statistics, Gating measurement, Math measurement, History measurement and Ref measurement
- Math function (FFT, addition, subtraction, multiplication, division, integration, differential, square root)
- High Speed hardware based Pass/ Fail function
- 16 Digital channels (MSO), Maximum waveform capture rate up to 500 MSa/s, Record length up to 140 Mpts/CH
- 25 MHz function/arbitrary waveform generator, built-in 10 types of waveforms
- Large 8 inch TFT-LCD display with 800 * 480 resolution
- Abundant interfaces: USB Host, USB Device (USBTMC), LAN (VXI-11), Pass / Fail, Trigger Out
- Supports SCPI remote control commands
- Supports Multi-language display and embedded online help

Characteristics



• 8 inch TFT-LCD Display and 10 One-button Menus

- 8-inch TFT-LCD display with 800 * 480 resolution
- Most commonly used functions are accessible using 10 different one-button operation keys: Auto Setup, Default, Cursors, Measure, Roll, History, Display/Persist, Clear Sweeps, Zoom and Print
- Supports auto detection of 10X probe with read-out port (200 MHz and 300 MHz versions only)

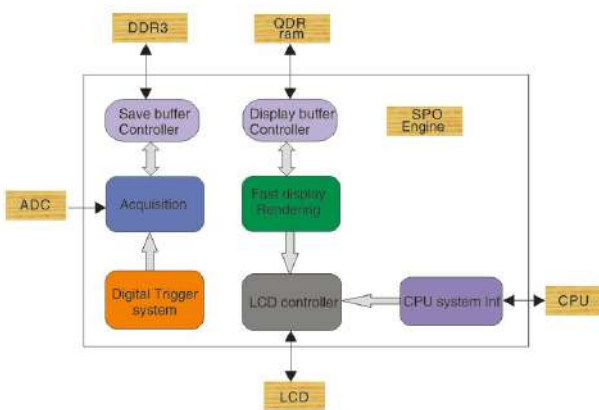

SPO Super Phosphor Oscilloscope

- Waveform capture rate up to 140,000 wfms/s (normal mode), and 500,000 wfms/s (sequence mode)
- Supports 256-level intensity grading and color temperature display
- Record length up to 140 Mpts
- Digital trigger system

• Waveform Capture Rate up to 500,000 wfms/s



With a waveform capture rate of up to 500,000 wfms/s (sequence mode), the oscilloscope can easily capture the unusual or low-probability events.

• Record Length of up to 140 Mpts



Using hardware-based Zoom technique and record length of up to 140 Mpts, users are able to use a higher sampling rate to capture more of the signal, and then quickly zoom in to focus on the area of interest.

• 256-level Intensity Grading and Color Temperature Display

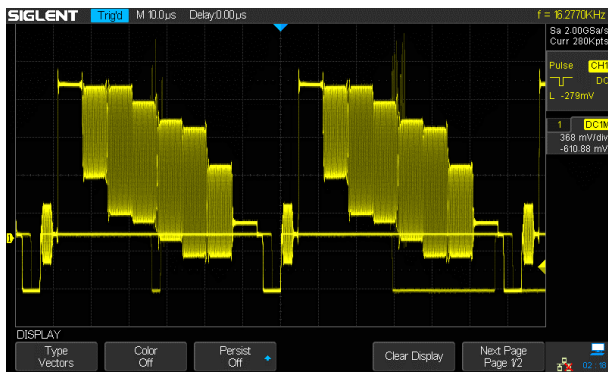

256-level intensity grading display on waveform.

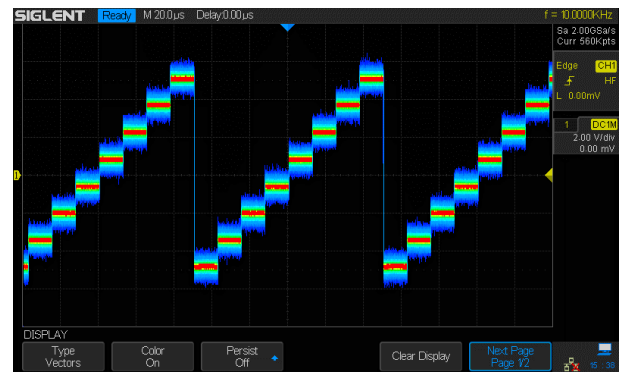

Color temperature display.

• Abundant Trigger Functions

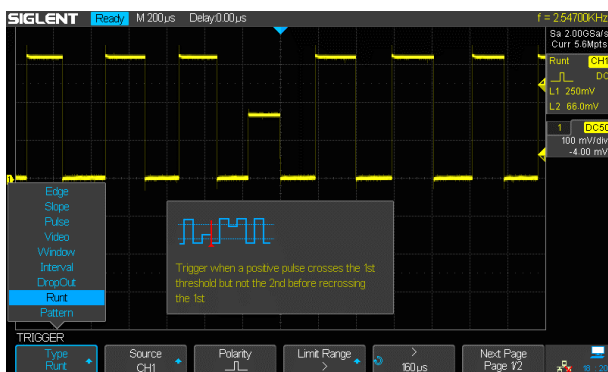

Edge, Slope, Pulse, Video, Windows, Runt, Interval, Dropout, Pattern, IIC, SPI, UART/RS232, LIN and CAN.

• History Mode

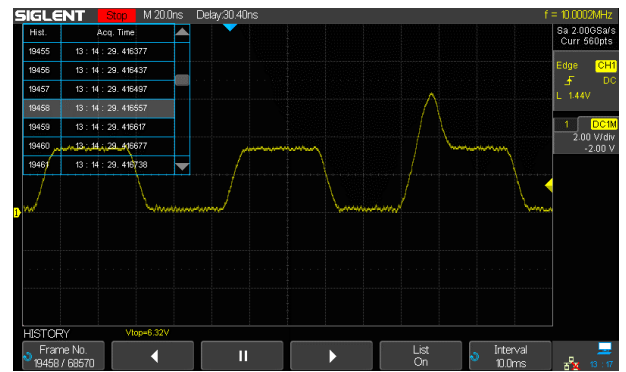

History function can record up to 80,000 frames of waveforms. The recording is executed automatically, so that the customer can play back the history waveforms at any time to observe unusual events, and locate the source quickly through the cursors or measurements. Located on the keyboard Panel, this function is easily accessible.

• Sequence Mode



Segmented memory collection will store the waveform into multiple (up to 80,000) memory segments and each segment will store a triggered waveform, as well as the dead time information. The dead time between segments could be as small as 2 µs. All the segments can be played back using History function.

• Comprehensive Statistical Functions

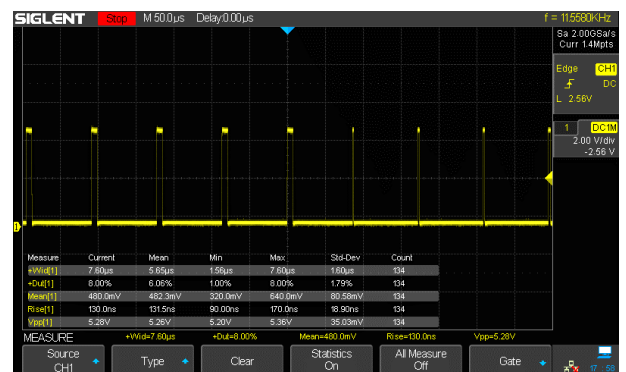

Parametric statistical functions to display 5 parameters of any measurements: current, mean, minimum value, maximum value, and standard deviation. The measurement count is also displayed. The maximum number of measurements that can be run and simultaneously analyzed statistically is five. Supports Gating measurements, Math measurement, History measurement and Ref measurement.

• Advanced Math Function

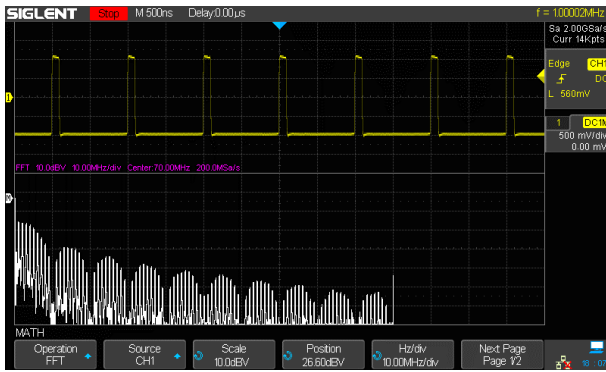

In addition to the traditional (+, -, X, /) operations, FFT, integration, differential, and square root operations are supported. The integration operation supports gating, which uses cursors to define the domain of integration.

• 16 Digital Channels / MSO (Optional)



4 analog channels plus 16 digital channels enables users to acquire and trigger on the waveforms then analyze the pattern, simultaneously with one instrument.

• Built-in 25 MHz Function/Arbitrary Waveform Generator (Optional)

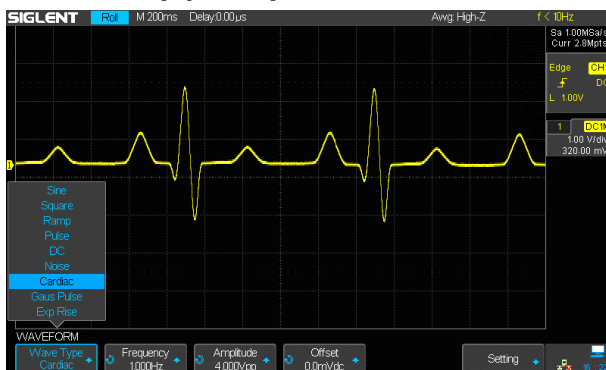

10 built-in waveforms plus 4 ARBs. The arbitrary waveforms can be accessed and edited by the EasyWave PC software.

• ERES Mode

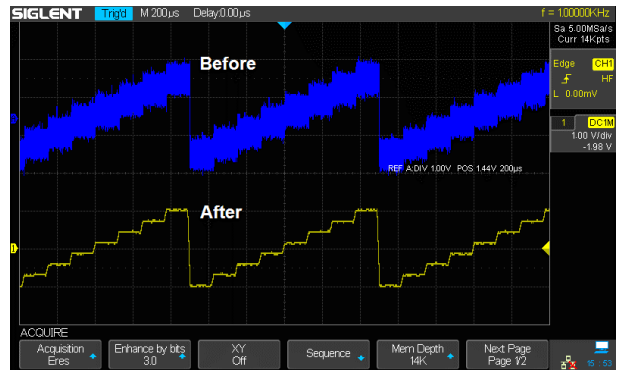

ERES mode can improve the SNR effectively, without the dependence on the periodicity of signal and stable triggering.

• Serial Bus Decoding Function (Optional)

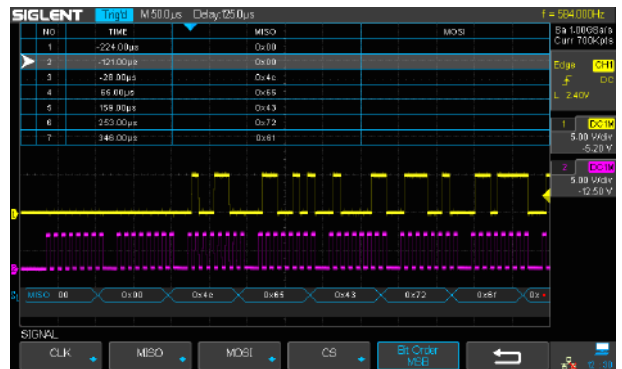

Displays the decoding through the events list. Bus protocol information can be quickly and intuitively displayed in table form.

• Complete Connectivity



USB Host, USB Device (USBTMC), LAN(VXI-11), Pass/Fail and Trigger Out.

Specifications

Model	SDS2072X (2 CH) SDS2074X (4 CH)	SDS2102X (2 CH) SDS2104X (4 CH)	SDS2202X (2 CH) SDS2204X (4 CH)	SDS2302X (2 CH) SDS2304X (4 CH)
Bandwidth	70 MHz	100 MHz	200 MHz	300 MHz
Sampling Rate (Max.)	2 GSa/s			
Channels	2 + EXT 4 + EXT			
Memory Depth (Max.)	140 Mpts (Single-Channel), 70 Mpts (Dual-Channel)			
Waveform Capture Rate (Max.)	140,000 wfm/s (normal mode), 500,000 wfm/s (sequence mode)			
Trigger Type	Edge, Slope, Pulse width, Window, Runt, Interval, Dropout, Pattern, Video			
Serial Trigger	I ² C, SPI, UART/RS232, CAN, LIN			
Decoder Type (Optional)	I ² C, SPI, UART/RS232, CAN, LIN			
16 Digital Channels (MSO Option)	Maximum waveform capture rate up to 500 MSa/s, Record length up to 14 Mpts/CH			
Waveform Generator (Optional)	Single channel, Max. frequency up to 25 MHz, 125 MSa/s sampling rate, 16 Kpts wave length			
I/O	USB Host, USB Device, LAN, Pass/Fail, Trigger Out			
Probe (Std)	PB470 70 MHz 1 pcs for each channel	PP510 100 MHz 1 pcs for each channel	SP2030A 300 MHz 1 pcs for each channel	SP2030A 300 MHz 1 pcs for each channel
Display	8 inch TFT LCD (800x480)			

Ordering Information

Description	Model
70 MHz, 2 CH, 2 GSa/s (Max.), 140 Mpts	SDS2072X
70 MHz, 4 CH, 2 GSa/s (Max.), 140 Mpts	SDS2074X
100 MHz, 2 CH, 2 GSa/s (Max.), 140 Mpts	SDS2102X
100 MHz, 4 CH, 2 GSa/s (Max.), 140 Mpts	SDS2104X
200 MHz, 2 CH, 2 GSa/s (Max.), 140 Mpts	SDS2202X
200 MHz, 4 CH, 2 GSa/s (Max.), 140 Mpts	SDS2204X
300 MHz, 2 CH, 2 GSa/s (Max.), 140 Mpts	SDS2302X
300 MHz, 4 CH, 2 GSa/s (Max.), 140 Mpts	SDS2304X
Standard Accessories	
USB Cable -1	
Passive Probe -4	
Power Cord -1	
Quick Start -1	
Certification -1	
Certificate of Calibration -1	
Optional Accessories	
SDS-2000X-DC	IIC, SPI, UART/RS232, CAN, LIN Decoder
SDS-2000X-FG	25 MHz Function/Arbitrary Waveform Generator
SDS-2000X-PA	Power Analyze Software
SDS-2000X-16LA	16 Digital Channels (Software)
SPL2016	16 Channel Logic Probe
ISFE	Isolated Front End
STB-3	STB Demo Source
DF2001A	Power analysis Deskew Fixture
HPB4010	High Voltage Probe
CP4020/CP4050/CP4070/ CP4070A/CP5030/ CP5030A/CP5150/CP5500	Current Probe
DPB4080/DPB5150/ DPB5150A/DPB5700/ DPB5700A	High Voltage Differential Probe

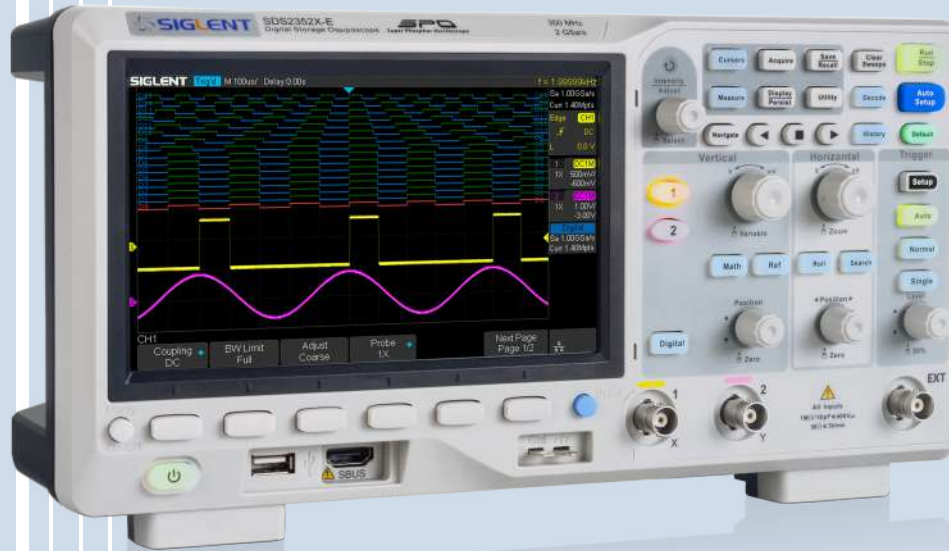

SDS2000X-E Super Phosphor Oscilloscope

Key Features

- 200 MHz, 350 MHz bandwidth models
- Real-time sampling rate up to 2 GSa/s (1 GSa/s per channel, if both channels active)
- Record length up to 28 Mpts
- Intelligent triggers: Edge, Slope, Pulse Width, Window, Runt, Interval, Time out (Dropout), Pattern
- Serial bus triggering and decoding (standard), supports protocols I²C, SPI, UART, CAN, LIN
- Low background noise with voltage scales from 500 μ V/div to 10V/div
- 10 types of one-button shortcuts, supports Auto Setup, Default, Cursors, Measure, Roll, History, Display/Persist, Clear Sweep, Zoom and Print
- History waveform record (history) function (maximum recorded waveform length is 80,000 frames)
- 1 Mpt FFT
- Math and measurement functions use all sampled data points in memory (up to 28 Mpts)
- Math functions (FFT, addition, subtraction, multiplication, division, integration, differential, square root)
- Large 7 inch TFT -LCD display with 800 * 480 resolution
- Supports Multi-language display and embedded online help

Characteristics

- Maximum sample rate of 2 GSa/s, record Length of up to 28 Mpts



Using hardware-based Zoom technologies and max record length of up to 28 Mpts, users are able to oversample to capture for longer time periods at higher resolution and use the zoom feature to see more details within each signal.

- Serial Bus Decoding Function (Standard)

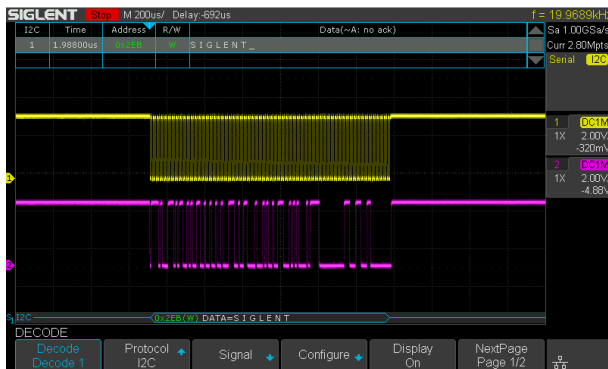

SDS2000-XE displays the decoding through the events list. Bus protocol information can be quickly and intuitively displayed in a tabular format.

- True measurement to 28 M points

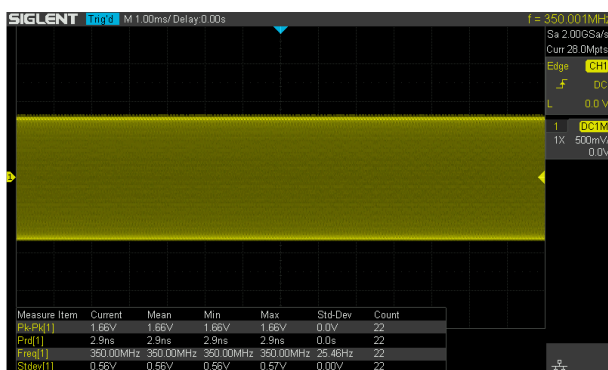

SDS2000-XE can apply automatic measurements on all sampled data points up to 28 Mpts. This ensures the accuracy of measurements while the math co-processor decreases measurement time and increases ease-of-use.

- Waveform Capture Rate up to 400,000 wfms/s

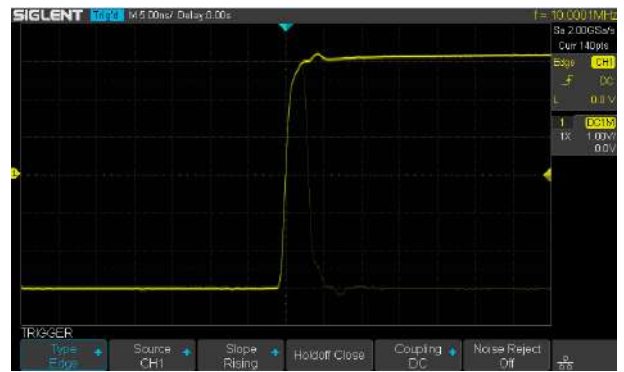

With a waveform capture rate of up to 400,000 wfms/s (sequence mode), the oscilloscope can easily capture the unusual or low-probability events.

- History Waveforms (History) Mode and Segmented Acquisition (Sequence)

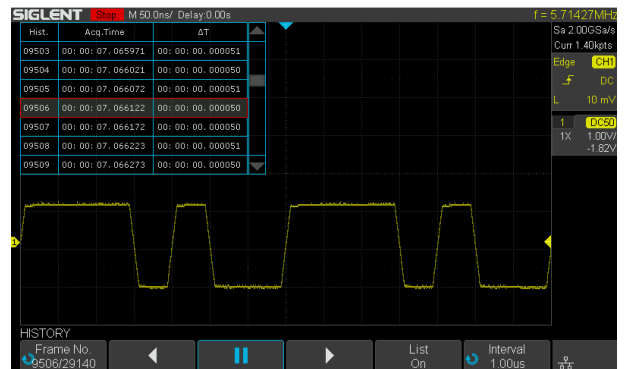

Playback the latest triggered events using the history function. Segmented memory collection will store trigger events into multiple (Up to 80,000) memory segments, each segment will store triggered waveforms and timestamp of each frame.

- 1 Mpoint FFT

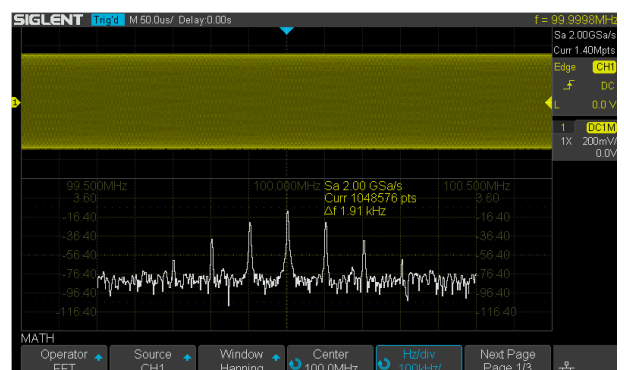

The new math co-processor enables FFT analysis of incoming signals using up to 1 million samples per waveform. This provides high frequency resolution with a fast refresh rate. The FFT function also supports a variety of window functions so that it can adapt to different spectrum measurement needs.

Digital Oscilloscope

• Hardware-Based High Speed Pass/Fail function

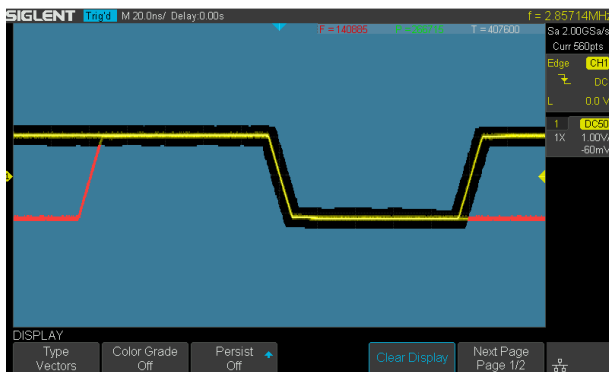

The SDS2000X-E utilizes a hardware-based Pass/Fail function, performing up to 40,000 Pass / Fail decisions each second. Easily generate user defined test templates provide trace mask comparison making it suitable for long-term signal monitoring or automated production line testing.

• USB 25 MHz AWG Module (option)



The optional 25 MHz function/arbitrary waveform generator is operated from the USB host connection. Functions include Sine, Square, Ramp, Pulse, Noise, DC and 45 additional built-in waveforms. The arbitrary waveforms can be accessed and edited by the SIGLENT EasyWave PC software.

• Bode Plot

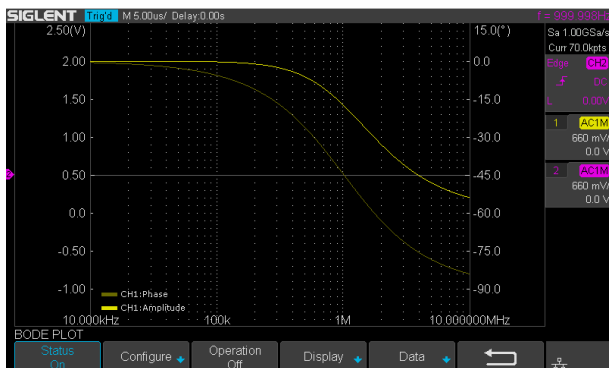

SDS2000X-E can control the USB AWG module or an independent SIGLENT SDG instrument, scan a circuits amplitude and phase frequency response, and display the data as a Bode Plot. It can also show the result lists, and export the data to a USB disk.

• 16 Digital Channels/MSO (option)

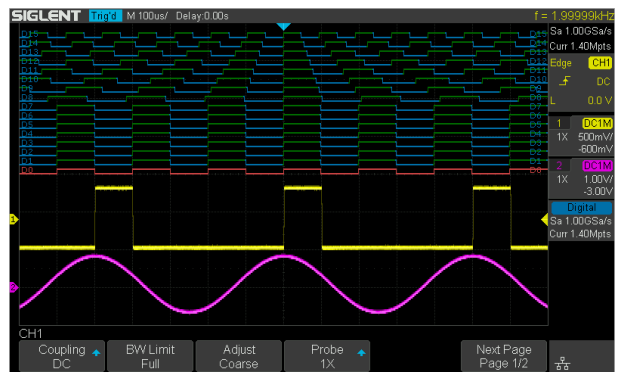

16 digital channels enables users to acquire and trigger on digital input channels and view both digital and analog waveforms simultaneously with one instrument.

• Search and Navigate

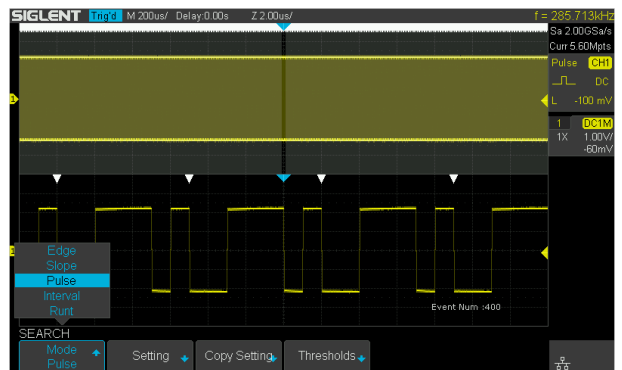

The SDS2000X-E can search events specified by the user in a frame. It can also navigate by time (delay position) and historical frames.

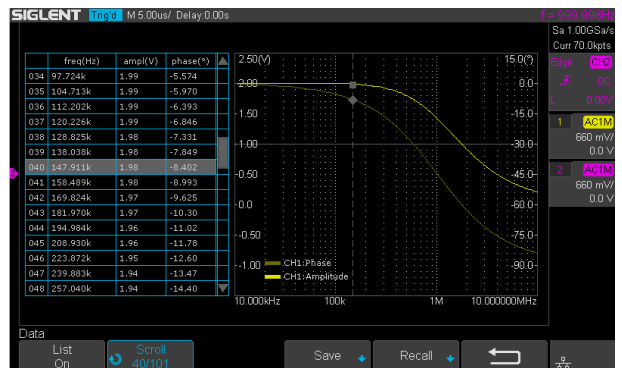

- **USB WIFI Adapter (option)**



WiFi control of instrumentation can provide a convenient and safe method of configuring and collecting data. This new feature works with a SIGLENT approved WiFi adapter to provide wireless control and communications with SIGLENT SDS2000X-E scopes.

- **Web control**



With the new embedded web server, users can control the SDS2000X-E from a simple web page. This provides wonderful remote troubleshooting and monitoring capabilities. The web page has PC and mobile styles that include an embedded virtual control panel.

- **Real-time update screen in web page**



With 100 Mbps LAN, the internal web page can update at a rate of up to 10 times/s, providing a nearly-real time update of waveform data and measurements. When viewed on a PC, the screen can be displayed in full screen mode. With this feature and a PC VGA interface, you can easily use a projector or other video display device to deliver the screen information to a larger audience.

- **Complete Connectivity**



SDS2000X -E supports USB Host, USB Device (USB -TMC), LAN, Pass/Fail and Trigger Out.

Models and key Specification

Model	SDS2202X-E	SDS2352X-E
Bandwidth	200 MHz	350 MHz
Sample Rate (Max.)	2 GSa/s	
Channels	2+EXT	
Memory Depth (Max.)	14 Mpts/CH (not interleave mode) 28 Mpts/CH (interleave mode)	
Waveform Capture Rate (Max.)	110,000 wfm/s (normal mode), 400,000 wfm/s (sequence mode)	
Trigger Type	Edge, Slope, Pulse Width, Window, Runt, Interval, Dropout, Pattern, Video	
Serial Trigger and decoder (Standard)	I ² C, SPI, UART, CAN, LIN	
16 Digital Channels (option)	Maximum waveform capture rate up to 1GSa/s, Record length up to 14 Mpts/CH	
USB AWG module (option)	One channel, 25 MHz, sample rate of 125 MHz, 16 kpts waveform memory sample size	
Bode plot	Minimum start frequency of 10 Hz, minimum scan bandwidth of 500 Hz, maximum scan bandwidth of 120 MHz (dependent on Oscilloscope and AWG bandwidth), 500 maximum scan frequency points	
USB WIFI adapter (option)	802.11b/g/n, WPA-PSK NOTE: To ensure compatibility, we recommend using only SIGLENT WiFi accessories	
I/O	USB Host, USB Device, LAN, Pass/Fail, Trigger Out, Sbus (Siglent MSO)	
Probe (Std)	2 pcs passive probe PP215	2 pcs passive probe SP2035
Display	7 inch TFT-LCD (800 x 480 pixels)	
Weight	Without package 2.6 Kg; With package 3.8 Kg	

Ordering Information

Product Name	SDS2000X-E Series Digital Oscilloscope	
	SDS2202X-E 200 MHz	
	SDS2352X-E 350 MHz	
Standard Accessories	USB Cable -1	
	Quick Start -1	
	Passive Probe -2	
	Certification of Calibration -1	
	Power Cord -1	
Optional Accessories	16 Channels MSO Software	SDS2000X-E-16LA
	16 Channels Logic Analyzer	SLA1016
	AWG Software	SDS2000X-E-FG
	USB AWG Module Hardware	SAG1021I
	WIFI Software	SDS2000X-E-WIFI
	USB WIFI Adapter	TL_WN725N
	Isolated Front End	ISFE
	STB Demo Source	STB-3
	High Voltage Probe	HPB4010
	Current Probes	CP4020/CP4050/CP4070/CP4070A/CP5030/CP5030A/CP5150/CP5500
	Differential Probes	DPB4080/DPB5150/DPB5150A/DPB5700/DPB5700A
Rack Mount	SDS1X-E-RMK	

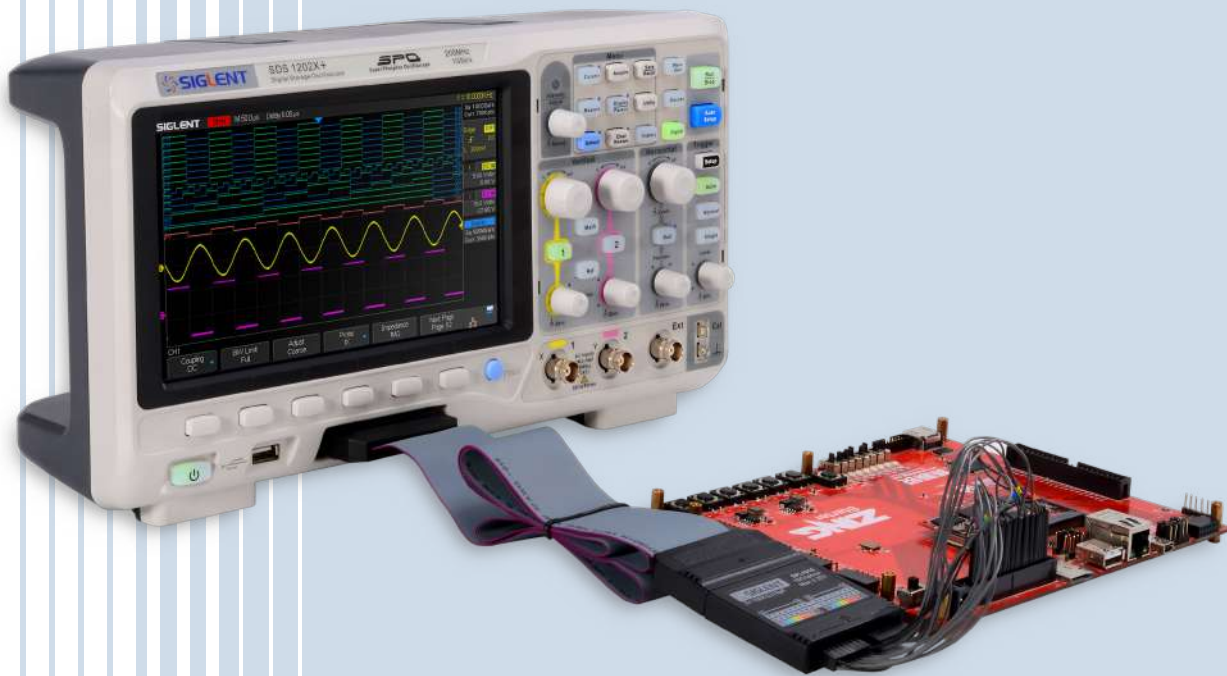

SDS1000X / SDS1000X+ Super Phosphor Oscilloscope

Key Features

- 100 MHz, 200 MHz bandwidth models
- Real-time sampling rate up to 1 GSa/s
- New generation of SPO technology
 - Waveform capture rate up to 60,000 wfm/s (normal mode), and 400,000 wfm/s (sequence mode)
 - Supports 256-level intensity grading and color temperature display
 - Record length up to 14 Mpts
 - Digital trigger system
- Intelligent trigger: Edge, Slope, Pulse, Window, Runt, Interval, Time out (Dropout), Pattern
- Serial bus triggering and decode, supports protocols I²C, SPI, UART/RS232, CAN, LIN
- Video trigger, supports HDTV
- Low background noise, supports 500 μ V / div to 10 V / div voltage scales
- 10 types of one-button shortcuts, supports Auto Setup, Default Setup, Cursor, Measure, Roll, History, Persistence, Clear Sweep, Zoom and Print
- Segmented acquisition (Sequence) mode, the maximum record length can be divided into 80,000 segments, according to trigger conditions set by the user, with a very small dead time segment to capture qualifying event
- History waveform record (History) function, the maximum recorded waveform length is 80,000 frames
- Automatic measurement function on 37 parameters, supports statistics calculations, Gating measurement, Math measurement, History measuring, Ref measurement
- Waveform math function (FFT, addition, subtraction, multiplication, division, integration, differentiation, square root)
- High Speed hardware based Pass/ Fail function
- 16 Digital channels (MSO), Maximum waveform capture rate up to 500 MSa/s, Record length up to 14 Mpts/CH (Optional for SDS1000X+ models)
- 25 MHz DDS arbitrary waveform generator, built-in 10 kinds of waveforms (Standard for SDS1000X+ Series)
- Large 8 inch TFT-LCD display with 800 * 480 resolution, Abundant interfaces: USB Host, USB Device (USBTMC), LAN (VXI-11), Pass / Fail, Trigger Out
- Supports SCPI remote control commands
- Supports Multi-language display and embedded online help

Digital Oscilloscope

Characteristics

- 8 inch TFT-LCD display and 10 one-button menus



Equipped with 8" TFT-LCD display with a resolution of 800 * 480. Most commonly used functions are accessible using 10 different one-button operation keys: Auto Setup, Default Setup, Cursor, Measure, Roll, History, Persist, Clear Sweep, Zoom, Print.

- Waveform capture rate up to 60,000 wfm/s



Up to 60,000 frames / second waveform capture rate, the oscilloscope can easily capture the transient events or low-probability events.

- Record length of up to 14 Mpts

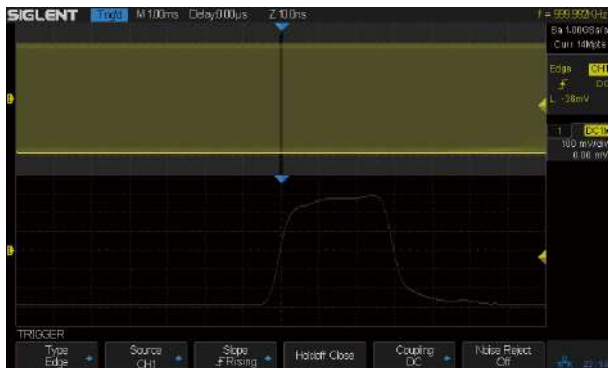

Using hardware-based Zoom technologies and record length of up to 14 Mpts, users are able to use a higher sampling rate to capture more of the signal, and then quickly zoom in to focus on the area of interest.

- 16 Digital Channels/MSO (Optional for SDS1000X+)

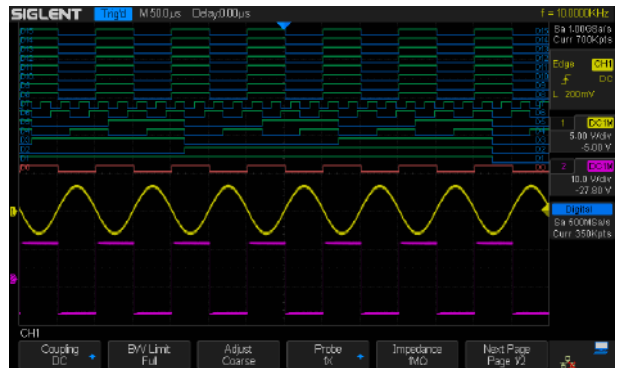

2 analog channels plus 16 digital channels enables users to acquire and trigger on the waveforms then analyze the pattern, simultaneously with one instrument.

- 256-level intensity grading and color temperature display

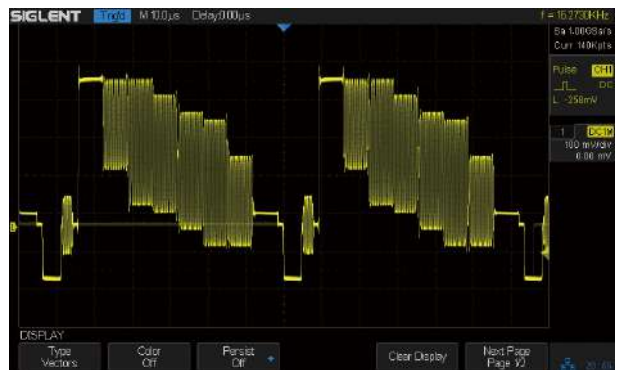

SPO display technology provides for fast refresh rates. The resulting intensity-graded trace is brighter for more often-occurring display points and dimmer in less-often-occurring points.

↓ Color Temperature Display

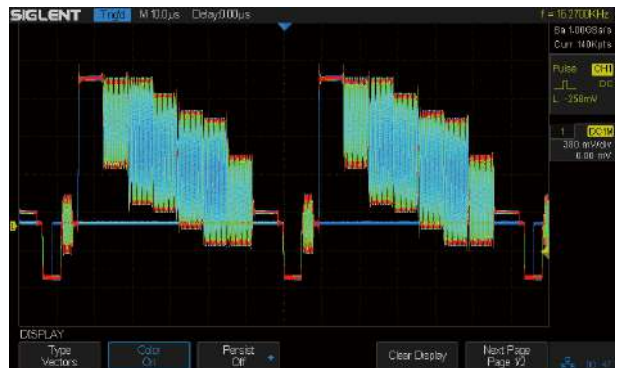

The color temperature display is similar to the intensity-graded trace except that the trace occurrence is represented by different colors (color "temperature") as opposed to changes in the intensity of one color. Red represents the most common occurrences or probabilities while blue are the least common points.

Serial bus decoding Function (Standard)

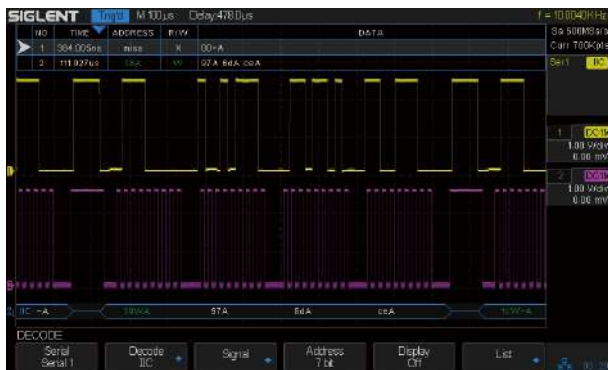

SDS1000X/SDS1000X+ displays the decoding through the events list. Bus protocol information can be quickly and intuitively displayed in table form.

Built-in 25 MHz function/arbitrary waveform Generator (Standard for SDS1000X+ Models)



The SDS1000X+ has a built-in 25 MHz function / arbitrary waveform generator (standard), including 10 built-in waveforms plus 4 ARBs. The arbitrary waveforms can be accessed and edited by the EasyWave PC software.

Advanced Math Function

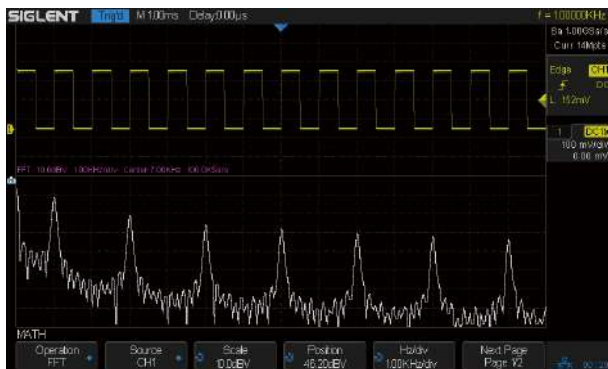

In addition to the traditional (+, -, X, /) operation, SDS1000X/SDS1000X+ oscilloscopes supports FFT, integration, differentiation, and square root operations.

Comprehensive statistical functions

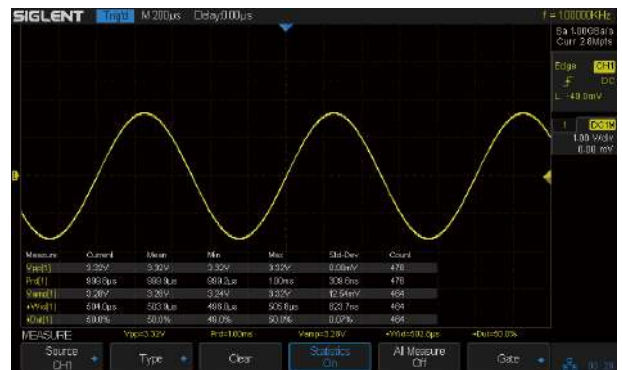

Parametric statistical functions to display any parameters of the five measurements: current, average, Minimum value, Maximum value, and the standard deviation. The measurement count is also displayed. The maximum number of parameters that can be measured and simultaneously analyzed statistically is five. Support Gating measurements, Math measurement, History measurement, Ref measurement.

Hardware-Based High Speed Pass/Fail Function

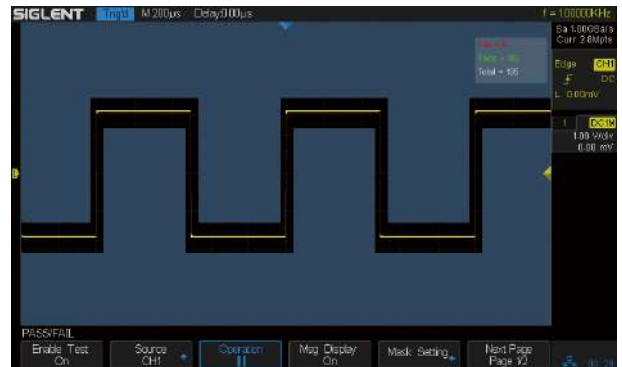

The SDS1000X/SDS1000X+ utilizes a hardware-based Pass / Fail function, performing up to 40,000 Pass / Fail decisions each second. With easy to generate user-defined test templates, the SDS1000X/SDS1000X+ compares the current measured trace to the template mask trace making it suitable for long-term signal monitoring or automated production line testing.

Complete connectivity



SDS1000X/SDS1000X+ supports USB Host, USB Device (USB-TMC), LAN (VXI-11), Pass/Fail and Trigger Out.

Specifications

Model	SDS1102X	SDS1102X+	SDS1202X	SDS1202X+
Bandwidth	100 MHz		200 MHz	
Sample Rate (Max)	1 GSa/s			
Channels	2+EXT			
Memory Depth (Max)	7 Mpts/CH (Dual-Channel); 14 Mpts/CH (Single-Channel)			
Waveform Capture Rate	60,000 wfm/s (normal mode), 400,000 wfm/s (sequence mode)			
Trigger Type	Edge, Slope, Pulse width, Window, Runt, Interval, Dropout, Pattern, Video			
Serial Trigger	I ² C, SPI, UART/RS232, CAN, LIN			
Decode Type (Optional)	I ² C, SPI, UART/RS232, CAN, LIN			
DDS Waveform Generator	No	Yes	No	Yes
	Single Channel, Max. Frequency up to 25 MHz, 125 MSa/s sampling rate, 16 Kpts wave length SDS1000X+ Supported (Standard); SDS1000X Not supported			
16 Digital Channels (MSO Option)	Maximum waveform capture rate up to 500 MSa/s, Record length up to 14 Mpts/CH SDS1000X+ Supported (Optional); SDS1000X Not supported			
Logic Probe	SPL1016 (Optional)			
I/O	USB Host, USB Device, LAN, Pass/Fail, Trigger Out, 1 KHz Cal			
Probe (Std)	2 pcs passive probe PP510		2 pcs passive probe PP215	
Display	8 inch TFT LCD (800x480)			
Weight	Net weight 3.26 Kg, Gross weight 4.25 Kg			

Ordering Information

Product Description	Product Name
100 MHz Two Channels	SDS1102X
200 MHz Two Channels	SDS1202X
100 MHz Two Channels, Built-In Waveform Generator (Standard), 16 Digital Channels (Option, *Requires SPL1016 & SDS-1000X-16LA)	SDS1102X+
200 MHz Two Channels, Built-In Waveform Generator (Standard), 16 Digital Channels (Option, *Requires SPL1016 & SDS-1000X-16LA)	SDS1202X+
Standard Accessories	
USB Cable -1	
Quick Start -1	
Certificate -1	
Passive Probe -2	
Power Cord -1	
Optional Accessories	
I ² C,SPI,UART/RS232,CAN,LIN Decode key	SDS-1000X-DC
16 Channels MSO (Software)	SDS-1000X-16LA
16 Digital Channels Logic Probe	SPL1016
Isolated Front End	ISFE
STB Demo Source	STB-3
High Voltage Probe	HPB4010
Current Probe	CP4020/CP4050/CP4070/ CP4070A/CP5030/CP5030A/ CP5150/CP5500
Differential Probe	DPB4080/ DPB5150/ DPB5150A/ DPB5700/ DPB5700A



SDS1000X-E Super Phosphor Oscilloscope

Key Features

- Two channel series have one 1 GSa/s ADC, four channel series have two 1 GSa/s ADCs. When all channels are enabled, each channel has a maximum sample rate of 500 MSa/s. When a single channel per ADC is active, it has sample rate of 1 GSa/s
- The newest generation of SPO technology
 - Waveform capture rate up to 100,000 wfm/s (normal mode), and 400,000 wfm/s (sequence mode)
 - Supports 256-level intensity grading and color display modes
 - Record length up to 14 Mpts
 - Digital trigger system
- Intelligent trigger: Edge, Slope, Pulse Width, Window, Runt, Interval, Time out (Dropout), Pattern
- Serial bus triggering and decoding (Standard), supports protocols I²C, SPI, UART, RS232, CAN, LIN
- Segmented acquisition (Sequence) mode, divides the maximum record length into multiple segments (up to 80,000), according to trigger conditions set by the user, with a very small dead time segment to capture the qualifying event
- 1 Mpts FFT
- Math and measurement functions use all sampled data points (up to 14 Mpts)
- MSO, 16 digital channels (four channel series only, optional)
- Search and navigate (four channel series only)
- USB AWG module (four channel series only, optional)
- USB WIFI adapter (four channel series only, optional)

Function & Characteristics

- When all channels are enabled, each channel has a maximum sample rate of 500 MSa/s. When a single channel per pair is active, that channel has sample rate of 1 GSa/s

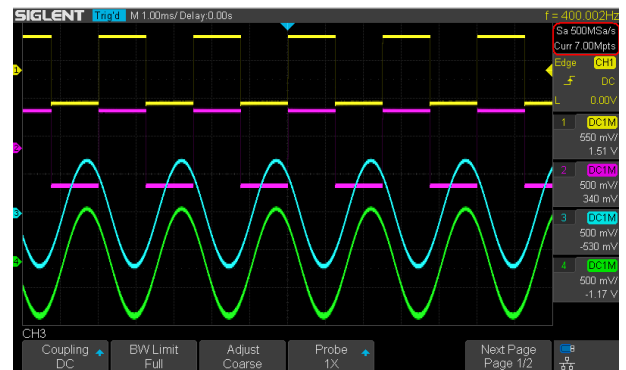
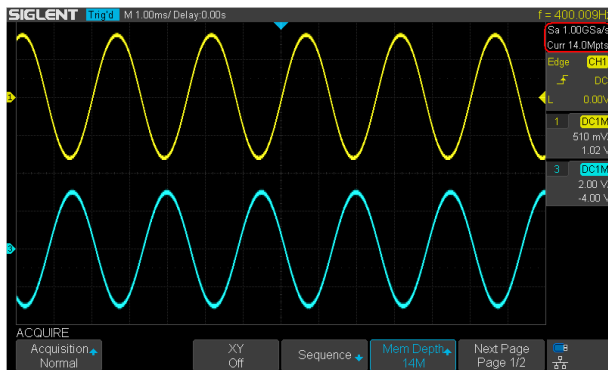

The four channel series has two 1 GSa/s ADC chips (channel 1 and 2 share one, channel 3 and 4 share another), so that each channel can achieve sample rates up to 500 MSa/s and work on bandwidths of 200 MHz when all channels are enabled.

- Record Length of Up to 14 Mpts (single channel/ pair mode), 7 Mpts/CH (two channels/pair mode)

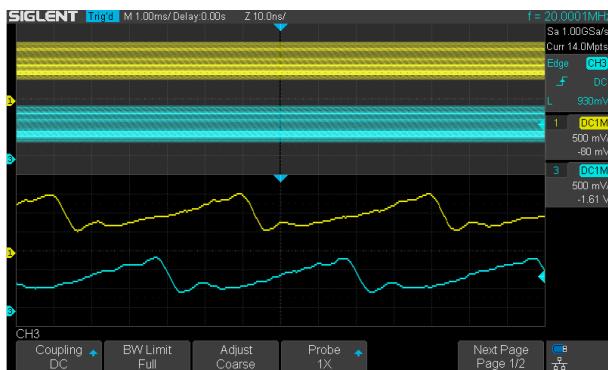

Using hardware-based Zoom technologies and max record length of up to 14 Mpts, users are able to oversample to capture for longer time periods at higher resolution and use the zoom feature to see more details within each signal.

- Waveform Capture Rate Up to 400,000 wfms/s

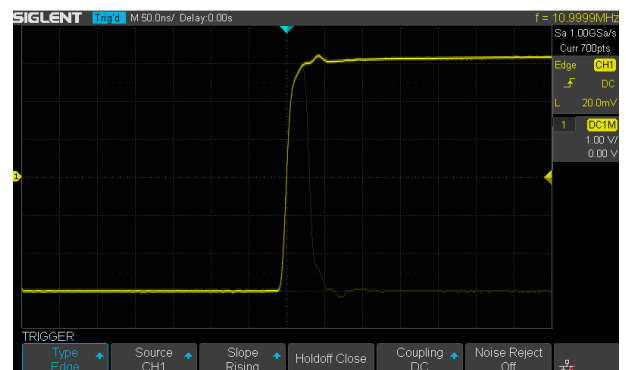

With a waveform capture rate of up to 400,000 wfms/s (sequence mode), the oscilloscope can easily capture the unusual or low-probability events.

- 256 -Level Intensity Grading and Color Temperature Display

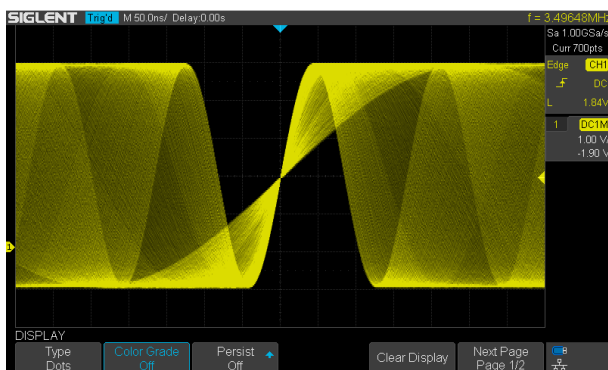

SPO display technology provides for fast refresh rates. The resulting intensity-graded trace is brighter for events that occur with more frequency and dims when the events occur with less frequency.

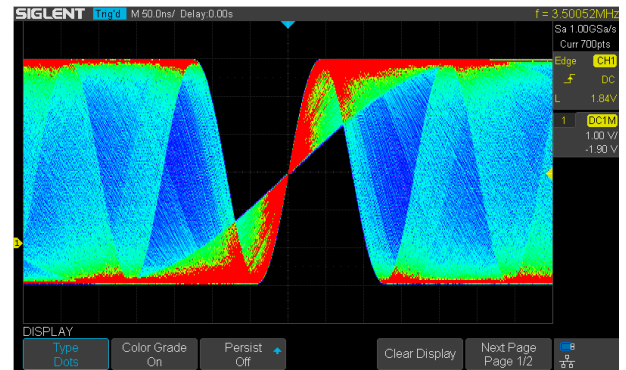

The color temperature display is similar to the intensity-graded trace function, but the trace occurrence is represented by different colors (color "temperature") as opposed to changes in the intensity of one color. Red colors represents the more frequent events, while blue is used to mark points that occur less frequently.

• Search and Navigate (four channel series only)

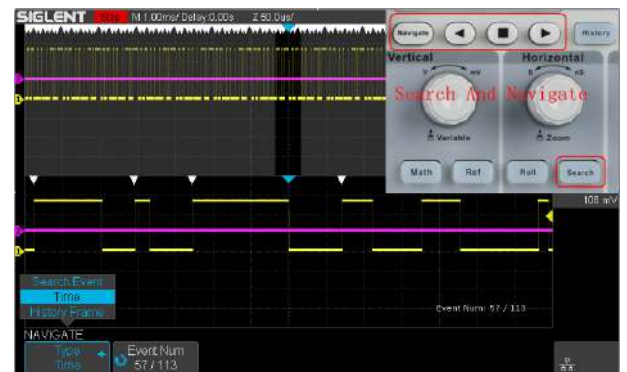
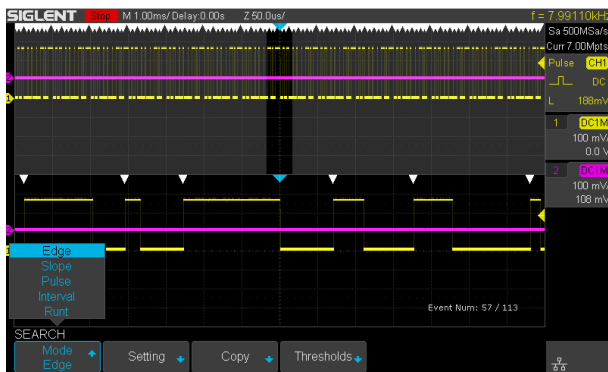

The SDS1000X-E can search events specified by the user in a frame. It can also navigate by time (delay position) and historical frames.

• 16 Digital Channels/MSO (four channel series only, optional)

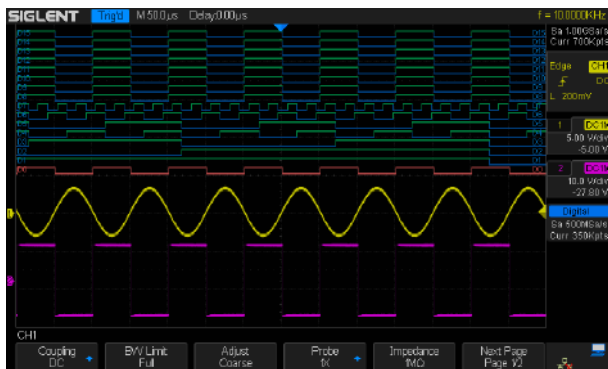

16 digital channels enables users to acquire and trigger on the waveforms then analyze the pattern, simultaneously with one instrument.

• USB 25 MHz AWG Module (four channel series only, optional)



The four channel series supports a USB 25 MHz function/arbitrary waveform generator that is operated from the USB host connection. Functions include Sine, Square, Ramp, Pulse, Noise, DC and 45 built-in waveforms. The arbitrary waveforms can be accessed and edited by the Siglent EasyWave PC software.

• 7 inch TFT-LCD display and 10 one-button menus

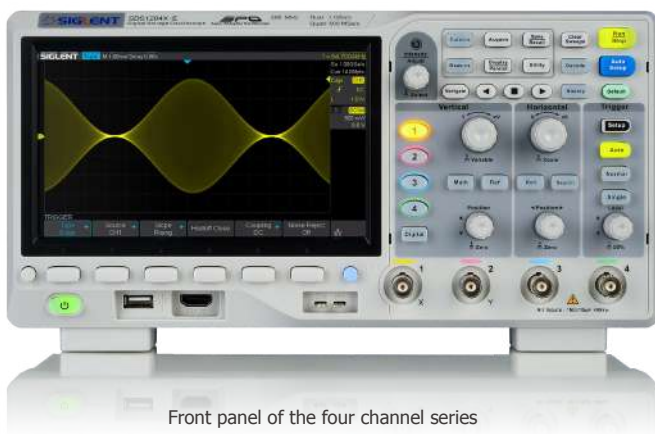

Front panel of the four channel series

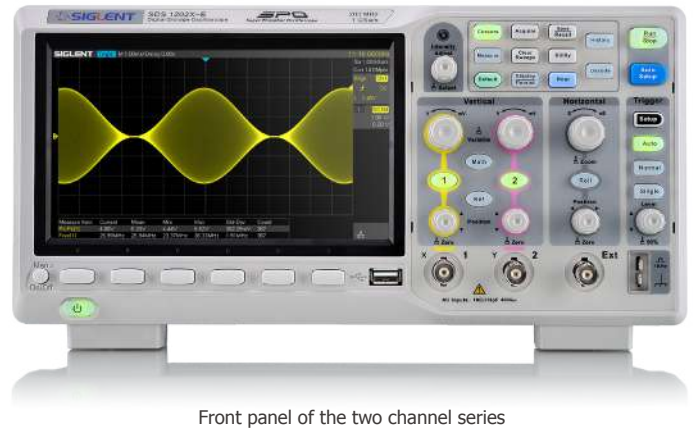

Front panel of the two channel series

- 7-inch TFT -LCD display with 800 * 480 resolution
- Most commonly used functions are accessible using 10 different one-button operation keys: Auto Setup, Default, Cursor, Measure, Roll, History, Persist, Clear Sweep, Zoom, Print

Models and key Specification

Model	SDS1104X-E	SDS1204X -E SDS1202X-E
Bandwidth	100 MHz	200 MHz
Sampling Rate (Max.)	Two channel series have a single 1 GSa/s ADC, four channel series have two 1 GSa/s ADCs. When all channels are enabled, each channel has a maximum sample rate of 500 MSa/s. When a single channel per pair is active, that channel has sample rate of 1 GSa/s	
Channels	4 (four channel series) 2+EXT (two channel series)	
Memory Depth (Max.)	7 Mpts/CH (not interleave mode); 14 Mpts/CH (interleave mode)	
Waveform Capture Rate (Max.)	100,000 wfm/s (normal mode), 400,000 wfm/s (sequence mode)	
Trigger Type	Edge, Slope, Pulse Width, Window, Runt, Interval, Dropout, Pattern, Video	
Serial Trigger and decoder (Standard)	I ² C, SPI, UART/RS232, CAN, LIN	
16 Digital Channels (four channel series only, optional)	Maximum waveform capture rate up to 1 GSa/s, Record length up to 14 Mpts/CH	
USB AWG module (four channel series only, optional)	One channel, 25 MHz, sample rate of 125 MHz, wave length of 16 kpts	
Bode plot (four channel series only)	Minimum start frequency of 10 Hz, minimum scan bandwidth of 500 Hz, maximum scan bandwidth of 120 MHz (dependent on Oscilloscope and AWG bandwidth), 500 maximum scan frequency points	
USB WIFI adapter (four channel series only, optional)	802.11b/g/b, WPA-PSK	
I/O	USB Host, USB Device, LAN, Pass/Fail, Trigger Out, Sbus (Siglent MSO)	
Probe (Std)	4 pcs passive probe PP510	4/2 pcs passive probe PP215
Display	7 inch TFT -LCD (800x480)	
Weight	Four channel series: Without package 2.6 Kg; With package 3.8 Kg Two channel series: Without package 2.5 Kg; With package 3.5 Kg	

Ordering information		
Product Name	SDS1104X-E 100 MHz Four Channels	
	SDS1204X-E 200 MHz Four Channels	
	SDS1202X-E 200 MHz Two Channels	
Standard Accessories	USB Cable -1	
	Quick Start -1	
	Passive Probe -2/4	
	Certification -1	
	Power Cord -1	
Optional Accessories	16 Channels MSO Software (four channel series only)	SDS1000X-E-16LA
	16 Channels Logic Analyzer (four channel series only)	SLA1016
	AWG Software (four channel series only)	SDS1000X-E-FG
	USB AWG Module Hardware (four channel series only)	SAG1021I
	WIFI Software (four channel series only)	SDS1000X-E-WIFI
	USB WIFI Adapter (four channel series only)	TL_WN725N
	Isolated Front End	ISFE
	STB Demo Source	STB-3
	High Voltage Probe	HPB4010
	Current Probes	CP4020/CP4050/CP4070/CP4070A/CP5030/CP5030A/CP5150/CP5500
Differential Probes	DPB4080/DPB5150/DPB5150A/DPB5700/DPB5700A	

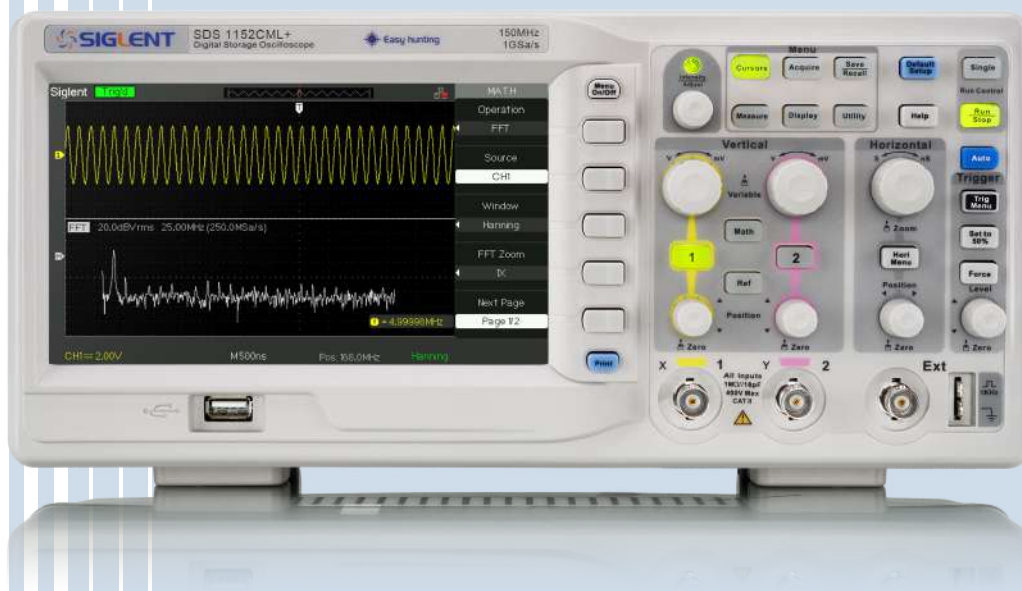

SDS1000DL+ /CML+ Series Digital Oscilloscope

Application

- Electronic circuit design and debugging
- Electrical circuit function test
- Inspect instantaneous signal
- Industrial control and measuring
- Products quality control
- Education and training

Key Features

- 50 MHz to 150 MHz Bandwidth
- 500 MSa/s~1 GSa/s sampling rate, 32 Kpts~2 Mpts memory depth
- 7 inch (8*18 div) color TFT-LCD display
- 6 digits hardware frequency counter, real time counting display
- Waveform record and play back function
- Unique digital filter and data recorder function
- Embedded 12 languages, online help, one key storing and one key printing
- Interface: USB Device, USB Host, LAN, Pass/Fail
- Supports USB-TMC protocol and SCPI programming command control

Specifications

Model	SDS1052DL+	SDS1072CML+	SDS1102CML+	SDS1152CML+
Bandwidth	50 MHz	70 MHz	100 MHz	150 MHz
Channels	2 CH +1 EXT			
Real time sampling rate	500 MSa/s	1 GSa/s	1 GSa/s	1 GSa/s
Equivalent sampling rate	50 GSa/s			
Memory depth	32 Kpts	2 Mpts	2 Mpts	2 Mpts
Input impedance	1 M Ω 17 pF	1 M Ω 17 pF	1 M Ω 17 pF	1 M Ω 17 pF
Vertical sensitivity	2 mv~10 v/div	2 mv~10 v/div	2 mv~10 v/div	2 mv~10 v/div
Vertical resolution	8 bit			
Trigger source	CH1, CH2, Ext, Ext/5, AC Line			
Trigger types	Edge, Pulse, Video, Slope, Alternative			
Math operation	+, -, *, /, FFT			
Digital filter	High pass, Low pass, Band pass, Band stop			
Data recorder function	√	√	√	√
Max input voltage	± 400 V (DC+AC Pk-Pk)			
Internal storage	2 groups of reference waveform, 20 groups of setting, 10 groups of waveform			
External storage	Bitmap save, CSV save, Waveform save, Setting save			
Lasting	Turn off, 1 s, 2 s, 5 s, infinite			
Language	English, French, German, Russian, Spanish, Simplified Chinese, Traditional Chinese, Portuguese, Japanese, Korean, Italian, Arabic			
Interface	USB Host, USB Device, LAN, Pass/Fail			
Display	7 inch color TFT-LCD			
Power	AC 100-240 V, 45 Hz-440 Hz, 50 VA Max			

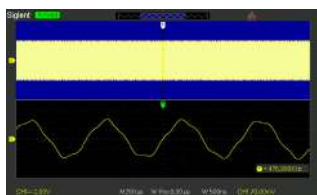

Normal Memory (40 kpts)

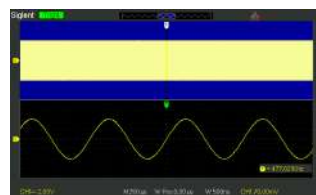

Long Memory (2 Mpts)



32 types of auto measurements



5 parameters display

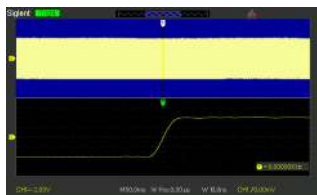

Zoom Function

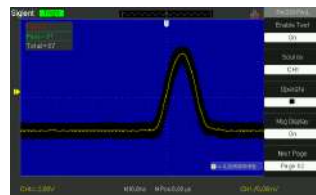

Pass/Fail Function

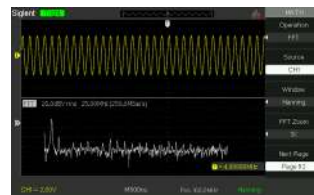

Math Function



Embedded Online Help

Standard Accessories



SDG6000X Series Pulse/Arbitrary Waveform Generator

 **Easy Pulse**

True Arb



Key Features

- Dual-Channel, 500 MHz maximum bandwidth, 20 Vpp maximum output amplitude, high fidelity output with 80 dB dynamic range
- High-performance sampling system with 2.4 GSa/s sampling rate and 16-bit vertical resolution
- Innovative TrueArb technology, based on a point-by-point architecture, supports any 8 pts~8 Mpts Arb waveform with a sampling rate in range of 1 μ Sa/s~75 MSa/s
- Innovative EasyPulse technology, capable of generating lower jitter Square or Pulse waveforms, brings a wide range and extremely high precision in pulse width and rise/fall times adjustment
- Multi-function signal generator, meeting requirements in wide range, Continuous Wave Generator, Pulse Generator, Function Arbitrary Waveform Generator, IQ Signal Generator (optional), Noise Generator, PRBS Generator
- Sweep and Burst function
- Harmonics function
- Waveform Combining function
- Channel Coupling, Copy and Tracking function
- 196 built-in arbitrary waveforms
- High precision Frequency Counter
- Standard interfaces include: USB Host, USB Device (USBTMC), LAN (VXI-11, Socket, Telnet), GPIB (Optional)
- 4.3" touch screen display for easier operation

Characteristics

- Continuous Wave

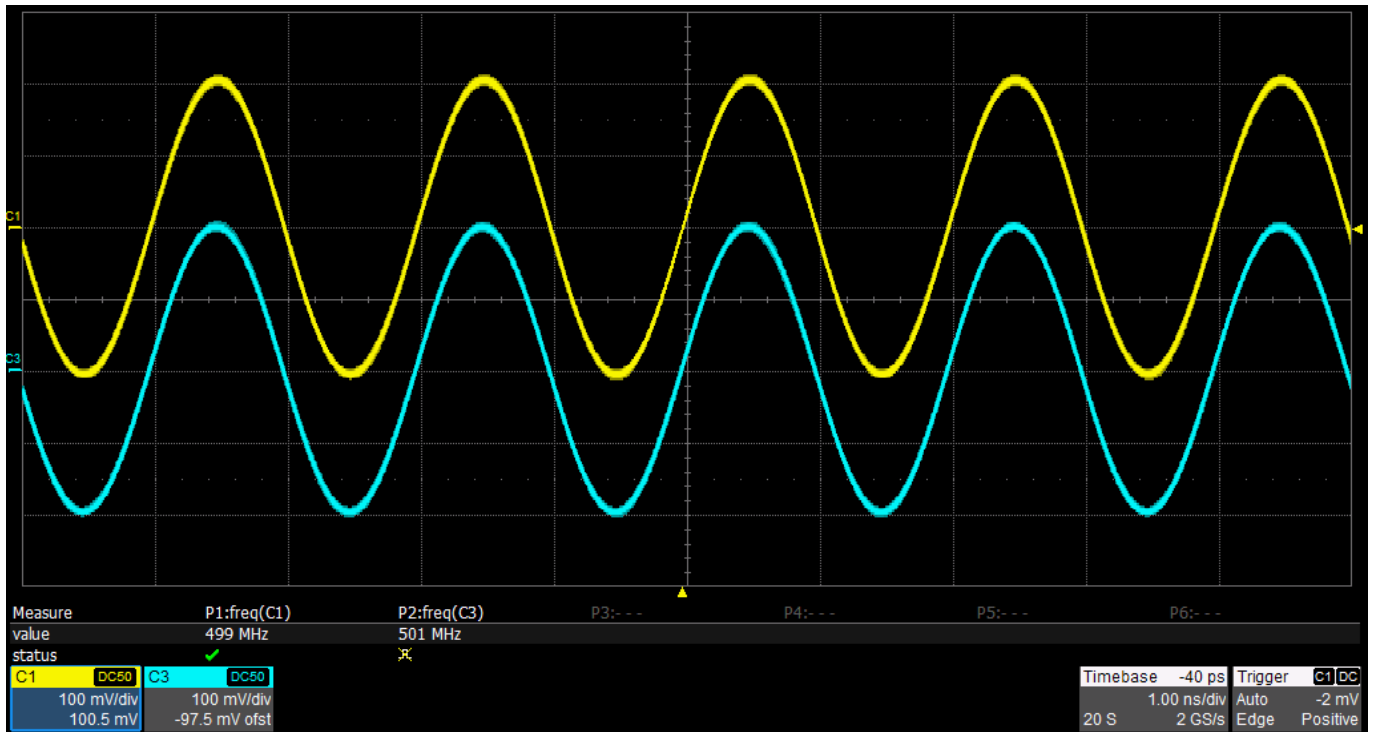

Up to 500 MHz continuous sine wave.

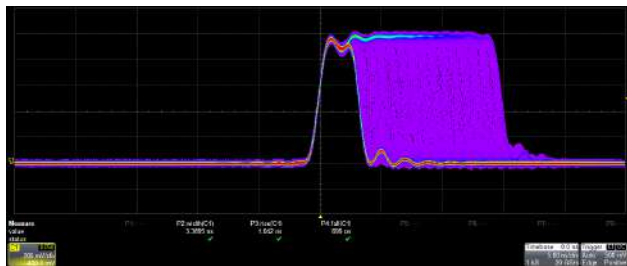

- Pulse *Easy Pulse*

- ◀ Adjustable Pulse Width

The pulse width can be fine-tuned to the minimum of 3.3 ns with an adjustment step as small as 100 ps, at any frequency.

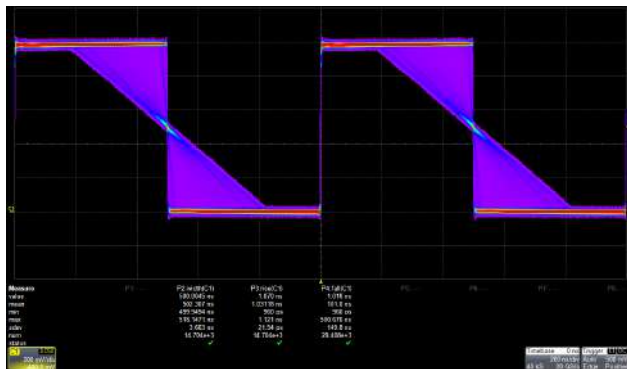

- ◀ Adjustable Edge

The rise/fall times can be set independently to the minimum of 1 ns at any frequency with a minimum adjustment step as small as 100 ps.



- ◀ Low Jitter

When a Square/Pulse waveform is generated by traditional DDS, there can be additional jitter if the sampling rate is not an integer-related multiple of the output frequency. EasyPulse technology successfully overcomes this weakness in DDS designs and helps to produce low jitter Square/Pulse waveforms.

• Arbitrary Waveform **True Arb**

Traditional DDS designs can lead to additional jitter and distortion when sourcing arbitrary waveforms. The SIGLENT TrueArb design minimizes jitter and distortion to help deliver high fidelity arbitrary waveforms.

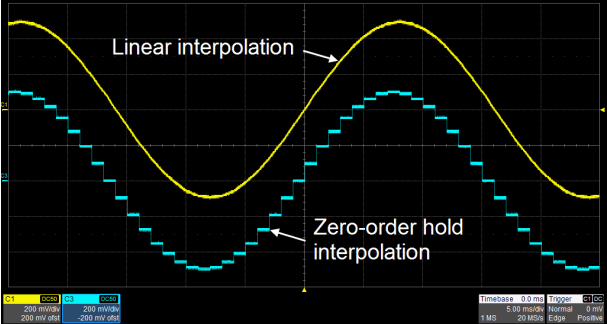

Point by Point Output

TrueArb generates arbitrary waveforms point-by-point. It never skips any point so that it can reconstruct all the details of the waveform, as defined. Two interpolation modes are available: linear and zero-order hold.

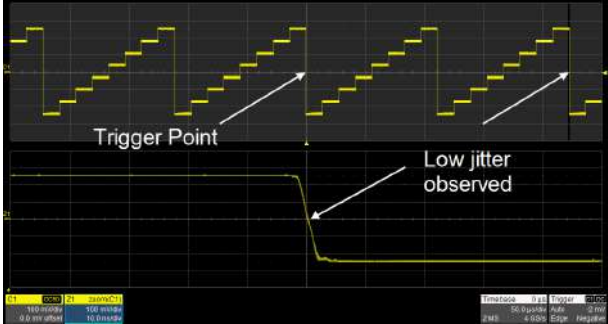

Low Jitter

As with EasyPulse, TrueArb effectively overcomes the clock jitter that can effect traditional DDS generators.

• PRBS

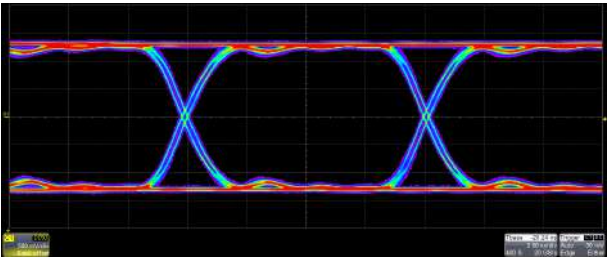

PRBS3 ~ PRBS32 with finely adjustable 10^6 bps ~ 300 Mbps bit rate and 1 ns ~ 1us edge.

*CH1:PRBS.ON.50Ω		CH2:PRBS.ON.50Ω	
		Bit Rate	122.880 000Mbps
		Amplitude	800.0mVpp
		Offset	850.0mVdc
		Length	PRBS-30
		Rise/Fall	2.0ns
		Load	50 Ω
		Output	ON
TTL/CMOS	LVTTTL LVCOMS	ECL	LVPECL
			LVDS
			Differential ON

Preset common logic levels such as TTL, LVCMOS, LVPECL and LVDS. An added differential mode provides an easy way to generate differential signals using the both channels.

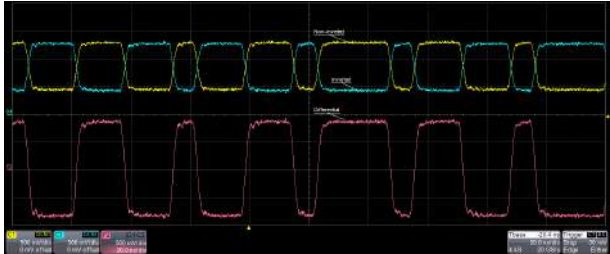

Waveform Generator

- IQ (optional)

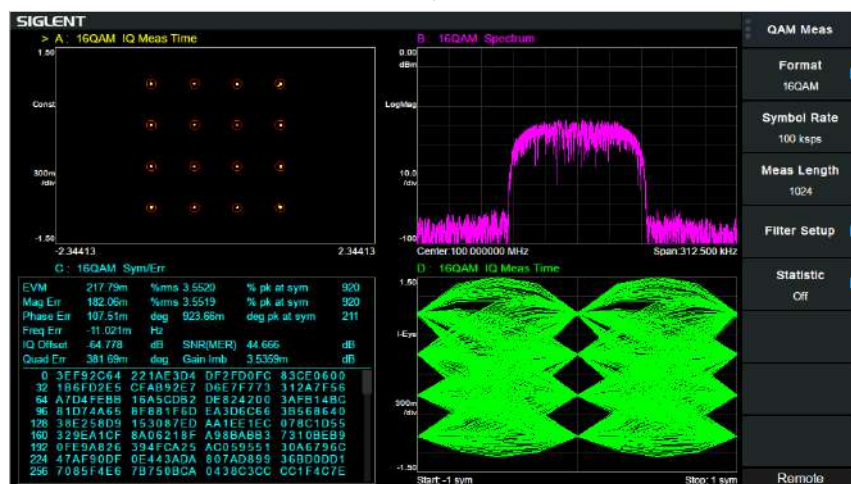
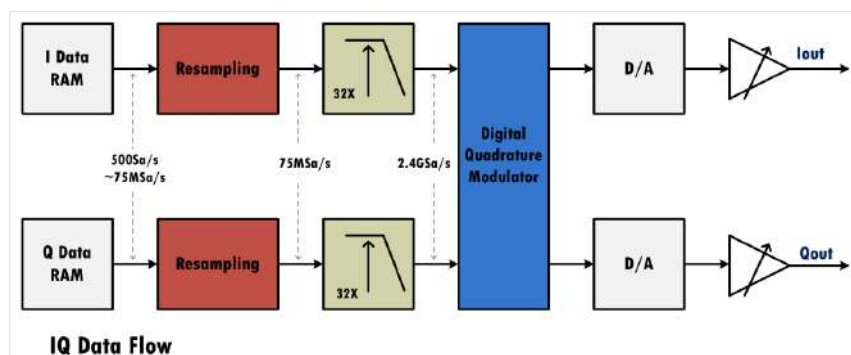

The SDG6000X supports popular modulation types such as ASK, FSK, PSK, and QAM. Proprietary resampling technology provides excellent EVM performance at arbitrary symbol rates between 250 Symb/s ~ 37.5 MSymb/s. Built-in digital quadrature modulator provides the possibility to generate IQ signals from baseband to 500 MHz intermediate frequency.



IQ waveforms can be generated by the PC software EasyIQ.

• Complex Signals Generation

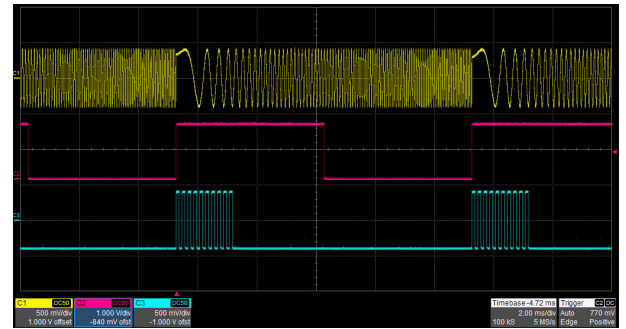
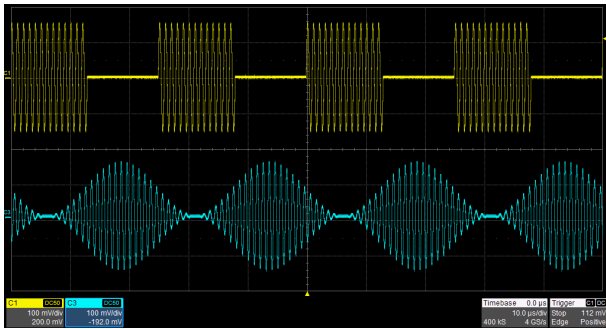

Modulation

Plenty of modulation types, such as AM, FM, PM, FSK, ASK, PSK, DSB-AM, PWM are supported. The modulation source can be configured as "Internal" or "External".

Sweep and Burst

Sweep modes include "Linear" and "Log". Burst modes includes "N cycle" and "Gated". Both Sweep and Burst can be triggered by "Internal", "External" or "Manual" source.

Waveform Combining

The waveform combining function superimposes CH1 and CH2 waveforms internally and provides the combined waveform to a user-selected output. Easily combine basic waveforms, random noise, modulation signals, sweep signals, burst signals, EasyPulse waveforms and TrueArb waveforms.

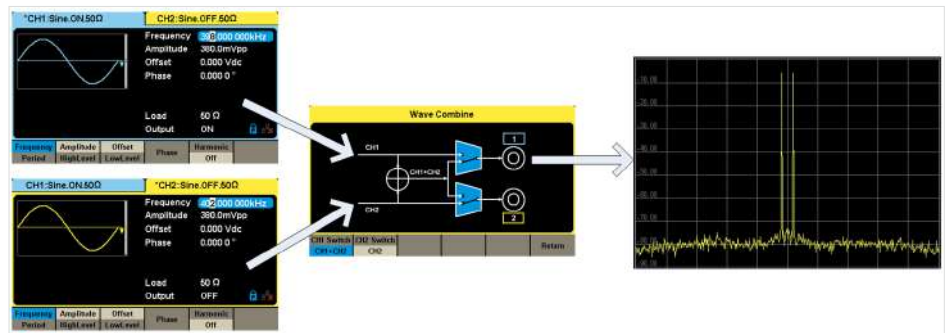

Harmonics Function

Harmonics function gives you the ability to add higher-order elements to your signal.

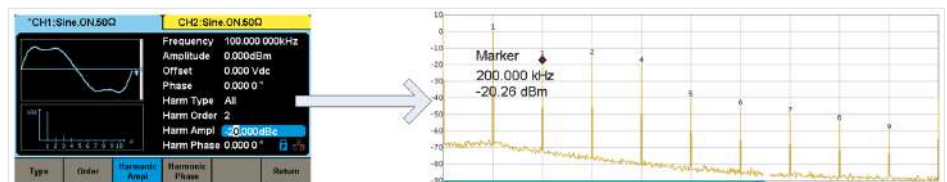

• Two Dual-channel Operation Mode

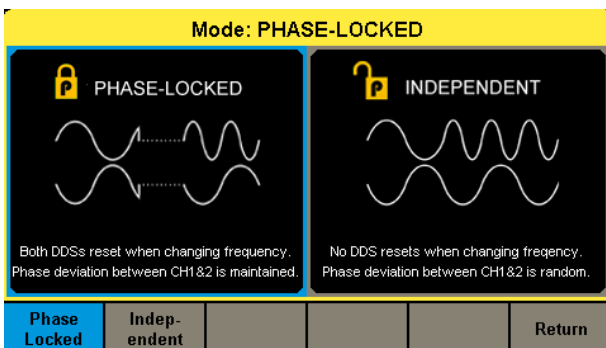

"Phase-Locked" mode automatically aligns the phases of each output. While "Independent" mode permit the two channels to be used as two independent generators. Independent mode also smoothes parameter (frequency, amplitude) changes made to an active channel.

• Frequency Counter

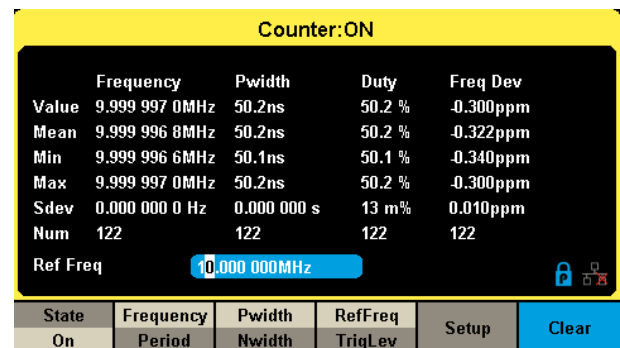

8-digit hardware frequency counter with statistics function and input range of 0.1 Hz ~ 400 MHz.

Specifications

Model	SDG6022X	SDG6032X	SDG6052X
Bandwidth	200 MHz	350 MHz	500 MHz
Number of channels	2		
Sampling rate	2.4 GSa/s (2X Interpolation)		
Vertical resolution	16 bit		
Arbitrary waveform length	2 ~ 20 Mpts		
Display	4.3" touch screen display, 480 x 272 x RGB		
Interface	Standard: USB Host, USB Device, LAN Optional: GPIB (USB-GPIB adaptor)		

Frequency	
Resolution	±1 ppm (25°C)
	±2 ppm (0-40°C)
1st-year aging	±1 ppm (25°C)
10-year aging	±3.5 ppm (25°C)

Sine	
Harmonic distortion	0~1 MHz (included) < -65 dBc
	1~60 MHz (included) < -60 dBc
	60~100 MHz (included) < -50 dBc
	100~200 MHz (included) < -40 dBc
	200~300 MHz (included) < -30 dBc
	300 MHz (included) < -28 dBc
Total Harmonic Distortion	10 Hz ~ 20 kHz < 0.075%
Non-harmonic spurious	≤350 MHz < -60 dBc
	>350 MHz < -55 dBc

Pulse	
Frequency	1 μHz ~ 150 MHz (SDG6052X, SDG6032X) 1 μHz ~ 80 MHz (SDG6022X)
Pulse Width	≥3.3 ns
Pulse width accuracy	±(0.01%+0.3 ns)
Rise time (setting range)	1 ns (10% ~ 90%) SDG6052X, SDG6032X 2 ns (10% ~ 90%) SDG6022X
Overshoot	3%, 100 kHz, 1 Vpp, 50 Ω load , 2 ns edge
Duty cycle	0.001% ~ 99.999% Limited by frequency setting
Duty cycle resolution	0.001%
Jitter (rms) cycle to cycle	<100 ps, 1 Vpp, 50 Ω load

Arbitrary Wave	
Frequency setting range	1 μHz ~ 50 MHz
Waveform length	2 pts ~ 20 Mpts
Sampling rate	1 uSa/s ~ 300 MSa/s (TrueArb mode)
	1.2 GSa/s (DDS mode)
Vertical resolution	16 bit
Jitter (rms) cycle to cycle	≤100 ps (1 Vpp, 50 Ω load , TrueArb mode)

Square	
Frequency	1 μ Hz~ 120 MHz (SDG6052X, SDG6032X) 1 μ Hz~ 80 MHz (SDG6022X)
Rise /fall times	2 ns~2.4 ns (10% ~ 90%, 1 Vpp, 50 Ω load)
Overshoot	\leq 3% (100 kHz, 1 Vpp, 50 Ω load)
Duty cycle	10% ~ 90% (Limited by frequency setting)
Jitter (rms) cycle to cycle	<100 ps (1 Vpp, 50 Ω load)

Output	
Accuracy	\pm (1%+1 mVpp) (10 kHz sine, 0 V offset)
Amplitude flatness	\pm 0.3 dB (50 Ω load, 0.5 Vpp, compare to 1 MHz Sine)
Output impedance	50 \pm 0.5 Ω (100 kHz sine)
Output current	-200 ~ 200 mA
Crosstalk	< -60 dBc (CH1=CH2=0 dBm, Sine, 50 Ω load)

IQ (optional)	
Symbol rate	250 Symb/s ~ 37.5 MSymb/s (Limited by the oversampling factor)
Vertical resolution	16 bit
Modulation type	2ASK, 4ASK, 8ASK, BPSK, QPSK, 8PSK, DBPSK, DQPSK, D8PSK, 8QAM, 16QAM, 32QAM, 64QAM, 128QAM, 256QAM, 2FSK, 4FSK, 8FSK, 16FSK, MSK, MultiTone, custom (Supported by EasyIQ software)
Pattern	PN7, PN9, PN15, PN23, User file, Custom (Supported by EasyIQ software)
Output Range	1 mVrms ~ 0.5 Vrms ($\sqrt{I^2 + Q^2}$, 50 Ω load)
Carrier frequency	500 MHz (IF Output)

PRBS	
Bit rate	1 ubps~ 300 Mbps (SDG6052X, SDG6032X) 1 ubps~ 160 Mbps (SDG6022X)
Sequence length	2 ^{m-1} , m = 3, 4, ... , 32
Rise/fall times	1 ns ~ 1 μ s (SDG6052X, SDG6032X. 10% ~ 90%, 1 Vpp, 50 Ω load) 2 ns ~ 1 μ s (SDG6022X. 10% ~ 90%, 1 Vpp, 50 Ω load)
Output Range (Note)	2 mVpp ~ 20 Vpp \leq (40 Mbps, HiZ load)
	2 mVpp ~ 10 Vpp (40 ~ 240 Mbps (included), HiZ load)
	2 mVpp ~ 5 Vpp (240 Mbps, HiZ load)

Ordering Information

Product Description	
SDG6052X	500 MHz, 2-CH, 2.4 GSa/s, 16-bit
SDG6032X	350 MHz, 2-CH, 2.4 GSa/s, 16-bit
SDG6022X	200 MHz, 2-CH, 2.4 GSa/s, 16-bit

Standard Configurations	
Quick start	\times 1
Power cord	\times 1
Calibration certificate	\times 1
USB cable	\times 1
BNC coaxial cable	\times 2

Optional Configurations	
SPA1010	10 W Power Amplifier
ATT-20dB	20 dB Attenuator
USB-GPIB	USB-GPIB Adapter
SDG-6000X-IQ	IQ Signal Generator Function

SDG2000X Series Function/Arbitrary Waveform Generator

 **Easy Pulse**

True Arb



Key Features

- Dual-channel, 120 MHz maximum bandwidth, 20 Vpp maximum output amplitude, high fidelity output with 80 dB dynamic range
- High-performance sampling system with 1.2 GSa/s sampling rate and 16-bit vertical resolution. No detail in the waveforms will be lost
- Innovative TrueArb technology, based on a point-by-point architecture, supports any 8 pts~8 Mpts Arb waveform with a sampling rate in range of 1 μ Sa/s~75 MSa/s
- Innovative EasyPulse technology, capable of generating lower jitter Square or Pulse waveforms, brings a wide range and extremely high precision in pulse width and rise/fall times adjustment
- Plenty of analog and digital modulation types: AM、DSB-AM、FM、PM、PSK、FSK、ASK and PWM
- Practical functions: Channel Copy, Channel Coupling, Channel Track, harmonic generator, overvoltage protection function
- Sweep and Burst function, Harmonics mode supported
- High precision Frequency Counter
- Standard interfaces: USB Host, USB Device (USBTMC) , LAN (VXI-11)
- Optional interface: USB-GPIB
- 4.3" touch screen display for easier operation

Characteristics

- Excellent Analog Channel Performance

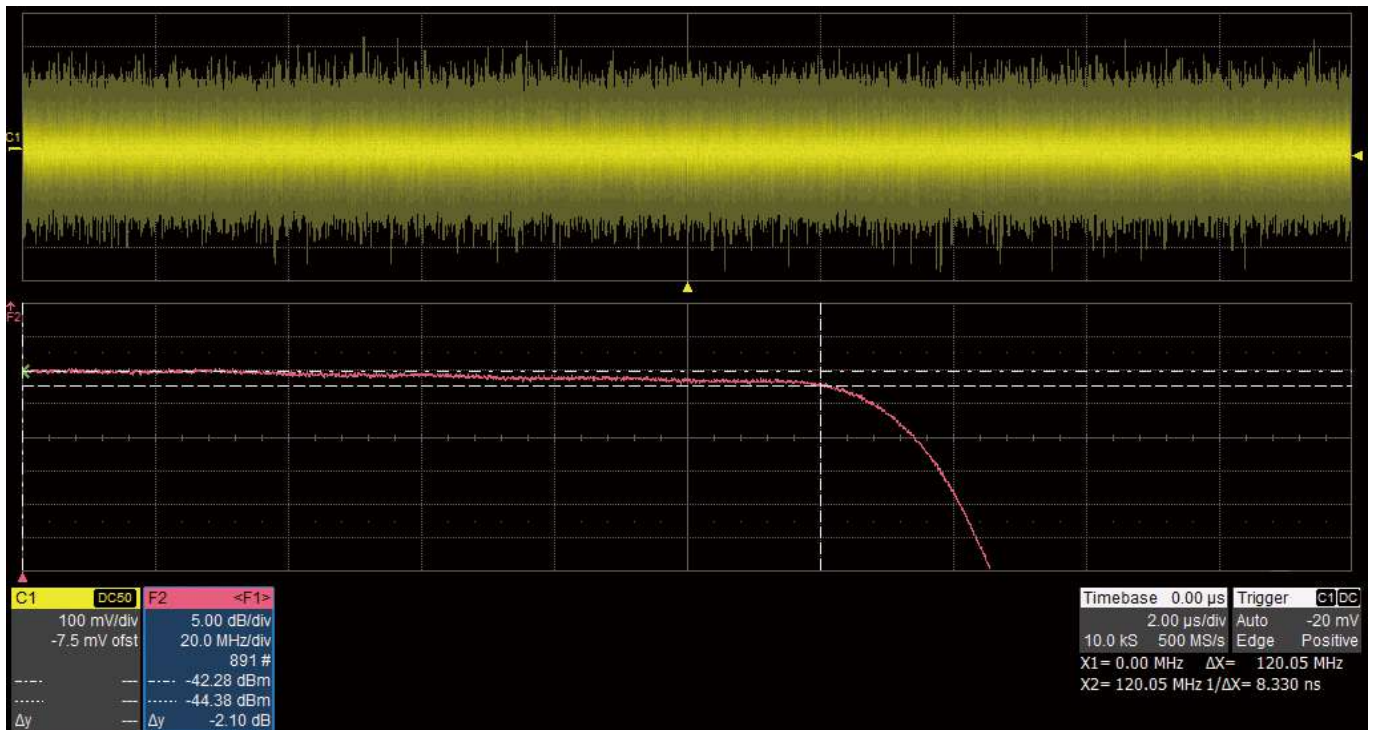

▲ The bandwidth of analog channels proves to be greater than 120 MHz, via doing a frequency response test with white noise.

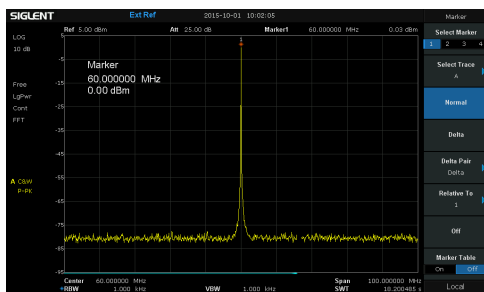

◀ High fidelity sine output. Almost no spurious observed @60 MHz, 0 dBm.

▶ Capacity of outputting large signal at high frequency. Dual-channel, 20 Vpp amplitude can be guaranteed even @20 MHz.

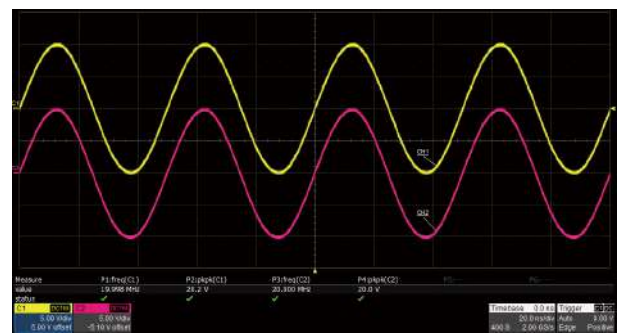

▶ Low noise floor, improves signal-noise ratio.

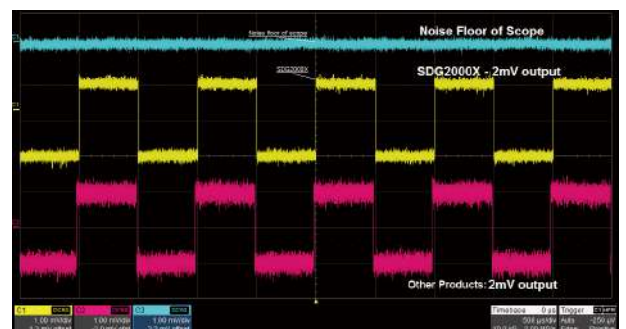

Waveform Generator

• Innovative EasyPulse Technology

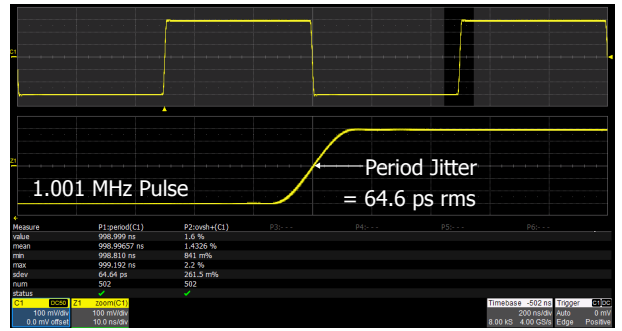
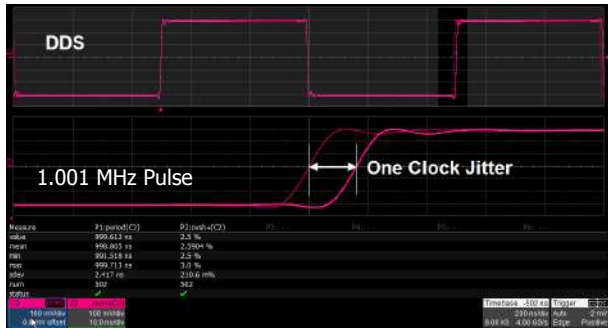

When a Square/Pulse waveform is generated by DDS, there will be a one-clock-jitter if the sampling rate is not an integer-related multiple of the output frequency. SDG2000X EasyPulse technology successfully overcomes this weakness in DDS designs and helps to produce low jitter Square/Pulse waveforms.

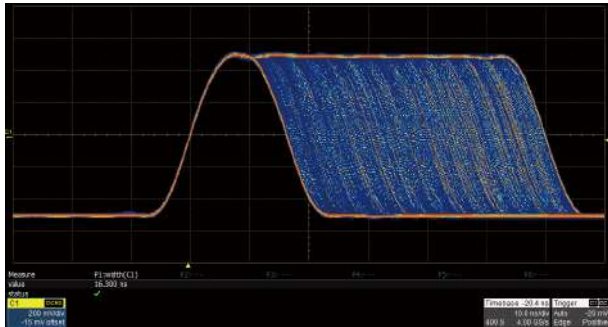

The Pulse width can be fine-tuned to the minimum of 16.3 ns with the adjustment step as small as 100 ps.

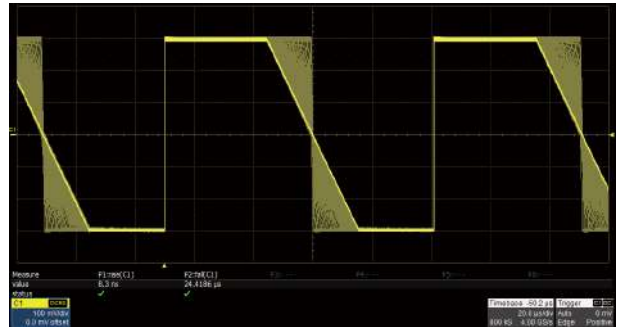

The rise/fall times can be set independently to the minimum of 8.4 ns at any frequency and to the maximum of 22.4 s. The adjustment step is as small as 100 ps.

• Innovative TrueArb Technology

For arbitrary waveforms, TrueArb not only has all the advantages of traditional DDS, but also eliminates the probability that DDS may cause serious jitter and distortion.

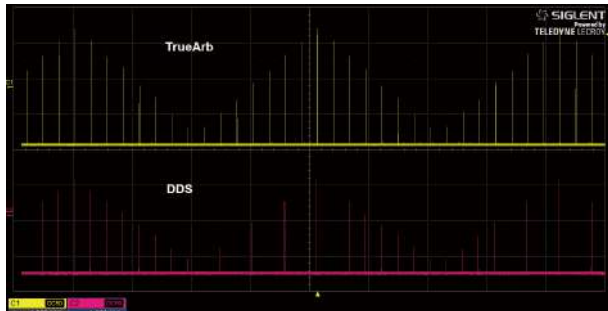

TrueArb generates arbitrary waveforms point by point, never skips any point so that it can reconstruct all the details of the waveform as defined.

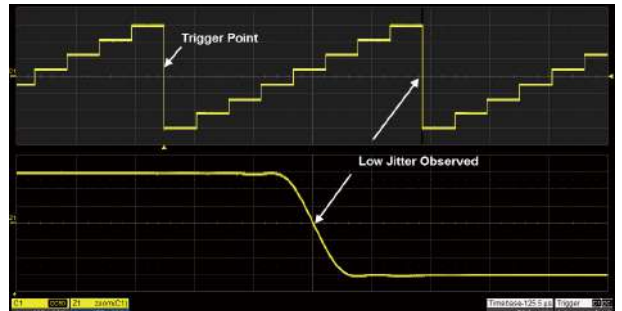

As with EasyPulse, TrueArb effectively overcomes the defect that DDS may cause the one-clock-jitter in arbitrary waveforms.

• 4.3" Touch Screen Display

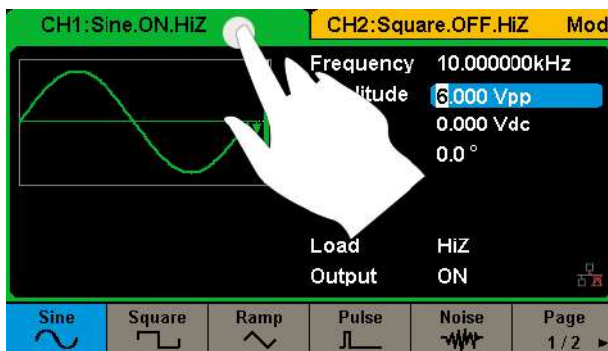

4.3" touch screen display, makes operation much more convenient.

• Arbitrary Waveform Software EasyWave

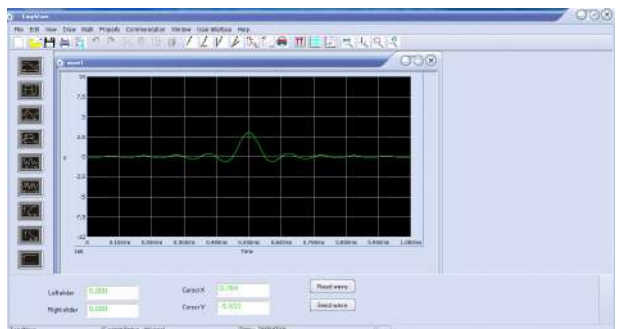

EasyWave is a powerful arbitrary waveform editing software that supports several ways to generate arbitrary waveform such as manual drawing, line-drawing, equation-drawing, coordinate-drawing, etc. It is quite convenient for users to edit their own arbitrary waveforms through EasyWave.

Characteristics

• High-performance Sampling System

Benefiting from a 1.2 GSa/s and 16-bit sampling system, SDG2000X achieves extremely high accuracy performance in both time domain and amplitude, which results in more accurately reconstructed waveforms and lower distortion.

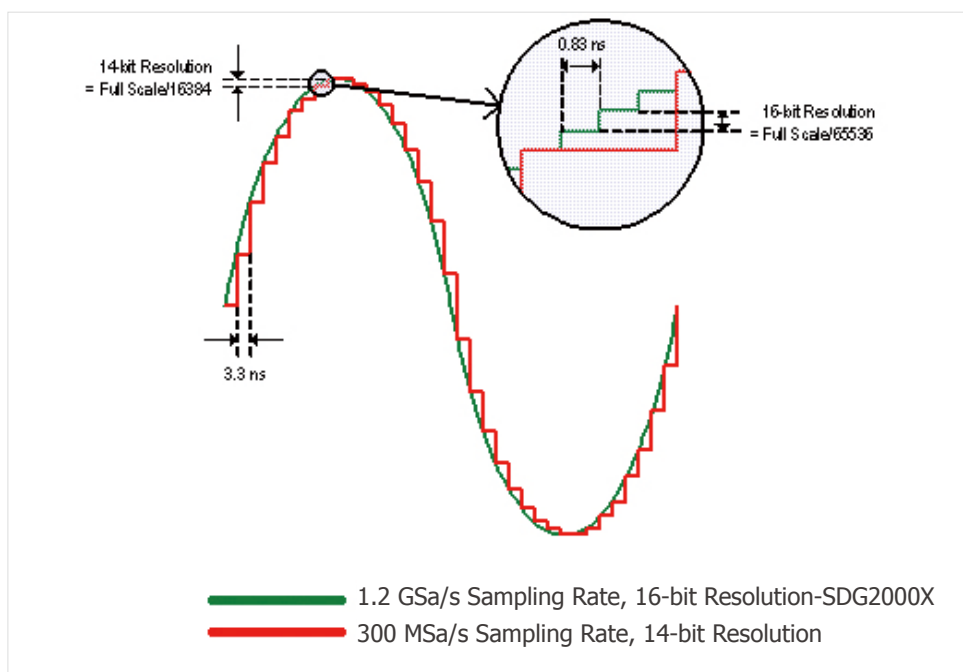

Specifications

Product Model	SDG2042X	SDG2082X	SDG2122X
Bandwidth	40 MHz	80 MHz	120 MHz
Sampling rate	1.2 GSa/s (4 X Interpolation)		
Vertical resolution	16 bit		
Num. of channels	2		
Max. amplitude	±10 V		
Display	4.3" touch screen display, 480 x 272 x RGB		
Interface	Standard: USB Host, USB Device, LAN Optional: GPIB (USB-GPIB adaptor)		

Frequency Characteristics					
Parameter	Min.	Typ.	Max.	Unit	Condition
Resolution			1 μ	Hz	
Initial accuracy	-1		+1	ppm	25°C
	-2		+2	ppm	0~40°C
1 st -year aging	-1		+1	ppm	25°C
10-year aging	-3.5		+3.5	ppm	25°C

Sine Characteristics					
Parameter	Min.	Typ.	Max.	Unit	Condition
Frequency	1 μ		120 M	Hz	
Harmonic distortion			-65	dBc	0 dBm, 0~10 MHz (Included)
			-60	dBc	0 dBm, 10~20 MHz (Included)
			-55	dBc	0 dBm, 20~40 MHz (Included)
			-50	dBc	0 dBm, 40~60 MHz (Included)
			-45	dBc	0 dBm, 60~80 MHz (Included)
			-40	dBc	0 dBm, 80~100 MHz (Included)
			-38	dBc	0 dBm, 100~120 MHz (Included)
Total Harmonic Distortion			0.075	%	0 dBm, 10 Hz ~ 20 kHz
Non-harmonic spurious			-70	dBc	≤50 MHz
			-65	dBc	>50 MHz

Waveform Generator

Square Characteristics					
Parameter	Min.	Typ.	Max.	Unit	Condition
Frequency	1 μ		25 M	Hz	
Rise/fall times			9	ns	10% ~ 90%, 1 Vpp, 50 Ω Load
Overshoot			3	%	100 kHz, 1 Vpp, 50 Ω Load
Duty cycle	0.001		99.999	%	Limited by frequency setting
Jitter (rms), Cycle to cycle			150	ps	1 Vpp, 50 Ω Load

Pulse Characteristics					
Parameter	Min.	Typ.	Max.	Unit	Condition
Frequency	1 μ		25 M	Hz	
Pulse width	16.3			ns	
Pulse width accuracy			$\pm(0.01\%+0.3 \text{ ns})$		
Rise/fall times	8.4 n		22.4	s	10% ~ 90%, 1 Vpp, 50 Ω Load, Subject to pulse width limits
Overshoot			3	%	100 kHz, 1 Vpp
Duty cycle	0.001		99.999	%	Limited by frequency setting
Duty cycle resolution	0.001			%	
Jitter (rms) cycle to cycle			150	ps	1 Vpp, 50 Ω Load

Arbitrary Wave characteristics					
Parameter	Min.	Typ.	Max.	Unit	Condition
Frequency	1 μ		20 M	Hz	
Waveform length	8		8 M	pts	
Sampling rate	1 μ		75 M	Sa/s	TrueArb mode
	300			MSa/s	DDS mode
Vertical resolution	16			bit	
jitter (rms)			150	ps	1 Vpp, 50 Ω Load, TrueArb mode

Output Characteristics					
Parameter	Min.	Typ.	Max.	Unit	Condition
Range	2 m		20	Vpp	≤ 20 MHz, HiZ load
(Note 1)	2 m		10	Vpp	> 20 MHz, HiZ load
	1 m		10	vpp	≤ 20 MHz, 50 Ω load
	1 m		5	vpp	> 20 MHz, 50 Ω load
Accuracy	$\pm (1\%+1 \text{ mVpp})$				10 kHz sine, 0 V offset
Amplitude flatness	-0.3		+0.3	dB	0~100 MHz (Included), 50 Ω load, 2.5 Vpp, compare to 10 kHz Sine
	-0.4		+0.4	dB	100~120 MHz (Included), 50 Ω load, 2.5 Vpp, compare to 10 kHz Sine
Output impedance	49.5	50	50.5	Ω	10 kHz sine
Output current	-200		200	mA	
Crosstalk			-60	dBc	CH1 - CH2/CH2 - CH1

Note 1: The specification will be divided by 2 while applied to a 50 Ω load.

Ordering Information

Product Description	SDG2000X Series Function/Arbitrary Waveform Generator
Product code	SDG2042X 40 MHz SDG2082X 80 MHz SDG2122X 120 MHz
Standard configurations	A Quick Start, A Power Cord, A USB Cable, A Calibration Certificate, A BNC Coaxial Cable
Optional configurations	USB-GPIB adapter

SDG1000X

Function/Arbitrary Waveform Generator

Easy Pulse

True Arb



Application

- IC test
- Simulate sensor
- Simulate environment signals
- Electrical circuit function test
- Education and training

Key Features

- Dual-channel, with bandwidth up to 60 MHz, and amplitude up to 20 Vpp
- 150 MSa/s sampling rate, 14-bit vertical resolution, and 16 kpts waveform length
- Innovative EasyPulse technology, capable of generating lower jitter Pulse waveforms, brings a wide range and extremely high precision in pulse width and rise/fall times adjustment
- Innovative TrueArb technology, based on a point-by-point architecture, supports any 8 pts~8 Mpts Arb waveform with a sampling rate in range of 1 μ Sa/s~75 MSa/s
- Special circuit for Square wave function, can generate Square waves up to 60 MHz with jitter less than 300 ps+0.05 ppm of period
- Plenty of analog and digital modulation types: AM, DSB-AM, FM, PM, FSK, ASK, PSK and PWM
- Sweep and Burst functions
- Harmonics Generator function
- Waveform Combining function
- High precision Frequency Counter
- Standard interfaces: USB Host, USB Device (USBTMC), LAN (VXI-11)
- Optional interface: GPIB
- 4.3" TFT-LCD display

Models and Key Specifications

Product Model	SDG1032X	SDG1062X
Bandwidth	30 MHz	60 MHz
Sampling rate	150 MSa/s	
Vertical resolution	14-bit	
Waveform Length	16 kpts	
Num. of channels	2	
Max. amplitude	±10 V	
Display	4.3" display, 480 x 272 x RGB	
Interface	Standard: USB Host, USB Device, LAN Optional: GPIB (USB-GPIB adaptor)	

Characteristics

• Identical dual output-channels with high performance

Capable of outputting large signals at high frequencies. dual-channels, 20 Vpp amplitude can be guaranteed at up to 10 MHz.

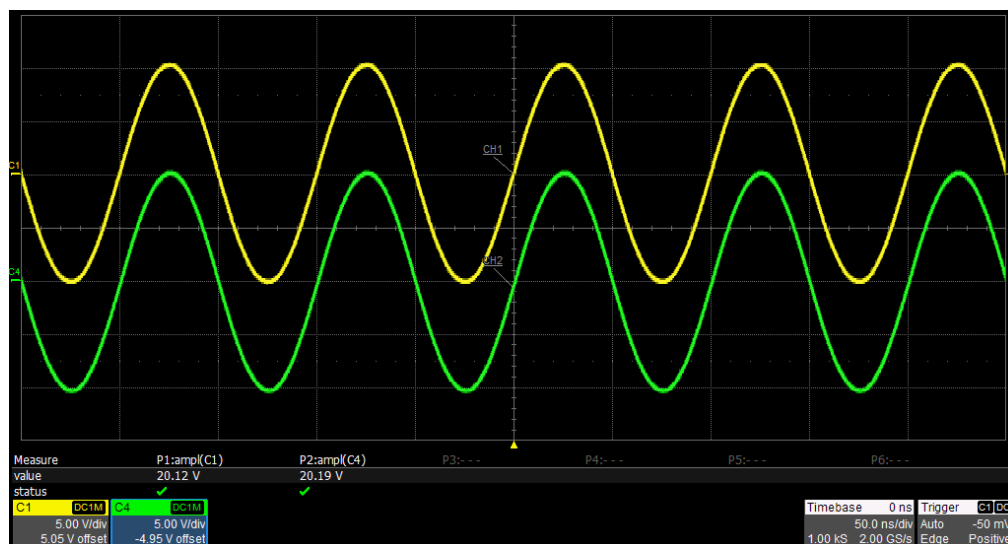

• Low Distortion Output

With 0 dBm output, the THD (Total Harmonic Distortion) is less than 0.075%. Harmonics and spurs are less than -40 dBc throughout the entire bandwidth.

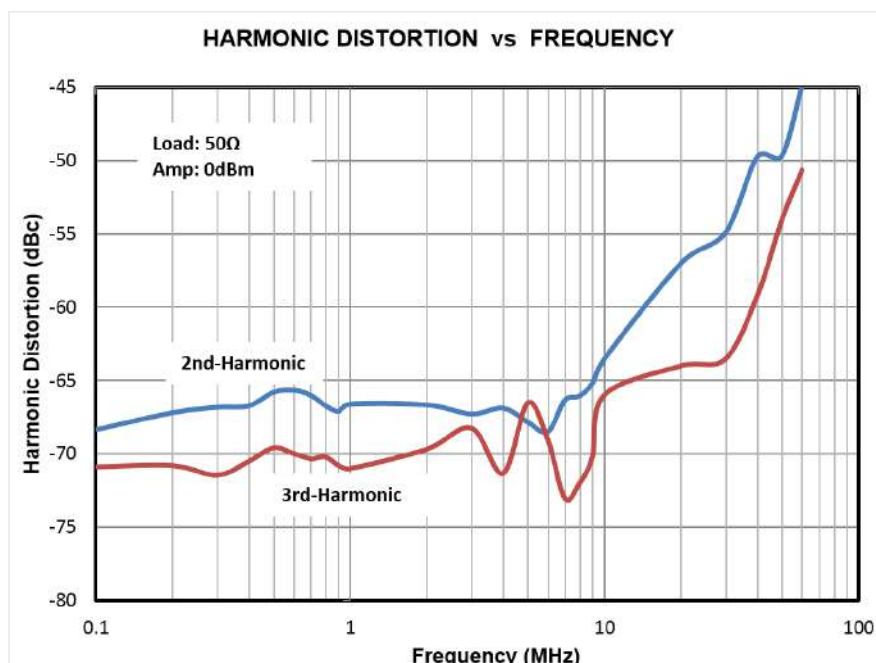

• Innovative EasyPulse Technology

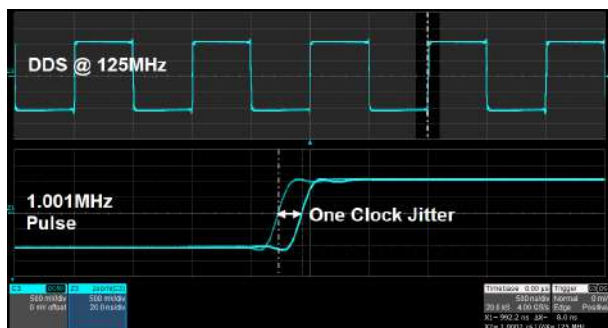

When a Pulse waveform is generated by a common DDS generator, there will be a one-clock-jitter if the sampling rate is not an integer-related multiple of the output frequency. SDG1000X EasyPulse technology successfully overcomes this weakness in DDS designs and helps to produce low jitter Pulse waveforms.

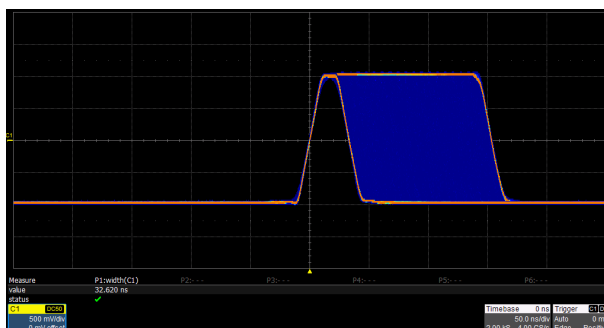
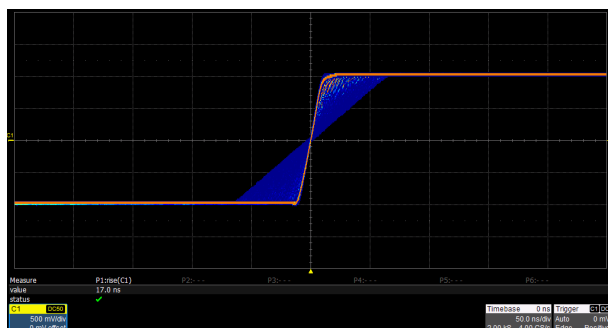

The rise/fall times can be set independently to the minimum of 16.8 ns at any frequency and to the maximum of 22.4 s. The adjustment step is as small as 100 ps. The Pulse width can be fine-tuned to the minimum of 32.6 ns with the adjustment step as small as 100 ps.

• High performance Square Waves

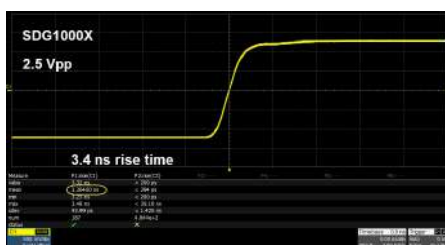
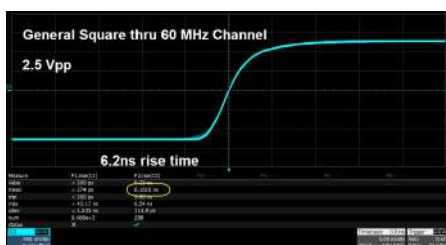

Benefiting from a special square-wave generating circuitry, the Square from the SDG1000X breaks the 60 MHz bandwidth barrier, reaching rise/fall times of less than 4.2 ns, and frequencies up to 60 MHz.

▶ The Square wave exhibits the same excellent jitter performance as the Pulse waveform.

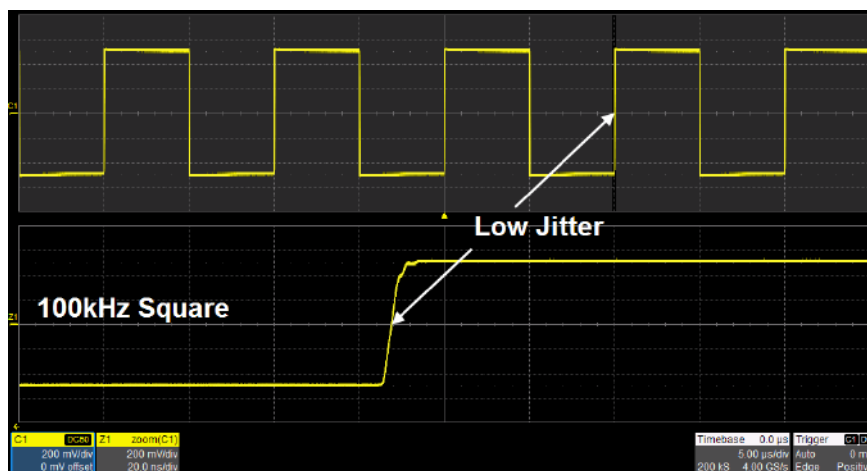

Characteristics

• Modulation

Type	Source	AM Depth	Shape	AM Freq
AM	Internal	120.0 %	Sine	100.000 000 Hz

Multiple modulation types: AM, DSB-AM, FM, PM, FSK, ASK, PSK and PWM. The modulation source can be configured as "Internal" or "External".

• Harmonics Function

Type	Order	Harmonic Ampl	Harmonic Phase	Cancel
	3	800.0mVpp	0.00°	

Up to 10 harmonics may be generated. Amplitude and phase of each harmonic can be set independently.

• Frequency Counter

Value	Frequency	Pwidth	Duty	Freq Dev
9.999 980 2MHz	50.5ns	50.5 %	-1.981ppm	
9.999 980 7MHz	50.4ns	50.4 %	-1.928ppm	
9.999 979 8MHz	39.2ns	39.2 %	-2.021ppm	
9.999 982 3MHz	61.9ns	61.9 %	-1.767ppm	
515.388 20MHz	2.4ns	2.4 %	0.049ppm	
46	46	46	46	

State	Frequency	Pwidth	RefFreq	Setup	Clear
On	Period	Nwidth	TrigLev		

High precision Frequency Counter with an input frequency range of 0.1 Hz~200 MHz.

• Waveform Combining

CH1 Switch	CH2 Switch	CH1+CH2	CH2	Return

Capable of combining the waveforms of 2 channels from internal, providing more flexible tools to generate complex waveforms.

Ordering Information

Product Description	
30 MHz, 2 CH, 150 MSa/s, 14 bit	SDG1032X
60 MHz, 2 CH, 150 MSa/s, 14 bit	SDG1062X
Standard configurations	
Quick Start -1	
Power Cord-1	
Calibration Certificate -1	
USB Cable -1	
Optional configurations	
BNC Coaxial Cable	SDG-BNC
20 dB Attenuator	ATT-20dB
USB-GPIB Adapter	USB-GPIB



SDG800 Easy Pulse Function/Arbitrary Waveform Generator

Application

- Simulate sensor
- Simulate environmental signal
- Circuit function test
- IC chip test
- Research and education

Key Features

- Advanced DDS technology, 125 MSa/s sampling rate, 14 bit vertical resolution
- Single channel output, 5 kinds of standard waveforms, built-in 46 kinds of arbitrary waveforms (including DC)
- Complete modulation functions: AM, DSB-AM, FM, PM, FSK, ASK, PWM, linear/logarithmic sweep and burst
- Innovative EasyPulse technology, can output pulse of low jitter, quick rising/falling edge
- Standard interfaces: USB Device, USB Host, support U-Disk storage and software update
- Provide 10 nonvolatile storage spaces for user's arbitrary waveforms
- Be capable of seamlessly connected to SIGLENT Digital Storage Oscilloscope
- Configurable with powerful arbitrary waveform editing software EasyWave

Specifications

Model	SDG805	SDG810	SDG830
Maximum output frequency	5 MHz	10 MHz	30 MHz
Output channels	1		
Sampling rate	125 MSa/s		
Wave length	16 kpts		
Frequency resolution	1 μ Hz		
Vertical resolution	14 bit		
Waveform	Sine, Square, Ramp, Pulse, Gaussian white noise, Arbitrary waveform, 46 types of built-in arbitrary waveforms		
Sine wave	1 μ Hz ~ 5 MHz	1 μ Hz ~ 10 MHz	1 μ Hz ~30 MHz
Square wave	1 μ Hz ~ 5 MHz	1 μ Hz ~ 10 MHz	1 μ Hz ~10 MHz
Pulse	500 μ Hz ~ 5 MHz	500 μ Hz ~ 5 MHz	500 μ Hz ~5 MHz
Ramp/Triangular	1 μ Hz ~ 300 kHz	1 μ Hz ~ 300 kHz	1 μ Hz ~ 300 kHz
Gaussian white noise	>5 MHz bandwidth (-3 dB)	>10 MHz bandwidth (-3 dB)	>30 MHz bandwidth (-3 dB)
Arbitrary waveform	1 μ Hz ~ 5 MHz	1 μ Hz ~ 5 MHz	1 μ Hz ~ 5 MHz
Modulation function	AM, FM, PM, DSB-AM, FSK, ASK, PWM, Sweep, Burst		
Standard configuration	USB Host & USB Device		
Amplitude (high impedance)	4 mVpp~20 Vpp (\leq 10 MHz) 4 mVpp~10 Vpp ($>$ 10 MHz)		

SPD3303

Programmable Linear DC Power Supply



Application

- R&D lab general purpose testing
- Teaching lab experiment
- Automotive electronic test
- Production testing and quality assessment inspection

Key Features (SPD3303X/SPD3303X-E)

- 3 independent controlled and isolated output, 32 V/3.2 A \times 2, 2.5 V/3.3 V/5 V/3.2 A \times 1, total 220 W
- Max 5 digits Voltage, 4 digits Current Display, Minimum Resolution: 1 mV/1 mA
- Supports panel timing output functions
- 4.3 inch true color TFT- LCD 480 \times 272 display
- 3 types of output modes: independent, series, parallel
- 100 V/120 V/220 V/230 V compatible design to meet the needs of different power grids.
- Intelligent temperature-controlled fan , effectively reducing noise
- Clear graphical interface, with the waveform display function
- Internal 5 groups of system parameter save/recall, supports data storage space expansion
- Provides PC software: Easypower , supports SCPI , LabView driver

Key Features (SPD3303C)

- 3 independent high precision output: 32 V/3.2 A \times 2, 2.5 V/3.3 V/5 V/3.2 A \times 1, total 220 W
- 4 digits voltage and 3 digits current display, min resolution: 10 mV, 10 mA
- Three output modes: independent, series and parallel
- 100 V/120 V/220 V/230 V compatible design, to meet the need of different power grids
- Smart temperature controlled fan, effectively reduce the noise
- Save/Recall 5 group system specifications, support data storage expansion
- Connected to PC via USB Device, support SCPI command, to meet the control and communication needs

Specifications

Model	SPD3303C	SPD3303X-E	SPD3303X
Channels	CH1: DC voltage range: 0-32 V, DC current range: 0-3.2 A CH2: DC voltage range: 0-32 V, DC current range: 0-3.2 A CH3: DC voltage range: 2.5/3.3/5.0 V, DC current range: 0-3.2 A		
Max output power	220 W		
Resolution	10 mV / 10 mA		1 mV / 1 mA
Display digits	LED display 4 digits voltage 3 digits current	4.3 inch TFT-LCD display 4 digits voltage 3 digits current	4.3 inch TFT-LCD display 5 digits voltage 4 digits current
Ripple noise	CV/CH3: ≤ 1 mVrms (5 Hz~1 MHz) CC: ≤ 3 mArms		
Standard interface	USB Device	USB Device, LAN	
Dimension	225 mm (W)×136 mm (H)×275 mm (D)		
Weight	7.5 kg (SPD3303C) 8 kg (SPD3303X/X-E)		

• Panel displays the timing output

Through front panel operation, 5 groups of timing settings and output control can be displayed, which provides users a simple power programming function. Also a connection can be made with Siglent's EasyPower PC software providing a full range of communication and control requirements.

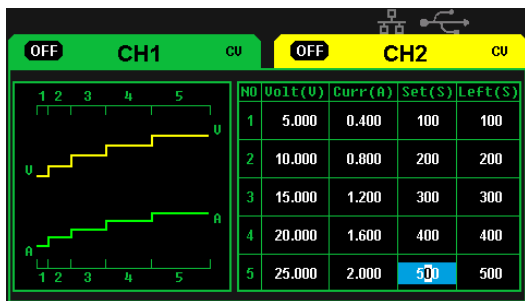

Panel timing output

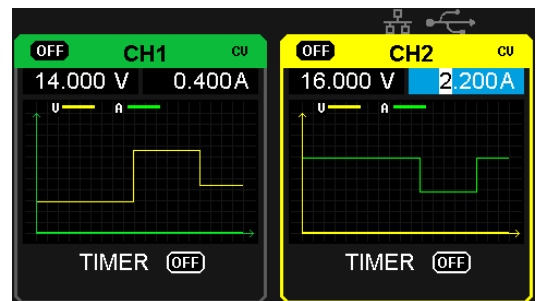

Real time wave display

• Save/Recall setting parameters

SPD3000X series programmable power supply can save or recall 5 groups of setting parameter in internal storage, also supports external storage expansion. You can easily obtain the settings you needed.

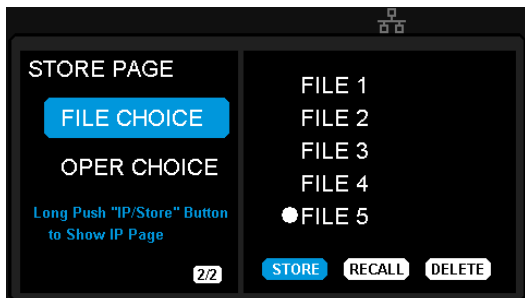

Internal Storage

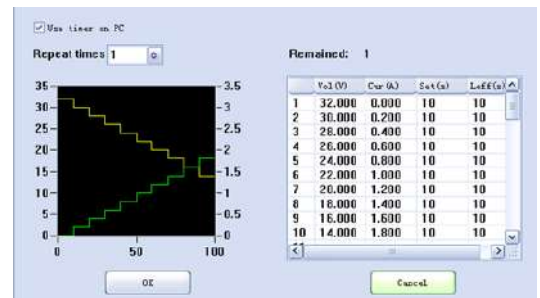

PC Timer



SPD1000X Programmable Linear DC Power Supply

Main Features

- Single path high-precision programmable voltage output:
 - 16 V/8 A, total power up to 128 W
 - 30 V/5 A, total power up to 150 W
- Stable, reliable, Low ripple and noise: $\leq 350 \mu\text{Vrms}/3 \text{ mVpp}$; $< 2 \text{ mArms}$
- Fast transient response time: $< 50 \mu\text{s}$
- 5 digit Voltage, 4 digit Current Display, Minimum Resolution: 1 mV/1 mA
- Supports front panel timing output functions
- 2.8 inch true color TFT- LCD 240 *320 display
- 2 types of output modes: Two-wire output mode, 4-wire compensation output mode, Maximum compensation voltage 1 V
- 100/120/220/230 V compatible design to meet the needs of different power grids
- Intelligent temperature-controlled fan reduces noise
- Clear graphical interface, with the waveform display function
- Internal 5 groups of system parameter save/recall
- Includes PC software: Easypower, supports SCPI, LabView driver

Design Features

- **High-resolution and high-precision output**

The SPD1000X power supply features a high measurement resolution of 1 mV/1 mA . This ensures accurate output even with very small changes in voltage or current. This is impossible for a low resolution power supply.

- **4-wire SENSE compensation mode function**

In the 4-wire SENSE compensation output mode: By using a separate measurement circuit, the supply can more accurately compensate for any voltage drops due to high resistance connections or long cables. Maximum compensation voltage is 1 V.

- **Low ripple and noise**

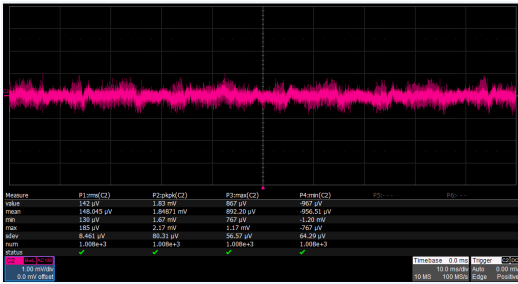

- **Fast transient response time**

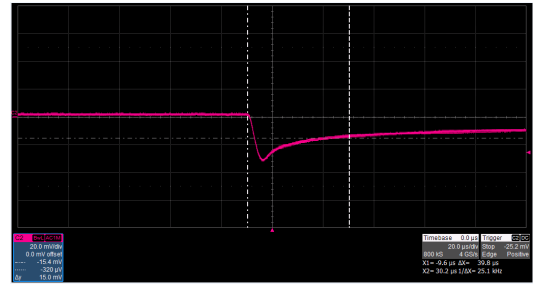

- **Low voltage overshoot**

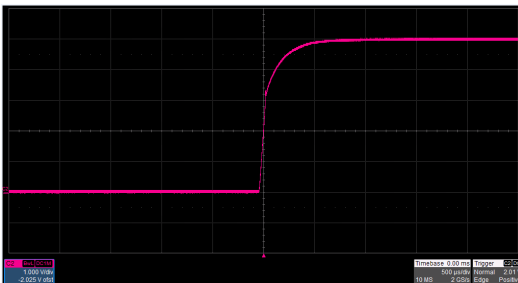

- **0.01% Load Regulation & 0.2% Line Regulation**



- **Panel displays the timing output**

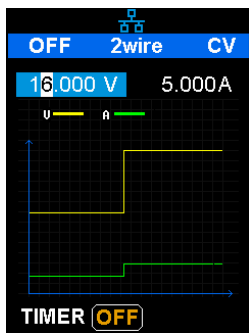

Panel timing output

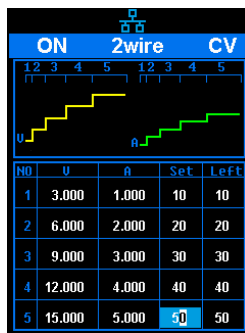

Real time wave display

- **Save/Recall setting parameters**

SPD1000X programmable power supply can save or recall 5 groups of setting parameters in internal storage. You can easily recall the settings you need.

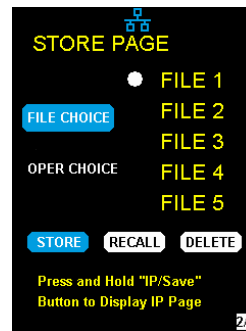

Internal Storage

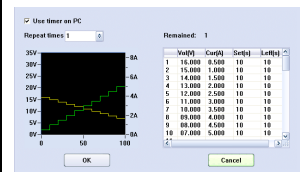

PC Timer

Specifications

All the specifications are guaranteed when the instrument has been working for more than 30 minutes under the specified operating temperature. Unless otherwise noted, the specifications are applicable to all the channels of the specified model.

Model		SPD1168X	SPD1305X
DC Output (0 °C to 40°C)		Output Voltage: 0 to 16 V Output Current: 0 to 8 A	Output Voltage: 0 to 30 V Output Current: 0 to 5 A
Display		2.8 inch true color TFT-LCD 5 digit voltage/4 digit current	
Resolution		1 mV/1 mA	
Program Accuracy (25 ± 5 °C)		Voltage: ±(0.03% of reading+10 mV)	
		Current: ±(0. 3% of reading+10 mA)	
Program Accuracy (25 ± 5 °C)		Voltage: ±(0.03% of reading+10 mV)	
		Current: ±(0. 3% of reading+10 mA)	
Temperature Coefficient per °C (Output Percentage + Offset)		Voltage: ±(0.01% of reading+3 mV)	
		Current: ±(0.01% of reading+3 mA)	
Constant Voltage Mode	Load Regulation	≤ 0.01% + 2 mV	
	Ripple & Noise	≤ 350 uVrms/3 mVpp (20 Hz to 20 MHz)	
	Recovery Time	< 50 μs (50% load change, minimum load 0.5 A)	
Constant Current Mode	Line Regulation	≤ 0.2% + 3 mA	
	Load Regulation	≤ 0.2% + 3 mA	
	Ripple & Noise	≤ 2 mArms	
Locking Key		Yes	
Memory Save/Recall		5 Sets	
Max Output Power		128 W	150 W
Power Source		AC 100 /120/220/230 V ± 10% 50/60 Hz	
Standard Configuration Interface		USB Device, LAN	
Insulation		Case to Terminal ≥ 20 MΩ (DC 500 V) Case to AC line ≥ 30 MΩ (DC 500 V)	
Operating Environment		Outdoor Usage: Elevation: ≤2000 m Environment Temperature 0 to 40 °C Relative Humidity ≤ 80% Installation Level: II Pollution Level: 2	
Storage Environment		Environment Temperature: -10 to 70 °C Relative Humidity ≤ 70%	
Dimension		154.6 (W) × 144.5 (H) × 280(D) mm	
Weight		≈5.5 kg	



SDL1000X Series Programmable DC Electronic Load

Main Feature

- SDL1020X (Single channel): DC 150 V/30 A, total power up to 200 W
- SDL1030X (Single channel): DC 150 V/30 A, total power up to 300 W
- 4 static modes / Dynamic mode: CC/CV/CR/CP
- CC Dynamic mode: Continuous, pulsed, toggled
- CC Dynamic mode: 25 kHz, CP Dynamic mode: 12.5 kHz, CV Dynamic mode: 0.5 Hz
- Measuring speed of voltage and current: up to 500 kHz
- Adjustable current rise time range: 0.001 A/us~2.5 A/us
- Min. readback resolution: 0.1 mV, 0.1 mA
- Short-circuit, Battery test, CR-LED mode, and factory test functions
- 4-wire SENSE compensation mode function
- List function supports editing as many as 100 steps
- Program function supports 50 groups of steps
- OCP, OVP, OPP, OTP and LRV protection
- External analog control
- Voltage, Current monitoring via 0-10 V
- 3.5 inch TFT-LCD display, capable of displaying multiple parameters and states simultaneously
- Built-in RS232/USB/LAN communication interface, USB-GPIB module (optional)
- Waveform trend chart and ease-to-use file storage and call functions
- Includes PC software: Supports SCPI, LabView driver

Design Features

Steady state operating mode

The SDL features four operating modes to provide flexible test capabilities. In CC mode, the electronic load will sink a constant current, regardless of the voltage at its terminals. In CV mode, the electronic load will cause a constant voltage to appear at its terminals. In CR mode, the electronic load will behave as a fixed resistance value. As shown in the figure, the electronic load will linearly change the current according to the input voltage. In CP mode, the electronic load will cause a constant power to be dissipated in the load.

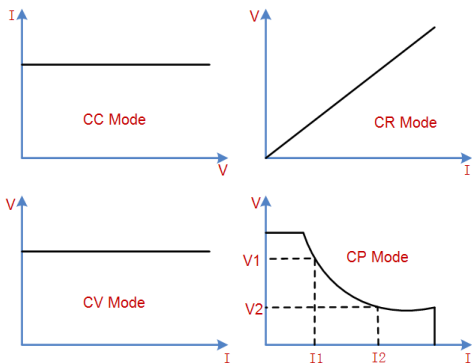

Dynamic test mode up to 25 kHz (CC)

The transient test allows switching between two different load values. A common application is to test the dynamic characteristics of a DC source or DUT (Device Under Test). The transient test function enables the load to periodically switch between two set levels (Level A and Level B). The highest frequency can be set to 25 kHz in CC mode. The highest frequency can be set to 12.5 kHz in CP modes.

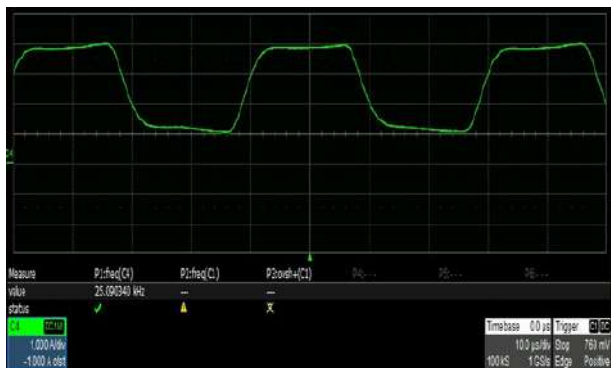

Simplify complex sequencing using the list operation function

You can generate complex load sequences quickly using the list operation function. Here, you can edit the setpoints, dwell time, and slew rate for each step in the test. *Slew rate can only be edited in CC mode.

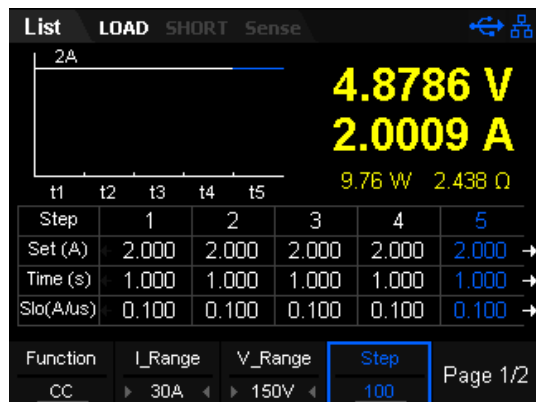
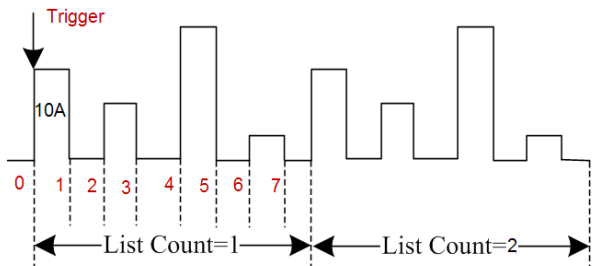

4-wire SENSE compensation mode function

In CC/CV/CR/CW mode, when a load is connected to a power supply, it will cause a large voltage-drop on the connection lines between tested instrument and terminals of load. Using remote sense, you can measure the voltage at the DUTs input terminals, effectively removing the additional error due to the voltage drop in the connection wires.

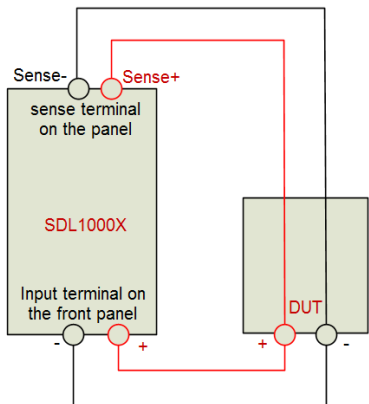

• Program function

In program (auto-test) mode, you can generate a sequence of tests using different modes, mode parameters and durations. This function is useful for automatically executing a set of tests on a device then display whether the tests passed or failed. Test results are easily viewed by pressing the up and down buttons. The load provides 8 nonvolatile registers to save auto-test file for recall later. Each file contains 1-50 steps to set up. Auto-test function is especially useful in the designing battery charging circuitry.

step	1	2	3	4	5
mode	CC	CC	CC	CC	CC
Irange	30A	30A	30A	30A	30A
Vrange	150V	150V	150V	150V	150V
paus	OFF	OFF	OFF	OFF	OFF
short	OFF	OFF	OFF	OFF	OFF
Ton	10.000s	1.000s	1.000s	1.000s	1.000s
Toff	1.000s	1.000s	1.000s	1.000s	1.000s
Tdly	1.000s	1.000s	1.000s	1.000s	1.000s

Step	Storage	Trig	Result
5			

• Battery discharge function

The SDL1000X can also provide insight into battery performance by analyzing the discharge characteristics of the DUT. The SDL features three stop conditions for the discharge test: Voltage, capacity or time. The discharge process is immediately terminated if the stop conditions are met. This provides more control over the test termination and an extra layer of safety during critical tests. Throughout the test process the battery voltage, discharge current, discharge time and discharged capability is displayed clearly on the LCD panel.

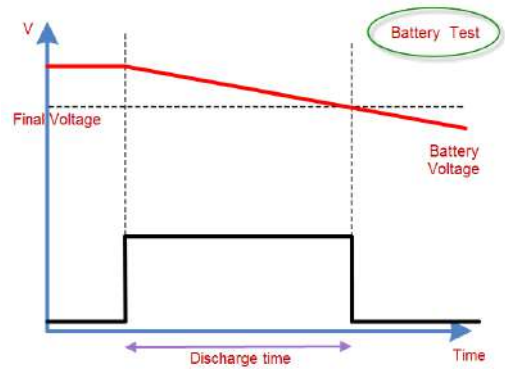

• OCPT/OPPT Mode

Over-current protection (OCPT) mode prevents drawing too much current from the DUT. After the input voltage reaches the Von point, the DC load will start to draw a current from the source after a delay time. The current value will increase by a certain step size at regular intervals. Simultaneously, the DC load will compare the input voltage to the OCP voltage: If it is lower, then the present current value will be compared to see if it is in the current range you have set. Within the range, the OCP test will evaluate Pass or Fail. If it is outside of the set range, the DC load will increase drawing current and compare the voltage again.

OCPT	LOAD	SHORT	Sense
4.9395 V	0.9973 A		
4.93 W	4.952 Ω		

I_Range	V_Range	OCP_V	I_Step	Page 1/3
30A	150V	1.00V	1.000A	

• CR-LED Mode

The SDL1000X includes a CR-LED mode specifically for LED driver testing. Basing on the traditional CR mode, CR-LED mode adds a diode break-over voltage setting. When the input voltage is above this set value, the DC load start to work. Thus, it can emulate the actual characteristics of an LED.

LED	LOAD	SHORT	Sense
4.7505 V	0.8566 A		
4.07 W	5.501 Ω		

I_Range	V_Range	Io	Vo	Rco
30A	150V	1.000A	5.00V	0.2000

Overpower-protection (OPPT) mode: When the input voltage has reached the Von point, the load will draw power after a delay time. The power value will increase by a step size at regular intervals. Simultaneously, the DC load will judge whether the input voltage is lower than OPP voltage you have set, if it is, then the present current value will be compared to see if it is in the current range you have set. Within the range, the OPP test will Pass or Fail. If it is outside of the set power, the load will continue to increase the power draw within the cut-off current range and compare OPP voltage with the input.

• Voltage Rise/Fall speed test

The electronic load is also equipped to directly measure voltage rise and fall times. It can calculate the time from one voltage to another without the need for additional measurement instrumentation. With an SDL1000X, you can save money and improve efficiency.



• Waveform trend chart function

The electronic load includes a waveform display function and supports the following operations for the waveform: Pause, recording, and capturing the waveform. You can quickly observe the trends of parameter changes as they occur throughout the test.

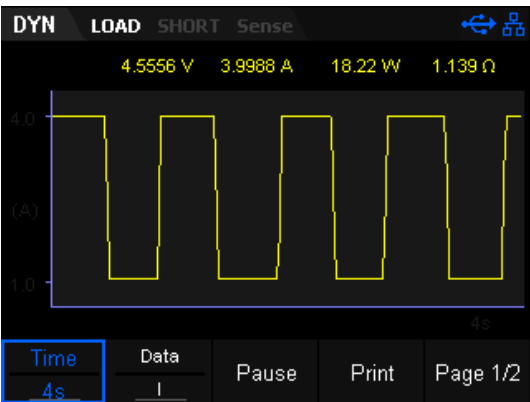

• External analog control

The load allows the user to control current or voltage through external analog terminals (EXT PRG). Input a 0-10 V analog to adjust 0-100% rated voltage and current. It is very useful for those applications that need to change the input value with external signals.

• Voltage threshold function

The SDL1000X can be set to turn on or off if the input voltage is at, above, or below a set value. By defining these thresholds, you control when the load is active. Which minimizes test time and increases safety.

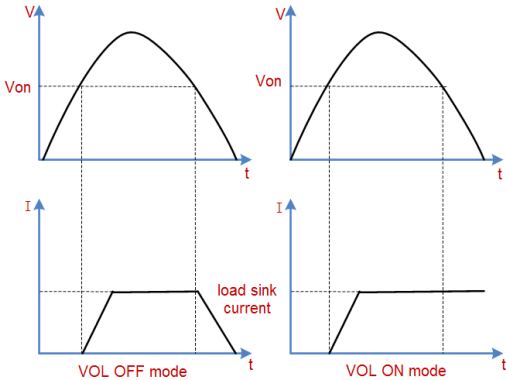

• Save/Recall setting parameters

The load allows you to save different types of files to the internal and external memories. You can recall and read them when necessary.

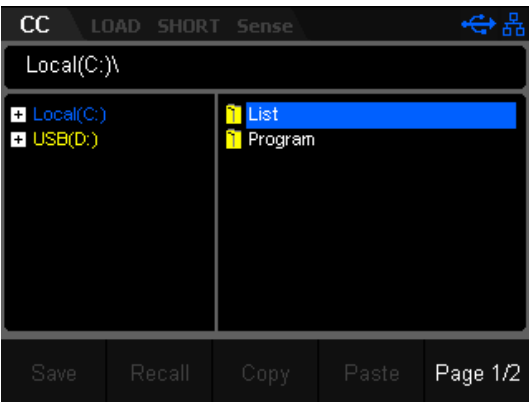

• Multiple protection modes

The SDL1000X series Programmable DC Electronic Load provides five protection types: OVP, OCP, OPP, OTP and LRV. When OVP/OCP/OPP/OTP/reverse voltage protection (LRV) occurs, the load will immediately turn off the input and stop sinking. Then, a prompt message is displayed.



SDM3065X Digital Multimeter

Application

- Research Laboratory
- Development Laboratory
- Detection and Maintenance
- Calibration Laboratory
- Automatic Production Test

Main Feature (SDM3065X/SDM3065X-SC)

- 4.3" TFT-LCD, 480*272
- Real 6½ digits readings resolution (2,200,000 counts)
- 1Gb Nand flash size, Mass storage configuration files and data files
- True-RMS AC Voltage and AC Current measuring
- Supports double display, Chinese and English Menu
- File management (support for U-disc and local storage)
- Built-in cold terminal compensation for thermocouple
- Comes with easy, convenient and flexible any sensor measurement control software: EasyDMM
- Standard interfaces: USB Device, USB Host, LAN (Optional Accessories: USB- GPIB Adapter)
- Scanner Card SC1016 (Only for SDM3065X-SC)
- Built-in Help system makes information acquisition easier
- Support remote control operation via SCPI commands. Compatible with commands of other main stream multimeters
- Supports intelligent management system for laboratory based on BS framework and LAN

Special Features

- Histogram

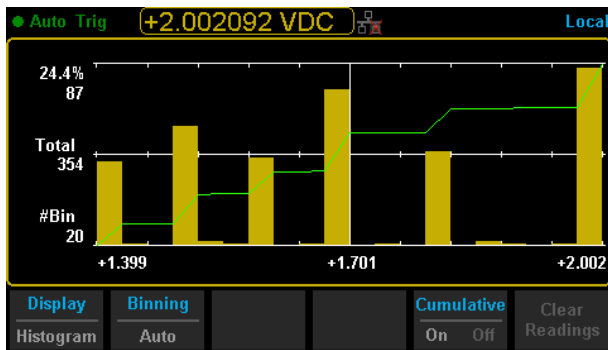

- Trend Chart

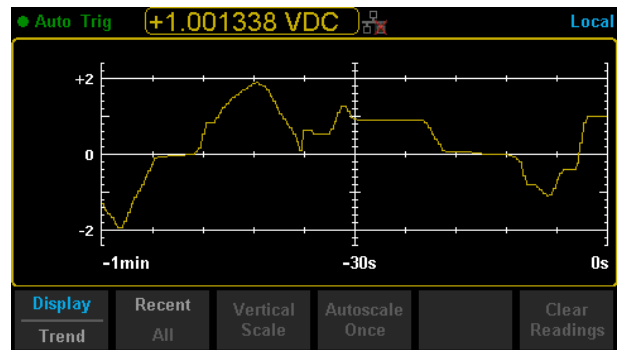

- "Analog" Bar Display

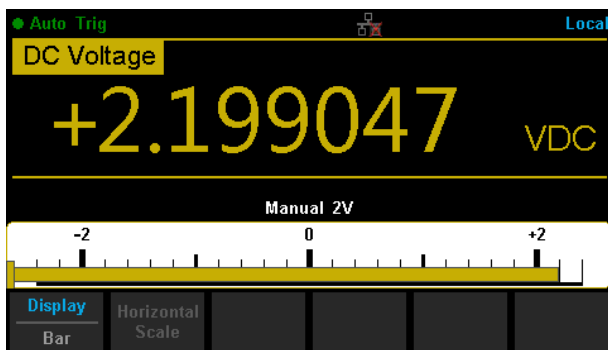

- Statistics

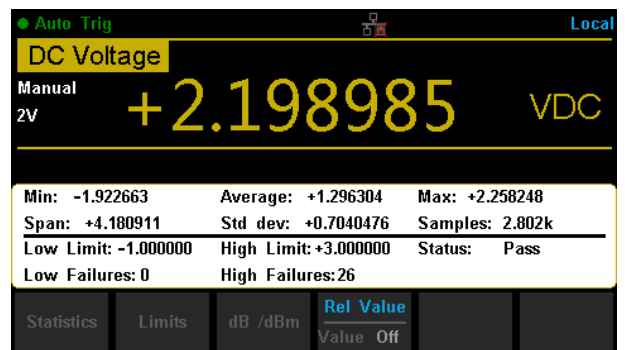

- Dual Measurement Display

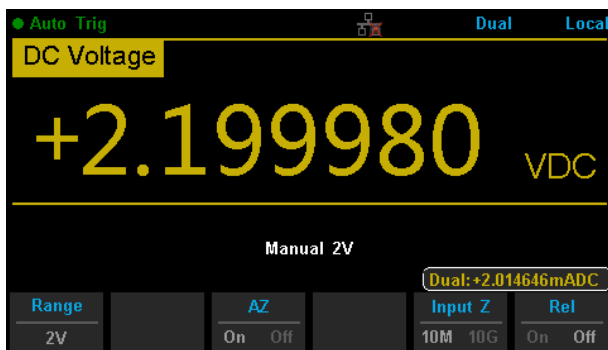

- Hold Measurement

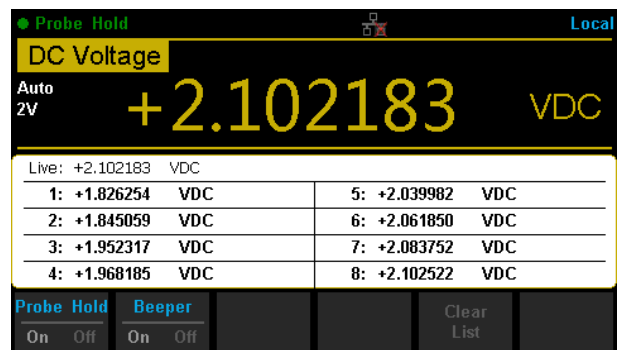

- dBm Hold Measurement

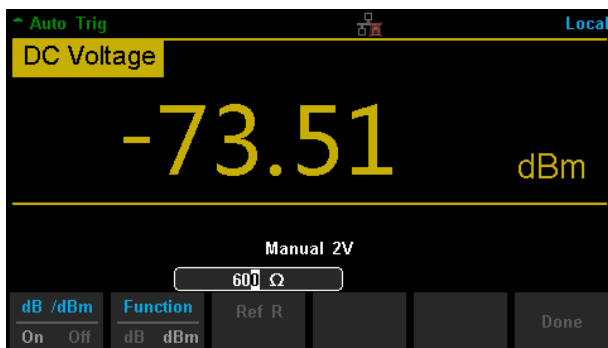

- Interface



Scanner card SC1016 (Only for SDM3065X-SC)

The SIGLENT Scanner Card SC1016 is a multiplexer that provides multi-point measurement capabilities to the SDM3065X-SC. The scanner features 12 multi-purpose + 4 current channels and supports the following measurement functions: DCV, ACV, DCI, ACI, 2WR, 4WR, CAP, FREQ, DIODE, CONT and TEMP (RTD and Thermocouple). It provides a convenient and versatile solution for test applications that require multiple measurement points or signals and is an ideal tool for R&D burn-in and production testing.

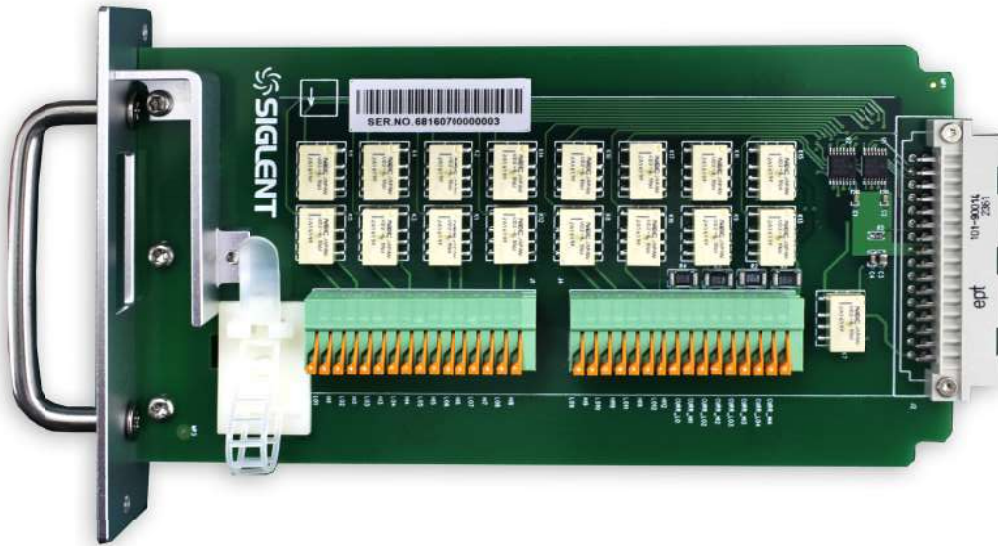

Ordering Information

Standard Accessories	
Power Cord -1	
USB Cable -1	
Quick Start -1	
warranty Card -1	
EasyDMM ^[1]	software
Test Leads and Alligator Clips -2	
Optional Accessories	
USB-GPIB	USB-GPIB adapter

[1]The latest version of EasyDMM can be downloaded for free from the SDM3000 series of digital multimeter. Please see our web site at www.siglent.com for more information.



SDM3055 Digital Multimeter

Application

- Research & Development Laboratory
- Detection and Maintenance
- Calibration Laboratory
- Automatic Production Test

Main Features (SDM3055/SDM3055-SC)

- Real 5½ digits readings resolution (240, 000 counts)
- Up to 150 rdgs/s measurement speed
- True-RMS AC Voltage and AC Current measuring
- 1 Gb Nand flash size, Mass storage configuration files and data files
- Built-in cold terminal compensation for thermocouple temperature measurements
- With easy, convenient and flexible PC software: EasyDMM
- standard interfaces: USB Host, LAN (Optional Accessories USB-GPIB Adapter)
- Scanner Card SC1016 (Only for SDM3055-SC)
- Support remote control operation via SCPI commands. Compatible with commands of main stream multimeters

Special Features

• Histogram

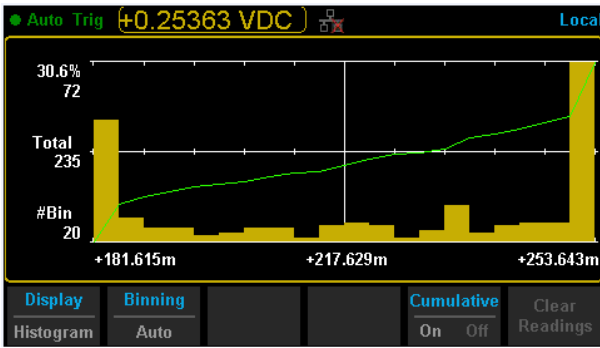

• Trend Chart

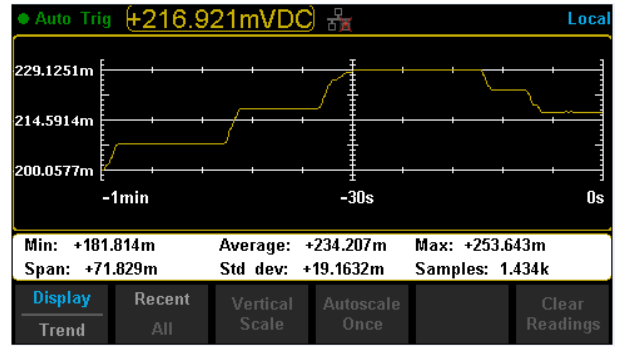

• Bar Chart

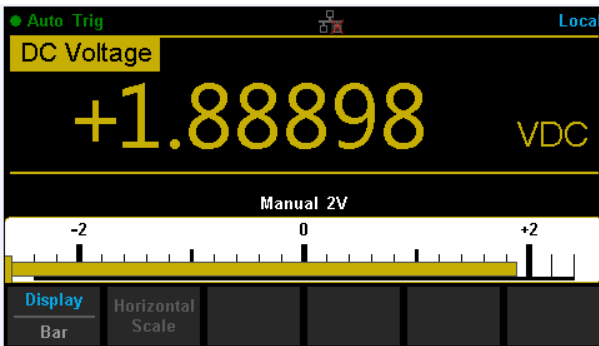

• Statistics

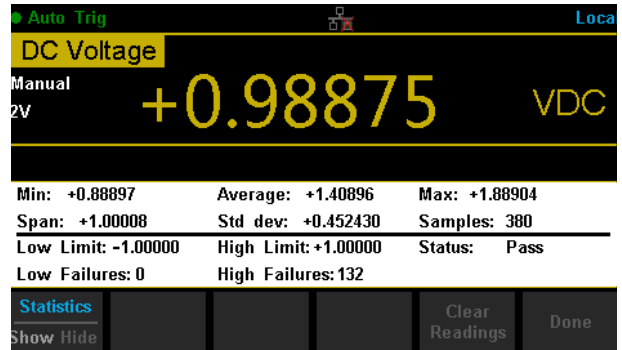

• Dual Display

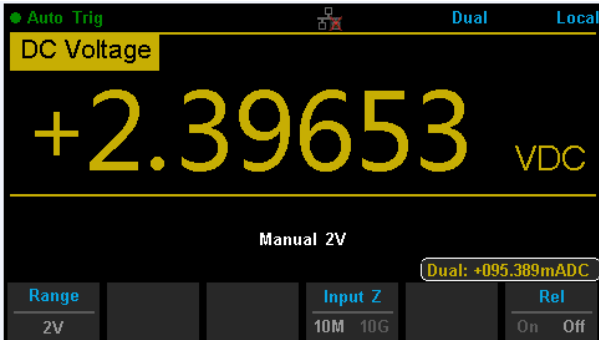

• Hold Measurement

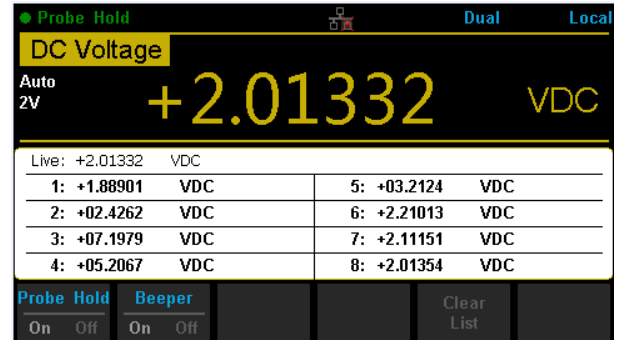

• dBm Hold Measurement

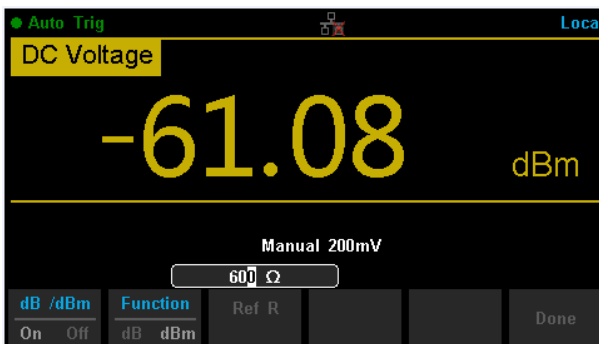

• Interface



Scanner card SC1016 (Only for SDM3055-SC)

The SIGLENT Scanner Card SC1016 is a multiplexer that provides multi-point measurement capabilities to the SDM3055-SC. The scanner features 12 multi-purpose + 4 current channels and supports the following measurement functions: DCV, ACV, DCI, ACI, 2WR, 4WR, CAP, FREQ, DIODE, CONT and TEMP (RTD and Thermocouple). It provides a convenient and versatile solution for test applications that require multiple measurement points or signals and is an ideal tool for R&D burn-in and production testing.

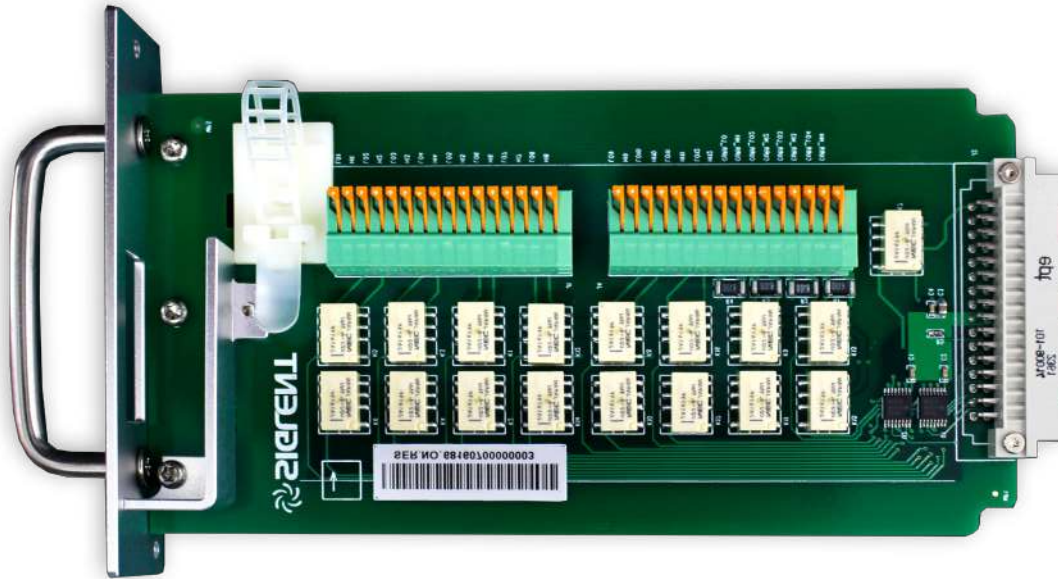

Ordering Information

Standard Accessories	
Power Cord -1	
USB Cable -1	
Quick Start -1	
warranty Card -1	
EasyDMM ^[1]	software
Test Leads and Alligator Clips -2	
Optional Accessories	
USB-GPIB	USB-GPIB adapter

[1]The latest version of EasyDMM can be downloaded for free from the SDM3000 series of digital multimeter. Please see our web site at www.siglent.com for more information.



SDM3045X Digital Multimeter

Application

- Research Laboratory
- Development Laboratory
- Detection and Maintenance
- Calibration Laboratory
- Automatic Production Test

Main Features SDM3045X

- Real 4½ digit (60000 count) readings resolution
- Up to 150 rdgs/s measurement speed
- True-RMS AC Voltage and AC Current measuring
- 1 Gb NAND flash size, Mass storage configuration files and data files
- Built-in cold terminal compensation for thermocouple
- With easy, convenient and flexible PC software: EasyDMM
- Standard interface: USB Device, USB Host, LAN (Optional Accessories: USB-GPIB Adapter)
- USB & LAN remote interfaces support common SCPI command set. Compatible with other popular DMMs on the market

Special Features

• Histogram



• Trend Chart

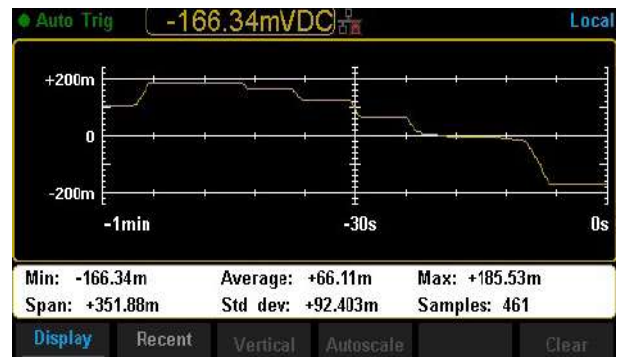

• Bar Chart

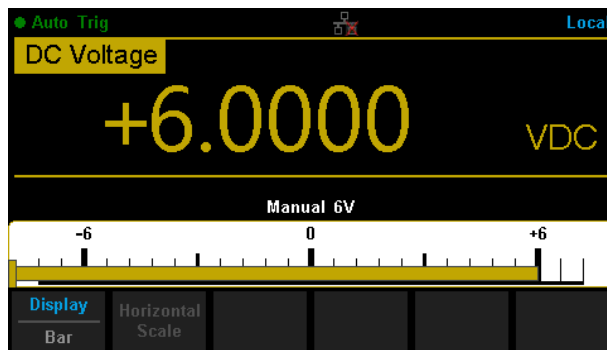

• Statistics

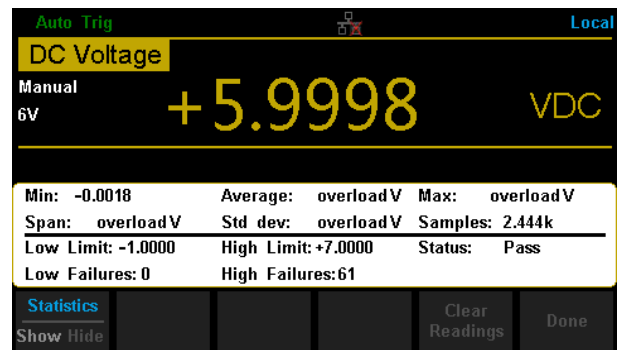

• Dual Display

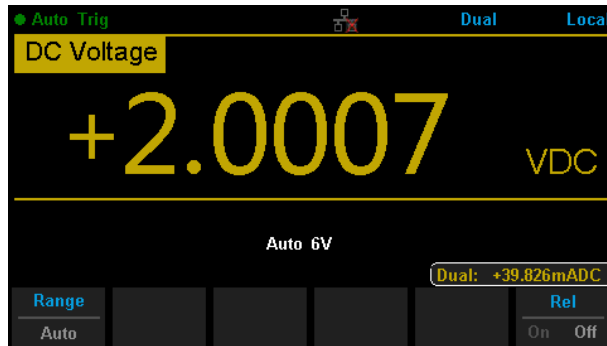

• Hold Measurement

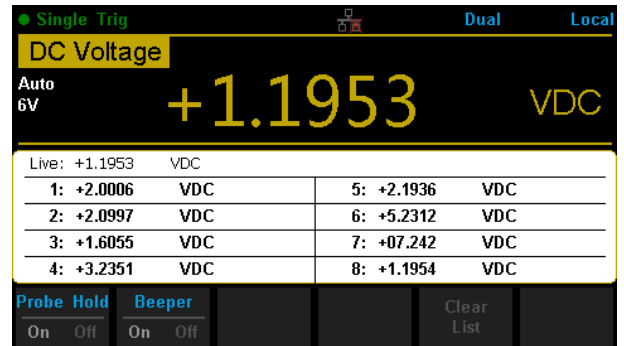

• dBm Hold Measurement

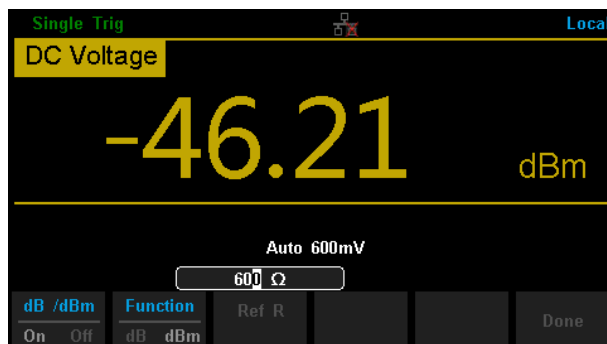

• Interface



Ordering Information

Standard Accessories	
Power Cord -1	
USB Cable -1	
Quick Start -1	
warranty Card -1	
EasyDMM ^[1]	software system
Test Leads and Alligator Clips -2	
Optional Accessories	
USB-GPIB adapter	USB-GPIB

[1] The latest version of EasyDMM can be downloaded for free from the SDM3000 series of digital multimeter. Please see our web site at www.siglent.com for more information.



SSG5000X Series RF Generator

Features and Benefits

- Frequency up to 4 GHz/6 GHz
- 0.001 Hz frequency setting resolution
- High output power up to +26 dBm (typ.)
- Phase Noise: -120 dBc/ Hz @ 1 GHz, 20 kHz offset (typ.)
- User flatness correction with power sensor to correct the cable loss
- Provides AM, FM, PM analog modulation with internal, external or Int+Ext source
- Single pulse, double pulse and Pulse train generator (option)
- Internal IQ modulation with 150 MHz modulation bandwidth with perfect in-factory calibration
- Internal include some digital communication stand file such as 5G-NR, LTE, WCDMA, WLAN, and playback them
- Internal Custom mode generate common IQ signal such as QAM, FSK, ASK, MSK
- Analog differential I/Q outputs
- External analog I/Q input
- USB-power meter measurement
- 5inch TFT capacitive touch screen, mouse and keyboard supported
- Web browser remote control on PC and mobile terminals
- Standard interface included USB Host, USB Device (USB TMC), LAN (VXI-11, Socket, Telnet). Optional interface: GPIB

Design Features

- Double pulse modulation

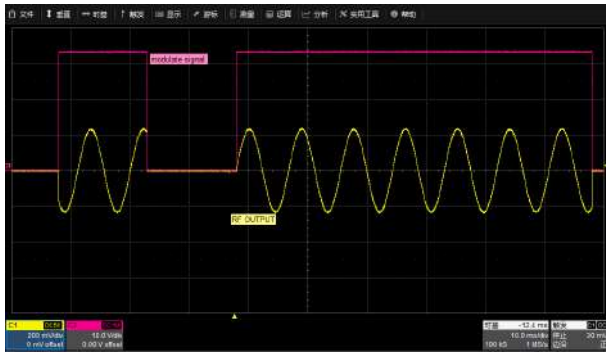

- Pulse train generator

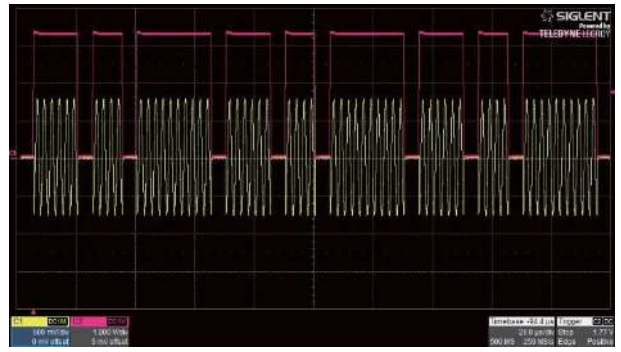

- Works with Power sensor to use the measured values to compensate the cable losses with internal control functions

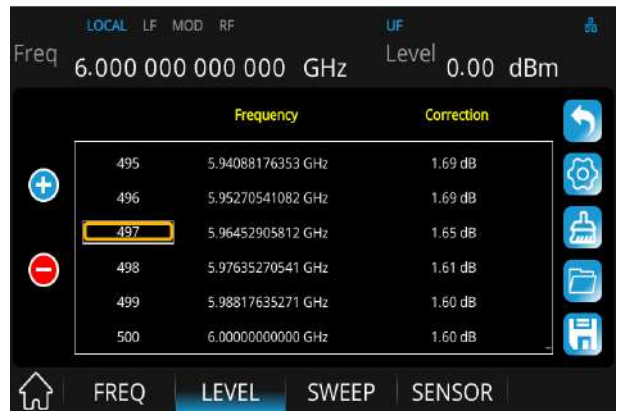
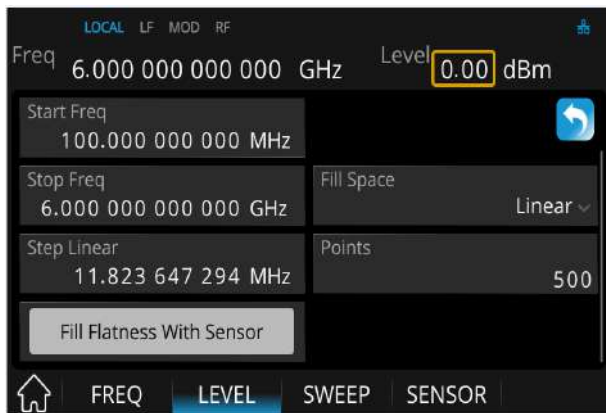

- Custom mod can generate IQ modulated signal such as QAM, PSK, ASK, FSK, the maximum sample rate is 120 Msps/s

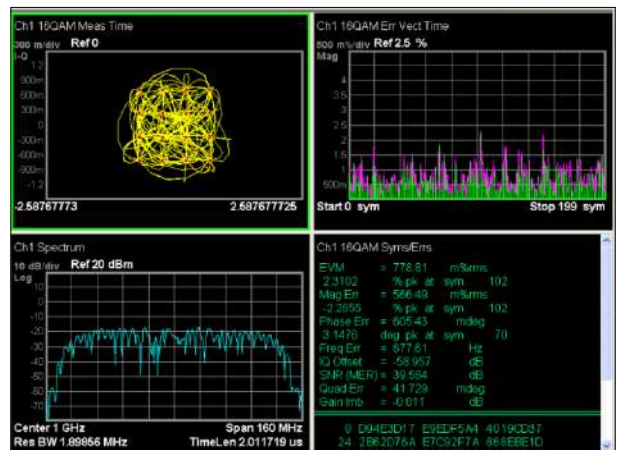
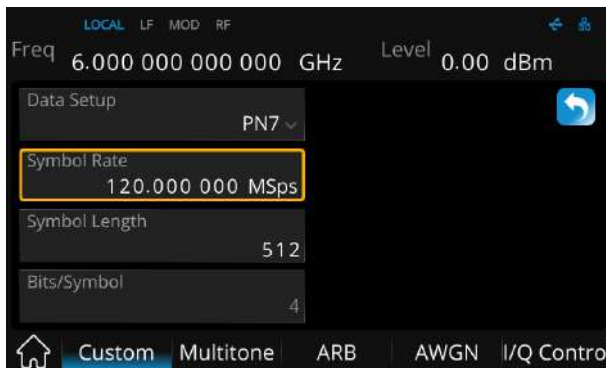

- Multi-tone mode to output multi-signal

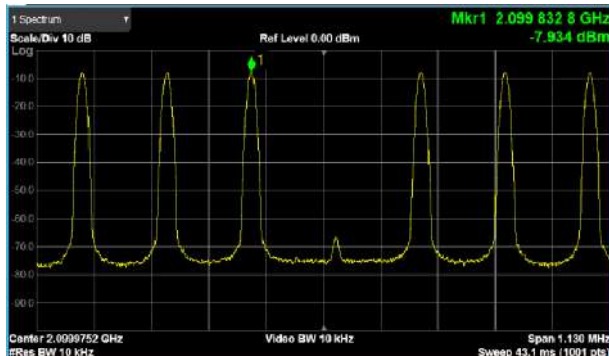

- ARB mode to build and replay waveform sequence

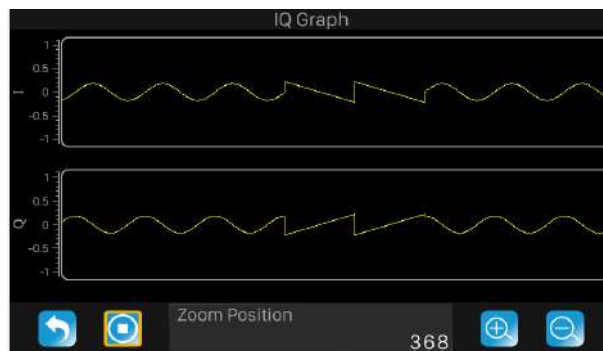

- Arb mode to replay back communication stand files

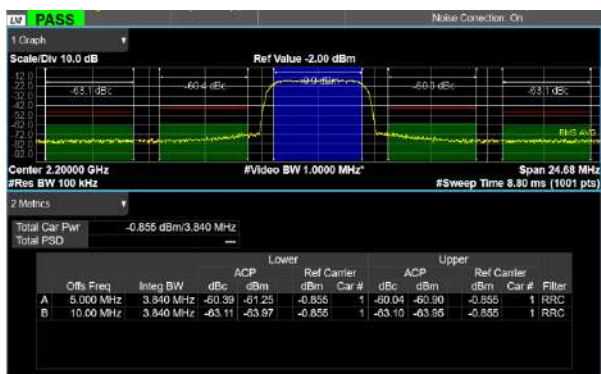

3GPP WCDMA TM1-64DPCH ACPR

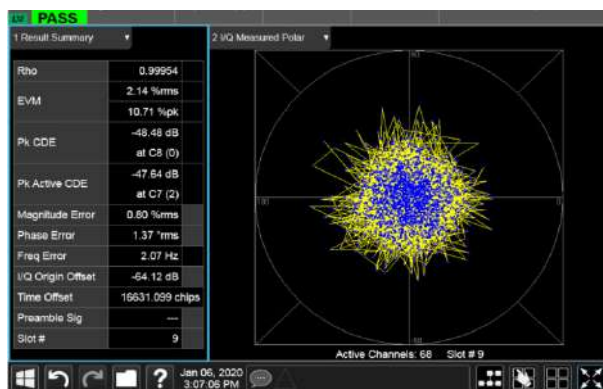

3GPP WCDMA TM1-64DPCH EVM

- ARB mod to generate multi-carrier

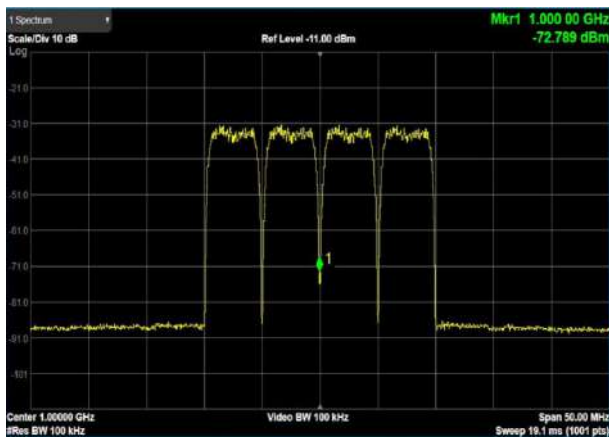

- ARB mod to use the marker to label symbol of the waveform files and simultaneously output a pulse from the invent interface, this can synchronize another device.

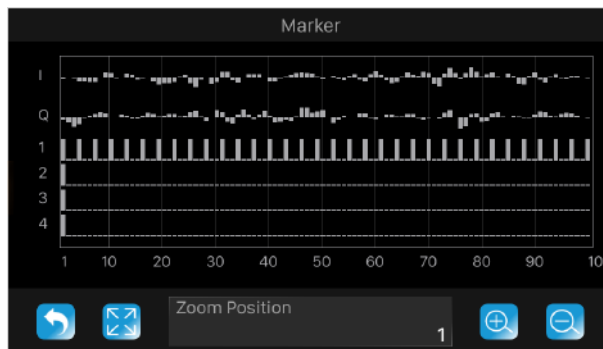

RF Signal Generator

- ARB mode to add real time AWGN to the digital IQ to satisfy the receiver performance tests of receiver

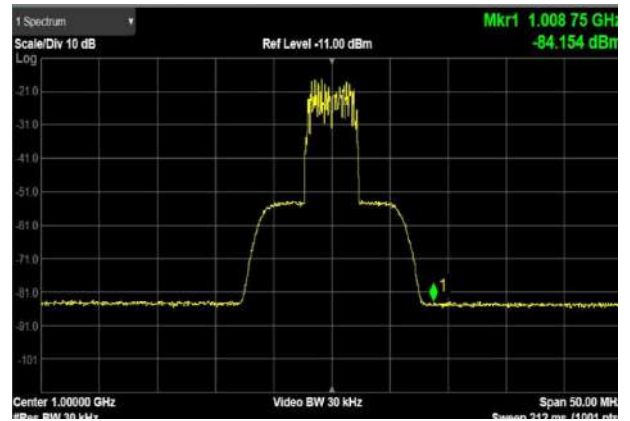
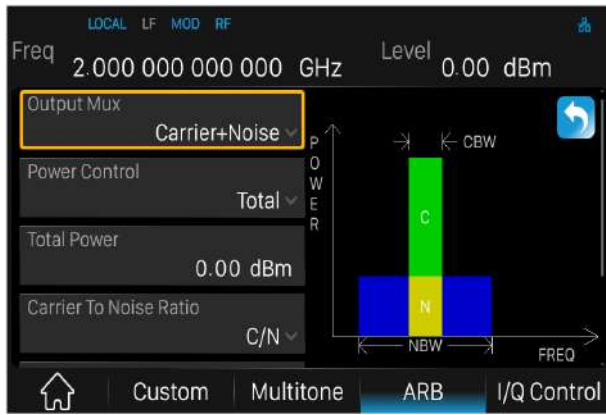

- ARB mod to clip the signal of the peak power and display the CCDF (cytotoxic cell differentiation factor)

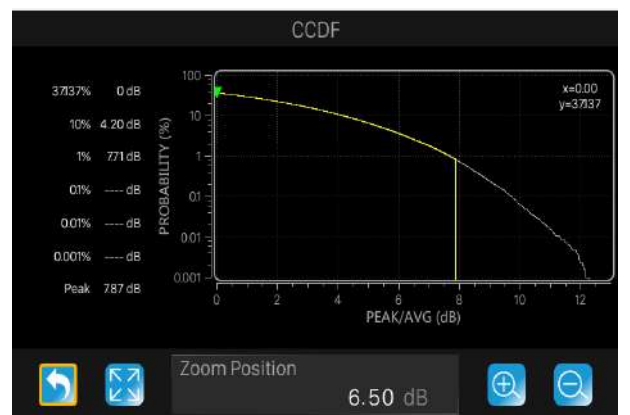
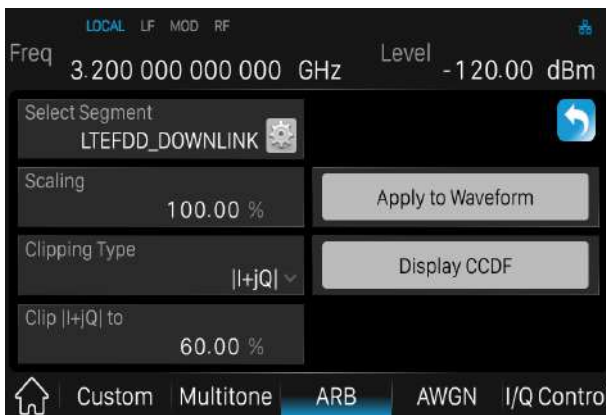

Model and Main index

Model	SSG5040X	SSG5060X	SSG5040X-V	SSG5060X-V
Frequency Range	CW MODE 9 kHz~4 GHz	CW MODE 9 kHz~6 GHz	CW MODE 9 kHz~4 GHz IQ MODE 10 MHz~4 GHz	CW MODE 9 kHz~6 GHz IQ MODE 10 MHz~6 GHz
Frequency Resolution	0.001 Hz			
Amplitude Resolution	0.01 dB			
Level accuracy	0.7 dB (typ.)			
Phase noise	-120 dBc/Hz @1 GHz, offset 20 kHz (typ.)			
Display	5inch capacitance touch screen, RGB (800*480)			

Ordering Information

Product Description	SSG5000X Signal Generator	Order Number
Product code	Analog Signal Generator 9 kHz~4 GHz	SSG5040X
		SSG5060X
	Vector Signal Generator 10 MHz~6 GHz	SSG5040X-V
		SSG5060X-V
Standard configurations	quick start, an USB cable, calibration certificate, power cord	
option	pulse train generator	SSG5000X-PT
	rack mount kit	SSG-RMK
	USB-GPIB adapter	USB-GPIB
	Upgrade 4 GHz to 6 GHz	SSG5000X-F60
	Upgrade IQ bandwidth from 75 MHz to 150 MHz	SSG5000XV-B150
	Precision Frequency Reference	10M_OCXO_L



SSG3000X RF Signal Generator

Key Features

- Frequency up to 2.1 GHz/3.2 GHz
- 0.01 Hz frequency setting resolution
- Level output from -110 dBm to +13 dBm
- Maximum level up to +20 dBm (typ.)
- Phase Noise: -110 dBc/ Hz @ 1 GHz , 20 kHz offset (typ.)
- Level accuracy ≤ 0.7 dB (typ.)
- Provides AM, FM & PM analog modulation with internal, external or Int+Ext source
- Pulse modulation, on/off ratio ≥ 70 dBc
- Pulse train generator (option)
- External IQ modulation with SDG6000X as the baseband IQ signal
- USB-power meter measurement
- 5 inch TFT capacitive touch screen, mouse and keyboard supported
- Web browser remote control on PC and mobile terminals
- Standard interface include USB Host, USB Device (USB TMC), LAN (VXI-11, Socket, Telnet). Optional interface: GPIB

Characteristics

- Provides double-tone signal with IQ modulation, easily do TOI testing

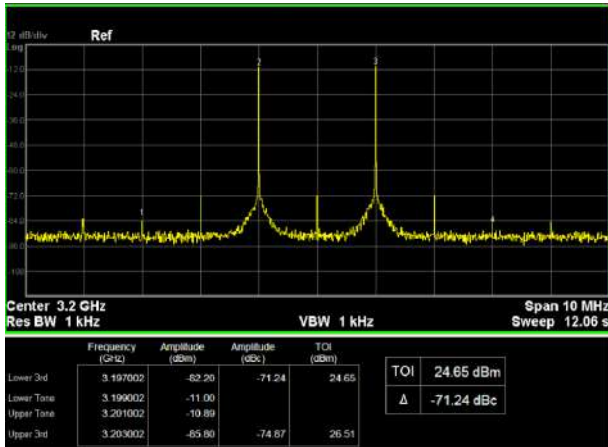

- Maximum output level up to +20 dBm

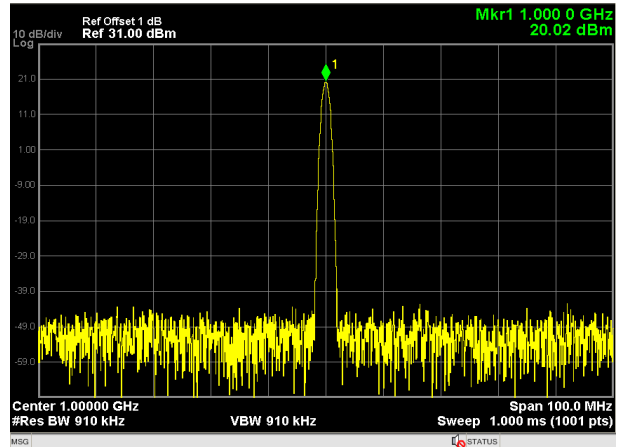

- Double pulse modulation

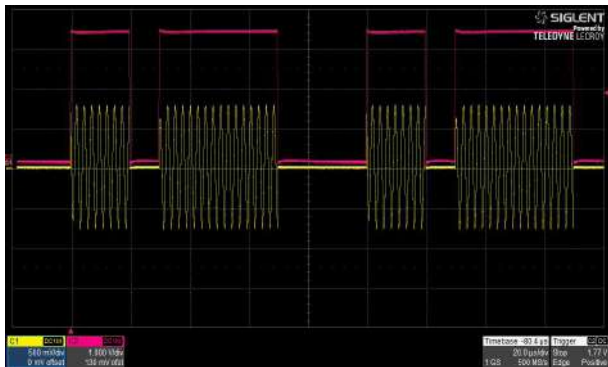

- Pulse train generator

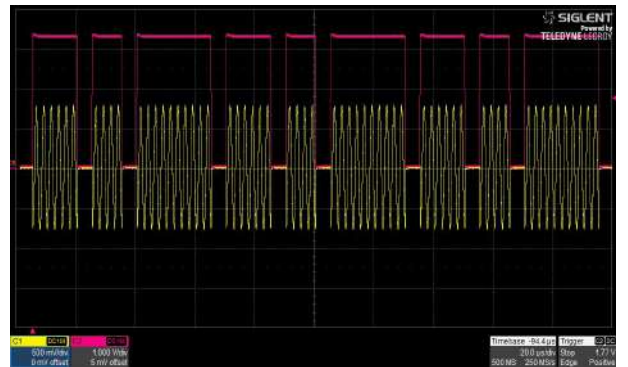

- Power output display using USB power sensor

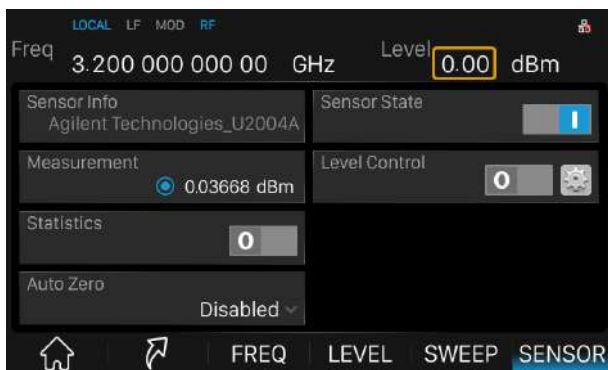

- Power output control using USB power sensor

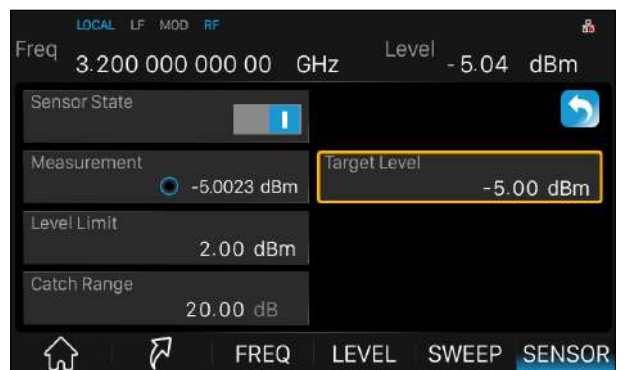

- Example for auto level control



- External IQ modulation using the SDG600X as the baseband source

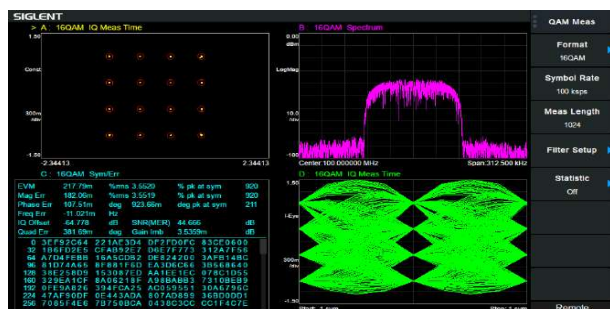

- 5 inch touch screen, keyboard and mouse support

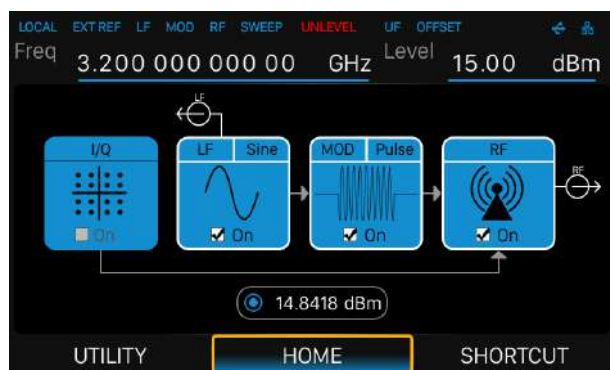

Specifications

Specifications are valid under the following condition: The instrument is within the calibration period, has been stored between 0 and 50°C for at least 2 hours prior to use, and has been powered on and warmed up for at least 40 minutes. The specifications include the measurement uncertainty, unless otherwise noted.

Specifications: All products are guaranteed to meet published specifications when operating temperatures from 5 to 45°C, unless otherwise noted.

Typical(typ.): Performance deemed typical implies that 80 percent of the measurement results will meet the typical published performance with a 95th percentile confidence level at room temperature (approximately 25°C). Typical performance is not warranted and does not include measurement uncertainty.

Nominal(nom.): This value indicate the expected mean or average performance, or an attribute whose performance is by design, such as the 50 ohm connector.

Model and Main index

Model	SSG3032X	SSG3021X	SSG3032X-IQE	SSG3021X-IQE
Frequency Range	CW MODE 9 kHz~3.2 GHz	CW MODE 9 kHz~2.1 GHz	CW MODE 9 kHz~3.2 GHz IQ MODE 10 MHz~3.2 GHz	CW MODE 9 kHz~2.1 GHz IQ MODE 10 MHz~2.1 GHz
Frequency Resolution	0.01 Hz			
Amplitude Resolution	0.01 dB			
Level accuracy	0.7 dB (typ.)			
Phase noise	-110 dBc/Hz @1 GHz ,offset 20 kHz (typ.)			
Display	5 inch capacitance touch screen, RGB (800*480)			

Ordering Information

Product Description	SSG3000X Signal Generator	Order Number
Product code	Signal Generator 9 kHz~3.2 GHz	SSG3032X
		SSG3032X-IQE
	Signal Generator 9 kHz~2.1 GHz	SSG3021X
		SSG3021X-IQE
Standard configurations	quick start, an USB cable, calibration certificate, power cord	
option	pulse train generator	SSG3000X-PT
	rack mount kit	SSG-RMK
	USB-GPIB adapter	USB-GPIB
	Upgrade 2.1 GHz to 3.2 GHz	SSG3000X-21BW32
	Upgrade 2.1 GHz to 3.2 GHz (with external IQ)	SSG3000X-IQE-21BW32



SSA3000X Spectrum Analyzer

Key Features

- All-Digital IF Technology
- Frequency Range from 9 kHz up to 3.2 GHz
- -161 dBm/Hz Displayed Average Noise Level (Typ.)
- -98 dBc/Hz @10 kHz Offset Phase Noise (1 GHz, Typ.)
- Total Amplitude Accuracy < 0.7 dB
- 1 Hz Minimum Resolution Bandwidth (RBW)
- Preamplifier Standard
- Up to 3.2 GHz Tracking Generator Kit
- Reflection Measurement Kit (Opt.)
- Advanced Measurement Kit (Opt.)
- EMI Pre-compliance Measurements Kit (Opt.)
- 10.1 Inch WVGA (1024x600) Display

Characteristics

- Support four traces and cursors independently

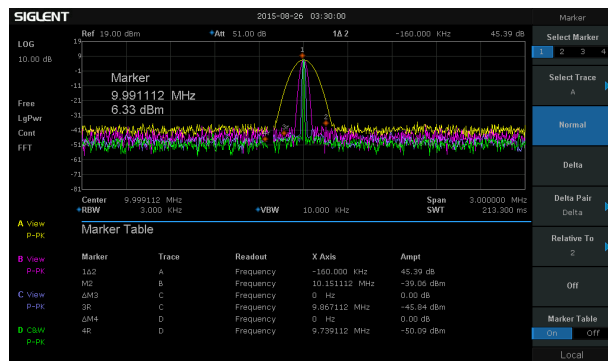

- 151 dBm Displayed Average Noise Level (RBW=10 Hz)

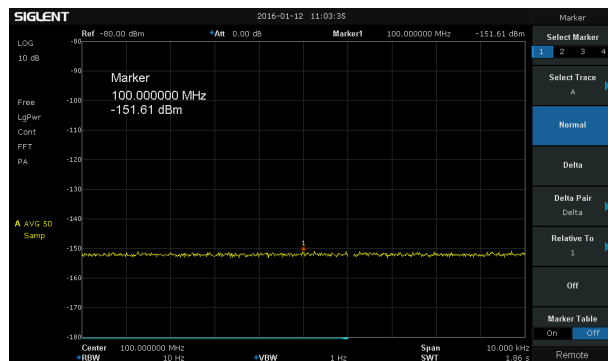

- Demodulation at the zero span

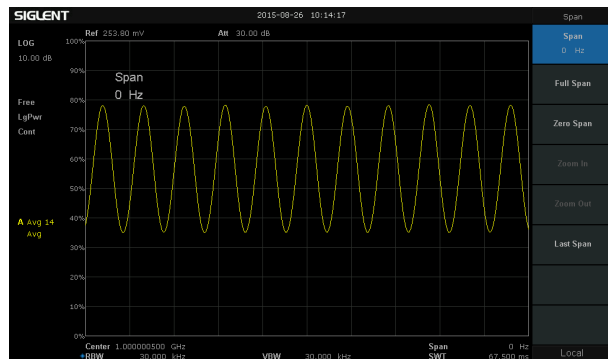

- Reflection measurement, acquire characteristic curve of the Return Loss

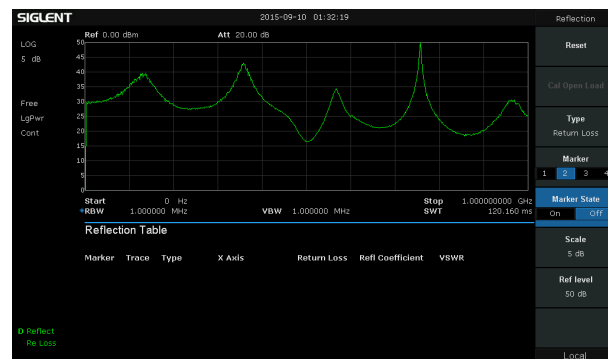

- 1 Hz Minimum Resolution Bandwidth (RBW)

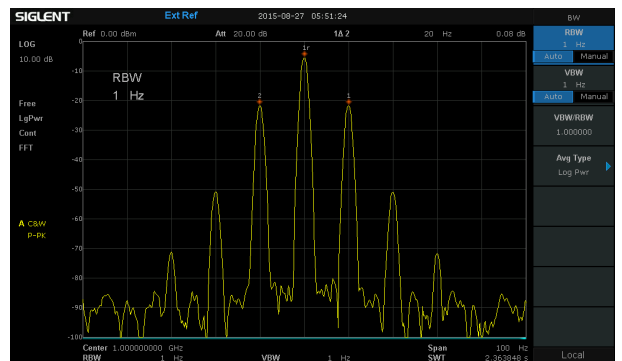

- Phase noise -98 dBc/Hz@1 GHz, offset 10 kHz

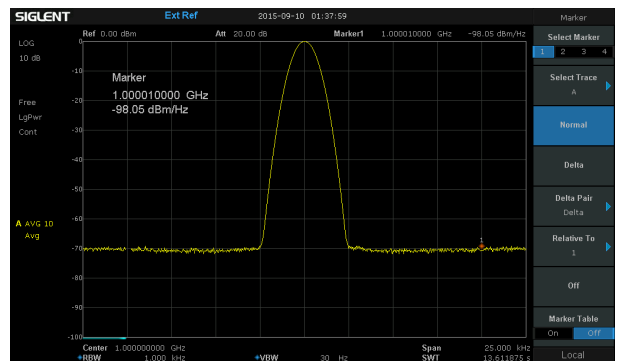

- Advanced power measurement, calculate the ACPR parameters

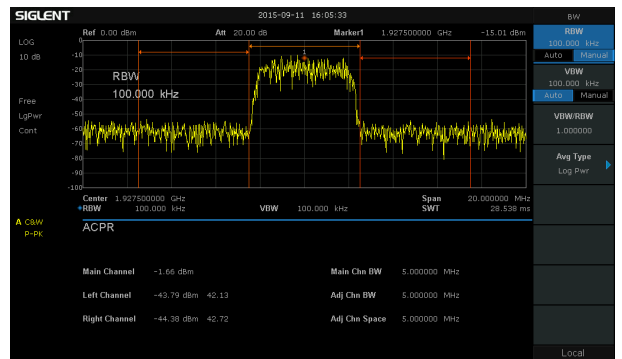

- EMI filter, Quasi-Peak detector following CISPR 16

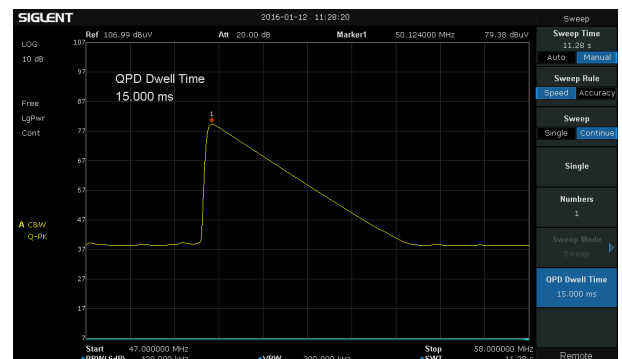

Specifications

Model	SSA3032X	SSA3021X
Frequency Range	9 kHz~3.2 GHz	9 kHz~2.1 GHz
Resolution Bandwidth	1 Hz~1 MHz, in 1-3-10 sequence	1 Hz~1 MHz, in 1-3-10 sequence
Displayed Average Noise Level	-161 dBm/Hz, Normalize to 1 Hz (typ.)	-161 dBm/Hz, Normalize to 1 Hz (typ.)
Phase Noise	<-98 dBc/Hz@1 GHz, 10 kHz offset	<-98 dBc/Hz@1 GHz, 10 kHz offset
Amplitude Precision	< 0.7 dB	< 0.7 dB

Ordering Information

Product Description	SSA3000X Spectrum Analyzer	Order Number	
Product code	Spectrum Analyzer, 9 kHz~3.2 GHz	SSA3032X	
	Spectrum Analyzer, 9 kHz~2.1 GHz	SSA3021X	
Standard configurations	A Quick Start, A Product Certification, A USB Cable, A Calibration Certificate	QG-SSA3000X	
Utility Options	Advanced Measurement Kit (Software)	AMK-SSA3000X	
	Utility Kit: N (M)-SMA (M) cable N (M)-N (M) cable N (M)-BNC (F) adaptor (2 pcs) N (M)-SMA (F) adaptor (2 pcs) 10 dB attenuator	UKitSSA3X	
	N (M)-SMA (M) cable	N-SMA-6L	
	N (M)-N (M) cable	N-N-6L	
	N (M)-BNC (M) cable	N-BNC-2L	
	Soft carrying bag	BAG-S2	
	EMI Options	EMI Measurement Kit: EMI Filter and Quasi Peak Detector, EMI test option in EasySpectrum Software	EMI-SSA3000X
		Near Field Probe:H field probe sets (20 mm, 10 mm, 5 mm) , E field probe (5 mm), 300 kHz~3.0 GHz	SRF5030-T
Tracking Generator Kit (standard)		TG-SSA3000X	
Reflect Measurement Options	Reflect Measurement Kit (Software)	SSA3000-Ref1	
	VSWR Bridge Kit: including SSA3000-Ref1 VSWR Bridge(1 MHz~2 GHz) N(M)-N(M) adaptor(2 pcs)	RBSSA3X20	

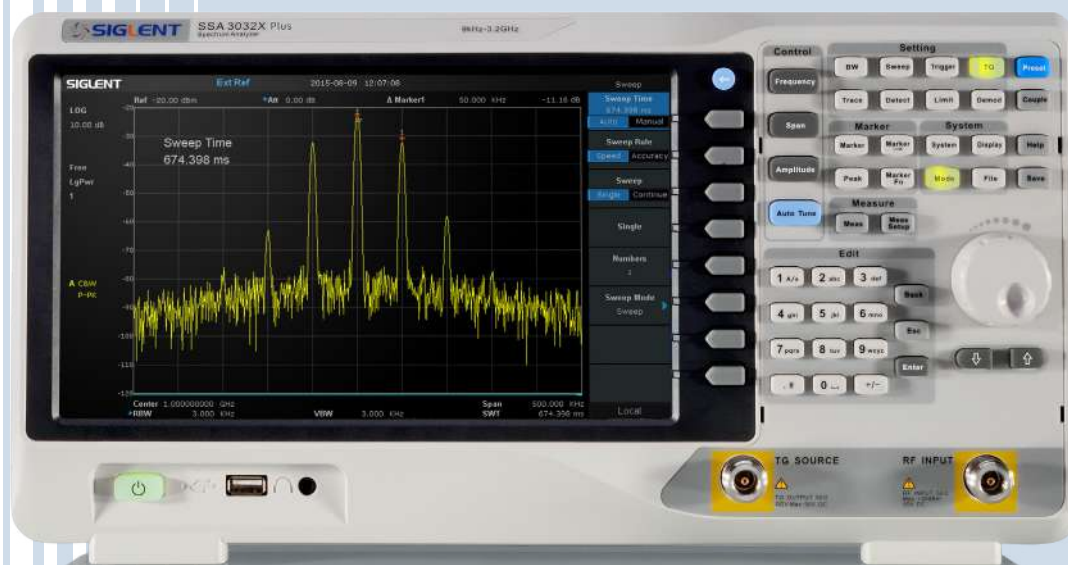

SSA3000X Plus Spectrum Analyzer

Features and Benefits

- Frequency Range from 9 kHz up to 7.5 GHz
- -165 dBm/Hz Displayed Average Noise Level (Typ.)
- -98 dBc/Hz.@10 kHz Offset Phase Noise (1 GHz, Typ.)
- Level Measurement Uncertainty < 0.7 dB (Typ.)
- 1 Hz Minimum Resolution Bandwidth (RBW)
- Preamplifier Standard
- Tracking Generator included at no charge
- Vector Signal Modulation Analysis (Opt.)
- EMI Filter and Quasi-Peak Detector (Opt.)
- Advanced Measurement Kit (Opt.)
- 10.1 Inch Multi-Touch Screen , Mouse and Keyboard supported
- Web Browser Remote Control on PC and Mobile Terminals and File Operation

Design features

- 10.1 Inch (1024x600) Touch Screen

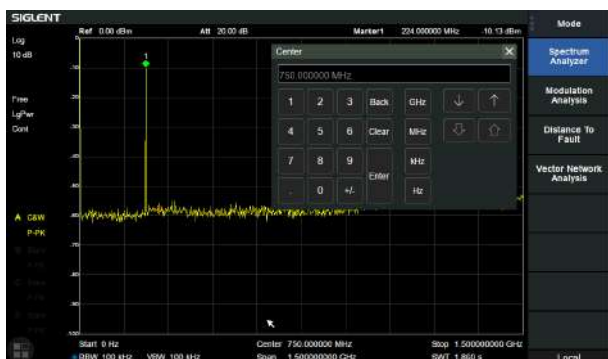

- Minimum 1 Hz Resolution Bandwidth (RBW)

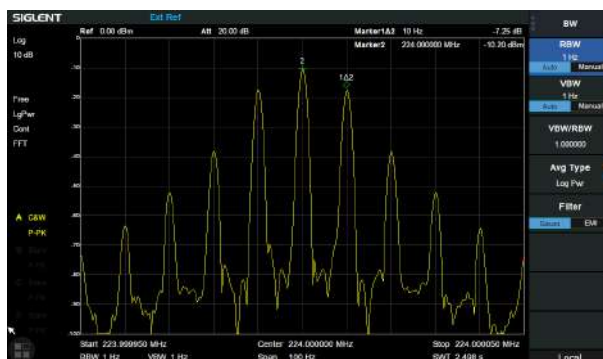

- -165 dBm/Hz Displayed Average Noise Level

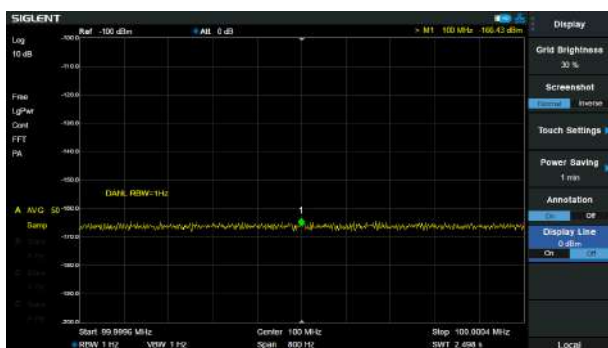

- Phase noise <math>< -98 \text{ dBc/Hz}@1 \text{ GHz}</math>

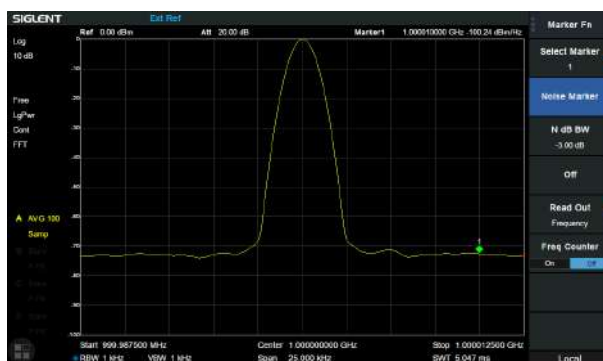

- Advanced Measurement Kit



- Spectrum Monitor in Advanced Measurement Kit

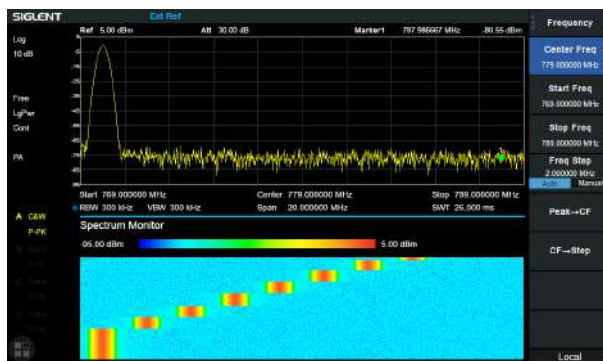

- Digital Modulation Analysis Mode

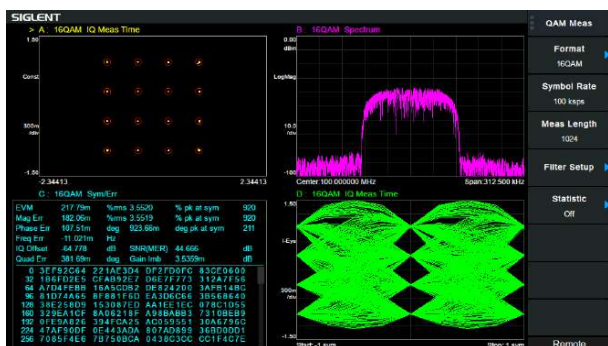

- EMI filter and Quasi-peak Detector for EMI Pre-compliance Test

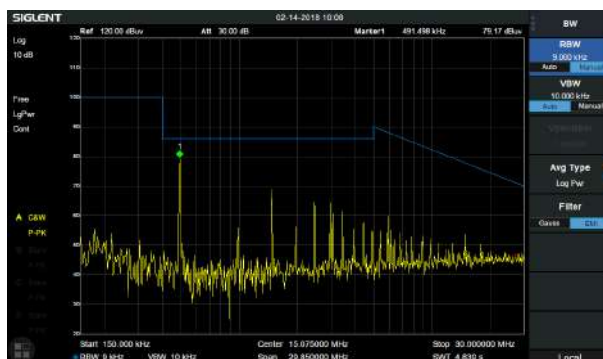

• Easy Spectrum^T Software for Free

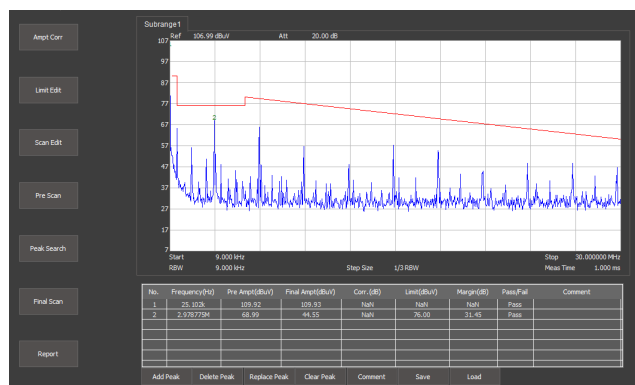

• Remote Control on Web Browser

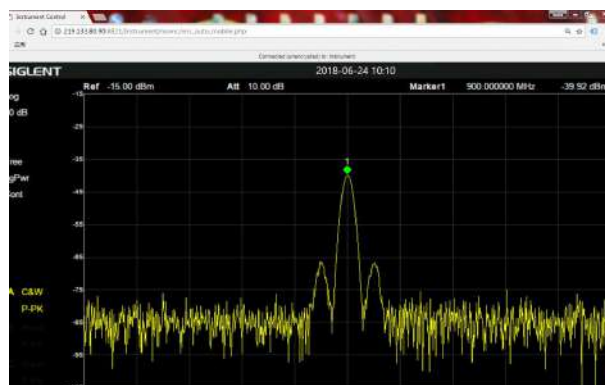

Model and Main index

Model	SSA3021X Plus	SSA3032X Plus	SSA3075X Plus
Frequency Range	9 kHz ~ 2.1 GHz	9 kHz~3.2 GHz	9 kHz~7.5 GHz
Resolution Bandwidth	1 Hz~1 MHz	1 Hz~1 MHz	1 Hz~3 MHz
Displayed Average Noise Level	-161 dBm/Hz	-161 dBm/Hz	-165 dBm/Hz
SSB Phase Noise	< -98 dBc/Hz	<-98 dBc/Hz	<-98 dBc/Hz
Total Amplitude Accuracy	< 0.7 dB	< 0.7 dB	< 0.7 dB
Tracking Generator	100 kHz ~ 2.1 GHz	100 kHz~3.2 GHz	100 kHz~7.5 GHz
Touch Screen	Multi Touch, Mouse and Keyboard supported		
Advanced Measurement	CHP, ACPR, OBW, CNR, Harmonic, TOI, Monitor		
Reflection Measurement	VSWR measurement using Reflection Bridge		
EMI Test	EMI Filter and Quasi-Peak Detector, Log Scale and Limit Line		
Modulation Analysis	AM, FM; ASK, FSK, MSK, PSK, QAM		
Communication Interface	LAN, USB Device, USB Host (USB-GPIB)		
Remote Control Capability	SCPI/Labview/IVI based on USB-TMC/VXI-11/Socket/Telnet		
Remote Controller	NI-MAX, Web Browser, Easy Spectrum software, File Explorer		

Ordering Information

Product	Description	Order Number
Product Code	Spectrum Analyzer, 9 kHz ~ 2.1 GHz	SSA3021X Plus
	Spectrum Analyzer, 9 kHz ~ 3.2 GHz	SSA3032X Plus
	Spectrum Analyzer, 9 kHz ~ 7.5 GHz	SSA3075X Plus
Standard Accessories	Quick Start, USB Cable, Power Cord	
Common Options and Accessories	Tracking Generator	SSA3000XP-TG
	Advanced Measurement Kit	SSA3000XP-AMK
	Utility Kit: N(M)-SMA(M) cable (6 GHz), N(M)-N(M) cable (6 GHz), N(M)-BNC(F) adaptor x 2, N(M)-SMA(F) adaptor x 2, 10 dB 1W attenuator	UKitSSA3X
	N(M)-SMA(M) cable, 70cm, 6 GHz	N-SMA-6L
	N(M)-N(M) cable, 70cm, 6 GHz	N-N-6L
	N(M)-BNC(M) cable, 70cm, 2 GHz	N-BNC-2L
	USB-GPIB Adaptor	USB-GPIB
	Soft carrying bag	BAG-S2
	6U Rack Mount Kit	SSA-RMK
Reflection Measurement Options	Tracking Generator	SSA3000XP-TG
	Reflection Measurement	SSA3000-Ref1
	Reflection Bridge Kit: Reflection Bridge (1 MHz ~ 2.5 GHz), N(M)-N(M) adaptors (2 pcs)	RB3X25
	50 Ω, N type Male, 4.5 GHz Economic Calibration Kit: Open(M), Short(M), Match(M), Through Adapter(F-F)	F503ME
EMI test Options	EMI Measurement Kit: EMI Filter and Quasi Peak Detector, EMI Receiver Mode in EasySpectrum Software	SSA3000XP-EMI
	300 kHz~3 GHz Near Field Probe Kit: 3 H-probes (20/10/5 mm), 1 E-probe (5 mm)	SRF5030T
Modulation Analysis Options	Digital Modulation: ASK, FSK, MSK, PSK, QAM	SSA3000XP-DMA
	Analog Modulation: AM, FM	SSA3000XP-AMA

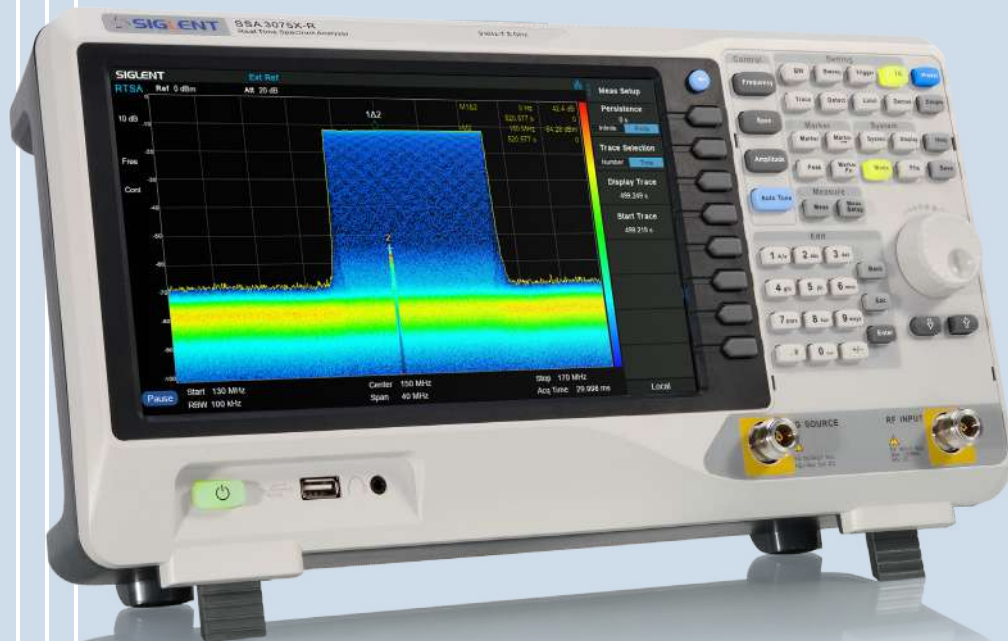

SSA3000X-R Real-Time Spectrum Analyzer

Features and Benefits

- Spectrum Analyzer Frequency Range from 9 kHz up to 5.0 GHz / 7.5 GHz
- -165 dBm/Hz Displayed Average Noise Level (Typ.)
- -98 dBc/Hz.@10 kHz Offset Phase Noise (1 GHz, Typ.)
- Level Measurement Uncertainty < 0.7 dB (Typ.)
- 1 Hz Minimum Resolution Bandwidth (RBW)
- Preamplifier Standard
- Tracking Generator Standard
- Up to 40 MHz Real Time Analysis Bandwidth
- 100% POI 7.20 μ s, Dynamic Range 60 dB
- Multi-view for Density, Spectrogram, PVT, and multi trigger and FMT
- Modulation Analysis up to 40 MHz BW (Opt.)
- Reflection Measurement Kit (Opt.)
- EMI Filter and Quasi-Peak Detector Kit(Opt.)
- Advanced Measurement Kit (Opt.)
- 10.1 inch Multi-Touch Screen , Mouse and Keyboard supported
- Web Browser Remote Control on PC and Mobile Terminals and File Operation

Design features

- 10.1 Inch Display with Multi-Touch Screen

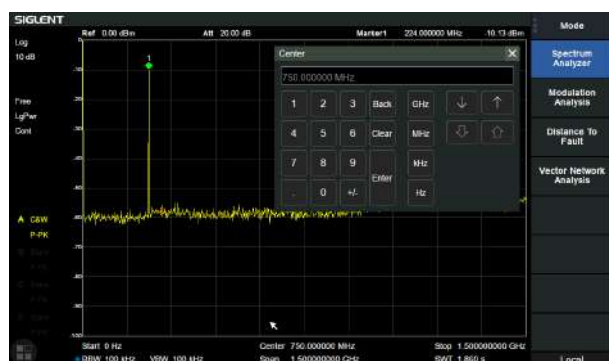

- Phase noise <math><-98\text{ dBc/Hz}@1\text{ GHz}</math>

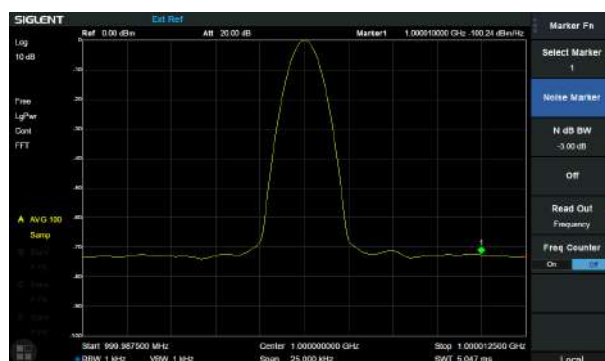

- Minimum 1 Hz Resolution Bandwidth (RBW)

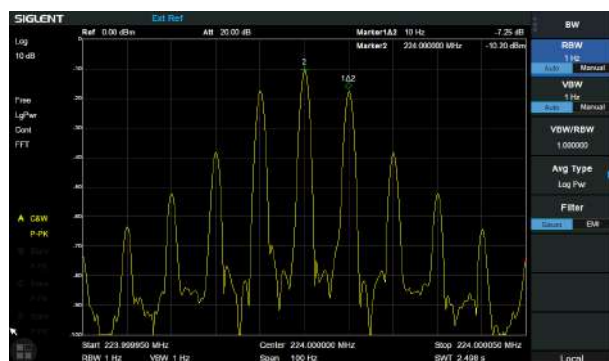

- ACPR in Advanced Measurement Kit



- -165 dBm/Hz Displayed Average Noise Level

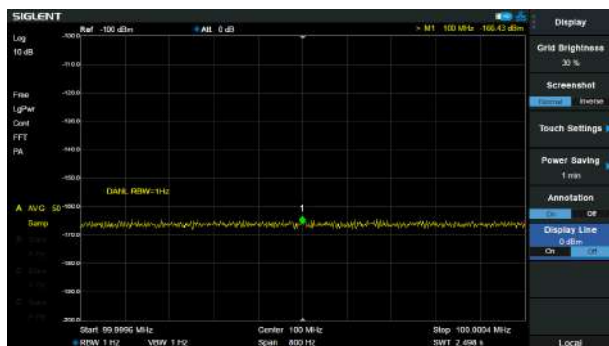

- Monitor in Advanced Measurement Kit

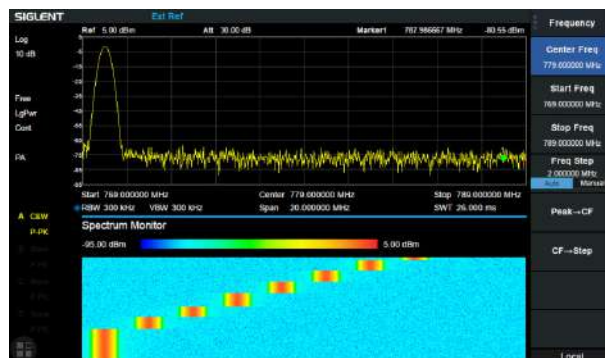

Real-Time Spectrum Analyzer

• Modulation Analysis Mode

AM/FM, ASK/FSK/PSK/MSK/QAM Vector Signal Modulation Analysis and EVM evaluation. The analysis BW is same with real-time BW in RTSA mode

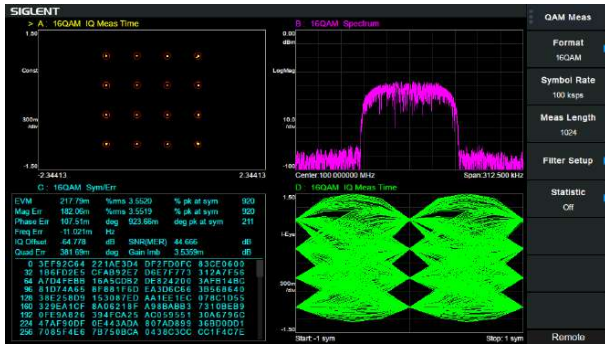

• Real Time Analysis Mode

Density,3D,Spectrogram,PvT,Multi-view and dimensions to monitor complex signals

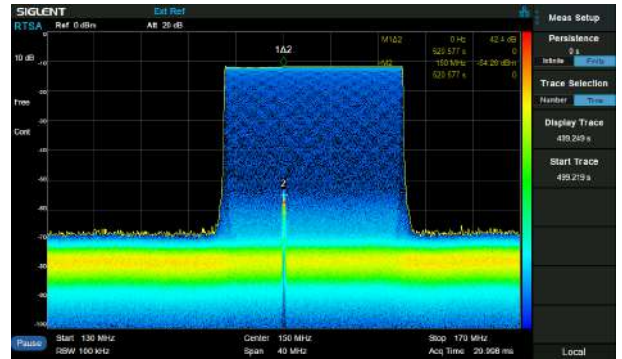

• Reflection Measurement

VSWR and Return Loss measurement with Q value measurement



• EMI Pre-Compliance Test

CISPR 16-1-1 EMI filter and Quasi-peak Detector , Log scale and Limit line

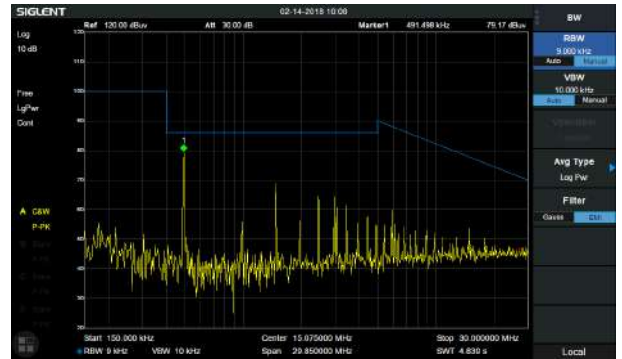

Model and Main index

Model	SSA3050X-R	SSA3075X-R
Frequency Range	9 kHz~5.0 GHz	9 kHz~7.5 GHz
Resolution Bandwidth	1 Hz~3 MHz	1 Hz~3 MHz
Displayed Average Noise Level	-165 dBm/Hz	-165 dBm/Hz
SSB Phase Noise	<-98 dBc/Hz	<-98 dBc/Hz
Total Amplitude Accuracy	< 0.7 dB	< 0.7 dB
Tracking Generator	100 kHz - 5.0 GHz	100 kHz - 7.5 GHz
Real Time Band Width	25 MHz, 40 MHz (Option)	
SFDR	60 dB	
100% POI	7.20 μs	
RTSA Measurement	Density, Spectrogram, 3D, PvT	
Touch Screen	Multi Touch, Mouse and Keyboard supported	
Advanced Measurement	CHP, ACPR, OBW, CNR, Harmonic, TOI, Monitor	
Modulation Analysis	AM, FM, ASK, FSK, MSK, PSK, QAM	
Reflection Measurement	VSWR measurement using Reflection Bridge	
EMI Test	EMI Filter and Quasi-Peak Detector, Log Scale and Limit Line	
Communication Interface	LAN, USB Device, USB Host (USB-GPIB)	
Remote Control Capability	SCPI/Labview/IVI based on USB-TMC/VXI-11/Socket/Telnet	
Remote Controller	NI-MAX, Web Browser, Easy Spectrum software, File Explorer	

Ordering Information

Product	Description	Order Number
Product Code	Real Time Spectrum Analyzer, 5.0 GHz	SSA3050X-R
	Real Time Spectrum Analyzer, 7.5 GHz	SSA3075X-R
Standard Accessories	Quick Start, USB Cable, Power Cord	
Common Options and Accessories	Advanced Measurement Kit	SSA3000XR-AMK
	Utility Kit: N(M)-SMA(M) cable, N(M)-N(M) cable, N(M)-BNC(F) adaptor (2 pcs), N(M)-SMA(F) adaptor (2 pcs), 10 dB attenuator	UKitSSA3X
	N(M)-SMA(M) cable, 70cm, 6 GHz	N-SMA-6L
	N(M)-N(M) cable, 70cm, 6 GHz	N-N-6L
	N(M)-BNC(M) cable, 70cm, 2 GHz	N-BNC-2L
	N(M)-SMA(M) cable, 100cm, 18 GHz	N-SMA-18L
	N(M)-N(M) cable, 100cm, 18 GHz	N-N-18L
	USB-GPIB Adaptor	USB-GPIB
	Soft carrying bag	BAG-S2
	6U Rack Mount Kit	SSA-RMK
Real-Time Options	40 MHz Real-Time BandWidth	SSA3000XR-RT40
Reflection Measurement Options	Reflection Measurement	SSA3000-Ref1
	Reflection Bridge Kit: Reflection Bridge (1 MHz ~ 2.5 GHz), N(M)-N(M) adaptors (2 pcs)	RB3X25
EMI test Options	EMI Measurement Kit: EMI Filter and Quasi Peak Detector, EMI Receiver Mode in EasySpectrum Software	SSA3000XR-EMI
	300 kHz~3 GHz Near Field Probe Kit: 3 H-probes (20/10/5 mm), 1 E-probe (5 mm)	SRF5030T
Modulation Analysis Options	Analog Modulation Analysis: AM, FM	SSA3000XR-AMA
	Digital Modulation Analysis: ASK, FSK, MSK, PSK, QAM. The analysis BW is the real-time BW in RTSA mode	SSA3000XR-WDMA

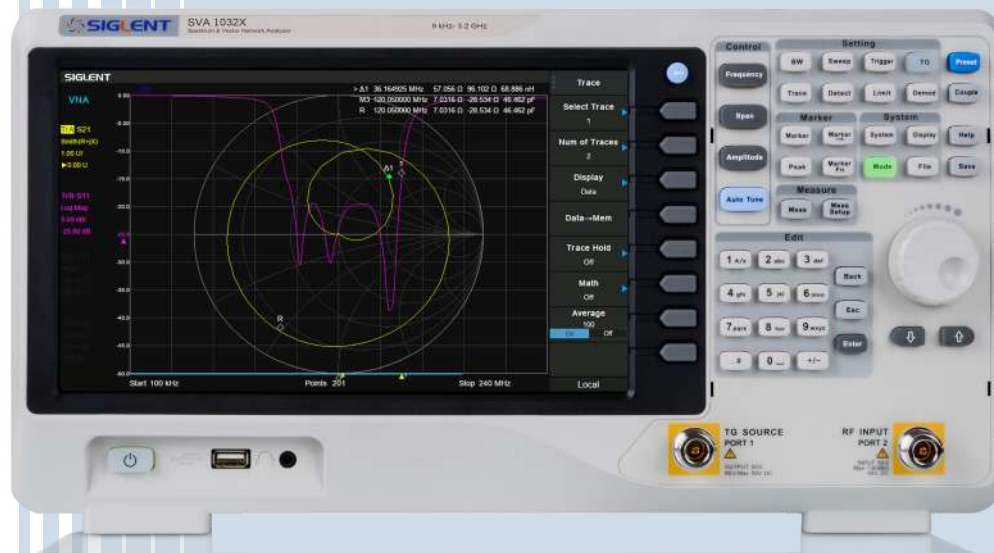

SVA1000X Spectrum & Vector Network Analyzer

Features and Benefits

- Spectrum Analyzer Frequency Range from 9 kHz up to 7.5 GHz
- Vector Network Analyzer Frequency Range from 100 kHz up to 7.5 GHz
- -165 dBm/Hz Displayed Average Noise Level (Typ.)
- -98 dBc/Hz.@10 kHz Offset Phase Noise (1 GHz, Typ.)
- Level Measurement Uncertainty < 0.7 dB (Typ.)
- 1 Hz Minimum Resolution Bandwidth (RBW)
- Pre-amplifier Standard
- Tracking Generator Standard
- Distance To Fault (Opt.)
- Vector Signal Modulation Analysis (Opt.)
- EMI Filter and Quasi-Peak Detector Kit (Opt.)
- Advanced Measurement Kit (Opt.)
- 10.1 Inch Multi-Touch Screen , Mouse and Keyboard supported
- Web Browser Remote Control on PC and Mobile Terminals and File Operation

Design features

- 10.1 Inch Display with Multi-Touch Screen

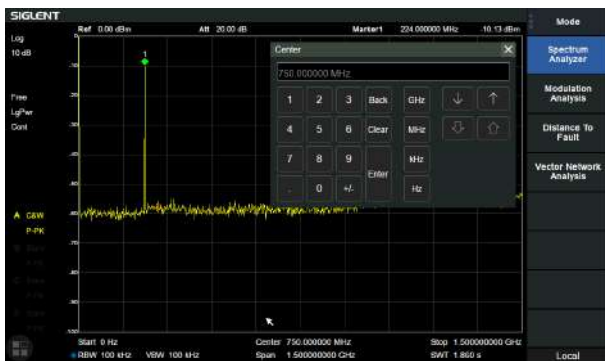

- Phase noise <math><-99\text{ dBc/Hz}@1\text{ GHz}</math>, offset 10 kHz

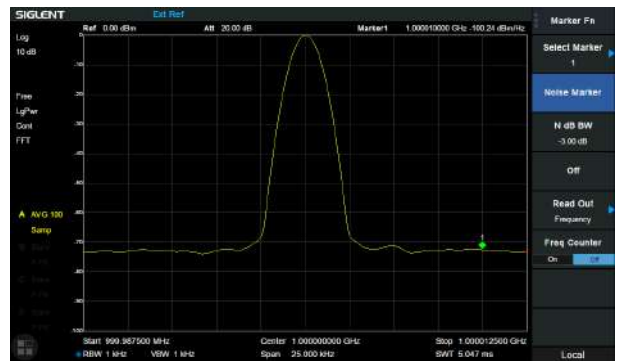

- Minimum 1 Hz Resolution Bandwidth (RBW)

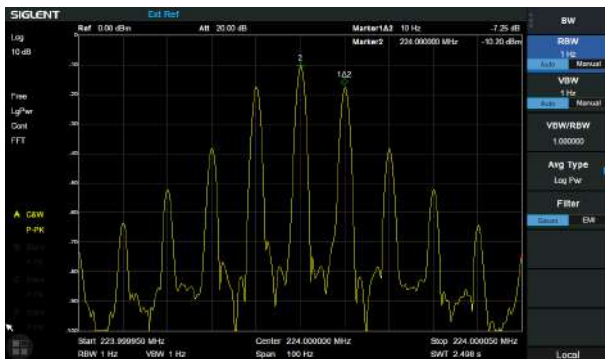

- ACPR in Advanced Measurement Kit



- -165 dBm/Hz Displayed Average Noise Level

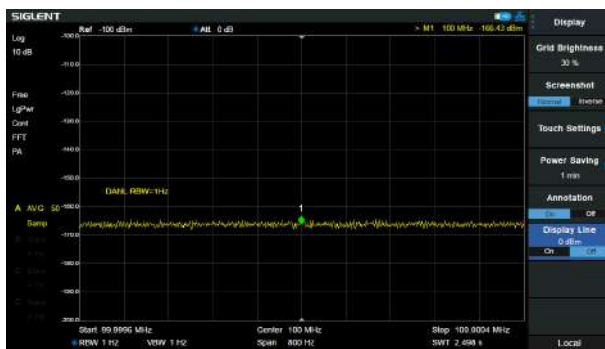

- Monitor in Advanced Measurement Kit

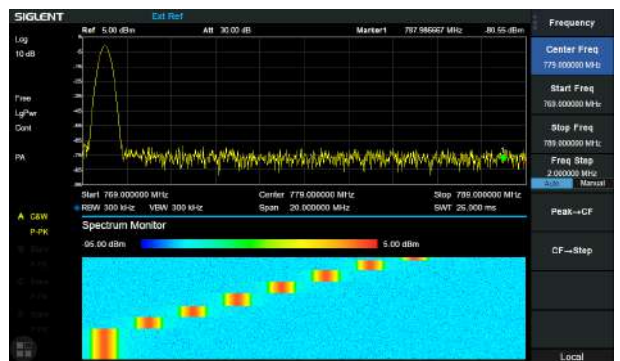

- 100k-7.5GHz Vector S11 and S21 measurement, Multi Formats Overlay Display

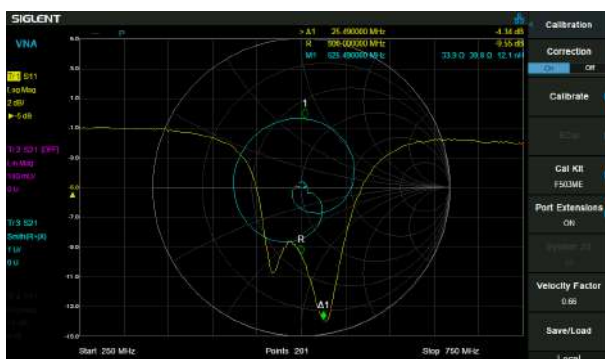

- Cable and Antenna Test based on Timing Domain Analysis

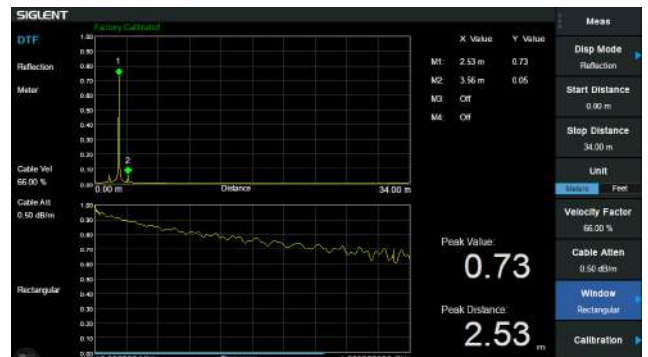

• **AM/FM,ASK/FSK/PSK/MSK/QAM Vector Signal Modulation Analysis**

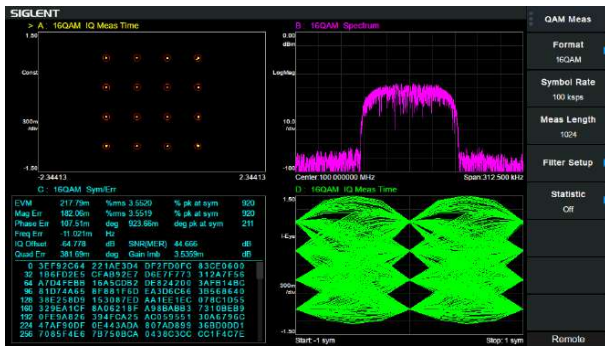

• **CISPR 16-1-1 EMI filter and Quasi-peak Detector , Log scale and limit line**

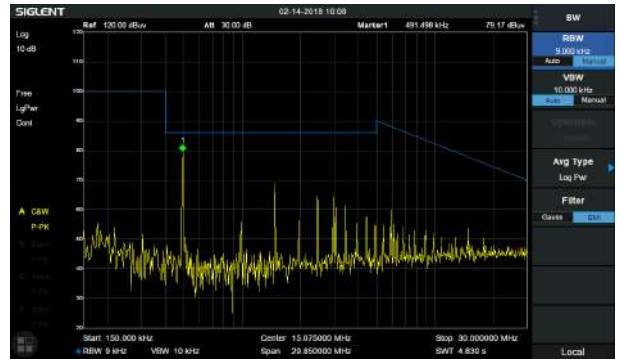

• **Easy Spectrum^T Software for Free**

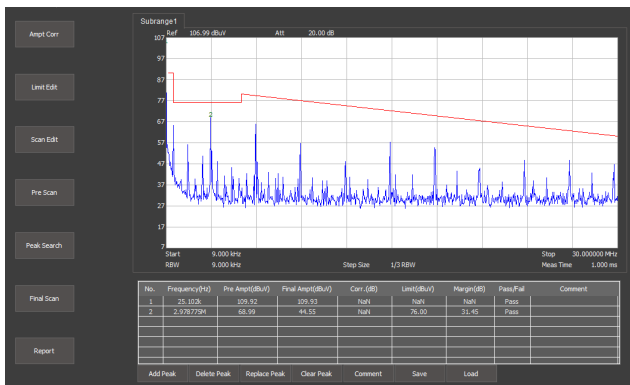

• **Remote Control on Web Browser**

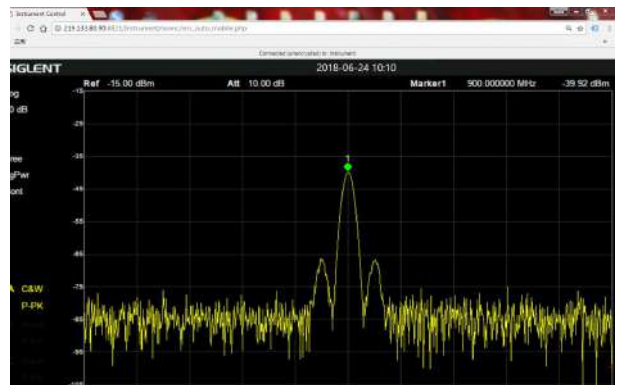

Model and Main index

Model	SVA1015X	SVA1032X	SVA1075X
Spectrum Analyzer Frequency Range	9 kHz~1.5 GHz	9 kHz~3.2 GHz	9 kHz~7.5 GHz
Vector Network Analyzer Frequency Range	10 MHz~1.5 GHz	100 kHz~3.2 GHz	100 kHz~7.5 GHz
Resolution Bandwidth	1 Hz~1 MHz	1 Hz~1 MHz	1 Hz~3 MHz
Displayed Average Noise Level	-156 dBm/Hz	-161 dBm/Hz	-165 dBm/Hz
SSB Phase Noise	<-99 dBc/Hz	<-98 dBc/Hz	<-98 dBc/Hz
Total Amplitude Accuracy	< 1.2 dB	< 0.7 dB	< 0.7 dB
Tracking Generator	5 MHz~1.5 GHz	100 kHz~3.2 GHz	100 kHz~7.5 GHz
VNA measurement	Vector S11, Vector S21		
Distance to Fault	VNA Timing Domain Analysis Locator		
Touch Screen	Multi Touch, Mouse and Keyboard supported		
Advanced Measurement	CHP, ACPR, OBW, CNR, Harmonic, TOI, Monitor		
Reflection Measurement	VSWR measurement using Reflection Bridge		
EMI Test	EMI Filter and Quasi-Peak Detector, Log Scale and Limit Line		
Modulation Analysis	AM, FM; ASK, FSK, MSK, PSK, QAM		
Communication Interface	LAN, USB Device, USB Host (USB-GPIB)		
Remote Control Capability	SCPI/Labview/IVI based on USB-TMC/VXI-11/Socket/Telnet		
Remote Controller	NI-MAX, Web Browser, Easy Spectrum software, File Explorer		

Ordering Information

Product	Description	Order Number
Product Code	Spectrum & Vector Network Analyzer, 1.5 GHz	SVA1015X
	Spectrum & Vector Network Analyzer, 3.2 GHz	SVA1032X
	Spectrum & Vector Network Analyzer, 7.5 GHz	SVA1075X
Standard Accessories	Quick Start, USB Cable, Power Cord	
Common Options and Accessories	Advanced Measurement Kit	SVA1000X-AMK
	Utility Kit: N(M)-SMA(M) cable (6 GHz), N(M)-N(M) cable (6 GHz), N(M)-BNC(F) adaptor x 2, N(M)-SMA(F) adaptor x 2, 10 dB 1W attenuator	UKitSSA3X
	N(M)-SMA(M) cable, 70cm, 6 GHz	N-SMA-6L
	N(M)-N(M) cable, 70cm, 6 GHz	N-N-6L
	N(M)-BNC(M) cable, 70cm, 2 GHz	N-BNC-2L
	N(M)-N(M) cable, 100cm, 18 GHz	N-N-18L
	N(M)-SMA(M) cable, 100cm, 18 GHz	N-SMA-18L
	USB-GPIB Adaptor	USB-GPIB
	Soft carrying bag	BAG-S2
	6U Rack Mount Kit	SSA-RMK
VNA Options	Distance To Fault	SVA1000X-DTF
	Mechanical Calibration Kit: Open(M), Short(M), Match(M,50), Through(F-F), 4.5 GHz, N-Male connector	F503ME
	Mechanical Calibration Kit: OSLT, DC - 4.5 GHz, N-Female connector	F503FE
	Mechanical Calibration Kit: OSLT, DC - 4.5 GHz, 3.5mm SMA-Male connector	F603ME
	Mechanical Calibration Kit: Open(M), Short(M), Match(M,50), Through(F-F), 4.5 GHz, SMA-Female connector	F603FE
	Mechanical Calibration Kit: OSLT, DC - 9 GHz, N-Male connector	F504MS
	Mechanical Calibration Kit: OSLT, DC - 9 GHz, N-Female connector	F504FS
	Mechanical Calibration Kit: OSLT, DC - 9 GHz, 3.5mm SMA-Male connector	F604MS
	Mechanical Calibration Kit: OSLT, DC - 9 GHz, 3.5mm SMA-Female connector	F604FS
EMI test Options	EMI Measurement Kit: EMI Filter and Quasi Peak Detector, EMI Receiver Mode in EasySpectrum Software	SVA1000X-EMI
	300 kHz~3 GHz Near Field Probe Kit: 3 H-probes (20/10/5 mm), 1 E-probe (5 mm)	SRF5030T
Modulation Analysis Options	Digital Modulation: ASK, FSK, MSK, PSK, QAM	SVA1000X-DMA
	Analog Modulation: AM, FM	SVA1000X-AMA



SHS1000 Handheld Digital Oscilloscope

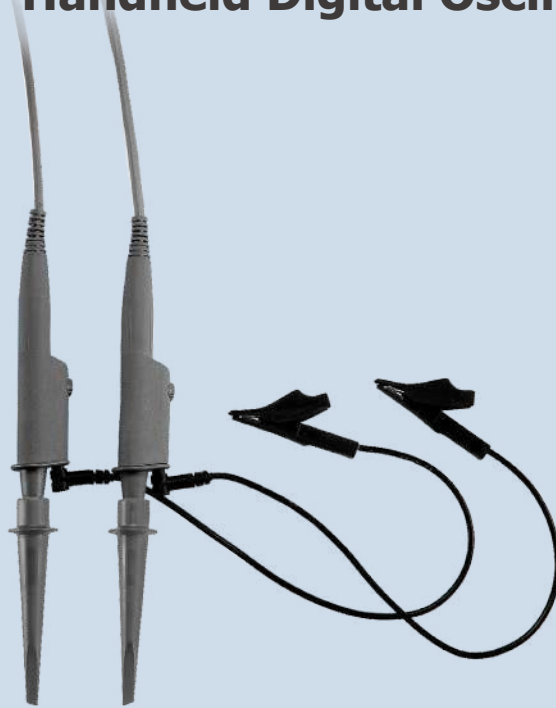

Application

- Embedded electronic circuit design and test
- Mechanical and electrical products design and analysis
- Manufacturing and circuit function test
- Differential signal analysis
- Floating signal measurements

Key Features

- Combines the functions of oscilloscope, multimeter and recorder in one
- Isolated oscilloscope channels, isolation level: CAT II 1000 V and CAT III 600 V
- 60 MHz/100 MHz bandwidth, 1 G sampling rate, 2 M memory depth, 7 M recording length
- Built-in lithium battery
- 5.7 inch color TFT-LCD

Specification

Model	SHS1102	SHS1062
Bandwidth	100 MHz	60 MHz
Rise time	≤3.5 ns	≤5.8 ns
Real time sampling rate	1 GSa/s	
Equivalent sampling rate	50 GSa/s	
Vertical sensitivity	5 mV – 100 V/div	
Time base range	2.5 ns – 50 ns/div Scan: 100 ms – 50 s/div	5 ns – 50 s/div
Memory depth	2 Mpts	
Triggering	Edge, Pulse, Video, Slope, Alternative	
Vertical resolution	8 bit	
Triggering frequency counter	6 digits	
Data recorder	7 M points	
Trend plot	800 K/CH	
Interface	USB Device, USB Host	
Math operation	+, -, *, /, FFT	

Multimeter Specification

Maximum resolution	6000 Counts	
Item	Range	Accuracy
DC voltage	60 mV	±1%±15 digit
	600 mV – 1000 V	±1%±5 digit
AC voltage	60 mV	±1%±15 digit
	600 mV – 750 V	±1%±5 digit
DC current	60 mA – 600 mA	±1%±5 digit
	6 A – 10 A	±1.5%±5 digit
AC current	60 mA – 600 mA	±1%±5 digit
	6 A – 10 A	±1.5%±5 digit
Capacitance	40 nF	±3%±10 digit
	400 nF – 400 uF	±4%±5 digit
Resistance	600 Ω-60 MΩ	±1%±5 digit
Continuity	<50 Ω Buzzer sounds	
Diode	0 V – 2 V	
Trend plot	1.2 M points	
Measuring mode	Manual/Auto	

Isolation Level

Max input Voltage	
Input by input port directly	CATII 300 V
Input by 10: 1 probe	CATII 1000 V, CAT III 600 V
The Max input voltage of Multimeter	DC 1000 V, AC 750 V
Max floating voltage	
Float voltage between BNC reference and earth ground	CATII 1000 V, CAT III 600 V
Float voltage between BNC reference	CATII 1000 V, CAT III 600 V
Float voltage between multimeter reference and earth ground	CATII 600 V, CAT III 300 V

Security: Isolated Handheld Digital Oscilloscope should be designed according to the standard of level II and pollution degree level II which apply to measure 1000 V. Or according to the standard of level III and pollution degree level III which apply to measure 600 V

Multimeter Specification

Display	5.7 inch color TFT-LCD, 320*234
Power supply	With battery or apply DC adapter to get power from outside
Power mode	Lithium battery: 7.4 V 4500 mAh, Battery persisting > 4 hours DC adapter: 100-240 V 50/60 Hz input 9 V 4 A output
Net Weight	1.5 Kg
Dimension	259.5 mm*163.2 mm*53.3 mm
Accessories	Two Passive Probes, Multimeter pen, USB data cable, DC adapter, Manual, Toolbox

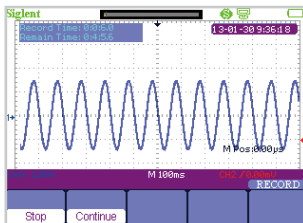

High-performance oscilloscope

- Bandwidth: 100 MHz, 60 MHz
- Real-time sampling rate: 1 GSa/s
- Memory depth: 2 Mpts.

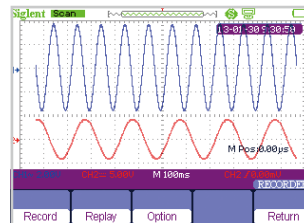

Data recorder function

- 7 M internal storage, up to 18 hours recording time
- USB port, up to 3000 hours recording time
- Record, replay function supported

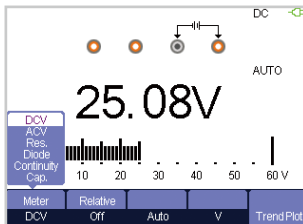

High precision multimeter

- 6000 counts display
- Accurate measurement of DCV, ACV, DCI, ACI
- Accurate measurement of Resistance, Diode, Capacitance, Continuity

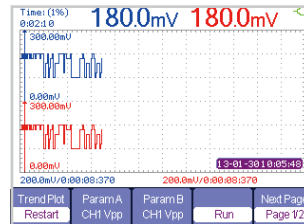

Trend Plot

- 32 measurement trend plot analyzer
- Scope: 800 k/CH points capacity, more than 24 hours recording
- Meter: 1.2 M points capacity 6000 hours recording time at 0.05 Sa/s



SHS800 Handheld Digital Oscilloscope



Application

- Automotive electronics, electric automobile test
- Power system strong electricity test
- Plant automation control system

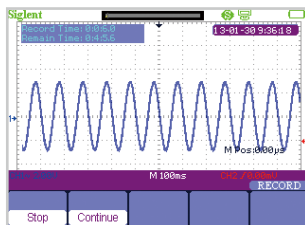

High-performance oscilloscope

- Bandwidth: 100 MHz, 60 MHz
- Real-time sampling rate: 1 GSa/s
- Memory depth: 2 Mpts

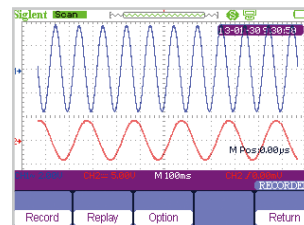

Data recorder function

- 7 M internal storage, up to 18 hours recording time
- USB port, up to 3000 hours recording time
- Record, replay function supported

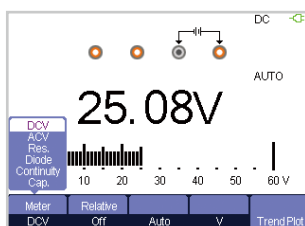

High precision multimeter

- 6000 counts display
- Accurate measurement of DCV, ACV, DCI, ACI
- Accurate measurement of Resistance, Diode, Capacitance, Continuity

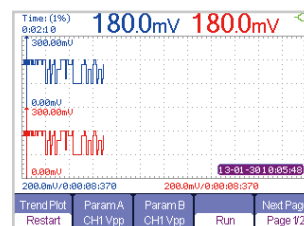

Trend Plot

- 32 measurement trend plot analyzer
- Scope: 800 k/CH points capacity, more than 24 hours recording
- Meter: 1.2 M points capacity 6000 hours recording time at 0.05 Sa/s

Handheld Oscilloscope

Oscilloscope Specification

Model	SHS820	SHS810	SHS806
Bandwidth	200 MHz	100 MHz	60 MHz
Rise time	≤1.75 ns	≤3.5 ns	≤5.8 ns
Real time sampling rate	500 MSa/s	1 GSa/s	
Equivalent sampling rate	50 GSa/s		
Vertical sensitivity	2 mV – 100 V/div		
Time base range	2.5 ns – 50 ns/div Scan:100 ms – 50 s/div		5 ns – 50 s/div
Memory depth	32 Kpts	2 Mpts	
Triggering	Edge, Pulse, Video, Slope, Alternative		
Vertical resolution	8 bit		
Triggering frequency counter	6 digits		
Data Recorder	7 M points		
Trend plot	800 K/CH		
Interface	USB Device, USB Host		
Math operation	+, -, *, /, FFT		

Multimeter Specification





Maximum resolution	6000 Counts	
Item	Range	Accuracy
DC Voltage	60 mv 60 mv – 1000 v	±1%±15 digit ±1%±5 digit
AC Voltage	60 mv 600 mV – 750 V	±1%±15 digit ±1%±5 digit
DC Current	60 mA 6 A – 10 A	±1%±5 digit ±1.5%±5 digit
AC Current	60 mA 6 A – 10 A	±1%±5 digit ±1.5%±5 digit
Capacitance	40 nF 400 nF – 400 μF	±3%±10 digit ±4%±5 digit
Resistance	600 Ω – 60 MΩ	±1%±5 digit
Continuity	<50 Ω Buzzer sounds	
Diode	0 V – 2 V	
Trend plot	1.2 M points	
Measuring mode	Manual/Auto	









General Feature











Display	5.7 inch color TFT-LCD, 320*234
Power supply	Charging/Battery
Power mode	Lithium battery: 7.4 V 5000 mAh, Battery lasts >5 hours; DC adapter, 100-240 V 50/60 Hz input, 9 V 4 A output
Net weight	1.5 Kg
Dimension	259.5 mm*163.2 mm*53.3 mm
Accessories	Two passive probes, multimeter pen, USB data cable, DC adapter, manual

Probes and Accessories

Type	Model	Picture	Specifications
Passive Probe	PB470 PP510 PP215 PP430		PB470, 70 MHz bandwidth PP510, 100 MHz bandwidth PP215, 200 MHz bandwidth PP430, 300 MHz bandwidth 1 X/10 X decay, 1 M/10 Mohm, 300 V/600 V
	PB925		Bandwidth 250 MHz, fixed 10X decay, the rise time of about 1.2 ns, input capacitance: 16 pF, compensation range: 10 pF-35 pF, input impedance 10 MΩ, length 120 cm, safe voltage levels: CAT II 1000 V, CAT III 600 V
	PB830		Bandwidth 300 MHz, fixed 10 X decay, the rise time of about 1 ns, input capacitance: 16 pF, compensation range: 10 pF-20 pF, input impedance 10 MΩ, length 140 cm, safe voltage levels: CAT II 1000 V, CAT III 600 V
Current Probe	CPL5100		Bandwidth: DC-600 kHz; Current range L, H; Maximum operation current 10 A(L)/ 100 A(H); Max operation voltage 600 V ; DC Accuracy: 3%±50 mA (L) ; 1500 mA~40 A Peak: 4%±50 mA; 40 A~100 A Peak: ±15% Maximum (H); 9 V alkaline layer-built battery/ 15 H
	CP4020		Bandwidth : 100 KHz; Maximum continuous current 20 Arms; Peak current 60 A; Switching ratio: 50 mV/A; 5 mV/A; DC measurement accuracy: 50 mV/A (0.4 A-10 ApK) ± 2%; 5 mV/A (1 A-60 ApK)±2%; 9 V battery-powered
	CP4050		Bandwidth: 1 MHz; Maximum continuous current 50 Arms; Peak current 140 A; Switching ratio: 500 mV/A; 50 mV/A; DC measurement accuracy: 500 mV/A (20 mA-14 ApK) ±3%±20 mA; 50 mV/A (200 mA-100 ApK)±4%± 200 mA; 50 mV/A (100 A-140 ApK)±15% max; 9V battery-powered
	CP4070		Bandwidth: 150 KHz; Maximum continuous current 70 Arms; Peak current 200 A; Switching ratio: 50 mV/A; 5 mV/A; DC measurement accuracy: 50 mV/A (0.4 A-10 ApK) ±2%, 5 mV/A (1 A-200 ApK)±2%;9 V battery-powered
	CP4070A		Bandwidth: 300 KHz; Maximum continuous current 70 Arms; Peak current 200 A;Switching ratio: 100 mV/A;10 mV/A; DC measurement accuracy: 100 mV/A (50 mA-10 ApK) ±3%±50 mA; 10 mV/A (500 mA-40 ApK) ±4%±50 mA; 10 mV/A (40 A-200 ApK) ±15% max; 9 V battery-powered
	CP5030		Bandwidth: 50 MHz; Maximum continuous current 30 Arms; Peak current 50 A; Switching ratio: 100 mV/A; 1 V/A; AC/DC measurement accuracy: 1 A (±1%±1 mA); 100 mV/A (±1%±10 mA); Standard DC 12 V/1.2 A power adapter

Type	Model	Picture	Specifications
Current Probe	CP5030A		Bandwidth: 100 MHz; Maximum continuous current 30 Arms; Peak current 50 A; Switching ratio: 100 mV/A; 1 V/A; AC/DC measurement accuracy: 1 A ($\pm 1\% \pm 1$ mA); 100 mV/A ($\pm 1\% \pm 10$ mA); Standard DC 12 V/ 1.2 A power adapter
	CP5150		Bandwidth: 12 MHz; Maximum continuous current 150 Arms; Peak current 300 A; Switching ratio: 100 mV/A; 1 V/A; AC/DC measurement accuracy: 100 mV/A($\pm 1\% \pm 1$ mA); 10 mV/A ($\pm 1\% \pm 10$ mA); Standard DC 12 V/1.2 A power adapter
	CP5500		Bandwidth: 5 MHz; Maximum continuous current 500 Arms; Peak current 750 A; Switching ratio: 100 mV/A; 10 mV/A; AC/DC measurement accuracy: 100 mV/A ($\pm 1\% \pm 1$ mA); 10 mV/A ($\pm 1\% \pm 10$ mA); Standard DC 12 V/1.2 A power adapter
High Voltage Differential Probe	DPB1300		Bandwidth: DC-50 MHz, Rise time ≤ 7 ns; DC Accuracy $\pm 2\%$; Attenuation Ratio 50 X/500 X; Max Differential Test Voltage (DC + Peak AC) 50 X: ± 130 V, 500 X: ± 1300 V; DC 12 V/1.2 A Power
	DPB4080		Bandwidth: 50 MHz; Maximum input differential voltage 800 V (DC + Peak AC); Range selection (attenuation ratio):10 X/100 X; Accuracy: $\pm 1\%$; Standard DC 9 V/1 A power adapter
	DPB5150		Bandwidth: 70 MHz; Maximum input differential voltage 1500 V (DC + Peak AC); Range selection (attenuation ratio): 50 X/500 X; Accuracy: $\pm 2\%$; Standard 5 V/ 1 A USB power adapter
	DPB5150A		Bandwidth: 100 MHz; Maximum input differential voltage 1500 V (DC + Peak AC); Range selection (attenuation ratio): 50 X/500 X; Accuracy: $\pm 2\%$; Standard 5 V/ 1 A USB power adapter
	DPB5700		Bandwidth: 70 MHz; Maximum input differential voltage 7000 V (DC + Peak AC); Range selection (attenuation ratio): 100 X/1000 X; Accuracy: $\pm 2\%$; Standard 5 V/1 A USB power adapter
	DPB5700A		Bandwidth: 100 MHz; Maximum input differential voltage 7000 V (DC + Peak AC); Range selection (attenuation ratio): 100 X/1000 X; Accuracy: $\pm 2\%$; Standard 5 V/1 A USB power adapter
High Voltage Probe	HPB4010		Bandwidth: 40 MHz; Maximum measurement voltage DC: 10 KV; AC(rms): 7 KV (sine); AC (Vpp): 20 KV (Pulse); attenuation ratio:1:1000; Accuracy: $\leq 3\%$

Type	Model	Picture	Specifications
Logic Probe	SPL1016		Logic Probe for SDS1000X+ series, 16-channel, 500 MSa/s
	SLA1016		16 logic analyzer hardware module, suitable for SDS1000X-E 4 channel series and SDS2000X-E series oscilloscope
	SPL2016		Logic Probe for SDS2000X, SDS2000X Plus and SDS5000X series, 16-channel, 500 MSa/s
Near-field Probe	SRF5030T		Near Field Probe: H field probe sets (20 mm, 10 mm, 5 mm) , E field probe (5 mm), 300 kHz~3.0 GHz; distinguished within 10 cm range of the magnetic field; for EMI radiation interference and the intensity detector
Isolated Front End	ISFE		Realize isolation among ordinary oscilloscope channels, isolation between the measured signal and ground, use USB 5 V power supply, plug and play, the maximum input voltage of up to ± 600 Vpk
GPIB	USB-GPIB		The USB Device interface extends into the GPIB interface, USB-GPIB adapter can more easily complete the task of the operation command through the GPIB, USB follow the USB2.0 specification, GPIB follow the IEEE488.2 standard
Demo Board (STB Test Board)	STB3		Output signals include square waves, sine, AM, pulse, PWM, fast edge, I2C, CAN, LIN signal etc
Deskew Fixture	DF2001A		Supporting power analysis software for calibration phase voltage and current probes generated during transmission
Cable	N-BNC-2L		N-BNC cable for SSA3000X Series; 2 GHz bandwidth

Type	Model	Picture	Specifications
Cable	N-N-6L		N-N cable for SSA3000X, SSA3000X Plus, SSA3000X-R, SVA1000X Series; 6 GHz bandwidth
	N-N-18L		N(M)-N(M) cable for SSA3000X, SSA3000X Plus, SSA3000X-R, SVA1000X series, 100cm, 18 GHz bandwidth
	N-SMA-18L		N(M)-SMA(M) cable for SSA3000X, SSA3000X Plus, SSA3000X-R, SVA1000X series, 100cm, 18 GHz bandwidth
	N-SMA-6L		N-SMA cable for SSA3000X, SSA3000X Plus, SSA3000X-R, SVA1000X Series; 6 GHz bandwidth
Reflection Bridge	RB3X25		VSWR bridge: (1 MHz~2.5 GHz), N (M) -N (M) adaptor (2 pcs)
SSA3000X Utility Kit	UKitSSA3X		Utility Kit for SSA3000X Series: N (M) -SMA (M) cable, N (M) -N (M) cable, N (M) -BNC (F) adaptor (2 pcs), N (M) -SMA (F) adaptor (2 pcs), 10 dB attenuator
WIFI Adapter	TL_WN725N		usb-wifi adapter, suitable for SDS1000X-E 4 channel series oscilloscope
USB AWG Module	SAG1021I		Output Sine, Square, Ramp, pulse, Noise, DC and 45 built-in waveforms. The arbitrary waveforms can be accessed and edited by the EasyWave PC software. Isolated voltage ± 42 Vpk.
Rack Mount	SDS1X-E-RMK		The height is 4U, suitable for SDS1000X-E oscilloscope
	SDG-RMK		Single instrument rack mount kit 19" shelf design is compatible with the SDG800, SDG1000, SDG1000X, SDG2000X, SDG6000X, and SDG5000 series function generators as well as the SDM3000 series of DMMs
	SDG-2-RMK		Rackmount kit for two instruments, compatible with the SDG800, SDG1000, SDG1000X, SDG2000X, SDG5000 and SDG6000X series function generator and SDM3045X, SDM3055, SDM3065X digital multimeter

Type	Model	Picture	Specifications
Rack Mount	SSA-RMK		Single instrument rack mount kit for SSA3000X, SVA1000X series
	SPD3000-RMK		Compatible with SPD3000X / X-E / D / S / C models.4U rack height
	SDS2000-RMK		19" rack mount kit for a single SDS2000 or SDS2000X series oscilloscopes
Amplifier	SPA1010		<p>Increase the voltage and current output capabilities to generators like the SIGLENT SDG family.</p> <p>Typical Input Impedance: 15kΩ</p> <p>Input:</p> <ul style="list-style-type: none"> +/- 6.5V Vpp (Gain: X1) +/- 1.3 V (Gain: X10) <p>Gain: Switched 10V/1V and 10V/10V</p> <p>Output Voltage: 25.4 Vpp</p> <p>Output Current: 1.12 A</p> <p>Slew Rate: ≥ 90 V/μs</p> <p>Overshoot: $\leq 4\%$</p> <p>Compatible with all SIGLENT SDG series generators</p>
Attenuator	ATT-20 dB		20dB attenuator
Carry Bag	BAG-S1		Soft Carry Case for SDS1000DL+/CML+, SDS1000X, SDS1000X-E, SDS2000X-E Series
	BAG-S2		Soft Carry Case for SDS2000X, SDS5000X, SSA3000X, SVA1000X, SSA3000X Plus

Service Promise:

Since the date of purchase, we offer three year's warranty for the main unit:

- During the warranty period, if the products cause any hardware or software failure because of the quality, Siglent's after-sales service center or Siglent's designated maintenance points will offer the maintenance of the fault products for the user.
- Because of improper use or any other artificial reason, the damage won't be included in the free maintenance.

1. Extension after-sales service

Extension service is based on the main unit (not including accessories) as an object. During the extension service, Siglent still offer free maintenance after the standard warranty period.

1.1 Three advantages:

- Guarantee investment. To extend the life cycle of the products.
- Save money. To prevent the high cost of maintenance after the warranty period.
- Avoid the repeated investment. To prevent buying new equipments because it can't be repaired after the warranty period.

1.2 The content of the extension service

You can buy the following extension service according to your demand:

Solution	Viability	Instruction
ES4	One year after the warranty period	According to the service terms, Siglent will offer another one year for the after-sales maintenance service
ES5	Two years after the warranty period	According to the service terms, Siglent will offer another two years for the after-sales maintenance service

2. Calibration services

After long-term use, oscilloscope will cause the deviation of measured value and waveform display, because of its work temperature and humidity. Siglent will restore the original performance and accuracy of factory setting to calibrate the deviation.

- Eliminate the error of measurement
- Restore the original performance and accuracy of the factory setting to the "new" state
- The upgrade of the firmware and the software
- Make the instruments comply with the standard of the ISO9001 quality management process
- Traceable calibration certificates



About SIGLENT

SIGLENT is an international high-tech company, concentrating on R&D, sales, production and services of electronic test & measurement instruments.

SIGLENT first began developing digital oscilloscopes independently in 2002. After more than a decade of continuous development, SIGLENT has extended its product line to include digital oscilloscopes, function/arbitrary waveform generators, RF generators, digital multimeters, DC power supplies, spectrum analyzers, vector network analyzers, isolated handheld oscilloscopes, electronic load and other general purpose test instrumentation. Since its first oscilloscope, the ADS7000 series, was launched in 2005, SIGLENT has become the fastest growing manufacturer of digital oscilloscopes. We firmly believe that today SIGLENT is the best value in electronic test & measurement.

Headquarters:

SIGLENT Technologies Co., Ltd
Add: Bldg No.4 & No.5, Antongda Industrial
Zone, 3rd Liuxian Road, Bao'an District,
Shenzhen, 518101, China
Tel: + 86 755 3688 7876
Fax: + 86 755 3359 1582
Email: sales@siglent.com
Website: int.siglent.com

USA:

SIGLENT Technologies America, Inc
6557 Cochran Rd Solon, Ohio 44139
Tel: 440-398-5800
Toll Free: 877-515-5551
Fax: 440-399-1211
Email: info@siglent.com
Website: www.siglentna.com

Europe:

SIGLENT Technologies Germany GmbH
Add: Liebigstrasse 2-20, Gebaeude 14, 22113
Hamburg Germany
Tel: +49(0)-819-95946
Fax: +49(0)-819-95947
Email: info-eu@siglent.com
Website: www.siglenteu.com

Follow us on
Facebook: SiglentTech

