

# ESD SIMULATOR

# NSG 435

## OPERATING INSTRUCTIONS

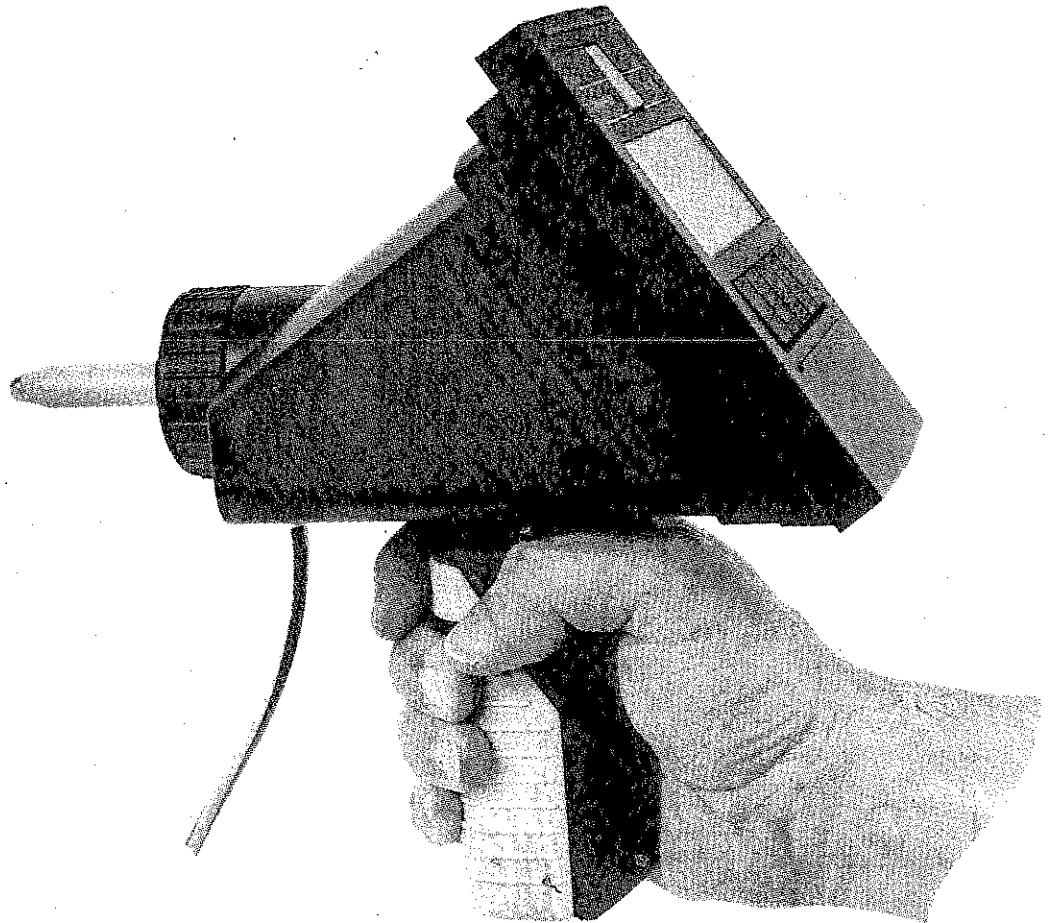

601-131C

## BATTERY HANDLING

Please respect correct handling when placing the battery-pack:

1. Place lower end into the hand-grip of the instrument.
2. Pull battery-pack down against spring-blade.
3. While pulling, tilt in the upper end.

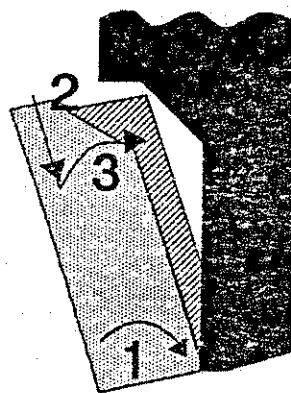

PS: Charge batteries before first use.  
See operating instructions, section 3.3.2

wenden —>

## CONTENTS

<b>1</b>	<b>Safety</b> .....	<b>1</b>
<b>2</b>	<b>Introduction</b> .....	<b>3</b>
	2.1 Electrostatic discharge (ESD) .....	3
	2.2 Simulation .....	4
	2.3 Effects on the EUT .....	6
<b>3</b>	<b>The NSG 435 system</b> .....	<b>7</b>
	3.1 System description .....	7
	3.2 The generator .....	8
	3.2.1 Function modules .....	8
	3.2.2 Block diagram .....	9
	3.2.3 Operating elements .....	10
	3.3 System components .....	12
	3.3.1 Basic set .....	12
	3.3.2 Charger / battery-pack .....	13
	3.3.3 Options .....	14
	3.3.4 Mains power supply unit .....	14
	3.3.5 Networks .....	15
	3.3.6 Remote triggering .....	16
	3.3.7 Measurement adapter .....	17
<b>4</b>	<b>Commissioning</b> .....	<b>18</b>
	4.1 Inspection .....	18
	4.2 Function check .....	18
<b>5</b>	<b>Operation</b> .....	<b>20</b>
	5.1 General .....	20
	5.2 Switching on .....	20
	5.3 Battery monitor .....	21
	5.4 Air / Contact-discharge .....	22
	5.5 Voltage .....	23
	5.6 Polarity .....	24
	5.7 Repetition frequency .....	24
	5.8 Counter .....	25
	5.9 Preselect counter .....	26
	5.10 Automatic polarity change .....	28
	5.11 Continuous operation .....	30
	5.12 Storing voltage settings .....	32

<b>6</b>	<b>Test procedures</b> .....	<b>34</b>
6.1	Standard-conform procedures .....	34
6.2	Other conditions .....	34
<b>7</b>	<b>Verification of the pulse data</b> .....	<b>36</b>
<b>8</b>	<b>Typical pulse data</b> .....	<b>37</b>
<b>9</b>	<b>Maintenance</b> .....	<b>38</b>
9.1	Servicing .....	38
9.2	Calibration .....	38
9.3	Exchanging the R-C network .....	41
9.4	Repairs .....	43
9.5	Disposal .....	43
<b>10</b>	<b>Technical specifications</b> .....	<b>44</b>
<b>11</b>	<b>ESD standards</b> .....	<b>46</b>
<b>12</b>	<b>Warranty</b> .....	<b>47</b>
<b>13</b>	<b>Ordering information</b> .....	<b>48</b>

## 1 Safety

This item of equipment, together with its accessories, works at high voltages of up to 16.5 kV. Any careless handling or non-observance of the operating instructions can have dangerous consequences.

The NSG 435 generator is not a toy! It is a professional tool and belongs only in the hands of specialists and appropriately trained personnel.

When powered by its own batteries the generator can be active even without any power cable being connected.

The instrument must not be switched on unless a correctly connected earth or ground cable (pulse current return path) is in place. The original earth cable supplied with the instrument is to be used. Any replacement cables must be fabricated in such a way that they cannot be accidentally connected to a mains outlet socket.

Do not touch the test finger! There is a danger of an unpleasant electric shock if the instrument is switched on (LC-display active).

Only trained personnel may operate the instrument.

Personnel fitted with a heart-pacemaker must not operate the instrument nor approach the test rig while it is in operation.

These operating instructions form an integral part of the instrument and must be available to the operating personnel at all times.

The instrument must not be used for any purpose other than testing the ESD-immunity of electronic equipment.

The construction of the generator is not designed for use in an explosive environment.

Each electrostatic discharge produces powerful electromagnetic interference. Nearby electronic equipment can be seriously disrupted unless the appropriate counter-measures are taken. Perform ESD tests preferably in a shielded room.

The rechargeable batteries in the hand-grip must not be short-circuited under any circumstances. They must only be recharged with the original charging unit supplied with the generator. Should they have to be replaced, kindly observe the relevant recommendations for the disposal of nickel-cadmium batteries.

The instrument must not be opened. Repairs, maintenance work and internal adjustments are only to be carried out by a qualified service engineer.

Use the instrument only in dry surroundings. Any condensation that occurs must be allowed to evaporate before putting the generator into operation.

Long periods of exposure to sunlight and excessive warming by external energy sources are to be avoided.

Do not continue to use the instrument should any mechanical damage occur. The instrument's housing has both an insulating and a screening function which can only be assured while the housing is intact. Return a damaged generator to a SCHAFFNER service centre immediately for repair.

SCHAFFNER ELEKTRONIK AG Luterbach, Switzerland and the associated sales organisations accept no responsibility for personal or material damage nor for any consequential damage that results from irresponsible operation of this instrument.



## 2 Introduction

### 2.1 Electrostatic discharge (ESD\*)

Under appropriate ambient conditions, both material objects and even the human body itself can become charged with electrical energy. This effect is due to "electrostatics", a phenomenon that has been known since the earliest times. Thales von Milet (600 BC) noticed how amber attracted very light particles when it was rubbed. Touching a charged item against a conductive object leads to a charge equalisation through a spark discharge which produces a brief but powerful electro-magnetic field.

This effect can be explained as follows: Two insulating substances with differing dielectric constants become charged when rubbed together, i.e. one material gives electrons to the other one. This effect is known as electrostatic charging. The same can happen to a person. When somebody walks around in a dry atmosphere on a carpet with good insulating properties, a charge of several thousand volts can be built up. If, now, that person comes close to a conductive surface, the charge that he or she is carrying flows away through a hefty spark discharge.

The high equalizing current that flows, and the associated large electromagnetic field that hence results, can cause electronic devices (computers, terminals, process controllers, vehicle electronics, solid state devices, credit or memory cards, etc.) to malfunction or even be destroyed.

\* ESD = electrostatic discharge

## 2.2 Simulation

A systematic investigation of electronic equipment and installations to determine their electromagnetic compatibility (EMC) is, today, a necessity if one is not prepared to suffer the economic disadvantages that could otherwise ensue. As a logical consequence, appropriate testing is now a legal requirement for the sale of electronic products within the EC.

The ESD-test plays an important role in the range of interference sensitivity tests. It simulates frequently occurring effects and guides the development engineer to any weak spots in an instrument or item of equipment through a combination of high voltage and high frequency properties.

A simulation device must be constructed so that it reproduces practical conditions realistically. Furthermore, the results obtained (interference sensitivity threshold) must be reproducible.

The interference immunity of an instrument is not only dependent on its construction, it is also largely dependent on the quality or the consistency of the mass production techniques used. Knowing this has led to the demand for individual testing or at least random sample testing.

Further weak spots, which could affect the overall interference immunity, can arise through the assembly of instruments into complete systems because of the installation method used, the cabling and the earthing. An ESD check on systems is therefore also prescribed. Such tests provide valuable information about the immunity of the system to effects that occur only sporadically under operating conditions and hence represent difficult to detect sources of disruption.



The ESD-generator NSG 435 fulfils the requirements of various applications in an ideal manner:

Ergonomic shape	For non-tiring use
Operation	Operating elements and display always in view of the user. Constant check on the test values.
Battery-powered	Independence from a mains power feed.
Compact and hand-held	No bench unit as the high voltage source, no high voltage cable. Optimal freedom of movement around the device or system to be tested.
Carrying case	Generator and accessories can be handily packed and conveniently transported.
Microprocessor-control	All the functions are "on-board", including a pre-settable counter, pre-programmed test values, discharge voltage measurement, etc.
Precision	The test parameters are maintained precisely for reliably reproducible tests.
Flexibility	The specifications prescribed in the standards are more than fulfilled in every respect. The instrument also offers many additional handy features.
Safety	The high voltage generator is automatically deactivated if the instrument remains unused for a period of time.
Long-term operation	Automatic long-term operation for stationary applications with mounting on a tripod.
Application field	Development optimisation, type-approval, EMC-certification, batch testing (individually), testing of fully installed systems.

The most significant interference components of an electrostatic discharge are of a high frequency nature. The interference paths and effects have to be assessed in the range from about 30 MHz to 1 GHz.

The extremely rapid rise time of a discharge affects an object under test mostly through:

- magnetic HF-coupling between electrical conductors in the electronics and the discharge current path.
- electrical coupling between the discharge current and signal lines. A discharge current to the EUT flows proportionally through all the associated conductors (earth, mains, data lines, screening, etc.) according to their relative impedance.

Malfunctions in insufficiently immune electronic equipment and systems make themselves apparent through:

- program crashes
- blocking of command sequences
- incorrect commands, statuses or data being processed
- partial system resets (e.g. only in peripheral modules which lead to errors that the system does not recognize)
- disturbance or destruction of interface chips
- destruction of insufficiently protected MOS components.

ESD (electrostatic discharge) testing usually shows up all the weak spots in the HF-range of a piece of equipment simultaneously. The uses to which the NSG 435 simulator can be put hence go way beyond those called for in standard-conform applications.

This instrument provides the engineer with a means to detect sources of error caused by unsuitable earthing, poor ground connections, insulation problems, etc.

The generator also serves as a reliable aid for localizing hidden wiring faults during acceptance trials on installations.

Use can also be made of the instrument as an insulation tester to determine the breakdown voltage of switches, relay contacts, insulators, etc.

### 3 The NSG 435 system

#### 3.1 System description

By using the latest materials, construction methods and manufacturing techniques for the robust housing shell, together with highly insulated modules, the newest high voltage technology and a control unit built using the SMD-technique, it has been possible to integrate all the functions that a comprehensive simulator system should offer into one compact instrument.

Professional industrial designers have ensured an optimized ergonomic concept. The instrument, with its well balanced hand-grip, sits comfortably in the user's hand and guarantees non-tiring operation. Both the operating elements and the display window remain in view of the user while work is in progress.

Thanks to its battery-pack, the NSG 435 offers optimal freedom of movement around the work-place and is an ideal test instrument not just for the development engineer but also the quality control purposes, system tests and for investigations in the field.

As supplied in the basic set, the system is equipped with a 150pF/330 $\Omega$  discharge network for the IEC 801-2/1991 standard. The discharge voltage of up to 16.5 kV for air-discharges and up to 9 kV for contact discharges ensure a comfortable test margin over and above the levels called for in the standard.

The instrument is well equipped to cope with other (and future) standards. The accessories include various networks and test fingers that can be attached by the user himself.

The basic set contains everything necessary for general use. For special tasks a rich assortment of accessories is available such as a mains power unit for long-term operation, a remote triggering unit via an optical link, spare battery-packs, discharge networks, test fingers, etc.

3.2 The generator

3.2.1 Function modules

The NSG 435 generator is modularly constructed from a number of function units that are all housed in a multi-part, moulded shell.

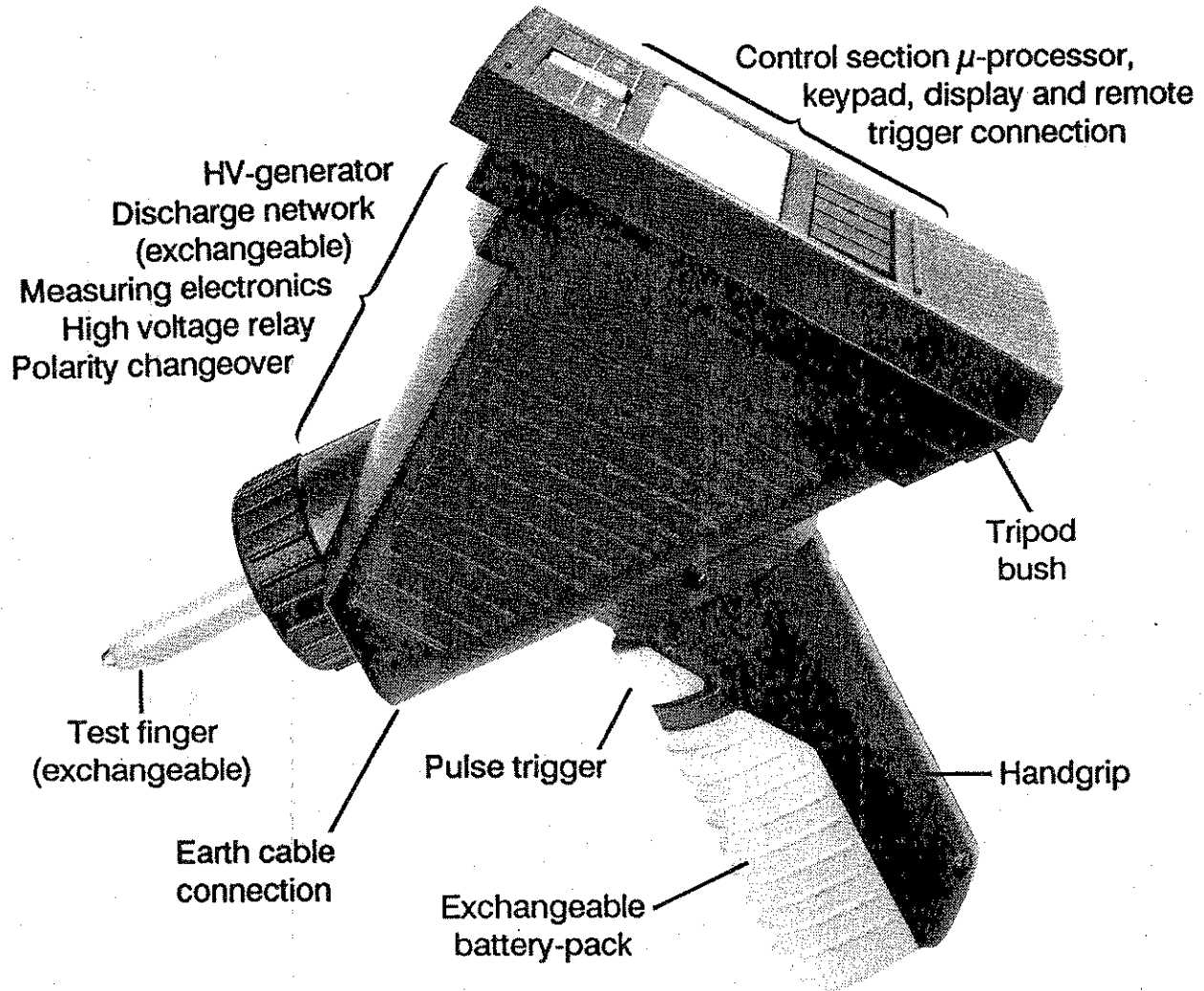

## 3.2.2 Block diagram

The function units are shown in the block diagram:

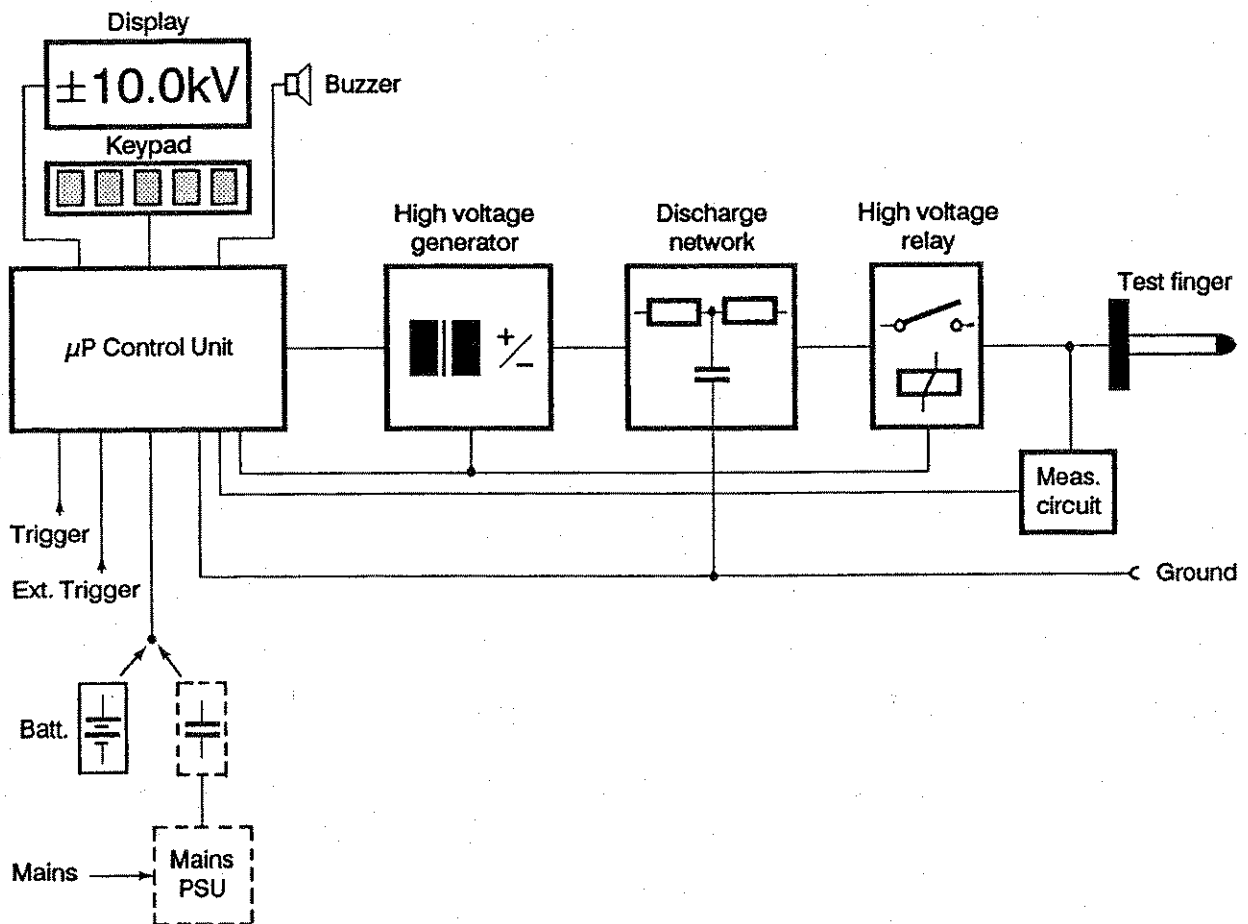

The microprocessor controls and monitors all the generator functions:

- Keypad entries are checked for plausibility. Unacceptable entries are rejected and an acoustic warning notifies the user of the error.
- Values entered are clearly shown on the large display screen. Further information shows the operating status and the counter settings.
- The battery charge state is continuously monitored. A tendency towards low voltage is shown on the display. The instrument's functions are inhibited once the battery voltage is insufficient to guarantee the pulse parameters.



- The high voltage generation is dynamically controlled by the processor. Varying load conditions, supply voltages, etc. can thus be taken into account and have no effect on the pulse parameters.
- The instrument switches itself off automatically if it is not used for a while. The pulse parameters and operating mode remain stored and ready for use once the generator is switched on again.
- The charge voltage to the network is kept constant as long as the trigger is active. The high voltage is discharged internally when the trigger is reset.
- If no discharge occurs when set for an air-discharge and the trigger is active, the processor waits for about 15 seconds then autonomously resets the trigger and discharges the network internally. An acoustic warning is also sounded.
- A measurement facility at the pulse output measures the actual arc-voltage reached during an air-discharge and shows the result on the display.
- Pulse triggering is monitored. Once an arc has occurred the network is discharged internally so that no further arcing is possible.

### 3.2.3 Operating elements

Apart from the trigger button itself (pulse triggering), all the operating elements are on the surface of the instrument that faces the operator.

The NSG 435 is switched on and off with the main switch.

The significance of the elements in the display field can be seen in the following picture. Further information can be found in Section 6 'Operation'.



Operation of the whole instrument is effected via the five multi-function buttons (soft-keys). These buttons perform different functions depending on the stage of operation. The current function is shown on the display in each case.

The designation F1 to F5 used for these buttons in the following notes serve to simplify the descriptions in this manual.

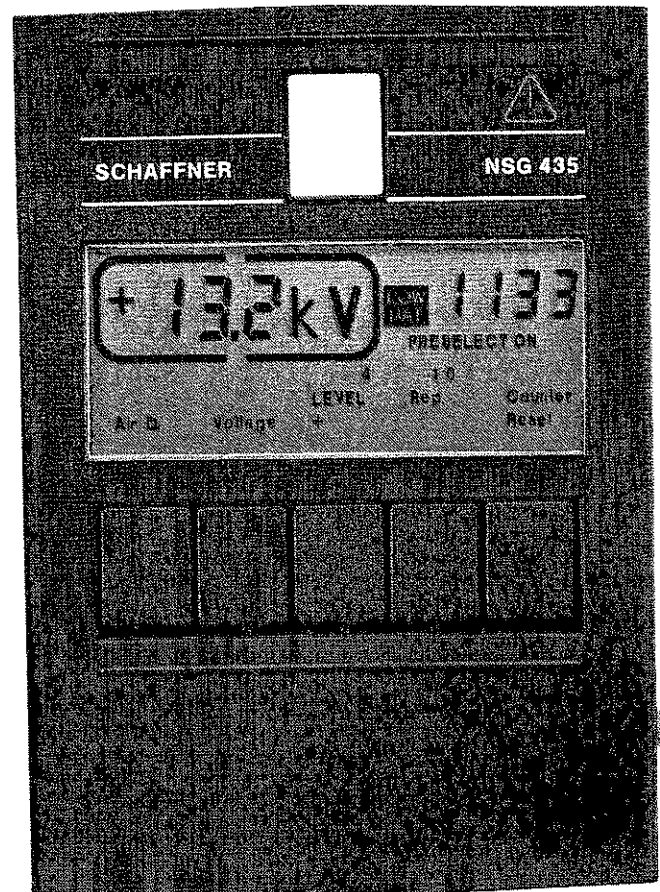

- F1** - Toggle between air and contact-discharge (and vice-versa)
  - Increment voltage and counter
- F2** - Activation of voltage setting
  - Decrement voltage and counter
- F3** - Polarity switching
  - Selection of pre-programmed test levels
  - Preselect counter on/off
- F4** - Selection of discharge mode:
  - Single discharge
  - Repetitive discharge at 0.5, 1, 5, 10, 20, 25 Hz for air-discharge
  - Repetitive discharge at 0.5, 1, 5, 10 Hz for contact-discharge
  - Automatic polarity switching
  - Storage of programmed test levels
- F5** - Resets the counter
  - Return from second function

The trigger button in the hand-grip works as follows, depending on the operating mode selected:

- For single discharge as a pulse button  
(1 pulse when pressed)
- For repetitive discharges as on/off button  
(discharges while the button is pressed)
- For repetitive discharges with Preselect counter active as a holding on/off button  
(switch on by pressing the button, switch off by pressing the button again)

The remote triggering facility is a substitute for the manual trigger button by producing the relevant control signals.

### 3.3 System components

#### 3.3.1 Basic set

The basic set is packaged in a practical carrying case and comprises:

- carrying case 42 x 32 x 13.5 cm  
(16.5" x 12.5" x 5.5" approx.)
- ESD generator NSG 435 with battery-pack and 150pF/330 $\Omega$  discharge network conforming to IEC 801-2, 1991
- one test finger each for air and contact discharges
- earth cable
- battery charger
- operating instructions

This set contains all the items necessary under normal conditions to perform tests conforming to IEC 801-2, 1991.

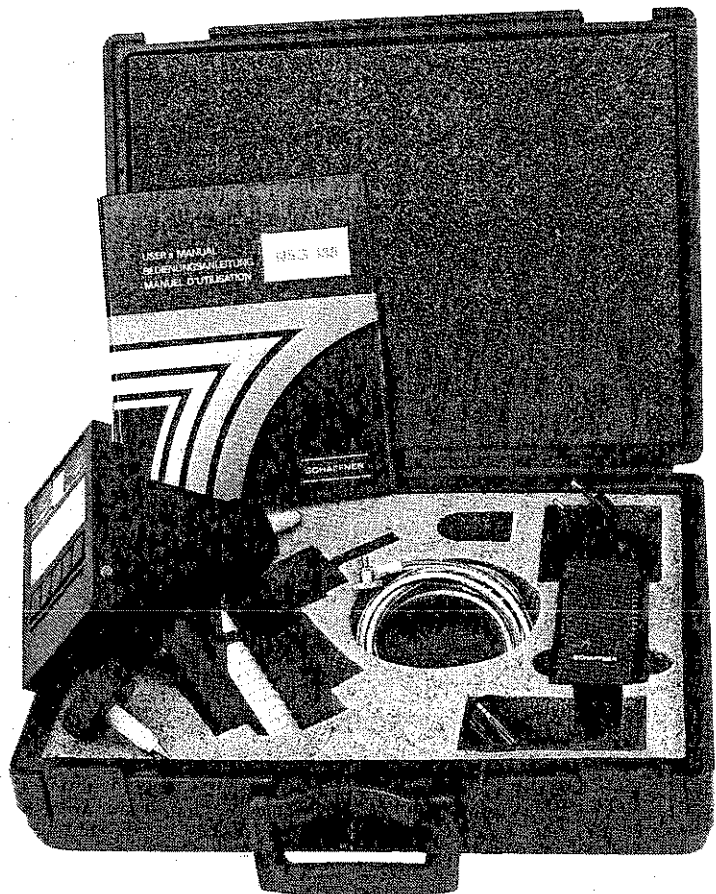

### 3.3.2 Charging unit/battery-pack

The battery charger supplied in the set is designed for the following mains supplies, depending on where it is intended to use the instrument:

- switchable 115 / 230 V (50 /60 Hz) with 2-pin Euro-plug
- switchable 115 / 230 V (50 /60 Hz) with US-plug
- 100 V (50 /60 Hz) with US plug

The chargers conform to protection class 2 and need no earth connection. The test symbol confirms conformity with the safety specifications.

Charging of the battery follows the VI load-line and takes about 3 hours. At this point a timer switches the charger to a reduced charging current and the indicator lamp is extinguished.

The battery has to be removed from the NSG 435 for charging via the jack connector. One charge is sufficient for several days of normal test operation.

#### Battery life expectancy:

Ambient temperatures over 50°C can lead to degradation of the battery. If treated carefully, more than 300 charge/discharge cycles can be expected without a noticeable reduction in capacity.

The charger and battery-pack form a matched entity. The battery must not be charged from any other unit and the charger is to be used exclusively for the intended purpose.

#### Operating advice:

- Check that the mains voltage setting is correct for the local mains supply.
- Use the equipment only in dry surroundings.
- Do not switch the mains off while charging otherwise the timer will be restarted.
- Avoid short-circuits. Keep the contacts clean.
- Never leave the battery in a discharged state for a long time.
- Do not attempt to recharge a full battery.
- Recharge the battery about every 6 months even if the instrument is not being used.



### 3.3.3 Options

A range of additional accessories is available for special applications and for testing to other standards:

- Spare battery-pack
- Mains power supply with adapter
- Remote triggering unit with 5 m (16.5') optical cable
- Discharge networks and test fingers for other standards
- Coaxial measurement adapter (target)
- Accessory case 42 x 32 x 13.5 cm (16.5" x 12.5" x 5.5" approx.)



### 3.3.4 Mains power unit

Instead of using the normal battery-pack, a mains power supply unit type INA 402 can be used for stationary applications and for long-term test purposes.

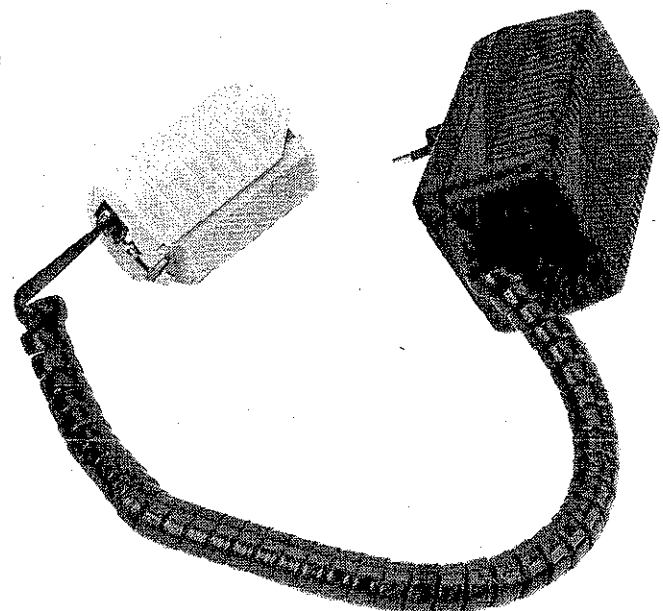

The hand-grip adapter is an integral part of this power supply unit. It contains electrical components that are necessary for this mode of operation. It is not permissible to operate the NSG 435 with a power supply unit from another system.

The power supply unit can be used on all common ac mains supplies without having to make any adjustments, thus:

80 ... 240 V (50 /60 Hz) with 3-pin IEC connector  
Matching 3-core mains cable

The power supply unit must be connected to a mains outlet having a protective earth.

The protective earth connection does not replace the earth cable for the operation of the NSG 435. To ensure safe and valid test operation the earth cable must be correctly connected as the pulse return path in every case.

The mains power supply unit is constructed in conformity with the relevant safety standards and carries the appropriate test symbol.

### 3.3.5 Discharge networks

The basic set contains a discharge network and test fingers that conform to IEC 801-2, 1991.

Alternative networks can be installed for testing in accordance with other standards.

The discharge network and test fingers form a mutually matched combination. They are labelled with a corresponding INA number. The specified pulse data are only achieved while this combination is maintained.

Several combinations are given in the order-list. The C and R values of the discharge network can also be specified for other applications.

Networks conforming to other standards can be built upon request. The specifications of the standard must be fully defined.

Exchanging the discharge network is described in Section 9.2.

### 3.3.6 Remote triggering

A remote triggering unit can be connected to operate the NSG 435 inside a Faraday cage with external pulse triggering or for test pulse triggering in synchronism with other conditions.

The optical input for remote triggering is insensitive to external light sources.

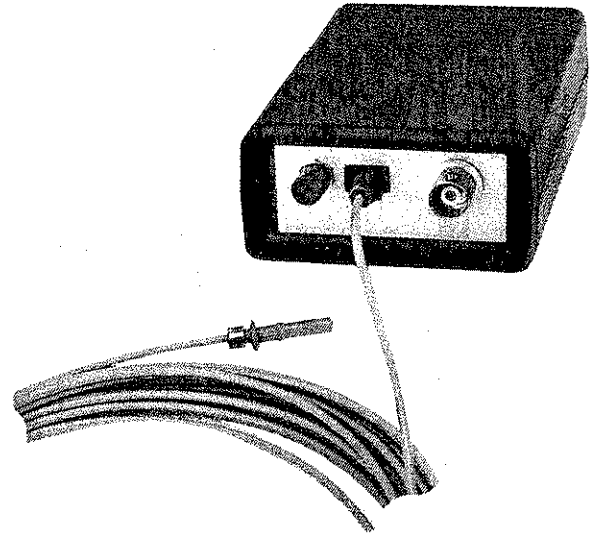

The remote trigger unit consists of a "trigger-box" and 5 m (16.5') of optical cable.

The remote trigger works in parallel with the "trigger-button" on the NSG 435. Pulse triggering, or the on/off switching in the case of repetitive discharges, can be effected by a push-button or an electrical signal applied to the trigger-box.

The electrical signal at the BNC connector must fulfil the following conditions:

ON:  $V = 2.4 \dots 10 \text{ V}$ ,  $I > 2 \text{ mA}$ ,  $t > 10 \text{ ms}$

OFF:  $V < 0.8 \text{ V}$

Repetition rate:  $< 5 \text{ Hz}$

The remote trigger is powered by a conventional 9 V battery. The current consumption is so low that a battery switch has been dispensed with.

On NSG 435 with two optical connectors connect the optical cable to the blue terminal.

It is recommended to remove the battery if the unit is not going to be used for a long time.



### 3.3.7 Measurement adapter

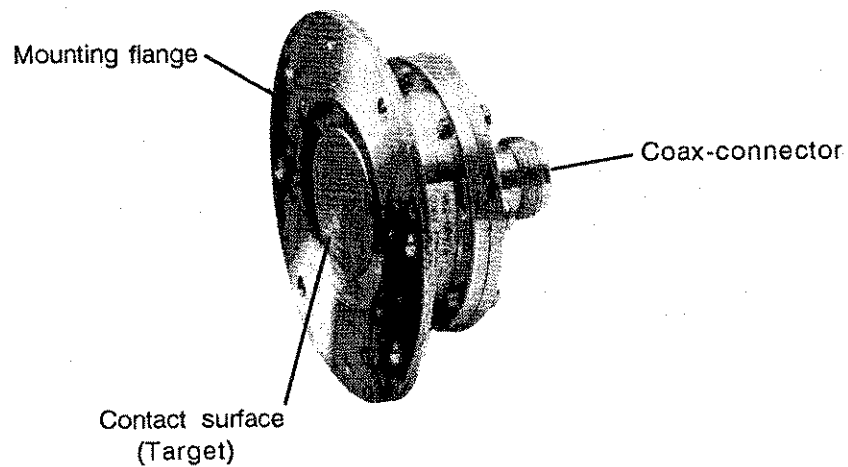

The measurement adapter type MD 101 as per IEC 801-2, 1991 serves to verify pulse amplitudes and pulse shapes. It is designed for mounting in the side wall of a Faraday cage in which an oscilloscope has been installed. This measurement adapter, also known as a "Pellegrini-Target" has the flat impedance curve to well over 1 GHz that is necessary for the purpose.

Use of this adapter is only worthwhile in conjunction with a test rig that is laid out in strict conformity with the relevant standard (see Section 7).

## 4 Commissioning

### 4.1 Inspection

Immediately upon receipt, check the instrument and the accessories for completeness and look for any transport damage. Damage incurred in transit must be reported to the transportation undertaking without delay.

Before putting the instrument into operation:

- Study the manual.
- Take the necessary safety precautions.
- Set the voltage selector on the battery charger to suit the local mains voltage.
- Charge the battery (see Section 3.3.2).
- Connect the earth cable correctly. (The NSG 435 must never be switched on without an earth cable being connected).
- Allow the instrument to dry out if any condensation has occurred.

### 4.2 Function test

#### Inserting the battery

Insert the lower end of the battery (the part with the spring-blade) into the hand-grip. Gently pull down against the spring so that the battery can be snapped inwards and then release the pressure.

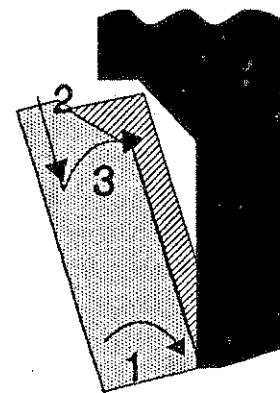

Switch the generator on with the main switch.

A display appears in the window showing values representing the status of the instrument before it was last switched off.

A typical set of values might look like this:

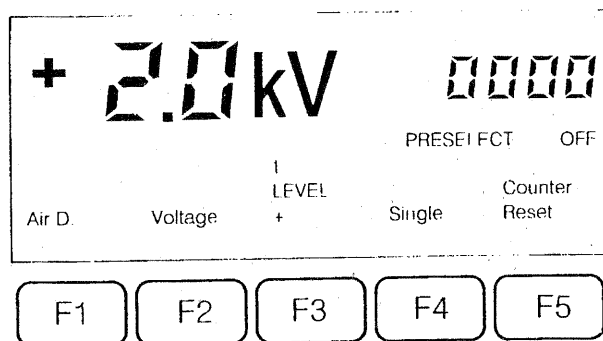

The instrument performs audible switching functions for a while that result from various self-tests and calibration procedures.

High voltage generation is activated by pressing and holding the trigger button. By bringing the test finger close to the earthing point an arc discharge occurs which is acknowledged acoustically and the display shows the effective discharge voltage in a frame. (This applies under the following conditions: air-discharge, single-pulse, preselect counter off).

The instrument is now ready to use.

## 5 Operation

### 5.1 General

This section provides a guide through the numerous setting possibilities of the NSG 435. The operation, which is strictly logical and hierarchically arranged, is easy to remember.

The display shows unmistakable information about the parameters that have been set and the operating status of the generator. Equally logically, the instrument refuses to accept any invalid entries.

It is recommended to carry out the examples directly on the instrument (not forgetting to connect the earth cable!).

### 5.2 Switching on

When the instrument is switched on, the last-used settings will be reinstated. The following illustration is hence just one example from a multitude of possibilities.

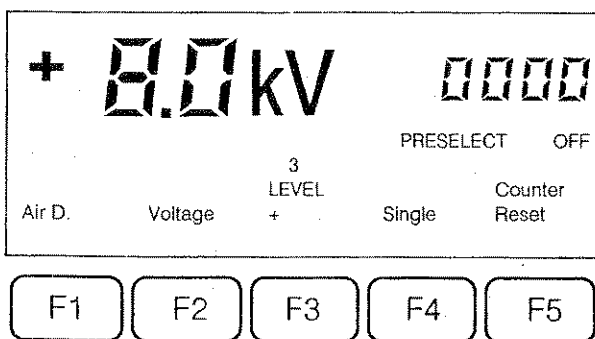

The instrument is ready for use immediately after the execution of a self-test and calibration procedure.

Press and hold the trigger button to activate the high voltage generation. The active high voltage state is shown on the display by the "kV" indication blinking.

The measured value of the breakdown voltage is displayed once an arc has been achieved in the air-discharge mode. This differs from the display of the set value because of the frame around the value.

The effective discharge voltage depends on various factors such as the distance to the discharge point, speed of approach, nature of the EUT, etc.

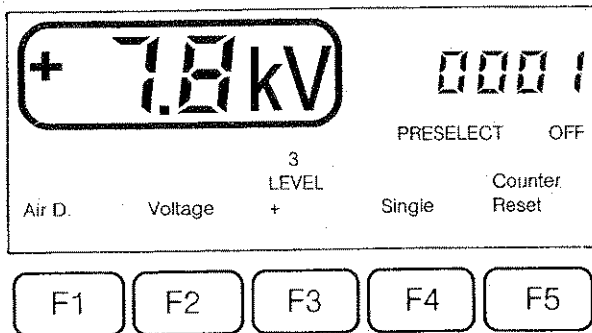

In the case of a contact-discharge this measurement is not carried out since only a discharge current can occur.

The instrument switches itself off automatically after a period of 30 minutes of non-use although the parameters that have been set will remain stored in memory.

### 5.3 Battery monitoring

The battery charge state is monitored continuously. An insufficiently charged or empty battery is indicated on the display.

"LOW BAT" blinks: Change or charge the battery soon.  
The instrument's functions and the pulse data are still assured.

"LOW BAT" steady: Battery empty. The instrument's functions are inhibited since the pulse data can no longer be assured.

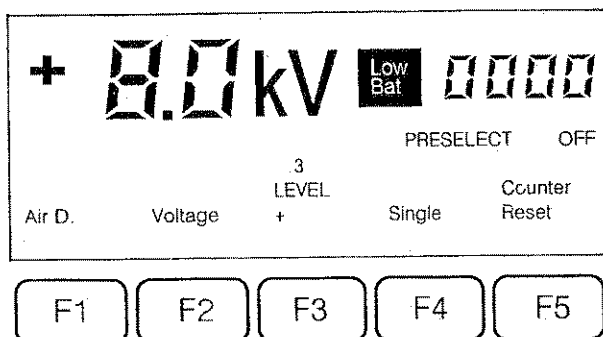

Note: One battery charge will last for several days of normal test operation. The useful working time depends, of course, to a large extent on the operating conditions.

The following figures have been obtained by way of reference:

- Battery freshly charged
- Air-discharge at 15 kV
- More than 10000 discharges until "LOW BAT" blinks
- A further 3000+ discharges until "LOW BAT" remains constant

### 5.4 Air/contact-discharge

F1 toggles between air-discharge and contact-discharge and vice-versa.

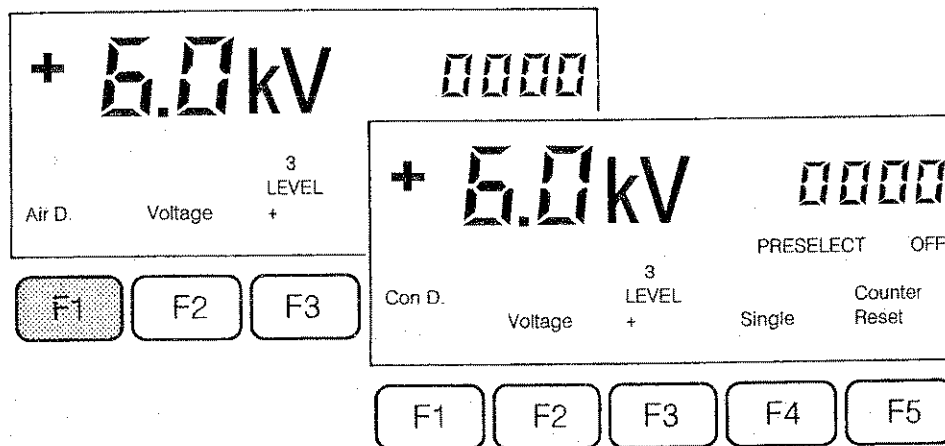

The change to contact-discharge is prevented if:

- the voltage set for this operating mode is too high, i.e. over 9 kV
- the repetition frequency set for this operating mode is too high, i.e. over 10 pulses/s

The instrument notifies the error with a beep and the erroneous setting blinks for 5 s.

When working with fixed voltage levels, the relevant value is automatically loaded upon toggling between the air/contact-discharge mode.

The corresponding test finger must, of course, be attached to suit the particular discharge mode:

- Air-discharge = rounded test finger
- Contact-discharge = pointed test finger



### 5.5 Voltage

Press F2 to branch into the sub-menu for voltage setting. Some of the other buttons take on different functions as shown on the display:

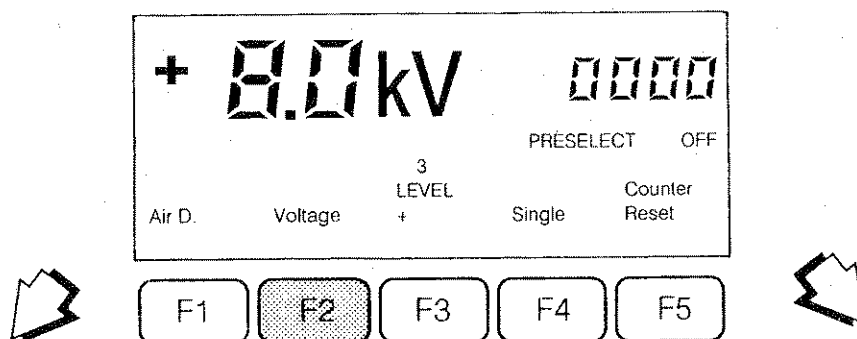

Free setting

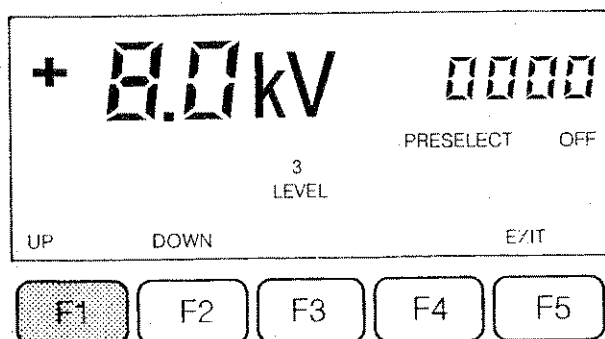

Pressing F1 or F2 raises or lowers the voltage respectively in steps of 100 V. Pressing the buttons continuously changes the voltage level with increasing rapidity.

Call stored values

LEVEL 1-4 (4 values each for air-discharge and contact discharge)

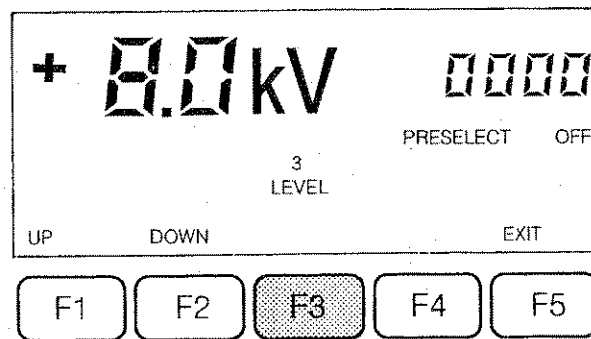

Press F3 to select the four stored voltage values in each case. (To change a stored value, see Section 5.12).

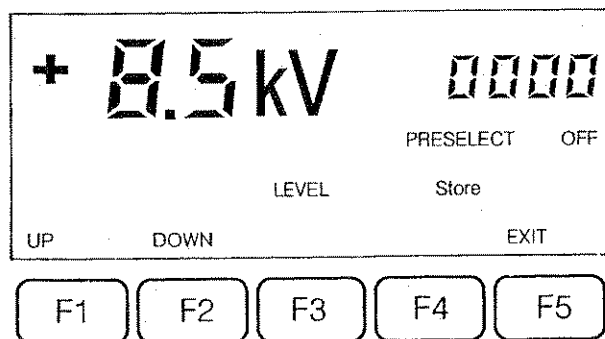

Press F5 to return to the starting menu level. (This return will also be made automatically after about 10 s).

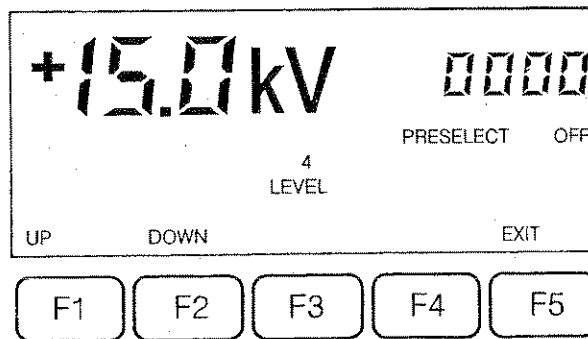

Pulse triggering is described in Section 5.7.

5.6 Polarity

F3 toggles between positive and negative polarity. The sign shown in the display alters correspondingly.

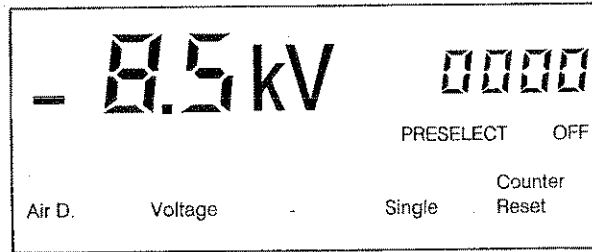
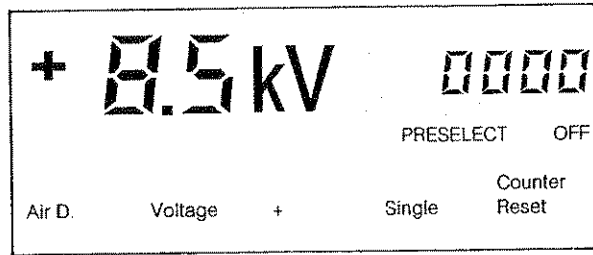

5.7 Repetition frequency

Use F4 to scroll from SINGLE (single discharges) through all the possible frequencies for repetitive discharges: 0.5/1/5/10/20/25 Hz for air-discharge  
0.5/1/5/10 Hz for contact-discharge

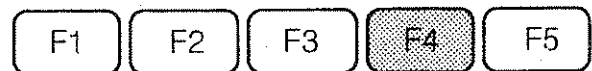
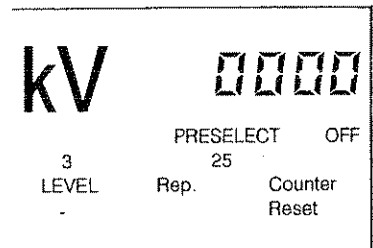
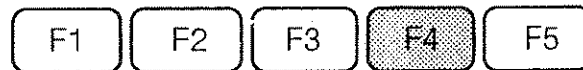
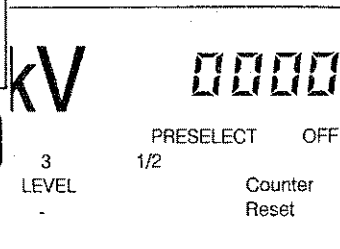
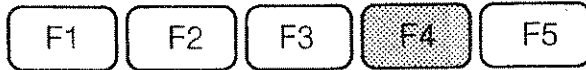
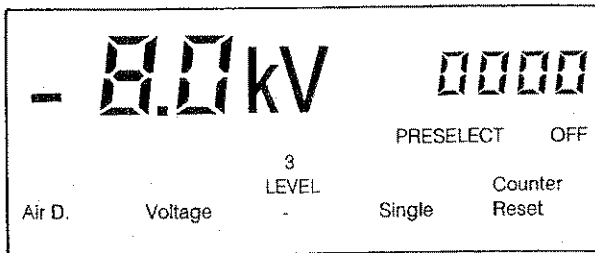

..... etc.

In the SINGLE MODE a discharge is released each time the trigger button is pressed. The discharge is confirmed by a beep-tone. In the REPETITIVE MODE discharges are released at the chosen rate for as long as the trigger button remains pressed (no acoustic confirmation).

**Air-discharge:** The instrument generates the programmed HV for as long as the trigger button is pressed. Once an arc has occurred, any remaining charge is discharged internally and the HV continues to be generated at the specified repetition frequency.

**Contact-discharge:** The instrument performs switching operations on the HV relay, hence causing discharges, at the specified repetition frequency for as long as the trigger button is pressed.

### 5.8 Counter

The counter sums the number of discharges, irrespective of the operating mode and irrespective of whether other pulse parameters have been set in the meanwhile.

The counter works in a decrementing manner in the preselect counter mode.

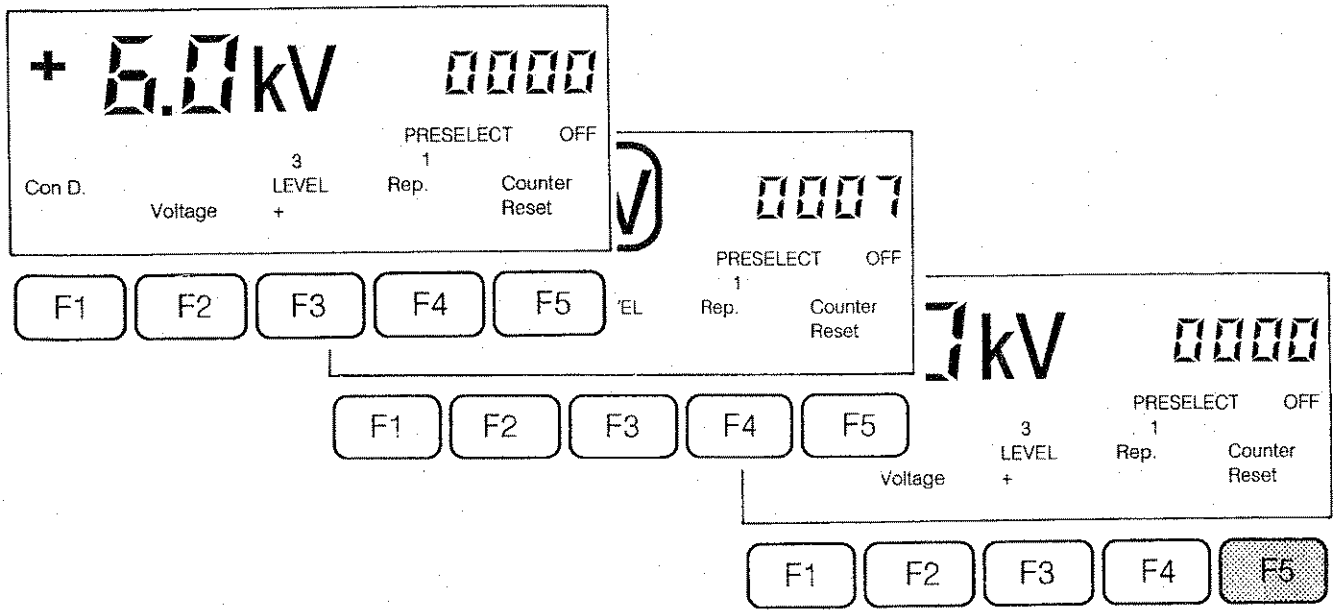

F5 sets the counter either back to 0000 or to the preset value if the preselect counter mode has been chosen.

Pressing F5 a second time causes a branch to the preselect counter menu.

5.9 Preselect counter

A specified number of discharges (0...9999) can be pre-programmed with this function. These can then be triggered singly by hand or automatically.

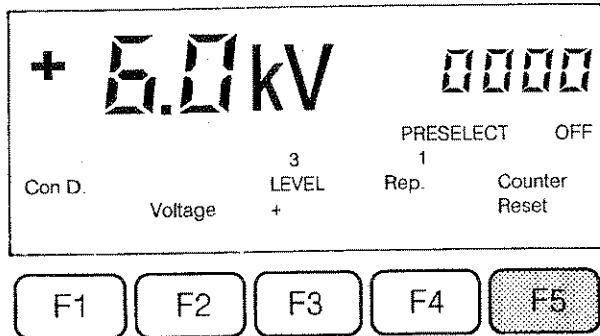

F5 first resets the counter then, when pressed a second time, branches into the preselect counter menu.

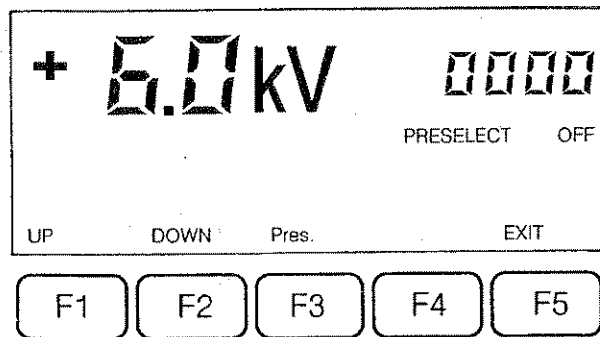

F3 switches the preselect counter operation on and off. (PRESELECT ON/OFF)

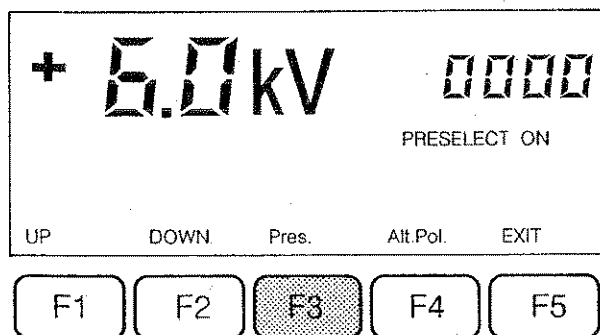

Use F1 and F2 to raise or lower the preset value. Keeping either button pressed causes the change to occur with increasing rapidity.

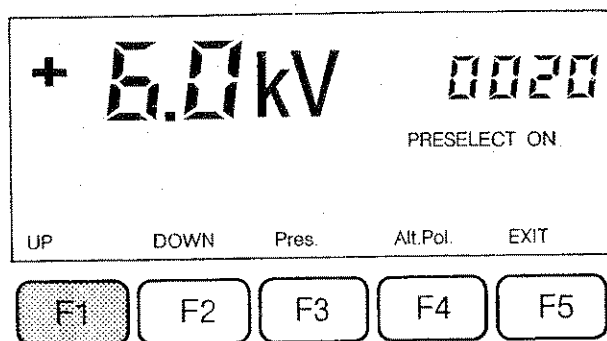

Press F5 to return to the original menu level. (This return also occurs automatically after about 10 s)

The preselect counter mode can be used with either single or with repetitive discharges.

Each time there is a discharge the counter content is decremented by 1.

In the repetitive mode the discharge sequence is started when the trigger button is first pressed and is halted when the button is pressed a second time. The sequence can be continued by pressing it again.

Pulse triggering is terminated when the counter content reaches 0000.

F5 reloads the preselect counter with the original value.

Once the counter reaches 0000 and the procedure has been stopped, the counter can also be reloaded with the original value again and the test sequence started anew simply by pressing the trigger button

### 5.10 Automatic polarity switching

The IEC standards call for equal quantities of positive and then negative discharges to be applied to a test point. The NSG 435 can execute this function automatically.

The automatic polarity switch operates in conjunction with the preselect counter.

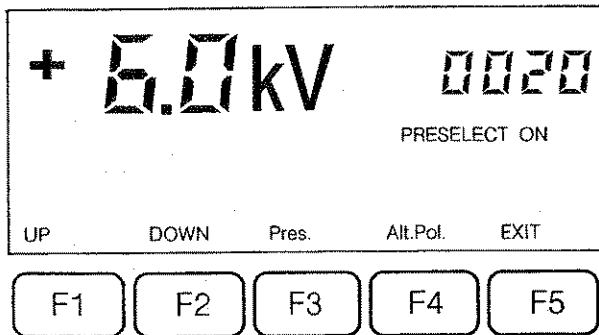

F5 branches into the preselect counter menu.

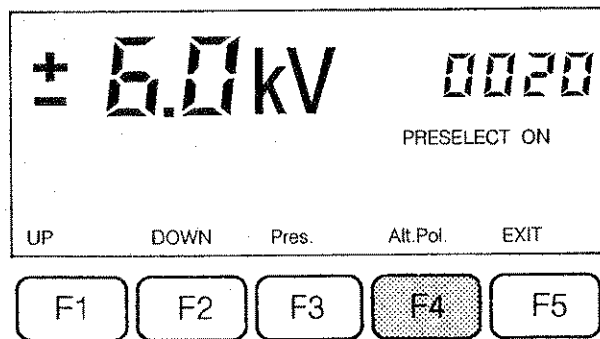

F4 switches the function "Automatic polarity change" on and off. (Precondition: PRESELECT ON)  
The active state is shown by the sign in front of the voltage alternating on the display.



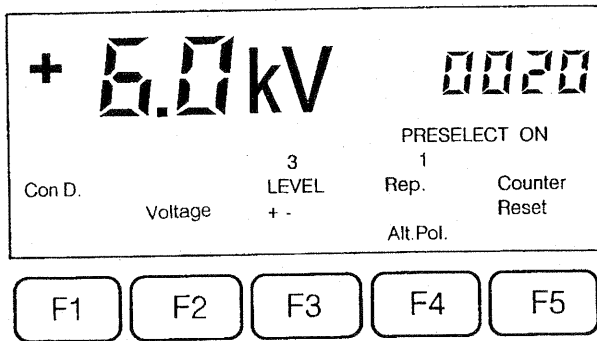

Use F5 to return to the original menu level. (This return also occurs automatically after about 10 s). The "Automatic polarity change" function is identified by "ALT.POL." over F4 and +/- over F3.

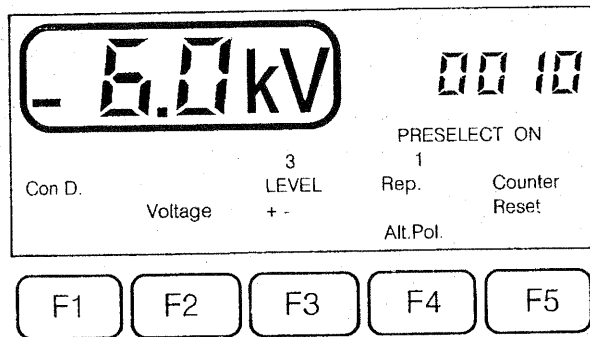

The instrument switches over from positive to negative polarity once half of the preset number of pulses has been released (the sign on the display changes)

This automatic function works in both the single pulse mode as well as with repetitive discharges.

Reinitialize the operation in single pulse mode after each cycle. Reset the counter and select the counter menu again (press F5 three times).

### 5.11 Continuous operation

A continuous operating mode can be selected for repetitive discharges. Pressing the trigger button starts the continuous operation; pressing it a second time stops the operation.

Attention: - Continuous operation should only be selected if absolutely necessary. Since every electrostatic discharge radiates electromagnetic interference care must be taken to ensure minimum disturbance to the surroundings.

- The test area must be barred to unauthorized persons.
- The test and the test duration must be supervised.
- The available time for a continuous test is naturally limited if battery operation is used.

Activate continuous operation:

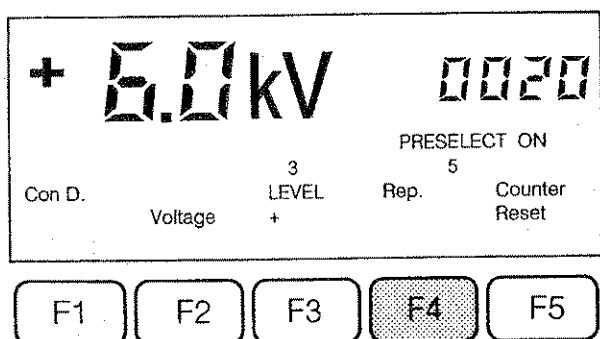

Select the repetition frequency in the basic menu with F4.

F5 branches into the preselect counter menu.

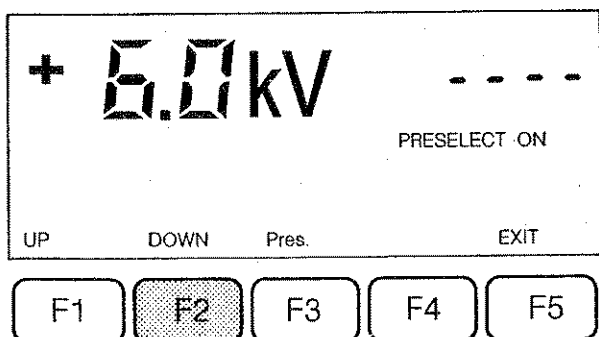

Hold F2 down until the counter content is 0000. Press F2 again to activate continuous operation. The display shows - - - -.

Use F5 to return to the original menu level.

## Switch off continuous operation

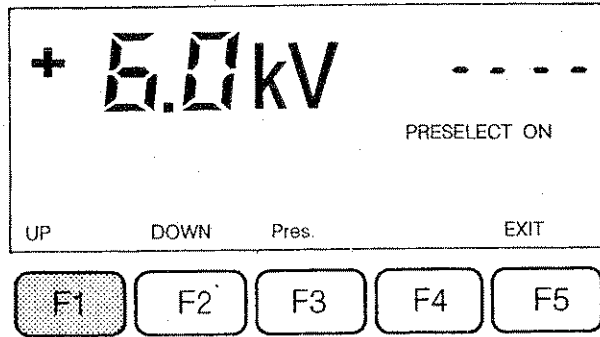

F5 branches into the preselect counter menu.

Press F1 or F2. The counter shows 0000 or 9999 respectively. Continuous operation is switched off.

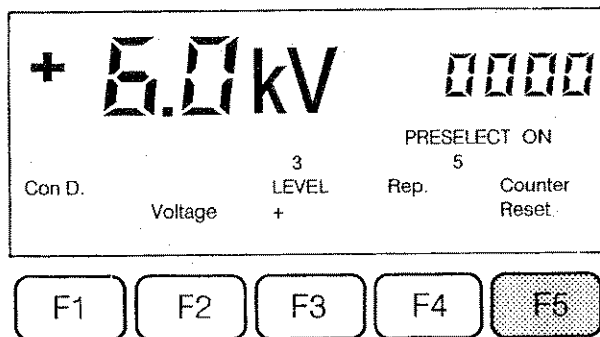

Use F5 to return to the original menu level.

5.12 Storing voltage settings

Pre-programmed discharge voltage values can be stored in four memory locations for both air and contact-discharges. As delivered, the instrument has the test levels set according to IEC 801-2.

Level	Test voltage Contact-discharge kV	Test voltage Air-discharge kV
1	2	2
2	4	4
3	6	8
4	8	15

The values stored in memory can be altered arbitrarily.

Select discharge mode (Air D. or Con. D) with F1.

Call up "Voltage" sub-menu with F2.

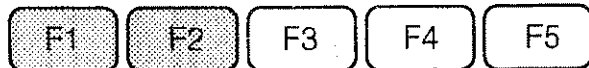
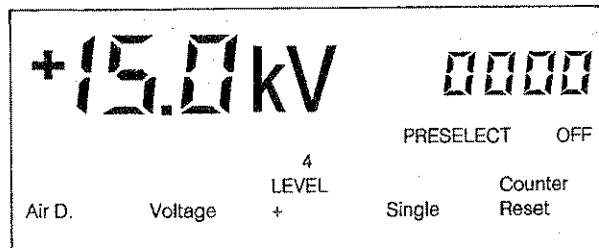

Set the required voltage with F1 or F2.

Range for Air: 0.2 ... 16.5 kV

Range for Contact: 0.2 ... 9 kV

The "LEVEL n" indication shown over F3 disappears. "STORE" appears over F4.

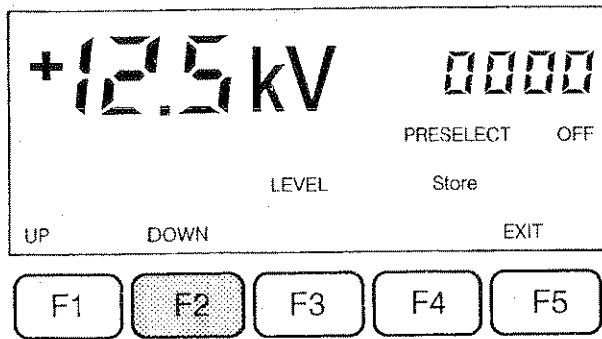

Press F4; a memory location (1 ... 4) appears over F3.

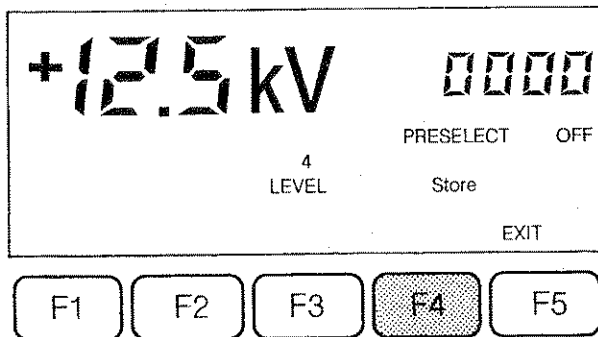

Use F3 to specify the required memory location. Press F4 again and the value is stored.

Use F5 to return to the original menu level.

## 6 Test procedures

### 6.1 Standard-conform procedures

Test standards such as the IEC 801-2, 1991 give detailed information about setting up a test rig, the organisation of a test and the documentation.

The ESD Simulator System NSG 435 is constructed and calibrated in accordance with the requirements of the standards.

The test engineer cannot be relieved of the duty to study the applicable test prescriptions closely and to adapt the conditions to the test object in question.

The necessary documents can be obtained directly from the IEC, ANSI, IEEE, etc. or they can be obtained through the relevant national standards bureau.

### 6.2 Other conditions

It is not always possible to set up a test rig in precise conformity with the standards. By observing a few basics, however, it is nevertheless possible to make credible assessments of the interference immunity of a test object and to obtain worthwhile pointers to ways of improving it.

An electrostatic discharge always exhibits high frequency properties with parts of the spectrum extending to over 1 GHz. Screening and filtering measures must therefore also be effective up into these frequency ranges.

The possible paths that the pulse may take has to be considered. The pulse return path must, without doubt, be through the earth cable connected to the generator.

The contact-discharge method is to be used in preference to the air-discharge method. The former must, however, be implemented in such a way that there is a true metal-to-metal contact with the EUT.

Repetitive discharges can only really be used to localize weak spots or to find sensitive conditions in program sequences quickly. Single pulses then have to be used for a detailed investigation and assessment of the interference sensitivity.



The test conditions must always be documented exactly including photos of the test rig, information about the type and number of discharges, details of the prevailing climatic conditions, comments regarding the effects observed, etc.

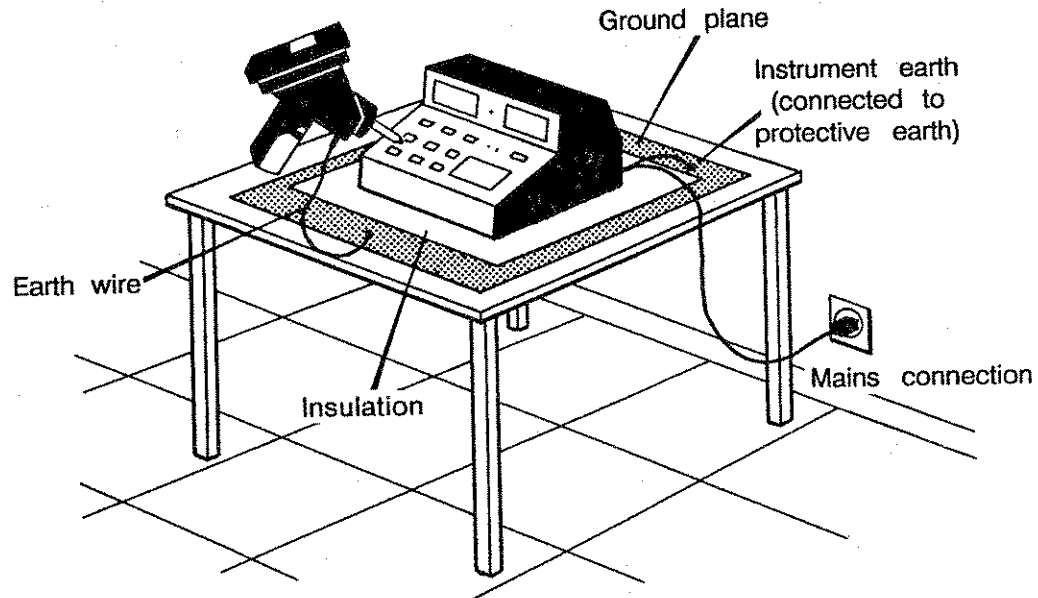

*Example of a simplified test rig for a table-top instrument  
(not standard-conform)*

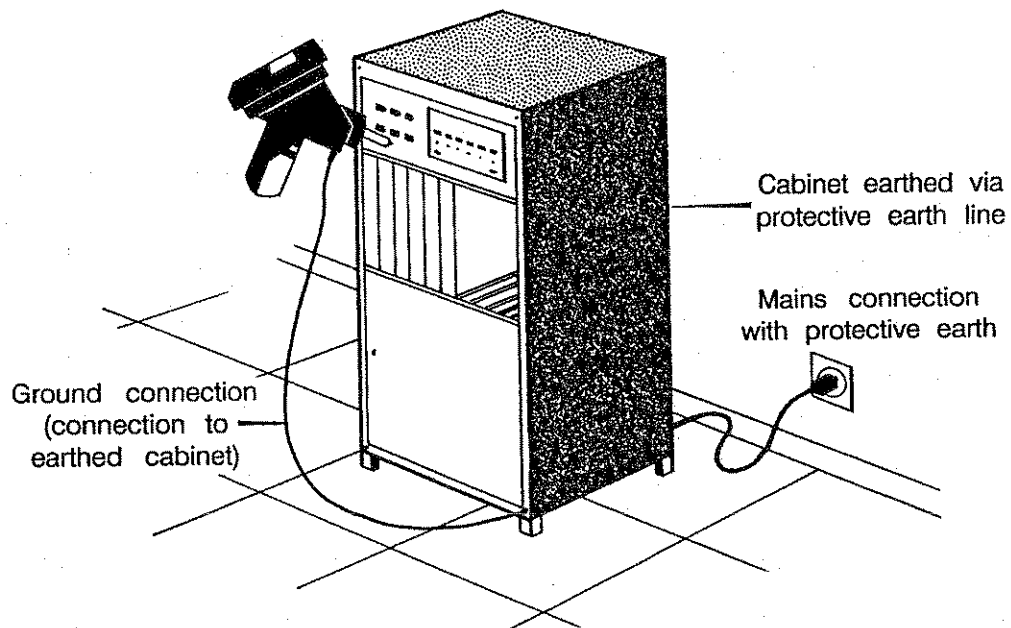

*Example of a test rig for a system*

## 7 Verification of the pulse data

The calibration and verification of the pulse data necessitates a specialized measurement equipment arrangement. The IEC standard lays down minimal requirements.

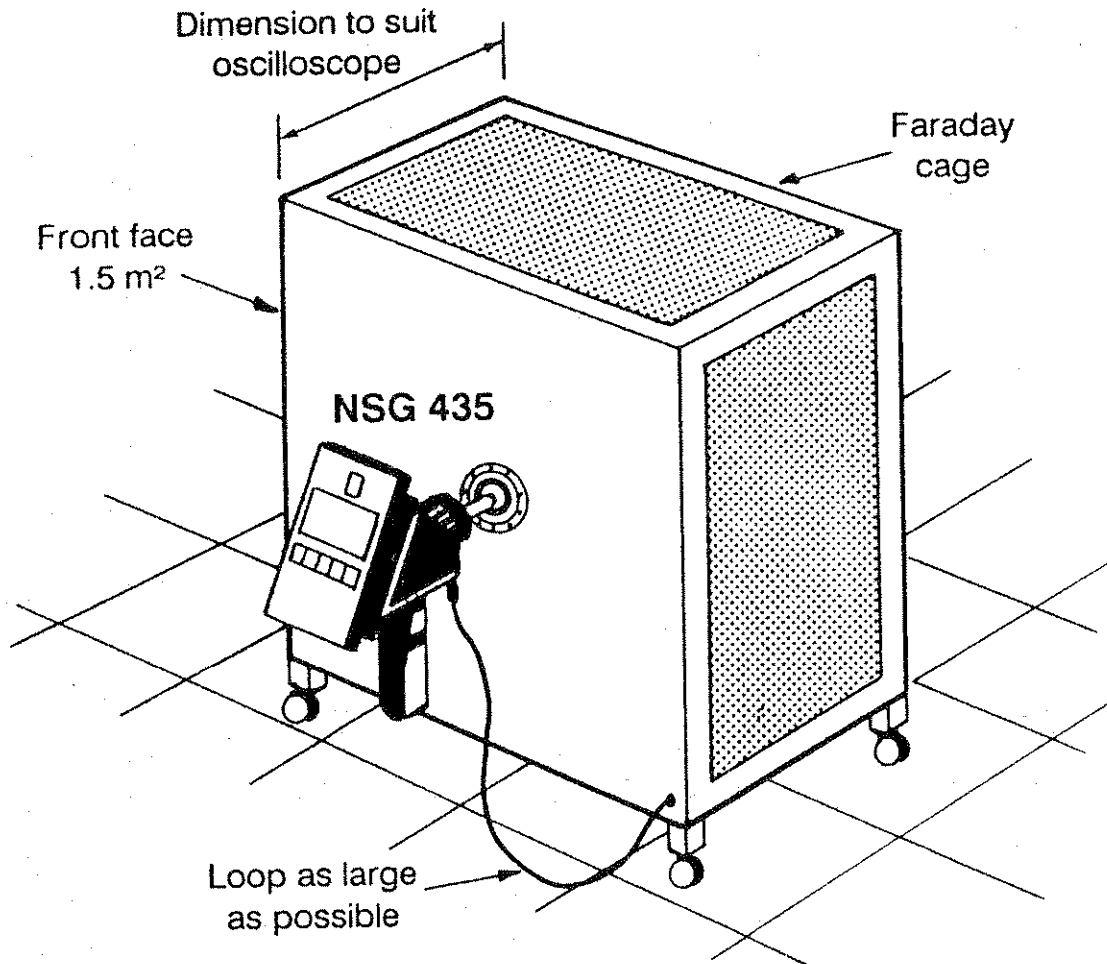

SCHAFFNER uses the following instruments for calibration purposes:

- Oscilloscope with 1 GHz bandwidth
- Coaxial measurement adapter MD 101 (Pellegrini Target as per IEC 801-2)
- 20 dB attenuator DC-12.4 GHz
- SUCOFLEX-HF-coaxial cable
- DC-High voltage voltmeter ( $R_i > 30 \text{ G}\Omega$ )

The measuring instruments are periodically recalibrated in compliance with ISO 9001.

## 8 Typical pulse specifications

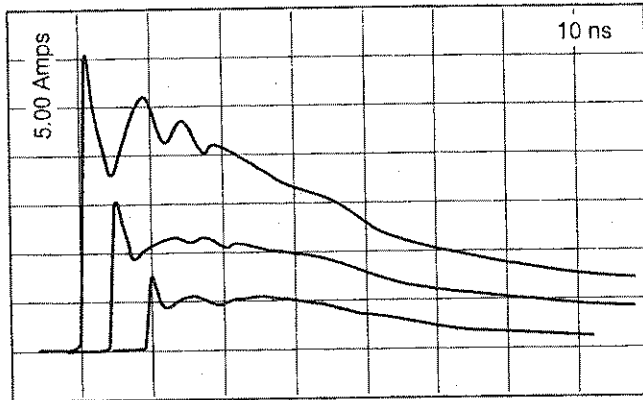

IEC 801-2, 1991, Contact-discharge  
voltage 8 kV / 4 kV / 2 kV

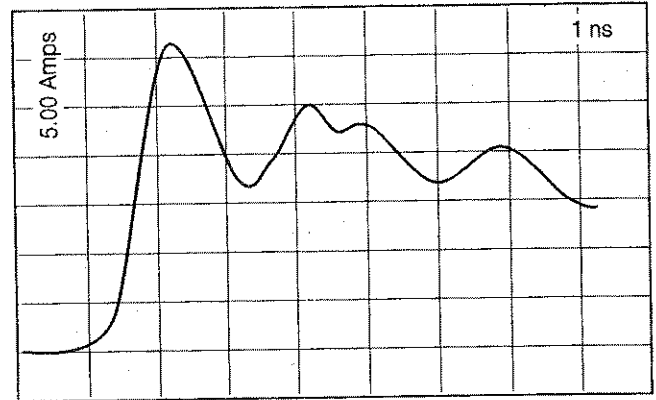

IEC 801-2, 1991, Contact-discharge  
8 kV, pulse rising edge ( $t_r$ , ca. 0.7 ns)

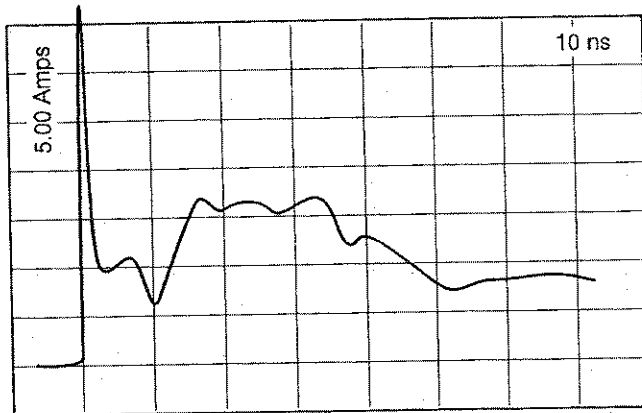

ANSI C63.16, Hand-Metal-Model,  
Contact-discharge, 6 kV  
Network INA 422

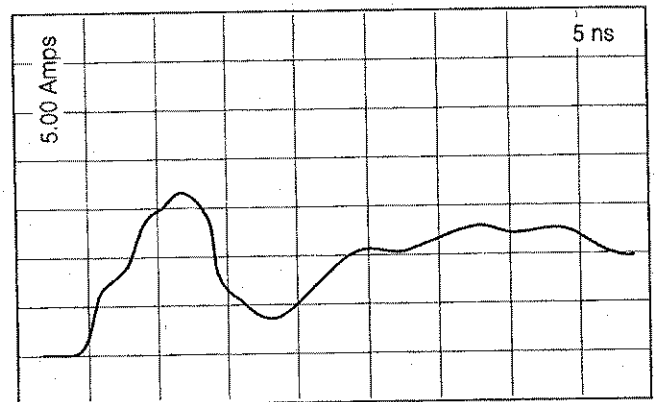

ANSI C63.16, Hand-Metal-Model  
Air-discharge, 10 kV  
Network INA 422

## 9 Maintenance

### 9.1 Servicing

#### *Care:*

The housing can be cleaned with a moist cloth with possibly just a trace of detergent liquid.

Industrial spirit is also a suitable cleaning agent.

Other solvents are not permitted.

#### *Fuses:*

The instrument contains no fuses that are accessible to the user.

### 9.2 Calibration

Trimming procedures in the NSG 435 are carried out digitally and automatically. The instrument contains no elements that are foreseen for adjustment by the user. A component defect must be suspected if the calibration measurements differ from the published technical data and the instrument is to be returned to an authorized SCHAFFNER service centre.

Measurements can only be undertaken by trained specialists. A prerequisite is the availability of the necessary measurement equipment as listed in Section 7.

#### Charge voltage check

Equipment: EHT voltmeter with 20 kV voltage range  
Internal resistance > 20 G $\Omega$   
Measurement accuracy < 1 %

Check the voltage level under the following conditions:

Air-discharge

Single discharge

Polarity: positive and negative

Voltage settings: 2, 4, 8 and 15 kV

Permissible deviation: <  $\pm 5$  % of the set value

Check the discharge current pulse shape

Measuring equipment and test rig as in Section 7.

Check to be made under the following conditions:

Contact-discharge

Single discharge

Polarity: positive and negative

Voltage settings: 2, 4, 6 and 8 kV

Compare the results obtained against the reference figures quoted in IEC 801-2, 1991.

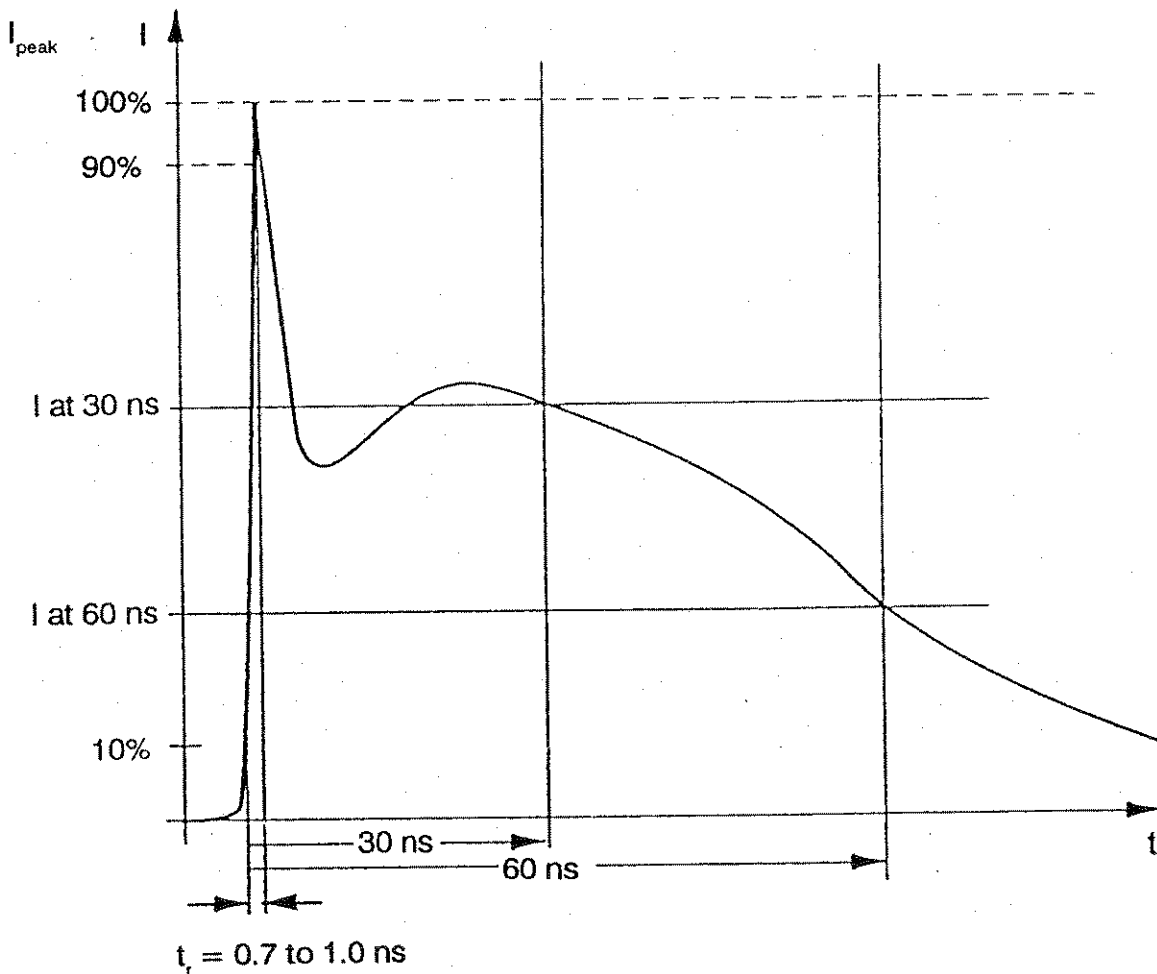

Level	Indicated voltage kV	First peak current of discharge $\pm 10\%$ A	Rise time $t_r$ with discharge switch ns	Current ( $\pm 30\%$ ) at 30 ns A	Current ( $\pm 30\%$ ) at 60 ns A
1	2	7.5	0.7 to 1.0	4	2
2	4	15	0.7 to 1.0	8	4
3	6	22.5	0.7 to 1.0	12	6
4	8	30	0.7 to 1.0	16	8

These figures only apply to the discharge network and test fingers that comply with IEC 801-2, 1991.

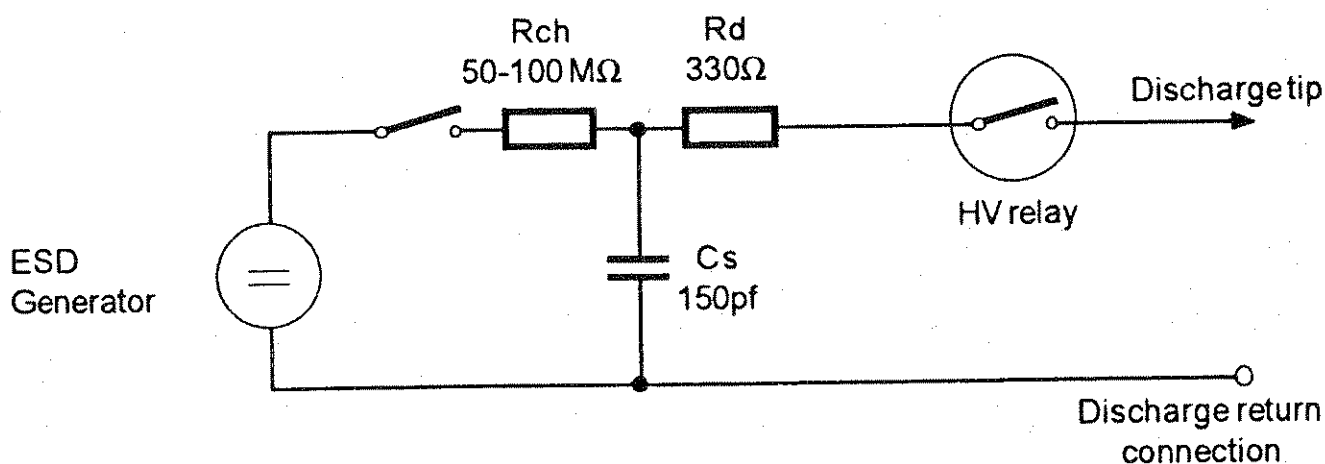

Note: SCHAFFNER offers a calibration service to carry out such work.



### 9.3 Exchanging the R-C network

Exchanging the discharge networks is to be undertaken by knowledgeable personnel. A clean and well-lit working area is necessary.

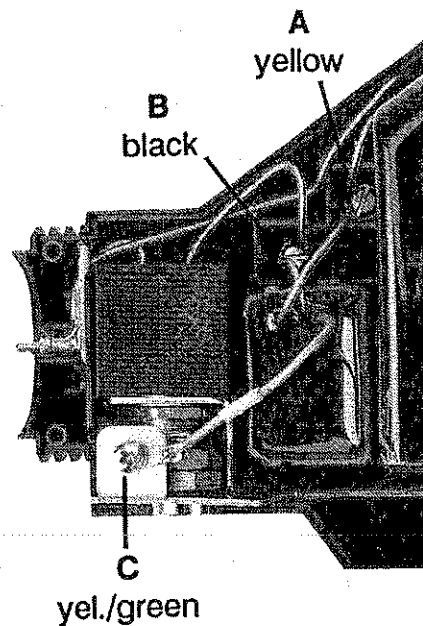
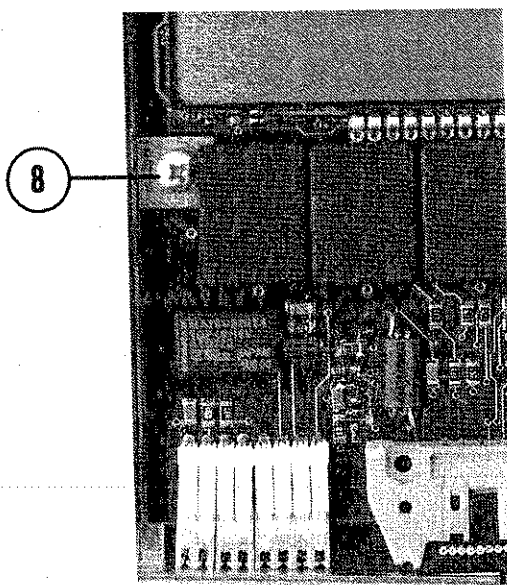
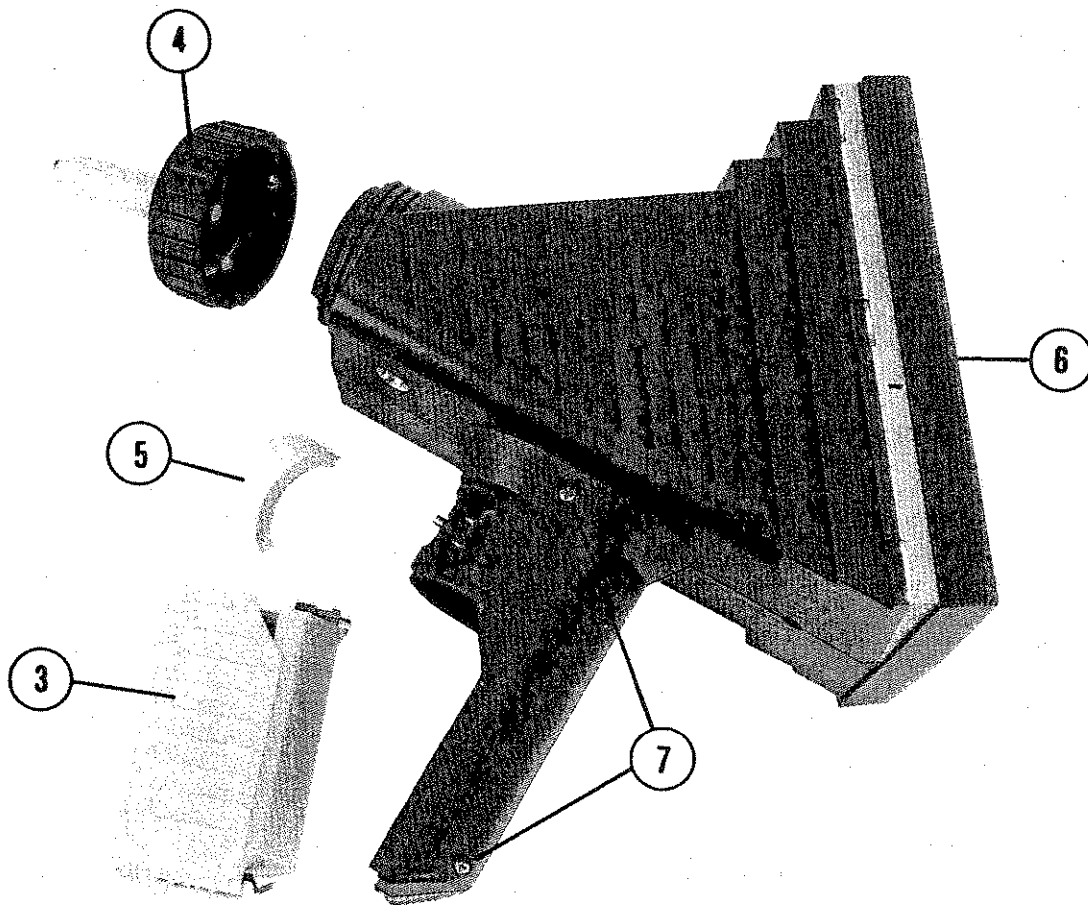

## Procedure:

- 1 Switch the instrument off
- 2 Remove the earth cable
- 3 Take out the battery
- 4 Unscrew the test finger
- 5 Pull out the trigger button
- 6 Remove the rear cover  
(The cover locks into 3 notches in the housing on both sides. The cover can be removed by carefully lifting it at the points where the notches are and gradually sliding it back).
- 7 Lay the instrument on its side and remove the screws
- 8 Remove the screw in the printed circuit board
- 9 Remove the upper part of the housing with a rocking movement
  
- 10 Note the arrangement of the wiring
- 11 Release the network connecting screws in the given order
- 12 Remove the network
- 13 Insert the replacement network
- 14 Firmly screw the colour-coded network connections into place as shown in the illustration
- 15 Take care with the placement of the wires so that none become trapped while re-assembling the generator
- 16 Carefully screw the upper part of the housing back into place
- 17 Continue re-assembly in the reverse order of points 8 .. 1 above  
(Attach the test finger belonging to the set!)
- 18 Check the operation of the generator by observing the spark-gap  
(The high voltage generator adjusts itself automatically to the new network)
- 19 If in doubt, a voltage check can be carried out as given in Section 9.2
- 20 A calibration measurement is not normally necessary

## 9.4 Repairs

Repair work is to be executed exclusively by authorized SCHAFFNER repair departments.

Only original replacement parts and accessories are to be used.

Do not continue to use the instrument in the event of mechanical damage occurring. The moulded housing also performs insulating and protective functions which are only assured as long as it is in its original condition. A damaged instrument should be returned without delay to a SCHAFFNER service centre.

## 9.5 Disposal

The following list shows the principal materials that are used in the construction of the NSG 435. The relevant national regulations are to be observed when disposing of the instrument.

Item	Material	Remark
Housing	ABS with glass-fibre	
Control unit	Epoxy circuit board with SMD components	
LC-display	Glass	
LCD window	Acrylic	
Chassis plate	Galvanized steel	
HV unit/ Network	Polyurethane block with electr. components and copper wire	
HV relay	Various metals, ceramic, various insulating materials	
Test finger	Brass, plastics, electrical components	
Battery	Nickel-cadmium ABS housing epoxy circuit board	Observe any special regulations regarding disposal of Ni-Cad's
Charger	ABS housing with transformer, pcb with electr. components	
Carrying case	Polyethelene	

## 10 Technical specification

Description	Compact ESD-generator with microprocessor-controller, large-surface LC-display, built-in HV-relay for contact-discharges, mains-independent
Pulse data	- standard Conforms to IEC 801-2, 1991
	- special With exchangeable networks/ test fingers for other standards
Pulse network	- standard 150 pF/330 $\Omega$ as per IEC, exchangeable Networks for other standards as accessories Range R = 0 $\Omega$ ... 10 k $\Omega$ Range C = 60 pF ... 500 pF
Discharge voltage (air-discharge)	200 V ... 16.5 kV (in 100 V steps) (Tolerance $\pm$ 5%, 1 ... 16 kV)
Discharge voltage (contact-discharge)	200 V ... 9 kV (in 100 V steps) (Tolerance $\pm$ 5%, 1 ... 9 kV)
Test finger	- standard Ball and point as per IEC, exchangeable via locking ring
Voltage measurement	On HV-side, dynamic Accuracy better than $\pm$ 5% (1 kV ... 16.5 kV)
Arcing recognition	Indicated also acoustically in the 'Single' operating mode
Holding time	> 5 s
Charge resistor R <sub>ch</sub>	50 M $\Omega$
Triggering	Trigger button in hand-grip or remotely via optical link
Power supply	Battery in hand-grip, exchangeable, charging time: 3 hrs approx. Mains power unit as an accessory

Operation	Via push-buttons and microprocessor
Discharge modes	Air-discharge Contact-discharge
Polarity	Pos., neg. and automatic switch-over
Operating modes	Single Repetitive at 0.5, 1, 5, 10, 20 or 25 Hz Pulse counter 0 ... 9999 Preselect counter 0 ... 9999 Continuous operation
Discharge voltage	200 V ... 16.5 kV (air-discharge) 200 V ... 9 kV (contact-discharge) Fixed levels, 4 values each, programmable
Auto-shut-off	After 30 mins idle time (without loss of the test parameters)
Display	LCD panel showing <ul style="list-style-type: none"> <li>- Discharge voltage</li> <li>- Breakdown voltage</li> <li>- Polarity</li> <li>- Air / Contact-discharge</li> <li>- Counter / preselect counter content</li> <li>- Soft-key functions</li> <li>- Battery monitor</li> </ul>
Weight	NSG 435 with battery: 1.2 kg (2.6 lbs) approx.
Ambient conditions	Operating +5° ... +40°C 20 ... 80 % r.h. (non-condensing) 68 ... 106 kPa



## 11 ESD standards

The IEC 801-2, 1991 standard can be taken as a basis.

Later, it is foreseen to rename this as IEC 1000-4-02 and EN 601000-4-02 respectively. These are expected to be accepted into national standards in keeping with the attempts at European harmonisation.

The following documents are either already identical or compatible to a large extent:

EN 50082-1	Generic Immunity Standard for Domestic, Commercial & Light Industry
prEN 50082-2	Generic Immunity Standard for Industrial Environment
prEN 55101-2	Immunity of ITE for ESD
EN 60204	Ausrüstungen von Industriemaschinen
CENELEC HD 481.2	Mess-, Steuer und Regeleinrichtungen in der industriellen Prozesstechnik
DIN/VDE 0843 T2/)	As CENELEC HD 481.2
ECMA TR/40	EMV Test for ITE
NAMUR Recommendation	NAMUR Working Group AK 05 EMV
VDE, DIN and VG Stds.	Diverse
Diverse PTT-Standards	
OIML Doc No. 11	Equipment subject to calibration

Special discharge networks and test fingers are called for by:

ANSI C63.16, Draft	Guide for ESD
ISO 10606/E	Road Vehicles ESD
SAE J1113, Part 5	Vehicle Component ESD
and others	



## 12 Warranty

SCHAFFNER grants a warranty of 1 year on this instrument, effective from the date of purchase.

During this period, any defective component part will be repaired or replaced free of charge or, if necessary, the instrument will be replaced by another of equivalent value. The decision regarding the method of reinstating the functional capability is at the sole discretion of SCHAFFNER.

Excluded from the warranty are damage or consequential damage caused through negligent operation or use as well as the replacement of parts subject to degradation.

The warranty is rendered invalid by any intervention on the part of the customer or a third party.

The goods are to be returned in the original packing or other equivalent packing suitable for the purpose of the foreseen means of transport.

SCHAFFNER can accept no responsibility for damage in transit.

13 Ordering information

NSG 435 basic kit consisting of:	Order No.	Quantity
NSG 435 ESD simulator complete with: Carrying case Network for IEC 801-2, 1991 (150pF/330Ω) Test fingers, ball and point Battery-pack Earth cable Operating instructions Charging unit, 110/230 V, 50/60 Hz, with Euro-connector	NSG435-01	.....
As above but with: Charging unit, 110/230 V, 50/60 Hz, with US-connector	NSG435-04	.....
As above but with: Charging unit, 100 V, 50/60 Hz, with US-connector	NSG435-07	.....

Options	Order No.	Quantity
Option carrying case	INA 410	.....
Mains power supply, 80...240 V, 50/60 Hz, incl. grip-adapter	INA 402-....*	.....
Spare battery-pack	INA 405	.....
Remote triggering unit including 5 m opto-cable	INA 415	.....
Networks and test fingers		
ANSI C63.16, draft 1991, hand-metal-mod. (180pF/330Ω)	INA 422	.....
ANSI C63.16, draft 1991, furniture (180 pF/15Ω/75Ω)	INA 423	.....
IEC 801-2 1984 (150pF/150Ω)	INA 421	.....
Special test finger for IEC 801-2, 1991, but for fast leading edge < 400 ps	INA 420	.....
Discharge networks, special versions R and C are to be specified	.....pF/.....Ω	.....
Measuring adapter IEC 801-2, 1991	MD101	.....

\* Specify mains cable: - 01 = SCHUKO; - 02 = SEV 13; - 04 = UL 498; - 05 = BS 1363

Date:

Company:

Signature:

Hersteller Producer Fabricant

Schaffner Elektronik AG  
CH-4708 Luterbach  
Switzerland  
Telephone .. 41 / 65 / 41 11 81  
Telefax .. 41 / 65 / 42 14 04

Tochtergesellschaften:  
Subsidiary companies:  
Succursales:

**Schweiz:**  
ALTRAC AG  
CH-8953 Dietikon  
Telefon (01) 741 46 44  
Telefax (01) 741 19 60

**USA:**  
Schaffner EMC Inc.  
US-Springfield, NJ 07081  
Phone (201) 379 7778  
Fax (201) 379 1151

**Deutschland:**  
Schaffner Elektronik GmbH  
D-76185 Karlsruhe  
Telefon (0721) 56 91 - 0  
Telefax (0721) 56 91 - 10

**United Kingdom:**  
Schaffner EMC Ltd.  
GB-Wokingham  
Phone (01734) 77 00 70  
Fax (01734) 79 29 69

**France:**  
Schaffner S.A.  
F-95100 Argenteuil  
Téléphone (1) 39 47 86 36  
Télécopieur (1) 39 47 02 28

**Ireland:**  
Schaffner Intepro  
IR-Limerick  
Phone (061) 33 22 33  
Fax (061) 33 25 84

**Sweden:**  
Schaffner EMC AB  
S-19186 Sollentuna  
Phone (08) 92 11 21  
Fax (08) 92 96 90

**Japan:**  
Schaffner EMC K.K.  
J-Tokyo 154  
Phone (03) 3418 5822  
Fax (03) 3418 3013

