

R&S® SMU200A

Vector Signal Generator

Operating Manual



1007.9845.32 – 17

This document describes the R&S®SMU200A, stock no. 1141.2005.02 and its options.

- R&S®SMU-B9/B10/B11
- R&S®SMU-B13
- R&S®SMU-B16
- R&S®SMU-B17
- R&S®SMU-B18
- R&S®SMU-B20
- R&S®SMU-B22
- R&S®SMU-B31/B36
- R&S®SMU-B81
- R&S®SMU-B82
- R&S®SMU-B90
- R&S®SMU-B104/B106
- R&S®SMU-K61
- R&S®SMU-K62
- R&S®SMU-K80

The firmware of the instrument makes use of several valuable open source software packages. The most important of them together with their corresponding open source license and the verbatim license texts are provided on the user documentation CD-ROM (included in delivery).

The OpenSSL Project for use in the OpenSSL Toolkit (<http://www.openssl.org/>) includes cryptographic software written by Eric Young (eay@cryptsoft.com) and software written by Tim Hudson (tjh@cryptsoft.com).

Rohde & Schwarz would like to thank the open source community for their valuable contribution to embedded computing.

© 2011 Rohde & Schwarz GmbH & Co. KG

Muehldorfstr. 15, 81671 Munich, Germany

Phone: +49 89 41 29 - 0

Fax: +49 89 41 29 12 164

E-mail: info@rohde-schwarz.com

Internet: <http://www.rohde-schwarz.com>

Printed in Germany – Subject to change – Data without tolerance limits is not binding.

R&S® is a registered trademark of Rohde & Schwarz GmbH & Co. KG.

Trade names are trademarks of the owners.

The following abbreviations are used throughout this manual: R&S®SMU200A is abbreviated as R&S SMU, R&S®WinIQSIM2 is abbreviated as R&S WinIQSIM2.

Basic Safety Instructions

Always read through and comply with the following safety instructions!









All plants and locations of the Rohde & Schwarz group of companies make every effort to keep the safety standards of our products up to date and to offer our customers the highest possible degree of safety. Our products and the auxiliary equipment they require are designed, built and tested in accordance with the safety standards that apply in each case. Compliance with these standards is continuously monitored by our quality assurance system. The product described here has been designed, built and tested in accordance with the attached EC Certificate of Conformity and has left the manufacturer's plant in a condition fully complying with safety standards. To maintain this condition and to ensure safe operation, you must observe all instructions and warnings provided in this manual. If you have any questions regarding these safety instructions, the Rohde & Schwarz group of companies will be happy to answer them.







Furthermore, it is your responsibility to use the product in an appropriate manner. This product is designed for use solely in industrial and laboratory environments or, if expressly permitted, also in the field and must not be used in any way that may cause personal injury or property damage. You are responsible if the product is used for any intention other than its designated purpose or in disregard of the manufacturer's instructions. The manufacturer shall assume no responsibility for such use of the product.

The product is used for its designated purpose if it is used in accordance with its product documentation and within its performance limits (see data sheet, documentation, the following safety instructions). Using the product requires technical skills and a basic knowledge of English. It is therefore essential that only skilled and specialized staff or thoroughly trained personnel with the required skills be allowed to use the product. If personal safety gear is required for using Rohde & Schwarz products, this will be indicated at the appropriate place in the product documentation. Keep the basic safety instructions and the product documentation in a safe place and pass them on to the subsequent users.

Observing the safety instructions will help prevent personal injury or damage of any kind caused by dangerous situations. Therefore, carefully read through and adhere to the following safety instructions before and when using the product. It is also absolutely essential to observe the additional safety instructions on personal safety, for example, that appear in relevant parts of the product documentation. In these safety instructions, the word "product" refers to all merchandise sold and distributed by the Rohde & Schwarz group of companies, including instruments, systems and all accessories.

Symbols and safety labels

							
Notice, general danger location Observe product documentation	Caution when handling heavy equipment	Danger of electric shock	Warning! Hot surface	PE terminal	Ground	Ground terminal	Be careful when handling electrostatic sensitive devices

					
ON/OFF supply voltage	Standby indication	Direct current (DC)	Alternating current (AC)	Direct/alternating current (DC/AC)	Device fully protected by double (reinforced) insulation

Tags and their meaning

The following signal words are used in the product documentation in order to warn the reader about risks and dangers.



indicates a hazardous situation which, if not avoided, will result in death or serious injury.



indicates a hazardous situation which, if not avoided, could result in death or serious injury.



indicates a hazardous situation which, if not avoided, could result in minor or moderate injury.



indicates the possibility of incorrect operation which can result in damage to the product.

In the product documentation, the word ATTENTION is used synonymously.

These tags are in accordance with the standard definition for civil applications in the European Economic Area. Definitions that deviate from the standard definition may also exist in other economic areas or military applications. It is therefore essential to make sure that the tags described here are always used only in connection with the related product documentation and the related product. The use of tags in connection with unrelated products or documentation can result in misinterpretation and in personal injury or material damage.

Operating states and operating positions

The product may be operated only under the operating conditions and in the positions specified by the manufacturer, without the product's ventilation being obstructed. If the manufacturer's specifications are not observed, this can result in electric shock, fire and/or serious personal injury or death. Applicable local or national safety regulations and rules for the prevention of accidents must be observed in all work performed.

1. Unless otherwise specified, the following requirements apply to Rohde & Schwarz products: predefined operating position is always with the housing floor facing down, IP protection 2X, pollution severity 2, overvoltage category 2, use only indoors, max. operating altitude 2000 m above sea level, max. transport altitude 4500 m above sea level. A tolerance of $\pm 10\%$ shall apply to the nominal voltage and $\pm 5\%$ to the nominal frequency.
2. Do not place the product on surfaces, vehicles, cabinets or tables that for reasons of weight or stability are unsuitable for this purpose. Always follow the manufacturer's installation instructions when installing the product and fastening it to objects or structures (e.g. walls and shelves). An installation that is not carried out as described in the product documentation could result in personal injury or death.
3. Do not place the product on heat-generating devices such as radiators or fan heaters. The ambient temperature must not exceed the maximum temperature specified in the product documentation or in the data sheet. Product overheating can cause electric shock, fire and/or serious personal injury or death.

Electrical safety

If the information on electrical safety is not observed either at all to the extent necessary, electric shock, fire and/or serious personal injury or death may occur.

1. Prior to switching on the product, always ensure that the nominal voltage setting on the product matches the nominal voltage of the AC supply network. If a different voltage is to be set, the power fuse of the product may have to be changed accordingly.
2. In the case of products of safety class I with movable power cord and connector, operation is permitted only on sockets with an earthing contact and protective earth connection.
3. Intentionally breaking the protective earth connection either in the feed line or in the product itself is not permitted. Doing so can result in the danger of an electric shock from the product. If extension cords or connector strips are implemented, they must be checked on a regular basis to ensure that they are safe to use.
4. If the product does not have a power switch for disconnection from the AC supply network, the plug of the connecting cable is regarded as the disconnecting device. In such cases, always ensure that the power plug is easily reachable and accessible at all times (corresponding to the length of connecting cable, approx. 2 m). Functional or electronic switches are not suitable for providing disconnection from the AC supply network. If products without power switches are integrated into racks or systems, a disconnecting device must be provided at the system level.
5. Never use the product if the power cable is damaged. Check the power cable on a regular basis to ensure that it is in proper operating condition. By taking appropriate safety measures and carefully laying the power cable, you can ensure that the cable will not be damaged and that no one can be hurt by, for example, tripping over the cable or suffering an electric shock.
6. The product may be operated only from TN/TT supply networks fused with max. 16 A (higher fuse only after consulting with the Rohde & Schwarz group of companies).
7. Do not insert the plug into sockets that are dusty or dirty. Insert the plug firmly and all the way into the socket. Otherwise, sparks that result in fire and/or injuries may occur.
8. Do not overload any sockets, extension cords or connector strips; doing so can cause fire or electric shocks.
9. For measurements in circuits with voltages $V_{\text{rms}} > 30 \text{ V}$, suitable measures (e.g. appropriate measuring equipment, fusing, current limiting, electrical separation, insulation) should be taken to avoid any hazards.
10. Ensure that the connections with information technology equipment, e.g. PCs or other industrial computers, comply with the IEC60950-1/EN60950-1 or IEC61010-1/EN 61010-1 standards that apply in each case.
11. Unless expressly permitted, never remove the cover or any part of the housing while the product is in operation. Doing so will expose circuits and components and can lead to injuries, fire or damage to the product.
12. If a product is to be permanently installed, the connection between the PE terminal on site and the product's PE conductor must be made first before any other connection is made. The product may be installed and connected only by a licensed electrician.
13. For permanently installed equipment without built-in fuses, circuit breakers or similar protective devices, the supply circuit must be fused in such a way that anyone who has access to the product, as well as the product itself, is adequately protected from injury or damage.

Basic Safety Instructions

14. Use suitable overvoltage protection to ensure that no overvoltage (such as that caused by a bolt of lightning) can reach the product. Otherwise, the person operating the product will be exposed to the danger of an electric shock.
15. Any object that is not designed to be placed in the openings of the housing must not be used for this purpose. Doing so can cause short circuits inside the product and/or electric shocks, fire or injuries.
16. Unless specified otherwise, products are not liquid-proof (see also section "Operating states and operating positions", item 1. Therefore, the equipment must be protected against penetration by liquids. If the necessary precautions are not taken, the user may suffer electric shock or the product itself may be damaged, which can also lead to personal injury.
17. Never use the product under conditions in which condensation has formed or can form in or on the product, e.g. if the product has been moved from a cold to a warm environment. Penetration by water increases the risk of electric shock.
18. Prior to cleaning the product, disconnect it completely from the power supply (e.g. AC supply network or battery). Use a soft, non-linting cloth to clean the product. Never use chemical cleaning agents such as alcohol, acetone or diluents for cellulose lacquers.

Operation

1. Operating the products requires special training and intense concentration. Make sure that persons who use the products are physically, mentally and emotionally fit enough to do so; otherwise, injuries or material damage may occur. It is the responsibility of the employer/operator to select suitable personnel for operating the products.
2. Before you move or transport the product, read and observe the section titled "Transport".
3. As with all industrially manufactured goods, the use of substances that induce an allergic reaction (allergens) such as nickel cannot be generally excluded. If you develop an allergic reaction (such as a skin rash, frequent sneezing, red eyes or respiratory difficulties) when using a Rohde & Schwarz product, consult a physician immediately to determine the cause and to prevent health problems or stress.
4. Before you start processing the product mechanically and/or thermally, or before you take it apart, be sure to read and pay special attention to the section titled "Waste disposal", item 1.
5. Depending on the function, certain products such as RF radio equipment can produce an elevated level of electromagnetic radiation. Considering that unborn babies require increased protection, pregnant women must be protected by appropriate measures. Persons with pacemakers may also be exposed to risks from electromagnetic radiation. The employer/operator must evaluate workplaces where there is a special risk of exposure to radiation and, if necessary, take measures to avert the potential danger.
6. Should a fire occur, the product may release hazardous substances (gases, fluids, etc.) that can cause health problems. Therefore, suitable measures must be taken, e.g. protective masks and protective clothing must be worn.
7. If a laser product (e.g. a CD/DVD drive) is integrated into a Rohde & Schwarz product, absolutely no other settings or functions may be used as described in the product documentation. The objective is to prevent personal injury (e.g. due to laser beams).

Repair and service

1. The product may be opened only by authorized, specially trained personnel. Before any work is performed on the product or before the product is opened, it must be disconnected from the AC supply network. Otherwise, personnel will be exposed to the risk of an electric shock.
2. Adjustments, replacement of parts, maintenance and repair may be performed only by electrical experts authorized by Rohde & Schwarz. Only original parts may be used for replacing parts relevant to safety (e.g. power switches, power transformers, fuses). A safety test must always be performed after parts relevant to safety have been replaced (visual inspection, PE conductor test, insulation resistance measurement, leakage current measurement, functional test). This helps ensure the continued safety of the product.

Batteries and rechargeable batteries/cells

If the information regarding batteries and rechargeable batteries/cells is not observed either at all or to the extent necessary, product users may be exposed to the risk of explosions, fire and/or serious personal injury, and, in some cases, death. Batteries and rechargeable batteries with alkaline electrolytes (e.g. lithium cells) must be handled in accordance with the EN 62133 standard.

1. Cells must not be taken apart or crushed.
2. Cells or batteries must not be exposed to heat or fire. Storage in direct sunlight must be avoided. Keep cells and batteries clean and dry. Clean soiled connectors using a dry, clean cloth.
3. Cells or batteries must not be short-circuited. Cells or batteries must not be stored in a box or in a drawer where they can short-circuit each other, or where they can be short-circuited by other conductive materials. Cells and batteries must not be removed from their original packaging until they are ready to be used.
4. Keep cells and batteries out of the hands of children. If a cell or a battery has been swallowed, seek medical aid immediately.
5. Cells and batteries must not be exposed to any mechanical shocks that are stronger than permitted.
6. If a cell develops a leak, the fluid must not be allowed to come into contact with the skin or eyes. If contact occurs, wash the affected area with plenty of water and seek medical aid.
7. Improperly replacing or charging cells or batteries that contain alkaline electrolytes (e.g. lithium cells) can cause explosions. Replace cells or batteries only with the matching Rohde & Schwarz type (see parts list) in order to ensure the safety of the product.
8. Cells and batteries must be recycled and kept separate from residual waste. Rechargeable batteries and normal batteries that contain lead, mercury or cadmium are hazardous waste. Observe the national regulations regarding waste disposal and recycling.

Transport

1. The product may be very heavy. Therefore, the product must be handled with care. In some cases, the user may require a suitable means of lifting or moving the product (e.g. with a lift-truck) to avoid back or other physical injuries.

2. Handles on the products are designed exclusively to enable personnel to transport the product. It is therefore not permissible to use handles to fasten the product to or on transport equipment such as cranes, fork lifts, wagons, etc. The user is responsible for securely fastening the products to or on the means of transport or lifting. Observe the safety regulations of the manufacturer of the means of transport or lifting. Noncompliance can result in personal injury or material damage.
3. If you use the product in a vehicle, it is the sole responsibility of the driver to drive the vehicle safely and properly. The manufacturer assumes no responsibility for accidents or collisions. Never use the product in a moving vehicle if doing so could distract the driver of the vehicle. Adequately secure the product in the vehicle to prevent injuries or other damage in the event of an accident.

Waste disposal

1. If products or their components are mechanically and/or thermally processed in a manner that goes beyond their intended use, hazardous substances (heavy-metal dust such as lead, beryllium, nickel) may be released. For this reason, the product may only be disassembled by specially trained personnel. Improper disassembly may be hazardous to your health. National waste disposal regulations must be observed.
2. If handling the product releases hazardous substances or fuels that must be disposed of in a special way, e.g. coolants or engine oils that must be replenished regularly, the safety instructions of the manufacturer of the hazardous substances or fuels and the applicable regional waste disposal regulations must be observed. Also observe the relevant safety instructions in the product documentation. The improper disposal of hazardous substances or fuels can cause health problems and lead to environmental damage.

Informaciones elementales de seguridad

Es imprescindible leer y observar las siguientes instrucciones e informaciones de seguridad!

El principio del grupo de empresas Rohde & Schwarz consiste en tener nuestros productos siempre al día con los estándares de seguridad y de ofrecer a nuestros clientes el máximo grado de seguridad. Nuestros productos y todos los equipos adicionales son siempre fabricados y examinados según las normas de seguridad vigentes. Nuestro sistema de garantía de calidad controla constantemente que sean cumplidas estas normas. El presente producto ha sido fabricado y examinado según el certificado de conformidad adjunto de la UE y ha salido de nuestra planta en estado impecable según los estándares técnicos de seguridad. Para poder preservar este estado y garantizar un funcionamiento libre de peligros, el usuario deberá atenerse a todas las indicaciones, informaciones de seguridad y notas de alerta. El grupo de empresas Rohde & Schwarz está siempre a su disposición en caso de que tengan preguntas referentes a estas informaciones de seguridad.

Además queda en la responsabilidad del usuario utilizar el producto en la forma debida. Este producto está destinado exclusivamente al uso en la industria y el laboratorio o, si ha sido expresamente autorizado, para aplicaciones de campo y de ninguna manera deberá ser utilizado de modo que alguna persona/cosa pueda sufrir daño. El uso del producto fuera de sus fines definidos o sin tener en cuenta las instrucciones del fabricante queda en la responsabilidad del usuario. El fabricante no se hace en ninguna forma responsable de consecuencias a causa del mal uso del producto.







Informaciones elementales de seguridad

Se parte del uso correcto del producto para los fines definidos si el producto es utilizado conforme a las indicaciones de la correspondiente documentación del producto y dentro del margen de rendimiento definido (ver hoja de datos, documentación, informaciones de seguridad que siguen). El uso del producto hace necesarios conocimientos técnicos y ciertos conocimientos del idioma inglés. Por eso se debe tener en cuenta que el producto solo pueda ser operado por personal especializado o personas instruidas en profundidad con las capacidades correspondientes. Si fuera necesaria indumentaria de seguridad para el uso de productos de Rohde & Schwarz, encontraría la información debida en la documentación del producto en el capítulo correspondiente. Guarde bien las informaciones de seguridad elementales, así como la documentación del producto, y entréguelas a usuarios posteriores.

Tener en cuenta las informaciones de seguridad sirve para evitar en lo posible lesiones o daños por peligros de toda clase. Por eso es imprescindible leer detalladamente y comprender por completo las siguientes informaciones de seguridad antes de usar el producto, y respetarlas durante el uso del producto. Deberán tenerse en cuenta todas las demás informaciones de seguridad, como p. ej. las referentes a la protección de personas, que encontrarán en el capítulo correspondiente de la documentación del producto y que también son de obligado cumplimiento. En las presentes informaciones de seguridad se recogen todos los objetos que distribuye el grupo de empresas Rohde & Schwarz bajo la denominación de "producto", entre ellos también aparatos, instalaciones así como toda clase de accesorios.

Símbolos y definiciones de seguridad

							
Aviso: punto de peligro general Observar la documentación del producto	Atención en el manejo de dispositivos de peso elevado	Peligro de choque eléctrico	Advertencia: superficie caliente	Conexión a conductor de protección	Conexión a tierra	Conexión a masa	Aviso: Cuidado en el manejo de dispositivos sensibles a la electrostática (ESD)

					
Tensión de alimentación de PUESTA EN MARCHA / PARADA	Indicación de estado de espera (Standby)	Corriente continua (DC)	Corriente alterna (AC)	Corriente continua / Corriente alterna (DC/AC)	El aparato está protegido en su totalidad por un aislamiento doble (reforzado)

Palabras de señal y su significado

En la documentación del producto se utilizan las siguientes palabras de señal con el fin de advertir contra riesgos y peligros.



PELIGRO identifica un peligro inminente con riesgo elevado que provocará muerte o lesiones graves si no se evita.



ADVERTENCIA identifica un posible peligro con riesgo medio de provocar muerte o lesiones (graves) si no se evita.



ATENCIÓN identifica un peligro con riesgo reducido de provocar lesiones leves o moderadas si no se evita.



AVISO indica la posibilidad de utilizar mal el producto y, como consecuencia, dañarlo.

En la documentación del producto se emplea de forma sinónima el término CUIDADO.

Las palabras de señal corresponden a la definición habitual para aplicaciones civiles en el área económica europea. Pueden existir definiciones diferentes a esta definición en otras áreas económicas o en aplicaciones militares. Por eso se deberá tener en cuenta que las palabras de señal aquí descritas sean utilizadas siempre solamente en combinación con la correspondiente documentación del producto y solamente en combinación con el producto correspondiente. La utilización de las palabras de señal en combinación con productos o documentaciones que no les correspondan puede llevar a interpretaciones equivocadas y tener por consecuencia daños en personas u objetos.

Estados operativos y posiciones de funcionamiento

El producto solamente debe ser utilizado según lo indicado por el fabricante respecto a los estados operativos y posiciones de funcionamiento sin que se obstruya la ventilación. Si no se siguen las indicaciones del fabricante, pueden producirse choques eléctricos, incendios y/o lesiones graves con posible consecuencia de muerte. En todos los trabajos deberán ser tenidas en cuenta las normas nacionales y locales de seguridad del trabajo y de prevención de accidentes.

1. Si no se convino de otra manera, es para los productos Rohde & Schwarz válido lo que sigue: como posición de funcionamiento se define por principio la posición con el suelo de la caja para abajo, modo de protección IP 2X, grado de suciedad 2, categoría de sobrecarga eléctrica 2, uso solamente en estancias interiores, utilización hasta 2000 m sobre el nivel del mar, transporte hasta 4500 m sobre el nivel del mar. Se aplicará una tolerancia de $\pm 10\%$ sobre el voltaje nominal y de $\pm 5\%$ sobre la frecuencia nominal.
2. No sitúe el producto encima de superficies, vehículos, estantes o mesas, que por sus características de peso o de estabilidad no sean aptos para él. Siga siempre las instrucciones de instalación del fabricante cuando instale y asegure el producto en objetos o estructuras (p. ej. paredes y estantes). Si se realiza la instalación de modo distinto al indicado en la documentación del producto, pueden causarse lesiones o incluso la muerte.
3. No ponga el producto sobre aparatos que generen calor (p. ej. radiadores o calefactores). La temperatura ambiente no debe superar la temperatura máxima especificada en la documentación del producto o en la hoja de datos. En caso de sobrecalentamiento del producto, pueden producirse choques eléctricos, incendios y/o lesiones graves con posible consecuencia de muerte.

Seguridad eléctrica

Si no se siguen (o se siguen de modo insuficiente) las indicaciones del fabricante en cuanto a seguridad eléctrica, pueden producirse choques eléctricos, incendios y/o lesiones graves con posible consecuencia de muerte.

1. Antes de la puesta en marcha del producto se deberá comprobar siempre que la tensión preseleccionada en el producto coincida con la de la red de alimentación eléctrica. Si es necesario modificar el ajuste de tensión, también se deberán cambiar en caso dado los fusibles correspondientes del producto.
2. Los productos de la clase de protección I con alimentación móvil y enchufe individual solamente podrán enchufarse a tomas de corriente con contacto de seguridad y con conductor de protección conectado.
3. Queda prohibida la interrupción intencionada del conductor de protección, tanto en la toma de corriente como en el mismo producto. La interrupción puede tener como consecuencia el riesgo de que el producto sea fuente de choques eléctricos. Si se utilizan cables alargadores o regletas de enchufe, deberá garantizarse la realización de un examen regular de los mismos en cuanto a su estado técnico de seguridad.
4. Si el producto no está equipado con un interruptor para desconectarlo de la red, se deberá considerar el enchufe del cable de conexión como interruptor. En estos casos se deberá asegurar que el enchufe siempre sea de fácil acceso (de acuerdo con la longitud del cable de conexión, aproximadamente 2 m). Los interruptores de función o electrónicos no son aptos para el corte de la red eléctrica. Si los productos sin interruptor están integrados en bastidores o instalaciones, se deberá colocar el interruptor en el nivel de la instalación.
5. No utilice nunca el producto si está dañado el cable de conexión a red. Compruebe regularmente el correcto estado de los cables de conexión a red. Asegúrese, mediante las medidas de protección y de instalación adecuadas, de que el cable de conexión a red no pueda ser dañado o de que nadie pueda ser dañado por él, p. ej. al tropezar o por un choque eléctrico.
6. Solamente está permitido el funcionamiento en redes de alimentación TN/TT aseguradas con fusibles de 16 A como máximo (utilización de fusibles de mayor amperaje solo previa consulta con el grupo de empresas Rohde & Schwarz).
7. Nunca conecte el enchufe en tomas de corriente sucias o llenas de polvo. Introduzca el enchufe por completo y fuertemente en la toma de corriente. La no observación de estas medidas puede provocar chispas, fuego y/o lesiones.
8. No sobrecargue las tomas de corriente, los cables alargadores o las regletas de enchufe ya que esto podría causar fuego o choques eléctricos.
9. En las mediciones en circuitos de corriente con una tensión $U_{\text{eff}} > 30 \text{ V}$ se deberán tomar las medidas apropiadas para impedir cualquier peligro (p. ej. medios de medición adecuados, seguros, limitación de tensión, corte protector, aislamiento etc.).
10. Para la conexión con dispositivos informáticos como un PC o un ordenador industrial, debe comprobarse que éstos cumplan los estándares IEC60950-1/EN60950-1 o IEC61010-1/EN 61010-1 válidos en cada caso.
11. A menos que esté permitido expresamente, no retire nunca la tapa ni componentes de la carcasa mientras el producto esté en servicio. Esto pone a descubierto los cables y componentes eléctricos y puede causar lesiones, fuego o daños en el producto.

12. Si un producto se instala en un lugar fijo, se deberá primero conectar el conductor de protección fijo con el conductor de protección del producto antes de hacer cualquier otra conexión. La instalación y la conexión deberán ser efectuadas por un electricista especializado.
13. En el caso de dispositivos fijos que no estén provistos de fusibles, interruptor automático ni otros mecanismos de seguridad similares, el circuito de alimentación debe estar protegido de modo que todas las personas que puedan acceder al producto, así como el producto mismo, estén a salvo de posibles daños.
14. Todo producto debe estar protegido contra sobretensión (debida p. ej. a una caída del rayo) mediante los correspondientes sistemas de protección. Si no, el personal que lo utilice quedará expuesto al peligro de choque eléctrico.
15. No debe introducirse en los orificios de la caja del aparato ningún objeto que no esté destinado a ello. Esto puede producir cortocircuitos en el producto y/o puede causar choques eléctricos, fuego o lesiones.
16. Salvo indicación contraria, los productos no están impermeabilizados (ver también el capítulo "Estados operativos y posiciones de funcionamiento", punto 1). Por eso es necesario tomar las medidas necesarias para evitar la entrada de líquidos. En caso contrario, existe peligro de choque eléctrico para el usuario o de daños en el producto, que también pueden redundar en peligro para las personas.
17. No utilice el producto en condiciones en las que pueda producirse o ya se hayan producido condensaciones sobre el producto o en el interior de éste, como p. ej. al desplazarlo de un lugar frío a otro caliente. La entrada de agua aumenta el riesgo de choque eléctrico.
18. Antes de la limpieza, desconecte por completo el producto de la alimentación de tensión (p. ej. red de alimentación o batería). Realice la limpieza de los aparatos con un paño suave, que no se deshilache. No utilice bajo ningún concepto productos de limpieza químicos como alcohol, acetona o diluyentes para lacas nitrocelulósicas.

Funcionamiento

1. El uso del producto requiere instrucciones especiales y una alta concentración durante el manejo. Debe asegurarse que las personas que manejen el producto estén a la altura de los requerimientos necesarios en cuanto a aptitudes físicas, psíquicas y emocionales, ya que de otra manera no se pueden excluir lesiones o daños de objetos. El empresario u operador es responsable de seleccionar el personal usuario apto para el manejo del producto.
2. Antes de desplazar o transportar el producto, lea y tenga en cuenta el capítulo "Transporte".
3. Como con todo producto de fabricación industrial no puede quedar excluida en general la posibilidad de que se produzcan alergias provocadas por algunos materiales empleados, los llamados alérgenos (p. ej. el níquel). Si durante el manejo de productos Rohde & Schwarz se producen reacciones alérgicas, como p. ej. irritaciones cutáneas, estornudos continuos, enrojecimiento de la conjuntiva o dificultades respiratorias, debe avisarse inmediatamente a un médico para investigar las causas y evitar cualquier molestia o daño a la salud.
4. Antes de la manipulación mecánica y/o térmica o el desmontaje del producto, debe tenerse en cuenta imprescindiblemente el capítulo "Eliminación", punto 1.

5. Ciertos productos, como p. ej. las instalaciones de radiocomunicación RF, pueden a causa de su función natural, emitir una radiación electromagnética aumentada. Deben tomarse todas las medidas necesarias para la protección de las mujeres embarazadas. También las personas con marcapasos pueden correr peligro a causa de la radiación electromagnética. El empresario/operador tiene la obligación de evaluar y señalar las áreas de trabajo en las que exista un riesgo elevado de exposición a radiaciones.
6. Tenga en cuenta que en caso de incendio pueden desprenderse del producto sustancias tóxicas (gases, líquidos etc.) que pueden generar daños a la salud. Por eso, en caso de incendio deben usarse medidas adecuadas, como p. ej. máscaras antigás e indumentaria de protección.
7. En caso de que un producto Rohde & Schwarz contenga un producto láser (p. ej. un lector de CD/DVD), no debe usarse ninguna otra configuración o función aparte de las descritas en la documentación del producto, a fin de evitar lesiones (p. ej. debidas a irradiación láser).

Reparación y mantenimiento

1. El producto solamente debe ser abierto por personal especializado con autorización para ello. Antes de manipular el producto o abrirlo, es obligatorio desconectarlo de la tensión de alimentación, para evitar toda posibilidad de choque eléctrico.
2. El ajuste, el cambio de partes, el mantenimiento y la reparación deberán ser efectuadas solamente por electricistas autorizados por Rohde & Schwarz. Si se reponen partes con importancia para los aspectos de seguridad (p. ej. el enchufe, los transformadores o los fusibles), solamente podrán ser sustituidos por partes originales. Después de cada cambio de partes relevantes para la seguridad deberá realizarse un control de seguridad (control a primera vista, control del conductor de protección, medición de resistencia de aislamiento, medición de la corriente de fuga, control de funcionamiento). Con esto queda garantizada la seguridad del producto.

Baterías y acumuladores o celdas

Si no se siguen (o se siguen de modo insuficiente) las indicaciones en cuanto a las baterías y acumuladores o celdas, pueden producirse explosiones, incendios y/o lesiones graves con posible consecuencia de muerte. El manejo de baterías y acumuladores con electrolitos alcalinos (p. ej. celdas de litio) debe seguir el estándar EN 62133.

1. No deben desmontarse, abrirse ni triturarse las celdas.
2. Las celdas o baterías no deben someterse a calor ni fuego. Debe evitarse el almacenamiento a la luz directa del sol. Las celdas y baterías deben mantenerse limpias y secas. Limpiar las conexiones sucias con un paño seco y limpio.
3. Las celdas o baterías no deben cortocircuitarse. Es peligroso almacenar las celdas o baterías en estuches o cajones en cuyo interior puedan cortocircuitarse por contacto recíproco o por contacto con otros materiales conductores. No deben extraerse las celdas o baterías de sus embalajes originales hasta el momento en que vayan a utilizarse.
4. Mantener baterías y celdas fuera del alcance de los niños. En caso de ingestión de una celda o batería, avisar inmediatamente a un médico.
5. Las celdas o baterías no deben someterse a impactos mecánicos fuertes indebidos.

6. En caso de falta de estanqueidad de una celda, el líquido vertido no debe entrar en contacto con la piel ni los ojos. Si se produce contacto, lavar con agua abundante la zona afectada y avisar a un médico.
7. En caso de cambio o recarga inadecuados, las celdas o baterías que contienen electrolitos alcalinos (p. ej. las celdas de litio) pueden explotar. Para garantizar la seguridad del producto, las celdas o baterías solo deben ser sustituidas por el tipo Rohde & Schwarz correspondiente (ver lista de recambios).
8. Las baterías y celdas deben reciclarse y no deben tirarse a la basura doméstica. Las baterías o acumuladores que contienen plomo, mercurio o cadmio deben tratarse como residuos especiales. Respete en esta relación las normas nacionales de eliminación y reciclaje.

Transporte

1. El producto puede tener un peso elevado. Por eso es necesario desplazarlo o transportarlo con precaución y, si es necesario, usando un sistema de elevación adecuado (p. ej. una carretilla elevadora), a fin de evitar lesiones en la espalda u otros daños personales.
2. Las asas instaladas en los productos sirven solamente de ayuda para el transporte del producto por personas. Por eso no está permitido utilizar las asas para la sujeción en o sobre medios de transporte como p. ej. grúas, carretillas elevadoras de horquilla, carros etc. Es responsabilidad suya fijar los productos de manera segura a los medios de transporte o elevación. Para evitar daños personales o daños en el producto, siga las instrucciones de seguridad del fabricante del medio de transporte o elevación utilizado.
3. Si se utiliza el producto dentro de un vehículo, recae de manera exclusiva en el conductor la responsabilidad de conducir el vehículo de manera segura y adecuada. El fabricante no asumirá ninguna responsabilidad por accidentes o colisiones. No utilice nunca el producto dentro de un vehículo en movimiento si esto pudiera distraer al conductor. Asegure el producto dentro del vehículo debidamente para evitar, en caso de un accidente, lesiones u otra clase de daños.

Eliminación

1. Si se trabaja de manera mecánica y/o térmica cualquier producto o componente más allá del funcionamiento previsto, pueden liberarse sustancias peligrosas (polveros con contenido de metales pesados como p. ej. plomo, berilio o níquel). Por eso el producto solo debe ser desmontado por personal especializado con formación adecuada. Un desmontaje inadecuado puede ocasionar daños para la salud. Se deben tener en cuenta las directivas nacionales referentes a la eliminación de residuos.
2. En caso de que durante el trato del producto se formen sustancias peligrosas o combustibles que deban tratarse como residuos especiales (p. ej. refrigerantes o aceites de motor con intervalos de cambio definidos), deben tenerse en cuenta las indicaciones de seguridad del fabricante de dichas sustancias y las normas regionales de eliminación de residuos. Tenga en cuenta también en caso necesario las indicaciones de seguridad especiales contenidas en la documentación del producto. La eliminación incorrecta de sustancias peligrosas o combustibles puede causar daños a la salud o daños al medio ambiente.

Kundeninformation zur Batterieverordnung (BattV)

Dieses Gerät enthält eine schadstoffhaltige Batterie. Diese darf nicht mit dem Hausmüll entsorgt werden.

Nach Ende der Lebensdauer darf die Entsorgung nur über eine Rohde&Schwarz-Kundendienststelle oder eine geeignete Sammelstelle erfolgen.

Safety Regulations for Batteries (according to BattV)

This equipment houses a battery containing harmful substances that must not be disposed of as normal household waste.

After its useful life, the battery may only be disposed of at a Rohde & Schwarz service center or at a suitable depot.

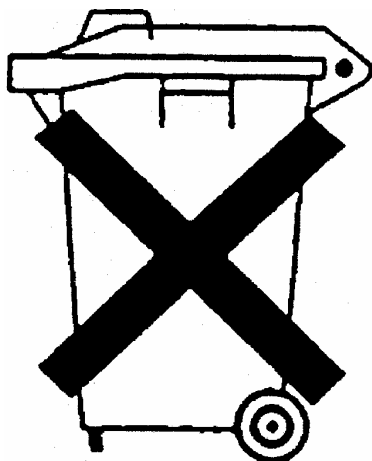

Normas de Seguridad para Baterías (Según BattV)

Este equipo lleva una batería que contiene sustancias perjudiciales, que no se debe desechar en los contenedores de basura domésticos.

Después de la vida útil, la batería sólo se podrá eliminar en un centro de servicio de Rohde & Schwarz o en un depósito apropiado.

Consignes de sécurité pour batteries (selon BattV)

Cet appareil est équipé d'une pile comprenant des substances nocives. Ne jamais la jeter dans une poubelle pour ordures ménagères.

Une pile usagée doit uniquement être éliminée par un centre de service client de Rohde & Schwarz ou peut être collectée pour être traitée spécialement comme déchets dangereux.

Customer Information Regarding Product Disposal

The German Electrical and Electronic Equipment (ElektroG) Act is an implementation of the following EC directives:

- 2002/96/EC on waste electrical and electronic equipment (WEEE) and
- 2002/95/EC on the restriction of the use of certain hazardous substances in electrical and electronic equipment (RoHS).

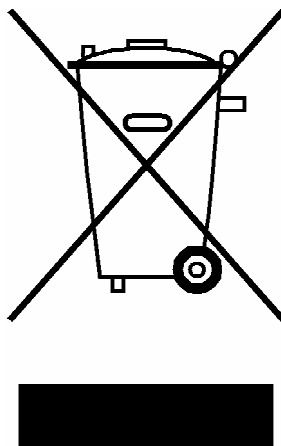

Product labeling in accordance with EN 50419

Once the lifetime of a product has ended, this product must not be disposed of in the standard domestic refuse. Even disposal via the municipal collection points for waste electrical and electronic equipment is not permitted.

Rohde & Schwarz GmbH & Co. KG has developed a disposal concept for the environmental-friendly disposal or recycling of waste material and fully assumes its obligation as a producer to take back and dispose of electrical and electronic waste in accordance with the ElektroG Act.

Please contact your local service representative to dispose of the product.



Qualitätszertifikat

Certificate of quality

Certificat de qualité

Certified Quality System
ISO 9001

Certified Environmental System
ISO 14001

Sehr geehrter Kunde,

Sie haben sich für den Kauf eines Rohde&Schwarz-Produktes entschieden. Hiermit erhalten Sie ein nach modernsten Fertigungsmethoden hergestelltes Produkt. Es wurde nach den Regeln unseres Qualitätsmanagementsystems entwickelt, gefertigt und geprüft. Das Rohde&Schwarz-Qualitätsmanagementsystem ist u.a. nach ISO9001 und ISO14001 zertifiziert.

Der Umwelt verpflichtet

- ▮ Energie-effiziente, RoHS-konforme Produkte
- ▮ Kontinuierliche Weiterentwicklung nachhaltiger Umweltkonzepte
- ▮ ISO 14001-zertifiziertes Umweltmanagementsystem

Dear Customer,

You have decided to buy a Rohde&Schwarz product. You are thus assured of receiving a product that is manufactured using the most modern methods available. This product was developed, manufactured and tested in compliance with our quality management system standards. The Rohde&Schwarz quality management system is certified according to standards such as ISO9001 and ISO14001.

Environmental commitment

- ▮ Energy-efficient products
- ▮ Continuous improvement in environmental sustainability
- ▮ ISO 14001-certified environmental management system

Cher client,

Vous avez choisi d'acheter un produit Rohde&Schwarz. Vous disposez donc d'un produit fabriqué d'après les méthodes les plus avancées. Le développement, la fabrication et les tests respectent nos normes de gestion qualité. Le système de gestion qualité de Rohde&Schwarz a été homologué, entre autres, conformément aux normes ISO9001 et ISO14001.

Engagement écologique

- ▮ Produits à efficience énergétique
- ▮ Amélioration continue de la durabilité environnementale
- ▮ Système de gestion de l'environnement certifié selon ISO 14001



ROHDE & SCHWARZ

www.valuetronics.com



ROHDE & SCHWARZ

CE Declaration of Conformity



Certificate No.: 2009-4

This is to certify that:

Equipment type	Stock No.	Designation
SMU200A	1141.2005.02	Vector Signal Generator

complies with the provisions of the Directive of the Council of the European Union on the approximation of the laws of the Member States

- relating to electrical equipment for use within defined voltage limits (2006/95/EC)
- relating to electromagnetic compatibility (2004/108/EC)

Conformity is proven by compliance with the following standards:

EN 61010-1: 2001
EN 61326-1: 2006
EN 61326-2-1: 2006
EN 55011: 2007 + A2: 2007
EN 61000-3-2: 2006
EN 61000-3-3: 1995 + A1: 2001 + A2: 2005

For the assessment of electromagnetic compatibility, the limits of radio interference for Class A equipment as well as the immunity to interference for operation in industry have been used as a basis.

ROHDE & SCHWARZ GmbH & Co. KG
Mühldorfstr. 15, D-81671 München

Munich, 2010-02-05

Central Quality Management MF-QZ / Radde

CE

E-1

Customer Support

Technical support – where and when you need it

For quick, expert help with any Rohde & Schwarz equipment, contact one of our Customer Support Centers. A team of highly qualified engineers provides telephone support and will work with you to find a solution to your query on any aspect of the operation, programming or applications of Rohde & Schwarz equipment.

Up-to-date information and upgrades

To keep your instrument up-to-date and to be informed about new application notes related to your instrument, please send an e-mail to the Customer Support Center stating your instrument and your wish. We will take care that you will get the right information.

Europe, Africa, Middle East

Phone +49 89 4129 12345
customersupport@rohde-schwarz.com

North America

Phone 1-888-TEST-RSA (1-888-837-8772)
customer.support@rsa.rohde-schwarz.com

Latin America

Phone +1-410-910-7988
customersupport.la@rohde-schwarz.com

Asia/Pacific

Phone +65 65 13 04 88
customersupport.asia@rohde-schwarz.com



Contents

1	Preparing for Use.....	15
1.1	Front Panel Tour.....	15
1.1.1	Utility Keys.....	16
1.1.2	Standby LEDs and Standby Key.....	16
1.1.3	Display.....	17
1.1.4	Setup Keys.....	17
1.1.4.1	Keys for Setting Paramters.....	17
1.1.4.2	Display Keys.....	18
1.1.5	Keypad for data entry.....	19
1.1.6	Rotary Knob and Navigation Keys.....	20
1.1.7	Front Panel Connectors.....	21
1.2	Rear Panel Tour.....	23
1.2.1	Description of the Connectors.....	23
1.3	Putting into Operation.....	27
1.3.1	Unpacking and Checking the Instrument.....	29
1.3.2	Placing or Mounting the Instrument.....	29
1.3.3	Connecting the Instrument to the AC Supply.....	30
1.3.4	Starting the Instrument.....	30
1.3.4.1	Standby and Ready state.....	31
1.3.4.2	Start Display and Booting.....	31
1.3.4.3	Function Check.....	32
1.3.4.4	Default Settings.....	32
1.3.5	Shutting Down the Instrument.....	34
1.4	Connecting External Accessories.....	34
1.4.1	Connecting USB Devices.....	35
1.4.2	Connecting a Monitor.....	36
1.5	Windows Operating System.....	36
1.5.1	Virus Protection.....	37
1.5.2	Service Packs and Updates.....	37
1.5.3	Login.....	38
1.5.4	Accessing the Start Menu.....	38

1.6	Setting Up a Network (LAN) Connection.....	38
1.6.1	Connecting the Instrument to the Network.....	39
1.6.2	Assigning the IP Address.....	40
1.6.3	Using computer names.....	41
1.6.4	Changing the Windows Firewall Settings.....	41
1.6.5	Working with Directories.....	42
1.7	Remote Access via an External Controller.....	42
1.7.1	Using a Web Browser for Remote Access.....	44
1.7.2	Remote Desktop Connection.....	45
1.7.3	Remote Access via Ultr@VNC.....	47
1.8	Using Virus-Protection Software.....	53
1.9	LXI Configuration.....	54
1.9.1	LXI Browser Interface.....	56
1.9.2	LAN Configuration.....	57
1.9.2.1	Advanced LAN Configuration.....	58
1.9.2.2	Ping.....	59
2	Getting Started.....	61
2.1	Brief Introduction to the Instrument's Concept.....	61
2.2	Applications of the Instrument.....	63
2.2.1	Generation of digitally modulated signal.....	63
2.2.2	Two Baseband Generators, One RF Path.....	65
2.2.3	One Baseband Path and Two RF Paths.....	66
2.2.4	Fully Equipped Two-Path Instrument.....	67
2.3	Baseband Section.....	67
2.3.1	Description of Individual Diagram Blocks of the Baseband Section.....	69
2.4	RF Section.....	71
2.4.1	Description of Individual Diagram Blocks of the RF Section.....	71
2.5	Example of Setup.....	73
3	Manual Operation.....	81
3.1	Key Features.....	81
3.2	Display.....	85
3.2.1	Settings Displayed in the Header Section.....	86
3.2.2	Status Information and Messages.....	87

3.2.2.1	Status Information.....	87
3.2.2.2	Messages.....	87
3.2.2.3	Volatile messages.....	87
3.2.2.4	Permanent Messages.....	88
3.2.3	Info Window.....	88
3.2.4	Block Diagram	89
3.2.4.1	Function Blocks in the Block Diagram.....	89
3.2.4.2	Signal Flow and Input/Output Symbols in the Block Diagram.....	90
3.2.5	Winbar and Softkeys.....	91
3.2.6	Structure of the Dialogs.....	91
3.2.7	Graphical Display of Output Signal Characteristics.....	92
3.3	Accessing Dialogs.....	93
3.4	Setting Parameters.....	94
3.4.1	Working with the Cursor.....	95
3.4.2	Selecting a Control Element.....	96
3.4.3	Switching Parameters On/Off.....	96
3.4.4	Entering a Value.....	96
3.4.5	Working with Units	98
3.4.6	Selecting a Value from a List.....	99
3.4.7	Terminating Entries with Confirmation.....	99
3.4.8	Restoring the Previous Value.....	100
3.5	Editors.....	101
3.5.1	Working with List Editor.....	101
3.5.2	Working with Data Editor.....	103
3.5.3	Working with Control and Marker List Editor.....	104
3.6	How to Use the Help System.....	108
3.7	File Management.....	110
3.7.1	File Select Dialog.....	111
3.7.2	File Manager.....	113
3.7.2.1	Extensions for User Files.....	114
3.8	Legend of Front-Panel Controls.....	116
3.8.1	Front Panel Key Emulation.....	118
3.8.2	On-screen Keyboard.....	118

4 Instrument Function.....	121
4.1 Overview of Instrument Functions.....	121
4.2 General Instrument Settings.....	124
4.2.1 Overview of General Instrument Settings.....	124
4.2.2 Default Instrument Settings - Preset Key.....	124
4.2.3 General Configuration of Instrument - Setup Key.....	125
4.2.3.1 Internal Adjustments.....	126
4.2.3.2 Hardware Config.....	128
4.2.3.3 Software / Options.....	129
4.2.3.4 Manage License Keys.....	131
4.2.3.5 Gui Update.....	132
4.2.3.6 NRP-Z Info/Update.....	133
4.2.3.7 Update.....	134
4.2.3.8 Selftest.....	134
4.2.3.9 Check Front Panel.....	136
4.2.3.10 Global Trigger/Clock/External Input Settings.....	136
4.2.3.11 Display/Keyboard Settings.....	138
4.2.3.12 User Marker / AUX I/O Settings.....	139
4.2.3.13 Remote Channel Settings.....	143
4.2.3.14 LXI Status.....	143
4.2.3.15 Protection.....	145
4.2.3.16 Security.....	145
4.2.3.17 Save/Recall.....	147
4.2.3.18 Factory Preset.....	148
4.2.3.19 Help.....	148
4.2.4 Switching to Manual Control - Local Key.....	148
4.2.5 Generating a Hard Copy of the Display.....	149
4.2.5.1 Hardcopy Dialog.....	150
4.2.5.2 Hardcopy Options.....	150
4.2.6 Messages - Info Key.....	153
4.2.7 Help System - Help Key.....	153
4.2.8 Storing and Loading Instrument Data - File Key.....	155
4.2.8.1 File Menu.....	156

4.2.8.2	Storing Instrument Settings.....	156
4.2.8.3	Loading Instrument Settings.....	158
4.2.8.4	File Manager.....	159
4.3	Graphical Display - Graphics.....	161
4.3.1	Graphics Settings Menu.....	162
4.3.2	Bar of Graphics Window.....	164
4.3.3	Signal Displays.....	166
4.3.3.1	I/Q Diagram.....	166
4.3.3.2	Vector Diagram.....	167
4.3.3.3	Constellation Diagram.....	168
4.3.3.4	Eye Diagram.....	169
4.3.3.5	CCDF Display.....	170
4.3.3.6	Power Spectrum.....	171
4.4	Bit and Block Error Rate Measurements - BERT Block.....	172
4.4.1	Test setup.....	173
4.4.2	PRBS data.....	174
4.4.3	CRC polynomial.....	174
4.4.4	Clock signal.....	174
4.4.5	Ending the measurement.....	175
4.4.6	Interrupt-free measurement.....	175
4.4.7	Restart function.....	175
4.4.8	Data Enable.....	176
4.4.9	Pattern Ignore.....	177
4.4.10	Bit Error Rate Menu.....	177
4.4.10.1	General Settings.....	178
4.4.10.2	Configuration.....	181
4.4.11	Block Error Rate Menu.....	186
4.4.11.1	General Settings.....	187
4.4.11.2	Configuration.....	189
4.5	RF Signal and Analog Modulations - RF Block.....	192
4.5.1	Overview of RF Signal.....	192
4.5.1.1	RF Output.....	192
4.5.1.2	Overview of the RF Signal Settings.....	193

4.5.2	RF Frequency Settings.....	194
4.5.2.1	RF frequency vs. RF output frequency.....	194
4.5.2.2	Configuring RF frequency.....	195
4.5.2.3	Frequency Menu.....	195
4.5.3	Phase Settings.....	197
4.5.3.1	Phase Menu.....	197
4.5.3.2	Phase Continuous Frequency Setting.....	198
4.5.4	Reference Oscillator.....	203
4.5.4.1	Reference Oscillator Dialog.....	203
4.5.5	Local Oscillator - LO Coupling.....	205
4.5.5.1	Phase Coherence.....	205
4.5.5.2	Typical Applications.....	206
4.5.5.3	LO Coupling Menu.....	207
4.5.6	NRP-Z Power Viewer.....	209
4.5.6.1	NRP-Z Power Viewer Settings.....	210
4.5.7	RF Level/EMF.....	215
4.5.7.1	Overview RF Level Settings.....	215
4.5.7.2	RF Level.....	217
4.5.7.3	Power-On/EMF Settings.....	220
4.5.8	Automatic Level Control - ALC.....	221
4.5.8.1	Automatic Level Control Settings.....	222
4.5.9	User Correction.....	223
4.5.9.1	User Correction Menu.....	224
4.5.9.2	Filling the Correction List automatically.....	229
4.5.9.3	Filling the Correction List with Power Sensor Measurement Data.....	230
4.5.10	Reverse Power Protection.....	232
4.5.11	Analog Modulations.....	233
4.5.11.1	Overview.....	233
4.5.11.2	Amplitude Modulation (AM).....	234
4.5.11.3	Broadband Amplitude Modulation (BB-AM).....	237
4.5.11.4	Frequency Modulation (FM).....	238
4.5.11.5	Phase Modulation (PhiM).....	241
4.5.11.6	Pulse Modulation (PM).....	244

4.5.12	LF Generator and LF Output - Mod Gen.....	246
4.5.12.1	LF Generator Overview.....	246
4.5.12.2	LF Output.....	246
4.5.13	Sweep Mode.....	247
4.5.13.1	Overview.....	247
4.5.13.2	RF Frequency Sweep.....	248
4.5.13.3	RF Level Sweep.....	255
4.5.13.4	LF Frequency Sweep.....	262
4.5.14	List Mode.....	268
4.5.14.1	List Mode Dialog.....	268
4.5.14.2	Filling the List Mode Data automatically.....	275
4.6	I/Q Modulation - I/Q Mod Block.....	277
4.6.1	I/Q Modulator.....	278
4.6.2	I/Q Settings	279
4.6.2.1	General I/Q Mod Settings.....	280
4.6.2.2	Impairments.....	280
4.6.2.3	I/Q Swap and I/Q Wideband.....	287
4.6.2.4	Analog Wideband I/Q Input.....	288
4.7	Impairment of Digital I/Q Signal and Noise Generator - AWGN/IMP Block.....	290
4.7.1	Impairments.....	291
4.7.1.1	Impairment Settings Menu.....	291
4.7.2	AWGN - Noise Generator.....	302
4.7.2.1	AWGN Settings Dialog.....	303
4.7.3	Output of the Baseband Signal - I/Q Out.....	310
4.7.3.1	I/Q Out Settings Menu.....	310
4.7.3.2	Analog I/Q Output.....	311
4.7.3.3	Digital I/Q Output Settings.....	315
4.7.4	I/Q Level - Info.....	319
4.7.4.1	Baseband Signal Level.....	320
4.7.4.2	Baseband Signal Level Measurement.....	321
4.8	Baseband Signal - Baseband Block.....	323
4.8.1	Working with the Baseband Signal.....	324
4.8.2	Data and Signal Sources in Baseband.....	331

4.8.2.1	Internal PRBS Data and Data Patterns.....	332
4.8.2.2	Internal Modulation Data from Lists.....	332
4.8.2.3	External Synchronous Modulation Data.....	333
4.8.2.4	Clock Signals.....	334
4.8.2.5	Synchronizing Data Signals and Clock Signals.....	335
4.8.2.6	Control Signals.....	338
4.8.2.7	Trigger Signals.....	340
4.8.2.8	Marker Output Signals.....	341
4.8.3	Digital Modulation - Custom Digital Modulation.....	341
4.8.3.1	Overview and Required Options.....	342
4.8.3.2	Modulation Types - Custom Digital Mod.....	342
4.8.3.3	Coding - Custom Digital Mod.....	346
4.8.3.4	Baseband Filter - Custom Digital Mod.....	349
4.8.3.5	Conflicting Settings - Custom Digital Mod.....	353
4.8.3.6	Custom Digital Mod User Interface.....	353
4.8.4	Arbitrary Waveform Generator ARB.....	383
4.8.4.1	ARB User Interface.....	386
4.8.4.2	Multi Segment Waveforms.....	408
4.8.4.3	Multi Carrier Waveforms.....	419
4.8.5	Multi Carrier Continuous Wave.....	431
4.8.5.1	Multi Carrier CW User Interface.....	431
4.9	External Baseband Signal - Baseband Input.....	445
4.9.1	BB Input Block.....	446
4.9.1.1	Baseband Input Settings Menu.....	447
4.9.1.2	Signal Routing and Frequency Shifting.....	453
5	Remote Control Basics.....	457
5.1	Remote Control Interfaces and Protocols.....	457
5.1.1	VISA Libraries.....	458
5.1.2	Messages.....	458
5.1.3	LAN Interface.....	459
5.1.3.1	VXI-11 Protocol.....	460
5.1.3.2	Socket Communication.....	460
5.1.3.3	LAN Interface Messages.....	460

5.1.4	GPIB Interface (IEC/IEEE Bus Interface).....	461
5.1.4.1	GPIB Interface Messages.....	461
5.1.4.2	GPIB Instrument Address.....	462
5.2	Starting a Remote Control Session.....	463
5.2.1	Switching to Remote Control.....	463
5.2.2	Returning to Manual Operation.....	464
5.2.3	Examples.....	465
5.2.3.1	Remote Control over GPIB.....	465
5.2.3.2	Remote Control over LAN using VXI-11 Protocol.....	466
5.2.3.3	Remote Control over LAN using Socket Communication.....	469
5.3	SCPI Command Structure.....	476
5.3.1	Syntax for Common Commands.....	476
5.3.2	Syntax for Device-Specific Commands.....	477
5.3.3	SCPI Parameters.....	479
5.3.4	Overview of Syntax Elements.....	482
5.3.5	Structure of a command line.....	482
5.3.6	Responses to Queries.....	483
5.4	Command Sequence and Synchronization.....	484
5.4.1	Preventing Overlapping Execution.....	485
5.5	Status Reporting System.....	487
5.5.1	Hierarchy of status registers.....	487
5.5.2	Structure of a SCPI Status Register.....	489
5.5.3	Contents of the Status Registers.....	490
5.5.3.1	Status Byte (STB) and Service Request Enable Register (SRE).....	490
5.5.3.2	IST Flag and Parallel Poll Enable Register (PPE).....	491
5.5.4	Event Status Register (ESR) and Event Status Enable Register (ESE).....	491
5.5.5	Application of the Status Reporting System.....	492
5.5.5.1	Service Request.....	493
5.5.5.2	Serial Poll.....	493
5.5.5.3	Parallel Poll.....	493
5.5.5.4	Query of an instrument status.....	494
5.5.5.5	Error Queue.....	494
5.5.6	Reset Values of the Status Reporting System.....	494

5.6	General Programming Recommendations	495
6	Remote Control Commands	497
6.1	Common Commands	497
6.2	Preset Commands	501
6.3	R&S Signal Generator Waveform and List Format	503
6.3.1	Tag Description.....	504
6.3.2	Creating a Waveform Manually.....	515
6.3.3	Creating an ASCII C-List Manually.....	519
6.4	BERT and BLER Subsystems	520
6.5	CALibration Subsystem	530
6.6	CLOCK Subsystem	533
6.7	DIAGnostic Subsystem	534
6.8	DISPlay Subsystem	536
6.9	FORMat Subsystem	537
6.10	HCOPY Subsystem	538
6.11	KBOard Subsystem	546
6.12	MMEMory Subsystem	547
6.12.1	File Naming Conventions.....	548
6.12.2	Extensions for User Files.....	548
6.12.3	Examples.....	551
6.12.4	Remote Control Commands.....	552
6.13	OUTPut Subsystem	557
6.14	SENSe, READ and INITiate Subsystems	562
6.15	SOURce Subsystem	570
6.15.1	SOURce:AM Subsystem.....	571
6.15.2	SOURce:AWGN Subsystem.....	574
6.15.3	SOURce:BB Subsystem.....	583
6.15.3.1	SOURce:BB Subsystem General Commands.....	583
6.15.3.2	SOURce:BB:ARB Subsystem.....	585
6.15.3.3	SOURce:BB:DM Subsystem.....	629
6.15.3.4	SOURce:BB:GRAPhics Subsystem.....	665
6.15.3.5	SOURce:BB:IMPairment Subsystem.....	667
6.15.3.6	SOURce:BB:MCCW Subsystem.....	676

6.15.3.7	SOURce:BB:MEASurement Subsystem.....	695
6.15.3.8	SOURce:BB:POWer Subsystem.....	698
6.15.4	SOURce:BBIN Subsystem.....	699
6.15.5	SOURce:CORRection Subsystem.....	707
6.15.6	SOURce:FM Subsystem.....	716
6.15.7	SOURce:FREQuency Subsystem.....	719
6.15.8	SOURce:INPut Subsystem.....	729
6.15.9	SOURce:IQ Subsystem.....	732
6.15.10	SOURce:IQ:OUTput Subsystem.....	736
6.15.10.1	Analog I/Q Outputs.....	736
6.15.10.2	Digital I/Q Outputs.....	741
6.15.11	SOURce:LFOutput Subsystem.....	747
6.15.12	SOURce:LIST Subsystem.....	755
6.15.13	SOURce:MODulation Subsystem.....	768
6.15.14	SOURce:PATH Subsystem.....	768
6.15.15	SOURce:PHASe Subsystem.....	769
6.15.16	SOURce:PM Subsystem.....	769
6.15.17	SOURce:POWer Subsystem.....	772
6.15.18	SOURce:PULM Subsystem.....	780
6.15.19	SOURce:ROSCillator Subsystem.....	782
6.15.20	SOURce:SWEep Subsystem.....	784
6.16	STATus Subsystem.....	792
6.17	SYSTem Subsystem.....	796
6.18	TEST Subsystem.....	803
6.19	TRIGger Subsystem.....	806
6.20	UNIT Subsystem.....	811
6.21	Alphabetical List of R&S SMIQ Commands.....	811
7	Maintenance.....	835
7.1	Storing and Packing.....	835
8	Error Messages.....	837
8.1	Status Information.....	837
8.1.1	Status information displayed between the frequency and level fields.....	837
8.1.2	Status information displayed to the left of the Info line.....	838

8.1.3	Status information displayed in the Info line.....	839
8.2	Error Messages.....	840
8.2.1	Volatile messages.....	840
8.2.2	Permanent messages.....	840
8.3	SCPI-Error Messages.....	841
8.4	Device-Specific Error Messages.....	841
A	Hardware Interfaces.....	845
A.1	GPIB Bus Interface.....	845
A.2	AUX I/O Connector.....	846
A.3	Monitor Connector (MONITOR).....	848
A.4	BERT Connector.....	848
	List of Commands.....	851
	Index.....	867

1 Preparing for Use

The following topics will help you to get familiar with the instrument and perform the first steps:

- [Front Panel Tour](#)
- [Rear Panel Tour](#)
- [Putting into Operation](#)

This section explains the control elements and connectors of the Signal Generator R&S SMU with the aid of the front and rear views and describes how to put the instrument into operation. It also describes the connection of peripherals such as printer, keyboard or mouse. Specifications of interfaces can be found in the data sheet.

The [chapter 2, "Getting Started"](#), on page 61 of this manual provides an overview of the generator functions and introduces the operating concept. Detailed operating instructions and an overview of menus follow in [chapter 3, "Manual Operation"](#), on page 81.

For all reference information concerning manual and remote control of the instrument refer to the online help system or its printed/printable version. A more detailed description of the hardware connectors and interfaces is also part of the help system.

1.1 Front Panel Tour

The front panel of the R&S Signal Generator consists of the VGA display with the softkey area, some utility keys (left side) and the hardkey area with connectors and control interfaces (right side). The subsequent sections provide brief explanations on the controls and connectors, the hardkey area and the front panel.

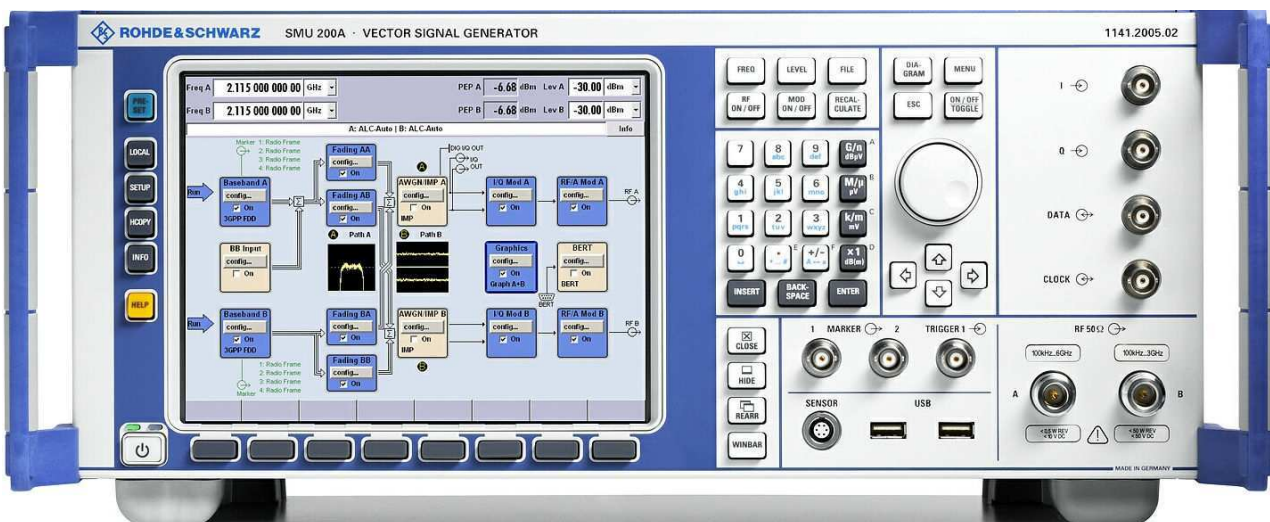

Fig. 1-1: Front panel view

1.1.1 Utility Keys



The keys to the left of the display cause the R&S SMU to return to a definite instrument state and provide information on the instrument and assistance.

For more information refer to chapter "Instrument Settings".

PRESET

Sets the instrument to a defined state (see [chapter 1.3.4.4, "Default Settings"](#), on page 32).

LOCAL

Switches from remote control to local (manual) control.

SETUP

Opens the "Setup" dialog for configuring presettings.

For more information, see [chapter 4.2.3, "General Configuration of Instrument - Setup Key"](#), on page 125.

HCOPI

Opens the "Hardcopy" menu for configuring and starting printing.

For more information, see [chapter 4.2.5, "Generating a Hard Copy of the Display"](#), on page 149.

INFO

Displays status messages, error messages and warnings.

HELP

Displays context-sensitive help text.

1.1.2 Standby LEDs and Standby Key

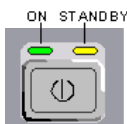

The standby LEDs and the ON/STANDBY key are located in the bottom left corner of the front panel.

The ON/STANDBY key toggles the instrument between standby and ready state (indicated by the standby LEDs).

The standby LEDs indicate the instrument states as follow:

- the green LED (left) is on when the instrument is ready for operation,
- the yellow LED (right) is on in the standby mode.

See also [chapter 1.3.4.1, "Standby and Ready state"](#), on page 31.

1.1.3 Display

The display clearly shows all main settings and signal generator states.

The display is divided into the following sections:

- Frequency and level display with info line
 - Frequency and level settings containing offset and peak envelope power (PEP). In two-path instruments, frequency, level and PEP are displayed in two lines.
 - Status messages
 - Brief error messages.
To access an window with detailed information for a message, use the INFO key.
- Block diagram
The block diagram shows the current configuration and the signal flow in the generator with the aid of function blocks containing an on/off switch. Selecting a function block opens a list of associated setting menus. Active menus, info windows and graphs are displayed on top of the block diagram. The block diagram can be displayed in the foreground anytime with the **DIAGRAM** key.
- "Winbar" with labelled softkeys
Open menus are indicated by a labelled button in the "Winbar". The buttons determine the softkey functions for front-panel control. When a button or softkey is pressed, the associated menu is displayed either in the foreground or minimized in the "Winbar". If required, the WINBAR is covered by a row of buttons to which menu-specific functions of the active menu are assigned. By pressing the WINBAR key, the "Winbar" can be displayed in the foreground again. This allows the user to toggle between the button and softkey functions.

For detailed information, see [chapter 3.2, "Display"](#), on page 85.

1.1.4 Setup Keys

The keys to the right of the display set parameters, select views and control the windows.

1.1.4.1 Keys for Setting Paramters

These keys provide direct access to the settings in the header of the instrument and can be used for fast changing the state of the modulation and the RF signal.



For more information refer to chapter "Instrument Functions".

FREQ

Activates frequency entry.

In the two-path mode, the frequency entry field that was active last is activated. Pressing the key again activates frequency entry for the second path.

RF ON/OFF

Switches the RF signal on and off.

In the two-path mode, the RF ON/OFF key switches all RF signals off. A second stroke restores the status that was active before the last switch-off.

"RF OFF" is displayed in the header next to the "Frequency" field.

LEVEL

Activates level entry.

In the two-path mode, the level entry field that was active last is activated. Pressing the key a second time activates level entry for the second path.

MOD ON/OFF

Switches the modulations on and off.

In the two-path mode, the MOD ON/OFF key switches all modulations off. Pressing the key again restores the status that was active before the last switch-off.

"MOD OFF" is displayed in the info line of the header next to the "Level" field.

FILE

Activates the menu for storing or loading files (see [chapter 3.7, "File Management"](#), on page 110).

RECALCULATE

Starts the recalculation of instrument settings.

If time-consuming calculations are required, the active modulation is automatically switched off and the calculation is interrupted to allow the user to make further settings. Calculation is restarted by a keystroke and the modulation is switched on again after the calculation is completed.

1.1.4.2 Display Keys



The keys on top of the rotary knob and the keys below the numeric key pad arrange different windows on the display.

DIAGRAM

Brings the block diagram to the foreground. Active menus are minimized.

Active menus are indicated by the buttons in the "Winbar".

ESC

The function of this key depends on the current cursor position.

- Calls the next higher selection level.
- Closes the open window without accepting new entries; the old value or parameter is retained.
- In dialog boxes that contain a "Cancel" button it activates that button.

- Closes all kinds of dialog boxes, if the edit mode is not active.
- Quits the edit mode, if the edit mode is active.
- Switches between different entry fields of a menu.
- Shifts the entry cursor from the header display to the previously active menu, or to the previously highlighted block in the block diagram if no menu is active.
- Shifts the cursor from a function block in the diagram to the first item in the "Winbar". If no menus are open, the current cursor position remains unchanged.

TOGGLE

- Switches highlighted elements or a function block on and off.
- Switches between two or more settings, e.g. items of selection lists. At the end of a list, the cursor is set on the first entry again.

MENU

Calls the menu tree.



CLOSE

Closes the active menu.

- If the entry mode is active, changes are cancelled.
- If settings in this menu require acknowledgement by means of an "Accept" button, a query is displayed asking whether the changes made should be cancelled.

HIDE

Minimizes the active open menu. The associated button in the "Winbar" remains visible.

REARR

Automatic rearrangement of open menus.

WINBAR

Toggles between display and blanking of the "Winbar".

1.1.5 Keypad for data entry

The keys in the data entry keypad are used to enter alphanumeric data and units.

Data entry keys are only enabled while the cursor is placed on a data input field in a dialog. Their function depends on the data type of the input field.



Keys	Description
0...9/abc	Enters the corresponding numbers (in numeric input fields) or characters (character input fields).
.	Inserts a decimal point (numeric input fields) or dot (character input fields) at the cursor position. Multiple decimal points are not allowed.
+/-	Changes the sign of a numeric parameter. In the case of an alphanumeric parameter, inserts a hyphen at the cursor position.
Unit keys	Selects a unit and thus determine the absolute value, or changes the unit, i.e. trigger a recalculation without changing the absolute value. The function depends on the time at which the UNIT key is used during parameter entry (see chapter 3.4.5, "Working with Units" , on page 98). For unit-free values, the X1 key is equivalent to ENTER. It confirms the previous entry and deactivates the input field.
_	Adds a blank in a character input field.
*... #	Enters special characters. Toggles through the available characters if the key is pressed several times in a row.
A <-> a	Toggles between uppercase and lowercase characters.
A, B, C, D, E, F	Enters hexadecimal values. The letters assigned to the keys are automatically active when an entry field with a hexadecimal value is active.

INSERT

Toggles between insert and overwrite mode (see also [chapter 3.4.4, "Entering a Value"](#), on page 96).

BACKSPACE

Deletes the last character before the cursor position or the selected character sequence.

ENTER

Pressing the rotary knob has the same effect.

- Concludes the entry of dimensionless entries. For other entries, this key can be used instead of the default unit key. The new value is accepted.
- Confirms ("OK") and closes open input windows.
- In a dialog box, selects the default or focused button.
- In a dialog box, activates the edit mode for the focused area, if available.
- In a dialog box, activates or deactivates the selected option of the focused area, if the edit mode is active.
- Calls the next menu level.

1.1.6 Rotary Knob and Navigation Keys

The rotary knob and the arrow keys are alternative control elements for data variation and navigation in the graphical user interface.



ROTARY KNOB

The rotary knob has several functions:

- Increases (clockwise direction) or decreases (counter-clockwise direction) numeric values at a defined step width in editing mode
- Moves the cursor, e.g. to a function block in the block diagram
- Scrolls within lists, tables or tree views
- Acts like the ENTER key, when it is pressed.
- Shifts the selection bar within focused areas (e.g. lists), if the edit mode is activated.

Note: Turning or pressing the rotary knob is equivalent to pressing the UP and DOWN keys or the ENTER key in the keypad.



NAVIGATION KEYS

The navigation keys consist of 4 arrow keys which are used for navigation, alternatively to the rotary knob.

UP/ DOWN KEYS

The up and down arrow keys do the following:

- In a numeric edit dialog box, increase or decrease the instrument parameter.
- In a list, table, window or dialog box, scroll vertically.

LEFT/ RIGHT KEYS

The left and right arrow keys do the following:

- In an alphanumeric edit dialog box, move the cursor forward and back.
- In a list, table, window or dialog box, scroll horizontally.

1.1.7 Front Panel Connectors

The RF and I/O connectors and various additional interface connectors are located on the front panel.

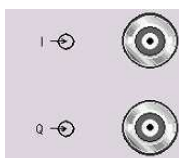

I, Q

I and Q inputs for external analog modulation signal in case of I/Q modulation.

This inputs are also used for external analog baseband signal (option R&S SMU-B17, Baseband Input).

For more information see:

- [chapter 4.8.2, "Data and Signal Sources in Baseband"](#), on page 331
- [chapter 4.9.1.1, "Baseband Input Settings Menu"](#), on page 447



DATA

Signal for Path A only.

Input for external serial data signal in case of digital modulation.

Output for serial data signal in case of digital modulation.

For more information see:

- [chapter 4.8.2, "Data and Signal Sources in Baseband"](#), on page 331
- [chapter 4.9.1.1, "Baseband Input Settings Menu"](#), on page 447

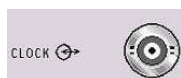
**CLOCK**

Signal for Path A only.

Input for external clock signal (bit or symbol clock, multiple of symbol clock) for synchronizing the external data signal in case of multivalent modulation. The active edge can be set.

Output for clock signal (bit or symbol clock) in the internal mode.

**RF A, RF B**

Outputs for RF signal of path A and path B.

NOTICE! Maximum Input Levels. Do not overload the RF output. The maximum permissible back-feed is specified in the data sheet.

**TRIGGER 1**

Input for triggering digital modulations, standards and ARB.

For more information see [chapter 4.2.3.10, "Global Trigger/Clock/External Input Settings"](#), on page 136.

**MARKER 1, 2**

Outputs 1 and 2 for triggering and control of external devices with user-definable marker signals.

The instrument provides four outputs for marker signals. Marker signals 1 to 3 are permanently assigned to the outputs; marker signal 4 can be routed to one of the four USER outputs. The assignment is as follow:

Path A

- Marker 1,2: BNC connectors MARKER 1 / 2 on the front panel.
- Marker 3: MARKER 3 pin of AUX I/O connector on the rear panel.
- Marker 4: BNC connector USER 1 or USER 2/3/4 pins of AUX I/O connector on rear panel.

Path B

- Marker 1: MARKER 1B output on rear panel.
- Marker 2/3: MARKER 2 B / 3 B pins of AUX I/O connector on rear panel.
- Marker 4: BNC connector USER 1 or USER 2/3/4 pins of AUX I/O connector on rear panel.

For more information see [chapter 4.2.3.10, "Global Trigger/Clock/External Input Settings"](#), on page 136.

**USB**

USB (universal serial bus) interfaces of type A (host USB).

- Connection of peripherals such as mouse or keyboard
- Connection of memory stick for file transmission
- Firmware update

Note: Another USB interface type A (host USB) and a USB interface type B (device USB for data transmission) are available on the rear panel.

See also [chapter 1.4.1, "Connecting USB Devices"](#), on page 35.



SENSOR

Connector for R&S NRP-Zxx sensors.

With the aid of the "User Correction" function, a table with correction values for external test assemblies can be automatically determined, e.g. for compensating the frequency response of cables.

The power sensors are connected by inserting the male connector. To disconnect hold the connector by its sleeve. Pulling on the sensor cable will not release the sensor connector.

See also [chapter 4.5.6, "NRP-Z Power Viewer"](#), on page 209.

1.2 Rear Panel Tour

This section gives an overview of connectors on the rear panel of the instrument. Each connector is briefly described and a reference is given to the chapters containing detailed information. For technical data of the connectors refer to the data sheet.

If a connector of a two-path instrument is available for one path only (e.g. path A) or for either of the two (path A or B), a note is made in the brief description.



Fig. 1-2: Rear panel view

1.2.1 Description of the Connectors



LF

(path A only)

Output for internal LF modulation generator signal.

See also data sheet and [chapter 4.5.12.1, "LF Generator Overview"](#), on page 246, [chapter 4.5.12.2, "LF Output"](#), on page 246.



MARKER 1B

Output for user-programmable marker signal 1 of path B for triggering and control of external devices. Marker outputs are permanently assigned (see "[MARKER 1, 2](#)" on page 22).

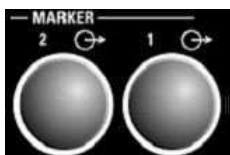

MARKER 1/ MARKER 2

Rear Panel Connectors for path A (option R&S SMU-B81) and path B (option R&S SMU-B82).

These options are recommended for use of the instrument in a 19" rack. Installing the instrument in a 19" rack requires a rack adapter or an adapter for telescopic sliders (refer to data sheet for order number).

Marker outputs are permanently assigned (see "[MARKER 1, 2](#)" on page 22).

See also [chapter 1.3.2, "Placing or Mounting the Instrument"](#), on page 29.

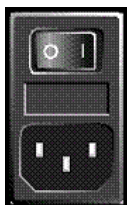

AC SUPPLY AND POWER SWITCH

When the R&S SMU is connected to the AC supply, it automatically sets itself to the correct range for the applied voltage (range: see type label). There is no need to set the voltage manually or change fuses.

The instrument comes with or without a power switch, depending on the design of the otherwise technically equivalent power supply unit.

The power switch can be set to two positions:

- **0**
The instrument is disconnected from the mains.
- **I**
The instrument is power-supplied. It is either ready for operation (STANDBY) or in operating mode, depending on the position of the ON/STANDBY switch on the instrument front.

See also data sheet and [chapter 1.3.3, "Connecting the Instrument to the AC Supply"](#), on page 30.



I OUT / Q OUT

(path A or path B)

Direct output or Differential (non-inverting) output for analog I/Q signal.

Option option R&S SMU-B16 is required.

See also [chapter 4.7.3, "Output of the Baseband Signal - I/Q Out"](#), on page 310.



I OUT BAR / Q OUT BAR

(path A or path B)

Differential (inverting) output for analog I/Q signal.

See also [chapter 4.7.3, "Output of the Baseband Signal - I/Q Out"](#), on page 310.

I/Q/DATA/CLOCK

Rear Panel Connectors for path A (option R&S SMU-B81) and path B (option R&S SMU-B82).

This options are recommended for use of the instrument in a 19" rack. Installing the instrument in a 19" rack requires a rack adapter or an adapter for telescopic sliders (refer to data sheet for order number).

See also [chapter 1.3.2, "Placing or Mounting the Instrument"](#), on page 29.

Note: Option R&S SMU-B16 (Differential Outputs) and options R&S SMU-B81/B82 cannot be fitted both, because they use the same connectors.

**REF OUT**

Output of internal reference signal.

See also [chapter 4.5.4, "Reference Oscillator"](#), on page 203.

**REF IN**

Input for external reference signal.

The external reference is used for both paths.

See also [chapter 4.5.4, "Reference Oscillator"](#), on page 203.

**EXT MOD**

Input for external analog modulation signals.

See also ["External Modulation Sources"](#) on page 234.

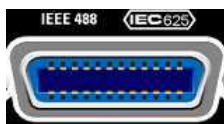
**IEC 625/IEEE 488**

IEC-bus (IEEE 488) interface for remote control of the instrument.

See also [chapter A.1, "GPIB Bus Interface"](#), on page 845 and [chapter 5.1.4, "GPIB Interface \(IEC/IEEE Bus Interface\)"](#), on page 461.

Note: In order to avoid electromagnetic interference (EMI) caused by open lines, always terminate any connected IEC-bus cable with an instrument or a controller.

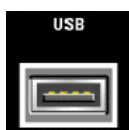

USB

USB CONNECTORS TYPE A

USB (universal serial bus) interfaces of type A (host USB).

- Connection of peripherals such as mouse, keyboard, etc.
- Connection of memory stick for file transmission
- Firmware update

Further USB interface type A are available on the front panel.

See also [chapter 1.4.1, "Connecting USB Devices"](#), on page 35.



USB IN

USB IN

USB (universal serial bus) interface of type B (device USB).

This port is reserved for future extensions.



MONITOR

MONITOR

Connector for external monitor (see [chapter 1.4.2, "Connecting a Monitor"](#), on page 36).

For description of this connector, refer to [chapter A.3, "Monitor Connector \(MONITOR\)"](#), on page 848.

AUX I/O

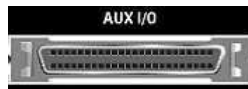

Parallel input/output for data signals as well as settable trigger and control signals of the baseband. Input for device trigger.

Assignment of the AUX I/O interface and of USER pins can be configured in the "Setup > Global Trigger/Clock/External Inputs" and "Setup > USER Marker / AUX I/O Settings".

Use this dialogs to configure also the arbitrary assignment of pins to path A or B.

Note: An adapter of the AUX I/O interface to coaxial BNC connectors is available as an accessory (R&S SMU-Z5, see data sheet).

See also [chapter 4.2.3.10, "Global Trigger/Clock/External Input Settings"](#), on page 136 and [chapter 4.2.3.12, "User Marker / AUX I/O Settings"](#), on page 139.

For detailed description of the AUX I/O connector, refer to [chapter A.2, "AUX I/O Connector"](#), on page 846.



BERT

Input for data, clock and control signals for bit and block error rate measurements, level 0.0128..1.998V.



BASEBAND DIGITAL IN/OUT

Digital Interface:

- Input for external digital I/Q signal (BBIN) in case of digital modulation (option R&S SMU-B17, Baseband Input (digital/analog)).
- Output of the digital I/Q signal (BBOUT) (option R&S SMU-B18 Digital I/Q Out).

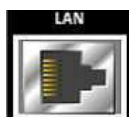

LAN CONNECTOR

Ethernet interface

- For integrating signal generators in a network
- Remote control of signal generator
- Input of external asynchronous data
- Remote access to the signal generator
- Firmware update

See also:

- [chapter 1.6, "Setting Up a Network \(LAN\) Connection"](#), on page 38
- [chapter 5.1.3, "LAN Interface"](#), on page 459

RF A / RF B

Rear Panel Connectors for path A (option R&S SMU-B81) and path B (option R&S SMU-B82). This options are recommended for use of the instrument in a 19" rack. Installing the instrument in a 19" rack requires a rack adapter or an adapter for telescopic sliders (refer to data sheet for order number).

See also [chapter 1.3.2, "Placing or Mounting the Instrument"](#), on page 29.

**LO IN, LO OUT**

Local oscillator input and output:

- LO IN: Input for external LO signals
- LO OUT: Output for internal LO signals.

See also [chapter 4.5.5, "Local Oscillator - LO Coupling"](#), on page 205.

**CLOCK OUT**

Output for internal clock signal.

This connector is used for path A only. The internal clock signal of path B can be output at one of the USER interfaces.

See also [chapter 4.8.2.4, "Clock Signals"](#), on page 334.

**INSTR TRIG**

Input for external trigger of analog modulations, sweeps and list mode. HOP input for control of the frequency hop mode with external source in the list mode.

This connector is used for path A only. The instrument trigger input for path B is part of the AUX I/O interface.

See also [chapter 4.5.14, "List Mode"](#), on page 268 and [chapter 4.5.13.1, "Overview"](#), on page 247.

**USER**

Input/output for configurable signals for triggering and control.

The following signals can be applied to the connector:

- Marker 4
- Clock Out (bit or symbol)
- CW mode Out
- No signal (blank) marker
- HOP

Note: With exception of the Clock Out signal, the signals for triggering and control apply for both paths.

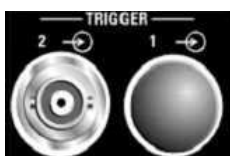
**TRIGGER 1 / 2**

TRIGGER 2: Input for external triggering of digital modulations and standards and ARB.

TRIGGER 1: Rear Panel Connectors for path A (option R&S SMU-B81) and path B (option R&S SMU-B82).

This options are recommended for use of the instrument in a 19" rack. Installing the instrument in a 19" rack requires a rack adapter or an adapter for telescopic sliders (refer to data sheet for Order No.).

See also [chapter 1.3.2, "Placing or Mounting the Instrument"](#), on page 29.

1.3 Putting into Operation

This section describes the basic steps to be taken when setting up the R&S SMU for the first time.

⚠ WARNING**Shock hazard**

Do not open the instrument casing. As a rule, normal operation of the instrument does not require opening the casing. Observe the general safety instructions and regulations at the beginning of the manual.

NOTICE**Risk of instrument damage**

Note that the general safety instructions also contain information on operating conditions that will prevent damage to the instrument. The instrument's data sheet may contain additional operating conditions.

NOTICE**Risk of instrument damage**

Before switching on the instrument, make sure that the following conditions are met:

- Instrument casing is closed and all fasteners are tightened.
- All fan openings are unobstructed and the airflow perforations are unimpeded. The minimum distance from the wall is 10 cm.
- The instrument is dry and shows no sign of condensation.
- The instrument is operated in the horizontal position on an even surface.
- The ambient temperature does not exceed the range specified in the data sheet.
- Signal levels at the input connectors are all within the specified ranges.
- Signal outputs are correctly connected and are not overloaded.

Failure to meet these conditions may cause damage to the instrument or other devices in the test setup.

NOTICE**Risk of electrostatic discharge**

Protect the work area against electrostatic discharge to avoid damage to electronic components in the modules. For details, refer to the safety instructions at the beginning of this manual.



EMI impact on measurement results

Electromagnetic interference (EMI) can affect the measurement results. To avoid any impact, make sure that the following conditions are met:

- Use suitable double-shielded cables.
- Do not use USB connecting cables exceeding 1 m in length.
- Use only USB devices that remain within the permissible EMI limits.
- Always terminate any connected IEC-bus cables with an instrument or controller.

Outputs and lines have to be terminated properly with 50 Ohms.

For digital interfaces only the cable R&S SMU-Z6 is permitted for connection. The associated cable is available under part number 1415.0201.02.

1.3.1 Unpacking and Checking the Instrument

To remove the instrument from its packaging and check the equipment for completeness proceed as follows:

1. Pull off the polyethylene protection pads from the instrument's rear feet and then carefully remove the pads from the instrument handles at the front.
2. Pull off the corrugated cardboard cover that protects the rear of the instrument.
3. Carefully unthread the corrugated cardboard cover at the front that protects the instrument handles and remove it.
4. Check the equipment for completeness using the delivery note and the accessory lists for the various items.
5. Check the instrument for any damage. If there is damage, immediately contact the carrier who delivered the instrument. Make sure not to discard the box and packing material.



Packing material

Retain the original packing material. If the instrument needs to be transported or shipped at a later date, you can use the material to prevent control elements and connectors from being damaged.

1.3.2 Placing or Mounting the Instrument

The R&S SMU is designed for use under laboratory conditions, either on a bench top or in a rack using a rack adapter kit (order number see data sheet).

Bench Top Operation

If the R&S SMU is operated on a bench top, the surface should be flat. The instrument can be used in horizontal position, standing on its feet, or with the support feet on the bottom extended.

CAUTION

Risk of injury

The feet may fold in if they are not folded out completely or if the instrument is shifted. Fold the feet completely in or completely out to ensure stability of the instrument and personal safety. To avoid injuries, never shift the instrument when its feet are folded out. When the instrument is standing on its folded-out feet, do not work under the instrument and do not put anything under it, otherwise injuries or material damage could occur. The feet may break if they are overloaded. The overall load on the folded-out feet must not exceed 500 N.

Rackmounting

The R&S SMU can be installed in a rack using a rack adapter kit (Order No. see data sheet). The installation instructions are part of the adapter kit.

NOTICE

Risk of instrument damage

For rack installation, make sure that all fan openings are unobstructed and that the airflow perforations are unimpeded. This helps to prevent the instrument from overheating.

1.3.3 Connecting the Instrument to the AC Supply

The R&S SMU is automatically adapted to the AC voltage supplied. There is no need to set the voltage manually or change fuses. The [AC SUPPLY AND POWER SWITCH](#) is at the rear of the unit.

- ▶ Connect the instrument to the AC power source using the AC power cable delivered with the instrument.

Note: The instrument is in compliance with safety class EN61010-1.
Connect the instrument only to a socket with earthing contact.

1.3.4 Starting the Instrument

The R&S SMU comes with or without a power switch, depending on the design of the otherwise technically equivalent power supply unit.



Switching off the AC power

You can leave the AC power on permanently to preserve your last instrument settings. Switching off is required only if the instrument must be completely disconnected from all power supplies.

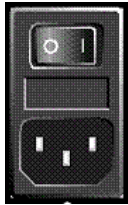

Starting up instruments with power switch

1. Connect the instrument to the AC supply.
2. To turn the power on, press the main power switch to position I (On).

After power-up, the instrument is in **standby or ready state**, depending on the state of the ON/STANDBY key at the front panel of the instrument when the instrument was switched off for the last time.

3. In case the instrument is in standby mode, i.e. the yellow LED is on, press the ON/STANDBY key to switch the instrument to ready state.



Starting up instruments without power switch

1. Connect the instrument to the AC supply.

After connection to the AC supply, the instrument is in **standby or ready state**, depending on the state of the ON/STANDBY key at the front panel of the instrument when the instrument was switched off for the last time.

2. In case the instrument is in standby mode, i.e. the yellow LED is on, press the ON/STANDBY key to switch the instrument to ready state.

1.3.4.1 Standby and Ready state

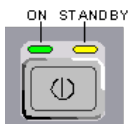

The ON/STANDBY key is located in the bottom left corner of the front panel.

Switching between standby and ready state

- ▶ Press the ON/STANDBY key briefly to switch the instrument from the standby to ready state or vice versa.

In ready state, the left, green LED is on. The instrument is ready for operation. All modules are power-supplied and the R&S SMU initiates its **startup procedure**.

In standby state, the right, yellow LED is on. The standby power only supplies the power switch circuits and the oven-controlled crystal oscillator to keep it at its operating temperature. In this state it is safe to switch off the AC power and disconnect the instrument from the power supply.

1.3.4.2 Start Display and Booting

After power-on, the start display indicates for a few seconds the installed BIOS version and the processor characteristics.

The instrument boots the operating system, starts the instrument firmware and automatically performs a selftest. If the previous session was terminated regularly, the instrument uses the last setup with the relevant instrument settings.

Once the startup procedure has been terminated, the block diagram opened in the previous session is displayed and the instrument is ready for operation.



Use the PRESET key to return the instrument to its definite reset/preset state, if the current setup is not anymore relevant.

To customize the start settings, use the "File" dialog.



Rebooting the instrument

Press the STANDBY key for approx. 5 s. to reboot the instrument, if the software stops unexpectedly.

1.3.4.3 Function Check

The signal generator automatically monitors the main functions when the instrument is switched on and continuously during operation.

A detected fault is indicated by a "ERROR" message displayed in the info line together with a brief error description. For in-depth identification of the error, press the INFO key. In response, a description of the error(s) is displayed.

For more information, refer to [chapter 8, "Error Messages"](#), on page 837.

Additionally to the automatic monitoring, the R&S SMU offers the following capabilities to ensure correct functioning:

- Internal Adjustments
Press the SETUP key and select "System > Internal Adjustments" to access the dialog for performing and configuring of the adjustments settings. A maximum level accuracy can be obtained, for instance.
- Selftest
A selftest is provided for service purposes. The selftest is a protected test procedure, which can be accessed if protection level 1 is disabled.

1.3.4.4 Default Settings

When the instrument is switched on, it is not the preset state that is active, but rather the instrument state that was set before the instrument was switched off. It is also recommended that you use the PRESET key to return the instrument to its defined preset state every time a new configuration is required or the current setup is not anymore relevant.

The R&S SMU offers a three-stage preset concept:

- Preset of the settings belonging to a digital standard or associated with one dialog.

Most of the dialog boxes provide a special "Set to Default" button that resets directly the settings associated to the corresponding dialog, e.g. all digital modulation settings in the "Custom Digital Mod" dialog.

These settings are identical to those which are called up using the PRESET key.

- Preset the instrument to a predefined state
The PRESET key calls up a defined instrument setup. All parameters and switching states are preset (also those of inactive operating modes). The default instrument settings provide a reproducible initial basis for all other settings. However, functions that concern the integration of the instrument into a measurement setup are not changed, e.g. GPIB bus address or reference oscillator source settings. In remote control it is possible to preset the settings of the two instrument's paths separately (see section "Preset Commands").
- Preset the instrument to its factory settings
The instrument can also be forced to load its default factory settings. To access the corresponding dialog box, press the SETUP key and select the "Factory Preset". For more information and an overview of the settings affected by the factory preset function, see [chapter 4.2.3.18, "Factory Preset"](#), on page 148.

Overview of the Most Important Preset States

The following list gives an overview of the presets for the most important generator settings. The other presets can be found in the preset tables of the individual menus and the information accompanying the remote commands.

- "RF frequency" = 1 GHz
- "RF level" RF output switched off
- "Offsets" = 0
- "Modulations State" = Off
- Uninterrupted level settings are switched off
"Level Attenuator Mode" = AUTO
- Internal level control "Level ALC" = AUTO
- User correction "Level Ucor" = OFF
- "LF output State" = Off
- "Sweep State" = Off
- "List mode State" = Off

Settings that are not affected by the PRESET key

- Reference frequency settings ("Ref Oscillator" menu)
- Power on settings ("Level/EMF" menu)
- Network settings ("Setup" menu)
- GPIB address ("Setup" menu)
- Password and settings protected by passwords ("Setup" menu)
- Start/Stop Gui Update ("Setup" menu)
- Display and keyboard settings ("Setup" menu)



User-defined instrument states can be stored and called up in the "File" dialog.

1.3.5 Shutting Down the Instrument

To shut down the R&S SMU, proceed as described below.

NOTICE

Risk of losing data

If you switch off the running instrument using the rear panel switch or by disconnecting the power cord, the instrument loses its current settings. Furthermore, program data may be lost.

Press the ON/STANDBY key first to shut down the application properly.

1. Press the ON/STANDBY key to save the current setup, shut down the operating system and set the instrument to standby state.

The yellow LED must be on.

2. To turn the power off:
 - a) For instruments with power switch, press the main power switch to position 0 (Off).
 - b) For instruments without power switch, pull the power cable at the rear of the instrument.

Tip:

Switching off the AC power

You can leave the AC power on permanently to preserve your last instrument settings. Switching off is required only if the instrument must be completely disconnected from all power supplies.

None of the front-panel LEDs should be on.

1.4 Connecting External Accessories

The equivalent USB ports on the front and/or rear panel of the R&S SMU can be used to connect a variety of accessories.

In addition the instrument provides interfaces for monitor connection and network integration (see [chapter 1.4.2, "Connecting a Monitor"](#), on page 36 and [chapter 1.6.1, "Connecting the Instrument to the Network"](#), on page 39).

1.4.1 Connecting USB Devices

The USB interfaces on the front and (optionally) rear panels of the R&S SMU allow you to connect USB devices directly to the instrument. This number can be increased as necessary by using USB hubs. Due to the large number of available USB devices, there is almost no limit to the expansions that are possible with the R&S SMU.

The following list shows various USB devices that can be useful:

- Memory stick for easy transfer of data to/from a computer (e.g. firmware updates)
- CD-ROM drives for easy installation of firmware applications
- Keyboard or mouse to simplify the entry of data, comments, file names, etc.
- Printer for printing out measurement results
- Power sensors, e.g. of the NRP Zxy family

Installing USB devices is easy under Windows XP, because all USB devices are plug&play. After a device is connected to the USB interface, Windows XP automatically searches for a suitable device driver.

If Windows XP does not find a suitable driver, it will prompt you to specify a directory that contains the driver software. If the driver software is on a CD, connect a USB CD-ROM drive to the instrument before proceeding.

When a USB device is subsequently disconnected from the R&S SMU, Windows XP immediately detects the change in hardware configuration and deactivates the corresponding driver.

All USB devices can be connected to or disconnected from the instrument during operation.

Connecting a memory stick or CD-ROM drive

If installation of a memory stick or CD-ROM drive is successful, Windows XP informs you that the device is ready to use. The device is made available as a new drive ("D:") and is displayed under Windows Explorer. The name of the drive is manufacturer-dependent.

Connecting a keyboard

The keyboard is detected automatically when it is connected. The default input language is English – US.

Use the "Start > Control Panel > Keyboard" or the "Regional and Language Options" menu of Windows XP to configure the keyboard properties. To access Windows XP, press the Windows key on the external keyboard.

Connecting a mouse

The mouse is detected automatically when it is connected.

Use the "Start > Control Panel > Mouse" menu of Windows XP to configure the mouse properties. To access Windows XP, press the Windows key on the external keyboard.

Connecting a printer

When printing a file, the instrument checks whether a printer is connected and turned on and whether the appropriate printer driver is installed. If required, printer driver installation is initiated using Windows XP's "Add Printer" wizard. A printer driver needs to be installed only once.

You can load updated and improved driver versions or new drivers from an installation disk, USB memory stick or another external storage medium. If the instrument is integrated in a network, you can also install driver data stored in a network directory. Use the "Add Printer" wizard on the "Start > Settings > Printer and Faxes" menu to install the driver. To access Windows XP, press the Windows key on the external keyboard.

1.4.2 Connecting a Monitor

An external monitor with an analog interface can be connected to the MONITOR connector on the rear panel of the instrument. Per default, the external monitor connector is disabled and has to be enabled before operation.



Connecting external devices

Before connecting any external device such as a monitor, make sure that the instrument is switched off (or in standby mode). Otherwise, correct operation cannot be assured. This does not apply to USB devices.

1. **Shut down the instrument.**

None of the front-panel LEDs should be on.

2. Plug in the monitor cable to the MONITOR connector on the rear panel of the instrument.

3. **Start up the instrument.**

The green LED must be on.

The external monitor is detected.

The entire display of the instrument, containing the status bar, the block diagram and the winbar is displayed on the monitor additionally. Further settings are not required.

The MONITOR interface is described in "Appendix A: Hardware Interfaces" in the Operating Manual.

1.5 Windows Operating System

The instrument contains the Windows XP operating system which has been configured according to the instrument's features and needs. To ensure that the instrument software functions properly, certain rules must be adhered to concerning the operating system.

NOTICE**Risk of causing instrument unusability**

The instrument is equipped with the Windows XP operating system. Additional software can therefore be installed on the instrument. The use and installation of additional software may impair instrument function. Thus, run only programs that Rohde & Schwarz has tested for compatibility with the instrument software.

The drivers and programs used on the instrument under Windows XP have been adapted to the instrument. Existing instrument software must always be modified using only update software released by Rohde & Schwarz.

The following program packages have been tested:

- R&S Power Viewer - virtual power meter for displaying results of the Power Sensor R&S NRP-Zxx
- Windows XP Remote Desktop
- Symantec Norton AntiVirus – Virus-protection software

In certain cases, the use of these programs can impair the performance of the instrument.

1.5.1 Virus Protection

Users must take appropriate steps to protect their instruments from infection. Beside the use of strong firewall settings and regularly scanning any removable storage device used with a R&S instrument, it is also recommended that anti-virus software be installed on the instrument. While Rohde & Schwarz does NOT recommend running anti-virus software in the background ("on-access" mode) on Windows-based instruments, due to potentially degrading instrument performance, it does recommend running it during non-critical hours.

For details and recommendations, see the R&S White Paper "Malware Protection" available at <http://www.rohde-schwarz.com/appnote/1EF73>.

1.5.2 Service Packs and Updates

Microsoft regularly creates security updates and other patches to protect Windows-based operating systems. These are released through the Microsoft Update website and associated update server. Instruments using Windows, especially those that connect to a network, should be updated regularly.

For more details and information on configuring automatic updates see the R&S White Paper "Malware Protection" (available at <http://www.rohde-schwarz.com/appnote/1EF73>).

Changes in the system setup are only required when peripherals like keyboard or a printer are installed or if the network configuration does not comply with the default settings (see [chapter 1.6.1, "Connecting the Instrument to the Network"](#), on page 39). After the R&S

SMU is started, the operating system boots and the instrument firmware is started automatically.

1.5.3 Login

Windows XP requires that users identify themselves by entering a user name and password in a login window. The instrument provides a factory-installed auto login function, i.e. login is carried out automatically in the background. The ID used for autologin has administrator rights so that printer and network installations are possible. The user name and password are set to "instrument".

1.5.4 Accessing the Start Menu

The Windows XP "Start" menu provides access to the Windows XP functionality and installed programs. To open the "Start" menu, press the Windows key or the CTRL + ESC key combination on your keyboard.

All necessary system settings can be made in the "Start > Control Panel" menu (for required settings refer to the Windows XP manual and to the hardware description).



Accessing Operating System

The operating system can only be accessed if an external keyboard and/or a mouse is connected. Windows XP provides an on-screen keyboard that can be operated using a mouse, thus enabling operation by mouse only. An external keyboard is recommended for extensive entries.

Energy saving mode

An energy saving mode is a default setting in the instrument. The hard disk switches to power-save mode if it is not accessed for 30 minutes. The energy-saving mode is exited by accessing the hard disk again.

1.6 Setting Up a Network (LAN) Connection

The R&S SMU is equipped with a network interface and can be connected to an Ethernet LAN (local area network). Provided the appropriate rights have been assigned by the network administrator and the Window XP firewall configuration is adapted accordingly, the interface can be used, for example:

- To transfer data between a controller and the tester, e.g. in order to run a remote control program. See chapter "Remote Control"
- To access or control the measurement from a remote computer using the "Remote Desktop" application (or a similar tool)
- To connect external network devices (e.g. printers)
- To transfer data from a remote computer and back, e.g. using network folders

This section describes how to configure the LAN interface. It includes the following topics:

- [chapter 1.6.1, "Connecting the Instrument to the Network"](#), on page 39
- [chapter 1.6.2, "Assigning the IP Address"](#), on page 40



LXI

The R&S SMU complies with LXI Class C. LXI gives you direct access to the LAN settings described below.



Accessing Operating System

The operating system can only be accessed if an external keyboard and/or a mouse is connected. Windows XP provides an on-screen keyboard that can be operated using a mouse, thus enabling operation by mouse only. An external keyboard is recommended for extensive entries.

1.6.1 Connecting the Instrument to the Network

There are two methods to establish a LAN connection to the instrument:

- A non-dedicated network (Ethernet) connection from the instrument to an existing network made with an ordinary RJ-45 network cable. The instrument is assigned an IP address and can coexist with a computer and with other hosts on the same network.
- A dedicated network connection (Point-to-point connection) between the instrument and a single computer made with a (crossover) RJ-45 network cable. The computer must be equipped with a network adapter and is directly connected to the instrument. The use of hubs, switches, or gateways is not required, however, data transfer is still performed using the TCP/IP protocol. An IP address has to be assigned to the instrument and the computer, see [chapter 1.6.2, "Assigning the IP Address"](#), on page 40.

The R&S SMU uses the IP addresses 192.168.xxx.yyy for this purposes, where xxx and yyy may take values between 1...254; the subnet mask is always 255.255.255.0.

NOTICE

Risk of network failure

Before connecting the instrument to the network or configuring the network, consult your network administrator. Errors may affect the entire network.

- ▶ To establish a non-dedicated network connection, connect a commercial RJ-45 cable to one of the LAN ports.
To establish a dedicated connection, connect a (crossover) RJ-45 cable between the instrument and a single PC.

If the instrument is connected to the LAN, Windows XP automatically detects the network connection and activates the required drivers.

The network card can be operated with a 10/100/1000 Mbps Ethernet IEEE 802.3u interface.

1.6.2 Assigning the IP Address

Depending on the network capacities, the TCP/IP address information for the instrument can be obtained in different ways.

- If the network supports dynamic TCP/IP configuration using the Dynamic Host Configuration Protocol (DHCP), all address information can be assigned automatically.
- If the network does not support DHCP, or if the instrument is set to use alternate TCP/IP configuration, the addresses must be set manually.

By default, the instrument is configured to use dynamic TCP/IP configuration and obtain all address information automatically. This means that it is safe to establish a physical connection to the LAN without any previous instrument configuration.

NOTICE

Risk of network errors

Connection errors can affect the entire network. If your network does not support DHCP, or if you choose to disable dynamic TCP/IP configuration, you must assign valid address information before connecting the instrument to the LAN. Contact your network administrator to obtain a valid IP address.

Assigning the IP address manually

1. Obtain the IP address and subnet mask for the R&S SMU and the IP address for the local default gateway from your network administrator. If necessary, also obtain the name of your DNS domain and the IP addresses of the DNS and WINS servers on your network. If you use more than one LAN connector, you need separate address information for each connector.
2. Press the "Windows" key to access the operating system.
3. Open the "Control Panel" by selecting "Start > Settings > Control Panel".
4. Select "Network Connections".
5. Right-click "Local Area Connection" and select "Properties" from the context-sensitive menu, or click "Local Area Connection" and then "File > Properties".
6. On the "General" tab, click "Internet Protocol (TCP/IP)" and then select "Properties".
7. Select "Use the following IP address" and enter the address information as obtained from the network administrator.

8. If necessary, you can also select "Use the following DNS server addresses" and enter your own DNS addresses.

For more information refer to the Windows XP Help.

1.6.3 Using computer names

Alternatively to the IP address, each PC or instrument connected in a LAN can be accessed via an unambiguous computer name. Each instrument is delivered with an assigned computer name, but this name can be changed.

Querying and changing a computer name

1. Press the "Windows" key to access the operating system.
2. Select "Start > My Computer > Properties > Computer Name".
The computer name is displayed under "Full Computer Name".
3. To change the computer name, select "Change", enter the new computer name and confirm the entry.

1.6.4 Changing the Windows Firewall Settings

A firewall protects an instrument by preventing unauthorized users from gaining access to it through a network. Rohde & Schwarz highly recommends the use of the firewall on your instrument. R&S instruments are shipped with the Windows firewall enabled and preconfigured in such a way that all ports and connections for remote control are enabled. For more details on firewall configuration see the R&S White Paper "Malware Protection" (available at http://www2.rohde-schwarz.com/file_13784/1EF73_0E.pdf) and the Windows XP help system.

Note that changing firewall settings requires administrator rights.



To transfer waveform files generated on an external PC using R&S WinIQSIM2, you have to disable the firewall.

NOTICE

Risk of Unauthorized Access

Disabling the firewall or allowing exceptions may make your instrument more vulnerable to viruses and intruders.

It is recommended that you restore the default firewall configuration after completing a task which requires modified settings.

1.6.5 Working with Directories

Access to network drives depends on access rights and whether the drives in question have been enabled. The complete integration of the R&S Signal Generator into a larger network with the necessary allocation of rights is highly complex and normally performed by a network administrator.

However, the hard disk of a computer also connected to the network can be accessed from the instrument relatively easily. The only precondition is that the directory on the remote computer that the instrument should access is enabled for remote access. Subsequently, this directory is accessed from the instrument using a Windows XP search function. This procedure is also of importance for a point-to-point connection, for instance in order to start a firmware update for which the files have been stored on the hard disk of the remote computer.



The computer and the instrument must both be provided with a computer name and an IP address (see [chapter 1.6.2, "Assigning the IP Address"](#), on page 40).

Enabling directories on the remote computer



The menu name may deviate from the name specified in the operating sequence, depending on the language and on the operating system used on the computer.

1. On the remote computer, in Windows Explorer, click the directory to be enabled.
2. From the context menu, select "Properties".
3. Select the "Sharing" tab and enable "Share this folder".

Accessing the enabled directory

1. On the instrument, select "Start > Search > For Files and Folders > Printers, Computers > A Computer in the Network".
2. Enter the computer name and press ENTER to start the search.
The computer and its name appears in the results list.
3. Click the computer's name to display the enabled directory.

Note: If a user name and password are requested when you click the computer, the login name and password used on the computer must be entered.

The files in this directory can be accessed by the instrument.

1.7 Remote Access via an External Controller

The R&S SMU can be remote accessed from a remote computer (external controller) via a network link. This allows convenient operation of the instrument from the desktop although the instrument is integrated in a rack somewhere else.



For an overview of the instrument's operating concept and the different ways to control and operate the instrument, see [chapter 2.1, "Brief Introduction to the Instrument's Concept"](#), on page 61.

There are different ways to establish a remote access connection to the signal generator but all of them require an established LAN connection between the instrument and the remote computer. The simplest way to remote access the instrument is to use a Web browser, such as Windows Internet Explorer or Mozilla Firefox for instance. Alternatively a remote access via a special application can be used.

Two free-of-charge programs are available for setting up the remote access connection: the Windows application Remote Desktop for PCs with Window operating system and the program Ultr@VNC for PCs with Linux/Unix or Windows operating system. Using of each of this two applications requires additional installation.

See the following table for an overview of the different ways to establish a remote access connection to the signal generator.

Table 1-1: Remote access via an external computer

Remote access via	LAN connection	Installation of the additional application	
		on the instrument	on the remote computer
Web Browser e.g. Windows Internet Explorer or Mozilla Firefox see chapter 1.7.1, "Using a Web Browser for Remote Access" , on page 44	required	no	no
Remote Desktop Windows application for PCs with Window operating system see chapter 1.7.2, "Remote Desktop Connection" , on page 45	required	no	required
Ultr@VNC for PCs with Linux/Unix or Windows operating system see chapter 1.7.3, "Remote Access via Ultr@VNC" , on page 47	required	required	VNC Viewer required

When the connection is set up with Remote Desktop, the device firmware of the signal generator is disabled. Direct control on the instrument is not possible while manual remote-control is active. The access of an external PC is indicated by the logon screen of Windows XP Embedded which identifies the accessing user.

When the connection is set up with Ultr@VNC, direct control on the instrument is possible while remote access is established.

For return to direct operation on the instrument, the connection must be cut. After cutting the connection, it is still enabled and can be established again any time. The connection is disabled only after deactivation of the program.

This section gives an information on how to use the Web browser for remote access, how to install the applications for remote access and how to establish the connection between the instrument and an external computer with Windows operating system. Remote access via an external computer with Linux/Unix operating system is performed accordingly.



Accessing Operating System

The operating system can only be accessed if an external keyboard and/or a mouse is connected. Windows XP provides an on-screen keyboard that can be operated using a mouse, thus enabling operation by mouse only. An external keyboard is recommended for extensive entries.



Default password

Remote-access and file access require the user "instrument" with default password "instrument".

1.7.1 Using a Web Browser for Remote Access

The instrument can be remote-accessed via any Web browser, like Windows Internet Explorer or Mozilla Firefox for instance.

To remote access the instrument via Web browser:

1. Connect the instrument and the remote computer to a LAN, see [chapter 1.6.1, "Connecting the Instrument to the Network"](#), on page 39.
2. Instal the Java Runtime Environment JRE on the remote computer.
3. Type the instruments' IP address in the address field of the Web browser on your PC, e.g. *http://10.111.11.1*

The "VNC Authentication" screen appears.



4. Enter the password and select "OK".

The default password is "instrument".

After the connection is established, the current signal generator screen with the block diagram is displayed and the instrument can be remote-accessed from the remote computer.

1.7.2 Remote Desktop Connection

Remote Desktop is a Windows application which can be used to access and control the instrument from a remote computer through a LAN connection. While the instrument is in operation, the instrument screen contents are displayed on the remote computer, and Remote Desktop provides access to all of the applications, files, and network resources of the instrument. Thus, remote operation of the instrument is possible.

NOTICE

Risk of Unauthorized Access

If the Windows Remote Desktop application is enabled on the instrument (go to "Start > Settings > Control Panel > System"), any user in the network who knows the computer name and login data can access it. To prevent this, make sure that the Remote Desktop application on the instrument is disabled.

To set up a Remote Desktop connection

1. Enable remote desktop control on the instrument.
2. Connect the instrument and the remote computer to a LAN, see [chapter 1.6.1, "Connecting the Instrument to the Network"](#), on page 39.
3. Set up the Remote Desktop connection between the remote computer and the instrument.



Remote Desktop Client

With Windows XP, Remote Desktop Client is part of the operating system and can be accessed via "Start > Programs > Accessories > [Communications >] Remote Desktop Connection".

For other versions of Windows, Microsoft offers the Remote Desktop Client as an add-on.

Enabling remote desktop control on the instrument

1. Press the "Windows" key to access the operating system.
2. Open the Control Panel by selecting "Start > Settings > Control Panel".
3. Select "System" and switch to the "Remote" tab.
4. Under "Remote Desktop", activate the "Allow users to connect remotely to this computer" option.

Note: Remote Desktop access and firewall settings.

When you enable or disable the Windows Remote Desktop option (in the "System Properties"), the associated firewall settings are adapted automatically.

5. If necessary, click "Select Remote Users" and select users who are to be given access to the R&S SMU via Remote Desktop. The user account under which configuration is carried out is automatically enabled for Remote Desktop.

Setting up the Remote Desktop connection on the remote computer

1. On the remote computer, select "Start > Programs > Accessories > [Communications >] Remote Desktop Connection."
2. Enter the instrument's name or IP address in the dialog box (see also [chapter 1.6.2, "Assigning the IP Address"](#), on page 40).
3. Enter the user ID and password for the instrument (see also [chapter 1.5, "Windows Operating System"](#), on page 36).
4. Click "Connect".

When the connection has been set up, the instrument's screen appears on the remote computer.



Disabled Direct Control

While remote access is active, the direct control of the instrument is disabled.

Remote access is indicated on the instrument by the logon screen of the operating system. The logon screen identifies the accessing user.

For simultaneous remote access of several instruments from the same PC, a separate Remote Desktop session must be opened for each instrument.

For detailed information about Remote Desktop and the connection refer to the Windows XP Help.

Helpful settings for Remote Desktop

The following settings for the Remote Desktop connection can make working on the remote PC more convenient.

1. When setting up the connection to the instrument, you can configure the connection settings in the "Remote Desktop Connection" dialog box.
Click the "Options >>" button.
The dialog box is expanded to display the configuration data.
2. Customize the settings:
 - **On the "Experience" tab:**
 - Select the appropriate connection to optimize the connection speed.
 - To improve the performance, you can deactivate options you do not require under "Allow the following".
 - **On the "Local Resources" tab:**

- If you need to access drives of the remote PC from the instrument (e.g. in order to store settings or to copy files from the PC to the instrument), activate the "Disk drives" option. Windows XP will then map drives of the remote PC to the corresponding network drives. When a connection is established, a warning is displayed on the PC indicating that the drives are enabled for access from the instrument.
- To use printers connected to the remote PC while accessing them from the instrument, activate the "Printers" options. Do not change the remaining settings.
- **On the "Display" tab:**
 - Under "Remote desktop size", set the size of the R&S SMU window on the desktop of the remote PC.
 - Activate the "Display the connection bar when in full screen mode" option. A bar showing the network address of the instrument is displayed on the screen which you can use to reduce, minimize or close the window.
- **On the "General" tab:**

You can save the connection settings for later use using the "Save As" button.

Terminating Remote Desktop Control

A Remote Desktop connection can be terminated either on the R&S SMU or on the remote PC. The connection can be established again any time as long as remote control is enabled on the instrument. Consider the notice above concerning unauthorized access due to Remote Desktop!

1. To terminate the connection on the instrument, click "Disconnect" in the remote-control message menu of the R&S SMU.
2. To terminate the connection on the remote PC, close the "Remote Desktop" window, or select "Start > Disconnect".

Disabling Remote Desktop Control

To disable the remote access, deactivate the Remote Desktop on the instrument.

- ▶ Under "Remote Desktop", disable the "Allow users to connect remotely to this computer" option and confirm with "OK".

The connection is disabled, it is no longer possible to access the instrument via Remote Desktop.

1.7.3 Remote Access via Ultr@VNC

Ultr@VNC is an application which can be used to access and control the instrument from a remote computer through a LAN connection. The program is included in operating system Linux/Unix. It is available as a free-of-charge download on the internet for operating system Window XP (<http://www.uvnc.com/download/index.html>) and on the instrument's CD-ROM.

NOTICE**Risk of Unauthorized Access**

If the VNC application is enabled on the instrument, any user in the network who knows the computer name and login data can access it. To prevent this, make sure that the VNC server service on the instrument is disabled.

Setting up a VNC connection

1. Connect the instrument and the remote computer to a LAN, see [chapter 1.6.1, "Connecting the Instrument to the Network"](#), on page 39.
2. [Install the Ultr@VNC application](#) and enable it on the instrument.
3. In the ICF firewall, enable communication on the network via Ultr@VNC program. See ["Configuring Internet Connection Firewall for VNC Connection"](#) on page 50.
4. Install the VNC Viewer on the remote computer with Windows operating system, see ["Installing the VNC Viewer on a Windows PC"](#) on page 51.
5. Set up the VNC connection between the instrument and:
 - a) the remote computer with Linux/Unix operating system, see ["Setting up the VNC connection on the Linux/Unix remote computer"](#) on page 52;
 - b) the remote computer with Windows operating system, see ["Setting up the VNC connection on the Windows remote computer"](#) on page 52.

**Enabled Direct Control**

The direct control of the instrument is not disabled and the instrument can be controlled from the front panel and via the remote computer alternately.

Installing the Ultr@VNC application

1. Download the program from the internet and copy it to a directory that can be accessed.
2. On the instrument, shut down firmware using the ALT+F4 key combination.
3. Double click on the setup file to start the installation.
The setup wizard leads through the installation. This description focus only on the relevant settings.

a) Select installation of all components.

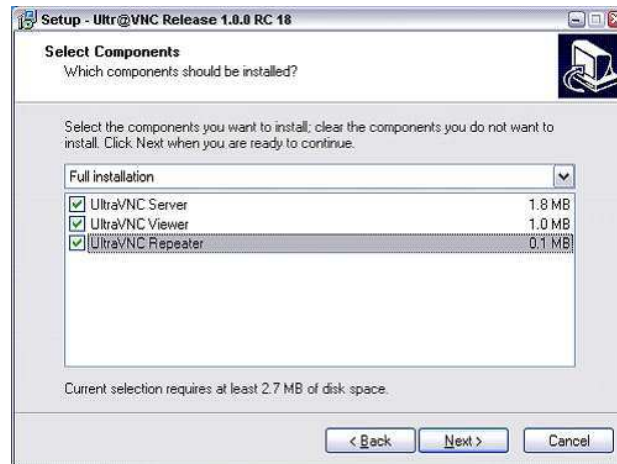

b) In the "Additional Task Panel", enable all entries.

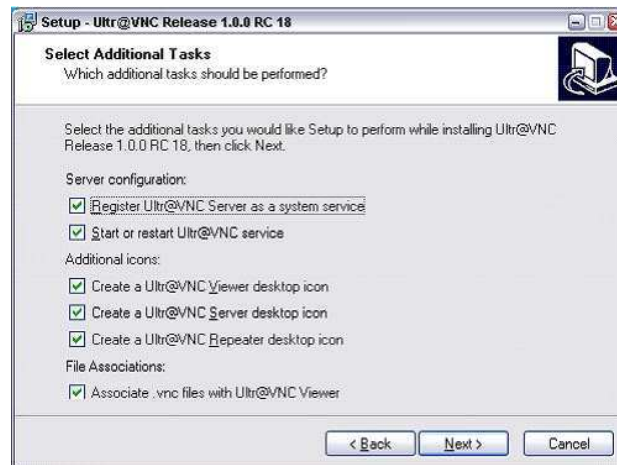

A successful installation is indicated by a message.



At the same time a warning is displayed stating that a password must be set.



4. Select "OK".

The "Default Local System Properties" panel opens.

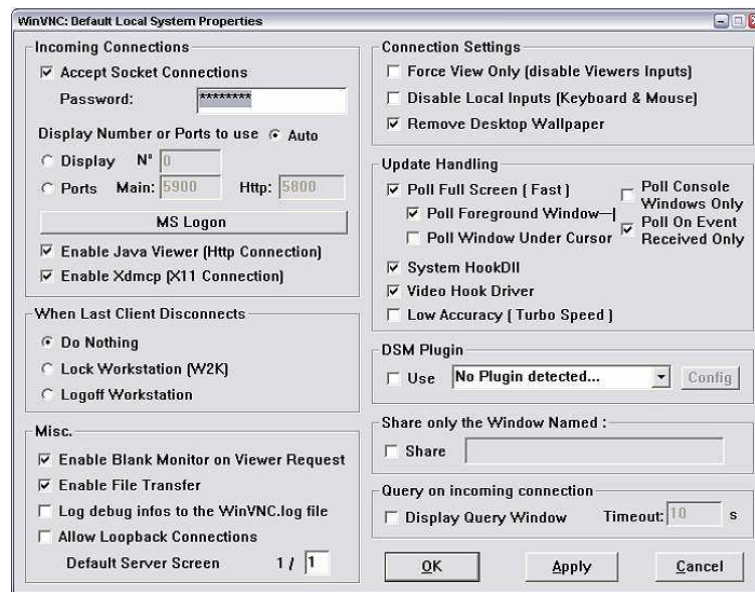

5. Enter a password with a length of at least five digits.

This password is used on the remote computer to access the instrument. Other settings may be changed according to the user-specific security requirements.

After the installation the Ultr@VNC program is automatically started together with the operating system. On mouse over, the IP address of the instrument is indicated. This IP address and the user-defined password are the prerequisites to enable remote access on the remote computer. Terminated connection is indicated by changed icon color.

Configuring Internet Connection Firewall for VNC Connection

To enable remote access of an instrument in a local network via VNC connection, the connection must be specifically permitted in the firewall.

1. Press the "Windows" key to access the operating system and select "Start > Settings > Control Panel > Windows Firewall" to open the "Windows Firewall".
2. Select "Exceptions > Add Program... > Run Ultr@VNC SERVER" and confirm with "OK".

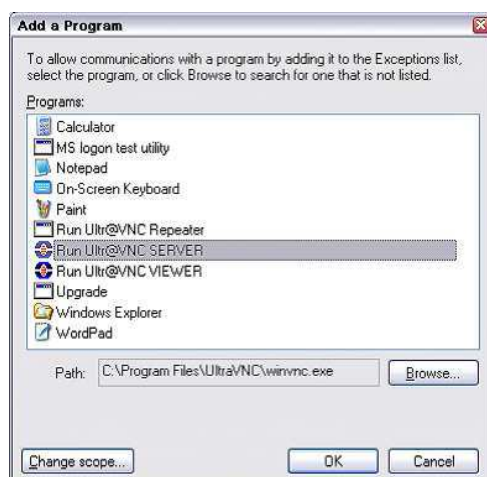

- In the "Exceptions" tab, enable "Run Ultr@VNC SERVER".

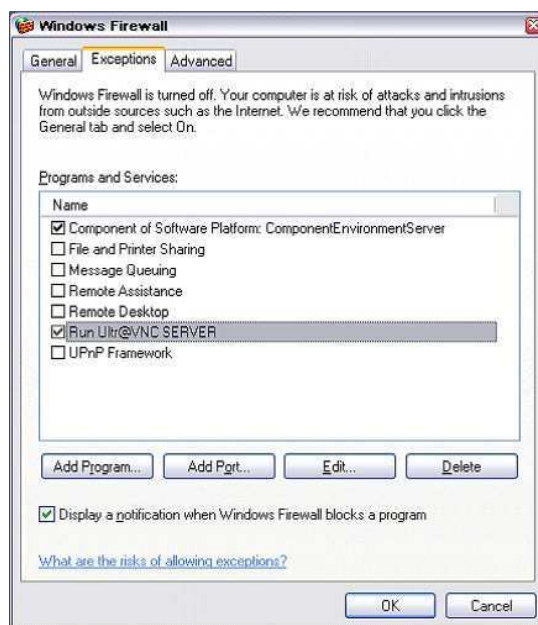

Installing the VNC Viewer on a Windows PC

- Download the Ultr@VNC program from internet and follow the installation instructions.

Only the program component VNC Viewer is required.

Note: The VNC Viewer program is included in the download for the installation of the Ultr@VNC program on the signal generator if "Full installation" was selected in the "Select Component" panel. In this case, the program `ultr@vncviewer.exe` can be copied to the Windows PC.

- Install VNC Viewer program component on the remote computer.

Setting up the VNC connection on the Linux/Unix remote computer

The VNC program is available per default for Linux/Unix operating systems.

1. Start a Web browser on the remote computer and enter the IP address of the instrument.
2. Enter the following address:
vnc://<IP-address of the instrument>, e.g. `vnc://192.168.1.1`.
A dialog is opened and the password for the remote VNC connection is requested.
3. Enter the password as defined in the "Default Local System Properties" panel of the Ultr@VNC program and select "Log On".

The connection is established, the instrument is remote accessed and the current signal generator screen with the block diagram is displayed. The individual functions are operated using the mouse and keyboard.

In contrast to remote access via Remote Desktop, the direct control of the instrument is not disabled and the instrument can be controlled from the front panel and via the remote computer alternately.

Setting up the VNC connection on the Windows remote computer

1. Start VNC Viewer program component on the PC, select "VNC Server" and enter IP address of the instrument.

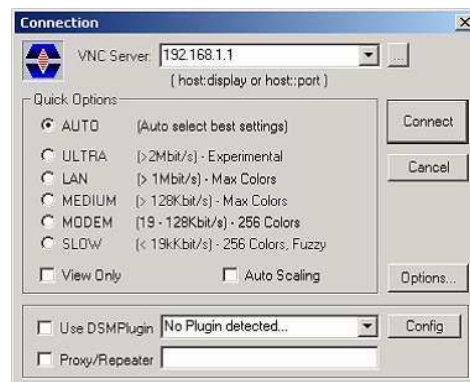

2. To initialize the connection, select "Connect".
A message requesting the password appears.



3. Enter the password as defined in the "Default Local System Properties" panel of the Ultr@VNC program and select "Log On".

The connection is established, the instrument is remote accessed and the current signal generator screen with the block diagram is displayed. The individual functions are operated using the mouse and keyboard.



Enabled Direct Control

The direct control of the instrument is not disabled and the instrument can be controlled from the front panel and via the remote computer alternately.

Terminating VNC Connection

The remote access via VNC connection can be terminated either on the R&S SMU or on the external PC. Terminating the connection does not disable it. It can be established again any time. See the notice above concerning unauthorized access due to VNC connection!

1. Terminate the connection on the R&S SMU
 - a) Press the "Windows" key to access the operating system.
 - b) Right-click on the VNC icon on the task bar and select "Kill all clients".
2. To terminate the connection on the external Linux/Unix PC, close the internet browser or close the signal generator window.
3. To terminate the connection on the external Windows PC, close the VNC Viewer program.

The connection is terminated. The color of the VNC icon in the status bar of the instrument changes.

A message on the external PC indicates the disconnection.

Disabling Remote Access via Ultr@VNC

The VNC connection can be disabled by removing the program on the instrument or by deactivating the VNC Server service.

1. Remove the VNC program
 - a) Press the "Windows" key to access the operating system and open the "Add or Remove Programs" by selecting "Start > Settings > Control Panel > Add or Remove Programs".
 - b) Remove the VNC program.
2. Deactivate the VNC Server service
 - a) Press the "Windows" key to access the operating system and open the "Services" by selecting "Start > Settings > Control Panel > Services".
 - b) Deactivate the VNC Server service.

The connection is disabled, the VNC icon disappears from the task bar of the instrument.

1.8 Using Virus-Protection Software

Virus-protection software Symantec Antivirus 10.1.7.7000 has been successfully tested for compatibility with the instrument software on R&S Signal Generator.

However, Symantec Antivirus may affect the behaviour of the instrument in terms of settling time or stability. Symantec Antivirus 10.1.7.7000 has been subjected to detailed tests with R&S Signal Generator and a page file of 1024 MB. The system remains very reliable. However, rare impact on the settling time has been experienced (slight degradations of settling time in 2% of samples out of specification).

Preparing the Installation of Symantec Antivirus

The installation is performed in the Windows XP operating system.



Accessing Operating System

The operating system can only be accessed if an external keyboard and/or a mouse is connected. Windows XP provides an on-screen keyboard that can be operated using a mouse, thus enabling operation by mouse only. An external keyboard is recommended for extensive entries.

1. Press the "Windows" key to access the operating system and open the "System" dialog by selecting "Start > Settings > Control Panel > System".
2. In the "System" dialog, select the "Advanced > Performance > Settings > Change".
3. Enable "Drive D: [DATA]" and "System managed size", confirm with "Set" and close the dialog.

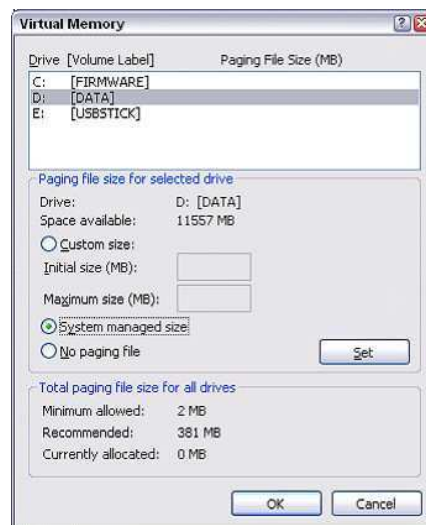

The Symantec Antivirus program can be installed.

1.9 LXI Configuration

LAN eXtensions for Instrumentation (LXI) is an instrumentation platform for measuring instruments and test systems that is based on standard Ethernet technology. LXI is intended to be the LAN-based successor to GPIB, combining the advantages of Ethernet with the simplicity and familiarity of GPIB.

Like GPIB, LXI determines and standardizes the way the instrument behaves in a LAN. The LXI implementation by the R&S Signal Generators allows you to change certain LAN settings, to reset the LAN connection as well as to easily identify the instrument.

LXI classes and LXI functionality

LXI-compliant instruments are divided into three classes, A, B and C, with the functionality of the classes hierarchically based one upon the other:

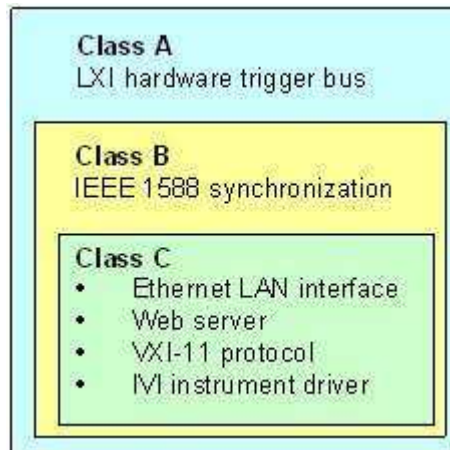

- **Class C** instruments are characterized by a common LAN implementation, including an ICMP ping responder for diagnostics. The instruments can be configured via a web browser; a LAN Configuration Initialize (LCI) mechanism resets the LAN configuration. The LXI class C instruments shall also support automatic detection in a LAN via the VXI-11 discovery protocol and programming by means of IVI drivers.
- **Class B** adds IEEE 1588 Precision Time Protocol (PTP) and peer-to-peer communication to the base class. IEEE 1588 allows all instruments on the same network to automatically synchronize to the most accurate clock available and then provide time stamps or time-based synchronization signals to all instruments with exceptional accuracy.
- **Class A** instruments are additionally equipped with the eight-channel hardware trigger bus (LVDS interface) defined in the LXI standard.



For information about the LXI standard refer to the LXI website at <http://www.lxistandard.org>. See also "News from Rohde & Schwarz, article 2006/II - 190".

Instruments of classes A and B can generate and receive software triggers via LAN messages and communicate with each other without involving the controller.

The R&S SMU complies with LXI class C and provides an integrated "LXI Status" dialog for LXI status indication and reset of the LAN configuration (LAN Configuration Initialize, LCI). To access the LXI Status dialog, press the SETUP key and select "Remote > LXI Status".

For further information, see section "LXI Status" in the Operating Manual.



Firmware update

After a firmware update, shut-down and re-start the instrument in order to enable the full LXI functionality.

Default state of the network settings

According to the LXI standard, an LCI must set the following parameters to a default state.

Parameter	Value
TCP/IP Mode	DHCP + Auto IP Address
Dynamic DNS	Enabled
ICMP Ping	Enabled
Password for LAN configuration	LxiWebIfc

The LCI for the R&S SMU also resets the following parameters:

Parameter	Value
Hostname	<Instrument-specific host name>
Description	Vector Signal Generator
Negotiation	Auto Detect
VXI-11 Discovery	Enabled

The LAN settings are configured using the instrument's "LXI Browser Interface".

1.9.1 LXI Browser Interface

The instrument's LXI browser interface works correctly with all W3C compliant browsers. Typing the instrument's host name or IP address in the address field of the browser on your PC, e.g. *http://10.113.10.203*, opens the "Instrument Home Page" (welcome page).



Do not add the missing zeros in the IP address, while opening the Instrument Home Page.

The screenshot displays the 'Instrument Home Page' for an R&S SMU 200A. On the left is a navigation pane with links for LXI, Home, Lan Configuration, Status, Help, Glossary, and the website URL. The main content area is titled 'Instrument Home Page' and contains 'Instrument Properties' and a 'Status' section. The properties table lists various technical details, and the status section indicates 'No error'. At the bottom right, there is a copyright notice for 2008 ROHDE&SCHWARZ.

Instrument Properties	
Instrument Model	R&S SMU 200A
Manufacturer	Rohde & Schwarz GmbH & Co. KG
Serial Number	999014
Description	Rohde & Schwarz Vector Signal Generator SMU200A 999014
LXI Class	C
LXI Version	1.1
Host Name	10.111.10.130
MAC Address	00:E0:33:62:01:56
TCP/IP Address	10.111.10.130
Firmware Revision	02.05.104 beta (Release) (2008-04-18; 15:04:42), Compass 2.1.65.0 (Release)
Current Time	Thursday, 2008/04/24, 14:23:12
Current Time source	Operating System
VISA resource string	TCPIP::10.111.10.130::inst0::INSTR
Device Indicator	Inactive (press to toggle)

Status
No error

© 2008 ROHDE&SCHWARZ. All rights reserved

The "Instrument Home Page" displays the device information required by the LXI standard including the VISA resource string in read-only format.

- ▶ Press the "Inactive (press to toggle)" button to indicate the device.

ACTIVE (press to toggle)



Pressing this button causes a LAN Status indicator on the instrument's home page to flash (if active).

A green LXI status symbol on the instrument's home page indicates that a LAN connection has been established; a red LED indicates that no LAN cable is connected. The status of the LAN connection is also indicated by the "LAN Status indicator" in the "LXI Status" dialogbox.

The "Device Indicator" setting is not password-protected.

For further information, see section "LXI Status" in the Operating Manual.

The navigation pane of the browser interface contains the following control elements:

- "LAN Configuration" opens the LAN Configuration page.
- "LXI Glossary" opens a document with a glossary of terms related to the LXI standard.
- "Status" displays information about the LXI status of the instrument.

1.9.2 LAN Configuration

The "LAN Configuration" web page displays all mandatory LAN parameters and allows their modification.

The "TCP/IP Mode" configuration field controls how the IP address for the instrument gets assigned (see also [chapter 1.6.2, "Assigning the IP Address"](#), on page 40). For the manual configuration mode, the static IP address, subnet mask, and default gateway are used to configure the LAN. The automatic configuration mode uses DHCP server or Dynamic Link Local Addressing (Automatic IP) to obtain the instrument IP address.



Changing the LAN configuration is password-protected. The password is *LxiWebIfc* (notice upper and lower case characters). This password cannot be changed in the current firmware version.

The links at the bottom of the "LAN Configuration" page open other pages:

- "Ping Client" provides the ping utility to verify the connection between the instrument and other devices.
- "Advanced LAN Configuration" provides LAN settings that are not declared mandatory by the LXI standard.

1.9.2.1 Advanced LAN Configuration

The "Advanced LAN Configuration" menu provides LAN settings that are not declared mandatory by the LXI standard.

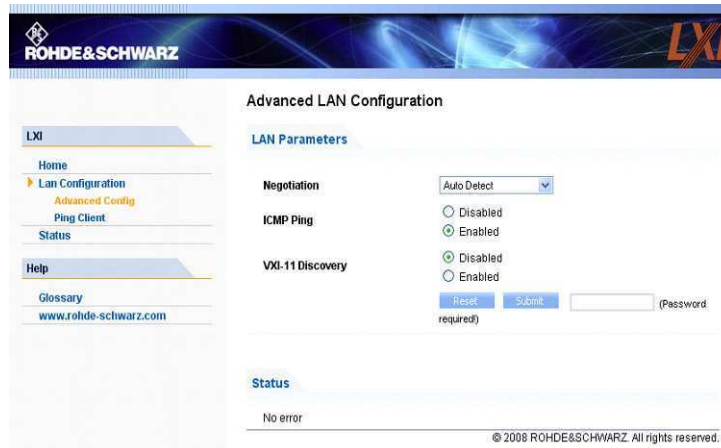

The "Advanced LAN Configuration" parameters are used as follows:

- The "Negotiation" configuration field provides different Ethernet speed and duplex mode settings. In general, the "Auto Detect" mode is sufficient.
- "ICMP Ping" must be enabled to use the ping utility.
- "VXI-11" is the protocol that is used to detect the instrument in the LAN. According to the standard, LXI devices must use VXI-11 to provide a detection mechanism; other additional detection mechanisms are permitted.

1.9.2.2 Ping

Ping is a utility that verifies the connection between the LXI-compliant instrument and another device. The ping command uses the ICMP echo request and echo reply packets to determine whether the LAN connection is functional. Ping is useful for diagnosing IP network or router failures. The ping utility is not password-protected.

To initiate a ping between the LXI-compliant instrument and a second connected device:

1. Enable "ICMP Ping" on the "Advanced LAN Configuration" page (enabled after an LCI).
2. Enter the IP address of the second device **without the ping command and without any further parameters** into the "Destination Address" field (e.g. *10.113.10.203*).
3. Click "Submit".



2 Getting Started

This section helps you to get familiar with the R&S SMU and provides an introduction to the general concept of the instrument with a sample of the possible application fields as well as a description of the main blocks in the signal generation flow.

This section also explains the operating concept in general and includes a brief introduction to operation by a step-by-step description of the configuration. The example is intended to provide a quick overview of the settings provided. No additional equipment is required.

2.1 Brief Introduction to the Instrument's Concept

The R&S SMU combines up to two independent signal generators in one cabinet and offers unrivaled RF and baseband characteristics. Due to its **modular design**, the instrument can be optimally adapted to the requirements of different applications. Both RF paths can be equipped with one of the available frequency options with different upper frequency limit. Up to two generators can also be installed in the baseband section. They generate complex signals in realtime and are equipped with an arbitrary waveform generator.

The R&S SMU provides an entirely digital baseband section for generating I/Q signals and an RF section with I/Q modulator. The instrument uses I/Q (vector) modulation. Digital data streams are converted to an I/Q baseband signal. The baseband signal is then D/A-converted and modulated onto the target RF carrier frequency with the aid of an I/Q modulator.



The R&S SMU may contain two paths; through the user documentation, the first being is called path A and the second path B, respectively.

For a detailed description of the blocks in the baseband and RF sections, refer to [chapter 2.3, "Baseband Section"](#), on page 67 and [chapter 2.4, "RF Section"](#), on page 71 respectively.

The **operating concept** of the R&S SMU employs the following three ways of instrument control:

- Manual operation
- Remote control
- Remote access

Manual Operation

The R&S SMU can be entirely operated from the front panel. Peripherals such as mouse or keyboard can be connected but are not essential.

The R&S SMU is equipped with an intuitive user interface. The central element of the display is the block diagram that shows the signal flow and processing from the left on the display to most right, i.e. the generated signal can be seen at a glance.

Each block represents a functional unit of the instrument. Thus the user always knows the position at which a parameter has an effect in the signal flow. The main settings of a block are indicated in the block. The interconnection of employed inputs and outputs is also shown. The user is thus always informed about the connection of inputs and outputs in the signal flow and where they can be configured. A window is opened for each menu where parameters can be set. When the window is opened, an entry is made in the "Winbar" below the display. All open menus are of equal priority (not modal) and can be accessed any time.

The block diagram in the figure below shows a fully equipped instrument.

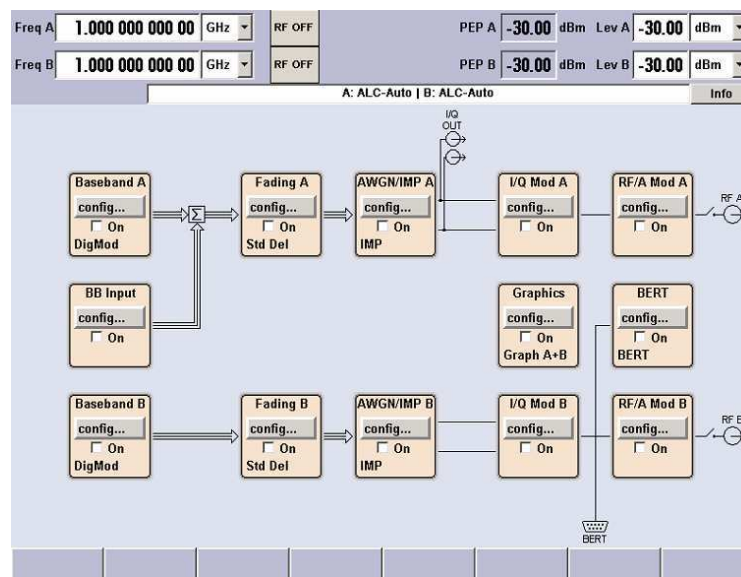

Fig. 2-1: Block diagram of a fully equipped two-path R&S Signal Generator

With the aid of the rotary knob, the user can navigate in the block diagram and the dialogs, and can operate the instrument with one hand. The cursor is moved line by line through the block diagram or dialog. Turning the button clockwise advances the cursor. The selected block can be activated or deactivated with the TOGGLE key. Active blocks are highlighted by a colored background.

The instrument comprises a comprehensive info and help system. Context-sensitive help can be called any time with the HELP (F1) key. The help system indicates the currently selected parameter and offers additional services such as cross references, index and contents. The content of the help system corresponds to the operating manual of the instrument.

Warning and conflict messages caused by incorrect operation as well as further information are displayed in the "Info" line. A complete list of existing conflicts is displayed when the INFO (CTRL+I) key is pressed. Additional information on entries can be requested from the help system. The history function permits display of all messages.

Assistants simplify the completion of tables. After data entry in the assistant, the table is modified only after the "Accept" button has been pressed. Pressing the "Accept" button also stores the assistant data.

For an introduction into the manual operating of the instrument, detailed operating instructions and an overview of menus refer to [chapter 3, "Manual Operation"](#), on page 81.

For an indepth description of the dialog boxes and the instrument functions refer to section [chapter 4.1, "Overview of Instrument Functions"](#), on page 121.

Remote Control

Remote control is an operation of the instrument by means of remote control commands or programs that automatize repeating settings. The instrument is connected to a computer running the program.

This way of operation and the instructions how to set up a connection for remote control are described in the [chapter 5, "Remote Control Basics"](#), on page 457. The description of the remote control commands is provided in [chapter 6, "Remote Control Commands"](#), on page 497.

Remote Access

Remote access is the operating of the instrument from a remote computer. Both the R&S SMU and the computer are connected in a LAN.

Remote access in contrast to **remote control** does not use remote-control commands but a separate software which is installed on the remote computer. After its start, the software simulates the user interface of the instrument. The instrument can thus be operated from the remote computer as on the unit itself. The individual functions are operated using the mouse and keyboard. Specific instrument functions can be executed using specific key combinations on the keyboard or a front panel key emulation that can be operated with the mouse.

This way of operation and the instructions how to set up a connection for remote access are described in [chapter 1.7, "Remote Access via an External Controller"](#), on page 42.

2.2 Applications of the Instrument

The modular design of the R&S SMU allows the instrument to be equipped with two paths. This allows a multitude of applications to be performed for which several signal generators were previously required. A few examples are given below.

2.2.1 Generation of digitally modulated signal

The main field of application of the R&S SMU is the generation of digitally modulated signals. In the instrument, a digitally modulated signal can be generated in several ways.

Internally generated I/Q signal

The I/Q signal is generated internally in the R&S SMU. One or two baseband generators can be installed. The signals produced by the two generators can be added (possibly with frequency offset).

In this case the instrument must be equipped with

- at least one baseband generator (option R&S SMU-B10) and
- at least one baseband main module (option R&S SMU-B13).

Fading scenarios can be created with the aid of a fading module (option R&S SMU-B14, Fading Simulator).

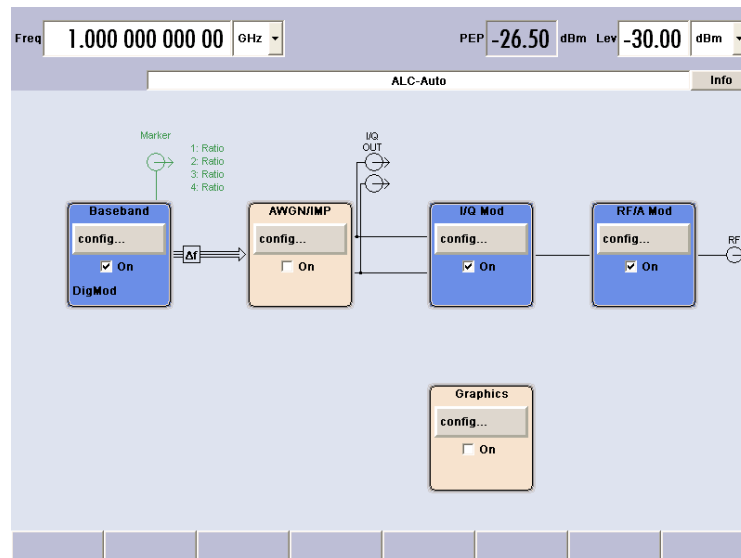

Fig. 2-2: Operation of I/Q modulator with I/Q signals from the internal baseband section

Externally generated I/Q signal

The I/Q signal is generated by an external instrument and coupled in via the baseband input module (option R&S SMU-B17, Baseband Input). The baseband input module is capable of processing analog I/Q signals. If options are installed for internal baseband generation, external and internal baseband signals can be added (possibly with frequency offset). In this operating mode, the fading module can also process external I/Q signals.

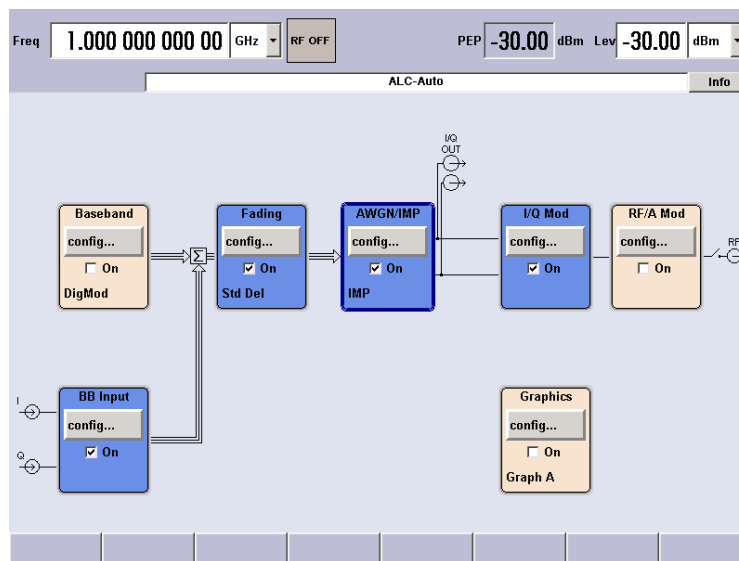

Fig. 2-3: Operation of I/Q modulator with external I/Q signals applied to the baseband section

Analog Wideband I/Q operation

An external analog I/Q signal is directly applied to the I/Q modulator of the R&S SMU. In this mode, the entire bandwidth of the I/Q modulator can be utilized. The various capabilities of the baseband section (AWGN, addition of signals, etc) are disabled, however.

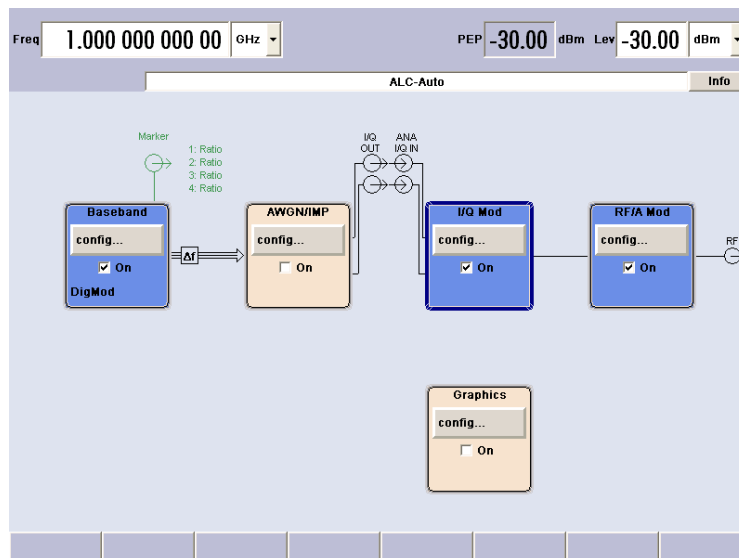

Fig. 2-4: Operation of I/Q modulator with external analog I/Q signals directly applied to the I/Q modulator

2.2.2 Two Baseband Generators, One RF Path

Examples of the possible applications of an instrument equipped with two baseband generators and one RF path are:

- Addition of real time signals of different standards, e.g. GSM/EDGE and 3GPP FDD

- Generation of multicarrier signals with real time components
- Simulation of antenna diversity

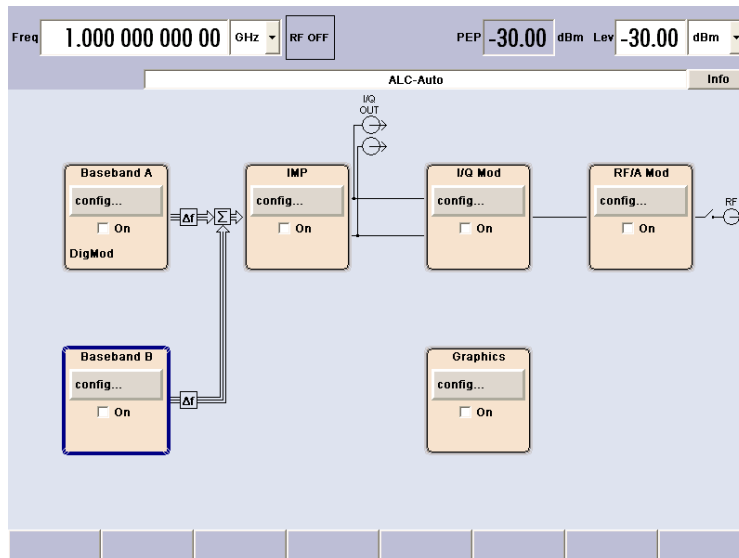

Fig. 2-5: Operation of R&S Signal Generator with two baseband generators and one RF path

2.2.3 One Baseband Path and Two RF Paths

An examples of the possible applications of an instrument equipped with one baseband path and two RF paths is:

- Generation of a modulated signal on path A and a CW interferer on path B.

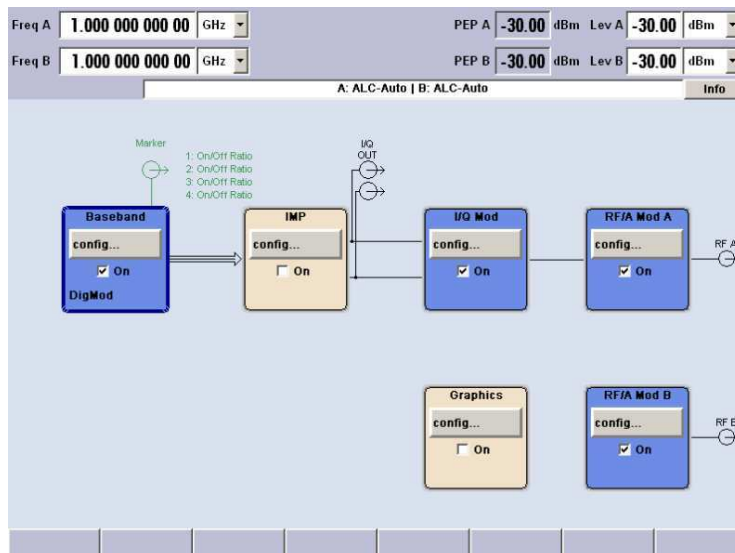

Fig. 2-6: Operation of R&S Signal Generator with one baseband generator and two RF paths

2.2.4 Fully Equipped Two-Path Instrument

Examples of the possible applications of a fully equipped two-path instrument are:

- Generation of a wanted signal and an interfering signal for receiver tests
- Generation of multicarrier signals with extremely wide bandwidth (>80 MHz)
- Generation of fading scenarios with external I/Q signal

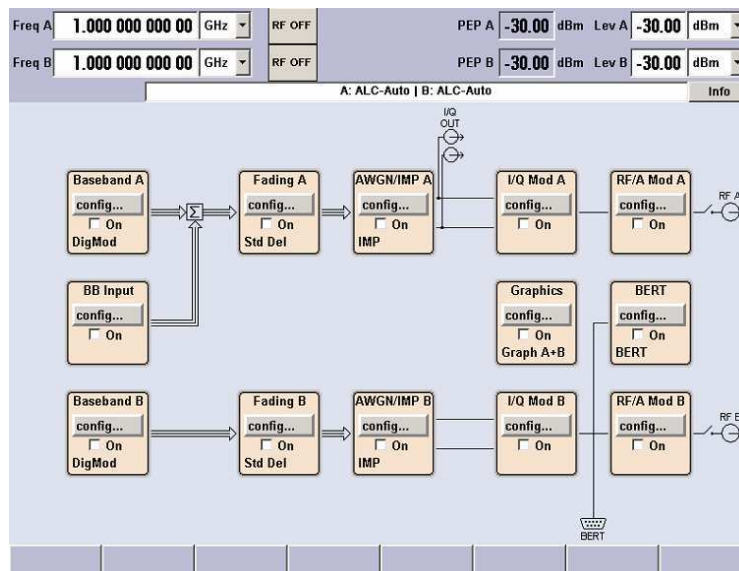

Fig. 2-7: Fully equipped two-path instrument

2.3 Baseband Section

The baseband section of the R&S Signal Generator is fully digital and contains the hardware for generating and processing I/Q signals.

The baseband section may contain two paths.

For detailed information on available options, refer to the R&S SMU data sheet and the R&S SMU configuration guide.

Up-to-date information is available at R&S SMU homepage on the internet <http://www2.rohde-schwarz.com/product/smu200a.html>.

Baseband generator (option R&S SMU-B10)

The generator produces baseband signals. It contains modules for real time signal generation and an arbitrary waveform generator (ARB).

The different baseband options feature a different ARB memory size (see data sheet). But apart from the memory size, all options have the same functionality and are installed alternatively.

One or two baseband generators can be fitted in an R&S SMU and operated separately. Signals from the baseband generators can be routed from path A to B and vice versa, and added (possibly with frequency offset).

The option Baseband Generator contains real time Custom Digital Modulation and ARB. Software options providing various digital standards are offered in addition. Option R&S SMU-K40, for instance, generates signals to GSM/EDGE standard, option R&S SMU-K42 signals to 3GPP FDD standard.

Baseband input module (option R&S SMU-B17)

With the aid of this module, external I/Q signals can be applied to the baseband section of the R&S SMU. The I/Q signals can be further processed in the baseband section (e.g. fading, addition of noise). If the R&S SMU is equipped for internal baseband signal generators, external and internal baseband signals can be added. The output of the baseband input module can be connected to baseband path A or path B (if available) provided at least one baseband main module or one fading module is installed. Otherwise the baseband input module is permanently linked to path A.



The R&S SMU-B17 option can be used together with the R&S® EX-IQ-BOX digital interface module, providing a versatile digital baseband interface with various formats.

Baseband main module (option R&S SMU-B13)

The baseband main module can be installed twice, for each of both paths A and B respectively.

At the end of the baseband path, the digital signal is converted to an analog I/Q signal. The analog I/Q signal is fed to the I/Q modulator of the RF path. This module also routes signals to the analog I/Q outputs. The module is absolutely required for coupling out the baseband signal from the baseband section.

At this stage routing from A to B or vice versa is no longer possible. If a two-path RF section is available, two baseband main modules are required if the signals from the baseband section are to be output to the two RF paths.

This module also offers digital I/Q impairment functions. The I/Q signal can be deliberately corrupted, e.g. for testing the receiver quality.

Additional White Gaussian Noise (option R&S SMU-K62)

Additive white noise, which may be required for instance for measurements on mobile radio base stations, can be produced with the AWGN software option (R&S SMU-K62).

Fading module (option R&S SMU-B14)

This module enables fading effects to be produced on baseband signals in real time. In the case of TDMA fading, up to 20 fading paths (40 fading paths with option R&S SMU-B15) can be created simultaneously.

Provided two RF paths are installed, option R&S SMU-B15 permits also real two-channel fading irrespective of the RF carrier spacing of the two channels.

Software option R&S SMU-B71 comprises the 3GPP dynamic fading configurations moving propagation and birth-death propagation as well as the fine delay fading configurations offering enhanced delay resolution.

Digital output module (option R&S SMU-B18)

The R&S SMU can be equipped with a standardized digital I/Q interface (LVDS) for online transfer of digital I/Q data. The digital output module (option R&S SMU-B18) enables the digital output of the I/Q baseband signal.



The R&S SMU-B18 option can be used together with the R&S® EX-IQ-BOX digital interface module, providing a versatile digital baseband interface with various formats.

2.3.1 Description of Individual Diagram Blocks of the Baseband Section

The baseband section of the R&S SMU comprises two paths (paths A and B). Therefore, if two baseband generators are available, two baseband signals can be processed independently of each other. Routing from path A to path B and vice versa is also possible, but not after the "IMP" or "AWGN/IMP" block.



Each function block can be activated or deactivated with the "ON" check box (on/off toggling).

The ON/OFF TOGGLE key at the front panel (see "TOGGLE" on page 19) switches the currently selected block on or off.

A detailed description of the blocks is provided below.



Baseband A block

In this block, the (first) baseband source is configured and activated. The block is displayed only if a baseband generator is available in the instrument.

Depending on the installed software options, various digital standards, user-configured digital real time modulation or the built-in waveform generator (ARB) can be selected. The selected modulation is displayed in the block.

The TOGGLE ON/OFF key switches the selected modulation (digital standard, digital modulation or ARB) on or off.

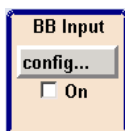

External Baseband In block

This block controls the baseband input module for external I/Q signals. The block is displayed only if the baseband input module (option R&S SMU-B17) is installed. External I/Q signals can be applied to the analog I/Q input. The output of the baseband input module can be connected to baseband path A or (if available) path B provided at least one baseband main module or one fading module is installed. Otherwise the baseband input module is permanently linked to path A. (The reason is that the baseband input module does not contain a router chip. For switchover, at least one baseband module with a router chip is required).

The TOGGLE ON/OFF key switches the input of external modulation signal on or off.



Baseband B block

Configures the second baseband source (if installed). The block is displayed only if the instrument contains two baseband generators. Depending on the installed software option, various digital standards, user-configured digital real time modulation or the built-in waveform generator (ARB) can be selected.

Note: If two baseband generators are installed and two signals of the same standard (e.g. GSM/EDGE) should be output simultaneously, the two associated software options must also be installed (in this case R&S SMU-K40).

If only one R&S SMU-K40 is installed and GSM/EDGE is selected in the first baseband generator, the second baseband generator is disabled for GSM/EDGE.

However, a software option is not tied to a specific baseband generator. In our example, either the first or the second baseband generator can output a GSM/EDGE signal.



Fading block

This block controls the fading module. It is displayed only if a fading simulator (option R&S SMU-B14) is installed. Signal routing at the output of the fading module is also configured in this block.

For instance, two-channel fading can be selected if the instrument contains two RF paths and two faders (option path extension, R&S SMU-B15).

The TOGGLE ON/OFF key switches the fading simulation on or off.

Note: Under certain signal routing conditions only one fader can be activated



AWGN/IMP A block

This block is displayed only if a baseband main module is installed.

In this block (digital) I/Q impairments for the baseband path can be set. With the aid of the software for AWGN generation (option R&S SMU-K62), an (additive) noise signal can be produced.

AWGN and impairments can be activated independently of each other in the appropriate menus. The settings are displayed in the block. The entire block can be activated or deactivated. If the block is deactivated, the signal passes through the block unchanged.

In addition, the differential I/Q output is configured in this block (option R&S SMU-B16).

The TOGGLE ON/OFF key switches the active functions of the block on or off. The functions (AWGN, impairments or both) are activated in the respective menus.



AWGN/IMP B block

This block is displayed only if two baseband main modules (option R&S SMU-B13) are installed. In this block (digital) I/Q impairments for baseband path B can be set. With the aid of the software for AWGN generation (option R&S SMU-K62), an (additive) noise signal can be produced in path B.

If a noise signal should be applied to path A and B simultaneously, two software options R&S SMU-K62 are required.



Graphics block

With this block, the baseband signal (of path A or B) can be graphically displayed in real time. The block is displayed only if at least one baseband main module is installed.

The TOGGLE ON/OFF key opens or closes the graphics window.



BERT block

In this block an integrated bit and block error rate tester can be set. The bit error tester makes it possible to evaluate a signal demodulated and decoded by a DUT by measuring the bit error rate. The data used to drive the DUT can be generated by the R&S SMU or an user-defined external source. In addition, the block error rate measurement can be used to verify CRC checksums.

The TOGGLE ON/OFF key switches the active function(s) of the block on or off. The functions (BERT and BLER) are activated in the respective menus.

2.4 RF Section

The RF section of the R&S SMU may also contain two paths.

An RF path is configured by installing a frequency option that comprises all required modules.



One of the following options must be installed.

Frequency options (Path A)

- R&S SMU-B102 (up to 2.2 GHz)
- R&S SMU-B103 (up to 3 GHz)
- R&S SMU-B104 (up to 4 GHz)
- R&S SMU-B106 (up to 6 GHz)

Frequency options (Path B)

- R&S SMU-B202 (up to 2 GHz)
- R&S SMU-B203 (up to 3 GHz)



RF path B can be I/Q-modulated only if the baseband section is equipped with two Baseband Main Modules R&S SMU-B13.

In addition, each RF path can be equipped with

- high-power option for higher output levels (R&S SMU-B31/B36)

For detailed information on available options, refer to the R&S SMU data sheet and the R&S SMU Configuration guide.

Up-to-date information is available at R&S SMU homepage on the internet <http://www2.rohde-schwarz.com/product/smu200a.html>).

2.4.1 Description of Individual Diagram Blocks of the RF Section

This section gives an overview of the available blocks and a detailed description of their functions.



I/Q Mod A block

The (first) I/Q modulator is configured in this block. Also the Analog Wideband I/Q mode can be selected here, which allows external I/Q signals to be directly applied to the I/Q modulator, i.e. not via the baseband section. If no baseband modules are installed, I/Q modulation is possible only in the Analog Wideband I/Q mode.

This block can be used to select whether the signal of path A or path B is applied to the analog I/Q outputs.

I and Q components can also be swapped (I/Q Swap). (Analog) I/Q impairments can be set in addition. Unlike the impairments in the "AWGN/IMP" block, impairments in the "I/Q Mod" block also affect the externally applied signals in the Analog Wideband I/Q mode.

The status display in the block shows whether I/Q impairments and/or I/Q swap is active. I/Q modulation is switched on or off with the TOGGLE ON/OFF key.

Note: An I/Q modulator provided in the R&S SMU is automatically activated when a connected baseband source is switched on. The I/Q modulator can also be separately switched on and off (select the "I/Q Mod" block and press the TOGGLE ON/OFF key). This permits the following configuration to be obtained with a single-path R&S SMU. The baseband source generates an I/Q signal that is output via the analog I/Q output. At the same time, the RF section generates an unmodulated carrier.



I/Q Mod B block

This block controls the I/Q modulator of RF path B. It is displayed only if a second RF path and two baseband main modules are installed.

Note: The I/Q modulator B can only be driven by modulation signals from the R&S SMU baseband section. Operation with external analog I/Q signals is not possible.

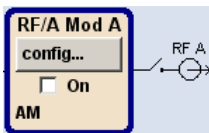

RF/A Mod A block

In this block, the RF parameters and the analog modulation modes of path A are set.

The active analog modulation modes are displayed in the block. The TOGGLE ON/OFF key switches the RF signal on and off. When the RF signal is switched off, the switch before the RF output symbol is open.

RF settings include:

- Frequency and reference frequency
- Attenuator settings.
 - If required, switching to the high-power mode if a high-power option is installed for path A.
- Frequency and level sweep
- List Mode settings. In this mode, extremely fast frequency and level settings can be made.

Note: Numeric values for frequency and level are entered best and quickest with the aid of the FREQ and LEVEL keys.

Available analog modulation modes:

- Amplitude modulation
- Broadband amplitude modulation
- Frequency modulation (option R&S SMU-B20/B22)
- Phase modulation (option R&S SMU-B20/B22)
- Pulse modulation.

Note: For modulation modes that can be simultaneously used, refer to the R&S SMU data sheet.



RF/A Mod B

In this block, settings are made for analog modulation and RF parameters of path B. This block is displayed only if a second RF path is installed.

Available analog modulation modes:

- Amplitude modulation
- Pulse modulation.

2.5 Example of Setup

This section provides an example on how to configure the instrument to generate and display a simple QPSK-modulated signal.

Configuring and displaying a QPSK-modulated signal

To generate and display a QPSK-modulated signal, proceed as follow:

1. Activate default (preset) state.
Press the PRESET key to set a defined instrument state.

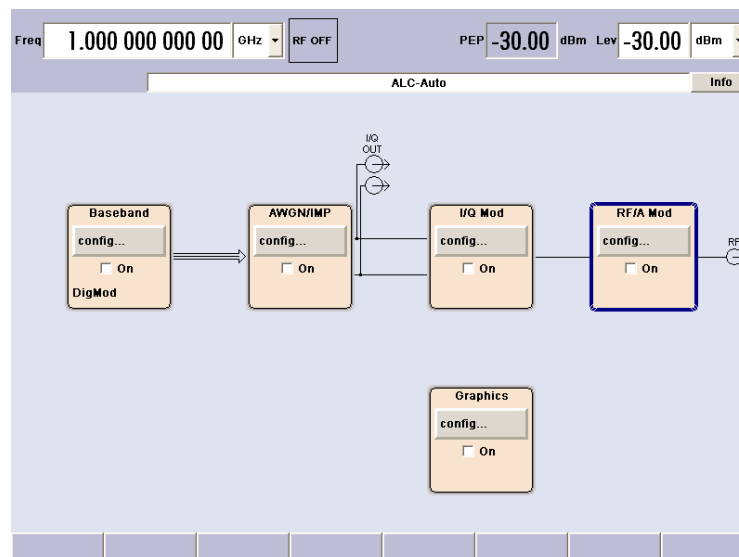

2. Select and activate digital modulation

- a) Turn the rotary knob and select the "Baseband A" block.

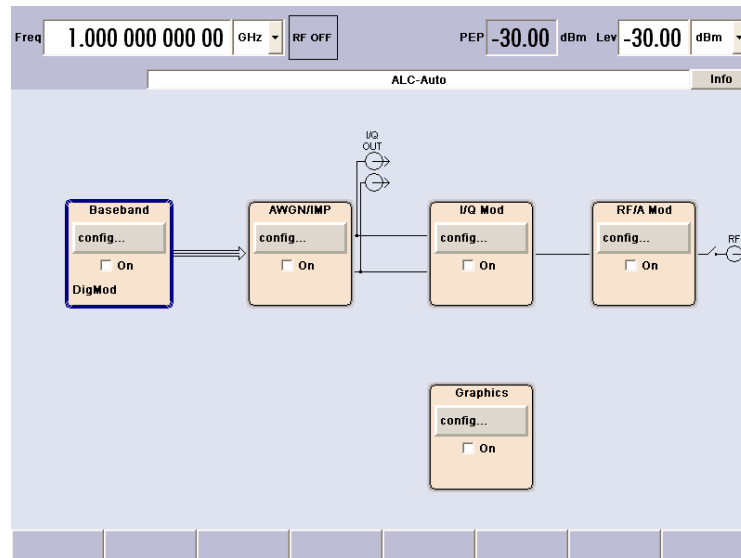

- b) Press the rotary knob to open the menu where the digital modulation can be selected (different modulation modes are available depending on the options installed).

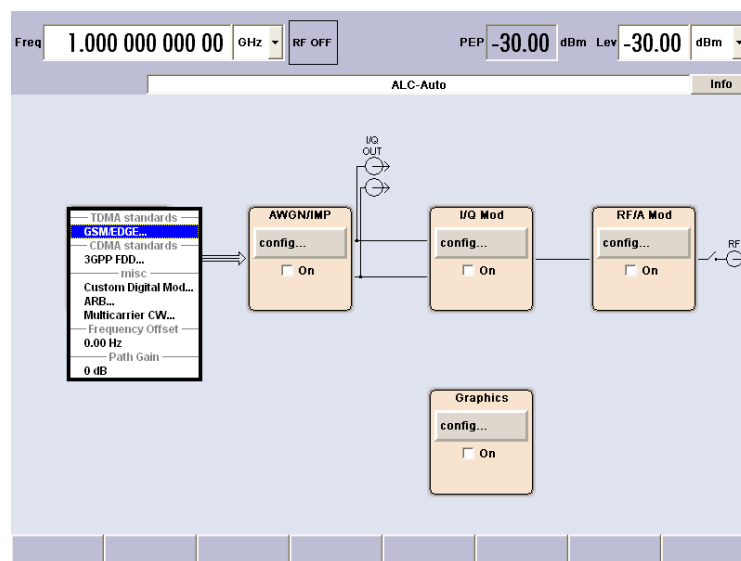

- c) Turn the rotary knob and highlight "Custom Digital Mod...".



Press the rotary knob to open the "Custom Dig. Mod." dialog.

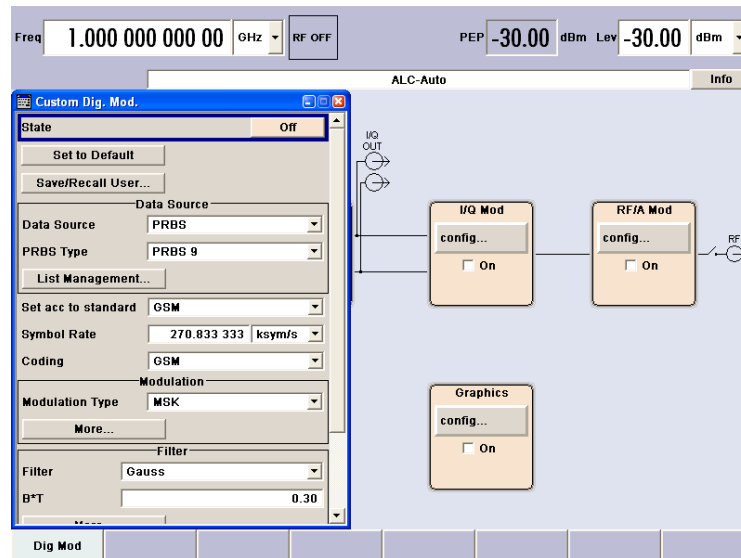

- d) Turn the rotary knob to select parameter "Symbol Rate", press the rotary knob to allow editing and enter the preferred symbol rate with the aid of the numeric keypad and the unit keys.

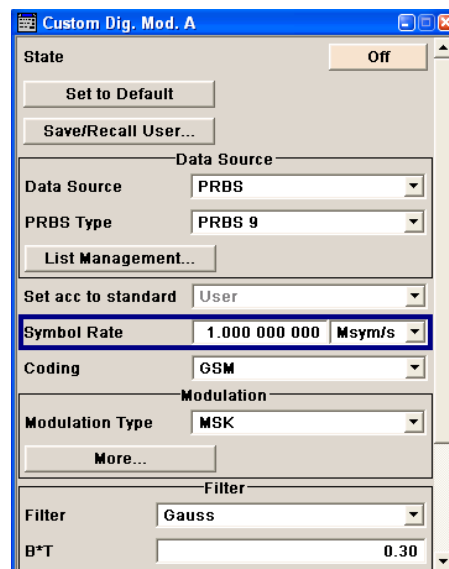

- e) Turn the rotary knob to select parameter "Coding".
Press the button to open the selection list.
Turn the rotary knob to select "Off" and press the knob to activate the selected item.

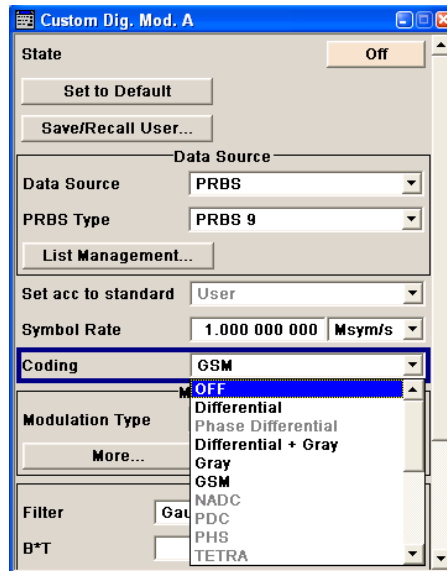

- f) Use the rotary knob in the same way to set "Modulation Type" QPSK and "Filter" Root Cosine with "Roll Off Factor" 0.3.

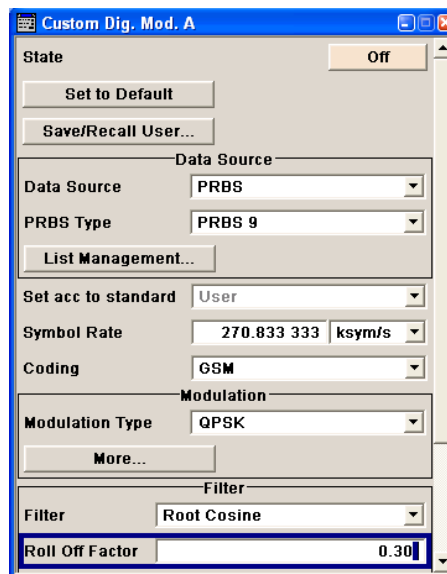

- g) Finally, select "State" and press the rotary knob to switch on the digital modulation.

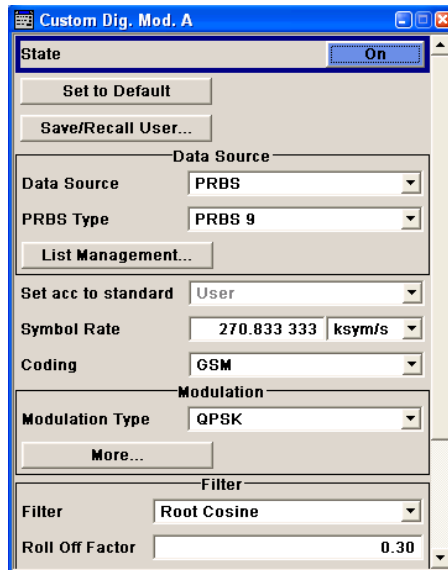

- h) Press the DIAGRAM key to display the complete block diagram.

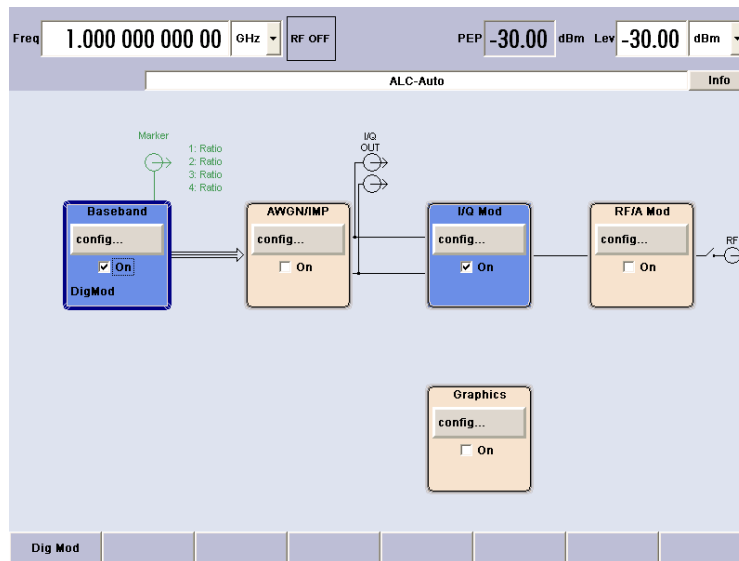

To indicate the active state, the "Baseband" block is displayed in blue.

- i) The entry in the Winbar indicates that the "Custom Dig. Mod." menu is still open in the background.
To display the menu in the foreground, press the softkey below the button in the "Windbar".

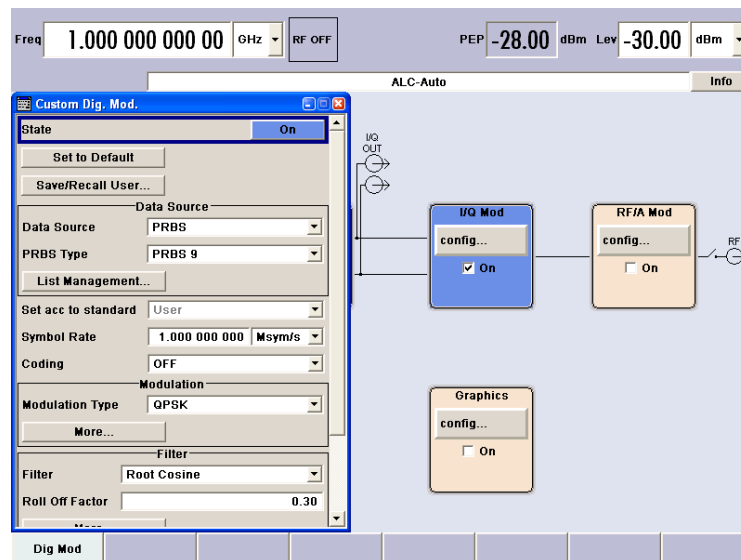

Press the HIDE key to minimize the menu again.

The "I/Q Mod" block is automatically activated.
The "RF/A Mod" is not yet active, which means that no RF signal is output.

3. Set frequency and level and activate RF signal
 - a) Press the FREQ key to activate the editing mode for frequency entry. The "Frequency" entry field in the header section of the display is highlighted.



Enter the frequency using the numeric keypad and terminate the entry by pressing a unit key.

- b) Press the LEVEL key and enter the level settings in the same way.



- c) Press the DIAGRAM key to display the complete block diagram.
 - d) Turn the rotary knob to select the "RF/A Mod" block.
Press the TOGGLE ON/OFF key to activate the "RF/A Mod" block.

The QPSK modulation signal is now present at the RF output.

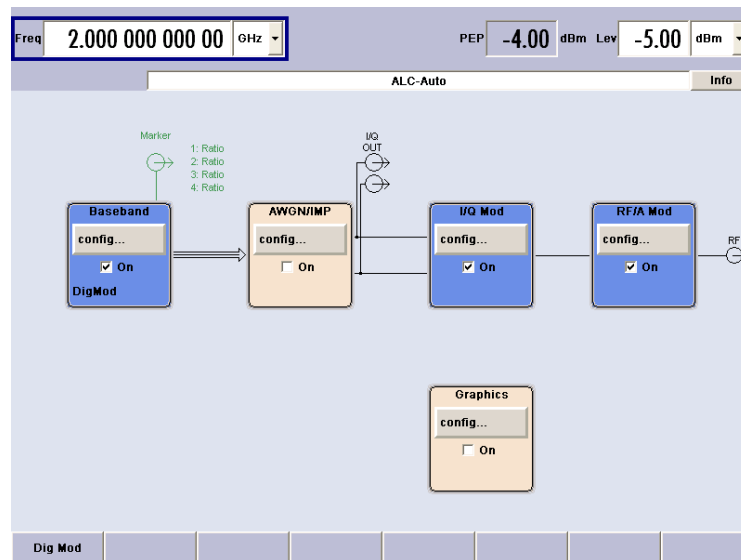

4. Select graphics display of I/Q signal
 - a) Turn the rotary knob to select the "Graphics" block and open the respective menu.

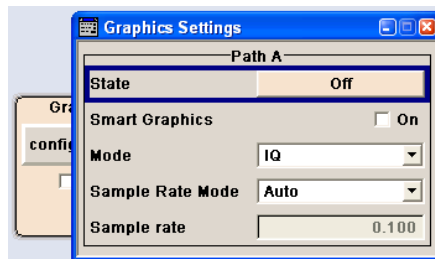

- b) Select "State On" with the rotary knob to activate display of the I/Q diagram.

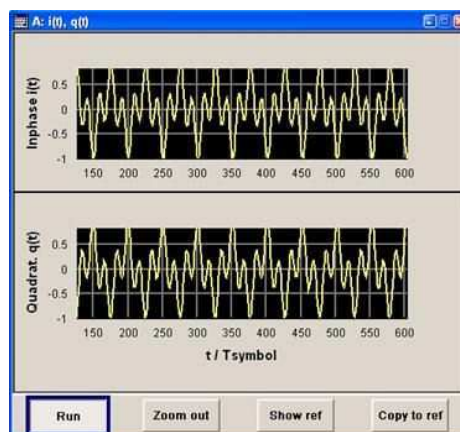

3 Manual Operation

The R&S SMU can be operated intuitively either via the interactive block diagram or via a menu tree. All menus are in the form of windows that can be operated in the same way. Rotary knob, keys and softkeys, or alternatively a mouse, allow direct and therefore convenient access to entries and settings.

The clear-cut display shows the current signal generator state. Graphs, spectra, vector diagrams, etc. can be called for a visual check of the output signal. Numerous help functions support the user in signal configuration.

This section describes the concept of manual operation of the signal generator. This includes a description of the general structure of a dialog box, working with dialog boxes and the block diagram and the setting of parameters.

For an in-depth description of the dialog boxes and the instrument functions refer to section "Instrument Functions".

3.1 Key Features

The manual operating concept of the R&S SMU enables the user to make settings as intuitively as possible and at the same time gives a permanent overview of characteristics of the generated signal and of the current instrument state. Numerous online help functions support user settings.

Block diagram

The block diagram is the core of the operating concept.

A graphics display shows the current configuration and the signal flow in the form of a block diagram. All graphical elements can be accessed for operation. An element is selected by means of the arrow keys and the associated setting function is called by pressing Enter. Required menus and graphs are displayed on the block diagram which is displayed again in the foreground whenever the DIAGRAM (CTRL+D) key is pressed.

Permanent frequency and level display

The main characteristics of the RF signal, frequency and level, are permanently displayed in the header section of the screen and can be directly set in the display fields after the FREQ (CTRL+F) or LEVEL (CTRL+L) key is pressed. Status messages for the output signal are displayed in addition to frequency and level.



Operation via Graphical User Interface

- **Functional blocks**

Menus are assigned to the specific function blocks in the block diagram. The function blocks represent elements of signal generation. Function blocks displayed with a blue frame can be directly switched on and off by means of the TOGGLE ON/OFF (CTRL

+T) key. The menus of the highlighted function blocks can be called by pressing the ENTER key.

– **Example:**

The "Baseband" block contains all menus required for baseband signal configuration.



In this block all digital standards and the digital modulation can be selected.

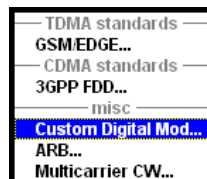

- **Signal flow**

The signal flow between the function blocks and the employed inputs and outputs are also shown.

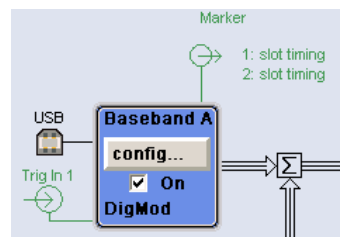

- **Menu tree**

The menu tree can be opened and closed with the MENU (CTRL+M) key. The menu tree is organized in the same way as the directories under Windows. The function blocks correspond to the first directory level, the menus to subdirectories.



Operation corresponds to the Windows concept

To offer the user a familiar environment, operation is very similar to operation of Windows user interfaces. All menus and tables are made up of known elements, such as selection lists, check boxes and entry fields.

A blue frame indicates that the selected item is active. In the highlighted element, entries can be made.

Rotary knob



Operation is possible via front-panel keys, an external keyboard and the mouse. However, most of the settings can be easily made with the rotary knob:

- Turning the rotary knob shifts the entry focus to the target element.
- Pressing the rotary knob activates the selected entry field. Depending on the parameter, the submenu is called, the numeric value varied, the list entry selected or the check box activated or deactivated.
- If a value is entered, the entry is stored by another click on the rotary knob and the editing mode is exited.

Clear settings with the aid of independent subdialogs

A separate window is opened for each dialog and subdialog. The dialogs can be operated independently of each other, i.e. none of the dialogs requires that settings in other dialogs be completed before it can be closed. This ensures flexible operation at all times.

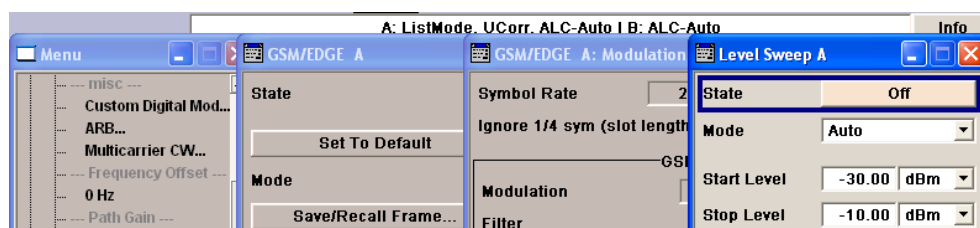

Winbar

The Winbar gives an overview of menus and simplifies their access.

The menus are displayed on top of the block diagram but they can be "hidden" with the aid of the HIDE (CTRL+H) key, i.e. displayed in the form of a button in the "Winbar" at the lower end of the screen.

They can be displayed again in full size by a keystroke (REARR (CTRL+A) key). This makes room on the screen for other displays that may be required but the setting menus can be still accessed any time.

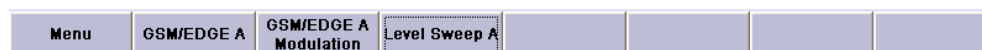

Keys with assigned simple functions

Most keys on the front panel of the R&S SMU directly perform a simple function.

Since a great number of settings can thus be made by a keystroke, operation is easy. For instance, the CLOSE (ESC) key closes the active menu; with the RF ON/OFF (CTRL+R) key the RF output signal can be switched on or off.

An exception are keys that call a menu such as the MENU (CTRL+M) key which opens the complete menu tree of the instrument, the SETUP (CTRL+E) key which opens the menus for general instrument settings or the FILE (CTRL+S) key which opens the menu for file management.

Help functions for user support

Numerous help functions support the user in signal configuration.

- **Value ranges**

The valid setting range is displayed for each numeric parameter. This requires a short wait after activation of the entry field. The range is then displayed automatically after a few seconds.

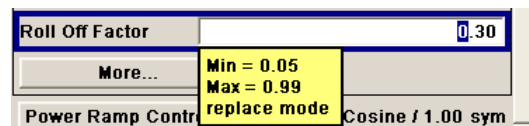

If the entered value is outside the permissible range, the next permissible value is automatically set and a message is output.

- **Context-sensitive help**

Context-sensitive help for each parameter can be called with the HELP or F1 key.

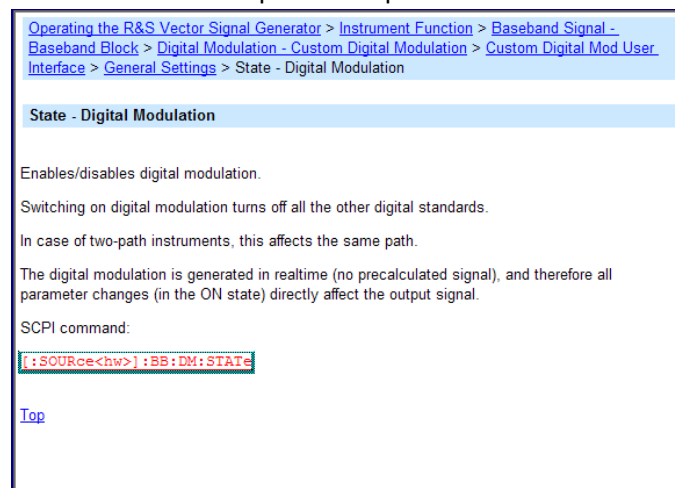

- **Comprehensive online help**

Each help page is part of a comprehensive online help function which can be called by means of an index, a content tree or the "Previous/Next" buttons.

Info line with messages for indication of the current instrument state

A great variety of different messages such as status messages, error messages, warnings or information are displayed in the header field of the screen. With the aid of the INFO (CTRL+I) key, help pages can be called for most of the messages. They provide background information on the message and indicate operating steps that may be required. All messages are explained in the online help which can be called with the HELP (F1) key.



Graphical display of data structure

The structure of the baseband signal is graphically displayed in the respective menus; the individual signal elements can be graphically selected for processing.

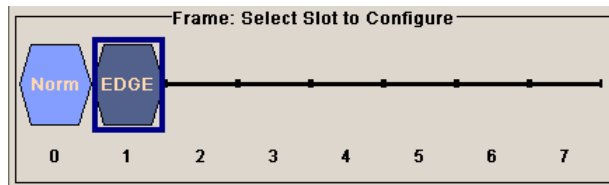

Graphics editor for definition of control signals

Control signals are also graphically configured.

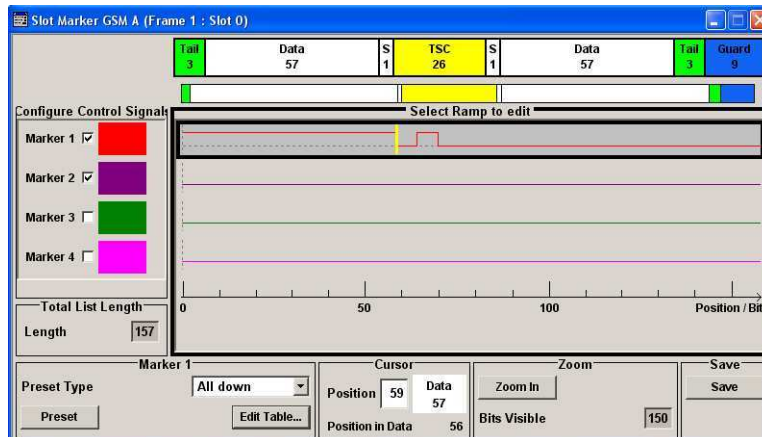

Graphical display of output signal in a diagram

The output signal can be graphically displayed in a number of diagrams. This allows a fast check of signal characteristics. Zoom functions and the insertion of a reference trace permit in-depth evaluation without an external analyzer being required.

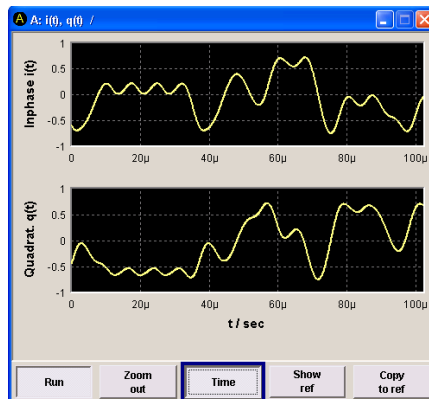

3.2 Display

The display shows the current signal generator state and offers graphical elements for direct operation. It is divided into three sections:

- The frequency and level display with info line indicates the main output signal parameters and reports the current state with status, error and warning messages.

- The block diagram shows the instrument configuration, the signal characteristic as well as the inputs and outputs used and permits interactive operation via graphics elements. Active menus and graphs are displayed on top of the block diagram.
- Winbar with labelled softkeys for menu display.

The block diagram in the figure below shows a fully equipped instrument.

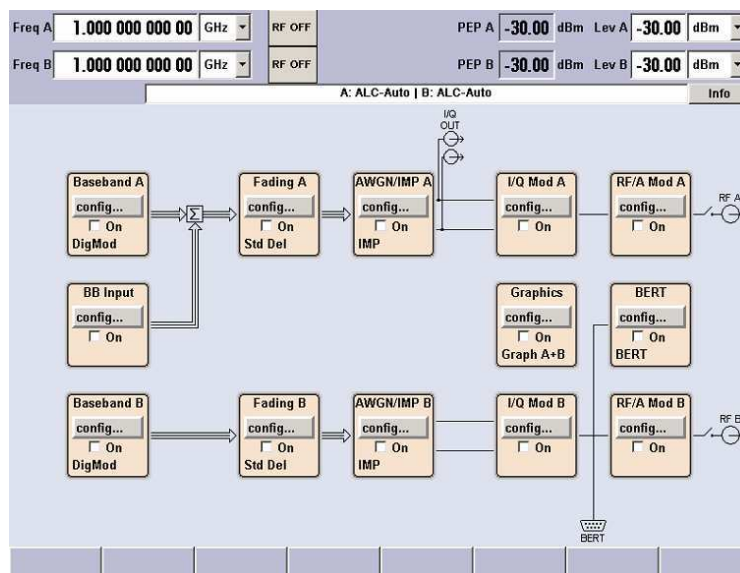

Fig. 3-1: Block diagram of a fully equipped two-path R&S Signal Generator

3.2.1 Settings Displayed in the Header Section

Frequency/level settings and a few status messages (see [chapter 3.2.2, "Status Information and Messages"](#), on page 87) are displayed in the header field of the screen. The display may vary depending on the instrument's operating mode:

- In the case of two-path instruments, the RF information for the two paths is displayed in two lines.
- In the sweep mode, the current frequency or level of the output signal is displayed. The status message "SweepMode" is displayed in the info line.
- In the list mode, neither the current frequency nor level is displayed, the indication is dimmed.
- If user correction is active, the status message "UCorr" is displayed in the info line.
- In the case of digital modulation, "Freq" indicates the frequency, "PEP" the peak envelope power and "Level" the average level.



The value displayed in the "Freq" and "Level" field does not consider any offset set. For more information see [chapter 4.5.2, "RF Frequency Settings"](#), on page 194 and [chapter 4.5.7.1, "Overview RF Level Settings"](#), on page 215.

3.2.2 Status Information and Messages

The status information and messages are displayed in the header section of the screen. The messages differ with respect to their importance (errors, warnings, info) and the time of their appearance (brief and permanent messages). They require different treatment by the user. Further information on all messages can be called in the info window (see [chapter 3.2.3, "Info Window"](#), on page 88).

Refer to [chapter 8, "Error Messages"](#), on page 837 for an overview of all status information and messages as well as instructions for error elimination.

3.2.2.1 Status Information

The status information gives the user an overview of the main operating states and settings of the instrument. The states are indicated for information only and do not necessitate any action by the user.

Status information is displayed between the frequency and level fields, at the left of the info line or in the info line itself.

On two-path instruments, all states that can occur independently in the two paths are displayed separately for each path. The associated path is indicated in the info line.

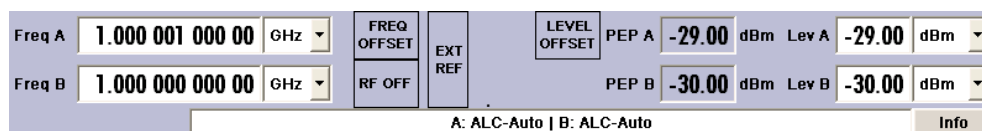

3.2.2.2 Messages

Messages indicate errors in the instrument. They are displayed in the info line in different colors depending on their importance and display duration. Errors (e.g. no calibration data) are displayed in red, information (e.g. file not found) and warnings in black. Warnings indicate less significant errors (e.g. the instrument operates outside specified data).

3.2.2.3 Volatile messages

Brief messages report automatic settings in the instrument (e.g. switching off of incompatible types of modulation) or on illegal entries that are not accepted by the instrument (e.g. range violations). They are displayed in the info line on a yellow background. They are displayed on top of status information or permanent messages.

Volatile messages do not normally demand user actions and disappear automatically after a brief period of time. They are stored in the history, however.

These messages can be read from remote using `SYST:ERR?` or `SYST:ERR:ALL?`.

3.2.2.4 Permanent Messages

Permanent messages are displayed if an error occurs that impairs further instrument operation, e.g. a hardware fault. The error signalled by a permanent message must be eliminated before correct instrument operation can be ensured.

The message is displayed until the error is eliminated. It covers the status display in the info line. After error elimination, the message automatically disappears and is also recorded in the history.

These messages can be read from remote using `SYST:SERR?`.

3.2.3 Info Window

A few operating states and the current message are displayed in the info line.

The INFO window with a list of current permanent messages and a detailed description of each message can be opened with the INFO (CTRL+I) key.

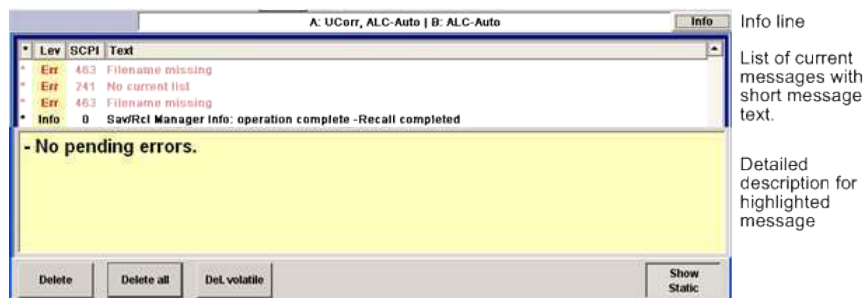

The upper section of the info window contains a list of all current permanent messages in the order of their occurrence, i.e. the most recent message is displayed first. In the lower section of the window, additional information on the highlighted message is displayed. A history of all messages that have occurred since instrument switch-on can be called with the "History" key. The most recent message is displayed first.

The messages are color-coded according to their level. Device-specific messages are red, info and remote control error are black. The level is also indicated in the "Lev" column (Err, Sys or Info). Column "SCPI" indicates the SCPI error code.

With the aid of the softkey buttons, error messages can be cleared and a history of all messages called.

Delete

Clears the highlighted message.

This button is available only if the history of the messages is displayed.

Delete All

Clears all messages.

This button is available only if the history of the messages is displayed.

Del. volatile

Clears all volatile messages.

This button is available only if the history of the messages is displayed.

SCPI command:

[SYSTem:ERRor:ALL](#) on page 799

Each time a `SYST:ERR:ALL?` query is sent, the error queue is returned and at the same time cleared.

History

Calls the list of all messages that have occurred since instrument switch-on. The most recent messages are displayed at the top of the list. When the button is pressed again, the list of current messages is displayed.

SCPI command:

[SYSTem:ERRor\[:NEXT\]](#) on page 801 or [STATus:QUEue\[:NEXT\]](#) on page 796

Each time a `SYST:ERR?` or `STAT:QUE?` query is sent, the oldest entry in the error queue is returned and at the same time cleared in the list.

3.2.4 Block Diagram

The block diagram shows provided options, signal configuration and the currently selected signal flow of the generator with inputs and outputs used. Signal generation can be completely operated from the block diagram. The highlighted function block can be directly switched on and off with the TOGGLE ON/OFF (CTRL+T) key. Pressing the Enter opens the associated setting menu.

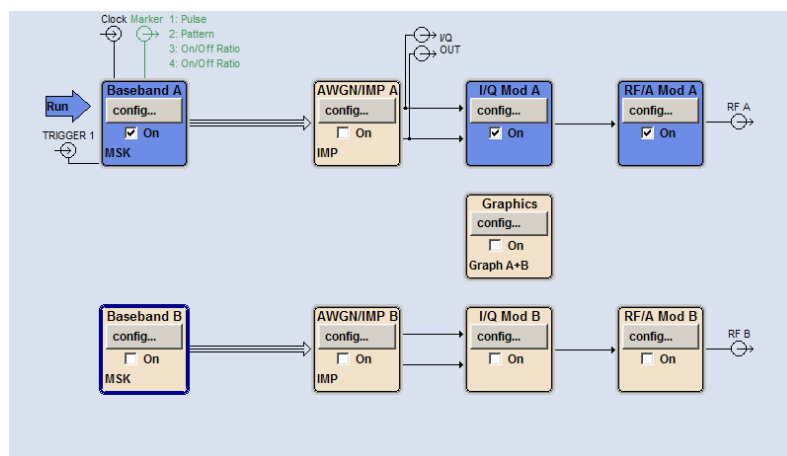

3.2.4.1 Function Blocks in the Block Diagram

Each block represents a function of signal generation. The function is indicated in the headline of the block. In the check box, the respective function can be quickly activated/deactivated with the TOGGLE ON/OFF (CTRL+T) key. After activation, the block is displayed in blue. Status information is displayed below the check box. It is different for the different blocks.

Pressing the rotary knob (front panel) or the "Config..." button (mouse) opens the associated setting menu.

In all function blocks where the signal flow can be influenced, the top menu level for setting signal routing parameters is offered.

Example: Baseband block

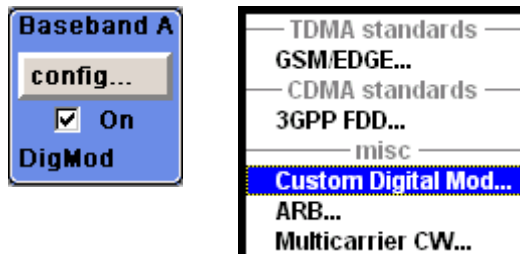

In this block, the digital modulation signal, the digital standards, arbitrary waveform generation and multicarrier CW are set. The status information of the "Baseband" block indicates the selected modulation and associated additional information, e.g. the number of channels.

3.2.4.2 Signal Flow and Input/Output Symbols in the Block Diagram

The input/output symbols in the block diagram show the currently used inputs and outputs of the signal generator. Unused inputs and outputs are not shown. The lines indicate the signal flow.

Symbols and labels refer to the corresponding inputs and outputs on the front and rear panel of the signal generator. The direction - input or output - is indicated by an arrow.

Example:

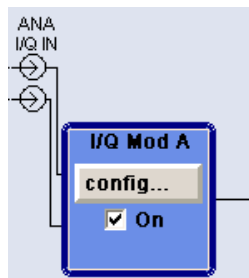

The symbols indicate the inputs for the analog I and Q signal.

In case of configurable user inputs/outputs, the name and the current assignment are indicated: Marker signals 1 to 3 of the two paths are assigned to fixed output User 1 interface, configured as output for the clock signal of path B.

If several markers are active, the marker characteristics are listed next to the marker symbol of the active markers.

Symbols and lines are displayed in different colors depending on their function.

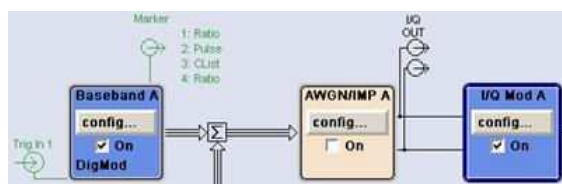

- The baseband signal is indicated by a three line arrow, the I- and Q-components of the signal by a single-line arrow.
- Addition of signals is indicated by the summation sign.
- Connections are indicated by a "solder point".
- Black is used for the generated signal.
- Green is used for control signals.

The signal flow is configured in the individual menus. User interfaces are configured in:

- the "Setup > USER Marker /AUX I/O Settings" dialog and
- the "Setup > Global Trigger/Clock/External Inputs" dialog.

3.2.5 Winbar and Softkeys

The "Winbar" with eight buttons is displayed below the block diagram. Labelled buttons represent open menus, the label indicates the menu. If several menus are open, the button of the currently active menu is displayed in a lighter colour. The buttons also assign functions to the softkeys of the next lower level for front-panel operation. Up to eight menus may be open simultaneously. When the ninth menu is opened, the menu that was opened first is automatically closed.

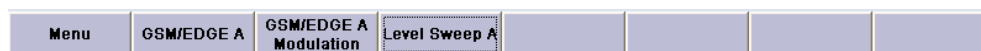

Some menus, e.g. data and list editor menus, cover the "Winbar" and assign menu-specific functions to the front-panel softkeys by way of the menu buttons.

Any of the open menus can be activated either with the respective button in the "Winbar" or the front-panel softkey. In combination with the keys for menu operation (CLOSE (ESC), HIDE (CTRL+H) and REARR (CTRL+A)), convenient menu operation can be ensured.

Working with menus and dialog boxes is described in [chapter 3.3, "Accessing Dialogs"](#), on page 93.

3.2.6 Structure of the Dialogs

The parameters are set in the menus. Menus are accessed either via the function blocks in the diagram or by means of the MENU (CTRL+M) key. The menus are displayed on top of the block diagram.

If the menu buttons assign menu-specific functions to the softkeys, the "Winbar" is hidden.

Working with menus and dialog boxes is described in [chapter 3.3, "Accessing Dialogs"](#), on page 93; the setting of parameters in [chapter 3.4, "Setting Parameters"](#), on page 94.

The menus are in Windows format. The menus differ in details depending on their function but they consist of the same main elements. Each menu consists of a menu header and one or more menu areas with various fields for setting parameters.

The header line contains the name of the menu and the buttons for minimizing and closing the menu. To operate the buttons, use the mouse or the front keys HIDE (CTRL+H) and CLOSE (ESC).

Several fields of associated but separately set parameters are organized in menu areas. A menu area is framed and labelled with the function common to all parameters.

Example: Impairments

Impairments	
State	<input type="checkbox"/>
I Leakage	0.00 %
Q Leakage	0.00 %
Imbalance	0.00 %
Quadrature Offset	0.00 deg

Each of the setting fields is assigned a parameter name. The kind of setting varies depending on the parameter to be set. Some settings can only be made in a specific configuration. If setting is not permitted with the specific configuration selected, the respective item is disabled and displayed in gray and the entry or selection field cannot be accessed.

3.2.7 Graphical Display of Output Signal Characteristics

The graphical display of the output signal enables the user to rapidly check signal characteristics without connecting an analyzer. Zoom functions and the display of a reference trace allow in-depth evaluation. The diagram is displayed on top of the block diagram. It can be minimized and called in the same way as a menu.

Example: I/Q diagram

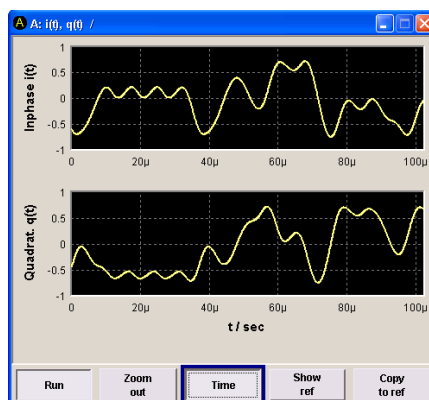

To access the "Graphics Settings" dialog for selecting the graphics display of the output signal, select the "Graphics" function block in the diagram or press the MENU (CTRL+M) key.

Operation of the graphics windows is analogous to menu operation.

The menu and the individual graphical displays are described in [chapter 4.3, "Graphical Display - Graphics"](#), on page 161.

3.3 Accessing Dialogs

The MENU (CTRL+M) key opens the complete menu tree. Selecting a functional block and pressing the ENTER key opens the menu associated with this block.

An alternative way to access a dialog is to use the Winbar buttons or front-panel softkeys or to use the HIDE (CTRL+H), CLOSE (ESC), DIAGRAM (CTRL+D) and REARR (CTRL+A) keys on the front panel.

For a quick access to the dialogs, use one of the following alternative methods.

Displaying the block diagram or a dialog in the foreground

1. Press the DIAGRAM (CTRL+D) key to move the cursor to the block diagram.
All active menus are minimized and displayed in the form of Winbar buttons.
2. Press the associated softkey (CTRL+F1 .. F8) to display the dialog in the foreground again.

Accessing the menu tree

- ▶ Press the MENU (CTRL+M) key to open the complete menu tree.

Calling the File, Setup or Hardcopy dialogs

- ▶ Use the FILE (CTRL+S), SETUP (CTRL+E) or HCOPY (CTRL+Y) keys to open the respective dialog.

Minimizing an active menu

- ▶ Use the HIDE (CTRL+H) key to minimize an active menu.
It is displayed in the form of a Winbar button.

Automatically arranging displayed menus

- ▶ Press the REARR (CTRL+A) key to rearrange all open menus so that they overlap as little as possible.

Activating the Windbar

- ▶ Use the WINBAR (CTRL+W) key to toggle the cursor between a button of the "Winbar" and the block diagram.

The button that was active last in the Winbar is highlighted.

Closing an active menu

- ▶ Press the CLOSE key to close an active menu.

Tip: If the cursor is at the highest menu level, you can also use the ESC key to close the active menu.

Accessing the header area

- ▶ Press the FREQ (CTRL+F) and LEVEL (CTRL+L) keys to activate the "Frequency" or "Level" entry fields in the header area.



Keyboard Shortcuts

Keyboard shortcuts (e.g. "Ctrl + D" for the displaying the block diagram in the foreground) provide direct access to all utility dialogs of the instrument (see [chapter 3.8, "Legend of Front-Panel Controls"](#), on page 116).

3.4 Setting Parameters

The R&S SMU offers several and sometimes alternative possibilities for setting parameters. Operation is possible from the front panel, with the aid of a mouse and/or from a PC keyboard.



The examples within this description focus on the operation from the front panel.



For more information, refer to:

- [chapter 3.8, "Legend of Front-Panel Controls"](#), on page 116 for an overview of key functions and a cross-reference between the front panel keys and the keyboard shortcuts
 - section "Instrument Functions" for a detailed description of key functions.
-

Most of the parameters are set in the different menus. The R&S SMU provides alternative ways for accessing the dialogs. Turn the rotary knob and navigate to the corresponding block in the block diagram and press the knob to open the dialog or perform a mouse click on the "Config..." button.

An exception are the "Setup", "File" and "Hcopy" dialogs. In the "Setup" dialog, general settings are made which are not directly concerned with signal generation, e.g. setting of the GPIB-bus address. In the "File" dialog, files and lists are managed; in the "Hcopy"

dialog, printout is configured and hardcopies can be made. These menus can only be called with the SETUP (CTRL+E), FILE (CTRL+S) and HCOPI (CTRL+Y) keys.

Frequency and level are directly set in the header area of the display using the FREQ and LEVEL keys.

Specific settings can also be made directly in the block diagram, e.g. activating a function block by means of the TOGGLE ON/OFF (CTRL+T) key or switching the RF output on and off with the aid of the RF ON/OFF (CTRL+R) key. Changes affecting the signal flow are immediately visible in the graphics display.

The R&S SMU uses the Windows XP® operating system. Settings at system level are only rarely required, e.g. installation of a new printer driver. For convenient operation of Windows XP®, a keyboard and a mouse are required.

This section provides an information about the parameter handling that comprises of the following main steps:

- [chapter 3.4.1, "Working with the Cursor"](#), on page 95
- [chapter 3.4.2, "Selecting a Control Element"](#), on page 96
- [chapter 3.4.3, "Switching Parameters On/Off"](#), on page 96
- [chapter 3.4.4, "Entering a Value"](#), on page 96
- [chapter 3.4.5, "Working with Units "](#), on page 98
- [chapter 3.4.6, "Selecting a Value from a List"](#), on page 99
- [chapter 3.4.7, "Terminating Entries with Confirmation"](#), on page 99
- [chapter 3.4.8, "Restoring the Previous Value"](#), on page 100

3.4.1 Working with the Cursor

After the instrument is switched on, the cursor is always on the first function block of the diagram (default setting).

Moving the cursor on the display

► To move the cursor, use one of the following alternative methods:

- a) Use the rotary knob or the arrow keys.
- b) Use the appropriate softkeys (CTRL+F1..F8) to move the cursor to the "Winbar".
If the "Winbar" is covered by a menu, press the WINBAR (CTRL+W) key to display it in the foreground.
- c) Use the ESC key.

Tip: Be aware that the function of the ESC key depends on the current cursor position. The function of this key depends on the current cursor position.

- Calls the next higher selection level.
- Closes the open window without accepting new entries; the old value or parameter is retained.
- In dialog boxes that contain a "Cancel" button it activates that button.
- Closes all kinds of dialog boxes, if the edit mode is not active.
- Quits the edit mode, if the edit mode is active.

- Switches between different entry fields of a menu.
- Shifts the entry cursor from the header display to the previously active menu, or to the previously highlighted block in the block diagram if no menu is active.
- Shifts the cursor from a function block in the diagram to the first item in the "Winbar". If no menus are open, the current cursor position remains unchanged.

Moving the cursor to the heading area

- ▶ Press the **FREQ** (CTRL+F) or **LEVEL** (CTRL+L) key to move the cursor to the header area.

3.4.2 Selecting a Control Element

Control elements are always selected in the same way no matter whether a function block in the diagram, a menu in the menu tree, a parameter in the menu or an entry in a list or table is concerned.

- ▶ To activate an element, put the cursor on it.



An active element is highlighted by a blue frame.

3.4.3 Switching Parameters On/Off

A parameter can be activated and deactivated using a button or a check box.

1. Select the parameter.
2. To change the state of a parameter, use the "Enter" function of the different control media:
 - Press the rotary knob
 - Press ENTER
 - Press the **TOGGLE ON OFF** (CTRL+T) key.

Colour and label of a button change, the check box is ticked or the tick is removed.

3.4.4 Entering a Value

Numeric and alphanumeric values can be edited in the entry fields. In the editing mode, cursors of different colour are used. A blue cursor indicates the overwrite mode, a green cursor the insert mode.



Changing between the Insert and Overwrite mode

The insert mode is the default setting.

Use the **INSERT** key to toggle between the insert and overwrite mode.

Numeric and alphanumeric values can either be newly entered or the existing value can be changed. Incorrect entries are cleared with the BACKSPACE key.

Entering a new numerical value

1. Select the parameter.
2. Press a numeric key to activate the editing mode.
The previous value is cleared and the new value can be entered.

Editing a value in the insert mode (default setting)

1. Press the rotary knob (= Enter) to activate the editing mode.
If the cursor is placed at the right of the total value, the insert mode is always active.
2. Set the cursor to the left of the number to be changed using the LEFT/RIGHT arrow keys.
The cursor is displayed in green.
3. Click on a numeric key to insert a new value.



Editing a value in the overwrite mode

1. Activate the editing mode.
2. Set the cursor on the numeric digit to be changed using the LEFT/RIGHT arrow keys.
The cursor is displayed in blue and the number to be replaced is highlighted.
3. Click on a numeric key to overwrite the highlighted value.



Varying a value

1. Activate the editing mode.
2. Set the cursor to the left of the number to be changed using the LEFT/RIGHT arrow keys.
The value at the cursor position is varied.
3. To vary the selected value, use the UP/DOWN arrow key or turn the rotary knob.
The value is increased or decreased.

Entering a new alphanumeric value

1. Select the parameter.
2. Press an alphanumeric key to start the editing mode.
The new value is entered.

Editing an alphanumerical value

An existing value, e.g. a file name, can be changed in the insert mode (see example) or in the overwrite mode.

1. Select the parameter and activate the editing mode.
2. Set the cursor to the left of the alphanumerical value using the LEFT/RIGHT arrow keys.

Tip: If hexadecimal values are to be entered, the numeric front-panel keys are automatically changed to hexadecimal values.

3. Click on an alphanumeric key to insert a new alphanumerical value.



Terminating the entry of a numeric value

To terminate the entry of a numeric value:

1. Press the rotary knob (= Enter).
2. Press a UNIT key on the front panel.
3. Select a "Unit" in the selection field next to the parameter value.

3.4.5 Working with Units

The unit of a parameter is displayed next to the value. When the parameter is edited, the unit is selected either from the list or by means of the front-panel keys. When the entry is completed, the unit can be changed. In this case the value remains unchanged but is automatically adapted to the new unit.



While operating the instrument by means of a mouse, assign the unit to the selected parameter before entering its value.

Assigning a unit

To assign a unit to a value, use one of the following alternatives:

1. Press a UNIT key on the front panel.



2. Select a "Unit" in the selection field next to the parameter value.
Press the ENTER key.

The unit displayed in the entry field next to the value is assigned.

Changing a unit

To subsequently change a unit, i.e. after the entry has been terminated and when the editing mode is not active, use one of the following alternatives:

1. Press a UNIT key on the front panel.
2. Select "Unit" in the selection field next to the parameter value.

The value remains unchanged but the display is automatically adapted to the new unit, i.e. the value is recalculated to suit the new unit.

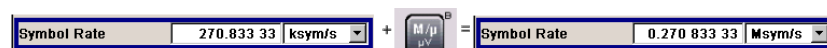

The new unit is indicated in the value field of the menu.

3.4.6 Selecting a Value from a List

Selection lists provide a list of predefined values for the selected parameter.

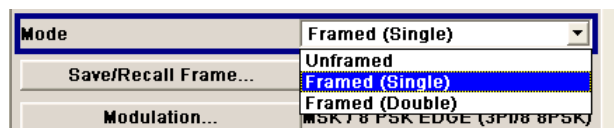

To select a item from a list, proceed as follow:

1. Press ENTER key to open the list.
2. Use one of the following alternatives to navigate through the list:
 - a) Turn the rotary knob or use the UP/DOWN arrow keys.
The selected item is highlighted.
 - b) Press TOGGLE ON/OFF key several times until the preferred entry is displayed in the selection field.
3. To confirm the selection, press the ENTER key.

3.4.7 Terminating Entries with Confirmation

The instrument behaves different by the termination of entries depending on the parameter type and the way this parameter is set.

Confirming settings

- ▶ To confirm the settings, press the rotary knob or one of the UNIT keys (see also [chapter 3.4.5, "Working with Units"](#), on page 98).

Note: Variations by means of the rotary knob are immediately set.

Confirming multiple values

In some cases, like for instance when configuring the carriers for a multicarrier CW signal in a carrier table, it is useful first to enter few values and to confirm them together. Such settings require additional confirmation. Not yet confirmed settings are displayed on a yellow background as an indication that the currently displayed values do not represent the target signal.

- ▶ To confirm these settings, select the "Accept" button.

Confirming parameters with On/Off state

Most of the instrument functions with enabled and disabled states are calculated and effective only after this functions have been enabled. However, there are functions like the frequency variation of the reference oscillator for instance, that are immediately set after confirmation.

- ▶ To confirm a parameter with On/Off state, enable the parameter.

If time-consuming calculations are required, signal generation is automatically switched off and calculation is interrupted to allow the user to make further settings. Calculation is restarted with the RECALCULATE key and the modulation is switched on again when the calculation is completed.



Preventing recalculation

If an instrument function requires several parameter settings, switch the function off to prevent a recalculation.

Enable the function after the entire configuration of the settings have been completed. The signal is recalculated only once.

3.4.8 Restoring the Previous Value

Parameter variations with the rotary knob are immediately set and therefore not reversible.

Normally, values cannot be restored in the case of mouse control because no explicit confirmation is required in this case and entries are automatically confirmed when the entry or selection field is exited.

Restoring values

In the case of front-panel control or operation from the keyboard, previous values can be restored as long as the new value is not confirmed, i.e. the entry is not completed.

- ▶ To restore the values, press the ESC key.

Restoring values that require confirmation

All settings that are not confirmed with the "Accept" button but require this additional confirmation can be restored.

1. Press the ESC key.

A confirmation query is displayed.

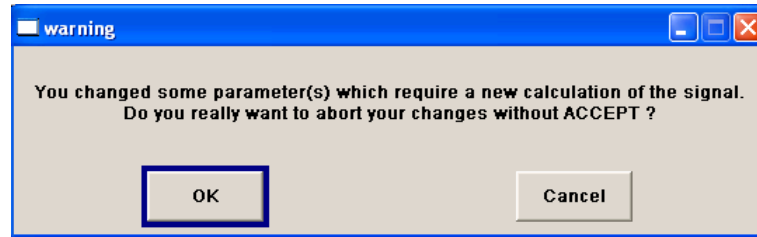

2. Confirm with "OK" to abort the changes.
Select "Cancel" to return to the dialog. The previous selected settings are displayed.

Restoring values after an extended calculation has been started

Calculation and setting might require different period of time. Many settings are made without noticeable calculation times; such operations are indicated by a "BUSY" message displayed in the status field of the header section.

A window with a progress indicates that the instrument performs an extended calculation that requires longer calculation time. The termination of such a calculation restores the previous values.

- ▶ Press the ABORT button to terminate the calculation.
All previous values are restored.

3.5 Editors

The R&S SMU provides user-friendly editors for defining data lists as well as control and marker signals. Lists containing frequency and level value pairs are used for the list mode and the user-defined level correction.

Internally generated data lists can be used for digital modulation and digital standards; the same applies to internally defined control and marker signals.

The lists are saved to files and may thus have any length. The file name of the lists and the directory to which the files are saved are user-selectable. The file prefix is different for each list type and is permanently assigned by the system.

For information about file handling and overview of the automatically assigned file prefixes, refer to [chapter 3.7, "File Management"](#), on page 110.

3.5.1 Working with List Editor

The "User Correction" and "List Mode" dialogs provide a list editor for defining the frequency/level value pairs.

Editing list mode data lists

1. To access a list editor and open an existing data list for editing, use the cursor keys to select the associated button "Edit User Correction Data..." or "Edit List Mode Data..." (if available) in the individual menu.

The selected list is displayed and the cursor marks the first row of the "Frequency/Hz" column.

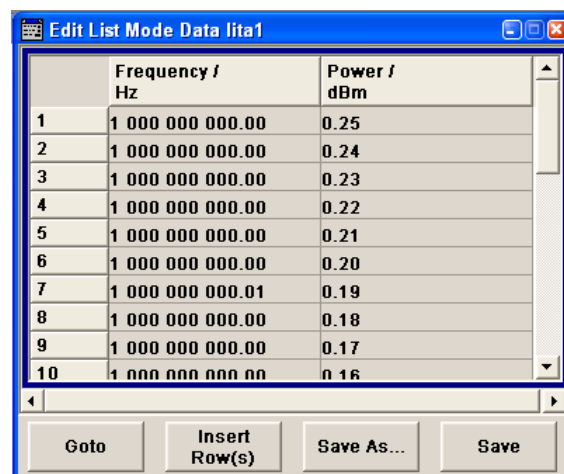

	Frequency / Hz	Power / dBm
1	1 000 000 000.00	0.25
2	1 000 000 000.00	0.24
3	1 000 000 000.00	0.23
4	1 000 000 000.00	0.22
5	1 000 000 000.00	0.21
6	1 000 000 000.00	0.20
7	1 000 000 000.01	0.19
8	1 000 000 000.00	0.18
9	1 000 000 000.00	0.17
10	1 000 000 000.00	0.16

If no list has been selected, a blank list of only one row is displayed.

2. Press the LEFT/RIGHT arrow keys to change between the columns.
Use the UP/DOWN arrow keys to mark a row.
3. Use the numeric keys to enter the value for the value pairs in the "Frequency/Hz" and "Power/dBm" table columns. A blank row is inserted at the end of the list.
An existing list can be edited in the insert or overwrite mode; use the INSERT key to toggle between this two modes.
Terminate the entry by pressing a UNIT key.
4. To select a row, select the "GoTo" button and press the ENTER key.
Use the numeric keys to enter the row index in the entry field and press the ENTER key to confirm the entry.
The cursor moves to the selected row.
5. To insert a new row in the table, select the row above which the new row is to be inserted and select "Insert Row(s)".
A row is inserted above the currently marked row.
If no row has been selected, a row is inserted at the beginning of the list.
6. Use the "Save"/"Save As..." function to save the edited list under its current name or under a new name.
Enter the file name in the "File Select" dialog and select the directory (see [chapter 3.7.1, "File Select Dialog"](#), on page 111).
Only complete value pairs are taken into consideration; rows containing an entry in only one column are ignored.

Creating a new list mode data list

A new list can be created under a new name either by generating a blank file in the "File Select" menu (see section [chapter 3.7, "File Management"](#), on page 110) or by changing an existing list which will then be saved under a new name.

1. To create an empty data list, select "RF > List Mode > List Mode Data... > New List" or respectively "RF > User Correction > User Cor. Data... > New User Correction Data" and enter the file name of the new data list.
2. To open the data list for editing, select the associated button "Edit User Correction Data..." or "Edit List Mode Data..." in the individual menu. Edit the list and save it under a new name.

3.5.2 Working with Data Editor

The "Data Editor" is used to internally generate binary data lists for digital modulation and digital standards.

A list of binary values with a maximum length of 2^{31} bits can be entered in the "Data Editor". This value corresponds to a file size of approx. 268 Mbyte. While it is being processed, the file is continuously automatically buffered. When the dialog is exited, the file is automatically saved with the new values, i.e. there is no extra "Save" button. Depending on the size of the file, saving may take some time.

Editing an existing data list

1. To **access** a data editor and open an existing data list for editing, use the arrow keys to select the associated button "Edit Data List... " in the individual menu.

The selected data list is displayed.

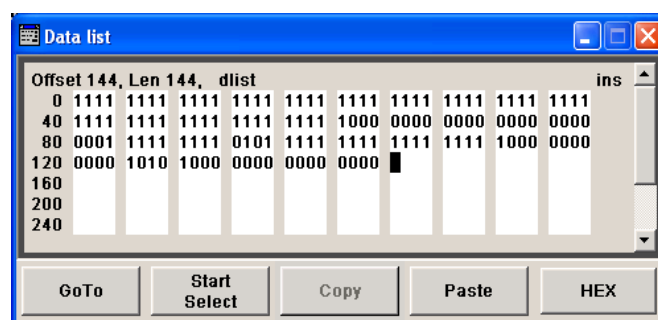

The cursor marks the start value of the list.

To increase readability, the bits are displayed in groups of four. The current cursor position, the length of the list and the list file name are displayed above the list. The offset starts with the value 0 which corresponds to the bit position on the left side of the first row, i.e. the beginning of the list. On the left edge of the editor, the last three offset positions are specified at the beginning of the row.

2. Use the numeric keys to enter the values 0 or 1. An existing list can be edited in the insert or overwrite mode. Use the INSERT key to toggle between these two modes.

3. To **delete** a value, use the arrow keys to mark the bit that follows the value to be deleted.
Press the INSERT key to activate the insert mode. Values cannot be deleted in the overwrite mode.
Press the BACKSPACE key.
The value before the marked bit is deleted.
4. To **select a bit position**, select the "GoTo" button and press the ENTER key.
Enter the bit position in the "GoTo Offset" entry field by means of the numeric keys and confirm the entry.
The cursor marks the bit at the selected position.
5. To **copy and paste** any range of bits at any position in the list:
 - a) Use the the arrow keys to mark the start bit of the selection.
 - b) Select the "Start Select" button and use the the arrow keys to mark the selection.
 - c) Click the "Copy" button.
 - d) Navigate to the insert position and select "Paste".The selected and copied bits are pasted after the selected position.
6. To **display and edit** the values in hexadecimal form, select the "Hex" button.
Each four bits are displayed as a hexadecimal value: To increase readability, the hexadecimal values in turn are displayed in pairs of two. The hex functions are automatically assigned to the numeric keys at the front panel.
7. To **save** the data list, press the ESC key.
The list is saved automatically when the dialog is closed.

Creating a new data list

1. To create an empty data list, in the individual menu select "List Management > Select Data List to Edit... > Create Data List" and enter the file name of the new data list.
2. To open the data list for editing, select the associated button "Edit Data List..." in the individual menu.

3.5.3 Working with Control and Marker List Editor

The control and marker signals for digital modulation and digital standards can be very conveniently graphically defined in a "Control and Marker List Editor". The available marker signals – and, with custom digital modulation, the CW, Hop, Burst Gate and Lev Att control signals – can be defined in this editor.

While it is being processed, the file is continuously automatically buffered. Depending on the size of the file, saving may take some time.



The various functions of the editor are explained in the individual menus. This section focuses to the general use of the graphic editor.

Example:

The following figure shows the "Slot Marker Definition Editor" of the "GSM/EDGE" dialog as an example.

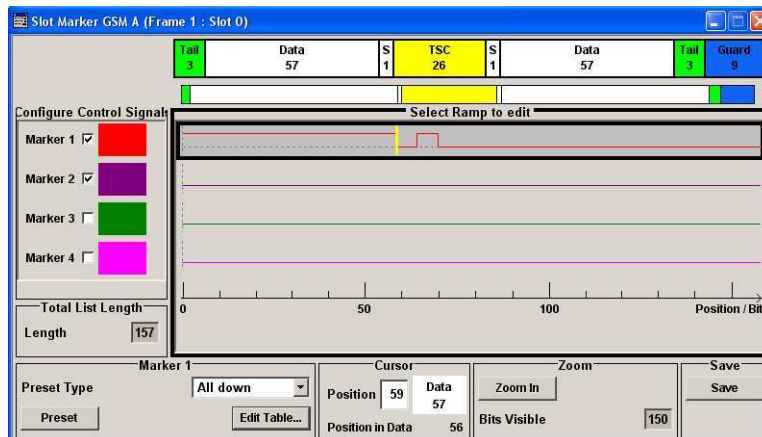

The upper area displays the signal for which the marker signals are to be defined. On the left side, the available signals (marker and control signals) are listed and colour-coded.

Auxiliary functions are offered in the lower editor area, e.g. presetting for the ramps in the marker signal, cursor positioning by entering the bit position and possible editing by means of value entries in a table.

The actual graphic definition of the control signals occurs in the center area of the editor. Each control signal is represented by means of a colored line along the bit axis. A cursor can be shifted alongside this line and marks the position where a ramp is to be set. The color of the cursor changes depending on the current function.

Use the ENTER key to switch over between the colors (and therefore functions):

- black: marks the bit position on the marker line
- yellow: sets a ramp
- green: activates the marked ramp for shifting.

Accessing control and marker list

1. To access the control list editor (e.g. "CList Dig Mod") and open an existing list for editing, use the arrow keys to select "Custom Digital Mod > List Management > Edit Control List".

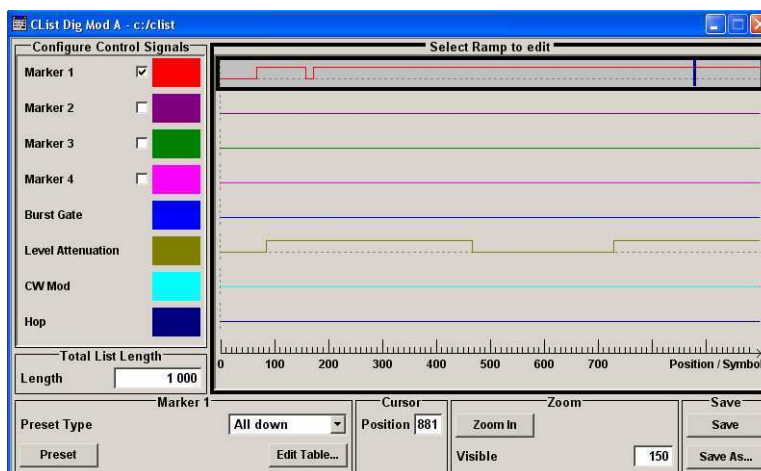

- To access the slot marker list editor (e.g. "Slot Marker") and open an existing list for editing, use the arrow keys to select "GSM/EDGE > Burst Editor > Slot Marker Definition".

Editing an existing control or marker list

- Activate control/marker signal line for editing.
Use the arrow keys to mark the editable graphic area and press the ENTER key.
Select the control/marker signal line to be edit and press the ENTER key.
The cursor is active for the selected line.
- Define the cursor position.
Select the parameter "Cursor Position", specify the position by means of the numeric keys and confirm the entry.
The cursor is positioned according to the entry. If the entered value exceeds the selected length of the definition range, the length is adjusted automatically.
- Configure the control and marker signals (see "[Handling of Ramps](#)" on page 107).
- Define length of control list ("Custom Dig Mod" only).
Select the "Total List Length" entry field and press the ENTER key. Enter the length by means of the numeric keys and confirm the entry.
The control list length is defined.
- Zoom displayed range ("Custom Dig Mod" only) in long control lists.
To zoom the displayed area around the current "Cursor Position", select the parameter "Visible/Bits Visible", enter the number of symbols/bits to be displayed by means of the numeric keys and confirm the entry.
Select the "Zoom In" button and press the ENTER key.
The selected number of symbols/bits around the current cursor position are displayed.
Ramps outside the displayed area are not lost by zooming.
- Use the "Save"/"Save As..." function to save the edited control/marker list under its current name or under a new name.

Enter the file name in the "Create File" dialog and select the directory (see [chapter 3.7.1, "File Select Dialog"](#), on page 111).

Handling of Ramps

1. Set a new ramp

Use the arrow keys or use the parameter "Cursor Position" to move the cursor to the position where the ramp is to be inserted. Press the ENTER key.

The ramp transition of the newly set ramp depends on the current status (high or low) of the control signal. If the signal is low, a ramp with low-high transition is generated; if the signal is high, a ramp with high-low transition is generated.

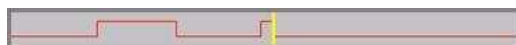

When ramps are set between existing ramps, the transition of the new ramp is also defined by the status of the signal before the new ramp. For this reason, a ramp that has already been set can be assigned low-low or high-high transition (as in the example), i.e. it will have no effect on the control signal in this configuration. However, the ramp remains saved, and its position is indicated by a dashed line.

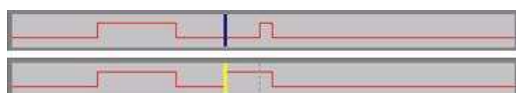

If another change produces effective transition, this ramp will be regenerated.

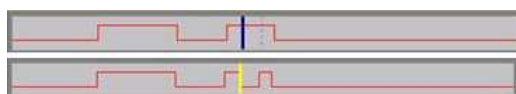

2. Shift a ramp

An existing ramp can be shifted to any positions. The transitions are adjusted accordingly.

Use the arrow keys to move the cursor to the ramp position; the cursor changes colour.

Press the ENTER key. The cursor again changes colour. The ramp will now be shifted by means of the cursor. Press the ENTER key. The ramp will be set at the current position.

The ramp transition depends on the status (high or low) of the control/marker signal before the ramp.



3. Delete a ramp

Use the arrow keys to move the cursor to the ramp position; the cursor changes colour.

Press the BACKSPACE key.

The ramp will be deleted. The ramp transitions of the other ramps are adapted to the changed signal status (high or low).

4. Set the ramps in a table

Select the "Edit Table..." button and define the positions and states of the ramps for the selected marker.

Confirm the entries with "Accept".

5. Preset a marker signal

Select the "Preset" button to preset the marker signal.

The ramps of the selected marker are adjusted according to the selected "Preset Type".

Creating a new control list

A new control list can be created under a new name either by generating a blank file or by changing an existing list which will then be saved under a new name.

1. To create an empty control list, select "BB > Cust Dig Mod > List Management... > Select Control List to Edit > Create Control List" and enter the file name of the new control list.
2. To open the control list for editing, select the associated button "BB > Cust Dig Mod > List Management... > Select Control List to Edit > Edit Control List..." and select an existing control list.

3.6 How to Use the Help System

The R&S SMU is equipped with a context-sensitive help function. A help page is available for each parameter and can be called any time during instrument operation.



Compiled online help systems are also available for all functions of the R&S SMU on the CD-ROM supplied with the instrument. This help program can be called on any controller with Internet Explorer version V4.0 and higher.

Calling context-sensitive and general help

- ▶ To display the general help dialog box, press the HELP (F1) key.

The help dialog is displayed. A topic containing information about the current menu or the currently opened dialog box and its function is displayed.

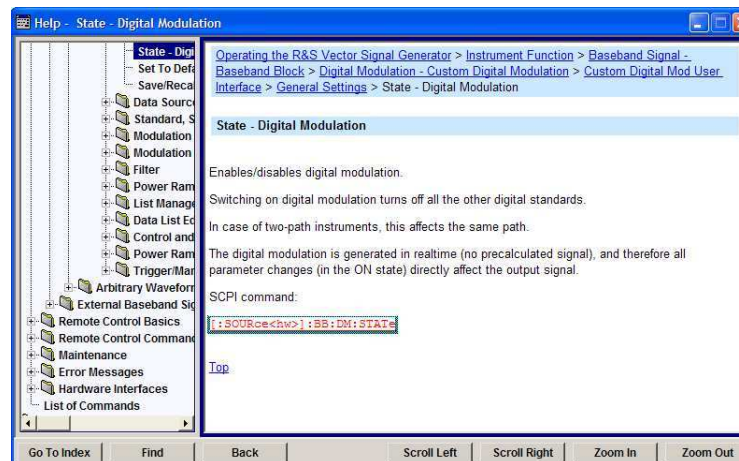

Contents of the help dialog box

The help dialog box contains two main areas:

- "Contents" - contains a table of help contents
- "Topic" - contains a specific help topic

The help system provides additionally an "Index" and a "Find" area, as well as "Zoom" functions that are accessed by means of the corresponding buttons.

Navigating in the table of contents

1. To move through the displayed contents entries, use the UP/DOWN keys. Entries that contain further entries are marked with a plus sign.
2. To display a help topic, press the "ENTER" key.
The corresponding help topic is displayed.

Navigating in the help topics

1. To scroll through a page, use the UP/DOWN arrow keys.
2. To jump to the linked topic, press the link text.
3. Use the "Previous" or "Next" links to jump to the corresponding topic.
4. Use the "Scroll Right" or "Scroll Left" buttons to shift the indicated area of the navigation window to the left or right.

Using the Index

1. Select the "Go to Index" button.
2. Enter the first characters of the topic you are interested in. The entries starting with these characters are displayed.
3. Press the ENTER key to change the focus.
4. Use the UP/DOWN keys to navigate and select the suitable keyword.

5. Press the ENTER key to display the help topic.

The corresponding help topic is displayed.

Closing the help window

- ▶ Press the HELP (F1) key.

3.7 File Management

The R&S SMU uses files to save all instrument data, i.e. system and user data.

The user data includes saved instrument settings, data for the different digital standards, lists for the List mode and the user correction as well as the waveforms for the arbitrary waveform generator.

The files are stored on the hard disk of the instrument. Drive `D:\` can be used to save user-defined data; any directory structure can be created on `D:\`. Some default directories are predefined, but can be changed at any time. The `C:\` drive is a protected system drive. The files on this drive contain data that must not be changed. Therefore, this drive should not be accessed, since reconstruction of the system partition will lead to data loss. To prevent inadvertent deletion or overwriting of system files, this drive is not specified in the file menus. It can be accessed if a protection level (see section "Protection Level" in the Operating Manual) is revoked.

Files can be exchanged either via a memory stick or a connected network. A memory stick is connected to the USB interface and is assigned the `E:` drive. In the case of a connected network, all network drives that can be accessed are available. The files are accessed in a "Save/Recall" dialog in the individual menus.

The files are differentiated according to their extensions; each type of file is assigned a specific file content. The extension is usually of no consequence to the user since access to the files occurs in the individual menu where only the relevant type of file is available. See [chapter 3.7.2.1, "Extensions for User Files"](#), on page 114 for an overview of the supported file extensions.

The user data can be roughly divided into the following data types:

- Settings
Settings, e.g. the frame setting of the GSM/EDGE standard, can be loaded and current setting saved to the specified file.
- Lists
Lists, e.g. user correction lists, can be loaded. They can be generated either externally or internally. For internal generation, a new list must be created in the "File Select" dialog which will then be edited in the list editor of the individual menu.
- Complex modulation and control data
User data of this type can be loaded. It can be generated either externally or internally. For internal generation, a new list must be created which will then be edited in the data and control list editor. These functions are offered in the "Data List Management" dialog of the individual modulation menu.
- Waveforms

Waveforms are generated externally (e.g. by means of the R&S WinIQSIM2 program that is supplied together with the optional Baseband Generator R&S SMU-B10) and can be loaded in the "Arbitrary Waveform Generation" dialog.



Softkeys are assigned to some of the functions and can be used for convenient operation.



For more information, refer to:

- [chapter 3.8, "Legend of Front-Panel Controls"](#), on page 116 for an overview of key functions and a cross-reference between the front panel keys and the keyboard shortcuts
- to section "Instrument Functions" for a detailed description of key functions.

Accessing files with user data

1. To access an editable user data file, select the "Save/Recall" or "File Manager" function in the individual dialog.



2. To access a loadable data file, select the "Select/New" or "File Manager" function in the individual dialog.

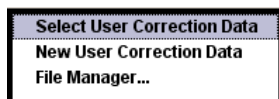

3. To access the "File Manager" function, press the SETUP (CTRL+E) key and select "Save/Recall > File Manager".

A "File Select" window for loading, saving or creating a file or the "File Manager" dialog for managing all files is displayed.



Saving and loading of all instrument settings

All instrument settings are saved and loaded in the "File" menu.

To access the "File" menu, press the FILE (CTRL+S) key.

For more information, see [chapter 4.2.8, "Storing and Loading Instrument Data - File Key"](#), on page 155.

3.7.1 File Select Dialog

The "Save/Recall" dialog displays the available drives and directories. In the upper part, "Recent Data Sets", the files last used are listed.

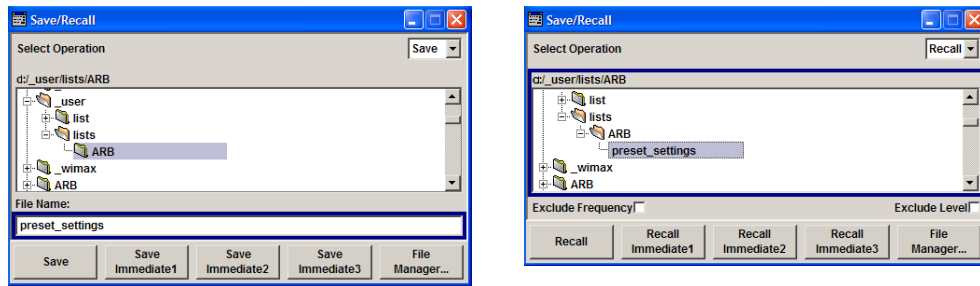

The available drives and directories and the files of the selected directory are displayed. The currently selected path is displayed above the window. Only the relevant files without file extensions are displayed. If the area is opened several times, the path last selected is displayed. When a file is saved or created, its name is user-selectable; the extension is assigned automatically and cannot be entered. The file is saved to the selected path.

In addition to the files saved by the user, some menus also offer files containing predefined contents. These files are saved to a specific directory on system drive; for this reason, this directory cannot be chosen from the "File Select" menu.

Example:

The following example shows the "File Select" menu of the GSM/EDGE digital standard when "Recall Predefined Frames" is selected.

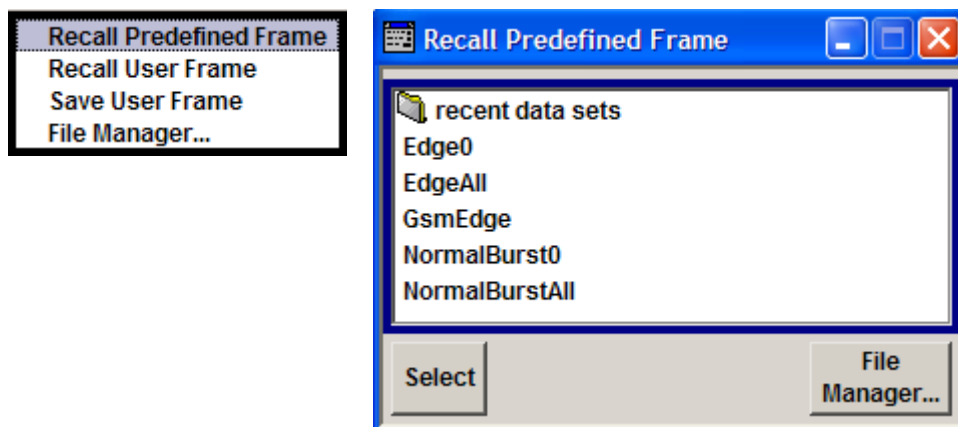

Working with the File Select dialog

1. Access the "File Select" dialog (see ["Accessing files with user data"](#) on page 111).
2. Navigate in the "File Select" dialog.
3. Load an existing file.
In the "Recall Settings" dialog, mark a file and press the "Select" button.
4. Save a file.
In the "Save Settings" dialog, enter file name in the "File Name:" field.
Select the directory to which the file is to be saved and then select the "Save" button.
5. Create a new file.

To create a new file, use the "Save Settings" functionality, i.e. specify file name and directory and save the file.

The created file is empty; it must be filled with the necessary values in the individual editor.

3.7.2 File Manager

The "File Manager" allows general file management such as copying, shifting, renaming and deleting files as well as generating new directories.

Thus, also externally created files, for example waveforms created by using the R&S®WinIQSIM2 program, can be saved to the R&S SMU by copying them from a memory stick or a network to the internal hard disk.

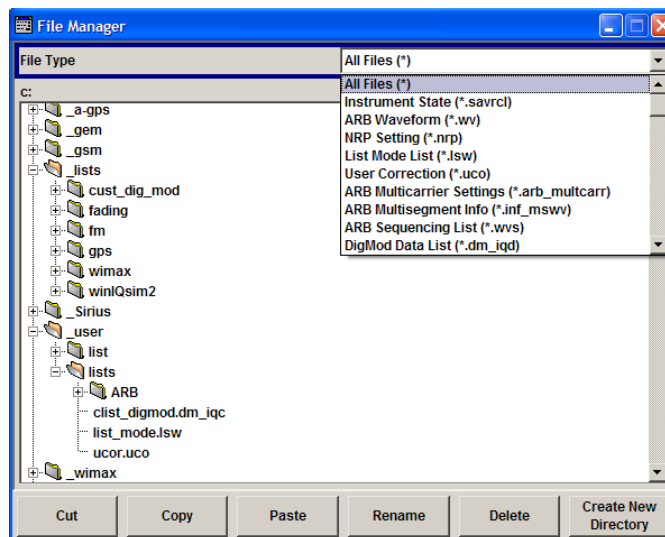

Use the "File Type" to select a file type from the list. This can be used to process either all files (all files (*) selection) or a specific selection of files. See [chapter 3.7.2.1, "Extensions for User Files"](#), on page 114 for an overview of the supported file extensions. The available drives and directories and the files of the selected directory are displayed. The currently selected path is displayed above the windows. If the area is opened several times, the path last selected is displayed. Unlike the "File Select" window, the "File Manager" displays the full file names including extensions.

Working with the File Manager dialog

1. Accessing the "File Manager" dialog (see ["Accessing files with user data"](#) on page 111).
2. Navigating in the "File Manager" dialog.
Operation is similar to the operation of menus with several areas.
3. Moving, duplicating, deleting or renaming files
To move a file, select the file and press the "Cut" button. Mark the directory to which the file is to be moved and select the "Paste" button. If the target directory already

contains a file with the same name, a confirmation query is displayed to confirm overwriting of this file.

Perform the similar steps and cut/copy/rename/delete the file.

Tip: The operation corresponds to the Windows concept.

4. Creating a new directory

Mark drive or directory level where the new directory is to be created, select the "Create New Directory" button and enter the name of the new directory in the entry window that opens. Confirm with ENTER.

3.7.2.1 Extensions for User Files

The following table list all available file extensions for user files. The currently available files on the instrument depends on the installed options.

Table 3-1: List of the automatically assigned file extensions in the instrument

Function/Digital Standard	List type	Contents	File suffix
Instrument State	Settings	Instrument settings	*.savrc1
"User Correction"	List	User-defined level correction values	*.uco
"List Mode"	List	User-defined frequency/level value pairs	*.lsw
"Frequency Response Correction"	Settings	User-defined frequency response correction file	*.frc
"Arbitrary Waveform Generator"	Waveform	ARB waveforms ARB multi segment waveforms	*.wv
	Waveform	ARB multi carrier settings	*.arb_multcarr
	Configuration data	Configuration file for creation of multisegment ARB waveforms	*.inf_mswv
	Play List	ARB Sequencing List	*.wvs
"DM"	Data List	Digital modulation data	*.dm_iqd *.tdm
	Control List	Data to control digital modulation	*.dm_iqc
	Settings	Digital modulation settings	*.dm
	User Standard	Digital modulation user standard	*.dm_stu
	User Mapping	Digital modulation user mapping	*.vam
	User Filter	Digital modulation user filter	*.vaf
"NRP Settings"	Settings	NRP Settings	*.nrp
EX-IQ-Box	User Settings	EX-IQ-Box User Defined Settings	*.iqbox
"Fading"	Fading	Fading data	*.fad
"GSM/EDGE"	Settings	GSM/EDGE settings	*.gsm

Function/Digital Standard	List type	Contents	File suffix
	Slot	User-defined slot data	*.gsm_slu
	Frame	User-defined frame data	*.gsm_fu
	Slot	Higher symbol rate slot	*.gsm_hslu
	Frame	Higher symbol rate frame	*.gsm_hfu
"Bluetooth"	Bluetooth Settings	Complete setting of the Bluetooth menu	*.bto
"TETRA"	TETRA Settings	Complete setting of the TETRA menu	*.tetra
"3GPP FDD"	Settings	Complete setting of the 3GPP (FDD) menu	*.3g
	Settings	Channel coding enhanced DPCH channels (downlink)	*.3g_ccod_dl_s
	Settings	Channel coding enhanced DPDCH channels (uplink)	*.3g_ccod_ul
"CDMA2000"	Settings	Complete setting of the CDMA2000 menu	*.cdma2k
"TD-SCDMA2000"	Settings	Complete setting of the TD-SCDMA2000 menu	*.tdscdma
	Settings	Test Model for TD-SCDMA2000	*.tdtmd
1xEV-DO	Settings	Complete setting of the 1xEV-DO menu	*.evdo
"IEEE 802.11 WLAN"	Settings	Complete setting of the IEEE 802.11 WLAN menu	*.wlan
"IEEE 802.11 n WLAN"	Settings	Complete setting of the IEEE 802.11n WLAN menu	*.wlann
	Settings	Beamforming data	*.bmf
"IEEE 802.16 WiMAX"	Settings	Complete setting of the IEEE 802.16 WiMAX menu	*.wimax
"EUTRA/LTE"	Settings	Complete setting of the EUTRA/LTE menu	*.eutra
	Settings	TDD Settings	*.lte_tdd
	Settings	User-defined IQ-File	*.iqw
"GPS"	Settings	Complete setting of the GPS/A-GPS menu	*.gps
	Settings	GPS Almanac Settings	*.txt *.alm *.al3
	Settings	GPS Waypoints File	*.txt
	Settings	GPS Generated Almanac File	*rs_alm *.rs_yuma
	Settings	GPS Ionospheric File	*.rs_ion
	Settings	GPS Navigation Data	*.rs_nav

Function/Digital Standard	List type	Contents	File suffix
	Settings	GPS UTC File	*.rs_utc *.rs_acq
"FM-Stereo"	Settings	Complete setting of the FM-Stereo menu	*.fmstereo
	Settings	FM-Stereo Group Type Settings	*.fm_gt
	Settings	FM-Stereo Group Hex Type Settings	*.fm_ghex
	Waveform File	Waveform File	*.wav
"Sirius"	Settings	Complete setting of the Sirius menu	*.sirius
"XM-Radio"	Settings	Complete setting of the XM-Radio menu	*.xmradio
	Settings	XM-Radio TWTA Data	*.twta
"DVB"	Settings	Complete setting of the DVB menu	*.dvb
	Settings	DVB Transport Stream	*.gts *.ts *.trp
"DAB/T-DMB"	Settings	Complete setting of the DAB/T-DMB menu	*.dab
	Settings	DAB ETI Files	*.eti *.xeti

3.8 Legend of Front-Panel Controls

The following table lists all key functions available on the front panel. Key combinations used on the PC keyboard to trigger key functions on the instrument front panel are also described. Keyboard labels are described in alphabetical order.

In addition, a front panel key emulation and an on-screen keyboard can be used for manual operation by mouse only.

Table 3-2: Cross-reference between the front panel keys and keyboard shortcuts

Front-panel key	Key of PC keyboard	Function
Turning the rotary knob	Tab key (towards the right) Shift + Tab (towards the left)	Sets the cursor with the rotary knob.
Pressing the rotary knob	Enter	Pressing the rotary knob confirms an entry; it has the same function as the ENTER key.
Arrow keys	Arrow keys	Moves the cursor.
*1 / dB(m)	ALT + F12	Confirms entries in the base unit and values without a unit. Selects dBm for the RF level and dB for level offset and level step width.
./ *...#	./ *...#	Enters a period/decimal point. Enters a special character.

Legend of Front-Panel Controls

Front-panel key	Key of PC keyboard	Function
+/- / A<->a	- / (shift+) a—z	Enters the sign. Switches between upper-case and lower-case letters.
0-9 / a...z	CTRL+ 0-9 / a...z CTRL	Enters the number/letter.
BACKSPACE	Backspace	Clears the last entry (number, sign or decimal point)
CLOSE	CTRL + G	Closes an active menu.
DIAGRAM	CTRL+ D	Sets the cursor on the block diagram and hides all menus.
ENTER	Enter	Terminates an entry.
ESC	ESC	Selects the next higher menu/selection level. When the editing mode is exited with ESC, the previous value is restored.
FILE	CTRL + S	Activates the menu for storing instrument settings.
FREQ	CTRL+ F	Activates the frequency entry.
G/n / dBuV	ALT + F9	Selects the unit Giga/Nano, dBuV for the RF level and dBu for the LF level.
HCOPY	CTRL+ Y	Opens the menu for configuring and starting a hard-copy.
HELP	F1	Opens/closes context-sensitive help.
HIDE	CTRL+ H	Minimizes the active menu. Pressing the respective button in the Winbar opens the menu again.
INFO	CTRL + I	Opens/closes the info window
INSERT	Ins	Activates the insert mode.
k/m / uV	ALT + F11	Selects the units Kilo/Milli and uV for RF levels.
LEVEL	CTRL + L	Activates the level entry.
LOCAL	CTRL + Q	Switches the instrument from remote control to manual control.
M/u / uV	ALT + F10	Selects the units Mega/Micro and uV for RF levels.
MENU	CTRL + M	Calls the menu selection list.
MOD ON/OFF	CTRL + O	Switches modulation on/off. "MOD OFF" is indicated in the status line.
TOGGLE	CTRL + T	Switches a block or parameter on/off. Toggles between the different possibilities of setting a selection parameter.
PRESET	CTRL + P	Restores a defined basic instrument setup.
REARR	CTRL + A	Adjusts the size of the active menu to use the whole height of the display.
RECALCULATE	CTRL + C	Starts recalculation of the signal.

Front-panel key	Key of PC keyboard	Function
RF ON/OFF	CTRL + R	Switches the RF output signal on/off. "RF OFF" is indicated in the status line. Both RF output signals are always deactivated in the case of two-path instruments.
SETUP	CTRL + E	Opens the setup menu for general instrument settings.
Softkeys	CTRL + F1 – F8	Triggers the function assigned to the softkey.
WINBAR	CTRL + W	Displays the Winbar in the foreground/background.

3.8.1 Front Panel Key Emulation

The R&S SMU provides a front panel key emulation to enable execution of the front panel key functions by mouse e.g. for remote access. The emulation is called by a right mouse click. The front panel key functions are executed by a mouse click on the associated button.



3.8.2 On-screen Keyboard

In addition, the Windows XP operating system provides a keyboard emulation that can be used for system settings if no external keyboard but a mouse is available.

To access the on-Screen Keyboard, select "Start > Programs > Accessories > Accessibility > On-Screen Keyboard".



4 Instrument Function

4.1 Overview of Instrument Functions

This chapter explains the functions of the R&S SMU and the options available in the setting menus. The associated SCPI command is specified for each parameter (where applicable).

The description begins with the general instrument settings which do not directly affect signal generation. The majority of these settings can be accessed by means of front-panel softkey menus and not by means of function block menus.

One exception is, for example, the signal graphics which are called up in the "Graphics" block.

The signal generation functions are then described, beginning with the RF section functions which affect the RF signal and the analog modulations and which are compiled in the "RF/A Mod" block of the block diagram.

This is followed by an explanation of all functions which are in the signal flow prior to being fed into the RF block and which do not affect the internal generation of a baseband signal - I/Q modulation, noise generation and impairment of the digital signal, fading and the input of external baseband signals. These functions are accessed by means of the function blocks "Baseband Input", "Fading", "I/Q Mod" and "AWGN/IMP".

The remaining (and largest) part of the chapter describes the functions used for the internal generation of the signals in the baseband (these functions are provided in the "Baseband" block).

The general instrument settings include various functions, such as:

- Setting a defined basic setup using the PRESET key
see [chapter 4.2.2, "Default Instrument Settings - Preset Key"](#), on page 124
- Switching from remote control to manual control using the LOCAL key
see [chapter 4.2.4, "Switching to Manual Control - Local Key"](#), on page 148
- Configuring the generator and its interfaces in the "Setup" menu - e.g. setting the GPIB address, starting an adjustment, querying instrument data
see [chapter 4.2.3, "General Configuration of Instrument - Setup Key"](#), on page 125
- Generating a hardcopy of the display using the HCOPY key
see [chapter 4.2.5, "Generating a Hard Copy of the Display"](#), on page 149
- Calling up the online help using the HELP key
see [chapter 4.2.7, "Help System - Help Key"](#), on page 153
- Querying messages using the INFO key
see [chapter 4.2.6, "Messages - Info Key"](#), on page 153
- Loading and storing complete instrument settings in the "File" menu
see [chapter 4.2.8, "Storing and Loading Instrument Data - File Key"](#), on page 155
- Calling up the baseband signal graphics in the "Graphics" function block
see [chapter 4.3, "Graphical Display - Graphics"](#), on page 161

The integrated bit error rate and block error tester is configured and activated in the "BERT" function block:

- Bit error rate and block error measurement
see [chapter 4.4, "Bit and Block Error Rate Measurements - BERT Block"](#), on page 172

The RF signal is configured and the analog modulations activated in the "RF/A Mod" function block:

- CW mode
see [chapter 4.5.1, "Overview of RF Signal"](#), on page 192
- List mode
see [chapter 4.5.14, "List Mode"](#), on page 268
- Sweep mode
see [chapter 4.5.13.1, "Overview"](#), on page 247
- Analog modulations
see [chapter 4.5.11.1, "Overview"](#), on page 233

In the "I/Q-Mod" function block, I/Q modulation is possible with external analog signals and internally generated baseband signals.

- I/Q modulator
see [chapter 4.6, "I/Q Modulation - I/Q Mod Block"](#), on page 277

Noise can be added to the baseband signal and the baseband signal can be impaired before input into the I/Q modulator. It is therefore possible to output a baseband signal with impairments via the I/Q-OUT outputs ("AWGN/IMP" function block). Impairment is also possible during I/Q modulation ("I/Q Mod" function block).

- Impairing the signal
see [chapter 4.7.1, "Impairments"](#), on page 291
- Adding noise
see [chapter 4.7.2, "AWGN - Noise Generator"](#), on page 302
- Fading the signal
see description "Fading Simulation - Fader Block"

The baseband signal is available at the I/O outputs.

- Output of the baseband signal
see [chapter 4.7.3, "Output of the Baseband Signal - I/Q Out"](#), on page 310

The R&S Signal Generator offers various possibilities for generating digital modulation signals in compliance with the definitions of digital standards or with characteristics which can to a large extent be freely defined. The range of software options for this is being extended continuously.

- Baseband signals - Introduction
see [chapter 4.8, "Baseband Signal - Baseband Block"](#), on page 323
- External Baseband signals
see [chapter 4.9, "External Baseband Signal - Baseband Input"](#), on page 445
- Digital modulation
see [chapter 4.8.3, "Digital Modulation - Custom Digital Modulation"](#), on page 341
- Arbitrary waveform generator ARB

see [chapter 4.8.4, "Arbitrary Waveform Generator ARB"](#), on page 383

- Multi Carrier CW signals
see [chapter 4.8.5, "Multi Carrier Continuous Wave"](#), on page 431
- Digital standard GSM/EDGE
see description "Digital Standard GSM/EDGE"
- Digital standard 3GPP FDD (WCDMA)
see description "Digital Standard 3GPP FDD (WCDMA)"
- Digital standard CDMA2000®
see description "Digital Standard CDMA2000®"
- Digital standard TD-SCDMA
see description "Digital Standard TD-SCDMA"
- Digital standard 1xEV-DO
see description "Digital Standard 1xEV-DO"
- Digital standard IEEE 802.11 (a/b/g) (WLAN)
see description "Digital Standard IEEE 802.11 (a/b/g) (WLAN)"
- Digital standard IEEE 802.11n (WLAN-N)
see description "Digital Standard IEEE 802.11n (WLAN-N)"
- Digital standard IEEE 802.16 (WiMAX)
see description "Digital Standard IEEE 802.16 (WiMAX)"
- Digital Standard EUTRA/LTE
see description "Digital Standard EUTRA/LTE"
- Digital standard GPS/A-GPS
see description "Digital Standard GPS"
- Digital Standard XM Radio
see description "Digital Standard XM Radio"
- FM Stereo/RDS
see description "FM Stereo/RDS"
- Digital Standard DVB-H
see description "Digital Standard DVB-H"
- Digital Standard DAB / T-DMB
see description "Digital Standard DVB / T-DMB"

In addition, external baseband signals can be fed into the baseband path with the aid of the external Digital Interface Module R&S EX-IQ-BOX.

- Digital Interface Module
see description "Digital Interface Module R&S EX-IQ-BOX".

4.2 General Instrument Settings

4.2.1 Overview of General Instrument Settings

This section describes the settings which do not directly affect signal generation. Most of these settings can only be accessed by means of menus which are opened using keys or key combinations on the external keyboard or keys on the front panel key emulation.

This does not apply to the graphical representation of output signals which is activated in the "Graphics" function block, or settings which can additionally be called up in the menus of the function blocks, e.g. input configuration which is possible in the "Setup" menu and in almost every menu of the "Baseband" function block.

See also [chapter 3.8, "Legend of Front-Panel Controls"](#), on page 116.

The general instrument settings therefore affect various functions, such as storing instrument settings using the FILE key or setting the GPIB address in the menu of the SETUP key. The order in which the descriptions are given corresponds to the layout of the keys on the front panel of the R&S SMU (from top left to bottom right).

4.2.2 Default Instrument Settings - Preset Key

The PRESET key calls up a defined instrument setup. All parameters and switching states are preset (also those of inactive operating modes). The default instrument settings provide a reproducible initial basis for all other settings.

However, functions that concern the integration of the instrument into a measurement setup are not changed, e.g. GPIB address or reference oscillator source settings.

In addition, only those settings associated with the menu can be reset directly in the individual menus, e.g. all digital modulation settings in the "Custom Digital Mod" menu. These settings are identical to those which are called up using the PRESET key.

When the instrument is switched on, it is not the preset state that is active, but rather the instrument state that was set before the instrument was switched on.

User-defined instrument states can be stored and called up in the "File" menu.



Resetting the instrument to the factory state is possible with the [Factory Preset](#) function.

Preset

Presets all parameters and switching states.

The following list gives an overview of the presets for the most important generator settings. The other presets can be found in the preset tables of the individual menus and the information accompanying the remote commands.

- "RF frequency" = 1 GHz
- "RF level" RF output switched off
- "Offsets" = 0

- "Modulations State" = Off
- Uninterrupted level settings are switched off
"Level Attenuator Mode" = AUTO
- Internal level control "Level ALC" = AUTO
- User correction "Level Ucor" = OFF
- "LF output State" = Off
- "Sweep State" = Off
- "List mode State" = Off

Settings that are not affected by the PRESET key

- Reference frequency settings ("Ref Oscillator" menu)
- Power on settings ("Level/EMF" menu)
- Network settings ("Setup" menu)
- GPIB address ("Setup" menu)
- Password and settings protected by passwords ("Setup" menu)
- Start/Stop Gui Update ("Setup" menu)
- Display and keyboard settings ("Setup" menu)

Note: In remote control it is possible to preset the settings of the two instrument path separately (see [chapter 6.2, "Preset Commands"](#), on page 501).

Resetting the instrument to the factory state is possible in the [Factory Preset](#) dialog.

SCPI command:

*RST on page 500

4.2.3 General Configuration of Instrument - Setup Key

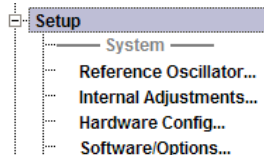

The SETUP key opens the "Setup" dialog.

The "Setup" dialog is divided into several sections.

- The "System" section is used to set general instrument parameters.
- The "Test" section is used to perform function tests.
- The "Environment" section is used to configure the controller interfaces.
- The "Remote" section is used to configure the remote control interfaces.
- The "Protection" is used to set the protection level for service functions and security settings.
- The "Settings" section is used to save or recall instrument settings or to preset the instrument to factory settings.

Most submenus of this key can be accessed only via the SETUP key or the menu tree (MENU key), with the following exceptions:

- The "Reference Oscillator" dialog can also be called up in the "RF" block and is therefore described in the section on this block (see [chapter 4.5.4, "Reference Oscillator"](#), on page 203).
- The "Save/Recall" dialog can also be called up with the FILE key and is therefore described in the section on this key (see [chapter 4.2.8, "Storing and Loading Instrument Data - File Key"](#), on page 155).

- The "Global Trigger/Clock/ External Inputs" dialog is also available in all modulation menus of the "Baseband" function block where it can be called up with the "Global Trigger/Clock Settings" button in the corresponding "Trigger/Marker/Clock" dialog. See also [chapter 4.2.3.10, "Global Trigger/Clock/External Input Settings"](#), on page 136.

4.2.3.1 Internal Adjustments

The R&S Signal Generator is extremely accurate thanks to the integrated procedures for adjustments.

All internal adjustments for which no external measuring equipment is needed can be started in the "Internal Adjustments..." dialog. The adjustments with external measuring equipment are described in the Service Manual (on CD ROM, supplied with the instrument).

Adjustment is recommended if the temperature range in which the instrument is operated changes, or prior to all applications which require maximum level and frequency accuracy.

During adjustment a bar indicates the status of progress. If an error occurs, adjustment is terminated and an error message is output in the info line.

NOTICE

Risk of invalid adjustment

In order to achieve correct adjustment of the instrument, make sure that the instrument is warm before performing adjustments. The warm-up time is 30 minutes.

In the case of two-path instruments, adjustment can be performed separately for the two paths.

To access the "Internal Adjustments" dialog, press the SETUP or MENU key under "System".

The adjustments offered also depend on the installed options.

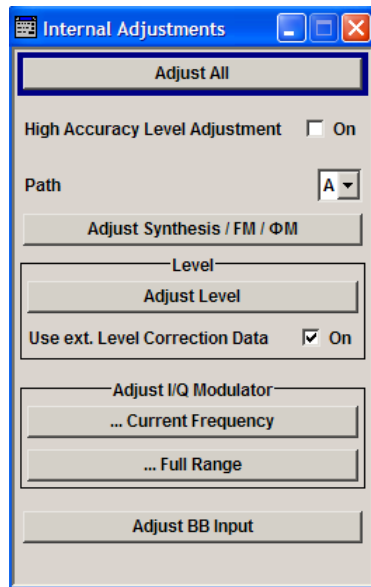

Adjust All

Starts all internal adjustments for which no external measuring equipment is needed. The adjustments with external measuring equipment are described in the Service Manual (supplied).

With two-path instruments, adjustment is performed for both paths.

SCPI command:

`:CALibration:ALL[:MEASure]` on page 530

High Accuracy Level Adjustment

Enables/disables level adjustment with high accuracy.

SCPI command:

`:CALibration<hw>:LEVel:HACCuracy[:STATe]` on page 533

Path (Internal Adjustments)

Selects the path for which the following adjustments are to be performed. With remote control, the path is selected using the numerical suffix under CALibrate.

SCPI command:

n.a.

Adjust Synthesis

Performs all adjustments which affect the frequency.

The adjustment affects the selected path.

This includes adjustment of option R&S SMU-B20/B22, FM/PhiM Modulator / and Low Phase Noise.

SCPI command:

`:CALibration<hw>:FREQuency[:MEASure]` on page 531

Adjust Level

Performs all adjustments which affect the level. The acquired correction values improve the settling time and the signal quality.

The adjustment affects the selected path.

SCPI command:

`:CALibration<hw>:LEVel[:MEASure]` on page 532

Use ext. Level Correction Data

Switch on or off use of external level correction data (see service manual, chapter 2, "Adjustment"). This switch can be used in case of corrupt external level correction data.

The adjustment affects the selected path.

SCPI command:

`:CALibration<hw>:LEVel:STATe` on page 532

Adjust I/Q Modulator Current Frequency

Starts the adjustment for the I/Q modulator for the currently set frequency, I/Q swap, and baseband gain. The I/Q modulator is adjusted with respect to carrier leakage, I/Q imbalance and quadrature.

Adjustment for only the set frequency is considerably faster than adjustment across the entire frequency range. This is possible with "Full Range".

SCPI command:

`:CALibration<hw>:IQModulator:LOCal` on page 532

Adjust I/Q Modulator Full Range

Starts the adjustment for the I/Q modulator for the entire frequency range. The I/Q modulator is adjusted with respect to carrier leakage, I/Q imbalance and quadrature.

SCPI command:

`:CALibration<hw>:IQModulator:FULL` on page 532

Adjust Baseband Input

Starts the adjustment for the baseband input. The I/Q input is adjusted with respect to DC offset and gain.

SCPI command:

`:CALibration<hw>:BBIN[:MEASure]` on page 531

4.2.3.2 Hardware Config

In the "Hardware Config" dialog, the installed assemblies together with their variants and revision states can be displayed for servicing purposes.

To open the "Hardware Config" dialog, select "System" and press the SETUP or MENU key.

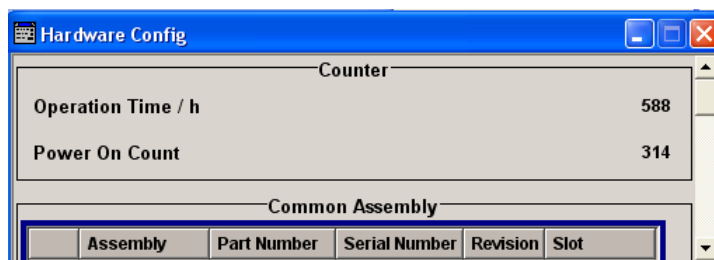

Section "Counter" in the upper part of the menu shows the "Operation Time" (in hours) and the number of power-on ("Power On Counter").

The second part of the menu is a table that lists the installed assemblies. It is divided into the sections:

- "Common Assembly"
- "RF Assembly"
- "Baseband Assembly"

Operation Time / h

Displays the operation time in hours.

SCPI command:

[:DIAGnostic:INFO:OTIME](#) on page 535

Power On Count

Displays the number of power-on.

SCPI command:

[:DIAGnostic:INFO:POCount](#) on page 536

Assembly

The tables list the installed assemblies.

"Path" Shows the path to which the assembly belongs.

"Assembly" Assembly name

"Part Number" Part Number of assembly

"Serial Number" Serial Number of assembly

"Revision" Revision state of assembly

"Slot" Indicates whether the assembly is connected to the serial bus or PCI bus.

SCPI command:

[:DIAGnostic<hw>:BGInfo](#) on page 534

4.2.3.3 Software / Options

The "Software/Options" dialog shows the firmware version of the instrument software as well as all installed hardware and software options.



Software options purchased at a later stage can be activated with a keycode. The activation code is supplied with the software option. How to install options is described in Chapter 4 of the Service Manual (supplied with the instrument).

The installation of hardware options purchased at a later stage is also described in Chapter 4 of the Service Manual (supplied with the instrument). Most hardware options need to be installed at an authorized Rohde&Schwarz service shop.

To access the "Software/Options" dialog, select "System" and press the SETUP or MENU key.

The menu is divided into the following sections:

- "Firmware"
- "Hardware Options"
- "Software Options"
- "WinIQSIM"
- "Loaded Modules"

Package	Version
SMU Base Software	01.05.14.00 (Release) (01/15/2004; 10:18:23)
R&S Software Platform	1.40.5.1 (Release)

Firmware

The Firmware section of the menu shows the firmware version and the version of the software platform.

Note: Your instrument is delivered with the latest firmware version available. Firmware updates as well as the Release Notes describing the improvements and modifications are provided on the Internet at the download site of the Rohde & Schwarz Signal generator home page. This home page always offers the latest information on your signal generator, e.g. also on changes of the firmware update procedure.

SCPI command:

n.a.

Hardware Options / Software Options

The tables in the sections "Hardware", "Software" and "WinIQSIM2" list the installed hardware and software options.

"Option" Short name of option

"Designation" Name of Option

"Licenses" (optional)
Number of licenses.

The licenses for the software options are "floating licenses". This means that in the case of two-path instruments just one license is required to use the option for either of the two paths. However, two licenses must be purchased to use an option on both paths simultaneously.

"Expiration Date" For regular options, "Permanent" is indicated in this column. Some options are available as trial versions. This column shows their expiration date. After this date, the option is no longer available on the instrument.

SCPI command:

***OPT** on page 499

***IDN** on page 498

Loaded Modules

Section "Loaded Modules" is provided for service purposes. It lists all loaded software modules with their versions and offers a short description of each module.

SCPI command:

n.a.

4.2.3.4 Manage License Keys

This dialog is the central dialog for managing licenses, like enabling newly purchased and/or newly registered options or performing the required instrument related steps during the process of unregistration of licenses.

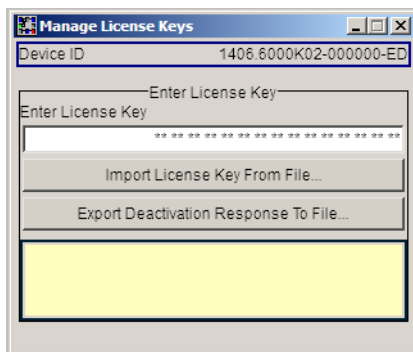

An option is ready to operate after it is enabled by means of a license key code supplied with the option. The license key is delivered as a file or on paper. Unregistered licenses must be registered for a particular instrument prior to the corresponding option can be enabled for operation.



License Registration

If your purchased license is delivered unregistered, you must register it before you can activate the option.

For detailed information about the license registration, refer to the installation instructions provided with the option (Supplement A) and the documentation of the online tool "Manage Licenses" (<https://extranet.rohde-schwarz.com/service>).



Only if the R&S Signal Generator is equipped with an older firmware version, a firmware update prior to enabling the software option may be required. The information on the valid firmware versions for the purchased software option is provided together with the option. The firmware update is described in the service manual, chapter 4 (on CD ROM, supplied with the instrument).

Device ID

Displays the instrument specific identification number. The device ID is a unique string with the following structure:

```
<stock number>-<serial number>-<checksum>
```

Enter License Key

Type here the license key provided with the option.

For license keys delivered as a file, use [Import License Key from File...](#)

Import License Key from File...

Opens a dialog for selecting the file with the license key.

Export Deactivation Response to File...

Exports the generated deactivation response key to a file and opens a file management dialog to save the file. This key is required during the unregistration process.

Status Information

Displays status information.

4.2.3.5 Gui Update

The "Start/Stop Gui Update" dialog provides the possibility to switch off update of the displayed parameters in order to increase speed for certain settings.

The indicated values are not updated and may therefore differ from the internal, used values.

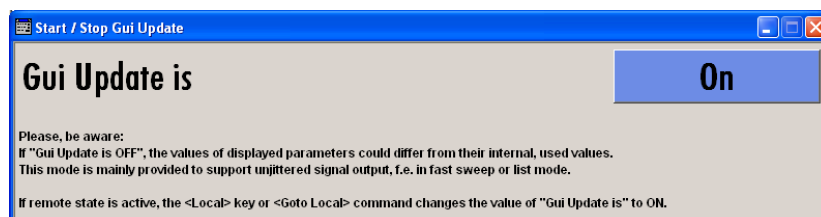

On/Off GUI Update

Switches on/off update of the displayed parameters.

Switching off the update of the displayed parameters increases the speed for certain settings.

Note: It is especially recommended to switch off the GUI update for optimum sweep performance with short dwell times and for fast settling times.

SCPI command:

:SYSTEM:DISPlay:UPDate on page 799

4.2.3.6 NRP-Z Info/Update

In the "NRP-Z Info/Update..." dialog, the connected power sensors are indicated together with their serial number, revision state and features. The software of a connected sensor can be updated to a new version.

To access the "NRP-Z Info/Update..." dialog, select "System" and press the SETUP or MENU key.

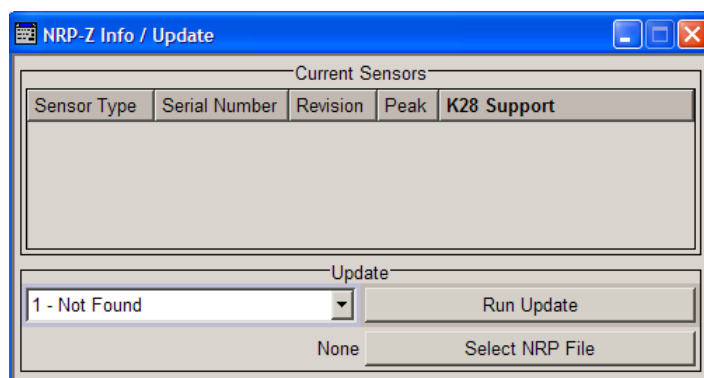

Current Sensors

Section "Current Sensors" lists the sensors that are connected to the generator and indicates their serial number, the revision state and some features.

SCPI command:

n.a.

Update

Section "Update" provides access to the file system in order to select a file for an R&S NRP sensor update (Button "Select NRP File"), the selected file is indicated to the left of the button. On the left side, the sensor to be updated is selected.

Button "Run Update" starts the update. If the update is interrupted for example by accidentally pulling off the sensor, selection "Rescue" is offered to restart the update process. Prerequisite is that no other sensor is connected to the instrument.

The procedure is as follows:

- Do not reconnect the sensor but keep it ready to be connected
- Select "Rescue" in the left sensor selection field
- Activate "Run Update"
- Confirm query in message box
- Connect sensor within 4 seconds

The update starts, a bar informs about the progress.

SCPI command:

`SENSe<ch>[:POWer]:TYPE` on page 569

`SENSe<ch>[:POWer]:SVERsion` on page 569

`SENSe<ch>[:POWer]:SNUMber` on page 568

4.2.3.7 Update

After a firmware update it is occasionally required to also update the "PCI-FPGA". This is enabled in the "Update" dialog.

At the first start of the new firmware, a message appears during the boot process if a "PCI-FPGA" update is required. Execute a PCI-FPGA update by pressing the "PCI-FPGA" button.

NOTICE

Impairment of instrument functions

To avoid impairment of instrument functions, the update of the "PCI-FPGA" must not be cancelled and the instrument must not be switched off during this update.



4.2.3.8 Selftest

A selftest is provided for service purposes. The selftest is a protected test procedure, which can be accessed if protection level 1 is disabled. The protection dialog is called in the "Setup" menu (see [chapter 4.2.3.15, "Protection"](#), on page 145).

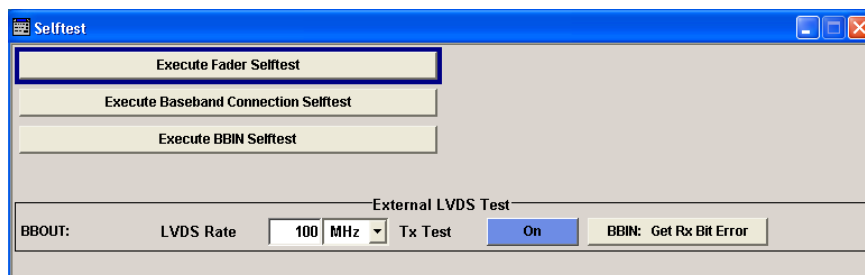

The following tests are only available via remote control:

- `:TEST:CONNector:AUXIo` on page 805
- `:TEST<hw>:DIRect` on page 805

Execute Fader Selftest

Performs a selftest on the fading simulator and the hardware options of the fading simulator extension. The result (succeeded or failed) is displayed in the status field next to the "Fader Selftest" button.

SCPI command:

`:TEST:FADer` on page 805

Execute Baseband Connection Selftest

Performs a connection test on each of the internal digital baseband links. This implies all installed options as baseband inputs, motherboard, universal coding generators, fading simulators, and baseband outputs. The result (succeeded or failed) is displayed in the status field next to the "Execute Baseband Connection Selftest" button.

SCPI command:

`:TEST:BB:CONNECTION` on page 804

Execute BBIN A/B Selftest

Performs a selftest on the baseband input hardware options. Several analog diagnostics points are checked to verify the correct function of the module. The result (succeeded or failed) is displayed in the status field next to the "Execute BBIN: x Selftest" button.

SCPI command:

`:TEST:BBIN` on page 804

BBOUT LVDS Rate

Sets the interface speed.

The "External LVDS Test" is used to check the correct data transmission of the digital baseband outputs (BBOUT) and the correct data reception of the digital baseband inputs (BBIN).

An external cable connection is needed to perform this test successfully. An output must be connected to an input with the digital I/Q cable. Always an input/output pair is tested together. The input and the output can be on the same instrument, or alternatively on two different instruments. Given an arbitrary cable connection, the appropriate Tx test can be activated with different interface speeds (LVDS rate).

On the connected input, this test sequence is received and can be compared with the expected test signal.

SCPI command:

`:TEST<hw>:BBOut:LRATe` on page 804

Tx Test

Activates the transmission of a known pseudo-random sequence (On).

SCPI command:

`:TEST<hw>:BBOut:TTESt[:STATe]` on page 805

BBIN Get Rx Bit Error

Performs a bit error rate test of the received test signal. The result (succeeded or failed) is displayed in the status field next to the "BBIN: GET Rx Bit Error" button.

SCPI command:

:TEST<hw>:BBIN:RBERror on page 804

4.2.3.9 Check Front Panel

The "Check Front Panel" dialog is used to check whether the front panel keys are functioning correctly. The menu displays all the front panel keys arranged in the same way as on the front panel. The respective function is executed by pressing the associated key.

**4.2.3.10 Global Trigger/Clock/External Input Settings**

The "Global Trigger/Clock/External Inputs" menu can be opened using the SETUP or MENU key under the "Setup" menu as well as in all clock and trigger menus of the "Baseband" function block.

This menu is used to determine the physical characteristics of the input connectors for trigger, clock and control signals.

The user inputs/outputs (BNC connector and pins of the AUX I/O connector) are assigned in the dialog "User Marker AUX I/O".

A common trigger threshold and input impedance is effective for all trigger and control signal inputs (Path A and Path B). The settings influence the digital modulations, the generation of waveforms or multicarrier signals, and all digital standards. Irrespective of this, a common threshold and input impedance is effective for the serial and parallel data input (Path A only). These data sources are available for digital modulation ("Custom Digital Modulation").

The instrument trigger setting influences all sweeps and is effective in the List mode (Instrument Trigger, Path A and Path B).

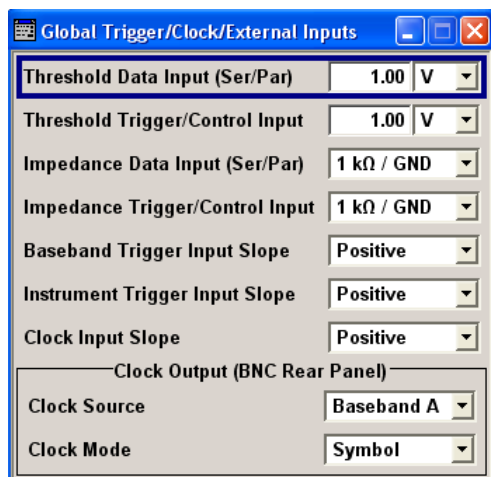

Threshold Data Input

Sets the high/low threshold in volts for the serial and parallel data input.

The serial data is input at the DATA connector of the instrument. The parallel data is input via the DATA pins of the AUX I/O interface.

SCPI command:

[\[:SOURce\]:INPut:DATA:THReshold](#) on page 729

Threshold Trigger/Control Input

Sets the high/low threshold in volts for the trigger and control signal inputs of the base-band section.

The setting affects the TRIGGER 1 and TRIGGER 2 inputs (BNC connectors) and the CW, BURST and LEV_ATT inputs of the AUX I/O interface.

SCPI command:

[\[:SOURce\]:INPut:TRIGger:LEVel](#) on page 731

Impedance Data Input

Selects the input impedance for the serial and parallel data inputs.

50 Ohm/GND should be selected for high clock rates.

The serial data is input at the DATA connector of the instrument. The parallel data is input via the DATA pins of the AUX I/O interface.

SCPI command:

[\[:SOURce\]:INPut:DATA:IMPedance](#) on page 729

Impedance Trigger/Control Input

Selects the input impedance for the external trigger and control signal inputs.

50 Ohm/GND should be selected for high clock rates.

The setting affects the TRIGGER 1 and TRIGGER 2 inputs (BNC connectors) and the CW, BURST and LEV_ATT inputs of the AUX I/O interface.

SCPI command:

[\[:SOURce\]:INPut:TRIGger:IMPedance](#) on page 730

Baseband Trigger Input Slope

Selects the polarity of the active slope of an externally applied trigger signal.

This setting affects the TRIGGER inputs (BNC connectors).

SCPI command:

[\[:SOURce\]:INPut:TRIGger:BBANd:SLOPe](#) on page 730

Trigger Input Slope

Sets the polarity of the active slope of an applied instrument trigger.

In the case of two-path instruments this setting is valid for both paths. It affects the INSTR TRIG for path A and the INST TRIG B input of the AUX I/O interface for path B.

"Positive" The rising edge of the trigger signal is active.

"Negative" The falling edge of the trigger signal is active.

SCPI command:

[\[:SOURce\]:INPut:TRIGger:SLOPe](#) on page 731

Clock Input Slope

Sets the polarity of the active slope of an externally applied bit clock pulse or symbol clock pulse.

This setting affects the CLOCK input (BNC connector).

An external clock signal can only be supplied for Path A.

SCPI command:

[:CLOCK:INPut:SLOPe](#) on page 533

Clock Output Source

Indicates the path for which the clock signal at the CLOCK OUT connector is to be output (always Path A).

This setting is only possible for two-path instruments.

SCPI command:

[:CLOCK:OUTPut:SOURce](#) on page 534

Clock Output Mode

Sets the output of bit or symbol clock pulses at the CLOCK OUT connector at the rear panel.

SCPI command:

[:CLOCK:OUTPut:MODE](#) on page 534

4.2.3.11 Display/Keyboard Settings

In the "Display/Keyboard Settings" menu the power-save mode and external keyboard settings are made. It is opened using the SETUP or MENU key under "Environment".

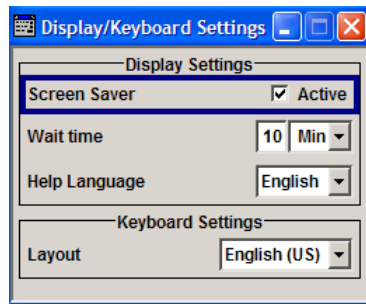

Screen Saver Active

Activates/deactivates the screen-save mode of the display.

If activated, the display including backlight is completely switched off after the elapse of the "Wait Time" when no entries via front panel, external mouse or external keyboard are made.

This mode is recommended for preserving the display especially if the instrument is exclusively operated via remote control.

SCPI command:

[:DISPlay:PSAVe\[:STATe\]](#) on page 536

Wait Time

Enters the idle time that must elapse before the display lamp is shut off when no entries are made.

SCPI command:

[:DISPlay:PSAVe:HOLDoff](#) on page 536

Help Language

Selects the help language.

The online help is provided in English and Chinese.

SCPI command:

n.a.

Layout (Keyboard)

Selects the keyboard layout for the selected keyboard language.

The assignment of some keys depends on the selected layout and language.

SCPI command:

[:KBOard:LAYout](#) on page 547

[:KBOard:LANGuage](#) on page 547

4.2.3.12 User Marker / AUX I/O Settings

The R&S Signal Generator provides four "USER" interfaces which can be freely assigned a selection of signals and which can be configured as both inputs and outputs.

The following table gives an overview of the signals that can be applied at the USER connector.

For two-path instruments, these signals are available for Path A or B.

Table 4-1: USER Connector Signals

Signal	Description
"Marker 4"	A broad selection of suitable marker signals is offered in the marker menus of the "Baseband" block. In addition, they can be freely configured in the "Custom Dig Mod > Control List Editor" and "GSM/EDGE > Slot Marker Editor". The selected markers are activated when switching on the "Baseband" block. When using markers defined in a control list ("Marker" = "CList") the related control list must be loaded in addition ("Custom Dig Mod").
"CW Mode Out"	This signal marks the CW mode in which digital modulation ("Custom Dig Mod") is deactivated and the RF signal is output in unmodulated form. The CW signal is defined in a control list and activated by loading the control list and setting the "Modulation<-> CW Switching State" to On in the "More" submenu. With standards where it is possible to change between various modulation modes, the signal indicates the active modulation mode (standard GSM: signal high (1) = modulation mode GMSK and signal low (0) = modulation mode 8PSK EDGE). In this cases, the signal is generated automatically when the standard is switched on.
"No Signal (Blank) Marker"	This signal marks the blank time in the List mode. The signal is generated automatically when the list mode is switched on.
"HOP"	This signal marks the hop trigger for frequency hopping in the List mode for "Custom Digital Mod". The hop signal is defined in a control list and activated by loading the control list in the "Custom Dig Mod" menu.
"Trigger"	This signal marks the trigger event caused by the selected trigger signal (internally or externally). Separate trigger signals are available for Path A and B. The trigger is defined in the respective trigger submenu of the "Baseband" block menus.

Additional signals for Path B are available in the case of two-path instruments. The corresponding signals for Path A are applied at the pins of the "AUX I/O" interface and at the BNC connector CLOCK.

Table 4-2: USER Connector Signals (Path B)

Signal	Description
"Clock Out"	output Path B; bit or symbol clock pulse This signal corresponds to the clock signal for digital modulations. The signal is generated automatically when the standard is switched on.
"LEV_ATT"	input/output Path B With active envelope curve control, this signal determines whether or not the signal level is attenuated. With external envelope curve control, the interface is input, otherwise output. The envelope curve control is activated in the "Custom Digital Modulation > Power Ramp Control" dialog. The internal "LEV_ATT" control signal is defined in a control list which must be loaded in the main menu.
"BURST"	This signal corresponds to the control signal for envelope curve control. With external envelope curve control, the interface is input, otherwise output. The envelope curve control is activated in the "Custom Digital Modulation > Power Ramp Control" dialog. The internal "BURST" control signal is defined in a control list which must be loaded in the main menu.

To access the "User Marker / AUX I/O" dialog:



1. Select "Setup > Environment > Global Trigger/Clock/External Inputs" or
2. In the "Baseband" function block select any digital standard, e.g. "GSM/EDGE" and select "Trigger > Global Trigger/Clock/External Inputs".

The signals are assigned to the USER interfaces in the "Mapping Configuration" section. The pin assignment of the AUX I/Oconnector is also displayed. An adapter between the AUX I/O interface and coaxial BNC connections is available as an accessory (accessories for R&S Signal Generator-Z5, see data sheet).

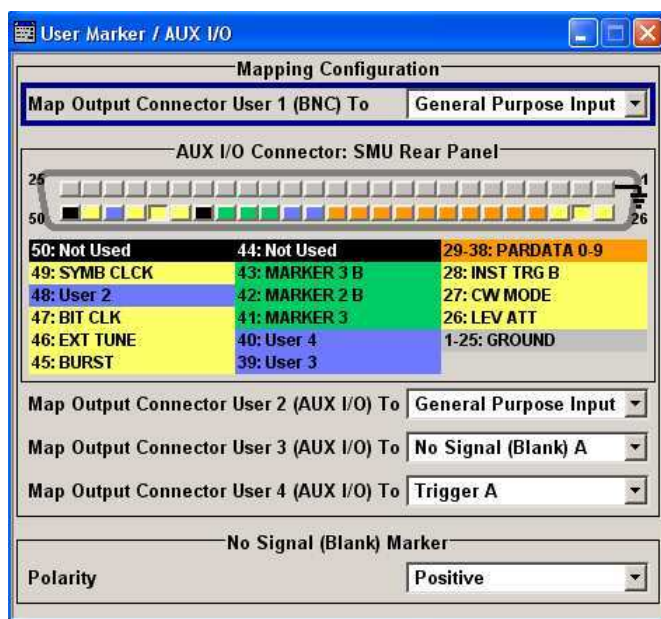
The polarity of the blank marker is selected in the "No Signal (Blank) Marker" section.



AUX I/O Connector

An illustration of the AUX I/O interface is shown. The inputs are indicated by a "depressed" pin , outputs by a non-depressed pin .

The assignment is shown in tabular form underneath the interface. The colors indicate the signal type. A distinction is made between control signals (yellow), marker signals (green), data (orange), freely selectable signals at the user pins (blue), ground (gray), and unused pins (black).

If no path letter is specified, the pin is assigned to the signals of Path A. Pins with signals from Path B are indicated by a "B" to the right of the signal name. This does not apply to the EXT TUNE input via which the signal for external impairment of the reference frequency is supplied; this impairment signal applies to both paths.

For detailed description of the AUX I/O connector, refer to [chapter A.2, "AUX I/O Connector"](#), on page 846.

User Connector Signal

Selects the signal for USER interface 1 (BNC), 2, 3 or 4 (AUX I/O). The signals which are available for selection are given in [table 4-1](#).

SCPI command:

`:OUTPut:USER<ch>:SOURCE` on page 562

Polarity (No Signal Marker)

Selects the polarity of the No Signal Marker.

If Positive is selected, the signal is high (2.5 V) when the marker is active; if Negative is selected, the signal is low (0 V).

SCPI command:

`:OUTPut:BLANk:POLARity` on page 560

4.2.3.13 Remote Channel Settings

The "Remote Channel Settings" dialog provides access to the settings for remote control. The dialog is opened using the SETUP or MENU key under "Remote".

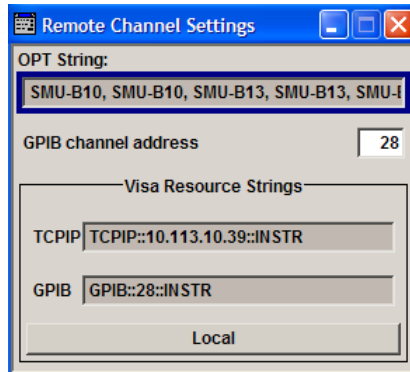

GPIB channel address

Sets the GPIB address of the instrument.

SCPI command:

`:SYSTEM:COMMunicate:GPIB[:SELF]:ADDRESS` on page 798

Visa Resource Strings

Indicates the visa resource strings, used for remote control of the instrument. A separate string is provided for remote control via the different interfaces.

SCPI command:

`:SYSTEM:COMMunicate:NETWork:RESource` on page 798

`:SYSTEM:COMMunicate:GPIB:RESource` on page 798

Local (Remote Channel Settings)

Switches the instrument to operate in local control mode.

Switching from remote to local control mode can be also done with one of the following actions:

- manually with the LOCAL key on the front panel
- with the interface command `>L` via the remote-control interface
- with the key combination CTRL + Q.

SCPI command:

`>L`

4.2.3.14 LXI Status

The "LXI - LAN eXtensions for Instruments - Status..." dialog displays the settings and status of the LAN and allows to reset the LAN connection.

For more information about LXI, see [chapter 1.9, "LXI Configuration"](#), on page 54.

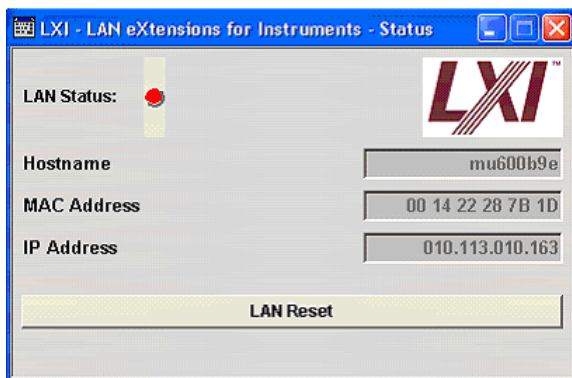

LAN Status

The LED indicates the LXI status.

The LAN Status is also indicated with the LED "LAN Status" on the front panel of the instrument.

- "green" normal operation
- "green (flash- device identification
- ing"
- "red" LAN fault

SCPI command:
n.a.

LAN Reset

Initiates the network configuration reset mechanism for the instrument and resets the hostname, MAC address, and IP address.

Alternatively, the LAN RESET button on the front panel of the instrument can be used. To initiate the network configuration reset, press the button longer than 4 sec and wait for the signal tone.

According to the LXI standard, an LAN Reset must place the following network settings to a default state:

Parameter	Value
TCP/IP Mode	DHCP + Auto IP Address
Dynamic DNS	Enabled
ICMP Ping	Enabled
Password for LAN configuration	LxiWebIfc

The LAN Reset for the R&S Signal Generator also resets the following parameters:

Parameter	
Hostname	Instrument-specific host name
Description	Vector Signal Generator

Parameter	
Negotiation	Auto Detect
VXI-11 Discovery	Enabled

The LAN settings are configured using the instrument's LXI Browser Interface described in [chapter 1.9, "LXI Configuration"](#), on page 54.

To open the "Instrument Home Page" (welcome page), type the instrument's computer name (host name) or IP address in the address field of the browser on your PC, e.g. *http://10.111.10.175*.

Note: Do not add the missing zeros in the IP address, while opening the Instrument Home Page.

SCPI command:

n.a.

4.2.3.15 Protection

The "Protection" menu provides access to the unlocking of protected service functions (authorized personnel of R&S Service Departments only). To deactivate the protection, the correct password has to be entered. After the instrument has been switched on, the protection levels 1 to 5 are automatically activated.

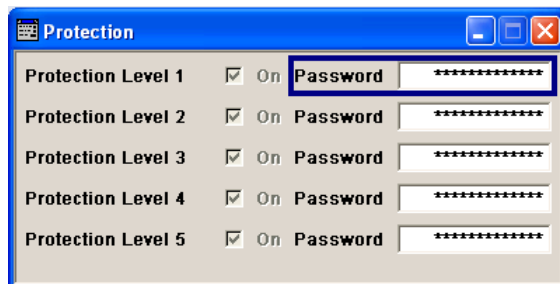

Protection Level/Password

Protection Level 1 can be activated to expand the functionality of the internal adjustment and to access the selftests.

The password is 123456.

SCPI command:

`:SYSTEM:PROTECT<ch>[:STATE]` on page 801

4.2.3.16 Security

The "Security" dialog provides access to the passwords and mass storage security settings. To open this menu, use the SETUP or MENU key under "Protection".

The menu is divided into the password sections and the security settings section. In the password section, the passwords for securing a controlled access to the instrument are defined and changed.

A change of passwords for the operating system and security password requires the entry of the old and new password and the conformation of the new password. All settings are only accepted after the "Change Password" button is pressed.



Old Password (Security Password)

Enters the currently used security password. The default password is '123456'.

Note: It is highly recommended to change the default security password before connecting the instrument to the network.

The security password is required when changing the status of the USB and LAN interface.

SCPI command:

n.a.

New Password (Security Password)

Enters the new security password.

The security password may contain decimal characters only.

SCPI command:

n.a.

Confirm Password (Security Password)

Enters the new password for conformation.

The new password is only valid after the "Change Password" button is pressed.

SCPI command:

n.a.

Change Password (Security Password)

Changes the password accordingly.

SCPI command:

n.a.

USB Device

Enables/disables the USB interfaces.

The instrument does not recognize any device connected to the USB interface when the interface is disabled.

The setting requires the entry of the security password and is only accepted after the "Accept" button is pressed.

SCPI command:
n.a.

LAN Connection

Enables/disables the LAN interfaces.

It is not possible to access the instrument via LAN while the LAN connection is disabled.

The setting requires the entry of the security password and is only accepted after the "Accept" button is pressed.

SCPI command:
n.a.

Security Password

Enters the password that is required to enable or to disable the settings protected by a security password. Default is '123456'.

Note: It is highly recommended to change the default security password before connecting the instrument to the network.

All settings are only accepted after the "Accept" button is pressed.

SCPI command:
n.a.

Accept - Security

Accepts a new entry or selection and changes the settings accordingly.

SCPI command:
n.a.

Bluetooth Pin

Requires a USB Bluetooth adapter (recommended extra, see data sheet).

Enters the Bluetooth pin of an external Bluetooth device. The pin is required to enable remote control via an external Bluetooth device.

SCPI command:
n.a.

4.2.3.17 Save/Recall

The "Save/Recall" submenu can also be called up with the FILE key and is therefore described in the section of this key (see [chapter 4.2.8, "Storing and Loading Instrument Data - File Key"](#), on page 155).

4.2.3.18 Factory Preset

The "Factory Preset" dialog provides a function to reset the instrument's settings to their factory state. This function is activated by pressing the "Execute Factory Preset" button.



Factory Preset

Reset the instrument's settings to their factory state.

Note: Since Factory Preset resets the Remote Channel and network settings to the default values, executing Factory Preset via remote control terminates the connection to the instrument, if these settings had been configured to values different to the default ones!

The factory preset function resets nearly all instrument settings. In addition to the regular preset by means of the PRESET key, a "Factory Preset" resets also the following values:

- Reference frequency settings ("Ref Oscillator" menu)
- Power on settings ("Level/EMF" menu)
- Network settings including hostname ("Setup" menu)
- Remote Channel settings including GPIB address ("Setup" menu)
- Start/Stop Gui Update ("Setup" menu)
- Display and keyboard settings ("Setup" menu).

To maintain security, password settings and all settings protected by these passwords like disabled USB and LAN connections are not changed.

Not affected by the "Factory Preset" are also user data, lists or instrument settings files, created for example by means of the Save/Recall function.

SCPI command:

:SYSTem:FPReset on page 502

4.2.3.19 Help

The "Help" dialog offers comprehensive online help for the R&S Signal Generator. A desired topic can be selected via the table of contents (select "Manual") or the index (select "Index").

For context-sensitive information about a marked parameter, press the HELP key. For a description of the "Help" menu, refer to the section covering to the HELP key (see [chapter 4.2.7, "Help System - Help Key"](#), on page 153).

4.2.4 Switching to Manual Control - Local Key

In remote control mode a status message appears in the display header. The rest of the display remains unchanged and shows the current instrument status, i.e. the status which exists under the remote control settings. The instrument can be operated (e.g. menus can be opened). However, it is not possible to enter or change values.

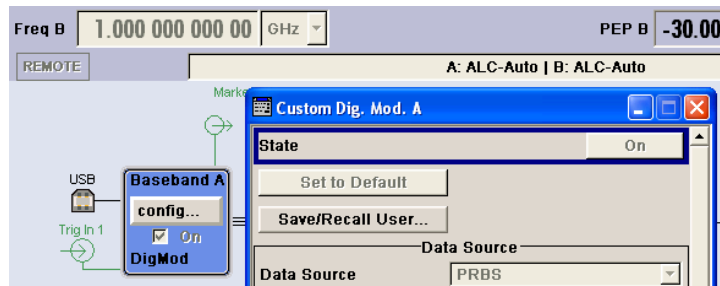

The status message additionally indicates whether the LOCAL key is disabled or enabled.

See also [chapter 5.2.1, "Switching to Remote Control"](#), on page 463.

If the "REMOTE" status message is shown, the LOCAL key switches the instrument from remote control to manual control. The current command must be fully processed before the mode is switched, otherwise the instrument switches immediately back to remote control.

If the "REM-LLO" status message is displayed, the instrument can be switched from remote control to manual control by means of remote control only (e.g. with the Visual Basic command `CALL IBLOC (generator%)`); the LOCAL key is disabled. The key is disabled by remote control with the command LLO.

When switching from remote to manual control, the display update suppression function, if active ("SETUP > GUI Update" is Off), is automatically deactivated ("SETUP > GUI Update" is On).

4.2.5 Generating a Hard Copy of the Display

The "HCOPY" key opens a window for configuring the hardcopy setting, like output file format, printer or path and file name. The parameters to be set change in dependency of the selected output device.

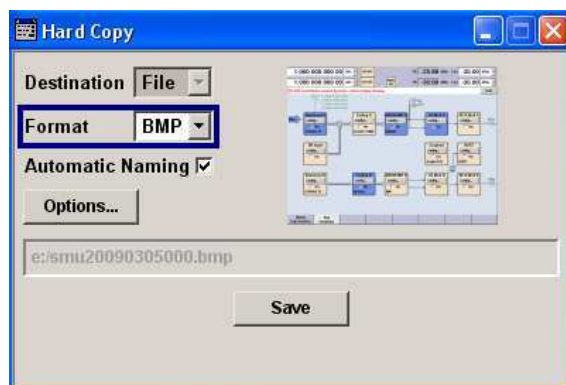
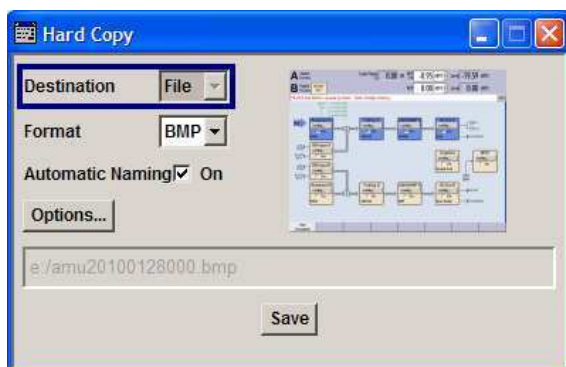

4.2.5.1 Hardcopy Dialog

Destination

Selects if the hardcopy is printed or stored in a file (see also "[Printer Options](#)" on page 151 or "[File Options](#)" on page 152).

SCPI command:

`:HCOPY:DEVIce` on page 539

Options

Opens the Hardcopy Options dialog for configuring the hardcopy. Depending on the selected destination either the printer or the file parameters can be set (see also "[Printer Options](#)" on page 151 or "[File Options](#)" on page 152).

SCPI command:

n.a.

Printer

If device printer is selected some settings are already offered in the hardcopy dialog. All configuration parameters are available in "[Printer Options](#)" on page 151.

File

Some configuration parameters are already offered in the Hardcopy dialog. All configuration parameters are available in "[File Options](#)" on page 152.

Automatic Naming

Activates, deactivates automatic generation of the file name. Automatic naming is configured in the "Options..." submenu, see "[File Options](#)" on page 152.

SCPI command:

`:HCOPY:FILE[:NAME]:AUTO:STATe` on page 544

File Info

Indicates the file name. The file name can be entered either manually via the file manager (button "File...") or generated automatically (Automatic naming checkbox). Automatic naming is configured in the "Options..." submenu.

SCPI command:

`:HCOPY:FILE[:NAME]` on page 540

`:HCOPY:FILE[:NAME]:AUTO:FILE` on page 541

4.2.5.2 Hardcopy Options

This section describes the "Hardcopy Options" dialog.

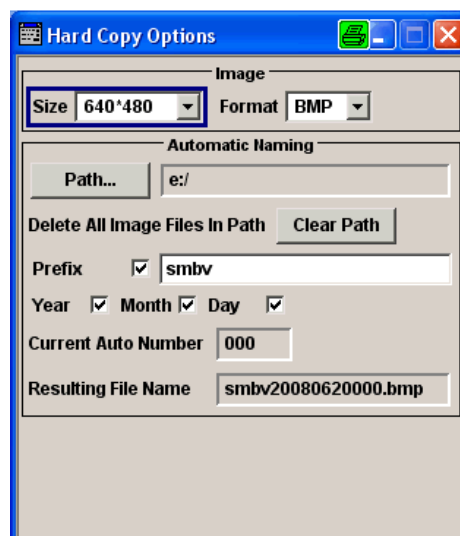
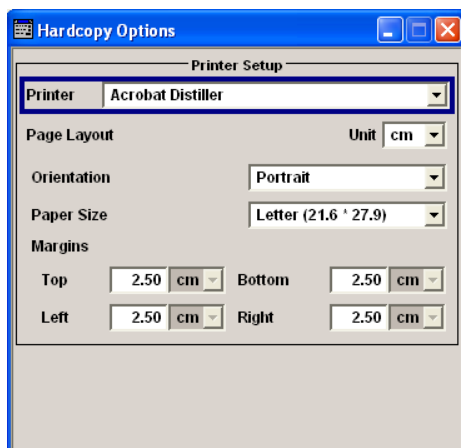

Printer Options

Dialog for setting the printer parameters.

- "Printer" Selects a printer from a list of available printers. The name of the selected printer is indicated in the selection field. If the list is empty, no printer driver is installed. In this case, a printer has to be installed via the Windows XP operating system.
For more information, see [chapter 1.4, "Connecting External Accessories"](#), on page 34.

SCPI command:

[:HCOPY:PRINTER:LIST](#) on page 545

[:HCOPY:PRINTER\[:NAME\]](#) on page 545

- "Unit" Defines the physical unit of the page size and margins used for the hardcopy. The selectable units are inches or centimeter.

SCPI command:

[:HCOPY:PRINTER:PAGE:UNIT](#) on page 546

- "Orientation" Defines the orientation of the printer page for the hardcopy.
"Portrait" - the page's height is greater than its width.
"Landscape" - the page's width is greater than its height.

SCPI command:

[:HCOPY:PRINTER:PAGE:ORIENTATION](#) on page 546

- "Paper Size" Selects the size of the printer paper for the hardcopy. The currently selectable paper formats are "Letter", "Legal", "Executive", "A4" and "A5". For information on the paper format width and height values are indicated additionally. Depending on the set physical unit by the parameter "Unit", width and height are expressed in cm or inches.

SCPI command:

[:HCOPY:PRINTER:PAGE:SIZE](#) on page 546

"Margins" Defines the margins of the paper size for printing the hardcopy. "Top", "bottom", "left" and "right" margin values have to be entered in this sequence, separated by commas. Decimal places are separated by a decimal point. Depending on the set physical unit by the parameter "Unit", width and height are expressed in cm or inches.

SCPI command:

`:HCOPY:PRINTer:PAGE:MARGins` on page 545

File Options

Dialog for setting the file parameters.

"Size" Defines the size of the bitmap in terms of pixels. The first value of the size setting defines the width, the second value the height of the image.

SCPI command:

`:HCOPY:IMAGe:SIZE` on page 545

"Format" Selects the image format. Several bitmap formats are available.

SCPI command:

`:HCOPY:DEVIce:LANGuage` on page 540

"Automatic Naming" Determines the rules to create the file names and sets the directory the files are saved into.

As default the automatically generated file name is composed of:
`<Path>/<Prefix><YYYY><MM><DD><Number>.<Format>`

Each component can be deactivated/activated separately to individually design the file name. The resulting file name is indicated.

"Path..." Opens the "Select Hard Copy Destination Path" dialog to select a path for storing the hardcopy.

Note: For selecting the destination path a file name must be entered as well. Otherwise the error message "The name of a list may not be empty" is displayed and the selection will be canceled.

Directory, path and file name are displayed in the infoline right to the "Path" button.

SCPI command:

`:HCOPY:FILE[:NAME]:AUTO:DIRectory` on page 541

`:HCOPY:FILE[:NAME]:AUTO` on page 540

"Clear Path" Deletes all image files with extensions `bmp`, `img`, `png`, `xpm` and `csv` in the directory set for automatic naming. Before deleting the image files a warning message is displayed requiring the confirmation.

SCPI command:

`:HCOPY:FILE[:NAME]:AUTO:DIRectory:CLEar` on page 541

"Prefix" Activates the usage of the prefix in the automatic file name. The prefix is entered in the field to the right of checkbox.

SCPI command:

`:HCOPY:FILE[:NAME]:AUTO[:FILE]:PREFIx:STATe` on page 543

"Enter prefix" Enters the prefix for the automatically generated file name. The use of the prefix is activated in the checkbox to the left.

SCPI command:

`:HCOPY:FILE[:NAME]:AUTO[:FILE]:PREFIX` on page 543

"Date - Year / Month / Day" Defines the components of the automatically generated file name. The selectable parameters are year, month and day. If activated the current year, month or day used in the file name.

SCPI command:

`:HCOPY:FILE[:NAME]:AUTO[:FILE]:YEAR:STATE` on page 544

`:HCOPY:FILE[:NAME]:AUTO[:FILE]:MONTH:STATE` on page 543

`:HCOPY:FILE[:NAME]:AUTO[:FILE]:DAY:STATE` on page 542

"Current Auto Number" Indicates the number which is used in the automatically generated file name.

Note: On initially switching on the device the number will be reset to the lowest possible value. Starting with number 0 the output directory will be scanned for already existing files. As long as files with the same name are existing the number will be increased by 1. The number will be automatically set to a number so that the resulting file name will be unique within the selected path. The current number will not be saved in the save recall file but will be temporarily stored within the database. On subsequent saves the number will be increased.

SCPI command:

`:HCOPY:FILE[:NAME]:AUTO[:FILE]:NUMBER` on page 543

"Resulting File Name" Indicates the automatically generated file name.

SCPI command:

`:HCOPY:FILE[:NAME]:AUTO:FILE` on page 541

Print / Save

Triggers the generation of a hardcopy.

SCPI command:

`:HCOPY[:EXECUTE]` on page 540

4.2.6 Messages - Info Key

The INFO key opens a window containing a detailed description of every message displayed in the info bar, see [chapter 3.2.3, "Info Window"](#), on page 88 and [chapter 8, "Error Messages"](#), on page 837.

4.2.7 Help System - Help Key

The HELP key opens a browser window containing a context-sensitive description of the highlighted parameter.

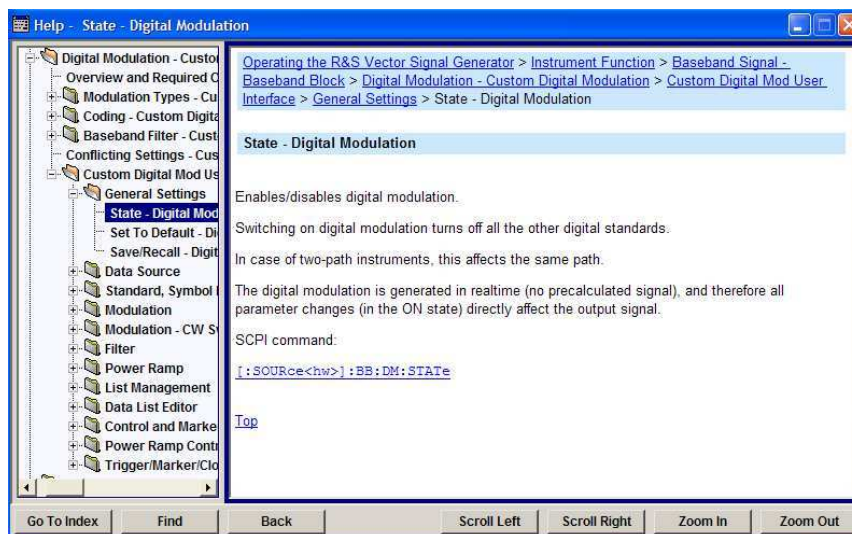

The context-sensitive page which is opened with the HELP key is part of a comprehensive help system. It is possible to move from this context-sensitive page to any page of the help system. The following navigation aids are available:

- Internal links in the text
They open pages which are directly linked to the described function. In this way it is possible, for example, to call up the description of the GPIB command for any particular function.
- Previous/Next links
The Previous/Next links allow scroll through the help pages. The sequence of the described functions corresponds to their position in the menus.
- Back button
The Back button calls up the page last viewed.
- Contents in the navigation panel
The contents list is used to open the individual help pages. It has a hierarchical structure. The highlighted line indicates where the currently displayed page is within the contents list.
- Index in the navigation panel
The index is used to call up all pages which contain the selected entry. The index has an alphabetical structure and also contains all GPIB commands.
- Find
The find function allows you to look for freely selectable terms in all help pages. A list of the pages containing the entered term is displayed as the search result. The search can be limited to words in the page title to increase the number of hits.

The softkeys are used to determine the entry focus for front panel operation, to select the content of the navigation window and to change the font size. To determine the entry focus for front panel operation the Cursors UP/Down are used. The links are highlighted in blue, and can be selected and called up using the rotary knob.

4.2.8 Storing and Loading Instrument Data - File Key

The R&S SMU allows complete instrument settings to be stored in files on the hard disk.

Defined and complex instrument settings can then be reproduced at any time by loading this data. If required, these settings can be loaded to various signal generators.

The corresponding menu is available under "Save/Recall" in the "Setup" menu or accessible by means of the FILE key. The instrument settings are saved in files which can be stored in data directories.

Additionally there are intermediate memories in which the current instrument setting can be stored and then called up again by just pressing a key. This provides fast switching between different instrument settings.

Only settings which differ from the preset values and configuration data for the operating elements (e.g. window positions) are stored. As a result the files remain relatively small. Furthermore, instrument settings can easily be transferred between different equipped signal generators since the files contain only relevant information. When loaded, the referenced settings are implemented and all non-referenced parameters are set to the associated preset values.

If list data is part of the instrument settings, e.g. a list of user correction data, a reference to this list is stored, not the list itself. The list is reactivated when the associated settings are loaded, but the list may have been modified or deleted in the meantime or may not be available on a different instrument. If the list has been modified, the new entries will be used. An error message appears if an attempt is made to access a non-existing list or to activate settings which are not supported by the instrument.



- Network settings and remote settings are not saved and restored.
 - Lists are stored and loaded in the appropriate menus. For example, the user correction data list is created and stored in the "User Correction" menu.
-

When loading an instrument setting, it is possible to select whether the current frequency and level setting is to be retained or whether the stored settings are to be activated. It is possible to delete stored instrument settings. A file can be copied by loading it with "Recall" and then storing it under a new name.

Settings can be transferred easily between instruments with different equipment options and/or firmware versions because only the settings which differ from the preset values are affected. When settings are loaded, only those which are possible on the instrument are implemented. Error messages indicate the settings which cannot be implemented.

The stored file is transferred from one instrument to another using the memory stick or by means of a network drive.

General file management functions such as copying and moving data are available in the "File Manager" dialog.

4.2.8.1 File Menu

The settings available in the File menu "Save/Recall" depend on the operation selected under "Select Operation".



For more information, see [chapter 3.7.1, "File Select Dialog"](#), on page 111.

Select Operation

Selects the file function.

- "Save..." Calls the menu for storing the current instrument setting (see [chapter 4.2.8.2, "Storing Instrument Settings"](#), on page 156).
- "Recall..." Calls the menu for calling up a stored instrument setting (see [chapter 4.2.8.3, "Loading Instrument Settings"](#), on page 158).

4.2.8.2 Storing Instrument Settings

If "Save" is selected under "Select Operation", the File menu provides options for storing the current instrument setting in a file.

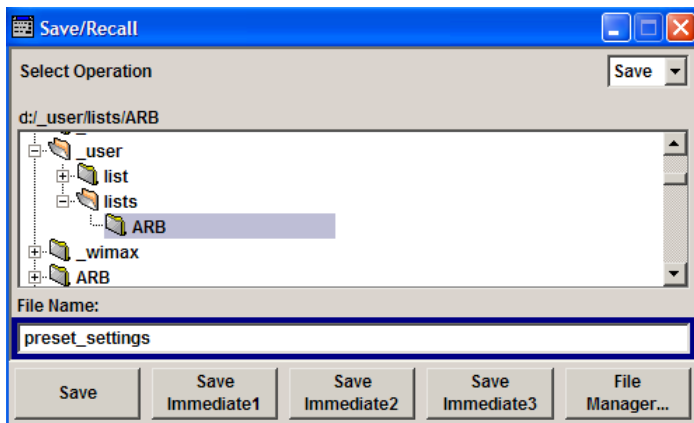

Recent files

Displays the files last used.

SCPI command:

n.a.

Directory

Selects the directory in which the file is to be stored.

The window opposite lists all settings files in this directory.

A new directory can be created in the "File Manager" dialog.

SCPI command:

[:MMEMory:CDIRectory](#) on page 553

File List

Displays the files which are in the selected directory.

If a file is highlighted, it is overwritten when the file is stored.

SCPI command:

[:MMEMory:CATalog](#) on page 552

File Name

Enter the file name of the file without file extension. This file is then created.

SCPI command:

n.a.

Save

Stores the current instrument settings under the specified path.

SCPI command:

[*SAV](#) on page 500

[:MMEMory:STORe:STATe](#) on page 557

Fast Save

Determines whether the instrument performs an absolute or a differential storing of the settings.

Enable this function to accelerate the saving process by saving only the settings with values different to the default ones.

However, in some test setups, e.g while analyzing the generated WiMAX signal with R&S FSQ, it is required to disable the fast save option.

Note: This function is not affected by the [Preset](#) function.

SCPI command:

[\[:SOURce<hw>\]:BB:DM:SETTing:STORe:FAST](#) on page 663

Refer to the descriptions of the firmware options for the correct syntax of the corresponding SCPI command.

Save Immediate x

Stores the current instrument setting in one of the three intermediate memories.

These instrument settings are retained until a different instrument setting is stored in the intermediate memory. When the instrument is switched off, the contents of the intermediate memories are retained.

SCPI command:

[*SAV](#) on page 500

File Manager

Calls the "File Management" menu.

Directories can be created and files managed in this menu (see [chapter 4.2.8.4, "File Manager"](#), on page 159).

SCPI command:

n.a.

4.2.8.3 Loading Instrument Settings

If "Recall" is selected under "Select Operation", the "File" menu provides options for loading complete instrument settings. Here it is possible to select whether the current or stored frequency and level settings are to be used.

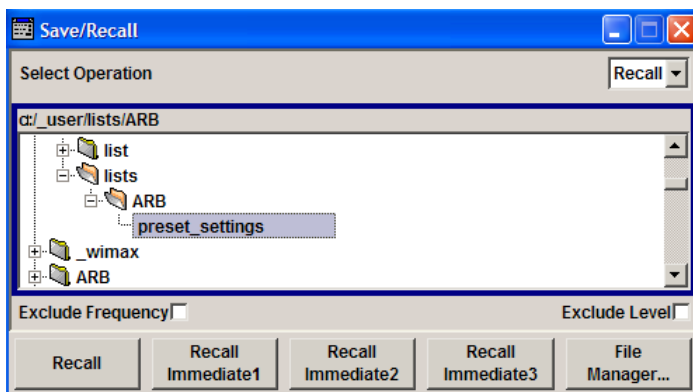

Recent data sets

Displays the files last used. The entire path is shown.

If the desired file is in the list, it can be selected.

SCPI command:

n.a.

Directory

Enter the directory in which the file with the instrument setting to be loaded is located.

The "Selected file" window lists all the files in this directory.

SCPI command:

[:MMEMory:CDIRectory](#) on page 553

File List

Selects the file with the desired instrument configuration.

SCPI command:

[:MMEMory:CATalog](#) on page 552

Exclude Frequency

The current frequency is retained when a stored instrument setting is loaded.

SCPI command:

[\[:SOURce<hw>\]:FREQuency\[:CW|:FIXed\]:RCL](#) on page 722

Exclude Level

The current level is retained when a stored instrument setting is loaded.

SCPI command:

[\[:SOURce<hw>\]:POWer\[:LEVel\]\[:IMMediate\]:RCL](#) on page 775

Recall

Load the selected configuration.

If an instrument setting in which a sweep was activated is stored, the sweep is started when the recall command is called.

If an instrument setting which accesses lists is stored, this list is also loaded.

If the list has been deleted in the meantime, an error message appears when the instrument setting is loaded. If the list has been overwritten in the meantime, the new entries will be used.

SCPI command:

:MMEMory:LOAD:STATe on page 556

*RCL on page 500

Recall Immediate x

Loads the selected configuration from one of the three intermediate memories.

If an instrument setting in which a sweep was activated is stored, the sweep is started when the recall command is called.

If an instrument setting which accesses lists is stored, this list is also loaded.

If the list has been deleted in the meantime, an error message appears when the instrument setting is loaded. If the list has been overwritten in the meantime, the new entries will be used.

A message appears if no instrument configuration is stored in this memory.

SCPI command:

*RCL on page 500

4.2.8.4 File Manager

The "File Manager" dialog provides all the functions required for file management. Directories can be created, and files copied, deleted and moved between the directories on the drives (hard disk, memory stick and network drives).

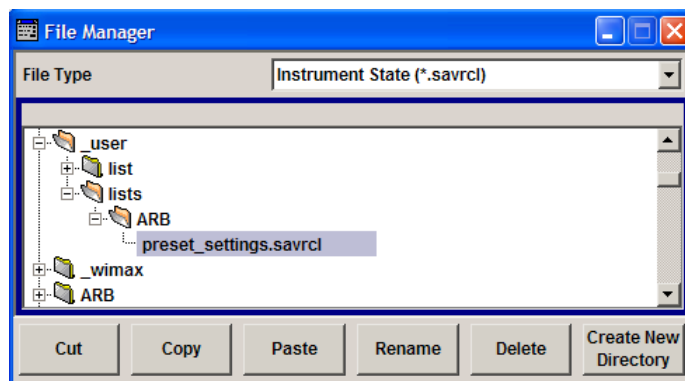

For more information, see [chapter 3.7.2, "File Manager"](#), on page 113.

File Type

Selects the file types to be indicated. If a file type with a specific file extension is selected only files with this extension are indicated in the selected directory.

SCPI command:

n.a.

Directory and File Name

Selects the directory in which the file to be deleted or copied is located. The window lists all files in this directory. The file to be deleted or copied can be highlighted. The path is indicated above the directory window.

SCPI command:

`:MMEMory:CDIRectory` on page 553

Cut

Cuts the selected file. It can be pasted into a different directory using the "Paste" button.

SCPI command:

`:MMEMory:DELeTe` on page 555

Copy

Copies the selected file. It can be pasted into a different or the same directory using the "Paste" button. When pasting the file into the same directory file name `Copy` of `<file name>` is given automatically. When pasting the file into a different directory, the original file name is kept.

SCPI command:

`:MMEMory:COpy` on page 553

Paste

Pastes the file that has been copied or cut before.

SCPI command:

n.a.

Rename

Renames the selected file or directory. The new name can be entered in the "New File-name" dialog.

SCPI command:

`:MMEMory:MOve` on page 556

Delete

Deletes the selected file. Before the file is deleted, a message appears prompting the user to confirm deletion of the file.

SCPI command:

`:MMEMory:DELeTe` on page 555

Create New Directory

Creates a new directory. The name of the new directory can be entered in the "New Directory" dialog.

Note: When the subdirectory is entered, it is possible to enter an absolute path name (e.g. `D:USER/MEAS`) or the path relative to the current directory (e.g. `../MEAS`).

The directory is created as a subdirectory in the selected level.

SCPI command:

`:MMEMory:MDIRectory` on page 556

4.3 Graphical Display - Graphics

The R&S Signal Generator can be used to graphically display the generated baseband signal. A selection of different signal displays assists the user in assessing and checking the increasingly complex modulation signals.

Most graphical displays are possible both for internally generated and externally applied baseband signals.



The Graphics function block is available for instruments with the option:

- R&S SMU-B13 (Baseband Main Module) and one of the options R&S SMU-B9/B10/B11 (UniCod + ARB)
- R&S SMU-B17 (Baseband input)
- R&S SMU-B62 (Noise Generator)

It is the baseband signal actually generated that is recorded and displayed, and not a signal calculated on the basis of the set parameters.

This graphical display allows the user to quickly view and check the current signal characteristics and also gives an overview of the changes in the signal over time. The signal quality can be permanently monitored. The results of parameter changes on the signal, such as a change in modulation mode, or the effects of certain configurations, e.g. the activation of several base stations in the case of (W)CDMA signals, can be analyzed directly in the display. Freezing the signal and then zooming permit a detailed evaluation of any signal segment. The definition and display of one or more reference curves makes it possible to compare various signals (i.e. by comparing the CCDF (Complementary Cumulative Distribution Function) with different channelization codes, or the spectra if different filter parameters are selected).

An externally applied signal can be checked with respect to the anticipated signal characteristics.

The displayed signal segment can be influenced by selecting the trigger that defines the time for recording to start. With automatic triggering, the signal is tapped at the point in the signal path that is best for the respective display. The displayed signal segment is selected internally depending on the signal such that the signal characteristics of interest (e.g. the useful signal) are displayed. This selection is appropriate for a representative display of the complete signal.

In addition, a user-definable trigger is available with which the displayed signal segment can be limited.

The time resolution can be set either automatically or manually, whereby for manual setting the bandwidth for which the trace is to be displayed is selected. The transient recorders used for signal recording have a variable recording depth which is specified under the respective display.

In addition to the large graphics window, the display can also be shown in a small window ("smart graphics"). This window is fitted into the block diagram as a block, and can be used for basic checking purposes (e.g. whether the signal is still being generated).

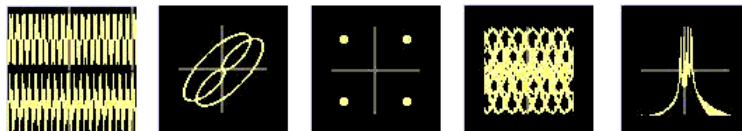

In the case of two-path instruments, the baseband signals of both paths can be displayed simultaneously.

4.3.1 Graphics Settings Menu

The "Graphics Settings" menu for selecting the graphical display of the output signal is opened either in the "Graphics" function block or in the menu with the same name which is opened using the MENU key.

The signal display can be selected and activated in the menu.

With two-path instruments, the settings for the two paths can be entered separately. The signals can be displayed simultaneously in two separate windows.

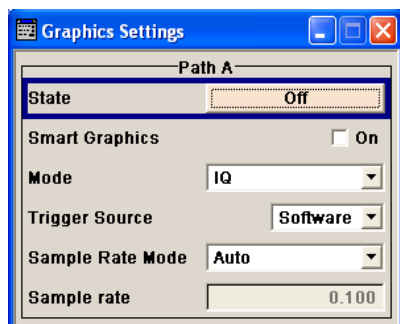

State

Activates the selected graphical display.

After activation, the diagram selected with "Mode" is displayed in the block diagram.

At the bottom of each graphics window there are several buttons for freezing and zooming the display and for activating a reference curve.

For more information, see [chapter 4.3.2, "Bar of Graphics Window"](#), on page 164.

SCPI command:

`[:SOURce<hw>] :BB:GRAPhics:STATe` on page 666

Smart Graphics

Activates the "smart graphics".

The graphic is displayed in a small window which is roughly the size of a block. These windows are displayed permanently in the block diagram until they are deactivated, and allow basic checking of the signal. They do not contain any buttons.

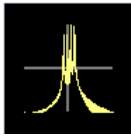

SCPI command:

[\[:SOURce<hw>\]:BB:GRAPhics:SMARt:STATe](#) on page 665

Mode

Selects the graphical signal display. The display is not shown until it has been activated with "Status On".

The individual signal displays are described in the [chapter 4.3.3, "Signal Displays"](#), on page 166.

SCPI command:

[\[:SOURce<hw>\]:BB:GRAPhics:MODE](#) on page 665

Trigger Source

Defines the trigger for the starting time of the graphic recording.

- | | |
|------------|---|
| "Software" | Recording of signals is started automatically in specified intervals. This asynchronous method is appropriate when a representative display of the complete signal is desired, as recording starts in a random time reference to the signal. |
| "Marker 1" | The starting point for recording signals is determined by marker 1 in the menu of the active standard. This synchronous method is appropriate when specific signal segments are to be shown in greater detail. With periodic signals, a static image is obtained by selecting a period length of marker 1 that is equal to the signal period. The displayed signal segment can be shifted as needed by entering a marker delay in the Trigger/Marker menu of the active standard. |

SCPI command:

[\[:SOURce<hw>\]:BB:GRAPhics:TRIGger:SOURce](#) on page 667

Scrambling Code

(only if Code Domain (3GPP FDD DL) is selected)

Sets the scrambling code if the "Code Domain" display is selected. Since it is possible to select a different scrambling code in the menu for each of the 4 base stations and it is also possible to display an external signal, the scrambling code for which the display is to be generated must be explicitly specified here.

SCPI command:

n.a.

Sample Rate Mode

Sets how the time resolution of the signal is determined. Maximum resolution corresponds to a display covering the entire signal bandwidth. The higher the resolution is, the shorter the length of the displayed signal segment will be for the specified recording depth.

"Auto"	The resolution is set to an optimum value on the basis of the signal and display type.
"Full Bandwidth"	The resolution is set such that the display covers the entire signal bandwidth.
"User"	Under "Graphics Sample Rate", the user can determine the resolution by setting the signal bandwidth for which the display is to be generated.

SCPI command:

[\[:SOURce<hw>\]:BB:GRAPhics:SRATe:MODE](#) on page 665

Graphics Sample Rate

With "Auto" and "Full Bandwidth":

Displays the signal bandwidth for which the display is to be generated.

With "User":

Selects the signal bandwidth for which the display is to be generated. The setting range moves between the minimum and maximum bandwidth which is possible for the selected display. The selection is made graphically by moving the pointer.

SCPI command:

[\[:SOURce<hw>\]:BB:GRAPhics:SRATe:USER](#) on page 666

4.3.2 Bar of Graphics Window

At the bottom of each graphics window there are buttons for freezing and zooming the display and for defining and activating a reference curve.



Run

Freezes the current display.

Clicking the button again reactivates the normal, permanently updated display.

Freezing the display allows it to be analyzed more easily. Zooming the display at the same time permits detailed evaluation of any signal segment.

SCPI command:

n.a.

Zoom In (only possible with mouse)

The mouse can be used to freely select any section to be zoomed. This section is selected by pressing the left-hand mouse key and dragging a rectangular marquee. In this way a display can be zoomed in several steps. The zoom is cancelled by clicking the "Zoom Out" button.

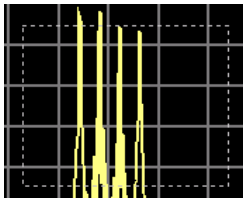

SCPI command:
n.a.

Zoom out

Cancels the zoom.

SCPI command:
n.a.

Time

(I/Q mode only)

Switches to seconds for time representation on the X axis of the I/Q diagram.

SCPI command:
n.a.

Show ref

Displays the reference curve(s). All defined reference curves are displayed simultaneously (see the description of the "Copy to ref" button).

The reference curves are displayed together with the current signal. They allow visual comparison of two or more signals with different settings, e.g. with different filters.

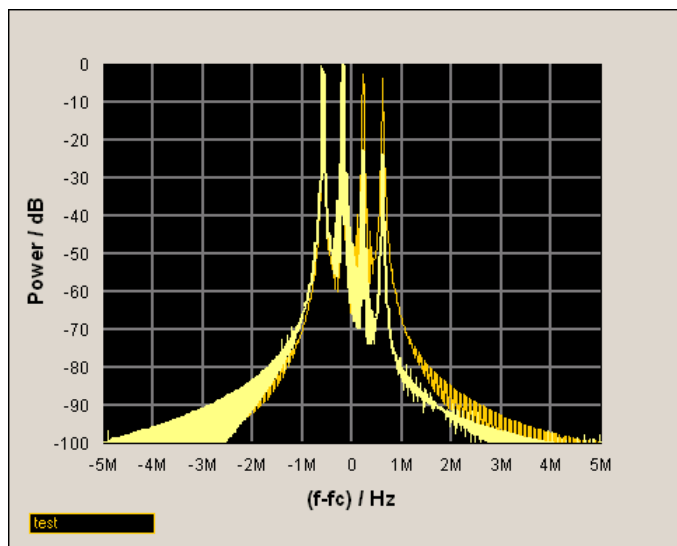

Clicking the button again hides the reference curves.

The reference curves must be defined beforehand using the "Copy to Ref" button.

SCPI command:
n.a.

Copy to ref

Defines the current curve as the reference curve.

A window opens in which the curve can be given a comment and a color.

First of all the desired color is highlighted in the top window. If this color has already been assigned to a reference curve, this curve is overwritten. The command is entered in the bottom "Comment" section. This comment then appears next to the highlighted color.

Up to 5 reference curves can be defined and displayed simultaneously in different colors together with the current signal.

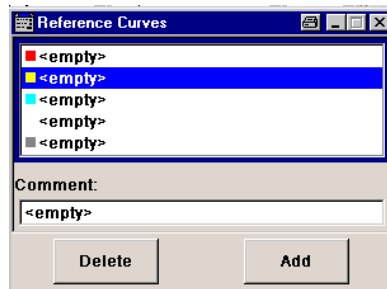

Each reference curve is available until it is deleted.

- "Display area" The comments entered for the defined reference curve are shown in the display area next the assigned color. A maximum of five colors (and reference curves) are available. If no reference curve is assigned to a particular color, the comment <empty> is displayed.
- "Comment" Enters a comment for the current curve which is to be defined as the reference curve. This comment then appears next to the highlighted color in the display area.
- "Delete" Deletes the curve highlighted in the display area. Curves which are no longer required can be deleted to reduce the number of reference curves displayed simultaneously.
- "Assign" Defines the current curve as the reference curve. The new reference curve is shown together with the entered comment next to the selected color in the display area.

SCPI command:

n.a.

4.3.3 Signal Displays

All signal displays which are used for analyzing a baseband signal can be selected. A number of signal displays are only available if the corresponding signal is generated, e.g. Code Domain only available for (W)CDMA signals.

4.3.3.1 I/Q Diagram

The I/Q diagram displays the inphase component ($i[t]$) and quadrature component ($q[t]$) of the I/Q signal over time.

The diagram is displayed in a window with two separate coordinate systems. The coordinate systems have identical X and Y axes. The time (in number of symbols, chips or samples depending on the signal) is plotted on the X axes, and the amplitude scaled to the peak envelope power (PEP) is plotted on the Y axes (minimum scaled amplitude = -1; maximum scaled amplitude = +1). The recording depth is 1 kSamples.

This signal is picked off at the output of the baseband main module ("Impairment" function block), i.e. contained in the displayed signal is:

- impairment of the signal as defined by the user and the addition of noise.
- Fading of the signal as defined by the user
- an added external (Baseband Input)
- an added internal signal (from the second path).

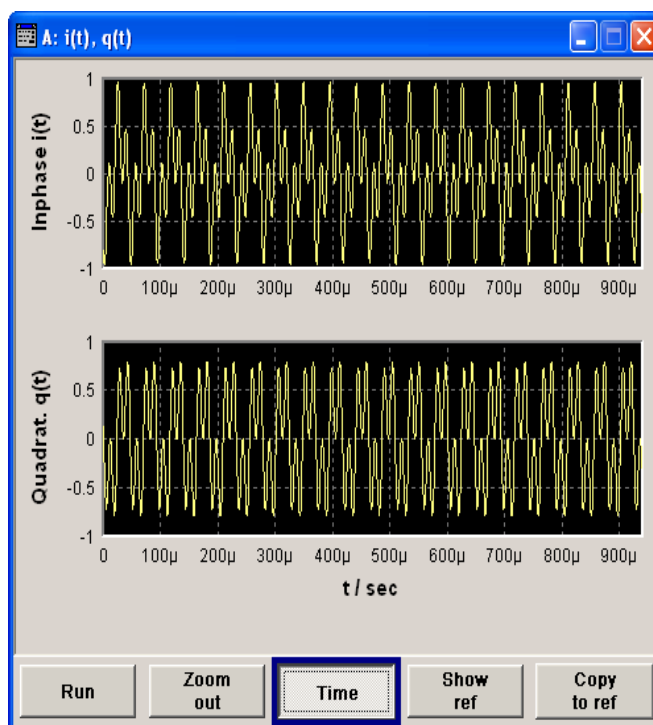

4.3.3.2 Vector Diagram

The Q component is displayed over the I component in the vector diagram. Each point is determined by a vector. The amplitudes of the signal components scaled to the peak envelope power (PEP) are plotted on the X and Y axis (minimum scaled amplitude = -1; maximum scaled amplitude = +1).

This display shows the curves between the various states of modulation mapping. The recording depth is 1 kSamples.

This signal is picked off at the output of the baseband main module ("Impairment" function block), i.e. contained in the displayed signal is:

- impairment of the signal as defined by the user and the addition of noise.
- Fading of the signal as defined by the user

- an added external (Baseband Input)
- an added internal signal (from the second path).

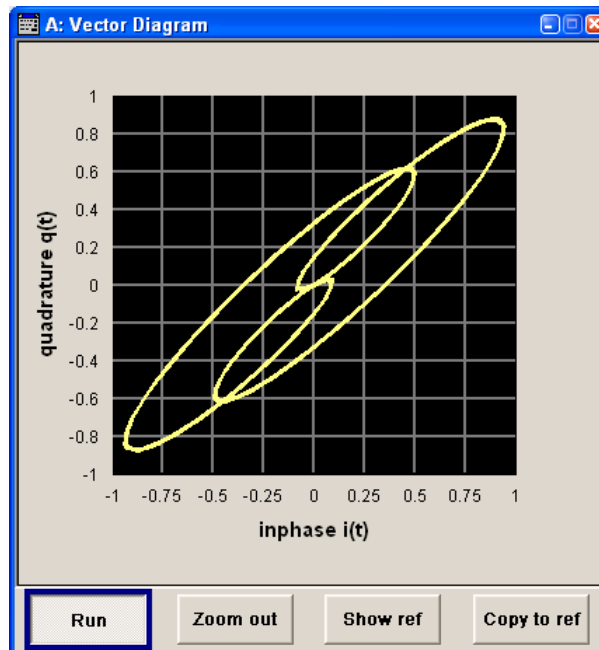

4.3.3.3 Constellation Diagram

In the constellation diagram, the Q component is also displayed over the I component. However, only the values at the constellation points (signal value at the ideal scanning instant of the symbol) are displayed, i.e. for each symbol only 1 value in the form of a circle is shown for the I and Q component.

The amplitudes of the signal components scaled to the peak envelope power (PEP) are plotted on the X and Y axis (minimum scaled amplitude = -1; maximum scaled amplitude = +1). The recording depth is 2kSamples.

This signal is picked off at the output of the baseband main module ("Impairment" function block), i.e. contained in the displayed signal is:

- impairment of the signal as defined by the user and the addition of noise.
- Fading of the signal as defined by the user
- an added external (Baseband Input)
- an added internal signal (from the second path).

This display shows the various states of modulation mapping which occur in the signal. The example shows the constellation diagram of a QPSK modulation signal.

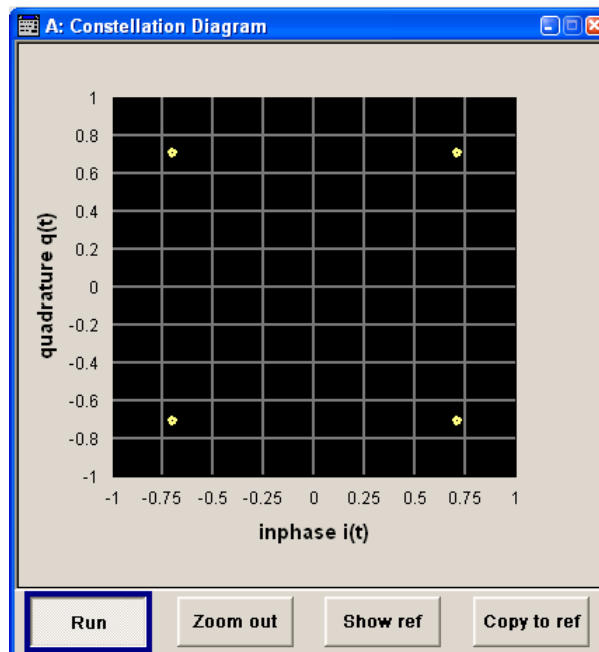

4.3.3.4 Eye Diagram

The eye diagram displays synchronized and superimposed sections of either the inphase or quadrature components of the signal.

The display width (eye length) is set at 2 symbols; several hundred curve segments are superimposed. The time (in the range ± 1 symbol) is plotted on the X axis, and the amplitude scaled to the peak envelope power (PEP) is plotted on the Y axis (minimum scaled amplitude = -1; maximum scaled amplitude = +1). The beginning of recording is synchronous to the symbol and chip clock pulse. The recording depth is 2kSamples.

This signal is picked off at the output of the baseband main module ("Impairment" function block), i.e. contained in the displayed signal is:

- impairment of the signal as defined by the user and the addition of noise.
- Fading of the signal as defined by the user
- an added external (Baseband Input)
- an added internal signal (from the second path).

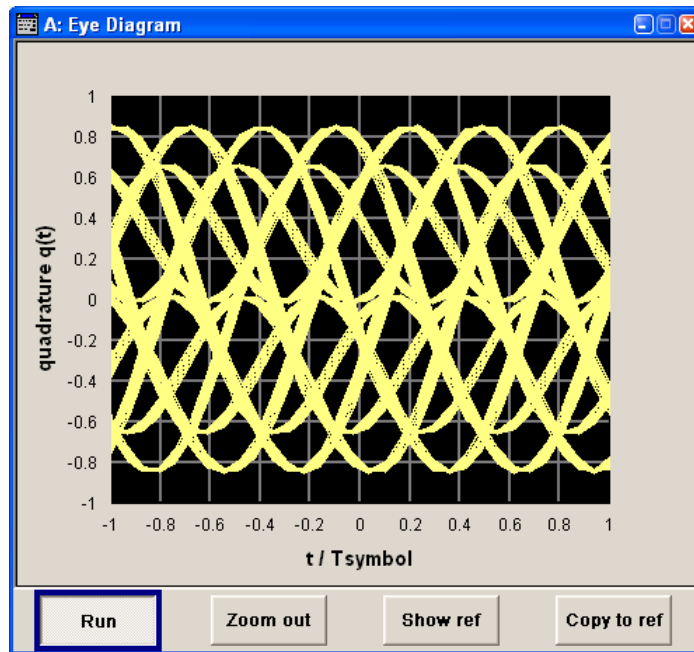

4.3.3.5 CCDF Display

The **Complementary Cumulative Distribution Function** shows the probability with which the output signal will exceed the average power.

The level over the average power is plotted from 0 to 20 dB on the X axis; the average power (RMS) corresponds to the origin. The probability of exceeding the average power is plotted between 0.0001% and 100% on the Y axis. The recording depth is 8kSamples.

This signal is picked off at the output of the baseband main module ("Impairment" function block), i.e. contained in the displayed signal is:

- impairment of the signal as defined by the user and the addition of noise.
- Fading of the signal as defined by the user
- an added external (Baseband Input)
- an added internal signal (from the second path).

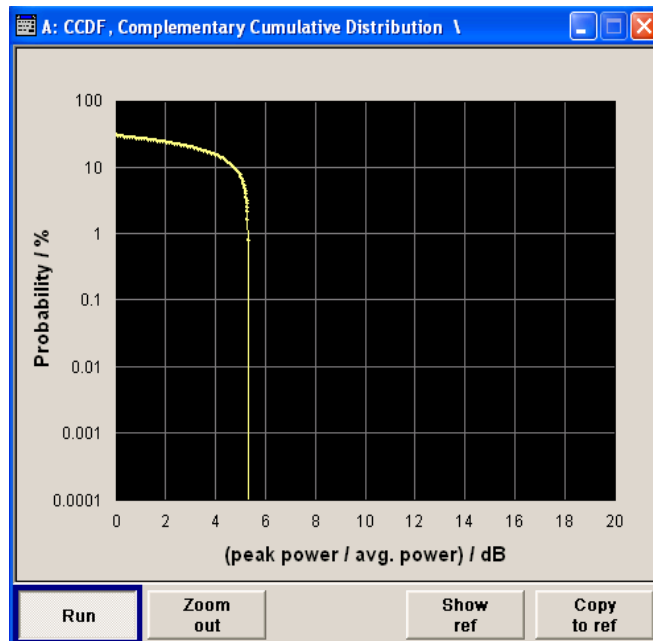

4.3.3.6 Power Spectrum

With the spectrum display, the signal spectrum is calculated from the I/Q signal by means of Fast Fourier Transform (FFT).

The power density over frequency is displayed. The power density is plotted on the Y axis, and the frequency is plotted symmetrically on the X axis (-sampling rate/2 to +sampling rate/2). FFT Points indicates the number of I/Q value pairs which are used for calculating a (part-)FFT. AVG indicates the number of subspectra used for averaging. The recording depth is 8kSamples.

This signal is picked off at the output of the baseband main module ("Impairment" function block), i.e. contained in the displayed signal is:

- impairment of the signal as defined by the user and the addition of noise.
- Fading of the signal as defined by the user
- an added external (Baseband Input)
- an added internal signal (from the second path).

The spectrum display of the output signal is particularly suitable for checking multi carrier signals.

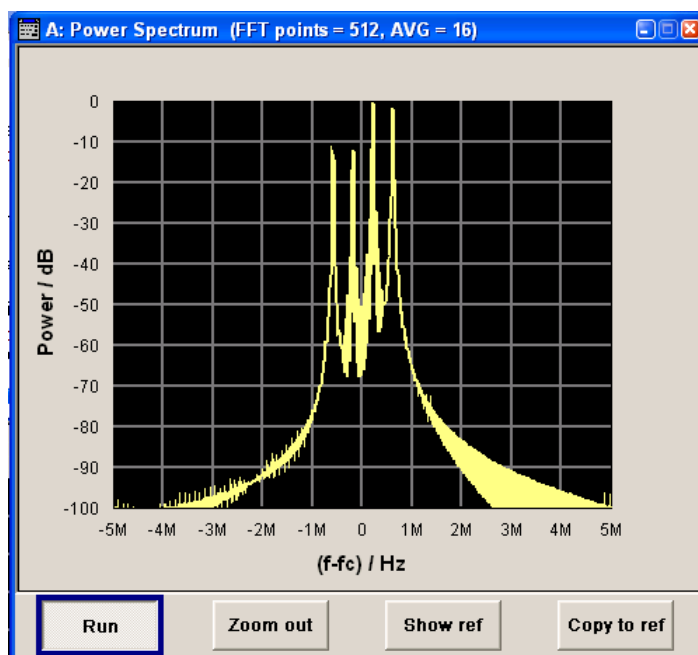

4.4 Bit and Block Error Rate Measurements - BERT Block

The R&S Signal Generator contains an integrated bit error rate tester which makes it possible to evaluate a signal demodulated and decoded by a DUT by measuring the bit error rate. A known PRBS-modulated data sequence (PRBS = **p**seudo **r**andom **b**inary **s**equences) is sent to the DUT. The PRBS data sequence is decoded by the DUT and sent to the R&S Signal Generator in the form of clock and data signals. The bit error rate tester of the R&S Signal Generator synchronizes to the known PRBS sequence and counts the bit errors. The quotient obtained by dividing the number of error bits by the total number of bits is the BER.

In addition, a block error rate measurement can be used to verify CRC checksums. The ratio of errored blocks to total blocks yields the block error rate.

The settings are shown in the block diagram in the "BERT" function block and in the menu of the same name that is accessed via the MENU button.

The equipment layout for the basic unit (R&S Signal Generator with B10x frequency option) includes the option R&S SMU-K80 (Bit Error Rate Tester).

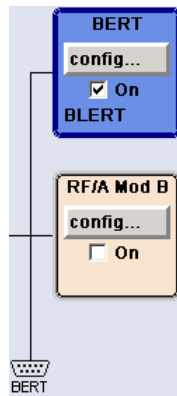

The "BERT" interface is located on the rear panel. Besides the data and clock input, it provides further inputs for masking data containing the PRBS sequence. The interface description can be found in [chapter A.4, "BERT Connector"](#), on page 848.

4.4.1 Test setup

The following figure shows the test setup for the bit/block error rate measurement. The data used to drive the DUT can be generated by the R&S Signal Generator or an user-defined external source. The R&S Signal Generator can generate any externally computed modulation signals that were created using e.g. R&S WinIQSIM2 software (see [chapter 4.8.4.1, "ARB User Interface"](#), on page 386).

A known PRBS sequence must be used for the bit error rate measurement.

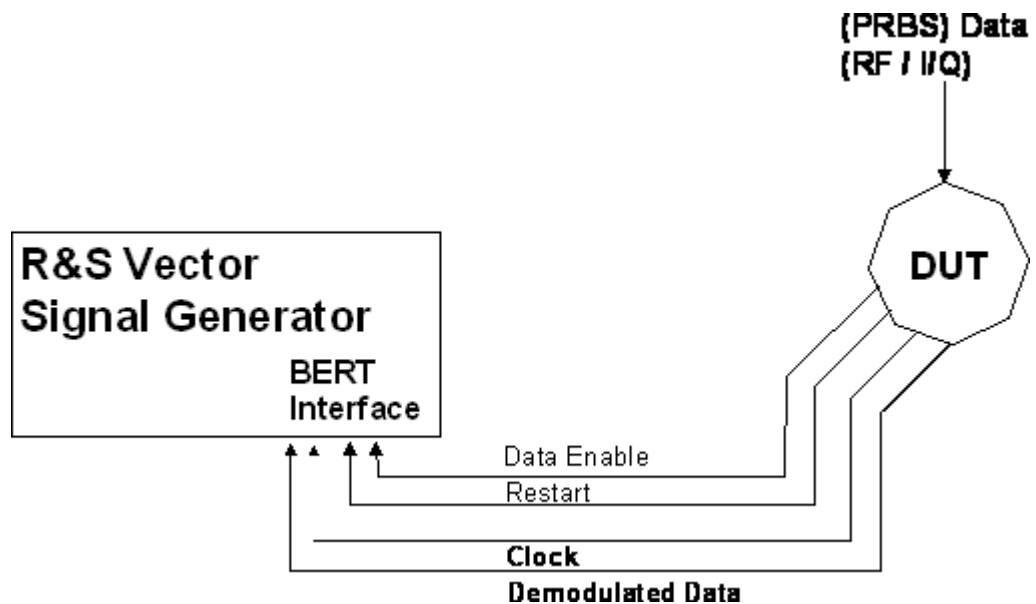

Fig. 4-1: Test setup for bit or block error rate measurement.

The DUT is driven using a known data sequence. It demodulates the data and sends it together with a clock signal to the R&S Signal Generator. The Data Enable signal marks

the user data of the signal. The restart signal for restarting the PRBS calculation is only important for the bit error rate measurement.

4.4.2 PRBS data

To be able to detect faulty bits by a BER measurement, the data generation polynomial must be known. PRBS sequences are therefore used as the method for computing the data (see [chapter 4.8.2.1, "Internal PRBS Data and Data Patterns"](#), on page 332). These quasi-random bit sequences are repeated periodically, depending on the polynomial selected. A randomly selected initial status yields exactly one subsequent status. The initial status and therefore the subsequent status occur only once in the whole sequence.

Hence an advantage of the PRBS data is that the bit error detector must know only the polynomial but not the entire sequence. At the start of a measurement, the feedback shift register is filled once with the applied data sequence (which corresponds to the synchronization time) and is subsequently switched from "fill" to "feedback". This creates a defined initial status and generates exactly the same data that the applied data stream should have. Faulty bits can thus be identified and counted by comparing the received data with the results obtained from the shift register.

Creating a defined initial status makes it possible to start the analysis anywhere in the bit stream, i.e. the bit-stream source and the analyzer need not be synchronized. Delays of the DUT and transmission over long air paths, where the transmitter and the receiver are located at separate sites, therefore do not present a problem.

4.4.3 CRC polynomial

In the block error rate measurement, the checksum (CRC) that contains the data signal fed to the DUT is compared with the checksum that the block error rate tester calculates from the feedback data. If the two checksums differ, a block error is counted. The quotient obtained by dividing the number of faulty blocks by the total number of blocks is the block error rate.

At the beginning of the data, the shift register is initialized with 0. All user data bits are then shifted through the shift register. The CRC component is then read into a second register and compared bit by bit with the result of the calculation.

CCITT CRC 16 : $G(x) = x^{16} + x^{12} + x^5 + x^1$ is the CRC polynomial supported.

The user data is marked by a signal that comes from the DUT and is fed to the "Data Enable" input of the BERT interface.

4.4.4 Clock signal

Usually the clock signal is provided by the DUT. If not, the bit clock can be extracted from the CLOCK output connector (only with "Custom Dig Mod" signals in realtime). If signals complying with other digital standards are generated or if ARB waveforms are used, a marker signal can be used as a clock. As the DUT causes a delay, the ratio of clock-to-data travel times must always be taken into account and checked with an oscilloscope if

necessary. The R&S Signal Generator indicates the status of the clock and data lines and of the synchronization in the menus.

4.4.5 Ending the measurement

The measurement results usually lie in the range of 10^{-2} to 10^{-9} for the bit error rate, and in the range of 10^{-2} to 10^{-4} for the block error rate. This means that a very large number of bits or blocks may have to be tested before a faulty bit or block occurs. Because of the large number of bits/blocks involved, the measurement time is usually very long. Since 32-bit-wide counters are used for the total number of bits/blocks and the number of error bits, the maximum measurement time is 4.29×10^9 bits.

To keep the measurement times short for both small and large bit/block error rates, the R&S Signal Generator provides a number of ways to end the measurement. In addition to manually interrupting the count, two termination criteria can be selected:

1. reaching a user-defined number of checked data bits/blocks;
2. a maximum number of detected errors.

The measurement stops as soon as one of the two criteria has been met. The display shows which of the two criteria caused the measurement to stop.



The BER/BLER measurement measures statistical bit/block errors, i.e. errors which do not occur at regular intervals but at random. Although a single measurement determines the exact number of errors in the measured interval, a statistically reliable BER/BLER can only be obtained when a sufficient number of errors occur in the observed interval. This is the only way to ensure that the single BER/BLER measurement result approaches the true error rate with high probability.

Bit error rates of approximately 50 % indicate a faulty measurement.

4.4.6 Interrupt-free measurement

In the case of continuously generated signals that contain whole-number multiples of the PRBS sequence, the measurement occurs without interruption. Only the data and clock lines of the BERT interface are used for the measurement. The length of the random sequence is 2 to the power of the degree of the polynomial minus 1. For example, PRBS9 length of 511 (2^9 equals 512 minus 1).

4.4.7 Restart function

The "Restart" function makes it possible to perform BER measurements with short signals or with signals that are not continuously generated (and therefore do not contain any whole-number multiples of PRBS sequences). An external signal at the BERT input halts the measurement and restarts it when the data sequence begins, and the BER results of the relevant (sub)sequences are integrated.

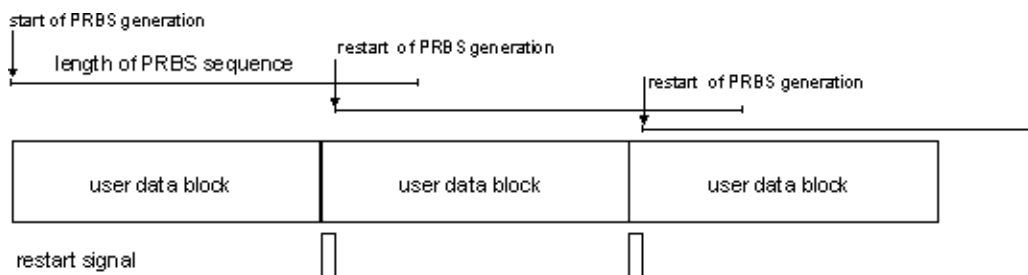

Fig. 4-2: The length of the signal is too short for a complete PRBS sequence; PRBS generation is restarted by the Restart signal when the signal begins anew.

Frames generated by the R&S Signal Generator or the R&S WinIQSIM2 software contain continuous PRBS data, i.e. the PRBS sequence is continuously written to the user data fields. Consequently, if the R&S Signal Generator is used as a data source, a restart is only necessary if (e.g. when using a waveform) the total length of the signal does not equal a whole-number multiple of a PRBS sequence.

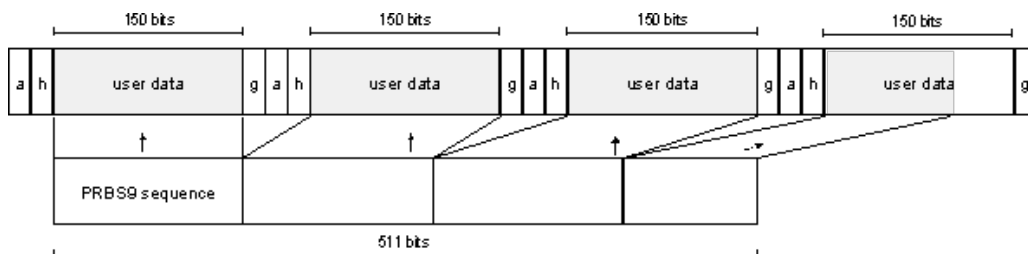

Fig. 4-3: TDMA signal generated by the R&S Signal Generator with user data that contains the PRBS data sequence. The PRBS sequence is continuously written to the user data fields.

4.4.8 Data Enable

In the case of the bit error rate measurement, the data signals usually contain not only PRBS data but also other data (e.g. sync and preambles, see figure) that would result in bit errors. The BER measurement for this data can then be interrupted using the "Data Enable" signal. The "Data Enable" signal is fed in at the BERT input.

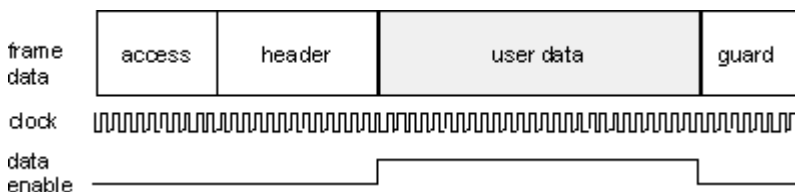

Fig. 4-4: TDMA signal with user data that contains the PRBS data sequence and various check fields which should be ignored for the bit error rate measurement. Below that are the associated clock and Data Enable signals.

In the case of the block error rate measurement, the "Data Enable" signal masks the user data (see following figure).

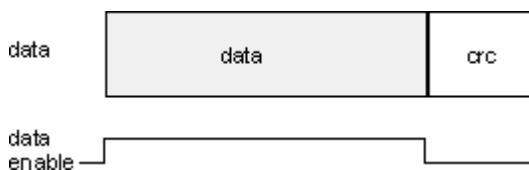

Fig. 4-5: Data Enable signal with block error rate measurement.

4.4.9 Pattern Ignore

Bit sequences of 32 bits or more with only "1" or "0", which some mobile radio standards provide instead of frame data when faulty frames are detected, can also be excluded from the measurement using the "Pattern Ignore" function (see figure).

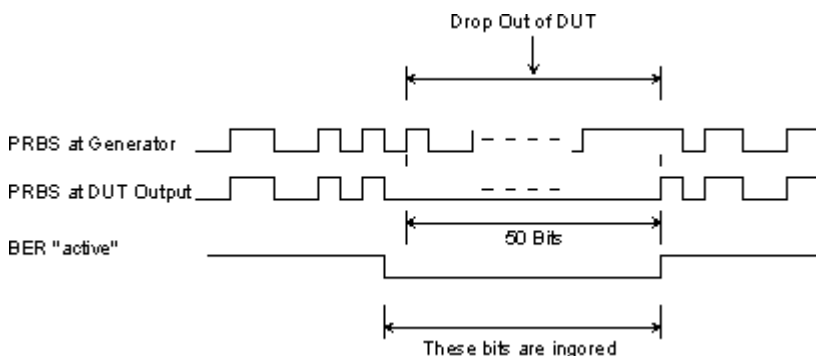
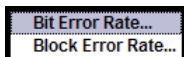

Fig. 4-6: Example of functionality of Pattern Ignore: 50 bits were set to "0" by the DUT. These 50 bits plus the preceding "0" are ignored in the bit error rate measurement.

4.4.10 Bit Error Rate Menu



The "Bit Error Rate" menu for configuring the bit error rate measurement is called either in the "BERT" function block or via the MENU button under "BERT"

The top section of the "Bit Error Rate" menu is used to switch on the bit error rate measurement and display the results and current status of the measurement.

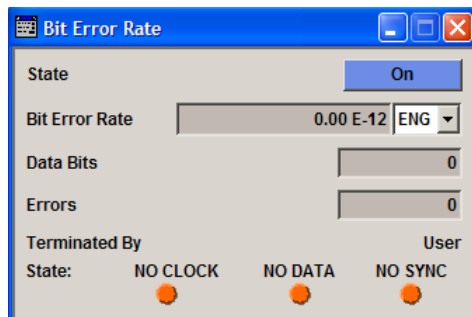

The "Configuration" section is used to select the type of measurement the data source and the termination criteria.

If the data is not cyclically continued, the measurement can be selectively interrupted and restarted. Certain data sections and frames that have been marked as faulty can be excluded from the measurement.

Configuration

Mode: Single Execute Single

Max. Data Bits: 10 000 000

Max. Errors: 100

PRBS: PRBS 9

Data Polarity: Norm

Clock Slope: Pos

External Restart: On

Data Enable: Not Used

Pattern Ignore: Off

Threshold (BER): 1.00 V

Impedance (BER): 1 kΩ / GND

4.4.10.1 General Settings

State

Switches the bit error rate measurement on/off. Depending on the selection in the "Mode" box, either a continuous measurement ("Auto") or a single measurement ("Single") is carried out. A single measurement must be started by clicking the "Execute Single" button.

SCPI command:

[:BERT:STATE](#) on page 528

Bit Error Rate

Displays the measured bit error rate.

The bit error rate is the ratio of occurred errors to transmitted data bits.

The display unit can be selected in the box to the right of the value.

"ENG"	The bit error rate is output in exponential notation with the exponent – 3 or –6.
"SCI"	The bit error rate is output in scientific notation, i.e. standardized to one place to the left of the decimal.
"%"	The bit error rate is output in percent.
"ppm"	The bit error rate is output in parts per million.

SCPI command:

[:BLER:RESult](#) on page 521

[:BERT:UNIT](#) on page 529

Data Bits

Displays the current number of data bits checked.

SCPI command:

[:BERT:RESult](#) on page 521

Errors

Displays the current number of occurred errors.

SCPI command:

[:BERT:RESult](#) on page 521

Terminated By

Displays the termination criterion for the measurement.

These criteria can be entered to keep the duration of the measurement short for low as well as high bit error rates.

The last measurement result is displayed after the measurement has been terminated.

"User" The measurement was manually terminated by the user switching the state to off.

"Number of Data Bits" The measurement was terminated because the specified number of data bits was reached

"Number of Errors" The measurement was terminated because the specified number of errors was reached.

SCPI command:

[:BERT:STATE](#) on page 528

[:BERT:STOP](#) on page 528

State

Displays the status of the measurement.

This enables the user to check whether the measurement functions. The status of the data and clock lines and of synchronization is checked and displayed.

If a faulty status is displayed, the signals can be checked at the BERT interface using an oscilloscope.

"Clock" The applied clock signal was detected.

"No Clock" The applied clock signal was not detected. Possible causes are:

- Clock recovery is not available (e.g. with tests of RF components). If the signal is generated using the R&S Signal Generator, the bit clock can be extracted from the CLOCK output connector (only with "Custom Dig Mod" signals in realtime). If signals complying with other digital standards are generated or if ARB waveforms are used, a marker signal can be used as a clock. As the DUT causes a delay, the ratio of clock-to-data travel times must always be taken into account and checked with an oscilloscope if necessary.
- The wrong impedance for the applied clock rate was selected (see "Impedance" parameter).
- The wrong threshold for the applied clock signal was selected (see "Threshold").

"Data"	The applied data signal was detected.
"No Data"	<p>The applied data signal was not detected. Only clocked-in signals are detected; if the clock signal is missing, then data changes will also not be detected.</p> <p>If the data is not detected despite the detected clock signal, this may be caused by the following:</p> <ul style="list-style-type: none">• The signal from the DUT is missing.• The wrong impedance for the applied clock rate was selected (see "Impedance" parameter).• The wrong threshold for the applied data signal was selected (see Threshold parameter).
"Sync"	The measurement is synchronized.

"No Sync"

The measurement is not synchronized.

Generally, a measurement cannot be synchronized until a clock and a data signal have been detected. If synchronization still does not occur, this may be caused by the following:

- The selected PRBS is not correct. For the bit error rate measurement, the PRBS sequence on which the data is based must be set on the bit error rate tester. If the PRBS is not correct, the BER measurement cannot synchronize to the data (due to the incorrect polynomial).
- A wrong clock slope is used, which violates setup or hold times (see "Clock Slope" parameter).
- The travel times of clock and data are unfavorable (e.g. clock slope at data change). Check the relationship of clock to data using an oscilloscope and optimize the travel times (e.g. clock slope when the data signal applied is stable).
- Reflections on the clock line occur, clocking the data signal into the BER measurement twice, e.g. on lines without termination. The R&S Signal Generator input is not terminated.
- Incorrect polarity of data signal (or "Data Enable" signal). In this case the PRBS cannot synchronize. Note that an inversion of the output signal specified for some cases by the PRBS standard is performed automatically upon PRBS selection. Manual inversion of the data signal is therefore not required.

No Sync status and an error rate of approx. 50%:

- A bit error occurs during synchronization (e.g. nine data bits with PRBS9). The BER measurement is set up incorrectly. This fault is internally detected and automatically corrected.
- If data that is not cyclically continued (i.e. when a break in the sequence occurs at the memory wrap-around), the measurement will not be started at the right time. The signal on the "Restart" line enables the measurement to be started optimally at the beginning of the sequence.

SCPI command:

`:BERT:RESult` on page 521

4.4.10.2 Configuration

The "Configuration" section is used to select the type of measurement, the data source and the termination criteria. If the data is not cyclically continued, the measurement can be selectively interrupted and restarted. Certain data areas and frames that have been marked as faulty can be excluded from the measurement.

Mode

Selects the type of measurement: single or continuous measurement.

- "Auto" Continuous measurement of bit error rate. If either or both of the termination criteria are met, the measurement in progress is terminated and immediately a new one is started automatically. Depending on the settings made, a measurement may take considerable time. During the first measurement, intermediate results are displayed. For the measurements that follow, only the final results are shown. The parameters "Data Bits" and "Errors" are continuously updated and indicate the relative values for the measurement in progress. To start a continuous measurement, use the command `:BERT:START` on page 528. To stop a measurement, use the command `:BERT:STOP` on page 528.
- "Single" Single measurement of bit error rate. The measurement is started by clicking the "Execute Single" button. If a measurement is in progress, the current values for "Bit Error Rate", "Errors" and "Data Bits" are cyclically displayed. The measurement is terminated when either or both of the termination criteria have been reached. To start a new measurement, the "Execute Single" button must be clicked again.

SCPI command:

`:BERT:SEquence` on page 522

Max Data Bits

Enter the number of transmitted data bits to be checked before the measurement is terminated.

This criterion terminates the BER measurement after the specified number of data bits, even if very few errors or none at all have been detected. With a low number of bit errors, the measurement result may be statistically unreliable.

If the measurement is terminated because the number of data bits entered here was checked, "Number of Data Bits" appears to the right of "Terminated By".

Data excluded from the measurement by "Data Enable" or "Pattern Ignore" is not counted.

SCPI command:

`:BERT:SETup:MCOUNT` on page 526

Max Errors

Enter the number of bit errors to occur before the measurement is terminated.

This criterion terminates the measurement relatively quickly if the error rate is high. The measurement result is statistically reliable, since many errors were already counted.

If the measurement is terminated because the number of bit errors entered here was reached, Number of Errors appears to the right of Terminated By.

SCPI command:

`:BERT:SETup:MERRor` on page 526

PRBS

Selects the PRBS sequence. The data generated by the PRBS generator is used as a reference for the measurement.

Note: Standard-compliant data inversion for PRBS15 and PRBS23 is performed automatically when the PRBS is selected. "Data Polarity" remains unaffected.

SCPI command:

`:BERT:SETup:TYPE` on page 527

Data Polarity

Sets the polarity of the feedback data bits.

Note: Standard-compliant data inversion for PRBS15 and PRBS23 is performed automatically when the PRBS is selected. "Data Polarity" remains unaffected.

"Norm" High level stands for logic 1, low level for logic 0.

"Inv" Low level stands for logic 1, high level for logic 0.

SCPI command:

`:BERT:SETup:DATA[:POLarity]` on page 524

Clock Slope

Sets the polarity of the active slope of the feedback clock.

"Pos" The positive slope of the clock signal is active.

"Neg" The negative slope of the clock signal is active.

SCPI command:

`:BERT:SETup:CLOCK[:POLarity]` on page 523

Impedance

Sets the input impedance of the BERT inputs "Clock", "Data", "Data Enable" and "Restart".

For high clock rates, 50 Ohms should be selected.

SCPI command:

`[:SOURce]:INPut:BERT:IMPedance` on page 529

Threshold

Sets high/low threshold in volts for the BERT inputs "Clock", "Data", "Data Enable" and "Restart".

The variable threshold makes it possible to align the BERT interface with the level of different input signals. In addition, reflections and other interference can be suppressed by selecting the appropriate threshold.

SCPI command:

`[:SOURce]:INPut:BERT:THReshold` on page 529

External Restart

Activates/deactivates an external restart of the BER measurement.

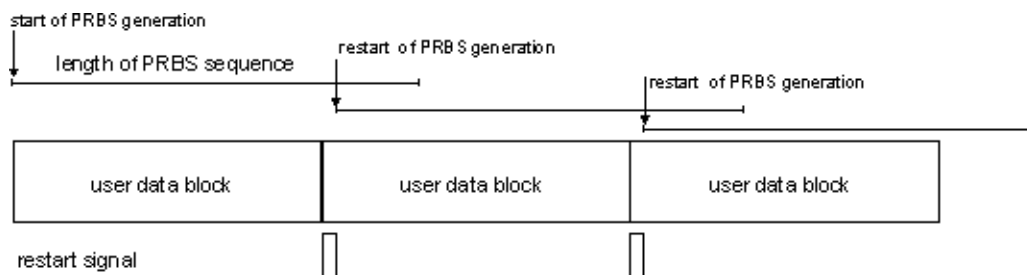

The length of the signal is too short for a complete PRBS sequence; PRBS generation is restarted by the "Restart" signal when the signal begins anew.

"On" The reset signal for the BER measurement is fed via the "Restart" input of the BERT interface.

If the PRBS cannot be continued uninterruptedly, the BER measurement must be stopped at the end of the data sequence and subsequently restarted at the beginning of the new data sequence. The measurement is stopped and started via a 0-1-0 slope of the restart signal. A transition from logic 0 to 1 causes a partial result to be generated and the measurement to be stopped. A transition from 1 to 0 starts the measurement for the next subinterval. This measurement is synchronized anew.

If the R&S Signal Generator is used as a data source, a signal in which a single 1 was coded at the end of the data sequence can be used as a restart signal at the R&S Signal Generator marker output. This causes the BER measurement to stop briefly at the end of the data sequence and start again.

Partial results (number of data and error bits) are added up until the predefined total number of data or error bits is reached or exceeded. The measurement is reset by "Pattern Ignore" or "Data Enable", regardless of its status.

"Off" The reset signal for the BER measurement is generated internally. This setting is suitable for PRBS sequences that run continuously and thus ensure uninterrupted repetition.

SCPI command:

[:BERT:SETup:REStart:STATe](#) on page 526

Data Enable

Activates/deactivates the use of the "Data Enable" signal and sets the polarity of this signal if it is used.

The "Data Enable" signal marks the data that is actually to be evaluated for the BER measurement. Any data in addition to the PRBS sequence is masked and thus not evaluated (e.g. sync, preambles, other channels, etc that are present in the data bits supplied by the DUT).

The signal is fed in at the "Data Enable" input of the BERT interface. It is generated by the DUT but can also be provided by the R&S Signal Generator in the form of a marker signal.

Note: If the data is not enabled, the BER measurement is stopped completely. The identification circuit for "Pattern Ignore" as well as the PRBS generator of the BER measure-

ment wait as long as data is not enabled. If the data is enabled, the measurement is continued.

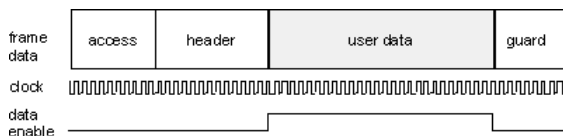

The figure shows a TDMA signal with user data that contains the PRBS data sequence and various check fields which should be ignored for the bit error rate measurement. Below that are the associated clock and "Data Enable" signals.

- "Not Used" Any signal at the "Data Enable" input is ignored; all data at the BERT data input is used for the measurement.
- "High" The "Data Enable" signal is used. The only data measured is the data at the BERT data input during a high level of the "Data Enable" signal. The measurement is interrupted during a low level of the "Data Enable" signal.
- "Low" The "Data Enable" signal is used. The only data measured is the data at the BERT data input during a low level of the "Data Enable" signal. The measurement is interrupted during a high level of the "Data Enable" signal.

SCPI command:

[:BERT:SETup:DENable](#) on page 524

Pattern Ignore

Activates/deactivates ignoring of pure "0" or "1" bit sequences at least 32 bits long. Activating "Pattern Ignore" excludes faulty frames from the measurement.

In the case of some mobile radio standards, pure "0" or "1" bit sequences are generated when errors (e.g. an incorrect checksum) are detected within a frame. These sequences, instead of the frame data, are provided for the BER measurement and signal that the frame in question should not be used for the measurement.

The R&S Signal Generator ignores sequences of 32 bits or longer.

Note: While ignoring the bits, the PRBS generator for the BER measurement keeps running. Following the "0" or "1" sequence, the BER measurement is continued as if the ignored sequence had contained PRBS data.

If "Pattern Ignore" is switched on, synchronization time is 32 bits longer.

If "Pattern Ignore" and "External Restart" are active at the same time, the measurement terminates immediately when the restart signal is applied. None of the 32 bits within the "Pattern Ignore" detector is evaluated.

If "Data Enable" and "Pattern Ignore" are active at the same time, "Data Enable" is given priority, i.e. bits that are not enabled are not examined for "0" or "1" sequences.

Example:

50 bits were set to "0" by the DUT. These 50 bits plus the preceding "0" are ignored in the bit error rate measurement.

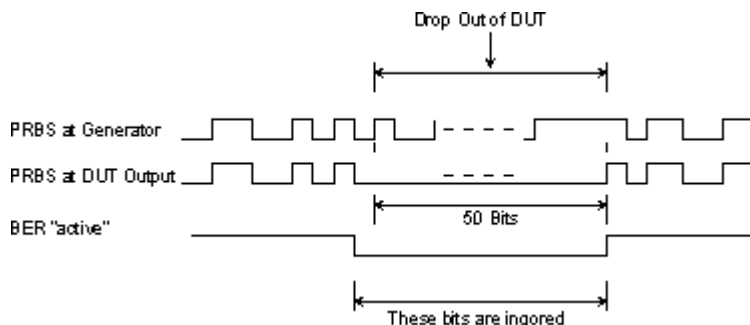

- "Off" Pattern Ignore is not active.
- "All 1" Bit sequences consisting of 32 or more consecutive "1" data are not used (i.e. ignored) for the BER measurement.
- "All 0" Bit sequences consisting of 32 or more consecutive "0" data are not used (i.e. ignored) for the BER measurement.

SCPI command:

[:BERT:SETup:IGNore](#) on page 525 :[BERT:SETup:DEnable](#) on page 524

4.4.11 Block Error Rate Menu

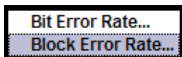

The "Block Error Rate" menu for configuring the block error rate measurement is called either in the "BERT" function block or via the MENU button under "BERT."

The top section of the "Block Error Rate" menu is used to switch on the block error rate measurement and display the results and current status of the measurement.

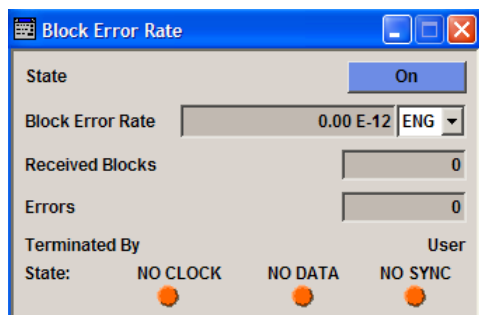

The "Configuration" section is used to select the type of measurement and the termination criteria and to set the polarity of the input signals.

Configuration	
Mode	Single
Max. Received Blocks	100 000
Max. Errors	100
BLER Type	CRC 16
CRC Order	LSB first
Data Polarity	Norm
Clock Slope	Pos
Data Enable	Low
Threshold (BER)	1.00 V
Impedance (BER)	1 kΩ / GND

4.4.11.1 General Settings

State

Switches the block error rate measurement on/off.

Depending on the setting in the "Mode" box, either a continuous measurement ("Auto") or a single measurement ("Single") is carried out. A single measurement must be started by clicking the "Execute Single" button.

SCPI command:

:BLER:STATe on page 528

Block Error Rate

Displays the measured block error rate.

The block error rate is the ratio of faulty blocks to total blocks.

The display unit can be selected in the box to the right of the value.

"ENG" The block error rate is output in exponential notation with the exponent -3 or -6 .

"SCI" The block error rate is output in scientific notation, i.e. standardized to one place to the left of the decimal.

"%" The block error rate is output in percent.

"ppm" The block error rate is output in parts per million.

SCPI command:

:BLER:UNIT on page 529

Received Blocks

Displays the current number of data blocks checked.

SCPI command:

:BLER:RESult on page 521

Errors

Displays the current number of occurred errors.

SCPI command:

[:BLER:RESult](#) on page 521

Terminated By

Displays the termination criterion for the measurement.

These criteria can be entered to keep the duration of the measurement short for low as well as high block error rates.

The last measurement result is displayed after the measurement has been terminated.

"User" The measurement was manually terminated by the user switching the state to off.

SCPI command:

[:BLER:STATE](#) on page 528

[:BLER:STOP](#) on page 528

"Number of Data Blocks" The measurement was terminated because the specified number of data blocks was reached.

"Number of Errors" The measurement was terminated because the specified number of errors was reached.

SCPI command:

[:BLER:RESult](#) on page 521

State

Displays the status of the measurement.

A green LED indicates a correct status, a red LED a critical status.

This allows the user to check whether the measurement functions. The status of the data and clock lines and of synchronization is checked and displayed.

If a faulty status is displayed, the signals can be checked at the BERT interface using an oscilloscope.

"Clock" The applied clock signal was detected.

"No Clock" The applied clock signal was not detected.

Possible causes are:

- Clock recovery is not available (e.g. with tests of RF components). If the signal is generated using the instrument family, the bit clock can be extracted from the CLOCK output connector (only with "Custom Dig Mod" signals in realtime). If signals complying with other digital standards are generated or if ARB waveforms are used, a marker signal can be used as a clock. As the DUT causes a delay, the ratio of clock-to-data travel times must always be taken into account and checked with an oscilloscope if necessary.
- The wrong impedance for the applied clock rate was selected (see "Impedance" parameter).
- The wrong threshold for the applied clock signal was selected (see "Threshold" parameter).

"Data"	The applied data signal was detected.
"No Data"	The applied data signal was not detected. Possible causes are: <ul style="list-style-type: none"> • The signal from the DUT is missing. • The wrong impedance for the applied clock rate was selected (see "Impedance" parameter). • The wrong threshold for the applied data signal was selected (see "Threshold" parameter)
"Sync"	The measurement is synchronized.
"No Sync"	The measurement is not synchronized. Generally, a measurement cannot be synchronized until a clock and a data signal have been detected. If synchronization still does not occur, this may be caused by the following: <ul style="list-style-type: none"> • A wrong clock slope is used, which violates setup or hold times (see "Clock Slope" parameter). • Reflections on the clock line occur and clock the data signal into the BER measurement twice, e.g. on lines without termination. The R&S Signal Generator input is not terminated. • The travel times of clock and data are unfavorable (e.g. clock slope with data change). Check the relationship of clock to data using an oscilloscope and optimize the travel times (e.g. clock slope when the data signal applied is stable).

SCPI command:

:BLER:RESult on page 521

4.4.11.2 Configuration

The "Configuration" section is used to select the type of measurement and the termination criteria and to set the polarity of the input signals.

Mode

Selects the type of measurement: single or continuous measurement.

"Auto"	Continuous measurement of block error rate. If either or both of the termination criteria are met, the current measurement is terminated and immediately a new one is started automatically. Depending on the settings made, a measurement may take considerable time. During the first measurement, intermediate results are displayed. For the measurements that follow, only the final results are shown. The parameters "Received Blocks" and "Errors" are continuously updated and indicate the relative values for the measurement in progress. To start a continuous measurement, use the command :BLER:START on page 528. To stop a measurement, use the command :BLER:STOP on page 528.
--------	--

"Single" Single measurement of bit error rate. The measurement is started by clicking the "Execute Single" button.
If a measurement is in progress, the current values for "Block Error Rate", "Errors" and "Received Blocks" are cyclically displayed. The measurement is terminated when either or both of the termination criteria have been reached. To start a new measurement, the "Execute Single" button must be clicked again.

SCPI command:

[:BLER:SEQuence](#) on page 522

[:TRIGger:BLER\[:IMMediate\]](#) on page 530

Max Received Blocks

Enter the number of transmitted data blocks to be checked before the measurement is terminated.

This criterion will terminate the BLER measurement after the specified number of data blocks, even if very few errors or none at all have been detected. With a low number of block errors, the measurement result may be statistically unreliable.

If the measurement is terminated because the number of data blocks entered here was checked, "Number of Data Blocks" appears to the right of "Terminated By".

SCPI command:

[:BLER:SETup:MCOUNT](#) on page 526

Max Errors

Enter the number of block errors to occur before the measurement is terminated.

This criterion terminates the measurement relatively quickly if the error rate is high. The measurement result is statistically reliable, since many errors were already counted.

If the measurement is terminated because the number of block errors entered here was reached, "Number of Errors" appears to the right of "Terminated By".

SCPI command:

[:BLER:SETup:MERRor](#) on page 526

CRC Order

Selects the byte order of the checksum (CRC).

"LSB" The checksum starts with the least significant byte.

"MSB" The checksum starts with the most significant byte.

SCPI command:

[:BLER:SETup:CORDer](#) on page 523

BLER Type

Displays the CRC polynomial used. CCITT CRC 16 : $G(x) = x^{16} + x^{12} + x^5 + x^1$ is the CRC polynomial supported.

SCPI command:

[:BLER:SETup:TYPE](#) on page 527

Data Polarity

Sets the polarity of the feedback data blocks.

SCPI command:

[:BLER:SETup:DATA\[:POLarity\]](#) on page 524

Clock Slope

Sets the polarity of the active slope of the feedback clock.

SCPI command:

[:BLER:SETup:CLOCK\[:POLarity\]](#) on page 523

Impedance

Sets the input impedance of the BERT inputs "Clock", "Data", "Data Enable" and "Restart".

For high clock rates, 50 Ohms should be selected.

SCPI command:

[\[:SOURce\]:INPut:BERT:IMPedance](#) on page 529

Threshold

Sets high/low threshold in volts for the BERT inputs "Clock", "Data", "Data Enable" and "Restart".

The variable threshold makes it possible to align the BERT interface with the level of different signals. In addition, reflections and other interference can be suppressed by selecting the appropriate threshold.

SCPI command:

[\[:SOURce\]:INPut:BERT:THReshold](#) on page 529

Data Enable

Sets the polarity of the "Data Enable" signal.

The "Data Enable" signal marks the user data of the signal.

The signal is generated by the DUT and fed in at the "Data Enable" input of the BERT interface.

"High"	If the "Data Enable" signal is at a high level, the data bits at the BERT data input are interpreted as user data. During a low level of the "Data Enable" signal, they are interpreted as checksum bits.
"Low"	If the "Data Enable" signal is at a low level, the data bits at the BERT data input are interpreted as user data. During a high level of the "Data Enable" signal, they are interpreted as checksum bits.

SCPI command:

[:BLER:SETup:DENable](#) on page 524

4.5 RF Signal and Analog Modulations - RF Block

4.5.1 Overview of RF Signal

Settings for the RF output signal and analog modulation are made under "RF Signal" and "Analog Modulations". These settings can be accessed in the block diagram by way of the "RF/A MOD" function block, or by means of the menu with the same name which is opened using the MENU key.

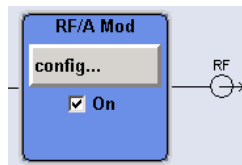

The function block is available for the basic unit (R&S SMU + frequency option R&S SMU-B10x) without additional equipment options. An additional frequency option (R&S SMU-20x) is required for a two-path instrument.

For instruments equipped with one of the frequency options it is possible to install the option High Power (R&S SMU-B3x options) separately for both RF paths.

4.5.1.1 RF Output

To activate and deactivate the RF output signal, use one of the following alternatives:

- directly using the TOGGLE ON/OFF key (the function block must be highlighted beforehand)
- by means of the RF ON/OFF key (the current entry focus is irrelevant)
- by changing the state of the "RF/A Mod" functional block (see ["State RF"](#) on page 193)
- by enabling/disabling the RF in the "Configure" menu of the "RF/A Mod" block (see ["RF Output State"](#) on page 193).

Both RF output signals are always deactivated in the case of two-path instruments. The previous state is restored when the signals are reactivated.

The current state of the RF output (activated and deactivated) is indicated in the block diagram by means of the different block color and the status of the "On" checkbox.

The disconnected connection to the output is additionally shown when the output is deactivated.

Active analog modulation is also indicated in the block.

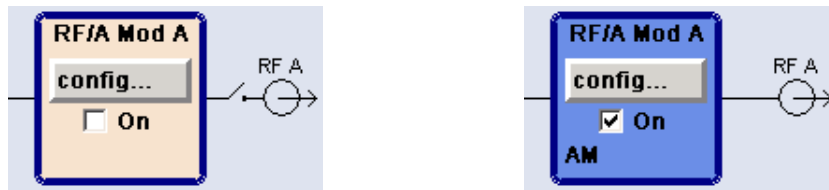

To query the impedance of the RF outputs, use the command `:OUTPut<hw>:IMPedance` on page 560.

State RF

Activated/deactivates the RF output by changing the state of the "RF" functional block. Alternatively, the RF ON/OFF key can be used.

In case of two-path instrument, this affects the selected path.

SCPI command:

`:OUTPut<hw>[:STATe]` on page 561

`:OUTPut:ALL[:STATe]` on page 558

RF Output State

Activated/deactivates the RF output by enabling/disabling the RF in the "Configure" dialog of the "RF" block.

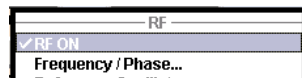

SCPI command:

`:OUTPut<hw>[:STATe]` on page 561

4.5.1.2 Overview of the RF Signal Settings

The CW, Sweep and List modes are available for generating the RF signal.

- **CW**
The RF signal is generated with the set frequency and level. This is the default mode.
- **Sweep**
The RF signal is generated as a sweep with the set parameters.
It is not possible to activate frequency, level and LF sweep simultaneously.
- **List Mode**
The RF signal is generated on the basis of a list of predefined frequency and level values. The duration of the individual steps can be predefined.

Instruments connected downstream can be taken into consideration when setting the frequency and level by entering a frequency and/or level offset.

Automatic level control ("ALC") ensures maximum level accuracy, even with I/Q modulation.

User-specific lists which contain level correction values for any frequency range ("User Correction") can be created to, for example, compensate the cable attenuation in a test assembly setup.

The R&S Signal Generator generates the RF signal in unmodulated or analog form. The signal generator is equipped therefore with the following sources for analog modulations:

- an internal LF generator
- the external modulation input EXT MOD at the rear of the instrument

An external trigger signal for the analog modulations, the sweeps and the LIST mode can be provided at the INST TRIG input.

In case of two-path instrument, both paths are triggered separately. The BNC connector INST TRIG is assigned to Path A, and the pin INST TRIG B of the AUX I/O interface is assigned to Path B.

The input REF IN is used to input an external instrument reference, and the output REF OUT serves as the output of the reference frequency (internal or external).

The RF signals in the case of two-path instruments are generated independently of each other. Both RF paths are, however, synchronized to the same reference frequency (internal or external).

4.5.2 RF Frequency Settings

The value of the RF frequency is displayed in the header of the instrument's display ("Freq"). This field provides the direct input of the RF frequency.

Freq A	100.000 000 00	MHz
Freq B	1.000 000 000 00	GHz

Be aware, that there is a difference between the displayed RF frequency in the header and the RF output frequency set in the "Frequency/Phase" dialog.

4.5.2.1 RF frequency vs. RF output frequency

The frequency entered and displayed in the frequency field in the header of the display takes any set frequency offset into consideration, e.g. an offset set for a downstream instrument, or a multiple of the frequency, when a frequency multiplier is used. This means that with a frequency offset the frequency displayed in the header does not correspond to the frequency at the RF output, but rather to the frequency at the output of the downstream instrument.

A set frequency offset is indicated by the "FREQ OFFSET" status message.

This instrument allows the desired frequency at the output of a downstream to be entered in the frequency field. The R&S Signal Generator changes the RF output frequency according to the entered offset.

Similarly, the instrument adjusts the output frequency, when a multiplier factor is set.

However, the frequency entered and displayed in the "Frequency/Phase" dialog of the "RF" function block always corresponds to the RF output frequency. Any frequency offset or multiplier factor is not taken into consideration.

The frequency offset is entered in the "Frequency/Phase" dialog. Here it is also possible to set the frequency without taking the offset into consideration, to set the step width for the frequency entry using the rotary knob, and to set the phase for the RF output signal.

The correlation between the RF frequency, the RF output frequency and the frequency offset is as follows:

"Freq" (in header) = "RF output frequency" (Frequency in menu) + "Freq offset" (Offset in menu) + Multiplier factor (Multiplier in menu)

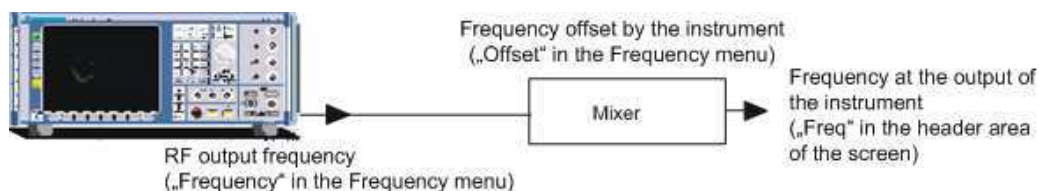

4.5.2.2 Configuring RF frequency

To change the RF frequency, press the **FREQ** key and enter the desired frequency. Changes to the RF frequency have an immediate effect (without confirmation with the **ENTER** key) on the output signal.

In the case of two-path instruments, adjustment of the RF frequency affects the respective path. To change the RF frequency of the Path B, press the **FREQ** key again.

RF Freq

Enters the RF frequency, considering the frequency offset.

Note: The SCPI command sets the level of the "Freq" display, i.e. an entered frequency offset and multiplier factor are taken into consideration in the frequency value.

SCPI command:

[:SOURce<hw>] :FREQuency [:CW | :FIXed] on page 722

4.5.2.3 Frequency Menu

The instrument provides an access to the frequency settings in the combined "Frequency/Phase" dialog.

To open the "Frequency/Phase" dialog, select "RF/A Mod > Configure > Frequency" or use the **MENU** key under "RF/A Mod".

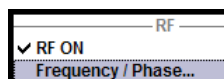

The "Frequency/Phase" dialog is divided into the several sections.

Frequency and offset of the RF output signal are set in the "Frequency Settings" section in the upper part of the group menu.

Frequency Settings

Frequency 1.000 000 000 00 GHz

Offset 0.00 Hz

Phase Continuous Frequency Settings

Phase Continuous Active On

"Phase Continuous Frequency Settings" can be activated in the respective section and are described in [chapter 4.5.3.2, "Phase Continuous Frequency Setting"](#), on page 198.

The step width which is used when setting the frequency using the rotary knob (with "Variation Active On") is set in the "User Variation" section.

User Variation

Variation Active

Variation Step 1.000 000 00 MHz

The phase of the output signal can be changed in the "Phase Settings" section. The "Phase Settings" menu is described in [chapter 4.5.3, "Phase Settings"](#), on page 197.

The part concern the settings of the reference oscillator and are described in [chapter 4.5.4, "Reference Oscillator"](#), on page 203.

The lower parts concern the settings of the local oscillator (LO) and are described in [chapter 4.5.5, "Local Oscillator - LO Coupling"](#), on page 205.

Frequency Settings

The frequency, offset and multiplier factor are set in the top section of the menu.

Frequency - RF Signal

Sets the RF frequency of the RF output connector. The frequency entered and displayed here corresponds to the frequency at the RF output, i.e. any offset entry is not taken into consideration.

Note: The SCPI command `SOUR:FREQ` sets the frequency of the "FREQ" display, i.e. the frequency containing offset.

SCPI command:
n.a.

Frequency Offset - RF Signal

Sets the frequency offset relative to the RF frequency. The frequency offset of a downstream instrument (e.g. a mixer) is entered.

The entry does not change the value of the RF frequency at the RF output. It only changes the RF frequency displayed in the display header. The value of the RF frequency in the header corresponds to the frequency at the output of the downstream instrument.

SCPI command:
`[:SOURce<hw>] :FREQuency:OFFSet` on page 724

Multiplier - RF Signal

Sets the multiplication factor for the RF frequency.

In the frequency field of the status bar, the instrument adjusts its frequency display according to the set multiplication factor. This frequency value shows the frequency at the output of the downstream multiplier. The entry does not change the RF frequency at the RF output of the R&S SMU.

SCPI command:

PRODError! Linktarget doesn't exist but @y.link.required='true'

Phase Continuous Frequency Settings

A phase continuous mode can be enabled in the "Phase Continuous Frequency Settings" section (see [chapter 4.5.3.2, "Phase Continuous Frequency Setting"](#), on page 198).

User Variation

If the frequency is set using the rotary knob, the step width is defined in the "User Variation" section.

Variation Active - RF Signal

Activates the user-defined step width used when varying the frequency value with the rotary knob.

- | | |
|-------|---|
| "ON" | The frequency value set with the rotary knob is varied using the user-defined step width which is entered under "Variation Step". |
| "OFF" | The frequency value set with the rotary knob is varied in steps of one unit at the cursor position (standard operating mode). |

SCPI command:

[:SOURce<hw>] :FREQuency:STEP:MODE on page 728

Variation Step - RF Signal

Sets the user-defined step width. This step width is used when entering the RF frequency using the rotary knob. Frequency variation with this step width must also be activated with "Variation Active".

SCPI command:

[:SOURce<hw>] :FREQuency:STEP [:INCRement] on page 728

4.5.3 Phase Settings

The phase of the RF output signal can be changed in the "Phase Settings" section of the "RF Frequency/Phase" menu.

4.5.3.1 Phase Menu

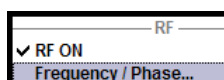

To open the "Frequency/Phase" menu, select "RF/A Mod" > "Configure" > "Frequency/Phase" or use the MENU key under RF/A Mod.

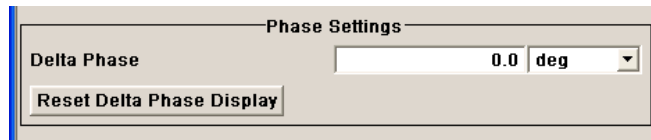

Delta Phase - RF Signal

Sets the phase of the RF signal. The current phase of the signal is used as the reference. This function allows, for example, the phase of the output signal to be synchronized with the phase of a signal from a second signal generator.

SCPI command:

[\[:SOURce<hw>\]:PHASe](#) on page 769

Reset Delta Phase Display - RF Signal

Resets delta phase value. The set phase is adopted as the new current phase, i.e. the delta phase value is reset to 0.

SCPI command:

[\[:SOURce<hw>\]:PHASe:REFeRence](#) on page 769

4.5.3.2 Phase Continuous Frequency Setting

The phase continuous mode can be enabled in the "Phase Continuous Frequency Settings" section of the "Frequency" menu. In this mode, the output sinewave is phase continuous, i.e. there is no phase discontinuity or glitch when changing the frequency.

At the transition from one frequency to another an intermediate frequency (switching transient) occurs, which causes spurs (see figure below). The transient is due to changes of the synthesizer settings (e.g. dividers, filters, phase detectors).

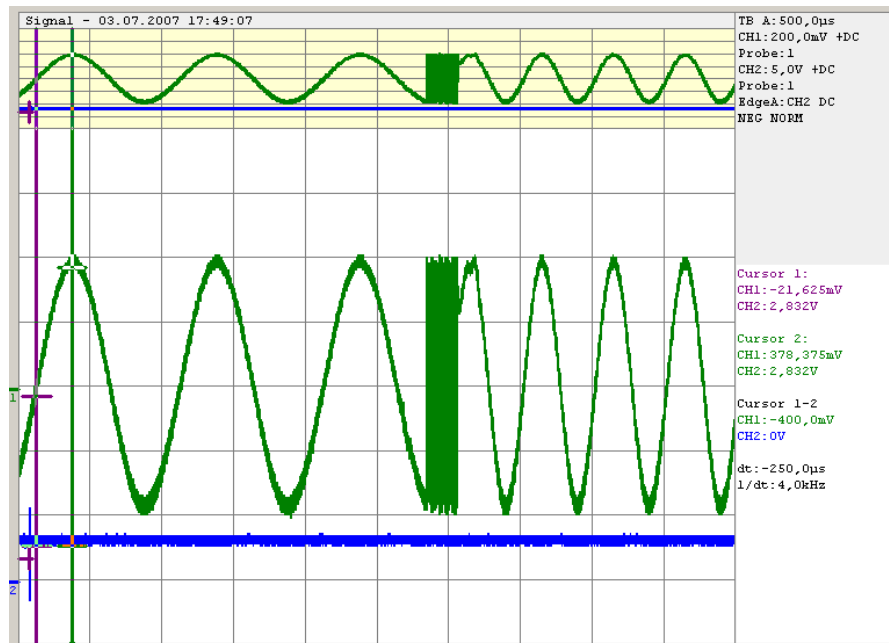

Fig. 4-7: Transition for a 1 kHz step at 1 GHz without phase continuous mode active. For the graphical display the signal is down converted into the kHz range.

The phase continuous mode freezes the settings of the synthesizer (e.g. dividers, filters, phase detectors) which could generate phase discontinuities when changed. The frequency change is effectively performed by changing the fine resolution synthesizer. This allows a phase continuous change from one frequency to another without any transients (see figure below).

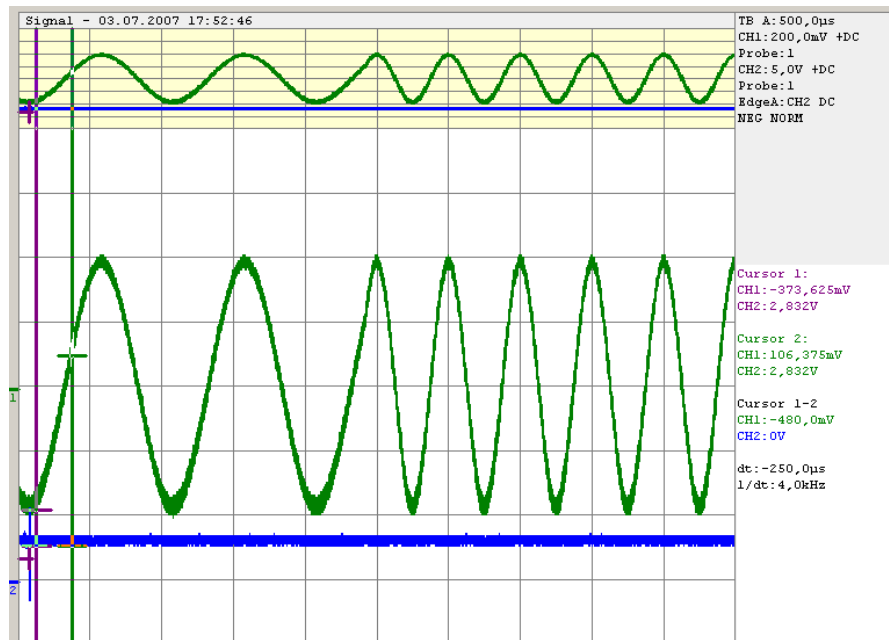

Fig. 4-8: Transition for a 1 kHz step at 1 GHz with phase continuous mode active. For the graphical display the signal is down converted into the kHz range.

The available frequency range for phase continuous settings is limited by the fine resolution synthesizer used and varies with the RF frequency setting at the point of activating the phase continuous mode.

Depending on the instrument equipment - with or without option R&S SMU-B22 - the fine resolution synthesizer used is a DDS (Direct Digital Synthesizer, with option R&S SMU-B22) or a Fractional N-Synthesizer (without option R&S SMU-B22). The DDS provides generally a wider frequency range for phase continuous settings. In addition, two modes (narrow and wide) allow a selection either in favor of higher signal quality or in favor of an especially wide frequency range.



When phase continuous frequency setting is active, data sheet values no longer apply. Activating frequency or phase modulation deactivates phase continuous settings and vice versa.

Setting a Phase Continuous Frequency Sweep

1. In the "RF Frequency Sweep" Menu, if the sweep is active, switch it off.
2. In the "RF Frequency" Menu under the "Phase Continuous Frequency Settings" dialog
 - a) If the "Phase Continuous Frequency Mode" is Active, switch it off
 - b) Set "Frequency Range" to "Narrow"
 - c) Select the RF frequency
 - d) Check displayed Frequency Range
 - e) If the "Frequency Range" corresponds to the selected frequency range, check the "Phase Continuous Active" box
 - f) If "Frequency Range" in Narrow Mode does not, select "Wide" for the Frequency Range and check the Phase Continuous Active box
3. In the "RF Frequency Sweep" dialog
 - a) Modify the "Start Freq" and "Stop Freq" or "Center Frequency" and "Span" as needed.
 - b) Set the RF frequency sweep State to "ON".

Optimum user settings for the phase continuous frequency sweep

In the "RF Frequency Sweep" dialog there are some settings that will improve the phase continuous sweep results for both "Narrow" and "Wide" mode choices.

1. "Step Lin": low step size
In order to get the best spur performance during frequency change, it is recommended to reduce the step size and (if necessary) increase the sweep speed by decreasing the Dwell Time. Effectively, the sweep will be performed in the same amount of time, but with smaller step sizes.
2. "Shape": Triangle sweep

The triangle sweep offers a uniform forward sweep and return to the beginning frequency. The saw tooth sweep produces a uniform forward sweep with an abrupt reset to the starting frequency. The abrupt reset can generate spurs.

Phase Continuous Frequency Settings Menu

The "Phase Continuous Frequency Settings" are available in the middle section of the "Frequency/Phase" dialog.

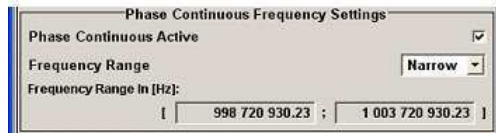

Phase Continuous Active

Activates/deactivates phase continuous frequency settings. For a given RF frequency setting, phase continuous frequency changes are possible in a limited frequency range.

An overview of the frequency ranges is provided in the table in "[Frequency Range - RF Signal](#)" on page 201.

For instrument without option B22:

The range is typically +/-0.5 MHz in the main synthesizer octave of 750 MHz to 1.5 GHz.

Note: If "Phase Continuous" is "Active" a setting of the "RF Frequency" outside the available "Frequency Range" causes an error. A settings conflict is displayed.

For instrument with option B22:

The frequency range is indicated in the table in section "[Frequency Range - RF Signal](#)" on page 201. The range indication is active even if phase continuous frequency setting is not yet activated. Thus, the desired range can be determined before activating the function. Two modes are available.

Note: If "Phase Continuous" is "Active" a setting of the "RF Frequency" outside the indicated "Frequency Range" is only possible for mode Wide. A settings conflict is displayed.

SCPI command:

`[:SOURce<hw>] :FREQuency:PHASe:CONTInuous:STATe` on page 726

Frequency Range - RF Signal

(instruments with R&S SMU-B22 option only)

Selects the mode for determining the frequency range for the phase continuous signal.

The frequency range depends on the selected mode.

RF frequency [MHZ]	Typ . range without R&S SMU-B22	Range with R&S SMU-B22 Narrow mode	Range with R&S SMU-B22 Wide mode
$f \leq 6.6$	125 kHz	625 kHz	2.5 MHz
$6.6 < f \leq 11.71875$	7.813 kHz	39.625 kHz	156.25 kHz
$11.71875 < f \leq 23.4375$	15.625 kHz	78.125 kHz	312.5 kHz
$23.4375 < f \leq 46.875$	31.25 kHz	156.25 kHz	625 kHz
$46.875 < f \leq 93.75$	62.5 kHz	312.5 kHz	1250 kHz

RF frequency [MHZ]	Typ . range without R&S SMU-B22	Range with R&S SMU-B22 Narrow mode	Range with R&S SMU-B22 Wide mode
93.75 < f <= 187.5	125 kHz	625 kHz	2.5 MHz
187.5 < f <= 375	250 kHz	1250 kHz	5 MHz
375 < f <= 750	500 kHz	2.5 MHz	10 MHz
750 < f <= 1500	1 MHz	5 MHz	20 MHz
1500 < f <= 3000	2 MHz	10 MHz	40 MHz
3000 < f <= 6000	4 MHz	20 MHz	80 MHz

"Narrow"

The available frequency range is smaller than with setting wide. It is asymmetrical around the RF frequency set at the point of activating the phase continuous settings (see table above).

In the narrow mode, a DDS frequency of 15 MHz to 20 MHz is used as reference signal to the phase detector. This provides a tuning range of 5 MHz in the main synthesizer octave from 750 MHz to 1.5 GHz. When activating the phase continuous settings, the current setting of the DDS is anywhere between 15 and 20 MHz, e.g. 17 MHz. Thus, the distribution around the center frequency most likely is asymmetrical, e.g. - 2 MHz and + 3 MHz for the 17 MHz. Signal quality is high because the larger mixing products are filtered by the low-pass filter (IF max. 20 MHz).

The narrow mode is recommended whenever possible due to the better signal quality (spectral purity).

It is not possible to set frequencies outside the available frequency range.

"Wide"

The wide mode provides a larger frequency range. The frequency range is symmetrical around the RF frequency set at the point of activating the phase continuous settings (see table above).

Due to an additional divider by 8 in the PLL the signal quality is reduced in this mode. At some frequencies non -harmonics will be present.

Setting frequencies outside the available frequency range is possible, however, a settings conflict is indicated. The usable overrange depends on the currently set RF frequency, e.g. at 1 GHz it reaches from 850 MHz to 1030 MHz.

SCPI command:

[\[:SOURce<hw>\]:FREQuency:PHASe:CONTinuous:MODE](#) on page 725

Frequency Range in [Hz] - RF Signal

(instruments with R&S SMU-B22 option only)

Displays the frequency range for phase continuous settings. The available frequency range depends on the mode selection ("Narrow" or "Wide").

The range indication is active even if phase continuous frequency settings are not yet activated. Thus, the desired range can be determined before activating the function.

SCPI command:

[:SOURce<hw>] :FREQuency:PHASe:CONTInuous:HIGH on page 725

[:SOURce<hw>] :FREQuency:PHASe:CONTInuous:LOW on page 725

4.5.4 Reference Oscillator

In the internal reference mode the internal reference signal is available at the REF OUT connector. The frequency of the internal reference signal is permanently set to 10 MHz.

The frequency of the internal reference oscillator can be impaired by means of the EXT TUNE input (AUX I/Q connector at rear of instrument) (**Frequency Adjustment**; see data sheet for technical information).

The reference frequency setting is effective for both paths.



The settings of the reference oscillator are not influenced by an instrument preset ("PRESET" key).

4.5.4.1 Reference Oscillator Dialog

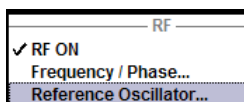

To open the "Reference Oscillator" dialog, select "RF/A Mod > Configure > Reference Oscillator" or use the MENU key under "RF/A Mod".

The reference oscillator is set in the lower area of the group menu "Frequency/Phase". The upper areas are for setting the frequency and phase of the RF output signal. For more information, see [chapter 4.5.2.3, "Frequency Menu"](#), on page 195 and [chapter 4.5.3, "Phase Settings"](#), on page 197 respectively.

The menu is used to select the source, to enter the frequency of an external reference signal and to adjust the reference frequency.

External Reference Frequency

Source: External

Deactivate RF Output (if external reference is missing): On

External Reference Frequency: 10 MHz

Synchronisation Bandwidth: Wide

Adjustment

Adjustment Active:

Adjustment DAC Value: 1 400

Source - Reference Oscillator

Selects the source of the reference frequency.

"Internal" The internal reference signal of 10 MHz is used, comprising either the calibrated or a user-defined adjustment value.

"External" An external reference signal is used. The frequency of the external reference signal must be selected under "External Reference Frequency".

SCPI command:

[\[:SOURce\]:ROSCillator:SOURce](#) on page 784

Deactivate RF Output - Reference Oscillator

Determines if the RF output is switched off in case of a missing external reference signal for selection external source.

If enabled, this setting ensures that no improper RF signal due to the missing external reference signal is output and used for measurements.

In addition to the error message "Ext Ref missing", the information "RF output deactivated" is indicated.

This setting is not influenced by a reset.

SCPI command:

[\[:SOURce\]:ROSCillator:EXTernal:RFOFF:STATe](#) on page 782

External Reference Frequency

Selects the frequency of the external reference signal. An external reference signal with a frequency of 5 MHz, 10 MHz or 13 MHz can be used.

SCPI command:

[\[:SOURce\]:ROSCillator:EXTernal:FREQuency](#) on page 782

Synchronization Bandwidth - RF Signal

(Source External only)

Selects the synchronization bandwidth for an external reference signal. The wideband setting is provided for using very good reference sources of high spectral purity.

"Narrow" Synchronization bandwidth is 1 Hz.

"Wide" Synchronization bandwidth is 750 Hz.

SCPI command:

[\[:SOURce\]:ROSCillator:EXTernal:SBANdwidth](#) on page 783

Adjustment Active - Reference Oscillator

Selects adjustment mode.

"OFF" The calibrated adjustment value of the internal reference frequency is used. This value is determined at one of the R&S service shops during calibration.

"ON" A user-defined adjustment value is used. The value is entered under "Adjustment DAC Value". This allows the frequency to be impaired freely, for example to simulate a frequency error. The instrument is no longer in the calibrated state. However, the calibration value is not changed and the instrument resumes the calibrated state after switching the "Adjustment State" to Off.

SCPI command:

`[:SOURce] :ROSCillator [:INTernal] :ADJust [:STATe]` on page 783

Adjustment DAC Value

Enters a user-defined adjustment value for the internal reference frequency. This value is not used unless "Adjustment Active On" is selected.

SCPI command:

`[:SOURce] :ROSCillator [:INTernal] :ADJust :VALue` on page 783

4.5.5 Local Oscillator - LO Coupling

The LO Coupling function allows a distribution of the local oscillator signal in way that multiple RF signals can be driven by the same LO signal. This is mandatory for minimizing the phase drift between these RF signals.

The LO Coupling function is available only for instruments equipped with the option R&S SMU-B90 (Phase Coherence).

The local oscillator signal is available at the LO OUT connector (rear of instrument).

In the external local oscillator mode, an external signal must be input at the LO IN connector.

4.5.5.1 Phase Coherence

Phase coherence of two RF signals means that there is a defined and stable phase relationship between two (or more) RF carriers, i.e. there is a fixed delta phase $\Delta\Phi$ between the carriers. Strictly speaking, phase coherence is only defined for CW carriers with the same frequency (or for CW carriers at frequencies that are multiples of each other).

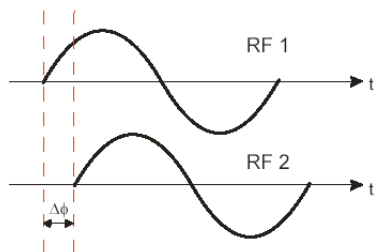

If two signal generators are coupled via their 10 MHz reference, they are generating exactly the same frequency but only from the long term perspective. Having a closer look

into the instantaneous differential phase (“delta phase”) of these two RF signals, this is quite instable due to:

- phase noise of the two synthesizers
- “weak” coupling at 10 MHz and a long synthesis chain up to the RF domain
- temperature differences which cause a change of the effective electrical length of some synthesizer components

Most critical for a stable delta phase is the thermal RF phase drift between multiple RF synthesizers. This drift can be minimized down to 0.1° by use of a common synthesizer, i.e. a common local oscillator (LO) signal, for all RF carriers. Only if this LO signal (which is internally used for upconverting the baseband signal to the RF) is the same for all carriers, a stable phase between the RF signals can be achieved.

4.5.5.2 Typical Applications

The LO Coupling function can be used to generate a MxN MIMO signal.

- Generation of 2xN MIMO signal with two R&S Signal Generators, working in External mode.

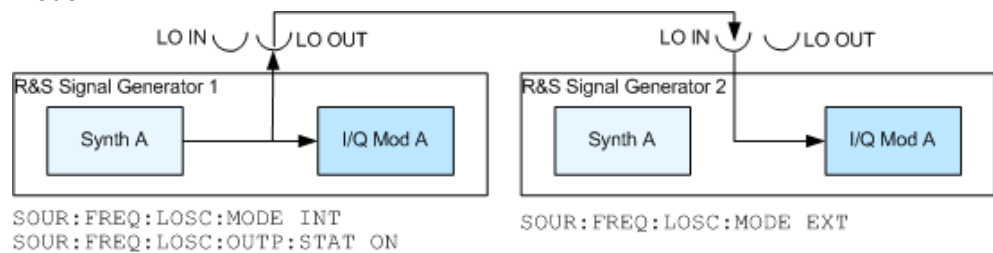

- Generation of 2xN MIMO signal with one R&S Signal Generator, working in Coupled A->B mode.

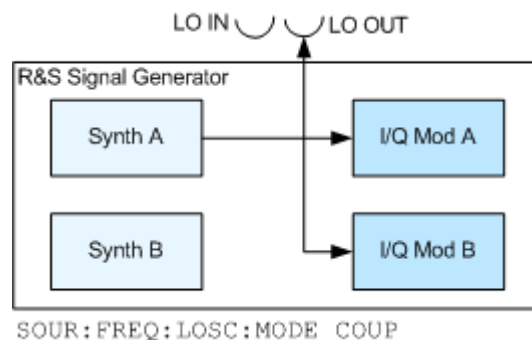

- Generation of 4xN MIMO signal with two R&S Signal Generators, R&S Signal Generator 1 working in Coupled A->B mode and R&S Signal Generator 2 working in External Coupled A->B mode.

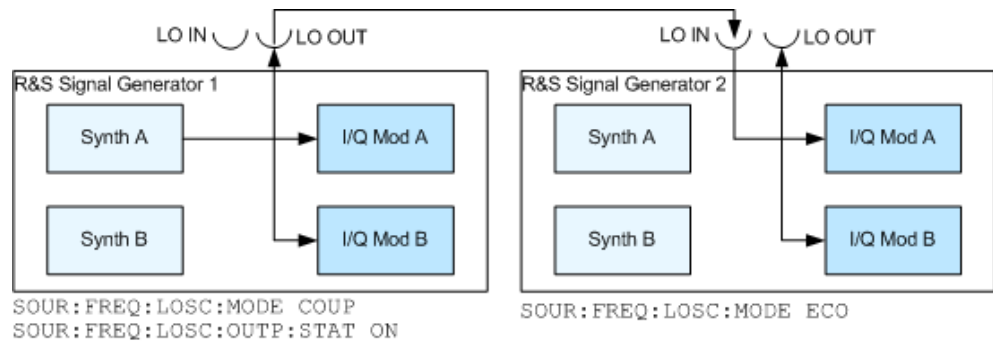

4.5.5.3 LO Coupling Menu

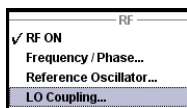

To open the "LO Coupling" menu, select "RF/A Mod > Configure > LO Coupling" or use the MENU key under "RF/A Mod".

The menu is available only for instruments equipped with the option R&S SMU-B90.

This option enables phase coherent RF outputs of two or more RF paths.

The local oscillator coupling is set in the lower area of the group menu "Frequency/Phase". The menu is used to select the mode of the LO coupling and the state of the local oscillator output.

For more information about the upper areas, see:

- [chapter 4.5.2.3, "Frequency Menu"](#), on page 195
- [chapter 4.5.3.1, "Phase Menu"](#), on page 197
- [chapter 4.5.4.1, "Reference Oscillator Dialog"](#), on page 203

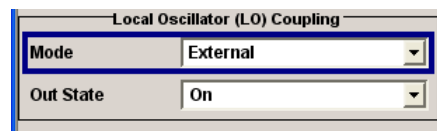

Mode - LO Coupling

Selects the mode of the local oscillator coupling.

- "Internal" This mode corresponds to a normal operation.
The internal local oscillators are used for each RF path.

"External"

An external signal is used.

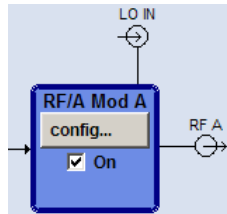

In case of a two-path instrument, the internal local oscillator signal is used for path B.

Note: Selection of LO Coupling "External" mode, disables all parameters in the "Frequency/Phase/Ref Osc" menu.

In case of two-path instrument, this affects the same path.

"Coupled A -> B"

(the parameter is enabled for two-path instruments only)

The local oscillator signal of path A is used also for path B (see also section [chapter 4.5.5.2, "Typical Applications"](#), on page 206).

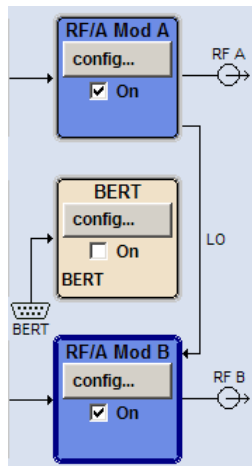

Note: Selection of LO Coupling Coupled A->B mode, disables all parameters in the Frequency/Phase/Ref Osc menu of the other path. The frequency of path A will be set to the smaller of both frequencies of path A and B.

"External Coupled A -> B" (the parameter is enabled for two-path instruments only)
 An external signal is input on the LO IN connector and used for the coupled paths A and B (see also [chapter 4.5.5.2, "Typical Applications"](#), on page 206).

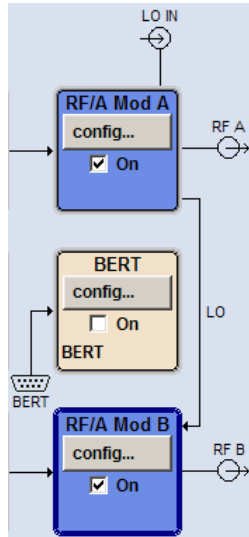

Note: Selection of LO Coupling External "Coupled A->B" mode, disables all parameters in the "Frequency/Phase/Ref Osc" menu of both paths.

SCPI command:

`[:SOURce<hw>] :FREQuency:LOSCillator:MODE` on page 720

Out State - LO Coupling

Switches on/off the LO output.

"On" The internal local oscillator signal is also available on the LO OUT connector (in order to couple two instruments).

"Off" The LO OUT signal is switched off.

SCPI command:

`[:SOURce<hw>] :FREQuency:LOSCillator:OUTPut:STATe` on page 721

4.5.6 NRP-Z Power Viewer

Up to four R&S NRP power sensors can be connected to the generator. The SENSOR connector for the first R&S NRP power sensor is on the front panel, further R&S NRP power sensors can be connected via the USB interfaces on the front and rear panel. The connection via USB requires an USB adapter R&S NRP-Z3 or R&S NRP-Z4. The instrument automatically detects connected R&S NRP power sensors and indicates them in the "NRP-Z Power Viewer" dialog.

The output signals of the two RF signal path with the set RF level as reference level can be measured. It is also possible to select any signal source.

The average signal power is continuously measured by the R&S NRP power sensor(s) and indicated in the "NRP-Z Power Viewer" dialog. The dialog also provides setting the permanent display of the results in the block diagram.

The signal generator supports the use of R&S NRP power sensors for the acquisition of level correction data. The acquired level correction data is used to create and activate lists in which level correction values predefined by the user are freely assigned to RF frequencies. Correction is performed by the user-defined table values being added to the output level for the respective RF frequency (see [chapter 4.5.9, "User Correction"](#), on page 223).



Refer to the corresponding R&S NRP-Zxx power sensor manual for detailed information on the used power sensor.

4.5.6.1 NRP-Z Power Viewer Settings

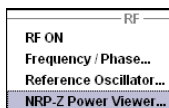

To open the "NRP-Z Power Viewer" menu, select "RF/A Mod > Configure > NRP-Z Power Viewer" or use the MENU key under "RF/A Mod".

The menu is structured like a table showing the values for sensor 1 in the left "column" and the values of the second/third sensor in the middle/right "column". The instrument detects connected sensors automatically and indicates them in the dialog.

"Sensor 1" is fixed to the sensor on the circled SENSOR socket. If no sensor is connected to this socket, the fields remain unaccounted. The sensors no. 2 ... 4 represent the sensors at the USB ports, according to the sequence of connection.

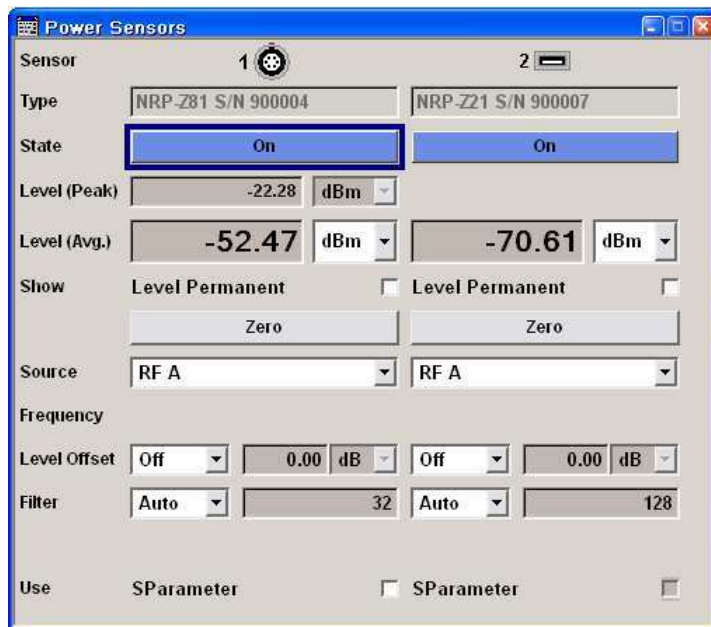

Sensor - Power Viewer

Indicates the connector used for the detected sensors. The values listed below belong to the respective sensor.

In remote control, the sensors are set up using the `SENSe` commands. The remote measurement is triggered by the `READ` query which also provides the measurement results. The sensor is selected by suffix 1, 2, 3 or 4 in key word `SENSe` or `READ` of the command header.

Suffix 1 denotes the sensor connected to `SENSOR`, suffix 2 the one at the first USB interface, and suffix 3 and 4 are assigned to the sensors at the following USB interfaces. The suffix is identical to the index which is assigned automatically to each sensor upon connection.

Note: The software version of the connected power sensor can be retrieved by means of the remote control command `:SENS:POW:TYPE?`.

Use the "Setup >" [chapter 4.2.3.6, "NRP-Z Info/Update"](#), on page 133 dialog to update the sensor software.

SCPI command:

`SENSe<ch>[:POWer]:STATus[:DEVIce]` on page 569

Type - Power Sensors

Indicates the type and the serial number of the connected R&S NRP power sensor. The sensor type is automatically detected.

SCPI command:

`SENSe<ch>[:POWer]:TYPE` on page 569

`SENSe<ch>[:POWer]:SNUMber` on page 568

State - Power Sensors

Activates/deactivates level measurement by the power sensor.

The local state is set with the `INIT` command. Switching the local state off enhances the measurement performance.

In remote control, the sensors are set up using the `SENSe` commands. The remote measurement is triggered by the `READ` query which also provides the measurement results. The state is not influenced by these commands, measurements results can be retrieved with local State on or off.

The sensor is selected by suffix 1, 2, 3 or 4 in key word `SENSe` or `READ` of the command header.

Suffix 1 denotes the sensor connected to `SENSOR`, suffix 2 the one at the first USB interface, and suffix 3 and 4 are assigned to the sensors at the following USB interfaces. The suffix is identical to the index which is assigned automatically to each sensor upon connection.

To query the availability of a sensor at a given connector, use the command

`SENSe<ch>[:POWer]:STATus[:DEVIce]` on page 569.

SCPI command:

`INITiate<ch>[:POWer]:CONTinuous` on page 563

Level (Peak) - Power Sensors

With certain power sensors only, e.g. R&S NRP-Z81.

Indicates the measured peak level value with the selected unit.

SCPI command:

[READ<ch>\[:POWer\]](#) on page 563

Level (Avg.) - Power Sensors

Indicates the measured level value with the selected unit.

SCPI command:

[READ<ch>\[:POWer\]](#) on page 563

Unit - Power Sensors

Selects the unit used for result display.

The power sensor provides the measured value in Watt.

In which unit the measured value is indicated is selected here and might be Watt, dBm or dBuV.



SCPI command:

[SENSe<ch>:UNIT\[:POWer\]](#) on page 570

Permanent Display State - Power Sensors

Activates the permanent indication of the power measurement result in the upper right corner of the block diagram. The instrument shows the type of sensor, the corresponding connector, the measurement source and - if set - the offset.

It is possible to switch the permanent display active for several sensors. The instrument indicates the values of a maximum of two sensors simultaneously, in ascending order of connected channels. If you activate the display of a third sensor, the instrument fades out the values of the last highest channel number automatically.

2	 NRP-0815	-30.41 dBm	RF A
3	 NRP-0815	-30.62 dBm	RF B

SCPI command:

[SENSe<ch>\[:POWer\]:DISPlay:PERManent:STATe](#) on page 564

Display Priority - Power Sensors

Selects whether the average or the peak power measurement result is indicated when permanent display is active.

SCPI command:

[SENSe<ch>\[:POWer\]:DISPlay:PERManent:PRIority](#) on page 565

Zero - Power Sensors

Activates the auto zero function.

Zeroing calibrates the external power sensor by adjusting its reading at zero signal power. For this purpose, the RF power source must be switched off or disconnected from the sensor (see tips below). R&S power sensors automatically detect the presence of any significant input power. This aborts zeroing and generates an error message. Zeroing can take a few seconds, depending on the sensor model; refer to the documentation of your external power sensor for more information.

Tips for zeroing

Zeroing should be performed:

- During warm-up after switching on or connecting the instrument
- After a substantial change of the ambient temperature
- After fastening the power sensor module to an RF connector at high temperature
- After several hours of operation
- When very low-power signals are to be measured, e.g. less than 10 dB above the lower measurement limit.
- Switch off the RF power source for zeroing; do not disconnect it from the power sensor. In this way you will maintain the thermal equilibrium, and zeroing will also compensate for the noise superimposed on the measured signal (e.g. from a broadband amplifier).

SCPI command:

[SENSe<ch>\[:POWER\]:ZERO](#) on page 570

Source - Power Sensors

Selects the source for measurement.

- | | |
|--------|---|
| "RF" | Measurement source is the RF signal of the generator. The RF frequency is used as the measurement frequency of the sensor and the corresponding correction factor is used.
In this mode the RF frequency of the generator is send to the sensor automatically if changed.
If two sensors are connected, both sensor can be allocated the same path, e.g. for measurements before and after the DUT.
For single path instruments, only selection RF A is offered. |
| "User" | Measurements source is any freely selectable source. The frequency is entered manually under frequency (e.g. for measurement of amplifier gain with 2 sensors). |

SCPI command:

[SENSe<ch>\[:POWER\]:SOURCE](#) on page 568

Frequency - Power Sensors

Source User only

Enters the frequency for measurement source "User".

SCPI command:

[SENSe<ch>\[:POWER\]:FREQUENCY](#) on page 567

Level Offset - Power Sensors

Activates and defines a level offset which is added to the measured value. This allows e.g. an attenuator in the signal path to be taken into account. The offset is always entered in dB, irrespective of the selected unit for result display.

SCPI command:

[SENSe<ch>\[:POWER\]:OFFSET:STATE](#) on page 568

[SENSe<ch>\[:POWER\]:OFFSET](#) on page 568

Auto Once

Searches for the optimum filter length for the current measurement conditions and indicates value in the "Filter Length" field above.

SCPI command:

`SENSe<ch>[:POWer]:FILTer:SONCe` on page 566

Filter Length - Power Sensors

Selects the filter length used for measurement. The filter length is the multiplier for the measurement time and thus directly influences it.

The averaging filter is used to reduce fluctuations in the measured result to the extent desired. Such fluctuations can be caused by inherent noise of the measuring instrument, modulation of the measurement signal or beats from the superposition of adjacent carriers. A more stable display has to be traded off against longer measurements. The measurement result is obtained from a two-stage averaging process.

Note: Longer measurements does not mean that it takes longer to display a new result, but rather that it takes longer for the result to settle when the power changes.

Measurements are continuously repeated in a predefined time window. The measurement result is obtained by averaging the measured values for the last 2N time windows. The number N is the filter length, the factor of 2 arises because the output signals from the microwave detector to suppress low-frequency noise are chopped at the same rate as the time windows, which means that an independent measured value can only be obtained from two consecutive values. As the filter length is the multiplier for the time window it directly influences the measurement time.

The filter length can be selected automatically or can be manually set to a fixed value. As a preliminary, you should always check if the auto mode is giving satisfactory results because you will always have to adjust an optimal, manual filter-length setting if the power is not constant.

Selection "Fixed Noise" is offered for reaching defined measurement accuracy.

"Auto" The filter length is automatically selected and adapted to the currently measured value. With very high signals the filter length and therefore the measurement time can be short. With very low signal levels the filter length and therefore the measurement time is increased in order to reduce noise. The used filter length is indicated in the field to the right.

"User" The filter length is set manually.
The filter length is entered in the entry window to the right. As the filter length works as a multiplier for the time window, this results in a constant measurement time. Values 1 and 2ⁿ are settable.

Note: The time window varies depending on the used sensor. For most sensors it is fixed to 20 ms. For the R&S NRP-Z81 sensor it is 10 us. Therefore, the user filter length for the R&S NRP-Z81 has be about 1000 times larger than the filter length for other sensors in order to achieve the same filtering result.

The "Auto Once" button can be used to search for the optimum filter length for the current measurement conditions. The found filter length is indicated in the field to the right.

"Fixed Noise" The averaging factor is selected so that the sensor's intrinsic noise (2 standard deviations) does not exceed the specified noise content. The desired noise content is entered in the entry field to the right. To avoid very long settling times when the power is low, the averaging factor can be limited with the "Timeout" parameter.

SCPI command:

`SENSe<ch>[:POWer]:FILTer:TYPE` on page 567

`SENSe<ch>[:POWer]:FILTer:LENGTh:AUTO` on page 565

`SENSe<ch>[:POWer]:FILTer:LENGTh[:USER]` on page 565

`SENSe<ch>[:POWer]:FILTer:NSRatio` on page 566

`SENSe<ch>[:POWer]:FILTer:NSRatio:MTIME` on page 566

Use SParameter - Power Sensors

Activates the use of the S-Parameters correction data of the connected power sensor. For sensor with attenuator this checkbox is automatically checked.

Refer to the manual of the connected R&S NRP-Zxx power sensor for a description on how to use the s-parameters table.

SCPI command:

`SENSe<ch>[:POWer]:CORRection:SPDevice:STATe` on page 564

Use Sensor for RF Lev. Control - Power Sensors

Enables/disables controlling of the RF level via the power sensor.

SCPI command:

n.a.

4.5.7 RF Level/EMF

4.5.7.1 Overview RF Level Settings



Message "Level overrange/underrange"

If this message appears in the status line, the following parameter is in the overrange (see data sheet):

- the set level ("Level")
- the displayed peak envelope power ("PEP") for Digital Modulation or Digital Standard

The correct level setting and signal quality cannot be guaranteed if the set level is in the overrange/underrange.

The value of the RF level is displayed in the level field in the header of the instrument's display and the easiest way to set the RF level is to set it directly in this field.

PEP A	30.00	dBm	Lev A	20.00	dBm
PEP B	30.00	dBm	Lev B	20.00	dBm

The center line ("Level") and, to the left of this, the peak envelope power ("PEP") of the modulated RF output signal is displayed in the case of digital modulation or digital standard.

A two-line display appears in the case of two-path instruments. The frequency and level of Path A are shown in the top line, and the frequency and level of Path B in the bottom line.



The "Level" display does not consider the power difference between both paths based on unequal steering matrix, i.e. the displayed power level has to be reduced by a special MIMO Fading Power Correction value (see ["MIMO Fading Power Correction - Digital Impairments - Measurement"](#) on page 322).

Be aware, that there is a difference between the RF level displayed in the header and the RF output level set in the "Level/EMF" dialog of the "RF" block.

RF level vs. RF output level

The level entered and displayed in the "Level" field takes the offset of any downstream attenuators/amplifiers into consideration by way of calculation. This means that with a level offset the level displayed in the header does not correspond to the level at the RF output, but rather to the level at the output of the downstream instrument.

This allows the desired level at the output of downstream instruments to be entered. The R&S Signal Generator changes the RF output level according to the set offset.

However, the level entered and displayed in the "Level" menu of the "RF" function block always corresponds to the RF output level. Any level offset is not taken into consideration.

The level offset is entered in the "Level" menu. Here it is also possible to set the level without taking the offset into consideration, and to make other settings, such as level offset, attenuator mode, power-on state.

The correlation is as follows:

"Level" (in header) = "RF output level" (Level in menu) + "Level offset" (Offset in menu)

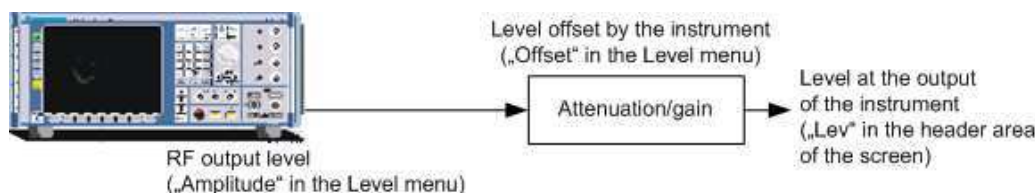

The RF output is protected against overloading by an external signal applied to the RF output (see ["Reverse Power Protection"](#) on page 220).

Setting the RF level

To change the RF level, press the LEVEL key and enter the desired level. Changes to the RF level have an immediate effect (without confirmation with the Enter key) on the output signal.

In the case of two-path instruments, adjustment of the RF level affects the respective path. To change the RF frequency of the Path B, press the LEVEL key again.

RF Level

Enters the RF level, considering the level offset (see ["RF level vs. RF output level"](#) on page 216).

Note: Some SW options have specific requirements about the calculation of the level of the output signal, e.g. the displayed value corresponds to the level at the start simulation time, there are correction coefficients to be applied, etc. In cases like this, the displayed value in the header of the instrument does not always correspond to the level at the RF output!

When working with a SW option, always refer to the corresponding documentation for related specific information.

dBm, dBuV, mV and uV can be used as the level units. The 4 unit keys are labeled with these units.

Note: The SCPI command sets the level of the "Level" display, i.e. an entered level offset is taken into consideration in the level value.

SCPI command:

`[:SOURce<hw>] :POWER [:LEVel] [:IMMediate] [:AMPLitude]` on page 774

4.5.7.2 RF Level

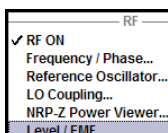

To open the "RF Level/EMF" dialog, select "RF/A Mod > Configure > Level/EMF" or use the MENU key under "RF/A Mod".

The combined menu "RF Level / EMF" is divided into the several sections.

The top sections of this dialog provide access to the level settings.

The offset-free level, level offset and level limit are set in the top section of the menu. The attenuator mode is set in the "Attenuator Settings" section.

The step width which is used when setting the level using the rotary knob (with "Variation Active On") is set in the "User Variation" section.

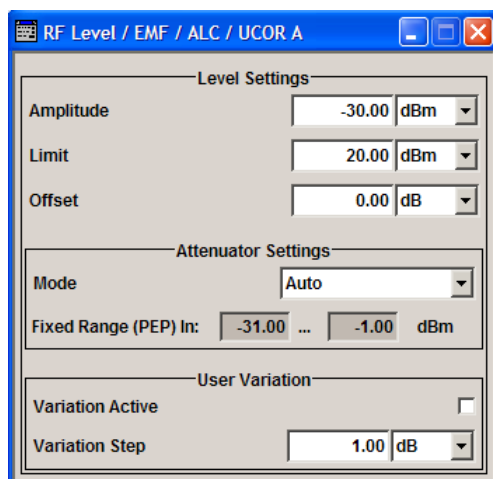

The power-on behavior of the instrument and the level display in the display header are set in the "Power-On / EMF Settings" section (see [chapter 4.5.7.3, "Power-On/EMF Settings"](#), on page 220).

The lower sections provide access to the "Automatic Level Control" settings and to function User Correction settings. For more information about this functions, see [chapter 4.5.8, "Automatic Level Control - ALC"](#), on page 221 and [chapter 4.5.9, "User Correction"](#), on page 223.

Level Settings

The offset-free level, attenuation mode, level offset and level limit are set in the top section of the menu.

Amplitude - RF Level

Sets the RF level of the RF output connector.

The level entered and displayed here corresponds to the level at the RF output, i.e. any offset entry is not taken into consideration.

Note: The SCPI command `[:SOURce<hw>] :POWer [:LEVel] [:IMMediate] [:AMPLitude]` sets the level of the "Level" display, i.e. the level containing offset.

SCPI command:

`[:SOURce<hw>] :POWer :POWer` on page 778

Limit - RF Level

Sets the level limit.

The value specifies the upper limit of the level at the RF output connector. A message appears if an attempt is made to set a level above this limit and the level at the RF output is confined to the upper limit. However, the level indication is not influenced.

The value is not affected by an instrument preset (PRESET key), *RST and the "Save/Recall" function. This parameter is influenced only by the [Factory Preset](#) and its factory value is equal to the upper limit.

SCPI command:

`[:SOURce<hw>] :POWer :LIMit [:AMPLitude]` on page 776

Offset (Level) - RF Level

Sets the level offset relative to the RF level.

The level offset of a downstream instrument (e.g. an attenuator or amplifier) is entered.

The entry does not change the value of the RF level at the RF output. It only changes the RF level displayed in the display header. The value of the RF level in the header corresponds to the level at the output of the downstream instrument.

SCPI command:

`[:SOURce<hw>] :POWer [:LEVel] [:IMMediate] :OFFSet` on page 775

Attenuator Settings

The attenuator mode is set in the Attenuator Settings section.

Attenuator Mode - RF Level

Sets the attenuator mode at the RF output.

The selection of Normal and High Power is only available when the instrument is equipped with the high-power output option (R&S SMU-B31 or R&S SMU-B36).

"Auto"	<p>Standard mode.</p> <p>The electronically switching attenuator switches with a 5 dB step width at fixed switching points.</p> <p>With high-power output option: The entire level range is available. The level settings are made in the area of the electronically switching attenuator as well as the relay-switched option (longer switchover time, wear).</p>
"Normal"	<p>(Option High Power only)</p> <p>The level settings are made only in the area of the electronically switching attenuator. The high level ranges are not available.</p> <p>This setting is wear-free, as the relays are not switched.</p>
"High Power"	<p>(Option High Power only)</p> <p>The level settings are made only in the area of the high-power bypass. Only the high level range is available. The relays are not switched.</p>
"Fixed"	<p>The level settings are made without switching the attenuator and the relays.</p> <p>When this operating mode is switched on, the attenuator and the relays are fixed in their current positions to provide level settings without interruption. The resulting variation range is defined and displayed under "Attenuator Fixed Range".</p> <p>Note: The function is effective when automatic level control is activated ("ALC State = On").</p> <p>If the normal variation range is overranged or underranged, level errors increase considerably and the warning "Level under/overrange" appears in the info line. The spectral purity of the output signal decreases with high attenuation.</p>

SCPI command:

[:OUTPut<hw>:AMODe](#) on page 559

Fixed Range (PEP) In

Displays the level range in which the level is set without interruption for the "Attenuator Mode fixed" setting.

SCPI command:

[:OUTPut<hw>:AFIXed:RANGe:UPPer](#) on page 558

[:OUTPut<hw>:AFIXed:RANGe:LOWer](#) on page 558

User Variation

If the level is set using the rotary knob, the step width is defined in the "User Variation" section.

Variation Active - RF Level

Activates the user-defined step width used when varying the level value with the rotary knob.

"ON"	The level value set with the rotary knob is varied using the user-defined step width which is entered under "Variation Step".
------	---

"OFF" The level value set with the rotary knob is varied in steps of one unit at the cursor position (standard operating mode).

SCPI command:

`[:SOURce<hw>] :POWer:STEP:MODE` on page 779

Variation Step - RF Level

Sets the user-defined step width for entering the RF level using the rotary knob. Level variation with this step width must also be activated with "Variation Active".

SCPI command:

`[:SOURce<hw>] :POWer:STEP [:INCRement]` on page 779

Reverse Power Protection

The R&S Signal Generator (all frequency options) is equipped against overloading by an external signal applied to the RF output.



An R&S SMU with serial number lower than 103001 requires:

- additional option Overvoltage Protection and High Power - R&S SMU-B32 (Path A) and R&S SMU-B37 (Path B) or
- additional option Overvoltage Protection -R&S SMU-B30 (Path A) and R&S SMU-B35 (Path B).

The reverse power protection is tripped when the power of the external signal becomes too high. A relay opens and interrupts the internal connection to the RF output. This condition is indicated in the display header by the "OVERLOAD" status message.

Overload

If an "Overload" status message is indicated in the display header, reset the overload protection by pressing the RF ON/OFF key.

The RF input is activated when the overload protection is reset.

SCPI command:

`:OUTPut<hw>:PROTection:TRIPped` on page 561

`:OUTPut<hw>:PROTection:CLEar` on page 560

`:OUTPut<hw> [:STATe]` on page 561

4.5.7.3 Power-On/EMF Settings

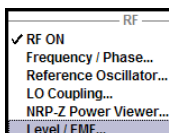

The power-on behavior of the R&S SMU and the level display in the display header are set in the "Power-On / EMF Settings" section of the "RF Level/EMF/ALC/UCOR" dialog.

To open the "RF Level/EMF" dialog, select "RF/A Mod > Configure > Level/EMF" or use the MENU key under "RF/A Mod".

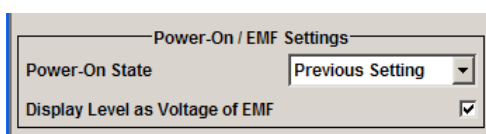

Power-On State - RF Signal

Selects the state which the RF output is to assume after the instrument is switched on.

"RF Off" The output is deactivated when the instrument is switched on.

"Previous Setting" When the instrument is switched on, the output assumes the same state as it had when the instrument was switched off.

SCPI command:

:OUTPut<hw> [:STATe] :PON on page 561

Display Level as Voltage of EMF - RF Level

Activates display of the signal level as voltage of the EMF (no-load voltage). If this setting is deactivated, the level is displayed as a voltage over a 50 Ohm load (preset state).

SCPI command:

n.a.

4.5.8 Automatic Level Control - ALC

Your signal generator is equipped with an automatic level control unit to obtain best RF level accuracy.

Automatic Level Control (ALC) is an adaptive control system to stabilize the RF output level. It continuously monitors the current level and adjusts it to keep a steady state over temperature and time.



ALC is active in almost all applications by default. However, the **Pulse Modulation** mode excludes ALC, as the control loop would detect incorrect values and result in level deviations.

Also note that ALC may detect incorrect values in **multi-transmitter** test setups. If multiple generators are coupled, reverse power may affect the ALC readings. Based on incorrect values, ALC would have an impact on the signal to intermodulation ratio.

ALC States

The following description basically explains the ALC states and their principle of operation. In particular **ALC OFF (Sample & Hold)** gives an overview on the function in terms of the equipment of the generator.

The R&S SMU offers the ALC states:

- AUTO
automatically adjusts the output level to the operating conditions.
- On
enables ALC permanently, regardless of the currently selected mode.
- Off
deactivates ALC.

The instrument switches to **Sample & Hold (S&H)** state, which still allows to maintain a constant output level.

The following section explains the functionality of "Sample & Hold", to provide an overview and to indicate what is to be considered. "On" and "Auto" require no additional explanation. Furthermore, find the ALC state settings described in detail in [State - ALC](#).

ALC OFF (Sample & Hold)

In "S&H" mode, the signal generator switches for a short period of time into CW mode and activates ALC. ALC adjusts the level to the set value and the generator holds the value (freeze). Then, the generator switches ALC off again and back to the operating mode.

RF output behaviour during Sample & Hold depends on the configuration of your instrument. Instruments equipped with...:

- an **electronic step attenuator**
The level is decreased by 30 dB.
- a **mechanical step attenuator**

The level control status is permanently displayed as a status message in the info line.



4.5.8.1 Automatic Level Control Settings

To open the "Automatic Level Control" dialog, select "RF/A Mod > Configure > Automatic Level Control" or use the MENU key under "RF/A Mod".

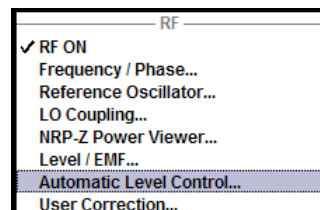

The combined dialog "ALC / UCOR" is divided into the several sections and provides access to the "Automatic Level Control" settings and to function "User Correction", see [chapter 4.5.9, "User Correction"](#), on page 223).

The top sections of the dialog provide access to the level and attenuator settings (see [chapter 4.5.7.3, "Power-On/EMF Settings"](#), on page 220 and [chapter 4.5.7.2, "RF Level"](#), on page 217).



State - ALC

Activates/deactivates internal level control.

"Auto"	The instrument selects the most appropriate ALC mode automatically. ALC is on in most operating conditions. Default state.
"On"	Activates ALC, regardless of the operating conditions. If "Attenuator Mode Fixed" is selected in addition, the instrument adjusts the level of every level and frequency setting.
"Off (Sample & Hold)"	Deactivates internal level control. Sample & hold closes the level control loop at every frequency and level change for a short period of time. The level control voltage is sampled and then clamped.

SCPI command:

`[:SOURce<hw>] :POWer:ALC [:STATe]` on page 773

Search Once - ALC

Forces the generator to execute level adjustment once, although the "Sample & Hold" mode is active.

SCPI command:

`[:SOURce<hw>] :POWer:ALC:SONCe` on page 773

Protect RF Output - ALC

The signal is attenuated for about 40 dB to protect external devices against internal signals, if the following prerequisites are fulfilled

- ALC state is On or AUTO
- High-Power Mode is Off
- I/Q Modulator is On
- Baseband is armed

SCPI command:

`:OUTPut<hw>:PROTection:STATe` on page 561

4.5.9 User Correction

The "User Correction" function is used to create and activate lists in which level correction values predefined by the user are freely assigned to RF frequencies. Correction is performed by the user-defined table values being added to the output level for the respective RF frequency.

With frequencies which are not contained in the list, the level correction is determined by interpolation of the closest correction values.

The lists are created in the "List Editor". Each list is stored in its own file with the predefined file extension `*.uco`. The name of the User Correction file can be freely selected. The files are loaded from the "Lists..." file manager. Externally created tables with pairs of frequency and level values can be converted into User Correction files using the import function. The external files must have the file extension `*.txt` or `*.csv`. These file formats are provided e.g. by the Microsoft Excel program. The separators for table columns and for decimal floating-point numerals can be set. In addition, internally created User Correction data can be exported into ASCII files using the export function.

The amplitude can also be linearized automatically by means of an R&S NRP power sensor connected to one of the generator output signals. With the aid of the "Fill with Sensor" function, a table with correction values for external test assemblies can be automatically determined, e.g. for compensating the frequency response of cables. The User Correction list with the correction values acquired by the sensor is generated in the "Edit User Correction List" menu. The correction values can be acquired any time irrespective of the modulation settings of the generator.

Multi level measurements allow to take into account the changing VSWR for the different attenuator settings.

If user correction is activated, the "UCOR" display (User Correction) is shown in the header together with the "Level" display. The RF output level is the sum of both values.

"Level" + "UCOR" = Output level

If activated, user correction is effective in all operating modes.

4.5.9.1 User Correction Menu

Automatic Level Control...
User Correction...

To open the "User Correction" menu, select "RF/A Mod > Configure User Correction" or use the MENU key under "RF/A Mod".

The combined menu "ALC/UCOR" is divided into the several sections.

The top sections provide access to the level and attenuator settings, see [chapter 4.5.7.2, "RF Level"](#), on page 217, and to the automatic level control settings, see [chapter 4.5.8, "Automatic Level Control - ALC"](#), on page 221.

User Correction Settings

The "User Correction" settings are set in the most lower section of the combined dialog; this section is used to activate/deactivate user correction, and to create, select and activate the lists.

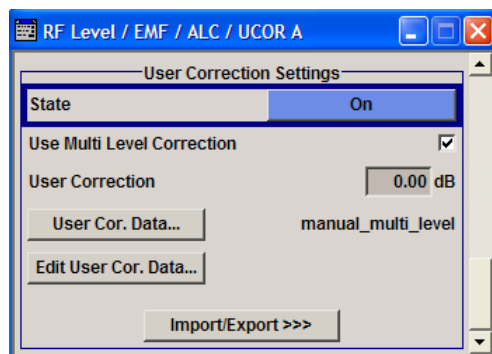

State - User Correction

Activates/deactivates user correction.

The "UCOR" status message appears in the frequency and level display.

SCPI command:

`[:SOURce<hw>] :CORRection [:STATe]` on page 716

Use Multi Level Correction - User Correction

Activates the use of the multi level correction data (see [chapter 4.5.9.3, "Filling the Correction List with Power Sensor Measurement Data"](#), on page 230) if checked. Otherwise the Single Level Correction measurement data is used.

SCPI command:

`[:SOURce<hw>] :CORRection:MLEVel:STATe` on page 716

User Correction Value - User Correction

Indicates the current value for level correction.

SCPI command:

`[:SOURce<hw>] :CORRection:VALue` on page 716

User Cor. Data - User Correction

Calls the "File Select" menu for selecting and creating a list or the "File Manager".

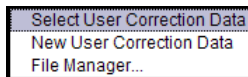

SCPI command:

`[:SOURce] :CORRection:CSET:DELeTe` on page 711

`[:SOURce<hw>] :CORRection:CSET [:SELeCt]` on page 715

Edit User Cor. Data - User Correction

Calls the editor for editing the selected user correction list.

A list consists of any number of frequency/level value pairs. The currently selected list is displayed.

Each list is saved as a separate file with extension * .uco. The file name and the directory to which the file is saved are user-selectable.

Multi level lists which are filled automatically using the Fill with sensor function consist of nine level columns, one for each attenuator stage (see [chapter 4.5.9.3, "Filling the Correction List with Power Sensor Measurement Data"](#), on page 230).

Note: Save list only after filling both columns (frequency and level), otherwise the entries are lost.

	Frequency / Hz	Power / dB	Power [1] @ HP/ dB	Power [2] @ 0 dB/ dB	Power [3] @ 5 dB/ dB
1	10 000 000.00	3.00	3.56	3.51	3.52
2	20 000 000.00	3.96	3.52	3.90	3.96
3	30 000 000.00	4.07	3.79	4.07	4.06
4	40 000 000.00	3.70	3.84	3.73	3.70
5	50 000 000.00	3.38	3.56	3.35	3.38
6	60 000 000.00	3.59	3.68	3.58	3.59
7	70 000 000.00	4.04	4.02	4.06	4.04
8	80 000 000.00	4.06	3.90	4.12	4.15
9	90 000 000.00	3.88	3.58	3.82	3.88
10	100 000 000.00	3.64	3.84	3.68	3.63
11	110 000 000.00	3.79	4.26	3.85	3.79
12	120 000 000.00	4.17	4.03	4.07	4.16
13	130 000 000.00	4.36	3.58	4.27	4.35
14	140 000 000.00	4.18	3.94	4.27	4.18
15	150 000 000.00	3.85	4.48	3.96	3.84
16	160 000 000.00	3.91	4.25	3.80	3.90
17	170 000 000.00	4.29	3.71	4.15	4.28

"Frequency / Hz"

Enters the frequency to which the level correction value applies.

Note: The "Fill..." function allows to automatically enter any number of frequencies with freely selectable range and increment.

Using the "Fill With Sensor" function of the "Edit" sub menu requires only the entry of the frequency values. The level values are automatically acquired by the connected power sensor.

"Power / Power[1..9] @ HP.. 35 dB"

Enters the level correction value to which the specified frequency applies. The values can be entered manually or automatically with the "Fill With Sensor" function (available in the "Edit" sub menu).

"Goto"

Selects row for editing.

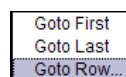

If Goto row is selected, a window opens for entering the requested row.

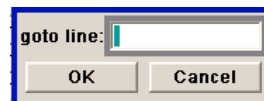

"Edit"

Calls a selection of possible actions described below.

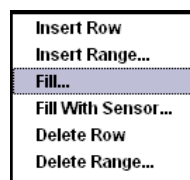

"Insert Row"

Insert a new row before the marked row.

"Insert Range" Insert new rows before the marked row. The number of rows to be inserted can be defined in an entry window.

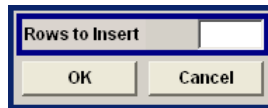

"Fill..." Opens a sub menu for defining a set of list values to be automatically entered in the ucor list (see [chapter 4.5.9.2, "Filling the Correction List automatically"](#), on page 229).

"Fill With Sensor" Calls the menu to activate the filling of the user correction list with level values acquired by the selected power sensor (see [chapter 4.5.9.3, "Filling the Correction List with Power Sensor Measurement Data"](#), on page 230).

"Delete Row" Deletes the marked row.

"Delete Range..." Allows to delete any number of rows starting with the marked row. The number of rows to be deleted can be defined in an entry window.

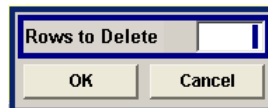

"Save as" Open the file menu to save the list under a new name.

Note: Save list only after filling both columns (frequency and level), otherwise the entries are lost.

Each list is saved to the R&S Signal Generator hard disk as a separate file with the file prefix *.uco. The file name and the directory to which the file is saved are user-selectable.

"Save" The list is saved under its current name.

SCPI command:

[\[:SOURce<hw>\]:CORRection:CSET\[:SElect\]](#) on page 715

[\[:SOURce<hw>\]:CORRection:CSET:DATA:FREQuency](#) on page 709

[\[:SOURce<hw>\]:CORRection:CSET:DATA:POWer](#) on page 709

Import/Export

User correction list can be imported from externally created files or exported into text or CSV-files. The import/export settings are available after clicking the "Import/Export" button.

Import/Export >>>

Expands the menu with the area for import and export of user correction files.

Externally edited Excel tables with any number of frequency/level value pairs can be imported as text or CSV-files and used for user correction.

Multi level lists which are filled automatically using the "Fill with sensor" function consist of nine level columns, one for each attenuator stage (see [chapter 4.5.9.3, "Filling the Correction List with Power Sensor Measurement Data"](#), on page 230).

Conversely, you can also export internally created user correction lists as text or CSV-files.

Mode - User Correction

Selects if user correction lists should be imported or exported. The settings offered depend on the selected mode.

SCPI command:

[\[:SOURce<hw>\]:CORRection:DEXChange:MODE](#) on page 714

Extension - User Correction

Selects the file extension of the ASCII file to be imported or exported. Selection "TXT" (text file) or "CSV" (Excel file) is available.

SCPI command:

[\[:SOURce<hw>\]:CORRection:DEXChange:AFILe:EXTension](#) on page 712

Decimal Point - User Correction

Selects the decimal separator used in the ASCII data between '.' (decimal point) and ',' (comma) with floating-point numerals.

SCPI command:

[\[:SOURce<hw>\]:CORRection:DEXChange:AFILe:SEParator:DECimal](#)
on page 713

Column Separator- User Correction

Selects the separator between the frequency and level column of the ASCII table the user correction list is exported to or imported from.

SCPI command:

[\[:SOURce<hw>\]:CORRection:DEXChange:AFILe:SEParator:COLumn](#)
on page 713

Select ASCII Source / Destination - User Correction

Calls the "File Manager" for selecting the ASCII file to be imported into a user correction list (source) or the ASCII file the user correction list is exported (destination) in.

SCPI command:

[\[:SOURce<hw>\]:CORRection:DEXChange:AFILe:SELeCt](#) on page 712

Destination / Source - User Correction

Calls the "File Manager" for selecting the user correction list to be exported (source) into an ASCII file or the destination for the ASCII file to be imported (destination) in.

SCPI command:

`[:SOURce<hw>] :CORRection:DEXChange:SElect` on page 715

Import / Export - User Correction

Starts the export or import of the selected file.

When import is selected, the ASCII file is imported as user correction list.

When export is selected, the user correction list is exported into the selected ASCII file.

SCPI command:

`[:SOURce<hw>] :CORRection:DEXChange:EXECute` on page 714

4.5.9.2 Filling the Correction List automatically

The "Fill Table" menu enables you to automatically set the level correction values.

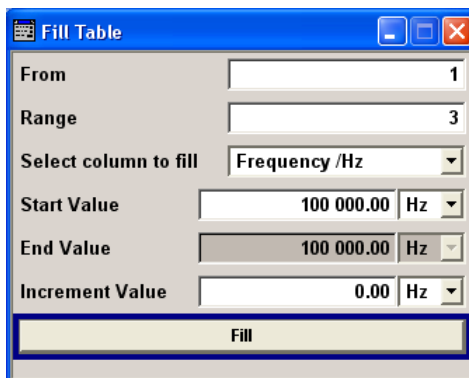

The start line and the number of rows to be filled are defined under "From" and "Range."

The column to be filled is selected under "Select column to fill". Depending on the selection here, the default for start, end, and increment value are set. As the settings are interdependent, a change of one parameter may result in the automatic change of one or more of the other parameters. The filling of the column with the selected value settings is started with button "Fill".



The correction list entries are only computed when the "Fill" button is pressed.

From

Sets the start value of the index range.

SCPI command:

n.a.

Range

Sets the range for filling the table.

SCPI command:

n.a.

Select column to fill

Selects either the frequency or the level column to be filled with the value defined below.

SCPI command:

n.a.

Start value

Sets the start value for the frequency or the level entries.

SCPI command:

n.a.

End value

Displays the end value for the frequency or the level entries.

SCPI command:

n.a.

Increment value

Sets the increment for the frequency or the level entries.

SCPI command:

n.a.

Fill

Fills the selected column in the set range with values, starting with the start value and using the set increment.

SCPI command:

n.a.

4.5.9.3 Filling the Correction List with Power Sensor Measurement Data

The level correction values for the user correction list can be acquired by means of R&S NRP power sensors. The R&S NRP sensors are connected to either the SENSOR connector or to one of the USB interfaces. Configuration of the connection is performed in the "Power Sensor" menu (see [chapter 4.5.6, "NRP-Z Power Viewer"](#), on page 209). The filling of the ucor list with measurement data is performed in the ucor list editor (see ["Edit User Cor. Data - User Correction"](#) on page 225).

In the editor, the frequencies for which the correction values are to be acquired are entered in the frequency column (either manually or by means of the "Fill..." menu).



Do not save the list at this point, because the frequency entries are lost as long as there are no entries for the level column also. In the following these entries are automatically acquired by the connected power sensor.

All level correction values for the given frequency values are measured using the Power Sensor and automatically filled in the selected list after the "Execute" button is pressed. The list is automatically stored and recalled again after filling.

Fill User Correction Data with Sensor Settings

The "Fill with Sensor" button of the "Edit User Correction Data" menu opens the associated menu.

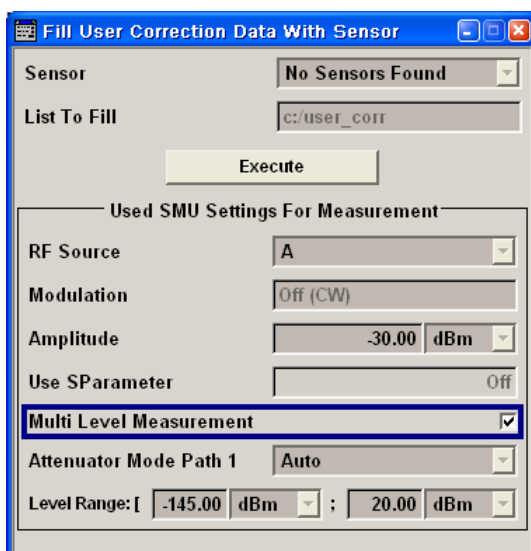

The menu indicates the relevant generator settings.

Fill User Correction Data with Sensor

All settings are read-only, except the "Sensor" and "Multi Level Measurements".

In case more than one sensor is connected to the instrument, the sensor can be selected in the "Sensor" field of the menu; "Multi Level Correction" can be activated.

The "RF Source" (RF A or RF B) is defined by the path for which the correction menu settings are made.

The "Execute" button is only enabled if a sensor is detected and the user correction list contains at least one frequency value.

SCPI command:

```
[ :SOURce<hw> ] :CORRection:CSET:DATA [ :SENSor<ch> ] [ :POWER ] :SONCe
```

on page 711

Multi Level Correction

When "Multi Level Correction" is activated, separate measurements are made for the different attenuator settings up to 35 dB. Thus, the changes in VSWR for the different settings are taken into account, the level accuracy increases. For ranges from 40 dB on the changes in VSWR are negligible. The reference level is set internally and cannot be controlled by the user. The measurement results are entered into additional columns of the "User Correction" list.

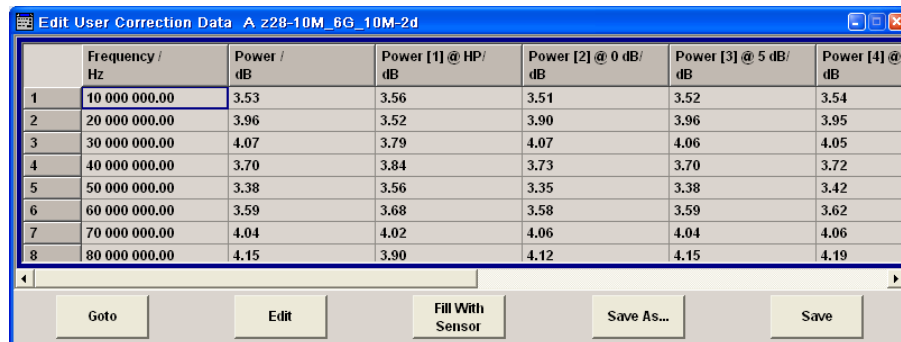

	Frequency / Hz	Power / dB	Power [1] @ HP/ dB	Power [2] @ 0 dB/ dB	Power [3] @ 5 dB/ dB	Power [4] @ dB
1	10 000 000.00	3.53	3.56	3.51	3.52	3.54
2	20 000 000.00	3.96	3.52	3.90	3.96	3.95
3	30 000 000.00	4.07	3.79	4.07	4.06	4.05
4	40 000 000.00	3.70	3.84	3.73	3.70	3.72
5	50 000 000.00	3.38	3.56	3.35	3.38	3.42
6	60 000 000.00	3.59	3.68	3.58	3.59	3.62
7	70 000 000.00	4.04	4.02	4.06	4.04	4.06
8	80 000 000.00	4.15	3.90	4.12	4.15	4.19

The Multi Level Correction measurements are made in addition to a Single Level Correction measurement. When the user correction list is activated, it is possible to select which of the measurements is to be used for level correction.

Multi Level Values

The measurement values for the different attenuator settings are retrieved separately. The numeric suffix at MLEV correlates to the index of the column, e.g. suffix 3 denotes the column with the values for attenuator setting 5 dB.

SCPI command:

`[:SOURce<hw>] :CORRection:CSET:DATA:POWer:MLEV<1>:STATe` on page 710

`[:SOURce<hw>] :CORRection:CSET:DATA:POWer:MLEV<ch>` on page 710

4.5.10 Reverse Power Protection

The R&S Signal Generator (all frequency options) is equipped against overloading by an external signal applied to the RF output.



An R&S SMU with serial number lower than 103001 requires:

- additional option Overvoltage Protection and High Power - R&S SMU-B32 (Path A) and R&S SMU-B37 (Path B) or
- additional option Overvoltage Protection -R&S SMU-B30 (Path A) and R&S SMU-B35 (Path B).

The reverse power protection is tripped when the power of the external signal becomes too high. A relay opens and interrupts the internal connection to the RF output. This condition is indicated in the display header by the "OVERLOAD" status message.

Overload

If an "Overload" status message is indicated in the display header, reset the overload protection by pressing the RF ON/OFF key.

The RF input is activated when the overload protection is reset.

SCPI command:

`:OUTPut<hw>:PROTection:TRIPped` on page 561

`:OUTPut<hw>:PROTection:CLEAr` on page 560

`:OUTPut<hw>[:STATe]` on page 561

4.5.11 Analog Modulations

4.5.11.1 Overview

The R&S Signal Generator provides the analog modulations amplitude modulation (AM), broadband amplitude modulation (BB-AM) and pulse modulation (Pulse) for the basic unit (R&S SMU+ frequency option R&S SMU-B10x) without additional equipment options.

Two-path instruments require a second RF path (R&S SMU-B20x option).

However, the analog modulations frequency modulation (FM) and phase modulation (PhiM) require option R&S SMU-B20 (FM/PhiM Modulator) or R&S SMU-B22 (FM/PhiM Modulator and Low Phase Noise).

Settings for the modulation are made in separate modulation menus. These menus can be accessed in the block diagram by way of the "RF/A Mod" function block, or by means of the menu with the same name which is opened using the MENU key.

Enabling/Disabling Analog Modulations using the MOD On/Off Key

The MOD ON/OFF key switches the modulations on and off.

MOD ON/OFF

Press the MOD ON/OFF key to enable/disable analog modulations.

In the two-path mode, this key switches all modulations off.

Pressing the key again restores the status that was active before the last switch-off. "MOD OFF" is displayed in the info line of the header next to the "Level" field.

SCPI command:

`[:SOURce<hw>] :MODulation [:ALL] :STATe` on page 768

Modulation Sources

The following modulations use internal and external modulation sources:

- Amplitude modulation
- Pulse modulation
- Frequency modulation
- Phase modulation

Only external modulation sources can be used for a BB-AM.

Internal Modulation Sources

The LF generator is available as internal modulation source. The generator supplies sinusoidal signals in the frequency range 0.1 Hz to 1 MHz. With pulse modulation, the sinusoidal signal from the LF generator is formed internally into a rectangular signal used to actuate the pulse modulator.

With two-path instruments, the frequency settings are always effective for both paths since an LF generator is available for both paths in the instrument.

The noise generator supplies white noise with selectable bandwidth and level distribution.

See also [chapter 4.5.12.1, "LF Generator Overview"](#), on page 246.

External Modulation Sources

The EXT MOD input at the rear of the instrument is provided as the external modulation source for amplitude, pulse, frequency and phase modulation. The external signal for broadband amplitude modulation is fed in via the I-input.

The external modulation signal at the input must have a voltage of $U_S = 1 \text{ V}$ ($U_{EFF} = 0.707 \text{ V}$) in order to achieve the displayed modulation depth and range. The input voltage should not exceed 1.1 Vs, otherwise modulation distortions might occur. With external pulse modulation, the switching point is max. 2.4 V and the voltage at the input should not exceed 5 V. The maximum modulation frequency is 10 MHz for frequency and phase modulation.

Simultaneous Operation of Several Modulations or Other Operating Modes

The table shows the modulations and operating modes which can be activated simultaneously (+) or which deactivate each other (-).

	AM	FM	PhiM	Pulse	BB-AM	I/Q	DM	ARB
Amplitude modulation (AM)	/	+	+	+	-	-	-	-
Frequency modulation (FM)	+	/	-	+	+	+	+	+
Phase modulation (PhiM)	+	-	/	+	+	+	+	+
Pulse modulation	+	+	+	/	+	+	+	+
Broadband AM (BB-AM)	-	+	+	+	/	-	-	-
Vector modulation (I/Q)	-	+	+	+	-	/	-	-
Digital modulation (DM)	-	+	+	+	-	-	/	-
ARB	-	+	+	+	-	-	-	/

4.5.11.2 Amplitude Modulation (AM)

An internal or external source can be selected for amplitude modulation. The LF GEN modulation generator is available as the internal source. The I/Q modulator is used for amplitude modulation. Two-tone AM is possible by simultaneously switching on the external and internal source.

The EXT MOD input connector for external feed of analog modulation signals is at the rear of the instrument. The coupling mode of the input (AC or DC) can be selected.

It is not possible to use AM simultaneously with:

- broadband AM,
- I/Q modulation,
- arbitrary waveform generation,
- digital modulation and
- digital standards.

The AM modulation depth is limited by the maximum peak envelope power (PEP).

Amplitude Modulation Menu

To open the "Amplitude Modulation" menu, select "RF/A Mod > Configure > Amplitude Modulation" or use the MENU key under "RF/A Mod".

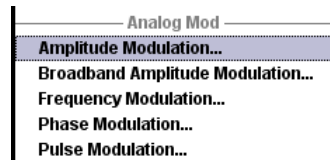

The middle section of the combined menu "Pulse/Amplitude Modulation/Broadband AM" provides access to the amplitude modulation settings.

The top section provides access to the pulse modulation settings, see [chapter 4.5.11.6, "Pulse Modulation \(PM\)"](#), on page 244.

The lower section provides access to the broadband amplitude modulation settings, see [chapter 4.5.11.3, "Broadband Amplitude Modulation \(BB-AM\)"](#), on page 237.

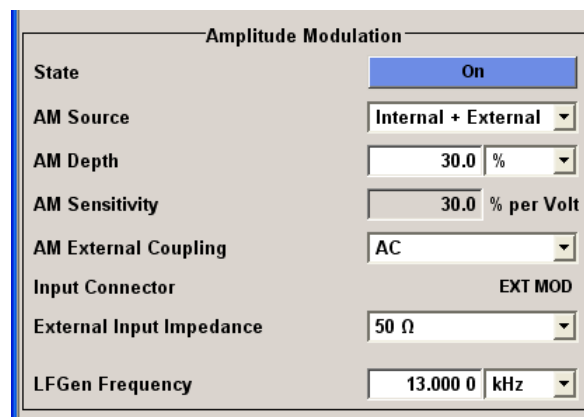

State

Activates/deactivates AM modulation.

Activation of AM deactivates:

- BB AM,
- I/Q modulation,
- arbitrary waveform generation,
- digital modulation and
- digital standards.

SCPI command:

`[:SOURce<hw>] :AM:STATe` on page 574

AM Source

Selects the source for the AM signal.

"Internal" Selects the internal LF generator as the source for AM modulation.

"External" Selects the external source.
The external signal is input via the EXT MOD connector.

"Intern + Extern" Selects the internal and external source at the same time. This setting enables two-tone AM modulation.

SCPI command:

[\[:SOURce<hw>\]:AM:SOURce](#) on page 573

AM Depth

Sets the modulation depth in percent.

SCPI command:

[\[:SOURce<hw>\]:AM\[:DEPTh\]](#) on page 572

LF Gen Frequency

Sets the frequency of the LF generator.

This setting affects all analog modulations which use the LF generator as the internal modulation source.

With two-path instruments, the setting affects both paths.

SCPI command:

[\[:SOURce\]:LFOuTput:FREQuency](#) on page 748

AM Sensitivity

(Source External only)

Displays the input sensitivity of the EXT MOD input in %/V.

The modulation depth entered under "AM Depth" is reached with 1 volt modulation of the input.

SCPI command:

[\[:SOURce<hw>\]:AM:SENSitivity](#) on page 573

AM External Coupling

(Source External only)

Selects the coupling mode (AC or DC) for external feed.

Note: Coupling for external feed via input EXT MOD can be set independently for all modulations with external source.

SCPI command:

[\[:SOURce<hw>\]:AM:EXTErnal:COUPling](#) on page 573

AM Input Connector

Displays the modulation input. The display only appears in the case of external modulation.

SCPI command:

n.a.

External Input Impedance

(Source External only)

Selects the impedance for external feed via the EXT MOD input.

Selection 50 Ohm and high (>100 kOhm) is available.

Note: This setting affects all analog modulations which use the external modulation source.

SCPI command:

[:SOURce<hw>] :INPut:MODext:IMPedance on page 730

4.5.11.3 Broadband Amplitude Modulation (BB-AM)

With broadband amplitude modulation the I/Q modulator is used for amplitude modulation.

Broadband amplitude modulation (BB-AM) is only possible for Path A.

An external source is always used. The modulation input is the I-input of the I/Q modulator. The sensitivity for broadband amplitude modulation is 0.25V / 100% modulation depth. It is not possible to set a modulation depth for BB-AM.

It is not possible to use BB-AM simultaneously with:

- AM,
- I/Q modulation,
- arbitrary waveform generation (ARB),
- digital modulation and
- digital standards.

The upper level limit for BB-AM is the same as that for I/Q modulation. PEP is up to 6 dB above the display value, depending on the modulation depth.

Broadband Amplitude Modulation Menu

To open the "Broadband Amplitude Modulation" menu, select "RF/A Mod > Configure > Broadband Amplitude Modulation" or use the MENU key under "RF/A Mod".

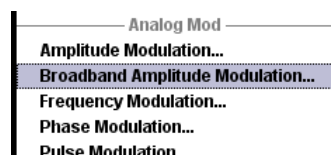

The combined menu "Pulse Modulation/Amplitude Modulation /Broadband AM" provides access to the Broadband AM configuration in the bottom section.

The top section provides access to the pulse modulation settings; see [chapter 4.5.11.6, "Pulse Modulation \(PM\)"](#), on page 244.

The middle section provides access to the amplitude modulation settings; see [chapter 4.5.11.2, "Amplitude Modulation \(AM\)"](#), on page 234.

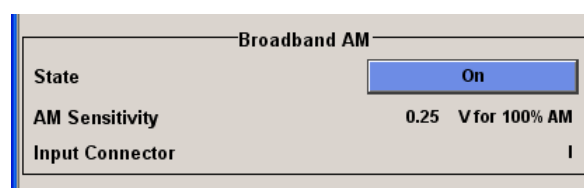

State

Activates/deactivates broadband AM modulation. Activation of broadband AM deactivates AM, I/Q modulation, digital modulation and digital standards.

SCPI command:

`[:SOURce<hw>] :AM:BBANd [:STATe]` on page 572

AM Sensitivity

Displays the input sensitivity of the I IN input in V/100% modulation depth. The input sensitivity cannot be influenced in the case of broadband AM since it is not possible to set the range.

SCPI command:

`[:SOURce<hw>] :AM:BBANd:SENSitivity` on page 572

Input Connector

Displays the modulation input (I-input connector of the I/Q modulator).

SCPI command:

n.a.

4.5.11.4 Frequency Modulation (FM)

Frequency modulation (FM) requires option R&S Signal Generator-B20 (FM/PhiM Modulator) or R&S Signal Generator-B22 (FM/PhiM Modulator and Low Phase Noise). These options are available for Path A only.

An internal and/or external source can be selected for frequency modulation. The LF GEN modulation generator is available as the internal source. Two-tone FM is possible by simultaneously switching on the external and internal source.

The EXT MOD input connector for external feed is at the rear of the instrument. The coupling mode of the input (AC or DC) and 50 Ohm or high (> 10 kOhm) impedance can be selected.

Selection between Low Noise mode (with better signal/noise ratio, but reduced setting range for modulation bandwidth and deviation, see data sheet) and standard mode is possible (option R&S SMU-B22 only).



It is not possible to use frequency modulation simultaneously with phase modulation.

Frequency Modulation Settings

To open the "Frequency Modulation" menu, select "RF/A Mod > Configure > Frequency Modulation" or use the MENU key under "RF/A Mod".

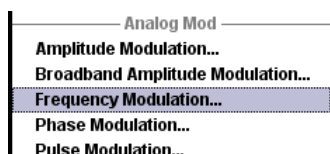

The top section of the combined menu "Frequency/Phase Modulation" provides access to the frequency modulation settings.

The the lower section of the combined menu provides access to phase modulation, see [chapter 4.5.11.5, "Phase Modulation \(PhiM\)"](#), on page 241

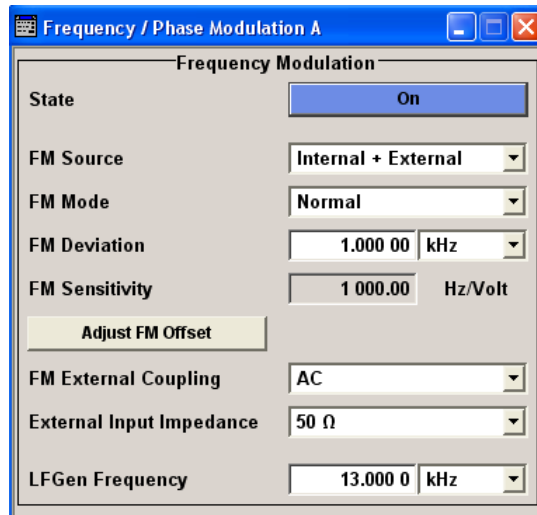

State

Activates/deactivates FM modulation.

Activation of FM deactivates phase modulation.

SCPI command:

`[:SOURce<hw>] :FM:STATe` on page 719

FM Source

Selects the source for the FM signal.

"Internal" Selects the internal LF generator as the source for FM modulation.

"External" Selects the external source.
The external signal is input via the EXT MOD connector.

"Internal + External" Selects the internal and external source at the same time.
This setting enables two-tone FM modulation.

SCPI command:

`[:SOURce<hw>] :FM:SOURce` on page 718

FM Mode

Selects the mode for the frequency modulation.

"Normal" The maximum range for modulation bandwidth and FM deviation is available.

"Low Noise" (requires option R&S Signal Generator-B22)
Frequency modulation with phase noise and spurious characteristics close to CW mode. The range for modulation bandwidth and FM deviation is reduced (see data sheet).

SCPI command:

`[:SOURce<hw>] :FM:MODE` on page 718

FM Deviation

Sets the modulation deviation in Hz.

The deviation is given as the absolute deviation in relation to the set center frequency, e.g. a deviation 5 MHz at a center frequency of 1 GHz leads to a frequency modulation between 995 MHz and 1005 MHz.

The maximal deviation depends on the RF frequency set and the selected modulation mode (see data sheet). It is possible to enter a deviation that is too high for a certain RF frequency or to vary the RF frequency to a range in which the deviation can no longer be set. In this case the maximally possible deviation is set and an error message is displayed.

The deviation of the internal source must not exceed the deviation of the external source in case of modulation source "Int+Ext".

SCPI command:

`[:SOURce<hw>] :FM[:DEVIation]` on page 717

LF Gen Frequency

Sets the frequency of the LF generator.

This setting affects all analog modulations which use the LF generator as the internal modulation source.

With two-path instruments, the setting affects both paths.

SCPI command:

`[:SOURce] :LFOutput:FREQuency` on page 748

FM Sensitivity

(Source External only)

Displays the input sensitivity of the EXT MOD input in Hz/V.

The modulation depth entered under "FM Depth" is reached with 1 Volt (= U_{peak}) of the input signal.

Note: The input voltage should not exceed $1.1 V_p$ otherwise modulation distortions might occur.

SCPI command:

`[:SOURce<hw>] :FM:SENSitivity` on page 718

Adjust FM Offset

Starts the adjustment for the FM/PhiM modulator. The option is adjusted with respect to DC-offset.

SCPI command:

`:CALibration<hw>:FMOffset [:MEASure]` on page 531

FM External Coupling

(Source External only)

Selects the coupling mode (AC or DC) for external feed.

Note: Coupling for external feed via input EXT MOD can be set independently for all modulations with external source.

"AC" The d.c. voltage content is separated from the modulation signal.

"DC" The modulation signal is not altered.

SCPI command:

[\[:SOURce<hw>\]:FM:EXTernal:COUpling](#) on page 717

External Input Impedance

(Source External only)

Selects the impedance for external feed via the EXT MOD input.

Selection 50 Ohm and high (>100 kOhm) is available.

Note: This setting affects all analog modulations which use the external modulation source.

SCPI command:

[\[:SOURce<hw>\]:INPut:MODext:IMPedance](#) on page 730

4.5.11.5 Phase Modulation (PhiM)

Phase modulation (PhiM) requires option R&S SMU-B20 (FM/PhiM Modulator) or R&S SMU-B22 (FM/PhiM Modulator and Low Phase Noise). These options are available for Path A only.



It is not possible to use phase modulation simultaneously with frequency modulation.

An internal and/or external source can be selected for phase modulation. The LF GEN modulation generator is available as the internal source.

The EXT MOD input connector for external feed of analog modulation signals is at the rear of the instrument. The coupling mode of the input (AC or DC) and the impedance can be selected.

Selection between the following modulation modes is possible:

- "High Bandwidth" mode with full setting range for modulation bandwidth and limited PhiM deviation.
- "Low Noise" mode with better signal/noise ratio, but reduced setting range for modulation bandwidth and deviation (see data sheet)
- "High Deviation" mode with full setting range for PhiM deviation and a reduced setting range for modulation bandwidth. Phase noise is reduced in the lower modulation frequency range compared to the default mode.

Phase Modulation Menu

To open the "Phase Modulation" menu, select "RF/A Mod > Configure > Phase Modulation" or use the MENU key under "RF/A Mod".

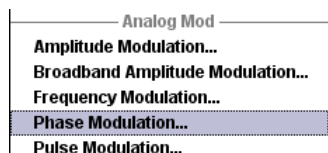

The lower section of the combined menu Frequency/Phase Modulation provides access to the phase modulation settings.

The upper section provides access to the frequency modulation, see [chapter 4.5.11.4, "Frequency Modulation \(FM\)"](#), on page 238

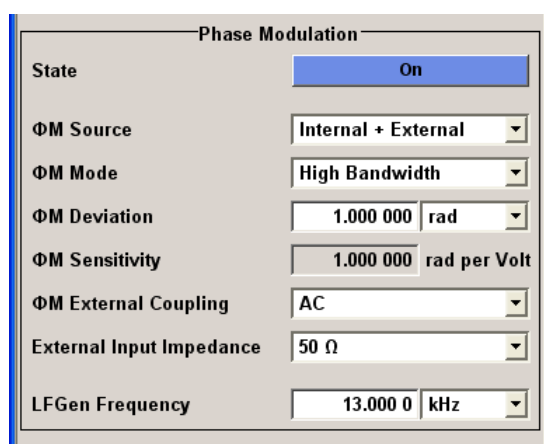

State

Activates/deactivates PhiM modulation.

Activation of PhiM deactivates frequency modulation.

SCPI command:

[:SOURce<hw>] :PM:STATe on page 772

PhiM Source

Selects the source for the PhiM signal.

"Internal" Selects the internal LF generator as the source for PhiM modulation.

"External" Selects the external source.
The external signal is input via the EXT MOD connector.

"Internal + External" Selects the internal and external source at the same time.

SCPI command:

[:SOURce<hw>] :PM:SOURce on page 772

PhiM Mode

Selects the mode for the phase modulation.

"High Bandwidth"	The maximum range for modulation bandwidth is available. However, phase noise is increased for low frequencies. The range for PhiM deviation is limited. This mode is recommended for high modulation frequencies.
"High Deviation"	The maximum range for PhiM deviation is available. Phase noise is improved for low frequencies compared to the default mode. The range for modulation frequency is limited (see data sheet). This mode is recommended for low modulation frequencies and/or high PhiM deviation.
"Low Noise"	(with option R&S SMU-B22 only) Phase modulation with phase noise and spurious characteristics close to CW mode. The range for modulation bandwidth and PM deviation is limited (see data sheet). This mode is useful for generating a tailed CW signal.

SCPI command:

`[:SOURce<hw>] :PM:MODE` on page 771

PhiM Deviation

Sets the modulation depth in RAD or degrees.

The maximal deviation depends on the RF frequency set and the selected modulation mode (see data sheet). It is possible to enter a deviation that is too high for a certain RF frequency or to vary the RF frequency to a range in which the deviation can no longer be set. In this case the maximally possible deviation is set and an error message is displayed.

SCPI command:

`[:SOURce<hw>] :PM[:DEVIation]` on page 770

LF Gen Frequency

Sets the frequency of the LF generator.

This setting affects all analog modulations which use the LF generator as the internal modulation source.

With two-path instruments, the setting affects both paths.

SCPI command:

`[:SOURce] :LFOutput:FREQuency` on page 748

PhiM Sensitivity

(Source External only)

Displays the input sensitivity of the EXT MOD input in RAD/V.

The modulation depth entered under "PhiM Depth" is reached with 1 volt ($=U_{\text{peak}}$) of the input signal.

Note: The input voltage should not exceed $1.1 V_p$ otherwise modulation distortions might occur.

SCPI command:

`[:SOURce<hw>] :PM:SENSitivity` on page 771

Mod External Coupling

Selects the coupling mode (AC OR DC) for external feed.

Note: Coupling for external feed via input EXT MOD can be set independently for all modulations with external source.

"AC" The DC voltage content is separated from the modulation signal.

"DC" The modulation signal is not altered.

SCPI command:

`[:SOURce<hw>] :PM:EXTernal:COUPling` on page 770

External Input Impedance

(Source External only)

Selects the impedance for external feed via the EXT MOD input.

Selection 50 Ohm and high (>100 kOhm) is available.

Note: This setting affects all analog modulations which use the external modulation source.

SCPI command:

`[:SOURce<hw>] :INPut:MODext:IMPedance` on page 730

4.5.11.6 Pulse Modulation (PM)

Pulse modulation is available for the basic unit (R&S SMU + frequency option R&S SMU-B10x) without additional equipment options.

An additional frequency option (R&S SMU-B20x) is required for a two-path instrument.

An internal or external source can be selected for pulse modulation. A simple rectangular signal with selectable repetition frequency is available as the internal signal. This signal is formed from the sinusoidal signal supplied by the LF generator.

The external signal is input via the EXT MOD connector at the rear of the instrument. The polarity of the external pulse modulation can be selected. If Polarity is set to Normal, the RF level is ON if the level is HIGH at the modulation input.



Automatic Level Control is deactivated with pulse modulation!

When pulse modulation is activated, the ALC state of the R&S SMU is automatically changed to "ALC OFF" ("Sample & Hold"). In this state, the ALC loop is opened and the output level is not regulated but the level modulator is set directly. In order to set the correct output level, a sample & hold measurement is executed after each frequency or level setting.

The level is decreased by 30 dB during "Sample&Hold" measurement.

Pulse Modulation Settings

To open the "Pulse Modulation" menu, select "RF/A Mod > Configure > Pulse Modulation" or use the MENU key under "RF/A Mod".

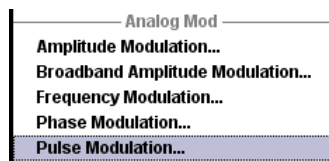

In the upper section of the menu, the modulation source is selected and the modulation switched on. The configuration of the selected external and/or internal modulation source is performed in the lower section of the menu.

The menu varies according to the selected modulation source.

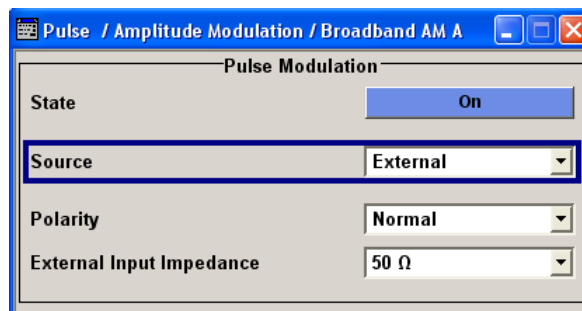

State

Activates/deactivates pulse modulation.

Activation of pulse modulation deactivates ALC and power ramping.

SCPI command:

[\[:SOURce<hw>\]:PULM:STATe](#) on page 781

Source

Selects the source for the pulse modulation signal.

"Internal" Selects the internal source. The LF generator generates a rectangular pulse with the set frequency.

"External" Selects the external source.
The external modulation signal is input via the PULSE EXT connector.

SCPI command:

[\[:SOURce<hw>\]:PULM:SOURce](#) on page 781

LFGen Frequency - Pulse Modulation

Sets the repetition frequency of the internal signal.

This setting affects all analog modulations which use the LF generator as the internal modulation source.

With two-path instruments, the setting affects both paths.

SCPI command:

[\[:SOURce\]:LFOutput:FREQuency](#) on page 748

External Input Impedance

(Source External only)

Selects the impedance for external feed via the EXT MOD input.

Selection 50 Ohm and high (>100 kOhm) is available.

Note: This setting affects all analog modulations which use the external modulation source.

SCPI command:

[\[:SOURce<hw>\]:INPut:MODext:IMPedance](#) on page 730

Polarity

(External Source only)

Selects the polarity of the modulation signal.

"Normal" The RF signal is **On** while the level is high at the modulation input.

"Inverted" The RF signal is **Off** while the level is high at the modulation input.

SCPI command:

[\[:SOURce<hw>\]:PULM:POLarity](#) on page 781

4.5.12 LF Generator and LF Output - Mod Gen

4.5.12.1 LF Generator Overview

The internal LF generator is available as the internal source for the analog modulations AM, FM / PM and Pulse, and also as the signal source for the LF output at the rear of the instrument.

The frequency setting for the LF generator can be made both in the modulation menus and in the "LF Output" menu.

A change to the frequency of the LF generator automatically has an effect on modulation if the LF generator is selected as the modulation source (i.e. "Internal" is selected as "Source").

With two-path instruments, the frequency setting is always effective for both paths since an LF generator is available for both paths in the instrument.

The LF Sweep mode is activated in the "LF Sweep" dialog (see [chapter 4.5.13.4, "LF Frequency Sweep"](#), on page 262). "RF frequency" and "RF Level" sweeps are activated in the respective menus of the RF block.

4.5.12.2 LF Output

To open the "LF Output" dialog, select "RF/A Mod > Configure > LF Output" or use the MENU key under "RF/A Mod".

The combined menu "LF Output / LF Frequency Sweep" provides access to the LF output configuration in the bottom section. The top sections provide access to the LF Sweep mode settings, see [chapter 4.5.13.4, "LF Frequency Sweep"](#), on page 262.

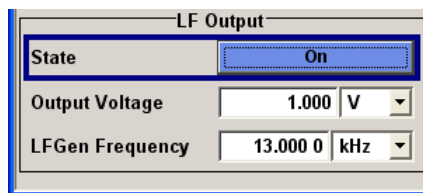

LF Output Menu

State - LF Output

Activates/deactivates the LF output. This setting has no effect on the modulations.

The modulation signal is output at the LF OUTPUT connector of the instrument.

SCPI command:

[\[:SOURce\]:LFOutput\[:STATe\]](#) on page 750

Output Voltage - LF Output

Sets the output voltage of the LF output. The entered value determines the peak voltage.

SCPI command:

[\[:SOURce\]:LFOutput:VOLTagE](#) on page 755

LF Gen Frequency

Sets the frequency of the LF generator.

This setting affects all analog modulations which use the LF generator as the internal modulation source.

With two-path instruments, the setting affects both paths.

SCPI command:

[\[:SOURce\]:LFOutput:FREQuency](#) on page 748

4.5.13 Sweep Mode

4.5.13.1 Overview

The R&S Signal Generator offers three different sweep types (frequency sweep, level sweep and LF sweep) to be activated alternatively. Each type has 6 modes which differ with respect to the sweep cycle mode (continuous, individual and step-by-step) and triggering mode (automatic, internal and external).



Sweeps and List mode can not be activated simultaneously, they deactivate each other.

A phase continuous frequency sweep can be generated after activating the phase continuous mode, see "[Setting a Phase Continuous Frequency Sweep](#)" on page 200.

Setting a sweep

A sweep is set in five basic steps which are shown below taking a frequency sweep as an example.

1. Set the sweep range ("Start Freq" and "Stop Freq" or "Center Freq" and "Span").
2. Select linear or logarithmic sweep spacing ("Spacing").
3. Set the step width ("Step Lin/Log") and dwell time ("Dwell Time").
4. Activate the sweep ("Mode" to Auto, Single, Step or Extern Single, Extern Step).
5. Trigger the sweep, except for Auto mode ("Execute Single Sweep", Current Frequency or External Trigger Signal).



It is recommended to switch off the GUI update for optimum sweep performance especially with short dwell times (see [chapter 4.2.3.5, "Gui Update"](#), on page 132).

4.5.13.2 RF Frequency Sweep

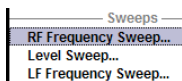

The dialog is used to activate and configure a sweep for the RF frequency.

To open the "Frequency Sweep" menu, select "RF/A Mod > Configure > RF Frequency Sweep" or use the menu tree of the MENU key under "RF Signal".

In the top section of the menu, the RF sweep mode is activated and the sweep mode is selected.

The buttons are used to reset the RF sweep (all sweep modes) or to execute the RF sweep ("Single" mode).

The sweep range, sweep spacing and dwell time are set in the bottom section.

The sweep range of the RF sweep can be entered in two ways, either by entering the "Start" and "Stop" value or by entering the "Center" and "Span".

The two sets of parameters influence each other in the following way:

- "Start Freq" = "Center Freq" - "Span"/2
- "Stop Freq" = "Center Freq" + "Span"/2
- "Center Freq" = ("Start Freq" + STOP FREQ)/2
- "Span" = "Stop Freq" - "Start Freq"

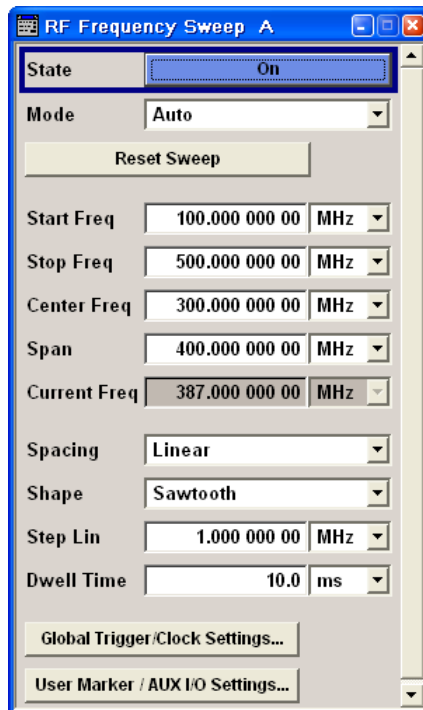

RF Frequency Sweep Settings

State - Frequency Sweep

Activates/deactivates RF sweep mode.

Note: Activating the RF-Sweep mode automatically disables other sweep modes, and the list mode.

In case of two-path instrument, this affects the respective path.

SCPI command:

[:SOURce<hw>] :FREQuency:MODE on page 723

Mode - Frequency Sweep

Selects the sweep instrument operating mode and the sweep mode.

"Auto" Sets an automatic repeated sweep cycle. If a different sweep mode was activated prior to the "Auto" mode, the cycle continues from the current sweep setting.
The "Reset Sweep" button resets the sweep to the start frequency.

Example:

```
SOUR:SWE:FREQ:MODE AUTO
TRIG:FSW:SOUR AUTO
SOUR:FREQ:MODE SWE
```

"Single" Sets a single sweep cycle. The sweep is triggered by the "Execute Single Sweep" button.
 If a different sweep mode was activated prior to the "Single" mode, the current sweep is stopped. The "Single" sweep always starts at the start frequency when triggered.
 The "Reset Sweep" button resets the sweep to the start frequency.

Example:

```
SOUR:SWE:FREQ:MODE AUTO
TRIG:FSW:SOUR SING
SOUR:FREQ:MODE SWE
SOUR:SWE:FREQ:EXEC
```

"Step" Sets a step-by-step sweep cycle.
 If this mode is activated, the cursor moves to the value displayed for "Current Freq". Any variation to the "Current Freq" value triggers a sweep step. The step width is set below at entry field "Step Lin" or "Step Log".
 If a different sweep mode was activated prior to the "Step" mode, the current sweep is stopped. The "Step" sweep starts at the current RF frequency when triggered.
 The "Reset Sweep" button resets the sweep to the start frequency.

Example:

```
SOUR:SWE:FREQ:MODE MAN
SOUR:FREQ:MODE SWE
SOUR:SWE:FREQ:SPAC LIN
SOUR:SWE:FREQ:STEP:LIN 0.5E4
SOUR:FREQ:MAN 1GHz
```

The value entered with command `SOUR:SWE:FREQ:STEP:LIN|LOG` sets the step width.

The value entered with command `SOUR:FREQ:MAN` has no effect, the command only triggers the next sweep step. However, the value has to be in the currently set sweep range (start to stop). In remote control only a step-by-step sweep from start to stop frequency is possible.

"Extern Single" Sets a single sweep cycle. The sweep is triggered by an external trigger signal.

If a different sweep mode was activated prior to the "Extern Single" mode, the current sweep is stopped. The "Extern Single" sweep always starts at the start frequency when triggered.

Refer to the description of the rear panel for information about the connectors for external trigger signal input (see [chapter 1.2, "Rear Panel Tour"](#), on page 23).

The BNC connector INST TRIG is provided for Path A, and the pin INST TRIG B on the AUX I/O interface for Path B.

The "Reset Sweep" button resets the sweep to the start frequency.

Example:

```
SOUR:SWE:FREQ:MODE AUTO
TRIG:FSW:SOUR EXT
SOUR:FREQ:MODE SWE (External trigger)
```

"Extern Step" Sets a step-by-step sweep cycle. Each sweep step is triggered by an external trigger signal (trigger source as described under "Extern Single"). The step width is set below at entry field "Step Lin" or "Step Log".

If a different sweep mode was activated prior to the "Extern Step" mode, the current sweep is stopped. The "Extern Step" sweep always starts at the start frequency when triggered.

The "Reset Sweep" button resets the sweep to the start frequency.

Example:

```
SOUR:SWE:FREQ:MODE STEP
SOUR:SWE:FREQ:SPAC LIN
SOUR:SWE:FREQ:STEP:LIN 1MHz
TRIG:FSW:SOUR EXT
SOUR:FREQ:MODE SWE (External trigger)
```

"Extern Start/ Stop" Sets an automatically repeated sweep cycle that is started, stopped and restarted by subsequent external trigger events. The first external trigger signal starts the sweep (Start). The next external trigger signal stops the sweep at the current frequency (Stop). The third external trigger signal starts the sweep at the start frequency (Start). If a different sweep mode was activated prior to the "Extern Start/ Stop" mode, the current sweep is stopped and the "Extern Start/Stop" sweep starts at the start frequency when triggered. The "Reset" button resets the sweep to the start frequency. Refer to the description of the rear panel for information about the connectors for external trigger signal input. The external trigger signal is input at the rear of the instrument (BNC connector INST TRIG).

Example:

```
SOUR:SWE:FREQ:MODE AUTO
TRIG:FSW:SOUR EAUT
SOUR:FREQ:MODE SWE (External trigger)
```

SCPI command:

[\[:SOURce<hw>\]:SWEep\[:FREQuency\]:MODE](#) on page 786
[:TRIGger<hw>:FSWEEP:SOURce](#) on page 808
[\[:SOURce<hw>\]:FREQuency:MODE](#) on page 723

Execute Single Sweep - Frequency Sweep

Triggers the sweep manually. A manual sweep can only be triggered if "Mode Single" is selected.

SCPI command:

[\[:SOURce<hw>\]:SWEep\[:FREQuency\]:EXECute](#) on page 786

Reset Sweep - Frequency Sweep

Resets the sweep. The start frequency is set and the next sweep starts from there.

SCPI command:

[\[:SOURce<hw>\]:SWEep:RESet\[:ALL\]](#) on page 792

Start Freq - Frequency Sweep

Sets the start frequency.

SCPI command:

[\[:SOURce<hw>\]:FREQuency:START](#) on page 727

Stop Freq - Frequency Sweep

Sets the stop frequency.

SCPI command:

[\[:SOURce<hw>\]:FREQuency:STOP](#) on page 727

Center Freq - Frequency Sweep

Sets the center frequency.

SCPI command:

[\[:SOURce<hw>\]:FREQuency:CENTer](#) on page 720

Span - Frequency Sweep

Sets the span.

SCPI command:

[\[:SOURce<hw>\]:FREQuency:SPAN](#) on page 726

Current Freq - Frequency Sweep

Displays the current frequency.

If "Step" is set, the frequency for the next frequency step of the sweep is entered here.

SCPI command:

[\[:SOURce<hw>\]:FREQuency:MANual](#) on page 723

Spacing - Frequency Sweep

Selects linear or logarithmic sweep spacing.

"Linear" With the linear sweep, the step width is a fixed frequency value which is added to the current frequency. The step width is entered below.

"Logarithmic" With the logarithmic sweep, the step width is a constant fraction of the current frequency. This fraction is added to the current frequency. The logarithmic step width is entered below in %.

SCPI command:

[\[:SOURce<hw>\]:SWEep\[:FREQuency\]:SPACing](#) on page 787

Shape - RF Frequency Sweep

Selects the cycle mode for a sweep sequence (shape).

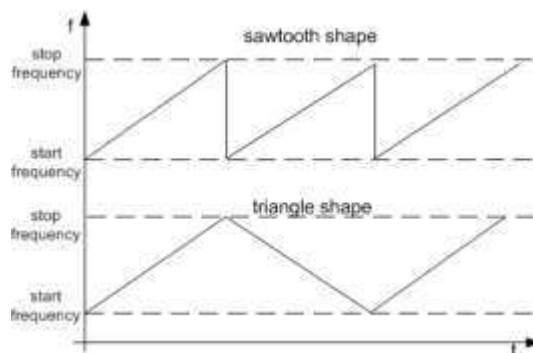

"Sawtooth" One sweep runs from start to stop frequency. Each subsequent sweep starts at the start frequency, i.e. the shape of the sweep sequence resembles a sawtooth.

"Triangle" One sweep runs from start to stop frequency and back, i.e. the shape of the sweep resembles a triangle. Each subsequent sweep starts at the start frequency.

SCPI command:

[\[:SOURce<hw>\]:SWEep\[:FREQuency\]:SHAPE](#) on page 787

Step Lin/Log - Frequency Sweep

Sets the step width for the individual sweep steps. This entry is effective for all sweep modes.

"Step Lin" or "Step Log" is displayed depending on whether "Spacing Lin" or "Log" is selected.

"Step Lin" With the linear sweep, the step width is a fixed frequency value which is added to the current frequency. The linear step width is entered in Hz.

SCPI command:

[\[:SOURce<hw>\]:SWEep\[:FREQuency\]:STEP\[:LINear\]](#) on page 788

"Step Log" With the logarithmic sweep, the step width is a constant fraction of the current frequency. This fraction is added to the current frequency. The logarithmic step width is entered in %.

SCPI command:

[\[:SOURce<hw>\]:SWEep\[:FREQuency\]:STEP:LOGarithmic](#) on page 789

Dwell Time - Frequency Sweep

Sets the dwell time. The dwell time determines the duration of the individual sweep steps.

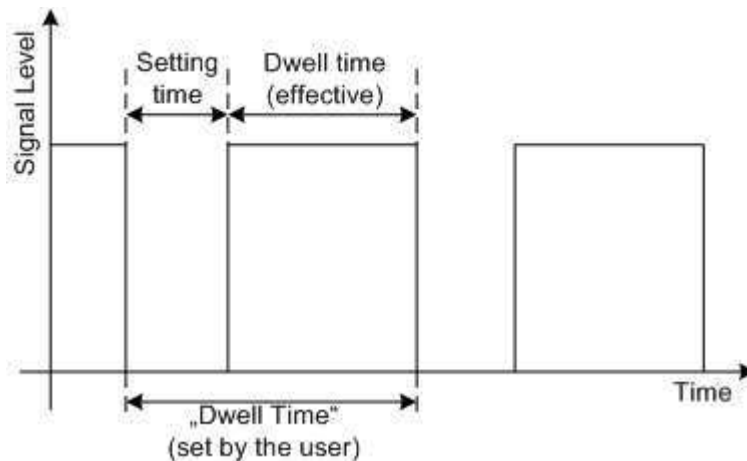

The "Dwell Time" set by the user is used as the step time of the sweep. The effective net dwell time is shorter, reduced by the setting time. This setting time may be greater than the time specified in the data sheet.

Note:

It is recommended to switch off the GUI update for optimum sweep performance especially with short dwell times (see [chapter 4.2.3.5, "Gui Update"](#), on page 132).

SCPI command:

[\[:SOURce<hw>\]:SWEep\[:FREQuency\]:DWELl](#) on page 785

Global Trigger/Clock Settings

Calls the "Global Trigger/Clock Settings" dialog. This dialog is used among other things for setting the polarity of the active slope of an applied instrument trigger.

In the case of two-path instruments this setting is valid for both paths. It affects the INST TRIG input (BNC connector at the rear of the instrument, instrument trigger for Path A) and the INST TRIG B input of the AUX I/O interface at the rear of the instrument, instrument trigger for Path B).

See [chapter 4.2.3.10, "Global Trigger/Clock/External Input Settings"](#), on page 136.

User Marker / AUX I/O

Calls the menu for configuring the AUX I/O and user interfaces (see [chapter 4.2.3.12, "User Marker / AUX I/O Settings"](#), on page 139).

The pin assignment of the AUX I/O interface is shown in the "User Marker / AUX I/O Configuration" menu; the assignment of the USER pins 2...4 and USER 1 BNC connector can be changed.

With two-path instruments, the current assignment to the respective path is given in addition to the pin assignment.

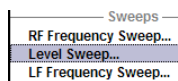
4.5.13.3 RF Level Sweep

To open the "Level Sweep" menu, select "RF/A Mod > Configure > Level Sweep" or use the MENU key under "RF/A Mod".

RF Level Sweep Settings

The "RF Level Sweep" dialog is used to activate and configure a sweep for the RF level.

In the top section, the Level Sweep is activated and the sweep mode is selected. The buttons are used to reset the level sweep (all sweep modes) or to execute the level sweep ("Single" mode).

The level range for the sweeps is selected for instruments with Option High Power.

The sweep range, sweep spacing and dwell time are set in the bottom section.

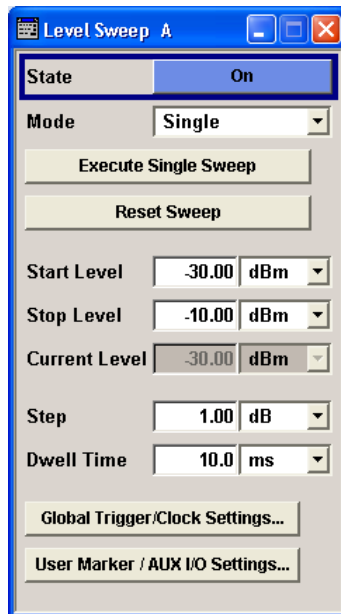

State - Level Sweep

Activates Level Sweep mode.

Note: Activating the RF level sweep mode automatically disables other sweep modes, and the list mode.

In case of two-path instrument, this affects the respective path.

SCPI command:

[\[:SOURce<hw>\]:POWer:MODE](#) on page 777

Mode - Level Sweep

Selects the level sweep instrument operating mode and the sweep mode.

"Auto" Sets an automatically repeated sweep cycle. If a different sweep mode was activated prior to the "Auto" mode, the cycle continues from the current sweep setting.
The "Reset Sweep" button resets the sweep to the start level.

Example:

```
SOUR:SWE:POW:MODE AUTO
TRIG:PSW:SOUR AUTO
SOUR:POW:MODE SWE
```

"Single" Sets a single sweep cycle. The sweep is triggered by the "Execute Single Sweep" button.
 If a different sweep mode was activated prior to the "Single" mode, the current sweep is stopped. The single sweep always starts at the start level.
 The "Reset Sweep" button resets the sweep to the start level.

Example:

```
SOUR:SWE:POW:MODE AUTO
TRIG:PSW:SOUR SING
SOUR:POW:MODE SWE
SOUR:SWE:POW:EXEC
```

"Step" Sets a step-by-step sweep cycle.
 If this mode is activated, the cursor moves to the value displayed for "Current Level". Each sweep step is triggered by a variation of the value in the "Current Level" entry window. The step width is set below at entry field "Step".
 If this mode is activated, the cursor moves to the value displayed for "Current Level". If a different sweep mode was activated prior to the "Step" mode, the current sweep is stopped. The step sweep starts at the current level value.
 The "Reset Sweep" button resets the sweep to the start level.

Example:

```
SOUR:SWE:POW:MODE MAN
SOUR:SWE:POW:STEP 0.5
SOUR:POW:MODE SWE
SOUR:POW:MAN -16
```

The value entered with command `SOUR:SWE:POW:STEP` sets the step width.

The value entered with command `SOUR:POW:MAN` has no effect, the command only triggers the next sweep step. However, the value has to be in the currently set sweep range (start to stop). In remote control only a step-by-step sweep from start to stop frequency is possible.

"Extern Single" Sets a single sweep cycle. The sweep is triggered by an external trigger signal.
If a different sweep mode was activated prior to the "Extern Single" mode, the current sweep is stopped. The "Extern Single" sweep always starts at the start level.
Refer to the description of the rear panel for information about the connectors for external trigger signal input (see [chapter 1.2, "Rear Panel Tour"](#), on page 23).
The BNC connector INST TRIG is provided for Path A, and the pin INST TRIG B on the AUX I/O interface for Path B.
The "Reset Sweep" button resets the sweep to the start level.

Example:

```
SOUR:SWE:POW:MODE AUTO
TRIG:PSW:SOUR EXT
SOUR:POW:MODE SWE (External trigger)
```

"Extern Step" Sets a step-by-step sweep cycle. Each sweep step is triggered by an external trigger signal (trigger source as described under "Extern Single"). The step width corresponds to the step width of the rotary knob. If a different sweep mode was activated prior to the "Extern Step" mode, the current sweep is stopped. The "Extern Step" sweep always starts at the start level.
The "Reset Sweep" button resets the sweep to the start level.

Example:

```
SOUR:SWE:POW:MODE STEP
SOUR:SWE:POW:STEP 0.5
TRIG:PSW:SOUR EXT
SOUR:POW:MODE SWE (External trigger)
```

"Extern Start/ Stop" Sets an automatically repeated sweep cycle that is started, stopped and restarted by subsequent external trigger events. The first external trigger signal starts the sweep (Start). The next external trigger signal stops the sweep at the current frequency (Stop). The third external trigger signal starts the sweep at the start frequency (Start). If a different sweep mode was activated prior to the "Extern Start/ Stop" mode, the current sweep is stopped and the "Extern Start/Stop" sweep starts at the start frequency when triggered. The "Reset" button resets the sweep to the start level. Refer to the description of the rear panel for information about the connectors for external trigger signal input (see [chapter 1.2, "Rear Panel Tour"](#), on page 23).

Example:

```
SOUR:SWE:POW:MODE AUTO
TRIG:PSW:SOUR EAUT
SOUR:POW:MODE SWE (External trigger)
```

SCPI command:

[\[:SOURce<hw>\]:SWEep:POWer:MODE](#) on page 790
[:TRIGger<hw>:PSWEEP:SOURce](#) on page 809.
[\[:SOURce<hw>\]:POWer:MODE](#) on page 777

Reset Sweep - Level Sweep

Resets the sweep. The start level is set and the next sweep starts from there.

SCPI command:

[\[:SOURce<hw>\]:SWEep:RESet \[:ALL\]](#) on page 792

Execute Single Sweep - Level Sweep

Triggers the sweep manually. A manual sweep can only be triggered if "Mode Single" is selected.

Example:

```
SOUR:SWE:POW:MODE AUTO
TRIG:PSW:SOUR SING
SOUR:POW:MODE SWE
SOUR:SWE:EXEC
```

SCPI command:

[\[:SOURce<hw>\]:SWEep:POWer:EXECute](#) on page 790

Start Level - Level Sweep

Sets the start level.

SCPI command:

[\[:SOURce<hw>\]:POWer:STARt](#) on page 778

Stop Level - Level Sweep

Sets the stop level.

SCPI command:

[\[:SOURce<hw>\]:POWer:STOP](#) on page 780

Current Level - Level Sweep

Displays the current level.

If "Step" is set, the level for the next level step of the sweep is entered here.

SCPI command:

[\[:SOURce<hw>\]:POWer:MANual](#) on page 776

Shape - RF Level Sweep

Selects the cycle mode for a sweep sequence (shape).

"Sawtooth" One sweep runs from the start level to the stop level. The subsequent sweep starts at the start level again, i.e. the shape of sweep sequence resembles a sawtooth.

"Triangle" One sweep runs from start to stop level and back, i.e. the shape of the sweep resembles a triangle. Each subsequent sweep starts at the start level again.

SCPI command:

[\[:SOURce<hw>\]:SWEep:POWer:SHApe](#) on page 791

Step - Level Sweep

Sets the step width for the individual sweep steps. This entry is effective for all sweep modes.

With the level sweep, the logarithmic step width is a constant fraction of the current level. This fraction is added to the current level. The logarithmic step width is entered in dB.

SCPI command:

[\[:SOURce<hw>\]:SWEep:POWer:STEP\[:LOGarithmic\]](#) on page 792

Dwell Time - Level Sweep

Enters the dwell time and determines the duration of the individual sweep steps.

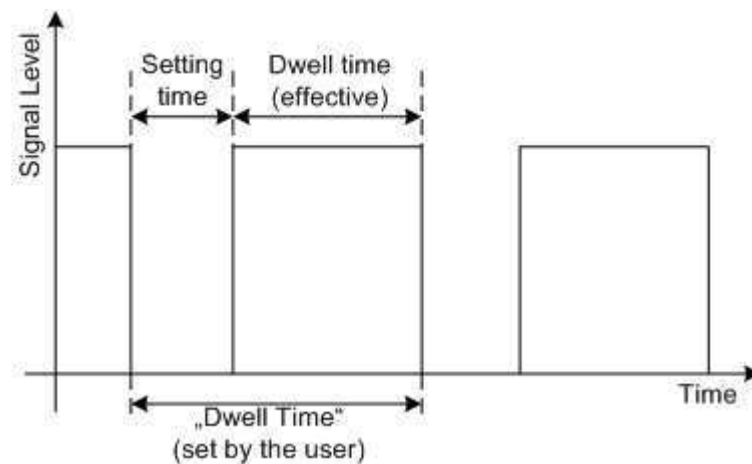

The "Dwell Time" set by the user is used as the step time of the sweep. The effective net dwell time is shorter, reduced by the setting time. This setting time may be greater than the time specified in the data sheet.

Note:

It is recommended to switch off the GUI update for optimum sweep performance especially with short dwell times (see [chapter 4.2.3.5, "Gui Update"](#), on page 132).

SCPI command:

[:SOURce<hw>] :SWEep:POWer:DWELl on page 790

Global Trigger/Clock Settings

Calls the "Global Trigger/Clock Settings" dialog. This dialog is used among other things for setting the polarity of the active slope of an applied instrument trigger.

In the case of two-path instruments this setting is valid for both paths. It affects the INST TRIG input (BNC connector at the rear of the instrument, instrument trigger for Path A) and the INST TRIG B input of the AUX I/O interface at the rear of the instrument, instrument trigger for Path B).

See [chapter 4.2.3.10, "Global Trigger/Clock/External Input Settings"](#), on page 136.

User Marker / AUX I/O

Calls the menu for configuring the AUX I/O and user interfaces (see [chapter 4.2.3.12, "User Marker / AUX I/O Settings"](#), on page 139).

The pin assignment of the AUX I/O interface is shown in the "User Marker / AUX I/O Configuration" menu; the assignment of the USER pins 2...4 and USER 1 BNC connector can be changed.

With two-path instruments, the current assignment to the respective path is given in addition to the pin assignment.

Attenuator Mode - Level Sweep with High Power Option

(High Power Option only)

Sets the ranges of level settings for the level sweep. The sweep is either performed in the low level (electronically switching attenuator) or in the high level (relay-switched high-power-bypass) ranges.

Parameter "Attenuator Mode" is only available when the instrument is equipped with the high-power output option, R&S SMU-B31 or R&S SMU-B36.

Note: An error message is generated and the best possible level is set if the level setting for the current sweep step is outside the selected range.

- | | |
|---------------|--|
| "Normal " | The level settings for the level sweep are made in the area of the electronically switching attenuator. The high level ranges are not available. |
| "High Power " | The level settings for the level sweep are made in the area of the option. Only the high level range is available. |

SCPI command:

[:SOURce<hw>] :SWEep:POWer:AMODe on page 789

4.5.13.4 LF Frequency Sweep

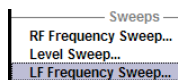

The "LF Frequency Sweep" dialog is used to activate and configure a sweep for the LF frequency.

To open the "LF Frequency Sweep" menu, select "RF/A Mod > Configure > LF Frequency Sweep" or use the MENU key under "RF/A Mod".

With two-path instruments, the frequency settings are always effective for both paths since an LF generator is available for both paths in the instrument.

The top sections of the combined menu "LF Output / LF Frequency Sweep" provide access to the "LF Frequency Sweep" mode settings.

In the top section, the LF Sweep mode is activated and the sweep mode is selected. The buttons are used to reset the LF sweep (all sweep modes) or to execute the LF sweep ("Single" mode).

The sweep range, sweep spacing and dwell time are set in the bottom of the section.

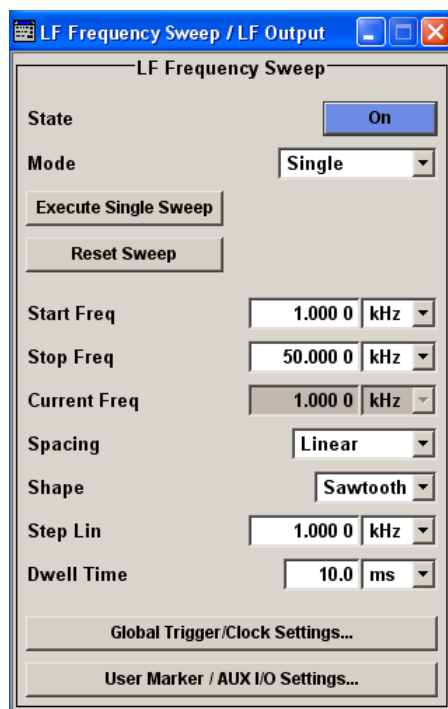

The lower section provides access to the "LF Output" settings, see [chapter 4.5.12.2, "LF Output"](#), on page 246.

State - LF Sweep

Activates LF Sweep mode.

Note: Activating the LF frequency sweep automatically deactivates the list mode, RF level sweep and RF frequency sweep.

In case of two-path instrument, this affects the respective path.

SCPI command:

`[:SOURce] :LFOutput :FREQuency:MODE` on page 749

Mode - LF Sweep

Selects the Sweep instrument operating mode and Sweep mode.

"Auto" Sets are automatic repeated sweep cycle. If a different sweep mode was activated prior to the "Auto" mode, the cycle continues from the current sweep setting.
The "Reset Sweep" button resets the sweep to the start frequency.

Example:

```
SOUR:LFO:SWE:FREQ:MODE AUTO
```

```
TRIG0:SWE:SOUR AUTO
```

```
SOUR:LFO:FREQ:MODE SWE
```

"Single" Sets a single sweep cycle. The sweep is triggered by the "Execute Single Sweep" button.

If a different sweep mode was activated prior to the "Single" mode, the current sweep is stopped. The "Single" sweep always starts at the start frequency.

The "Reset Sweep" button resets the sweep to the start frequency.

Example:

```
SOUR:LFO:SWE:FREQ:MODE AUTO
```

```
TRIG0:SWE:SOUR SING
```

```
SOUR:LFO:FREQ:MODE SWE
```

```
SOUR:LFO:SWE:FREQ:EXEC
```

"Step" Sets a step-by-step sweep cycle. Each sweep step is triggered by a variation of the value in the "Current Freq" entry window.

If this mode is activated, the cursor moves to the value displayed for "Current Freq". If a different sweep mode was activated prior to the "Step" mode, the current sweep is stopped. The "Step" sweep starts at the current LF frequency.

The "Reset Sweep" button resets the sweep to the start frequency.

Example:

```
SOUR:LFO:SWE:FREQ:MODE MAN
```

```
SOUR:LFO:FREQ:MODE SWE
```

```
SOUR:LFO:SWE:FREQ:SPAC LIN
```

```
SOUR:LFO:SWE:FREQ:STEP:LIN 1E34
```

```
SOUR:LFO:FREQ:MAN 12 kHz
```

The value entered with command

```
SOUR:LFO:SWE:FREQ:STEP:LIN|LOG
```

 sets the step width.

The value entered with command `SOUR:LFO:FREQ:MAN` has no effect, the command only sets the next sweep step. In remote control only a step-by-step sweep from start to stop frequency is possible

"Extern Single" Sets a single sweep cycle. The sweep is triggered by an external trigger signal.
If a different sweep mode was activated prior to the "Extern Single" mode, the current sweep is stopped. The "Extern Single" sweep always starts at the start frequency.
The external trigger signal is input at the BNC connector INST TRIG. The BNC connector INST TRIG is provided for Path A, and the pin INST TRIG B on the AUX I/O interface for Path B.
The "Reset Sweep" button resets the sweep to the start frequency.

Example:

```
SOUR:LFO:SWE:FREQ:MODE AUTO
```

```
TRIG0:SWE:SOUR EXT
```

```
SOUR:LFO:FREQ:MODE SWE (External trigger)
```

"Extern Step" Sets a step-by-step sweep cycle. Each sweep step is triggered by an external trigger signal (trigger source as described under "Extern Single"). The step width corresponds to the step width set for the rotary knob.
If a different sweep mode was activated prior to the "Extern Step" mode, the current sweep is stopped. The "Extern Step" sweep always starts at the LF start frequency.
The "Reset Sweep" button resets the sweep to the start frequency.

Example:

```
SOUR:LFO:SWE:FREQ:MODE AUTO
```

```
TRIG0:SWE:SOUR EXT
```

```
SOUR:LFO:FREQ:MODE SWE (External trigger)
```

"Extern Start/ Stop" Sets an automatically repeated sweep cycle that is started, stopped and restarted by subsequent external trigger events.
 The first external trigger signal starts the sweep (Start).
 The next external trigger signal stops the sweep at the current frequency (Stop).
 The third external trigger signal starts the sweep at the start frequency (Start).
 If a different sweep mode was activated prior to the "Extern Start/ Stop" mode, the current sweep is stopped and the "Extern Start/Stop" sweep starts at the start frequency when triggered.
 The "Reset" button resets the sweep to the start frequency.
 The external trigger signal is input at the BNC connector INST TRIG.

Example:

```
SOUR:LFO:SWE:FREQ:MODE AUTO
TRIG0:SWE:SOUR EAUT
SOUR:LFO:FREQ:MODE SWE (External trigger)
```

SCPI command:

[\[:SOURce\]:LFOutput:SWEep\[:FREQuency\]:MODE](#) on page 751
[:TRIGger<hw>\[:SWEep\]:SOURce](#) on page 810
[\[:SOURce\]:LFOutput:FREQuency:MODE](#) on page 749

Execute Single Sweep - LF Sweep

Triggers the sweep manually. A manual sweep can only be triggered if "Mode Single" is selected.

SCPI command:

[\[:SOURce\]:LFOutput:SWEep\[:FREQuency\]:EXECute](#) on page 751

Reset Sweep - LF Sweep

Resets the sweep. The start frequency is set and the next sweep starts from there.

SCPI command:

[\[:SOURce<hw>\]:SWEep:RESet\[:ALL\]](#) on page 792

Start Freq - LF Sweep

Sets the start frequency.

SCPI command:

[\[:SOURce\]:LFOutput:FREQuency:START](#) on page 749

Stop Freq - LF Sweep

Sets the stop frequency.

SCPI command:

[\[:SOURce\]:LFOutput:FREQuency:STOP](#) on page 750

Current Freq - LF Sweep

Displays the current frequency.

If "Step" is set, the frequency for the next frequency step of the sweep is entered here.

SCPI command:

[\[:SOURce\]:LFOutput:FREQuency:MANual](#) on page 748

Spacing - LF Sweep

Selects linear or logarithmic sweep spacing.

SCPI command:

[\[:SOURce\]:LFOutput:SWEep\[:FREQuency\]:SPACing](#) on page 753

Shape - LF Frequency Sweep

Selects the cycle mode for a sweep sequence (shape)

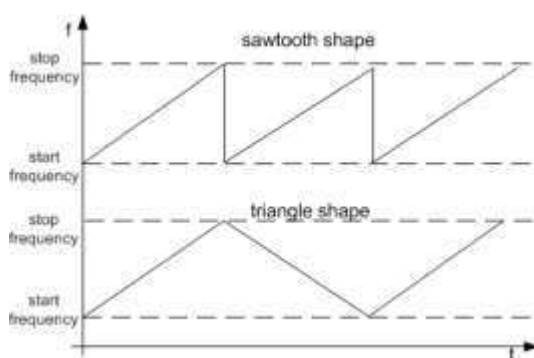

"Sawtooth" One sweep runs from start to stop frequency. Each subsequent sweep starts at the start frequency, i.e. the shape of the sweep sequence resembles a sawtooth.

"Triangle" One sweep runs from start to stop frequency and back, i.e. the shape of the sweep resembles a triangle. Each subsequent sweep starts at the start frequency.

SCPI command:

[\[:SOURce\]:LFOutput:SWEep\[:FREQuency\]:SHAPE](#) on page 753

Step Lin/Log - LF Sweep

Sets the step width for the individual sweep steps. This entry is effective for all sweep modes.

"Step Lin" or "Step Log" is displayed depending on whether "Spacing Lin" or "Log" is selected.

"Step Lin" With the linear sweep, the step width is a fixed frequency value which is added to the current frequency. The linear step width is entered in Hz.

SCPI command:

[\[:SOURce\]:LFOutput:SWEep\[:FREQuency\]:STEP\[:LINear\]](#) on page 753

"Step Log" With the logarithmic sweep, the step width is a constant fraction of the current frequency. This fraction is added to the current frequency. The logarithmic step width is entered in %.

SCPI command:

[\[:SOURce\]:LFOutput:SWEep\[:FREQuency\]:STEP:LOGarithmic](#) on page 754

Dwell Time - LF Sweep

Sets the dwell time. The dwell time determines the duration of the individual sweep steps.

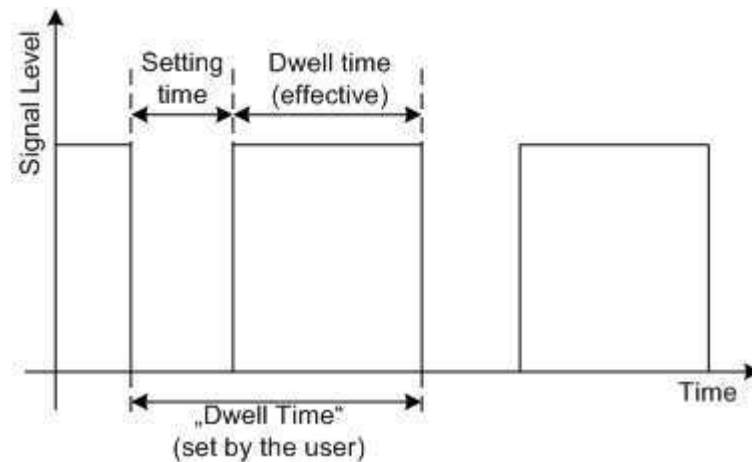

The "Dwell Time" set by the user is used as the step time of the sweep. The effective net dwell time is shorter, reduced by the setting time. This setting time may be greater than the time specified in the data sheet.

Note:

It is recommended to switch off the GUI update for optimum sweep performance especially with short dwell times (see [chapter 4.2.3.5, "Gui Update"](#), on page 132).

SCPI command:

`[:SOURce] :LFOutput :SWEep [:FREQuency] :DWELL` on page 751

Global Trigger/Clock Settings

Calls the "Global Trigger/Clock Settings" dialog. This dialog is used among other things for setting the polarity of the active slope of an applied instrument trigger.

In the case of two-path instruments this setting is valid for both paths. It affects the INST TRIG input (BNC connector at the rear of the instrument, instrument trigger for Path A) and the INST TRIG B input of the AUX I/O interface at the rear of the instrument, instrument trigger for Path B).

See [chapter 4.2.3.10, "Global Trigger/Clock/External Input Settings"](#), on page 136.

User Marker / AUX I/O

Calls the menu for configuring the AUX I/O and user interfaces (see [chapter 4.2.3.12, "User Marker / AUX I/O Settings"](#), on page 139).

The pin assignment of the AUX I/O interface is shown in the "User Marker / AUX I/O Configuration" menu; the assignment of the USER pins 2...4 and USER 1 BNC connector can be changed.

With two-path instruments, the current assignment to the respective path is given in addition to the pin assignment.

4.5.14 List Mode

Similar to a sweep, a series of previously defined frequency and level points is processed in List mode. In contrast to a sweep, however, a list with freely selectable value pairs (frequency and level) can be created. The value range for frequency and level covers the entire configurable value range of the instrument.



List mode and sweeps can not be activated simultaneously, they deactivate each other.

The lists can be created in the "List Editor". Each list is stored in its own file with the predefined file extension `*.lsw`. The name of the list file can be freely selected. The files are loaded from the "Lists..." file manager. Externally created tables with pairs of frequency and level values can be converted into List files using the import function. The external files must have the file extension `*.txt` or `*.csv`. These file formats are provided e.g. by the Microsoft®Excel program. The separators for table columns and for decimal floating-point numerals can be set. In addition, internally created List data can be exported into ASCII files using the export function.

The necessary hardware settings are calculated the first time a list is processed. With long dwell times, this calculation can be performed while the list is being processed; the entered dwell times are observed. With very short dwell times, calculation of the hardware settings increases the dwell time for the initial processing cycle; the entered value is only observed from the second processing cycle onwards. In this case a message appears to inform the user that there is a deviation between the current and set dwell times. No further calculations are required after the first run through a list. The current dwell times will definitely no longer deviate from the set dwell times.

The list is processed from the beginning to the end of the list (modes "Auto", ("External") "Single", ("External") "Step").

4.5.14.1 List Mode Dialog

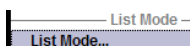

To open the "List Mode" menu, select "RF/A Mod > Configure > List Mode" or use the MENU key under "RF/A Mod".

The menu is used to activate/deactivate the operating mode List, to create, select and activate the lists, and to select the trigger mode and the dwell time.

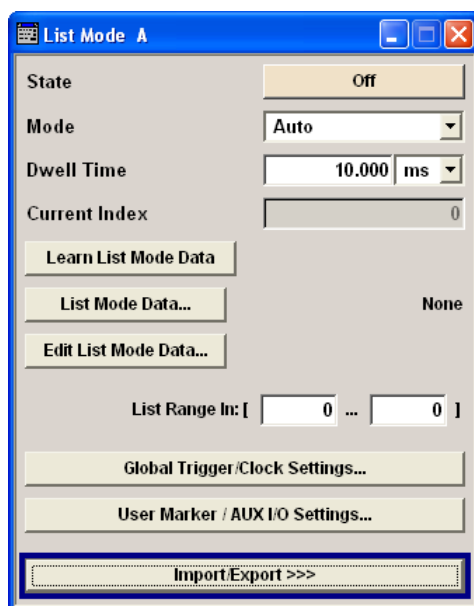

General Settings

State - List Mode

Activates/deactivates the List mode. The currently selected list is processed.

In case of a new or modified list, the necessary hardware settings are automatically determined on activation of the list mode. The data determined in this way is stored along with the list and is available whenever the list is used again.

This means that when activating the list mode, the system checks whether any hardware settings are present. If so, the list is started immediately, but if not they are automatically determined (the list is learnt).

A "Learn List Mode Data" button is available for deliberately activating list learning.

Note: Activating the list mode automatically deactivates all sweeps. During list mode the frequency and level indications do not display the currently set values.

SCPI command:

[:SOURce<hw>] :FREQuency:MODE on page 723

Attenuator Mode – List Mode with High Power Option

(High Power Option only)

Sets the ranges of level settings for the level sweep. The sweep is either performed in the low level (electronically switching attenuator) or in the high level (relay-switched high-power-bypass) ranges.

Parameter "Attenuator Mode" is only available when the instrument is equipped with the high-power output option, R&S SMU-B31 or R&S SMU-B36.

Note: An error message is generated and the best possible level is set if the level setting for the current sweep step is outside the selected range.

"Normal " The level settings for the level sweep are made in the area of the electronically switching attenuator. The high level ranges are not available.

"High Power " The level settings for the level sweep are made in the area of the option. Only the high level range is available.

SCPI command:

[:SOURce<hw>] :LIST:POWer:AMODE on page 765

Mode - List Mode

Selects the cycle mode of the List mode.

"Auto" Cycle from the beginning to the end of the list with automatic restart at the beginning. If a different mode was activated prior to the Auto mode, the cycle continues from the beginning of the list. The duration of a list step is determined by the set dwell time.

Button "Reset" restarts the list at the starting point.

"Single" Single cycle from the beginning to the end of the list. If "Single" is selected, the cycle is not started immediately. The "Execute Single" button appears under the "Mode" line. The cycle is started with this button. The duration of a list step is determined by the set dwell time. Button "Reset" restarts the list at the starting point.



"Step" Manual, step-by-step processing of the list. Activating "Step" stops the current list and the cursor moves to the value displayed for "Current Index". It is now possible to scroll up and down in the list in discrete steps by varying the index. The duration of a list step is determined by the time between two index entries.

Button "Reset" restarts the list at the starting point.



"Extern Single" Single cycle from the beginning to the end of the list as with "Single", but started by an external trigger. The external trigger signal is input at the BNC connector INST TRIG. The BNC connector INST TRIG is provided for Path A, and the pin INST TRIG B on the AUX I/O interface for Path B. Button "Reset" restarts the list at the starting point.

"Extern Step" Step-by-step cycle using the external trigger signal. Each trigger event starts a single step. The duration of a list step is determined by the time between two trigger events.

The external trigger signal is input at the BNC connector INST TRIG. The BNC connector INST TRIG is provided for Path A, and the pin INST TRIG B on the AUX I/O interface for Path B.

Button "Reset" restarts the list at the starting point.

SCPI command:

[:SOURce<hw>] :LIST:MODE on page 765

[:SOURce<hw>] :LIST:TRIGger:SOURce on page 767

Execute Single - List Mode

Triggers the list manually. This button is available only if mode "Single" is selected.

SCPI command:

[\[:SOURce<hw>\]:LIST:TRIGger:EXECute](#) on page 767

Reset - List Mode

Resets the list to the starting point.

SCPI command:

[\[:SOURce<hw>\]:LIST:RESet](#) on page 766

Dwell Time - List Mode

Enters the dwell time. The dwell time determines the duration of a list step in list operating modes "Auto", "Single" and "Extern Single". In these modes a complete list is processed either once or continuously.

In list operating modes "Step" and "Extern Step", the set dwell time does not affect signal generation. In this case, the duration of a list step is determined by the time between two (internal or external) trigger events.

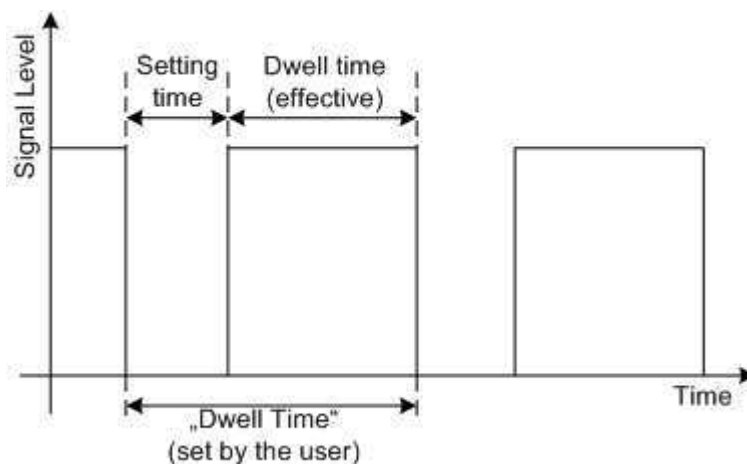

The "Dwell Time" set by the user is used as the step time of the list mode. The effective net dwell time is shorter, reduced by the setting time. This setting time may be greater than the time specified in the data sheet.

SCPI command:

[\[:SOURce<hw>\]:LIST:DWELL](#) on page 762

Current Index - List Mode

Sets the list index in "Step" mode.

SCPI command:

[\[:SOURce<hw>\]:LIST:INDEX](#) on page 763

Blank RF Output (Default ON) - List Mode

Activates/deactivates RF output blanking. If activated, blanking occurs on all frequency changes. If deactivated, blanking is always disabled.

SCPI command:

[:OUTPut<hw>:BLANK:LIST:STATE](#) on page 560

Learn List Mode Data... - List Mode

Starts the determination of the hardware setting for the selected list. The data determined in this way is stored along with the list.

It may be necessary to deliberately activate list learning in the event of greatly altered environmental conditions that require new hardware settings.

If this is not done, a previously learned hardware setting will continue to be used when list mode is switched on ("State = On"). If no setting is available, e.g. when the list is used for the first time, learning is automatically activated.

SCPI command:

`[:SOURce<hw>] :LIST:LEARn` on page 764

List Mode Data... - List Mode

Calls the "File Select" menu for selecting and creating a list or the "File Manager".



SCPI command:

`[:SOURce<hw>] :LIST:SElect` on page 766

`[:SOURce<hw>] :LIST:DElete` on page 757

`[:SOURce<hw>] :LIST:DElete:ALL` on page 757

Edit List Mode Data... - List Mode

Calls the editor for editing the selected list. A list consists of any number of frequency/level value pairs. The currently selected list is displayed.

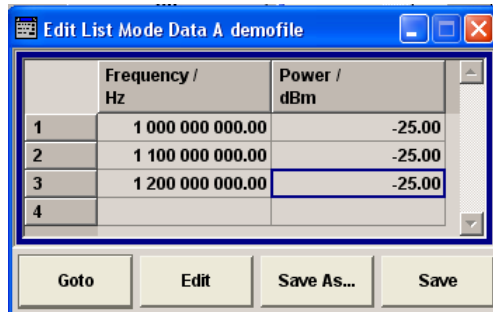

"Frequency / Hz" Enter the frequency of the frequency/power value pair.

SCPI command:

`[:SOURce<hw>] :LIST:FREQuency` on page 762

"Power /dBm" Enter the level of the frequency/power value pair.

SCPI command:

`[:SOURce<hw>] :LIST:POWer` on page 765

"Goto" Selects row for editing.



If "Goto row" is selected, a window opens for entering the requested row.

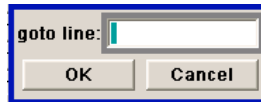

"Edit" Calls a selection of possible actions described below.



"Insert Row" Inserts a new row before the marked row.

"Insert Range" Inserts new rows before the marked row. The number of rows to be inserted can be defined in an entry window.

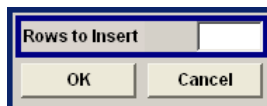

"Fill..." Opens a sub menu for defining a set of list values to be automatically entered in the List Mode table (see [chapter 4.5.14.2, "Filling the List Mode Data automatically"](#), on page 275).

"Delete Row" Deletes the marked row.

"Delete Range..." Allows to delete any number of rows starting with the marked row. The number of rows to be deleted can be defined in an entry window.

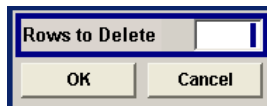

"Save as" Open the file menu to save the list under a new name. Each list is saved to the instrument's hard disk as a separate file with the file prefix *.lsw. The file name and the directory to which the file is saved are user-selectable.

"Save" The list is saved under its current name.

List Range In - List Mode

Defines an index range in the current list by setting the start and stop index. Only the values in the selected index range are processed in List mode, all other list entries are ignored.

SCPI command:

[:SOURce<hw>] :LIST:INDEX:START on page 763

[:SOURce<hw>] :LIST:INDEX:STOP on page 764

Global Trigger/Clock Settings

Calls the "Global Trigger/Clock Settings" dialog. This dialog is used among other things for setting the polarity of the active slope of an applied instrument trigger.

In the case of two-path instruments this setting is valid for both paths. It affects the INST TRIG input (BNC connector at the rear of the instrument, instrument trigger for Path A) and the INST TRIG B input of the AUX I/O interface at the rear of the instrument, instrument trigger for Path B).

See [chapter 4.2.3.10, "Global Trigger/Clock/External Input Settings"](#), on page 136.

User Marker / AUX I/O

Calls the menu for configuring the AUX I/O and user interfaces (see [chapter 4.2.3.12, "User Marker / AUX I/O Settings"](#), on page 139).

The pin assignment of the AUX I/O interface is shown in the "User Marker / AUX I/O Configuration" menu; the assignment of the USER pins 2...4 and USER 1 BNC connector can be changed.

With two-path instruments, the current assignment to the respective path is given in addition to the pin assignment.

Import/Export

Lists can be imported from externally created files or exported into text or CSV-files. The import/export settings are available after clicking the "Import/Export" button.

Import/Export - List Mode

Expands the menu with the area for import and export of list mode files.

Externally edited Excel tables with frequency/level pairs can be imported as text or CSV-files and used for list mode.

On the other hand, internally created list mode lists can be exported as text or CSV-files.

Mode - List Mode

Selects if list mode lists should be imported or exported. The settings offered below depend on the selected mode.

SCPI command:

[\[:SOURce<hw>\]:LIST:DEXChange:MODE](#) on page 761

Extension - List Mode

Selects the file extension of the ASCII file to be imported or exported. Selection TXT (text file) or CSV (Excel file) is available.

SCPI command:

[\[:SOURce<hw>\]:LIST:DEXChange:AFILe:EXTension](#) on page 758

Decimal Point - List Mode

Selects the decimal separator used in the ASCII data between '.' (decimal point) and ',' (comma) with floating-point numerals.

SCPI command:

[\[:SOURce<hw>\]:LIST:DEXChange:AFILe:SEParator:DECimal](#) on page 760

Column Separator- List Mode

Selects the separator between the frequency and level column of the ASCII table.

SCPI command:

[\[:SOURce<hw>\]:LIST:DEXChange:AFILe:SEParator:COLumn](#) on page 759

Select ASCII Source / Destination - List Mode

Calls the "File Manager" for selecting the ASCII file to be imported into a list mode list (source) or the ASCII file the list mode list is exported (destination) in.

SCPI command:

[\[:SOURce<hw>\]:LIST:DEXChange:AFILe:SElect](#) on page 759

Select Destination / Source - List Mode

Calls the "File Manager" for selecting the list mode list to be exported (source) into an ASCII file or the destination for the ASCII file to be imported (destination) in.

SCPI command:

[\[:SOURce<hw>\]:LIST:DEXChange:SElect](#) on page 761

Import / Export - List Mode

Starts the export or import of the selected file.

When import is selected, the ASCII file is imported as list mode list.

When export is selected, the list mode list is exported into the selected ASCII file.

SCPI command:

[\[:SOURce<hw>\]:LIST:DEXChange:EXECute](#) on page 760

4.5.14.2 Filling the List Mode Data automatically

The "Fill List Mode Data" menu enables you to automatically set the values in the List Mode table.

The start line and the number of rows to be filled are defined under "From" and "Range".

The column to be filled is selected under "Select column to fill". Depending on the selection here, the default for start, end, and increment value are set. As the settings are interdependent, a change of one parameter may result in the automatic change of one or more of the other parameters.

The filling of the column with the selected value settings is started with button "Fill".



The list entries are only computed when the "Fill" button is pressed.

From

Sets the start value of the index range.

SCPI command:

n.a.

Range

Sets the range for filling the table.

SCPI command:

n.a.

Select column to fill

Selects either the frequency or the level column to be filled with the value defined below.

SCPI command:

n.a.

Start value

Sets the start value for the frequency or the level entries.

SCPI command:

n.a.

End value

Sets the end value for the frequency or the level entries.

SCPI command:

n.a.

Increment value

Sets the increment for the frequency or the level entries.

SCPI command:

n.a.

Fill

Fills the selected column in the set range with values, starting with the start value and using the set increment.

SCPI command:

n.a.

4.6 I/Q Modulation - I/Q Mod Block

The R&S Signal Generator offers I/Q modulation with:

- external analog I/Q signals,
- external digital signals,
- internal digital signals.

Either the external analog signal (Path A only) or the externally or internally generated baseband signal (Path A and B) is fed into the I/Q modulator ("I/Q Mod A/B" function block).

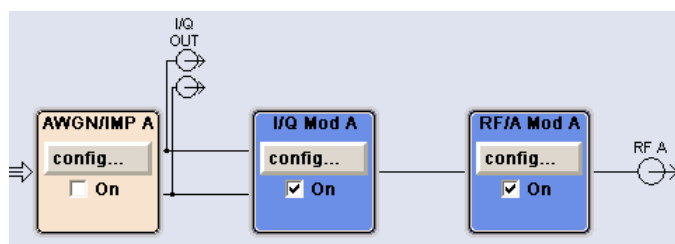
**Path A**

I/Q modulation with an external analog I/Q signal is possible for the basic unit (R&S SMU with frequency option R&S SMU-B10x) without additional equipment options.

The basic equipment configuration for generating an internal baseband signal includes the options R&S SMU-B13 (Baseband Main Module) and R&S SMU-B9/B10/B11 (Unicod and ARB).

Externally generated realtime baseband signals can be fed into the digital signal path via the digital interface (digital signals) or the analog inputs (analog signals) (Option R&S SMU-B17, Baseband Input).

Path B

External signals cannot be fed into the I/Q modulator. The second I/Q modulator is available if the option R&S SMU-B20x (Path B), a second R&S SMU-B13 option (Baseband Main Module), and one of the options R&S SMU-B9/B10/B11 (Baseband Generator),

R&S SMU-B17 (External Baseband Input) or R&S SMU-K62 (Noise Generator) are installed.

The external signal is input via the I and Q connector and transferred directly to the I/Q modulator of Path A (I/Q Mod function block).

The internally generated baseband signal is configured in the Baseband function block (see [chapter 4.8, "Baseband Signal - Baseband Block"](#), on page 323). Before the signal is fed into the I/Q modulator, noise can be added and/or the signal can be impaired. Impairment at this point along the signal flow is offered to allow a signal to be output at the I/Q-OUT outputs (a signal which, for example, compensates signal distortion in a connected test object (DUT)).

Prior to impairing and noise adding, the signal can also be faded in the Fading function block.

Impairment is integrated in the basic unit. The generation of noise requires the option R&S SMU-K62 (AWGN).

In the case of two-path instruments, the baseband signals of both paths can be added with or without frequency offset.

Impairments can also be set in the I/Q Mod menu to allow an externally applied analog I/Q signal to be impaired. An internal baseband signal can thus be impaired both digital (in the Impairment block in the Impairment menu) and analog in the I/Q modulator. If impairments are set in both menus, they superimpose each other in the signal.

4.6.1 I/Q Modulator

To select the input signal of the I/Q modulator and to open the "I/Q Settings" menu, select "I/Q Mod > Configure".

The "I/Q Settings" menu containing the modulation settings is opened in the top section (see [chapter 4.6, "I/Q Modulation - I/Q Mod Block"](#), on page 277).

Use the the "I/Q Mod In" section to select the input signal:

- select "Analog Wideband I/Q In", if the external analog signal is fed into the I/Q modulator.
The maximum available RF bandwidth is described in the instruments specifications (see data sheet).
- select "Internal Baseband I/Q In", if the internally generated baseband signal is used.
The RF bandwidth is reduced (see data sheet).
- select "Internal Baseband I/Q In", in case the external analog signal fed into the digital signal path.
The RF bandwidth is reduced (see data sheet).

Alternatively, the input signal can be selected in the "I/Q Settings" menu (see [chapter 4.6, "I/Q Modulation - I/Q Mod Block"](#), on page 277).

4.6.2 I/Q Settings

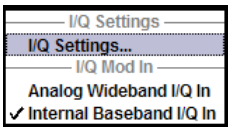

To open the menu for setting the I/Q modulation parameters, select "I/Q Mod > Configure > I/Q Settings" or use the MENU key.



System error correction of the I/Q modulator permits precise and repeatable measurements. The correction routine should be called in the case of temperature fluctuations of several degrees. To call the routine, press the SETUP key and select "System > Internal Adjustment " and execute the desired adjustment procedure.

It is not possible to activate an I/Q modulation with an external analog signal ("Analog Wideband I/Q In") simultaneously with:

- AM,
- digital modulation,
- digital standards,
- fading,
- external baseband input,
- noise,
- arbitrary waveform generation and
- multi carrier CW

I/Q modulation is activated and the source entered in the top section of the menu.

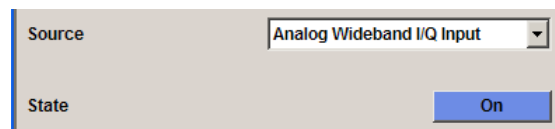

I/Q impairment for specific impairment of the I/Q modulation is set in the "Impairments" section.

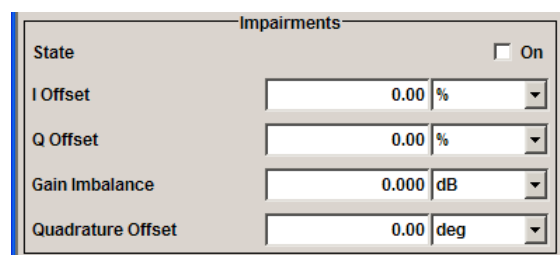

I/Q control can be swapped in the lower section of the menu and the optimized settings for wideband modulation signals can be activated.



The bottom section of the menu differs depending on the selected input signal ("Analog Wideband I/Q Input" or "Internal Baseband").

The crest factor is input for the external signal.

The gain is selected for the internal and external signal.

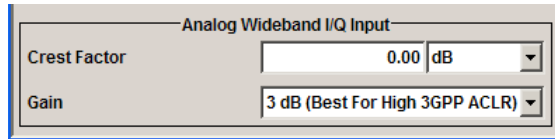

4.6.2.1 General I/Q Mod Settings

IQ Source - I/Q Mod

Selects the input signal for the I/Q modulator.

This selection is only available for path A.

"Analog Wideband I/Q In" Selects an external analog signal as the input signal. The signal must be applied at the inputs I and Q.

"Internal Baseband I/Q In" Selects the internal baseband signal as the input signal. This setting requires the additional equipment options for generating the various baseband signals.

SCPI command:

`[:SOURce<hw>] : IQ : SOURce` on page 734

State - I/Q Mod

Activates/deactivates I/Q modulation.

If "Analog Wideband I/Q In" is selected, the I/Q modulator is also deactivated and activated.

If "Internal Baseband I/Q In" is selected, the I/Q modulator is always activated automatically as soon as signal generation is activated in the "Baseband" block. It can, however, be deactivated later, e.g. if only the baseband signal which is output at the I/Q outputs is relevant.

SCPI command:

`[:SOURce<hw>] : IQ : STATE` on page 735

4.6.2.2 Impairments

I/Q impairment for specific impairment of the I/Q modulation is set in the "Impairments" section.

State - Impairments I/Q Mod

Activates/deactivates I/Q impairment.

If activated, the settings for leakage, I/Q imbalance and quadrature offset become effective.

Whether or not I/Q impairment is activated is indicated in the function block.

Note: It is advisable to switch automatic level control to the Sample&Hold mode, as otherwise level errors may occur (see [chapter 4.5.8, "Automatic Level Control - ALC"](#), on page 221).

SCPI command:

`[:SOURce<hw>] :IQ:IMPairment [:STATe]` on page 734

Offset - I/Q Mod

Sets the carrier offset (in percent) of the amplitudes (scaled to the peak envelope power (PEP) for the I and/or Q signal component).

An ideal I/Q modulator suppresses the carrier offset completely (offset = 0 percent). If an offset value is entered for a component, a carrier offset with fixed amplitude is added to the signal. In the diagram, all I values or Q values are offset by a fixed amplitude value depending on the entered percentage.

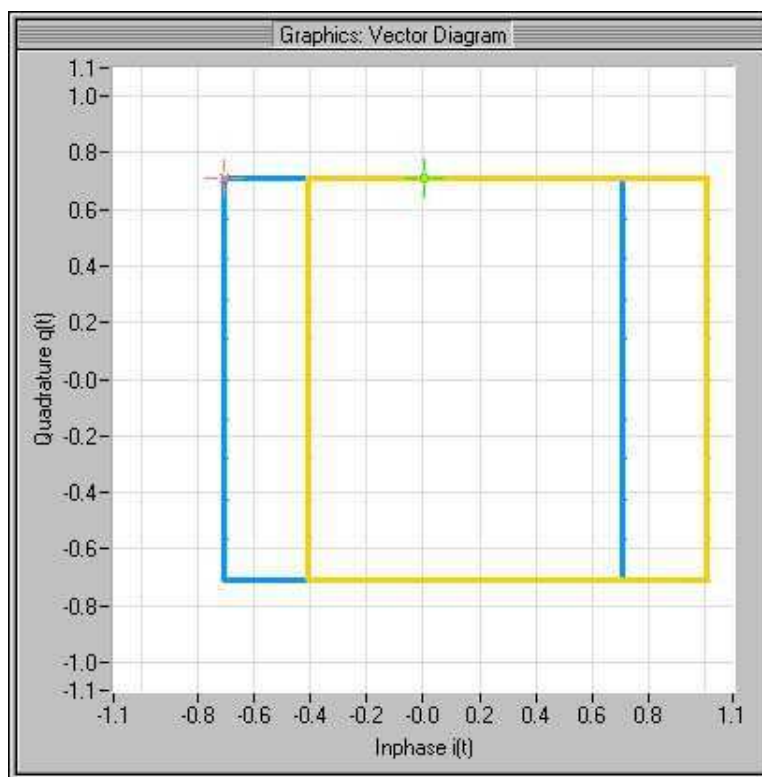

Fig. 4-9: Effect of offset for the I component

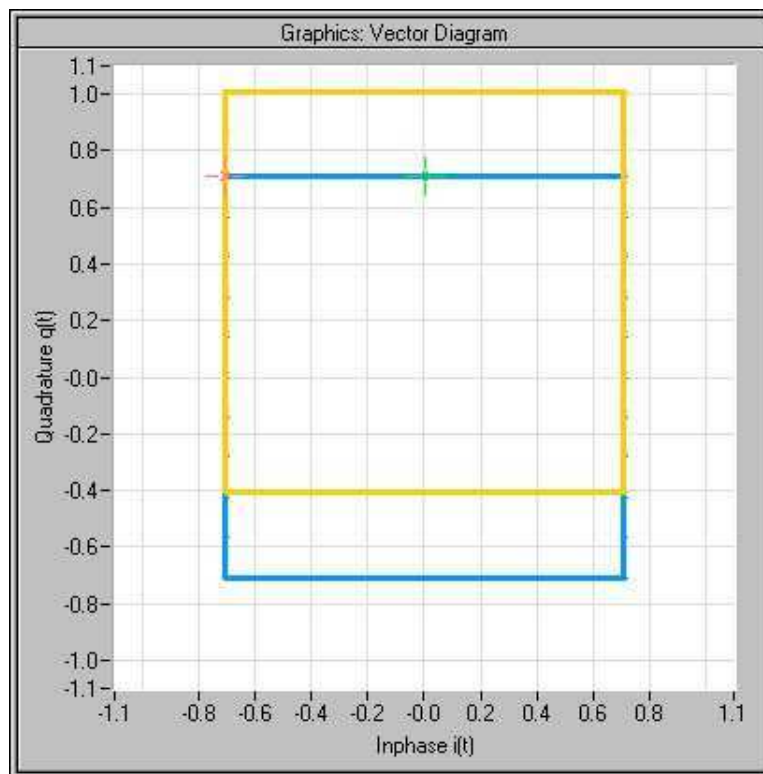

Fig. 4-10: Effect of offset for the Q component

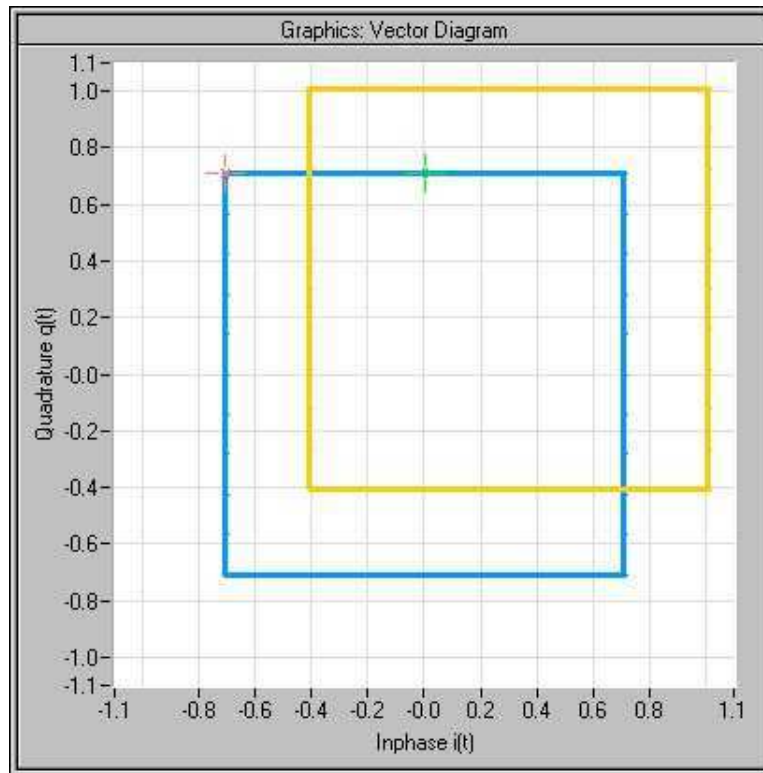

Fig. 4-11: Effect of an identical offset for both signal components

SCPI command:

`[:SOURce<hw>] :IQ:IMPairment:LEAKage:I` on page 733

`[:SOURce<hw>] :IQ:IMPairment:LEAKage:Q` on page 734

Gain Imbalance - I/Q Mod

Sets the imbalance of the I and Q vector.

The entry is made in dB (default) or %, where 1 dB offset is roughly 12 % according to the following:

$$\text{Imbalance [dB]} = 20 \log (| \text{GainQ} | / | \text{GainI} |)$$

An ideal I/Q modulator amplifies the I and Q signal path by exactly the same degree. The imbalance corresponds to the difference in amplification of the I and Q channel and therefore to the difference in amplitude of the signal components. In the vector diagram, the length of the I vector changes relative to the length of the Q vector.

Positive values mean that the Q vector is amplified more than the I vector by the corresponding percentage.

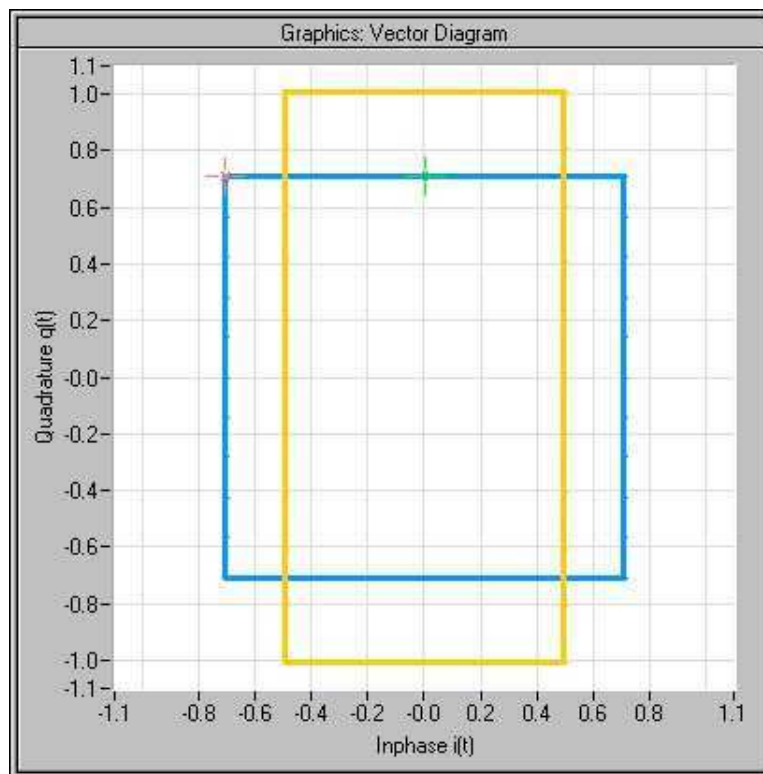

Fig. 4-12: Effect of a positive gain imbalance

Negative values mean that the I vector is amplified more than the Q vector by the corresponding percentage:

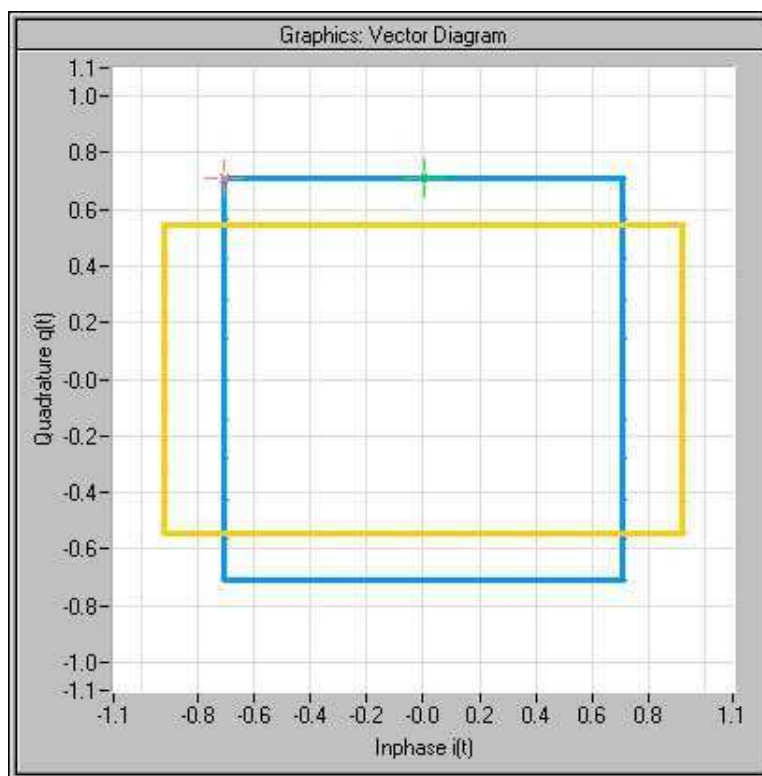

Fig. 4-13: Effect of a negative gain imbalance

SCPI command:

`[:SOURce<hw>] :IQ:IMPairment:IQRatio[:MAGNitude]` on page 733

Quadrature Offset - I/Q Mod

Sets the quadrature offset.

An ideal I/Q modulator sets the phase angle to exactly 90 degrees. With a quadrature offset, the phase angle between the I and Q vector deviates from the ideal 90 degrees, the amplitudes of both components are of the same size. In the vector diagram, the quadrature offset causes the coordinate system to shift.

A positive quadrature offset means a phase angle greater than 90 degrees:

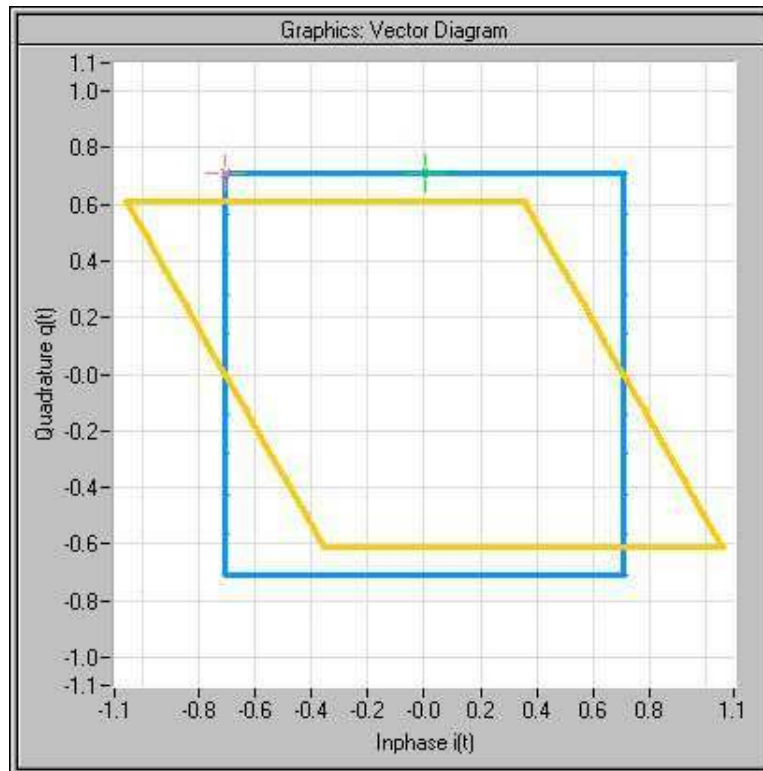

Fig. 4-14: Effect of a positive quadrature offset

A negative quadrature offset means a phase angle less than 90 degrees:

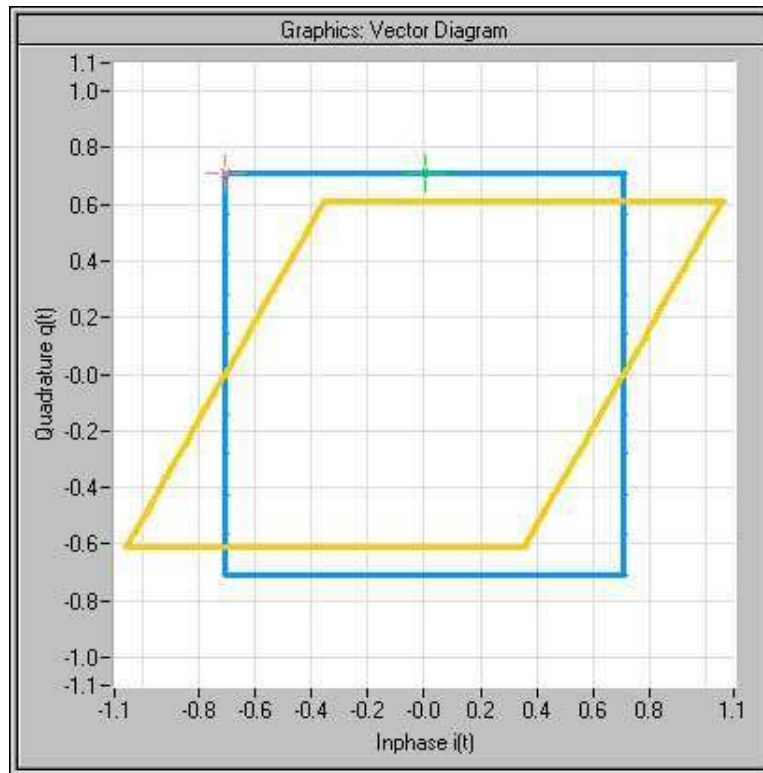

Fig. 4-15: Effect of a negative quadrature offset

SCPI command:

`[:SOURce<hw>] :IQ:IMPairment:QUADrature: [ANGLE]` on page 734

4.6.2.3 I/Q Swap and I/Q Wideband

The I/Q control can be swapped and the optimized setting for wideband signals can be selected in the middle section of the menu.

I/Q-Swap - I/Q Mod

Selects normal or swapped I/Q control for an external analog signal. The modulation sidebands are inverted by swapping the I and Q signals.

This parameter enables I/Q modulation to be performed on signals according to IS2000 (cdma2000 standard) and the majority of all other standards. As a result, an I/Q demodulator defined according to IS2000 can also be used for demodulating the generated signals.

The I/Q modulator defined in the IS2000 standard differs from the definition in the R&S Signal Generator. The definition on which the R&S Signal Generator is based is used by virtually all digital communication standards (except IS95 and IS2000).

In the final step, the filtered I/Q signal is modulated to the desired RF in a different way in the I/Q modulator:

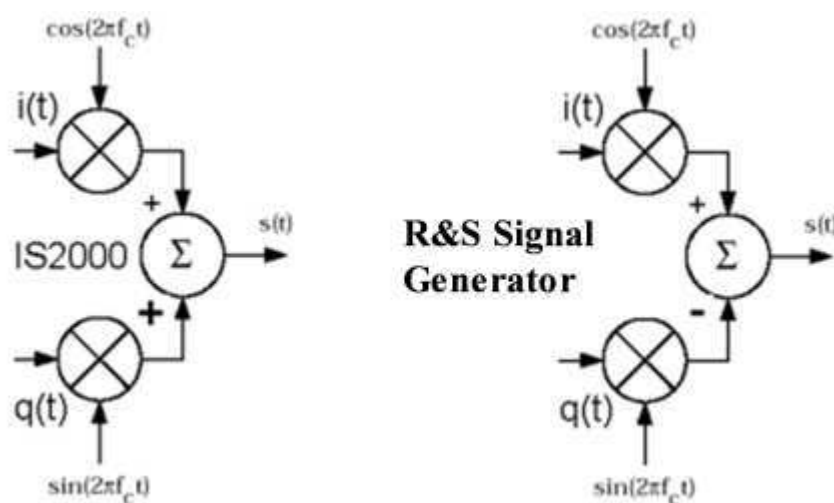

Fig. 4-16: Definition of I/Q modulator in IS2000 and R&S Signal Generator *f*

According to IS2000, the RF signal $s(t)$ is derived from the baseband I/Q signal as follows:
 $s(t) = i(t)\cos(2\pi f_c t) + q(t)\sin(2\pi f_c t)$

The instrument family is based on the following definition:

$$s(t) = i(t)\cos(2\pi f_c t) - q(t)\sin(2\pi f_c t)$$

"I/Q Swap" must now be set to "On" so that an I/Q modulator defined according to IS2000 can cope with the RF signal generated by the R&S Signal Generator.

"Off" I/Q control is normal.

"On" The I and Q signals are swapped.

SCPI command:

[\[:SOURce<hw>\]:IQ:SWAP\[:STATe\]](#) on page 735

I/Q-Wideband - I/Q Mod

Optimized setting for wideband modulation signals (>5 MHz). Optimized setting for wideband modulation signals (>5 MHz).

The modulation frequency response is decreased at the expense of poorer harmonic suppression. This is achieved by shifting the switching frequencies of the lowpass filters in the output section.

SCPI command:

[\[:SOURce<hw>\]:IQ:WBState](#) on page 735

4.6.2.4 Analog Wideband I/Q Input

In the bottom section of the menu the crest factor is input for the external signal and the gain is selected for the internal and external signal ("Analog Wideband I/Q Input" or "Internal Baseband").

Crest Factor - I/Q Mod

(Analog Wideband I/Q Input only)

Sets the crest factor of the external analog signal.

The crest factor gives the difference in level between the peak envelope power (PEP) and average power value (RMS) in dB.

This value is necessary to allow the correct output power to be generated at the RF output. When the set output power is generated, the R&S Signal Generator uses this value to compensate the average power which is lower compared to the peak power.

The maximum input voltage at the I/Q input is equated to the peak power and is used as the "reference" for setting the level of the output signal. Since the signal does not usually supply the peak power at a constant level and instead supplies a lower average power, the crest factor specifies how many dB have to be added internally so that the correct output power is achieved.

Note: The crest factor of vector modulation for an external signal that is fed into the baseband path is entered in the "Baseband Input" menu ("BB Input block", option R&S SMU-B17).

See also [chapter 4.9, "External Baseband Signal - Baseband Input"](#), on page 445.

SCPI command:

`[:SOURce<hw>] :IQ:CREStfactor` on page 732

Baseband Gain-Gain - I/Q Mod

Optimizes the modulation of the I/Q modulator for any measurement requirement.

The modulation is determined by selecting the gain.

Note:

The remote-control commands to be used depend on the selected I/Q input signal (`SOURce:IQ:SOURce ANALog | BAsEband`).

- For the Analog Wideband I/Q input signal, the commands of system `SOURce:IQ:GAIN` are valid.
- For the internal or external Baseband I/Q input signal (`SOURce:IQ:SOURce BAsEband`), the commands of system `SOURce:BB:IQGain` are valid.

"Auto"	(digital baseband signal only) With this setting, the modulation is automatically optimized for the internally set baseband signal.
"- 3dB (Low Distortion)"	Activates -3 dB gain. With this setting, signal distortions are minimized.
"0 dB (Standard)"	Activates 0 dB gain
"3 dB (High 3GPP ACLR)"	Activates 3 dB gain. This setting is recommended for 3GPP signals with very high adjacent channel power ratio (ACPR).
"6dB (Low Noise)"	Activates 6 dB gain. With this setting, signal noise is minimized.

SCPI command:

`[:SOURce<hw>] :IQ:GAIN` on page 732 (for analog I/Q signal)

`[:SOURce<hw>] :BB:IQGain` on page 736 (for digital I/Q signal)

4.7 Impairment of Digital I/Q Signal and Noise Generator - AWGN/IMP Block

The R&S SMU allows the digital I/Q signal to be impaired before it is passed on to the I/Q modulator, and also noise to be added to the signal. The noise generator can also be used to generate a pure noise signal.

These settings are available in the block diagram in the "AWGN/IMP" function block as well as in the menu with the same name which is opened using the MENU key.

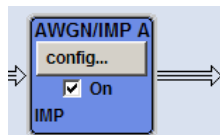

The equipment options for the basic unit (R&S SMU with frequency option R&S SMU-B10x) include the option R&S SMU-B13 (Baseband Main Module) for Impairments and the option R&S SMU-K62 (Noise Generator) for "AWGN".

Two-path instruments require a second RF path (option R&S SMU-B20x) and a second R&S SMU-B13 option (Baseband Main Module) for impairment of a signal on Path B. Noise can be generated alternately for both paths using an option R&S SMU-K62 (Noise Generator). Simultaneous noise generation on both paths requires a second option.

In case of two-path instruments, the output connectors can be assigned either to path A or path B.

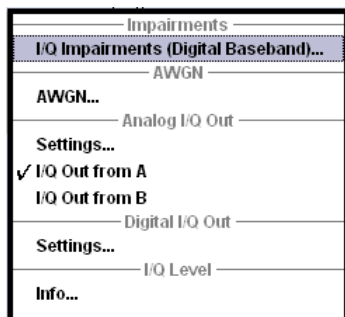

Selecting the menu item "I/Q Impairments (Digital Baseband)..." opens the I/Q impairment settings dialog. This dialog covers the settings for I/Q impairment, like carrier leakage, imbalance and quadrature offset.

To access the AWGN settings, select "AWGN...". This dialog contains the settings of the RFI signal generator, noise level configuration and CW interfering parameters.

Selecting the menu item "I/Q Out Settings" opens a dialog with the parameters for the I/Q output signal.

The "I/Q Out Settings" dialog is available for analog and digital I/Q output signals. These dialogs are accessible under the menu sections with the corresponding names.

In case of two-path instruments, the analog I/Q output signal can be assigned either to path A or path B.

The settings for the digital I/Q output signal are available for path A only.

"Info..." opens a dialog, displaying information on the baseband signal level.

The single ended or differential output requires option R&S SMU-B16, Differential Output.

4.7.1 Impairments

Impairment of the digital I/Q signal can be used, for example, to compensate the distortion of a test object or to check the effect of a disturbed signal on a test object. For this purpose, the I/Q signal can be output at the I/Q OUT outputs. On the other hand, the I/Q impairments used internally for compensating signal distortion can be deactivated by the I/Q modulator in order to, for example, test its own baseband components.

Equipped with the **R&S SMU RF and Baseband Correction Toolkit** (option R&S SMU-K63) signal distortion of the I/Q signal output or, deterioration in the quality of modulation or the spectral properties of multi carrier signals can be corrected. The correction data are created by Matlab software and stored on the instrument's hard disk.

For two path instruments, equipped with two baseband main modules (option R&S SMU-B13) and two RF paths, a second option R&S SMU-K63 is required for signal correction in the second path.



In addition to impairment of the digital I/Q signal, the R&S SMU also allows impairment of the analog signal to be set in the I/Q modulator. The relevant settings are made in the I/Q Mod function block (see [chapter 4.6, "I/Q Modulation - I/Q Mod Block"](#), on page 277).

4.7.1.1 Impairment Settings Menu

To access the "Impairment Settings" menu for setting the digital I/Q impairments, select "AWGN/IMP > Configure > I/Q Impairments" or use the MENU key under "AWGN/IMP".

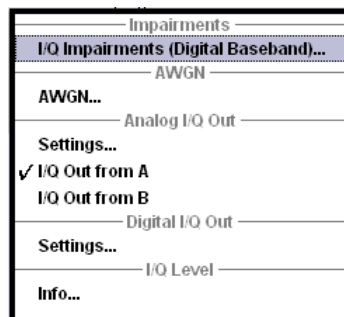

I/Q impairment is activated and set in the "I/Q Impairments" section.

Impairment of Digital I/Q Signal and Noise Generator - AWGN/IMP Block

I/Q Impairments	
State	<input type="button" value="On"/>
I Offset	0.00 %
Q Offset	0.00 %
Gain Imbalance	0.000 dB
Quadrature Offset	0.00 deg

"Internal compensation" of signal distortions of the RF output can be activated / deactivated.

<input checked="" type="checkbox"/> Optimize Internal I/Q Impairments For RF Output
Optimization Mode: Fast

Correction Files for user defined correction of the RF output, supported by the **R&S SMU RF and Baseband Correction Toolkit** (option R&S SMU-K63) can be loaded in the lower section of the dialog box.

The R&S SMU-K63 File Info section displays header information on the loaded frequency response correction file.

Optimization Mode	User Correction
Load Correction File...	...T153607_A_Resp_Norm_1500-1800MHz_m10-10dBm
Correction File Status	OK

Correction File Info	
Type	RF Image
Accuracy	Normal
Frequency Range	1.500 0 GHz ... 1.800 0 GHz
Level Range	-10 dBm ... 10 dBm
Include ATT Fixed	Off
External Devices	On
Bandwidth	5 MHz
Frequency Offset	0 Hz
Level Offset	10 dB

I/Q Impairments

In the "I/Q Impairments" section the parameters for carrier leakage, imbalance and quadrature offset can be set and I/Q impairment is activated.

State - Digital Impairments

Activates/deactivates digital I/Q impairment.

When activated, the settings for carrier leakage, I/Q imbalance and quadrature offset become effective.

Internal predistortion for compensating the I/Q modulator is not influenced by this setting.

SCPI command:

`[:SOURce<hw>] :BB:IMPairment:STATe` on page 675

I/Q Offset - Digital Impairments

Sets the carrier leakage (in percent) of the amplitudes (scaled to the peak envelope power (PEP)) for the I and/or Q signal component.

An ideal I/Q modulator suppresses the carrier leakage completely (offset = 0 percent). If an offset is entered for a component, a carrier leakage with fixed amplitude is added to the signal. In the diagram, all I values or Q values are offset by a fixed amplitude value depending on the entered percentage.

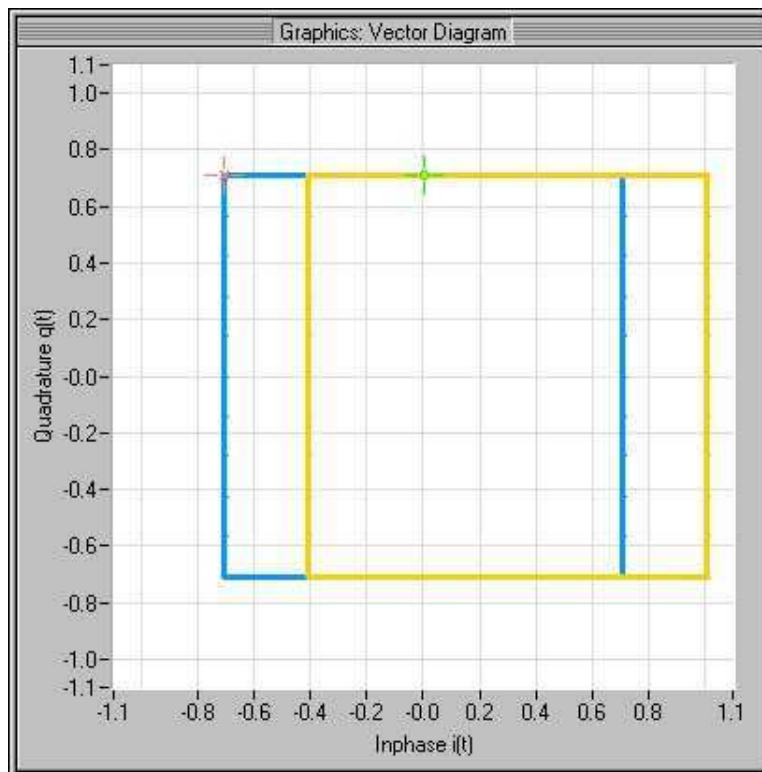

Fig. 4-17: Effect of offset for the I component

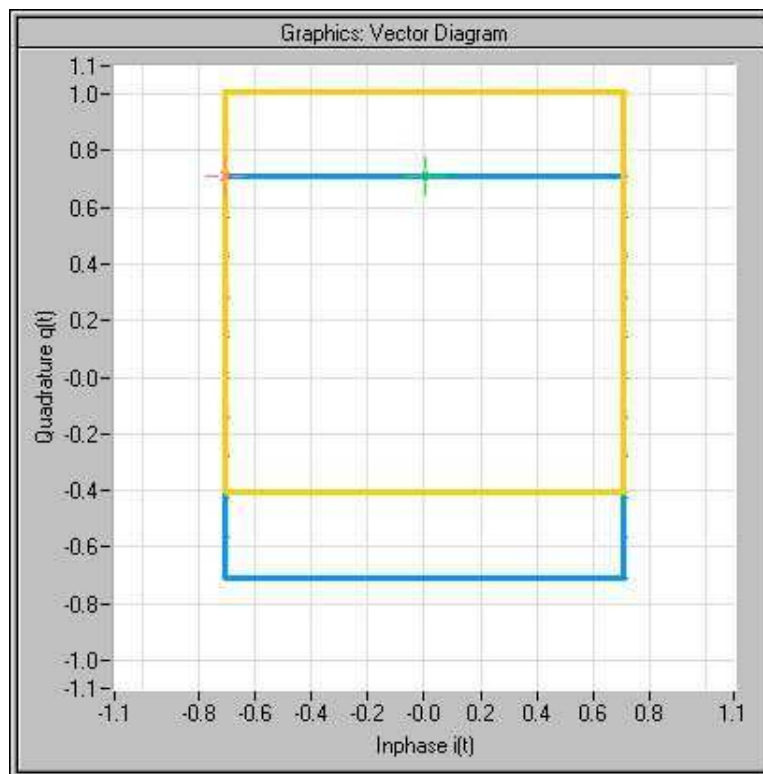

Fig. 4-18: Effect of offset for the Q component

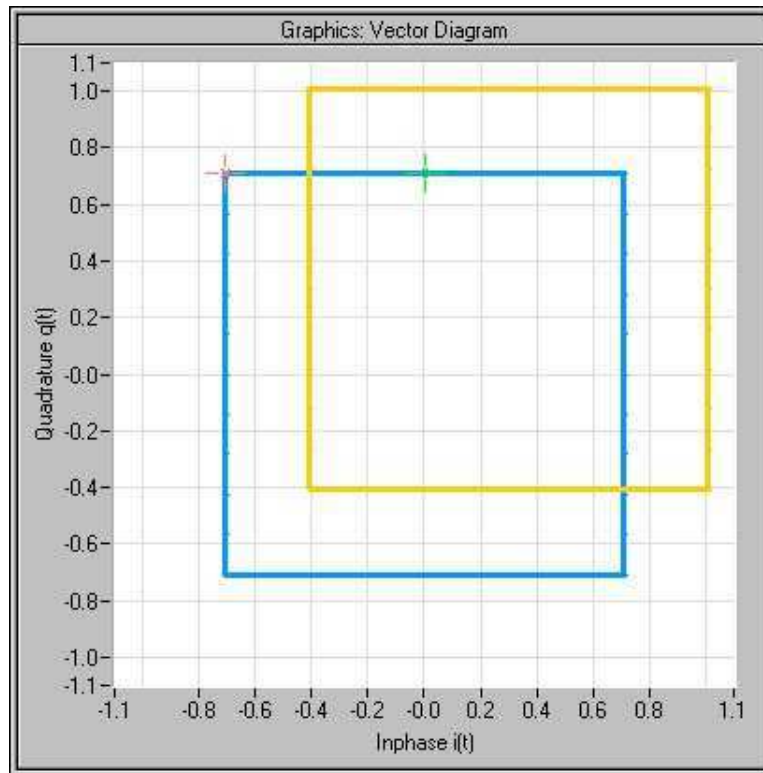

Fig. 4-19: Effect of an identical offset for both signal components

SCPI command:

`[:SOURce<hw>] :BB:IMPairment:LEAKage:I` on page 668

`[:SOURce<hw>] :BB:IMPairment:LEAKage:Q` on page 668

Gain Imbalance - Digital Impairments

Sets the imbalance of the I and Q vector.

The entry is made in dB (default) or %, where 1 dB offset is roughly 12 % according to the following:

$$\text{Imbalance [dB]} = 20 \log (| \text{GainQ} | / | \text{GainI} |)$$

An ideal I/Q modulator amplifies the I and Q signal path by exactly the same degree. The imbalance corresponds to the difference in amplification of the I and Q channel and therefore to the difference in amplitude of the signal components. In the vector diagram, the length of the I vector changes relative to the length of the Q vector.

Positive values mean that the Q vector is amplified more than the I vector by the corresponding percentage.

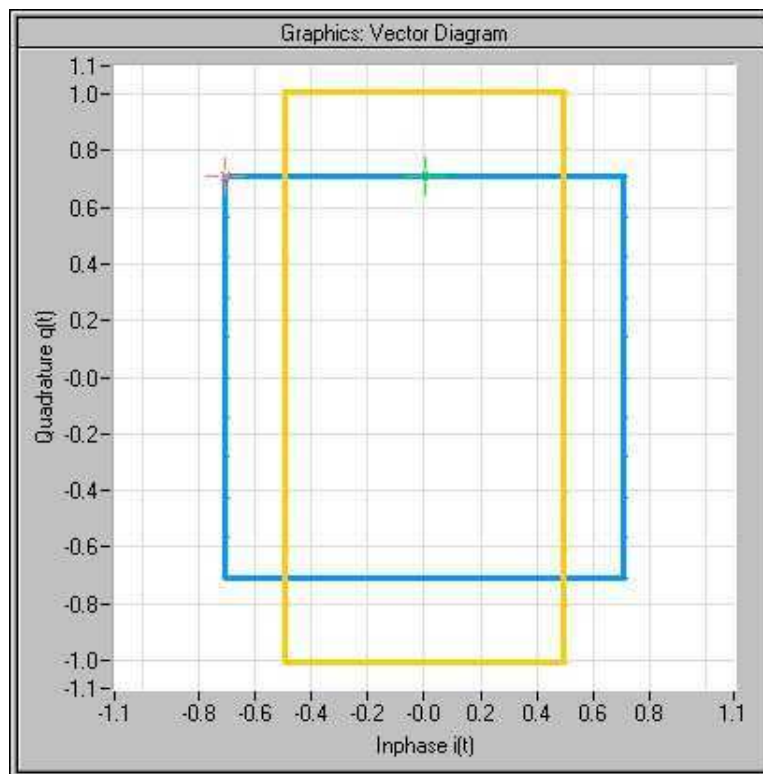

Fig. 4-20: Effect of a positive gain imbalance

Negative values mean that the I vector is amplified more than the Q vector by the corresponding percentage:

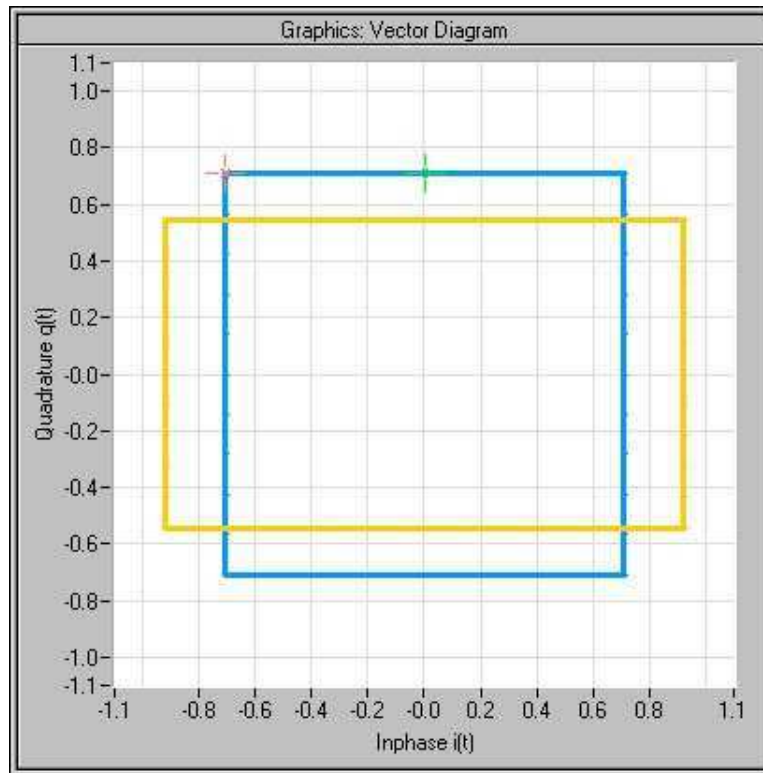

Fig. 4-21: Effect of a negative gain imbalance

SCPI command:

[\[:SOURce<hw>\]:BB:IMPairment:IQRatio](#) on page 668

Quadrature Offset - Digital Impairments

Sets the quadrature offset.

An ideal I/Q modulator sets the phase angle to exactly 90 degrees. With a quadrature offset, the phase angle between the I and Q vector deviates from the ideal 90 degrees, the amplitudes of both components are of the same size. In the vector diagram, the quadrature offset causes the coordinate system to shift.

A positive quadrature offset means a phase angle greater than 90 degrees:

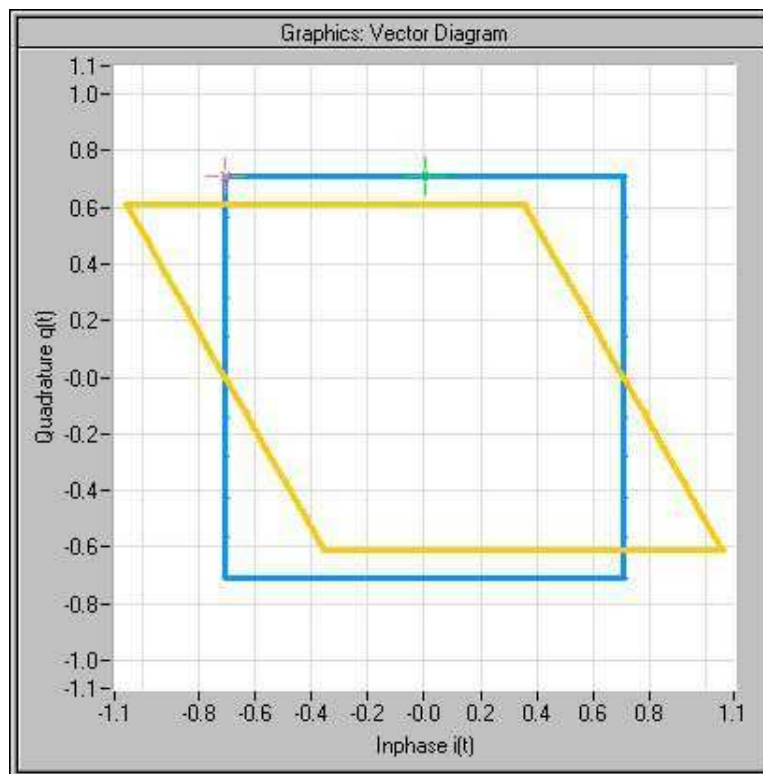

Fig. 4-22: Effect of a positive quadrature offset

A negative quadrature offset means a phase angle less than 90 degrees:

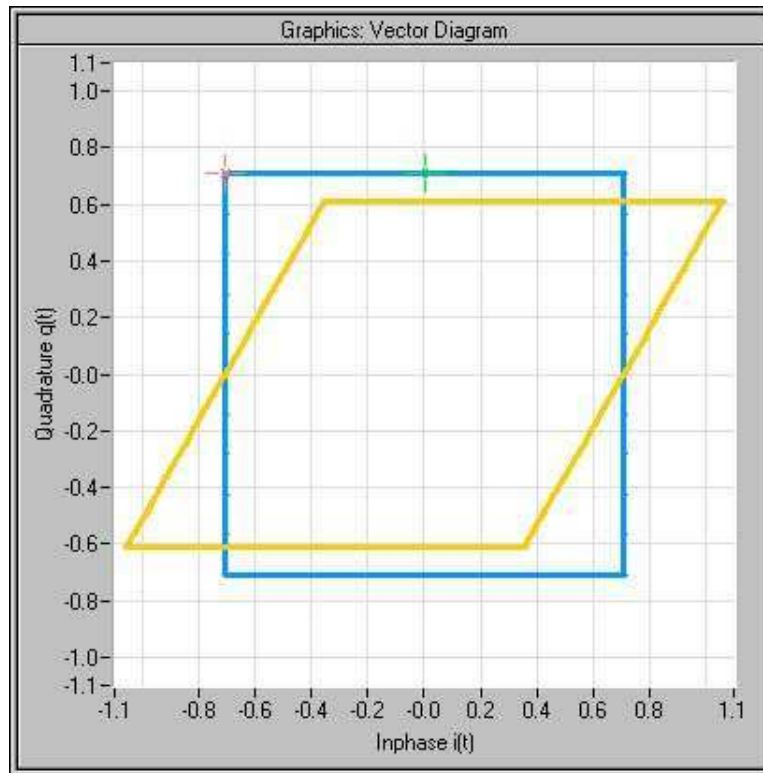

Fig. 4-23: Effect of a negative quadrature offset

SCPI command:

`[:SOURCE<hw>] :BB:IMPAirment:QUADrature [:ANGLE]` on page 675

Internal Compensation

"Internal compensation" of signal distortions "of the RF output "can be activated / deactivated.

Optimize internal IQ-Impairments for RF Output - Digital Impairments

Activates or deactivates internal compensation of signal distortions of the RF output. Signal distortions can be either optimized for the RF output (active) or for the differential I/Q output (not active).

SCPI command:

`[:SOURCE<hw>] :BB:IMPAirment:OPTimization:STATe` on page 669

Optimization Mode - Digital Impairments

Selects the optimization mode.

- "Fast" Optimization is reached by compensation for I/Q skew.
- "High Quality" Optimization is reached by compensation for I/Q skew and frequency response correction.

"User Correction" **Note:** User correction can be operated if the instrument is equipped with an R&S SMU-K63.

Optimization is reached by data generated with the **R&S SMU RF and Baseband Correction Toolkit**.

SCPI command:

`[:SOURce<hw>] :BB:IMPairment:OPTimization:MODE` on page 669

Frequency Response Correction

Correction Files for **user defined correction of the RF output**, supported by the R&S SMU RF and Baseband Correction Toolkit (option R&S SMU-K63) can be loaded in the lower section of the dialog box.

The R&S SMU K63 File Info section displays header "information on" the loaded "frequency response correction file".

Load Correction File... - I/Q Impairments (Digital Baseband)

Opens the standard file dialog box used to load and store lists or data, i.e. in this particular case files containing correction data. Each file is stored with the predefined file extension `*.frc` (Frequency Response Correction). The standard directory for frequency correction files is `D:\SMxRFandBBCorrectionToolKit\SMxK63`.

Note: The frc parameters get values from this file. If the file is not existing or corrupted the info parameters will not be updated. An error message is displayed in the info line of the status bar. If no further user correction file is loaded the default corrections will be applied in high quality mode.

SCPI command:

`[:SOURce<hw>] :BB:IMPairment:OPTimization:UCORrection:FILE`

on page 671

Correction File Status - I/Q Impairments (Digital Baseband)

Displays whether the frequency response correction file `*.frc` could be loaded properly.

"OK"	File type and data of the correction file are ok. The file can be used for frequency response correction.
"Missing"	File not found. Error message, displayed in the info line: "There are no valid data available for optimization mode "high quality". Therefore an optimization is NOT possible."
"Incompatible"	The file is not compatible with the instrument or the path and could not be loaded. Error message, displayed in the info line: "The selected frequency response correction file is incompatible - due to wrong device and serial number and path".
"Corrupt"	The frequency response correction data is corrupt and the file could not be loaded.

SCPI command:

`[:SOURce<hw>] :BB:IMPairment:OPTimization:UCORrection:FILE:STATus`

on page 671

Correction File Info - I/Q Impairments (Digital Baseband)

Displays the most important header information on the loaded frequency response correction file.

Correction File Info	
Type	RF Image
Accuracy	Normal
Frequency Range	1.500 0 GHz ... 1.800 0 GHz
Level Range	-10 dBm ... 10 dBm
Include ATT Fixed	Off
External Devices	On
Bandwidth	5 MHz
Frequency Offset	0 Hz
Level Offset	10 dB

"Type" Displays the type of the baseband frequency response correction data.

SCPI command:

```
[ :SOURce<hw> ] :BB:IMPairment:OPTimization:UCORrection:TYPE
```

on page 675

"Accuracy" Displays the accuracy of the baseband frequency response correction data.

SCPI command:

```
[ :SOURce<hw> ] :BB:IMPairment:OPTimization:UCORrection:ACCuracy
```

on page 669

"Frequency Range" Displays the frequency range (maximum and minimum frequency values) of the baseband frequency response correction data.

SCPI command:

```
[ :SOURce<hw> ] :BB:IMPairment:OPTimization:UCORrection:FREQuency:
```

MAX on page 672

```
[ :SOURce<hw> ] :BB:IMPairment:OPTimization:UCORrection:FREQuency:
```

MIN on page 672

"Level Range" Displays the level range (maximum and minimum level values) of the baseband frequency response correction data.

SCPI command:

```
[ :SOURce<hw> ] :BB:IMPairment:OPTimization:UCORrection:LEVel:MAX
```

on page 674

```
[ :SOURce<hw> ] :BB:IMPairment:OPTimization:UCORrection:LEVel:MIN
```

on page 674

Impairment of Digital I/Q Signal and Noise Generator - AWGN/IMP Block

"Include ATT Fixed" Displays the status of the attenuator, included in the frequency response correction data. When the operating mode Fixed is switched on, the attenuator is fixed in its current position and the resulting variation range is defined.

SCPI command:

`[:SOURce<hw>] :BB:IMPairment:OPTimization:UCORrection:IAFixed`
on page 673

"External Devices" Set to **On** the parameters bandwidth, frequency offset and level offset are indicated below.

SCPI command:

`[:SOURce<hw>] :BB:IMPairment:OPTimization:UCORrection:EDEVICES`
on page 670

"Bandwidth" Displays the bandwidth of the frequency response correction data in 10 MHz or 5 MHz intervals.

Note: Bandwidth is displayed if external devices are activated.

SCPI command:

`[:SOURce<hw>] :BB:IMPairment:OPTimization:UCORrection:BWIDth`
on page 670

"Frequency Offset" Displays the frequency offset of the baseband frequency response correction data.

Note: Frequency offset is displayed if external devices are activated.

SCPI command:

`[:SOURce<hw>] :BB:IMPairment:OPTimization:UCORrection:FREQUENCY:OFFSet` on page 673

"Level Offset" Displays the level offset of the baseband frequency response correction data.

Note: Level offset is displayed if external devices are activated.

SCPI command:

`[:SOURce<hw>] :BB:IMPairment:OPTimization:UCORrection:LEVel:OFFSet` on page 674

4.7.2 AWGN - Noise Generator

The noise generator generates an AWGN signal (Additive White Gaussian Noise) in the digital baseband, i.e. the noise power density has a Gaussian distribution and is distributed evenly across the frequency. This noise signal superimposes the (interference-free) useful signal ("Additive Noise" mode). Typical applications for the noise generator are bit-error or block-error measurements, depending on the set S/N or C/N ratio.

The Gaussian noise is generated by means of feedback shift registers with subsequent probability transformation. The switching configuration is such that virtually ideal statistical characteristics are achieved:

- I and Q paths are decorrelated from each other.
- The crest factor of 18 dB allows very small probabilities to be realized.

- The period of the noise signal depends on the selected system bandwidth. The relationship of period P to system bandwidth B_{sys} is approximated:

$$P \approx 1 \cdot 10^{13} / B_{\text{sys}}$$

This results in periods between 317 years with minimum bandwidth and approximately 2 days with maximum bandwidth.

This results in a period of approximately one month for 3GPP FDD with a bandwidth of 3.84 Mcps, and a period of 427 days for GSM with 270.833 ksps.

Scalable low-pass filters are used to produce a noise level with both a broad dynamic range and a broad bandwidth range (from 1 kHz to 60 MHz).

Apart from the "Additive Noise" mode, there are also the "Noise Only" and the "CW Interferer" mode. In the "Noise Only" mode a pure noise signal is generated and modulated to the carrier. In the "CW Interferer mode", a sinusoidal signal with an adjustable frequency offset to the baseband signal is generated and added to the baseband signal by means of a counter instead of a shift register.

4.7.2.1 AWGN Settings Dialog

To open the "AWGN Settings" menu for setting the noise generator, select "AWGN/IMP > Configure > AWGN" or use the MENU key under "AWGN/IMP".

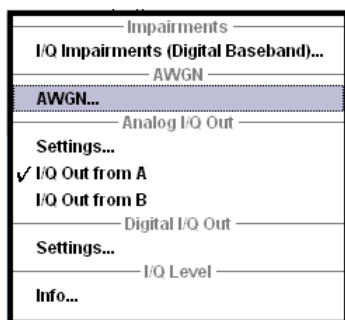

The "AWGN Settings" menu is divided into the following sections.

The RFI signal generator is activated, the mode selected and the interfering signal is configured in the top section of the menu.

The level of the interfering signal is configured in the "Noise Level Configuration And Output Results" section.

In "Additive Noise" and "CW interferer" mode, the interfering level can be defined and the resulting total level displayed here.

In "Noise Only" mode, only the noise level can be set here.

AWGN Settings

The RFI signal generator is activated, the mode selected and the interfering signal is configured in the top section of the menu.

State - AWGN

Activates/deactivates the RFI signal generator. The interferer (AWGN or CW interferer, depending on the selected mode) is generated as after the generator is activated.

SCPI command:

`[:SOURce<hw>] :AWGN:STATe` on page 582

Mode - AWGN

Selects the mode for generating the interfering signal.

"Additive Noise" The AWGN noise signal with selectable system bandwidth is added to the baseband signal.

"Noise Only" The pure AWGN noise signal with selectable system bandwidth is modulated to the carrier. The connection to the baseband is interrupted.

"CW Interferer" A sine with a defined frequency offset is added to the baseband signal. The calculation of E_b/N_0 ratio is omitted.

SCPI command:

`[:SOURce<hw>] :AWGN:MODE` on page 579

System Bandwidth - AWGN

(Additive Noise and Noise Only)

Sets the RF bandwidth to which the set carrier/noise ratio relates.

Within this frequency range, the signal is superimposed with a noise signal whose level corresponds exactly to the set C/N or S/N ratio.

Note: The noise signal is not generated arbitrarily for a particular bandwidth, but instead it is generated in steps. Noise therefore also occurs outside the set system bandwidth.

SCPI command:

`[:SOURce<hw>] :AWGN:BWIDth` on page 575

Minimum Noise/System Bandwidth Ratio - AWGN

(Additive Noise and Noise Only)

Sets the ratio of minimum noise bandwidth to system bandwidth.

Note: The noise signal is not generated arbitrarily for a particular bandwidth, but instead it is generated in steps. Noise therefore also occurs outside the set system bandwidth.

With this parameter the minimum real noise bandwidth can be set as required by some standards. It does not influence the calculation of level from the set C/N or S/N ratio in relation to system bandwidth.

The overall bandwidth is calculated as follow and may not exceed 80 MHz.

Overall Bandwidth = System BW x Minimum Noise/System BW Ratio

SCPI command:

`[:SOURce<hw>] :AWGN:BWIDth:RATio` on page 576

Noise Bandwidth - AWGN

(Additive Noise and Noise Only)

Indicates the real noise bandwidth. The value is only indicated for "State On".

Note: The noise signal is not generated arbitrarily for a particular bandwidth, but instead it is generated in steps. Noise therefore also occurs outside the set system bandwidth.

SCPI command:

[\[:SOURce<hw>\]:AWGN:BWIDth:NOISe](#) on page 575

Display Mode - AWGN

Sets the display mode to Baseband or RF.

SCPI command:

[\[:SOURce<hw>\]:AWGN:DISP:MODE](#) on page 577

Display Output Results For - AWGN

(Additive Noise and Noise Only)

Selects the display of output results for the analog (DACIF) or the digital (BBOUT) signal path.

Note: This selection field is only available with the option R&S SMU-B18, Baseband Digital I/Q Out. If the instrument is not equipped with this option the parameters of the analog signal path are displayed.

"Analog Output" The parameters of the analog signal path are displayed.

"Digital Output" The parameters of the digital signal path are displayed.

SCPI command:

[\[:SOURce<hw>\]:AWGN:DISP:OREsults](#) on page 577

Target CW Frequency - AWGN

(CW Interferer mode only)

Sets the desired frequency of the sine in "CW Interferer" mode.

SCPI command:

[\[:SOURce<hw>\]:AWGN:FREQuency:TARGet](#) on page 578

Resulting CW Frequency - AWGN

(CW Interferer mode only)

Indication of the actual CW frequency of the sinusoidal signal in "CW Interferer" mode.

The actual frequency may differ from the desired frequency, since the resolution is limited to 0.7 Hz.

Tip: The desired frequency constellation can be precisely set with an accuracy of up to 0.01 Hz by selecting a suitable frequency offset of the baseband source (e.g. Custom Dig Mod) and by correcting the RF frequency by the difference between Resulting and Target CW Frequency.

SCPI command:

[\[:SOURce<hw>\]:AWGN:FREQuency:RESult](#) on page 578

Noise/Interferer Level Configuration And Output Results

The interfering signal is configured in the "Noise/Interferer Level Configuration and Output Results" section.

Set Noise Level via - AWGN

(Additive Noise only)

Selects the mode for setting the noise level

- "C/N ""S/N" The noise level is set on the basis of the value entered for the carrier/noise or signal/noise ratio. Whether a selection of C/N or S/N is enabled, depends on the selected "Display Mode". With digital modulation, the associated E_b/N_0 value is determined and displayed.
- " E_b/N_0 " The noise level is set on the basis of the value entered for the ratio of bit energy to noise power density. The associated C/N or S/N value is displayed. The correlation between the two values is as follows:
 C/N or $S/N = (E_b/N_0) \cdot (f_{bit}/B_{sys})$, where
 f_{bit} is the Bit rate (Symbol rate x Modulation value)
 B_{sys} is the System bandwidth
 With "Custom Dig Mod" signals, the bit rate used for calculation is defined by the selected standard in the "Custom Digital Mod" dialog. With "Digital Standard" signals, the bit rate to be used for calculating the E_b/N_0 can be entered at "Bit Rate".
 Some test cases with the 3GPP base station tests (TS 25.141) specify, for example, E/N settings that apply to channel-coded data or block segments.

SCPI command:

[\[:SOURce<hw>\]:AWGN:POWer:MODE](#) on page 580**Reference Mode - AWGN**

(Additive Noise and CW Interferer, Display Mode set to RF)

Select reference mode if the C/N or E_b/N_0 ratio is changed.

- "Carrier" If the C/N value or E_b/N_0 value changes, the carrier level is kept constant and the noise level is adjusted. This is the standard procedure for measuring the bit error rate versus the noise power.
- "Noise" If the C/N value or E_b/N_0 value changes, the noise level is kept constant and the carrier level is adjusted.
 Some test cases of 3GPP Base Station Tests (TS 25.141) specify, for example, that the noise power be permanently set as a function of the base station power class, whereas the carrier power is variable.

SCPI command:

[\[:SOURce<hw>\]:AWGN:POWer:RMODe](#) on page 581**Bit Rate - AWGN**

(Additive Noise only)

Sets or indicates the bit rate used for converting C/N or S/N to E_b/N_0 .

With "Custom Digital Mod" signals, the bit rate used is indicated here. It is defined by the choice of the standard in the "Custom Digital Mod" menu.

With "Digital Standard" signals, the bit rate used for converting C/N or S/N to E_b/N_0 is set here.

When generating a "Digital Standard", it is thus possible to select which bit rate is to be used for calculating the ratio of bit energy to noise power density, e.g. the bit rate before or after channel coding.

SCPI command:

[:SOURce<hw>] :AWGN:BRATe on page 575

Carrier/Noise Ratio / Signal/Noise Ratio

(Additive Noise and CW Interferer only)

Sets the carrier/noise, signal/noise or signal/interferer ratio.

Whether a configuration of C/N or S/N is enabled, depends on the selected "Display Mode".

- In "Carrier Reference Mode", this entry determines the RFI power and thus the power of the output signal. It does not affect the power of the useful signal, i.e. the carrier power remains constant.
- In "Noise Reference Mode", this entry determines the power of the useful signal, i.e. the carrier power. The RFI power remains constant.
- The level of the noise signal which is derived from the entered C/N or S/N value is displayed in the menu under "Noise Level". The value is displayed automatically in the units of the useful signal.
- The level of the useful signal is displayed in the menu under "Carrier Level" and can also be changed there. The displayed value corresponds to the value in the "Level" display field.
- The level of the output signal is displayed under "Carrier Level + Noise".

If "Set Noise Level via E_b/N_0 " is selected, the associated C/N or S/N value is displayed here.

SCPI command:

[:SOURce<hw>] :AWGN:CNRatio on page 576

E_b/N_0 - AWGN

(Additive Noise only)

Sets the ratio of bit energy to noise power density in "Additive Noise" mode.

- In "Carrier Reference Mode", this entry determines the noise level and therefore also the level of the output signal. It does not affect the level of the useful signal, i.e. the carrier level is kept constant.
- In "Noise Reference Mode", this entry determines the level of the useful signal, i.e. the carrier level. the noise level is kept constant.
- The level of the noise signal which is derived from the entered E_b/N_0 value is displayed under "Noise Level". The value is displayed automatically in the units of the useful signal.
- The level of the useful signal is displayed in the menu under "Carrier Level". The displayed value corresponds to the value in the "Level" display field.
- The level of the output signal is displayed under "Carrier Level + Noise".

If "Set Noise Level via C/N or S/N" is selected, the associated E_b/N_0 value is displayed here.

SCPI command:

`[:SOURce<hw>] :AWGN:ENRatio` on page 577

Carrier Level / Signal Level

(Additive Noise and CW Interferer)

The name of this parameter depends on the selected "Display Mode".

- In "Carrier Reference Mode", this parameter sets the carrier level. This entry corresponds to the level entered in the Level header.
The level of the noise signal which is derived from the entered C/N or S/N value is displayed under "Noise Level". The value is displayed automatically in the units of the useful signal.
- In "Noise Reference Mode", this parameter indicates the carrier level which is derived from the entered C/N or S/N value. This indication corresponds to the level indicated in the "Level" header.
The noise level can be set under "Noise Level".

Note: The peak envelope power (PEP) specified in the header corresponds to the PEP value of the carrier. The PEP value of the overall signal is displayed in the menu under "Carrier+Noise PEP".

SCPI command:

`[:SOURce<hw>] :AWGN:POWer:CARRier` on page 579

Noise Level (System Bandwidth) / Interferer Level

(Additive Noise, Noise Only, CW Interferer)

- "Noise Only" mode
Sets the level of the noise signal. This entry corresponds to the level entered in the "Level" header.
- "Additive Noise" mode
 - "Noise Reference Mode"
Sets the level of the noise signal. The level of the carrier is derived from the entered C/N or S/N or E_b/N_0 value.
 - "Carrier Reference Mode"
Displays the level of the noise signal in the system bandwidth. The level of the noise signal is derived from the entered C/N or S/N or E_b/N_0 value. The carrier level is entered under "Carrier Level"; respectively the signal level is displayed under "Signal Level".
- "CW Interferer" mode
 - "Noise Reference Mode"
Sets the level of the interfering signal. The level of the carrier is derived from the entered C/N or S/N value.
 - "Carrier Reference Mode"
Displays the level of the interfering signal. The level of the interfering signal is derived from the entered C/N or S/N value. The carrier level is entered under "Carrier Level".

Note: The noise signal is not generated arbitrarily for a particular bandwidth, but instead it is generated in steps. Noise therefore also occurs outside the set system bandwidth. This means that the total measurable noise level (see below) usually exceeds the value

Impairment of Digital I/Q Signal and Noise Generator - AWGN/IMP Block

displayed here. Correct measurement of the noise level within the system bandwidth is possible by means of channel power measurement using a signal analyzer.

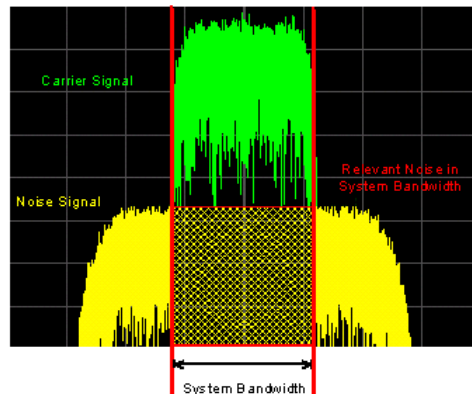

SCPI command:

`[:SOURce<hw>] :AWGN:POWer:NOISe` on page 580

Noise Level (Total Bandwidth) - AWGN

Displays the level of the noise signal in the total bandwidth in "Noise Only" and "Additive Noise" mode.

SCPI command:

`[:SOURce<hw>] :AWGN:POWer:NOISe:TOTal` on page 581

Carrier + Noise Level / Signal + Noise Level (System Bandwidth) / Carrier + Interferer Level / Signal + Interferer Level

(Additive Noise and CW Interferer)

Displays the overall level of the noise/interferer signal plus useful signal.

Tip: In the mode "Additive Noise" the "Display Output Results For" (analog or digital) has to be set before.

The name of this parameter depends on the selected "Display Mode".

SCPI command:

`[:SOURce<hw>] :AWGN:POWer:SUM` on page 581

Carrier + Noise PEP / Signal + Noise PEP (Total Bandwidth) / Carrier + Interferer PEP / Signal + Interferer PEP

(Additive Noise and CW Interferer)

Displays the peak envelope power of the overall signal comprised of noise signal plus useful signal.

The name of this parameter depends on the selected "Display Mode".

Note: The peak envelope power (PEP) specified in the header corresponds to the PEP value of the carrier.

In the mode "Additive Noise" the "Display Output Results For" (analog or digital) has to be set before.

SCPI command:

`[:SOURce<hw>] :AWGN:POWer:SUM:PEP` on page 582

4.7.3 Output of the Baseband Signal - I/Q Out

The R&S Signal Generator provides various outputs of the baseband signal.

The digitally modulated signal can either be output directly or converted to an analog I/Q baseband output signal. The **analog baseband signal** can be output single-ended or differential (non-inverted).

The single ended or differential output requires option R&S SMU-B16, Differential Output.

The analog signal is output at the I/Q output connectors I OUT/I OUT BAR and Q OUT/Q OUT BAR on the rear panel of the instrument.

In case of two-path instruments, these connectors can be assigned either to Path A or Path B.

The output of the **digital baseband signal** requires the option R&S SMU-B18, Digital I/Q Out. The signal is output at the standardized (LVDS) digital I/Q interface on the rear panel.

Digital signal output is possible for path A only.



4.7.3.1 I/Q Out Settings Menu

The settings dialogs for the analog and digital signal output are available in the block diagram in the "AWGN/IMP" function block as well as in the menu with the same name which is opened using the MENU key.

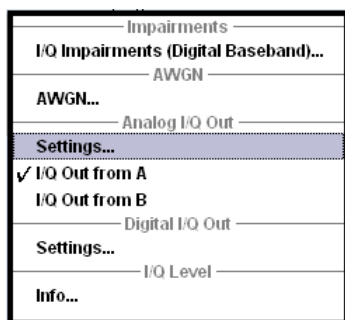

Selecting the menu item "I/Q Out Settings" opens a dialog with the parameters for the I/Q output signal.

The "I/Q Out" Settings dialog is available for analog and digital I/Q output signals. These dialogs are accessible under the menu sections with the corresponding names.

In case of two-path instruments, the analog I/Q output signal can be assigned either to path A or path B.

The settings for the digital I/Q output signal are available for path A only.

I/Q Out - AWGN/IMP

Selects the path to which the I/Q output connectors are assigned (two-path instruments only).

"Settings...." Opens the submenu to set the output type and voltages, see [chapter 4.7.3.2, "Analog I/Q Output"](#), on page 311.
The menu is only available when option Differential Outputs (R&S SMU-B16) is fitted.

"I/Q Out from A" The I/Q output connectors are assigned to Path A.

"I/Q Out from B" The I/Q output connectors are assigned to Path B.

SCPI command:

[\[:SOURce\]:BB:IQOutput:SOURce](#) on page 737

4.7.3.2 Analog I/Q Output

The differential output of the R&S Signal Generator provides symmetrical signals for differential inputs of DUTs without the need of additional external electric network.

The operating point of the inputs can be set by a definable DC-voltage (bias). In addition an offset between inverting and non-inverting output can be set to balance a difference of the best operating points.

The differential output can be assigned either to Path A or Path B ("Impairment > I/Q Out").

The equipment options for the basic unit (R&S SMU with frequency option R&S SMU-B10x) include the option R&S SMU-B13 (Baseband Main Module) and the option R&S SMU-B16 (Differential Output) for "I/Q Out...".



Option R&S SMU-B16 (Differential Outputs) cannot be fitted together with options R&S SMU-B81/B82 (Rear Panel Connectors), because they use the same connectors.

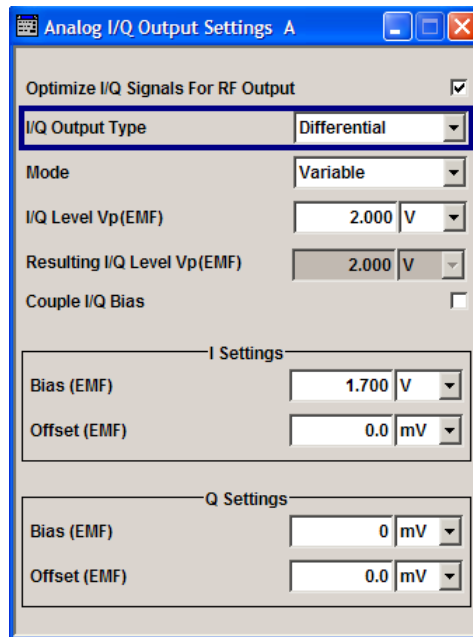

Optimize IQ-Signals for RF Output

Activates/deactivates optimization of level accuracy and imbalance for RF Output.

Level accuracy and imbalance can be either optimized for RF output (active) or for differential outputs (not active).

With a second option Baseband Main Module (R&S SMU-B13) it is possible to optimize a signal for RF output in one path and for the differential output in the other path.

SCPI command:

`[:SOURCE<hw>] :IQ:OUTPut:BIAS:OPTimization[:RF]:STATe` on page 738

I/Q Output Type

Selects the type of output. The analog outputs can be operated in "Single Ended" mode or "Differential" (non-inverted) mode. The menu changes depending on the selected output mode

- "Differential" Differential output at I OUT and I OUT BAR or Q OUT and Q OUT BAR.
The analog I/Q signal components are output at I/Q OUT and I/Q OUT BAR. A bias to set the operating point of DUT can be defined. In addition an offset between inverting and non-inverting output can be set to balance a difference of the best operating points.

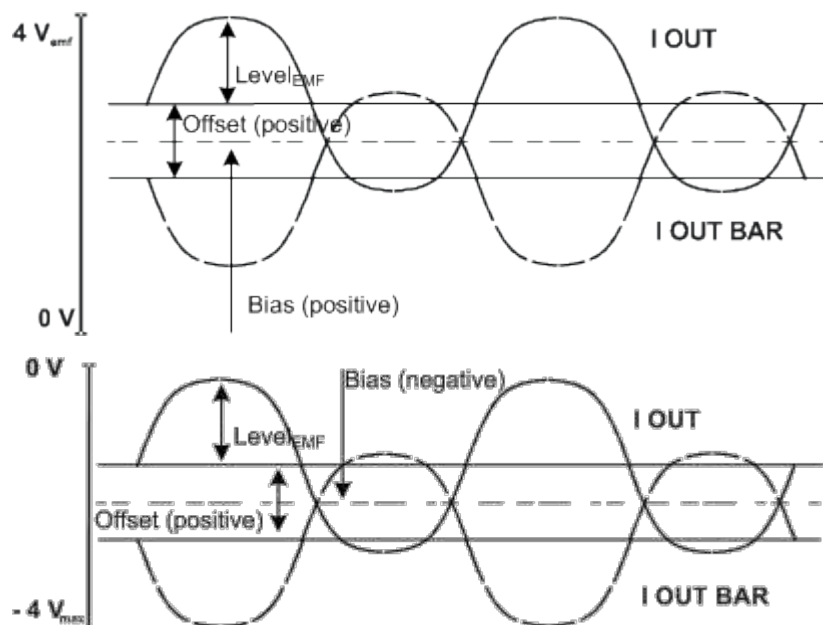

- "Single Ended" Single-ended output at I OUT and Q OUT.
A bias between I/Q OUT and ground can be defined (requires the option R&S SMU-B16, Differential I/Q Output).

SCPI command:

[\[:SOURce<hw>\]:IQ:OUTPut:TYPE](#) on page 741

Output Mode

Selects the mode for setting the outputs - independent or together. The menu changes depending on the selection here.

- "Fixed" The settings for the I/Q signal components are fixed and cannot be changed.

- "Level Vp (EMF)" (Single ended) = 1.0 V
- "Level Vp (EMF)" (Differential) = 2.0 V
- "Bias" = 0 V
- "Offset" = 0 V

- "Variable" The settings for the I/Q signal components are not fixed and can be modified.

SCPI command:

[\[:SOURce<hw>\]:IQ:OUTPut:MODE](#) on page 739

I/Q Level Vp EMF

Sets the output voltage for both signal components. Small differences at the inputs can be taken into account via impairment settings (see [chapter 4.7.1.1, "Impairment Settings Menu"](#), on page 291).

Single ended Output:

- Value range: 20 mV ... 2 V EMF.
- The maximum overall output voltage (" $\text{Level}_{\text{EMF}}$ " + " $|\text{Bias}_{\text{EMF}}|$ ") is 3.7 V.

Differential Output:

- Value range: 40 mV ... 4 V EMF.
- The maximum overall output voltage (" $0.5 * \text{Level}_{\text{EMF}}$ " + " $|\text{Bias}_{\text{EMF}}|$ " + " $0.5 * \text{Offset}$ ") is 3.7 V.

SCPI command:

[\[:SOURce<hw>\]:IQ:OUTPut\[:ANALog\]:POWer:PEP](#) on page 738

Resulting I/Q Level Vp EMF

Displays the resulting output off-load voltage of both signal components at the rear panel.

SCPI command:

[\[:SOURce<hw>\]:IQ:OUTPut\[:ANALog\]:POWer:PEP:RESult](#) on page 739

Couple IQ Bias

(Variable output mode only)

Activates/deactivates coupling of bias setting of the I-signal and Q-signal component. For activated coupling, the setting can be made for the I-signal component, it automatically applies to the Q-signal component as well. The fields for setting the Q-signal component are shaded.

SCPI command:

[\[:SOURce<hw>\]:IQ:OUTPut:BIAS:COUPling\[:STATe\]](#) on page 737

Bias (EMF)

Sets the bias. A DC voltage is superimposed upon the I or Q signal. The maximum overall voltage (" $\text{Level}_{\text{EMF}}$ " + " Bias_{EMF} " + " $\text{Offset}_{\text{EMF}}$ ") is 3.7 volts.

This way, the operating point of a DUT can be set.

SCPI command:

[\[:SOURce<hw>\]:IQ:OUTPut:BIAS:I](#) on page 737

[\[:SOURce<hw>\]:IQ:OUTPut:BIAS:Q](#) on page 738

Offset (EMF)

(available only for output type "Differential" only)

Sets an offset between the inverting and the non-inverting output.

The value range is dynamically adjusted in order to respect the following constrains:

The maximum overall voltage (" $\text{Level}_{\text{EMF}}$ " + " Bias_{EMF} " + " Offset ") is 3.7 V.

The set value is set half in the positive and half in the negative direction:

- A **positive offset** is set with half of the value in positive direction at the non-inverting outputs, in negative direction at the inverting outputs, respectively.

For example, if a 100.0 mV offset value is set for the I signal component, the output signal at "I OUT" will have a 50.0 mV offset and the output signal at "I OUT Bar" will have a -50.0mV offset.

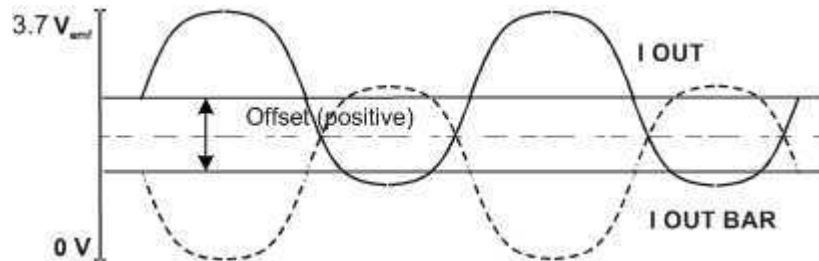

- A **negative offset** is set with half of the value in negative direction at the non-inverting outputs, in positive direction at the inverting outputs, respectively.

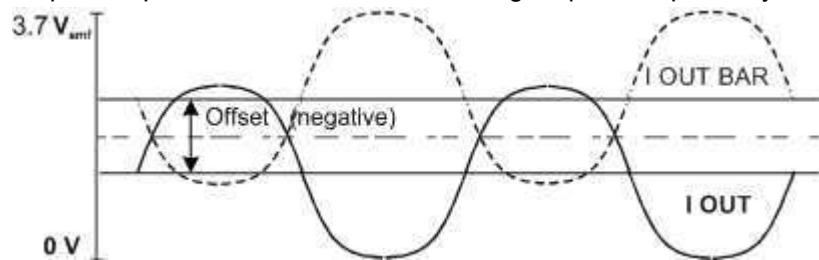

SCPI command:

[\[:SOURce<hw>\]:IQ:OUTPut:OFFSet:I](#) on page 740

[\[:SOURce<hw>\]:IQ:OUTPut:OFFSet:Q](#) on page 740

4.7.3.3 Digital I/Q Output Settings

The digital baseband signal is output at a standardized (LVDS) digital I/Q interface.

To access the settings for the digital I/Q output:

1. select "Block Diagram > AWGN/IMP > Config... > Digital I/Q Out > Settings" or
2. press the MENU key and select "AWGN/IMP > Digital I/Q Output > Settings".

The output of the digital baseband signal is available with the option R&S SMU-B18, Digital I/Q Out. Two-path instruments require a second option R&S SMU-B18, Digital I/Q Out for digital output.

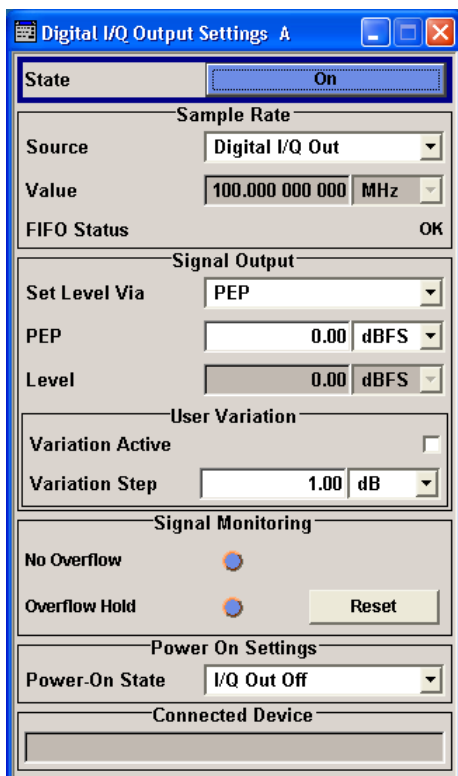

If an "R&S EX-IQ-BOX" is connected the R&S SMU recognizes this module automatically. Then, the button "EX-I/Q-Box Settings..." is displayed in the "Digital I/Q Output Settings" dialog for configuring the parameters of the R&S EX-IQ-BOX (see "R&S EX-IQ-BOX" Manual). Additionally the components of the recognized R&S EX-IQ-BOX are listed in the Hardware Config, section Baseband Assembly.

Digital I/Q Output General Settings

State - Digital I/Q Output

Switches On/Off the digital I/Q output signal.

"On" Switches on the digital I/Q output signal of the currently selected path.

"Off" Switches off the I/Q output signal of the currently selected path.

SCPI command:

`[[:SOURce<hw>]:IQ:OUTPut:DIGital:STATe` on page 746

EX-I/Q-Box Settings... - Digital I/Q Output

(With a connected R&S EX-IQ-BOX only)

Opens the main settings dialog of the R&S EX-IQ-BOX.

SCPI command:

n.a.

Sample Rate

In the "Sample Rate" section the sample rate for the digital I/Q output signal can be set and the state of signal transmission is indicated by the FIFO Status.

Sample Rate Source - Digital I/Q Output

Selects the source for the sample rate of the digital I/Q output signal.

Note: With a connected **R&S EX-IQ-BOX** either the internal clock source (User defined) or an external clock (Digital I/Q In) can be selected in the settings dialog of the R&S EX-IQ-BOX. Therefore, the sample rate source is only indicated in this field.

- "User Defined" The internally generated clock reference signal is used. The sample rate is calculated and displayed in the field "Value".
- "Digital I/Q In" An external clock reference signal is used. The clock signal is fed in via a "Baseband Input Module" (option R&S SMU-B17). The sample rate is estimated and displayed in the field "Value".
- "Digital I/Q Out" An external clock reference signal is used. The clock signal is directly fed in via pin CLK2 of the digital output interface (option R&S SMU-B18, Digital I/Q Out). The sample rate is estimated and displayed in the field "Value".

SCPI command:

[\[:SOURce<hw>\]:IQ:OUTPut:DIGital:SRATe:SOURce](#) on page 746

Sample Rate Value - Digital I/Q Output

Sets or displays the sample rate of the digital I/Q output signal, depending on the selected sample rate "Source".

SCPI command:

[\[:SOURce<hw>\]:IQ:OUTPut:DIGital:SRATe](#) on page 745

FIFO Status - Digital I/Q Output

Indicates the state of the signal transmission.

- "OK" Resampling is working properly.
- "OFL = Over-flow" The external sample rate frequency is too high which causes an overflow in signal transmission.
- "URUN = Underrun" The external sample rate is too low which causes an underrun in signal transmission.

SCPI command:

[\[:SOURce<hw>\]:IQ:OUTPut:DIGital:SRATe:FIFO\[:STATus\]](#) on page 745

Signal Output

The level of the output signal is set in the "Signal Output" section. For entering the value, level type "PEP" or "Level" can be selected.

Set Level Via - Digital I/Q Out

Selects the level type (PEP/Level) that is used to set the signal level. Either the PEP or the Level entry field can be edited.

Impairment of Digital I/Q Signal and Noise Generator - AWGN/IMP Block

"PEP" The signal level is expressed in terms of a peak envelope power value (PEP).
The level entry fields and the corresponding units are displayed in the status bar.

"Level" The signal level is expressed in terms of an rms value.
The level entry fields and the corresponding units are displayed in the status bar.

SCPI command:

[\[:SOURce<hw>\]:IQ:OUTPut:POWer:VIA](#) on page 745

PEP - Digital I/Q Out

The signal level is expressed in terms of a peak envelope power value (PEP).

The level entry fields and the corresponding units are displayed in the status bar. The level display always refers to both signal components ($\text{SQR}(I^2+Q^2)$).

SCPI command:

[\[:SOURce<hw>\]:IQ:OUTPut:DIGital:POWer:PEP](#) on page 743

Level - Digital I/Q Out

The signal level is expressed in terms of an rms level value.

The level entry fields and the corresponding unit are displayed in the status bar. The level display always refers to both signal components ($\text{SQR}(I^2+Q^2)$).

SCPI command:

[\[:SOURce<hw>\]:IQ:OUTPut:DIGital:POWer:LEVel](#) on page 743

User Variation

If the level is set using the rotary knob, the step width is defined in the User Variation section.

Variation Active - Digital I/Q Out

Activates the user-defined step width that is used by varying the level value with the rotary knob.

"On" The level value set with the rotary knob is varied using the user-defined step width which is entered under "Variation Step".

"Off" The level value set with the rotary knob is varied in steps of one unit at the cursor position (standard operating mode).

SCPI command:

[\[:SOURce<hw>\]:IQ:OUTPut:DIGital:POWer:STEP:MODE](#) on page 744

Variation Step - Digital I/Q Out

Sets the user defined step width for entering the level value using the rotary knob. Level variation with this step width must be activated with "Variation Active ON".

SCPI command:

[\[:SOURce<hw>\]:IQ:OUTPut:DIGital:POWer:STEP\[:INCRement\]](#) on page 744

Signal Monitoring

The section "Signal Monitoring" indicates digital signal clipping.

Overflow - Digital I/Q Out

Indicates that the I/Q output signal is currently clipped. This indication also appears in the block diagram close to the digital I/Q Out connector.

Overload may occur, e.g. if the level of the output signal, or the noise level (AWGN) are too high.

SCPI command:

`[:SOURce] : IQ : OUTPut : DIGital : OFLow : STATe` on page 742

Overflow Hold - Digital I/Q Out

Indicates an overflow since last reset.

The overflow hold state can be reset via the "Reset" button next to the LED, or is reset automatically by starting a new signal generation or by setting new values to the output level.

SCPI command:

`[:SOURce] : IQ : OUTPut : DIGital : OFLow : HOLD : STATe` on page 742

Reset - Digital I/Q Out

Executes a reset of the overflow hold state and LED.

SCPI command:

`[:SOURce] : IQ : OUTPut : DIGital : OFLow : HOLD : RESet` on page 742

Power On Settings

The power on behaviour of the R&S SMU is set in the "Power On Settings" section.

Power-On State - Digital I/Q Out

Selects the state which the digital I/Q Output is to resume after the instrument is switched on.

"I/Q Out Off" The output is deactivated when the instrument is switched on.

"Previous Setting" When the instrument is switched on the digital I/Q output resumes to the status that was active before the last switch off.

SCPI command:

`[:SOURce<hw>] : IQ : OUTPut : DIGital : PON` on page 743

Connected Device - Digital I/Q Out

Indicates the ID of an externally connected R&S Instrument.

SCPI command:

`[:SOURce<hw>] : IQ : OUTPut : DIGital : CDEvice` on page 742

4.7.4 I/Q Level - Info...

The signal levels and the crest factor of the baseband signal at the I/Q output connectors are indicated in the dialog box "Baseband Signal Level".

This information is needed by the user, for example, in order to use the I/Q signal externally and to adjust the level correctly there, or to see how the signal is modulated.



Up to baseboard version DacBoard 1141.8090.xx the calculated signal levels are displayed. From "DacBoard 1141.8190.02" or higher monitoring the measurement with or without interfering is provided.

Information on the baseband I/Q signal during measurement is indicated in the section "Baseband Signal Level Measurement". Level, crest factor and duration of the measurement can be displayed for the signal either with or without interfering.



Monitoring the measurement of the digital I/Q baseband signal requires the baseboard version "DacBoard 1141.8190.02" or higher. Up to baseboard version DacBoard 1141.8090.xx only the calculated signal levels are provided.

The currently equipped DacBoard is listed in the dialog "Setup > System > Hardware Config, section Baseband Assembly" (see [chapter 4.2.3.2, "Hardware Config"](#), on page 128).

To open the "Info..." dialog for information on the baseband I/Q signal during measurement, select "AWGN/IMP > Configure > Info" or use the MENU key under "AWGN/IMP".

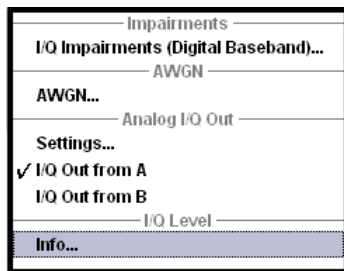

4.7.4.1 Baseband Signal Level

The signal levels and the crest factor of the baseband signal at the I/Q output connectors are indicated in the dialog box "Baseband Signal Level".

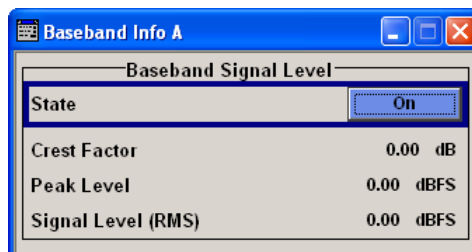

Crest Factor - Digital Impairments

Indicates the crest factor of the baseband signal.

The crest factor is calculated from the two level parameters as follows:

$Crest[dB]=Peak_Level[dBFs]/Signal_Level[dBFs]$

SCPI command:

[:SOURce<hw>] :BB:CFACTOR on page 698

Peak Level - Digital Impairments

Indicates the peak level of the baseband signal relative to full scale of 0.5 V (in terms of dB full scale).

SCPI command:

[:SOURce<hw>] :BB:POWer:PEAK on page 699

Signal Level (RMS) - Digital Impairments

Indicates the rms level of the baseband signal relative to full scale of 0.5 V (in terms of dB full scale).

SCPI command:

[:SOURce<hw>] :BB:POWer:RMS on page 699

4.7.4.2 Baseband Signal Level Measurement

Information on the baseband I/Q signal during measurement is indicated in the section "Baseband Signal Level Measurement". Level, crest factor and duration of the measurement can be displayed for the signal either with or without interfering.

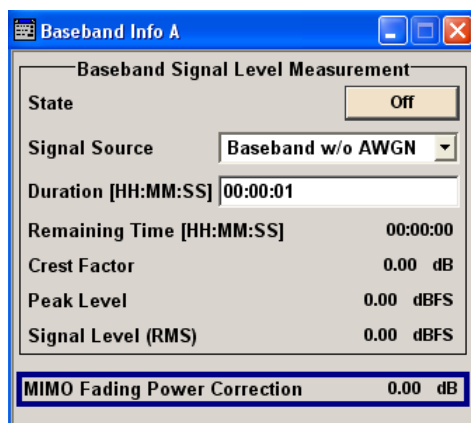

State - Digital Impairments - Measurement

Activates/deactivates the measurement of the digital I/Q baseband signal.

When activated, information on the peak level, rms level and crest factor are indicated. Additionally the duration of the measurement can be set.

SCPI command:

[:SOURce<hw>] :BB:MEASurement [:STATe] on page 697

Signal Source - Digital Impairments - Measurement

Selects the signal for the measurement. The signal level and crest factor can be retrieved either from the interference-free digital I/Q baseband signal or the signal superimposed by the noise generator AWGN.

Impairment of Digital I/Q Signal and Noise Generator - AWGN/IMP Block

"Baseband w/o AWGN" Activates the measurement of the interference-free baseband signal.

"Baseband with AWGN" Activates the measurement of the baseband signal after an AWGN noise signal is added.

SCPI command:

[\[:SOURce<hw>\]:BB:MEASurement:SOURce](#) on page 697

Duration - Digital Impairments - Measurement

Enters the time for the measurement of the digital I/Q baseband signal in the range of 1 s ... 3 h. The time is to be entered in format "hh:mm:ss".

SCPI command:

[\[:SOURce<hw>\]:BB:MEASurement:DURation](#) on page 696

Remaining Time - Digital Impairments - Measurement

Indicates the remaining time until the measurement of the digital I/Q baseband signal is completed. The time is displayed in format "hh:mm:ss".

SCPI command:

[\[:SOURce<hw>\]:BB:MEASurement:RTIME](#) on page 697

Crest Factor - Digital Impairments - Measurement

Indicates the crest factor of the baseband signal during measurement.

SCPI command:

[\[:SOURce<hw>\]:BB:MEASurement:CFACTOR](#) on page 695

Peak Level - Digital Impairments - Measurement

Indicates the peak level of the baseband signal relative to full scale of 0.5 V (in terms of dB full scale) during measurement.

SCPI command:

[\[:SOURce<hw>\]:BB:MEASurement:POWer:PEAK](#) on page 696

Signal Level (RMS) - Digital Impairments - Measurement

Indicates the rms level of the baseband signal relative to full scale of 0.5 V (in terms of dB full scale) during measurement.

SCPI command:

[\[:SOURce<hw>\]:BB:MEASurement:POWer:RMS](#) on page 696

MIMO Fading Power Correction - Digital Impairments - Measurement

The MIMO Fading Power Correction represents the relative power offset of the selected path compared to the power level of the other path.

The resulting power level of the selected path is then the RF level displayed on the header of the instrument reduced by the MIMO Fading Power Correction value.

The MIMO Fading Power Correction is necessary in case a MIMO Fading mode with unequal steering matrix's elements is selected in the Fading block (see section "Multiple Input Multiple Output" in the description "Fading Simulator"). Such a steering matrix is used to simulate antennas with different power level.

While working in a 4x2 or 3x2 MIMO mode that requires two two-path R&S Signal Generators, the MIMO Fading Power Correction for path A of both instruments is identical and respectively this correction coefficient is identical for both B paths.

However, for two R&S Signal Generators connected and configured to simulate a 2x4 or 2x3 MIMO configurations, there are individual MIMO Fading Power Correction coefficients for each path and the resulting power level of each of the paths has to be calculated separately.

Example:

```
SOUR:FSIM:MIMO:TAP:MATR:ROW1:COL1:RAT 0.9
SOUR:FSIM:MIMO:TAP:MATR:ROW2:COL2|3|4:RAT 1
SOUR:FSIM:MIMO:TAP:MATR:ACC
SOUR:BB:MFPC?
Response: 0.23
SOUR2:BB:MFPC?
Response: 0
```

The signal of path B is with 0.23 dB stronger than the signal of path A.

SCPI command:

[\[:SOURce<hw>\]:BB:MFPCorrection](#) on page 698

4.8 Baseband Signal - Baseband Block

The R&S Signal Generator provides you with the ability to generate digital modulation signals in accordance with the definitions in the digital standards or with user-definable characteristics. Signals are generated in realtime or from a data store with the aid of external and internal data. You can also load externally computed modulation signals into the R&S Signal Generator in the form of waveform files.

Several digital standards are provided, plus digital modulation with user-definable signal characteristics, generation of waveforms with the aid of the Arbitrary Waveform Generator and generation of multi carrier CW signals with the aid of Multi Carrier CW.

The settings for digital modulation can be accessed in the block diagram via the "Baseband" function block or with the aid of the MENU key.

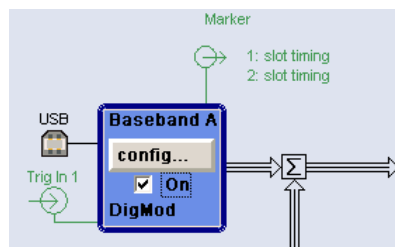

The equipment layout for generating the internal, digital modulation signals includes the options Baseband Main Module (B13) and one of the options Baseband Generator (B9/B10/B11). The three Baseband Generator options feature different ARB memory sizes

(see data sheet). Apart from the memory size, however, the options offer the same functionality, either one can be installed.

In addition, the appropriate option is required for the digital standards. These options are specified in the description of the respective standard.

The minimum equipment for a two-path instrument is a second R&S SMU-B9/B10/B11 option. This can be used simultaneously on the second path to generate a modulation signal which can either be routed via path A or added to the signal on path A with a frequency offset that can be set. In the case of a fully two-path layout, path B can be operated as a second signal generator independently of path A (see also data sheet).

If the appropriate options are fitted, externally supplied real-time baseband signals can be added to the internally generated signals.

In the subsequent signal route the baseband signals can be frequency-shifted, faded, detuned or loaded with noise (see [chapter 4.9, "External Baseband Signal - Baseband Input"](#), on page 445, [chapter 4.7, "Impairment of Digital I/Q Signal and Noise Generator - AWGN/IMP Block"](#), on page 290 and the description "Fading Simulator").

4.8.1 Working with the Baseband Signal

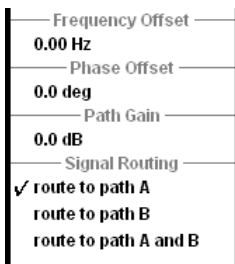

In the case of two-path instruments, signal routing, frequency offset and path gain definition are defined at the topmost menu level in the "Baseband" block or by using the MENU button under "Baseband".

The upper part of the "Baseband" dialog is used for selecting digital standards, digital modulation and waveform generation. These menus are described in the respective chapters relating to the modulation systems.

The lower part of the "Baseband" dialog can be used to define a frequency offset a path gain, a phase offset, and the signal routing for two-path instruments.

Frequency Offset

Enters the frequency offset for the baseband signal.

The frequency offset shifts the baseband frequency interval and provides a quick way to shift the used frequency band in the RF frequency section without modifying the RF settings.



Wenn a frequency offset is defined, an icon is displayed in the signal flow right to the baseband block.

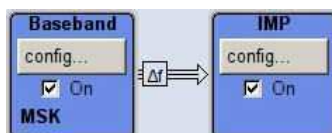

Note: For sample rates of exactly 100 MHz (Mode **Digital Input (Native100MHz)**) it is not possible to enter a frequency offset. The digital signal is fed into the signal path directly and not routed to the resampler where the frequency offset takes place. This type of entry is also prohibited if the noise generator ("AWGN" block) is on.

The complex I/Q bandwidth of the shifted useful signal must not exceed 80 MHz in total.

The following applies:

$$f_{\text{offset}} - f_{\text{use}}/2 \geq -80\text{MHz}/2 \text{ and } f_{\text{offset}} + f_{\text{use}}/2 \leq +80\text{MHz}/2$$

f_{use} = the complex useful bandwidth of the I/Q signal before the offset.

f_{offset} = frequency offset.

The following graph illustrates the setting range for the frequency offset.

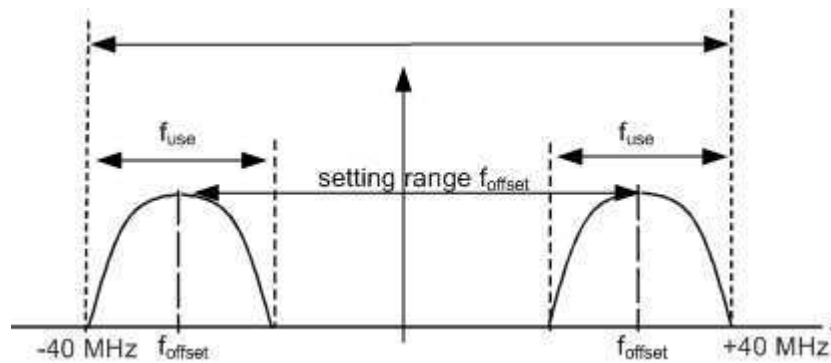

Fig. 4-24: Setting range for frequency offset

Example:

Fig. 4-25: 3GPP FDD signal (chip rate 3.84 Mcps, root-cosine filter 0.22).

The complex useful bandwidth of a signal which has been filtered using a root-cosine filter with roll off alpha is calculated as follows:

$$f_{\text{use}} = (1 + \alpha) * f_{\text{symbol}}$$

f_{symbol} = the symbol rate or chip rate of the signal.

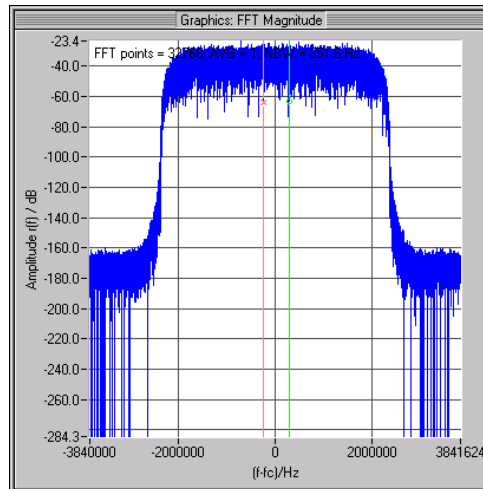
In the example the complex useful bandwidth is calculated as follows:

$$f_{\text{use}} = (1 + 0.22) * 3.84 \text{ MHz} = 4.6848 \text{ MHz.}$$

So as to comply with the condition requiring a maximum I/Q bandwidth of 40 MHz, the valid range of values for the frequency offset is then:

$$-40\text{MHz} + 4.6848\text{MHz}/2 \leq f_{\text{offset}} \leq 40\text{MHz} - 4.6848\text{MHz}/2$$

$$-35.3152\text{MHz} \leq f_{\text{offset}} \leq 35.3152\text{MHz}$$

In the case of ARB signals, the output clock rate can be used for estimating the maximum I/Q bandwidth of the waveform.

SCPI command:

[\[:SOURce<hw>\]:BB:FOFFset](#) on page 584

Phase Offset

Enters the phase offset for the baseband signal of the selected path compared to the baseband signal of the other path.



For instruments equipped with an external baseband input ("BB Input"), this parameter also enters the phase offset of the baseband signal of the selected path compared to the external baseband input.

The phase offset affects the signal on the "Baseband block" output.

SCPI command:

[\[:SOURce<hw>\]:BB:POFFset](#) on page 584

Path Gain

Enters the path gain for the baseband signal of the selected path compared to the baseband signal of the other path.

In case an external baseband input ("BB Input") is used, this parameter also determines the path gain for the baseband signal of the selected path compared to the baseband signal of this external data source.

The gain affects the signal on the "Baseband block" output.

Note: In case the baseband signal is additionally faded and routed at the output of the fading simulator, so that the faded signals from both paths are summed, the real path gain is measured at the output of the "Fading" block and set with the fading parameter "Summation Ratio A/B" (see description "Fading Simulator", section "Summation Ratio A/B").

The relative gain set with the parameter "Path Gain" in the "Baseband" block is ignored.

The "Path Gain" of the different baseband sources define the relative gain of the associated signals. The real gain depends on the following parameters along with the set path gain:

- Signal characteristics, in particular the crest factor
- Number of baseband sources
- Overall RF output level.

The sum baseband signal can be verified in the spectrum display in the "Graphics" block.

SCPI command:

[\[:SOURce<hw>\]:BB:PGAin](#) on page 584

Signal Routing

Selects the signal route for the baseband signal of a two-path instrument.

The following table shows the combination of signal routes allowed for two-path instruments.

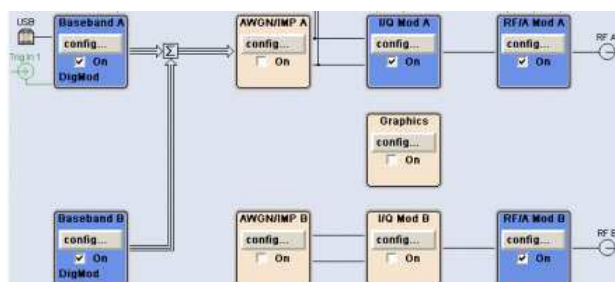

Table 4-3: Combinations of signal routings for two-path instruments

Routing Base-band A	Routing Base-band B	Block diagram
Route to path A	Route to path A	
Route to path A	Route to path B	
Route to path A	Route to path A and B	

Routing Baseband A	Routing Baseband B	Block diagram
Route to path B	Route to path A	
Route to path B	Route to path B	
Route to path B	Route to path A and B	

Routing Baseband A	Routing Baseband B	Block diagram
Route to path A and B	Route to path A	
Route to path A and B	Route to path B	
Route to path A and B	Route to path A and B	

"Route to path A"

The baseband signal is introduced into path A. The signals from both paths are summed if necessary.

"Route to path B"

The baseband signal is introduced into path B. The signals from both paths are summed if necessary.

"Route to path A and B" The baseband signal is introduced into path A and path B. The signals from both paths are summed if necessary.

SCPI command:

[:SOURce] :BB:PATH:COUNT on page 583

[:SOURce<hw>] :BB:ROUTE on page 585

4.8.2 Data and Signal Sources in Baseband

This section describes the common characteristics of the signals used for generating the baseband signal for all standards, including for example all listed data sources. The selection in the digital menus at any given time depends on the parameter and standard concerned and is clear from the selection list offered in the menu. The external data sources may therefore not be available in certain cases.

Characteristics which are uniquely specific to particular standards are described in the corresponding manual.

For instruments equipped with option Baseband Input, R&S SMU-B17, externally generated analog baseband signals can be fed into the digital signal path via the analog I/Q input "I IN" and "Q IN".

The following input signals are used when digital modulation signals are being generated:

- Modulation data
- Clock signals
- Control signals

The input signals can be both internally generated and supplied from an external source. The internally generated data and clock signals are output not only on the DATA and CLOCK connectors but also on the corresponding pins of the AUX I/O interface.

In the case of two-path instruments, the external data and clock sources are permanently allocated to path A, and data output is always for path A.

Likewise control signals and also trigger signals for triggering signal generation in the R&S Signal Generator can be internally generated or supplied from an external source.

Up to four marker output signals for synchronizing external instruments can be user-defined for each path.

Externally computed waveform files can be loaded in the instrument using computer interfaces or IEC bus.

Waveform files are processed with the aid of the Arbitrary Waveform Generator (ARB), see [chapter 4.8.4, "Arbitrary Waveform Generator ARB"](#), on page 383.

Internally the "Multi Carrier CW" menu for defining multi carrier waveforms is available (see [chapter 4.8.5, "Multi Carrier Continuous Wave"](#), on page 431).

4.8.2.1 Internal PRBS Data and Data Patterns

PRBS generators deliver pseudo-random binary sequences of differing length and duration. They are known as maximum length sequences, and are generated with the aid of ring shift registers with feedback points determined by the polynomial.

By way of example, the diagram below shows a 9-bit generator with feedback to registers 4 and 0 (output).

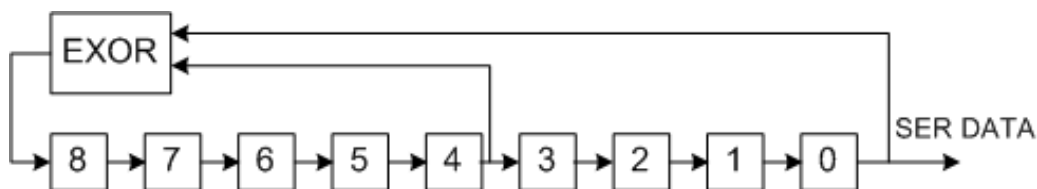
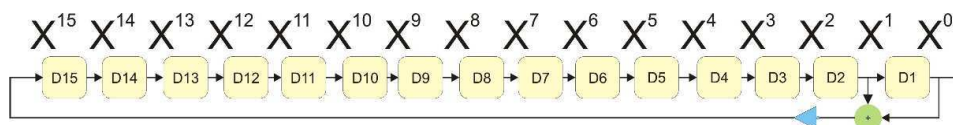

Fig. 4-26: 9-bit PRBS generator



For PRBS15 and PRBS23, a CCITT V.52-compliant data inversion is performed in the feedback path automatically as shown below:



The pseudo-random sequence from a PRBS generator is uniquely defined by the register number and the feedback. The following table describes all the available PRBS generators:

Table 4-4: PRBS generators

PRBS generator	Length in bits	Feedback to	Menu selection
9-bit	$2^9 - 1 = 511$	Registers 4, 0	PRBS 9
11-bit	$2^{11} - 1 = 2047$	Registers 2, 0	PRBS 11
16-bit	$2^{16} - 1 = 65535$	Registers 5, 3, 2, 0	PRBS 16
20-bit	$2^{20} - 1 = 1048575$	Registers 3, 0	PRBS 20
21-bit	$2^{21} - 1 = 2097151$	Registers 2, 0	PRBS 21

The "Data Source" selection for PRBS data from the menus is "PN11, ...".

Simple data patterns such as binary 0 strings or 1 strings can also be used as internal modulation data. The "Data Source" selection from the menus is "ALL 0", "ALL 1". A variable bit string with a maximum length of 64 bits can be entered in an input field by selecting "Pattern."

4.8.2.2 Internal Modulation Data from Lists

Internal modulation data can be generated and stored in the form of binary lists. A separate file is created for each list and held on the instrument's hard disk.

The file name can be defined by the user.

The "Data Source" selection from the menus is "Data List". When this menu item is chosen the "Select Data List" button appears; this opens the file-selection window for data lists. A list can be created and edited in the "Data List Editor", which is accessed from the menu via the "List Management" or "Data List Management" button.

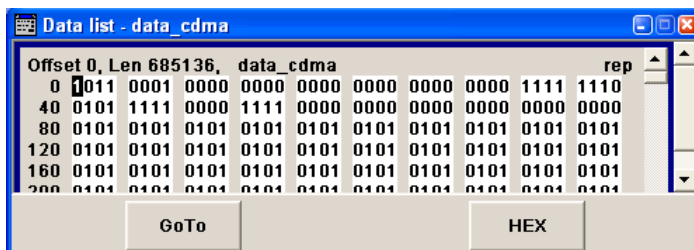

The maximum length of a data list is determined by the size of the data list memory (see data sheet). There is no restriction on the number of lists that can be stored.

4.8.2.3 External Synchronous Modulation Data

External Serial Modulation Data via the DATA Connector

For "Custom Digital Modulation", serial modulation data can be supplied bit-by-bit via the DATA connector. The "Data Source" selection from the menu is "Extern Serial".

In the case of two-path instruments the DATA input is permanently allocated to path A.



In the case of modulation modes with more than 1bit/symbol, the most significant bit (MSB) must be fed in first (MSB first).

The clock reference (symbol clock) used to read in the data can be either internal or external.

External serial data is output on the PARDATA pins of the AUX I/O interface as parallel data LSB-justified.

The maximum data rate for serial data processing can be found in the data sheet.

External Parallel Modulation Data via the AUX I/O Interface

For "Custom Digital Modulation", parallel data can be supplied symbol-by-symbol via the AUX I/O interface (D0 – D9). The "Data Source" selection from the menu is "Extern Parallel".

In the case of two-path instruments the data lines from the AUX I/O interface are allocated to pathA permanently.



In the case of modulation modes with fewer than 10bits/symbol, the data must be applied LSB-justified. In the case of 8-PSK modulation for example (3bits/symbol) only data lines D0, D1 and D2 are used.

The clock reference (symbol clock) used to read in the data can be either internal or external.

External parallel data is output on the DATA connector serially. However, there is a maximum data rate above which serial data processing becomes impossible and the DATA connector becomes high-impedance. The maximum data rate for parallel data processing is shown in the data sheet.

4.8.2.4 Clock Signals

The clock reference used for generating the timing pulse can be either internal or external ("Clock Source" selection from the menu: "Internal / External").

Internal clock reference



The table below gives an overview of the generated clock signals and the connectors they are output at for the case a internal clock reference is selected.

Connector	Location	Clock Mode
CLOCK	front panel	Bit clock
CLOCK OUT	rear panel	Choice of bit clock or symbol clock
BITCLK	AUX I/O interface, rear panel	Bit clock
SYMBCLK	AUX I/O interface, rear panel	Symbol clock

If required, in the case of two-path instruments the internal bit clock or symbol clock from path B can be output on one of the USER interfaces.

The clock output signals are assigned in the menu sequence "Setup > Environment > Global Trigger/Clock/External Inputs > USER Marker /AUX I/O Settings".

External clock reference

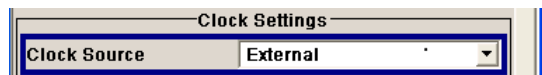

An external clock is always supplied via the CLOCK connector. When the external clock reference is selected, the internal clock is synchronized to it. The table below gives an overview of the connectors the internal clocks are output at.

Connector	Location	Clock Mode
CLOCK OUT	rear panel	Choice of bit clock or symbol clock
BITCLK	AUX I/O interface, rear panel	Bit clock
SYMBCLK	AUX I/O interface, rear panel	Symbol clock

The active edge of the external clock signal on the CLOCK input is selectable (menu "Setup > System > Global Trigger/Clock/External Inputs"). Internally the rising edge is always taken as the active edge. The active rising edge of the internal clocks is therefore synchronized with either the rising or the falling edge of the external clock reference. A symbol clock can be supplied externally or, if internally generated or externally asynchronous data is being fed in, a multiple of a symbol clock can be supplied.

In the case of two-path instruments the external clock signal is applied to path A.

In order for the clock synthesizer on the R&S SMU to be synchronized correctly, the external clock reference must first be applied and the correct symbol rate must then be set. Until this has been done the external clock source must not be selected ("Clock Source External").



The symbol rate set must not deviate from the symbol rate of the external signal by more than 2% (see also data sheet).

The synchronization of data signals and clock signals for the various data sources and clock sources is described in [chapter 4.8.2.5, "Synchronizing Data Signals and Clock Signals"](#), on page 335.

4.8.2.5 Synchronizing Data Signals and Clock Signals

When selecting data signals and clock signals, the following operating modes are possible:

- Internal clock and internal data
- Internal clock and external synchronous data
- External clock and external synchronous data
- External clock and either internal data or external asynchronous data

Internal Clock and Internal Data

When internal data is selected for path A, this data is output in serial mode on the DATA connector or in parallel mode on the PARADATA pins of the AUX I/O interface ("Custom Digital Modulation").

In modulation modes with fewer than 10bits/symbol, the parallel data is output LSB-justified. In the case of 8-PSK modulation for example (3bits/symbol) only data lines D0, D1 and D2 are used.

The internal data of path B is not output in two-path instruments. For synchronization purposes, however, it is possible to output the bit clock or symbol clock from this path to one of the USER connectors.

In the following example, the diagram shows the output signals of an 8-PSK modulation (3 bits per symbol) on the serial DATA interface. The positive edge of the clock is always used when outputting data. The data source is a data list with 15 bits = 001 010 100 101 110 (5 symbols).

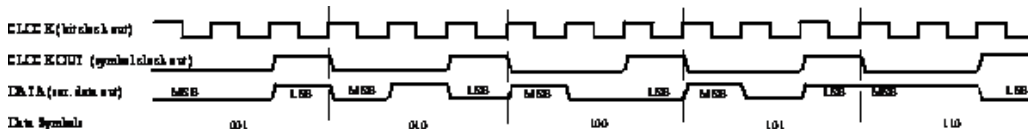

Fig. 4-27: Output signal on the serial data interface and clock output signals on the AUX I/O interface

There is a maximum data rate above which serial data processing becomes impossible. This data rate can be found in the data sheet. If the rate is exceeded the DATA connector becomes high-impedance, and the output on the CLOCK connector is the symbol clock instead of the bit clock.

In the following example, the diagram shows the output signals of an 8-PSK modulation (3 bits per symbol) on the parallel interface. The data source is a data list with 15 bits = 001 010 100 101 110 (5 symbols).

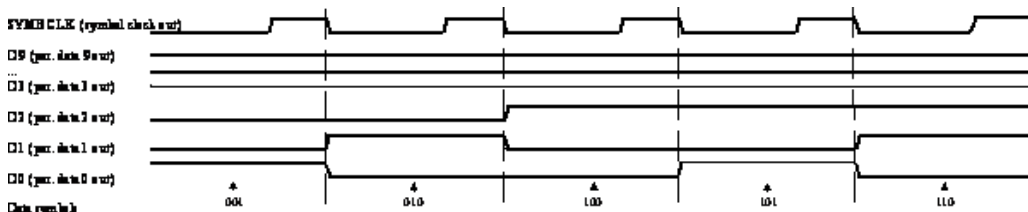

Fig. 4-28: Data and clock output signals on the parallel AUX I/O interface

In order for parallel external data to be retrieved correctly the rising edge of the symbol clock must be used, since the timing between the falling edge of the symbol clock and the data switch on the parallel interface is undefined.

Internal Clock and External Synchronous Data

External serial data

When serial data for "Custom Digital Modulation" is being fed in via the DATA connector on the front panel, the symbol clock acts as a scanning pulse (strobe) so as to mark the least significant bit in a symbol.

The clock signals are output on the CLOCK and CLOCK OUT connectors (front panel and rear panel respectively, choice of bit clock or symbol clock on the latter) and on the BITCLK or SYMBCLK pins on the AUX I/O interface. Optimum timing is achieved from using the output signal on the CLOCK connector on the front panel. The setup and hold times (see following diagram, tsetup and thold) that must be maintained in the R&S Signal Generator to ensure that the serial data is accepted correctly can be found in the data sheet.

The following diagram illustrates the timing ratios between data and clock when serial data is being supplied from an external source and the internal clock source is being used.

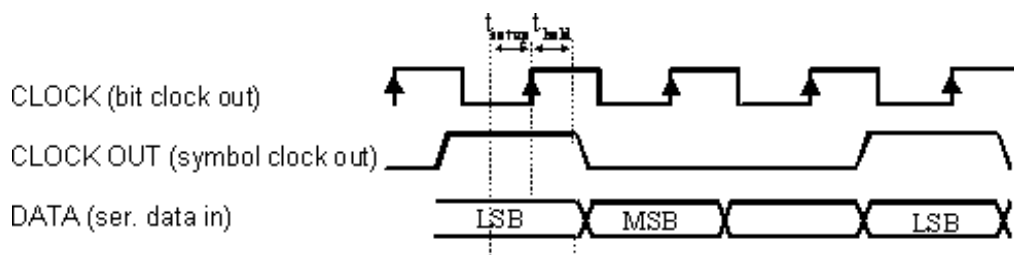

Fig. 4-29: External serial data and the clock signals which are output (bit clock and symbol clock). The setup time (t_{setup}) and hold time (t_{hold}) can be found in the data sheet.

External parallel data

When parallel data for "Custom Digital Modulation" is being fed in via the AUX I/O interface (D0 – D9), the internal symbol clock is used.

The symbol clock is output on the CLOCK OUT connector (rear panel, choice of bit clock or symbol clock) and on the SYMBCLK pin on the AUX I/O interface. Optimum timing is achieved by using the symbol clock on the SYMBCLK pin on the AUX I/O interface. The setup and hold times (see following diagram, t_{setup} and t_{hold}) that must be maintained in the R&S Signal Generator to ensure that the serial data is accepted correctly can be found in the data sheet.

The following diagram illustrates the timing ratios between data and clock when parallel data is being supplied from an external source and the internal clock source is being used.

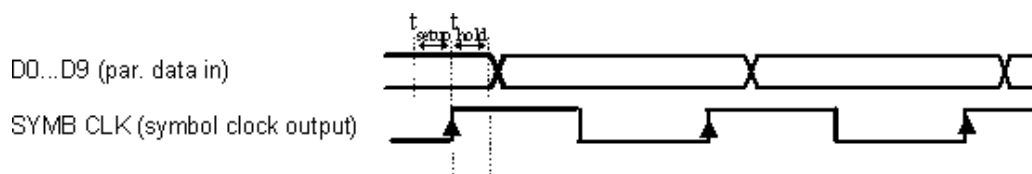

Fig. 4-30: External parallel data, internal clock signal and the clock signal that is output on the AUX I/O interface. The setup time (t_{setup}) and hold time (t_{hold}) can be found in the data sheet.

External Clock and External Synchronous Data

When synchronous modulation data is being fed in from an external source for "Custom Digital Modulation", clock generation in the R&S Signal Generator can be synchronized on the rising or falling edge of an external symbol clock. The clock reference is supplied on the CLOCK connector (front panel).

The clock signals generated as a result are output on the CLOCK OUT connector (rear panel, choice of bit clock or symbol clock) and on the BITCLK or SYMBCLK pins on the AUX I/O interface.

External serial data

The following diagram illustrates the timing ratios between data and clock when serial data is being supplied from an external source and an external reference clock is being used.

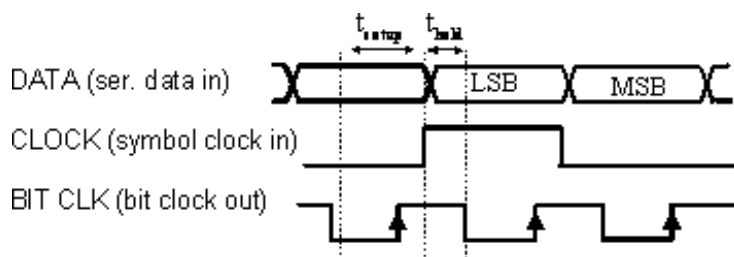

Fig. 4-31: External serial data and external symbol clock - 3 bits/symbol with high and low active symbol clock for marking the LSB. The data and the symbol clock must change state simultaneously. The setup time (t_{setup}) and hold time (t_{hold}) can be found in the data sheet.

A bit clock is generated from the externally supplied symbol clock and is used for reading the serial data into the R&S Signal Generator. The active edge of this bit clock is located ahead of the symbol clock.

External parallel data

The following diagram illustrates the timing ratios between data and clock when parallel data is being supplied from an external source and an external reference clock is being used.

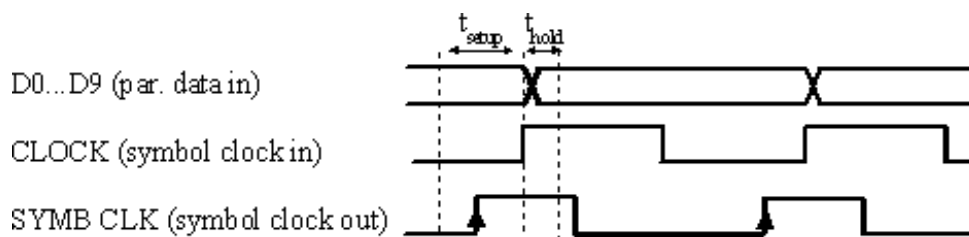

Fig. 4-32: External parallel data with high and low active external symbol clock. The setup time (t_{setup}) and hold time (t_{hold}) can be found in the data sheet.

The R&S Signal Generator uses the externally supplied symbol clock to generate an internal symbol clock that defines the sampling points at which the parallel data is read into the R&S Signal Generator. These sampling points are also located a little ahead of the external symbol clock.

External Clock and Internal or External Asynchronous Data

If the modulation data is generated internally or supplied asynchronously from an external source, clock generation in the R&S SMU can be synchronized on an external symbol clock, or a multiple thereof, which is fed in on the CLOCK connector (front panel). Synchronization can be based on the rising edge or falling edge according to choice. The maximum permissible multiple symbol clock can be found in the data sheet.

4.8.2.6 Control Signals

The following control signals are processed in the R&S SMU:

- "Burst Gate" for power ramping
- "Level Attenuation" for power ramping
- "CW" for controlling the CW (continuous wave) mode

The "CW" signal turns off digital modulation. The signal is output in unmodulated form. In case of standards in which it is possible to switch between different modulation modes, the signal is output only and cannot be supplied from an external source. In such cases it indicates the modulation mode internally (standard GSM: signal high (1) = modulation mode GMSK and signal low (0) = modulation mode 8PSK EDGE).

The CW control signal is generated internally and fed to the AUX I/O interface. The control signals for power ramping can be provided externally for Custom Digital Modulation only. When generated internally the signals are output on the AUX I/O interface.

A dedicated internal "Control Data Editor" is provided for defining the control signals. This editor with its intuitive graphical interface can be used to define and save control signals. Definition by generating or editing a binary list is no longer necessary (though it is still possible via the IEC bus).

A separate file with the file extension *.dm_iqc is created for each defined control signal and held on the R&S Signal Generator hard disk.

If the "Component Data Editor" is used, the "Control Data Editor" is integrated with it. The defined control data is not held separately, but stored with the data structure. This applies both to signals of the Data Editor Realtime and the Data Editor Offline.

Power Ramping and Level Attenuation

In TDMA radio networks it is necessary to control the RF output signal envelope synchronously for the purpose of digital modulation. The signals "Burst" Gate and "Lev Att" are used for this. These signals are internally generated.

In case of "Custom Digital Modulation", they can also be supplied from an external source via the AUX I/O interface.

When power ramping is enabled, a ramp is generated whenever there is a data switch on the "Burst" signal (from high to low or low to high). The steepness of this ramp can be adjusted. Power ramping is enabled and configured in the "Power Ramp Control" sub-menu.

The "Lev_Att" signal is used to control a defined level attenuation. If level attenuation is enabled, the modulation signal level is attenuated by a defined value if the "Lev_Att" signal is high. The level attenuation value is defined in the "Power Ramp Control" menu. For the "GSM/EDGE" standard a maximum of 7 different level attenuation values can be defined and allocated separately to the 8 slots quite independently of one another. Level attenuation is enabled either in the "Power Ramp Control" menu (Custom Digital Modulation) or in the "Burst Editor" (GSM/EDGE).

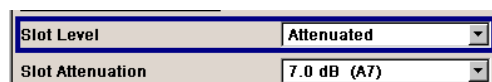

Level attenuation enables to simulate radio stations located at various distances.

The diagram below shows an example of how the power ramping signals work.

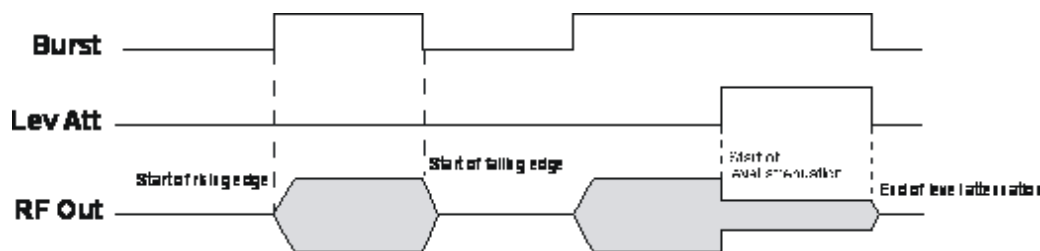

Fig. 4-33: Signal behavior when power ramping is enabled. The Burst Gate signal defines the start of the rising and falling edges of the envelope, and the Lev Att signal defines the start and end of level attenuation. The level attenuation value is defined in the Power Ramp Control menu.

4.8.2.7 Trigger Signals

In the R&S Signal Generator, trigger signals are internally generated or externally supplied signals which start signal generation at a particular point in time.

Signal generation can also take place without triggering, in which case the signal is then generated in full after modulation is powered up. A trigger event either has no effect on signal generation (menu setting "Trigger Mode Auto") or triggers a signal restart (menu setting "Trigger Mode Retrigger").

If signal generation is triggered, the signal is continuously generated after the first trigger. In the "Armed_Auto" mode, a further trigger event has no effect. In the "Armed_Retrigger" mode, every additional trigger event triggers a restart of the signal. In both cases, triggering can be reset to the initial state ("armed"), i.e. signal generation is stopped and the instrument waits for the next trigger to start signal generation anew.

The status of signal generation ("Running" or "Stopped") is displayed for all trigger modes in the corresponding trigger menu of the digital standard currently switched on. The signal generation status particularly with an external trigger can thus be checked.

Internal and external trigger sources are available for triggering.

- Internally, triggering is carried out manually by pressing the "Execute Trigger" button (menu selection "Internal").
- In the case of two-path instruments, internal triggering can be caused by the trigger signal on the second path (menu selection "Internal (Baseband A/B)"). This makes it possible to synchronize the signal on one of the two paths with the signal on the second path. Using an external trigger source, it is possible to set the trigger signal to be delayed or suppressed.
- External trigger signals can be fed in via the TRIGGER connector (menu selection "External").

In the case of external triggering and internal triggering by the trigger signal on the second path, the start can be delayed by a definable number of symbols (menu setting "Trigger Delay External"). This makes it possible to purposely simulate the time delay between a base station signal and a user equipment signal, for example in the course of base station tests.

The effect of a restarted trigger signal in the "Retrigger" trigger mode can be suppressed for a definable number of symbols (menu setting "External Trigger Inhibit"). By this means the trigger can be suppressed for a definable number of frames, for

example in the course of base station tests, and yet the signal can still be generated synchronously. In each frame the base station generates a trigger which would cause a signal generation restart every time but for the suppression.

Example:

Entering 1000 samples means that after a trigger event, any subsequent trigger signal is ignored for the space of 1000 samples.

A signal which marks the trigger event set off by the current internal or external trigger of path A or B can be output at the USER connectors (AUX IO interface or USER BNC connector).



The trigger mode setting, the selection of the trigger source and the setting of a delay and trigger suppression in the case of external triggering are carried out independently for each of the two paths. On the other hand configuration of the trigger connectors (polarity and impedance) is carried out jointly for both paths.

4.8.2.8 Marker Output Signals

The R&S Signal Generator generates user-definable marker output signals which can be used to synchronize external instruments. By this means a slot clock or frame clock can be set, for instance, or the start of a particular modulation symbol can be marked.

Four marker outputs are available for each path. The outputs for markers 1 to 3 are defined, but marker 4 can be placed on one of the USER outputs according to choice.

Path	Marker	Connector	Location
Path A	Markers 1/2	MARKER 1 / 2 BNC connectors	front panel
	Marker 3	MARKER 3 pin of the AUX I/O connector	rear panel
	Marker 4	USER1 BNC connector or USER2/3/4 pins of the AUX I/O connector	rear panel
Path B	Marker 1	MARKER 1B BNC connector	rear panel
	Markers 2/3	MARKER 2B / 3B pins of the AUX I/O connector	rear panel
	Marker 4	USER1 BNC connector or USER2/3/4 pins of the AUX I/O connector	rear panel

4.8.3 Digital Modulation - Custom Digital Modulation

The R&S Signal Generator can generate digital modulation signals with user-definable characteristics. Baseband filtering and the symbol rate can be set within wide limits.

4.8.3.1 Overview and Required Options

The equipment layout for generating the digital modulation signals includes the options Baseband Main Module (R&S SMU-B13) and Baseband Generator (R&S SMU-B9/B10/B11).

In the case of two-path instruments, at least one further Baseband Generator (R&S SMU-B9/B10/B11) option is needed for signal generation in the second path. Using this option a signal can be defined in path B and then either routed via path A or added to the signal on path A with a frequency offset that can be set. When path B is fully expanded with a second option Baseband Main Module (R&S SMU-B13) and an RF section frequency option (R&S SMU-B20x) the modulation signal can be output on RF output B.

When modulation is ON, a two-part level indication is shown in the header section of the display. This displays both the average power (LEVEL) and the peak envelope power (PEP) of the modulated output signal.



The difference between PEP and LEVEL depends on the modulation type and the filtering: Both values are pre-measured internally so that the displayed values match the true values in the signal. When external signals are used, they are replaced by PRBS data during pre-measurement.

4.8.3.2 Modulation Types - Custom Digital Mod

The available predefined modulation types are ASK (amplitude shift keying), FSK (frequency shift keying), PSK (phase shift keying) and QAM (quadrature amplitude modulation). Additionally, a user defined modulation mapping can be applied (see ["User Mapping"](#) on page 346).

The actual modulation procedure is described by mapping, which assigns I and Q values (PSK and QAM) or frequency shifts (FSK) to every modulation symbol that occurs. This is represented graphically in the constellation diagrams.

The mapping for the selected modulation type is displayed in the "More..." submenu in the "Modulation" menu section (see ["More - Modulation Type - Digital Modulation"](#) on page 361).

The QAM procedures 16QAM, 32QAM, 64QAM have been produced in accordance with ETSI standard ETS 300429 for digital video broadcasting (DVB). The QAM procedures 256QAM and 1024QAM are not specified in this standard, but have been produced according to the same basic principles.

In the case of all FSK procedures, the user can set the symbol rate fSYMB up to a maximum value (see data sheet). If MSK is selected, the frequency deviation (FSK deviation) cannot be set since it is permanently set to $\frac{1}{4}$ of the symbol rate.

Table 4-5: Modulation type and associated mapping

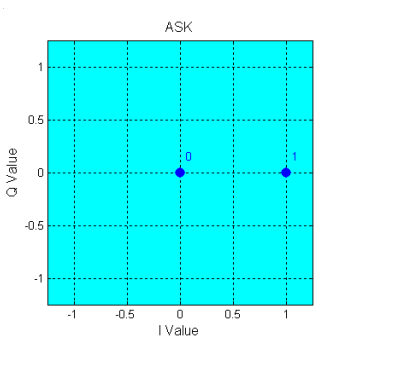
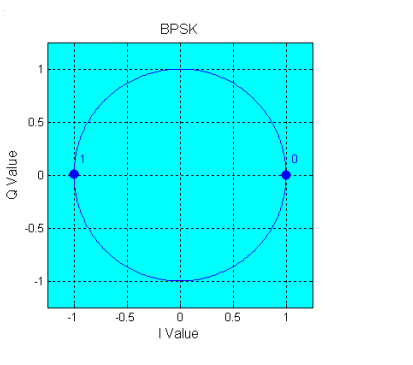
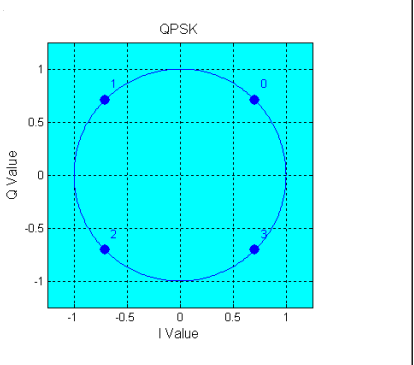
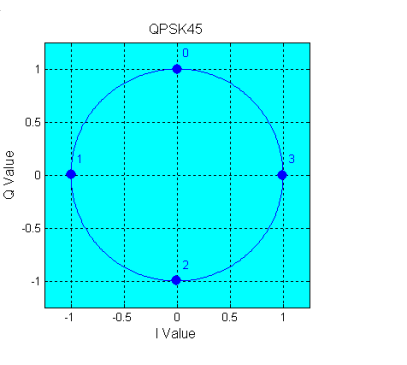
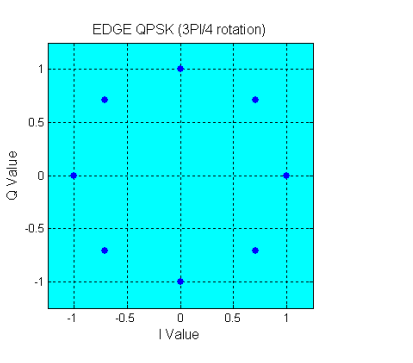
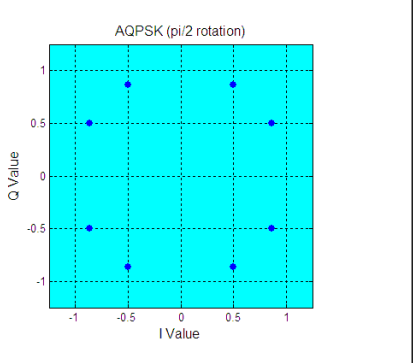
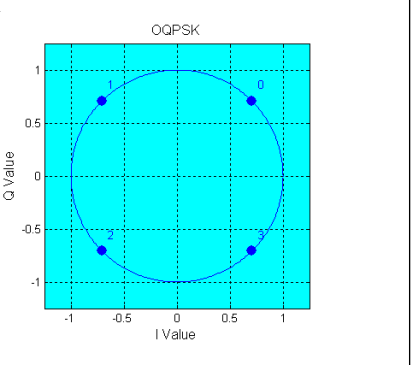
<p>ASK 1 bit per symbol SOUR:BB:DM:FORM ASK</p> 		
<p>PSK</p>		
<p>BPSK 1 bit per symbol SOUR:BB:DM:FORM BPSK</p> 	<p>QPSK 2 bits per symbol SOUR:BB:DM:FORM QPSK</p> 	<p>QPSK 45° Offset 2 bits per symbol, 45° rotation SOUR:BB:DM:FORM QPSK45</p> 
<p>QPSK EDGE 2 bits per symbol, 3pi/4 rotation SOUR:BB:DM:FORM QEDGE</p> 	<p>AQPSK 2 bits per symbol, pi/2 rotation SOUR:BB:DM:FORM AQPSK</p> 	<p>OQPSK 2 bits per symbol, Q offset SOUR:BB:DM:FORM OQPSK</p> 

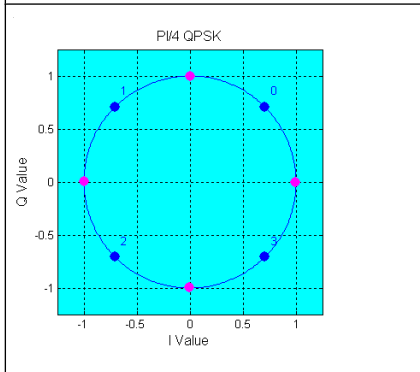
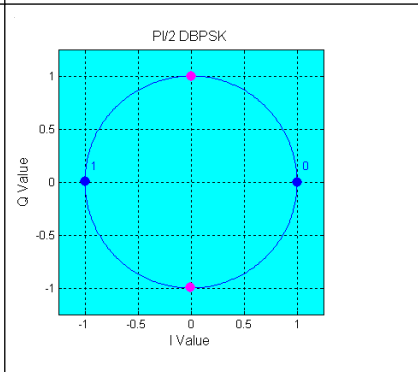
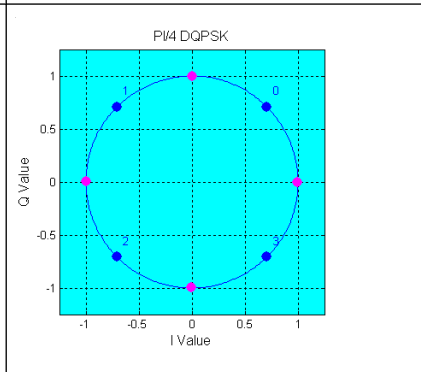
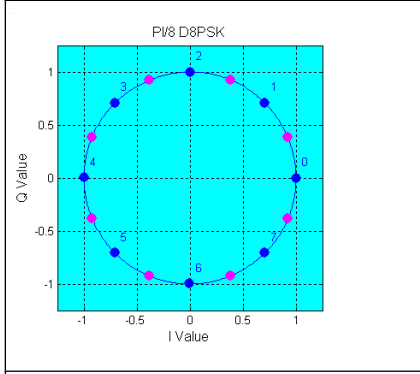
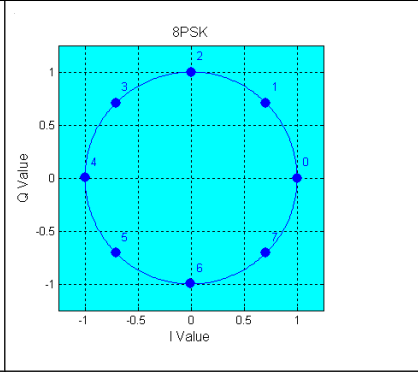
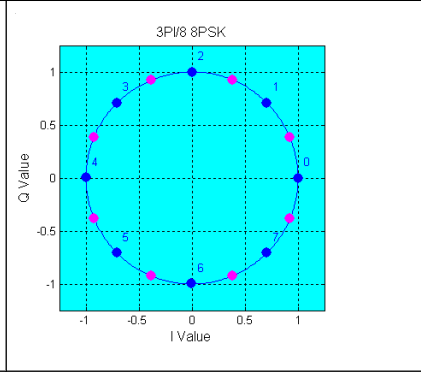
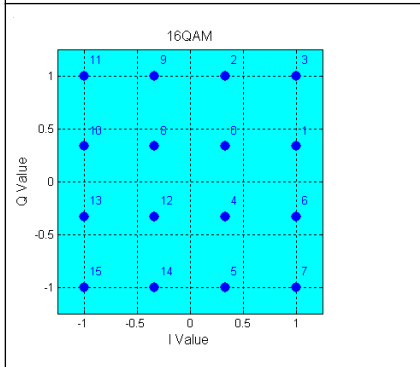
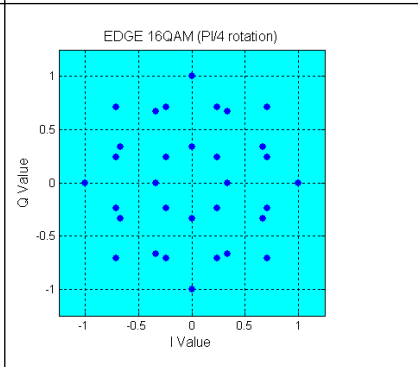
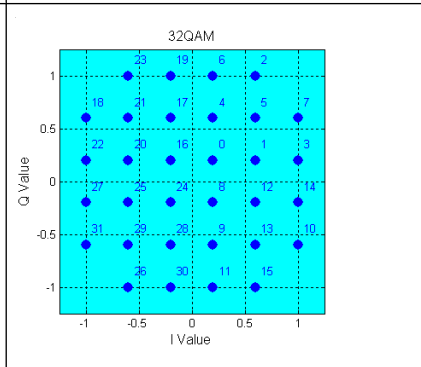
<p>pi/4-QPSK 2 bits per symbol pi/4rotation SOUR:BB:DM:FORM P4QP</p>	<p>pi/2-DBPSK 1 bit per symbol Differential coding, pi/2 rotation SOUR:BB:DM:FORM P2DB</p>	<p>pi/4-DQPSK 2 bits per symbol Differential coding, pi/4 rotation SOUR:BB:DM:FORM P4DQ</p>
		
<p>pi/8-D8PSK 3 bits per symbol Differential coding, pi/8 rotation SOUR:BB:DM:FORM P8D8</p>	<p>8PSK 3 bits per symbol SOUR:BB:DM:FORM PSK8</p>	<p>8PSK EDGE (3pi/8 8PSK) 3 bits per symbol Edge coding, 3pi/8 rotation SOUR:BB:DM:FORM P8ED</p>
		
<p>QAM</p>		
<p>16QAM 4 bits per symbol SOUR:BB:DM:FORM QAM16</p>	<p>16QAM EDGE 4 bits per symbol, pi/4 rotation SOUR:BB:DM:FORM QAM16EDGE</p>	<p>32QAM 5 bits per symbol SOUR:BB:DM:FORM QAM32</p>
		

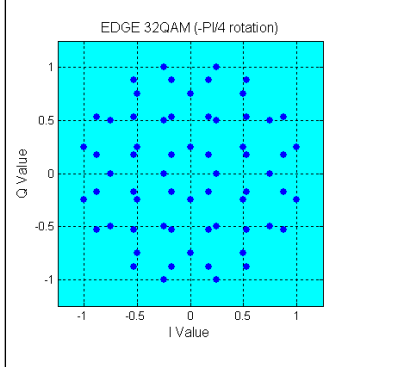
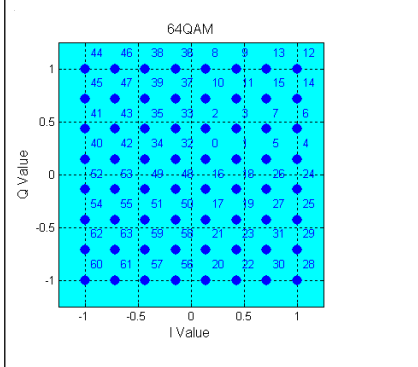
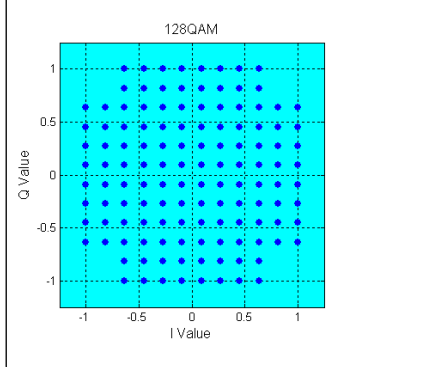
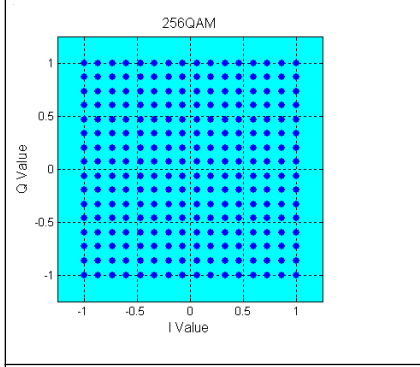
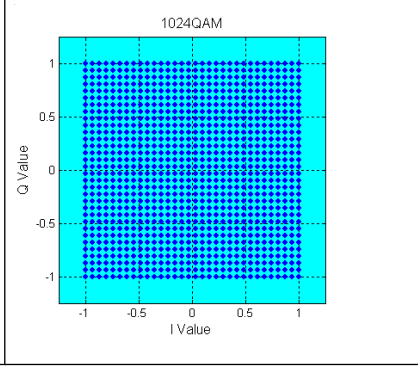
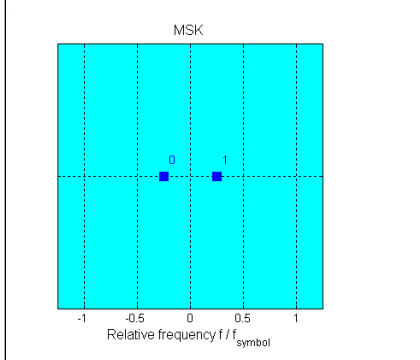
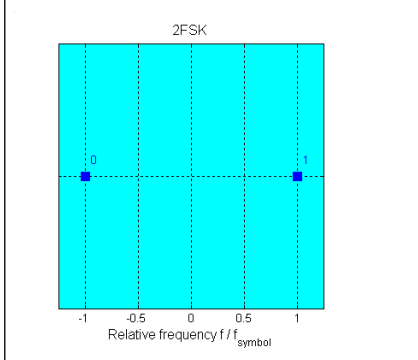
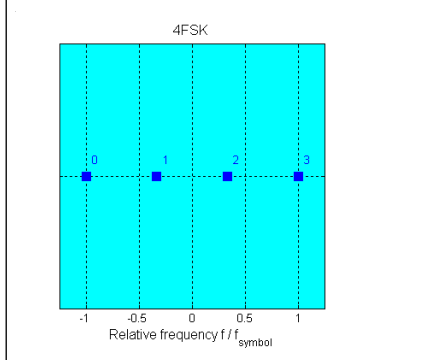
<p>32QAM EDGE 5 bits per symbol, $-\pi/4$ rotation SOUR:BB:DM:FORM QAM32Edge</p> 	<p>64QAM 6 bits per symbol SOUR:BB:DM:FORM QAM64</p> 	<p>128QAM 7 bits per symbol SOUR:BB:DM:FORM QAM128</p> 
<p>256QAM 8 bits per symbol SOUR:BB:DM:FORM QAM256</p> 	<p>1024QAM 10 bits per symbol SOUR:BB:DM:FORM QAM1024</p> 	
<p>FSK</p>		
<p>MSK 1 bit per symbol, FSK deviation SOUR:BB:DM:FORM MSK SOUR:BB:DM:FSK:DEV 0.1 MHz</p> 	<p>2FSK 1 bit per symbol SOUR:BB:DM:FORM FSK2</p> 	<p>4FSK 2 bit per symbol SOUR:BB:DM:FORM FSK4</p> 

In addition to the FSK modulations, a variable FSK modulation with definable deviation per symbol is available.

[:SOURce<hw>] :BB:DM:FORMat on page 648

User Mapping

A user defined modulation mapping file can also be selected as modulation mapping source. The user modulation mapping file must have extension *.vam and can be created with the R&S mapping wizard. The mapping wizard (mapwiz) is a tool from Rohde & Schwarz designed for editing modulation schemes (e.g. QPSK, 32QAM). Its main purpose is the assignment of logical symbol numbers to constellation points and the selection of modulation specific parameters. Beyond this it supports the creation of nearly any arbitrarily chosen constellation diagram. The output of mapwiz is a mapping file (*.vam) that can be imported on a R&S SMU. The program was developed on a 32-bit Microsoft Windows platform under MATLAB. For more information, refer to the description "Introduction to "mapwiz" Mapping Editor" on the Rohde&Schwarz Internet page.

4.8.3.3 Coding - Custom Digital Mod

Modulation symbols are coded directly before I and Q values or frequency shifts are assigned. Coding is thus directly related to modulation methods, which is the reason why codings are not freely combinable with modulation methods. The following table shows which of the coding combinations are available and defines the modulation types for which the various coding procedures can be used.

In the notation used below a_n denotes the n-th input symbol and b_n denotes the correspondingly coded output symbol. Individual bits in the symbols from the LSB (least significant bit) to the MSB (most significant bit) are denoted by a_{0n} , a_{1n} and so on. The same applies to the output symbols.

Table 4-6: Permissible coding combinations for modulation symbols and modulation type

	OFF	Differ- ential	Phase Diff.	Diff. +Gray	Gray	GSM	NADC, PDC, PHS, TETRA, APCO25 (PSK), PWT	TFTS/ TETRA	INMARSAT, ICO, WCDMA, cdma2000	VDL	APCO25 (FSK)	APCO25 (8PSK)
ASK	X	X		X	X							
BPSK	X	X		X	X							
$\pi/2$ DBPSK	X				X							
QPSK	X	X		X	X				X			
QPSK EDGE	X											
QPSK45° Off- set	X	X		X	X							
$\pi/4$ QPSK	X	X			X							
$\pi/4$ DQPSK	X				X	X	X	X				
8PSK	X	X		X	X					X		
AQPSK	X	X		X	X							

	OFF	Differ- ential	Phase Diff.	Diff. +Gray	Gray	GSM	NADC, PDC, PHS, TETRA, APCO25 (PSK), PWT	TFTS/ TETRA	INMARSAT, ICO, WCDMA, cdma2000	VDL	APCO25 (FSK)	APCO25 (8PSK)
OQPSK	X	X		X	X							
8PSK_EDGE	X											
PI/8 D8PSK	X				X							X
MSK	X	X		X	X	X						
2FSK	X	X		X	X	X						
4FSK	X	X		X	X						X	
8FSK	X	X		X	X							
16FSK	X	X		X	X							
16QAM	X	X	X	X	X							
16QAM EDGE	X											
32QAM	X	X	X	X	X							
32QAM EDGE	X											
64QAM	X	X	X	X	X							
128QAM	X	X	X	X	X							
256QAM	X	X	X	X	X							
1024QAM	X	X	X	X	X							

Modulation type pi/4DQPSK

With differential coding switched on at the same time, a constellation diagram is obtained for pi/4DQPSK which is similar to that obtained for 8PSK. Phase shifts are however assigned to the individual modulation symbols. The following tables show the assignment of modulation symbols to phase shifts of the I/Q vector in relation to the selected coding.

Table 4-7: Phase shifts for pi/4DQPSK

Modulation symbol a_n (binary indication: MSB, LSB)	00	01	10	11
Phase shifts without coding	+ 45°	+ 135°	- 135°	- 45°
Phase shifts with coding NADC, PDC, PHS, TETRA or APCO25 (PSK)	+ 45°	+ 135°	- 45°	- 135°
Phase shifts with coding TFTS	- 135°	+ 135°	- 45°	+ 45°

Coding algorithms

Common coding types are listed in the following table.

Table 4-8: Coding algorithms

Coding	Coding algorithm	Applicable for K bit/symbol
NONE	$b_n = a_n$	$k = 1 \dots 8$
Differential	$b_n = (a_n + b_{n-1}) \text{ modulo } 2^k$	$k = 1 \dots 7$
Differential + Gray	Gray coding with additional differential coding	$k = 1 \dots 7$
GSM	$dc_n = \text{not}(d_n \text{ exor } d_{n-1})$	$k = 1$

Example: Differential coding for QPSK modulation with K = 2 bit/symbol

Decimal display; value range for modulation symbols

$$a_n \in \{0; 1; 2; 3\}$$

Recursive coding is defined as follows: $b_n = (a_n + b_{n-1}) \text{ modulo } 4$

Depending on the state of a preceding modulation symbol b_{n-1} the coded modulation symbol b_n is obtained for example from modulation symbol $a_n = 2$ as follows:

$a_n = 2$	b_{n-1}	b_n
	0	2
	1	3
	2	0
	3	1

By means of differential coding, the assignment between modulation symbols and phase differences shown in the following table is generated:

Modulation symbol a_n (binary, MSB, LSB)	00	01	10	11
Phase difference	0°	90°	180°	270°

Example: Gray and differential coding for 8PSK modulation

First, a gray coding is performed according to the gray code. Afterwards, a differential coding is performed according to the recursive coding algorithm quoted above. The assignment between modulation symbols and phase differences shown in the following table is generated:

"Differential coding according to VDL" can be used for modulation types with 3 bits/symbol, e.g. 8PSK.

Table 4-9: Differential coding according to VDL

Modulation symbol d_n (binary, MSB, LSB)	000	001	010	011	100	101	110	111
Phase difference	0°	45°	135°	90°	315°	270°	180°	225°

"Phase differential coding" INMARSAT and PHASE DIFF correspond to system standards Inmarsat-M and DVB according to ETS 300 429. The INMARSAT coding can generally be used for modulation types with 2 bits/symbol, such as QPSK. It uses the following algorithm.

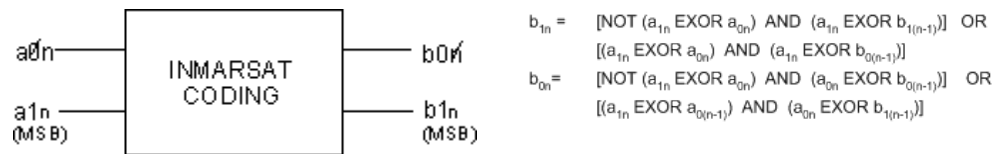
**4.8.3.4 Baseband Filter - Custom Digital Mod**

The R&S SMU offers a wide selection of predefined baseband filters. The filter characteristic for the selected filter is displayed in the "More..." submenu in the "Filter" menu section (see "Filter" on page 363). Additionally, a user defined filter can be selected (see "User filter" on page 352).

The following table shows the filters that are available, together with the associated parameters and IEC bus commands. The filter characteristic is displayed in graphical form.

Table 4-10: Baseband filter

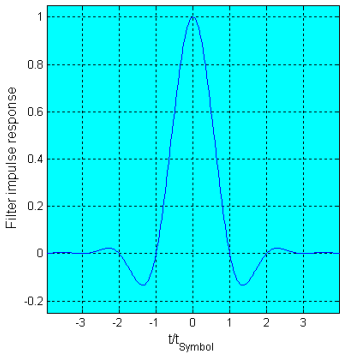
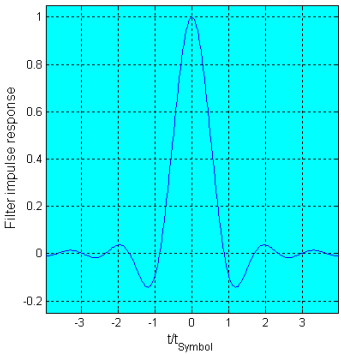
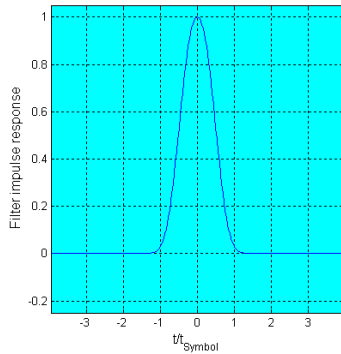
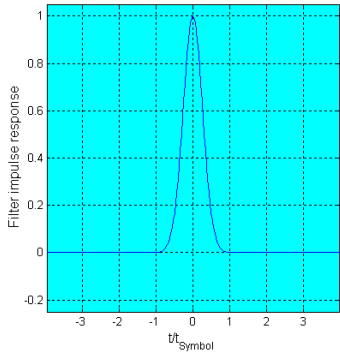
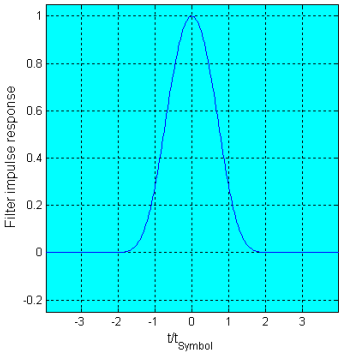
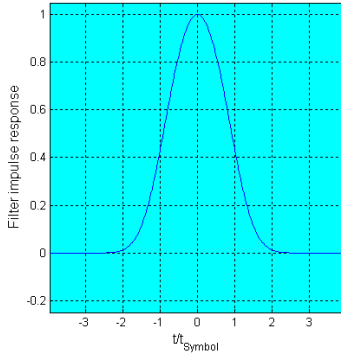
<p>Cosine Roll Off Factor SOUR:BB:DM:FILT:TYPE COS SOUR:BB:DM:FILT:PAR:COS 0.99 Bandwidth SOUR:BB:DM:FILT:PAR:COS:BAND 7200</p>	<p>Root Cosine Roll Off Factor SOUR:BB:DM:FILT:TYPE RCOS SOUR:BB:DM:FILT:PAR:RCOS 0.99</p>	<p>Gauss (FSK) B x T SOUR:BB:DM:FILT:TYPE GAUS SOUR:BB:DM:FILT:PAR:GAUS 2.5</p>
		
<p>Pure Gauss B x T SOUR:BB:DM:FILT:TYPE PGA SOUR:BB:DM:FILT:PAR:PGA 2.5</p>	<p>Gauss Linearized SOUR:BB:DM:FILT:TYPE LGA</p>	<p>Edge Narrow Pulse Shape SOUR:BB:DM:FILT:TYPE ENPShape</p>
		
<p>Edge Wide Pulse Shape SOUR:BB:DM:FILT:TYPE EWPShape</p>	<p>cdmaOne SOUR:BB:DM:FILT:TYPE CONE</p>	<p>cdmaOne 705 kHz SOUR:BB:DM:FILT:TYPE COF705</p>

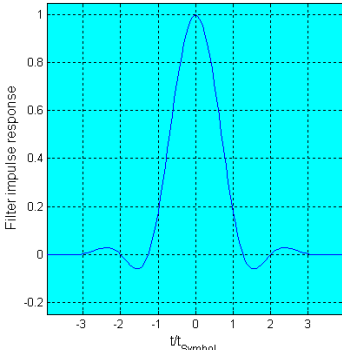
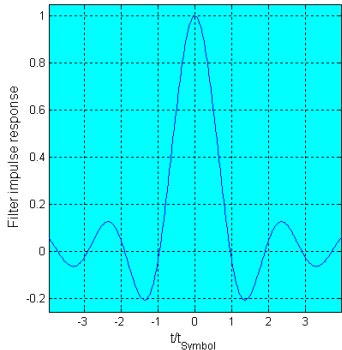
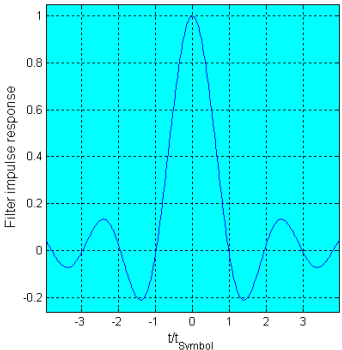
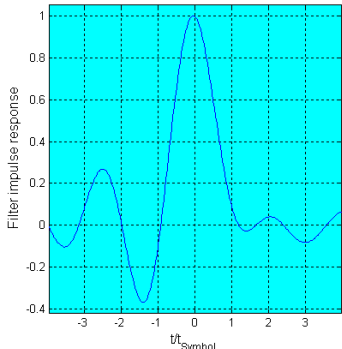
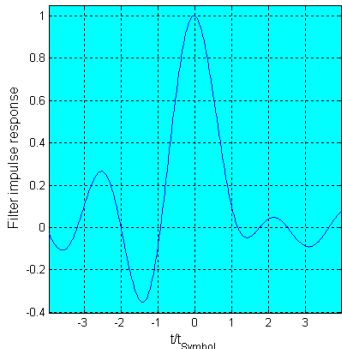
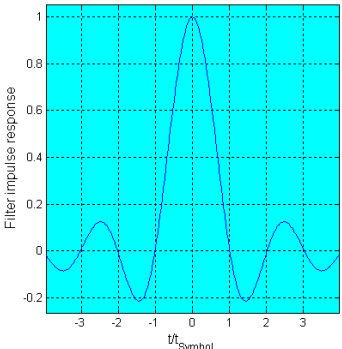
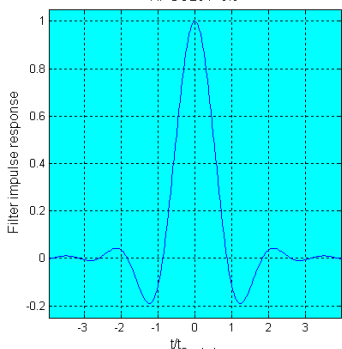
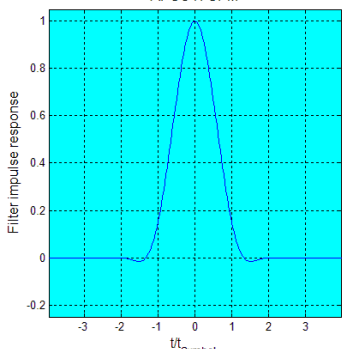
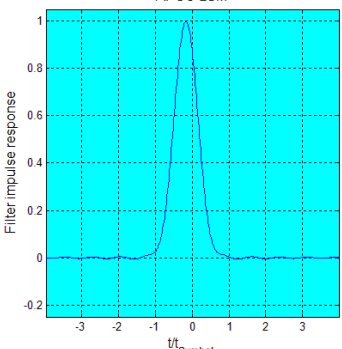
<p>Edge Wide Pulse Shape</p> 	<p>CdmaOne</p> 	<p>CdmaOne 705kHz</p> 
<p>cdmaOne + Equalizer SOUR:BB:DM:FILT:TYPE COE</p>	<p>cdmaOne 705 kHz + Equalizer SOUR:BB:DM:FILT:TYPE COFE228</p>	<p>cdma2000 3X SOUR:BB:DM:FILT:TYPE DM3x</p>
<p>CdmaOne with equalizer</p> 	<p>CdmaOne 705 kHz with equalizer</p> 	<p>Cdma2000 3X</p> 
<p>APCO25 Roll Off Factor SOUR:BB:DM:FILT:TYPE APCO25 SOUR:BB:DM:FILT:PAR:APC 0.5</p>	<p>APCO25 (H-CPM) SOUR:BB:DM:FILT:TYPE APCO25Hcpm</p>	<p>APCO25 (LSM) SOUR:BB:DM:FILT:TYPE APCO25Lsm Gauss Cut Off Frequency SOUR:BB:DM:FILT:PAR:APCO25L:GAUSS 25000 Gauss Cut Off Frequency SOUR:BB:DM:FILT:PAR:APCO25:LOWP 75000</p>
<p>APCO25 r=0.5</p> 	<p>APCO H-CPM</p> 	<p>APCO LSM</p> 

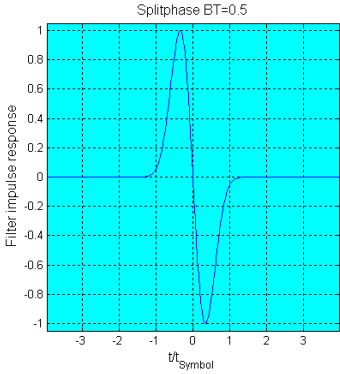
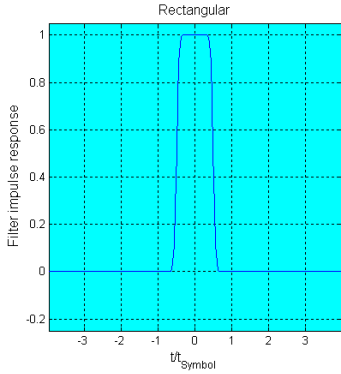
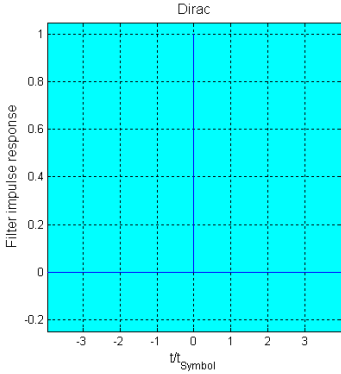
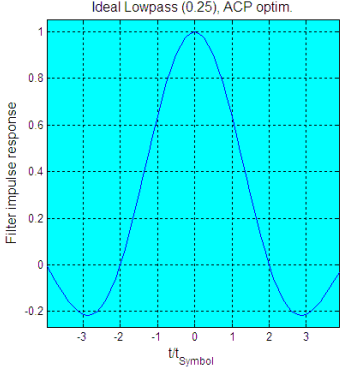
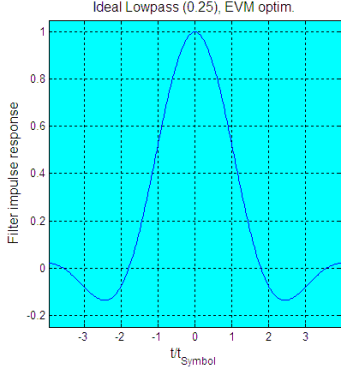
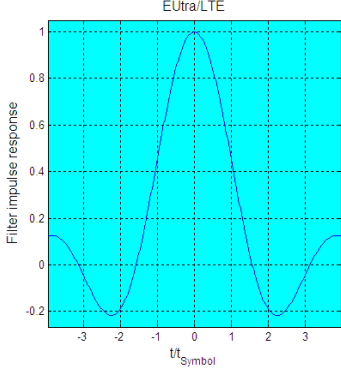
<p>Split Phase BxT SOUR:BB:DM:FILT:TYPE SPH SOUR:BB:DM:FILT:PAR:SPH 0.15</p>	<p>Rectangular SOUR:BB:DM:FILT:TYPE RECT</p>	<p>Dirac SOUR:BB:DM:FILT:TYPE DIRac</p>
		
<p>Lowpass ACP opt. SOUR:BB:DM:FILT:TYPE LPASs SOUR:BB:DM:FILT:PAR:LAPS 0.5</p>	<p>Lowpass EVM opt. BB:DM:FILT:TYPE LPASSEVM BB:DM:FILT:PAR:LAPSEVM 0.5</p>	<p>EUTRA/LTE SOUR:BB:DM:FILT:TYPE LTEFilter</p>
		

User filter

The user filter file must have extension `*.vaf` and can be created with the R&S filter wizard.

The filter wizard (filtwiz) is a tool from Rohde & Schwarz designed for creating filter files that can be imported on a R&S SMU. Its main purpose is the conversion of user-defined finite impulse response (FIR) filters into the filter format (`*.vaf`). Beyond this filt wiz provides designs for standard filters, e.g. Root Raised Cosine, Gaussian.

The program was developed on a 32-bit Microsoft Windows platform under MATLAB.

For more information, refer to the description "Introduction to "filtwiz" Filter Editor" on the Rohde&Schwarz Internet page.

4.8.3.5 Conflicting Settings - Custom Digital Mod

Having selected a modulation procedure, not every combination is possible when selecting the settings for the modulation parameters "Symbol Rate" and "Coding". These restrictions inevitably give rise to conflicting settings if a parameter is changed and leads to a prohibited combination.

A conflicting setting is indicated by a message on the Info line in the display. The R&S SMU displays the setting entered by the user, but the modulation signal actually generated does not correspond to this display. A conflict of settings can be triggered if the user changes a parameter inappropriately. The message disappears as soon as a conflict-free setting is entered.

A list of the possible settings conflicts and messages in digital modulation can be found in [chapter 8, "Error Messages"](#), on page 837.

4.8.3.6 Custom Digital Mod User Interface

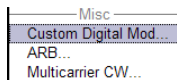

The menu for setting digital modulation can be opened either in the "Baseband" block or in the menu tree under "Baseband".

The "Custom Digital Modulation" menu enables direct selection of the data source, standard, symbol rate, coding, modulation type and filter. All other settings are entered in submenus which are called via "More" buttons.

The upper part of the menu is used for powering up digital modulation as well as for calling the default settings and user-defined standards.



The data source is selected and set in the "Data Source" section.

The "List Management" button opens a submenu for calling the data editor and the file manager.

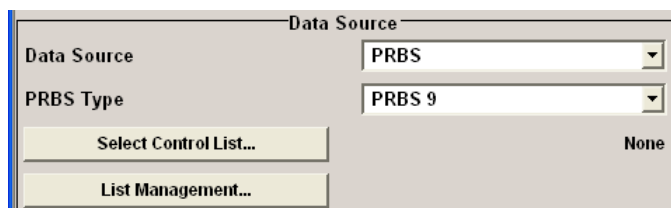

The middle part of the menu is used for selecting the standard, the symbol rate and the coding.

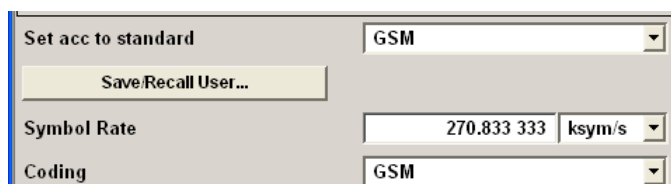

The modulation type is set in the "Modulation" section.

The "More" button opens a submenu that displays the mapping for the selected modulation.

This submenu can also be used to enable switching the signal between modulated and unmodulated.



The filter is set in the "Filter" section. The "More" button opens a submenu where the filter characteristic of the selected filter is displayed.

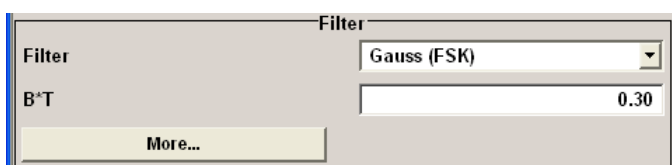

The buttons in the lower part of the menu open submenus for power ramping and for configuring triggers, markers and clocks.

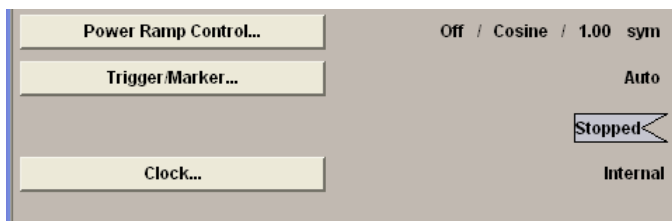

In each case the current setting is displayed next to the button.

General Settings

The upper part of the menu is used for powering up digital modulation as well as for calling the default settings and user-defined standards.

State - Digital Modulation

Enables/disables digital modulation.

Switching on digital modulation turns off all the other digital standards.

In case of two-path instruments, this affects the same path.

The digital modulation is generated in realtime (no precalculated signal), and therefore all parameter changes (in the ON state) directly affect the output signal.

SCPI command:

[:SOURce<hw>] :BB:DM:STATe on page 632

Set To Default - Digital Modulation

Calls default settings. The values are shown in the following table.

Parameter	Value
State	Not affected by Set to Default
Data Source	PRBS 9
Standard	GSM
Symbol Rate	270.833 ksymb/s
Coding	GSM
Modulation Type	MSK
Filter	Gauss (FSK)
Filter Parameter BxT	0.3
Power Ramp Control	
Attenuation	15 dB
Ramp Time	1 sym
Ramp Function	Cosine
Fall Delay	0
Rise Delay	0
Source	Internal
State	Off
Trigger	Mode Auto, Source Internal
Clock	
Source	Internal
Mode	Symbol

SCPI command:

[:SOURce<hw>] :BB:DM:PRESet on page 631

Save/Recall - Digital Modulation

Calls the "Save/Recall" dialog.

From the "Save/Recall" dialog the "File Select" windows for saving and recalling the complete settings in the "Custom Digital Modulation" menu can be called.

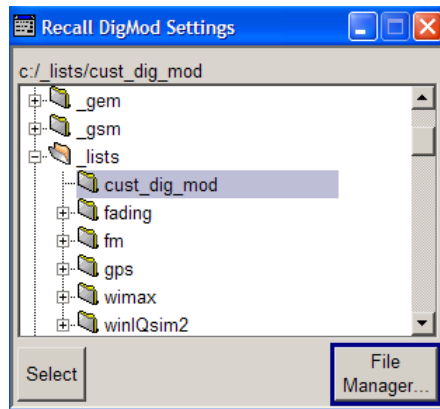

The Digital Modulation Settings are stored as files with the predefined file extension * .dm. The file name and the directory they are stored in are user-definable.

The complete settings in the "Custom Digital Modulation" dialog are saved and recalled.

SCPI command:

[\[:SOURce<hw>\]:BB:DM:SETTING:CATalog](#) on page 662

[\[:SOURce<hw>\]:BB:DM:SETTING:DELeTe](#) on page 662

[\[:SOURce<hw>\]:BB:DM:SETTING:LOAD](#) on page 663

[\[:SOURce<hw>\]:BB:DM:SETTING:STORe](#) on page 663

Fast Save

Determines whether the instrument performs an absolute or a differential storing of the settings.

Enable this function to accelerate the saving process by saving only the settings with values different to the default ones.

Note: This function is not affected by the "Preset" function.

SCPI command:

[\[:SOURce<hw>\]:BB:DM:SETTING:STORe:FAST](#) on page 663

[\[:SOURce<hw>\]:BB:ARB:MCARrier:SETTING:STORe:FAST](#) on page 613

refer to the description of firmware options for the syntax of the corresponding SCPI commands

Data Source

The data source is selected and set in the "Data Source" section. The parameters offered depend on the data source selected. The More button opens a submenu for calling the data editor and the file manager.

Data Source - Digital Modulation

Selects the data source (see [chapter 4.8.2, "Data and Signal Sources in Baseband"](#), on page 331).

You may choose from the following data sources:

"All 0, All 1" 0 data or 1 data is internally generated.

"PRBS, PRBS Type" PRBS data in accordance with the IUT-T with period lengths between 29-1 and 223-1 are internally generated. The length is selected in the "PRBS Type" input box.



SCPI command:

[:SOURce<hw>] :BB:DM:PRBS [:LENGth] on page 630

"Pattern" A user-definable bit pattern with a maximum length of 64 bits is internally generated. The bit pattern is defined in the "Pattern" input box.

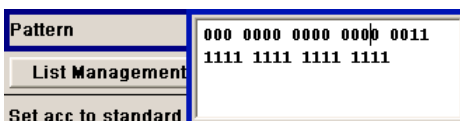

"Data List ..., Select Data" Data lists will be used. Data lists can be generated internally in the data editor or externally. Data lists are selected in the "File Select" window, which is called by means of the "Select Data" button.



The "File" "Manager" is used to transmit external data lists to the R&S Signal Generator, and can be called within every "File" Select window by means of the "File" "Manager" button.

SCPI command:

[:SOURce<hw>] :BB:DM:DLIST:SElect on page 660

"External Serial" External serial data is supplied via the DATA connector.

"External Parallel (AUX I/O)" External parallel data is supplied externally via the PARADATA pins on the AUX I/O interface.

SCPI command:

[:SOURce<hw>] :BB:DM:SOURce on page 631

List Management - Digital Modulation

Calls the menu for managing data and control lists (see "List Management" on page 365).

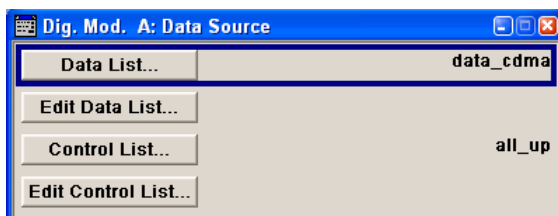

SCPI command:

n.a.

Standard, Symbol Rate, Coding

The middle part of the menu is used for selecting the standard, the symbol rate and the coding.

Set acc. to Standard - Digital Modulation

Selects a standard.

After selection, modulation parameters "Modulation Type", "Symbol Rate", "Filter" and "Coding" are automatically set in accordance with the standard.

If one of these parameters is subsequently altered, the display changes to User. The User setting can be saved to a file so that it can be recalled at some later time ("Save/Recall User.." button).

The following table shows the standards that are available, together with the associated settings of the modulation parameters.

Table 4-11: Standards - Custom Digital Modulation

Standard	Modulation	Symbol Rate	Filter	Coding	Parameter for SCPI command
APCO Phase1 C4FM	4FSK, Deviation 1.8 KHz	4.8 ksym/s	APCO25, roll off = 0.2	APCO25(FSK)	APCOPH1C4fm
APCO Phase1 CQPSK	pi/4-DQPSK	4.8 ksym/s	Cosine, roll off = 0.2, BW = 4.8 KHz	APCO25(PSK)	APCOPH1CQpsk
APCO Phase2 H-CPM	4FSK, Deviation 3 KHz	6 ksym/s	APCO25 (H-CPM)	APCO25(FSK)	APCOPH2HCpm
APCO Phase2 H-DQPSK	pi/4-DQPSK	6 ksym/s	Cosine, roll off = 1, BW = 7.2 KHz	APCO25(PSK)	APCOPH2HDQpsk
APCO Phase2 H-D8PSK Wide	pi/8-D8PSK	4 ksym/s	Cosine, roll off = 1, BW = 7.2 KHz	APCO25(8PSK)	APCOPH2HD8PSKW
APCO Phase2 H-D8PSK Narrow	pi/8-D8PSK	4 ksym/s	Cosine, roll off = 1, BW = 5 KHz	APCO25(8PSK)	APCOPH2HD8PSKN
APCO Phase1 LSM	pi/4-DQPSK	4.8 ksym/s	APCO25 (LSM), Gauss Cut Off = 2.04 KHz, Low-pass Cut Off = 6.2 KHz	APCO25(8FSK)	APCOPH1Lsm
APCO Phase1 WCQPSK	pi/4-DQPSK	4.8 ksym/s	Cosine, roll off = 1, BW = 7.2 KHz	APCO25(8FSK)	APCOPH1Wcqpsk
Bluetooth	2FSK, Deviation 160.0 kHz	1.0 Msym/s	Gauss, B*T = 0.5	OFF	BLUetooth
DECT	2FSK, Deviation 288.0 kHz	1.152 Msym/s	Gauss, B*T = 0.5	OFF	DECT
ETC (ARIB STD T55)	ASK, ASK Depth 100%	1.024 Msym/s	Split Phase, B*T = 2.0	OFF	ETC
GSM	MSK	270.833333 ksym/s	Gauss, B*T = 0.3	GSM	GSM
GSM EDGE	8PSK EDGE (3pi/8 8PSK)	270.833333 ksym/s	Gauss linear	OFF	GSMEdge
NADC	pi/4 DQPSK	24.3 ksym/s	Root Cosine, alpha = 0.35	NADC	NADC

Standard	Modulation	Symbol Rate	Filter	Coding	Parameter for SCPI command
PDC	pi/4 DQPSK	21.0 ksym/s	Root Cosine, alpha = 0.50	PDC	PDC
PHS	pi/4 DQPSK	192.0 ksym/s	Root Cosine, alpha = 0.50	PHS	PHS
TETRA	pi/4 DQPSK	18.0 ksym/s	Root Cosine, alpha = 0.35	TETRA	TETRA
WCDMA 3GPP	QPSK 45° Offset	3.84 Msym/s	Root Cosine, alpha = 0.22	WCDMA 3GPP	W3GPP
TD-SCDMA	QPSK 45° Offset	1.28 Msym/s	Root Cosine, alpha = 0.22	OFF	TCSCdma
cdma2000 Forward	QPSK	1.2288 Msym/s	cdmaOne + Equalizer	cdma2000	CFORward
cdma2000 Reverse	Offset QPSK	1.2288 Msym/s	cdmaOne	cdma2000	CREVerse
Worldspace	QPSK	1.84 Msym/s	Root Cosine, alpha = 0.40	OFF	WORLdspace
TFTS	pi/4 DQPSK	22.1 ksym/s	Root Cosine, alpha = 0.40	TFTS/ TETRA	TFTS

SCPI command:

[\[:SOURCE<hw>\]:BB:DM:STANDARD](#) on page 632

Save/Recall User - Digital Modulation

Calls the "Save/Recall User" menu.

From the "Save/Recall User Standard" menu the "File Select" windows for saving and recalling user-defined standards and the "File Manager" can be called.



User standards are stored as files with the predefined file extension *.dm_stu. The file name and the directory they are stored in are user-definable.

SCPI command:

[\[:SOURCE<hw>\]:BB:DM:STANDARD:ULIST:CATALOG](#) on page 663

[\[:SOURCE<hw>\]:BB:DM:STANDARD:ULIST:DELETE](#) on page 664

[\[:SOURCE<hw>\]:BB:DM:STANDARD:ULIST:LOAD](#) on page 664

[\[:SOURCE<hw>\]:BB:DM:STANDARD:ULIST:STORE](#) on page 664

Symbol Rate - Digital Modulation

Selects the symbol rate.

The value range is dependent on the selected modulation type.

When the modulation type changes, the range is automatically redefined. If the set symbol rate is outside this range, an error message is generated and the maximum value for the newly chosen modulation type is automatically set.

SCPI command:

[\[:SOURCE<hw>\]:BB:DM:SRATE](#) on page 632

Coding - Digital Modulation

Selects the coding (see [chapter 4.8.3.3, "Coding - Custom Digital Mod"](#), on page 346).

The menu offers only the coding settings that are permissible for the chosen modulation type. The other coding methods are grayed out.

If the system is subsequently switched to a modulation type for which the selected coding is not available, coding is automatically set to OFF.

SCPI command:

[:SOURce<hw>] :BB:DM:CODing on page 648

Modulation

The modulation type is set in the "Modulation section". The parameters offered depend on what is currently selected. The "More..." button opens a submenu for displaying the user-defined mapping.

Modulation Type - Digital Modulation

Selects a modulation type.

The associated symbol mapping is displayed in the "More..." submenu (see [chapter 4.8.3.2, "Modulation Types - Custom Digital Mod"](#), on page 342).

If the "coding" that is set is not possible with the chosen modulation type, "coding" is set to "Off".

For selection "Variable FSK", the deviation of each symbol can be set in the "More..." submenu.

SCPI command:

[:SOURce<hw>] :BB:DM:FORMat on page 648

Load User Mapping - Digital Modulation

Selects user defined mapping table. This opens the "Select List File User Mapping" window in which the mapping table can be selected (see ["User Mapping"](#) on page 346). The button is only available if modulation type "USER" is selected.

The button "File Manager" calls the "File Manager" menu. The "File" "Manager" menu is used to display and delete files.

SCPI command:

[:SOURce<hw>] :BB:DM:MLISt:SElect on page 662

[:SOURce<hw>] :BB:DM:MLISt:CATalog on page 654

[:SOURce<hw>] :BB:DM:MLISt:DElete on page 661

ASK Depth - Digital Modulation

Sets the modulation depth m for ASK modulation.

$$m = (\text{Amplitude}_{\text{max}} - \text{Amplitude}_{\text{min}}) / (\text{Amplitude}_{\text{max}} + \text{Amplitude}_{\text{min}})$$

SCPI command:

[:SOURce<hw>] :BB:DM:ASK:DEPTh on page 647

FSK Deviation - Digital Modulation

Sets the frequency deviation for FSK modulation. The range of values depends on the chosen symbol rate (see data sheet).

Whenever "MSK" is selected, the deviation corresponds to 1/4 of the symbol rate and cannot be set.

SCPI command:

[\[:SOURce<hw>\]:BB:DM:FSK:DEVIation](#) on page 649

Angle Alpha

For AQPSK modulation, sets the angle alpha between the point (0,0) and the I axis.

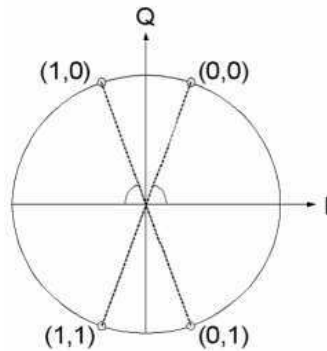

SCPI command:

[\[:SOURce<hw>\]:BB:DM:AQPSk:ANGLe](#) on page 647

More - Modulation Type - Digital Modulation

Calls the submenu which displays the mapping of the currently selected modulation type and the digital modulation delay in the case of an external data source.

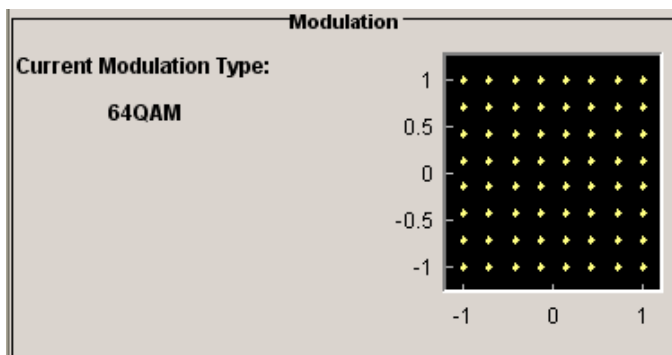

The "Modulation - CW Switching" section can be used to enable switching of the signal between modulated and unmodulated.

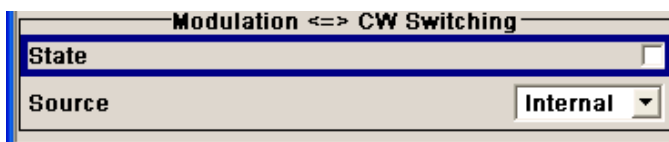

In case of selection "Variable FSK", the FSK type and the deviation for each symbols is set in the "Variable FSK" section.

Variable FSK	
FSK Type	4FSK
Deviation 0000	-135.416 5 kHz
Deviation 0001	45.138 8 kHz
Deviation 0010	45.138 8 kHz
Deviation 0011	135.416 5 kHz

FSK Type - Digital Modulation

(Variable FSK only)

Selects the FSK modulation type for selection "Variable FSK".

You may choose from 4FSK, 8FSK and 16FSK.

SCPI command:

[\[:SOURce<hw>\]:BB:DM:FSK:VARiable:TYPE](#) on page 649

Deviation xxxx - Digital Modulation

(Variable FSK only)

Set the deviation of the associated symbol. The number of symbols depends on the selected modulation type. The value of each symbol is indicated in binary format.

SCPI command:

[\[:SOURce<hw>\]:BB:DM:FSK:VARiable:SYMBOL<ch>:DEVIation](#) on page 649

Modulation Delay - Digital Modulation

(Data Source ext serial and ext parallel only)

Displays the digital modulation delay from the data input to the I/Q output.

The value is displayed only if an external synchronous data source is selected. In this case the value represents the delay between the active clock edge for data and the corresponding peak I/Q value (associated with this data item) on the I/Q connectors.

SCPI command:

[\[:SOURce<hw>\]:BB:DM:MDELay](#) on page 650

Current Modulation Type - Digital Modulation

Displays the currently selected modulation type together with its associated mapping.

SCPI command:

n.a.

Modulation - CW Switching

The "Modulation <=> CW Switching" section is used to enable switching the signal between modulated and unmodulated.

State Mod - CW - Digital Modulation

Enables switching between a modulated and an unmodulated signal.

Switching is carried out by a control signal (CW) that is defined internally in the control list or supplied from an external source via a user-defined input.

SCPI command:

[\[:SOURce<hw>\]:BB:DM:SWITching:STATe](#) on page 633

Source Mod - CW - Digital Modulation

Selects the CW control signal for switching between a modulated and an unmodulated signal.

"Internal" The CW signal in the control list is used for the control.
The internal signal can be output on one of the user interfaces.

"External" The control signal on the CW pin of the AUX I/O connector is used.
For two path instruments, path A and B.

SCPI command:

[\[:SOURce<hw>\]:BB:DM:SWITching:SOURce](#) on page 633

Filter

The filter is set in the Filter section.

Filter - Digital Modulation

Selects the baseband filter (see [chapter 4.8.3.4, "Baseband Filter - Custom Digital Mod"](#), on page 349).

SCPI command:

[\[:SOURce<hw>\]:BB:DM:FILTer:TYPE](#) on page 646

Filter Parameter - Digital Modulation

Sets the filter parameter.

The filter parameter offered ("Roll Off Factor" or "B x T") depends on the currently selected filter type.

SCPI command:

[\[:SOURce<hw>\]:BB:DM:FILTer:PARAmeter:APCO25](#) on page 645

[\[:SOURce<hw>\]:BB:DM:FILTer:PARAmeter:COSine\[:ROLLoff\]](#) on page 645

[\[:SOURce<hw>\]:BB:DM:FILTer:PARAmeter:GAUSSs](#) on page 645

[\[:SOURce<hw>\]:BB:DM:FILTer:PARAmeter:PGAuss](#) on page 645

[\[:SOURce<hw>\]:BB:DM:FILTer:PARAmeter:RCOSine](#) on page 645

[\[:SOURce<hw>\]:BB:DM:FILTer:PARAmeter:SPHase](#) on page 645

Cut Off Frequency Factor - Digital Modulation

(available for filter parameter Lowpass and APCO25 (LSM) only)

Sets the value for the cut off frequency factor. The cut off frequency of the filter can be adjusted to reach spectrum mask requirements.

SCPI command:

[\[:SOURce<hw>\]:BB:DM:FILTer:PARAmeter:LPASs](#) on page 645

[\[:SOURce<hw>\]:BB:DM:FILTer:PARAmeter:LPASSEVM](#) on page 645

[\[:SOURce<hw>\]:BB:DM:FILTer:PARAmeter:APCO25Lsm:GAUSSs](#) on page 646

[\[:SOURce<hw>\]:BB:DM:FILTer:PARAmeter:APCO25Lsm:LOWPass](#) on page 646

Bandwidth - Digital Modulation

Determines the bandwidth of the cosine filter, so that the function $H(f) = 0$ is fulfilled for $f \geq (1 + \text{RollOff}) * \text{Bandwidth} / 2$.

SCPI command:

`[:SOURce<hw>] :BB:DM:FILTER:PARAMeter:COSSine:BANDwidth` on page 646

Oversampling - Digital Modulation

Determines the upsampling factor. If the check box is activated, the most sensible parameter values are selected. The value depends on the coherence check. If the check box is deactivated, the values can be changed manually.

SCPI command:

`[:SOURce<hw>] :BB:DM:FILTER:OSAMpling:AUTO` on page 645

`[:SOURce<hw>] :BB:DM:FILTER:OSAMpling` on page 644

More - Filter - Digital Modulation

Calls the menu for displaying the filter characteristic of the currently selected filter.

Load User Filter- Filter - Digital Modulation

Calls the menu "Select List User Filter" for selecting a user-defined filter file with extension `*.vaf` (see "User filter" on page 352). The button is only available if filter type "USER" is selected.

The button "File" "Manager" calls the "File" "Manager" menu. The "File" "Manager" menu is used to display and delete files.

SCPI command:

`[:SOURce<hw>] :BB:DM:FLIST:SElect` on page 661

`[:SOURce<hw>] :BB:DM:FLIST:CATalog` on page 654

`[:SOURce<hw>] :BB:DM:FLIST:DElete` on page 660

Current Filter Response

Displays the filter characteristic of the currently selected filter.

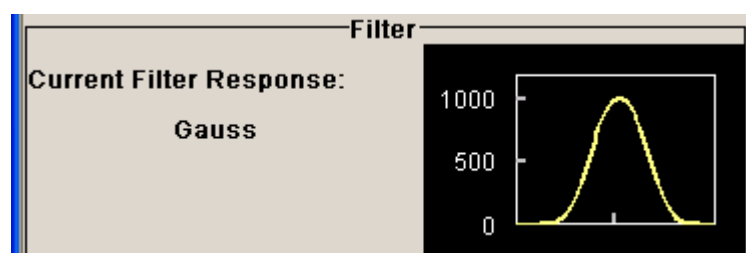

SCPI command:

n.a.

Power Ramp

The lower part of the Custom Digital Modulation menu is used for setting triggers, marker and clocks, as well as for power ramp settings.

Power Ramp Control - Digital Modulation

Calls the power ramp control menu (see ["Power Ramp Control"](#) on page 372).

SCPI command:
n.a.

Trigger/Marker - Digital Modulation

Calls the "Trigger/Marker/Clock" dialog, used to select the trigger source, set the time delay on an external trigger signal and configure the marker output signals.

See ["Trigger/Marker/Clock"](#) on page 375.

SCPI command:
n.a.

Execute Trigger - Digital Modulation

Executes trigger manually. A manual trigger can be executed only when an internal trigger source and a trigger mode other than Auto have been selected.

SCPI command:
`[:SOURce<hw>] :BB:DM:TRIGger:EXECute` on page 636

Clock - Digital Modulation

Calls the "Trigger/Marker/Clock" menu. The "Trigger/Marker/Clock" menu is used to select the clock source (see ["Clock Settings"](#) on page 382).

SCPI command:
n.a.

List Management

The "List Management" menu is called from the "Custom Digital Modulation" main menu.

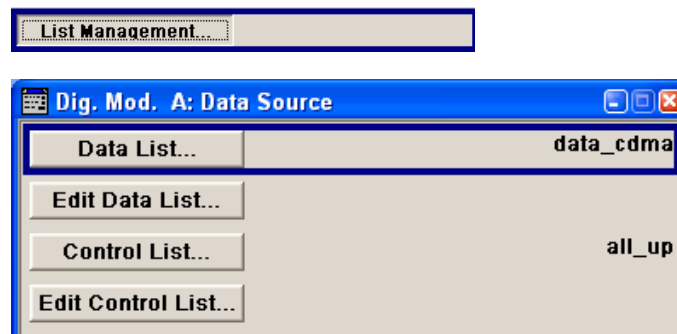

The data and control lists are selected and created in the "File Select" menu which is called up by means of the "Data List..." and "Control List..." buttons.



The "File Manager" is used to copy, rename and delete files and to create directories.

For more information, see [chapter 3.7, "File Management"](#), on page 110.

To ensure that the selected data or control list is used for generating the digital signal, the list must be selected as the data source:

Data	Parameter	Selection
Digital data	"Source"	DList
Marker	"Marker Mode"	CList
Control signals CW, Level Attenuation and Burst Gate	"Source"	Internal

The data editor is called using the "Edit Data List..." and "Edit Control List ..." buttons. The contents of the selected list are displayed.

Operating the list editors is described in [chapter 3.5.1, "Working with List Editor"](#), on page 101.

Select Data/Control List - Digital Modulation

Selects data/control list. This opens the "File Select" window in which the data/control list can be selected.

SCPI command:

[\[:SOURce<hw>\]:BB:DM:DLIST:SElect](#) on page 660

[\[:SOURce<hw>\]:BB:DM:CLIST:SElect](#) on page 657

Create Data/Control List - Digital Modulation

Creates new data/control list. This opens the "File Select" window in which the data/control list can be created.

The file name has to be entered in field "File Name:". The new list contains no data, it can be edited in the list editor.

SCPI command:

[\[:SOURce<hw>\]:BB:DM:DLIST:SElect](#) on page 660

[\[:SOURce<hw>\]:BB:DM:CLIST:SElect](#) on page 657

File Manager - Digital Modulation

Calls the "File Manager".

The "File Manager" is used to copy, delete and rename files and to create new directories.

For detailed description, see [chapter 3.7.2, "File Manager"](#), on page 113.

SCPI command:

[\[:SOURce<hw>\]:BB:DM:DLIST:SElect](#) on page 660

[\[:SOURce<hw>\]:BB:DM:DLIST:COpy](#) on page 655

[\[:SOURce<hw>\]:BB:DM:DLIST:DElete](#) on page 659

[\[:SOURce<hw>\]:BB:DM:CLIST:SElect](#) on page 657

[\[:SOURce<hw>\]:BB:DM:CLIST:COpy](#) on page 655

[\[:SOURce<hw>\]:BB:DM:CLIST:DElete](#) on page 657

Data List Editor

The "Data List Editor" for editing the selected data list is called up in the "List Management" submenu of the "Custom Digital Modulation" main menu by means of the "Edit Data List..." button.

See [chapter 3.5, "Editors"](#), on page 101 for description on how to use the editor.

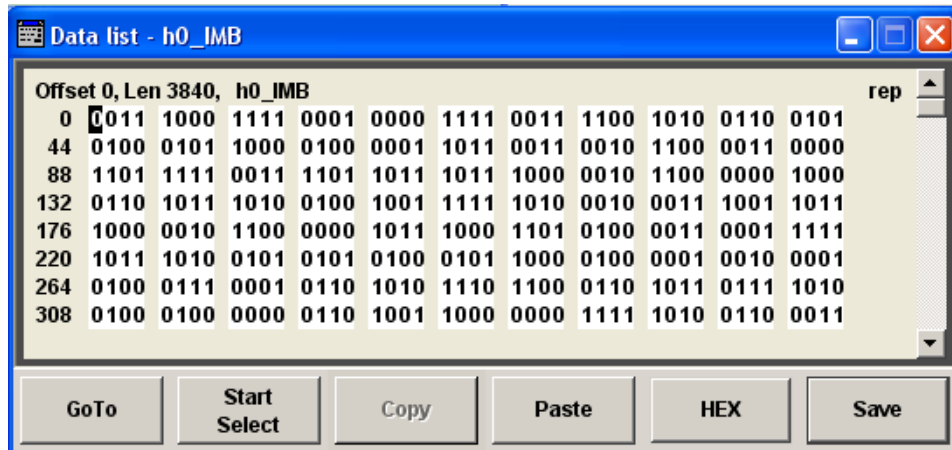

Data List Editor

A list of binary values with a maximum length of 2^{31} bits can be entered in the "Data List Editor". This value corresponds to a file size of approx. 268 Mbyte.

To increase readability, the bits are displayed in groups of four. The current cursor position, the length of the list and the list file name are displayed above the list. The offset starts with the value 0 which corresponds to the bit position on the left side of the first row, i.e. the beginning of the list. On the left edge of the editor, the last three offset positions are specified at the beginning of the row.

An existing list can be edited in the insert or overwrite mode.

SCPI command:

[\[:SOURce<hw>\]:BB:DM:DLIST:SElect](#) on page 660

[\[:SOURce<hw>\]:BB:DM:DLIST:DATA](#) on page 658

[\[:SOURce<hw>\]:BB:DM:DLIST:DATA:APPend](#) on page 658

GoTo ← Data List Editor

Opens the entry window for the bit position. The cursor marks the bit at the selected position.

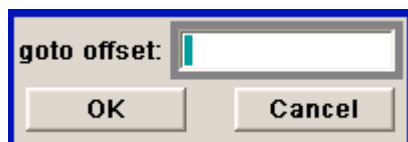

SCPI command:

n.a.

Start Select ← Data List Editor

Defines the current cursor position as the start position for the range to be marked. The stop position is defined by entering an offset under "GoTo".

When a start position has been activated, the button will be re-labelled to "Undo Select". When the button is clicked now, the selected range will be deactivated.

SCPI command:

n.a.

Copy ← Data List Editor

Copies the selected values.

SCPI command:

n.a.

Cut ← Data List Editor

Cuts the selected values.

SCPI command:

n.a.

Paste ← Data List Editor

Pastes the values that have been copied or cut before.

SCPI command:

n.a.

Hex ← Data List Editor

Switchover to hexadecimal display.

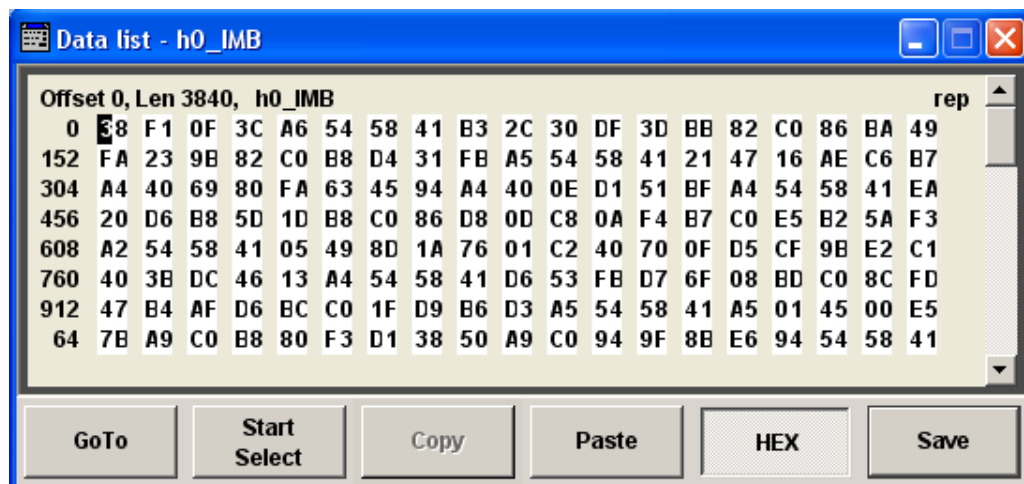

Each four bits are displayed as a hexadecimal value: To increase readability, the hexadecimal values in turn are displayed in pairs of two. The hex functions are automatically assigned to the numeric keys at the front panel.

SCPI command:

n.a.

Save (Data List) ← Data List Editor

Saves the changes made to the Data List file selected for editing.

SCPI command:
n.a.

Control and Marker List Editor

The "Control and Marker List Editor" for editing the selected control list is called up in the "List Management" submenu of the "Custom Digital Modulation" main menu by means of the "Edit Control List"... button.

Edit Control List...

The available marker signals and the CW, Hop, Burst Gate and Level Attenuation control signals can be defined in the "Control and Marker List Editor".



The marker signals defined in the Control and Marker List Editor are activated by selecting the Marker mode "CList" in the "Trigger/Marker/Clock" menu. The control signals have to be activated by selecting an "Internal Source" in the respective setting menu, e.g. the "Power Ramp Control" menu for the Burst Gate and Level Attenuation control signals.

The available marker/control signals are color-coded. In the left "Configure Control Signal" section, each individual signal is assigned a colour; a check in the check box shows the marker for which the "CList" marker type has been selected and the control signal for which the "Internal" source has been selected.



In the "Select Ramp to Edit" section the signal characteristics are graphically displayed. The scaling of the x-axis is always adapted to the overall length of the control list to provide constant overview of all defined ramps.

The ramps can be assigned the exact bit position in the signal by means of

- The bit scale below the marker/control signal characteristic.

- The display of the current cursor position in the "Cursor" menu section if the cursor marks the ramp.

The ramps can be set either graphically in the "Select Ramp to Edit" section or in the table of the "Positions <Signal>" section in the lower right corner. To make the setting easy, a selection of preset ramp characteristics is offered in the "Preset Ramp <Signal>" section.

Edit Control List

The configuration of the currently selected control list is displayed. This list is either selected in the "File Select" menu ("List Management" submenu by means of the "Control List..." button) or via the remote-control command.

SCPI command:

`[:SOURce<hw>] :BB:DM:CLISt:SElect` on page 657

`[:SOURce<hw>] :BB:DM:CLISt:DATA` on page 656

Configure Control Signal - Digital Modulation

Displays the colour the marker/control signal has been assigned.

Displays whether the "CList" marker type has been selected in the Trigger/Marker/Clock menu for this marker.

Displays whether the "Internal" source has been selected for this control signal in the individual setting menu.

Burst Gate and Level Attenuation are set in the "Power Ramping" submenu, CW in the "Modulation" submenu.

The source "CList/Internal" for the individual marker/control signal can be selected here as well and will then be used in the associated menus.

SCPI command:

n.a.

Select Ramp to Edit - Digital Modulation

Graphically edit marker/control signals.

For this purpose, the cursor is set to the position where a ramp is required. The ramp is generated by pressing Enter (e.g. clicking on the rotary knob). Any number of ramps can be defined per marker. Each of the generated ramp positions will be saved even if the definition of another ramp produces a low/low or high/high transition. These ramps are displayed as dashed lines.

Existing ramps can be shifted after the cursor has been placed on the ramp and Enter has been pressed - it then changes colour twice. The ramp is shifted by using the cursor keys or the rotary knob. The new position is determined by pressing Enter again.

Ramps can be deleted by means of the BACKSPACE key after the cursor has been placed on the ramp.

For detailed information on how to operate the control and marker list editor, see [chapter 3.5.3, "Working with Control and Marker List Editor"](#), on page 104.

SCPI command:

n.a.

Total List Length - Digital Modulation

Enters the length of the definition range of the control list in bits. The starting value is always bit 0. The entire definition range is displayed, i.e. the bit scale is adapted to the entry.

With very long control lists, the displayed area can be zoomed around the current cursor position ("Zoom in" button).

The preset functions set the ramp in the center of the currently selected area.

If the definition range is decreased, the ramps outside the range are lost.

When used, the control list is always repeated over the length of the definition range if the length of the data list exceeds the length of the control list.

SCPI command:

n.a.

Preset Type - Digital Modulation

Activates presetting for the ramp characteristic of the selected control signal. The pre-setting is selected with "Preset Type" and activated by means of the "Preset" button.

You can select from:

"All Up "	The marker/control signal is continuously high.
"All Down"	The marker/control signal is continuously low.
"Ramp Up"	The marker/control signal contains a ramp from low to high. The ramp is shifted to the center of the displayed signal area and can subsequently be shifted as required.
"Ramp Down"	The marker/control signal contains a ramp from high to low. The ramp is shifted to the center of the displayed signal area and can subsequently be shifted as required.
"Ramp Up/ Down"	The marker/control signal contains a ramp from low to high and from high to low. The ramps are symmetrically shifted around the center of the displayed signal area and can subsequently be shifted as required.
"Ramp Down/ Up"	The marker/control signal contains a ramp from high to low and from low to high. The ramps are symmetrically shifted around the center of the displayed signal area and can subsequently be shifted as required.

SCPI command:

n.a.

Cursor Position - Digital Modulation

Enters the cursor position.

In the graphic display, the cursor is positioned according to the entry.

Vice versa, graphically shifting the cursor will change the displayed value.

If the entered value exceeds the selected length of the definition range, the length is adjusted automatically.

SCPI command:

n.a.

Positions Control Signal - Digital Modulation

Opens table by using the "Edit Table .." button.

The ramps of the selected signal can be edited in the table. When the table is opened, the current configuration of the selected marker/control signal is displayed.

	Ramp Positions	Ramp State
1	20	High
2	50	Low
3	66	High
4	71	Low
5	81	High
6	223	Low
7		Low High

The bit position is specified in the "Ramp Position" column, the high or low signal status in the "Ramp State" column. At the end of the list, there is always a blank row for entering new values.

The changes are accepted in the graphic display after pressing the "Accept" button.

SCPI command:

n.a.

Zoom/Visible - Digital Modulation

Zooms the displayed area of the control list. The designation of the button changes from "Zoom in" to "Zoom out".

With long control lists, the displayed area can be zoomed around the current "Cursor Position".

Parameter "Visible/Bits Visible" determines the number of symbols/bits to be displayed.

Ramps outside the displayed area are not lost by zooming.

SCPI command:

n.a.

Save/Save As - Digital Modulation

Pressing the "Save" button saves the changes made to the CList file selected for editing.

Selecting the "Save As" button creates a new control list. This opens the "Create Lists Files Which Name?" window in which the control list can be created.

The file name has to be entered in field "File Name."

SCPI command:

n.a.

Power Ramp Control

The Power Ramp Control menu is accessed via the "Custom Digital Modulation" main menu.

The menu is used to set the power ramping. Control signals "Burst" and "Lev_Att" are used to control power ramping (see "[Power Ramping and Level Attenuation](#)" on page 339).



Power ramping is possible up to a symbol rate of 5 MHz. If a higher symbol rate is set, power ramping is automatically switched off and an error message is output.

State	Off
Source	Internal
Ramp Function	Cosine
Ramp Time	1.00 sym
Rise Delay	0.00 sym
Fall Delay	0.00 sym
Attenuation	15.0 dB
Power Ramping / Level Attenuation	
In Baseband Only	<input type="checkbox"/> On

State - Power Ramp Control - Digital Modulation

Enables/disables power ramping.

SCPI command:

[\[:SOURce<hw>\]:BB:DM:PRAMP\[:STATe\]](#) on page 652

Source - Power Ramp Control - Digital Modulation

Enters the source for the power ramp control signals.

"Internal" The control signals in the internal control list are used for control purposes.
The signals are output on the LEV_ATT and BURST pin on the AUX I/O interface of path A.
In the case of two-path instruments, the path B signal can be placed on one of the USER interfaces.

"External Digital" The control signal is fed in via the AUX I/O interface.
For two-path instruments, path A = LEV-ATT pin, path B = user-definable USER pin or USER connector.

SCPI command:

[\[:SOURce<hw>\]:BB:DM:PRAMP:SOURce](#) on page 652

Ramp Function - Digital Modulation

Enters the form of the transmitted power, i.e. the shape of the rising and falling edges during power ramp control.

"Linear" The transmitted power rises and falls linear fashion.

"Cosine" The transmitted power rises and falls with a cosine-shaped edge. This gives rise to a more favorable spectrum than the "Linear" setting.

SCPI command:

[:SOURce<hw>] :BB:DM:PRAMP:SHAPE on page 652

Ramp Time - Digital Modulation

Enters the power ramping rise time and fall time for a burst. The setting is expressed in symbols.

SCPI command:

[:SOURce<hw>] :BB:DM:PRAMP:TIME on page 652

Rise Delay - Power Ramp Control - Digital Modulation

Sets the offset in the rising edge of the envelope at the start of a burst.

A positive value gives rise to a delay (the envelope length decreases) and a negative value causes an advance (the envelope length increases). The setting is expressed in symbols.

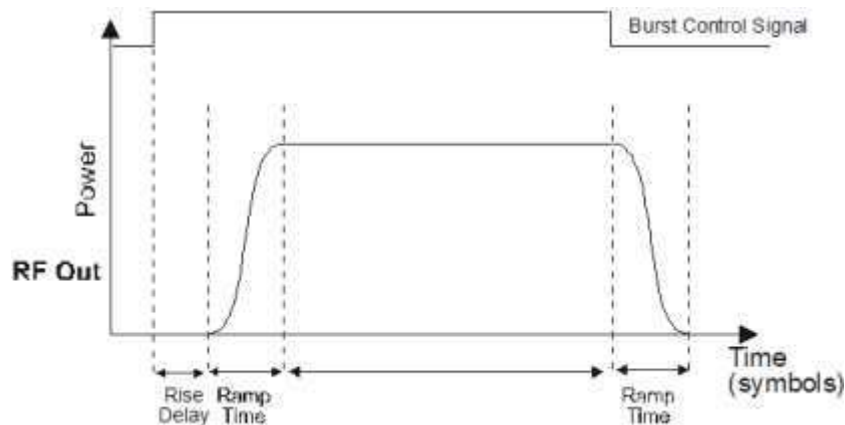

SCPI command:

[:SOURce<hw>] :BB:DM:PRAMP:RDELay on page 651

Fall Delay - Power Ramp Control - Digital Modulation

Sets the offset in the falling edge of the envelope at the end of a burst.

A positive value gives rise to a delay, the envelope length increases and a negative value causes an advance (the envelope length decreases). The setting is expressed in symbols.

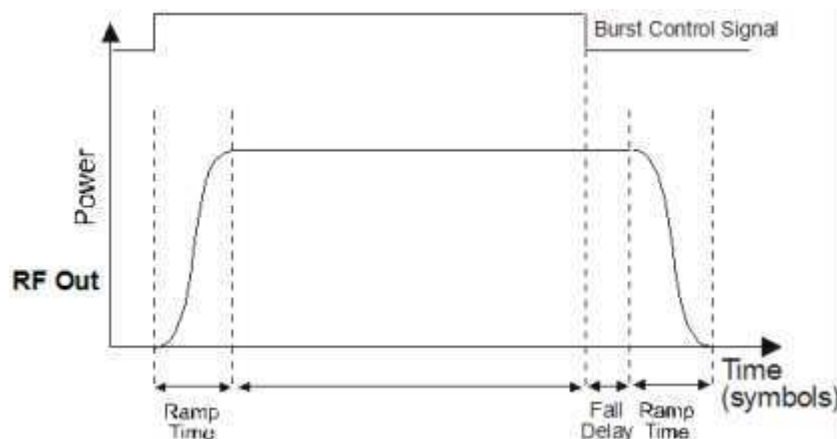

SCPI command:

[\[:SOURce<hw>\]:BB:DM:PRAMP:FDELay](#) on page 651

Attenuation - Power Ramp Control - Digital Modulation

Sets the level attenuation relative to the average level for the signal ranges in which the level is set to "attenuated" (LEV_ATT control signal).

The LEV_ATT control signal is defined in "the Control Data Editor" or supplied via the LEV_ATT pin on the AUX I/O interface.

In case of two-path instruments, the LEV_ATT control signal is supplied via the LEV_ATT pin for path A or via a user-defined USER pin for path B.

SCPI command:

[\[:SOURce<hw>\]:BB:DM:PRAMP:ATTenuation](#) on page 650

Baseband Only - Power Ramp Control - Digital Modulation

Restricts power ramping to the baseband signal.

"Off" Level attenuation is effected via the attenuator stages in the RF section; only the remaining part is attenuated in the baseband. The signal is issued at the RF output with the defined level values.

"On" Level attenuation is effected in the baseband only. This setting is mandatory in the following cases: When only the baseband signal is issued at the I/Q outputs. It is thus ensured that, with power ramping active, this signal is output with the defined level values. In case of two-path instruments, when a baseband signal is applied to two RF paths. The RF paths having separate frequency and level settings, the remaining attenuation to be effected in the baseband would have to be different for the two paths and is therefore not possible.

SCPI command:

[\[:SOURce<hw>\]:BB:DM:PRAMP:BBONly\[:STATe\]](#) on page 651

Trigger/Marker/Clock

The "Trigger/Marker/Clock" dialogis accessed via the "Custom Digital Modulation" main menu.

The "Trigger In" section is where the trigger for the modulation signal is set. Various parameters will be provided for the settings, depending on which trigger source - internal or external - is selected. The current status of signal generation ("Running" or "Stopped") is indicated for all trigger modes.

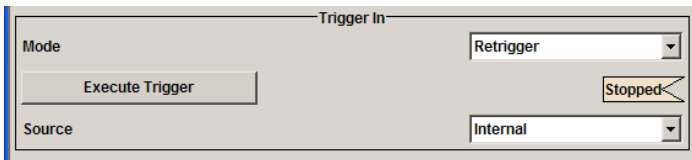

The "Marker Mode" section is where the marker signals at the MARKER output connectors are configured.

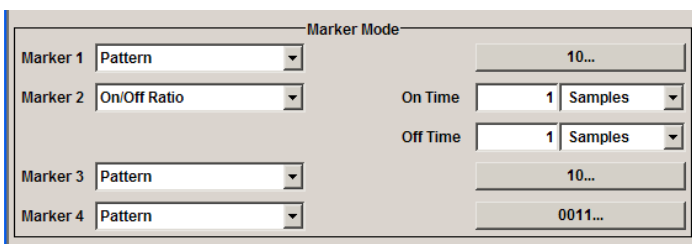

The "Marker Delay" section is where a marker signal delay can be defined, either without restriction or restricted to the dynamic section, i.e., the section in which it is possible to make settings without restarting signal and marker generation.

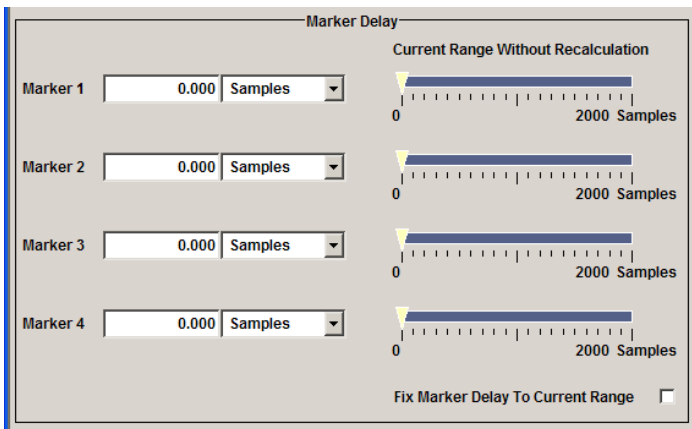

The "Clock Settings" section is where the clock source is selected and - in the case of an external source - the clock type.

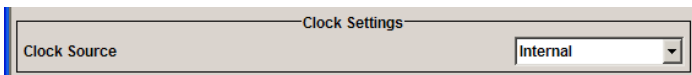

The "Global Trigger/Clock Settings" button leads to a submenu for general trigger, clock and external input settings.

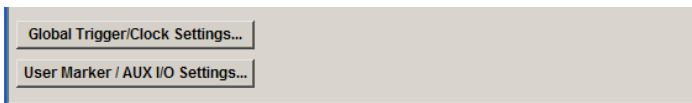

Trigger In

The "Trigger In" section is used to configure the trigger signal for the digital modulation. The current status of signal generation is indicated for all trigger modes.

Trigger Mode - Digital Modulation

Selects trigger mode.

"Auto"	The digital modulation signal is generated continuously.
"Retrigger"	The digital modulation signal is generated continuously. A trigger event (internal with "Execute Trigger" or external) causes a restart.
"Armed_Auto"	The digital modulation signal is generated only when a trigger event occurs. Then the digital modulation signal is generated continuously. Button "Arm" stops signal generation. A subsequent trigger event (internal with "Execute Trigger" or external) causes a restart.
"Armed_Retrigger"	The digital modulation signal is generated only when a trigger event occurs. Then the signal is generated continuously. Every subsequent trigger event (internal with "Execute Trigger" or external) causes a restart. The button "Arm" stops signal generation. A subsequent trigger event (internal with "Execute Trigger" or external) causes a restart.
"Single"	The digital modulation signal is generated only when a trigger event occurs. Then the signal is generated once to the length specified at "Signal Duration". Every subsequent trigger event (internal with "Execute Trigger" or external) causes a restart.

SCPI command:

[\[:SOURce<hw>\]:BB:DM\[:TRIGger\]:SEQuence](#) on page 641

Trigger Signal Duration - Digital Modulation

Enters the length of the signal sequence to be output in the "Single" trigger mode. The input is to be expressed in symbols.

SCPI command:

[\[:SOURce<hw>\]:BB:DM:TRIGger:SLENgth](#) on page 639

Running - Stopped - Digital Modulation

Displays the status of signal generation for all trigger modes. This display appears only when Custom Dig Mod is enabled (State On).

"Running"	The digital modulation signal is generated; a trigger was (internally or externally) initiated in triggered mode. If Armed_Auto and Armed_Retrigger have been selected, generation of signals can be stopped with the "Arm" button. A new trigger (internally with "Execute Trigger" or externally) causes a restart.
"Stopped"	The signal is not generated, and the instrument waits for a trigger event (internal or external).

SCPI command:

[\[:SOURce<hw>\]:BB:DM:TRIGger:RMODe](#) on page 638

Arm - Digital Modulation

Stops signal generation. This button appears only with "Running" signal generation in the "Armed_Auto" and "Armed_Retrigger" trigger modes.

Signal generation can be restarted by a new trigger (internally with "Execute Trigger" or externally).

SCPI command:

[\[:SOURce<hw>\]:BB:DM:TRIGger:ARM:EXECute](#) on page 635

Execute Trigger - Digital Modulation

Executes trigger manually. A manual trigger can be executed only when an internal trigger source and a trigger mode other than "Auto" have been selected.

SCPI command:

[\[:SOURce<hw>\]:BB:DM:TRIGger:EXECute](#) on page 636

Trigger Source - Digital Modulation

Selects trigger source.

"Internal"	The trigger event is executed by "Execute Trigger". As a precondition a trigger mode other than "Auto" must be selected.
"Internal (Baseband A/B)"	The trigger event is executed by the trigger signal from the second path (two-path instruments only).
"External (TRIGGER)"	The trigger event is executed with the aid of the active edge of an external trigger signal. The trigger signal is supplied via the TRIGGER connector. The polarity, the trigger threshold and the input impedance of the TRIGGER input can be set in the GLOBAL TRIGGER SETTINGS menu.

SCPI command:

[\[:SOURce<hw>\]:BB:DM:TRIGger:SOURce](#) on page 639

Sync. Output to External Trigger

(enabled for "Trigger Source" External)

Enables/disables output of the signal synchronous to the external trigger event.

"On"

Corresponds to the default state of this parameter.

The signal calculation starts simultaneously with the external trigger event but because of the instrument's processing time the first samples are cut off and no signal is outputted. After elapsing of the internal processing time, the output signal is synchronous to the trigger event.

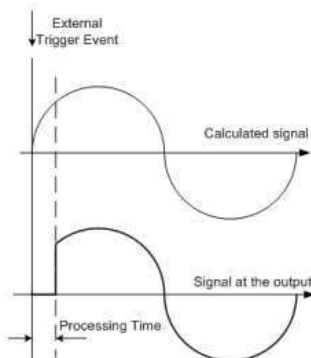

"Off"

The signal output begins after elapsing of the processing time and starts with sample 0, i.e. the complete signal is outputted.

This mode is recommended for triggering of short signal sequences with signal duration comparable with the processing time of the instrument.

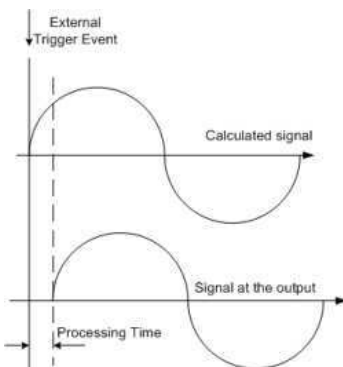

SCPI command:

`[:SOURce<hw>] :BB:DM:TRIGger:EXTernal:SYNChronize:OUTPut`
on page 636

External Delay - Digital Modulation

Sets trigger signal delay in symbols on external triggering.

In case of two-path instruments, this applies on the internal triggering via the second path.

This enables the R&S SMU to be synchronized with the device under test or other external devices.

Note: For two path instruments, the delay can be set separately for each of the two paths.

SCPI command:

`[:SOURce<hw>] :BB:DM:TRIGger [:EXTernal<ch>] :DELay` on page 640

`[:SOURce<hw>] :BB:DM:TRIGger:OBASeband:DELay` on page 637

External Inhibit - Digital Modulation

(available on external triggering or triggering via the second path)

Sets the duration for inhibiting a new trigger event subsequent to triggering. The input is to be expressed in symbols.

In the "Retrigger" mode every trigger signal causes signal generation to restart. This restart is inhibited for the specified number of samples.

Note: For two-path instruments, the trigger inhibit can be set separately for each of the two paths.

SCPI command:

[\[:SOURce<hw>\]:BB:DM:TRIGger\[:EXternal<ch>\]:INHibit](#) on page 640

[\[:SOURce<hw>\]:BB:DM:TRIGger:OBASeband:INHibit](#) on page 637

Marker Mode

The marker output signal for synchronizing external instruments is configured in the Marker Settings section "Marker Mode".

Marker x - Digital Modulation

Selects a marker signal for the associated MARKER output.

"CList" A marker signal that is defined in the selected control list is generated.

"Pulse" A regular marker signal is generated. The clock frequency is defined by entering a divider. The frequency is derived by dividing the sample rate by the divider. The input box for the divider opens when "Pulse" is selected, and the resulting pulse frequency is displayed below it.

Divider	8.00
Frequency	33.854 17 kHz

SCPI command:

[\[:SOURce<hw>\]:BB:DM:TRIGger:OUTPut<ch>:PULSe:DIVider](#) on page 643

"Pattern" A marker signal that is defined by a bit "pattern" is generated. The "pattern" has a maximum length of 64 bits and is defined in an input field which opens when "pattern" is selected.

0000 0000

SCPI command:

[\[:SOURce<hw>\]:BB:DM:TRIGger:OUTPut<ch>:PATtern](#) on page 643

"ON/OFF ratio" A regular marker signal that is defined by an ON/OFF ratio is generated. A period lasts one ON and OFF cycle.

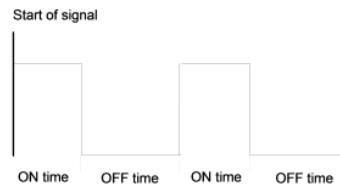

The ON time and OFF time are each expressed as a number of symbols and are set in an input field which opens when "ON/OFF ratio" is selected.

On Time	2	Sym
Off Time	3	Sym

SCPI command:

[\[:SOURce<hw>\]:BB:DM:TRIGger:OUTPut<ch>:OFFTime](#) on page 642

[\[:SOURce<hw>\]:BB:DM:TRIGger:OUTPut<ch>:ONTime](#) on page 643

SCPI command:

[\[:SOURce<hw>\]:BB:DM:TRIGger:OUTPut<ch>:MODE](#) on page 642

Marker Delay

The "Marker Delay" section can be used to set a delay for the markers.

Marker x Delay - Digital Modulation

Enters the delay between the marker signal at the marker outputs and the start of the signal.

The input is expressed as a number of symbols.

If the setting "Fix marker delay to dynamic range" is enabled, the setting range is restricted to the dynamic range. In this range the delay of the marker signals can be set without restarting the marker and signal.

The allocation of marker signals to the outputs is described in the section [chapter 4.8.2.8, "Marker Output Signals"](#), on page 341.

SCPI command:

[\[:SOURce<hw>\]:BB:DM:TRIGger:OUTPut<ch>:DElay](#) on page 638

Current Range without Recalculation - Digital Modulation

Displays the dynamic range within which the delay of the marker signals can be set without restarting the marker and signal.

The delay can be defined by moving the setting mark.

SCPI command:

[\[:SOURce<hw>\]:BB:DM:TRIGger:OUTPut<ch>:DElay:MAXimum](#) on page 638

[\[:SOURce<hw>\]:BB:DM:TRIGger:OUTPut<ch>:DElay:MINimum](#) on page 638

Fix marker delay to current range - Digital Modulation

Restricts the marker delay setting range to the dynamic range. In this range the delay can be set without restarting the marker and signal.

SCPI command:

`[:SOURce<hw>] :BB:DM:TRIGger:OUTPut:DELay:FIXed` on page 637

Clock Settings

The clock source is selected in the Clock Settings section.

Clock Source - Digital Modulation

Selects the clock source (also see section "Clock Signals", page 2).

"Internal" The internal clock reference is used.

"External" The external clock reference is fed in as the symbol clock or a multiple thereof via the CLOCK connector.
The chip rate must be correctly set to an accuracy of ($\pm 2\%$ (see data sheet)).
The polarity of the clock input can be changed with the aid of "Global Trigger/Clock/External Input" Settings.
In the case of two-path instruments, this selection applies to path A.

SCPI command:

`[:SOURce<hw>] :BB:DM:CLOCK:SOURCE` on page 634

Clock Mode - Digital Modulation

Enters the type of externally supplied clock.

"Symbol" A symbol clock is supplied via the CLOCK connector.

"Multiple Symbol" A multiple of the symbol clock is supplied via the CLOCK connector, the symbol clock is derived internally from this.
The "Multiplier" window provided allows the multiplication factor to be entered.

Note: This setting is not possible if the serial or parallel external data source is selected.

"Bit" A bit clock is supplied via the CLOCK connector; the symbol clock is derived internally from this.

Note: This setting is not possible if the serial or parallel external data source is selected.

SCPI command:

`[:SOURce<hw>] :BB:DM:CLOCK:MODE` on page 633

Symbol Clock Multiplier - Digital Modulation

Enters the multiplication factor for clock type "Multiple".

SCPI command:

`[:SOURce<hw>] :BB:DM:CLOCK:MULTIPLIER` on page 634

Measured External Clock

Displays the measured frequency of the external clock signal. This enables the user to permanently monitor the frequency of the externally introduced clock.

This information is displayed only if the external clock source has been selected.

SCPI command:

[:CLOCK:INPut:FREQuency](#) on page 533

Global Trigger/Clock/Input Settings - Digital Modulation

Calls the "Global Trigger/Clock/Input Settings" menu. This menu is used among other things for setting the trigger threshold, the input impedance and the polarity of the clock and trigger inputs.

In the case of two-path instruments, these settings are valid for both paths.

The parameters in this menu affect all digital modulations and standards, and are described in the [chapter 4.2.3.10, "Global Trigger/Clock/External Input Settings"](#), on page 136.

SCPI command:

n.a.

4.8.4 Arbitrary Waveform Generator ARB

The Arbitrary Waveform Generator (ARB) is an I/Q modulation source forming an integral part of the R&S Signal Generator. It can be used to output any externally calculated modulation signals or internally generated multi carrier signals or waveform files.

The Arbitrary Waveform Generator is incorporated in the Baseband Generator (R&S SMU-B9/B10/B11) option. The Baseband Main Module (R&S SMU-B13) option is also required.

The three Baseband Generator options feature different ARB memory sizes (see data sheet). Apart from the memory size, however, the three options offer the same functionality, either one can be installed.

In the case of two-path instruments, at least one further Baseband Generator option is needed for waveform output in the second path. Using this option a waveform can be read in on path B and then either routed via path A or added to the signal on path A with a frequency offset that can be set.

When path B is fully expanded with a second option Baseband Main Module (R&S SMU-B13) and an RF section frequency option (B20x) the waveform can be output on RF output B.

Sources for waveform files

The R&S Signal Generator can generate ARB waveforms internally. The ARB generator enables the calculation and the generation of multi segment and mutli carrier waveform files. Several digital standards provide the special function "Generate Waveform File" and enable the calculation and storage of the signal as a waveform file that can be afterwards processed by the ARB generator.

The ARB can also process externally generated waveform files, e.g. the waveform files generated on a PC by the Windows software package R&S WinIQSIM2 or signals calculated using a mathematical program such as Matlab. For more information, see Application Note 1MA28, "IQWizard - I/Q Signal Measurement and Conversion", which can be obtained from the Rohde&Schwarz web site at <http://www.rohde-schwarz.com>.

The externally generated waveform files can be loaded into the instrument via one of the available interfaces (USB, LAN or GPIB).

Multi segment and multi carrier waveforms

To fulfill the requirements of some test systems and to enable rapid alternation between different waveforms with differing test signals, the R&S Signal Generator provides the functionality to generate multi segment waveform files. A multi segment waveform is a combination of multiple waveforms called segments. Each segment represents a completely independent waveform that can be output with its own marker and clock settings. The entire multi segment waveform is loaded into memory. The segment intended to be output at any given moment can be selected by the user. It is therefore possible to alternate between the individual waveform segments without experiencing any delay due to the loading operation.

There are however additionally requirements concerning the clock settings if some special triggering is necessary.

If very high switchover speeds are required, the test signals can be continuously scrolled through with the aid of an external trigger or by applying a predefined "play list". For this purpose the segments must have a common sample rate. If the combined waveforms have different sample rates, they can be adapted to a common sample rate by resampling. By the same procedure the instantaneous amplitude of the various waveforms can be scaled to a common RMS level.

Typical applications for the multi segment mode are described in the section "[Typical Applications for Multi Segment Waveforms](#)" on page 418.

Multi carrier waveforms consisting of up to 512 carriers modulated by user-selectable baseband signals can be created in order to simulate complex multi carrier scenarios with different baseband signals (e.g. CDMA2000 or 3GPP FDD).

Waveform sample rate

The Arbitrary Waveform Generator includes a resampling unit that interpolates the input samples to reach a target digital output I/Q sample rate before digital-to-analog conversion (DAC). The input sample rate f_{input} is given by the default sample rate tag of the waveform file or is set by the user in the ARB panel.

The R&S SMU uses a 100 MHz system clock and a sample rate of 100 MSamples/s.

The resampling lowpass limits the signal bandwidth to a maximum of $1.36 \times f_{input}$. Within a bandwidth of $0.68 \times f_{input}$ the resampler lowpass is distortion-free. Thus, an externally created waveform file have to provide a sample rate f_{input} that is high enough for perfect signal reconstruction.

For distortion-free resampling the lower bound of the required sample rate f_{input} is calculated by:

$$f_{\text{input}} \geq \text{Signal bandwidth} / 0.68$$

In case of digital modulation this means that the oversampling factor ($f_{\text{input}} = \text{symbol rate} \times \text{oversampling factor}$) that is applied for impulse forming is high enough.

The lower bound of the oversampling factor is given by:

$$\text{oversampling factor} \geq \text{signal bandwidth} / (\text{symbol rate} \times 0.68)$$

Example:

For the WCDMA standard 3GPP FDD with root raised cosine filter ($\alpha = 0.22$) and a symbol rate (chip rate) of 3.84 MHz the minimum oversampling factor is calculated as follow:

$$3.84 \text{ MHz} \times (1+0.22) / (3.84 \text{ MHz} \times 0.68) = 1.794$$

A modulation signal with a sample rate of 100 MHz is passed directly to the digital-to-analog converter (DAC), i.e. the resampling unit is bypassed (see figure below). After the DAC the signal is finally limited to a maximum bandwidth of 80 MHz.

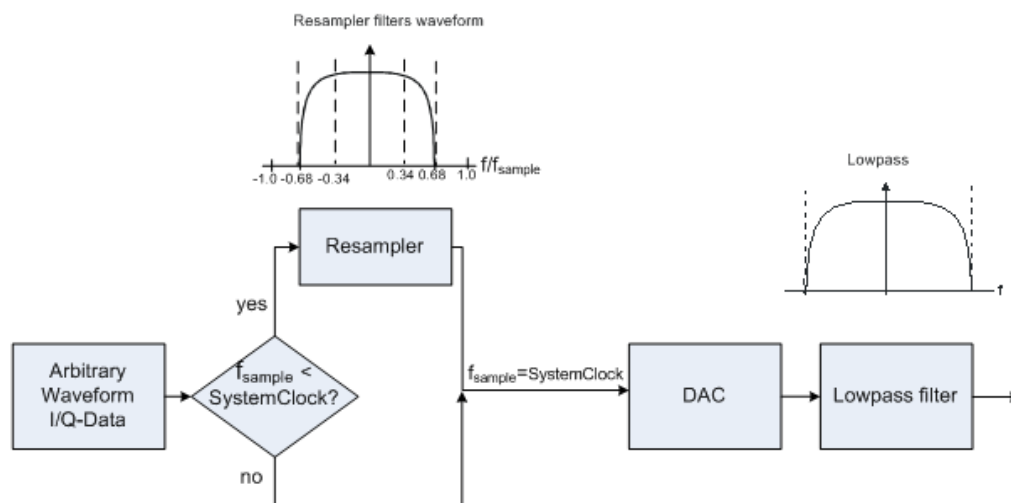

Waveforms generated by the R&S WinIQSIM2 software can be optimized by choosing a suitable integer oversampling factor.

In comparison with conventional ARB generators that often assume oversampling factors of 4, the ARB generator of the R&S Signal Generator requires low oversampling factors (see the example above), but still providing excellent signal quality in terms of EVM and ACP.

A reduced sample rate saves significantly the amount of memory or allows an increased signal cycle time, vice versa.

Dependency between the number of marker signals and the waveform length

The R&S Signal Generator provides the possibility to define marker signals, that are sent to the marker outputs in synchronicity with the I/Q output signals. Marker signals can be either predefined or subsequently defined; marker setting such as delay can be adjusted in the corresponding [Trigger/Marker/Clock Settings](#) dialog.

The I/Q data and marker data are located in separate memory areas of the SDRAM and can be independently configured whereas each marker signal requires one bit of the available memory size. In some cases, it might be useful to generate a modulation signal without additional marker signal in order to increase the maximum waveform length.

The example below explains the dependency between the number of enabled marker signals, the available memory size and the resulting waveform length.

The calculation for an instrument equipped with option R&S SMU-B10 is as follows:

Memory	Size	256 MB
Required	for I/Q data	2 x 16 bits = 32 bits (16 bits per I/Q channel)
Memory	for 4 enabled markers	4 x 1 bit = 4 bits
Size	total	32 + 4 = 36 bits = 4.5 bytes
Waveform	Length (with 4 markers)	256 MB / 4.5 bytes (56 MSamples
Maximum	Waveform Length	256 MB / 4 bytes = 64 MSamples

Hence a memory size of 256 MB yields a maximum waveform length of 56 MSamples if four markers are enabled. The maximum waveform length increases to 64 MSamples if the internal hardware markers are used, and the complete memory is available for I/Q data.

A maximum waveform length of 16 MSamples is available therefore for instruments equipped with option R&S SMU-B11.

The minimum length of a waveform is 512 samples. If a waveform is shorter than this, it is automatically repeated until it reaches the minimum length.

4.8.4.1 ARB User Interface

To access the ARB dialog, select "Baseband > ARB" or use the MENU key under "Baseband".

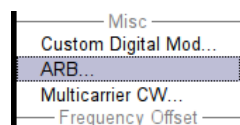

The "ARB" dialog is divided into an upper and a lower general part together with a "Marker" section.

The upper part of the menu is used for powering up, selecting and configuring ARB modulation.

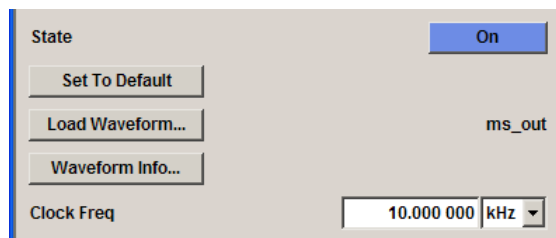

The section "Multi Segment Waveform Options" is only indicated if a multi segment waveform is loaded. In this part, the segment to be output is selected.

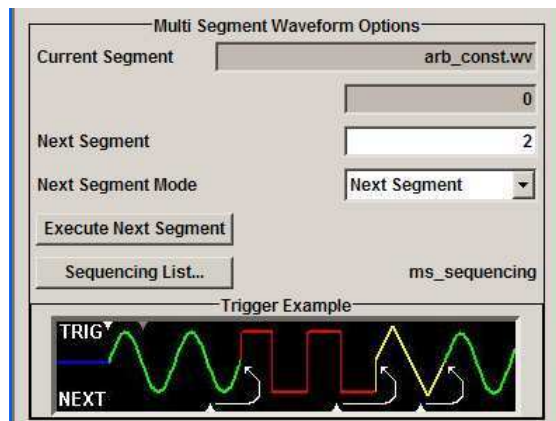

The buttons in the lower part of the menu open submenus for setting triggers and clocks, for configuring the test signal and for calculating a multi segment waveform or a multi carrier waveform.

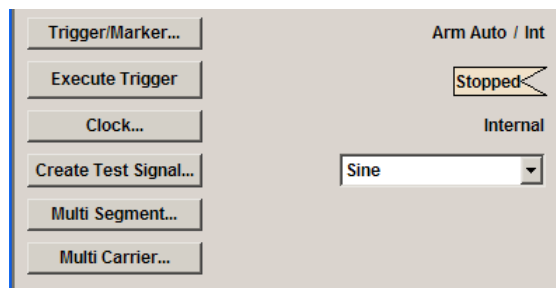

ARB MOD Main Menu

The upper part of the menu is used for powering up, selecting and configuring ARB modulation.

The lower part of the menu is used for setting triggers and clocks, as well as for file management. Test signals can be output for test purposes.

Multi Segment Waveform Options

The section "Multi Segment Waveform Options" of the menu is only displayed if a multi segment waveform is loaded.

The section comprises the settings necessary to adjust the trigger for the switch between the segments of a multi segment waveform. The parameters displayed depend on the selected trigger source.

The parameters in this sections are identical with the parameters in the section "Next Segment Trigger In" in the "Trigger/Marker" dialog; for detailed information see "[Next Segment Trigger In](#)" on page 397.

State (ARB)

Enables/disables ARB modulation.

Switching on this standard turns off all the other digital standards and digital modulation types.

In case of two-path instruments, this affects the same path.

The output is based on the waveform file that is loaded. The name of the waveform file is displayed next to "Load Waveform".

If a multi segment waveform is loaded the section "Multi Segment Waveform Options" is indicated. In this section, the segment to be output is selected.

If no waveform file is loaded, ARB modulation cannot be powered up. "None" will be displayed next to "Load Waveform". An error message asks the user to load a waveform file:

"No waveform file loaded. ARB MOD state remains off. Please select a waveform file to load, before switching ARB MOD state on."

SCPI command:

[\[:SOURce<hw>\]:BB:ARB:STATe](#) on page 586

Set To Default

Calls default settings. The values are shown in the [table 4-12](#).

Table 4-12: Default Settings

Parameter	Value
State	Off
Clock Freq.	1 MHz
Trigger Mode	Auto
Trigger Source	Internal
Marker State	Off
Marker Mode	Unchanged
Clock Source	Internal

SCPI command:

[\[:SOURce<hw>\]:BB:ARB:PRESet](#) on page 586

Load Waveform

Calls the "File Select "menu for loading the waveform file.

The files last used are listed in the "Recent Data Sets" section. The directory can be selected from the center left section. All waveform files (file extension *.wv) available from the selected directory are listed on the right side. The file info (tag contents and multi segment state) for the selected file is displayed below the file section.

The "Select..." button selects the marked file. This file is loaded when the ARB modulation is enabled ("State On").

The "File Manager..." button leads to the file manager.

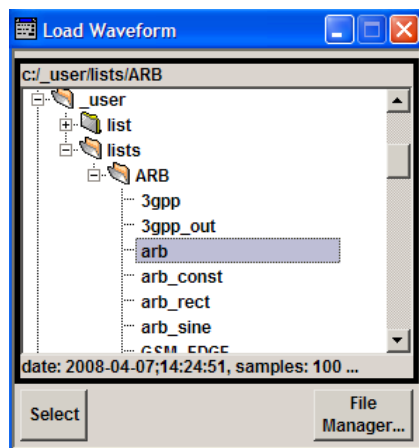

SCPI command:

[:SOURce<hw>] :BB:ARB:WAVEform:SElect on page 619

Waveform Info

Opens a dialog with detailed information about the currently selected waveform.

The waveform information displayed in this dialog depends on whether the selected waveform file is a multi segment one or not. All parameters are read-only.

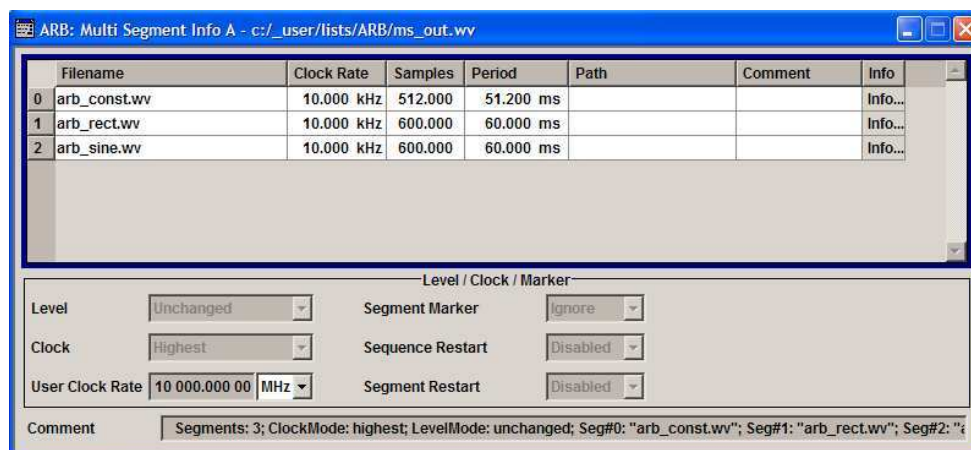

For non-multi segment waveform files, the values of the settings can be queried by means of the Tag commands (see [chapter 6.3, "R&S Signal Generator Waveform and List Format"](#), on page 503).

SCPI command:

n.a.

HDD Streaming

Enables/disables the streaming of modulation data direct form the hard drive (HDD).

HDD streaming is recommended for processing of large files that require more ARB memory than the currently installed one.

HDD Streaming is enabled for waveform with "Clock Freq." \leq 1 MHz and "Number of Samples" $>$ 16 MS.

SCPI command:

[\[:SOURce<hw>\]:BB:ARB:WAVEform:HDDStreaming:STATE](#) on page 618

Streaming Buffer

(enabled for waveform with "Clock Freq." \leq 1MHz and "Number of Samples" $>$ 16MS)

Displays the filling level of the streaming buffer.

During normal operation, the streaming buffer level should have a value of 90% .. 100%. Buffer level around 0% indicates a buffer underrun and the signal processing will be interrupted.

Adjustment in the parameter value or state usually results in short decreasing of the streaming buffer level but this buffer state should not be misunderstood as buffer under-run.

SCPI command:

[\[:SOURce<hw>\]:BB:ARB:WAVEform:HDDStreaming:BLEVel](#) on page 617

Clock Frequency

Displays or enters the ARB output clock rate.

When the waveform file is loaded, this value is automatically set to the clock rate defined in the file (Clock tag). The user can subsequently alter the value if necessary.

When intending to work with an external clock source, the frequency to be applied must be entered here.

SCPI command:

[\[:SOURce<hw>\]:BB:ARB:CLOCK](#) on page 586

Trigger/Marker

Calls the Trigger and Marker menu.

This menu is used to select the trigger source, set the time delay on an external trigger signal and configure the marker output signals (see "[Trigger/Marker/Clock Settings](#)" on page 391).

SCPI command:

n.a.

Execute Trigger

Executes trigger manually. A manual trigger can be executed only when an internal trigger source and a trigger mode other than Auto are selected.

SCPI command:

[\[:SOURce<hw>\]:BB:ARB:TRIGger:EXECute](#) on page 589

Clock

Calls the "Clock" menu. The "Clock" menu is used to select the clock source (see ["Clock Settings"](#) on page 404).

SCPI command:

n.a.

Create Test Signal...

Selects the form of the test signal and calls the menu for generating it. A sinusoidal, rectangular or test signal with constant I/Q can be selected.

See the corresponding section for detailed description of the parameters for the selected test signal:

- ["Sine Test Signals"](#) on page 405
- ["Rect Test Signal"](#) on page 406
- ["Const IQ Test Signal"](#) on page 408

SCPI command:

n.a.

Multi Segment

Calls the menu for calculating multi segment waveforms (see [chapter 4.8.4.2, "Multi Segment Waveforms"](#), on page 408).

SCPI command:

n.a.

Multi Carrier

Calls the menu for calculating multi carrier waveforms (see [chapter 4.8.4.3, "Multi Carrier Waveforms"](#), on page 419).

SCPI command:

n.a.

Trigger/Marker/Clock Settings

To access this dialog, select "Main Menu > Trigger/Marker".

The "Trigger In" section is where the trigger for the signal is set. Various parameters will be provided for the settings, depending on which trigger source - internal or external - is selected. The current status of signal generation ("Running" or "Stopped") is indicated for all trigger modes.

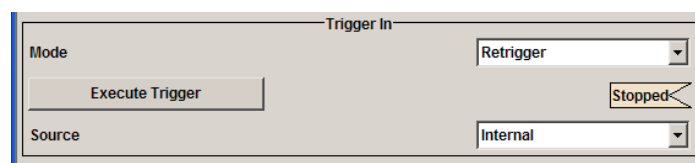

The "Next Segment Trigger In" is where the segment triggering is configured. This section is enabled only for multi segment waveforms.

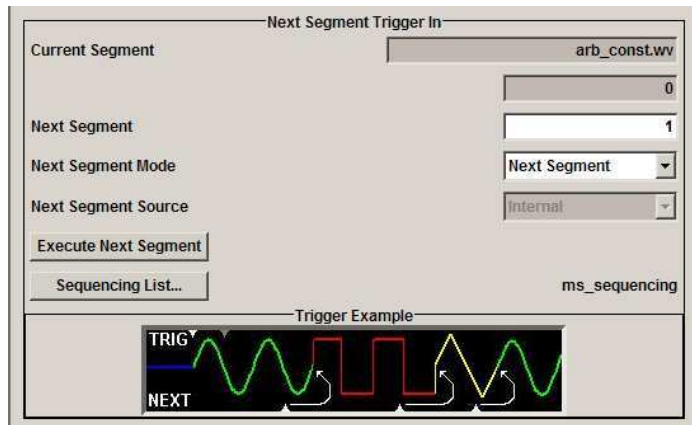

The "Marker Mode" section is where the marker signals at the MARKER output connectors are configured.

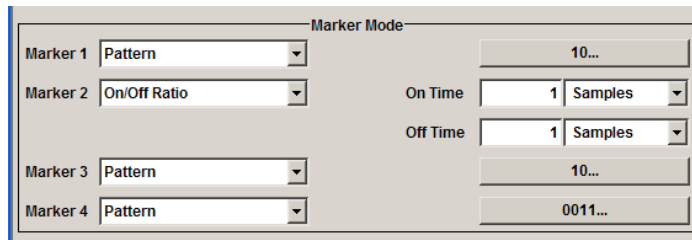

The "Marker Delay" section is where a marker signal delay can be defined, either without restriction or restricted to the dynamic section, i.e., the section in which it is possible to make settings NEXT without restarting signal and marker generation.

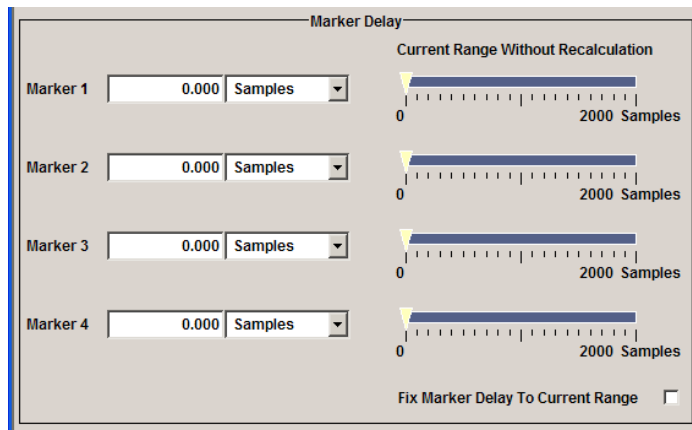

The "Clock Settings" section is where the clock source is selected and - in the case of an external source - the clock type.

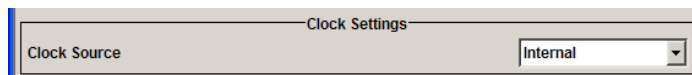

The buttons in the last section lead to submenu for general trigger, clock and mapping settings.



Trigger In

The "Trigger In" section is where the trigger for the signal is set. Various parameters will be provided for the settings, depending on which trigger source - internal or external - is selected. The current status of signal generation ("Running" or "Stopped") is indicated for all trigger modes.

Trigger Mode

Selects trigger mode.

The trigger mode determines the effect of a trigger on the signal generation.

"Auto"	The signal is generated continuously.
"Retrigger"	The signal is generated continuously. A trigger event (internal or external) causes a restart.
"Armed_Auto"	The signal is generated only when a trigger event occurs. Then the signal is generated continuously. Button "Arm" stops signal generation. A subsequent trigger event (internal with "Execute Trigger" or external) causes a restart.
"Armed_Retrigger"	The signal is generated only when a trigger event occurs. Then the signal is generated continuously. Every subsequent trigger event causes a restart. Button "Arm" stops signal generation. A subsequent trigger event (internal with "Execute Trigger" or external) causes a restart.
"Single"	The signal is generated only when a trigger event occurs. Then the signal is generated once to the length specified at "Signal Duration". Every subsequent trigger event (internal with "Execute Trigger" or external) causes a restart.

SCPI command:

[\[:SOURce<hw>\]:BB:ARB\[:TRIGger\]:SEQUence](#) on page 595

Signal Duration Unit

Defines the unit for the entry of the length of the signal sequence to be output in the "Single" trigger mode.

SCPI command:

[\[:SOURce<hw>\]:BB:ARB:TRIGger:SLUNit](#) on page 593

Signal Duration

Defines the length of the signal sequence to be output in the "Single" trigger mode. The unit of the entry is defined under "Signal Duration Unit". It is then possible to output deliberately just part of the signal, an exact sequence of the signal, or a defined number of repetitions of the signal.

SCPI command:

[\[:SOURce<hw>\]:BB:ARB:TRIGger:SLENgth](#) on page 592

Running/Stopped

Displays the status of signal generation for all trigger modes. This display appears only when signal generation is enabled ("State" On).

"Running"	The waveform is output; a trigger was (internally or externally) initiated in triggered mode. If "Armed_Auto" and "Armed_Retrigger" have been selected, generation of signals can be stopped with the "Arm" button. A new trigger (internally with "Execute Trigger" or externally) causes a restart.
"Stopped"	The Waveform output is stopped. The instrument waits for an internal or external trigger event to restart. ARB modulation is disabled (State Off).

SCPI command:

[\[:SOURce<hw>\]:BB:ARB:TRIGger:RMODE](#) on page 592

Arm

Stops waveform output. This button appears only with "Running" signal generation in the "Armed_Auto" and "Armed_Retrigger" trigger modes.

Signal output can be restarted by a new trigger (internally with "Execute Trigger" or externally).

SCPI command:

[\[:SOURce<hw>\]:BB:ARB:TRIGger:ARM:EXECute](#) on page 588

Execute Trigger

Executes trigger manually. A manual trigger can be executed only when an internal trigger source and a trigger mode other than "Auto" have been selected.

SCPI command:

[\[:SOURce<hw>\]:BB:ARB:TRIGger:EXECute](#) on page 589

Trigger Source

Selects trigger source. This setting is effective only when a trigger mode other than "Auto" has been selected.

"Internal"	The trigger event is executed by "Execute Trigger".
"Internal (Baseband A/ B)"	(two-path instruments only) The trigger event is executed by the trigger signal from the second path. This makes it possible for instance to start the two paths synchronously or with a defined delay.

"External
(TRIGGER 1 /
2)"

The trigger event is executed with the aid of the active edge of an external trigger signal.

The trigger signal is supplied via the TRIGGER connector.

The polarity, the trigger threshold and the input impedance of the TRIGGER input can be set in the "Global Trigger/Clock Settings" dialog.

Note: For multi segment waveforms, an external trigger source can be used for cyclical output of the segments. Each trigger event starts the output of the next segment. After the last segment, the first segment is output again.

SCPI command:

[:SOURce<hw>] :BB:ARB:TRIGger :SOURce on page 594

Sync. Output to External Trigger

(enabled for "Trigger Source" External)

Enables/disables output of the signal synchronous to the external trigger event.

"On"

Corresponds to the default state of this parameter.

The signal calculation starts simultaneously with the external trigger event but because of the instrument's processing time the first samples are cut off and no signal is outputted. After elapsing of the internal processing time, the output signal is synchronous to the trigger event.

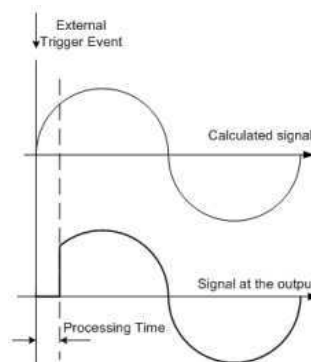

"Off"

The signal output begins after elapsing of the processing time and starts with sample 0, i.e. the complete signal is outputted.

This mode is recommended for triggering of short signal sequences with signal duration comparable with the processing time of the instrument.

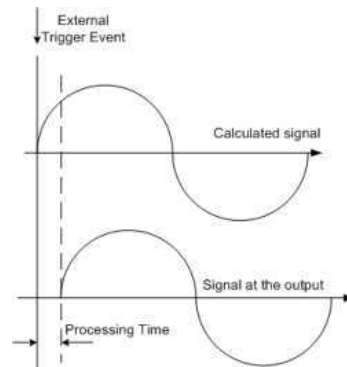

SCPI command:

`[:SOURce<hw>] :BB:ARB:TRIGger:EXTErnal:SYNChronize:OUTPut`
on page 589

Trigger Delay

Sets the trigger signal delay in samples on external triggering or on internal triggering via the second path.

Sets the trigger signal delay in samples on external triggering.

This enables the R&S Signal Generator to be synchronized with the device under test or other external devices.

For two-path instruments, the delay can be set separately for each of the two paths.

SCPI command:

`[:SOURce<hw>] :BB:ARB:TRIGger [:EXTErnal<1|2>] :DElAY` on page 594
`[:SOURce<hw>] :BB:ARB:TRIGger:OBASeband:DElAY` on page 590

Trigger Inhibit

Sets the duration for inhibiting a new trigger event subsequent to triggering. The input is to be expressed in samples.

In the "Retrigger" mode, every trigger signal causes signal generation to restart. This restart is inhibited for the specified number of samples.

This parameter is only available on external triggering or on internal triggering via the second path.

For two-path instruments, the trigger inhibit can be set separately for each of the two paths.

SCPI command:

`[:SOURce<hw>] :BB:ARB:TRIGger [:EXTErnal<1|2>] :INHibit` on page 594
`[:SOURce<hw>] :BB:ARB:TRIGger:OBASeband:INHibit` on page 590

Next Segment Trigger In

The section "Next Segment Trigger" In of the menu is only displayed if a multi segment waveform is loaded.

The section comprises the settings necessary to adjust the trigger for the switch between the segments of a multi segment waveform. The parameters displayed depend on the selected trigger source.

Current Segment

Indication of the waveform segment (segment file name and index) that is currently output.

SCPI command:

[:SOURce<hw>] :BB:ARB:WSEgment on page 620

[:SOURce<hw>] :BB:ARB:WSEgment:NAME on page 627

Next Segment

Selects the waveform segment to be output next. It determines the start segment when switching on the ARB and enables switchover to any other segment.

The switchover is performed either after receiving an external next segment trigger event or, for the internal trigger case, by changing the segment index in the "Next Segment" field. The definition whether the new segment is generated immediately or only after the previous segment has been fully generated (wrap around) is determined by the parameter [Next Segment Mode](#).

The segment currently being output (segment index and file name) is displayed at "Current Segment". The subsequent trigger event after the last segment causes the first segment to be output again.

SCPI command:

[:SOURce<hw>] :BB:ARB:WSEgment:NEXT on page 627

Next Segment Mode

Sets the segmented trigger mode of a multi segment waveform, i.e. defines the way the **switch over between the segments** in a multi segment waveform will be executed:

- In "Same Segment" mode, the processing of the multi segment waveform file is similar to the processing of a non-multi segment waveform, i.e. there is no switching to consecutive segment the upon receiving of a trigger event.
Switching between the segments is triggered by changing the segment index in the "Next Segment" field.
- When "Next Segment" is selected, the current segment ceases to be output as soon as a trigger event for a new segment occurs, and the new segment starts to be output after a system-imposed signal gap.
The following figure shows an example of the transition from a sinewave signal segment to a sawtooth segment (I channel, above) in the case of next segment external triggering (below).

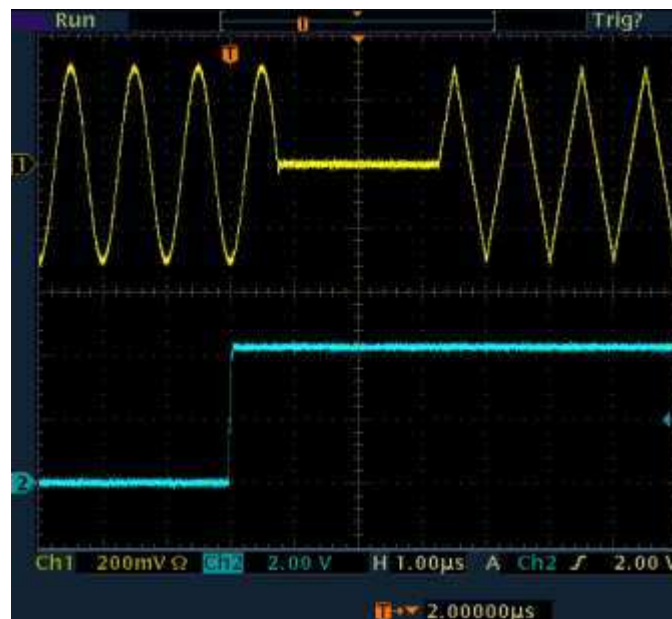

- When "Next Segment" Seamless is selected and a new segment trigger event occurs, the new segment is not output until the whole of the current segment has been output (wrap around). In this case the signal transition is seamless. As a prerequisite for a seamless switchover, all segments must have the same sample rate. The following figure shows an example of the seamless transition from a sinewave signal segment to a sawtooth segment (1 channel, above) in the case of next segment external triggering (below).

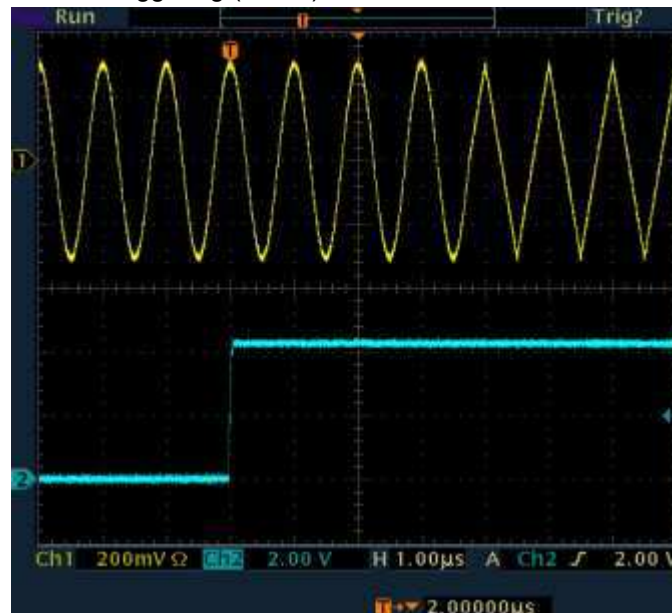

The regular trigger mode for starting the waveform generation and **triggering the whole multi segment sequence** is set with the parameters in the "Trigger In" section of the "Trigger/Marker/Clock" dialog.

The segment currently being output is displayed at "Current Segment".

The "Trigger Example" graph displays schematically the waveform output, depending on the activated trigger and the next segment settings.

"Same Segment"

Depending on the trigger setting, the currently selected segment is continuously output either immediately or after a trigger event.

Signal generation takes place differently according to the trigger selected in the "Trigger In" section:

- In the case of "Trigger = Auto", output starts at once and the segment is generated continuously. Trigger events are ignored. If the segment is changed in "Next Segment", output of the current segment is stopped and the new segment is output immediately, following a system-imposed signal gap (see above).
- In the case of "Trigger = Armed_Auto", output starts after the first trigger event. The segment is then generated continuously. Further trigger events are ignored. If the segment is changed in "Next Segment", signal output is stopped and the new segment is not output until a trigger occurs.
- In the case of "Trigger = Retrigger", output starts at once and the segment is generated continuously, a trigger event causes a restart. If the segment is changed in "Next Segment", output of the current segment is stopped and the new segment is output immediately, following a system-imposed signal gap (see above).
- In the case of "Trigger = Armed_Retrigger", output starts after the first trigger event. The segment is then generated continuously. Further trigger events cause a restart. If the segment is changed in "Next Segment", signal output is stopped and the new segment is not output until a trigger occurs.
- In the case of "Trigger = Single", output starts after the first trigger event. The segment is then generated once. Further trigger events cause a restart. If the segment is changed in "Next Segment", signal output is not stopped. The new segment is not output until a trigger occurs.

"Next Segment"

Depending on the trigger setting, the segment selected under "Next Segment" is output either immediately or after a trigger event.

- In the case of "internal Trigger = Auto", output starts at once and the segment is generated continuously.
If the segment index is changed in "Next Segment", output of the current segment is stopped and the new segment is output immediately, following a system-imposed signal gap.
- In the case of "internal Trigger = Armed_Auto", output starts after the first trigger event. The segment is then generated continuously.
If the segment index is changed in "Next Segment", output of the current segment is stopped and the new segment is output immediately, following a system-imposed signal gap.
- In the case of "internal Trigger = Armed_Auto", output starts after the first trigger event. The segment is then generated continuously.
If the segment index is changed in "Next Segment", signal output is stopped and the new segment is not output until a trigger occurs.
- In the case of "internal Trigger = Single", output starts after the first trigger event. The segment is then generated once. Further trigger events cause a restart.
If the segment index is changed in "Next Segment", the new segment is not output until a trigger occurs.
- In the case of "External Trigger = Auto", output starts at once and the segment is generated continuously.
Each trigger event switches over to outputting the subsequent segment, following a system-imposed signal gap.
If the segment index is changed in "Next Segment", output of the current segment is stopped and the new segment is output immediately, following a system-imposed signal gap.
The subsequent trigger event after the last segment causes the first segment to be output again.
- In the case of "External Trigger = Armed_Auto", output starts after the first trigger event. The segment is then generated continuously.
Each trigger event switches over to outputting the subsequent segment, following a system-imposed signal gap.
If the segment is changed in Next Segment, signal output is stopped and the new segment is not output until a trigger occurs.
The subsequent trigger event after the last segment causes the first segment to be output again.
- In the case of "External Trigger = Single", output starts after the first trigger event. The segment is then generated once.
Each trigger event switches over to outputting the subsequent segment once.
If the segment is changed in "Next Segment", signal output is not stopped. The new segment is not output until a trigger occurs.
The subsequent trigger event after the last segment causes the first segment to be output again.
The remaining trigger modes ("Retrigger" and "Armed_Retrigger") are not available.

"Next Segment Seamless"	<p>The segment selected under "Next Segment" is output. This mode is only available if all segments have the same sample rate.</p> <ul style="list-style-type: none"> • In the case of "Internal Trigger = Auto", output starts at once and the segment is generated continuously. If the segment is changed in "Next Segment", the new segment is output seamlessly after the output of the current segment is complete. • In the case of "internal Trigger = Armed_Auto", output starts after the first trigger event. The segment is then generated continuously. If the segment is changed in "Next Segment", signal output is stopped and the new segment is not output until a trigger occurs. • In the case of "External Trigger = Auto", output starts at once and the segment is generated continuously. Each trigger event switches over to outputting the subsequent segment once the output of the current segment has been completed. If the segment is changed in "Next Segment", the new segment is output seamlessly after the output of the current segment is complete. • In the case of "External Trigger = Armed_Auto", output starts after the first trigger event. The segment is then generated continuously. Each trigger event switches over to outputting the subsequent segment once the output of the current segment has been completed. If the segment is changed in "Next Segment", signal output is stopped and the new segment is not output until a trigger occurs. <p>The remaining trigger modes ("Retrigger" and "Armed_Retrigger") are not available.</p>
"Sequencer"	<p>The waveform files are processed according to the order and repetition cycles defined in the special sequencing list file (*.wvs) assigned to the multi segment waveform file.</p> <p>This "play list" is defined in the Multi Segment Waveform Sequencing dialog.</p> <p>Note: This feature is disabled in case the segments in the multi segment waveform file have different clock rates.</p>

SCPI command:

[:SOURce<hw>] :BB:ARB:TRIGger:SMODE on page 593

Next Segment Source

Displays the next segment source, internal or external, as selected with the parameter "Trigger Source".

SCPI command:

[:SOURce<hw>] :BB:ARB:WSEGment:NEXT:SOURce on page 628

Execute Next Segment

Triggers manually switchover to the subsequent segment in the mutli segment file. A manual trigger can be executed only when an internal "Next Segment Source" has been selected.

To perform a switchover to any segment within the multi segment file, adjust the parameter "Next Segment".

This parameter is disabled, if a sequencing play list is enabled.

SCPI command:

`[:SOURce<hw>] :BB:ARB:WSEgment:NEXT:EXECute` on page 628

Sequencing List

Open a dialog box for defining the "play lists" (see "[Multi Segment Waveform Sequencing](#)" on page 415).

SCPI command:

`[:SOURce<hw>] :BB:ARB:WSEgment:SEquence:SElect` on page 629

Trigger Example

Displays an example of a multi segment waveform. The currently enabled trigger and next segment mode are considered. After the instrument switch on, the graph of the last loaded waveform is displayed.

Note: The curves plotted in this dialog box are textbook examples, "not measured" waveforms. They are intended to visualize the trigger and next segment settings more clearly.

SCPI command:

n.a.

Marker Mode

The marker output signal for synchronizing external instruments is configured in the "Marker Settings" section "Marker Mode".

Marker Mode

Selects a marker signal for the associated "MARKER" output.

Note: The marker trace in the waveform file remains unchanged in any case. It is not overwritten, even if something else than Unchanged has been selected.

- | | |
|-------------|---|
| "Unchanged" | The marker signal remains unchanged as defined in the waveform file. |
| "Restart" | A marker signal is generated at the start of each ARB sequence. This marker mode is not enabled for muti segment waveforms. |
| "Pulse" | A regular marker signal is generated. The pulse frequency is defined by entering a divider. The frequency is derived by dividing the sample rate by the divider. The input box for the divider opens when "Pulse" is selected, and the resulting pulse frequency is displayed below it. The precision of the frequency setting depends on the sampling rate. The maximum pulse frequency is equal to half of the sampling rate. |

SCPI command:

`[:SOURce<hw>] :BB:ARB:TRIGger:OUTPut<ch>:PULSe:DIVider` on page 597

`[:SOURce<hw>] :BB:ARB:TRIGger:OUTPut<ch>:PULSe:FREquency`
on page 597

"Pattern " A marker signal that is defined by a bit pattern is generated. The pattern has a maximum length of 64 bits and is defined in an input field which opens when "pattern" is selected.
The pattern bits switch the marker signal to high and low state.

SCPI command:

[\[:SOURce<hw>\]:BB:ARB:TRIGger:OUTPut<ch>:PATTern](#) on page 597

"ON/OFF Period" A regular marker signal that is defined by an ON/OFF ratio is generated. A period lasts one ON and OFF cycle.

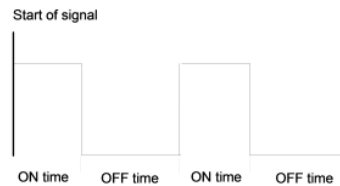

The "ON Time" and "OFF Time" are each expressed as a number of samples and are set in an input field which opens when ON/OFF ratio is selected.

SCPI command:

[\[:SOURce<hw>\]:BB:ARB:TRIGger:OUTPut<ch>:OFFTime](#) on page 596

[\[:SOURce<hw>\]:BB:ARB:TRIGger:OUTPut<ch>:ONTime](#) on page 596

SCPI command:

[\[:SOURce<hw>\]:BB:ARB:TRIGger:OUTPut<ch>:MODE](#) on page 596

Marker Delay

The delay of the signals on the MARKER outputs is set in the "Marker Delay" section.

Marker x Delay

Enters the delay between the marker signal at the marker outputs and the start of the frame or slot.

The input is expressed as a number of symbols. If the setting "Fix marker delay to dynamic range" is enabled, the setting range is restricted to the dynamic range. In this range the delay of the marker signals can be set without restarting the marker and signal.

SCPI command:

[\[:SOURce<hw>\]:BB:ARB:TRIGger:OUTPut<ch>:DELay](#) on page 591

Current Range without Recalculation

Displays the dynamic range within which the delay of the marker signals can be set without restarting the marker and signal.

The delay can be defined by moving the setting mark.

SCPI command:

[\[:SOURce<hw>\]:BB:ARB:TRIGger:OUTPut<ch>:DELay:MINimum](#) on page 591

[\[:SOURce<hw>\]:BB:ARB:TRIGger:OUTPut<ch>:DELay:MAXimum](#) on page 591

Fix marker delay to current range

Restricts the marker delay setting range to the dynamic range. In this range the delay can be set without restarting the marker and signal.

SCPI command:

`[:SOURce<hw>] :BB:ARB:TRIGger:OUTPut:DElay:FIXed` on page 590

Clock Settings

The "Clock Settings" is used to set the clock source and a delay if required.

Clock Source

Selects the clock source.

- | | |
|------------|---|
| "Internal" | The internal clock reference is used to generate the symbol clock. |
| "External" | The external clock reference is fed in as the symbol clock or multiple thereof via the CLOCK connector.
The symbol rate must be correctly set to an accuracy of +/-2 % (see data sheet).
The polarity of the clock input can be changed with the aid of "Global Trigger/Clock Settings".
In the case of two-path instruments this selection applies to path A. |

SCPI command:

`[:SOURce<hw>] :BB:ARB:CLOCK:SOURCE` on page 588

Clock Mode

Enters the type of externally supplied clock.

- | | |
|-------------------|---|
| "Sample" | A sample clock is supplied via the CLOCK connector. |
| "Multiple Sample" | A multiple of the sample clock is supplied via the CLOCK connector; the sample clock is derived internally from this.
The "Multiplier" window provided allows the multiplication factor to be entered. |

SCPI command:

`[:SOURce<hw>] :BB:ARB:CLOCK:MODE` on page 587

Sample Clock Multiplier

Enters the multiplication factor for clock type "Multiple".

SCPI command:

`[:SOURce<hw>] :BB:ARB:CLOCK:MULTIplier` on page 587

Measured External Clock

Indicates the measured frequency of the external clock signal. This enables the user to permanently monitor the frequency of the externally introduced clock.

This information is displayed only if the external clock source has been selected.

SCPI command:

`CLOC:INP:FREQ?`

Global Settings

The buttons in this section lead to submenu for general trigger, clock and mapping settings.

Global Trigger/Clock Settings

Calls the "Global Trigger/Clock/Input Settings" dialog.

This dialog is used among other things for setting the trigger threshold, the input impedance and the polarity of the clock and trigger inputs.

In the case of two-path instruments, these settings are valid for both paths.

The parameters in this menu affect all digital modulations and standards, and are described in [chapter 4.2.3.10, "Global Trigger/Clock/External Input Settings"](#), on page 136.

User Marker / AUX I/O Settings

Calls the "User Marker AUX I/O Settings" menu, used used to map the connector on the rear of the instruments.

See also [chapter 4.2.3.12, "User Marker / AUX I/O Settings"](#), on page 139.

Sine Test Signals

To access the "Sine Test Signals" dialog, in the "ARB MOD" dialog set the parameter "Create Test Signal" to Sine and press "Create Test Signal".

The menu can be used to configure a sinusoidal test signal. A sine wave is generated on the I path, and a sine wave of the same frequency but phase-shifted is generated on the Q path.

The signal actually set is displayed in graphical form in the center of the menu.

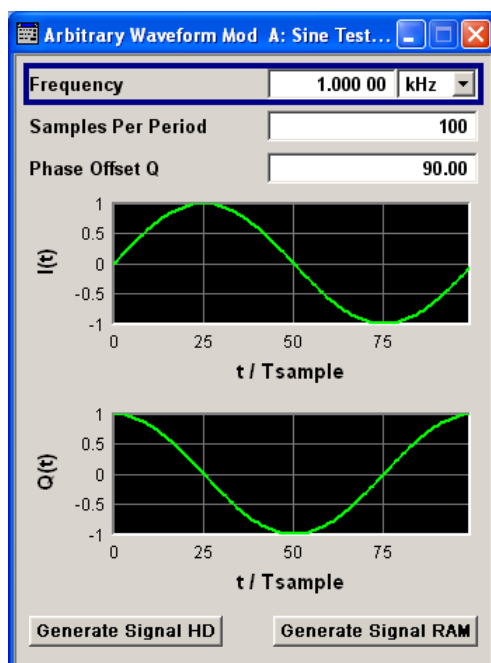

Frequency (Sine Test Signal)

Enters the frequency of the test signal.

SCPI command:

[\[:SOURce<hw>\]:BB:ARB:TSIGnal:SINE:FREQuency](#) on page 600

Samples per Period (Sine Test Signal)

Enters the number of sample values required from the sine wave per period.

The resulting clock rate must not exceed the maximum ARB clock rate (see data sheet). The number of sample values is automatically restricted by reference to the set frequency.

SCPI command:

[\[:SOURce<hw>\]:BB:ARB:TSIGnal:SINE:SAMPles](#) on page 601

Phase Offset Q (Sine Test Signal)

Enters the phase offset of the sinewave signal on the Q channel relative to the sinewave signal on the I channel.

SCPI command:

[\[:SOURce<hw>\]:BB:ARB:TSIGnal:SINE:PHASe](#) on page 600

Generate Signal HD (Sine Test Signal)

Generates a signal and saves it to a file.

The File Select window opens automatically and the signal can be stored as a waveform file.

SCPI command:

[\[:SOURce<hw>\]:BB:ARB:TSIGnal:SINE:CREate:NAMed](#) on page 598

Generate Signal RAM (Sine Test Signal)

Generates a signal and uses it as output straight away.

SCPI command:

[\[:SOURce<hw>\]:BB:ARB:TSIGnal:SINE:CREate](#) on page 598

Rect Test Signal

To access the "Sine Test Signals" dialog, in the "ARB MOD" dialog set the parameter "Create Test Signal" to Rect and press "Create Test Signal".

The dialog can be used to configure a rectangular test signal. A rectangular test signal with a duty factor of 0.5 is created. Amplitude and offset are adjustable. Both paths, I and Q, get the same signal.

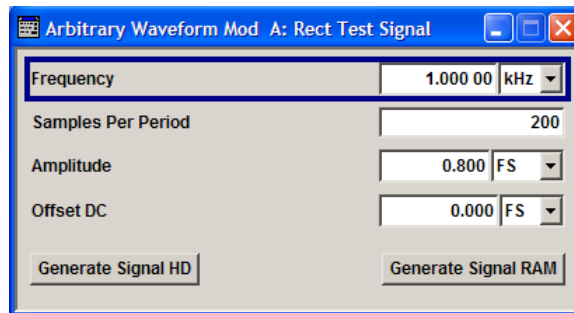
**Frequency (Rect Test Signal)**

Enters the frequency of the test signal.

SCPI command:

[\[:SOURce<hw>\]:BB:ARB:TSIGnal:RECTangle:FREQuency](#) on page 599

Samples per Period (Rect Test Signal)

Enters the number of sample values required for the rectangular signal per period.

The resulting clock rate must not exceed the maximum ARB clock rate (see data sheet). The number of sample values is automatically restricted by reference to the set frequency.

SCPI command:

[\[:SOURce<hw>\]:BB:ARB:TSIGnal:RECTangle:SAMPles](#) on page 600

Amplitude (Rect Test Signal)

Enters the digital amplitude of the rectangular wave.

The abbreviation FS means full scale.

SCPI command:

[\[:SOURce<hw>\]:BB:ARB:TSIGnal:RECTangle:AMPLitude](#) on page 599

Offset DC (Rect Test Signal)

Enters a DC component.

SCPI command:

[\[:SOURce<hw>\]:BB:ARB:TSIGnal:RECTangle:OFFSet](#) on page 599

Generate Signal HD (Rect Test Signal)

Generates a signal and saves it to a file.

The File Select window opens automatically and the signal can be stored as a waveform file.

SCPI command:

[\[:SOURce<hw>\]:BB:ARB:TSIGnal:RECTangle:CREate:NAMed](#) on page 598

Generate Signal RAM (Rect Test Signal)

Generates a signal and uses it as output straight away.

SCPI command:

[\[:SOURce<hw>\]:BB:ARB:TSIGnal:SINE:CREate](#) on page 598

Const IQ Test Signal

To access the "Sine Test Signals" dialog, in the "ARB MOD" dialog set the parameter "Create Test Signal" to Const I/Q and press "Create Test Signal".

The dialog can be used to configure a continuous test signal with constant I/Q. The I and Q values for each path are adjustable but constant. The I and Q values are entered as a decimal number, which is decimal-to-binary converted internally. The signal is provided as a 16-bit wide digital signal for both I and Q channels.

Converted to analog the signal is output directly at the BNC connectors I and Q outputs of the instrument.

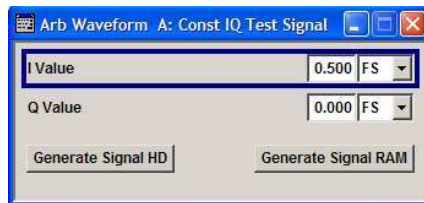

I Value (Const IQ Test Signal)

Enters the value for the I component of the test signal.

SCPI command:

[\[:SOURce<hw>\]:BB:ARB:TSIGnal:CIQ:I](#) on page 599

Q Value (Const IQ Test Signal)

Enters the value for the Q component of the test signal.

SCPI command:

[\[:SOURce<hw>\]:BB:ARB:TSIGnal:CIQ:Q](#) on page 599

Generate Signal HD

Generates a signal and saves it to a file.

The File Select window opens automatically and the signal can be stored as a waveform file.

SCPI command:

[\[:SOURce<hw>\]:BB:ARB:TSIGnal:CIQ:CREate:NAMed](#) on page 598

Generate Signal RAM

Generates a signal and uses it as output straight away.

SCPI command:

[\[:SOURce<hw>\]:BB:ARB:TSIGnal:CIQ:CREate](#) on page 598

4.8.4.2 Multi Segment Waveforms

To fulfill the requirements of some test systems and to enable rapid alternation between different waveforms with differing test signals, the R&S Signal Generator provides the functionality to generate multi segment waveform files. A multi segment waveform is a combination of multiple waveforms called segments. Each segment represents a completely independent waveform that can be output with its own marker and clock settings.

The entire multi segment waveform is loaded into memory. The segment intended to be output at any given moment can be selected by the user. It is therefore possible to alternate between the individual waveform segments without experiencing any delay due to the loading operation.

If very high switchover speeds are required, the test signals can be continuously scrolled through with the aid of an external trigger or by applying a predefined "play list". For this purpose the segments must have a common sample rate. If the combined waveforms have different sample rates, they can be adapted to a common sample rate by resampling. By the same procedure the instantaneous amplitude of the various waveforms can be scaled to a common RMS level.

To access the "Multi Segment" dialog, select "Baseband > ARB > Multi Segment...".

The menu can be used to create a multi segment waveform from existing waveforms and save it under its own name. As with normal waveforms, the file extension is *.wv. Information on whether a file is a multi segment waveform is displayed in the File menu with the tag information when a waveform is loaded. Additionally, an information about the waveform can be acquired in the "Waveform Info" dialog.

If the combined waveforms have different sample rates, they can be adapted to a common sample rate by resampling. By the same procedure the instantaneous amplitude of the various waveforms can be scaled to a common rms level.

The configuration of a multi segment waveform, that is to say details of how it is made up from different waveforms, the level and clock rate settings, and the file name, can be saved separately in a list. The file extension is *.inf_mswv. This method can be used to create any number of configurations as a basis for defining further multi segment waveforms.

Example for the creation of a multi segment waveform file.

1. Select "New List" to create empty list.
2. Use the "Append" function to add two or more waveform files.
3. Adjust the "Level", "Clock" and "Segment Marker" settings.
4. Select the "Output File" and enter file name.
5. Select "Save List" to save the configuration.
6. Select "Create" or "Create and Load" to create and save the multi segment waveform.

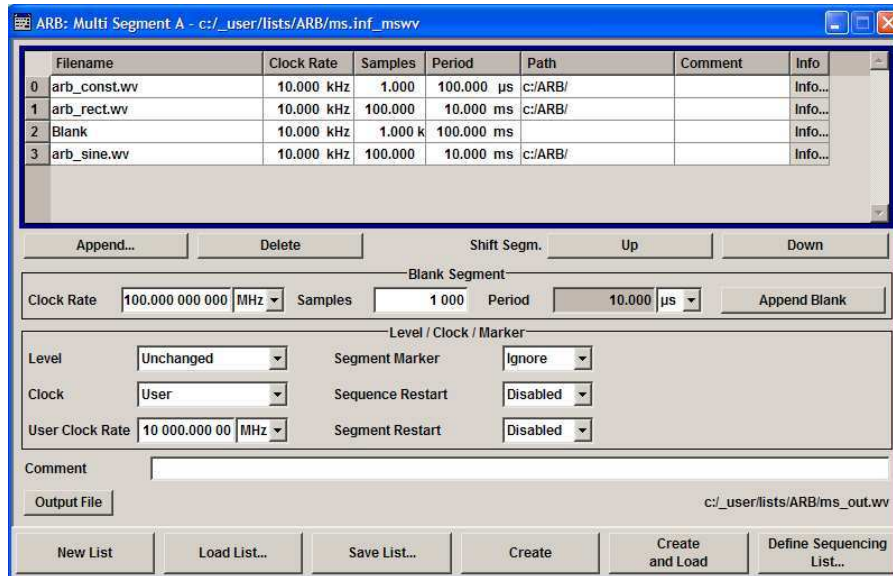

Multi Segment File Contents

The upper part of the dialog provides the functions, necessary to create and adjust the contents of the multi segment file.

Multi Segment Table

The table lists the individual waveforms (segments) of the selected multi segment waveform. The information about the segments is taken from the tags of the corresponding waveform files.

"Segment#"	Indication of segment index. The segment index is used to select the segment to be output. The segment index also defines the sequence of the output during triggering in the "Next Segment" or "Next Segment Seamless".
"Waveform"	Indication of the waveform file name of the segment.
"Clock Rate"	Indication of the clock rate of the segment.
"Samples"	Indication of the number of samples in the segment.
"Period"	Indication of the segment duration.
"Path"	Indication of the location of the waveform file used for the corresponding segment.
"Comment"	Indication of the comment on the segment.

"Info" Opens a dialog with detailed information about the currently selected waveform.

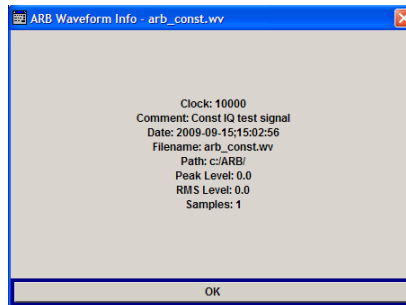

SCPI command:
n.a.

Append

Opens the file menu to enter the file name of the waveform file to be appended.

SCPI command:

[\[:SOURce<hw>\]:BB:ARB:WSEGment:CONFigure:SEGment:CATalog](#)
on page 626

[\[:SOURce<hw>\]:BB:ARB:WSEGment:CONFigure:SEGment:APPend](#) on page 626

Delete

Deletes the selected segment.

SCPI command:

[\[:SOURce<hw>\]:BB:ARB:WSEGment:CONFigure:DELeTe](#) on page 623

Shift Seg.# Up/Down

Shifts the selected segment up and down.

Blank Segment

The Blank Segment section is where a blank segment can be configured.

Clock Rate

Selects the clock rate of the blank segment.

SCPI command:

[\[:SOURce<hw>\]:BB:ARB:WSEGment:CONFigure:BLANk:APPend](#) on page 621

Samples

Selects the number of samples for the blank segment.

SCPI command:

[\[:SOURce<hw>\]:BB:ARB:WSEGment:CONFigure:BLANk:APPend](#) on page 621

Period

Displays the resulting period for the blank segment.

SCPI command:

n.a.

Append Blank

Adds the blank segment to the multi segment file.

SCPI command:

`[:SOURce<hw>] :BB:ARB:WSEgment:CONFigure:BLANk:APPend` on page 621

Level / Clock /Marker

The Level/Marker/Clock section provides the parameters necessary to adjust the level, marker and clock settings for the selected multi segment waveform file.

Level

Defines the level mode for the multi segment waveform.

"Unchanged" Concerning the level settings, the segments are output exactly as defined in the files. The "Level" display applies only to the segment with the highest rms value. In some circumstances the remaining segments are output at a lower level than that displayed.

"Equal RMS" Segments are output so that all segments have the same rms value. The "Level" display applies to all segments.

SCPI command:

`[:SOURce<hw>] :BB:ARB:WSEgment:CONFigure:LEVel [:MODE]` on page 623

Clock

Selects the clock rate mode for the multi segment waveform.

"Unchanged" A segment is output with the clock rate defined in the file. If segments have different clock rates, extended trigger mode "Next Segment" allows internal segment switchovers only ("Internal" trigger source). Extended trigger mode "Next Segment Seamless" can only be selected if all segments have the same clock rate.

"Highest" All segments are output at the highest available clock rate. This mode provides very short switchover times between segments. The time for calculating the multi segment waveform is increased since the individual segments have to be resampled.

"User" All segments are output at the clock rate defined in "User Clock". This mode provides very short switchover times between segments. The time for calculating the multi segment waveform is increased since the individual segments have to be resampled.

SCPI command:

`[:SOURce<hw>] :BB:ARB:WSEgment:CONFigure:CLOCK:MODE` on page 622

User Clock Rate

Defines the sample rate used for multi segment waveform output in case of Clock Mode "User".

SCPI command:

`[:SOURce<hw>] :BB:ARB:WSEgment:CONFigure:CLOCK` on page 622

Segment Marker

Defines the way the marker information within the separate segments is processed.

- | | |
|-------------|--|
| "Ignore" | The marker information carried in the individual segment waveform files is not considered. |
| "Take Over" | The output waveform file contains the marker information as configured in the individual waveform files. |

SCPI command:

`[:SOURce<hw>] :BB:ARB:WSEgment:CONFigure:MARKer:MODE` on page 625

Sequence Restart

Enables/disables the generation of an additional marker restart signal in the output waveform file.

If additional marker generation is enabled, the existing marker signals in the individual segment waveform files are not considered.

- | | |
|---------------------|---|
| "Disable" | No additional marker is generated. |
| "Marker
1/2/3/4" | Generates a restart marker signal at the beginning of the first segment for the corresponding marker.
Use this setting to generate a restart marker for the complete sequence. |

SCPI command:

`[:SOURce<hw>] :BB:ARB:WSEgment:CONFigure:MARKer:FSEgment`
on page 624

Segment Restart

Enables/disables the generation of an additional marker restart signal in the output waveform file.

If additional marker generation is enabled, the existing marker signals in the individual segment waveform files are not considered.

- | | |
|---------------------|---|
| "Disable" | No additional marker is generated. |
| "Marker
1/2/3/4" | Generates a restart marker signal at the beginning of each segment for the corresponding marker.
The segment begin is defined by the low-high slope of the marker. This applies for switching between two segments as well as in case of segment replay. |

SCPI command:

`[:SOURce<hw>] :BB:ARB:WSEgment:CONFigure:MARKer:ESEgment`
on page 624

Output File

In the Output File section, the output file name is specified and a comment can be added to the file.

Comment

Adds a comment to the multi segment file.

SCPI command:

`[:SOURce<hw>] :BB:ARB:WSEgment:CONFigure:COMMent` on page 623

Output file

Opens the File menu, where the file name of the multi segment waveform which has to be calculated can be entered. The multi segment waveform is saved under this name by clicking the "Create" or "Create and Load" button.

A name must also be entered here before the list can be saved as a configuration file ("Save List"). In this case the name is needed for internal storage procedures. It is entered as the default name for the multi segment waveform file when loading the list.

SCPI command:

[\[:SOURce<hw>\]:BB:ARB:WSEGment:CONFigure:OFILe](#) on page 625

Handling of Multi Segment Files

The buttons in this sections are provided for handling of the multi segment files.

Save List

Saves the current entries of the table in a configuration file, including the level mode, clock mode, segment marker mode and output file name settings.

The file name is entered in the "File" menu. Configuration files have the file extension *.inf_mswv. They can be used later as the basis for further multi segment waveforms.

Before a multi segment configuration file can be saved, a file name must be entered in "Output File", since this is saved with the configuration file for internal purposes.

SCPI command:

The configuration file to be used for the creation of the multi segment waveform is defined with the command:

[\[:SOURce<hw>\]:BB:ARB:WSEGment:CREate](#)

or [\[:SOURce<hw>\]:BB:ARB:WSEGment:CLOad](#)

The file name of the waveform file is always determined with the command [\[:SOURce<hw>\]:BB:ARB:WSEGment:CONFigure:OFILe](#)

Load List

Opens the file menu to select the configuration file to be edited.

SCPI command:

[\[:SOURce<hw>\]:BB:ARB:WSEGment:CONFigure:CATalog](#) on page 622

[\[:SOURce<hw>\]:BB:ARB:WSEGment:CONFigure:SElect](#) on page 626

New List

Calls the "Create Multi Segment Waveform List" dialog to enter the name of the new file.

A new new configuration table is created.

SCPI command:

[\[:SOURce<hw>\]:BB:ARB:WSEGment:CONFigure:SElect](#) on page 626

Define Sequencing List

Open a dialog box for configuring of the play lists (see "[Multi Segment Waveform Sequencing](#)" on page 415).

SCPI command:

n.a.

Create

Creates a new multi segment waveform using the current table entries.

This multi segment waveform is saved with the file name specified in "Output File". As with normal waveforms, the file extension is "*.wv".

Depending on the configuration of the multi segment waveform, calculation may take some time. A panel with a progress bar and an "Abort" button appears during creating of the multi segment waveform.

In remote control the configuration file to be used for the creation of the multi segment waveform is defined with the command: `[:SOURce<hw>] :BB:ARB:WSEGment : CREate` or `[:SOURce<hw>] :BB:ARB:WSEGment : CLOad`.

The file name of the waveform file is always determined with the command `[: SOURce<hw>] :BB:ARB:WSEGment : CONFigure : OFILe`

SCPI command:

`[:SOURce<hw>] :BB:ARB:WSEGment : CREate` on page 627

Create and Load

Creates a new multi segment waveform using the current table entries.

This multi segment waveform is saved with the file name specified in "Output File". As with normal waveforms, the file extension is *.wv.

Depending on the configuration of the multi segment waveform, calculation may take some time.

Following this the "Create Multi Segment Waveform File" submenu is closed and the new multi segment waveform is loaded.

In remote control the configuration file to be used for the creation of the multi segment waveform is defined with the command: `[:SOURce<hw>] :BB:ARB:WSEGment : CREate` or `[:SOURce<hw>] :BB:ARB:WSEGment : CLOad`.

The file name of the waveform file is always determined with the command `[: SOURce<hw>] :BB:ARB:WSEGment : CONFigure : OFILe`

SCPI command:

`[:SOURce<hw>] :BB:ARB:WSEGment : CLOad` on page 620

Multi Segment Waveform Sequencing

The settings provided in the "Multi Segment Waveform Sequencing" dialog can be adjusted to create a "play list", i.e. to define the sequence in which the waveform file segments are processed and how many times each of them is repeated. The configured play list is displayed in form of a "Sequencing Graphic".



All segments in a "play list" must have the same clock rate.

In the "ARB" main dialog or in the "ARB Trigger/Marker/Clock" dialog, set the "Next Segment Mode" to "Sequencer" to activate the configured "play list".

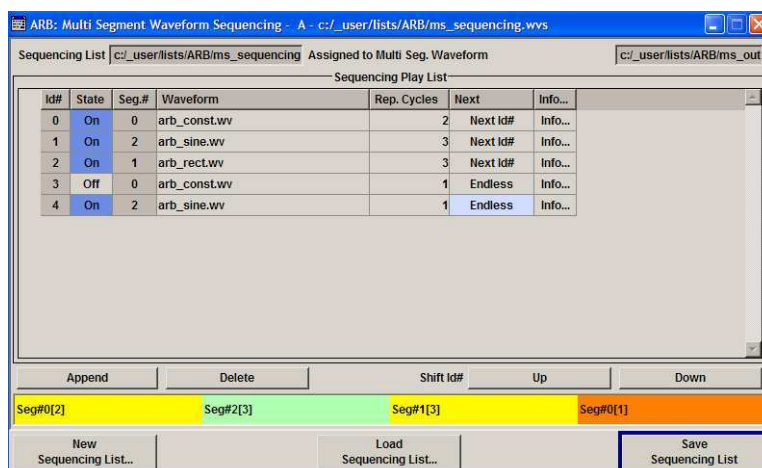

Sequencing List

Displays the name of the selected sequencing list file, i.e. the file with the “play list” settings.

The sequencing list file has an extension *.wvs and is automatically assigned to but independent from the multi segment file. By default, both files have the same name and are located in the same file directory. More than one sequencing list files can be created per multi segment waveform file.

The sequencing list file carries information only about the segment number, the corresponding wavefile names are retrieved from the assigned multi segment waveform file, i.e. the same sequencing list file can be reused for different multi segment waveform files with the same number of segments.

Changes and re-calculations of a multi segment waveform file cause a re-check whether the assigned sequencing list files are still valid. A message is displayed to inform about necessary corrections in the “play list”.

SCPI command:

n.a.

Assigned to Multi Seg. Waveform

Displays the name of the multi segment waveform file the current sequencing list file is assigned to.

SCPI command:

n.a.

Sequencing Play List

The "Sequencing Play List" table is used to define the sequence in which the waveform file segments are processed and how many times each of them is repeated.

Id# ← Sequencing Play List

Indication of the row number.

n.a.

State ← Sequencing Play List

Enables/disables the selected row. Only active segments are processed.

n.a.

Segment# ← Sequencing Play List

Indication of segment index.

The sequencing list file carries information only about the segment index, the corresponding wavefile names are retrieved from the assigned multi segment waveform file.

n.a.

Waveform ← Sequencing Play List

Indication of the waveform file name of the segment. The file name is retrieved from the assigned multi segment waveform file.

Available for selection are only waveform files from the pool of segments of the selected multi segment waveform file.

n.a.

Repetition Cycles ← Sequencing Play List

Sets the number of times the selected segment is cyclically repeated before the next segment in the sequence is processed.

n.a.

Next ← Sequencing Play List

Determines the action after completing the current one, like for instance which segment is processed after the processing of the current one is finished.

"Next Id#"	The next active segment in the play list is processed.
"Blank"	After the processing of the current segment is completed, the signal output is stopped until a signal restart like a retrigger signal is received. A restart signal causes a complete restart of the sequencing play list.
"Endless"	The current segment is re-played until a signal restart like a retrigger signal is received and the complete sequencing play list is restarted. Only active segments are considered.
"Goto Id#"	Determines the row number of the segment to be processed next. This feature is currently limited for the first 32 rows.

SCPI command:

n.a.

Info ← Sequencing Play List

Opens a dialog with detailed information about the currently selected waveform.

See also "[Waveform Info](#)" on page 389.

SCPI command:

n.a.

Append

Inserts a new row at the end of the sequencing play list table.

SCPI command:

[:SOURce<hw>] :BB:ARB:WSEGment:SEquence:SElect on page 629

[:SOURce<hw>] :BB:ARB:WSEGment:SEquence:APPend on page 628

Delete

Deletes the selected row.

SCPI command:

n.a.

Shift Id# Up/Down

Shifts the selected row up and down.

SCPI command:

n.a.

Sequencing Graphic

Displays the play list graph according to the current configuration.

The graph shows the segment sequence, the segment number and the number of times, the segment is repeated; considered are only the active segments.

SCPI command:

n.a.

New Sequencing List

Opens the "Select Sequencing List" dialog to enter the name of the new file.

SCPI command:

n.a.

Load Sequencing List

Opens the "Select Sequencing List" dialog to select an existing play list file.

SCPI command:

n.a.

Save Sequencing List

Saves the current entries of the table in a play list file.

The default file name of the play list file is the same as the multi segment waveform file name, but it can be changed.

Play list files have the file extension *.wvs.

SCPI command:

n.a.

Typical Applications for Multi Segment Waveforms

This section gives examples of the typical applications for multi segment waveforms.

High Speed Switchovers

To test DUTs/chips using different test signals at high throughput requires extremely fast switchovers (for instance when testing ATE devices during manufacture). The following settings enable switching times of approx. 5 us and the test signals are scrolled through with the aid of an external trigger signal:

1. "Trigger Mode" = "Auto"

2. "Trigger Source" = "External Trigger"
3. If the waveforms have different sample rates:
"Clock Mode" = "Highest" or "User" (when creating the waveform in the Multi Segment Editor)

Flexible Dynamic Switchovers

When testing DUTs using different test signals, it may be necessary to switch dynamically and flexibly between any of the test signals, for instance depending on the outcome of the previous test. When using remote control via an external computer, the following settings enable switching times of approx. 20 ms for segments with the same sample rate and approx. 200 ms for segments with different sample rates:

1. "Extended Trigger Mode" = "Next Segment"
2. "Trigger Mode" = "Auto"
3. "Trigger Source" = "Internal"

Flexible Dynamic Switchovers without Signal Interruptions

Testing receivers requires a continuous output of different test signals without interrupting the signal. The test signals then produce a complex total signal with no signal gaps on switchover. Control procedures can use a simulated back channel of the receiver (trigger line or remote control).

Switching times depend on the length of the segment currently being output, since switchover to the next segment does not take place until the current segment comes to an end.

1. "Extended Trigger Mode" = "Next Segment Seamless"
2. "Trigger Mode" = "Auto"
3. "Trigger Source" = "Internal or External"
If the waveforms have different sample rates:
4. "Clock Mode" = "Highest" or "User" (when creating the waveform in the Multi Segment Editor)

4.8.4.3 Multi Carrier Waveforms

Multi carrier waveforms consisting of up to 32 carriers modulated by user-selectable baseband signals can be created in order to simulate complex multi carrier scenarios with different baseband signals (e.g. CDMA2000 or 3GPP FDD).

The carriers are equally spaced and centered toward the RF frequency or baseband DC line, respectively. The carrier spacing is adjustable within the total available baseband bandwidth of 80 MHz. Each carrier can be separately defined in terms of power, phase and modulated input signal. Optionally, crest factor optimization can be applied.

Thus, multi carrier waveforms can be very easily configured as broadband test signals and used for such purposes as transmitter or receiver tests. Even complex multi carrier

scenarios composed of signals from different digital standards can be created and used for these tests.

Example for the creation of a multi carrier waveform file

1. Configure general settings
2. Configure carrier table
3. Enter file name of multi carrier waveform ("Output File")
4. Save and load multi carrier waveform ("Create" or "Create and Load")

User Interface

To access the "Multi Carrier" dialog, select "Baseband > ARB > Multi Carrier...".

The menu can be used to create a multi carrier waveform and save it under its own name. As with normal waveforms, the file extension is *.wv. Information on clock rate, number of samples and creation day is displayed in the File menu when a waveform is loaded.

The "Multi Carrier" dialog is divided into the following sections.

The upper part of the menu is used for calling the default settings and saving and recalling the submenu settings.

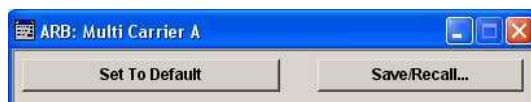

The General Settings section is used to configure the main multi carrier waveform.

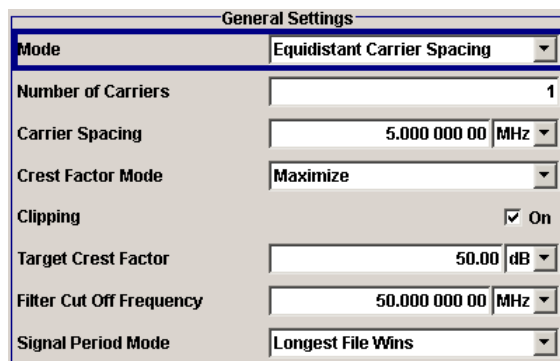

The buttons in the middle part of the menu open submenus for defining the carrier table. The carrier settings can be checked in the graphical "Carrier Graph" submenu.



The "Output Settings" section indicates the name, the size and the clock rate of the multi carrier waveform (after calculation).

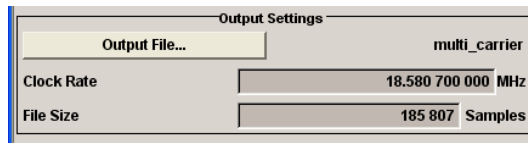

The buttons in the lower part of the menu activate creation and optionally loading of multi carrier waveform files into the main ARB menu.

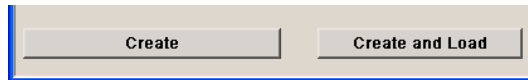

Default Settings and State

The upper part of the dialog is used for calling the default settings and saving and recalling existing ARB multi carrier submenu settings.

Set to Default

Calls default settings. The values are shown in the following table.

Parameter	Value
Number of Carriers	1
Carrier Spacing	0 MHz
Crest Factor Mode	Off
Signal Period Mode	Longest file wins

SCPI command:

[\[:SOURce<hw>\]:BB:ARB:MCARrier:PRESet](#) on page 612

Save/Recall Frame

Calls the "Save/Recall" menu.

From the "Save/Recall" menu the "File Select" windows for saving and recalling the configurations of the ARB "Multi Carrier" submenu and the "File Manager" can be called.



Multi Carrier configurations are stored as files with the predefined file extension `*.arb_multcarr`. The file name and the directory they are stored in are user-definable.

The complete settings in the Multi Carrier menu are saved and recalled.

"Recall Multi Carrier Settings" Opens the "File Select" window for loading a saved Multi Carrier configuration. The configuration of the selected (highlighted) file is loaded by pressing the "Select" button.

"Save Multi Carrier Settings"	<p>Opens the "File Select" window for saving the current Multi Carrier signal configuration.</p> <p>The name of the file is specified in the "File name" entry field, the directory selected in the "Save Into" field. The file is saved by pressing the "Save" button.</p> <p>The "Fast Save" checkbox determines whether the instrument performs an absolute or a differential storing of the settings. Enable this function to accelerate the saving process by saving only the settings with values different to the default ones. "Fast Save" is not affected by the "Preset" function.</p>
"File Manager"	<p>Calls the "File Manager".</p> <p>The "File Manager" is used to copy, delete, and rename files and to create new directories.</p>

SCPI command:

[\[:SOURce<hw>\]:BB:ARB:MCARrier:SETTing:CATalog](#) on page 613

[\[:SOURce<hw>\]:BB:ARB:MCARrier:SETTing:LOAD](#) on page 613

[\[:SOURce<hw>\]:BB:ARB:MCARrier:SETTing:STORe:FAST](#) on page 613

[\[:SOURce<hw>\]:BB:ARB:MCARrier:SETTing:STORe](#) on page 613

General Settings

The "General Settings" section is used to configure the Multi Carrier signal.

Mode

Selects the carrier frequency mode.

"Equidistant Carrier Spacing"	Sets an equidistant carrier spacing. The carrier frequency in the carrier table is not configurable.
-------------------------------	--

"Arbitrary Carrier Frequency"	Enables you to specify the carrier frequency in the carrier table. Carrier spacing is irrelevant.
-------------------------------	---

SCPI command:

[\[:SOURce<hw>\]:BB:ARB:MCARrier:CARRier:MODE](#) on page 602

Number of Carriers

Sets the number of carriers for the multi carrier waveform.

By default the multi carrier table lists 1 carrier. A maximum of 32 carriers can be configured and activated.

When the number of carriers is increased, the multi carrier table is extended by adding further lines at the end of the table. If these carrier already have been defined before, the settings are preset according to the former settings. Otherwise the parameters are preset with the default values.

SCPI command:

[\[:SOURce<hw>\]:BB:ARB:MCARrier:CARRier:COUNt](#) on page 602

Carrier Spacing

Sets the frequency spacing between adjacent carriers of the multi carrier waveform.

The carriers are arranged symmetrically around the RF carrier.

The maximum carrier spacing is limited to

Carrier spacing = Total baseband bandwidth / (Number of carriers - 1);

The total baseband bandwidth is 80 MHz.

Note: In order to avoid wrap-around problems, the effective "Carrier Spacing" might be slightly modified.

The Carrier Spacing is rounded in that way that the carrier closest to the center RF frequency shows no phase jump assuming that the carrier is unmodulated.

- For odd number of carriers:
RoundedCarrierSpacing=1/OutputSignalDuration* round(CarrierSpacing * OutputSignalDuration);
- For even number of carriers:
RoundedCarrierSpacing=2/OutputSignalDuration*round(0.5 *CarrierSpacing *OutputSignalDuration).

SCPI command:

[\[:SOURce<hw>\]:BB:ARB:MCARrier:CARRier:SPACing](#) on page 603

Crest Factor Mode

Selects the mode for optimizing the crest factor by calculating the carrier phases.

The crest factor represents the ratio of the peak voltage value to the rms voltage value. The higher the crest factor and resulting dynamics of a signal, the greater the requirement for a power amplifier fed by the signal to be linear.

The following modes are available:

"Off"	There is no automatic setting for minimizing or maximizing the crest factor. The "Phase" setting as defined in the carrier table is in use.
"Minimize"	The crest factor is minimized by internally calculating optimized carrier phases. The Phase setting displayed in the carrier table is invalid.
"Maximize"	The crest factor is maximized by internally calculating optimized carrier phases. The Phase setting displayed in the carrier table is invalid.

SCPI command:

[\[:SOURce<hw>\]:BB:ARB:MCARrier:CFACTOR:MODE](#) on page 605

Clipping

Switches baseband clipping on and off.

Clipping reduces the peak power of the resulting multi carrier signal according to the input parameter "Target Crest Factor".

The resulting clipped peak power is defined by sum of the the RMS level of the unclipped multi carrier signal and the input parameter "Target Crest Factor". Note that clipping reduces also the RMS level. Hence the resulting crest factor of the clipped signal is slightly above the "Target Crest Factor". In order to get the unclipped parts of the clipped multi-carrier signal matched with the unclipped multicarrier signal, the RF output power should be reduced by the difference between resulting crest factor and "Target Crest Factor".

SCPI command:

[\[:SOURce<hw>\]:BB:ARB:MCARrier:CLIPping\[:STATe\]](#) on page 607

Target Crest Factor

Sets the value of the desired crest factor, if baseband clipping is enabled.

A "Target Crest Factor" above the crest factor of the unclipped multicarrier signal has no effect.

SCPI command:

`[:SOURce<hw>] :BB:ARB:MCARrier:CLIPping:CFACTOR` on page 606

Filter Cut Off Frequency

Sets the cut off frequency of the final lowpass filter, if baseband clipping is enabled.

When the cut off frequency is set as half of the output sample rate, a final lowpass filter improves the spectrum of the clipped multicarrier signal, but may also increase the resulting crest factor.

SCPI command:

`[:SOURce<hw>] :BB:ARB:MCARrier:CLIPping:CUToff` on page 606

Signal Period Mode

Selects the mode for calculating the resulting signal period of the multi carrier waveform. The carrier table provides an information button to obtain sample rate and file length data of each carrier.

The resulting period is always calculated for all carriers in the carrier table irrespective of their state (ON/OFF).

Note: Wrap-around and timing problems may occur when I/Q signals of different length are used. Thus, demodulation of a carrier may be difficult or even impossible. It is therefore recommended to consider the timing already when creating the input I/Q files or to adjust the signal duration to the carrier which is subsequently demodulated (in this case, the other carriers are for interfering the signal only). These problems do not arise with signals of the same standard (e.g. 3GPP).

The following modes are available:

"Longest File Wins"	The resulting signal period is defined by the longest I/Q file in the carrier table. Shorter I/Q files are periodically repeated.
"Shortest File Wins"	The resulting signal period is defined by the shortest I/Q file in the carrier table. Only the first part of longer I/Q files is used.
"User"	The signal period can be set by the user in the "Signal Period" field. Shorter I/Q files are repeated periodically, and only the first part of longer I/Q files is used.

SCPI command:

`[:SOURce<hw>] :BB:ARB:MCARrier:TIME:MODE` on page 614

Signal Period

Sets the signal period in Signal Duration Mode "User". Shorter I/Q files are repeated periodically, and only the first part of longer I/Q files is used.

SCPI command:

`[:SOURce<hw>] :BB:ARB:MCARrier:TIME` on page 614

Carrier Table Submenu

Calls the table for configuring individual carriers. A selectable carrier range can be set with the aid of the optional "Carrier Table Assistant" (see "[Multi Carrier Table](#)" on page 426).

The multi carrier configuration can be checked with the aid of the "Carrier Graph".

Carrier Graph

Calls a graphical representation of the current multi carrier configuration in the frequency domain.

The height of the bars corresponds to the chosen gain of each individual carrier. The bandwidth of the carriers signals is indicated by the width of the bars.

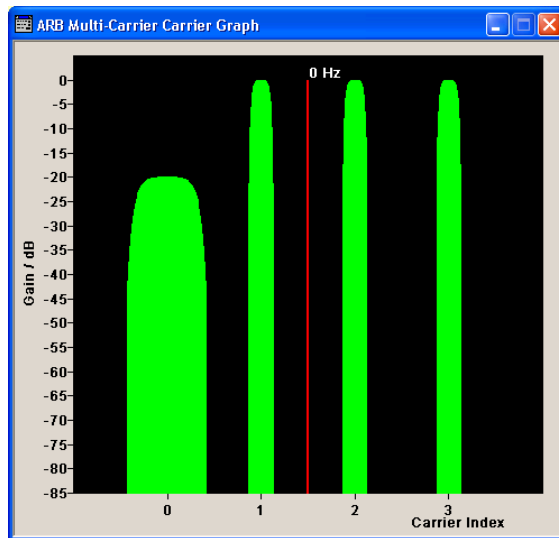

Output Settings

The "Output Settings" section in the multi carrier main menu indicates the name, the size and the clock rate of the currently calculated multi carrier output file.

File

Opens the "File" menu, where the output file name of the multi carrier waveform which has to be calculated can be entered.

The multi carrier waveform is calculated and saved under this name by clicking the "Create" or "Create and Load" button.

SCPI command:

[\[:SOURce<hw>\]:BB:ARB:MCARrier:OFILe](#) on page 612

Clock Rate

Displays the resulting sample rate at which the multi carrier waveform is output by the arbitrary waveform generator. The output clock rate depends on the number of carriers, carrier spacing and input sample rate of the leftmost or rightmost carriers.

SCPI command:

[\[:SOURce<hw>\]:BB:ARB:MCARrier:CLOCK](#) on page 608

File Size

Displays the resulting number of samples of the multi carrier waveform.

SCPI command:

[\[:SOURce<hw>\]:BB:ARB:MCARrier:SAMPles](#) on page 612

Create

Creates a new multi carrier waveform defined by the multi carrier table and General Setting entries.

This multi carrier waveform is saved with the file name specified in "Output File". If no file name is specified, the File Manager opens so that the file name can be entered. As with normal waveforms, the file extension is *.wv.

Depending on the configuration of the multi carrier waveform, calculation may take some time. A panel with a progress bar and an "Abort" button appears during the calculation process.

SCPI command:

`[:SOURce<hw>] :BB:ARB:MCARrier:CREate` on page 608

Create and Load

Creates a new multi carrier waveform defined by the multi carrier table and General Setting entries and loads it subsequently in the "ARB" main menu.

This multi carrier waveform is saved with the file name specified in "Output File". If no file name is specified, the File Manager opens so that the file name can be entered. As with normal waveforms, the file extension is *.wv.

Depending on the configuration of the multi carrier waveform, calculation may take some time. A panel with a progress bar and an "Abort" button appears during the calculation process.

SCPI command:

`[:SOURce<hw>] :BB:ARB:MCARrier:CLoad` on page 607

Muti Carrier Table

The "Multi Carrier Table" manu is oped by means of the "Carrier Table" button in the middle part of the Multi Carrier Waveforms menu. The carrier settings can be checked in the graphical "Carrier Graph" submenu.

The "Carrier Table Assistant" section can be used to set a selectable carrier range. This section serves as a optional mean to quickly set up a multi carrier scenario within a specified carrier range.

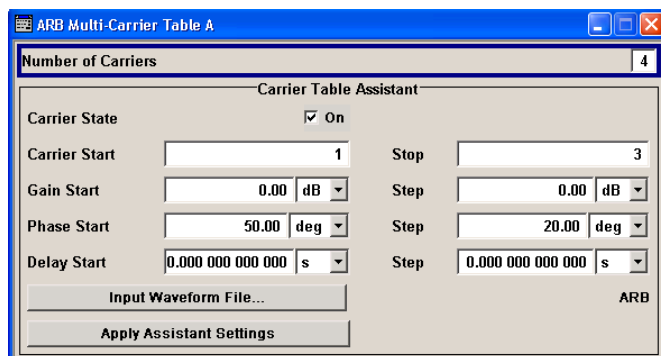

	State	Carrier Freq [MHz]	Gain [dB]	Phase [deg]	Delay [ns]	File	Info	!!!
0	On	-7.500 000	0.00	0.00		0 \Lists\Arb\ArbMccwDummy	Info...	
1	On	-2.500 000	0.00	0.00		0 \Lists\Arb\ArbMccwDummy	Info...	
2	On	2.500 000	0.00	0.00		0 \Lists\Arb\ArbMccwDummy	Info...	
3	Off	7.500 000	0.00	0.00		0 \Lists\Arb\ArbMccwDummy	Info...	

Carrier Table Assistant

Number of Carriers

Defines the number of carriers of the multi carrier waveform.

This parameter is identical to that in the "General Setting" section.

SCPI command:

`[:SOURce<hw>] :BB:ARB:MCARrier:CARRier:COUNT` on page 602

Carrier State

Switches the carriers in the range "Carrier Start" to "Carrier Stop" on/off.

SCPI command:

`[:SOURce<hw>] :BB:ARB:MCARrier:EDIT:CARRier:STATe` on page 612

Carrier Start

Defines the start index of the carrier range to which the assistant settings are intended to apply.

SCPI command:

`[:SOURce<hw>] :BB:ARB:MCARrier:EDIT:CARRier:START` on page 611

Carrier Stop

Defines the stop index of the carrier range to which the assistant settings are intended to apply.

SCPI command:

`[:SOURce<hw>] :BB:ARB:MCARrier:EDIT:CARRier:STOP` on page 611

Gain Start

Sets the gain of the carrier marked by "Carrier Start".

SCPI command:

`[:SOURce<hw>] :BB:ARB:MCARrier:EDIT:CARRier:POWER[:START]`
on page 611

Gain Step

Sets the step width that is used to increment the gain

The resulting carrier gain in the carrier table equals:

GainStart + n* Gain Step

where n ranges from 0 to (Carrier Stop - Carrier Start).

SCPI command:

`[:SOURce<hw>] :BB:ARB:MCARrier:EDIT:CARRier:POWER:STEP` on page 611

Phase Start

Sets the phase of the carrier marked by "Carrier Start".

SCPI command:

```
[ :SOURce<hw> ] :BB:ARB:MCARrier:EDIT:CARRier:PHASe [ :STARt ]
```

on page 610

Phase Step

Sets the step width that is used to increment the phase.

The resulting phase in the carrier table equals:

PhaseStart + n* PhaseStep

where n ranges from 0 to (Carrier Stop – Carrier Start)

SCPI command:

```
[ :SOURce<hw> ] :BB:ARB:MCARrier:EDIT:CARRier:POWer:STEP on page 611
```

Delay Start

Sets the delay of the carrier marked by "Carrier Start".

SCPI command:

```
[ :SOURce<hw> ] :BB:ARB:MCARrier:EDIT:CARRier:DELay [ :STARt ]
```

on page 609

Delay Step

Sets the step width that is used to increment the delay

The resulting delay in the carrier table equals:

DelayStart + n* DelayStep

where n ranges from 0 to (Carrier Stop – Carrier Start).

SCPI command:

```
[ :SOURce<hw> ] :BB:ARB:MCARrier:EDIT:CARRier:DELay:STEP on page 608
```

Input Waveform File

Calls the "File" menu for selecting the inputfile with the I/Q signal to be modulated onto all carriers of the selected carrier range.

SCPI command:

```
[ :SOURce<hw> ] :BB:ARB:MCARrier:EDIT:CARRier:FILE on page 610
```

Apply Assistant Settings

Transfer the assistant settings to the carrier table.

SCPI command:

```
[ :SOURce<hw> ] :BB:ARB:MCARrier:EDIT:CARRier:EXECute on page 609
```

Carrier Table

The table displays the settings of all available carriers. Previously applied assistant settings can be further refined. The number of lines corresponds to the number of carriers.

Note: The phase/deg settings are only valid if optimization of the crest factor is disabled ("Crest Factor Mode" = Off).

	State	Carrier Freq [MHz]	Gain [dB]	Phase [deg]	Delay [ns]	File	Info	!!!
0	On	-7.500 000	0.00	0.00		0 \Lists\Arb\ArbMccwDummy	Info...	
1	On	-2.500 000	0.00	0.00		0 \Lists\Arb\ArbMccwDummy	Info...	
2	On	2.500 000	0.00	0.00		0 \Lists\Arb\ArbMccwDummy	Info...	
3	Off	7.500 000	0.00	0.00		0 \Lists\Arb\ArbMccwDummy	Info...	

No ← Carrier Table

Indicates the carrier index ranging from 0 to (number of carriers -1).

Individual carriers can be set using the remote control commands by specifying the index in the parameter CARR.

State ← Carrier Table

Switches On/Off a carrier.

SCPI command:

[\[:SOURce<hw>\]:BB:ARB:MCARrier:CARRier<ch>:STATe](#) on page 605

Carrier Freq [MHz] ← Carrier Table

Sets the carrier frequency.

Note: The carrier frequency can only be set in "Arbitrary Carrier frequency" mode. For "Equidistant Carrier Spacing", the carrier spacing is determined automatically.

SCPI command:

[\[:SOURce<hw>\]:BB:ARB:MCARrier:CARRier<ch>:FREQuency](#) on page 604

Gain ← Carrier Table

Sets the gain of a carrier.

SCPI command:

[\[:SOURce<hw>\]:BB:ARB:MCARrier:CARRier<ch>:POWER](#) on page 605

Phase ← Carrier Table

Sets the starting phase of a carrier.

SCPI command:

[\[:SOURce<hw>\]:BB:ARB:MCARrier:CARRier<ch>:PHASe](#) on page 605

Delay ← Carrier Table

Sets the starting delay of a carrier.

SCPI command:

[\[:SOURce<hw>\]:BB:ARB:MCARrier:CARRier<ch>:DELay](#) on page 604

File ← Carrier Table

Calls the "File" menu for selecting the input file with the I/Q signal to be modulated onto the carrier.

SCPI command:

[\[:SOURce<hw>\]:BB:ARB:MCARrier:CARRier<ch>:FILE](#) on page 604

Info ← Carrier Table

Indicates the sample rate, number of I/Q value pairs (number of samples), and the resulting signal period of the selected I/Q input file.

SCPI command:

n.a.

!!! ← Carrier Table

Indicates an occurred conflict by a means of a red LED. A conflict arises when the carriers overlap.

Example:

A conflict is indicated both in the table, as well as in the graph, as shown in the following figures:

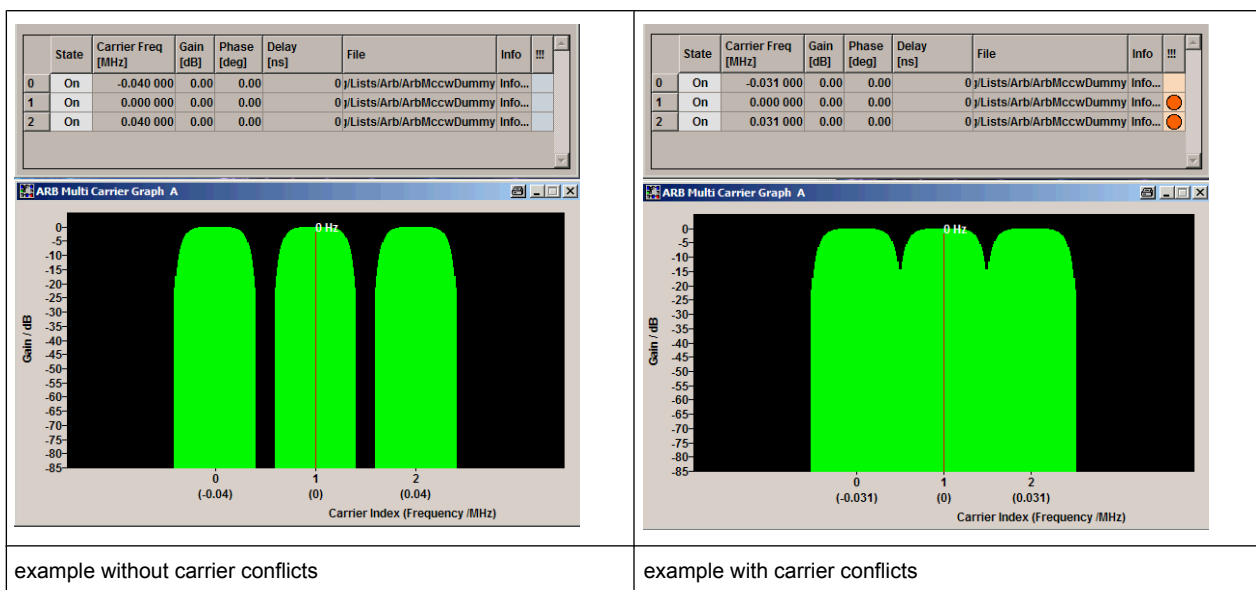

SCPI command:

`[:SOURce<hw>] :BB:ARB:MCARrier:CARRier<ch>:CONFLICT` on page 603

Typical Applications for Multi Carrier Waveforms

High Power Amplifiers of multi carrier base stations face increased requirements in terms of linearity and acceptable intermodulation performance.

A standard transmitter test might be quickly setup by the following instructions:

1. Load a standardized 3GPP downlink test model, e.g. "Test Model 1_16" and set State to "ON".
2. Create a 3GPP Testmodel ARB file by activating "Generate Waveform File".
3. Setup a multi carrier scenario with 4 carriers and a carrier spacing of 5 MHz.
4. Apply the input file containing the previously generated 3GPP testmodel to all 4 carriers.

4.8.5 Multi Carrier Continuous Wave

The R&S SMU can generate a Multi Carrier CW signal with user-definable offset from carrier, based on a selection of up to 8192 unmodulated carriers. Each carrier can be separately set and switched on, or multiple carriers can be jointly configured. Automatic start phase setting is provided in order to minimize the crest factor.

Multi Carrier CW signals can be very easily configured as broadband test signals and used for such purposes as receiver tests.

To access the dialog for setting a Multi Carrier CW signal, select "Baseband > Multi Carrier CW" or use MENU key under "Baseband".



4.8.5.1 Multi Carrier CW User Interface

The "Multi Carrier CW" dialog is divided into the following sections.

The upper part of the menu is used for powering up the Multi Carrier CW and calling the default settings.

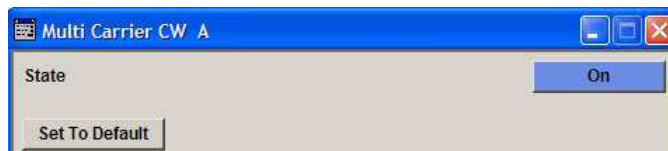

The "Carrier Setup" section is used to configure the Multi Carrier CW signal.

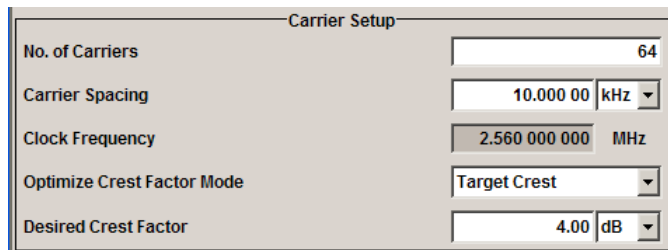

The "Table Setup Assistant" section can be used to set a selectable carrier range.

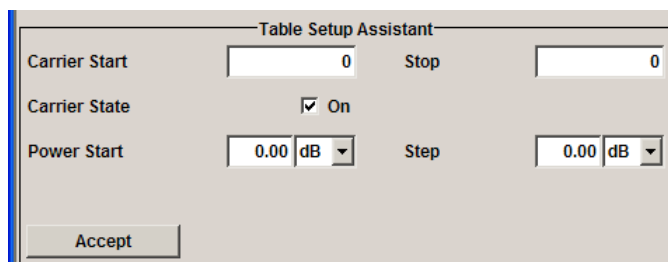

The buttons in the lower part of the menu open dialogs for defining carrier tables and for configuring markers, triggers and clocks.

The carrier settings can be visualized in the graphical "Carrier Graph" dialog.

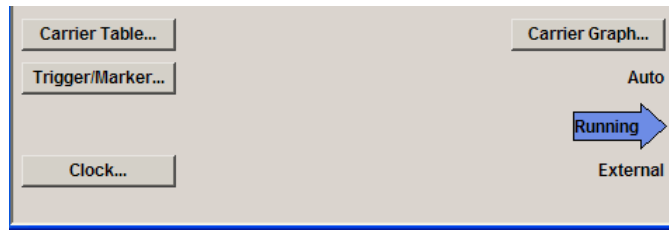

General Settings for Multi Carrier CW

The upper part of the menu is used for powering up the Multi Carrier CW signal and calling the default settings.

State

Enables/disables the Multi Carrier CW.

Switching on this standard turns off all the other digital standards and digital modulation modes.

In case of two-path instruments, this affects the same path.

Since Multi Carrier CW signals are computed in arbitrary waveform mode, changes to the settings of individual carriers are not adopted until the Accept button is pressed. This applies to the settings in the "Table Setup Assistant" section and the "Carrier Table" dialog.

SCPI command:

[:SOURce<hw>] :BB:MCCW:STATe on page 676

Set to Default

Calls default settings. The values are shown in the following table.

Parameter	Value
State	Not affected by "Set to Default"
Carrier Setup	
Number of Carriers	64
Carrier Spacing	10 kHz
Optimize Crest Factor	Chirp
Desired Crest Factor	3 dB
Trigger	
Mode	Auto
Source	Internal
Ext. Delay	0
Ext. Inhibit	0
Marker	
Channel 1...4	Restart
Clock	

Parameter	Value
Source	Internal
Multi Channel Setup	
Start Carrier	0
Stop Carrier	0
State	ON
Power	0 dB
Power Step	0 dB
Initial Phase	0°
Phase Step	0°
Channel Setup	
State	ON
Phase	0°
Power	0 dB

SCPI command:

[\[:SOURce<hw>\]:BB:MCCW:PRESet](#) on page 677

Carrier Setup

The "Carrier Setup" section is used to configure the Multi Carrier CW.

Number of Carriers

Sets the number of carriers for the Multi Carrier CW signal.

By default the multi carrier table already lists 64 carriers that are preset to the settings State = ON, Power = 0 dB, Phase = 0°.

When entering fewer carriers than the table contains, the approach is generally to delete the superfluous entries from the table, and when entering more carriers than the table contains the missing entries are usually added at the end of the table.

SCPI command:

[\[:SOURce<hw>\]:BB:MCCW:CARRier:COUNT](#) on page 677

Carrier Spacing

Sets the spacing between carriers for the Multi Carrier CW signal.

The carriers are arranged symmetrically around the HF carrier.

The total bandwidth is calculated as follow:

Total Bandwidth = ("Number of Carriers" - 1) * "Carrier Spacing"

The result must not exceed the system bandwidth of the instrument (see data sheet).

SCPI command:

[\[:SOURce<hw>\]:BB:MCCW:CARRier:SPACing](#) on page 679

Clock Frequency

Displays the clock rate at which the multi carrier signal is output by the arbitrary waveform generator. The output clock rate depends on the number of carriers and the selected carrier offset.

The value indicates the resolution during the marker generation.

SCPI command:

[:SOURce<hw>] :BB:MCCW:CLOCK on page 681

Optimize Crest Factor Mode

Selects the mode for automatically minimizing the crest factor.

The carrier start phases are automatically set to this.

The crest factor represents the ratio of the peak voltage value to the rms voltage value. The higher the crest factor and resulting dynamics of a signal, the greater the requirement for a power amplifier fed by the signal to be linear.

A very high crest factor arises when the carriers have an identical start phase, since the carriers are periodically superposed and very high peak voltages occur in relation to the rms voltage values.

Methods of reducing the crest factor differ with regard to both the optimization achievable and the time required for computation.

"Off"	There are no automatic settings for minimizing the crest factor. The "Phase" setting has an effect.
"Chirp"	Very rapid crest factor optimization regardless of the number of carriers. A minimal crest factor of < 3 dB is only obtained for multi carrier signals in which all carriers are switched on and the power of the carriers is identical. In a configuration which differs from this, the achievable crest factor is worse.
"Target Crest"	Optimization of the crest factor to a desired value for all carrier configurations. The optimization time depends on the number of carriers and the desired crest factor. Computation time increases only when the number of carriers exceeds 256 and the crest factor is below 4 dB. The desired value can be entered in "Desired Crest Factor". Note: Optimization can be cancelled at any time, and the current value being displayed at that moment is then used.

SCPI command:

[:SOURce<hw>] :BB:MCCW:CFACTOR:MODE on page 680

Desired Crest Factor

Enters the desired crest factor.

This is only possible when the optimization "Target Crest" has been selected.

SCPI command:

[:SOURce<hw>] :BB:MCCW:CFACTOR on page 680

Table Setup Assistant

The "Table Setup Assistant" section can be used to set a selectable carrier range. The carrier table can be edited in the "Carrier Table" dialog.

Carrier Start

Defines the start index of the carrier range to which the following settings are intended to apply.

SCPI command:

`[:SOURce<hw>] :BB:MCCW:EDIT:CARRier:START` on page 683

Carrier Stop

Defines the stop index of the carrier range to which the following settings are intended to apply.

SCPI command:

`[:SOURce<hw>] :BB:MCCW:EDIT:CARRier:STOP` on page 684

Carrier State

Switches the carriers in the carrier range on/off.

SCPI command:

`[:SOURce<hw>] :BB:MCCW:EDIT:CARRier:STATe` on page 684

Power Start

Sets the power of the starting carrier.

SCPI command:

`[:SOURce<hw>] :BB:MCCW:EDIT:CARRier:POWer [:START]` on page 683

Power Step

Sets the width of the step with which the power will be changed from carrier to carrier.

The carrier power that is set with **Power + n* Power Step** must be within the valid value range -80 dB to 0 dB.

SCPI command:

`[:SOURce<hw>] :BB:MCCW:EDIT:CARRier:POWer:STEP` on page 683

Phase Start

Sets the phase of the starting carrier. This setting is only available for "Optimize Crest Factor Mode" = Off.

SCPI command:

`[:SOURce<hw>] :BB:MCCW:EDIT:CARRier:PHASe [:START]` on page 682

Phase Step

Sets the width of the step with which the phase will be changed from carrier to carrier.

The phase that is set with **Phase + n* Phase Step** must be within the valid value range 0° to 360°.

This setting is only available for "Optimize Crest Factor Mode" = Off.

SCPI command:

`[:SOURce<hw>] :BB:MCCW:EDIT:CARRier:PHASe:STEP` on page 682

Accept

Adopts the carrier range setting into the table ("Carrier Table").

SCPI command:

[\[:SOURce<hw>\]:BB:MCCW:EDIT:CARRIER:EXECute](#) on page 681

Carrier Table and Carrier Graph

The lower part of the menu is used to open submenus for configuring carrier tables and for setting triggers, markers and clocks.

Carrier Table

Calls the table for configuring individual carriers. This configuration can be checked with the aid of the "Carrier Graph".

	State	Power / dB	Phase / deg
0	On	0.00	0.00
1	On	0.00	0.00
2	On	0.00	0.00
3	Off	0.00	0.00
4	Off	0.00	0.00
5	Off	0.00	0.00
6	On	0.00	0.00
7	On	0.00	0.00
8	On	0.00	0.00

The table displays the settings of all available carriers. Carriers in the On state are highlighted. All carrier parameters can be edited in the table.

The Multi Carrier CW signal is only computed when the "Accept" button is pressed. Whenever the table contains settings that have not yet been adopted with the "Accept" button, the background is yellow.

Note: The phase/deg settings are only valid if optimization of the crest factor is disabled ("Optimize Crest Factor" = Off).

"No."	This is the carrier index.
"State"	Switch a carrier on/off
"Power"	Sets the power of a carrier.
"Phase"	Sets the starting phase of a carrier.
"Accept"	Transfer the settings in the carrier table into the instrument.

SCPI command:

[\[:SOURce<hw>\]:BB:MCCW:CARRIER:LIST:STATE](#) on page 678

[\[:SOURce<hw>\]:BB:MCCW:CARRIER:STATE](#) on page 680

[\[:SOURce<hw>\]:BB:MCCW:CARRIER:LIST:POWER](#) on page 678

[\[:SOURce<hw>\]:BB:MCCW:CARRIER:POWER](#) on page 679

[\[:SOURce<hw>\]:BB:MCCW:CARRIER:LIST:PHASE](#) on page 677

[\[:SOURce<hw>\]:BB:MCCW:CARRIER:PHASE](#) on page 678

Carrier Graph

Calls a graphical representation of the chosen carrier configuration.

The carriers are on the X-axis and the colored bars represent those carriers which are in the On state. Power is on the Y-axis, and the height of the bars corresponds to the chosen power of each individual carrier.

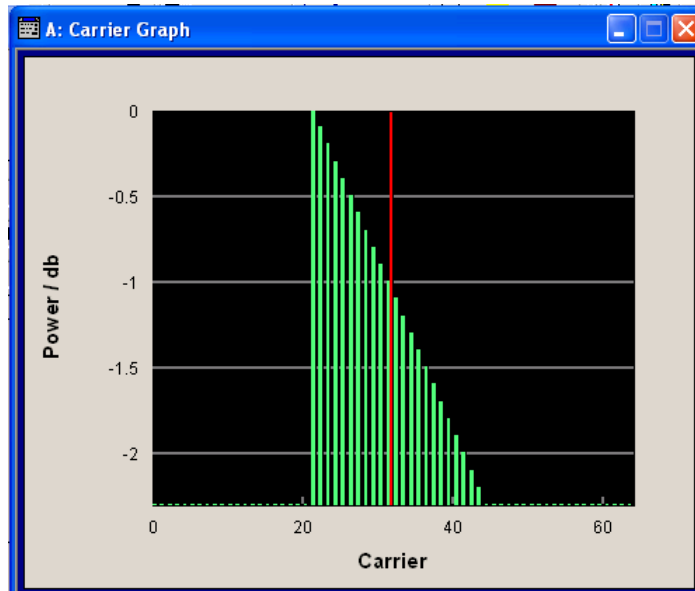

SCPI command:

n.a.

Trigger/Marker

Calls the "Trigger/Marker" dialog (see ["Trigger/Marker/Clock Settings"](#) on page 437).

This dialog is used to select the trigger source, set the time delay on an external trigger signal and configure the marker output signals.

SCPI command:

n.a.

Clock

Calls the "Clock" dialog for selecting the clock source (see ["Clock Settings"](#) on page 443).

SCPI command:

n.a.

Trigger/Marker/Clock Settings

To access this dialog, select "Main Menu > Trigger/Marker".

The "Trigger In" section is where the trigger for the signal is set. Various parameters will be provided for the settings, depending on which trigger source - internal or external - is selected. The current status of signal generation ("Running" or "Stopped") is indicated for all trigger modes.

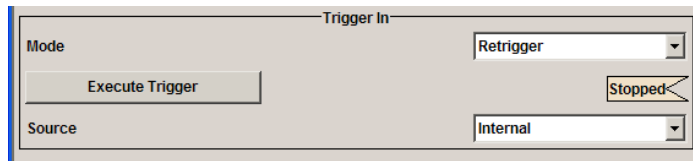

The "Marker Mode" section is where the marker signals at the MARKER output connectors are configured.

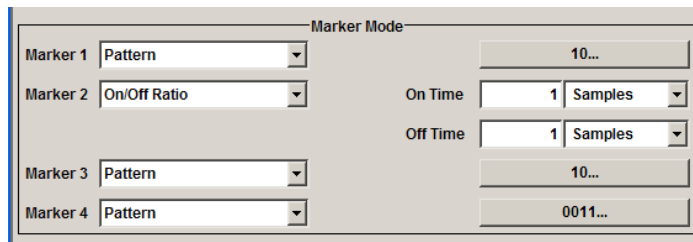

The "Marker Delay" section is where a marker signal delay can be defined, either without restriction or restricted to the dynamic section, i.e., the section in which it is possible to make settings without restarting signal and marker generation.

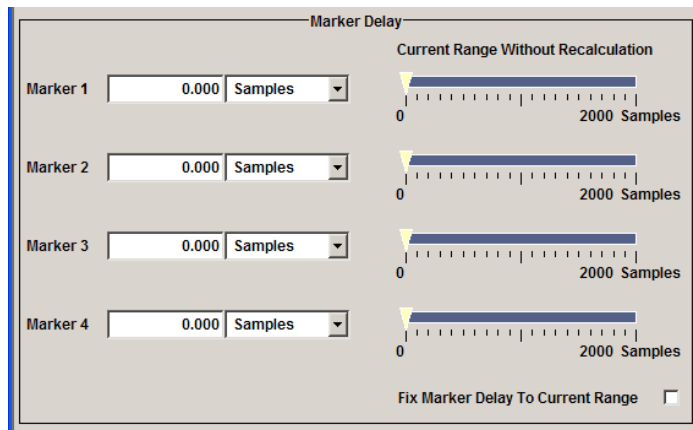

The "Clock Settings" section is where the clock source is selected and - in the case of an external source - the clock type.

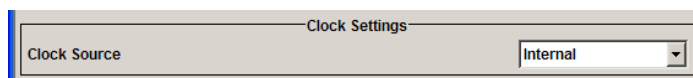

The buttons in the last section lead to submenu for general trigger, clock and mapping settings.



Trigger In

The "Trigger In" section is where the trigger for the signal is set. Various parameters will be provided for the settings, depending on which trigger source - internal or external - is

selected. The current status of signal generation ("Running" or "Stopped") is indicated for all trigger modes.

Trigger Mode

Selects trigger mode.

The trigger mode determines the effect of a trigger on the signal generation.

"Auto"	The signal is generated continuously.
"Retrigger"	The signal is generated continuously. A trigger event (internal or external) causes a restart.
"Armed_Auto"	The signal is generated only when a trigger event occurs. Then the signal is generated continuously. Button "Arm" stops signal generation. A subsequent trigger event (internal with "Execute Trigger" or external) causes a restart.
"Armed_Retrigger"	The signal is generated only when a trigger event occurs. Then the signal is generated continuously. Every subsequent trigger event causes a restart. Button "Arm" stops signal generation. A subsequent trigger event (internal with "Execute Trigger" or external) causes a restart.
"Single"	The signal is generated only when a trigger event occurs. Then the signal is generated once to the length specified at "Signal Duration". Every subsequent trigger event (internal with "Execute Trigger" or external) causes a restart.

SCPI command:

[\[:SOURce<hw>\]:BB:MCCW\[:TRIGger\]:SEQuence](#) on page 689

Signal Duration

Defines the length of the signal sequence to be output in the "Single" trigger mode. The unit of the entry is defined under "Signal Duration Unit". It is then possible to output deliberately just part of the signal, an exact sequence of the signal, or a defined number of repetitions of the signal.

SCPI command:

[\[:SOURce<hw>\]:BB:MCCW:TRIGger:SLENgth](#) on page 687

Running/Stopped

Displays the status of signal generation for all trigger modes. This display appears only when signal generation is enabled ("State" On).

"Running"	The modulation signal is generated; a trigger was (internally or externally) initiated in triggered mode. If "Armed_Auto" and "Armed_Retrigger" have been selected, generation of signals can be stopped with the "Arm" button. A new trigger (internally with "Execute Trigger" or externally) causes a restart.
"Stopped"	The signal is not generated, and the instrument waits for a trigger event (internal or external).

SCPI command:

[\[:SOURce<hw>\]:BB:MCCW:TRIGger:RMODE](#) on page 687

Arm

Stops signal generation. This button appears only with "Running" signal generation in the "Armed_Auto" and "Armed_Retrigger" trigger modes.

Signal generation can be restarted by a new trigger (internally with "Execute Trigger" or externally).

SCPI command:

[\[:SOURce<hw>\]:BB:MCCW:TRIGger:ARM:EXECute](#) on page 685

Execute Trigger

Executes trigger manually. A manual trigger can be executed only when an internal trigger source and a trigger mode other than "Auto" have been selected.

SCPI command:

[\[:SOURce<hw>\]:BB:MCCW:TRIGger:EXECute](#) on page 685

Trigger Source

Selects trigger source. This setting is effective only when a trigger mode other than "Auto" has been selected.

"Internal"	The trigger event is executed by "Execute Trigger".
"Internal (Baseband A/ B)"	(two-path instruments only) The trigger event is executed by the trigger signal from the second path
"External (TRIGGER 1 / 2)"	The trigger event is executed with the aid of the active edge of an external trigger signal. The trigger signal is supplied via the TRIGGER connector. The polarity, the trigger threshold and the input impedance of the TRIGGER input can be set in the "Global Trigger/Clock Settings" dialog.

SCPI command:

[\[:SOURce<hw>\]:BB:MCCW:TRIGger:SOURce](#) on page 688

Sync. Output to External Trigger

(enabled for Trigger Source External)

Enables/disables output of the signal synchronous to the external trigger event.

"On"

Corresponds to the default state of this parameter.

The signal calculation starts simultaneously with the external trigger event but because of the instrument's processing time the first samples are cut off and no signal is outputted. After elapsing of the internal processing time, the output signal is synchronous to the trigger event.

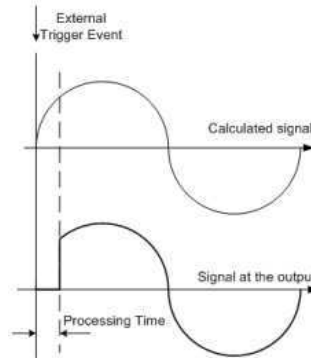

"Off"

The signal output begins after elapsing of the processing time and starts with sample 0, i.e. the complete signal is outputted. This mode is recommended for triggering of short signal sequences with signal duration comparable with the processing time of the instrument.

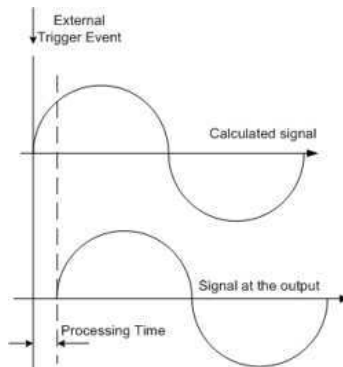

SCPI command:

`[:SOURce<hw>] :BB:MCCW:TRIGger:EXTernal:SYNChronize:OUTPut`
on page 685

Trigger Delay

Sets the trigger signal delay in samples on external triggering or on internal triggering via the second path.

Sets the trigger signal delay in samples on external triggering.

This enables the R&S Signal Generator to be synchronized with the device under test or other external devices.

For two-path instruments, the delay can be set separately for each of the two paths.

SCPI command:

`[:SOURce<hw>] :BB:MCCW:TRIGger [:EXTernal<ch>] :DELay` on page 688
`[:SOURce<hw>] :BB:MCCW:TRIGger:OBASeband:DELay` on page 686

Trigger Inhibit

Sets the duration for inhibiting a new trigger event subsequent to triggering. The input is to be expressed in samples.

In the "Retrigger" mode, every trigger signal causes signal generation to restart. This restart is inhibited for the specified number of samples.

This parameter is only available on external triggering or on internal triggering via the second path.

For two-path instruments, the trigger inhibit can be set separately for each of the two paths.

SCPI command:

[\[:SOURce<hw>\]:BB:MCCW:TRIGger\[:EXTernal<ch>\]:INHibit](#) on page 688

[\[:SOURce<hw>\]:BB:MCCW:TRIGger:OBASeband:INHibit](#) on page 686

Marker Mode

The marker output signal for synchronizing external instruments is configured in the marker settings section "Marker Mode".

Marker Mode

Selects a marker signal for the associated "MARKER" output.

"Restart" A marker signal is generated at the start of the waveform.

"Pulse" A regular marker signal is generated. The pulse frequency is defined by entering a divider. The frequency is derived by dividing the sample rate by the divider. The input box for the divider opens when "Pulse" is selected, and the resulting pulse frequency is displayed below it.

SCPI command:

[\[:SOURce<hw>\]:BB:MCCW:TRIGger:OUTPut<ch>:PULSe:DIVider](#) on page 693

[\[:SOURce<hw>\]:BB:MCCW:TRIGger:OUTPut<ch>:PULSe:FREQuency](#)

on page 693

"Pattern " A marker signal that is defined by a bit pattern is generated. The pattern has a maximum length of 64 bits and is defined in an input field which opens when pattern is selected.

SCPI command:

[\[:SOURce<hw>\]:BB:MCCW:TRIGger:OUTPut<ch>:PATtern](#) on page 692

"ON/OFF Period"

A regular marker signal that is defined by an ON/OFF ratio is generated. A period lasts one ON and OFF cycle. The "ON Time" and "OFF Time" are each expressed as a number of samples and are set in an input field which opens when ON/OFF ratio is selected.

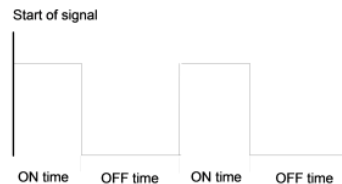

SCPI command:

[\[:SOURce<hw>\]:BB:MCCW:TRIGger:OUTPut<ch>:ONTime](#) on page 692

[\[:SOURce<hw>\]:BB:MCCW:TRIGger:OUTPut<ch>:OFFTime](#) on page 692

SCPI command:

[\[:SOURce<hw>\]:BB:MCCW:TRIGger:OUTPut<ch>:MODE](#) on page 691

Marker Delay

The delay of the signals on the MARKER outputs is set in the "Marker Delay" section.

Marker x Delay

Enters the delay between the marker signal at the marker outputs and the start of the frame or slot.

The input is expressed as a number of symbols. If the setting "Fix marker delay to dynamic range" is enabled, the setting range is restricted to the dynamic range. In this range the delay of the marker signals can be set without restarting the marker and signal.

SCPI command:

[\[:SOURce<hw>\]:BB:MCCW:TRIGger:OUTPut<ch>:DELaY](#) on page 690

Current Range without Recalculation

Displays the dynamic range within which the delay of the marker signals can be set without restarting the marker and signal.

The delay can be defined by moving the setting mark.

SCPI command:

[\[:SOURce<hw>\]:BB:MCCW:TRIGger:OUTPut<ch>:DELaY:MINimum](#) on page 691

[\[:SOURce<hw>\]:BB:MCCW:TRIGger:OUTPut<ch>:DELaY:MAXimum](#) on page 690

Fix marker delay to current range

Restricts the marker delay setting range to the dynamic range. In this range the delay can be set without restarting the marker and signal.

SCPI command:

[\[:SOURce<hw>\]:BB:MCCW:TRIGger:OUTPut:DELaY:FIXed](#) on page 690

Clock Settings

The Clock Settings is used to set the clock source and a delay if required.

Clock Source

Selects the clock source.

- "Internal" The internal clock reference is used to generate the symbol clock.
- "External" The external clock reference is fed in as the symbol clock or multiple thereof via the CLOCK connector.
The polarity of the clock input can be changed with the aid of "Global Trigger/Clock Settings".
In the case of two-path instruments this selection applies to path A.

SCPI command:

[\[:SOURce<hw>\]:BB:MCCW:CLOCK:SOURce](#) on page 695

Clock Mode

Enters the type of externally supplied clock.

- "Sample" A sample clock is supplied via the CLOCK connector.
- "Multiple Sam- A multiple of the sample clock is supplied via the CLOCK connector;
ple" the sample clock is derived internally from this.

SCPI command:

[\[:SOURce<hw>\]:BB:MCCW:CLOCK:MODE](#) on page 694

Clock Multiplier

Enters the multiplication factor for clock type "Multiple".

SCPI command:

[\[:SOURce<hw>\]:BB:MCCW:CLOCK:MULTiplier](#) on page 694

Measured External Clock

Indicates the measured frequency of the external clock signal. This enables the user to permanently monitor the frequency of the externally introduced clock.

This information is displayed only if the external clock source has been selected.

SCPI command:

`:CLOC:INP:FREQ?`

Global Settings

The buttons in this section lead to submenu for general trigger, clock and mapping settings.

Global Trigger/Clock Settings

Calls the "Global Trigger/Clock/Input Settings" dialog.

This dialog is used among other things for setting the trigger threshold, the input impedance and the polarity of the clock and trigger inputs.

In the case of two-path instruments, these settings are valid for both paths.

The parameters in this menu affect all digital modulations and standards, and are described in [chapter 4.2.3.10, "Global Trigger/Clock/External Input Settings"](#), on page 136.

User Marker / AUX I/O Settings

Calls the "User Marker AUX I/O Settings" menu, used used to map the connector on the rear of the instruments.

See also [chapter 4.2.3.12, "User Marker / AUX I/O Settings"](#), on page 139.

4.9 External Baseband Signal - Baseband Input

The R&S Signal Generator makes it possible to feed an external analog or digital baseband signal into the signal path.

User-specific wanted signals or interference signals can thus be added to internally generated signals and subsequently - provided the instrument is fitted with the required options - be faded, detuned or loaded with noise (see description "Fading Simulator" and [chapter 4.7, "Impairment of Digital I/Q Signal and Noise Generator - AWGN/IMP Block"](#), on page 290).

An analog signal is fed in via the "I/Q" connectors and then A/D-converted. The complex analog baseband input bandwidth is 60 MHz, i.e. the I and Q components of the signal are each filtered with a 30 MHz lowpass.

Digital signals are input via the LVDS interface "Digital Input". This interface provides direct communication with other R&S instruments. additionally, the external digital signal interface module (R&S EX-IQ-BOX) can be connected, providing parallel or serial signal transmission from external devices.

The externally input signal can be added to the internally generated signals and be frequency-shifted as well as loaded with a relative gain.

The equipment options for the basic unit (R&S SMU with frequency option R&S SMU-B10x) includes option R&S SMU-B17 (Baseband Input digital/analog) and options R&S SMU-B9/B10/B11 (Baseband Generator) and R&S SMU-B13 (Baseband Main Module).

With two-path instruments, the signal can be routed to path A, path B or to both paths. The external analog signal can also be directly applied to the I/Q modulator; the I/Q modulation settings are then made exclusively in the I/Q Mod menu. In this case, the option R&S SMU-B17 (Baseband Input digital/analog) is not necessary (selection Analog Wideband I/Q In, see [chapter 4.6, "I/Q Modulation - I/Q Mod Block"](#), on page 277).

The range for the sample rate of the external digital signals is 400 Hz to 100 MHz. The resampler operates in such a way that a baseband signal with a sample rate of less than 100 MHz is interpolated on the 100-MHz sample rate and then used as output.

A sample rate less than 100 MHz must fulfill the following condition:

Sample Rate * 0.31 >= Modulation Bandwidth

With a sample rate of 100 MHz (Sample Rate Source "User Defined"), the modulation bandwidth has a value of 40 MHz.

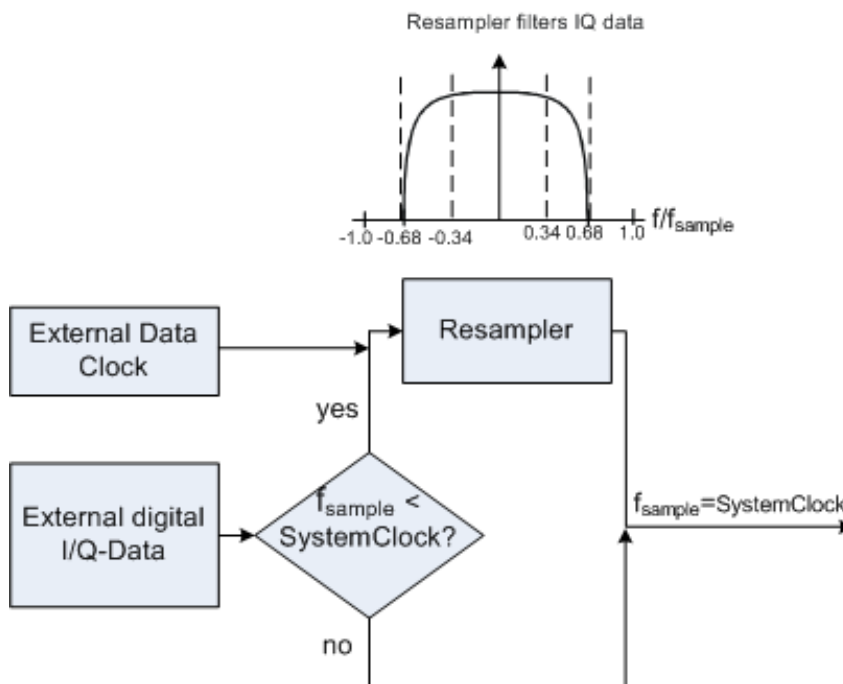

Fig. 4-34: External Baseband Signals

For sample rates in the range of 400 Hz ... <100 MHz, the external clock must be provided, it is required to reconstruct the signal (Baseband In Mode "Digital Input" (Sample Rate Source "Digital I/Q In")).

For sample rates of exactly 100 MHz the digital signal is directly fed into the digital signal path (Baseband In Mode "Digital Input" (Sample Rate Source "User Defined")).



The signal source (typically a second R&S Instrument) and the receiving R&S Instrument have to be synchronized.



Analog Wideband I/Q In and Baseband Input are not possible simultaneously and therefore switch each other off. In addition to the I/Q impairments in the Impairments block, it is also possible to set analog I/Q impairments in the I/Q Modulator menu of the R&S Signal Generator.

4.9.1 BB Input Block

Baseband Input Settings...	
Frequency Offset	0.00 Hz
Path Gain	0.0 dB
Signal Routing	<input checked="" type="checkbox"/> route to path A <input type="checkbox"/> route to path B <input type="checkbox"/> route to path A and B

The settings for signal routing, frequency offset and path gain are available in the "BB Input" function block of each path or in the "BB Input" menus which are opened using the MENU key.

If an R&S EX-IQ-BOX is connected, the R&S instrument recognizes this module automatically and indicates a labeled symbol of the R&S EX-IQ-BOX at the corresponding function block. Additionally, the components of the recognized R&S EX-IQ-BOX are listed in the "Hardware Config", section "Baseband Assembly". A button for configuring the

settings of the R&S EX-IQ-BOX is displayed in the "Baseband Input Settings" dialog (see "R&S EX-IQ-BOX Manual").

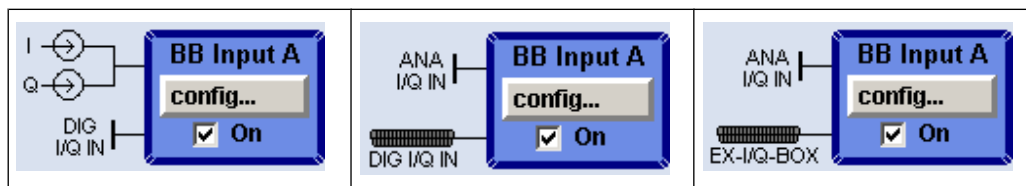

The external baseband signal is activated by switching on in the Baseband Input settings menu as well as by ticking the checkbox of the "BB Input" function block.

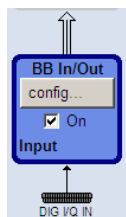

The "Baseband Input Settings" menu containing the external baseband signal settings is opened under the first item of the "BB Input" block menu (see [chapter 4.9.1.1, "Baseband Input Settings Menu"](#), on page 447).

A frequency offset and a path gain can be set in the two following menu items of the "BB Input" block menu – provided the instrument is equipped with at least two baseband sources.

For two-path instruments the routing of the signals can be defined in the "Signal Routing" section of the "BB Input" block.

4.9.1.1 Baseband Input Settings Menu

The settings for the external baseband signal are available in the "BB Input" function block of each path or in the "BB Input" menus which are opened using the MENU key.

Baseband Input General Settings

State

Switches On/Off the feeding of an external analog or digital signal into the signal path.

An external analog signal is A/D-converted and fed into path A or path B or into both paths simultaneously.

As an alternative, analog signals can be directly applied to the I/Q modulator. In this case, the settings are made in the I/Q Mod menu (see section [chapter 4.6, "I/Q Modulation - I/Q Mod Block"](#), on page 277).

If no signal is applied at the input selected with parameter "Mode" an error message is displayed.

"On" Switches On the external I/Q input signal of the corresponding BB Input block. The input symbols display the active signal mode (digital DIG I/Q IN or analog I and Q).

"Off" Switches Off the external I/Q input signal of the corresponding BB Input block.

SCPI command:

`[:SOURce] :BBIN:STATe` on page 707

Mode

Selects the signal mode (analog or digital) of the external input signal for the BB Input block.

"Analog Input" An external analog baseband signal ("BB Input") is fed in via the "I" and "Q" analog inputs. The block diagram shows the BNC connectors at the "BB Input" block. The signals are A/D-converted using the 100MHz system clock and fed into the digital signal path. The external analog input signal for the "BB Input" block and the external analog input signal for the I/Q modulator are both fed in via the "I" and "Q" analog inputs. The instrument therefore responds as follows if either of the two modes is activated: The I/Q modulator is automatically set to "Internal Baseband" when the "BB Input" block is switched on.

"Digital Input" The external digital baseband signal is fed into the digital signal path via the Digital Input connector. The internal signal processing is based on a sample rate of 100MHz. External input signals with sample rates less than 100MHz are upsampled. The external sample rate can be estimated or defined by the user in the appropriate entry fields.

Note: This item is available only with BBinS Revision 05.02 or higher and BBinR Revision 02.06 or higher (see menu Setup-Hardware Config).

SCPI command:

`[:SOURce<hw>] :BBIN:MODE` on page 702

EX-I/Q-Box Settings...

Digital Input with connected R&S EX-IQ-BOX only.

Opens the main settings dialog of the R&S EX-IQ-BOX.

I/Q-Swap

Activates swapping of the I and Q signal components, which mirrors the spectrum at the $f=0$ line and inverts the sign of the frequency.

The I/Q swap may be needed if an external CDMA signal is to be added to an internally generated baseband signal (see description "Digital Standard CDMA2000").

SCPI command:

`[:SOURce] :BBIN:IQSWap [:STATe]` on page 702

Sample Rate

For digital input signals the section "Sample Rate" is available in the "Baseband Input Settings" dialog. The sample rate of the external digital baseband signal can be set and the state of signal transmission is indicated by the FIFO Status.

Sample Rate Source

Digital Input only

Selects the source for estimating the sample rate or defining it by the user.

Note: With a connected "R&S EX-IQ-BOX" either the internal clock source (User defined) or an external clock (Digital I/Q In) can be selected in the settings dialog of the R&S EX-IQ-BOX. Therefore, the sample rate source is only indicated in this field.

"User Defined" Enables the user to define the sample rate in the entry field value.

"Digital I/Q In" Estimates the sample rate on the digital I/Q input and displays the value in the value field.

Note: Estimation works best if the sample rate is close to the user defined value.

SCPI command:

`[:SOURce<hw>] :BBIN:SRATe :SOURce` on page 706

Sample Rate Value

Digital Input only

Sets the sample rate of the external digital baseband input signal.

Note: The maximum value is 90 MHz with BBinR Revision 02.xx and 100 MHz with BBinR Revision 03.00 or higher.

SCPI command:

`[:SOURce] :BBIN:SRATe :ACTual` on page 705

FIFO Status

Digital Input only

Indicates the state of the signal transmission.

Note: The FIFO status is a SCPI parameter that is not displayed in the GUI.

"OK" Resampling is working properly.

"OFL = Overflow" The external sample rate frequency is too high which causes an overflow in signal transmission.

"URUN = Underrun" The external sample rate frequency is too low which causes an under-run in signal transmission.

SCPI command:

[\[:SOURce<hw>\]:BBIN:SRATe:FIFO\[:STATus\]](#) on page 706

Baseband Input Level

The crest factor and the peak power of the external baseband signal are entered in the section "Baseband Input Level". These values are necessary for a correct internal signal processing in the R&S Signal Generator. They can also be automatically estimated by a measurement using the "Auto Level Set" button.

Baseband Input Level	
Measurement Period	2 s
Auto Level Set	
Crest Factor	0.00 dB
PEP	0.00 dBFS
Level	0.00 dBFS

DIG IQ Auto Setting

Activates automatic adjustment of the baseband input signal.

The R&S SMU receives PEP, level and crest factor values directly from the connected transmitter and recognizes changes automatically.

SCPI command:

[\[:SOURce<hw>\]:BBIN:DIGital:ASETting:STATe](#) on page 701

Measurement Period

Sets the recording duration for measuring the baseband input signal by "Auto Level Set". For accurate level measurements, the measurement period should be set to a time value that is long enough to capture several periods of the input signal.

SCPI command:

[\[:SOURce<hw>\]:BBIN:MPERiod](#) on page 702

Auto Level Set

Starts measuring the input signal. The measurement estimates the crest factor, the peak power and rms power. The estimated values are automatically entered into the input fields "Crest Factor", "PEP" and "Level". Using these estimated values the internal gain control adjusts the input signal gain to achieve an optimal dynamic range.

SCPI command:

`[:SOURce] :BBIN :ALEVel :EXECute` on page 700

Crest Factor

Sets the crest factor of the external analog or digital baseband signal. Indicates the crest factor acquired with "Auto Level Set".

SCPI command:

`[:SOURce] :BBIN :CFACtor` on page 700

PEP

Enters the peak level of the external analog or digital baseband signal relative to full scale of 0.5 V (in terms of dB full scale).

Indicates the peak level acquired with "Auto Level Set".

SCPI command:

`[:SOURce] :BBIN :POWer :PEAK` on page 704

Level

Indicates the estimated rms level acquired with "Auto Level Set".

SCPI command:

`[:SOURce] :BBIN :POWer :RMS` on page 704

Impairments

For analog input signals the section "Impairments" is available in the "Baseband Input Settings" dialog. Additionally to the internal calibration of the instrument a DC offset, gain imbalance and time delay can be set to I and Q signal components. The section Signal Monitoring indicates the overload of the A/D - Converter.

Impairments		
Gain Imbalance (Q versus I)	0.000	dB
I Offset	0.000	%FS
Q Offset	0.000	%FS
I/Q Skew (Q Delay)	0.000	ns

Gain Imbalance (Q versus I)

Analog Input only

Enables to amplify the Q component of the input signal additionally to the internal calibration. This setting is needed e.g. to balance the I and Q signal channel by exactly the same degree.

SCPI command:

`[:SOURce<hw>] :BBIN :GIMBalance` on page 701

I Offset

Analog Input only

Sets a DC offset to the I component of the input signal additionally to the internal calibration. This setting is needed to compensate an offset that has been fed in from the external signal.

SCPI command:

[:SOURce<hw>] :BBIN:OFFSet:I on page 703

Q Offset

Analog Input only

Sets a DC offset to the Q component of the input signal additionally to the internal calibration. This setting is needed to compensate an offset that has been fed in from the external signal.

SCPI command:

[:SOURce<hw>] :BBIN:OFFSet:Q on page 703

I/Q-Skew (Q Delay)

Analog Input only

Determines the delay between Q and I channel. Positive values represent a delay for Q versus I.

SCPI command:

[:SOURce] :BBIN:SKEW on page 705

Signal Monitoring

The section "Signal Monitoring" indicates the overload of the A/D - Converter.

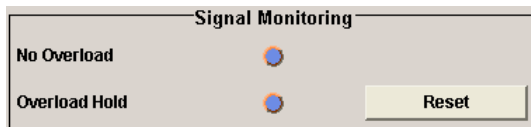
**Overload**

Indicates that the I/Q input is currently overloaded. This indication also appears in the block diagram close to the I/Q connector of the Baseband Input block.

If overload is indicated either the amplitude of the external signal is too high (full scale of 0.5 V) and must be reduced or the entered "Peak Level" (in dB full scale) value does not correspond with the real value and must be corrected. It also can be evaluated automatically with button "Auto Level Set".

SCPI command:

[:SOURce] :BBIN:OLOad:STATe on page 703

Overload Hold

Indicates an overload since last reset for evaluating the measurement.

The Overload Hold state can be reset via the "Reset" button next to the LED, or is reset automatically by starting a new measurement ("Auto Level Set") or by setting new values (Crest Factor, PEP, Level).

SCPI command:

`[:SOURce] :BBIN:OLOad:HOLD:STATe` on page 703

Reset

Executes a reset of the Overload Hold State and LED.

SCPI command:

`[:SOURce] :BBIN:OLOad:HOLD:STATe` on page 703

Connected Device

Digital Input only

Indicates the ID and the transmitter sample rate, if supported by the transmitter.

SCPI command:

`[:SOURce<hw>] :BBIN:CDEvice` on page 700

4.9.1.2 Signal Routing and Frequency Shifting

A frequency offset and a path gain can be set in the corresponding menu items of the "BB Input" block menu.

For two-path instruments, the routing of the signals can be defined in the "Signal Routing" section of the "BB Input block".

The section "Path Gain" is used to enter the relative gain of the external signal compared with the signals of the other baseband sources.

The section "Signal Routing" is used to define the signal routes of a external baseband signals in two-path instruments.

Frequency Offset

Enters the frequency offset for the external baseband signal.

The offset affects the signal on the output of the "Baseband" block.

It shifts the useful baseband signal in the center frequency.

Note: For sample rates of exactly 100 MHz (Baseband In Mode Digital Input, i.e. Sample Rate Source User Defined) it is not possible to enter a frequency offset. The digital signal is fed into the signal path directly and not routed to the resampler where the frequency offset takes place.

The complex I/Q bandwidth of the shifted useful signal must not exceed 80 MHz in total (see also "Frequency Offset" on page 324).

The following applies:

$$f_{\text{offset}} - f_{\text{use}}/2 \geq -80\text{MHz}/2 \text{ and } f_{\text{offset}} + f_{\text{use}}/2 \leq +80\text{MHz}/2$$

f_{use} = the complex useful bandwidth of the I/Q signal before the offset.

f_{offset} = frequency offset.

Example:

The following graph shows the setting range for the frequency offset.

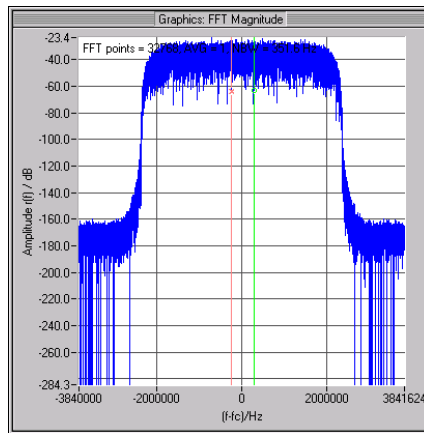

Fig. 4-35: 3GPP FDD signal (chip rate 3.84 Mcps, root-cosine filter 0.22).

The complex useful bandwidth of a signal which has been filtered using a root-cosine filter with roll off alpha is calculated as follows:

$$f_{\text{use}} = (1 + \alpha) * f_{\text{symbol}}$$

f_{symbol} = the symbol rate or chip rate of the signal.

In the example the complex useful bandwidth is calculated as follows:

$$f_{\text{use}} = (1 + 0.22) * 3.84 \text{ MHz} = 4.6848 \text{ MHz.}$$

So as to comply with the condition requiring a maximum I/Q bandwidth of 40 MHz, the valid range of values for the frequency offset is then:

$$-40\text{MHz} + 4.6848\text{MHz}/2 \leq f_{\text{offset}} \leq 40\text{MHz} - 4.6848\text{MHz}/2 \text{ or}$$

$$-35.3152\text{MHz} \leq f_{\text{offset}} \leq 35.3152\text{MHz}$$

In the case of ARB signals, the output clock rate can be used for estimating the maximum I/Q bandwidth of the waveform.

SCPI command:

[\[:SOURce\]:BBIN:FOFFset](#) on page 701

Path Gain

Enters the relative gain for the external baseband signal compared with the signals of the other baseband sources. The gain affects the signal on the output of the "BB Input" block.

Note: In case the baseband signal is additionally faded and routed at the output of the fading simulator, so that the faded signals from both paths are summed, the real path gain is measured at the output of the "Fading" block and set with the fading parameter "Summation Ratio A/B" (see description "Fading Simulator", section "Summation Ratio A/B").

The relative gain set with the parameter "Path Gain" in the "Baseband" block is ignored.

The "Path Gains" of the different baseband sources (Baseband In A, Baseband In B, Baseband A and Baseband B) determine the gain of the associated signals relative to each other. The actual gain of the different baseband signals depends not only on the path gain setting but also on the signal characteristics like the crest factor, on the number of used sources and on the total output level.

The cumulative baseband signal can be verified in the "Graphics" block in the spectrum view.

SCPI command:

```
[ :SOURce<hw> ] :BBIN:PGain on page 704
```

Signal Routing

Selects the signal route for the external baseband signal of a two-path instrument. The following table shows the combination of signal routes allowed for two-path instruments. However, mirrored capabilities are not displayed (e.g. only the setting 3 x path A but not also 3 x path B).

The following table shows some of the possible combinations of signal routes for two-path instruments.

Table 4-13: Combinations of signal routings for two-path instruments

Routing base-band A	Routing base-band B	Routing base-band In	Block diagram
Route to path A	Route to path A	Route to path A	
Route to path A	Route to path B	Route to path A	
Route to path A	Route to path A and B	Route to path A	
Route to path A	Route to path A and B	Route to path B	

External Baseband Signal - Baseband Input

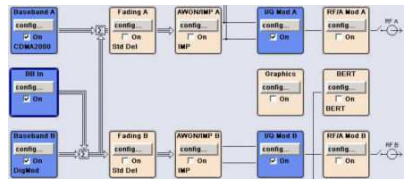
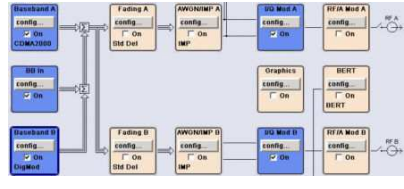
Routing base-band A	Routing base-band B	Routing base-band In	Block diagram
Route to path A	Route to path A and B	Route to path A and B	
Route to path A and B	Route to path A and B	Route to path A and B	

- "Route to path A" The external baseband signal is fed into pathA. If an internal signal from pathA is generated at the same time, the two signals are summed.
- "Route to path B" The external baseband signal is fed into path B. If an internal signal from pathB is generated at the same time, the two signals are summed.
- "Route to path A and B" The external baseband signal is fed into path A and path B. If internal signals from one or two paths are generated at the same time, all signals in each path are summed.

SCPI command:

[:SOURce] :BBIN:ROUTE on page 705

5 Remote Control Basics

This chapter provides basic information on operating an instrument via remote control.

5.1 Remote Control Interfaces and Protocols

The instrument supports different interfaces for remote control. The following table gives an overview.

Table 5-1: Remote control interfaces and protocols

Interface	Protocols, VISA ^{*)} address string	Remarks
Local Area Network (LAN)	Protocols: <ul style="list-style-type: none"> VXI-11 socket communication (Raw Ethernet, simple telnet) VISA ^{*)} address string: TCP/IP::host address[:LAN device name][:INSTR]	A LAN connector is located on the front or rear panel of the instrument, or both. The interface is based on TCP/IP and supports various protocols. For a description of the protocols refer to: <ul style="list-style-type: none"> chapter 5.1.3.1, "VXI-11 Protocol", on page 460 chapter 5.1.3.2, "Socket Communication", on page 460
GPIB (IEC/IEEE Bus Interface)	VISA ^{*)} address string: GPIB::primary address[:INSTR] (no secondary address)	Optional GPIB bus interfaces according to standard IEC 625.1/IEEE 488.1 are located on the rear panel of the instrument. For a description of the interface refer to chapter 5.1.4, "GPIB Interface (IEC/IEEE Bus Interface)" , on page 461.

^{*)} VISA is a standardized software interface library providing input and output functions to communicate with instruments. A VISA installation on the controller is a prerequisite for remote control over LAN (when using VXI-11 protocol). However, no VISA installation is necessary to remote control while using socket communication. For more information, see [chapter 5.1.1, "VISA Libraries"](#), on page 458.



Within this interface description, the term GPIB is used as a synonym for the IEC/IEEE bus interface.

SCPI (Standard Commands for Programmable Instruments)

SCPI commands - messages - are used for remote control. Commands that are not taken from the SCPI standard follow the SCPI syntax rules. The instrument supports the SCPI version 1999. The SCPI standard is based on standard IEEE 488.2 and aims at the standardization of device-specific commands, error handling and the status registers. The tutorial "Automatic Measurement Control - A tutorial on SCPI and IEEE 488.2" from John M. Pieper (R&S order number 0002.3536.00) offers detailed information on concepts and definitions of SCPI.

Tables provide a fast overview of the bit assignment in the status registers. The tables are supplemented by a comprehensive description of the status registers.

5.1.1 VISA Libraries

VISA is a standardized software interface library providing input and output functions to communicate with instruments. The I/O channel (LAN or TCP/IP, USB, GPIB,...) is selected at initialization time by means of the channel-specific address string ("VISA resource string"), or by an appropriately defined VISA alias (short name). A VISA installation is a prerequisite for remote control using the following interfaces:

- [chapter 5.1.3.1, "VXI-11 Protocol"](#), on page 460
- [chapter 5.1.4, "GPIB Interface \(IEC/IEEE Bus Interface\)"](#), on page 461

For more information about VISA refer to the user documentation.

5.1.2 Messages

The messages transferred on the data lines are divided into the following categories:

- **Interface messages**
Interface messages are transmitted to the instrument on the data lines, with the attention line being active (LOW). They are used to communicate between the controller and the instrument. Interface messages can only be sent by instruments that have GPIB bus functionality. For details see the sections for the required interface.
- **Instrument messages**
Instrument messages are employed in the same way for all interfaces, if not indicated otherwise in the description. Structure and syntax of the instrument messages are described in [chapter 5.3, "SCPI Command Structure"](#), on page 476. A detailed description of all messages available for the instrument is provided in the chapter "Remote Control Commands".
There are different types of instrument messages, depending on the direction they are sent:
 - Commands
 - Instrument responses

Commands

Commands (program messages) are messages the controller sends to the instrument. They operate the instrument functions and request information. The commands are subdivided according to two criteria:

- According to the effect they have on the instrument:
 - **Setting commands** cause instrument settings such as a reset of the instrument or setting the frequency.
 - **Queries** cause data to be provided for remote control, e.g. for identification of the instrument or polling a parameter value. Queries are formed by directly appending a question mark to the command header.
- According to their definition in standards:
 - **Common commands**: their function and syntax are precisely defined in standard IEEE 488.2. They are employed identically on all instruments (if implemented). They refer to functions such as management of the standardized status registers, reset and self test.

- **Instrument control commands** refer to functions depending on the features of the instrument such as frequency settings. Many of these commands have also been standardized by the SCPI committee. These commands are marked as "SCPI compliant" in the command reference chapters. Commands without this SCPI label are device-specific, however, their syntax follows SCPI rules as permitted by the standard.

Instrument responses

Instrument responses (response messages and service requests) are messages the instrument sends to the controller after a query. They can contain measurement results, instrument settings and information on the instrument status.

5.1.3 LAN Interface

To be integrated in a LAN, the instrument is equipped with a LAN interface, consisting of a connector, a network interface card and protocols. For remote control via a network, the PC and the instrument must be connected via the LAN interface to a common network with TCP/IP network protocol. They are connected using a commercial RJ45 cable. The TCP/IP network protocol and the associated network services are preconfigured on the instrument. Software for instrument control and (for specified protocols only) the VISA program library must be installed on the controller.

VISA library

Instrument access via VXI11 protocols is usually achieved from high level programming platforms using VISA as an intermediate abstraction layer. VISA encapsulates the low level VXI or GPIB function calls and thus makes the transport interface transparent for the user. See [chapter 5.1.1, "VISA Libraries"](#), on page 458 for details.

IP address

Only the IP address or the computer name (LAN device name) is required to set up the connection. The IP address/computer name is part of the "visa resource string" used by the programs to identify and control the instrument. The visa resource string has the form:

TCPIP::::LAN device name>::INSTR] , where:

- **TCPIP** designates the network protocol used
- **host address** is the IP address
- **LAN device name** is the computer name of the control device (alternative to IP address)
- **INSTR** indicates that the VXI-11 protocol is used

Example:

Instrument has the IP address *192.1.2.3*; the valid resource string is:

```
TCPIP::192.1.2.3::INSTR
```

Computer name is *RSSM1*; the valid resource string is:

```
TCPIP::RSSM1::INSTR
```



Identifying instruments in a network

If several instruments are connected to the network, each instrument has its own IP address and associated resource string. The controller identifies these instruments by means of the resource string.

5.1.3.1 VXI-11 Protocol

The VXI-11 standard is based on the ONC RPC (Open Network Computing Remote Procedure Call) protocol which in turn relies on TCP/IP as the network/transport layer. The TCP/IP network protocol and the associated network services are preconfigured. TCP/IP ensures connection-oriented communication, where the order of the exchanged messages is adhered to and interrupted links are identified. With this protocol, messages cannot be lost.

5.1.3.2 Socket Communication

An alternative way for remote control of the software is to establish a simple network communication using sockets. The socket communication, also referred as “Raw Ethernet communication”, does not necessary require a VISA installation on the remote controller side.

The simplest way to establish socket communication is to use the built-in telnet program. The telnet program is part of every operating system and supports a communication with the software on a command-by-command basis. For better utilization and to enable automation by means of programs, user defined sockets can be programmed.

Socket connections are established on a specially defined port. The socket address is a combination of the IP address or the host name of the instrument and the number of the port configured for remote-control. All R&S Signal Generator use port number 5025 for this purpose. The port is configured for communication on a command-to-command basis and for remote control from a program.

5.1.3.3 LAN Interface Messages

In the LAN connection, the interface messages are called low-level control messages. These messages can be used to emulate interface messages of the GPIB bus.

Command	Long term	Effect on the instrument
&ABO	Abort	Aborts processing of the commands just received.
&DCL	Device Clear	Aborts processing of the commands just received and sets the command processing software to a defined initial state. Does not change the instrument setting.
>L	Go to Local	Transition to the "local" state (manual control).
>R	Go to Remote	Transition to the "remote" state (remote control).
&GET	Group Execute Trigger	Triggers a previously active instrument function (e.g. a sweep). The effect of the command is the same as with that of a pulse at the external trigger signal input.

Command	Long term	Effect on the instrument
&LLO	Local Lockout	Disables switchover from remote control to manual control by means of the front panel keys.
&NREN	Not Remote Enable	Enables switchover from remote control to manual operation by means of the front panel keys
&POL	Serial Poll	Starts a serial poll.

5.1.4 GPIB Interface (IEC/IEEE Bus Interface)

To be able to control the instrument via the GPIB bus, the instrument and the controller must be linked by a GPIB bus cable. A GPIB bus card, the card drivers and the program libraries for the programming language used must be provided in the controller. The controller must address the instrument with the GPIB bus address (see [chapter 5.1.4.2, "GPIB Instrument Address"](#), on page 462).

Characteristics

The GPIB interface is described by the following characteristics:

- Up to 15 instruments can be connected
- The total cable length is restricted to a maximum of 15 m; the cable length between two instruments should not exceed 2m.
- A wired "OR"-connection is used if several instruments are connected in parallel, since the slowest instrument determines the speed.



Any connected IEC bus cable must be terminated by an instrument or controller.

5.1.4.1 GPIB Interface Messages

Interface messages are transmitted to the instrument on the data lines, with the attention line (ATN) being active (LOW). They are used for communication between the controller and the instrument and can only be sent by a computer which has the function of a GPIB bus controller. GPIB interface messages can be further subdivided into:

- **Universal commands:** act on all instruments connected to the GPIB bus without previous addressing
- **Addressed commands:** only act on instruments previously addressed as listeners

Universal Commands

Universal commands are encoded in the range 10 through 1F hex. They affect all instruments connected to the bus and do not require addressing.

Command	Effect on the instrument
DCL (Device Clear)	Aborts the processing of the commands just received and sets the command processing software to a defined initial state. Does not change the instrument settings.
IFC (Interface Clear) *)	Resets the interfaces to the default setting.
LLO (Local Lockout)	The LOC/IEC ADDR key is disabled.
SPE (Serial Poll Enable)	Ready for serial poll.
SPD (Serial Poll Disable)	End of serial poll.
PPU (Parallel Poll Unconfigure)	End of the parallel-poll state.
*) IFC is not a real universal command, it is sent via a separate line; however, it also affects all instruments connected to the bus and does not require addressing	

Addressed Commands

Addressed commands are encoded in the range 00 through 0F hex. They only affect instruments addressed as listeners.

Command	Effect on the instrument
GET (Group Execute Trigger)	Triggers a previously active instrument function (e.g. a sweep). The effect of the command is the same as with that of a pulse at the external trigger signal input.
GTL (Go to Local)	Transition to the "local" state (manual control).
GTR (Go to Remote)	Transition to the "remote" state (remote control).
PPC (Parallel Poll Configure)	Configures the instrument for parallel poll.
SDC (Selected Device Clear)	Aborts the processing of the commands just received and sets the command processing software to a defined initial state. Does not change the instrument setting.

5.1.4.2 GPIB Instrument Address

In order to operate the instrument via remote control, it must be addressed using the GPIB address. The remote control address is factory preset, but it can be changed if it does not fit in the network environment. For remote control, addresses 0 through 30 are allowed. The GPIB address is maintained after a reset of the instrument settings.

Changing the GPIB address of the instrument

The GPIB address can be changed manually or using a remote control command.

1. Manually: press the SETUP key and select "Remote > GPIB".



Select parameter "GPIB channel address" and set the GPIB address.

- Using remote control command:
`SYST:COMM:GPIB:ADDR 18`

5.2 Starting a Remote Control Session

The instrument and the controller have to be connected with the suitable cable and switched on.

A remote control program must open a connection to the instrument (using VISA functionality), before it can send commands to and receive device responses from the instrument.



Instrument Address

In order to operate the instrument via remote control it must be addressed using the defined interface address. See [chapter 5.1.3, "LAN Interface"](#), on page 459 or [chapter 5.1.4, "GPIB Interface \(IEC/IEEE Bus Interface\)"](#), on page 461 for details.



The VISA resource strings are indicated in the "Setup > Remote Channel Settings" menu.

Refer to [chapter 5.2.3, "Examples"](#), on page 465 for practical examples on setting up of a remote control link and starting of a remote control session.

5.2.1 Switching to Remote Control

When it is switched on, the instrument is always in the manual operating state and can be operated via the front panel controls (for instruments equipped with a display) or via mouse and external keyboard.

Starting remote control

- Send a command from a controller to the instrument.

The instrument is switched to remote control as soon as it receives a command from the controller.

While remote control is active, operation via the front panel or via mouse and keyboard is disabled and "REMOTE" is displayed in the status line.

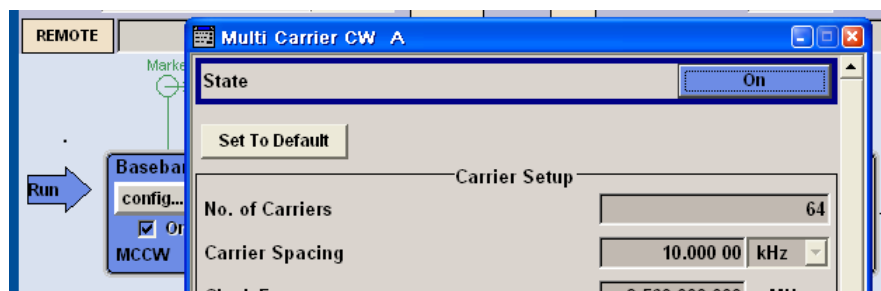

The instrument remains in the remote state until it is reset to the manual state via the instrument or via the remote control interface (see [chapter 5.2.2, "Returning to Manual Operation"](#), on page 464).

Tip: Switching from manual operation to remote control and vice versa does not affect the other instrument settings.

2. Although operation via front panel, mouse and keyboard is disabled, the dialog boxes can still be opened, e.g. to verify settings, but buttons and setting fields are displayed in gray and cannot be activated.

Use the command `SYST:KLOC ON` to disable the access to the dialogs.

3. To prevent unintentional return to manual operation, disable the LOCAL key of the instrument using the `&LLO` command (see [chapter 5.1.3.3, "LAN Interface Messages"](#), on page 460).

The instrument switches to "REM-LLO" state and transition to manual mode is not anymore possible via the remote control command `*GTL`.

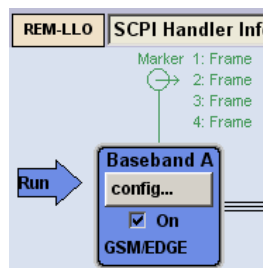

Switching to manual mode is only possible via remote control then.

4. Enable the LOCAL key with the interface message `&NREN`.

5.2.2 Returning to Manual Operation



Before returning to manual control, command processing must be completed. Otherwise, the instrument switches back to remote control immediately.

- ▶ To return to manual operation, use one of the following ways:
 - a) Press the LOCAL key on the front panel.
 - b) Select "Setup > Remote Control Channels" and press "Local".

- c) While using the socket communication, terminate the remote control session.
- d) Send the interface command `>L` via the remote control interface.

Tip: Use the `&NREN` to enable the LOCAL key if the key is disabled.

5.2.3 Examples

This sections provides examples for setting up of remote control connection and starting a remote control session over LAN and GPIB interfaces.

This section assumes basic knowledge of programming and operation of the controller. A description of the interface commands can be obtained from the relevant manuals.

5.2.3.1 Remote Control over GPIB

The program example in this section is written in VISUAL BASIC. A condition for programming in VISUAL BASIC is that the modules NIGLOBAL (`Niglobal.bas`) and VBIB32 (`Vbib_32.bas`) are added to the projects.



Drivers for instrument, e.g. IVI-COM and LabVIEW drivers, are available in the download area of the product website (http://www2.rohde-schwarz.com/en/products/test_and_measurement/product_categories/signal_generation/).

Starting a remote control session over GPIB

As a prerequisite, the GPIB address of the instrument, which is factory-set to 28, must not have been changed.

1. Connect instrument and controller using GPIB cable and switch them on.
2. Execute following commands on the controller:
 - a) Open port to the instrument
`CALL IBFIND("DEV1", generator%)`
 - b) Inform controller about instrument address
`CALL IBPAD(generator%, 28)`
 - c) Reset instrument
`CALL IBWRT(generator%, "*RST;*CLS")`
 - d) Set instrument to new address
`CALL IBWRT(generator%, "SYST:COMM:GPIB:ADDR 18")`
 - e) Inform controller about new address
`CALL IBPAD(generator%, 18)`

The GPIB address of the instrument is changed.

3. To return to manual operation, press the LOCAL key at the front panel.

5.2.3.2 Remote Control over LAN using VXI-11 Protocol

Through the examples in this section, the program 'Measurement & Automation Explorer' from National Instruments under Windows operating system is used for setting up a LAN remote control link and starting a remote control session.

Configuring the controller



The instrument is preconfigured for networks using DHCP (dynamic host configuration protocol). If this configuration is used, enter the computer name in the position of the IP address.

To enable the external controller to communicate with the software via TCP/IP protocol, set up a remote control link as follow:

1. Connect the controller and the instrument to the network (network cable) and switch them on.
2. Start the 'Measurement & Automation Control' program on the controller.
3. Select "Devices and Interfaces > Create New".



4. Select "VISA TCP/IP Resource" and confirm with "Next".



5. Choose the type of TCP/IP resource you wish to add and select Next.

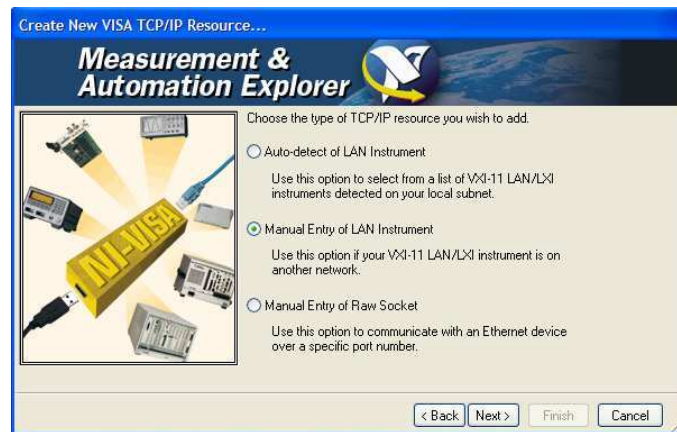

6. Enter the IP address or the host name of the R&S SMU and select "Next".



7. Enter the alias name if required.
The alias name must not be mistaken for the computer name. It is only used for instrument identification within the program and displayed in the menu as an option in case of an Ethernet link.
8. Confirm the settings with "Finish".
The instrument is configured and the settings are displayed in the "TCP/IP Settings" tab.

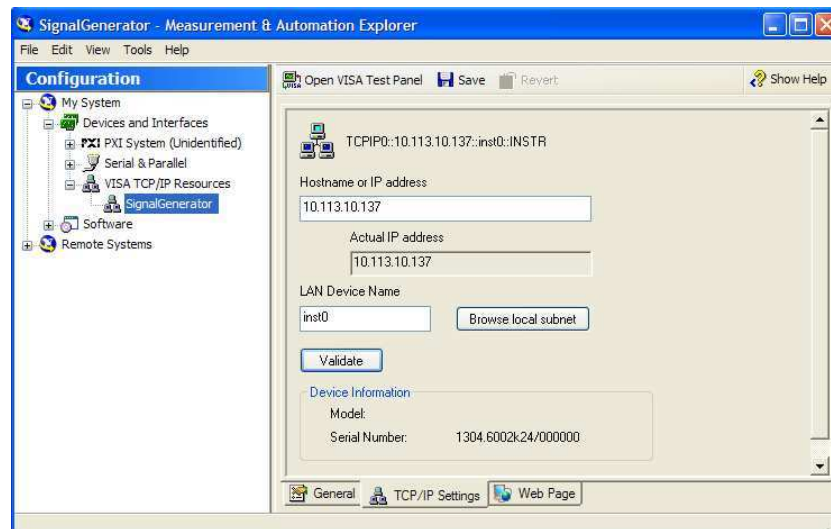

- To test the connection, select "Validate".
A message indicates whether the link to the instrument can be set up or not.

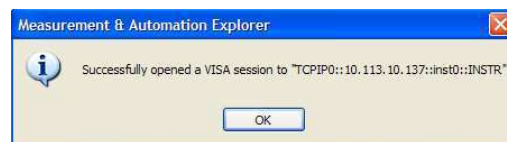

If a connection cannot be set up, check whether the controller and the instrument are connected to the network (network cable) and switched on. Correct spelling of the IP address or the computer name can also be checked. For further error location, inform the network administrator. In large networks, specification of additional addresses may be required for link setup, e.g. gateway and subnet mask, which are known to the network administrator.

The instrument is now registered in the program and can be addressed via the resource string or alias name.

Starting a remote control over LAN (using VXI-11)

- Start the 'Measurement & Automation Explorer' on the controller.
- In the "Configuration" window, select "Device and Interfaces > VISA TCP/IP Resources", select the required instrument and select "Open VISA Test Panel".

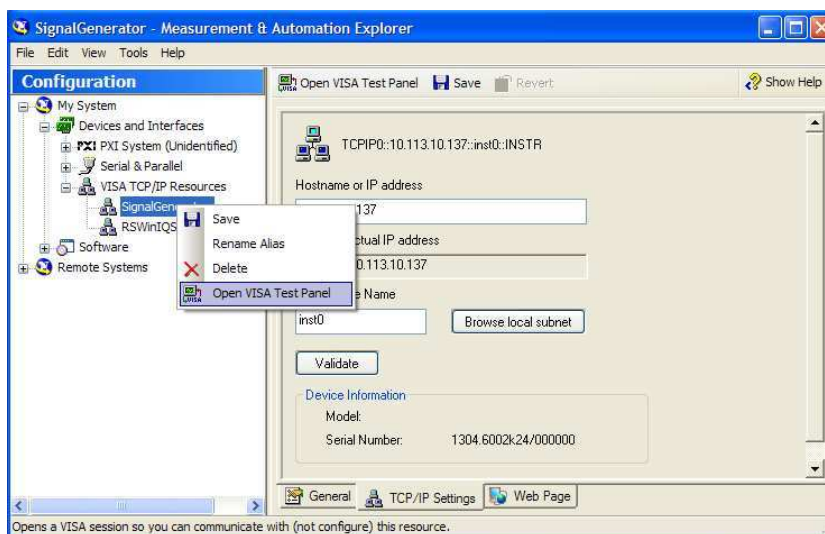

3. In the "viWrite" tab, write the command to be send to the instrument and select "Execute".

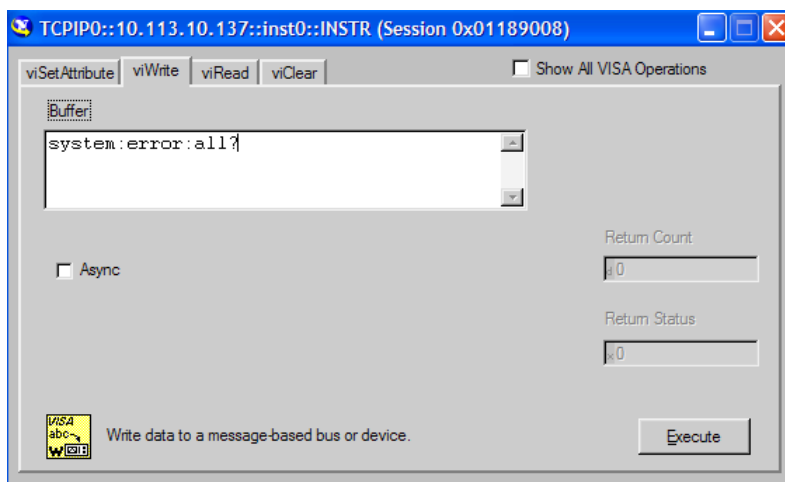

Instrument responses are displayed on the "viRead" tab.

Tip: For further program operation refer to the online help of the program.

5.2.3.3 Remote Control over LAN using Socket Communication

This chapter provides an example on how to establish a remote control connection over telnet protocol and a simple sockets-based program example that can be further developed.

Setting up a Telnet Connection

To control the software, only a telnet program is required. The telnet program is part of every operating system.

1. To establish a Telnet connection with the R&S SMU, start the telnet program and enter the socket address.

The socket address is a combination of the IP address or the host name of the R&S SMU and the number of the port configured for remote-control via telnet.

Tip: The R&S SMU uses the port number 5025 for remote connection via Telnet.

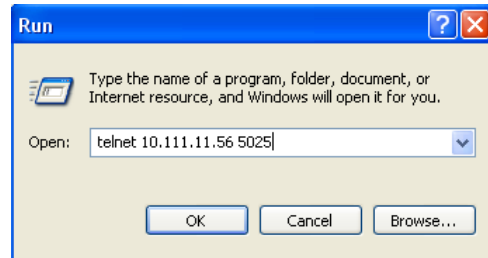

The connection to the instrument is set up and remote-control commands can be sent.

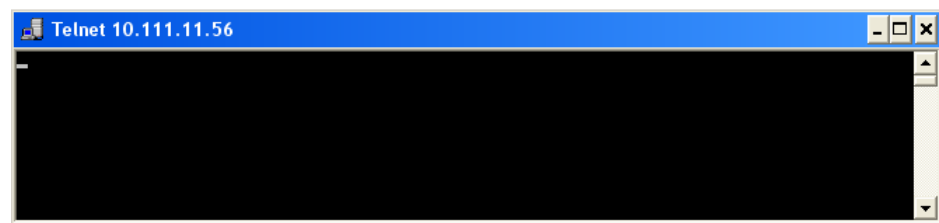

2. Even if the cursor is not visible on the screen, enter blind a remote-control command and confirm with Enter.

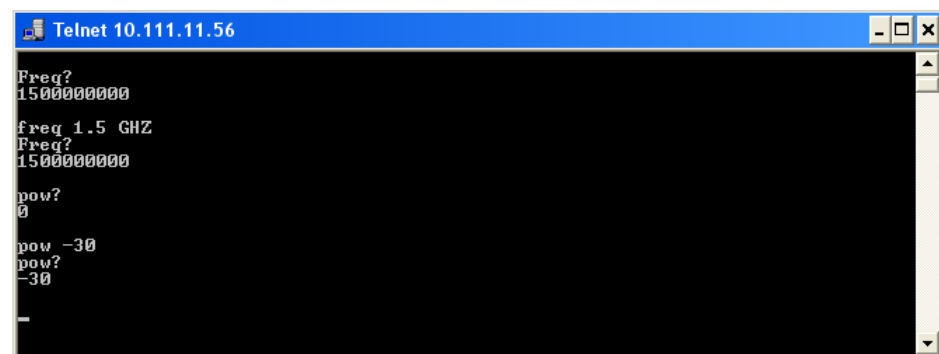

After the first remote-control command had been send, the instrument is in the "REMOTE" state, i.e. instrument control from the front panel or via mouse and keyboard is disabled and "REMOTE" is displayed in the status line.

TcpClient program examples

The following program example shows a simple TcpClient class that is intended to explain on how to get started with programming of sockets.

The example sets up a socket communication to R&S SMU and opens a simple user interface, very similar to the telnet, which allows input of commands. To enable real automation, further development of the program is required.

TcpClient.h

```
#include <string>
using namespace std;

//defines structs for socket handling
#ifndef LINUX
    #include "Winsock2.h"
#else
    #include <netinet/in.h>
#endif

typedef struct sockaddr_in SockAddrStruct;
typedef struct hostent HostInfoStruct;
class TcpClient
{
public:
    TcpClient();
    ~TcpClient();
    void connectToServer( string &hostname, int port );
    void disconnect( );
    void transmit( string &txString );
    void receive( string &rxString );
    string getCurrentHostName( ) const;
    int getCurrentPort( ) const;
private:
    string currentHostName;
    int currentPort;
    int currentSocketDescr;
    SockAddrStruct serverAddress;
    HostInfoStruct * currentHostInfo;
    bool clientIsConnected;
    int receiveBufferSize;
};
```

TcpClient.cpp

```
#ifndef LINUX
    #include <netdb.h>
    #include <unistd.h>
#endif

#include "TcpClient.h"
TcpClient::TcpClient()
: currentHostName( "" )
, currentPort( 0 )
, currentSocketDescr( 0 )
, serverAddress ( )
, currentHostInfo( NULL )
, clientIsConnected( false )
, receiveBufferSize( 1024 )
```



```

{}
TcpClient::~TcpClient()
{
    currentHostInfo = NULL;
}
void TcpClient::connectToServer( string &hostname, int port )
{
    currentHostInfo = gethostbyname( hostname.c_str( ) );
    if( currentHostInfo == NULL )
    {
        #ifndef LINUX
            int error = WSAGetLastError();
            switch (error)
            {
                case WSANOTINITIALISED: throw string(" A successful case WSStartup
call must occur before using this function."); break;
                case WSAENETDOWN: throw string
(" The network subsystem has failed."); break;
                case WSAHOST_NOT_FOUND: throw string
(" Authoritative answer host not found."); break;
                case WSATRY_AGAIN: throw string
(" Nonauthoritative host not found, or server failure."); break;
                case WSANO_RECOVERY: throw string
(" A nonrecoverable error occurred."); break;
                case WSANO_DATA: throw string
(" Valid name, no data record of requested type."); break;
                case WSAEINPROGRESS: throw string(" A blocking Windows Sockets 1.1 call
is in progress, or the service provider is still processing a callback function.");
; break;
                case WSAEFAULT: throw string
(" The name parameter is not a valid part of the user address space."); break;
                case WSAEINTR: throw string
(" A blocking Windows Socket 1.1 call was canceled through case
WSACancelBlockingCall."); break;
            }
        #endif

        currentHostName = "";
        currentPort = 0;
        currentHostInfo = NULL;
        clientIsConnected = false;
        throw string("error connecting host\n" );
    }
    else
    {
        currentHostName = hostname;
        currentPort = port;
        currentSocketDescr = socket(AF_INET, SOCK_STREAM, 0);
        if( currentSocketDescr == 0 )
        {

```

```

        currentHostName = "";
        currentPort = 0;
        currentHostInfo = NULL;
        clientIsConnected = false;
        throw string("can't create socket\n" );
    }
    serverAddress.sin_family = currentHostInfo->h_addrtype;
    serverAddress.sin_port = htons( currentPort );
    memcpy( (char *) &serverAddress.sin_addr.s_addr, currentHostInfo->
h_addr_list[0], currentHostInfo->h_length );
    if( connect( currentSocketDescr, ( struct sockaddr *) &serverAddress,
sizeof(serverAddress) ) < 0 )
    {
        throw string("can't connect server\n" );
    }
    clientIsConnected = true;
}
}
void TcpClient::disconnect( )
{
    if( clientIsConnected )
    {
        #ifndef LINUX
            closesocket( currentSocketDescr );
        #else
            close( currentSocketDescr );
        #endif
    }
    currentSocketDescr = 0;
    currentHostName = "";
    currentPort = 0;
    currentHostInfo = NULL;
    clientIsConnected = false;
}
void TcpClient::transmit( string &txString )
{
    if( !clientIsConnected )
    {
        throw string("connection must be established before any data can be sent\n");
    }
    char * transmitBuffer = new char[txString.length() +1];
    memcpy( transmitBuffer, txString.c_str(), txString.length() );
    transmitBuffer[txString.length()] = '\n'; //newline is needed!
    if( send( currentSocketDescr, transmitBuffer, txString.length() + 1, 0 ) < 0 )
    {
        throw string("can't transmit data\n");
    }
    delete [] transmitBuffer;
}
void TcpClient::receive( string &rxString )

```

```

{
    if( !clientIsConnected )
    {
        throw string("connection must be established before any data can be received\n");
    }
    char * receiveBuffer = new char[receiveBufferSize];
    memset( receiveBuffer, 0, receiveBufferSize );
    bool receiving = true;
    while( receiving )
    {
        int receivedByteCount = recv( currentSocketDescr, receiveBuffer,
            receiveBufferSize, 0 );
        if( receivedByteCount < 0 )
        {
            throw string("error while receiving data\n");
        }
        rxString += string( receiveBuffer );
        receiving = ( receivedByteCount == receiveBufferSize );
    }
    delete [] receiveBuffer;
}
string TcpClient::getCurrentHostName( ) const
{
    return currentHostName;
}
int TcpClient::getCurrentPort( ) const
{
    return currentPort;
}

```

TelnetClient.cpp

```

//TelnetClient.cpp: Defines the entry point for the console application.//

#include <iostream>
#include "TcpClient.h"
void printUsage()
{
    cout<<"usage: EthernetRawCommand <server-ip> [scpi-command]"<<endl;
}
int main( int argc, char *argv[] )
{
    int errorCode = 0; //no error
    bool useSingleCommand = false;
    string singleCommand = "";
    string hostname = "";
    int port = 5025;
    string input = "";
    TcpClient client;
    switch( argc )

```

```

{
case 3:
    useSingleCommand = true;
    singleCommand = argv[2];
case 2:
    hostname = argv[1];
    break;
default:
    printUsage();
    getchar();
    return(-1);
}
try
{
#ifdef LINUX
    WORD wVersionRequested = MAKEWORD( 2, 2 );
    WSADATA wsaData;
    int err = WSASStartup( wVersionRequested, &wsaData );
    if ( err != 0 )
    {
        throw string ("Could not find a usable WinSock DLL.");
    }
#endif
    client.connectToServer( hostname, port );
    bool terminate = false;
    while( !terminate )
    {
        char buffer[1024];
        if( useSingleCommand )
        {
            input = singleCommand; //send string
        }
        else
        {
            cout <<">";
            cin.getline( buffer, 1024 );
            input = buffer;
            if( input == "end" )
            {
                terminate = true;
            }
        }
        if( !terminate)
        {
            client.transmit( input ); //send string
            int qPos = input.find( "?", 0 );
            //receive string only when needed
            if( qPos > 0 )
            {
                string rcStr = "";

```

```

        client.receive( rcStr );
        cout << rcStr;
    }
}
if( useSingleCommand )
{
    terminate = true;
}
}
}catch( const string errorString )
{
    cout<<errorString<<endl<<endl;
    cout<<"Press Enter to exit"<<endl;
    getchar();
}
client.disconnect( );
return errorCode;
}

```

5.3 SCPI Command Structure

SCPI commands consist of a so-called header and, in most cases, one or more parameters. The header and the parameters are separated by a "white space" (ASCII code 0 to 9, 11 to 32 decimal, e.g. blank). The headers may consist of several mnemonics (keywords). Queries are formed by appending a question mark directly to the header.

The commands can be either device-specific or device-independent (common commands). Common and device-specific commands differ in their syntax.

5.3.1 Syntax for Common Commands

Common (=device-independent) commands consist of a header preceded by an asterisk (*) and possibly one or more parameters.

Examples:

*RST	RESET	Resets the instrument.
*ESE	EVENT STATUS ENABLE	Sets the bits of the event status enable registers.
*ESR?	EVENT STATUS QUERY	Queries the contents of the event status register.
*IDN?	IDENTIFICATION QUERY	Queries the instrument identification string.

5.3.2 Syntax for Device-Specific Commands



Not all commands used in the following examples are necessarily implemented in the instrument.

For demonstration purposes only, assume the existence of the following commands for this section:

- DISPLAY[:WINDow<1...4>]:MAXimize <Boolean>
- FORMat:READings:DATA <type>[,<length>]
- HCOpy:DEvice:COLor <Boolean>
- HCOpy:DEvice:CMAP:COLor:RGB <red>,<green>,<blue>
- HCOpy[:IMMediate]
- HCOpy:ITEM:ALL
- HCOpy:ITEM:LABel <string>
- HCOpy:PAGE:DIMensions:QUADrant [<N>]
- HCOpy:PAGE:ORientation LANDscape | PORTrait
- HCOpy:PAGE:SCALE <numeric value>
- MMEMory:COpy <file_source>,<file_destination>
- SENSE:BANDwidth|BWIDth[:RESolution] <numeric_value>
- SENSE:FREQuency:STOP <numeric value>
- SENSE:LIST:FREQuency <numeric_value>{,<numeric_value>}

Long and short form

The mnemonics feature a long form and a short form. The short form is marked by upper case letters, the long form corresponds to the complete word. Either the short form or the long form can be entered; other abbreviations are not permitted.

Example:

HCOpy:DEvice:COLor ON is equivalent to HCOP:DEV:COL ON.



Case-insensitivity

Upper case and lower case notation only serves to distinguish the two forms in the manual, the instrument itself is case-insensitive.

Numeric suffixes

If a command can be applied to multiple instances of an object, e.g. specific channels or sources, the required instances can be specified by a suffix added to the command. Numeric suffixes are indicated by angular brackets (<1...4>, <n>, <i>) and are replaced by a single value in the command. Entries without a suffix are interpreted as having the suffix 1.

Example:

Definition: `HCOPY:PAGE:DIMensions:QUADrant [<N>]`

Command: `HCOP:PAGE:DIM:QUAD2`

This command refers to the quadrant 2.

**Different numbering in remote control**

For remote control, the suffix may differ from the number of the corresponding selection used in manual operation. SCPI prescribes that suffix counting starts with 1. Suffix 1 is the default state and used when no specific suffix is specified.

Some standards define a fixed numbering, starting with 0. If the numbering differs in manual operation and remote control, it is indicated for the corresponding command.

Optional mnemonics

Some command systems permit certain mnemonics to be inserted into the header or omitted. These mnemonics are marked by square brackets in the description. The instrument must recognize the long command to comply with the SCPI standard. Some commands are considerably shortened by these optional mnemonics.

Example:

Definition: `HCOPY[:IMMEDIATE]`

Command: `HCOP:IMM` is equivalent to `HCOP`

**Optional mnemonics with numeric suffixes**

Do not omit an optional mnemonic if it includes a numeric suffix that is relevant for the effect of the command.

Example:

Definition: `DISPlay[:WINDow<1...4>]:MAXimize <Boolean>`

Command: `DISP:MAX ON` refers to window 1.

In order to refer to a window other than 1, you must include the optional `WINDow` parameter with the suffix for the required window.

`DISP:WIND2:MAX ON` refers to window 2.

Parameters

Parameters must be separated from the header by a "white space". If several parameters are specified in a command, they are separated by a comma (,). For a description of the parameter types, refer to [chapter 5.3.3, "SCPI Parameters"](#), on page 479.

Example:

Definition: `HCOPY:DEvice:CMAP:COLor:RGB <red>, <green>, <blue>`

Command: `HCOP:DEV:CMAP:COL:RGB 3, 32, 44`

Special characters

	<p>Parameters</p> <p>A vertical stroke in parameter definitions indicates alternative possibilities in the sense of "or". The effect of the command differs, depending on which parameter is used.</p> <p>Example:</p> <p>Definition: <code>HCOPY:PAGE:ORIENTATION LANDscape PORTRait</code></p> <p>Command <code>HCOPY:PAGE:ORI LAND</code> specifies landscape orientation</p> <p>Command <code>HCOPY:PAGE:ORI PORT</code> specifies portrait orientation</p> <p>Mnemonics</p> <p>A selection of mnemonics with an identical effect exists for several commands. These mnemonics are indicated in the same line; they are separated by a vertical stroke. Only one of these mnemonics needs to be included in the header of the command. The effect of the command is independent of which of the mnemonics is used.</p> <p>Example:</p> <p>Definition: <code>SENSE:BANDwidth BWIDTH[:RESolution] <numeric_value></code></p> <p>The two following commands with identical meaning can be created:</p> <p><code>SENS:BAND:RES 1</code></p> <p><code>SENS:BWID:RES 1</code></p>
[]	<p>Mnemonics in square brackets are optional and may be inserted into the header or omitted.</p> <p>Example: <code>HCOPY[:IMMEDIATE]</code></p> <p><code>HCOPY:IMM</code> is equivalent to <code>HCOPY</code></p>
{ }	<p>Parameters in curly brackets are optional and can be inserted once or several times, or omitted.</p> <p>Example: <code>SENSE:LIST:FREQUENCY <numeric_value>{,<numeric_value>}</code></p> <p>The following are valid commands:</p> <p><code>SENS:LIST:FREQ 10</code></p> <p><code>SENS:LIST:FREQ 10,20</code></p> <p><code>SENS:LIST:FREQ 10,20,30,40</code></p>

5.3.3 SCPI Parameters

Many commands are supplemented by a parameter or a list of parameters. The parameters must be separated from the header by a "white space" (ASCII code 0 to 9, 11 to 32 decimal, e.g. blank). Allowed parameters are:

- Numeric values
- Special numeric values
- Boolean parameters
- Text
- Character strings
- Block data

The parameters required for each command and the allowed range of values are specified in the command description.

Numeric values

Numeric values can be entered in any form, i.e. with sign, decimal point and exponent. Values exceeding the resolution of the instrument are rounded up or down. The mantissa may comprise up to 255 characters, the exponent must lie inside the value range -32000 to 32000. The exponent is introduced by an "E" or "e". Entry of the exponent alone is not allowed. In the case of physical quantities, the unit can be entered. Allowed unit prefixes are G (giga), MA (mega), MOHM and MHZ (also allowed), K (kilo), M (milli), U (micro) and N (nano). If the unit is missing, the basic unit is used.

Example: `SENS:FREQ:STOP 1.5GHz = SENS:FREQ:STOP 1.5E9`

Units

For physical quantities, the unit can be entered. Allowed unit prefixes are:

- G (giga)
- MA (mega), MOHM, MHZ
- K (kilo)
- M (milli)
- U (micro)
- N (nano)

If the unit is missing, the basic unit is used.

Example:

`SENSe:FREQ:STOP 1.5GHz = SENSe:FREQ:STOP 1.5E9`

Some settings allow relative values to be stated in percent. According to SCPI, this unit is represented by the `PCT` string.

Example:

`HCOP:PAGE:SCAL 90PCT`

Special numeric values

The texts listed below are interpreted as special numeric values. In the case of a query, the numeric value is provided.

- **MIN/MAX**
MINimum and MAXimum denote the minimum and maximum value.
- **DEF**
DEFault denotes a preset value which has been stored in the EPROM. This value conforms to the default setting, as it is called by the `*RST` command.
- **UP/DOWN**
UP, DOWN increases or reduces the numeric value by one step. The step width can be specified via an allocated step command for each parameter which can be set via UP, DOWN.
- **INF/NINF**

INFINITY, Negative INFINITY (NINF) represent the numeric values 9.9E37 or -9.9E37, respectively. INF and NINF are only sent as instrument responses.

- **NAN**

Not A Number (NAN) represents the value 9.91E37. NAN is only sent as a instrument response. This value is not defined. Possible causes are the division of zero by zero, the subtraction of infinite from infinite and the representation of missing values.

Example:

Setting command: `SENSe:LIST:FREQ MAXimum`

Query: `SENS:LIST:FREQ?`, Response: `3.5E9`



Queries for special numeric values

The numeric values associated to `MAXimum`/`MINimum`/`DEFault` can be queried by adding the corresponding mnemonics to the command. They must be entered following the quotation mark.

Example: `SENSe:LIST:FREQ? MAXimum`

Returns the maximum numeric value as a result.

Boolean Parameters

Boolean parameters represent two states. The "ON" state (logically true) is represented by "ON" or a numeric value 1. The "OFF" state (logically untrue) is represented by "OFF" or the numeric value 0. The numeric values are provided as the response for a query.

Example:

Setting command: `HCOPY:DEV:COL ON`

Query: `HCOPY:DEV:COL?`

Response: `1`

Text parameters

Text parameters observe the syntactic rules for mnemonics, i.e. they can be entered using a short or long form. Like any parameter, they have to be separated from the header by a white space. In the case of a query, the short form of the text is provided.

Example:

Setting command: `HCOPY:PAGE:ORIENTATION LANDscape`

Query: `HCOP:PAGE:ORI?`

Response: `LAND`

Character strings

Strings must always be entered in quotation marks (' or ").

Example:

```
HCOP:ITEM:LABel "Test1" or HCOP:ITEM:LABel 'Test1'
```

Block data

Block data is a format which is suitable for the transmission of large amounts of data. A command using a block data parameter has the following structure:

Example:

```
FORMat:READings:DATA #45168xxxxxxxx
```

The ASCII character # introduces the data block. The next number indicates how many of the following digits describe the length of the data block. In the example the 4 following digits indicate the length to be 5168 bytes. The data bytes follow. During the transmission of these data bytes all end or other control signs are ignored until all bytes are transmitted.

#0 specifies a data block of indefinite length. The use of the indefinite format requires a `NL^END` message to terminate the data block. This format is useful when the length of the transmission is not known or if speed or other considerations prevent segmentation of the data into blocks of definite length.

5.3.4 Overview of Syntax Elements

The following table provides an overview of the syntax elements:

:	The colon separates the mnemonics of a command. In a command line the separating semicolon marks the uppermost command level.
;	The semicolon separates two commands of a command line. It does not alter the path.
,	The comma separates several parameters of a command.
?	The question mark forms a query.
*	The asterisk marks a common command.
'' ..	Quotation marks introduce a string and terminate it (both single and double quotation marks are possible).
#	The hash symbol introduces binary, octal, hexadecimal and block data. <ul style="list-style-type: none"> • Binary: #B10110 • Octal: #O7612 • Hexa: #HF3A7 • Block: #21312
	A "white space" (ASCII-Code 0 to 9, 11 to 32 decimal, e.g. blank) separates the header from the parameters.

5.3.5 Structure of a command line

A command line may consist of one or several commands. It is terminated by one of the following:

- a <New Line>
- a <New Line> with EOI
- an EOI together with the last data byte

Several commands in a command line must be separated by a semicolon ";". If the next command belongs to a different command system, the semicolon is followed by a colon.

Example:

```
MMEM:COPY "Test1", "MeasurementXY";:HCOP:ITEM ALL
```

This command line contains two commands. The first command belongs to the MMEM system, the second command belongs to the HCOP system.

If the successive commands belong to the same system, having one or several levels in common, the command line can be abbreviated. To this end, the second command after the semicolon starts with the level that lies below the common levels. The colon following the semicolon must be omitted in this case.

Example:

```
HCOP:ITEM ALL;:HCOP:IMM
```

This command line contains two commands. Both commands are part of the HCOP command system, i.e. they have one level in common.

When abbreviating the command line, the second command begins with the level below HCOP. The colon after the semicolon is omitted. The abbreviated form of the command line reads as follows:

```
HCOP:ITEM ALL;IMM
```

A new command line always begins with the complete path.

Example:

```
HCOP:ITEM ALL
```

```
HCOP:IMM
```

5.3.6 Responses to Queries

A query is defined for each setting command unless explicitly specified otherwise. It is formed by adding a question mark to the associated setting command. According to SCPI, the responses to queries are partly subject to stricter rules than in standard IEEE 488.2.

- The requested parameter is transmitted without a header.
Example: HCOP:PAGE:ORI?, Response: LAND
- Maximum values, minimum values and all other quantities that are requested via a special text parameter are returned as numeric values.
Example: SENSE:FREQUENCY:STOP? MAX, Response: 3.5E9
- Numeric values are output without a unit. Physical quantities are referred to the basic units or to the units set using the Unit command. The response 3.5E9 in the previous example stands for 3.5 GHz.

- Truth values (Boolean values) are returned as 0 (for OFF) and 1 (for ON).

Example:

Setting command: `HCOPy:DEV:COL ON`

Query: `HCOPy:DEV:COL?`

Response: 1

- Text (character data) is returned in a short form.

Example:

Setting command: `HCOPy:PAGE:ORIENTATION LANDscape`

Query: `HCOp:PAGE:ORI?`

Response: LAND

5.4 Command Sequence and Synchronization

IEEE 488.2 defines a distinction between overlapped and sequential commands:

- A sequential command is one which finishes executing before the next command starts executing. Commands that are processed quickly are usually implemented as sequential commands. Sequential commands are not implemented in the instrument, however the execution time of most commands is so short that they act as sequential commands when sent in different command lines.
- An overlapping command is one which does not automatically finish executing before the next command starts executing. Usually, overlapping commands take longer to process and allow the program to do other tasks while being executed. If overlapping commands do have to be executed in a defined order, e.g. in order to avoid wrong measurement results, they must be serviced sequentially. This is called synchronization between the controller and the instrument.

Setting commands within one command line, even though they may be implemented as sequential commands, are not necessarily serviced in the order in which they have been received. In order to make sure that commands are actually carried out in a certain order, each command must be sent in a separate command line.

Example: Commands and queries in one message

The response to a query combined in a program message with commands that affect the queried value is not predictable.

The following commands always return the specified result:

```
:FREQ:STAR 1GHZ;SPAN 100 :FREQ:STAR?
```

Result:

```
1000000000 (1 GHz)
```

Whereas the result for the following commands is not specified by SCPI:

```
:FREQ:STAR 1GHz;STAR?;SPAN 1000000
```

The result could be the value of `START` before the command was sent since the instrument might defer executing the individual commands until a program message terminator is received. The result could also be 1 GHz if the instrument executes commands as they are received.



As a general rule, send commands and queries in different program messages.

Example: Overlapping command with *OPC

The instrument implements `INITiate[:IMMEDIATE]` as an overlapped command. Assuming that `INITiate[:IMMEDIATE]` takes longer to execute than `*OPC`, sending the following command sequence results in initiating a sweep and, after some time, setting the `OPC` bit in the `ESR`:

```
INIT; *OPC.
```

Sending the following commands still initiates a sweep:

```
INIT; *OPC; *CLS
```

However, since the operation is still pending when the instrument executes `*CLS`, forcing it into the "Operation Complete Command Idle" State (OCIS), `*OPC` is effectively skipped. The `OPC` bit is not set until the instrument executes another `*OPC` command.

Example: Overlapped command followed by non-conflicting commands

Suppose that the instrument is switched on to provide a real time test signal that requires some calculation time. At the same time some settings for the configuration of a different signal are made which do not interact with the generated signal (e.g. the signal may be used later on). The signal generation and the signal configuration are independent from each other, so none of the following overlapped commands needs to be synchronized:

```
SOUR:BB:3GPP:STAT ON
SOUR:BB:GSM:FORM FSK2
```

Example: Overlapped command followed by conflicting commands

Suppose that the generator is switched on to provide a real time test signal that requires some calculation time. This signal is to be added to a waveform from the second base-band generator. In this case the application program must ensure that the real signal is actually available in the added signal before further action is started. This involves an appropriate synchronization technique for the first command (the following sequence assumes an appropriate routing):

```
SOUR:BB:3GPP:STAT ON
```

The instrument waits until command has finished.

```
SOUR2:BB:GSM:STAT ON
```

Depending on the selected synchronization techniques, non-conflicting commands can be executed while waiting until the synchronized overlapped command has finished.

5.4.1 Preventing Overlapping Execution

To prevent an overlapping execution of commands, one of the commands `*OPC`, `*OPC?` or `*WAI` can be used. All three commands cause a certain action only to be carried out after the hardware has been set. By suitable programming, the controller can be forced to wait for the corresponding action to occur.

Table 5-2: Synchronization using *OPC, *OPC? and *WAI

Com-mand	Action	Programming the controller
*OPC	Sets the Operation Complete bit in the ESR after all previous commands have been executed.	<ul style="list-style-type: none"> • Setting bit 0 in the ESE • Setting bit 5 in the SRE • Waiting for service request (SRQ)
*OPC?	Stops command processing until 1 is returned. This is only the case after the Operation Complete bit has been set in the ESR. This bit indicates that the previous setting has been completed.	Sending *OPC? directly after the command whose processing should be terminated before other commands can be executed.
*WAI	Stops further command processing until all commands sent before *WAI have been executed.	Sending *WAI directly after the command whose processing should be terminated before other commands are executed.

Command synchronization using *WAI or *OPC? appended to an overlapped command is a good choice if the overlapped command takes only little time to process. The two synchronization techniques simply block overlapped execution of the command.

For time consuming overlapped commands it is usually desirable to allow the controller or the instrument to do other useful work while waiting for command execution. Use one of the following methods:

***OPC with a service request**

1. Set the OPC mask bit (bit no. 0) in the ESE: *ESE 1
2. Set bit no. 5 in the SRE: *SRE 32 to enable ESB service request.
3. Send the overlapped command with *OPC
4. Wait for a service request

The service request indicates that the overlapped command has finished.

***OPC? with a service request**

1. Set bit no. 4 in the SRE: *SRE 16 to enable MAV service request.
2. Send the overlapped command with *OPC?
3. Wait for a service request

The service request indicates that the overlapped command has finished.

Event Status Register (ESE)

1. Set the OPC mask bit (bit no. 0) in the ESE: *ESE 1
2. Send the overlapped command without *OPC, *OPC? or *WAI
3. Poll the operation complete state periodically (by means of a timer) using the sequence: *OPC; *ESR?

A return value (LSB) of 1 indicates that the overlapped command has finished.

***OPC? with short timeout**

1. Send the overlapped command without *OPC, *OPC? or *WAI
2. Poll the operation complete state periodically (by means of a timer) using the sequence: <short timeout>; *OPC?
3. A return value (LSB) of 1 indicates that the overlapped command has finished. In case of a timeout, the operation is ongoing.
4. Reset timeout to former value
5. Clear the error queue with `SYStem:ERRor?` to remove the "-410, Query interrupted" entries.

Using several threads in the controller application

As an alternative, provided the programming environment of the controller application supports threads, separate threads can be used for the application GUI and for controlling the instrument(s) via SCPI.

A thread waiting for a *OPC? thus will not block the GUI or the communication with other instruments.

5.5 Status Reporting System

The status reporting system stores all information on the current operating state of the instrument, and on errors which have occurred. This information is stored in the status registers and in the error queue. Both can be queried with the commands `STATus . . .`

5.5.1 Hierarchy of status registers

As shown in the following figure, the status information is of hierarchical structure.

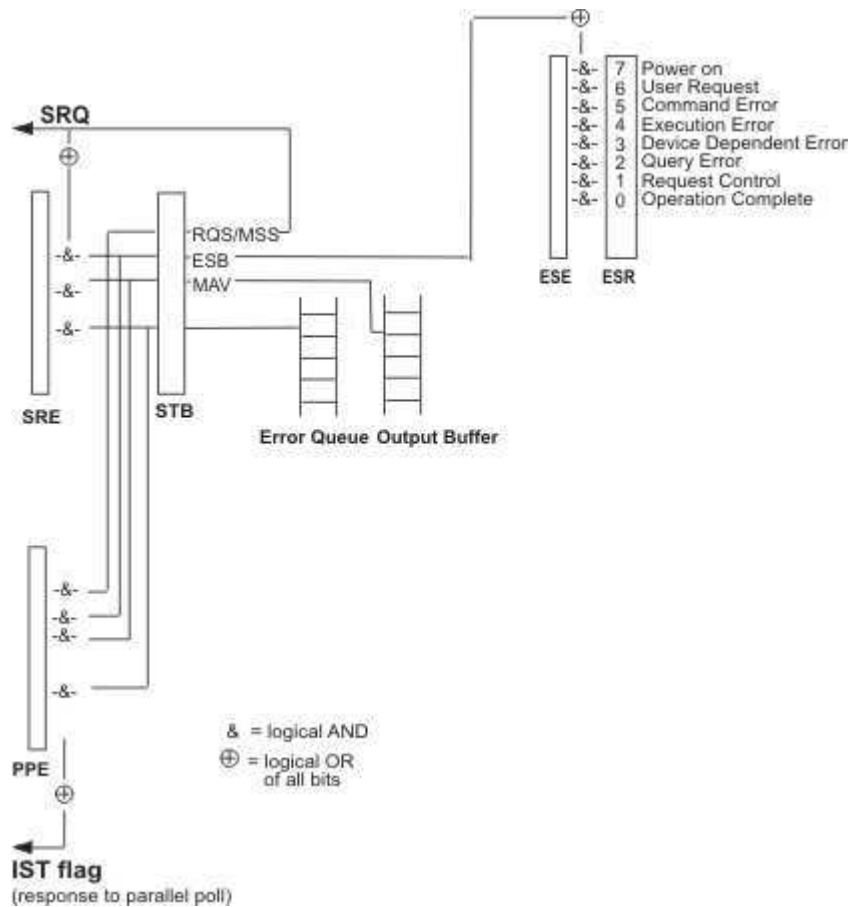

Fig. 5-1: Graphical overview of the status registers hierarchy

- **STB, SRE**

The STatus Byte (STB) register and its associated mask register Service Request Enable (SRE) form the highest level of the status reporting system. The STB provides a rough overview of the instrument status, collecting the information of the lower-level registers.

- **ESR, SCPI registers**

The STB receives its information from the following registers:

- The Event Status Register (ESR) with the associated mask register standard Event Status Enable (ESE).
- The STATUS:OPERation and STATUS:QUESTionable registers which are defined by SCPI and contain detailed information on the instrument.

- **IST, PPE**

The IST flag ("Individual STatus"), like the SRQ, combines the entire instrument status in a single bit. The PPE fulfills the same function for the IST flag as the SRE for the service request.

- **Output buffer**

The output buffer contains the messages the instrument returns to the controller. It is not part of the status reporting system but determines the value of the MAV bit in the STB and thus is represented in the overview.

All status registers have the same internal structure.



SRE, ESE

The service request enable register *SRE* can be used as *ENABLE* part of the *STB* if the *STB* is structured according to SCPI. By analogy, the *ESE* can be used as the *ENABLE* part of the *ESR*.

5.5.2 Structure of a SCPI Status Register

Each standard SCPI register consists of 5 parts. Each part has a width of 16 bits and has different functions. The individual bits are independent of each other, i.e. each hardware status is assigned a bit number which is valid for all five parts. Bit 15 (the most significant bit) is set to zero for all parts. Thus the contents of the register parts can be processed by the controller as positive integers.

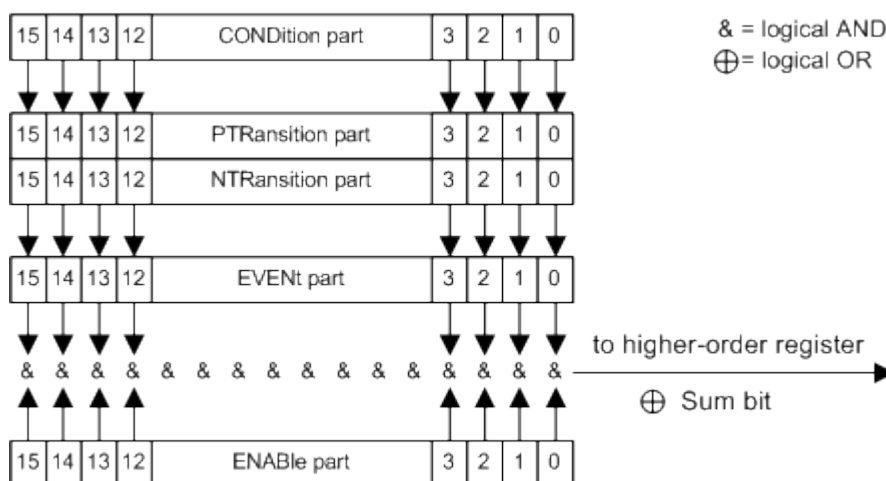

Fig. 5-2: The status-register model

Description of the five status register parts

The five parts of a SCPI register have different properties and functions:

- CONDITION**
 The *CONDition* part is written into directly by the hardware or the sum bit of the next lower register. Its contents reflect the current instrument status. This register part can only be read, but not written into or cleared. Its contents are not affected by reading.
- PTRansition**
 The two transition register parts define which state transition of the *CONDition* part (none, 0 to 1, 1 to 0 or both) is stored in the *EVENT* part.
 The *Positive-TRansition* part acts as a transition filter. When a bit of the *CONDition* part is changed from 0 to 1, the associated *PTR* bit decides whether the *EVENT* bit is set to 1.
 - *PTR* bit =1: the *EVENT* bit is set.
 - *PTR* bit =0: the *EVENT* bit is not set.

This part can be written into and read as required. Its contents are not affected by reading.

- **NTRansition**

The `NEGATIVE-TRANSITION` part also acts as a transition filter. When a bit of the `CONDITION` part is changed from 1 to 0, the associated `NTR` bit decides whether the `EVENT` bit is set to 1.

- `NTR` bit =1: the `EVENT` bit is set.
- `NTR` bit =0: the `EVENT` bit is not set.

This part can be written into and read as required. Its contents are not affected by reading.

- **EVENT**

The `EVENT` part indicates whether an event has occurred since the last reading, it is the "memory" of the condition part. It only indicates events passed on by the transition filters. It is permanently updated by the instrument. This part can only be read by the user. Reading the register clears it. This part is often equated with the entire register.

- **ENABLE**

The `ENABLE` part determines whether the associated `EVENT` bit contributes to the sum bit (see below). Each bit of the `EVENT` part is "ANDed" with the associated `ENABLE` bit (symbol '&'). The results of all logical operations of this part are passed on to the sum bit via an "OR" function (symbol '+').

`ENABLE` bit = 0: the associated `EVENT` bit does not contribute to the sum bit

`ENABLE` bit = 1: if the associated `EVENT` bit is "1", the sum bit is set to "1" as well.

This part can be written into and read by the user as required. Its contents are not affected by reading.

Sum bit

The sum bit is obtained from the `EVENT` and `ENABLE` part for each register. The result is then entered into a bit of the `CONDITION` part of the higher-order register.

The instrument automatically generates the sum bit for each register. Thus an event can lead to a service request throughout all levels of the hierarchy.

5.5.3 Contents of the Status Registers

In the following sections, the contents of the status registers are described in more detail.

5.5.3.1 Status Byte (STB) and Service Request Enable Register (SRE)

The `STATUS BYTE` (STB) is already defined in IEEE 488.2. It provides a rough overview of the instrument status by collecting the pieces of information of the lower registers. A special feature is that bit 6 acts as the sum bit of the remaining bits of the status byte.

The STB is read using the command `*STB` or a serial poll.

The `STATUS BYTE` (STB) is linked to the `SERVICE REQUEST ENABLE` (SRE) register. Each bit of the STB is assigned a bit in the SRE. Bit 6 of the SRE is ignored. If a bit is set in the SRE and the associated bit in the STB changes from 0 to 1, a service request

(SRQ) is generated. The SRE can be set using the command `*SRE` and read using the command `*SRE?`.

Table 5-3: Meaning of the bits used in the status byte

Bit No.	Meaning
0...1	Not used
2	Error Queue not empty The bit is set when an entry is made in the error queue. If this bit is enabled by the SRE, each entry of the error queue generates a service request. Thus an error can be recognized and specified in greater detail by polling the error queue. The poll provides an informative error message. This procedure is to be recommended since it considerably reduces the problems involved with remote control.
3	Not used.
4	MAV bit (message available) The bit is set if a message is available in the output buffer which can be read. This bit can be used to enable data to be automatically read from the instrument to the controller.
5	ESB bit Sum bit of the event status register. It is set if one of the bits in the event status register is set and enabled in the event status enable register. Setting of this bit indicates a serious error which can be specified in greater detail by polling the event status register.
6	MSS bit (master status summary bit) The bit is set if the instrument triggers a service request. This is the case if one of the other bits of this registers is set together with its mask bit in the service request enable register SRE.
7	Not used.

5.5.3.2 IST Flag and Parallel Poll Enable Register (PPE)

As with the SRQ, the IST flag combines the entire status information in a single bit. It can be read by means of a parallel poll (see [chapter 5.5.5.3, "Parallel Poll"](#), on page 493) or using the command `*IST`.

The parallel poll enable register (PPE) determines which bits of the STB contribute to the IST flag. The bits of the STB are "ANDed" with the corresponding bits of the PPE, with bit 6 being used as well in contrast to the SRE. The IST flag results from the "ORing" of all results. The PPE can be set using commands `*PRE` and read using command `*PRE?`.

5.5.4 Event Status Register (ESR) and Event Status Enable Register (ESE)

The ESR is defined in IEEE 488.2. The event status register can be read out using command `*ESR` on page 498. The ESE is the associated enable part. It can be set using the command `*ESE` on page 498 and read using the command `*ESE?`.

Table 5-4: Meaning of the bits used in the event status register

Bit No.	Meaning
0	Operation Complete This bit is set on receipt of the command *OPC exactly when all previous commands have been executed.
1	not used
2	Query Error This bit is set if either the controller wants to read data from the instrument without having sent a query, or if it does not fetch requested data and sends new instructions to the instrument instead. The cause is often a query which is faulty and hence cannot be executed.
3	Device-dependent Error This bit is set if a device dependent error occurs. An error message with a number between 300 and 399 or a positive error number, which denotes the error in greater detail, is entered into the error queue.
4	Execution Error This bit is set if a received command is syntactically correct but cannot be performed for other reasons. An error message with a number between 200 and 300, which denotes the error in greater detail, is entered into the error queue.
5	Command Error This bit is set if a command which is undefined or syntactically incorrect is received. An error message with a number between 100 and 200, which denotes the error in greater detail, is entered into the error queue.
6	User Request This bit is set on pressing the LOCAL key, i.e. when the instrument is switched over to manual operation.
7	Power On (supply voltage on) This bit is set on switching on the instrument.

5.5.5 Application of the Status Reporting System

The purpose of the status reporting system is to monitor the status of one or several devices in a measuring system. To do this and react appropriately, the controller must receive and evaluate the information of all devices. The following standard methods are used:

- **Service request (SRQ)** initiated by the instrument
- **Serial poll** of all devices in the bus system, initiated by the controller in order to find out who sent a SRQ and why
- **Parallel poll** of all devices
- Query of a **specific instrument status** by means of commands
- Query of the **error queue**

5.5.5.1 Service Request

Under certain circumstances, the instrument can send a service request (SRQ) to the controller. Usually this service request initiates an interrupt at the controller, to which the control program can react appropriately. An SRQ is always initiated if one or several of bits 2, 4 or 5 of the status byte are set and enabled in the SRE. Each of these bits combines the information of the error queue or the output buffer. In order to use the possibilities of the service request effectively, all bits should be set to "1" in the enable registers SRE and ESE.

Example:

Use command `*OPC` to generate an SRQ .

`*ESE 1` - set bit 0 of ESE (Operation Complete)

`*SRE 32` - set bit 5 of SRE (ESB).

After its settings have been completed, the instrument generates an SRQ.

The SRQ is the only possibility for the instrument to become active on its own. Each controller program should set the instrument such that a service request is initiated in the case of malfunction. The program should react appropriately to the service request.

5.5.5.2 Serial Poll

In a serial poll, just as with command `*STB`, the status byte of an instrument is queried. However, the query is realized via interface messages and is thus clearly faster.

The serial poll method is defined in IEEE 488.1 and used to be the only standard possibility for different instruments to poll the status byte. The method also works for instruments which do not adhere to SCPI or IEEE 488.2.

The serial poll is mainly used to obtain a fast overview of the state of several instruments connected to the controller.

5.5.5.3 Parallel Poll

In a parallel poll, up to eight instruments are simultaneously requested by the controller using a single command to transmit 1 bit of information each on the data lines, i.e., to set the data line allocated to each instrument to a logical "0" or "1".

In addition to the SRE register, which determines the conditions under which an SRQ is generated, there is a Parallel Poll Enable register (PPE) which is ANDed with the STB bit by bit, considering bit 6 as well. This register is ANDed with the STB bit by bit, considering bit 6 as well. The results are ORed, the result is possibly inverted and then sent as a response to the parallel poll of the controller. The result can also be queried without parallel poll using the command `*IST`.

The instrument first has to be set for the parallel poll using the command `PPC`. This command allocates a data line to the instrument and determines whether the response is to be inverted. The parallel poll itself is executed using `PPE`.

The parallel poll method is mainly used to find out quickly which one of the instruments connected to the controller has sent a service request. To this effect, SRE and PPE must be set to the same value.

5.5.5.4 Query of an instrument status

Each part of any status register can be read using queries. There are two types of commands:

- The common commands `*ESR?`, `*IDN?`, `*IST?`, `*STB?` query the higher-level registers.
- The commands of the `STATus` system query the SCPI registers (`STATus:QUEStionable...`)

The returned value is always a decimal number that represents the bit pattern of the queried register. This number is evaluated by the controller program.

Queries are usually used after an SRQ in order to obtain more detailed information on the cause of the SRQ.

5.5.5.5 Error Queue

Each error state in the instrument leads to an entry in the error queue. The entries of the error queue are detailed plain text error messages that can be looked up in the Error Log or queried via remote control using `SYSTEM:ERROR[:NEXT]?` or `SYSTEM:ERROR:ALL?`. Each call of `SYSTEM:ERROR[:NEXT]?` provides one entry from the error queue. If no error messages are stored there any more, the instrument responds with 0, "No error".

The error queue should be queried after every SRQ in the controller program as the entries describe the cause of an error more precisely than the status registers. Especially in the test phase of a controller program the error queue should be queried regularly since faulty commands from the controller to the instrument are recorded there as well.

5.5.6 Reset Values of the Status Reporting System

The following table contains the different commands and events causing the status reporting system to be reset. None of the commands, except `*RST` and `SYSTEM:PRESet`, influence the functional instrument settings. In particular, `DCL` does not change the instrument settings.

Table 5-5: Resetting the status reporting system

Event	Switching on supply voltage Power-On-Status-Clear		DCL, SDC (Device Clear, Selected Device Clear)	*RST or SYS-Tem:PRE-Set	STA-Tus:PRE-Set	*CLS
	0	1				
Clear STB, ESR	-	yes	-	-	-	yes
Clear SRE, ESE	-	yes	-	-	-	-
Clear PPE	-	yes	-	-	-	-
Clear error queue	yes	yes	-	-	-	yes
Clear output buffer	yes	yes	yes	1)	1)	1)
Clear command processing and input buffer	yes	yes	yes	-	-	-

1) The first command in a command line that immediately follows a <PROGRAM MESSAGE TERMINATOR> clears the output buffer.

5.6 General Programming Recommendations

Initial instrument status before changing settings

Manual operation is designed for maximum possible operating convenience. In contrast, the priority of remote control is the "predictability" of the instrument status. Thus, when a command attempts to define incompatible settings, the command is ignored and the instrument status remains unchanged, i.e. other settings are not automatically adapted. Therefore, control programs should always define an initial instrument status (e.g. using the *RST command) and then implement the required settings.

Command sequence

As a general rule, send commands and queries in different program messages. Otherwise, the result of the query may vary depending on which operation is performed first (see also Preventing Overlapping Execution).

Reacting to malfunctions

The service request is the only possibility for the instrument to become active on its own. Each controller program should instruct the instrument to initiate a service request in case of malfunction. The program should react appropriately to the service request.

Error queues

The error queue should be queried after every service request in the controller program as the entries describe the cause of an error more precisely than the status registers. Especially in the test phase of a controller program the error queue should be queried

regularly since faulty commands from the controller to the instrument are recorded there as well.

6 Remote Control Commands

In the following, all remote-control commands will be presented in detail with their parameters and the ranges of numerical values.

For an introduction to remote control and the status registers, refer to [chapter 5, "Remote Control Basics"](#), on page 457.

6.1 Common Commands

Common commands are described in the IEEE 488.2 (IEC 625-2) standard. These commands have the same effect and are employed in the same way on different devices. The headers of these commands consist of "*" followed by three letters. Many common commands are related to the Status Reporting System.

Available common commands:

*CAL.....	497
*CLS.....	497
*ESE.....	498
*ESR.....	498
*IDN.....	498
*IST.....	498
*OPC.....	499
*OPT.....	499
*PCB.....	499
*PRE.....	499
*PSC.....	499
*RCL.....	500
*RST.....	500
*SAV.....	500
*SRE.....	500
*STB.....	501
*TRG.....	501
*TST.....	501
*WAI.....	501

*CAL

Calibration Query

Initiates a calibration of the instrument and subsequently queries the calibration status. Responses > 0 indicate errors.

*CLS

CLear Status

Sets the status byte (STB), the standard event register (ESR) and the `EVENT` part of the `QUESTionable` and the `OPERation` registers to zero. The command does not alter the mask and transition parts of the registers. It clears the output buffer.

Usage: Setting only

***ESE <Value>**

Event Status Enable

Sets the event status enable register to the specified value. The query returns the contents of the event status enable register in decimal form.

Parameters:

<Value> Range: 0 to 255

***ESR?**

Event Status Read

Returns the contents of the event status register in decimal form and subsequently sets the register to zero.

Return values:

<Contents> Range: 0 to 255

Usage: Query only

***IDN?**

IDeNtification: returns the instrument identification.

Return values:

<ID> "Rohde&Schwarz,<device type>,<serial number>,<firmware version>"

Example: Rohde&Schwarz,ZVA8-4Port,12345,0.10.1.23

Usage: Query only

***IST?**

Individual SStatus query

Returns the contents of the IST flag in decimal form. The IST flag is the status bit which is sent during a parallel poll.

Return values:

<ISTflag> 0 | 1

Usage: Query only

***OPC**

Operation Complete

Sets bit 0 in the event status register when all preceding commands have been executed. This bit can be used to initiate a service request. The query form writes a "1" into the output buffer as soon as all preceding commands have been executed. This is used for command synchronization.

***OPT?**

OPTion identification query

Queries the options included in the instrument. For a list of all available options and their description refer to the CD-ROM.

Return values:

<Options> The query returns a list of options. The options are returned at fixed positions in a comma-separated string. A zero is returned for options that are not installed.

Usage: Query only

***PCB <Address>**

Pass Control Back

Indicates the controller address to which remote control is returned after termination of the triggered action.

Setting parameters:

<Address> Range: 0 to 30

Usage: Setting only

***PRE <Value>**

Parallel poll Register Enable

Sets parallel poll enable register to the indicated value. The query returns the contents of the parallel poll enable register in decimal form.

Parameters:

<Value> Range: 0 to 255

***PSC <Action>**

Power on Status Clear

Determines whether the contents of the `ENABLE` registers are preserved or reset when the instrument is switched on. Thus a service request can be triggered when the instrument is switched on, if the status registers ESE and SRE are suitably configured. The query reads out the contents of the "power-on-status-clear" flag.

Parameters:

<Action>	0 1
0	The contents of the status registers are preserved.
1	Resets the status registers.

***RCL** <Number>

ReCaLI calls up the instrument settings from an intermediate memory identified by the specified number. The instrument settings can be stored to this memory using the command ***SAV** with the associated number.

It also activates the instrument settings which are stored in a file and loaded using the `MMEMory:LOAD <number>, <file_name.extension>` command.

***RST**

ReSeT

Sets the instrument to a defined default status. The default settings are indicated in the description of commands.

The command is equivalent to `SYSTem:PRESet`.

Usage: Setting only

***SAV** <Number>

SAVe stores the current instrument settings under the specified number in an intermediate memory. The settings can be recalled using the command ***RCL** with the associated number.

To transfer the stored instrument settings in a file, use the command `:MMEMory:STORe:STATe`.

***SRE** <Contents>

Service Request Enable

Sets the service request enable register to the indicated value. This command determines under which conditions a service request is triggered.

Parameters:

<Contents>	Contents of the service request enable register in decimal form. Bit 6 (MSS mask bit) is always 0. Range: 0 to 255
------------	--

***STB?**

STatus Byte query

Reads the contents of the status byte in decimal form.

Usage: Query only

***TRG**

TRiGger

Triggers all actions waiting for a trigger event. In particular, *TRG generates a manual trigger signal (Manual Trigger). This common command complements the commands of the TRIGger subsystem.

Usage: Event

***TST?**

self TeST query

Triggers selftests of the instrument and returns an error code in decimal form (see Service Manual supplied with the instrument). "0" indicates no errors occurred.

Usage: Query only

***WAI**

WAIt to continue

Prevents servicing of the subsequent commands until all preceding commands have been executed and all signals have settled (see also command synchronization and *OPC).

Usage: Event

6.2 Preset Commands

The preset commands are not bundled in one subsystem. Therefore, they are listed separately in this section. In addition, a specific preset command is provided for each digital standard and for the fader. These specific commands are described in the associated subsystems.

Four presetting actions are available:

- Activating the default state of all internal instrument functions (*RST on page 500). Functions that concern the integration of the instrument into a measurement setup are not changed, e.g. GPIB address or reference oscillator source settings.
- Activating the preset state of the parameters related to the selected signal path (: SOURce<hw> : PRESet on page 502)

- Activating the preset state of all parameters that are not related to the signal path ([:DEVIce:PRESet](#) on page 502)
- Activating the original state of delivery (factory reset, [:SYSTem:FPreSet](#) on page 502). Only functions that are protected by a password remain unchanged as well as the passwords themselves.

:DEVIce:PRESet

The command presets all parameters which are not related to the signal path. This includes presetting the LF generator and bit/block error measurement.

Example: `DEV:PRESet`
presets all instruments settings that are not related to the signal path

Usage: Event

:SOURce<hw>:PRESet

The command presets all parameters which are related to the selected signal path.

Fading (if available) and transient recorder are only preset by command `*RST`.

Example: `SOUR:PRESet`
presets all settings that are related to signal path

SYSTem:PRESet

The command triggers an instrument reset. It has the same effect as:

- the PRESET key on the front panel
- the `*RST` command

For an overview of the settings affected by the preset function, see [chapter 4.2.2, "Default Instrument Settings - Preset Key"](#), on page 124.

Example: `SYST:PRESet`
All instrument settings (also those that are not currently active) are reset to their default values.

Usage: Setting only

:SYSTem:FPreSet

The command triggers an instrument reset to the original state of delivery.

Note: Since Factory Preset resets the Remote Channel and network settings to the default values, executing Factory Preset via remote control terminates the connection to the instrument, if these settings had been configured to values different to the default ones!

The factory preset function resets nearly all instrument settings. In addition to the regular preset by means of the PRESET key, a "Factory Preset" resets also the following values:

- Reference frequency settings ("Ref Oscillator" menu)
- Power on settings ("Level/EMF" menu)
- Network settings including hostname ("Setup" menu)
- Remote Channel settings including GPIB address ("Setup" menu)
- Start/Stop Gui Update ("Setup" menu)
- Display and keyboard settings ("Setup" menu).

To maintain security, password settings and all settings protected by these passwords like disabled USB and LAN connections are not changed.

Not affected by the "Factory Preset" are also user data, lists or instrument settings files, created for example by means of the Save/Recall function.

Example: `SYST:FPR`
all instrument settings (also those that are not currently active) are reset to the factory values.

Usage: Event

6.3 R&S Signal Generator Waveform and List Format

The R&S SMU uses a tag-oriented format for externally or internally generated waveforms as well as for data and control lists. The data can be transmitted via the GPIB interface from an external computer to the instrument and vice versa. For these purposes the file is transmitted as a binary data block, using SCPI command `[:SOURce<hw>] : BB:ARB:WAVEform:DATA`.



A waveform version number is not necessary due to the flexible, tag-based form.

Tags are self-contained information units. Their general format is `{Name: Data}` or `{Name-Length: Data}`. The colon separates the name part and the data part. The colon can be followed by a space for the sake of legibility.

The **Name** identifies the tag. It is always expressed in capital letters.

The **Data** is tag-specific, and in most cases it is in ASCII plain text.

The **Length** specifies the number of bytes in a `WAVEFORM` tag or `DATA LIST` tag (from `:` to `}`, ASCII integer).

Each waveform file must begin with the `TYPE` tag. The sequence of the remaining tags is arbitrary. For each tag an indication shows whether it must be included in the file concerned (mandatory) or may be included (optional).

Unknown tags are not analyzed by the R&S SMU. On the other hand they are left unchanged, are saved without an error message and can be read back again.

R&S AMIQ waveforms can also be loaded on the instrument, where they are converted internally into an R&S SMU waveform.

6.3.1 Tag Description

This section first describe the mandatory `TYPE` tag which identifies the file and is always located at the start of the file. The rest of the tags used in the R&S SMU are then described in alphabetical order. Most tags are valid for all three file types. If a tag is valid only for a single file type, e.g. only for a waveform, this fact is indicated in the description.

{TYPE: magic, xxxxxxxx}.....	504
{CLOCK: frequency}.....	505
{COMMENT: string}	506
{COPYRIGHT: string}.....	506
{DATA BITLENGTH: BitLength}.....	506
{DATA LIST-Length: #d0d1...dx...dN-1...}.....	507
{DATE: yyyy-mm-dd;hh:mm:ss}.....	507
{CONTROL LENGTH: ControlLength}.....	507
{LEVEL OFFS: RMSOffset_dB,PeakOffset_dB}	507
{SAMPLES: Samples}.....	508
{[TRACE] LIST [#]: Pos0:Val0;Pos1:Val1;...Posx:Valx;...PosN-1:ValN-1}.....	509
{WAVEFORM-Length: #I0Q0I1Q1...IxQx...IN-1QN-1...}.....	509
{MWV_SEGMENT_COUNT: NumOfSeg}.....	511
{MWV_SEGMENT_LENGTH: SamplesSeg0, SamplesSeg1, ..., SamplesSegN-1}.....	511
{MWV_SEGMENT_START: SampleStartOffsetSeg0, SampleStartOffsetSeg1, ..., SampleStartOffsetSegN-1}	512
{MWV_SEGMENT_CLOCK_MODE: Mode}.....	512
{MWV_SEGMENT_CLOCK: ClockSeg0, ClockSeg1, ..., ClockSegN-1}.....	513
{MWV_SEGMENT_LEVEL_OFFS: RMSOffset_dBSeg0, PeakOffset_dBSeg0, ...,RMSOffset_dBSegN-1, PeakOffset_dBSegN-1}	514
{MWV_SEGMENT_FILES: "FileNameSeg0.wv", "FileNameSeg1.wv", ..., "FileNameSegN-1.wv"}.....	514
{MWV_SEGMENTx_COMMENT: text}.....	514
{CONTROL LIST WIDTH4-Length: #m0m1...mx...mM-1}.....	514

{TYPE: magic, xxxxxxxx}

(mandatory, must be the first tag in the file)

The `TYPE` tag identifies the file as a valid R&S SMU file. It must be present and must be the first in the waveform. If a file of the same name already exists on the target medium, it is overwritten.

Tip: R&S AMIQ waveforms can also be loaded on the instrument, where they are converted internally into an R&S SMU waveform.

Setting parameters:

magic	Designates the file type and has the following values: SMU-WV The file contains a valid R&S SMU waveform. SMU-MWV The file contains a valid R&S SMU multi segment waveform. SMU-DL The file contains a valid R&S SMU data list. SMU-CL The file contains a valid R&S SMU control list.
xxxxxxx	Is an ASCII-coded checksum of the data part of the <code>WAVEFORM</code> tag in the file. This value is always 0 for data lists and control lists. The checksum for waveforms is used for detecting transmission errors. If the <code>TYPE</code> tag contains 0 or a non-numeric value for the checksum, it is ignored. It is calculated in accordance with the algorithm given bellow, where 'start' is a pointer to the first byte after the '#' character in the <code>WAVEFORM</code> tag and 'length' is the number of bytes between 'start' and the closing curly bracket (excluding the latter; 'length' must be divisible by 4 without a remainder): <pre>UINT32 checksum(void *start, UINT32 length) { UINT32 i, result = 0xA50F74FF; for(i=0; i < length/4; i++) result = result ^ ((UINT32 *)start)[i]; return(result); }</pre>
Example:	<pre>{TYPE: SMU-WV,106656} BB:ARB:WAV:TAG? 'TYPE'</pre> queries the content of the <code>TYPE</code> tag. Response: 'SMU-WV,106656' this is a valid waveform.

{CLOCK: frequency}**(mandatory for waveforms)**

The tag specifies the clock frequency at which the waveform has to be output, in Hz (on multi segment waveforms this tag contains the maximal clock of all segments).

A query of `ARB:CLOCK?` after loading the waveform returns the value set using the `CLOCK` tag. This value can subsequently be altered with the aid of the `ARB:CLOCK?` command.

Example:	<pre>{CLOCK: 54000000} BB:ARB:WAV:TAG? 'CLOCK'</pre> queries the content of the <code>CLOCK</code> tag. Response: 54000000 the clock frequency is set to 54 MHz.
-----------------	--

Usage: Setting only

{COMMENT: string}

The tag contains a plain text ASCII string of arbitrary length. The string is not analyzed in the R&S SMU. It is used to describe the file. The string is allowed to contain all printable ASCII characters except the closing curly bracket.

Example: `{COMMENT: File with data for 3GPP enhanced channels}`
`BB:ARB:WAV:TAG? 'COMMENT'`
 queries the content of the `COMMENT` tag of the selected waveform file.
 Response: `'File with data for 3GPP enhanced channels'`
 the comment on the waveform reads "File with data for 3GPP enhanced channels".

Usage: Setting only

{COPYRIGHT: string}

The tag contains an ASCII string of arbitrary length. The string is not analyzed in the R&S SMU. It is used to store copyright information about the file content.

Example: `{COPYRIGHT: Rohde&Schwarz}`
`BB:ARB:WAV:TAG? 'COPYRIGHT'`
 queries the content of the `COPYRIGHT` tag of the selected waveform file.
 Response: `'Rohde&Schwarz'`
 copyright resides with Rohde&Schwarz.

Usage: Setting only

{DATA BITLENGTH: BitLength}

(mandatory for data lists)

The tag contains the length of the data held in the `DATA LIST` tag in bits in ASCII format.

Example: `{DATA BITLENGTH: 444}`
`BB:DM:DLIS:TAG? 'DATA BITLENGTH'`
 queries the content of the `DATA BITLENGTH` tag of the selected data list file.
 Response: `'444'`
 the data list is 444 bits long.

Usage: Setting only

{DATA LIST-Length: #d0d1...dx...dN-1...}**(mandatory for data lists)**

The tag contains the actual bit sequence of the data list in binary format.

Setting parameters:

Length Defines the number of bytes in the `DATA LIST` tag in ASCII Format (for format see `WAVEFORM` length).

dx Data bits in binary format (8-bit unsigned characters, MSB first).

Example: `DATA LIST-17: #d0d1...dx...d127}`
16 bytes containing 128 data bits, first bit is the MS bit of the first byte.

Usage: Setting only

{DATE: yyyy-mm-dd;hh:mm:ss}**(optional)**

The tag contains the date and time at which the file was created. The year must be expressed as four digits. The instrument does not analyze this tag.

Example: `{DATE: 2009-04-02;14:32:12}`
`BB:ARB:WAV:TAG? 'DATE'`
queries the content of the `DATE` tag of the selected waveform file.
`Response: '2009-04-02;14:32:12'`
the waveform was created on April 2, 2009 at 14 hrs 32 min

Usage: Setting only

{CONTROL LENGTH: ControlLength}**(optional / recommended for marker and control lists)**

The tag contains the length of the control list in ASCII format. If this tag is not used, the marker and control list length is determined by the highest position used in one of the `LIST` tags. It is recommended to set this value to be equal to the number of samples in order to keep marker signals and wave data synchronized.

Example: `{CONTROL LENGTH: 444}`
`BB:ARB:WAV:TAG? 'CONTROL LENGTH'`
queries the length of the control list.
`Response: '444'`

Usage: Setting only

{LEVEL OFFS: RMSOffset_dB,PeakOffset_dB}**(recommended for waveforms)**

The tag determines the level of the ARB signal in the waveform file. The offset levels define the offset of rms and peak value relative to the 16-bit full scale modulation $(-32767$ to $+ 32767) = 0$ dB.

Setting parameters:

RMSOffset_dB Defines the RMS level offset of the signal relative to full scale ARB signal in the `WAVEFORM` tag. The offset is defined in ASCII float format. The value is always positive.
A 3dB value indicates that the RMS level of the signal is 3 dBs below the full scale.
full scale = max. amplitude of vector of I/Q samples = $|S_{IQ}|_{\max} = \sqrt{I^2+Q^2}_{\max} = 0$ dB

PeakOffset_dB Defines the peak level offset of the signal relative to full scale for the ARB signal in the `WAVEFORM` tag. The offset is defined in ASCII float format.
The value usually equals 0 dB as in the majority of cases the I/Q samples (signed 16-bit integer values) are modulated to full scale:
Full scale = 0 dB = max. amplitude of vector of I/Q samples = $|S_{IQ}|_{\max} = \sqrt{I^2+Q^2}_{\max} = (2^{15})-1 = 32767$.

A positive `PeakOffset_dB` value indicates that a headroom to full scale is provided when generating the waveform. A negative `PeakOffset_dB` value indicates that overrange is likely for some samples, i.e. clipping might occur.

The crest factor can be calculated from the two values as follows:
Crest Factor = $|PeakOffset_dB - RMSOffset_dB|$

Example: `{LEVEL OFFS: 3.45,2}`
`BB:ARB:WAV:TAG? 'LEVEL OFFS'`
queries the content of the 'LEVEL OFFS' tag of the selected waveform file.

Response: `'3.45,2'`
the level of the waveform is below full scale, clipping will not occur.

Usage: Setting only

{SAMPLES: Samples}

(recommended for waveforms)

The tag contains the number of I/Q samples in the waveform in ASCII format.

On multi segment waveforms, this tag contains the total I/Q samples of all segments.

Example: `{SAMPLES: 4333}`
`BB:ARB:WAV:TAG? 'SAMPLES'`
queries the content of the `SAMPLES` tag of the selected waveform file.

Response: `'4333'`
the waveform contains 4333 I/Q samples.

Usage: Setting only

{[TRACE] LIST [#]: Pos0:Val0;Pos1:Val1;...Posx:Valx;...PosN-1:ValN-1}

(mandatory for control lists / optional for waveforms)

The tag contains the data for the marker and control signals in the control list or the marker signals of ARB waveforms. To select which of these signals is defined, [TRACE] and the associated number are used. For ARB waveforms it is only meaningful to define marker signals (on ARB multi segment waveforms these tags will be ignored).

Setting parameters:

[TRACE]	Specifies the name of the marker or control signal. You may choose from the following names: MARKER; BURST; LEVATT; CW MODE; HOP, MAP
[#]	Specifies the number in the case of control signals and marker signals with the same name. There is a choice between 4 markers and 3 LEVATT signals. Lines LEVATT 1 and 2 are needed for internal purposes and should not be used.
Pos	Specifies in ASCII format the number of the position in the sequence, with effect from which the binary state of the marker or of the control signal changes from 0 to 1 or from 1 to 0.
Val	Specifies the binary state of the marker or of the control signal {0; 1} from Pos _x to Pos _{x+1} exclusive in ASCII format.

Example:

```
{MARKER LIST 1: 0:0;10:1;20:0;30:1}
BB:DM:CLIS:TAG? 'MARKER LIST 1'
```

queries the content of the MARKER LIST 1 tag of the selected control list file.

Response: '0:0;10:1;20:0;30:1'

the marker setting for samples 0 to 9 = 0 (low), for 10 to 19 = 1 (high) and for 20 to 29 = 0. From sample 30 onward the marker setting = 1.

Example:

```
{LEVATT LIST 1: 0:0;10:1;20:0;30:1}
BB:DM:CLIS:TAG? 'LEVATT LIST 1'
```

queries the content of the LEVATT LIST 1 tag of the selected control list file.

Response: '0:0;10:1;20:0;30:1'

level attenuation applies to data values 10 to 19 (high) and from data value 30 onward.

Usage: Setting only

{WAVEFORM-Length: #I0Q0I1Q1...IxQx...IN-1QN-1...}

(mandatory for waveforms)

The tag contains the actual waveform data or multi segment waveform data (I/Q stream).

The TYPE tag decides, whether the waveform file contains a normal waveform or a multi segment waveform.

The following figure shows the principle of multi segment work mode.

ARB Multi Segment

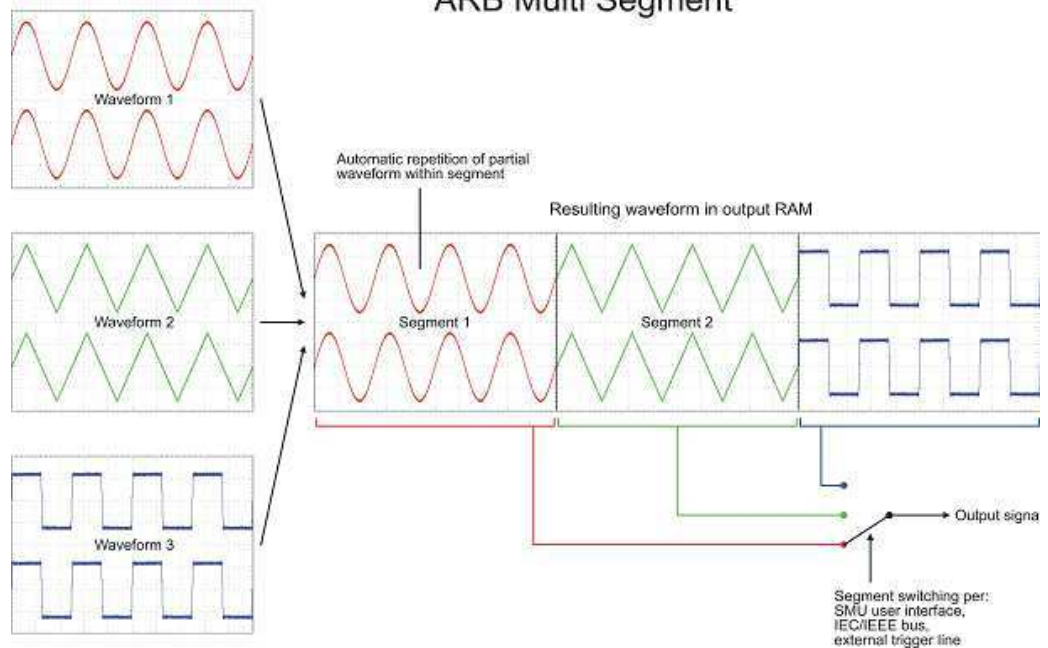

At 50 Ohm between the inner and outer conductors of the I and Q outputs, an amplitude V_p of ± 0.5 Volt arises on the I/Q output connectors of the R&S SMU. The illustration also applies to the Q output.

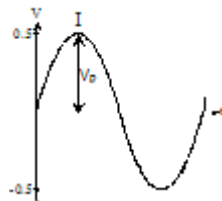
**Setting parameters:**

Length

Specifies the number of bytes in a WAVEFORM tag and is calculated as follow:

Length = Number of I/Q pairs * 4 (i.e. 2 bytes per I and 2 bytes per Q value) + 1 byte (i.e. the length of the #).

- I Q** $I \times Q \times \dots$ represents binary data (16-bit signed integer in 2's complement notation) containing the I and Q component alternately and starting with the I component. Each component consists of two bytes, least significant byte (LSB) first.
The values of the two bytes in an I component and a Q component are in the range 0x0 to 0xFFFF (-32767 to +32767). This value is transferred to the D/A converter.
This tag is also used to store multi segment waveforms. The I/Q streams of the individual waveforms are directly concatenated to one collectively waveform I/Q stream.
The number of segments and the start offset and length of the individual segments inside the total waveform I/Q stream is determined by the additional tags [MWV_SEGMENT_COUNT](#), [MWV_SEGMENT_START](#) and [MWV_SEGMENT_LENGTH](#).
Further [MWV_SEGMENT_...](#) tags are also available, i.e. for level and clock information etc.
- Example:** {WAVEFORM-401:#I₀,Q₀,I₁,Q₁,I₂,Q₂,...I₉₉,Q₉₉}
100 I/Q pairs with 4 bytes each are transmitted - none multi segment
- Example:** **Multi Segment**
{WAVEFORM-1201:
#I_{0,Seg0},Q_{0,Seg0},I_{1,Seg0},Q_{1,Seg0},...I_{99,Seg0},Q_{99,Seg0},I_{0,Seg1},Q_{0,Seg1},I_{1,Seg1},
Q_{1,Seg1},... I_{199,Seg1},Q_{199,Seg1}}
(2 segments: segment 0 with 100 I/Q pairs, segment 1 with 200 I/Q pairs. Each I/Q pair consist of 2*16 bit = 4 bytes)
The data is transmitted using SCPI command
BB:ARB:WAVE:DATA.
- Usage:** Setting only

{MWV_SEGMENT_COUNT: NumOfSeg}**(mandatory for multi segment waveforms)**

The tag contains the number of segments in the multi segment waveform in ASCII integer format.

Example: {MWV_SEGMENT_COUNT: 2}
Multi segment waveform with 2 segments

Usage: Setting only

{MWV_SEGMENT_LENGTH: SamplesSeg0, SamplesSeg1, ..., SamplesSegN-1}**(mandatory for multi segment waveforms)**

The tag contains a list of I/Q sample lengths for every segment in the multi segment waveform in ASCII integer format.

Example: {MWV_SEGMENT_LENGTH: 100,200}
 2 segments: 100 samples in segment 0 and 200 samples in segment 1.

Usage: Setting only

**{MWV_SEGMENT_START:
 SampleStartOffsetSeg0, SampleStartOffsetSeg1, ..., SampleStartOffsetSegN-1}**

(mandatory for multi segment waveforms)

The tag contains a list of I/Q sample start offsets for every segment in the multi segment waveform in ASCII integer format.

Example: {MWV_SEGMENT_START: 0,100}
 2 segments with 100 samples in segment 0 and 200 samples in segment 1.
 Sample start offset of first segment 0 is 0 samples, start offset of next segment 1 is the sample length of segment 0 = 100 samples.

Usage: Setting only

{MWV_SEGMENT_CLOCK_MODE: Mode}

(mandatory for multi segment waveforms)

The tag contains a string in ASCII format which supplies the clock rate mode, that was used for calculation of the multi segment output waveform.

The tag `CLOCK` contains always the highest clock rate of all segments.

The tag `MWV_SEGMENT_CLOCK` contains the clock rates of the individual segments.

Setting parameters:

Mode

UNCHANGED

The segments may have different clock rates.

During the multi segment calculation, the clock rates of all individual original waveforms were taken over unchanged in the segments of the multi segment output waveform (no software resampling is done).

If the segments have different clock rates, there are some restrictions on signal output, i.e. switching per external trigger and seamless switching between segments is not possible.

If all segments have already an identical clock rate, this mode is usually set to `HIGHEST`.

HIGHEST

All segments have an identical clock rate, which is the highest clock rate of all original waveforms.

If an individual original waveform has a lower clock rate, an upsampling to the highest clock rate will be performed on calculation of the multi segment output waveform.

USER

All segments have an identical clock rate, which is given by the user.

Note: Only upsampling is allowed, no downsampling!

If an individual original waveform has a lower clock rate, an upsampling to the user clock rate will be performed on calculation of the multi segment output waveform.

Example:

```
{MWV_SEGMENT_CLOCK_MODE: UNCHANGED}
{MWV_SEGMENT_CLOCK_MODE: HIGHEST}
{MWV_SEGMENT_CLOCK_MODE: USER}
```

Usage:

Setting only

{MWV_SEGMENT_CLOCK: ClockSeg0, ClockSeg1, ..., ClockSegN-1}

(mandatory for multi segment waveforms)

The tag contains a list of clock frequencies for every segment in the multi segment waveform in ASCII floating point format.

Example:

```
{MWV_SEGMENT_CLOCK: 100e6,80e6}
```

2 segments: clock of segment 0 is 100 MHz, clock of segment 1 is 80 MHz.

Note: If the segments have different clock frequencies, there are some restrictions on signal output, i.e. seamless switching between segments is only possible, if all segments have the same clock frequency. Software resampling (upsampling) can be used to bring all segments to the same clock.

Usage:

Setting only

{MWV_SEGMENT_LEVEL_OFFS:**RMSOffset_dBSeg0, PeakOffset_dBSeg0, ..., RMSOffset_dBSegN-1, PeakOffset_dBSegN-****(mandatory for multi segment waveforms)**

The tag contains a list of level pairs in ASCII floating point format, one pair for every segment in the multi segment waveform. The first value of a level pair defines the rms offset and the second value the peak offset relative to the 16-bit full scale modulation (-32767; + 32767) = 0 dB. The meaning of one level value pair is the same as in the [LEVEL OFFS](#) tag for normal waveforms.

Example: `{MWV_SEGMENT_LEVEL_OFFS: 3.0,0.0,6.0,0.0}`
 2 segments: RMS level of segment 0 is 3dB below full scale; RMS level of segment 1 ist 6dB below full scale. Peak level of both segments is 0 dB full scale.

Usage: Setting only

{MWV_SEGMENT_FILES:**"FileNameSeg0.wv", "FileNameSeg1.wv", ..., "FileNameSegN-1.wv"}****(optional for multi segment waveforms)**

The tag contains a list of file names for every segment in the multi segment waveform in ASCII format.

Example: `{MWV_SEGMENT_FILES: "d:\waveforms\sine.wv", "d:\waveforms\rect.wv"}`

Usage: Setting only

{MWV_SEGMENTx_COMMENT: text}**(optional for multi segment waveforms)**

The tag contains a user comment for a specific segment $x = [0 \dots \text{NumOfSeg}-1]$ in the multi segment waveform in ASCII format.

Example: `{MWV_SEGMENT1_FILES: segment 1 contains a QPSK signal.}`

Usage: Setting only

{CONTROL LIST WIDTH4–Length: #m0m1...mx...mM-1}**(optional for waveforms and multi segment waveforms)**

The tag contains a binary marker element stream, which will be given out synchronously to the I/Q sample sequence. One marker element m_x consists of 4 bit, which are assigned to the 4 possible marker lines of the instrument (one bit per marker line). One 4 bit marker elements is needed for every I/Q sample in the `WAVEFORM` tag - so the number of marker elements M should be equal to the number of I/Q samples. The `CONTROL LENGTH` tag has to contain the number of all marker elements M .

MSB 7	Byte						LSB 1
Marker element m_x (synchronous to I/Q Sample x)				Marker element m_{x+1} (synchronous to I/Q Sample $x+1$)			
Marker 4	Marker 3	Marker 2	Marker 1	Marker 4	Marker 3	Marker 2	Marker 1

Fig. 6-1: Marker element in 4-bit binary format bit order

For standard waveforms the `MARKER LIST x` tags are a more compact way to define markers, but in principle this `CONTROL LIST WIDTH4` format can also be used instead of the `MARKER LIST x` tags.

For multi segment waveforms this `CONTROL LIST WIDTH4` format is required for marker definition. The binary marker streams of the individual segments are directly concatenated (without any gap) to one collectively marker stream.

Setting parameters:

Length Defines the number of bytes in the `CONTROL LIST WIDTH4` tag in ASCII Format and is calculated as follow:

$$\text{Length} = \text{Size of "\#"} (1 \text{ byte}) + \text{Number of marker elements } m_x * (4 \text{ bit}) / (8 \text{ bits/byte})$$
The value is rounded up for byte alignment.

m_x Marker element in 4-bit binary format.

Example: `{CONTROL LIST WIDTH4-51: #m0m1...mx...m99}`
100 marker elements, each marker element with 4 bits

Usage: Setting only

6.3.2 Creating a Waveform Manually

We will use the example of a sine function in the I channel and a cosine function in the Q channel, each with 20 points, to explain how a waveform file `SICO.WV` is generated.

The sine and cosine values are calculated by a short program written in the programming language C (see the following example for creating a C-program). They are stored in the file `SICO.TXT` as follows:

Contents of `SICO.TXT`:
Sine (I) Cosine (Q)

```
0.000000 1.000000
0.309017 0.951057
0.587785 0.809017
0.809017 0.587785
0.951057 0.309017
1.000000 -0.000000
0.951056 -0.309017
0.809017 -0.587785
0.587785 -0.809017
```

```

0.309017 -0.951056
-0.000000 -1.000000
-0.309017 -0.951057
-0.587785 -0.809017
-0.809017 -0.587785
-0.951056 -0.309017
-1.000000 0.000000
-0.951056 0.309017
-0.809017 0.587785
-0.587785 0.809017
-0.309017 0.951057

```

The decimal values in `SICO.TXT` should be normalized such that they are between -1.0 and $+1.0$. The waveform file `SICO.WV` will be based on the contents of this file.

To be read by the R&S SMU these waveform data must be coded binary and packed into an appropriate `WAVEFORM` tag. A tag consists of a name and a data set and is enclosed in curved brackets. The tag is a kind of label carrying information about what the R&S SMU should do with the data set (see above and step 3 of the following instructions).

The following steps outline how to create the waveform file `SICO.WV`:

1. The values from the file `SICO.TXT` must be converted into binary format consisting of integer numbers without a sign and with 16-bit width. The numeric range between -1.0 and $+1.0$ corresponds to the modulation range of the waveform D/A converter of 65535 ($2^{16}-1$).

+1.0 ->	32767	= 0x7FFF
0.0 ->	0	= 0x0000
-1.0 ->	-32767	= 0x8001

A further C-program is suitable for creating the binary data set from the ASCII values stored in `SICO.TXT` file (see following example for creating a C-program). This program stores the binary data set to a file called `SICO.WV`.

The contents of the file `SICO.WV` reads as follows:

```
IQIQIQIQIQIQIQI ... IQ
```

Note: There is no readable representation for binary values in this document. This is why we use the sequence `IQIQIQ` to characterize the binary code in the present example.

2. The file `SICO.WV` now contains the binary data set corresponding to the 20 I/Q pairs. Before this binary data set can be further processed in step 3, the `TYPE` and the `CLOCK` tag must be placed in front.

To enter the `TYPE` tag in the `SICO.WV` file an ASCII editor which is able to handle binary data as well, e.g. the Microsoft Windows editor `NOTEPAD.EXE`, must be used.

Now the contents of the `SICO.WV` file read:

```
{TYPE: SMU-WV, 0}{CLOCK: 10e6} IQIQIQIQIQIQIQIQIQIQIQI ... IQ
```

To simplify our example the checksum is set to 0, i.e. the instrument does not evaluate a checksum.

- The binary data must now be packed into a **WAVEFORM** tag with the following structure:

```
{WAVEFORM-Length: #IQIQIQIQIQIQIQIQIQI ... IQ}
```

The editor mentioned above which can handle binary data is now used to place the string {WAVEFORM-81: # in front and the symbol } at the end of the data set.

The **Length** of the data set is the number of bytes of the data set and is calculated as the sum of the number of I/Q pairs * 4 (2 bytes per I and per Q value) and one 1 byte for the symbol #.

In our example containing a sine and a cosine with 20 pairs for each wave, the resulting length is 81.

Note: There is no readable representation for binary values in this document. This is why we use the sequence `IQIQIQ` to characterize the binary code in the present example!

The contents of the waveform file `SICO.WV` for 20 I/Q pairs is now ready for operation and reads.

```
{TYPE: SMU-WV,0}
{CLOCK: 10e6}
{WAVEFORM-81: #IQIQIQIQIQIQ ... IQ}
```

The tags `TYPE`, `CLOCK` and `WAVEFORM` are mandatory for each waveform. All other tags are optional and can be inserted after the `TYPE` tag in arbitrary order, e.g.

```
{TYPE: SMU-WV,0}
{COMMENT: I/Q=sine/cosine, 20 points, clock 10 MHz}
{CLOCK: 10e6}
{Samples:20}
{WAVEFORM-81:#IQIQIQIQIQIQ ... IQ}
```

C-programs for creating the `SICO.TXT` file and for generating the waveform file

C-program for creating the file `SICO.TXT` containing 20 sine and cosine pairs:

```
#include <stdlib.h>
#include <stdio.h>
#include <math.h>
void main(void)
{
    const unsigned int samples = 20;
    const float pi = 3.141592654;
    float grad, rad;
    FILE *fp;
    int i;
    fp = fopen("SICO.TXT", "w");
    if (fp == 0)
        return;
    for (i=0; i<samples; i++)
    {
        grad = (360.0 / (float)samples) * (float)i;
```

```

        rad = grad * (pi / 180.0);
        fprintf(fp, "%f %f\n", sin(rad), cos(rad));
    }
    fclose(fp);
}

```

Extract from a C-program generating a binary data set from the I/Q pairs in the file SICO.TXT and storing the result to file SICO.WV:

```

#include <stdlib.h>
#include <stdio.h>
#include <math.h>
void main(void)
{
    const unsigned int samples = 20; // Number of samples to convert
    FILE *fp_sour, *fp_dest;
    float i_float, q_float;
    unsigned short i_usint, q_usint;
    int i;
    fp_sour = fopen("SICO.TXT", "rt");
    if (fp_sour == 0)
        return;
    fp_dest = fopen("SICO.WV", "wb");
    if (fp_dest == 0)
    {
        fclose(fp_sour);
        return;
    }
    // Write required tags to waveform file
    fprintf(fp_dest, "{TYPE: SMU-WV,0}");
    fprintf(fp_dest, "{CLOCK: 10e6}");
    fprintf(fp_dest, "{SAMPLES: %d}", samples);
    fprintf(fp_dest, "{WAVEFORM-%d:#", (samples * 4) + 1);
    for (i=0; i<samples; i++)
    {
        // Read I/Q pair from ASCII file
        if (fscanf(fp_sour, "%f %f", &i_float, &q_float) == EOF)
            break;
        // Convert I/Q pair to unsigned short
        i_usint = (unsigned short)floor((i_float * 32767.0) + 0.5);
        q_usint = (unsigned short)floor((q_float * 32767.0) + 0.5);
        // Write converted I/Q pair to waveform file
        fwrite(&i_usint, 2, 1, fp_dest);
        fwrite(&q_usint, 2, 1, fp_dest);
    }
    fprintf(fp_dest, "}");
    fclose(fp_dest);
    fclose(fp_sour);
}

```

6.3.3 Creating an ASCII C-List Manually

When you create the C-list in the editor, as shown in the figure, you get an ASCII file with the extension *.dm_iqc (see the example [C-List ASCII File](#)).

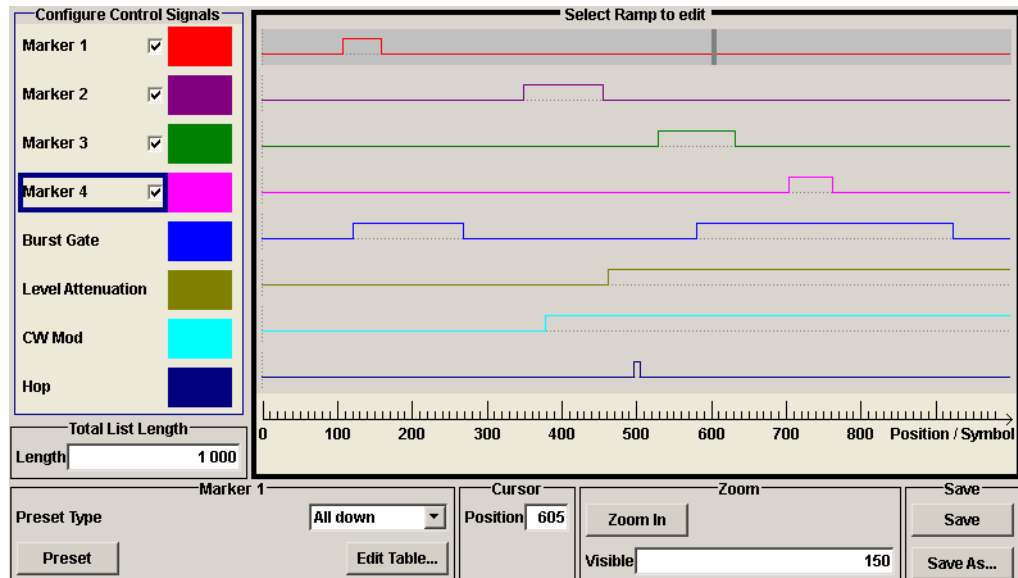

Fig. 6-2: Representation in the C-List Editor

Example: C-List ASCII File

C-List in ASCII format, corresponding to C-List editor [figure 6-2](#):

```
{TYPE:SMU-CL}{COPYRIGHT:2003 Rohde&Schwarz SMU}{DATE:2011-07-19;14:58:44}
{HOP LIST:0:0;498:1;506:0}{CW MODE LIST:0:0;380:1}{LEVATT LIST 1:0:0;464:1}
{BURST LIST:0:0;122:1;270:0;582:1;924:0}
{MARKER LIST 4:0:0;706:1;764:0}{MARKER LIST 3:0:0;530:1;633:0}
{MARKER LIST 2:0:0;350:1;457:0}{MARKER LIST 1:0:0;108:1;160:0}
{CONTROL LENGTH:1000}
```

The tags to the traces in the C-List editor are:

- HOP LIST
- CW MODE LIST
- LEVATT LIST 1
- BURST LIST
- MARKER LIST 4
- MARKER LIST 3
- MARKER LIST 2
- MARKER LIST 1
- CONTROL LENGTH

CONTROL LENGTH defines the periodicity of the total C-List. The remaining tags define the individual markers or control traces in a combined state/starting time way within the C-List period.

If you want to write an ASCII C-List directly without using the C-List editor, a special syntax has to be taken into account:

- The tag and the following [state: start time]-pairs are separated by a colon ":".
- The [state: start time] pairs in turn are separated by semicolons ";".
- The list state can be either 0 or 1.
- The time unit is the simple period.

Example:

"CW MODE LIST 0:0;380:1" for a CW trace:

The list status starts at time 0 with 0, and at time point 380 symbol periods after start, it changes to 1.



With the commands `BB:DM:CLIST:...` you can also generate control lists in binary format, if required. See "[DM Lists](#)" on page 653.

6.4 BERT and BLER Subsystems

These subsystems contain the commands for the bit and block error rate measurement. Since the commands for these two subsystems are essentially identical, they are summarized in the following section.

<code>:BLER:RESult</code>	521
<code>:BERT:RESult</code>	521
<code>:BLER:SEQuence</code>	522
<code>:BERT:SEQuence</code>	522
<code>:BLER:SETup:CLOCK[:POLarity]</code>	523
<code>:BERT:SETup:CLOCK[:POLarity]</code>	523
<code>:BLER:SETup:CORDer</code>	523
<code>:BLER:SETup:DATA[:POLarity]</code>	524
<code>:BERT:SETup:DATA[:POLarity]</code>	524
<code>:BLER:SETup:DENable</code>	524
<code>:BERT:SETup:DENable</code>	524
<code>:BERT:SETup:IGNore</code>	525
<code>:BLER:SETup:MCOunt</code>	526
<code>:BERT:SETup:MCOunt</code>	526
<code>:BLER:SETup:MERRor</code>	526
<code>:BERT:SETup:MERRor</code>	526
<code>:BERT:SETup:REStart:STATe</code>	526
<code>:BERT:SETup:TYPE</code>	527
<code>:BLER:SETup:TYPE</code>	527
<code>:BLER:STARt</code>	528
<code>:BERT:STARt</code>	528
<code>:BLER:STATe</code>	528
<code>:BERT:STATe</code>	528
<code>:BLER:STOP</code>	528
<code>:BERT:STOP</code>	528

:BLER:UNIT.....	529
:BERT:UNIT.....	529
[:SOURce]:INPut:BERT:IMPedance.....	529
[:SOURce]:INPut:BERT:THReshold.....	529
:TRIGger:BLER[:IMMediate].....	530
:TRIGger:BERT[:IMMediate].....	530

:BLER:RESult?**:BERT:RESult?**

Queries the result of the last BER measurement/BLER measurement. The response consists of seven results separated by commas. In the first measurement following the start, intermediate results for the number of data bits/data blocks, error bits/errors and error rate are also queried. In the following measurements (only for `BERT:SEQ AUTO/` for `BLER:SEQ AUTO`) only the final results of each single measurement are queried

Note: At the end of a measurement, the restart of a new one is delayed until the first measurement result has been queried with `BERT:RES`. The resulting brief measurement interruption is irrelevant because the subsequent measurement will be synchronized within 24 data bits.

Return values:

<Result>

string

<data bits/data blocks>

Number of checked data bits/data blocks

<errors>

Number of error bits/errors

<error rate>

If no termination criterion has been reached since the beginning of the measurement, the current quotient of "Number of error bits/errors" and "Number of data bits/data blocks" is entered. As soon as at least one final result has been reached in continuous measurement, the most recent final result is entered.

<measurement status>

Status of measurement.

1 = Measurement has been terminated, i.e. the number of data bits/data blocks or error bits/errors preset by the commands

`BERT|BLER:SETup:MCOunt` and

`BERT|BLER:SETup:MERRor` has been reached, or the measurement has been stopped by the command `BERT|BLER:STOP`.

0 = Measurement has not been terminated.

<clock detected>

Status of clock line

1 = Clock line active

0 = Clock line not active

<data detected>

Status of data line

1 = Data line active (only clocked data is detected; if the clock signal is missing, a data change is also not detected).

0 = Data line is not active.

<synchronization status>

1 = The measurement is synchronized, i.e. the clock and data lines are active and the "Number of error bits/errors" to "Number of data bits/data blocks" ratio is better than 0.1, so that the measurement ratio can be assumed to be realistic.

0 = The measurement is not synchronized.

Example:`BERT:RES`

queries the results of the bit error rate measurement.

Response: "1000,5,5E-4,1,1,1,1"

The measurement has been terminated, and synchronization has been performed. Out of 1000 data bits, 5 error bits were measured, yielding an error rate of 0.005.

Usage:

Query only

:BLER:SEQuence <Sequence>

:BERT:SEQuence <Sequence>

Selects the type of measurement: single or continuous measurement.

These commands are automatically set to AUTO by `BERT:START` or `BLER:START`.

Parameters:

<Sequence>

AUTO | SINGle

AUTO

Continuous measurement. If one or both termination criteria are met, the measurement in progress is terminated. At the end of a measurement, the restart of a new one is delayed until the first measurement result has been queried with `BERT:RES`. The resulting brief measurement interruption is irrelevant because the subsequent measurement will be synchronized within 24 data bits.

SINGle

Single measurement. A single measurement must be started with `:TRIG:BERT`. A single measurement is terminated once the set number of data bits/blocks or number of errors is reached

*RST: AUTO

Example:`BERT:SEQ SING`

selects single measurement.

Example:`TRIG: BERT`

starts the single measurement.

Options:

Dependencies: These commands are automatically set to AUTO by `BERT:START` or `BLER:START`

:BLER:SETup:CLOCK[:POLarity] <Polarity>**:BERT:SETup:CLOCK[:POLarity]** <Polarity>

Sets the polarity of the active slope of the feedback clock.

Parameters:

<Polarity>

RISing | FALLing

RISing

The positive slope of the clock signal is active.

FALLing

The negative slope of the clock signal is active.

*RST: RISing

Example:`BERT:SET:CLOC FALL`

selects the falling slope of the clock signal as the active slope.

:BLER:SETup:CORDer <COrder>

Sets the byte order of the checksum (CRC).

Parameters:

<COrder> LSB | MSB

LSB

The checksum starts with the least significant byte.

MSB

The checksum starts with the most significant byte.

*RST: LSB

Example:

BLER:SET:CORD MSB

the checksum starts with the most significant byte.

:BLER:SETup:DATA[:POLarity] <Polarity>

:BERT:SETup:DATA[:POLarity] <Polarity>

Sets the polarity of the feedback data bits.

Parameters:

<Polarity> NORMal | INVerted

NORMal

High level stands for a logic 1, low level for a logic 0.

INVerted

Low level stands for a logic 1, high level for a logic 0.

*RST: NORMal

Example:

BERT:SET:DATA INV

sets inversion of data signal.

:BLER:SETup:DENable <DENable>

:BERT:SETup:DENable <DENable>

Activates/deactivates the use of the **Data Enable** signal and the polarity of the signal if it is used. The **Data Enable** signal marks the data that is actually to be evaluated for the BER measurement. Any data in addition to the PRBS sequence is masked and thus not evaluated (e.g. sync, preambles, other channels, etc that are present in the data bits supplied by the DUT).

Parameters:

<DEnable>

OFF | LOW | HIGH

OFF

Any signal at the **Data Enable** input is ignored; all data at the BERT data input is used for the measurement.

HIGH

The **Data Enable** signal is used. The only data measured is the data at the BERT data input during a high level of the **Data Enable** signal. The measurement is interrupted during a low level of the **Data Enable** signal.

LOW

The **Data Enable** signal is used. The only data measured is the data at the BERT data input during a low level of the **Data Enable** signal. The measurement is interrupted during a high level of the **Data Enable** signal.

*RST: OFF

Example:

BERT:SET:DEN HIGH

The measurement is interrupted during the low level of the **Data Enable** input.

:BERT:SETup:IGNore <Ignore>

Activates/deactivates ignoring of pure "0" or "1" bit sequences at least 32 bits long. Activating excludes faulty frames from the measurement. In the case of some mobile radio standards, pure "0" or "1" bit sequences are generated when errors (e.g. an incorrect checksum) are detected within a frame. These sequences, instead of the frame data, are provided for the BER measurement and signal that the frame in question should not be used for the measurement.

Parameters:

<Ignore>

OFF | ZERO | ONE

OFF

Pattern Ignore is not active.

ONE

Bit sequences consisting of 32 or more consecutive "1" data are not used (i.e. ignored) for the BER measurement.

ZERO

Bit sequence consisting of 32 or more consecutive "0" data are not used (i.e. ignored) for the BER measurement.

*RST: 0

Example:

BERT:SET:IGN ONE

specifies that bit sequences of "1" data at least 32 bits long are not used for the measurement.

```
:BLER:SETup:MCOunt <Mcount>
```

```
:BERT:SETup:MCOunt <Mcount>
```

Enters the number of transmitted data bits/data blocks to be checked before the measurement is terminated. With a BER measurement, data that was suppressed by `BERT:SETup:DEnable` is not counted. This termination criterion always terminates the measurement after the specified number of data bits/data blocks. Starting from this point, the fourth value is output with 1 (= terminate measurement) if the result is queried with `:BERT|BLER:RES`. If the continuous measurement mode (`BERT|BLER:SEQ AUTO`) has been selected, the measurement is restarted once the results have been queried.

Parameters:

```
<Mcount>          integer
                   Range:    0 to 4294967295
                   Increment: 1
                   *RST:    1E7
```

Example: `BERT:SET:MCO 1E6`
sets a measurement over 1000000 data bits.

Example: `BLER:SET:MCO 1E3`
sets a measurement over 1000 data blocks.

```
:BLER:SETup:MERRor <Merror>
```

```
:BERT:SETup:MERRor <Merror>
```

Enters the number of errors to occur before the measurement is terminated. This termination criterion always terminates the measurement after the specified number of errors. Starting from this point, the fourth value is output with 1 (= terminate measurement) if the measurement result is queried with `:BERT|BLER:RES`.

Parameters:

```
<Merror>          integer
                   Range:    0 to 4294967295
                   Increment: 1
                   *RST:    100
```

Example: `BERT:SET:MERR 1E4`
sets a measurement over 1000 errors.

```
:BERT:SETup:REStart:STATe <State>
```

Activates/deactivates an external restart of the BER measurement.

Parameters:

<State>

0 | 1 | OFF | ON

OFF

The reset signal for the BER measurement is generated internally. This setting is suitable for PRBS sequences that run continuously and thus ensure uninterrupted repetition.

ON

The reset signal for the BER measurement is fed via the **Restart** input of the BERT interface.

If the PRBS sequence cannot be continued uninterruptedly, the BER measurement must be stopped at the end of the data sequence and subsequently restarted at the beginning of the new data sequence. The measurement is stopped and started via a 0-1-0 slope of the **Restart** signal. A transition from logic 0 to 1 causes a partial result to be generated and the measurement to be stopped. A transition from 1 to 0 starts the measurement for the next subinterval. This measurement is synchronized anew. If the R&S Vector Signal Generator is used as a data source, a signal in which a single 1 was coded at the end of the data sequence can be used as a restart signal at the R&S Vector Signal Generator marker output. This causes the BER measurement to stop briefly at the end of the data sequence and start again.

Partial results (number of data and error bits) are added up until the predefined total number of data or error bits is reached or exceeded.

The measurement is reset by **Pattern Ignore** or **Data Enable**, regardless of its status.

```
*RST:      0
```

Example:

```
BERT:SET:REST:STAT ON
```

The external signal restarts the measurement.

:BERT:SETup:TYPE <Type>

Selects the PRBS sequence. The data generated by the PRBS generator is used as a reference for the measurement.

Parameters:

<Type>

```
PRBS9 | PRBS11 | PRBS15 | PRBS16 | PRBS20 | PRBS21 |
PRBS23 | PN9 | PN11 | PN15 | PN16 | PN20 | PN21 | PN23
```

```
*RST:      PRBS9
```

Example:

```
BERT:SET:TYPE PN15
```

sets a pseudo random binary sequence consisting of 32767 bits.

:BLER:SETup:TYPE?

Queries the CRC polynomial used. CCITT CRC 16 : $G(x) = x^{16} + x^{12} + x^5 + x^1$ is the CRC polynomial supported.

Return values:

<Type> CRC16
 *RST: CRC16

Example:

BLER:SET:TYPE
 queries the type of measurement.

Example:

Response: CRC16

Usage:

Query only

:BLER:START**:BERT:START**

Starts a continuous measurement.

These commands automatically set BERT:SEQ:MODE or BLER:SEQ:MODE to AUTO and BERT:STATE or BLER:STATE to ON.

Example:

BERT:START
 starts a continuous measurement.

Usage:

Event

:BLER:STATE <State>**:BERT:STATE <State>**

Switches the measurement on/off. Depending on the selected mode, either a continuous measurement (BERT|BLER:SEQ:AUTO) or a single measurement (BERT|BLER:SEQ:SING) is carried out. A single measurement must be triggered (:TRIG:BERT|BLER).

These commands are automatically set to ON by BERT:START or BLER:START and to OFF by BERT:STOP or BLER:STOP.

Parameters:

<State> 0 | 1 | OFF | ON
 *RST: 0

Example:

BERT:SEQ:SING
 selects a single measurement.
 BERT:STATE ON
 switches the BER measurement on.

Example:

TRIG:BERT
 starts a single measurement.

:BLER:STOP**:BERT:STOP**

Stops an ongoing measurement.

These commands automatically set BERT:STATE or BLER:STATE to OFF

Example: `BERT:STOP`
stops the measurement. To start a new measurement, the BER measurement must be switched on again by `BERT:STATe ON`.

Usage: Event

:BLER:UNIT <Unit>

:BERT:UNIT <Unit>

Sets the unit for the error rate display on the screen. `BERT|BLER:RES` always specifies the error rate as the quotient of "Number of errors" and "Number of data items", unaffected by this command.

Parameters:

<Unit> ENGINEering | SCientific | PCT | PPM

ENGINEering

The error rate is output in exponential notation with the exponent -3 or -6 .

SCientific

The error rate is output in scientific notation, i.e. standardized to one place to the left of the decimal.

PCT

The error rate is output in percent.

PPM

The error rate is output in parts per million.

*RST: ENGINEering

Example: `BERT:UNIT PPM`
selects the unit "ppm" for the display of the error rate.

[:SOURce]:INPut:BERT:IMPedance <Impedance>

The command sets the impedance of the BERT inputs **CLOCK**, **DATA**, **DATA ENABLE** and **RESTART**.

Parameters:

<Impedance> G1K | G50 | G10K

*RST: G1K

Example: `INP:BERT:IMP G50`
The impedance of the BERT inputs is set to 50 ohm to ground.

[:SOURce]:INPut:BERT:THReshold <Threshold>

The command sets the high/low threshold of the BERT inputs **Clock**, **Data**, **Data Enable** and **Restart**. In the case of positive polarity, this threshold determines the point as of which a signal is high (active) or low (inactive).

Parameters:

<Threshold> float
 Range: 0.01 to 2
 Increment: 0.01
 *RST: 1.00V
 Default unit: Volt

Example:

```
INP:BERT:THR 1 V
```

A high/low threshold of 1 volt is set at the BERT inputs. The signal is high (active) for a signal voltage of 1 volt and higher.

:TRIGger:BLER[:IMMediate]**:TRIGger:BERT[:IMMediate]**

Triggers a single bit error rate or block error rate measurement if the single trigger mode (BERT|BLER:SEQ SING) is selected.

Example:

```
BERT:SEQ SING
```

selects the single trigger mode.

Example:

```
TRIG:BERT
```

starts a single bit error rate measurement.

Usage:

Event

6.5 CALibration Subsystem

The CALibration system contains the commands for adjustment. Adjustment is triggered by the query commands. The response "0" indicates error-free adjustment, and the response "1" means that an error occurred during adjustment.

:CALibration:ALL[:MEASure].....	530
:CALibration<hw>:BBIN[:MEASure].....	531
:CALibration<hw>:FMOFset[:MEASure].....	531
:CALibration<hw>:FREQuency[:MEASure].....	531
:CALibration<hw>:IQModulator:FULL.....	532
:CALibration<hw>:IQModulator:LOCal.....	532
:CALibration<hw>:LEVel[:MEASure].....	532
:CALibration<hw>:LEVel:STATe.....	532
:CALibration<hw>:LEVel:HACCuracy[:STATe].....	533

:CALibration:ALL[:MEASure]?

The command starts all internal adjustments for which no external measuring equipment is needed.

With two-path instruments, adjustment is performed for both paths.

Return values:

<Measure> 0 | 1

Example: `CAL:ALL:MEAS?`
starts the adjustment of all functions for the entire instrument.
Response: "0"
adjustment has been performed successfully.

Usage: Query only
SCPI confirmed

:CALibration<hw>:BBIN[:MEASure]?

The command starts adjustment of the analog I/Q input. The I/Q input is adjusted with respect to DC offset and gain.

Return values:
<Measure> 0 | 1 | OFF | ON
*RST: 0

Example: `CAL:BBIN:MEAS?`
starts the adjustment of the analog I/Q input.
Response: 0
adjustment has been performed successfully.

Usage: Query only

:CALibration<hw>:FMOFfset[:MEASure]?

The command starts all adjustment for the FM/PhiM modulator.

Return values:
<Measure> 0 | 1

Example: `CAL:FMOF?`
starts the adjustments for the FM/PhiM modulator.
Response: "0"
the adjustments have been performed successfully

Usage: Query only

:CALibration<hw>:FREQuency[:MEASure]?

The command starts all adjustments which affect the frequency.

In case of two-path instruments, this affects the selected path.

Return values:
<Measure> 0 | 1

Example: `CAL:FREQ:MEAS?`
starts the adjustments for maximum frequency accuracy.
Response: "0"
the adjustments have been performed successfully.

Usage: Query only

:CALibration<hw>:IQModulator:FULL?

The command starts adjustment of the I/Q modulator for the entire frequency range. The I/Q modulator is adjusted with respect to carrier leakage, I/Q imbalance and quadrature.

Return values:

<Full> 0 | 1

Example:

CAL:IQM:FULL?

starts adjustments for the I/Q modulator across the entire frequency range.

Response: "0"

adjustment has been performed successfully

Usage:

Query only

:CALibration<hw>:IQModulator:LOCAL?

The command starts adjustment of the I/Q modulator for the currently set frequency, I/Q swap and baseband gain. The I/Q modulator is adjusted with respect to carrier leakage, I/Q imbalance and quadrature.

Return values:

<Local> 0 | 1

Example:

CAL:IQM:LOC?

starts adjustment for the I/Q modulator for the currently set frequency.

Response: 0

adjustment has been performed successfully

Usage:

Query only

:CALibration<hw>:LEVEL[:MEASURE]?

The command starts all adjustments which affect the level.

In case of two-path instruments, this affects the selected path.

Return values:

<Measure> 0 | 1

Example:

CAL:LEV:MEAS?

starts adjustments for maximum level accuracy.

Response: "0"

adjustment has been performed successfully.

Usage:

Query only

:CALibration<hw>:LEVEL:STATE <State>

The command switches on or off internal level correction.

Parameters:

<State> ON | OFF
 *RST: ON

Example:

CAL:LEV:STAT
 switches on Level correction.

:CALibration<hw>:LEVel:HACCuracy[:STATe] <State>

Enables/disables level adjustment with high accuracy.

Parameters:

<State> 0 | 1 | OFF | ON
 *RST: OFF

Example:

CAL:LEV:HACC:STAT ON
 switches on High Accuracy Level Adjustment

6.6 CLOCK Subsystem

The CLOCK system contains the commands for configuration of the signals at the clock output and input connectors.

:CLOCK:INPut:FREQuency.....	533
:CLOCK:INPut:SLOPe.....	533
:CLOCK:OUTPut:MODE.....	534
:CLOCK:OUTPut:SOURce.....	534

:CLOCK:INPut:FREQuency?

The command sets the measured frequency of the external clock signal. An external clock reference must be supplied at the CLOCK input.

Return values:

<Frequency> float

Example:

CLOC:INP:FREQ
 queries the measured frequency of the external clock reference.

Usage:

Query only

:CLOCK:INPut:SLOPe <Slope>

The command sets the active slope of an externally applied clock signal at the CLOCK connector.

Parameters:

<Slope> NEGative | POSitive
 *RST: POSitive

Example: CLOC:INP:SLOP NEG
The active slope of the external clock signal at the CLOCK connector is the falling slope.

:CLOCK:OUTPUT:MODE <Mode>

The command sets the output of bit or symbol clock pulses at the CLOCK OUT connector at the rear panel.

Parameters:

<Mode> SYMBol | BIT
*RST: SYMBol

Example: CLOC:OUTP:MODE SYMB
The internal symbol clock is output at the CLOCK OUT connector.

:CLOCK:OUTPUT:SOURce? <Source>

The command queries the path for which the clock signal at the CLOCK OUT connector is to be output.

Return values:

<Source> A
*RST: A

Example: CLOC:OUTP:SOUR
queries the path for which the clock signal at the CLOCK OUT connector is to be output.
Response: A
The clock signal of path is output at the CLOCK OUT connector.

Usage: Query only

6.7 DIAGnostic Subsystem

The `DIAGnostic` system contains the commands used for instrument diagnosis and servicing. SCPI does not define any `DIAGnostic` commands; the commands listed here are all Device-specific. All `DIAGnostic` commands are query commands which are not influenced by `*RST`.

:DIAGnostic<hw>:BGInfo.....	534
:DIAGnostic<hw>:BGInfo:CATalog.....	535
:DIAGnostic:INFO:OTIME.....	535
:DIAGnostic:INFO:POCount.....	536

:DIAGnostic<hw>:BGInfo?

The command checks the modules available in the instrument using the variant and revision state.

If the command is sent without parameters being specified, a complete list of all modules is returned (the various entries are separated by commas). The length of the list is variable and depends on the instrument equipment configuration.

If the command is sent with parameters, a list of the specified modules is returned (the various entries are separated by commas). A list of modules names can be called up using the command `:DIAGnostic<hw>:BGInfo:CATalog` on page 535.

For two-path instruments, the path for which the query is performed is determined by the numerical suffix.

Return values:

<Bginfo> < Module name> <Module stock number incl. variant> <Module revision> <Module serial number>

Each entry for one module consists of four parts which are separated by space characters.

Example:

DIAG:BGIN

Queries the instrument configuration.

Response: MBRD, SSYN, IQOP3, IQOP3_LCM,

returns the data of all available modules.

DIAG:BGIN? 'MBRD'

Queries the configuration of the motherboard.

Response: MBRD 1141.3501.02 1.5.3 100023

Module motherboard with stock number 1141.3501.01 has revision 1.5.3 and serial number 100023.

Usage: Query only

:DIAGnostic<hw>:BGInfo:CATalog?

The command queries the names of the assemblies available in the instrument.

A complete list of all assemblies is returned (the various entries are separated by commas). The length of the list is variable and depends on the instrument equipment configuration.

For two-path instruments, the path for which the query is performed is determined by the numerical suffix.

Return values:

<Catalog> string

Example:

DIAG:BGIN:CAT

queries the names of the assemblies.

Response: MBRD, SSYN, IQOP3, IQOP3_LCM,

Usage: Query only

:DIAGnostic:INFO:OTIME?

The command queries the number of operation hours.

Return values:

<OTIMe> float

Example:

DIAG:INFO:OTIM

queries the operation hours.

Response: 100023

The instrument was operated for 100023 hours up to now.

Usage:

Query only

:DIAGnostic:INFO:POCount?

The command queries the number of power-on events.

Return values:

<Pocount> float

Example:

DIAG:INFO:POC

queries the number of power on events.

Response: 123

The instrument was switched on for 123 times up to now.

Usage:

Query only

6.8 DISPlay Subsystem

The DISPlay system contains the commands to set the power-save mode of the instrument.

:DISPlay:PSAVe:HOLDoff <Holdoff>

This command sets the wait time for the screen-save mode of the display. The available value range is 1 to 60 minutes, the resolution 1 minute. The entry is dimensionless.

Parameters:

<Holdoff> float

Range: 1 to 60

*RST: 1

Default unit: minute

Example:

DISP:PSAV:HOLD 10

sets the wait for the screen saver mode to 10 minutes.

:DISPlay:PSAVe[:STATe] <State>

This command activates/deactivates the screen-save mode of the display. With the screen-save mode activated the display including backlight is completely switched off after the elapse of the wait time (see command `DISPlay:PSAVe:HOLDoff`) when no entries via front panel, external mouse or external keyboard are made.

This mode is recommended for preserving the display especially if the instrument is exclusively operated via remote control.

Parameters:

<State> 0 | 1 | OFF | ON
 *RST: OFF

Example:

DISP:PSAV ON
 activates screen saver mode.

6.9 FORMat Subsystem

The FORMat subsystem contains the commands which determine the format of the data that the R&S SMU returns to the controller. This affects all query commands which return a list of numerical data or block data. Reference is made to this in the descriptions of the commands.

For two-path instruments, the data format is set simultaneously for both paths.

:FORMat:BORDER.....	537
:FORMat[:DATA].....	537
:FORMat:SREGister.....	538

:FORMat:BORDER <Border>

The command determines the sequence of bytes within a binary block. This only affects blocks which use the IEEE754 format internally.

Parameters:

<Border> NORMal | SWAPped

NORMal

The instrument expects (with setting commands) and sends (with queries) the least significant byte of each IEEE754 floating-point number first and the most significant byte last.

SWAPped

The instrument expects (with setting commands) and sends (with queries) the most significant byte of each IEEE754 floating-point number first and the least significant byte last.

*RST: NORMal

Example:

FORM:BORD SWAP
 the data is transferred with the most significant bit first.

:FORMat[:DATA] <Data>

The command determines the data format which the R&S Signal Generator uses to return data. When data is transferred from the control computer to the instrument, the instrument detects the data format automatically. In this case, the value set here is irrelevant.

Parameters:

<Data>

ASCIi | PACKed

ASCIi

Numerical data is transferred as plain text separated by commas.

PACKed

Numerical data is transferred as binary block data. The format within the binary data depends on the command. The various binary data formats are explained in the description of the parameter types.

*RST: ASCIi

Example:

FORM ASC

The data is transferred as ASCII data.

:FORMat:SREGister <Sregister>

The command determines the numerical format which is returned when the status registers are queried.

Parameters:

<Sregister>

ASCIi | BINary | HEXadecimal | OCTal

ASCIi

The register content is returned as a decimal number.

BINary

The register content is returned as a binary number. #B is placed in front of the number.

HEXadecimal

The register content is returned as a hexadecimal number. #H is placed in front of the number.

OCTal

The register content is returned as an octal number. #Q is placed in front of the number.

*RST: ASCIi

Example:

FORM: SREG HEX

The register content is returned as a hexadecimal number.

6.10 HCOPI Subsystem

The HCOPI subsystem contains the commands to generate a hardcopy of the display.

:HCOPI:DATA.....	539
:HCOPI:DEVIce.....	539
:HCOPI:DEVIce:LANGUage.....	540
:HCOPI[:EXECute].....	540
:HCOPI:FILE[:NAME].....	540
:HCOPI:FILE[:NAME]:AUTO.....	540

:HCOPY:FILE[:NAME]:AUTO:DIRectory.....	541
:HCOPY:FILE[:NAME]:AUTO:DIRectory:CLear.....	541
:HCOPY:FILE[:NAME]:AUTO:FILE.....	541
:HCOPY:FILE[:NAME]:AUTO[:FILE]:DAY.....	542
:HCOPY:FILE[:NAME]:AUTO[:FILE]:DAY:STATe.....	542
:HCOPY:FILE[:NAME]:AUTO[:FILE]:MONTH.....	542
:HCOPY:FILE[:NAME]:AUTO[:FILE]:MONTH:STATe.....	543
:HCOPY:FILE[:NAME]:AUTO[:FILE]:NUMBer.....	543
:HCOPY:FILE[:NAME]:AUTO[:FILE]:PREFix.....	543
:HCOPY:FILE[:NAME]:AUTO[:FILE]:PREFix:STATe.....	543
:HCOPY:FILE[:NAME]:AUTO[:FILE]:YEAR.....	544
:HCOPY:FILE[:NAME]:AUTO[:FILE]:YEAR:STATe.....	544
:HCOPY:FILE[:NAME]:AUTO:STATe.....	544
:HCOPY:IMAGe:FORMat.....	544
:HCOPY:IMAGe:SIZE.....	545
:HCOPY:PRINter:LIST.....	545
:HCOPY:PRINter[:NAME].....	545
:HCOPY:PRINter:PAGE:MARGins.....	545
:HCOPY:PRINter:PAGE:ORientation.....	546
:HCOPY:PRINter:PAGE:SIZE.....	546
:HCOPY:PRINter:PAGE:UNIT.....	546

:HCOPY:DATA?

The commands transfers the hardcopy data directly as a NByte stream to the remote client.

Return values:

<Data> string

Example:

```
HCOP:DEV:LANG JPG
HCOP:DATA?
```

transfers the hardcopy to the remote client.

Usage:

Query only

:HCOPY:DEVIce <Device>

The command selects the destination to which the hardcopy (snapshot) should be transferred to. The hardcopy either can be printed out by selecting `PRINter` or can be saved in a file by selecting `FILE`.

Parameters:

<Device> FILE | PRINter
*RST: FILE

Example:

```
HCOP:DEV FILE
```

the hardcopy will be stored in a file.

:HCOPY:DEVice:LANGUage <Language>

The command selects the bitmap graphic format for the screenshot. It is also possible to directly retrieve the data using command `HCOPY:DATA?`. This command is an alias to command `HCOPY:IMAGE:FORMat`.

Parameters:

<Language> BMP | JPG | XPM | PNG
*RST: BMP

Example:

```
HCOPY:DEV:LANG BMP
selects bitmap as image format.
HCOPY:FILE 'E:/HCOPY'
defines the directory, path and file name for storing the hardcopy.
HCOPY
triggers the hardcopy generation.
```

:HCOPY[:EXECute]

The command triggers the generation of a hardcopy.

The data is either written into a file or sent to the selected printer.

Example:

```
HCOPY
triggers the generation of a hardcopy of the current display.
```

Usage:

Event

:HCOPY:FILE[:NAME] <Name>

This command creates/selects a file into which the hardcopy will be stored. The path is specified together with the file name. Access to the file via remote control is possible using the commands of the MMEM-Subsystem. In contrast, command `HCOPY:DATA?` transfers the hardcopy contents directly to the remote client where they can be further processed.

If automatic file naming is activated, the hardcopy is stored into a file with an automatically generated name (commands `HCOPY:FILE[:NAME]:AUTO:...`).

Parameters:

<Name> string

Example:

```
HCOPY:FILE:NAME 'E:/HCOPY'
defines the hardcopy file name.
```

:HCOPY:FILE[:NAME]:AUTO?

This command queries the path including the file name of the file with automatically generated name.

Return values:

<Auto> string

Example: HCOP:DEV:LANG BMP
 selects output format *,bmp.
 HCOP:FILE:AUTO:DIR 'E:/HCOPY'
 defines the destination directory 'E:/HCOPY'.
 HCOP:FILE:AUTO:PREF 'gen'
 the file name starts with the prefix 'gen'. The usage of automatic naming with prefix and date in the file name is preset (...:STAT ON).
 HCOP
 triggers the generation of a hardcopy of the current trace.
 HCOP:FILE:AUTO?
 queries the path including the file name
 Response:
 E:/HCOPY/gen101012008001.bmp'

Usage: Query only

:HCOPY:FILE[:NAME]:AUTO:DIRectory <Directory>

This command defines the directory into which the hardcopy files will be stored if auto naming is activated (HCOP:FILE:AUTO:STAT ON). The directory will be created if it does not exist yet.

Parameters:

<Directory> string
 *RST: .\HCOPY

Example: HCOP:FILE:AUTO:DIR 'E:/HCOPY'
 defines the destination directory 'E:/HCOPY'

:HCOPY:FILE[:NAME]:AUTO:DIRectory:CLEar

This command deletes all files with extensions "bmp", "img", "png" and "xpm" in the directory set for automatic naming.

Example: HCOP:FILE:AUTO:DIR:CLE
 deletes all image files with extensions "bmp", "img", "png" and "xpm".

Usage: Event

:HCOPY:FILE[:NAME]:AUTO:FILE?

This command queries the file name that what generated using the automatic naming settings. By default the automatically generated file name is composed of:

<Prefix><YYYY><MM><DD><Number>.<Format>.

Each component can be deactivated/activated separately to individually design the file name.

Return values:**<File>** string**Example:**

```

HCOP:DEV:LANG BMP
selects output format *.bmp.
HCOP:FILE:AUTO:DIR 'E:/HCOPY'
defines the destination directory 'E:/HCOPY'
HCOP:FILE:AUTO:PREF 'gen'
the file name starts with the prefix 'gen'. The usage of automatic
naming with prefix and date in the file name is preset (...:STAT
ON).
HCOP
triggers the generation of a hardcopy of the current trace.
HCOP:FILE:AUTO:FILE?
queries the file name
Response: 'gen101012008001.bmp'

```

Usage: Query only**:HCOPY:FILE[:NAME]:AUTO[:FILE]:DAY?**

The command returns the day of the current system date which will be used in the file name if automatic naming is activated.

Return values:**<Day>** float**Example:**

```

HCOP:FILE:AUTO:DAY?
returns the day in the date part of the automatic file name.

```

Usage: Query only**:HCOPY:FILE[:NAME]:AUTO[:FILE]:DAY:STATe <State>**

This command activates the usage of the day in the automatic file name.

Parameters:

```

<State> 0 | 1 | OFF | ON
*RST: ON

```

Example:

```

HCOP:FILE:AUTO:DAY:STAT OFF
deactivates the use of the day in the automatically generated file
name.

```

:HCOPY:FILE[:NAME]:AUTO[:FILE]:MONTH?

This command queries the month in the date part in the automatic file name.

Return values:**<Month>** float**Example:**

```

HCOP:FILE:AUTO:MONTH?
queries the month in the date part in the automatic file name.

```

Usage: Query only

:HCOPY:FILE[:NAME]:AUTO[:FILE]:MONTH:STATe <State>

This command activates the usage of the month in the automatic file name.

Parameters:

<State> 0 | 1 | OFF | ON
 *RST: ON

Example: `HCOP:FILE:AUTO:MONT:STAT OFF`
 deactivates the usage of the month in the automatic file name.

:HCOPY:FILE[:NAME]:AUTO[:FILE]:NUMBer?

This command queries the number in the automatic file name. The number is assigned in such a way that always the lowest possible value for an unique file name within the selected path is used.

On initially switching on the device the number will be reset to the lowest possible value. Starting with number 0 the output directory will be scanned for already existing files. As long as files with the same name are existing the number will be incremented by 1. The number will be automatically set to a number so that the resulting file name will be unique within the selected path. The current number will not be saved in the save recall file but will be temporarily stored within the database. On subsequent saves the number will be incremented.

Return values:

<Number> float

Example: `HCOP:FILE:AUTO:NUMB?`
 queries the number in the automatic file name.

Usage: Query only

:HCOPY:FILE[:NAME]:AUTO[:FILE]:PREFix <Prefix>

This command defines the prefix part in the automatic file name. The usage of the prefix is activated with command `HCOP:FILE:AUTO:PREF:STAT ON`.

Parameters:

<Prefix> string
 *RST: HCopy

Example: `HCOP:FILE:AUTO:PREF 'Snapshot'`
 appends "Snapshot" as prefix to the generated file name.

:HCOPY:FILE[:NAME]:AUTO[:FILE]:PREFix:STATe <State>

This command activates the usage of the prefix in the automatic file name. The prefix is entered with command `HCOP:FILE:AUTO:PREF`.

Parameters:

<State> 0 | 1 | OFF | ON
 *RST: ON

Example:

HCOPY:FILE:AUTO:PREF:STAT OFF
 deactivates the usage of the prefix in the automatic file name.

:HCOPY:FILE[:NAME]:AUTO[:FILE]:YEAR?

This command queries the year in the date part in the automatic file name.

Return values:

<Year> float

Example:

HCOPY:FILE:AUTO:YEAR?
 queries the year in the date part in the automatic file name.

Usage:

Query only

:HCOPY:FILE[:NAME]:AUTO[:FILE]:YEAR:STATe <State>

This command activates the usage of the year in the automatic file name.

Parameters:

<State> 0 | 1 | OFF | ON
 *RST: ON

Example:

HCOPY:FILE:AUTO:YEAR:STAT OFF
 deactivates the usage of the year in the automatic file name.

:HCOPY:FILE[:NAME]:AUTO:STATe <State>

This command activates/deactivates automatic naming of the hardcopy files.

Parameters:

<State> 0 | 1 | OFF | ON
 *RST: ON

Example:

HCOPY:FILE:AUTO:STAT OFF
 deactivates automatic naming.

:HCOPY:IMAGe:FORMat <Format>

This command selects the bitmap graphic format for the screenshot. It is also possible to directly retrieve the data using command `HCOPY:DATA?`.

This command is an alias to command `HCOPY:DEVIce:LANGUage`.

Parameters:

<Format> BMP | JPG | XPM | PNG
 *RST: BMP

Example: `HCOP:IMAG:FORM XPM`
selects the image format XPM.

:HCOPY:IMAGe:SIZE <Size>

The command selects the image size of the hardcopy. The first value of the size setting defines the width, the second value the height of the image.

Parameters:

<Size> 320,640 | 640,480 | 800,600 | 1024,768
*RST: depends on device

Example: `HCOP:IMAG:SIZE 640,480`
sets width and height of the image.

:HCOPY:PRINter:LIST?

The command queries the available printers. If the list is empty, no printer driver is installed.

Return values:

<List> string

Example: `HCOP:PRIN:LIST?`
returns a list of the available printers.

Usage: Query only

:HCOPY:PRINter[:NAME] <Name>

The command selects the printer.

Parameters:

<Name> string

Example: `HCOP:PRIN:NAME "printer1"`
selects printer printer1.

:HCOPY:PRINter:PAGE:MARGInS <Margins>

The command defines the margins of the paper for printing the hardcopy. The values are entered in the sequence <top,bottom,left,right>, the values are separated by commas. A dot is used as decimal separator. Depending on the set physical unit by the parameter Unit, width and height are expressed in cm or inches.

Parameters:

<Margins> *RST: 2.5,2.5,2.5,2.5

Example: `HCOP:PRIN:PAGE:UNIT IN`
sets the physical unit for the page layout values to inches.
`HCOP:PRIN:PAGE:MARG 2.5,2.0,1.5,1.5`
sets the margin values of the page layout to top=2.5 inches, bottom=2.0 inches, left=1.5 inches and right=1.5 inches.

:HCOPy:PRINter:PAGE:ORientation <Orientation>

The command defines the orientation of the printer page..

Parameters:

<Orientation> PORTrait | LANDscape
*RST: PORTrait

Example: `HCOP:PRIN:PAGE:ORI LAND`
selects landscape orientation for the printer page.

:HCOPy:PRINter:PAGE:SIZE <Size>

The command selects the size of the printer paper.

Parameters:

<Size> LETTer | LEGal | EXECutive | A4 | A5
*RST: LETTer

Example: `HCOP:PRIN:PAGE:SIZE LETT`
sets the page size to letter format.
`HCOP:PRIN:PAGE:SIZE?`
returns the selected page size, e.g. LETT

:HCOPy:PRINter:PAGE:UNIT <Unit>

This command defines the physical unit used for defining the page size and margins.

Parameters:

<Unit> CM | IN
*RST: CM

Example: `HCOP:PRIN:PAGE:UNIT IN`
selects unit inch.

6.11 KBOard Subsystem

The KBOard system contains the commands to set the external keyboard.

[:KBOard:LANGuage](#).....547
[:KBOard:LAYout](#).....547

:KBOard:LANGUage <Language>

This command selects the keyboard language. The assignment of some keys depends on the selected language.

Parameters:

<Language> US | DE
*RST: US

Example:

KBO:LANG US
selects keyboard language American English.

Usage:

SCPI confirmed

:KBOard:LAYout?

This command selects the keyboard language. The assignment of some keys depends on the selected language.

Return values:

<Layout> CHINese | DANish | DUTCh | ENGUK | ENGUS | FINNish |
FRENch | FREBe | FRECa | GERMan | ITALian | JAPANese |
KORean | NORWegian | PORTuguese | RUSSian | SPANish |
SWEDish
*RST: US

Example:

KBO:LAY US
activates American keyboard layout.

Usage:

Query only
SCPI confirmed

6.12 MMEMory Subsystem

The MMEMory subsystem (**Mass Memory**) contains the commands for managing files and directories as well as for loading and storing complete instrument settings in files.

The various drives can be selected using the "mass storage unit specifier" <msus>. The internal hard disk is selected with **D**: \, and a memory stick which is inserted at the USB interface is selected with **E**: \. The resources of a network can also be selected with <msus> in the syntax of the respective network, e.g. using the UNC format (Universal Naming Convention): \\server\share.

The default drive is determined using the command `MMEMory:MSIS <msus>`.



The **C**: drive is a protected system drive. This drive should not be accessed. Reconstruction of the system partition will not be possible without loss of data.

6.12.1 File Naming Conventions

To enable files in different file systems to be used, the following file naming conventions should be observed.

The file name can be of any length and no distinction is made between uppercase and lowercase letters. The file and the optional file extension are separated by a dot. All letters and numbers are permitted (numbers are, however, not permitted at the beginning of the file name). Where possible, special characters should not be used. Use of the slashes "/" and "\" should be avoided since they are used in file paths. A number of names are reserved by the operating system, e.g. CLOCK\$, CON, AUX, COM1 . . . COM4, LPT1 . . . LPT3, NUL and PRN.

In the R&S Signal Generator all files in which lists and settings are stored are given a characteristic extension. The extension is separated from the actual file name by a dot (see [chapter 3.7.2.1, "Extensions for User Files"](#), on page 114 for an overview the file types).

The two characters "*" and "?" function as "wildcards", i.e. they are used for selecting several files. The "?" character represents exactly one character, while the "*" character represents all characters up to the end of the file name. "*.*" therefore stands for all the files in a directory.

When used in conjunction with the commands, the parameter <file_name> is specified as a string parameter with quotation marks. It can contain either the complete path including the drive, only the path and file name, or only the file name. The file name must include the file extension. The same applies for the parameters <directory_name> and <path>.

Depending on how much information is provided, either the values specified in the parameter or the values specified with the commands MMEM:MSIS (default drive) and MMEM:CDIR (default directory) are used for the path and drive setting in the commands.

Before the instrument settings can be stored in a file, they have to be stored in an intermediate memory using common command *SAV <number>. The specified number is subsequently used in the :MMEMory:STORe:STATe command. Also, subsequently to loading a file with instrument settings with command :MMEMory:LOAD:STATe, these settings have to be activated with the common command *RCL <number>.

6.12.2 Extensions for User Files

The following table list all available file extensions for user files. The currently available files on the instrument depends on the installed options.

Table 6-1: List of the automatically assigned file extensions in the instrument

Function/Digital Standard	List type	Contents	File suffix
Instrument State	Settings	Instrument settings	*.savrcl
"User Correction"	List	User-defined level correction values	*.uco
"List Mode"	List	User-defined frequency/level value pairs	*.lsw

Function/Digital Standard	List type	Contents	File suffix
"Frequency Response Correction"	Settings	User-defined frequency response correction file	*.frc
"Arbitrary Waveform Generator"	Waveform	ARB waveforms ARB multi segment waveforms	*.wv
	Waveform	ARB multi carrier settings	*.arb_multcarr
	Configuration data	Configuration file for creation of multisegment ARB waveforms	*.inf_mswv
	Play List	ARB Sequencing List	*.wvs
"DM"	Data List	Digital modulation data	*.dm_iqd *.tdm
	Control List	Data to control digital modulation	*.dm_iqc
	Settings	Digital modulation settings	*.dm
	User Standard	Digital modulation user standard	*.dm_stu
	User Mapping	Digital modulation user mapping	*.vam
	User Filter	Digital modulation user filter	*.vaf
"NRP Settings"	Settings	NRP Settings	*.nrp
EX-IQ-Box	User Settings	EX-IQ-Box User Defined Settings	*.iqbox
"Fading"	Fading	Fading data	*.fad
"GSM/EDGE"	Settings	GSM/EDGE settings	*.gsm
	Slot	User-defined slot data	*.gsm_slu
	Frame	User-defined frame data	*.gsm_fu
	Slot	Higher symbol rate slot	*.gsm_hslu
	Frame	Higher symbol rate frame	*.gsm_hfu
"Bluetooth"	Bluetooth Settings	Complete setting of the Bluetooth menu	*.bto
"TETRA"	TETRA Settings	Complete setting of the TETRA menu	*.tetra
"3GPP FDD"	Settings	Complete setting of the 3GPP (FDD) menu	*.3g
	Settings	Channel coding enhanced DPCH channels (downlink)	*.3g_ccod_dl_s
	Settings	Channel coding enhanced DPDCH channels (uplink)	*.3g_ccod_ul
"CDMA2000"	Settings	Complete setting of the CDMA2000 menu	*.cdma2k
"TD-SCDMA2000"	Settings	Complete setting of the TD-SCDMA2000 menu	*.tdscdma
	Settings	Test Model for TD-SCDMA2000	*.tdtmd

Function/Digital Standard	List type	Contents	File suffix
1xEV-DO	Settings	Complete setting of the 1xEV-DO menu	*.evdo
"IEEE 802.11 WLAN"	Settings	Complete setting of the IEEE 802.11 WLAN menu	*.wlan
"IEEE 802.11 n WLAN"	Settings	Complete setting of the IEEE 802.11n WLAN menu	*.wlann
	Settings	Beamforming data	*.bmf
"IEEE 802.16 WiMAX"	Settings	Complete setting of the IEEE 802.16 WiMAX menu	*.wimax
"EUTRA/LTE"	Settings	Complete setting of the EUTRA/LTE menu	*.eutra
	Settings	TDD Settings	*.lte_tdd
	Settings	User-defined IQ-File	*.iqw
"GPS"	Settings	Complete setting of the GPS/A-GPS menu	*.gps
	Settings	GPS Almanac Settings	*.txt *.alm *.al3
	Settings	GPS Waypoints File	*.txt
	Settings	GPS Generated Almanac File	*rs_al *.rs_yuma
	Settings	GPS Ionospheric File	*.rs_ion
	Settings	GPS Navigation Data	*.rs_nav
	Settings	GPS UTC File	*.rs_utc *.rs_acq
"FM-Stereo"	Settings	Complete setting of the FM-Stereo menu	*.fmstereo
	Settings	FM-Stereo Group Type Settings	*.fm_gt
	Settings	FM-Stereo Group Hex Type Settings	*.fm_ghex
	Waveform File	Waveform File	*.wav
"Sirius"	Settings	Complete setting of the Sirius menu	*.sirius
"XM-Radio"	Settings	Complete setting of the XM-Radio menu	*.xmradio
	Settings	XM-Radio TWTA Data	*.twta
"DVB"	Settings	Complete setting of the DVB menu	*.dvb
	Settings	DVB Transport Stream	*.gts *.ts *.trp

Function/Digital Standard	List type	Contents	File suffix
"DAB/T-DMB"	Settings	Complete setting of the DAB/T-DMB menu	*.dab
	Settings	DAB ETI Files	*.eti *.xeti

6.12.3 Examples

In these examples, the current instrument setting is stored in the file `test1.savrcl` in the directory `user`.

Storing and Loading Current Settings

1. Store the current setting in an intermediate memory with number 4. This setting can be called using command `*RCL` and the associated number of the memory, e.g. `*RCL 4`.
`*SAV 4`
2. To store the settings in a file in a specific directory, specify the complete path.
`MMEM:STOR:STAT 4,"d:\user\test.savrcl"`
3. To store the settings in a file in the default drive, set the default drive and specify only the file name.
`MMEM:MSIS 'D:\user'*SAV 4`
`MMEM:STOR:STAT 4,"test.savrcl"`
4. Load the file `test.savrcl` in the `user` directory.
`MMEM:LOAD:STAT 4,'D:/user/test.savrcl'`
5. Activate the instrument setting of the file `test.savrcl`.
`*RCL 4`

Working with Files and Directories

1. Read out all files in the specified directory.

```
MMEM:CAT? 'E:/user'
```

```
Response: 127145265,175325184,"test,DIR,0","temp,DIR,0",
"readme.txt,ASC,1324","state.savrcl,STAT,5327",
"waveform.wv,BIN,2342"
```

the directory `E:/user` contains the subdirectories `test` and `temp` as well as the files `readme.txt`, `state.savrcl` and `waveform.wv` which have different file types.

Tip: To query only the subdirectories of the current or specified directory, perform:

```
MMEM:DCAT? 'E:/user'
```

```
Response: 'test', 'temp'
```

To query only the number of subdirectories in the current or specified directory, perform:

```
MMEM:DCAT:LENG? 'E:/user'
```

Response: 2

- To query the number of files in the current or specified directory, perform:

```
MMEM:CAT:LENG? 'E:/user'
```

Response: 3

- Create a new subdirectory for mass memory storage in the specified directory.

```
MMEM:MDIR 'E:/user/new'
```

- Copy the file `state` to a new file.

```
MMEM:COPY 'D:/user/state.savrcl','E:/user/new'
```

- Rename the file `state`.

```
MMEM:MOVE 'state.savrcl','state_new.savrcl'
```

- Remove the `test` directory.

```
MMEM:RDIR 'E:/user/test'
```

6.12.4 Remote Control Commands

:MMEMory:CATalog.....	552
:MMEMory:CATalog:LENGth.....	553
:MMEMory:CDIRectory.....	553
:MMEMory:COPIY.....	553
:MMEMory:DATA.....	554
:MMEMory:DCATalog.....	555
:MMEMory:DCATalog:LENGth.....	555
:MMEMory:DELeTe.....	555
:MMEMory:LOAD:STATe.....	556
:MMEMory:MDIRectory.....	556
:MMEMory:MOVE.....	556
:MMEMory:MSIS.....	557
:MMEMory:RDIRectory.....	557
:MMEMory:STORe:STATe.....	557

:MMEMory:CATalog? <path>

Returns the content of the current or a specified directory.

Query parameters:

<path> string

String parameter to specify the directory. If the directory is omitted, the command queries the content of the current directory, queried with `MMEM:CDIR` command.

Return values:

<path> <used_memory>, <free_memory>, <file_name>, <file_entry>, ...

<used_memory>
Total amount of storage currently used in the directory, in bytes.

<free_memory>
Total amount of storage available in the directory, in bytes.

<file_entry>
All files of the directory are listed with their file name, format and size in bytes.

Example: See ["Working with Files and Directories"](#) on page 551.

Usage: Query only

:MMEMory:CATalog:LENGth?

Returns the number of files in the current or in the specified directory.

Return values:

<Length> <path>
String parameter to specify the directory. If the directory is omitted, the command queries the content of the current directory, queried with `MMEM:CDIR` command.

<count> Number of files

Example: See ["Working with Files and Directories"](#) on page 551.

Usage: Query only

:MMEMory:CDIRectory <Cdirectory>

Changes the default directory for mass memory storage. The directory is used for all subsequent `MMEM` commands if no path is specified with them. It is also possible to change to a higher directory using two dots `'..'`.

Setting parameters:

<Cdirectory> <directory_name>

Example: See ["Working with Files and Directories"](#) on page 551.

Usage: Setting only
SCPI confirmed

:MMEMory:COpy <file_source>[,<file_destination>]

Copies an existing to a new file. Instead of just a file, this command can also be used to copy a complete directory together with all its files.

It is also possible to specify the path using another parameter. The command is:

```
MMEMory:COPY
<file_source><msus_source>[,<file_destination>,
<msus_destination>]
```

Setting parameters:

<file_source> string
String parameter to specify the name of the file to be copied. If <destination> is not specified, <source> is copied to the MMEM:MSIS drive and the MMEM:CDIR directory. Files which already exist with the same name in the destination directory are overwritten without an error message. It is also possible to specify the path using another parameter. The command is: MMEMory:COPY
<file_source><msus_source>[,<file_destination>, <msus_destination>]

file_destination string
String parameter to specify the name of the new file. If no file destination is specified, the source file is copied to the current directory, queried with the MMEM:CDIR command. Files which already exist with the same name in the destination directory are overwritten without an error message.

Example: See "[Working with Files and Directories](#)" on page 551.

Usage: Event
SCPI confirmed

```
:MMEMory:DATA <file_name>[,<binary block data>]
:MMEMory:DATA? <file_name>
```

Writes the block data <binary block data> to the file identified by <file_name>. The IEC/IEEE-bus terminator should be set to EOI in order to ensure correct data transfer.

The associated query command transfers the specified file from the instrument to the IEC/IEEE bus and then on to the control computer. It is important to ensure that the intermediate memory on the control computer is large enough to take the file. In this case, the setting for the IEC/IEEE-bus terminator is irrelevant. This command can be used to read/transfer stored instrument settings or waveforms directly from/to the instrument.

Parameters:

<file_name> String parameter to specify the name of the file.

Setting parameters:

<binary block data> #<number><length entry><block data>
always comes first in the binary block
<number> the first digit indicates how many digits the subsequent length entry has
<length entry> indicates the number of subsequent bytes
<binary block data> binary block data for the specified length.

Example: `M MEM:DATA 'TEST1.WV',#3767<binary data>`
 writes the block data to the file `test1.wv`.
 The digit "3" indicates a length entry of 3 digits; the digits "767" indicate a length of the binary data in bytes.
`M MEM:DATA? 'TEST1.WV'`
 sends the data of the file `Test1.wv` from the instrument to the controller in the form of a binary block.

:MMEMory:DCATalog?

Returns the subdirectories of the current or specified directory.

Query parameters:

`<path_name>` String parameter to specify the directory. If the directory is omitted, the command queries the content of the current directory, queried with `M MEM:CDIR` command.

Return values:

`<Dcatalog>` `<file_entry>`
 Names of the subdirectories separated by colons. The first two strings are related to the parent directory.

Example: See ["Working with Files and Directories"](#) on page 551.

Usage: Query only

:MMEMory:DCATalog:LENGth? [<path_name>]

Returns the number of subdirectories in the current or specified directory.

Query parameters:

`<path_name>` String parameter to specify the directory. If the directory is omitted, the command queries the contents of the current directory, to be queried with `M MEM:CDIR` command.

Return values:

`<file_entry_count>` Number of parent and subdirectories.

Example: See ["Working with Files and Directories"](#) on page 551.

:MMEMory:DELeTe <Delete>

Removes a file from the specified directory.

Setting parameters:

`<Delete>` `<file_name>`
 String parameter to specify the name and directory of the file to be removed.

Example: See ["Working with Files and Directories"](#) on page 551.

Usage: Event
 SCPI confirmed

:MMEMory:LOAD:STATE <sav_rcl_state_number>, <file_name>

This command loads the specified file stored under the specified name in an internal memory.

After the file has been loaded, the instrument setting must be activated using an *RCL command.

Setting parameters:

<sav_rcl_state_number> Determines to the specific <number> to be used with the *RCL command, e.g. *RCL 4.

<file_name> String parameter to specify the file name with extension *.savrcl.

Example: See "[Storing and Loading Current Settings](#)" on page 551.

Usage: Setting only

:MMEMory:MDIRectory <directory_name>

Creates a new subdirectory for mass memory storage in the specified directory. If no directory is specified, a subdirectory is created in the default directory. This command can also be used to create a directory tree.

Setting parameters:

<directory_name> string
String parameter to specify the new directory.

Example: See "[Working with Files and Directories](#)" on page 551.

Usage: Setting only

:MMEMory:MOVE <file_source>, <file_destination>

Moves an existing file to a new location or, if no path is specified, renames an existing file.

It is also possible to specify the path using another parameter. The command is:

```
MMEMory:MOVE
file_source,msus_source[, file_destination, msus_destination]
```

Setting parameters:

<file_source> String parameter to specify the name of the file to be moved.

<file_destination> String parameters to specify the name of the new file.

Example: See "[Working with Files and Directories](#)" on page 551.

Usage: Setting only
SCPI confirmed

:MMEMory:MSIS <Msis>

The command sets the drive (or network resource in the case of networks) using `msus` (MSIS = Mass Storage Identification String). This setting is effective for all `MMEMory` commands where the drive is not explicitly specified in the parameter.

Parameters:

<Msis> string
*RST: D:\

Example: See ["Storing and Loading Current Settings"](#) on page 551.

Usage: SCPI confirmed

:MMEMory:RDIRectory <Rdirectory>

Removes an existing directory from the mass memory storage system. If no directory is specified, the subdirectory with the specified name is deleted in the default directory.

Setting parameters:

<Rdirectory> string
String parameter to specify the directory to be deleted.

Example: See ["Working with Files and Directories"](#) on page 551.

Usage: Setting only

:MMEMory:STORe:STATe <sav_rcl_state_number>, <file_name>

Stores the current instrument setting in the specified file.

The instrument setting must first be stored in an internal memory with the same number using the common command `*SAV`.

Setting parameters:

<sav_rcl_state_number> corresponds to the specific <number> defined with the `*SAV` command, e.g. `*SAV 4`.

<file_name> String parameter to specify the file name with extension `*.savrcl`.

Example: See ["Storing and Loading Current Settings"](#) on page 551.

Usage: Event

6.13 OUTPut Subsystem

The `OUTPut` system contains the commands which set the properties of the RF `OUTPUT` connectors and `USER` connectors.

The properties of the LF output connector are set in the [chapter 6.15.11, "SOURCE:LFOutput Subsystem"](#), on page 747 system.

In two-path instruments with a second path, the properties can be set separately and independently for the two outputs A and B.

:OUTPut:ALL[:STATe].....	558
:OUTPut<hw>:AFIXed:RANGe:LOWer.....	558
:OUTPut<hw>:AFIXed:RANGe:UPPer.....	558
:OUTPut<hw>:AMODe.....	559
:OUTPut<hw>:BLANK:LIST:STATe.....	560
:OUTPut:BLANK:POLarity.....	560
:OUTPut<hw>:IMPedance.....	560
:OUTPut<hw>:PROTection:CLEar.....	560
:OUTPut<hw>:PROTection:STATe.....	561
:OUTPut<hw>:PROTection:TRIPped.....	561
:OUTPut<hw>[:STATe].....	561
:OUTPut<hw>[:STATe]:PON.....	561
:OUTPut:USER<ch>:SOURce.....	562

:OUTPut:ALL[:STATe] <State>

The command switches on or off all RF output signals of the instrument.

Parameters:

<State> 0 | 1 | OFF | ON
 *RST: OFF

Example:

OUTP:ALL OFF
 switches off all RF output signals.

:OUTPut<hw>:AFIXed:RANGe:LOWer?

The command queries the minimum level which can be set without the attenuator being adjusted (Attenuator FIXed).

Return values:

<Lower> float
 Default unit: dBm

Example:

OUTP:AFIX:RANG:LOW
 queries the minimum level for the FIXed setting.

Example:

Response: -50
 The minimum level is -50 dBm.

Usage:

Query only

:OUTPut<hw>:AFIXed:RANGe:UPPer?

The command queries the maximum level which can be set without the attenuator being adjusted (Attenuator FIXed).

Return values:

<Upper> float
 Default unit: dBm

Example:

OUTP:AFIX:RANG:UPP
 queries the maximum level for the FIXed setting for the RF output.

Example:

Response: -27
 The maximum level is -27 dBm.

Usage:

Query only

:OUTPut<hw>:AMODe <Amode>

The command switches the mode of the attenuator at the RF output (Attenuator MODE).

Parameters:

<Amode> AUTO | FIXed | NORMal | HPOWer

AUTO

The electronically switching attenuator switches with a 5 dB step width at fixed switching points.

With option High Power: The level settings are made in the area of the electronically switching attenuator as well as the relay-switched option. The entire level range is available.

FIXed

The attenuator is fixed at the current position. The uninterrupted level settings are made if automatic level control is activated (SOURce:POWer:ALC ON).

With option High Power: The level settings are made without switching the high-power output option. When this operating mode is switched on, the options are fixed in their current positions and the resulting variation range is defined.

NORMal

(with Option High Power only)

The level settings are made only in the area of the electronically switching attenuator. The high level ranges are not available.

HPOWer

(with Option High Power only)

The level settings are made only in the area of the high level ranges. Only the high level range is available. The relays are not switched.

*RST: AUTO

Example:

POW:ALC ON
 activates automatic level control for RF output.
 OUTP:AMOD FIX
 sets the fixed mode with uninterrupted level for RF output.

:OUTPut<hw>:BLANk:LIST:STATe <State>

The command activates/deactivates RF output blanking.

Parameters:

<State> 0 | 1 | OFF | ON
*RST: ON

Example: OUTP:BLAN:LIST:STAT ON
 activates the RF Output blanking.

:OUTPut:BLANk:POLarity <Polarity>

The command sets the polarity of the No Signal (Blank) Marker.

Parameters:

<Polarity> NORMal | INVerted
*RST: NORMal

Example: OUTP:BLAN:POL NORM

:OUTPut<hw>:IMPedance?

The command queries the impedance of the RF outputs. This permits converting the output level between units V and W. The impedances cannot be changed.

Return values:

<Impedance> G50 | G1K | G10K
 Default unit: Ohm

Example: OUTP:IMP
 queries the impedance of RF output.
 Response: 50
 the impedance is 50 ohms

Usage: Query only
 SCPI confirmed

:OUTPut<hw>:PROTEction:CLEar

The command resets the protective circuit after it has been tripped. The state of the output is again determined by `OUTPut:STATe`.

The outputs are protected by a protective circuit which deactivates the output in the case of an externally applied overvoltage. This does not change the value of `OUTPut:STATe`.

Note: An R&S SMU with serial number lower than 103001 requires:

- additional Option Overvoltage Protection and High Power - R&S SMU-B32 (Path A) and R&S SMU-B37 (Path B) or
- additional Option Overvoltage Protection - R&S SMU-B30 (Path A) and R&S SMU-B35 (Path B).

Example: `OUTP:PROT:CLE`
resets the protective circuit for RF output.

Usage: Event
SCPI confirmed

:OUTPut<hw>:PROTection:STATe <State>

The command attenuates the RF output signal for about 40 dB to protect external devices against internal signals.

Parameters:
<State> 0 | 1 | OFF | ON
*RST: OFF

Example: `OUTP:PROT:STAT ON`
attenuates the RF Output signal for about 40 dB.

Usage: SCPI confirmed

:OUTPut<hw>:PROTection:TRIPped?

The command queries the state of the protective circuit.

Return values:
<Tripped> 0 | 1 | OFF | ON

Example: `OUTP:PROT:TRIP`
Queries the state of the protective circuit for RF output A.
Response: 0
The protective circuit has not tripped.
Response: 1
The protective circuit has tripped.

Usage: Query only

:OUTPut<hw>[:STATe] <State>

This command activates and deactivates the RF output.

Parameters:
<State> 0 | 1 | OFF | ON

Example: `OUTP OFF`
deactivates the RF output.

Usage: SCPI confirmed

:OUTPut<hw>[:STATe]:PON <Pon>

This command selects the state which the RF output assumes when the instrument is switched on.

Parameters:`<Pon>` OFF | UNCHanged**OFF**

The output is deactivated when the instrument is switched on.

UNCHanged

When the instrument is switched on, the output remains in the same state as it was when the instrument was switched off.

Example:`OUTP:PON OFF`

RF output A is deactivated when the instrument is switched on.

:OUTPUT:USER<ch>:SOURCE <Source>

The command selects the signal for the specified USER interface.

Some signals which can be applied at the USER interface are permanently assigned and some are assigned using a dedicated command (e.g. `OUTP:CW:SOURCE` for the CW control signal).

An example of permanently assigned signal is the LEV-ATT control signal of Path B.

The general purpose input (`GPINput`) is available for USER interfaces 1 and 2 only.**Parameters:**`<Source>` AMARk4 | BMARk4 | ACW | BCW | ABLank | BBLank | AHOP | BHOP | BBITclock | BSYMBOLclock | BATTenuator | BBURst | ATRig | BTRig | GPINput***RST:** USER1 = AMARker4; USER 2 = ACW; USER 3 = ABLank; USER 4 = ATRig**Example:**`OUTP:USER2 AMAR`

causes the marker signal to be output at the USER2 pin of the AUX I/O interface.

`OUTP:CLOC:MODE SYMB`

specifies that the internally generated clock pulse is a symbol clock pulse.

`OUTP:CLOC:STAT ON`

activates output of the symbol clock pulse at the USER2 pin

6.14 SENSe, READ and INITiate Subsystems

The SENSe subsystem contains the commands for configuring the power measurements with power R&S NRP-Zxx power sensor(s) connected to the generator. The measurement is started and the measurement result retrieved with the `READ` command. The description of this commands is included in the following.

Up to four sensors can be connected to the signal generator. They are distinguished by means of the suffix under SENSe:

- Power sensor connected to the SENSOR port = `SENSe [1]`

- power sensor connected first to one of the USB interfaces = `SENSe 2`
- further power sensors connected second and third via USB = `SENSe 3` and `SENSe 4`

<code>INITiate<ch>[:POWer]:CONTInuous</code>	563
<code>READ<ch>[:POWer]</code>	563
<code>SENSe<ch>[:POWer]:CORRection:SPDeVice:STATe</code>	564
<code>SENSe<ch>[:POWer]:DISPlay:PERManent:STATe</code>	564
<code>SENSe<ch>[:POWer]:DISPlay:PERManent:PRlority</code>	565
<code>SENSe<ch>[:POWer]:FILTer:LENGth:AUTO</code>	565
<code>SENSe<ch>[:POWer]:FILTer:LENGth[:USER]</code>	565
<code>SENSe<ch>[:POWer]:FILTer:NSRatio</code>	566
<code>SENSe<ch>[:POWer]:FILTer:NSRatio:MTIME</code>	566
<code>SENSe<ch>[:POWer]:FILTer:SONCe</code>	566
<code>SENSe<ch>[:POWer]:FILTer:TYPE</code>	567
<code>SENSe<ch>[:POWer]:FREQUency</code>	567
<code>SENSe<ch>[:POWer]:OFFSet</code>	568
<code>SENSe<ch>[:POWer]:OFFSet:STATe</code>	568
<code>SENSe<ch>[:POWer]:SNUMber</code>	568
<code>SENSe<ch>[:POWer]:SOURce</code>	568
<code>SENSe<ch>[:POWer]:STATus[:DEVice]</code>	569
<code>SENSe<ch>[:POWer]:SVERsion</code>	569
<code>SENSe<ch>[:POWer]:TYPE</code>	569
<code>SENSe<ch>[:POWer]:ZERO</code>	570
<code>SENSe<ch>:UNIT[:POWer]</code>	570

`INITiate<ch>[:POWer]:CONTInuous <Continuous>`

The command switches the local state of the continuous power measurement by the R&S NRP-Zxx power sensors on and off. Switching the local state off enhances the measurement performance during remote control

The remote measurement is triggered by the READ query (command `READ<ch>[:POWer]`) which also provides the measurement results. The local state is not influenced by this command, measurements results can be retrieved with local state on or off.

Parameters:

`<Continuous>` 0 | 1 | OFF | ON
 *RST: OFF

Example:

```
INIT:CONT ON
switches local state of continuous power measurement on.
```

`READ<ch>[:POWer]?`

The command triggers the measurement with power sensors and provides the power measurement result of the selected power sensor. The value is provided with the unit set with command `SENSe:UNIT[:POWer]`.

For certain power sensors, e.g. R&S NRP-Z81, two values are returned, first the value for the average level and - separated by a comma - the peak level

Note: The local state is not influenced by this command, measurements results can be retrieved with local state on or off. For long measurement times it is recommended to use a SRQ (MAV bit) for command synchronization.

Return values:

<Power> string

Example:

SENS:UNIT DBM

selects unit dBm for presentation of measurement result.

READ1?

queries the measurement result of the sensor connected to the SENSOR interface.

Response: -45.6246576745440230

-45.6 dBm were measured at the given frequency.

or e.g. for R&S NRP-Z81

Response:

-55.62403263352178, -22.419472478812476

-55,6 dbm is the measured average level, -22.4 dBm is the measured peak level at the given frequency

Usage: Query only

SENSe<ch>[:POWer]:CORRection:SPDevice:STATe <State>

The command activates the use of the s-parameters correction data of the selected power sensor.

Note: For power sensor with attenuator this command is automatically set to ON.

Parameters:

<State> 0 | 1 | OFF | ON

*RST: OFF

Example:

SENS:POW:CORR:SPD:STAT ON

activates the use of the s-parameters correction data of power sensor 1.

SENSe<ch>[:POWer]:DISPlay:PERManent:STATe <State>

The command switches on and off the permanent indication of the power measurement result in the upper right corner of the block diagram. For each sensor, the type of sensor, the connector, the measurement source and - if set - the offset is indicated.

Parameters:

<State> 0 | 1 | OFF | ON

*RST: OFF

Example:

SENS1:POW:DISP:PERM:STAT ON

the permanent viewer is switched on.

SENSe<ch>[:POWer]:DISPlay:PERManent:PRiority <Priority>

The command selects which power measurement result (average or peak power) is indicated when permanent display is active.

Parameters:

<Priority> AVERAge | PEAK
*RST: AVERAge

Example:

```
SENS1:DISP:PERM:STAT ON
the permanent viewer is switched on.
SENS1:DISP:PERM:PRI AVER
the measured average power is indicated.
```

SENSe<ch>[:POWer]:FILTer:LENGth:AUTO?

The command queries the current filter length for auto filter mode
(:SENSe<[1]...3>:POWer:FILTer:TYPE AUTO)

Return values:

<Auto> float

Example:

```
SENS1:FILT:TYPE AUTO
selects auto filter mode for the power sensor connected to the
SENSOR connector.
SENS1:FILT:LENG:AUTO?
queries the automatically set filter length.
Response: 1024
```

Usage:

Query only

SENSe<ch>[:POWer]:FILTer:LENGth[:USER] <User>

The command selects the filter length for user filter mode
(SENSe:POWer:FILTer:TYPE USER). As the filter length works as a multiplier for the time window, a constant filter length results in a constant measurement time. Values 1 and 2ⁿ are settable.

The time window is fixed to 20 ms.

Parameters:

<User> float
Range: 1 to 65536
*RST: 1

Example:

```
SENS:FILT:TYPE USER
selects user filter mode.
SENS:FILT:LENG 16
sets a filter length of 16. The resulting measurement time is 640
ms (2x16x20 ms).
```

SENSe<ch>[:POWer]:FILTer:NSRatio <Nsratio>

The command defines the noise content for fixed noise filter mode (:SENSe<[1]...3>:POWer:FILTer:TYPE NSRatio). This value determines the proportion of intrinsic noise in the measured result.

Parameters:

<Nsratio> float
 Range: 0.0001 to 1.0
 *RST: 0.01

Example:

```
SENS1:FILT:TYPE NSR
selects fixed noise filter mode for the power sensor connected to
the SENSOR connector.
SENS1:FILT:NSR 0.2
sets a noise content of 0.2.
```

SENSe<ch>[:POWer]:FILTer:NSRatio:MTIME <Mtime>

The command defines the timeout for fixed noise filter mode (:SENSe<[1]...3>:POWer:FILTer:TYPE NSRatio). This value ensures limited settling times.

Parameters:

<Mtime> float
 Range: 1.0 to 999.99
 *RST: 4
 Default unit: s

Example:

```
SENS1:FILT:TYPE NSR
selects fixed noise filter mode for the power sensor connected to
the SENSOR connector.
SENS1:FILT:NSR .2
sets a noise content of 0.2.
SENS1:FILT:NSR:MTIM 5
limits the settling time to 5 seconds
```

SENSe<ch>[:POWer]:FILTer:SONCe

The command activates the search for the optimum filter length for the current measurement conditions. The found filter length can be retrieved with command :SENSe:POWer:FILTer:LENGth:USER?. This command is only available for user filter mode (:SENSe:POWer:FILTer:TYPE USER).

Example:

```

SENS:FILT:TYPE USER
selects user filter mode.
SENS:FILT:SONC
activates the search for the optimum filter length.
SENS:FILT:LENG?
returns the found optimum filter length.
Response: 128

```

Usage:

Event

SENSe<ch>[:POWER]:FILTer:TYPE <Type>

The command selects the filter mode. The filter length is the multiplier for the time window and thus directly influences the measurement time.

Parameters:

<Type>

AUTO | USER | NSRatio

AUTO

The filter length is automatically selected depending on the measured value. For high values, a short filter length is selected and for low values a long filter length is selected.

USER

The filter length is set manually. As the filter length works as a multiplier for the measurement time, this results in a constant measurement time.

NSRatio

The filter length (averaging factor) is selected so that the sensor's intrinsic noise (2 standard deviations) does not exceed the specified noise content. The desired noise content is entered with command `SENSe:FILTer:NSRatio`.

To avoid very long settling times when the power is low, the averaging factor can be limited with the Timeout parameter (command `SENSe:FILTer:NSRatio:MTIME`).

*RST: AUTO

Example:

```

SENS:FILT:TYPE AUTO
selects automatic filter selection.

```

SENSe<ch>[:POWER]:FREQuency <Frequency>

The command sets the RF frequency of the source if the user source is selected (`SENSe[:POWER]:SOURce USER`).

Parameters:

<Frequency>

float

*RST: 1 GHz

Example: `SENS:SOUR USER`
 selects user-defined source.
 `SENS:FREQ 2.44 GHz`
 enters the RF frequency of the source which is 2.44 GHz.

SENSe<ch>[:POWER]:OFFSet <Offset>

The command enters a level offset which is added to the measured level value after activation with command `SENSe[:POWER]:OFFSet:STATe ON`. This allows e.g. an attenuator in the signal path to be taken into account.

Parameters:

<Offset> float
 Range: -100.0 to 100.0
 *RST: 0
 Default unit: dB

Example: `SENS:POW:OFFS 10.0`
 sets a level offset of 10 dB

SENSe<ch>[:POWER]:OFFSet:STATe <State>

The command activates the addition of the level offset to the measured value. The level offset value is set with command `SENSe[:POWER]:OFFSet`.

Parameters:

<State> 0 | 1 | OFF | ON
 *RST: OFF

Example: `SENS1:POW:OFFS 0.4dB`
 sets a level offset of 0.4 dB
 `SENS1:POW:OFFS:STAT ON`
 a level offset of 0.4 dB is added to the measured value.

SENSe<ch>[:POWER]:SNUMber?

The command queries the serial number of the sensor.

Return values:

<Snumber> string

Example: `SENS:SNUM?`
 queries the serial number.

Usage: Query only

SENSe<ch>[:POWER]:SOURce <Source>

The command selects the signal source for the measurement.

In case of two-path instruments, the RF signal of path A or path B or a user defined source can be selected.

Parameters:

<Source> A | B | USER
 *RST: A

Example:

SENS:SOUR A
 selects the RF signal as measurement source. The RF frequency is used as the measurement frequency of the sensor and the corresponding correction factor is used. The level setting of the instrument serves as reference level of the measurement.

SENSe<ch>[:POWER]:STATus[:DEVice]?

The command queries if a sensor is connected to the signal generator.

The sensor is selected by suffix in the keyword SENSE or READ of the command header. Suffix 1 denotes the sensor connected to the SENSOR connector, suffix 2 the sensor connected first to one of the USB interfaces and suffix 3 the sensor connected second to one of the USB interfaces.

Return values:

<DEVice> 0 | 1 | OFF | ON

Example:

SENS:STAT?
 queries if a sensor is connected to the instrument.
 Response: 1
 a sensor is connected to the POWER SENSOR interface.

Usage:

Query only

SENSe<ch>[:POWER]:SVERsion?

The command queries the software version of the connected R&S NRP power sensor.

Return values:

<Sversion> string

Example:

SENS:POW:SVER?
 queries the software version of the R&S NRP power sensor.

Usage:

Query only

SENSe<ch>[:POWER]:TYPE?

The command queries the type of sensor. The type is automatically detected.

In case of two-path instruments, the sensor connected at the selected port is queried.

Return values:

<Type> string

Example: `SENS:TYPE?`
 queries the type of sensor connected to the POWER SENSOR connector.
 Response: `NRP-Z21`
 the R&S NRP-Z21 sensor is used.

Usage: Query only

SENSe<ch>[:POWER]:ZERO

The command activates the autozero function. Zeroing is required in regular interval (at least once a day) and if the temperature has varied more than about 5 °C, if the sensor has been replaced or if measurements of signals with very low power are to be performed. The RF power source must be switched off or disconnected from the sensor before starting the autozero function.

Example: `SENS:ZERO`
 activates autozero function.

Usage: Event

SENSe<ch>:UNIT[:POWER] <Power>

The command selects the unit used for result query with command READ. The power sensor provides the measured value in Watt. In which unit the measured value is returned is selected here and might be either Watt, dBm or dBuV.

Parameters:
 <Power> DBM | DBUV | WATT
 *RST: DBM

Example: `SENS2:UNIT DBM`
 selects unit dBm for the measured value returned by command READ.
`READ2?`
 Response: `7.34`
 7.34 dBm are measured by sensor 2.

6.15 SOURce Subsystem

The SOURce subsystem contains the commands for configuring the digital and analog signals.

SOURce<hw>

For one-path instruments, the keyword SOURce is optional and can be omitted.

The numeric suffix to SOURce distinguishes between multicarrier generation for path A and path B in the case of two-path instruments:

- SOURce[1] = Path A

The keyword `SOURce` is optional and can be omitted

- `SOURce2 = Path B`
The keyword `SOURce` is mandatory, i.e. the command must contain the keyword with suffix 2.
- `LF output = SOURce:LFOutput`
The keyword `SOURce` is optional and can be omitted



With the R&S SMIQ generator family, the LF signal source is selected using the numerical suffix 2 under `SOURce`. With this signal generator, however, `SOURce2` selects RF output B. The two instrument families are therefore incompatible with respect to actuation of the LF generator.

• SOURce:AM Subsystem	571
• SOURce:AWGN Subsystem	574
• SOURce:BB Subsystem	583
• SOURce:BBIN Subsystem	699
• SOURce:CORRection Subsystem	707
• SOURce:FM Subsystem	716
• SOURce:FREQUency Subsystem	719
• SOURce:INPUt Subsystem	729
• SOURce:IQ Subsystem	732
• SOURce:IQ:OUTput Subsystem	736
• SOURce:LFOutput Subsystem	747
• SOURce:LIST Subsystem	755
• SOURce:MODulation Subsystem	768
• SOURce:PATH Subsystem	768
• SOURce:PHASe Subsystem	769
• SOURce:PM Subsystem	769
• SOURce:POWEr Subsystem	772
• SOURce:PULM Subsystem	780
• SOURce:ROSCillator Subsystem	782
• SOURce:SWEEp Subsystem	784

6.15.1 SOURce:AM Subsystem

The AM subsystem contains the commands for checking the amplitude modulation and also the broadband amplitude modulation.

The settings for the internal modulation source (LF generator) are made in the `SOURce:LFOutput` subsystem.

[:SOURce<hw>]:AM:BBANd:SENSitivity	572
[:SOURce<hw>]:AM:BBANd[:STATe]	572
[:SOURce<hw>]:AM[:DEPTh]	572
[:SOURce<hw>]:AM:EXTernal:COUPling	573
[:SOURce<hw>]:AM:SENSitivity	573
[:SOURce<hw>]:AM:SOURce	573
[:SOURce<hw>]:AM:STATe	574

[[:SOURce<hw>]:AM:BBANd:SENSitivity?

The command queries the input sensitivity in V/100% modulation depth.

For two-path instruments, broadband amplitude modulation is only possible for Path A.

Return values:

<Sensitivity> float

Example:

AM:BBAN:SENS?

queries the input sensitivity for the BB-AM modulation signal at the I input.

Response: 0.25

the input sensitivity is 0.25 V / 100 % depth

Usage:

Query only
SCPI confirmed

[[:SOURce<hw>]:AM:BBANd[:STATe] <State>

The command activates/deactivates the broadband amplitude modulation. It is not possible to set a modulation depth for BB-AM. The modulation input is the I IN connector.

For two-path instruments, broadband amplitude modulation is only possible for Path A

Activation of broadband amplitude modulation deactivates AM, ARB, I/Q modulation, digital modulation and all digital standards.

Parameters:

<State> 0 | 1 | OFF | ON
*RST: OFF

Example:

AM:BBAN ON

activates BB-AM modulation.

Usage:

SCPI confirmed

[[:SOURce<hw>]:AM[:DEPTH] <Depth>

The command sets the modulation depth of the amplitude modulation in percent. The modulation depth is limited by the maximum peak envelope power (PEP).

Parameters:

<Depth> float
Range: 0 to 100
Increment: See data sheet
*RST: 30
Default unit: PCT

Example:

AM 15PCT

sets the AM modulation depth to 15 percent

Usage:

SCPI confirmed

[:SOURce<hw>]:AM:EXTernal:COUPling <Coupling>

The command selects the coupling mode for the external modulation input in the case of amplitude modulation.

Parameters:

<Coupling> AC | DC

AC

The DC voltage component is disconnected from the modulation signal.

DC

The modulation signal is not changed.

*RST: AC

Example:

AM:EXT:COUP AC

Selects the coupling mode AC for external amplitude modulation.

Usage:

SCPI confirmed

[:SOURce<hw>]:AM:SENSitivity?

The command queries the input sensitivity of the external modulation input in %/V. The command is only effective if the external modulation source is selected (SOUR:AM:SOUR EXT). The returned value depends on the modulation depth setting (SOUR:AM:DEPT h). This value is assigned to the voltage value for full modulation of the input.

Return values:

<Sensitivity> float

Example:

AM:DEPT 50

sets a modulation depth of 50 %.

AM:SENS?

queries the input sensitivity at the external modulation input input.

Response: 50

since the voltage value for full modulation is 1V, the resulting sensitivity is precisely 50%/V.

Usage:

Query only

SCPI confirmed

[:SOURce<hw>]:AM:SOURce <Source>

The command selects the modulation source for amplitude modulation.

Internal and external modulation source can be selected at the same time.

Parameters:

<Source> INT | EXT

INT

INT is the LF generator. The frequency of the internal modulation signal can be set in the `SOURce:LFOutput` subsystem.

EXT

The external signal is input at the EXT MOD connector.

*RST: INTERNAL

Example:

```
AM:SOUR INT
```

selects the internal modulation source.

Usage:

SCPI confirmed

[:SOURce<hw>]:AM:STATe <State>

The command activates/deactivates amplitude modulation.

Activation of amplitude modulation deactivates ARB, I/Q modulation, digital modulation and all digital standards.

Parameters:

<State> 0 | 1 | OFF | ON

Example:

```
AM:STAT ON
```

activates AM modulation.

Usage:

SCPI confirmed

6.15.2 SOURce:AWGN Subsystem

The `SOURce:AWGN` subsystem contains the commands for setting the noise generator.

<code>[:SOURce<hw>]:AWGN:BRATe</code>	575
<code>[:SOURce<hw>]:AWGN:BWIDth</code>	575
<code>[:SOURce<hw>]:AWGN:BWIDth:NOISe</code>	575
<code>[:SOURce<hw>]:AWGN:BWIDth:RATio</code>	576
<code>[:SOURce<hw>]:AWGN:CNRatio</code>	576
<code>[:SOURce<hw>]:AWGN:DISP:MODE</code>	577
<code>[:SOURce<hw>]:AWGN:DISP:ORESults</code>	577
<code>[:SOURce<hw>]:AWGN:ENRatio</code>	577
<code>[:SOURce<hw>]:AWGN:FREQuency:RESult</code>	578
<code>[:SOURce<hw>]:AWGN:FREQuency:TARGet</code>	578
<code>[:SOURce<hw>]:AWGN:MODE</code>	579
<code>[:SOURce<hw>]:AWGN:POWer:CARRier</code>	579
<code>[:SOURce<hw>]:AWGN:POWer:MODE</code>	580
<code>[:SOURce<hw>]:AWGN:POWer:NOISe</code>	580
<code>[:SOURce<hw>]:AWGN:POWer:NOISe:TOTal</code>	581
<code>[:SOURce<hw>]:AWGN:POWer:RMODE</code>	581
<code>[:SOURce<hw>]:AWGN:POWer:SUM</code>	581
<code>[:SOURce<hw>]:AWGN:POWer:SUM:PEP</code>	582

`[:SOURce<hw>]:AWGN:STATe`.....582

`[:SOURce<hw>]:AWGN:BRATe <BRate>`

This command sets the bit rate which is used for calculation of bit energy to noise power ratio from carrier/noise ratio for Digital Standard signals

For "Custom Digital Mod" signals, the bit rate which is used for calculation can be queried with this command.

Valid units are bps, kbps and mabps as well as b/s, kb/s and mab/s.

Parameters:

`<BRate>` float
 Range: 400 bps to 250E6 bps
 Increment: 0.001
 *RST: 100000

Example:

`AWGN:BRAT?`
 queries the bit rate which is used for calculation of the Eb/N0 value from the C/N value.

`[:SOURce<hw>]:AWGN:BWIDth <BWidth>`

This command sets the system bandwidth. The noise signal at the level which corresponds to the specified carrier/noise ratio is generated in the bandwidth specified here.

This command is available for modes Additive Noise and Noise Only (`SOUR:AWGN:MODE ADD|ONLY`).

Parameters:

`<BWidth>` float
 Range: 1.0E3 to 100.0E6
 Increment: 0.1 kHz
 *RST: 3.84 MHz

Example:

`AWGN:BWID 10 MHz`
 sets a system bandwidth of 10 MHz.

Options:

B13 and K62
 SOURce2 only with a second option B13 and at least one of the options -B9/10/11 or -B17

`[:SOURce<hw>]:AWGN:BWIDth:NOISe?`

Queries the real noise bandwidth.

This command is available for modes Additive Noise and Noise Only (`SOUR:AWGN:MODE ADD|ONLY`).

Return values:

<Noise> float
 Range: 0 to 200E6
 Increment: 100
 *RST: 0

Example:

AWGN:BWID:NOIS?
 queries the noise bandwidth.

Usage:

Query only

[:SOURce<hw>]:AWGN:BWIDth:RATio <Ratio>

This command is available for modes **Additive Noise** and **Noise Only**
 (SOUR:AWGN:MODE ADD|ONLY).

This command sets the ratio of minimum real noise bandwidth to system bandwidth.

The overall bandwidth is calculated as follow and may not exceed 80 MHz:

Overall Bandwidth = System BW x Minimum Noise/System BW Ratio

Therefore, the available value range depends on the selected system bandwidth.

Parameters:

<Ratio> float
 Range: 1 to Max
 Increment: 0.1
 *RST: 1

Example:

AWGN:BWID:RAT 2
 sets a minimum noise/system bandwidth ratio of 2.

[:SOURce<hw>]:AWGN:CNRatio <CnRatio>

This command sets the carrier/interferer ratio. The value range depends on the selected AWGN mode (AWGN:MODE ADD|ONLY|CW).

- "Reference Mode Carrier" (AWGN:POW:RMODE CARRIER)
 The noise level is adjusted to the set C/N ratio and the carrier level is kept constant.
- "Reference Mode Noise" (AWGN:POW:RMODE NOISE)
 The carrier level is adjusted to the set C/N ratio and the noise level is kept constant.

This command is available for modes "Additive Noise" and "CW Interferer"
 (SOUR:AWGN:MODE ADD|CW).

Parameters:

<CnRatio> float
 Range: -50.00 to 40.00
 Increment: 0.01
 *RST: 0
 Default unit: dB

Example: AWGN:CNR 10
 sets a carrier/noise ratio of 10 dB.

[:SOURce<hw>]:AWGN:DISP:MODE <Mode>

Selects the display mode to Bseband or RF.

Parameters:

<Mode> RF | BB
 *RST: RF

Example: AWGN:DISP:MODE RF
 sets the display mode to RF

[:SOURce<hw>]:AWGN:DISP:OReSults <OResults>

This command selects the display of output results for the analog (DACIF) or the digital (BBOUT) signal path.

Note: This command is only available with the option R&S SMU-B18, Baseband Digital I/Q Out. If the instrument is not equipped with this option the parameters of the analog signal path are displayed.

This command is available for modes Additive Noise and Noise Only (SOUR:AWGN:MODE ADD|ONLY) and for Display Mode set to Baseband (AWGN:DISP:MODE BB).

Parameters:

<OResults> ANALog | DIGital
 ANALog
 The parameters of the analog signal path are displayed.
 DIGital
 The parameters of the digital signal path are displayed.
 *RST: ANALog

Example: AWGN:MODE ONLY
 activates the generation of a pure noise for path A.
 AWGN:DISP:MODE BB
 sets the display mode to Baseband.
 AWGN:DISP:MODE DIG
 displays the output results of the digital signal of path A.

[:SOURce<hw>]:AWGN:ENRatio <EnRatio>

This command sets the ratio of bit energy to noise power density in "Additive Noise" mode.

Depending on the selected reference mode either the noise level (AWGN:POW:RMODE NOISE) or the carrier level (AWGN:POW:RMODE CARRIER) is adjusted to the set E_b/N_0 ratio.

- "Reference Mode Carrier" (AWGN:POW:RMODE CARRIER)
the noise level is adjusted to the set E_b/N_0 ratio and the carrier level is kept constant.

- "Reference Mode Noise" (AWGN:POW:RMOd NOISe)
the carrier level is adjusted to the set E_b/N_0 ratio and the noise level is kept constant.

For **Digital Standard** signals, the bit rate used for calculation of E_b/N_0 value from C/N value can be entered with command `SOUR:AWGN:BRAT`.

For **Custom Digital Mod** signals the bit rate used for calculation of E_b/N_0 value from C/N value is determined by the selected standard (`SOURce:BB:DM:STANdard`) and cannot be changed.

Parameters:

<EnRatio> float
Range: -30 to 30
Increment: 0.001
*RST: 0
Default unit: dB

Example:

`AWGN:ENR 10`
sets a ratio of bit energy to noise power density of 10 dB

[:SOURce<hw>]:AWGN:FREQuency:RESult?

This command queries the actual frequency of the sine in the **CW Interferer** mode.

The actual frequency may differ from the desired frequency, since the resolution is limited to 0.7 Hz.

Return values:

<Result> float
Range: -40E6 to 40E6
Increment: 0.01
*RST: 0

Example:

`AWGN:FREQ:RES?`
queries the actual frequency of the interfering sine

Usage:

Query only

[:SOURce<hw>]:AWGN:FREQuency:TARGet <Target>

This command sets the desired frequency of the sine in "CW Interferer" mode (`AWGN:MODE CW`).

The resulting frequency may differ from the desired frequency because of the limited frequency resolution of 0.7 Hz.

Parameters:

<Target> float
Range: -40E6 to 40E6
Increment: 0.01
*RST: 0

Example: `AWGN:FREQ:TARG 2kHz`
sets a frequency of 2 kHz for the interfering sine.

[:SOURce<hw>]:AWGN:MODE <Mode>

This command selects the mode for generating the interfering signal.

Parameters:

<Mode> ONLY | ADD | CW

ADD

The AWGN noise signal is added to the baseband signal.

ONLY

The pure AWGN noise signal is modulated to the carrier. The connection to the baseband is interrupted

CW

The sine interfering signal is added to the baseband signal.

*RST: ADD

Example: `AWGN:MODE ONLY`
activates the generation of a pure noise.
`AWGN:STAT ON`
switches on the generation of a pure noise.

[:SOURce<hw>]:AWGN:POWer:CARRier <Carrier>

available for modes "Additive Noise" and "CW Interferer" (`SOUR:AWGN:MODE ADD|CW`)

This command either sets or queries the carrier or signal level depending on the selected reference mode.

- "Reference Mode Carrier" (`SOUR:AWGN:POW:RMOD CARR`)
Sets the carrier level. The level of the noise signal is derived from the entered C/N value.
- "Reference Mode Noise" (`SOUR:AWGN:POW:RMOD NOIS`)
queries the carrier level which is derived from the entered C/N value. The noise level is set with command `SOUR:AWGN:POW:NOISe`.

Parameters:

<Carrier> float
Range: min to 20
Increment: 0.01
*RST: 0
Default unit: dBm

Example: `AWGN:DISP:MODE RF`
sets the display mode to RF
`AWGN:POW:CARR?`
queries the carrier level

[:SOURce<hw>]:AWGN:POWer:MODE <Mode>

This command selects the mode for setting the noise level.

This command is available for mode "Additive Noise" (SOUR:AWGN:MODE ADD).

Parameters:

<Mode>

CN | SN | EN

CN|SN

available for mode Additive Noise (SOUR:AWGN:MODE ADD).

The noise level is set on the basis of the value entered for the carrier/noise or signal/noise ratio (AWGN:CNR|SNR).

Whether a selection of C/N or S/N is enabled, depends on the selected "Display Mode" (AWGN:DISP:MODE BB|RF)

EN

The noise level is set on the basis of the value entered for the ratio of bit energy to noise power density (AWGN:ENR).

*RST: CN|SN

Example:

AWGN:DISP:MODE RF

sets the display mode to RF

SOUR:AWGN:POW:MODE CN

the noise level is set on the basis of the value entered for the carrier/noise ratio (AWGN:CNR).

[:SOURce<hw>]:AWGN:POWer:NOISe <Noise>

Available for modes Additive Noise, Noise Only and CW Interferer (SOUR:AWGN:MODE ADD|ONLY|CW).

This command sets or queries the noise level in the system bandwidth depending on the selected modes:

- "Additive Noise" and "CW Interferer" mode (SOUR:AWGN:MODE ADD|CW)
 - "Reference Mode Carrier" (SOUR:AWGN:POW:RMODE CARR)

The command queries the noise/interferer level which is derived from the entered C/N value. The carrier level is set with command SOUR:AWGN:POW:CARRier.
 - "Reference Mode Noise" (SOUR:AWGN:POW:RMODE NOIS)

The command sets the noise/interferer level. The level of the carrier signal is derived from the entered C/N value.
- "Noise Only" mode

The command sets the noise level.

Parameters:

<Noise>

float

Default unit: dBm

Example:

SOUR:AWGN:POW:NOIS?

queries the noise level in the system bandwidth.

Response: 10

the noise level in the system bandwidth is 10 dBm.

[:SOURce<hw>]:AWGN:POWer:NOISe:TOTal?

Available for modes Additive Noise and Noise Only (SOUR:AWGN:MODE ADD|ONLY)

This command queries the noise level in the total bandwidth.

Tip: "Display Output Results For" ([:SOURce<hw>]:AWGN:DISP:ORESuLts) the analog or digital signal path has to be set before.

Return values:

<Total> float
 Range: -145 to 20
 Increment: 0.01
 *RST: -30

Example:

SOUR:AWGN:POW:NOIS:TOT?
 queries the noise level in the total bandwidth.
 Response: 15
 the noise level in the total bandwidth is 15 dBm.

Usage:

Query only

[:SOURce<hw>]:AWGN:POWer:RMODE <RMode>

This command selects the mode for setting the interfering signal.

This command is available for modes "Additive Noise" and "CW Interferer" (SOUR:AWGN:MODE ADD|CW) and Display Mode set to RF (AWGN:DISP:MODE RF).

Parameters:

<RMode> CARRier | NOISe

CARRier

The carrier level is kept constant when the C/N value or Eb/N0 value is changed. The noise level is adjusted.

NOISe

The noise level is kept constant when the C/N value or Eb/N0 value is changed. The carrier level is adjusted.

*RST: CARRier

Example:

AWGN:MODE ADD
 selects Additive Noise mode.
 AWGN:DISP:MODE RF
 sets the display mode to RF
 AWGN:POW:RMODE NOIS
 selects Reference Mode Noise. The noise level is kept constant when the C/N value or Eb/N0 value is changed. The carrier level is adjusted.

[:SOURce<hw>]:AWGN:POWer:SUM?

Available for modes "Additive Noise" and "CW Interferer" (SOUR:AWGN:MODE ADD|CW)

This command queries the overall level of the noise signal plus useful signal.

Tip: "Display Output Results For" (`[:SOURce<hw>] :AWGN:DISP:ORESults`) the analog or digital signal path has to be set before.

Return values:

<Sum> float
 Range: -145 to 20
 Increment: 0.01
 *RST: 0

Example: `SOUR:AWGN:POW:SUM?`
 queries the overall level of the noise signal plus useful signal.

Usage: Query only

[:SOURce<hw>] :AWGN:POWer:SUM:PEP?

Available for modes Additive Noise and CW Interferer (`SOUR:AWGN:MODE ADD|CW`)

This command queries the peak envelope power of the overall signal comprised of noise signal plus useful signal.

Tip: "Display Output Results For" (`[:SOURce<hw>] :AWGN:DISP:ORESults`) the analog or digital signal path has to be set before.

Return values:

<Pep> float
 Range: -145 to 20
 Increment: 0.01
 *RST: 0

Example: `SOUR:AWGN:POW:SUM:PEP?`
 queries the peak envelope power of the overall signal.

Usage: Query only

[:SOURce<hw>] :AWGN:STATe <State>

This command activates or deactivates the white noise (AWGN = Averaged White Gaussian Noise). The noise signal is either superimposed on the baseband signal ("Additive Noise" mode (`SOUR:AWGN:MODE ADD`)) or is output as a pure noise signal ("Noise Only" mode (`SOUR:AWGN:MODE ONLY`)). In addition, a sine with adjustable frequency offset to the baseband signal can be generated as an RFI signal ("CW Interferer" mode; `SOUR:AWGN:MODE CW`).

Parameters:

<State> 0 | 1 | OFF | ON
 *RST: 0

Example: `AWGN:STAT ON`
 activates the RFI signal generator.

6.15.3 SOURce:BB Subsystem

This subsystem contains all commands for digital signal generation. It is divided into several subsystems which are described separately.

OUTPut<ch>

The numeric suffix to OUTPut distinguishes between the available markers.

EXTERNAL<ch>

The numeric suffix to EXTERNAL distinguishes between the available external trigger inputs.

• SOURce:BB Subsystem General Commands.....	583
• SOURce:BB:ARB Subsystem.....	585
• SOURce:BB:DM Subsystem.....	629
• SOURce:BB:GRAPhics Subsystem.....	665
• SOURce:BB:IMPairment Subsystem.....	667
• SOURce:BB:MCCW Subsystem.....	676
• SOURce:BB:MEASurement Subsystem.....	695
• SOURce:BB:POWer Subsystem.....	698

6.15.3.1 SOURce:BB Subsystem General Commands

The following section describes the commands for setting the frequency shift and the phase offset for the signal at the "Baseband" block output.

[:SOURce]:BB:PATH:COUNT.....	583
[:SOURce<hw>]:BB:FOFFset.....	584
[:SOURce<hw>]:BB:PGAin.....	584
[:SOURce<hw>]:BB:POFFset.....	584
[:SOURce<hw>]:BB:ROUTE.....	585

[:SOURce]:BB:PATH:COUNT?

The command queries the number of installed baseband paths.

Return values:

<Count> integer

Example:

PATH: COUN?

queries the number of baseband paths.

Response: 1

The instrument is equipped with one baseband path.

Usage:

Query only

[[:SOURce<hw>]:BB:FOFFset <FOffset>

The command sets the frequency offset for the baseband signal. The offset affects the signal on the baseband block output. It shifts the useful baseband signal in the center frequency.

Note: It is not possible to enter a frequency offset if a waveform with a sample rate of exactly 100 MHz is introduced. A signal of this nature is not routed via the resampler in which the frequency shift takes place. This type of entry is also prohibited if the noise generator ("AWGN" block) is on.

The complex I/Q bandwidth of the useful signal must not exceed 80 MHz in total.

The following applies:

$$f_{\text{offset}} - f_{\text{use}}/2 \Rightarrow -40\text{MHz} \text{ and } f_{\text{offset}} + f_{\text{use}}/2 \Rightarrow +40\text{MHz}$$

where:

f_{use} = the complex useful bandwidth of the I/Q signal before the offset.

f_{offset} = frequency offset.

Parameters:

<FOffset> float
 Increment: 0.01 Hz
 *RST: 0 Hz

Example:

BB:FOFF 2MHZ
 sets a frequency offset of 2 MHz.

[[:SOURce<hw>]:BB:PGAin <PGain>

The command sets the relative path gain for the selected baseband signal compared to the baseband signals of the other baseband sources (second path or external baseband). The gain affects the signal on the "baseband block" output.

Parameters:

<PGain> float
 Range: -50 to 50
 Increment: 1E-3
 *RST: 0

Example:

BB:PGA 3dB
 sets a relative path gain of 3 dB for the baseband signal of path A compared to the baseband signal of path B.

[[:SOURce<hw>]:BB:POFFset <POffset>

The command sets the relative phase offset for the selected baseband signal compared to the baseband signals of the other baseband sources (second path or external baseband).

The phase offset affects the signal on the "baseband block" output.

Parameters:

<POffset> float
 Range: 0 to 359.9
 Increment: 0.01
 *RST: 0
 Default unit: DEG

Example:

BB:POFF 0.5DEG
 sets a relative phase offset of 0.5 DEG for the baseband signal

[:SOURce<hw>]:BB:ROUTe <Route>

The command selects the signal route for the baseband signal of a two-path instrument.

Parameters:

<Route> A | B | AB
A
 The baseband signal is introduced into path A. The signals from both paths are summed if necessary.
B
 The baseband signal is introduced into path B. The signals from both paths are summed if necessary.
AB
 The baseband signal is introduced into path A and path B. The signals from both paths are summed if necessary.
 *RST: A

Example:

SOUR2:BB:ROUT A
 the baseband signal of path B is introduced into path A.

6.15.3.2 SOURce:BB:ARB Subsystem

The ARB subsystem contains the commands for setting the ARB Generator. Settings for clock and trigger interfaces and for external outputs are entered in the SOURce:INPut and SOURce:OUTput subsystems.

Section [chapter 6.3, "R&S Signal Generator Waveform and List Format"](#), on page 503 describes the ARB waveform format and how it is used to transmit waveforms via the IEC bus.

- [Common Settings](#).....586
- [Clock Settings](#).....586
- [Trigger Settings](#).....588
- [Marker Settings](#).....596
- [Test Signals Settings](#).....598
- [SOURce:BB:ARB:MCAR Subsystem](#).....601
- [SOURce:BB:ARB:WAV Subsystem](#).....615
- [SOURce:BB:ARB:WSEG Subsystem](#).....619

Common Settings

[:SOURce<hw>]:BB:ARB:PRESet	586
[:SOURce<hw>]:BB:ARB:STATe	586

[:SOURce<hw>]:BB:ARB:PRESet

The command sets all ARB generator parameters to their default values.

Example: `BB:ARB:PRES`
resets the ARB generator to default values.

Usage: Event

[:SOURce<hw>]:BB:ARB:STATe <State>

The command enables the ARB generator. Any other standards or digital modulation that may be in the ON state are automatically turned OFF.

In case of two-path instruments, this affects the same path.

`ARB:STAT ON` is only possible after the selection of a waveform. The selected waveform is output straight away (`ARB:SEQ AUTO|RETRigger`) or after the first trigger event (`ARB:SEQ AAUT|ARET`), depending on the trigger setting.

Parameters:

<State> 0 | 1 | OFF | ON
*RST: 0

Example: `BB:ARB:WAV:SEL 'wave1'`
loads waveform file `wave1.wv` from the default directory.
`BB:ARB:TRIG:SEQ RETR`
sets trigger mode Retrigger.
`BB:ARB:STAT ON`
switches on the ARB generator. The selected waveform is output straight away. A trigger event causes signal output to restart.

Clock Settings

[:SOURce<hw>]:BB:ARB:CLOCK	586
[:SOURce<hw>]:BB:ARB:CLOCK:MODE	587
[:SOURce<hw>]:BB:ARB:CLOCK:MULTIplier	587
[:SOURce<hw>]:BB:ARB:CLOCK:SOURce	588

[:SOURce<hw>]:BB:ARB:CLOCK <Clock>

The command sets the clock rate in samples. Loading a waveform waveform (`ARB:WAV:SEL <name>`) sets the clock rate that is defined in the waveform tag 'clock'. The command subsequently changes the clock rate; see data sheet for value range.

In the case of an external clock source (selection `ARB:CLOCK:SOURce EXTernal`) the clock for the external source must be entered with this command.

Parameters:

<Clock> float
 Range: 400 Hz to 100 MHz
 Increment: 0.001 Hz
 *RST: 1 MHz

Example:

BB:ARB:CLOC:SOUR INT
 selects the internal clock source for generating waveforms.
 BB:ARB:CLOC 0.5 MHz
 sets the clock rate to 0.5 MHz.

[:SOURce<hw>]:BB:ARB:CLOCK:MODE <Mode>

The command enters the type of externally supplied clock (:BB:ARB:CLOCK:SOURce EXTERNAL). When MSAMPLE is used, a multiple of the sample clock is supplied via the CLOCK connector and the sample clock is derived internally from this. The multiplier is entered with the command :BB:ARB:CLOCK:MULTIPLIER.

For two-path instruments, the only numerical suffix allowed for SOURce is 1, since the external clock source is permanently allocated to path A.

Parameters:

<Mode> SAMPLE | MSAMPLE
 *RST: SAMPLE

Example:

BB:ARB:CLOC:MODE SAMP
 selects clock type "Sample", i.e. the supplied clock is a sample clock.

[:SOURce<hw>]:BB:ARB:CLOCK:MULTIPLIER <Multiplier>

The command specifies the multiplier for clock type "Multiple Samples" (:BB:ARB:CLOCK:MODE MSAM) in the case of an external clock source.

For two-path instruments, the only numerical suffix allowed for SOURce is 1, since the external clock source is permanently allocated to path A.

Parameters:

<Multiplier> integer
 Range: 1 to 64
 *RST: 4

Example:

BB:ARB:CLOC:SOUR EXT
 selects the external clock source. The clock is supplied via the CLOCK connector.
 BB:ARB:CLOC:MODE MSAM
 selects clock type Multiple Samples, i.e. the supplied clock has a rate which is a multiple of the sample rate.
 BB:ARB:CLOC:MULT 12
 The multiplier for the external clock rate is 12.

[:SOURce<hw>]:BB:ARB:CLOCK:SOURce <Source>

The command selects the source for the digital modulation clock.

Parameters:

<Source> INTernal | EXTernal | AINTernal

INTernal

The internal clock reference is used.

EXTernal

The external clock reference is supplied to the CLOCK connector.

*RST: INTernal

Example:

BB:ARB:CLOC:SOUR EXT

selects an external clock reference. The clock is supplied via the CLOCK connector.

BB:ARB:CLOC:MODE SAMP

enters clock type sample.

Trigger Settings

[:SOURce<hw>]:BB:ARB:TRIGger:ARM:EXECute.....	588
[:SOURce<hw>]:BB:ARB:TRIGger:EXECute.....	589
[:SOURce<hw>]:BB:ARB:TRIGger:EXTernal:SYNChronize:OUTPut.....	589
[:SOURce<hw>]:BB:ARB:TRIGger:OBASeband:DELay.....	590
[:SOURce<hw>]:BB:ARB:TRIGger:OBASeband:INHibit.....	590
[:SOURce<hw>]:BB:ARB:TRIGger:OUTPut:DELay:FIXed.....	590
[:SOURce<hw>]:BB:ARB:TRIGger:OUTPut<ch>:DELay.....	591
[:SOURce<hw>]:BB:ARB:TRIGger:OUTPut<ch>:DELay:MAXimum.....	591
[:SOURce<hw>]:BB:ARB:TRIGger:OUTPut<ch>:DELay:MINimum.....	591
[:SOURce<hw>]:BB:ARB:TRIGger:RMODE.....	592
[:SOURce<hw>]:BB:ARB:TRIGger:SLENgth.....	592
[:SOURce<hw>]:BB:ARB:TRIGger:SLUNit.....	593
[:SOURce<hw>]:BB:ARB:TRIGger:SMODE.....	593
[:SOURce<hw>]:BB:ARB:TRIGger:SOURce.....	594
[:SOURce<hw>]:BB:ARB:TRIGger[:EXTernal<1 2>]:DELay.....	594
[:SOURce<hw>]:BB:ARB:TRIGger[:EXTernal<1 2>]:INHibit.....	594
[:SOURce<hw>]:BB:ARB[:TRIGger]:SEQuence.....	595

[:SOURce<hw>]:BB:ARB:TRIGger:ARM:EXECute

The command stops waveform output for trigger modes Armed_Auto and Armed_Ret-rigger. A subsequent internal or external trigger event restart waveform output.

Example:

```
BB:ARB:TRIG:SOUR INT
sets internal triggering.
BB:ARB:TRIG:SEQ ARET
sets Armed_Retrigger mode, i.e. every trigger event causes wave-
form output to restart.
BB:ARB:TRIG:EXEC
executes a trigger, waveform output is started.
BB:ARB:TRIG:ARM:EXEC
waveform output is stopped.
BB:ARB:TRIG:EXEC
executes a trigger, waveform output is started again.
```

Usage: Event

[[:SOURce<hw>]:BB:ARB:TRIGger:EXECute

The command executes a trigger. The internal trigger source must be selected using the command `ARB:TRIGger:SOURce INTernal` and a trigger mode other than `AUTO` must be selected using the command `:ARB:SEQUence`.

Example:

```
BB:ARB:TRIG:SOUR INT
sets internal triggering.
BB:ARB:SEQ RETR
sets Retrigger mode, i.e. every trigger event causes signal output
to restart.
BB:ARB:TRIG:EXEC
executes a trigger.
```

Usage: Event

[[:SOURce<hw>]:BB:ARB:TRIGger:EXTernal:SYNChronize:OUTPut <Output>

(enabled for "Trigger Source" External)

Enables/disables output of the signal synchronous to the external trigger event.

Parameters:

<Output> 0 | 1 | OFF | ON

ON

The signal calculation starts simultaneously with the external trigger event but because of the instrument's processing time the first samples are cut off and no signal is outputted. After elapsing of the internal processing time, the output signal is synchronous to the trigger event.

OFF

The signal output begins after elapsing of the processing time and starts with sample 0, i.e. the complete signal is outputted.

This mode is recommended for triggering of short signal sequences with signal duration comparable with the processing time of the instrument.

*RST: ON

Example: `BB:ARB:TRIG:SOUR EXT`
sets external triggering.
`BB:ARB:TRIG:EXT:SYNC:OUTP ON`
enables synchronous output to external trigger

[:SOURce<hw>]:BB:ARB:TRIGger:OBASeband:DELay <Delay>

The command specifies the trigger delay (expressed as a number of samples) for triggering by the signal from the second path (two-path instruments only).

Parameters:

<Delay> float
Range: 0 to 65535
Increment: 0.01
*RST: 0
Default unit: sample

Example: `BB:ARB:TRIG:SOUR OBAS`
sets for path A the internal trigger executed by the signal from the second path (path B).
`BB:ARB:TRIG:DEL 200`
sets a delay of 200 samples for the trigger.

[:SOURce<hw>]:BB:ARB:TRIGger:OBASeband:INHibit <Inhibit>

The command specifies the number of samples by which a restart is to be inhibited following a trigger event.

This command applies only for triggering by the second path.

Parameters:

<Inhibit> float
Range: 0 to 67108863
Increment: 1
*RST: 0
Default unit: sample

Example: `BB:ARB:TRIG:SOUR OBAS`
sets for path A the internal trigger executed by the signal from the second path (path B).
`BB:ARB:TRIG:INH 200`
sets a restart inhibit for 200 samples following a trigger event.

[:SOURce<hw>]:BB:ARB:TRIGger:OUTPut:DELay:FIXed <Fixed>

The command restricts the marker delay setting range to the dynamic range. In this range the delay can be set without restarting the marker and signal. If a delay is entered in setting ON but is outside this range, the maximum possible delay is set and an error message is output.

The setting always affects every marker.

Parameters:

<Fixed> 0 | 1 | OFF | ON
 *RST: 0

Example:

BB:ARB:TRIG:OUTP:DEL:FIX ON
 restricts the marker signal delay setting range to the dynamic range.

[[:SOURce<hw>]:BB:ARB:TRIGger:OUTPut<ch>:DELay <Delay>

The command defines the delay between the signal on the marker outputs and the start of the signals, expressed in terms of samples.

Command :BB:ARB:TRIGger:OUTPut:DELay:FIXed ON can be used to restrict the range of values to the dynamic range, i.e. the range within which a delay of the marker signals can be set without restarting the marker and signal.

Parameters:

<Delay> float
 Range: 0 to 2²⁰-1
 Increment: 1
 *RST: 0
 Default unit: Symbol

Example:

BB:ARB:TRIG:OUTP2:DEL 16
 sets a delay of 16 samples for the signal on connector MARKER 2.

**[[:SOURce<hw>]:BB:ARB:TRIGger:OUTPut<ch>:DELay:MAXimum?
[:SOURce<hw>]:BB:ARB:TRIGger:OUTPut<ch>:DELay:MINimum?**

The command queries the minimum marker delay for setting :BB:ARB:TRIGger:OUTPut:DELay:FIXed ON.

Return values:

<Minimum> float
 Range: 0 to 16777215
 Increment: 1E-3
 *RST: 0

Example:

BB:ARB:TRIG:OUTP:DEL:FIX ON
 restricts the marker signal delay setting range to the dynamic range.

BB:ARB:TRIG:OUTP:DEL:MIN
 queries the minimum of the dynamic range.

Response: 0
 the minimum for the marker delay setting is 0 samples.

Usage:

Query only

[[:SOURce<hw>]:BB:ARB:TRIGger:RMODE?

The command queries the status of waveform output or all trigger modes with ARB on.

Return values:

<RMode>

STOP | RUN

RUN

The waveform is output. A trigger event occurred in the triggered mode.

STOP

The waveform is not output. A trigger event did not occur in the triggered modes, or waveform output was stopped by the command: `BB:ARB:TRIG:ARM:EXECute` (armed trigger modes only).

Example:

```
BB:ARB:TRIG:SOUR EXT
```

sets external triggering via the TRIGGER 1 connector.

```
BB:ARB:TRIG:MODE ARET
```

selects the Armed_Retrigger mode.

```
BB:ARB:TRIG:RMODE?
```

queries the current status of waveform output.

```
Response: RUN
```

the waveform is output, an external trigger was executed.

Usage:

Query only

[[:SOURce<hw>]:BB:ARB:TRIGger:SLENGTH <SLength>

The command defines the length of the signal sequence to be output in the Single trigger mode. The unit is defined with command `SOUR:BB:ARB:TRIG:SLUNIT`. It is possible to output deliberately just part of the waveform, an exact sequence of the waveform, or a defined number of repetitions of the waveform.

Parameters:

<SLength>

float

Range: 1 to $2^{32}-1$

*RST: 1 Waveform length

Default unit: sample

Example:

```
BB:ARB:SEQ SING
```

sets trigger mode Single.

```
BB:ARB:TRIG:SLUN SAMP
```

sets unit Samples for the entry of sequence length.

```
BB:ARB:TRIG:SLEN 200
```

sets a sequence length of 200 samples. The first 200 samples of the current waveform will be output after the next trigger event.

[:SOURce<hw>]:BB:ARB:TRIGger:SLUNit <SLunit>

The command defines the unit for the entry of the length of the signal sequence (SOUR:BB:ARB:TRIG:SLEN) to be output in the "Single" trigger mode (SOUR:BB:ARB:SEQ SING).

Parameters:

<SLunit> SEQUENCE | SAMPLE
*RST: SEQUENCE

Example:

```
BB:ARB:SEQ SING
sets trigger mode Single.
BB:ARB:TRIG:SLUN SEQ
sets unit Sequence length for the entry of sequence length.
BB:ARB:TRIG:SLEN 2
sets a sequence length of 2 waveforms. The current waveforms
will be output twice after the next trigger event.
```

[:SOURce<hw>]:BB:ARB:TRIGger:SMODE <SMode>

The command selects the extended trigger mode for multi segment waveforms.

Parameters:

<SMode> SAME | NEXT | SEQUencer | NSEam

SAME

The currently selected segment is output repeatedly.

NEXT

The current segment ceases to be output as soon as a new segment is entered with command :BB:ARB:WSEG:NEXT and the new segment starts to be output after a system-imposed signal gap.

NSEam

The segment selected with command :BB:ARB:WSEG:NEXT is not output until the whole of the current segment has been output (wrap around). In this case the signal transition is seamless.

SEQUencer

The waveform files are processed according to the order and repetition cycles defined in the special sequencing list file (*.WVS) assigned to the multi segment waveform file.

This "play list" is selected with the command

```
BB:ARB:WSEG:SEQ:SEL.
```

*RST: NEXT

Example:

```
SOUR2:BB:ARB:SEQ AUTO
selects trigger mode AUTO.
SOUR2:BB:ARB:TRIG:SMOD SAME
the same segment of the waveform is output repeatedly.
```

```
[:SOURce<hw>]:BB:ARB:TRIGger:SOURce <Source>
```

The command selects the trigger source.

Parameters:

<Source>

INTernal | EXTernal | BEXTernal | OBASeband

INTernal

Triggering is executed by means of the Trigger command in the case of remote control, and by means of "Execute Trigger" in the case of manual operation.

EXTernal

Triggering is executed by means of the signal on the TRIGGER 1 connector.

BEXTernal

Triggering is executed by means of the signal on the TRIGGER 2 connector.

OBASeband

Triggering is executed by means of the signal from the second path.

*RST: INTernal

Example:

```
BB:ARB:TRIG:SOUR INT
sets internal triggering.
```

```
[:SOURce<hw>]:BB:ARB:TRIGger[:EXTernal<1|2>]:DELay <Delay>
```

The command specifies the trigger delay (expressed as a number of samples) for external triggering.

The numeric suffix to EXTernal distinguishes between the external trigger via the TRIGGER 1 (suffix 1) and TRIGGER 2 (suffix 2) connector.

Parameters:

<Delay>

float

Range: 0 to 2³²-1

Increment: 1

*RST: 0

Default unit: sample

Example:

```
BB:ARB:TRIG:SOUR EXT
selects an external trigger via the TRIGGER 1 connector
BB:ARB:TRIG:DEL 200
sets a delay of 200 samples for the trigger.
```

```
[:SOURce<hw>]:BB:ARB:TRIGger[:EXTernal<1|2>]:INHibit <Inhibit>
```

The command specifies the number of samples by which a restart is to be inhibited following a trigger event. This command applies only in the case of external triggering.

The numeric suffix to EXTERNAL distinguishes between the external trigger via the TRIGGER 1 (suffix 1) and TRIGGER 2 (suffix 2) connector.

Parameters:

<Inhibit> float
 Range: 0 to 67108863
 *RST: 0
 Default unit: sample

Example:

```
BB:ARB:TRIG:SOUR EXT
selects an external trigger via the TRIGGER 1 connector
BB:ARB:TRIG:INH 200
sets a restart inhibit for 200 samples following a trigger event.
```

[[:SOURce<hw>]:BB:ARB[:TRIGger]:SEQUence <Sequence>

The command selects the trigger mode.

Parameters:

<Sequence>

AUTO | RETRigger | AAUTO | ARETrigger | SINGLE

AUTO

The waveform is output continuously.

RETRigger

The waveform is output continuously. A trigger event (internal or external) causes a restart.

AAUTO

The waveform is output only when a trigger event occurs. After the trigger event the waveform is output continuously. Waveform output is stopped with command `SOUR:BB:ARB:TRIG:ARM:EXEC` and started again when a trigger event occurs.

ARETrigger

The waveform is output only when a trigger event occurs. The device automatically toggles to RETRIG mode. Every subsequent trigger event causes a restart. Waveform output is stopped with command `SOUR:BB:ARB:TRIG:ARM:EXEC` and started again when a trigger event occurs.

SINGLE

The waveform is output only when a trigger event occurs. After the trigger event the waveform is output once to the set sequence length (`SOUR:BB:ARB:TRIG:SLen`). Every subsequent trigger event causes a restart.

*RST: RETRigger

Example:

```
BB:ARB:SEQ AAUT
sets the "Armed_auto" trigger mode; the device waits for the first
trigger (e.g. with *TRG) and then generates the signal continuously.
```

Marker Settings

<code>[:SOURce<hw>]:BB:ARB:TRIGger:OUTPut<ch>:MODE</code>	596
<code>[:SOURce<hw>]:BB:ARB:TRIGger:OUTPut<ch>:OFFTime</code>	596
<code>[:SOURce<hw>]:BB:ARB:TRIGger:OUTPut<ch>:ONTime</code>	596
<code>[:SOURce<hw>]:BB:ARB:TRIGger:OUTPut<ch>:PATTern</code>	597
<code>[:SOURce<hw>]:BB:ARB:TRIGger:OUTPut<ch>:PULSe:DIVider</code>	597
<code>[:SOURce<hw>]:BB:ARB:TRIGger:OUTPut<ch>:PULSe:FREQuency</code>	597

`[:SOURce<hw>]:BB:ARB:TRIGger:OUTPut<ch>:MODE <Mode>`

The command defines the signal for the selected marker output.

Parameters:

<Mode>

UNCHanged | REStart | PULSe | PATTern | RATio

UNCHanged

A marker signal as defined in the waveform file (tag 'marker mode x') is generated.

REStart

A marker signal is generated at every waveform start.

PULSe

A pulsed marker signal is generated. The pulse frequency (= symbol rate/divider) is defined with the

`SOUR:BB:ARB:TRIG:OUTP:PULS:DIV` command and can be queried with the `SOUR:BB:ARB:TRIG:OUTP:PULS:FREQ?` command.

PATTern

A marker signal is generated with the aid of a user-definable bit pattern. The bit pattern is entered with the aid of command `:BB:ARB:TRIGger:OUTPut:PATTern`. The bit pattern is a maximum of 32 bits long.

RATio

A regular marker signal corresponding to the Time Off / Time On specifications in the com-

mands `:ARB:TRIGger:OUTPut:OFFTime`

and `:ARB:TRIGger:OUTPut:ONTime` is generated.

*RST: UNCHanged

Example:

`BB:ARB:TRIG:OUTP2:MODE PULS`

selects the pulsed marker signal on output MARKER 2.

`BB:ARB:TRIG:OUTP2:STAT ON`

activates the pulsed marker signal on output MARKER 2.

`[:SOURce<hw>]:BB:ARB:TRIGger:OUTPut<ch>:OFFTime <OffTime>`

`[:SOURce<hw>]:BB:ARB:TRIGger:OUTPut<ch>:ONTime <OnTime>`

The command sets the number of samples in a period (ON time + OFF time) during which the marker signal in setting `:ARB:TRIGger:OUTPut:MODE RATio` on the marker outputs is ON.

Parameters:

<OnTime> float
 Range: 1 to 14913079
 *RST: 1

Example:

BB:ARB:TRIG:OUTP2:ONT 20
 sets an ON time of 20 samples for marker 2
 In case of two-path instruments, on path A.

[[:SOURce<hw>]:BB:ARB:TRIGger:OUTPut<ch>:PATTern <Pattern>

The command defines the bit pattern used to generate the marker signal in the setting SOURce:BB:ARB:TRIGger:OUTPut:MODE PATTern 0 is marker off, 1 is marker on.

Parameters:

<Pattern> <32 bits pattern>
 *RST: 0

Example:

BB:ARB:TRIG:OUTP2:PATT #H39FE0000,32
 sets a bit pattern.
 BB:ARB:TRIG:OUTP2:MODE PATT
 activates the marker signal according to a bit pattern on output
 MARKER 2.

[[:SOURce<hw>]:BB:ARB:TRIGger:OUTPut<ch>:PULSe:DIVider <Divider>

The command sets the divider for the pulsed marker signal in the setting SOURce:BB:ARB:TRIGger:OUTPut:MODE PULSe. The pulse frequency is derived by dividing the symbol rate by the divider.

Parameters:

<Divider> integer
 Range: 2 to 1024
 Increment: 1
 *RST: 2

Example:

BB:ARB:TRIG:OUTP2:PULS:DIV 2
 sets the divider for the marker signal on output MARKER 2 to the
 value 2.
 BB:ARB:TRIG:OUTP2:FREQ?
 queries the resulting pulse frequency of the marker signal
 Response: 66 000
 the resulting pulse frequency is 66 kHz.

[[:SOURce<hw>]:BB:ARB:TRIGger:OUTPut<ch>:PULSe:FREQuency?

The command queries the pulse frequency of the pulsed marker signal in the setting SOURce:BB:ARB:TRIGger:OUTPut:MODE PULSe. The pulse frequency is derived by dividing the symbol rate by the divider. The divider is defined with command :BB:ARB:TRIG:OUTP:PULS:DIV.

Return values:

<Frequency> float

Example:

```
BB:ARB:TRIG:OUTP2:PULS:DIV 4
sets the divider for the marker signal on output MARKER 2 to the
value 4.
BB:ARB:TRIG:OUTP2:MODE PULS
enables the pulsed marker signal.
BB:ARB:TRIG:OUTP2:PULS:FREQ?
queries the pulse frequency of the marker signal.
Response: 33 000
the resulting pulse frequency is 33 kHz.
```

Usage: Query only**Test Signals Settings**

<code>[SOURce<hw>]:BB:ARB:TSIGnal:CIQ:CREate</code>	598
<code>[SOURce<hw>]:BB:ARB:TSIGnal:RECTangle:CREate</code>	598
<code>[SOURce<hw>]:BB:ARB:TSIGnal:SINE:CREate</code>	598
<code>[SOURce<hw>]:BB:ARB:TSIGnal:CIQ:CREate:NAMed</code>	598
<code>[SOURce<hw>]:BB:ARB:TSIGnal:RECTangle:CREate:NAMed</code>	598
<code>[SOURce<hw>]:BB:ARB:TSIGnal:SINE:CREate:NAMed</code>	598
<code>[SOURce<hw>]:BB:ARB:TSIGnal:CIQ:I</code>	599
<code>[SOURce<hw>]:BB:ARB:TSIGnal:CIQ:Q</code>	599
<code>[SOURce<hw>]:BB:ARB:TSIGnal:RECTangle:AMPLitude</code>	599
<code>[SOURce<hw>]:BB:ARB:TSIGnal:RECTangle:FREQuency</code>	599
<code>[SOURce<hw>]:BB:ARB:TSIGnal:RECTangle:OFFSet</code>	599
<code>[SOURce<hw>]:BB:ARB:TSIGnal:RECTangle:SAMPles</code>	600
<code>[SOURce<hw>]:BB:ARB:TSIGnal:SINE:FREQuency</code>	600
<code>[SOURce<hw>]:BB:ARB:TSIGnal:SINE:PHASe</code>	600
<code>[SOURce<hw>]:BB:ARB:TSIGnal:SINE:SAMPles</code>	601

```
[SOURce<hw>]:BB:ARB:TSIGnal:CIQ:CREate
[SOURce<hw>]:BB:ARB:TSIGnal:RECTangle:CREate
[SOURce<hw>]:BB:ARB:TSIGnal:SINE:CREate
```

Generates a signal and uses it as output straight away.

Example: `BB:ARB:TSIG:SINE:CRE`
generates a test sine signal and uses it as output straight away.

Usage: Event

```
[SOURce<hw>]:BB:ARB:TSIGnal:CIQ:CREate:NAMed <Filename>
[SOURce<hw>]:BB:ARB:TSIGnal:RECTangle:CREate:NAMed <Filename>
[SOURce<hw>]:BB:ARB:TSIGnal:SINE:CREate:NAMed <Filename>
```

Generates a signal and saves it to a waveform file.

Setting parameters:

<Filename> string

Example: `BB:ARB:TSIG:SINE:CRE:NAM 'sine_test'`
generates a test sine signal and saves it into the wavefile `sine_test`.

Usage: Setting only

**[[:SOURce<hw>]:BB:ARB:TSIGnal:CIQ:I <I>
[:SOURce<hw>]:BB:ARB:TSIGnal:CIQ:Q <TSig>**
Sets the value for the Q component of the test signal

Parameters:

<TSig> float
Range: -0.5 to 0.5
Increment: 0.001
*RST: 0
Default unit: FS

Example: `BB:ARB:TSIG:CIQ:Q 0.5`
sets the value for the Q component of the test signal.

[[:SOURce<hw>]:BB:ARB:TSIGnal:RECTangle:AMPLitude <Amplitude>

Sets the digital amplitude of the rectangular wave.

Parameters:

<Amplitude> float
Range: 0 to 1
Increment: 0.001
*RST: 0.800
Default unit: FS

Example: `BB:ARB:TSIG:RECT:AMPL 0.5`
sets the amplitude of the test signal

[[:SOURce<hw>]:BB:ARB:TSIGnal:RECTangle:FREQuency <Frequency>

The command sets the frequency of the test signal.

Parameters:

<Frequency> float
Range: 100 Hz to 25.0E6 Hz
Increment: 0.01
*RST: 1 kHz

Example: `BB:ARB:TSIG:RECT:FREQ 100 kHz`
sets the frequency of the test signal of 100 kHz.

[[:SOURce<hw>]:BB:ARB:TSIGnal:RECTangle:OFFSet <Offset>

Sets the DC component.

Parameters:

<Offset> float
 Range: -1 to 1
 Increment: 0.001
 *RST: 0
 Default unit: FS

Example:

BB:ARB:TSIG:RECT:OFFS 0.5
 sets the DC component

[:SOURce<hw>]:BB:ARB:TSIGnal:RECTangle:SAMPles <Samples>

Sets the number of sample values required for the rectangular signal per period.

Parameters:

<Samples> integer
 Range: 4 to 1000
 Increment: 1
 *RST: 100

Example:

BB:ARB:TSIG:RECT:SAMP 400
 sets 400 samples per period

[:SOURce<hw>]:BB:ARB:TSIGnal:SINE:FREQuency <Frequency>

The command sets the frequency of the simple sinusoidal test signal. This signal is used as output via the I channel. A sine wave of the same frequency but optionally phase-shifted is generated on the Q path (ARB:TSIGnal:SINE:POFFset).

Parameters:

<Frequency> float
 Range: 100 to Max
 Increment: 0.01
 *RST: 1000
 Default unit: Hz

Example:

BB:ARB:TSIG:SINE:FREQ 100 kHz
 sets a sine signal of 100 kHz.

[:SOURce<hw>]:BB:ARB:TSIGnal:SINE:PHASe <Phase>

The command sets the phase offset of the sine wave on the Q channel relative to the sine wave on the I channel.

Parameters:

<Phase> float
 Range: -180 to 180
 Increment: 0.01
 *RST: 90
 Default unit: DEG

Example: `BB:ARB:TSIG:SINE:PHAS 90`
sets a phase offset of 90 degrees.

[:SOURce<hw>]:BB:ARB:TSIGnal:SINE:SAMPles <Samples>

The command sets the sample rate for the sine signal in samples per period.

The resulting clock rate must not exceed the maximum ARB clock rate of 100 MHz.

The maximum value is automatically restricted by reference to the set frequency and has to fulfill the rule $\text{Frequency} * \text{Samples} \leq \text{ARB clock rate}$.

Parameters:

<Samples> integer
Range: 4 to 1000
Increment: 1
*RST: 100
Default unit: 100 samples per period

Example: `BB:ARB:TSIG:SINE:SAMP 100`
sets a sample rate of 100 samples per period.

SOURce:BB:ARB:MCAR Subsystem

The `MCARrier` subsystem contains the commands for setting the Multi Carrier Waveform Generator.

Section [chapter 6.3, "R&S Signal Generator Waveform and List Format"](#), on page 503 describes the ARB waveform format and how it is used to transmit waveforms via the IEC bus.

CARRier<ch>

The numerical suffix under `CARRier` distinguish between the carriers. The value range is 0 .. 31.

<code>[:SOURce<hw>]:BB:ARB:MCARrier:CARRier:COUNT</code>	602
<code>[:SOURce<hw>]:BB:ARB:MCARrier:CARRier:MODE</code>	602
<code>[:SOURce<hw>]:BB:ARB:MCARrier:CARRier:SPACing</code>	603
<code>[:SOURce<hw>]:BB:ARB:MCARrier:CARRier<ch>:CONFLict</code>	603
<code>[:SOURce<hw>]:BB:ARB:MCARrier:CARRier<ch>:DELay</code>	604
<code>[:SOURce<hw>]:BB:ARB:MCARrier:CARRier<ch>:FILE</code>	604
<code>[:SOURce<hw>]:BB:ARB:MCARrier:CARRier<ch>:FREQuency</code>	604
<code>[:SOURce<hw>]:BB:ARB:MCARrier:CARRier<ch>:PHASe</code>	605
<code>[:SOURce<hw>]:BB:ARB:MCARrier:CARRier<ch>:POWer</code>	605
<code>[:SOURce<hw>]:BB:ARB:MCARrier:CARRier<ch>:STATe</code>	605
<code>[:SOURce<hw>]:BB:ARB:MCARrier:CFACtor:MODE</code>	605
<code>[:SOURce<hw>]:BB:ARB:MCARrier:CLIPping:CFACtor</code>	606
<code>[:SOURce<hw>]:BB:ARB:MCARrier:CLIPping:CUTOff</code>	606
<code>[:SOURce<hw>]:BB:ARB:MCARrier:CLIPping[STATe]</code>	607
<code>[:SOURce<hw>]:BB:ARB:MCARrier:CLOad</code>	607
<code>[:SOURce<hw>]:BB:ARB:MCARrier:CLOCK</code>	608

<code>[SOURce<hw>]:BB:ARB:MCARrier:CREate</code>	608
<code>[SOURce<hw>]:BB:ARB:MCARrier:EDIT:CARRier:DELay:STEP</code>	608
<code>[SOURce<hw>]:BB:ARB:MCARrier:EDIT:CARRier:DELay[:STARt]</code>	609
<code>[SOURce<hw>]:BB:ARB:MCARrier:EDIT:CARRier:EXECute</code>	609
<code>[SOURce<hw>]:BB:ARB:MCARrier:EDIT:CARRier:FILE</code>	610
<code>[SOURce<hw>]:BB:ARB:MCARrier:EDIT:CARRier:PHASe:STEP</code>	610
<code>[SOURce<hw>]:BB:ARB:MCARrier:EDIT:CARRier:PHASe[:STARt]</code>	610
<code>[SOURce<hw>]:BB:ARB:MCARrier:EDIT:CARRier:POWER:STEP</code>	611
<code>[SOURce<hw>]:BB:ARB:MCARrier:EDIT:CARRier:POWER[:STARt]</code>	611
<code>[SOURce<hw>]:BB:ARB:MCARrier:EDIT:CARRier:STARt</code>	611
<code>[SOURce<hw>]:BB:ARB:MCARrier:EDIT:CARRier:STOP</code>	611
<code>[SOURce<hw>]:BB:ARB:MCARrier:EDIT:CARRier:STATe</code>	612
<code>[SOURce<hw>]:BB:ARB:MCARrier:OFILe</code>	612
<code>[SOURce<hw>]:BB:ARB:MCARrier:PRESet</code>	612
<code>[SOURce<hw>]:BB:ARB:MCARrier:SAMPles</code>	612
<code>[SOURce<hw>]:BB:ARB:MCARrier:SETTing:CATalog</code>	613
<code>[SOURce<hw>]:BB:ARB:MCARrier:SETTing:LOAD</code>	613
<code>[SOURce<hw>]:BB:ARB:MCARrier:SETTing:STORe</code>	613
<code>[SOURce<hw>]:BB:ARB:MCARrier:SETTing:STORe:FAST</code>	613
<code>[SOURce<hw>]:BB:ARB:MCARrier:TIME</code>	614
<code>[SOURce<hw>]:BB:ARB:MCARrier:TIME:MODE</code>	614

`[SOURce<hw>]:BB:ARB:MCARrier:CARRier:COUNT <Count>`

The command sets the number of carriers in the ARB multi carrier waveform.

The total bandwidth (**Number of carriers - 1**) ***Carrier spacing** is 80 MHz.

The number of carriers entered therefore defines the maximum carrier spacing (`:BB:ARB:MCARrier:CARRier:SPACing`) and the carrier spacing is reduced if the total bandwidth is not respected when entering the number of carriers.

Parameters:

`<Count>` integer
 Range: 1 to 512
 Increment: 1
 *RST: 1

Example:

`BB:ARB:MCAR:CARR:COUN 10`
 sets 10 carriers for the multi carrier waveform.

`[SOURce<hw>]:BB:ARB:MCARrier:CARRier:MODE <mode>`

The command sets the carrier frequency mode.

Parameters:

<mode> EQUidistant | ARBitrary

EQUidistant

Sets an equidistant carrier spacing. The carrier frequency in the carrier table is not configurable.

ARBitrary

Enables you to specify the carrier frequency in the carrier table. Carrier spacing is irrelevant.

*RST: EQUidistant

Example:

BB:ARB:MCAR:CARR:MODE EQU

sets an equidistant carrier spacing. The carrier frequency can not be set.

[:SOURce<hw>]:BB:ARB:MCARrier:CARRier:SPACing <Spacing>

The command sets the frequency spacing between adjacent carriers of the multi carrier waveform. The carriers are generated symmetrically around the RF carrier. The maximum carrier spacing is limited to **Carrier spacing = Total baseband bandwidth / (Number of carriers - 1)**.

The total baseband bandwidth is 80 MHz.

Note:In order to avoid wrap-around problems, the effective "Carrier Spacing" might be slightly modified. The "Carrier Spacing" is rounded in that way that the carrier closest to the center RF frequency shows no phase jump assuming that the carrier is unmodulated.

- For odd number of carriers:
RoundedCarrierSpacing=1/OutputSignalDuration* round(CarrierSpacing * OutputSignalDuration);
- For even number of carriers:
RoundedCarrierSpacing=2/OutputSignalDuration*round(0.5 *CarrierSpacing * OutputSignalDuration);

Parameters:

<Spacing> float
Range: 0.0 to 120E6
Increment: 0.01
*RST: 0
Default unit: Hz

Example:

BB:ARB:MCAR:CARR:SPAC 10 MHz
sets a carrier spacing of 10 MHz.

[:SOURce<hw>]:BB:ARB:MCARrier:CARRier<ch>:CONFLICT?

Queries carrier conflicts. A conflict arises when the carriers overlap.

Return values:

<conflict> 0 | 1 | OFF | ON
*RST: 0

Example: `BB:ARB:MCAR:CARR:CONF?`
 queries the multi carrier conflict state.
 Response: 0 no conflict has occurred.

Usage: Query only

[:SOURce<hw>]:BB:ARB:MCARrier:CARRier<ch>:DELay <Delay>

The command sets the start delay of the selected carrier.

Parameters:

<Delay> float
 Range: 0 to 1
 Increment: 1E-9
 *RST: 0
 Default unit: s

Example: `BB:ARB:MCAR:CARR15:DEL 5us`
 sets a start delay of 50 us for carrier 15.

[:SOURce<hw>]:BB:ARB:MCARrier:CARRier<ch>:FILE <File>

The command selects the file with I/Q data to be modulated onto the selected carrier.

Parameters:

<File> <file name>

Example: `BB:ARB:MCAR:CARR15:FILE 'D:/IQ_wcdma'`
 selects file IQ_wcdma. The data of the file is modulated onto carrier 15.

[:SOURce<hw>]:BB:ARB:MCARrier:CARRier<ch>:FREQuency <Frequency>

Sets or indicates the carrier frequency, depending on the selected carrier frequency mode.

The carrier frequency can be set in "Arbitrary Carrier frequency" mode. For "Equidistant Carrier Spacing", the carrier spacing is determined automatically.

Parameters:

<Frequency> integer
 Range: -40.0E6 to 40.0E6
 Increment: 1
 *RST: 0

Example: `BB:ARB:MCAR:CARR:MODE ARB`
 activates ARB multi carrier mode.
`BB:ARB:MCAR:CARR:FREQ 5.0`
 sets 5.0 MHz carrier frequency.

[[:SOURce<hw>]:BB:ARB:MCARrier:CARRier<ch>:PHASe <Phase>

The command sets the start phase of the selected carrier.

The phase settings are only valid if optimization of the crest factor is disabled
([:SOURce:BB:ARB:MCARrier:CFACTOR:MODE OFF).

Parameters:

<Phase> float
 Range: 0 to 359.99
 Increment: 0.01
 *RST: 0
 Default unit: DEG

Example: BB:ARB:MCAR:CARR15:PHAS 90 DEG
 sets a start phase of 90° for carrier 15.

[[:SOURce<hw>]:BB:ARB:MCARrier:CARRier<ch>:POWER <Power>

The command sets the gain of the selected carrier.

Parameters:

<Power> float
 Range: -80 to 0
 Increment: 0.01
 *RST: 0
 Default unit: dB

Example: BB:ARB:MCAR:CARR15:POW -50 dB
 sets the power of carrier 15 to -50 dB.

[[:SOURce<hw>]:BB:ARB:MCARrier:CARRier<ch>:STATE <State>

The command switches the selected carrier on or off.

Parameters:

<State> 0 | 1 | OFF | ON
 *RST: ON

Example: BB:ARB:MCAR:CARR15:STAT ON
 switches carrier 15 on.

[[:SOURce<hw>]:BB:ARB:MCARrier:CFACTOR:MODE <Mode>

The command sets the mode for optimizing the crest factor by calculating the carrier phases.

Parameters:

<Mode>

OFF | MIN | MAX

OFF

There is no automatic setting for minimizing or maximizing the crest factor. The Phase setting (command `BB:ARB:MCAR:CARR:PHAS`) is in use.

MIN

The crest factor is minimized by internally calculating optimized carrier phases. The Phase setting (command `BB:ARB:MCAR:CARR:PHAS`) is invalid.

MAX

The crest factor is maximized by internally calculating optimized carrier phases. The Phase setting (command `BB:ARB:MCAR:CARR:PHAS`) is invalid.

*RST: OFF

Example:`BB:ARB:MCAR:CFAC:MODE OFF`

switches off automatic crest factor optimization. The setting `SOUR:BB:ARB:MCAR:CARR:PHAS` has an effect.

[[:SOURce<hw>]:BB:ARB:MCARrier:CLIPping:CFACtor <CFactor>

Sets the value of the desired crest factor, if baseband clipping is enabled (`BB:ARB:MCAR:CLIP:STAT ON`).

A Target Crest Factor above the crest factor of the unclipped multicarrier signal has no effect.

Parameters:

<CFactor>

float

Range: -50 to 50

Increment: 0.01

*RST: 50

Default unit: dB

Example:`BB:ARB:MCAR:CLIP:STAT ON`

enables clipping.

`BB:ARB:MCAR:CLIP:CFAC 37 dB`

sets the target crest factor.

[[:SOURce<hw>]:BB:ARB:MCARrier:CLIPping:CUToff <Cutoff>

Sets the cut off frequency of the final lowpass filter, if baseband clipping is enabled (`BB:ARB:MCAR:CLIP:STAT ON`).

When the cut off frequency is set as half of the output sample rate, a final lowpass filter improves the spectrum of the clipped multicarrier signal, but may also increase the resulting crest factor.

Parameters:

<Cutoff> float
 Range: 0 to 50E6
 Increment: 0.01
 *RST: 50E6
 Default unit: MHz

Example:

```
BB:ARB:MCAR:CLIP:STAT ON
enables clipping
BB:ARB:MCAR:CLIP:CUT 50 MHz
sets the cut off frequency of the filter.
```

[:SOURce<hw>]:BB:ARB:MCARrier:CLIPping[:STATe] <State>

Switches baseband clipping on and off.

Clipping reduces the peak power of the resulting multi carrier signal according to the value set with the command `BB:ARB:MCAR:CLIP:CFAC`.

The resulting clipped peak power is defined by sum of the the RMS level of the unclipped multi carrier signal and the input parameter Target Crest Factor. Note that clipping reduces also the RMS level. Hence the resulting crest factor of the clipped signal is slightly above the Target Crest Factor. In order to get the unclipped parts of the clipped multi-carrier signal matched with the unclipped multicarrier signal, the RF output power should be reduced by the difference between resulting crest factor and Target Crest Factor.

Parameters:

<State> 0 | 1 | OFF | ON
 *RST: 0

Example:

```
BB:ARB:MCAR:CLIP:STAT ON
enables clipping
BB:ARB:MCAR:CLIP:CFAC 37 dB
sets the target crest factor.
```

[:SOURce<hw>]:BB:ARB:MCARrier:CLOad <Cload>

This command creates a multi carrier waveform using the current entries of the carrier table.

This multi carrier waveform is saved with the file name specified with command `SOUR:BB:ARB:MCAR:OFIL`. The file extension is `*.wv`. Digital standard "ARB" is activated, the new multi carrier waveform is loaded and is output in accordance to the trigger settings.

Parameters:

<Cload> <file name>

Example: `MMEM:CDIR 'D:/user/waveform'`
 sets the default directory to `D:/user/waveform`.
`BB:ARB:MCAR:OFIL 'mcar1_2'`
 defines the file name `mcar1_2.wv` for the multi carrier waveform.
`BB:ARB:MCAR:CLO`
 creates multi carrier waveform `mcar1_2.wv`.
 The new multi carrier waveform is loaded and digital standard "ARB" is activated.

Usage: Event

[:SOURce<hw>]:BB:ARB:MCARrier:CLOCK?

The command queries the resulting sample rate at which the multi carrier waveform is output by the arbitrary waveform generator. The output clock rate depends on the number of carriers, carrier spacing and input sample rate of the leftmost or rightmost carriers.

Return values:

<Clock> float
 Range: 400 to Max
 Increment: 1E-3

Example: `BB:ARB:MCAR:CLOC?`
 queries the ARB multi carrier output clock rate.

Usage: Query only

[:SOURce<hw>]:BB:ARB:MCARrier:CREate

This command creates a multi carrier waveform using the current settings of the carrier table. The multi carrier waveform is saved into the file defined with command `SOUR:BB:ARB:MCAR:OFIL`. The file extension is `*.wv`.

Example: `MMEM:CDIR 'D:/user/waveform'`
 sets the default directory to `D:/user/waveform`.
`BB:ARB:MCAR:OFIL 'multi_wv1'`
 defines the file name `multi_wv1.wv` for the multi carrier waveform.
`BB:ARB:MCAR:CRE`
 creates multi carrier waveform `multi_wv1.wv`.

Usage: Event

[:SOURce<hw>]:BB:ARB:MCARrier:EDIT:CARRier:DELay:STEP <Step>

The command sets the step width by which the start delays of the carriers in the defined carrier range will be incremented.

Parameters:

<Step> float
 Range: -1 to 1
 Increment: 1E-9
 *RST: 0
 Default unit: s

Example:

BB:ARB:MCAR:EDIT:CARR:DEL 5 us
 sets a start delay of 5 us for the carriers in the carrier range.
 BB:ARB:MCAR:EDIT:CARR:DEL:STEP 1 us
 the start delay is incremented by 1us for each carrier, i.e. the first carrier has a start delay of 5us, the second a start delay of 6 us, etc.

[[:SOURce<hw>]:BB:ARB:MCARrier:EDIT:CARRier:DELay[:STARt] <Start>

The command sets the start delay for the individual carriers in the defined carrier range. If the command :BB:ARB:MCAR:EDIT:CARR:DEL:STEP is used to define a step width, the delay entered here applies only to the starting carrier. The delays of the remaining carriers are stepped up or down by the delay value specified in the :BB:ARB:MCAR:EDIT:CARR:DEL:STEP command.

Parameters:

<Start> float
 Range: 0 to 1
 Increment: 1E-9
 *RST: 0
 Default unit: s

Example:

BB:ARB:MCAR:EDIT:CARR:DEL 5us
 sets a start delay of 5 us for the carriers in the carrier range.

[[:SOURce<hw>]:BB:ARB:MCARrier:EDIT:CARRier:EXECute

The command adopts the settings for the carrier range which has been defined using the :BB:ARB:MCAR:EDIT:CARR:... commands.

Example:

BB:ARB:MCAR:EDIT:CARR:STAR 4
 the carrier range starts at carrier 2.
 BB:ARB:MCAR:EDIT:CARR:STOP 20
 the carrier range stops at carrier 20.
 BB:ARB:MCAR:EDIT:CARR:STAT ON
 sets all the carriers in the carrier range (2 to 20) to ON.
 BB:ARB:MCAR:EDIT:CARR:EXEC
 transfers the assistant settings for carrier 2 to 20 into the carrier table.

Usage: Event

```
[:SOURce<hw>]:BB:ARB:MCARrier:EDIT:CARRier:FILE <File>
```

Parameters:

```
<File>          string
```

Example: `BB:ARB:MCAR:EDIT:CARR:FILE 'D:/IQ_wcdma'`
selects input file `IQ_wcdma`. The data of the file are modulated onto the carriers in the defined carrier range.

```
[:SOURce<hw>]:BB:ARB:MCARrier:EDIT:CARRier:PHASe:STEP <Step>
```

The command sets the step width by which the start phases of the carriers in the defined carrier range will be incremented.

The phase settings are only valid if optimization of the crest factor is disabled (`:SOURce:BB:ARB:MCARrier:CFACTOR:MODE OFF`).

Parameters:

```
<Step>          float
Range:          -359.99 to 359.99
Increment:      0.01
*RST:           0
Default unit:   DEG
```

Example: `BB:ARB:MCAR:EDIT:CARR:PHAS 90 DEG`
sets a start phase of 90° for the carriers in the carrier range.
`BB:ARB:MCAR:EDIT:CARR:PHAS:STEP 1 DEG`
the start phase is incremented by 1° for each carrier, i.e. the first carrier has a start phase of 90°, the second a start phase of 91°, etc.

```
[:SOURce<hw>]:BB:ARB:MCARrier:EDIT:CARRier:PHASe[:START] <Start>
```

The command sets the start phase for the individual carriers in the defined carrier range. If the command `:BB:ARB:MCAR:EDIT:CARR:PHAS:STEP` is used to define a step width, the phase entered here applies only to the starting carrier. The phases of the remaining carriers are stepped up or down by the phase value specified in the `:BB:ARB:MCAR:EDIT:CARR:PHAS:STEP` command.

The phase settings are only valid if optimization of the crest factor is disabled (`:SOURce:BB:ARB:MCARrier:CFACTOR:MODE OFF`).

Parameters:

```
<Start>         float
Range:           0 to 359.99
Increment:       0.01
*RST:            0
Default unit:    DEG
```

Example: `BB:ARB:MCAR:EDIT:CARR:PHAS 90 DEG`
sets a start phase of 90° for the carriers in the carrier range.

[[:SOURce<hw>]:BB:ARB:MCARrier:EDIT:CARRier:POWER:STEP <Step>

The command sets the step width by which the starting power of the carriers in the defined carrier range will be incremented.

Parameters:

<Step> float
 Range: -80 to 80
 Increment: 0.01
 *RST: 0
 Default unit: dB

Example:

BB:ARB:MCAR:EDIT:CARR:POW -80dB
 sets a power of -80 dB for the carriers in the carrier range.
 BB:ARB:MCAR:EDIT:CARR:POW:STEP 1 dB
 the power is incremented by 1dB for each carrier, i.e. the first carrier has -80dB, the second -79dB, etc.

[[:SOURce<hw>]:BB:ARB:MCARrier:EDIT:CARRier:POWER[:START] <Start>

The command sets the power for the individual carriers in the defined carrier range. If the command :BB:ARB:MCAR:EDIT:CARR:POW:STEP is used to define a step width, the power entered here applies only to the starting carrier. The power of the remaining carriers is stepped up or down by the power specified in the :BB:ARB:MCAR:EDIT:CARR:POW:STEP command.

Parameters:

<Start> float
 Range: -80 to 0
 Increment: 0.01
 *RST: 0
 Default unit: dB

Example:

BB:ARB:MCAR:EDIT:CARR:POW -50 dB
 sets the power of the carriers in the carrier range to -50 dB.

[[:SOURce<hw>]:BB:ARB:MCARrier:EDIT:CARRier:START <Start>

[[:SOURce<hw>]:BB:ARB:MCARrier:EDIT:CARRier:STOP <Stop>

The command selects the last carrier in the carrier range to which the settings with the :BB:ARB:MCAR:EDIT:CARR:.. commands shall apply.

Parameters:

<Stop> integer
 Range: 0 to 511
 Increment: 1
 *RST: 0

Example:

BB:ARB:MCAR:EDIT:CARR:STOP 4
 the carrier range stops at carrier 4.

[:SOURce<hw>]:BB:ARB:MCARrier:EDIT:CARRier:STATe <State>

The command switches all the carriers in the selected carrier range on or off.

Parameters:

<State> 0 | 1 | OFF | ON
 *RST: 1

Example:

BB:ARB:MCAR:EDIT:CARR:STAT ON
 sets all the carriers in the carrier range to ON.

[:SOURce<hw>]:BB:ARB:MCARrier:OFILe <OFile>

This command defines the output file name for the multi carrier waveform. This file name is used when a waveform is calculated (command SOUR:BB:ARB:MCAR:CLoad or SOUR:BB:ARB:MCAR:CREate). The file extension is *.wv.

Parameters:

<OFile> string

Example:

MMEM:CDIR 'D:/user/waveform'
 sets the default directory to D:/user/waveform.
 BB:ARB:MCAR:OFIL 'mcar1_2'
 defines the file name mcar1_2.wv for the multi carrier waveform file

[:SOURce<hw>]:BB:ARB:MCARrier:PRESet

The command sets all ARB multi carrier parameters to their default values.

Example:

BB:ARB:MCAR:PRES
 resets the ARB multi carrier parameters to default values.

Usage:

Event

[:SOURce<hw>]:BB:ARB:MCARrier:SAMPles?

The command queries the resulting file size. The file size is returned in samples.

Return values:

<Samples> integer
 Range: 0 to INT_MAX
 Increment: 1
 *RST: 0

Example:

BB:ARB:MCAR:SAMP?
 queries the file size of the currently calculated multi carrier waveform.

Usage:

Query only

[[:SOURce<hw>]:BB:ARB:MCARrier:SETTing:CATalog?

This command queries the available settings files in the specified default directory. The settings files are used to set the ARB multi carrier submenu. Only files with the file extension `*.arb_multcarr` will be listed.

Return values:

<Catalog> string

Example:

```
MMEM:CDIR 'D:/user/waveform'
sets the default directory to D:/user/waveform.
BB:ARB:MCAR:SETT:CAT?
reads out all the settings files in the default directory.
Response: mcar1, mcar2
the directory contains the configuration files mcar1.arb_multcarr and mcar2.arb_multcarr.
```

Usage: Query only

[[:SOURce<hw>]:BB:ARB:MCARrier:SETTing:LOAD <Filename>

The command loads the settings file. If a settings file with the specified name does not yet exist, it is created. The file extension may be omitted. Only files with the file extension `*.arb_multcarr` will be loaded or created.

Setting parameters:

<Filename> string

Example:

```
BB:ARB:MCAR:SETT:LOAD 'D:/user/waveform/new'
creates settings file new.arb_multcarr.
```

Usage: Setting only

[[:SOURce<hw>]:BB:ARB:MCARrier:SETTing:STORe <Filename>

The command stores the current settings of submenu "Multi Carrier" in a file in the specified directory. The file extension may be omitted, the files are stored with the file extension `*.arb_multcarr`.

Setting parameters:

<Filename> string

Example:

```
BB:ARB:MCAR:SETT:STOR 'D:/user/waveform/mcarr2'
stores settings file mcarr2.arb_multcarr in the default directory.
```

Usage: Setting only

[[:SOURce<hw>]:BB:ARB:MCARrier:SETTing:STORe:FAST <Fast>

Determines whether the instrument performs an absolute or a differential storing of the settings.

Enable this function to accelerate the saving process by saving only the settings with values different to the default ones.

Note: This function is not affected by the "Preset" function.

Parameters:

<Fast> 0 | 1 | OFF | ON
 *RST: 1

[:SOURce<hw>]:BB:ARB:MCARrier:TIME <Time>

The command sets the user-defined signal period. This setting is only possible for Signal Period Mode User (BB:ARB:MCAR:TIME:MODE USER).

Parameters:

<Time> float
 Range: 0 to 1E9
 Increment: 1E-9
 *RST: 0
 Default unit: s

Example:

BB:ARB:MCAR:TIME:MODE USER
 selects Signal Period Mode User.
 BB:ARB:MCAR:TIME 10 s
 sets a signal period of 10 seconds

[:SOURce<hw>]:BB:ARB:MCARrier:TIME:MODE <Mode>

The command selects the mode for calculating the resulting signal period of the multi carrier waveform. The resulting period is always calculated for all carriers in the carrier table irrespective of their state (ON/OFF).

Parameters:

<Mode> USER | LONG | SHORt

LONG

The resulting signal period is defined by the longest I/Q file in the carrier table. Shorter I/Q files are periodically repeated.

SHORt

The resulting signal period is defined by the shortest I/Q file in the carrier table. Only the first part of longer I/Q files is used.

USER

The signal period can be set with command SOUR:BB:ARB:MCARr:TIME. Shorter I/Q files are repeated periodically, and only the first part of longer I/Q files is used.

*RST: LONG

Example:

BB:ARB:MCAR:TIME:MODE LONG
 selects signal period mode long

SOURce:BB:ARB:WAV Subsystem

The WAVeform subsystem contains the commands for working with waveform files.

<code>[:SOURce<hw>]:BB:ARB:WAVeform:CATalog</code>	615
<code>[:SOURce<hw>]:BB:ARB:WAVeform:CATalog:LENGth</code>	615
<code>[:SOURce<hw>]:BB:ARB:WAVeform:DATA</code>	616
<code>[:SOURce<hw>]:BB:ARB:WAVeform:DELeTe</code>	617
<code>[:SOURce<hw>]:BB:ARB:WAVeform:FREE</code>	617
<code>[:SOURce<hw>]:BB:ARB:WAVeform:HDDStreaming:BLEVel</code>	617
<code>[:SOURce<hw>]:BB:ARB:WAVeform:HDDStreaming:STATe</code>	618
<code>[:SOURce<hw>]:BB:ARB:WAVeform:POINts</code>	618
<code>[:SOURce<hw>]:BB:ARB:WAVeform:SELeCt</code>	619
<code>[:SOURce<hw>]:BB:ARB:WAVeform:TAG</code>	619

`[:SOURce<hw>]:BB:ARB:WAVeform:CATalog?`

This command reads out the files in the default directory. The default directory is set using command `MMEM:CDIRectory`. When the names of the waveform files are returned they are separated by commas. Only files with the file extension `*.wv` will be listed.

Return values:

`<Catalog>` string

Example:

```
MMEM:CDIR 'D:/user/waveform'
sets the default directory to D:/user/waveform.
BB:ARB:WAV:CAT?
reads out all the files in the default directory.
Response: sin1, wave
the directory contains the waveform files sin1.wv and
wave.wv.
```

Usage: Query only

`[:SOURce<hw>]:BB:ARB:WAVeform:CATalog:LENGth?`

This command reads out the files in the default directory and returns the number of waveform files in this directory. The default directory is set using command `MMEM:CDIRectory`. Only files with the file extension `*.wv` will be listed.

Return values:

`<Length>` integer
 Number of waveform files in default directory
 Range: 0 to INT_MAX
 Increment: 1
 *RST: 0

Example: `MMEM:CDIR 'D:/user/waveform'`
 sets the default directory to D:/user/waveform.
`BB:ARB:WAV:CAT?`
 reads out all the files in the default directory.
 Response: `sin1, wave`
 the directory contains the waveform files 'sin1.wv' and
 'wave.wv'.
`BB:ARB:WAV:CAT:LEN?`
 Response: `2`

Usage: Query only

[SOURce<hw>]:BB:ARB:WAVEform:DATA <Filename>, <Data>
[SOURce<hw>]:BB:ARB:WAVEform:DATA? <Tag>

The **setting** command writes the block data <binary data block> to the file identified by <waveform filename>. The complete content of the waveform file is transmitted as binary data block.

The IEC bus delimiter should be set to EOI when this is done, in order to ensure trouble-free data transmission.

The **query** command queries the content of the specified tag of the selected waveform file (see [chapter 6.3, "R&S Signal Generator Waveform and List Format"](#), on page 503).

By default, the waveform files are saved in the default directory of the instrument (C:\Program Files\Rohde&Schwarz\SMUFirmware\Lists).

To access the waveform files in this default directory, only the file name is required, without the path and the file extension.

However, to access waveform files located in a directory different to the default one, the complete file path and file name are required.

Parameters:

<Filename> string

Setting parameters:

<Data> string

Specifies the name of the wavefile in that the binary data will be copied. Waveform data is stored only in files with the specific file extensions *.wv.

Query parameters:

<Tag> 'comment' | 'copyright' | 'date' | 'lacpfilter' | 'marker name' | 'poweroffset'

Example:

Setting

`BB:ARB:WAV:DATA 'D:/user/TEST1.WV', #3767<bin data block>`

writes the block data to file 'test1.wv' in the D:/user directory.

Example:**Query**

BB:ARB:WAV:DATA? 'D:/user/TEST1.WV', 'comment'
 queries the content of the 'comment' tag of file wave1.wv in the user directory

Response: "Sine wave for test purposes"

[:SOURce<hw>]:BB:ARB:WAVeform:DELeTe <Filename>

The command deletes the specified waveform file. If the file is not on the default path, the path must be specified at the same time. The file extension may be omitted. Only files with the file extension *.wv will be deleted.

Setting parameters:

<Filename> string

Example:

BB:ARB:WAV:DEL 'D:/user/wave1.wv'
 deletes waveform file wave1.wv.

Usage:

Setting only

[:SOURce<hw>]:BB:ARB:WAVeform:FREE?

The command queries the free disk space on the default path of the instrument's harddisk.

Return values:

<Free> integer
 Range: 0 to INT_MAX
 Increment: 1
 *RST: 1

Example:

MMEM:CDIR 'D:/user/waveform'
 sets the default directory to D:/user/waveform.
 BB:ARB:WAV:FREE?
 queries the free disk space in directory D:/user/waveform.

Usage:

Query only

[:SOURce<hw>]:BB:ARB:WAVeform:HDDStreaming:BLEVeI?

Queries the filling level of the streaming buffer.

During normal operation, the streaming buffer level should have a value of 90% .. 100%. Buffer level around 0% indicates a buffer underrun and the signal processing will be interrupted.

Adjustment in the parameter value or state usually results in short decreasing of the streaming buffer level but this buffer state should not be mislead with buffer underrun.

Return values:

<BLevel> integer
 Range: 0 to 100
 Increment: 1
 *RST: 0

Example:

BB:ARB:WAV:HDDS:STAT ON
 enables HDD streaming.
 BB:ARB:WAV:HDDS:BLEV?
 queries the streaming buffer level.
 Response: 94%

Usage:

Query only

[[:SOURce<hw>]:BB:ARB:WAVeform:HDDStreaming:STATe <State>

Enables/disables the streaming of modulation data direct form the hard drive (HDD).

HDD streaming is recommended for processing of large files that require more ARB memory than the currently installed one.

Parameters:

<State> 0 | 1 | OFF | ON
 *RST: 1

Example:

BB:ARB:WAV:HDDS:STAT ON
 enables HDD streaming.

[[:SOURce<hw>]:BB:ARB:WAVeform:POINTs?

The command queries the number of samples in the waveform file selected using command :ARB:WAV:SEL. Only the file name has to be entered. Only files with the file extension *.wv will be read out.

Return values:

<Points> <waveform filename>
 Range: 0 to 1000
 Increment: 1
 *RST: 1

Example:

BB:ARB:WAV:POINT?
 queries the number of I/Q values pairs in the waveform file.
 Response: 401
 the waveform file contains 401 I/Q values pairs.

Usage:

Query only

[:SOURce<hw>]:BB:ARB:WAVEform:SElect <Filename>

The command selects the waveform file. If the file is not on the default path, the path must be specified at the same time. If no file of the specified name exists, it is created. The file extension may be omitted. Only files with the file extension *.wv will be created or loaded.

Parameters:

<Filename> string

Example:

```
BB:ARB:WAV:SEL 'D:/user/wave1.wv'
selects waveform file 'wave1.wv' from the D:/user directory and
loads it..
BB:ARB:TRIG:SEQ AAUT
sets trigger mode Armed_Auto.
BB:ARB:TRIG:SOUR INT
selects internal triggering.
BB:ARB:STAT ON
switches on the ARB generator.
BB:ARB:TRIG:EXEC
starts generating the selected waveform.
```

[:SOURce<hw>]:BB:ARB:WAVEform:TAG?

The command queries the content of the specified tag of the selected Waveform file file (see [chapter 6.3, "R&S Signal Generator Waveform and List Format"](#), on page 503).

Return values:

<Tag> string

Example:

```
BB:ARB:WAV:TAG? 'comment'
queries the content of the 'comment' tag.
Response: "Sine wave for test purposes"
```

Usage: Query only

SOURce:BB:ARB:WSEG Subsystem

The WSEGment subsystem contains the commands for setting the Multi Segment Waveform Generator.

Section [chapter 6.3, "R&S Signal Generator Waveform and List Format"](#), on page 503 describes the ARB waveform format and how it is used to transmit waveforms via the IEC bus.

[:SOURce<hw>]:BB:ARB:WSEGment.....	620
[:SOURce<hw>]:BB:ARB:WSEGment:CLOad.....	620
[:SOURce<hw>]:BB:ARB:WSEGment:CONFigure:BLANK:APPend.....	621
[:SOURce<hw>]:BB:ARB:WSEGment:CONFigure:CATalog.....	622
[:SOURce<hw>]:BB:ARB:WSEGment:CONFigure:CLOCK.....	622
[:SOURce<hw>]:BB:ARB:WSEGment:CONFigure:CLOCK:MODE.....	622
[:SOURce<hw>]:BB:ARB:WSEGment:CONFigure:COMMENT.....	623
[:SOURce<hw>]:BB:ARB:WSEGment:CONFigure:DELeTe.....	623

<code>[:SOURce<hw>]:BB:ARB:WSEGment:CONFigure:LEVel[:MODE]</code>	623
<code>[:SOURce<hw>]:BB:ARB:WSEGment:CONFigure:MARKer:ESEGment</code>	624
<code>[:SOURce<hw>]:BB:ARB:WSEGment:CONFigure:MARKer:FSEGment</code>	624
<code>[:SOURce<hw>]:BB:ARB:WSEGment:CONFigure:MARKer:MODE</code>	625
<code>[:SOURce<hw>]:BB:ARB:WSEGment:CONFigure:OFILe</code>	625
<code>[:SOURce<hw>]:BB:ARB:WSEGment:CONFigure:SEGMENT:APPend</code>	626
<code>[:SOURce<hw>]:BB:ARB:WSEGment:CONFigure:SEGMENT:CATalog</code>	626
<code>[:SOURce<hw>]:BB:ARB:WSEGment:CONFigure:SELEct</code>	626
<code>[:SOURce<hw>]:BB:ARB:WSEGment:CREate</code>	627
<code>[:SOURce<hw>]:BB:ARB:WSEGment:NAME</code>	627
<code>[:SOURce<hw>]:BB:ARB:WSEGment:NEXT</code>	627
<code>[:SOURce<hw>]:BB:ARB:WSEGment:NEXT:EXECute</code>	628
<code>[:SOURce<hw>]:BB:ARB:WSEGment:NEXT:SOURce</code>	628
<code>[:SOURce<hw>]:BB:ARB:WSEGment:SEQuence:APPend</code>	628
<code>[:SOURce<hw>]:BB:ARB:WSEGment:SEQuence:SELEct</code>	629

`[:SOURce<hw>]:BB:ARB:WSEGment?`

This command queries the currently output segment of the multi segment waveform.

Return values:

<code><Wsegment></code>	integer
	Range: 0 to 1023
	Increment: 1
	*RST: 0

Example: `BB:ARB:WSEG?`
 queries the currently output segment.
 Response 2
 segment 2 is currently output.

Usage: Query only

`[:SOURce<hw>]:BB:ARB:WSEGment:CLOad <Filename>`

This command creates a multi segment waveform using the current entries of the specified configuration file.

This multi segment waveform is saved with the file name specified in the configuration file. The file extension is *.wv. Digital standard "ARB" is activated, the new multi segment waveform is loaded and the first segment is output in accordance to the trigger settings.

Setting parameters:

<code><Filename></code>	string
-------------------------------	--------

Example: `MMEM:CDIR 'D:/user/waveform'`
 sets the default directory to D:/user/waveform.
`BB:ARB:WSEG:CONF:SEL 'multi_sin'`
 creates the configuration file `multi_sin.inf_mswv` in the default directory.
`BB:ARB:WSEG:CONF:SEGM:APP 'sinus1'`
 includes waveform `sinus1.wv` as segment 1 in the configuration file. The waveform must be available in the default directory.
`BB:ARB:WSEG:CONF:SEGM:APP 'sinus2'`
 includes waveform `sinus2.wv` as segment 2 in the configuration file. The waveform must be available in the default directory.
`BB:ARB:WSEG:CONF:OFIL 'mseg1_2'`
 defines the file name `mseg1_2.wv` for the multi segment waveform.
`BB:ARB:WSEG:CLO 'multi_sin'`
 creates multi segment waveform `mseg1_2.wv` using the settings of the configuration file `multi_sin.inf_mswv`.
 The new multi segment waveform is loaded and digital standard "ARB" is activated.

Usage: Setting only

[:SOURce<hw>]:BB:ARB:WSEGment:CONFigure:BLANK:APPend <SampCount>, <Frequency>

Adds a blank segment to the multi segment file.

Setting parameters:

<SampCount> float
 Specifies the number of samples.
 Range: 512 to 1E7
 Increment: 1
 *RST: 1000

<Frequency> float
 Determines the clock rate.
 Range: 400 Hz to Max (depends on instrument type)
 Increment: 0.001
 *RST: 1E8

Example: `SOUR:BB:ARB:WSEG:CONF:SEL "MSegFile"`
 selects a multi segment file.
`SOUR:BB:ARB:WSEG:CONF:BLAN:APP 1000,100000000`
 adds a blank segment with 1000 samples and 100 MHz clock rate to the selected multi segment file

Usage: Setting only

[:SOURce<hw>]:BB:ARB:WSEgment:CONFigure:CATalog?

This command queries the available configuration files in the specified default directory. The configuration files are used to create multi segment waveform files.

Return values:

<Catalog> string

Example:

```
MMEM:CDIR 'D:/user/waveform'
sets the default directory to D:/use/waveform.
BB:ARB:WSEG:CONF:CAT?
reads out all the configuration files in the default directory.
Response: mult1, multi2
the directory contains the configuration files multi1.inf_mswv
and multi2.inf_mswv.
```

Usage: Query only

[:SOURce<hw>]:BB:ARB:WSEgment:CONFigure:CLOCK <Clock>

This command defines the clock rate used for multi segment waveform output in case of Clock Mode "User" (:BB:ARB:WSEG:CONF:CLOCK:MODE USER).

Parameters:

<Clock> float
 Increment: 1E-3
 *RST: max SampleRate

Example:

```
BB:ARB:WSEG:CONF:CLOC:MODE USER
selects Clock Mode User.
BB:ARB:WSEG:CONF:CLOC 50MHz
defines a clock rate of 50 MHz.
```

[:SOURce<hw>]:BB:ARB:WSEgment:CONFigure:CLOCK:MODE <Mode>

This command selects the clock rate mode for the multi segment waveform.

Parameters:

<Mode> UNCHanged | HIGHest | USER

UNCHanged

The segments are output with the clock rate defined in the waveform file. Extended Trigger Mode "Next Segment Seamless" (:BB:ARB:TRIG:SMOD NSEam) can only be selected if all segments have the same clock rate. Extended Trigger Mode "Next Segment" (:BB:ARB:TRIG:SMOD NEXT) can only be selected if trigger mode "Internal" is selected (:BB:ARB:TRIG:SOUR INT).

HIGHest

The segments are output at the highest available clock rate.

USER

The segments are output with the clock rate defined with command :BB:ARB:WSEG:CONF:CLOC

*RST: UNCHanged

Example:

BB:ARB:WSEG:CONF:CLOC:MODE UNCH
selects clock mode unchanged. The segments are output with the clock rate defined in the waveform file.

[:SOURce<hw>]:BB:ARB:WSEGment:CONFigure:COMment <Comment>

This command enters a comment for the configuration file. The configuration file must be specified with command :BB:ARB:WSEG:CONF:SEL.

Parameters:

<Comment> string

Example:

BB:ARB:WSEG:CONF:COMM <3gpp_up>
enters comment "3gpp_up".

[:SOURce<hw>]:BB:ARB:WSEGment:CONFigure:DELeTe <Filename>

This command deletes the configuration file. The configuration files are used to create multi segment waveform files.

Setting parameters:

<Filename> string

Example:

MMEM:CDIR 'D:/user/waveform'
sets the default directory to D:/user/waveform.
BB:ARB:WSEG:CONF:DEL 'multil'
deletes configuration file multil.inf_mswv.

Usage:

Setting only

[:SOURce<hw>]:BB:ARB:WSEGment:CONFigure:LEVel[:MODE] <Mode>

This command selects the level mode for the multi segment waveform.

Parameters:

<Mode> UNCHanged | ERMS

UNCHanged

The segments are output exactly as defined in the files.

ERMS

The segments are output so that all segments have the same rms value.

*RST: UNCHanged

Example:

BB:ARB:WSEG:CONF:LEV:MODE UNCH

selects level mode unchanged. The segments are output as defined in the waveform file.

[[:SOURce<hw>]:BB:ARB:WSEGment:CONFigure:MARKer:ESEGment <Mode>

Enables/disables the generation of an additional marker restart signal in the output waveform file.

If additional marker generation is enabled, the existing marker signals in the individual segment waveform files are not considered.

Parameters:

<Mode> OFF | MRK1 | MRK2 | MRK3 | MRK4

OFF

No additional marker is generated.

MRK1|MRK2|MRK3|MRK4

Generates a restart marker signal at the beginning of each segment for the corresponding marker.

The segment begin is defined by the low-high slope of the marker. This applies for switching between two segments as well as in case of segment replay.

*RST: OFF

Example:

BB:ARB:WSEG:CONF:SEL 'ConfComm'

BB:ARB:WSEG:CONF:MARK:ESEG MRK3

[[:SOURce<hw>]:BB:ARB:WSEGment:CONFigure:MARKer:FSEGment <Mode>

Enables/disables the generation of an additional marker restart signal in the output waveform file.

If additional marker generation is enabled, the existing marker signals in the individual segment waveform files are not considered.

Parameters:

<Mode>

OFF | MRK1 | MRK2 | MRK3 | MRK4

OFF

No additional marker is generated.

MRK1|MRK2|MRK3|MRK4

Generates a restart marker signal at the beginning of the first segment for the corresponding marker.

Use this setting to generate a restart marker for the complete sequence.

*RST: OFF

Example:

```
BB:ARB:WSEG:CONF:SEL 'ConfComm'
BB:ARB:WSEG:CONF:MARK:FSEG MRK3
```

[:SOURce<hw>]:BB:ARB:WSEGment:CONFigure:MARKer:MODE <Mode>

Defines the way the marker information within the separate segments is processed.

Parameters:

<Mode>

IGNore | TAKE

IGNore

The marker information carried in the individual segment waveform files is not considered.

TAKE

The output waveform file contains the marker information as configured in the individual waveform files.

*RST: TAKE

Example:

```
BB:ARB:WSEG:CONF:SEL 'ConfComm'
BB:ARB:WSEG:CONF:MARK:MODE TAKE
```

[:SOURce<hw>]:BB:ARB:WSEGment:CONFigure:OFILe <OFile>

This command defines the file name for the multi segment waveform. This file name is stored in the configuration file and is used when a waveform is created (command :BB:ARB:WSEG:CLOad or :BB:ARB:WSEG:CREate). The file extension is *.wv.

Parameters:

<OFile>

string

Example:

```
M MEM:CDIR 'D:/user/waveform'
sets the default directory to D:/user/waveform.
BB:ARB:WSEG:CONF:SEL 'multil'
creates the configuration file multil.inf_mswv in default directory.
BB:ARB:WSEG:CONF:OFIL 'mseg1_2'
defines the file name mseg1_2.wv for the multi segment waveform file created using configuration file multil.inf_mswv.
```

[:SOURce<hw>]:BB:ARB:WSEgment:CONFigure:SEGMent:APPend <Waveform>

This command appends the specified waveform to the configuration file.

Setting parameters:

<Waveform> string

Example:

```
MMEM:CDIR 'D:/user/waveform'
sets the default directory to D:/user/waveform.
BB:ARB:WSEG:CONF:SEL 'new'
creates the configuration file new.inf_mswv in the default direc-
tory.
BB:ARB:WSEG:CONF:SEGM:APP 'arb1'
appends waveform arb1.wv to configuration file new. Waveform
arb1 will be the first segment of a multi segment waveform cre-
ated with configuration file new.
```

Usage: Setting only

[:SOURce<hw>]:BB:ARB:WSEgment:CONFigure:SEGMent:CATalog?

This command queries the segments of the currently selected configuration file.

Return values:

<Catalog> string

Example:

```
MMEM:CDIR 'D:/user/waveform'
sets the default directory to D:/user/waveform.
BB:ARB:WSEG:CONF:SEL 'multi_sin'
selects the configuration file multi_sin.inf_mswv .
BB:ARB:WSEG:CONF:SEGM:CAT?
queries the segments of the selected configuration file.
Response: arb4, arb2
The configuration file includes the segments arb4.wv and
arb2.wv.
```

Usage: Query only

[:SOURce<hw>]:BB:ARB:WSEgment:CONFigure:SELEct <Filename>

The command selects the configuration file in the default directory. A path can also be specified, in which case the files in the specified directory are selected. If a configuration file with the specified name does not yet exist, it is created. The file extension may be omitted. Only files with the file extension *.inf_mswv will be selected or created.

Parameters:

<Filename> string

Example:

```
MMEM:CDIR 'D:/user/waveform'
sets the default directory to D:/user/waveform.
BB:ARB:WSEG:CONF:SEL 'new'
create configuration file new.inf_mswv in the default directory.
```

[[:SOURce<hw>]:BB:ARB:WSEGment:CREate <Filename>

This command creates a multi segment waveform using the current settings of the specified configuration file. The multi segment waveform is saved into the file defined in the configuration file. The file extension is *.wv.

Setting parameters:

<Filename> string

Example:

```
MMEM:CDIR 'D:/user/waveform'
sets the default directory to D:/user/waveform.
BB:ARB:WSEG:CONF:SEL 'new'
creates the configuration file new.inf_mswv in the default directory.
BB:ARB:WSEG:CONF:SEGM:APP 'arb1.wv'
'includes waveform arb1.wv as segment 1 in the configuration file. The waveform must be available in the default directory.
BB:ARB:WSEG:CONF:OFIL 'multi_wv1'
defines the file name multi_wv1.wv for the multi segment waveform.
BB:ARB:WSEG:CRE 'new'
creates multi segment waveform multi_wv1.wv using the settings of the configuration file new.inf_mswv.
```

Usage: Setting only

[[:SOURce<hw>]:BB:ARB:WSEGment:NAME?

This command queries the name of the waveform of the currently output segment of the multi segment waveform.

Return values:

<Name> string

Example:

```
BB:ARB:WSEG:NAME?
queries the currently output segment.
```

Usage: Query only

[[:SOURce<hw>]:BB:ARB:WSEGment:NEXT <Next>

This command selects the segment to be output.

Parameters:

<Next> integer
 Range: 0 to 1023
 Increment: 1
 *RST: 0

Example:

```
MMEM:CDIR 'D:/user/waveform'
```

sets the default directory to root/user/waveform.

```
BB:ARB:WSEG:NEXT 2
```

selects segment 2 to be output.

```
BB:ARB:TRIG:SMOD NEXT
```

selects extended trigger mode next, i.e. the segment specified with command :BB:ARB:WSEG:NEXT will be output.

```
BB:ARB:SEQ AUTO
```

selects trigger mode Auto.

```
BB:ARB:WAV:SEL 'multi_wv1'
```

loads multi segment waveform multi_wv1.wv. Generation of segment 2 starts.

```
BB:ARB:WSEG:NEXT 3
```

switched at once to output of segment 3.

[:SOURce<hw>]:BB:ARB:WSEGment:NEXT:EXECute

Triggers manually switchover to the subsequent segment in the mutli segment file. A manual trigger can be executed only when an internal next segment source (BB:ARB:WSEG:NEXT:SOUR INT) has been selected.

To perform a switchover to any segment within the multi segment file, select the next segment with the command BB:ARB:WSEG:NEXT.

This command is disabled, if a sequencing play list is enabled.

Example:

```
BB:ARB:WSEG:NEXT:SOUR INT
```

selects internal next segment source.

```
BB:ARB:WSEG:NEXT 2
```

selects segment 2 to be output.

```
BB:ARB:WSEG:NEXT:EXEC
```

executes a switchover to the next segment.

Usage: Event

[:SOURce<hw>]:BB:ARB:WSEGment:NEXT:SOURce <Source>

Queries the next segment source.

Parameters:

<Source> INTernal | USR1
*RST: INTernal

Example:

```
BB:ARB:WSEG:NEXT:SOUR?
```

queries the next segment source.

[:SOURce<hw>]:BB:ARB:WSEGment:SEQuence:APPend <State>, <Segment>, <Count>, <Next>

Appends a new segment to the selected sequencing play list.

Setting parameters:

<State>	ON OFF activates/deactivates the appended segment *RST: ON
<Segment>	integer indicates the number of the segment as in the multi segment waveform file Range: 0 to SegmentCount - 1 Increment: 1
<Count>	integer defines how many times this segment is repeated Range: 1 to 65535 Increment: 1
<Next>	NEXT BLANK ENDLess SEG0 SEG1 ... SEG31 0...maxSegment determines the action after completing the current segment, like for instance which segment is processed after the processing of the current one is finished.

Example:

```
BB:ARB:WSEG:SEQ:SEL 'D:
/user/waveform/play_list_1'
selects the sequencing list play_list_1.wvs.
BB:ARB:WSEG:SEQ:APP ON,3,15,BLANK
appends the segment number 3 as a new segment to the sequencing list; this segment is activated and will be repeated 15 times and followed by a blank segment.
```

Usage:

Setting only

```
[[:SOURce<hw>]:BB:ARB:WSEGment:SEQuence:SELEct <Filename>
```

Selects the sequencing list (files with extension *.wvs)

Parameters:

<Filename> string

Example:

```
BB:ARB:WSEG:SEQ:SEL 'D:
/user/waveform/play_list_1'
selects the sequencing list play_list_1.wvs.
```

6.15.3.3 SOURce:BB:DM Subsystem

The commands in the SOURce:BB:DM subsystem are described in two sections, separated into configuring digital modulation and lists for digital modulation.

DM General Remote-Control Commands

The following section contains the commands for generating the digital modulation signal.

• Common Settings.....	630
• Clock Settings.....	633
• Trigger Settings.....	635
• Marker Settings.....	641
• Filter Settings.....	644
• Modulation Settings.....	647
• Power Ramp.....	650

Common Settings

[:SOURce<hw>]:BB:DM:PATTern.....	630
[:SOURce<hw>]:BB:DM:PRBS[:LENGth].....	630
[:SOURce<hw>]:BB:DM:PRESet.....	631
[:SOURce<hw>]:BB:DM:SOURce.....	631
[:SOURce<hw>]:BB:DM:SRATe.....	632
[:SOURce<hw>]:BB:DM:STANdard.....	632
[:SOURce<hw>]:BB:DM:STATe.....	632
[:SOURce<hw>]:BB:DM:SWITChing:SOURce.....	633
[:SOURce<hw>]:BB:DM:SWITChing:STATe.....	633

[:SOURce<hw>]:BB:DM:PATTern <Pattern>

The command selects the data pattern for the internal data when PATTern is selected as the data source. The maximum length is 64 bits.

Parameters:

<Pattern> integer
 Range: #B0,1 to #B111...1,64
 *RST: #B0,1

Example:

```
BB:DM:SOUR PATT
selects Pattern as the data source for digital modulation.
BB:DM:PATT #B01110111010101010,17
generates the user-defined sequence of 0/1 data.
```

[:SOURce<hw>]:BB:DM:PRBS[:LENGth] <Length>

The command defines the length of the pseudo-random sequence in accordance with the following equation:

$$\text{Length} = (2^{\text{Length}}) - 1$$

Parameters:

<Length> 9 | 11 | 15 | 16 | 20 | 21 | 23
 *RST: 9

Example: `BB:DM:SOUR PRBS`
 The internal pseudo-random generator is used as the data source.
`BB:DM:PRBS 9`
 An internal pseudo-random sequence of 511 bits will be generated.

[:SOURce<hw>]:BB:DM:PRESet

The command calls the default settings for digital modulation.

Example: `BB:DM:PRES`
 calls the default settings for DM.

Usage: Event

[:SOURce<hw>]:BB:DM:SOURce <Source>

The command selects the data source.

Parameters:

<Source>

ZERO | ONE | PRBS | PATTern | DLIS | SERial | PARallel

ZERO

An internally generated 0 data sequence is used.

ONE

An internally generated 1 data sequence is used.

PRBS

The pseudo-random sequence generator is used as the data source. The length of the random sequence is defined with the aid of command `SOURce:BB:DM:PRBS`.

PATTern

Internally generated data with a fixed pattern is used. The data pattern is defined using command `SOURce:BB:DM:PATTern`.

DLIS

Data from the selected data list is used.

SERial

External data from the serial interface is used.

In case of two-path instruments, this affects path A.

PARallel

External data from the serial interface is used.

In case of two-path instruments, this affects path A.

*RST: PRBS

Example: `BB:DM:SOUR DLIS`
 the internal data generator is used.
`BB:DM:DLIS:SEL 'test'`
 the data list `test.dm_iqd` is used.

[:SOURce<hw>]:BB:DM:SRATe <SRate>

The command sets the symbol rate. The value range is dependent on the selected modulation type. On changing to an FSK modulation type, excessively high values are automatically limited to the maximum value that can be set for FSK (see data sheet). The symbol rate can be entered in Hz/kHz/MHz or Symb/s / kSymb/s and MSymb/s.

When a standard is selected (DM:STANdard), the symbol rate is automatically set to the appropriate default value.

The value range is dependent on the selected modulation type (:BB:DM:FORM). When a standard is selected (:BB:DM:STAN), the symbol rate is set to the default value.

Parameters:

<SRate> float
 Range: 400Hz to 15MHz (FSK) / 25 MHz
 Increment: 0.001Hz
 *RST: 270833kHz
 Default unit: Hz

Example:

BB:DM:SRAT 10 MHz
 sets a symbol rate of 10 MHz.

[:SOURce<hw>]:BB:DM:STANdard <Standard>

The command selects the standard. After selection, modulation parameters "Modulation Type" (:BB:DM:FORMat), "Symbol Rate" (:BB:DM:SRATe), "Filter" (:BB:DM:FILTer:TYPE and :BB:DM:FILTer:PARAmeter:...) and "Coding" (:BB:DM:CODing) are automatically set in accordance with the standard. The USER parameter cannot be set. A query returns this value if a user-defined Custom Dig Mod setting was loaded or if one of the associated settings was changed subsequent to the selection of a standard. The user defined settings are stored and loaded with commands :BB:DM:STAN:ULIS:... (see "DM Lists" on page 653).

Parameters:

<Standard> USER | BLUetooth | DECT | ETC | GSM | GSMEdge | NADC | PDC | PHS | TETRa | W3GPp | TDSCdma | CFORward | CREVerse | WORLdspace | TFTS | APCOPH1C4fm | APCOPH1CQpsk | APCOPH2HCpm | APCOPH2HDQpsk | APCOPH2HD8PSKW | APCOPH2HD8PSKN | APCOPH1Lsm | APCOPH1Wcqpsk
 *RST: GSM

Example:

BB:DM:STAN DECT
 selects digital modulation according to the DECT standard.

[:SOURce<hw>]:BB:DM:STATe <State>

The command enables or disables digital modulation. Switching on digital modulation turns off all the other digital standards.

Enabling digital modulation (`BB:DM:STAT ON`) turns off all the other standards.

In case of two-path instruments, this affects the same path.

Parameters:

<State> 0 | 1 | OFF | ON
*RST: OFF

Example:

`BB:DM:STAT ON`
switches digital modulation on.

[:SOURce<hw>]:BB:DM:SWITching:SOURce <Source>

The command selects the source of the CW control signal for switching between a modulated and an unmodulated signal.

Parameters:

<Source> INTernal | EXTernal

INTernal

The CW signal in the control list is used for the control.
The internal signal can be output on one of the user interfaces.

EXTernal

The control signal on the CW pin of the AUX I/Q connector is used.
In case of two-path instruments, path A and B.

*RST: INTernal

Example:

`BB:DM:SWIT INT`
the CW signal in the control list is used for the control.

[:SOURce<hw>]:BB:DM:SWITching:STATe <State>

The command enables switching between a modulated and an unmodulated signal.

Parameters:

<State> 0 | 1 | OFF | ON
*RST: 0

Example:

`BB:DM:SWIT:STAT INT`
CW switching is active.

Clock Settings

[:SOURce<hw>]:BB:DM:CLOCK:MODE.....	633
[:SOURce<hw>]:BB:DM:CLOCK:MULTiplier.....	634
[:SOURce<hw>]:BB:DM:CLOCK:SOURce.....	634

[:SOURce<hw>]:BB:DM:CLOCK:MODE <Mode>

The command enters the type of externally supplied clock (`:BB:DM:CLOCK:SOURce EXTernal`).

The bit clock and the symbol clock differ only in the case of modulations that have more than two states, i.e. that require more than one bit for encoding each state. When `MSYMBOL` is used, a multiple of the symbol clock is supplied via the `CLOCK` connector and the symbol clock is derived internally from this. The multiplier is entered with the command `:BB:DM:CLOCK:MULTIPLIER`.

It is not possible to select `BIT` and `MSYMBOL` in the case of an external serial or external parallel data source (`SOUR:BB:DM:SOUR SER` and `PAR`).

For two-path instruments, the only numerical suffix allowed for `SOURCE` is 1, since the external clock source is permanently allocated to path A.

Parameters:

<Mode> SYMBOl | MSYMBOL | BIT
*RST: SYMBOl

Example:

`BB:DM:CLOCK:MODE SYMB`
selects clock type Symbols, i.e. the supplied clock is a symbol clock.

[:SOURCE<hw>]:BB:DM:CLOCK:MULTIPLIER <Multiplier>

The command specifies the multiplier for clock type **Multiple Symbols** (`BB:DM:CLOCK:MODE MSYM`) in the case of an external clock source.

For two-path instruments, the only numerical suffix allowed for `SOURCE` is 1, since the external clock source is permanently allocated to path A.

Parameters:

<Multiplier> float
Range: 1 to 64
Increment: 1
*RST: 4

Example:

`BB:DM:CLOCK:SOUR EXT`
selects the external clock source. The clock is supplied via the `CLOCK` connector.
`BB:DM:CLOCK:MODE MSYM`
selects clock type Multiple Symbols, i.e. the supplied clock has a rate which is a multiple of the symbol rate.
`BB:DM:CLOCK:MULT 12`
the multiplier for the external clock rate is 12.

[:SOURCE<hw>]:BB:DM:CLOCK:SOURCE <Source>

The command selects the source for the digital modulation clock.

For two-path instruments, selecting `COUPLED` and `EXTERNAL` is only possible for path A, since the external clock source is permanently allocated to path A; clock source `AINT` is only allowed for path B.

Parameters:

<Source>

INTernal | EXTernal | COUPled | AINTernal

INTernal

The internal clock reference is used.

EXTernal

The external clock reference is supplied to the CLOCK connector.

COUPled

The clock reference (internal or external) is selected automatically according to the selected data source, i.d. if the data source changes (BB:DM:DATA:SOUR) the clock source is automatically changed correspondingly as well.

*RST: INTernal

Example:

BB:DM:CLOC:SOUR INT

selects the internal clock reference.

Trigger Settings

The numeric suffix to OUTPut distinguishes between the available markers.

[SOURce<hw>]:BB:DM:TRIGger:ARM:EXECute.....	635
[SOURce<hw>]:BB:DM:TRIGger:EXECute.....	636
[SOURce<hw>]:BB:DM:TRIGger:EXTernal:SYNChronize:OUTPut.....	636
[SOURce<hw>]:BB:DM:TRIGger:OBASeband:DELAy.....	637
[SOURce<hw>]:BB:DM:TRIGger:OBASeband:INHibit.....	637
[SOURce<hw>]:BB:DM:TRIGger:OUTPut:DELAy:FIXed.....	637
[SOURce<hw>]:BB:DM:TRIGger:OUTPut<ch>:DELAy.....	638
[SOURce<hw>]:BB:DM:TRIGger:OUTPut<ch>:DELAy:MINimum.....	638
[SOURce<hw>]:BB:DM:TRIGger:OUTPut<ch>:DELAy:MAXimum.....	638
[SOURce<hw>]:BB:DM:TRIGger:RMODE.....	638
[SOURce<hw>]:BB:DM:TRIGger:SLENgth.....	639
[SOURce<hw>]:BB:DM:TRIGger:SOURce.....	639
[SOURce<hw>]:BB:DM:TRIGger[:EXTernal<ch>]:DELAy.....	640
[SOURce<hw>]:BB:DM:TRIGger[:EXTernal<ch>]:INHibit.....	640
[SOURce<hw>]:BB:DM[:TRIGger]:SEQuence.....	641

[SOURce<hw>]:BB:DM:TRIGger:ARM:EXECute

The command stops signal generation for trigger modes Armed_Auto and Armed_Ret-rigger. A subsequent internal or external trigger event restart signal generation.

Example:

```
BB:DM:TRIG:SOUR INT
sets internal triggering.
BB:DM:TRIG:SEQ ARET
sets Armed_Retrigger mode, i.e. every trigger event causes signal
generation to restart.
BB:DM:TRIG:EXEC
executes a trigger, signal generation is started.
BB:DM:TRIG:ARM:EXEC
signal generation is stopped.
BB:DM:TRIG:EXEC
executes a trigger, signal generation is started again.
```

Usage: Event

[:SOURce<hw>]:BB:DM:TRIGger:EXECute

The command executes a trigger. The internal trigger source must be selected using the command `BB:DM:TRIG:SOUR INT` and a trigger mode other than AUTO must be selected using the command `BB:DM:TRIG:SEQ`.

Example:

```
BB:DM:TRIG:SOUR INT
sets internal triggering.
BB:DM:TRIG:SEQ RETR
sets Retrigger mode, i.e. every trigger event causes signal gen-
eration to restart.
BB:DM:TRIG:EXEC
executes a trigger.
```

Usage: Event

[:SOURce<hw>]:BB:DM:TRIGger:EXTernal:SYNChronize:OUTPut <Output>

(enabled for "Trigger Source" External)

Enables/disables output of the signal synchronous to the external trigger event.

Parameters:

<Output> 0 | 1 | OFF | ON

ON

The signal calculation starts simultaneously with the external trigger event but because of the instrument's processing time the first samples are cut off and no signal is outputted. After elapsing of the internal processing time, the output signal is synchronous to the trigger event.

OFF

The signal output begins after elapsing of the processing time and starts with sample 0, i.e. the complete signal is outputted.

This mode is recommended for triggering of short signal sequences with signal duration comparable with the processing time of the instrument.

*RST: ON

Example: `BB:DM:TRIG:SOUR EXT`
sets external triggering.
`BB:DM:TRIG:EXT:SYNC:OUTP ON`
enables synchronous output to external trigger

[:SOURce<hw>]:BB:DM:TRIGger:OBASband:DELay <Delay>

The command specifies the trigger delay (expressed as a number of symbols) for triggering by the trigger signal from the second path (two-path instruments only).

Parameters:

<Delay> float
Range: 0 to 65535
Increment: 0.01
*RST: 0
Default unit: symbol

Example: `BB:DM:TRIG:SOUR OBAS`
sets for path A the internal trigger executed by the trigger signal from the second path (path B).
`BB:DM:TRIG:OBAS:DEL 50`
sets a delay of 50 symbols for the trigger.

[:SOURce<hw>]:BB:DM:TRIGger:OBASband:INHibit <Inhibit>

The command specifies the number of symbols by which a restart is to be inhibited following a trigger event. This command applies only for triggering by the second path (two-path instruments only).

Parameters:

<Inhibit> float
Range: 0 to 67108863
*RST: 0
Default unit: symbol

Example: `BB:DM:TRIG:SOUR OBAS`
sets for path A the internal trigger executed by the trigger signal from the second path (path B).
`BB:DM:TRIG:INH 200`
sets a restart inhibit for 200 symbols following a trigger event.

[:SOURce<hw>]:BB:DM:TRIGger:OUTPut:DELay:FIXed <Fixed>

The command restricts the marker delay setting range to the dynamic range. In this range the delay can be set without restarting the marker and signal. If a delay is entered in setting ON but is outside this range, the maximum possible delay is set and an error message is generated.

The numeric suffix in `OUTPut` has no significance for this command, since the setting always affects every marker.

Parameters:

<Fixed> 0 | 1 | OFF | ON
 *RST: 0

Example:

BB:DM:TRIG:OUTP:DEL:FIX ON
 restricts the marker signal delay setting range to the dynamic range.

[:SOURce<hw>]:BB:DM:TRIGger:OUTPut<ch>:DELay <Delay>

The command defines the delay between the signal on the marker outputs and the start of the signal, expressed in terms of symbols. Command [:SOURce<hw>]:BB:DM:TRIGger:OUTPut:DELay:FIXed can be used to restrict the range of values to the dynamic range, i.e. the range within which a delay of the marker signals can be set without restarting the marker and signal.

Parameters:

<Delay> float
 Range: 0 to 100 000 Symbols
 Increment: 1 symbol
 *RST: 0 symbol

Example:

BB:DM:TRIG:OUTP2:DEL 16
 sets a delay of 16 symbols for the signal on connector MARKER 2.

**[:SOURce<hw>]:BB:DM:TRIGger:OUTPut<ch>:DELay:MINimum?
 [:SOURce<hw>]:BB:DM:TRIGger:OUTPut<ch>:DELay:MAXimum?**

The command queries the maximum marker delay for setting :BB:DM:TRIG:OUTP:DEL:FIX ON.

Return values:

<Maximum> float

Example:

BB:DM:TRIG:OUTP:DEL:FIX ON
 restricts the marker signal delay setting range to the dynamic range.
 BB:DM:TRIG:OUTP:DEL:MAX
 queries the maximum of the dynamic range.
 Response: 2000
 the maximum for the marker delay setting is 2000 symbols.

Usage:

Query only

[:SOURce<hw>]:BB:DM:TRIGger:RMODE?

The command displays the status of signal generation for all trigger modes with digital modulation on.

Return values:

<RMode>

STOP | RUN

RUN

The signal is generated. A trigger event occurred in the triggered mode.

STOP

The signal is not generated. A trigger event did not occur in the triggered modes, or signal generation was stopped by the command `:BB:DM:TRIG:ARM:EXECute` (armed trigger modes only).

Example:

```
BB:DM:TRIG:SOUR EXT
```

sets external triggering via the TRIGGER 1 connector.

```
BB:DM:TRIG:MODE ARET
```

selects the Armed_Retrigger mode

```
BB:DM:TRIG:RMODE?
```

queries the current status of signal generation.

Response: RUN

the signal is generated, an external trigger was executed.

Usage:

Query only

[:SOURce<hw>]:BB:DM:TRIGger:SLENgth <SLength>

The command defines the length of the signal sequence to be output in the "Single" trigger mode.

Parameters:

<SLength>

float

Range: 1 to 4294967295

*RST: 1000

Default unit: symbol

Example:

```
BB:DM:SEQ SING
```

sets trigger mode Single.

```
BB:DM:TRIG:SLEN 200
```

sets a sequence length of 200 symbols. 200 symbols will be output after the next trigger event.

[:SOURce<hw>]:BB:DM:TRIGger:SOURce <Source>

The command selects the trigger source.

Parameters:

<Source>

INTernal | EXTernal | BEXTernal | OBASeband

INTernal

Triggering is executed by means of the Trigger command

SOURce:BB:DM:TRIGger:EXECute,

TRIGger:BB:DM:IMMediate or *TRG in the case of remote

control and by means of "Execute Trigger" in the case of manual operation.

EXTernal

Triggering is executed by means of the signal on the TRIGGER 1 connector.

BEXTernal

Triggering is executed by means of the signal on the TRIGGER 2 connector.

OBASeband

Triggering is executed by means of the trigger signal from the second path.

Example:

BB:DM:TRIG:SOUR EXT

sets external triggering via the TRIGGER 1 connector.

[:SOURce<hw>]:BB:DM:TRIGger[:EXTernal<ch>]:DELay <Delay>

The command specifies the trigger delay (expressed as a number of symbols) for external triggering.

Parameters:

<Delay>

float

Range: 0 to 65535

*RST: 0

Default unit: symbol

Example:

BB:DM:TRIG:SOUR EXT

selects an external trigger via the TRIGGER 1 connector.

BB:DM:TRIG:DEL 50

sets a delay of 50 symbols for the trigger.

[:SOURce<hw>]:BB:DM:TRIGger[:EXTernal<ch>]:INHibit <Inhibit>

The command specifies the number of symbols by which a restart is to be inhibited following a trigger event. This command applies only in the case of external triggering.

Parameters:

<Inhibit>

float

Range: 0 to 67108863

*RST: 0

Default unit: symbol

Example: `BB:DM:TRIG:SOUR EXT`
 selects an external trigger via the TRIGGER 1 connector.
`BB:DM:TRIG:INH 200`
 sets a restart inhibit for 200 symbols following a trigger event.

[:SOURce<hw>]:BB:DM[:TRIGger]:SEQUence <Sequence>

The command selects the trigger mode.

Parameters:

<Sequence>

AUTO | RETRigger | AAUTO | ARETrigger | SINGLE

AUTO

The modulation signal is generated continuously.

RETRigger

The modulation signal is generated continuously. A trigger event (internal or external) causes a restart.

AAUTO

The modulation signal is generated only when a trigger event occurs. After the trigger event the signal is generated continuously. Signal generation is stopped with command

`SOUR:BB:DM:TRIG:ARM:EXEC` and started again when a trigger event occurs.

ARETrigger

The modulation signal is generated only when a trigger event occurs. The device automatically toggles to RETRIG mode. Every subsequent trigger event causes a restart. Signal generation is stopped with command `SOUR:BB:DM:TRIG:ARM:EXEC` and started again when a trigger event occurs.

SINGLE

The modulation signal is generated only when a trigger event occurs. After the trigger event the signal is generated once to the set sequence length (`SOUR:BB:DM:TRIG:SLen`). Every subsequent trigger event caused a restart.

*RST: AUTO

Example:

`BB:DM:SEQ AAUT`

sets the "Armed_auto" trigger mode; the device waits for the first trigger (e.g. with *TRG) and then generates the signal continuously.

Marker Settings

<code>[:SOURce<hw>]:BB:DM:TRIGger:OUTPut<ch>:MODE</code>	642
<code>[:SOURce<hw>]:BB:DM:TRIGger:OUTPut<ch>:OFFTime</code>	642
<code>[:SOURce<hw>]:BB:DM:TRIGger:OUTPut<ch>:ONTime</code>	643
<code>[:SOURce<hw>]:BB:DM:TRIGger:OUTPut<ch>:PATtern</code>	643
<code>[:SOURce<hw>]:BB:DM:TRIGger:OUTPut<ch>:PULSe:DIVider</code>	643
<code>[:SOURce<hw>]:BB:DM:TRIGger:OUTPut<ch>:PULSe:FREQUency</code>	644

```
[:SOURce<hw>]:BB:DM:TRIGger:OUTPut<ch>:MODE <Mode>
```

The command defines the signal for the selected marker output.

Parameters:

<Mode>

CLISt | PULSe | PATTeRn | RATio | TRIGger

CLISt

A marker signal that is defined in the selected control list is generated.

PULSe

A pulsed marker signal is generated. The pulse frequency (= symbol rate/divider) is defined with the

`SOUR:BB:DM:TRIG:OUTP:PULSe:DIVider` command and can be queried with the

`SOUR:BB:DM:TRIG:OUTP:PULSe:FREQuency?` command.

PATTeRn

A marker signal is generated with the aid of a user-definable bit pattern. The bit pattern is entered with the aid of command

`SOURce:BB:DM:TRIGger:OUTPut:PATTeRn`. The bit pattern is a maximum of 32 bits long.

RATio

A regular marker signal corresponding to the Time Off / Time On specifications in the commands

`SOURce:BB:DM:TRIGger:OUTPut:OFFT` and

`SOURce:BB:DM:TRIGger:OUTPut:ONT` is generated.

*RST: RATio

Example:

```
BB:DM:TRIG:OUTP2:MODE PULS
```

selects the pulsed marker signal on output MARKER 2.

```
[:SOURce<hw>]:BB:DM:TRIGger:OUTPut<ch>:OFFTime <OffTime>
```

The command sets the number of symbols in a period (ON time + OFF time) during which the marker signal in setting `SOURce:BB:DM:TRIGger:OUTPut:MODE RATio` on the marker outputs is OFF.

Parameters:

<OffTime>

integer

Range: 1 to 16777215

Increment: 1

*RST: 1

Default unit: symbol

Example:

```
BB:DM:TRIG:OUTP2:OFFT 20
```

sets an OFF time of 20 symbols for marker signal 2.

In case of two-path instruments, on path A.

[[:SOURce<hw>]:BB:DM:TRIGger:OUTPut<ch>:ONTime <OnTime>

The command sets the number of symbols in a period (ON time + OFF time) during which the marker signal in setting `SOURce:BB:DM:TRIGger:OUTPut:MODE RATIO` on the marker outputs is ON.

Parameters:

<OnTime> float
 Range: 1 to 16777215
 *RST: 1
 Default unit: symbol

Example: `BB:DM:TRIG:OUTP2:ONT 20`
 sets an ON time of 20 symbols for marker 2

[[:SOURce<hw>]:BB:DM:TRIGger:OUTPut<ch>:PATTern <Pattern>

The command defines the bit pattern used to generate the marker signal in the setting `SOURce:BB:DM:TRIGger:OUTPut:MODE PATTern`. 0 is marker off, 1 is marker on.

Parameters:

<Pattern> integer
 Range: #B0,1 to #B111...1,32
 *RST: #B,1

Example: `BB:DM:TRIG:OUTP2:PATT #B000000011111111,15`
 sets a bit pattern.
`BB:DM:TRIG:OUTP2:MODE PATT`
 activates the marker signal according to a bit pattern on output MARKER 2.

[[:SOURce<hw>]:BB:DM:TRIGger:OUTPut<ch>:PULSe:DIVider <Divider>

The command sets the divider for Pulse marker mode (`SOUR:BB:DM:TRIGr:OUTP:MODE PULSe`). The resulting pulse frequency is derived by dividing the symbol rate by the divider.

Parameters:

<Divider> integer
 Range: 2 to 1024
 Increment: 1
 *RST: 2

Example: `BB:DM:TRIG:OUTP2:PULS:DIV 2`
 sets the divider to 2 for the marker signal on output MARKER 2.
`BB:DM:TRIG:OUTP2:FREQ?`
 queries the resulting pulse frequency of the marker signal.
 Response: 66 000
 the resulting pulse frequency is 66 kHz.

[[:SOURce<hw>]:BB:DM:TRIGger:OUTPut<ch>:PULSe:FREQUency?

The command queries the pulse frequency of the pulsed marker signal in the setting `SOURce:BB:DM:TRIGger:OUTPut:MODE PULSe`. The pulse frequency is derived by dividing the symbol rate by the divider.

Return values:

<Frequency> float

Example:

```
BB:DM:TRIG:OUTP2:PULS:DIV 2
sets the divider marker signal on output MARKER 2 to the value
2.
BB:DM:TRIG:OUTP2:MODE PULS
enables the pulsed marker signal.
BB:DM:TRIG:OUTP2:PULS:FREQ?
queries the pulse frequency of the marker signal.
Response: 33 000
the resulting pulse frequency is
```

Usage: Query only

Filter Settings

[:SOURce<hw>]:BB:DM:FILTer:OSAMpling.....	644
[:SOURce<hw>]:BB:DM:FILTer:OSAMpling:AUTO.....	645
[:SOURce<hw>]:BB:DM:FILTer:PARAmeter:COsine[:ROLLoff].....	645
[:SOURce<hw>]:BB:DM:FILTer:PARAmeter:GAUSS.....	645
[:SOURce<hw>]:BB:DM:FILTer:PARAmeter:LPASS.....	645
[:SOURce<hw>]:BB:DM:FILTer:PARAmeter:LPASSEVM.....	645
[:SOURce<hw>]:BB:DM:FILTer:PARAmeter:PGAuss.....	645
[:SOURce<hw>]:BB:DM:FILTer:PARAmeter:RCOSine.....	645
[:SOURce<hw>]:BB:DM:FILTer:PARAmeter:SPHase.....	645
[:SOURce<hw>]:BB:DM:FILTer:PARAmeter:APCO25.....	645
[:SOURce<hw>]:BB:DM:FILTer:PARAmeter:COsine:BANDwidth.....	646
[:SOURce<hw>]:BB:DM:FILTer:PARAmeter:APCO25Lsm:GAUSS.....	646
[:SOURce<hw>]:BB:DM:FILTer:PARAmeter:APCO25Lsm:LOWPass.....	646
[:SOURce<hw>]:BB:DM:FILTer:TYPE.....	646

[[:SOURce<hw>]:BB:DM:FILTer:OSAMpling <OSampling>

The command sets the upsampling factor.

Parameters:

<OSampling> integer
 Range: 1 to 32
 Increment: 1
 *RST: 32

Example:

```
BB:DM:FILT:OSAM 32
sets the upsampling factor to 32.
```

```
[[:SOURce<hw>]:BB:DM:FILTer:OSAMpling:AUTO <Auto>
```

The command activates/deactivates the upsampling factor state. If activated, the most sensible parameter values are selected. The value depends on the coherence check. If deactivated, the values can be changed manually.

Parameters:

```
<Auto>          0 | 1 | OFF | ON
*RST:           1
```

Example:

```
BB:DM:FILT:OSAM:AUTO ON
```

The most sensible parameters are selected automatically.

```
[[:SOURce<hw>]:BB:DM:FILTer:PARAMeter:COsine[:ROLLoff] <Cosine>
```

```
[[:SOURce<hw>]:BB:DM:FILTer:PARAMeter:GAUSs <Gauss>
```

```
[[:SOURce<hw>]:BB:DM:FILTer:PARAMeter:LPASs <LPass>
```

```
[[:SOURce<hw>]:BB:DM:FILTer:PARAMeter:LPASSEVM <LPassEvm>
```

```
[[:SOURce<hw>]:BB:DM:FILTer:PARAMeter:PGAuss <PGauss>
```

```
[[:SOURce<hw>]:BB:DM:FILTer:PARAMeter:RCOSine <RCosine>
```

```
[[:SOURce<hw>]:BB:DM:FILTer:PARAMeter:SPHase <SPHase>
```

```
[[:SOURce<hw>]:BB:DM:FILTer:PARAMeter:APCO25 <Apco25>
```

The command sets the roll-off factor for filter type APCO25.

On selecting filter APCO25, the filter parameter is set to the default value.

Parameters:

```
<Apco25>        float
                  Range:    0.05 to 0.99
                  Increment: 0.01
                  *RST:     0.2

<Cosine>        float
                  Range:    0.05 to 1.0
                  Increment: 0.01
                  *RST:     0.35

<Gauss>         float
                  Range:    0.15 to 100000
                  Increment: 0.01
                  *RST:     0.3

<LPass>         float
                  Range:    0.05 to 2
                  Increment: 0.01
                  *RST:     0.5

<LPassEvm>     float
                  Range:    0.05 to 2
                  Increment: 0.01
                  *RST:     0.5
```

<PGauss>	float
	Range: 0.15 to 2.5
	Increment: 0.01
	*RST: 0.3
<RCosine>	float
	Range: 0.05 to 1.0
	Increment: 0.01
	*RST: 0.35
<SPhase>	float
	Range: 0.15 to 2.5
	Increment: 0.01
	*RST: 2

Example: `BB:DM:FILT:PAR:APCO25 0.2`
sets the roll-off factor to 0.2 for filter type APCO25.

[:SOURce<hw>]:BB:DM:FILT:PAR:PARAMeter:COsine:BA NDwidth <FiltParm>

Sets the bandwidth of the cosine filter.

Parameters:

<FiltParm>	float
	Range: 400 to 25E6
	Increment: 1E-3
	*RST: 270833.333

Example: `:BB:DM:FILT:TYPE COS`
`:BB:DM:FILT:PAR:COS:BA ND 7200`

[:SOURce<hw>]:BB:DM:FILT:PAR:PARAMeter:APCO25Lsm:GAUSs <FiltParm>
[:SOURce<hw>]:BB:DM:FILT:PAR:PARAMeter:APCO25Lsm:LOWPass <FiltParm>

Sets the cut off frequency for the lowpass/ gauss filter.

Parameters:

<FiltParm>	float
	Range: 400 to 25E6
	Increment: 1E-3
	*RST: 270833.333

Example: `:BB:DM:FILT:TYPE APCO25Lsm`
`:BB:DM:FILT:PAR:APCO25L:LOWP 5166.667`
`:BB:DM:FILT:PAR:APCO25L:GAUS 1700`

[:SOURce<hw>]:BB:DM:FILT:TYPE <Type>

The command selects the filter type.

When a standard is selected (:BB:DM:STAN), the filter type and filter parameter are set to the default value.

Parameters:

<Type> RCOSine | COSine | GAUSs | LGAuss | CONE | COF705 |
 COEQUALizer | COFEQUALizer | C2K3x | APCO25 | SPHase |
 RECTangle | USER | PGAuss | LPASs | DIRac | ENPShape |
 EWPSHape | LTEFilter | LPASSEVM | APCO25Hcpm |
 APCO25Lsm
 *RST: GAUSs

Example:

BB:DM:FILT:TYPE COS
 selects the Cosine filter type.

Modulation Settings

[SOURce<hw>]:BB:DM:AQPSk:ANGLE.....	647
[SOURce<hw>]:BB:DM:ASK:DEPTH.....	647
[SOURce<hw>]:BB:DM:CODing.....	648
[SOURce<hw>]:BB:DM:FORMat.....	648
[SOURce<hw>]:BB:DM:FSK:DEVIation.....	649
[SOURce<hw>]:BB:DM:FSK:VARiable:SYMBOL<ch>:DEVIation.....	649
[SOURce<hw>]:BB:DM:FSK:VARiable:TYPE.....	649
[SOURce<hw>]:BB:DM:MDELay.....	650

[SOURce<hw>]:BB:DM:AQPSk:ANGLE <Angle>

For AQPSK modulation, sets the angle alpha between the point (0,0) and the I axis.

Parameters:

<Angle> float
 Range: 0 to 180
 Increment: 0.01
 *RST: 0
 Default unit: Deg

Example:

BB:DM:FORM AQPS
 selects modulation type AQPSK.
 BB:DM:AQPS:ANGL 45

[SOURce<hw>]:BB:DM:ASK:DEPTH <Depth>

The command sets the ASK modulation depth when modulation type ASK is selected.

Parameters:

<Depth> float
 Range: 0 to 100
 Increment: 0.1PCT
 *RST: 100
 Default unit: PCT

Example: `BB:DM:FORM ASK`
selects the ASK modulation type.
`BB:DM:ASK:DEPT 50 PCT`
sets a modulation depth of 50 percent.

[:SOURce<hw>]:BB:DM:CODing <Coding>

The command selects the modulation coding.

If the modulation type selected (`:BB:DM:FORM`) is not possible with the coding that has been set, it is automatically set to OFF (`:BB:DM:COD OFF`).

When a standard is selected (`:BB:DM:STAN`), the coding is set to the default value.

Parameters:

<Coding> OFF | DIFF | DPHS | DGRay | GRAY | GSM | NADC | PDC | PHS |
TETRa | APCO25 | PWT | TFTS | INMarsat | VDL | EDGE |
APCO25FSK | ICO | CDMA2000 | WCDMA | APCO258PSK

DPHS

Phase Difference

DGRay

Difference + Gray

*RST: INTernal

Example: `BB:DM:COD GRAY`
selects GRAY coding. This coding is valid for all modulation types.

[:SOURce<hw>]:BB:DM:FORMat <Format>

The command selects the modulation type.

If the coding that is set (`:BB:DM:COD`) is not possible with the modulation type selected, it is automatically set to OFF (`:BB:DM:COD OFF`).

When a standard is selected (`:DM:STAN`), the modulation type is set to the default value.

Parameters:

<Format> ASK | BPSK | P2DBpsk | QPSK | QPSK45 | OQPSk | P4QPSk |
P4DQpsk | PSK8 | P8D8psk | P8EDge | QAM16 | QAM32 |
QAM64 | QAM256 | QAM1024 | MSK | FSK2 | FSK4 | USER |
FSKVar | QAM128 | QEDGe | QAM16EDge | QAM32EDge |
AQPSk

*RST: MSK

Example: `BB:DM:FORM QPSK`
selects modulation type QPSK.

[[:SOURce<hw>]:BB:DM:FSK:DEVIation <Deviation>

The command sets the frequency deviation when FSK modulation is selected. The range of values depends on the symbol rate that is set (see data sheet) and the maximum deviation is 10 MHz.

If the symbol rate that is set exceeds the maximum possible value for the chosen frequency deviation, it is suitably adapted (:BB:DM:SRAT).

Parameters:

<Deviation> float
 Range: 1 to 40E6
 Increment: 0.5
 *RST: 135416.5

Example:

```
BB:DM:FORM FSK
selects FSK modulation.
BB:DM:FSK:DEV 10 MHz
sets the frequency deviation to 10 MHz.
```

[[:SOURce<hw>]:BB:DM:FSK:VARiable:SYMBOL<ch>:DEVIation <Deviation>

The command sets the deviation of the selected symbol for variable FSK modulation mode.

Suffix:

<ch> 0 .. 16
 The number of symbols (and therefore the suffix range) depends on the selected FSK modulation type.

Parameters:

<Deviation> float
 The range of values depends on the symbol rate that is set (see data sheet) and the maximum deviation is 10 MHz.
 Range: -40E6 to 40E6
 Increment: 0.5
 Default unit: Hz

Example:

```
BB:DM:FORM FSKV
selects Variable FSK modulation.
BB:DM:FSK:VAR:TYPE FSK16
selects 16FSK modulation.
BB:DM:FSK:VAR:SYMBOL:DEV 135000
sets the frequency deviation of the least significant symbol to 135 kHz.
```

[[:SOURce<hw>]:BB:DM:FSK:VARiable:TYPE <Type>

The command selects the modulation type for Variable FSK.

Parameters:

<Type> FSK4 | FSK8 | FSK16
 *RST: FSK4

Example:

BB:DM:FORM FSKV
 selects Variable FSK modulation.
 BB:DM:FSK:VAR:TYPE FSK16
 selects 16FSK modulation.

[:SOURce<hw>]:BB:DM:MDElay?

The command queries the digital modulation delay from the data input to the I/Q output in the case of external modulation.

Return values:

<MDElay> float

Example:

BB:DM:MDEL?
 queries the delay in the case of external modulation.
 Response: 0.4 ms
 the delay is 0.4 ms.

Usage:

Query only

Power Ramp

[:SOURce<hw>]:BB:DM:PRAMP:ATTenuation	650
[:SOURce<hw>]:BB:DM:PRAMP:BBONLY[:STATe]	651
[:SOURce<hw>]:BB:DM:PRAMP:FDElay	651
[:SOURce<hw>]:BB:DM:PRAMP:RDElay	651
[:SOURce<hw>]:BB:DM:PRAMP:SHAPE	652
[:SOURce<hw>]:BB:DM:PRAMP:SOURce	652
[:SOURce<hw>]:BB:DM:PRAMP:TIME	652
[:SOURce<hw>]:BB:DM:PRAMP[:STATe]	652

[:SOURce<hw>]:BB:DM:PRAMP:ATTenuation <Attenuation>

The command sets the level attenuation for signal ranges that are flagged with level attribute **attenuated** by the LEV_ATT control signal.

Parameters:

<Attenuation> float
 Range: 0 to 50
 Increment: 0.1
 *RST: 15
 Default unit: dB

Example:

BB:DM:PRAMP:ATT 15 dB
 sets a level attenuation of 15 dB.

[[:SOURce<hw>]:BB:DM:PRAMP:BBONLY[:STATe] <State>

This command selects power ramping in the baseband only or mixed power ramping in the baseband and the RF section.

The **ON** setting is mandatory if, with power ramping active, only the baseband signal is output (I/Q outputs)

In case of two-path instruments, the **ON** setting is also mandatory if a baseband signal is applied to two RF paths (RF A and RF B).

Only then can a signal with a defined, predictable level be output.

Parameters:

<State> 0 | 1 | OFF | ON
 *RST: OFF

Example:

BB:DM:PRAMP:BBON ON
 selects power ramping in the baseband only.

[[:SOURce<hw>]:BB:DM:PRAMP:FDElay <FDelay>

The command sets the delay in the falling edge. A positive value gives rise to a delay and a negative value causes an advance. The setting is expressed in symbols.

Parameters:

<FDelay> float
 Range: -4 to 4
 Increment: 0.01
 *RST: 0
 Default unit: symbol

Example:

BB:DM:PRAMP:FDEL 1
 The falling edge starts 1 symbol later.

[[:SOURce<hw>]:BB:DM:PRAMP:RDElay <RDelay>

The command sets the delay in the rising edge. A positive value gives rise to a delay and a negative value causes an advance. The setting is expressed in symbols.

Parameters:

<RDelay> float
 Range: -4 to 4
 Increment: 0.01
 *RST: 0
 Default unit: symbol

Example:

BB:DM:PRAMP:RDEL 1
 The rising edge starts 1 symbol later.

[:SOURce<hw>]:BB:DM:PRAMP:SHAPE <Shape>

The command sets the edge shape of the ramp envelope.

Parameters:

<Shape> LINear | COSine
 *RST: COSine

Example:

BB:DM:PRAMP:SHAP COS
 selects a cosine-shaped rise and fall for the transmitted power edge.

[:SOURce<hw>]:BB:DM:PRAMP:SOURce <Source>

The command sets the source for the power ramp control signals.

Parameters:

<Source> INTernal | EXTernal

INTernal

The internal control signals LEV_ATT and BURST are used. Control signals are stored in dedicated lists. When remote control is in use, the list to be used is defined, selected and enabled with the aid of SOURce:BB:DM:CLIST: . . . commands.

EXTernal

The digital control signals LEV_ATT and BURST are supplied via the control signal inputs on the AUX I/O connector.

*RST: INTernal

Example:

BB:DM:PRAMP:SOUR INT
 enables the use of internal control signals for power ramp control.

[:SOURce<hw>]:BB:DM:PRAMP:TIME <Time>

The command sets the power ramping rise time and fall time for a burst.

Parameters:

<Time> float
 Range: 0.25 to 16
 Increment: 0.01
 *RST: 1
 Default unit: symbol

Example:

BB:DM:PRAMP:TIME 2
 sets a time of 2 symbols for the edges to rise and fall.

[:SOURce<hw>]:BB:DM:PRAMP[:STATe] <State>

The command enables or disables power ramping.

Parameters:

<State> 0 | 1 | OFF | ON
 *RST: 0

Example:

BB:DM:PRAM:STAT ON
 switches power ramping on.

DM Lists

The following section brings together the commands for defining and managing the data lists and control lists for digital modulation.

Lists are stored as files with specific file extensions in a user-definable directory (see [table 6-2](#)). The directory which applies to the commands that follow is defined using the command `MMEMORY:CDIR`. Files in this directory can be accessed by quoting the file name. The path and extension are not needed.

Table 6-2: Overview of the used list types

List type	Content	File extension
Data List	Digital modulation data	*.dm_iqd
Control List	Digital modulation control data	*.dm_iqc
User Standards	User settings of digital modulation	*.dm_stu
Usr Filter	Usr filter settings	*.vaf
User Mapping	User mapping settings	*.vam

It is not possible to use other file extensions with the commands. Attempting to do so will cause an error message. If the file extension is changed in any other way (e.g. by directly accessing the file system) the lists are no longer recognized and therefore invalid.



Since the format of control lists refer to the input, the `CLIST` commands always create a binary control list, even if ASCII format is specified. Note therefore, if you want to create a *.wav file with R&S WinIQSIM2 using a control list, you have to use the input control list in ASCII format. See the example in [chapter 6.3.3, "Creating an ASCII C-List Manually"](#), on page 519 for information on how to create a C-list in ASCII format.

List of Commands

<code>[[:SOURce<hw>]:BB:DM:CLIST:CATalog</code>	654
<code>[[:SOURce<hw>]:BB:DM:DLIST:CATalog</code>	654
<code>[[:SOURce<hw>]:BB:DM:FLIST:CATalog</code>	654
<code>[[:SOURce<hw>]:BB:DM:MLIST:CATalog</code>	654
<code>[[:SOURce<hw>]:BB:DM:CLIST:FREE</code>	654
<code>[[:SOURce<hw>]:BB:DM:DLIST:FREE</code>	654
<code>[[:SOURce<hw>]:BB:DM:FLIST:FREE</code>	655
<code>[[:SOURce<hw>]:BB:DM:MLIST:FREE</code>	655
<code>[[:SOURce<hw>]:BB:DM:CLIST:COPY</code>	655
<code>[[:SOURce<hw>]:BB:DM:DLIST:COPY</code>	655
<code>[[:SOURce<hw>]:BB:DM:CLIST:TAG</code>	655

<code>[:SOURce<hw>]:BB:DM:DLIST:TAG</code>	655
<code>[:SOURce<hw>]:BB:DM:CLIST:DATA</code>	656
<code>[:SOURce<hw>]:BB:DM:CLIST:DELeTe</code>	657
<code>[:SOURce<hw>]:BB:DM:CLIST:POINts</code>	657
<code>[:SOURce<hw>]:BB:DM:CLIST:SELeCt</code>	657
<code>[:SOURce<hw>]:BB:DM:DLIST:DATA</code>	658
<code>[:SOURce<hw>]:BB:DM:DLIST:DATA:APPend</code>	658
<code>[:SOURce<hw>]:BB:DM:DLIST:DELeTe</code>	659
<code>[:SOURce<hw>]:BB:DM:DLIST:POINts</code>	659
<code>[:SOURce<hw>]:BB:DM:DLIST:SELeCt</code>	660
<code>[:SOURce<hw>]:BB:DM:FLIST:DELeTe</code>	660
<code>[:SOURce<hw>]:BB:DM:FLIST:POINts</code>	660
<code>[:SOURce<hw>]:BB:DM:FLIST:SELeCt</code>	661
<code>[:SOURce<hw>]:BB:DM:MLIST:DELeTe</code>	661
<code>[:SOURce<hw>]:BB:DM:MLIST:POINts</code>	661
<code>[:SOURce<hw>]:BB:DM:MLIST:SELeCt</code>	662
<code>[:SOURce<hw>]:BB:DM:SETTing:CATalog</code>	662
<code>[:SOURce<hw>]:BB:DM:SETTing:DELeTe</code>	662
<code>[:SOURce<hw>]:BB:DM:SETTing:LOAD</code>	663
<code>[:SOURce<hw>]:BB:DM:SETTing:STORe</code>	663
<code>[:SOURce<hw>]:BB:DM:SETTing:STORe:FAST</code>	663
<code>[:SOURce<hw>]:BB:DM:STANdard:ULIST:CATalog</code>	663
<code>[:SOURce<hw>]:BB:DM:STANdard:ULIST:DELeTe</code>	664
<code>[:SOURce<hw>]:BB:DM:STANdard:ULIST:LOAD</code>	664
<code>[:SOURce<hw>]:BB:DM:STANdard:ULIST:STORe</code>	664

`[:SOURce<hw>]:BB:DM:CLIST:CATalog?`

`[:SOURce<hw>]:BB:DM:DLIST:CATalog?`

`[:SOURce<hw>]:BB:DM:FLIST:CATalog?`

`[:SOURce<hw>]:BB:DM:MLIST:CATalog?`

Queries the user mapping lists present in the default directory. The default directory is set using command `MMEM:CDIRectory`. When the names of the files are returned they are separated by commas.

The command only reads out files with the `*.vam` extension (see also [table 6-2](#)).

Return values:

<Catalog> string

Example:

`BB:DM:FORM USER`

selects the User modulation type.

`MMEM:CDIR 'D:/user/mapping_List'`

sets the default directory for the user mapping lists.

`BB:DM:MLIS:CAT?`

queries the user mapping lists in the directory.

Usage: Query only

`[:SOURce<hw>]:BB:DM:CLIST:FREE?`

`[:SOURce<hw>]:BB:DM:DLIST:FREE?`

**[[:SOURce<hw>]:BB:DM:FLIS:FREE?
[:SOURce<hw>]:BB:DM:MLIS:FREE?**

Queries the user modulation mapping list free memory.

Return values:

<Free> integer
Range: 0 to INT_MAX
Increment: 1
*RST: 0

Example:

BB:DM:FORM USER
selects the User modulation type.
BB:DM:FLIS:FREE?
queries the free memory.

Usage: Query only

**[[:SOURce<hw>]:BB:DM:CLIS:COPY <Filename>
[:SOURce<hw>]:BB:DM:DLIS:COPY <Filename>**

The command copies the selected data list into the data list specified by <list name>. If a data list with the specified name already exists, it is overwritten. If it does not yet exist, it is created.

The source file has to be available in the default directory. The default directory is set using command `MMEM:CDIRectory`. A path can be specified, in which case the source file is copied into the file <list name> in the specified directory. The file extension may be omitted.

Only files with the file extension `*.dm_iqc` will be copied (see also [table 6-2](#)).

Setting parameters:

<Filename> string

Example:

BB:DM:DLIS 'd_list1'
selects data list d_list1.
BB:DM:DLIS:COPY 'd_list2'
copies the content of data list d_list1 into data list d_list2.
Any existing content in data list d_list2 is overwritten.

Usage: Setting only

**[[:SOURce<hw>]:BB:DM:CLIS:TAG?
[:SOURce<hw>]:BB:DM:DLIS:TAG?**

The command queries the content of the specified tag in the selected file.

Return values:

<Tag> <control list>,<tag name>

Example: BB:DM:DLIS:TAG 'D_list1','date'
 queries the Date tag in control list D_list1.
 Response:10.10.2008
 the data list was created on 10.10.2008.

Usage: Query only

[:SOURce<hw>]:BB:DM:CLIST:DATA <Data>

The command sends the data to the currently selected control list. If the list already contains data, it is overwritten. This command only writes data into the data section of the file.

The values for the control signals are sent, arranged in a 8-bit value as follows:

Signal	Order	Decimal value of bits
Marker 1	LSBit	1
Marker 2		2
Marker 3		4
Marker 4		8
Burst =	LSBit	16
LevAtt1	LSBit	32
CWMod	LSBit	64
Hop	MSBit	128

The data can also be sent as a binary block, each binary block being a 2-byte value in which the 16 bits represent the binary values (16-bit unsigned integer, 2 bytes, LSByte first). When binary data transmission is in use, command `:SYSTEM:COMMunicate:GPIB:LTERminator EOI` should be used to set the termination character mode to 'EOI control data message only' so that a random LF in the data sequence is not interpreted as End, thereby prematurely terminating the data transmission. The command `...LTER STANDard` resets the mode.

For query purposes, the command `:FORMat ASCII | PACKed` can be used to switch between the formats. The byte sequence is defined in the IEC bus standard as 'most significant byte first'

Note: C-Lists are created in binary format. However, if you need the C-List in ASCII format, e.g. for creating a waveform file with R&S WinQSIM2, see the example in [chapter 6.3.3, "Creating an ASCII C-List Manually"](#), on page 519.

*RST has no effect on data lists. This command is without query.

Setting parameters:

<Data> string

Example: BB:DM:CLIS:SEL 'c_list1'
selects the control list.
BB:DM:CLIS:DATA 0,0,0,0,8,8,8,0,0,0,0...
enters the control values in list c_list1. In the example, only ramps for marker 4 are set.

Usage: Setting only

[SOURce<hw>]:BB:DM:CLIS:DELeTe <Filename>

The command deletes the specified control list from the default directory. The default directory is set using command `MMEM:CDIRectory`. A path can also be specified, in which case the files in the specified directory are deleted. The file extension may be omitted. Only files with the file extension `*.dm_iqc` will be deleted.

Setting parameters:

<Filename> <list name>

Example: BB:DM:CLIS:DEL 'c_list3'
deletes control list c_list3.

Usage: Setting only

[SOURce<hw>]:BB:DM:CLIS:POINts?

The command queries the number of lines (2 bytes) in the currently selected list.

Return values:

<Points> integer
Range: 0 to INT_MAX
Increment: 1
*RST: 0

Example: BB:DM:CLIS:SEL "c_list1"
selects control list c_list1.
BB:DM:CLIS:POIN?
queries the number of lines in the control list.
Response: 20
the control list consists of 20 lines.

Usage: Query only

[SOURce<hw>]:BB:DM:CLIS:SELeCt <Filename>

The command selects the control list in the default directory. The default directory is set using command `MMEM:CDIRectory`. A path can also be specified, in which case the files in the specified directory are selected. If a control list with the specified name does not yet exist, it is created. The file extension may be omitted. Only files with the file extension `*.dm_iqc` will be selected or created.

Parameters:

<Filename> <list name>

Example:

```
BB:DM:CLIS:SEL 'c_list1'
selects control list c_list1.
```

[:SOURce<hw>]:BB:DM:DLIS:DATA <Data>

The **Setting** command sends the bit data to the data list selected with the aid of `:BB:DM:DLIS:SElect`. Any existing content in the data list is overwritten. This command only writes data into the data section of the file.

This command sends the bit data to the selected data list, which is overwritten. The data can also be sent as block data in binary or PACKed format, each byte being interpreted as 8 data bits. In this case, command `:SYSTEM:COMMunicate:GPIB:LTERminator EOI` should be used to set the termination character mode to 'EOI control data message only' so that a random LF in the data sequence is not interpreted as End, thereby prematurely terminating the data transmission. The command `...LTER STAN` resets the mode.

The **query** reads out the data part of the data list. If the query is expanded by using the two parameters <start> and <length>, the list is read out in smaller sections. Start and Length are expressed in bits. Without the parameters the total length is always read out starting from address 1. The command `:FORMat ASCii | PACKed` can be used to select the data format. The byte sequence is defined in the IEC bus standard (read/write most significant byte first). *RST has no effect on data lists.

Parameters:

<Data> integer

Example:

```
BB:DM:DLIS:SEL 'dlist1'
selects data list dlist1. If the file does not yet exist, it is created.
BB:DM:DLIS:DATA 1,1,1,0,0,0,1,1,0,1...
sends the specified data to file dlist1. Any data already present is
overwritten.
```

Example:

```
BB:DM:DLIS:SEL 'dlist1'
selects data list dlist1.
FORM ASCI
selects ASCII data transmission format.
BB:DM:DLIS:DATA? 2048,1024
queries the data starting at bit 2048 for 1024 bits.
```

[:SOURce<hw>]:BB:DM:DLIS:DATA:APPend <Bits>

The command appends the bit data onto the end of the existing data in the selected data list. This means that existing content in the data list is not overwritten. By this means very long data lists can be built up piecemeal. The data format is as specified in command `SOURce:BB:DM:DLIS:DATA`.

The command cannot be used with an empty data list, such as one that has just been created, for example. In this case the command `SOURce:BB:DM:DLIS:DATA` must first be used to enter modulation data in the list.

*RST has no effect on data lists.

Setting parameters:

<Bits> 0 | 1 {,0 | 1 } | block data

Example:

```
BB:DM:DLIS:SEL ' d_list2'
selects data list d_list2.
FORM ASC
selects ASCII data transmission format.
BB:DM:DLIS:DATA:APP 1,1,1,0,0,0,1,1,0,1...
adds the specified numeric data to the existing data in data list
d_list2.
```

Usage: Setting only

[:SOURce<hw>]:BB:DM:DLIS:DELeTe <Filename>

The command deletes the specified data list. from the default directory. The default directory is set using command `MMEM:CDIRectory`. A path can also be specified, in which case the files in the specified directory are deleted. The file extension may be omitted. Only files with the file extension `*.dm_iqd` will be deleted.

The numeric suffix on `SOURce<[1]2>` is ignored in this command.

Setting parameters:

<Filename> string

Example:

```
BB:DM:DLIS:DEL ' d_list2'
deletes data list d_list2.
```

Usage: Setting only

[:SOURce<hw>]:BB:DM:DLIS:POINts <Points>

The command defines the number of bits in the selected data list to be utilized. When a list is being filled with block data, this data is only ever sent in multiples of 8 bits. However the exact number of bits to be exploited can be set to a different figure. The superfluous bits in the list are then ignored.

Parameters:

<Points> integer
 Range: 0 to INT_MAX
 Increment: 1
 *RST: 0

Example:

```
BB:DM:DLIS:POIN 234
defines the number of bits in the data list to be utilized as 234 bits.
If the list was filled with block data, at least the last 6 bits will be
ignored.
```

[[:SOURce<hw>]:BB:DM:DLIS:SElect <Select>

The command selects the data list in the default directory. The default directory is set using command `MMEM:CDIRectory`. A path can also be specified, in which case the files in the specified directory are selected. If a data list with the specified name does not yet exist, it is created. The file extension may be omitted. Only files with the file extension `*.dm_iqd` will be selected or created.

The modulation data in this data list is used when the data source is selected using the command `SOURce:BB:DM:SOURce DLIS`.

Setting parameters:

<Select> <list name>

Example: `BB:DM:DLIS:SEL 'd_list2'`
selects data list `d_list2`.

Usage: Setting only

[[:SOURce<hw>]:BB:DM:FLIS:DElete <Filename>

Deletes the specified user filter file. The default directory is set using command `MMEM:CDIRectory`. A path can also be specified, in which case the files in the specified directory are read. The file extension may be omitted. Only files with the file extension `*.vaf*.vaf` will be deleted.

Setting parameters:

<Filename> string

Example: `BB:DM:FILT:TYPE USER`
selects the User filter type.
`MMEM:CDIR 'D:/user/Filter_List'`
sets the default directory for the user-defined filters.
`BB:DM:FLIS:DEL user_filter3`
deletes the user-defined filter.

Usage: Setting only

[[:SOURce<hw>]:BB:DM:FLIS:POINts?

Queries the user filter list length.

Return values:

<Points> integer
Range: 0 to INT_MAX
Increment: 1
*RST: 0

Example: `BB:DM:FILT:TYPE USER`
selects the User filter type.
`BB:DM:FLIS:POIN?`
queries the list length.

Usage: Query only

[:SOURce<hw>]:BB:DM:FLIS:SElect <Filename>

The command selects the user-defined filter (* .vaf).

The directory applicable to the following command is defined with the command `MMEM:CDIRectory`. To access the files in this directory, only the file name is required, without the path and the file extension.

Parameters:

<Filename> string

Example:

```
BB:DM:FILT:TYPE USER
selects the User filter type.
MMEM:CDIR 'D:/user/Filter_List'
sets the default directory for the user-defined filters.
BB:DM:FLIS:SEL user_filter3
selects the user-defined filter.
```

[:SOURce<hw>]:BB:DM:MLIS:DElete <Filename>

Deletes the specified user mapping file. The default directory is set using command `MMEM:CDIRectory`. A path can also be specified, in which case the files in the specified directory are read. The file extension may be omitted. Only files with the file extension * .vam will be deleted.

Setting parameters:

<Filename> string

Example:

```
BB:DM:FORM USER
selects the User modulation type.
MMEM:CDIR 'D:/user/mapping_List'
sets the default directory for the user mapping lists.
BB:DM:MLIS:DEL user_mapping3
deletes the user mapping list.
```

Usage: Setting only

[:SOURce<hw>]:BB:DM:MLIS:POINTs?

Queries the user modulation mapping list length.

Return values:

<Points> integer

Range: 0 to INT_MAX
 Increment: 1
 *RST: 0

Example: BB:DM:FORM USER
selects the User modulation type.
BB:DM:MLIS:POIN?
queries the list length.

Usage: Query only

[:SOURce<hw>]:BB:DM:MLIS:SElect <Filename>

The command selects the user mapping list in the default directory. The default directory is set using command `MMEM:CDIRectory`. A path can also be specified, in which case the files in the specified directory are selected. If a user mapping list with the specified name does not yet exist, it is created. The file extension may be omitted. Only files with the file extension `*.vam` will be selected or created.

Parameters:

<Filename> string

Example: BB:DM:MLIS:SEL 'c_list1'
selects the user mapping list `c_list1`.

[:SOURce<hw>]:BB:DM:SETTing:CATalog?

This command reads out the files with Custom Digital Modulation settings in the default directory. The default directory is set using command `MMEM:CDIRectory`. Only files with the file extension `*.dm` will be listed.

Return values:

<Catalog> string

Example: MMEM:CDIR 'D:/user/dig_mod'
sets the default directory.
BB:DM:SETT:CAT?
reads out all the files with Custom Digital Modulation settings in the default directory.
Response: 'DM_1'
the file `DM_1` with Custom Digital Modulation settings is available.

Usage: Query only

[:SOURce<hw>]:BB:DM:SETTing:DELeTe <Filename>

This command deletes the selected file with Custom Digital Modulation settings. The directory is set using command `MMEM:CDIRectory`. A path can also be specified, in which case the files in the specified directory are read. The file extension may be omitted. Only files with the file extension `*.dm` will be deleted.

Setting parameters:

<Filename> string

Example: BB:DM:STAN:ULIS:DEL 'DM_1'
deletes file `DM_1`.

Usage: Setting only

[:SOURce<hw>]:BB:DM:SETTing:LOAD <Filename>

This command loads the selected file with Custom Digital Modulation settings. The directory is set using command `MMEM:CDIRectory`. A path can also be specified, in which case the files in the specified directory are read. The file extension may be omitted. Only files with the file extension `*.dm` will be loaded.

Setting parameters:

<Filename> string

Example: `BB:DM:STAN:ULIS:LOAD 'DM_1'`
loads file `DM_1`.

Usage: Setting only

[:SOURce<hw>]:BB:DM:SETTing:STORe <Filename>

This command stores the current Custom Digital Modulation settings into the selected file. The directory is set using command `MMEM:CDIRectory`. A path can also be specified, in which case the files in the specified directory are read. Only the file name has to be entered. User Standards are stored as files with the specific file extensions `*.dm`.

Setting parameters:

<Filename> string

Example: `BB:DM:STAN:ULIS:STOR 'DM_QAM'`
stores the current Custom Digital Modulation settings into file `DM_QAM`.

Usage: Setting only

[:SOURce<hw>]:BB:DM:SETTing:STORe:FAST <Fast>

Determines whether the instrument performs an absolute or a differential storing of the settings.

Enable this function to accelerate the saving process by saving only the settings with values different to the default ones.

Note: This function is not affected by the "Preset" function.

Parameters:

<Fast> 0 | 1 | OFF | ON
*RST: 1

[:SOURce<hw>]:BB:DM:STANdard:ULIS:t:CATalog?

This command reads out the files with Digital Standard settings in the default directory. The default directory is set using command `MMEM:CDIRectory`. Only files with the file extension `*.dm_stu` will be listed.

Return values:

<Catalog> string

Example:

MMEM:CDIR 'D:/user/dig_mod'

sets the default directory.

BB:DM:STAN:ULIS:CAT?

reads out all the files with Digital Standard settings in the default directory.

Response: 'DM_QAM'

the file DM_QAM with Digital Standard settings is available.

Usage:

Query only

[:SOURce<hw>]:BB:DM:STANDARD:ULIST:DELETE <Filename>

This command deletes the selected file with Digital Standard settings. The directory is set using command `MMEM:CDIRECTORY`. A path can also be specified, in which case the files in the specified directory are read. The file extension may be omitted. Only files with the file extension `*.dm_stu` will be deleted.

Setting parameters:

<Filename> string

Example:

BB:DM:STAN:ULIS:DEL 'DM_QAM'

deletes file 'DM_QAM'.

Usage:

Setting only

[:SOURce<hw>]:BB:DM:STANDARD:ULIST:LOAD <Filename>

This command loads the selected file with Digital Standard settings. The directory is set using command `MMEM:CDIRECTORY`. A path can also be specified, in which case the files in the specified directory are read. The file extension may be omitted. Only files with the file extension `*.dm_stu` will be loaded.

Setting parameters:

<Filename> string

Example:

BB:DM:STAN:ULIS:LOAD 'DM_QAM'

loads file 'DM_QAM'.

Usage:

Setting only

[:SOURce<hw>]:BB:DM:STANDARD:ULIST:STORE <Filename>

This command stores the current Digital Standard settings into the selected file. The directory is set using command `MMEM:CDIRECTORY`. A path can also be specified, in which case the files in the specified directory are read. Only the file name has to be entered. User Standards are stored as files with the specific file extensions `*.dm_stu`.

Setting parameters:

<Filename> string

Example: `BB:DM:STAN:ULIS:STOR 'DM_QAM'`
stores the current Digital Standard settings into file 'DM_QAM'.

Usage: Setting only

6.15.3.4 SOURce:BB:GRAPhics Subsystem

This subsystem contains the commands used to setup the graphical display.

<code>[:SOURce<hw>]:BB:GRAPhics:MODE</code>	665
<code>[:SOURce<hw>]:BB:GRAPhics:SMART:STATe</code>	665
<code>[:SOURce<hw>]:BB:GRAPhics:SRATe:MODE</code>	665
<code>[:SOURce<hw>]:BB:GRAPhics:SRATe:USER</code>	666
<code>[:SOURce<hw>]:BB:GRAPhics:STATe</code>	666
<code>[:SOURce<hw>]:BB:GRAPhics:TRIGger:SOURce</code>	667

[:SOURce<hw>]:BB:GRAPhics:MODE <Mode>

Selects the graphical signal display.

Parameters:

<Mode> IQ | VECTor | CCDF | PSPectrum | CONSTellation | EYEI |
 EYEQ
 *RST: IQ

Example: `BB:GRAP:MODE VECT`
selects vector diagram.

[:SOURce<hw>]:BB:GRAPhics:SMART:STATe <State>

Activates/deactivates the "smart graphics".

Parameters:

<State> 0 | 1 | OFF | ON
 *RST: 0

Example: `BB:GRAP:SMAR:STAT ON`
Activates smart graphics.

[:SOURce<hw>]:BB:GRAPhics:SRATe:MODE <Mode>

Sets how the time resolution of the signal is determined. Maximum resolution corresponds to a display covering the entire signal bandwidth. The higher the resolution is, the shorter the length of the displayed signal segment will be for the specified recording depth.

Parameters:

<Mode> AUTO | FULL | USER

AUTO

The resolution is set to an optimum value on the basis of the signal and display type.

FULL

The resolution is set such that the display covers the entire signal bandwidth.

USER

with the command `SOUR:BB:GRAP:SRAT:USER`, the user can determine the resolution by setting the signal bandwidth for which the display is to be generated

*RST: AUTO

Example:

`BB:GRAP:SRAT:MODE FULL`
sets the sample rate mode.

[:SOURce<hw>]:BB:GRAPhics:SRATe:USER <User>

(Enabled for `BB:GRAPH:SRAT:MODE USER`)

Selects the signal bandwidth for which the display is to be generated. The setting range moves between the minimum and maximum bandwidth which is possible for the selected display. The selection is made graphically by moving the pointer.

Parameters:

<User> float
Range: 0.1 to 100
Increment: 0.1
*RST: 10
Default unit: PCT

Example:

`BB:GRAP:SRAT:MODE USER`
sets the sample rate mode.

Example:

`BB:GRAP:SRAT:USER 20`
sets the sample rate factor.

[:SOURce<hw>]:BB:GRAPhics:STATe <State>

Activates/deactivates the selected graphical display.

Parameters:

<State> 0 | 1 | OFF | ON
*RST: 0

Example:

`BB:GRAP:STAT ON`
activates the graphical graphics.

[:SOURce<hw>]:BB:GRAPhics:TRIGger:SOURce <Source>

Defines the trigger for the starting time of the graphic recording.

Parameters:

<Source> SOFTware | MARKer

SOFTWARE

Recording of signals is started automatically in specified intervals. This asynchronous method is appropriate when a representative display of the complete signal is desired, as recording starts in a random time reference to the signal.

MARKER

The starting point for recording signals is determined by "Marker 1" in the menu of the active standard.

This synchronous method is appropriate when specific signal segments are to be shown in greater detail. With periodic signals, a static image is obtained by selecting a period length of "Marker 1" that is equal to the signal period.

The displayed signal segment can be shifted as needed by entering a "Marker Delay" in the "Trigger/Marker" menu of the active standard.

*RST: SOFTware

Example:

BB:GRAP:TRIG:SOUR MARK
sets the trigger source.

6.15.3.5 SOURce:BB:IMPairment Subsystem

This subsystem contains the commands for the digital I/Q impairments.

Included in this section is also the description of command

SOURce:BB:IQOutput:SOURce that determined the source for the I/Q output connectors.

[:SOURce<hw>]:BB:IMPairment:IQRatio.....	668
[:SOURce<hw>]:BB:IMPairment:LEAKage:I.....	668
[:SOURce<hw>]:BB:IMPairment:LEAKage:Q.....	668
[:SOURce<hw>]:BB:IMPairment:OPTimization:MODE.....	669
[:SOURce<hw>]:BB:IMPairment:OPTimization:STATe.....	669
[:SOURce<hw>]:BB:IMPairment:OPTimization:UCORrection:ACCuracy.....	669
[:SOURce<hw>]:BB:IMPairment:OPTimization:UCORrection:BWIDth.....	670
[:SOURce<hw>]:BB:IMPairment:OPTimization:UCORrection:CATalog.....	670
[:SOURce<hw>]:BB:IMPairment:OPTimization:UCORrection:EDEVices.....	670
[:SOURce<hw>]:BB:IMPairment:OPTimization:UCORrection:FILE.....	671
[:SOURce<hw>]:BB:IMPairment:OPTimization:UCORrection:FILE:STATus.....	671
[:SOURce<hw>]:BB:IMPairment:OPTimization:UCORrection:FREQUency:MAX.....	672
[:SOURce<hw>]:BB:IMPairment:OPTimization:UCORrection:FREQUency:MIN.....	672
[:SOURce<hw>]:BB:IMPairment:OPTimization:UCORrection:FREQUency:OFFSet.....	673
[:SOURce<hw>]:BB:IMPairment:OPTimization:UCORrection:IAFixed.....	673
[:SOURce<hw>]:BB:IMPairment:OPTimization:UCORrection:LEVel:MAX.....	674
[:SOURce<hw>]:BB:IMPairment:OPTimization:UCORrection:LEVel:MIN.....	674

<code>[:SOURce<hw>]:BB:IMPairment:OPTimization:UCORrection:LEVel:OFFSet</code>	674
<code>[:SOURce<hw>]:BB:IMPairment:OPTimization:UCORrection:TYPE</code>	675
<code>[:SOURce<hw>]:BB:IMPairment:QUADrature[:ANGLE]</code>	675
<code>[:SOURce<hw>]:BB:IMPairment:STATE</code>	675

`[:SOURce<hw>]:BB:IMPairment:IQRatio <lqRatio>`

This command sets the ratio of I modulation to Q modulation (amplification “imbalance”). The input may be either in dB or %. The resolution is 0.001 dB, an input in percent is rounded to the closest valid value in dB. A query returns the value in dB.

Parameters:

<code><lqRatio></code>	float
Range:	-1 to 1
Increment:	1E-4
*RST:	0

Example:

```
BB:IMP:IQR 3 PCT
sets the imbalance to 3 percent.
BB:IMP:IQR?
queries the imbalance.
Response: 0.259000
the value is returned in dB
BB:IMP:IQR 1
sets the imbalance to 1 dB.
```

`[:SOURce<hw>]:BB:IMPairment:LEAKage:I <l>`

This command sets the carrier leakage amplitude for the I-signal component.

Parameters:

<code><l></code>	float
Range:	-10 to 10
Increment:	0.01
*RST:	0
Default unit:	PCT

Example:

```
BB:IMP:LEAK:I 3 PCT
sets the leakage for the I-component to 3 percent.
```

`[:SOURce<hw>]:BB:IMPairment:LEAKage:Q <q>`

This command sets the carrier leakage amplitude for the Q-signal component.

Parameters:

<code><q></code>	float
Range:	-10 to 10
Increment:	0.01
*RST:	0
Default unit:	PCT

Example: `BB:IMP:LEAK:Q 3 PCT`
sets the leakage for the Q-component to 3 percent.

[[:SOURce<hw>]:BB:IMPairment:OPTimization:MODE <Mode>

This command sets the optimization mode.

Parameters:

<Mode> FAST | QHIGh | UCORrection

FAST

Optimization is reached by compensation for I/Q skew.

QHIGh

Optimization is reached by compensation for I/Q skew and frequency response correction.

UCOR

Optimization is reached by data generated with the R&S SMU RF and Baseband Correction Toolkit.

Note: User correction can only be operated if the instrument is equipped with an R&S SMU-K63.

*RST: FAST

Example: `BB:IMP:OPT:MODE FAST`
sets the optimization mode Fast.

[[:SOURce<hw>]:BB:IMPairment:OPTimization:STATe <State>

This command activates and deactivates internal compensation of signal distortions by the I/Q modulator.

Parameters:

<State> 0 | 1 | OFF | ON

*RST: OFF

Example: `BB:IMP:OPT:STAT ON`
activates internal compensation of signal distortions.

[[:SOURce<hw>]:BB:IMPairment:OPTimization:UCORrection:ACCuracy?

Note: The accuracy of the user correction data is only indicated if the instrument is equipped with an R&S SMx-K63.

This command queries the accuracy of the baseband frequency response correction data.

Return values:

<Accuracy> LOW | NORMAl | HIGH

*RST: NORMAl

Example: `SOURce:BB:IMP:OPT:UCOR:ACC?`
 queries the accuracy of the frequency response correction data.
 Response: `LOW | NORMAl | HIGH`

Usage: Query only

[:SOURce<hw>]:BB:IMPairment:OPTimization:UCORrection:BWIDth?

Note: Bandwidth of the user correction data is only indicated if the instrument is equipped with an R&S SMx-K63 and external devices are enabled.

This command queries the bandwidth of the frequency response correction data.

Return values:

<BWidth> `BWFRange | BW5M | BW10M | BW15M | BW20M | BW30M |
 BW40M | BW60M | BW80M`
 *RST: `BWFRange`

Example: `SOURce:BB:IMP:OPT:UCOR:BWID?`
 queries the bandwidth of the frequency response correction data.
 Response: `BWFRange | BW5M | BW10M | BW15M |
 BW20M | BW30M | BW40M | BW60M | BW80M`

Usage: Query only

[:SOURce<hw>]:BB:IMPairment:OPTimization:UCORrection:CATalog?

The command queries the names of the frequencies response correction files with the predefined file extension *.frc. The standard directory for frequency response correction files is `D:\SMxRFandBBCorrectionToolkit\SMxK63` on the hard disk of the instrument. A complete list of all files is returned (the various entries are separated by commas).

Return values:

<Catalog> `string`

Example: `MMEM:CDIR 'd:
 /SMxRFandBBCorrectionToolkit/SMxK63'`
 switches to the default directory for *.frc files.
`SOUR:BB:IMP:OPT:UCOR:CAT?`
 queries the names of the frequency response correction files.

Usage: Query only

[:SOURce<hw>]:BB:IMPairment:OPTimization:UCORrection:EDEVices?

Set to On this command enables that the parameters bandwidth, frequency offset and level offset are displayed.

Return values:

<EDevices> 0 | 1 | OFF | ON

ON

The parameters bandwidth, frequency offset and level offset are displayed.

OFF

The parameters bandwidth, frequency offset and level offset are not indicated

*RST: 1

Example:

SOUR:BB:IMP:OPT:UCOR:EDEV?

queries the status of the parameter external devices.

Response: ON

Usage:

Query only

[:SOURce<hw>]:BB:IMPairment:OPTimization:UCORrection:FILE <File>

Note: A correction file can only be loaded if the instrument is equipped with an R&S SMx-K63.

The command opens the standard file dialog box used to load and store list or data files, i.e. in this particular case files containing correction data. Each file is stored with the predefined file extension *.frc (Frequency Response Correction). The standard directory for frequency correction files is D:\SMxRFandBBCorrectionToolkit\SMxK63.

Note: The frc parameters get values from this file. If the file is not existing or corrupted the info parameters will not be updated. An error message is displayed in the infor line of the status bar.

Parameters:

<File> string

Example:

MMEM:CDIR 'd:

/SMxRFandBBCorrectionToolkit/SMxK63'

switches to the default directory for *.frc files.

SOUR:BB:IMP:OPT:UCOR:FILE 'test.frc'

selects the file "test.frc" for frequency response correction.

[:SOURce<hw>]:BB:IMPairment:OPTimization:UCORrection:FILE:STATus?

Note: The status of the correction file is only indicated if the instrument is equipped with an R&S SMx-K63.

The command indicates whether the frequency response correction file *.frc could be loaded properly.

Return values:

<Status>

OK | MISSing | INCompatible | CORRupt

OK

File type and data of the correction file are ok. The file can be used for frequency response correction.

MISS

File not found.

INC

The file is not compatible with the instrument or the path and could not be loaded.

CORR

The frequency response correction data is corrupt. An error occurred and the file could not be loaded.

*RST: MISSing

Example:

```
SOUR:BB:IMP:OPT:UCOR:FILE:STAT?
```

queries the status of file loading.

Response: OK

Usage:

Query only

[[:SOURce<hw>]:BB:IMPairment:OPTimization:UCORrection:FREQUENCY:MAX?

Note: Frequency values of the user correction data are only indicated if the instrument is equipped with an R&S SMx-K63.

The command displays the maximum frequency value of the frequency response correction data.

Return values:

<Max>

float

Range: 1E5 to 6E9

Increment: 1E5

*RST: 6E9

Example:

```
SOURce:BB:IMP:OPT:UCOR:FREQ:MAX?
```

queries the maximum frequency value of the correction data.

Response: xxxx.x MHz

Usage:

Query only

[[:SOURce<hw>]:BB:IMPairment:OPTimization:UCORrection:FREQUENCY:MIN?

Note: Frequency values of the user correction data are only indicated if the instrument is equipped with an R&S SMx-K63.

The command displays the minimum frequency value of the frequency response correction data.

Return values:

<Min> float
 Range: 1E5 to 6E9
 Increment: 1E5
 *RST: 1E5

Example:

SOURce:BB:IMP:OPT:UCOR:FREQ:MIN?
 queries the minimum frequency value of the correction data
 Response: yyyy.y MHz

Usage:

Query only

[:SOURce<hw>]:BB:IMPAirment:OPTimization:UCORrection:FREQuency:OFFSet?

Note: Frequency offset of the user correction data is only indicated if the instrument is equipped with an R&S SMx-K63 and external devices are enabled.

The command displays the frequency offset value of the frequency response correction data.

Return values:

<Offset> integer
 Range: 1E3 to 40E6
 Increment: 1
 *RST: 40E6

Example:

SOURce:BB:IMP:OPT:UCOR:FREQ:OFFS?
 queries the frequency offset of the correction data.
 Response: xxxx.x MHz

Usage:

Query only

[:SOURce<hw>]:BB:IMPAirment:OPTimization:UCORrection:IAFixed?

Note: The status of the correction file is only indicated if the instrument is equipped with an R&S SMx K63.

The command displays the status of the attenuator, included in the baseband frequency response correction data. When the operating mode Fixed is switched on, the attenuator is fixed in its current position and the resulting variation range is defined.

Return values:

<IaFixed> 0 | 1 | OFF | ON
 *RST: 0

Example:

SOURce:BB:IMP:OPT:UCOR:FREQ:IAF?
 queries the status (enabled / disabled) of the attenuator.
 Response: ON | OFF

Usage:

Query only

[[:SOURce<hw>]:BB:IMPairment:OPTimization:UCORrection:LEVel:MAX?

Note: Level values of the user correction data are only indicated if the instrument is equipped with an R&S SMx-K63.

The command displays the maximum level value of the baseband frequency response correction data.

Return values:

<Max> integer
 Range: -145 to 30
 Increment: 1
 *RST: 30

Example:

SOURce:BB:IMP:OPT:UCOR:LEV:MAX?
 queries the maximum signal level of the correction data.
 Response: uu dB

Usage: Query only

[[:SOURce<hw>]:BB:IMPairment:OPTimization:UCORrection:LEVel:MIN?

Note: Level values of the user correction data are only indicated if the instrument is equipped with an R&S SMx-K63.

The command displays the minimum level value of the baseband frequency response correction data.

Return values:

<Min> integer
 Range: -145 to 30
 Increment: 1
 *RST: -145

Example:

SOURce:BB:IMP:OPT:UCOR:LEV:MIN?
 queries the minimum signal level of the correction data.
 Response: vv dB

Usage: Query only

[[:SOURce<hw>]:BB:IMPairment:OPTimization:UCORrection:LEVel:OFFSet?

Note: Level offset of the user correction data is only indicated if the instrument is equipped with an R&S SMx-K63 and external devices are enabled.

The command displays the level offset value of the baseband frequency response correction data.

Return values:

<Offset> integer
 Range: 0 to 100
 Increment: 1
 *RST: 100

Example: `SOURce:BB:IMP:OPT:UCOR:LEV:OFFS?`
queries the signal level offset of the correction data.
Response: `uu dB`

Usage: Query only

[:SOURce<hw>]:BB:IMPAirment:OPTimization:UCORrection:TYPE?

Note: The user correction type is only indicated if the instrument is equipped with an R&S SMx-K63.

The command displays type of the baseband frequency response correction data.

Return values:

<Type> `RFResponse | RFImage | RFRImage`
*RST: `RFResponse`

Example: `SOURce:BB:IMP:OPT:UCOR:TYPE?`
queries the type of the correction data.
Response: `RFResponse | RFImage | RFRImage`

Usage: Query only

[:SOURce<hw>]:BB:IMPAirment:QUADrature[:ANGLe] <Angle>

This command sets the quadrature offset for the digital I/Q signal.

Parameters:

<Angle> `float`
Range: `-10 to 10`
Increment: `0.01`
*RST: `0`
Default unit: `DEG`

Example: `BB:IMP:QUAD:ANGL -5DEG`
sets the quadrature offset to -5 degrees.

[:SOURce<hw>]:BB:IMPAirment:STATe <State>

The command activates (ON) and deactivates (OFF) the three impairment or correction values LEAKage, QUADrature and IQRatio for the digital baseband signal prior to input into the I/Q modulator.

Parameters:

<State> `0 | 1 | OFF | ON`
*RST: `0`

Example: `BB:IMP:STAT OFF`
deactivates digital impairment.

6.15.3.6 SOURce:BB:MCCW Subsystem

This subsystem contains the commands for setting the Multi Carrier CW signals.

Suffixes

SOURce<hw>

For one-path instruments, the keyword SOURce is optional and can be omitted.

The numeric suffix to SOURce distinguishes between signal generation for path A and path B in the case of two-path instruments:

- SOURce [1] = path A
The keyword SOURce is optional and can be omitted
- SOURce2 = path B
The keyword SOURce is mandatory, i.e. the command must contain the keyword with suffix 2.

OUTPut<ch>

The numeric suffix to OUTPut distinguishes between the available markers.

General Settings and Carrier Setup Settings

[SOURce<hw>]:BB:MCCW:STATe.....	676
[SOURce<hw>]:BB:MCCW:PRESet.....	677
[SOURce<hw>]:BB:MCCW:CARRier:COUNT.....	677
[SOURce<hw>]:BB:MCCW:CARRier:LIST:PHASe.....	677
[SOURce<hw>]:BB:MCCW:CARRier:LIST:POWer.....	678
[SOURce<hw>]:BB:MCCW:CARRier:LIST:STATe.....	678
[SOURce<hw>]:BB:MCCW:CARRier:PHASe.....	678
[SOURce<hw>]:BB:MCCW:CARRier:POWer.....	679
[SOURce<hw>]:BB:MCCW:CARRier:SPACing.....	679
[SOURce<hw>]:BB:MCCW:CARRier:STATe.....	680
[SOURce<hw>]:BB:MCCW:CFACTOR.....	680
[SOURce<hw>]:BB:MCCW:CFACTOR:MODE.....	680
[SOURce<hw>]:BB:MCCW:CLOCK.....	681
[SOURce<hw>]:BB:MCCW:EDIT:CARRier:EXECute.....	681
[SOURce<hw>]:BB:MCCW:EDIT:CARRier:PHASe:STEP.....	682
[SOURce<hw>]:BB:MCCW:EDIT:CARRier:PHASe[:START].....	682
[SOURce<hw>]:BB:MCCW:EDIT:CARRier:POWer:STEP.....	683
[SOURce<hw>]:BB:MCCW:EDIT:CARRier:POWer[:START].....	683
[SOURce<hw>]:BB:MCCW:EDIT:CARRier:START.....	683
[SOURce<hw>]:BB:MCCW:EDIT:CARRier:STATe.....	684
[SOURce<hw>]:BB:MCCW:EDIT:CARRier:STOP.....	684

[SOURce<hw>]:BB:MCCW:STATe <State>

The command turns on the Multi Carrier CW signal. Any other digital standards or digital modulation that may be in the ON state will be automatically turned OFF.

In case of two-path instruments, this affects the same path.

Parameters:

<State> 0 | 1 | OFF | ON
 *RST: OFF

Example:

BB:MCCW:STAT ON
 switches on generation of the Multi Carrier CW signal.

[:SOURce<hw>]:BB:MCCW:PRESet

The command sets all multi carrier signal parameters to their default values.

Example:

BB:MCCW:PRESet
 resets the Multi Carrier settings to default values.

Usage:

Event

[:SOURce<hw>]:BB:MCCW:CARRier:COUNT <Count>

The command sets the number of carriers in the Multi Carrier CW signal. The total bandwidth is calculated as (Number of carriers - 1) * Carrier spacing and must not exceed the system bandwidth of the instrument (see data sheet).

The carrier spacing (:BB:MCCW:CARRier:SPACing) is reduced if the total bandwidth is not respected when entering the number of carriers.

The number of carriers entered therefore defines the maximum carrier spacing (:BB:MCCW:CARRier:SPACing).

Parameters:

<Count> integer
 Range: 1 to 8192
 *RST: 64

Example:

BB:MCCW:CARR:COUNT 10
 sets 10 CW carriers for the multi carrier signal.

[:SOURce<hw>]:BB:MCCW:CARRier:LIST:PHASe <Phase>

The command sets the start phase of the carrier with the aid of a value list. The first value in the list is assigned to the carrier with index 0, the second value to the carrier with index 1, etc. The maximum length corresponds to the maximum number of multi carriers. There is no need to enter all the values every time. Values not set by the value list are set with the default values provided they have already been explicitly set by a previous command. If this is the case, the values continue to apply until overwritten.

Parameters:

<Phase> string
 Range: 0 to 360
 Increment: 0.01
 *RST: 0
 Default unit: DEG

Example: BB:MCCW:CARR:LIST:PHAS 90 DEG, 90 DEG, 90 DEG,
80 DEG
sets a start phase for carriers 0, 1, 2 and 3.
BB:MCCW:CARR:LIST:PHAS 2, 3
queries the phase of carrier 1, 2 and 3.
Response: 90, 90, 80

[:SOURce<hw>]:BB:MCCW:CARRier:LIST:POWER <Power>

The command sets the power of the carrier with the aid of a value list. The first value in the list is assigned to the carrier with index 0, the second value to the carrier with index 1, etc. The maximum length corresponds to the maximum number of multi carriers. There is no need to enter all the values every time. Values not set by the value list are set with the default values provided they have already been explicitly set by a previous command. If this is the case, the values continue to apply until overwritten.

Parameters:

<Power> string
Increment: 0.01 dB
*RST: 0 dB

Example: BB:MCCW:CARR:LIST:POW -65 dB, -30 dB, -50
dB, . . .
sets the power of carrier 0 to -65 dB, carrier 1 to -30 dB and so on.
BB:MCCW:CARR:LIST:POW 2, 2
queries the power of carrier 1 and 2.
Response: -30, -50

[:SOURce<hw>]:BB:MCCW:CARRier:LIST:STATe <State>

The command switches the carrier on or off with the aid of a value list. The first value in the list is assigned to the carrier with index 0, the second value to the carrier with index 1, etc. The maximum length corresponds to the maximum number of multi carriers. There is no need to enter all the values every time. Values not set by the value list are set with the default values provided they have already been explicitly set by a previous command. If this is the case, the values continue to apply until overwritten.

Parameters:

<State> ON | OFF[,ON | OFF,...]
*RST: ON

Example: BB:MCCW:CARR:LIST:STAT ON, OFF, ON,
switches carrier 0 on, carrier 1 off, etc.
BB:MCCW:CARR:LIST:POW 2, 2
queries the states of carrier 1 and 2.
Response: 0, 1

[:SOURce<hw>]:BB:MCCW:CARRier:PHASe <Phase>

The command sets the start phase of the selected carrier.

The phase settings are only valid if optimization of the crest factor is disabled
(:SOURce:BB:MCCW:CFACTOR:MODE OFF).

Parameters:

<Phase> float
Sets the start phase of the selected carrier.
Range: 0 to 359.99
Increment: 0.01
*RST: 0
Default unit: DEG

Example: BB:MCCW:CARR:PHAS 15,90
sets a start phase of 90 DEG for carrier 15.

[:SOURce<hw>]:BB:MCCW:CARRIER:POWER <Power>

The command sets the power of the selected carrier.

Parameters:

<Power> float
Sets the power of the selected carrier.
Range: -80 to 0
Increment: 0.01
*RST: 0

Example: BB:MCCW:CARR:POW 15, -50 dB
sets the power of carrier 15 to -50 dB.

[:SOURce<hw>]:BB:MCCW:CARRIER:SPACING <Spacing>

The command sets the carrier spacing.

The carriers are generated symmetrically around the center carrier. The total bandwidth is calculated as ("Number of carriers" - 1) * "Carrier spacing" and must not exceed the system bandwidth of the instrument (see data sheet).

The maximum carrier spacing that can be set is dependent on the chosen number of carriers

The maximum carrier spacing is automatically reduced so that the maximum total bandwidth is not exceeded on entering the number of carriers

(:BB:MCCW:CARRIER:COUNT).

Parameters:

<Spacing> float
Range: 0 to 120E6
Increment: 0.01
*RST: 10E3

Example: BB:MCCW:CARR:SPAC 10 MHz
sets a carrier spacing of 10 MHz.

[[:SOURce<hw>]:BB:MCCW:CARRier:STATe <State>

The command switches the selected carrier on or off.

The counting in remote control differs from the numbers in the carrier table. Index 0 corresponds to number 1 (first line) in the table. Therefore, switching the state of the channel via remote control always switches the state of <channel index> + 1 in the table.

Parameters:

<State> 0 | 1 | OFF | ON
 *RST: 0

Example:

BB:MCCW:CARR:STAT 15, ON
 switches carrier 16 on.

[[:SOURce<hw>]:BB:MCCW:CFACTOR <CFactor>

The command sets the desired crest factor for the multi carrier signal on selection of the command `SOUR:BB:MCCW:CFAC:MODE SLOW`.

Parameters:

<CFactor> float
 Range: 0 to 30
 Increment: 0.01
 *RST: 3

Example:

BB:MCCW:CFAC:MODE SLOW
 sets the Target Crest optimization mode.
 BB:MCCW:CFAC 10 dB
 sets the desired crest factor to 10 dB.

[[:SOURce<hw>]:BB:MCCW:CFACTOR:MODE <Mode>

The command sets the mode by which automatic settings will minimize the crest factor or hold it at a chosen value.

Parameters:

<Mode>

OFF | CHIRp | SLOW

OFF

Crest factor optimization is switched off. The carrier PHASE setting has an effect.

CHIRp

The crest factor is very rapidly optimized to < 3 dB for multi carrier signals so that all carriers are switched on and have the same amplitude. The computation time is independent of the number of carriers. In other carrier configurations the achievable crest factor is worse.

SLOW

The crest factor entered using `SOURCEBB:MCCW:CFACtor` is maintained for all carrier configurations by means of automatic settings. The computation time depends on the number of carriers and on the crest factor that has been set. Computation time increases only when the number of carriers exceeds 256 and the crest factor is above 4 dB.

*RST: CHIRp

Example:

BB:MCCW:CFAC:MODE OFF

switches off automatic crest factor optimization.

The setting `SOURCEBB:MCCW:CARR:PHAS` has an effect.

[[:SOURce<hw>]:BB:MCCW:CLOCK?

The command queries the output clock rate. The output clock rate depends on the number of carriers and the selected carrier spacing.

Return values:

<Clock>

float

Range: 0 to Max

Increment: 1E-3

*RST: 0

Example:

BB:MCCW:CLOC?

queries the output clock rate.

Response: 256 000 000

the output clock rate is 256 MHz.

Usage:

Query only

[[:SOURce<hw>]:BB:MCCW:EDIT:CARRIER:EXECute

The command adopts the settings for the carrier range which has been defined using the `:BB:MCCW:EDIT:CARR:...` commands.

Example:

```
BB:MCCW:EDIT:CARR:STAR 4
the carrier range starts at carrier 4.
BB:MCCW:EDIT:CARR:STOP 400
the carrier range stops at carrier 400.
BB:MCCW:EDIT:CARR:STAT ON
sets all the carriers in the carrier range to ON.
BB:MCCW:EDIT:CARR:EXEC
adopts the settings for all the carriers in the carrier range.
BB:MCCW:STAT
starts generation of the multi carrier signal. Carriers 4 to 400 are
in the ON state.
```

Usage: Event

[:SOURce<hw>]:BB:MCCW:EDIT:CARRier:PHASe:STEP <Step>

The command sets the step width by which the start phases of the carriers in the defined carrier range will be incremented.

The phase settings are only valid if optimization of the crest factor is disabled
(:SOURce:BB:MCCW:CFACTOR:MODE OFF).

Parameters:

<Step> float
 Range: -359.99 to 359.99
 Increment: 0.01
 *RST: 0

Example:

```
BB:MCCW:EDIT:CARR:PHAS 90 DEG
sets a start phase of 90° for the carriers in the carrier range.
BB:MCCW:EDIT:CARR:PHAS:STEP 1 DEG
the start phase is incremented by 1° for each carrier, i.e. the first
carrier has a start phase of 90°, the second a start phase of 91°,
etc.
```

[:SOURce<hw>]:BB:MCCW:EDIT:CARRier:PHASe[:START] <Start>

The command sets the start phase for the individual carriers in the defined carrier range. If the command :BB:MCCW:EDIT:CARR:PHAS:STEP is used to define a step width, the phase entered here applies only to the starting carrier. The phases of the remaining carriers are stepped up or down by the phase value specified in the :BB:MCCW:EDIT:CARR:PHAS:STEP command.

The phase settings are only valid if optimization of the crest factor is disabled
(SOURce:BB:MCCW:CFACTOR:MODE OFF).

Parameters:

<Start> float
 Range: 0 to 359.99
 Increment: 0.01
 *RST: 0

Example: `BB:MCCW:EDIT:CARR:PHAS 90 DEG`
sets a start phase of 90° for the carriers in the carrier range.

[:SOURce<hw>]:BB:MCCW:EDIT:CARRIER:POWER:STEP <Step>

The command sets the step width by which the starting power of the carriers in the defined carrier range will be incremented.

Parameters:

<Step> float
Range: -80 to 80
Increment: 0.01
*RST: 0

Example: `BB:MCCW:EDIT:CARR:POW -80dB`
sets a power of -80 dB for the carriers in the carrier range.
`BB:MCCW:EDIT:CARR:POW:STEP 1 dB`
the power phase is incremented by dB for each carrier, i.e. the first carrier has -80 dB, the second -79 dB, etc.

[:SOURce<hw>]:BB:MCCW:EDIT:CARRIER:POWER[:START] <Start>

The command sets the power for the individual carriers in the defined carrier range. If the command `:BB:MCCW:EDIT:CARR:POW:STEP` is used to define a step width, the power entered here applies only to the starting carrier. The power of the remaining carriers is stepped up or down by the power specified in the `:BB:MCCW:EDIT:CARR:POW:STEP` command.

Parameters:

<Start> float
Range: -80 to 0
Increment: 0.01
*RST: 0

Example: `BB:MCCW:EDIT:CARR:POW -50 dB`
sets the power of the carrier to -50 dB.

[:SOURce<hw>]:BB:MCCW:EDIT:CARRIER:START <Start>

The command selects the first carrier in the carrier range to which the settings with the `:BB:MCCW:EDIT:CARR:...` commands shall apply.

Parameters:

<Start> integer
Range: 0 to 8191
Increment: 1
*RST: 0

Example: `BB:MCCW:EDIT:CARR:STAR 4`
the carrier range starts at carrier 4.

[:SOURce<hw>]:BB:MCCW:EDIT:CARRIER:STATE <State>

The command switches all the carriers in the selected carrier range on or off.

Parameters:

<State> 0 | 1 | OFF | ON
*RST: 1

Example:

BB:MCCW:EDIT:CARR:STAT ON
sets all the carriers in the carrier range to ON.

[:SOURce<hw>]:BB:MCCW:EDIT:CARRIER:STOP <Stop>

The command selects the last carrier in the carrier range to which the settings with the :BB:MCCW:EDIT:CARR:... commands shall apply.

Parameters:

<Stop> integer
Range: 0 to 8191
Increment: 1
*RST: 0

Example:

BB:MCCW:EDIT:CARR:STOP 40
the carrier range stops at carrier 40.

Trigger Settings

The trigger settings are available for R&S SMx and R&S AMU instruments only.

EXTernal<ch>

The numeric suffix to EXTernal<ch> distinguishes between the external trigger via the TRIGGER 1 (suffix 1) and TRIGGER 2 (suffix 2) connector.

[:SOURce<hw>]:BB:MCCW:TRIGger:ARM:EXECute	685
[:SOURce<hw>]:BB:MCCW:TRIGger:EXECute	685
[:SOURce<hw>]:BB:MCCW:TRIGger:EXTernal:SYNChronize:OUTPut	685
[:SOURce<hw>]:BB:MCCW:TRIGger:OBASeband:DELay	686
[:SOURce<hw>]:BB:MCCW:TRIGger:OBASeband:INHibit	686
[:SOURce<hw>]:BB:MCCW:TRIGger:RMODE	687
[:SOURce<hw>]:BB:MCCW:TRIGger:SLENgth	687
[:SOURce<hw>]:BB:MCCW:TRIGger:SOURce	688
[:SOURce<hw>]:BB:MCCW:TRIGger[:EXTernal<ch>]:DELay	688
[:SOURce<hw>]:BB:MCCW:TRIGger[:EXTernal<ch>]:INHibit	688
[:SOURce<hw>]:BB:MCCW[:TRIGger]:SEQuence	689

[:SOURce<hw>]:BB:MCCW:TRIGger:ARM:EXECute

The command stops signal generation for trigger modes Armed_Auto and Armed_Retrigger. A subsequent internal or external trigger event restart signal generation.

Example:

```
BB:MCCW:TRIG:SOUR INT
sets internal triggering.
BB:MCCW:TRIG:SEQ ARET
sets Armed_Retrigger mode, i.e. every trigger event causes signal
generation to restart.
BB:MCCW:TRIG:EXEC
executes a trigger, signal generation is started.
BB:MCCW:TRIG:ARM:EXEC
signal generation is stopped.
BB:MCCW:TRIG:EXEC
executes a trigger, signal generation is started again.
```

Usage: Event

[:SOURce<hw>]:BB:MCCW:TRIGger:EXECute

The command executes a trigger. The internal trigger source must be selected using the command `MCCW:TRIGger:SOURce INTernal` and a trigger mode other than `AUTO` must be selected using the command `:BB:MCCW:TRIGger:MODE`.

Example:

```
BB:MCCW:TRIG:SOUR INT
sets internal triggering.
BB:MCCW:TRIG:SEQ RETR
sets Retrigger mode, i.e. every trigger event causes signal gen-
eration to restart.
BB:MCCW:TRIG:EXEC
executes a trigger.
```

Usage: Event

[:SOURce<hw>]:BB:MCCW:TRIGger:EXTernal:SYNChronize:OUTPut <Output>

(enabled for Trigger Source External)

Enables/disables output of the signal synchronous to the external trigger event.

Parameters:

<Output>

0 | 1 | OFF | ON

ON

The signal calculation starts simultaneously with the external trigger event but because of the instrument's processing time the first samples are cut off and no signal is outputted. After elapsing of the internal processing time, the output signal is synchronous to the trigger event.

OFF

The signal output begins after elapsing of the processing time and starts with sample 0, i.e. the complete signal is outputted. This mode is recommended for triggering of short signal sequences with signal duration comparable with the processing time of the instrument.

*RST: 1

Example:

BB:MCCW:TRIG:SOUR EXT

sets external triggering.

BB:MCCW:TRIG:EXT:SYNC:OUTP ON

enables synchronous output to external trigger.

[[:SOURce<hw>]:BB:MCCW:TRIGger:OBASeband:DELay <Delay>

The command specifies the trigger delay (expressed as a number of samples) for external triggering.

Parameters:

<Delay>

float

Range: 0 to 65535

Increment: 0.01

*RST: 0

Example:

BB:MCCW:TRIG:SOUR EXT

selects an external trigger via the TRIGGER 1 connector.

BB:MCCW:TRIG:DEL 200

sets a delay of 200 samples for the trigger.

[[:SOURce<hw>]:BB:MCCW:TRIGger:OBASeband:INHibit <Inhibit>

The command specifies the number of samples by which a restart is to be inhibited following a trigger event. This command applies only in the case of external triggering.

Parameters:

<Inhibit>

integer

Range: 0 to 67108863

Increment: 1

*RST: 0

Example: `BB:MCCW:TRIG:SOUR EXT`
 selects an external trigger via the TRIGGER 1 connector.
`BB:MCCW:TRIG:INH 200`
 sets a restart inhibit for 200 samples following a trigger event.

[:SOURce<hw>]:BB:MCCW:TRIGger:RMODE?

The command queries the current status of signal generation for all trigger modes with Multi Carrier CW on.

Return values:

<RMode> STOP | RUN

RUN
 The signal is generated. A trigger event occurred in the triggered mode.

STOP
 The signal is not generated. A trigger event did not occur in the triggered modes, or signal generation was stopped by the command `BB:MCCW:TRIG:ARM:EXECute` (armed trigger modes only).

Example: `SOURBB:MCCW:TRIG:SOUR EXT`
 sets external triggering via the TRIGGER 1 connector.
`SOURBB:MCCW:TRIG:MODE ARET`
 selects the Armed_Retrigger mode
`SOURBB:MCCW:TRIG:RMODE?`
 queries the current status of signal generation.
 Response: RUN
 the signal is generated, an external trigger was executed.

Usage: Query only

[:SOURce<hw>]:BB:MCCW:TRIGger:SLENgth <SLength>

The command defines the length of the signal sequence to be output in the "Single" trigger mode. The input is to be expressed in samples. It is then possible to output deliberately just part of the waveform, an exact sequence of the waveform, or a defined number of repetitions of the waveform.

Parameters:

<SLength> integer

Range: 1 to 1000

Increment: 1

*RST: 1

Example: `SOURBB:MCCW:SEQ SING`
 sets trigger mode Single.
`SOURBB:MCCW:TRIG:SLEN 200`
 sets a sequence length of 200 samples. The first 200 samples of the current waveform will be output after the next trigger event.

```
[:SOURce<hw>]:BB:MCCW:TRIGger:SOURce <Source>
```

The command selects the trigger source.

Parameters:

<Source> INTernal | EXTernal | BEXTernal | OBASeband

INTernal

Triggering is executed by means of the Trigger command `BB:MCCW:TRIG:EXECute` in the case of remote control, and by means of "Execute Trigger" in the case of manual operation.

EXTernal

Triggering is executed by means of the signal on the TRIGGER 1 connector.

BEXTernal

Triggering is executed by means of the signal on the TRIGGER 2 connector.

OBASeband

Triggering is executed by means of the signal from the second path (two-path instruments only).

*RST: INT

Example:

```
BB:MCCW:TRIG:SOUR INT
sets internal triggering.
```

```
[:SOURce<hw>]:BB:MCCW:TRIGger[:EXTernal<ch>]:DELay <Delay>
```

The command specifies the trigger delay (expressed as a number of samples) for external triggering.

Parameters:

<Delay> float
 Range: 0 to 65535
 Increment: 0.01
 *RST: 0

Example:

```
BB:MCCW:TRIG:SOUR EXT
selects an external trigger via the TRIGGER 1 connector
BB:MCCW:TRIG:DEL 200
sets a delay of 200 samples for the trigger.
```

```
[:SOURce<hw>]:BB:MCCW:TRIGger[:EXTernal<ch>]:INHibit <Inhibit>
```

The command specifies the number of samples by which a restart is to be inhibited following a trigger event. This command applies only in the case of external triggering.

Parameters:

<Inhibit> integer
 Range: 0 to 67108863
 Increment: 1
 *RST: 0

Example: `BB:MCCW:TRIG:SOUR EXT`
selects an external trigger via the TRIGGER 1 connector.
`BB:MCCW:TRIG:INH 200`
sets a restart inhibit for 200 samples following a trigger event.

[:SOURce<hw>]:BB:MCCW[:TRIGger]:SEQuence <Sequence>

The command selects the trigger mode.

Parameters:

<Sequence>

AUTO | RETRigger | AAUTo | ARETrigger | SINGLE

AUTO

The multi carrier signal is generated continuously.

RETRigger

The multi carrier signal is generated continuously. A trigger event (internal or external) causes a restart.

AAUTo

The multi carrier signal is generated only when a trigger event occurs. After the trigger event the signal is generated continuously. Signal generation is stopped with command `SOURBB:MCCW:TRIG:ARM:EXEC` and started again when a trigger event occurs.

ARETrigger

The multi carrier signal is generated only when a trigger event occurs. The device automatically toggles to RETRIG mode. Every subsequent trigger event causes a restart. Signal generation is stopped with command `SOURBB:MCCW:TRIG:ARM:EXEC` and started again when a trigger event occurs.

SINGLE

The multi carrier signal is output only when a trigger event occurs. After the trigger event the signal is output once to the set sequence length (`SOURBB:MCCW:TRIG:SLEN`). Every subsequent trigger event causes a restart.

*RST: RETRigger

Example: `BB:MCCW:SEQ AAUT`
sets the "Armed_auto" trigger mode; the device waits for the first trigger (e.g. with *TRG) and then generates the signal continuously.

Marker Settings

This section lists the remote control commands, necessary to configure the markers.



The marker delay settings are available for R&S SMx and R&S AMU instruments only.

`[:SOURce<hw>]:BB:MCCW:TRIGger:OUTPut:DELAy:FIXed.....690`

<code>[:SOURce<hw>]:BB:MCCW:TRIGger:OUTPut<ch>:DELay</code>	690
<code>[:SOURce<hw>]:BB:MCCW:TRIGger:OUTPut<ch>:DELay:MAXimum</code>	690
<code>[:SOURce<hw>]:BB:MCCW:TRIGger:OUTPut<ch>:DELay:MINimum</code>	691
<code>[:SOURce<hw>]:BB:MCCW:TRIGger:OUTPut<ch>:MODE</code>	691
<code>[:SOURce<hw>]:BB:MCCW:TRIGger:OUTPut<ch>:OFFTime</code>	692
<code>[:SOURce<hw>]:BB:MCCW:TRIGger:OUTPut<ch>:ONTime</code>	692
<code>[:SOURce<hw>]:BB:MCCW:TRIGger:OUTPut<ch>:PATTern</code>	692
<code>[:SOURce<hw>]:BB:MCCW:TRIGger:OUTPut<ch>:PULSe:DIVider</code>	693
<code>[:SOURce<hw>]:BB:MCCW:TRIGger:OUTPut<ch>:PULSe:FREQuency</code>	693

`[:SOURce<hw>]:BB:MCCW:TRIGger:OUTPut:DELay:FIXed <Fixed>`

The command restricts the marker delay setting range to the dynamic range. In this range the delay can be set without restarting the marker and signal. If a delay is entered in setting ON but is outside this range, the maximum possible delay is set and an error message is generated.

The numeric suffix in OUTPut has no significance for this command, since the setting always affects every marker.

Parameters:

<Fixed> 0 | 1 | OFF | ON
 *RST: 0

Example:

`BB:MCCW:TRIG:OUTP:DEL:FIX ON`
 restricts the marker signal delay setting range to the dynamic range.

`[:SOURce<hw>]:BB:MCCW:TRIGger:OUTPut<ch>:DELay <Delay>`

The command defines the delay between the signal on the marker outputs and the start of the signals, expressed in terms of samples. Command `:BB:MCCW:TRIGger:OUTPut:DELay:FIXed ON` can be used to restrict the range of values to the dynamic range, i.e. the range within which a delay of the marker signals can be set without restarting the marker and signal.

Parameters:

<Delay> float
 Range: 0 to $2^{20}-1$ symbols
 Increment: 1E-3
 *RST: 0 symbols

Example:

`BB:MCCW:TRIG:OUTP2:DEL 16`
 sets a delay of 16 samples for the signal on connector MARKER 2.

`[:SOURce<hw>]:BB:MCCW:TRIGger:OUTPut<ch>:DELay:MAXimum?`

The command queries the maximum marker delay for setting `:BB:MCCW:TRIGger:OUTPut:DELay:FIXed ON`.

Return values:

<Maximum> float
 Range: 0 to 16777215
 Increment: 1E-3

Example:

BB:MCCW:TRIG:OUTP:DEL:FIX ON
 restricts the marker signal delay setting range to the dynamic range.
 BB:MCCW:TRIG:OUTP:DEL:MAX
 queries the maximum of the dynamic range.
 Response: 2000
 the maximum for the marker delay setting is 2000 samples.

Usage: Query only

[[:SOURce<hw>]:BB:MCCW:TRIGger:OUTPut<ch>:DELay:MINimum?

The command queries the minimum marker delay for setting :BB:MCCW:TRIGger:OUTPut: DELay:FIXed ON.

Return values:

<Minimum> float
 Range: 0 to 16777215
 Increment: 1E-3
 *RST: 0

Example:

BB:MCCW:TRIG:OUTP:DEL:FIX ON
 restricts the marker signal delay setting range to the dynamic range.
 BB:MCCW:TRIG:OUTP:DEL:MIN
 queries the minimum of the dynamic range.
 Response: 0
 the minimum for the marker delay setting is 0 samples.

Usage: Query only

[[:SOURce<hw>]:BB:MCCW:TRIGger:OUTPut<ch>:MODE <Mode>

The command defines the signal for the selected marker output.

Parameters:

<Mode>

REStart | PULSe | PATTern | RATio

REStart

A brief marker signal is generated at the start of the waveform.

PULSe

A pulsed marker signal is generated. The pulse frequency (= sample rate/divider) is defined with the

SOUR:BB:MCCW:TRIG:OUTP:PULSe:DIVider command and can be queried with the

SOUR:BB:MCCW:TRIG:OUTP:PULSe:FREQuency? command.

PATTern

A marker signal is generated with the aid of a user-definable bit pattern. The bit pattern is entered with the aid of command

SOURce:BB:MCCW:TRIGger:OUTPut:PATTern. The bit pattern is a maximum of 32 bits long.

RATio

A regular marker signal corresponding to the Time Off / Time On specifications in the commands

SOURce:BB:MCCW:TRIGger:OUTPut:OFFT and

SOURce:BB:MCCW:TRIGger:OUTPut:ONT is generated.

*RST: REStart

Example:

BB:MCCW:TRIG:OUTP2:MODE PULS

selects the pulsed marker signal on output MARKER 2.

[:SOURce<hw>]:BB:MCCW:TRIGger:OUTPut<ch>:OFFTime <OffTime>

[:SOURce<hw>]:BB:MCCW:TRIGger:OUTPut<ch>:ONTime <OnTime>

The command sets the number of samples in a period (ON time + OFF time) during which the marker signal in setting SOURce:BB:MCCW:TRIGger:OUTPut:MODE RATio on the marker outputs is ON.

Parameters:

<OnTime>

integer

Range: 1 to 16777215

Increment: 1

*RST: 1

Example:

BB:MCCW:TRIG:OUTP2:ONT 20

sets an ON time of 20 samples for marker 2.

[:SOURce<hw>]:BB:MCCW:TRIGger:OUTPut<ch>:PATTern <Pattern>

The command defines the bit pattern used to generate the marker signal in the setting SOURce:BB:MCCW:TRIGger:OUTPut:MODE PATTern 0 is marker off, 1 is marker on.

Parameters:

<Pattern>

<32 bit pattern>

*RST: 0

Example: `BB:MCCW:TRIG:OUTP2:PATT #HE0F52,20`
sets a bit pattern.
`BB:MCCW:TRIG:OUTP2:MODE PATT`
activates the marker signal according to a bit pattern on output
MARKER 2.

[:SOURce<hw>]:BB:MCCW:TRIGger:OUTPut<ch>:PULSe:DIVider <Divider>

The command sets the divider for Pulse marker mode
(`SOUR:BB:MCCW:TRIG:OUTP:MODE PULSe`). The resulting pulse frequency is derived
by dividing the symbol rate by the divider.

Parameters:

<Divider> integer
Range: 2 to 1024
Increment: 1
*RST: 2

Example: `BB:MCCW:TRIG:OUTP2:PULS:DIV 2`
sets the divider for the marker signal on output MARKER 2 to the
value 2.
`BB:MCCW:TRIG:OUTP2:FREQ?`
queries the resulting pulse frequency of the marker signal
Response: 66 000
the resulting pulse frequency is 66 kHz.

[:SOURce<hw>]:BB:MCCW:TRIGger:OUTPut<ch>:PULSe:FREQuency?

The command queries the pulse frequency of the pulsed marker signal in the setting
`SOUR:BB:MCCW:TRIG:OUTP:MODE PULS`. The pulse frequency is derived by dividing
the symbol rate by the divider. The divider is defined with command
`SOUR:BB:MCCW:TRIG:OUTP:PULS:DIV`.

Return values:

<Frequency> float
Increment: 1E-3

Example: `BB:MCCW:TRIG:OUTP2:PULS:DIV 4`
sets the divider for the marker signal on output MARKER 2 to the
value 4.
`BB:MCCW:TRIG:OUTP2:MODE PULS`
enables the pulsed marker signal
`BB:MCCW:TRIG:OUTP2:PULS:FREQ?`
queries the pulse frequency for the marker signal.
Response: "33 000"
the resulting pulse frequency is 33 kHz.

Usage: Query only

Clock Settings

This section lists the remote control commands, necessary to configure the clock.



The clock settings are available for R&S SMx and R&S AMU instruments only.

<code>[:SOURce<hw>]:BB:MCCW:CLOCK:MODE</code>	694
<code>[:SOURce<hw>]:BB:MCCW:CLOCK:MULTiplier</code>	694
<code>[:SOURce<hw>]:BB:MCCW:CLOCK:SOURce</code>	695

`[:SOURce<hw>]:BB:MCCW:CLOCK:MODE <Mode>`

The command enters the type of externally supplied clock (`:BB:MCCW:CLOCK:SOURce EXTERNAL`). When `MSAMple` is used, a multiple of the sample clock is supplied via the `CLOCK` connector and the sample clock is derived internally from this. The multiplier is entered with the command `BB:MCCW:CLOCK:MULTiplier`.

For two path instruments, the only numerical suffix allowed for `SOURce` is 1, since the external clock source is permanently allocated to path A.

Parameters:

<Mode> SAMPLE | MSAMple
*RST: SAMPLE

Example:

`BB:MCCW:CLOCK:MODE SAMP`
selects clock type "Sample", i.e. the supplied clock is a sample clock.

`[:SOURce<hw>]:BB:MCCW:CLOCK:MULTiplier <Multiplier>`

The command specifies the multiplier for clock type "Multiple Samples" (`:BB:MCCW:CLOCK:MODE MSAM`) in the case of an external clock source.

For two-path instruments, the only numerical suffix allowed for `SOURce` is 1, since the external clock source is permanently allocated to path A.

Parameters:

<Multiplier> integer
Range: 1 to 64
Increment: 1
*RST: 4

Example:

`BB:MCCW:CLOCK:SOUR EXT`
selects the external clock source. The clock is supplied via the `CLOCK` connector.
`BB:MCCW:CLOCK:MODE MSAM`
selects clock type "Multiple Samples", i.e. the supplied clock has a rate which is a multiple of the sample rate.
`BB:MCCW:CLOCK:MULT 12`
the multiplier for the external clock rate is 12.

[:SOURce<hw>]:BB:MCCW:CLOCK:SOURce <Source>

The command selects the source for the digital modulation clock.

For two-path instruments, selecting EXTERNAL is only possible for path A, since the external clock source is permanently allocated to path A.

Parameters:

<Source> INTernal | EXTernal | AINTernal

INTernal

The internal clock reference is used.

EXTernal

The external clock reference is supplied to the CLOCK connector.

*RST: INTernal

Example:

BB:MCCW:CLOC:SOUR EXT

selects an external clock reference. The clock is supplied via the CLOCK connector.

6.15.3.7 SOURce:BB:MEASurement Subsystem

This subsystem contains the commands for measuring the level values of the digital baseband signal.



Monitoring the measurement of the digital I/Q baseband signal requires the baseboard version "DacBoard 1141.8190.02" or higher. Up to baseboard version DacBoard 1141.8090.xx only the calculated signal levels are provided.

The currently equipped DacBoard is listed in the dialog "Setup > System > Hardware Config, section Baseband Assembly" (see [chapter 4.2.3.2, "Hardware Config"](#), on page 128).

[:SOURce<hw>]:BB:MEASurement:CFACtor?

This command indicates the crest factor of the baseband signal during measurement.

Return values:

<CFactor> float
 Range: 0 to 100
 Increment: 0.01
 *RST: 0
 Default unit: dB

Example:

BB:MEAS:CFAC

Queries the measured crest factor of the baseband signal.

Usage:

Query only

[[:SOURce<hw>]:BB:MEASurement:DURation <Duration>

This command sets the time for the measurement of the digital I/Q baseband signal in the range of 1 s ... 3 h. The time is to be entered in format "hh:mm:ss".

Parameters:

<Duration> string
 Range: 1s to 3h
 *RST: 1s
 Default unit: hh:mm:ss

Example: BB:MEAS:DUR "00:15:30"
 sets the measurement duration to 15 minutes and 30 seconds.

[[:SOURce<hw>]:BB:MEASurement:POWER:PEAK?

This command indicates the peak level of the baseband signal relative to full scale of 0.5 V (in terms of dB full scale) during measurement.

Return values:

<Peak> float
 Range: -10 to 10
 Increment: 0.01
 *RST: 0
 Default unit: dBfs

Example: BB:MEAS:POW:PEAK
 Queries the peak level of the baseband signal.

Usage: Query only

[[:SOURce<hw>]:BB:MEASurement:POWER:RMS?

This command indicates the rms level of the baseband signal relative to full scale of 0.5 V (in terms of dB full scale) during measurement.

Return values:

<Rms> float
 Range: -100 to 10
 Increment: 0.01
 *RST: 0
 Default unit: dBfs

Example: BB:MEAS:POW:RMS
 Queries the rms level of the baseband signal.

Usage: Query only

[[:SOURce<hw>]:BB:MEASurement:RTIME?

This command indicates the remaining time until the measurement of the digital I/Q baseband signal is completed. The time is displayed in format "hh:mm:ss".

Return values:

<RTIME> string

Example:

BB:MEAS:RTIME

Queries the remaining measurement duration.

Usage:

Query only

[[:SOURce<hw>]:BB:MEASurement:SOURce <Source>

This command selects the signal source for the measurement. The signal level and crest factor can be retrieved either from the interference-free digital I/Q baseband signal or the signal superimposed by the noise generator AWGN.

Parameters:

<Source> BB | BAWGn

BB

(Baseband Signal without AWGN)

Selects the measurement of the interference-free baseband signal.

BAWGn

(Baseband with AWGN)

Selects the measurement of the baseband signal after an AWGN noise signal is added.

*RST: BB

Example:

BB:MEAS:SOURC BAWG

selects the measurement of the digital baseband signal interfered with a noise signal.

[[:SOURce<hw>]:BB:MEASurement[:STATe] <State>

Activates/deactivates the measurement of the digital I/Q baseband signal. When activated, information on the peak level, rms level and crest factor are indicated. Additionally the duration of the measurement can be set.

Parameters:

<State> 0 | 1 | OFF | ON

*RST: OFF

Example:

BB:MEAS:STAT ON

starts measuring the real level values of the digital I/Q baseband signal.

[[:SOURce<hw>]:BB:MFPCorrection?

The MIMO Fading Power Correction represents the relative power offset of the selected path compared to the power level of the other path.

The resulting power level of the selected path is then the RF level displayed on the header of the instrument reduced by the MIMO Fading Power Correction value.

The MIMO Fading Power Correction is necessary in case a MIMO Fading mode with unequal steering matrix's elements is selected in the Fading block (see section "Multiple Input Multiple Output" in the description "Fading Simulator"). Such a steering matrix is used to simulate antennas with different power level.

While working in a 4x2 or 3x2 MIMO mode that requires two R&S Signal Generators, the MIMO Fading Power Correction for path A of both instruments is identical and respectively this correction coefficient is identical for both B paths.

However, for two R&S Signal Generators connected and configured to simulate a 2x4 or 2x3 MIMO configurations, there are individual MIMO Fading Power Correction coefficients for each path and the resulting power level of each of the paths has to be calculated separately.

Return values:

<MfpCorrection> float
 Range: -1000 to 1000
 Increment: 0.01
 *RST: 0

Example:

BB:MFPC
 queries the MIMO Fading Power Correction of path A.
 Response: 0.23

Usage:

Query only

6.15.3.8 SOURce:BB:POWER Subsystem

This subsystem contains the commands for retrieving the level values of the digital baseband signal.

[[:SOURce<hw>]:BB:CFACTOR?

This command queries the crest factor of the baseband signal.

Return values:

<CFactor> float
 Range: 0 to 100
 Increment: 0.01
 *RST: 0
 Default unit: dB

Example:

BB:CFAC
 queries the crest factor of the baseband signal.

Usage:

Query only

[[:SOURce<hw>]:BB:POWER:PEAK?

This command queries the peak level of the baseband signal relative to full scale of 0.5 V (in terms of dB full scale).

Return values:

<Peak> float
 Range: -145 to 30
 Increment: 0.01
 *RST: 0
 Default unit: dBfs

Example:

BB:POW:PEAK
 queries the peak level of the baseband signal.

Usage:

Query only

[[:SOURce<hw>]:BB:POWER:RMS?

This command queries the rms level of the baseband signal relative to full scale of 0.5V (in terms of dB full scale).

Return values:

<Rms> float
 Range: -145 to 30
 Increment: 0.01
 *RST: 0
 Default unit: dBfs

Example:

BB:POW:RMS
 queries the rms level of the baseband signal.

Usage:

Query only

6.15.4 SOURce:BBIN Subsystem

The SOURce:BBIN subsystem contains the commands for setting the external digital and analog baseband signals.

The external baseband signal A can be routed to path A, path B, or both paths. The external baseband signal B can be routed to path B only.

[[:SOURce]:BBIN:ALEVel:EXECute.....	700
[[:SOURce<hw>]:BBIN:CDEVice.....	700
[[:SOURce]:BBIN:CFACtor.....	700
[[:SOURce<hw>]:BBIN:DIGital:ASETting:STATe.....	701
[[:SOURce]:BBIN:FOFFset.....	701
[[:SOURce<hw>]:BBIN:GIMBalance.....	701
[[:SOURce]:BBIN:IQSWap[::STATe].....	702
[[:SOURce<hw>]:BBIN:MODE.....	702
[[:SOURce<hw>]:BBIN:MPERiod.....	702
[[:SOURce<hw>]:BBIN:OFFSet.l.....	703

<code>[:SOURce<hw>]:BBIN:OFFSet:Q</code>	703
<code>[:SOURce]:BBIN:OLOad:HOLD:RESet</code>	703
<code>[:SOURce]:BBIN:OLOad:HOLD:STATe</code>	703
<code>[:SOURce]:BBIN:OLOad:STATe</code>	703
<code>[:SOURce<hw>]:BBIN:PGAin</code>	704
<code>[:SOURce]:BBIN:POWer:PEAK</code>	704
<code>[:SOURce]:BBIN:POWer:RMS</code>	704
<code>[:SOURce]:BBIN:ROUte</code>	705
<code>[:SOURce]:BBIN:SKEW</code>	705
<code>[:SOURce]:BBIN:SRATe:ACTual</code>	705
<code>[:SOURce<hw>]:BBIN:SRATe:FIFO[STATus]</code>	706
<code>[:SOURce<hw>]:BBIN:SRATe:SOURce</code>	706
<code>[:SOURce]:BBIN:STATe</code>	707

`[:SOURce]:BBIN:ALEVel:EXECute`

This command starts measuring the input signal. The measurement estimates the crest factor and the peak power.

Example: `BBIN:ALEV:EXEC`
starts measuring the input signal.

Usage: Event

`[:SOURce<hw>]:BBIN:CDEVice?`

Digital Input only.

Indicates the ID of an externally connected R&S Instrument or R&S Device.

Return values:

<CDevice> string

Example: `BBIN:CDEV`
queries the connected device ID.

Usage: Query only

`[:SOURce]:BBIN:CFACTOR <CFactor>`

This command enters the crest factor of the external baseband signal.

Parameters:

<CFactor> float
Range: 0 to 30
Increment: 0.01
*RST: 0
Default unit: dB

Example: `BBIN:CFAC 10`
enters a crest factor of 10 dB for the external baseband signal.

[[:SOURce<hw>]:BBIN:DIGital:ASETting:STATe <State>

Activates automatic adjustment of the baseband input signal.

The R&S SMU receives PEP, level and crest factor values directly from the connected transmitter and recognizes changes automatically.

Parameters:

<State> 0 | 1 | OFF | ON
*RST: 0

Example:

BBIN:DIG:ASET:STAT ON
switches on automatic adjustment of the baseband input signal.

[[:SOURce]:BBIN:FOFFset <FOffset>

This command enters the frequency offset for the external baseband signal. The offset affects the signal on the output of the "Baseband" block.

The complex I/Q bandwidth of the shifted useful signal must not exceed 80 MHz in total. The following applies:

$$f_{\text{offset}} - (f_{\text{use}} / 2) \Rightarrow -(80/2) \text{ MHz and } f_{\text{offset}} + (f_{\text{use}} / 2) \Rightarrow +(80/2) \text{ MHz}$$

f_{use} = the complex useful bandwidth of the I/Q signal before the offset.

f_{offset} = frequency offset.

Parameters:

<FOffset> float
Range: -40E6 to 40E6
Increment: 0.01
*RST: 0
Default unit: Hz

Example:

BBIN:FOFF 2 MHz
sets a frequency offset of 2 MHz.

[[:SOURce<hw>]:BBIN:GIMBalance <GImbalance>

This command enters a gain to the Q component of the external baseband signal.

Parameters:

<GImbalance> float
Range: -3 to 3
Increment: 0.001
*RST: 0
Default unit: dB

Example:

BBIN:GIMB -1.0dB
amplifies the Q component of the external input signal with -1.0 dB.

[[:SOURce]:BBIN:IQSWap[:STATe] <State>

This command swaps the I and Q channel if set to ON.

Parameters:

<State> 0 | 1 | OFF | ON
 *RST: 0

Example:

BBIN:IQSW ON
 swaps the I and Q channel of the external baseband signal.

[[:SOURce<hw>]:BBIN:MODE <Mode>

This command selects the external input signal mode for the "Baseband In" block.

Parameters:

<Mode> ANALog | DIGital

ANALog

The external analog baseband signal is supplied via the inputs I and Q.

DIGital

The external digital baseband signal is fed into the signal path via the "Digital Input" connector. The internal signal processing is based on a sample rate of 100 MHz. Input signals with a sample rate less than 100 MHz are upsampled. The sample rate can be estimated or defined by the user in the appropriate entry fields.

Note: This item is available only with BBinS Revision 05.02 or higher and BBinR Revision 02.06 or higher (see [chapter 4.2.3.2, "Hardware Config"](#), on page 128).

*RST: ANALog

Example:

BBIN:SOUR ANAL
 selects an external analog signal as the input signal. The signal must be applied at the inputs I and Q.

[[:SOURce<hw>]:BBIN:MPERiod <MPeriod>

Sets the recording duration for measuring the baseband input signal by Auto Level Set.

Parameters:

<MPeriod> float
 Range: 1 to 32
 Increment: 1
 *RST: 2
 Default unit: s

Example:

BBIN:MPER 4s
 sets the recording duration for Auto Level Set to 4 seconds.

```
[:SOURce<hw>]:BBIN:OFFSet:I <I>
[:SOURce<hw>]:BBIN:OFFSet:Q <Q>
```

This command enters a DC offset to the Q component of the external baseband signal.

Parameters:

```
<Q>          float
              Range:    -10 to 10
              Increment: 0.001
              *RST:     0
              Default unit: %FS
```

Example: BBIN:OFFS:Q -0.1PCT
sets -0.1 %FS DC offset to the Q component of the external input signal.

```
[:SOURce]:BBIN:OLOad:HOLD:RESet
```

This command executes a reset of the Overload Hold State and LED.

Example: BBIN:MODE DIG
selects the digital baseband input mode.
BBIN:OLO:HOLD:RES
resets the overload hold state.

Usage: Event

```
[:SOURce]:BBIN:OLOad:HOLD:STATe?
```

This command queries an overload since the last reset for evaluating the measurement. The Overload Hold state can be reset via the "Reset" command, or is reset automatically by starting a new measurement ("Auto Level Set") or by setting new values (Crest Factor, PEP, Level).

Return values:

```
<State>      0 | 1 | OFF | ON
              *RST:    0
```

Example: BBIN:MODE DIG
selects the digital baseband input mode.
BBIN:OLO:HOLD:STAT?
queries the overload state.
Response: 0
the AC/DC converter has not been overloaded.

Usage: Query only

```
[:SOURce]:BBIN:OLOad:STATe?
```

This command queries the current overload state of the A/D converter.

Return values:

<State> 0 | 1 | OFF | ON
 *RST: 0

Example:

BBIN:MODE DIG
 selects the digital baseband input mode.
 BBIN:OLO:STAT?
 queries the overload state.
 Response: 0
 The AC/DC converter is not overloaded.

Usage:

Query only

[[:SOURce<hw>]:BBIN:PGain <PGain>

This command enters the relative gain for the external baseband signal compared with the signals of the other baseband sources. The actual gain of the different baseband signals depends not only on the path gain setting but also on the signal characteristics such as the crest factor and on the number of used sources, used and on the total RF output power. The gain affects the signal on the "Baseband" In block output.

Parameters:

<PGain> float
 Range: -50 to 50
 Increment: 1E-3
 *RST: 0
 Default unit: dB

Example:

BBIN:PGA 3dB
 sets the relative gain of 3 dB for the external baseband signal.

[[:SOURce]:BBIN:POWER:PEAK <Peak>

This command enters the peak level of the external baseband signal relative to full scale of 0.5 V (in terms of dB full scale).

Parameters:

<Peak> float
 Range: -60 to 3.02
 Increment: 0.01
 *RST: 0
 Default unit: dBfs

Example:

BBIN:POW:PEAK -2
 enters the peak level of -2 dBfs.

[[:SOURce]:BBIN:POWER:RMS?

This command queries the rms level of the external digital baseband signal.

Return values:

<Rms> float
 Range: -100 to 10
 Increment: 0.01
 *RST: 0

Example:

BBIN:POW:RMS
 queries the estimated rms level.

Usage:

Query only

[[:SOURce]:BBIN:ROUTE <Route>

This command selects the signal route for the external baseband signal of a two-path instrument.

Parameters:

<Route> A | B | AB

A

The external baseband signal is introduced into path A. The signals are summed if necessary.

B

The external baseband signal is introduced into path B. The signals are summed if necessary.

AB

The external baseband signal is introduced into path A and path B. The signals are summed if necessary.

*RST: A

Example:

BBIN:ROUT A
 The external baseband signal is introduced into path A.

[[:SOURce]:BBIN:SKEW <Skew>

This command determines the delay between Q and I channel. Positive values represent a delay for Q versus I.

Parameters:

<Skew> float
 Range: -1E-9 to 1E-9
 Increment: 1E-12
 *RST: 0
 Default unit: s

Example:

BBIN:SKEW -23PS
 enters a delay between Q and I channel of 23 picoseconds.

[[:SOURce]:BBIN:SRATe:ACTual?

This command queries the sample rate of the external digital baseband signal.

Note: The maximum value is 90 MHz with BBinR Revision 02.xx and 100 MHz with BBinR Revision 03.00 or higher.

Return values:

<Actual> float
Range: 400 Hz to 100 MHz

Example:

BBIN:SRAT
queries the sample rate value of the external digital baseband signal.

Usage:

Query only

[:SOURce<hw>]:BBIN:SRATe:FIFO[:STATus]?

This command indicates the state of the signal transmission.

Return values:

<Status> OK | OFLow | URUN

OK

Resampling is working properly.

OFL = Overflow

The external sample rate frequency is too high which causes an overflow in signal transmission.

URUN = Underrun

The external sample rate frequency is too low which causes an underrun in signal transmission.

*RST: OK

Example:

BBIN:SRAT:FIFO:STAT
queries the FIFO Status of the sample rate.

Usage:

Query only

[:SOURce<hw>]:BBIN:SRATe:SOURce <Source>

This command queries the source for estimating the sample rate of the digital input signal or defining it by the user.

Note: With a connected **R&S EX-IQ-Box** either the internal clock source (User defined) or an external clock (Digital I/Q In) can be selected in the settings dialog of the R&S EX-IQ-Box. Therefore, the sample rate source is only indicated in this field.

Parameters:

<Source> USER | DIN
*RST: USER

Example:

BBIN:SRAT:SOUR
queries the sample rate mode of the external digital baseband signal.

[:SOURce]:BBIN:STATe <State>

This command switches the feeding of an external analog signal into the signal path on/off.

Parameters:

<State> 0 | 1 | OFF | ON
 *RST: 0

Example:

BBIN:SOUR ANAL
 selects an external analog signal as the input signal. The signal must be applied at the inputs I and Q.
 BBIN:STAT ON
 switches on the Baseband In block. The external analog signal is A/D-converted and fed into the digital signal.

6.15.5 SOURce:CORRection Subsystem

The output level is corrected in the CORRection subsystem. Correction is performed by user-defined table values being added to the output level for the respective RF frequency. In the R&S SMU, this subsystem is used to select, transfer and activate user correction tables.

Each list is stored as a file. The name of the user correction file can be freely selected. The file extension *.uco is assigned automatically and cannot be changed.

The files can be stored in a freely selectable directory and opened from there. The default directory is set using command :MMEMory:CDIRectory on page 553. In the case of files which are stored in the default directory, only the file name has to be specified in commands. Otherwise, the complete absolute path has to be specified with every command. The extension can be omitted in any case.



In the following command examples, the files are stored in the default directory.

The amplitude can also be linearized automatically by means of a R&S NRP power sensor connected to the generator output signal. With the aid of the command [:SOURce<hw>]:CORRection:CSET:DATA[:SENSor<ch>][:POWer]:SONCe, a list with correction values for external test assemblies can be automatically determined, e.g. for compensating the frequency response of cables. The correction values can be acquired any time irrespective of the modulation settings of the generator.

Multi level measurements allow to take into account the changing VSWR for the different attenuator settings (see [:SOURce<hw>]:CORRection:CSET:DATA:POWer:MLEVel<ch> on page 710).



For two-path instruments, the same tables are, accessed for both paths. File operations such as creating, deleting and querying files are therefore path-independent. In this case, the suffix under SOURce must be omitted. An error message is displayed if the suffix is specified.

<code>[:SOURce]:CORRection:CSET:CATalog</code>	708
<code>[:SOURce<hw>]:CORRection:CSET:DATA:FREQUency</code>	709
<code>[:SOURce<hw>]:CORRection:CSET:DATA:FREQUency:POINts</code>	709
<code>[:SOURce<hw>]:CORRection:CSET:DATA:POWEr</code>	709
<code>[:SOURce<hw>]:CORRection:CSET:DATA:POWEr:POINts</code>	710
<code>[:SOURce<hw>]:CORRection:CSET:DATA:POWEr:MLEVel<ch></code>	710
<code>[:SOURce<hw>]:CORRection:CSET:DATA:POWEr:MLEVel:STATe</code>	710
<code>[:SOURce<hw>]:CORRection:CSET:DATA[:SENSor<ch>][:POWEr]:SONCe</code>	711
<code>[:SOURce]:CORRection:CSET:DELeTe</code>	711
<code>[:SOURce<hw>]:CORRection:DEXChange:AFILe:CATalog</code>	712
<code>[:SOURce<hw>]:CORRection:DEXChange:AFILe:EXTension</code>	712
<code>[:SOURce<hw>]:CORRection:DEXChange:AFILe:SELeCt</code>	712
<code>[:SOURce<hw>]:CORRection:DEXChange:AFILe:SEParator:COLumn</code>	713
<code>[:SOURce<hw>]:CORRection:DEXChange:AFILe:SEParator:DECimal</code>	713
<code>[:SOURce<hw>]:CORRection:DEXChange:EXECute</code>	714
<code>[:SOURce<hw>]:CORRection:DEXChange:MODE</code>	714
<code>[:SOURce<hw>]:CORRection:DEXChange:SELeCt</code>	715
<code>[:SOURce<hw>]:CORRection:CSET[:SELeCt]</code>	715
<code>[:SOURce<hw>]:CORRection:MLEVel:STATe</code>	716
<code>[:SOURce<hw>]:CORRection[:STATe]</code>	716
<code>[:SOURce<hw>]:CORRection:VALue</code>	716

`[:SOURce]:CORRection:CSET:CATalog?`

The command requests a list of user correction tables. The individual lists are separated by commas.

The lists are stored with the fixed file extensions * . uco in a directory of the user's choice. The directory applicable to the commands is defined with the command
MMEMory:CDIR.

Return values:

<Catalog> string

Example:

MMEM:CDIR 'D:/Lists/ucor'

selects the directory for the user correction files.

CORR:CSET:CAT?

queries which correction tables are available.

Response:UCOR1,UCOR2,UCOR3

the correction tables UCOR1, UCOR2 and UCOR3 are available.

Usage: Query only

[[:SOURce<hw>]:CORRection:CSET:DATA:FREQuency <Frequency>

The command transfers the frequency data to the table selected with :CORRection:CSET:SELEct.

The numerical suffix at SOURce must not be used for this command.

Parameters:

<Frequency> Frequency#1[, Frequency#2, ...]
 Range: 300 kHz to RFmax (depending on model)
 Default unit: Hz

Example:

```
CORR:CSET 'D:/Lists/ucor/ucor1'
selects the table ucor1.
CORR:CSET:DATA:FREQ 100MHz,102MHz,103MHz,...
enters the frequency value in the table ucor1.
```

[[:SOURce<hw>]:CORRection:CSET:DATA:FREQuency:POINts?

The command queries the number of frequency values in the selected table.

The numerical suffix at SOURce must not be used for this command.

Return values:

<Points> float

Example:

```
CORR:CSET 'D:/Lists/ucor/ucor1'
selects the table ucor1.
CORR:CSET:DATA:FREQ:POIN?
queries the number of frequency values in the table ucor1.
Response: 440
the table ucor1 contains 440 frequency values.
```

Usage:

Query only

[[:SOURce<hw>]:CORRection:CSET:DATA:POWEr <Power>

The command transfers the level data to the table selected with :CORRection:CSET:SELEct.

*RST does not affect data lists. The numerical suffix at SOURce must not be used for this command.

Parameters:

<Power> Power#1[, Power#2, ...]
 Range: -40 dB to 6 dB
 Default unit: dB

Example:

```
CORR:CSET 'D:/Lists/ucor/ucor1'
selects the table ucor1.
CORR:CSET:DATA:POW 1dB, 0.8dB, 0.75dB,...
enters the level values in the table ucor1.
```

[[:SOURce<hw>]:CORRection:CSET:DATA:POWer:POINts?

The command queries the number of level values in the selected table.

The numerical suffix at SOURce must not be used for this command.

Return values:

<Points> float

Example:

```
CORR:CSET 'D:/Lists/ucor/ucor1'
```

selects the table ucor1.

```
CORR:CSET:DATA:POW:POIN?
```

queries the number of level values in the table ucor1.

Response: 440

the table ucor1 contains 440 level values.

Usage: Query only

[[:SOURce<hw>]:CORRection:CSET:DATA:POWer:MLEVel<ch>?

The command queries the measurement results of a multi channel measurement. The values of each column of the user correction list are queried separately, i.e. the correction values for a specific attenuator setting.

Suffix:

<ch> 1..9
Numeric suffix 1 denotes the high power measurement, suffixes 2 to 9 the different attenuator settings starting at 0 dB up to 35 dB in 5 dB steps.

Return values:

<MLEVel> string
*RST: OFF

Example:

```
SOUR:CORR:CSET:DATA:POW:MLEV4?
```

queries the level correction values for attenuator setting 10 dB.

Usage: Query only

[[:SOURce<hw>]:CORRection:CSET:DATA:POWer:MLEVel:STATe <State>

The command activates the acquisition of multi level data with a connected power sensor. Separate measurements are made for the different attenuator ranges up to 40 dB. Thus, the changes in VSWR for the different ranges are taken into account, the level accuracy increases. For ranges from 40 dB on the changes in VSWR are negligible. The reference level is set internally and cannot be controlled by the user. The measurement results are entered into additional columns of the User Correction list. The Multi Level Correction measurements are made in addition to a Single Level Correction measurement. When the user correction list is activated, it is possible to select which of the measurements is to be used for level correction (command SOUR:CORR:MLEV:STAT ON).

Parameters:

<State> 0 | 1 | OFF | ON
 *RST: OFF

Example:

SOUR:CORR:CSET:DATA:POW:MLEV:STAT ON
 activates the acquisition of multi level data with a connected power sensor.

[:SOURce<hw>]:CORRection:CSET:DATA[:SENSor<ch>][:POWER]:SONCe

The command fills the selected user correction list with the level values measured by the power sensor for the given frequencies.

The power sensor used is selected by the suffix in key word *SENSe* of the command header.

Suffix:

<ch> 1 .. 3
 Suffix 1 denotes the sensor connected to the SENSOR connector, suffix 2 the sensor connected first to one of the USB interfaces and suffix 3 the sensor connected second to one of the USB interfaces.

Example:

CORR:CSET:DATA:SENS:POW:SONC
 fills the user correction list with level values acquired by the power sensor connector to the SENSOR connector.

Usage:

Event

[:SOURce]:CORRection:CSET:DELeTe <Delete>

The command deletes the specified table.

The lists are stored with the fixed file extensions * .ucor in a directory of the user's choice. The directory applicable to the commands is defined with the command *MMEMory:CDIR*. A path can also be specified in command *:SOUR:CORR:CSET:CAT?*, in which case the file in the specified directory is deleted.

The numerical suffix under *SOURce* is irrelevant.

Setting parameters:

<Delete> <table name>

Example:

MMEM:CDIR 'D:/Lists/ucor'
 selects the directory for the user correction files.
 CORR:CSET:DEL 'UCOR1'
 deletes the table ucor1.

Usage:

Event

[:SOURce<hw>]:CORRection:DEXChange:AFILe:CATalog?

The command requests a list of available ASCII files for export/import of user correction data. The individual files are separated by commas.

The ASCII files are stored with the fixed file extensions `*.txt` or `*.csv` in a directory of the user's choice. The directory applicable to the commands is defined with the command `MMEMoRY:CDIR`.

Return values:

<Catalog> string

Example:

```
MMEM:CDIR 'D:/lists/ucor/import'
selects the directory for the ASCII files with frequency and level
value pairs.
CORR:DEXC:AFIL:EXT TXT
selects that ASCII files with extension *.txt are listed.
CORR:DEXC:AFIL:CAT?
queries the available files with extension *.txt.
Response: 'ucor1,ucor2'
the ASCII files ucor1.txt and ucor2.txt are available.
```

Usage: Query only

[:SOURce<hw>]:CORRection:DEXChange:AFILe:EXTension <Extension>

The command selects the file extension of the ASCII file to be imported or exported. Selection TXT (text file) or CSV (Excel file) is available.

Parameters:

<Extension> TXT | CSV
*RST: TXT

Example:

```
MMEM:CDIR 'D:/lists/ucor/import'
selects the directory for the ASCII files with frequency and level
value pairs.
CORR:DEXC:AFIL:EXT TXT
selects that ASCII files with extension *.txt are listed.
CORR:DEXC:AFIL:CAT?
queries the available files with extension *.txt.
Response: 'list1,list2'
the ASCII files ucor1.txt and ucor2.txt are available.
```

[:SOURce<hw>]:CORRection:DEXChange:AFILe:SElect <Select>

The command selects the ASCII file to be imported or exported.

The ASCII files are stored with the fixed file extensions `*.txt` or `*.csv` in a directory of the user's choice. The directory applicable to the commands is defined with the command `MMEMoRY:CDIR`. A path can also be specified in command

`SOUR:CORR:DEXC:AFIL:SEL`, in which case the files are stored or loaded in the specified directory.

Parameters:**<Select>** <ascii file name>**Example:**

CORR:DEXC:MODE IMP

selects that ASCII files with frequency and level value pairs are imported and transferred into user correction lists.

CORR:DEXC:AFIL:SEL 'D:

/user/ucor/import/ucor.csv'

selects that ASCII file ucor.csv is imported.

CORR:DEXC:SEL 'D:/user/ucor/import/ucor_imp'

selects that the ASCII file ucor.csv is imported into user correction list ucor_imp.

[[:SOURce<hw>]:CORRection:DEXChange:AFILe:SEParator:COLumn <Column>

The command selects the separator between the frequency and level column of the ASCII table.

Parameters:**<Column>** TABulator | SEMicolon | COMMa | SPACe***RST:** SEMicolon|**Example:**

CORR:DEXC:MODE EXP

selects that the user correction list is exported into an ASCII file.

CORR:DEXC:AFIL:SEL 'D:

/user/ucor/import/ucor.csv'

selects ASCII file ucor.csv as destination for the user correction list data.

CORR:DEXC:AFIL:SEP:COL TAB

the pairs of frequency and level values are separated by a tabulator.

CORR:DEXC:AFIL:SEP:DEC DOT

selects the decimal separator dot.

CORR:DEXC:SEL 'D:/user/ucor/import/ucor_imp'

selects that the user correction list ucor_imp is imported into ASCII file ucor.csv.

[[:SOURce<hw>]:CORRection:DEXChange:AFILe:SEParator:DECimal <Decimal>

The command the decimal separator used in the ASCII data between '.' (decimal point) and ',' (comma) with floating-point numerals.

Parameters:**<Decimal>** DOT | COMMa***RST:** DOT

Example:

```
CORR:DEXC:MODE EXP
selects that the user correction list is exported into an ASCII file.
CORR:DEXC:AFIL:SEL 'D:
/user/ucor/import/ucor.csv'
selects ASCII file ucor.csv as destination for the user correction
list data.
CORR:DEXC:AFIL:SEP:COL TAB
the pairs of frequency and level values are separated by a tabu-
lator.
CORR:DEXC:AFIL:SEP:DEC DOT
selects the decimal separator dot.
CORR:DEXC:SEL 'D:/user/ucor/import/ucor_imp'
selects that the user correction list ucor_imp is imported into ASCII
file ucor.csv.
```

[:SOURce<hw>]:CORRection:DEXChange:EXECute

The command starts the export or import of the selected file. When import is selected, the ASCII file is imported as user correction list. When export is selected, the user correction list is exported into the selected ASCII file.

Example:

```
CORR:DEXC:MODE IMP
selects that ASCII files with frequency and level value pairs are
imported and transferred into user correction lists.
CORR:DEXC:AFIL:SEL 'D:
/user/ucor/import/ucor.csv'
selects that ASCII file ucor.csv is imported.
CORR:DEXC:SEL 'D:/user/ucor/import/ucor_imp'
selects that the ASCII file ucor.csv is imported into user correction
list ucor_imp.
CORR:DEXC:EXEC
starts the import of the ASCII file data into the user correction file.
```

Usage: Event

[:SOURce<hw>]:CORRection:DEXChange:MODE <Mode>

The command selects if user correction lists should be imported or exported. Depending on the selection here, the file select command defines either the source or the destination for user correction lists and ASCII files.

Parameters:

<Mode> IMPort | EXPort
 *RST: IMPort

Example: `CORR:DEXC:MODE IMP`
 selects that ASCII files with frequency and level value pairs are imported and transferred into user correction lists.
`CORR:DEXC:AFIL:SEL 'D:/user/ucor/import/ucor.csv'`
 selects that ASCII file `ucor.csv` is imported.
`CORR:DEXC:SEL 'D:/user/ucor/import/ucor_imp'`
 selects that the ASCII file `ucor.csv` is imported into user correction list `ucor_imp`.

[:SOURce<hw>]:CORRection:DEXChange:SElect <Select>

The command selects the user correction list to be imported or exported.

The user correction files are stored with the fixed file extensions `*.uco` in a directory of the user's choice. The directory applicable to the commands is defined with the command `MMEMoRY:CDIR`. A path can also be specified in command `SOUR:CORR:DEXC:SEL`, in which case the files are stored or loaded in the specified directory.

Parameters:

<Select> <list name>

Example: `CORR:DEXC:MODE IMP`
 selects that ASCII files with frequency and level value pairs are imported and transferred into user correction lists.
`CORR:DEXC:AFIL:SEL 'D:/user/ucor/import/ucor.csv'`
 selects that ASCII file `ucor.csv` is imported.
`CORR:DEXC:SEL 'D:/user/ucor/import/ucor_imp'`
 selects that the ASCII file `ucor.csv` is imported into user correction list `ucor_imp`.

[:SOURce<hw>]:CORRection:CSET[:SElect] <Select>

The command selects the table for user correction. Level correction must also be activated with the command `SOURce<hw>:CORRection:CSET:STATe ON`.

The lists are stored with the fixed file extensions `*.uco` in a directory of the user's choice. The directory applicable to the commands is defined with the command `MMEMoRY:CDIR`. A path can also be specified in command `:SOUR:CORR:CSET:SEL`, in which case the files in the specified directory are selected.

Parameters:

<Select> <table name>

Example: `CORR:CSET 'D:/Lists/ucor/ucor1'`
 selects the table `ucor1`.
`CORR ON`
 activates level correction. Correction is performed using the table `ucor1`.
 The correction applies for RF output A.

Usage: Event

[:SOURce<hw>]:CORRection:MLEVel:STATe <State>

The command activates the use of multi level data for user correction. The setting is only available for user correction list with multi level correction data (see command `SOUR:CORR:CSET:DATA:POW:MLEV:STAT ON`).

Parameters:

<State> 0 | 1 | OFF | ON
*RST: OFF

Example: `SOUR:CORR:MLeV:STAT ON`
activates the use of multi level correction data for user correction.

[:SOURce<hw>]:CORRection[:STATe] <State>

The command activates/deactivates level correction. Level correction is performed using the table which has been selected with the command `CORRection:CSET:SElect`.

Parameters:

<State> 0 | 1 | OFF | ON
*RST: OFF

Example: `SOUR:CORR:CSET 'D:/lists/ucor/ucor1'`
selects the table `ucor1`.
`SOUR:CORR ON`
activates user correction.

[:SOURce<hw>]:CORRection:VALue?

The command requests the current value for user correction.

Return values:

<Value> float

Example: `CORR:VAL?`
queries the value currently used for level correction.
Response: -3
the correction value is - 3 dB.

Usage: Query only

6.15.6 SOURce:FM Subsystem

The FM subsystem contains the commands for checking the frequency modulation.

The settings for the internal modulation source (LF generator) are made in the `SOURce:LFOuTput` subsystem /see [chapter 6.15.11, "SOURce:LFOuTput Subsystem"](#), on page 747).

For information about the required options, see [chapter 4.5.11.4, "Frequency Modulation \(FM\)"](#), on page 238.

[:SOURce<hw>]:FM[:DEVIation]	717
[:SOURce<hw>]:FM:EXTernal:COUPling	717
[:SOURce<hw>]:FM:MODE	718
[:SOURce<hw>]:FM:SENSitivity	718
[:SOURce<hw>]:FM:SOURce	718
[:SOURce<hw>]:FM:STATe	719

[\[:SOURce<hw>\]:FM\[:DEVIation\]](#) <Deviation>

The command sets the modulation deviation of the frequency modulation in Hz. The maximal deviation depends on the RF frequency set and the selected modulation mode (see data sheet).

Parameters:

<Deviation>	float
	Range: 0 Hz to 10 MHz
	Increment: See data sheet
	*RST: 10 kHz
	Default unit: Hz

Example: FM 5E3
sets the FM modulation deviation to 5 kHz.

Usage: SCPI confirmed

[\[:SOURce<hw>\]:FM:EXTernal:COUPling](#) <Coupling>

The command selects the coupling mode for the external modulation input in the case of frequency modulation.

Note: Coupling for external feed via input EXT MOD can be set independently for modulations AM, FM and PhiM.

Parameters:

<Coupling>	AC DC
	AC
	The DC voltage component is disconnected from the modulation signal.
	DC
	The modulation signal is not changed.
	*RST: AC

Example: FM:EXT:COUP AC
selects the coupling mode AC for external frequency modulation.

Usage: SCPI confirmed

[:SOURce<hw>]:FM:MODE <Mode>

The command selects the mode for the frequency modulation.

Parameters:

<Mode> NORMal | LNOise

NORMal

The maximum range for modulation bandwidth and FM deviation is available.

LNOise

(requires option R&S SMU-B22)

Frequency modulation with phase noise and spurious characteristics close to CW mode. The range for modulation bandwidth and FM deviation is reduced (see data sheet).

*RST: NORMal

Example:

FM:MODE NORM

selects normal mode for external frequency modulation.

Usage:

SCPI confirmed

[:SOURce<hw>]:FM:SENSitivity?

The command queries the input sensitivity of the EXT MOD input in Hz/V.

The command is only effective if the external modulation source is selected (SOUR:FM:SOUR EXT). The returned value depends on the modulation deviation setting (SOUR:FM:DEVIation). This value is assigned to the voltage value for full modulation of the input signal.

Return values:

<Sensitivity> float

Example:

FM:DEV 5E3

sets a modulation deviation of 5 kHz.

FM:SENS

queries the input sensitivity at the external modulation input.

Response: 5E3

since the voltage value for full modulation is 1V, the resulting sensitivity is precisely 5000Hz/V.

Usage:

Query only

SCPI confirmed

[:SOURce<hw>]:FM:SOURce <Source>

The command selects the modulation source for frequency modulation. Internal and external modulation source can be selected at the same time.

Parameters:

<Source> INT | EXT | INT,EXT

INT

INT is the LF generator. The frequency of the internal modulation signal can be set in the SOURce:LFOutput subsystem.

EXT

The external signal is input at the EXT MOD connector.

*RST: INTernal

Example:

FM:SOUR INT

selects the internal modulation source.

Usage:

SCPI confirmed

[:SOURce<hw>]:FM:STATe <State>

The command activates/deactivates frequency modulation.

Activation of FM (FM:STAT ON) deactivates phase modulation.

Parameters:

<State> 0 | 1 | OFF | ON

*RST: OFF

Example:

FM:STAT ON

Activates FM modulation.

Usage:

SCPI confirmed

6.15.7 SOURce:FREQuency Subsystem

This subsystem contains the commands used to define the frequency settings for the RF sources and sweeps.

[:SOURce<hw>]:FREQuency:CENTer.....	720
[:SOURce<hw>]:FREQuency:LOSCillator:MODE.....	720
[:SOURce<hw>]:FREQuency:LOSCillator:OUTPut:STATe.....	721
[:SOURce<hw>]:FREQuency[:CW]:FIXed].....	722
[:SOURce<hw>]:FREQuency[:CW]:FIXed]:RCL.....	722
[:SOURce<hw>]:FREQuency:MANual.....	723
[:SOURce<hw>]:FREQuency:MODE.....	723
[:SOURce<hw>]:FREQuency:OFFSet.....	724
[:SOURce<hw>]:FREQuency:PHASe:CONTinuous:HIGH.....	725
[:SOURce<hw>]:FREQuency:PHASe:CONTinuous:LOW.....	725
[:SOURce<hw>]:FREQuency:PHASe:CONTinuous:MODE.....	725
[:SOURce<hw>]:FREQuency:PHASe:CONTinuous:STATe.....	726
[:SOURce<hw>]:FREQuency:SPAN.....	726
[:SOURce<hw>]:FREQuency:START.....	727
[:SOURce<hw>]:FREQuency:STOP.....	727
[:SOURce<hw>]:FREQuency:STEP[:INCRement].....	728
[:SOURce<hw>]:FREQuency:STEP:MODE.....	728

[[:SOURce<hw>]:FREQUENCY:CENTer <Center>

The command sets the center frequency of the sweep. This setting in combination with the span setting ([SOURce:]FREQUENCY:SPAN) defines the sweep range.

This command is linked to the commands [SOURce:]FREQUENCY:START and [SOURce:]FREQUENCY:STOP, i.e. changing these values causes the CENTER value to change, and vice versa:

$$\text{CENTer} = (\text{START} + \text{STOP}) / 2$$

As with the "Frequency" value entered in the header, the OFFSet value is also taken into consideration with this command. The specified value range is therefore only effective if OFFSet is set to 0. The value range for other OFFSet values can be calculated using the following formula:

$$300 \text{ kHz} + \text{OFFSet} \dots \text{RF}_{\text{max}} + \text{OFFSet}$$

Parameters:

<Center>	float
Range:	300kHz to RFmax (RFmax depending on model)
Increment:	0.01Hz
*RST:	300MHz
Default unit:	Hz

Example:

```
FREQ:CENT 400 MHz
```

sets the center frequency for the frequency sweep to 400 MHz.

```
FREQ:SPAN 200 MHz
```

sets a span of 200 MHz. This sets the sweep range to 300 MHz to 500 MHz.

Usage:

SCPI confirmed

[[:SOURce<hw>]:FREQUENCY:LOSCillator:MODE <Mode>

Selects the mode of the local oscillator coupling.

Parameters:

<Mode>

INTernal | EXTernal | COUPlac | ECOuplac

INTernal

The signal of the internal local oscillator is used. This mode corresponds to a normal operation.

EXTernal

An external signal is used for path A.

In case of a two-path instrument, the internal local oscillator signal is used for path B.

Note: Selection of LO Coupling "External" mode, disables all parameters in the "Frequency/Phase/Ref Osc" dialog of the selected path.

COUPlac

(the parameter is enabled for two-path instruments only)

The LO signal of path A (master) is coupled to path B.

Note:

Selection of LO Coupling "Coupled A->B" mode, disables all parameters of the `SOURce:FREQuency` Subsystem of the other path.

The frequency of path A will be set to the smaller of both frequencies of path A and B.

ECOuplac

(the parameter is enabled for two-path instruments only)

An external signal is input on the LO IN connector and used for the coupled paths A and B.

Note: Selection of LO Coupling "External Coupled A->B" mode, disables all parameters of the `SOURce:FREQuency` Subsystem of both paths.

*RST: INT

Example:

```
FREQ:LOSC:MODE EXT
```

sets the LO coupling mode to External.

Usage:

SCPI confirmed

[[:SOURce<hw>]:FREQuency:LOSCillator:OUTPut:STATe <State>

Switches on/off the LO output.

Parameters:

<State>

0 | 1 | OFF | ON

*RST: OFF

Example:

```
FREQ:LOSC:OUTP:STAT ON
```

switches on the LO output state.

Usage:

SCPI confirmed

[[:SOURce<hw>]:FREQuency[:CW|:FIXed] <Fixed>

The command sets the frequency of the RF output signal for CW mode (SOURce:FREQuency:MODE CW). In Sweep mode (SOURce:FREQuency:MODE SWEep), this value is linked to the current sweep frequency.

In addition to a numerical value, it is also possible to specify UP and DOWN. The frequency is then increased or decreased by the value which is set under

[SOURce<[1] | 2>:]FREQuency:STEP.

As with the "FREQ" value entered in the display, the OFFSet value is also taken into consideration with this command. The specified value range is therefore only effective if OFFSet is set to 0. The value range for other OFFSet values can be calculated using the following formula:

$300 \text{ kHz} + \text{OFFSet} \dots \text{RF}_{\text{max}} + \text{OFFSet}$

Correlation: FREQ for FREQ:MODE SWE is linked to sweep frequency.

Parameters:

<Fixed> float
 Range: 300kHz to RFmax
 Increment: 0.01Hz
 *RST: 1GHz
 Default unit: Hz

Example: FREQ 500kHz
 sets the frequency of RF output signal A to 500 kHz.

Usage: SCPI confirmed

[[:SOURce<hw>]:FREQuency[:CW|:FIXed]:RCL <Rcl>

The command determines whether the current frequency setting is retained or whether the stored frequency setting is adopted when an instrument configuration is loaded.

*RST does not affect this setting.

In case of two-path instruments, the setting is valid for both paths. If a suffix is specified, it is ignored.

Parameters:

<Rcl> INCLude | EXCLude

INCLude

The stored frequency is also loaded when a stored instrument configuration is loaded.

EXCLude

The RF frequency is not loaded when a stored instrument configuration is loaded. The current frequency is retained.

*RST: no default

Example: FREQ:RCL INCL
 The stored frequency is set if the Recall command is called.

Usage: SCPI confirmed

[:SOURce<hw>]:FREQuency:MANual <Manual>

In Sweep mode (:SOUR:FREQ:MODE SWE) the command sets the frequency for the next sweep step in the "Step" sweep mode (SOUR:SWE:MODE MAN). Here only frequency values between the settings [SOUR]:FREQ:STAR and . . . :STOP are permitted. Each sweep step is triggered by a separate SOUR:FREQ:MAN command.

As with the "Frequency" value entered in the header, the OFFSet value is also taken into consideration with this command. The specified value range is therefore only effective if OFFSet is set to 0. The value range for other OFFSet values can be calculated using the following formula:

$$\text{START} + \text{OFFSet} \dots \text{STOP} + \text{OFFSet}$$

Parameters:

<Manual> float
 Range: START to STOP
 Increment: 0.01Hz
 *RST: 100MHz
 Default unit: Hz

Example: SWE:MODE MAN
 sets the Step sweep mode.

Example: FREQ:MAN 500MHz
 sets an RF frequency of 500 MHz for the next step in the Step sweep mode.
 FREQ:MODE SWE
 sets the Frequency Sweep mode. An RF frequency of 500 MHz is output.
 FREQ:MAN 550MHz
 triggers the next sweep step with an RF frequency of 550 MHz.

Usage: SCPI confirmed

[:SOURce<hw>]:FREQuency:MODE <Mode>

The command sets the instrument operating mode and therefore also the commands used to set the output frequency.

Parameters:

<Mode>

CW | FIXed | SWEep | LIST

CW|FIXed

The instrument operates in fixed-frequency mode; CW and FIXed are synonyms. The output frequency is set with :SOURce:FREQuency:CW|FIXed.

In case of two-path instruments, for the selected path.

SWEep

The instrument operates in SWEep mode. The frequency is set using the commands SOURce:FREQuency:STARt; STOP; CENTer; SPAN; MANual.

In case of two-path instruments, for the selected path.

LIST

The instrument processes a list of frequency and level settings for the selected path.

The List mode settings are made in the [SOURce:LIST Subsystem](#). The setting SOURce:FREQuency:MODE LIST also sets the command SOURce:POWer:MODE automatically to LIST.

Correlation: `FREQ:MODE LIST sets POW:MODE LIST`

*RST: CW

Example:

```
FREQ:MODE SWE
```

sets the SWEep mode. The settings under

```
SOURce:FREQuency:STARt; STOP; CENTer; SPAN; MANual
```

become effective.

Usage:

SCPI confirmed

[[:SOURce<hw>]:FREQuency:OFFSet <Offset>

The command sets the frequency offset of a downstream instrument, e.g. a mixer. If a frequency offset is entered, the frequency entered with SOURce:FREQuency: . . . no longer corresponds to the RF output frequency. The following correlation applies:

`SOURce:FREQuency: . . . = RF output frequency + SOURce:FREQuency:OFFSet.`

Entering an offset does not change the RF output frequency, but rather the query value of SOURce:FREQuency:

Parameters:

<Offset>

float

Range: -67GHz to 67GHz

Increment: 0.01Hz

*RST: 0Hz

Default unit: Hz

Example:

```
FREQ:OFFS 500kHz
```

sets the frequency offset to 500 kHz.

Usage:

SCPI confirmed

[:SOURce<hw>]:FREQuency:PHASe:CONTInuous:HIGH?

Queries the maximum frequency of the frequency range for phase continuous settings.

The maximum frequency of the frequency range depends on the mode selected with the command `SOURce:FREQuency:PHASe:CONTInuous:MODE`.

Return values:

<High> float
 Increment: 0.01Hz
 Default unit: Hz

Example: `FREQ:PHAS:CONT:MODE NARR`
 selects mode narrow.
`FREQ:PHAS:CONT:HIGH`
 queries the max frequency.

Example: Response: 1 003 720 930.23

Usage: Query only

Options: R&S SMx-B22

[:SOURce<hw>]:FREQuency:PHASe:CONTInuous:LOW?

Queries the minimum frequency of the frequency range for for phase continuous settings.

The minimum frequency of the frequency range depends on the mode selected with the command `SOURce:FREQuency:PHASe:CONTInuous:MODE`.

Return values:

<Low> float
 Increment: 0.01Hz
 Default unit: Hz

Example: `FREQ:PHAS:CONT:MODE NARR`
 selects mode narrow.
`FREQ:PHAS:CONT:LOW`
 queries the max frequency.
 Response: 998 720 930.20

Usage: Query only

Options: R&S SMx-B22

[:SOURce<hw>]:FREQuency:PHASe:CONTInuous:MODE <Mode>

Selects the mode for determining the frequency range for the phase continuous signal (see [chapter 4.5.3.2, "Phase Continuous Frequency Setting"](#), on page 198).

The minimum and maximum frequency (`SOUR:FREQ:PHAS:CONT:HIGH` and `SOUR:FREQ:PHAS:CONT:LOW`) of the frequency range depends on the mode selected with this command.

Parameters:

<Mode> NARRow | WIDE

NARRow

The available frequency range is smaller than with setting wide. It is asymmetrical around the RF frequency set at the point of activating the phase continuous settings.

WIDE

The wide mode provides a larger frequency range. The frequency range is symmetrical around the RF frequency set at the point of activating the phase continuous settings.

*RST: NARRow

Example:

FREQ:PHAS:CONT:MODE NARR

selects narrow mode.

FREQ:PHAS:CONT:LOW

queries the max frequency.

Response: -3 518 518.52

Options:

R&S SMx-B22

[[:SOURce<hw>]:FREQuency:PHASe:CONTInuous:STATe <State>

Activates/deactivates phase continuous frequency settings. For a given RF frequency setting, phase continuous frequency changes are possible in a limited frequency range (see [chapter 4.5.3.2, "Phase Continuous Frequency Setting"](#), on page 198).

The output sinewave is phase continuous, i.e there will be no phase discontinuity or glitch when changing the frequency.

Note: Restricted structure of command line. As long as phase continuous mode is active, only one command in a command line is processed. A second command in the command line will be ignored.

Parameters:

<State> 0 | 1 | OFF | ON

*RST: OFF

Example:

FREQ:PHAS:CONT:STAT ON

activates phase continuous mode.

**[[:SOURce<hw>]:FREQuency:SPAN **

This command specifies the span for the sweep. This setting in combination with the center frequency setting ([SOUR]:FREQ:CENT) defines the sweep range.

This command is linked to the commands [SOUR]:FREQ:STAR and [:SOUR]:FREQ:STOP, i.e. changing these values causes the SPAN value to change, and vice versa:

$$\text{SPAN} = (\text{STOP} - \text{START})$$

Negative values for SPAN are permitted; START > STOP then applies.

Parameters:

 float
 Range: 0 to RFmax
 Increment: 0.01Hz
 *RST: 400MHz

Example:

FREQ:CENT 400 MHz
 sets the center frequency of the frequency sweep to 400 MHz.
 FREQ:SPAN 200 MHz
 sets a span of 200 MHz. This sets the sweep range to 300 MHz to 500 MHz.

Usage: SCPI confirmed

[:SOURce<hw>]:FREQuency:START <Start>

This command sets the start frequency for the sweep mode. *START* can be greater than *STOP*.

This command is linked to the commands `[SOUR]:FREQ:CENT` and `[SOUR]:FREQ:SPAN`, i.e. changing these values causes the *START* value to change, and vice versa:

$$START = (CENTer - SPAN/2).$$

As with the "Frequency" value entered in the header, the *OFFSet* value is also taken into consideration with this command. The specified value range is therefore only effective if *OFFSet* is set to 0. The value range for other *OFFSet* values can be calculated using the following formula:

$$300 \text{ kHz} + OFFSet \dots RF_{max} + OFFSet$$

Parameters:

<Start> float
 Range: 300kHz to RFmax
 Increment: 0.01Hz
 *RST: 100MHz

Example:

FREQ:START 1 MHz
 sets the start frequency for the frequency sweep to 1 MHz.
 FREQ:STOP 2 GHz
 sets the stop frequency for the frequency sweep to 2 GHz.

Usage: SCPI confirmed

[:SOURce<hw>]:FREQuency:STOP <Stop>

This command sets the stop frequency for the sweep mode. *STOP* can be less than *START*.

This command is linked to the commands `[SOUR]:FREQ:CENT` and `[SOUR]:FREQ:SPAN`, i.e. changing these values causes the *START* value to change, and vice versa:

$$\text{STOP} = (\text{CENTer} + \text{SPAN}/2)$$

As with the "Frequency" value entered in the header, the `OFFSet` value is also taken into consideration with this command. The specified value range is therefore only effective if `OFFSet` is set to 0. The value range for other `OFFSet` values can be calculated using the following formula:

$$300 \text{ kHz} + \text{OFFSet} \dots \text{RF}_{\text{max}} + \text{OFFSet}$$

Parameters:

<Stop> float
 Range: 300kHz to RFmax
 Increment: 0.01Hz
 *RST: 500 MHz
 Default unit: Hz

Example:

`FREQ:STOP 2 GHz`
 sets the stop frequency for the frequency sweep to 2 GHz.
`FREQ:STAR 1 MHz`
 sets the start frequency for the frequency sweep to 1 MHz.

Usage:

SCPI confirmed

[:SOURce<hw>]:FREQUENCY:STEP[:INCRement] <Increment>

The command sets the step width for the frequency setting if the frequency values `UP/DOWN` are used and variation mode `SOUR:FREQ:STEP:MODE USER` is selected. The command is linked to "Variation Step" for manual control, i.e. the command also sets the step width of the rotary knob for "Variation Active" on.

In the case of two-path instruments, the step width can be set separately for each path.

Parameters:

<Increment> float
 Range: 0Hz to RFmax - 100kHz
 Increment: 0.01Hz
 *RST: 1MHz

Example:

`FREQ:STEP 50 kHz`
 sets the step width for the frequency setting to 50 kHz.

[:SOURce<hw>]:FREQUENCY:STEP:MODE <Mode>

This command activates (`USER`) or deactivates (`DECimal`) the user-defined step width used when varying the frequency value with the frequency values `UP/DOWN`. The command is linked to the command "Variation Active" for manual control, i.e. the command also activates/deactivates the user-defined step width used when varying the frequency value with the rotary knob.

In the case of two-path instruments, the step width can be set separately for each path.

Parameters:

<Mode> DECimal | USER
 *RST: DECimal

Example:

```
FREQ:STEP 50 kHz
sets the step width for the frequency setting to 50 kHz.
FREQ:STEP:MODE USER
activates this step width for frequency variation with the rotary knob
(manual control) and with frequency values UP/DOWN (remote
control).
```

6.15.8 SOURce:INPut Subsystem

The `SOURce:INPut` subsystem contains the commands for configuring the inputs for trigger, data and control signals. A common trigger threshold and input impedance is effective for all trigger and control signal inputs.

In case of a two-path instrument, this affects both paths.

The settings influence the digital modulations, the generation of waveforms or multicarrier signals, and all digital standards. Irrespective of this, a common threshold and input impedance is effective for the serial and parallel data input (Path A only). These data sources are available for digital modulation ("Custom Digital Modulation").

<code>[:SOURce]:INPut:DATA:IMPedance</code>	729
<code>[:SOURce]:INPut:DATA:THReshold</code>	729
<code>[:SOURce<hw>]:INPut:MODext:IMPedance</code>	730
<code>[:SOURce]:INPut:TRIGger:BBANd:SLOPe</code>	730
<code>[:SOURce]:INPut:TRIGger:IMPedance</code>	730
<code>[:SOURce]:INPut:TRIGger:LEVel</code>	731
<code>[:SOURce]:INPut:TRIGger:SLOPe</code>	731

`[:SOURce]:INPut:DATA:IMPedance` <Impedance>

The command sets the impedance of all data inputs.

The setting affects the serial data input DATA at the front of the instrument and the serial data inputs DATA at the AUX I/O interface at the rear of the instrument.

Parameters:

<Impedance> G1K | G50
 *RST: G1K

Example:

```
INP:DATA:IMP G50
all data inputs are set to 50 ohm to ground.
```

`[:SOURce]:INPut:DATA:THReshold` <Threshold>

The command sets the high/low threshold of the data inputs in the baseband section. In the case of positive polarity, this threshold determines the point as of which a signal is high (active) or low (inactive).

The setting affects the serial data input DATA at the front of the instrument and the serial data inputs DATA at the AUX I/O interface at the rear of the instrument.

Parameters:

<Threshold> float
 Range: 0 to 2
 *RST: 1V
 Default unit: V

Example:

INP:DATA:THR 1 V
 a high/low threshold of 1 volt is set at all data inputs of the base-band section. The signal is high (active) for a signal voltage of 1 volt and higher.

[[:SOURce<hw>]:INPut:MODext:IMPedance <Impedance>

Selects the impedance for external feed via the EXT MOD input.

Parameters:

<Impedance> HIGH | G50
HIGH
 > 100 kOhm to ground
G50
 50 Ohm to ground
 *RST: HIGH

Example:

INP:MOD:IMP HIGH
 the EXT MOD input is set to > 100 kOhm to ground.

[[:SOURce]:INPut:TRIGger:BBANd:SLOPe <Slope>

The command sets the active slope of an externally applied trigger signal at the TRIGGER connectors. The setting is effective for both connectors at the same time.

Parameters:

<Slope> NEGative | POSitive
 *RST: POSitive

Example:

INP:TRIG:BBAN:SLOP NEG
 the active slope of the external trigger signal at the TRIGGER connectors is the falling slope.

[[:SOURce]:INPut:TRIGger:IMPedance <Impedance>

The command sets the impedance of the trigger and control signal inputs and affects:

- TRIGGER inputs
- CLOCK inputs
- CW, BURST, and LEV_ATT inputs (AUX I/O connector)

Parameters:

<Impedance> G1K | G50

G1K
1 kOhm to ground

G50
50 Ohm to ground

*RST: G1K

Example:

INP:TRIG:IMP G50
all trigger and control signal inputs are set to 50 ohm to ground.
This setting is recommended in the case of high clock rates.

[:SOURce]:INPut:TRIGger:LEVel <Level>

The command sets the high/low threshold of the trigger and control signal inputs in the baseband section. In the case of positive polarity, this threshold determines the point at which a signal is high (active) or low (inactive).

The command affects:

- TRIGGER inputs
- CLOCK inputs
- CW, BURST, and LEV_ATT inputs (AUX I/O connector)

Parameters:

<Level> float

Range: 0.01 to 2

Increment: 0.01

*RST: 1

Default unit: V

Example:

INP:TRIG:LEV 1 V
a high/low threshold of 1 volt is set at all trigger and control signal inputs of the baseband section. In the case of positive polarity, the signal is high (active) for a signal voltage of 1 volt and higher.

[:SOURce]:INPut:TRIGger:SLOPe <Slope>

Sets the polarity of the active slope of an externally applied trigger signal at the trigger input (BNC connector at the rear of the instrument).

For two-path instruments, the external trigger for path B is applied at the INST TRIG pin at the AUX I/O interface.

Parameters:

<Slope> NEGative | POSitive

*RST: POSitive

Example:

INP:TRIG:SLOP NEG
the active slope of the external trigger signal at the trigger input is the falling slope.

6.15.9 SOURce:IQ Subsystem

This subsystem contains the commands for checking the I/Q modulation.

<code>[SOURce<hw>]:IQ:CREStfactor</code>	732
<code>[SOURce<hw>]:IQ:GAIN</code>	732
<code>[SOURce<hw>]:IQ:IMPAirment:IQRatio[MAGNitude]</code>	733
<code>[SOURce<hw>]:IQ:IMPAirment:LEAKage:I</code>	733
<code>[SOURce<hw>]:IQ:IMPAirment:LEAKage:Q</code>	734
<code>[SOURce<hw>]:IQ:IMPAirment:QUADrature[ANGLE]</code>	734
<code>[SOURce<hw>]:IQ:IMPAirment[STATE]</code>	734
<code>[SOURce<hw>]:IQ:SOURce</code>	734
<code>[SOURce<hw>]:IQ:STATe</code>	735
<code>[SOURce<hw>]:IQ:SWAP[STATE]</code>	735
<code>[SOURce<hw>]:IQ:WBState</code>	735
<code>[SOURce<hw>]:BB:IQGain</code>	736

`[SOURce<hw>]:IQ:CREStfactor <Crestfactor>`

This command specifies the crest factor of the external analog signal.

Parameters:

<code><Crestfactor></code>	float
	Range: 0dB to 30dB
	Increment: 0.01dB
	*RST: 0dB
	Default unit: dB

Example:

`IQ:CRES 10`
specifies a crest factor of 10 dB for the external analog signal.

`[SOURce<hw>]:IQ:GAIN <Gain>`

This command specifies the baseband gain for the external analog wideband I/Q signal. Thus, the modulation of the I/Q modulator can be optimized for any measurement requirement. The gain settings for an internal or external baseband signal are performed with command `SOUR:BB:IQGain`.

Parameters:

<Gain>

DBM3 | DB0 | DB3 | DB6

DBM3

Activates -3 dB gain.

With this setting, signal distortions are minimized.

DB0

Activates 0 dB gain (standard settings).

DB3

Activates 3 dB gain.

This setting is recommended for 3GPP signals with very high adjacent channel power ratio (ACPR).

DB6

Activates 6 dB gain.

Activates 0 dB gain.

With this setting, signal noise is minimized.

Increment: 0.01dB

*RST: External Wideband: 3 dB

Example:

IQ:SOUR ANAL

selects an external analog signal as the input signal for the I/Q modulator. The signal must be applied at the inputs I and Q.

Example:

IQ:GAIN DB0

sets gain 0 dB (standard).

[:SOURce<hw>]:IQ:IMPairment:IQRatio[:MAGNitude] <Magnitude>

This command sets the ratio of I modulation to Q modulation (amplification “imbalance”).

Parameters:

<Magnitude>

float

Range: -1.0dB to +1.0dB

Increment: 0.005dB

*RST: 0

Default unit: 0dB

Example:

IQ:IMP:IQR 0.5 dB

sets the imbalance.

[:SOURce<hw>]:IQ:IMPairment:LEAKage:I <I>

This command sets the carrier offset for the I-channel of the I/Q modulation.

Parameters:

<I>

float

Range: -10 to 10

Increment: 0.02PCT

*RST: 0

Default unit: PCT

Example: `IQ:IMP:LEAK:I 3 PCT`
sets the leakage for the I-channel to 3 percent.

[:SOURce<hw>]:IQ:IMPAirment:LEAKage:Q <Q>

This command sets the carrier leakage amplitude for the Q-channel of the I/Q modulation.

Parameters:

<Q> float
Range: -10 to 10
Increment: 0.02PCT
*RST: 0PCT
Default unit: PCT

Example: `IQ:IMP:LEAK:Q 3 PCT`
sets the leakage for the Q-channel to 3 percent.

[:SOURce<hw>]:IQ:IMPAirment:QUADrature:[ANGLe] <Angle>

This command sets the quadrature offset for the I/Q modulation.

Parameters:

<Angle> float
Range: -10.0DEG to 10.0DEG
Increment: 0.02DEG
*RST: 0DEG
Default unit: DEG

Example: `IQ:IMP:QUAD:ANGL -5DEG`
sets the quadrature offset to -5 degrees.

[:SOURce<hw>]:IQ:IMPAirment[:STATe] <State>

The command activates (ON) and deactivates (OFF) the three impairment or correction values LEAKage, QUADrature and IQRatio for the analog signal in the I/Q modulator.

Parameters:

<State> 0 | 1 | OFF | ON
*RST: OFF

Example: `IQ:IMP OFF`
deactivates I/Q impairment.

[:SOURce<hw>]:IQ:SOURce <Source>

This command selects the input signal for the I/Q modulator.

In case of two-path instruments, this selection is only available for Path A (SOURce [1]). The input signal for the I/Q modulator of Path B is always the internal baseband signal (BASEband).

Selecting ANALog (Wideband I/Q In) switches off:

- SOURce:AM:STATe OFF
- SOURce:BBAM:STATe OFF
- SOURce:BB:DM:STATe OFF
- SOURce:BB:<Dig. Standard>:STATe OFF
- SOURce:BBIN:STATe OFF

Parameters:

<Source> BASEband | ANALog
*RST: BASEband

Example:

IQ:SOUR ANAL
selects an external analog signal as the input signal. The signal must be applied at the inputs I and Q.

[:SOURce<hw>]:IQ:STATe <State>

This command activates and deactivates I/Q modulation.

Parameters:

<State> 0 | 1 | OFF | ON
*RST: OFF

Example:

IQ:STAT ON
activates I/Q modulation.

[:SOURce<hw>]:IQ:SWAP[:STATe] <State>

When set to ON, this command swaps the I and Q channel.

Parameters:

<State> 0 | 1 | OFF | ON
*RST: OFF

Example:

IQ:SWAP ON
swaps the I and Q channel.

[:SOURce<hw>]:IQ:WBSTate <Wbstate>

This command selects optimized setting for wideband modulation signals (>5 MHz) (State ON).

Parameters:

<Wbstate> 0 | 1 | OFF | ON
*RST: OFF

Example:

IQ:WBST ON
activates optimized setting for wideband signals.

[[:SOURce<hw>]:BB:IQGain <lqgain>

This command specifies the baseband gain for the internal baseband signal.

This command specifies the baseband gain for the internal or in case of two-path instruments, external baseband signal.

Thus, the modulation of the I/Q modulator can be optimized for any measurement requirement. The gain settings for an external analog wideband signal (**Analog Wideband I/Q In**) are performed with command :SOURce:IQ:GAIN

Parameters:

<lqgain>

AUTO | DBM3 | DB0 | DB3 | DB6

AUTO

Activates automatic setting. The modulation is automatically optimized for the internally set baseband signal

DBM3

Activates -3 dB gain.

With this setting, signal distortions are minimized.

DB0

Activates 0 dB gain (standard settings).

DB3

Activates 3 dB gain.

DB6

Activates 6 dB gain.

With this setting, signal noise is minimized.

Increment: 0.01 dB

*RST: AUTO

Example:

`IQ:SOUR BAS`

selects the internal baseband signal as the input signal of the I/Q modulator.

`BB:IQG DB6`

sets gain 6dB (best for low noise).

6.15.10 SOURce:IQ:OUTput Subsystem

6.15.10.1 Analog I/Q Outputs

This subsystem contains the commands for configuring the differential output.

For information about the required options, see [chapter 4.7.3.2, "Analog I/Q Output"](#), on page 311.

<code>[[:SOURce]:BB:IQOutput:SOURce</code>	737
<code>[[:SOURce<hw>]:IQ:OUTPut:BIAS:COUPling[:STATe]</code>	737
<code>[[:SOURce<hw>]:IQ:OUTPut:BIAS:I</code>	737
<code>[[:SOURce<hw>]:IQ:OUTPut:BIAS:Q</code>	738
<code>[[:SOURce<hw>]:IQ:OUTPut:BIAS:OPTimization[:RF]:STATe</code>	738

<code>[:SOURce<hw>]:IQ:OUTPut:LEVel</code>	738
<code>[:SOURce<hw>]:IQ:OUTPut[:ANALog]:POWer:PEP</code>	738
<code>[:SOURce<hw>]:IQ:OUTPut[:ANALog]:POWer:PEP:RESult</code>	739
<code>[:SOURce<hw>]:IQ:OUTPut:MODE</code>	739
<code>[:SOURce<hw>]:IQ:OUTPut:OFFSet:I</code>	740
<code>[:SOURce<hw>]:IQ:OUTPut:OFFSet:Q</code>	740
<code>[:SOURce<hw>]:IQ:OUTPut:TYPE</code>	741

`[:SOURce]:BB:IQOutput:SOURce <Source>`

This command selects the output signal at the I/Q OUT connectors for a two-path instrument.

Parameters:

`<Source>` A | B
 *RST: A

Example:

`BB:IQO:SOUR A`
 the I/Q components of path A baseband signal are output at the I/Q OUT connectors.

`[:SOURce<hw>]:IQ:OUTPut:BIAS:COUPling[:STATe] <State>`

This command activates/deactivates coupling of bias setting of the I-signal and Q-signal component.

If coupling is activated, settings made for the I-signal component (`SOUR:IQ:OUT:BIAS:I`) automatically applies to the Q-signal (`SOUR:IQ:OUT:BIAS:Q`)

For two-path instruments, the outputs are assigned with command `SOURce:BB:IQOut:SOURce`.

Parameters:

`<State>` 0 | 1 | OFF | ON
 *RST: 0

Example:

`IQ:OUTP:BIAS:COUP ON`
 activates coupling of bias settings of the two components.

`[:SOURce<hw>]:IQ:OUTPut:BIAS:I <I>`

This command sets the amplifier bias.

The maximum overall voltage depends on the I/Q output type.

- Single ended: `IQ:OUTP:POW:PEP + SOUR:IQ:OUTP:BIAS:I|Q <= 3.7 volts`.
- Differential:
`0.5 * IQ:OUTP:POW:PEP + SOUR:IQ:OUTP:BIAS:I|Q + 0.5 * SOUR:IQ:OUTP:OFFS:I|Q <= 3.7 volts`.

For two-path instruments, the outputs are assigned with command `[:SOURce] :BB : IQOutput : SOURce` on page 737.

Parameters:

<I> float
 Range: -3.6 to 3.6
 Increment: 0.002
 *RST: 0

[:SOURce<hw>] : IQ : OUTPut : BIAS : Q <Q>

This command sets the amplifier bias.

The maximum overall voltage depends on the I/Q output type.

- Single ended: $IQ:OUTP:POW:PEP + SOUR:IQ:OUTP:BIAS:I|Q \leq 3.7$ volts.
- Differential:
 $0.5 * IQ:OUTP:POW:PEP + SOUR:IQ:OUTP:BIAS:I|Q + 0.5 * SOUR: IQ:OUTP:OFFS:I|Q \leq 3.7$ volts.

For two-path instruments, the outputs are assigned with command `[:SOURce] :BB : IQOutput : SOURce` on page 737.

Parameters:

<Q> float
 Range: -3.6 to 3.6
 Increment: 0.002
 *RST: 0

Example:

`IQ:OUTP:BIAS:Q 0.1 V`
 sets a bias of 100 mV for the Q-signal.

[:SOURce<hw>] : IQ : OUTPut : BIAS : OPTimization [: RF] : STATe <State>

This command activates/deactivates optimization of level accuracy and imbalance for RF Output. Level accuracy and imbalance can be either optimized for RF output (active) or for differential outputs (not active).

For two-path instruments, the outputs are assigned with command `SOURce : BB : IQOut : SOURce`

Parameters:

<State> 0 | 1 | OFF | ON
 *RST: 0

Example:

`IQ:OUTP:BIAS:OPT:STAT ON`
 activates optimization for RF output.

[:SOURce<hw>] : IQ : OUTPut : LEVel <Level>**[:SOURce<hw>] : IQ : OUTPut [: ANALog] : POWer : PEP <Pep>**

This command sets the off-load voltage.

Single ended Output:

- Value range: 20 mV ... 2 V EMF.
- The maximum overall output voltage
(`SOUR:IQ:OUTP:POW:PEP + SOUR:IQ:OUTP:BIAS:I|Q`) is 3.7 V

Differential Output:

- Value range: 40 mV ... 4 V EMF.
- The maximum overall output voltage
($0.5 * \text{SOUR:IQ:OUTP:POW:PEP} + \text{SOUR:IQ:OUTP:BIAS:I|Q} + 0.5 * \text{SOUR:IQ:OUTP:OFFS:I|Q}$) is 3.7 V

For two-path instruments, the outputs are assigned with command `[:SOURce] :BB : IQOutput : SOURce` on page 737.

Parameters:

<Pep> float
 Range: 0.02 to 2
 Increment: 0.001
 *RST: 1
 Default unit: V

Example: `IQ:OUTP:POW:PEP 2 V`
 sets a off-load level of 2 V

[:SOURce<hw>] : IQ : OUTPut [: ANALog] : POWer : PEP : RESult ?

Displays the resulting output off-load voltage of both signal components at the rear panel.

For two-path instruments, the outputs are assigned with command `SOURce : BB : IQOut : SOURce`.

Return values:

<Result> float
 Range: 0.02 to 4
 Increment: 0.001
 *RST: 1

Usage: Query only

[:SOURce<hw>] : IQ : OUTPut : MODE <Mode>

This command selects the mode for setting the outputs.

Selection `FIXed` locks all `IQ:OUTPut`-commands except for `IQ:OUTPut:TYPE` and sets them to predefined values (`*RST`).

For two-path instruments, the outputs are assigned with command `[:SOURce] :BB : IQOutput : SOURce`.

Parameters:

<Mode> FIXed | VARiable

FIXed

The settings are fixed and cannot be changed.

Single ended: IQ:OUTP:POW:PEP = 1V.

Differential: IQ:OUTP:POW:PEP = 2V.

IQ:OUTPut:BIAS:I|Q = 0V

IQ:OUTPut:OFFSet:I|Q = 0V

VARiable

The settings can be changed (command [:SOURce<hw>]:IQ:OUTPut[:ANALog]:POWER:PEP on page 738).

*RST: FIXed

Example:

SOUR:IQ:OUTP:MODE VAR

SOUR:IQ:OUTP:ANAL:POW:PEP 2V

[:SOURce<hw>]:IQ:OUTPut:OFFSet:I <I>

The command is only valid for output type Differential (IQ:OUTP:TYPE DIFF).

This command sets an offset between the inverting and non-inverting output.

The maximum overall voltage

(0.5 * IQ:OUTP:POW:PEP + SOUR:IQ:OUTP:BIAS:I|Q + 0.5 * SOUR:IQ:OUTP:OFFS:I|Q) is 3.7 volts.

For two-path instruments, the outputs are assigned with command [:SOURce]:BB:IQOutput:SOURce on page 737.

Parameters:

<I> float

Range: -0.3 to 0.3

Increment: 2E-4

*RST: 0

Default unit: V

Example:

IQ:OUTP:TYPE DIFF

the I/Q-signal components are output differential

:IQ:OUTP:OFFS:I 0.05 V

sets an offset of 50 mV for the I-signal.

[:SOURce<hw>]:IQ:OUTPut:OFFSet:Q <Q>

The command is only valid for output type Differential (IQ:OUTP:TYPE DIFF).

This command sets an offset between the inverting and non-inverting output.

The maximum overall voltage

(0.5 * IQ:OUTP:POW:PEP + SOUR:IQ:OUTP:BIAS:I|Q + 0.5 * SOUR:IQ:OUTP:OFFS:I|Q) is 3.7 volts.

For two-path instruments, the outputs are assigned with command `[:SOURce] :BB : IQOutput : SOURce` on page 737.

Parameters:

<Q> float
 Range: -0.3 to 0.3
 Increment: 2E-4
 *RST: 0

Example:

```
IQ:OUTP:TYPE DIFF
The I/Q-signal components are output differential.
IQ:OUTP:OFFS:I 0.05 V
sets an offset of 50 mV for the I-signal.
```

[:SOURce<hw>] : IQ : OUTPut : TYPE <Type>

This command selects the output type.

For two-path instruments, the outputs are assigned with command `[:SOURce] :BB : IQOutput : SOURce` on page 737.

Parameters:

<Type> SINGle | DIFFerential
SINGle
 The I/Q-signal components are output single-ended.
DIFFerential
 The I/Q-signal components are output differential.
 A bias can be defined.
 *RST: SINGle

Example:

```
IQ:OUTP:TYPE DIFF
the I/Q-signal components are output differential.
```

6.15.10.2 Digital I/Q Outputs

This subsystem contains the commands for configuring the digital I/Q output. The digital signal can be output with the aid of a standardized (LVDS) digital user interface.

For information about the required options, see [chapter 4.7.3.3, "Digital I/Q Output Settings"](#), on page 315.

<code>[:SOURce<hw>] : IQ : OUTPut : DIGital : CDEvice</code>	742
<code>[:SOURce] : IQ : OUTPut : DIGital : OFLow : HOLD : RESet</code>	742
<code>[:SOURce] : IQ : OUTPut : DIGital : OFLow : HOLD : STATE</code>	742
<code>[:SOURce] : IQ : OUTPut : DIGital : OFLow : STATE</code>	742
<code>[:SOURce<hw>] : IQ : OUTPut : DIGital : PON</code>	743
<code>[:SOURce<hw>] : IQ : OUTPut : DIGital : POWER : LEVel</code>	743
<code>[:SOURce<hw>] : IQ : OUTPut : DIGital : POWER : PEP</code>	743
<code>[:SOURce<hw>] : IQ : OUTPut : DIGital : POWER : STEP [: INCRement]</code>	744
<code>[:SOURce<hw>] : IQ : OUTPut : DIGital : POWER : STEP : MODE</code>	744
<code>[:SOURce<hw>] : IQ : OUTPut : POWER : VIA</code>	745

<code>[:SOURce<hw>]:IQ:OUTPut:DIGital:SRATe</code>	745
<code>[:SOURce<hw>]:IQ:OUTPut:DIGital:SRATe:FIFO[:STATus]</code>	745
<code>[:SOURce<hw>]:IQ:OUTPut:DIGital:SRATe:SOURce</code>	746
<code>[:SOURce<hw>]:IQ:OUTPut:DIGital:STATe</code>	746

`[:SOURce<hw>]:IQ:OUTPut:DIGital:CDEvice?`

Digital Output only.

This command indicates the ID of a connected R&S Instrument or R&S Device.

Return values:

<CDevice> string

Example: `IQ:OUTP:DIG:CDEV?`
queries the connected device ID.

Usage: Query only

`[:SOURce]:IQ:OUTPut:DIGital:OFLow:HOLD:RESet`

This command executes a reset of the overflow hold state and LED.

Example: `SOUR:IQ:OUTP:DIG:OFL:HOLD:RESet`
resets the overflow hold state.

Usage: Event

`[:SOURce]:IQ:OUTPut:DIGital:OFLow:HOLD:STATe?`

This command queries an overflow since the last reset. The overflow hold state can be reset via the Reset button next to the LED, or is reset automatically by starting a new signal generation or by setting new values to the output level.

Return values:

<State> 0 | 1 | OFF | ON
*RST: 0

Example: `SOUR:IQ:OUTP:DIG:OFL:HOLD:STAT?`
queries the overflow state.
Response: "0" (no overflow)

Usage: Query only

`[:SOURce]:IQ:OUTPut:DIGital:OFLow:STATe?`

This command queries the current overflow state of the output signal and indicates that the I/Q output signal is currently clipped.

Return values:

<State> 0 | 1 | OFF | ON
*RST: 0

Example: `IQ:OUTP:DIG:OFL:STAT?`
 queries the overflow state.
 Response: "0" (no overflow).

Usage: Query only

[:SOURce<hw>]:IQ:OUTPut:DIGital:PON <Pon>

This command selects the state which the digital I/Q Output is to assume after the instrument is switched on.

For two-path instruments the power-on state can be set separately for each path.

Parameters:

<Pon> OFF | UNCHanged
 *RST: OFF

Example: `IQ:OUTP:DIG:PON OFF`
 deactivates the output when the instrument is switched on.
`IQ:OUTP:DIG:PON UNCH`
 sets the output to the status that was active before the last switch off.

Options: B13 and B18

[:SOURce<hw>]:IQ:OUTPut:DIGital:POWER:LEVel <Level>

This command sets the rms level of the digital output signal. The level entry fields and the appropriate units (dBFS) are displayed in the status bar. The level display refers to both signal components ($\sqrt{I^2+Q^2}$).

Parameters:

<Level> float
 Range: -90 to 0
 Increment: 0.01
 *RST: 0
 Default unit: dBFS

Example: `IQ:OUTP:DIG:POW:LEV -10`
 sets the output signal level to -10 dBFS.

Options: B13 and B18

[:SOURce<hw>]:IQ:OUTPut:DIGital:POWER:PEP <Pep>

This command sets the peak envelope power of the digital output signal (PEP). The level entry fields and the appropriate units (dBFS) are displayed in the status bar. The level display refers to both signal components ($\sqrt{I^2+Q^2}$).

Parameters:

<Pep> float
 Range: -90 to 0
 Increment: 0.01
 *RST: 0
 Default unit: dBFS

Example:

`IQ:OUTP:DIG:POW:PEP -10`
 sets the signal output level to -10 dBFS.

Options:

B13 and B18

[[:SOURce<hw>]:IQ:OUTPut:DIGital:POWer:STEP[:INCRement] <Increment>

The command sets the step width for the frequency setting if the frequency values UP/DOWN are used and variation mode `SOUR:IQ:OUTP:DIG:POW:STEP:MODE USER` is selected. The command is linked to "Variation Step" for manual operation, i.e. the command also sets the step width of the rotary knob for "Variation Active ON".

For two-path instruments the step width can be set separately for each path.

Parameters:

<Increment> float
 Range: 0 to 100
 Increment: 0.01
 *RST: 1
 Default unit: dB

Example:

`SOUR:IQ:OUTP:ANAL:POW:STEP:INCR 50 mV`
 sets the step width for the level setting to 50 mV.

Options:

B13 and B18

[[:SOURce<hw>]:IQ:OUTPut:DIGital:POWer:STEP:MODE <Mode>

This command activates (USER) or deactivates (DECimal) the user-defined step width used when varying the level value with the level values UP/DOWN. The command is linked to setting **Variation Active** for manual operation, i.e. the command also activates/deactivates the user-defined step width used when varying the level value with the rotary knob.

For two-path instruments the step width can be set separately for each path.

Parameters:

<Mode> DECimal | USER
 *RST: DECimal

Example:

`IQ:OUTP:DIG:POW:STEP:MODE USER`
 activates the step width for level variation with the rotary knob (manual operation) and with level values UP/DOWN (remote control).

Options:

B13 and B18

[[:SOURce<hw>]:IQ:OUTPut:POWer:VIA <Via>

This command activates the selected I/Q output level entry fields of the currently selected signal path in the status bar.

Parameters:

<Via> PEP | LEVel

PEP

The signal level is expressed in terms of a peak envelope power value (PEP). The level entry fields and the corresponding units are displayed in the status bar.

LEVel

The signal level is expressed in terms of a rms value. The level entry field and the corresponding units are displayed in the status bar.

*RST: PEP

Example:

`IQ:OUTP:POW:VIA PEP`

the I/Q-signal level is set via PEP for the signal of path A.

[[:SOURce<hw>]:IQ:OUTPut:DIGital:SRATe <SRate>

Using the sample rate source User the command sets the sample rate value of the output signal. This command is not active for external clock sources

Parameters:

<SRate> float
 Range: 400 to 100 MHz
 Increment: 0.01 Hz
 *RST: 1E8

Example:

`IQ:OUTP:DIG:SRAT:MODE USER`

with sample rate source User the internally generated clock reference signal is selected.

`IQ:OUTP:DIG:SRAT 100 MHz`

the sample rate for the output signal is set to 100 MHz.

Options:

B13 and B18

[[:SOURce<hw>]:IQ:OUTPut:DIGital:SRATe:FIFO[:STATus]?

This command queries the state of the signal transmission.

Return values:

<Status>

OK | OFLow | URUN

OK

Resampling is working properly.

OFLow (Overflow)

The external sample rate frequency is too high which causes an overflow in signal transmission.

URUN (Underrun)

The external sample rate is too low which causes an underrun in signal transmission.

*RST: OK

Example:

SOUR:BBIN:SRAT:FIFO:STATus?

queries the FIFO Status of the sample rate.

Usage:

Query only

[:SOURce<hw>]:IQ:OUTPut:DIGital:SRATe:SOURce <Source>

This command selects the source for setting the sample rate of the digital I/Q output signal.

Note: With a connected R&S EX-IQ-Box either the internal clock source (User defined) or an external clock (Digital I/Q In) can be selected in the settings dialog of the R&S EX-IQ-Box. Therefore, the sample rate source is only indicated in this field.

Parameters:

<Source>

USER | DIN | DOUT | USER | DOUT | DIN

USER

The internally generated clock reference signal is used (option R&S SMU-B13). The sample rate is calculated and displayed in the field "Value".

DIN

An external clock reference signal is used. The clock signal is fed in via a "Baseband Input Module" (option R&S SMU-B17). The sample rate is estimated and displayed in the field "Value".

DOUT

An external clock reference signal is used. The clock signal is directly fed in via pin CLK2 of the digital output interface (option R&S SMU-B18, Digital I/Q Out). The sample rate is displayed in the field "Value".

*RST: USER

Example:

IQ:OUTP:DIG:SRAT:SOUR USER

the internally generated clock reference signal is selected.

[:SOURce<hw>]:IQ:OUTPut:DIGital:STATe <State>

This command switches on and off the digital I/Q output signals.

Parameters:

<State> 0 | 1 | OFF | ON
 *RST: 0

Example:

IQ:OUTP:DIG:STAT ON
 the digital I/Q output signals of path A are activated.

Options:

B13 and B18

6.15.11 SOURce:LFOutput Subsystem

This subsystem contains the commands for setting the LF signal source in CW and Sweep mode as well as for analog modulation.

Example

The following example shows how to set an LF sweep.

1. Set the sweep range.
 LFOutput:FREQuency:START 4 kHz
 LFOutput:FREQuency:STOP 10 kHz
2. Select linear or logarithmic sweep spacing.
 LFOutput:SWEep[:FREQuency]:SPACing LIN
3. Set the step width and dwell time.
 LFOutput:SWEep[:FREQuency]:STEP[:LINear] 100 Hz
 LFOutput:SWEep[:FREQuency]:DWELL 20 ms
4. Determine the sweep mode.
 LFOutput:SWEep:MODE AUTO
5. Determine the trigger.
 TRIGger0:SOURce SINGLE
6. Activate the sweep.
 LFOutput:FREQuency:MODE SWEep
7. Trigger the sweep (depending on the mode).
 LFOutput:SWEep:EXECute

[:SOURce]:LFOutput:FREQuency.....	748
[:SOURce]:LFOutput:FREQuency:MANual.....	748
[:SOURce]:LFOutput:FREQuency:MODE.....	749
[:SOURce]:LFOutput:FREQuency:START.....	749
[:SOURce]:LFOutput:FREQuency:STOP.....	750
[:SOURce]:LFOutput[:STATe].....	750
[:SOURce]:LFOutput:SWEep[:FREQuency]:DWELL.....	751
[:SOURce]:LFOutput:SWEep[:FREQuency]:EXECute.....	751
[:SOURce]:LFOutput:SWEep[:FREQuency]:MODE.....	751
[:SOURce]:LFOutput:SWEep[:FREQuency]:POINTs.....	752
[:SOURce]:LFOutput:SWEep[:FREQuency]:SHAPE.....	753

<code>[:SOURce]:LFOOutput:SWEep[:FREQUENCY]:SPACing</code>	753
<code>[:SOURce]:LFOOutput:SWEep[:FREQUENCY]:STEP[:LINear]</code>	753
<code>[:SOURce]:LFOOutput:SWEep[:FREQUENCY]:STEP:LOGarithmic</code>	754
<code>[:SOURce]:LFOOutput:VOLTage</code>	755

`[:SOURce]:LFOOutput:FREQUENCY` <Frequency>

The command sets the frequency of the LF signal for CW mode (`:SOUR:MODE CW` mode). The setting is valid for all analog modulations (AM/FM/PhiM/Pulse) with internal modulation source.

In Sweep mode (`SOUR:LFO:FREQ:MODE SWE`), the frequency is linked to the sweep frequency.

Parameters:

<Frequency> float
 Range: 0.1 Hz to 1 MHz
 Increment: 0.1 Hz
 *RST: 1KHz
 Default unit: Hz

Example: `LFO:FREQ 5kHz`
 sets the frequency of the LF signal to 5 kHz

Usage: SCPI confirmed

`[:SOURce]:LFOOutput:FREQUENCY:MANual` <Manual>

In Sweep mode (`SOUR:LFO:FREQ:MODE SWE`) the command sets the frequency for the next sweep step in the "Step" sweep mode (`SOUR:LFO:SWE:MODE MAN`). Here only frequency values between the settings `SOUR:LFO:FREQ:STAR` and `...:STOP` are permitted. Each sweep step is triggered by a separate `SOUR:LFO:FREQ:MAN` command.

Parameters:

<Manual> float
 Range: START to STOP
 Increment: 0.1 Hz
 *RST: 1 kHz

Example: `LFO:SWE:MODE MAN`
 sets the "Step" sweep mode.
 `LFO:FREQ:MAN 5 kHz`
 sets an LF frequency of 5 kHz for the next step in the "Step" sweep mode.
 `LFO:FREQ:MODE SWE`
 sets the LF Sweep mode. An LF frequency of 5 kHz is output.
 `LFO:FREQ:MAN 5.1 kHz`
 triggers the next sweep step with a frequency of 5.1 kHz.

Usage: SCPI confirmed

[:SOURce] :LFOutput:FREQuency:MODE <Mode>

The command sets the instrument operating mode and therefore also the commands used to set the output frequency.

Parameters:

<Mode> CW | FIXed | SWEep

CW|FIXed

The instrument operates in fixed-frequency mode. CW and FIXed are synonyms.

The output frequency is set with [:SOURce] :LFOutput:FREQuency.

SWEep

The instrument operates in SWEep mode. The frequency is set using the commands [:SOURce] :LFOutput:FREQuency:START, [:SOURce] :LFOutput:FREQuency:STOP or [:SOURce] :LFOutput:FREQuency:MANual.

*RST: CW

Example:

LFO:FREQ:MODE SWE

sets the SWEep mode. The settings under SOURce:LFOutput:FREQuency:START; STOP; MANual become effective.

Usage:

SCPI confirmed

[:SOURce] :LFOutput:FREQuency:START <Start>

This command sets the start frequency for the LF Sweep mode.

Parameters:

<Start> float

Range: 0.1 Hz to 1 MHz

Increment: 0.1 Hz

*RST: 1 kHz

Example:

```
RST*
```

activates all presettings.

```
LFO:SWE:MODE AUTO
```

sets the AUTO sweep mode, i.e. each trigger triggers a complete sweep.

```
TRIG0:SOUR SING
```

sets the SINGLE trigger mode, i.e. the sweep is triggered by the command :LFOOutput:SWEep:EXECute or *TRG.

```
LFO:FREQ:STAR 100 kHz
```

sets the start frequency for the LF sweep to 100 kHz.

```
LFO:FREQ:STOP 200 kHz
```

sets the stop frequency of the LF sweep to 200 kHz.

```
LFO:FREQ:MODE SWE
```

sets the LF sweep mode.

```
LFO:SWE:EXEC
```

a one-off LF sweep from 100 kHz to 200 kHz is performed. The linear step width is 1 kHz with a dwell time of 15 ms (preset values).

Usage: SCPI confirmed

[:SOURce]:LFOOutput:FREQuency:STOP <Stop>

This command sets the stop frequency for the LF sweep.

Parameters:

<Stop>	float
Range:	0.1 Hz to 1 MHz
Increment:	0.1 Hz
*RST:	50 kHz

Example:

```
LFO:FREQ:STOP 200 kHz
```

sets the stop frequency for the LF sweep to 200 kHz.

```
LFO:FREQ:STAR 100 kHz
```

sets the start frequency for the LF sweep to 100 kHz.

Usage: SCPI confirmed

[:SOURce]:LFOOutput[:STATe] <State>

The command activates/deactivates the LF output.

Parameters:

<State>	0 1 OFF ON
*RST:	OFF

Example:

```
LFO ON
```

activates the LF output. The settings under LFO:FREQ and LFO:SWE become effective.

[:SOURce] : LFOutput : SWEep [: FREQuency] : DWELI <Dwell>

The command sets the dwell time for each frequency step of the sweep.

Tip: It is recommended to switch off the "GUI Update" for optimum sweep performance especially with short dwell times ([SYSTem:DISPlay:UPDate OFF](#)).

Parameters:

<Dwell> float
 Range: 1.0E-3 to 100
 Increment: 100.0E-6
 *RST: 15.0E-3
 Default unit: s

Example: LFO:SWE:DWEL 20 ms
 sets a dwell time of 20 ms.

[:SOURce] : LFOutput : SWEep [: FREQuency] : EXECute

The command immediately starts an LF sweep.

The MODE setting ([\[:SOURce \] : LFOutput : SWEep \[: FREQuency \] : MODE](#)) determines which sweep is executed, e.g. [SOURce : LFOutput : SWEep : FREQuency : MODE STEP](#).

The command corresponds to the manual-control [Execute Single Sweep - LF Sweep](#).

Example: LFO:SWE:MODE SING
 sets the single cycle mode of the LF sweep.
 LFO:SWE:EXEC
 starts one cycle of the LF sweep.

Usage: Event

[:SOURce] : LFOutput : SWEep [: FREQuency] : MODE <Mode>

The command sets the cycle mode of the LF sweep.

The assignment of the GPIB commands to the sweep modes is given in the description of the sweep menus.

Parameters:

<Mode>

AUTO | MANual | STEP

AUTO

Each trigger triggers exactly one complete sweep.

MANual

The trigger system is not active. Each frequency step of the sweep is triggered individually, either by varying the "Current Frequency" value using the rotary knob under manual control or by means of a :LFOuTput:FREQ:MAN command under remote control.

With manual control, the frequency increases or decreases (depending on the direction of the rotary encoder) by the value specified under SOUR:LFO:SWE:FREQ:STEP:LIN (linear spacing) or . . . :STEP:LOG (logarithmic spacing).

With remote control, the frequency increases by the value specified under LFO:SWE:FREQ:STEP:LIN|LOG which each sent [:SOURce]:LFOuTput:FREQuency:MANual command, irrespective the value entered there.

STEP

Each trigger triggers one sweep step only. The frequency increases by the value entered under

```
[SOURce:]LFOuTput:SWEep:STEP.
```

```
*RST:    AUTO
```

Example:

```
LFO:SWE:MODE AUTO
selects Mode Auto.
```

[[:SOURce]:LFOuTput:SWEep[:FREQuency]:POINTs] <Points>

The command sets the number of steps in an LF sweep.

The command is linked to the command :LFOuTput:SWEep[:FREQuency]:STEP as follows:

- for linear sweeps and START < STOP
 $POINTs = ((STOP - START) / STEP:LIN) + 1$
- for logarithmic sweeps and START < STOP
 $POINTs = ((\log STOP - \log START) / \log STEP:LOG) + 1$

If POINTs changes, the value of STEP is adjusted. The START and STOP value is retained.

Two separate POINTs values are used for linear or logarithmic sweep spacing (LFOuTput:SWEep[:FREQuency]:SPACing LIN | LOG). The command is always effective for the currently set sweep spacing.

Parameters:

<Points>

float

Increment: 1

*RST: 100

Example:

```
LFO:FREQ:STAR
sets the start frequency to 2 kHz.
LFO:FREQ:STOP
sets the stop frequency to 20 kHz
LFO:SWE:SPAC LIN
sets linear sweep spacing.
LFO:SWE:POIN 11
sets 11 sweep steps for linear sweep spacing. The sweep step
width (STEP) is automatically set to 2 kHz.
```

[:SOURce]:LFOOutput:SWEep[:FREQuency]:SHAPE <Shape>

The command sets the cycle mode for a sweep sequence (shape).

Parameters:

<Shape> SAWTooth | TRiangle

SAWTooth

One sweep runs from start to stop frequency. Each subsequent sweep starts at the start frequency, i.e. the shape of the sweep sequence resembles a sawtooth.

TRiangle

One sweep runs from start to stop frequency and back, i.e. the shape of the sweep resembles a triangle. Each subsequent sweep starts at the start frequency.

*RST: SAWTooth

Example:

```
SOUR:LFO:SWE:SHAP TRI
selects the sweep cycle with alternating ascending and descend-
ing sweep directions.
```

[:SOURce]:LFOOutput:SWEep[:FREQuency]:SPACING <Spacing>

The command selects linear or logarithmic sweep spacing.

Parameters:

<Spacing> LINear | LOGarithmic

*RST: LINear

Example:

```
LFO:SWE:SPAC LIN
selects linear sweep spacing.
```

[:SOURce]:LFOOutput:SWEep[:FREQuency]:STEP[:LINear] <Linear>

The command sets the step width for the linear sweep.

This command is linked to the command `:LFOOutput:SWEep[:FREQuency]:POINTs` as follow.

- for `START < STOP:`
 $POINTs = ((STOP-START) / STEP:LIN) + 1$

If `STEP:LIN` changes, the value of `POINTS` is adjusted. The `START` and `STOP` value is retained.

Parameters:

<Linear> float
 Range: 0 to `STOP-START`
 Increment: 0.1 Hz

Example:

```
LFO:FREQ:STAR
sets the start frequency to 2 kHz.
LFO:FREQ:STOP
sets the stop frequency to 20 kHz.
LFO:SWE:SPAC LIN
sets linear sweep spacing.
LFO:SWE:STEP 2 kHz
sets the sweep step width to 2 kHz. The number of sweep steps
for linear sweep spacing (POINTS) is automatically set to 11.
```

[:SOURce]:LFOOutput:SWEep[:FREQuency]:STEP:LOGarithmic <Logarithmic>

The command specifies the step width factor for logarithmic sweeps. The next frequency value of a sweep is calculated (for `START < STOP`) using the following formula:

New frequency = Old frequency + `STEP:LOG` x Old frequency

`STEP:LOG` therefore gives the fraction of the old frequency. The frequency is increased by this fraction for the next sweep step. Usually `STEP:LOG` is given in percent, whereby the suffix `PCT` must always be used.

The command is linked to the command `:LFOOutput:SWEep[:FREQuency]:POINTS` as follows:

- for logarithmic sweeps and `START < STOP`:

$$POINTS = ((\log STOP - \log START) / \log STEP:LOG) + 1$$

If `STEP:LOG` changes, the value of `POINTS` is adjusted. The `START` and `STOP` value is retained.

Parameters:

<Logarithmic> float
 Range: 0.01PCT to 100PCT
 Increment: 0.01PCT
 *RST: 1

Example:

```
LFO:FREQ:STAR
sets the start frequency to 1 kHz.
LFO:FREQ:STOP
sets the stop frequency to 100 kHz.
LFO:SWE:SPAC LOG
sets logarithmic sweep spacing.
LFO:SWE:STEP:LOG 10PCT
sets the step width for logarithmic sweep spacing to 10% of the
previous frequency in each instance.
```

[:SOURce]:LFOutput:VOLTage <Voltage>

The command sets the output voltage of the LF output.

Parameters:

<Voltage>	float
	Range: 0 to 4
	Increment: 0.001
	*RST: 1
	Default unit: V

Example: LFO:VOLT 3 V
sets the voltage of the LF output to 3 V.

6.15.12 SOURce:LIST Subsystem

This subsystem contains the commands for the List mode of the instrument.



The same lists are, accessed for both paths. File operations such as creating, deleting and querying lists are therefore path-independent. In this case, the suffix under SOURce must be omitted. An error message is displayed if the suffix is specified.

The following settings are required to operate the instrument in List mode:

1. Create a list.
If a list which does not exist is selected with the `:LIST:SEL` command, an empty list with the name of the selected list is created.
`SOURce1:LIST:SEL "New_list"`
2. Fill the list with values.
All list components must be of the same length. This does not apply to components of length 1. This is interpreted as if the component has the same length as the other components and as if all values are the same as the first value.
`SOURce1:LIST:FREQ 100 MHz, 110 MHz, 120 MHz...`
`SOURce1:LIST:POW 2dBm, -1dBm, 0dBm...`
3. Select a list.
If a new empty file has been created with the `:LIST:SEL` command, this file is selected, otherwise an existing list must be selected before the List mode is activated.
`SOURce1:LIST:SEL "Old_list"`
4. Set the dwell time.
The dwell time determines the duration of the individual list steps.
`SOURce1:LIST:DWELL 3ms`
5. Set the List mode.
The List mode determines the way in which the list is processed. In the example the list is processed once only or repeatedly depending on the trigger setting.
`SOURce1:LIST:MODE AUTO`

6. Determine the trigger.
In the example each trigger causes the list to be processed once from beginning to end.

```
SOURce:LIST:TRIGger:SOURce SINGLE
```

7. Activate the List mode.
SOURce1:FREQuency:MODE LIST
8. Trigger the list (depending on the mode).
SOURce1:LIST:TRIGger:EXECute

9. Deactivate the List mode.
SOURce1:FREQuency:MODE CW



SCPI refers to the individual lists as segments.

[:SOURce<hw>]:LIST:CATalog.....	756
[:SOURce<hw>]:LIST:DELeTe.....	757
[:SOURce<hw>]:LIST:DELeTe:ALL.....	757
[:SOURce<hw>]:LIST:DEXChange:AFILe:CATalog.....	758
[:SOURce<hw>]:LIST:DEXChange:AFILe:EXTension.....	758
[:SOURce<hw>]:LIST:DEXChange:AFILe:SELeCt.....	759
[:SOURce<hw>]:LIST:DEXChange:AFILe:SEPARator:COLumn.....	759
[:SOURce<hw>]:LIST:DEXChange:AFILe:SEPARator:DECimal.....	760
[:SOURce<hw>]:LIST:DEXChange:EXECute.....	760
[:SOURce<hw>]:LIST:DEXChange:MODE.....	761
[:SOURce<hw>]:LIST:DEXChange:SELeCt.....	761
[:SOURce<hw>]:LIST:DWELL.....	762
[:SOURce<hw>]:LIST:FREQuency.....	762
[:SOURce<hw>]:LIST:FREQuency:POINts.....	763
[:SOURce<hw>]:LIST:INDex.....	763
[:SOURce<hw>]:LIST:INDex:STARt.....	763
[:SOURce<hw>]:LIST:INDex:STOP.....	764
[:SOURce<hw>]:LIST:LEARn.....	764
[:SOURce<hw>]:LIST:MODE.....	765
[:SOURce<hw>]:LIST:POWer.....	765
[:SOURce<hw>]:LIST:POWer:AMode.....	765
[:SOURce<hw>]:LIST:POWer:POINts.....	766
[:SOURce<hw>]:LIST:RESet.....	766
[:SOURce<hw>]:LIST:SELeCt.....	766
[:SOURce<hw>]:LIST:TRIGger:EXECute.....	767
[:SOURce<hw>]:LIST:TRIGger:SOURce.....	767

[:SOURce<hw>]:LIST:CATalog?

The command requests a list of available lists. The individual lists are separated by commas.

The lists are stored with the fixed file extensions *.lsw in a directory of the user's choice. The directory applicable to the commands is defined with the command `MMEMoRY:CDIR`.

Return values:

<Catalog> string

Example:

```
MMEM:CDIR 'D:/Lists/Listmode'
selects the directory for the list mode files.
LIST:CAT?
queries the available lists.
Response: 'list1,list2'
the lists list1 and list2 are available.
```

Usage: Query only

[[:SOURce<hw>]:LIST:DELeTe <Delete>

The command deletes the specified list.

The files are stored with the fixed file extensions *.lsw in a directory of the user's choice. The directory applicable to the command is defined with the command `MMEMoRY:CDIR`. To access the files in this directory, only the file name has to be given, without the path and the file extension. A path can also be specified in command `:SOUR:LIST:CAT?`, in which case the file in the specified directory is deleted.

*RST does not affect data lists.

Setting parameters:

<Delete> <list file name>

Example:

```
MMEM:CDIR 'D:/Lists/Listmode'
selects the directory for the list mode files.
LIST:DEL 'LIST1'
deletes the list list1.
```

Usage: Setting only

[[:SOURce<hw>]:LIST:DELeTe:ALL

The command deletes all lists in the set directory. The List mode must be deactivated beforehand to ensure that no lists are selected when this command is called (`SOUR:FREQ:MODE CW` or `SWE`).

The files are stored with the fixed file extensions *.lsw in a directory of the user's choice. The directory applicable to the command is defined with the command `MMEMoRY:CDIR`. A path can also be specified in command `SOUR:LIST:CAT?`, in which case all list mode files in the specified directory are deleted.

*RST does not affect data lists.

Example: `MMEM:CDIR 'D:/Lists/Listmode'`
selects the directory for the list mode files.

`FREQ:MODE SWE`
deactivates the List mode for RF output and activates the Sweep mode.

`SOUR2:FREQ:MODE SWE`
deactivates the List mode for RF output and activates Sweep mode.

`LIST:DEL:ALL`
deletes all list mode files available in the set directory.

Usage: Event

[[:SOURce<hw>]:LIST:DEXChange:AFILe:CATalog?

The command requests a list of available ASCII files for export/import of list mode data. The individual files are separated by commas.

The ASCII files are stored with the fixed file extensions `*.txt` or `*.csv` in a directory of the user's choice. The directory applicable to the commands is defined with the command `MMEMory:CDIR`.

Return values:

<Catalog> string

Example: `MMEM:CDIR 'D:/lists/listmode/import'`
selects the directory for the ASCII files with frequency and level value pairs.

`LIST:DEXC:AFIL:EXT TXT`
selects that ASCII files with extension `*.txt` are listed.

`LIST:DEXC:AFIL:CAT?`
queries the available files with extension `*.txt`.

Response: 'list1,list2'
the ASCII files `list1.txt` and `list2.txt` are available.

Usage: Query only

[[:SOURce<hw>]:LIST:DEXChange:AFILe:EXTension <Extension>

The command selects the file extension of the ASCII file to be imported or exported. Selection `TXT` (text file) or `CSV` (Excel file) is available.

Parameters:

<Extension> `TXT | CSV`
`*RST: TXT`

Example: `MMEM:CDIR 'D:/lists/listmode/import'`
 selects the directory for the ASCII files with frequency and level value pairs.
`LIST:DEXC:AFIL:EXT TXT`
 selects that ASCII files with extension `*.txt` are listed.
`LIST:DEXC:AFIL:CAT?`
 queries the available files with extension `*.txt`.
 Response: `'list1,list2'`
 the ASCII files `list1.txt` and `list2.txt` are available.

[[:SOURce<hw>]:LIST:DEXChange:AFILe:SElect <Select>

The command selects the ASCII file to be imported or exported.

The ASCII files are stored with the fixed file extensions `*.txt` or `*.csv` in a directory of the user's choice. The directory applicable to the commands is defined with the command `MMEMemory:CDIR`. A path can also be specified in command `SOUR:LIST:DEXC:AFIL:SEL`, in which case the files are stored or loaded in the specified directory.

Parameters:

<Select> <ascii_file_name>

Example:

`LIST:DEXC:MODE IMP`
 selects that ASCII files with frequency and level value pairs are imported and transferred into list mode lists.
`LIST:DEXC:AFIL:SEL 'D:
 /user/listmode/import/list.csv'`
 selects that ASCII file `list.csv` is imported.
`LIST:DEXC:SEL 'D:
 /user/listmode/import/list_imp'`
 selects that the ASCII file `list.csv` is imported into list mode list `list_imp`.

[[:SOURce<hw>]:LIST:DEXChange:AFILe:SEParator:COLumn <Column>

The command selects the separator between the frequency and level column of the ASCII table.

Parameters:

<Column> TABulator | SEMicolon | COMMa | SPACe
 *RST: COMMa

Example:

```
LIST:DEXC:MODE EXP
selects that the list mode list is exported into an ASCII file.
LIST:DEXC:AFIL:SEL 'D:
/user/listmode/import/list.csv'
selects ASCII file list.csv as destination for the list mode list
data.
LIST:DEXC:AFIL:SEP:COL TAB
the pairs of frequency and level values are separated by a tabu-
lator.
LIST:DEXC:AFIL:SEP:DEC DOT
selects the decimal separator dot.
LIST:DEXC:SEL 'D:
/user/listmode/import/list_imp'
selects that the list mode list list_imp is imported into ASCII file
list.csv.
```

[:SOURce<hw>]:LIST:DEXChange:AFILe:SEParator:DECimal <Decimal>

The command the decimal separator used in the ASCII data between '.' (decimal point) and ',' (comma) with floating-point numerals.

Parameters:

<Decimal> DOT | COMMa
*RST: DOT

Example:

```
LIST:DEXC:MODE EXP
selects that the list mode list is exported into an ASCII file.
LIST:DEXC:AFIL:SEL 'D:
/user/listmode/import/list.csv'
selects ASCII file list.csv as destination for the list mode list
data.
LIST:DEXC:AFIL:SEP:COL TAB
the pairs of frequency and level values are separated by a tabu-
lator.
LIST:DEXC:AFIL:SEP:DEC DOT
selects the decimal separator dot.
LIST:DEXC:SEL 'rootD:
/user/listmode/import/list_imp'
selects that the list mode list list_imp is imported into ASCII file
list.csv.
```

[:SOURce<hw>]:LIST:DEXChange:EXECute

The command starts the export or import of the selected file. When import is selected, the ASCII file is imported as list mode list. When export is selected, the list mode list is exported into the selected ASCII file.

Example:

```
LIST:DEXC:MODE IMP
selects that ASCII files with frequency and level value pairs are
imported and transferred into list mode lists.
LIST:DEXC:AFIL:SEL 'D:
/user/listmode/import/list.csv'
selects that ASCII file list.csv is imported.
LIST:DEXC:SEL 'D:
/user/listmode/import/list_imp'
selects that the ASCII file list.csv is imported into list mode list
list_imp.
LIST:DEXC:EXEC
starts the import of the ASCII file data into the list mode file.
```

Usage: Event

[[:SOURce<hw>]:LIST:DEXChange:MODE <Mode>

The command selects if list mode lists should be imported or exported. Depending on the selection here, the file select command defines either the source or the destination for list mode lists and ASCII files.

Parameters:

<Mode> IMPort | EXPort
*RST: IMPort

Example:

```
LIST:DEXC:MODE IMP
selects that ASCII files with frequency and level value pairs are
imported and transferred into list mode lists.
LIST:DEXC:AFIL:SEL 'D:
/user/listmode/import/list.csv'
selects that ASCII file list.csv is imported.
LIST:DEXC:SEL 'rootD:
/user/listmode/import/list_imp'
selects that the ASCII file list.csv is imported into list mode list
list_imp.
```

[[:SOURce<hw>]:LIST:DEXChange:SELEct <Select>

The command selects the list mode list to be imported or exported.

The list mode files are stored with the fixed file extensions *.lsw in a directory of the user's choice. The directory applicable to the commands is defined with the command `MMEMory:CDIR`. A path can also be specified in command `SOUR:LIST:DEXC:SEL`, in which case the files are stored or loaded in the specified directory.

Parameters:

<Select> <list_name>

Example: LIST:DEXC:MODE IMP
selects that ASCII files with frequency and level value pairs are imported and transferred into list mode lists.

LIST:DEXC:AFIL:SEL 'D:
/user/listmode/import/list.csv'
selects that ASCII file list.csv is imported.

LIST:DEXC:SEL 'D:
/user/listmode/import/list_imp'
selects that the ASCII file list.csv is imported into list mode list list_imp.

[SOURce<hw>]:LIST:DWELI <Dwell>

The command sets the time for which the instrument retains a setting.

Parameters:

<Dwell> float
Range: 0.7E-3 to 100
Increment: 0.1E-3
*RST: 15.0E-3
Default unit: s

Example: LIST:DWEL 15
each setting in the list is retained for 15 ms.

[SOURce<hw>]:LIST:FREQuency <Frequency>

The command fills the FREQuency part of the selected list with data.

*RST does not affect data lists.

Parameters:

<Frequency> <Frequency#1>{, <Frequency#2>, ...} | block data
The data can be given either as a list of numbers (list can be of any length and list entries must be separated by commas) or as binary block data. When block data is transferred, 8 (4) bytes are always interpreted as a floating-point number with double accuracy (see :FORMat [:DATA] on page 537).
Range: 300 kHz to RFmax (RFmax depending on model)

Example: LIST:SEL 'D:/Lists/Listmode/list3'
selects list3 for editing. List3 is created if it does not yet exist.
SOUR:LIST:FREQ 1.4GHz, 1.3GHz, 1.2GHz, ...
specifies the frequency values in list3. If the list already contains data, it is overwritten.

Usage: SCPI confirmed

[[:SOURce<hw>]:LIST:FREQuency:POINts?

The command queries the length (in points) of the FREQuency component of the selected list.

Return values:

<Points> float

Example:

```
LIST:SEL 'D:/Lists/Listmode/list3'
selects list3 for editing. List3 is created if it does not yet exist.
LIST:FREQ:POIN?
queries the number of frequency values in list3.
Response: 327
list3 has 327 frequency entries.
```

Usage: Query only

[[:SOURce<hw>]:LIST:INDex <Index>

The command sets the list index in step mode (LIST:MODE STEP).

After the trigger signal the frequency and level settings of the selected index are processed in List mode.

Parameters:

<Index> float
*RST: 0

Example:

```
LIST:SEL 'D:/Lists/Listmode/list3'
selects list3 for use in List mode.
FREQ:MODE LIST
activates List mode. List3 is processed.
LIST:MODE STEP
selects manual, step-by-step processing of the list.
LIST:IND 5
the frequency/level value pair with index 5 is executed.
TRIG:LIST:SOUR SING
selects triggering by means of the single trigger. The list is executed once.
SOUR:LIST:TRIG:EXEC
triggers the processing of the selected list.
```

[[:SOURce<hw>]:LIST:INDex:STARt <Start>

The command sets the start index of the index range which defines a subgroup of frequency/level value pairs in the current list. Only the values in the set index range (:LIST:INDex:STARt ... :LIST:INDex:STOP) are processed in List mode.

Parameters:

<Start> float
Range: 0 to list length
*RST: 0

Example:

```
LIST:SEL 'D:/Lists/Listmode/list3'
```

selects list3 for use in List mode.

```
LIST:IND:STAR 25
```

sets 25 as start index of the index range.

```
LIST:IND:STOP 49
```

sets 49 as stop index of the index range.

```
FREQ:MODE LIST
```

activates List mode. The frequency/level value pairs from index 25 to index 49 in list3 are processed. All other entries of the list are ignored.

[[:SOURce<hw>]:LIST:INDEX:STOP <Stop>

The command sets the stop index of the index range which defines a subgroup of frequency/level value pairs in the current list. Only the values in the set index range (:LIST:INDEX:START ... :LIST:INDEX:STOP) are processed in List mode.

Parameters:

<Stop> float

Range: 0 to list length

*RST: 0

Example:

```
LIST:SEL 'D:/Lists/Listmode/list3'
```

selects list3 for use in List mode.

```
LIST:IND:STAR 25
```

sets 25 as start index of the index range.

```
LIST:IND:STOP 49
```

sets 49 as stop index of the index range.

```
FREQ:MODE LIST
```

activates List mode. The frequency/level value pairs from index 25 to index 49 in list3 are processed. All other entries of the list are ignored.

[[:SOURce<hw>]:LIST:LEARN

The command learns the selected list, i.e. it determines the hardware setting for the entire list. The data determined in this way is stored together with the list. When the list is activated for the first time, these settings are calculated automatically.

Example:

```
LIST:SEL 'D:/Lists/Listmode/list3'
```

selects list3. List3 is created if it does not yet exist.

```
LIST:LEAR
```

starts learning of the hardware setting for list3 and stores the setting.

Usage: Event

[[:SOURce<hw>]:LIST:MODE <Mode>

The command specifies how the list is to be processed (similar to `SOURce:SWEep:MODE`).

Parameters:

<Mode> AUTO | STEP

AUTO

Each trigger event triggers a complete list cycle. Possible trigger settings for `:LIST:TRIGger:SOURce` are `AUTO`, `SINGLE` and `EXT`.

STEP

Each trigger event triggers only one step in the list processing cycle. The list is processed in ascending order.

Possible trigger settings for `:LIST:TRIGger:SOURce` are `SINGLE` and `EXT`

*RST: AUTO

Example:

```
LIST:MODE STEP
```

selects step-by-step processing of the list.

Usage:

SCPI confirmed

[[:SOURce<hw>]:LIST:POWer <Power>

The command fills the Level part of the selected list with data.

*RST does not affect data lists.

Parameters:

<Power> <Power#1>{, <Power#2>, ...} | block data

The data can be given either as a list of numbers (list can be of any length and list entries must be separated by commas) or as binary block data. When block data is transferred, 8 (4) bytes are always interpreted as a floating-point number with double accuracy (see `:FORMat[:DATA]` on page 537).

Range: Minimum level to Maximum level

Default unit: dBm

Example:

```
LIST:SEL 'D:/Lists/Listmode/list3'
```

selects list3 for editing. List3 is created if it does not yet exist.

```
LIST:POW 0dBm, 2dBm, 2dBm, 3dBm, ..
```

specifies the level values in list3. The number of level values must correspond to the number of frequency values. The previous data is overwritten.

Usage:

SCPI confirmed

[[:SOURce<hw>]:LIST:POWer:AMODE <Amode>

(With Option High Power only)

The command selects the ranges of level settings for the list mode. The level settings are either performed in the low level or in the high level ranges.

Parameters:

<Amode> NORMAl | HPOWer

NORMAl

The level settings are made in the range of the electronically switching attenuator. The high level ranges are not available.

HPOWer

The level settings are made in the range of the option. Only the high level range is available.

*RST: NORMAl

Example:

```
LIST:POW:AMOD HPOW
selects the high level ranges for List Mode.
```

[[:SOURce<hw>]:LIST:POWER:POINTS?

The command queries the length (in points) of the LEVel part of the selected list.

Return values:

<points> float

Example:

```
LIST:SEL 'D:/Lists/Listmode/list3'
selects list3 for editing. List3 is created if it does not yet exist.
LIST:POW:POIN?
queries the number of levels in list3.
Response: 327
LIST2 has 327 level entries.
```

Usage:

Query only
SCPI confirmed

[[:SOURce<hw>]:LIST:RESet

The command resets the list to the starting point.

Example:

```
LIST:RES
resets the list to the starting point.
```

Usage:

Event

[[:SOURce<hw>]:LIST:SElect <Select>

The command selects the specified list. If a new list is to be created, the name can be entered here. The list is created if it does not yet exist. The list selected here is available for the further processing steps (editing) and is used in the instrument when the List mode is activated.

The files are stored with the fixed file extensions *.lsw in a directory of the user's choice. The directory applicable to the command is defined with the command `MMEMory:CDIR`. A path can also be specified in command `:SOUR:LIST:SEL` in which case the list mode file in the specified directory is selected.

*RST does not affect data lists.

Parameters:

<Select> '<list name>'

Example:

`LIST:SEL 'D:/Lists/Listmode/list3'`
selects list3 for editing. List3 is created if it does not yet exist.

[:SOURce<hw>]:LIST:TRIGger:EXECute

The command immediately starts the processing of a list in list mode. It corresponds to the manual-control command "Execute Single."

Example:

`SOUR:LIST:TRIG:EXEC`
triggers the processing of the selected list.

Usage:

Event

[:SOURce<hw>]:LIST:TRIGger:SOURce <Source>

The command sets the trigger source for the LIST mode.

The names of the parameters correspond to those under sweep mode. SCPI uses other names for the parameters; these names are also accepted by the instrument. The SCPI names should be used if compatibility is an important consideration. An overview of the various names is given in the following table:

R&S name	SCPI name	Command under manual control
AUTO	IMMediate	MODE AUTO
SINGle	BUS	MODE SINGLE or STEP
EXTernal	EXTernal	MODE EXT TRIG SINGLE or EXT TRIG STEP

Parameters:

<Source>

AUTO | IMMEDIATE | SINGLE | BUS | EXTERNAL

AUTO|IMMEDIATE

The trigger is free-running, i.e. the trigger condition is fulfilled continuously. The selected list in List mode is restarted as soon as it is finished.

SINGLE|BUS

The list is triggered by the GPIB commands [:SOURce<hw>]:LIST:TRIGger:EXECute. The list is executed once.

EXTERNAL

The list is triggered externally via the INST TRIG connector. The list is executed once.

The BNC connector INST TRIG is provided for Path A, and the pin INST TRIG B on the AUX I/O interface for Path B.

*RST: SINGLE

Example:

LIST:TRIG:SOUR EXT

selects triggering by means of the external trigger.

6.15.13 SOURce:MODulation Subsystem

This subsystem contains the command for switching on/off all modulations.

[:SOURce<hw>]:MODulation[:ALL]:STATe <State>

The command switches the modulations on and off.

The command SOUR:MOD:ALL:STAT OFF switches all modulations off. A subsequent command SOUR:MOD:ALL:STAT ON restores the status that was active before the last switch-off. "MOD OFF" is displayed in the info line of the header next to the "Level" field.

Parameters:

<State>

0 | 1 | OFF | ON

Example:

MOD:STAT OFF

switches off all modulations.

6.15.14 SOURce:PATH Subsystem

This subsystem contains the command for retrieving the number of installed RF paths.

[:SOURce]:PATH:COUNT?

The command queries the number of installed RF paths.

Return values:

<Count>

integer

Range: 1 to INT_MAX

*RST: 1

Example: `PATH:COUN?`
 queries the number of RF paths.
 Response: 1
 the instrument is equipped with one RF path.

Usage: Query only

6.15.15 SOURce:PHASe Subsystem

This subsystem contains the commands for adjusting the phase of the RF output signal relative to a reference signal of the same frequency.

[\[:SOURce<hw>\]:PHASe](#).....769
[\[:SOURce<hw>\]:PHASe:REFerence](#).....769

[:SOURce<hw>]:PHASe <Phase>

The command specifies the phase variation relative to the current phase. The variation can be specified in RADians.

Parameters:

<Phase>	float
	Range: -359.9 to 359.9
	Increment: 0.1 deg
	*RST: 0.0 deg

Example: `PHAS 2DEG`
 changes the phase by 2 degrees relative to the current phase.
 `PHAS:REF`
 adopts the set phase as the current phase.

Usage: SCPI confirmed

[:SOURce<hw>]:PHASe:REFerence

The command adopts the phase set with `SOURce:PHASe:ADJust` as the current phase.

Example: `PHAS 0.1RAD`
 changes the phase by 0.1 RAD relative to the current phase.
 `PHAS:REF`
 adopts the set phase as the current phase.

Usage: Event
 SCPI confirmed

6.15.16 SOURce:PM Subsystem

The PM subsystem contains the commands for checking the phase modulation. The settings for the internal modulation source (LF generator) are made in the [SOURce:LFOuTput](#) subsystem.

For information about the required options, see [chapter 4.5.11.5, "Phase Modulation \(PhiM\)"](#), on page 241.

[:SOURce<hw>]:PM[:DEVIation]	770
[:SOURce<hw>]:PM:EXTernal:COUPling	770
[:SOURce<hw>]:PM:MODE	771
[:SOURce<hw>]:PM:SENSitivity	771
[:SOURce<hw>]:PM:SOURce	772
[:SOURce<hw>]:PM:STATe	772

[\[:SOURce<hw>\]:PM\[:DEVIation\]](#) <Deviation>

The command sets the modulation deviation of the phase modulation in RAD. The maximal deviation depends on the RF frequency set and the selected modulation mode (see data sheet).

The deviation of the internal source must not exceed the deviation of the external source in case of modulation source "Int+Ext" (`PM:SOURce INT,EXT`).

Parameters:

<Deviation> float
 Range: 0 to 20
 Increment: See data sheet
 *RST: 1
 Default unit: RAD

Example: PM 5
 sets the PM modulation deviation to 5 RAD

Usage: SCPI confirmed

[\[:SOURce<hw>\]:PM:EXTernal:COUPling](#) <Coupling>

The command selects the coupling mode for the external modulation input in the case of phase modulation.

Note: Coupling for external feed via input EXT MOD can be set independently for modulations AM, PM and PhiM.

Note: Coupling for external feed via input FM/PM EXT can be set independently for modulations PM and PhiM.

Parameters:

<Coupling> AC | DC
 AC
 The DC voltage component is disconnected from the modulation signal.
 DC
 The modulation signal is not changed.
 *RST: AC

Example: PM:EXT:COUP AC
 selects the coupling mode AC for external phase modulation.

Usage: SCPI confirmed

[[:SOURce<hw>]:PM:MODE <Mode>

The command selects the mode for the phase modulation.

Parameters:

<Mode> HBANdwidth | HDEVIation | LNOise

HBANdwidth

The maximum range for modulation bandwidth is available. However, phase noise is increased for low frequencies. The range for PhiM deviation is limited. This mode is recommended for high modulation frequencies.

HDEVIation

The maximum range for PhiM deviation is available. Phase noise is improved for low frequencies. The range for modulation frequency is limited (see data sheet). This mode is recommended for low modulation frequencies and/or high PhiM deviation.

LNOise

Phase modulation with phase noise and spurious characteristics close to CW mode. The range for modulation bandwidth and PM deviation is limited (see data sheet)

*RST: HBANdwidth

Example: PM:MODE LNO
selects Low Noise mode for external phase modulation.

Usage: SCPI confirmed

[[:SOURce<hw>]:PM:SENSitivity?

The command queries the input sensitivity of the EXT MOD input in RAD/V. The command is only effective if the external modulation source is selected (SOUR:PM:SOUR EXT). The returned value depends on the modulation deviation setting (SOUR:PM:DEVIation). This value is assigned to the voltage value for full modulation of the input.

Return values:

<Sensitivity> float

Example: PM:DEV 1
sets a modulation deviation of 1RAD.
PM:SENS?
queries the input sensitivity at the EXT MOD input.
Response: 1
since the voltage value for full modulation is 1V, the resulting sensitivity is precisely 1RAD/V.

Usage: Query only
SCPI confirmed

[:SOURce<hw>]:PM:SOURce <Source>

The command selects the modulation source for phase modulation.

Parameters:

<Source> INTernal | EXTernal | INT,EXT

INTernal

INT is the LF generator. The frequency of the internal modulation signal can be set in the `SOURce:LFOutput` subsystem.

EXTernal

The external signal is input at the EXT MOD connector.

INT,EXT

Internal and external modulation source can be selected at the same time.

*RST: INTernal

Example:

`PM:SOUR INT`
selects the internal modulation source.

Usage:

SCPI confirmed

[:SOURce<hw>]:PM:STATe <State>

The command activates/deactivates phase modulation. Activation of phase modulation deactivates frequency modulation.

Parameters:

<State> 0 | 1 | OFF | ON

*RST: OFF

Example:

`PM:STAT ON`
activates PM modulation.

Usage:

SCPI confirmed

6.15.17 SOURce:POWer Subsystem

This subsystem contains the commands for setting the output level, level control and level correction of the RF signal.

Other units can also be used instead of dBm:

- by entering the unit directly after the numerical value (example `:POW 0.5V`)
- by changing the DEFault unit in the UNIT system (see the command `:UNIT:POWer`).

<code>[:SOURce<hw>]:POWer:ALC:OMODE</code>	773
<code>[:SOURce<hw>]:POWer:ALC:SONCe</code>	773
<code>[:SOURce<hw>]:POWer:ALC[:STATe]</code>	773
<code>[:SOURce<hw>]:POWer[:LEVel][:IMMediate][:AMPLitude]</code>	774
<code>[:SOURce<hw>]:POWer[:LEVel][:IMMediate]:OFFSet</code>	775

<code>[:SOURce<hw>]:POWer[:LEVel][:IMMediate]:RCL</code>	775
<code>[:SOURce<hw>]:POWer:LIMit[:AMPLitude]</code>	776
<code>[:SOURce<hw>]:POWer:MANual</code>	776
<code>[:SOURce<hw>]:POWer:MODE</code>	777
<code>[:SOURce<hw>]:POWer:PEP</code>	778
<code>[:SOURce<hw>]:POWer:POWer</code>	778
<code>[:SOURce<hw>]:POWer:STARt</code>	778
<code>[:SOURce<hw>]:POWer:STEP[:INCRement]</code>	779
<code>[:SOURce<hw>]:POWer:STEP:MODE</code>	779
<code>[:SOURce<hw>]:POWer:STOP</code>	780

`[:SOURce<hw>]:POWer:ALC:OMODE <OffMode>`

The command sets the level control mode which becomes active when automatic level control is deactivated (ALC Off).

Parameters:

<OffMode>

SHOLd

SHOLd

Level control is activated briefly if the level or frequency changes ("ALC Off Sample & Hold").

*RST: SHOLd

Example:

`POW:ALC OFF`

deactivates automatic level control for RF output A.

`POW:ALC:OMOD SHOL`

level control is briefly activated if the frequency or level changes.

`[:SOURce<hw>]:POWer:ALC:SONCe`

The command briefly activates level control for correction purposes.

Example:

`POW:ALC OFF`

deactivates automatic level control for RF output A.

`POW:ALC:SONC`

level control is performed once only.

Usage:

Event

`[:SOURce<hw>]:POWer:ALC[:STATe] <State>`

The command activates/deactivates automatic level control.

Parameters:

<State>

ON | OFF | AUTO

ON

Internal level control is permanently activated.

OFF

Internal level control is deactivated; Sample & Hold mode is activated.

AUTO

Internal level control is activated/deactivated automatically depending on the operating state.

*RST: AUTO

Example:

POW:ALC ON

activates automatic level control for RF output A.

[:SOURce<hw>] :POWER[:LEVel][:IMMediate][:AMPLitude] <Amplitude>

The command sets the RF output level in CW mode. In addition to numerical values, it is also possible to specify UP and DOWN. The level is then increased or decreased by the value specified under [:SOURce<hw>] :POWER:STEP.

As with the **Level** value entered in the header, the **OFFSet** value is also taken into consideration with this command.

The specified value range is therefore only effective if :SOURce:POWER:OFFSet is set to 0. The value range for other OFFSet values can be calculated using the following formula:

$$\text{Minimum level} + \text{OFFSet} \dots \text{Maximum level} + \text{OFFSet}$$

The keywords of this command are largely optional. Therefore, both the long and short form of the command are shown in the example.

Parameters:

<Amplitude>

Minimum level ... Maximum level

The value range for the level setting varies according to the instrument model.

The value range depends on whether or not the instrument is equipped with the option **High Power**.

The values are given in the data sheet.

Increment: 0.01 dB

*RST: -30 dBm

Default unit: dBm

Example:

SOUR:POW:LEV:IMM:AMPL 15

or

:POW 15

sets the RF level at output A to 15 dBm.

Usage:

SCPI confirmed

```
[:SOURce<hw>]:POWER[:LEVel][:IMMediate]:OFFSet <Offset>
```

Note: The level offset is also effective for level sweeps!

The command specifies the constant level offset of a downstream attenuator/amplifier. If a level offset is entered, the level entered with `:POWER` no longer corresponds to the RF output level.

The following correlation applies:

$$:POWER = \text{RF output level} + \text{POWER:OFFSet.}$$

Entering a level offset does not change the RF output level, but rather the query value of `:POWER`.

For more information, see ["RF level vs. RF output level"](#) on page 216.

Only dB is permitted as the unit here. The linear units (V, W, etc.) are not permitted.

The keywords of this command are largely optional. Therefore, both the long and short form of the command are shown in the example.

Parameters:

<code><Offset></code>	float
	Range: -100 dB to 100 dB
	Increment: 0.01 dB
	*RST: 0 dB
	Default unit: dB

Example:

```
SOURce:POWER:LEVel:IMMediate:OFFSet -10
or
POW:OFFS 10
sets the RF level offset to 10 dB
```

Usage: SCPI confirmed

```
[:SOURce<hw>]:POWER[:LEVel][:IMMediate]:RCL <Rcl>
```

The command determines whether the current level is retained or whether the stored level setting is adopted when an instrument configuration is loaded.

*RST does not affect this setting.

The setting is valid for both paths. If a suffix is specified, it is ignored.

Parameters:

<code><Rcl></code>	INCLude EXCLude
	INCLude
	The stored level is also loaded when a stored instrument configuration is loaded.
	EXCLude
	The RF level is not loaded when a stored instrument configuration is loaded. The current level is retained.
	*RST: no default

Example: POW:RCL INCL
the stored level is set if the Recall command is called.

Usage: SCPI confirmed

[:SOURce<hw>]:POWER:LIMit[:AMPLitude] <Amplitude>

The command limits the maximum RF output level in CW and SWEEP mode. It does not influence the "Level" display or the response to the POW? query command.

The value is not affected by an instrument preset (PRESET key), *RST and the Save/Recall function. This parameter is influenced only by the factory preset (SYST:FPR) and its factory value is equal to the upper limit.

Parameters:

<Amplitude> float

Minimum level ... Maximum level

The value range for the level setting varies according to the instrument model.

The value range depends on whether or not the instrument is equipped with the option High Power.

The values are given in the data sheet.

Increment: 0.01 dB

*RST: 30 dBm

Default unit: dBm

Example: SOURce:POWer:LIMit:AMPLitude 10
or
:POW:LIM 10
limits the RF level to maximum +10 dBm.

Usage: SCPI confirmed

[:SOURce<hw>]:POWER:MANual <Manual>

In Sweep mode (:SOUR:POW:MODE SWE) the command sets the level for the next sweep step in the Step sweep mode (:SOUR:SWE:POW:MODE MAN). Here only level values between the settings [:SOUR]:POW:STAR and [:SOUR]:POW:STOP are permitted. Each sweep step is triggered by a separate :SOUR:POW:MAN command.

As with the "Level" value entered in the "RF Level" menu, the OFFSet value is also taken into consideration with this command.

The specified value range is therefore only effective if :SOURce:POWer:OFFSet is set to 0. The value range for other OFFset values can be calculated using the following formula:

Minimum level + OFFSet ... Maximum level + OFFSet

Parameters:

<Manual>

float

Minimum level ... Maximum level

The value range for the level setting varies according to the instrument model

The value range depends on whether or not the instrument is equipped with the option **High Power**.

The values are given in the data sheet.

Increment: 0.01 dBm

*RST: -30 dBm

Default unit: dBm

Example:

```
POW:SWE:MODE MAN
```

sets the Step sweep mode for RF output A.

```
POW:MAN -5 dBm
```

sets an RF level of -5 dBm for the next setting in the Step sweep mode for RF output A.

```
POW:MODE SWE
```

sets the Level Sweep mode for RF output A.

```
POW:MAN -5.5 dBm
```

triggers the next sweep step with a level of -5.5 dBm.

Usage:

SCPI confirmed

[[:SOURce<hw>]:POWer:MODE <Mode>

The command sets the instrument operating mode and therefore also the commands used to set the output level.

In case of two-path instrument, this affects the selected path.

Parameters:

<Mode>

CW | FIXed | SWEep

CW|FIXed

The instrument operates at a constant level. CW and FIXed are synonyms. The output level is set with :SOURce:POWer.

SWEep

The instrument operates in SWEep mode.

The level is set using the commands SOURce:POWer:START; STOP; MANual.

LIST

The instrument processes a list of frequency and level settings. The List mode settings are made in the [SOURce:LIST Subsystem](#) subsystem.

The setting SOURce:POWer:MODE LIST also sets the command SOURce:FREQuency:MODE automatically to LIST.

*RST: CW

Example: `POW:MODE SWEEp`
sets the SWEEp mode. The settings under `SOURCE:POW:START; STOP; MANual` become effective.

Usage: SCPI confirmed

`[:SOURCE<hw>]:POWER:PEP?`

With digital modulation and all digital standards, the command returns the peak envelope power (PEP) in dBm (the value which is shown under the **Level** specification in the PEP lines in the display header).

Return values:

<Pep> float

Example: `POW:PEP?`
queries the PEP value for RF output A in the case of digital modulation.
Response: 4
the PEP value for RF output A is 4 dBm.

Usage: Query only
SCPI confirmed

`[:SOURCE<hw>]:POWER:POWER <Power>`

Sets the RF level of the RF output connector.

The level entered with this command corresponds to the level at the RF output, i.e. any offset entry is not taken into consideration.

Note: The SCPI command `[:SOURCE<hw>]:POWER[:LEVEL][:IMMEDIATE][:AMPLITUDE]` sets the level of the the "Level" display, i.e. the level containing offset.

Parameters:

<Power> Minimum level ... Maximum level
The value range for the level setting varies according to the instrument model.
The value range depends on whether or not the instrument is equipped with the option **High Power**.
The values are given in the data sheet.
Increment: 0.01 dB
*RST: -30 dBm
Default unit: dBm

Example: `SOUR:POW:POW 15`
sets the RF level at output to 15 dBm.

`[:SOURCE<hw>]:POWER:START <Start>`

The command sets the RF start level in Sweep mode.

As with the "Level" value entered in the "RF Level" menu, the `OFFSet` value is also taken into consideration with this command.

The specified value range is therefore only effective if `:SOURce:POWer:OFFSet` is set to 0. The value range for other `OFFSet` values can be calculated using the following formula:

Minimum level + `OFFSet` ... Maximum level + `OFFSet`

Parameters:

<Start> float

Minimum level ... Maximum level

The value range for the level setting varies according to the instrument model. The values are given in the data sheet.

The value range additionally depends on whether or not the instrument is equipped with the option High Power.

Increment: 0.01 dB

*RST: -30 dBm

Default unit: dBm

Example:

`POW:STAR -20 dBm`

sets the start level for the level sweep to -15 dBm for RF output A.

Usage:

SCPI confirmed

`[:SOURce<hw>]:POWer:STEP[:INCRement] <Increment>`

The command sets the step width for the level setting if `UP` and `DOWN` are used as the level values and variation mode `:SOUR:POW:STEP:MODE USER` is selected. The command is linked to setting "Variation Step" for manual control, i.e. the command also sets the step width of the rotary knob for "Variation Active On".

In the case of two-path instruments, the step width can be set separately for each path.

Parameters:

<Increment> float

Range: 0 dB to 100 dB

Increment: 0.01 dB

*RST: 1 dB

Default unit: dB

Example:

`SOURce:POWer:STEP:INCRement 2`

or

`POW:STEP 2`

sets the step width for entering the RF level to 2 dB.

`[:SOURce<hw>]:POWer:STEP:MODE <Mode>`

This command activates (`USER`) or deactivates (`DECimal`) the user-defined step width used when varying the level value with the level values `UP/DOWN`. The command is linked to setting "Variation Active" for manual control, i.e. the command also activates/deactivates the user-defined step width used when varying the level value with the rotary knob.

In the case of two-path instruments, the step width can be set separately for each path.

Parameters:

<Mode> DECimal | USER
*RST: DECimal

Example:

POW:STEP 2
sets the step width for the level setting to 2 dB.
POW:STEP:MODE USER
activates this step width for level variation with the rotary knob (manual control) and with level values UP/DOWN (remote control).

[:SOURce<hw>]:POWer:STOP <Stop>

The command sets the stop level in Sweep mode.

As with the **Level** value entered in the **RF Level** menu, the **OFFSet** value is also taken into consideration with this command.

The specified value range is therefore only effective if **:SOURce:POWer:OFFSet** is set to 0. The value range for other **OFFSet** values can be calculated using the following formula:

Minimum level + **OFFSet** ... Maximum level + **OFFSet**

Parameters:

<Stop> float

Minimum level ... Maximum level

The value range for the level setting varies according to the instrument model.

The value range depends on whether or not the instrument is equipped with the option **High Power**.

The values are given in the data sheet.

Increment: 0.01 dB

*RST: -10 dBm

Default unit: dBm

Example:

POW:STOP 3
sets the stop level for the level sweep to 3 dBm for RF output A.

Usage:

SCPI confirmed

6.15.18 SOURce:PULM Subsystem

This subsystem contains the commands for setting the pulse modulation.

The LF generator is used as the internal modulation source. The pulse frequency of the internal rectangular signal is therefore set in the **SOURce:LFOuTput** subsystem.

[:SOURce<hw>]:PULM:POLarity.....781
[:SOURce<hw>]:PULM:SOURce.....781
[:SOURce<hw>]:PULM:STATe.....781

[:SOURce<hw>]:PULM:POLarity <Polarity>

The command sets the polarity between modulating and modulated signal. This command is only effective for an external modulation signal.

Parameters:

<Polarity> NORMal | INVerted

NORMal

The RF signal is suppressed during the pulse pause.

INVerted

The RF signal is suppressed during the pulse.

*RST: NORMal

Example:

PULM:SOUR EXT

selects the external modulation source.

Example:

PULM:POL INV

selects inverted polarity.

[:SOURce<hw>]:PULM:SOURce <Source>

The command selects the source for pulse modulation.

Parameters:

<Source> INTernal | EXTernal

INTernal

The internally generated rectangular signal is used for the pulse modulation. The frequency of the internal signal can be set in the SOURce:LFOutput subsystem.

EXTernal

The signal applied externally via the EXT MOD connector is used for the pulse modulation.

*RST: INTernal

Example:

PULM:SOUR INT

selects the internal modulation source.

Example:

PULM:STAT ON

activates the pulse modulation.

Usage:

SCPI confirmed

[:SOURce<hw>]:PULM:STATe <State>

The command activates/deactivates the pulse modulation.

Parameters:

<State> 0 | 1 | OFF | ON

*RST: OFF

Example: PULM:STAT ON
activates pulse modulation with the modulation source selected under SOURce:PULM:SOURce.

Usage: SCPI confirmed

6.15.19 SOURce:ROSCillator Subsystem

This subsystem contains the commands for setting the external and internal reference frequency.



The commands of this subsystem are not affected by an instrument reset (*RST on page 500).

[SOURce]:ROSCillator:EXTernal:FREQuency.....	782
[SOURce]:ROSCillator:EXTernal:RFOff:STATe.....	782
[SOURce]:ROSCillator:EXTernal:SBANdwidth.....	783
[SOURce]:ROSCillator[:INTernal]:ADJust:VALue.....	783
[SOURce]:ROSCillator[:INTernal]:ADJust[:STATe].....	783
[SOURce]:ROSCillator:SOURce.....	784

[SOURce]:ROSCillator:EXTernal:FREQuency <Frequency>

The command informs the instrument of the frequency of the external reference.

Parameters:

<Frequency> 5MHz | 10MHz | 13MHz
Default unit: Hz

Example:

ROSC:SOUR EXT
selects the external source. The reference must be input at the REF IN input.

ROSC:EXT:FREQ 5MHz
informs the instrument that the external reference frequency is 5MHz.

Usage: SCPI confirmed

[SOURce]:ROSCillator:EXTernal:RFOff:STATe <State>

The command determines if the RF output is switched off in case of a missing external reference signal for selection external source.

If enabled, this setting ensures that no improper RF signal due to the missing external reference signal is output and used for measurements.

In addition to the error message "Ext Ref missing", message "RF output deactivated" is generated.

Parameters:

<State> 0 | 1 | OFF | ON

Example: `ROSC:SOUR EXT`
selects the external source. The reference must be input at the REF IN input.

Example: `ROSC:EXT:RFOF:STAT ON`
In case of a missing external signal, no RF signal is output.

[:SOURce]:ROSCillator:EXTernal:SBANdwidth <Sbandwidth>

The command selects the synchronization bandwidth for an external reference signal.

Parameters:

<Sbandwidth> WIDE | NARRow
NARRow
 Synchronization bandwidth is approx. 1 Hz.
WIDE
 Synchronization bandwidth is approx. 750 Hz.

Example: `ROSC:SOUR EXT`
selects the external source.
`ROSC:EXT:FREQ 5 MHz`
informs the instrument that the external reference has a frequency of 5 MHz.
`ROSC:EXT:SBAN WID`
selects wideband setting for synchronization bandwidth.

[:SOURce]:ROSCillator[:INTernal]:ADJust:VALue <Value>

The command specifies the frequency correction value (adjustment value).

Parameters:

<Value> float
 Range: 0 to 4095
 Increment: 1

Example: `ROSC:ADJ:VAL 1400`
sets the adjustment value to 1400.

[:SOURce]:ROSCillator[:INTernal]:ADJust[:STATe] <State>

The command determines whether the calibrated (OFF) or a user-defined (ON) adjustment value is used for fine adjustment of the frequency. With STATe ON, the instrument is no longer in the calibrated state. However, the calibration value is not changed and the instrument resumes the calibrated state after switching the Adjustment State to Off.

Parameters:

<State> 0 | 1 | OFF | ON
 *RST: 0

Example:

```
ROSC:SOUR INT
selects the internal source.
ROSC:ADJ ON
activates use of a user-defined adjustment value.
ROSC:ADJ:VAL 1400
sets the adjustment value to 1400.
```

[:SOURce]:ROSCillator:SOURce <Source>

The command selects between internal and external reference frequency.

Parameters:

<Source> INTernal | EXTernal

INTernal

The internal reference oscillator is used.

EXTernal

An external reference signal is used. It must be input at the REF IN connector at the rear of the instrument.

The instrument is informed of the frequency of the external reference signal by means of the command `[:SOURce] :ROSCillator:EXTernal:FREQuency`.

`ROSCillator:EXTernal:FREQuency`.

Example:

```
ROSC:SOUR EXT
selects the external source.
ROSC:EXT:FREQ 5 MHz
informs the instrument that the external reference has a frequency of 5 MHz.
```

6.15.20 SOURce:SWEep Subsystem

This subsystem contains the commands for checking the RF sweeps, i.e. the sweeps of the RF generators. Sweeps are always triggered, except for the `MANual` sweep mode. The frequency sweep is activated by the command `SOURce:FREQuency:MODE SWEep`, and the level sweep by the command `SOURce:POWer:MODE SWEep`. All sweeps, including the LF sweep, can be set independently of each other.

This example shows how to set up a frequency sweep.

1. Set the sweep range.

```
[SOURce:]FREQuency:CENTer 200 MHz
[SOURce:]FREQuency:SPAN 300 MHz
```
2. Select linear or logarithmic spacing.

```
[SOURce:]SWEep[:FREQuency]:SPACing LIN
```
3. Set the step width and dwell time.

```
[SOURce:]SWEep[:FREQuency]:STEP:LINear 20 MHz
[SOURce:]SWEep[:FREQuency]:DWELl 12 ms
```
4. Select the trigger mode.

TRIGger:]FSweep:SOURce SINGLE

5. Select the sweep mode and activate the sweep.

```
[SOURce:]SWEep[:FREQuency]:MODE AUTO
[SOURce:]FREQuency:MODE SWEep
```
6. Trigger the sweep.

```
[SOURce:]SWEep[:FREQuency]:EXECute
```



It is recommended to switch off the "GUI Update" for optimum sweep performance especially with short dwell times (`SYSTEM:DISPlay:UPDate OFF`).

<code>[:SOURce<hw>]:SWEep[:FREQuency]:DWELl</code>	785
<code>[:SOURce<hw>]:SWEep[:FREQuency]:EXECute</code>	786
<code>[:SOURce<hw>]:SWEep[:FREQuency]:MODE</code>	786
<code>[:SOURce<hw>]:SWEep[:FREQuency]:POINts</code>	786
<code>[:SOURce<hw>]:SWEep[:FREQuency]:SHAPE</code>	787
<code>[:SOURce<hw>]:SWEep[:FREQuency]:SPACing</code>	787
<code>[:SOURce<hw>]:SWEep[:FREQuency]:STEP[:LINear]</code>	788
<code>[:SOURce<hw>]:SWEep[:FREQuency]:STEP:LOGarithmic</code>	789
<code>[:SOURce<hw>]:SWEep:POWer:AMODE</code>	789
<code>[:SOURce<hw>]:SWEep:POWer:DWELl</code>	790
<code>[:SOURce<hw>]:SWEep:POWer:EXECute</code>	790
<code>[:SOURce<hw>]:SWEep:POWer:MODE</code>	790
<code>[:SOURce<hw>]:SWEep:POWer:POINts</code>	791
<code>[:SOURce<hw>]:SWEep:POWer:SHAPE</code>	791
<code>[:SOURce<hw>]:SWEep:POWer:SPACing:MODE</code>	791
<code>[:SOURce<hw>]:SWEep:POWer:STEP[:LOGarithmic]</code>	792
<code>[:SOURce<hw>]:SWEep:RESet[:ALL]</code>	792

`[:SOURce<hw>]:SWEep[:FREQuency]:DWELl <Dwell>`

The command sets the time taken for each frequency step of the sweep.

The keyword `[:FREQuency]` can be omitted (see example). The command is then SCPI-compliant.

Tip: It is recommended to switch off the "GUI Update" for optimum sweep performance especially with short dwell times (`SYSTEM:DISPlay:UPDate OFF`).

Parameters:

`<Dwell>` float
 Range: 2.0E-3 to 100
 Increment: 100.0E-6
 *RST: 15.0E-3
 Default unit: s

Example:

`SWE:DWEL 12 ms`
 sets a dwell time of 12 ms for a frequency sweep at the RF output.

[:SOURce<hw>]:SWEep[:FREQuency]:EXECute

The command triggers a sweep.

The command is only valid for sweep mode Single (SOURce :SWEep :FREQuency :MODE SINGLE). The command corresponds to the manual-control command "Execute Single Sweep".

Example: SWE:FREQ:EXEC
triggers a frequency sweep at the RF output.

Usage: Event

[:SOURce<hw>]:SWEep[:FREQuency]:MODE <Mode>

The command sets the sweep mode.

The keyword [:FREQuency] can be omitted (see example). The command is then SCPI-compliant.

Parameters:
<Mode> AUTO | MANual | STEP

AUTO

Each trigger triggers exactly one complete sweep.

MANual

The trigger system is not active. Each frequency step of the sweep is triggered individually, either by varying the "Current Frequency" value using the rotary knob under manual control or by means of a FREQ:MAN command under remote control. With manual control, the frequency increases or decreases (depending on the direction of the rotary encoder) by the value specified under FREQ:STEP:INCRement. With remote control, the frequency is set directly with the command :FREQ:MAN.

STEP

Each trigger triggers one sweep step only (Mode Single Step).

The frequency increases by the value entered under

SOUR:SWE:FREQ:STEP:LIN (linear spacing)

or . . . :STEP:LOG (logarithmic spacing).

*RST: AUTO

Example: SWE:MODE AUTO
selects **Mode Auto** for a frequency sweep at the RF output.

[:SOURce<hw>]:SWEep[:FREQuency]:POINTs <Points>

The command sets the number of steps in an RF sweep.

The command is linked to the command :SWEep [:FREQuency] :STEP as follows:

- for linear sweeps
POINTs = (SPAN / STEP:LIN) + 1

- logarithmic sweeps and $START < STOP$:
 $POINTS = ((\log STOP - \log START) / \log STEP:LOG) + 1$

If `POINTS` changes, the value of `STEP` is adjusted. The `START` and `STOP` value is retained.

Two separate `POINTS` values are used for linear or logarithmic sweep spacing (`:SWEep[:FREQUENCY]:SPACing LIN | LOG`). The command is always effective for the currently set sweep spacing.

Parameters:

<Points> float

Example:

`FREQ:STAR`

sets the start frequency to 100 MHz.

`FREQ:STOP`

sets the stop frequency to 500 MHz.

`SWE:SPAC LIN`

sets linear sweep spacing.

`SWE:POIN 401`

sets 401 sweep steps for linear sweep spacing. The sweep step width (`STEP`) is automatically set to 1 MHz.

[:SOURce<hw>]:SWEep[:FREQUENCY]:SHAPE <Shape>

The command sets the cycle mode for a sweep sequence (shape).

Parameters:

<Shape> SAWTooth | TRIangle

SAWTooth

One sweep runs from start to stop frequency. Each subsequent sweep starts at the start frequency, i.e. the shape of the sweep sequence resembles a sawtooth.

TRIangle

One sweep runs from start to stop frequency and back, i.e. the shape of the sweep resembles a triangle. Each subsequent sweep starts at the start frequency.

*RST: SAWTooth

Example:

`SOUR:SWE:SHAP TRI`

selects the sweep cycle with alternating ascending and descending sweep directions.

[:SOURce<hw>]:SWEep[:FREQUENCY]:SPACing <Spacing>

The command selects the sweep spacing.

The keyword `[:FREQUENCY]` can be omitted (see example). The command is then SCPI-compliant.

Parameters:

<Spacing>

LINear | LOGarithmic

LINear

With the linear sweep, the step width is a fixed frequency value which is added to the current frequency. The step width for linear sweep is entered in Hz (see [:SOURce<hw>]:SWEep[:FREQuency]:STEP[:LINear] on page 788).

LOGarithmic

With the logarithmic sweep, the step width is a constant fraction of the current frequency. This fraction is added to the current frequency. The logarithmic step width is entered in % (see [:SOURce<hw>]:SWEep[:FREQuency]:STEP:LOGarithmic on page 789).

*RST: LIN

Example:

SWE:SPAC LIN

selects linear sweep spacing for a frequency sweep at the RF output.

[:SOURce<hw>]:SWEep[:FREQuency]:STEP[:LINear] <Linear>

The command sets the step width for linear sweeps.

This command is linked to the command :SWEep[:FREQuency]:POINTs as follows:

$$\text{POINTs} = (\text{SPAN} / \text{STEP:LIN}) + 1$$

If STEP:LIN changes, the value of POINTs is adjusted. The START and STOP value is retained.

The keywords [:FREQuency] and [:LINear] can be omitted (see example). The command is then SCPI-compliant.

Parameters:

<Linear>

float

Range: 0 to (STOP - START)

Increment: 0.1Hz

*RST: 1MHz

Default unit: Hz

Example:

FREQ:STAR

sets the start frequency to 100 MHz.

FREQ:STOP

sets the stop frequency to 500 MHz.

SWE:SPAC LIN

sets linear sweep spacing.

SWE:STEP 2 MHz

sets the step width for linear sweep spacing to 2 MHz (RF sweep at the RF output. The number of sweep steps for linear sweep spacing (POINTs) is automatically set to 201.

[[:SOURce<hw>]:SWEep[:FREQuency]:STEP:LOGarithmic <Logarithmic>

The command specifies the step width factor for logarithmic sweeps. The next frequency value of a sweep is calculated (for `START < STOP`) using the following formula:

New frequency = Old frequency + `STEP:LOG` x Old frequency

`STEP:LOG` therefore gives the fraction of the old frequency. The frequency is increased by this fraction for the next sweep step. Usually `STEP:LOG` is given in percent, whereby the suffix `PCT` must always be used.

The command is linked to the command `:SWEep[:FREQuency]:POINTs` for `START < STOP` as follows:

$$\text{POINTs} = ((\log \text{STOP} - \log \text{START}) / \log \text{STEP:LOG}) + 1$$

If `STEP:LOG` changes, the value of `POINTs` is adjusted. The `START` and `STOP` value is retained.

Parameters:

<Logarithmic> float
 Range: 0.01 to 9999
 Increment: 0.01PCT
 *RST: 1PCT

Example:

```
FREQ:STAR
sets the start frequency to 100 MHz.
FREQ:STOP
sets the stop frequency to 500 MHz.
SWE:SPAC LOG
sets logarithmic sweep spacing.
SWE:STEP:LOG 10PCT
sets the step width for logarithmic sweep spacing to 10% of the
previous frequency in each instance (for a frequency sweep).
```

[[:SOURce<hw>]:SWEep:POWer:AMODe <Amode>

(With Option High Power only)

The command selects the ranges of level settings for the level sweep. The sweep is either performed in the low level or in the high level ranges.

Parameters:

<Amode> NORMAl | HPOWer
NORMAl
 The level settings are made in the range of the electronically switching attenuator. The high level ranges are not available.
HPOWer
 The level settings are made in the high level range.
 *RST: NORMAl

Example:

```
SWE:POW:AMOD HPOW
selects the high level ranges for level sweep.
```

[[:SOURce<hw>]:SWEep:POWer:DWELI <Dwell>

The command sets the time taken for each level step of the sweep.

Tip: It is recommended to switch off the "GUI Update" for optimum sweep performance especially with short dwell times (`SYSTem:DISPlay:UPDate OFF`).

Parameters:

<Dwell> float
 Range: 1.0E-3 to 100
 Increment: 100.0E-6
 *RST: 15.0E-3
 Default unit: s

Example:

`SWE:POW:DWEL 12 ms`
 sets a dwell time of 12 ms for a level sweep at the RF output.

[[:SOURce<hw>]:SWEep:POWer:EXECute

The command triggers a sweep.

Example:

`SWE:POW:EXEC`
 triggers a level sweep at the RF output.

Usage:

Event

[[:SOURce<hw>]:SWEep:POWer:MODE <Mode>

The command sets the cycle mode of the level sweep.

Parameters:

<Mode> AUTO | MANual | STEP

AUTO

Each trigger triggers exactly one complete sweep.

MANual

The trigger system is not active. Each level step of the sweep is triggered individually, either by varying the "Current Level" value using the rotary knob under manual control or by means of a `POW:MAN` command under remote control.

With manual control, the level increases or decreases (depending on the direction of the rotary encoder) by the value specified under `SOUR:SWE:POW:STEP`. With remote control, the level increases by the value specified under `SWEep:POW:STEP` which each sent `:POW:MAN` command, irrespective the value entered there.

STEP

Each trigger triggers one sweep step only. The level increases by the value entered under `:SWEep:POWer:STEP`.

*RST: AUTO

Example:

`SWE:POW:MODE AUTO`
 selects Mode Auto for a level sweep at RF output.

[[:SOURce<hw>]:SWEep:POWer:POINts <Points>

The command sets the number of steps in a level sweep. The command is linked to the command `:SWEep:POWer:STEP` as follows:

$$\text{POINTs} = ((\text{STOP} - \text{START}) / \text{STEP:LOG}) + 1$$

If `POINTs` changes, the value of `STEP` is adjusted. The `START` and `STOP` value is retained.

Parameters:

<Points> float
*RST: 20dB

Example:

`POW:STAR - 30 dBm`
sets the start frequency to -30 dBm.
`POW:STOP - 10 dBm`
sets the stop frequency to -10 dBm.
`SWE:POW:POIN 20`
sets 20 sweep steps. The sweep step width (`STEP`) is automatically set to 1 dB.

[[:SOURce<hw>]:SWEep:POWer:SHAPE <Shape>

The command sets the cycle mode for a sweep sequence (shape).

Parameters:

<Shape> SAWTooth | TRIangle

SAWTooth

One sweep runs from the start level to the stop level. The subsequent sweep starts at the start level again, i.e. the shape of sweep sequence resembles a sawtooth.

TRIangle

One sweep runs from start to stop level and back, i.e. the shape of the sweep resembles a triangle. Each subsequent sweep starts at the start level again.

*RST: SAWTooth

Example:

`SOUR:SWE:POW:SHAP TRI`
selects the sweep cycle with alternating ascending and descending sweep directions.

[[:SOURce<hw>]:SWEep:POWer:SPACing:MODE?

The command queries the sweep spacing. The sweep spacing for level sweeps is always linear.

Example:

`SWE:POW:SPAC:MODE?`
queries the sweep spacing for a level sweep at RF output.
Result: LIN
linear spacing

Usage:

Query only

[:SOURce<hw>]:SWEep:POWer:STEP[:LOGarithmic] <Logarithmic>

The command sets the step width factor for logarithmic sweeps. The next level value of a sweep is calculated (for `START < STOP`) using the following formula:

$$\text{New level} = \text{Old level} + \text{STEP:LOG} \times \text{Old level}$$

`STEP:LOG` therefore gives the fraction of the old level. The level is increased by this fraction for the next sweep step. Usually `STEP:LOG` is given in decibels, whereby the suffix `dB` must always be used.

The command is linked to the command `:SWEep:POWer:POINTs` for `START < STOP` as follows:

$$\text{POINTs} = ((\text{STOP} - \text{START}) / \text{STEP:LOG}) + 1$$

If `STEP:LOG` changes, the value of `POINTs` is adjusted. The `START` and `STOP` value is retained.

Parameters:

<Logarithmic> float
 Range: 0.01 to 165 dB
 Increment: 0.01dB
 *RST: 1
 Default unit: dB

Example:

`SWE:POW:STEP 10dB`

sets the step width for logarithmic sweep spacing to 10 dB of the previous level in each instance (for a level sweep).

[:SOURce<hw>]:SWEep:RESet[:ALL]

The command resets all active sweeps to the starting point.

Example:

`SWE:RES`

resets all active sweeps to the starting point.

6.16 STATus Subsystem

This system contains the commands for the status reporting system. *RST on page 500 has no effect on the status registers.

Queries return the current value of the respective register, which permits a check of the device status. A decimal value between 0 and 32767 ($=2^{15}-1$) is returned.

The configuration commands set the respective register thus determining which status changes of the R&S SMU causes the status registers to be changed. A decimal value between 0 and 32767 ($=2^{15}-1$) is set.

<code>STATus:OPERation:CONDition</code>	793
<code>STATus:OPERation:ENABLE</code>	793
<code>STATus:OPERation[:EVENT]</code>	793

STATus:OPERation:NTRansition.....	794
STATus:OPERation:PTRansition.....	794
STATus:PRESet.....	794
STATus:QUEStionable:CONDition.....	795
STATus:QUEStionable:ENABle.....	795
STATus:QUEStionable[:EVENT].....	795
STATus:QUEStionable:NTRansition.....	795
STATus:QUEStionable:PTRansition.....	796
STATus:QUEue[:NEXT].....	796

STATus:OPERation:CONDition? <Condition >

The command queries the content of the CONDition part of the STATus:OPERation register. This part contains information on the action currently being performed in the instrument. The content is not deleted after being read out since it indicates the current hardware status.

Parameters:

<Condition > string

Example:

STAT:OPER:COND
queries the Status:Operation:Condition register.

Usage:

Query only
SCPI confirmed

STATus:OPERation:ENABle <Enable>

The command sets the bits of the ENABle part of the STATus:OPERation register. This setting determines which events of the Status-Event part are forwarded to the sum bit in the status byte. These events can be used for a service request.

Parameters:

<Enable> string

Example:

STAT:OPER:ENAB 32767
all events are forwarded to the sum bit of the status byte.

Usage:

SCPI confirmed

STATus:OPERation[:EVENT]? <EVENT>

The command queries the content of the EVENT part of the STATus:OPERation register. This part contains information on the actions performed in the instrument since the last readout. The content of the EVENT part is deleted after being read out.

Parameters:

<EVENT> string

Example:

STAT:OPER:EVENT
queries the STATus:OPERation:EVENT register.

Usage: Query only
SCPI confirmed

STATus:OPERation:NTRansition <Ntransition>

The command sets the bits of the NTRansition part of the STATus:OPERation register. If a bit is set, a transition from 1 to 0 in the condition part causes an entry to be made in the EVENT part of the register. The disappearance of an event in the hardware is thus registered, e.g. the end of an adjustment.

Parameters:

<Ntransition> string

Example:

STAT:OPER:NTR 0

a transition from 1 to 0 in the condition part of the Status:Operation register does not cause an entry to be made in the EVENT part.

Usage: SCPI confirmed

STATus:OPERation:PTRansition <Ptransition>

The command sets the bits of the PTRansition part of the STATus:OPERation register. If a bit is set, a transition from 0 to 1 in the condition part causes an entry to be made in the EVENT part of the register. A new event in the hardware is thus registered, e.g. the start of an adjustment.

Parameters:

<Ptransition> string

Example:

STAT:OPER:PTR 32767

all transitions from 0 to 1 in the condition part of the Status:Operation register cause an entry to be made in the EVENT part.

Usage: SCPI confirmed

STATus:PRESet <Preset>

The command resets the status registers. All PTRansition parts are set to FFFFh (32767), i.e. all transitions from 0 to 1 are detected. All NTRansition parts are set to 0, i.e. a transition from 1 to 0 in a CONDition bit is not detected. The ENABLE parts of STATus:OPERation and STATus:QUESTionable are set to 0, i.e. all events in these registers are not passed on.

Parameters:

<Preset> string

Example:

STAT:PRES

resets the status registers.

Usage: Event
SCPI confirmed

STATus:QUESTionable:CONDition? <Condition >

The command queries the content of the CONDition part of the STATus:QUESTionable register. This part contains information on the action currently being performed in the instrument. The content is not deleted after being read out since it indicates the current hardware status.

Parameters:

<Condition > string

Example:

STAT:OPER:COND
queries the Status:Questionable:Condition register.

Usage:

Query only
SCPI confirmed

STATus:QUESTionable:ENABLE <Enable>

The command sets the bits of the ENABLE part of the STATus:QUESTionable register. This setting determines which events of the Status-Event part are enabled for the sum bit in the status byte. These events can be used for a service request.

Parameters:

<Enable> string

Example:

STAT:OPER:ENAB 1
problems when performing an adjustment cause an entry to be made in the sum bit.

Usage:

SCPI confirmed

STATus:QUESTionable[:EVENT]? <EVENT>

The command queries the content of the EVENT part of the STATus:QUESTionable register. This part contains information on the actions performed in the instrument since the last readout. The content of the EVENT part is deleted after being read out.

Parameters:

<EVENT> string

Example:

STAT:QUES:EVENT?
queries the Status:Questionable:Event register.

Usage:

Query only
SCPI confirmed

STATus:QUESTionable:NTRansition <Ntransition>

The command sets the bits of the NTRansition part of the STATus:QUESTionable register. If a bit is set, a transition from 1 to 0 in the condition part causes an entry to be made in the EVENT part of the register.

Parameters:

<Ntransition> string

Example:

STAT:OPER:NTR 0

A transition from 1 to 0 in the condition part of the Status:Questionable register does not cause an entry to be made in the EVENT part.

Usage:

SCPI confirmed

STATus:QUESTionable:PTRansition <Ptransition>

The command sets the bits of the NTRansition part of the STATus:QUESTionable register. If a bit is set, a transition from 1 to 0 in the condition part causes an entry to be made in the EVENT part of the register.

Parameters:

<Ptransition> string

Example:

STAT:OPER:PTR 32767

All transitions from 0 to 1 in the condition part of the Status:Questionable register cause an entry to be made in the EVENT part.

Usage:

SCPI confirmed

STATus:QUEue[:NEXT]?

The command queries the oldest entry in the error queue and then deletes it. Positive error numbers denote device-specific errors, and negative error numbers denote error messages defined by SCPI. If the error queue is empty, 0 ("No error") is returned. The command is identical to SYSTem:ERRor?

Return values:

<NEXT> string

Example:

STAT:QUE

queries the oldest entry in the error queue.

Response: 0, 'no error'

No errors have occurred since the error queue was last read out.

Usage:

Query only
SCPI confirmed

6.17 SYSTem Subsystem

The SYSTem subsystem contains a series of commands for general functions which do not directly affect signal generation.

:SYSTem:BEEPPer:STATe.....	797
:SYSTem:COMMunicate:GPIB:LTERminator.....	797
:SYSTem:COMMunicate:GPIB[:SELF]:ADDRess.....	798

:SYSTem:COMMunicate:NETWork[:COMMOn]:WORKGroup.....	798
:SYSTem:COMMunicate:NETWork:RESource.....	798
:SYSTem:COMMunicate:GPIB:RESource.....	798
:SYSTem:COMMunicate:SOCKet:RESource.....	799
:SYSTem:DATE.....	799
:SYSTem:DISPlay:UPDate.....	799
SYSTem:ERRor:ALL.....	799
SYSTem:ERRor:CODE:ALL.....	800
SYSTem:ERRor:CODE[:NEXT].....	800
SYSTem:ERRor:COUNT.....	800
SYSTem:ERRor[:NEXT].....	801
:SYSTem:KLOCK.....	801
:SYSTem:PROTect<ch>[:STATe].....	801
SYSTem:SERRor.....	802
:SYSTem:STARtup:COMPLete.....	802
:SYSTem:TIME.....	803
SYSTem:VERSion.....	803

:SYSTem:BEEPer:STATe <State>

This command switches the key beep on or off.

Parameters:

<State> 0 | 1 | OFF | ON
 *RST: OFF

Example:

SYST:BEEP:STAT OFF

No acoustic signal is output when a key on the front panel is pressed.

Usage:

SCPI confirmed

:SYSTem:COMMunicate:GPIB:LTERminator <Lterminator>

The command sets the terminator recognition for remote control via the IEC/IEEE bus.

Parameters:

<Lterminator> STANdard | EOI

EOI

The terminator must be sent together with the line message EOI (End of Line). This setting is recommended for binary block transmissions where a character could coincidentally have the value LF (Line Feed) but is not intended as the terminator. This setting must be selected for block data with undefined length.

STANdard

An LF (Line Feed) is recognized as the terminator regardless of whether it is sent with or without EOI.

*RST: STANdard

Example: `SYST:COMM:GPIB:LTER EOI`
only a character which is sent simultaneously with the line message EOI is accepted as the terminator.

:SYSTem:COMMunicate:GPIB[:SELF]:ADDRess <Address>

The command sets the GPIB address.

Parameters:

<Address> float
Range: 1 to 30
*RST: 28

Example: `SYST:COMM:GPIB:ADDR 14`
sets GPIB address.

Usage: SCPI confirmed

:SYSTem:COMMunicate:NETWork[:COMMon]:WORKgroup <Workgroup>

The command enters the individual workgroup name of the instrument.

Parameters:

<Workgroup> string

Example: `SYST:COMM:NETW:COMM:WORK 'TEST_09'`
enters the workgroup name 'TEST_09'.

:SYSTem:COMMunicate:NETWork:RESource <Resource>

The command queries the visa resource string. This string is used for remote control of the instrument.

Parameters:

<Resource> string

Example: `SYST:COMM:NETW:RES`
queries the VISA resource string.
Response: `TCPIP::192.1.2.3::INSTR`

:SYSTem:COMMunicate:GPIB:RESource?

The command queries the visa resource string for remote control via the GPIB interface. This string is used for remote control of the instrument.

To change the GPIB address, use the command `SYST:COMM:GPIB:ADDR.`

Return values:

<Resource> string

Example: `SYST:COMM:GPIB:RES`
queries the VISA resource string.
Response: `GPIB::28::INSTR`

Usage: Query only

:SYSTEM:COMMunicate:SOCKet:RESource?

The command queries the visa resource string for remote control via the Socket interface.

Return values:

<Resource> string

Example: SYST:COMM:SOCK:RES?

Usage: Query only

:SYSTEM:DATE <Date>

The command sets the date for the instrument-internal calendar.

Parameters:

<Date> <year>,<month>,<day>

Example: SYST:DATE 2011,05,01
sets May 1, 2011.

:SYSTEM:DISPlay:UPDate <Update>

The command switches the update of the display on/off. A switchover from remote control to manual control always sets the status of the update of the display to ON.

Parameters:

<Update> 0 | 1 | OFF | ON
*RST: ON

Example: SYST:DISP:UPD OFF
switches update of displayed parameter values off.

SYSTEM:ERRor:ALL?

The command queries all entries in the error queue and then deletes them.

Parameters:

<All> string

0

"No error", i.e the error queue is empty.

positive value

Positive error numbers denote device-specific errors.

negative value

Negative error numbers denote error messages defined by SCPI

Example:

SYST:ERR:ALL?

queries all entries in the error queue.

Response: 0, 'no error'

No errors have occurred since the error queue was last read out.

Usage: Query only

SYSTem:ERRor:CODE:ALL?

The command queries all entries in the error queue and then deletes them. Only the error numbers are returned and not the entire error text.

Return values:

<All> string
0
"No error", i.e. the error queue is empty
positive value
Positive error numbers denote device-specific errors
negative value
Negative error numbers denote error messages defined by SCPI.

Example:

```
SYST:ERR:CODE:ALL
queries all entries in the error queue.
Response: 0
no errors have occurred since the error queue was last read out.
```

Usage: Query only

SYSTem:ERRor:CODE[:NEXT]?

The command queries the oldest entry in the error queue and then deletes it. Only the error number is returned and not the entire error text.

Return values:

<Next> string
0
"No error", i.e. the error queue is empty
positive value
Positive error numbers denote device-specific errors
negative value
Negative error numbers denote error messages defined by SCPI.

Example:

```
SYST:ERR:CODE
queries the oldest entry in the error queue.
Response: 0
No errors have occurred since the error queue was last read out.
```

Usage: Query only

SYSTem:ERRor:COUNT?

The command queries the number of entries in the error queue. If the error queue is empty, '0' is returned.

Return values:**<Count>** string**Example:**`SYST:ERR:COUN`

queries the number of entries in the error queue.

Response: 1

One error has occurred since the error queue was last read out.

Usage:

Query only

SYSTem:ERRor[:NEXT]?

The command queries the oldest entry in the error queue and then deletes it.

The command is identical to the command `STATus:QUEue:NEXT`.**Return values:****<Next>** string**0**

"No error", i.e. the error queue is empty

positive value

Positive error numbers denote device-specific errors

negative value

Negative error numbers denote error messages defined by SCPI.

Example:`SYST:ERR?`

queries the oldest entry in the error queue.

Response: 0, 'no error'

No errors have occurred since the error queue was last read out.

Usage:

Query only

:SYSTem:KLOCK <Klock>This command (**K**eyboard **L**OCK) disables the front panel keyboard of the instrument including the LOCAL key, or enables it again (OFF).**Parameters:****<Klock>** 0 | 1 | OFF | ON***RST:** OFF**Example:**`SYST:KLOC ON`activates the keyboard lock. The keyboard cannot be operated again until it has been enabled with `SYST:KLOC OFF`.**:SYSTem:PROTECT<ch>[:STATe] <State>,<password>**

The command activates and deactivates the specified protection level.

Suffix:	
<ch>	Indicates the protection level. There are several protection levels which disable specific service functions (authorized personnel of R&S Service Departments only).
Parameters:	
<State>	0 1 OFF ON
<password>	The respective functions are disabled when the protection level is activated. No password is required for activation. A password must be entered to deactivate the protection level. The password for the first level is 123456. This protection level can be used to lock-out internal adjustments.
Example:	<pre>SYST:PROT1 ON</pre> <p>activates protection level 1. Internal adjustments are only possible after deactivating the lock-out.</p> <pre>SYST:PROT1 OFF, 123456</pre> <p>deactivates protection level 1. Internal adjustments are enabled again.</p>
Usage:	SCPI confirmed

SYSTem:SERRor?

This command returns a list of all errors existing at the time when the query is started. This list corresponds to the display on the info page under manual control.

Return values:

<Serror> string

Example:

```
SYST:SERR
```

queries all errors existing in the error queue.

Example: Response: -221, 'Settings conflict', 153, 'Input voltage out of range'
The two returned errors have occurred since the error queue was last queried.

Usage: Query only

:SYSTem:STARtup:COMPlete?

The command queries if the startup of the instrument is completed.

Return values:

<Complete> 0 | 1 | OFF | ON
*RST: 0

Example:

```
SYST:STAR:COMP
```

Response: 1
The startup of the instrument is completed.

Usage: Query only

:SYSTem:TIME <Time>

The command sets the time for the instrument-internal clock.

Parameters:

<Time> 0...23,0...59,0...59

Example:

SYST:TIME 12,0,0
sets the time to precisely 12 pm.

SYSTem:VERSion?

The command queries the SCPI version with which the instrument complies.

Return values:

<Version> string

Example:

SYST:VERS
queries the SCPI version.
Response: 1996
The instrument complies with the version from 1996.

Usage: Query only

6.18 TEST Subsystem

The TEST system contains the commands for performing the routines as well as for direct manipulation of the hardware assemblies (:TEST:DIRect).

The self tests return a "0" if the test is performed successfully, otherwise a value other than "0" is returned. None of the commands of this system have an *RST value.

NOTICE

Improper use may destroy the assembly!

The respective hardware assembly responds directly to the :TEST:DIRect command; any safety mechanisms are bypassed. The command is used for servicing purposes and should not be applied by the user.

:TEST:BB:CONNection.....	804
:TEST:BBIN.....	804
:TEST<hw>:BBIN:RBERror.....	804
:TEST<hw>:BBOut:LRATe.....	804
:TEST<hw>:BBOut:TTEST[:STATe].....	805
:TEST:CONNector:AUXio.....	805
:TEST<hw>:DIRect.....	805
:TEST:FADer.....	805

:TEST:BB:CONNECTION?

The command performs a connection test on each of the internal digital baseband links. This implies all installed options as baseband inputs, motherboard, universal coding generators, fading simulators, and baseband outputs.

Return values:

<Connection> 0 | 1 | OFF | ON

Example:

TEST:BB:CONNECTION?

Response: "0" on success, "1" on fail

Usage:

Query only

:TEST:BBIN?

This command performs a selftest on the baseband input hardware options. Several analog diagnostics points are checked to verify the correct function of the module.

Return values:

<Bbin> 0 | 1 | OFF | ON

Example:

TEST:BBIN?

Response: "0" on success, "1" on fail

Usage:

Query only

:TEST<hw>:BBIN:RBERROR?

This command performs a bit error rate test of the received test signal.

Return values:

<RbError> 0 | 1 | OFF | ON

Example:

TEST:BBIN:RBERROR?

Response: "0" on success, "1" on fail

Usage:

Query only

:TEST<hw>:BBOUt:LRATe <LRate>

The command sets the interface speed.

The "External LVDS Test" is used to check the correct data transmission of the digital baseband outputs (BBOUt).

This test is also used to the correct data reception of the digital baseband inputs (BBIN).

An external cable connection is needed to perform this test successfully. An output must be connected to an input with the digital I/Q cable. Always an input/output pair is tested together. The input and the output can be on the same instrument, or alternatively on two different instruments. Given an arbitrary cable connection, the appropriate Tx test can be activated with different interface speeds (LVDS rate).

On the connected input, this test sequence is received and can be compared with the expected test signal.

Parameters:

<LRate> float
Range: 66 MHz to 100 MHz

Example:

TEST:BBOut:LRATE 90MHZ
sets the LVDS interface rate to 90 MHz

:TEST<hw>:BBOut:TTEST[:STATE] <State>

This command activates the transmission of a known pseudo-random sequence (On).

Parameters:

<State> 0 | 1 | OFF | ON
*RST: 0

Example:

TEST:BBO:TTEST:STAT ON
starts the transmission of a signal test sequence .

:TEST:CONNector:AUXio?

The command triggers a test of the AUX IQ interface (see Service Manual Instrument, section "Performance Test"). This function is only available via remote control.

Example:

TEST:CONN:AUX?

Usage:

Query only

:TEST<hw>:DIRect <HW_assembly>,<subadress>,<hex data string>**:TEST<hw>:DIRect? <HW_assembly>,<subadress>**

The respective hardware assembly responds directly to the command; any safety mechanisms are bypassed. This function is only available via remote control.

Example:

TEST:DIR 'SSYN',0,#H12345678
TEST:DIR? 'SSYN',0
Response: #H12345678

:TEST:FADer?

This command performs a selftest on the fading simulator and the hardware options of the fading simulator extension.

Return values:

<Fader> 0 | 1 | OFF | ON

Example:

TEST:FAD?
Response: "0" on success, "1" on fail

Usage:

Query only

6.19 TRIGger Subsystem

The TRIGger system contains the commands for selecting the trigger source for the RF and LF sweep. The trigger input connectors are configured in the SOURce:INPut subsystem.

The trigger system of the R&S SMU is a simplified implementation of the SCPI trigger system. The TRIGger system differs from the SCPI system as follows:

- No INITiate command; the instrument behaves as if INITiate:CONTinuous ON were set.
- Under TRIGger several sweep subsystems exist.

Other commands associated with the trigger system of the R&S SMU can be found in the modulation and RF signal subsystems.

TRIGger<hw>

For one-path instruments:

- Suffix TRIGger<1|2> is not permitted
- TRIGger0 activates the LF output.

In case of two-path instruments, the numeric suffix to TRIGger determines also the path for which the trigger setting is effective:

- TRIGger[1] = path A
- TRIGger2 = path B

Table 6-3: Cross-reference between the manual and remote control

R&S name	SCPI name	Command under manual control
AUTO	IMMediate	"Auto" mode
SINGle	BUS	"Single" mode.
EXTernal	EXTernal	"Ext Single" and "Ext Step" mode. Use command LFO:SWEep:MODE to select between the two sweep modes.
EAUTO	-	"Ext Start/Stop" mode.

TRIGger0[:SWEep]:SOURce.....	807
:TRIGger<hw>:LFFSweep:SOURce.....	807
:TRIGger<hw>:FSWep[:IMMediate].....	807
:TRIGger<hw>:FSWep:SOURce.....	808
:TRIGger<hw>:PSWep[:IMMediate].....	808
:TRIGger<hw>:PSWep:SOURce.....	809
:TRIGger<hw>[:SWEep][:IMMediate].....	810
:TRIGger<hw>[:SWEep]:SOURce.....	810

TRIGger0[:SWEep]:SOURce <Source>
:TRIGger<hw>:LFFSweep:SOURce <Source>

The command sets the trigger source for the LF sweep. The trigger is triggered by the command `:SOURce:LFOutput:SWEep[:FREQuency]EXECute`.

The names of the parameters correspond directly to the various settings under manual control. SCPI uses other names for the parameters; these names are also accepted by the instrument. The SCPI names should be used if compatibility is an important consideration.

An overview of the various names is given in the [table 6-3](#).

Parameters:

<Source>	AUTO IMMEDIATE SINGLE BUS EXTERNAL EAUTO
	AUTO IMMEDIATE
	The trigger is free-running, i.e. the trigger condition is fulfilled continuously. As soon as one sweep is finished, the next sweep is started.
	SINGLE BUS
	One complete sweep cycle is triggered by the GPIB commands <code>[:SOURce]:LFOutput:SWEep[:FREQuency]:EXECute</code> or <code>*TRG</code> .
	The mode has to be set to AUTO (<code>[:SOURce]:LFOutput:SWEep[:FREQuency]:MODE</code>).
	EXTERNAL
	The sweep is triggered externally via the INST TRIG connector. Path A = BNC connector; Path B = Pin at AUX I/O interface
	EAUTO
	The sweep is triggered externally via the INST TRIG connector. As soon as one sweep is finished, the next sweep is started. A second trigger event stops the sweep at the current frequency, a third trigger event starts the trigger at the start frequency, and so on.
	*RST: SINGLE

Example: `TRIG:LFFS:SOUR EXT`
 selects triggering with an external trigger.

:TRIGger<hw>:FSWEEP[:IMMEDIATE]

The command immediately starts an RF frequency sweep cycle.

The command is only effective for sweep mode "Single" (`SOUR:SWE:FREQ:MODE AUTO` in combination with `TRIG:FSW:SOUR SING`).

The command corresponds to the manual control "Execute Single Sweep".

Example:	<pre>SWE:FREQ:MODE AUTO</pre> <p>sets the triggered sweep mode, i.e. a trigger is required to start the sweep.</p> <pre>TRIG:FSW:SOUR SING</pre> <p>sets the "Single" trigger mode, i.e. a trigger starts a single sweep.</p> <pre>TRIG:FSW</pre> <p>starts a single RF frequency sweep.</p>
Usage:	Event

:TRIGger<hw>:FSWEEP:SOURce <Source>

The command sets the trigger source for the RF frequency sweep.

The names of the parameters correspond directly to the various settings under manual control. SCPI uses other names for the parameters; these names are also accepted by the instrument. The SCPI names should be used if compatibility is an important consideration.

An overview of the various names is given in [table 6-3](#).

Parameters:

<Source>

AUTO | IMMEDIATE | SINGLE | BUS | EXTERNAL | EAUTO

AUTO|IMMEDIATE

The trigger is free-running, i.e. the trigger condition is fulfilled continuously. As soon as one sweep is finished, the next sweep is started.

SINGLE|BUS

One complete sweep cycle is triggered by the GPIB commands `[:SOURce<hw>] :SWEep [:FREQuency] :EXECute, :TRIGger<hw>:FSWEEP [:IMMEDIATE]` or *TRG. The mode has to be set to AUTO (`:SOURce:SWEep:FREQuency:MODE AUTO`).

EXTERNAL

The sweep is triggered externally via the INST TRIG connector. Path A = BNC connector; Path B = Pin at AUX I/O interface

EAUTO

The sweep is triggered externally via the INST TRIG connector. As soon as one sweep is finished, the next sweep is started. A second trigger event stops the sweep at the current frequency, a third trigger event starts the trigger at the start frequency, and so on.

*RST: SINGLE

Example:	<pre>TRIG:FSW:SOUR EXT</pre> <p>selects triggering with an external trigger.</p>
-----------------	--

:TRIGger<hw>:PSWEEP[:IMMEDIATE]

The command immediately starts an RF level sweep.

The command is only effective for sweep mode "Single" (SOURCE:SWEEP:POWER:MODE AUTO in combination with TRIG:PSW:SOUR SING).

The command corresponds to the manual control "Execute Single Sweep".

Example:

```
SWE:POW:MODE AUTO
selects the triggered sweep mode, i.e. a trigger is required to start
the sweep.
TRIG:PSW:SOUR AUTO
sets the Single trigger mode, i.e. a trigger starts a single sweep.
TRIG:PSW
starts a single RF level sweep.
```

Usage: Event

:TRIGger<hw>:PSWEEP:SOURce <Source>

The command sets the trigger source for the RF level sweep.

The names of the parameters correspond directly to the various settings under manual control. SCPI uses other names for the parameters; these names are also accepted by the instrument. The SCPI names should be used if compatibility is an important consideration.

An overview of the various names is given in [table 6-3](#).

Parameters:

<Source>

AUTO | IMMEDIATE | SINGLE | BUS | EXTERNAL | EAUTO

AUTO|IMMEDIATE

The trigger is free-running, i.e. the trigger condition is fulfilled continuously. As soon as one sweep is finished, the next sweep is started.

SINGLE|BUS

One complete sweep cycle is triggered by the GPIB commands [:SOURCE<hw>]:SWEEP:POWER:EXECUTE, :TRIGger<hw>:PSWEEP[:IMMEDIATE] or *TRG. The mode has to be set to AUTO (:SOURCE:SWEEP:LEVEL:MODE AUTO).

EXTERNAL

The sweep is triggered externally via the INST TRIG connector. Path A = BNC connector; Path B = Pin at AUX I/O interface

EAUTO

The sweep is triggered externally via the INST TRIG connector. As soon as one sweep is finished, the next sweep is started. A second trigger event stops the sweep at the current frequency, a third trigger event starts the trigger at the start frequency, and so on.

*RST: SINGLE

Example:

```
TRIG:PSW:SOUR EXT
selects triggering with an external trigger.
```

:TRIGger<hw>[:SWEep][:IMMediate]

The command starts all sweeps which are activated for the respective path. The command starts all sweeps which are activated.

The sweep to be executed depends on the respective MODE setting (`:SOUR:SWEep:POW|FREQ:MODE` and `:SOUR:LFO:SWEep[:FREQ]:MODE`).

The command corresponds to the manual-control command "Execute Trigger".

Example: TRIG
starts all active sweeps.

Usage: Event

:TRIGger<hw>[:SWEep]:SOURce <Source>

The command sets the trigger source for all sweeps.

The names of the parameters correspond directly to the various settings under manual control. SCPI uses other names for the parameters; these names are also accepted by the instrument. The SCPI names should be used if compatibility is an important consideration.

An overview of the various names is given in the [table 6-3](#).

Parameters:

<Source> AUTO | IMMediate | SINGle | BUS | EXTernal | EAUTO

AUTO|IMMediate
The trigger is free-running, i.e. the trigger condition is fulfilled continuously. As soon as one sweep is finished, the next sweep is started.

SINGle|BUS
One complete sweep cycle is triggered by the GPIB commands `:SOURce:SWEep:POWer|FREQuency:EXEC, TRIGger:PSWeep|FSWeep:IMMediate` or `*TRG`.
If `:SOURce:SWEep:POWer:MODE` is set to `STEP`, one step is executed.
The mode has to be set to `AUTO`.

EXTernal
The sweep is triggered externally via the INST TRIG connector. Path A = BNC connector; Path B = Pin at AUX I/O interface

EAUTO
The sweep is triggered externally via the INST TRIG connector. As soon as one sweep is finished, the next sweep is started. A second trigger event stops the sweep at the current frequency, a third trigger event starts the trigger at the start frequency, and so on.

*RST: SINGle

Example:	TRIG0:SOUR EXT selects triggering with an external trigger. The trigger is input via the INST TRIG connector.
Usage:	Setting only

6.20 UNIT Subsystem

The UNIT subsystem contains the commands specifying which units are valid if no unit is indicated in a command. These settings are valid for the entire instrument.

:UNIT:ANGLE <Angle>

The command defines the default unit for the phase modulation angle. It is not valid for other commands which determine angle values, e.g. RF phase. It does not influence the manual control parameter unit and the display.

Parameters:

<Angle> DEGree | DEGRee | RADian
*RST: RADian

Example: UNIT:ANGL DEG
sets default unit DEG for all commands which determine angle values.

:UNIT:POWer <Power>

The command defines the default unit for power. It is valid for all commands which determine power values. It does not influence the manual control parameter unit and the display.

Parameters:

<Power> V | DBUV | DBM
*RST: DBM

Example: UNIT:POW V
sets default unit V for all commands which determine power values.

6.21 Alphabetical List of R&S SMIQ Commands

The table lists the commands of the R&S SMIQ in the "R&S SMIQ command column" and describes their function in the "Short description" column. The symbol "X" in the "R&S SMU" column indicates that the command is also implemented in the R&S SMU. Differences between the two sets of commands are specified in the "Remarks" column.

Alphabetical List of R&S SMIQ Commands

R&S SMIQ Command	Short description	R&S SMU	Remarks
ABORT:...	Reset		
ABORT[:SWEep]	Reset sweep	X	
ABORT:LIST	Reset list mode	X	
BERT:...	Bit Error Rate Measurement		
BERT:RESult?	Result of the bit error rate measurement	X	
BERT:SEQuence	BERT Mode	X	
BERT:SETup:CLOCK[:POLarity]	Polarity of the active clock slope	X	
BERT:SETup:DATA[:POLarity]	Polarity of the active clock slope	X	
BERT:SETup:DENable	Configuration of the Data Enable input	X	
BERT:SETup:IGNore	Ignoring of complete 0 or 1 frames	X	
BERT:SETup:MCOunt	Number of data bits	X	
BERT:SETup:MERRor	Number of errors	X	
BERT:SETup:REStart:StAte	External restart of measurement	X	
BERT:SETup:TYPE	PRBS data	X	
BERT:START	Starting a measurement	X	
BERT:StAte	Starting a measurement	X	
BERT:STOP	Stopping a measurement	X	
BERT:UNIT	Unit for error rate display	X	
BLER:...	Block Error Rate Measurement		
BLER:RESult?	Result of the block error rate measurement	X	
BLER:SEQuence	BERT Mode	X	
BLER:SETup:CLOCK[:POLarity]	Polarity of the active clock slope	X	
BLER:SETup:DATA[:POLarity]	Polarity of the active clock slope	X	
BLER:SETup:DENable	Configuration of the Data Enable input	X	
BLER:SETup:MCOunt	Number of data blocks	X	
BLER:SETup:MERRor	Number of errors	X	
BLER:SETup:TYPE?	CRC polynomial	X	

Alphabetical List of R&S SMIQ Commands

R&S SMIQ Command	Short description	R&S SMU	Remarks
BLER:START	Starting a measurement	X	
BLER:STATE	Starting a measurement	X	
BLER:STOP	Stopping a measurement	X	
BLER:UNIT	Unit for error rate display	X	
ARB:...	Arbitrary Waveform Generator		[SOURCE<[1] 2>:]BB:ARB:...
ARB:ASET:...	Automatic settings on/off	-	
ARB:CLOCK	Clock rate	X	
ARB:CLOCK:DELAY	Clock delay	-	
ARB:CLOCK:SOURCE	Clock source	X	
ARB:IQ:...	IQ settings	-	
ARB:SEQUENCE	Trigger mode	X	
ARB:STATE	ARB generator on/off	X	
ARB:TRIGGER:DELAY	Trigger delay	X	
ARB:TRIGGER:INHIBIT	Trigger inhibition	X	
ARB:TRIGGER:OUTPUT<[1] 2>:DELAY	Marker delay	X	
ARB:TRIGGER:OUTPUT<[1] 2>:MODE	Marker signal	X	
ARB:TRIGGER:OUTPUT<[1] 2>:MODE:CATALOG	Marker files	-	
ARB:TRIGGER:OUTPUT<[1] 2>:OFFTIME	OFF period for TRIGGER:OUTPUT:MODE USER	X	OFF period for TRIGGER:OUTPUT:MODE RATIO
ARB:TRIGGER:OUTPUT<[1] 2>:ONTIME	ON period for TRIGGER:OUTPUT<[1] 2>:MODE USER	X	ON period for TRIGGER:OUTPUT<[1] 2>:MODE RATIO
ARB:TRIGGER:OUTPUT<[1] 2>:POLARITY	Polarity of marker signal	-	
ARB:TRIGGER:SOURCE	Trigger source	X	
ARB:WAVEFORM:CATALOG?	Waveform files	X	
ARB:WAVEFORM:CATALOG:LENGTH?	Number of waveform files	X	
ARB:WAVEFORM:DATA	Waveform data	X	
ARB:WAVEFORM:DELETE	Delete waveform	X	
ARB:WAVEFORM:FREE?	Free memory	-	
ARB:WAVEFORM:POINTS?	Waveform length	X	

Alphabetical List of R&S SMIQ Commands

R&S SMIQ Command	Short description	R&S SMU	Remarks
ARB:WAVEform:SElect	Select waveform file	X	
ARB:WAVEform:TAG?	Tag contents	X	
CALibration:...	Adjustment of instrument functions	-	New functions
CALibration:ALL?	Overall adjustment	X	
DIAGnostic:...	Calculate checksum of control list	-	New functions
DISPlay:...	Display Configuration	-	
FORMat:...	Data format		
FORMat:BORDER	Sequence of bytes within a binary block	X	
FORMat[:DATA]	Data format	X	
MEMory:...	Memory configuration	-	New functions
OUTPut[1]:...	RF output settings	X	OUTPut <ul style="list-style-type: none"> • OUTPut1 = path A • OUTPut2 = path B
OUTPut[1]:AFIXed:RANGe:LOWer?	Minimum level	X	
OUTPut[1]:AFIXed:RANGe:UPPer?	Maximum level	X	
OUTPut[1]:AMode	Attenuator mode	X	
OUTPut[1]:BLANK:POLarity?	Polarity of the No Signal (Blank) marker	X	
OUTPut[1]:IMPedance	Impedance of RF-output	-	
OUTPut[1]:PROTection:CLEar	Resets protective circuit	X	
OUTPut[1]:PROTection:TRIPped?	State of the protective circuit	X	
OUTPut[1][:STATe]	RF output on/off	X	
OUTPut[1][:STATe]:PON	State of RF-output after switch-on	X	
OUTPut2:...	LF output settings		LF output = SOURce:LFOutput: ...
OUTPut2:VOLTage	Output voltage of the LF output	X	
OUTPut2[:STATe]	LF output on/off	X	
[SOURce[1]:]AM:...	Amplitude Modulation		[SOURce<[1] 2>:]....
[SOURce[1]:]AM:BBAND[:STATe]	BB-AM on/off	X	

Alphabetical List of R&S SMIQ Commands

R&S SMIQ Command	Short description	R&S SMU	Remarks
[SOURCE[1]:]AM[:DEPTH]	Modulation depth AM	X	
[SOURCE[1]:]AM:EXTERNAL:COUPLING	Coupling mode EXT MOD (AM) input	X	
[SOURCE[1]:]AM:INTERNAL:FREQUENCY	AM modulation frequency	X	
[SOURCE[1]:]AM:SOURCE	AM modulation source	X	
[SOURCE[1]:]AM:STATE	AM on/off	X	
[SOURCE[1]:]CORRECTION:....	User Correction		[SOURCE<[1] 2>:]....
[SOURCE[1]:]CORRECTION:CSET:CATALOG?	List of user correction tables	X	
[SOURCE[1]:]CORRECTION:CSET:DATA:FREQUENCY	Frequency data	X	
[SOURCE[1]:]CORRECTION:CSET:DATA:POWER	Level data	X	
[SOURCE[1]:]CORRECTION:CSET:DELETE	Deletes the specified table	X	
[SOURCE[1]:]CORRECTION:CSET[:SELECT]	Table for user correction	X	
[SOURCE[1]:]CORRECTION[:STATE]	Level correction	X	
[SOURCE[1]:]DM:....	Custom Dig Mod		[SOURCE<[1] 2>:]BB:DM:....
[SOURCE[1]:]DM:ASK:DEPTH	ASK depth	X	
[SOURCE[1]:]DM:CLIST:CATALOG?	Query control list catalog	X	
[SOURCE[1]:]DM:CLIST:CONTROL[:STATE]	Enable control list	-	
[SOURCE[1]:]DM:CLIST:COPY	Copy control list	X	
[SOURCE[1]:]DM:CLIST:DATA	Control list data	X	
[SOURCE[1]:]DM:CLIST:DELETE	Delete Control list	X	
[SOURCE[1]:]DM:CLIST:FREE?	Free space for control data	X	
[SOURCE[1]:]DM:CLIST:POINTS?	Query length of control list	X	
[SOURCE[1]:]DM:CLIST:SELECT	Select control list	X	
[SOURCE[1]:]DM:CLOCK:DELAY	Clock delay	-	
[SOURCE[1]:]DM:CLOCK:MODE	Clock mode	X	

Alphabetical List of R&S SMIQ Commands

R&S SMIQ Command	Short description	R&S SMU	Remarks
[SOURce[1]:]DM:CLOCK:POLarity	Clock Polarity	-	
[SOURce[1]:]DM:CLOCK:SOURce	Clock source	X	
[SOURce[1]:]DM:CODing	Coding	X	
[SOURce[1]:]DM:DLIST:CATAlog?	Queries data list catalog	X	
[SOURce[1]:]DM:DLIST:COPIY	Copy data list	X	
[SOURce[1]:]DM:DLIST:DATA	Fill data into data list	X	
[SOURce[1]:]DM:DLIST:DATA:APPend	Append data in data list	X	
[SOURce[1]:]DM:DLIST:DATA?	Read out data of data list	X	
[SOURce[1]:]DM:DLIST:DELEte	Delete Data list	X	
[SOURce[1]:]DM:DLIST:FREE?	Free space for data	X	
[SOURce[1]:]DM:DLIST:POINTs?	Query length of data list	X	
[SOURce[1]:]DM:DLIST:SELEct	Select data list	X	
[SOURce[1]:]DM:FILTEr:MODE	Filter mode	-	
[SOURce[1]:]DM:FILTEr:PARAMeter	Filter parameter	-	
[SOURce[1]:]DM:FILTEr:TYPE	Filter type	X	
[SOURce[1]:]DM:FLIST:...	Filter lists	-	
[SOURce[1]:]DM:FORMat	Modulation type	X	
[SOURce[1]:]DM:FSK:DEVIation	Frequency deviation	X	
[SOURce[1]:]DM:INPUt:IMPedance	Impedance of all data and clock inputs	X	
[SOURce[1]:]DM:LDISTortion:STATe	Low distortion on/off	-	
[SOURce[1]:]DM:MDELAy?	Modulation delay for external modulation	X	
[SOURce[1]:]DM:MLIST:..	Mapping lists	-	
[SOURce[1]:]DM:PATTern	Data pattern	X	
[SOURce[1]:]DM:PRAMP:ATTenuation	Level attenuation	X	
[SOURce[1]:]DM:PRAMP:DELAy	Position of ramp envelope	-	
[SOURce[1]:]DM:PRAMP:SHAPE	Edge shape	X	

Alphabetical List of R&S SMIQ Commands

R&S SMIQ Command	Short description	R&S SMU	Remarks
[SOURce[1]:]DM:PRAMP: SOURce	Source for the power ramp control signals	X	
[SOURce[1]:]DM:PRAMP:TIME	Power ramping rise time and fall time	X	
[SOURce[1]:]DM:PRAMP[: STATe]	Power ramping on/off	X	
[SOURce[1]:]DM:PRBS[: LENGth]	PRBS length	X	
[SOURce[1]:]DM:SEQuence	Trigger mode	X	
[SOURce[1]:]DM:SOURce	Data source	X	
[SOURce[1]:]DM:SRATe	Symbol rate	X	
[SOURce[1]:]DM:STANdard	Standard	X	
[SOURce[1]:]DM:STATe	Digital modulation on/off	X	
[SOURce[1]:]DM:THREshold[: ALL]	High/low threshold of digital inputs	X	
[SOURce[1]:]DM:TRIGger: DELay	Trigger delay	X	
[SOURce[1]:]DM:TRIGger: INHibit	Trigger inhibition	X	
[SOURce[1]:]DM:TRIGger: SLOPe	Trigger slope	X	
[SOURce[1]:]DM:TRIGger: SOURce	Trigger source	X	
[SOURce[1]:]DM:IQ:---	I/Q modulation	-	SOURce<[1] 2>:IQ: ...
[SOURce[1]:]DM:IQ: CREStfactor	Crest-Factor	X	
[SOURce[1]:]DM:IQ:FILTer: FREQuency	Select I/Q filter	-	
[SOURce[1]:]DM:IQ:FILTer: STATe	IQ-Filter on/off	-	
[SOURce[1]:]DM:IQ: IMPAirment[:STATe]	IQ impairment on/off	X	
[SOURce[1]:]DM:IQ: LEAKage[:MAGNitude]	Leakage amplitude for the Q-channel	X	
[SOURce[1]:]DM:IQ: QUADrature:ANGLE	Quadrature offset	X	
[SOURce[1]:]DM:IQ:PRAMP	Power ramping state	-	
[SOURce[1]:]DM:IQ:STATe	I/Q-modulation on/off	X	
[SOURce[1]:]DM:IQ: TRANsition	IQ filter transition time	-	

Alphabetical List of R&S SMIQ Commands

R&S SMIQ Command	Short description	R&S SMU	Remarks
[SOURce[1]:]DM:IQRatio[:MAGNitude]	Imbalance	X	
[SOURce[1]:]DM:IQSWap[:STATe]	Swaps the I and Q channels	X	
[SOURce[1]:]FM:....			
[SOURce[1]:]FM[:DEVIation]	FM deviation	X	
[SOURce[1]:]FM:EXTernal1 2:COUPling	Coupling of external mod. input	X	
[SOURce[1]:]FM:INTernal:FREQuency	Modulation frequency	X	
[SOURce[1]:]FM:PREEmphasis	Preemphasis	-	
[SOURce[1]:]FM:SOURce	Modulation source	X	
[SOURce[1]:]FM:STATe	State	X	
[SOURce[1]:]FREQuency:....			SOURce<[1] 2>
[SOURce[1]:]FREQuency:CENTer	RF-sweep center frequency	X	
[SOURce[1]:]FREQuency[:CW FIXed]	RF frequency	X	
[SOURce[1]:]FREQuency[:CW :FIXed]:RCL	Recall RF frequency	X	
[SOURce[1]:]FREQuency:MANual	Frequency for the next sweep step	X	
[SOURce[1]:]FREQuency:MODE	RF operating mode	X	
[SOURce[1]:]FREQuency:OFFSet	RF-frequency offset	X	
[SOURce[1]:]FREQuency:SPAN	Span for the sweep	X	
[SOURce[1]:]FREQuency:START	Start frequency for the sweep mode	X	
[SOURce[1]:]FREQuency:STEP[:INCRement]	Step width for the frequency setting	X	
[SOURce[1]:]FREQuency:STOP	Stop frequency for the sweep mode	X	
:SOURce2:....	LF generator frequency		SOURce:LFOutput:FREQuency
:SOURce2:FREQuency:MODE	LF operating mode	X	
:SOURce2:FREQuency:START	Start frequency for the LF Sweep	X	
:SOURce2:FREQuency:STOP	Stop frequency for the LF sweep	X	

Alphabetical List of R&S SMIQ Commands

R&S SMIQ Command	Short description	R&S SMU	Remarks
:SOURce2:FREQuency[: CW FIXed]	Frequency LF signal	X	
[SOURce[1]:]FSIMulator:	Fading Simulation		
[SOURce[1]:]FSIMulator: BIRThdeath:DEFault	Default Birth Death	-	
[SOURce[1]:]FSIMulator: BIRThdeath:ILOSS:MODE	Insertion loss mode	-	
[SOURce[1]:]FSIMulator: BIRThdeath:PATH:SPEEd	Speed of moving path	X	
[SOURce[1]:]FSIMulator: BIRThdeath:SPEEd:UNIT	Speed unit for Birth Death	-	
[SOURce[1]:]FSIMulator: BIRThdeath:STATe	Birth Death on/off	X	
[SOURce[1]:]FSIMulator: CFACtor:EXTern	Crest factor for two channel fading	-	
[SOURce[1]:]FSIMulator: CONFigure	Number of paths	-	
[SOURce[1]:]FSIMulator: COUPle:CORRelation: COEFFicient	Coupling of correlation coefficient	-	
[SOURce[1]:]FSIMulator: COUPle:LOGNormal:CSTD	Coupling of standard deviation	X	
[SOURce[1]:]FSIMulator: COUPle:LOGNormal:LCONstant	Coupling of local constant	X	
[SOURce[1]:]FSIMulator: COUPle:SPEEd	Coupling of speed	X	
[SOURce[1]:]FSIMulator: Default	Preset fading simulation	X	
[SOURce[1]:]FSIMulator: FDElay:Delay	Delay Fine Delay	-	
[SOURce[1]:]FSIMulator: FDElay:PATH<n>:FDOPpler	Doppler shift Fine Delay	X	
[SOURce[1]:]FSIMulator: FDElay:PATH<n>:FRATio	Ratio of doppler frequencies	X	
[SOURce[1]:]FSIMulator: FDElay:PATH<n>:LOSS	Path attenuation	X	
[SOURce[1]:]FSIMulator: FDElay:PATH<n>:PROFile	Fading profile	X	
[SOURce[1]:]FSIMulator: FDElay:PATH<n>:SPEEd	Speed	X	
[SOURce[1]:]FSIMulator: FDElay:PATH<n>:STATe	path on/off	X	

Alphabetical List of R&S SMIQ Commands

R&S SMIQ Command	Short description	R&S SMU	Remarks
[SOURce[1]:]FSIMulator: FDElay:SPEEd:UNIT	Speed unit Fine Delay	-	
[SOURce[1]:]FSIMulator: FDElay:STANdard	Standard Fine Delay	-	
[SOURce[1]:]FSIMulator: FDElay[:STATe]	Fine Delay configuration on/off	X	
[SOURce[1]:]FSIMulator: IGNore:RFCHanges	Ignore frequency changes	X	
[SOURce[1]:]FSIMulator: ILOs:MODE	Insertion loss	X	
[SOURce[1]:]FSIMulator: MDElay:DEFault	Default Moving Delay	-	
[SOURce[1]:]FSIMulator: MDElay:MOVing:DElay:MEAN	Mean delay	X	
[SOURce[1]:]FSIMulator: MDElay:MOVing:DElay: VARiation	Delay range	X	
[SOURce[1]:]FSIMulator: MDElay:MOVing:LOSS	Insertion loss of moving path	X	
[SOURce[1]:]FSIMulator: MDElay:MOVing:VPERiod	Speed of the delay variation	X	
[SOURce[1]:]FSIMulator: MDElay:STATe	Moving Delay State	X	
[SOURce[1]:]FSIMulator: PATH:DCOMponent:STATe	Discrete component on/off	-	
[SOURce[1]:]FSIMulator: PATH<n>:CORRelation: COEFFicient	Correlation coefficient	X	
[SOURce[1]:]FSIMulator: PATH<n>:CORRelation:PATH	Correlation off and pcorrelated pathsPfade	-	
[SOURce[1]:]FSIMulator: PATH<n>:CORRelation:PHASe	Correlation phase	X	
[SOURce[1]:]FSIMulator: PATH<n>:CPHase	Constant phase	X	
[SOURce[1]:]FSIMulator: PATH<n>:FDOPpler	Doppler shift	X	
[SOURce[1]:]FSIMulator: PATH:FRATio	Ratio of Doppler frequencies	X	
[SOURce[1]:]FSIMulator: PATH<n>:LOGNormal:CSTD	Standard deviation Lognormal Fading	X	
[SOURce[1]:]FSIMulator: PATH<n>:LOGNormal: LCONstant	Local constant Lognormal-Fading	X	

Alphabetical List of R&S SMIQ Commands

R&S SMIQ Command	Short description	R&S SMU	Remarks
[SOURce[1]]:FSIMulator:PATH<n>:LOGNormal:STATe	Lognormal fading on/off	X	
[SOURce[1]]:FSIMulator:PATH<n>:LOSS	Path loss	X	
[SOURce[1]]:FSIMulator:PATH<n>:PROFile	Fading profile	X	
[SOURce[1]]:FSIMulator:PATH<n>:PRATio	Power ratio Rice-Fading	X	
[SOURce[1]]:FSIMulator:PATH<n>:SPEEd	Speed	X	
[SOURce[1]]:FSIMulator:PATH<n>:STATe	Path on/off	X	
[SOURce[1]]:FSIMulator:SEQuence	Pseudo Noise Generator on/off	-	
[SOURce[1]]:FSIMulator:SEQuence:RESet	Reset of Pseudo Noise Generator	-	
[SOURce[1]]:FSIMulator:SPEEd:UNIT	Speed unit	X	
[SOURce[1]]:FSIMulator:STANdard	Standard settings	X	
[SOURce[1]]:FSIMulator[STATe]	Fading Simulator on/off	X	
[SOURce[1]]:FSIMulator:BIRThdeath:PATH<[1] 2>:DELay	Delay offset	-	
[SOURce[1]]:FSIMulator:BIRThdeath:PATH<[1] 2>:FDOPpler	Doppler frequency	X	
[SOURce[1]]:FSIMulator:BIRThdeath:PATH<[1] 2>:FDOPpler	Doppler frequency	X	
[SOURce[1]]:FSIMulator:BIRThdeath:PATH<[1] 2>:FRATio	Frequency ratio	X	
[SOURce[1]]:FSIMulator:BIRThdeath:PATH<[1] 2>:HOPPing:DWELl	Hopping dwell	X	
[SOURce[1]]:FSIMulator:BIRThdeath:PATH<[1] 2>:LOSS	Path loss	X	
[SOURce[1]]:FSIMulator:BIRThdeath:PATH<[1] 2>:PROFile?	Profile	X	
[SOURce[1]]:FSIMulator:MDELay:REFErence:DELay	Delay of the reference path	X	

Alphabetical List of R&S SMIQ Commands

R&S SMIQ Command	Short description	R&S SMU	Remarks
[SOURce[1]]:FSIMulator:MDelay:REFErence:LOSS	Loss of the reference path	X	
[SOURce[1]]:GSM:...	Standard GSM		SOURce<[1] 2>:BB:GSM...
[SOURce[1]]:GSM:CLOCK:DElay	SOURceClock delay	-	
[SOURce[1]]:GSM:CLOCK:SOURce	SOURceClock source	X	
[SOURce[1]]:GSM:DLIST:...	SOURceData lists	-	SOURce<[1] 2>:BB:DM:DLIST..
[SOURce[1]]:GSM:FILTer:TYPE	SOURceFilter type	X	
[SOURce[1]]:GSM:FILTer:PARAmeter	SOURceFilter parameter	X	
[SOURce[1]]:GSM:FLIST:...	SOURceFilter lists	-	
[SOURce[1]]:GSM:FORMat	SOURceModulation type	X	
[SOURce[1]]:GSM:FSK:DEVIation	SOURceFSK modulation deviation	X	
[SOURce[1]]:GSM:PRAMP:DElay	SOURceRamp envelope offset	X	
[SOURce[1]]:GSM:PRAMP:FOFFset	SOURceOffset in the falling edge	X	
[SOURce[1]]:GSM:PRAMP:PRESet	Preset PRAMP	-	
[SOURce[1]]:GSM:PRAMP:ROFFset	Offset in the rising edge	X	
[SOURce[1]]:GSM:PRAMP:SHAPE	Edge shape	X	
[SOURce[1]]:GSM:PRAMP:TIME	Edge slope	X	
[SOURce[1]]:GSM:SEQuence	Trigger mode	X	
[SOURce[1]]:GSM:SLOT:ATTenuation	Level attenuation	-	
[SOURce[1]]:GSM:SLOT<0 [1]..7>:LEVEl	Power control level	X	
[SOURce[1]]:GSM:SLOT<0 [1]..7>:SF	Stealing Flag	X	
[SOURce[1]]:GSM:SLOT<0 [1]..7>:TSC:SElect	Training sequence	X	
[SOURce[1]]:GSM:SLOT<0 [1]..7>:TSC:USER	Training's sequence	X	

Alphabetical List of R&S SMIQ Commands

R&S SMIQ Command	Short description	R&S SMU	Remarks
[SOURce[1]:]GSM: SLOT<0 [1]..7>:TYPE	Burst type	X	
[SOURce[1]:]GSM: SLOT<0 [1]..7>[:SOURce]: DATA	Data source	X	
[SOURce[1]:]GSM: SLOT<0 [1]..7>[:SOURce]: DATA:DLIST	Selection of data list	X	
[SOURce[1]:]GSM:SLOT<n>: HOPping:TRIGger	Trigger for hopping (LIST Mode)	-	
[SOURce[1]:]GSM:SLOT<n>: PRESet	Preset slot	-	
[SOURce[1]:]GSM:SRATe	Symbol clock	X	
[SOURce[1]:]GSM:STANdard	Preset	-	
[SOURce[1]:]GSM:STATe	GSM on/off	X	
[SOURce[1]:]GSM:TRIGger: DELay	Trigger delay	X	
[SOURce[1]:]GSM:TRIGger: INHibit	Trigger inhibit	X	
[SOURce[1]:]GSM:TRIGger: OUTPut<[1] 2>	Trigger signal	-	
[SOURce[1]:]GSM:TRIGger: OUTPut<[1] 2>:DELay	Marker delay	X	
[SOURce[1]:]GSM:TRIGger: OUTPut<[1] 2>:PERiod	Frame marker period	X	
[SOURce[1]:]GSM:TRIGger: OUTPut<[1] 2>:POLarity	Polarity of marker output	-	
[SOURce[1]:]GSM:TRIGger: SOURce	Trigger source	X	
[:SOURce]:LIST:...	List mode		SOURce<[1] 2>: LIST:....
[:SOURce]:LIST:CATalog?	Queries available lists	X	
[:SOURce]:LIST:DELete	Deletes the specified list	X	
[:SOURce]:LIST:DELete:ALL	Deletes all lists	X	
[:SOURce]:LIST:DWELl	Dwell time	X	
[:SOURce]:LIST:FREe?	Free memory	X	
[:SOURce]:LIST:FREQuency	Input of frequency values	X	
[:SOURce]:LIST:FREQuency: POINts?	Number of frequency values	X	
[:SOURce]:LIST:LEARn	Learns the current list	X	

Alphabetical List of R&S SMIQ Commands

R&S SMIQ Command	Short description	R&S SMU	Remarks
[:SOURce] :LIST:MODE	List-operating mode	X	
[:SOURce] :LIST:POWer	Level values for list	X	
[:SOURce] :LIST:POWer:POINts?	Length of the LEVel part	X	
[:SOURce] :LIST:SElect	Selects the specified list.	X	
[:SOURce] :MARKer:...	Marker settings for sweeps	-	
[SOURce[1]]:MODulation:...	Modulation state	-	
[SOURce[1]]:NOISe:...	Noise settings	-	SOURce<[1] 2>:AWGN
[:SOURce] :NOISe:BANDwidth BWIDth	Noise bandwidth	X	
[:SOURce] :NOISe:SNRatio	Signal/noise ratio	X	
[:SOURce] :NOISe[:STATe]	Activates noise generator	X	
[SOURce[1]]:PHASe:....	Phase settings		SOURce<[1] 2>:PHASe:....
[SOURce[1]]:PHASe:REFerence	Sets the phase	X	
[SOURce[1]]:PHASe[:ADJust]	Phase variation relative to the current phase	X	
[SOURce[1]]:PM:....			
[SOURce[1]]:PM[:DEViation]	PM deviation	X	
[SOURce[1]]:PM:EXTernal<1 2>:COUPling	Coupling of external mod. input	X	
[SOURce[1]]:PM:INTernal:FREQuency	Modulation frequency	X	
[SOURce[1]]:PM:SOURce	Modulation source	X	
[SOURce[1]]:PM:STATe	State	X	
[SOURce[1]]:POWer:...	Level settings		SOURce<[1] 2>:POWer:....
[SOURce[1]]:POWer:ALC:SEARCh	Level control mode	-	
[SOURce[1]]:POWer:ALC:TABLE[:MEASure]?	Correction values for level table	-	
[SOURce[1]]:POWer:ALC[:STATe]	Automatic level control on/off	X	
[SOURce[1]]:POWer:LIMit[:AMPLitude]	Level limit	X	
[SOURce[1]]:POWer:MANual	Level for the next sweep step	X	
[SOURce[1]]:POWer:MODE	Operating mode	X	

Alphabetical List of R&S SMIQ Commands

R&S SMIQ Command	Short description	R&S SMU	Remarks
[SOURce[1]:]POWer:PEP?	Queries PEP	X	
[SOURce[1]:]POWer:START	RF start level	X	
[SOURce[1]:]POWer:STEP[: INCRement]	Step width for the level setting	X	
[SOURce[1]:]POWer:STOP	Stop level	X	
[SOURce[1]:]POWer[: LEVEl][:IMMediate]:OFFSet	Level offset	X	
[SOURce[1]:]POWer[: LEVEl][:IMMediate][: AMPLitude]	RF output level	X	
[SOURce[1]:]POWer[: LEVEl][:IMMediate]:RCL	Recall RF level	X	
[SOURce[1]:]PULM:...	Pulse modulation		SOURce<[1] 2>: PULM:....
[SOURce[1]:]PULM:POLarity	Polarity pulse modulation	X	
[SOURce[1]:]PULM:STATe	Pulse modulation on/off	X	
[SOURce[1]:]ROSCillator: ...	Reference frequency	X	
[SOURce[1]:]ROSCillator: EXTernal:FREQuency	Frequency of the external ref- erence	X	
[SOURce[1]:]ROSCillator[: INTernal]:ADJust:VALue	Adjustment value	X	
[SOURce[1]:]ROSCillator[: INTernal]:ADJust[:STATe]	Fine adjustment of the fre- quency on/off	X	
[SOURce[1]:]ROSCillator: SOURce	Reference frequency source	X	
[SOURce[1]:]SWEep...	RF sweeps		SOURce<[1] 2>: SWEep:....
[SOURce[1]:]SWEep:BTIME	Blank time sweep	-	
[SOURce[1]:]SWEep[: FREQuency]:DWEll	Dwell time	X	
[SOURce[1]:]SWEep[: FREQuency]:MODE	Sweep mode	X	
[SOURce[1]:]SWEep[: FREQuency]:POINts	Number of steps in an RF sweep	X	
[SOURce[1]:]SWEep[: FREQuency]:SPACing	Sweep spacing	X	
[SOURce[1]:]SWEep[: FREQuency]:STEP: LOGarithmic	Step width factor for logarith- mic sweeps	X	

Alphabetical List of R&S SMIQ Commands

R&S SMIQ Command	Short description	R&S SMU	Remarks
[SOURce[1]:]SWEep[:FREQuency]:STEP[:LINear]	Step width for linear sweeps	X	
[SOURce[1]:]SWEep:POWer:DWELL	Time for each level step	X	
[SOURce[1]:]SWEep:POWer:MODE	Sweep mode	X	
[SOURce[1]:]SWEep:POWer:POINts	Number of steps in a level sweep	X	
[SOURce[1]:]SWEep:POWer:STEP[:LOGarithmic]	Step width factor for logarithmic sweeps	X	
:SOURce2:...	LF generator sweep		SOURce<[1] 2>:LFOutput:SWEep
:SOURce2:SWEep:BTIME	Blank Time	-	
:SOURce2:SWEep[:FREQuency]:DWELL	Dwell time for each frequency step	X	
:SOURce2:SWEep[:FREQuency]:MODE	Sweep mode LF sweep	X	
:SOURce2:SWEep[:FREQuency]:POINts	Number of steps in an LF sweep	X	
:SOURce2:SWEep[:FREQuency]:SPACing	Lin or log LF sweep	X	
:SOURce2:SWEep[:FREQuency]:STEP:LOGarithmic	Step width for the log sweep	X	
:SOURce2:SWEep[:FREQuency]:STEP[:LINear]	Step width for the linear sweep	X	
[:SOURce]:W3GPp:....	3GPP FDD		[SOURce<[1] 2>:]BB:W3GPp:...
[:SOURce]:W3GPp:BSTation:ENHAnced:..	Enhanced base station	-	extended functions
[:SOURce]:W3GPp:BSTation<n>:CHANnel<n>:CCODE	Channelization code	X	
[:SOURce]:W3GPp:BSTation<n>:CHANnel<n>:DATA	Data source	X	
[:SOURce]:W3GPp:BSTation<n>:CHANnel<n>:DATA:PATtern	Data pattern	X	
[:SOURce]:W3GPp:BSTation<n>:CHANnel<n>:MCODe	Multicode on/off	-	

Alphabetical List of R&S SMIQ Commands

R&S SMIQ Command	Short description	R&S SMU	Remarks
[:SOURce] :W3GPp : BSTation<n> :CHANnel<n> : PLENgtH	Length of the pilot fields	-	
[:SOURce] :W3GPp : BSTation<n> :CHANnel<n> : POWer	Channel power	X	
[:SOURce] :W3GPp : BSTation<n> :CHANnel<n> : SRATE	Symbol rate	X	
[:SOURce] :W3GPp : BSTation<n> :CHANnel<n> : STATE	Channel on/off	X	
[:SOURce] :W3GPp : BSTation<n> :CHANnel<n> : TOFFset	Timing Offset	X	
[:SOURce] :W3GPp : BSTation<n> :CHANnel<n> :TPC	TPC data source	-	
[:SOURce] :W3GPp : BSTation<n> :CHANnel<n> : TPC :PATTErn	TPC pattern	-	
[:SOURce] :W3GPp : BSTation<n> :DOMain :ERRor ?	Queries code domain conflicts	-	
[:SOURce] :W3GPp : BSTation<n> :MCHannel : EXECute ?	Multichannel setting on/off	-	
[:SOURce] :W3GPp :BSTation : PINDicator :COUNT	Number of Page Indicators	X	
[:SOURce] :W3GPp : BSTation<n> :SCODE	Scrambling code	X	
[:SOURce] :W3GPp : BSTation<n> :SCODE :STATE	Scrambling on/off	X	
[:SOURce] :W3GPp : BSTation<n> :SSCG ?	Secondary Synchronization Code Group	X	
[:SOURce] :W3GPp : BSTation<n> :STATE	Base station on/off	X	
[:SOURce] :W3GPp : BSTation<n> :TFCI	TFCI value	-	
[:SOURce] :W3GPp : BSTation<n> :TFCI :STATE	TFCI on/off	-	
[:SOURce] :W3GPp : BSTation<n> :TPC :MISuse	Misuse TPC	-	
[:SOURce] :W3GPp : BSTation<n> :TPC :POWer :STEP	Step width for MisUse TPC	-	
[:SOURce] :W3GPp : BSTation<n> :TPC :READ	Read out mode TPC	-	

Alphabetical List of R&S SMIQ Commands

R&S SMIQ Command	Short description	R&S SMU	Remarks
[:SOURce] :W3GPp : BSTation<n> :TRANsmit : DIVersity	Transmit Diversity on/off	-	
[:SOURce] :W3GPp :CALCulate : PROGress?	Calculation progress	-	
[:SOURce] :W3GPp :CLIPping : LEVel	Clipping level	X	
[:SOURce] :W3GPp :CLOCK : DELay	Clock Delay	-	
[:SOURce] :W3GPp :CLOCK :MODE	Clock type	X	
[:SOURce] :W3GPp :CLOCK : SOURce	Clock source	X	
[:SOURce] :W3GPp :COPY : COFFset	Offset Channelization Code for copying	X	
[:SOURce] :W3GPp :COPY : DESTination	Destination for copy process	X	
[:SOURce] :W3GPp :COPY : EXECute	Starting the copy process	X	
[:SOURce] :W3GPp :COPY : SOURce	Source for copy process	X	
[:SOURce] :W3GPp :CRATE : VARIation	Output chip rate	X	
[:SOURce] :W3GPp :CRATE?	Queries chip rate	X	
[:SOURce] :W3GPp :FILTer : MODE	Filter mode	-	
[:SOURce] :W3GPp :FILTer : PARAmeter	Filter parameter	-	
[:SOURce] :W3GPp :FILTer : SELEct	Selection of User filter	-	
[:SOURce] :W3GPp :FILTer : TYPE	Filter type	X	
[:SOURce] :W3GPp :GPP3 : VERSion?	3GPP version	X	
[:SOURce] :W3GPp :LINK	Transmission direction	X	
[:SOURce] :W3GPp :MCHannel : ...	Multi channel settings	-	
[:SOURce] :W3GPp :MSTation : ADDITIONal :COUNT	Number of add. UE	X	
[:SOURce] :W3GPp :MSTation : ADDITIONal :POWER :OFFSet	Power offset of add. UE	X	
[:SOURce] :W3GPp :MSTation : ADDITIONal :SCODE :STEP	Step width for increase of scrambling code	X	

Alphabetical List of R&S SMIQ Commands

R&S SMIQ Command	Short description	R&S SMU	Remarks
[:SOURce]:W3GPp:MSTation:ADDDitional:STATe	Add. UE on/off	X	
[:SOURce]:W3GPp:MSTation<n>:ENHanced:..		-	extended functions
[:SOURce]:W3GPp:MSTation<n>:DPCCh:FBI:DATA	Data source FBI field	-	
[:SOURce]:W3GPp:MSTation<n>:DPCCh:FBI:MODE	Number of bits FBI field	X	
[:SOURce]:W3GPp:MSTation<n>:DPCCh:FBI:PATtern	FBI Pattern	X	
[:SOURce]:W3GPp:MSTation<n>:DPCCh:POWer	Power DPCCH	X	
[:SOURce]:W3GPp:MSTation<n>:DPCCh:TFCI	Value of TFCI field	X	
[:SOURce]:W3GPp:MSTation<n>:DPCCh:TFCI:STATe	TFCI on/off	X	
[:SOURce]:W3GPp:MSTation<n>:DPCCh:TOFFset?	Queries Timing Offset	X	
[:SOURce]:W3GPp:MSTation<n>:DPCCh:TPC:MISuse	TPC Misuse	X	
[:SOURce]:W3GPp:MSTation<n>:DPCCh:TPC:PSTep	Step width TPC Misuse	X	
[:SOURce]:W3GPp:MSTation<n>:DPDCh:DATA	Data source DPDCH	-	
[:SOURce]:W3GPp:MSTation<n>:DPDCh:ORATe	Overall symbol rate	X	
[:SOURce]:W3GPp:MSTation<n>:DPDCh:POWer	Channel power DPDCH	X	
[:SOURce]:W3GPp:MSTation<n>:DPDCh:TYPE?	Channel Type	-	
[:SOURce]:W3GPp:MSTation<n>:DPDCh:CCODE?	Channelization Code	-	
[:SOURce]:W3GPp:MSTation<n>:DPDCh:PATtern	Pattern DPDCH	-	
[:SOURce]:W3GPp:MSTation<n>:DPDCh:SRATe?	Queries symbol rate	-	
[:SOURce]:W3GPp:MSTation<n>:MODE	Signal of user equipment	X	
[:SOURce]:W3GPp:MSTation<n>:PCPCh:ASLot	Access Slot	X	

Alphabetical List of R&S SMIQ Commands

R&S SMIQ Command	Short description	R&S SMU	Remarks
[:SOURce] :W3GPp : MSTation<n> :PCPCh :CPOWer	Power of the control component of the PCPCH	X	
[:SOURce] :W3GPp : MSTation<n> :PCPCh :DATA	Data source PCPCh	X	
[:SOURce] :W3GPp : MSTation<n> :PCPCh :DPOWer	Power of the data component of the PCPCH	X	
[:SOURce] :W3GPp : MSTation<n> :PCPCh :FBI :DATA	Data source FBI field	-	
[:SOURce] :W3GPp : MSTation<n> :PCPCh :FBI :MODE	FBI mode	X	
[:SOURce] :W3GPp : MSTation<n> :PCPCh :FBI : PATtern	FBI pattern	X	
[:SOURce] :W3GPp : MSTation<n> :PCPCh :MLENgtH	Length of the message component	X	
[:SOURce] :W3GPp : MSTation<n> :PCPCh :PATtern	Pattern DATA part	X	
[:SOURce] :W3GPp : MSTation<n> :PCPCh :PLENgtH	Length of the power control preamble	X	
[:SOURce] :W3GPp : MSTation<n> :PCPCh :PPOWer	Power of the preamble component	X	
[:SOURce] :W3GPp : MSTation<n> :PCPCh :PPOWer : STEP	Step width of the power increase	X	
[:SOURce] :W3GPp : MSTation<n> :PCPCh : PREPetition	Number of preamble components	X	
[:SOURce] :W3GPp : MSTation<n> :PCPCh : SIGNature	Signature	X	
[:SOURce] :W3GPp : MSTation<n> :PCPCh :SRATe	Symbol rate PDPCH	X	
[:SOURce] :W3GPp : MSTation<n> :PCPCh :TFCl	TFCl	X	
[:SOURce] :W3GPp : MSTation<n> :PRACH :ASLot	Access slot	X	
[:SOURce] :W3GPp : MSTation<n> :PRACH :CPOWer	Power of the control component of the PRACH	X	
[:SOURce] :W3GPp : MSTation<n> :PRACH :DATA	Data source PRACH	X	
[:SOURce] :W3GPp : MSTation<n> :PRACH :DATA : PATtern	Pattern DATA-part	X	

Alphabetical List of R&S SMIQ Commands

R&S SMIQ Command	Short description	R&S SMU	Remarks
[:SOURce] :W3GPp :MSTation<n> :PRACH :DPOWer	Power of the data component of PRACH	X	
[:SOURce] :W3GPp :MSTation<n> :PRACH :MLENgtH	Length of the message component	X	
[:SOURce] :W3GPp :MSTation<n> :PRACH :PPOWer	Power of the preamble component	X	
[:SOURce] :W3GPp :MSTation<n> :PRACH :PREPetition	Number of PRACH preamble components	X	
[:SOURce] :W3GPp :MSTation<n> :PRACH :SIGNature	Signature	X	
[:SOURce] :W3GPp :MSTation<n> :PRACH :SRATe	Symbol rate PRACH	X	
[:SOURce] :W3GPp :MSTation<n> :PRACH :TFCI	TFCI value PRACH	X	
[:SOURce] :W3GPp :MSTation<n> :SCODE	Scrambling Code	X	
[:SOURce] :W3GPp :MSTation<n> :SCODE :MODE	Scrambling Code Type	X	
[:SOURce] :W3GPp :MSTation<n> :STATe	User equipment on/off	X	
[:SOURce] :W3GPp :MSTation<n> :TPC :DATA	Data source TPC field PCPCH	X	
[:SOURce] :W3GPp :MSTation<n> :TPC :PATTern	Pattern TPC field PCPCH	-	
[:SOURce] :W3GPp :MSTation<n> :TPC :READ	Read out mode TPC PCPCh	-	
[:SOURce] :W3GPp :OCNS	OCNS channels on/off	-	
[:SOURce] :W3GPp :POWER :ADJusT	Adjustment of power	X	
[:SOURce] :W3GPp :POWER ?	Total Power	X	
[:SOURce] :W3GPp :PPARAmeter :...	Predefined parameters	-	
[:SOURce] :W3GPp :PRESet	Preset	X	
[:SOURce] :W3GPp :SEQuence	Trigger mode	X	
[:SOURce] :W3GPp :SETTing :CATalog ?	Query predefined settings	X	
[:SOURce] :W3GPp :SETTing :DELete	Delete predefined settings	X	
[:SOURce] :W3GPp :SETTing :LOAD	Load predefined settings	X	

Alphabetical List of R&S SMIQ Commands

R&S SMIQ Command	Short description	R&S SMU	Remarks
[:SOURce] :W3GPp :SETTing :STORe	Store predefined settings	X	
[:SOURce] :W3GPp :SETTing :TMODe1 :BST	Loads test model downlink	X	
[:SOURce] :W3GPp :SETTing :TMODe1 :BST :CATalog ?	Test models downlink	X	
[:SOURce] :W3GPp :SETTing :TMODe1 :MST	Loads test model uplink	X	
[:SOURce] :W3GPp :SETTing :TMODe1 :MST :CATalog ?	Test models uplink	X	
[:SOURce] :W3GPp :SLENgth	Sequence length of ARB component	X	
[:SOURce] :W3GPp :STATe	3GPP FDD modulation on/off	X	
[:SOURce] :W3GPp :TRIGger :DELay	Trigger delay	X	
[:SOURce] :W3GPp :TRIGger :INHibit	Trigger inhibition	X	
[:SOURce] :W3GPp :TRIGger :OUTPut < [1] 2 >	Marker signal	-	
[:SOURce] :W3GPp :TRIGger :OUTPut < [1] 2 > :DELay	Marker delay	X	
[:SOURce] :W3GPp :TRIGger :OUTPut < [1] 2 > :POLarity	Polarity of marker	-	
[:SOURce] :W3GPp :TRIGger < [1] 2 > :SOURce	Trigger source	X	
STATus : . . .	Status register		
STATus : OPERation : . . .	STATus : OPERation register	X	
STATus : PRESet	Reset status registers	X	
STATus : QUEStionable :	STATus : QUEStionable register	X	
STATus : QUEue [:NEXT] ?	Query oldest entry in error queue	X	
SYSTem : . . .	General instrument settings		
SYSTem : BEEPer : STATe	Key beeper on/off	X	
SYSTem : COMMunicate : GPIB : LTERminator	Terminator recognition remote control	X	
SYSTem : COMMunicate : GPIB [:SELf] : ADDRess	GPIB address	X	
SYSTem : COMMunicate : SDAta : BAUD	Baud rate	-	

Alphabetical List of R&S SMIQ Commands

R&S SMIQ Command	Short description	R&S SMU	Remarks
SYSTem:COMMunicate:SERial: ...	Serial interface	-	
SYSTem:ERRor?	Query latest error	-	
SYSTem:KLOCK	Disable the front panel key-board	X	
SYSTem:PRESet	Instrument reset	X	
SYSTem:PROTect[:STATe]	Protection level	X	
SYSTem:SREStore	Fast restore	-	
SYSTem:SSAVe	Save for fast restore	-	
SYSTem:SSErRor?	Query all errors	X	
SYSTem:VERSion?	SCPI version	X	
TEST:...	Module test	-	Extended functions
TRIGger:...	Trigger		
TRIGger[1]:BERT[: IMMediate]	Trigger for BER	X	
TRIGger[1]:BLER[: IMMediate]	Trigger for BLER	X	
TRIGger[1]:DM[:IMMediate]	Trigger mode for DM and digital standards	X	
TRIGger[1]:DM:SOURce	Trigger source for DM and digital standards	X	
TRIGger[1]:LIST:SOURce	Trigger source list mode	X	
TRIGger[1]:LIST[: IMMediate]	Triggers list mode	X	
TRIGger[1]:SLOPe	Active slope of the trigger signal	X	
TRIGger[1][:SWEep:]SOURce	Trigger source RF sweeps	X	
TRIGger[1][:SWEep][: IMMediate]	Triggers RFsweep	X	
TRIGger2:SWEep:SOURce	Trigger source LF sweep	X	TRIGger0:SWEep: SOURce
TRIGger2[:SWEep][: IMMediate]	Triggers LF sweep	X	
TRIGger:SLOPe	Active slope of trigger signal	X	
UNIT:...	Select unit	-	
UNIT:ANGLE	Angle units	X	
UNIT:POWer	Power unit	X	

7 Maintenance

The instrument does not need periodic maintenance. Only the cleaning of the instrument is essential. The outside of the instrument is suitably cleaned using a soft, line-free dust cloth. Make sure that the air vents are not obstructed.

WARNING

Shock hazard

Before cleaning the instrument, make sure that the instrument is switched off and disconnected from all power supplies.

NOTICE

Instrument damage caused by cleaning agents

Cleaning agents contain substances that may damage the instrument, e.g. cleaning agents that contain a solvent may damage the front panel labeling or plastic parts.

Never use cleaning agents such as solvents (thinners, acetone, etc), acids, bases, or other substances.

The outside of the instrument can be cleaned sufficiently using a soft, lint-free dust cloth.

Follow the instructions in the service manual and the safety instructions when exchanging modules or ordering spares. The order no. for spare parts is included in the service manual. The service manual includes further information particularly on troubleshooting, repair, exchange of modules and alignment.

The address of our support center and a list of all Rohde & Schwarz service centers can be found at the beginning of this manual.

7.1 Storing and Packing

The storage temperature range of the instrument is given in the data sheet. If the instrument is to be stored for a longer period of time, it must be protected against dust.

Repack the instrument as it was originally packed when transporting or shipping. The two protective foam plastic parts prevent the control elements and connectors from being damaged. The antistatic packing foil avoids any undesired electrostatic charging to occur.

If you do not use the original packaging, use a sturdy cardboard box of suitable size and provide for sufficient padding to prevent the instrument from slipping inside the package. Wrap antistatic packing foil around the instrument to protect it from electrostatic charging.

8 Error Messages

This chapter describes the error messages of the R&S SMU. The error messages are output in the "Info" line on the screen and entered in the error/event queue of the status reporting system.

A great variety of different messages such as status messages, error messages, warnings or information are displayed in the header field of the screen. Some error messages require that the error must be eliminated before correct instrument operation can be ensured. The info window with a list of current messages and a detailed description of each message can be opened with the INFO key.

In the remote control mode, error messages are entered in the error/event queue of the status reporting system and can be queried with the command `SYSTEM:ERROR?`. If the error queue is empty, 0 ("No error") is returned.

8.1 Status Information

The status messages are displayed in the header section of the screen. The status information gives the user an overview of the main operating states and settings of the instrument. The states are indicated for information only and do not necessitate any action by the user. Status information is displayed between the frequency and level fields, at the left of the info line or in the info line itself.

On two-path instruments, all states that can occur independently in the two paths are displayed separately for each path. The associated path is indicated in the info line.

8.1.1 Status information displayed between the frequency and level fields

This chapter gives an overview of the status messages displayed between the frequency and level fields.

RF OFF

The RF output is switched off

MOD OFF

All modulations are switched off

FREQ OFFSET

A frequency offset is set.

The frequency entered and displayed in the "Frequency" field takes any set frequency offset into consideration, e.g. an offset set for a downstream instrument. This means that with a frequency offset the frequency displayed in the header does not correspond to the frequency at the RF output, but rather to the frequency at the output of the downstream instrument.

This allows the target frequency at the output of a downstream instrument to be entered in the frequency field. The signal generator changes the RF output frequency according to the entered offset.

However, the frequency entered and displayed in the "Frequency/Phase" dialog of the "RF" function block always corresponds to the RF output frequency. Any frequency offset is not taken into consideration.

The correlation is as follows:

Freq in header = RF output frequency (= Freq in dialog) + Freq offset (= Offset in dialog)

OVERLOAD

The power of the external signal applied to the RF output is too high. The overload protection is tripped and the connection between the RF output and attenuator is interrupted. The overload protection is reset by pressing the RF ON/OFF key. The RF input is activated when the overload protection is reset.

LEVEL OFFSET

A level offset is set.

The level entered and displayed in the "Level" field takes the offset of any downstream attenuators/amplifiers into consideration by way of calculation. This means that with a level offset the level displayed in the header does not correspond to the level at the RF output, but rather to the level at the output of the downstream instrument.

This allows the target level at the output of downstream instruments to be entered. The signal generator changes the RF output level according to the set offset.

However, the level entered and displayed in the "Level" dialog of the "RF" function block always corresponds to the RF output level. Any level offset is not taken into consideration.

The correlation is as follows:

Level in header = RF output level (= Level in dialog) + Level offset

EXT REF

An external reference is used.

The external signal with selectable frequency and defined level must be input at the REF IN connector. It is output at the REF OUT connector.

The reference frequency setting is effective for both paths.

BUSY

A setting or calculation is executed.

8.1.2 Status information displayed to the left of the Info line

This chapter gives an overview of the status messages displayed to the left of the Info line.

REMOTE

The instrument is remote controlled.

The keys on the front panel are usable, but all parameters are in read only mode.

The LOCAL key switches the instrument from remote control to manual operation. The current command must be fully processed before the mode is switched, otherwise the instrument switches immediately back to remote control.

REM-LLO

The instrument is remote (**REM**ote) controlled. The LOCAL key is disabled by remote control with the command **LLO (LocalLockOut)**.

The keys on the front panel are usable, but all parameters are in read only mode.

The instrument can be switched from remote control to manual operation by means of remote control only (e.g. with the Visual Basic command **CALL IBLOC (generator%)** or by **&NREN**).

LOC-LLO

For operating directly the instrument is placed from remote control to manual operation (Local State). The LOCAL key was disabled by remote control with the command **LLO (LocalLockOut)**.

With the next activating of the remote control mode, the instrument cannot be switched to manual operation by the operator. The status information changes to "REM-LLO".

The instrument can be switched to manual operation by means of remote control only (e.g. with the Visual Basic command **CALL IBLOC (generator%)**).

SYS CTRL

Indicates that the instrument is controlling another instrument.

8.1.3 Status information displayed in the Info line

This chapter gives an overview of the status messages displayed in the Info line.

RFSweep / LevelSweep / LFSweep

The indicated sweep is enabled.

ALC On / Auto / S&H

The status of the automatic level control is indicated:

- ON
automatic level control permanently on
- Auto
automatic level control is automatically adapted to the operating states
- S&H
automatic level control off, recalibration of the level whenever the level or frequency is set (sample and hold mode)

ListMode

List mode is active.

The values of the frequency/level pairs in the selected list are set for the chosen dwell time.

AttFixed

Attenuator fixed mode is active.

The uninterrupted level settings are made in a fixed range without attenuator switching. The variation range is set automatically when this mode is activated. The range is displayed under "Attenuator Fixed Range" in the "Level" dialog.

UCorr

User Correction is active.

The level is corrected by the given values in the selected user correction list. Correction is performed by the user-defined list values being added to the output level for the respective RF frequency. With frequencies which are not contained in the list, the level correction is determined by interpolation of the closest correction values.

OvenCold

The reference oscillator has not yet reached its nominal frequency.

When switching on from the STANDBY mode, the specified frequency accuracy is reached immediately. If the power switch was switched off, the reference oscillator needs some warm-up time to reach its nominal frequency. During this period of time, the output frequency does not yet reach its final value either.

8.2 Error Messages

Messages indicate errors in the instrument. They are displayed in the info line in different colors depending on their importance and display duration. Errors (e.g. no calibration data) are displayed in red, information (e.g. file not found) and warnings in black. Warnings indicate less significant errors (e.g. the instrument operates outside specified data).

8.2.1 Volatile messages

Volatile messages report automatic settings in the instrument (e.g. switching off of incompatible types of modulation) or on illegal entries that are not accepted by the instrument (e.g. range violations). They are displayed in the info line on a yellow background. They are displayed on top of status information or permanent messages.

Volatile messages do not normally demand user actions and disappear automatically after a brief period of time. They are stored in the history, however.

SCPI command: `SYSTem:ERRor:ALL` or `SYSTem:ERRor[:NEXT]`

8.2.2 Permanent messages

Permanent messages are displayed if an error occurs that impairs further instrument operation, e.g. a hardware fault. The error signaled by a permanent message must be eliminated before correct instrument operation can be ensured.

The message is displayed until the error is eliminated. It covers the status display in the info line. After error elimination, the message automatically disappears and is also recorded in the history.

SCPI command: `SYSTem:SERRor`

8.3 SCPI-Error Messages

The SCPI error messages are the same in all SCPI instruments. Detailed information and an overview of all error messages as defined in SCPI standard can be found in the corresponding documentation.

The errors are assigned negative numbers. The error text being entered into the error/event queue or being displayed is printed in bold face on the left together with the error code. Below the error text, there is an explanation as to the respective error.

8.4 Device-Specific Error Messages

The following table contains all error messages specific for the instrument in alphabetical order, as well as an explanation of the error situation. The positive error codes mark the errors specific of the instrument.

The device-specific error messages set bit 3 in the ESR register.



The index provides a list of the error messages sorted according to their error codes.

Error Code	Error	Description	Remedy
50	Extern reference out of range or disconnected	External reference is selected but no external signal is applied or the signal is out of range.	<ul style="list-style-type: none"> Check the selected reference signal source (internal or external) in the "Setup > Reference Oscillator" dialog. Change setting to 'internal' if no appropriate external source is available.
140	This modulation forces other modulations off	<p>A modulation has been switched on which cannot be used at the same time as an already active modulation. The previous modulation has been switched off.</p> <p>Example: Enabling modulation GSM/EDGE switches any active digital modulation off.</p>	

Error Code	Error	Description	Remedy
180	Adjustment failed	Adjustment could not be executed	The adjustment data have to be generated first by an internal or external adjustment or to be loaded into the device (see chapter 4.2.3.1, "Internal Adjustments" , on page 126.
182	Adjustment data missing	Adjustment data are missing.	The adjustment data have to be generated first by an internal or external adjustment or to be loaded into the instrument.
183	Adjustment data invalid	Adjustment data are invalid and must be restored.	The adjustment data have to be generated again by an internal or external adjustment or to be loaded into the instrument.
200	Cannot access hardware	The data transmission to a module was unsuccessful.	The module is not installed, not properly installed or missing.
201	Hardware revision out of date	A later version of certain parts of the instrument is necessary to execute the function selected.	The driver does not support the installed version of a module.
202	Cannot access the EEPROM	A error occurs when writing or reading a EEPROM.	The EEPROM might be defect and has to be replaced.
203	Invalid EEPROM data	Reading a EEPROM is possible, however the data are inconsistent.	
204	Driver initialization failed	Initialization of a driver fails when booting the instrument firmware.	The driver is not compatible with the hardware or software configuration of the instrument.
241	No current list	There is no list selected. To execute the required operation, a list has to be selected in the related menu. If no list is available, a new list must be created.	
242	Unknown list type specified	The list type selected is not valid for the required operation. For instance, the file extension for waveform list files is *.vv. It is not possible to enter another file extension when selecting a list.	Check the selected list type.
261	Waveform Protected	The selected waveform file cannot be transferred to a controller. The waveform is produced with simulation software R&S WinIQSIM2 and is protected.	
460	Cannot open file	The selected file can not be opened.	Check the path and file name.
461	Cannot write file	The file can not be written.	Check if the file is read-only.
462	Cannot read file	The file can not be read.	Check if the file contents are compatible with the file type.

Error Code	Error	Description	Remedy
463	Filename missing	The required operation cannot be executed because the file name is not specified.	A file name has to be entered when creating a new list.
464	Invalid filename extension	The file extension is not valid for the required operation.	Check the file extension. For instance, the file extension for waveform list files is *.wv. It is not possible to enter another file extension when storing a list.
465	File contains invalid data	The selected file contains data that is not valid for the file type. The file extension determines the data that is valid for this file type. If the file extension is changed the lists are no longer recognized and the data are therefore invalid. Example: the extension of a waveform file (= *.wv) was changed to *.txt	Check the file extension.

A Hardware Interfaces

This section covers hardware related topics, like pin assignment of the GPIB bus interface, monitor and AUX I/O connectors.

The remote control interfaces are described in details in [chapter 5, "Remote Control Basics"](#), on page 457.

All other interfaces are described in [chapter 1.1, "Front Panel Tour"](#), on page 15 and [chapter 1.2, "Rear Panel Tour"](#), on page 23.

For specifications refer to the data sheet.

A.1 GPIB Bus Interface

Pin assignment

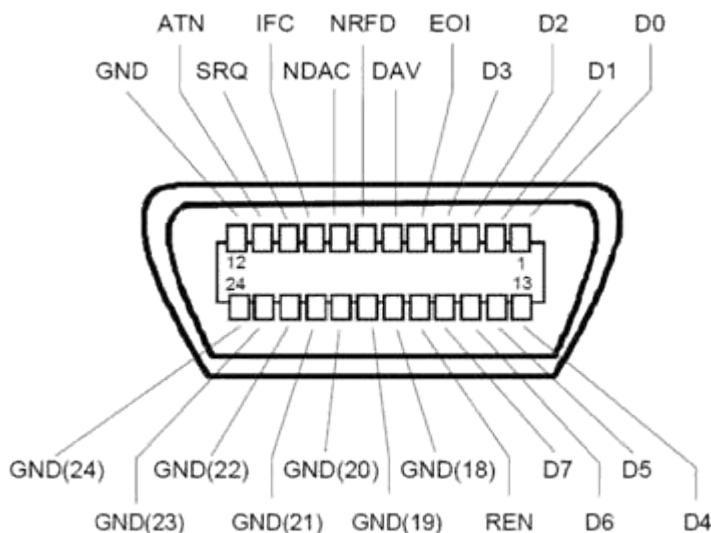

Fig. 1-1: Pin assignment of GPIB bus interface

Bus lines

- Data bus with 8 lines D0 to D7:
The transmission is bit-parallel and byte-serial in the ASCII/ISO code. D0 is the least significant bit, D7 the most significant bit.
- Control bus with five lines:
IFC (Interface Clear): active LOW resets the interfaces of the instruments connected to the default setting.
ATN (Attention): active LOW signals the transmission of interface messages, inactive HIGH signals the transmission of device messages.

SRQ (Service Request): active LOW enables the connected device to send a service request to the controller.

REN (Remote Enable): active LOW permits switchover to remote control.

EOI (End or Identify): has two functions in connection with ATN:

- ATN=HIGH active LOW marks the end of data transmission.
- ATN=LOW active LOW triggers a parallel poll.

- Handshake bus with three lines:

DAV (Data Valid): active LOW signals a valid data byte on the data bus.

NRFD (Not Ready For Data): active LOW signals that one of the connected devices is not ready for data transfer.

NDAC (Not Data Accepted): active LOW signals that the instrument connected is accepting the data on the data bus.

Interface Functions

Instruments which can be controlled via GPIB bus can be equipped with different interface functions. The interface function for the R&S SMU are listed in the following table.

Table 1-1: GPIB bus interface functions

Control character	Interface function
SH1	Handshake source function (source handshake), full capability
AH1	Handshake sink function (acceptor handshake), full capability
L4	Listener function, full capability, de-addressed by MTA.
T6	Talker function, full capability, ability to respond to serial poll, deaddressed by MLA
SR1	Service request function (Service Request), full capability
PP1	Parallel poll function, full capability
RL1	Remote/Local switch over function, full capability
DC1	Reset function (Device Clear), full capability
DT1	Trigger function (Device Trigger), full capability

A.2 AUX I/O Connector



For an overview of the signals that can be applied at the USER connector, see [table 4-1](#).

Table 1-2: Pin assignment of the AUX I/O Connector connector

Pin	Signal	Description
1 .. 25	Ground \perp	Ground
26	LEV ATT	Signal input/output for controlling the level attenuation. For two-path instruments, the signal for Path B can be applied to one of the USER interfaces. With external envelope curve control ("Custom Digital Modulation" only), the pin is the input for the control signal LEV_ATT. With internal envelope curve control, the control signal LEV_ATT is output for Path A.
27	CW MODE	Signal input for controlling the switchover between the modulated and unmodulated RF signal with activated external modulation/CW switching in the "Custom Digital Modulation" menu. For two-path instruments, the CW control signal affects Path A and/or Path B. Signal output for the CW control signal with internal source selected. This signal marks the CW mode in which digital modulation is deactivated and the RF signal is output in unmodulated form. In the case of digital standards with selectable modulation mode, the signal indicates the active modulation mode (GSM: (G)MSK = high, 8PSK EDGE = low).
28	INST TRIG B	Input for external triggering of the analog modulations, sweeps and List mode. HOP input for controlling the frequency hopping mode with external source in List mode (Path B). The instrument trigger input for Path A is input via the DIGITAL I/O interface.
29 .. 38	PARDATA0 .. PARDATA9	Parallel data input/output 0...D with 10-bit word width for digital modulation. If the data source "External Parallel" is selected, these pins are the data inputs. If a different data source is selected, the data is output here ("Custom Digital Modulation", Path A).
39	USER 3	USER input/output which can be configured for various purposes.
40	USER 4	USER input/output which can be configured for various purposes.
41	MARKER 3	Output for the freely programmable marker signal 3 of Path A. The output is permanently assigned.
42	MARKER 2 B	Output for the freely programmable marker signal 2 of Path B.
43	MARKER 3 B	Output for the freely programmable marker signal 3 of Path B. The output is permanently assigned.
44	not used	not used
45	BURST	Signal input/output for controlling the burst ramp. For two-path instruments, the signal for Path B can be applied to one of the USER interfaces. With external envelope curve control ("Custom Digital Modulation" only), the pin is the input for the control signal "BURST_RAMP". With internal envelope curve control, the control signal "BURST_RAMP" is output for Path A.
46	EXT TUNE	Tuning input for the internal reference frequency.

Pin	Signal	Description
47	BITCLK	Output Bit clock for internal mode. For two-path instruments, the signal for Path B can be applied to one of the USER interfaces.
48	USER 2	USER input/output which can be configured for various purposes.
49	SYMBCLK	Symbol clock output for internal mode. With two-path instruments, the signal for Path B can be applied to one of the USER interfaces.
50	not used	not used

A.3 Monitor Connector (MONITOR)

The 15-pin Sub-D female connector MONITOR at the rear panel is intended for connecting an external VGA monitor.

Table 1-3: Pin assignment of the MONITOR connector

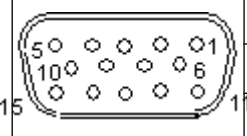
Monitor Connector	Pin	Signal	Pin	Signal	Pin	Signal
	1	Red (output)	6	GND	11	(NC)
	2	Green (output)	7	GND	12	(NC)
	3	Blue (output)	8	GND	13	HSYNC (output)
	4	(NC)	9	GND	14	VSYNC (output)
	5	GND	10	GND	15	(NC)

A.4 BERT Connector

The 9-pin Sub-D connector BERT at the rear panel is available for the input signals of the integrated bit error rate tester (option BER/BLE Measurement (R&S SMU-K80)).

Table 1-4: Pin assignment of the BERT connector

Monitor Connector	Pin	Signal	Pin	Signal
	1	GND	6	CLOCK
	2	GND	7	DATA
	3	GND	8	DATA ENABLE
	4	GND	9	RESTART
	5	GND		

The input signals are not terminated in the instrument. The impedance (50 ohm) and the threshold (0.0128..1.998 V) of the inputs can be set in the "BERT" menu.

The following figure shows the circuit diagram of the BERT function.

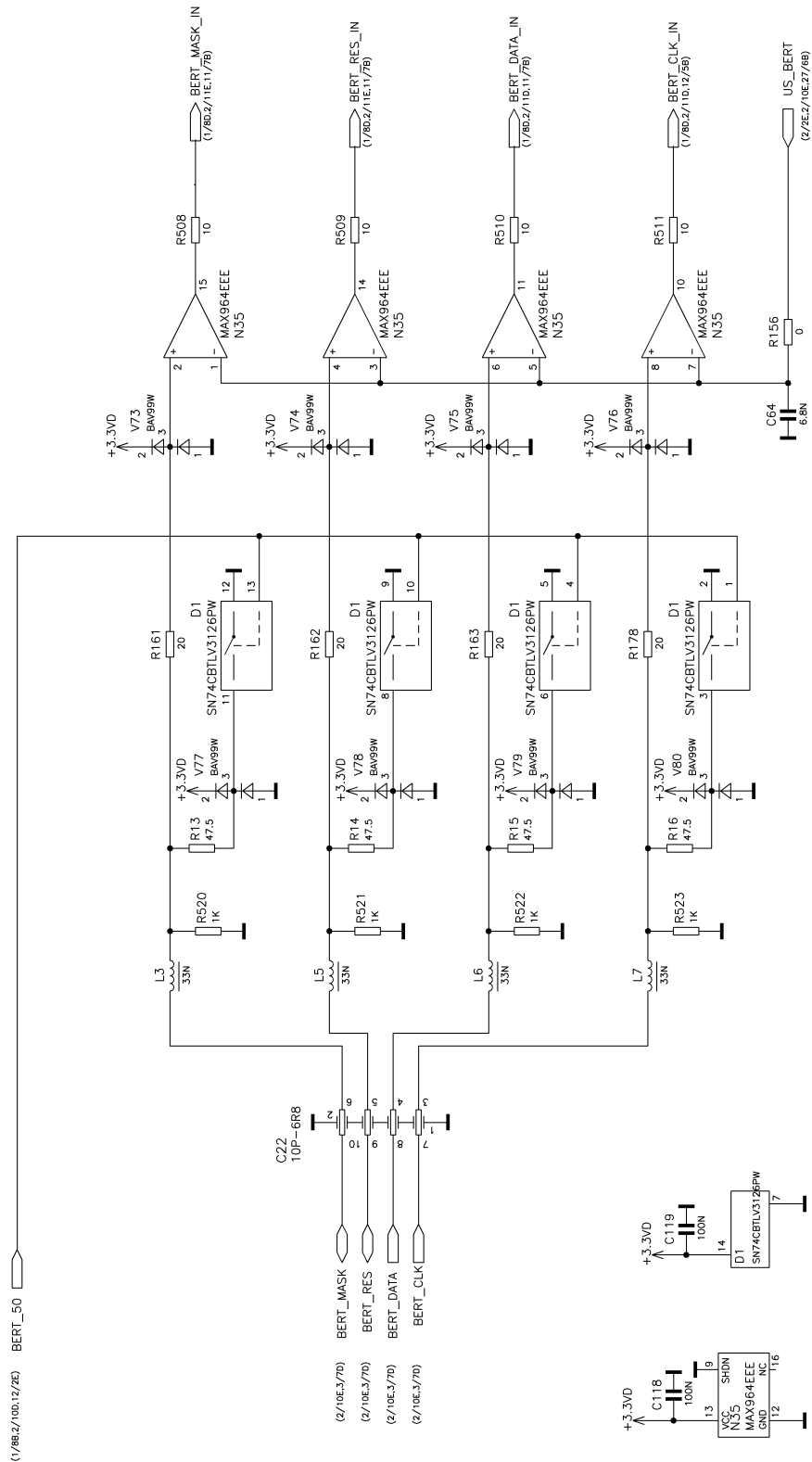

Fig. 1-2: BERT circuit diagram

List of Commands

*CAL.....	497
*CLS.....	497
*ESE.....	498
*ESR.....	498
*IDN.....	498
*IST.....	498
*OPC.....	499
*OPT.....	499
*PCB.....	499
*PRE.....	499
*PSC.....	499
*RCL.....	500
*RST.....	500
*SAV.....	500
*SRE.....	500
*STB.....	501
*TRG.....	501
*TST.....	501
*WAI.....	501
:BERT:RESult.....	521
:BERT:SEQuence.....	522
:BERT:SETup:CLOCK[:POLarity].....	523
:BERT:SETup:DATA[:POLarity].....	524
:BERT:SETup:DENable.....	524
:BERT:SETup:IGNore.....	525
:BERT:SETup:MCOunt.....	526
:BERT:SETup:MERRor.....	526
:BERT:SETup:REStart:STATe.....	526
:BERT:SETup:TYPE.....	527
:BERT:START.....	528
:BERT:STATe.....	528
:BERT:STOP.....	528
:BERT:UNIT.....	529
:BLER:RESult.....	521
:BLER:SEQuence.....	522
:BLER:SETup:CLOCK[:POLarity].....	523
:BLER:SETup:CORDer.....	523
:BLER:SETup:DATA[:POLarity].....	524
:BLER:SETup:DENable.....	524
:BLER:SETup:MCOunt.....	526
:BLER:SETup:MERRor.....	526
:BLER:SETup:TYPE.....	527
:BLER:START.....	528
:BLER:STATe.....	528
:BLER:STOP.....	528

:BLER:UNIT.....	529
:CALibration:ALL[:MEASure].....	530
:CALibration<hw>:BBIN[:MEASure].....	531
:CALibration<hw>:FMOFset[:MEASure].....	531
:CALibration<hw>:FREQuency[:MEASure].....	531
:CALibration<hw>:IQModulator:FULL.....	532
:CALibration<hw>:IQModulator:LOCal.....	532
:CALibration<hw>:LEVel:HACCuracy[:STATe].....	533
:CALibration<hw>:LEVel:STATe.....	532
:CALibration<hw>:LEVel[:MEASure].....	532
:CLOCK:INPut:FREQuency.....	533
:CLOCK:INPut:SLOPe.....	533
:CLOCK:OUTPut:MODE.....	534
:CLOCK:OUTPut:SOURce.....	534
:DEvice:PRESet.....	502
:DIAGnostic:INFO:OTIME.....	535
:DIAGnostic:INFO:POCount.....	536
:DIAGnostic<hw>:BGInfo.....	534
:DIAGnostic<hw>:BGInfo:CATalog.....	535
:DISPlay:PSAVe:HOLDoff.....	536
:DISPlay:PSAVe[:STATe].....	536
:FORMat:BORDER.....	537
:FORMat:SREGister.....	538
:FORMat[:DATA].....	537
:HCOPY:DATA.....	539
:HCOPY:DEvice.....	539
:HCOPY:DEvice:LANGuage.....	540
:HCOPY:FILE[:NAME].....	540
:HCOPY:FILE[:NAME]:AUTO.....	540
:HCOPY:FILE[:NAME]:AUTO:DIRectory.....	541
:HCOPY:FILE[:NAME]:AUTO:DIRectory:CLEar.....	541
:HCOPY:FILE[:NAME]:AUTO:FILE.....	541
:HCOPY:FILE[:NAME]:AUTO:STATe.....	544
:HCOPY:FILE[:NAME]:AUTO[:FILE]:DAY.....	542
:HCOPY:FILE[:NAME]:AUTO[:FILE]:DAY:STATe.....	542
:HCOPY:FILE[:NAME]:AUTO[:FILE]:MONTH.....	542
:HCOPY:FILE[:NAME]:AUTO[:FILE]:MONTH:STATe.....	543
:HCOPY:FILE[:NAME]:AUTO[:FILE]:NUMBer.....	543
:HCOPY:FILE[:NAME]:AUTO[:FILE]:PREFix.....	543
:HCOPY:FILE[:NAME]:AUTO[:FILE]:PREFix:STATe.....	543
:HCOPY:FILE[:NAME]:AUTO[:FILE]:YEAR.....	544
:HCOPY:FILE[:NAME]:AUTO[:FILE]:YEAR:STATe.....	544
:HCOPY:IMAGe:FORMat.....	544
:HCOPY:IMAGe:SIZE.....	545
:HCOPY:PRINter:LIST.....	545
:HCOPY:PRINter:PAGE:MARGins.....	545
:HCOPY:PRINter:PAGE:ORientation.....	546
:HCOPY:PRINter:PAGE:SIZE.....	546

:HCOPy:PRINter:PAGE:UNIT.....	546
:HCOPy:PRINter[:NAME].....	545
:HCOPy[:EXECute].....	540
:KBOard:LANGUage.....	547
:KBOard:LAYout.....	547
:MMEMory:CATalog.....	552
:MMEMory:CATalog:LENGth.....	553
:MMEMory:CDIRectory.....	553
:MMEMory:COPI.....	553
:MMEMory:DATA.....	554
:MMEMory:DCATalog.....	555
:MMEMory:DCATalog:LENGth.....	555
:MMEMory:DELeTe.....	555
:MMEMory:LOAD:STATe.....	556
:MMEMory:MDIRectory.....	556
:MMEMory:MOVE.....	556
:MMEMory:MSIS.....	557
:MMEMory:RDIRectory.....	557
:MMEMory:STORe:STATe.....	557
:OUTPut:ALL[:STATe].....	558
:OUTPut:BLANK:POLarity.....	560
:OUTPut:USER<ch>:SOURce.....	562
:OUTPut<hw>:AFIXed:RANGe:LOWer.....	558
:OUTPut<hw>:AFIXed:RANGe:UPPer.....	558
:OUTPut<hw>:AMODE.....	559
:OUTPut<hw>:BLANK:LIST:STATe.....	560
:OUTPut<hw>:IMPedance.....	560
:OUTPut<hw>:PROTEction:CLEar.....	560
:OUTPut<hw>:PROTEction:STATe.....	561
:OUTPut<hw>:PROTEction:TRIPped.....	561
:OUTPut<hw>[:STATe].....	561
:OUTPut<hw>[:STATe]:PON.....	561
:SOURce<hw>:PRESet.....	502
:SYSTem:BEEPer:STATe.....	797
:SYSTem:COMMunicate:GPIB:LTERminator.....	797
:SYSTem:COMMunicate:GPIB:RESource.....	798
:SYSTem:COMMunicate:GPIB[:SELF]:ADDRess.....	798
:SYSTem:COMMunicate:NETWork:RESource.....	798
:SYSTem:COMMunicate:NETWork[:COMMOn]:WORKgroup.....	798
:SYSTem:COMMunicate:SOCKet:RESource.....	799
:SYSTem:DATE.....	799
:SYSTem:DISPlay:UPDate.....	799
:SYSTem:FPReset.....	502
:SYSTem:KLOCK.....	801
:SYSTem:PROTEct<ch>[:STATe].....	801
:SYSTem:STARtup:COMPLete.....	802
:SYSTem:TIME.....	803
:TEST:BB:CONNecion.....	804

:TEST:BBIN.....	804
:TEST:CONNector:AUXio.....	805
:TEST:FADer.....	805
:TEST<hw>:BBIN:RBERror.....	804
:TEST<hw>:BBOut:LRATe.....	804
:TEST<hw>:BBOut:TTEST[:STATe].....	805
:TEST<hw>:DIRect.....	805
:TRIGger:BERT[:IMMediate].....	530
:TRIGger:BLER[:IMMediate].....	530
:TRIGger<hw>:FSWeep:SOURce.....	808
:TRIGger<hw>:FSWeep[:IMMediate].....	807
:TRIGger<hw>:LFFSweep:SOURce.....	807
:TRIGger<hw>:PSWeep:SOURce.....	809
:TRIGger<hw>:PSWeep[:IMMediate].....	808
:TRIGger<hw>[:SWEep]:SOURce.....	810
:TRIGger<hw>[:SWEep][:IMMediate].....	810
:UNIT:ANGLE.....	811
:UNIT:POWer.....	811
INITiate<ch>[:POWer]:CONTInuous.....	563
READ<ch>[:POWer].....	563
SENSe<ch>:UNIT[:POWer].....	570
SENSe<ch>[:POWer]:CORRection:SPDeVice:STATe.....	564
SENSe<ch>[:POWer]:DISPlay:PERManent:PRiority.....	565
SENSe<ch>[:POWer]:DISPlay:PERManent:STATe.....	564
SENSe<ch>[:POWer]:FILTer:LENGth:AUTO.....	565
SENSe<ch>[:POWer]:FILTer:LENGth[:USER].....	565
SENSe<ch>[:POWer]:FILTer:NSRatIo.....	566
SENSe<ch>[:POWer]:FILTer:NSRatIo:MTIME.....	566
SENSe<ch>[:POWer]:FILTer:SONCe.....	566
SENSe<ch>[:POWer]:FILTer:TYPE.....	567
SENSe<ch>[:POWer]:FREQuency.....	567
SENSe<ch>[:POWer]:OFFSet.....	568
SENSe<ch>[:POWer]:OFFSet:STATe.....	568
SENSe<ch>[:POWer]:SNUMber.....	568
SENSe<ch>[:POWer]:SOURce.....	568
SENSe<ch>[:POWer]:STATus[:DEVice].....	569
SENSe<ch>[:POWer]:SVERsion.....	569
SENSe<ch>[:POWer]:TYPE.....	569
SENSe<ch>[:POWer]:ZERO.....	570
STATus:OPERation:CONDition.....	793
STATus:OPERation:ENABle.....	793
STATus:OPERation:NTRansition.....	794
STATus:OPERation:PTRansition.....	794
STATus:OPERation[:EVENT].....	793
STATus:PRESet.....	794
STATus:QUEStionable:CONDition.....	795
STATus:QUEStionable:ENABle.....	795
STATus:QUEStionable:NTRansition.....	795

STATus:QUESTionable:PTRansition.....	796
STATus:QUESTionable[:EVENT].....	795
STATus:QUEue[:NEXT].....	796
SYSTem:ERRor:ALL.....	799
SYSTem:ERRor:CODE:ALL.....	800
SYSTem:ERRor:CODE[:NEXT].....	800
SYSTem:ERRor:COUNT.....	800
SYSTem:ERRor[:NEXT].....	801
SYSTem:PRESet.....	502
SYSTem:SERRor.....	802
SYSTem:VERSion.....	803
TRIGger0[:SWEep]:SOURce.....	807
[:SOURce<hw>]:AM:BBANd:SENSitivity.....	572
[:SOURce<hw>]:AM:BBANd[:STATe].....	572
[:SOURce<hw>]:AM:EXTernal:COUPling.....	573
[:SOURce<hw>]:AM:SENSitivity.....	573
[:SOURce<hw>]:AM:SOURce.....	573
[:SOURce<hw>]:AM:STATe.....	574
[:SOURce<hw>]:AM[:DEPTh].....	572
[:SOURce<hw>]:AWGN:BRATe.....	575
[:SOURce<hw>]:AWGN:BWIDth.....	575
[:SOURce<hw>]:AWGN:BWIDth:NOISe.....	575
[:SOURce<hw>]:AWGN:BWIDth:RATio.....	576
[:SOURce<hw>]:AWGN:CNRatio.....	576
[:SOURce<hw>]:AWGN:DISP:MODE.....	577
[:SOURce<hw>]:AWGN:DISP:ORESults.....	577
[:SOURce<hw>]:AWGN:ENRatio.....	577
[:SOURce<hw>]:AWGN:FREQuency:RESult.....	578
[:SOURce<hw>]:AWGN:FREQuency:TARGet.....	578
[:SOURce<hw>]:AWGN:MODE.....	579
[:SOURce<hw>]:AWGN:POWer:CARRier.....	579
[:SOURce<hw>]:AWGN:POWer:MODE.....	580
[:SOURce<hw>]:AWGN:POWer:NOISe.....	580
[:SOURce<hw>]:AWGN:POWer:NOISe:TOTal.....	581
[:SOURce<hw>]:AWGN:POWer:RMODE.....	581
[:SOURce<hw>]:AWGN:POWer:SUM.....	581
[:SOURce<hw>]:AWGN:POWer:SUM:PEP.....	582
[:SOURce<hw>]:AWGN:STATe.....	582
[:SOURce<hw>]:BB:ARB:CLOCK.....	586
[:SOURce<hw>]:BB:ARB:CLOCK:MODE.....	587
[:SOURce<hw>]:BB:ARB:CLOCK:MULTiplier.....	587
[:SOURce<hw>]:BB:ARB:CLOCK:SOURce.....	588
[:SOURce<hw>]:BB:ARB:MCARRier:CARRier:COUNT.....	602
[:SOURce<hw>]:BB:ARB:MCARRier:CARRier:MODE.....	602
[:SOURce<hw>]:BB:ARB:MCARRier:CARRier:SPACing.....	603
[:SOURce<hw>]:BB:ARB:MCARRier:CARRier<ch>:CONFLict.....	603
[:SOURce<hw>]:BB:ARB:MCARRier:CARRier<ch>:DELay.....	604
[:SOURce<hw>]:BB:ARB:MCARRier:CARRier<ch>:FILE.....	604

[:SOURce<hw>]:BB:ARB:MCARrier:CARRier<ch>:FREQuency.....	604
[:SOURce<hw>]:BB:ARB:MCARrier:CARRier<ch>:PHASe.....	605
[:SOURce<hw>]:BB:ARB:MCARrier:CARRier<ch>:POWER.....	605
[:SOURce<hw>]:BB:ARB:MCARrier:CARRier<ch>:STATe.....	605
[:SOURce<hw>]:BB:ARB:MCARrier:CFACTOR:MODE.....	605
[:SOURce<hw>]:BB:ARB:MCARrier:CLIPping:CFACTOR.....	606
[:SOURce<hw>]:BB:ARB:MCARrier:CLIPping:CUTOFF.....	606
[:SOURce<hw>]:BB:ARB:MCARrier:CLIPping[:STATe].....	607
[:SOURce<hw>]:BB:ARB:MCARrier:CLOCK.....	608
[:SOURce<hw>]:BB:ARB:MCARrier:CLOAD.....	607
[:SOURce<hw>]:BB:ARB:MCARrier:CREate.....	608
[:SOURce<hw>]:BB:ARB:MCARrier:EDIT:CARRier:DELay:STEP.....	608
[:SOURce<hw>]:BB:ARB:MCARrier:EDIT:CARRier:DELay[:START].....	609
[:SOURce<hw>]:BB:ARB:MCARrier:EDIT:CARRier:EXECute.....	609
[:SOURce<hw>]:BB:ARB:MCARrier:EDIT:CARRier:FILE.....	610
[:SOURce<hw>]:BB:ARB:MCARrier:EDIT:CARRier:PHASe:STEP.....	610
[:SOURce<hw>]:BB:ARB:MCARrier:EDIT:CARRier:PHASe[:START].....	610
[:SOURce<hw>]:BB:ARB:MCARrier:EDIT:CARRier:POWER:STEP.....	611
[:SOURce<hw>]:BB:ARB:MCARrier:EDIT:CARRier:POWER[:START].....	611
[:SOURce<hw>]:BB:ARB:MCARrier:EDIT:CARRier:START.....	611
[:SOURce<hw>]:BB:ARB:MCARrier:EDIT:CARRier:STATe.....	612
[:SOURce<hw>]:BB:ARB:MCARrier:EDIT:CARRier:STOP.....	611
[:SOURce<hw>]:BB:ARB:MCARrier:OFILe.....	612
[:SOURce<hw>]:BB:ARB:MCARrier:PRESet.....	612
[:SOURce<hw>]:BB:ARB:MCARrier:SAMPles.....	612
[:SOURce<hw>]:BB:ARB:MCARrier:SETTING:CATalog.....	613
[:SOURce<hw>]:BB:ARB:MCARrier:SETTING:LOAD.....	613
[:SOURce<hw>]:BB:ARB:MCARrier:SETTING:STORE.....	613
[:SOURce<hw>]:BB:ARB:MCARrier:SETTING:STORE:FAST.....	613
[:SOURce<hw>]:BB:ARB:MCARrier:TIME.....	614
[:SOURce<hw>]:BB:ARB:MCARrier:TIME:MODE.....	614
[:SOURce<hw>]:BB:ARB:PRESet.....	586
[:SOURce<hw>]:BB:ARB:STATe.....	586
[:SOURce<hw>]:BB:ARB:TRIGger:ARM:EXECute.....	588
[:SOURce<hw>]:BB:ARB:TRIGger:EXECute.....	589
[:SOURce<hw>]:BB:ARB:TRIGger:EXTernal:SYNChronize:OUTPut.....	589
[:SOURce<hw>]:BB:ARB:TRIGger:OBASeband:DELay.....	590
[:SOURce<hw>]:BB:ARB:TRIGger:OBASeband:INHibit.....	590
[:SOURce<hw>]:BB:ARB:TRIGger:OUTPut:DELay:FIXed.....	590
[:SOURce<hw>]:BB:ARB:TRIGger:OUTPut<ch>:DELay.....	591
[:SOURce<hw>]:BB:ARB:TRIGger:OUTPut<ch>:DELay:MAXimum.....	591
[:SOURce<hw>]:BB:ARB:TRIGger:OUTPut<ch>:DELay:MINimum.....	591
[:SOURce<hw>]:BB:ARB:TRIGger:OUTPut<ch>:MODE.....	596
[:SOURce<hw>]:BB:ARB:TRIGger:OUTPut<ch>:OFFTime.....	596
[:SOURce<hw>]:BB:ARB:TRIGger:OUTPut<ch>:ONTTime.....	596
[:SOURce<hw>]:BB:ARB:TRIGger:OUTPut<ch>:PATTern.....	597
[:SOURce<hw>]:BB:ARB:TRIGger:OUTPut<ch>:PULSe:DIVider.....	597
[:SOURce<hw>]:BB:ARB:TRIGger:OUTPut<ch>:PULSe:FREQuency.....	597

[:SOURce<hw>]:BB:ARB:TRIGger:RMODE.....	592
[:SOURce<hw>]:BB:ARB:TRIGger:SLenGth.....	592
[:SOURce<hw>]:BB:ARB:TRIGger:SLUnit.....	593
[:SOURce<hw>]:BB:ARB:TRIGger:SMODE.....	593
[:SOURce<hw>]:BB:ARB:TRIGger:SOURce.....	594
[:SOURce<hw>]:BB:ARB:TRIGger[:EXTernal<1 2>]:DELay.....	594
[:SOURce<hw>]:BB:ARB:TRIGger[:EXTernal<1 2>]:INHibit.....	594
[:SOURce<hw>]:BB:ARB:TSIGnal:CIQ:CREate.....	598
[:SOURce<hw>]:BB:ARB:TSIGnal:CIQ:CREate:NAMed.....	598
[:SOURce<hw>]:BB:ARB:TSIGnal:CIQ:I.....	599
[:SOURce<hw>]:BB:ARB:TSIGnal:CIQ:Q.....	599
[:SOURce<hw>]:BB:ARB:TSIGnal:RECTangle:AMPLitude.....	599
[:SOURce<hw>]:BB:ARB:TSIGnal:RECTangle:CREate.....	598
[:SOURce<hw>]:BB:ARB:TSIGnal:RECTangle:CREate:NAMed.....	598
[:SOURce<hw>]:BB:ARB:TSIGnal:RECTangle:FREQuency.....	599
[:SOURce<hw>]:BB:ARB:TSIGnal:RECTangle:OFFSet.....	599
[:SOURce<hw>]:BB:ARB:TSIGnal:RECTangle:SAMPles.....	600
[:SOURce<hw>]:BB:ARB:TSIGnal:SINE:CREate.....	598
[:SOURce<hw>]:BB:ARB:TSIGnal:SINE:CREate:NAMed.....	598
[:SOURce<hw>]:BB:ARB:TSIGnal:SINE:FREQuency.....	600
[:SOURce<hw>]:BB:ARB:TSIGnal:SINE:PHASe.....	600
[:SOURce<hw>]:BB:ARB:TSIGnal:SINE:SAMPles.....	601
[:SOURce<hw>]:BB:ARB:WAVeform:CATalog.....	615
[:SOURce<hw>]:BB:ARB:WAVeform:CATalog:LENGth.....	615
[:SOURce<hw>]:BB:ARB:WAVeform:DATA.....	616
[:SOURce<hw>]:BB:ARB:WAVeform:DELete.....	617
[:SOURce<hw>]:BB:ARB:WAVeform:FREE.....	617
[:SOURce<hw>]:BB:ARB:WAVeform:HDDStreaming:BLEVel.....	617
[:SOURce<hw>]:BB:ARB:WAVeform:HDDStreaming:STATe.....	618
[:SOURce<hw>]:BB:ARB:WAVeform:POINts.....	618
[:SOURce<hw>]:BB:ARB:WAVeform:SELect.....	619
[:SOURce<hw>]:BB:ARB:WAVeform:TAG.....	619
[:SOURce<hw>]:BB:ARB:WSEGment.....	620
[:SOURce<hw>]:BB:ARB:WSEGment:CLOad.....	620
[:SOURce<hw>]:BB:ARB:WSEGment:CONFigure:BLANK:APPend.....	621
[:SOURce<hw>]:BB:ARB:WSEGment:CONFigure:CATalog.....	622
[:SOURce<hw>]:BB:ARB:WSEGment:CONFigure:CLOCK.....	622
[:SOURce<hw>]:BB:ARB:WSEGment:CONFigure:CLOCK:MODE.....	622
[:SOURce<hw>]:BB:ARB:WSEGment:CONFigure:COMMeNt.....	623
[:SOURce<hw>]:BB:ARB:WSEGment:CONFigure:DELete.....	623
[:SOURce<hw>]:BB:ARB:WSEGment:CONFigure:LEVel[:MODE].....	623
[:SOURce<hw>]:BB:ARB:WSEGment:CONFigure:MARKer:ESEGment.....	624
[:SOURce<hw>]:BB:ARB:WSEGment:CONFigure:MARKer:FSEGment.....	624
[:SOURce<hw>]:BB:ARB:WSEGment:CONFigure:MARKer:MODE.....	625
[:SOURce<hw>]:BB:ARB:WSEGment:CONFigure:OFILe.....	625
[:SOURce<hw>]:BB:ARB:WSEGment:CONFigure:SEGMeNt:APPend.....	626
[:SOURce<hw>]:BB:ARB:WSEGment:CONFigure:SEGMeNt:CATalog.....	626
[:SOURce<hw>]:BB:ARB:WSEGment:CONFigure:SELect.....	626

[[:SOURce<hw>]:BB:ARB:WSEgment:CREate.....	627
[[:SOURce<hw>]:BB:ARB:WSEgment:NAME.....	627
[[:SOURce<hw>]:BB:ARB:WSEgment:NEXT.....	627
[[:SOURce<hw>]:BB:ARB:WSEgment:NEXT:EXECute.....	628
[[:SOURce<hw>]:BB:ARB:WSEgment:NEXT:SOURce.....	628
[[:SOURce<hw>]:BB:ARB:WSEgment:SEQuence:APPend.....	628
[[:SOURce<hw>]:BB:ARB:WSEgment:SEQuence:SELEct.....	629
[[:SOURce<hw>]:BB:ARB[:TRIGger]:SEQuence.....	595
[[:SOURce<hw>]:BB:CFACTOR.....	698
[[:SOURce<hw>]:BB:DM:AQPSk:ANGLE.....	647
[[:SOURce<hw>]:BB:DM:ASK:DEPTH.....	647
[[:SOURce<hw>]:BB:DM:CLISt:CATalog.....	654
[[:SOURce<hw>]:BB:DM:CLISt:COPI.....	655
[[:SOURce<hw>]:BB:DM:CLISt:DATA.....	656
[[:SOURce<hw>]:BB:DM:CLISt:DELEte.....	657
[[:SOURce<hw>]:BB:DM:CLISt:FREE.....	654
[[:SOURce<hw>]:BB:DM:CLISt:POINts.....	657
[[:SOURce<hw>]:BB:DM:CLISt:SELEct.....	657
[[:SOURce<hw>]:BB:DM:CLISt:TAG.....	655
[[:SOURce<hw>]:BB:DM:CLOCK:MODE.....	633
[[:SOURce<hw>]:BB:DM:CLOCK:MULTIplier.....	634
[[:SOURce<hw>]:BB:DM:CLOCK:SOURce.....	634
[[:SOURce<hw>]:BB:DM:CODing.....	648
[[:SOURce<hw>]:BB:DM:DLISt:CATalog.....	654
[[:SOURce<hw>]:BB:DM:DLISt:COPI.....	655
[[:SOURce<hw>]:BB:DM:DLISt:DATA.....	658
[[:SOURce<hw>]:BB:DM:DLISt:DATA:APPend.....	658
[[:SOURce<hw>]:BB:DM:DLISt:DELEte.....	659
[[:SOURce<hw>]:BB:DM:DLISt:FREE.....	654
[[:SOURce<hw>]:BB:DM:DLISt:POINts.....	659
[[:SOURce<hw>]:BB:DM:DLISt:SELEct.....	660
[[:SOURce<hw>]:BB:DM:DLISt:TAG.....	655
[[:SOURce<hw>]:BB:DM:FILTer:OSAMpling.....	644
[[:SOURce<hw>]:BB:DM:FILTer:OSAMpling:AUTO.....	645
[[:SOURce<hw>]:BB:DM:FILTer:PARAmeter:APCO25.....	645
[[:SOURce<hw>]:BB:DM:FILTer:PARAmeter:APCO25Lsm:GAUSSs.....	646
[[:SOURce<hw>]:BB:DM:FILTer:PARAmeter:APCO25Lsm:LOWPass.....	646
[[:SOURce<hw>]:BB:DM:FILTer:PARAmeter:COSSine:BANDwidth.....	646
[[:SOURce<hw>]:BB:DM:FILTer:PARAmeter:COSSine[:ROLLoff].....	645
[[:SOURce<hw>]:BB:DM:FILTer:PARAmeter:GAUSSs.....	645
[[:SOURce<hw>]:BB:DM:FILTer:PARAmeter:LPASSEVM.....	645
[[:SOURce<hw>]:BB:DM:FILTer:PARAmeter:LPASS.....	645
[[:SOURce<hw>]:BB:DM:FILTer:PARAmeter:PGAuss.....	645
[[:SOURce<hw>]:BB:DM:FILTer:PARAmeter:RCOSSine.....	645
[[:SOURce<hw>]:BB:DM:FILTer:PARAmeter:SPHase.....	645
[[:SOURce<hw>]:BB:DM:FILTer:TYPE.....	646
[[:SOURce<hw>]:BB:DM:FLISt:CATalog.....	654
[[:SOURce<hw>]:BB:DM:FLISt:DELEte.....	660

[:SOURce<hw>]:BB:DM:FLISt:FREE.....	655
[:SOURce<hw>]:BB:DM:FLISt:POINts.....	660
[:SOURce<hw>]:BB:DM:FLISt:SELEct.....	661
[:SOURce<hw>]:BB:DM:FORMat.....	648
[:SOURce<hw>]:BB:DM:FSK:DEViatiOn.....	649
[:SOURce<hw>]:BB:DM:FSK:VARiable:SYMBol<ch>:DEViatiOn.....	649
[:SOURce<hw>]:BB:DM:FSK:VARiable:TYPE.....	649
[:SOURce<hw>]:BB:DM:MDELay.....	650
[:SOURce<hw>]:BB:DM:MLISt:CATalog.....	654
[:SOURce<hw>]:BB:DM:MLISt:DELEte.....	661
[:SOURce<hw>]:BB:DM:MLISt:FREE.....	655
[:SOURce<hw>]:BB:DM:MLISt:POINts.....	661
[:SOURce<hw>]:BB:DM:MLISt:SELEct.....	662
[:SOURce<hw>]:BB:DM:PATTern.....	630
[:SOURce<hw>]:BB:DM:PRAMp:ATTenuatiOn.....	650
[:SOURce<hw>]:BB:DM:PRAMp:BBONly[:STATe].....	651
[:SOURce<hw>]:BB:DM:PRAMp:FDELay.....	651
[:SOURce<hw>]:BB:DM:PRAMp:RDELay.....	651
[:SOURce<hw>]:BB:DM:PRAMp:SHAPE.....	652
[:SOURce<hw>]:BB:DM:PRAMp:SOURce.....	652
[:SOURce<hw>]:BB:DM:PRAMp:TIME.....	652
[:SOURce<hw>]:BB:DM:PRAMp[:STATe].....	652
[:SOURce<hw>]:BB:DM:PRBS[:LENGth].....	630
[:SOURce<hw>]:BB:DM:PRESet.....	631
[:SOURce<hw>]:BB:DM:SETTing:CATalog.....	662
[:SOURce<hw>]:BB:DM:SETTing:DELEte.....	662
[:SOURce<hw>]:BB:DM:SETTing:LOAD.....	663
[:SOURce<hw>]:BB:DM:SETTing:STORE.....	663
[:SOURce<hw>]:BB:DM:SETTing:STORE:FAST.....	663
[:SOURce<hw>]:BB:DM:SOURce.....	631
[:SOURce<hw>]:BB:DM:SRATe.....	632
[:SOURce<hw>]:BB:DM:STANdard.....	632
[:SOURce<hw>]:BB:DM:STANdard:ULISt:CATalog.....	663
[:SOURce<hw>]:BB:DM:STANdard:ULISt:DELEte.....	664
[:SOURce<hw>]:BB:DM:STANdard:ULISt:LOAD.....	664
[:SOURce<hw>]:BB:DM:STANdard:ULISt:STORE.....	664
[:SOURce<hw>]:BB:DM:STATe.....	632
[:SOURce<hw>]:BB:DM:SWITChing:SOURce.....	633
[:SOURce<hw>]:BB:DM:SWITChing:STATe.....	633
[:SOURce<hw>]:BB:DM:TRIGger:ARM:EXECute.....	635
[:SOURce<hw>]:BB:DM:TRIGger:EXECute.....	636
[:SOURce<hw>]:BB:DM:TRIGger:EXTernal:SYNChronize:OUTPut.....	636
[:SOURce<hw>]:BB:DM:TRIGger:OBASeband:DELay.....	637
[:SOURce<hw>]:BB:DM:TRIGger:OBASeband:INHibit.....	637
[:SOURce<hw>]:BB:DM:TRIGger:OUTPut:DELay:FIXed.....	637
[:SOURce<hw>]:BB:DM:TRIGger:OUTPut<ch>:DELay.....	638
[:SOURce<hw>]:BB:DM:TRIGger:OUTPut<ch>:DELay:MAXimum.....	638
[:SOURce<hw>]:BB:DM:TRIGger:OUTPut<ch>:DELay:MINimum.....	638

[:SOURce<hw>]:BB:DM:TRIGger:OUTPut<ch>:MODE.....	642
[:SOURce<hw>]:BB:DM:TRIGger:OUTPut<ch>:OFFTime.....	642
[:SOURce<hw>]:BB:DM:TRIGger:OUTPut<ch>:ONTime.....	643
[:SOURce<hw>]:BB:DM:TRIGger:OUTPut<ch>:PATTern.....	643
[:SOURce<hw>]:BB:DM:TRIGger:OUTPut<ch>:PULSe:DIVider.....	643
[:SOURce<hw>]:BB:DM:TRIGger:OUTPut<ch>:PULSe:FREQUency.....	644
[:SOURce<hw>]:BB:DM:TRIGger:RMODe.....	638
[:SOURce<hw>]:BB:DM:TRIGger:SLENgth.....	639
[:SOURce<hw>]:BB:DM:TRIGger:SOURce.....	639
[:SOURce<hw>]:BB:DM:TRIGger[:EXTernal<ch>]:DELAY.....	640
[:SOURce<hw>]:BB:DM:TRIGger[:EXTernal<ch>]:INHibit.....	640
[:SOURce<hw>]:BB:DM[:TRIGger]:SEQUence.....	641
[:SOURce<hw>]:BB:FOFFset.....	584
[:SOURce<hw>]:BB:GRAPhics:MODE.....	665
[:SOURce<hw>]:BB:GRAPhics:SMARt:STATe.....	665
[:SOURce<hw>]:BB:GRAPhics:SRATe:MODE.....	665
[:SOURce<hw>]:BB:GRAPhics:SRATe:USER.....	666
[:SOURce<hw>]:BB:GRAPhics:STATe.....	666
[:SOURce<hw>]:BB:GRAPhics:TRIGger:SOURce.....	667
[:SOURce<hw>]:BB:IMPairment:IQRatio.....	668
[:SOURce<hw>]:BB:IMPairment:LEAKage:I.....	668
[:SOURce<hw>]:BB:IMPairment:LEAKage:Q.....	668
[:SOURce<hw>]:BB:IMPairment:OPTimization:MODE.....	669
[:SOURce<hw>]:BB:IMPairment:OPTimization:STATe.....	669
[:SOURce<hw>]:BB:IMPairment:OPTimization:UCORrection:ACCuracy.....	669
[:SOURce<hw>]:BB:IMPairment:OPTimization:UCORrection:BWIDth.....	670
[:SOURce<hw>]:BB:IMPairment:OPTimization:UCORrection:CATalog.....	670
[:SOURce<hw>]:BB:IMPairment:OPTimization:UCORrection:EDEVices.....	670
[:SOURce<hw>]:BB:IMPairment:OPTimization:UCORrection:FILE.....	671
[:SOURce<hw>]:BB:IMPairment:OPTimization:UCORrection:FILE:STATus.....	671
[:SOURce<hw>]:BB:IMPairment:OPTimization:UCORrection:FREQUency:MAX.....	672
[:SOURce<hw>]:BB:IMPairment:OPTimization:UCORrection:FREQUency:MIN.....	672
[:SOURce<hw>]:BB:IMPairment:OPTimization:UCORrection:FREQUency:OFFSet.....	673
[:SOURce<hw>]:BB:IMPairment:OPTimization:UCORrection:IAFixed.....	673
[:SOURce<hw>]:BB:IMPairment:OPTimization:UCORrection:LEVel:MAX.....	674
[:SOURce<hw>]:BB:IMPairment:OPTimization:UCORrection:LEVel:MIN.....	674
[:SOURce<hw>]:BB:IMPairment:OPTimization:UCORrection:LEVel:OFFSet.....	674
[:SOURce<hw>]:BB:IMPairment:OPTimization:UCORrection:TYPE.....	675
[:SOURce<hw>]:BB:IMPairment:QUADrature[:ANGLE].....	675
[:SOURce<hw>]:BB:IMPairment:STATe.....	675
[:SOURce<hw>]:BB:IQGain.....	736
[:SOURce<hw>]:BB:MCCW:CARRier:COUNt.....	677
[:SOURce<hw>]:BB:MCCW:CARRier:LIST:PHASe.....	677
[:SOURce<hw>]:BB:MCCW:CARRier:LIST:POWer.....	678
[:SOURce<hw>]:BB:MCCW:CARRier:LIST:STATe.....	678
[:SOURce<hw>]:BB:MCCW:CARRier:PHASe.....	678
[:SOURce<hw>]:BB:MCCW:CARRier:POWer.....	679
[:SOURce<hw>]:BB:MCCW:CARRier:SPACing.....	679

[:SOURce<hw>]:BB:MCCW:CARRier:STATe.....	680
[:SOURce<hw>]:BB:MCCW:CFACTOR.....	680
[:SOURce<hw>]:BB:MCCW:CFACTOR:MODE.....	680
[:SOURce<hw>]:BB:MCCW:CLOCK.....	681
[:SOURce<hw>]:BB:MCCW:CLOCK:MODE.....	694
[:SOURce<hw>]:BB:MCCW:CLOCK:MULTIPLIER.....	694
[:SOURce<hw>]:BB:MCCW:CLOCK:SOURce.....	695
[:SOURce<hw>]:BB:MCCW:EDIT:CARRier:EXECute.....	681
[:SOURce<hw>]:BB:MCCW:EDIT:CARRier:PHASe:STEP.....	682
[:SOURce<hw>]:BB:MCCW:EDIT:CARRier:PHASe[:START].....	682
[:SOURce<hw>]:BB:MCCW:EDIT:CARRier:POWER:STEP.....	683
[:SOURce<hw>]:BB:MCCW:EDIT:CARRier:POWER[:START].....	683
[:SOURce<hw>]:BB:MCCW:EDIT:CARRier:START.....	683
[:SOURce<hw>]:BB:MCCW:EDIT:CARRier:STATe.....	684
[:SOURce<hw>]:BB:MCCW:EDIT:CARRier:STOP.....	684
[:SOURce<hw>]:BB:MCCW:PRESet.....	677
[:SOURce<hw>]:BB:MCCW:STATe.....	676
[:SOURce<hw>]:BB:MCCW:TRIGGer:ARM:EXECute.....	685
[:SOURce<hw>]:BB:MCCW:TRIGGer:EXECute.....	685
[:SOURce<hw>]:BB:MCCW:TRIGGer:EXTernal:SYNChronize:OUTPut.....	685
[:SOURce<hw>]:BB:MCCW:TRIGGer:OBASeband:DElay.....	686
[:SOURce<hw>]:BB:MCCW:TRIGGer:OBASeband:INHibit.....	686
[:SOURce<hw>]:BB:MCCW:TRIGGer:OUTPut:DElay:FIXed.....	690
[:SOURce<hw>]:BB:MCCW:TRIGGer:OUTPut<ch>:DElay.....	690
[:SOURce<hw>]:BB:MCCW:TRIGGer:OUTPut<ch>:DElay:MAXimum.....	690
[:SOURce<hw>]:BB:MCCW:TRIGGer:OUTPut<ch>:DElay:MINimum.....	691
[:SOURce<hw>]:BB:MCCW:TRIGGer:OUTPut<ch>:MODE.....	691
[:SOURce<hw>]:BB:MCCW:TRIGGer:OUTPut<ch>:OFFTime.....	692
[:SOURce<hw>]:BB:MCCW:TRIGGer:OUTPut<ch>:ONTime.....	692
[:SOURce<hw>]:BB:MCCW:TRIGGer:OUTPut<ch>:PATTern.....	692
[:SOURce<hw>]:BB:MCCW:TRIGGer:OUTPut<ch>:PULSe:DIVider.....	693
[:SOURce<hw>]:BB:MCCW:TRIGGer:OUTPut<ch>:PULSe:FREQUency.....	693
[:SOURce<hw>]:BB:MCCW:TRIGGer:RMODE.....	687
[:SOURce<hw>]:BB:MCCW:TRIGGer:SLENgth.....	687
[:SOURce<hw>]:BB:MCCW:TRIGGer:SOURce.....	688
[:SOURce<hw>]:BB:MCCW:TRIGGer[:EXTernal<ch>]:DElay.....	688
[:SOURce<hw>]:BB:MCCW:TRIGGer[:EXTernal<ch>]:INHibit.....	688
[:SOURce<hw>]:BB:MCCW[:TRIGGer]:SEQUence.....	689
[:SOURce<hw>]:BB:MEASurement:CFACTOR.....	695
[:SOURce<hw>]:BB:MEASurement:DURation.....	696
[:SOURce<hw>]:BB:MEASurement:POWER:PEAK.....	696
[:SOURce<hw>]:BB:MEASurement:POWER:RMS.....	696
[:SOURce<hw>]:BB:MEASurement:RTIME.....	697
[:SOURce<hw>]:BB:MEASurement:SOURce.....	697
[:SOURce<hw>]:BB:MEASurement[:STATe].....	697
[:SOURce<hw>]:BB:MFPCCorrection.....	698
[:SOURce<hw>]:BB:PGAin.....	584
[:SOURce<hw>]:BB:POFFset.....	584

[[:SOURce<hw>]:BB:POWer:PEAK.....	699
[[:SOURce<hw>]:BB:POWer:RMS.....	699
[[:SOURce<hw>]:BB:ROUte.....	585
[[:SOURce<hw>]:BBIN:CDEvice.....	700
[[:SOURce<hw>]:BBIN:DIGital:ASETting:STATe.....	701
[[:SOURce<hw>]:BBIN:GIMBalance.....	701
[[:SOURce<hw>]:BBIN:MODE.....	702
[[:SOURce<hw>]:BBIN:MPERiod.....	702
[[:SOURce<hw>]:BBIN:OFFSet:I.....	703
[[:SOURce<hw>]:BBIN:OFFSet:Q.....	703
[[:SOURce<hw>]:BBIN:PGAin.....	704
[[:SOURce<hw>]:BBIN:SRATE:FIFO[:STATus].....	706
[[:SOURce<hw>]:BBIN:SRATE:SOURce.....	706
[[:SOURce<hw>]:CORRection:CSET:DATA:FREQuency.....	709
[[:SOURce<hw>]:CORRection:CSET:DATA:FREQuency:POINts.....	709
[[:SOURce<hw>]:CORRection:CSET:DATA:POWer.....	709
[[:SOURce<hw>]:CORRection:CSET:DATA:POWer:MLEVel:STATe.....	710
[[:SOURce<hw>]:CORRection:CSET:DATA:POWer:MLEVel<ch>.....	710
[[:SOURce<hw>]:CORRection:CSET:DATA:POWer:POINts.....	710
[[:SOURce<hw>]:CORRection:CSET:DATA[:SENSor<ch>][:POWer]:SONCe.....	711
[[:SOURce<hw>]:CORRection:CSET[:SElect].....	715
[[:SOURce<hw>]:CORRection:DEXChange:AFILe:CATalog.....	712
[[:SOURce<hw>]:CORRection:DEXChange:AFILe:EXTension.....	712
[[:SOURce<hw>]:CORRection:DEXChange:AFILe:SElect.....	712
[[:SOURce<hw>]:CORRection:DEXChange:AFILe:SEParator:COLumn.....	713
[[:SOURce<hw>]:CORRection:DEXChange:AFILe:SEParator:DECimal.....	713
[[:SOURce<hw>]:CORRection:DEXChange:EXECute.....	714
[[:SOURce<hw>]:CORRection:DEXChange:MODE.....	714
[[:SOURce<hw>]:CORRection:DEXChange:SElect.....	715
[[:SOURce<hw>]:CORRection:MLEVel:STATe.....	716
[[:SOURce<hw>]:CORRection:VALue.....	716
[[:SOURce<hw>]:CORRection[:STATe].....	716
[[:SOURce<hw>]:FM:EXTernal:COUPling.....	717
[[:SOURce<hw>]:FM:MODE.....	718
[[:SOURce<hw>]:FM:SENSitivity.....	718
[[:SOURce<hw>]:FM:SOURce.....	718
[[:SOURce<hw>]:FM:STATe.....	719
[[:SOURce<hw>]:FM[:DEVIation].....	717
[[:SOURce<hw>]:FREQuency:CENTer.....	720
[[:SOURce<hw>]:FREQuency:LOSCillator:MODE.....	720
[[:SOURce<hw>]:FREQuency:LOSCillator:OUTPut:STATe.....	721
[[:SOURce<hw>]:FREQuency:MANual.....	723
[[:SOURce<hw>]:FREQuency:MODE.....	723
[[:SOURce<hw>]:FREQuency:OFFSet.....	724
[[:SOURce<hw>]:FREQuency:PHASe:CONTInuous:HIGH.....	725
[[:SOURce<hw>]:FREQuency:PHASe:CONTInuous:LOW.....	725
[[:SOURce<hw>]:FREQuency:PHASe:CONTInuous:MODE.....	725
[[:SOURce<hw>]:FREQuency:PHASe:CONTInuous:STATe.....	726

[:SOURce<hw>]:FREQuency:SPAN.....	726
[:SOURce<hw>]:FREQuency:STARt.....	727
[:SOURce<hw>]:FREQuency:STEP:MODE.....	728
[:SOURce<hw>]:FREQuency:STEP[:INCRement].....	728
[:SOURce<hw>]:FREQuency:STOP.....	727
[:SOURce<hw>]:FREQuency[:CW]:FIXed].....	722
[:SOURce<hw>]:FREQuency[:CW]:FIXed]:RCL.....	722
[:SOURce<hw>]:INPut:MODext:IMPedance.....	730
[:SOURce<hw>]:IQ:CREStfactor.....	732
[:SOURce<hw>]:IQ:GAIN.....	732
[:SOURce<hw>]:IQ:IMPairment:IQRatio[:MAGNitude].....	733
[:SOURce<hw>]:IQ:IMPairment:LEAKage:I.....	733
[:SOURce<hw>]:IQ:IMPairment:LEAKage:Q.....	734
[:SOURce<hw>]:IQ:IMPairment:QUADrature[:ANGLe].....	734
[:SOURce<hw>]:IQ:IMPairment[:STATe].....	734
[:SOURce<hw>]:IQ:OUTPut:BIAS:COUPling[:STATe].....	737
[:SOURce<hw>]:IQ:OUTPut:BIAS:I.....	737
[:SOURce<hw>]:IQ:OUTPut:BIAS:OPTimization[:RF]:STATe.....	738
[:SOURce<hw>]:IQ:OUTPut:BIAS:Q.....	738
[:SOURce<hw>]:IQ:OUTPut:DIGital:CDEvice.....	742
[:SOURce<hw>]:IQ:OUTPut:DIGital:PON.....	743
[:SOURce<hw>]:IQ:OUTPut:DIGital:POWer:LEVel.....	743
[:SOURce<hw>]:IQ:OUTPut:DIGital:POWer:PEP.....	743
[:SOURce<hw>]:IQ:OUTPut:DIGital:POWer:STEP:MODE.....	744
[:SOURce<hw>]:IQ:OUTPut:DIGital:POWer:STEP[:INCRement].....	744
[:SOURce<hw>]:IQ:OUTPut:DIGital:SRATe.....	745
[:SOURce<hw>]:IQ:OUTPut:DIGital:SRATe:FIFO[:STATus].....	745
[:SOURce<hw>]:IQ:OUTPut:DIGital:SRATe:SOURce.....	746
[:SOURce<hw>]:IQ:OUTPut:DIGital:STATe.....	746
[:SOURce<hw>]:IQ:OUTPut:LEVel.....	738
[:SOURce<hw>]:IQ:OUTPut:MODE.....	739
[:SOURce<hw>]:IQ:OUTPut:OFFSet:I.....	740
[:SOURce<hw>]:IQ:OUTPut:OFFSet:Q.....	740
[:SOURce<hw>]:IQ:OUTPut:POWer:VIA.....	745
[:SOURce<hw>]:IQ:OUTPut:TYPE.....	741
[:SOURce<hw>]:IQ:OUTPut[:ANALog]:POWer:PEP.....	738
[:SOURce<hw>]:IQ:OUTPut[:ANALog]:POWer:PEP:RESult.....	739
[:SOURce<hw>]:IQ:SOURce.....	734
[:SOURce<hw>]:IQ:STATe.....	735
[:SOURce<hw>]:IQ:SWAP[:STATe].....	735
[:SOURce<hw>]:IQ:WBState.....	735
[:SOURce<hw>]:LIST:CATalog.....	756
[:SOURce<hw>]:LIST:DELeTe.....	757
[:SOURce<hw>]:LIST:DELeTe:ALL.....	757
[:SOURce<hw>]:LIST:DEXChange:AFILe:CATalog.....	758
[:SOURce<hw>]:LIST:DEXChange:AFILe:EXTension.....	758
[:SOURce<hw>]:LIST:DEXChange:AFILe:SELect.....	759
[:SOURce<hw>]:LIST:DEXChange:AFILe:SEPArator:COLumn.....	759

[:SOURce<hw>]:LIST:DEXChange:AFILe:SEParator:DECimal.....	760
[:SOURce<hw>]:LIST:DEXChange:EXECute.....	760
[:SOURce<hw>]:LIST:DEXChange:MODE.....	761
[:SOURce<hw>]:LIST:DEXChange:SElect.....	761
[:SOURce<hw>]:LIST:DWELI.....	762
[:SOURce<hw>]:LIST:FREQUency.....	762
[:SOURce<hw>]:LIST:FREQUency:POINts.....	763
[:SOURce<hw>]:LIST:INDEx.....	763
[:SOURce<hw>]:LIST:INDEx:STARt.....	763
[:SOURce<hw>]:LIST:INDEx:STOP.....	764
[:SOURce<hw>]:LIST:LEARn.....	764
[:SOURce<hw>]:LIST:MODE.....	765
[:SOURce<hw>]:LIST:POWEr.....	765
[:SOURce<hw>]:LIST:POWEr:AMODE.....	765
[:SOURce<hw>]:LIST:POWEr:POINts.....	766
[:SOURce<hw>]:LIST:RESEt.....	766
[:SOURce<hw>]:LIST:SElect.....	766
[:SOURce<hw>]:LIST:TRIGger:EXECute.....	767
[:SOURce<hw>]:LIST:TRIGger:SOURce.....	767
[:SOURce<hw>]:MODulation[:ALL]:STATe.....	768
[:SOURce<hw>]:PHASe.....	769
[:SOURce<hw>]:PHASe:REFerence.....	769
[:SOURce<hw>]:PM:EXTernal:COUPling.....	770
[:SOURce<hw>]:PM:MODE.....	771
[:SOURce<hw>]:PM:SENSitivity.....	771
[:SOURce<hw>]:PM:SOURce.....	772
[:SOURce<hw>]:PM:STATe.....	772
[:SOURce<hw>]:PM[:DEViation].....	770
[:SOURce<hw>]:POWEr:ALC:OMODE.....	773
[:SOURce<hw>]:POWEr:ALC:SONCe.....	773
[:SOURce<hw>]:POWEr:ALC[:STATe].....	773
[:SOURce<hw>]:POWEr:LIMit[:AMPLitude].....	776
[:SOURce<hw>]:POWEr:MANual.....	776
[:SOURce<hw>]:POWEr:MODE.....	777
[:SOURce<hw>]:POWEr:PEP.....	778
[:SOURce<hw>]:POWEr:POWEr.....	778
[:SOURce<hw>]:POWEr:STARt.....	778
[:SOURce<hw>]:POWEr:STEP:MODE.....	779
[:SOURce<hw>]:POWEr:STEP[:INCRement].....	779
[:SOURce<hw>]:POWEr:STOP.....	780
[:SOURce<hw>]:POWEr[:LEVel][[:IMMediate]:OFFSet].....	775
[:SOURce<hw>]:POWEr[:LEVel][[:IMMediate]:RCL].....	775
[:SOURce<hw>]:POWEr[:LEVel][[:IMMediate][:AMPLitude].....	774
[:SOURce<hw>]:PULM:POLarity.....	781
[:SOURce<hw>]:PULM:SOURce.....	781
[:SOURce<hw>]:PULM:STATe.....	781
[:SOURce<hw>]:SWEep:POWEr:AMODE.....	789
[:SOURce<hw>]:SWEep:POWEr:DWELI.....	790

[[:SOURce<hw>]:SWEep:POWer:EXECute.....	790
[[:SOURce<hw>]:SWEep:POWer:MODE.....	790
[[:SOURce<hw>]:SWEep:POWer:POINts.....	791
[[:SOURce<hw>]:SWEep:POWer:SHAPE.....	791
[[:SOURce<hw>]:SWEep:POWer:SPACing:MODE.....	791
[[:SOURce<hw>]:SWEep:POWer:STEP[:LOGarithmic].....	792
[[:SOURce<hw>]:SWEep:RESet[:ALL].....	792
[[:SOURce<hw>]:SWEep[:FREQUency]:DWELI.....	785
[[:SOURce<hw>]:SWEep[:FREQUency]:EXECute.....	786
[[:SOURce<hw>]:SWEep[:FREQUency]:MODE.....	786
[[:SOURce<hw>]:SWEep[:FREQUency]:POINts.....	786
[[:SOURce<hw>]:SWEep[:FREQUency]:SHAPE.....	787
[[:SOURce<hw>]:SWEep[:FREQUency]:SPACing.....	787
[[:SOURce<hw>]:SWEep[:FREQUency]:STEP:LOGarithmic.....	789
[[:SOURce<hw>]:SWEep[:FREQUency]:STEP[:LINear].....	788
[[:SOURce]:BB:IQOutput:SOURce.....	737
[[:SOURce]:BB:PATH:COUNT.....	583
[[:SOURce]:BBIN:ALEVel:EXECute.....	700
[[:SOURce]:BBIN:CFACTOR.....	700
[[:SOURce]:BBIN:FOFFset.....	701
[[:SOURce]:BBIN:IQSWap[:STATe].....	702
[[:SOURce]:BBIN:OLOad:HOLD:RESet.....	703
[[:SOURce]:BBIN:OLOad:HOLD:STATe.....	703
[[:SOURce]:BBIN:OLOad:STATe.....	703
[[:SOURce]:BBIN:POWer:PEAK.....	704
[[:SOURce]:BBIN:POWer:RMS.....	704
[[:SOURce]:BBIN:ROUTE.....	705
[[:SOURce]:BBIN:SKEW.....	705
[[:SOURce]:BBIN:SRATe:ACTual.....	705
[[:SOURce]:BBIN:STATe.....	707
[[:SOURce]:CORRection:CSET:CATalog.....	708
[[:SOURce]:CORRection:CSET:DELeTe.....	711
[[:SOURce]:INPut:BERT:IMPedance.....	529
[[:SOURce]:INPut:BERT:THReShold.....	529
[[:SOURce]:INPut:DATA:IMPedance.....	729
[[:SOURce]:INPut:DATA:THReShold.....	729
[[:SOURce]:INPut:TRIGger:BBANd:SLOPe.....	730
[[:SOURce]:INPut:TRIGger:IMPedance.....	730
[[:SOURce]:INPut:TRIGger:LEVel.....	731
[[:SOURce]:INPut:TRIGger:SLOPe.....	731
[[:SOURce]:IQ:OUTPut:DIGital:OFLOW:HOLD:RESet.....	742
[[:SOURce]:IQ:OUTPut:DIGital:OFLOW:HOLD:STATe.....	742
[[:SOURce]:IQ:OUTPut:DIGital:OFLOW:STATe.....	742
[[:SOURce]:LFOutput:FREQUency.....	748
[[:SOURce]:LFOutput:FREQUency:MANual.....	748
[[:SOURce]:LFOutput:FREQUency:MODE.....	749
[[:SOURce]:LFOutput:FREQUency:START.....	749
[[:SOURce]:LFOutput:FREQUency:STOP.....	750

[:SOURce]:LFOutput:SWEep[:FREQuency]:DWELL.....	751
[:SOURce]:LFOutput:SWEep[:FREQuency]:EXECute.....	751
[:SOURce]:LFOutput:SWEep[:FREQuency]:MODE.....	751
[:SOURce]:LFOutput:SWEep[:FREQuency]:POINTs.....	752
[:SOURce]:LFOutput:SWEep[:FREQuency]:SHAPE.....	753
[:SOURce]:LFOutput:SWEep[:FREQuency]:SPACing.....	753
[:SOURce]:LFOutput:SWEep[:FREQuency]:STEP:LOGarithmic.....	754
[:SOURce]:LFOutput:SWEep[:FREQuency]:STEP[:LINear].....	753
[:SOURce]:LFOutput:VOLTagE.....	755
[:SOURce]:LFOutput[:STATe].....	750
[:SOURce]:PATH:COUnT.....	768
[:SOURce]:ROSCillator:EXTernal:FREQuency.....	782
[:SOURce]:ROSCillator:EXTernal:RFOFF:STATe.....	782
[:SOURce]:ROSCillator:EXTernal:SBANdwidth.....	783
[:SOURce]:ROSCillator:SOURce.....	784
[:SOURce]:ROSCillator[:INTernal]:ADJust:VALue.....	783
[:SOURce]:ROSCillator[:INTernal]:ADJust[:STATe].....	783
{CLOCK: frequency}.....	505
{COMMENT: string}.....	506
{CONTROL LENGTH: ControlLength}.....	507
{CONTROL LIST WIDTH4–Length: #m0m1...mx...mM-1}.....	514
{COPYRIGHT: string}.....	506
{DATA BITLENGTH: BitLength}.....	506
{DATA LIST–Length: #d0d1...dx...dN-1...}.....	507
{DATE: yyyy-mm-dd;hh:mm:ss}.....	507
{LEVEL OFFS: RMSOffset_dB,PeakOffset_dB}.....	507
{MWV_SEGMENT_CLOCK: ClockSeg0, ClockSeg1, ..., ClockSegN-1}.....	513
{MWV_SEGMENT_CLOCK_MODE: Mode}.....	512
{MWV_SEGMENT_COUNT: NumOfSeg}.....	511
{MWV_SEGMENT_FILES: "FileNameSeg0.wv", "FileNameSeg1.wv", ..., "FileNameSegN-1.wv"}.....	514
{MWV_SEGMENT_LENGTH: SamplesSeg0, SamplesSeg1, ..., SamplesSegN-1}.....	511
{MWV_SEGMENT_LEVEL_OFFS: RMSOffset_dBSeg0, PeakOffset_dBSeg0, ...,RMSOffset_dBSegN-1, PeakOffset_dBSegN-1}.....	514
{MWV_SEGMENT_START: SampleStartOffsetSeg0, SampleStartOffsetSeg1, ..., SampleStartOffsetSegN-1}.....	512
{MWV_SEGMENTx_COMMENT: text}.....	514
{SAMPLES: Samples}.....	508
{TYPE: magic, xxxxxxxx}.....	504
{WAVEFORM–Length: #I0Q0I1Q1...IxQx...IN-1QN-1...}.....	509
{[TRACE] LIST [#]: Pos0:Val0;Pos1:Val1;...Posx:Valx;...PosN-1:ValN-1}.....	509

Index

- 50 - Extern reference out of range or disconnected 841
 - 140 - This modulation forces other modulations off 841
 - 180 - Adjustment failed 842
 - 182 - Adjustment data missing 842
 - 183 - Adjustment data invalid 842
 - 200 - Cannot access hardware 842
 - 201 - Hardware revision out of date 842
 - 202 - Cannot access the EEPROM 842
 - 203 - Invalid EEPROM data 842
 - 204 - river initialization failed 842
 - 241 - No current list 842
 - 242 - Unknown list type specified 842
 - 261 - Waveform Protected 842
 - 460 - Cannot open file 842
 - 461 - Cannot write file 842
 - 462 - Cannot read file 842
 - 463 - Filename missing 843
 - 464 - Invalid filename extension 843
 - 465 - File contains invalid data 843
 - >L 464
 - &LLO 464
 - &NREN 464
 - *OPC 486
 - *OPC? 486
 - *RST 495
 - *WAI 486
- A**
- Abort button 101
 - Abort calculation 101
 - Accept
 - Security Settings 147
 - Accept Carrier Table - MCCW 436
 - Accept - MCCW 436, 681
 - Access denied 92
 - AC supply 24
 - Activating noise generator 582
 - Additional White Gaussian Noise (option R&S SMU-K62) 68
 - Additive Noise 304, 305, 577, 579
 - Adjust All 127, 530
 - Adjust Baseband Input 128, 531
 - Adjust FM Offset 531
 - Adjust I/Q modulator 128, 532
 - Adjust Level 128, 532
 - Adjustment Active 204, 783
 - Adjustment Frequency 205, 783
 - Adjustment Path A/B 127
 - Adjustment value - Reference frequency 205, 783
 - Adjust Synthesis 127, 531
 - Adjust Synthesis Extension 127
 - ALC (automatic level control) 221, 773
 - ALC Auto 839
 - ALC On 221, 839
 - ALC S&H 839
 - ALC Table 839
 - AM Depth 236, 572
 - AM External Coupling 236, 573
 - AM Frequency 748
 - Amplitude of test signal 407
 - AM Sensitivity 236, 238, 572, 573
 - AM Source 235, 573
 - AM State 235, 574
 - Analog Wideband I/Q In 280, 734
 - Angle Alpha 361
 - Append 411, 417
 - Append Blank 412
 - Apply Assistant Settings 428, 609
 - ARB Default settings 586
 - ARbitrary Waveform Generator 383
 - ARB Multi Carrier
 - carrier frequency 429, 604
 - conflict 430, 603
 - mode 422, 602
 - ARB State 586
 - Architecture of the instrument 61
 - Arm 394, 440
 - Armed_Auto 393, 595, 641, 689
 - DM 377
 - Armed_Retrigger 393, 595, 641, 689
 - DM 377
 - Arm Trigger 588, 635, 685
 - Arm Trigger - DM 378
 - Arrow keys 20
 - ASCII file import/export
 - List Mode 268
 - ASK Depth - DM 360, 647
 - Assemblies display 128, 534, 535
 - ATN 845
 - Attention 845
 - Attenuation - DM 375, 650
 - Attenuator 218, 559
 - Attenuator Mode 218, 559
 - List Mode 269
 - Sweep 261, 789
 - Attenuator Mode - List Mode 765
 - AttFixed 840
 - Auto 393, 595, 641, 689
 - DM 377
 - Auto Level Set 451
 - Auto Level Set - Baseband Input 700
 - Automatic Naming Hardcopy 544
 - Auto Once
 - Power Sensors 214
 - Auto Once - Power Sensors 566
 - AUX I/O interface 142
- B**
- Bandwidth - DM 364
 - Baseband block menu 324
 - Baseband Connection Selftest 135
 - Baseband Gain (I/Q) 289, 736
 - Baseband generator (option R&S SMU-B9/B10/B11) 67
 - Baseband In - Crest-Faktor 700
 - Baseband Input 446
 - Baseband Input - EX-IQ-BOX Settings 449
 - Baseband input module (option R&S SMU-B17) 68
 - Baseband main module (option R&S SMU-B13) 68
 - Baseband Only - DM 375, 651
 - Baseband section 67
 - Baseband Trigger Input Slope 138, 730

BB-AM State	238, 572
BBIN Get Rx Bit Error Selftest	136, 804
Bias - I/Q out	314, 737, 738
BITCLK	848
Bit energy to noise power density	307, 577
Bit Error Rate Measurement	172, 520
Bit Rate - AWGN	306, 575
BLER Type	190, 527
Block Error Rate Measurement	172, 520
Bluetooth Pin	147
Boolean parameters	481
BURST	847
Burst gate	339
BUSY	838
B x T	645
B x T - DM	363
C	
Calibration	
remote	497
Carrier/Noise Ratio	307
Carrier / Noise Ratio	576
Carrier + Interferer Level	309, 581
Carrier + Interferer PEP	309, 582
Carrier + Noise Level	309, 581
Carrier + Noise PEP	309, 582
Carrier Delay	429
Carrier frequency	429, 604
Carrier Gain	429
Carrier Graph	425
Carrier Graph - MCCW	437
Carrier Index	429
Carrier level - AWGN	308, 579
Carrier Spacing	422, 603
Carrier Spacing - MCCW	433, 679
Carrier Start	427, 611
Carrier Start - MCCW	435, 683
Carrier State	427, 429, 605, 612
Carrier State - MCCW	435, 678, 680
Carrier Stop	427, 611
Carrier Stop - MCCW	435, 684
Carrier Table Assistant	427, 611
Carrier Table Assistant - MCCW	435, 683
Carrier Table button- ARB	424
Carrier Table - MCCW	436
Case-sensitivity	
SCPI	477
CCDF display	170
Center Freq	253, 720
Change Password - Setup	146
Channel x	402
Check Front Panel	136
Clear status	
remote	497
Clipping	423
Clock Frequency	390, 586
Clock input slope	533
Clock Input Slope	138
Clock Mode	404, 444, 587, 694
Clock Mode - DM	382, 633
Clock Multiplier	404, 444, 587, 634, 694
Clock Multiplier - DM	382
Clock out mode	534
Clock Output Mode	138
Clock output source	138
Clock out source	534
Clock Parameter	404
Clock rate	390, 411, 608
Clock rate mode	412, 622
Clock Reference	334
Clock Slope	183, 191
BERT	523
BLER	523
Clock Source	404, 444, 588, 695
DM	382
Clock Source - DM	634
Coding	648
Coding - DM	359
Colon	482
Column Separator Import/Export	
List Mode data	759
Column Separator Import/Export - User Correction data	228, 713
Comma	482
Commands	458
Colon	482
Comma	482
Command line structure	482
common	458
Double dagger	482
GBIP, addressed	462
GBIP, universal	461
instrument control	458
Overlapping	484
Question mark	482
Quotation mark	482
SCPI compliant	458
Sequential	484
Syntax elements	482
White space	482
Command sequence	
recommendation	495
remote	501
Comment	413
Common commands	
Syntax	476
Computer name	
Changing	41
CONDition	489
Configure Control Signal - DM	370
Confirm Password - Setup	146
Conflict	430, 603
Connected device	453
Connected device - Baseband Input	700
Connected device - Digital I/Q Output Settings	319, 742
Connection to an external controller	42
Connector	
AUX I/O	26
Baseband digital input	26
Baseband digital output	26
BERT	26
CLOCK	22, 25
CLOCK OUT	27
DATA	21, 25
EXT MOD	25
GPIB	25
I	21, 25
IEC/IEEE	25
INSTR TRIG	27
I OUT	24
I OUT BAR	24
LAN	26

LF	23	Current Frequency	128, 532
LO IN	27	Current Index	763
LO OUT	27	List Mode	271
MARKER 1, 2	22, 24	Current Level	260, 776
MARKER 1B	24	Current Range without Recalculation	403, 443, 591, 638, 690, 691
Monitor	25	Current Range without Recalculation - DM	381
Q	21, 25	Current Segment	397
Q OUT	24	Current Sensors	133
Q OUT BAR	24	Cursor keys	20
REF IN	25	Cursor Length - DM	371
REF OUT	25	Cursor Position - DM	371
RF A	22	Cust Dig Mod	629
RF A / RF B	26	Cut	160
RF B	22	Cut – Data Editor	368
SENSOR	23	Cut Off Frequency Factor - DM	363
TRIGGER 1	22	CW (continuous wave)	338
TRIGGER 1, 2	27	CW Interferer	304
USB	22	CW Mode	847
USB type A	25	CW Switching - DM	362, 633
USB type B	25		
USER	27		
Constellation diagram	168	D	
Const IQ Test Signal	408	DATA	847
Control bus	845	Data Bits	179, 521
Controller, external	42	Data Enable	184, 191
Control Lists - DM	365, 654	Data Enable - BERT	524
Control signals	338	Data List	332
Copy – Data Editor	368	Data Lists - DM	365, 654
Copy instrument settings	160, 553	Data pattern	630
Correction file status - Corrupt	300	Data pattern - DM	356
Correction file status - frequency response correction	300, 301, 671	Data Polarity	183, 191
Correction file status - Incompatible	300	BERT	524
Correction file status - Missing	300	BLER	524
Correction file status - OK	300	Data Source	631
Correction file status - User correction accuracy	669	Data Source - DM	356
Correction file status - User correction bandwidth	670	Data Valid	845
Correction file status - User correction external devices	670	DAV	845
Counter	128, 535, 536	Day Hardcopy File Name	542
Count – LF Frequency Sweep	752	DCL	462
Couple I/Q Bias	314	Deactivate RF output	204, 782
Coupling mode	241	Decimal Point Import/Export	760
external modulation input	573	List Mode data	275
EXT MOD	770	Decimal Point Import/Export - List Mode data	275
FM	717	Decimal Point Import/Export - User Correction data	228, 713
Coupling mode - EXT MOD (AM)	236	DEF	480
CRC Order	190	Default instrument settings	32, 124, 502
CRC Order - BLER	523	Default settings	388, 421, 612, 631
Create	415, 426	Default settings - DM	354
Create and Load	415, 426	Default settings - MCCW	432, 677
Create Multi Carrier Waveforms	419	Default values	500
Create Multi Segment Waveforms	408	remote	500
Create New Directory	160	Delay - Falling Edge of Ramp Envelope - DM	374, 651
Crest Factor	451	Delay - Marker	591, 638, 690
Crest factor (I/Q)	288, 732	Delay - Marker - DM	381
Crest factor - baseband	320, 698	Delay - Rising Edge of Ramp Envelope - DM	374, 651
Crest factor - Baseband Signal Level Measurement	322, 695	Delay Start	428, 604, 609
Crest Factor - Basisband In	700	Delay Step	428, 608
Crest Factor - MCCW	434	Delay - Trigger	594, 640, 686, 688
Crest Factor Mode	423, 605	Delay - Trigger - DM	379
Current Freq		Delete	411, 418
LF Sweep	748	Delete Hardcopy Files	541
Current Freq (LF Sweep)	265	Delete instrument settings	160, 555
Current Freq (RF Sweep)	253, 723	Delta Phase	198, 769

Desired Crest Factor	680
Desired Crest Factor - MCCW	434
Destination - Hardcopy	150
Destination Import/Export	
List Mode data	761
User Correction data	229
Destination Import/Export - List Mode data	275
Destination Import/Export - User Correction data	715
Deviation - FSK Modulation	649
Deviation - FSK Modulation - DM	360
Deviation - Variable FSK Modulation	649
Deviation - Variable FSK Modulation - DM	362
Device ID	132
Device reset	502
Device-specific commands	458
Device-specific error messages	841
DHCP	40
Differential coding	648
Differential coding - DM	359
Differential output	311
Differential settings storing	356
DIG IQ Auto Setting	450
Digital I/Q Output - EX-IQ-BOX Settings	316
Digital I/Q Output Level - I/Q OUT	743
Digital I/Q Output PEP - I/Q OUT	318, 743
Digital I/Q Output Power-On State - I/Q OUT	319, 743
Digital I/Q Output Sample Rate - I/Q OUT	745
Digital I/Q Output State - I/Q OUT	316, 746
Digital I/Q Output Step width - I/Q OUT	318, 744
Digital I/Q Output Variation Active - I/Q OUT	318, 744
Digital I/Q Output Variation Step - I/Q OUT	318, 744
Digital Modulation	629
Digital output module (option R&S SMU-B18)	69
Directory	158, 553
Directory Hardcopy	541
Display	85
Display I/Q Output Level Via - I/Q OUT	317, 745
Display Mode - AWGN	305, 577
Display Output Results - AWGN	305, 577
Display permanent priority - Power Sensors	212
Double dagger	482
DOWN	480
Duration Baseband Signal Level Measurement	696
Duration - Baseband Signal Level Measurement	322
Dwell time	
List Mode	762
Dwell Time	254, 260, 267, 271
Level Sweep	790
LF Sweep	751
List Mode	271
RF Sweep	785
E	
Edge form of ramp envelope - DM	373, 652
Edge slope of ramp envelope - DM	374, 652
Edit User Correction Data	225
EFC (Electronic Frequency Control)	203
EMF - Level display	221
ENABLE	489
Enable/disable beep	797
Enable registers	
remote	499
Enter License Key	132
EOI	845
Error messages	88
Adjustment data invalid (183)	842
Adjustment data missing (182)	842
Adjustment failed (180)	842
Cannot access hardware (200)	842
Cannot access the EEPROM (202)	842
Cannot open file (460)	842
Cannot read file (462)	842
Cannot write file (461)	842
Driver initialization failed (204)	842
Extern reference out of range or disconnected (50)	841
File contains invalid data (465)	843
Filename missing (463)	843
Hardware revision out of date (201)	842
Invalid EEPROM data (203)	842
Invalid filename extension (464)	843
No current list (241)	842
This modulation forces other modulations off (140)	841
Unknown list type specified (242)	842
Waveform Protected (261)	842
Error Messages	840
device-specific	841
SCPI	841
Error messages - display list	802
Error queue query	796, 799, 800, 801
Error queues	
recommendations	495
Errors	179, 188, 521
ESR	488
EVENT	489
Event status enable register	
remote	498
Event status register	
remote	498
Exclude Frequency	158, 722
Exclude Level	158, 775
Execute:Baseband Connection Selftest	804
Execute:Fader Selftest	805
Execute BBIN A/B Selftest	135, 804
Execute Next Segment	401, 628
Execute Single	
List Mode	271
Execute Single - List Mode	767
Execute Single Sweep	
Frequency Sweep	252, 786
Level Sweep	259, 790
LF Sweep	751
Execute Single Sweep - LF Sweep	265
Execute Trigger	390, 394, 440, 589, 636, 685
Execute Trigger - DM	365
EX-IQ-BOX Settings	449
EX-IQ-BOX Settings - Digital I/Q Output	316
Expiration date of option	130
Export Deactivation Response	132
Extension Import/Export	
List Mode data	758, 759
Extension Import/Export - List Mode data	275
Extension Import/Export - User Correction data	228, 712
External Baseband I/Q In	702
External impedance	730
External mode - Local OScillator	205
External modulation data	333
External modulation signal	234

FM 238
 External modulation signal - PhiM 241
 External Reference Frequency 204, 782
 External Restart 183
 External Restart - BERT 526
 External Trigger Delay 594, 640, 686, 688
 External Trigger Delay - DM 379
 External Trigger Inhibit 594, 640, 686, 688
 EXT REF 838
 EXT TUNE 847
 Eye diagram 169

F

Factory Preset 148, 502
 Fader Selftest 135
 Fading module (option R&S SMU-B14) 68
 Fall Delay - DM 374, 651
 Fast Save 356
 FIFO Status 450
 FIFO Status - Baseband Input 706
 FIFO Status - Digital I/Q Output Settings 317, 745
 FIFO Status - OK 317, 745
 FIFO Status - Overflow 317, 745
 FIFO Status - Underrun 317
 File 429
 frequency response correction 671
 File catalog- frequency response correction 670
 File - Hardcopy dialog 150
 File list 158, 552
 File Management 388
 File menu 156
 File Name - Hardcopy 150
 File setup - Hardcopy 152
 File size 612
 File type selection 159
 Fill Table
 List Mode 272
 Fill Table From 276
 Fill Table - List mode 275
 Fill Table Range 229, 276
 Filter
 Power Sensors 214
 Filter Cut Off Frequency 424
 Filter - DM 363
 Filter Length
 Power Sensors 214
 Filter Length - Power Sensors 565, 566, 567
 Filter Parameter 645
 Filter Parameter - DM 363
 Filter Type 646
 Fine adjustment - Reference frequency 204, 783
 Firmware version 130
 Fix marker delay to current range 404, 443, 590, 690
 Fix marker delay to current range - DM 382, 637
 Floating licences 130
 FM-DC mode 203
 FM Deviation 240, 717
 FM External Coupling 241, 717
 FM Mode 239, 718
 FM Sensibility 718
 FM Sensitivity 240
 FM Source 239, 718
 FM State 239, 719
 FREQ OFFSET 837
 Frequency 216

AM 748
 List mode 762
 List Mode 272
 PM 245, 748
 Power Sensors 213
 RF output signal 722
 RF Sweep 727
 Frequency display 86
 Frequency - Multiplier 196
 Frequency Offset 196, 324, 453, 724
 Frequency Offset - Baseband 584
 Frequency Offset - Baseband Input 701
 Frequency Offset - frequency response correction 673
 Frequency of test signal 407
 Frequency Range Mode - RF Signal 201, 725
 Frequency Range - RF Signal 202, 725
 Frequency response correction
 File 671
 Frequency response correction - Accuracy 669
 Frequency response correction - Bandwidth 670
 Frequency response correction - External devices 670
 Frequency response correction - File catalog 670
 Frequency - RF output signal 195
 Frequency - RF Signal 196
 Frequency - RF Sweep 252
 Frequency - Test Signal 600
 Frequency - Test Signal ARB 406
 Front panel key emulation 118
 FSK Deviation 649
 FSK Deviation - DM 360
 FSK Type (Variable FSK) 649
 FSK Type (Variable FSK) - DM 362
 Full Range 128, 532
 Fuses 30

G

Gain 605
 Gain (I/Q) 289, 732
 Gain Imbalance 451
 Gain Imbalance - Baseband In 701
 Gain Start 427
 Gain Step 427
 Generate Signal HD 406, 407, 408, 598
 Generate Signal HD - Test Signal 598
 Generate Signal HD - Test Signal ARB 598
 Generate Signal RAM 406, 407, 408, 598
 Generate Signal RAM - Test Signal ARB 598
 GET 462
 Getting started 61
 Global Trigger/Clock/External Input Settings 136
 Global Trigger/Clock Settings 405, 444
 GPIB 143
 Characteristics 461
 interface messages 461
 Remote control interface 457
 GPIB address 462, 798
 GPIB bus address 143
 GPIB bus control
 remote 499
 GPIB - Visa Resource String 143
 Graphical display of output signal 161
 Graphics block 161
 GTL 462

H

Hardcopy - Destination	150, 539
Hardcopy Device Size	545
Hardcopy dialog - File	150
Hardcopy dialog - Printer	150
Hardcopy File Name	540, 541
Hardcopy - File setup	152
Hardcopy Format	540, 544
Hardcopy Path	540
Hardcopy - Printer setup	151
Hardware Config	128, 534
Hardware options	129
HDD Streaming	390, 618
Help Language	139
High Accuracy Level Adjustment	127, 533
High Power Option	218, 261, 269
HOP (hopping)	140

I

I/Q diagram	166
I/Q File	604, 610
I/Q modulation	277, 280, 735
I/Q modulation - baseband gain	289, 736
I/Q modulation - Crest factor	288, 732
I/Q modulation - gain	289, 732
I/Q modulation - Impairments	280, 734
I/QOutput Type - I/Q out	312
I/Q-Skew	452
I/Q-Skew - Baseband Input	705
I/Q-Swap	449
I/Q-Swap - Baseband Input	702
I/Q Swap - I/Q	287, 735
I/Q Wideband - I/Q	288, 735
Identification	
remote	498
IdPDbsweepResAll	792
IFC	462, 845
Imbalance - I/Q analog	283, 733
Imbalance - I/Q digital	295, 668
Impairments digital	697
Impairments analog	280, 734
Impairments digital	292, 321, 322, 675, 696, 697
Impedance	183, 191
BERT	529
BLER	529
external input	236, 241, 244, 245
Impedance data input (ser/par)	729
Impedance Data Input (ser/par)	137
Impedance - RF outputs	560
Impedance trigger/control signal input (ser/par)	137, 730
Import/Export	
List Mode data	275, 760
User Correction data	227, 229
Import/Export - List Mode data	274
Import/Export - User Correction data	714
Import License Key	132
Included Attenuator - frequency response correction	673
INF	480
INFO key	88
Input	
BURST	847
CW Mode	847
DATA	847

EXT TUNE	847
INST TRIG B	847
LEV-ATT	847
USER 2	848
USER 3	847
USER 4	847
Input connector	21, 22, 25, 26, 27
Input - INST TRIG B	847
Input Waveform File	428
Installed Assembly	129
Instrument Config	128, 534
Instrument messages	458
Instrument settings	
recall	500, 556
save	500, 557
Instrument settings - recall	158
Instrument settings - save	156
Instrument Trigger	138
Instrument trigger input slope	731
Interface	
functions (GPIB bus)	846
Interface - AUX I/O	142
Interface Clear	845
Interface messages	458, 460
Interfaces	
GPIB	461
Internal Baseband I/Q In	280, 734
Interrupt	493
I Offset	452
I Offset - Baseband In	703
IP address	459
Changing	40
Remote Desktop	46
IST	488
IST flag	491
remote	498
I Value - Test Signal ARB	408

K

Key

Arrow key	21
BACKSPACE	20
CLOSE	19
Cursor key	21
DIAGRAM	18
ENTER	20
ESC	18
FILE	18, 155
FREQ	17
HCOPY	16
HELP	16
HIDE	19
INFO	16
INSERT	20
LEVEL	18
LOCAL	16
MENU	19
MOD ON/OFF	18, 233
ON/OFF	19
PRESET	16, 32, 124
REARR	19
RECALCULATE	18
RF ON/OFF	18
SETUP	16, 125
TOGGLE	19
WINBAR	19

- Keyboard emulation 118
Keyboard Language 547
Keyboard Layout 139, 547
Key combinations 116
Key - HELP 153
Key - LOCAL 148
Keypad 19
Keywords
 see Mnemonics 476
- L**
- LAN
 Configuration 38
 Interface 459
 IP address 459
 Remote control interface 457
 VISA 459
 VXI protocol 460
LAN Connection - Setup 147
Language Keyboard 547
LAN Status - LXI 144
Layout Keyboard 139, 547
Leakage - I/Q digital 293, 668
Learn List Mode Data 272, 764
LEV ATT 847
Level 217
 Power Sensors 211, 212
 RF output 218, 774
 Step width 779
Level attenuation 339
Level Attenuation - DM 375, 650
Level control 221, 773
Level display 86
Level display EMF 221
Level EMF - I/Q out 314
Level limit 218, 776
Level mode 412
Level mode - ARB 623
Level offset 218, 775
Level Offset
 Power Sensors 213
LEVEL OFFSET 838
Level Offset - frequency response correction 674
Level - Step width 220
Level Sweep 255, 777
LevelSweep 839
Level - Uninterrupted setting 218, 559
Level user correction 223
LF generator 246
LF Gen Frequency 236, 240, 243, 247, 748
LF Gen Voltage 247, 755
LF output 246, 247
LF Output State 247, 750
LF Sweep 265, 749
LFSweep 839
Licence for software option 130
License Key 131
Limit
 Level 776
Limit - Level 218
Linux controller 47
List Management - DM 357
List mode 268, 777
 manual processing of lists 270
ListMode 839
List Mode Data 272
- List Range In 273, 763, 764
LLO 462
Load correction file
 frequency response correction 671
Load correction file - frequency response correction 300
Load instrument settings 158, 500, 556
Load list 414
Load Sequencing List 418
Load User Filter - DM 364
Load User Mapping 662
Load User Mapping - DM 360
Load Waveform 388, 617, 619
Local oscillator 205
Local - Remote Channel Control 143
Local to remote switchover 463, 464
Lock keyboard 801
LOC-LLO 839
Login
 Operating system 38
LO IN connector 205
LO OUT output 205
LVDS Rate Selftest 135, 804
LXI 143
 Browser interface 56
 Configuration 54
 LAN configuration 57
 Ping 59
- M**
- Malfunctions
 reacting 495
Manual Remote Control 42
Manual trigger 636
Manual Trigger 390, 589, 685
Manual trigger - DM 365
Map output connector user x to 142
MARKER 2B 847
MARKER 3 847
MARKER 3B 847
Marker Channel x 642
Marker Channel x - DM 380
Marker CH x 596
Marker Delay 591, 638, 690
Marker Delay - DM 381
Marker Mode 402, 442
Marker output signals 341
Marker Pattern 597
Marker Positions - DM 371
Marker x Delay 403, 443
MAX 480
Max Data Bits 182
Max Data Bits - BERT 526
Max Errors 182, 190
 BERT 526
 BLER 526
Maximal deviation 243
 FM 240, 717
 PhiM 770
Maximum frequency - frequency response correction 672
Maximum level - frequency response correction 674
Max Received Blocks 190
Max Received Blocks - BLER 526
Measured External Clock 383, 404, 444

- Measurement Period 450
 - Measurement Period - Baseband Input 702
 - Menu structure
 - access denied 92
 - header 92
 - menu area 92
 - Messages
 - commands 458
 - instrument 458
 - instrument responses 459
 - interface 458
 - MIMO Fading Power Correction - Baseband Signal Level
 - Measurement 322, 698
 - MIN 480
 - Minimum frequency - frequency response correction 672
 - Minimum level - frequency response correction 674
 - Minimum Noise/System Bandwidth Ratio - AWGN 304, 576
 - Mnemonics 476
 - Optional 478
 - Mode 181, 189, 242, 422, 602
 - FM 239, 718
 - Level Sweep 256, 777, 790
 - LF Gen 263, 749
 - LF Sweep 263, 749, 751
 - List Mode 270, 765
 - PhiM 771
 - RF Frequency 723
 - RF frequency Sweep 249
 - RF Sweep 723, 786
 - Mode - BERT 522
 - Mode - BLER 522
 - Mode - I/Q out 739
 - Mode Import/Export
 - List Mode data 761
 - Mode Import/Export - List Mode data 274
 - Mode Import/Export - User Correction data 228, 714
 - Mode - LO Coupling 207, 720
 - MOD OFF 837
 - MOD ON/OFF Key 233
 - Modular design 61
 - Modulation
 - AM 234
 - BB-AM 237
 - FM 238
 - PhiM 241
 - PM 244
 - Pulse modulation 244
 - Modulation - BB-AM 238, 572
 - Modulation data external 333
 - Modulation Delay for ext. Data 650
 - Modulation Delay for ext. Data - DM 362
 - Modulation depth
 - PhiM 243
 - Modulation depth - AM 236, 572
 - Modulation deviation
 - FM 240, 717
 - PhiM 770
 - Modulation - DM 361
 - Modulation - I/Q 280, 735
 - Modulation input 25
 - Modulation Type 648
 - Modulation Type - DM 360
 - Month Hardcopy File Name 542, 543
 - Multi Carrier CW 431, 676
 - Multi Carrier Waveforms 419
 - Multiplier 587, 634, 694
 - Multiplier - DM 382
 - Multiplier - Frequency 196
 - Multi Segment table 410
 - Multi Segment Waveforms 408
 - Multi transmitter measurements 221
- ## N
- NAN 480
 - Navigation keys 20
 - NDAC 845
 - New list 414
 - New Password - Setup 146
 - New Sequencing List 418
 - Next Segment 397
 - Next Segment Mode 397
 - NINF 480
 - No Clock 521
 - No Clock BERT 179
 - No Clock BLER 188
 - Noise Bandwidth - AWGN 304, 575
 - Noise generator, switching on 304
 - Noise level - AWGN 308, 580
 - Noise level Total Bandwidth - AWGN 309, 581
 - Noise Only 304, 305, 577, 579
 - No-load voltage (EMF) 221
 - No Sync 521
 - No Sync BERT 179
 - No Sync BLER 188
 - NRFD 845
 - NRP-Z Info 133
 - NTRansition 489
 - Number Hardcopy File Name 543
 - Number of Carriers 422, 602, 677
 - Number of Carriers - MCCW 433
 - Number of licences 130
 - Numeric values
 - Special 480
- ## O
- Offset
 - Frequency 724
 - Level 775
 - Offset DC 407
 - Offset - Frequency 196
 - Offset - I/Q analog 281, 733
 - Offset - I/Q out 314
 - Offset - Level 218
 - Old password - Setup 146
 - ON/OFF Ratio Marker 402, 596, 692
 - ON/OFF Ratio Marker - DM 380, 642
 - Online help
 - Working with 108
 - Operating concept 61
 - Operating system 36
 - Login 38
 - service packs 37
 - Operation complete
 - remote 499
 - Operation hours 129, 535, 536
 - Optimization mode 299
 - Optimize Crest Factor 423, 605
 - Optimize Crest Factor - MCCW 434, 680
 - Optimize I/Q-Signals for RF Output 312, 738

- Optimize internal I/Q-Impairments for RF Output 299, 669
- Option
- ARB-Baseband Generator 383
 - Baseband Generator (B9/B10/B11) 323
 - Baseband Main Module (B13) 323
 - Hardware 129
 - High Power 261, 269
 - R&S SMBV-K18 (Digital Baseband Connectivity) 315
 - R&S SMU-B17 (Baseband Input) 445
 - SMx-B31, High Power, Path A 218
 - SMx-B36, High Power, Path B 218
 - Software 129
- Option: expiration date 130
- Option identification
- remote 499
- Option - R&S SMx-B16 (Differential Output) 311
- Options - Hardcopy 150
- Orientation- Hardcopy 545, 546
- Output
- BITCLK 848
 - BURST 847
 - DATA 847
 - LEV-ATT 847
 - MARKER 2B 847
 - MARKER 3 847
 - MARKER 3B 847
 - SYMBCLK 848
 - USER 2 848
 - USER 3 847
 - USER 4 847
- Output buffer 488
- Output connector 21, 22, 23, 24, 25, 26, 27
- Output File 414, 425
- Output - LF 246
- Output Mode - IQ Out 313
- Output Type - IQ out 741
- Output Voltage - LF output 247
- Out State - LO Coupling 209, 721
- OvenCold 840
- Overflow - Digital I/Q Output Settings 319, 742
- Overflow Hold - Digital I/Q Output Settings 319, 742
- Overlapping
- preventing 486
- Overlapping commands 484
- Overload 220, 232, 452
- OVERLOAD 838
- Overload - Basisband In 703
- Overload Hold 452
- Overload Hold - Basisband In 703
- Oversampling 644
- Oversampling Auto State 645
- Oversampling - DM 364
- P**
- Packing 835
- Paper size - Hardcopy 546
- Parallel poll register enable
- remote 499
- Parameters
- Block data 482
 - Boolean 481
 - SCPI 479
 - Special numeric values 480
 - String 482
 - Text 481
 - Units 480
- Part numbers 128
- Password
- Remote Desktop 46
- Paste 160
- Paste - Data Editor 368
- Path Gain 327, 454
- Path Gain - Baseband 584
- Path reset 502
- Pattern 630
- Pattern - DM 356
- Pattern Ignore 185
- Pattern Ignore - BERT 525
- PCI bus 129
- Peak Level - Baseband Input 704
- Peak Level - Baseband Signal Level Measurement 322, 696
- Peak level of baseband 321, 699
- Peak power 451
- Period 411
- Phase
- RF output signal 769
 - Phase continuous Active 201
 - Phase continuous Active - RF Signal 726
 - Phase Offset 326
 - Phase Offset - Baseband 584
 - Phase Offset Q - Test Signal 600
 - Phase Offset Q - Test Signal ARB 406
 - Phase - RF output signal 198
 - Phase Start 428, 605, 677
 - Phase Start - MCCW 435, 678
 - Phase Step 428, 610
 - Phase Step - MCCW 435, 682
 - PhiM Depth 243
 - PhiM External Coupling 243, 770
 - PhiM Mode 242
 - PhiM Sensitivity 243
 - PhiM Source 242, 772
 - PhiM State 242, 772
 - Ping 59
 - Play list 402, 414, 416
 - PM Deviation 770
 - PM Frequency 245, 748
 - PM Sensitivity 771
 - PniM Mode 771
 - Point-to-point connection 39
 - Polarity
 - Pulse Modulation 246, 781 - Polarity - No signal (blank) marker 142, 560
- Power
- List Mode 272
 - Power of starting carrier 427, 605, 678
 - Power of starting carrier - MCCW 435, 679
 - Power-On Count 128, 129
 - Power-On Counter 536
 - Power-On State 221, 561
 - Power ramping 339
 - Power ramping - DM 373, 652
 - Power spectrum 171
 - Power Start 605, 678
 - Power Start - MCCW 435, 679
 - Power Step 611
 - Power Step - MCCW 435, 683
 - PPC 462
 - PPE 488
 - PPE register 491

- PPU 462
 PRBS 182
 PRBS_BERT 527
 PRBS generator 332
 PRBS Type - DM 356, 630
 Prefix Hardcopy File Name 543
 Preset 32
 Preset instrument settings 32
 Preset - instrument settings 124, 502
 Printer - Hardcopy dialog 150
 Printer setup - Hardcopy 151
 Protection 145
 Protect RF Output - ALC 223, 561
 Protocol
 VXI 460
 PTRansition 489
 Pulse Divider Marker 402, 597, 693
 Pulse Divider Marker - DM 380, 643
 Pulse Frequency Marker 402, 597, 644, 693
 Pulse Frequency Marker - DM 380
 Pulse modulation 244
 repetition frequency 245, 748
- Q**
- Q Offset 452
 Q Offset - Baseband In 703
 Quadrature Offset - I/Q analog 285, 734
 Quadrature Offset - I/Q digital 297, 675
 Queries 458, 483
 Status 494
 Question mark 482, 483
 Quotation mark 482
 Q Value - Test Signal ARB 408
- R**
- Rackmounting 30
 Ramp Function - DM 373, 652
 Ramp Time - DM 374, 652
 Ratio Noise/System Bandwidth - AWGN 304, 576
 Recall instrument settings 158, 500, 556
 Recall intermediate 500
 Recall Intermediate 159
 Received Blocks 187
 Recent data sets 158
 Recommendations
 remote control programming 495
 Rect Test Signal 406
 Reference frequency
 external 204
 Reference frequency adjustment mode 204, 783
 Reference frequency - external 782
 Reference Level - AWGN 306
 Reference Mode - AWGN 581
 Reference oscillator 203
 REF OUT output 203
 Registers 488
 Remaining Time - Baseband Signal Level Measurement
 322, 697
 REM-LLO 839
 REMOTE 838
 Remote access 42
 Remote control
 Basics 457
 GPIB address 462
 Interfaces 457
 Protocols 457
 Remote Control
 GPIB 465
 Remote control switchover 463
 Remote Desktop 45
 Remote operation 45
 REN 845
 Rename 160, 556
 Resart Marker 413
 Reset 453
 List Mode 271
 Reset - Baseband In 703
 Reset Delta Phase Display 198, 769
 Reset device parameters 502
 Reset - Digital I/Q Output Settings 319, 742
 Reset instrument settings 32, 124, 502
 Reset path 502
 Reset values
 remote 500
 Result 179, 187, 521
 Resulting CW Frequency - AWGN 305, 578
 Resulting I/Q Level EMF 314, 739
 Retrigger 393, 595, 641, 689
 DM 377
 Reveived Blocks 521
 Reverse power protection 220, 232
 Revisions 128
 RF frequency 196, 722
 RFI signal generator, switching on 304
 RF OFF 837
 RF ON/OFF key 192, 561
 RF output
 Power-on state 221
 RF output level 218, 774
 RF output - Power-on state 561
 RF output signal
 Phase adjustment 769
 RF output signal - Phase adjustment 198
 RF section 71
 RF Signal - Frequency 196
 RFSweep 839
 Rise Delay - DM 374, 651
 rms Level - Baseband Input 704
 RMS power 451
 Roll off factor 645
 Roll off factor - DM 363
 Rotary knob 21
 Route to path A/B 327, 455, 585
 RST:MCCW - Carrier State:ON 678
 RST:MCCW - Trigger Source:INTernal 688
 Running 394, 439
 Running Mode 638
 Running - Trigger 687
 Running - Trigger - DM 377
 Run Update 133
- S**
- Sample&Hold mode 221
 Sample-and-Hold mode 773
 Sample Rate - Baseband Input 705
 Sample Rate Sorurce 449
 Sample Rate Source - Baseband Input 706
 Sample Rate Source - Digital I/Q Output Settings
 317, 746
 Sample Rate Value 449
 Sample Rate Value- Digital I/Q Output Settings 317

Samples	411
Samples per Period	407
Samples per Period - Test Signal	601
Samples per Period - Test Signal ARB	406
Save/Recall	421
Save As - DM	372
Save - DM	368, 372
Save immediate	156
Save instrument settings	156, 500, 557
Save intermediate	500
Save List	414
Save Sequencing List	418
SCPI	
Parameters	479
Syntax	476
Version	457
SCPI compliant commands	458
SCPI - error messages	841
Screen Saver	139
Screen Saver - Setup	536
SDC	462
Search Once - ALC	223, 773
Security Password - Setup	147
Security Settings	
Accept	147
Change Password	146
Confirm Password	146
LAN Connection	147
New Password	146
Old Password	146
Security Password	147
USB Device	146
Segment #	410
Segment Down	411, 418
Segment Marker	413, 625
Segment Up	411, 418
Select ASCII Destination	
User Correction data	228
Select ASCII Destination - List Mode data	275
Select ASCII Source	
User Correction data	228
Select List	272, 766
Select NRP File	133
Select Operation - File menu	156
Select Preset Type - DM	371
Select Ramp to Edit - DM	370
Selftest	
Baseband Connection Selftest	135
BBIN Get Rx Bit Error	136, 804
Execute BBIN A/B Selftest	135
Fader Selftest	135
LVDS Rate	135, 804
remote	501
Tx Test	135, 805
Selftest:Execute	
Fader Selftest	805
Selftest:Execute:Baseband Connection Selftest	804
Selftest:Execute:BBIN A/B Selftest	804
Sensor - Power Sensors	210
Sequencing Graphic	418
Sequencing List	402, 414, 416
Sequential commands	484
Serial bus	129
Serial numbers	128
Serial - Visa Resource String	143
Service packs	37
Service request (SRQ)	490, 493
Service request enable	
remote	500
Service request enable register (SRE)	490
Set acc. to Standard	632
Set acc. to Standard - DM	358
Set Noise Level via	306, 580
Setting commands	458
Setting not possible	92
Setting parameters	94
Set to default	388, 421, 586, 612, 631
Set to default - DM	354
Set to default - MCCW	432, 677
Setup key	125
Shape	
LF Sweep	753
RF Level Sweep	260, 791
RF Sweep	787
Shape - LF Frequency Sweep	266
Shape - RF Sweep	253
Show level permanent - Power Sensors	212, 564
Signal/Noise Ratio	307
Signal + Interferer Level	309, 581
Signal + Interferer PEP	309, 582
Signal + Noise Level	309, 581
Signal + Noise PEP	309, 582
Signal Duration	393, 424, 439
Signal Duration - Trigger	592, 639
Signal Duration - Trigger	687
Signal Duration Unit	393
Signal Duration Unit - Trigger	593
Signal Level (RMS)	321, 699
Signal Level (RMS) - Baseband Signal Level Measurement	322, 696
Signal level - AWGN	308
Signal Period Mode	424, 614
Signal Routing	327, 455
Signal Routing - Baseband Input	705
Sine Test Signals	405
Slope	
Instrument trigger input	731
Slope - External baseband trigger	138, 730
Softkey	91
Software options	129
Source	
AM	573
FM	239, 718
Level Sweep Trigger	256, 809
LF Sweep Trigger	263, 807
List Mode	270
List Mode Trigger	767
PhiM	242, 772
Power Sensors	213
Pulse Modulation	245, 781
Reference Oscillator	784
RF frequency Sweep Trigger	249
RF Sweep Trigger	808
Source - AM	235
Source - Baseband Signal Level Measurement	321, 697
Source Import/Export	
List Mode data	761
User Correction data	229
Source Import/Export- User Correction data	715
Source Power Ramp Control	652
Source Power Ramp Control - DM	373
Source - Power Sensors	568
Source - Reference Oscillator	203

Spacing	
Level Sweep	260, 791
LF Sweep	753
RF Sweep	787
Spacing - LF Sweep	266
Spacing - RF Sweep	253
Span (RF sweep)	253, 726
SPD	462
SPE	462
Special characters	
SCPI	479
Spectrum display	171
SRE	488
SRE (service request enable register)	490
SRQ	845
SRQ (service request)	490, 493
Standard	632
Standard - DM	358
Standard settings	388, 421, 631
Standard settings - DM	354
Standard settings - MCCW	432, 677
Standby mode	16
Start	
BERT	528
BLER	528
Power Sensors	563
Start/Stop Gui Update	132, 799
Start delay	428, 604
Start Freq	252, 727
LF Sweep	749
Start Freq - LF Sweep	265
Starting gain	427
Starting power	605, 678
Starting power - MCCW	435, 679
Start Level	259, 778
Start phase	428, 605, 677
Start phase - MCCW	435, 678
Start Select – Data Editor	368
Startup complete	802
State	178, 187, 388, 448
ALC	222, 773
BERT	528
BLER	528
List Mode	269, 723
PhiM	242
Power Sensors	211
Pulse Modulation	245, 781
State - analog Impairments	280, 734
State - AWGN	304, 582
State - Baseband Input	707
State - Baseband Signal Level Measurement	321, 697
State - digital Impairments	292, 675
State - DM	354, 632
State - MCCW	432, 676
State Power Ramp Control - DM	373, 652
State - User Correction	224
Status	
Queries	494
Status byte	
remote	497, 501
Status Information	132
status messages	
ALC On	839
AttFixed	840
Auto	839
BUSY	838
EXT REF	838
FREQ OFFSET	837
LEVEL OFFSET	838
LevelSweep	839
LFSweep	839
ListMode	839
LOC-LLO	839
MOD OFF	837
OvenCold	840
OVERLOAD	838
REM-LLO	839
REMOTE	838
RF OFF	837
RFSweep	839
S&H	839
SYS CTRL	839
Table	839
UCorr	840
Status registers	488
CONDITION	489
ENABLE	489
EVENT	489
model	489
NTRansition	489
parts	489
PTRansition	489
Status reporting system	487
Application	492
common commands	497
STB	488
Step	
Level Sweep	260, 792
Step Lin	
LF Sweep	753
RF Sweep	788
Step Lin - LF Sweep	266
Step Lin - RF Sweep	254
Step Log	
LF Sweep	754
RF Sweep	789
Step Log - LF Sweep	266
Step Log - RF Sweep	254
Step width	
Frequency	728
Level Sweep	260, 792
RF Sweep	788
Step width - Frequency	197
Step width - RF Sweep	254
Stop	
BERT	528
BLER	528
Stop Freq	
LF Sweep	750
RF Sweep	727
Stop Freq - LF Sweep	265
Stop Freq - RF Sweep	252
Stop Level	260, 780
Stopped	394, 439
Stopped - DM	377
Storing	835
Streaming Buffer	390, 617
Suffixes	478
Sweep	
Center frequency	720
LF start frequency	749
LF stop frequency	750
RF frequency Sweep	249

RF Sweep	723, 777, 786
Start Level	259, 778
Stop Level	260, 780
Trigger	252, 259, 810
Sweep - Center frequency	253
Sweep - LF start frequency	265
Sweep - LF stop frequency	265
Sweep shape	
LF Sweep	753
RF Level Sweep	260, 791
RF Sweep	787
Sweep shape - LF Frequency Sweep	266
Sweep shape - RF Sweep	253
Sweep spacing	
Level Sweep	260, 791
RF Sweep	787
Sweep spacing - RF Sweep	253
Sweep - Trigger	265
Symantec Antivirus	53
SYMBCLK	848
Symbol Clock Multiplier	634
Symbol Clock Multiplier - DM	382
Symbol Rate	632
Symbol Rate - DM	359
Sync. Output to External Trigger	378, 395, 440
Synchronization bandwidth – Reference oscillator	204
Synchronization bandwidth	
Reference oscillator	783
Syntax elements	
SCPI	482
SYS CTRL	839
System Bandwidth - AWGN	304, 575
System directory	547

T

Tag Type	512, 513
Clock	505
Comment	506
Control Length	507
Control List Width4	514
Copyright	506
Data Bitlength	506
Data List	507
Date	507
Level Offset	507
Magic	504
Samples	508
Segment Clock Mode	512
Segment Comment	514
Segment Count	511
Segment Files	514
Segment Length	511
Segment Level Offset	514
Trace List	509
Waveform-Length	509
Target Crest Factor	423
Target CW Frequency - AWGN	305
TCPIP - Visa Resource String	143
Terminator recognition	797
Test Signal	406, 407
Threshold	183, 191
Threshold - BERT	529
Threshold - BLER	529
Threshold data input (ser/par)	137, 729
Threshold trigger/control signal input	137, 731

Trigger	181, 189
BERT	530
BLER	530
Trigger Delay	396, 441
Trigger Delay External	594, 640, 686, 688
Trigger Delay External - DM	379
Trigger Delay Other Baseband	590, 637
Trigger Delay Other Baseband - DM	379
Trigger event	
remote	501
Trigger Example	402
Triggering sweep manually	259, 786, 790
Trigger Inhibit	396, 442
Trigger Inhibit External	594, 640, 686, 688
Trigger Inhibit Other Baseband	590
Trigger Inhibit Other Baseband - DM	637
Trigger Input Slope	138
Trigger Mode	393, 593, 595, 641, 689
Armed	439
Auto	439
DM	377
Retrigger	439
Single	439
Trigger parameters - DM	375
Trigger Signal Duration - DM	377
Trigger signals	340
Trigger Source	394, 440, 594, 688
Level Sweep	256, 809
LF Sweep	263, 807
List Mode	270, 767
RF frequency Sweep	249
RF Sweep	808
Trigger Source - DM	378, 639
Trigger Source - Graphics	163
Trigger Status	592
Tx Test Selftest	135, 805
Type	
Power Sensors	211
Type - frequency response correction	675
Type - Power Sensors	569, 570

U

UCorr	840
Ultr@VNC	47
Uninterrupted level setting	218, 559
Unit	178, 187
BERT	529
BLER	529
Power Sensors	212
Unit - Power Sensors	563
Units	480
Input	19
UNIX controller	47
UP	480
Update sensor	133
Update - Setup System	134
USB Device - Setup	146
Use Level Adjustment Data	128, 532
USER 2	848
USER 3	847
USER 4	847
User Clock	412, 622
User Correction	223
User Correction Data	225, 709
User Filter	661
User Filter Catalog - DM	364, 654

- User Filter Delete - DM 364, 660
- User Filter Free Memory 655
- User Filter List Length - DM 660
- User ID
- Remote Desktop 46
- User Mapping Catalog - DM 360
- User Mapping Delete - DM 360
- User mapping Free Memory 655
- User mapping Lists Catalog 654
- User Mapping Lists Delete 661
- User Marker / AUX I/O Settings 405, 445
- User Marker - AUX I/O Configuration 255, 261, 267, 274
- User Modulation Mapping List Length 661
- Use Sensor for RF Level Control - Power Sensors 215
- Use SParameters
- Power Sensors 215
- Use SParameters - Power Sensors 564
- V**
- Value - User Correction 225
- Variable FSK Deviation 649
- Variable FSK Deviation - DM 362
- Variation Active 197
- Variation Step 197, 220, 728, 779
- Vector diagram 167
- Vector modulation 277
- Virus protection 37
- Virus-Protection Software 53
- VISA 457, 459
- Libraries 458
 - Resource string 458, 459
- Visa Resource String 143
- Ethernet 798
 - GPIB 798
 - Socket 799
- Visual check of signal characteristics 161
- VNC connection 47
- Voltage - LF output 755
- Voltage threshold 137, 731
- VXI protocol 460
- W**
- Wait
- remote 501
- Wait Time 139
- Wait Time - Setup 536
- Warnings 88, 840
- Waveform File 388, 617, 619
- Waveform Info 389, 410, 417
- White space 482
- Wideband setting - I/Q 280, 735
- Winbar 91
- Windows XP
- access 38
- Workgroup - Setup 798
- Y**
- Year Hardcopy File Name 544
- Z**
- Zero - Power Sensors 212, 570
- Zoom - DM 372