



**ROHDE & SCHWARZ**

Test and Measurement  
Division

**Operating Manual**

**SIGNAL GENERATOR**

**SMP**

**1035.5005.02/03/04/22**

Printed in the Federal  
Republic of Germany



# Tabbed Divider Overview

## Contents

### Data Sheet

Safety Instructions

Certificate of quality

EC Certificate of Conformity

List of R & S Representatives

### Tabbed Divider

<b>1</b>	<b>Chapter 1: Preparation for Use</b>
<b>2</b>	<b>Chapter 2: Manual Operation</b>
<b>3</b>	<b>Chapter 3: Remote Control</b>
<b>4</b>	<b>Chapter 4: Maintenance</b>
<b>5</b>	<b>Chapter 5: Performance Test</b>
<b>6</b>	<b>Annex A: Interfaces</b>
<b>7</b>	<b>Annex B: List of Error Messages</b>
<b>8</b>	<b>Annex C: List of Commands (with SCPI Conformity Information)</b>
<b>9</b>	<b>Annex D: Programming Example</b>
<b>10</b>	<b>Index</b>



# Contents

<b>1</b>	<b>Preparation for Use .....</b>	<b>1.1</b>
1.1	Putting into Operation.....	1.1
1.1.1	Supply Voltage .....	1.1
1.1.2	Power Fuses .....	1.1
1.1.3	Switching On/Off the Instrument .....	1.1
1.1.4	Initial Status.....	1.2
1.1.5	Setting Contrast and Brightness of the Display.....	1.2
1.1.6	RAM With Battery Back-Up.....	1.2
1.1.7	Preset Setting.....	1.3
1.2	Functional Test.....	1.3
1.3	Fitting the Options.....	1.4
1.3.1	Opening the Casing.....	1.4
1.3.2	Overview of the Slots .....	1.5
1.3.3	Option SM-B1 - Reference Oscillator OCXO .....	1.5
1.3.4	Option SM-B2 - LF Generator .....	1.6
1.3.5	Option SM-B5 - FM/PM Modulator .....	1.7
1.3.6	Option SMP-B11 - Frequency Range Extension 0.01 to 2 GHz.....	1.7
1.3.7	Options SMP-B12 - Pulse Modulator 2 to 20 / 2 to 27 / 2 to 40 GHz .....	1.7
1.3.8	Options SMP-B13 - Pulse Modulator 0.01 to 2 GHz .....	1.7
1.3.9	Option SMP-B14 - Pulse Generator .....	1.8
1.3.10	Options SMP-B15/B17 - Attenuator 20 GHz / 40 GHz .....	1.8
1.3.11	Option SMP-B18 - Auxiliary Interface.....	1.8
1.3.12	Option SMP-B19 /SMP-B20 - Rear Panel Connections for RF and LF.....	1.9
1.4	Mounting into a 19" Rack .....	1.9
<b>2</b>	<b>Operation.....</b>	<b>2.1</b>
2.1	Explanation of Front and Rear Panel.....	2.1
2.1.1	Elements of the Front Panel.....	2.1
2.1.1.1	Display .....	2.1
2.1.1.2	Controls .....	2.3
2.1.1.3	Inputs/Outputs .....	2.11
2.1.2	Elements of the Rear Panel .....	2.13
2.2	Operating Concept .....	2.18
2.2.1	Display.....	2.18
2.2.2	Basic Operating Steps.....	2.19
2.2.2.1	Calling the Menu .....	2.19
2.2.2.2	Selection and Change of Parameters.....	2.20
2.2.2.3	Triggering Action.....	2.21
2.2.2.4	Quick Selection of Menu (QUICK SELECT).....	2.21
2.2.2.5	Use of [FREQ] and [LEVEL] Keys .....	2.22
2.2.2.6	Use of [RF ON / OFF] and [MOD ON / OFF] Keys.....	2.22
2.2.2.7	Changing Unit of Level .....	2.22
2.2.2.8	Correction of Input .....	2.23
2.2.3	Sample Setting for First Users .....	2.23

2.2.4	List Editor .....	2.28
2.2.4.1	Select and Generate - SELECT LIST .....	2.29
2.2.4.2	Deletion of Lists - DELETE LIST .....	2.30
2.2.4.3	Edition of Lists .....	2.31
2.2.4.4	Pattern Setting to Operate the List Editor .....	2.35
2.2.5	Save/Recall - Storing/Calling of Instrument Settings.....	2.39
<b>2.3</b>	<b>Menu Summary.....</b>	<b>2.40</b>
<b>2.4</b>	<b>RF Frequency.....</b>	<b>2.41</b>
2.4.1	Frequency Offset and Multiplier .....	2.42
<b>2.5</b>	<b>RF Level.....</b>	<b>2.43</b>
2.5.1	Level Offset .....	2.45
2.5.2	Interrupt-free Level Setting.....	2.45
2.5.3	Level Control (ALC).....	2.46
2.5.4	User Correction (UCOR).....	2.48
2.5.5	Automatic level correction .....	2.50
2.5.6	EMF.....	2.51
2.5.7	[RF ON / OFF]-Key.....	2.51
<b>2.6</b>	<b>Modulation .....</b>	<b>2.52</b>
2.6.1	Modulation Sources.....	2.52
2.6.1.1	Simultaneous Modulation .....	2.53
2.6.1.2	Alternate Switching Off of Modulations.....	2.53
2.6.1.3	[MOD ON/OFF] Key.....	2.54
2.6.2	Analog Modulation.....	2.55
2.6.2.1	LF-Generator .....	2.55
2.6.2.2	Amplitude Modulation .....	2.56
2.6.2.3	Frequency Modulation .....	2.57
2.6.2.4	Phase Modulation .....	2.59
2.6.2.5	Pulse Modulation .....	2.61
2.6.3	Digital Modulation ASK and FSK.....	2.64
<b>2.7</b>	<b>LF-Output .....</b>	<b>2.66</b>
<b>2.8</b>	<b>Sweep .....</b>	<b>2.68</b>
2.8.1	Setting the Sweep Range (START, STOP, CENTER and SPAN).....	2.68
2.8.2	Selecting the Sweep Run (SPACING LIN, LOG) .....	2.69
2.8.3	Operating Modes (MODE).....	2.69
2.8.4	Trigger Inputs .....	2.70
2.8.5	Sweep Outputs .....	2.70
2.8.6	RF-Sweep .....	2.72
2.8.7	LEVEL Sweep .....	2.74
2.8.8	LF-Sweep .....	2.75
<b>2.9</b>	<b>LIST Mode .....</b>	<b>2.77</b>
2.9.1	Operating Modes (MODE).....	2.77
2.9.2	Inputs/Outputs .....	2.78
<b>2.10</b>	<b>Memory Sequence.....</b>	<b>2.82</b>

<b>2.11 Utilities.....</b>	<b>2.86</b>
2.11.1 IEC-Bus Address (SYSTEM-GPIB).....	2.86
2.11.2 Parameter of the RS232 Interface (SYSTEM-RS232).....	2.87
2.11.3 Suppressing Indications and Deleting Memories (SYSTEM-SECURITY).....	2.88
2.11.4 Indication of the IEC-Bus Language (LANGUAGE).....	2.89
2.11.5 Reference Frequency Internal/External (REF OSC).....	2.89
2.11.6 Phase of the Output Signal (PHASE).....	2.90
2.11.7 Password Input With Functions Protected (PROTECT).....	2.91
2.11.8 Calibration (CALIB).....	2.92
2.11.9 Indications of Module Variants (DIAG-CONFIG).....	2.93
2.11.10 Voltage Indication of Test Points (DIAG-TPOINT).....	2.94
2.11.11 Indications of Service Data (DIAG-PARAM).....	2.95
2.11.12 Test (TEST).....	2.95
2.11.13 Assigning Modulations to the [MOD ON/OFF] Key (MOD-KEY).....	2.96
2.11.14 Setting Auxiliary Inputs/Outputs (AUX - I/O).....	2.97
2.11.15 Switching On/Off Beeper (BEEPER).....	2.98
<b>2.12 The Help System.....</b>	<b>2.99</b>
<b>2.13 Status.....</b>	<b>2.99</b>
<b>2.14 Error Messages.....</b>	<b>2.100</b>
<b>3 Remote Control.....</b>	<b>3.1</b>
<b>3.1 Introduction.....</b>	<b>3.1</b>
<b>3.2 Brief Instructions.....</b>	<b>3.1</b>
3.2.1 IEC-Bus.....	3.1
3.2.2 RS-232 Interface.....	3.2
<b>3.3 Switchover to Remote Control.....</b>	<b>3.2</b>
3.3.1 Remote Control via IEC Bus.....	3.3
3.3.1.1 Setting the Device Address.....	3.3
3.3.1.2 Indications during Remote Control.....	3.3
3.3.1.3 Return to Manual Operation.....	3.3
3.3.2 Remote Control via RS-232-Interface.....	3.4
3.3.2.1 Setting the Transmission Parameters.....	3.4
3.3.2.2 Indications during Remote Control.....	3.4
3.3.2.3 Return to Manual Operating.....	3.4
<b>3.4 Messages.....</b>	<b>3.4</b>
3.4.1 Interface Message.....	3.4
3.4.2 Device Messages (Commands and Device Responses).....	3.5
<b>3.5 Structure and Syntax of the Device Messages.....</b>	<b>3.5</b>
3.5.1 SCPI Introduction.....	3.5
3.5.2 Structure of a Command.....	3.6
3.5.3 Structure of a Command Line.....	3.8
3.5.4 Responses to Queries.....	3.8
3.5.5 Parameter.....	3.9
3.5.6 Overview of Syntax Elements.....	3.11

<b>3.6</b>	<b>Description of Commands</b> .....	<b>3.12</b>
3.6.1	Notation .....	3.12
3.6.2	Common Commands .....	3.14
3.6.3	ABORt System .....	3.17
3.6.4	CALibration-System .....	3.18
3.6.5	DIAGnostic-System .....	3.19
3.6.6	DISPLAY-System .....	3.21
3.6.7	FORMat-System.....	3.22
3.6.8	INPut-System .....	3.23
3.6.9	MEMory System .....	3.23
3.6.10	OUTPut-System .....	3.24
3.6.11	SOURce-System .....	3.26
3.6.11.1	SOURce:AM Subsystem .....	3.26
3.6.11.2	SOURce:CORRection Subsystem .....	3.28
3.6.11.3	SOURce:DM Subsystem.....	3.30
3.6.11.4	SOURce:FM Subsystem .....	3.32
3.6.11.5	SOURce:FREQuency Subsystem.....	3.35
3.6.11.6	SOURce:LIST Subsystem .....	3.38
3.6.11.7	SOURce:MARKer Subsystem.....	3.41
3.6.11.8	SOURce:PHASe Subsystem .....	3.43
3.6.11.9	SOURce:PM Subsystem .....	3.44
3.6.11.10	SOURce:POWer Subsystem .....	3.46
3.6.11.11	SOURce:PULM Subsystem .....	3.49
3.6.11.12	SOURce:PULSe Subsystem.....	3.51
3.6.11.13	SOURce:ROSCillator Subsystem .....	3.52
3.6.11.14	SOURce:SWEEp Subsystem.....	3.53
3.6.12	SOURce0 2 System .....	3.57
3.6.12.1	SOURce0 2:FREQuency Subsystem.....	3.57
3.6.12.2	SOURce 0 2:FUNcTion-Subsystem .....	3.59
3.6.12.3	SOURce2:MARKer-Subsystem .....	3.60
3.6.12.4	SOURce2:SWEEp-Subsystem.....	3.61
3.6.13	STATus-System .....	3.63
3.6.14	SYSTem-System.....	3.65
3.6.15	TEST-System .....	3.70
3.6.16	TRIGger-System .....	3.72
3.6.17	UNIT-System.....	3.75
<b>3.7</b>	<b>Instrument Model and Command Processing</b> .....	<b>3.76</b>
3.7.1	Input Unit .....	3.76
3.7.2	Command Recognition.....	3.77
3.7.3	Data Set and Instrument Hardware.....	3.77
3.7.4	Status Reporting System.....	3.77
3.7.5	Output Unit .....	3.78
3.7.6	Command Sequence and Command Synchronization .....	3.78
<b>3.8</b>	<b>Status Reporting System</b> .....	<b>3.79</b>
3.8.1	Structure of an SCPI Status Register.....	3.79
3.8.2	Overview of the Status Registers .....	3.81
3.8.3	Description of the Status Registers .....	3.82
3.8.3.1	Status Byte (STB) and Service Request Enable Register (SRE) .....	3.82
3.8.3.2	IST Flag and Parallel Poll Enable Register (PPE) .....	3.83
3.8.3.3	Event Status Register (ESR) and Event Status Enable Register (ESE).....	3.83
3.8.3.4	STATus:OPERation Register .....	3.84
3.8.3.5	STATus:QUEStionable Register.....	3.85
3.8.4	Application of the Status Reporting Systems .....	3.86
3.8.4.1	Service Request, Making Use of the Hierarchy Structure .....	3.86



3.8.4.2	Serial Poll.....	3.86
3.8.4.3	Parallel Poll.....	3.87
3.8.4.4	Query by Means of Commands.....	3.87
3.8.4.5	Error Queue Query.....	3.87
3.8.5	Resetting Values of the Status Reporting Systems.....	3.88
<b>4</b>	<b>Maintenance and Troubleshooting.....</b>	<b>4.1</b>
<b>4.1</b>	<b>Maintenance.....</b>	<b>4.1</b>
4.1.1	Cleaning the Outside.....	4.1
4.1.2	Storage.....	4.1
4.1.3	Exchange of the Lithium Battery.....	4.1
<b>4.2</b>	<b>Functional Test.....</b>	<b>4.4</b>
<b>5</b>	<b>Testing the Rated Specifications.....</b>	<b>5.1</b>
<b>5.1</b>	<b>Test Instruments and Utilities.....</b>	<b>5.1</b>
5.1.1	Test Setups to Measure Modulation Characteristics.....	5.2
5.1.1.1	Standard Test System.....	5.2
5.1.1.2	Test System for Pulse Modulation.....	5.2
<b>5.2</b>	<b>Test Procedures.....</b>	<b>5.3</b>
5.2.1	Display and Keyboard.....	5.3
5.2.2	Frequency Setting.....	5.3
5.2.3	Reference Frequency.....	5.4
5.2.4	Suppression of Harmonics.....	5.4
5.2.5	Suppression of Subharmonics.....	5.6
5.2.6	Suppression of Nonharmonics.....	5.6
5.2.7	SSB Phase Noise.....	5.7
5.2.8	Maximum RF Level.....	5.8
5.2.9	RF Level Accuracy.....	5.10
5.2.10	AM Modulation Depth Setting.....	5.11
5.2.11	AM Distortion.....	5.11
5.2.12	AM Frequency Response.....	5.12
5.2.13	Amplitude Shift Keying (ASK).....	5.13
5.2.14	FM Deviation Setting.....	5.13
5.2.15	FM Distortion.....	5.15
5.2.16	FM Frequency Response.....	5.16
5.2.17	Frequency Shift Keying (FSK).....	5.17
5.2.18	Pulse Modulation Rise/Fall Time.....	5.18
5.2.19	Pulse Modulation On /Off Ratio.....	5.19
5.2.20	Internal Modulation Generator.....	5.20
5.2.21	LF Generator (Option SM-B2).....	5.20
5.2.22	Pulse Generator (Option SMP-B14).....	5.21
<b>5.3</b>	<b>Test Report.....</b>	<b>5.22</b>

<b>Annex A .....</b>	<b>6A.1</b>
IEC/IEEE Bus Interface .....	6A.1
Characteristics of the Interface .....	6A.1
Bus Lines .....	6A.1
Interface Messages .....	6A.3
RS-232-C Interface .....	6A.4
Interface characteristics.....	6A.4
Signal lines.....	6A.4
Transmission parameters .....	6A.5
Interface functions .....	6A.5
Handshake .....	6A.6
 <b>Annex B .....</b>	 <b>7B1.1</b>
List of Error Messages.....	7B1.1
SCPI-Specific Error Messages .....	7B1.1
SMP-Specific Error Messages.....	7B1.5
 <b>Annex C .....</b>	 <b>8C.1</b>
List of Commands (with SCPI Conformity Information).....	8C.1
 <b>Annex D .....</b>	 <b>9D.1</b>
1. Including IEC-Bus Library for QuickBasic.....	9D.1
2. Initialization and Default Status .....	9D.1
2.1. Initiate Controller.....	9D.1
2.2. Initiate Instrument .....	9D.1
3. Transmission of Instrument Setting Commands .....	9D.2
4. Switchover to Manual Control.....	9D.2
5. Reading out Instrument Settings .....	9D.2
6. List Management .....	9D.3
7. Command synchronization .....	9D.3
8. Service Request .....	9D.4
9. Operating the Generator in the IEC-Bus Controller Mode.....	9D.6

## TABLES

Table 2-1	Input sockets for the different types of modulation	2.52
Table 2-2	Status messages in the case of a deviation	2.53
Table 2-3	Modulations which cannot be operated simultaneously	2.54
Table 2-4	Modulation generators as component parts	2.55
Table 2-5	Parameters for the various frequency modulation modes	2.57
Table 2-6	LIST mode; Example of a list	2.77
Table 2-7	MEMORY SEQUENCE; Example of a list	2.82
Table 3-1	Common Commands	3.14
Table 3-2	Device Response to *OPT?	3.15
Table 3-3	Synchronization with *OPC, *OPC? and *WAI	3.78
Table 3-4	Meaning of the bits used in the status byte	3.82
Table 3-5	Meaning of the bits used in the event status register	3.83
Table 3-6	Meaning of the bits used in the STATUS:OPERATION register	3.84
Table 3-7	Meaning of the bits used in the STATUS:QUESTIONABLE register	3.85
Table 3-8	Resetting instrument functions	3.88

## FIGURES

Fig. 1-1	SMP, View from the top	1.5
Fig. 2-1	Front panel view	2.2
Fig. 2-2	Rear panel view	2.12
Fig. 2-3	Design of the display	2.18
Fig. 2-4	MODULATION-AM menu	2.19
Fig. 2-5	Display after AM setting	2.25
Fig. 2-6	Display after pattern setting	2.27
Fig. 2-7	OPERATION page of the MEM SEQ menu	2.28
Fig. 2-8	SELECT-LIST-selection window	2.29
Fig. 2-9	DELETE-LIST selection window	2.30
Fig. 2-10	Edit function EDIT/VIEW	2.31
Fig. 2-11	Block function FILL: Input window	2.32
Fig. 2-12	Edit function INSERT: Input window	2.34
Fig. 2-13	Edit function DELETE: Input window	2.35
Fig. 2-14	Starting point of the pattern setting	2.36
Fig. 2-15, a to c	Pattern setting - Edition of a list	2.38
Fig. 2-16	Menu FREQUENCY	2.41
Fig. 2-17	Example of a circuit with frequency offset or multiplier	2.42
Fig. 2-18	Menu LEVEL	2.43
Fig. 2-19	Example of a circuit with level offset	2.45
Fig. 2-20	Basic principle of level control of the SMP	2.46
Fig. 2-21	Example of external power control using a power meter	2.46
Fig. 2-22	Menu LEVEL - ALC	2.47
Fig. 2-23	Menu LEVEL - UCOR - OPERATION page	2.48
Fig. 2-24	Menu UCOR - LEVEL-EDIT page	2.49
Fig. 2-25 a	Automatic level correction	2.50
Fig. 2-25 b	Measurement	2.50
Fig. 2-26	Menu LEVEL-EMF	2.51
Fig. 2-27	Menu MODULATION-AM	2.56
Fig. 2-28	Operating modes for frequency modulation	2.57
Fig. 2-29	Menu MODULATION-FM	2.58
Fig. 2-30	Menu MODULATION - PM fitted with option SM-B2, LF-generator (LFGEN2), and option SM-B5, FM/PM-modulator	2.60
Fig. 2-31	Signal example 1: single pulse, TRIGGER MODE = AUTO	2.61
Fig. 2-32	Signal example 2: double pulse	2.62

Fig. 2-33	Menu MODULATION-PULSE	2.62
Fig. 2-34	Menu DIGITAL MOD-ASK	2.64
Fig. 2-36	Menu LF OUTPUT	2.66
Fig. 2-37	Signal example sweep 0 to 20 GHz:	2.71
Fig. 2-38	Signal example sweep: MODE = SINGLE, BLANK TIME = LONG	2.72
Fig. 2-39	Menu SWEEP - FREQ	2.72
Fig. 2-40	Menu SWEEP - LEVEL	2.74
Fig. 2-41	Menu SWEEP - LF GEN	2.75
Fig. 2-42	Signal example LIST mode: MODE = EXT-STEP	2.79
Fig. 2-43	Menu LIST - OPERATION page	2.79
Fig. 2-44	Menu List - EDIT page	2.81
Fig. 2-45	Menu MEM SEQ -OPERATION-page (preset setting)	2.84
Fig. 2-46	Menu MEM SEQ - EDIT page	2.85
Fig. 2-47	Menu UTILITIES -SYSTEM -GPIB	2.86
Fig. 2-48	Menu UTILITIES - SYSTEM - RS232	2.87
Fig. 2-49	Menu UTILITIES - SYSTEM-SECURITY	2.88
Fig. 2-50	Menu UTILITIES - REF OSC (preset setting)	2.89
Fig. 2-51	Menu UTILITIES - PHASE (preset setting)	2.90
Fig. 2-52	Menu UTILITIES - PROTECT (preset setting)	2.91
Fig. 2-53	Menu UTILITIES - CALIB - PULSE GEN	2.92
Fig. 2-54	Menu UTILITIES - DIAG - CONFIG	2.93
Fig. 2-55	Menu UTILITIES - DIAG - TPOINT	2.94
Fig. 2-56	Menu UTILITIES - DIAG - PARAM	2.95
Fig. 2-57	Menu UTILITIES - MOD KEY (preset setting)	2.96
Fig. 2-58	Menu UTILITIES - AUX I/O	2.97
Fig. 2-59	Menu UTILITIES - BEEPER	2.98
Fig. 2-60	Menu STATUS page	2.99
Fig. 2-61	ERROR page	2.100
Fig. 3-1	Tree structure of the SCPI command systems	3.6
Fig. 3-2	Instrument model in the case of remote control	3.76
Fig. 3-3	The status -register model	3.79
Fig. 3-4	Overview of the status register	3.81
Fig. 4-1	Shielding cover of controller and front panel module	4.3
Fig. 4-2	Position of the RAM battery on the PCB	4.3
Fig. 4-3	UTILITIES-TEST menu,	4.4



**Before putting the product into operation for the first time, make sure to read the following**



## **S a f e t y I n s t r u c t i o n s**

Rohde & Schwarz makes every effort to keep the safety standard of its products up to date and to offer its customers the highest possible degree of safety. Our products and the auxiliary equipment required for them are designed and tested in accordance with the relevant safety standards. Compliance with these standards is continuously monitored by our quality assurance system. This product has been designed and tested in accordance with the EC Certificate of Conformity and has left the manufacturer's plant in a condition fully complying with safety standards. To maintain this condition and to ensure safe operation, observe all instructions and warnings provided in this manual. If you have any questions regarding these safety instructions, Rohde & Schwarz will be happy to answer them.

Furthermore, it is your responsibility to use the product in an appropriate manner. This product is designed for use solely in industrial and laboratory environments or in the field and must not be used in any way that may cause personal injury or property damage. You are responsible if the product is used for an intention other than its designated purpose or in disregard of the manufacturer's instructions. The manufacturer shall assume no responsibility for such use of the product.

The product is used for its designated purpose if it is used in accordance with its operating manual and within its performance limits (see data sheet, documentation, the following safety instructions). Using the products requires technical skills and knowledge of English. It is therefore essential that the products be used exclusively by skilled and specialized staff or thoroughly trained personnel with the required skills. If personal safety gear is required for using Rohde & Schwarz products, this will be indicated at the appropriate place in the product documentation.

### **Symbols and safety labels**

Observe operating instructions	Weight indication for units >18 kg	Danger of electric shock	Warning! Hot surface	PE terminal	Ground	Ground terminal	Attention! Electrostatic sensitive devices

Supply voltage ON/OFF	Standby indication	Direct current (DC)	Alternating current (AC)	Direct/alternating current (DC/AC)	Device fully protected by double/reinforced insulation

## Safety Instructions

Observing the safety instructions will help prevent personal injury or damage of any kind caused by dangerous situations. Therefore, carefully read through and adhere to the following safety instructions before putting the product into operation. It is also absolutely essential to observe the additional safety instructions on personal safety that appear in other parts of the documentation. In these safety instructions, the word "product" refers to all merchandise sold and distributed by Rohde & Schwarz, including instruments, systems and all accessories.

### Tags and their meaning

DANGER	This tag indicates a safety hazard with a high potential of risk for the user that can result in death or serious injuries.
WARNING	This tag indicates a safety hazard with a medium potential of risk for the user that can result in death or serious injuries.
CAUTION	This tag indicates a safety hazard with a low potential of risk for the user that can result in slight or minor injuries.
ATTENTION	This tag indicates the possibility of incorrect use that can cause damage to the product.
NOTE	This tag indicates a situation where the user should pay special attention to operating the product but which does not lead to damage.

These tags are in accordance with the standard definition for civil applications in the European Economic Area. Definitions that deviate from the standard definition may also exist. It is therefore essential to make sure that the tags described here are always used only in connection with the associated documentation and the associated product. The use of tags in connection with unassociated products or unassociated documentation can result in misinterpretations and thus contribute to personal injury or material damage.

### Basic safety instructions

1. The product may be operated only under the operating conditions and in the positions specified by the manufacturer. Its ventilation must not be obstructed during operation. Unless otherwise specified, the following requirements apply to Rohde & Schwarz products:  
prescribed operating position is always with the housing floor facing down, IP protection 2X, pollution severity 2, overvoltage category 2, use only in enclosed spaces, max. operation altitude max. 2000 m. Unless specified otherwise in the data sheet, a tolerance of  $\pm 10\%$  shall apply to the nominal voltage and of  $\pm 5\%$  to the nominal frequency.
2. Applicable local or national safety regulations and rules for the prevention of accidents must be observed in all work performed. The product may be opened only by authorized, specially trained personnel. Prior to performing any work on the product or opening the product, the product must be disconnected from the supply network. Any adjustments, replacements of parts, maintenance or repair must be carried out only by technical personnel authorized by Rohde & Schwarz. Only original parts may be used for replacing parts relevant to safety (e.g. power switches, power transformers, fuses). A safety test must always be performed after parts relevant to safety have been replaced (visual inspection, PE conductor test, insulation resistance measurement, leakage current measurement, functional test).
3. As with all industrially manufactured goods, the use of substances that induce an allergic reaction (allergens, e.g. nickel) such as aluminum cannot be generally excluded. If you develop an allergic reaction (such as a skin rash, frequent sneezing, red eyes or respiratory difficulties), consult a physician immediately to determine the cause.

## Safety Instructions

4. If products/components are mechanically and/or thermally processed in a manner that goes beyond their intended use, hazardous substances (heavy-metal dust such as lead, beryllium, nickel) may be released. For this reason, the product may only be disassembled, e.g. for disposal purposes, by specially trained personnel. Improper disassembly may be hazardous to your health. National waste disposal regulations must be observed.
5. If handling the product yields hazardous substances or fuels that must be disposed of in a special way, e.g. coolants or engine oils that must be replenished regularly, the safety instructions of the manufacturer of the hazardous substances or fuels and the applicable regional waste disposal regulations must be observed. Also observe the relevant safety instructions in the product documentation.
6. Depending on the function, certain products such as RF radio equipment can produce an elevated level of electromagnetic radiation. Considering that unborn life requires increased protection, pregnant women should be protected by appropriate measures. Persons with pacemakers may also be endangered by electromagnetic radiation. The employer is required to assess workplaces where there is a special risk of exposure to radiation and, if necessary, take measures to avert the danger.
7. Operating the products requires special training and intense concentration. Make certain that persons who use the products are physically, mentally and emotionally fit enough to handle operating the products; otherwise injuries or material damage may occur. It is the responsibility of the employer to select suitable personnel for operating the products.
8. Prior to switching on the product, it must be ensured that the nominal voltage setting on the product matches the nominal voltage of the AC supply network. If a different voltage is to be set, the power fuse of the product may have to be changed accordingly.
9. In the case of products of safety class I with movable power cord and connector, operation is permitted only on sockets with earthing contact and protective earth connection.
10. Intentionally breaking the protective earth connection either in the feed line or in the product itself is not permitted. Doing so can result in the danger of an electric shock from the product. If extension cords or connector strips are implemented, they must be checked on a regular basis to ensure that they are safe to use.
11. If the product has no power switch for disconnection from the AC supply, the plug of the connecting cable is regarded as the disconnecting device. In such cases, it must be ensured that the power plug is easily reachable and accessible at all times (length of connecting cable approx. 2 m). Functional or electronic switches are not suitable for providing disconnection from the AC supply. If products without power switches are integrated in racks or systems, a disconnecting device must be provided at the system level.
12. Never use the product if the power cable is damaged. By taking appropriate safety measures and carefully laying the power cable, ensure that the cable cannot be damaged and that no one can be hurt by e.g. tripping over the cable or suffering an electric shock.
13. The product may be operated only from TN/TT supply networks fused with max. 16 A.
14. Do not insert the plug into sockets that are dusty or dirty. Insert the plug firmly and all the way into the socket. Otherwise this can result in sparks, fire and/or injuries.
15. Do not overload any sockets, extension cords or connector strips; doing so can cause fire or electric shocks.
16. For measurements in circuits with voltages  $V_{rms} > 30 V$ , suitable measures (e.g. appropriate measuring equipment, fusing, current limiting, electrical separation, insulation) should be taken to avoid any hazards.
17. Ensure that the connections with information technology equipment comply with IEC 950/EN 60950.
18. Never remove the cover or part of the housing while you are operating the product. This will expose circuits and components and can lead to injuries, fire or damage to the product.

## Safety Instructions

19. If a product is to be permanently installed, the connection between the PE terminal on site and the product's PE conductor must be made first before any other connection is made. The product may be installed and connected only by a skilled electrician.
20. For permanently installed equipment without built-in fuses, circuit breakers or similar protective devices, the supply circuit must be fused in such a way that suitable protection is provided for users and products.
21. Do not insert any objects into the openings in the housing that are not designed for this purpose. Never pour any liquids onto or into the housing. This can cause short circuits inside the product and/or electric shocks, fire or injuries.
22. Use suitable overvoltage protection to ensure that no overvoltage (such as that caused by a thunderstorm) can reach the product. Otherwise the operating personnel will be endangered by electric shocks.
23. Rohde & Schwarz products are not protected against penetration of water, unless otherwise specified (see also safety instruction 1.). If this is not taken into account, there exists the danger of electric shock or damage to the product, which can also lead to personal injury.
24. Never use the product under conditions in which condensation has formed or can form in or on the product, e.g. if the product was moved from a cold to a warm environment.
25. Do not close any slots or openings on the product, since they are necessary for ventilation and prevent the product from overheating. Do not place the product on soft surfaces such as sofas or rugs or inside a closed housing, unless this is well ventilated.
26. Do not place the product on heat-generating devices such as radiators or fan heaters. The temperature of the environment must not exceed the maximum temperature specified in the data sheet.
27. Batteries and storage batteries must not be exposed to high temperatures or fire. Keep batteries and storage batteries away from children. If batteries or storage batteries are improperly replaced, this can cause an explosion (warning: lithium cells). Replace the battery or storage battery only with the matching Rohde & Schwarz type (see spare parts list). Batteries and storage batteries are hazardous waste. Dispose of them only in specially marked containers. Observe local regulations regarding waste disposal. Do not short-circuit batteries or storage batteries.
28. Please be aware that in the event of a fire, toxic substances (gases, liquids etc.) that may be hazardous to your health may escape from the product.
29. Please be aware of the weight of the product. Be careful when moving it; otherwise you may injure your back or other parts of your body.
30. Do not place the product on surfaces, vehicles, cabinets or tables that for reasons of weight or stability are unsuitable for this purpose. Always follow the manufacturer's installation instructions when installing the product and fastening it to objects or structures (e.g. walls and shelves).
31. Handles on the products are designed exclusively for personnel to hold or carry the product. It is therefore not permissible to use handles for fastening the product to or on means of transport such as cranes, fork lifts, wagons, etc. The user is responsible for securely fastening the products to or on the means of transport and for observing the safety regulations of the manufacturer of the means of transport. Noncompliance can result in personal injury or material damage.
32. If you use the product in a vehicle, it is the sole responsibility of the driver to drive the vehicle safely. Adequately secure the product in the vehicle to prevent injuries or other damage in the event of an accident. Never use the product in a moving vehicle if doing so could distract the driver of the vehicle. The driver is always responsible for the safety of the vehicle; the manufacturer assumes no responsibility for accidents or collisions.
33. If a laser product (e.g. a CD/DVD drive) is integrated in a Rohde & Schwarz product, do not use any other settings or functions than those described in the documentation. Otherwise this may be hazardous to your health, since the laser beam can cause irreversible damage to your eyes. Never try to take such products apart, and never look into the laser beam.





**Por favor lea imprescindiblemente antes de la primera puesta en funcionamiento las siguientes informaciones de seguridad**



## Informaciones de seguridad

Es el principio de Rohde & Schwarz de tener a sus productos siempre al día con los standards de seguridad y de ofrecer a sus clientes el máximo grado de seguridad. Nuestros productos y todos los equipos adicionales son siempre fabricados y examinados según las normas de seguridad vigentes. Nuestra sección de gestión de la seguridad de calidad controla constantemente que sean cumplidas estas normas. Este producto ha sido fabricado y examinado según el comprobante de conformidad adjunto según las normas de la CE y ha salido de nuestra planta en estado impecable según los standards técnicos de seguridad. Para poder preservar este estado y garantizar un funcionamiento libre de peligros, deberá el usuario atenerse a todas las informaciones, informaciones de seguridad y notas de alerta. Rohde&Schwarz está siempre a su disposición en caso de que tengan preguntas referentes a estas informaciones de seguridad.

Además queda en la responsabilidad del usuario utilizar el producto en la forma debida. Este producto solamente fue elaborado para ser utilizado en la industria y el laboratorio o para fines de campo y de ninguna manera deberá ser utilizado de modo que alguna persona/cosa pueda ser dañada. El uso del producto fuera de sus fines definidos o despreciando las informaciones de seguridad del fabricante queda en la responsabilidad del usuario. El fabricante no se hace en ninguna forma responsable de consecuencias a causa del maluso del producto.

Se parte del uso correcto del producto para los fines definidos si el producto es utilizado dentro de las instrucciones del correspondiente manual del uso y dentro del margen de rendimiento definido (ver hoja de datos, documentación, informaciones de seguridad que siguen). El uso de los productos hace necesarios conocimientos profundos y el conocimiento del idioma inglés. Por eso se deberá tener en cuenta de exclusivamente autorizar para el uso de los productos a personas peritas o debidamente minuciosamente instruidas con los conocimientos citados. Si fuera necesaria indumentaria de seguridad para el uso de productos de R&S, encontrará la información debida en la documentación del producto en el capítulo correspondiente.

### Símbolos y definiciones de seguridad

Ver manual de instrucciones del uso	Informaciones para maquinaria con un peso de > 18kg	Peligro de golpe de corriente	¡Advertencia! Superficie caliente	Conexión a conductor protector	Conexión a tierra	Conexión a masa conductora	¡Cuidado! Elementos de construcción con peligro de carga electrostática

potencia EN MARCHA/PARADA	Indicación Stand-by	Corriente continua DC	Corriente alterna AC	Corriente continua/alterna DC/AC	El aparato está protegido en su totalidad por un aislamiento de doble refuerzo

## Informaciones de seguridad

Tener en cuenta las informaciones de seguridad sirve para tratar de evitar daños y peligros de toda clase. Es necesario de que se lean las siguientes informaciones de seguridad concienzudamente y se tengan en cuenta debidamente antes de la puesta en funcionamiento del producto. También deberán ser tenidas en cuenta las informaciones para la protección de personas que encontrarán en otro capítulo de esta documentación y que también son obligatorias de seguir. En las informaciones de seguridad actuales hemos juntado todos los objetos vendidos por Rohde&Schwarz bajo la denominación de „producto“, entre ellos también aparatos, instalaciones así como toda clase de accesorios.

### Palabras de señal y su significado

PELIGRO	Indica un punto de peligro con gran potencial de riesgo para el usuario. Punto de peligro que puede llevar hasta la muerte o graves heridas.
ADVERTENCIA	Indica un punto de peligro con un potencial de riesgo mediano para el usuario. Punto de peligro que puede llevar hasta la muerte o graves heridas .
ATENCIÓN	Indica un punto de peligro con un potencial de riesgo pequeño para el usuario. Punto de peligro que puede llevar hasta heridas leves o pequeñas
CUIDADO	Indica la posibilidad de utilizar mal el producto y a consecuencia dañarlo.
INFORMACIÓN	Indica una situación en la que deberían seguirse las instrucciones en el uso del producto, pero que no consecuentemente deben de llevar a un daño del mismo.

Las palabras de señal corresponden a la definición habitual para aplicaciones civiles en el ámbito de la comunidad económica europea. Pueden existir definiciones diferentes a esta definición. Por eso se debiera tener en cuenta que las palabras de señal aquí descritas sean utilizadas siempre solamente en combinación con la correspondiente documentación y solamente en combinación con el producto correspondiente. La utilización de las palabras de señal en combinación con productos o documentaciones que no les correspondan puede llevar a malinterpretaciones y tener por consecuencia daños en personas u objetos.

### Informaciones de seguridad elementales

1. El producto solamente debe ser utilizado según lo indicado por el fabricante referente a la situación y posición de funcionamiento sin que se obstruya la ventilación. Si no se convino de otra manera, es para los productos R&S válido lo que sigue: como posición de funcionamiento se define principalmente la posición con el suelo de la caja para abajo , modo de protección IP 2X, grado de suciedad 2, categoría de sobrecarga eléctrica 2, utilizar solamente en estancias interiores, utilización hasta 2000 m sobre el nivel del mar.  
A menos que se especifique otra cosa en la hoja de datos, se aplicará una tolerancia de  $\pm 10\%$  sobre el voltaje nominal y de  $\pm 5\%$  sobre la frecuencia nominal.
2. En todos los trabajos deberán ser tenidas en cuenta las normas locales de seguridad de trabajo y de prevención de accidentes. El producto solamente debe de ser abierto por personal périto autorizado. Antes de efectuar trabajos en el producto o abrirlo deberá este ser desconectado de la corriente. El ajuste, el cambio de partes, la manutención y la reparación deberán ser solamente efectuadas por electricistas autorizados por R&S. Si se reponen partes con importancia para los aspectos de seguridad (por ejemplo el enchufe, los transformadores o los fusibles), solamente podrán ser sustituidos por partes originales. Despues de cada recambio de partes elementales para la seguridad deberá ser efectuado un control de

## Informaciones de seguridad

- seguridad (control a primera vista, control de conductor protector, medición de resistencia de aislamiento, medición de medición de la corriente conductora, control de funcionamiento).
3. Como en todo producto de fabricación industrial no puede ser excluido en general de que se produzcan al usarlo elementos que puedan generar alergias, los llamados elementos alergénicos (por ejemplo el níquel). Si se produjeran en el trato con productos R&S reacciones alérgicas, como por ejemplo urticaria, estornudos frecuentes, irritación de la conjuntiva o dificultades al respirar, se deberá consultar inmediatamente a un médico para averiguar los motivos de estas reacciones.
  4. Si productos / elementos de construcción son tratados fuera del funcionamiento definido de forma mecánica o térmica, pueden generarse elementos peligrosos (polvos de sustancia de metales pesados como por ejemplo plomo, berilio, níquel). La partición elemental del producto, como por ejemplo sucede en el tratamiento de materias residuales, debe de ser efectuada solamente por personal especializado para estos tratamientos. La partición elemental efectuada inadecuadamente puede generar daños para la salud. Se deben tener en cuenta las directivas nacionales referentes al tratamiento de materias residuales.
  5. En el caso de que se produjeran agentes de peligro o combustibles en la aplicación del producto que debieran de ser transferidos a un tratamiento de materias residuales, como por ejemplo agentes refrigerantes que deben ser repuestos en periodos definidos, o aceites para motores, deberán ser tenidas en cuenta las prescripciones de seguridad del fabricante de estos agentes de peligro o combustibles y las regulaciones regionales para el tratamiento de materias residuales. Cuiden también de tener en cuenta en caso dado las prescripciones de seguridad especiales en la descripción del producto.
  6. Ciertos productos, como por ejemplo las instalaciones de radiación HF, pueden a causa de su función natural, emitir una radiación electromagnética aumentada. En vista a la protección de la vida en desarrollo deberían ser protegidas personas embarazadas debidamente. También las personas con un bypass pueden correr peligro a causa de la radiación electromagnética. El empresario está comprometido a valorar y señalar áreas de trabajo en las que se corra un riesgo de exposición a radiaciones aumentadas de riesgo aumentado para evitar riesgos.
  7. La utilización de los productos requiere instrucciones especiales y una alta concentración en el manejo. Debe de ponerse por seguro de que las personas que manejen los productos estén a la altura de los requerimientos necesarios referente a sus aptitudes físicas, psíquicas y emocionales, ya que de otra manera no se pueden excluir lesiones o daños de objetos. El empresario lleva la responsabilidad de seleccionar el personal usuario apto para el manejo de los productos.
  8. Antes de la puesta en marcha del producto se deberá tener por seguro de que la tensión preseleccionada en el producto equivalga a la del la red de distribución. Si es necesario cambiar la preselección de la tensión también se deberán en caso dabo cambiar los fusibles correspondientes del producto.
  9. Productos de la clase de seguridad I con alimentación móvil y enchufe individual de producto solamente deberán ser conectados para el funcionamiento a tomas de corriente de contacto de seguridad y con conductor protector conectado.
  10. Queda prohibida toda clase de interrupción intencionada del conductor protector, tanto en la toma de corriente como en el mismo producto ya que puede tener como consecuencia el peligro de golpe de corriente por el producto. Si se utilizaran cables o enchufes de extensión se deberá poner al seguro, que es controlado su estado técnico de seguridad.
  11. Si el producto no está equipado con un interruptor para desconectarlo de la red, se deberá considerar el enchufe del cable de distribución como interruptor. En estos casos deberá asegurar de que el enchufe sea de fácil acceso y nabejo (medida del cable de distribución aproximadamente 2 m). Los interruptores de función o electrónicos no son aptos para el corte de la red eléctrica. Si los productos sin interruptor están integrados en construcciones o instalaciones, se deberá instalar el interruptor al nivel de la instalación.

## Informaciones de seguridad

12. No utilice nunca el producto si está dañado el cable eléctrico. Asegure a través de las medidas de protección y de instalación adecuadas de que el cable de eléctrico no pueda ser dañado o de que nadie pueda ser dañado por él, por ejemplo al tropezar o por un golpe de corriente.
13. Solamente está permitido el funcionamiento en redes de distribución TN/TT aseguradas con fusibles de como máximo 16 A.
14. Nunca conecte el enchufe en tomas de corriente sucias o llenas de polvo. Introduzca el enchufe por completo y fuertemente en la toma de corriente. Si no tiene en consideración estas indicaciones se arriesga a que se originen chispas, fuego y/o heridas.
15. No sobrecargue las tomas de corriente, los cables de extensión o los enchufes de extensión ya que esto pudiera causar fuego o golpes de corriente.
16. En las mediciones en circuitos de corriente con una tensión de entrada de  $U_{eff} > 30 \text{ V}$  se deberá tomar las precauciones debidas para impedir cualquier peligro (por ejemplo medios de medición adecuados, seguros, limitación de tensión, corte protector, aislamiento etc.).
17. En caso de conexión con aparatos de la técnica informática se deberá tener en cuenta que estos cumplan los requisitos de la EC950/EN60950.
18. Nunca abra la tapa o parte de ella si el producto está en funcionamiento. Esto pone a descubierto los cables y componentes eléctricos y puede causar heridas, fuego o daños en el producto.
19. Si un producto es instalado fijamente en un lugar, se deberá primero conectar el conductor protector fijo con el conductor protector del aparato antes de hacer cualquier otra conexión. La instalación y la conexión deberán ser efectuadas por un electricista especializado.
20. En caso de que los productos que son instalados fijamente en un lugar sean sin protector implementado, autointerruptor o similares objetos de protección, deberá la toma de corriente estar protegida de manera que los productos o los usuarios estén suficientemente protegidos.
21. Por favor, no introduzca ningún objeto que no esté destinado a ello en los orificios de la caja del aparato. No vierta nunca ninguna clase de líquidos sobre o en la caja. Esto puede producir corto circuitos en el producto y/o puede causar golpes de corriente, fuego o heridas.
22. Asegúrese con la protección adecuada de que no pueda originarse en el producto una sobrecarga por ejemplo a causa de una tormenta. Si no se verá el personal que lo utilice expuesto al peligro de un golpe de corriente.
23. Los productos R&S no están protegidos contra el agua si no es que exista otra indicación, ver también punto 1. Si no se tiene en cuenta esto se arriesga el peligro de golpe de corriente o de daños en el producto lo cual también puede llevar al peligro de personas.
24. No utilice el producto bajo condiciones en las que pueda producirse y se hayan producido líquidos de condensación en o dentro del producto como por ejemplo cuando se desplaza el producto de un lugar frío a un lugar caliente.
25. Por favor no cierre ninguna ranura u orificio del producto, ya que estas son necesarias para la ventilación e impiden que el producto se caliente demasiado. No pongan el producto encima de materiales blandos como por ejemplo sofás o alfombras o dentro de una caja cerrada, si esta no está suficientemente ventilada.
26. No ponga el producto sobre aparatos que produzcan calor, como por ejemplo radiadores o calentadores. La temperatura ambiental no debe superar la temperatura máxima especificada en la hoja de datos.

## Informaciones de seguridad

27. Baterías y acumuladores no deben de ser expuestos a temperaturas altas o al fuego. Guardar baterías y acumuladores fuera del alcance de los niños. Si las baterías o los acumuladores no son cambiados con la debida atención existirá peligro de explosión (atención celulas de Litio). Cambiar las baterías o los acumuladores solamente por los del tipo R&S correspondiente (ver lista de piezas de recambio). Baterías y acumuladores son deshechos problemáticos. Por favor tirenlos en los recipientes especiales para este fin. Por favor tengan en cuenta las prescripciones nacionales de cada país referente al tratamiento de deshechos. Nunca sometan las baterías o acumuladores a un corto circuito.
28. Tengan en consideración de que en caso de un incendio pueden escaparse gases tóxicos del producto, que pueden causar daños a la salud.
29. Por favor tengan en cuenta que en caso de un incendio pueden desprenderse del producto agentes venenosos (gases, líquidos etc.) que pueden generar daños a la salud.
30. No sitúe el producto encima de superficies, vehículos, estantes o mesas, que por sus características de peso o de estabilidad no sean aptas para él. Siga siempre las instrucciones de instalación del fabricante cuando instale y asegure el producto en objetos o estructuras (por ejemplo paredes y estantes).
31. Las asas instaladas en los productos sirven solamente de ayuda para el manejo que solamente está previsto para personas. Por eso no está permitido utilizar las asas para la sujecion en o sobre medios de transporte como por ejemplo grúas, carretillas elevadoras de horquilla, carros etc. El usuario es responsable de que los productos sean sujetados de forma segura a los medios de transporte y de que las prescripciones de seguridad del fabricante de los medios de transporte sean tenidas en cuenta. En caso de que no se tengan en cuenta pueden causarse daños en personas y objetos.
32. Si llega a utilizar el producto dentro de un vehículo, queda en la responsabilidad absoluta del conductor que conducir el vehículo de manera segura. Asegure el producto dentro del vehículo debidamente para evitar en caso de un accidente las lesiones u otra clase de daños. No utilice nunca el producto dentro de un vehículo en movimiento si esto pudiera distraer al conductor. Siempre queda en la responsabilidad absoluta del conductor la seguridad del vehículo y el fabricante no asumirá ninguna clase de responsabilidad por accidentes o colisiones.
33. Dado el caso de que esté integrado un producto de laser en un producto R&S (por ejemplo CD/DVD-ROM) no utilice otras instalaciones o funciones que las descritas en la documentación. De otra manera pondrá en peligro su salud, ya que el rayo laser puede dañar irreversiblemente sus ojos. Nunca trate de descomponer estos productos. Nunca mire dentro del rayo laser.



## Certified Quality System

**DIN EN ISO 9001 : 2000**  
**DIN EN 9100 : 2003**  
**DIN EN ISO 14001 : 1996**

**DQS REG. NO 001954 QM/ST UM**

### QUALITÄTSZERTIFIKAT

*Sehr geehrter Kunde,*

Sie haben sich für den Kauf eines Rohde & Schwarz-Produktes entschieden. Hiermit erhalten Sie ein nach modernsten Fertigungsmethoden hergestelltes Produkt. Es wurde nach den Regeln unseres Managementsystems entwickelt, gefertigt und geprüft.

Das Rohde & Schwarz Managementsystem ist zertifiziert nach:

DIN EN ISO 9001:2000  
DIN EN 9100:2003  
DIN EN ISO 14001:1996

### CERTIFICATE OF QUALITY

*Dear Customer,*

you have decided to buy a Rohde & Schwarz product. You are thus assured of receiving a product that is manufactured using the most modern methods available. This product was developed, manufactured and tested in compliance with our quality management system standards.

The Rohde & Schwarz quality management system is certified according to:

DIN EN ISO 9001:2000  
DIN EN 9100:2003  
DIN EN ISO 14001:1996

### CERTIFICAT DE QUALITÉ

*Cher Client,*

vous avez choisi d'acheter un produit Rohde & Schwarz. Vous disposez donc d'un produit fabriqué d'après les méthodes les plus avancées. Le développement, la fabrication et les tests respectent nos normes de gestion qualité.

Le système de gestion qualité de Rohde & Schwarz a été homologué conformément aux normes:

DIN EN ISO 9001:2000  
DIN EN 9100:2003  
DIN EN ISO 14001:1996



**ROHDE & SCHWARZ**







Certificate No.: 9502006

This is to certify that:

Equipment type	Order No.	Designation
SMP02	1035.5005.02	Signal Generator
SMP03	1035.5005.03	
SMP04	1035.5005.04	
SMP22	1035.5005.22	
SMP-B11	1036.6240.02	Frequency Extension
SMP-B12	1036.5750.02/.03/.04	Pulse Modulator
SMP-B13	1036.7147.02	Pulse Modulator
SMP-B14	1036.7347.02	Pulse Generator
SMP-B15	1036.5250.02	RF Attenuator
SMP-B17	1036.5550.02	RF Attenuator
SMP-B18	1036.8920.02	Auxiliary Interface

complies with the provisions of the Directive of the Council of the European Union on the approximation of the laws of the Member States

- relating to electrical equipment for use within defined voltage limits  
(73/23/EEC revised by 93/68/EEC)
- relating to electromagnetic compatibility  
(89/336/EEC revised by 91/263/EEC, 92/31/EEC, 93/68/EEC)

Conformity is proven by compliance with the following standards:

EN61010-1 : 1991  
EN50081-1 : 1992  
EN50082-1 : 1992

Affixing the EC conformity mark as from 1995

**ROHDE & SCHWARZ GmbH & Co. KG**  
Mühldorfstr. 15, D-81671 München

Munich, 1997-08-26

Central Quality Management FS-QZ / Becker

1035.5005.02

CE

E-3



# Customer Support

## Technical support – where and when you need it

For quick, expert help with any Rohde & Schwarz equipment, contact one of our Customer Support Centers. A team of highly qualified engineers provides telephone support and will work with you to find a solution to your query on any aspect of the operation, programming or applications of Rohde & Schwarz equipment.

## Up-to-date information and upgrades

To keep your Rohde & Schwarz equipment always up-to-date, please subscribe to our electronic newsletter at

<http://www.rohde-schwarz.com/www/response.nsf/newsletterpreselection>

or request the desired information and upgrades via email from your Customer Support Center (addresses see below).

## Feedback

We want to know if we are meeting your support needs. If you have any comments please email us and let us know [CustomerSupport.Feedback@rohde-schwarz.com](mailto:CustomerSupport.Feedback@rohde-schwarz.com).

---

### USA & Canada

Monday to Friday (except US public holidays)

8:00 AM – 8:00 PM Eastern Standard Time (EST)

Tel. from USA 888-test-rsa (888-837-8772) (opt 2)

From outside USA +1 410 910 7800 (opt 2)

Fax +1 410 910 7801

E-mail [Customer.Support@rsa.rohde-schwarz.com](mailto:Customer.Support@rsa.rohde-schwarz.com)

### East Asia

Monday to Friday (except Singaporean public holidays)

8:30 AM – 6:00 PM Singapore Time (SGT)

Tel. +65 6 513 0488

Fax +65 6 846 1090

E-mail [Customersupport.asia@rohde-schwarz.com](mailto:Customersupport.asia@rohde-schwarz.com)

### Rest of the World

Monday to Friday (except German public holidays)

08:00 – 17:00 Central European Time (CET)

Tel. from Europe +49 (0) 180 512 42 42

From outside Europe +49 89 4129 13776

Fax +49 (0) 89 41 29 637 78

E-mail [CustomerSupport@rohde-schwarz.com](mailto:CustomerSupport@rohde-schwarz.com)





# 1 Preparation for Use

## 1.1 Putting into Operation

Before putting the SMP into operation, please make sure that

- the covers of the casing are put on and screwed,
- the ventilation openings are free,
- no signal voltage levels exceeding the permissible limits are applied at the inputs,,
- the outputs of the instrument are not overloaded or connected incorrectly.

If these points are not observed, the instrument might be damaged.

### 1.1.1 Supply Voltage

The SMP can be operated at a.c. systems from 90 to 132 V and 180 to 265 V at system frequencies from 47 to 440 Hz. The power supply socket is situated at the rear of the instrument. The instrument automatically sets itself to the voltage applied within the permissible voltage ranges. It is not necessary to set the instrument to a certain supply voltage.

### 1.1.2 Power Fuses

The SMP is protected against short circuits by means of two fuses according to nameplate of the power supply. The fuses are situated in the draw-out fuse holder which is inserted between power supply socket and power switch (see below).

### 1.1.3 Switching On/Off the Instrument

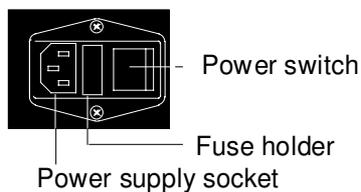

Power switch at the rear of the instrument

Switch on/off:

- Press power switch at the top/bottom  
When the instrument is switched off, the marking "O" is visible at the left of the power switch.

The power switch can remain switched on permanently. Switching off is only necessary when the instrument is to be completely disconnected from the mains.

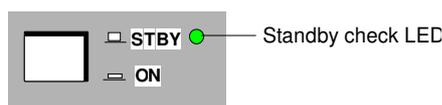

On/off switch at the front of the instrument

Switch on:

- Press switch.  
The instrument is ready for operation.

Switch off:

- Release switch.  
The instrument assumes the STANDBY mode.

### 1.1.4 Initial Status

Upon switching on, the instrument automatically assumes the status which was set when it was switched off.

If the instrument need not to be operated from the initial status any further, a defined default status should be established by pressing the [PRESET] key prior to further settings.

#### STANDBY Mode

In the STANDBY mode the optional reference oscillator (option SM-B1) remains switched on, which increases frequency accuracy.

#### Frequency accuracy after switching on when the oven-controlled reference oscillator is fitted (option SM-B1)

When switching on from the STANDBY mode, the specified frequency accuracy is reached immediately. If the power switch was switched off, the reference oscillator needs some minutes of warm-up time to reach its nominal frequency. During this period of time, the output frequency does not yet reach its final value either. In the status line in the header field of the display the message "OVEN COLD" is displayed for this time.

### 1.1.5 Setting Contrast and Brightness of the Display

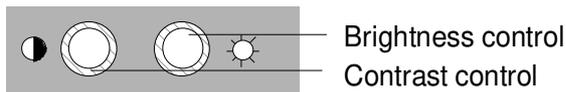

Contrast and brightness of the display can be set by means of the contrast and brightness controls situated below the display.

### 1.1.6 RAM With Battery Back-Up

The SMP has a static read-write memory (CMOS-RAM) with battery back-up, in which 50 different complete settings of the instrument can be stored (cf. Chapter 2, section "Storing and Calling of Instrument Settings"). In addition, all data and/or lists the user enters himself, such as for list mode, memory sequence, and user correction of the level, are stored in the RAM. Further, all data of the calibrations running within the instrument in the SMP are stored in the RAM (cf. Chapter 2, section "Calibration").

A lithium battery with a service life of approx. 5 years serves to supply the RAM with power. When the battery is discharged, the data stored will be lost. Exchanging the battery is described in Chapter 4.

### 1.1.7 Preset Setting

A defined setting status is achieved by pressing the [PRESET] key.

#### Preset Status:

RF frequency	10 GHz
RF level	-30 dBm (-20 dBm without option SMP-B15/B17, Attenuator)
Reference frequency	internal, adjustment off
Offsets	0
Modulations	switched off
Transient-free level setting	switched off, level attenuator mode: AUTO
Internal level control	level ALC: ON
User correction	level UCOR: OFF
PLL bandwidth	auto
LF output	switched off
Sweep	switched off
List mode	switched off
Memory sequence	switched off
Suppression of indications	system security: unaltered
Protection of calibration data	protection lock: unaltered
Settings stored	unaltered
Data, lists etc. stored	unaltered
IEC-bus address	unaltered
Beeper	unaltered

All parameters and circuit states, even those of operating modes which are not activated, are preset by means of Preset.

The presettings going beyond the above list can be seen from the menu representations as of Section 2.4 which each indicate the Preset setting status.

## 1.2 Functional Test

On switching on the instrument and permanently during operation, the SMP carries out a self test. The ROM contents as well as the battery of the non-volatile RAM are checked on switching on the instrument and the RAM contents with every calling the memory. The most important instrument functions are automatically monitored during operation.

If an error is detected, the message "ERROR" is displayed in the status line. For further identification of the error, press the [ERROR] key. Thereupon a description of the error/s is displayed (cf. Chapter 2, section "Error Messages"). Return to the menu exited by pressing the [RETURN] key.

If required, the self tests can be induced purposefully. See section "Functional Test".

Further, internal test points can be polled by the user and the results be read out and displayed. See section "Voltage Indication of Test Points".

## 1.3 Fitting the Options

Due to its variety of options, the SMP offers the possibility of providing the instrument with the equipment exactly corresponding to the application. Newly fitted options are automatically recognized and the relevant parameters added in the menu.

After every change of the instrument configuration, the CMOS RAM has to be cleared as the storage data shift:

- Switch off the instrument
- Switch the instrument on again with the [RESET] key pressed

The internal calibration routines YFOM, ALC AMP and PULSE GEN now have to be called up again to restore the cleared calibration values.

These routines are accessible via menu UTILITIES-CALIB (see Section "Calibration" and service manual). The calibration routines have to be carried out in the following order:

1. YFOM
2. ALC AMP
3. PULSE GEN (if installed)

### 1.3.1 Opening the Casing



*Caution:*

*Prior to opening the SMP unplug the power connector.*

#### **Remove paneling**

- Remove four screws in the two tilt feet at the rear of the instrument.
- Remove the upper paneling towards the top and rear.
- Turn the instrument.
- Remove the lower paneling towards the top and rear.

#### **Open ventilation ducts**

When an option is fitted at a slot which has not been used up to now, the appropriate ventilation duct of the plexiglas plate at the left in the casing frame must be opened. The openings are pre-punched so that the respective part is easy to break out.



### 1.3.2 Overview of the Slots

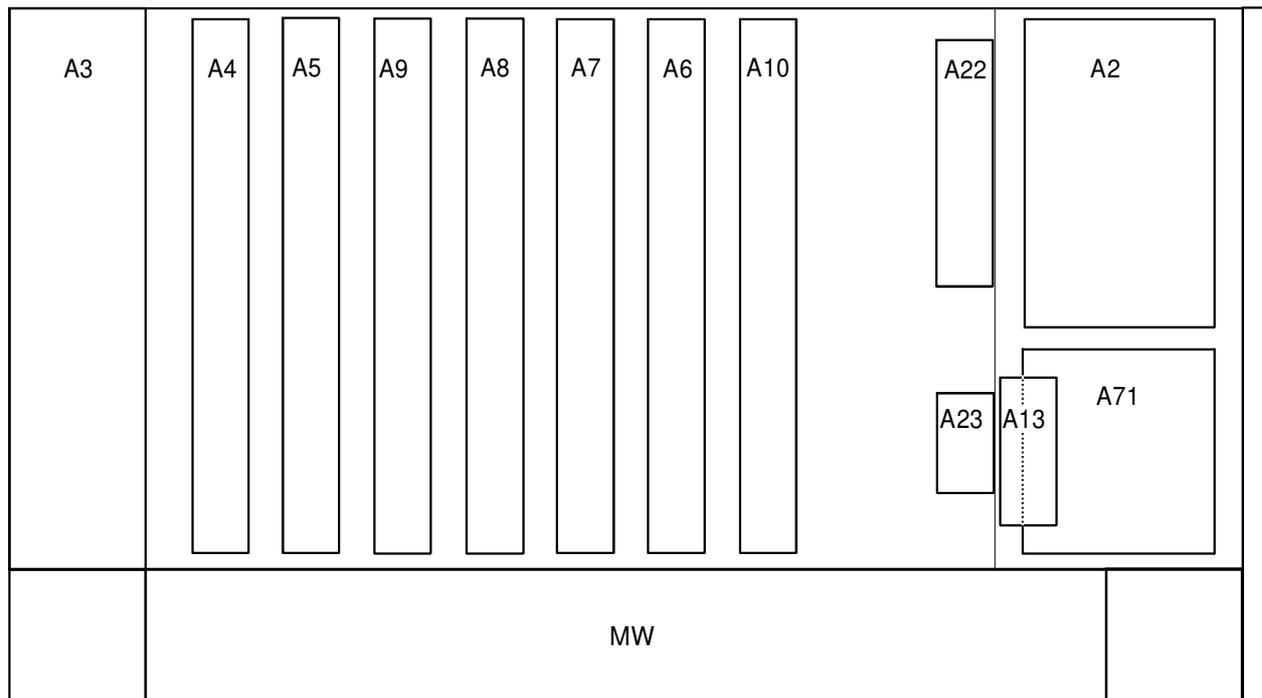

A2 = power supply	A9 = ALC amplifier
A3 = front unit	A10 = YIG-PLL
A4 = option	A13 = auxiliary interface
A5 = option	A22 = frequency range ext. 0.01 to 2 GHz
A6 = FM modulator	A23 = pulse modulator 0.01 to 2 GHz
A7 = reference/step synthesis	A71 = reference oscillator
A8 = digital synthesis	MW = microwave unit

Fig. 1-1 SMP, View from the top

### 1.3.3 Option SM-B1 - Reference Oscillator OCXO

#### Fitting the option

- Fasten the option at the back end of the side panel by means of the screw provided.
- Plug ribbon cable W710 into pin contact strip X710 on the motherboard.
- Lay coaxial cable W710 from socket X711 to connector X74 at the A7 module, reference/step synthesis, via the motherboard and secure it at the second partition by means of cable ties.

Set tuning voltage and calibrate OCXO

The crystal oscillator was factory-tuned to nominal frequency and the appropriate tuning voltage indicated on the cover of the module. The calibration value now has to be calculated from this value and transferred to the memory of the signal generator.

Calculate calibration value      The tuning voltage is generated by a 12b-bit-D/A converter which is scaled such that a tuning voltage of 12 volts is generated with calibration value (CALIBRATION DATA) 4000.  
The calibration value is thus calculated from the tuning voltage ( $V_{tun}$ ) as follows

$$\text{CALIBRATION DATA} = V_{tun} \times 4000 / 12$$

For checking purposes, the voltage at pin 16 of plug X710 on the motherboard can be remeasured and corrected if necessary. A check by means of frequency measurement may only be made after a warm-up of 2 hours and against a calibrated reference.

Store calibration value      ➤ Call menu UTILITIES-CALIB-REF OSC.  
➤ Enter the calculated calibration voltage with CALIBRATION DATA by means of the rotary knob or keypad.  
➤ Select STORE CALIBRATION DATA  
➤ Terminate entry using the [SELECT] key  
The new calibration value is stored in the EPROM.

**Note:** *The flash EPROM does not permit the deletion of individual data. Thus new memory space is occupied for each calibration. If there is no memory space available any more, the EPROM must be cleared by an authorized service shop and be written into anew. Thus a calibration should only be made if necessary*

### 1.3.4 Option SM-B2 - LF Generator

Fitting as 1st generator      As 1st generator, the LF generator is fitted at the rear slot A5.  
➤ Withdraw jumper X30/31 on module A9, ALC amplifier.  
➤ Plug jumper X3 at position 2-3 (on the right) on the option (to the right of multipoint connector X50).

Fitting as 2nd generator      If there already is a generator at slot A5, the LF generator is mounted at slot A4.  
➤ Withdraw jumper X32/33 on module A9, ALC amplifier..  
➤ Plug jumper X3 at position 1-2 on the option.

### 1.3.5 Option SM-B5 - FM/PM Modulator

The FM/PM modulator is fitted at slot A6.

Fitting the option

- Withdraw cable W105 from X89 of module A8, digital synthesis, and use again.
- Establish the following connections:

Cable	From	To	Signal
W65	A6-X65	A7-X71	REF100
W67	A6-X67	A8-X89	FDSYN
W105	A6-X69	A10-X15	FDFM

### 1.3.6 Option SMP-B11 - Frequency Range Extension 0.01 to 2 GHz

The frequency range of the SMP can be extended to 0.01 to 2 GHz using option SMP-B11. As the frequency response has to be recalibrated after the option has been fitted, fitting can only be carried out at an authorized servicing shop. Please contact the representative of our company responsible for you.

### 1.3.7 Options SMP-B12 - Pulse Modulator 2 to 20 / 2 to 27 / 2 to 40 GHz

With option SMP-B12, SMP supplies a pulse-modulated RF signal of high quality in the frequency range 2 to 20 GHz (SMP02/22), 2 to 27 GHz (SMP03) and 2 to 40 GHz (SMP04). As the frequency response has to be recalibrated after the option has been fitted, fitting can only be carried out at an authorized servicing shop. Please contact the representative of our company responsible for you.

### 1.3.8 Options SMP-B13 - Pulse Modulator 0.01 to 2 GHz

With option SMP-B13, SMP supplies a pulse-modulated RF signal of high quality in the frequency range 0.01 to 2 GHz. As the frequency response has to be recalibrated after the option has been fitted, fitting can only be carried out at an authorized servicing shop. Please contact the representative of our company responsible for you.

### 1.3.9 Option SMP-B14 - Pulse Generator

The pulse generator is fitted within module A4, pulse modulator.

Fitting the option

- Withdraw cable W81 from X72 of module A7, reference/step synthesis, and use again.
- Establish the following connections:

Cable	From	To	Signal
W41	A4-X41	A7-X72	REF50
W43	A4-X43	rear panel	VIDEO
W44	A4-X44	rear panel	SYNC
W47	A4-X47	front panel	PULSE
W49	A4-X49	A26-X260	PULSE
W81	A8-X81	A4-X42	REF50

### 1.3.10 Options SMP-B15/B17 - Attenuator 20 GHz / 40 GHz

Options SMP-B15 and SMP-B17 (SMP04) extend the setting range of the RF level to -130 dBm. As the frequency response has to be recalibrated after the option has been fitted, fitting can only be carried out at an authorized servicing shop. Please contact the representative of our company responsible for you.

### 1.3.11 Option SMP-B18 - Auxiliary Interface

Option SMP-B18 provides the V/GHz output as well as a programmable frequency mark output.

Fitting the option

- Fasten the option at the power supply panel by means of the screw provided.
- Plug the ribbon cable into pin contact strip X14 on the motherboard.
- Insert the sub-D socket of ribbon cable W131 through the hole provided at the rear panel (AUX INTERFACE) and fasten by means of the mounting bolts.
- Plug the other socket of ribbon cable W131 onto pin contact strip X2 of the option.

### 1.3.12 Option SMP-B19 /SMP-B20 - Rear Panel Connections for RF and LF

With options SMP-B19 and SMP-B20, the inputs and outputs can be changed from the front to the rear panel. The mounting instructions are attached to the option. As the frequency response has to be recalibrated after the option has been fitted, fitting can only be carried out at an authorized servicing shop. Please contact the representative of our company responsible for you.

## 1.4 Mounting into a 19" Rack

**Caution:** *Ensure free air inlet at the perforation of the side walls and air outlet at the rear of the instrument in rack mounting.*

The SMP can be mounted into a 19" rack by means of rack adapter ZZA-94 (stock no. 396.4905.00). The mounting instructions are attached to the adapter .



## 2 Operation

### 2.1 Explanation of Front and Rear Panel

#### 2.1.1 Elements of the Front Panel

##### 2.1.1.1 Display

(cf. Fig. 2-1 Front panel view, display)

1

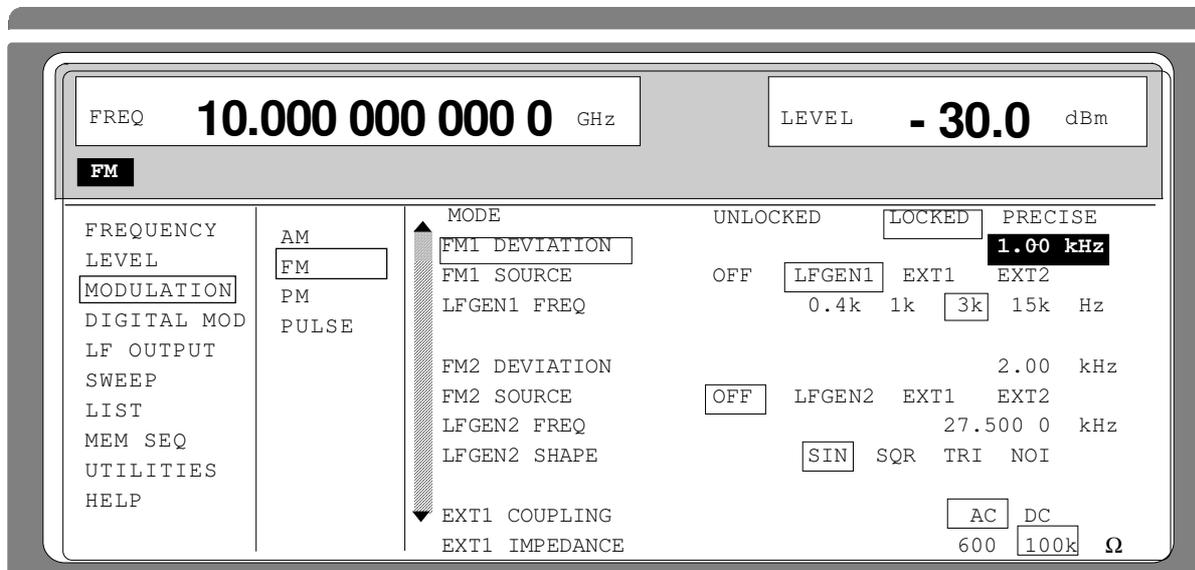

The display shows in the

header field:

- the current frequency and level settings.
- status messages.
- error messages.

menu field:

- the main menu and the submenus selected with the current settings.

Parameters can be selected and changed in the menus indicated.

**See as well**  
Section  
"Display"

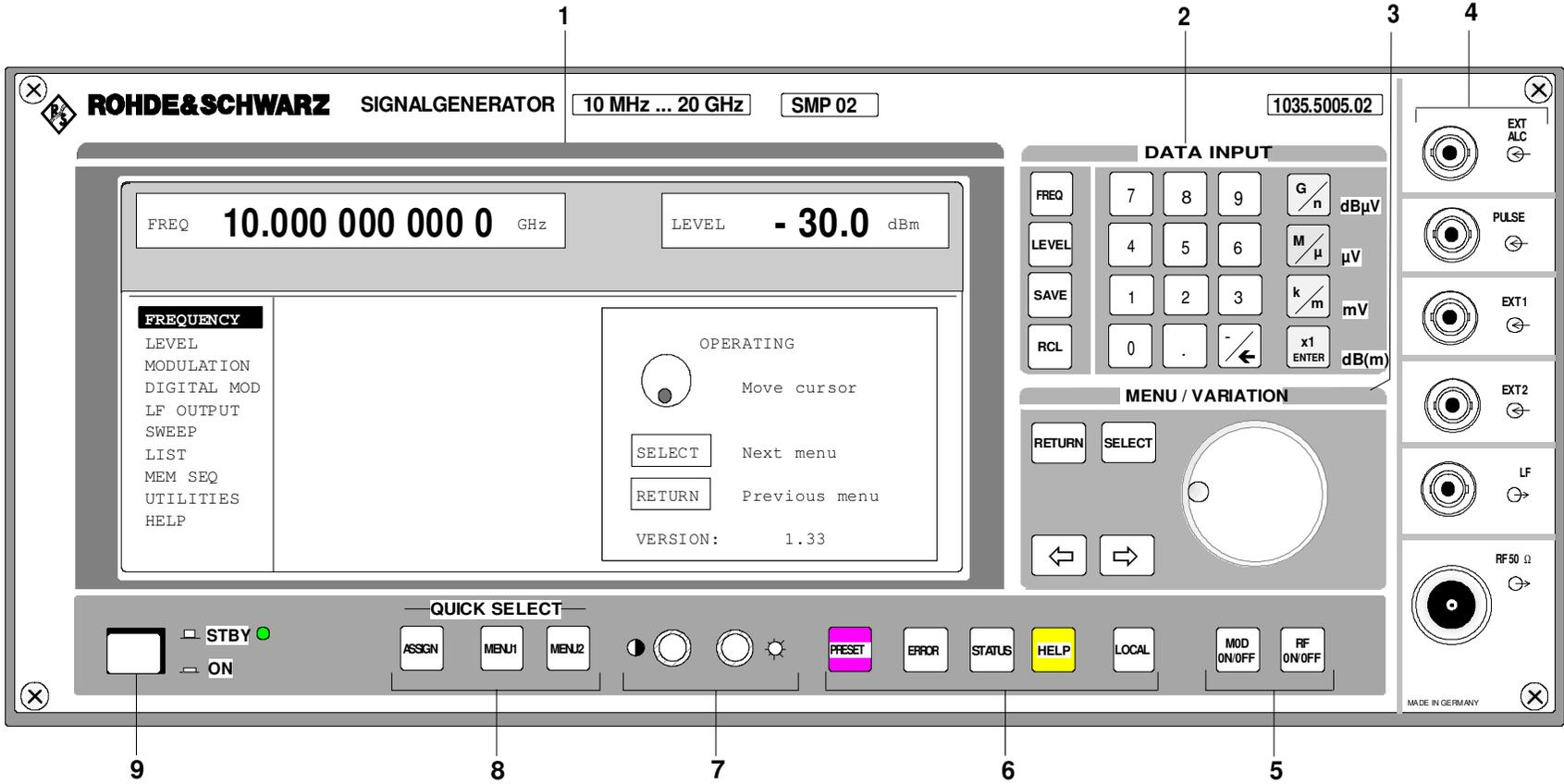

Fig. 2-1 A, Front panel view

1035.5005.02

2.2

E-8



### 2.1.1.2 Controls

(cf. Fig. 2-1 A and B, front panel view, controls)

## 2 DATA INPUT

### Parameter field



Parameters RF frequency and RF level can be entered directly by means of the parameter keys, alternatively to menu operation. Further, complete instrument settings can be stored and called.

- FREQ** Opens the setting of the RF frequency via value input or variation by means of a rotary knob. The current menu is maintained. Return to the menu by means of the [RETURN] key. (Setting of the RF frequency also in the FREQUENCY menu).
- LEVEL** Opens the setting of the RF level via value input or variation by means of a rotary knob. The current menu is maintained. Return to the menu by means of the [RETURN] key. (Setting of the RF level also in the LEVEL menu).
- SAVE** Opens the storing of the current instrument setting. Memory selection is effected by entering a number (1 to 50) and is finished by means of the [ENTER] key.
- RCL** Opens the calling of an instrument setting stored. Memory selection is effected by entering a number (1 to 50) and is finished by means of the [ENTER] key.

### See as well

Section  
"Use of [FREQ] and [LEVEL] Keys"

Section  
"RF Frequency"

Section  
"RF Level"

Section  
"Storing and Calling of Instrument Settings"

### Numeric input field

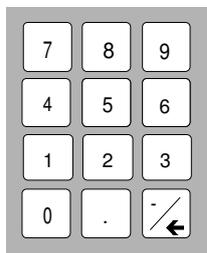

Numeric values, decimal point and minus sign can be entered by means of the digital keys.

- 0 to 9 Enters the digit.
- Enters the decimal point
  - /← Enters the minus sign.  
Deletes the last input (digit, sign or decimal point) - key [BACKSPACE].

### See as well

Section  
"Basic Operating Steps"

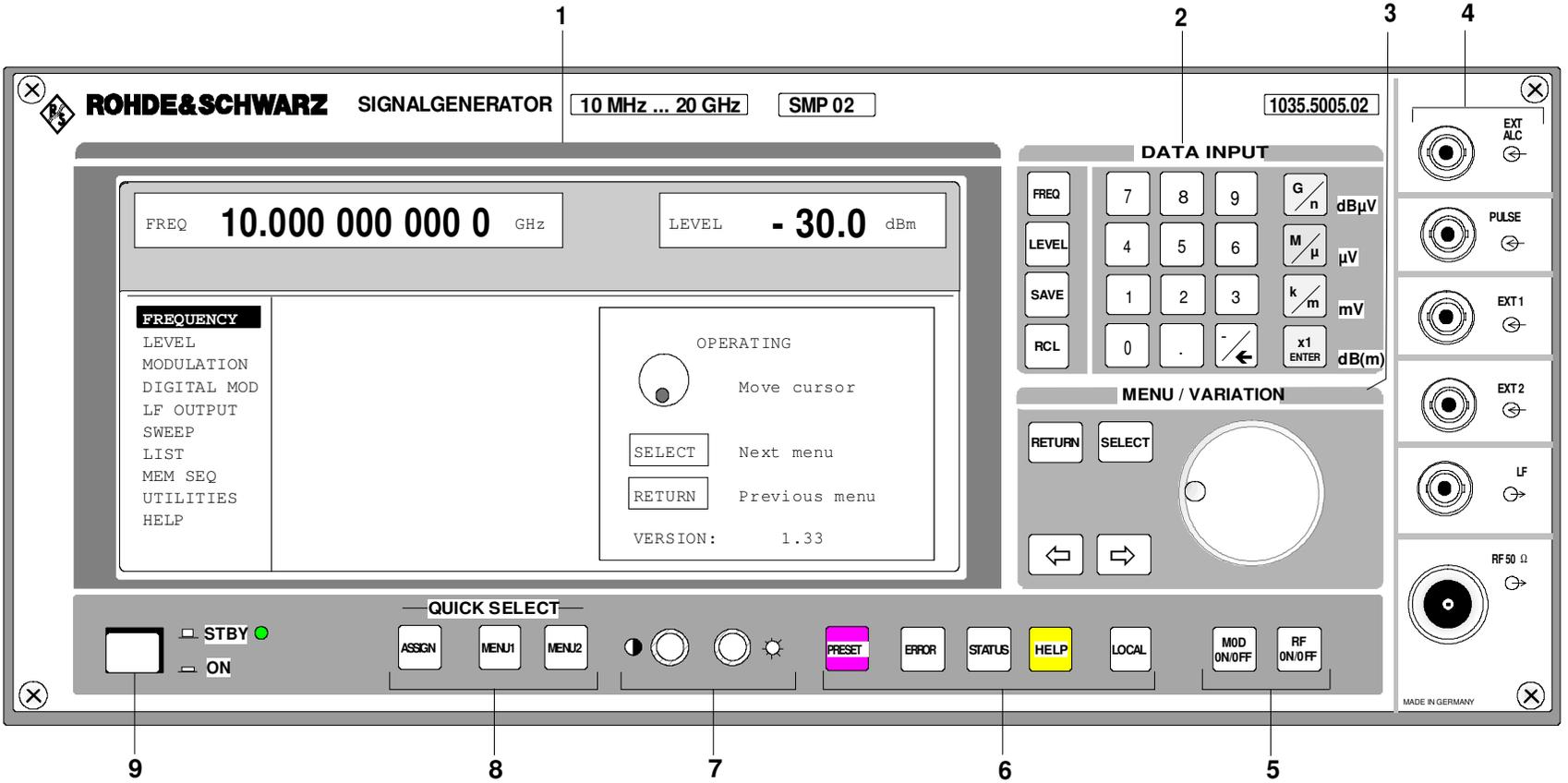
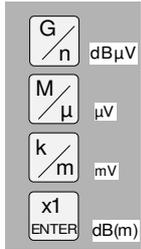

Fig.2-1 B, Front panel view

## 2 DATA INPUT

### Unit keys with enter function



The unit keys terminate the input of values and specify the multiplication factor for the respective basic unit. The basic units are displayed next to the input field while numbers are entered. In the case of level settings, the unit keys specify the unit.

G/n	dBμV	Selects giga/nano, with RF level dBμV, with LF level dBu.
M/μ	μV	Selects mega/micro, with level μV.
k/m	MV	Selects kilo/milli, with level mV.
1x		
Enter	dB(m)	Terminates entries in the basic unit and value inputs without unit. Selects with level dBm Selects with level offset and level step width dB.

In order to change to another level unit, simply press the unit key desired. Parameter LEVEL must be activated, e.g. by pressing the [LEVEL] key.

### See as well

Section  
"Basic Operating Step"

Section  
"Change Unit of Leve"

## 3 MENU/VARIATION

### Menu keys

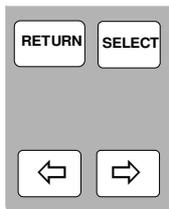

The menu keys access the menus and settings within the menus.

RETURN	Returns the menu cursor to the next higher menu level.
SELECT	Acknowledges the choice marked by the menu cursor
⇐	Moves the digit cursor to the left by one position in the marked value indication. Moves the menu cursor to the left by one position in a 1-out-of-n selection.
⇒	Moves the digit cursor to the right by one position in the marked value indication. Moves the menu cursor to the right by one position in a 1-out-of-n selection.

### See as well

Section  
"Basic Operating Steps"

Fig.2-1 B, Front panel view

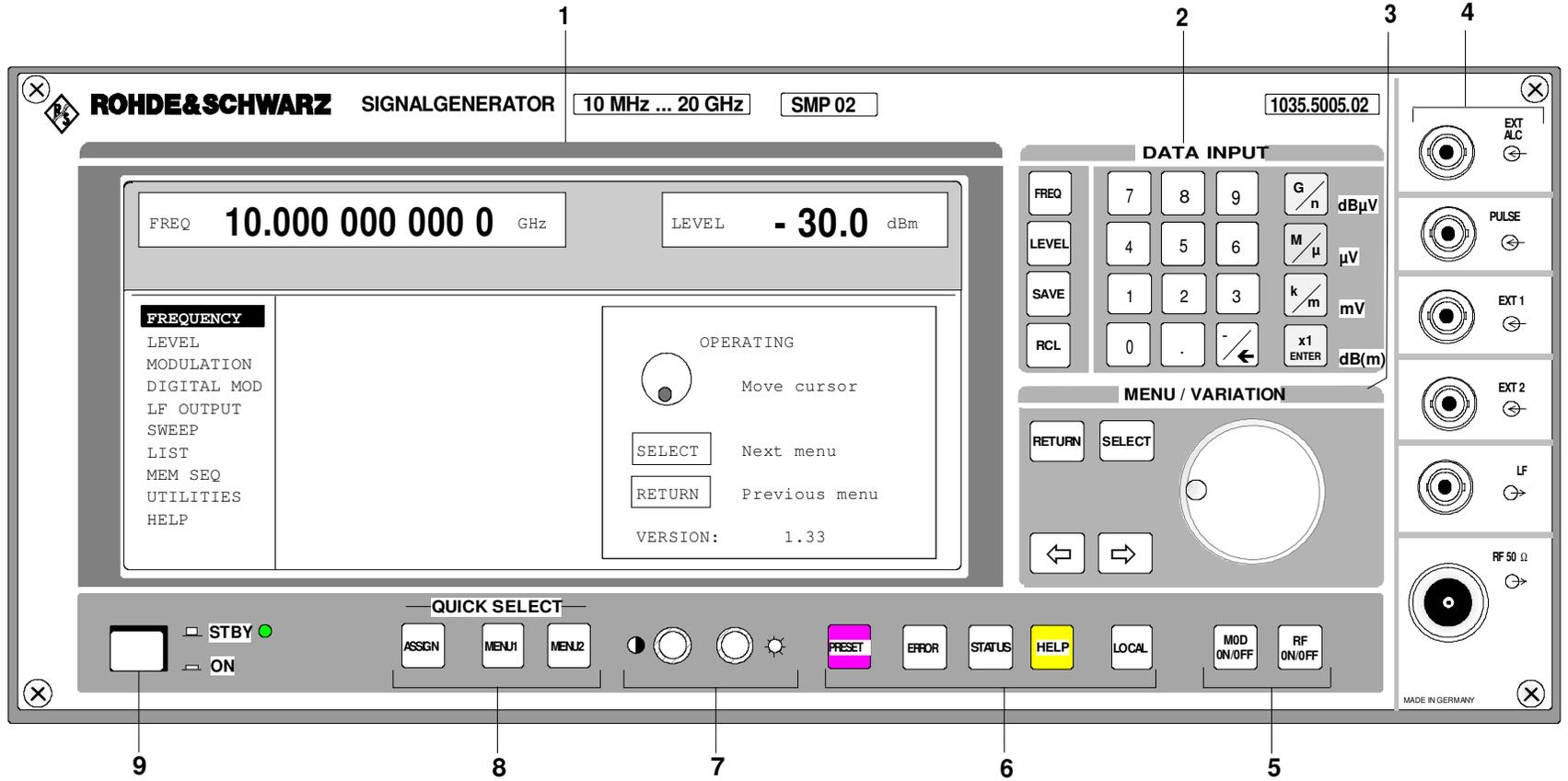

Front Panel

SMP

**3 MENU/VARIATION**

**Rotary knob**

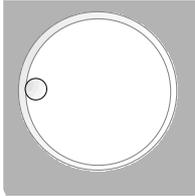

The rotary knob moves the menu cursor over the positions of a menu level to choose from or varies the value of a parameter. The variation is either effected in steps of one or in a step width that can be specified at will.

**See as well**  
 Section  
 "Basic Operating Steps"  
 Section  
 "Sample Setting for First Users"

**4**

See Section "Inputs/Outputs".

**5**



RF  
ON/OFF  
  
MOD  
ON/OFF

Switches on/off the RF signal.  
  
Switches on/off the modulation selected in the UTILITIES MOD KEY menu.

**See as well**  
 Section  
 "Use of [RF ON/OFF] and [MOD ON/OFF] Keys"

**6**



PRESET Establishes a defined instrument status.  
 ERROR\* Indicates error and caution messages.  
 STATUS\* Indicates the instrument status.  
 HELP\* Indicates context-sensitive auxiliary text.  
 LOCAL Switches the instrument from the REMOTE mode (remote control) to the LOCAL mode (manual control).

**See as well**  
 Section  
 "Preset Setting"  
 Section  
 "Help System"  
 Section  
 "Status"  
 Section  
 "Error Messages"  
 Section  
 "Remote Control"

\* Exit the menus using the [RETURN] key.

Fig.2-1 B, Front panel view

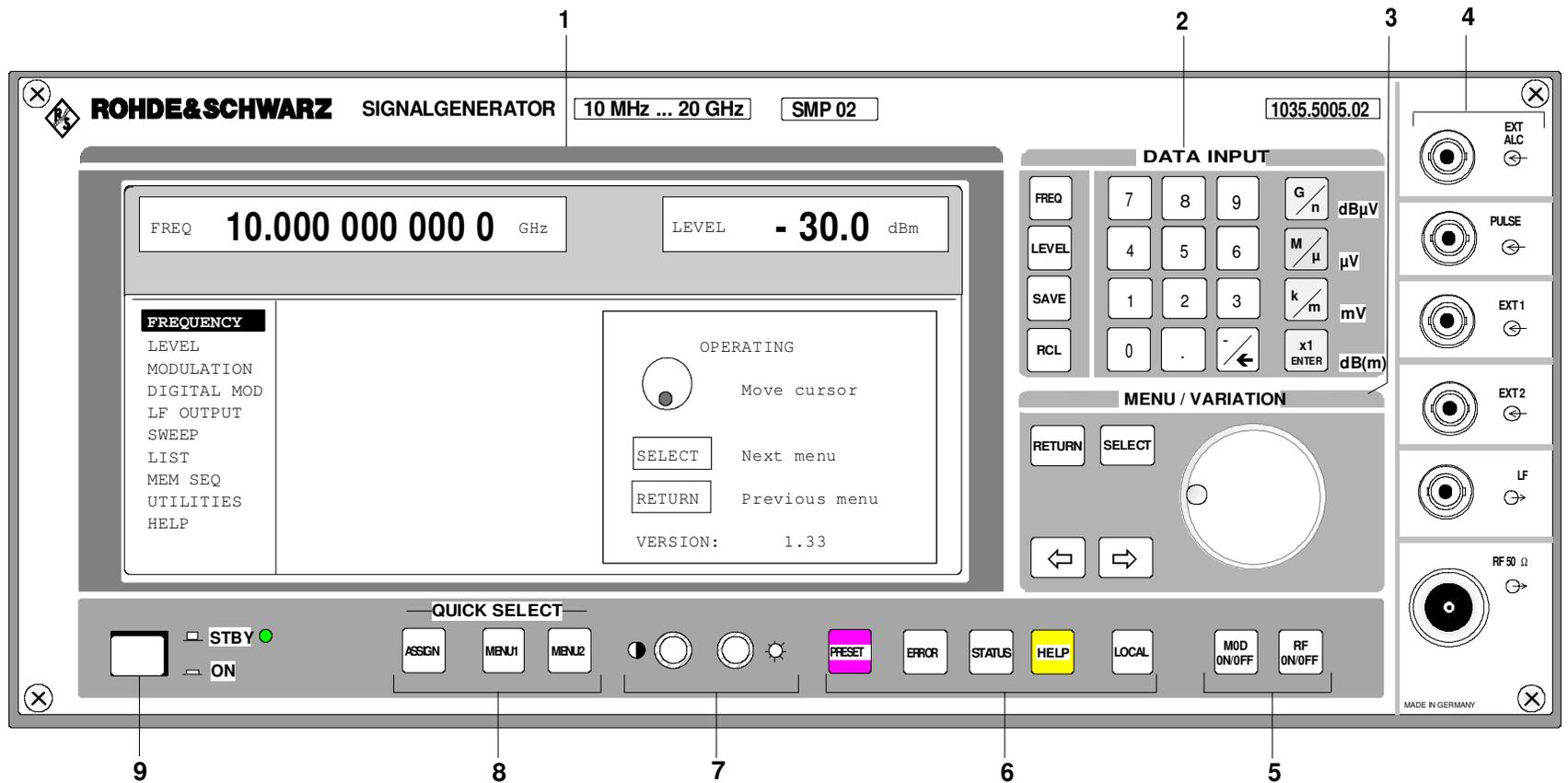

Front Panel

SMP

## 7



Brightness and contrast of the display can be set using the rotary knobs.

-  Contrast
-  Brightness

**See as well**

Section

"Setting of Contrast and Brightness of the Display"

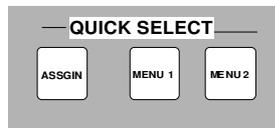
8 **QUICK SELECT**

The menu-quick-selection keys permit fast access to two menus selected.

- ASSIGN** Stores the current menu as menu1 when the MENU1 key is pressed afterwards or as menu2 when the MENU2 key is pressed afterwards.
- MENU1** Activates menu1 stored.
- MENU2** Activates menu2 stored.

**See as well**

Section

"Basic Operating Steps"

9 **Switching On/Off**

The On/Off switch switches the instrument from the standby mode to the ready-for-operation status. Prerequisite: The power switch at the rear of the instrument must be switched on.

- STBY** LED is illuminated in the standby mode.

**See as well**

Section

"Switching On/Off the Instrument"

Section

"Elements of the Rear Panel, Power Switch"

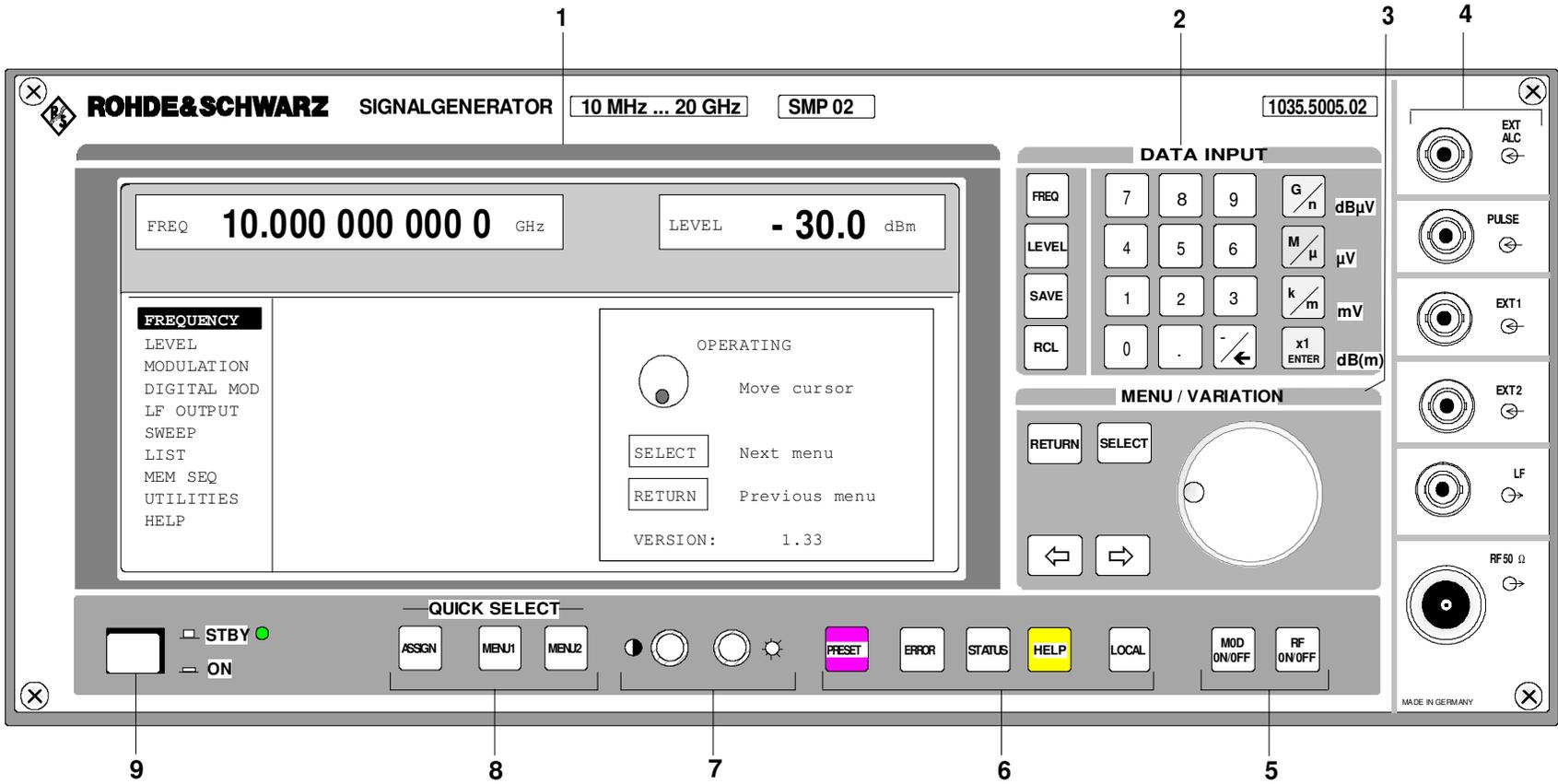

Fig.2-1 C, Front panel view

1035.5005.02

2.10

E-8



### 2.1.1.3 Inputs/Outputs

(Cf. Fig. 2-1, C Front panel view, Inputs/Outputs)

4

	EXT ALC	Input detection voltage of an external level detector. Input impedance $1\text{ M}\Omega \parallel 50\text{ pF}$	<b>See as well</b> Section "Level Control"
	PULSE	Input for triggering the pulse generator or for direct control of the pulse modulation. Input resistance $600\ \Omega / 100\text{ k}\Omega$ , selectable, Level: TTL	
	EXT 1	Input external modulation signal, alternatively for AM or FM (PM). Input resistance $600\ \Omega / 100\text{ k}\Omega$ .	Section "Pulse Modulation"
	EXT 2	Input external modulation signal for FM (PM). Input resistance $>100\text{ k}\Omega$ .	
	LF	Output* LF signal of the internal LF-generators LF Gen 1 and LF Gen 2. Source resistance $< 10\ \Omega$ .	Section "LF outputs"
	RF	Output RF signal. Source resistance $50\ \Omega$	

\* Option SM-B2

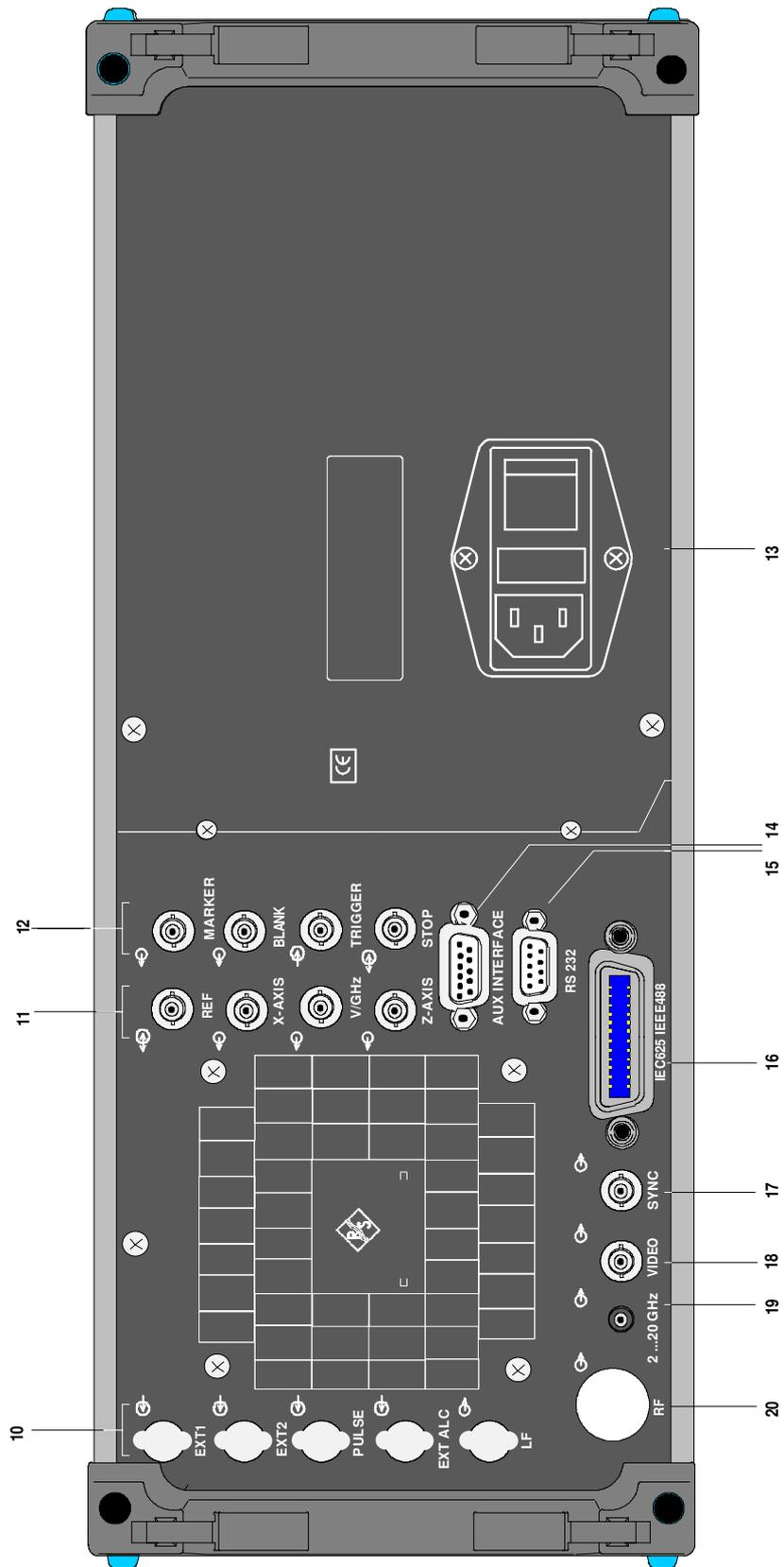
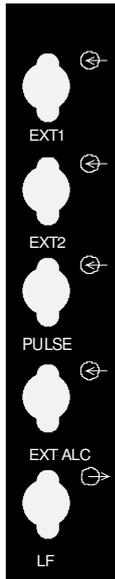

Fig. 2-2 Rear panel view

## 2.1.2 Elements of the Rear Panel

(Cf. Fig. 2-2, Rear panel view)

### 10



Cut-outs, provided to relocate the inputs/outputs at the front to rear of the rear of the instrument.

#### See as well

Section  
"Inputs/Outputs"

### 11

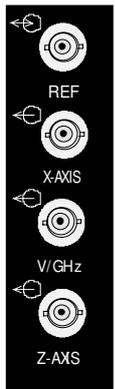

**REF** Output of the internal 10-MHz-reference signal with reference internal.  
Source resistance 50  $\Omega$ .  
Input for external reference frequency with reference external. Selectable in steps of 1 MHz to external reference frequencies from 1 MHz to 16 MHz.  
Input resistance 200  $\Omega$ .

**X-AXIS** Output voltage ramp 0 to 10 V in the Sweep operating mode.

**V/GHz** Output of frequency-proportional voltage. Selectable from 0.5 V/GHz to 1 V/GHz.  
Source resistance 680  $\Omega$  (up to 20 GHz).

**Z-AXIS** not used

#### See as well

Section  
"Reference Frequency  
int / ext"

Section  
"Sweep Outputs"

Section  
"Sweep Outputs"

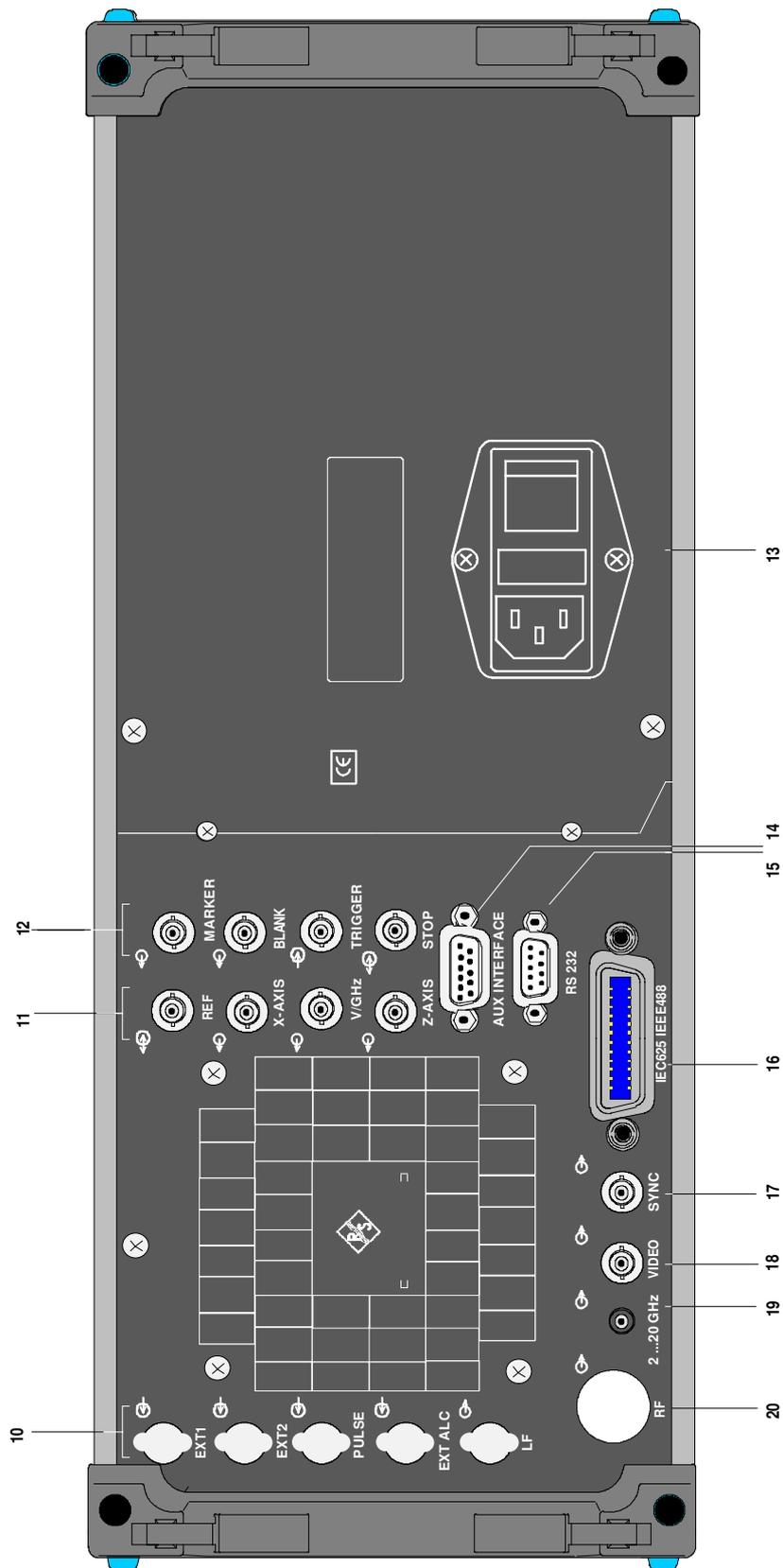
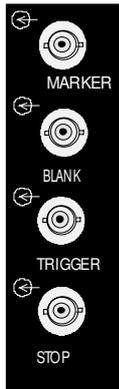

Fig.2-2 Rear panel view

## 12



MARKER	Output of mark signal for the Sweep operating mode. Level: TTL
BLANK	Output of blanking for the Sweep operating mode. Level: TTL
TRIGGER	Input to trigger sweep, memory sequence and list mode. Level: TTL.
STOP	Input for stopping the sweep. Level: TTL

**See as well**  
 section  
 "Sweep Inputs"  
 section  
 "Sweep Inputs"  
 section  
 "Setting Auxiliary  
 Inputs/Outputs  
 (AUX I/O)"

## 16

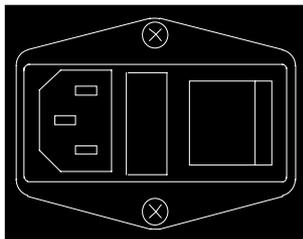

Power switch  
 On when pressed at the top  
 Fuse holder  
 F1 and F2  
 Power supply connection

**See as well**  
 Section  
 "Supply Voltage"  
 Section  
 "Power Fuses"  
 Section  
 "Switching On/Off the  
 Instrument"

## 14



AUX INTERFACE  
 Interface for direct control of external  
 additional instruments.

## 15



RS-232  
 RS-232 interface  
 used for software update, the loading of  
 calibration data, and remote control. The  
 pin assignment corresponds to the pin  
 assignment of a PC.

**See as well**  
 Section  
 "Parameters of the  
 RS-232 Interface  
 annex A"

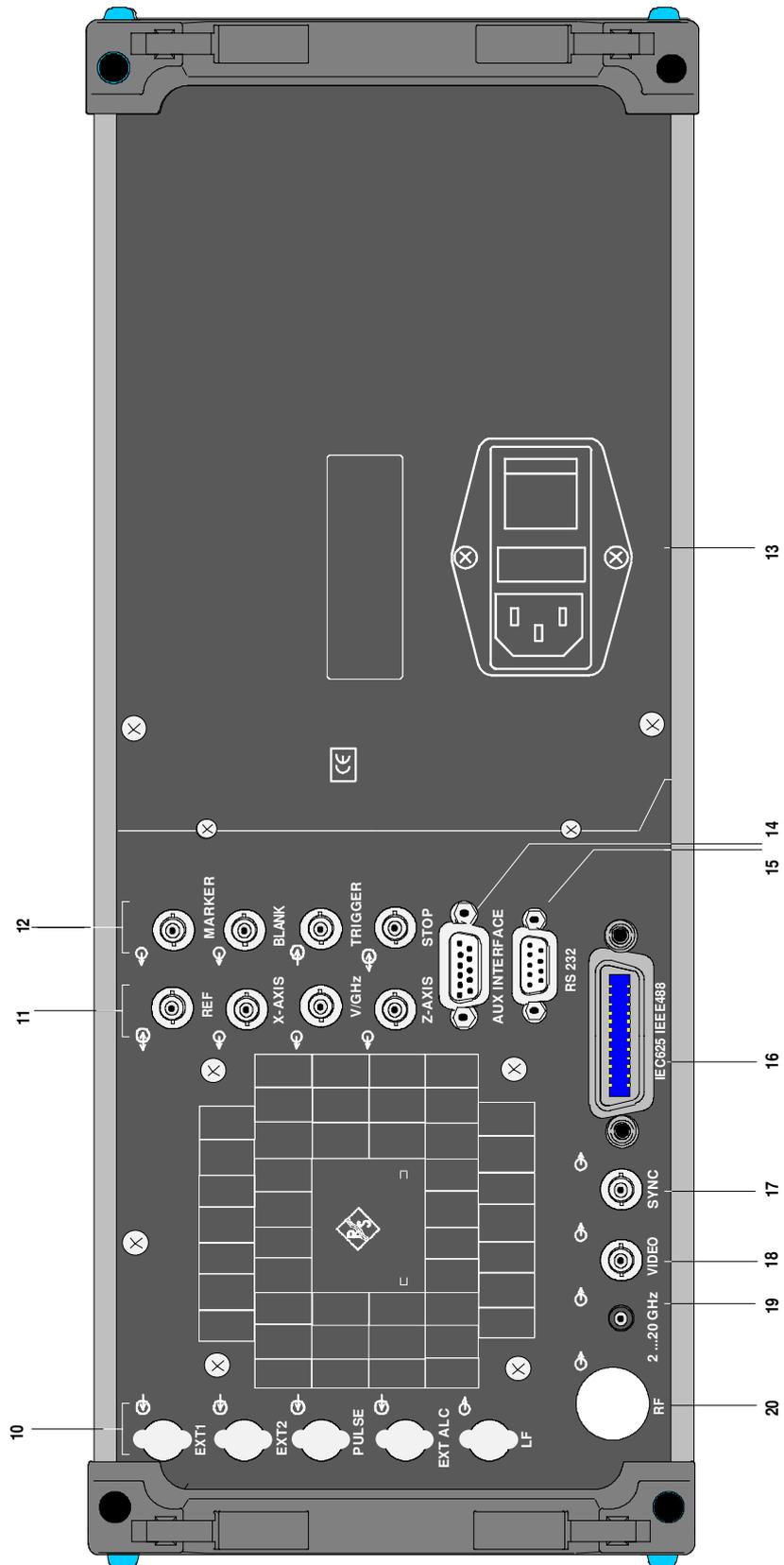
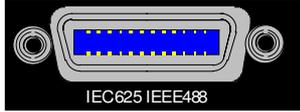

Fig.2-2 Rear panel view

## 16



IEC 625 IEC-Bus (IEEE 488)  
 IEEE 488 Remote-control interface

**See as well**  
 Section  
 "Remote Control"

## 17



SYNC Output SYNC signal with pulse modulation.  
 Level: TTL

**See as well**  
 Section  
 "Pulse Generator"

## 18



VIDEO Output video signal with pulse modulation.  
 The signal is synchronous with the RF  
 pulse.  
 Level: TTL

**See as well**  
 Section  
 "Pulse Generator"

## 19



2 to 20 GHz Check output. The signal has the same  
 frequency as the RF signal at the RF  
 frequencies of 2 to 20 GHz.  
 For frequencies below 2 GHz it is  
 6 GHz higher than the RF signal.  
 For frequencies above 20 GHz (SMP03/04)  
 it is half of the RF signal.  
 Source impedance: 50  $\Omega$

## 20

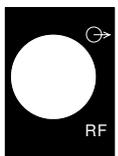

RF Cut-out, provided to relocate the RF output  
 at the front to the rear of the instrument.

## 2.2 Operating Concept

### 2.2.1 Display

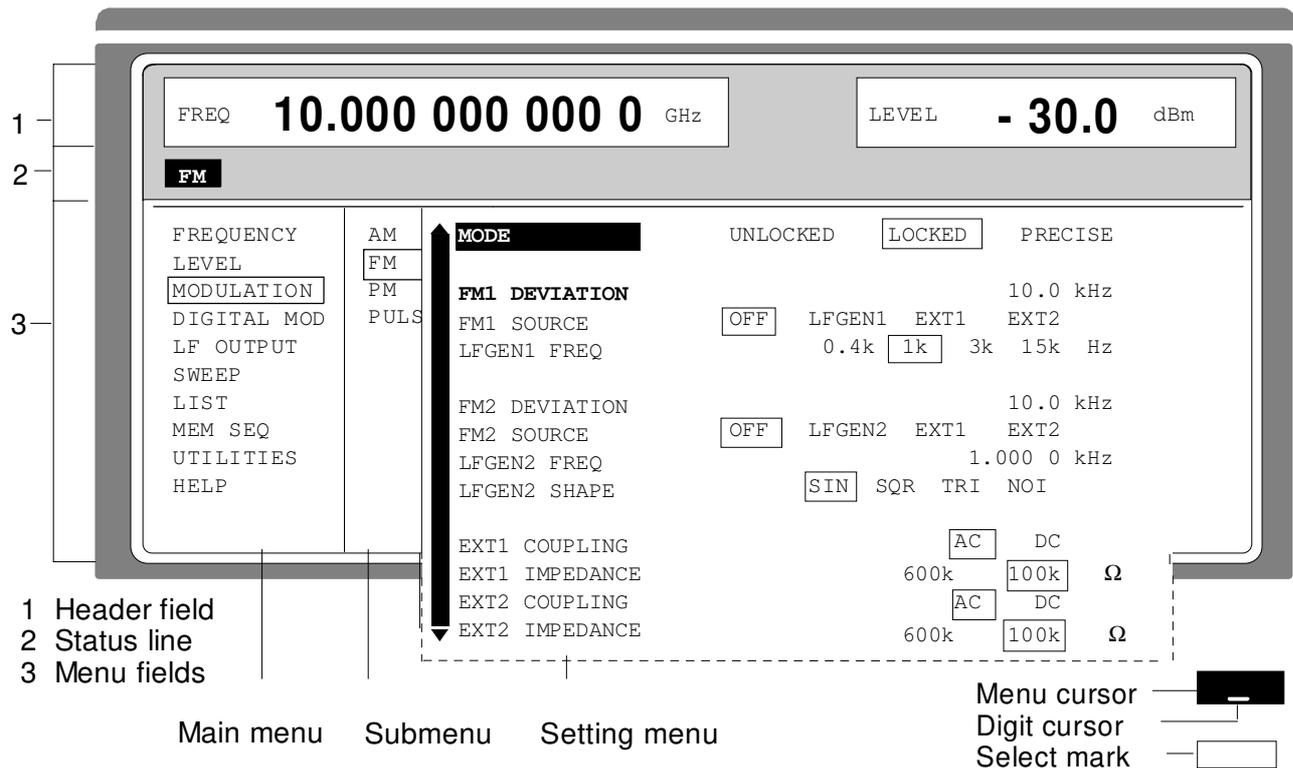

Fig. 2-3 Design of the display

**Header field** (1)The header field of the display indicates frequency and level of the RF output signal. In the RF-sweep operating mode, the start and stop frequencies are displayed in two lines one above the other. The start and stop levels are indicated in the LEVEL-sweep operating mode correspondingly.

**Status line** (2) The status line below describes operating mode and operating state of the instrument. Error messages and notes for caution are also displayed in the status line.

**Menu fields** (3)The indication fields below the header field are reserved for the menu representations. The image contents of these fields change as a function of the menu selected. The field at the left-hand display margin is occupied with the main menu, the topmost level of the menu structure. The main menu is always faded in.

Each further field adjacent at the right contains submenus.

The field ending with the right-hand display margin shows the setting menu. In this menu all setting values and setting states connected with the menu selected are indicated. When accessing submenus, the higher-order menus remain in the display. The current menu path is evident through the select marks.

**Menu cursor** The menu cursor shows the user at which position in the menu he is. The position of the menu cursor is evident from the inverse notation of the term (white characters on a black background)

**Digit cursor** As an underscore, the digit cursor marks the position which can be varied by means of the rotary knob in a value indication.

**Select mark** The frame around a term marks current menus or valid settings in the setting menu.



## 2.2.2 Basic Operating Steps

The operating principle is explained in this section. For better understanding, please read sections "Display" and "Sample Setting for First Users" in addition.

To operate the instrument, menus are called in the display. All setting possibilities and the current setting status are evident from the menus. All settings can be made by accessing the menus.

RF frequency and RF level can also be set without menu operation using keys [FREQ] and [LEVEL]. RF signal and modulation can also be switched on/off without menu operation using keys [RF ON/OFF] and/or [MOD ON/OFF].

### 2.2.2.1 Calling the Menus

Accessing the menus is effected using rotary knob [VARIATION], [SELECT] key and [RETURN] key.

**Rotary knob** Rotary knob [VARIATION] moves the menu cursor over the positions of a menu level to be selected.

If a scrollbar is visible at the left-hand margin of a menu, the menu is larger than the screen window. If the menu cursor is moved to the margin of the screen window, the covered lines become visible.

**[SELECT] key** The [SELECT] acknowledges the selection marked by means of the menu cursor.

**[RETURN] key** The [RETURN] key

- returns the menu cursor to the next higher menu level.

The menu cursor is shifted to the left into the preceding column of the menu structure.

- resets the menu cursor from frequency or level value indication in the header field into the menu field to the menu called last.
- closes the display pages called using keys [STATUS], [HELP] and [ERROR] again.

Settings are accessed in the setting menus ending with the right-hand display margin.

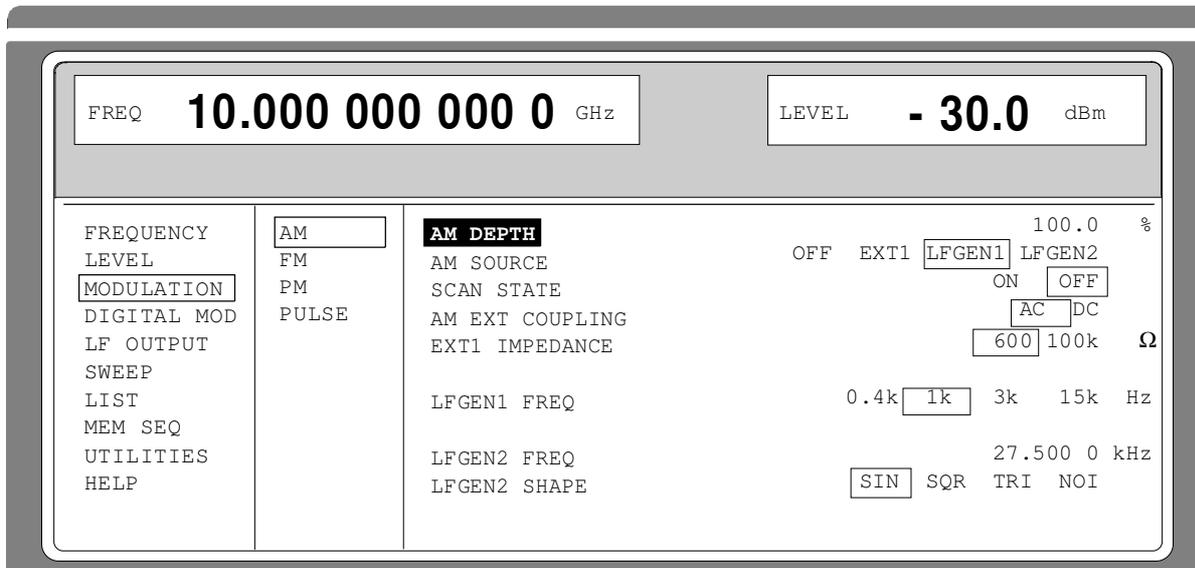

Fig. 2-4 MODULATION-AM menu

### 2.2.2.2 Selection and Change of Parameters

- Select parameter** ➤ Set the menu cursor to the name of the parameter desired using the rotary knob, e.g. to AM DEPTH in the AM menu, Fig. 2.4..
- Change setting value**
- Select parameters.
  - Press the [SELECT] key.
  - The menu cursor changes from the parameter selected in the left-hand column of the setting menu to the setting value on the right, e.g. from AM DEPTH to 100%, Fig. 2-4.
- via value inputs
- Press the first digit of the new value or minus sign.  
The old value is deleted, the entry is indicated in the marked field.
  - Enter further digits.
  - Terminate the input using a unit key or, in the case of inputs in the base unit or in the case of inputs without unit, using the [1x/Enter] key.
  - Press the [RETURN] key.  
The menu cursor wraps back to the appropriate parameter.
- using rotary knob
- Set the underscore to the position of the setting value to be varied using keys [⇨] [⇩].
  - Turn the rotary knob.  
The position underscored is varied in steps of 1.
- Note:** *RF frequency and RF level can also be varied in a step width which can be defined arbitrarily using the rotary knob. In the respective setting menu (FREQUENCY or LEVEL) the step width is entered as KNOB STEP USER and the KNOB STEP set from DECIMAL to USER. To point to the fact that the step width has been converted to the value programmed, the underscore as a symbol of the digit cursor disappears in the respective value indication.*
- 1-out-of-n selection**
- Select parameters.
  - Press the [SELECT] key.  
The menu cursor changes from the parameter selected in the left-hand column of the setting menu to the current selection on the right, e.g. from LFGEN1 FREQ to 0.4 kHz, Fig. 2-4.
  - Set the menu cursor to the position desired within the 1-out-of-n selection using the rotary knob or cursor keys [⇐] [⇨].
  - Press the [SELECT] key.  
The setting is made.  
The selection mark which has marked the setting valid up to now wraps to the new position.
  - Press the [RETURN] key.  
The menu cursor wraps back to the respective parameter

**Quick selection of a parameter**

The quick selection of a parameter reduces the number of operating steps if several parameters are set successively. The menu cursor can directly be set further from line to line in the column of the setting values.

- Press the [SELECT] key.

The menu cursor wraps from the setting value of a parameter to the setting value of the parameter in the next line.

The following is true:

- The wrap from a 1-out-of-n selection line into the next line is effected when menu cursor and selection mark are superimposed.
- Actions which can be carried out are skipped.
- If necessary, scrolling is triggered at window limits.
- A wraparound is effected at the end of the menu.
- The column of the setting values can be exited at each position by pressing the [RETURN] key.

**2.2.2.3 Triggering Action**

Lines in the setting menu which are marked with the "▶" symbol at the end of the line qualify an action which can be carried out. Instruction SEARCH ONCE ▶ in the LEVEL-ALC menu, e.g., switches on level control for level calibration for a short period of time.

**Trigger action**

- Set the menu cursor to the respective instruction.
- Press the [SELECT] key.

The action is triggered.

While the action is carried out, the instruction remains framed by the selection mark.

**2.2.2.4 Quick Selection of Menu (QUICK SELECT)**

The keys of the QUICK SELECT control field are used to call selected menus quickly by one keystroke.

**Store menus**

- Establish the desired operating status of the current menu.
- Press the [ASSIGN] key.
- Press key [MENU1] or [MENU2].

The current menu is stored as menu1 or menu2. That is to say, 2 menus can be stored in total.

**Call menus**

- Press key [MENU1] or [MENU2].

Menu1 or menu2 stored is displayed. Exactly the operating status which was current at the point of time of storing is reconstructed.

### 2.2.2.5 Use of [FREQ] and [LEVEL] Keys

RF frequency and RF level can be set without menu operation as well using direct keys [FREQ] and [LEVEL].

- Key [FREQ]/ [LEVEL]**
- Press the [FREQ] or [LEVEL] key.  
The frequency and/or the level indication in the header field of the display is marked.  
The current menu at the display is maintained.
  - Alter the value via a value input or the rotary knob.
  - Press the [RETURN] key.  
The menu cursor wraps to the position marked last in the menu.

### 2.2.2.6 Use of [RF ON / OFF] and [MOD ON / OFF] Keys

RF signal and modulation can be switched on/off without menu operation as well using direct keys [RF ON / OFF] and/or [MOD ON / OFF] (see Section [MOD ON/OFF] key as well).

- Key [RF ON / OFF]**
- Press the [RF ON / OFF] key.  
The RF output signal is switched on/off.  
IEC-bus short command: `:OUTP:STAT ON`

- Key [MOD ON / OFF]**
- Press the [MOD ON / OFF] key.  
The modulation is switched on/off.  
A direct IEC-bus command is not available. The modulations have to be switched on and off in the respective modulation submenus.

### 2.2.2.7 Changing Unit of Level

For the level, the unit of the value set can be changed without a new value input.

- Change level unit**
- Activate LEVEL parameter.
    - Press the [LEVEL] key or
    - set the menu cursor in the LEVEL menu to the setting value of the AMPLITUDE parameter.
  - Press the unit key with the desired level unit.  
The level is indicated in the desired unit.

### 2.2.2.8 Correction of Input

Digital entries can be corrected by one of the unit/Enter keys before terminating the input.

**Key [-/←]** The backspace key deletes the value entered digit by digit. When the last digit is deleted, the previous value is displayed.

**Key [RETURN]** Pressing the [RETURN] key deletes the entire entry and results in the previous value being indicated again.

For a subsequent new input in the setting menu, the menu cursor is to be set to the setting value again using the [SELECT] key.

For a subsequent new input via the [FREQ] or [LEVEL] keys, the respective key has to be pressed again.

**Key [FREQ]/ [LEVEL]** In the case of a frequency or level input by means of the [FREQ] or [LEVEL] keys, pressing the [FREQ] and/or [LEVEL] key again deletes the entire input.

### 2.2.3 Sample Setting for First Users

First users most quickly become familiar with the operation of the instrument if they execute the pattern setting of this section.

First frequency and level of the RF output signal are set via keys [FREQ] and [LEVEL] in the DATA INPUT field:

- Frequency 2,5 GHz
- Level 10 dBm

Operating steps	Explanations
	Reset the instrument to the defined state.
<p style="text-align: center;">DATA INPUT</p>     	Set the frequency to 2,5 GHz. The menu cursor marks the permanent frequency indication.
<p style="text-align: center;">DATA INPUT</p>    	Set the level to 10 dBm. The menu cursor marks the permanent level indication.
	Reset the menu cursor to the menu field.

The output signal is to be amplitude-modulated next.

- AM modulation depth 15.5 %
- AM signal 3-kHz sine

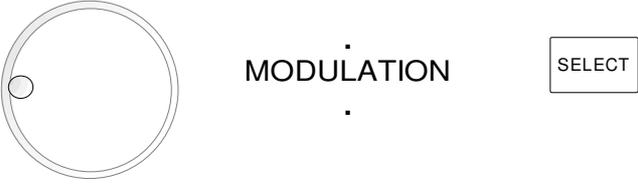
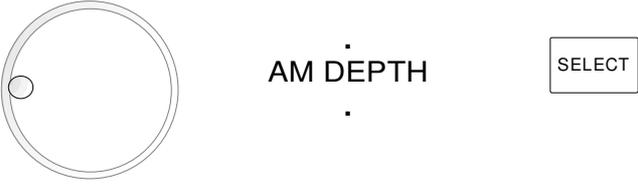
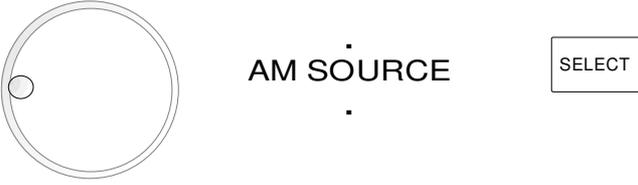
Operating steps	Explanations
 <p>MENU / VARIATION MENU / VARIATION</p> <p>MODULATION</p> <p>SELECT</p>	<p>Select MODULATION menu.</p> <p>➤ Set menu cursor to MODULATION using the rotary knob and subsequently press [SELECT] key.</p> <p>The submenu is displayed</p>
 <p>MENU / VARIATION MENU / VARIATION</p> <p>AM</p> <p>SELECT</p>	<p>Select AM submenu</p> <p>The AM setting menu is displayed.</p>
 <p>MENU / VARIATION MENU / VARIATION</p> <p>AM DEPTH</p> <p>SELECT</p>	<p>Select AM DEPTH parameter.</p> <p>The menu cursor marks the setting value.</p>
<p>DATA INPUT</p> <p>1 5 . 5 x1 ENTER</p>	<p>Enter modulation depth 15.5 % and acknowledge.</p>
<p>RETURN</p>	<p>Reset menu cursor to AM DEPTH.</p>
 <p>MENU / VARIATION MENU / VARIATION</p> <p>AM SOURCE</p> <p>SELECT</p>	<p>Select AM SOURCE.</p> <p>The menu cursor marks the current 1-out-of-n selection.</p>

Operating steps	Explanations
	<p>Select LF generator 1 as modulation source.</p> <p>The selection mark marks LFGEN1. AM is faded in the status line as a hint that AM is switched on.</p>
	<p>Reset menu cursor to AM SOURCE INT.</p>
	<p>Select parameter LFGEN1 FREQ.</p> <p>The menu cursor marks the current frequency selection.</p>
	<p>Set the frequency of LF generator 1 to 3 kHz.</p> <p>The selection mark marks 3 kHz.</p> <p>The indications on the display are represented in Fig. 2-5.</p>

The AM modulation setting is completed.

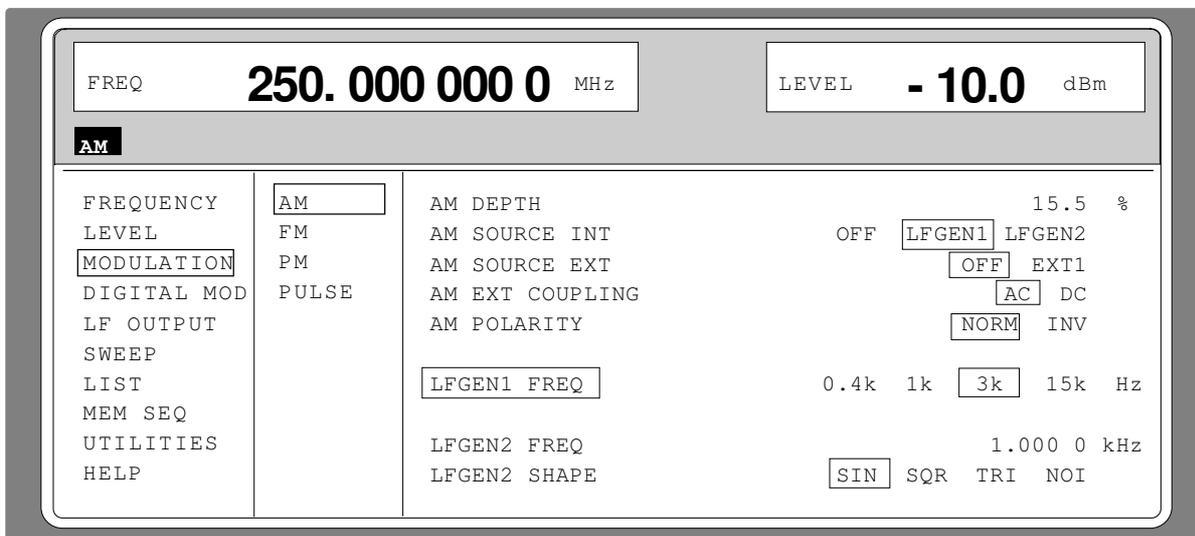
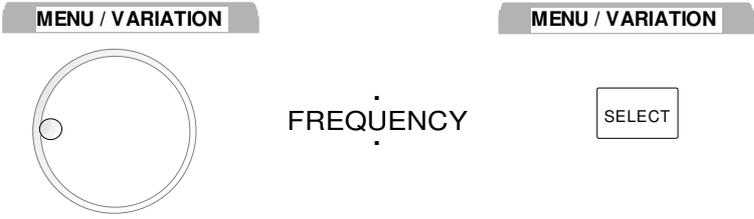
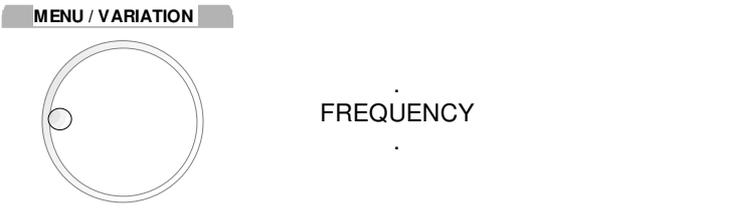
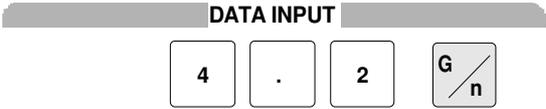

Fig. 2-5 Display after AM setting

Subsequently to the above setting, 4.2 GHz as new RF frequency and 12.5 kHz as the step width for the RF frequency variation are set in the following. Parameter quick select is used, which reduces the number of operating steps.

Operating steps	Explanations
	Reset the menu cursor to the main menu in 2 steps.
	Select FREQUENCY menu. The frequency setting menu is displayed.
	Select FREQUENCY parameter. The menu cursor marks the setting value.
	Enter frequency 4.2 GHz and acknowledge.
	Set menu cursor to the setting value of parameter KNOB STEP USER.
	Enter step width 12.5 kHz.
	Set menu cursor to the current KNOB STEP selection.



Operating steps	Explanations
 <p>MENU / VARIATION</p> <p>. USER .</p> <p>SELECT</p>	<p>Select USER (user-defined step width).</p> <p>The selection mark marks USER.</p> <p>This results in step width 12.5 kHz being used in the case of variation using the rotary knob.</p>
 <p>RETURN</p> <p>RETURN</p>	<p>Reset the menu cursor to the main menu in 2 steps.</p>

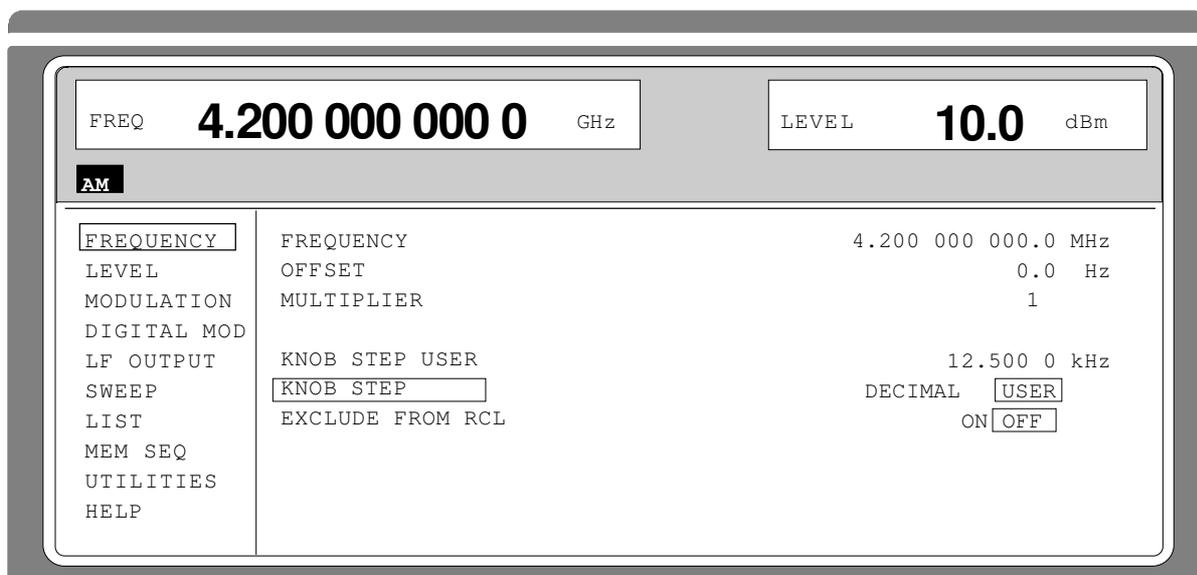

Fig. 2-6 Display after pattern setting

## 2.2.4 List Editor

The SMP offers the possibility to generate lists. Lists are used for setting sequences (LIST mode or memory sequence), or for level correction which can be defined by the user (UCOR). They consist of elements which are defined by an index and at least one parameter per index. Each list is marked by a separate name and can be selected via this name. The lists are accessed in the menus assigned in each case, e.g. to the settings sequences of frequency and level value pairs in the LIST menu. However, the lists are always generated and processed in the same way and the procedures are hence explained in detail by the example of the memory sequence mode (menu MEM SEQ) in this section. A pattern setting at the end of this section allows the user to become familiar with the operation of the list editor.

Setting menus providing list processing are structured in two pages:

The first page, called OPERATION page in the following contains the general configuration parameters for processing a list. Further, the general list functions such as selecting and deleting the list as well as calling an editing mode are provided. The second page, the EDIT page, is automatically displayed when calling an edit function and serves to enter and modify the parameters of the list.

The OPERATION page has a similar arrangement with all list editors. As an example, the OPERATION page of the MEM SEQ menu is shown:

Menu selection: MEM SEQ

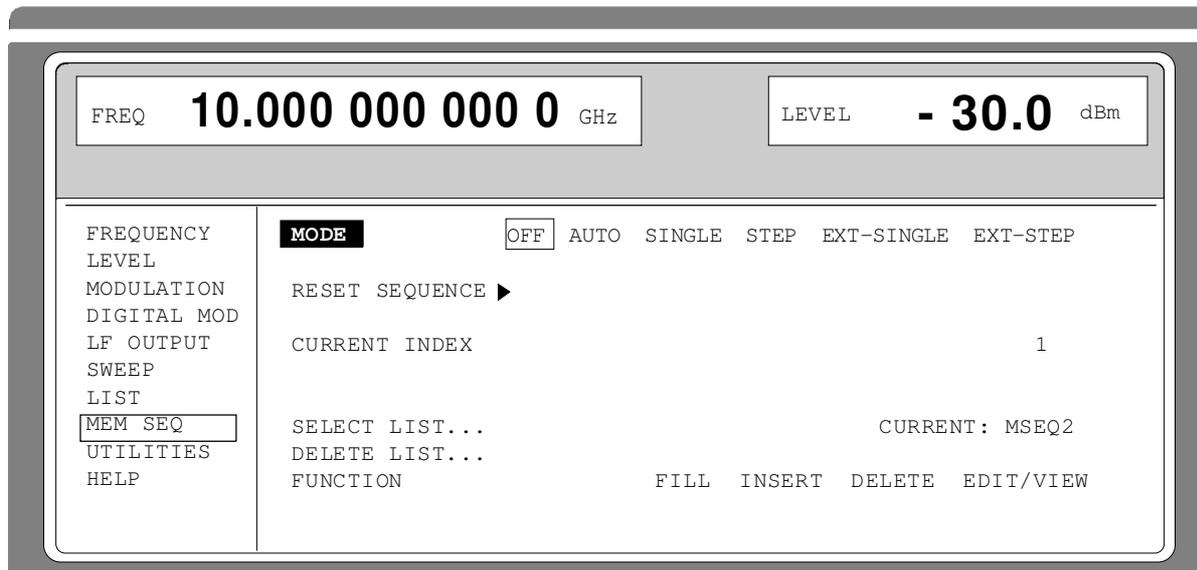

Fig. 2-7 OPERATION page of the MEM SEQ menu

The settings for MODE, CURRENT INDEX, etc. are irrelevant for the general description of the list editors and are described in greater detail in Section, MEMORY SEQUENCE mode.

The last three menu lines of the OPERATION page always exist and are reserved for selecting and deleting lists as well as for calling the edit functions (and hence the EDIT page)

**SELECT LIST** Opens a selection window in which a list can be selected from the existing lists or a new, empty list can be generated. In this line the active list is always displayed.

**DELETE LIST** Opens a selection window in which the list to be deleted can be selected..

<b>FUNCTION</b>	Selection of the edit function for processing the lists. The EDIT page is automatically called through the selection.
FILL	Filling a list with elements.
INSERT	Insertion of elements into a list.
DELETE	Deletion of elements of a list.

### 2.2.4.1 Select and Generate - SELECT LIST

SELECT LIST opens a selection window in which either an existing list can be selected or a new, empty list can be generated (cf. Fig. 2-8). By pressing the [RETURN] key, the selection window is closed without changing the setting.

- Select list
  - Mark the list desired using the rotary knob.
  - Press [SELECT] key.
    - The selected list is included in the instrument setting. The selection window is closed. The selected list is displayed under CURRENT.
  
- Generate list
  - Mark CREATE NEW LIST ➤ using rotary knob.
  - Press [SELECT] key.
    - A new empty list is automatically generated which can be filled using functions FILL or EDIT. The selection window is closed. The new list is displayed under CURRENT.
  
- No modification of the setting
  - Press [RETURN] key.

Selection:                   SELECT LIST

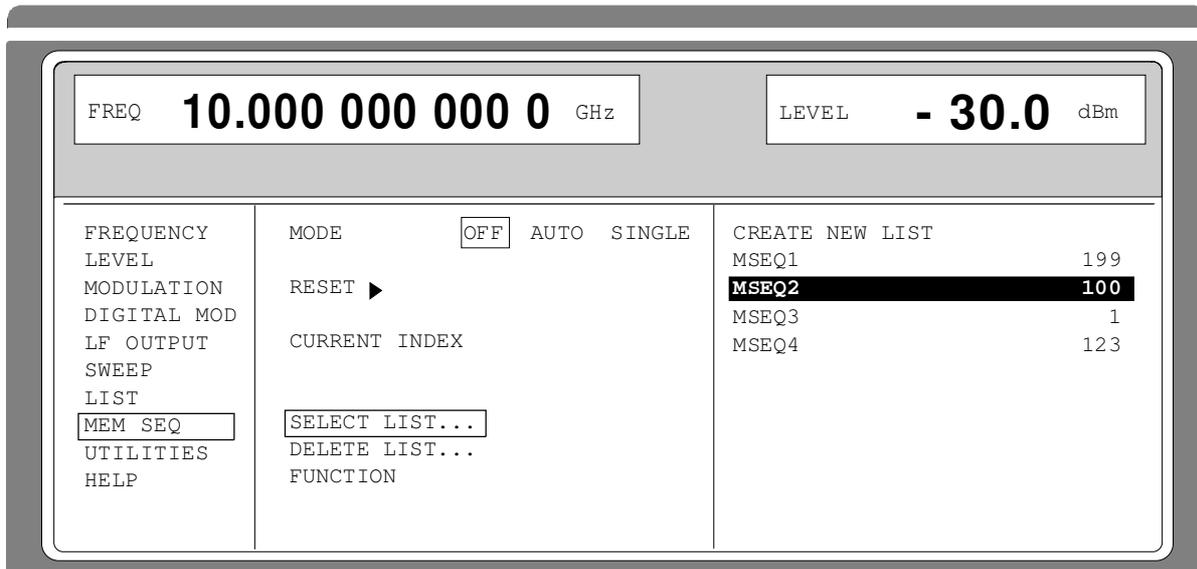

Fig. 2-8      SELECT-LIST-selection window

**CREATE NEW LIST ►** Generating a new list. The name of the list cannot be selected freely in the case of manual control. A definite list name is automatically generated in the following form:

MSEQ<n>, with <n> ∈ {0 to 9}, e.g. MSEQ1 (with Memory Sequence)

This applies correspondingly to the other operating modes. In the case of LIST mode, LIST1 would be generated for example. If a list is created via IEC bus, an arbitrary list name can be given. Unrestricted access is also possible by means of the selection window.

**MSEQ2 100** The list currently set is marked in the selection window by means of the selection mark, here MSEQ2. In addition to the list name, the length of the list is given, here 100 elements.

### 2.2.4.2 Deletion of Lists - DELETE LIST

DELETE LIST opens a selection window in which the list to be deleted can be selected.. The lists are represented together with their name and their length (cf. Fig. 2-9). By pressing the [RETURN] key the selection window is exited without deleting a list.

- Delete list
- Mark desired list using the rotary knob.
  - Press [SELECT] key.
    - The prompt "enter [SELECT to delete list/sequence?" is displayed
  - Press [SELECT] key.
    - The list is deleted. If the prompt is acknowledged with the [RETURN] key, however, the list is not deleted. The selection window is automatically closed due to the acknowledgment of the prompt.

Selection: DELETE LIST

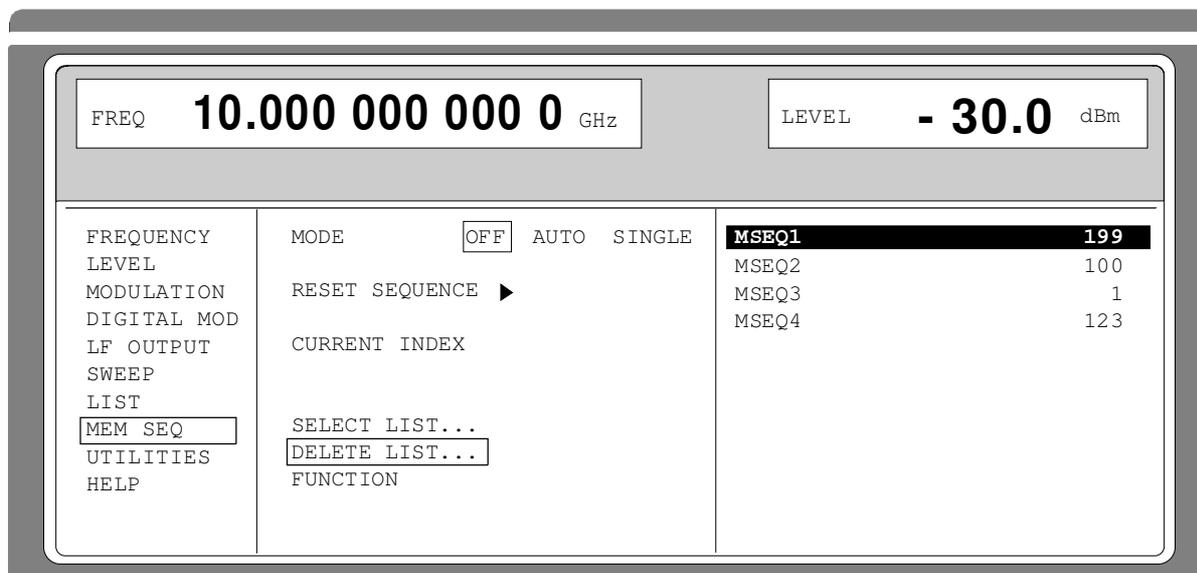

Fig. 2-9 DELETED-LIST selection window

### 2.2.4.3 Edition of Lists

Due to the selection of an edit mode on the OPERATION page the EDIT page is automatically activated. When the EDIT/VIEW function is selected, the largest possible section of the list is displayed (cf. Fig. 2-10). In the case of block functions FILL, INSERT and DELETE, an input window is additionally displayed (cf. Fig. 2-11 to 2-13).

Functions SELECT LIST and FUNCTION are available on the EDIT page as on the OPERATION page. Return to the OPERATION page is effected by pressing the [SELECT] key twice.

#### Single-value function EDIT/VIEW

By selecting the EDIT/VIEW function, the entire list can be viewed or modifications of single values be carried out.

If the cursor marks a value in the INDEX column of the list, the EDIT mode is exited by pressing the [RETURN] key. The menu cursor then marks FUNCTION again.

There is no separate function for storing the list. This means that every modification of the list is transferred to the internal data set and has an effect on exiting the EDIT/VIEW function.

Selection: FUNCTION EDIT/VIEW

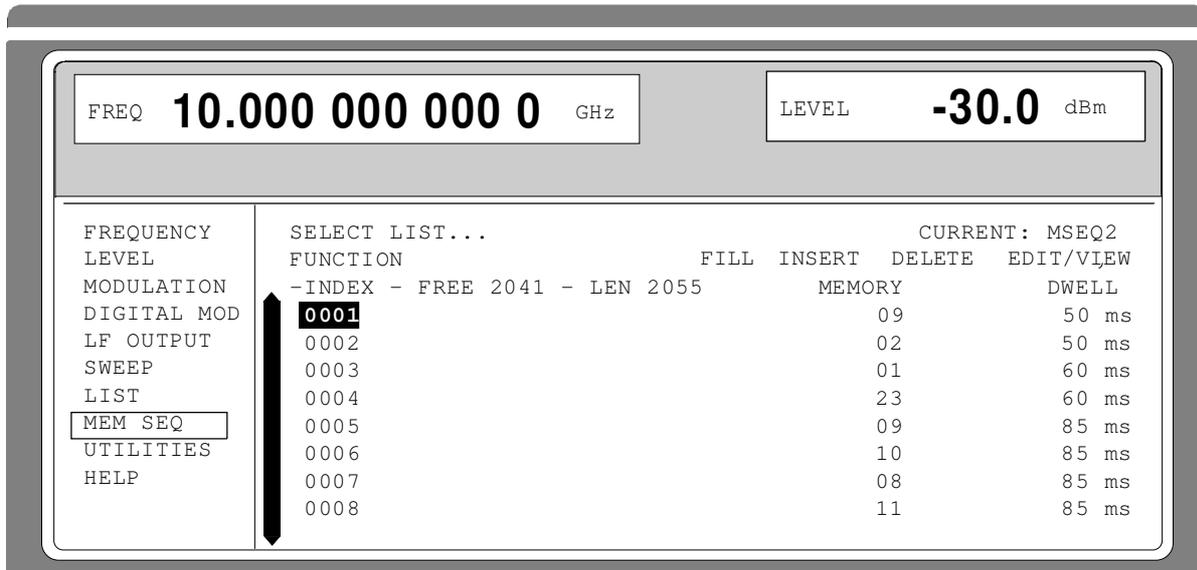

Fig. 2-10 Edit function EDIT/VIEW

- INDEX** Position in the list
- FREE** Space available. FREE 2041 means that space for 2041 parameter elements is available in the list memory in total.
- LEN** Occupied space. LEN 2055 means that the current list occupies 2055 elements in the list memory.
- MEMORY DWELL** Identification of the column below. The number of parameter columns is different for the various list editors.

- Select parameters
- Mark the index associated to the parameter using the rotary knob or directly enter the value of the index via the numeric keys.
  - Press [SELECT] key.  
Parameter MEMORY is marked. If the second parameter DWELL is to be marked, press the [SELECT] key again.
- Modify parameters
- Vary the value of the parameter selected using the rotary knob or enter the value directly using numeric keys.
  - Press the [ENTER] key or unit keys.  
The value is included in the data set. The menu cursor marks the value of the next column. In the last column, the menu cursor then marks the next line of column MEMORY.
  - Press the [RETURN] key.  
The menu cursor wraps back to the INDEX column. The EDIT mode is exited by repeatedly pressing the [RETURN] key.

### Block function FILL

Using function FILL, a parameter, e.g. MEMORY, is overwritten with constant or linearly increasing/decreasing values within a defined range. The input window is exited by pressing the [RETURN] key without a modification being carried out.

If the filler range exceeds the end of the list, the list is automatically extended.

The list entry, in the example for MEMORY, with index [AT +n] is calculated as follows from the information AT, RANGE, starting value (MEMORY) and WITH INCREMENT:

$$\text{MEMORY[AT+n]} = \text{starting value (MEMORY)} + n \cdot \text{increment} \quad | \quad (0 \leq n \leq \text{RANGE1})$$

Selection: FUNCTION-FILL

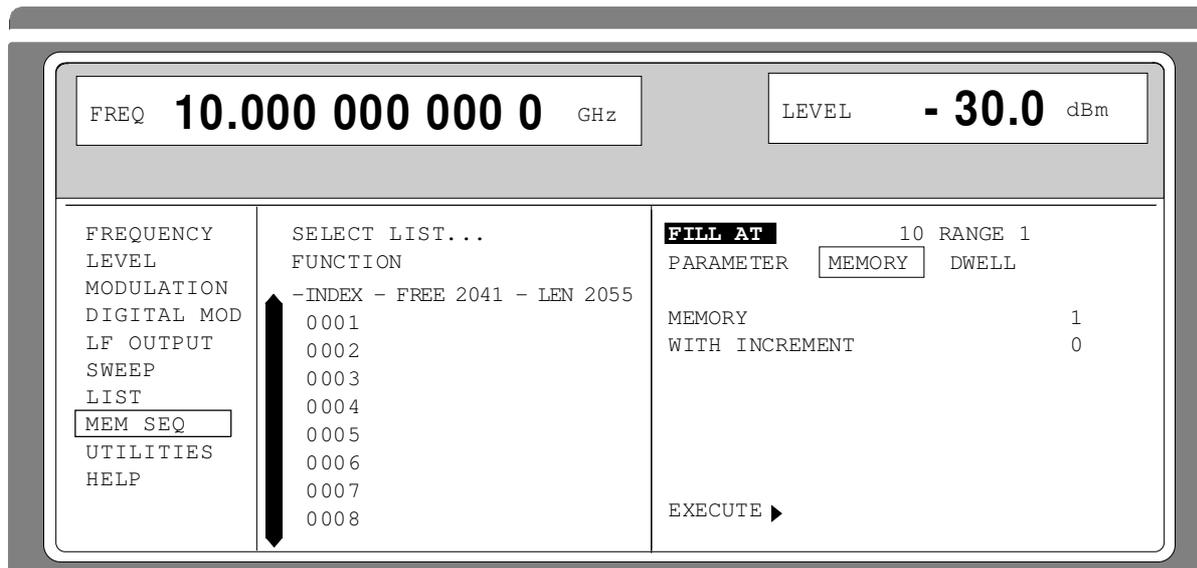

Fig. 2-11 Block function FILL: Input window

<b>FILL AT</b>	Setting the filling range. AT        Lower limit (index) RANGE    Number of the elements to be inserted
<b>PARAMETER</b>	Selection on which of the parameters the filling function is to have an effect. This menu option is eliminated if the list only includes elements with one parameter.
<b>MEMORY or DWELL</b>	Input of the starting value for the parameter selected. This option is only displayed if a selection has been made under PARAMETER MEMORY or DWELL.
<b>WITH INCREMENT</b>	Input of the increment between two successive values. If 0 is entered as increment, a filling procedure with constant values is achieved. This option is only displayed if a selection has been made under PARAMETER MEMORY or DWELL.
<b>EXECUTE ►</b>	Starts the filling sequence. After the function has been executed, the input window is automatically exited. The current index points to the first element after the processed range.

Filling a list	<p>After selection of function FILL, the menu cursor marks FILL AT.</p> <ul style="list-style-type: none"> <li>➤ Press the [SELECT] key. The menu cursor marks the value at AT.</li> <li>➤ Vary index value using the rotary knob or enter using the numeric keys and the [ENTER] key.</li> <li>➤ Press the [SELECT] key. The menu cursor marks the value at RANGE.</li> <li>➤ Vary value using the rotary knob or enter using the numeric keys and the [ENTER] key.</li> <li>➤ Press the [SELECT] key. The menu cursor marks MEMORY or DWELL in input line PARAMETER.</li> <li>➤ Select MEMORY using the rotary knob (if not yet marked) and press the [SELECT] key. The menu cursor marks the value in input line MEMORY.</li> <li>➤ Vary starting value for column MEMORY using the rotary knob or enter using the numeric keys and the [ENTER] key.</li> <li>➤ Press the [SELECT] key The menu cursor marks the value in input line WITH INCREMENT.</li> <li>➤ Vary the value of the increment desired using the rotary knob or enter using the numeric keys and the [ENTER] key.</li> <li>➤ Press the [RETURN] key.</li> <li>➤ Mark the action EXECUTE ►</li> <li>➤ Press the [SELECT] key. The filling sequence is initiated. After the function has been carried out, the input window is automatically exited. The menu cursor marks FUNCTION. The EDIT page shows the end of the range that has been filled right now.</li> </ul>
----------------	--

**Block function INSERT**

Function INSERT inserts the desired number of elements with constant or linearly increasing/decreasing values before the element with the given starting index. All elements which had been stored from the starting index are shifted to the end of the range to be inserted.

Input is effected analogously to filling a list.

By pressing the [RETURN] key the input window is exited without a modification being effected. The menu cursor then marks FUNCTION.

The list entry, in the example for MEMORY, with index [AT +n] is calculated as follows from the information AT, RANGE, starting value (MEMORY) and WITH INCREMENT:

$$\text{MEMORY[AT+n]} = \text{starting value (MEMORY)} + n \cdot \text{Increment} \quad | \quad (0 \leq n \leq \text{RANGE}-1)$$

Selection: FUNCTION INSERT

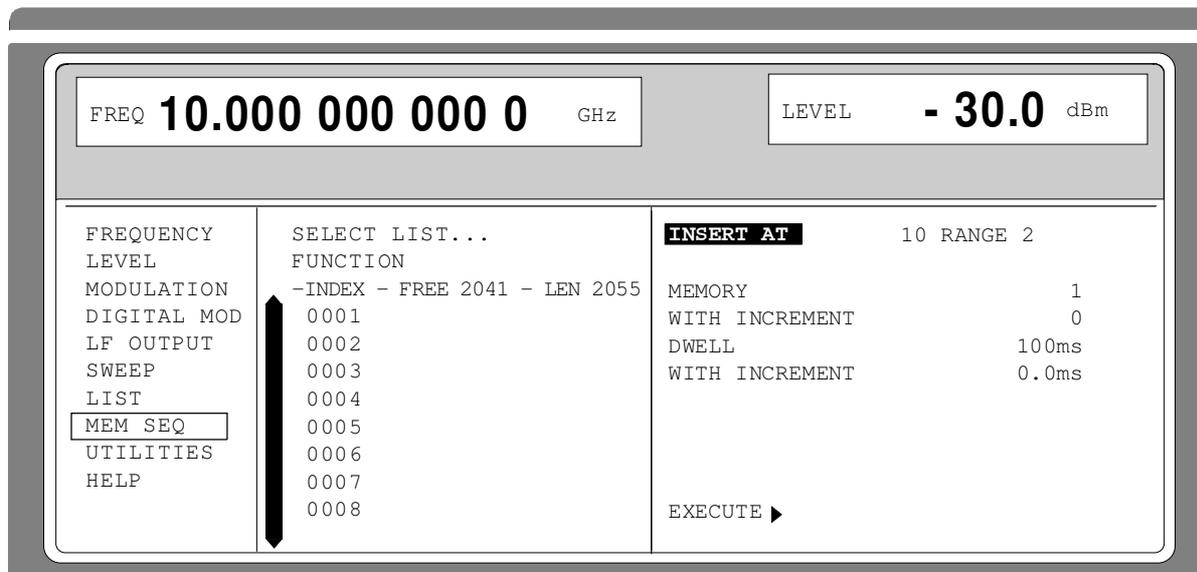

Fig. 2-12 Edit function INSERT: Input window

**INSERT AT** Input of the starting index and the number of the elements to be inserted.  
**AT** Starting index before which the insert operation is to be effective.  
**RANGE** Number of the elements to be inserted

**MEMORY** Input of the starting value for MEMORY.

**DWELL** Input of the starting value for DWELL.

**WITH INCREMENT** Input of the increment between two successive values for MEMORY or DWELL. If 0 is indicated as increment, constant values are achieved to be inserted RANGE times.

**EXECUTE ►** Starts the inserting sequence. After the function has been executed, the input window is automatically exited. The menu cursor marks FUNCTION. The EDIT page shows the beginning of the range that has moved forward.



## Block function DELETE

Function DELETE deletes the elements of the range indicated. This does not leave a gap in the list but the remaining elements move forward. If the given range exceeds the end of the list, deletion until the end of the list is effected.

Input is analog to filling a list.

By pressing the [RETURN] key, the input window is exited without a modification being carried out. The menu cursor then marks FUNCTION.

Selection: Function DELETE

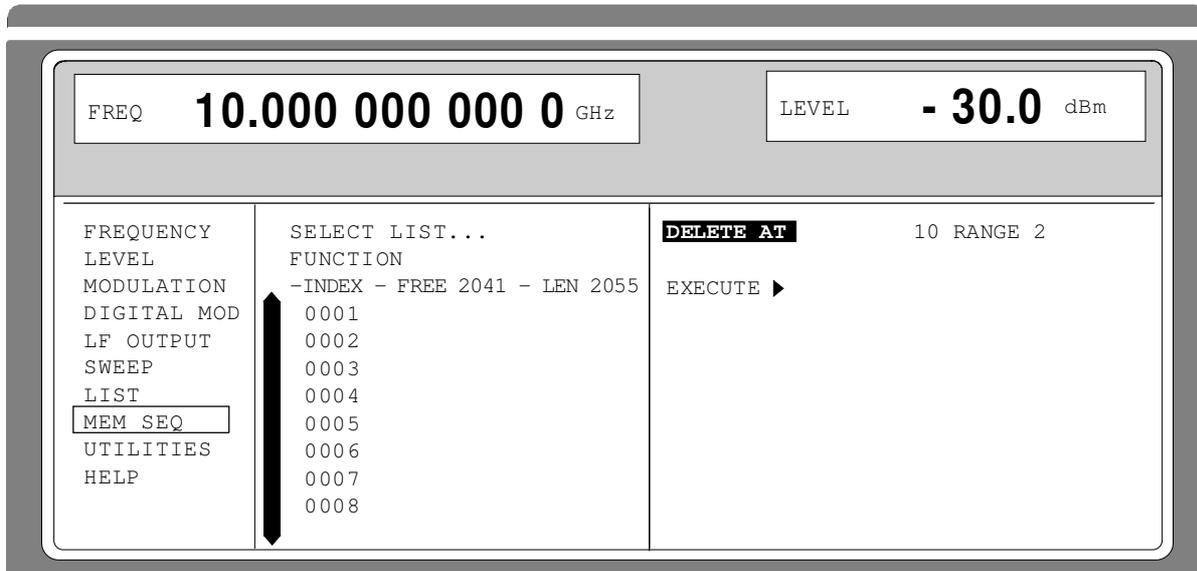

Fig. 2-13 Edit function DELETE: Input window

**DELETE AT**            Input of the block of the list to be deleted  
                           AT            Lower limit (INDEX)  
                           RANGE    Number of elements to be deleted.

**EXECUTE ►**            Starts the deletion. After the function has been executed, the input window is automatically exited. The menu cursor marks FUNCTION. The EDIT page shows the beginning of the range that has moved forward.

### 2.2.4.4 Pattern Setting to Operate the List Editor

The user can become familiar with the operation of the list editor by means of the following pattern setting in the MEM SEQ menu. List MSEQ2 shall be changed using the single-value function EDIT/VIEW:

- Memory location number of the first element    20
- Dwell time of the first element                    15s
- Memory location number of the second element 1.

When the setting has been terminated, return to the OPERATION page of the MEM SEQ menu.

At the beginning of the operation sequence, menu MEM SEQ is called. List MSEQ2 is active. The menu cursor marks a parameter of the setting menu on the OPERATION page (c.f. Fig. 2-14).

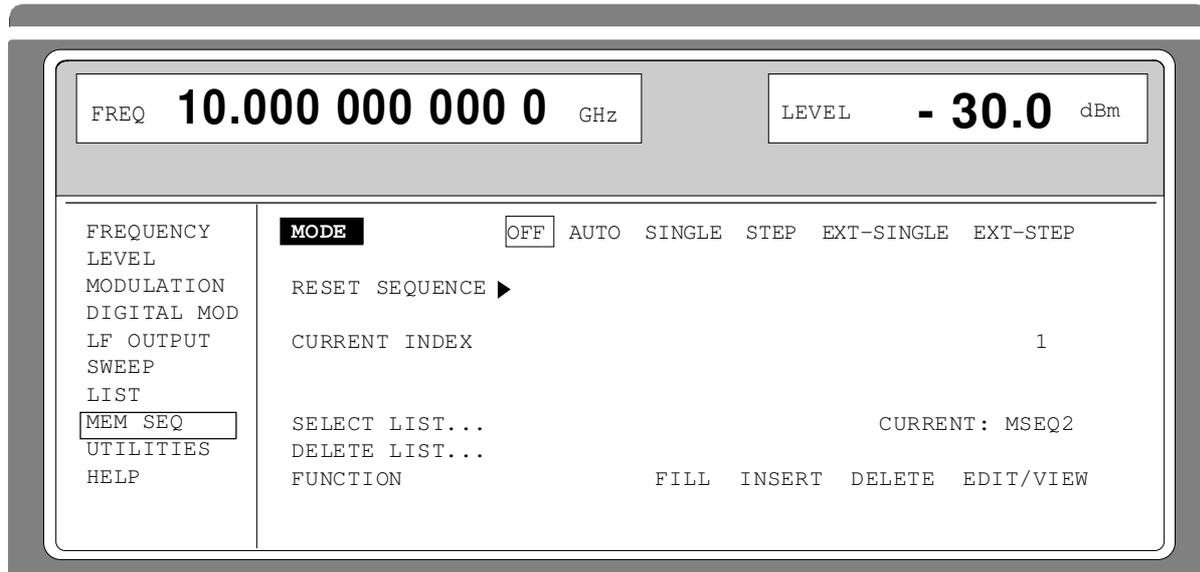
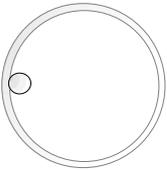
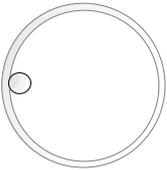

Fig. 2-14 Starting point of the pattern setting

Operating steps	Explanations
<p>MENU / VARIATION</p>  <p>FUNCTION</p> <p>SELECT</p>	<p>Select the FUNCTION menu item.</p>
<p>MENU / VARIATION</p>  <p>. EDIT/VIEW .</p> <p>SELECT</p>	<p>Select single-value function EDIT/VIEW. The EDIT page of the MEM SEQ menu is called. The menu cursor marks the index of the first element of list SEQ2.</p>
<p>SELECT</p>	<p>Set the menu cursor to the memory location number value of the first element (c.f. Fig. 2-15,A).</p>

Operating steps	Explanations
<p style="text-align: center;"><b>DATA INPUT</b></p> <div style="display: flex; justify-content: space-around; align-items: center;"> <div style="border: 1px solid black; padding: 2px 10px;">2</div> <div style="border: 1px solid black; padding: 2px 10px;">0</div> <div style="border: 1px solid black; padding: 2px 5px;">x1 ENTER</div> </div>	<p>Enter MEMORY 20.</p> <p>The menu cursor automatically wraps to the DWELL value of the first element (Fig. 2-15,B).</p>
<p style="text-align: center;"><b>DATA INPUT</b></p> <div style="display: flex; justify-content: space-around; align-items: center;"> <div style="border: 1px solid black; padding: 2px 10px;">1</div> <div style="border: 1px solid black; padding: 2px 10px;">5</div> <div style="border: 1px solid black; padding: 2px 5px;">x1 ENTER</div> </div>	<p>Enter DWELL 15 s.</p> <p>The menu cursor automatically wraps to the MEMORY value of the second element.</p>
<p style="text-align: center;"><b>DATA INPUT</b></p> <div style="display: flex; justify-content: space-around; align-items: center;"> <div style="border: 1px solid black; padding: 2px 10px;">1</div> <div style="border: 1px solid black; padding: 2px 5px;">x1 ENTER</div> </div>	<p>Enter MEMORY 1.</p> <p>The menu cursor automatically wraps to the DWELL value of the second element.</p>
<div style="border: 1px solid black; padding: 2px 10px; width: fit-content;">RETURN</div>	<p>Reset the menu cursor to the index.</p>
<div style="border: 1px solid black; padding: 2px 10px; width: fit-content;">RETURN</div>	<p>Reset the menu cursor to the FUNCTION menu item of the EDIT page of menu MEM SEQ (c.f. Fig. 2-15,C).</p>
<div style="border: 1px solid black; padding: 2px 10px; width: fit-content;">RETURN</div>	<p>Reset the menu cursor to the FUNCTION menu item of the OPERATION page of menu MEM SEQ.</p>

**Note:** With the return to the OPERATION page the operation of the list editor is finished. In the list mode (menu LIST), function LEARN ► must be activated subsequently to ensure that the settings are transferred to the hardware.

A

FREQ **100.000 000 0** MHz

LEVEL **- 30.0** dBm

FREQUENCY LEVEL MODULATION DIGITAL MOD LF OUTPUT SWEEP LIST <b>MEM SEQ</b> UTILITIES HELP	<table style="width: 100%; border-collapse: collapse;"> <tr> <td style="width: 30%;">SELECT LIST...</td> <td style="width: 40%; text-align: right;">CURRENT: MSEQ0</td> </tr> <tr> <td>FUNCTION</td> <td style="text-align: right;">FILL INSERT DELETE EDIT/VIEW</td> </tr> <tr> <td>-INDEX - FREE 0246 - LEN 0010</td> <td style="text-align: right;">MEMORY DWELL</td> </tr> <tr> <td>0001</td> <td></td> </tr> </table>	SELECT LIST...	CURRENT: MSEQ0	FUNCTION	FILL INSERT DELETE EDIT/VIEW	-INDEX - FREE 0246 - LEN 0010	MEMORY DWELL	0001	
SELECT LIST...	CURRENT: MSEQ0								
FUNCTION	FILL INSERT DELETE EDIT/VIEW								
-INDEX - FREE 0246 - LEN 0010	MEMORY DWELL								
0001									

B

FREQ **100.000 000 0** MHz

LEVEL **- 30.0** dBm

FREQUENCY LEVEL MODULATION DIGITAL MOD LF OUTPUT SWEEP LIST <b>MEM SEQ</b> UTILITIES HELP	<table style="width: 100%; border-collapse: collapse;"> <tr> <td style="width: 30%;">SELECT LIST...</td> <td style="width: 40%; text-align: right;">CURRENT: MSEQ2</td> </tr> <tr> <td>FUNCTION</td> <td style="text-align: right;">FILL INSERT DELETE EDIT/VIEW</td> </tr> <tr> <td>-INDEX - FREE 0246 - LEN 0010</td> <td style="text-align: right;">MEMORY DWELL</td> </tr> <tr> <td>0001</td> <td style="text-align: right;">20 <b>100 ms</b></td> </tr> <tr> <td>0002</td> <td></td> </tr> </table>	SELECT LIST...	CURRENT: MSEQ2	FUNCTION	FILL INSERT DELETE EDIT/VIEW	-INDEX - FREE 0246 - LEN 0010	MEMORY DWELL	0001	20 <b>100 ms</b>	0002	
SELECT LIST...	CURRENT: MSEQ2										
FUNCTION	FILL INSERT DELETE EDIT/VIEW										
-INDEX - FREE 0246 - LEN 0010	MEMORY DWELL										
0001	20 <b>100 ms</b>										
0002											

C

FREQ **100.000 000 0** MHz

LEVEL **- 30.0** dBm

FREQUENCY I.F. FREQ. MODULATION DIGITAL MOD LF OUTPUT SWEEP LIST <b>MEM SEQ</b> UTILITIES HELP	<table style="width: 100%; border-collapse: collapse;"> <tr> <td style="width: 30%;">SELECT LIST...</td> <td style="width: 40%; text-align: right;">CURRENT: MSEQ2</td> </tr> <tr> <td><b>FUNCTION</b></td> <td style="text-align: right;">FILL INSERT DELETE EDIT/VIEW</td> </tr> <tr> <td>-INDEX - FREE 0246 - LEN 0010</td> <td style="text-align: right;">MEMORY DWELL</td> </tr> <tr> <td>0001</td> <td style="text-align: right;">20 15.00 s</td> </tr> <tr> <td>0002</td> <td style="text-align: right;">07 100 ms</td> </tr> <tr> <td>0003</td> <td></td> </tr> </table>	SELECT LIST...	CURRENT: MSEQ2	<b>FUNCTION</b>	FILL INSERT DELETE EDIT/VIEW	-INDEX - FREE 0246 - LEN 0010	MEMORY DWELL	0001	20 15.00 s	0002	07 100 ms	0003	
SELECT LIST...	CURRENT: MSEQ2												
<b>FUNCTION</b>	FILL INSERT DELETE EDIT/VIEW												
-INDEX - FREE 0246 - LEN 0010	MEMORY DWELL												
0001	20 15.00 s												
0002	07 100 ms												
0003													

Fig. 2-15, a to c Pattern setting - Edition of a list

## 2.2.5 Save/Recall - Storing/Calling of Instrument Settings

50 complete instrument settings can be stored in memory locations 1 to 50.

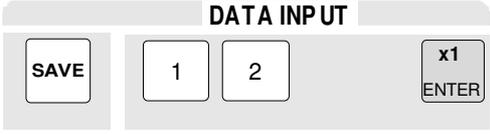
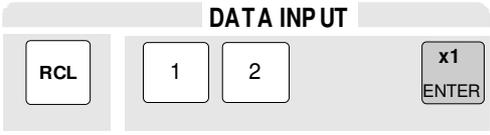
Operating steps	Explanations
 <p>The screenshot shows a grey rectangular window titled "DATA INPUT". On the left is a button labeled "SAVE". To its right are two square buttons labeled "1" and "2". Further right is a button labeled "x1" with "ENTER" written below it.</p>	<p>Store current instrument setting in memory location 12.</p>
 <p>The screenshot shows a grey rectangular window titled "DATA INPUT". On the left is a button labeled "RCL". To its right are two square buttons labeled "1" and "2". Further right is a button labeled "x1" with "ENTER" written below it.</p>	<p>Call instrument setting of memory location 12.</p>

The digital display during a save or recall entry is faded in a window.

Memory location 0 has a special function. Here the instrument setting which was current prior to the last memory recall and prior to a preset setting is automatically stored. This permits the resetting of instrument settings which have inadvertently been deleted using Recall 0.

If an instrument setting is stored in which a sweep was switched on, the sweep is started using the recall.

The parameter EXCLUDE FROM RCL in the FREQUENCY and LEVEL-LEVEL menus determines whether the saved RF frequency and RF level are loaded when an instrument setting is loaded, or whether the current settings are maintained.

Store IEC-bus command:            "**\*\*SAV 12"**

Call IEC-bus command:            "**\*\*RCL 12"**

**Note:** *The contents of lists, as they are used for the LIST mode or for user correction (UCOR), is not saved in the SAVE memory. It is stored under the respective list name and can be called. If instrument settings are called which go back to list data such as level setting using UCOR, the current list contents is used. If this has been altered, it is not identical to the list contents at the point of storing any more.*

## 2.3 Menu Summary

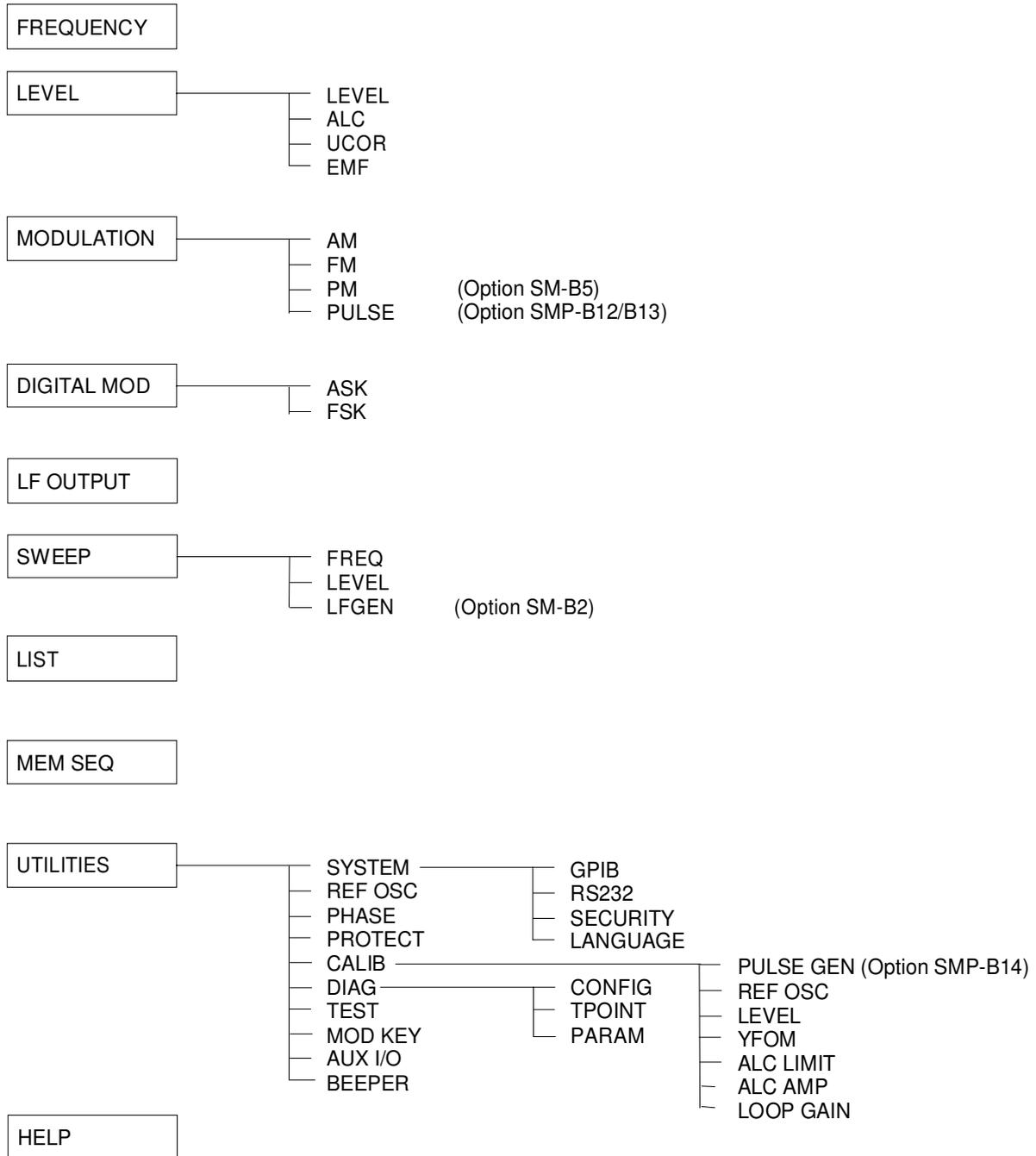

## 2.4 RF Frequency

The frequency of the RF output signal can be set directly using the [FREQ] key or by accessing menu FREQUENCY.

In the header field of the display, the frequency of the RF output signal is indicated under FREQ. In the case of frequency settings opened by means of the [FREQ] key, the value entered directly is the frequency of the RF output signal.

The input value of frequency settings effected in the FREQUENCY menu considers the offset in calculation. This offers the possibility of entering the desired output frequency of these series-connected instruments in the menu. The SMP then changes the RF output frequency correspondingly. Offset and multiplier can also be entered in the FREQUENCY menu.

**Note:** Further settings: Frequency sweep  
LF frequency

Menu SWEEP  
Menu MODULATION  
Menu LF-OUTPUT

int./ext. reference frequency

Menu UTILITIES-REF OSC

Phase of the output signal

Menu UTILITIES-PHASE

Menu selection: FREQUENCY

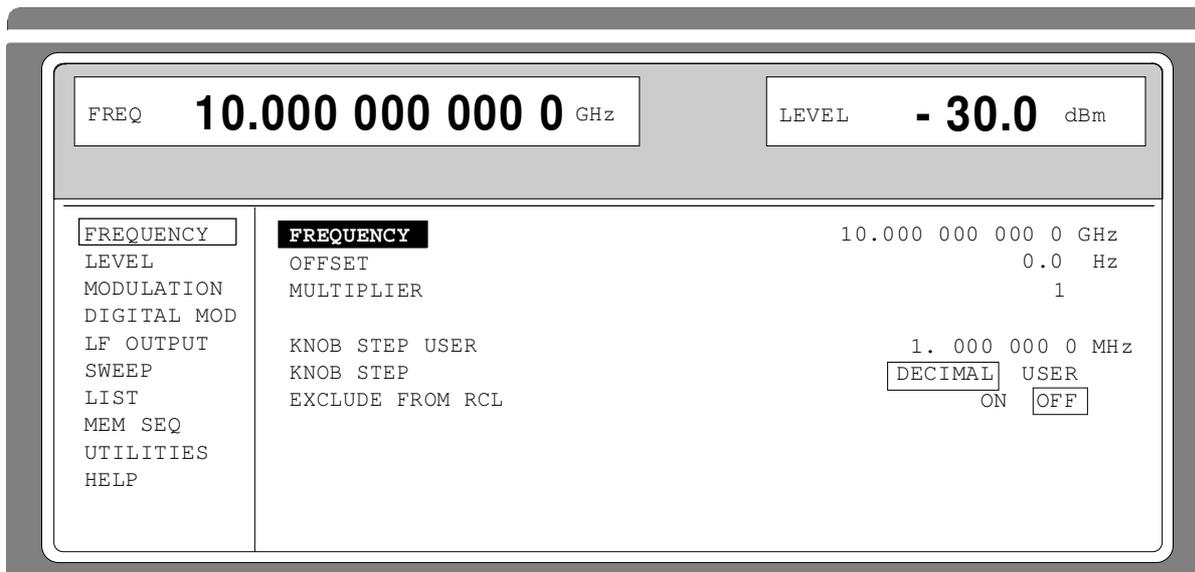

Fig. 2-16 Menu FREQUENCY (preset setting)

### FREQUENCY

Input value of the RF frequency considering the OFFSET and MULTIPLIER input values. The frequency of the RF output signal is determined by the input values FREQUENCY, OFFSET and MULTIPLIER (cf. Section "Frequency Offset and Multiplier").

IEC-bus short command :FREQ 10E9

### OFFSET

Input value of the frequency offset, e.g., of a series-connected mixer (cf. Section "Frequency Offset and Multiplier").

IEC-bus short command :FREQ:OFFS 0

### MULTIPLIER

Input value of a multiplication factor, e.g., of a series-connected frequency multiplier (cf. Section "Frequency Offset and Multiplier").

IEC-bus short command :FREQ:MULT 1

<b>KNOB STEP USER</b>	Input value of the step width for frequency variation using the rotary knob. The RF frequency is varied in the step width entered if KNOB STEP is set to USER. IEC-bus short command :FREQ:STEP 1MHz
<b>KNOB STEP</b>	DECIMAL: Variation step width corresponding to the position of the digit cursor. USER: "User Defined", variation step width as entered under KNOB STEP USER .
<b>EXCLUDE FROM RCL</b>	OFF Default setting. The saved frequency is loaded as well when instrument settings are loaded with the [RCL] key or with a memory sequence. IEC-bus short command :FREQ:RCL INCL ON The RF frequency is not loaded when instrument settings are loaded, the current frequency settings are maintained. IEC-bus short command :FREQ:RCL EXCL

### 2.4.1 Frequency Offset and Multiplier

The SMP offers the possibility of entering an offset and multiplier of possibly series-connected instruments in the FREQUENCY menu. The indication/input value under FREQUENCY considers this entries and represents the frequency value of the RF signal at the output of these instruments (cf. Fig. 2-17). If frequency offset as well as multiplier have been entered, it is taken for granted in calculating the values that the RF signal is multiplied first and then the offset is added.

Hence the frequency of the new RF output signal is calculated from the entries FREQUENCY, OFFSET and MULTIPLIER according to the formula:

$$\text{RF-output frequency} = (\text{FREQUENCY} - \text{OFFSET}) / \text{MULTIPLIER}$$

Offset and multiplier entries do not have an influence on the RF output signal of the SMP. I. e., an entry does not change the RF-output frequency but only the FREQUENCY value indicated in the FREQUENCY menu.

The RF output frequency of the SMP is indicated in the header field of the display. It can be entered directly using the [FREQ] key, i.e. without considering the offset and multiplier.

The offset setting also remains effective with the frequency sweep.

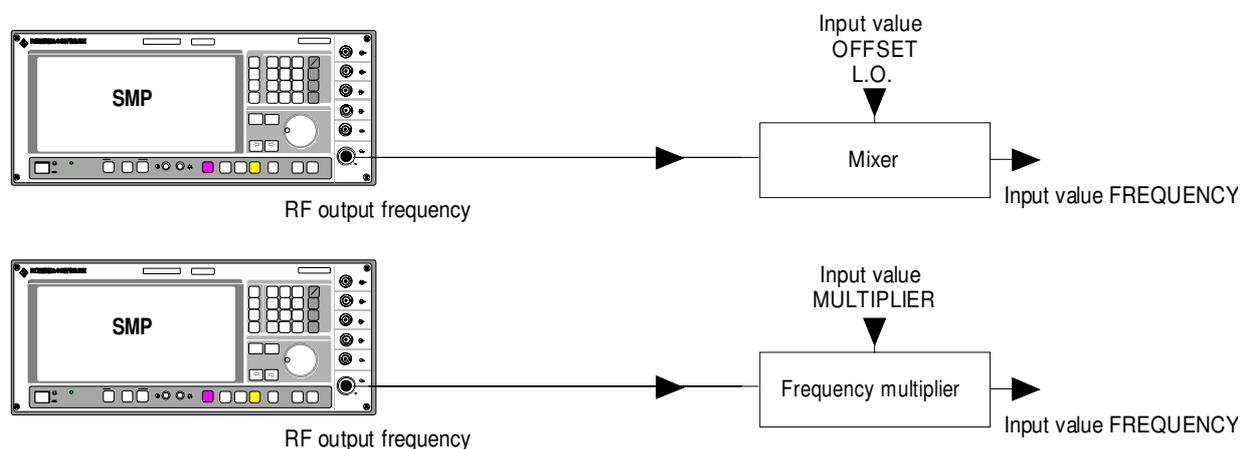

Fig. 2-17 Example of a circuit with frequency offset or multiplier



## 2.5 RF Level

The RF output level can be set directly using the [LEVEL] key or by accessing the LEVEL menu.

In the header field of the display, the set RF output level is indicated under LEVEL.

The input value of level settings opened using the [LEVEL] key directly corresponds to the RF output level.

The input value of the level settings effected in the LEVEL-LEVEL menu mathematically considers the offset of an attenuation/amplification element which is possibly series-connected (cf. Section "Level Offset"). This offers the possibility of entering the desired level at the output of series-connected instruments, the SMP then alters the RF output level correspondingly. The offset can also be entered in the LEVEL-LEVEL menu.

dBm, dB $\mu$ V, mV and  $\mu$ V can be used as level units. The 4 unit keys are directly labeled with these units. In order to change to another level unit, simply press the desired unit key.

**Notes:**

- The message *UNLEVELED* is indicated in the status line if the level displayed is not reached. The maximum possible RF-output level depends on the instrument model and the options fitted (cf. data sheet).

- Further settings:           Level sweep   menu SWEEP

Menu selection:   LEVEL - LEVEL

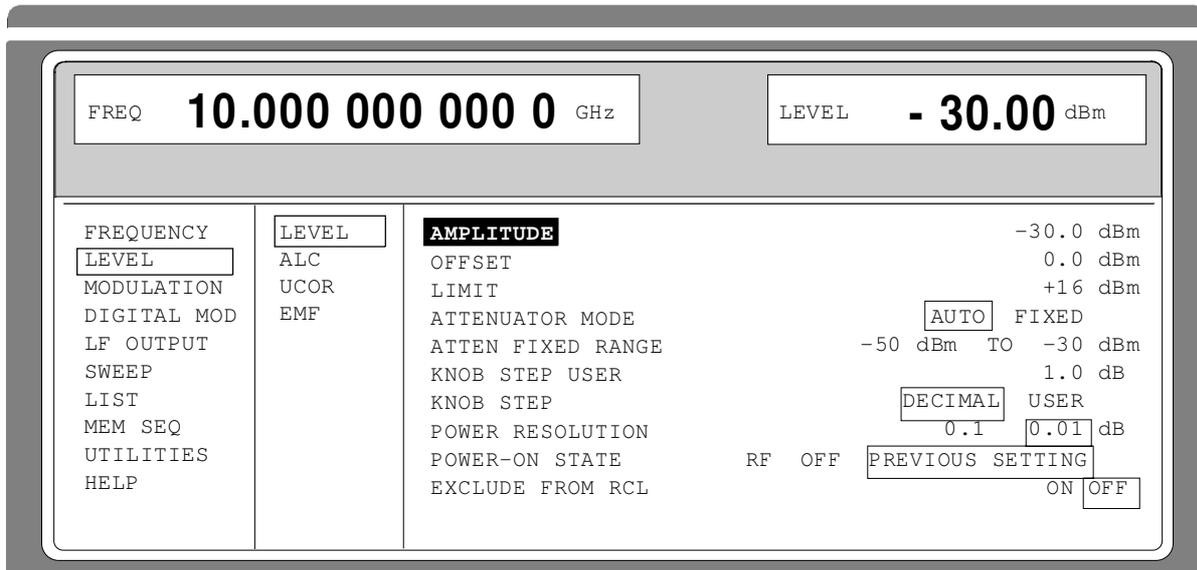

Fig. 2-18 Menu LEVEL (preset setting), fitted with option SMP-B15, attenuator 20 GHz; parameter POWER RESOLUTION is set to 0.01 dB

### AMPLITUDE

Input value of the RF level considering the OFFSET input value. The level of the RF output signal is determined by input values AMPLITUDE and OFFSET (cf. Section "Level Offset").

IEC-bus short command   : SOUR:POW -30

### OFFSET

Input value of the level offset of a series-connected attenuation/amplification element. Input in dB (cf. Section "Level Offset").

IEC-bus short command   : SOUR:POW:OFFS 0

<b>LIMIT</b>		Input value of level limitation. This value indicates the upper limit of the level at the RF output connector. If a level above this limit is attempted to be set, a warning is displayed in the status line. IEC-bus short command     : SOUR:POW:LIM 16 dBm
<b>ATTENUATOR MODE</b>	AUTO	Normal operation. The attenuator switching mechanically switches in steps of 5 dB, the switching points being fixed. IEC-bus short command     : OUTP:AMOD AUTO
	FIXED	Level settings are effected in a 20-dB range without switching the attenuator (cf. Section "Interrupt-free Level Setting"). IEC-bus short command     : OUTP:AMOD FIX
<b>ATTEN FIXED RANGE</b>		Indication of the level range in which the level is set without interruption in the "ATTENUATOR MODE FIXED" operating mode.
<b>KNOB STEP USER</b>		Input value of the step width for level variation using the rotary knob. The RF level is varied in the step width entered if KNOB STEP is set to USER. IEC-bus short command     : SOUR:POW:STEP 1
<b>KNOB STEP</b>	DECIMAL	Variation step width according to the position of the digit cursor.
	USER	User Defined, variation step width as entered under KNOB STEP USER.
<b>POWER RESOLUTION</b>	0.1 dB	The resolution of the LEVEL indication is set to 0.1 dB.
	0.01 dB	The resolution of the LEVEL indication is set to 0.01 dB.
<b>POWER-ON STATE</b>	RF OFF	Selection of the state the RF output is to assume after power-on of the unit Output is switched off
	PREVIOUS SETTING	Same state as before switch-off
	IEC-bus short command	: OUTP:PON ON
<b>EXCLUDE FROM RCL</b>	OFF	Default setting. The saved RF level is loaded as well when instrument settings are loaded with the [RCL] key or with a memory sequence. IEC-bus short command     : SOUR:POW:RCL INCL
	ON	The RF level is not loaded when instrument settings are loaded, the current level settings are maintained. IEC-bus short command     : SOUR:POW:RCL EXCL

### 2.5.1 Level Offset

The SMP offers the possibility of entering the offset (OFFSET) of a possibly series-connected attenuator/amplification element in the LEVEL-LEVEL menu. The indication/input value under AMPLITUDE considers this input (see below) and represents the level value of the signal at the output of the series-connected instrument (cf. Fig. 2-19).

The level of the RF-output signal is thus calculated from the input values AMPLITUDE and OFFSET in the LEVEL-LEVEL menu according to the formula:

$$\text{RF-output level} = \text{AMPLITUDE} - \text{OFFSET}$$

Entering an offset value does not affect the RF-output signal of the SMP. I.e., an entry does not change the RF-output level but only the displayed AMPLITUDE value in the LEVEL-LEVEL menu.

The RF output level of the SMP is indicated in the header field of the display. It can be entered directly, i.e. without considering an offset, using the [LEVEL] key.

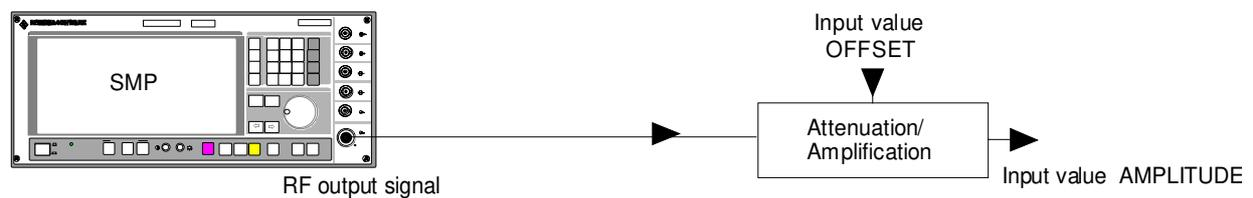

Fig. 2-19 Example of a circuit with level offset

### 2.5.2 Interrupt-free Level Setting

(With option SMP-B15/SMP-B17 (SMP04), attenuator 20 GHz/40 GHz (SMP04)).

In the ATTENUATOR MODE FIXED operating mode, level settings are carried out without interruption. An attenuation is set electronically instead of using the interrupting attenuator.

The 20-dB range of the level which can be set interrupt-free extends from the level set on switching on the ATTENUATOR FIXED MODE to 20 dB below. Within this 20-dB range, the level can be set by means of the keyboard, the rotary knob or via IEC/IEEE-bus.

Outside the 20-dB range, levels are set via the interrupting mechanical attenuator. Relative to this new level, a new level in the range of 0 to –20 dB is set interrupt-free again.

### 2.5.3 Level Control (ALC)

Menu LEVEL-ALC offers access to settings for level control.

Level control can be deactivated and various bandwidths of the level control can be switched on.

Switching off level control (ALC STATE OFF) switches over the internal level control into a sample-and-hold operation. In this operating mode, level control is automatically switched on for a short period of time after every level and frequency setting, and then the level control is held at the value achieved. Switching off the level control is used with multi-transmitter measurements to achieve a larger intermodulation ratio.

The basic functions of level control are shown in Fig. 2-20.

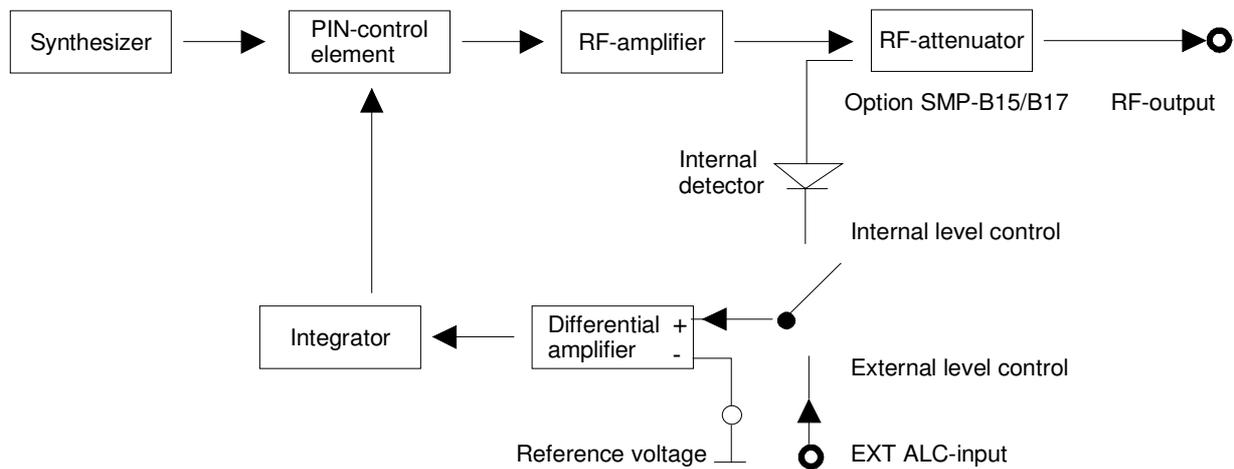

Fig. 2-20 Basic principle of level control of the SMP

An application example for external level control is shown in Fig. 2-21.

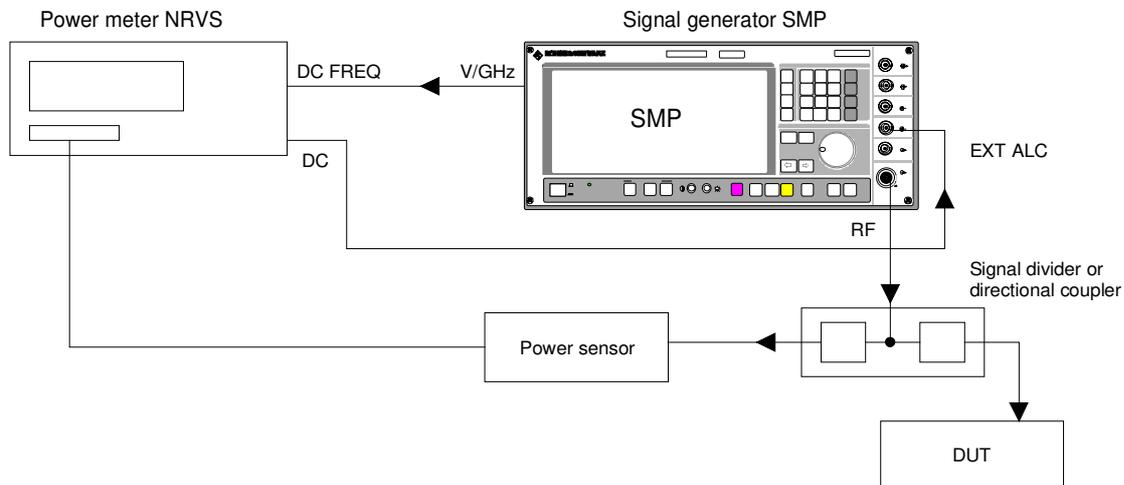

Fig. 2-21 Example of external power control using a power meter

Menu selection: LEVEL - ALC

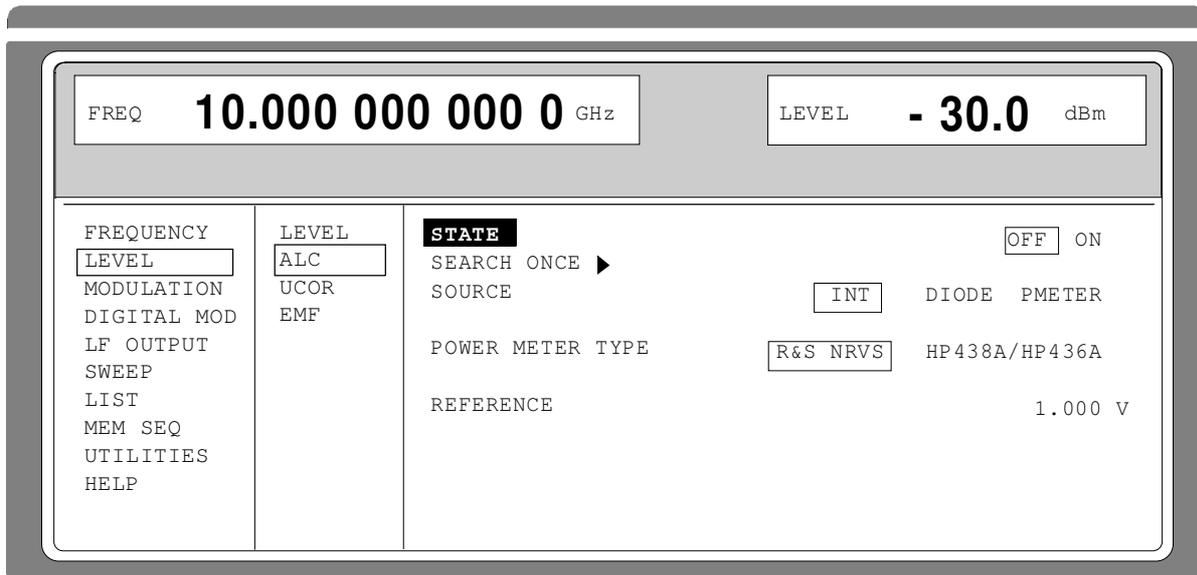

Fig. 2-22 Menu LEVEL - ALC (preset setting)

<b>STATE</b>	<p>ON Normal state. Internal level control is permanently switched on. IEC-bus short command : SOUR:POW:ALC ON</p> <p>OFF Internal level control is deactivated. In this state no AM and no ASK is possible. IEC-bus short command : SOUR:POW:ALC OFF</p>
<b>SEARCH ONCE</b> ►	<p>Manual short-time switching on of the level control for level calibration in the ALC STATE OFF operating mode. IEC-bus short command : SOUR:POW:ALC ON;ALC OFF</p>
<b>SOURCE</b>	<p>Selecting the detector for level control.</p> <p>INT The internal detector is switched on. IEC-bus short command : SOUR:POW:ALC:SOUR INT</p> <p>DIODE A diode detector can be connected at input EXT ALC. IEC-bus short command : SOUR:POW:ALC:SOUR DIOD</p> <p>PMETER A power meter can be connected at input EXT ALC. IEC-bus short command : SOUR:POW:ALC:SOUR PMET</p>
<b>POWER METER TYPE</b>	<p>Selection of a power meter.</p> <p>R&amp;S NRVS Selection of NRVS power meter by Rohde &amp; Schwarz</p> <p>HP438A Selection of Hewlett-Packard power meters HP438A or HP436A /HP436A</p> <p>IEC-bus short command : SOUR:POW:ALC:SOUR:PMET RS_NRVS</p>
<b>REFERENCE</b>	<p>Input value of the reference voltage for operation with an external diode detector or with the power meters by Hewlett-Packard.</p> <p>IEC-bus short command : SOUR:POW:ALC:REF 1</p>

## 2.5.4 User Correction (UCOR)

Function "User Correction" can be used to create and activate lists in which arbitrary RF frequencies are assigned level correction values.

Up to 10 lists with a total of 160 correction values can be compiled. For frequencies which are not included in the list the level correction is determined by means of interpolation of the nearest correction values.

When user correction is switched on, the LEVEL indication is completed by the indication UCOR (User Correction) in the header field of the display. The RF output level is the sum of both values.

$$\text{Output Level} = \text{LEVEL} + \text{UCOR}$$

If the offset setting is used at the same time, the LEVEL indication value is the difference of the input values AMPLITUDE and OFFSET of the menu LEVEL.

$$\text{AMPLITUDE} - \text{OFFSET} = \text{LEVEL}$$

The user correction is effective in all operating modes if switched on.

Menu selection: LEVEL - UCOR

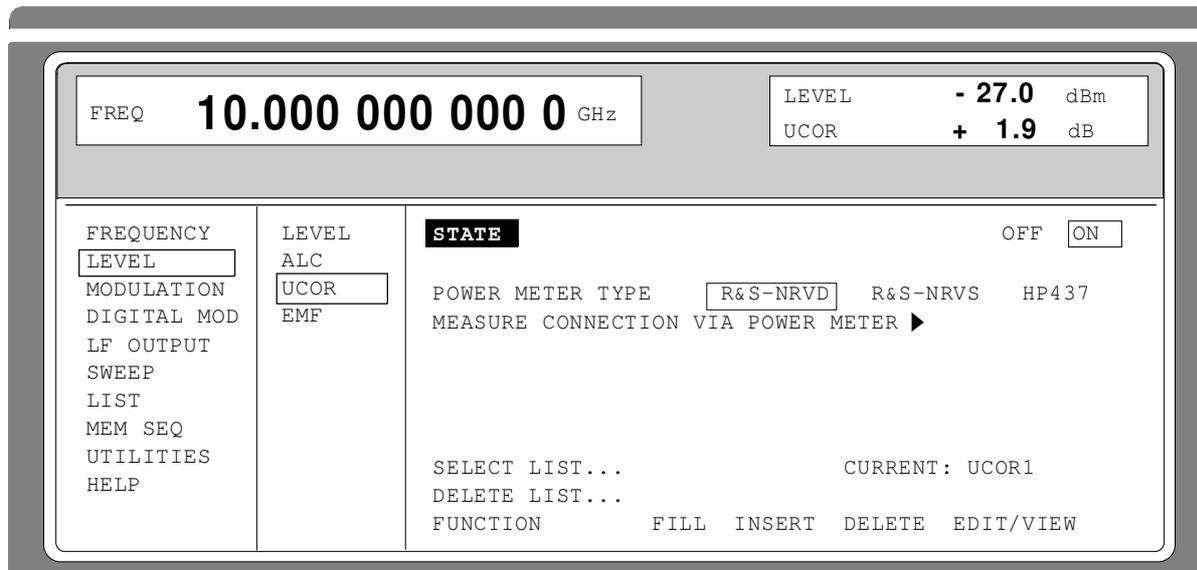

Fig. 2-23 Menu LEVEL - UCOR - OPERATION page

<b>STATE</b>	Switching on/off user correction. IEC-bus short command : SOUR:CORR ON
<b>POWER METER TYPE</b>	Selection of a power meter for automatic level correction (see next section, "Automatic Level Correction"). R&S NRVD Selection of Rohde & Schwarz power meter NRVD R&S NRVS Selection of Rohde & Schwarz power meter NRVS HP437 Selection of power meter HP437 by Hewlett-Packard
<b>MEASURE CORRECTION VIA POWER METER ►</b>	Start of automatic level correction (see next section, "Automatic Level Correction").

- SELECT LIST...** Selection of a list or generation of a new list (cf. Section "List Editor")  
 IEC-bus short command : SOUR:CORR:CSET "UCOR1"
- DELETE LIST...** Deletion of a list (cf. Section "List Editor")  
 IEC-bus short command : SOUR:CORR:CSET:DEL "UCOR2"
- FUNCTION** Selection of the editing mode to edit the selected list (cf. Section "List Editor")  
 IEC-bus short : SOUR:CORR:CSET:DATA:FREQ 10.5 GHz, 10.7 GHz..  
 commands : SOUR:CORR:CSET:DATA:POW 1.9dB, 1.2dB, ...

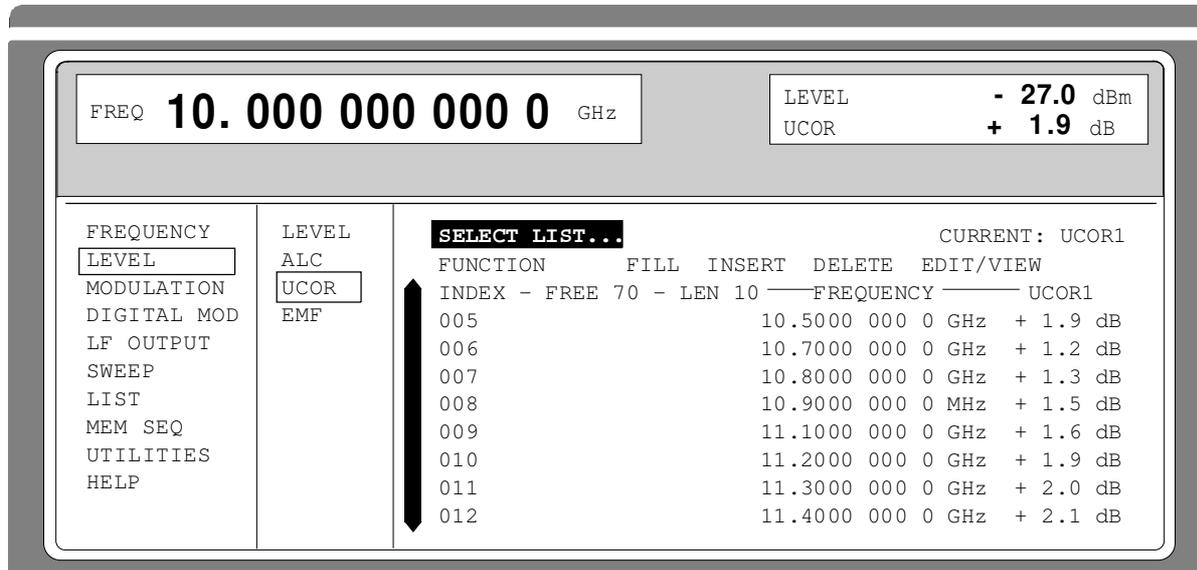

Fig. 2-24 Menu UCOR - LEVEL-EDIT page

## 2.5.5 Automatic level correction

Fig. 2-25 shows a typical application using automatic level correction.

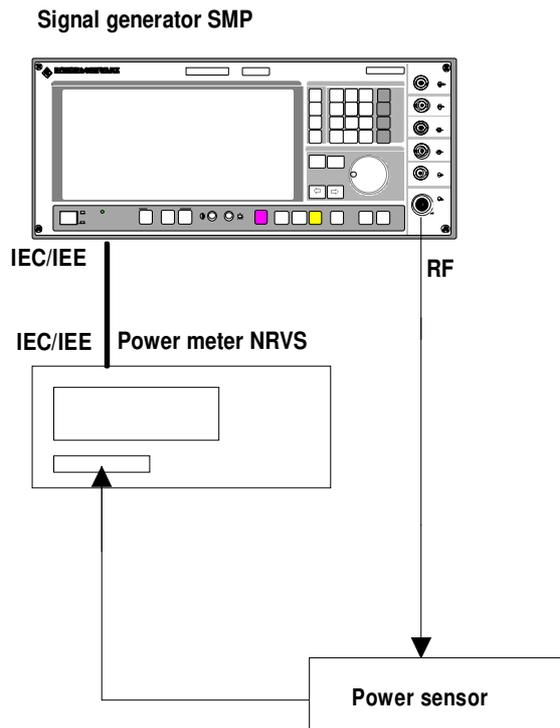

Fig. 2-25 a Determining the correction values

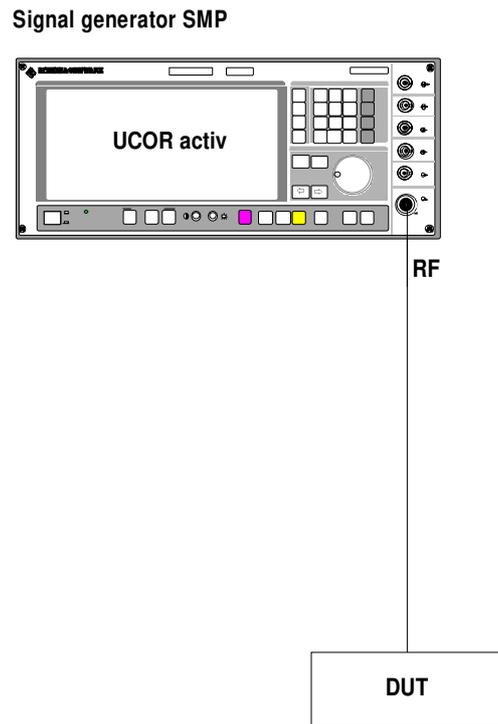

Fig. 2-25 b Measurement

The settings for automatic level correction can be accessed via the LEVEL-UCOR menu.

Automatic level correction is activated with MEASURE CORRECTION VIA POWER METER ►. The power meter used must be selected first via POWER METER TYPE.

When the automatic level correction is started, the instrument displays a warning:

**ATTENTION:**  
This function overwrites the level values  
of your current UCOR List!

Automatic level correction can be continued by pressing the [SELECT] key. It is aborted by pressing [RETURN].

The IEC-bus address of the power meter and the power sensor used are indicated while the measured values are read into the UCOR list.

**Attention:** *The frequencies of the UCOR list must lie inside the frequency range of the sensor. Frequencies located outside the frequency range of the sensor lead to faulty measurements.*



## 2.5.6 EMF

The signal level can also be set and indicated as the voltage of EMF (open-circuit voltage).

EMF is displayed in the header field of the display after the unit of the level indication.

Menu selection: LEVEL - EMF

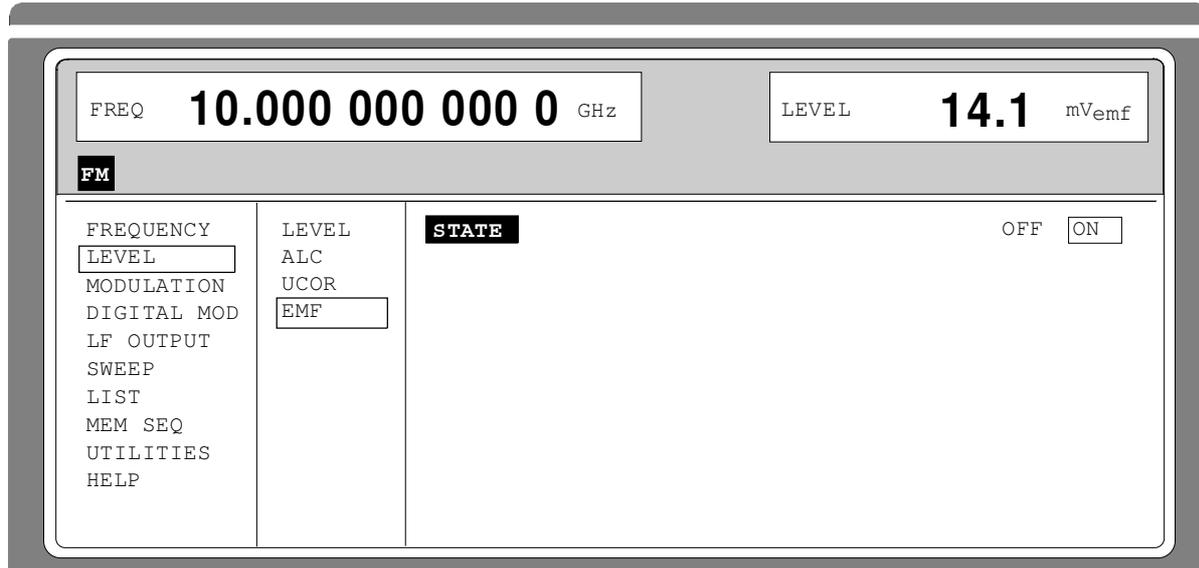

Fig2-26 Menu LEVEL-EMF

**STATE**            ON            Voltage value of the level is the voltage of EMF.  
                       OFF            Voltage value of the level is voltage at 50 Ω (preset setting).

## 2.5.7 [RF ON / OFF]-Key

The RF output signal is switched on and off again using the [RF ON / OFF] key. This does not influence the current menu. When the output signal is switched off, the message "RF OFF" is displayed in the LEVEL indication of the header field. If RF OFF is displayed, the 50-Ω source resistance is maintained.

IEC-bus short command            :OUTP OFF

## 2.6 Modulation

The SMP offers the following modulations:

- Amplitude modulation (AM)
- Logarithmic amplitude modulation (AM)
- Frequency modulation (FM)
- Phase modulation (PM) \*
- Pulse modulation (PULSE) \*
- Digital modulations (ASK and FSK)

\*only with options fitted

Internal or external modulation sources can be used for the analog modulations. Digital modulations require an external modulation source.

### 2.6.1 Modulation Sources

#### Internal Modulation Sources

Internal modulation generators LF GEN1 and LF GEN2 are available for AM, FM and PM depending on the equipment. For a more detailed description, cf. Section "LF Generator".

For internal pulse modulation, the instrument can be equipped with a pulse generator (option SMP-B14). For a more detailed description, cf. Section "Pulse Generator".

#### External Modulation Sources

The input sockets appropriate for the various modulations in the case of external supply can be taken from table 2-1. External AM, FM and PM can be AC or DC-coupled.

Table 2-1 Input sockets for the different types of modulation

Modulation	Inputs		
	EXT1	EXT2	PULSE
AM	X		
FM1	X	X	
FM2	X	X	
PM1	X	X	
PM2	X	X	
PULSE			X
ASK	X		
FSK	X		

The external modulation signal must show a voltage of  $V_p = 1 \text{ V}$  ( $V_{rms} = 0.707 \text{ V}$ ) in order to maintain the modulation depth or frequency deviation indicated. Deviations of more than  $\pm 3 \%$  from the rated voltage are signaled in the status line by means of the following messages (cf. table 2-2).

Table 2-2 Status messages in the case of a deviation from the rated value at the external modulation input

Message	Deviation
EXT1-HIGH	Voltage at EXT1 too high
EXT1-LOW	Voltage at EXT1 too low
EXT2-HIGH	Voltage at EXT2 too high
EXT2-LOW	Voltage at EXT2 too low
EXT-HI/HI	Voltage at EXT1 and EXT2 too high
EXT-LO/LO	Voltage at EXT1 and EXT2 too low
EXT-HI/LO	Voltage at EXT1 too high and EXT2 too low
EXT-LO/HI	Voltage at EXT1 too low and EXT2 too high

### 2.6.1.1 Simultaneous Modulation

Basically, every combination of AM, FM and pulse modulation is possible. Instead of FM, phase modulation (PM) can be switched on as well. There are only restrictions for modulations of the same kind and for the multiple use of the 2nd LF generator (cf. table 2-3).

Two-tone AM is possible by simultaneously switching on the external and internal source.

Two-tone FM or two-tone PM is possible by simultaneously switching on FM1 and FM2 or PM1 and PM2. For FM1 and FM2 (PM1 and PM2) separate deviations can be set and separate sources switched on.

**Note:** *With two-tone modulation please observe that the set deviation or modulation depth is valid for one signal and the sum deviation or sum modulation depth is determined by adding both signals. This results in overmodulation if the maximum value for deviation or modulation depth is exceeded.*

### 2.6.1.2 Alternate Switching Off of Modulations

Due to the multiple use of some functional modules in the instrument some modulations cannot be set at the same time (cf. table 2-3). In the case of manual control, incompatible modulations deactivate one another, a short-time warning is displayed in the status line.

**Note:** *The IEC-bus control according to SCPI forbids the mutual influence of types of modulation on one another. In the case of remote control, an error message is output when an attempt is made to switch on incompatible types of modulation (cf. annex B).*

Table 2-3 Modulations which cannot be operated simultaneously

	AM INT1	AM INT2	AM EXT1	AS K	FM1 INT1	FM1 EXT1	FM1 EXT2	FM1 FSK	FM2 INT2	FM2 EXT1	FM2 EXT2	FM2 FSK	PM1 INT1	PM1 EXT1	PM1 EXT2	PM2 INT2	PM2 EXT1	PM2 EXT2
AM INT1		<input type="checkbox"/>	<input type="checkbox"/>	<input type="checkbox"/>														
AM INT2	<input type="checkbox"/>			<input type="checkbox"/>														
AM EXT1	<input type="checkbox"/>	<input type="checkbox"/>		<input type="checkbox"/>				X				X						
ASK	<input type="checkbox"/>	<input type="checkbox"/>	<input type="checkbox"/>			X				X								
FM1 INT1						<input type="checkbox"/>	<input type="checkbox"/>	<input type="checkbox"/>					X	X	X	X	X	X
FM1 EXT1				X	<input type="checkbox"/>		<input type="checkbox"/>	<input type="checkbox"/>				X	X	X	X	X	X	X
FM1 EXT2					<input type="checkbox"/>	<input type="checkbox"/>		<input type="checkbox"/>					X	X	X	X	X	X
FM1 FSK			X		<input type="checkbox"/>	<input type="checkbox"/>	<input type="checkbox"/>			X			X	X	X	X	X	X
FM2 INT2										<input type="checkbox"/>	<input type="checkbox"/>	<input type="checkbox"/>	X	X	X	X	X	X
FM2 EXT1				X				X	<input type="checkbox"/>		<input type="checkbox"/>	<input type="checkbox"/>	X	X	X	X	X	X
FM2 EXT2									<input type="checkbox"/>			<input type="checkbox"/>	X	X	X	X	X	X
FM2 FSK			X				X		<input type="checkbox"/>	<input type="checkbox"/>	<input type="checkbox"/>		X	X	X	X	X	X
PM1 INT1					X	X	X	X	X	X	X	X		<input type="checkbox"/>	<input type="checkbox"/>			
PM1 EXT1					X	X	X	X	X	X	X	X	<input type="checkbox"/>		<input type="checkbox"/>			
PM1 EXT2					X	X	X	X	X	X	X	X	<input type="checkbox"/>	<input type="checkbox"/>				
PM2 INT2					X	X	X	X	X	X	X	X					<input type="checkbox"/>	<input type="checkbox"/>
PM2 EXT1					X	X	X	X	X	X	X	X				<input type="checkbox"/>		<input type="checkbox"/>
PM2 EXT2					X	X	X	X	X	X	X	X				<input type="checkbox"/>	<input type="checkbox"/>	

X Mutual switching off in the case of manual control  
 Switching off by means of 1-out-of-n selection

### 2.6.1.3 [MOD ON/OFF] Key

The modulations can directly be switched on/off using the key or by accessing the MODULATION menu. When switching on using the [MOD ON/OFF] key, the modulation sources which are set in the modulation menus are used.

The [MOD ON/OFF] key can either be effective for all modulations or for a selected modulation. The selection for which modulation the [MOD ON/OFF] key is effective is made in the UTILITIES-MOD KEY menu.

Once a certain type of modulation has been selected, it is switched on or off each time that the [MOD ON/OFF] key is pressed.

If "all modulations" are selected, the [MOD ON/OFF] key has the following effect:

- At least one modulation is active:  
Pressing the [MOD ON/OFF] key switches off all active modulations. Which modulations were active is stored.
- No modulation is active:  
Pressing the [MOD ON/OFF] key switches on the modulations which were last switched off using the [MOD ON/OFF] key.

## 2.6.2 Analog Modulation

### 2.6.2.1 LF-Generator

The SMP is equipped with a fixed-frequency generator as internal modulation source as a standard. The generator supplies sinusoidal signals of the frequencies of 0.4, 1, 3 and 15 kHz.

In addition to the standard equipment, the SMP can be equipped with the optional LF modulation source SM-B2, LF-generator.

It is possible to fit two optional modulation sources unless option SM-B3, pulse modulator, is fitted. If two options are fitted, the access to the internal standard generator is eliminated. The different possibilities of modulation generator fitting are visible from Table 2-4:

Table 2-4 Modulation generators as component parts

LF-Generator 1	LF-Generator 2
Standard generator	---
Standard generator	Option SM-B2, LF-generator
Option SM-B2, LF-generator	Option SM-B2, LF-generator

The shape and frequency of the internal modulation signals can be selected in one of the modulation menus ( AM, FM, PM) as well as in the LF-output menu.

- Notes:**
- *In conformance to the possibilities of the modulation generator options fitted, there are differences in the modulation menus for AM, FM and PM.*
  - *The settings LFGEN SHAPE NOI and LF sweep deactivate one another.*

### 2.6.2.2 Amplitude Modulation

Menu MODULATION-AM offers access to settings for amplitude modulation.

- Notes:** - The maximal level guaranteed of the SMP is different depending on model and options fitted (cf. data sheet). The specified AM data are only valid up to 6 dB under the respective maximal level. If this value is exceeded, the AM data are only guaranteed for a linearly decreasing modulation depth.
- When a modulation depth is set that is too high, "WARNING" is displayed in the status line or the message "WARN -221 Settings conflict; modulation forces peak level into overrange" is displayed after pressing the ERROR key.

Menu selection: MODULATION- AM

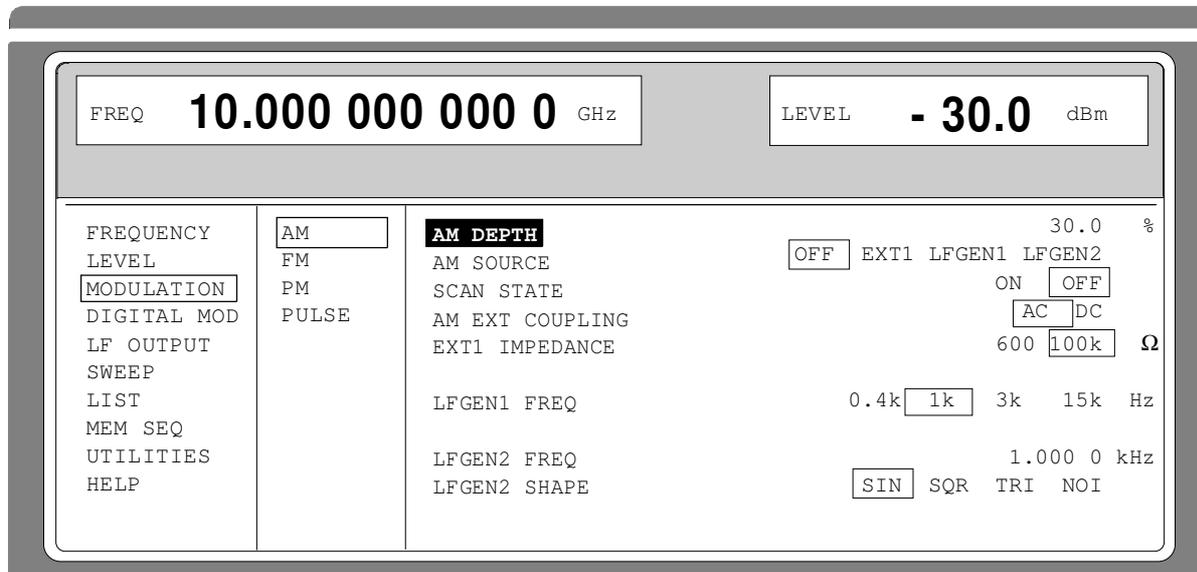

Fig. 2-27 Menu MODULATION-AM (preset setting), fitted with option SM-B2, LF-generator (LFGEN2)

<b>AM DEPTH</b>	Input value of the modulation depth
or	or
<b>SCAN SENSITIVITY</b>	Input value of the scan sensitivity (for SCAN STATE ON). IEC-bus short command :SOUR:AM 30PCT / :AM:SCAN:SENS 10dB
<b>AM SOURCE</b>	Selection of the modulation source. IEC-bus short command :SOUR:AM:SOUR INT1; STAT ON
<b>SCAN STATE</b>	Switching on and off the logarithmic amplitude modulation IEC-bus short command :SOUR:AM:SCAN ON
<b>AM EXT COUPLING</b>	Selection of the kind of coupling AC or DC for external supply (input EXT1). IEC-bus short command :SOUR:AM:EXT:COUP AC
<b>EXT1 IMPEDANCE</b>	Selection of the input impedance of the external input EXT1 IEC-bus short command :SOUR:AM:EXT:IMP 100kOhm
<b>LFGEN1 FREQ</b>	Selection of the frequency of the 1st LF generator. IEC-bus short command :SOUR:AM:INT1:FREQ 1kHz
<b>LFGEN2 FREQ</b>	Input value of the frequency of the 2nd LF generator. IEC-bus short command :SOUR:AM:INT2:FREQ 1kHz
<b>LFGEN2 SHAPE</b>	Selection of the shape of the 2nd LF generator. IEC-bus short command :SOUR2:FUNC SIN

### 2.6.2.3 Frequency Modulation

#### Operating modes

If the option SM-B5, FM/PM-modulator, is fitted, three operating modes for frequency modulation of the RF-signal are available. The operating mode selected determines the modulation frequency range, the maximum frequency deviation and the frequency accuracy (see Table 2-5).

Without the option, frequency modulation of the RF-signal is possible in the LOCKED and UNLOCKED modes (see Fig. 2-27)

Table 2-5 Parameters for the various frequency modulation modes

Mode	Modulation Frequency Range	Maximum Frequency Deviation	Frequency Accuracy
LOCKED (operation with reference oscillator connected)	10 kHz ... 5 MHz	≤ 20 GHz: 10 MHz > 20 GHz: 20 MHz	same as reference frequency
UNLOCKED (free-run mode, reference oscillator disconnected)	DC ... 5 MHz	≤ 20 GHz: 10 MHz > 20 GHz: 20 MHz	typ. approx. $< 5 \times 10^{-4}$
PRECISE (operation with increased RF-accuracy; only with option SM-B5, FM/PM-modulator)	DC ... 1 MHz	≤ 20 GHz: 1 MHz > 20 GHz: 2 MHz	approx. 1% of the frequency deviation set

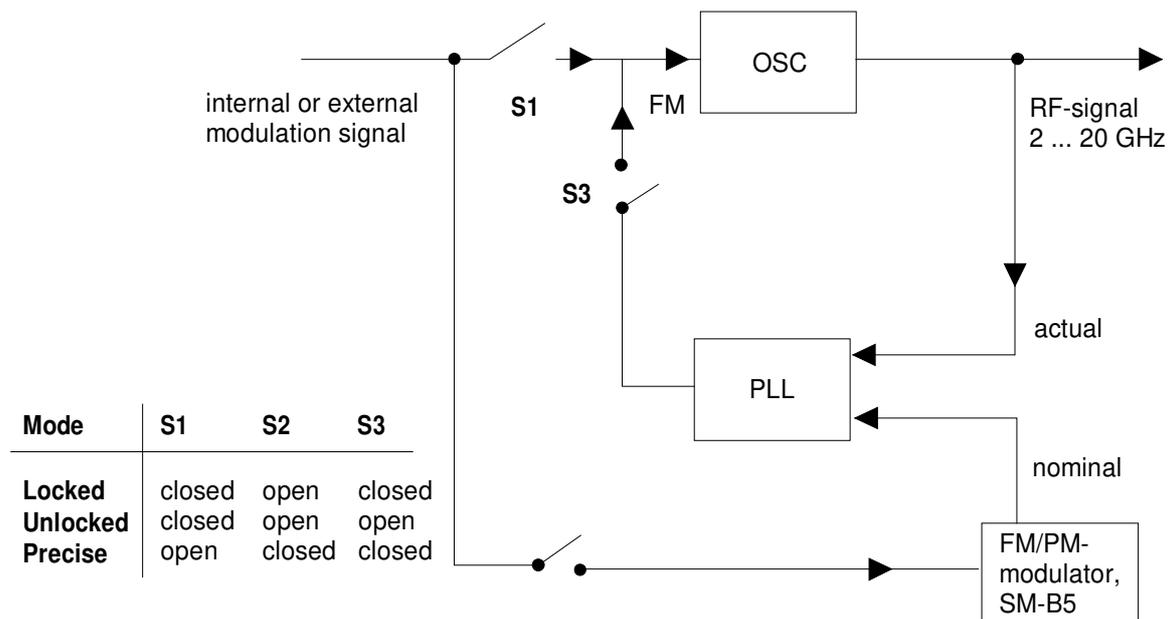

Fig. 2-28 Operating modes for frequency modulation (principle)

The MODULATION-FM menu offers access to settings for frequency modulation.

Menu selection: MODULATION-FM

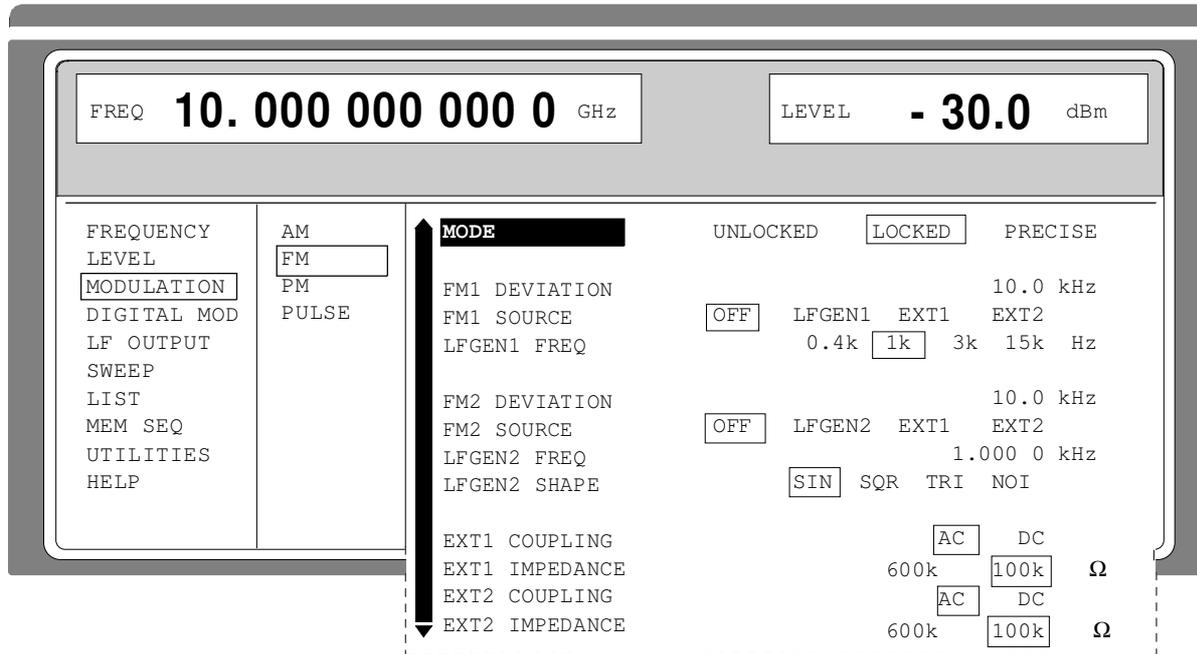

Fig. 2-29 Menu MODULATION-FM (preset setting), instrument fitted with option SM-B2, LF-generator (LFGEN2) and option SM-B5, FM/PM-modulator

- MODE** Selection of FM-mode (see Table 2-5). PRECISE is indicated only if the SMP is fitted with option SM-B5, FM/PM-modulator.  
IEC-bus short command :SOUR:FM:MODE UNL
- FM1 DEVIATION** Input value of the deviation for FM1.  
IEC-bus short command :SOUR:FM1 10kHz
- FM1 SOURCE** Switching on and off FM1 and selection of the modulation source.  
IEC-bus short commands :SOUR:FM1:SOUR INT; STAT ON
- LFGEN1 FREQ** Selection of the frequency of the 1st LF generator.  
EC-bus short command :SOUR:FM1:INT:FREQ 1kHz
- FM2 DEVIATION** Input value of the deviation for FM2.  
EC-bus short command :SOUR:FM2 10kHz
- FM2 SOURCE** Switching on and off FM2 and selection of the modulation source.  
EC-bus short command :SOUR:FM2:STAT OFF
- LFGEN2 FREQ** Input value of the LFGEN2 frequency.  
EC-bus short command :SOUR:FM2:INT:FREQ 1kHz
- LFGEN2 SHAPE** Selection of the waveform of the 2nd LF generator.  
EC-bus short command :SOUR2:FUNC SIN



- EXT1 COUPLING**      Selection of the type of coupling AC or DC for the external input EXT1.  
IEC-bus short command      : SOUR:FM1:EXT1:COUP AC
  
- EXT1 IMPEDANCE**    Selection of the input impedance for the external input EXT1.  
IEC-bus short command      : SOUR:FM1:EXT1:IMP 100kOhm
  
- EXT2 COUPLING**      Selection of the type of coupling AC or DC for the external input EXT2.  
IEC-bus short command      : SOUR:FM1:EXT2:COUP AC
  
- EXT2 IMPEDANCE**    Selection of the input impedance for the external input EXT2.  
IEC-bus short command      : SOUR:FM1:EXT2:IMP 100kOhm

### 2.6.2.4 Phase Modulation

Menu MODULATION-PM offers access to settings for phase modulation.

Menu selection:    MODULATION - PM

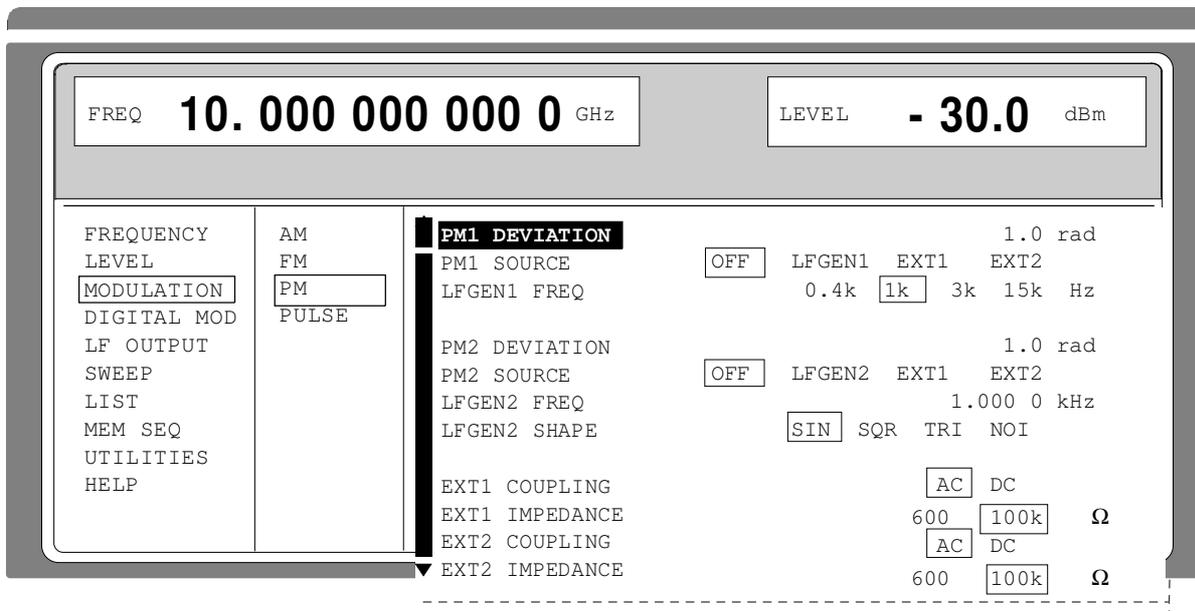

Fig. 2-30    Menu MODULATION - PM (preset setting) fitted with option SM-B2, LF-generator LFGEN2), and option SM-B5, FM/PM-modulator

- PM1 DEVIATION**      Input value of the deviation for PM1.  
IEC-bus short command      : SOUR:PM1 1RAD
  
- PM1 SOURCE**        Switching on and off PM1 and selection of the modulation source.  
IEC-bus short command      : SOUR:PM1:SOUR:INT; STAT ON
  
- LFGEN1 FREQ**        Selection of the frequency of the 1st LF generator.  
IEC-bus short command      : SOUR:PM1:INT:FREQ 1kHz
  
- PM2 DEVIATION**      Input value of the deviation for PM2.  
IEC-bus short command      : SOUR:PM2 1RAD

<b>PM2 SOURCE</b>	Switching on and off PM2 and selection of the modulation source. IEC-bus short command :SOUR:PM2:SOUR INT; STAT ON
<b>LFGEN2 FREQ</b>	Input value of the LFGEN2 frequency. IEC-bus short command :SOUR:PM2:INT:FREQ 1kHz
<b>LFGEN2 SHAPE</b>	Selection of the waveform of the 2nd LF generator. IEC-bus short command :SOUR2:FUNC SIN
<b>EXT1 COUPLING</b>	Selection of the type of coupling AC or DC with external supply for PM1 (input EXT1). IEC-bus short command :SOUR:PM:EXT1:COUP AC
<b>EXT1 IMPEDANCE</b>	Selection of input impedance for the external input EXT1. IEC-bus short command :SOUR:PM:EXT1:IMP 100kOhm
<b>EXT2 COUPLING</b>	Selection of the type of coupling AC or DC with external supply for PM2 (input EXT2). IEC-bus short command :SOUR:PM:EXT2:COUP AC
<b>EXT2 IMPEDANCE</b>	Selection of input impedance for the external input EXT2. IEC-bus short command :SOUR:PM:EXT2:IMP 100kOhm

### 2.6.2.5 Pulse Modulation

The pulse modulator can be controlled by an external source as well as by the internal pulse generator. In the case of external control, the external source directly feeds the pulse modulator. The envelope of the RF is identical to the control signal. In the case of control by the internal pulse generator, the pulse form of the pulse generator determines the envelope of the RF. Pulse delay, pulse width and period can be set.

The polarity of the pulse modulation is selectable. With POLARITY = NORM, the RF level is on with HIGH level at modulation input PULSE. With option SMP-B14, the input impedance can be switched between 50  $\Omega$  and 10 k  $\Omega$ . If no option is fitted, it is fixed to 50  $\Omega$ .

**Note:** *Option SMP-B12, pulse modulator, improves the measured data in the frequency domain beyond 2 GHz. Option SMP-B13, pulse modulator 0,01 to 2 GHz, allows pulse modulation in the frequency range between 0,01 and 2 GHz.*

#### 2.6.2.5.1 Pulse Generator

As an internal modulation source, the pulse generator (option SMP-B14) offers the possibility to set single and double pulses with variable pulse delay, pulse width and period. The pulse generator can be triggered internally or by means of an external signal at the PULSE input. The internal triggering is derived from the reference frequency and hence very stable. In trigger mode EXT, the positive or the negative edge can be used to trigger the pulse generator.

The pulse generator can also be operated as an independent function without the pulse modulator being controlled if the pulse modulation source SOURCE is switched to OFF or EXT. The pulse can be tapped at the VIDEO output.

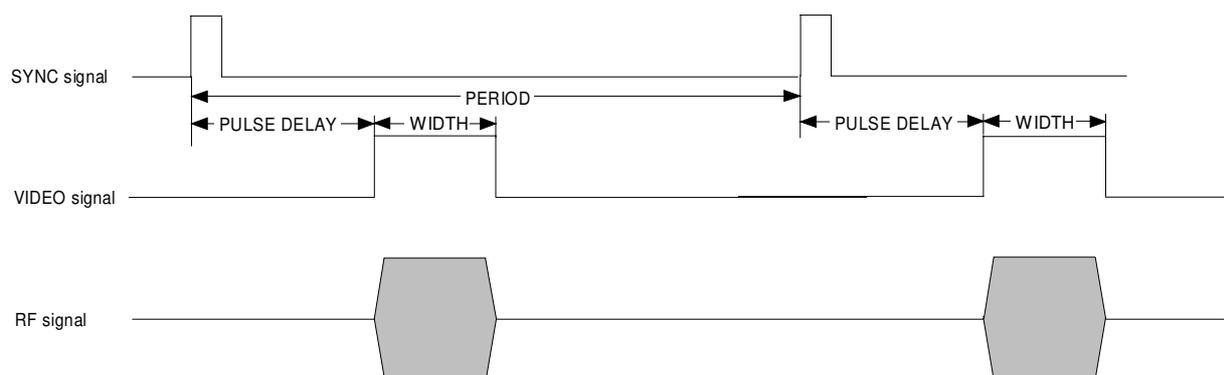

Fig. 2-31

Signal example 1: single pulse, TRIGGER MODE = AUTO

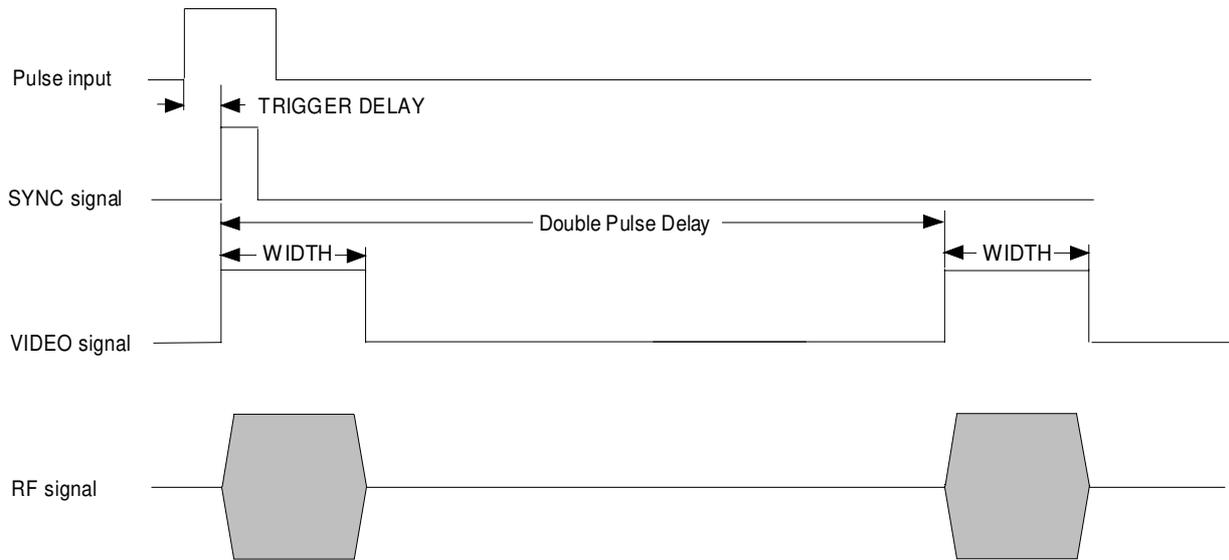

Fig. 2-32 Signal example 2: double pulse, TRIGGER MODE = EXT, SLOPE = POS

Menu MODULATION-PULSE offers access to settings for pulse modulation and to the pulse generator.

Menu selection: MODULATION - PULSE

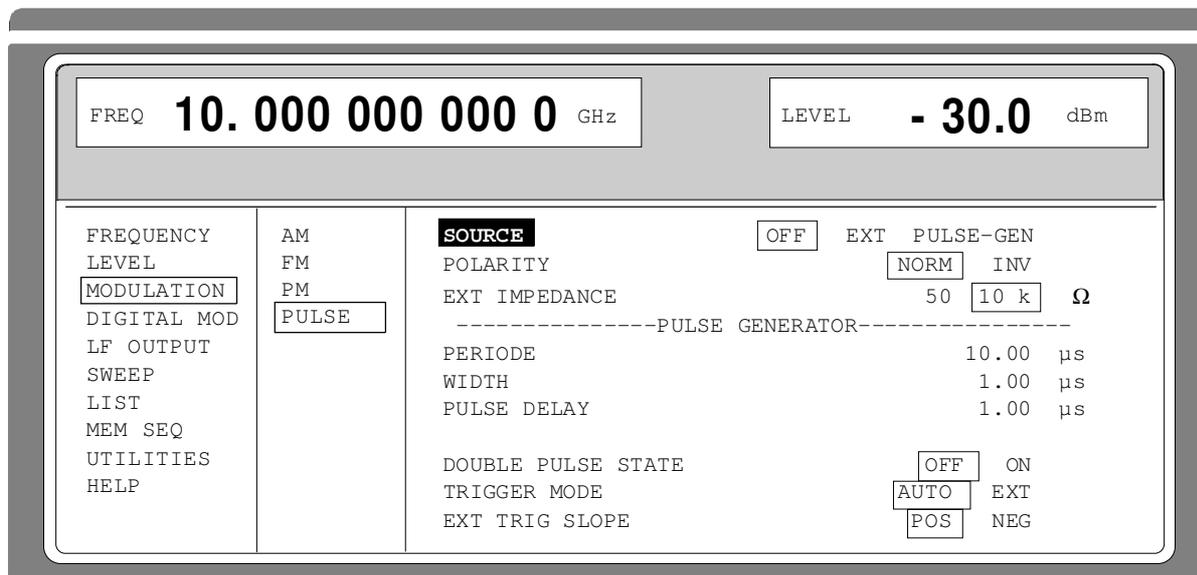

Fig. 2-33 Menu MODULATION-PULSE (preset setting), fitted with option SMP-B14, pulse generator.

<b>SOURCE</b>	Selection of the modulation source. IEC-bus short command :SOUR:PULM:SOUR INT; STAT ON
<b>POLARITY</b>	Selection of the polarity of the modulation NORM The RF signal is on during high level. INV The RF signal is suppressed during high level. IEC-bus short command :SOUR:PULM:POL NORM
<b>EXT IMPEDANCE</b>	Selection of the input resistance 50 $\Omega$ or 10 k $\Omega$ . IEC-bus short command :SOUR:PULM:EXT:IMP 50
<b>PERIOD</b>	Input value of the period. IEC-bus short command :SOUR:PULS:PER 10us
<b>WIDTH</b>	Input value of the pulse width. IEC-bus short command :SOUR:PULS:WIDT 1us
<b>PULSE DELAY</b>	Input value of the single-pulse delay. Is only displayed if DOUBLE PULSE STATE is set to be OFF. IEC-bus short command :SOUR:PULS:DEL 1us
<b>DOUBLE PULSE DELAY</b>	Input value of the double-pulse delay. IEC-bus short command :SOUR:PULS:DOUB:DEL 1us
<b>DOUBLE PULSE STATE</b>	Switching on/off the double pulses. ON Double pulse is switched on OFF Single pulse IEC-bus short command :SOUR:PULS:DOUB ON
<b>TRIGGER MODE</b>	Selection of the trigger mode. AUTO Period as entered under PERIOD. EXT Period is determined by the external signal at the PULSE input. IEC-bus short command :TRIG:PULS:SOUR AUTO
<b>EXT TRIG SLOPE</b>	Selection of the active edge of the external trigger signal. POS Pulse generator triggers on positive edge of the external signal. NEG Pulse generator triggers on negative edge of the external signal. IEC-bus short command :TRIG:PULS:SLOP POS

### 2.6.3 Digital Modulation ASK and FSK

Menu DIGITAL MOD-ASK offers access to settings for ASK modulation.

Menu selection: DIGITAL MOD-ASK

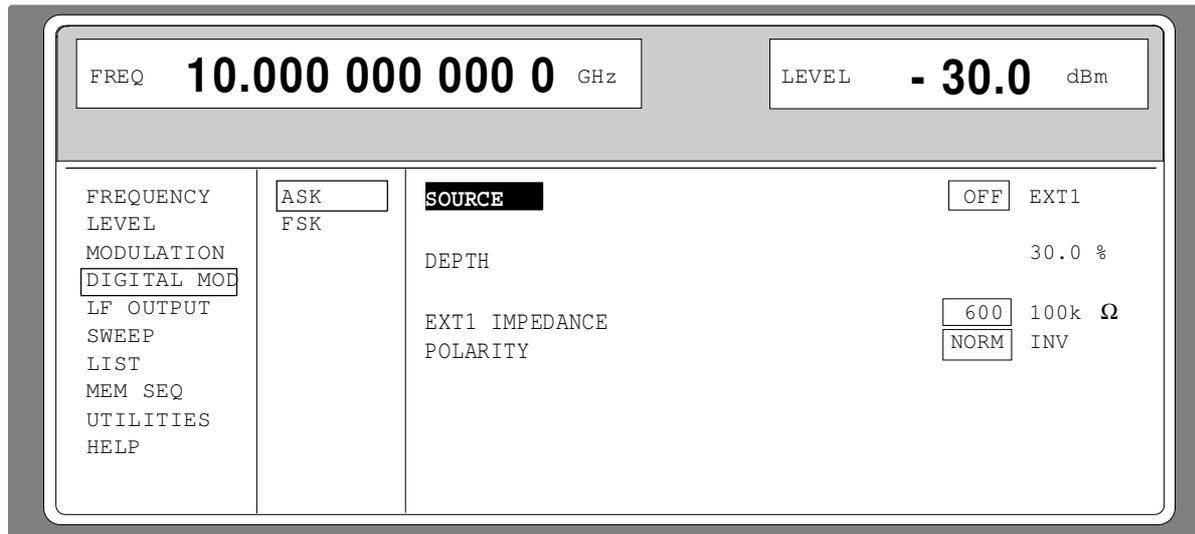

Fig. 2-34 Menu DIGITAL MOD-ASK (preset setting)

<b>SOURCE</b>	Selection of the modulation source ASK ( <u>A</u> mplitude <u>S</u> hift <u>K</u> eying). IEC-bus short command :SOUR:DM:TYPE ASK; SOUR EXT; STAT ON
<b>DEPTH</b>	Input value of the deviation for ASK. IEC-bus short command :SOUR:DM:ASK:DEPT 30PCT
<b>EXT1 IMPEDANCE</b>	Selection of the input impedance of external input EXT1. IEC-bus short command :SOUR:DM:EXT:IMP 100kOHM
<b>POLARITY</b>	Selection of polarity of modulation IEC-bus short command :SOUR:DM:ASK:POL NORM

Menu DIGITAL MOD-FSK offers access to settings for FSK modulation.

Menu selection: DIGITAL MOD-FSK

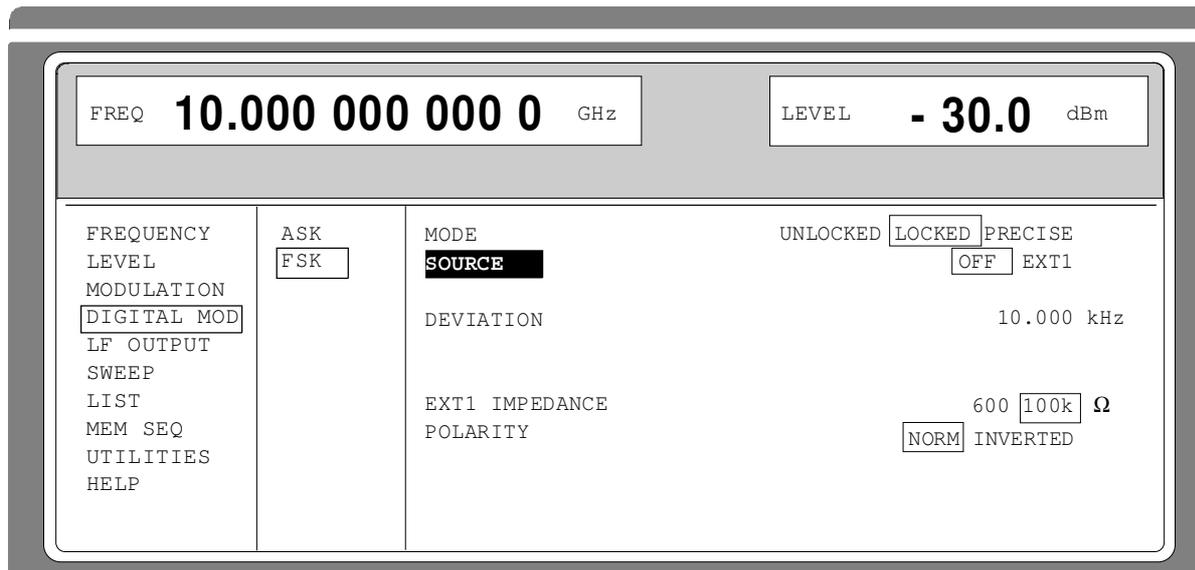

Fig. 2-35 Menu DIGITAL MOD - FSK (preset setting), fitted with option SM-B5, FM $\phi$ M modulator

<b>MODE</b>	Selection of the operating mode of the frequency modulation (cf. Section " Frequency Modulation"). IEC-bus short command : SOUR:DM:FSK:MODE LOCK
<b>SOURCE</b>	Selection of the modulation source FSK (Frequency Shift Keying). IEC-bus short command : SOUR:DM:TYPE FSK; SOUR EXT; STAT ON
<b>DEVIATION</b>	Input value of the deviation for FSK IEC-bus short command : SOUR:DM:FSK:DEV 10kHz
<b>EXT1 IMPEDANCE</b>	Selection of the input impedance of external input EXT1. IEC-bus short command : SOUR:DM:EXT:IMP 100kOhm
<b>POLARITY</b>	Selection of polarity of modulation IEC-bus short command : SOUR:DM:FSK:POL NORM

## 2.7 LF-Output

Depending on which options are fitted (cf. table 2-4), internal LF generator 1 and/or 2 are available as a signal source for the LF output.

Menu LF OUTPUT offers access to the settings of the LF output.

- Notes:**
- An alteration of the waveform or frequency of the internal modulation generators in the LF-output menu has a parallel effect on the modulation for which the respective generator is selected as modulation source.
  - The SWEEP function of LF generator 2 can be activated in menu SWEEP-LF-GEN2.
  - Key [G/n] dB $\mu$  switches the unit of the display / LF level output voltage setting to dBu.

Menu selection: LF OUTPUT

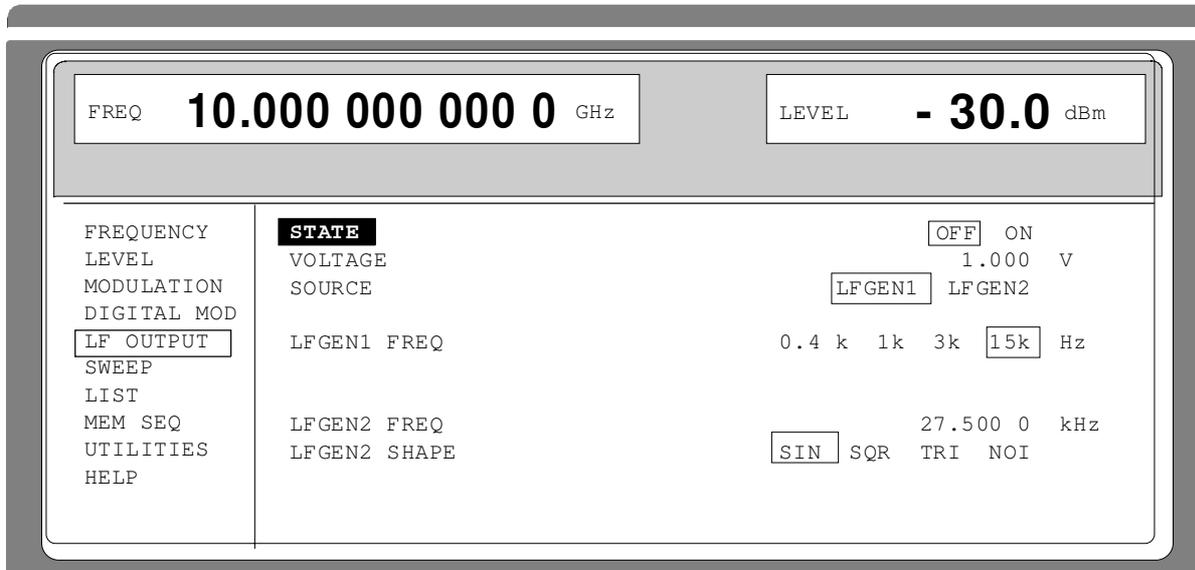

Fig. 2-36 Menu LF OUTPUT (preset setting), fitted with option SM-B6, multifunction generator

**STATE** Switching on/off the LF output. Parameter LF STATE has no influence on the modulation settings.

IEC bus short command :OUTP2 ON

**VOLTAGE** Input value of the output voltage of the LF output. The input is effected in the form of a peak voltage. If no LF generator option is fitted, the constant output voltage of the standard generator ( $V_S = 1\text{ V}$ ) is indicated.

IEC Bus short command :OUTP2:VOLT 1V

**LF SOURCE** Selection of the signal source for the LF output.

IEC bus short command :OUTP2:SOUR 0 (Selection of LF generator 1)

:OUTP2:SOUR 2 (Selection of LF generator 2)



---

<b>LFGEN1 FREQ</b>	Input value of the frequency of internal modulation generator 1. IEC bus short command :SOUR0:FREQ 15kHz
<b>LFGEN1 SHAPE</b>	Input value of the signal shape for modulation generator 1. The signal shape of modulation generator 1 can only be set if two modulation generator options are fitted. IEC bus short command :SOUR0:FUNC SIN
<b>LFGEN2 FREQ</b>	Input value of the frequency of internal modulation generator 2. This parameter is only displayed if a modulation generator option is fitted. IEC bus short command :SOUR2:FREQ 27.5kHz
<b>LFGEN2 SHAPE</b>	Input value of the signal shape of modulation generator 2. This parameter is only displayed if a modulation generator option is fitted. IEC bus short command :SOUR2:FUNC SIN

## 2.8 Sweep

The SMP offers a digital step-by-step sweep for parameters:

- RF frequency
- LF frequency
- RF level

In addition to the digital step-by-step sweep, an analog sweep for RF frequency and RF level is possible by switching on frequency or amplitude modulation with an internal saw tooth.

Setting a sweep is effected in five basic steps which are shown in the following example, the setting of a frequency sweep:

1. Set sweep range (START and STOP or CENTER and SPAN).
2. Select linear or logarithmic sequence (SPACING).
3. Set step width (STEP) and dwell time (DWELL).
4. Activate marker if desired (MARKER).
5. Switch on sweep (MODE set to AUTO, SINGLE or STEP).

### 2.8.1 Setting the Sweep Range (START, STOP, CENTER and SPAN)

The sweep range of the RF sweep can be entered in two different ways. Either by entering the START and STOP value or by entering CENTER and SPAN. Please observe that the two parameter sets influence one another. The influence is exerted in the following way:

- START frequency altered:
 

STOP	=	unaltered
CENTER	=	$(START + STOP)/2$
SPAN	=	$(STOP - START)$
- STOP frequency altered:
 

START	=	unaltered
CENTER	=	$(START + STOP)/2$
SPAN	=	$(STOP - START)$
- CENTER frequency altered
 

SPAN	=	unaltered
START	=	$(CENTER - SPAN/2)$
STOP	=	$(CENTER + SPAN/2)$
- SPAN frequency altered:
 

CENTER	=	unaltered
START	=	$(CENTER - SPAN/2)$
STOP	=	$(CENTER + SPAN/2)$

## 2.8.2 Selecting the Sweep Run (SPACING LIN, LOG)

The sweep run, linear or logarithmic, can be selected using SPACING. For the RF and LF sweep, a linear or logarithmic run is possible. For level sweep, only the logarithmic run is possible.

With the logarithmic sweep, step width STEP is equal to a constant fraction of the present setting. The logarithmic step width is entered in unit % with RF or LF sweep, in unit dB with level sweep.

## 2.8.3 Operating Modes (MODE)

The following sweep operating modes are available:

**AUTO** Sweep from the starting point to the stop point, with automatic restart at the starting point. If another sweep operating mode was activated prior to the AUTO operating mode, continuation is made from the current sweep setting (cf. Fig. 2-37).

IEC bus short commands:

RF sweep:

LF sweep:

Level sweep:

```
SOUR:FREQ:MODE SWE SOUR2:FREQ:MODE SWE SOUR:POW:MODE SWE
SOUR:SWE:MODE AUTO SOUR2:SWE:MODE AUTO SOUR:SWE:POW:MODE AUTO
TRIG:SOUR AUTO TRIG2:SOUR AUTO TRIG:SOUR AUTO
```

### SINGLE

Single run from the starting point to the stop point. If SINGLE is selected, the run is not started yet. Function EXECUTE SINGLE SWEEP ► to be executed, which can be used to start the run, is displayed below the MODE line (cf. Fig. 2-38).

IEC bus short commands:

RF sweep:

LF sweep:

Level sweep:

```
SOUR:FREQ:MODE SWE SOUR2:FREQ:MODE SWE SOUR:POW:MODE SWE
SOUR:SWE:MODE AUTO SOUR2:SWE:MODE AUTO SOUR:SWE:POW:MODE AUTO
TRIG:SOUR SING TRIG2:SOUR SING TRIG:SOUR SING
```

### STEP

Step-by-step, manual run within the sweep limits. Activating STEP stops a running sweep and the cursor wraps to the indication value of CURRENT. The sweep run can now be controlled upwards or downwards in discrete steps using the rotary knob or the numeric keys.

IEC bus short commands:

RF sweep:

LF sweep:

Level sweep:

```
SOUR:FREQ:MODE SWE SOUR2:FREQ:MODE SWE SOUR:POW:MODE SWE
SOUR:SWE:MODE STEP SOUR2:SWE:MODE STEP SOUR:SWE:POW:MODE STEP
TRIG:SOUR SING TRIG2:SOUR SING TRIG:SOUR SING
```

### EXT-SINGLE

Single run from the starting point to the stop point as in the case of SINGLE, but triggered by an external trigger signal.

IEC-bus short commands:

RF sweep:

LF sweep:

Level sweep:

```
SOUR:FREQ:MODE SWE SOUR2:FREQ:MODE SWE SOUR:POW:MODE SWE
SOUR:SWE:MODE AUTO SOUR2:SWE:MODE AUTO SOUR:SWE:POW:MODE AUTO
TRIG:SOUR EXT TRIG2:SOUR EXT TRIG:SOUR EXT
```

<b>EXT-STEP</b>	<p>Step-by-step run by means of the external trigger signal. Each trigger event triggers a single step.</p> <p>IEC-bus short commands:</p> <table border="0"> <tr> <td>RF sweep:</td> <td>LF sweep:</td> <td>Level sweep:</td> </tr> <tr> <td>SOUR:FREQ:MODE SWE</td> <td>SOUR2:FREQ:MODE SWE</td> <td>SOUR:POW:MODE SWE</td> </tr> <tr> <td>SOUR:SWE:MODE STEP</td> <td>SOUR2:SWE:MODE STEP</td> <td>SOUR:SWE:POW:MODE STEP</td> </tr> <tr> <td>TRIG:SOUR EXT</td> <td>TRIG2:SOUR EXT</td> <td>TRIG:SOUR EXT</td> </tr> </table>	RF sweep:	LF sweep:	Level sweep:	SOUR:FREQ:MODE SWE	SOUR2:FREQ:MODE SWE	SOUR:POW:MODE SWE	SOUR:SWE:MODE STEP	SOUR2:SWE:MODE STEP	SOUR:SWE:POW:MODE STEP	TRIG:SOUR EXT	TRIG2:SOUR EXT	TRIG:SOUR EXT
RF sweep:	LF sweep:	Level sweep:											
SOUR:FREQ:MODE SWE	SOUR2:FREQ:MODE SWE	SOUR:POW:MODE SWE											
SOUR:SWE:MODE STEP	SOUR2:SWE:MODE STEP	SOUR:SWE:POW:MODE STEP											
TRIG:SOUR EXT	TRIG2:SOUR EXT	TRIG:SOUR EXT											
<b>OFF</b>	<p>The sweep operating mode is switched off.</p> <p>IEC-bus short commands:</p> <table border="0"> <tr> <td>RF sweep:</td> <td>LF sweep:</td> <td>Level sweep:</td> </tr> <tr> <td>SOUR:FREQ:MODE CW</td> <td>SOUR2:FREQ:MODE CW</td> <td>SOUR:POW:MODE CW</td> </tr> </table>	RF sweep:	LF sweep:	Level sweep:	SOUR:FREQ:MODE CW	SOUR2:FREQ:MODE CW	SOUR:POW:MODE CW						
RF sweep:	LF sweep:	Level sweep:											
SOUR:FREQ:MODE CW	SOUR2:FREQ:MODE CW	SOUR:POW:MODE CW											

## 2.8.4 Trigger Inputs

<b>TRIGGER</b>	An external signal at the rear input triggers the sweep in the EXT-SINGLE and EXT-STEP operating modes. The polarity of the active trigger edge can be set in menu UTILITIES - AUX I/O EXT TRIG SLOPE.
<b>STOP</b>	An external signal at the rear input stops the sweep in all operating modes. The polarity of the signal can be set in the UTILITIES-AUX I/O-STOP POLARITY menu.

## 2.8.5 Sweep Outputs

Outputs X-AXIS, V/GHz, BLANK and MARKER are available at the rear of the instrument to control and trigger oscilloscopes or XY recorders.

<b>X-AXIS</b>	With sweep switched on, this output supplies a voltage ramp of 0 to 10 V for the X-deflection of an oscilloscope or an XY recorder.
<b>V/GHZ</b>	(for equipment with option SMP-B18). This output supplies a voltage proportional to the current frequency. The slope, either 0.5 V/GHz or 1 V/GHz, corresponds to a range from 5 mV to 10 V and 10 mV to 20 V for 10 MHz to 20 GHz. A slope of 5 V/GHz is available above 20 GHz (SMP03/04). The slope can be set under UTILITIES AUX I/O V/GHz. The voltage is always available even with sweep switched off.
<b>BLANK</b>	This output supplies a signal (0V/5V) to trigger and blank an oscilloscope or for the PEN LIFT control of an XY recorder. The polarity and the period of the signal can be set under UTILITIES - AUX I/O - BLANK POLARITY and - BLANK TIME.
<b>MARKER</b>	This output becomes active when the sweep run has reached the mark. The MARKER signal can be used for the brightness control of an oscilloscope. Up to three marks can be set in order to mark certain positions in the sweep run. The polarity of the signal can be set in menu UTILITIES - AUX I/O - MARKER POLARITY. The period of the active signal is equal to the dwell time (DWELL) of a step.

## Signal examples

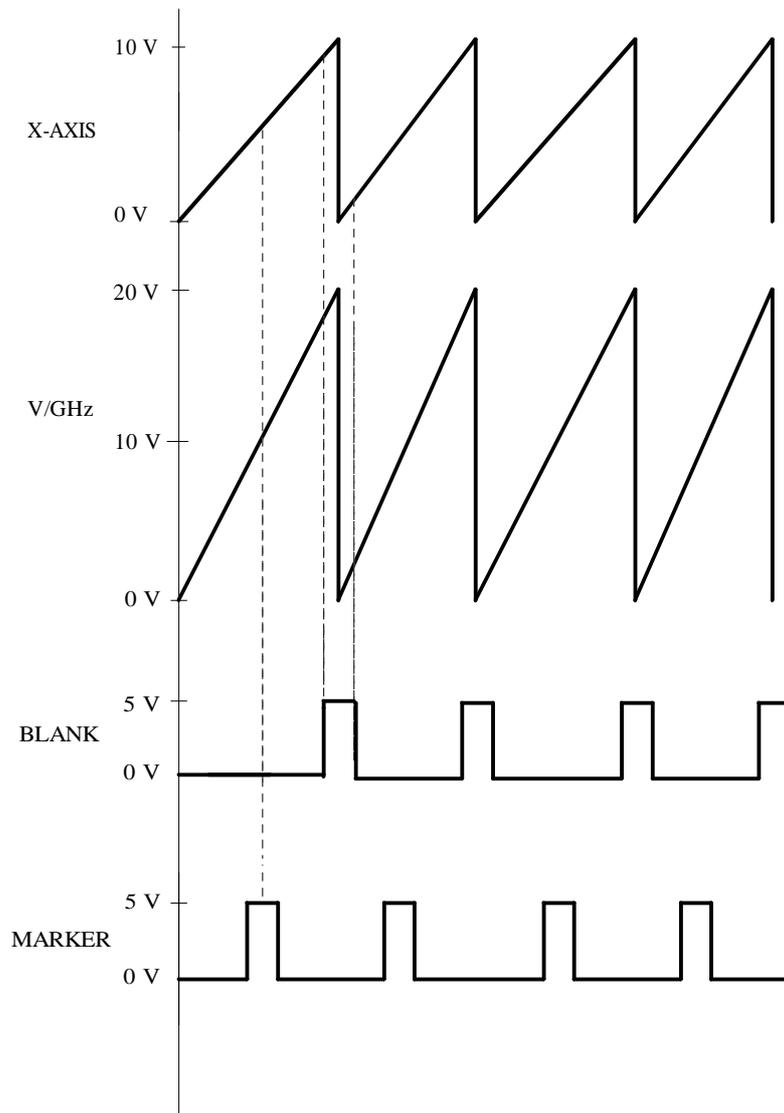

Fig. 2-37 Signal example sweep 0 to 20 GHz: MODE = AUTO, V/GHz = 1V/GHz, BLANK TIME = NORMAL

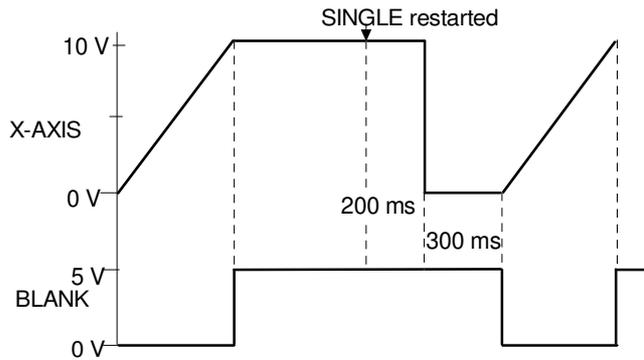

Fig. 2-38 Signal example sweep: MODE = SINGLE, BLANK TIME = LONG

### 2.8.6 RF-Sweep

Menu SWEEP - FREQ offers access to settings for RF sweep.

Menu selection: SWEEP - FREQ

The screenshot shows the 'SWEEP - FREQ' menu. At the top, 'START FREQ' is 10.000 000 000 0 GHz and 'STOP FREQ' is 20.000 000 000 0 GHz. The 'LEVEL' is -30.0 dBm. The main menu items are:

- FREQUENCY: FREQ
- LEVEL: LEVEL
- MODULATION: LFGEN
- DIGITAL MOD
- LF OUTPUT
- SWEEP
- LIST
- MEM SEQ
- UTILITIES
- HELP

The 'RF-SWP' section shows the following settings:

- START FREQ: 10.000 000 000 0 GHz
- STOP FREQ: 20.000 000 000 0 GHz
- CENTER FREQ: 15.000 000 000 0 GHz
- SPAN: 10.000 000 000 0 GHz
- CURRENT FREQ: 10.000 000 000 0 GHz
- SPACING: LIN LOG
- STEP LIN: 1.000 000 0 MHz
- DWELL: 15.0 ms
- MODE: OFF AUTO SINGLE STEP EXT-SINGLE EXT-STEP
- EXECUTE SINGLE SWEEP
- RESET SWEEP
- MARKER 1 FREQ: 10.000 000 0 GHz
- MARKER 1 STATE: OFF ON
- AMPLITUDE MARKER 1: OFF ON
- MARKER 2 FREQ: 15.000 000 0 GHz
- MARKER 2 STATE: OFF ON
- AMPLITUDE MARKER 2: OFF ON
- MARKER 3 FREQ: 20.000 000 0 GHz
- MARKER 3 STATE: OFF ON
- AMPLITUDE MARKER 3: OFF ON

Fig. 2-39 Menu SWEEP - FREQ

<b>START FREQ</b>	Input value of the starting frequency. IEC bus short command : SOUR:FREQ:STAR 10GHz
<b>STOP FREQ</b>	Input value of the stop frequency. IEC bus short command : SOUR:FREQ:STOP 20GHz
<b>CENTER FREQ</b>	Input value of the center frequency. IEC bus short command : SOUR:FREQ:CENT 15GHz
<b>SPAN</b>	Input value of the span. IEC bus short command : SOUR:FREQ:SPAN 10GHz
<b>CURRENT FREQ</b>	Indication of the current frequency value. Operating mode STEP: Input value of the frequency.
<b>SPACING</b>	Input value of the dwell time per step. IEC bus short command : SOUR:SWE:SPAC LIN
<b>STEP LIN (LOG)</b>	Input value of the step width. Depending on whether SPACING LIN or LOG is selected, STEP LIN or STEP LOG is displayed. IEC bus short command : SOUR:SWE:STEP:LIN 1MHz
<b>DWELL</b>	Input value of the dwell time per step. IEC bus short command : SOUR:SWE:DWEL 15ms
<b>MODE</b>	Selection of the sweep operating mode. IEC bus short commands : SOUR:FREQ:MODE SWE; : SOUR:SWE:MODE AUTO; : TRIG:SOUR SING
<b>EXECUTE SINGLE SWEEP ►</b>	Starts a single sweep run. This action to be executed is only indicated and is only effective if MODE SINGLE has been selected. IEC bus short command : TRIG
<b>RESET SWEEP ►</b>	Sets the starting frequency. IEC bus short command : ABOR
<b>MARKER 1 FREQ MARKER 2 FREQ MARKER 3 FREQ</b>	Input value of the frequency for the marker selected IEC bus short command : SOUR:MARK1:FREQ 10GMHz
<b>MARKER 1 STATE MARKER 2 STATE MARKER 3 STATE</b>	Switching on/off the marker selected IEC bus short command : SOUR:MARK1 OFF
<b>AMPLITUDE MARKER1 AMPLITUDE MARKER 2 AMPLITUDE MARKER 3</b>	Switching on/off the amplitude marker selected OFF Input value of the frequency for the marker selected ON Amplitude marker is switched on. On reaching the mark the output level is reduced by 1 dB. IEC bus short command : SOUR:MARK1:AMPL OFF

## 2.8.7 LEVEL Sweep

Menu SWEEP - LEVEL offers access to settings for LEVEL sweep.

Menu selection: SWEEP - LEVEL

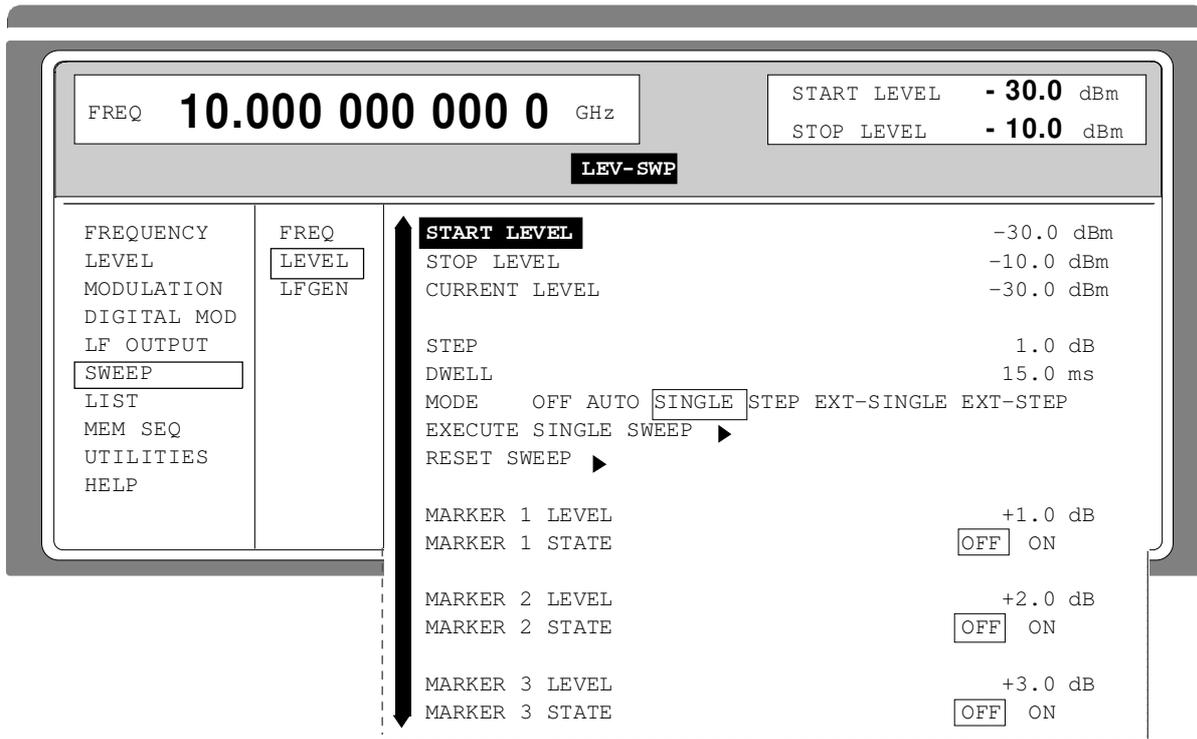

Fig. 2-40 Menu SWEEP - LEVEL

<b>START LEVEL</b>	Input value of the starting level. IEC bus short command : SOUR:POW:STAR -30dBm
<b>STOP LEVEL</b>	Input value of the stop level. IEC bus short command : SOUR:POW:STOP -10dBm
<b>CURRENT LEVEL</b>	Indication of the current level. Operating mode STEP: Input value of the level.
<b>STEP</b>	Input value of the step width. IEC bus short command : SOUR:SWE:POW:STEP 1dB
<b>DWELL</b>	Input value of the dwell time per step IEC bus short command : SOUR:SWE:POW:DWEL 15ms
<b>MODE</b>	Selection of the sweep operating mode. IEC bus short command : SOUR:POW:MODE SWE; : SOUR:SWE:POW:MODE AUTO; :TRIG:SOUR SING



- EXECUTE SINGLE SWEEP ▶** Starts a single sweep run. This action to be executed is only indicated and is only effective if MODE SINGLE is selected.  
IEC bus short command :TRIG
  
- RESET SWEEP ▶** Sets the starting level.  
IEC bus short command :ABOR
  
- MARKER 1 LEVEL**  
**MARKER 2 LEVEL**  
**MARKER 3 LEVEL** Input value of the level for the marker selected.  
IEC bus short command :SOUR:MARK1:PSW:POW 1dBm
  
- MARKER 1 STATE**  
**MARKER 2 STATE**  
**MARKER 3 STATE** Switching on/off the marker selected.  
IEC bus short command :SOUR:MARK1:PSW OFF

### 2.8.8 LF-Sweep

Menu SWEEP - LF GEN offers access to settings for LF sweep.

**Note:** Settings LF SWEEP and SOURCE LFGEN2 SHAPE NOI deactivate one another.

Menu selection: SWEEP - LF GEN2

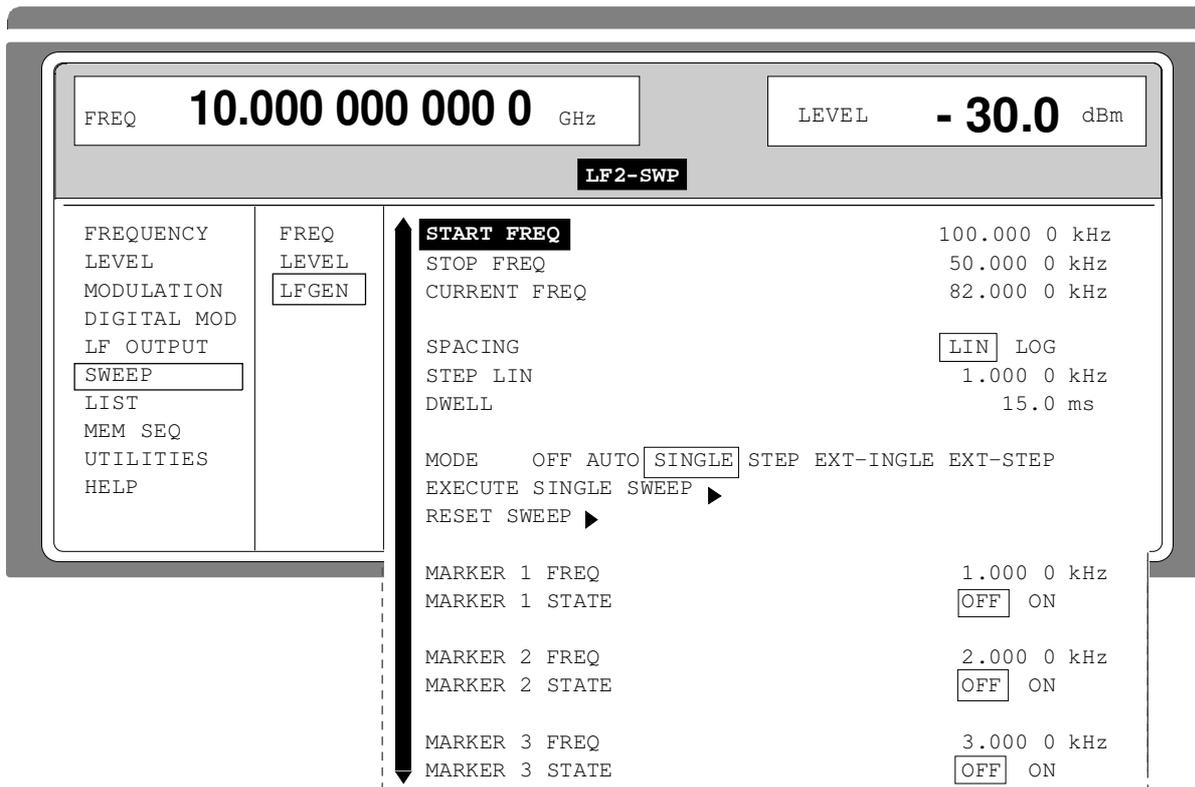

Fig. 2-41 Menu SWEEP - LF GEN

<b>START FREQ</b>	Input value of the starting frequency. IEC bus short command :SOUR2:FREQ:STAR 100kHz
<b>STOP FREQ</b>	Input value of the stop frequency. IEC bus short command :SOUR2:FREQ:STOP 50kHz
<b>CURRENT FREQ</b>	Indication of the current frequency value. Operating mode STEP: Input value of the frequency.
<b>STEP</b>	Input value of the step width. IEC bus short command :SOUR2:SWE:STEP:LIN 1kHz
<b>DWELL</b>	Input value of the dwell time per step. IEC bus short command :SOUR2:SWE:DWEL 15ms
<b>SPACING</b>	Selection of the sweep run, linear or logarithmic. IEC bus short command :SOUR2:SWE:SPAC LIN
<b>MODE</b>	Selection of the sweep operating mode. IEC bus short command :SOUR2:FREQ:MODE SWE :SOUR2:SWE:MODE AUTO :TRIG2:SOUR SING
<b>EXECUTE SINGLE SWEEP ►</b>	Starts a single sweep run. This action to be executed is only indicated and is only effective if MODE SINGLE is selected. IEC bus short command :TRIG
<b>RESET SWEEP ►</b>	Sets the starting frequency. IEC bus short command :ABOR
<b>MARKER 1 FREQ MARKER 2 FREQ MARKER 3 FREQ</b>	Input value of the frequency for the marker selected. IEC bus short command :SOUR2:MARK1:FREQ 100kHz
<b>MARKER 1 STATE MARKER 2 STATE MARKER 3 STATE</b>	Switching on/off the marker selected. IEC bus short command :SOUR2:MARK1 OFF

## 2.9 LIST Mode

A sequence of predefined frequency and level points is executed in the LIST mode, similar as in a sweep. Differently from the sweep, however, a list with freely selectable pairs of values (frequency and level) can be generated. The specified range of the frequency comprises the entire adjustable frequency range of the instrument. The specified range of the level covers a 20-dB range. If the permissible variation range is exceeded, the level error increases.

**Caution:** After the generation or change of a list in the LIST mode, function LEARN has to be started to ensure that the new settings are transferred to the hardware.

Table 2-6 LIST mode; Example of a list

Index	Frequency	Level
0001	2 GHz	0 dBm
0002	10 GHz	13 dBm
0003	15 GHz	7 dBm
0100	3 GHz	5 dBm
:	:	:

Up to 10 lists can be created. The total amount of possible pairs of values including all lists may maximally be 2000. I.e., a list may have 2000 entries at the most, or less if several lists have been created.

Each list is identified by a separate name and selected via this name. A detailed description how to process the lists can be found in Section "List Editor".

### 2.9.1 Operating Modes (MODE)

The following LIST-operating modes are available:

**AUTO** Run from the beginning to the end of the list with automatic restart at the beginning. If another mode was activated prior to the AUTO operating mode, continuation is made from the current index.

IEC bus short commands: :SOUR:FREQ:MODE LIST  
:SOUR:LIST:MODE AUTO  
:TRIG:LIST:SOUR AUTO

**SINGLE** Single run from the beginning to the end of the list. If SINGLE is selected, the run is not yet started. Function EXECUTE SINGLE LIST ► to be executed, which can be used to start the run, is displayed below the MODE line.

IEC bus short commands: :SOUR:FREQ:MODE LIST  
:SOUR:LIST:MODE AUTO  
:TRIG:LIST:SOUR SING

<b>STEP</b>	<p>Step-by-step manual processing of the list. Activating STEP stops a list running and the cursor wraps to the indication value of CURRENT INDEX. The list can now be controlled upwards or downwards in discrete steps using the rotary knob or the numeric keys.</p> <p>IEC bus short commands:   : SOUR:FREQ:MODE LIST                                          : SOUR:LIST:MODE STEP                                          : TRIG:LIST:SOUR SING</p>
<b>EXT-SINGLE</b>	<p>Single run from the beginning to the end of the list as with SINGLE, but triggered by an external trigger signal.</p> <p>IEC bus short commands:   : SOUR:FREQ:MODE LIST;                                          : SOUR:LIST:MODE AUTO                                          : TRIG:LIST:SOUR EXT</p>
<b>EXT-STEP</b>	<p>Step-by-step run by means of the external trigger signal. Each trigger event triggers a single step.</p> <p>IEC bus short commands:   : SOUR:FREQ:MODE LIST                                          : SOUR:LIST:MODE STEP                                          : TRIG:LIST:SOUR EXT</p>
<b>OFF</b>	<p>Operating mode LIST is switched off.</p> <p>IEC bus short command:   : SOUR:FREQ:MODE CW</p>

## 2.9.2 Inputs/Outputs

TRIGGER input and BLANK output are available at the rear of the instrument for synchronization with other instruments.

<b>TRIGGER</b>	<p>An external signal at this input triggers the LIST mode in operating modes EXT-SINGLE and EXT-STEP. The polarity of the active trigger edge can be set in the UTILITIES - AUX I/O - EXT TRIG SLOPE menu.</p>
<b>BLANK</b>	<p>This output supplies a signal (0 V/5 V) to blank the settling process by means of pulse modulation or AM. The signal can also be used to synchronize other instruments. The polarity of the signal can be set in the UTILITIES - AUX I/O - BLANK POLARITY menu.</p>
<b>MARKER</b>	<p>At the first step of the LIST mode, this output provides an approx. 200 <math>\mu</math>s trigger signal immediately after blanking. At small DWELL times, this signal can be used for an accurate synchronization to trigger other devices and shows the first stable output frequency. The delay to the fed-in signal at the TRIGGER input for EXT-SINGLE or EXT-STEP is 1.5 to 2 ms and has a jitter of 0.5 ms.</p>

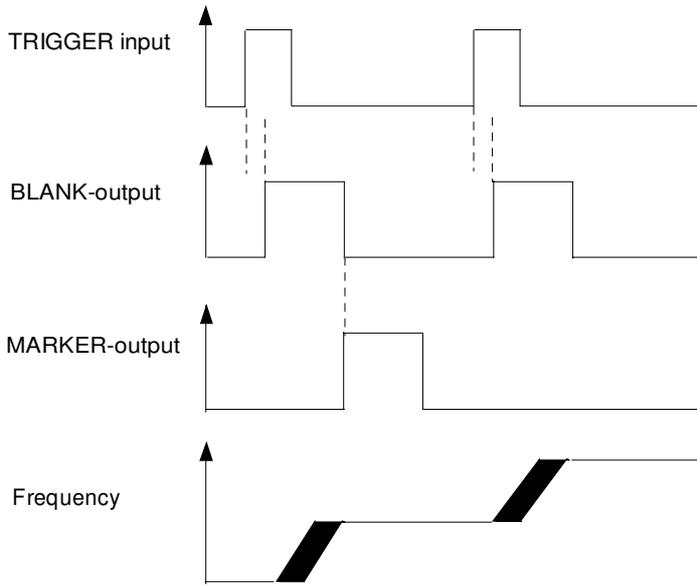

Fig. 2-42 Signal example LIST mode: MODE = EXT-STEP

The LIST menu offers access to settings for the LIST mode.

Menu selection: LIST

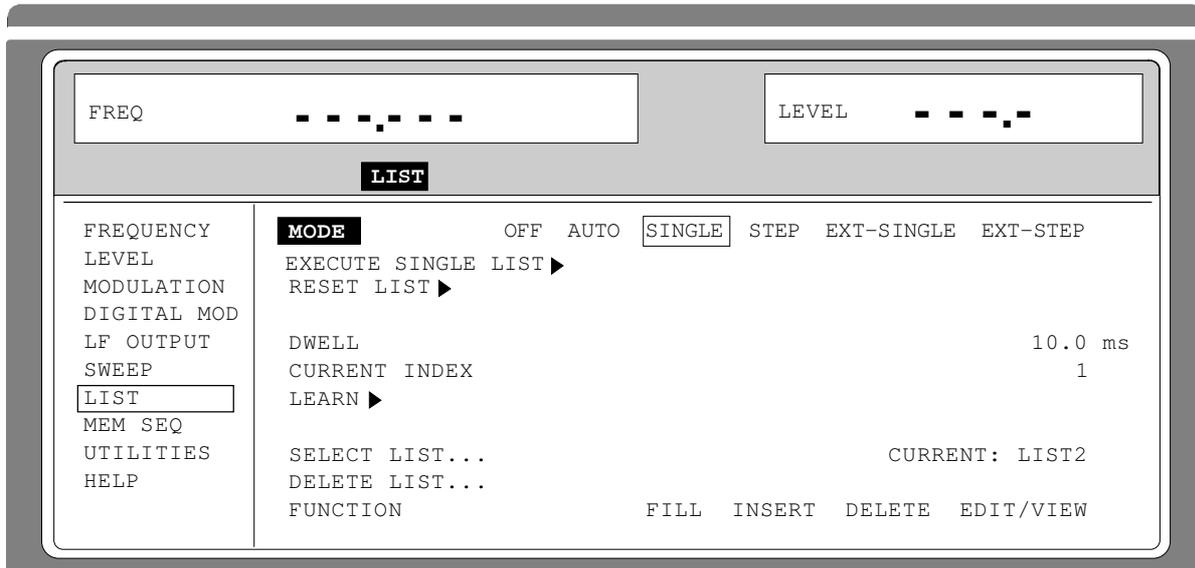

Fig. 2-43 Menu LIST - OPERATION page

**MODE** Selection of the operating mode (cf. Section "operatin").  
 IEC bus short commands : :SOUR:FREQ:MODE LIST;  
 :SOUR:LIST:MODE AUTO;  
 :TRIG:LIST:SOUR SING

**EXECUTE SINGLE LIST ►** Starts a single run of a list. This menu option is only visible if MODE SINGLE is selected.  
 IEC bus short command : :TRIG:LIST

---

<b>RESET LIST ►</b>	Sets the starting point. IEC-bus short command :ABOR:LIST
<b>DWELL</b>	Input value of the dwell time per step. IEC-bus short command :SOUR:LIST:DWEL 10ms
<b>CURRENT INDEX</b>	Indication of the current list index. Setting value of the current list index in the STEP operating mode.
<b>LEARN ►</b>	Starts the LEARN function. All value pairs of the active list are subsequently set by the instrument with the current additional parameters, and the hardware setting data are stored.  <b>Caution:</b> <i>This function must be called after every creating and altering the list (or the remaining setting data).</i> IEC-bus short command :SOUR:LIST:LEAR
<b>SELECT LIST...</b>	Selection of a list or creation of a new list (cf. Section "List Editor"). IEC-bus short command :SOUR:LIST:SEL "LIST2"
<b>DELETE LIST...</b>	Deletion of a list (cf. "List Editor"). IEC-bus short command :SOUR:LIST:DEL "LIST1"
<b>FUNCTION</b>	Selection of the editor functions to process a list (cf. Section "List Editor"). IEC-bus short command :SOUR:LIST:FREQ 100MHz, 1.2GHz; POW 0dBm, 6dBm

The second page of the LIST menu, the EDIT page is automatically activated if one of the editor functions of line FUNCTION is selected. The list which is displayed as CURRENT LIST in the SELECT LIST line is shown.

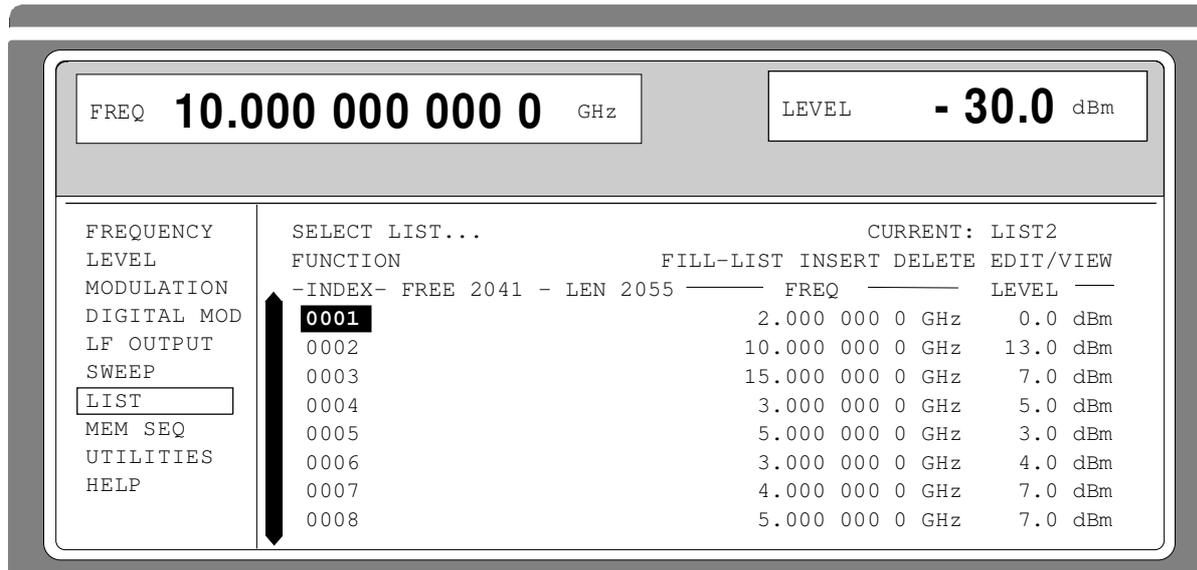

Fig. 2-44 Menu List - EDIT page

- INDEX**            Index of the list.
- FREE**            Indication of the list entries still vacant.
- LENGTH**        Length of the current list.
- FREQ**            Parameter: Frequency.
- LEVEL**          Parameter: Level; specified range 20 dB.

## 2.10 Memory Sequence

In the memory-sequence operating mode the instrument automatically services a list with stored instrument settings. Memory locations 1 to 50, which are loaded using SAVE and whose stored settings are called either separately using RECALL or automatically and subsequently in the SEQUENCE mode, are available.

The list is continuously serviced from the beginning to the end with a continual index. The order of the memories to be passed through is arbitrary. Each setting can be assigned a freely selectable dwell time. The dwell time determines the duration of the setting, its minimal value is 50 ms, its maximal value 60 sec.

The list is divided up into 3 columns for list index, memory location number (Memory) and dwell time (Dwell).. The beginning of the list has index 1.

Table 2-7 MEMORY SEQUENCE; Example of a list

Index	Memory	Dwell
001	09	50.0 ms
002	02	50.0 ms
003	01	75.0 ms
004	10	75.0 ms
...	...	...

Up to 10 sequence lists can be created. The total number of possible list elements is maximally 256. I.e., a list can have 256 entries at the most, or less if several lists have been created.

Each list is identified by a separate name and selected via this name. A detailed description how to process the lists can be found in Section "List Editor".

**Note:** *Frequently changing the level in the operating mode MEMORY SEQUENCE can stress the mechanically switched attenuator. The attenuator is also actuated when AM is switched on or off. For this reason we recommend that you make use of the non-interrupting level setting as much as possible and that you use the setting AM 0% instead of switching AM off.*

### Operating Modes (MODE)

The following operating modes are available:

#### AUTO

Run from the beginning to the end of the list with automatic restart at the beginning. If another mode was activated prior to the AUTO operating mode, continuation is made from the current index.

IEC-bus short command: `:SYST:MODE MSEQ;`  
`:SYST:MSEQ:MODE AUTO`  
`:TRIG:MSEQ:SOUR AUTO`



- SINGLE** Single run from the beginning to the end of the list. If SINGLE is selected, the run is not yet started. Below the MODE line, function EXECUTE SINGLE SEQUENCE ► to be executed is displayed which can be used to start the run.
- IEC-bus short command :SYST:MODE MSEQ;  
:SYST:MSEQ:MODE AUTO  
:TRIG:MSEQ:SOUR SING
- STEP** Step-by-step manual processing of the list. Activating STEP stops an automatic run and the cursor wraps to the indication value of CURRENT INDEX. The list can now be passed through upwards or downwards step by step using the rotary knob.
- IEC-bus short command :SYST:MODE MSEQ;  
:SYST:MSEQ:MODE STEP  
:TRIG:MSEQ:SOUR SING
- EXT-SINGLE** Single run from the beginning to the end of the list as with SINGLE, but triggered by an external trigger signal.
- IEC-bus short command :SYST:MODE MSEQ;  
:SYST:MSEQ:MODE AUTO  
:TRIG:MSEQ:SOUR EXT
- EXT-STEP** Step-by-step run using the external trigger signal. Each trigger event triggers a single step.
- IEC-bus short command :SYST:MODE MSEQ;  
:SYST:MSEQ:MODE STEP  
:TRIG:MSEQ:SOUR EXT
- OFF** Step-by-step run using the external trigger signal. Each trigger event triggers a single step.
- IEC-bus short command :SYST:MODE FIX

## External Trigger

An external signal at the rear input TRIGGER triggers the MEMORY SEQUENCE in the EXT-SINGLE and EXT-STEP operating modes. The polarity of the active trigger edge can be set in the UTILITIES - AUX I/O - EXT TRIG SLOPE menu.

Menu MEM SEQ with the two menu pages OPERATION and EDIT offers access to the memory-sequence operating mode.

Menu selection: MEM SEQ

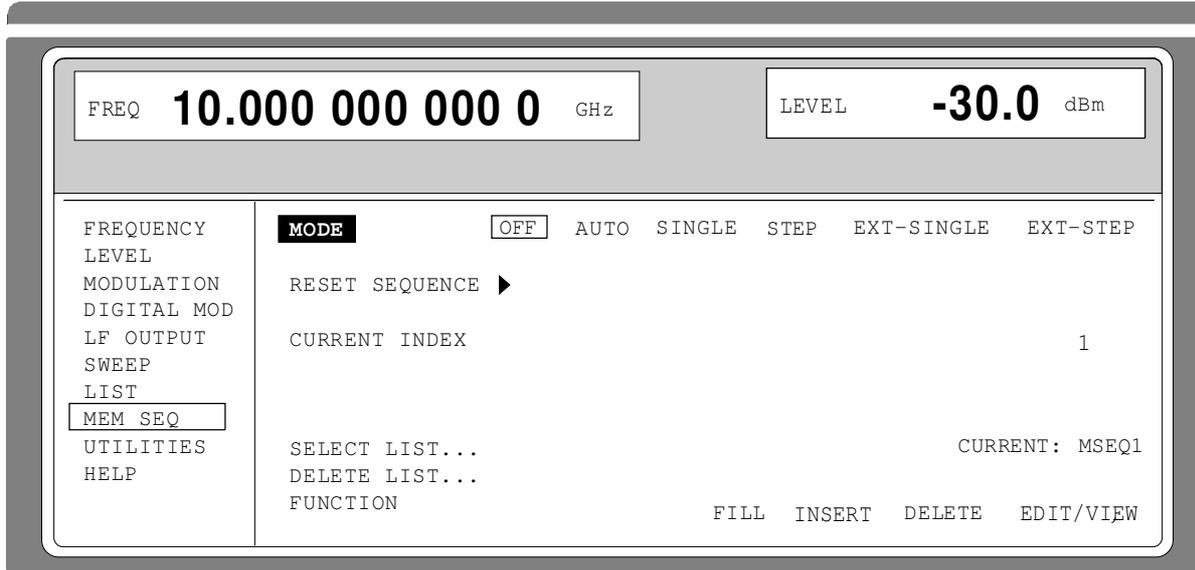

Fig. 2-45 Menu MEM SEQ -OPERATION- page (preset setting)

- MODE** Selection of the operating mode; setting the operating mode regards various command systems at the IEC bus (cf. above).
  
- EXECUTE SINGLE SEQUENCE ►** Starts the single run of a memory sequence. This menu option is only visible if MODE SINGLE is selected.  
IEC-bus short command :TRIG:MSEQ
  
- RESET SEQUENCE ►** Wrap to the beginning of the list.  
IEC-bus short command :ABOR:MSEQ
  
- CURRENT INDEX** Indication of the current list index. Setting value of the current list index in the MODE STEP operating mode.
  
- SELECT LIST...** Selection of a list or generation of a new list (cf. Section "List Editor").  
IEC-bus short command :SYST:MSEQ:SEL "MSEQ1"
  
- DELETE LIST...** Deletion of a list (cf. Section "List Editor").  
IEC-bus short command :SYST:MSEQ:DEL "MSEQ2"
  
- FUNCTION** Selection of the editor functions to process a list (cf. Section "List Editor").  
IEC-bus short command :SYST:MSEQ 9,2,...;  
:SYST:MSEQ:DWEL 50ms, 50ms, .

The second page of menu MEM SEQ, the EDIT page, is automatically activated if one of the editor functions of the FUNCTION line is selected. The list which is entered as CURRENT LIST in the SELECT LIST line is shown.

The screenshot shows the MEM SEQ - EDIT page with the following fields and data:

FREQ 10.000 000 000 0 GHz      LEVEL -30.0 dBm

FREQUENCY	SELECT LIST...	CURRENT: MSEQ1
LEVEL	FUNCTION	FILL    INSERT    DELETE    EDIT/VIEW
MODULATION	-INDEX - FREE 2041 - LEN 2055	MEMORY    DWELL
DIGITAL MOD	001	09    50 ms
LF OUTPUT	002	02    50 ms
SWEEP	003	01    60 ms
LIST	004	23    60 ms
MEM SEQ	005	09    85 ms
UTILITIES	006	10    85 ms
HELP	007	08    85 ms
	008	11    85 ms

Fig 2-46 Menu MEM SEQ - EDIT page

<b>INDEX</b>	Index of the list.
<b>FREE</b>	Indication of the list entries still vacant.
<b>LEN</b>	Length of the current list.
<b>MEMORY</b>	Parameter: number of memory location; range 1 to 50.
<b>DWELL</b>	Parameter: dwell time; specified range 50 ms to 60 sec, step width 1 ms.

## 2.11 Utilities

The UTILITIES menu contains submenus for general functions which do not directly relate to the signal generation.

### 2.11.1 IEC-Bus Address (SYSTEM-GPIB)

Submenu SYSTEM-GPIB offers access to the remote-control address. The setting range is 0 to 30. At the point of delivery address 28 is set.

Menu selection: UTILITIES -SYSTEM -GPIB

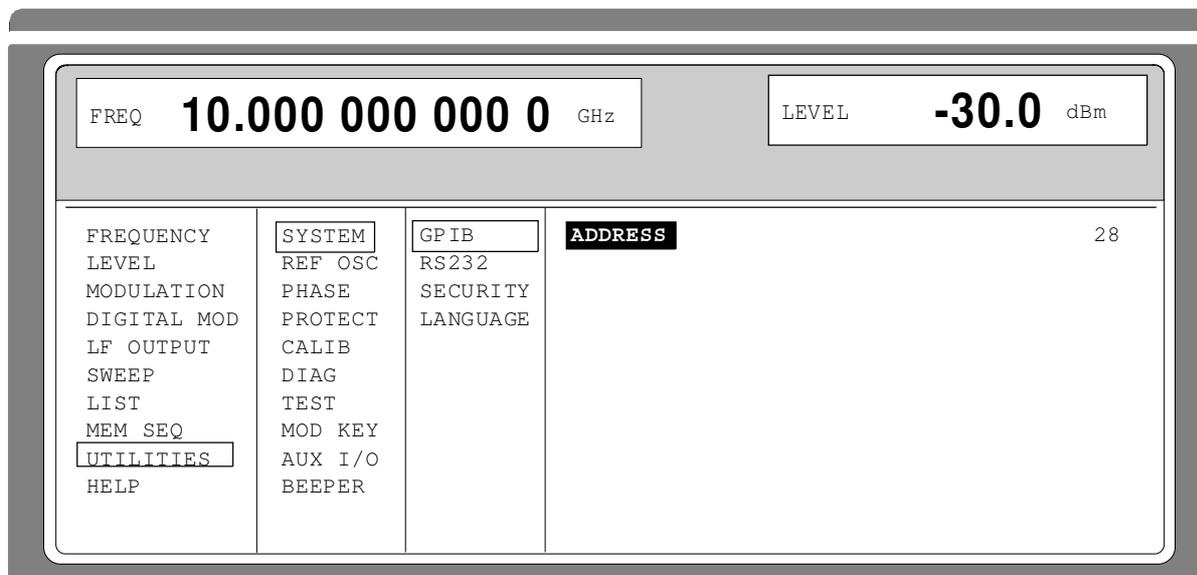

Fig. 2-47 Menu UTILITIES -SYSTEM -GPIB

**ADDRESS** Input value of the IEC-bus address  
 IEC-bus short command :SYST:COMM:GPIB:ADDR 28

## 2.11.2 Parameter of the RS232 Interface (SYSTEM-RS232)

Submenu SYSTEM-RS232 offers access to the configuration of the RS-232 interface. The pin assignment of the interface corresponds to the pin assignment of a PC.

Menu selection: UTILITIES - SYSTEM - RS232

FREQ		10.000 000 000 0 GHz		LEVEL		-30.0 dBm	
FREQUENCY	SYSTEM	GPIB	<b>DATA FORMAT</b>	8 Bits			
LEVEL	REF OSC	RS232	PARITY	NO			
MODULATION	PHASE	SECURITY	STOP BIT	1			
DIGITAL MOD	PROTECT	LANGUAGE	BAUD RATE	9600		bps	
LF OUTPUT	CALIB		HANDSHAKE	OFF	RTS/CTS	XON/XOFF	
SWEEP	DIAG						
LIST	TEST						
MEM SEQ	MOD KEY						
UTILITIES	AUX I/O						
HELP	BEEPER						

Fig. 2-48 Menu UTILITIES - SYSTEM - RS232

**DATA FORMAT** Indication of the number of data bits. This value cannot be changed.

**PARITY** Indication of parity. This value cannot be changed.

**STOP BIT** Indication of the number of stop bits. This value cannot be changed.

**BAUD RATE** Selection of the baud rate.  
IEC-bus short command :SYST:COMM:SER:BAUD 9600

**HANDSHAKE** Selection of the handshake.  
OFF No handshake  
IEC-bus short command :SYST:COMM:SER:PACE NONE  
:SYST:COMM:SER:CONT:RTS ON

RTS/CTS Hardware handshake using the interface lines RTS and CTS. This mode always is to be preferred to XON/XOFF mode, if permitted by the configuration of the host computer.

IEC-bus short command :SYST:COMM:SER:CONT:RTS RFR

XON/XOFF Software handshake using the ASCII codes 11h <XON> and 13h <XOFF>. This mode is not recommended for binary data and for baud rates above 9600 baud.

IEC-bus short command :SYST:COMM:SER:PACE XON

### 2.11.3 Suppressing Indications and Deleting Memories (SYSTEM-SECURITY)

For security interests, indications can be suppressed and memories deleted in the SYSTEM-SECURITY submenu.

Menu selection: UTILITIES - SYSTEM-SECURITY

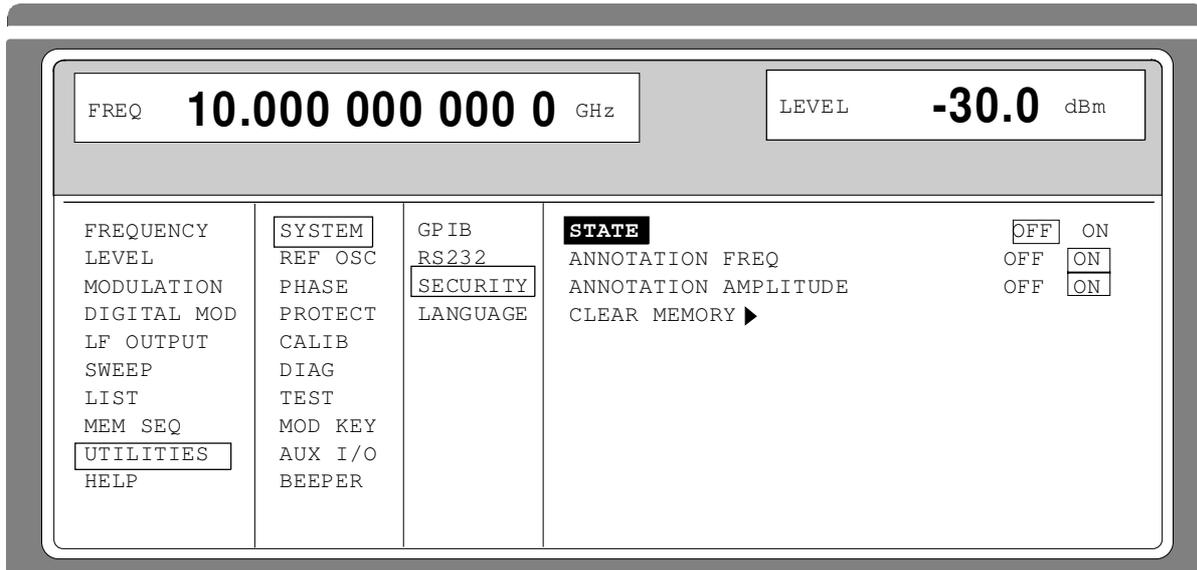

Fig. 2-49 Menu UTILITIES - SYSTEM-SECURITY

- STATE** Selection of the SECURITY state
- ON Locks the suppression of the indications. Can only be set via IEC bus.
  - OFF Deactivates the interlock of the indication suppression. The preset state is set in the transition ON → OFF, and all data stored such as settings are deleted. Can only be set via IEC bus.
- IEC-bus short command :SYST:SEC OFF
- ANNOTATION FREQ**
- OFF All frequency indications are suppressed.
  - ON The frequency setting is displayed..
- IEC-bus short command :DISP:ANN:FREQ ON
- ANNOTATION AMPLITUDE**
- OFF All level indications are suppressed.
  - ON The level setting is displayed.
- IEC-bus short command :DISP:ANN:AMPL ON
- CLEAR MEMORY ►**
- Deletion of all data stored such as settings, user correction and list settings stored.
- For this action, two commands are necessary at the IEC bus:
- IEC-bus short command :SYST:SEC ON; SEC OFF

### 2.11.4 Indication of the IEC-Bus Language (LANGUAGE)

Submenu UTILITIES-SYSTEM LANGUAGE indicates the IEC-bus language and the current SCPI version.

### 2.11.5 Reference Frequency Internal/External (REF OSC)

In the internal-reference operating mode, the internal reference signal at a frequency of 10 MHz is available at the REF socket (rear of the instrument).

Signal level:  $V_{\text{eff}}$  (EMF, sine) = 1 V.

The frequency of the internal reference oscillator can be detuned via the TUNE input (rear of the instrument). Input voltage range  $\pm 10$  V, pulling range  $\pm 1 \times 10^{-6}$ .

The external detuning is possible in both states of the ADJUSTMENT STATE (ON or OFF) unless option SM-B1, reference oscillator OCXO, is fitted. If option SM-B1, reference oscillator OCXO, is fitted, the detuning via the TUNE input is only possible if the ADJUSTMENT STATE selection has been switched to ON in the UTILITIES-REF OSC menu.

In the external-reference operating mode, an external signal at a frequency of 1 MHz to 16 MHz (spacing 1 MHz) is to be fed into socket REF. The setting to external frequency is effected in the UTILITIES-REF OSC menu.

Signal level:  $V_{\text{eff}} = 0.1$  to 2 V

The message "EXT REF" is displayed in the status line in the header field of the display in the external-reference operating mode.

Menu selection: UTILITIES - REF OSC

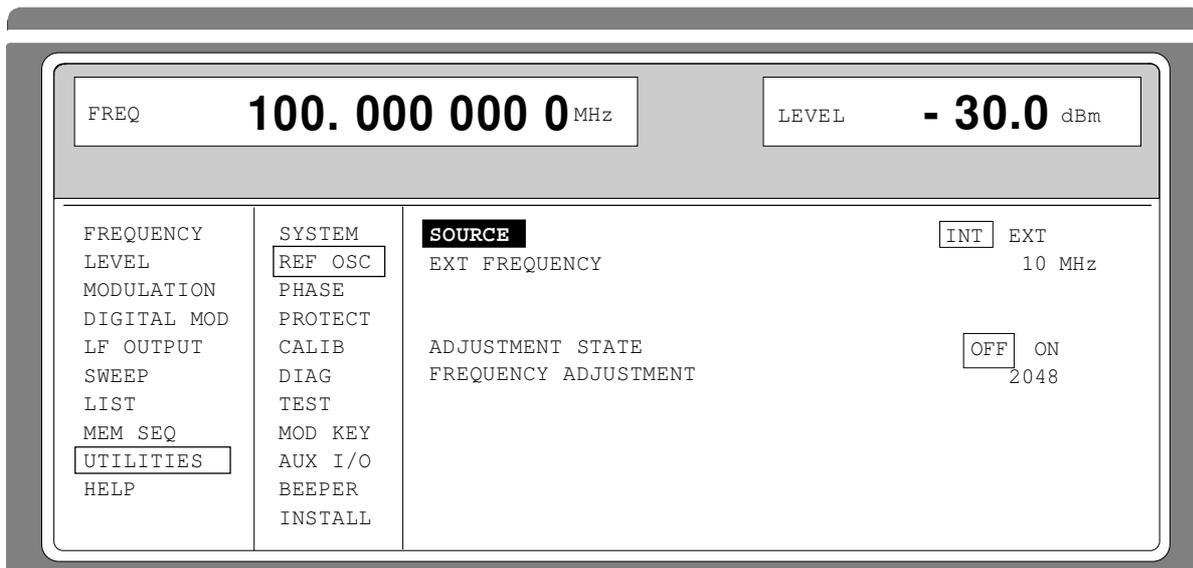

Fig. 2-50 Menu UTILITIES - REF OSC (preset setting)

#### SOURCE

Selection of the operating mode.

INT Internal-reference operating mode

EXT External-reference operating mode

IEC-bus short command : SOUR:ROSC:SOUR INT

<b>EXT FREQUENCY</b>	Input value of the external reference frequency (1 MHz to 16 MHz, spacing 1 MHz). IEC-bus short command : SOUR:ROSC:EXT:FREQ 10E6
<b>ADJUSTMENT STATE</b>	<p>OFF Tuning value of the internal reference frequency as calibrated (cf. menu UTILITIES-CALIB)</p> <p>ON Tuning value according to setting value FREQUENCY ADJUSTMENT. Option SM-B1, reference oscillator OCXO, is switched off. Only the standard reference oscillator is in operation.</p> <p>IEC-bus short command : SOUR:ROSC:ADJ:STAT ON</p>
<b>FREQUENCY ADJUSTMENT</b>	Input value in the range 0 to 4095 to set the internal reference frequency. Pulling range $\pm 4 \times 10^{-6}$ IEC-bus short command : SOUR:ROSC:ADJ:VAL 2048

### 2.11.6 Phase of the Output Signal (PHASE)

Menu UTILITIES-PHASE offers access to the phase setting of the RF output signal with respect to a reference signal of the same frequency.

Menu selection: UTILITIES - PHASE

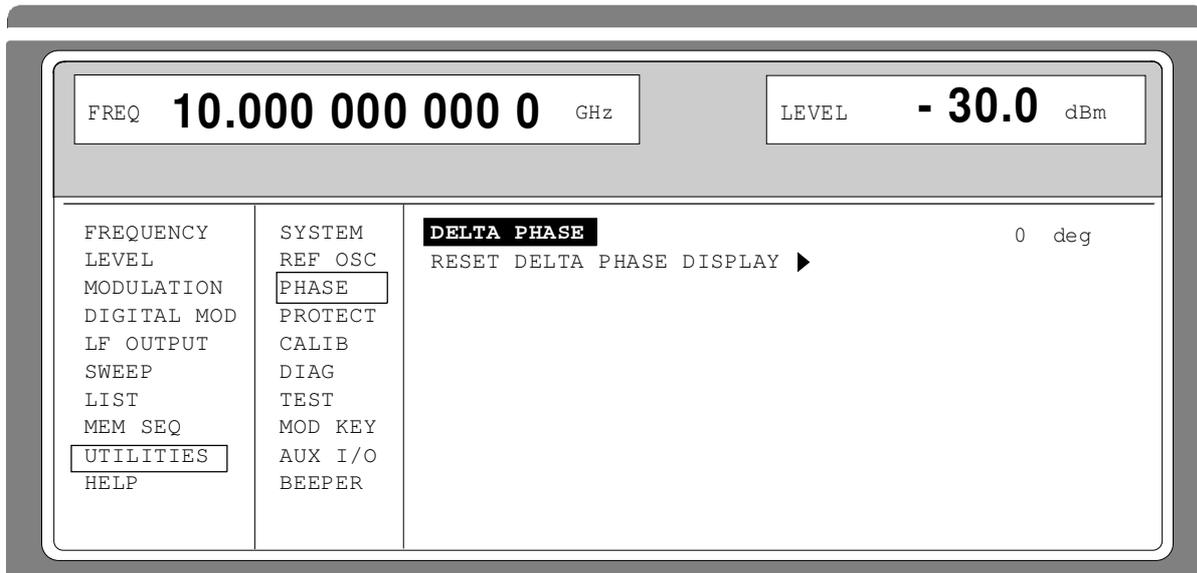

Fig. 2-51 Menu UTILITIES - PHASE (preset setting)

<b>DELTA PHASE</b>	Setting value of the phase. IEC-bus short command : SOUR:PHAS 0
<b>RESET DELTA PHASE DISPLAY ►</b>	Sets the display of the DELTA PHASE to 0 without the phase of the output signal being influenced. IEC-bus short command : SOUR:PHAS:REF



### 2.11.7 Password Input With Functions Protected (PROTECT)

The execution of calibrating and service functions is protected by a password. To unlock the lock-out, the correct password, a 6-digit number, has to be entered and then the [ENTER] key has to be pushed. After the instrument has been switched on, the lock-out is automatically activated.

- Password 1 unlocks the lock-out for calibrations LEVEL, YFOM, ALC AMP, ALC LIMIT and PULSE GEN.
- Password 2 unlocks the lock-out for calibration REF OSC.
- Password 3 permits the input of the serial number and the value of the counter for POWER ON, operating hours and attenuator circuits.

Menu UTILITIES-PROTECT offers access to the unlocking of protected functions.

Menu selection: UTILITIES - PROTECT

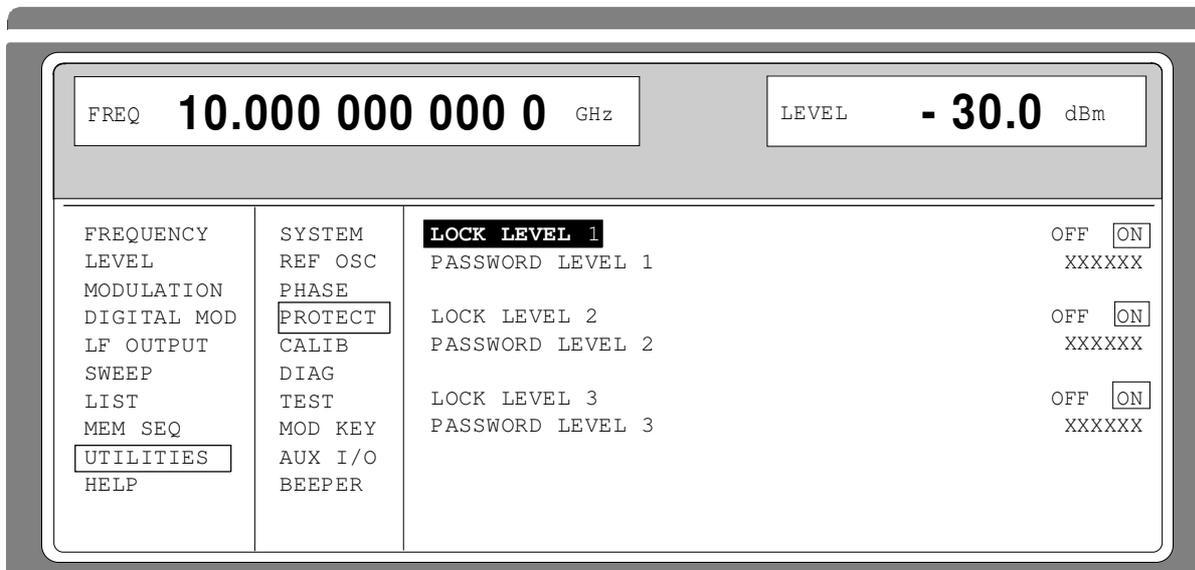

Fig. 2-52 Menu UTILITIES - PROTECT (preset setting)

#### LOCK LEVEL x

Activating/deactivating the lock-out.

ON The lock-out is activated.

OFF The cursor automatically wraps to the input of the password. After the password has been entered, the lock-out is deactivated.

IEC-bus short command :SYST:PROT1 ON

#### PASSWORD LEVEL x

Input of the password; termination with [ENTER] key.

IEC-bus short command :SYST:PROT1 OFF, 123456

### 2.11.8 Calibration (CALIB)

The following menus offer access to calibrating routines and correction values:

- UTILITIES - CALIB - PULSE GEN
- REF OSC (cf. service manual)
- LEVEL (cf. service manual)
- YFOM (cf. service manual)
- ALC LIMIT (cf. service manual)
- ALC AMP (cf. service manual)
- LOOP GAIN (cf. service manual)

**Caution:** Execute calibration routines only when the instrument has warmed up.

Calibration routines LEVEL, REF OSC, YFOM, ALC AMP, ALC LIMIT and LOOP GAIN are described in the service manual (stock no. 1035.5015.24).

#### Calibration PULSE GEN

A programmable oscillator determines the accuracy of the pulse width and the pulse delay of the pulse generator. To compensate for the temperature dependence of the oscillator (approx. 0.2%/degree) an internal calibration is offered. The adjustment accuracy is approx. +/-0.5%. The calibration routine is to be executed even after a data loss in the RAM or after an exchange of modules.

**Function:** The frequency of the oscillator is measured using a counter which is synchronized with the crystal reference. The oscillator is readjusted until the deviation is minimized. The calibration value thus achieved is stored.

Internal calibration routine REF OSC is protected by a password. It can only be executed if the lock-out in the UTILITIES - PROTECT menu has been unlocked. The password is PASSWORD LEVEL 1 = "123456".

Menu selection: UTILITIES - CALIB - PULSE GEN

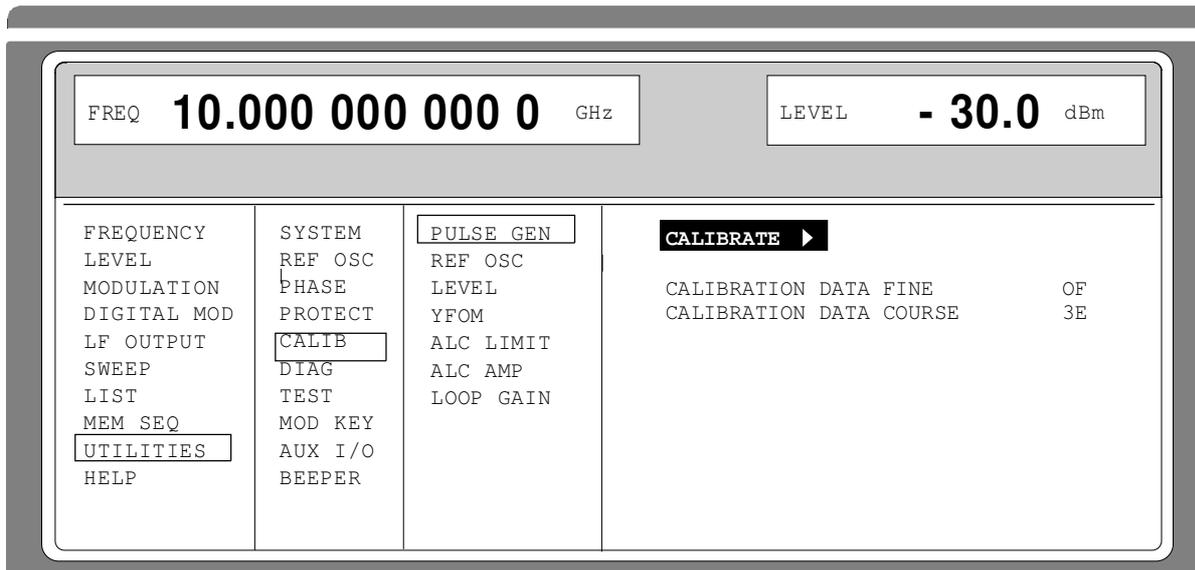

Fig. 2-53 Menu UTILITIES - CALIB - PULSE GEN

- CALIBRATE** ▶ Triggers the calibration for the pulse generator  
IEC-bus short command :CAL:PULS?
- CALIBRATION DATA FINE** Indication of the fine adjustment in hexadecimal form.  
IEC-bus short command :CAL:PULS?
- CALIBRATION DATA COURSE** Indication of the course adjustment in hexadecimal form.  
IEC-bus short command :CAL:PULS?

### 2.11.9 Indications of Module Variants (DIAG-CONFIG)

For service purposes, the modules installed can be indicated with their variants and states of modification. Submenu DIAG-CONFIG offers access to the module indication.

Menu selection: UTILITIES - DIAG - CONFIG

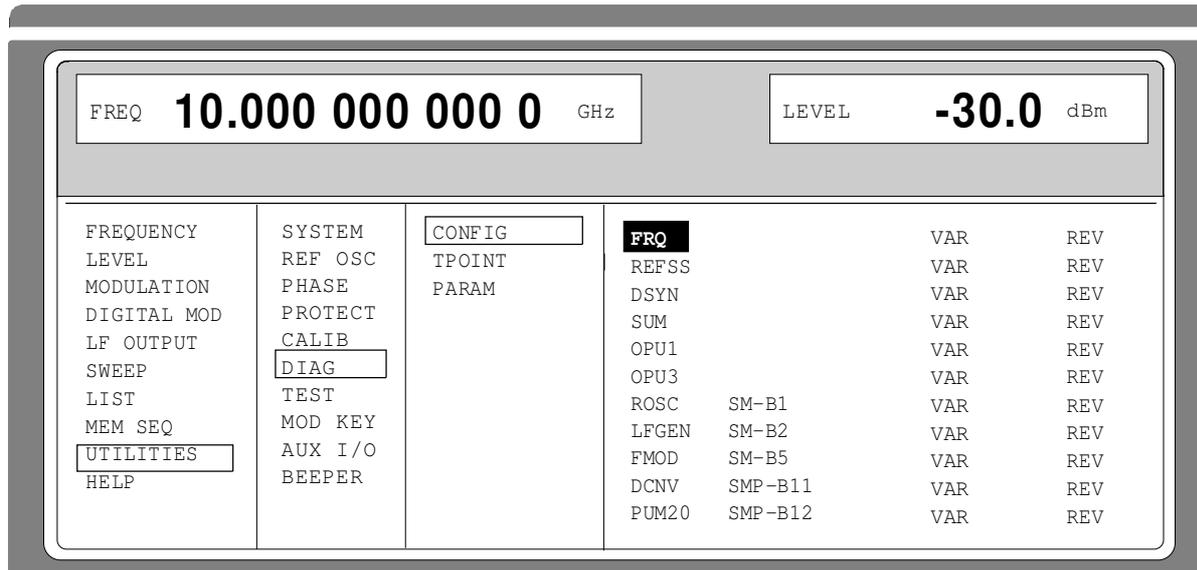

Fig. 2-54 Menu UTILITIES - DIAG - CONFIG

IEC-bus short command :DIAG:INFO:MOD?

### 2.11.10 Voltage Indication of Test Points (DIAG-TPOINT)

Submenu DIAG-TPOINT offers access to internal test points. If a test point is switched on, the voltage indication is displayed in a window in the header field. For greater detail, see service manual (stock no. 1035.5015.24).

Menu selection: UTILITIES - DIAG - TPOINT

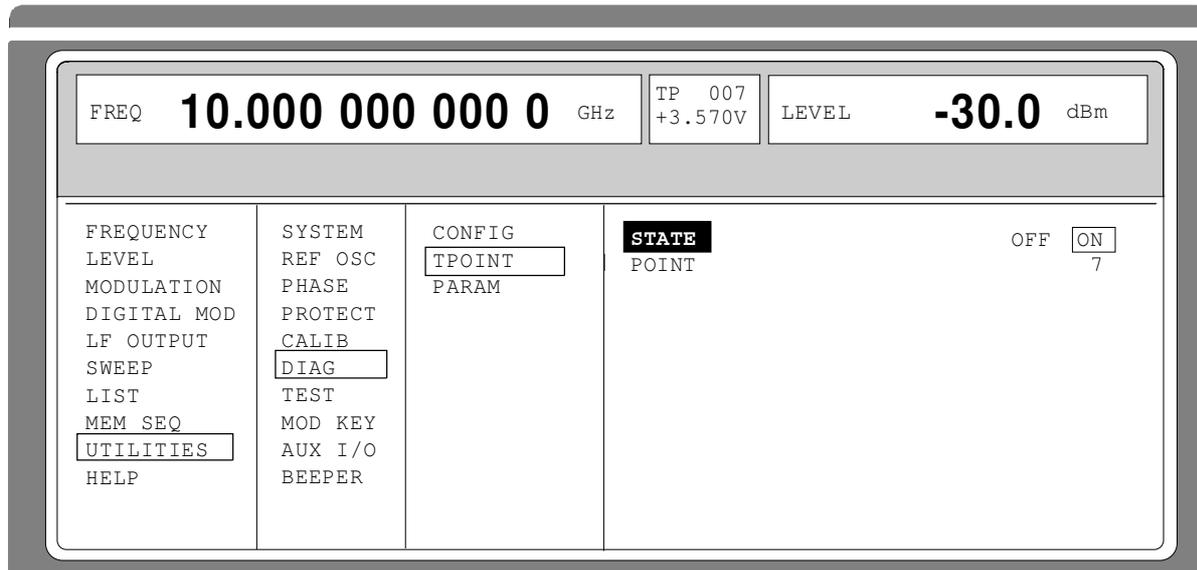

Fig. 2-55 Menu UTILITIES - DIAG - TPOINT

- STATE**                      Switching on/off the voltage indication in the headerfield.
- POINT.....**              Input value of the test point.  
IEC-bus short command      :DIAG:POINxx?

### 2.11.11 Indications of Service Data (DIAG-PARAM)

Submenu DIAG-PARAMETER offers access to different parameters such as serial number, software version, operating-hours counter and attenuator circuits.

Menu selection: UTILITIES - DIAG - PARAM

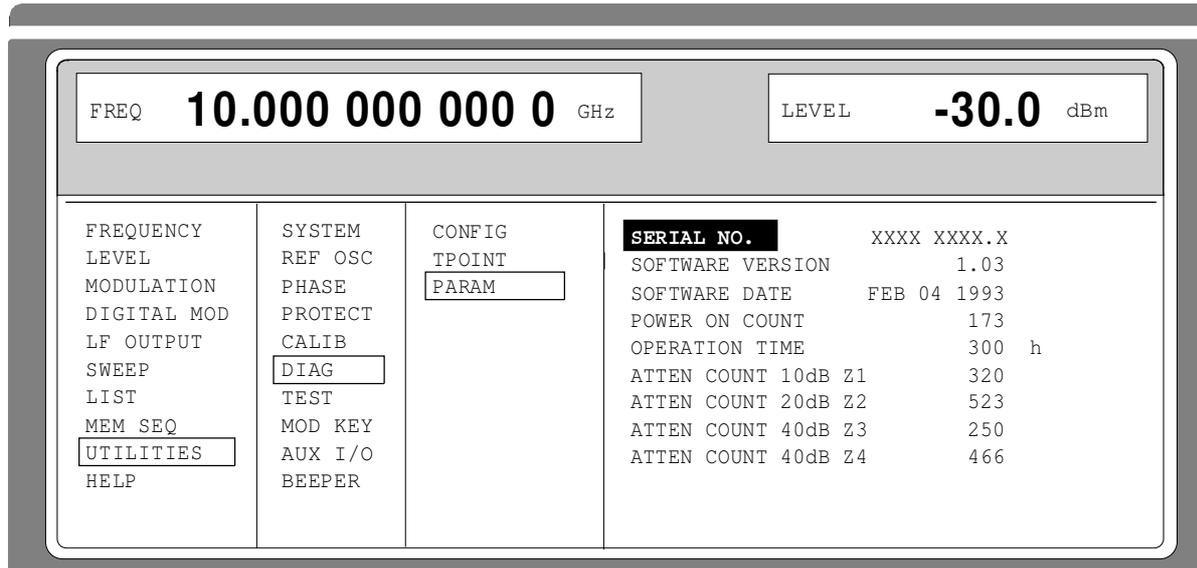

Fig. 2-56 Menu UTILITIES - DIAG - PARAM

For IEC-bus commands, cf. Section "DIAGnostic System".

### 2.11.12 Test (TEST)

(cf. Section "Functional Test")

### 2.11.13 Assigning Modulations to the [MOD ON/OFF] Key (MOD-KEY)

The modulations can be switched on/off in the individual modulation menus and parallelly by means of the [MOD ON/OFF] key.

For which modulations the [MOD ON/OFF] key is effective can be defined in the UTILITIES-MOD KEY menu. The key can either be effective for all modulations or for a selected one.

Function of the [MOD ON/OFF] key if effective for a type of modulation:

- Every pressing a key alters the state (ON or OFF) of the selected modulation.

Function of the [MOD ON/OFF] key if effective for all types of modulation (ALL):

- If at least one modulation is switched on, pressing the [MOD ON/OFF] key switches the modulation/s off. Which modulations were switched on is stored.

If no modulation is switched on, pressing the [MOD ON/OFF] key switches on the modulations which were last switched off using the [MOD ON/OFF] key.

On switching on using the [MOD ON/OFF] key, the modulation sources are used as defined in the modulation menus.

Access to the selection of the modulation to be switched using the [MOD ON/OFF] key is possible in the UTILITIES-MOD KEY menu.

Menu selection: UTILITIES - MOD KEY

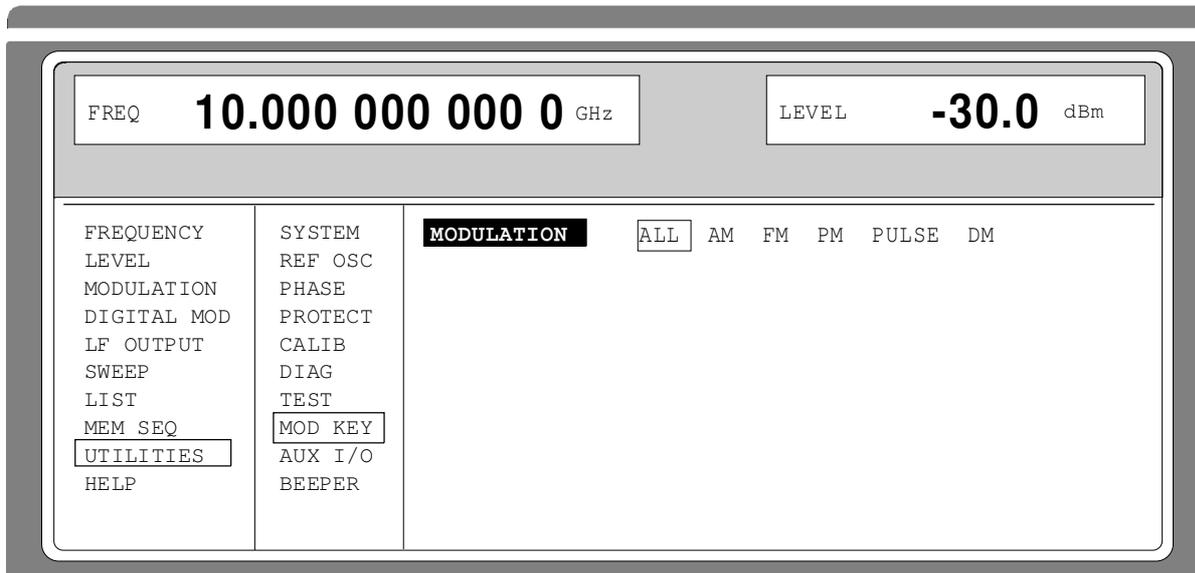

Fig. 2-57 Menu UTILITIES - MOD KEY (preset setting)

**MODULATION**

Selection for which modulation the [MOD ON/OFF] key is to be effective.

**Note:** Preset switches off all modulations, sets the selection to ALL and stores AM 30%, AM SOURCE INT: LF GEN1 as default setting.

### 2.11.14 Setting Auxiliary Inputs/Outputs (AUX - I/O)

Menu UTILITIES - AUX I/O offers access to settings for the TRIGGER input, BLANK output and MARKER output. Sections Sweep, List Mode and Memory Sequence provide further information.

Menu selection: UTILITIES - AUX I/O

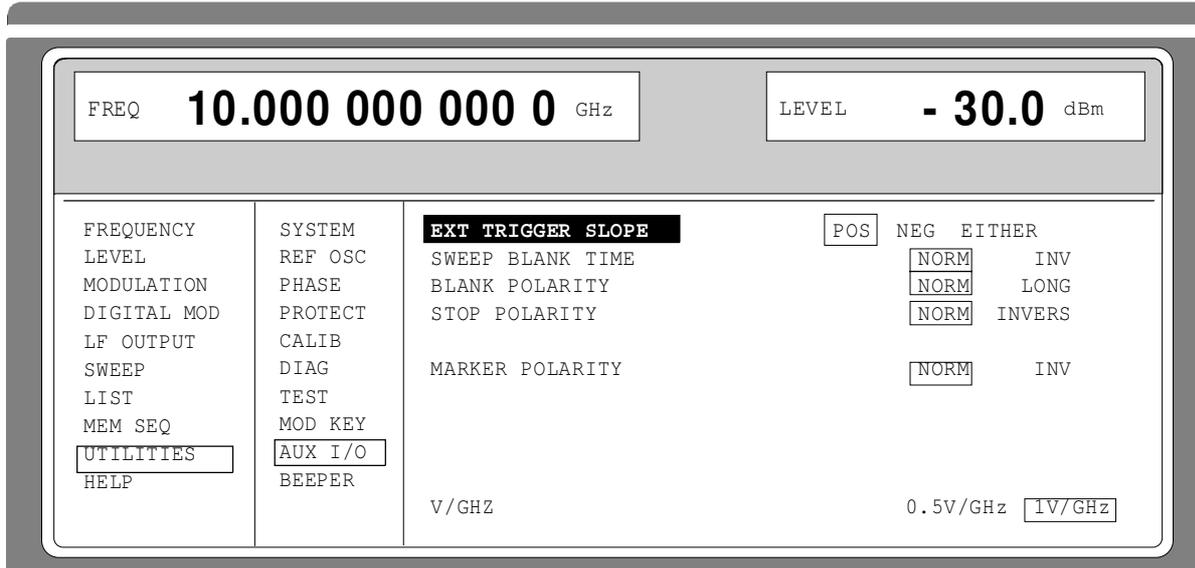

Fig. 2-58 Menu UTILITIES - AUX I/O

#### EXT TRIGGER SLOPE

Selection of the active edge of the external trigger signal.

**POS** The instrument triggers on the positive edge of the external signal.

**NEG** The instrument triggers on the negative edge of the external signal.

**EITHER** The instrument triggers on both edges of the external signal.

IEC-bus short command :TRIG:SLOP POS

#### STOP POLARITY

Selection of the polarity for the external STOP signal.

**NORM** The sweep is stopped by means of a HIGH signal.

**INV** The sweep is stopped by means of a LOW signal.

IEC-bus short command :INPut:POL NORM

#### SWEEP BLANK TIME

Selection of the blank duration.

**NORM** BLANK duration is set to the shortest duration possible.

**LONG** The BLANK duration is set for the PEN LIFT control of an XY recorder (approx. 500ms).

IEC-bus short command :SOUR2:SWE:BTIM NORM

#### BLANK POLARITY

Selection of the polarity for the blank signal.

**NORM** With active BLANK, the output signal is HIGH.

**INV** Polarity is inverted.

IEC-bus short command :OUTP:BLAN NORM

**MARKER POLARITY** Selection of the polarity for the marker signal.  
 NORM The output signal is HIGH when the sweep cycle reaches the mark.  
 INV Polarity is inverted.  
 IEC-bus short command :SOUR:MARK:POL NORM

**V/GHz** Selection of the slope of the signal at the V/GHz output  
 IEC-bus short command :OUT3:SCAL 0.5

**2.11.15 Switching On/Off Beeper (BEEPER)**

Menu UTILITIES-BEEPER offers access to the switching on/off of the beeper.

**Note:** Preset does not alter the current state (ON or OFF).

Menu selection: UTILITIES - BEEPER

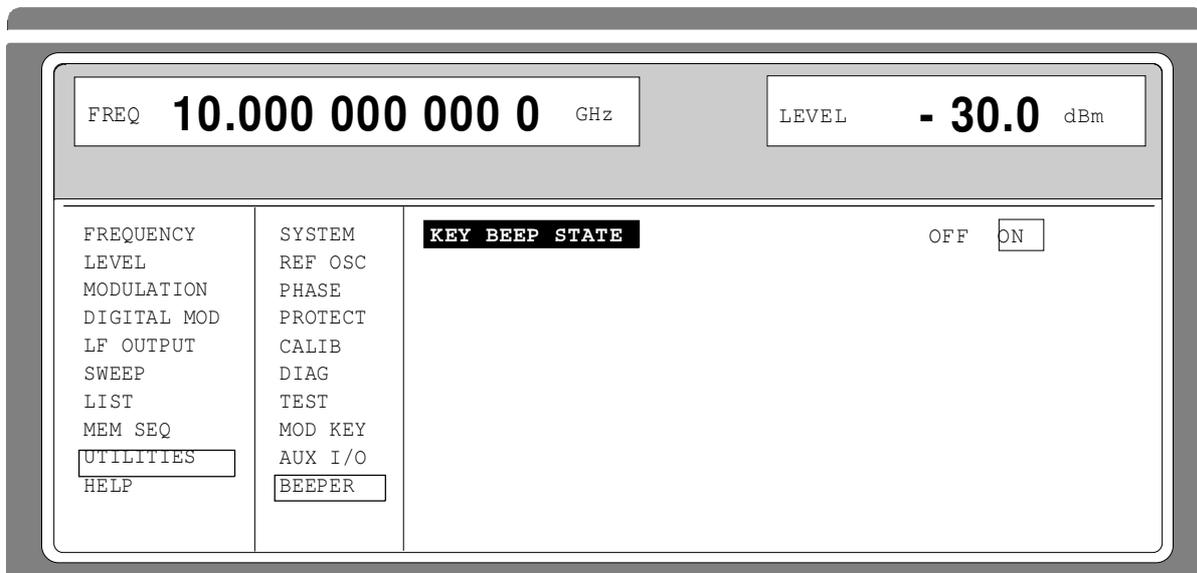

Fig. 2-59 Menu UTILITIES - BEEPER

**KEY BEEP STATE** Switching on/off the beeper  
 IEC-bus command :SYST:BEEP:STAT ON



## 2.12 The Help System

The SMP has two help systems. On the one hand the context-sensitive help which is called by means of the HELP key and which gives information on the current menu. On the other hand, auxiliary texts can be selected according to headwords in alphabetical order by accessing menu HELP.

### HELP Key

The yellow HELP key can be pressed at any point in time. The current setting menu is faded out and context-sensitive text faded in. The help panel can be exited by means of the RETURN key.

### Menu HELP

After calling the help menu, access to all auxiliary texts is possible via an index. Operation is analog to menu operation.

- Set the menu cursor to the index desired using the shaft encoder.
- Press the [SELECT] key.
- The information for the index marked is displayed.
- Press the [RETURN] key to exit the menu.

## 2.13 Status

By means of a STATUS page, the SMP permits an overview over all settings of the instrument. The settings are displayed in an abbreviated form. The STATUS page is called by pressing the [STATUS] key. Return to the preceding menu is effected using the [RETURN] key.

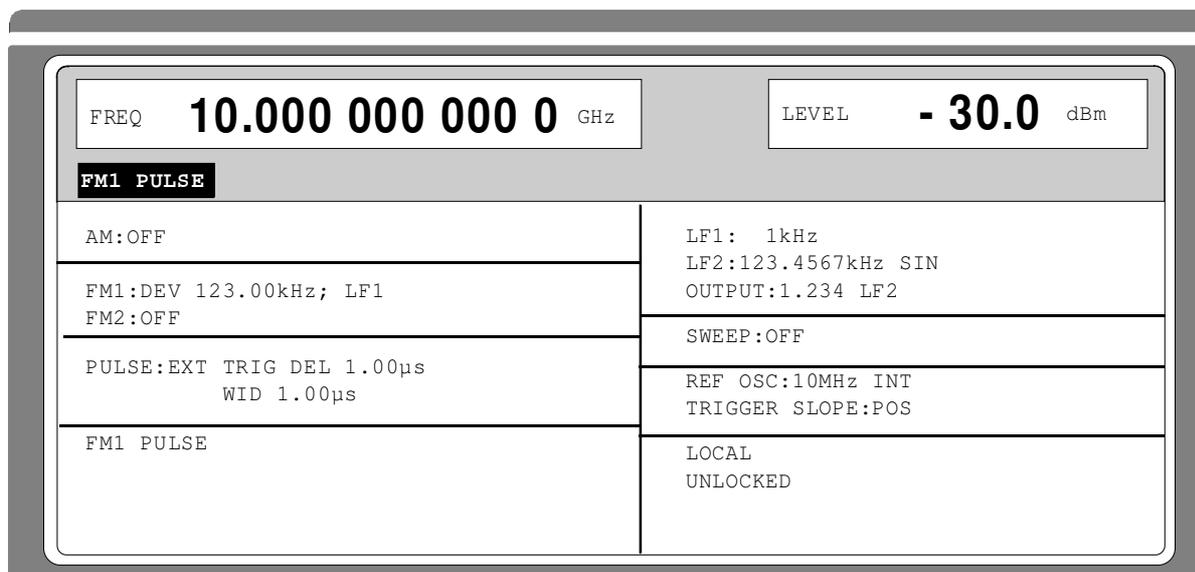

Fig. 2-60 Menu STATUS page

## 2.14 Error Messages

The SMP displays error and caution messages in a different manner, depending on how long, for a short period of time or permanently, the cause exists.

### Short-term message

The short-term message is displayed in the status line. Part of it overwrites the status indications and disappears after approx. 2 seconds or in the case of a new entry.

The instrument shows, e.g., short-term messages if the attempt is made to enter an overrange or if incompatible operating modes deactivate one another.

### Long-term message

The long-term message is displayed in the status line by means of the message "WARNING" or "ERROR". Pressing the [ERROR] key calls the ERROR page in which the messages are entered. Several messages can be entered at the same time. The long-term message remains existing until there is no cause any more. The ERROR page is exited using the [RETURN] key.

The instrument displays, e.g., the long-term message "ERROR" if there is a hardware error or "WARNING" if overrange settings have been made.

- Notes:** – An error message "ERROR" does not necessarily point to a defect instrument. There are various operating states which can cause an ERROR message. E. g. if the instrument is set to external reference but no external reference is connected.
- Error 313 indicates the loss of calibration data and is also applicable in case of a cold start (key [PRESET] is pressed during switch-on). The calibration values can be restored with internal calibration routines. These routines are accessible via menu UTILITIES-CALIB (see section on calibration).

The ERROR page offers access to long-term messages if the [ERROR] key is pressed.

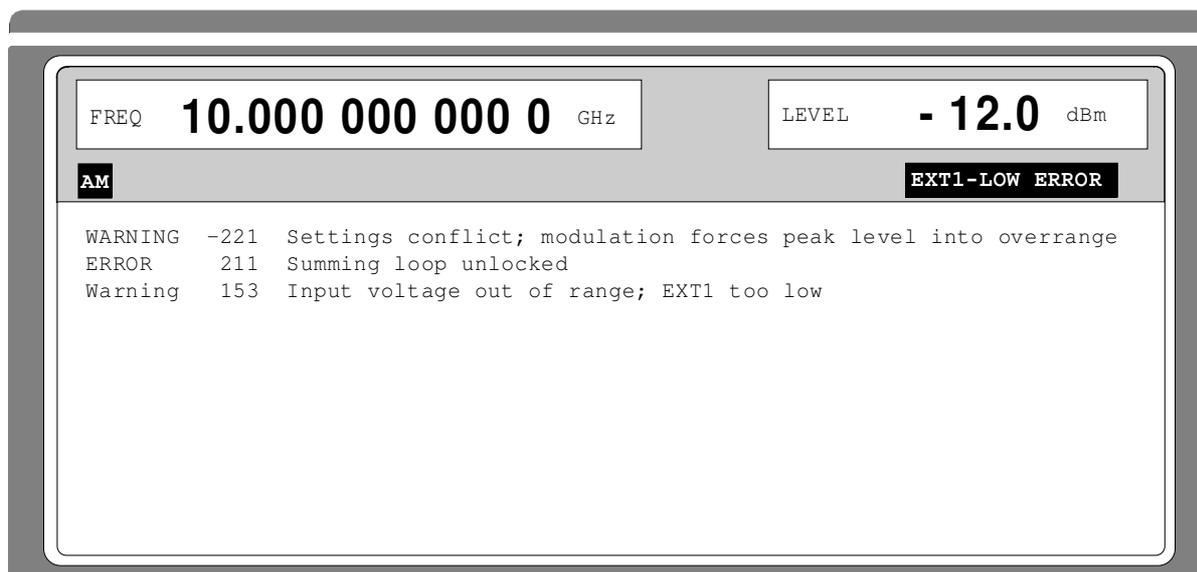

Fig. 2-61 ERROR page

A list of the possible error messages is to be found in annex B.

## 3 Remote Control

### 3.1 Introduction

The instrument is equipped with an IEC-bus interface according to standard IEC 625.1/IEEE 488.1 and a RS-232 interface. The connectors are located at the rear of the instrument and permit to connect a controller for remote control. The instrument supports the SCPI version 1994.0 (Standard Commands for Programmable Instruments). The SCPI standard is based on standard IEEE 488.2 and aims at the standardization of device-specific commands, error handling and the status registers.

This section assumes basic knowledge of IEC-bus programming and operation of the controller. A description of the interface commands is to be obtained from the relevant manuals.

The requirements of the SCPI standard placed on command syntax, error handling and configuration of the status registers are explained in detail in the respective sections. Tables provide a fast overview of the commands implemented in the instrument and the bit assignment in the status registers. The tables are supplemented by a comprehensive description of every command and the status registers. Detailed program examples of the main functions are to be found in annex D. The program examples for IEC-bus programming are all written in QuickBASIC.

**Note:** *In contrast to manual control, which is intended for maximum possible operating convenience, the priority of remote control is the predictability of the device status. This means that when incompatible settings (e.g. activation of PM and FM at the same time) are attempted, the command is ignored and the device status remains unchanged, i.e. is not adapted to other settings. Therefore, IEC/IEEE-bus control programs should always define an initial device status (e.g. with command \*RST) and then implement the required settings.*

### 3.2 Brief Instructions

The short and simple operating sequence given below permits fast putting into operation of the instrument and setting of its basic functions.

#### 3.2.1 IEC-Bus

It is assumed that the IEC-bus address, which is factory-set to 28 has not yet been changed.

1. Connect instrument and controller using IEC-bus cable.
2. Write and start the following program on the controller:

CALL IBFIND("DEV1", generator%)	Open port to the instrument
CALL IBPAD(generator%, 28)	Inform controller about instrument address
CALL IBWRT(generator%, "*RST;*CLS")	Reset instrument
CALL IBWRT(generator%, "FREQ 5 GHz")	Set frequency to 5 GHz
CALL IBWRT(generator%, "POW -7.3dBm")	Set output level -7.3m dBm
CALL IBWRT(generator%, "OUTP:STAT ON")	Switch on RF-output
CALL IBWRT(generator%, "AM:SOUR INT1")	Set AM modulation source LFGEN1
CALL IBWRT(generator%, "AM:INT1:FREQ 15kHz")	Set AM modulation frequency to 15 kHz
CALL IBWRT(generator%, "AM 30PCT")	Set AM modulation depth 30%
CALL IBWRT(generator%, "AM:STAT ON")	Switch on AM

An amplitude-modulated signal is now applied at the output of the instrument.

3. To return to manual control, press the LOCAL key at the front panel.

### 3.2.2 RS-232 Interface

It is assumed that the configuration of the RS-232 interface at the unit has not yet been changed.

1. Connect unit and controller using the 0-modem cable.
2. Enter the following command at the controller to configure the controller interface:

```
mode com1: 9600, n, 8, 1
```

3. Create the following ASCII file:

```
*RST;*CLS
FREQ 5 GHz
POW -7.3dBm
OUTP:STAT ON
AM:SOUR INT1
AM:INT1:FREQ 15kHz
AM 30PCT
AM:STAT ON
```

```
Switch instrument to remote control (Return key)
Reset instrument
Set frequency 5 GHz
Set output level -7.3 dBm
Switch on RF output
Set AM modulation source LFGEN1
Set modulation frequency 15 kHz
Set AM modulation depth 30%
Switch on AM
(Return key)
```

4. Transfer ASCII file to unit via RS-232 interface. Enter the following command at the controller:

```
copy <filename> com1:
```

An amplitude-modulated signal is now applied at the output of the instrument.

5. To return to manual control, press the [LOCAL] key at the front panel.

### 3.3 Switchover to Remote Control

On power-on, the instrument is always in the manual operating state ("LOCAL" state) and can be operated via the front panel.

The instrument is switched to remote control ("REMOTE" state)

IEC-bus as soon as it receives an addressed command from a controller.

RS-232 as soon as it receives either a carriage return <CR> (=0Dh) or a line feed <LF> (0Ah) from a controller.

During remote control, operation via the front panel is disabled. The instrument remains in the remote state until it is reset to the manual state via the front panel or via IEC bus. Switching from manual operation to remote control and vice versa does not affect the remaining instrument settings.

### 3.3.1 Remote Control via IEC Bus

#### 3.3.1.1 Setting the Device Address

The IEC-bus address of the instrument is factory-set to 28. It can be changed manually in the UTILITIES-SYSTEM-GPIB-ADDRESS menu or via IEC bus. Addresses 0 to 30 are permissible.

**Manually:**

- Call UTILITIES-SYSTEM-GPIB-ADDRESS menu
- Enter desired address
- Terminate input using the [1x/ENTER] key

**Via IEC bus:**

<pre>CALL IBFIND("DEV1", generator%) CALL IBPAD(generator%, 28)</pre>	<p>Open port to the instrument Inform controller about old address</p>
<pre>CALL IBWRT(generator%, "SYST:COMM:GPIB:ADDR 20") CALL IBPAD(generator%, 20)</pre>	<p>Set instrument to new address Inform controller about new address</p>

#### 3.3.1.2 Indications during Remote Control

The state of the remote control is evident by the words "IEC REMOTE" or "LOCAL" on the STATUS page. The STATUS page is always displayed in the REMOTE state.

LOCKED indicates that the key [LOCAL] is disabled, i.e. switchover to manual operation is only possible via IEC/IEEE bus. With UNLOCKED indicated, switchover to manual control is possible via the key [LOCAL].

#### 3.3.1.3 Return to Manual Operation

Return to manual operation is possible via the front panel or the IEC bus.

**Manually:** ➤ Press the [LOCAL] key.

**Notes:**

- Before switchover, command processing must be completed as otherwise switchover to remote control is effected immediately.
- The [LOCAL] key can be disabled by the universal command LLO (see annex A) in order to prevent unintentional switchover. In this case, switchover to manual mode is only possible via the IEC bus.
- The [LOCAL] key can be enabled again by deactivating the REN control line of the IEC bus (see annex A).

**Via IEC bus:**

<pre>... CALL IBLOC(generator%) ...</pre>	<p>Set instrument to manual operation.</p>
---	--

### 3.3.2 Remote Control via RS-232-Interface

#### 3.3.2.1 Setting the Transmission Parameters

To enable an error-free and correct data transmission, the parameters of the unit and the controller should have the same setting. To prevent any problems during binary data transmission, the RS-232 interface is set for 8 data bits, no parity and 1 stop bit. This data format corresponds to the current IEEE P1174 standard. Parameters baud rate and handshake can be manually changed in menu UTILITIES-SYSTEM-RS-232.

- Call UTILITIES-SYSTEM-RS232 menu
- Select desired baudrate and handshake
- Terminate input using the [1x/ENTER] key

#### 3.3.2.2 Indications during Remote Control

The state of the remote control is evident by the words "RS-232 REMOTE" or "LOCAL" on the STATUS page. The STATUS page is always displayed in the REMOTE state.

#### 3.3.2.3 Return to Manual Operating

Return to manual operation is possible via the front panel.

- Press the [LOCAL] key.

**Note:** Before switchover, command processing must be completed as otherwise switchover to remote control is effected immediately.

## 3.4 Messages

The messages transferred via the data lines of the IEC bus (see annex A) can be divided into two groups:

- **interface messages** and
- **device messages.**

No interface messages are defined for the RS-232 interface.

### 3.4.1 Interface Message

Interface messages are transferred on the data lines of the IEC bus, the ATN control line being active. They are used for communication between controller and instrument and can only be sent by a controller which has the IEC-bus control. Interface commands can be subdivided into

- **universal commands** and
- **addressed commands.**

Universal commands act on all devices connected to the IEC bus without previous addressing, addressed commands only act on devices previously addressed as listeners. The interface messages relevant to the instrument are listed in annex A.

Some control characters are defined for the control of the RS-232-interface (see annex A)

### 3.4.2 Device Messages (Commands and Device Responses)

Device messages are transferred on the data lines of the IEC bus, the "ATN" control line not being active. ASCII code is used. The device messages are largely identical for the two interfaces (IEC bus and RS-232).

A distinction is made according to the direction in which they are sent on the IEC bus:

- **Commands** are messages the controller sends to the instrument. They operate the device functions and request information.  
The commands are subdivided according to two criteria:
  1. According to the effect they have on the instrument:
    - Setting commands** cause instrument settings such as reset of the instrument or setting the output level to 1 volt.
    - Queries** cause data to be provided for output on the IEC-bus, e.g. for identification of the device or polling the active input.
  2. According to their definition in standard IEEE 488.2:
    - Common Commands** are exactly defined as to their function and notation in standard IEEE 488.2. They refer to functions such as management of the standardized status registers, reset and selftest.
    - Device-specific commands** refer to functions depending on the features of the instrument such as frequency setting. A majority of these commands has also been standardized by the SCPI committee.
- **Device responses** are messages the instrument sends to the controller after a query. They can contain measurement results, instrument settings and information on the instrument status.

Structure and syntax of the device messages are described in Section "Structure and Syntax of the Device Messages". The commands are listed and explained in detail in Section "Description of Commands".

## 3.5 Structure and Syntax of the Device Messages

### 3.5.1 SCPI Introduction

SCPI (Standard Commands for Programmable Instruments) describes a standard command set for programming instruments, irrespective of the type of instrument or manufacturer. The goal of the SCPI consortium is to standardize the device-specific commands to a large extent. For this purpose, a model was developed which defines the same functions inside a device or for different devices. Command systems were generated which are assigned to these functions. Thus it is possible to address the same functions with identical commands. The command systems are of a hierarchical structure. Fig. 3-1 illustrates this tree structure using a section of command system SOURCE, which operates the signal sources of the devices. The other examples concerning syntax and structure of the commands are derived from this command system.

SCPI is based on standard IEEE 488.2, i.e. it uses the same syntactic basic elements as well as the common commands defined in this standard. Part of the syntax of the device responses is defined with greater restrictions than in standard IEEE 488.2 (see Section "Responses to").

### 3.5.2 Structure of a Command

The commands consist of a so-called header and, in most cases, one or more parameters. Header and parameter are separated by a "white space" (ASCII code 0 to 9, 11 to 32 decimal, e.g. blank). The headers may consist of several key words. Queries are formed by directly appending a question mark to the header.

**Note:** The commands used in the following examples are not in every case implemented in the instrument.

#### Common Commands

Common commands consist of a header preceded by an asterisk "\*" and one or several parameters, if any.

Examples: \*RST RESET, resets the device  
 \*ESE 253 EVENT STATUS ENABLE, sets the bits of the event status enable registers  
 \*ESR? EVENT STATUS QUERY, queries the contents of the event status register.

#### Device-specific commands

Hierarchy:

Device-specific commands are of hierarchical structure (see Fig. 3-1). The different levels are represented by combined headers. Headers of the highest level (root level) have only one key word. This key word denotes a complete command system.

Example: SOURce This key word denotes the command system SOURce.

For commands of lower levels, the complete path has to be specified, starting on the left with the highest level, the individual key words being separated by a colon ":".

Example: SOURce:FM:EXTernal:COUPling AC

This command lies in the fourth level of the SOURce system. It sets the coupling of the external signal source to AC.

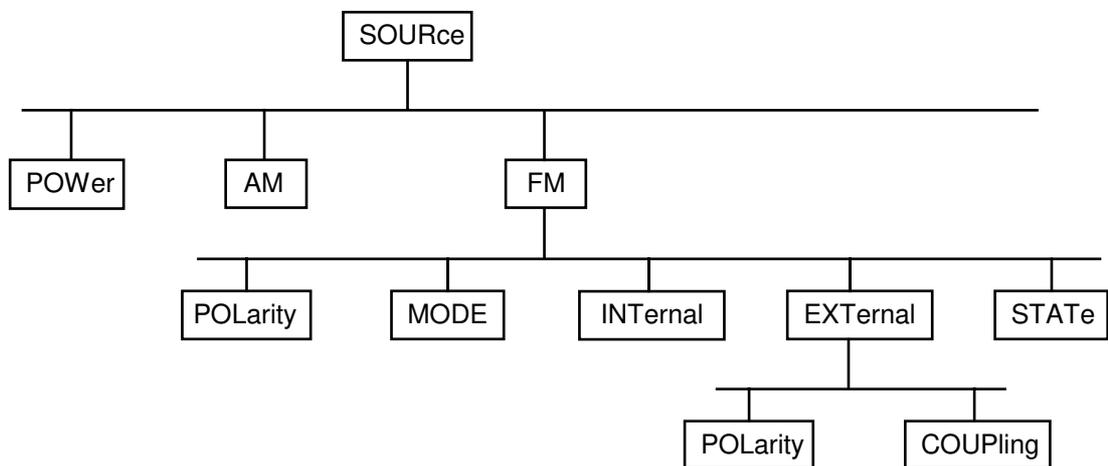

Fig. 3-1 Tree structure of the SCPI command systems using the SOURce system as an example



Some key words occur in several levels within one command system. Their effect depends on the structure of the command, that is to say, at which position in the header of a command they are inserted.

Example: `SOURce:FM:POLarity NORMal`

This command contains key word POLarity in the third command level. It defines the polarity between modulator and modulation signal.

`SOURce:FM:EXTernal:POLarity NORMal`

This command contains key word POLarity in the fourth command level. It defines the polarity between modulation voltage and the resulting direction of the modulation only for the external signal source indicated.

Optional key words:

Some command systems permit certain key words to be optionally inserted into the header or omitted. These key words are marked by square brackets in the description. The full command length must be recognized by the instrument for reasons of compatibility with the SCPI standard. Some commands are considerably shortened by these optional key words.

Example: `[SOURce]:POWer[:LEVel][:IMMediate]:OFFSet 1`

This command immediately sets the offset of the signal to 1 volt. The following command has the same effect:

`POWer:OFFSet 1`

**Note:** *An optional key word must not be omitted if its effect is specified in detail by a numeric suffix.*

Long and short form:

The key words feature a long form and a short form. Either the short form or the long form can be entered, other abbreviations are not permissible.

Example: `STATus:QUESTionable:ENABle 1= STAT:QUES:ENAB 1`

**Note:** *The short form is marked by upper-case letters, the long form corresponds to the complete word. Upper-case and lower-case notation only serve the above purpose, the instrument itself does not make any difference between upper-case and lower-case letters.*

Parameter:

The parameter must be separated from the header by a "white space". If several parameters are specified in a command, they are separated by a comma ",". A few queries permit the parameters MINimum, MAXimum and DEFault to be entered. For a description of the types of parameter, refer to Section "Parameters".

Example: `SOURce:POWer:ATTenuation? MAXimum Response: 60`

This query requests the maximal value for the attenuation.

Numeric suffix:

If a device features several functions or features of the same kind, e.g. inputs, the desired function can be selected by a suffix added to the command. Entries without suffix are interpreted like entries with the suffix 1.

Example: `SOURce:FM:EXTernal2:COUPling AC`

This command sets the coupling of the second external signal source.

### 3.5.3 Structure of a Command Line

A command line may consist of one or several commands. It is terminated by a <New Line>, a <New Line> with EOI or an EOI together with the last data byte. Quick BASIC automatically produces an EOI together with the last data byte.

Several commands in a command line are separated by a semicolon ";". If the next command belongs to a different command system, the semicolon is followed by a colon.

Example:

```
CALL IBWRT(generator%, "SOURCE:POWER:CENTER MINIMUM;:OUTPUT:ATTENUATION 10")
```

This command line contains two commands. The first command is part of the SOURCE system and is used to specify the center frequency of the output signal. The second command is part of the OUTPUT system and sets the attenuation of the output signal.

If the successive commands belong to the same system, having one or several levels in common, the command line can be abbreviated. To this end, the second command after the semicolon starts with the level that lies below the common levels (see also Fig. 3-1). The colon following the semicolon must be omitted in this case.

Example:

```
CALL IBWRT(generator%, "SOURCE:FM:MODE LOCKED;:SOURCE:FM:INTERNAL:FREQUENCY 1kHz")
```

This command line is represented in its full length and contains two commands separated from each other by the semicolon. Both commands are part of the SOURCE command system, subsystem FM, i.e. they have two common levels.

When abbreviating the command line, the second command begins with the level below SOURCE:FM. The colon after the semicolon is omitted.

The abbreviated form of the command line reads as follows:

```
CALL IBWRT(generator%, "SOURCE:FM:MODE LOCKED;INTERNAL:FREQUENCY 1kHz")
```

However, a new command line always begins with the complete path.

Example: `CALL IBWRT(generator%, "SOURCE:FM:MODE LOCKED")`  
`CALL IBWRT(generator%, "SOURCE:FM:INTERNAL:FREQUENCY 1kHz")`

### 3.5.4 Responses to Queries

A query is defined for each setting command unless explicitly specified otherwise. It is formed by adding a question mark to the associated setting command. According to SCPI, the responses to queries are partly subject to stricter rules than in standard IEEE 488.2.

1. The requested parameter is transmitted without header.

Example: `SOURCE:EXTERNAL:COUPLING?` Response: AC

2. Maximum values, minimum values and all further quantities, which are requested via a special text parameter are returned as numerical values.

Example: `FREQUENCY? MAX` Response: 10E3

3. Numerical values are output without a unit. Physical quantities are referred to the basic units or to the units set using the Unit command.

Example: `FREQUENCY?` Response: 1E6 for 1 MHz

4. Truth values <Boolean values> are returned as 0 (for OFF) and 1 (for ON).

Example: `OUTPUT:STATE?` Response: 1

5. Text (character data) is returned in a short form.

Example: `SOURCE:FM:SOURCE?` Response: INT1

### 3.5.5 Parameter

Most commands require a parameter to be specified. The parameters must be separated from the header by a "white space". Permissible parameters are numerical values, Boolean parameters, text, character strings and block data. The type of parameter required for the respective command and the permissible range of values are specified in the command description.

**Numerical values** Numerical values can be entered in any form, i.e. with sign, decimal point and exponent. Values exceeding the resolution of the instrument are rounded up or down. The mantissa may comprise up to 255 characters, the exponent must lie inside the value range -32000 to 32000. The exponent is introduced by an "E" or "e". Entry of the exponent alone is not permissible. In the case of physical quantities, the unit can be entered. Permissible unit prefixes are G (giga), MA (mega), MOHM and MHZ are also permissible), K (kilo), M (milli), U (micro) and N (nano). If the unit is missing, the basic unit is used.

Example: `SOURce:FREQuency 1.5 kHz = SOURce:FREQuency 1.5E3`

**Special numerical values** The texts MINimum, MAXimum, DEFault, UP and DOWN are interpreted as special numerical values.

In the case of a query, the numerical value is provided.

Example: Setting command: `SOURce:VOLTage MAXimum`  
 Query: `SOURce:VOLTage?` Response: 15

MIN/MAX MINimum and MAXimum denote the minimum and maximum value.

DEF DEFault denotes a preset value which has been stored in the EPROM. This value conforms to the default setting, as it is called by the \*RST command.

UP/DOWN UP, DOWN increases or reduces the numerical value by one step. The step width can be specified via an allocated step command (see annex C, List of Commands) for each parameter which can be set via UP, DOWN.

INF/NINF INFINITY, Negative INFINITY (NINF) represent the numerical values -9.9E37 or 9.9E37, respectively. INF and NINF are only sent as device responses.

NAN Not a Number (NAN) represents the value 9.91E37. NAN is only sent as device response. This value is not defined. Possible causes are the division of zero by zero, the subtraction of infinite from infinite and the representation of missing values.

**Boolean Parameters** Boolean parameters represent two states. The ON state (logically true) is represented by ON or a numerical value unequal to 0. The OFF state (logically untrue) is represented by OFF or the numerical value 0. 0 or 1 is provided in a query.

Example: Setting command: `SOURce:FM:STATe ON`  
 Query: `SOURce:FM:STATe?` Response: 1

**Text** Text parameters observe the syntactic rules for key words, i.e. they can be entered using a short or long form. Like any parameter, they have to be separated from the header by a white space. In the case of a query, the short form of the text is provided.

Example: Setting command: `OUTPut:FILTer:TYPE EXTernal`  
 Query: `OUTPut:FILTer:TYPE?` Response: EXT

**Strings**

Strings must always be entered in quotation marks (' or ").

Example: `SYSTem:LANGUage "SCPI"` or  
`SYSTem:LANGUage 'SCPI'`

**Block data**

Block data are a transmission format which is suitable for the transmission of large amounts of data. A command using a block data parameter has the following structure:

Example: `HEADer:HEADer #45168xxxxxxxx`

ASCII character # introduces the data block. The next number indicates how many of the following digits describe the length of the data block. In the example the 4 following digits indicate the length to be 5168 bytes. The data bytes follow. During the transmission of these data bytes all End or other control signs are ignored until all bytes are transmitted. Data elements comprising more than one byte are transmitted with the byte being the first which was specified by SCPI command `"FORMat:BORDER"`.

The format of the binary files within the block depends on the IEC-bus command

The commands

```
:SOURce:LIST:DWELI
:SOURce:LIST:FREQuency
:SOURce:LIST:POWer
:SOURce:CORRection:CSET:DATA:FREQuency
:SOURce:CORRection:CSET:DATA:POWer
:SYSTem:MSEQuence:DWELI
:SYSTem:MSEQuence:RCL
```

use the IEEE-754 format for double precision floating point numbers. Each number is represented by 8 bytes.

**Example:**

`a# = 125.345678E6`

`b# = 127.876543E6`

```
CALL IBWRT(generator%, "SOURCE:CORRECTION:CSET:DATA:FREQ
#216" + MKD$(a#) + MKD$(b#))
```

- '#' in the command string introduces the binary block,
- '2' indicates that 2 digits specifying the length will follow next,
- '16' is the length of the binary block (in bytes), here: 2 double precision floating point number with 8 bytes each.
- The actual binary data follow now. As the function IBWRT requires a text string, MKD\$ is used for the type conversion.

The following ASCII format has the same effect:

```
CALL IBWRT(generator%, "SOURCE:CORRECTION:CSET:DATA:FREQ
125.345678E6, 127.876543E6")
```

### 3.5.6 Overview of Syntax Elements

The following survey offers an overview of the syntax elements.

- :** The colon separates the key words of a command.  
In a command line the separating semicolon marks the uppermost command level.
  
- ;** The semicolon separates two commands of a command line.  
It does not alter the path.
  
- ,** The comma separates several parameters of a command.
  
- ?** The question mark forms a query.
  
- \*** The asterix marks a common command.
  
- "** Quotation marks introduce a string and terminate it.
  
- #** ASCII character # introduces block data.
  
- A "white space" (ASCII-Code 0 to 9, 11 to 32 decimal, e.g. blank) separates header and parameter.

## 3.6 Description of Commands

### 3.6.1 Notation

In the following sections, all commands implemented in the instrument are first listed in tables and then described in detail, separated according to the command system. The notation corresponds to the one of the SCPI standards to a large extent. The SCPI conformity information can be taken from the list of commands in annex C.

#### Table of Commands

Command:	In the command column, the table provides an overview of the commands and their hierarchical arrangement (see indentations).
Parameter:	In the parameter column the requested parameters are indicated together with their specified range.
Unit:	The unit column indicates the basic unit of the physical parameters.
Remark:	In the remark column an indication is made on <ul style="list-style-type: none"> <li>- whether the command does not have a query form,</li> <li>- whether the command has only one query form ,</li> <li>- whether this command is implemented only with a certain option of the instrument.</li> </ul>

#### Indentations

The different levels of the SCPI command hierarchy are represented in the table by means of indentations to the right. The lower the level is, the farther the indentation to the right is. Please observe that the complete notation of the command always includes the higher levels as well.

Example: `SOURce:FM:MODE` is represented in the table as follows:

SOURce	first level
:FM	second level
:MODE	third level

In the individual description, the complete notation of the command is given. An example for each command and - if it exists - the default value is written out at the end of the individual description.

#### Upper/lower case notation

Upper/lower case letters serve to mark the long or short form of the key words of a command in the description. The instrument itself does not distinguish between upper and lower case letters.

**Special characters** | A selection of key words with an identical effect exists for several commands. These key words are indicated in the same line, they are separated by a vertical stroke. Only one of these key words has to be indicated in the header of the command. The effect of the command is independent of which of the key words is indicated.

Example: `SOURce`  
          `:FREQuency`  
          `:CW|:FIXed`

The two following commands of identical meaning can be formed. They set the frequency of the constantly frequent signal to 1 kHz:

```
SOURce:FREQuency:CW 1E3 = SOURce:FREQuency:FIXed 1E3
```

A vertical stroke in indicating the parameters marks alternative possibilities in the sense of "or". The effect of the command is different, depending on which parameter is entered.

Example: Selection of the parameters for the command

```
SOURce:COUPling AC | DC
```

If parameter AC is selected, only the AC content is fed through, in the case of DC, the DC as well as the AC content.

- [ ] Key words in square brackets can be omitted when composing the header (cf. Section "Optional Key"). The full command length must be accepted by the instrument for reasons of compatibility with the SCPI standards. Parameters in square brackets can optionally be incorporated in the command or omitted as well.
- { } Parameters in braces can optionally be incorporated in the command either not at all, once or several times.

### 3.6.2 Common Commands

The common commands are taken from the IEEE 488.2 (IEC 625-2) standard. Some commands have the same effect on different devices. The headers of these commands consist of an asterisk "\*" followed by three letters. Many common commands refer to the status reporting system which is described in detail in Section "Status Reporting System".

Table 3-1 Common Commands

Command	Parameter	Unit	Remark
*CLS			No query
*ESE	0 to 255		
*ESR?			Only query
*IDN?			Only query
*IST?			Only query
*OPC			
*OPT?			Only query
*PCB			
*PRE	0 to 255		
*PSC	0   1		
*RCL	0 to 50		No query
*RST			No query
*SAV	1 to 50		No query
*SRE	0 to 255		
*STB?			Only query
*TRG			No query
*TST?			Only query
*WAI			

#### \*CLS

**CLEAR STATUS** sets the status byte (STB), the standard event register (ESR) and the EVENT-part of the QUESTIONable and the OPERATION register to zero. The command does not alter the mask and transition parts of the registers. It clears the output buffer

#### \*ESE 0 to 255

**EVENT STATUS ENABLE** sets the event status enable register to the value indicated. Query \*ESE? returns the contents of the event status enable register in decimal form.

#### \*ESR?

**STANDARD EVENT STATUS QUERY** returns the contents of the event status register in decimal form (0 to 255) and subsequently sets the register to zero.



**\*IDN?**

**IDENTIFICATION QUERY** queries the instrument identification.

The device response is for example: "Rohde&Schwarz, SMP02,00000001, 1.04"

02 = variant identification

00000001 = serial number

1.04 = firmware version number

**\*IST?**

**INDIVIDUAL STATUS QUERY** returns the contents of the IST flag in decimal form (0 | 1). The IST flag is the status bit which is sent during a parallel poll.

**\*OPC**

**OPERATION COMPLETE** sets bit 0 in the event status register when all preceding commands have been executed. This bit can be used to initiate a service request.

**\*OPT?**

**OPTION IDENTIFICATION QUERY** queries the options included in the instrument and returns a list of the options installed. The options are separated from each other by means of commas. For every option, a fixed position is provided in the response.

Table 3-2 Device Response to \*OPT?

Position	Option	
1	SM-B1	Reference oscillator OCXO
2	SM-B2	LF generator
3	SM-B2	2nd LF generator
4	SM-B5	FM/ϕM modulator
5	reserved	
6	reserved	
7	reserved	
8	SMP-B11	Frequency extension 0.01 to 2 GHz
9	SMP-B12	Pulse modulator 2 to 20/27/40 GHz
10	SMP-B13	Pulse modulator 0.01 to 2 GHz
11	SMP-B14	Pulse generator
12	SMP-B15	Attenuator 27 GHz
13	reserved	
14	SMP-B17	Attenuator 40 GHz
15	SMP-B18	Auxiliary interface

Example for a device response: SM-B1,SM-B2,0,0,0,0,0,0,0,SMP-B15,0,0,0

**\*PCB**

**PASS CONTROL BACK** indicates to the potential controller the address where the control is to be passed back later. This command is sent by the current controller to a potential controller (see programming example in Appendix D).

**\*PRE** 0 to 255

**PARALLEL POLL REGISTER ENABLE** sets the parallel poll enable register to the value indicated. Query **\*PRE?** returns the contents of the parallel poll enable register in decimal form.

**\*PSC** 0 | 1

**POWER ON STATUS CLEAR** determines whether the contents of the ENABLE registers is maintained or reset in switching on.

**\*PSC = 0** causes the contents of the status registers to be maintained. Thus a service request can be triggered in switching on in the case of a corresponding configuration of status registers ESE and SRE.

**\*PSC ≠ 0** resets the registers.

Query **\*PSC?** reads out the contents of the power-on-status-clear flag. The response can be 0 or 1.

**\*RCL** 0 to 50

**RECALL** calls the instrument state which was stored under the number supplied using command **\*SAV**. 50 instrument states can be stored.

**\*RST**

**RESET** sets the instrument to a defined default status. The command essentially corresponds to pressing the [PRESET] key. The state of the RF-output is an exception: The RF-output is deactivated after **\*RST**, however, it is activated after the [RESET] key has been pressed. The default setting is indicated in the description of the commands.

**\*SAV** 1 to 50

**SAVE** stores the current instrument state under the number indicated (cf. **\*RCL** as well).

**\*SRE** 0 to 255

**SERVICE REQUEST ENABLE** sets the service request enable register to the value indicated. Bit 6 (MSS mask bit) remains 0. This command determines under which conditions a service request is triggered. Query **\*SRE?** reads the contents of the service request enable register in decimal form. Bit 6 is always 0.

**\*STB?**

**READ STATUS BYTE QUERY** reads out the contents of the status byte in decimal form.

**\*TRG**

**TRIGGER** triggers all actions waiting for a trigger event. Special trigger events can be started by command system "TRIGger" (see section "TRIGger System").

**\*TST?**

**SELF TEST QUERY** triggers all selftests of the instrument indicated in Section "Functional Test" and outputs an error code in decimal form.

**\*WAI**

**WAIT-to-CONTINUE** only permits the servicing of the subsequent commands after all preceding commands have been executed and all signals have settled (cf. **\*OPC** as well).

### 3.6.3 ABORt System

The ABORt system contains the commands to abort actions triggered. After an action has been aborted, it can be triggered again at once. All commands trigger an event, thus they have no \*RST value.

Further commands for the trigger system of the SMP can be found in the TRIGger system.

Command	Parameter	Default Unit	Remark
:ABORt [:SWEep] :LIST :MSEquence			No query No query No query

#### :ABORt[:SWEep]

The command aborts a sweep.

Example: :ABOR:SWE

#### :ABORt:LIST

The command aborts a list execution.

Example: :ABOR:LIST

#### :ABORt:MSEquence

The command aborts a Memory Sequence.

Example: :ABOR:MSEQ

### 3.6.4 CALibration-System

The CALibration system contains the commands to calibrate the SMP. On triggering the calibration by means of `:MEASure`, response "0" displays a faultless calibration, response "1" means that an error has occurred during calibration. As to the meaning of the data in the case of query `:DATA?`, cf. Section "Calibration" and service manual, stock no. 1036.5015.24.

Command	Parameter	Default Unit	Remark
<code>:PULSe</code> <code>[:MEASure]?</code> <code>:DATA?</code>			Query only Query only

#### **:CALibration:PULSe**

The commands to calibrate the pulse generator are under this node (option SMP-B14).

#### **:CALibration:PULSe[:MEASure]?**

The command triggers a calibration measurement. The command triggers an event and thus has no \*RST value.

Example: `:CAL:PULS:MEAS?`

Response: 0

#### **:CALibration:PULSe:DATA?**

The command queries the correction data. It returns the correction data as two integers separated by a comma. The first number indicates the fine adjustment, the second the coarse adjustment.

Example: `:CAL:PULS:DATA?`

Response: 26,2

### 3.6.5 DIAGnostic-System

The DIAGnostic system contains the commands for diagnostic test and service of the instrument. SCPI does not define DIAGnostic commands, the commands listed here are SMP-specific. All DIAGnostic commands are queries which are not influenced by \*RST. Hence no default setting values are stated.

Command	Parameter	Default Unit	Remark
<b>:DIAGnostic</b> <b>:INFO</b> <b>:CCOunt</b> <b>:ATTenuator1 2 3 4?</b> <b>:POWER?</b> <b>:MODules?</b> <b>:OTIME?</b> <b>:SDATE?</b> <b>[ :MEASure]</b> <b>:POINT?</b>			Query only Query only Query only Query only Query only Query only

#### **:DIAGnostic:INFO**

The commands which can be used to query all information which does not require hardware measurement are under this node.

#### **:DIAGnostic:INFO:CCOunt**

The commands which can be used to query all counters in the instrument are under this node (Cycle COunt).

#### **:DIAGnostic:INFO:CCOunt:ATTenuator 1 | 2 | 3 | 4?**

The command queries the number of switching processes of the different attenuator stages. The stages are designated with Z1 to Z4 within the instrument. In this command they are differentiated by a numeric suffix whose name corresponds to the number:

Suffix	Name	Function
1	Z1	10-dB-stage
2	Z2	20-dB- stage
3	Z3	40-dB- stage
4	Z4	40-dB- stage

Example:    :DIAG:INFO:CCO:ATT1?

Response: 1487

#### **:DIAGnostic:INFO:CCOunt:POWER?**

The command queries the number of switch-on processes.

Example:    :DIAG:INFO:CCO:POW?

Response: 258

**:DIAGnostic:INFO:MODules?**

The command queries the modules existing in the instrument with their model and state-of-modification numbers. The response supplied is a list in which the different entries are separated by commas. The length of the list is variable and depends on the equipment of the instrument. Each entry consists of three parts which are separated by means of blanks:

1. Name of module;
2. Variant of module in the form VarXX (XX = 2 digits)
3. Revision of module in the form RevXX (XX = 2 digits)

Example :DIAG:INFO:MOD?

Response: ROSC VAR01 RREV03,  
DSYN VAR03 REV12,  
...

**:DIAGnostic:INFO:OTIME?**

The command reads out the internal operating-time counter. The response supplies the number of hours the instrument has been in operation.

Example: :DIAG:INFO:OTIM?

Response: 19

**:DIAGnostic:INFO:SDATE?**

The command queries the date of software creation. The response is returned in the form year, month, day.

Example: :DIAG:INFO:SDAT?

Response: 1992, 12, 19

**:DIAGnostic[:MEASure]**

The commands which trigger a measurement in the instrument and return the measured value are under this node.

**:DIAGnostic[:MEASure]:POINT?**

The command triggers a measurement at a measuring point and returns the voltage measured. The measuring point is specified by a numeric suffix (cf. service manual, stock no. 1036.5015.24).

Example: :DIAG:MEAS:POIN2?

Response: 3.52

### 3.6.6 DISPLAY-System

This system contains the commands to configure the screen. If system security is activated using command `SYSTem:SECurity ON`, the display cannot be switched on and off arbitrarily (cf. below)

Command	Parameter	Default Unit	Remark
<code>:DISPlay</code> <code>:ANNotation</code> <code>[:ALL]</code> <code>:AMPLitude</code> <code>:FREQuency</code>	ON   OFF ON   OFF ON   OFF		

#### `:DISPlay:ANNotation`

The commands determining whether frequency and amplitude are indicated are under this node.

**Caution:** *With `SYSTem:SECurity ON`, the indications cannot be switched from OFF to ON. In this case `*RST` does not influence the `ANNotation` settings either. With `SYSTem:SECurity OFF`, the `*RST` value is ON for all `ANNotation` parameters.*

#### `:DISPlay:ANNotation[:ALL] ON | OFF`

The command switches the frequency and amplitude indication on or off.

Command `:DISPlay:ANNotation:ALL ON` can only be executed if `SYSTem:SECurity` is set to OFF.

With `SECurity OFF` - `*RST` value is ON.

Example: `:DISP:ANN:ALL ON`

#### `:DISPlay:ANNotation:AMPLitude ON | OFF`

The command switches on or off the amplitude indication.

Command `:DISPlay:ANNotation:AMPLitude ON` can only be executed if `SYSTem:SECurity` is set to OFF.

With `SYSTem:SECurity OFF` - `*RST` value is ON.

Example: `:DISP:ANN:AMPL ON`

#### `:DISPlay:ANNotation:FREQuency ON | OFF`

The command switches on or off the amplitude indication.

Command `:DISPlay:ANNotation:AMPLitude ON` can only be executed if `SYSTem:SECurity` is set to OFF.

With `SYSTem:SECurity OFF` - `*RST` value is ON.

Example: `:DISP:ANN:FREQ ON`





### 3.6.8 INPut-System

This system provides the commands defining the properties of the STOP input of the SMP.

Command	Parameters	Default Unit	Remark
<b>:INPut</b> :POLarity	NORMal   INVerted		

#### **:INPut:POLarity** NORMal | INVerted

The command selects the polarity of the STOP input.

NORMal The sweep is stopped by a high-level.

INVerted The sweep is stopped by a low-level.

Example: :INP:POL INV

\*RST-value is NORMal

### 3.6.9 MEMory System

This system contains the commands for the memory management of the SMP.

Command	Parameter	Default Unit	Remark
<b>:MEMory</b> :NSTates?			Query only

#### **:MEMory:NSTates?**

The command returns the number of \*SAV/\*RCL memories available. The SMP has 50 \*SAV/\*RCL memories in total.

Example: :MEM:NST?

Response: 50

### 3.6.10 OUTPut-System

This system contains the commands specifying the characteristics of the RF and LF output sockets and the auxiliary sockets BLANK, Z-AXIS and V/GHz. The following numbers are assigned to these outputs:

- OUTPut1: RF output BLANK output and ZAXIS output,
- OUTPut2: LF output,
- OUTPut2: V/GHz output.

Command	Parameters	Default Unit	Remark
<b>:OUTPut1 2 3</b> <b>:AMODe</b> <b>:BLANk</b> <b>:POLarity</b> <b>:IMPedance?</b> <b>:SCALe</b> <b>:SOURce</b> <b>[:STATe]</b> <b>:PON</b> <b>:VOLTage</b>	AUTO   FIXed  NORMAl   INVerted  0.5   1 0   2 ON   OFF OFF   UNCHanged 0 V to 4 V	V	Query only

**:OUTPut1:AMODe** AUTO | FIXed

The command switches over the operating mode of the attenuator (Attenuator MODe) at the RF output (output1).

AUTO The attenuator is switched whenever possible.

FIXed The attenuator is switched when certain fixed levels are exceeded/not reached.

Example: :OUTP:AMOD AUTO \*RST value is AUTO

**:OUTPut1:BLANk:POLarity** NORMAl | INVerted

The command sets the polarity of the BLANk signal (output1).

NORMAl The active BLANk state is indicated by the more positive or higher output voltage.

INVers The active BLANk state is indicated by the more negative or lower output voltage.

Example: :OUTP:BLAN:POL NORM RST value is NORM

**:OUTPut1:IMPedance?**

The command queries the impedance of the RF output (output1). This permits converting the output level between the units V and W. The impedance itself cannot be changed. For the RF output, it is fixed at the value of 50 Ohm.

Example: :OUTP:IMP? Response: 50

**:OUTPut3:SCALe 0.5 | 1**

The command defines the signal scale at the V/GHz-output (output3) (see also section "Sweep Outputs").

Example: `:OUTP3:SCAL 0.5?` \*RST-value is 1

**:OUTPut2:SOURce 0 | 2**

The command selects which LF-generator is connected to the LF-output socket (output2). It is available with option SM-B2.

0 LF-generator 1

2 LF-generator 2

Example: `:OUTP2:SOUR 2` \*RST-value is 0, LF-generator 1 is connected to the output

**:OUTPut1:STATe] ON | OFF**

The command switches on or off the RF output (output1). The RF output can also be switched off by the response of the protective circuit. But this has no influence on this parameter.

**Note:** *In contrast to the PRESET key, command \*RST sets the value for output1 to OFF, the RF-output is deactivated.*

Example: `:OUTP:STAT ON` \*RST value is OFF

**:OUTPut1[:STATe]:PON OFF | UNCHanged**

This command selects the state the RF output (output1) is to assume after power-on of the unit. It only exists for the RF output. \*RST does not influence the set value.

OFF Output is switched off.

UNCHanged Same state as before switch-off

Example: `:OUTP:PON OFF`

**:OUTPut2:VOLTage 0V to 4V**

The command sets the voltage of the LF-output (output2). The voltage is a characteristic of the output, not of the source. I.e., the voltage is maintained even if another generator is connected to the output.

Example: `:OUTP2:VOLT 3.0V` \*RST-value is 1V

### 3.6.11 SOURce-System

This system contains the commands to configure the RF signal source. Keyword SOURce is optional, i.e., it can be omitted. The LF signal sources (option SM-B2) are configured in the SOURce0|2 system.

The following subsystems are realized in the instrument:

Subsystem	Settings
[:SOURce] :AM :CORRection :DM :FM :FREQuency :LIST :MARKer :PHASe :PM :POWer :PULM :PULSe :ROSCillator :SWEep	Amplitude modulation Correction of the output level Digital modulation Frequency modulation Frequencies including sweep LIST operating mode Marker generation with sweeps Phase between output signal and reference oscillator signal Phase modulation Output level, level control and level correction Pulse modulation Pulse generator Reference oscillator Sweeps

#### 3.6.11.1 SOURce:AM Subsystem

This subsystem contains the commands to control the amplitude modulation. Up to two LF generators which serve as internal modulation sources can be fitted in the instrument (options SM-B2 and SM-B6). Part of their settings is effected under SOURce0|2.

Command	Parameters	Default Unit	Remark
[:SOURce] :AM [:DEPTH] :EXTernal :COUPling :IMPedance :INTernal1 2 :FREQuency :SCAN :SENSitivity :SOURce :STATe	0 to 100PCT AC   DC 600 Ohm   100 kOhm 400 Hz, 1 kHz, 4 kHz, 15 kHz or 0.1 Hz to 500 kHz or 0.1 Hz to 1 MHz ON   OFF 0 to 10 dB/V EXT   INT1 2   EXT, INT1 2 ON   OFF	PCT Ohm Hz Hz	option SM-B2

#### [:SOURce]:AM[:DEPTH] 0 to 100PCT

The command sets the modulation depth in percent.

\*RST value is 30PCT

Example: :SOUR:AM:DEPT 15PCT

#### [:SOURce]:AM:EXTernal

The commands to set the external AM input are under this node.

**[[:SOURce]:AM:EXTernal:COUPling AC | DC**

The command selects the type of coupling for the external AM input.

AC The d.c. voltage content is separated from the modulation signal.

DC The modulation signal is not altered.

\*RST value is AC

Example: :SOUR:AM:EXT:COUP AC

**[[:SOURce]:AM:EXTernal:IMPedance 600Ohm | 100kOhm**

The command defines the input impedance of the external AM-input. This command is coupled to the commands

:SOURce:FM:EXTernal:IMPedance,

:SOURce:DM:EXTernal:IMPedance and

:SOURce:PM:EXTernal:IMPedance.

\*RST value is 100 kOhm

Example: :SOUR:AM:EXT:IMP 100kOhm

**[[:SOURce]:AM:INTernal1|2**

The settings for the internal AM inputs are effected under this node.

INT1 is LF generator 1,

INT2 is LF generator 2.

Here the same hardware is set for AM, PM, FM and SOURce0|2. This means that, for example, the following commands are coupled to each other and have the same effect:

SOUR:AM:INT2:FREQ

SOUR:FM2:INT:FREQ

SOUR:PM2:INT:FREQ

SOUR2:FREQ:CW

**[[:SOURce]:AM:INTernal1|2:FREQuency 400 Hz | 1 kHz | 3 kHz | 15 kHz  
or 0.1 Hz to 500 kHz (SM-B2)**

The command sets the modulation frequency. Only certain specified ranges are permissible depending on the equipment of the instrument.

If option SM-B2 is not fitted, the values 400 Hz, 1 kHz, 3 kHz and 15 kHz are permitted for INT1. With option SM-B2, values in the range from 0.1 Hz to 500 kHz are permitted.

Example: :SOUR:AM:INT:FREQ 15kHz

\*RST value is 1 kHz

**[[:SOURce]:AM:SCAN ON| IOFF**

The command switches scan modulation on or off.

Example: :SOUR:AM:SCAN OFF

\*RST value is OFF

**[[:SOURce]:AM:SCAN:SENSitivity 0 to 10dB/V**

The command sets the scan sensitivity. The resolution is 0.01dB/V.

Example: :SOUR:AM:SCAN:SENS 10dB

**[[:SOURce]:AM:SOURce EXT | INT1|2 | EXT, INT1|2**

The command selects the modulation source. INT1 is LF generator 1, INT2 LF generator 2 (option SM-B2). An external and an internal modulation source can be specified at the same time (see example). \*RST value is INT1

Example: :SOUR:AM:SOUR EXT, INT1

**[[:SOURce]:AM:STATe ON | OFF**

The command switches amplitude modulation on or off.

\*RST value is OFF

Example: :SOUR:AM:STAT ON

### 3.6.11.2 SOURce:CORRection Subsystem

The CORRection subsystem permits a correction of the output level. The correction is effected by adding user-defined table values to the output level as a function of the RF frequency. In the SMP, this subsystem serves to select, transmit and switch on USER-CORRECTION tables (see Chapter 2, Section "User Correction (UCOR)" as well).

Command	Parameters	Default Unit	Remark
[:SOURce] :CORRection [:STATe] :CSET :CATalog? [:SElect] :DATA :FREQuency :POWer :DElete	ON   OFF  "name of table"  2 to 20/27/40 GHz {,2 to 20/27/40 GHz }  +6 to -6dB {,+6 to -6dB }  "name of table"	Hz  dB	query only  with option SMP-B11 above 10 MHz

#### [:SOURce]:CORRection[:STATe] ON | OFF

The command switches the table selected using SOURce:CORRection:CSET on or off.

Example: :SOUR:CORR:STAT ON \*RST value is OFF

#### [:SOURce]:CORRection:CSET

The commands to select and edit the UCOR tables are under this node.

#### [:SOURce]:CORRection:CSET:CATalog?

The command requests a list of UCOR tables. The individual lists are separated by means of commas. This command is a query and has no \*RST value.

Example: :SOUR:CORR:CAT? Answer: "UCOR1", "UCOR2", "UCOR3"

#### [:SOURce]:CORRection:CSET[:SElect] "Name of table"

The command selects a UCOR table. This command alone does not yet effect a correction. First the table selected must be activated (cf. :SOURce:CORRection:STATe). If there is no table of this name, a new table is created. The name may contain up to 7 letters. This command triggers an event and hence has no \*RST value.

Example: :SOUR:CORR:CSET:SEL "UCOR1"

**[[:SOURce]:CORRection:CSET:DATA**

The commands to edit the UCOR tables are under this node.

**[[:SOURce]:CORRection:CSET:DATA:FREQuency** 2 to 20/27/40 GHz {,2 to 20/27/40 GHz }  
(with option SMP-B11 above 10 MHz)

The command transmits the frequency data for the table selected using :SOURce:CORRection:CSET. The frequency values must be entered in ascending order. \*RST does not influence data lists.

Example: :SOUR:CORR:CSET:DATA:FREQ 100MHz,102MHz,103MHz,...

**[[:SOURce]:CORRection:CSET:DATA:POWer** +6 to -6dB {,+6 to -6dB }

The command transmits the level data for the table selected using :SOURce:CORRection:CSET. \*RST does not influence data lists.

Example: :SOUR:CORR:CSET:DATA:POWer 1dB, 0.8dB, 0.75dB,...

**[[:SOURce]:CORRection:CSET:DELeTe** "Name of table"

The command deletes the table indicated from the instrument memory. This command triggers an event and hence has no \*RST value.

Example: :SOUR:CORR:CSET:DEL "UCOR3"

### 3.6.11.3 SOURce:DM Subsystem

In this subsystem, the digital modulations ASK and FSK are controlled (see Chapter 2, Section "Digital Modulations ASK and FSK"). An external input (EXT1) is available as a data source. This source is set independently of the type of modulation selected. The settings hence affect both types of digital modulations.

Command	Parameters	Default Unit	Remark
[:SOURce] :DM :TYPE :STATe :EXTernal :IMPedance :ASK :DEPT <sub>h</sub> :POLarity :FSK :DEViation :MODE :POLarity	ASK   FSK ON   OFF 600 Ohm   100 kOhm 0 to 100PCT NORMal   INVerted below 20 GHz: 0 to 10 MHz or 0 to 1 MHz above 20 GHz: 0 to 20 MHz or 0 to 2 MHz LOCKed   UNLOCKed   PRECise NORMal   INVerted	Ohm PCT Hz	

#### [:SOURce]:DM:TYPE ASK | FSK

The command selects the modulation type.

ASK        Amplitude Shift KeYing

FSK        Frequency Shift KeYing

Example:    :SOUR:DM:TYPE FSK

\*RST value is FSK

#### [:SOURce]:DM:STATe ON | OFF

The command switches on or off the modulation selected under :SOURce:DM:TYPE.

Example:    :SOUR:DM:STAT OFF

\*RST value is OFF

#### [:SOURce]:DM:EXTernal

The commands to configure the EXT1-input are under this node.

#### [:SOURce]:DM:EXTernal:IMPedance 600 Ohm | 100 kOhm

The command defines the input impedance of the external DM-input (EXT1).

This command is coupled to the commands SOURce:AM:EXTernal:IMPedance, SOURce:FM:EXTernal:IMPedance and SOURce:PM:EXTernal:IMPedance.

Example:    :SOUR:DM:EXT:IMP 100kOhm

\*RST value is 100 kOhm



**[[:SOURce]:DM:ASK**

The commands to set the external data source for the digital amplitude modulation are under this node.

**[[:SOURce]:DM:ASK:DEPTH 0 to 100%**

This command sets the modulation depth.

\*RST value is 10

Example: :SOUR:DM:ASK:DEPT 10

**[[:SOURce]:DM:ASK:POLarity NORMal | INVerted**

The command defines the polarity of the modulation.

NORMal A "0" from the data source reduces the amplitude, a "1" increases it.

INVerted A "1" from the data source reduces the amplitude, a "0" increases it.

Example: :SOUR:DM:ASK:POL INV

\*RST value is NORMal

**[[:SOURce]:DM:FSK**

The commands to set the data source for the digital frequency modulation are under this node.

**[[:SOURce]:DM:FSK:DEVIation 0 to 1 MHz (FM/FSK-mode PRECise),  
0 to 10 MHz (FM/FSK-mode LOCKed/UNLOCKed),  
SMP03/04 above 20 GHz: 0 to 2 MHz or 0 to 20 MHz**

This command sets the frequency deviation of the FSK-modulation. The maximum deviation possible depends on the FM/FSK mode set and – for SMP03/04 – also on the selected frequency (see FSK:MODE, Section "SOURce:FM-Subsystem" and Chapter 2, Section "Frequency Modulation").

Example: :SOUR:DM:FSK:DEV 3kHz

\*RST value is 10 kHz

**[[:SOURce]:DM:FSK:MODE UNLOCKed | LOCKed | PRECise**

The command defines the FSK-modulation mode. It is coupled to the command SOUR:FM:MODE (see description of the command SOUR:FM:MODE in Section "SOURce:FM-Subsystem").

Example: :SOUR:DM:FSK:MODE UNL

\*RST value is LOCKed

**[[:SOURce]:DM:FSK:POLarity NORMal | INVerted**

The command specifies the polarity of the modulation.

NORMal Logical "0" reduces the frequency, logical "1" increases it.

INVerted Logical "1" reduces the frequency, logical "0" increases it.

Example: :SOUR:DM:FSK:POL INV

\*RST value is NORMal

### 3.6.11.4 SOURce:FM Subsystem

This subsystem contains the commands to control the frequency modulation and to set the parameters of the modulation signal. The SMP can be equipped with two independent frequency modulators (option SM-B5). They are distinguished by a suffix after FM (:SOURce:FM1 and :SOURce:FM2).

Command	Parameters	Default Unit	Remark
[[:SOURce] :FM1 2 :MODE [:DEVIation] :EXTernal1 2 :COUPling :IMPedance :INTernal :FREQUency :SOURce :STATe	LOCKed   UNLOCKed   PRECise below 20 GHz: 0 to 10 MHz or 0 to 1 MHz above 20 GHz: 0 to 20 MHz or 0 to 2 MHz AC   DC 600 Ohm   100 kOhm 20 kHz to 500 kHz or 0.1 Hz to 500 kHz INT   EXT1   EXT2 ON   OFF	Hz Ohm Hz	option SM-B5

**[[:SOURce]:FM1|2:MODE UNLOCKed | LOCKed | PRECise**

The command defines the frequency modulation mode for both frequency modulators, a suffix after FM is ignored. The parameter PRECise is effective only if the SMP is fitted with option SM-B5.

The command is coupled to the command SOUR:DM:FSK:MODE (see command description for SOUR:DM:FSK:MODE in Section "SOURce:DM-Subsystem").

Selection of the mode influences the frequency range of the modulation, the maximum frequency deviation and the frequency stability of the output signal (see Chapter 2, Section "Frequency Modulation").

**LOCKed** The FM-signal is synchronized by means of a PLL on the reference oscillator. The frequency of the RF-signal is accurate in the modulation frequency range 10 kHz to 5 MHz. The maximum frequency deviation is 10/20 MHz.

**UNLOCKed** The reference oscillator is not used to generate the FM-signal. The frequency of the RF-signal is accurate in the modulation frequency range DC to 5 MHz. The maximum frequency deviation is 10/20 MHz.

**PRECise** The FM-signal is generated by option SM-B5. This setting is valid if option SM-B5 is fitted. The frequency of the RF-signal is accurate in the modulation frequency range DC to 1 MHz. The maximum frequency deviation is 1/2 MHz.

Example: :SOUR:DM:FM:MODE LOCK \*RST value is LOCKed

**[[:SOURce]:FM1|2[:DEVIation]** 0 to 1 MHz or 0 to 10 MHz; >20GHz 0 to 2 MHz or 0 to 20 MHz

The command specifies the frequency variation caused by the FM. Although the LF generators are used as modulation sources, the frequency variation is independent of the voltage at the LF output. The maximum possible DEVIation depends on the selected FM-mode and for SMP03/04 also on the selected frequency (SOURce:FREQuency).

LOCKed and UNLOCKed:	$f \leq 20 \text{ GHz}$	DEV MAX = 10 MHz
	$f > 20 \text{ GHz}$	DEV MAX = 20 MHz
PRECise:	$f \leq 20 \text{ GHz}$	DEV MAX = 1 MHz
	$f > 20 \text{ GHz}$	DEV MAX = 2 MHz

Example: :SOUR:FM1:DEV 5kHz

\*RST value is 10 kHz

**[[:SOURce]:FM1|2:EXTernal 2**

The commands to set the external FM input are under this node. The settings under EXTernal for modulations AM, FM and PM are independent of each other. The settings are always related to the socket which is determined by the numeric suffix after EXTernal. The suffix after FM is ignored then. With the following commands, e.g., the settings are both related to EXT2 input:

```
:SOUR:FM1:EXT2:COUP AC
:SOUR:FM2:EXT2:COUP AC
```

A command without suffix is interpreted like a command with suffix 1.

**[[:SOURce]:FM1|2:EXTernal1|2:COUPling** AC | DC

The command selects the type of coupling for the external FM input.

AC The d.c. voltage content is separated from the modulation signal.

DC The modulation signal is not altered.

\*RST value is AC

Example: :SOUR:FM:EXT:COUP AC

**[[:SOURce]:FM1|2:EXTernal1|2:IMPedance** 600 Ohm | 100 kOhm

The command defines the input impedance of the external FM-input. This command is coupled to the commands SOURce:AM:EXTernal:IMPedance, SOURce:DM:EXTernal:IMPedance and SOURce:PM:EXTernal:IMPedance.

Example: :SOUR:FM:EXT:IMP 100kOhm

\*RST value is 100 kOhm

**[[:SOURce]:FM1|2:INTernal**

The settings for the internal FM generators are effected under this node. For FM1, this is always LF generator 1, for FM2, always LF generator 2. Here the same hardware is set for FM1, PM1, AM:INT1 as well as SOURce0, just like for FM2, PM2 and AM:INT2 as well as SOURce2. This means that, e.g., the following commands are coupled to each other and have the same effect:

```
SOUR:AM:INT2:FREQ
SOUR:FM2:INT:FREQ
SOUR:PM2:INT:FREQ
SOUR2:FREQ:CW
```

**[[:SOURCE]:FM1|2:INTERNAL:FREQUENCY** 10 kHz/ DC to 5 MHz / DC to 1 MHz

The command sets the modulation frequency. Depending on the FM-mode selected, only a specific range is permitted (see Chapter 2, Section "Frequency Modulation").

LOCKed      FREQ = 10 kHz to 5 MHz

UNLOCKed    FREQ = DC to 5 MHz

PRECise      FREQ = DC Hz to 1 MHz

Example:     : SOUR:FM:INT:FREQ 10kHz

\*RST value is 1 kHz

**[[:SOURCE]:FM1|2:SOURCE** INTERNAL | EXTERNAL1 | EXTERNAL2

The command selects the modulation source. A command without suffix is interpreted like a command with suffix 1. LF generator 1 is INT for FM1, LF generator 2 for FM2. An external and an internal modulation source can be specified at the same time (cf. example)

Example:     : SOUR:FM:SOUR INT1, EXT2

\*RST value for FM1: INT  
for FM2:EXT2

**[[:SOURCE]:FM1|2:STATE** ON | OFF

The command switches the frequency modulation on or off.

\*RST value is OFF.

Example:     SOUR:FM:STAT OFF

### 3.6.11.5 SOURce:FREQUENCY Subsystem

This subsystem contains the commands for the frequency settings of the RF source including the sweeps.

Command	Parameters	Default Unit	Remark
<b>[:SOURce]</b>			
<b>:FREQUENCY</b>			<b>with option SMP-B11</b>
<b>:CENTer</b>	2 to 20/27/40 GHz	Hz	10 to 20/27/40 GHz
<b>[:CW]:FIXed]</b>	2 to 20/27/40 GHz	Hz	10 to 20/27/40 GHz
<b>:RCL</b>	INCLude   EXCLude		
<b>:MANual</b>	2 to 20/27/40 GHz	Hz	10 to 20/27/40 GHz
<b>:MODE</b>	CW   FIXed   SWEEp   LIST		
<b>:MULTiplier</b>	1.0 to 10.0		
<b>:OFFSet</b>	-50 to +50 GHz	Hz	
<b>:SPAN</b>	0 to 18/25/38 GHz	Hz	0 to 19.9/26.9/39.9 GHz
<b>:START</b>	2 to 20/27/40 GHz	Hz	10 MHz to 20/27/40 GHz
<b>:STOP</b>	2 to 20/27/40 GHz	Hz	10 MHz to 20/27/40 GHz
<b>:STEP</b>			
<b>[:INCRement]</b>	0 to 10 GHz	Hz	

**[:SOURce]:FREQUENCY:CENTer** SMP02: 2 to 20 GHz, SMP03: 2 to 27 GHz, SMP04: 2 to 40 GHz

The command sets the sweep range by means of the center frequency. This command is coupled to the commands `:SOURce:FREQUENCY:START` and `:SOURce:FREQUENCY:STOP`.

Here – like for the input value FREQUENCY in the FREQUENCY menu – the OFFSET-value is taken into account. Thus the frequency range quoted is only valid for OFFSet = 0 and MULTiplier = 1. For other OFFSet and MULTiplier values, the range can be calculated according to the following formula (cf. Chapter 2, Section "Frequency Offset" as well):

$$2 \text{ GHz} \times \text{MULTiplier} + \text{OFFSet} \text{ to } 20/27/40 \text{ GHz} \times \text{MULTiplier} + \text{OFFSet}$$

Example: `:SOUR:FREQ:CENT 10GHZ` \*RST value is (START + STOP)/2

**[:SOURce]:FREQUENCY[:CW] | :FIXed]** 2 to 20/27/40 GHz (with option SMP-B11: 10 MHz to 20/27/40 GHz)

The command sets the frequency for CW operation. This value is coupled to the current sweep frequency. In addition to a numeric value, UP and DOWN can be indicated. The frequency is increased or reduced by the value set under `:SOURce:FREQUENCY:STEP`. (As to specified range, cf. `FREQUENCY:CENTer`).

Example: `:SOUR:FREQ:CW 10GHZ` \*RST value is 10 GHz

**[:SOURce]:FREQUENCY[:CW]:FIXed]:RCL** INCLude | EXCLude

The command determines the effect of the recall function on the frequency. \*RST value has no effect to this setting.

**INCLude** The saved frequency is loaded when instrument settings are loaded with the [RECALL] key or with a memory sequence.

**EXCLude** The RF frequency is not loaded when instrument settings are loaded, the current settings are maintained.

Example: `:SOUR:FREQ:RCL INCL`

**[:SOURCE]:FREQUENCY:MANual** 2 to 20/27/40 GHz (with option SMP-B11: 10 MHz to 20/27/ GHz)

The command sets the frequency if `SOURCE:SWEep:MODE MANual` and `SOURCE:FREQUENCY:MODE SWEep` are set. Only frequency values between the settings with `:SOURCE:FREQUENCY:START` and `:SOURCE:FREQUENCY:STOP` are permitted. (As to the permitted range, cf. `FREQUENCY:CENTer`) \*RST value is 10 GHz

Example: `:SOUR:FREQ:MAN 5GHz`

**[:SOURCE]:FREQUENCY:MODE** CW | FIXed | SWEep | LIST

The command specifies the operating mode and hence also specifies which commands control the FREQUENCY subsystem. The parameters are assigned as follows:

**CW | FIXed** CW and FIXed are synonyms. The output frequency is specified by means of `:SOURCE:FREQUENCY:CW | FIXed`.

**SWEep** The instrument operates in the SWEep-mode. The frequency is specified by means of commands `SOURCE:FREQUENCY:START; STOP; CENTer; SPAN; MANual`.

**LIST** The instrument processes a list of frequency and level settings. The settings are effected in the `SOURCE:LIST` subsystem. Setting `SOURCE :FREQUENCY:MODE LIST` automatically sets command `SOURCE:POWer :MODE` to LIST as well.

Example: `:SOUR:FREQ:MODE LIST` \*RST value is CW.

**[:SOURCE]:FREQUENCY:MULTiplier** 1.0 to 10.0

The command is used to enter the multiplier of a possible frequency multiplier connected in series (see Chapter 2, Section "Frequency Offset and Multiplier"). If a multiplier or a frequency offset value have been entered, the frequency entered using `SOURCE:FREQUENCY: . . .` is no longer identical with the RF-output frequency. The following relation holds:

`SOURCE:FREQUENCY: . . . = RF-output frequency x MULTiplier + OFFset.`

The entry of a multiplier does not change the RF-output frequency but only the value queried by `[:SOURCE]:FREQUENCY: . . . . .` \*RST value is 1

Example: `:SOUR:FREQ:MULT 2`

**[:SOURCE]:FREQUENCY:OFFSet** -50 to + 50 GHz

The command sets the frequency offset of an mixer which might be series-connected. (cf. above, `:FREQUENCY:MULTiplier`, and Chapter 2, Section "Frequency Offset and Multiplier").

Example: `:SOUR:FREQ:OFFS 100MHz` \*RST value is 0

**[:SOURCE]:FREQUENCY:SPAN** 2 to 18/25/38 GHz (with option SMP-B11: 0 to 19,9/26,9/39,9 GHz)

This command specifies the frequency range for the sweep. This parameter is coupled to the start and stop frequency. Negative values for SPAN are permitted, then `START > STOP` is true. The following relations hold:

`START = CENTer - SPAN/2`

`STOP = CENTer + SPAN/2`

\*RST value is (STOP - START)

Example: `:SOUR:FREQ:SPAN 10GHz`

**[[:SOURce]:FREQuency:STARt 2 to 20/27/40 GHz (with option SMP-B11: 10 MHz to 20/27/40 GHz)**

This command defines the starting value of the frequency for the sweep operation. Parameters STARt, STOP, SPAN and CENTer are coupled to each other. STARt may be larger than STOP. (As to specified range, cf. FREQuency:CENTer). \*RST value is 10 GHz

Example: :SOUR:FREQ:STAR 2GHz

**[[:SOURce]:FREQuency:STOP 2 to 20/27/40 GHz (with option SMP-B11: 10 MHz to 20/27/40 GHz)**

This command indicates the final value of the frequency for the sweep operation (see STARt as well). (As to the specified range, cf. FREQuency:CENTer). \*RST value is 20 GHz

Example: :SOUR:FREQ:STOP 15GHz

**[[:SOURce]:FREQuency:STEP**

The command to enter the step width for the frequency setting if frequency values UP or DOWN are used is under this node. This command is coupled to the KNOB STEP command in manual control. Only linear step widths can be set.

**[[:SOURce]:FREQuency:STEP[:INCRement] 0 to 10 GHz**

The command sets the step width for the frequency setting.

Example: :SOUR:FREQ:STEP:INCR 1MHz

\*RST value is 1MHz

### 3.6.11.6 SOURce:LIST Subsystem

This subsystem contains the commands for the LIST operating mode of the RF generator. Processing the lists is controlled by the TRIGger:LIST subsystem. Each list consists of a FREQUENCY, POWER and DWELI part. The list parts must all be of the same length except for parts of length 1. This is interpreted as if the part had the same length as the other parts and all values were equal to the first value. After a list has been created and changed, command :LIST:LEARN has to be entered to have the settings transferred to the hardware.

The LIST mode is activated by command SOURce:FREQUENCY:MODE LIST.

**Note:** SCPI designates the individual lists as segments.

Command	Parameters	Default Unit	Remark
[[:SOURce]] :LIST			
:CATalog?			query only
:DELeTe	"name of list"		
:ALL			
:DWELI	1ms to 5 s {,1 ms to 5 s}	s	
:POINTs?			query only
:FREE?			
:FREQUency	2 to 20/27/40 GHz {,2 to 20/27/40 GHz }   block data	Hz	with SMP-B11 above 10 MHz
:POINTs?			query only
:LEARN			
:MODE	AUTO   STEP		
:POWER	-130 to 27/22 dBm {, -130 to 27/22 dBm}   block data		-20 to 27/22 dBm without SMP-B15
:POINTs?			query only
:SELeCt	"name of list"		

#### [[:SOURce]]:LIST:CATalog?

The command requests a survey of the lists available separated by commas. The command is a query and hence has no \*RST value.

Example: :SOUR:LIST:CAT?

Answer: "MYLIST", "LIST1", "LIST2"

#### [[:SOURce]]:LIST:DELeTe "Name of list"

The command deletes the list indicated.

\*RST has no influence on data lists.

Example: :SOUR:LIST:DEL "LIST2"

#### [[:SOURce]]:LIST:DELeTe:ALL

The command deletes all lists.

\*RST has no influence on data lists.

Example: :SOUR:LIST:DEL:ALL



**[:SOURce]:LIST:DWELI 1 ms to 5 s {, 1 ms to 5 s}**

For every item of the FREQuency or POWer/VOLTage list contents, the command specifies the time the instrument "dwells" at this item.

**Note:** *The RF generator is not in a position to allocate different times to the individual items of the FREQuency and POWer list contents. Thus the DWELI part of the list should have length 1; the value is then valid for all items. If a list containing more than one element is indicated, all values must be equal.*

Example: `:SOUR:LIST:DWEL 0.15`

**[:SOURce]:LIST:DWELI:POINts?**

The command queries the length (in items) of the DWELI-part of the list. The command is a query and thus has no \*RST value.

Example: `:SOUR:LIST:DWEL:POIN?` Answer: 1

**[:SOURce]:LIST:FREE?**

The command queries two values. The first one indicates the space still vacant for lists (in items), the second one the space already occupied, also in items. The command is a query and thus has no \*RST value.

Example: `:SOUR:LIST:FREE?` Answer: 2400, 200

**[:SOURce]:LIST:FREQuency 2 to 20 27/40 GHz {, 2 to 20 27/40GHz }| block data**  
(option SMP-B11: above 10 MHz)

The command fills the FREQuency part of the list selected with data. The data can either be indicated as a list of numbers (separated by commas) of arbitrary length or as binary block data. In the case of block data transmission, always 8 (4) bytes are interpreted as a floating-point number of double accuracy (cf. command FORMat :DATA). \*RST does not influence data lists.

Example: `:SOUR:LIST:FREQ 14GHz, 13GHz, 12GHz, ...`

**[:SOURce]:LIST:FREQuency:POINts?**

The command queries the length (in items) of the FREQuency part of the list presently selected. The command is a query and thus has no \*RST value.

Example: `:SOUR:LIST:FREQ:POIN?` Answer: 327

**[:SOURce]:LIST:LEARn**

The command learns the list selected. I.e., it determines the hardware setting for the entire list. The data thus determined are stored together with the list. The command triggers an event and thus has no \*RST value.

Example: `:SOUR:LIST:LEAR`

**Caution:** *This command has to be given after every creating and changing of a list.*

**[:SOURce]:LIST:MODE AUTO | STEP**

The command indicates the mode in which the list is to be processed (by analogy with SOURce:SWEep:MODE).

AUTO Each trigger event triggers a complete list run.

STEP Each trigger event triggers only one step in processing the list.

Example: `:SOUR:LIST:MODE STEP` \*RST value is AUTO

**[[:SOURce]:LIST:POWer** -130 to 27 dBm {, -130 to 27 dBm} | block data  
(-20 to 27 dBm without option SMP-B15)

The command fills the POWer part of the RF list selected with data. The data can either be indicated as a list of numbers (separated by commas) of arbitrary length or as binary block data. As to the format of the data, cf. command :SOURce:LIST:FREQ. \*RST does not influence data lists.

Example: :SOUR:LIST:POW 0dBm,-2dBm,-2dBm,-3dBm,...

**[[:SOURce]:LIST:POWer:POINts?**

The command queries the length (in items) of the LEVel part of the list presently selected. The command is a query and thus has no \*RST value

Example: :SOUR:LIST:POW:POIN?

Answer: 327

**[[:SOURce]:LIST:SElect** "Name of list"

The command selects the list indicated. If there is no list of this name, a new list is created. The name may contain up to 7 letters. If the list does not exist yet, it is created. The command triggers an event and thus has no \*RST value

Example: :SOUR:LIST:SEL "LIST1"

### 3.6.11.7 SOURce:MARKer Subsystem

This subsystem contains the commands to control the generation of markers during the sweep. The SMP has three markers each for frequency and level sweeps which are distinguished by a numeric suffix after MARKer. The settings for frequency sweep and level sweep marker are independent of each other.

Command	Parameters	Default Unit	Remark
[:SOURce] :MARKer 1   2   3 [:FSWweep] :AMPLitude :AOFF :FREQuency [:STATe] :PSWweep :AOFF :POWer [:STATe] :POLarity	ON   OFF  2 to 20/27/40 GHz  ON   OFF  -130 dBm to 27/22 dBm  ON   OFF NORMal   INVerted	Hz   dBm	no query with option SMP-B11: above 10 MHz  no query -20 dBm to 27/22 dBm without option SMP-B15

#### [:SOURce]:MARKer1|2|3[:FSWweep]

The commands for the markers with frequency sweep are under this node. Keyword :FSWweep can be omitted, then the command conforms to SCPI regulations.

#### [:SOURce]:MARKer1|2|3[:FSWweep]:AMPLitude ON | OFF

The command specifies whether the marker influences the signal level.

ON The output level is reduced by a constant value when the marker frequency is executed.

OFF The output level remains unchanged. \*RST value is OFF

Example: :SOUR:MARK1:FSW:AMP ON

#### [:SOURce]:MARKer1|2|3[:FSWweep]:AOFF

Command (All markers off) switches off all frequency markers. This command triggers an event, thus it has no \*RST value and no query form.

Example: :SOUR:MARK:FSW:AOFF

#### [:SOURce]:MARKer1|2|3[:FSWweep]:FREQuency 2 to 20/27/40 GHz

The command sets the marker selected by the numeric suffix with MARKer to the frequency indicated.

Here – like for the input value MARKer in the SWEEP - FREQ menu – the OFFSET-values of the FREQuency subsystem are taken into account. Thus the specified range indicated is only valid for SOURce:FREQuency:OFFSet = 0, SOUR:FREQ:Mult = 1. The specified range for other OFFSet Multiplier values can be calculated according to the following formula (cf. Chapter 2, Section "Frequency Offset and Multiplier", as well):

10 MHz x MULTiplier – OFFSet to 20/27/40 GHz x MULTiplier – OFFSet

\*RST value for MARK1: 10 GHz

MARK2: 15 GHz

MARK3: 20 GHz

Example: :SOUR:MARK1:FSW:FREQ 3 GHz

#### **[[:SOURce]:MARKer1|2|3[:FSWeep][:STATe] ON | OFF**

The command switches the marker selected by the numeric suffix after MARKer on or off.

Example: :SOUR:MARK1:FSW:STAT ON \*RST value is OFF

#### **[[:SOURce]:MARKer1|2|3:PSWeep**

The commands for the markers with level sweep are under this node (Power sweep). The three markers are distinguished by a numeric suffix after MARKer.

#### **[[:SOURce]:MARKer1|2|3:PSWeep:AOFF**

The command switches all level markers off. This command is an event and thus has no \*RST value and no query form.

Example: :SOUR:MARK:PSW:AOFF

#### **[[:SOURce]:MARKer1|2|3:PSWeep:POWER -130 dBm to +27 dBm (without option SMP-B15: -20 dBm to 27 dBm; SMP03/04: below 22 dBm)**

The command sets the marker selected by the numeric suffix with MARKer to the level indicated.

In this command, the OFFSet value of subsystem (menu) POWER (LEVEL) is considered in correspondence with input value MARKer in the SWEEP LEVEL menu. Thus the specified range indicated is only valid for SOURce:POWer:OFFSet = 0. The specified range with other OFFSet values can be calculated according to the following formula (cf. Chapter 2, Section "Level Offset" as well):

-130 dBm – OFFSet to 27/22 dBm – OFFSet

\*RST value for MARK1: 1 dBm

MARK2: 2 dBm

Example: :SOUR:MARK1:PSW:POW -2dBm

MARK3: 3 dBm

#### **[[:SOURce]:MARKer1|2|3:PSWeep[:STATe] ON | OFF**

The command switches the marker selected by the numeric suffix with MARKer on or off.

Example: :SOUR:MARK1:PSW:STAT ON \*RST value is OFF

#### **[[:SOURce]:MARKer1|2|3:POLarity NORMal | INVerted**

The command specifies the polarity of the marker signal.

**NORMal** When running through the marker condition, TTL level is applied at the marker output, otherwise 0 V.

**INVerted** When running through the marker condition, 0 V is applied at the marker output, otherwise TTL level. \*RST value is NORM

Example: :SOUR:MARK:POL INV

### 3.6.11.8 SOURce:PHASe Subsystem

Command	Parameters	Default Unit	Remark
[:SOURce] :PHASe [:ADJust] :REFerence	-360 deg to +360 deg	rad	no query

#### [:SOURce]:PHASe[:ADJust] -360 deg to +360 deg

The command indicates the phase between output signal and reference oscillator signal. This setting is only accepted using SOURce:PHASe:REFerence (cf. below). An indication in RADian is possible.

Example: :SOUR:PHAS:ADJ 2DEG

:SOUR:PHAS:ADJ 0.1RAD

\*RST value is 0.0 DEG

#### [:SOURce]:PHASe:REFerence

The command accepts the phase set using SOURce:PHASe:ADJust as a new reference phase. The command has no \*RST value.

Example: :SOUR:PHAS:REF

### 3.6.11.9 SOURce:PM Subsystem

This subsystem contains the commands to check the phase modulation and to set the parameters of the modulation signal. The SMP can be equipped with two independent phase modulators, PM1 and PM2 (option SM-B5). They are distinguished by a suffix after PM.

Command	Parameters	Default Unit	Remark
<b>[:SOURce]</b> <b>:PM 1   2</b>			option SM-B5
<b>[:DEVIation]</b>	0 to 10/20 rad	rad	
<b>:EXTernal 1   2</b>			
<b>:COUPling</b>	AC   DC		
<b>:IMPedance</b>	600 Ohm   100 kOhm	Ohm	
<b>:INTernal</b>			
<b>:FREQUency</b>	400 Hz   1 kHz   3 kHz   15 kHz or 0.1Hz to 100 kHz	Hz	option SM-B2
<b>:SOURce</b>	INT   EXT1   EXT2		
<b>:STATe</b>	ON   OFF		

**[:SOURce]:PM1|2[:DEVIation]** 0 to 10 rad (SMP03/04 above 20 GHz: 0 to 20 rad)

The command sets the modulation deviation in Radian. DEGRee is accepted, too.

Example: `SOUR:PM:DEV 20DEGR`

\*RST value is 1 rad

**[:SOURce]:PM1|2:EXTernal1|2**

The commands to check the external input of the PM modulators are under this node. The settings under EXTernal for modulations AM, FM and PM are independent of each other. The settings are always related to the socket determined by the suffix after EXTernal. The suffix after PM is ignored then. With the following commands, e.g., the settings are both related to socket EXT2:

```
:SOUR:PM1:EXT2:COUP AC
:SOUR:PM2:EXT2:COUP AC
```

A command without suffix is interpreted like a command with suffix 1.

**[:SOURce]:PM1|2:EXTernal1|2:COUPling** AC | DC

The command selects the type of coupling for the external PM input.

AC The d.c. voltage content is separated from the modulation signal.

DC The modulation signal is not changed.

\*RST value is AC

Example: `:SOUR:PM:COUP DC`

**[:SOURce]:PM 1|2:EXTernal1|2:IMPedance** 600 Ohm | 100 kOhm

The command defines the input resistance of the selected external PM-input. This command is coupled to the commands `SOURce:AM:EXTernal:IMPedance`, `SOURce:DM:EXTernal:IMPedance` and `SOURce:FM:EXTernal:IMPedance`.

Example: `:SOUR:PM:IMP100kOhm`

\*RST value is 100 kOhm







**[[:SOURce]:POWer:ALC:SOURce INTERNAL | DIODE | PMETER**

The command selects the detector for power control.

INTERNAL The internal detector is used.

DIODE A diode detector can be connected at the external ALC-input.

PMETER A power meter can be connected at the external ALC-input.

Example: :SOUR:POW:ALC:SOUR INT \*RST value is INTERNAL

**[[:SOURce]:POWer:ALC:SOURce:PMETER RS\_NRVS | HP436A**

The command indicates the type of power meter connected.

RS\_NRVS Rohde & Schwarz NRVD or NRVS (Id.-no. 857.8008.02 or 1020.1809.02).

HP436A Hewlett-Packard HP436A.

Example: :SOUR:POW:ALC:SOUR:PMET RS\_NRVS \*RST value is RS\_NRVS

**[[:SOURce]:POWer:ALC[:STATe] ON | OFF**

The command switches the level control on or off.

ON Level control is permanently switched on.

OFF Level control is switched on for a short period of time if the level changes.

Example: :SOUR:POW :ALC:STAT ON \*RST value is ON

**[[:SOURce]:POWer[:LEVel][:IMMediate]**

The commands to set the output levels for the CW- and SWEEP modes are under this node.

**[[:SOURce]:POWer[:LEVel][:IMMediate][:AMPLitude] –130 dBm to 27 dBm (without option SMP-B15: –20 dBm to 27 dBm; SMP03/04: below 22 dBm)**

The command sets the RF output level in operating mode CW. UP and DOWN can be indicated in addition to numeric values. Then the level is increased or reduced by the value indicated under :SOURce:POWer:STEP.

In this command, the OFFSET value is considered as with input value AMPLITUDE in the LEVEL-LEVEL menu. Thus the specified range indicated is only valid for :POWer:OFFSet = 0. The specified range with other OFFSET values can be calculated according to the following formula (cf. Chapter 2, Section "Level Offset" as well):

$$-130 \text{ dBm} + \text{OFFSet to } 22/27 \text{ dBm} + \text{OFFSet}$$

The keywords of this command are optional to a large extent, thus the long as well as the short form of the command is shown in the example. \*RST value is –30 dBm or –20 dBm

Example: :SOUR:POW:LEV:IMM:AMPL -15 or  
:POW -15

**[[:SOURce]:POWer[:LEVel][:IMMediate][:AMPLitude]:OFFSet –100 to +100 dB**

The command enters the constant level offset of a series-connected attenuator/ amplifier (cf. Section "Level Offset"). If a level offset is entered, the level entered using :POWer:AMPLitude does no longer conform to the RF output level. The following relation is true:

$$:\text{POWer} = \text{RF output level} + \text{POWer:OFFSet.}$$

Entering a level offset does not change the RF output level but only the value queried by of :POWer:AMPLitude.

Only dB is permissible as a unit here, linear units (V, W etc.) are not permitted.

Example: :SOUR:POW:LEV:IMM:AMPL:OFFS 0 or \*RST value is 0 dB  
:POW:OFFS 0

**[[:SOURce]:POWer:LIMit[:AMPLitude]** –130 dBm to 27 dBm (without option SMP-B15: –20 dBm to 27 dBm; SMP03/04: below 22 dBm)

The command limits the maximum RF output level in operating mode CW and SWEEP. It does not influence the display LEVEL and the answer to query POW?.

Example: :SOUR:POW:LIM:AMPL -15 \*RST value is +16 dBm

**[[:SOURce]:POWer:MANual** –130 dBm to 27 dBm (without option SMP-B15: –20 dBm to 27 dBm; SMP03/04: below 22 dBm)

The command sets the level if SOURce:POWer:MODE is set to SWEEP and SOURce:SWEEP:MODE to MANUAL. Only level values between START and STOP are permitted. (As to specified range, cf. :POWer).

Example: :SOUR:POW:MAN 1dBm \*RST value is –30 dBm or –20 dBm

**[[:SOURce]:POWer:MODE** FIXed | SWEEP | LIST

The command specifies the operating mode and thus also by means of which commands the level setting is checked.

**FIXed** The output level is specified by means of commands under :SOURce:POWer:LEVel.

**SWEEP** The instrument operates in the SWEEP mode. The level is specified by means of :SOURce:POWer; START; STOP; CENTer; SPAN and MANual.

**LIST** The instrument processes a list of frequency and level settings. The settings are effected in the SOURce:LIST subsystem.

**Setting** :SOURce:POWer:MODE LIST automatically sets command :SOURce:FREQuency:MODE to LIST as well.

Example: :SOUR:POW:MODE FIX \*RST value is FIXed

**[[:SOURce]:POWer:STARt** –130 dBm to 27 dBm (without option SMP-B15: –20 dBm to 27 dBm; SMP03/04: below 22 dBm)

The command sets the starting value for a level sweep. STARt may be larger than STOP, then the sweep runs from the high to the low level (As to specified range, cf. :POWer:AMPLitude).

Example: :SOUR:POW:STAR -20 \*RST value is –30dBm or –20 dBm

**[[:SOURce]:POWer:STOP** –130 dBm to 27 dBm (without option SMP-B15: –20 dBm to 27 dBm; SMP03/04: below 22 dBm)

The command sets the final value for a level sweep. STOP may be smaller than STARt. (As to specified range, cf. :POWer:AMPLitude).

Example: :SOUR:POW:STOP 3 \*RST value is -10dBm

**[[:SOURce]:POWer:STEP[:INCRement]** 0.1 to 10 dB

The command sets the step width with the level setting if UP and DOWN are used as level values. The command is coupled to KNOB STEP in the manual control, i.e., it also specifies the step width of the shaft encoder.

Only dB is permissible as a unit here, the linear units (V, W etc.) are not permitted.

Example: :SOUR:POW:STEP:INCR 2 \*RST value is 1dB



**[:SOURCE]:PULM:SOURCE** EXTernal | INTernal

The command selects the source of the modulating signal.

INTernal Internal pulse generator (option SM-B4).

EXTernal Signal fed externally

Example: :SOUR:PULM:SOUR INT

\*RST value is INTernal

**[:SOURCE]:PULM:STATE** ON | OFF

The command switches on or off the pulse modulation.

Example: :SOUR:PULM:STAT ON

\*RST value is OFF



### 3.6.11.13 SOURce:ROSCillator Subsystem

This subsystem contains the commands to set the external and internal reference oscillator.

Command	Parameters	Default Unit	Remark
[:SOURce] :ROSCillator :EXTernal :FREQuency [:INTernal] :ADJust [:STATe] :VALue :SOURce	1 to 16 MHz  ON   OFF 0 to 4095 INTernal   EXTernal	Hz	

#### [:SOURce]:ROSCillator:EXTernal

The commands to set the external reference oscillator are under this node.

#### [:SOURce]:ROSCillator:EXTernal:FREQuency 1 to 16 MHz

The command informs the instrument about at which frequency the external reference oscillator oscillates.

Example: `:SOUR:ROSC:FREQ 5MHz` \*RST value is 10 MHz

#### [:SOURce]:ROSCillator[:INTernal]:ADJust

The commands for frequency adjustment (fine-tuning of the frequency) are under this node.

#### [:SOURce]:ROSCillator[:INTernal]:ADJust[:STATe] ON | OFF

The command switches the frequency adjustment on or off.

Example: `:SOUR:ROSC:INT:ADJ:STAT ON` \*RST value is OFF

#### [:SOURce]:ROSCillator[:INTernal]:ADJust:VALue 0 to 4095

The command indicates the frequency correction value (tuning value). For a detailed definition, cf. Chapter 2, Section "Reference Frequency Internal/External".

Example: `:SOUR:ROSC:INT:ADJ:VAL 2048` \*RST value is 2048

#### [:SOURce]:ROSCillator:SOURce INTernal | EXTernal

The command selects the reference source.

INTernal The internal oscillator is used.

EXTernal The reference signal is fed externally.

Example: `:SOUR:ROSC:SOUR EXT` \*RST value is INTernal

### 3.6.11.14 SOURce:SWEep Subsystem

This subsystem contains the commands to control the RF sweep, i.e., sweeps of the RF generators. Sweeps are triggered on principle. The frequency sweep is activated by command `SOURce:FREQuency:MODE SWEep`, the level sweep by command `SOURce:POWer:MODE SWEep`.

Command	Parameters	Default Unit	Remark
<b>[[:SOURce]]</b> <b>:SWEep</b> <b>:BTIme</b> <b>[[:FREQuency]]</b> <b>:DWELI</b> <b>:MODE</b> <b>:POINts</b> <b>:SPACing</b> <b>:STEP</b> <b>[[:LINear]]</b> <b>:LOGarithmic</b> <b>:POWer</b> <b>:DWELI</b> <b>:MODE</b> <b>:POINts</b> <b>:SPACing</b> <b>:STEP</b> <b>:LOGarithmic</b>	NORMAl   LONG  10 ms to 5 s AUTO   MANUal   STEP number Linear   Logarithmic  0 to 10 GHz 0.01 to 50 PCT  10 ms to 5 s AUTO   MANUal   STEP number Logarithmic  0 to 10 dB	   s          Hz PCT  s          dB	

#### [[:SOURce]]:SWEep:BTIme NORMAl | LONG

The command sets the blank time of the sweep. The setting is valid for all sweeps, i.e., also for LF sweeps.

**NORMAl** Blank time as short as possible.

**LONG** Blank time long enough to permit an XY recorder to return to 0.

Example: `:SOUR:SWE:BTIM LONG`

\*RST value is NORM

#### [[:SOURce]]:SWEep[:FREQuency]

The commands to set the frequency sweeps are under this node. Keyword `[[:FREQuency]]` can be omitted (cf. examples). The commands are SCPI compatible then unless stated otherwise.

#### [[:SOURce]]:SWEep[:FREQuency]:DWELI 10 ms to 5 s

The command sets the dwell time per frequency step.

Example: `:SOUR:SWE:DWEL 12ms`

\*RST value is 15 ms

**[ :SOURce]:SWEep[:FREQUENCY]:MODE AUTO | MANual | STEP**

The command specifies the run of the sweep.

**AUTO** Each trigger triggers exactly one entire sweep cycle.

**MANual** Each frequency step of the sweep is triggered by means of manual control or a `SOURce:FREQUENCY:MANual` command, the trigger system is not active. The frequency increases or decreases (depending on the direction of the shaft encoder) by the value indicated under `[ :SOURce]:FREQUENCY:STEP:INCRement`.

**STEP** Each trigger triggers only one sweep step (single-step mode). The frequency increases by the value indicated under `[ :SOURce]:SWEep:STEP:LOGarithmic`.

Example: `:SOUR:SWE:MODE AUTO` \*RST value is AUTO

**[ :SOURce]:SWEep[:FREQUENCY]:POINTS Number**

The command determines the number of steps in a sweep.

Instead of this command, commands `SOURce:SWEep:FREQUENCY:STEP:LINear` and `SOURce:SWEep:FREQUENCY:STEP:LOGarithmic` should be used, as `SOURce:SWEep:FREQUENCY:POINTS` has been adapted to the instrument characteristics in comparison to the SCPI command.

The value of **POINTS** depends on **SPAN** and **STEP** according to the following formulas..

The following is true for linear sweeps :  $POINTS = SPAN / STEP:LIN + 1$

The following is true for logarithmic sweeps and **START** < **STOP**:

$POINTS = ((\log STOP - \log START) / \log (1 + STEP:LOG))$

Two independent **POINTS** values are used for **SPACING** LOG and **SPACING** LIN. I.e., before **POINTS** is changed, **SPACING** must be set correctly. A change of **POINTS** results in an adaptation of **STEP**, but not of **START**, **STOP** and **SPAN**.

Example: `:SOUR:SWE:POIN 100`

**:SOURce:SWEep[:FREQUENCY]:SPACING LINear | LOGarithmic**

The command selects whether the steps have linear or logarithmic spacings.

Example: `:SOUR:SWE:SPAC LIN` \*RST value is LINear

**[ :SOURce]:SWEep[:FREQUENCY]:STEP**

The commands to set the step width for linear and logarithmic sweeps are under this node. The settings of **STEP:LIN** and **STEP:LOG** are independent of each other.

**[ :SOURce]:SWEep[:FREQUENCY]:STEP[:LINear] 0 to 10 GHz**

The command sets the step width with the linear sweep. If **STEP[:LINear]** is changed, the value of **POINTS** valid for **SPACING:LINear** also changes according to the formula stated under **POINTS**. A change of **SPAN** does not result in a change of **STEP[:LINear]**. Keyword **[:LINear]** can be omitted, then the command conforms to SCPI regulations (see example).

Example: `:SOUR:SWE:STEP 1MHz` \*RST value is 1 MHz



**[[:SOURce]:SWEep[:FREQUENCY]:STEP:LOGarithmic 0.01 to 50 PCT**

The command indicates the step width factor for logarithmic sweeps. The next frequency value of a sweep is calculated according to

new frequency = previous frequency + STEP:LOG x previous frequency (if START < STOP)

STEP:LOG indicates the fraction of the previous frequency by which this is increased for the next sweep step. Usually STEP:LOG is indicated in percent, with the suffix PCT having to be used explicitly. If STEP:LOG is changed, the value of POINTs valid for SPAC:LOG also changes according to the formula stated under POINTs. A change of START or STOP does not result in a change of STEP:LOG.

Example: :SOUR:SWE:STEP:LOG 10PCT

\*RST value is 1 PCT

**[[:SOURce]:SWEep:POWER**

The commands to set the power sweeps are under this node.

**[[:SOURce]:SWEep:POWER:DWELI 10 ms to 5 s**

The command sets the dwell time per level step.

Example: :SOUR:SWE:POW:DWEL 12ms

\*RST value is 15 ms

**[[:SOURce]:SWEep:POWER:MODE AUTO | MANual | STEP**

The command specifies the sweep mode.

AUTO Each trigger triggers exactly one entire sweep cycle.

MANual Each level step of the sweep is triggered by means of manual control or a SOURce:POWer:MANual command, the trigger system is not active. The level increases or decreases (depending on the direction of the shaft encoder) by the value stated under :SOURce:POWer:STEP: INCRement.

STEP Each trigger triggers only one sweep step (single-step mode). The level increases by the value indicated under :SOURce:POWer:STEP: INCRement.

Example: :SOUR:SWE:POW:MODE AUTO

\*RST value is AUTO

**[[:SOURce]:SWEep:POWER:POINTs number**

The command determines the number of steps in a sweep. Instead of this command, command SOURce:SWEep:POWer:STEP:LOGarithmic should be used, as POINTs has been adapted to the instrument characteristics in comparison to the SCPI command.

The value of :POINTs depends on .SPAN and :STEP according to the following formulas:

$$\text{POINTs} = ((\log \text{STOP} - \log \text{START}) / \log \text{STEP:LOG}) + 1$$

A change of POINTs results in an adaptation of STEP but not of START, STOP and SPAN.

Example: :SOUR:SWE:POW:POIN 100

**[[:SOURce]:SWEep:POWER:SPACing LOGarithmic**

The command defines that the sweep steps have logarithmic spacings. It permits the query of SPACing. \*RST value is LOGarithmic

Example: :SOUR:SWE:POW:SPAC LOG

**[[:SOURce]:SWEep:POWer:STEP**

The commands to set the step width for the sweep are under this node.

**[[:SOURce]:SWEep:POWer:STEP:LOGarithmic 0 to 10 dB**

The command indicates the step width factor for logarithmic sweeps. The next level value of a sweep is calculated according to

new level = previous level + STEP:LOG × previous level

STEP:LOG denotes the fraction of the previous level by which this is increased for the next sweep step. Usually STEP:LOG is entered in units of dB, with suffix dB having to be specified explicitly. If STEP:LOG is changed, the value of POINTs also changes according to the formula indicated under POINTs. A change of START or STOP does not result in a change of STEP:LOG. Keyword :LOG can be omitted, then the command conforms to SCPI regulation (see example).

Example: :SOUR:SWE:STEP 10dB

\*RST value is 1dB

### 3.6.12 SOURce0|2 System

The SOURce0|2 system contains the commands to configure the LF signal sources. The sources are assigned as follows:

- SOURce0:** Standard generator.  
Designated as INT1 if used as a modulation source (cf. command SOURce:AM:SOURce INT1, e.g.). The numbering as SOURce0 is different from the manual control.  
Second optional LF generator (option SM-B2).  
Replaces the standard generator which is cut out by this option. Is designated as INT1 if it is used as a modulation source; if it is used as an LF generator, it is designated as SOURce0 differently from the numbering of the manual control.
- SOURce2:** First optional LF or modulation generator (option SM-B2).  
Is designated as INT2 if it is used as a modulation source; if it is used as an LF generator, it is designated as SOURce2.

The commands to set the output voltage of the LF generators are in the OUTPut2 system.

Subsystems	Settings
:SOURce0   2 :FREQUency :FUNction :MARKer :SWEep	Frequency with CW and sweep operation. Waveform of the output signal Marker for LF sweeps (only possible using SOURce2) LF sweep (only possible using SOURce2)

#### 3.6.12.1 SOURce0|2:FREQUENCY Subsystem

This subsystem contains the commands for the frequency settings including the sweeps. Only command SOURce0:FREQUency:CW|FIXed is effective for the standard LF generator (SOURce0). For LF generator2 (SOURce2), sweep commands are effective as well.

Command	Parameter	Default Unit	Remark
:SOURce0   2 :FREQUency [:CW FIXed]	400 Hz   1 kHz   3 kHz   15 kHz bzw. 0.1 Hz to 500 kHz	Hz	Option SM-B2
:MANual	400 Hz   1 kHz   3 kHz   15 kHz bzw. 0.1 Hz to 500 kHz	Hz	Option SM-B2
:MODE	CW FIXed   SWEep		
:START	0.1 Hz to 500 kHz	Hz	Option SM-B2
:STOP	0.1 Hz to 500 kHz	Hz	Option SM-B2



### 3.6.12.2 SOURce 0|2:FUNCTION-Subsystem

This subsystem contains the commands specifying the waveform of the output signal.

Command	Parameter	Default Unit	Remark
:SOURce0 2 :FUNCTION [:SHAPE]	SINusoid   SQUare   TRlangle   PRNoise		Option SM-B2

**:SOURce0|2:FUNCTION[:SHAPE]** SINusoid | SQUare | TRlangle | PRNoise | SAWTooth

The command specifies the shape of the output signal. In the case of the standard generator, the signal is specified to be sinusoidal. Option SM-B2, LF generator, can be switched to generate all possible signal shapes. If two options SM-B2 are installed, SOURce0 can be set to the signal shapes of option SM-B2 as well.

SINusoid      Sine

SQUare        Square

TRlangle      Triangle

PRNoise       Periodic noise

\*RST value is SIN

Example:      :SOUR2:FUNC:SHAP SQU

### 3.6.12.3 SOURce2:MARKer-Subsystem

This subsystem contains the commands to control the marker generation in the case of LF sweeps. Operating mode SWEEP is only possible for SOURce2. The three markers existing are distinguished by a numeric suffix after marker.

Command	Parameter	Default Unit	Remark
:SOURce2 :MARKer1 2 3 [:FSWEEP] :AOFF :FREQuency [:STATe] :POLarity	0.1 Hz to 500 kHz ON   OFF NORMal   INVerted	Hz	Option SM-B2  No query

#### :SOURce2:MARKer1|2|3[:FSWEEP]

The commands for the markers with the LF frequency sweep (Frequency SWEEP) are under this node. Keyword [:FSWEEP] can also be omitted, then the command conforms to SCPI regulation (see examples).

#### :SOURce2:MARKer1|2|3[:FSWEEP]:AOFF

The command switches off all LF frequency markers. This command triggers an event, thus it has no \*RST value and no query form.

Example: :SOUR2:MARK:AOFF

:SOURce2:MARKer1|2|3[:FSWEEP]:FREQuency **0.1 Hz to 500 kHz** The command sets the marker selected by the numeric suffix at MARKer to the frequency defined.

\*RST value for MARK1: 100kHz

Example: :SOUR2:MARK1:FREQ 9000

MARK2: 10kHz  
MARK3: 1kHz

#### :SOURce2:MARKer1|2|3[:FSWEEP][:STATe] ON | OFF

The command switches on or off the marker selected by the numeric suffix at MARKer.

Example: :SOUR2:MARK1:STAT ON

\*RST value is OFF

#### :SOURce2:MARKer1|2|3:POLarity NORMal | INVerted

The command specifies the polarity of the marker signal as follows:

NORMal When running through the marker condition, TTL level is applied at the marker output, otherwise 0 V.

INVers When running through the marker condition, 0 V is applied at the marker output, otherwise TTL level. \*RST value is NORM

Example: :SOUR2:MARK1:POL INV



**:SOURce2:SWEep[:FREQUENCY]:POINTS** Number

The command determines the number of steps in a sweep. Instead of this command, commands `:SOURce2:FREQUENCY:STEP:LINEar` and `:SOURce2:FREQUENCY:STEP:LOGarithmic` should be used, as `:SOURce2:SWEep:FREQUENCY:POINTS` has been adapted to the instrument characteristics in comparison to the SCPI command. The value of POINTs depends on SPAN and STEP according to the following formulas.

The following is true of linear sweeps :  $POINTS = SPAN / STEP:LIN + 1$

The following is true of logarithmic sweeps and START < STOP:

$$POINTS = ((\log STOP \log START) / \log STEP:LOG) + 1$$

Two independent POINTs values are used for SPACing LOG and SPACing LIN. That is to say, before POINTs is changed, SPACing must be set correctly. A change of POINTs causes an adaption of STEP, but not of START, STOP and SPAN.

Example: `:SOUR2:SWE:POIN 50`

**:SOURce2:SWEep[:FREQUENCY]:SPACing** LINear | LOGarithmic

The command selects whether the steps have linear or logarithmic spacings.

Example: `:SOUR2:SWE:SPAC LOG` \*RST value is LINear

**:SOURce2:SWEep[:FREQUENCY]:STEP**

The commands to set the step width with linear and logarithmic sweeps are under this node. The settings of STEP:LIN and STEP:LOG are independent of each other.

**:SOURce2:SWEep[:FREQUENCY]:STEP[:LINEar]** 0 to 500 kHz

The command sets the step width with the linear sweep. If STEP:LINEar is changed, the value of POINTs valid for SPACing:LINEar also changes according to the formula defined under POINTs. A change of SPAN does not cause a change of STEP:LINEar. Keyword [:LINEar] can be omitted, then the command conforms to SCPI regulation (see example)

Example: `:SOUR2:SWE:STEP 10kHz` \*RST value is 1 kHz

**:SOURce2:SWEep[:FREQUENCY]:STEP:LOGarithmic** 0.01 to 50PCT

The command defines the step width factor for logarithmic sweeps. The next frequency value of a sweep is calculated according to (if START < STOP) :

new frequency = prior frequency + STEP:LOG x prior frequency

Thus STEP:LOG defines the fraction of the prior frequency by which this is increased for the next sweep step. Usually STEP:LOG is defined in percent, with the suffix PCT having to be used explicitly. If STEP:LOG is changed, the value of POINTs valid for SPACing:LOGarithmic also changes according to the formula stated unde

Example: `:SOUR2:SWE:STEP:LOG 5PCT` \*RST value is 1 PCT







### 3.6.14 SYSTem-System

In this system, a number of commands for general functions which are not immediately related to signal generation, are combined.

Command	Parameter	Default Unit	Remark
<b>:SYSTem</b>			
<b>:BEEPer</b>			
<b>:STATe</b>	ON   OFF		
<b>:COMMunicate</b>			
<b>:GPIB</b>			
[ <b>:SELF</b> ]			
<b>:ADDRess</b>	0 to 30		
<b>:SERial</b>			
<b>:CONTRol</b>	ON   IBFull   RFR		
<b>:RTS</b>	1200   2400   4800   9600   19200   38400   57600   115200		
<b>:BAUD</b>	XON   NONE		
<b>:PACE</b>			
<b>:ERRor?</b>	ON   OFF		Query only
<b>:KLOCK</b>	FIXed   MSEquence		
<b>:MODE</b>			
<b>:MSEquence</b>			Query only
<b>:CATalog?</b>	"Name of sequence"		
<b>:DELeTe</b>			
<b>:ALL</b>	50 ms to 60 s {,50 ms to 60 s}	s	
<b>:DWELI</b>			
<b>:FREE?</b>	AUTO   STEP		
<b>:MODE</b>	1 to 50 {,1 to 50}		
[ <b>:RCL</b> ]			
<b>:POINTs?</b>	"Name of sequence"		Query only
<b>:SELeCt</b>			No query
<b>:PRESet</b>			
<b>:PROTeCt</b>	ON   OFF , password		
[ <b>:STATe</b> ]			
<b>:SECurity</b>	ON   OFF		
[ <b>:STATe</b> ]			Query only
<b>:SERRor?</b>			Query only
<b>:VERSion?</b>			

**:SYSTem:BEEPer:STATe** ON | OFF

This node contains the commands to set the beeper fitted.

\*RST value is OFF

Example:       :SYST:BEEP:STAT OFF

**:SYSTem:COMMunicate**

The commands to set the remote control interfaces are under this node.

**:SYSTem:COMMunicate:GPIB**

The commands to control the IEC bus are under this node  
(GPIB = General Purpose Interface Bus)

**:SYSTem:COMMunicate:GPIB[:SELF]:ADDRess 1 to 30**

The command sets the IEC bus instrument address. \*RST value is 28

Example:       :SYST:COMM:GPIB:ADDR 1

**:SYSTem:COMMunicate:SERial**

The command to set the serial interface are under this node. The data format is fixedly set to 8 data bits, no parity and 1 stop bit. These values cannot be changed. The device represents a DTE (Data Terminal Equipment) in relation to the serial interface. Therefore the the controller must be connected via a 0-modem.

**:SYSTem:COMMunicate:SERial:BAUD 1200| 2400| 4800| 9600| 19200| 38400| 57600| 115200**

The commands sets the baud rate for both the transmit and the receive direction. \*RST has no influence on this parameter.

Example:       :SYST:COMM:SER:BAUD 1200 \*RST value is 9600

**:SYSTem:COMMunicate:SERial:CONTrol:RTS ON | IBFull | RFR**

he commands sets the hardware handshake. \*RST has no influence on this parameter.

ON             Interface line RTS is always active.

IBFull | RFR   Input Buffer Full | Ready For Receiving.

Interface line RTS remains active as long as the instrument is ready to receive data

Example:       :SYST:COMM:SER:CONT:RTS ON \*RST value is RFR

**:SYSTem:COMMunicate:SERial:PACE XON | NONE**

The command sets the software handshake. \*RST has no influence on this parameter.

XON            Software handshake using the ASCII codes 11h (XON) and 13h (XOFF).

**Note:** *This mode is not recommended for binary data and for baud rates above 9600 bauds.*

NONE           No software handshake.

Example:       :SYST:COMM:SER:PACE NONE \*RST value is NONE

**:SYSTem:ERRor?**

The command queries the entry that has been in the error queue for the longest time. Positive error numbers denote errors specific of the instrument, negative error numbers denote error messages specified by SCPI (see annex B). If the error queue is empty, 0, "No error", is returned. The command is identical to STATUS:QUEue:NEXT?

Example:       :SYST:ERR?                               Response: -221, "Settings conflict"





**:SYSTem:PROTect1|2|3 [:STATe] ON | OFF, password**

The command switches a protection level on or off. The passwords are 6-digit numbers. They are fixedly stored in the firmware. The password for the first level is 123456.

ON disables the functions belonging to this protection level. A password doesn't have to be entered.

OFF deactivates the disabling again if the correct password is entered. Otherwise an error -224, "Illegal parameter value" is generated and STATe remains ON.

Example: :SYST:PROT1:STAT OFF, 123456

**:SYSTem:SECurity**

The commands setting the security characteristics of the instrument are under this node.

**:SYSTem:SECurity[:STATe] ON | OFF**

The command switches the security state on or off. The command is not influenced by \*RST and \*RCL.

ON The following commands cannot be executed:

```
:DISPlay:ANNotation:ALL ON
:DISPlay:ANNotation:FREQ ON
:DISPlay:ANNotation:AMPLitude ON
:SYSTem:KLOCK OFF
```

OFF In the transition from ON to OFF all data existing in the instrument except for the calibrating data are deleted, especially all status registers, all instrument states and all lists.

Example: :SYST:SEC:STAT ON

**:SYSTem:SERRor?**

This command returns a list of all errors existing at the point of time of the query. This list corresponds to the indication on the ERROR page with manual control (cf. Section Error Messages).

Example: :SYST:SERR?

Response: -221, "Settings conflict", 153, "Input voltage out of range"

**:SYSTem:VERSion?**

The command returns the SCPI version number the instrument acts in accordance with. This command is a query and thus has no \*RST value.

Example: :SYST:VERS?

Response: 1994.0

### 3.6.15 TEST-System

This system contains the commands to execute the selftest routines (RAM?, ROM? and BATTery?) as well as to directly manipulate the hardware modules (:TEST:DIRect). The selftests return a "0" if the test has been executed successfully, otherwise a value unequal to "0". All commands of this system do not have an \*RST value.

**Caution:** *The commands under node :TEST:DIRect directly act on the respective hardware module circumventing any security mechanisms. They are provided for service purposes and should not be used by the user. Improper use of the commands may damage the module.*

Command	Parameter	Default Unit	Remark
:TEST			
:DIRect			
:ALCA	Subaddress, hex data string		
:AXIFC	Subaddress, hex data string		
:DSYN0MUX	Subaddress, hex data string		
:DSYN1MUX	Subaddress, hex data string		
:FMOD	Subaddress, hex data string		
:LFGENA	Subaddress, hex data string		
:LFGENB	Subaddress, hex data string		
:MWIFC	Subaddress, hex data string		
:PUM	Subaddress, hex data string		
:REFSS	Subaddress, hex data string		
:ROSC	Subaddress, hex data string		
:YPLL	Subaddress, hex data string		
:RAM?			query only
:ROM?			query only
:BATTery?			query only

#### :TEST:DIRect

This node contains the commands directly acting on the respective hardware module circumventing any security mechanisms. The commands under this node have no short form.

#### :TEST:DIRect:MWIFC Subaddress, hex data string

The command directly acts on module MWIFC. A subaddress (0 or 1) must be entered as a parameter. The data are entered as a <string> (i.e., an ASCII character string enclosed in quotation marks) representing hexadecimal numbers. Thus characters 0 to 9 A to F may occur in the character string.

Example: `:TEST:DIR:MWIFC 0, "2F004D"`



- TEST:DIRect:ALCA** Subaddress, hex data string  
The command acts on module ALCA. (cf. :TEST:DIR:MWIFC)
- :TEST:DIRect:AXIFC** Subaddress, hex data string  
The command acts on module AXIFC. (cf. :TEST:DIR:MWIFC)
- :TEST:DIRect:DSYN0MUX** Subaddress, hex data string  
The command acts on module DSYN. (cf. :TEST:DIR:MWIFC)
- :TEST:DIRect:DSYN1MUX** Subaddress, hex data string  
The command acts on module DSYN. (cf. :TEST:DIR:MWIFC)
- :TEST:DIRect:FMOD** Subaddress, hex data string  
The command acts on module FMOD. (cf. :TEST:DIR:MWIFC)
- :TEST:DIRect:LFGENA** Subaddress, hex data string  
The command acts on module LFGENA. (cf. :TEST:DIR:MWIFC)
- :TEST:DIRect:LFGENB** Subaddress, hex data string  
The command acts on module LFGENB. (cf. :TEST:DIR:MWIFC)
- :TEST:DIRect:PUM** Subaddress, hex data string  
The command acts on module PUM. (cf. :TEST:DIR:MWIFC)
- :TEST:DIRect:REFSS** Subaddress, hex data string  
The command acts on module REFSS. (cf. :TEST:DIR:MWIFC)
- :TEST:DIRect:ROSC** Subaddress, hex data string  
The command acts on module ROSC. (cf. :TEST:DIR:MWIFC)
- :TEST:DIRect:YPLL** Subaddress, hex data string  
The command acts on module YPLL. (cf. :TEST:DIR:MWIFC)
- :TEST:RAM?**  
The command triggers a test of the RAM.
- :TEST:ROM?**  
The command triggers a test of the main memory (EEPROM).
- :TEST:BATTery?**  
The command triggers a test of the battery voltage.

### 3.6.16 TRIGger-System

The TRIGger system contains the commands to select the trigger source and to configure the external trigger socket. The trigger sources for the individual signal sources (RF, LFGEN1, LFGEN2) are distinguished by a numerical suffix appended to TRIGger. The suffix conforms to the numbering of the SOURce system:

TRIGger1 = RF generator

TRIGger2 = LFGEN2

The trigger system of the SMP consists of a simplified implementation of the SCPI trigger system. Compared to SCPI, the TRIGger system shows the following differences:

- No INITiate command, the instrument behaves as if `INITiate:CONTinuous ON` was set.
- There are several subsystems denoting the different parts of the instrument under TRIGger (SWEep, LIST, PULSe, MSeQuence, DM).

Further commands as to the trigger system of the SMP can be found in the ABORt system.

Command	Parameter	Default Unit	Remark
<b>:TRIGger1 2</b> <b>[:SWEep]</b> <b>[:IMMediate]</b> <b>:SOURce</b>	SINGle   EXTernal   AUTO		No query
<b>:LIST</b> <b>[:IMMediate]</b> <b>:SOURce</b>	SINGle   EXTernal   AUTO		No query
<b>:MSeQuence</b> <b>[:IMMediate]</b> <b>:SOURce</b>	SINGle   EXTernal   AUTO		No query
<b>:PULSe</b> <b>:SOURce</b> <b>:SLOPe</b> <b>:SLOPe</b>	EXTernal   AUTO POSitive   NEGative POSitive   NEGative   EITHer		

#### **:TRIGger1|2[:SWEep]**

All commands to trigger a sweep are under this node. The settings here act on level and frequency sweeps for RF generator (TRIG1) and LF generator (TRIG2).

#### **:TRIGger1|2[:SWEep][:IMMediate]**

The command immediately starts a sweep. Which sweep is executed depends on the respective MODE setting, e.g. `:SOURce:FREQuency:MODE SWEep`. The command corresponds to manual-control command EXECUTE SINGLE SWEEP. This command triggers an event and thus has no \*RST value.

Example: `:TRIG:SWE:IMM`

**:TRIGger1|2[:SWEep]:SOURce** AUTO | SINGle | EXTernal

The command specifies the trigger source. The naming of the parameters directly corresponds to the different settings with manual control. SCPI uses other designations for the parameters the instrument accepts as well. These designations are to be preferred if compatibility is important. The following table provides an overview.

SMP designation	SCPI designation	Command with manual control
AUTO	IMMediate	MODE AUTO
SINGle	BUS	MODE SINGLE or STEP
EXTernal	EXTernal	MODE EXT TRIG SINGLE or EXT TRIG STEP

**AUTO** The trigger is free-running, i.e., the trigger requirement is permanently met. As soon as a sweep has been terminated, the next one is started.

**SINGle** Triggering is effected by means of IEC-bus commands `:TRIGger:SWEep:IMMediate` or `*TRG`. If `:SOURce:SWEep:MODE` is set to `STEP`, a step, in the case of the `AUTO` setting a complete sweep, is executed.

**EXTernal** Triggering is effected from outside via the `EXT.TRIG` socket or by the `GET` command via IEC/IEEE-bus (see annex A). The action triggered depends on the setting of the sweep mode as in the case of `SINGle`.

Example: `:TRIG:SWE:SOUR AUTO` \*RST value is `SINGle`

**:TRIGger:LIST**

This node contains all commands to trigger a list in the `LIST` mode. The commands are only valid for `TRIGger1`.

**:TRIGger:LIST[:IMMediate]**

The command immediately starts the processing of a list of the `LIST` mode. It corresponds to command `EXECUTE SINGLE MODE` of the manual control in the `LIST` menu. This command is an event and thus has no `*RST` value.

Example: `:TRIG:LIS:IMM`

**:TRIGger1|2:LIST:SOURce** AUTO | SINGle | EXTernal

The command specifies the trigger source. The naming of the parameters corresponds to the one with sweep mode. SCPI uses other designations for the parameters the instrument accepts as well. These designations are to be preferred if compatibility is important. The following table provides an overview:

SMP designation	SCPI designation	Command with manual control
AUTO	IMMediate	MODE AUTO
SINGle	BUS	MODE SINGLE or STEP
EXTernal	EXTernal	MODE EXT TRIG SINGLE or EXT TRIG STEP



### 3.6.17 UNIT-System

This system contains the commands specifying which units are valid if no unit is defined in a command. These settings are valid for the entire instrument.

Command	Parameter	Default Unit	Remark
<b>:UNIT</b> <b>:ANGLE</b> <b>:POWER</b>	DEGRee   DEGREE   RADian DBM   DBW   DBMW   DBUW   DBV   DBMV   DBUV   V		

**:UNIT:ANGLE** DEGRee | DEGREE | RADian

The command defines the unit for angles.

\*RST value is RADian

Example:       :UNIT:ANGL DEGR

**:UNIT:POWER** DBM | DBW | DBMW | DBUW | DBV | DBMV | DBUV | V

The command defines the unit for power.

\*RST value is DBM

Example:       :UNIT:POW V

### 3.7 Instrument Model and Command Processing

The instrument model shown in Fig. 3-2 has been made viewed from the standpoint of the servicing of IEC-bus commands. The individual components work independently of each other and simultaneously. They communicate by means of so-called "messages".

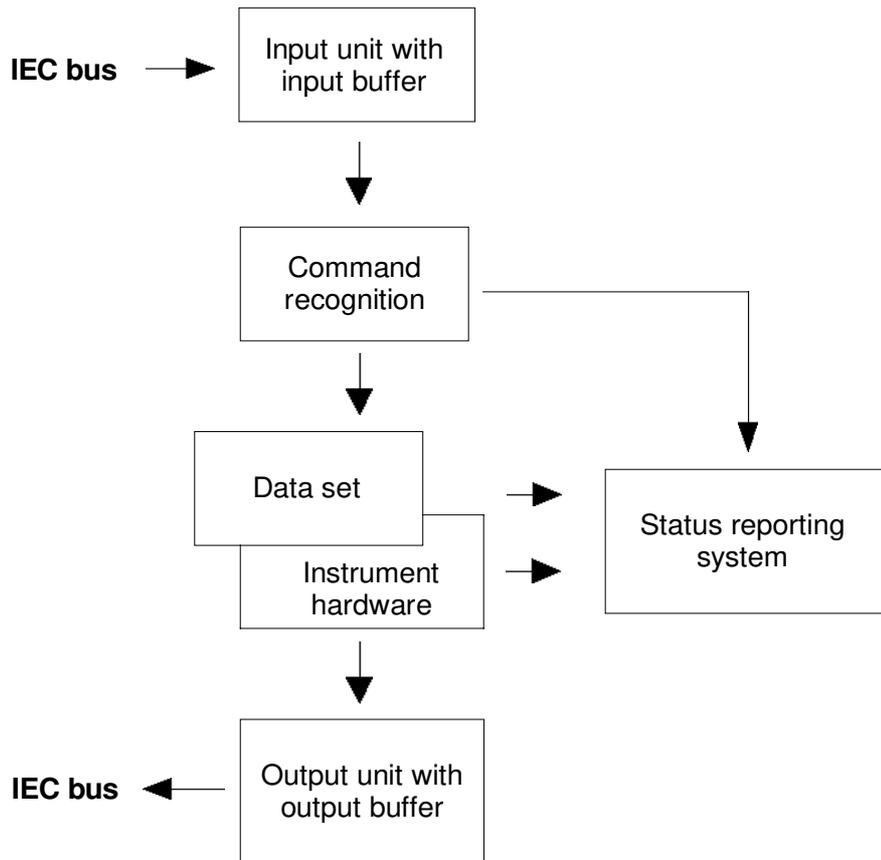

Fig. 3-2 Instrument model in the case of remote control by means of the IEC bus

#### 3.7.1 Input Unit

The input unit receives commands character by character from the IEC bus and collects them in the input buffer. The input buffer has a size of 256 characters. The input unit sends a message to the command recognition as soon as the input buffer is full or as soon as it receives a delimiter, <PROGRAM MESSAGE TERMINATOR>, as defined in IEEE 488.2, or the interface message DCL.

If the input buffer is full, the IEC-bus traffic is stopped and the data received up to then are processed. Subsequently the IEC-bus traffic is continued. If, however, the buffer is not yet full when receiving the delimiter, the input unit can already receive the next command during command recognition and execution. The receipt of a DCL clears the input buffer and immediately initiates a message to the command recognition.

### 3.7.2 Command Recognition

The command recognition analyses the data received from the input unit. It proceeds in the order in which it receives the data. Only a DCL is serviced with priority, a GET (Group Execute Trigger), e.g., is only executed after the commands received before as well. Each recognized command is immediately transferred to the data set but without being executed there at once.

Syntactical errors in the command are recognized here and supplied to the status reporting system. The rest of a command line after a syntax error is analyzed further if possible and serviced.

If the command recognition recognizes a delimiter or a DCL, it requests the data set to set the commands in the instrument hardware as well now. Subsequently it is immediately prepared to process commands again. This means for the command servicing that further commands can already be serviced while the hardware is still being set ("overlapping execution").

### 3.7.3 Data Set and Instrument Hardware

Here the expression "instrument hardware" denotes the part of the instrument fulfilling the actual instrument function - signal generation, measurement etc. The controller is not included.

The data set is a detailed reproduction of the instrument hardware in the software.

IEC-bus setting commands lead to an alteration in the data set. The data set management enters the new values (e.g. frequency) into the data set, however, only passes them on to the hardware when requested by the command recognition. As this is always only effected at the end of a command line, the order of the setting commands in the command line is not relevant.

The data are only checked for their compatibility among each other and with the instrument hardware immediately before they are transmitted to the instrument hardware. If the detection is made that an execution is not possible, an "execution error" is signaled to the status reporting system. All alterations of the data set are canceled, the instrument hardware is not reset. Due to the delayed checking and hardware setting, however, it is permissible to set impermissible instrument states within one command line for a short period of time without this leading to an error message (example: simultaneous activation of FM and PM). At the end of the command line, however, a permissible instrument state must have been reached again.

Before passing on the data to the hardware, the settling bit in the STATus:OPERation register is set. The hardware executes the settings and resets the bit again as soon as the new state has settled. This fact can be used to synchronize command servicing.

IEC-bus queries induce the data set management to send the desired data to the output unit.

### 3.7.4 Status Reporting System

The status reporting system collects information on the instrument state and makes it available to the output unit on request. The exact structure and function are described in Section "Starting Reporting System".

### 3.7.5 Output Unit

The output unit collects the information requested by the controller, which it receives from the data set management. It processes it according to the SCPI rules and makes it available in the output buffer. The output buffer has a size of 256 characters. If the information requested is longer, it is made available "in portions" without this being recognized by the controller.

If the instrument is addressed as a talker without the output buffer containing data or awaiting data from the data set management, the output unit sends error message "Query UNTERMINATED" to the status reporting system. No data are sent on the IEC bus, the controller waits until it has reached its time limit. This behavior is specified by SCPI.

### 3.7.6 Command Sequence and Command Synchronization

What has been said above makes clear that all commands can potentially be carried out overlapping. Equally, setting commands within one command line are not absolutely serviced in the order in which they have been received.

In order to make sure that commands are actually carried out in a certain order, each command must be sent in a separate command line, that is to say, with a separate IBWRT()-call.

In order to prevent an overlapping execution of commands, one of commands \*OPC, \*OPC? or \*WAI must be used. All three commands cause a certain action only to be carried out after the hardware has been set and has settled. By a suitable programming, the controller can be forced to wait for the respective action to occur (cf. table 3-0).

Table 3-3 Synchronization with \*OPC, \*OPC? and \*WAI

Com-mand	Action after the hardware has settled	Programming the controller
*OPC	Setting the operation-complete bit in the ESR	- Setting bit 0 in the ESE - Setting bit 5 in the SRE - Waiting for service request (SRQ)
*OPC?	Writing a "1" into the output buffer	Addressing the instrument as a talker
*WAI	Executing the next command Note: The IEC-bus handshake is not stopped	Sending the next command

An example as to command synchronization can be found in annex D "Program Examples".





<b>CONDition part</b>	The CONDition part is directly written into by the hardware or the sum bit of the next lower register. Its contents reflects the current instrument status. This register part can only be read, but not written into or cleared. Its contents is not affected by reading.
<b>PTRansition part</b>	The <u>Positive-TR</u> ansition part acts as an edge detector. When a bit of the CONDition part is changed from 0 to 1, the associated PTR bit decides whether the EVENT bit is set to 1. PTR bit =1: the EVENT bit is set. PTR bit =0: the EVENT bit is not set. This part can be written into and read at will. Its contents is not affected by reading.
<b>NTRansition part</b>	The <u>Negative-TR</u> ansition part also acts as an edge detector. When a bit of the CONDition part is changed from 1 to 0, the associated NTR bit decides whether the EVENT bit is set to 1. NTR bit =1: the EVENT bit is set. NTR bit =0: the EVENT bit is not set. This part can be written into and read at will. Its contents is not affected by reading. With these two edge register parts the user can define which state transition of the condition part (none, 0 to 1, 1 to 0 or both) is stored in the EVENT part.
<b>EVENT part</b>	The EVENT part indicates whether an event has occurred since the last reading, it is the "memory" of the condition part. It only indicates events passed on by the edge filters. It is permanently updated by the instrument. This part can only be read by the user. During reading, its contents is set to zero. In linguistic usage this part is often equated with the entire register.
<b>ENABLE part</b>	The ENABLE part determines whether the associated EVENT bit contributes to the sum bit (cf. below). Each bit of the EVENT part is ANDed with the associated ENABLE bit (symbol '&'). The results of all logical operations of this part are passed on to the sum bit via an OR function (symbol '+'). ENAB bit =0: the associated EVENT bit does not contribute to the sum bit ENAB bit =1: if the associated EVENT bit is "1", the sum bit is set to "1" as well. This part can be written into and read by the user at will. Its contents is not affected by reading.
<b>Sum bit</b>	As indicated above, the sum bit is obtained from the EVENT and ENABLE part for each register. The result is then entered into a bit of the CONDition part of the higher-order register. The instrument automatically generates the sum bit for each register. Thus an event, e.g. a PLL that has not locked, can lead to a service request throughout all levels of the hierarchy.
<b>Note:</b>	<i>The service request enable register SRE defined in IEEE 488.2 can be taken as ENABLE part of the STB if the STB is structured according to SCPI. By analogy, the ESE can be taken as the ENABLE part of the ESR.</i>

### 3.8.2 Overview of the Status Registers

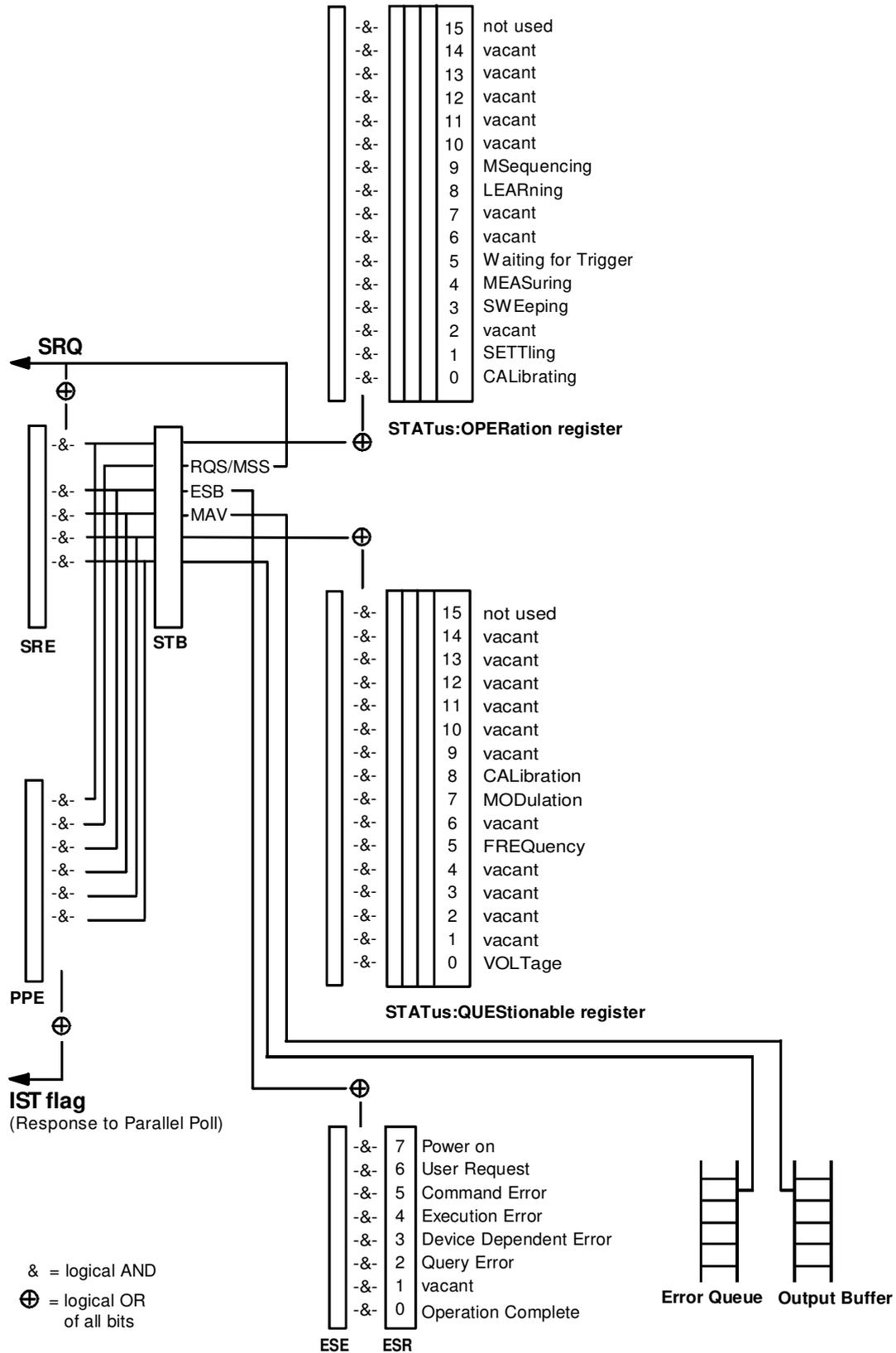

Fig. 3-4 Overview of the status register

### 3.8.3 Description of the Status Registers

#### 3.8.3.1 Status Byte (STB) and Service Request Enable Register (SRE)

The STB is already defined in IEEE 488.2. It provides a rough overview of the instrument status by collecting the pieces of information of the lower registers. It can thus be compared with the CONDition part of an SCPI register and assumes the highest level within the SCPI hierarchy. A special feature is that bit 6 acts as the sum bit of the remaining bits of the status byte.

The STATUS BYTE is read out using the command "\*STB?" or a serial poll.

The STB implies the SRE. It corresponds to the ENABLE part of the SCPI registers as to its function. Each bit of the STB is assigned a bit in the SRE. Bit 6 of the SRE is ignored. If a bit is set in the SRE and the associated bit in the STB changes from 0 to 1, a Service Request (SRQ) is generated on the IEC bus, which triggers an interrupt in the controller if this is appropriately configured and can be further processed there.

The SRE can be set using command "\*SRE" and read using "\*SRE?".

Table 3-4 Meaning of the bits used in the status byte

Bit no.	Meaning
2	<p><b>Error Queue not empty</b></p> <p>The bit is set when an entry is made in the error queue. If this bit is enabled by the SRE, each entry of the error queue generates a Service Request. Thus an error can be recognized and specified in greater detail by polling the error queue. The poll provides an informative error message. This procedure is to be recommended since it considerably reduces the problems involved with IEC-bus control.</p>
3	<p><b>QUESTIONable status sum bit</b></p> <p>The bit is set if an EVENT bit is set in the QUESTIONable status register and the associated ENABLE bit is set to 1. A set bit indicates a questionable instrument status, which can be specified in greater detail by polling the QUESTIONable status register.</p>
4	<p><b>MAV-Bit (Message Available)</b></p> <p>The bit is set if a message is available in the output buffer which can be read. This bit can be used to enable data to be automatically read from the instrument to the controller (cf. annex D, program examples).</p>
5	<p><b>ESB bit</b></p> <p>Sum bit of the event status register. It is set if one of the bits in the event status register is set and enabled in the event status enable register. Setting of this bit implies a serious error which can be specified in greater detail by polling the event status register.</p>
6	<p><b>MSS-Bit (Master Status Summary bit)</b></p> <p>The bit is set if the instrument triggers a service request. This is the case if one of the other bits of this register is set together with its mask bit in the service request enable register SRE.</p>
7	<p><b>OPERation status register sum bit</b></p> <p>The bit is set if an EVENT bit is set in the OPERation status register and the associated ENABLE bit is set to 1. A set bit indicates that the instrument is just performing an action. The type of action can be determined by polling the OPERation status register.</p>

### 3.8.3.2 IST Flag and Parallel Poll Enable Register (PPE)

By analogy with the SRQ, the IST flag combines the entire status information in a single bit. It can be queried by means of a parallel poll or using command "`*IST?`".

The parallel poll enable register (PPE) determines which bits of the STB contribute to the IST flag. The bits of the STB are ANDed with the corresponding bits of the PPE, with bit 6 being used as well in contrast to the SRE. The Ist flag results from the ORing of all results. The PPE can be set using commands "`*PRE`" and read using command "`*PRE?`".

### 3.8.3.3 Event Status Register (ESR) and Event Status Enable Register (ESE)

The ESR is already defined in IEEE 488.2. It can be compared with the EVENT part of an SCPI register. The event status register can be read out using command "`*ESR?`".

The ESE is the associated ENABLE part. It can be set using command "`*ESE`" and read using command "`*ESE?`".

Table 3-5 Meaning of the bits used in the event status register

Bit No.	Meaning
0	<b>Operation Complete</b> This bit is set on receipt of the command <code>*OPC</code> exactly when all previous commands have been executed.
2	<b>Query Error</b> This bit is set if either the controller wants to read data from the instrument without having sent a query, or if it does not fetch requested data and sends new instructions to the instrument instead. The cause is often a query which is faulty and hence cannot be executed.
3	<b>Device-dependent Error</b> This bit is set if a device-dependent error occurs. An error message with a number between -300 and -399 or a positive error number, which denotes the error in greater detail, is entered into the error queue (cf. annex B, Error Messages).
4	<b>Execution Error</b> This bit is set if a received command is syntactically correct, however, cannot be performed for other reasons. An error message with a number between -200 and -300, which denotes the error in greater detail, is entered into the error queue (cf. annex B, Error Messages).
5	<b>Command Error</b> This bit is set if a command which is undefined or syntactically incorrect is received. An error message with a number between -100 and -200, which denotes the error in greater detail, is entered into the error queue (cf. annex B, Error Messages).
6	<b>User Request</b> This bit is set on pressing the LOCAL key, i.e., when the instrument is switched over to manual control.
7	<b>Power On</b> (supply voltage on) This bit is set on switching on the instrument.

### 3.8.3.4 STATus:OPERation Register

In the CONDition part, this register contains information on which actions the instrument is being executing or, in the EVENt part, information on which actions the instrument has executed since the last reading. It can be read using commands "STATus:OPERation:CONDition?" or "STATus:OPERation [:EVENT]?"..

Table 3-6 Meaning of the bits used in the STATus:OPERation register

Bit-No.	Meaning
0	<b>CALibrating</b> This bit is set as long as the instrument is performing a calibration.
1	<b>SETTling</b> This bit is set as long as the new status is settling after a setting command. It is only set if the settling time is longer than the command processing time.
3	<b>SWEeping</b> This bit is set while the instrument is performing a sweep.
4	<b>MEASuring</b> This bit is set while the instrument is performing a measurement.
5	<b>WAIT for TRIGGER</b> This bit is set as long as the instrument is waiting for a trigger event.
8	<b>LEARning</b> This bit is set while the instrument is "learning" a list.
9	<b>MSEQuencing</b> This bit is set while the instrument is performing a memory sequence.

### 3.8.3.5 STATus:QUEStionable Register

This register contains information on questionable instrument states. They can occur, e.g. if the instrument is operated out of its specifications. It can be queried using commands "STATus:QUEStionable:CONDition?" or "STATus:QUEStionable[:EVENT]?".

Table 3-7 Meaning of the bits used in the STATus:QUEStionable register

Bit-No.	Meaning
0	<p><b>VOLTage</b></p> <p>This bit is set if the voltage at an output connector is not correct, if the voltage is above or below the specified limit values, if the level limit has responded, if the overvoltage protection has responded.</p>
5	<p><b>FREQuency</b></p> <p>The bit is set if a frequency at the RF output is not correct or if it is lower or higher than the specified values</p>
7	<p><b>MODulation</b></p> <p>The bit is set if a modulation is not correct or is operated outside the specifications.</p>
8	<p><b>CALibration</b></p> <p>The bit is set if a calibration is not performed properly.</p>

### 3.8.4 Application of the Status Reporting Systems

In order to be able to effectively use the status reporting system, the information contained there must be transmitted to the controller and further processed there. There are several methods which are represented in the following. Detailed program examples are to be found in annex D, Program Examples.

#### 3.8.4.1 Service Request, Making Use of the Hierarchy Structure

Under certain circumstances, the instrument can send a service request (SRQ) to the controller. Usually this service request initiates an interrupt at the controller, to which the control program can react with corresponding actions. As evident from Fig. 3.4, an SRQ is always initiated if one or several of bits 2, 3, 4, 5 or 7 of the status byte are set and enabled in the SRE. Each of these bits combines the information of a further register, the error queue or the output buffer. The corresponding setting of the ENABLE parts of the status registers can achieve that arbitrary bits in an arbitrary status register initiate an SRQ. In order to make use of the possibilities of the service request, all bits should be set to "1" in enable registers SRE and ESE.

Examples (cf. Fig. 3.4, Section "Program Examples", annex D as well):

Use of command "`*OPC`" to generate an SRQ

- Set bit 0 in the ESE (Operation Complete)
- Set bit 5 in the SRE (ESB)

After its settings have been completed, the instrument generates an SRQ.

Indication of the end of a sweep by means of an SRQ with the controller

- Set bit 7 in the SRE (sum bit of the STATUS:OPERation register)
- Set bit 3 (sweeping) in the STATUS:OPERation:ENABLE.
- Set bit 3 in the STATUS:OPERation:NTRansition so as to make sure that the transition of sweeping bit 3 from 1 to 0 (sweep end) is recorded in the EVENT part.

After a sweep has been completed, the instrument generates an SRQ.

The SRQ is the only possibility for the instrument to become active on its own. Each controller program should set the instrument such that a service request is initiated in the case of malfunction. The program should react appropriately to the service request. A detailed example for a service request routine is to be found in annex D, Program Examples.

#### 3.8.4.2 Serial Poll

In a serial poll, just as with command "`*STB`", the status byte of an instrument is queried. However, the query is realized via interface messages and is thus clearly faster. The serial-poll method has already been defined in IEEE 488.1 and used to be the only standard possibility for different instruments to poll the status byte. The method also works with instruments which do not adhere to SCPI or IEEE 488.2.

The quick-BASIC command for executing a serial poll is "`IBRSP ()`". Serial poll is mainly used to obtain a fast overview of the state of several instruments connected to the IEC bus.



### 3.8.4.3 Parallel Poll

In a parallel poll, up to eight instruments are simultaneously requested by the controller by means of a single command to transmit 1 bit of information each on the data lines, i.e., to set the data line allocated to each instrument to logically "0" or "1". By analogy to the SRE register which determines under which conditions an SRQ is generated, there is a parallel poll enable register (PPE) which is ANDed with the STB bit by bit as well considering bit 6. The results are ORed, the result is then sent (possibly inverted) as a response in the parallel poll of the controller. The result can also be queried without parallel poll by means of command "\*IST".

The instrument first has to be set for the parallel poll using quick-BASIC command "IBPPC ()". This command allocates a data line to the instrument and determines whether the response is to be inverted. The parallel poll itself is executed using "IBRPP ()".

The parallel-poll method is mainly used in order to quickly find out after an SRQ which instrument has sent the service request if there are many instruments connected to the IEC bus. To this effect, SRE and PPE must be set to the same value. A detailed example as to the parallel poll is to be found in annex D, Program Examples.

### 3.8.4.4 Query by Means of Commands

Each part of every status register can be read by means of queries. The individual commands are indicated in the detailed description of the registers in Section "Description of the Status Registers". What is returned is always a number which represents the bit pattern of the register queried. Evaluating this number is effected by the controller program.

Queries are usually used after an SRQ in order to obtain more detailed information on the cause of the SRQ.

### 3.8.4.5 Error Queue Query

Each error state in the instrument leads to an entry in the error queue. The entries of the error queue are detailed plain-text error messages which can be looked at in the ERROR menu via manual control or queried via the IEC bus using command "SYSTem:ERRor?". Each call of "SYSTem:ERRor?" provides one entry from the error queue. If no error messages are stored there any more, the instrument responds with 0, "No error"

The error queue should be queried after every SRQ in the controller program as the entries describe the cause of an error more precisely than the status registers. Especially in the test phase of a controller program the error queue should be queried regularly since faulty commands from the controller to the instrument are recorded there as well.

### 3.8.5 Resetting Values of the Status Reporting Systems

Table 3-0 comprises the different commands and events causing the status reporting system to be reset. None of the commands, except for \*RST and SYSTem:PRESet influences the functional instrument settings. In particular, DCL does not change the instrument settings.

Table 3-8 Resetting instrument functions

Event	Switching on supply voltage		DCL,SDC  (Device Clear, Selected Device Clear)	*RST or SYSTem:PRESet	STATus:PRESet	*CLS
	Power-On-Status-Clear					
	0	1				
Clear STB,ESR	—	yes	—	—	—	yes
Clear SRE,ESE	—	yes	—	—	—	—
Clear PPE	—	yes	—	—	—	—
Clear EVENT parts of the registers	—	yes	—	—	—	yes
Clear ENABLE parts of all OPERation-and QUESTionable registers, Fill ENABLE parts of all other registers with "1".	—	yes	—	—	yes	—
Fill PTRansition parts with „1“ Clear NTRansition parts	—	yes	—	—	yes	—
Clear error queue	yes	yes	—	—	—	yes
Clear output buffer	yes	yes	yes	1)	1)	1)
Clear command processing and input buffer	yes	yes	yes	—	—	—

1) Every command being the first in a command line, i.e. immediately following a <PROGRAM MESSAGE TERMINATOR> clears the output buffer.

## 4 Maintenance and Troubleshooting

The instrument does not need a periodic maintenance. What is necessary is essentially the cleaning of the instrument. However, it is recommended to check the rated data from time to time.

### 4.1 Maintenance

#### 4.1.1 Cleaning the Outside

The outside of the instrument is suitably cleaned using a soft, line-free dustcloth.

**Caution!** Do not use solvents such as thinners, acetone and similar things in any case, because otherwise the front panel labeling or plastic parts will be damaged.

#### 4.1.2 Storage

The storage temperature range of the instrument is -40 to +70 degrees Celsius. If the instrument is to be stored for a longer period of time, it must be protected against dust.

#### 4.1.3 Exchange of the Lithium Battery



**Caution!**

The battery used in the instrument is a power lithium cell. Short-circuit and charging of the battery have to be avoided at all costs, as the battery might otherwise explode. Do not open discharged batteries. They have to be disposed of as hazardous waste.

The instrument contains a lithium battery for non-volatile storage of data in the CMOS-RAM. The battery is located on the computer PCB.

The service life of the battery depends on the operation and the ambient temperature, it is 5 years on the average.

The battery voltages are checked after power-up of the unit (TEST POINT 0007 = RAM cell). If the voltage values are below 2.5 V storage of data can no longer be guaranteed and an error message is displayed.

In order to guarantee a perfect function, a flattened battery is to be replaced by a battery of the same type:

- SAFT LS3 CNA, (R&S stock no. 565.1687) or
- ELECTROCHE QTC85 1/2AA 3B960, (R&S stock no. 565.1687).

**Notes:** – When the RAM-battery is exchanged, the stored data (SAVE/RECALL, LIST, MEM SEQ, UCOR, IEC-bus address, calibration data) are lost. These data have to be reprogrammed after the exchange of the battery. Moreover, a calibration must be performed for PULSE GEN, YFOM and ALC AMP.



**Caution:**

Before opening the unit, disconnect power plug. When working on the open unit make sure to meet applicable ESD regulations.

**Opening the instrument**

- Switch off instrument and disconnect power plug
- Remove all cable connections.
- Screw off front panel (4 Phillips screws at the corners) and tilt towards the front.  
The shielding cover (cf. Fig. 4-1) of the controller and the front panel modules is now freely accessible.
- Detach cable connection to the IEC bus (Fig. 4-1, pos. 3) and to the RS-232 interface (Fig. 4.1, pos. 4). The connection to the motherboard (Fig. 4-1, pos. 2) can remain plugged in.
- Screw off cover (6 screws (Fig. 4-1, pos. 1)) and lift off.  
The computer PCB is now accessible from the top.

**Exchanging the battery**

The position of the battery on the computer PCB is evident from Fig.4-2.

- Detach jumper X300 (cf. Fig. 4-2, pos. 2).
- Cut off cable tie.
- Unsolder battery.
- Detach cable at plug connector X312 (cf. Fig. 4-2, pos. 1). The remaining cable connections can remain plugged in.
- Remove 2 fastening screws (cf. Fig. 4-2, pos. 5) on the computer PCB.
- Lift computer PCB and thread new battery clamp.
- Screw on computer PCB (cf. Fig. 4-2, pos. 5), establish plug connection X312 (cf. Fig. 4-2, pos. 1).
- Fix new battery in position using cable tie.  
**Caution!** *Observe the polarity when fixing and soldering the battery (cf. Fig. 4-2 and marking on the PCB). A wrong polarity will lead to the destruction of components.*
- Shorten connection wires to the necessary length and solder battery.
- Plug jumper X300 (cf. Fig. 4-2, pos. 2).

**Closing the instrument**

Closing the instrument is effected in the reverse order as opening it.

**Caution!** *Ensure that the braided cord in the casing slots is fitted correctly.*

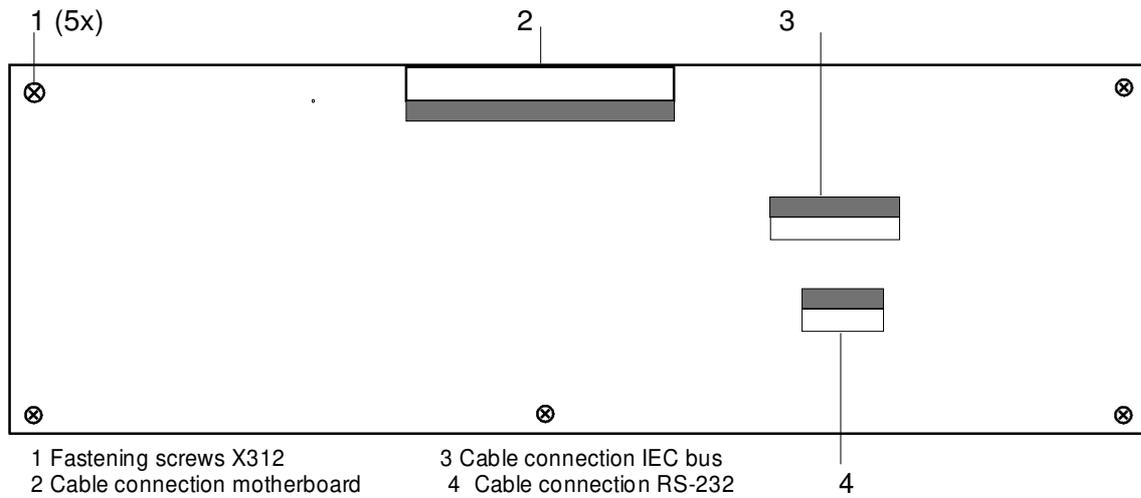

Fig. 4-1 Shielding cover of controller and front panel module

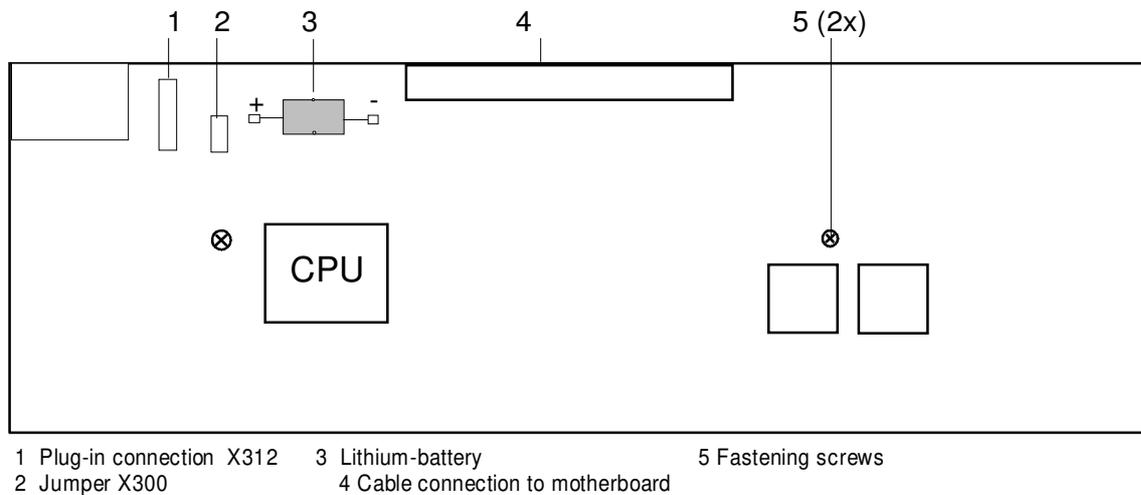

Fig. 4-2 Position of the RAM battery on the PCB (side where the components are fitted)

## 4.2 Functional Test

The SMP carries out a selftest on switching on the instrument and permanently during operation. On switching on, the RAM and ROM contents are checked and the batteries of the non-volatile RAMs and of the memory extension are tested. If an error is detected, this is indicated through a corresponding error message. The most important instrument functions are automatically monitored during operation.

If a faulty function is detected in the selftest, ERROR is displayed in the status line. To identify the error, the ERROR menu, in which the error messages are entered, can be called by pressing the [ERROR] key (cf. Section "Error Messages").

The tests can additionally be called via the menu.

Access to the tests is offered by the UTILITIES - TEST menu.

Menu selection: UTILITIES - TEST

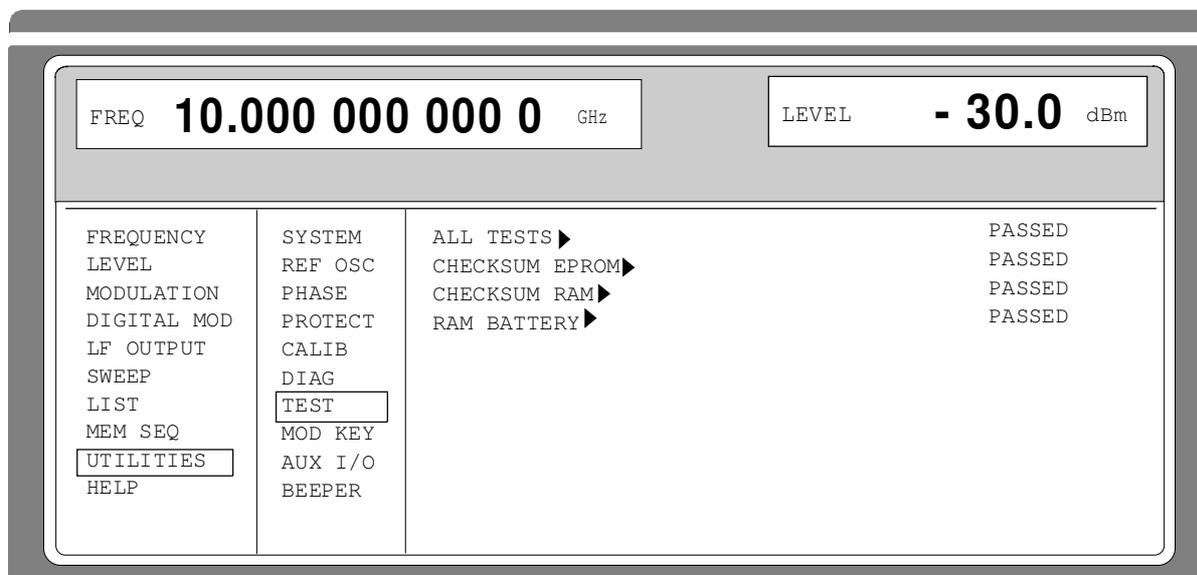

Fig 4-3 UTILITIES-TEST menu,

- ALL TESTS ►** All tests are executed.
- CHECKSUM EPROM ►** Tests the EPROM checksum. The test result is displayed in a window.
- CHECKSUM RAM ►** Tests the RAM checksum. The test result is displayed in a window.
- RAM BATTERY ►** Tests the RAM battery. The test result is displayed in a window.

## 5 Testing the Rated Specifications

### 5.1 Test Instruments and Utilities

Table 5-1 Test instruments and utilities

Item	Type of instrument	Specifications required	Suitable instrument	R&S order number	Application
1	Frequency counter (included in item 2)	10 MHz to 20 GHz (SMP02/22) 10 MHz to 27 GHz (SMP03) 10 MHz to 40 GHz (SMP04)			5.2.2 5.2.3
2	Spectrum analyzer	10 MHz to 20 GHz (SMP02/22)  10 MHz to 27 GHz (SMP03)  10 MHz to 40 GHz (SMP04)	FSM  FSM with FSM-Z18  FSM with FSM-Z18	1020.7020.52  1020.7020.52  1020.7020.52	5.1.1.1 5.2.4 5.2.5 5.2.6 5.2.7 5.2.10 5.2.11 5.2.12 5.2.13 5.2.14 5.2.15 5.2.16 5.2.17 5.2.19
3	RF power meter	10 MHz to 20 GHz (SMP02/22) 10 MHz to 27 GHz (SMP03) 10 MHz to 40 GHz (SMP04)	NRVD with NRV-Z52	857.8008.02 857.9204.02	5.2.8 5.2.9
4	Modulation analyzer	10 Hz to 1 MHz			5.1.1.1 5.2.10 5.2.11 5.2.12 5.2.13 5.2.14 5.2.15 5.2.16 5.2.17
5	Audio/LF analyzer	10 Hz to 1 MHz LF generator and level meter up to 1 MHz, distortion meter			5.1.1.1 5.2.10 5.2.11 5.2.12 5.2.13 5.2.14 5.2.15 5.2.16 5.2.17 5.2.22
6	Pulse generator	Pulse repetition rate up to 10 MHz Rise/fall time (10% /90%) < 1 ns TTL level			5.1.1.2 5.2.18 5.2.20
7	Sampling oscilloscope	10 MHz to 20 GHz (SMP02/22) 10 MHz to 27 GHz (SMP03) 10 MHz to 40 GHz (SMP04)			5.1.1.2 5.2.18
8	Oscilloscope (dual channel)	DC to 100 MHz			5.2.22
9	Feed-through termination 50 $\Omega$	DC to 100 MHz	RAD	289.8966.00	5.2.22

### 5.1.1 Test Setups to Measure Modulation Characteristics

#### 5.1.1.1 Standard Test System

Test equipment                      Spectrum analyzer (section 5.1, item 2)  
     Modulation analyzer (section 5.1, item 4)  
     Audio/LF analyzer (section 5.1, item 5)

Test setup

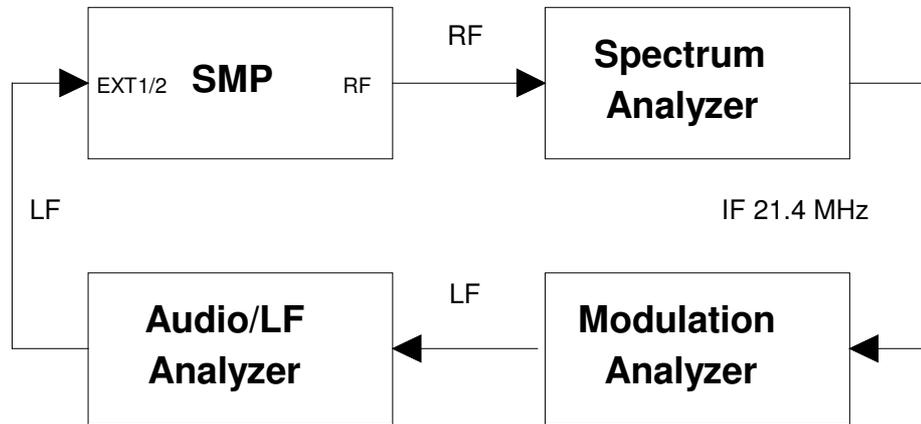

#### 5.1.1.2 Test System for Pulse Modulation

Test equipment                      Pulse generator (section 5.1, item 6)  
     Sampling oscilloscope (section 5.1, item 7)

Test setup

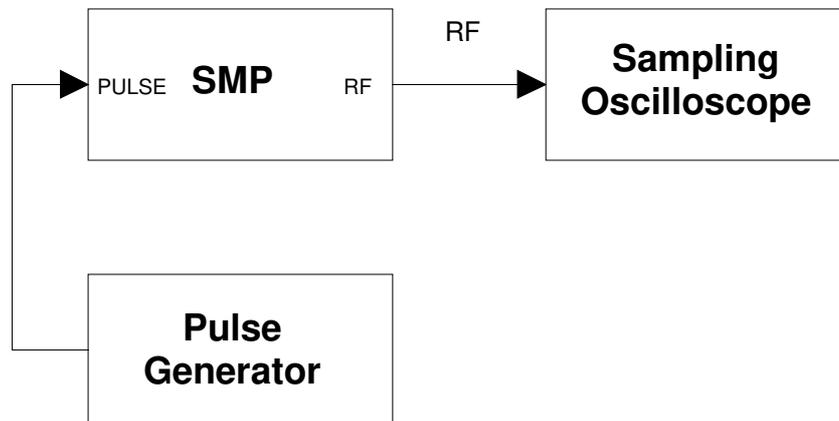



## 5.2 Test Procedures

### 5.2.1 Display and Keyboard

Testing	Display	<ul style="list-style-type: none"> <li>➤ Switch on instrument. The basic menu is displayed after several seconds.</li> <li>➤ Rotate contrast control (left-hand potentiometer at the lower edge). The contrast is varied from dark to bright.</li> <li>➤ Rotate brightness control (left-hand potentiometer at the lower edge). The brightness of the backlighting is varied.</li> <li>➤ Rotate brightness control (left-hand potentiometer at the lower edge). The contrast is varied from dark to bright.</li> </ul>
	Keyboard	<ul style="list-style-type: none"> <li>➤ Press keys and check response at the display.</li> </ul>

### 5.2.2 Frequency Setting

Test equipment	Frequency counter (section 5.1, item 1)
Test principle	The reference frequency is checked by means of a frequency counter whose reference frequency is synchronized with the one of the SMP.
Measurement	<ul style="list-style-type: none"> <li>➤ SMP settings:             <ul style="list-style-type: none"> <li>- All modulations off</li> <li>- RF frequency</li> <li>- Level 0 dBm</li> </ul> </li> </ul> <p>The values measured must be as exact as the frequency counter can display it due to its resolution.</p>
Recommended RF frequencies	see table 5-2

Table 5-2 Recommended RF frequencies

Model		RF frequencies
SMP02/SMP22	without option SMP-B11	2.0 GHz, 9.9 GHz, 10.0 GHz, 20.0 GHz
	with option SMP-B11	10 MHz, 1.9 GHz, 2.0 GHz, 9.9 GHz, 10.0 GHz, 20.0 GHz
SMP03	without option SMP-B11	2.0 GHz, 9.9 GHz, 10.0 GHz, 20.0 GHz, 27.0 GHz
	with option SMP-B11	10 MHz, 1.9 GHz, 2.0 GHz, 9.9 GHz, 10.0 GHz, 20.0 GHz, 27.0 GHz
SMP04	without option SMP-B11	2.0 GHz, 9.9 GHz, 10.0 GHz, 20.0 GHz, 27.0 GHz, 40 GHz
	with option SMP-B11	10 MHz, 1.9 GHz, 2.0 GHz, 9.9 GHz, 10.0 GHz, 20.0 GHz, 27.0 GHz, 40.0 GHz

### 5.2.3 Reference Frequency

**Caution:** Allow the SMP to warm up for at least 2 hours before measurement.

Test equipment	Frequency counter (section 5.1, item 1)
Test setup	Connect a calibrated frequency counter to the REF output at the rear panel of the SMP.
Measurement	<ul style="list-style-type: none"> <li>➤ Measure frequency.</li> <li>Standard ..... &lt; <math>(1 \cdot 10^{-6} + 2 \cdot 10^{-6}</math> per year of operating)</li> <li>With option SMP-B1 ... &lt; <math>(1 \cdot 10^{-9}</math> per day + <math>5 \cdot 10^{-8}</math> per year of operating)</li> </ul>

### 5.2.4 Suppression of Harmonics

Test equipment	Spectrum analyzer (section 5.1, item 2)
Test setup	Connect the spectrum analyzer to the RF output of the SMP.
Measurement	<ul style="list-style-type: none"> <li>➤ Measure the third and the second harmonics( fundamental x 2 or x 3) for each RF frequency. There is no need to measure harmonics that lie outside the nominal frequency range of the SMP model that is tested.</li> <li>➤ SMP settings:             <ul style="list-style-type: none"> <li>- All modulations off</li> <li>- Test frequency see table 5-3</li> <li>- Level see table 5-4</li> </ul> <p>Supression of harmonics ..... see table 5-4</p> </li> <li>➤ Measure harmonics when pulse modulation is switched on (only when option SMP-B12 is fitted).</li> <li>➤ Do not connect any external equipment (e.g. a pulse generator) to the PULSE input of the SMP.</li> <li>➤ SMP settings:             <ul style="list-style-type: none"> <li>- Select MODULATION\PULSE\EXT</li> <li>- Select MODULATION\PULSE\POLARITY\INV</li> <li>- RF frequency (<math>\geq 2</math> GHz only) see table 5-3</li> <li>- Level see table 5-4</li> </ul> <p>Suppression of harmonics ..... see table 5-5</p> </li> </ul>

Table 5-3 Recommended RF frequencies

Model		RF frequencies
SMP02/SMP22	without option SMP-B11	2 to 10 GHz (50 MHz steps) for 2nd harmonics 2 to 6.7 GHz (50 MHz steps) for 3rd harmonics
	with option SMP-B11	10 MHz to < 2 GHz (20 MHz steps) 2 to 10 GHz (50 MHz steps) for 2nd harmonics 2 to 6.7 GHz (50 MHz steps) for 3rd harmonics
SMP03	without option SMP-B11	2 to 13.5 GHz (50 MHz steps) for 2nd harmonics 2 to 9 GHz (50 MHz steps) for 3rd harmonics
	with option SMP-B11	10 MHz to < 2 GHz (20 MHz steps) 2 to 13.5 GHz (50 MHz steps) for 2nd harmonics 2 to 9 GHz (50 MHz steps) for 3rd harmonics
SMP04	without option SMP-B11	2 to 20 GHz (50 MHz steps) for 2nd harmonics 2 to 13.3 GHz (50 MHz steps) for 3rd harmonics
	with option SMP-B11	10 MHz to < 2 GHz (20 MHz steps) 2 to 20 GHz (50 MHz steps) for 2nd harmonics 2 to 13.3 GHz (50 MHz steps) for 3rd harmonics

Table 5-4 Suppression of harmonics without options SMP-B12 or/and SMP-B13, or with the options but pulse modulation off

RF frequency	SMP02	SMP22	SMP03	SMP04
< 1.8 GHz	< -30 dBc @ +8 dBm	< -25 dBc @ +8 dBm	< -30 dBc @ +3 dBm	< -30 dBc @ ±0 dBm
≥ 1.8 GHz	< -40 dBc @ +10 dBm	< -25 dBc @ +15 dBm	< -40 dBc @ +3 dBm	< -40 dBc @ ±0 dBm

Table 5-5 Suppression of harmonics with options SMP-B12 or/and SMP-B13, pulse modulation on

RF frequency	SMP02	SMP22	SMP03	SMP04
< 1.8 GHz	< -25 dBc @ +8 dBm	< -25 dBc @ +8 dBm	< -25 dBc @ +3 dBm	< -25 dBc @ ±0 dBm
≥ 1.8 GHz	< -25 dBc @ +11 dBm	< -25 dBc @ +11 dBm	< -25 dBc @ +3 dBm	< -25 dBc @ ±0 dBm

### 5.2.5 Suppression of Subharmonics

**Note:** Only SMP03 and SMP04 have to be tested for subharmonics. SMP02 and SMP22 do not generate any subharmonics.

Test equipment		Spectrum analyzer (section 5.1, item 2)
Test setup		Connect the spectrum analyzer to the RF output of the SMP03 or SMP04.
Measurement	SMP03	Measure all subharmonics found between 10 GHz and 27 GHz for each RF frequency.
	SMP04	Measure all subharmonics found between 10 GHz and 40 GHz for each RF frequency.
		<ul style="list-style-type: none"> <li>➤ SMP settings:                             <ul style="list-style-type: none"> <li>- All modulations off</li> <li>- RF frequency see table 5-6</li> <li>- Level 0 dBm</li> </ul> </li> </ul>
		Suppression of subharmonics
		SMP03 ..... < -40 dBc
		SMP04 ..... < -30 dBc

Table 5-6 Recommended RF frequencies

Model	RF frequencies
SMP03	> 20 to 27 GHz (50 MHz steps)
SMP04	> 20 to 40 GHz (50 MHz steps)

### 5.2.6 Suppression of Nonharmonics

Test equipment	Spectrum analyzer (section 5.1, item 2)
Test setup	Connect the spectrum analyzer to the RF output of the SMP.
Measurement	For each RF frequency, measure all nonharmonics in the entire frequency range of the SMP, except $\pm 10$ kHz from the carrier.
	<ul style="list-style-type: none"> <li>➤ SMP settings:                             <ul style="list-style-type: none"> <li>- All modulations off</li> <li>- RF frequency see table 5-7</li> <li>- Level 0 dBm</li> </ul> </li> </ul>
	Suppression of nonharmonics
	f < 2 GHz..... < -50 dBc
	2 to 20 GHz..... < - 60 dBc
	f > 20 GHz..... < -54 dBc

Table 5-7 Recommended RF frequencies

Model		RF frequencies
SMP02/SMP22	without option SMP-B11	2 to 20 GHz (500 MHz steps)
	with option SMP-B11	10 MHz to < 2 GHz (50 MHz steps); 2 to 20 GHz (500 MHz steps)
SMP03	without option SMP-B11	2 to 27 GHz (500 MHz steps)
	with option SMP-B11	10 MHz to < 2 GHz (50 MHz steps); 2 to 27 GHz (500 MHz steps)
SMP04	without option SMP-B11	2 to 40 GHz (500 MHz steps)
	with option SMP-B11	10 MHz to < 2 GHz (50 MHz steps); 2 to 40 GHz (500 MHz steps)

### 5.2.7 SSB Phase Noise

- Test equipment                      Spectrum analyzer (section 5.1, item 2)
- Test setup                              Connect the spectrum analyzer to the RF output of the SMP.
- Measurement                         Measure the SSB phase noise at each RF frequency.
- SMP settings:
    - All modulations off
    - RF frequency see table 5-8
    - Level 0 dBm
- SSB phase noise ..... see table 5-9

Table 5-8 Recommended RF frequencies

Model		RF frequencies
SMP02/SMP22	without option SMP-B11	2.0 GHz, 9.9 GHz, 10.0 GHz, 20.0 GHz
	with option SMP-B11	10 MHz, 1.9 GHz, 2.0 GHz, 9.9 GHz, 10.0 GHz, 20.0 GHz
SMP03	without option SMP-B11	2.0 GHz, 9.9 GHz, 10.0 GHz, 20.0 GHz, 20.1 GHz, 27.0 GHz
	with option SMP-B11	10 MHz, 1.9 GHz, 2.0 GHz, 9.9 GHz, 10.0 GHz, 20.0 GHz, 20.1 GHz, 27.0 GHz
SMP04	without option SMP-B11	2.0 GHz, 9.9 GHz, 10.0 GHz, 20.0 GHz, 20.1 GHz, 27.0 GHz, 40 GHz
	with option SMP-B11	10 MHz, 1.9 GHz, 2.0 GHz, 9.9 GHz, 10.0 GHz, 20.0 GHz, 20.1 GHz, 27.0 GHz, 40.0 GHz

Table 5-9 SSB phase noise

RF frequency	Offset from carrier			
	100 Hz	1 kHz	10 kHz	100 kHz
10 MHz to < 2 GHz	< -64 dBc/√Hz	< -92 dBc/√Hz	< -98 dBc/√Hz	< -101 dBc/√Hz
2 to 10 GHz	< -64 dBc/√Hz	< -92 dBc/√Hz	< -98 dBc/√Hz	< -101 dBc/√Hz
> 10 to 20 GHz	< -58 dBc/√Hz	< -86 dBc/√Hz	< -92 dBc/√Hz	< -95 dBc/√Hz
>20 to 40 GHz	< -54 dBc/√Hz	< -80 dBc/√Hz	< -86 dBc/√Hz	< -92 dBc/√Hz

### 5.2.8 Maximum RF Level

**Caution:** Measure the maximum RF level at room temperature (23 °C ± 5 °C).

- |                |   |
|----------------|---|
| Test equipment | RF power meter (section 5.1, item 3)  |
| Test setup     | Connect the RF power meter to the RF output of the SMP.   |
| Measurement    | <ul style="list-style-type: none"> <li>➤ For each RF frequency, set the output level to the guaranteed value (see tables 5-11 to 5-14). After that, the UNLEVELED message must not appear on the display of the SMP. Then increase the power until the UNLEVELED message occurs. The power that can be measured now, is the maximum available RF level.</li> <li>➤ SMP settings:             <ul style="list-style-type: none"> <li>- All modulations off</li> <li>- RF frequency see table 5-10</li> <li>- Level as mentioned above</li> </ul> </li> </ul> <p style="margin-left: 40px;">Maximum RF level .....see table 5-11 to 5-14</p> <ul style="list-style-type: none"> <li>➤ Measure the maximum level when pulse modulation is switched on (only when the option SMP-12 is fitted).</li> <li>➤ Do not connect any external equipment (e.g. a pulse generator) to the PULSE input of the SMP.</li> <li>➤ SMP settings:             <ul style="list-style-type: none"> <li>- Select MODULATION\PULSE\EXT</li> <li>- Select MODULATION\PULSE\POLARITY\INV</li> <li>- RF frequency (≥ 2 GHz) only see table 5-10.</li> <li>- Level as mentioned above</li> </ul> </li> </ul> <p style="margin-left: 40px;">Maximum RF level .....see table 5-11 to 5-14</p> |

Table 5-10 Recommended RF frequencies

Model		RF frequencies
SMP02/SMP22	without option SMP-B11	2 to 20 GHz (200 MHz steps)
	with option SMP-B11	10 MHz to 20 GHz (200 MHz steps)
SMP03	without option SMP-B11	2 to 27 GHz (200 MHz steps)
	with option SMP-B11	10 MHz to 27 GHz (200 MHz steps)
SMP04	without option SMP-B11	2 to 40 GHz (200 MHz steps)
	with option SMP-B11	10 MHz to 40 GHz (200 MHz steps)

Table 5-11 Maximum RF level SMP02/SMP22 without the options SMP-B12/SMP-B13

RF frequency	SMP02		SMP22	
	w/o SMP-B15	with SMP-B15	w/o SMP-B15	with SMP-B15
10 MHz to < 2 GHz	> +17 dBm		> +17 dBm	
2 to 20 GHz	> +11.5 dBm	> +10 dBm	> +20 dBm	> +18.5 dBm

Table 5-12 Maximum RF level SMP02/SMP22 with the options SMP-B12/SMP-B13

RF frequency	SMP02		SMP22	
	Pulse modulation off	Pulse modulation on	Pulse modulation off	Pulse modulation on
10 MHz to < 100 MHz	> +13 dBm		> +13 dBm	
100 MHz to 20 GHz	like maximum levels in table 5-11	> +13 dBm	like maximum levels in table 5-11	> +13 dBm

Table 5-13 Maximum RF level SMP03/SMP04 without the options SMP-B12/SMP-B13

RF frequency	SMP03		SMP04	
	w/o SMP-B15	with SMP-B15	w/o SMP-B15	with SMP-B15
10 MHz to < 2 GHz	> +14 dBm		> +14 dBm	
2 to < 18 GHz	> +10 dBm	> +8.5 dBm	> +10 dBm	> +8.5 dBm
18 to 20 GHz	> + 6 dBm	> +4.5 dBm	> + 6 dBm	> + 4.5 dBm
> 20 GHz to 27/33 GHz	> +12 dBm	> +11 dBm	> +12 dBm	> +10 dBm
> 33 to 40 GHz	-	-	> + 10 dBm	> + 8 dBm

Table 5-14 Maximum RF level SMP03/SMP04 with the options SMP-B12/SMP-B13

RF frequency	SMP03		SMP04	
	Pulse modulation off	Pulse modulation on	Pulse modulation off	Pulse modulation on
10 MHz to < 100 MHz	> +10 dBm		> +10 dBm	
100 MHz to 20 GHz	like maximum levels in table 5-13	> +10 dBm	like maximum levels in table 5-13	> +10 dBm
> 20 to 27 /40 GHz	like maximum levels in table 5-13		like maximum levels in table 5-13	

### 5.2.9 RF Level Accuracy

**Caution:** Measure the level accuracy at room temperature (23 °C ± 5 °C).

- |                |   |
|----------------|---|
| Test equipment | RF power meter (section 5.1, item 3)  |
| Test setup     | Connect the RF power meter to the RF output of the SMP.   |
| Measurement    | <ul style="list-style-type: none"> <li>➤ For each RF frequency, set the output level to +3 dBm and measure the actual level, then do so at -7 dBm.</li> <li>➤ SMP settings:             <ul style="list-style-type: none"> <li>- All modulations off</li> <li>- RF frequency see table 5-15</li> <li>- Level +3 dBm, -7 dBm</li> </ul> </li> </ul> <p style="margin-left: 40px;">Level accuracy</p> <ul style="list-style-type: none"> <li>f &lt; 2 GHz..... &lt; ±0.6 dB</li> <li>2 to 20 GHz..... &lt; ±0.7 dB</li> <li>f &gt; 20 GHz..... &lt; ±0.9 dB</li> </ul> <ul style="list-style-type: none"> <li>➤ Measure the maximum level when pulse modulation is switched on (only when the option SMP-12 is fitted).</li> <li>➤ Do not connect any external equipment (e.g. a pulse generator) to the PULSE input of the SMP.</li> <li>➤ SMP settings:             <ul style="list-style-type: none"> <li>- Select MODULATION\PULSE\EXT</li> <li>- Select MODULATION\PULSE\POLARITY\INV</li> <li>- RF frequency (≥ 2 GHz only) see table 5-15.</li> <li>- Level +3 dBm, -7 dBm</li> </ul> </li> </ul> <p style="margin-left: 40px;">Level accuracy ..... same as with pulse modulation off</p> |

Table 5-15 Recommended RF frequencies

Model		RF frequencies
SMP02/SMP22	without option SMP-B11	2 to 20 GHz (200 MHz steps)
	with option SMP-B11	10 MHz to 20 GHz (200 MHz steps)
SMP03	without option SMP-B11	2 to 27 GHz (200 MHz steps)
	with option SMP-B11	10 MHz to 27 GHz (200 MHz steps)
SMP04	without option SMP-B11	2 to 40 GHz (200 MHz steps)
	with option SMP-B11	10 MHz to 40 GHz (200 MHz steps)



### 5.2.10 AM Modulation Depth Setting

- Test equipment                      Test system 5.1.1.1
- Measurement
- SMP settings:
    - Select MODULATION\AM\AMSOURCE\LFGEN1
    - Modulation frequency 1 kHz
    - RF frequency (see table 5-16)
    - Level 0 dBm
  - For each RF frequency, vary the modulation depth from 10 % to 80 (10 % steps).
  - Measure the modulation depth with the audio/LF analyzer.
- AM modulation depth setting error ..... < (4 % of indication + 1 %)

Table 5-16 Recommended RF frequencies

Model		RF frequencies
SMP02/SMP22	without option SMP-B11	11 GHz
	with option SMP-B11	1 GHz, 11 GHz
SMP03	without option SMP-B11	11 GHz, 26 GHz
	with option SMP-B11	1 GHz, 11 GHz, 26 GHz
SMP04	without option SMP-B11	11 GHz, 26 GHz, 40 GHz
	with option SMP-B11	1 GHz, 11 GHz, 26 GHz, 40 GHz

### 5.2.11 AM Distortion

- Test equipment                      Test system 5.1.1.1
- Measurement
- SMP settings:
    - Select MODULATION\AM\AMSOURCE\LFGEN1
    - Modulation frequency 1 kHz
    - Modulation depth 60 %
    - RF frequency (see table 5-17)
    - Level 0 dBm
  - For each RF frequency, measure the AM distortion with the audio analyzer.
- AM distortion ..... < 1 %

Table 5-17 Recommended RF frequencies

Model		RF frequencies
SMP02/SMP22	without option SMP-B11	2 GHz, 9.9 GHz, 10 GHz, 20 GHz
	with option SMP-B11	10 MHz, 1 GHz, 1.9 GHz, 2 GHz, 9.9 GHz, 10 GHz, 20 GHz
SMP03	without option SMP-B11	2 GHz, 9.9 GHz, 10 GHz, 20 GHz, 21 GHz, 26 GHz
	with option SMP-B11	10 MHz, 1 GHz, 1.9 GHz, 2 GHz, 9.9 GHz, 10 GHz, 20 GHz, 26 GHz
SMP04	without option SMP-B11	2 GHz, 9.9 GHz, 10 GHz, 20 GHz, 21 GHz, 26 GHz, 40 GHz
	with option SMP-B11	10 MHz, 1 GHz, 1.9 GHz, 2 GHz, 9.9 GHz, 10 GHz, 20 GHz, 26 GHz, 40 GHz

5.2.12 AM Frequency Response

Test equipment

Test system 5.1.1.1

Measurement

- SMP settings:
  - Select MODULATION\AM\AMSOURCE\EXT1
  - Modulation depth 60 %
  - RF frequency see table 5-18
  - Level 0 dBm
- Modulation analyzer settings (LF generator):
  - LF frequency see table (5-19)
  - Generator level 1  $V_{peak}$
- For each RF frequency, vary the LF frequency as shown in table (5-19)
- Measure the modulation depth with the audio/LF analyzer.

AM frequency response (1 dB)

f < 2 GHz..... DC to 10 kHz

f ≥ 2 GHz..... DC to 50 kHz

AM frequency response (3 dB)..... DC to 100 kHz

Table 5-18 Recommended RF frequencies

Model		RF frequencies
SMP02/SMP22	without option SMP-B11	11 GHz
	with option SMP-B11	1 GHz, 11 GHz
SMP03	without option SMP-B11	11 GHz, 26 GHz
	with option SMP-B11	1 GHz, 11 GHz, 26 GHz
SMP04	without option SMP-B11	11 GHz, 26 GHz, 40 GHz
	with option SMP-B11	1 GHz, 11 GHz, 26 GHz, 40 GHz

Table 5-19 Recommended LF frequencies

RF frequency	LF frequencies
f < 2 GHz	(DC), 10 Hz, 30 Hz, 100 Hz, 300 Hz, 1 kHz, 3 kHz, 10 kHz, 30 kHz, 100 kHz
f ≥ 2 GHz	(DC), 10 Hz, 30 Hz, 100 Hz, 300 Hz, 1 kHz, 3 kHz, 10 kHz, 30 kHz, 50 kHz, 100 kHz

### 5.2.13 Amplitude Shift Keying (ASK)

- Test equipment                      Test system 5.1.1.1
- Measurement
- SMP settings:
    - Select DIGITAL MOD\ASK\SOURCE\EXT1
    - Modulation depth 80 %
    - RF frequency see table 5-20
    - Level 0 dBm
  - Audio analyzer settings:
    - Modulation frequency 1 kHz (squarewave)
    - Generator TTL level
  - For each RF frequency, measure the modulation depth with the modulation analyzer
- Modulation depth setting error ..... < ± 10 % (absolute value < ± 8 %!)

Table 5-20 Recommended RF frequencies

Model	RF frequencies
SMP02/SMP22	2 GHz, 20 GHz
SMP03	2 GHz, 20 GHz, 21 GHz, 26 GHz
SMP04	2 GHz, 20 GHz, 21 GHz, 26 GHz, 40 GHz

### 5.2.14 FM Deviation Setting

- Test equipment                      Test system 5.1.1.1
- Measurement
- SMP settings:
    - Select MODULATION\FM\FM1 SOURCE\EXT1
    - RF frequency (see table 5-21)
    - Level 0 dBm
  - Audio/LF analyzer settings:
    - Modulation frequency 100 kHz
    - Generator level 1 V<sub>peak</sub>
  - SMP settings:
    - Select MODULATION\FM\MODE\LOCKED
    - FM deviation 500 kHz
  - For each RF frequency, measure the FM deviation with the audio analyzer.
- FM deviation setting error ..... < 10 % of indication
- SMP setting:
    - Select MODULATION\FM\MODE\UNLOCKED
  - For each RF frequency, measure the FM deviation with the audio/LF analyzer. Because in the UNLOCKED mode the frequency the SMP

may change or drift a little, check the correct tuning of the spectrum analyzer, if necessary.

FM deviation setting error ..... < 10 % of indication

- The following test for the PRECISE mode can only be carried out when the option SM-B5 is fitted.

- SMP setting:
  - Select MODULATION\FM\MODE\PRECISE

- Audio/LF analyzer settings:
  - Modulation frequency 1 kHz

- For each RF frequency, vary the deviation as shown in table 5-22.

- Measure the FM deviation with the audio/LF analyzer.

FM deviation setting error ..... < 2 % of indication

Table 5-21 Recommended RF frequencies

Model		RF frequencies
SMP02/SMP22	without option SMP-B11	9.9 GHz, 10.1 GHz
	with option SMP-B11	9.9 GHz, 10.1 GHz
SMP03	without option SMP-B11	9.9 GHz, 10.1 GHz, 26 GHz
	with option SMP-B11	9.9 GHz, 10.1 GHz, 26 GHz
SMP04	without option SMP-B11	9.9 GHz, 10.1 GHz, 26 GHz
	with option SMP-B11	9.9 GHz, 10.1 GHz, 26 GHz

Table 5-22 Recommended test deviations

Test deviations
1 kHz, 5 kHz, 10 kHz, 20 kHz, 30 kHz, 40 kHz, 50 kHz, 60 kHz, 70 kHz, 80 kHz, 90 kHz, 100 kHz, 200 kHz, 300 kHz, 400 kHz, 500 kHz

### 5.2.15 FM Distortion

Test equipment

Test system 5.1.1.1

Measurement

- SMP settings:
  - Select MODULATION\FM\FM1 SOURCE\EXT1
  - RF frequency (see table 5-23)
  - Level 0 dBm
- Audio/LF analyzer settings:
  - Modulation frequency 50 kHz
  - Generator level 1  $V_{peak}$
- SMP settings:
  - Select MODULATION\FM\MODE\LOCKED
  - FM deviation 500 kHz
- For each RF frequency, measure the FM distortion with the audio analyzer.  
 FM distortion..... < 0.5 %
- SMP setting:
  - Select MODULATION\FM\MODE\UNLOCKED
- For each RF frequency, measure the FM distortion with the audio/LF analyzer. Because in the UNLOCKED mode the frequency the SMP may change or drift a little bit, check the correct tuning of the spectrum analyzer, if necessary.  
 FM distortion..... < 0.5 %
- The following test for the PRECISE mode can only be carried out when the option SM-B5 is fitted.
- SMP setting:
  - Select MODULATION\FM\MODE\PRECISE
- For each RF frequency, measure the FM distortion with the audio analyzer.  
 FM distortion..... < 0.5 %

Table 5-23 Recommended RF frequencies

Model		RF frequencies
SMP02/SMP22	without option SMP-B11	9.9 GHz, 10.1 GHz
	with option SMP-B11	9.9 GHz, 10.1 GHz
SMP03	without option SMP-B11	9.9 GHz, 10.1 GHz, 26 GHz
	with option SMP-B11	9.9 GHz, 10.1 GHz, 26 GHz
SMP04	without option SMP-B11	9.9 GHz, 10.1 GHz, 26 GHz
	with option SMP-B11	9.9 GHz, 10.1 GHz, 26 GHz

### 5.2.16 FM Frequency Response

Test equipment

Test system 5.1.1.1

Measurement

- SMP settings:
  - Select MODULATION\FM\FM1 SOURCE\EXT1
  - RF frequency see table 5-24
  - Level 0 dBm
  
- Audio/LF analyzer settings:
  - LF frequency see table 5-25
  - Generator TTL level
  
- SMP settings:
  - Select MODULATION\FM\MODE\LOCKED
  - FM deviation 100 kHz
  
- For each RF frequency, vary the LF frequency as shown in table 5-25.
  
- Measure the FM frequency response with the modulation analyzer.
  - FM frequency response
  - 20 kHz to 1 MHz ..... < 5 dB
  
- SMP setting:
  - Select MODULATION\FM\MODE\UNLOCKED
  - FM deviation 10 MHz
  
- For each RF frequency, vary the LF frequency as shown in table 5-25. Because in the UNLOCKED mode the frequency of the SMP may change or drift a little, check the correct tuning of the spectrum analyzer, if necessary.
  
- Measure the FM frequency response with the modulation analyzer.
  - FM frequency response
  - 10 Hz (DC) to < 50 kHz ..... < 1 dB
  - 50 kHz to 1 MHz ..... < 5 dB
  
- The following test for the PRECISE mode can only be carried out when the option SM-B5 is fitted.
  
- SMP setting:
  - Select MODULATION\FM\MODE\PRECISE
  - FM deviation 100 kHz
  
- For each RF frequency, vary the LF frequency as shown in table 5-25.
  
- Measure the FM frequency response with the modulation analyzer.
  - FM frequency response
  - 10 Hz (DC) to < 50 kHz ..... < 0.5 dB
  - 50 kHz to 1 MHz ..... < 4 dB

Table 5-24 Recommended RF frequencies

Model		RF frequencies
SMP02/SMP22	without option SMP-B11	9.9 GHz, 10.1 GHz
	with option SMP-B11	9.9 GHz, 10.1 GHz
SMP03	without option SMP-B11	9.9 GHz, 10.1 GHz, 26 GHz
	with option SMP-B11	9.9 GHz, 10.1 GHz, 26 GHz
SMP04	without option SMP-B11	9.9 GHz, 10.1 GHz, 26 GHz
	with option SMP-B11	9.9 GHz, 10.1 GHz, 26 GHz

Table 5-25 Recommended LF frequencies

FM mode	LF Frequencies
LOCKED	20 kHz, 40 kHz, 50 kHz, 60 kHz, 70 kHz, 80 kHz, 90 kHz, 100 kHz, 200 kHz, 300 kHz, 400 kHz, 500 kHz, 600 kHz, 700 kHz, 800 kHz, 900 kHz, 1 MHz
UNLOCKED, PRECISE	10 Hz, 30 Hz, 100 Hz, 1 kHz, 10 kHz, 20 kHz, 30 kHz, 40 kHz, 50 kHz, 60 kHz, 80 kHz, 100 kHz, 200 kHz, 300 kHz, 400 kHz, 500 kHz, 600 kHz, 700 kHz, 800 kHz, 900 kHz, 1 MHz

### 5.2.17 Frequency Shift Keying (FSK)

Test equipment

Test system 5.1.1.1

Measurement

- SMP settings:
  - Select DIGITAL MOD\FSK\SOURCE\EXT1
  - Deviation 10 MHz
  - RF frequency 6 GHz
  - Level 0 dBm
- Audio/LF analyzer settings:
  - Modulation frequency 100 kHz (squarewave)
  - Generator level 1  $V_{peak}$
- Measure the deviation with the modulation analyzer.  
 Deviation setting error ..... <  $\pm 10\%$

### 5.2.18 Pulse Modulation Rise/Fall Time

Test equipment

Test system 5.1.1.2

Measurement

- SMP settings:
  - Select MODULATION\PULSE\SOURCE\EXT
  - Polarity NORM
  - External impedance 50 Ω
  - RF frequency (see table 5-26)
  - Level 0 dBm
  
- Pulse generator settings:
  - Pulse repetition rate
    - without options SMP-B12/B13      500 kHz
    - with options SMP-B12/B13      10 MHz
  - Duty cycle 50 %
  - TTL level
  
- For each RF frequency, measure both rise and the fall time of the RF pulse with the sampling oscilloscope.
  - Rise/fall time (10%/90%)
    - without options SMP-B12/B13 ..... < 500 ns
    - with options SMP-B12/B13 ..... < 10 ns

Table 5-26 Recommended RF frequencies

Model			RF frequencies
SMP02/ SMP22	without options	without option SMP-B11	2 GHz, 9.9 GHz, 10 GHz, 20 GHz
	SMP-B12/B13	with option SMP-B11	2 GHz, 9.9 GHz, 10 GHz, 20 GHz
	with options SMP-B12/B13	without option SMP-B11	2 GHz, 9.9 GHz, 10 GHz, 20 GHz
		with SMP-B11	1 GHz, 1.9 GHz, 2 GHz, 9.9 GHz, 10 GHz, 20 GHz
SMP03	without options	without option SMP-B11	2 GHz, 9.9 GHz, 10 GHz, 20 GHz, 20.1 GHz, 27 GHz
	SMP-B12/B13	with option SMP-B11	2 GHz, 9.9 GHz, 10 GHz, 20 GHz, 20.1 GHz, 27 GHz
	with options SMP-B12/B13	without option SMP-B11	2 GHz, 9.9 GHz, 10 GHz, 20 GHz, 20.1 GHz, 27 GHz
		with option SMP-B11	1 GHz, 1.9 GHz, 2 GHz, 9.9 GHz, 10 GHz, 20 GHz, 20.1 GHz, 27 GHz
SMP04	without options	without option SMP-B11	2 GHz, 9.9 GHz, 10 GHz, 20 GHz, 20.1 GHz, 27 GHz, 40 GHz
	SMP-B12/B13	with option SMP-B11	2 GHz, 9.9 GHz, 10 GHz, 20 GHz, 20.1 GHz, 27 GHz, 40 GHz
	with options SMP-B12/B13	without option SMP-B11	2 GHz, 9.9 GHz, 10 GHz, 20 GHz, 20.1 GHz, 27 GHz, 40 GHz
		with option SMP-B11	1 GHz, 1.9 GHz, 2 GHz, 9.9 GHz, 10 GHz, 20 GHz, 20.1 GHz, 27 GHz, 40 GHz



### 5.2.19 Pulse Modulation On /Off Ratio

- Test equipment                      Spectrum analyzer (section 5.1, item 2)
- Test setup                              Connect the spectrum analyzer to the RF output of the SMP.
- Measurement
- SMP settings:
    - Select MODULATION\PULSE\SOURCE\EXT
    - Polarity INV
    - External impedance 50 Ω
    - RF frequency (see table 5-27)
    - Level 0 dBm
  - Do not connect any external equipment (e. g. pulse generator) to the PULSE input of the SMP.
  - For each RF frequency, measure the output power of the SMP with pulse polarity INV (= RF on) and NORM (= RF off). Calculate the on/off ratio in dB.
    - On/off ratio
    - without options SMP-B12/B13 ..... > 50 dB
    - with options SMP-B12/B13 ..... > 80 dB

Table 5-27 Recommended RF frequencies

Model			RF frequencies
SMP02/ SMP22	without options	without option SMP-B11	2 GHz, 9.9 GHz, 10 GHz, 20 GHz
	SMP-B12/B13	with option SMP-B11	2 GHz, 9.9 GHz, 10 GHz, 20 GHz
	with options SMP-B12/B13	without option SMP-B11	2 GHz, 9.9 GHz, 10 GHz, 20 GHz
		with SMP-B11	1 GHz, 1.9 GHz, 2 GHz, 9.9 GHz, 10 GHz, 20 GHz
SMP03	without options	without option SMP-B11	2 GHz, 9.9 GHz, 10 GHz, 20 GHz, 20.1 GHz, 27 GHz
	SMP-B12/B13	with option SMP-B11	2 GHz, 9.9 GHz, 10 GHz, 20 GHz, 20.1 GHz, 27 GHz
	with options SMP-B12/B13	without option SMP-B11	2 GHz, 9.9 GHz, 10 GHz, 20 GHz, 20.1 GHz, 27 GHz
		with option SMP-B11	1 GHz, 1.9 GHz, 2 GHz, 9.9 GHz, 10 GHz, 20 GHz, 20.1 GHz, 27 GHz
SMP04	without options	without option SMP-B11	2 GHz, 9.9 GHz, 10 GHz, 20 GHz, 20.1 GHz, 27 GHz, 40 GHz
	SMP-B12/B13	with option SMP-B11	2 GHz, 9.9 GHz, 10 GHz, 20 GHz, 20.1 GHz, 27 GHz, 40 GHz
	with options SMP-B12/B13	without option SMP-B11	2 GHz, 9.9 GHz, 10 GHz, 20 GHz, 20.1 GHz, 27 GHz, 40 GHz
		with option SMP-B11	1 GHz, 1.9 GHz, 2 GHz, 9.9 GHz, 10 GHz, 20 GHz, 20.1 GHz, 27 GHz, 40 GHz

### 5.2.20 Internal Modulation Generator

Test equipment	Audio/LF analyzer (section 5.1, item 5)
Test setup	Connect the audio/LF analyzer to the LF output of the SMP.
Measurement	<ul style="list-style-type: none"> <li>➤ SMP settings:                     <ul style="list-style-type: none"> <li>- Select LF OUTPUT\SOURCE\LFGEN1</li> <li>- Voltage 1 V</li> <li>- Subsequently 0.4 kHz, 1 kHz, 3 kHz, 15 kHz</li> </ul> </li> <li>➤ Measure both the actual frequency and the output level with the audio/LF analyzer.                     <ul style="list-style-type: none"> <li>Frequency error ..... &lt; 3 %</li> <li>Output level..... 1 V ± 1 %</li> </ul> </li> </ul>

### 5.2.21 LF Generator (Option SM-B2)

Test equipment	Audio/LF analyzer (section 5.1, item 5)
Test setup	Connect the audio/LF analyzer to the LF output of the SMP.
Measurement	<ul style="list-style-type: none"> <li>➤ SMP settings:                     <ul style="list-style-type: none"> <li>- Select LF OUTPUT\SOURCE\LFGEN2</li> <li>- Sinewave</li> <li>- Voltage 1V</li> <li>- Vary frequency from 20 Hz to 100 kHz</li> </ul> </li> <li>➤ Measure both the frequency error and the distortion with the audio analyzer                     <ul style="list-style-type: none"> <li>Frequency error ..... &lt; 1·10<sup>-4</sup></li> <li>Distortion ..... &lt; 0.1 %</li> </ul> </li> <li>➤ SMP settings:                     <ul style="list-style-type: none"> <li>- Set LFGEN2 FREQ to 1 kHz</li> <li>- Vary the voltage from 1 mV to 4 V</li> </ul> </li> <li>➤ Measure the output level with the audio/LF analyzer.                     <ul style="list-style-type: none"> <li>Output level error..... &lt; ± (1 % + 1 mV)</li> </ul> </li> <li>➤ SMP settings:                     <ul style="list-style-type: none"> <li>- Set voltage to 1 V</li> <li>- Vary the frequency from 10 Hz to 500 kHz</li> </ul> </li> <li>➤ Measure the frequency response with the audio/LF analyzer.                     <ul style="list-style-type: none"> <li>Frequency response                             <ul style="list-style-type: none"> <li>up to 100 kHz..... &lt; 0.3 dB</li> <li>up to 500 kHz..... &lt; 0.5 dB</li> </ul> </li> </ul> </li> </ul>

### 5.2.22 Pulse Generator (Option SMP-B14)

Test equipment	Oscilloscope (section 5.1, item 8) 2 feed-through terminations (section 5.1, item 9) Pulse generator (section 5.1, item 6)
Test setup	Connect both the SYNC and VIDEO outputs of the SMP to the Y inputs of the oscilloscope. Use 50 $\Omega$ feed-through terminations at the Y inputs. Connect the pulse generator to the PULSE input of the SMP.
Measurement	<p>Single pulses</p> <ul style="list-style-type: none"> <li>➤ SMP settings: <ul style="list-style-type: none"> <li>- Select MODULATION\PULSE\SOURCE PULSE-GEN</li> <li>- Period 100 ns</li> <li>- Width 20 ns</li> <li>- Pulse delay 20 ns</li> <li>- Double pulse state off</li> <li>- Trigger mode auto</li> <li>- Ext trigger slope pos.</li> </ul> </li> <li>➤ Oscilloscope settings: <ul style="list-style-type: none"> <li>- Time base 20 ns/div.</li> <li>- Both channels 2V/div.</li> <li>- Triggering from the SYNC signal</li> </ul> </li> <li>➤ Measure both the SYNC and the VIDEO signals with the oscilloscope. <p>SYNC signal ..... pulse train with a pulse period of 100 ns and a pulse width of 40 ns <math>\pm</math> 25 %</p> <p>VIDEO signal ..... pulse train with a pulse period of 100 ns and a pulse width of 20 ns <math>\pm</math> 20 % (the first edge appears after the first edge of the SYNC signal, delayed by 9 to 41 ns)</p> </li> </ul> <p>Double pulses</p> <ul style="list-style-type: none"> <li>➤ SMP settings: <ul style="list-style-type: none"> <li>- Double pulse state on</li> <li>- Width 20 ns</li> <li>- Double pulse delay 60 ns</li> <li>- Width 20 ns</li> </ul> </li> <li>➤ Measure the VIDEO signal with the oscilloscope. <p>VIDEO signal .....second pulse with a width of 20 ns <math>\pm</math> 25 % ..... spacing to the first pulse is 47 to 83 ns</p> </li> </ul> <p>xt. triggering</p> <ul style="list-style-type: none"> <li>➤ SMP settings: <ul style="list-style-type: none"> <li>- Trigger mode ext</li> </ul> </li> <li>➤ Pulse generator settings: <ul style="list-style-type: none"> <li>- Pulse repetition rate 10 MHz</li> </ul> <p>A stable pulse train must appear on the oscilloscope.</p> </li> <li>➤ Now trigger the oscilloscope with the signal at the PULSE input. <p>The pulse train on the oscilloscope may be shifted by up to 50 ns.</p> </li> <li>➤ Repeat the measurement with pulse periods of up to 85 s and pulse widths, pulse delays and double pulse spacings of up to 1 s.</li> </ul>

### 5.3 Test Report

<b>ROHDE &amp; SCHWARZ</b>	<b>SIGNAL GENERATOR SMP</b>	1035.5005.____
Serial number:		
Name:		
Date:		
Signature:		

Table 5-28 Test report

Item	Characteristic	Measur. acc. to section	Min.	Actual	Max.	Unit
1	Display and keyboard	5.2.1	checked	.....	–	–
2	Frequency setting	5.2.2	checked	.....	–	–
3	Reference frequency	5.2.3	–	.....	–	–
4	Suppression of harmonics a) Pulse mod. off (with/without options SMP-B12/B13)  SMP02 f < 1.8 GHz f ≥ 1.8 GHz  SMP22  SMP03/SMP04 f < 1.8 GHz f ≥ 1.8 GHz  b) Pulse mod. on (only with options SMP-B12/ B13)	5.2.4	– – – – – –	..... ..... ..... ..... .....	–30 –40 –25 –30 –40 –25	dBc dBc dBc dBc dBc dBc
5	Suppression of subharmonics SMP03 f > 20 GHz  SMP04 f > 20 GHz	5.2.5	– –	..... .....	–40 –30	dBc dBc
6	Suppression of nonharmonics f < 2 GHz 2 to 20 GHz f > 20 GHz	5.2.6	– – –	..... ..... .....	–50 –60 –54	dBc dBc dBc

Item	Characteristic	Measur. acc. to section	Min.	Actual	Max.	Unit
7	SSB phase noise 10 MHz to < 2 GHz Offset 100 Hz 1 kHz 10 kHz 100 kHz  2 to 10 GHz Offset 100 Hz 1 kHz 10 kHz 100 kHz  > 10 to 20 GHz Offset 100 Hz 1 kHz 10 kHz 100 kHz  > 20 to 40 GHz Offset 100 Hz 1 kHz 10 kHz 100 kHz	5.2.7	- - - -  - - - -  - - - -  - - - -  - - - -	..... ..... ..... .....  ..... ..... ..... .....  ..... ..... ..... .....  ..... ..... ..... .....  ..... ..... ..... .....	-64 -92 -98 -101  -64 -92 -98 -101  -58 -86 -92 -95  -54 -80 -86 -92	dBc/√1 Hz dBc/√1 Hz dBc/√1 Hz dBc/√1 Hz  dBc/√1 Hz dBc/√1 Hz dBc/√1 Hz dBc/√1 Hz  dBc/√1 Hz dBc/√1 Hz dBc/√1 Hz dBc/√1 Hz  dBc/√1 Hz dBc/√1 Hz dBc/√1 Hz dBc/√1 Hz
8	Maximum RF level a) Without options SMP-B12/-B13 SMP02 10 MHz to < 2 GHz 2 to 20 GHz w/o option SMP-B15 with option SMP-B15 SMP22 10 MHz to < 2 GHz 2 to 20 GHz w/o option SMP-B15 with option SMP-B15 SMP03 10 MHz to < 2 GHz 2 to < 18 GHz w/o option SMP-B15 with option SMP-B15 18 to 20 GHz w/o option SMP-B15 with option SMP-B15 > 20 to 27 GHz w/o option SMP-B15 with option SMP-B15 SMP04 10 MHz to < 2 GHz 2 to < 18 GHz w/o option SMP-B17 with option SMP-B17 18 to 20 GHz w/o option SMP-B17 with option SMP-B17 > 20 to 33 GHz w/o option SMP-B17 with option SMP-B17	5.2.8	+17  +11.5 10  +17  +20 18.5  +14  +10 +8.5  +6 +4.5  +12 +11  +14  +10 +8.5  +6 +4.5  +12 +10	.....  ..... .....  ..... ..... ..... .....  ..... ..... ..... .....  ..... ..... ..... .....  ..... ..... ..... .....	-  - -  - - - -  - - - -  - - - -  - - - -	dBm  dBm dBm  dBm dBm dBm dBm  dBm dBm dBm dBm  dBm dBm dBm dBm  dBm dBm dBm dBm

Item	Characteristic	Measur. acc. to section	Min.	Actual	Max.	Unit
	> 33 to 40 GHz w/o option SMP-B17 with option SMP-B17		+10 +8	..... .....	- -	dBm dBm
	b) With options SMP-B12/ -B13, Pulse mod. off					
8	SMP02 10 MHz to < 100 MHz 100 MHz to < 2 GHz 2 to 20 GHz w/o option SMP-B15 with option SMP-B15		+13 +17  +11.5 +10	..... .....  ..... .....	- -  - -	dBm dBm  dBm dBm
	SMP22 10 MHz to < 100 MHz 100 MHz to < 2 GHz 2 to 20 GHz w/o option SMP-B15 with option SMP-B15		+13 +17  +20 +18.5	..... .....  ..... .....	- -  - -	dBm dBm  dBm dBm
	SMP03 10 MHz to < 100 MHz 100 MHz to < 2 GHz 2 to < 18 GHz w/o option SMP-B15 with option SMP-B15 18 to 20 GHz w/o option SMP-B15 with option SMP-B15 > 20 to 27 GHz w/o option SMP-B15 with option SMP-B15		+10 +14  +10 +8.5  +6 +4.5  12 11	..... .....  ..... .....  ..... .....  ..... .....	- -  - -  - -  - -	dBm dBm  dBm dBm  dBm dBm  dBm dBBm
	SMP04 10 MHz to < 100 MHz 100 MHz to < 2 GHz 2 to < 18 GHz w/o option SMP-B17 with option SMP-B17 18 to 20 GHz w/o option SMP-B17 with option SMP-B17 > 20 to 33 GHz w/o option SMP-B17 with option SMP-B17 > 33 to 40 GHz w/o option SMP-B17 with option SMP-B17		+10 +14  +10 +8.5  +6 +4.5  12 10  +10 +8	..... .....  ..... .....  ..... .....  ..... .....  ..... .....	- -  - -  - -  - -  - -	dBm dBm  dBm dBm  dBm dBm  dBm dBm  dBm dBm
	c) With options SMP-B12/ -B13, Pulse mod. on					
	SMP02/SMP22 10 MHz to 20 MHz		+13	.....	-	dBm
	SMP03 10 MHz to 20 GHz > 20 to 27 GHz w/o option SMP-B15 with option SMP-B15		+10 +12 +11	..... ..... .....	- - -	dBm dBm dBm

Item	Characteristic	Measur em. acc. to section	Min.	Actual	Max.	Unit
	SMP04 10 MHz to 20 GHz > 20 to 33 GHz w/o option SMP-B17 with option SMP-B17 > 33 to 40 GHz w/o option SMP-B17 with option SMP-B17		+10  +12 +10  +10 +8	.....  ..... .....  ..... .....	-  - -  - -	dBm  dBm dBm  dBm dBm
9	RF level accuracy f < 2 GHz 2 to 20 GHz f > 20 GHz	5.2.9	-0.6 -0.7 -0.9	..... ..... .....	+0.6 +0.7 +0.9	dB dB dB
10	AM modulation depth setting 10 % 20 % 30 % 40 % 50 % 60 % 70 % 80 % 90 %	5.2.10	8.6 18.2 27.8 37.4 47 56.6 66.2 75.8 85.4	..... ..... ..... ..... ..... ..... ..... ..... .....	11.4 21.8 32.2 42.6 53 63.4 73.8 84.2 94.6	% % % % % % % % %
11	AM distortion	5.2.11	-	.....	1	%
12	AM frequency response f < 2 GHz, DC to 10 kHz f ≥ 2 GHz, DC to 50 kHz DC to 100 kHz	5.2.12	- - -	..... ..... .....	1 1 3	dB dB dB
13	Amplitude shift keying depth 80 %	5.2.13	72	.....	88	%
14	FM deviation setting LOCKED UNLOCKED PRECISE 1 kHz 5 kHz 10 kHz 20 kHz 30 kHz 40 kHz 50 kHz 60 kHz 70 kHz 80 kHz 90 kHz 100 kHz 200 kHz 300 kHz 400 kHz 500 kHz	5.2.14	450 450  0.98 4.9 9.8 19.6 29.4 39.2 49 58.8 68.6 78.4 88.2 98 196 294 392 490	..... ..... ..... ..... ..... ..... ..... ..... ..... ..... ..... ..... ..... ..... ..... ..... ..... ..... .....	550 550  1.02 5.1 10.2 20.4 30.6 40.8 51 61.2 71.4 81.6 91.8 102 204 306 408 510	kHz kHz  kHz kHz kHz kHz kHz kHz kHz kHz kHz kHz kHz kHz kHz kHz kHz kHz kHz

Item	Characteristic	Measur. acc. to section	Min.	Actual	Max.	Unit
15	FM distortion LOCKED UNLOCKED PRECISE	5.2.15	- - -	..... ..... .....	0.5 0.5 0.5	% % %
16	FM frequency response LOCKED 20 kHz to 1 MHz UNLOCKED DC to < 50 kHz 50 kHz to 1 MHz PRECISE DC to < 50 kHz 50 kHz to 1 MHz	5.2.16	- - - - -	..... ..... ..... ..... .....	5 1 5 0.5 4	dB dB dB dB
17	Frequency shift keying deviation 10 MHz	5.2.17	9	.....	11	MHz
18	Pulse modulation rise/fall time 10%/90% w/o options SMP-B12/ B13 with options SMP-B12/ B13	5.2.18	- -	..... .....	500 10	ns ns
19	Pulse modulation on/off ratio w/o options SMP-B12/B13 with options SMP-B12/B13	5.2.19	50 80	..... .....	- -	dB dB
20	Internal modulation generator frequency error 0.4 kHz 1 kHz 3 kHz 15 kHz output level error	5.2.20	0.388 0.97 2.91 0.9914.55	..... ..... ..... ..... .....	0.412 1.03 3.09 15.45 1.01	kHz kHz kHz kHz V
21	LF generator (option SM-B2) frequency error distortion output level error frequency response ≤ 100 kHz ≤ 500 kHz	5.2.21	- - - - -	..... ..... ..... ..... .....	1·10 <sup>-4</sup> 0.1 1% + 1 mV 0.3 0.5	%  dB dB
22	Pulse generator (option SMP-B14) pulse period pulse width pulse delay double pulse delay trigger delay	5.2.22	checked -5% - 3ns -5% - 3 ns - 5% - 5 ns -	..... ..... ..... ..... .....	- +5% + 3ns +5% + 3ns +5% + 20ns 50 ns	



# Annex A

## IEC/IEEE Bus Interface

The instrument is equipped with an IEC/IEEE-bus connection as a standard. The mating connector according to IEEE 488 is at the rear of the instrument. A controller for remote control can be connected via the interface. The connection is effected using a shielded cable.

### Characteristics of the Interface

- 8-bit parallel data transfer
- bidirectional data transfer
- three line handshake
- high data transfer rate of max. 350 kByte/s
- up to 15 devices can be connected
- maximal length of the connecting cables 15 m (single connection 2 m)
- wired OR if several instruments are connected in parallel.

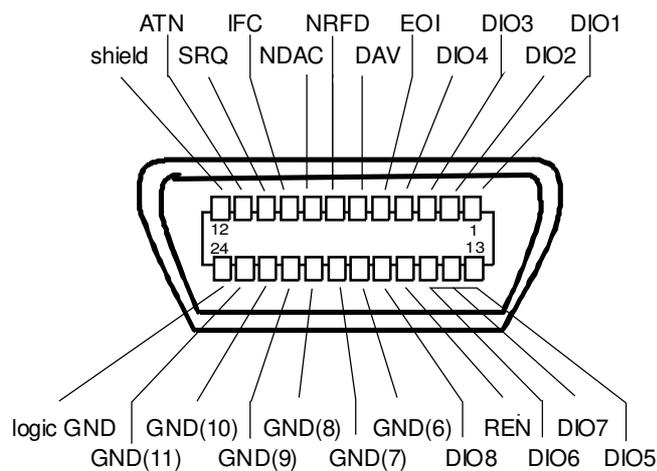

Fig. A-1 Contact Assignment of the IEC-bus socket

### Bus Lines

#### 1. Data bus with 8 lines DIO 1 to DIO 8.

The transmission is bit-parallel and byte-serial in the ASCII/ISO code. DIO1 is the bit of lowest order, DIO8 the bit of highest order.

**2. Control bus with 5 lines.**

**IFC** (Interface Clear),  
active low resets the interfaces of the instruments connected to the default setting.

**ATN** (Attention),  
active low signals the transmission of interface messages  
inactive high signals the transmission of device-dependent messages.

**SRQ** (Service Request),  
active low enables a device connected to send a service request to the controller.

**REN** (Remote Enable),  
active low permits the switchover to remote control.

**EOI** (End or Identify),  
has two functions in connection with ATN:  
active low marks the end of data transmission with ATN=high  
active low triggers a parallel poll with ATN=low.

**3. Handshake bus with three lines.**

**DAV** (Data Valid),  
active low signals a valid data byte on the data bus.

**NRFD** (Not Ready For Data),  
active low signals that one of the device connected is not ready for data transfer.

**NDAC** (Not Data Accepted),  
active low as long as the instrument connected is accepting the data present on the data bus.

**Interface Functions**

Instruments which can be remote-controlled via IEC bus can be equipped with different interface functions. Table A-1 lists the interface functions appropriate for the instrument.

Table A-1 Interface function

Control character	Interface function
SH1	Handshake source function (source handshake)
AH1	Handshake drain function (acceptor handshake)
L4	Listener function.
T6	Talker function, ability to respond to serial poll
SR1	Service request function (Service Request)
PP1	Parallel poll function
RL1	Remote/Local switchover function
DC1	Resetting function (Device Clear)
DT1	Trigger function (Device Trigger)

## Interface Messages

Interface messages are transmitted to the instrument on the data lines, with the attention line being active (LOW). They serve to communicate between instrument and controller.

### Universal Commands

The universal commands are encoded in the range 10 through 1F hex. They are effective for all instruments connected to the bus without addressing them before.

Tabelle A-2 Universal Commands

Command	QuickBASIC command	Effect on the instrument
DCL (Device Clear)	IBCMD (controller%, CHR\$(20))	Aborts the processing of the commands just received and sets the command processing software to a defined initial state. Does not change the instrument setting.
IFC (Interface Clear)	IBSIC (controller%)	Resets the interfaces to the default setting.
LLO (Local Lockout)	IBCMD (controller%, CHR\$(17))	The LOC/IEC ADDR key is disabled.
SPE (Serial Poll Enable)	IBCMD (controller%, CHR\$(24))	Ready for serial poll
SPD (Serial Poll Disable)	IBCMD (controller%, CHR\$(25))	End of serial poll
PPU (Parallel Poll Unconfigure)	IBCMD (controller%, CHR\$(21))	End of the parallel-poll polling state

### Addressed Commands

The addressed commands are encoded in the range 00 through 0F hex. They are only effective for instruments addressed as listeners.

Table A-3 Addressed Commands

Command	QuickBASIC command	Effect on the instrument
SDC (Selected Device Clear)	IBCLR (device%)	Aborts the processing of the commands just received and sets the command processing software to a defined initial state. Does not change the instrument setting.
GET (Group Execute Trigger)	IBTRG (device%)	Triggers a previously active device function (eg a sweep). The effect of the command is the same as with that of a pulse at the external trigger signal input.
GTL (Go to Local)	IBLOC (device%)	Transition to the "Local" state (manual control)
PPC (Parallel Poll Configure)	IBPPC (device%, data%)	Configure instrument for parallel poll. The QuickBASIC command additionally executes PPE / PPD.

## RS-232-C Interface

The instrument is fitted with an RS-232-C interface as standard. The 9-pin connector is at the rear panel. A controller can be connected via this interface for remote control.

### Interface characteristics

- Serial data transmission in asynchronous mode
- Bidirectional data transmission via two separate lines
- Transmission rate selectable from 1200 to 115200 baud
- Logic 0 signal from +3 V to +15 V
- Logic 1 signal from -15 V to -3 V
- An external instrument (controller) can be connected
- Software handshake (XON, XOFF)
- Hardware handshake

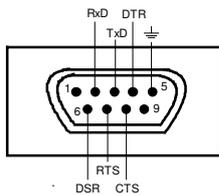

Fig. A-2 Pin assignment of RS-232-C connector

### Signal lines

**RxD** (Receive Data),

Data line, transmission from external controller to instrument.

**TxD** (Transmit Data),

Data line, transmission from instrument to external controller.

**DTR** (Data terminal ready),

Output (log. 0 = active). With DTR, the instrument indicates that it is ready to receive data. The DTR line controls whether the instrument is ready for reception or not.

**GND**,

Interface ground, connected to instrument ground.

**DSR** (Data set ready),

(Instead of the CTS line, the DSR connector is used for instruments with a VAR2 REV3 front module.)

**RTS** (Request to send),

Output (log 0 = active). With RTS, the instrument indicates that it is ready to receive data. The RTS line controls whether the instrument is ready for reception or not.

**CTS** (Clear to send),

Input (log 0 = active). CTS tells the instrument that the opposite station is ready to receive data.

## Transmission parameters

To ensure an error-free and correct data transmission, the parameters of the instrument and the controller should have the same settings. The parameters are set in menu UTILITIES-SYSTEM-RS232.

**Transmission rate (baud rate)** The following baud rates can be set in the instrument: 1200, 2400, 4800, 9600, 19200, 38400, 57600, 115200.

**Data bits** Data transmission is in 8-bit ASCII code. The first bit transmitted is the LSB (Least Significant Bit).

**Start bit** Each data byte begins with a start bit. The falling edge of the start bit indicates the beginning of the data byte.

**Parity bit** A parity bit is not used.

**Stop bit** The transmission of a data byte is terminated by a stop bit.

### Example:

Transmission of character A (41 hex) in the 8-bit ASCII code.

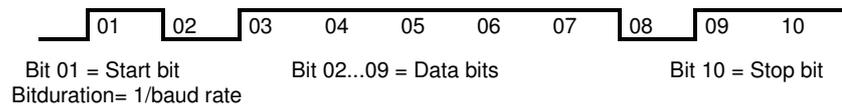

## Interface functions

For interface control, some control characters defined from 0 to 20 hex of the ASCII code can be transmitted via the interface (see Table A-4).

Table A-4 Interface functions (RS-232-C)

Control character	Interface function
<Ctrl Q> 11 hex	Enables character output (XON)
<Ctrl S> 13 hex	Inhibits character output (XOFF)
Break (at least 1 character only log 0)	Reset instrument
0Dhex, 0Ahex	Terminator <CR>, <LF> Switchover between local/remote

## Handshake

### Software handshake

The software handshake with the XON/XOFF protocol controls data transmission. If the receiver wishes to inhibit data entry, it sends XOFF to the transmitter. The transmitter then interrupts the data output until it receives a XON. The same function is provided at the transmitter side (controller).

**Note:** Software handshake is not suitable for transmission of binary data. Use the hardware handshake.

### Hardware handshake

In case of a hardware handshake the instrument signals that it is ready for reception via line DTR and RTS. A logic 0 means "ready" and a 1 means "not ready". Whether the controller is ready for reception or not is signalled to the instrument via lines CTS or DSR (see signal lines). The transmitter of the instrument is switched on by a 0 and off by a 1. Line RTS remains active as long as the serial interface is active. Line DTR controls whether the instrument is ready for reception or not.

### Connection between instrument and controller

Connection of the instrument with the controller is via a so-called 0-modem cable. In this case, the data, control and signalling lines have to be cross-connected. For a controller with a 9-pin or 25-pin connector the following circuit diagram applies.

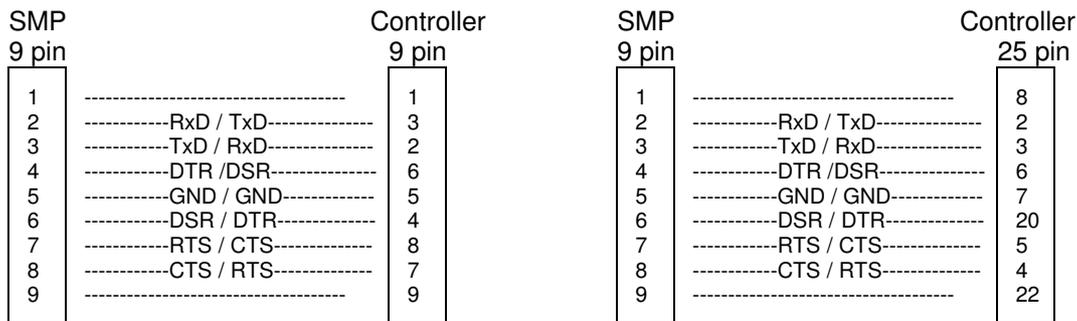

Fig. A-3 Wiring of data, control and signalling lines for hardware handshake

## Annex B

### List of Error Messages

The following list contains all error messages for errors occurring in the instrument. The meaning of negative error codes is defined in SCPI, positive error codes mark errors specific of the instrument.

The table contains the error code in the left-hand column. In the right-hand column the error text being entered into the error/event queue or being displayed is printed in bold face. Below the error text, there is an explanation as to the respective error.

### SCPI-Specific Error Messages

No Error

Error code	Error text in the case of queue poll Error explanation
0	<b>No error</b> This message is output if the error queue does not contain entries.

Command Error - Faulty command; sets bit 5 in the ESR register

Error code	Error text in the case of queue poll Error explanation
-100	<b>Command Error</b> The command is faulty or invalid.
-101	<b>Invalid Character</b> The command contains an invalid sign. Example: A header contains an ampersand, "SOURCE&".
-102	<b>Syntax error</b> The command is invalid. Example: The command contains block data the instrument does not accept.
-103	<b>Invalid separator</b> The command contains an impermissible sign instead of a separator. Example: A semicolon is missing after the command.
-104	<b>Data type error</b> The command contains an invalid value indication. Example: ON is indicated instead of a numeric value for frequency setting.
-105	<b>GET not allowed</b> A Group Execute Trigger (GET) is within a command line.
-108	<b>Parameter not allowed</b> The command contains too many parameters. Example: Command <code>SOURce:FM:INTernal:FREQuency</code> permits only one frequency indication.

Continuation: Command Error

Error code	Error text in the case of queue poll Error explanation
-109	<b>Missing parameter</b> The command contains too few parameters. Example: Command <code>SOURce:FM:INTernal:FREQuency</code> requires a frequency indication.
-112	<b>Program mnemonic too long</b> The header contains more than 12 signs.
-113	<b>Undefined header</b> The header is not defined for the instrument. Example: <code>*XYZ</code> is undefined for every instrument.
-114	<b>Header suffix out of range</b> The header contains an impermissible numeric suffix. Example: <code>SOURce3</code> does not exist in the instrument.
-123	<b>Exponent too large</b> The absolute value of the exponent is larger than 32000.
-124	<b>Too many digits</b> The number contains too many digits.
-128	<b>Numeric data not allowed</b> The command contains a number which is not allowed at this position. Example: Command <code>SOURce:FREQuency:MODE</code> requires the indication of a text parameter.
-131	<b>Invalid suffix</b> The suffix is invalid for this instrument. Example: <code>nHz</code> is not defined.
-134	<b>Suffix too long</b> The suffix contains more than 12 signs.
-138	<b>Suffix not allowed</b> A suffix is not allowed for this command or at this position of the command. Example: Command <code>*RCL</code> does not permit indicating a suffix.
-141	<b>Invalid character data</b> The text parameter either contains an invalid sign or it is invalid for this command Example: write error with parameter indication; <code>SOURce:FREQuency:MODE FIXSed</code> .
-144	<b>Character data too long</b> The text parameter contains more than 12 signs.
-148	<b>Character data not allowed</b> The text parameter is not allowed for this command or at this position of the command. Example: Command <code>*RCL</code> requires a number to be indicated.
-158	<b>String data not allowed</b> The command contains a valid character string at a position which is not allowed. Example: A text parameter is set in quotation marks, <code>SOURce:FREQuency:MODE "FIXed"</code>
-161	<b>Invalid block data</b> The command contains faulty block data. Example: An END message was received before the expected number of data had been received.



Execution Error - Error in executing the command; sets bit 4 in the ESR register

Error code	Error text in the case of queue poll Error explanation
-168	<b>Block data not allowed</b> The command contains valid block data at an impermissible position.
-178	<b>Expression data not allowed</b> The command contains a mathematical expression at an impermissible position.
-203	<b>Command protected</b> The desired command could not be executed as it was protected with a password. Use command <code>SYSTem:PROTect OFF, &lt;password&gt;</code> to enable the command. Example: The command <code>CALibrate:PULSe:MEASure?</code> is protected with a password.
-211	<b>Trigger ignored</b> The trigger (GET, *TRG or trigger signal) was ignored due to device timing considerations.
-221	<b>Settings conflict</b> There is a settings conflict between two parameters. Example: FM1 and PM1 cannot be switched on at the same time.
-222	<b>Data out of range</b> The parameter value is out of the range permitted by the instrument. Example: Command *RCL only permits entries in the range of 0 to 50
-223	<b>Too much data</b> The command contains too many data. Example: The instrument does not have sufficient storage space.
-224	<b>Illegal parameter value</b> The parameter value is invalid. Example: An invalid text parameter is indicated, <code>TRIGger:SWEEP:SOURce TASTE</code>
-225	<b>Out of memory</b> The storage space available in the instrument is exhausted. Example: An attempt is made to create more than 10 Memory Sequence lists.
-226	<b>Lists not of same length</b> The parts of a list have different lengths. This error message is also displayed if only part of a list has been transmitted via IEC bus. All parts of the list have to be transmitted always before it is executed. Example: The POWER list content is longer than the FREQUENCY list content, or only the POWER content is transmitted.
-230	<b>Data corrupt or stale</b> The data are incomplete or invalid. Example: The instrument has aborted a measurement.
-240	<b>Hardware error</b> The command cannot be executed due to problems with the instrument hardware.
-241	<b>Hardware missing</b> The command cannot be executed due to missing hardware. Example: An option is not fitted.
-255	<b>Directory full</b> The list management cannot accept any more lists as the maximum number of lists has already be attained. Example: Only 10 MEM SEQ lists can be created.

Device Specific Error - sets bit 3 in the ESR register.

Error code	Error text in the case of queue poll Error explanation
-310	<b>System error</b> This error message suggests an error within the instrument. Please inform the R&S Service.
-311	<b>Memory error</b> Error in the instrument memory.
-313	<b>Calibration memory lost</b> Loss of calibration data stored. The calibration data of YFOM and ALC AMP can be restored by internal routines (see "Section Calibration").
-314	<b>Save/recall memory lost</b> Loss of the non-volatile data stored using *SAV? command.
-315	<b>Configuration memory lost</b> Loss of the non-volatile configuration data stored by the instrument.
-330	<b>Self-test failed</b> The selftest could not be executed.
-350	<b>Queue overflow</b> This error code is entered into the queue instead of the actual error code if the queue is full. It indicates that an error has occurred but not been accepted. The queue can accept 5 entries.
-360	<b>Communication error</b> An error has occurred during the transmission or reception of data on the IEC/IEEE bus or via the RS-232 interface.

Query Error - Error in data request; sets bit 2 in the ESR register.

Error code	Error text in the case of queue poll Error explanation
-410	<b>Query INTERRUPTED</b> The query has been interrupted. Example: After a query, the instrument receives new data before the response has been sent completely.
-420	<b>Query UNTERMINATED</b> The query is incomplete. Example: The instrument is addressed as a talker and receives incomplete data.
-430	<b>Query DEADLOCKED</b> The query cannot be processed. Example: The input and output buffers are full, the instrument cannot continue operation.

## SMP-Specific Error Messages

Device-dependent Error - device-specific error; sets bit 3 in the ESR register.

Error code	Error text in the case of queue poll Error explanation
105	<b>Frequency underrange</b> The frequency is below the limit value guaranteed.
106	<b>Frequency overrange</b> The frequency is beyond the limit value guaranteed.
110	<b>Output unlevelled</b> The level control loop is deactivated.
115	<b>Level overrange</b> The level is above the limit value guaranteed.
116	<b>Level underrange</b> The level is below the limit value guaranteed.
117	<b>Dynamic level range exceeded</b> The difference between the maximal and minimal value of a level list is above 20 dBm. An exact level setting is no longer guaranteed.
130	<b>FM modulator VCO unlocked</b> FM modulator VCO is not synchronized.
131	<b>AM modulation frequency out of range</b> The AM modulation frequency is out of the permissible range.
132	<b>PM modulation frequency out of range</b> The PM modulation frequency is out of the permissible range.
133	<b>AM modulation overdriven</b> The amplitude modulation cannot generate the set modulation index..
134	<b>FM input of YFO module overdriven</b> The frequency modulator cannot generate the set frequency deviation
140	<b>This modulation forces other modulations OFF</b> A modulation has been switched on which cannot be used at the same time as an already active modulation. The previous modulation has been switched off.
152	<b>Input voltage out of range; EXT1 too high</b> The input voltage at the EXT1 socket is too high.
153	<b>Input voltage out of range; EXT1 too low</b> The input voltage at the EXT1 socket is too low.

Continuation: Device-dependent Error

Error code	Error text in the case of queue poll Error explanation
154	<b>Input voltage out of range; EXT2 too high</b> The input voltage at the EXT2 socket is too high.
155	<b>Input voltage out of range; EXT2 too low</b> The input voltage at the EXT2 socket is too low.
161	<b>Output protection tripped</b> The overvoltage protection has responded.
162	<b>LF output overdriven</b> The dependency of the LF output voltage on other parameters in stereo operation has caused that the LF output would have to supply more than 4 volts. However, the voltage has been limited to 4 volts.
171	<b>Oven cold</b> The reference oscillator has not yet reached its operating temperature.
172	<b>Reference frequency 100 MHz VCXO unlocked</b> The 100-MHz quartz oscillator of the reference frequency has not been synchronized.
173	<b>Step synthesis unlocked</b> The step synthesis has not been synchronized.
180	<b>Calibration failed</b> Calibration could not be executed.
181	<b>REF OSC calibration data not used because ADJUSTMENT STATE is ON</b> The reference-oscillator calibration data are not used as long as ADJUSTMENT STATE is activated.
182	<b>Calibration data missing</b> Calibration data are missing in the device memory. The calibration data have to be generated first by an internal or external calibration or to be loaded into the device.
200	<b>Cannot access hardware</b> The data transmission to a module was unsuccessful.
201	<b>Function not supported by this hardware revision</b> A later version of certain parts of the instrument is necessary to execute the function selected.
202	<b>Diagnostic A/D converter failure</b> Diagnostic A/D converter has failed.
211	<b>Summing loop unlocked</b> The PLL of the summing loop has not been synchronized.
221	<b>Digital synthesis buffer VCO unlocked</b> The VCO of the buffer loop has not been synchronized.
223	<b>YPLL unlocked</b> The PLL of the YIG loop has not been synchronized.

Continuation: Device-dependent Error

Error code	Error text in the case of queue poll Error explanation
241	<b>No list defined</b> There is no list defined..
242	<b>List not learned; execute LEARN command</b> The instrument has been switched to LIST mode and a list has been selected. However, command LEARN has not been executed.
243	<b>Dwell time adjusted</b> A dwell time given on a list cannot be processed by the unit. The setting was automatically adjusted.
251	<b>No User Correction Table; zero assumed</b> An attempt has been made to switch on user correction, but no UCOR table has been stored in the instrument yet. The instrument behaves as if a table was called which only contains 0-values.
260	<b>Invalid keyboard input ignored</b> An invalid input via the keyboard is not considered.
265	<b>This parameter is read only</b> An attempt has been made to change a fixedly specified value.
270	<b>Data output aborted</b> Data output was aborted on the IEC/IEEE-bus. Example: The key [LOCAL] was pressed.
304	<b>String too long</b> A character string which is too long was received via the IEC bus. The names of lists may have a length of maximally seven letters.
305	<b>Fill pattern too long; truncated</b> More data have been entered with block function FILL in the list editor than the filling range (RANGE) set permits. The exceeding data are ignored.
306	<b>No fill pattern specified</b> An attempt was made to execute a filler function without having to indicate a filler pattern.



# Annex C

## List of Commands (with SCPI Conformity Information)

The SMP supports SCPI version 1994.0. For remote control, commands which were specified or accepted in this SCPI version have been used to a large extent. Commands which are not part of the SCPI specification are marked "not-SCPI" in the SCPI info.

Structure and Syntax of messages are explained in Chapter 3.4, and a detailed description of commands is to be found in Chapter 3.5.

Command	Parameter	SCPI info	Page
ABORt:LIST		not SCPI	3.17
ABORt:MSEquence		not SCPI	3.17
ABORt[:SWEep]		not SCPI	3.17
CALibration:PULSe[:MEASure]?		not SCPI	3.18
CALibration:PULSe:DATA?		not SCPI	3.18
:DIAGnostic:INFO:CCOunt:ATTenuator 1   2   3   4?			3.19
:DIAGnostic:INFO:CCOunt:MODules?			3.20
:DIAGnostic:INFO:CCOunt:OTIME?			3.20
:DIAGnostic:INFO:CCOunt:POWEr?			3.19
:DIAGnostic:INFO:CCOunt:SDATe?			3.20
:DIAGnostic[:MEASure]:POINt?			3.20
:DISPlay:ANNotation[:ALL]	ON   OFF		3.21
:DISPlay:ANNotation:AMPLitude	ON   OFF		3.21
:DISPlay:ANNotation:FREQuency	ON   OFF		3.21
:FORMat:BORDer	NORMal   SWAPped		3.22
:FORMat:DATA	ASCIi  REAL,[ 32   64]   PACKed		3.22
:INPut:POLarity	NORMal   INVerted		3.23
:MEMory:NSTATes?			3.23
:OUTPut1 2 3:AMODE	AUTO   FIXed	not SCPI	3.24
:OUTPut1 2 3:BLANK:POLarity	NORMal   INVerted	not SCPI	3.24
:OUTPut1 2 3:IMPedance?			3.24
:OUTPut1 2 3:SCALE	0.5   1		3.25
:OUTPut1 2 3:SOURce	0   2		3.25
:OUTPut1 2 3[:STATe]	ON   OFF		3.25
:OUTPut1 2 3[:STATe]:PON	OFF   UNCHanged	not SCPI	3.25
:OUTPut1 2 3:VOLTage	0V to 4V	not SCPI	3.25
[:SOURce]:AM[:DEPTh]	0 to 100PCT		3.26
[:SOURce]:AM:EXTernal:COUPling	AC   DC		3.27
[:SOURce]:AM:INTernal:FREQuency	400 Hz   1 kHz   3 kHz   15 kHz or 0.1 Hz to 500 kHz (SM-B2)		3.27
[:SOURce]:AM:SCAN	EXT 0 to 10dB/V		3.27
[:SOURce]:AM:SOURce	EXT   INT1 2   EXT, INT1 2		3.27

Command	Parameter	SCPI info	Page
[[:SOURce]:AM:STATe	ON   OFF		3.27
[[:SOURce]:CORRection:CSET:CATalog?		not SCPI	3.28
[[:SOURce]:CORRection:CSET:DATA:FREQUency	2 to 20/27/40 GHz {,2 to 20/27/40 GHz} (with option SMP-B11 above 10 MHz)	not SCPI	3.29
[[:SOURce]:CORRection:CSET:DATA:POWer	+6 to -6dB {,+6 to -6dB }	not SCPI	3.29
[[:SOURce]:CORRection:CSET:DELeTe	'Name of table'	not SCPI	3.29
[[:SOURce]:CORRection:CSET[:SELeCt]	'Name of table'	not SCPI	3.28
[[:SOURce]:CORRection[:STATe]	ON   OFF		3.28
[[:SOURce]:DM:ASK:DEPTH	0 to 100PCT	not-SCPI	3.31
[[:SOURce]:DM:ASK:POLarity	NORMal   INVERTed	not-SCPI	3.31
[[:SOURce]:DM:EXTErnal:IMPedance	600 Ohm   100 kOhm	not SCPI	3.30
[[:SOURce]:DM:FSK:DEVIation	0 to 1 MHz (mode PRECise), 0 to 10 MHz (mode LOCKed/UNLOCKed), SMP03/04 above 20 GHz: 0 to 2 MHz or 0 to 20 MHz	not SCPI	3.31
[[:SOURce]:DM:FSK:MODE	UNLOCKed   LOCKed   PRECise	not SCPI	3.31
[[:SOURce]:DM:FSK:POLarity	NORMal   INVERTed	not SCPI	3.31
[[:SOURce]:DM:STATe	ON   OFF		3.30
[[:SOURce]:DM:TYPE	ASK   FSK	not SCPI	3.30
[[:SOURce]:FM1 2[:DEVIation]	0 to 1 MHz (mode PRECise), 0 to 10 MHz (mode LOCKed/UNLOCKed), SMP03/04 above 20 GHz: 0 to 2 MHz or 0 to 20 MHz		3.33
[[:SOURce]:FM1 2:EXTErnal1 2:COUPling	AC   DC		3.33
[[:SOURce]:FM1 2:EXTErnal1 2:IMPedance	600 Ohm   100 kOhm		3.33
[[:SOURce]:FM1 2:MODE	UNLOCKed   LOCKed   PRECise	not SCPI	3.32
[[:SOURce]:FM1 2:SOURce	INTernAl   EXTErnAl1   EXTErnAl2		3.34
[[:SOURce]:FM1 2:STATe	ON   OFF		3.34
[[:SOURce]:FREQUency:CENTer	SMP02: 2 to 20 GHz, SMP03: 2 to 27 GHz, SMP04: 2 to 40 GHz		3.35
[[:SOURce]:FREQUency[:CW   :FIXed]	2 to 20/27/40 GHz (with option SMP- B11: 10 MHz to 20/27/40 GHz)		3.35
[[:SOURce]:FREQUency[:CW[:FIXed]:RCL	INCLude   EXCLude		3.35
[[:SOURce]:FREQUency:MANual	2 to 20/27/40 GHz (with option SMP- B11: 10 MHz to 20/27/40 GHz)		3.36
[[:SOURce]:FREQUency:MODE	CW   FIXed   SWEEp   LIST		3.36
[[:SOURce]:FREQUency:MULTIplier	-1.0 to 10.0		3.36
[[:SOURce]:FREQUency:OFFSet	-50 to +50 GHz		3.36
[[:SOURce]:FREQUency:SPAN	2 to 18/25/28 GHz (with option SMP- B11: 0 to 19,9/26,9/39,9 GHz)		3.36
[[:SOURce]:FREQUency:STARt	2 to 20/27/40 GHz (with option SMP- B11: 10 MHz to 20/27/40 GHz)		3.37
[[:SOURce]:FREQUency:STEP[:INCRement]	0 to 10 GHz		3.37
[[:SOURce]:FREQUency:STOP	2 to 20/27/40 GHz (with option SMP- B11: 10 MHz to 20/27/40 GHz)		3.37
[[:SOURce]:LIST:CATalog?		not SCPI	3.38



Command	Parameter	SCPI info	Page
[[:SOURce]:LIST:DELeTe	'Name of list'	not SCPI	3.38
[[:SOURce]:LIST:DELeTe:ALL		not SCPI	3.38
[[:SOURce]:LIST:DWELI	1 ms to 1 s {, 1 ms to 1 s}		3.39
[[:SOURce]:LIST:DWELI:POINts?			3.39
[[:SOURce]:LIST:FREE?			3.39
[[:SOURce]:LIST:FREQUency	2 to 20/27/40 GHz {, 2 to 20/27/40 GHz }   block data (option SMP-B11: above 10 MHz)		3.39
[[:SOURce]:LIST:FREQUency:POINts?			3.39
[[:SOURce]:LIST:LEARn		not SCPI	3.39
[[:SOURce]:LIST:MODE	AUTO   STEP	not SCPI	3.39
[[:SOURce]:LIST:POWEr	-130 to 27 dBm {, -130 to 27 dBm }   block data (-20 to 27 dBm without option SMP-B15)		3.40
[[:SOURce]:LIST:POWEr:POINts?			3.40
[[:SOURce]:LIST:SELeCt	'Name of list'	not SCPI	3.40
[[:SOURce]:MARKer[:FSWeep]1 2 3:AMPLitude	ON   OFF		3.41
[[:SOURce]:MARKer[:FSWeep]1 2 3:AOff			3.41
[[:SOURce]:MARKer1 2 3[:FSWeep]:FREQUency	2.to 20/27/40 GHz		3.41
[[:SOURce]:MARKer1 2 3[:FSWeep][:STATe]	ON   OFF		3.42
[[:SOURce]:MARKer1 2 3:POLarity	NORMal   INVerted	not SCPI	3.42
[[:SOURce]:MARKer1 2 3:PSWeep:AOff		not SCPI	3.42
[[:SOURce]:MARKer1 2 3:PSWeep:POWEr	-130 dBm to +27 dBm (without option SMP-B15: -20 dBm to 27 dBm; SMP03/04: below 22 dBm)	not SCPI	3.42
[[:SOURce]:MARKer1 2 3:PSWeep[:STATe]	ON   OFF	not SCPI	3.42
[[:SOURce]:PHASe[:ADJust]	-360 deg to +360 deg	not SCPI	3.43
[[:SOURce]:PHASe:REFerence		not SCPI	3.43
[[:SOURce]:PM1 2[:DEViation]	0 to 10 rad (SMP03/04 above 20 GHz: 0 to 20 rad)		3.44
[[:SOURce]:PM1 2:EXTeRnal1 2:COUPLing	AC   DC		3.44
[[:SOURce]:PM1 2:EXTeRnal1 2:IMPedance	600 Ohm   100 kOhm		3.45
[[:SOURce]:PM1 2:INTeRnal:FREQUency	400 Hz   1 kHz   3 kHz   15 kHz or 0.1 Hz to 500 kHz (option SM-B2)		3.45
[[:SOURce]:PM1 2:SOURce	INTeRnal   EXTeRnal1   EXTeRnal2		3.45
[[:SOURce]:PM1 2:STATe	ON   OFF		3.45
[[:SOURce]:POWEr:ALC:REFerence	0 to 3 V		3.46
[[:SOURce]:POWEr:ALC:SEARch	ON   OFF   ONCE		3.47
[[:SOURce]:POWEr:ALC:SOURce	INTeRnal   DIODE   PMETer		3.47
[[:SOURce]:POWEr:ALC:SOURce:PMETer	RS_NRVs   HP436A		3.47
[[:SOURce]:POWEr:ALC[:STATe]	ON   OFF		3.47
[[:SOURce]:POWEr[:LEVel][:IMMEDIATE][:AMPLitude]	-130 dBm to 27 dBm (without option SMP-B15: -20 dBm to 27 dBm; SMP03/04: below 22 dBm)		3.47
[[:SOURce]:POWEr[:LEVel][:IMMEDIATE][:AMPLitude]:OFFSet	-100 to +100		3.48

Command	Parameter	SCPI info	Page
:SOURce]:POWer[:LEVel][:IMMEdiate][:AMPLitude]:RCL	INCLude   EXCLude		3.48
[:SOURce]:POWer:LIMit[:AMPLitude]	-130 dBm to 27 dBm (without option SMP-B15: -20 dBm to 27 dBm; SMP03/04: below 22 dBm)		3.48
[:SOURce]:POWer:MANual	-130 dBm to 27 dBm (without option SMP-B15: -20 dBm to 27 dBm; SMP03/04: below 22 dBm)		3.48
[:SOURce]:POWer:MODE	FIXed   SWEEp   LIST		3.48
[:SOURce]:POWer:START	-130 dBm to 27 dBm (without option SMP-B15: -20 dBm to 27 dBm; SMP03/04: below 22 dBm)		3.49
[:SOURce]:POWer:STOP	-130 dBm to 27 dBm (without option SMP-B15: -20 dBm to 27 dBm; SMP03/04: below 22 dBm)		3.49
[:SOURce]:POWer:STEP[:INCRement]	0.1 to 10 dB		3.49
[:SOURce]:PULM:EXTeRnal:IMPedance	50 Ohm   10 kOhm	not SCPI	3.50
[:SOURce]:PULM:INTeRnal:FREQUency	0.01176 Hz to 10 MHz	not SCPI	3.50
[:SOURce]:PULM:POLarity	NORMal   INVeRted	not SCPI	3.50
[:SOURce]:PULM:SOURce	EXTeRnal   INTeRnal	not SCPI	3.50
[:SOURce]:PULM:STATe	ON   OFF	not SCPI	3.50
[:SOURce]:PULSe:DELay	40 ns to 1 s	not SCPI	3.51
[:SOURce]:PULSe:DOUBle:DELay	60 ns to 1 s		3.51
[:SOURce]:PULSe:DOUBle:STATe]	ON   OFF		3.51
[:SOURce]:PULSe:PERiod	100 ns to 85 s		3.51
[:SOURce]:PULSe:WIDTh	20 ns to 1s		3.51
[:SOURce]:ROSCillator:EXTeRnal:FREQUency	1 to 16 MHz		3.52
[:SOURce]:ROSCillator[:INTeRnal]:ADJJust:VALue	0 to 4095	not SCPI	3.52
[:SOURce]:ROSCillator[:INTeRnal]:ADJJust[:STATe]	ON   OFF	not SCPI	3.52
[:SOURce]:ROSCillator:SOURce	INTeRnal   EXTeRnal	not SCPI	3.52
[:SOURce]:SWEEp:BTIME	NORMal   LONG	not SCPI	3.53
[:SOURce]:SWEEp[:FREQUency]:SPACing	LINear   LOGarithmic	not SCPI	3.54
[:SOURce]:SWEEp:POWer:DWELI	1 ms to 5 s	not SCPI	3.55
[:SOURce]:SWEEp:POWer:MODE	AUTO   MANual   STEP	not SCPI	3.55
[:SOURce]:SWEEp:POWer:POINts	number	not-SCPI	3.55
[:SOURce]:SWEEp:POWer:SPACing	LOGarithmic	not-SCPI	3.55
[:SOURce]:SWEEp:POWer:STEP:LOGarithmic	0 to 10 dB	not SCPI	3.56
[:SOURce]:SWEEp[:FREQUency]:DWELI	10 ms to 5 s	not SCPI	3.53
[:SOURce]:SWEEp[:FREQUency]:MODE	AUTO   MANual   STEP	not SCPI	3.54
[:SOURce]:SWEEp[:FREQUency]:POINts	Number	not SCPI	3.54
[:SOURce]:SWEEp[:FREQUency]:STEP:LOGarithmic	0.01 to 50 PCT	not SCPI	3.55
[:SOURce]:SWEEp[:FREQUency]:STEP[:LINear	0 to 10 GHz	not SCPI	3.54
:SOURce0]2:FREQUency[:CW   :FIXed]	400 Hz   1 kHz   3 kHz   15 kHz or 0.1 Hz to 500 kHz (Option SM-B2)		3.58

Command	Parameter	SCPI info	Page
:SOURce0 2:FREQuency:MANual	400 Hz   1 kHz   3 kHz   15 kHz or 0.1 Hz to 500 kHz (Option SM-B2)		3.58
SOURce0 2:FREQuency:MODE	CW FIXed   SWEEP		3.58
:SOURce0 2:FREQuency:STARt	0.1 Hz to 500 kHz		3.58
:SOURce0 2:FREQuency:STOP	0.1 Hz to 500 kHz		3.58
:SOURce0 2:FUNcTION[:SHAPE]	SINusoid   SQUare   TRIangle   PRNoise   SAWTooth		3.59
:SOURce2:MARKer1 2 3[:FSWEEP]:AOFF			3.60
:SOURce2:MARKer1 2 3[:FSWEEP]:FREQuency	0.1 Hz to 500 kHz		3.60
:SOURce2:MARKer1 2 3[:FSWEEP][:STATe]	ON   OFF		3.60
:SOURce2:MARKer1 2 3:POLarity	NORMal   INVerted	not-SCPI	3.60
:SOURce2:SWEEP:BTIME	NORMal   LONG	not-SCPI	3.61
:SOURce2:SWEEP[:FREQuency]:DWELl	1 ms to 5 s	not-SCPI	3.61
:SOURce2:SWEEP[:FREQuency]:MODE	AUTO   MANual   STEP	not-SCPI	3.61
:SOURce2:SWEEP[:FREQuency]:POINts	Number	not-SCPI	3.62
:SOURce2:SWEEP[:FREQuency]:SPACing	LINear   LOGarithmic	not-SCPI	3.62
:SOURce2:SWEEP[:FREQuency]:STEP[:LINear]	0 to 500 kHz	not-SCPI	3.62
:SOURce2:SWEEP[:FREQuency]:STEP:LOGarithmic	0.01 to 50PCT	not-SCPI	3.62
:STATus:OPERation:CONDition?			3.63
:STATus:OPERation:ENABle	0 to 32767		3.64
:STATus:OPERation[:EVENT]?			3.63
:STATus:OPERation:NTRansition	0 to 32767		3.63
:STATus:OPERation:PTRansition	0 to 32767		3.63
:STATus:PRESet			3.64
:STATus:QUEStionable:CONDition?			3.64
:STATus:QUEStionable:ENABle	0 to 32767		3.64
:STATus:QUEStionable[:EVENT]?			3.64
:STATus:QUEStionable:NTRansition	0 to 32767		3.64
:STATus:QUEStionable:PTRansition	0 to 32767		3.64
:STATus:QUEue [:NEXT]?			3.64
:SYSTem:BEEPer:STATe	ON   OFF		3.65
:SYSTem:COMMunicate:GPIB[:SELF]:ADDRess	1 to 30		3.66
:SYSTem:COMMunicate:SERial:BAUD	1200  2400  4800  9600  19200  38400  57600  115200		3.66
:SYSTem:COMMunicate:SERial:CONTRol:RTS	ON   IBFull   RFR		3.66
:SYSTem:COMMunicate:SERial:PACe	XON   NONE		3.66
:SYSTem:ERRor?			3.66
:SYSTem:KLOCK	ON   OFF		3.67
:SYSTem:MODE	FIXed   MSeQence	not-SCPI	3.67
:SYSTem:MSeQence:CATalog?		not-SCPI	3.67
:SYSTem:MSeQence:DELeTe	'Name of sequence'	not-SCPI	3.67
:SYSTem:MSeQence:DELeTe:ALL		not-SCPI	3.67

Command	Parameter	SCPI info	Page
:SYSTem:MSEquence:DWELI	50 ms to 60 s{,50 ms to 60 s}	not-SCPI	3.67
:SYSTem:MSEquence:FREE?		not-SCPI	3.68
:SYSTem:MSEquence:MODE	AUTO   STEP	not-SCPI	3.68
:SYSTem:MSEquence:SElect	'Name of sequence'	not-SCPI	3.68
:SYSTem:MSEquence[:RCL]	1 to 50 {,1 to 50}	not-SCPI	3.68
:SYSTem:MSEquence[:RCL]:POINts?		not-SCPI	3.68
:SYSTem:PRESet			3.68
:SYSTem:PROtect1 2 3[:STATe]	ON   OFF, password	not-SCPI	3.69
:SYSTem:SECurity[:STATe]	ON   OFF		3.69
:SYSTem:SERRor?		not-SCPI	3.69
:SYSTem:VERSion?		not-SCPI	3.69
:TEST:BATTery?			3.71
:TEST:DIRect:ALCA	Subaddress {,hex data string}		3.71
:TEST:DIRect:AXIFC	Subaddress {,hex data string}		3.71
:TEST:DIRect:DSYN0MUX	Subaddress, {,hex data string}		3.71
:TEST:DIRect:DSYN1MUX	Subaddress {,hex data string}		3.71
:TEST:DIRect:FMOD	Subaddress {,hex data string}		3.71
:TEST:DIRect:LFGENA	Subaddress {,hex data string}		3.71
:TEST:DIRect:LFGENB	Subaddress {,hex data string}		3.71
:TEST:DIRect:MWIFC	Subaddress {,hex data string}		3.70
:TEST:DIRect:PUM	Subaddress {,hex data string}		3.71
:TEST:DIRect:REFSS	Subaddress {,hex data string}		3.71
:TEST:DIRect:ROSC	Subaddress {,hex data string}		3.71
:TEST:DIRect:ROSC	Subaddress {,hex data string}		3.71
:TEST:DIRect:YPLL	Subaddress {,hex data string}		3.71
:TEST:RAM?			3.71
:TEST:ROM?			3.71
:TRIGger:LIST[:IMMediate]		not-SCPI	3.73
:TRIGger1 2:LIST:SOURce	AUTO   SINGLE   EXTERNAL	not-SCPI	3.73
:TRIGger:MSEquence:SOURce	AUTO   SINGLE   EXTERNAL	not-SCPI	3.74
:TRIGger:MSEquence[:IMMediate]		not-SCPI	3.74
:TRIGger:PULSe:SLOPe	POSitive   NEGative	not-SCPI	3.74
:TRIGger:PULSe:SOURce	EXTERNAL   AUTO	not-SCPI	3.74
:TRIGger:SLOPe	POSitive   NEGative   EITHer	not-SCPI	3.74
:TRIGger1 2[:SWEep]:SOURce	AUTO   SINGLE   EXTERNAL	not-SCPI	3.73
:TRIGger1 2[:SWEep][:IMMediate]		not-SCPI	3.72
:UNIT:ANGLE	DEGRee   DEGree   RADian		3.75
:UNIT:POWEr	DBM   DBW   DBMW   DBUW   DBV   DBMV   DBUV   V		3.75

# Annex D

## Programming Examples

The examples explain the programming of the instrument and can serve as a basis to solve more complex programming tasks.

QuickBASIC has been used as programming language. However, the programs can be translated into other languages.

### 1. Including IEC-Bus Library for QuickBasic

```
REM ----- Include IEC-bus library for quickbasic -----
'$INCLUDE: 'c:\qbasic\qbdecl4.bas
```

### 2. Initialization and Default Status

The IEC bus as well as the settings of the instrument are brought into a defined default status at the beginning of every program. Subroutines "InitController" and "InitDevice" are used to this effect.

#### 2.1. Initiate Controller

```
REM ----- Initiate Instrument -----
REM InitController
ieaddress% = 28                                'IEC-bus address of the instrument
CALL IBFIND("DEV1", generator%)                'Open port to the instrument
CALL IBPAD(generator%, ieaddress%)            'Inform controller on instrument address
CALL IBTMO(generator%, 11)                    'Response time to 1 sec
REM *****
```

#### 2.2. Initiate Instrument

The IEC-bus status registers and instrument settings of the SMP are brought into the default status.

```
REM ----- Initiate Instrument -----
REM InitDevice
CALL IBWRT(generator%, "*CLS")                 'Reset status register
CALL IBWRT(generator%, "*RST")                 'Reset instrument
CALL IBWRT(generator%, "OUTPUT ON")           'Switch on RF output
REM*****
```

### 3. Transmission of Instrument Setting Commands

Output frequency, output level and AM modulation are set in this example. The settings correspond to the sample setting for first users in manual control. By analogy to the step width setting of the rotary knob, the step width is additionally set for the alteration of the RF frequency in the case of UP and DOWN.

```
REM ----- Instrument setting commands -----
CALL IBWRT(generator%, "FREQUENCY 2.5E9")           'RF Frequency 2.50 GHz
CALL IBWRT(generator%, "POWER -10")                'Output power -10 dBm
CALL IBWRT(generator%, "AM 15.5")                  'AM with modulation index of 15.5%
CALL IBWRT(generator%, "AM:INTERNAL1:FREQUENCY 3KHZ") 'Modulation frequency 3kHz
CALL IBWRT(generator%, "AM:SOURCE INT1")           'Modulation source LF generator 1
CALL IBWRT(generator%, "FREQUENCY:STEP 12500")     'Step width RF frequency 12.5kHz
REM *****
```

### 4. Switchover to Manual Control

```
REM ----- Switch instrument over to manual control -----
CALL IBLOC(generator%)                             'Set instrument to Local state
REM *****
```

### 5. Reading out Instrument Settings

The settings made in example 3 are read out here. The abbreviated commands are used.

```
REM ----- Reading out instrument settings -----
Rffrequency$ = SPACE$(20)                          'Provide text variables with 20 characters
CALL IBWRT(generator%, "FREQ?")                     'Request frequency setting
CALL IBRD(generator%, Rffrequency$)                 'Read value

Rflevel$ = SPACE$(20)                               'Provide text variables with 20 characters
CALL IBWRT(generator%, "POW?")                      'Request level setting
CALL IBRD(generator%, Rflevel$)                     'Read value

AMmodulationdepth$ = SPACE$(20)                    'Provide text variables with 20 characters
CALL IBWRT(generator%, "AM?")                       'Request setting of modulation depth
CALL IBRD(generator%, AMmodulationdepth$)           'Read value

AMfrequency$ = SPACE$(20)                           'Provide text variables with 20 characters
CALL IBWRT(generator%, "AM:INT1:FREQ?")             'Request modulation frequency setting
CALL IBRD(generator%, AMfrequency$)                 'Read value

Stepwidth$ = SPACE$(20)                             'Provide text variables with 20 characters
CALL IBWRT(generator%, "FREQ:STEP?")                'Request step width setting
CALL IBRD(generator%, stepwidth$)                   'Read value

REM ----- Display values on the screen -----
PRINT "RF frequency:      "; Rffrequency$,
PRINT "RF level:         "; Rflevel$,
PRINT "AM modulationdepth: "; AMmodulationdepth$,
PRINT "AM frequency:     "; AMfrequency$,
PRINT "Step width:       "; stepwidth$
REM *****
```

## 6. List Management

```

REM ----- Example of list management -----
CALL IBWRT(generator%, "LIST:SELECT "+CHR$(34)+"LIST1"+CHR$(34))
'Select list "LIST1", is generated if necessary
CALL IBWRT(generator%, "LIST:POWER -30,-15,-10,-5,0,0.1)
'Fill power list with values
CALL IBWRT(generator%, "LIST:FREQ 1.4GHz,1.3GHz,1.2GHz,1.1GHz,1.2GHz,1.3GHz")
'Fill frequency list with values
CALL IBWRT(generator%, "LIST:DWELL 0.2")           '200ms per item
CALL IBWRT(generator%, "TRIGGER21:LIST:SOURCE AUTO") 'Permanently repeat list automatically
CALL IBWRT(generator%, "POWER:MODE LIST")         'Switch over instrument to list mode
REM *****

```

## 7. Command synchronization

The possibilities for synchronization implemented in the following example are described in Section "Command Order and Command Synchronization".

```

REM ----- Examples of command synchronization -----
REM Command ROSCILLATOR:SOURCE INT has a relatively long execution time
REM (over 300ms). It is to be ensured that the next command is only executed
REM when the reference oscillator has settled.

REM First possibility: Use of *WAI -----
CALL IBWRT(generator%, "ROSCILLATOR:SOURCE INT; *WAI; :FREQUENCY 100MHZ")

REM Second possibility: Use of *OPC? -----
OpcOk$ = SPACE$(2)           'Space for *OPC? - Provide response
CALL IBWRT(generator%, "ROSCILLATOR:SOURCE INT; *OPC?")
REM ----- here the controller can service other instruments -----
CALL IBRD(generator%, OpcOk$)           'Wait for "1" from *OPC?

REM Third possibility: Use of *OPC
REM In order to be able to use the service request function in conjugation with a National
REM Instruments GPIB driver, the setting "Disable Auto Serial Poll" must be changed to "yes"
REM by means of IBCONF.
CALL IBWRT(generator%, "*SRE 32")           'Permit service request for ESR
CALL IBWRT(generator%, "*ESE 1")           'Set event-enable bit for operation-complete bit
ON PEN GOSUB OpcReady                       'Initialization of the service request routine
PEN ON
CALL IBWRT(generator%, "ROSCILLATOR:SOURCE INT; *OPC")
REM Continue main program here
STOP                                         'End of program

OpcReady:
REM As soon as the reference oscillator has settled, this subroutine is activated
REM Program suitable reaction to the OPC service request.
ON PEN GOSUB OpcReady                       'Enable SRQ routine again
RETURN
REM *****

```

## 8. Service Request

The service request routine requires an extended initialization of the instrument in which the respective bits of the transition and enable registers are set.

In order to be able to use the service request function in conjunction with a National Instruments GPIB driver, the setting "Disable Auto Serial Poll" must be changed to "yes" by means of IBCONF.

```

REM ----- Example of initialization of the SRQ in the case of errors -----
CALL IBWRT(generator%, "**CLS")           'Reset status reporting system
CALL IBWRT(generator%, "**SRE 168")      'Permit service request for STAT:OPER-,
                                        'STAT:QUES- and ESR register
CALL IBWRT(generator%, "**ESE 60")      'Set event-enable bit for command, execution,
                                        'device-dependent and query error
CALL IBWRT(generator%, "STAT:OPER:ENAB 32767") 'Set OPERation enable bit for all events
CALL IBWRT(generator%, "STAT:OPER:PTR 32767") 'Set appropriate OPERation Ptransition bits
CALL IBWRT(generator%, "STAT:OPER:ENAB 32767") 'Set questionable enable bits for all events
CALL IBWRT(generator%, "STAT:OPER:PTR 32767") 'Set appropriate questionable Ptransition bits
ON PEN GOSUB Srq                       'Initialization of the service request routine
PEN ON
REM Continue main program here
STOP                                   'End of program

```

A service request is then processed in the service request routine.

**Note:** The variables *userN%* and *userM%* must be pre-assigned usefully.

```

Srq:
REM ----- Service request routine -----
DO
SRQFOUND% = 0
FOR I% = userN% TO userM%              'Poll all bus users
ON ERROR GOTO nouser                   'No user existing
CALL IBRSP(I%, STB%)                  'Serial poll, read status byte
IF STB% > 0 THEN                        'This instrument has bits set in the STB
SRQFOUND% = 1
IF (STB% AND 16) > 0 THEN GOSUB Outputqueue
IF (STB% AND 4) > 0 THEN GOSUB Failure
IF (STB% AND 8) > 0 THEN GOSUB Questionablestatus
IF (STB% AND 128) > 0 THEN GOSUB Operationstatus
IF (STB% AND 32) > 0 THEN GOSUB Esrread
END IF
nouser:
NEXT I%
LOOP UNTIL SRQFOUND% = 0
ON ERROR GOTO error handling
ON PEN GOSUB Srq: RETURN                'Enable SRQ routine again;
'End of SRQ routine

```



Reading out the status event registers, the output buffer and the error/event queue is effected in subroutines.

```

REM ----- Subroutines for the individual STB bits -----
Outputqueue:
Message$ = SPACE$(100)           'Reading the output buffer
                                  'Make space for response
CALL IBRD(generator%, Message$)
PRINT "Message in output buffer :"; Message$
RETURN

Failure:
ERROR$ = SPACE$(100)             'Read error queue
                                  'Make space for error variable
CALL IBWRT(generator%, "SYSTEM:ERROR?")
CALL IBRD(generator%, ERROR$)
PRINT "Error text :"; ERROR$
RETURN

Questionablestatus:
Ques$ = SPACE$(20)               'Read questionable status register
                                  'Preallocate blanks to text variable
CALL IBWRT(generator%, "STATus:QUEStionable:EVENT?")
CALL IBRD(generator%, Ques$)
IF (VAL(Ques$) AND 128) > 0 THEN PRINT "Calibration ?"
IF (VAL(Ques$) AND 1) > 0 THEN PRINT "Voltage ?"
                                  'Calibration is questionable
                                  'Output level is questionable
RETURN

Operationstatus:
Oper$ = SPACE$(20)               'Read operation status register
                                  'Preallocate blanks to text variable
CALL IBWRT(generator%, "STATus:OPERation:EVENT?")
CALL IBRD(generator%, Oper$)
IF (VAL(Oper$) AND 1) > 0 THEN PRINT "Calibration"
IF (VAL(Oper$) AND 2) > 0 THEN PRINT "Settling"
IF (VAL(Oper$) AND 8) > 0 THEN PRINT "Sweeping"
IF (VAL(Oper$) AND 32) > 0 THEN PRINT "Wait for trigger"
RETURN

Esrread:
Esr$ = SPACE$(20)               'Read event status register
                                  'Preallocate blanks to text variable
CALL IBWRT(generator%, "*ESR?")
                                  'Read ESR
CALL IBRD(generator%, Esr$)
IF (VAL(Esr$) AND 1) > 0 THEN PRINT "Operation complete"
IF (VAL(Esr$) AND 4) > 0 THEN GOTO Failure
IF (VAL(Esr$) AND 8) > 0 THEN PRINT "Device dependent error"
IF (VAL(Esr$) AND 16) > 0 THEN GOTO Failure
IF (VAL(Esr$) AND 32) > 0 THEN GOTO Failure
IF (VAL(Esr$) AND 64) > 0 THEN PRINT "User request"
IF (VAL(Esr$) AND 128) > 0 THEN PRINT "Power on"
RETURN
REM *****

REM ----- Error routine -----
Error handling:
PRINT "ERROR"                    'Output error message
STOP                              'Stop software

```

## 9. Operating the Generator in the IEC-Bus Controller Mode

```

----- Initializations -----
      ' ATTENTION: Specify your own addresses here!!

pcadr% = 0                ' enter IEC-bus-address of the PC !
gen_adr% = 28            ' enter IEC-bus-address of the SMP

CALL IBFIND("gpib0", pc)  ' set IEC-Bus-address of the PC
CALL IBPAD(pc, pcadr%)

CALL IBFIND("dev1", generator) ' SMP can be controlled under Device1
CALL IBPAD(generator, gen_adr%)

----- Main program -----
Command$ = "sour:corr:coll" ' SCPI-command for automatic UCOR

a$ = "*pcb " + STR$(pcadr%) ' tells the SMP to return control
CALL IBWRT(generator, a$)   ' to the address pcadr% afterwards

CALL IBWRT(generator, Command$) ' Readout of the command itself

CALL IBPCT(generator)       ' Control is given to the SMP

      ' --- Waiting for return of control

MASK% = &H4020             ' CIC or Timeout
CALL IBWAIT(brd%, MASK%)

IF IBSTA% AND &H4000 THEN
    PRINT "Timeout; control not received"
    END
ELSE
    PRINT "Control taken back"
END IF

```

# Index

## A

Abort actions triggered.....	3.17
Active edge	
external trigger	
PULSE input.....	2.63, 3.74
TRIGGER input.....	2.97, 3.74
Address IEC bus.....	3.3, 3.66
Addressed commands.....	8C.3
Alternate switching off of modulations.....	2.53
AM frequency.....	2.56, 3.27
Amplitude marker (RF-sweep).....	2.73, 3.41
Amplitude modulation (AM).....	2.56, 2.64, 3.26
ASCII character (#).....	3.11
Asterix.....	3.11
Attenuator.....	1.5, 2.44
Attenuator circuits indication.....	2.95

## B

Batterie exchange.....	4.1
Baud rate (RS232).....	2.87, 3.66, 5
Beeper.....	2.98, 3.65
BLANK	
output.....	2.15, 2.70, 2.78, 2.97
Blank time.....	3.53
Block data.....	3.22
Boolean parameter.....	3.9
Brightness	
control (oscilloscope).....	2.70
display.....	1.2, 2.9

## C

Calibration	
disable.....	3.68
password.....	2.92, 3.69
PULSE GEN.....	2.92
pulse generator.....	3.18
Call instrument settings.....	2.39
Caution messages.....	2.100
Center frequency (RF sweep).....	2.73, 3.35
Character data.....	3.8
Cleaning the outside.....	4.1
CLOCK (input/output).....	2.11
CMOS-RAM.....	1.2
Colon separates.....	3.11
Comma separates.....	3.11
Command	
addressed.....	8C.3
parameter.....	3.9
recognition.....	3.77
sequence.....	3.78
structure.....	3.6, 3.8
synchronization.....	3.78
syntax elements.....	3.11
universal.....	8C.3
Common commands.....	3.5, 3.14
Condition register.....	3.80
Contrast display.....	1.2, 2.9
Counter indication.....	2.95
Coupling	
EXT1 (AM).....	2.56
EXT1/2.....	3.27
FM.....	2.59, 3.33
PM.....	2.60, 3.44

## D

DATA	
input.....	2.11

output.....	2.11
Data bits (RS232).....	2.87, 5
Data lines (IEC/IEEE-bus).....	6A.1
Data set.....	3.77
DCL.....	3.76
Decimal point.....	2.3, 3.9
Delay	
double pulse.....	2.63, 3.51
pulse modulation.....	2.63, 3.51
Delete list entry.....	2.35
Deletion of all data stored.....	2.88
Delimiter.....	3.76
Delta phase.....	2.90, 3.43
Description of Commands.....	3.12
Detector (power control).....	3.47
Detuning external.....	2.89
Deviation	
FM.....	2.58, 3.33
FSK modulation.....	3.31
PM.....	2.59, 3.44
Digit cursor.....	2.18
Digital modulation (DM).....	3.30
Digital synthesis.....	1.5
Disabling keyboard.....	3.67
Double pulses.....	2.63, 3.51
Duration blank signal.....	2.97
DWELL.....	2.80
Dwell list	
LIST.....	3.39
MSEQ.....	2.82, 3.67
Dwell time	
frequency sweep.....	3.53
level sweep.....	3.55
LF sweep.....	2.76
MSEQ.....	2.82
RF sweep.....	2.73

## E

Edge	
external trigger	
PULSE input.....	3.74
PULSE modulation.....	2.63
TRIGGER input.....	2.97, 3.74
Edit list.....	2.31
EMF.....	2.50, 2.51
Enable register.....	3.80
EOI (command line).....	3.8
Error messages.....	2.100, 3.69
Error queue.....	3.64, 3.66, 3.87
ESE (event status enable register).....	3.83
Event status enable register (ESE).....	3.83
Exponent.....	3.9
EXT1/2	
coupling.....	2.56, 2.59, 2.60, 3.27, 3.33, 3.44
input.....	2.11
input impedance.....	3.27, 3.33
input resistance.....	3.44
External	
detuning.....	2.89
modulation sources.....	2.52
reference.....	2.89, 3.52
trigger	
LIST.....	2.78, 3.73
MSEQ.....	3.74
PULSE input.....	2.63, 3.74
pulse modulation.....	3.74
sweep.....	3.72
TRIGGER input.....	2.97, 3.74

## F

Fitting option.....	1.4
FM	
coupling.....	2.59, 3.33
deviation.....	2.58, 3.33
frequency.....	2.58, 3.34
modulator.....	1.7, 2.58
Format data (IEC bus).....	3.22
Frequency	
accuracy.....	1.2
AM.....	2.56, 3.27
FM.....	2.58, 3.34
indication.....	2.18, 2.88
LF generator.....	2.67, 3.58
LF sweep.....	2.75, 2.76, 3.58, 3.60, 3.61
list.....	2.77, 3.39
modulation (FM).....	2.57, 3.32
multiplier.....	3.36
offset.....	2.41, 3.36
PM.....	2.59, 3.45
pulse modulation.....	3.49
RF output signal.....	2.41, 3.35
RF sweep.....	2.73, 3.37, 3.41
Front unit.....	1.5
FSK modulation.....	3.31
Functional test.....	4.4

## G

GET (Group Execute Trigger).....	3.77
----------------------------------	------

## H

Handshake RS232.....	2.87, 3.66, 6
Header (commands).....	3.6
Header field (display).....	2.18

## I

IEC/IEEE-bus interface.....	6A.1
IEC-bus	
address.....	2.86, 3.3, 3.66
interface.....	2.17
language.....	2.89
Incompatible modulations.....	2.53
Indication	
attenuator circuits.....	2.95
counter.....	2.95
during Remote Control.....	3.4
error messages.....	3.64
modules.....	2.93, 3.20
operating-hours.....	2.95
operating-time counter.....	3.20
serial number.....	2.95
software version.....	2.95, 3.20
suppressed.....	2.88
Initial Status.....	1.2
Input	
buffer.....	3.76
CLOCK.....	2.11
correction.....	2.23
DATA.....	2.11
EXT1/2.....	2.11
impedance EXT1 (AM).....	3.27
impedance EXT1/2 FM.....	3.33
modulations.....	2.52
PULSE.....	3.74
resistance.....	2.11
resistance EXT1/2 PM.....	3.44
STOP.....	2.15
TRIGGER.....	2.78, 2.83, 2.97, 3.74
TUNE.....	2.89
Insert list entry.....	2.34

## Instrument settings

call.....	2.39
store.....	2.39
Instrument states (reset).....	3.68
Interface	
functions (IEC/IEEE-bus).....	6A.2
functions (RS-232-C).....	6A.5
messages (IEC/IEEE-bus).....	6A.3
Interface Messages.....	3.4
Intermodulation ratio.....	2.46
Interrupt.....	3.82
Interrupt-free level setting.....	2.45
IST flag.....	3.15

## K

## Key

-/ 2.3	
[ASSIGN].....	2.21
[ERROR].....	2.100
[FREQ].....	2.41
[G/n].....	2.5
[HELP].....	2.99
[LEVEL].....	2.43
[LOCAL].....	3.3
[M/].....	2.5
[MENU1/2].....	2.21
[MOD ON/OFF].....	2.54, 2.96
[PRESET].....	1.3
[RCL].....	2.39
[RETURN].....	2.19
[RF ON / OFF].....	2.22, 2.51
[SAVE].....	2.39
[SELECT].....	2.19
[STATUS].....	2.99
ASSIGN.....	2.9
ERROR*.....	2.7
FREQ.....	2.3
HELP.....	2.7
k/m.....	2.5
LEVEL.....	2.3
LOCAL.....	2.7
MENU 1/2.....	2.9
MOD ON/OFF.....	2.7
PRESET.....	2.7
RCL.....	2.3
RETURN.....	2.5
RF ON/OFF.....	2.7
SAVE.....	2.3
SELECT.....	2.5
STATUS.....	2.7
X1/Enter.....	2.5
Key words (commands).....	3.6
Keyboard disabling.....	3.67

## L

LEARN.....	2.80
LEARN (LIST mode).....	2.77, 3.39
Level	
control.....	2.46, 3.46
correction (list UCOR).....	2.48, 3.28
indication.....	2.18, 2.88
limit.....	3.48
limitation.....	2.44
list.....	2.77, 3.40
marker.....	3.42
offset.....	2.43, 3.47
RF output.....	3.47
sweep.....	2.74
unit.....	2.22, 2.43, 3.75
Dwell time.....	2.74
Starting level.....	2.74

- Stop level.....2.74  
Sweep .....2.74  
LF  
    generator..... 1.6, 2.66, 3.57  
        frequency..... 2.67, 3.58  
        signal shape.....2.67  
        waveform..... 2.58, 3.59  
    output.....2.11, 2.66  
    sweep.....3.58  
List  
    delete .....2.30, 2.35  
    dwell (LIST).....3.39  
    dwell (MSEQ).....2.82, 3.67  
    edit .....2.31  
    Error Messages.....7B.1  
    fill 2.32  
    frequency .....2.77, 3.39  
    generate.....2.29  
    insert.....2.34  
    instrument states (MSEQ).....3.68  
    level .....3.40  
    level (LIST).....2.77  
    level correction (UCOR) .....2.48, 3.28  
    open .....2.29  
    select .....2.29  
    store .....2.31  
LIST  
    function LEARN.....2.77, 3.39  
    inputs/outputs.....2.78  
    manual processing of the list.....2.78  
    mode..... 2.77, 3.39, 3.48, 3.73  
    operating modes.....2.77, 3.38  
Long form (commands).....3.7  
Lower-case (commands) .....3.7  
**M**  
Maintenance.....4.1  
Mantissa.....3.9  
MARKER  
    LF sweep .....2.76, 3.60  
    output..... 2.15, 2.78, 2.97, 3.42, 3.60  
    RF sweep..... 2.73, 3.41  
Maximum value (comands).....3.9  
Memory  
    delet .....2.88  
    list (MSEQ).....3.68  
    location.....2.35  
    sequence (MSEQ).....2.82, 3.67  
Menu  
    call .....2.21  
    cursor.....2.18  
    ERROR.....2.100  
    fields .....2.18  
    FREQUENCY.....2.41  
    HELP.....2.99  
    key .....2.5  
    LEVEL - ALC.....2.47  
    LEVEL - EMF .....2.51  
    LEVEL - LEVEL.....2.43  
    LEVEL - UCOR.....2.48  
    LF OUTPUT .....2.66  
    LIST .....2.79  
    MEM SEQ.....2.84  
    MODULATION - PM.....2.59  
    MODULATION - PULSE.....2.62  
    MODULATION- AM..... 2.56, 2.64, 2.65  
    MODULATION-FM.....2.58  
    path.....2.18  
    quick selection.....2.21  
    Status.....2.99  
    store.....2.21  
    summary.....2.40  
    SWEEP - FREQ .....2.72  
    SWEEP - LEVEL .....2.74  
    SWEEP - LF GEN2 .....2.75  
    UTILITIES - DIAG - TPOINT .....2.94  
    UTILITIES - YSTEM -PIB.....2.86  
    UTILITIES - AUX I/O .....2.97  
    UTILITIES - BEEPER .....2.98  
    UTILITIES - CALIB - VCO SUM.....2.92  
    UTILITIES - DIAG - CONFIG.....2.93  
    UTILITIES - DIAG - PARAM.....2.95  
    UTILITIES - MOD KEY .....2.96  
    UTILITIES - PHASE .....2.90  
    UTILITIES - PROTECT.....2.91  
    UTILITIES - REF OSC.....2.89  
    UTILITIES - SYSTEM - RS232.....2.87  
    UTILITIES - SYSTEM LANGUAGE .....2.89  
    UTILITIES - SYSTEM-SECURITY.....2.88  
    UTILITIES - TEST .....4.4  
Messages  
    IEC-bus .....3.5  
    RS232 .....3.5  
Minimum value (commands) .....3.8  
Mode  
    frequency modulation.....3.32  
    FSK-modulation.....3.31  
Modulation  
    AM..... 2.56, 2.64, 3.26  
    FM .....2.58, 3.32  
    FSK .....3.31  
    generators .....2.52  
    incompatible .....2.53  
    inputs.....2.52  
    PM..... 2.59, 3.44  
    pulse..... 2.61, 3.49  
    sources.....2.52  
Module indication .....2.93, 3.20  
MSEQ operating modes .....2.82  
Multi-transmitter .....2.46  
**N**  
Name of sequence (MSEQ) .....3.68  
NAN .....3.9  
New Line (command line).....3.8  
NINF .....3.9  
Notation .....3.12  
NTRansition register .....3.80  
Numeric  
    input field.....2.3  
    suffix.....3.7  
    values.....2.3, 3.9  
**O**  
Offset  
    frequency.....2.42  
    level.....2.43  
Opening the casing .....1.4  
Operating modes.....2.69  
Operating-hours indication .....2.95  
Operating-time counter.....3.20  
Option  
    fitting.....1.4  
    SM-B1 - Reference oscillator OCXO.....1.5, 2.89  
    SM-B2 - LF generator .....1.6, 2.59  
    SM-B3 - Pulse modulator 1.5 GHz.....1.7, 1.8  
    SM-B4 - Pulse generator .....1.8, 2.61  
    SM-B5 - FM/PM modulator .....1.7, 2.58, 2.59  
    SM-B8 - Pulse modulator 3 GHz.....1.7, 1.8  
    SM-B9 - Pulse modulator 6 GHz.....1.7, 1.8  
    SME-B19 - Rear panel connections for RF and LF ....1.9  
    SME-B42 - POCSAG.....1.8

- Output  
 2 to 20 GHz ..... 2.17  
 BLANK ..... 2.15, 2.70, 2.78, 2.97  
 buffer ..... 3.78  
 DATA ..... 2.11  
 LF2.11, 2.66, 3.25  
 MARKER ..... 2.15, 2.70, 2.78, 2.97, 3.42, 3.60  
 REF ..... 2.13, 2.89  
 RF ..... 2.11, 2.43, 3.24, 3.35  
 SYNC ..... 2.17  
 TRIGGER ..... 2.15  
 V/GHz ..... 2.13, 3.25  
 VIDEO ..... 2.17  
 voltage ..... 2.66  
 X-AXIS ..... 2.13, 2.70
- OVEN COLD ..... 1.2  
 Overlapping execution ..... 3.77  
 Overmodulation ..... 2.53  
 Overview status register ..... 3.81  
 Overview syntax elements ..... 3.11
- P**
- Parallel poll ..... 3.83, 3.87  
 Parameter (comands) ..... 3.9  
 Parity (RS232) ..... 3.66  
**Parity bit (RS-232-C)** ..... 6A.5  
 Password ..... 2.91, 3.69  
 Path (commands) ..... 3.6  
 Pattern setting (list editor) ..... 2.35  
 Period ..... 2.63
- Phase  
 modulation ..... 2.59, 3.44  
 RF output ..... 2.90, 3.43
- Physical quantities ..... 3.8
- PM  
 coupling ..... 2.60, 3.44  
 deviation ..... 2.59, 3.44  
 frequency ..... 2.59, 3.45  
 generator ..... 2.59, 3.45  
 input resistance ..... 3.44  
 modulator ..... 1.7, 2.59, 3.44
- Polarity  
 BLANK signal ..... 3.24  
 FSK modulation ..... 3.31  
 marker signal ..... 2.98  
 pulse modulation ..... 2.63, 3.49  
 signal ..... 2.97
- Power control  
 detector ..... 3.47  
 reference voltage ..... 3.46
- Power supply ..... 1.1, 1.5  
 Power sweep ..... 3.55  
 PPE (Parallel poll enable register) ..... 3.83  
 Preset (instrument states) ..... 3.68  
 Presetting ..... 1.3  
 Programming Examples ..... 9D.1  
 Protection level ..... 3.69  
 PTRansition register ..... 3.80  
 Pulling range ..... 2.89
- Pulse  
 delay ..... 2.63, 3.51  
 generator ..... 1.8, 2.61, 3.51  
 calibration ..... 3.18  
 input ..... 2.61, 3.74  
 modulation ..... 2.61, 3.49  
 polarity ..... 2.63, 3.49  
 modulator ..... 1.7, 1.8  
 period ..... 2.63, 3.51  
 width ..... 2.63, 3.51
- Putting into operation ..... 1.1
- Q**
- Queries ..... 3.5  
 Query data format ..... 3.22  
 Query responses ..... 3.8  
 Question ..... 3.11  
 Quick selection  
 menu ..... 2.21  
 parameter ..... 2.21  
 Quotation marks ..... 3.11
- R**
- Rack 19" ..... 1.9  
 RCL list (MSEQ) ..... 3.68  
 REF output ..... 2.89
- Reference  
 external ..... 2.89, 3.52  
 input/output ..... 3.52  
 internal ..... 3.52  
 oscillator OCXO ..... 1.5, 2.89, 3.52  
 step synthesis ..... 1.5  
 voltage (power control) ..... 3.46
- Remote-control interface  
 IEC-bus ..... 2.17  
 RS-232 ..... 2.15
- Remove paneling ..... 1.4  
 Reset status reporting system ..... 3.88  
 Responses to queries ..... 3.8  
 Return to Manual Operating ..... 3.4
- RF  
 frequency ..... 2.41  
 OFF ..... 2.51  
 output level ..... 2.11, 2.13, 2.43, 3.24, 3.47  
 sweep ..... 2.72, 3.53  
 Rotary knob ..... 2.7, 2.19  
 RS232 interface ..... 2.15, 2.87, 4
- S**
- Sample setting ..... 2.23  
 Sample-and-hold operation ..... 2.46
- SCPI  
 Introduction ..... 3.5  
 SCPI Conformity Information ..... 7B.1  
 Scrollbar ..... 2.19  
 Select mark ..... 2.18  
 Selection 1-out-of-n ..... 2.20  
 Self test ..... 3.70, 4.4  
 Selftest ..... 3.16  
 Semicolon separates ..... 3.11  
 Serial number indication ..... 2.95  
 Serial poll ..... 3.86  
 Service request (SRQ) ..... 3.16, 3.86  
 SERVICE REQUEST ENABLE ..... 3.16  
 Service request enable register (SRE) ..... 3.82  
 Setting commands ..... 3.5  
 Setting value change ..... 2.20  
 Settling bit ..... 3.84  
 Short form (commands) ..... 3.7  
 Sign ..... 3.9  
 Signal scale ..... 3.25  
 Signal shape LF generator ..... 2.67  
 Simultaneous modulation ..... 2.53  
 Single-pulse delay ..... 2.63  
 Slots ..... 1.5  
 Software version ..... 2.95, 3.20  
 Source resistance ..... 2.51  
 Span RF sweep ..... 2.73  
 Special characters ..... 3.13  
 Square brackets ..... 3.7  
 SRE (service request enable register) ..... 3.82  
 SRQ (service request) ..... 3.16, 3.86

- STANDBY mode..... 1.1, 1.2, 2.9  
 Start bit (RS-232-C)..... 6A.5  
 Start frequency  
     LF sweep ..... 2.76, 3.58  
     RF sweep..... 2.73, 3.37  
 Start level (level sweep)..... 3.48  
 State  
     REMOTE..... 3.2  
 STATus  
     OPERation register ..... 3.63, 3.84  
     QUEStionable register..... 3.64, 3.85  
 Status byte (STB) ..... 3.82  
 Status line..... 2.18  
 STATUS page ..... 2.99  
 Status register overview ..... 3.81  
 Status reporting system ..... 3.79  
 STB (status byte)..... 3.82  
 Step width  
     level ..... 2.74, 3.48  
     LF sweep ..... 2.76, 3.62  
     power sweep ..... 3.56  
     RF sweep ..... 2.73, 3.37, 3.54  
     rotary knob  
         frequency variation..... 2.42  
         level variation..... 2.44  
 Stop bit (RS232)..... 3.66, 5  
 Stop frequency  
     LF sweep ..... 2.76, 3.58  
     RF sweep..... 2.73, 3.37  
 Stop level (level sweep)..... 3.48  
 STOP-Input ..... 2.15  
     define polarity..... 3.23  
 Storage..... 4.1  
 Store  
     instrument settings ..... 2.39  
     list ..... 2.31  
 Structure  
     command ..... 3.6  
     command line..... 3.8  
 Structure and Syntax of the Device Messages ..... 3.5  
 Sum bit ..... 3.80  
 Sum deviation..... 2.53  
 Sum modulation depth ..... 2.53  
     two-tone modulation..... 2.53  
 Summing loop..... 1.5  
 Sweep  
     level sweep ..... 2.74, 3.48, 3.55  
     LF sweep ..... 2.75  
     outputs ..... 2.70  
     power sweep ..... 3.55  
     RF ..... 2.72  
     RF sweep..... 3.53  
     run  
         LF sweep ..... 2.76, 3.61  
         RF sweep..... 3.54  
     trigger ..... 3.72  
 Symbol..... 2.21  
 SYNC-Output ..... 2.17  
**T**  
 Test points ..... 2.94, 2.95, 3.20  
 Trigger  
     input..... 2.63, 2.70, 2.97, 3.74  
     LIST..... 3.73  
     lists ..... 2.78  
     MSEQ..... 2.83, 3.74  
     oscilloscope ..... 2.70  
     pulse modulation..... 2.63, 3.74  
     sweep ..... 3.72  
     XY recorder ..... 2.70  
 TRIGGER  
     input..... 2.78, 2.83, 2.97  
     output ..... 2.15  
 Trigger action ..... 2.21  
 Truth values ..... 3.8  
 TUNE input ..... 2.89  
 Tuning voltage ..... 2.90  
 Two-tone modulation..... 2.53  
**U**  
 UCOR (level correction) ..... 2.48, 3.28  
 Unit ..... 3.8  
 Units ..... 2.5, 3.75  
 Universal commands..... 8C.3  
 User correction (UCOR)..... 2.48, 3.28  
**V**  
 V/GHz-Output..... 2.13  
 Ventilation ducts..... 1.4  
 VIDEO output..... 2.17, 2.61  
 Voltage  
     external modulation signal ..... 2.53  
     output ..... 2.66  
**W**  
 waveform (LF generator)..... 2.58, 2.60, 3.59  
 White space ..... 3.11  
**X**  
 X-AXIS output ..... 2.13, 2.70  
 XY recorder..... 3.53