

# R&S® SMJ100A

## Vector Signal Generator

### Operating Manual



1403.7458.32 – 13



**ROHDE & SCHWARZ**

[www.valuetronics.com](http://www.valuetronics.com)

Test & Measurement

Operating Manual

This document describes the R&S®SMJ100A, stock no. 1403.4507.02 and its options.

- R&S®SMJ-B9/B10/B11
- R&S®SMJ-B13
- R&S®SMJ-B16
- R&S®SMJ-B18
- R&S®SMJ-B20
- R&S®SMJ-B50/B51
- R&S®SMJ-B81
- R&S®SMJ-B90
- R&S®SMJ-B104/B106
- R&S®SMJ-K61
- R&S®SMJ-K62
- R&S®SMJ-K80

The firmware of the instrument makes use of several valuable open source software packages. The most important of them together with their corresponding open source license and the verbatim license texts are provided on the user documentation CD-ROM (included in delivery).

The OpenSSL Project for use in the OpenSSL Toolkit (<http://www.openssl.org/>) includes cryptographic software written by Eric Young (eay@cryptsoft.com) and software written by Tim Hudson (tjh@cryptsoft.com).

Rohde & Schwarz would like to thank the open source community for their valuable contribution to embedded computing.

© 2012 Rohde & Schwarz GmbH & Co. KG

Muehldorfstr. 15, 81671 Munich, Germany

Phone: +49 89 41 29 - 0

Fax: +49 89 41 29 12 164

E-mail: [info@rohde-schwarz.com](mailto:info@rohde-schwarz.com)

Internet: <http://www.rohde-schwarz.com>

Printed in Germany – Subject to change – Data without tolerance limits is not binding.

R&S® is a registered trademark of Rohde & Schwarz GmbH & Co. KG.

Trade names are trademarks of the owners.

The following abbreviations are used throughout this manual: R&S®SMJ100A is abbreviated as R&S SMJ.

# Basic Safety Instructions

## Always read through and comply with the following safety instructions!









All plants and locations of the Rohde & Schwarz group of companies make every effort to keep the safety standards of our products up to date and to offer our customers the highest possible degree of safety. Our products and the auxiliary equipment they require are designed, built and tested in accordance with the safety standards that apply in each case. Compliance with these standards is continuously monitored by our quality assurance system. The product described here has been designed, built and tested in accordance with the attached EC Certificate of Conformity and has left the manufacturer's plant in a condition fully complying with safety standards. To maintain this condition and to ensure safe operation, you must observe all instructions and warnings provided in this manual. If you have any questions regarding these safety instructions, the Rohde & Schwarz group of companies will be happy to answer them.







Furthermore, it is your responsibility to use the product in an appropriate manner. This product is designed for use solely in industrial and laboratory environments or, if expressly permitted, also in the field and must not be used in any way that may cause personal injury or property damage. You are responsible if the product is used for any intention other than its designated purpose or in disregard of the manufacturer's instructions. The manufacturer shall assume no responsibility for such use of the product.

The product is used for its designated purpose if it is used in accordance with its product documentation and within its performance limits (see data sheet, documentation, the following safety instructions). Using the product requires technical skills and a basic knowledge of English. It is therefore essential that only skilled and specialized staff or thoroughly trained personnel with the required skills be allowed to use the product. If personal safety gear is required for using Rohde & Schwarz products, this will be indicated at the appropriate place in the product documentation. Keep the basic safety instructions and the product documentation in a safe place and pass them on to the subsequent users.

Observing the safety instructions will help prevent personal injury or damage of any kind caused by dangerous situations. Therefore, carefully read through and adhere to the following safety instructions before and when using the product. It is also absolutely essential to observe the additional safety instructions on personal safety, for example, that appear in relevant parts of the product documentation. In these safety instructions, the word "product" refers to all merchandise sold and distributed by the Rohde & Schwarz group of companies, including instruments, systems and all accessories.

## Symbols and safety labels

							
Notice, general danger location Observe product documentation	Caution when handling heavy equipment	Danger of electric shock	Warning! Hot surface	PE terminal	Ground	Ground terminal	Be careful when handling electrostatic sensitive devices

					
ON/OFF supply voltage	Standby indication	Direct current (DC)	Alternating current (AC)	Direct/alternating current (DC/AC)	Device fully protected by double (reinforced) insulation

### Tags and their meaning

The following signal words are used in the product documentation in order to warn the reader about risks and dangers.



indicates a hazardous situation which, if not avoided, will result in death or serious injury.



indicates a hazardous situation which, if not avoided, could result in death or serious injury.



indicates a hazardous situation which, if not avoided, could result in minor or moderate injury.



indicates the possibility of incorrect operation which can result in damage to the product.

In the product documentation, the word ATTENTION is used synonymously.

These tags are in accordance with the standard definition for civil applications in the European Economic Area. Definitions that deviate from the standard definition may also exist in other economic areas or military applications. It is therefore essential to make sure that the tags described here are always used only in connection with the related product documentation and the related product. The use of tags in connection with unrelated products or documentation can result in misinterpretation and in personal injury or material damage.

### Operating states and operating positions

*The product may be operated only under the operating conditions and in the positions specified by the manufacturer, without the product's ventilation being obstructed. If the manufacturer's specifications are not observed, this can result in electric shock, fire and/or serious personal injury or death. Applicable local or national safety regulations and rules for the prevention of accidents must be observed in all work performed.*

1. Unless otherwise specified, the following requirements apply to Rohde & Schwarz products: predefined operating position is always with the housing floor facing down, IP protection 2X, pollution severity 2, overvoltage category 2, use only indoors, max. operating altitude 2000 m above sea level, max. transport altitude 4500 m above sea level. A tolerance of  $\pm 10\%$  shall apply to the nominal voltage and  $\pm 5\%$  to the nominal frequency.
2. Do not place the product on surfaces, vehicles, cabinets or tables that for reasons of weight or stability are unsuitable for this purpose. Always follow the manufacturer's installation instructions when installing the product and fastening it to objects or structures (e.g. walls and shelves). An installation that is not carried out as described in the product documentation could result in personal injury or death.
3. Do not place the product on heat-generating devices such as radiators or fan heaters. The ambient temperature must not exceed the maximum temperature specified in the product documentation or in the data sheet. Product overheating can cause electric shock, fire and/or serious personal injury or death.

### Electrical safety

*If the information on electrical safety is not observed either at all to the extent necessary, electric shock, fire and/or serious personal injury or death may occur.*

1. Prior to switching on the product, always ensure that the nominal voltage setting on the product matches the nominal voltage of the AC supply network. If a different voltage is to be set, the power fuse of the product may have to be changed accordingly.
2. In the case of products of safety class I with movable power cord and connector, operation is permitted only on sockets with an earthing contact and protective earth connection.
3. Intentionally breaking the protective earth connection either in the feed line or in the product itself is not permitted. Doing so can result in the danger of an electric shock from the product. If extension cords or connector strips are implemented, they must be checked on a regular basis to ensure that they are safe to use.
4. If the product does not have a power switch for disconnection from the AC supply network, the plug of the connecting cable is regarded as the disconnecting device. In such cases, always ensure that the power plug is easily reachable and accessible at all times (corresponding to the length of connecting cable, approx. 2 m). Functional or electronic switches are not suitable for providing disconnection from the AC supply network. If products without power switches are integrated into racks or systems, a disconnecting device must be provided at the system level.
5. Never use the product if the power cable is damaged. Check the power cable on a regular basis to ensure that it is in proper operating condition. By taking appropriate safety measures and carefully laying the power cable, you can ensure that the cable will not be damaged and that no one can be hurt by, for example, tripping over the cable or suffering an electric shock.
6. The product may be operated only from TN/TT supply networks fused with max. 16 A (higher fuse only after consulting with the Rohde & Schwarz group of companies).
7. Do not insert the plug into sockets that are dusty or dirty. Insert the plug firmly and all the way into the socket. Otherwise, sparks that result in fire and/or injuries may occur.
8. Do not overload any sockets, extension cords or connector strips; doing so can cause fire or electric shocks.
9. For measurements in circuits with voltages  $V_{rms} > 30$  V, suitable measures (e.g. appropriate measuring equipment, fusing, current limiting, electrical separation, insulation) should be taken to avoid any hazards.
10. Ensure that the connections with information technology equipment, e.g. PCs or other industrial computers, comply with the IEC60950-1/EN60950-1 or IEC61010-1/EN 61010-1 standards that apply in each case.
11. Unless expressly permitted, never remove the cover or any part of the housing while the product is in operation. Doing so will expose circuits and components and can lead to injuries, fire or damage to the product.
12. If a product is to be permanently installed, the connection between the PE terminal on site and the product's PE conductor must be made first before any other connection is made. The product may be installed and connected only by a licensed electrician.
13. For permanently installed equipment without built-in fuses, circuit breakers or similar protective devices, the supply circuit must be fused in such a way that anyone who has access to the product, as well as the product itself, is adequately protected from injury or damage.

## Basic Safety Instructions

14. Use suitable overvoltage protection to ensure that no overvoltage (such as that caused by a bolt of lightning) can reach the product. Otherwise, the person operating the product will be exposed to the danger of an electric shock.
15. Any object that is not designed to be placed in the openings of the housing must not be used for this purpose. Doing so can cause short circuits inside the product and/or electric shocks, fire or injuries.
16. Unless specified otherwise, products are not liquid-proof (see also section "Operating states and operating positions", item 1. Therefore, the equipment must be protected against penetration by liquids. If the necessary precautions are not taken, the user may suffer electric shock or the product itself may be damaged, which can also lead to personal injury.
17. Never use the product under conditions in which condensation has formed or can form in or on the product, e.g. if the product has been moved from a cold to a warm environment. Penetration by water increases the risk of electric shock.
18. Prior to cleaning the product, disconnect it completely from the power supply (e.g. AC supply network or battery). Use a soft, non-linting cloth to clean the product. Never use chemical cleaning agents such as alcohol, acetone or diluents for cellulose lacquers.

### Operation

1. Operating the products requires special training and intense concentration. Make sure that persons who use the products are physically, mentally and emotionally fit enough to do so; otherwise, injuries or material damage may occur. It is the responsibility of the employer/operator to select suitable personnel for operating the products.
2. Before you move or transport the product, read and observe the section titled "Transport".
3. As with all industrially manufactured goods, the use of substances that induce an allergic reaction (allergens) such as nickel cannot be generally excluded. If you develop an allergic reaction (such as a skin rash, frequent sneezing, red eyes or respiratory difficulties) when using a Rohde & Schwarz product, consult a physician immediately to determine the cause and to prevent health problems or stress.
4. Before you start processing the product mechanically and/or thermally, or before you take it apart, be sure to read and pay special attention to the section titled "Waste disposal", item 1.
5. Depending on the function, certain products such as RF radio equipment can produce an elevated level of electromagnetic radiation. Considering that unborn babies require increased protection, pregnant women must be protected by appropriate measures. Persons with pacemakers may also be exposed to risks from electromagnetic radiation. The employer/operator must evaluate workplaces where there is a special risk of exposure to radiation and, if necessary, take measures to avert the potential danger.
6. Should a fire occur, the product may release hazardous substances (gases, fluids, etc.) that can cause health problems. Therefore, suitable measures must be taken, e.g. protective masks and protective clothing must be worn.
7. If a laser product (e.g. a CD/DVD drive) is integrated into a Rohde & Schwarz product, absolutely no other settings or functions may be used as described in the product documentation. The objective is to prevent personal injury (e.g. due to laser beams).

### Repair and service

1. The product may be opened only by authorized, specially trained personnel. Before any work is performed on the product or before the product is opened, it must be disconnected from the AC supply network. Otherwise, personnel will be exposed to the risk of an electric shock.
2. Adjustments, replacement of parts, maintenance and repair may be performed only by electrical experts authorized by Rohde & Schwarz. Only original parts may be used for replacing parts relevant to safety (e.g. power switches, power transformers, fuses). A safety test must always be performed after parts relevant to safety have been replaced (visual inspection, PE conductor test, insulation resistance measurement, leakage current measurement, functional test). This helps ensure the continued safety of the product.

### Batteries and rechargeable batteries/cells

*If the information regarding batteries and rechargeable batteries/cells is not observed either at all or to the extent necessary, product users may be exposed to the risk of explosions, fire and/or serious personal injury, and, in some cases, death. Batteries and rechargeable batteries with alkaline electrolytes (e.g. lithium cells) must be handled in accordance with the EN 62133 standard.*

1. Cells must not be taken apart or crushed.
2. Cells or batteries must not be exposed to heat or fire. Storage in direct sunlight must be avoided. Keep cells and batteries clean and dry. Clean soiled connectors using a dry, clean cloth.
3. Cells or batteries must not be short-circuited. Cells or batteries must not be stored in a box or in a drawer where they can short-circuit each other, or where they can be short-circuited by other conductive materials. Cells and batteries must not be removed from their original packaging until they are ready to be used.
4. Keep cells and batteries out of the hands of children. If a cell or a battery has been swallowed, seek medical aid immediately.
5. Cells and batteries must not be exposed to any mechanical shocks that are stronger than permitted.
6. If a cell develops a leak, the fluid must not be allowed to come into contact with the skin or eyes. If contact occurs, wash the affected area with plenty of water and seek medical aid.
7. Improperly replacing or charging cells or batteries that contain alkaline electrolytes (e.g. lithium cells) can cause explosions. Replace cells or batteries only with the matching Rohde & Schwarz type (see parts list) in order to ensure the safety of the product.
8. Cells and batteries must be recycled and kept separate from residual waste. Rechargeable batteries and normal batteries that contain lead, mercury or cadmium are hazardous waste. Observe the national regulations regarding waste disposal and recycling.

### Transport

1. The product may be very heavy. Therefore, the product must be handled with care. In some cases, the user may require a suitable means of lifting or moving the product (e.g. with a lift-truck) to avoid back or other physical injuries.

2. Handles on the products are designed exclusively to enable personnel to transport the product. It is therefore not permissible to use handles to fasten the product to or on transport equipment such as cranes, fork lifts, wagons, etc. The user is responsible for securely fastening the products to or on the means of transport or lifting. Observe the safety regulations of the manufacturer of the means of transport or lifting. Noncompliance can result in personal injury or material damage.
3. If you use the product in a vehicle, it is the sole responsibility of the driver to drive the vehicle safely and properly. The manufacturer assumes no responsibility for accidents or collisions. Never use the product in a moving vehicle if doing so could distract the driver of the vehicle. Adequately secure the product in the vehicle to prevent injuries or other damage in the event of an accident.

### **Waste disposal**

1. If products or their components are mechanically and/or thermally processed in a manner that goes beyond their intended use, hazardous substances (heavy-metal dust such as lead, beryllium, nickel) may be released. For this reason, the product may only be disassembled by specially trained personnel. Improper disassembly may be hazardous to your health. National waste disposal regulations must be observed.
2. If handling the product releases hazardous substances or fuels that must be disposed of in a special way, e.g. coolants or engine oils that must be replenished regularly, the safety instructions of the manufacturer of the hazardous substances or fuels and the applicable regional waste disposal regulations must be observed. Also observe the relevant safety instructions in the product documentation. The improper disposal of hazardous substances or fuels can cause health problems and lead to environmental damage.

## Informaciones elementales de seguridad

### **Es imprescindible leer y observar las siguientes instrucciones e informaciones de seguridad!**

El principio del grupo de empresas Rohde & Schwarz consiste en tener nuestros productos siempre al día con los estándares de seguridad y de ofrecer a nuestros clientes el máximo grado de seguridad. Nuestros productos y todos los equipos adicionales son siempre fabricados y examinados según las normas de seguridad vigentes. Nuestro sistema de garantía de calidad controla constantemente que sean cumplidas estas normas. El presente producto ha sido fabricado y examinado según el certificado de conformidad adjunto de la UE y ha salido de nuestra planta en estado impecable según los estándares técnicos de seguridad. Para poder preservar este estado y garantizar un funcionamiento libre de peligros, el usuario deberá atenerse a todas las indicaciones, informaciones de seguridad y notas de alerta. El grupo de empresas Rohde & Schwarz está siempre a su disposición en caso de que tengan preguntas referentes a estas informaciones de seguridad.

Además queda en la responsabilidad del usuario utilizar el producto en la forma debida. Este producto está destinado exclusivamente al uso en la industria y el laboratorio o, si ha sido expresamente autorizado, para aplicaciones de campo y de ninguna manera deberá ser utilizado de modo que alguna persona/cosa pueda sufrir daño. El uso del producto fuera de sus fines definidos o sin tener en cuenta las instrucciones del fabricante queda en la responsabilidad del usuario. El fabricante no se hace en ninguna forma responsable de consecuencias a causa del mal uso del producto.









## Informaciones elementales de seguridad

Se parte del uso correcto del producto para los fines definidos si el producto es utilizado conforme a las indicaciones de la correspondiente documentación del producto y dentro del margen de rendimiento definido (ver hoja de datos, documentación, informaciones de seguridad que siguen). El uso del producto hace necesarios conocimientos técnicos y ciertos conocimientos del idioma inglés. Por eso se debe tener en cuenta que el producto solo pueda ser operado por personal especializado o personas instruidas en profundidad con las capacidades correspondientes. Si fuera necesaria indumentaria de seguridad para el uso de productos de Rohde & Schwarz, encontraría la información debida en la documentación del producto en el capítulo correspondiente. Guarde bien las informaciones de seguridad elementales, así como la documentación del producto, y entréguelas a usuarios posteriores.

Tener en cuenta las informaciones de seguridad sirve para evitar en lo posible lesiones o daños por peligros de toda clase. Por eso es imprescindible leer detalladamente y comprender por completo las siguientes informaciones de seguridad antes de usar el producto, y respetarlas durante el uso del producto. Deberán tenerse en cuenta todas las demás informaciones de seguridad, como p. ej. las referentes a la protección de personas, que encontrarán en el capítulo correspondiente de la documentación del producto y que también son de obligado cumplimiento. En las presentes informaciones de seguridad se recogen todos los objetos que distribuye el grupo de empresas Rohde & Schwarz bajo la denominación de "producto", entre ellos también aparatos, instalaciones así como toda clase de accesorios.

### Símbolos y definiciones de seguridad

							
Aviso: punto de peligro general  Observar la documentación del producto	Atención en el manejo de dispositivos de peso elevado	Peligro de choque eléctrico	Advertencia: superficie caliente	Conexión a conductor de protección	Conexión a tierra	Conexión a masa	Aviso: Cuidado en el manejo de dispositivos sensibles a la electrostática (ESD)

					
Tensión de alimentación de PUESTA EN MARCHA / PARADA	Indicación de estado de espera (Standby)	Corriente continua (DC)	Corriente alterna (AC)	Corriente continua / Corriente alterna (DC/AC)	El aparato está protegido en su totalidad por un aislamiento doble (reforzado)

## Palabras de señal y su significado

En la documentación del producto se utilizan las siguientes palabras de señal con el fin de advertir contra riesgos y peligros.



PELIGRO identifica un peligro inminente con riesgo elevado que provocará muerte o lesiones graves si no se evita.



ADVERTENCIA identifica un posible peligro con riesgo medio de provocar muerte o lesiones (graves) si no se evita.



ATENCIÓN identifica un peligro con riesgo reducido de provocar lesiones leves o moderadas si no se evita.



AVISO indica la posibilidad de utilizar mal el producto y, como consecuencia, dañarlo.

En la documentación del producto se emplea de forma sinónima el término CUIDADO.

Las palabras de señal corresponden a la definición habitual para aplicaciones civiles en el área económica europea. Pueden existir definiciones diferentes a esta definición en otras áreas económicas o en aplicaciones militares. Por eso se deberá tener en cuenta que las palabras de señal aquí descritas sean utilizadas siempre solamente en combinación con la correspondiente documentación del producto y solamente en combinación con el producto correspondiente. La utilización de las palabras de señal en combinación con productos o documentaciones que no les correspondan puede llevar a interpretaciones equivocadas y tener por consecuencia daños en personas u objetos.

## Estados operativos y posiciones de funcionamiento

*El producto solamente debe ser utilizado según lo indicado por el fabricante respecto a los estados operativos y posiciones de funcionamiento sin que se obstruya la ventilación. Si no se siguen las indicaciones del fabricante, pueden producirse choques eléctricos, incendios y/o lesiones graves con posible consecuencia de muerte. En todos los trabajos deberán ser tenidas en cuenta las normas nacionales y locales de seguridad del trabajo y de prevención de accidentes.*

1. Si no se convino de otra manera, es para los productos Rohde & Schwarz válido lo que sigue: como posición de funcionamiento se define por principio la posición con el suelo de la caja para abajo, modo de protección IP 2X, grado de suciedad 2, categoría de sobrecarga eléctrica 2, uso solamente en estancias interiores, utilización hasta 2000 m sobre el nivel del mar, transporte hasta 4500 m sobre el nivel del mar. Se aplicará una tolerancia de  $\pm 10\%$  sobre el voltaje nominal y de  $\pm 5\%$  sobre la frecuencia nominal.
2. No sitúe el producto encima de superficies, vehículos, estantes o mesas, que por sus características de peso o de estabilidad no sean aptos para él. Siga siempre las instrucciones de instalación del fabricante cuando instale y asegure el producto en objetos o estructuras (p. ej. paredes y estantes). Si se realiza la instalación de modo distinto al indicado en la documentación del producto, pueden causarse lesiones o incluso la muerte.
3. No ponga el producto sobre aparatos que generen calor (p. ej. radiadores o calefactores). La temperatura ambiente no debe superar la temperatura máxima especificada en la documentación del producto o en la hoja de datos. En caso de sobrecalentamiento del producto, pueden producirse choques eléctricos, incendios y/o lesiones graves con posible consecuencia de muerte.

## Seguridad eléctrica

*Si no se siguen (o se siguen de modo insuficiente) las indicaciones del fabricante en cuanto a seguridad eléctrica, pueden producirse choques eléctricos, incendios y/o lesiones graves con posible consecuencia de muerte.*

1. Antes de la puesta en marcha del producto se deberá comprobar siempre que la tensión preseleccionada en el producto coincida con la de la red de alimentación eléctrica. Si es necesario modificar el ajuste de tensión, también se deberán cambiar en caso dado los fusibles correspondientes del producto.
2. Los productos de la clase de protección I con alimentación móvil y enchufe individual solamente podrán enchufarse a tomas de corriente con contacto de seguridad y con conductor de protección conectado.
3. Queda prohibida la interrupción intencionada del conductor de protección, tanto en la toma de corriente como en el mismo producto. La interrupción puede tener como consecuencia el riesgo de que el producto sea fuente de choques eléctricos. Si se utilizan cables alargadores o regletas de enchufe, deberá garantizarse la realización de un examen regular de los mismos en cuanto a su estado técnico de seguridad.
4. Si el producto no está equipado con un interruptor para desconectarlo de la red, se deberá considerar el enchufe del cable de conexión como interruptor. En estos casos se deberá asegurar que el enchufe siempre sea de fácil acceso (de acuerdo con la longitud del cable de conexión, aproximadamente 2 m). Los interruptores de función o electrónicos no son aptos para el corte de la red eléctrica. Si los productos sin interruptor están integrados en bastidores o instalaciones, se deberá colocar el interruptor en el nivel de la instalación.
5. No utilice nunca el producto si está dañado el cable de conexión a red. Compruebe regularmente el correcto estado de los cables de conexión a red. Asegúrese, mediante las medidas de protección y de instalación adecuadas, de que el cable de conexión a red no pueda ser dañado o de que nadie pueda ser dañado por él, p. ej. al tropezar o por un choque eléctrico.
6. Solamente está permitido el funcionamiento en redes de alimentación TN/TT aseguradas con fusibles de 16 A como máximo (utilización de fusibles de mayor amperaje solo previa consulta con el grupo de empresas Rohde & Schwarz).
7. Nunca conecte el enchufe en tomas de corriente sucias o llenas de polvo. Introduzca el enchufe por completo y fuertemente en la toma de corriente. La no observación de estas medidas puede provocar chispas, fuego y/o lesiones.
8. No sobrecargue las tomas de corriente, los cables alargadores o las regletas de enchufe ya que esto podría causar fuego o choques eléctricos.
9. En las mediciones en circuitos de corriente con una tensión  $U_{\text{eff}} > 30 \text{ V}$  se deberán tomar las medidas apropiadas para impedir cualquier peligro (p. ej. medios de medición adecuados, seguros, limitación de tensión, corte protector, aislamiento etc.).
10. Para la conexión con dispositivos informáticos como un PC o un ordenador industrial, debe comprobarse que éstos cumplan los estándares IEC60950-1/EN60950-1 o IEC61010-1/EN 61010-1 válidos en cada caso.
11. A menos que esté permitido expresamente, no retire nunca la tapa ni componentes de la carcasa mientras el producto esté en servicio. Esto pone a descubierto los cables y componentes eléctricos y puede causar lesiones, fuego o daños en el producto.

12. Si un producto se instala en un lugar fijo, se deberá primero conectar el conductor de protección fijo con el conductor de protección del producto antes de hacer cualquier otra conexión. La instalación y la conexión deberán ser efectuadas por un electricista especializado.
13. En el caso de dispositivos fijos que no estén provistos de fusibles, interruptor automático ni otros mecanismos de seguridad similares, el circuito de alimentación debe estar protegido de modo que todas las personas que puedan acceder al producto, así como el producto mismo, estén a salvo de posibles daños.
14. Todo producto debe estar protegido contra sobretensión (debida p. ej. a una caída del rayo) mediante los correspondientes sistemas de protección. Si no, el personal que lo utilice quedará expuesto al peligro de choque eléctrico.
15. No debe introducirse en los orificios de la caja del aparato ningún objeto que no esté destinado a ello. Esto puede producir cortocircuitos en el producto y/o puede causar choques eléctricos, fuego o lesiones.
16. Salvo indicación contraria, los productos no están impermeabilizados (ver también el capítulo "Estados operativos y posiciones de funcionamiento", punto 1). Por eso es necesario tomar las medidas necesarias para evitar la entrada de líquidos. En caso contrario, existe peligro de choque eléctrico para el usuario o de daños en el producto, que también pueden redundar en peligro para las personas.
17. No utilice el producto en condiciones en las que pueda producirse o ya se hayan producido condensaciones sobre el producto o en el interior de éste, como p. ej. al desplazarlo de un lugar frío a otro caliente. La entrada de agua aumenta el riesgo de choque eléctrico.
18. Antes de la limpieza, desconecte por completo el producto de la alimentación de tensión (p. ej. red de alimentación o batería). Realice la limpieza de los aparatos con un paño suave, que no se deshilache. No utilice bajo ningún concepto productos de limpieza químicos como alcohol, acetona o diluyentes para lacas nitrocelulósicas.

### **Funcionamiento**

1. El uso del producto requiere instrucciones especiales y una alta concentración durante el manejo. Debe asegurarse que las personas que manejen el producto estén a la altura de los requerimientos necesarios en cuanto a aptitudes físicas, psíquicas y emocionales, ya que de otra manera no se pueden excluir lesiones o daños de objetos. El empresario u operador es responsable de seleccionar el personal usuario apto para el manejo del producto.
2. Antes de desplazar o transportar el producto, lea y tenga en cuenta el capítulo "Transporte".
3. Como con todo producto de fabricación industrial no puede quedar excluida en general la posibilidad de que se produzcan alergias provocadas por algunos materiales empleados, los llamados alérgenos (p. ej. el níquel). Si durante el manejo de productos Rohde & Schwarz se producen reacciones alérgicas, como p. ej. irritaciones cutáneas, estornudos continuos, enrojecimiento de la conjuntiva o dificultades respiratorias, debe avisarse inmediatamente a un médico para investigar las causas y evitar cualquier molestia o daño a la salud.
4. Antes de la manipulación mecánica y/o térmica o el desmontaje del producto, debe tenerse en cuenta imprescindiblemente el capítulo "Eliminación", punto 1.

5. Ciertos productos, como p. ej. las instalaciones de radiocomunicación RF, pueden a causa de su función natural, emitir una radiación electromagnética aumentada. Deben tomarse todas las medidas necesarias para la protección de las mujeres embarazadas. También las personas con marcapasos pueden correr peligro a causa de la radiación electromagnética. El empresario/operador tiene la obligación de evaluar y señalar las áreas de trabajo en las que exista un riesgo elevado de exposición a radiaciones.
6. Tenga en cuenta que en caso de incendio pueden desprenderse del producto sustancias tóxicas (gases, líquidos etc.) que pueden generar daños a la salud. Por eso, en caso de incendio deben usarse medidas adecuadas, como p. ej. máscaras antigás e indumentaria de protección.
7. En caso de que un producto Rohde & Schwarz contenga un producto láser (p. ej. un lector de CD/DVD), no debe usarse ninguna otra configuración o función aparte de las descritas en la documentación del producto, a fin de evitar lesiones (p. ej. debidas a irradiación láser).

### **Reparación y mantenimiento**

1. El producto solamente debe ser abierto por personal especializado con autorización para ello. Antes de manipular el producto o abrirlo, es obligatorio desconectarlo de la tensión de alimentación, para evitar toda posibilidad de choque eléctrico.
2. El ajuste, el cambio de partes, el mantenimiento y la reparación deberán ser efectuadas solamente por electricistas autorizados por Rohde & Schwarz. Si se reponen partes con importancia para los aspectos de seguridad (p. ej. el enchufe, los transformadores o los fusibles), solamente podrán ser sustituidos por partes originales. Después de cada cambio de partes relevantes para la seguridad deberá realizarse un control de seguridad (control a primera vista, control del conductor de protección, medición de resistencia de aislamiento, medición de la corriente de fuga, control de funcionamiento). Con esto queda garantizada la seguridad del producto.

### **Baterías y acumuladores o celdas**

*Si no se siguen (o se siguen de modo insuficiente) las indicaciones en cuanto a las baterías y acumuladores o celdas, pueden producirse explosiones, incendios y/o lesiones graves con posible consecuencia de muerte. El manejo de baterías y acumuladores con electrolitos alcalinos (p. ej. celdas de litio) debe seguir el estándar EN 62133.*

1. No deben desmontarse, abrirse ni triturarse las celdas.
2. Las celdas o baterías no deben someterse a calor ni fuego. Debe evitarse el almacenamiento a la luz directa del sol. Las celdas y baterías deben mantenerse limpias y secas. Limpiar las conexiones sucias con un paño seco y limpio.
3. Las celdas o baterías no deben cortocircuitarse. Es peligroso almacenar las celdas o baterías en estuches o cajones en cuyo interior puedan cortocircuitarse por contacto recíproco o por contacto con otros materiales conductores. No deben extraerse las celdas o baterías de sus embalajes originales hasta el momento en que vayan a utilizarse.
4. Mantener baterías y celdas fuera del alcance de los niños. En caso de ingestión de una celda o batería, avisar inmediatamente a un médico.
5. Las celdas o baterías no deben someterse a impactos mecánicos fuertes indebidos.

6. En caso de falta de estanqueidad de una celda, el líquido vertido no debe entrar en contacto con la piel ni los ojos. Si se produce contacto, lavar con agua abundante la zona afectada y avisar a un médico.
7. En caso de cambio o recarga inadecuados, las celdas o baterías que contienen electrolitos alcalinos (p. ej. las celdas de litio) pueden explotar. Para garantizar la seguridad del producto, las celdas o baterías solo deben ser sustituidas por el tipo Rohde & Schwarz correspondiente (ver lista de recambios).
8. Las baterías y celdas deben reciclarse y no deben tirarse a la basura doméstica. Las baterías o acumuladores que contienen plomo, mercurio o cadmio deben tratarse como residuos especiales. Respete en esta relación las normas nacionales de eliminación y reciclaje.

### **Transporte**

1. El producto puede tener un peso elevado. Por eso es necesario desplazarlo o transportarlo con precaución y, si es necesario, usando un sistema de elevación adecuado (p. ej. una carretilla elevadora), a fin de evitar lesiones en la espalda u otros daños personales.
2. Las asas instaladas en los productos sirven solamente de ayuda para el transporte del producto por personas. Por eso no está permitido utilizar las asas para la sujeción en o sobre medios de transporte como p. ej. grúas, carretillas elevadoras de horquilla, carros etc. Es responsabilidad suya fijar los productos de manera segura a los medios de transporte o elevación. Para evitar daños personales o daños en el producto, siga las instrucciones de seguridad del fabricante del medio de transporte o elevación utilizado.
3. Si se utiliza el producto dentro de un vehículo, recae de manera exclusiva en el conductor la responsabilidad de conducir el vehículo de manera segura y adecuada. El fabricante no asumirá ninguna responsabilidad por accidentes o colisiones. No utilice nunca el producto dentro de un vehículo en movimiento si esto pudiera distraer al conductor. Asegure el producto dentro del vehículo debidamente para evitar, en caso de un accidente, lesiones u otra clase de daños.

### **Eliminación**

1. Si se trabaja de manera mecánica y/o térmica cualquier producto o componente más allá del funcionamiento previsto, pueden liberarse sustancias peligrosas (polveros con contenido de metales pesados como p. ej. plomo, berilio o níquel). Por eso el producto solo debe ser desmontado por personal especializado con formación adecuada. Un desmontaje inadecuado puede ocasionar daños para la salud. Se deben tener en cuenta las directivas nacionales referentes a la eliminación de residuos.
2. En caso de que durante el trato del producto se formen sustancias peligrosas o combustibles que deban tratarse como residuos especiales (p. ej. refrigerantes o aceites de motor con intervalos de cambio definidos), deben tenerse en cuenta las indicaciones de seguridad del fabricante de dichas sustancias y las normas regionales de eliminación de residuos. Tenga en cuenta también en caso necesario las indicaciones de seguridad especiales contenidas en la documentación del producto. La eliminación incorrecta de sustancias peligrosas o combustibles puede causar daños a la salud o daños al medio ambiente.

## Safety Instructions

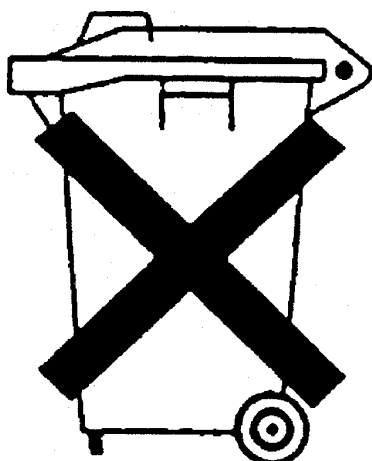

### Kundeninformation zum Batteriegesetz (BattG)

Dieses Gerät enthält eine Batterie bzw. Akkumulator. Diese dürfen nicht mit dem Hausmüll entsorgt werden.

Nach Ende der Lebensdauer darf die Entsorgung nur über eine geeignete Sammelstelle oder eine Rohde & Schwarz-Kundendienststelle erfolgen.

Beachten Sie unbedingt die Hinweise zu Batterien und Akkumulatoren in den grundlegenden Sicherheitshinweisen.

### Safety Regulations for Batteries (according to BattG)

This equipment houses a battery or rechargeable battery that may not be disposed of as normal household waste.

After its useful life, the battery or rechargeable battery may only be disposed of at a suitable depot or at a Rohde & Schwarz customer service center.

Always follow the instructions on batteries and rechargeable batteries in the basic safety instructions.

### Información para el cliente relativa a la Ley de Baterías (BattG)

Este equipo contiene una batería o acumulador, que no se deben desechar en los contenedores de basura domésticos.

Después de la vida útil, la batería solo se podrá eliminar en un depósito apropiado o en un centro de atención al cliente de Rohde & Schwarz.

Le rogamos que respete escrupulosamente las indicaciones referidas a baterías, acumuladores contenidas en las instrucciones de seguridad elementales.

### Consignes de sécurité pour batteries (selon la loi BattG)

Cet appareil contient des batteries (piles, batteries et accumulateurs) qui ne doivent pas être jetées dans une poubelle pour ordures ménagères.

Une fois usagées, elles doivent être éliminées dans un centre de collecte agréé ou un centre de service clients de Rohde & Schwarz.

Veillez à respecter scrupuleusement les consignes de sécurité fondamentales concernant les piles, batteries et accumulateurs.

# Customer Information Regarding Product Disposal

The German Electrical and Electronic Equipment (ElektroG) Act is an implementation of the following EC directives:

- 2002/96/EC on waste electrical and electronic equipment (WEEE) and
- 2002/95/EC on the restriction of the use of certain hazardous substances in electrical and electronic equipment (RoHS).

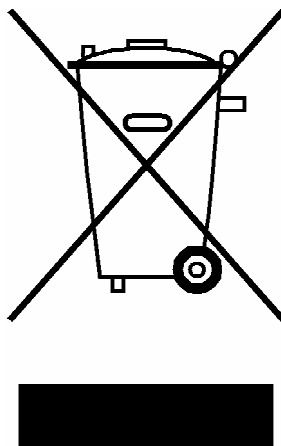

Product labeling in accordance with EN 50419

Once the lifetime of a product has ended, this product must not be disposed of in the standard domestic refuse. Even disposal via the municipal collection points for waste electrical and electronic equipment is not permitted.

Rohde & Schwarz GmbH & Co. KG has developed a disposal concept for the environmental-friendly disposal or recycling of waste material and fully assumes its obligation as a producer to take back and dispose of electrical and electronic waste in accordance with the ElektroG Act.

Please contact your local service representative to dispose of the product.





# Qualitätszertifikat

## Certificate of quality

## Certificat de qualité

Certified Quality System  
**ISO 9001**

Certified Environmental System  
**ISO 14001**

### Sehr geehrter Kunde,

Sie haben sich für den Kauf eines Rohde&Schwarz-Produktes entschieden. Hiermit erhalten Sie ein nach modernsten Fertigungsmethoden hergestelltes Produkt. Es wurde nach den Regeln unseres Qualitätsmanagementsystems entwickelt, gefertigt und geprüft. Das Rohde&Schwarz-Qualitätsmanagementsystem ist u.a. nach ISO9001 und ISO14001 zertifiziert.

### Der Umwelt verpflichtet

- ▮ Energie-effiziente, RoHS-konforme Produkte
- ▮ Kontinuierliche Weiterentwicklung nachhaltiger Umweltkonzepte
- ▮ ISO 14001-zertifiziertes Umweltmanagementsystem

### Dear Customer,

You have decided to buy a Rohde&Schwarz product. You are thus assured of receiving a product that is manufactured using the most modern methods available. This product was developed, manufactured and tested in compliance with our quality management system standards. The Rohde&Schwarz quality management system is certified according to standards such as ISO9001 and ISO14001.

### Environmental commitment

- ▮ Energy-efficient products
- ▮ Continuous improvement in environmental sustainability
- ▮ ISO 14001-certified environmental management system

### Cher client,

Vous avez choisi d'acheter un produit Rohde&Schwarz. Vous disposez donc d'un produit fabriqué d'après les méthodes les plus avancées. Le développement, la fabrication et les tests respectent nos normes de gestion qualité. Le système de gestion qualité de Rohde&Schwarz a été homologué, entre autres, conformément aux normes ISO9001 et ISO14001.

### Engagement écologique

- ▮ Produits à efficience énergétique
- ▮ Amélioration continue de la durabilité environnementale
- ▮ Système de gestion de l'environnement certifié selon ISO 14001



Certificate No.: 2010-19

This is to certify that:

Equipment type	Stock No.	Designation
SMJ100A	1403.4507.02	VEKTORSIGNALGENERATOR

complies with the provisions of the Directive of the Council of the European Union on the approximation of the laws of the Member States

- relating to electrical equipment for use within defined voltage limits (2006/95/EC)
- relating to electromagnetic compatibility (2004/108/EC)

Conformity is proven by compliance with the following standards:

EN 61010-1: 2001  
EN 61326-1: 2006  
EN 61326-2-1: 2006  
EN 55011: 2007 + A2: 2007, Class B, except when SMJ-B18 is installed then Class A  
EN 61000-3-2: 2006  
EN 61000-3-3: 1995 + A1: 2001 + A2: 2005

For the assessment of electromagnetic compatibility, the limits of radio interference for Class B equipment as well as the immunity to interference for operation in industry have been used as a basis.

**ROHDE & SCHWARZ GmbH & Co. KG**  
Mühldorfstr. 15, D-81671 München

Munich, 2010-02-18

Central Quality Management MF-QZ / Radde

CE

E-1

# Customer Support

## Technical support – where and when you need it

For quick, expert help with any Rohde & Schwarz equipment, contact one of our Customer Support Centers. A team of highly qualified engineers provides telephone support and will work with you to find a solution to your query on any aspect of the operation, programming or applications of Rohde & Schwarz equipment.

## Up-to-date information and upgrades

To keep your instrument up-to-date and to be informed about new application notes related to your instrument, please send an e-mail to the Customer Support Center stating your instrument and your wish. We will take care that you will get the right information.

### Europe, Africa, Middle East

Phone +49 89 4129 12345  
[customersupport@rohde-schwarz.com](mailto:customersupport@rohde-schwarz.com)

### North America

Phone 1-888-TEST-RSA (1-888-837-8772)  
[customer.support@rsa.rohde-schwarz.com](mailto:customer.support@rsa.rohde-schwarz.com)

### Latin America

Phone +1-410-910-7988  
[customersupport.la@rohde-schwarz.com](mailto:customersupport.la@rohde-schwarz.com)

### Asia/Pacific

Phone +65 65 13 04 88  
[customersupport.asia@rohde-schwarz.com](mailto:customersupport.asia@rohde-schwarz.com)

### China

Phone +86-800-810-8228 /  
+86-400-650-5896  
[customersupport.china@rohde-schwarz.com](mailto:customersupport.china@rohde-schwarz.com)



# Contents

<b>1</b>	<b>Preface</b> .....	<b>15</b>
1.1	Documentation Overview.....	15
1.2	Typographical Conventions.....	16
<b>2</b>	<b>Preparing for Use</b> .....	<b>19</b>
2.1	Front Panel Tour.....	19
2.1.1	Utility Keys.....	20
2.1.2	Standby LEDs and Standby Key.....	20
2.1.3	Display.....	21
2.1.4	Setup Keys.....	21
2.1.4.1	Keys for Setting Paramters.....	21
2.1.4.2	Display Keys.....	22
2.1.5	Keypad for data entry.....	23
2.1.6	Rotary Knob and Navigation Keys.....	24
2.1.7	Front Panel Connectors.....	25
2.2	Rear Panel Tour.....	26
2.2.1	Description of the Connectors.....	27
2.3	Putting into Operation.....	30
2.3.1	Unpacking and Checking the Instrument.....	32
2.3.2	Placing or Mounting the Instrument.....	32
2.3.3	Connecting the Instrument to the AC Supply.....	33
2.3.4	Starting the Instrument.....	34
2.3.4.1	Standby and Ready state.....	34
2.3.4.2	Start Display and Booting.....	35
2.3.4.3	Function Check.....	35
2.3.4.4	Default Settings.....	35
2.3.5	Shutting Down the Instrument.....	37
2.4	Connecting External Accessories.....	37
2.4.1	Connecting USB Devices.....	38
2.4.2	Connecting a Monitor.....	39
2.5	Windows Operating System.....	39
2.5.1	Virus Protection.....	40

2.5.2	Service Packs and Updates.....	40
2.5.3	Login.....	41
2.5.4	Accessing the Start Menu.....	41
<b>2.6</b>	<b>Setting Up a Network (LAN) Connection.....</b>	<b>41</b>
2.6.1	Connecting the Instrument to the Network.....	42
2.6.2	Assigning the IP Address.....	43
2.6.3	Using computer names.....	44
2.6.4	Changing the Windows Firewall Settings.....	44
2.6.5	Working with Directories.....	45
<b>2.7</b>	<b>Remote Access via an External Controller.....</b>	<b>45</b>
2.7.1	Using a Web Browser for Remote Access.....	47
2.7.2	Remote Desktop Connection.....	48
2.7.3	Remote Access via Ultr@VNC.....	50
<b>2.8</b>	<b>Using Virus-Protection Software.....</b>	<b>56</b>
<b>2.9</b>	<b>LXI Configuration.....</b>	<b>57</b>
2.9.1	LXI Browser Interface.....	59
2.9.2	LAN Configuration.....	60
2.9.2.1	Advanced LAN Configuration.....	61
2.9.2.2	Ping.....	62
<b>3</b>	<b>Getting Started.....</b>	<b>63</b>
<b>3.1</b>	<b>Brief Introduction to the Instrument's Concept.....</b>	<b>63</b>
<b>3.2</b>	<b>Applications of the Instrument.....</b>	<b>65</b>
3.2.1	Internally generated I/Q signal.....	65
3.2.2	Analog Wideband I/Q operation.....	66
<b>3.3</b>	<b>Baseband Section.....</b>	<b>67</b>
3.3.1	Description of Individual Diagram Blocks of the Baseband Section.....	68
<b>3.4</b>	<b>RF Section.....</b>	<b>69</b>
3.4.1	Description of Individual Diagram Blocks of the RF Section.....	69
<b>3.5</b>	<b>Example of Setup.....</b>	<b>70</b>
<b>4</b>	<b>Manual Operation.....</b>	<b>77</b>
<b>4.1</b>	<b>Key Features.....</b>	<b>77</b>
<b>4.2</b>	<b>Display.....</b>	<b>81</b>
4.2.1	Settings Displayed in the Header Section.....	82

4.2.2	Status Information and Messages.....	83
4.2.2.1	Status Information.....	83
4.2.2.2	Messages.....	83
4.2.2.3	Volatile messages.....	83
4.2.2.4	Permanent Messages.....	83
4.2.3	Info Window.....	84
4.2.4	Block Diagram .....	85
4.2.4.1	Function Blocks in the Block Diagram.....	85
4.2.4.2	Signal Flow and Input/Output Symbols in the Block Diagram.....	86
4.2.5	Winbar and Softkeys.....	87
4.2.6	Structure of the Dialogs.....	87
4.2.7	Graphical Display of Output Signal Characteristics.....	88
<b>4.3</b>	<b>Accessing Dialogs.....</b>	<b>89</b>
<b>4.4</b>	<b>Setting Parameters.....</b>	<b>90</b>
4.4.1	Working with the Cursor.....	91
4.4.2	Selecting a Control Element.....	92
4.4.3	Switching Parameters On/Off.....	92
4.4.4	Entering a Value.....	92
4.4.5	Working with Units .....	94
4.4.6	Selecting a Value from a List.....	95
4.4.7	Terminating Entries with Confirmation.....	95
4.4.8	Restoring the Previous Value.....	96
<b>4.5</b>	<b>Editors.....</b>	<b>97</b>
4.5.1	Working with List Editor.....	97
4.5.2	Working with Data Editor.....	99
4.5.3	Working with Control and Marker List Editor.....	100
<b>4.6</b>	<b>How to Use the Help System.....</b>	<b>104</b>
<b>4.7</b>	<b>File Management.....</b>	<b>106</b>
4.7.1	File Select Dialog.....	107
4.7.2	File Manager.....	109
4.7.2.1	Extensions for User Files.....	110
<b>4.8</b>	<b>Legend of Front-Panel Controls.....</b>	<b>112</b>
4.8.1	Front Panel Key Emulation.....	114

4.8.2	On-screen Keyboard.....	114
<b>5</b>	<b>Instrument Function.....</b>	<b>115</b>
<b>5.1</b>	<b>Overview of Instrument Functions.....</b>	<b>115</b>
<b>5.2</b>	<b>General Instrument Settings.....</b>	<b>117</b>
5.2.1	Overview of General Instrument Settings.....	117
5.2.2	Default Instrument Settings - Preset Key.....	118
5.2.3	General Configuration of Instrument - Setup Key.....	119
5.2.3.1	Internal Adjustments.....	119
5.2.3.2	Hardware Config.....	121
5.2.3.3	Software / Options.....	122
5.2.3.4	Manage License Keys.....	124
5.2.3.5	Gui Update.....	125
5.2.3.6	NRP-Z Info/Update.....	126
5.2.3.7	Update.....	127
5.2.3.8	Selftest.....	127
5.2.3.9	Check Front Panel.....	128
5.2.3.10	Global Trigger/Clock/External Input Settings.....	129
5.2.3.11	Display/Keyboard Settings.....	131
5.2.3.12	User Marker / AUX I/O Settings.....	132
5.2.3.13	Remote Channel Settings.....	133
5.2.3.14	LXI Status.....	134
5.2.3.15	Protection.....	135
5.2.3.16	Security.....	136
5.2.3.17	Save/Recall.....	139
5.2.3.18	Factory Preset.....	139
5.2.3.19	Help.....	139
5.2.4	Switching to Manual Control - Local Key.....	140
5.2.5	Generating a Hard Copy of the Display.....	140
5.2.5.1	Hardcopy Dialog.....	141
5.2.5.2	Hardcopy Options.....	142
5.2.6	Messages - Info Key.....	145
5.2.7	Help System - Help Key.....	145
5.2.8	Storing and Loading Instrument Data - File Key.....	146

5.2.8.1	File Menu.....	147
5.2.8.2	Storing Instrument Settings.....	147
5.2.8.3	Loading Instrument Settings.....	149
5.2.8.4	File Manager.....	150
<b>5.3</b>	<b>Graphical Display - Graphics.....</b>	<b>152</b>
5.3.1	Graphics Settings Menu.....	153
5.3.2	Bar of Graphics Window.....	155
5.3.3	Signal Displays.....	157
5.3.3.1	I/Q Diagram.....	157
5.3.3.2	Vector Diagram.....	158
5.3.3.3	Constellation Diagram.....	159
5.3.3.4	Eye Diagram.....	160
5.3.3.5	CCDF Display.....	161
5.3.3.6	Power Spectrum.....	162
<b>5.4</b>	<b>Bit and Block Error Rate Measurements - BERT Block.....</b>	<b>163</b>
5.4.1	Test setup.....	164
5.4.2	PRBS data.....	165
5.4.3	CRC polynomial.....	165
5.4.4	Clock signal.....	165
5.4.5	Ending the measurement.....	166
5.4.6	Interrupt-free measurement.....	166
5.4.7	Restart function.....	166
5.4.8	Data Enable.....	167
5.4.9	Pattern Ignore.....	168
5.4.10	Bit Error Rate Menu.....	168
5.4.10.1	General Settings.....	169
5.4.10.2	Configuration.....	172
5.4.11	Block Error Rate Menu.....	177
5.4.11.1	General Settings.....	178
5.4.11.2	Configuration.....	180
<b>5.5</b>	<b>RF Signal and Analog Modulations - RF Block.....</b>	<b>183</b>
5.5.1	Overview of RF Signal.....	183
5.5.1.1	RF Output.....	183



5.5.1.2	Overview of the RF Signal Settings.....	184
5.5.2	RF Frequency Settings.....	185
5.5.2.1	RF Frequency vs. RF Output Frequency.....	185
5.5.2.2	Configuring RF Frequency.....	185
5.5.2.3	Frequency Menu.....	186
5.5.3	Phase Settings.....	188
5.5.3.1	Phase Menu.....	188
5.5.3.2	Phase Continuous Frequency Setting.....	188
5.5.4	Reference Oscillator.....	191
5.5.4.1	Reference Oscillator Dialog.....	192
5.5.5	Local Oscillator - LO Coupling.....	193
5.5.5.1	Phase Coherence.....	194
5.5.5.2	Typical Applications.....	194
5.5.5.3	LO Coupling Menu.....	195
5.5.6	NRP-Z Power Viewer.....	196
5.5.6.1	NRP-Z Power Viewer Settings.....	197
5.5.7	RF Level/EMF.....	202
5.5.7.1	Overview of RF Level.....	202
5.5.7.2	RF Level.....	203
5.5.7.3	Power-On/EMF Settings.....	207
5.5.8	Automatic Level Control - ALC.....	207
5.5.8.1	Automatic Level Control Settings.....	208
5.5.9	User Correction.....	209
5.5.9.1	User Correction Menu.....	210
5.5.9.2	Filling the Correction List automatically.....	215
5.5.9.3	Filling the Correction List with Power Sensor Measurement Data.....	216
5.5.10	Reverse Power Protection.....	218
5.5.11	Analog Modulations.....	219
5.5.11.1	Overview.....	219
5.5.11.2	Amplitude Modulation (AM).....	220
5.5.11.3	Broadband Amplitude Modulation (BB-AM).....	223
5.5.11.4	Frequency Modulation (FM).....	224
5.5.11.5	Phase Modulation (PhiM).....	227

5.5.11.6	Pulse Modulation (PM).....	230
5.5.12	LF Generator and LF Output - Mod Gen.....	232
5.5.12.1	Overview of LF Generator.....	232
5.5.12.2	LF Output.....	232
5.5.13	Sweep Mode.....	233
5.5.13.1	Overview.....	233
5.5.13.2	RF Frequency Sweep.....	233
5.5.13.3	RF Level Sweep.....	240
5.5.13.4	LF Frequency Sweep.....	246
5.5.14	List Mode.....	252
5.5.14.1	List Mode Dialog.....	252
5.5.14.2	Filling the List Mode Data automatically.....	259
<b>5.6</b>	<b>I/Q Modulation - I/Q Mod Block.....</b>	<b>260</b>
5.6.1	I/Q Modulator.....	261
5.6.2	I/Q Settings .....	261
5.6.2.1	General I/Q Mod Settings.....	263
5.6.2.2	Impairments.....	263
5.6.2.3	I/Q Swap and I/Q Wideband.....	270
5.6.2.4	Analog Wideband I/Q Input.....	271
<b>5.7</b>	<b>Impairment of Digital I/Q Signal and Noise Generator - AWGN/IMP Block.....</b>	<b>273</b>
5.7.1	Impairments.....	273
5.7.1.1	Impairment Settings Menu.....	274
5.7.2	AWGN - Noise Generator.....	282
5.7.2.1	AWGN Settings Dialog.....	282
5.7.3	Output of the Baseband Signal - I/Q Out.....	290
5.7.3.1	I/Q Out Settings Menu.....	290
5.7.3.2	Analog I/Q Output.....	291
5.7.3.3	Digital I/Q Output Settings.....	294
5.7.4	I/Q Level - Info.....	298
5.7.4.1	Baseband Signal Level.....	299
5.7.4.2	Baseband Signal Level Measurement.....	300
<b>5.8</b>	<b>Baseband Signal - Baseband Block.....</b>	<b>301</b>
5.8.1	Data and Signal Sources in Baseband.....	302

5.8.1.1	Internal PRBS Data and Data Patterns.....	303
5.8.1.2	Internal Modulation Data from Lists.....	304
5.8.1.3	External Synchronous Modulation Data.....	304
5.8.1.4	Clock Signals.....	305
5.8.1.5	Synchronizing Data Signals and Clock Signals.....	306
5.8.1.6	Control Signals.....	309
5.8.1.7	Trigger Signals.....	310
5.8.1.8	Marker Output Signals.....	311
5.8.2	Digital Modulation - Custom Digital Modulation.....	312
5.8.2.1	Overview and Required Options.....	312
5.8.2.2	Modulation Types - Custom Digital Mod.....	312
5.8.2.3	Coding - Custom Digital Mod.....	316
5.8.2.4	Baseband Filter - Custom Digital Mod.....	319
5.8.2.5	Conflicting Settings - Custom Digital Mod.....	323
5.8.2.6	Custom Digital Mod User Interface.....	323
5.8.3	Arbitrary Waveform Generator ARB.....	352
5.8.3.1	ARB User Interface.....	355
5.8.3.2	Multi Segment Waveforms.....	376
5.8.3.3	Multi Carrier Waveforms.....	387
5.8.4	Multi Carrier Continuous Wave.....	399
5.8.4.1	Multi Carrier CW User Interface.....	399
<b>6</b>	<b>Remote Control Basics.....</b>	<b>413</b>
<b>6.1</b>	<b>Remote Control Interfaces and Protocols.....</b>	<b>413</b>
6.1.1	VISA Libraries.....	414
6.1.2	Messages.....	414
6.1.3	LAN Interface.....	415
6.1.3.1	HiSLIP Protocol.....	416
6.1.3.2	VXI-11 Protocol.....	416
6.1.3.3	Socket Communication.....	417
6.1.3.4	LAN Interface Messages.....	417
6.1.4	GPIB Interface (IEC/IEEE Bus Interface).....	417
6.1.4.1	GPIB Interface Messages.....	418
6.1.4.2	GPIB Instrument Address.....	419

<b>6.2</b>	<b>Starting a Remote Control Session.....</b>	<b>419</b>
6.2.1	Switching to Remote Control.....	420
6.2.2	Returning to Manual Operation.....	421
6.2.3	Examples.....	421
6.2.3.1	Remote Control over GPIB.....	421
6.2.3.2	Remote Control over LAN using VXI-11 Protocol.....	422
6.2.3.3	Remote Control over LAN using Socket Communication.....	426
<b>6.3</b>	<b>SCPI Command Structure.....</b>	<b>432</b>
6.3.1	Syntax for Common Commands.....	433
6.3.2	Syntax for Device-Specific Commands.....	433
6.3.3	SCPI Parameters.....	436
6.3.4	Overview of Syntax Elements.....	439
6.3.5	Structure of a command line.....	439
6.3.6	Responses to Queries.....	440
<b>6.4</b>	<b>Command Sequence and Synchronization.....</b>	<b>441</b>
6.4.1	Preventing Overlapping Execution.....	442
<b>6.5</b>	<b>Status Reporting System.....</b>	<b>444</b>
6.5.1	Hierarchy of status registers.....	444
6.5.2	Structure of a SCPI Status Register.....	445
6.5.3	Contents of the Status Registers.....	447
6.5.3.1	Status Byte (STB) and Service Request Enable Register (SRE).....	447
6.5.3.2	IST Flag and Parallel Poll Enable Register (PPE).....	448
6.5.4	Event Status Register (ESR) and Event Status Enable Register (ESE).....	448
6.5.5	Application of the Status Reporting System.....	449
6.5.5.1	Service Request.....	449
6.5.5.2	Serial Poll.....	450
6.5.5.3	Parallel Poll.....	450
6.5.5.4	Query of an instrument status.....	450
6.5.5.5	Error Queue.....	451
6.5.6	Reset Values of the Status Reporting System.....	451
<b>6.6</b>	<b>General Programming Recommendations.....</b>	<b>451</b>
<b>7</b>	<b>Remote Control Commands.....</b>	<b>453</b>
7.1	Common Commands.....	453

<b>7.2</b>	<b>Preset Commands</b> .....	<b>457</b>
<b>7.3</b>	<b>R&amp;S Signal Generator Waveform and List Format</b> .....	<b>459</b>
7.3.1	Tag Description.....	460
7.3.2	Creating a Waveform Manually.....	471
7.3.3	Creating an ASCII C-List Manually.....	475
<b>7.4</b>	<b>BERT and BLER Subsystems</b> .....	<b>476</b>
<b>7.5</b>	<b>CALibration Subsystem</b> .....	<b>486</b>
<b>7.6</b>	<b>CLOCK Subsystem</b> .....	<b>489</b>
<b>7.7</b>	<b>DIAGnostic Subsystem</b> .....	<b>490</b>
<b>7.8</b>	<b>DISPlay Subsystem</b> .....	<b>492</b>
<b>7.9</b>	<b>FORMat Subsystem</b> .....	<b>492</b>
<b>7.10</b>	<b>HCOPy Subsystem</b> .....	<b>494</b>
<b>7.11</b>	<b>KBOard Subsystem</b> .....	<b>502</b>
<b>7.12</b>	<b>MMEMory Subsystem</b> .....	<b>503</b>
7.12.1	File Naming Conventions.....	503
7.12.2	Extensions for User Files.....	504
7.12.3	Examples.....	506
7.12.4	Remote Control Commands.....	507
<b>7.13</b>	<b>OUTPut Subsystem</b> .....	<b>513</b>
<b>7.14</b>	<b>SENSE, READ and INITiate Subsystems</b> .....	<b>517</b>
<b>7.15</b>	<b>SOURce Subsystem</b> .....	<b>525</b>
7.15.1	SOURce:AM Subsystem.....	526
7.15.2	SOURce:AWGN Subsystem.....	528
7.15.3	SOURce:BB Subsystem.....	537
7.15.3.1	SOURce:BB Subsystem General Commands.....	537
7.15.3.2	SOURce:BB:ARB Subsystem.....	537
7.15.3.3	SOURce:BB:DM Subsystem.....	580
7.15.3.4	SOURce:BB:GRAPhics Subsystem.....	615
7.15.3.5	SOURce:BB:IMPairment Subsystem.....	617
7.15.3.6	SOURce:BB:MCCW Subsystem.....	620
7.15.3.7	SOURce:BB:MEASurement Subsystem.....	639
7.15.3.8	SOURce:BB:POWer Subsystem.....	641
7.15.4	SOURce:CORRection Subsystem.....	642

7.15.5	SOURce:FM Subsystem.....	652
7.15.6	SOURce:FREQuency Subsystem.....	655
7.15.7	SOURce:INPut Subsystem.....	663
7.15.8	SOURce:IQ Subsystem.....	666
7.15.9	SOURce:IQ:OUTput Subsystem.....	670
7.15.9.1	Analog I/Q Outputs.....	670
7.15.9.2	Digital I/Q Outputs.....	674
7.15.10	SOURce:LFOutput Subsystem.....	679
7.15.11	SOURce:LIST Subsystem.....	687
7.15.12	SOURce:MODulation Subsystem.....	700
7.15.13	SOURce:PHASe Subsystem.....	700
7.15.14	SOURce:PM Subsystem.....	701
7.15.15	SOURce:POWer Subsystem.....	704
7.15.16	SOURce:PULM Subsystem.....	713
7.15.17	SOURce:ROSCillator Subsystem.....	714
7.15.18	SOURce:SWEep Subsystem.....	717
<b>7.16</b>	<b>STATus Subsystem.....</b>	<b>725</b>
<b>7.17</b>	<b>SYSTem Subsystem.....</b>	<b>729</b>
<b>7.18</b>	<b>TEST Subsystem.....</b>	<b>736</b>
<b>7.19</b>	<b>TRIGger Subsystem.....</b>	<b>738</b>
<b>7.20</b>	<b>UNIT Subsystem.....</b>	<b>743</b>
<b>8</b>	<b>Maintenance.....</b>	<b>745</b>
<b>8.1</b>	<b>Storing and Packing.....</b>	<b>745</b>
<b>9</b>	<b>Error Messages.....</b>	<b>747</b>
<b>9.1</b>	<b>Status Information.....</b>	<b>747</b>
9.1.1	Status information displayed between the frequency and level fields.....	747
9.1.2	Status information displayed to the left of the Info line.....	748
9.1.3	Status information displayed in the Info line.....	749
<b>9.2</b>	<b>Error Messages.....</b>	<b>750</b>
9.2.1	Volatile messages.....	750
9.2.2	Permanent messages.....	750
<b>9.3</b>	<b>SCPI-Error Messages.....</b>	<b>751</b>
<b>9.4</b>	<b>Device-Specific Error Messages.....</b>	<b>751</b>

<b>A</b>	<b>Hardware Interfaces.....</b>	<b>755</b>
A.1	GPIB Bus Interface.....	755
A.2	AUX I/O Connector.....	756
A.3	Monitor Connector (MONITOR).....	758
A.4	BERT Connector.....	758
	<b>List of Commands.....</b>	<b>761</b>
	<b>Index.....</b>	<b>776</b>

# 1 Preface

## 1.1 Documentation Overview

The user documentation for the R&S SMJ consists of the following parts:

- Online Help system on the instrument,
- "Quick Start Guide" printed manual,
- Documentation CD-ROM with:
  - Online help system (\*.chm) as a standalone help,
  - Operating Manuals for base unit and options,
  - Service Manual,
  - Data sheet and specifications,
  - Links to useful sites on the R&S internet.

### Online Help

The Online Help is embedded in the instrument's firmware. It offers quick, context-sensitive access to the complete information needed for operation and programming. The online help contains help on operating the R&S SMJ and all available options.

### Quick Start Guide

This manual is delivered with the instrument in printed form and in PDF format on the Documentation CD-ROM. It provides the information needed to set up and start working with the instrument. Basic operations and an example of setup are described. The manual includes also general information, e.g., Safety Instructions.

### Operating Manuals

The Operating Manuals are a supplement to the Quick Start Guide. Operating Manuals are provided for the base unit and each additional (software) option.

These manuals are available in PDF format - in printable form - on the Documentation CD-ROM delivered with the instrument. In the Operating Manual for the base unit, all instrument functions are described in detail. Furthermore, it provides an introduction to remote control and a complete description of the remote control commands with programming examples. Information on maintenance, instrument interfaces and error messages is also given.

In the individual option manuals, the specific instrument functions of the option are described in detail. For additional information on default settings and parameters, refer to the data sheets. Basic information on operating the R&S SMJ is not included in the option manuals.

The following Operating Manuals are available for the R&S SMJ:

- Digital Standard GSM/EDGE, incl. EDGE+



- Digital Standard 3GPP FDD, 3GPP FDD enhanced MS/BS tests incl. HSDPA, 3GPP FDD HSUPA, 3GPP FDD HSPA+
- Digital Standard GPS and Assisted GPS
- Digital Standard CDMA2000® incl. 1xEV-DV
- Digital Standard 1xEV-DO Rev. A
- Digital Standard IEEE 802.11 (a/b/c) WLAN
- Digital Standard IEEE 802.16 WiMAX
- Digital Standard TD-SCDMA, inclusive TD-SCDMA enhanced features
- Digital Standard DVB-H
- Digital Standard DAB / T-DMB
- Digital Standard IEEE 802.11n WLAN-N
- Digital Standard EUTRA/LTE
- Digital Standard XM Radio
- FM Stereo / RDS
- Digital Standard Sirius Radio
- Digital Standard TETRA Release 2
- Digital Standard Bluetooth® Enhanced Data Rate
- HD Radio™ Test Waveforms

These manuals can also be orderd in printed form (see ordering information in the data sheet).

### Service Manual

This Service Manual is available in PDF format - in printable form - on the Documentation CD-ROM delivered with the instrument. It describes how to check compliance with rated specifications, on instrument function, repair, troubleshooting and fault elimination. It contains all information required for repairing the instrument by the replacement of modules.

This manual can also be orderd in printed form (see ordering information in the data sheet).

### Release Notes

The release notes describe new and modified functions, eliminated problems, and last minute changes to the documentation. The corresponding firmware version is indicated on the title page of the release notes. The current release notes are provided in the Internet.

## 1.2 Typographical Conventions

The following text markers are used throughout this documentation:

Convention	Description
"Graphical user interface elements"	All names of graphical user interface elements on the screen, such as dialog boxes, menus, options, buttons, and softkeys are enclosed by quotation marks.
KEYS	Key names are written in capital letters.
File names, commands, program code	File names, commands, coding samples and screen output are distinguished by their font.
<i>Input</i>	Input to be entered by the user is displayed in italics.
<a href="#">Links</a>	Links that you can click are displayed in blue font.
"References"	References to other parts of the documentation are enclosed by quotation marks.



## 2 Preparing for Use

The following topics will help you to get familiar with the instrument and perform the first steps:

- [Front Panel Tour](#)
- [Rear Panel Tour](#)
- [Putting into Operation](#)

This section explains the control elements and connectors of the Signal Generator R&S SMJ with the aid of the front and rear views and describes how to put the instrument into operation. It also describes the connection of peripherals such as printer, keyboard or mouse. Specifications of interfaces can be found in the data sheet.

The [chapter 3, "Getting Started"](#), on page 63 of this manual provides an overview of the generator functions and introduces the operating concept. Detailed operating instructions and an overview of menus follow in [chapter 4, "Manual Operation"](#), on page 77.

For all reference information concerning manual and remote control of the instrument refer to the online help system or its printed/printable version. A more detailed description of the hardware connectors and interfaces is also part of the help system.

### 2.1 Front Panel Tour

The front panel of the R&S Signal Generator consists of the VGA display with the softkey area, some utility keys (left side) and the hardkey area with connectors and control interfaces (right side). The subsequent sections provide brief explanations on the controls and connectors, the hardkey area and the front panel.

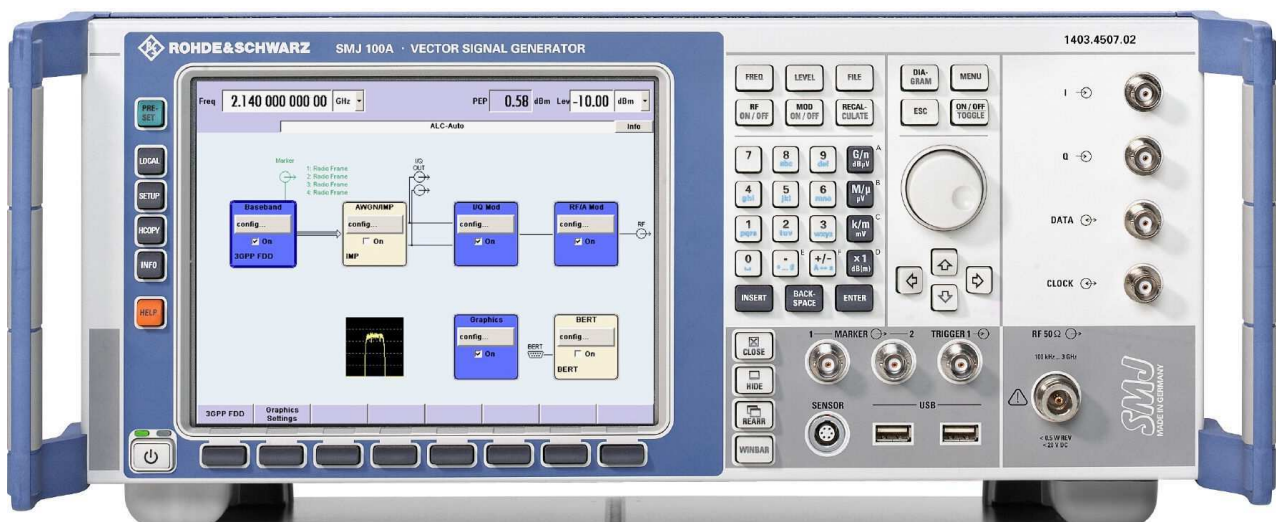

Fig. 2-1: Front panel view

### 2.1.1 Utility Keys



The keys to the left of the display cause the R&S SMJ to return to a definite instrument state and provide information on the instrument and assistance.

For more information refer to chapter "Instrument Settings".

#### PRESET

Sets the instrument to a defined state (see [chapter 2.3.4.4, "Default Settings"](#), on page 35).

#### LOCAL

Switches from remote control to local (manual) control.

#### SETUP

Opens the "Setup" dialog for configuring presettings.

For more information, see [chapter 5.2.3, "General Configuration of Instrument - Setup Key"](#), on page 119.

#### HCOPI

Opens the "Hardcopy" menu for configuring and starting printing.

For more information, see [chapter 5.2.5, "Generating a Hard Copy of the Display"](#), on page 140.

#### INFO

Displays status messages, error messages and warnings.

#### HELP

Displays context-sensitive help text.

### 2.1.2 Standby LEDs and Standby Key

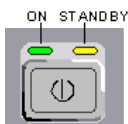

The standby LEDs and the ON/STANDBY key are located in the bottom left corner of the front panel.

The ON/STANDBY key toggles the instrument between standby and ready state (indicated by the standby LEDs).

The standby LEDs indicate the instrument states as follow:

- the green LED (left) is on when the instrument is ready for operation,
- the yellow LED (right) is on in the standby mode.

See also [chapter 2.3.4.1, "Standby and Ready state"](#), on page 34.

### 2.1.3 Display

The display clearly shows all main settings and signal generator states.

The display is divided into the following sections:

- Frequency and level display with info line
  - Frequency and level settings containing offset and peak envelope power (PEP).
  - Status messages
  - Brief error messages.  
To access a window with detailed information for a message, use the INFO key.
- Block diagram  
The block diagram shows the current configuration and the signal flow in the generator with the aid of function blocks containing an on/off switch. Selecting a function block opens a list of associated setting menus. Active menus, info windows and graphs are displayed on top of the block diagram. The block diagram can be displayed in the foreground anytime with the **DIAGRAM** key.
- "Winbar" with labelled softkeys  
Open menus are indicated by a labelled button in the "Winbar". The buttons determine the softkey functions for front-panel control. When a button or softkey is pressed, the associated menu is displayed either in the foreground or minimized in the "Winbar". If required, the WINBAR is covered by a row of buttons to which menu-specific functions of the active menu are assigned. By pressing the WINBAR key, the "Winbar" can be displayed in the foreground again. This allows the user to toggle between the button and softkey functions.

For detailed information, see [chapter 4.2, "Display"](#), on page 81.

### 2.1.4 Setup Keys

The keys to the right of the display set parameters, select views and control the windows.

#### 2.1.4.1 Keys for Setting Parameters

These keys provide direct access to the settings in the header of the instrument and can be used for fast changing the state of the modulation and the RF signal.



For more information refer to chapter "Instrument Functions".

#### **FREQ**

Activates frequency entry.

**RF ON/OFF**

Switches the RF signal on and off.

"RF OFF" is displayed in the header next to the "Frequency" field.

**LEVEL**

Activates level entry.

**MOD ON/OFF**

Switches the modulations on and off.

"MOD OFF" is displayed in the info line of the header next to the "Level" field.

**FILE**

Activates the menu for storing or loading files (see [chapter 4.7, "File Management"](#), on page 106).

**RECALCULATE**

Starts the recalculation of instrument settings.

If time-consuming calculations are required, the active modulation is automatically switched off and the calculation is interrupted to allow the user to make further settings. Calculation is restarted by a keystroke and the modulation is switched on again after the calculation is completed.

**2.1.4.2 Display Keys**

The keys on top of the rotary knob and the keys below the numeric key pad arrange different windows on the display.

**DIAGRAM**

Brings the block diagram to the foreground. Active menus are minimized.

Active menus are indicated by the buttons in the "Winbar".

**ESC**

The function of this key depends on the current cursor position.

- Calls the next higher selection level.
- Closes the open window without accepting new entries; the old value or parameter is retained.
- In dialog boxes that contain a "Cancel" button it activates that button.
- Closes all kinds of dialog boxes, if the edit mode is not active.
- Quits the edit mode, if the edit mode is active.
- Switches between different entry fields of a menu.
- Shifts the entry cursor from the header display to the previously active menu, or to the previously highlighted block in the block diagram if no menu is active.
- Shifts the cursor from a function block in the diagram to the first item in the "Winbar". If no menus are open, the current cursor position remains unchanged.

**TOGGLE**

- Switches highlighted elements or a function block on and off.

- Switches between two or more settings, e.g. items of selection lists. At the end of a list, the cursor is set on the first entry again.

### MENU

Calls the menu tree.



### CLOSE

Closes the active menu.

- If the entry mode is active, changes are cancelled.
- If settings in this menu require acknowledgement by means of an "Accept" button, a query is displayed asking whether the changes made should be cancelled.

### HIDE

Minimizes the active open menu. The associated button in the "Winbar" remains visible.

### REARR

Automatic rearrangement of open menus.

### WINBAR

Toggles between display and blanking of the "Winbar".

## 2.1.5 Keypad for data entry

The keys in the data entry keypad are used to enter alphanumeric data and units.

Data entry keys are only enabled while the cursor is placed on a data input field in a dialog. Their function depends on the data type of the input field.



Keys	Description
0...9/abc	Enters the corresponding numbers (in numeric input fields) or characters (character input fields).
.	Inserts a decimal point (numeric input fields) or dot (character input fields) at the cursor position. Multiple decimal points are not allowed.
+/-	Changes the sign of a numeric parameter. In the case of an alphanumeric parameter, inserts a hyphen at the cursor position.



Keys	Description
Unit keys	Selects a unit and thus determine the absolute value, or changes the unit, i.e. trigger a recalculation without changing the absolute value. The function depends on the time at which the UNIT key is used during parameter entry (see <a href="#">chapter 4.4.5, "Working with Units"</a> , on page 94). For unit-free values, the X1 key is equivalent to ENTER. It confirms the previous entry and deactivates the input field.
_	Adds a blank in a character input field.
*... #	Enters special characters. Toggles through the available characters if the key is pressed several times in a row.
A <-> a	Toggles between uppercase and lowercase characters.
A, B, C, D, E, F	Enters hexadecimal values. The letters assigned to the keys are automatically active when an entry field with a hexadecimal value is active.

**INSERT**

Toggles between insert and overwrite mode (see also [chapter 4.4.4, "Entering a Value"](#), on page 92 ).

**BACKSPACE**

Deletes the last character before the cursor position or the selected character sequence.

**ENTER**

Pressing the rotary knob has the same effect.

- Concludes the entry of dimensionless entries. For other entries, this key can be used instead of the default unit key. The new value is accepted.
- Confirms ("OK") and closes open input windows.
- In a dialog box, selects the default or focused button.
- In a dialog box, activates the edit mode for the focused area, if available.
- In a dialog box, activates or deactivates the selected option of the focused area, if the edit mode is active.
- Calls the next menu level.

**2.1.6 Rotary Knob and Navigation Keys**

The rotary knob and the arrow keys are alternative control elements for data variation and navigation in the graphical user interface.

**ROTARY KNOB**

The rotary knob has several functions:

- Increases (clockwise direction) or decreases (counter-clockwise direction) numeric values at a defined step width in editing mode
- Moves the cursor, e.g. to a function block in the block diagram
- Scrolls within lists, tables or tree views
- Acts like the ENTER key, when it is pressed.
- Shifts the selection bar within focused areas (e.g. lists), if the edit mode is activated.

**Note:** Turning or pressing the rotary knob is equivalent to pressing the UP and DOWN keys or the ENTER key in the keypad.

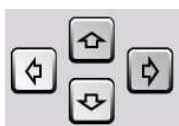

### NAVIGATION KEYS

The navigation keys consist of 4 arrow keys which are used for navigation, alternatively to the rotary knob.

#### UP/ DOWN KEYS

The up and down arrow keys do the following:

- In a numeric edit dialog box, increase or decrease the instrument parameter.
- In a list, table, window or dialog box, scroll vertically.

#### LEFT/ RIGHT KEYS

The left and right arrow keys do the following:

- In an alphanumeric edit dialog box, move the cursor forward and back.
- In a list, table, window or dialog box, scroll horizontally.

## 2.1.7 Front Panel Connectors

The RF and I/O connectors and various additional interface connectors are located on the front panel.

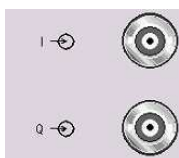

### I , Q

I and Q inputs for external analog modulation signal in case of I/Q modulation.

For more information see:

- [chapter 5.8.1, "Data and Signal Sources in Baseband"](#), on page 302



### DATA

Input for external serial data signal in case of digital modulation.

Output for serial data signal in case of digital modulation.

For more information see:

- [chapter 5.8.1, "Data and Signal Sources in Baseband"](#), on page 302



### CLOCK

Input for external clock signal (bit or symbol clock, multiple of symbol clock) for synchronizing the external data signal in case of multivalent modulation. The active edge can be set.

Output for clock signal (bit or symbol clock) in the internal mode.



### RF OUTPUT

Outputs for RF signal.

**NOTICE!** Maximum Input Levels. Do not overload the RF output. The maximum permissible back-feed is specified in the data sheet.



### TRIGGER 1

Input for triggering digital modulations, standards and ARB.



### MARKER 1, 2

Outputs 1 and 2 for triggering and control of external devices with user-definable marker signals.

The instrument provides four outputs for marker signals. Marker signals 1 to 3 are permanently assigned to the outputs; marker signal 4 can be routed to one of the four USER outputs. The assignment is as follows:

- Marker 1,2: BNC connectors MARKER 1 / 2 on the front panel.
- Marker 3: BNC connector MARKER 3 on the rear panel.
- Marker 4: BNC connector USER 1 or USER 2/3/4 pins of AUX I/O connector on rear panel.

For more information see [chapter 5.2.3.10, "Global Trigger/Clock/External Input Settings"](#), on page 129.



### USB

USB (universal serial bus) interfaces of type A (host USB).

- Connection of peripherals such as mouse or keyboard
- Connection of memory stick for file transmission
- Firmware update

**Note:** Another USB interface type A (host USB) and a USB interface type B (device USB for data transmission) are available on the rear panel.

See also [chapter 2.4.1, "Connecting USB Devices"](#), on page 38.



### SENSOR

Connector for R&S NRP-Zxx sensors.

With the aid of the "User Correction" function, a table with correction values for external test assemblies can be automatically determined, e.g. for compensating the frequency response of cables.

The power sensors are connected by inserting the male connector. To disconnect hold the connector by its sleeve. Pulling on the sensor cable will not release the sensor connector.

See also [chapter 5.5.6, "NRP-Z Power Viewer"](#), on page 196.

## 2.2 Rear Panel Tour

This section gives an overview of connectors on the rear panel of the instrument. Each connector is briefly described and a reference is given to the chapters containing detailed information. For technical data of the connectors refer to the data sheet.



Fig. 2-2: Rear panel view

## 2.2.1 Description of the Connectors



### LF

Output for internal LF modulation generator signal.

See also data sheet and [chapter 5.5.12.1, "Overview of LF Generator"](#), on page 232, [chapter 5.5.12.2, "LF Output"](#), on page 232.



### MARKER 3

Output for user-programmable marker signal 3 for triggering and control of external devices.

Marker outputs are permanently assigned (see ["MARKER 1, 2"](#) on page 25).

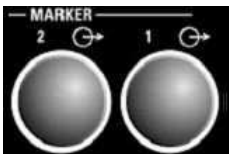

### MARKER 1/ MARKER 2

Rear Panel Connectors (option R&S SMJ-B81).

These options are recommended for use of the instrument in a 19" rack. Installing the instrument in a 19" rack requires a rack adapter or an adapter for telescopic sliders (refer to data sheet for order number).

Marker outputs are permanently assigned (see ["MARKER 1, 2"](#) on page 25).

See also [chapter 2.3.2, "Placing or Mounting the Instrument"](#), on page 32.

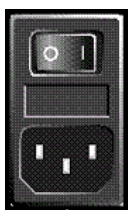

### AC SUPPLY AND POWER SWITCH

When the R&S SMJ is connected to the AC supply, it automatically sets itself to the correct range for the applied voltage (range: see type label). There is no need to set the voltage manually or change fuses.

The instrument comes with or without a power switch, depending on the design of the otherwise technically equivalent power supply unit.

The power switch can be set to two positions:

- **0**  
The instrument is disconnected from the mains.
- **I**  
The instrument is power-supplied. It is either ready for operation (STANDBY) or in operating mode, depending on the position of the ON/STANDBY switch on the instrument front.

See also data sheet and [chapter 2.3.3, "Connecting the Instrument to the AC Supply"](#), on page 33.



#### I OUT / Q OUT

Direct output or Differential (non-inverting) output for analog I/Q signal.

Option option R&S SMJ-B16 is required.

See also [chapter 5.7.3, "Output of the Baseband Signal - I/Q Out"](#), on page 290.



#### I OUT BAR / Q OUT BAR

Differential (inverting) output for analog I/Q signal.

See also [chapter 5.7.3, "Output of the Baseband Signal - I/Q Out"](#), on page 290.

#### I/Q/DATA/CLOCK

Rear Panel Connectors (option R&S SMJ-B81)

This options are recommended for use of the instrument in a 19" rack. Installing the instrument in a 19" rack requires a rack adapter or an adapter for telescopic sliders (refer to data sheet for order number).

See also [chapter 2.3.2, "Placing or Mounting the Instrument"](#), on page 32.

**Note:** Option R&S SMJ-B16 (Differential Outputs) and option R&S SMJ-B81 cannot be fitted both, because they use the same connectors.



#### REF OUT

Output of internal reference signal.

See also [chapter 5.5.4, "Reference Oscillator"](#), on page 191.



#### REF IN

Input for external reference signal.

See also [chapter 5.5.4, "Reference Oscillator"](#), on page 191.



#### EXT MOD

Input for external analog modulation signals.

See also ["External Modulation Sources"](#) on page 220.

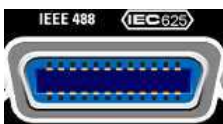

#### IEC 625/IEEE 488

IEC-bus (IEEE 488) interface for remote control of the instrument.

See also [chapter A.1, "GPIB Bus Interface"](#), on page 755 and [chapter 6.1.4, "GPIB Interface \(IEC/IEEE Bus Interface\)"](#), on page 417.

**Note:** In order to avoid electromagnetic interference (EMI) caused by open lines, always terminate any connected IEC-bus cable with an instrument or a controller.



### USB CONNECTORS TYPE A

USB (universal serial bus) interfaces of type A (host USB).

- Connection of peripherals such as mouse, keyboard, etc.
- Connection of memory stick for file transmission
- Firmware update

Further USB interface type A are available on the front panel.

See also [chapter 2.4.1, "Connecting USB Devices"](#), on page 38.



### USB IN

USB (universal serial bus) interface of type B (device USB).

This port is reserved for future extensions.



### MONITOR

Connector for external monitor (see [chapter 2.4.2, "Connecting a Monitor"](#), on page 39).

For description of this connector, refer to [chapter A.3, "Monitor Connector \(MONITOR\)"](#), on page 758.

### AUX I/O

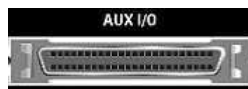

Parallel input/output for data signals as well as settable trigger and control signals of the baseband. Input for device trigger.

Assignment of the AUX I/O interface and of USER pins can be configured in the "Setup > Global Trigger/Clock/External Inputs" and "Setup > USER Marker / AUX I/O Settings".

**Note:** An adapter of the AUX I/O interface to coaxial BNC connectors is available as an accessory (R&S SMJ-Z5, see data sheet).

See also [chapter 5.2.3.10, "Global Trigger/Clock/External Input Settings"](#), on page 129 and [chapter 5.2.3.12, "User Marker / AUX I/O Settings"](#), on page 132.

For detailed description of the AUX I/O connector, refer to [chapter A.2, "AUX I/O Connector"](#), on page 756.



### BERT

Input for data, clock and control signals for bit and block error rate measurements, level 0.0128..1.998V.



### LAN CONNECTOR

Ethernet interface

- For integrating signal generators in a network
- Remote control of signal generator
- Input of external asynchronous data
- Remote access to the signal generator
- Firmware update

See also:

- [chapter 2.6, "Setting Up a Network \(LAN\) Connection"](#), on page 41

- [chapter 6.1.3, "LAN Interface"](#), on page 415

### RF A

Rear Panel Connector (option R&S SMJ-B81). This options are recommended for use of the instrument in a 19" rack. Installing the instrument in a 19" rack requires a rack adapter or an adapter for telescopic sliders (refer to data sheet for order number).

See also [chapter 2.3.2, "Placing or Mounting the Instrument"](#), on page 32.



### LO IN, LO OUT

Local oscillator input and output:

- LO IN: Input for external LO signals
- LO OUT: Output for internal LO signals.

See also [chapter 5.5.5, "Local Oscillator - LO Coupling"](#), on page 193.



### CLOCK OUT

Output for internal clock signal.

See also [chapter 5.8.1.4, "Clock Signals"](#), on page 305.

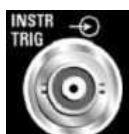

### INSTR TRIG

Input for external trigger of analog modulations, sweeps and list mode. HOP input for control of the frequency hop mode with external source in the list mode.

See also [chapter 5.5.14, "List Mode"](#), on page 252 and [chapter 5.5.13.1, "Overview"](#), on page 233.



### USER

Input/output for configurable signals for triggering and control.

The following signals can be applied to the connector:

- Marker 4
- CW mode Out
- No signal (blank) marker
- HOP

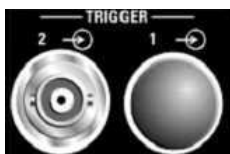

### TRIGGER 1 / 2

**TRIGGER 2:** Input for external triggering of digital modulations and standards and ARB.

**TRIGGER 1:** Rear Panel Connectors (option R&S SMJ-B81).

This options are recommended for use of the instrument in a 19" rack. Installing the instrument in a 19" rack requires a rack adapter or an adapter for telescopic sliders (refer to data sheet for Order No.).

See also [chapter 2.3.2, "Placing or Mounting the Instrument"](#), on page 32.

## 2.3 Putting into Operation

This section describes the basic steps to be taken when setting up the R&S SMJ for the first time.

**⚠ WARNING****Risk of injury and instrument damage**

The instrument must be used in an appropriate manner to prevent electric shock, fire, personal injury, or damage.

- Do not open the instrument casing.
- Read and observe the "Basic Safety Instructions" at the beginning of this manual or on the documentation CD-ROM, in addition to the safety instructions in the following sections. Notice that the data sheet may specify additional operating conditions.

**NOTICE****Risk of instrument damage**

Note that the general safety instructions also contain information on operating conditions that will prevent damage to the instrument. The instrument's data sheet may contain additional operating conditions.

**NOTICE****Risk of instrument damage during operation**

An unsuitable operating site or test setup can cause damage to the instrument and to connected devices. Ensure the following operating conditions before you switch on the instrument:

- All fan openings are unobstructed and the airflow perforations are unimpeded. The minimum distance from the wall is 10 cm.
- The instrument is dry and shows no sign of condensation.
- The instrument is positioned as described in the following sections.
- The ambient temperature does not exceed the range specified in the data sheet.
- Signal levels at the input connectors are all within the specified ranges.
- Signal outputs are correctly connected and are not overloaded.

**NOTICE****Risk of electrostatic discharge**

Protect the work area against electrostatic discharge to avoid damage to electronic components in the modules. For details, refer to the safety instructions at the beginning of this manual.





### EMI impact on measurement results

Electromagnetic interference (EMI) can affect the measurement results. To avoid any impact, make sure that the following conditions are met:

- Use suitable double-shielded cables.
- Do not use USB connecting cables exceeding 1 m in length.
- Use only USB devices that remain within the permissible EMI limits.
- Always terminate any connected IEC-bus cables with an instrument or controller.

Outputs and lines have to be terminated properly with 50 Ohms.

For digital interfaces only the cable R&S SMJ-Z6 is permitted for connection. The associated cable is available under part number 1415.0201.02.

## 2.3.1 Unpacking and Checking the Instrument

To remove the instrument from its packaging and check the equipment for completeness proceed as follows:

1. Pull off the polyethylene protection pads from the instrument's rear feet and then carefully remove the pads from the instrument handles at the front.
2. Pull off the corrugated cardboard cover that protects the rear of the instrument.
3. Carefully unthread the corrugated cardboard cover at the front that protects the instrument handles and remove it.
4. Check the equipment for completeness using the delivery note and the accessory lists for the various items.
5. Check the instrument for any damage. If there is damage, immediately contact the carrier who delivered the instrument. Make sure not to discard the box and packing material.



### Packing material

Retain the original packing material. If the instrument needs to be transported or shipped at a later date, you can use the material to protect the control elements and connectors.

## 2.3.2 Placing or Mounting the Instrument

The R&S SMJ is designed for use under laboratory conditions, either on a bench top or in a rack using a rack adapter kit (order number see data sheet).

### Bench Top Operation

If the R&S SMJ is operated on a bench top, the surface should be flat. The instrument can be used in horizontal position, standing on its feet, or with the support feet on the bottom extended.

**CAUTION****Risk of injury at the operating site**

The feet may fold in if they are not folded out completely or if the instrument is shifted. This may cause damage or injury.

- Fold the feet completely in or completely out to ensure stability of the instrument. Never shift the instrument when the feet are folded out.
- When the feet are folded out, do not work under the instrument or place anything underneath.
- The feet can break if they are overloaded. The overall load on the folded-out feet must not exceed 500 N.

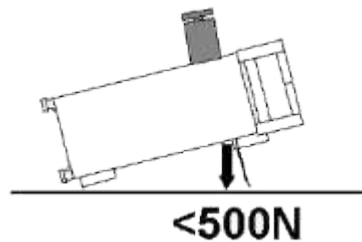
**Rackmounting**

The R&S SMJ can be installed in a rack using a rack adapter kit (Order No. see data sheet). The installation instructions are part of the adapter kit.

**NOTICE****Risk of instrument damage in a rack**

An insufficient airflow can cause the instrument to overheat, which may disturb the operation and even cause damage.

Make sure that all fan openings are unobstructed, that the airflow perforations are unimpeded, and that the minimum distance from the wall is 10 cm.

### 2.3.3 Connecting the Instrument to the AC Supply

The R&S SMJ is automatically adapted to the AC voltage supplied. There is no need to set the voltage manually or change fuses. The [AC SUPPLY AND POWER SWITCH](#) is at the rear of the unit.

- ▶ Connect the instrument to the AC power source using the AC power cable delivered with the instrument.

**Note:** The instrument is in compliance with safety class EN61010-1. Connect the instrument only to a socket with earthing contact.

### 2.3.4 Starting the Instrument

The R&S SMJ comes with or without a power switch, depending on the design of the otherwise technically equivalent power supply unit.



#### Switching off the AC power

You can leave the AC power on permanently to preserve your last instrument settings. Switching off is required only if the instrument must be completely disconnected from all power supplies.

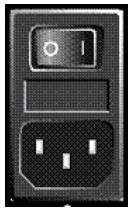

#### Starting up instruments with power switch

1. [Connect the instrument to the AC supply.](#)
2. To turn the power on, press the main power switch to position I (On).

After power-up, the instrument is in [standby or ready state](#), depending on the state of the ON/STANDBY key at the front panel of the instrument when the instrument was switched off for the last time.

3. In case the instrument is in standby mode, i.e. the yellow LED is on, press the ON/STANDBY key to switch the instrument to ready state.



#### Starting up instruments without power switch

1. [Connect the instrument to the AC supply.](#)

After connection to the AC supply, the instrument is in [standby or ready state](#), depending on the state of the ON/STANDBY key at the front panel of the instrument when the instrument was switched off for the last time.

2. In case the instrument is in standby mode, i.e. the yellow LED is on, press the ON/STANDBY key to switch the instrument to ready state.

#### 2.3.4.1 Standby and Ready state

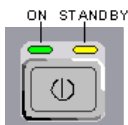

The ON/STANDBY key is located in the bottom left corner of the front panel.

#### Switching between standby and ready state

- ▶ Press the ON/STANDBY key briefly to switch the instrument from the standby to ready state or vice versa.

In ready state, the left, green LED is on. The instrument is ready for operation. All modules are power-supplied and the R&S SMJ initiates its [startup procedure](#).

In standby state, the right, yellow LED is on. The standby power only supplies the power switch circuits and the oven-controlled crystal oscillator to keep it at its operating temperature. In this state it is safe to switch off the AC power and disconnect the instrument from the power supply.

### 2.3.4.2 Start Display and Booting

After power-on, the start display indicates for a few seconds the installed BIOS version and the processor characteristics.

The instrument boots the operating system, starts the instrument firmware and automatically performs a selftest. If the previous session was terminated regularly, the instrument uses the last setup with the relevant instrument settings.

Once the startup procedure has been terminated, the block diagram opened in the previous session is displayed and the instrument is ready for operation.



Use the PRESET key to return the instrument to its definite reset/preset state, if the current setup is not anymore relevant.

To customize the start settings, use the "File" dialog.



#### Rebooting the instrument

Press the STANDBY key for approx. 5 s. to reboot the instrument, if the software stops unexpectedly.

### 2.3.4.3 Function Check

The signal generator automatically monitors the main functions when the instrument is switched on and continuously during operation.

A detected fault is indicated by a "ERROR" message displayed in the info line together with a brief error description. For in-depth identification of the error, press the INFO key. In response, a description of the error(s) is displayed.

For more information, refer to [chapter 9, "Error Messages"](#), on page 747.

Additionally to the automatic monitoring, the R&S SMJ offers the following capabilities to ensure correct functioning:

- **Internal Adjustments**  
Press the SETUP key and select "System > Internal Adjustments" to access the dialog for performing and configuring of the adjustments settings. A maximum level accuracy can be obtained, for instance.
- **Selftest**  
A selftest is provided for service purposes. The selftest is a protected test procedure, which can be accessed if protection level 1 is disabled.

### 2.3.4.4 Default Settings

When the instrument is switched on, it is not the preset state that is active, but rather the instrument state that was set before the instrument was switched off. It is also recommended that you use the PRESET key to return the instrument to its defined preset state every time a new configuration is required or the current setup is not anymore relevant.

The R&S SMJ offers a three-stage preset concept:

- Preset of the settings belonging to a digital standard or associated with one dialog. Most of the dialog boxes provide a special "Set to Default" button that resets directly the settings associated to the corresponding dialog, e.g. all digital modulation settings in the "Custom Digital Mod" dialog. These settings are identical to those which are called up using the PRESET key.
- Preset the instrument to a predefined state  
The PRESET key calls up a defined instrument setup. All parameters and switching states are preset (also those of inactive operating modes). The default instrument settings provide a reproducible initial basis for all other settings. However, functions that concern the integration of the instrument into a measurement setup are not changed, e.g. GPIB bus address or reference oscillator source settings.
- Preset the instrument to its factory settings  
The instrument can also be forced to load its default factory settings. To access the corresponding dialog box, press the SETUP key and select the "Factory Preset". For more information and an overview of the settings affected by the factory preset function, see [chapter 5.2.3.18, "Factory Preset"](#), on page 139.

### Overview of the Most Important Preset States

The following list gives an overview of the presets for the most important generator settings. The other presets can be found in the preset tables of the individual menus and the information accompanying the remote commands.

- "RF frequency" = 1 GHz
- "RF level" RF output switched off
- "Offsets" = 0
- "Modulations State" = Off
- Uninterrupted level settings are switched off  
"Level Attenuator Mode" = AUTO
- Internal level control "Level ALC" = AUTO
- User correction "Level Ucor" = OFF
- "LF output State" = Off
- "Sweep State" = Off
- "List mode State" = Off

Settings that are not affected by the PRESET key

- Reference frequency settings ("Ref Oscillator" menu)
- Power on settings ("Level/EMF" menu)
- Network settings ("Setup" menu)
- GPIB address ("Setup" menu)
- Password and settings protected by passwords ("Setup" menu)
- Start/Stop Gui Update ("Setup" menu)
- Display and keyboard settings ("Setup" menu)



User-defined instrument states can be stored and called up in the "File" dialog.

### 2.3.5 Shutting Down the Instrument

To shut down the R&S SMJ, proceed as described below.

#### **NOTICE**

##### **Risk of losing data**

If you switch off the running instrument using the rear panel switch or by disconnecting the power cord, the instrument loses its current settings. Furthermore, program data may be lost.

Press the ON/STANDBY key first to shut down the application properly.

1. Press the ON/STANDBY key to save the current setup, shut down the operating system and set the instrument to standby state.  
The yellow LED must be on.
2. To turn the power off:
  - a) For instruments with power switch, press the main power switch to position 0 (Off).
  - b) For instruments without power switch, pull the power cable at the rear of the instrument.

##### **Tip:**

Switching off the AC power

You can leave the AC power on permanently to preserve your last instrument settings. Switching off is required only if the instrument must be completely disconnected from all power supplies.

None of the front-panel LEDs should be on.

## 2.4 Connecting External Accessories

The equivalent USB ports on the front and/or rear panel of the R&S SMJ can be used to connect a variety of accessories.

In addition the instrument provides interfaces for monitor connection and network integration (see [chapter 2.4.2, "Connecting a Monitor"](#), on page 39 and [chapter 2.6.1, "Connecting the Instrument to the Network"](#), on page 42).

### 2.4.1 Connecting USB Devices

The USB interfaces on the front and (optionally) rear panels of the R&S SMJ allow you to connect USB devices directly to the instrument. This number can be increased as necessary by using USB hubs. Due to the large number of available USB devices, there is almost no limit to the expansions that are possible with the R&S SMJ.

The following list shows various USB devices that can be useful:

- Memory stick for easy transfer of data to/from a computer (e.g. firmware updates)
- CD-ROM drives for easy installation of firmware applications
- Keyboard or mouse to simplify the entry of data, comments, file names, etc.
- Printer for printing out measurement results
- Power sensors, e.g. of the NRP Zxy family

Installing USB devices is easy under Windows XP, because all USB devices are plug&play. After a device is connected to the USB interface, Windows XP automatically searches for a suitable device driver.

If Windows XP does not find a suitable driver, it will prompt you to specify a directory that contains the driver software. If the driver software is on a CD, connect a USB CD-ROM drive to the instrument before proceeding.

When a USB device is subsequently disconnected from the R&S SMJ, Windows XP immediately detects the change in hardware configuration and deactivates the corresponding driver.

All USB devices can be connected to or disconnected from the instrument during operation.

#### Connecting a memory stick or CD-ROM drive

If installation of a memory stick or CD-ROM drive is successful, Windows XP informs you that the device is ready to use. The device is made available as a new drive ("D:") and is displayed under Windows Explorer. The name of the drive is manufacturer-dependent.

#### Connecting a keyboard

The keyboard is detected automatically when it is connected. The default input language is English – US.

Use the "Start > Control Panel > Keyboard" or the "Regional and Language Options" menu of Windows XP to configure the keyboard properties. To access Windows XP, press the Windows key on the external keyboard.

#### Connecting a mouse

The mouse is detected automatically when it is connected.

Use the "Start > Control Panel > Mouse" menu of Windows XP to configure the mouse properties. To access Windows XP, press the Windows key on the external keyboard.

### Connecting a printer

When printing a file, the instrument checks whether a printer is connected and turned on and whether the appropriate printer driver is installed. If required, printer driver installation is initiated using Windows XP's "Add Printer" wizard. A printer driver needs to be installed only once.

You can load updated and improved driver versions or new drivers from an installation disk, USB memory stick or another external storage medium. If the instrument is integrated in a network, you can also install driver data stored in a network directory. Use the "Add Printer" wizard on the "Start > Settings > Printer and Faxes" menu to install the driver. To access Windows XP, press the Windows key on the external keyboard.

## 2.4.2 Connecting a Monitor

An external monitor with an analog interface can be connected to the MONITOR connector on the rear panel of the instrument. Per default, the external monitor connector is disabled and has to be enabled before operation.



### Connecting external devices

Before connecting any external device such as a monitor, make sure that the instrument is switched off (or in standby mode). Otherwise, correct operation cannot be assured. This does not apply to USB devices.

---

1. **Shut down the instrument.**

None of the front-panel LEDs should be on.

2. Plug in the monitor cable to the MONITOR connector on the rear panel of the instrument.

3. **Start up the instrument.**

The green LED must be on.

The external monitor is detected.

The entire display of the instrument, containing the status bar, the block diagram and the winbar is displayed on the monitor additionally. Further settings are not required.

The MONITOR interface is described in "Appendix A: Hardware Interfaces" in the Operating Manual.

## 2.5 Windows Operating System

The instrument contains the Windows XP operating system which has been configured according to the instrument's features and needs. To ensure that the instrument software functions properly, certain rules must be adhered to concerning the operating system.



**NOTICE****Risk of causing instrument unusability**

The instrument is equipped with the Windows XP operating system. Additional software can therefore be installed on the instrument. The use and installation of additional software may impair instrument function. Thus, run only programs that Rohde & Schwarz has tested for compatibility with the instrument software.

The drivers and programs used on the instrument under Windows XP have been adapted to the instrument. Existing instrument software must always be modified using only update software released by Rohde & Schwarz.

The following program packages have been tested:

- R&S Power Viewer - virtual power meter for displaying results of the Power Sensor R&S NRP-Zxx
- Windows XP Remote Desktop
- Symantec Norton AntiVirus – Virus-protection software

In certain cases, the use of these programs can impair the performance of the instrument.

### 2.5.1 Virus Protection

Users must take appropriate steps to protect their instruments from infection. Beside the use of strong firewall settings and regularly scanning any removable storage device used with a R&S instrument, it is also recommended that anti-virus software be installed on the instrument. While Rohde & Schwarz does NOT recommend running anti-virus software in the background ("on-access" mode) on Windows-based instruments, due to potentially degrading instrument performance, it does recommend running it during non-critical hours.

For details and recommendations, see the R&S White Paper "Malware Protection" available at <http://www.rohde-schwarz.com/appnote/1EF73>.

### 2.5.2 Service Packs and Updates

Microsoft regularly creates security updates and other patches to protect Windows-based operating systems. These are released through the Microsoft Update website and associated update server. Instruments using Windows, especially those that connect to a network, should be updated regularly.

For more details and information on configuring automatic updates see the R&S White Paper "Malware Protection" (available at <http://www.rohde-schwarz.com/appnote/1EF73>).

Changes in the system setup are only required when peripherals like keyboard or a printer are installed or if the network configuration does not comply with the default settings (see [chapter 2.6.1, "Connecting the Instrument to the Network"](#), on page 42). After the R&S

SMJ is started, the operating system boots and the instrument firmware is started automatically.

### 2.5.3 Login

Windows XP requires that users identify themselves by entering a user name and password in a login window. The instrument provides a factory-installed auto login function, i.e. login is carried out automatically in the background. The ID used for autologin has administrator rights so that printer and network installations are possible. The user name and password are set to "instrument".

### 2.5.4 Accessing the Start Menu

The Windows XP "Start" menu provides access to the Windows XP functionality and installed programs. To open the "Start" menu, press the Windows key or the CTRL + ESC key combination on your keyboard.

All necessary system settings can be made in the "Start > Control Panel" menu (for required settings refer to the Windows XP manual and to the hardware description).



#### Accessing Operating System

The operating system can only be accessed if an external keyboard and/or a mouse is connected. Windows XP provides an on-screen keyboard that can be operated using a mouse, thus enabling operation by mouse only. An external keyboard is recommended for extensive entries.

---

#### Energy saving mode

An energy saving mode is a default setting in the instrument. The hard disk switches to power-save mode if it is not accessed for 30 minutes. The energy-saving mode is exited by accessing the hard disk again.

## 2.6 Setting Up a Network (LAN) Connection

The R&S SMJ is equipped with a network interface and can be connected to an Ethernet LAN (local area network). Provided the appropriate rights have been assigned by the network administrator and the Window XP firewall configuration is adapted accordingly, the interface can be used, for example:

- To transfer data between a controller and the tester, e.g. in order to run a remote control program. See chapter "Remote Control"
- To access or control the measurement from a remote computer using the "Remote Desktop" application (or a similar tool)
- To connect external network devices (e.g. printers)
- To transfer data from a remote computer and back, e.g. using network folders

This section describes how to configure the LAN interface. It includes the following topics:

- [chapter 2.6.1, "Connecting the Instrument to the Network"](#), on page 42
- [chapter 2.6.2, "Assigning the IP Address"](#), on page 43



#### LXI

The R&S SMJ complies with LXI Class C. LXI gives you direct access to the LAN settings described below.

---



#### Accessing Operating System

The operating system can only be accessed if an external keyboard and/or a mouse is connected. Windows XP provides an on-screen keyboard that can be operated using a mouse, thus enabling operation by mouse only. An external keyboard is recommended for extensive entries.

---

## 2.6.1 Connecting the Instrument to the Network

There are two methods to establish a LAN connection to the instrument:

- A non-dedicated network (Ethernet) connection from the instrument to an existing network made with an ordinary RJ-45 network cable. The instrument is assigned an IP address and can coexist with a computer and with other hosts on the same network.
- A dedicated network connection (Point-to-point connection) between the instrument and a single computer made with a (crossover) RJ-45 network cable. The computer must be equipped with a network adapter and is directly connected to the instrument. The use of hubs, switches, or gateways is not required, however, data transfer is still performed using the TCP/IP protocol. An IP address has to be assigned to the instrument and the computer, see [chapter 2.6.2, "Assigning the IP Address"](#), on page 43.

The R&S SMJ uses the IP addresses 192.168.xxx.yyy for this purposes, where xxx and yyy may take values between 1...254; the subnet mask is always 255.255.255.0.

---

### NOTICE

#### Risk of network failure

Before connecting the instrument to the network or configuring the network, consult your network administrator. Errors may affect the entire network.

---

- ▶ To establish a non-dedicated network connection, connect a commercial RJ-45 cable to one of the LAN ports.  
To establish a dedicated connection, connect a (crossover) RJ-45 cable between the instrument and a single PC.

If the instrument is connected to the LAN, Windows XP automatically detects the network connection and activates the required drivers.

The network card can be operated with a 10/100/1000 Mbps Ethernet IEEE 802.3u interface.

## 2.6.2 Assigning the IP Address

Depending on the network capacities, the TCP/IP address information for the instrument can be obtained in different ways.

- If the network supports dynamic TCP/IP configuration using the Dynamic Host Configuration Protocol (DHCP), all address information can be assigned automatically.
- If the network does not support DHCP, or if the instrument is set to use alternate TCP/IP configuration, the addresses must be set manually.

By default, the instrument is configured to use dynamic TCP/IP configuration and obtain all address information automatically. This means that it is safe to establish a physical connection to the LAN without any previous instrument configuration.

---

### **NOTICE**

#### **Risk of network errors**

Connection errors can affect the entire network. If your network does not support DHCP, or if you choose to disable dynamic TCP/IP configuration, you must assign valid address information before connecting the instrument to the LAN. Contact your network administrator to obtain a valid IP address.

---

#### **Assigning the IP address manually**

1. Obtain the IP address and subnet mask for the R&S SMJ and the IP address for the local default gateway from your network administrator. If necessary, also obtain the name of your DNS domain and the IP addresses of the DNS and WINS servers on your network. If you use more than one LAN connector, you need separate address information for each connector.
2. Press the "Windows" key to access the operating system.
3. Open the "Control Panel" by selecting "Start > Settings > Control Panel".
4. Select "Network Connections".
5. Right-click "Local Area Connection" and select "Properties" from the context-sensitive menu, or click "Local Area Connection" and then "File > Properties".
6. On the "General" tab, click "Internet Protocol (TCP/IP)" and then select "Properties".
7. Select "Use the following IP address" and enter the address information as obtained from the network administrator.

8. If necessary, you can also select "Use the following DNS server addresses" and enter your own DNS addresses.

For more information refer to the Windows XP Help.

### 2.6.3 Using computer names

Alternatively to the IP address, each PC or instrument connected in a LAN can be accessed via an unambiguous computer name. Each instrument is delivered with an assigned computer name, but this name can be changed.

#### Querying and changing a computer name

1. Press the "Windows" key to access the operating system.
2. Select "Start > My Computer > Properties > Computer Name".  
The computer name is displayed under "Full Computer Name".
3. To change the computer name, select "Change", enter the new computer name and confirm the entry.

### 2.6.4 Changing the Windows Firewall Settings

A firewall protects an instrument by preventing unauthorized users from gaining access to it through a network. Rohde & Schwarz highly recommends the use of the firewall on your instrument. R&S instruments are shipped with the Windows firewall enabled and preconfigured in such a way that all ports and connections for remote control are enabled. For more details on firewall configuration see the R&S White Paper "Malware Protection" (available at [http://www2.rohde-schwarz.com/file\\_13784/1EF73\\_0E.pdf](http://www2.rohde-schwarz.com/file_13784/1EF73_0E.pdf)) and the Windows XP help system.

Note that changing firewall settings requires administrator rights.



To transfer waveform files generated on an external PC using R&S WinIQSIM2, you have to disable the firewall.

---

#### **NOTICE**

##### **Risk of Unauthorized Access**

Disabling the firewall or allowing exceptions may make your instrument more vulnerable to viruses and intruders.

It is recommended that you restore the default firewall configuration after completing a task which requires modified settings.

---

## 2.6.5 Working with Directories

Access to network drives depends on access rights and whether the drives in question have been enabled. The complete integration of the R&S Signal Generator into a larger network with the necessary allocation of rights is highly complex and normally performed by a network administrator.

However, the hard disk of a computer also connected to the network can be accessed from the instrument relatively easily. The only precondition is that the directory on the remote computer that the instrument should access is enabled for remote access. Subsequently, this directory is accessed from the instrument using a Windows XP search function. This procedure is also of importance for a point-to-point connection, for instance in order to start a firmware update for which the files have been stored on the hard disk of the remote computer.



The computer and the instrument must both be provided with a computer name and an IP address (see [chapter 2.6.2, "Assigning the IP Address"](#), on page 43).

---

### Enabling directories on the remote computer



The menu name may deviate from the name specified in the operating sequence, depending on the language and on the operating system used on the computer.

---

1. On the remote computer, in Windows Explorer, click the directory to be enabled.
2. From the context menu, select "Properties".
3. Select the "Sharing" tab and enable "Share this folder".

### Accessing the enabled directory

1. On the instrument, select "Start > Search > For Files and Folders > Printers, Computers > A Computer in the Network".
2. Enter the computer name and press ENTER to start the search.  
The computer and its name appears in the results list.
3. Click the computer's name to display the enabled directory.

**Note:** If a user name and password are requested when you click the computer, the login name and password used on the computer must be entered.

The files in this directory can be accessed by the instrument.

## 2.7 Remote Access via an External Controller

The R&S SMJ can be remote accessed from a remote computer (external controller) via a network link. This allows convenient operation of the instrument from the desktop although the instrument is integrated in a rack somewhere else.



For an overview of the instrument's operating concept and the different ways to control and operate the instrument, see [chapter 3.1, "Brief Introduction to the Instrument's Concept"](#), on page 63.

There are different ways to establish a remote access connection to the signal generator but all of them require an established LAN connection between the instrument and the remote computer. The simplest way to remote access the instrument is to use a Web browser, such as Windows Internet Explorer or Mozilla Firefox for instance. Alternatively a remote access via a special application can be used.

Two free-of-charge programs are available for setting up the remote access connection: the Windows application Remote Desktop for PCs with Window operating system and the program Ultr@VNC for PCs with Linux/Unix or Windows operating system. Using of each of this two applications requires additional installation.

See the following table for an overview of the different ways to establish a remote access connection to the signal generator.

**Table 2-1: Remote access via an external computer**

Remote access via	LAN connection	Installation of the additional application	
		on the instrument	on the remote computer
Web Browser e.g. Windows Internet Explorer or Mozilla Firefox see <a href="#">chapter 2.7.1, "Using a Web Browser for Remote Access"</a> , on page 47	required	no	no
Remote Desktop Windows application for PCs with Window operating system see <a href="#">chapter 2.7.2, "Remote Desktop Connection"</a> , on page 48	required	no	required
Ultr@VNC for PCs with Linux/Unix or Windows operating system see <a href="#">chapter 2.7.3, "Remote Access via Ultr@VNC"</a> , on page 50	required	required	VNC Viewer required

When the connection is set up with Remote Desktop, the device firmware of the signal generator is disabled. Direct control on the instrument is not possible while manual remote-control is active. The access of an external PC is indicated by the logon screen of Windows XP Embedded which identifies the accessing user.

When the connection is set up with Ultr@VNC, direct control on the instrument is possible while remote access is established.

For return to direct operation on the instrument, the connection must be cut. After cutting the connection, it is still enabled and can be established again any time. The connection is disabled only after deactivation of the program.

This section gives an information on how to use the Web browser for remote access, how to install the applications for remote access and how to establish the connection between the instrument and an external computer with Windows operating system. Remote access via an external computer with Linux/Unix operating system is performed accordingly.



### Accessing Operating System

The operating system can only be accessed if an external keyboard and/or a mouse is connected. Windows XP provides an on-screen keyboard that can be operated using a mouse, thus enabling operation by mouse only. An external keyboard is recommended for extensive entries.



### Default password

Remote-access and file access require the user "instrument" with default password "instrument".

## 2.7.1 Using a Web Browser for Remote Access

The instrument can be remote-accessed via any Web browser, like Windows Internet Explorer or Mozilla Firefox for instance.

To remote access the instrument via Web browser:

1. Connect the instrument and the remote computer to a LAN, see [chapter 2.6.1, "Connecting the Instrument to the Network"](#), on page 42.
2. Instal the Java Runtime Environment JRE on the remote computer.
3. Type the instruments' IP address in the address field of the Web browser on your PC, e.g. *http://10.111.11.1*

The "VNC Authentication" screen appears.

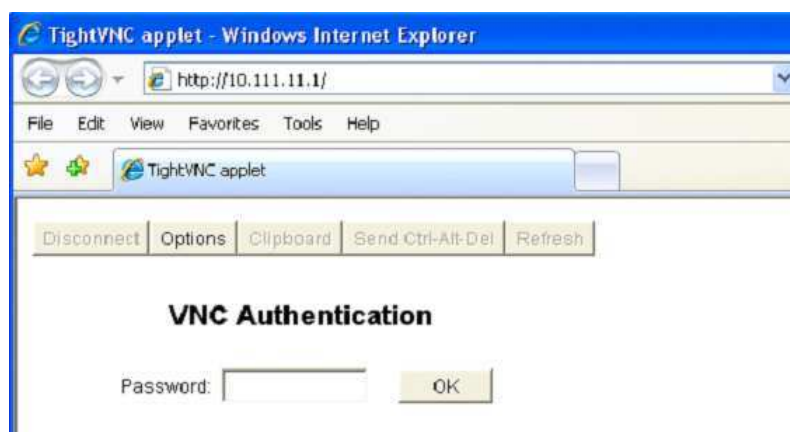

4. Enter the password and select "OK".



The default password is "instrument".

After the connection is established, the current signal generator screen with the block diagram is displayed and the instrument can be remote-accessed from the remote computer.

## 2.7.2 Remote Desktop Connection

Remote Desktop is a Windows application which can be used to access and control the instrument from a remote computer through a LAN connection. While the instrument is in operation, the instrument screen contents are displayed on the remote computer, and Remote Desktop provides access to all of the applications, files, and network resources of the instrument. Thus, remote operation of the instrument is possible.

### NOTICE

#### Risk of Unauthorized Access

If the Windows Remote Desktop application is enabled on the instrument (go to "Start > Settings > Control Panel > System"), any user in the network who knows the computer name and login data can access it. To prevent this, make sure that the Remote Desktop application on the instrument is disabled.

#### To set up a Remote Desktop connection

1. Enable remote desktop control on the instrument.
2. Connect the instrument and the remote computer to a LAN, see [chapter 2.6.1, "Connecting the Instrument to the Network"](#), on page 42.
3. Set up the Remote Desktop connection between the remote computer and the instrument.



#### Remote Desktop Client

With Windows XP, Remote Desktop Client is part of the operating system and can be accessed via "Start > Programs > Accessories > [Communications >] Remote Desktop Connection".

For other versions of Windows, Microsoft offers the Remote Desktop Client as an add-on.

#### Enabling remote desktop control on the instrument

1. Press the "Windows" key to access the operating system.
2. Open the Control Panel by selecting "Start > Settings > Control Panel".
3. Select "System" and switch to the "Remote" tab.
4. Under "Remote Desktop", activate the "Allow users to connect remotely to this computer" option.

**Note:** Remote Desktop access and firewall settings.

When you enable or disable the Windows Remote Desktop option (in the "System Properties"), the associated firewall settings are adapted automatically.

5. If necessary, click "Select Remote Users" and select users who are to be given access to the R&S SMJ via Remote Desktop. The user account under which configuration is carried out is automatically enabled for Remote Desktop.

#### Setting up the Remote Desktop connection on the remote computer

1. On the remote computer, select "Start > Programs > Accessories > [Communications >] Remote Desktop Connection."
2. Enter the instrument's name or IP address in the dialog box (see also [chapter 2.6.2, "Assigning the IP Address"](#), on page 43).
3. Enter the user ID and password for the instrument (see also [chapter 2.5, "Windows Operating System"](#), on page 39).
4. Click "Connect".

When the connection has been set up, the instrument's screen appears on the remote computer.



#### Disabled Direct Control

While remote access is active, the direct control of the instrument is disabled.

Remote access is indicated on the instrument by the logon screen of the operating system. The logon screen identifies the accessing user.

For simultaneous remote access of several instruments from the same PC, a separate Remote Desktop session must be opened for each instrument.

For detailed information about Remote Desktop and the connection refer to the Windows XP Help.

#### Helpful settings for Remote Desktop

The following settings for the Remote Desktop connection can make working on the remote PC more convenient.

1. When setting up the connection to the instrument, you can configure the connection settings in the "Remote Desktop Connection" dialog box. Click the "Options >>" button.  
The dialog box is expanded to display the configuration data.
2. Customize the settings:
  - **On the "Experience" tab:**
    - Select the appropriate connection to optimize the connection speed.
    - To improve the performance, you can deactivate options you do not require under "Allow the following".
  - **On the "Local Resources" tab:**

- If you need to access drives of the remote PC from the instrument (e.g. in order to store settings or to copy files from the PC to the instrument), activate the "Disk drives" option. Windows XP will then map drives of the remote PC to the corresponding network drives. When a connection is established, a warning is displayed on the PC indicating that the drives are enabled for access from the instrument.
- To use printers connected to the remote PC while accessing them from the instrument, activate the "Printers" options. Do not change the remaining settings.
- **On the "Display" tab:**
  - Under "Remote desktop size", set the size of the R&S SMJ window on the desktop of the remote PC.
  - Activate the "Display the connection bar when in full screen mode" option. A bar showing the network address of the instrument is displayed on the screen which you can use to reduce, minimize or close the window.
- **On the "General" tab:**

You can save the connection settings for later use using the "Save As" button.

### Terminating Remote Desktop Control

A Remote Desktop connection can be terminated either on the R&S SMJ or on the remote PC. The connection can be established again any time as long as remote control is enabled on the instrument. Consider the notice above concerning unauthorized access due to Remote Desktop!

1. To terminate the connection on the instrument, click "Disconnect" in the remote-control message menu of the R&S SMJ.
2. To terminate the connection on the remote PC, close the "Remote Desktop" window, or select "Start > Disconnect".

### Disabling Remote Desktop Control

To disable the remote access, deactivate the Remote Desktop on the instrument.

- ▶ Under "Remote Desktop", disable the "Allow users to connect remotely to this computer" option and confirm with "OK".

The connection is disabled, it is no longer possible to access the instrument via Remote Desktop.

## 2.7.3 Remote Access via Ultr@VNC

Ultr@VNC is an application which can be used to access and control the instrument from a remote computer through a LAN connection. The program is included in operating system Linux/Unix. It is available as a free-of-charge download on the internet for operating system Window XP (<http://www.uvnc.com/download/index.html>) and on the instrument's CD-ROM.

**NOTICE****Risk of Unauthorized Access**

If the VNC application is enabled on the instrument, any user in the network who knows the computer name and login data can access it. To prevent this, make sure that the VNC server service on the instrument is disabled.

**Setting up a VNC connection**

1. Connect the instrument and the remote computer to a LAN, see [chapter 2.6.1, "Connecting the Instrument to the Network"](#), on page 42.
2. [Install the Ultr@VNC application](#) and enable it on the instrument.
3. In the ICF firewall, enable communication on the network via Ultr@VNC program. See ["Configuring Internet Connection Firewall for VNC Connection"](#) on page 53.
4. Install the VNC Viewer on the remote computer with Windows operating system, see ["Installing the VNC Viewer on a Windows PC"](#) on page 54.
5. Set up the VNC connection between the instrument and:
  - a) the remote computer with Linux/Unix operating system, see ["Setting up the VNC connection on the Linux/Unix remote computer"](#) on page 55;
  - b) the remote computer with Windows operating system, see ["Setting up the VNC connection on the Windows remote computer"](#) on page 55.

**Enabled Direct Control**

The direct control of the instrument is not disabled and the instrument can be controlled from the front panel and via the remote computer alternately.

**Installing the Ultr@VNC application**

1. Download the program from the internet and copy it to a directory that can be accessed.
2. On the instrument, shut down firmware using the ALT+F4 key combination.
3. Double click on the setup file to start the installation.  
The setup wizard leads through the installation. This description focus only on the relevant settings.

a) Select installation of all components.

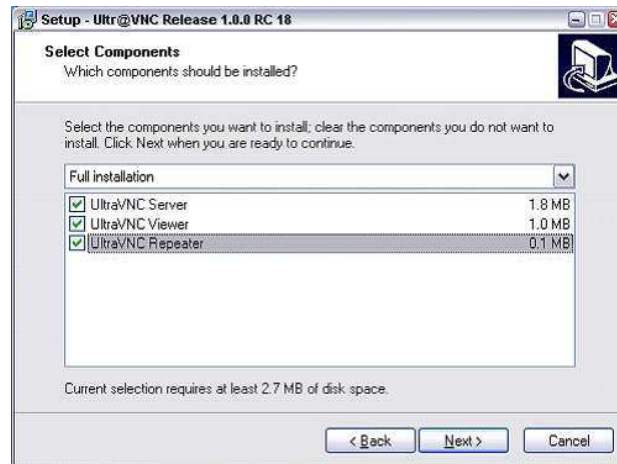

b) In the "Additional Task Panel", enable all entries.

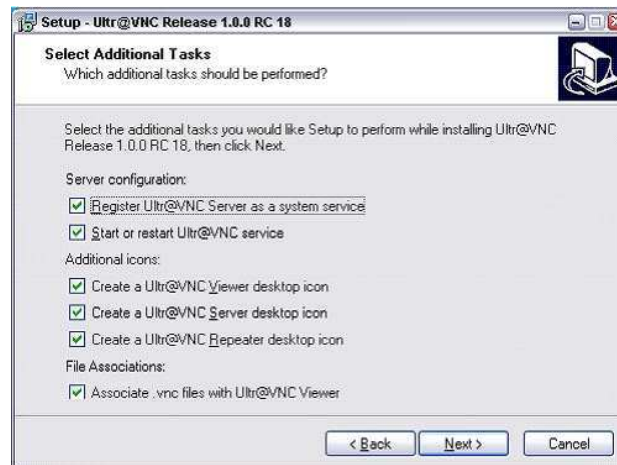

A successful installation is indicated by a message.

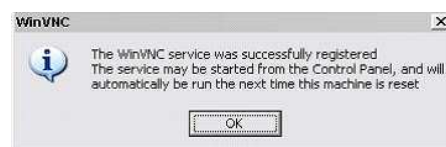

At the same time a warning is displayed stating that a password must be set.



4. Select "OK".

The "Default Local System Properties" panel opens.

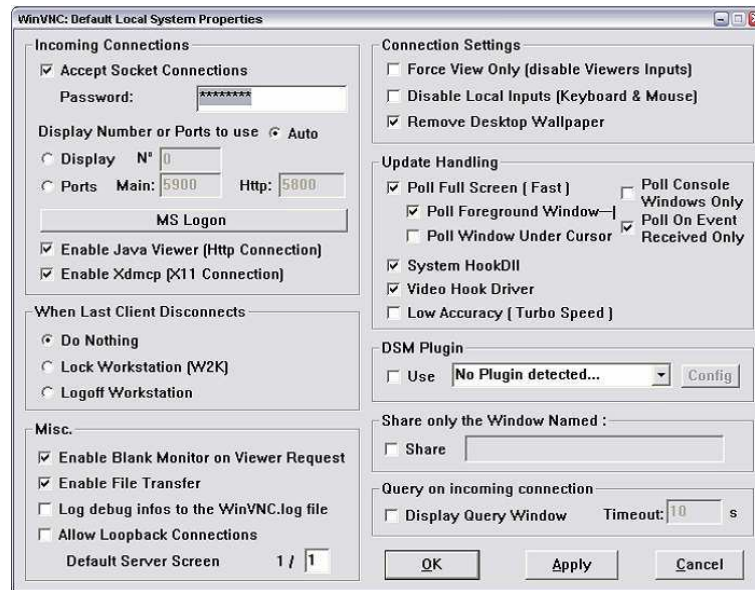

5. Enter a password with a length of at least five digits.

This password is used on the remote computer to access the instrument. Other settings may be changed according to the user-specific security requirements.

After the installation the Ultr@VNC program is automatically started together with the operating system. On mouse over, the IP address of the instrument is indicated. This IP address and the user-defined password are the prerequisites to enable remote access on the remote computer. Terminated connection is indicated by changed icon color.

### Configuring Internet Connection Firewall for VNC Connection

To enable remote access of an instrument in a local network via VNC connection, the connection must be specifically permitted in the firewall.

1. Press the "Windows" key to access the operating system and select "Start > Settings > Control Panel > Windows Firewall" to open the "Windows Firewall".
2. Select "Exceptions > Add Program... > Run Ultr@VNC SERVER" and confirm with "OK".

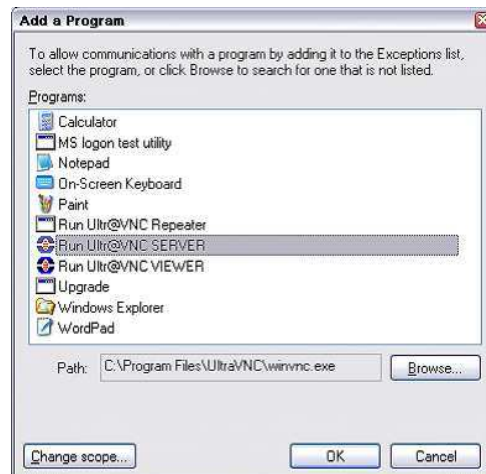

- In the "Exceptions" tab, enable "Run Ultr@VNC SERVER".

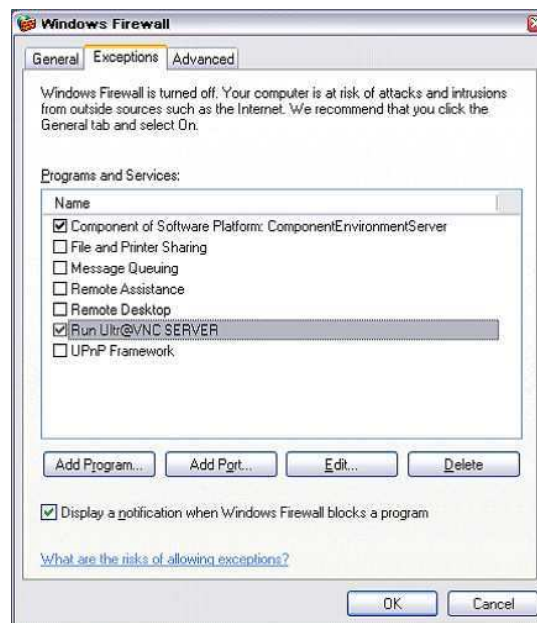

### Installing the VNC Viewer on a Windows PC

- Download the Ultr@VNC program from internet and follow the installation instructions.

Only the program component VNC Viewer is required.

**Note:** The VNC Viewer program is included in the download for the installation of the Ultr@VNC program on the signal generator if "Full installation" was selected in the "Select Component" panel. In this case, the program `ultr@vncviewer.exe` can be copied to the Windows PC.

- Install VNC Viewer program component on the remote computer.

### Setting up the VNC connection on the Linux/Unix remote computer

The VNC program is available per default for Linux/Unix operating systems.

1. Start a Web browser on the remote computer and enter the IP address of the instrument.
2. Enter the following address:  
vnc://<IP-address of the instrument>, e.g. *vnc://192.168.1.1*.  
A dialog is opened and the password for the remote VNC connection is requested.
3. Enter the password as defined in the "Default Local System Properties" panel of the Ultr@VNC program and select "Log On".

The connection is established, the instrument is remote accessed and the current signal generator screen with the block diagram is displayed. The individual functions are operated using the mouse and keyboard.

In contrast to remote access via Remote Desktop, the direct control of the instrument is not disabled and the instrument can be controlled from the front panel and via the remote computer alternately.

### Setting up the VNC connection on the Windows remote computer

1. Start VNC Viewer program component on the PC, select "VNC Server" and enter IP address of the instrument.

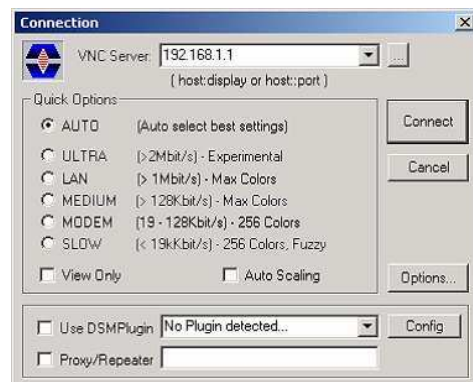

2. To initialize the connection, select "Connect".

A message requesting the password appears.



3. Enter the password as defined in the "Default Local System Properties" panel of the Ultr@VNC program and select "Log On".

The connection is established, the instrument is remote accessed and the current signal generator screen with the block diagram is displayed. The individual functions are operated using the mouse and keyboard.





### Enabled Direct Control

The direct control of the instrument is not disabled and the instrument can be controlled from the front panel and via the remote computer alternately.

### Terminating VNC Connection

The remote access via VNC connection can be terminated either on the R&S SMJ or on the external PC. Terminating the connection does not disable it. It can be established again any time. See the notice above concerning unauthorized access due to VNC connection!

1. Terminate the connection on the R&S SMJ
  - a) Press the "Windows" key to access the operating system.
  - b) Right-click on the VNC icon on the task bar and select "Kill all clients".
2. To terminate the connection on the external Linux/Unix PC, close the internet browser or close the signal generator window.
3. To terminate the connection on the external Windows PC, close the VNC Viewer program.

The connection is terminated. The color of the VNC icon in the status bar of the instrument changes.

A message on the external PC indicates the disconnection.

### Disabling Remote Access via Ultr@VNC

The VNC connection can be disabled by removing the program on the instrument or by deactivating the VNC Server service.

1. Remove the VNC program
  - a) Press the "Windows" key to access the operating system and open the "Add or Remove Programs" by selecting "Start > Settings > Control Panel > Add or Remove Programs".
  - b) Remove the VNC program.
2. Deactivate the VNC Server service
  - a) Press the "Windows" key to access the operating system and open the "Services" by selecting "Start > Settings > Control Panel > Services".
  - b) Deactivate the VNC Server service.

The connection is disabled, the VNC icon disappears from the task bar of the instrument.

## 2.8 Using Virus-Protection Software

Virus-protection software Symantec Antivirus 10.1.7.7000 has been successfully tested for compatibility with the instrument software on R&S Signal Generator.

However, Symantec Antivirus may affect the behaviour of the instrument in terms of settling time or stability. Symantec Antivirus 10.1.7.7000 has been subjected to detailed tests with R&S Signal Generator and a page file of 1024 MB. The system remains very reliable. However, rare impact on the settling time has been experienced (slight degradations of settling time in 2% of samples out of specification).

### Preparing the Installation of Symantec Antivirus

The installation is performed in the Windows XP operating system.



#### Accessing Operating System

The operating system can only be accessed if an external keyboard and/or a mouse is connected. Windows XP provides an on-screen keyboard that can be operated using a mouse, thus enabling operation by mouse only. An external keyboard is recommended for extensive entries.

1. Press the "Windows" key to access the operating system and open the "System" dialog by selecting "Start > Settings > Control Panel > System".
2. In the "System" dialog, select the "Advanced > Performance > Settings > Change".
3. Enable "Drive D: [DATA]" and "System managed size", confirm with "Set" and close the dialog.

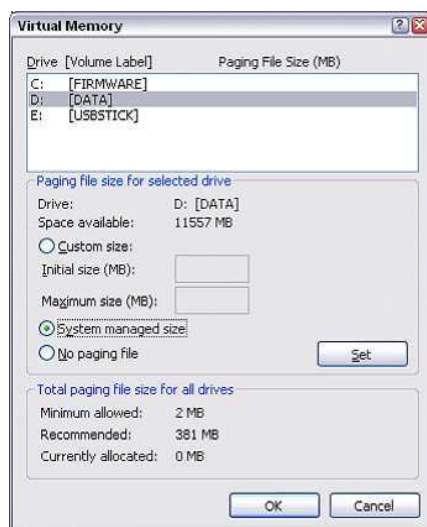

The Symantec Antivirus program can be installed.

## 2.9 LXI Configuration

LAN eXtensions for Instrumentation (LXI) is an instrumentation platform for measuring instruments and test systems that is based on standard Ethernet technology. LXI is intended to be the LAN-based successor to GPIB, combining the advantages of Ethernet with the simplicity and familiarity of GPIB.

Like GPIB, LXI determines and standardizes the way the instrument behaves in a LAN. The LXI implementation by the R&S Signal Generators allows you to change certain LAN settings, to reset the LAN connection as well as to easily identify the instrument.

### LXI classes and LXI functionality

LXI-compliant instruments are divided into three classes, A, B and C, with the functionality of the classes hierarchically based one upon the other:

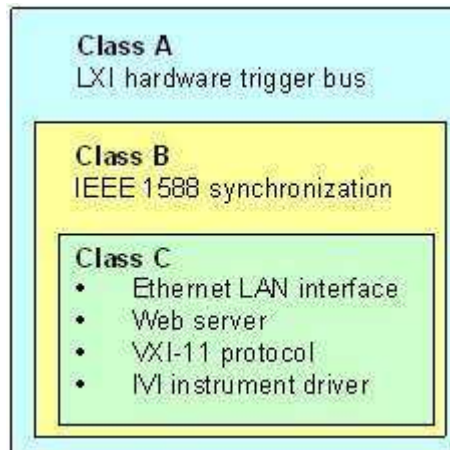

- **Class C** instruments are characterized by a common LAN implementation, including an ICMP ping responder for diagnostics. The instruments can be configured via a web browser; a LAN Configuration Initialize (LCI) mechanism resets the LAN configuration. The LXI class C instruments shall also support automatic detection in a LAN via the VXI-11 discovery protocol and programming by means of IVI drivers.
- **Class B** adds IEEE 1588 Precision Time Protocol (PTP) and peer-to-peer communication to the base class. IEEE 1588 allows all instruments on the same network to automatically synchronize to the most accurate clock available and then provide time stamps or time-based synchronization signals to all instruments with exceptional accuracy.
- **Class A** instruments are additionally equipped with the eight-channel hardware trigger bus (LVDS interface) defined in the LXI standard.



For information about the LXI standard refer to the LXI website at <http://www.lxistandard.org>. See also "News from Rohde & Schwarz, article 2006/II - 190".

Instruments of classes A and B can generate and receive software triggers via LAN messages and communicate with each other without involving the controller.

The R&S SMJ complies with LXI class C and provides an integrated "LXI Status" dialog for LXI status indication and reset of the LAN configuration (LAN Configuration Initialize, LCI). To access the LXI Status dialog, press the SETUP key and select "Remote > LXI Status".

For further information, see section "LXI Status" in the Operating Manual.

**Firmware update**

After a firmware update, shut-down and re-start the instrument in order to enable the full LXI functionality.

**Default state of the network settings**

According to the LXI standard, an LCI must set the following parameters to a default state.

Parameter	Value
TCP/IP Mode	DHCP + Auto IP Address
Dynamic DNS	Enabled
ICMP Ping	Enabled
Password for LAN configuration	LxiWebIfc

The LCI for the R&S SMJ also resets the following parameters:

Parameter	Value
Hostname	<Instrument-specific host name>
Description	Vector Signal Generator
Negotiation	Auto Detect
VXI-11 Discovery	Enabled

The LAN settings are configured using the instrument's "LXI Browser Interface".

**2.9.1 LXI Browser Interface**

The instrument's LXI browser interface works correctly with all W3C compliant browsers. Typing the instrument's host name or IP address in the address field of the browser on your PC, e.g. *http://10.113.10.203*, opens the "Instrument Home Page" (welcome page).



Do not add the missing zeros in the IP address, while opening the Instrument Home Page.

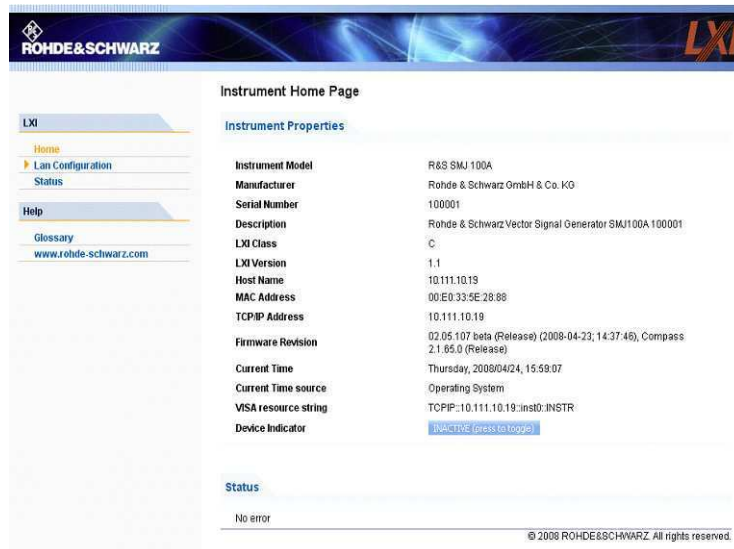

The "Instrument Home Page" displays the device information required by the LXI standard including the VISA resource string in read-only format.

- ▶ Press the "Inactive (press to toggle)" button to indicate the device.



Pressing this button causes a LAN Status indicator on the instrument's home page to flash (if active).

A green LXI status symbol on the instrument's home page indicates that a LAN connection has been established; a red LED indicates that no LAN cable is connected. The status of the LAN connection is also indicated by the "LAN Status indicator" in the "LXI Status" dialogbox.

The "Device Indicator" setting is not password-protected.

For further information, see section "LXI Status" in the Operating Manual.

The navigation pane of the browser interface contains the following control elements:

- "LAN Configuration" opens the LAN Configuration page.
- "LXI Glossary" opens a document with a glossary of terms related to the LXI standard.
- "Status" displays information about the LXI status of the instrument.

## 2.9.2 LAN Configuration

The "LAN Configuration" web page displays all mandatory LAN parameters and allows their modification.

The "TCP/IP Mode" configuration field controls how the IP address for the instrument gets assigned (see also [chapter 2.6.2, "Assigning the IP Address"](#), on page 43). For the manual configuration mode, the static IP address, subnet mask, and default gateway are used to configure the LAN. The automatic configuration mode uses DHCP server or Dynamic Link Local Addressing (Automatic IP) to obtain the instrument IP address.



Changing the LAN configuration is password-protected. The password is *LxiWebIfc* (notice upper and lower case characters). This password cannot be changed in the current firmware version.

The links at the bottom of the "LAN Configuration" page open other pages:

- "Ping Client" provides the ping utility to verify the connection between the instrument and other devices.
- "Advanced LAN Configuration" provides LAN settings that are not declared mandatory by the LXI standard.

### 2.9.2.1 Advanced LAN Configuration

The "Advanced LAN Configuration" menu provides LAN settings that are not declared mandatory by the LXI standard.

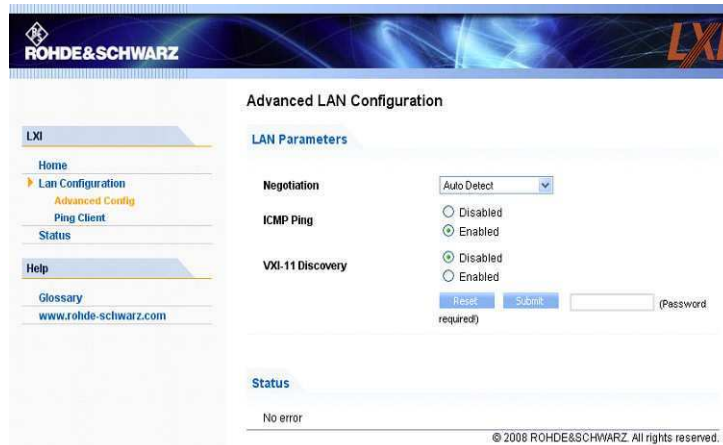

The "Advanced LAN Configuration" parameters are used as follows:

- The "Negotiation" configuration field provides different Ethernet speed and duplex mode settings. In general, the "Auto Detect" mode is sufficient.
- "ICMP Ping" must be enabled to use the ping utility.
- "VXI-11" is the protocol that is used to detect the instrument in the LAN. According to the standard, LXI devices must use VXI-11 to provide a detection mechanism; other additional detection mechanisms are permitted.

### 2.9.2.2 Ping

Ping is a utility that verifies the connection between the LXI-compliant instrument and another device. The ping command uses the ICMP echo request and echo reply packets to determine whether the LAN connection is functional. Ping is useful for diagnosing IP network or router failures. The ping utility is not password-protected.

To initiate a ping between the LXI-compliant instrument and a second connected device:

1. Enable "ICMP Ping" on the "Advanced LAN Configuration" page (enabled after an LCI).
2. Enter the IP address of the second device **without the ping command and without any further parameters** into the "Destination Address" field (e.g. *10.113.10.203*).
3. Click "Submit".



## 3 Getting Started

This section helps you to get familiar with the R&S SMJ and provides an introduction to the general concept of the instrument with a sample of the possible application fields as well as a description of the main blocks in the signal generation flow.

This section also explains the operating concept in general and includes a brief introduction to operation by a step-by-step description of the configuration. The example is intended to provide a quick overview of the settings provided. No additional equipment is required.

### 3.1 Brief Introduction to the Instrument's Concept

The R&S SMJ provides an entirely digital baseband section for generating I/Q signals and an RF section with I/Q modulator. The instrument uses I/Q (vector) modulation. Digital data streams are converted to an I/Q baseband signal. The baseband signal is then D/A-converted and modulated onto the target RF carrier frequency with the aid of an I/Q modulator.

For a detailed description of the blocks in the baseband and RF sections, refer to [chapter 3.3, "Baseband Section"](#), on page 67 and [chapter 3.4, "RF Section"](#), on page 69 respectively.

The **operating concept** of the R&S SMJ employs the following three ways of instrument control:

- Manual operation
- Remote control
- Remote access

#### Manual Operation

The R&S SMJ can be entirely operated from the front panel. Peripherals such as mouse or keyboard can be connected but are not essential.

The R&S SMJ is equipped with an intuitive user interface. The central element of the display is the block diagram that shows the signal flow and processing from the left on the display to most right, i.e. the generated signal can be seen at a glance.

Each block represents a functional unit of the instrument. Thus the user always knows the position at which a parameter has an effect in the signal flow. The main settings of a block are indicated in the block. The interconnection of employed inputs and outputs is also shown. The user is thus always informed about the connection of inputs and outputs in the signal flow and where they can be configured. A window is opened for each menu where parameters can be set. When the window is opened, an entry is made in the "Winbar" below the display. All open menus are of equal priority (not modal) and can be accessed any time.

The block diagram in the figure below shows a fully equipped instrument.



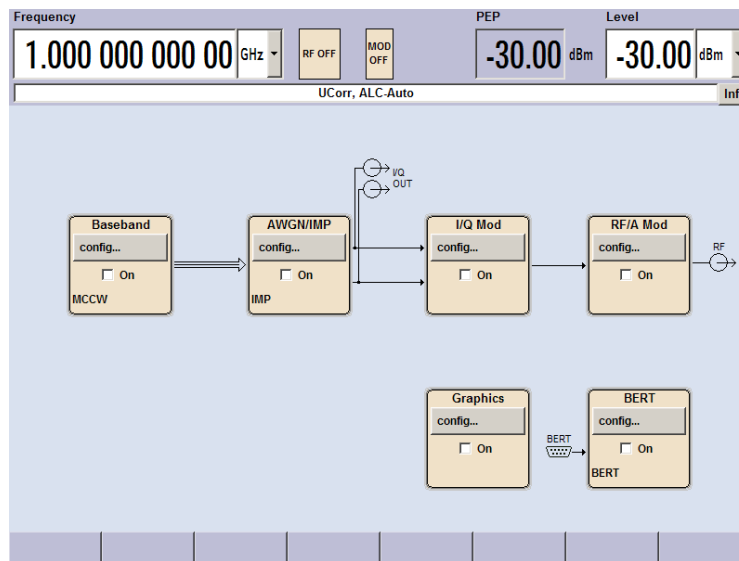

**Fig. 3-1: Block diagram of a fully equipped R&S Signal Generator**

With the aid of the rotary knob, the user can navigate in the block diagram and the dialogs, and can operate the instrument with one hand. The cursor is moved line by line through the block diagram or dialog. Turning the button clockwise advances the cursor. The selected block can be activated or deactivated with the TOGGLE key. Active blocks are highlighted by a colored background.

The instrument comprises a comprehensive info and help system. Context-sensitive help can be called any time with the HELP (F1) key. The help system indicates the currently selected parameter and offers additional services such as cross references, index and contents. The content of the help system corresponds to the operating manual of the instrument.

Warning and conflict messages caused by incorrect operation as well as further information are displayed in the "Info" line. A complete list of existing conflicts is displayed when the INFO (CTRL+I) key is pressed. Additional information on entries can be requested from the help system. The history function permits display of all messages.

Assistants simplify the completion of tables. After data entry in the assistant, the table is modified only after the "Accept" button has been pressed. Pressing the "Accept" button also stores the assistant data.

For an introduction into the manual operating of the instrument, detailed operating instructions and an overview of menus refer to [chapter 4, "Manual Operation"](#), on page 77.

For an in-depth description of the dialog boxes and the instrument functions refer to section [chapter 5.1, "Overview of Instrument Functions"](#), on page 115.

### Remote Control

Remote control is an operation of the instrument by means of remote control commands or programs that automatize repeating settings. The instrument is connected to a computer running the program.

This way of operation and the instructions how to set up a connection for remote control are described in the [chapter 6, "Remote Control Basics"](#), on page 413. The description of the remote control commands is provided in [chapter 7, "Remote Control Commands"](#), on page 453.

### Remote Access

Remote access is the operating of the instrument from a remote computer. Both the R&S SMJ and the computer are connected in a LAN.

**Remote access** in contrast to **remote control** does not use remote-control commands but a separate software which is installed on the remote computer. After its start, the software simulates the user interface of the instrument. The instrument can thus be operated from the remote computer as on the unit itself. The individual functions are operated using the mouse and keyboard. Specific instrument functions can be executed using specific key combinations on the keyboard or a front panel key emulation that can be operated with the mouse.

This way of operation and the instructions how to set up a connection for remote access are described in [chapter 2.7, "Remote Access via an External Controller"](#), on page 45.

## 3.2 Applications of the Instrument

The main field of application of the R&S SMJ is the **generation of digitally modulated signals**. In the instrument, a digitally modulated signal can be generated in several ways. A few examples are given below.

### 3.2.1 Internally generated I/Q signal

The I/Q signal is generated internally in the R&S SMJ. In this case the instrument must be equipped with a baseband generator (option R&S SMJ-B10) and a baseband main module (option R&S SMJ-B13).

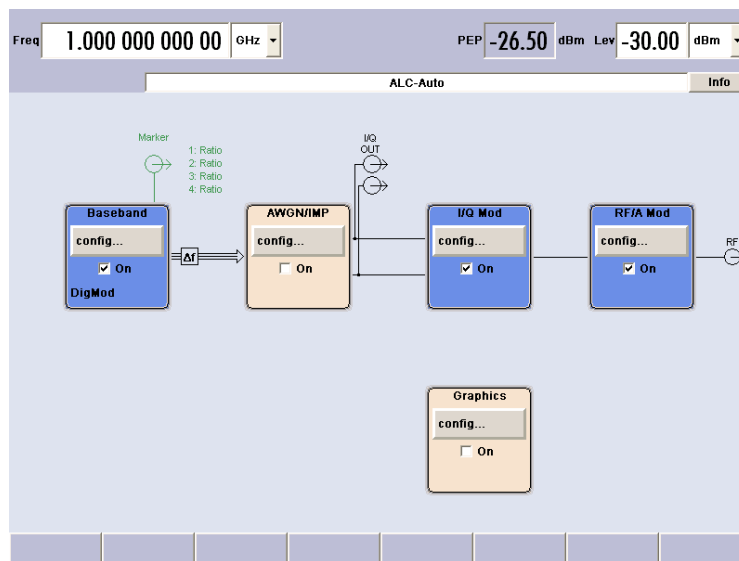

Fig. 3-2: Operation of I/Q modulator with I/Q signals from the internal baseband section

### 3.2.2 Analog Wideband I/Q operation

An external analog I/Q signal is directly applied to the I/Q modulator of the R&S SMJ. In this mode, the entire bandwidth of the I/Q modulator can be utilized. The various capabilities of the baseband section (AWGN, addition of signals, etc) are disabled, however.

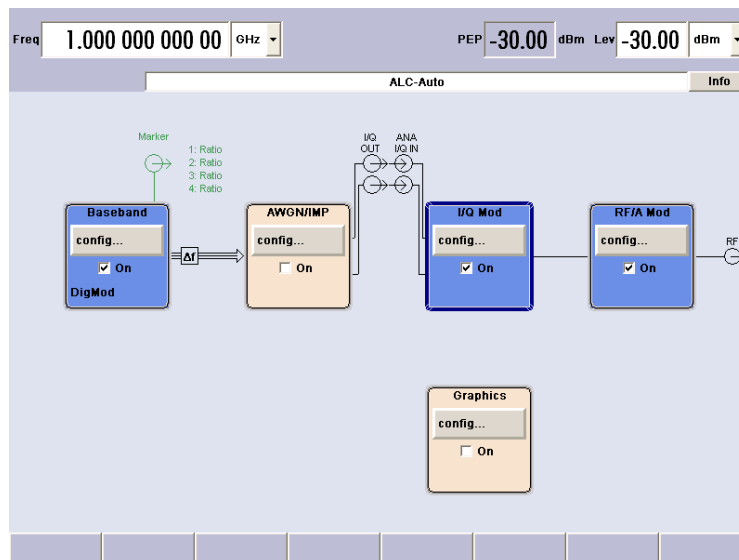

Fig. 3-3: Operation of I/Q modulator with external analog I/Q signals directly applied to the I/Q modulator

### 3.3 Baseband Section

The baseband section of the R&S Signal Generator is fully digital and contains the hardware for generating and processing I/Q signals.

For detailed information on available options, refer to the R&S SMJ data sheet and the R&S SMJ configuration guide.

Up-to-date information is available at R&S SMJ homepage on the internet <http://www2.rohde-schwarz.com/product/smj100a.html>.

#### **Baseband generator (option R&S SMJ-B10)**

The generator produces baseband signals. It contains modules for real time signal generation and an arbitrary waveform generator (ARB).

The different baseband options feature a different ARB memory size (see data sheet). But apart from the memory size, all options have the same functionality and are installed alternatively.

The option Baseband Generator contains real time Custom Digital Modulation and ARB. Software options providing various digital standards are offered in addition. Option R&S SMJ-K40, for instance, generates signals to GSM/EDGE standard, option R&S SMJ-K42 signals to 3GPP FDD standard.

#### **Baseband main module (option R&S SMJ-B13)**

At the end of the baseband path, the digital signal is converted to an analog I/Q signal. The analog I/Q signal is fed to the I/Q modulator of the RF path. This module also routes signals to the analog I/Q outputs. The module is absolutely required for coupling out the baseband signal from the baseband section.

This module also offers digital I/Q impairment functions. The I/Q signal can be deliberately corrupted, e.g. for testing the receiver quality.

#### **Additional White Gaussian Noise (option R&S SMJ-K62)**

Additive white noise, which may be required for instance for measurements on mobile radio base stations, can be produced with the AWGN software option (R&S SMJ-K62).

#### **Digital output module (option R&S SMJ-B18)**

The R&S SMJ can be equipped with a standardized digital I/Q interface (LVDS) for online transfer of digital I/Q data. The digital output module (option R&S SMJ-B18) enables the digital output of the I/Q baseband signal.



The R&S SMJ-B18 option can be used together with the R&S® EX-IQ-BOX digital interface module, providing a versatile digital baseband interface with various formats.

---

### 3.3.1 Description of Individual Diagram Blocks of the Baseband Section



Each function block can be activated or deactivated with the "ON" check box (on/off toggling).

The ON/OFF TOGGLE key at the front panel (see "TOGGLE" on page 22) switches the currently selected block on or off.

A detailed description of the blocks is provided below.



#### Baseband A block

In this block, the (first) baseband source is configured and activated. The block is displayed only if a baseband generator is available in the instrument.

Depending on the installed software options, various digital standards, user-configured digital real time modulation or the built-in waveform generator (ARB) can be selected. The selected modulation is displayed in the block.

The TOGGLE ON/OFF key switches the selected modulation (digital standard, digital modulation or ARB) on or off.



#### AWGN/IMP A block

This block is displayed only if a baseband main module is installed.

In this block (digital) I/Q impairments for the baseband path can be set. With the aid of the software for AWGN generation (option R&S SMJ-K62), an (additive) noise signal can be produced.

AWGN and impairments can be activated independently of each other in the appropriate menus. The settings are displayed in the block. The entire block can be activated or deactivated. If the block is deactivated, the signal passes through the block unchanged.

In addition, the differential I/Q output is configured in this block (option R&S SMJ-B16).

The TOGGLE ON/OFF key switches the active functions of the block on or off. The functions (AWGN, impairments or both) are activated in the respective menus.



#### Graphics block

With this block, the baseband signal can be graphically displayed in real time. The block is displayed only if a baseband main module is installed.

The TOGGLE ON/OFF key opens or closes the graphics window.



#### BERT block

In this block an integrated bit and block error rate tester can be set. The bit error tester makes it possible to evaluate a signal demodulated and decoded by a DUT by measuring the bit error rate. The data used to drive the DUT can be generated by the R&S SMJ or an user-defined external source. In addition, the block error rate measurement can be used to verify CRC checksums.

The TOGGLE ON/OFF key switches the active function(s) of the block on or off. The functions (BERT and BLER) are activated in the respective menus.

## 3.4 RF Section

An RF path is configured by installing a frequency option that comprises all required modules.



One of the following options must be installed.

- R&S SMJ-B103 (up to 3 GHz)
- R&S SMJ-B106 (up to 6 GHz)

For detailed information on available options, refer to the R&S SMJ data sheet and the R&S SMJ Configuration guide.

Up-to-date information is available at R&S SMJ homepage on the internet <http://www2.rohde-schwarz.com/product/smj100a.html>.

### 3.4.1 Description of Individual Diagram Blocks of the RF Section

This section gives an overview of the available blocks and a detailed description of their functions.



#### I/Q Mod A block

The (first) I/Q modulator is configured in this block. Also the Analog Wideband I/Q mode can be selected here, which allows external I/Q signals to be directly applied to the I/Q modulator, i.e. not via the baseband section. If no baseband modules are installed, I/Q modulation is possible only in the Analog Wideband I/Q mode.

I and Q components can also be swapped (I/Q Swap). (Analog) I/Q impairments can be set in addition. Unlike the impairments in the "AWGN/IMP" block, impairments in the "I/Q Mod" block also affect the externally applied signals in the Analog Wideband I/Q mode. The status display in the block shows whether I/Q impairments and/or I/Q swap is active. I/Q modulation is switched on or off with the TOGGLE ON/OFF key.

**Note:** An I/Q modulator provided in the R&S SMJ is automatically activated when a connected baseband source is switched on. The I/Q modulator can also be separately switched on and off (select the "I/Q Mod" block and press the TOGGLE ON/OFF key). This permits the following configuration to be obtained with a single-path R&S SMJ. The baseband source generates an I/Q signal that is output via the analog I/Q output. At the same time, the RF section generates an unmodulated carrier.

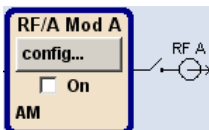

#### RF/A Mod A block

In this block, the RF parameters and the analog modulation modes are set.

The active analog modulation modes are displayed in the block. The TOGGLE ON/OFF key switches the RF signal on and off. When the RF signal is switched off, the switch before the RF output symbol is open.

RF settings include:

- Frequency and reference frequency
- Attenuator settings.

- Frequency and level sweep
- List Mode settings. In this mode, extremely fast frequency and level settings can be made.

**Note:** Numeric values for frequency and level are entered best and quickest with the aid of the FREQ and LEVEL keys.

Available analog modulation modes:

- Amplitude modulation
- Broadband amplitude modulation
- Frequency modulation (option R&S SMJ-B20)
- Phase modulation (option R&S SMJ-B20)
- Pulse modulation.

**Note:** For modulation modes that can be simultaneously used, refer to the R&S SMJ data sheet.

### 3.5 Example of Setup

This section provides an example on how to configure the instrument to generate and display a simple QPSK-modulated signal.

#### Configuring and displaying a QPSK-modulated signal

To generate and display a QPSK-modulated signal, proceed as follow:

1. Activate default (preset) state.  
Press the PRESET key to set a defined instrument state.

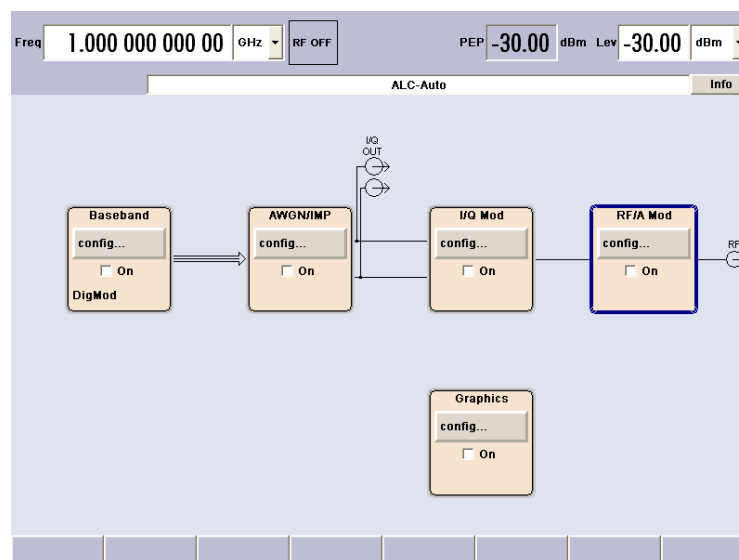

2. Select and activate digital modulation

- a) Turn the rotary knob and select the "Baseband A" block.

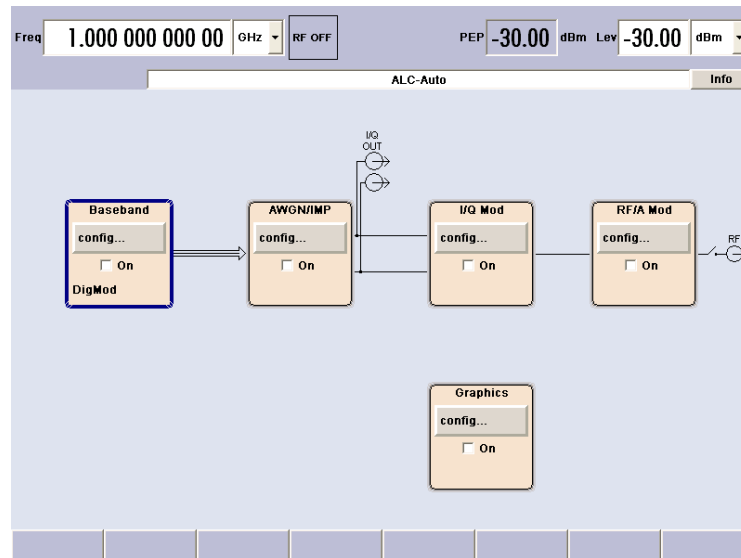

- b) Press the rotary knob to open the menu where the digital modulation can be selected (different modulation modes are available depending on the options installed).

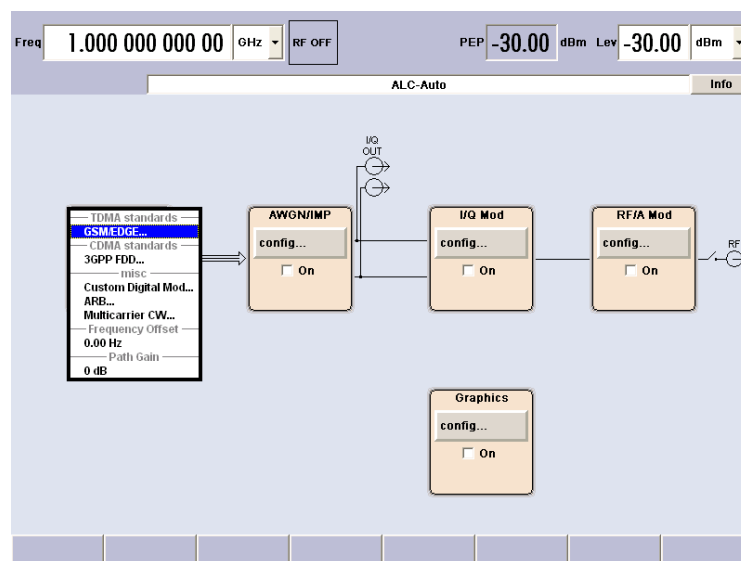



- c) Turn the rotary knob and highlight "Custom Digital Mod...".

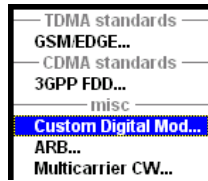

Press the rotary knob to open the "Custom Dig. Mod." dialog.

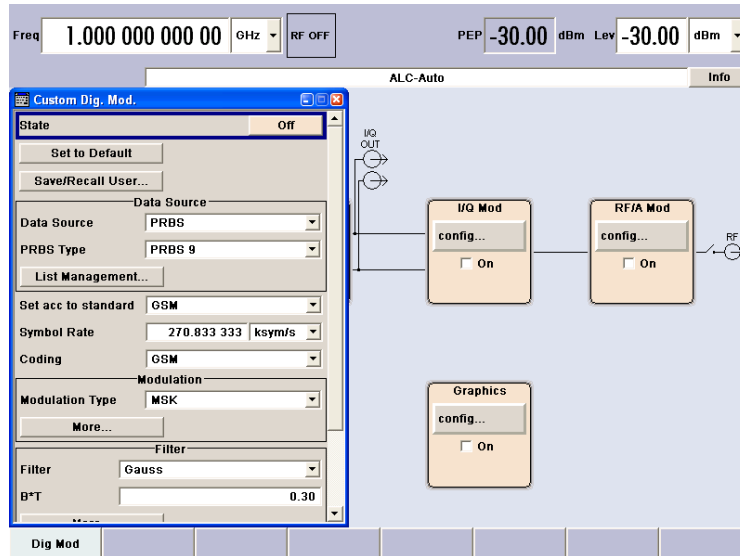

- d) Turn the rotary knob to select parameter "Symbol Rate", press the rotary knob to allow editing and enter the preferred symbol rate with the aid of the numeric keypad and the unit keys.

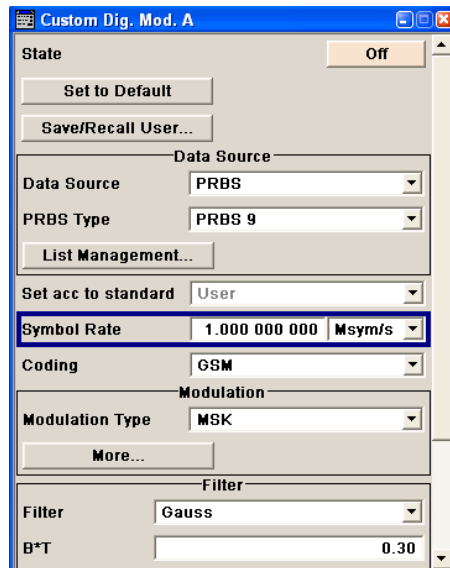

- e) Turn the rotary knob to select parameter "Coding".  
Press the button to open the selection list.  
Turn the rotary knob to select "Off" and press the knob to activate the selected item.

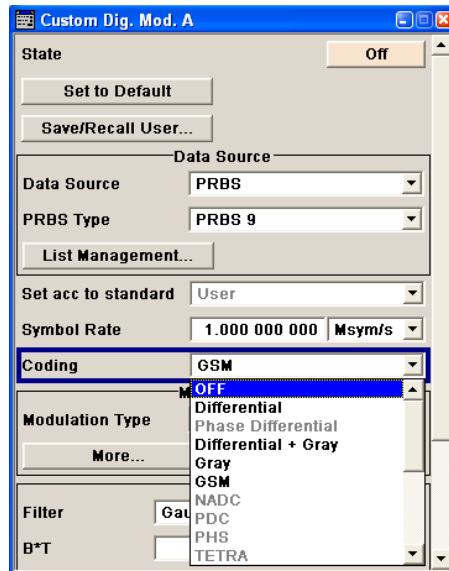

- f) Use the rotary knob in the same way to set "Modulation Type" QPSK and "Filter" Root Cosine with "Roll Off Factor" 0.3.

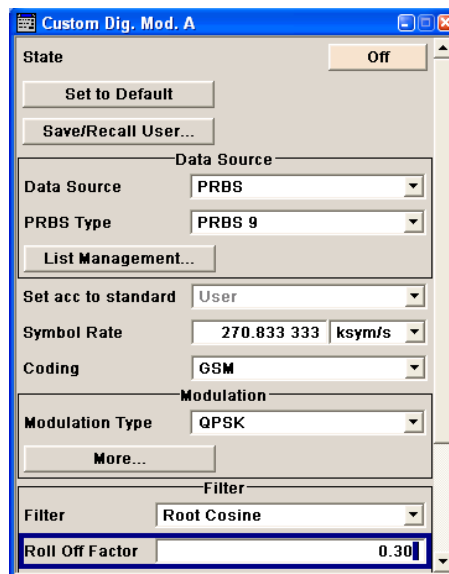

- g) Finally, select "State" and press the rotary knob to switch on the digital modulation.

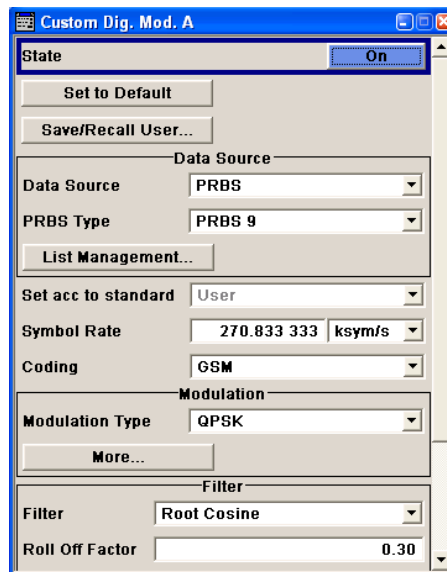

- h) Press the DIAGRAM key to display the complete block diagram.

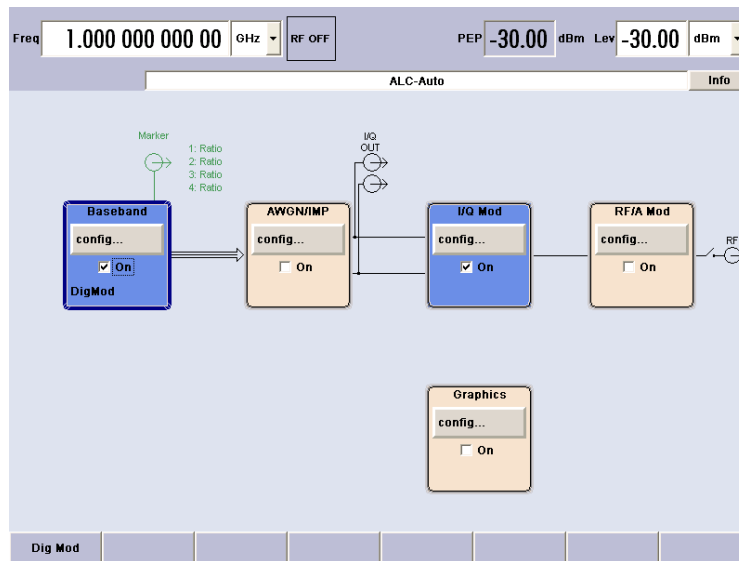

To indicate the active state, the "Baseband" block is displayed in blue.

- i) The entry in the Winbar indicates that the "Custom Dig. Mod." menu is still open in the background.  
To display the menu in the foreground, press the softkey below the button in the "Windbar".

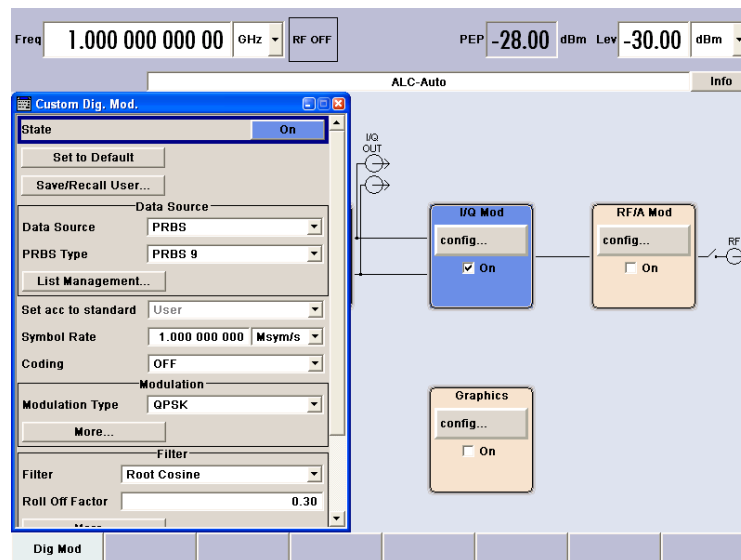

Press the HIDE key to minimize the menu again.

- The "I/Q Mod" block is automatically activated.  
The "RF/A Mod" is not yet active, which means that no RF signal is output.

3. Set frequency and level and activate RF signal
- Press the FREQ key to activate the editing mode for frequency entry. The "Frequency" entry field in the header section of the display is highlighted.



Enter the frequency using the numeric keypad and terminate the entry by pressing a unit key.

- Press the LEVEL key and enter the level settings in the same way.



- Press the DIAGRAM key to display the complete block diagram.
- Turn the rotary knob to select the "RF/A Mod" block.  
Press the TOGGLE ON/OFF key to activate the "RF/A Mod" block.

The QPSK modulation signal is now present at the RF output.

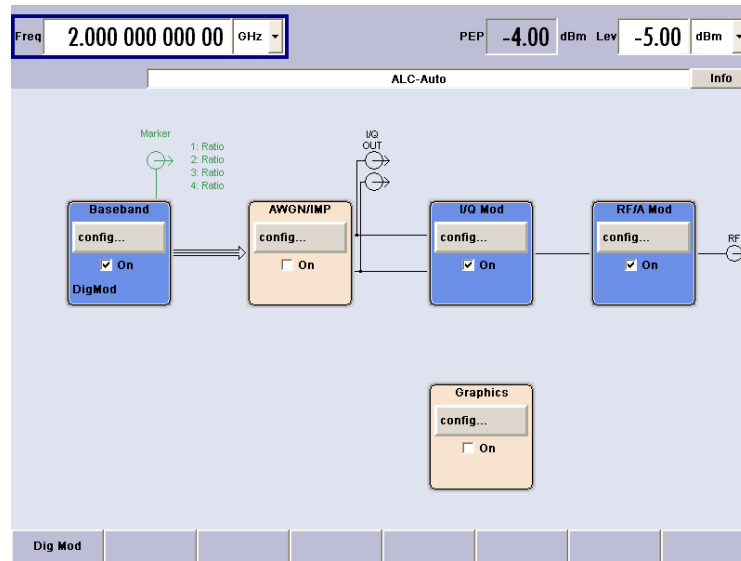

4. Select graphics display of I/Q signal
  - a) Turn the rotary knob to select the "Graphics" block and open the respective menu.

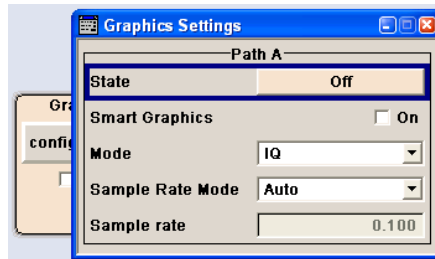

- b) Select "State On" with the rotary knob to activate display of the I/Q diagram.

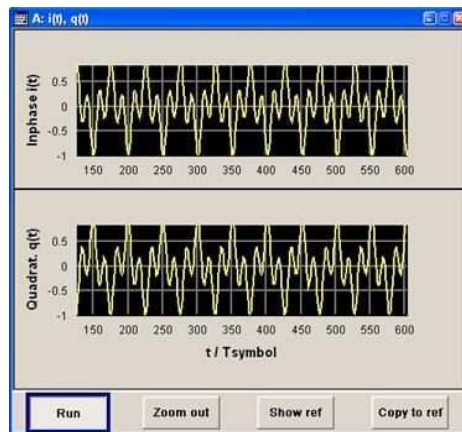

## 4 Manual Operation

The R&S SMJ can be operated intuitively either via the interactive block diagram or via a menu tree. All menus are in the form of windows that can be operated in the same way. Rotary knob, keys and softkeys, or alternatively a mouse, allow direct and therefore convenient access to entries and settings.

The clear-cut display shows the current signal generator state. Graphs, spectra, vector diagrams, etc. can be called for a visual check of the output signal. Numerous help functions support the user in signal configuration.

This section describes the concept of manual operation of the signal generator. This includes a description of the general structure of a dialog box, working with dialog boxes and the block diagram and the setting of parameters.

For an in-depth description of the dialog boxes and the instrument functions refer to section "Instrument Functions".

### 4.1 Key Features

The manual operating concept of the R&S SMJ enables the user to make settings as intuitively as possible and at the same time gives a permanent overview of characteristics of the generated signal and of the current instrument state. Numerous online help functions support user settings.

#### Block diagram

The block diagram is the core of the operating concept.

A graphics display shows the current configuration and the signal flow in the form of a block diagram. All graphical elements can be accessed for operation. An element is selected by means of the arrow keys and the associated setting function is called by pressing Enter. Required menus and graphs are displayed on the block diagram which is displayed again in the foreground whenever the DIAGRAM (CTRL+D) key is pressed.

#### Permanent frequency and level display

The main characteristics of the RF signal, frequency and level, are permanently displayed in the header section of the screen and can be directly set in the display fields after the FREQ (CTRL+F) or LEVEL (CTRL+L) key is pressed. Status messages for the output signal are displayed in addition to frequency and level.



#### Operation via Graphical User Interface

- **Functional blocks**

Menus are assigned to the specific function blocks in the block diagram. The function blocks represent elements of signal generation. Function blocks displayed with a blue frame can be directly switched on and off by means of the TOGGLE ON/OFF (CTRL

+T) key. The menus of the highlighted function blocks can be called by pressing the ENTER key.

– **Example:**

The "Baseband" block contains all menus required for baseband signal configuration.



In this block all digital standards and the digital modulation can be selected.

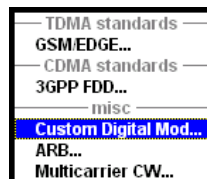

- **Signal flow**

The signal flow between the function blocks and the employed inputs and outputs are also shown.

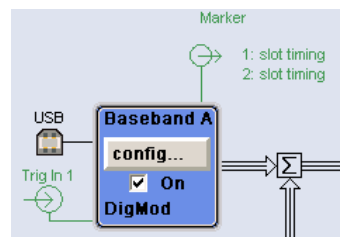

- **Menu tree**

The menu tree can be opened and closed with the MENU (CTRL+M) key. The menu tree is organized in the same way as the directories under Windows. The function blocks correspond to the first directory level, the menus to subdirectories.



### Operation corresponds to the Windows concept

To offer the user a familiar environment, operation is very similar to operation of Windows user interfaces. All menus and tables are made up of known elements, such as selection lists, check boxes and entry fields.

A blue frame indicates that the selected item is active. In the highlighted element, entries can be made.

### Rotary knob



Operation is possible via front-panel keys, an external keyboard and the mouse. However, most of the settings can be easily made with the rotary knob:

- Turning the rotary knob shifts the entry focus to the target element.
- Pressing the rotary knob activates the selected entry field. Depending on the parameter, the submenu is called, the numeric value varied, the list entry selected or the check box activated or deactivated.
- If a value is entered, the entry is stored by another click on the rotary knob and the editing mode is exited.

### Clear settings with the aid of independent subdialogs

A separate window is opened for each dialog and subdialog. The dialogs can be operated independently of each other, i.e. none of the dialogs requires that settings in other dialogs be completed before it can be closed. This ensures flexible operation at all times.

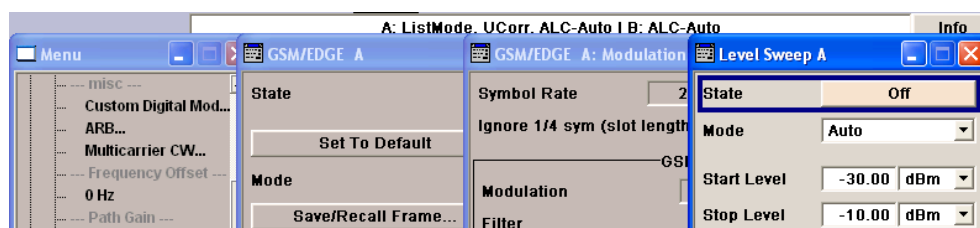

### Winbar

The Winbar gives an overview of menus and simplifies their access.

The menus are displayed on top of the block diagram but they can be "hidden" with the aid of the HIDE (CTRL+H) key, i.e. displayed in the form of a button in the "Winbar" at the lower end of the screen.

They can be displayed again in full size by a keystroke (REARR (CTRL+A) key). This makes room on the screen for other displays that may be required but the setting menus can be still accessed any time.

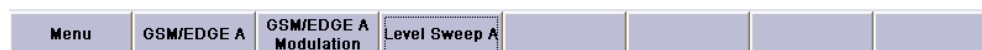

### Keys with assigned simple functions

Most keys on the front panel of the R&S SMJ directly perform a simple function.

Since a great number of settings can thus be made by a keystroke, operation is easy. For instance, the CLOSE (ESC) key closes the active menu; with the RF ON/OFF (CTRL+R) key the RF output signal can be switched on or off.

An exception are keys that call a menu such as the MENU (CTRL+M) key which opens the complete menu tree of the instrument, the SETUP (CTRL+E) key which opens the menus for general instrument settings or the FILE (CTRL+S) key which opens the menu for file management.



**Help functions for user support**

Numerous help functions support the user in signal configuration.

- **Value ranges**

The valid setting range is displayed for each numeric parameter. This requires a short wait after activation of the entry field. The range is then displayed automatically after a few seconds.

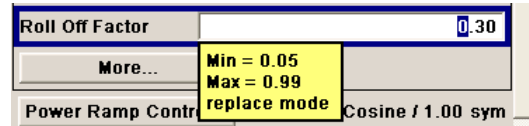

If the entered value is outside the permissible range, the next permissible value is automatically set and a message is output.

- **Context-sensitive help**

Context-sensitive help for each parameter can be called with the HELP or F1 key.

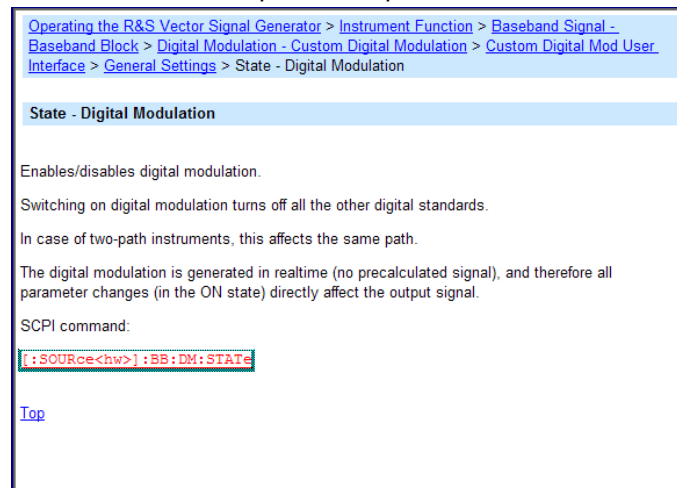

- **Comprehensive online help**

Each help page is part of a comprehensive online help function which can be called by means of an index, a content tree or the "Previous/Next" buttons.

**Info line with messages for indication of the current instrument state**

A great variety of different messages such as status messages, error messages, warnings or information are displayed in the header field of the screen. With the aid of the INFO (CTRL+I) key, help pages can be called for most of the messages. They provide background information on the message and indicate operating steps that may be required. All messages are explained in the online help which can be called with the HELP (F1) key.



**Graphical display of data structure**

The structure of the baseband signal is graphically displayed in the respective menus; the individual signal elements can be graphically selected for processing.

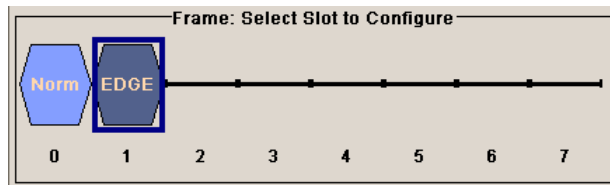

### Graphics editor for definition of control signals

Control signals are also graphically configured.

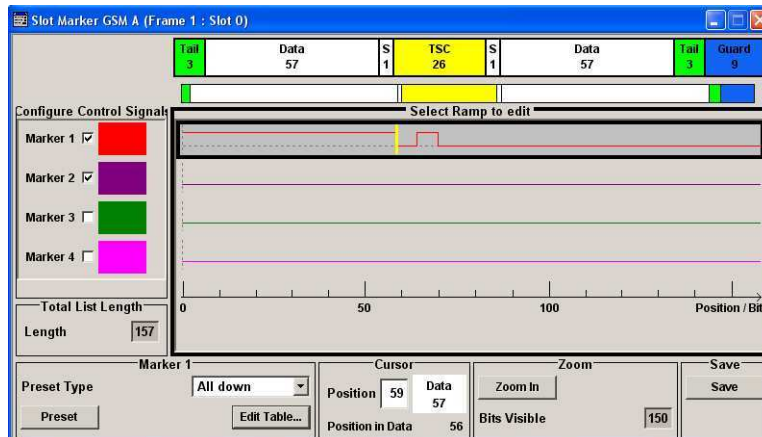

### Graphical display of output signal in a diagram

The output signal can be graphically displayed in a number of diagrams. This allows a fast check of signal characteristics. Zoom functions and the insertion of a reference trace permit in-depth evaluation without an external analyzer being required.

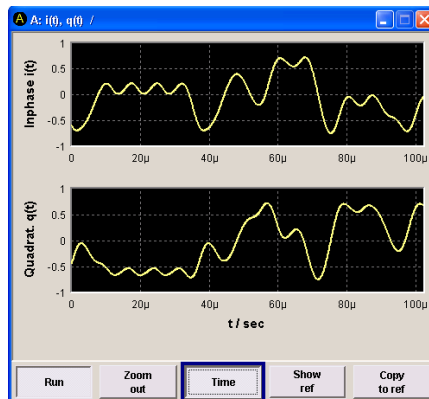

## 4.2 Display

The display shows the current signal generator state and offers graphical elements for direct operation. It is divided into three sections:

- The frequency and level display with info line indicates the main output signal parameters and reports the current state with status, error and warning messages.

- The block diagram shows the instrument configuration, the signal characteristic as well as the inputs and outputs used and permits interactive operation via graphics elements. Active menus and graphs are displayed on top of the block diagram.
- Winbar with labelled softkeys for menu display.

The block diagram in the figure below shows a fully equipped instrument.

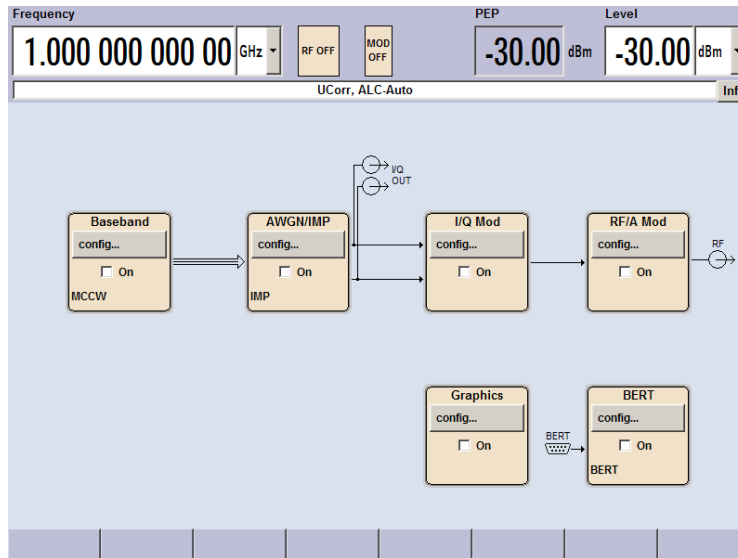

Fig. 4-1: Block diagram of a fully equipped R&S Signal Generator

#### 4.2.1 Settings Displayed in the Header Section

Frequency/level settings and a few status messages (see [chapter 4.2.2, "Status Information and Messages"](#), on page 83) are displayed in the header field of the screen.

The display may vary depending on the instrument's operating mode:

- In the sweep mode, the current frequency or level of the output signal is displayed. The status message "SweepMode" is displayed in the info line.
- In the list mode, neither the current frequency nor level is displayed, the indication is dimmed.
- If user correction is active, the status message "UCorr" is displayed in the info line.
- In the case of digital modulation, "Freq" indicates the frequency, "PEP" the peak envelope power and "Level" the average level.



The value displayed in the "Freq" and "Level" field does not consider any offset set or multiplier factor.

For more information see [chapter 5.5.2, "RF Frequency Settings"](#), on page 185 and [chapter 5.5.7.1, "Overview of RF Level"](#), on page 202.

## 4.2.2 Status Information and Messages

The status information and messages are displayed in the header section of the screen. The messages differ with respect to their importance (errors, warnings, info) and the time of their appearance (brief and permanent messages). They require different treatment by the user. Further information on all messages can be called in the info window (see [chapter 4.2.3, "Info Window"](#), on page 84).

Refer to [chapter 9, "Error Messages"](#), on page 747 for an overview of all status information and messages as well as instructions for error elimination.

### 4.2.2.1 Status Information

The status information gives the user an overview of the main operating states and settings of the instrument. The states are indicated for information only and do not necessitate any action by the user.

Status information is displayed between the frequency and level fields, at the left of the info line or in the info line itself.

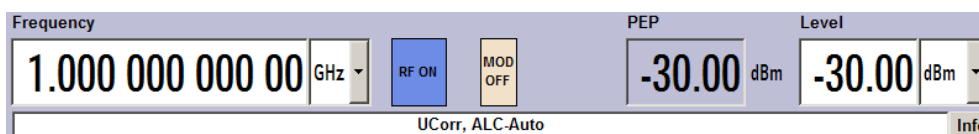

### 4.2.2.2 Messages

Messages indicate errors in the instrument. They are displayed in the info line in different colors depending on their importance and display duration. Errors (e.g. no calibration data) are displayed in red, information (e.g. file not found) and warnings in black. Warnings indicate less significant errors (e.g. the instrument operates outside specified data).

### 4.2.2.3 Volatile messages

Brief messages report automatic settings in the instrument (e.g. switching off of incompatible types of modulation) or on illegal entries that are not accepted by the instrument (e.g. range violations). They are displayed in the info line on a yellow background. They are displayed on top of status information or permanent messages.

Volatile messages do not normally demand user actions and disappear automatically after a brief period of time. They are stored in the history, however.

These messages can be read from remote using `SYST:ERR?` or `SYST:ERR:ALL?`.

### 4.2.2.4 Permanent Messages

Permanent messages are displayed if an error occurs that impairs further instrument operation, e.g. a hardware fault. The error signalled by a permanent message must be eliminated before correct instrument operation can be ensured.

The message is displayed until the error is eliminated. It covers the status display in the info line. After error elimination, the message automatically disappears and is also recorded in the history.

These messages can be read from remote using `SYST:SERR?`.

### 4.2.3 Info Window

A few operating states and the current message are displayed in the info line.

The INFO window with a list of current permanent messages and a detailed description of each message can be opened with the INFO (CTRL+I) key.

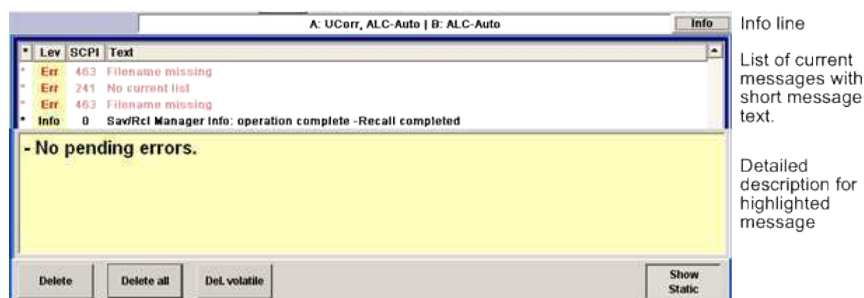

The upper section of the info window contains a list of all current permanent messages in the order of their occurrence, i.e. the most recent message is displayed first. In the lower section of the window, additional information on the highlighted message is displayed. A history of all messages that have occurred since instrument switch-on can be called with the "History" key. The most recent message is displayed first.

The messages are color-coded according to their level. Device-specific messages are red, info and remote control error are black. The level is also indicated in the "Lev" column (Err, Sys or Info). Column "SCPI" indicates the SCPI error code.

With the aid of the softkey buttons, error messages can be cleared and a history of all messages called.

#### Delete

Clears the highlighted message.

This button is available only if the history of the messages is displayed.

#### Delete All

Clears all messages.

This button is available only if the history of the messages is displayed.

#### Del. volatile

Clears all volatile messages.

This button is available only if the history of the messages is displayed.

SCPI command:

[SYSTem:ERRor:ALL](#) on page 732

Each time a `SYST:ERR:ALL?` query is sent, the error queue is returned and at the same time cleared.

### History

Calls the list of all messages that have occurred since instrument switch-on. The most recent messages are displayed at the top of the list. When the button is pressed again, the list of current messages is displayed.

SCPI command:

[SYSTem:ERRor\[:NEXT\]](#) on page 734 or [STATus:QUEue\[:NEXT\]](#) on page 729

Each time a `SYST:ERR?` or `STAT:QUE?` query is sent, the oldest entry in the error queue is returned and at the same time cleared in the list.

## 4.2.4 Block Diagram

The block diagram shows provided options, signal configuration and the currently selected signal flow of the generator with inputs and outputs used. Signal generation can be completely operated from the block diagram. The highlighted function block can be directly switched on and off with the TOGGLE ON/OFF (CTRL+T) key. Pressing the Enter opens the associated setting menu.

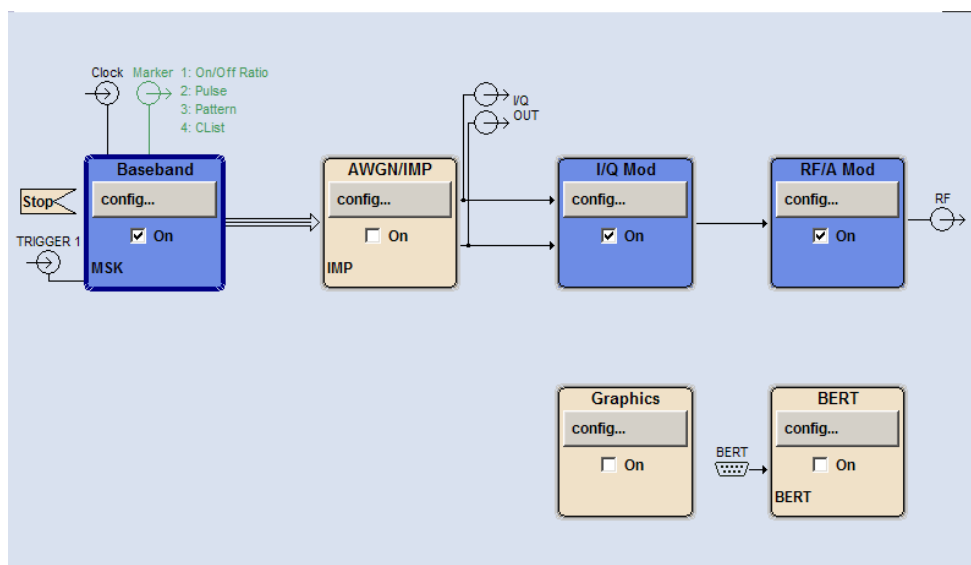

### 4.2.4.1 Function Blocks in the Block Diagram

Each block represents a function of signal generation. The function is indicated in the headline of the block. In the check box, the respective function can be quickly activated/deactivated with the TOGGLE ON/OFF (CTRL+T) key. After activation, the block is displayed in blue. Status information is displayed below the check box. It is different for the different blocks.

Pressing the rotary knob (front panel) or the "Config..." button (mouse) opens the associated setting menu.

In all function blocks where the signal flow can be influenced, the top menu level for setting signal routing parameters is offered.

#### Example: Baseband block

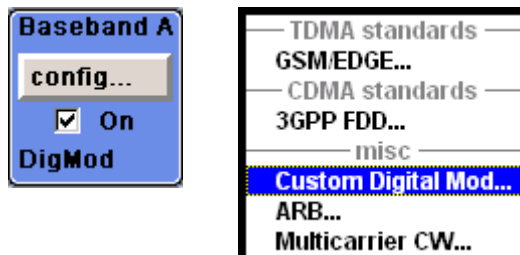

In this block, the digital modulation signal, the digital standards, arbitrary waveform generation and multicarrier CW are set. The status information of the "Baseband" block indicates the selected modulation and associated additional information, e.g. the number of channels.

#### 4.2.4.2 Signal Flow and Input/Output Symbols in the Block Diagram

The input/output symbols in the block diagram show the currently used inputs and outputs of the signal generator. Unused inputs and outputs are not shown. The lines indicate the signal flow.

Symbols and labels refer to the corresponding inputs and outputs on the front and rear panel of the signal generator. The direction - input or output - is indicated by an arrow.

#### Example:

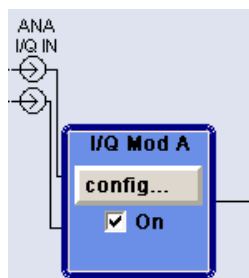

The symbols indicate the inputs for the analog I and Q signal.

If several markers are active, the marker characteristics are listed next to the marker symbol of the active markers.

Symbols and lines are displayed in different colors depending on their function.

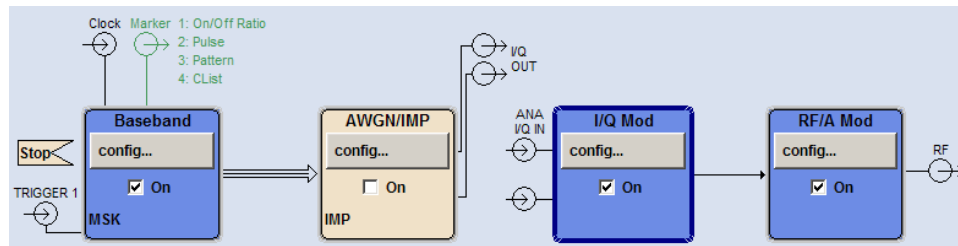

- The baseband signal is indicated by a three line arrow, the I- and Q-components of the signal by a single-line arrow.
- Connections are indicated by a "solder point".
- Black is used for the generated signal.
- Green is used for control signals.

The signal flow is configured in the individual menus. User interfaces are configured in:

- the "Setup > USER Marker /AUX I/O Settings" dialog and
- the "Setup > Global Trigger/Clock/External Inputs" dialog.

#### 4.2.5 Winbar and Softkeys

The "Winbar" with eight buttons is displayed below the block diagram. Labelled buttons represent open menus, the label indicates the menu. If several menus are open, the button of the currently active menu is displayed in a lighter colour. The buttons also assign functions to the softkeys of the next lower level for front-panel operation. Up to eight menus may be open simultaneously. When the ninth menu is opened, the menu that was opened first is automatically closed.



Some menus, e.g. data and list editor menus, cover the "Winbar" and assign menu-specific functions to the front-panel softkeys by way of the menu buttons.

Any of the open menus can be activated either with the respective button in the "Winbar" or the front-panel softkey. In combination with the keys for menu operation (CLOSE (ESC), HIDE (CTRL+H) and REARR (CTRL+A)), convenient menu operation can be ensured.

Working with menus and dialog boxes is described in [chapter 4.3, "Accessing Dialogs"](#), on page 89.

#### 4.2.6 Structure of the Dialogs

The parameters are set in the menus. Menus are accessed either via the function blocks in the diagram or by means of the MENU (CTRL+M) key. The menus are displayed on top of the block diagram.

If the menu buttons assign menu-specific functions to the softkeys, the "Winbar" is hidden.



Working with menus and dialog boxes is described in [chapter 4.3, "Accessing Dialogs"](#), on page 89; the setting of parameters in [chapter 4.4, "Setting Parameters"](#), on page 90.

The menus are in Windows format. The menus differ in details depending on their function but they consist of the same main elements. Each menu consists of a menu header and one or more menu areas with various fields for setting parameters.

The header line contains the name of the menu and the buttons for minimizing and closing the menu. To operate the buttons, use the mouse or the front keys HIDE (CTRL+H) and CLOSE (ESC).

Several fields of associated but separately set parameters are organized in menu areas. A menu area is framed and labelled with the function common to all parameters.

#### Example: Impairments

Impairments	
State	<input type="checkbox"/>
I Leakage	0.00 %
Q Leakage	0.00 %
Imbalance	0.00 %
Quadrature Offset	0.00 deg

Each of the setting fields is assigned a parameter name. The kind of setting varies depending on the parameter to be set. Some settings can only be made in a specific configuration. If setting is not permitted with the specific configuration selected, the respective item is disabled and displayed in gray and the entry or selection field cannot be accessed.

### 4.2.7 Graphical Display of Output Signal Characteristics

The graphical display of the output signal enables the user to rapidly check signal characteristics without connecting an analyzer. Zoom functions and the display of a reference trace allow in-depth evaluation. The diagram is displayed on top of the block diagram. It can be minimized and called in the same way as a menu.

#### Example: I/Q diagram

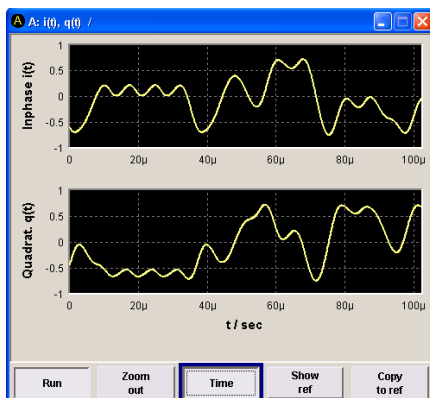

To access the "Graphics Settings" dialog for selecting the graphics display of the output signal, select the "Graphics" function block in the diagram or press the MENU (CTRL+M) key.

Operation of the graphics windows is analogous to menu operation.

The menu and the individual graphical displays are described in [chapter 5.3, "Graphical Display - Graphics"](#), on page 152.

## 4.3 Accessing Dialogs

The MENU (CTRL+M) key opens the complete menu tree. Selecting a functional block and pressing the ENTER key opens the menu associated with this block.

An alternative way to access a dialog is to use the Winbar buttons or front-panel softkeys or to use the HIDE (CTRL+H), CLOSE (ESC), DIAGRAM (CTRL+D) and REARR (CTRL+A) keys on the front panel.

For a quick access to the dialogs, use one of the following alternative methods.

### Displaying the block diagram or a dialog in the foreground

1. Press the DIAGRAM (CTRL+D) key to move the cursor to the block diagram.  
All active menus are minimized and displayed in the form of Winbar buttons.
2. Press the associated softkey (CTRL+F1 .. F8) to display the dialog in the foreground again.

### Accessing the menu tree

- ▶ Press the MENU (CTRL+M) key to open the complete menu tree.

### Calling the File, Setup or Hardcopy dialogs

- ▶ Use the FILE (CTRL+S), SETUP (CTRL+E) or HCOPI (CTRL+Y) keys to open the respective dialog.

### Minimizing an active menu

- ▶ Use the HIDE (CTRL+H) key to minimize an active menu.  
It is displayed in the form of a Winbar button.

### Automatically arranging displayed menus

- ▶ Press the REARR (CTRL+A) key to rearrange all open menus so that they overlap as little as possible.

**Activating the Windbar**

- ▶ Use the WINBAR (CTRL+W) key to toggle the cursor between a button of the "Winbar" and the block diagram.

The button that was active last in the Winbar is highlighted.

**Closing an active menu**

- ▶ Press the CLOSE key to close an active menu.

**Tip:** If the cursor is at the highest menu level, you can also use the ESC key to close the active menu.

**Accessing the header area**

- ▶ Press the FREQ (CTRL+F) and LEVEL (CTRL+L) keys to activate the "Frequency" or "Level" entry fields in the header area.

**Keyboard Shortcuts**

Keyboard shortcuts (e.g. "Ctrl + D" for the displaying the block diagram in the foreground) provide direct access to all utility dialogs of the instrument (see [chapter 4.8, "Legend of Front-Panel Controls"](#), on page 112).

---

## 4.4 Setting Parameters

The R&S SMJ offers several and sometimes alternative possibilities for setting parameters. Operation is possible from the front panel, with the aid of a mouse and/or from a PC keyboard.



The examples within this description focus on the operation from the front panel.

---



For more information, refer to:

- [chapter 4.8, "Legend of Front-Panel Controls"](#), on page 112 for an overview of key functions and a cross-reference between the front panel keys and the keyboard shortcuts
  - section "Instrument Functions" for a detailed description of key functions.
- 

Most of the parameters are set in the different menus. The R&S SMJ provides alternative ways for accessing the dialogs. Turn the rotary knob and navigate to the corresponding block in the block diagram and press the knob to open the dialog or perform a mouse click on the "Config..." button.

An exception are the "Setup", "File" and "Hcopy" dialogs. In the "Setup" dialog, general settings are made which are not directly concerned with signal generation, e.g. setting of the GPIB-bus address. In the "File" dialog, files and lists are managed; in the "Hcopy"

dialog, printout is configured and hardcopies can be made. These menus can only be called with the SETUP (CTRL+E), FILE (CTRL+S) and HCOPI (CTRL+Y) keys.

Frequency and level are directly set in the header area of the display using the FREQ and LEVEL keys.

Specific settings can also be made directly in the block diagram, e.g. activating a function block by means of the TOGGLE ON/OFF (CTRL+T) key or switching the RF output on and off with the aid of the RF ON/OFF (CTRL+R) key. Changes affecting the signal flow are immediately visible in the graphics display.

The R&S SMJ uses the Windows XP® operating system. Settings at system level are only rarely required, e.g. installation of a new printer driver. For convenient operation of Windows XP®, a keyboard and a mouse are required.

This section provides an information about the parameter handling that comprises of the following main steps:

- [chapter 4.4.1, "Working with the Cursor"](#), on page 91
- [chapter 4.4.2, "Selecting a Control Element"](#), on page 92
- [chapter 4.4.3, "Switching Parameters On/Off"](#), on page 92
- [chapter 4.4.4, "Entering a Value"](#), on page 92
- [chapter 4.4.5, "Working with Units "](#), on page 94
- [chapter 4.4.6, "Selecting a Value from a List"](#), on page 95
- [chapter 4.4.7, "Terminating Entries with Confirmation"](#), on page 95
- [chapter 4.4.8, "Restoring the Previous Value"](#), on page 96

#### 4.4.1 Working with the Cursor

After the instrument is switched on, the cursor is always on the first function block of the diagram (default setting).

##### Moving the cursor on the display

► To move the cursor, use one of the following alternative methods:

- a) Use the rotary knob or the arrow keys.
- b) Use the appropriate softkeys (CTRL+F1..F8) to move the cursor to the "Winbar".  
If the "Winbar" is covered by a menu, press the WINBAR (CTRL+W) key to display it in the foreground.
- c) Use the ESC key.

**Tip:** Be aware that the function of the ESC key depends on the current cursor position. The function of this key depends on the current cursor position.

- Calls the next higher selection level.
- Closes the open window without accepting new entries; the old value or parameter is retained.
- In dialog boxes that contain a "Cancel" button it activates that button.
- Closes all kinds of dialog boxes, if the edit mode is not active.
- Quits the edit mode, if the edit mode is active.

- Switches between different entry fields of a menu.
- Shifts the entry cursor from the header display to the previously active menu, or to the previously highlighted block in the block diagram if no menu is active.
- Shifts the cursor from a function block in the diagram to the first item in the "Winbar". If no menus are open, the current cursor position remains unchanged.

#### Moving the cursor to the heading area

- ▶ Press the **FREQ** (CTRL+F) or **LEVEL** (CTRL+L) key to move the cursor to the header area.

### 4.4.2 Selecting a Control Element

Control elements are always selected in the same way no matter whether a function block in the diagram, a menu in the menu tree, a parameter in the menu or an entry in a list or table is concerned.

- ▶ To activate an element, put the cursor on it.



An active element is highlighted by a blue frame.

### 4.4.3 Switching Parameters On/Off

A parameter can be activated and deactivated using a button or a check box.

1. Select the parameter.
2. To change the state of a parameter, use the "Enter" function of the different control media:
  - Press the rotary knob
  - Press ENTER
  - Press the **TOGGLE ON OFF** (CTRL+T) key.

Colour and label of a button change, the check box is ticked or the tick is removed.

### 4.4.4 Entering a Value

Numeric and alphanumeric values can be edited in the entry fields. In the editing mode, cursors of different colour are used. A blue cursor indicates the overwrite mode, a green cursor the insert mode.



#### Changing between the Insert and Overwrite mode

The insert mode is the default setting.

Use the **INSERT** key to toggle between the insert and overwrite mode.

Numeric and alphanumeric values can either be newly entered or the existing value can be changed. Incorrect entries are cleared with the BACKSPACE key.

### Entering a new numerical value

1. Select the parameter.
2. Press a numeric key to activate the editing mode.  
The previous value is cleared and the new value can be entered.

### Editing a value in the insert mode (default setting)

1. Press the rotary knob (= Enter) to activate the editing mode.  
If the cursor is placed at the right of the total value, the insert mode is always active.
2. Set the cursor to the left of the number to be changed using the LEFT/RIGHT arrow keys.  
The cursor is displayed in green.
3. Click on a numeric key to insert a new value.



### Editing a value in the overwrite mode

1. Activate the editing mode.
2. Set the cursor on the numeric digit to be changed using the LEFT/RIGHT arrow keys.  
The cursor is displayed in blue and the number to be replaced is highlighted.
3. Click on a numeric key to overwrite the highlighted value.



### Varying a value

1. Activate the editing mode.
2. Set the cursor to the left of the number to be changed using the LEFT/RIGHT arrow keys.  
The value at the cursor position is varied.
3. To vary the selected value, use the UP/DOWN arrow key or turn the rotary knob.  
The value is increased or decreased.

### Entering a new alphanumeric value

1. Select the parameter.
2. Press an alphanumeric key to start the editing mode.  
The new value is entered.

### Editing an alphanumerical value

An existing value, e.g. a file name, can be changed in the insert mode (see example) or in the overwrite mode.

1. Select the parameter and activate the editing mode.
2. Set the cursor to the left of the alphanumerical value using the LEFT/RIGHT arrow keys.

**Tip:** If hexadecimal values are to be entered, the numeric front-panel keys are automatically changed to hexadecimal values.

3. Click on an alphanumeric key to insert a new alphanumerical value.



### Terminating the entry of a numeric value

To terminate the entry of a numeric value:

1. Press the rotary knob (= Enter).
2. Press a UNIT key on the front panel.
3. Select a "Unit" in the selection field next to the parameter value.

## 4.4.5 Working with Units

The unit of a parameter is displayed next to the value. When the parameter is edited, the unit is selected either from the list or by means of the front-panel keys. When the entry is completed, the unit can be changed. In this case the value remains unchanged but is automatically adapted to the new unit.



While operating the instrument by means of a mouse, assign the unit to the selected parameter before entering its value.

### Assigning a unit

To assign a unit to a value, use one of the following alternatives:

1. Press a UNIT key on the front panel.



2. Select a "Unit" in the selection field next to the parameter value.  
Press the ENTER key.

The unit displayed in the entry field next to the value is assigned.

### Changing a unit

To subsequently change a unit, i.e. after the entry has been terminated and when the editing mode is not active, use one of the following alternatives:

1. Press a UNIT key on the front panel.
2. Select "Unit" in the selection field next to the parameter value.

The value remains unchanged but the display is automatically adapted to the new unit, i.e. the value is recalculated to suit the new unit.

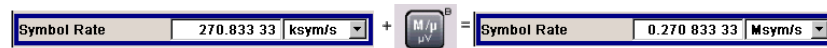

The new unit is indicated in the value field of the menu.

### 4.4.6 Selecting a Value from a List

Selection lists provide a list of predefined values for the selected parameter.

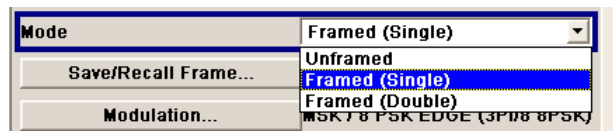

To select a item from a list, proceed as follow:

1. Press ENTER key to open the list.
2. Use one of the following alternatives to navigate through the list:
  - a) Turn the rotary knob or use the UP/DOWN arrow keys.  
The selected item is highlighted.
  - b) Press TOGGLE ON/OFF key several times until the preferred entry is displayed in the selection field.
3. To confirm the selection, press the ENTER key.

### 4.4.7 Terminating Entries with Confirmation

The instrument behaves different by the termination of entries depending on the parameter type and the way this parameter is set.

#### Confirming settings

- ▶ To confirm the settings, press the rotary knob or one of the UNIT keys (see also [chapter 4.4.5, "Working with Units"](#), on page 94).

**Note:** Variations by means of the rotary knob are immediately set.



### Confirming multiple values

In some cases, like for instance when configuring the carriers for a multicarrier CW signal in a carrier table, it is useful first to enter few values and to confirm them together. Such settings require additional confirmation. Not yet confirmed settings are displayed on a yellow background as an indication that the currently displayed values do not represent the target signal.

- ▶ To confirm these settings, select the "Accept" button.

### Confirming parameters with On/Off state

Most of the instrument functions with enabled and disabled states are calculated and effective only after this functions have been enabled. However, there are functions like the frequency variation of the reference oscillator for instance, that are immediately set after confirmation.

- ▶ To confirm a parameter with On/Off state, enable the parameter.

If time-consuming calculations are required, signal generation is automatically switched off and calculation is interrupted to allow the user to make further settings. Calculation is restarted with the RECALCULATE key and the modulation is switched on again when the calculation is completed.



### Preventing recalculation

If an instrument function requires several parameter settings, switch the function off to prevent a recalculation.

Enable the function after the entire configuration of the settings have been completed. The signal is recalculated only once.

## 4.4.8 Restoring the Previous Value

Parameter variations with the rotary knob are immediately set and therefore not reversible.

Normally, values cannot be restored in the case of mouse control because no explicit confirmation is required in this case and entries are automatically confirmed when the entry or selection field is exited.

### Restoring values

In the case of front-panel control or operation from the keyboard, previous values can be restored as long as the new value is not confirmed, i.e. the entry is not completed.

- ▶ To restore the values, press the ESC key.

### Restoring values that require confirmation

All settings that are not confirmed with the "Accept" button but require this additional confirmation can be restored.

1. Press the ESC key.

A confirmation query is displayed.

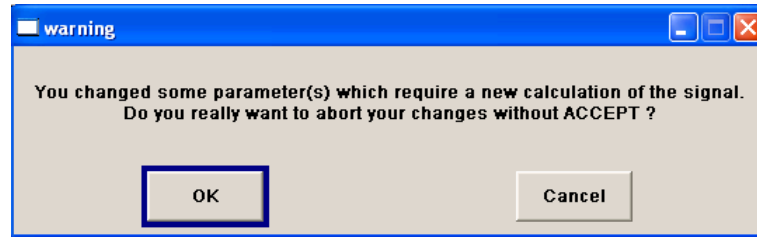

2. Confirm with "OK" to abort the changes.  
Select "Cancel" to return to the dialog. The previous selected settings are displayed.

### Restoring values after an extended calculation has been started

Calculation and setting might require different period of time. Many settings are made without noticeable calculation times; such operations are indicated by a "BUSY" message displayed in the status field of the header section.

A window with a progress indicates that the instrument performs an extended calculation that requires longer calculation time. The termination of such a calculation restores the previous values.

- ▶ Press the ABORT button to terminate the calculation.  
All previous values are restored.

## 4.5 Editors

The R&S SMJ provides user-friendly editors for defining data lists as well as control and marker signals. Lists containing frequency and level value pairs are used for the list mode and the user-defined level correction.

Internally generated data lists can be used for digital modulation and digital standards; the same applies to internally defined control and marker signals.

The lists are saved to files and may thus have any length. The file name of the lists and the directory to which the files are saved are user-selectable. The file prefix is different for each list type and is permanently assigned by the system.

For information about file handling and overview of the automatically assigned file prefixes, refer to [chapter 4.7, "File Management"](#), on page 106.

### 4.5.1 Working with List Editor

The "User Correction" and "List Mode" dialogs provide a list editor for defining the frequency/level value pairs.

### Editing list mode data lists

1. To access a list editor and open an existing data list for editing, use the cursor keys to select the associated button "Edit User Correction Data..." or "Edit List Mode Data..." (if available) in the individual menu.

The selected list is displayed and the cursor marks the first row of the "Frequency/Hz" column.

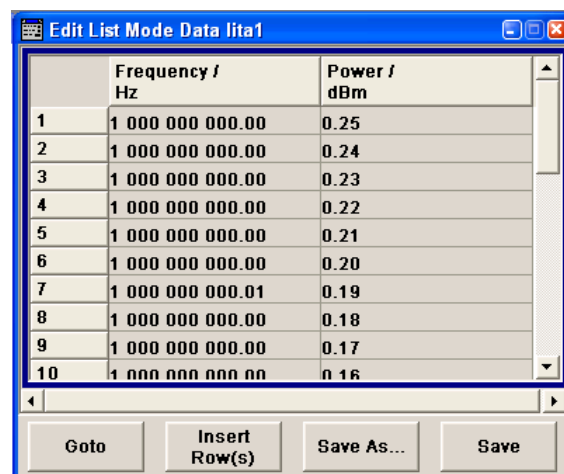

	Frequency / Hz	Power / dBm
1	1 000 000 000.00	0.25
2	1 000 000 000.00	0.24
3	1 000 000 000.00	0.23
4	1 000 000 000.00	0.22
5	1 000 000 000.00	0.21
6	1 000 000 000.00	0.20
7	1 000 000 000.01	0.19
8	1 000 000 000.00	0.18
9	1 000 000 000.00	0.17
10	1 000 000 000.00	0.16

If no list has been selected, a blank list of only one row is displayed.

2. Press the LEFT/RIGHT arrow keys to change between the columns.  
Use the UP/DOWN arrow keys to mark a row.
3. Use the numeric keys to enter the value for the value pairs in the "Frequency/Hz" and "Power/dBm" table columns. A blank row is inserted at the end of the list.  
An existing list can be edited in the insert or overwrite mode; use the INSERT key to toggle between this two modes.  
Terminate the entry by pressing a UNIT key.
4. To select a row, select the "GoTo" button and press the ENTER key.  
Use the numeric keys to enter the row index in the entry field and press the ENTER key to confirm the entry.  
The cursor moves to the selected row.
5. To insert a new row in the table, select the row above which the new row is to be inserted and select "Insert Row(s)".  
A row is inserted above the currently marked row.  
If no row has been selected, a row is inserted at the beginning of the list.
6. Use the "Save"/"Save As..." function to save the edited list under its current name or under a new name.  
Enter the file name in the "File Select" dialog and select the directory (see [chapter 4.7.1, "File Select Dialog"](#), on page 107).  
Only complete value pairs are taken into consideration; rows containing an entry in only one column are ignored.

### Creating a new list mode data list

A new list can be created under a new name either by generating a blank file in the "File Select" menu (see section [chapter 4.7, "File Management"](#), on page 106) or by changing an existing list which will then be saved under a new name.

1. To create an empty data list, select "RF > List Mode > List Mode Data... > New List" or respectively "RF > User Correction > User Cor. Data... > New User Correction Data" and enter the file name of the new data list.
2. To open the data list for editing, select the associated button "Edit User Correction Data..." or "Edit List Mode Data..." in the individual menu. Edit the list and save it under a new name.

## 4.5.2 Working with Data Editor

The "Data Editor" is used to internally generate binary data lists for digital modulation and digital standards.

A list of binary values with a maximum length of  $2^{31}$  bits can be entered in the "Data Editor". This value corresponds to a file size of approx. 268 Mbyte. While it is being processed, the file is continuously automatically buffered. When the dialog is exited, the file is automatically saved with the new values, i.e. there is no extra "Save" button. Depending on the size of the file, saving may take some time.

### Editing an existing data list

1. To **access** a data editor and open an existing data list for editing, use the arrow keys to select the associated button "Edit Data List... " in the individual menu.

The selected data list is displayed.

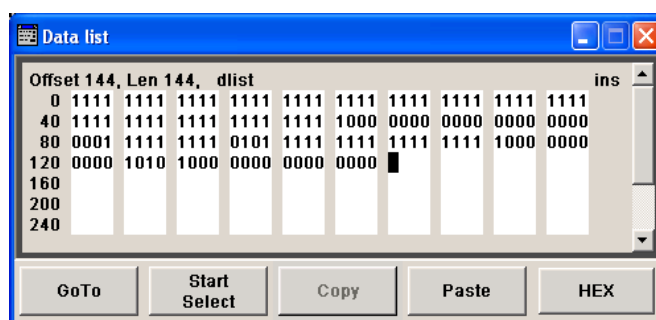

The cursor marks the start value of the list.

To increase readability, the bits are displayed in groups of four. The current cursor position, the length of the list and the list file name are displayed above the list. The offset starts with the value 0 which corresponds to the bit position on the left side of the first row, i.e. the beginning of the list. On the left edge of the editor, the last three offset positions are specified at the beginning of the row.

2. Use the numeric keys to enter the values 0 or 1. An existing list can be edited in the insert or overwrite mode. Use the INSERT key to toggle between these two modes.

3. To **delete** a value, use the arrow keys to mark the bit that follows the value to be deleted.  
Press the INSERT key to activate the insert mode. Values cannot be deleted in the overwrite mode.  
Press the BACKSPACE key.  
The value before the marked bit is deleted.
4. To **select a bit position**, select the "GoTo" button and press the ENTER key.  
Enter the bit position in the "GoTo Offset" entry field by means of the numeric keys and confirm the entry.  
The cursor marks the bit at the selected position.
5. To **copy and paste** any range of bits at any position in the list:
  - a) Use the the arrow keys to mark the start bit of the selection.
  - b) Select the "Start Select" button and use the the arrow keys to mark the selection.
  - c) Click the "Copy" button.
  - d) Navigate to the insert position and select "Paste".
 The selected and copied bits are pasted after the selected position.
6. To **display and edit** the values in hexadecimal form, select the "Hex" button.  
Each four bits are displayed as a hexadecimal value: To increase readability, the hexadecimal values in turn are displayed in pairs of two. The hex functions are automatically assigned to the numeric keys at the front panel.
7. To **save** the data list, press the ESC key.  
The list is saved automatically when the dialog is closed.

#### Creating a new data list

1. To create an empty data list, in the individual menu select "List Management > Select Data List to Edit... > Create Data List" and enter the file name of the new data list.
2. To open the data list for editing, select the associated button "Edit Data List..." in the individual menu.

### 4.5.3 Working with Control and Marker List Editor

The control and marker signals for digital modulation and digital standards can be very conveniently graphically defined in a "Control and Marker List Editor". The available marker signals – and, with custom digital modulation, the CW, Hop, Burst Gate and Lev Att control signals – can be defined in this editor.

While it is being processed, the file is continuously automatically buffered. Depending on the size of the file, saving may take some time.



The various functions of the editor are explained in the individual menus. This section focuses to the general use of the graphic editor.

**Example:**

The following figure shows the "Slot Marker Definition Editor" of the "GSM/EDGE" dialog as an example.

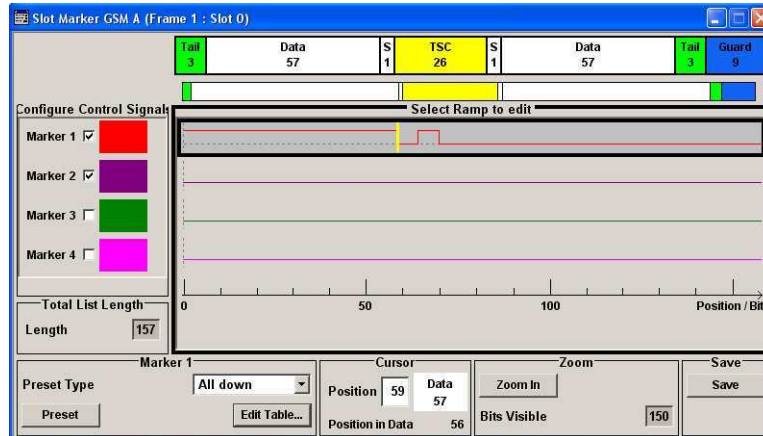

The upper area displays the signal for which the marker signals are to be defined. On the left side, the available signals (marker and control signals) are listed and colour-coded.

Auxiliary functions are offered in the lower editor area, e.g. presetting for the ramps in the marker signal, cursor positioning by entering the bit position and possible editing by means of value entries in a table.

The actual graphic definition of the control signals occurs in the center area of the editor. Each control signal is represented by means of a colored line along the bit axis. A cursor can be shifted alongside this line and marks the position where a ramp is to be set. The color of the cursor changes depending on the current function.

Use the ENTER key to switch over between the colors (and therefore functions):

- black: marks the bit position on the marker line
- yellow: sets a ramp
- green: activates the marked ramp for shifting.

**Accessing control and marker list**

1. To access the control list editor (e.g. "CList Dig Mod") and open an existing list for editing, use the arrow keys to select "Custom Digital Mod > List Management > Edit Control List".

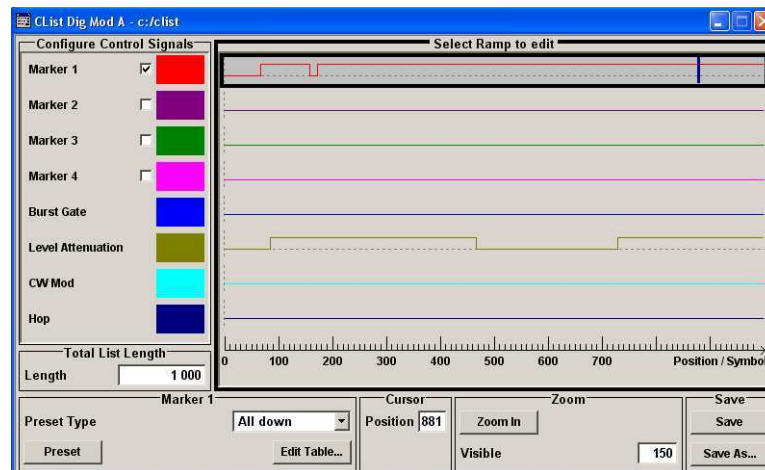

- To access the slot marker list editor (e.g. "Slot Marker") and open an existing list for editing, use the arrow keys to select "GSM/EDGE > Burst Editor > Slot Marker Definition".

#### Editing an existing control or marker list

- Activate control/marker signal line for editing.  
Use the arrow keys to mark the editable graphic area and press the ENTER key.  
Select the control/marker signal line to be edit and press the ENTER key.  
The cursor is active for the selected line.
- Define the cursor position.  
Select the parameter "Cursor Position", specify the position by means of the numeric keys and confirm the entry.  
The cursor is positioned according to the entry. If the entered value exceeds the selected length of the definition range, the length is adjusted automatically.
- Configure the control and marker signals (see "[Handling of Ramps](#)" on page 103).
- Define length of control list ("Custom Dig Mod" only).  
Select the "Total List Length" entry field and press the ENTER key. Enter the length by means of the numeric keys and confirm the entry.  
The control list length is defined.
- Zoom displayed range ("Custom Dig Mod" only) in long control lists.  
To zoom the displayed area around the current "Cursor Position", select the parameter "Visible/Bits Visible", enter the number of symbols/bits to be displayed by means of the numeric keys and confirm the entry.  
Select the "Zoom In" button and press the ENTER key.  
The selected number of symbols/bits around the current cursor position are displayed.  
Ramps outside the displayed area are not lost by zooming.
- Use the "Save"/"Save As..." function to save the edited control/marker list under its current name or under a new name.

Enter the file name in the "Create File" dialog and select the directory (see [chapter 4.7.1, "File Select Dialog"](#), on page 107).

### Handling of Ramps

#### 1. Set a new ramp

Use the arrow keys or use the parameter "Cursor Position" to move the cursor to the position where the ramp is to be inserted. Press the ENTER key.

The ramp transition of the newly set ramp depends on the current status (high or low) of the control signal. If the signal is low, a ramp with low-high transition is generated; if the signal is high, a ramp with high-low transition is generated.



When ramps are set between existing ramps, the transition of the new ramp is also defined by the status of the signal before the new ramp. For this reason, a ramp that has already been set can be assigned low-low or high-high transition (as in the example), i.e. it will have no effect on the control signal in this configuration. However, the ramp remains saved, and its position is indicated by a dashed line.

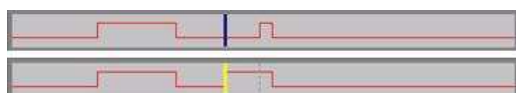

If another change produces effective transition, this ramp will be regenerated.

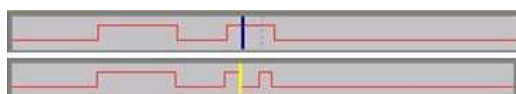

#### 2. Shift a ramp

An existing ramp can be shifted to any positions. The transitions are adjusted accordingly.

Use the arrow keys to move the cursor to the ramp position; the cursor changes colour.

Press the ENTER key. The cursor again changes colour. The ramp will now be shifted by means of the cursor. Press the ENTER key. The ramp will be set at the current position.

The ramp transition depends on the status (high or low) of the control/marker signal before the ramp.



#### 3. Delete a ramp

Use the arrow keys to move the cursor to the ramp position; the cursor changes colour.

Press the BACKSPACE key.

The ramp will be deleted. The ramp transitions of the other ramps are adapted to the changed signal status (high or low).

#### 4. Set the ramps in a table



Select the "Edit Table..." button and define the positions and states of the ramps for the selected marker.

Confirm the entries with "Accept".

5. Preset a marker signal

Select the "Preset" button to preset the marker signal.

The ramps of the selected marker are adjusted according to the selected "Preset Type".

#### Creating a new control list

A new control list can be created under a new name either by generating a blank file or by changing an existing list which will then be saved under a new name.

1. To create an empty control list, select "BB > Cust Dig Mod > List Management... > Select Control List to Edit > Create Control List" and enter the file name of the new control list.
2. To open the control list for editing, select the associated button "BB > Cust Dig Mod > List Management... > Select Control List to Edit > Edit Control List..." and select an existing control list.

## 4.6 How to Use the Help System

The R&S SMJ is equipped with a context-sensitive help function. A help page is available for each parameter and can be called any time during instrument operation.



Compiled online help systems are also available for all functions of the R&S SMJ on the CD-ROM supplied with the instrument. This help program can be called on any controller with Internet Explorer version V4.0 and higher.

---

#### Calling context-sensitive and general help

- ▶ To display the general help dialog box, press the HELP (F1) key.

The help dialog is displayed. A topic containing information about the current menu or the currently opened dialog box and its function is displayed.

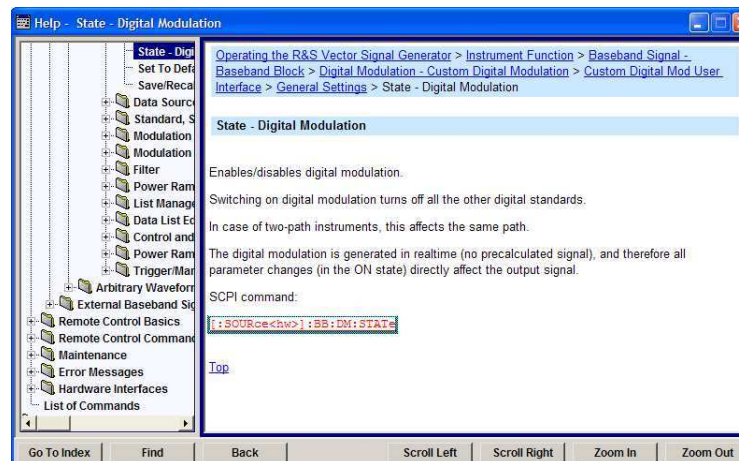

### Contents of the help dialog box

The help dialog box contains two main areas:

- "Contents" - contains a table of help contents
- "Topic" - contains a specific help topic

The help system provides additionally an "Index" and a "Find" area, as well as "Zoom" functions that are accessed by means of the corresponding buttons.

### Navigating in the table of contents

1. To move through the displayed contents entries, use the UP/DOWN keys. Entries that contain further entries are marked with a plus sign.
2. To display a help topic, press the "ENTER" key.  
The corresponding help topic is displayed.

### Navigating in the help topics

1. To scroll through a page, use the UP/DOWN arrow keys.
2. To jump to the linked topic, press the link text.
3. Use the "Previous" or "Next" links to jump to the corresponding topic.
4. Use the "Scroll Right" or "Scroll Left" buttons to shift the indicated area of the navigation window to the left or right.

### Using the Index

1. Select the "Go to Index" button.
2. Enter the first characters of the topic you are interested in. The entries starting with these characters are displayed.
3. Press the ENTER key to change the focus.
4. Use the UP/DOWN keys to navigate and select the suitable keyword.

5. Press the ENTER key to display the help topic.

The corresponding help topic is displayed.

#### Closing the help window

- ▶ Press the HELP (F1) key.

## 4.7 File Management

The R&S SMJ uses files to save all instrument data, i.e. system and user data.

The user data includes saved instrument settings, data for the different digital standards, lists for the List mode and the user correction as well as the waveforms for the arbitrary waveform generator.

The files are stored on the hard disk of the instrument. Drive `D:\` can be used to save user-defined data; any directory structure can be created on `D:\`. Some default directories are predefined, but can be changed at any time. The `C:\` drive is a protected system drive. The files on this drive contain data that must not be changed. Therefore, this drive should not be accessed, since reconstruction of the system partition will lead to data loss. To prevent inadvertent deletion or overwriting of system files, this drive is not specified in the file menus. It can be accessed if a protection level (see section "Protection Level" in the Operating Manual) is revoked.

Files can be exchanged either via a memory stick or a connected network. A memory stick is connected to the USB interface and is assigned the `E:` drive. In the case of a connected network, all network drives that can be accessed are available. The files are accessed in a "Save/Recall" dialog in the individual menus.

The files are differentiated according to their extensions; each type of file is assigned a specific file content. The extension is usually of no consequence to the user since access to the files occurs in the individual menu where only the relevant type of file is available. See [chapter 4.7.2.1, "Extensions for User Files"](#), on page 110 for an overview of the supported file extensions.

The user data can be roughly divided into the following data types:

- Settings  
Settings, e.g. the frame setting of the GSM/EDGE standard, can be loaded and current setting saved to the specified file.
- Lists  
Lists, e.g. user correction lists, can be loaded. They can be generated either externally or internally. For internal generation, a new list must be created in the "File Select" dialog which will then be edited in the list editor of the individual menu.
- Complex modulation and control data  
User data of this type can be loaded. It can be generated either externally or internally. For internal generation, a new list must be created which will then be edited in the data and control list editor. These functions are offered in the "Data List Management" dialog of the individual modulation menu.
- Waveforms

Waveforms are generated externally (e.g. by means of the R&S WinIQSIM2 program that is supplied together with the optional Baseband Generator R&S SMJ-B10) and can be loaded in the "Arbitrary Waveform Generation" dialog.



Softkeys are assigned to some of the functions and can be used for convenient operation.



For more information, refer to:

- [chapter 4.8, "Legend of Front-Panel Controls"](#), on page 112 for an overview of key functions and a cross-reference between the front panel keys and the keyboard shortcuts
- to section "Instrument Functions" for a detailed description of key functions.

### Accessing files with user data

1. To access an editable user data file, select the "Save/Recall" or "File Manager" function in the individual dialog.



2. To access a loadable data file, select the "Select/New" or "File Manager" function in the individual dialog.

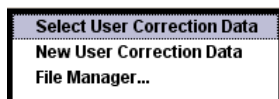

3. To access the "File Manager" function, press the SETUP (CTRL+E) key and select "Save/Recall > File Manager".

A "File Select" window for loading, saving or creating a file or the "File Manager" dialog for managing all files is displayed.



### Saving and loading of all instrument settings

All instrument settings are saved and loaded in the "File" menu.

To access the "File" menu, press the FILE (CTRL+S) key.

For more information, see [chapter 5.2.8, "Storing and Loading Instrument Data - File Key"](#), on page 146.

#### 4.7.1 File Select Dialog

The "Save/Recall" dialog displays the available drives and directories. In the upper part, "Recent Data Sets", the files last used are listed.

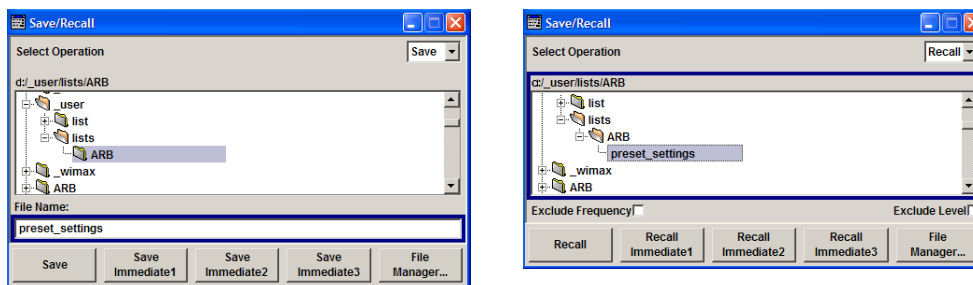

The available drives and directories and the files of the selected directory are displayed. The currently selected path is displayed above the window. Only the relevant files without file extensions are displayed. If the area is opened several times, the path last selected is displayed. When a file is saved or created, its name is user-selectable; the extension is assigned automatically and cannot be entered. The file is saved to the selected path.

In addition to the files saved by the user, some menus also offer files containing predefined contents. These files are saved to a specific directory on system drive; for this reason, this directory cannot be chosen from the "File Select" menu.

#### Example:

The following example shows the "File Select" menu of the GSM/EDGE digital standard when "Recall Predefined Frames" is selected.

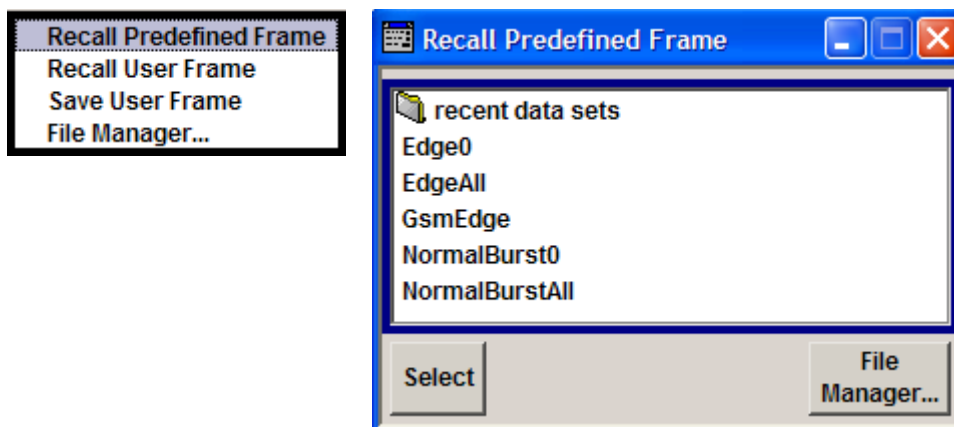

#### Working with the File Select dialog

1. Access the "File Select" dialog (see ["Accessing files with user data"](#) on page 107).
2. Navigate in the "File Select" dialog.
3. Load an existing file.  
In the "Recall Settings" dialog, mark a file and press the "Select" button.
4. Save a file.  
In the "Save Settings" dialog, enter file name in the "File Name:" field.  
Select the directory to which the file is to be saved and then select the "Save" button.
5. Create a new file.

To create a new file, use the "Save Settings" functionality, i.e. specify file name and directory and save the file.

The created file is empty; it must be filled with the necessary values in the individual editor.

## 4.7.2 File Manager

The "File Manager" allows general file management such as copying, shifting, renaming and deleting files as well as generating new directories.

Thus, also externally created files, for example waveforms created by using the R&S®WinIQSIM2 program, can be saved to the R&S SMJ by copying them from a memory stick or a network to the internal hard disk.

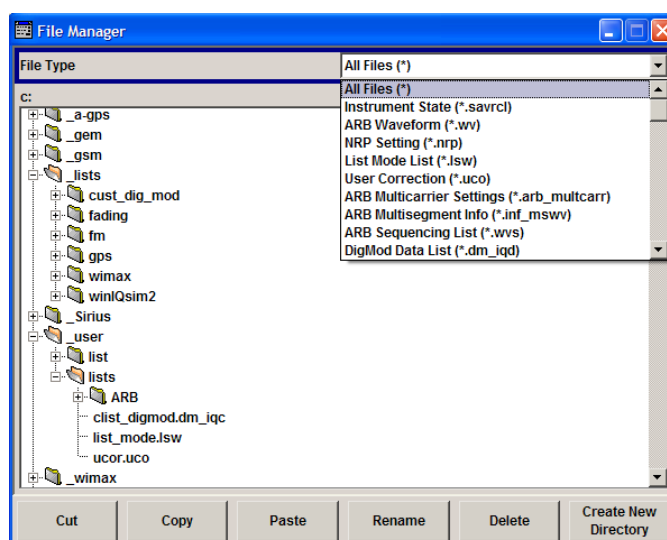

Use the "File Type" to select a file type from the list. This can be used to process either all files (all files (\*) selection) or a specific selection of files. See [chapter 4.7.2.1, "Extensions for User Files"](#), on page 110 for an overview of the supported file extensions. The available drives and directories and the files of the selected directory are displayed. The currently selected path is displayed above the windows. If the area is opened several times, the path last selected is displayed. Unlike the "File Select" window, the "File Manager" displays the full file names including extensions.

### Working with the File Manager dialog

1. Accessing the "File Manager" dialog (see ["Accessing files with user data"](#) on page 107).
2. Navigating in the "File Manager" dialog.  
Operation is similar to the operation of menus with several areas.
3. Moving, duplicating, deleting or renaming files  
To move a file, select the file and press the "Cut" button. Mark the directory to which the file is to be moved and select the "Paste" button. If the target directory already

contains a file with the same name, a confirmation query is displayed to confirm overwriting of this file.

Perform the similar steps and cut/copy/rename/delete the file.

**Tip:** The operation corresponds to the Windows concept.

#### 4. Creating a new directory

Mark drive or directory level where the new directory is to be created, select the "Create New Directory" button and enter the name of the new directory in the entry window that opens. Confirm with ENTER.

### 4.7.2.1 Extensions for User Files

The following table list all available file extensions for user files. The currently available files on the instrument depends on the installed options.

**Table 4-1: List of the automatically assigned file extensions in the instrument**

Function/Digital Standard	List type	Contents	File suffix
Instrument State	Settings	Instrument settings	*.savrc1
"User Correction"	List	User-defined level correction values	*.uco
"List Mode"	List	User-defined frequency/level value pairs	*.lsw
"Frequency Response Correction"	Settings	User-defined frequency response correction file	*.frc
"Arbitrary Waveform Generator"	Waveform	ARB waveforms ARB multi segment waveforms	*.wv
	Waveform	ARB multi carrier settings	*.arb_multcarr
	Configuration data	Configuration file for creation of multisegment ARB waveforms	*.inf_mswv
	Play List	ARB Sequencing List	*.wvs
"DM"	Data List	Digital modulation data	*.dm_iqd *.tdm
	Control List	Data to control digital modulation	*.dm_iqc
	Settings	Digital modulation settings	*.dm
	User Standard	Digital modulation user standard	*.dm_stu
	User Mapping	Digital modulation user mapping	*.vam
	User Filter	Digital modulation user filter	*.vaf
"NRP Settings"	Settings	NRP Settings	*.nrp
EX-IQ-Box	User Settings	EX-IQ-Box User Defined Settings	*.iqbox
"Fading"	Fading	Fading data	*.fad
"GSM/EDGE"	Settings	GSM/EDGE settings	*.gsm

Function/Digital Standard	List type	Contents	File suffix
	Slot	User-defined slot data	*.gsm_slu
	Frame	User-defined frame data	*.gsm_fu
	Slot	Higher symbol rate slot	*.gsm_hslu
	Frame	Higher symbol rate frame	*.gsm_hfu
"Bluetooth"	Bluetooth Settings	Complete setting of the Bluetooth menu	*.bto
"TETRA"	TETRA Settings	Complete setting of the TETRA menu	*.tetra
"3GPP FDD"	Settings	Complete setting of the 3GPP (FDD) menu	*.3g
	Settings	Channel coding enhanced DPCH channels (downlink)	*.3g_ccod_dl_s
	Settings	Channel coding enhanced DPCH channels (uplink)	*.3g_ccod_ul
"CDMA2000"	Settings	Complete setting of the CDMA2000 menu	*.cdma2k
"TD-SCDMA2000"	Settings	Complete setting of the TD-SCDMA2000 menu	*.tdscdma
	Settings	Test Model for TD-SCDMA2000	*.tdtmd
1xEV-DO	Settings	Complete setting of the 1xEV-DO menu	*.evdo
"IEEE 802.11 WLAN"	Settings	Complete setting of the IEEE 802.11 WLAN menu	*.wlan
"IEEE 802.11 n WLAN"	Settings	Complete setting of the IEEE 802.11n WLAN menu	*.wlann
	Settings	Beamforming data	*.bmf
"IEEE 802.16 WiMAX"	Settings	Complete setting of the IEEE 802.16 WiMAX menu	*.wimax
"EUTRA/LTE"	Settings	Complete setting of the EUTRA/LTE menu	*.eutra
	Settings	TDD Settings	*.lte_tdd
	Settings	User-defined IQ-File	*.iqw
"GPS"	Settings	Complete setting of the GPS/A-GPS menu	*.gps
	Settings	GPS Almanac Settings	*.txt *.alm *.al3
	Settings	GPS Waypoints File	*.txt
	Settings	GPS Generated Almanac File	*rs_alm *.rs_yuma
	Settings	GPS Ionospheric File	*.rs_ion
	Settings	GPS Navigation Data	*.rs_nav



Function/Digital Standard	List type	Contents	File suffix
	Settings	GPS UTC File	*.rs_utc *.rs_acq
"FM-Stereo"	Settings	Complete setting of the FM-Stereo menu	*.fmstereo
	Settings	FM-Stereo Group Type Settings	*.fm_gt
	Settings	FM-Stereo Group Hex Type Settings	*.fm_ghex
	Waveform File	Waveform File	*.wav
"Sirius"	Settings	Complete setting of the Sirius menu	*.sirius
"XM-Radio"	Settings	Complete setting of the XM-Radio menu	*.xmradio
	Settings	XM-Radio TWTA Data	*.twta
"DVB"	Settings	Complete setting of the DVB menu	*.dvb
	Settings	DVB Transport Stream	*.gts *.ts *.trp
"DAB/T-DMB"	Settings	Complete setting of the DAB/T-DMB menu	*.dab
	Settings	DAB ETI Files	*.eti *.xeti

## 4.8 Legend of Front-Panel Controls

The following table lists all key functions available on the front panel. Key combinations used on the PC keyboard to trigger key functions on the instrument front panel are also described. Keyboard labels are described in alphabetical order.

In addition, a front panel key emulation and an on-screen keyboard can be used for manual operation by mouse only.

**Table 4-2: Cross-reference between the front panel keys and keyboard shortcuts**

Front-panel key	Key of PC keyboard	Function
Turning the rotary knob	Tab key (towards the right) Shift + Tab (towards the left)	Sets the cursor with the rotary knob.
Pressing the rotary knob	Enter	Pressing the rotary knob confirms an entry; it has the same function as the ENTER key.
Arrow keys	Arrow keys	Moves the cursor.
*1 / dB(m)	ALT + F12	Confirms entries in the base unit and values without a unit. Selects dBm for the RF level and dB for level offset and level step width.
./ *...#	./ *...#	Enters a period/decimal point. Enters a special character.

## Legend of Front-Panel Controls

Front-panel key	Key of PC keyboard	Function
+/- / A<->a	- / (shift+) a—z	Enters the sign. Switches between upper-case and lower-case letters.
0-9 / a...z	CTRL+ 0-9 / a...z CTRL	Enters the number/letter.
BACKSPACE	Backspace	Clears the last entry (number, sign or decimal point)
CLOSE	CTRL + G	Closes an active menu.
DIAGRAM	CTRL+ D	Sets the cursor on the block diagram and hides all menus.
ENTER	Enter	Terminates an entry.
ESC	ESC	Selects the next higher menu/selection level. When the editing mode is exited with ESC, the previous value is restored.
FILE	CTRL + S	Activates the menu for storing instrument settings.
FREQ	CTRL+ F	Activates the frequency entry.
G/n / dBuV	ALT + F9	Selects the unit Giga/Nano, dBuV for the RF level and dBu for the LF level.
HCOPY	CTRL+ Y	Opens the menu for configuring and starting a hard-copy.
HELP	F1	Opens/closes context-sensitive help.
HIDE	CTRL+ H	Minimizes the active menu. Pressing the respective button in the Winbar opens the menu again.
INFO	CTRL + I	Opens/closes the info window
INSERT	Ins	Activates the insert mode.
k/m / uV	ALT + F11	Selects the units Kilo/Milli and uV for RF levels.
LEVEL	CTRL + L	Activates the level entry.
LOCAL	CTRL + Q	Switches the instrument from remote control to manual control.
M/u / uV	ALT + F10	Selects the units Mega/Micro and uV for RF levels.
MENU	CTRL + M	Calls the menu selection list.
MOD ON/OFF	CTRL + O	Switches modulation on/off. "MOD OFF" is indicated in the status line.
TOGGLE	CTRL + T	Switches a block or parameter on/off. Toggles between the different possibilities of setting a selection parameter.
PRESET	CTRL + P	Restores a defined basic instrument setup.
REARR	CTRL + A	Adjusts the size of the active menu to use the whole height of the display.
RECALCULATE	CTRL + C	Starts recalculation of the signal.

Front-panel key	Key of PC keyboard	Function
RF ON/OFF	CTRL + R	Switches the RF output signal on/off. "RF OFF" is indicated in the status line.
SETUP	CTRL + E	Opens the setup menu for general instrument settings.
Softkeys	CTRL + F1 – F8	Triggers the function assigned to the softkey.
WINBAR	CTRL + W	Displays the Winbar in the foreground/background.

### 4.8.1 Front Panel Key Emulation

The R&S SMJ provides a front panel key emulation to enable execution of the front panel key functions by mouse e.g. for remote access. The emulation is called by a right mouse click. The front panel key functions are executed by a mouse click on the associated button.



### 4.8.2 On-screen Keyboard

In addition, the Windows XP operating system provides a keyboard emulation that can be used for system settings if no external keyboard but a mouse is available.

To access the on-Screen Keyboard, select "Start > Programs > Accessories > Accessibility > On-Screen Keyboard".



## 5 Instrument Function

### 5.1 Overview of Instrument Functions

This chapter explains the functions of the R&S SMJ and the options available in the setting menus. The associated SCPI command is specified for each parameter (where applicable).

The description begins with the general instrument settings which do not directly affect signal generation. The majority of these settings can be accessed by means of front-panel softkey menus and not by means of function block menus.

One exception is, for example, the signal graphics which are called up in the "Graphics" block.

The signal generation functions are then described, beginning with the RF section functions which affect the RF signal and the analog modulations and which are compiled in the "RF/A Mod" block of the block diagram.

This is followed by an explanation of all functions which are in the signal flow prior to being fed into the RF block and which do not affect the internal generation of a baseband signal - I/Q modulation, noise generation and impairment of the digital signal. These functions are accessed by means of the function blocks "I/Q Mod" and "AWGN/IMP".

The remaining (and largest) part of the chapter describes the functions used for the internal generation of the signals in the baseband (these functions are provided in the "Baseband" block).

The general instrument settings include various functions, such as:

- Setting a defined basic setup using the PRESET key  
see [chapter 5.2.2, "Default Instrument Settings - Preset Key"](#), on page 118
- Switching from remote control to manual control using the LOCAL key  
see [chapter 5.2.4, "Switching to Manual Control - Local Key"](#), on page 140
- Configuring the generator and its interfaces in the "Setup" menu - e.g. setting the GPIB address, starting an adjustment, querying instrument data  
see [chapter 5.2.3, "General Configuration of Instrument - Setup Key"](#), on page 119
- Generating a hardcopy of the display using the HCOPY key  
see [chapter 5.2.5, "Generating a Hard Copy of the Display"](#), on page 140
- Calling up the online help using the HELP key  
see [chapter 5.2.7, "Help System - Help Key"](#), on page 145
- Querying messages using the INFO key  
see [chapter 5.2.6, "Messages - Info Key"](#), on page 145
- Loading and storing complete instrument settings in the "File" menu  
see [chapter 5.2.8, "Storing and Loading Instrument Data - File Key"](#), on page 146
- Calling up the baseband signal graphics in the "Graphics" function block  
see [chapter 5.3, "Graphical Display - Graphics"](#), on page 152

The integrated bit error rate and block error tester is configured and activated in the "BERT" function block:

- Bit error rate and block error measurement  
see [chapter 5.4, "Bit and Block Error Rate Measurements - BERT Block"](#), on page 163

The RF signal is configured and the analog modulations activated in the "RF/A Mod" function block:

- CW mode  
see [chapter 5.5.1, "Overview of RF Signal"](#), on page 183
- List mode  
see [chapter 5.5.14, "List Mode"](#), on page 252
- Sweep mode  
see [chapter 5.5.13.1, "Overview"](#), on page 233
- Analog modulations  
see [chapter 5.5.11.1, "Overview"](#), on page 219

In the "I/Q-Mod" function block, I/Q modulation is possible with external analog signals and internally generated baseband signals.

- I/Q modulator  
see [chapter 5.6, "I/Q Modulation - I/Q Mod Block"](#), on page 260

Noise can be added to the baseband signal and the baseband signal can be impaired before input into the I/Q modulator. It is therefore possible to output a baseband signal with impairments via the I/Q-OUT outputs ("AWGN/IMP" function block). Impairment is also possible during I/Q modulation ("I/Q Mod" function block).

- Impairing the signal  
see [chapter 5.7.1, "Impairments"](#), on page 273
- Adding noise  
see [chapter 5.7.2, "AWGN - Noise Generator"](#), on page 282

The baseband signal is available at the I/O outputs.

- Output of the baseband signal  
see [chapter 5.7.3, "Output of the Baseband Signal - I/Q Out"](#), on page 290

The R&S Signal Generator offers various possibilities for generating digital modulation signals in compliance with the definitions of digital standards or with characteristics which can to a large extent be freely defined. The range of software options for this is being extended continuously.

- Baseband signals - Introduction  
see [chapter 5.8, "Baseband Signal - Baseband Block"](#), on page 301
- Digital modulation  
see [chapter 5.8.2, "Digital Modulation - Custom Digital Modulation"](#), on page 312
- Arbitrary waveform generator ARB  
see [chapter 5.8.3, "Arbitrary Waveform Generator ARB"](#), on page 352
- Multi Carrier CW signals  
see [chapter 5.8.4, "Multi Carrier Continuous Wave"](#), on page 399
- Digital standard GSM/EDGE

- see description "Digital Standard GSM/EDGE"
- Digital standard 3GPP FDD (WCDMA)  
see description "Digital Standard 3GPP FDD (WCDMA)"
- Digital standard CDMA2000®  
see description "Digital Standard CDMA2000®"
- Digital standard TD-SCDMA  
see description "Digital Standard TD-SCDMA"
- Digital standard 1xEV-DO  
see description "Digital Standard 1xEV-DO"
- Digital standard IEEE 802.11 (a/b/g) (WLAN)  
see description "Digital Standard IEEE 802.11 (a/b/g) (WLAN)"
- Digital standard IEEE 802.11n (WLAN-N)  
see description "Digital Standard IEEE 802.11n (WLAN-N)"
- Digital standard IEEE 802.16 (WiMAX)  
see description "Digital Standard IEEE 802.16 (WiMAX)"
- Digital Standard EUTRA/LTE  
see description "Digital Standard EUTRA/LTE"
- Digital standard GPS/A-GPS  
see description "Digital Standard GPS"
- Digital Standard XM Radio  
see description "Digital Standard XM Radio"
- FM Stereo/RDS  
see description "FM Stereo/RDS"
- Digital Standard DVB-H  
see description "Digital Standard DVB-H"
- Digital Standard DAB / T-DMB  
see description "Digital Standard DVB / T-DMB"

In addition, external baseband signals can be fed into the baseband path with the aid of the external Digital Interface Module R&S EX-IQ-BOX.

- Digital Interface Module  
see description "Digital Interface Module R&S EX-IQ-BOX".

## 5.2 General Instrument Settings

### 5.2.1 Overview of General Instrument Settings

This section describes the settings which do not directly affect signal generation. Most of these settings can only be accessed by means of menus which are opened using keys or key combinations on the external keyboard or keys on the front panel key emulation.

This does not apply to the graphical representation of output signals which is activated in the "Graphics" function block, or settings which can additionally be called up in the

menus of the function blocks, e.g. input configuration which is possible in the "Setup" menu and in almost every menu of the "Baseband" function block.

See also [chapter 4.8, "Legend of Front-Panel Controls"](#), on page 112.

The general instrument settings therefore affect various functions, such as storing instrument settings using the FILE key or setting the GPIB address in the menu of the SETUP key. The order in which the descriptions are given corresponds to the layout of the keys on the front panel of the R&S SMJ (from top left to bottom right).

### 5.2.2 Default Instrument Settings - Preset Key

The PRESET key calls up a defined instrument setup. All parameters and switching states are preset (also those of inactive operating modes). The default instrument settings provide a reproducible initial basis for all other settings.

However, functions that concern the integration of the instrument into a measurement setup are not changed, e.g. GPIB address or reference oscillator source settings.

In addition, only those settings associated with the menu can be reset directly in the individual menus, e.g. all digital modulation settings in the "Custom Digital Mod" menu. These settings are identical to those which are called up using the PRESET key.

When the instrument is switched on, it is not the preset state that is active, but rather the instrument state that was set before the instrument was switched on.

User-defined instrument states can be stored and called up in the "File" menu.



Resetting the instrument to the factory state is possible with the [Factory Preset](#) function.

#### Preset

Presets all parameters and switching states.

The following list gives an overview of the presets for the most important generator settings. The other presets can be found in the preset tables of the individual menus and the information accompanying the remote commands.

- "RF frequency" = 1 GHz
- "RF level" RF output switched off
- "Offsets" = 0
- "Modulations State" = Off
- Uninterrupted level settings are switched off
- "Level Attenuator Mode" = AUTO
- Internal level control "Level ALC" = AUTO
- User correction "Level Ucor" = OFF
- "LF output State" = Off
- "Sweep State" = Off
- "List mode State" = Off

Settings that are not affected by the PRESET key

- Reference frequency settings ("Ref Oscillator" menu)
- Power on settings ("Level/EMF" menu)

- Network settings ("Setup" menu)
- GPIB address ("Setup" menu)
- Password and settings protected by passwords ("Setup" menu)
- Start/Stop Gui Update ("Setup" menu)
- Display and keyboard settings ("Setup" menu)

SCPI command:

\*RST on page 456

### 5.2.3 General Configuration of Instrument - Setup Key

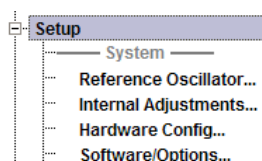

The SETUP key opens the "Setup" dialog.

The "Setup" dialog is divided into several sections.

- The "System" section is used to set general instrument parameters.
- The "Test" section is used to perform function tests.
- The "Environment" section is used to configure the controller interfaces.
- The "Remote" section is used to configure the remote control interfaces.
- The "Protection" is used to set the protection level for service functions and security settings.
- The "Settings" section is used to save or recall instrument settings or to preset the instrument to factory settings.

Most submenus of this key can be accessed only via the SETUP key or the menu tree ( MENU key), with the following exceptions:

- The "Reference Oscillator" dialog can also be called up in the "RF" block and is therefore described in the section on this block (see [chapter 5.5.4, "Reference Oscillator"](#), on page 191).
- The "Save/Recall" dialog can also be called up with the FILE key and is therefore described in the section on this key (see [chapter 5.2.8, "Storing and Loading Instrument Data - File Key"](#), on page 146).
- The "Global Trigger/Clock/ External Inputs" dialog is also available in all modulation menus of the "Baseband" function block where it can be called up with the "Global Trigger/Clock Settings" button in the corresponding "Trigger/Marker/Clock" dialog. See also [chapter 5.2.3.10, "Global Trigger/Clock/External Input Settings"](#), on page 129.

#### 5.2.3.1 Internal Adjustments

The R&S Signal Generator is extremely accurate thanks to the integrated procedures for adjustments.

All internal adjustments for which no external measuring equipment is needed can be started in the "Internal Adjustments..." dialog. The adjustments with external measuring equipment are described in the Service Manual (on CD ROM, supplied with the instrument).



Adjustment is recommended if the temperature range in which the instrument is operated changes, or prior to all applications which require maximum level and frequency accuracy.

During adjustment a bar indicates the status of progress. If an error occurs, adjustment is terminated and an error message is output in the info line.

## NOTICE

### Risk of invalid adjustment

In order to achieve correct adjustment of the instrument, make sure that the instrument is warm before performing adjustments. The warm-up time is 30 minutes.

To access the "Internal Adjustments" dialog, press the SETUP or MENU key under "System".

The adjustments offered also depend on the installed options.

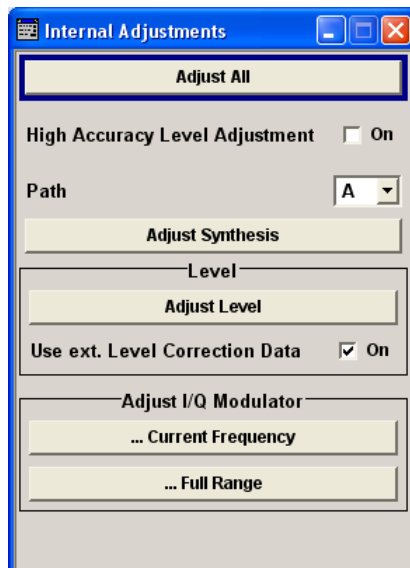

### Adjust All

Starts all internal adjustments for which no external measuring equipment is needed. The adjustments with external measuring equipment are described in the Service Manual (supplied).

SCPI command:

`:CALibration:ALL[:MEASure]` on page 486

### High Accuracy Level Adjustment

Enables/disables level adjustment with high accuracy.

SCPI command:

`:CALibration<hw>:LEVel:HACCuracy[:STATe]` on page 488

**Path (Internal Adjustments)**

Indicates the path for which the following adjustments are to be performed.

SCPI command:

n.a.

**Adjust Synthesis**

Performs all adjustments which affect the frequency.

This includes adjustment of option R&S SMJ-B20, FM/PhiM Modulator.

SCPI command:

[:CALibration<hw>:FREQuency\[:MEASure\]](#) on page 487

**Adjust Level**

Performs all adjustments which affect the level. The acquired correction values improve the settling time and the signal quality.

SCPI command:

[:CALibration<hw>:LEVel\[:MEASure\]](#) on page 488

**Use ext. Level Correction Data**

Switch on or off use of external level correction data (see service manual, chapter 2, "Adjustment"). This switch can be used in case of corrupt external level correction data.

SCPI command:

[:CALibration<hw>:LEVel:STATe](#) on page 488

**Adjust I/Q Modulator Current Frequency**

Starts the adjustment for the I/Q modulator for the currently set frequency, I/Q swap, and baseband gain. The I/Q modulator is adjusted with respect to carrier leakage, I/Q imbalance and quadrature.

Adjustment for only the set frequency is considerably faster than adjustment across the entire frequency range. This is possible with "Full Range".

SCPI command:

[:CALibration<hw>:IQModulator:LOCal](#) on page 488

**Adjust I/Q Modulator Full Range**

Starts the adjustment for the I/Q modulator for the entire frequency range. The I/Q modulator is adjusted with respect to carrier leakage, I/Q imbalance and quadrature.

SCPI command:

[:CALibration<hw>:IQModulator:FULL](#) on page 487

### 5.2.3.2 Hardware Config

In the "Hardware Config" dialog, the installed assemblies together with their variants and revision states can be displayed for servicing purposes.

To open the "Hardware Config" dialog, select "System" and press the SETUP or MENU key.

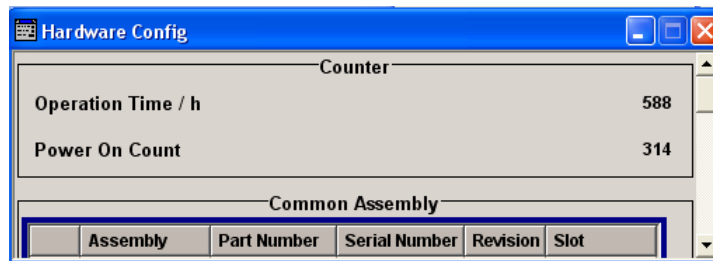

Section "Counter" in the upper part of the menu shows the "Operation Time" (in hours) and the number of power-on ("Power On Counter").

The second part of the menu is a table that lists the installed assemblies. It is divided into the sections:

- "Common Assembly"
- "RF Assembly"
- "Baseband Assembly"

#### Operation Time / h

Displays the operation time in hours.

SCPI command:

[:DIAGnostic:INFO:OTIME](#) on page 491

#### Power On Count

Displays the number of power-on.

SCPI command:

[:DIAGnostic:INFO:POCount](#) on page 491

#### Assembly

The tables list the installed assemblies.

"Assembly"	Assembly name
"Part Number"	Part Number of assembly
"Serial Number"	Serial Number of assembly
"Revision"	Revision state of assembly
"Slot"	Indicates whether the assembly is connected to the serial bus or PCI bus.

SCPI command:

[:DIAGnostic<hw>:BGInfo](#) on page 490

### 5.2.3.3 Software / Options

The "Software/Options" dialog shows the firmware version of the instrument software as well as all installed hardware and software options.



Software options purchased at a later stage can be activated with a keycode. The activation code is supplied with the software option. How to install options is described in Chapter 4 of the Service Manual (supplied with the instrument).

The installation of hardware options purchased at a later stage is also described in Chapter 4 of the Service Manual (supplied with the instrument). Most hardware options need to be installed at an authorized Rohde&Schwarz service shop.

To access the "Software/Options" dialog, select "System" and press the SETUP or MENU key.

The menu is divided into the following sections:

- "Firmware"
- "Hardware Options"
- "Software Options"
- "WinIQSIM"
- "Loaded Modules"

Package	Version		
SMJ100A Base Software	02.04.303.16 beta (Debug) (2007-10-30; 00:53:38)		
R&S COMPASS	2.1.57.0 (Debug)		
Bios Version	(unknown)		

### Firmware

The Firmware section of the menu shows the firmware version and the version of the software platform.

**Note:** Your instrument is delivered with the latest firmware version available. Firmware updates as well as the Release Notes describing the improvements and modifications are provided on the Internet at the download site of the Rohde & Schwarz Signal generator home page. This home page always offers the latest information on your signal generator, e.g. also on changes of the firmware update procedure.

SCPI command:

n.a.

### Hardware Options / Software Options

The tables in the sections "Hardware", "Software" and "WinIQSIM2" list the installed hardware and software options.

"Option"	Short name of option
"Designation"	Name of Option
"Licenses"	(optional) Number of licenses.

"Expiration Date" For regular options, "Permanent" is indicated in this column. Some options are available as trial versions. This column shows their expiration date. After this date, the option is no longer available on the instrument.

SCPI command:  
 \*OPT on page 455  
 \*IDN on page 454

**Loaded Modules**

Section "Loaded Modules" is provided for service purposes. It lists all loaded software modules with their versions and offers a short description of each module.

SCPI command:  
 n.a.

**5.2.3.4 Manage License Keys**

This dialog is the central dialog for managing licenses, like enabling newly purchased and/or newly registered options or performing the required instrument related steps during the process of unregistration of licenses.

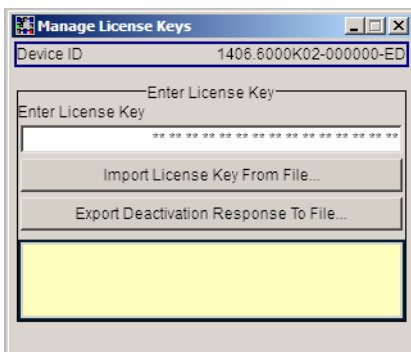

An option is ready to operate after it is enabled by means of a license key code supplied with the option. The license key is delivered as a file or on paper. Unregistered licenses must be registered for a particular instrument prior to the corresponding option can be enabled for operation.



**License Registration**

If your purchased license is delivered unregistered, you must register it before you can activate the option.

For detailed information about the license registration, refer to the installation instructions provided with the option (Supplement A) and the documentation of the online tool "Manage Licenses" (<https://extranet.rohde-schwarz.com/service>).



Only if the R&S Signal Generator is equipped with an older firmware version, a firmware update prior to enabling the software option may be required. The information on the valid firmware versions for the purchased software option is provided together with the option. The firmware update is described in the service manual, chapter 4 (on CD ROM, supplied with the instrument).

#### Device ID

Displays the instrument specific identification number. The device ID is a unique string with the following structure:

```
<stock number>-<serial number>-<checksum>
```

#### Enter License Key

Type here the license key provided with the option.

For license keys delivered as a file, use [Import License Key from File...](#)

#### Import License Key from File...

Opens a dialog for selecting the file with the license key.

#### Export Deactivation Response to File...

Exports the generated deactivation response key to a file and opens a file management dialog to save the file. This key is required during the unregistration process.

#### Status Information

Displays status information.

### 5.2.3.5 Gui Update

The "Start/Stop Gui Update" dialog provides the possibility to switch off update of the displayed parameters in order to increase speed for certain settings.

The indicated values are not updated and may therefore differ from the internal, used values.

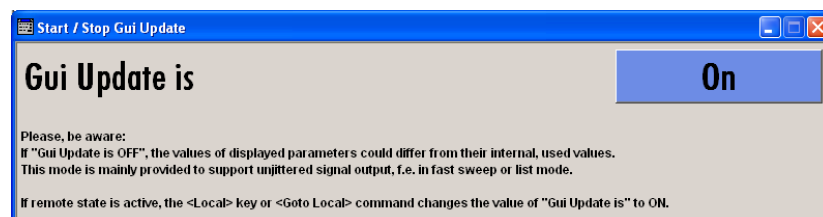

#### On/Off GUI Update

Switches on/off update of the displayed parameters.

Switching off the update of the displayed parameters increases the speed for certain settings.

**Note:** It is especially recommended to switch off the GUI update for optimum sweep performance with short dwell times and for fast settling times.

SCPI command:

[:SYSTEM:DISPlay:UPDate](#) on page 732

### 5.2.3.6 NRP-Z Info/Update

In the "NRP-Z Info/Update..." dialog, the connected power sensors are indicated together with their serial number, revision state and features. The software of a connected sensor can be updated to a new version.

To access the "NRP-Z Info/Update..." dialog, select "System" and press the SETUP or MENU key.

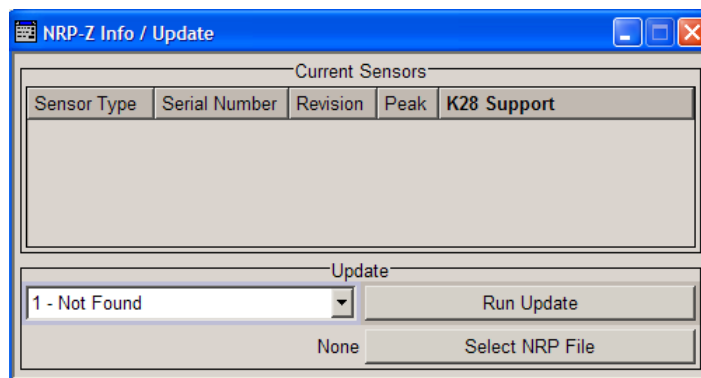

#### Current Sensors

Section "Current Sensors" lists the sensors that are connected to the generator and indicates their serial number, the revision state and some features.

SCPI command:

[SENSe<ch>\[:POWer\]:TYPE](#) on page 524

[SENSe<ch>\[:POWer\]:SVERsion](#) on page 524

[SENSe<ch>\[:POWer\]:SNUMber](#) on page 523

#### Update

Section "Update" provides access to the file system in order to select a file for an R&S NRP sensor update (Button "Select NRP File"), the selected file is indicated to the left of the button. On the left side, the sensor to be updated is selected.

Button "Run Update" starts the update. If the update is interrupted for example by accidentally pulling off the sensor, selection "Rescue" is offered to restart the update process. Prerequisite is that no other sensor is connected to the instrument.

The procedure is as follows:

- Do not reconnect the sensor but keep it ready to be connected
- Select "Rescue" in the left sensor selection field
- Activate "Run Update"
- Confirm query in message box
- Connect sensor within 4 seconds

The update starts, a bar informs about the progress.

SCPI command:

n.a.

### 5.2.3.7 Update

After a firmware update it is occasionally required to also update the "PCI-FPGA". This is enabled in the "Update" dialog.

At the first start of the new firmware, a message appears during the boot process if a "PCI-FPGA" update is required. Execute a PCI-FPGA update by pressing the "PCI-FPGA" button.

## NOTICE

### Impairment of instrument functions

To avoid impairment of instrument functions, the update of the "PCI-FPGA" must not be cancelled and the instrument must not be switched off during this update.

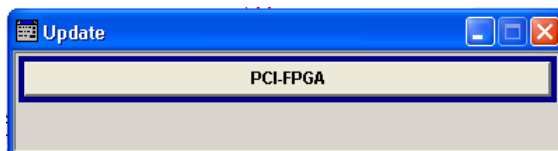

### 5.2.3.8 Selftest

A selftest is provided for service purposes. The selftest is a protected test procedure, which can be accessed if protection level 1 is disabled. The protection dialog is called in the "Setup" menu (see [chapter 5.2.3.15, "Protection"](#), on page 135).

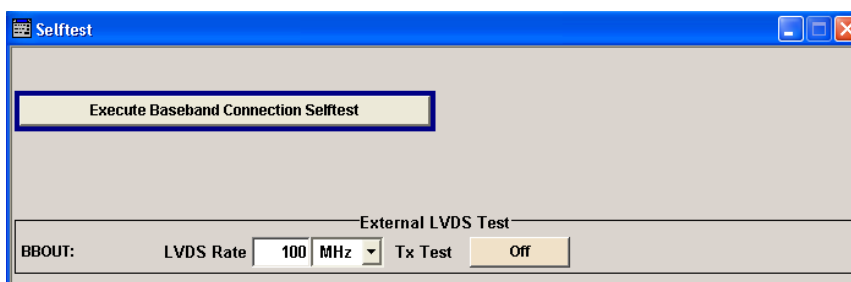

The following tests are only available via remote control:

- `:TEST:CONNector:AUXio` on page 737
- `:TEST<hw>:DIRect` on page 738



**Execute Baseband Connection Selftest**

Performs a connection test on each of the internal digital baseband links. This implies all installed options as baseband inputs, motherboard, universal coding generators, fading simulators, and baseband outputs. The result (succeeded or failed) is displayed in the status field next to the "Execute Baseband Connection Selftest" button.

SCPI command:

`:TEST:BB:CONNECTION` on page 736

**BBOU LVDS Rate**

Sets the interface speed.

The "External LVDS Test" is used to check the correct data transmission of the digital baseband outputs (BBOU) and the correct data reception of the digital baseband inputs (BBIN).

An external cable connection is needed to perform this test successfully. An output must be connected to an input with the digital I/Q cable. Always an input/output pair is tested together. The input and the output can be on the same instrument, or alternatively on two different instruments. Given an arbitrary cable connection, the appropriate Tx test can be activated with different interface speeds (LVDS rate).

On the connected input, this test sequence is received and can be compared with the expected test signal.

SCPI command:

`:TEST<hw>:BBOut:LRATE` on page 737

**Tx Test**

Activates the transmission of a known pseudo-random sequence (On).

SCPI command:

`:TEST<hw>:BBOut:TTESt[:STATe]` on page 737

**5.2.3.9 Check Front Panel**

The "Check Front Panel" dialog is used to check whether the front panel keys are functioning correctly. The menu displays all the front panel keys arranged in the same way as on the front panel. The respective function is executed by pressing the associated key.

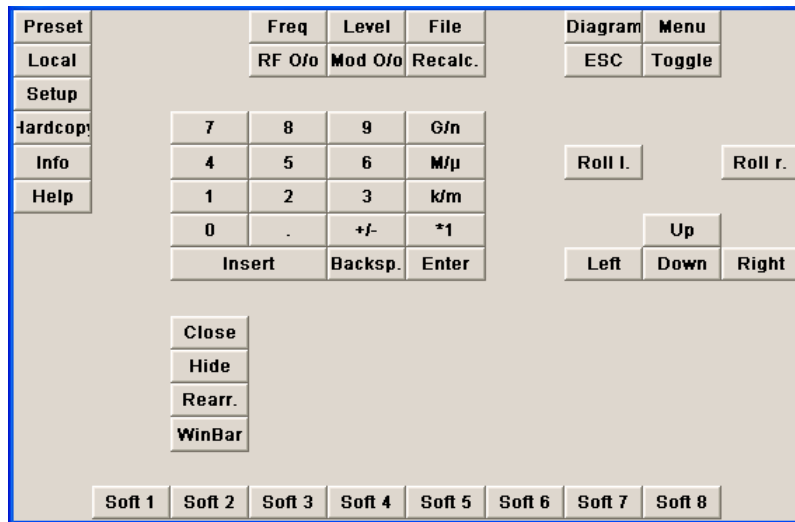

### 5.2.3.10 Global Trigger/Clock/External Settings

The "Global Trigger/Clock/External Inputs" menu can be opened using the SETUP or MENU key under the "Setup" menu as well as in all clock and trigger menus of the "Baseband" function block.

This menu is used to determine the physical characteristics of the input connectors for trigger, clock and control signals.

The user inputs/outputs (BNC connector and pins of the AUX I/O connector) are assigned in the dialog "User Marker AUX I/O".

A common trigger threshold and input impedance is effective for all trigger and control signal inputs. The settings influence the digital modulations, the generation of waveforms or multicarrier signals, and all digital standards. Irrespective of this, a common threshold and input impedance is effective for the serial and parallel data input. These data sources are available for digital modulation ("Custom Digital Modulation").

The instrument trigger setting influences all sweeps and is effective in the List mode.

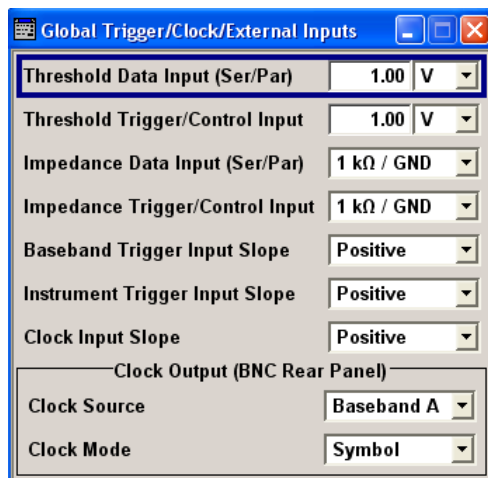

**Threshold Data Input**

Sets the high/low threshold in volts for the serial and parallel data input.

The serial data is input at the DATA connector of the instrument. The parallel data is input via the DATA pins of the AUX I/O interface.

SCPI command:

[\[:SOURce\]:INPut:DATA:THReshold](#) on page 663

**Threshold Trigger/Control Input**

Sets the high/low threshold in volts for the trigger and control signal inputs of the base-band section.

The setting affects the TRIGGER 1 and TRIGGER 2 inputs (BNC connectors) and the CW, BURST and LEV\_ATT inputs of the AUX I/O interface.

SCPI command:

[\[:SOURce\]:INPut:TRIGger:LEVel](#) on page 665

**Impedance Data Input**

Selects the input impedance for the serial and parallel data inputs.

50 Ohm/GND should be selected for high clock rates.

The serial data is input at the DATA connector of the instrument. The parallel data is input via the DATA pins of the AUX I/O interface.

SCPI command:

[\[:SOURce\]:INPut:DATA:IMPedance](#) on page 663

**Impedance Trigger/Control Input**

Selects the input impedance for the external trigger and control signal inputs.

50 Ohm/GND should be selected for high clock rates.

The setting affects the TRIGGER 1 and TRIGGER 2 inputs (BNC connectors) and the CW, BURST and LEV\_ATT inputs of the AUX I/O interface.

SCPI command:

[\[:SOURce\]:INPut:TRIGger:IMPedance](#) on page 664

**Baseband Trigger Input Slope**

Selects the polarity of the active slope of an externally applied trigger signal.

This setting affects the TRIGGER inputs (BNC connectors).

SCPI command:

[\[:SOURce\]:INPut:TRIGger:BBANd:SLOPe](#) on page 664

**Trigger Input Slope**

Sets the polarity of the active slope of an applied instrument trigger.

This setting affects the INST TRIG input (BNC connector at the rear of the instrument).

"Positive"           The rising edge of the trigger signal is active.

"Negative"           The falling edge of the trigger signal is active.

SCPI command:

[\[:SOURce\]:INPut:TRIGger:SLOPe](#) on page 665

**Clock Input Slope**

Sets the polarity of the active slope of an externally applied bit clock pulse or symbol clock pulse.

This setting affects the CLOCK input (BNC connector).

SCPI command:

`:CLOCK:INPut:SLOPe` on page 489

**Clock Output Mode**

Sets the output of bit or symbol clock pulses at the CLOCK OUT connector at the rear panel.

SCPI command:

`:CLOCK:OUTPut:MODE` on page 489

**5.2.3.11 Display/Keyboard Settings**

In the "Display/Keyboard Settings" menu the power-save mode and external keyboard settings are made. It is opened using the SETUP or MENU key under "Environment".

**Screen Saver Active**

Activates/deactivates the screen-save mode of the display.

If activated, the display including backlight is completely switched off after the elapse of the "Wait Time" when no entries via front panel, external mouse or external keyboard are made.

This mode is recommended for preserving the display especially if the instrument is exclusively operated via remote control.

SCPI command:

`:DISPlay:PSAVe[:STATe]` on page 492

**Wait Time**

Enters the idle time that must elapse before the display lamp is shut off when no entries are made.

SCPI command:

`:DISPlay:PSAVe:HOLDoff` on page 492

**Layout (Keyboard)**

Selects the keyboard layout for the selected keyboard language.

The assignment of some keys depends on the selected layout and language.

SCPI command:

:KBOard:LAYout on page 502

:KBOard:LANGuage on page 502

### 5.2.3.12 User Marker / AUX I/O Settings

The R&S Signal Generator provides four "USER" interfaces which can be freely assigned a selection of signals and which can be configured as both inputs and outputs.

The following table gives an overview of the signals that can be applied at the USER connector.

**Table 5-1: USER Connector Signals**

Signal	Description
"Marker 4"	A broad selection of suitable marker signals is offered in the marker menus of the "Baseband" block. In addition, they can be freely configured in the "Custom Dig Mod > Control List Editor" and "GSM/EDGE > Slot Marker Editor". The selected markers are activated when switching on the "Baseband" block. When using markers defined in a control list ("Marker" = "CList") the related control list must be loaded in addition ("Custom Dig Mod").
"CW Mode Out"	This signal marks the CW mode in which digital modulation ("Custom Dig Mod") is deactivated and the RF signal is output in unmodulated form. The CW signal is defined in a control list and activated by loading the control list and setting the "Modulation<-> CW Switching State" to <b>On</b> in the "More" submenu.  With standards where it is possible to change between various modulation modes, the signal indicates the active modulation mode (standard GSM: signal high (1) = modulation mode GMSK and signal low (0) = modulation mode 8PSK EDGE). In this cases, the signal is generated automatically when the standard is switched on.
"No Signal (Blank) Marker"	This signal marks the blank time in the List mode. The signal is generated automatically when the list mode is switched on.
"HOP"	This signal marks the hop trigger for frequency hopping in the List mode for "Custom Digital Mod". The hop signal is defined in a control list and activated by loading the control list in the "Custom Dig Mod" menu.
"Trigger"	This signal marks the trigger event caused by the selected trigger signal (internally or externally).  The trigger is defined in the respective trigger submenu of the "Baseband" block menus.

To access the "User Marker / AUX I/O" dialog:



1. Select "Setup > Environment > Global Trigger/Clock/External Inputs" or
2. In the "Baseband" function block select any digital standard, e.g. "GSM/EDGE" and select "Trigger > Global Trigger/Clock/External Inputs".

The signals are assigned to the USER interfaces in the "Mapping Configuration" section. The pin assignment of the AUX I/Oconnector is also displayed. An adapter between the

AUX I/O interface and coaxial BNC connections is available as an accessory (accessories for R&S Signal Generator-Z5, see data sheet).

The polarity of the blank marker is selected in the "No Signal (Blank) Marker" section.

#### AUX I/O Connector

An illustration of the AUX I/O interface is shown. The inputs are indicated by a "depressed" pin , outputs by a non-depressed pin .

The assignment is shown in tabular form underneath the interface. The colors indicate the signal type. A distinction is made between control signals (yellow), marker signals (green), data (orange), freely selectable signals at the user pins (blue), ground (gray), and unused pins (black).

For detailed description of the AUX I/O connector, refer to [chapter A.2, "AUX I/O Connector"](#), on page 756.

#### User Connector Signal

Selects the signal for USER interface 1 (BNC), 2, 3 or 4 (AUX I/O). The signals which are available for selection are given in [table 5-1](#).

SCPI command:

`:OUTPut:USER<ch>:SOURce` on page 516

#### Polarity (No Signal Marker)

Selects the polarity of the No Signal Marker.

If Positive is selected, the signal is high (2.5 V) when the marker is active; if Negative is selected, the signal is low (0 V).

SCPI command:

`:OUTPut:BLANk:POLarity` on page 514

### 5.2.3.13 Remote Channel Settings

The "Remote Channel Settings" dialog provides access to the settings for remote control. The dialog is opened using the SETUP or MENU key under "Remote".

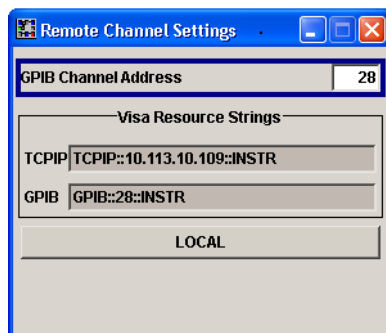

#### GPIB channel address

Sets the GPIB address of the instrument.

SCPI command:

`:SYSTem:COMMunicate:GPIB[:SELF]:ADDRes` on page 730

**Visa Resource Strings**

Indicates the visa resource strings, used for remote control of the instrument. A separate string is provided for remote control via the different interfaces.

SCPI command:

:SYSTem:COMMunicate:NETWork:RESource on page 731

:SYSTem:COMMunicate:SOCKet:RESource on page 731

:SYSTem:COMMunicate:GPIB:RESource on page 731

**Local (Remote Channel Settings)**

Switches the instrument to operate in local control mode.

Switching from remote to local control mode can be also done with one of the following actions:

- manually with the LOCAL key on the front panel
- with the interface command &GTL via the remote-control interface
- with the key combination CTRL + Q.

SCPI command:

&GTL

**5.2.3.14 LXI Status**

The "LXI - LAN eXtensions for Instruments - Status..." dialog displays the settings and status of the LAN and allows to reset the LAN connection.

For more information about LXI, see [chapter 2.9, "LXI Configuration"](#), on page 57.

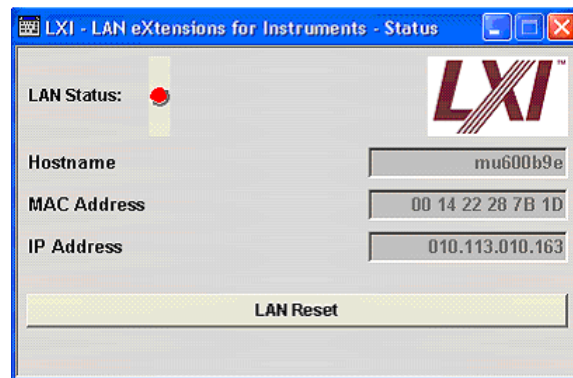
**LAN Status**

The LED indicates the LXI status.

The LAN Status is also indicated with the LED "LAN Status" on the front panel of the instrument.

"green"	normal operation
"green (flash- ing)"	device identification
"red"	LAN fault

SCPI command:

n.a.

**LAN Reset**

Initiates the network configuration reset mechanism for the instrument and resets the hostname, MAC address, and IP address.

Alternatively, the LAN RESET button on the front panel of the instrument can be used. To initiate the network configuration reset, press the button longer than 4 sec and wait for the signal tone.

According to the LXI standard, an LAN Reset must place the following network settings to a default state:

Parameter	Value
TCP/IP Mode	DHCP + Auto IP Address
Dynamic DNS	Enabled
ICMP Ping	Enabled
Password for LAN configuration	LxiWebIfc

The LAN Reset for the R&S Signal Generator also resets the following parameters:

Parameter	
Hostname	Instrument-specific host name
Description	Vector Signal Generator
Negotiation	Auto Detect
VXI-11 Discovery	Enabled

The LAN settings are configured using the instrument's LXI Browser Interface described in [chapter 2.9, "LXI Configuration"](#), on page 57.

To open the "Instrument Home Page" (welcome page), type the instrument's computer name (host name) or IP address in the address field of the browser on your PC, e.g. *http://10.111.10.175*.

**Note:** Do not add the missing zeros in the IP address, while opening the Instrument Home Page.

SCPI command:  
n.a.

**5.2.3.15 Protection**

This "Protection" dialog provides access to the unlocking of different protection levels. To open this dialog, use the SETUP or MENU key under "Protection".

After the instrument has been switched on, the protection levels 1 to 5 are automatically activated. To deactivate the protection, the correct password has to be entered. With the corresponding check boxes, you can activate the protection again.



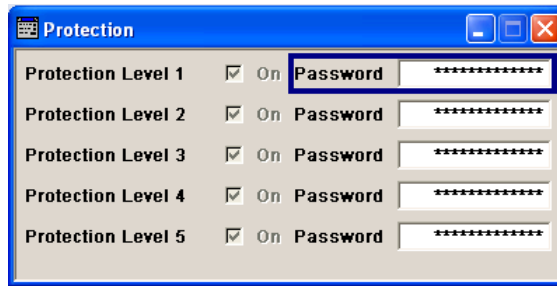

The following functions are protected in the respective levels:

- Protection Level 1  
protects against accidental changes to certain settings, such as clock and date, network settings or instrument names, etc. This level is accessible to the user.
- Protection Level 2  
provides access to the unlocking of protected service functions. It is accessible to authorized personnel of R&S Service Departments only.
- Protection Level 3-5  
are reserved for factory internal use.

#### Protection Level/Password

Protection Level 1 can be activated to expand the functionality of the internal adjustment and to access the selftests.

The password is 123456.

SCPI command:

`:SYSTEM:PROTECT<ch>[:STATE]` on page 734

#### 5.2.3.16 Security

The "Security" dialog provides access to the passwords and mass storage security settings. To open this menu, use the SETUP or MENU key under "Protection".

The menu is divided into the password sections and the security settings section. In the password section, the passwords for securing a controlled access to the instrument are defined and changed.

A change of passwords for the operating system and security password requires the entry of the old and new password and the conformation of the new password. All settings are only accepted after the "Change Password" button is pressed.

**Old Password (Security Password)**

Enters the currently used security password. The default password is '123456'.

**Note:** It is highly recommended to change the default security password before connecting the instrument to the network.

The security password is required when changing the status of the USB and LAN interface.

SCPI command:

n.a.

**New Password (Security Password)**

Enters the new security password.

The security password may contain decimal characters only.

SCPI command:

n.a.

**Confirm Password (Security Password)**

Enters the new password for conformation.

The new password is only valid after the "Change Password" button is pressed.

SCPI command:

n.a.

**Change Password (Security Password)**

Changes the password accordingly.

SCPI command:

n.a.

**USB Device**

Enables/disables the USB interfaces.

The instrument does not recognize any device connected to the USB interface when the interface is disabled.

The setting requires the entry of the security password and is only accepted after the "Accept" button is pressed.

SCPI command:  
n.a.

#### **LAN Connection**

Enables/disables the LAN interface.

It is not possible to access the instrument via LAN while the LAN connection is disabled.

The setting requires the entry of the security password and is only accepted after the "Accept" button is pressed.

SCPI command:  
n.a.

#### **Annotation Frequency**

Enables/disables the display of the currently used frequency in the header of the instrument.

The setting requires the entry of the security password and is only accepted after the "Accept" button is pressed.

SCPI command:  
n.a.

#### **Annotation Amplitude**

Enables/disables the display of the currently selected level in the header of the instrument.

The setting requires the entry of the security password and is only accepted after the "Accept" button is pressed.

SCPI command:  
n.a.

#### **Security Password**

Enters the password that is required to enable or to disable the settings protected by a security password. Default is '123456'.

**Note:** It is highly recommended to change the default security password before connecting the instrument to the network.

All settings are only accepted after the "Accept" button is pressed.

SCPI command:  
n.a.

#### **Accept - Security**

Accepts a new entry or selection and changes the settings accordingly.

SCPI command:  
n.a.

#### **Bluetooth Pin**

Requires a USB Bluetooth adapter (recommended extra, see data sheet).

Enters the Bluetooth pin of an external Bluetooth device. The pin is required to enable remote control via an external Bluetooth device.

SCPI command:  
n.a.

### 5.2.3.17 Save/Recall

The "Save/Recall" submenu can also be called up with the FILE key and is therefore described in the section of this key (see [chapter 5.2.8, "Storing and Loading Instrument Data - File Key"](#), on page 146).

### 5.2.3.18 Factory Preset

The "Factory Preset" dialog provides a function to reset the instrument's settings to their factory state. This function is activated by pressing the "Execute Factory Preset" button.



#### Factory Preset

Reset the instrument's settings to their factory state.

**Note:** Since Factory Preset resets the Remote Channel and network settings to the default values, executing Factory Preset via remote control terminates the connection to the instrument, if these settings had been configured to values different to the default ones!

The factory preset function resets nearly all instrument settings. In addition to the regular preset by means of the PRESET key, a "Factory Preset" resets also the following values:

- Reference frequency settings ("Ref Oscillator" menu)
- Power on settings ("Level/EMF" menu)
- Network settings including hostname ("Setup" menu)
- Remote Channel settings including GPIB address ("Setup" menu)
- Start/Stop Gui Update ("Setup" menu)
- Display and keyboard settings ("Setup" menu).

To maintain security, password settings and all settings protected by these passwords like disabled USB and LAN connections are not changed.

Not affected by the "Factory Preset" are also user data, lists or instrument settings files, created for example by means of the Save/Recall function.

SCPI command:  
:SYSTem:FPReset on page 458

### 5.2.3.19 Help

The "Help" dialog offers comprehensive online help for the R&S Signal Generator. A desired topic can be selected via the table of contents (select "Manual") or the index (select "Index").

For context-sensitive information about a marked parameter, press the HELP key. For a description of the "Help" menu, refer to the section covering to the HELP key (see [chapter 5.2.7, "Help System - Help Key"](#), on page 145).

### 5.2.4 Switching to Manual Control - Local Key

In remote control mode a status message appears in the display header. The rest of the display remains unchanged and shows the current instrument status, i.e. the status which exists under the remote control settings. The instrument can be operated (e.g. menus can be opened). However, it is not possible to enter or change values.

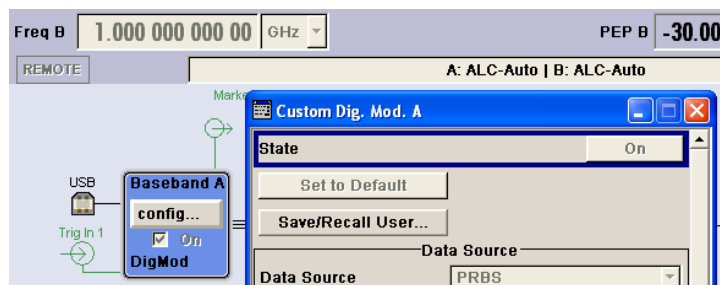

The status message additionally indicates whether the LOCAL key is disabled or enabled.

See also [chapter 6.2.1, "Switching to Remote Control"](#), on page 420.

If the "REMOTE" status message is shown, the LOCAL key switches the instrument from remote control to manual control. The current command must be fully processed before the mode is switched, otherwise the instrument switches immediately back to remote control.

If the "REM-LLO" status message is displayed, the instrument can be switched from remote control to manual control by means of remote control only (e.g. with the Visual Basic command `CALL IBLOC (generator%)`); the LOCAL key is disabled. The key is disabled by remote control with the command LLO.

When switching from remote to manual control, the display update suppression function, if active ("SETUP > GUI Update" is Off), is automatically deactivated ("SETUP > GUI Update" is On).

### 5.2.5 Generating a Hard Copy of the Display

The "HCOPY" key opens a window for configuring the hardcopy setting, like output file format, printer or path and file name. The parameters to be set change in dependency of the selected output device.

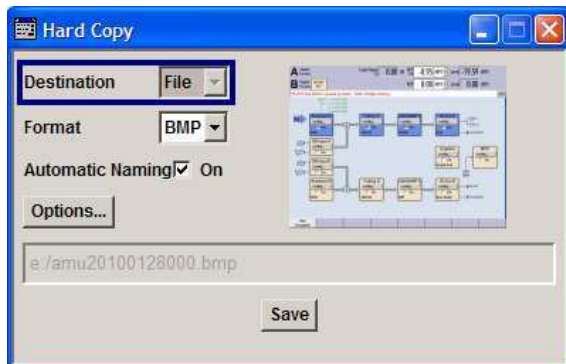

### 5.2.5.1 Hardcopy Dialog

#### Destination

Selects if the hardcopy is printed or stored in a file (see also "[Printer Options](#)" on page 142 or "[File Options](#)" on page 143).

SCPI command:

`:HCOPY:DEVIce` on page 495

#### Options

Opens the Hardcopy Options dialog for configuring the hardcopy. Depending on the selected destination either the printer or the file parameters can be set (see also "[Printer Options](#)" on page 142 or "[File Options](#)" on page 143).

SCPI command:

n.a.

#### Printer

If device printer is selected some settings are already offered in the hardcopy dialog. All configuration parameters are available in "[Printer Options](#)" on page 142.

#### File

Some configuration parameters are already offered in the Hardcopy dialog. All configuration parameters are available in "[File Options](#)" on page 143.

#### Automatic Naming

Activates, deactivates automatic generation of the file name. Automatic naming is configured in the "Options..." submenu, see "[File Options](#)" on page 143.

SCPI command:

`:HCOPY:FILE[:NAME]:AUTO:STATe` on page 500

### File Info

Indicates the file name. The file name can be entered either manually via the file manager (button "File...") or generated automatically (Automatic naming checkbox). Automatic naming is configured in the "Options..." submenu.

SCPI command:

:HCOPY:FILE[:NAME] on page 496

:HCOPY:FILE[:NAME]:AUTO:FILE on page 497

### 5.2.5.2 Hardcopy Options

This section describes the "Hardcopy Options" dialog.

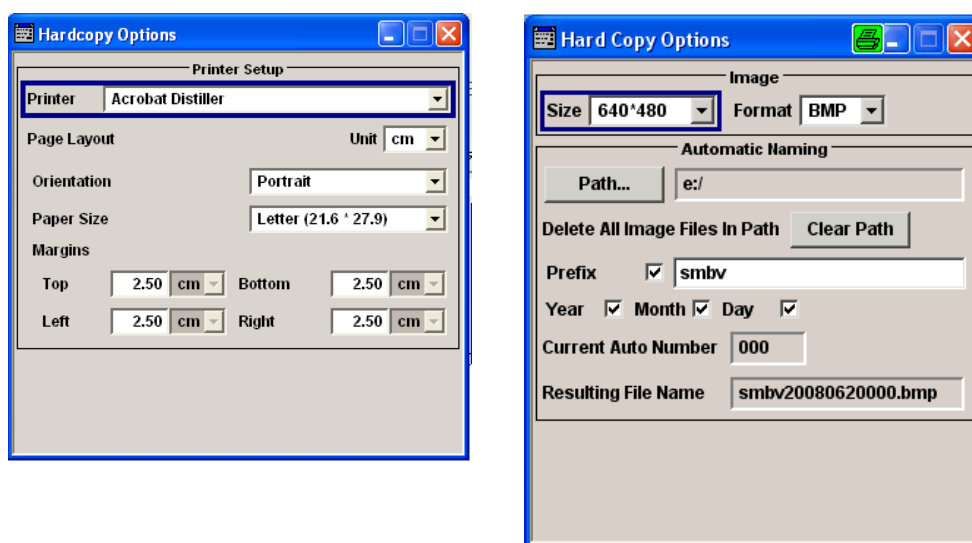

### Printer Options

Dialog for setting the printer parameters.

"Printer" Selects a printer from a list of available printers. The name of the selected printer is indicated in the selection field. If the list is empty, no printer driver is installed. In this case, a printer has to be installed via the Windows XP operating system.

For more information, see [chapter 2.4, "Connecting External Accessories"](#), on page 37.

SCPI command:

:HCOPY:PRINter:LIST on page 501

:HCOPY:PRINter[:NAME] on page 501

"Unit" Defines the physical unit of the page size and margins used for the hardcopy. The selectable units are inches or centimeter.

SCPI command:

:HCOPY:PRINter:PAGE:UNIT on page 502

"Orientation" Defines the orientation of the printer page for the hardcopy.  
 "Portrait" - the page's height is greater than its width.  
 "Landscape" - the page's width is greater than its height.

SCPI command:

[:HCOPY:PRINter:PAGE:ORIENTATION](#) on page 501

"Paper Size" Selects the size of the printer paper for the hardcopy. The currently selectable paper formats are "Letter", "Legal", "Executive", "A4" and "A5". For information on the paper format width and height values are indicated additionally. Depending on the set physical unit by the parameter "Unit", width and height are expressed in cm or inches.

SCPI command:

[:HCOPY:PRINter:PAGE:SIZE](#) on page 502

"Margins" Defines the margins of the paper size for printing the hardcopy. "Top", "bottom", "left" and "right" margin values have to be entered in this sequence, separated by commas. Decimal places are separated by a decimal point. Depending on the set physical unit by the parameter "Unit", width and height are expressed in cm or inches.

SCPI command:

[:HCOPY:PRINter:PAGE:MARGins](#) on page 501

### File Options

Dialog for setting the file parameters.

"Size" Defines the size of the bitmap in terms of pixels. The first value of the size setting defines the width, the second value the height of the image.

SCPI command:

[:HCOPY:IMAGe:SIZE](#) on page 500

"Format" Selects the image format. Several bitmap formats are available.

SCPI command:

[:HCOPY:DEVice:LANGuage](#) on page 495

"Automatic Naming" Determines the rules to create the file names and sets the directory the files are saved into.

As default the automatically generated file name is composed of:  
 <Path>/<Prefix><YYYY><MM><DD><Number>.<Format>

Each component can be deactivated/activated separately to individually design the file name. The resulting file name is indicated.

"Path..." Opens the "Select Hard Copy Destination Path" dialog to select a path for storing the hardcopy.

**Note:** For selecting the destination path a file name must be entered as well. Otherwise the error message "The name of a list may not be empty" is displayed and the selection will be canceled.

Directory, path and file name are displayed in the infoline right to the "Path" button.

SCPI command:

[:HCOPY:FILE\[:NAME\]:AUTO:DIRectory](#) on page 497

[:HCOPY:FILE\[:NAME\]:AUTO](#) on page 496



"Clear Path" Deletes all image files with extensions bmp, img, png, xpm and csv in the directory set for automatic naming. Before deleting the image files a warning message is displayed requiring the confirmation.

SCPI command:

`:HCOPY:FILE[:NAME]:AUTO:DIRectory:CLEar` on page 497

"Prefix" Activates the usage of the prefix in the automatic file name. The prefix is entered in the field to the right of checkbox.

SCPI command:

`:HCOPY:FILE[:NAME]:AUTO[:FILE]:PREFIX:STATe` on page 499

"Enter prefix" Enters the prefix for the automatically generated file name. The use of the prefix is activated in the checkbox to the left.

SCPI command:

`:HCOPY:FILE[:NAME]:AUTO[:FILE]:PREFIX` on page 499

"Date - Year / Month / Day" Defines the components of the automatically generated file name. The selectable parameters are year, month and day. If activated the current year, month or day used in the file name.

SCPI command:

`:HCOPY:FILE[:NAME]:AUTO[:FILE]:YEAR:STATe` on page 500

`:HCOPY:FILE[:NAME]:AUTO[:FILE]:MONTH:STATe` on page 498

`:HCOPY:FILE[:NAME]:AUTO[:FILE]:DAY:STATe` on page 498

"Current Auto Number" Indicates the number which is used in the automatically generated file name.

**Note:** On initially switching on the device the number will be reset to the lowest possible value. Starting with number 0 the output directory will be scanned for already existing files. As long as files with the same name are existing the number will be increased by 1. The number will be automatically set to a number so that the resulting file name will be unique within the selected path. The current number will not be saved in the save recall file but will be temporarily stored within the database. On subsequent saves the number will be increased.

SCPI command:

`:HCOPY:FILE[:NAME]:AUTO[:FILE]:NUMBER` on page 498

"Resulting File Name" Indicates the automatically generated file name.

SCPI command:

`:HCOPY:FILE[:NAME]:AUTO:FILE` on page 497

### Print / Save

Triggers the generation of a hardcopy.

SCPI command:

`:HCOPY[:EXECute]` on page 496

## 5.2.6 Messages - Info Key

The INFO key opens a window containing a detailed description of every message displayed in the info bar, see [chapter 4.2.3, "Info Window"](#), on page 84 and [chapter 9, "Error Messages"](#), on page 747.

## 5.2.7 Help System - Help Key

The HELP key opens a browser window containing a context-sensitive description of the highlighted parameter.

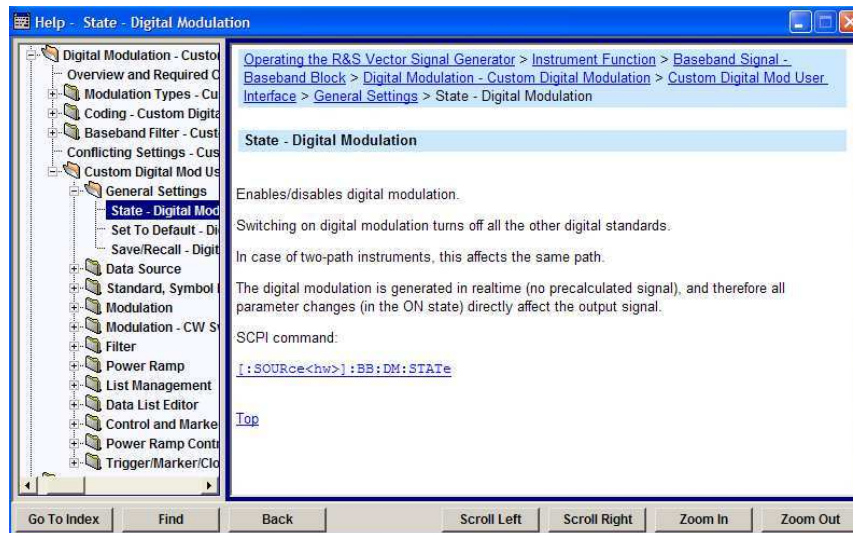

The context-sensitive page which is opened with the HELP key is part of a comprehensive help system. It is possible to move from this context-sensitive page to any page of the help system. The following navigation aids are available:

- Internal links in the text  
They open pages which are directly linked to the described function. In this way it is possible, for example, to call up the description of the GPIB command for any particular function.
- Previous/Next links  
The Previous/Next links allow scroll through the help pages. The sequence of the described functions corresponds to their position in the menus.
- Back button  
The Back button calls up the page last viewed.
- Contents in the navigation panel  
The contents list is used to open the individual help pages. It has a hierarchical structure. The highlighted line indicates where the currently displayed page is within the contents list.
- Index in the navigation panel  
The index is used to call up all pages which contain the selected entry. The index has an alphabetical structure and also contains all GPIB commands.
- Find

The find function allows you to look for freely selectable terms in all help pages. A list of the pages containing the entered term is displayed as the search result. The search can be limited to words in the page title to increase the number of hits.

The softkeys are used to determine the entry focus for front panel operation, to select the content of the navigation window and to change the font size. To determine the entry focus for front panel operation the Cursors UP/Down are used. The links are highlighted in blue, and can be selected and called up using the rotary knob.

### 5.2.8 Storing and Loading Instrument Data - File Key

The R&S SMJ allows complete instrument settings to be stored in files on the hard disk.

Defined and complex instrument settings can then be reproduced at any time by loading this data. If required, these settings can be loaded to various signal generators.

The corresponding menu is available under "Save/Recall" in the "Setup" menu or accessible by means of the FILE key. The instrument settings are saved in files which can be stored in data directories.

Additionally there are intermediate memories in which the current instrument setting can be stored and then called up again by just pressing a key. This provides fast switching between different instrument settings.

Only settings which differ from the preset values and configuration data for the operating elements (e.g. window positions) are stored. As a result the files remain relatively small. Furthermore, instrument settings can easily be transferred between different equipped signal generators since the files contain only relevant information. When loaded, the referenced settings are implemented and all non-referenced parameters are set to the associated preset values.

If list data is part of the instrument settings, e.g. a list of user correction data, a reference to this list is stored, not the list itself. The list is reactivated when the associated settings are loaded, but the list may have been modified or deleted in the meantime or may not be available on a different instrument. If the list has been modified, the new entries will be used. An error message appears if an attempt is made to access a non-existing list or to activate settings which are not supported by the instrument.



- Network settings and remote settings are not saved and restored.
  - Lists are stored and loaded in the appropriate menus. For example, the user correction data list is created and stored in the "User Correction" menu.
- 

When loading an instrument setting, it is possible to select whether the current frequency and level setting is to be retained or whether the stored settings are to be activated. It is possible to delete stored instrument settings. A file can be copied by loading it with "Recall" and then storing it under a new name.

Settings can be transferred easily between instruments with different equipment options and/or firmware versions because only the settings which differ from the preset values are affected. When settings are loaded, only those which are possible on the instrument are implemented. Error messages indicate the settings which cannot be implemented.

The stored file is transferred from one instrument to another using the memory stick or by means of a network drive.

General file management functions such as copying and moving data are available in the "File Manager" dialog.

### 5.2.8.1 File Menu

The settings available in the File menu "Save/Recall" depend on the operation selected under "Select Operation".



For more information, see [chapter 4.7.1, "File Select Dialog"](#), on page 107.

#### Select Operation

Selects the file function.

- "Save..." Calls the menu for storing the current instrument setting (see [chapter 5.2.8.2, "Storing Instrument Settings"](#), on page 147).
- "Recall..." Calls the menu for calling up a stored instrument setting (see [chapter 5.2.8.3, "Loading Instrument Settings"](#), on page 149).

### 5.2.8.2 Storing Instrument Settings

If "Save" is selected under "Select Operation", the File menu provides options for storing the current instrument setting in a file.

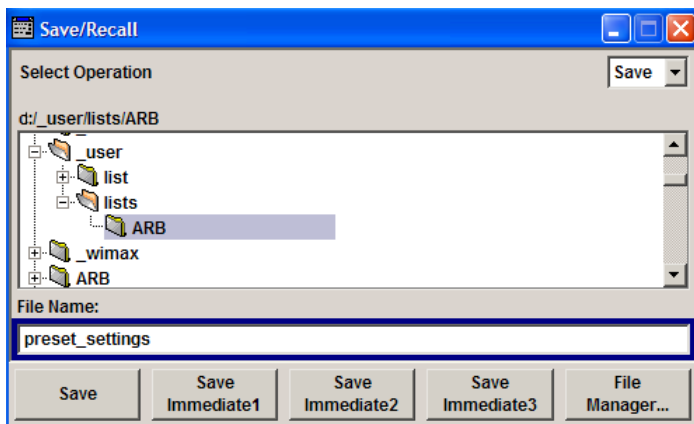

#### Recent files

Displays the files last used.

SCPI command:

n.a.

#### Directory

Selects the directory in which the file is to be stored.

The window opposite lists all settings files in this directory.

A new directory can be created in the "File Manager" dialog.

SCPI command:

[:MMEMory:CDIRectory](#) on page 509

#### File List

Displays the files which are in the selected directory.

If a file is highlighted, it is overwritten when the file is stored.

SCPI command:

[:MMEMory:CATalog](#) on page 508

#### File Name

Enter the file name of the file without file extension. This file is then created.

SCPI command:

n.a.

#### Save

Stores the current instrument settings under the specified path.

SCPI command:

[\\*SAV](#) on page 456

[:MMEMory:STORe:STATe](#) on page 512

#### Fast Save

Determines whether the instrument performs an absolute or a differential storing of the settings.

Enable this function to accelerate the saving process by saving only the settings with values different to the default ones.

However, in some test setups, e.g while analyzing the generated WiMAX signal with R&S FSQ, it is required to disable the fast save option.

**Note:** This function is not affected by the [Preset](#) function.

SCPI command:

[\[:SOURce<hw>\]:BB:DM:SETTing:STORe:FAST](#) on page 613

Refer to the descriptions of the firmware options for the correct syntax of the corresponding SCPI command.

#### Save Immediate x

Stores the current instrument setting in one of the three intermediate memories.

These instrument settings are retained until a different instrument setting is stored in the intermediate memory. When the instrument is switched off, the contents of the intermediate memories are retained.

SCPI command:

[\\*SAV](#) on page 456

#### File Manager

Calls the "File Management" menu.

Directories can be created and files managed in this menu (see [chapter 5.2.8.4, "File Manager"](#), on page 150).

SCPI command:  
n.a.

### 5.2.8.3 Loading Instrument Settings

If "Recall" is selected under "Select Operation", the "File" menu provides options for loading complete instrument settings. Here it is possible to select whether the current or stored frequency and level settings are to be used.

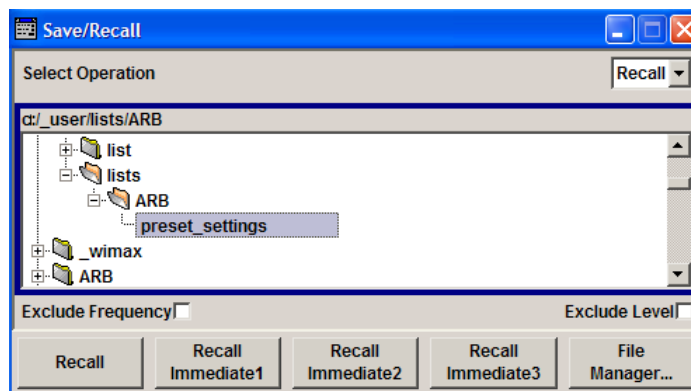

#### Recent data sets

Displays the files last used. The entire path is shown.

If the desired file is in the list, it can be selected.

SCPI command:  
n.a.

#### Directory

Enter the directory in which the file with the instrument setting to be loaded is located.

The "Selected file" window lists all the files in this directory.

SCPI command:  
[:MMEMory:CDIRectory](#) on page 509

#### File List

Selects the file with the desired instrument configuration.

SCPI command:  
[:MMEMory:CATalog](#) on page 508

#### Exclude Frequency

The current frequency is retained when a stored instrument setting is loaded.

SCPI command:  
[\[:SOURce<hw>\]:FREQuency\[:CW|:FIXed\]:RCL](#) on page 657

**Exclude Level**

The current level is retained when a stored instrument setting is loaded.

SCPI command:

`[ :SOURce<hw> ] :POWER [ :LEVel ] [ :IMMediate ] :RCL` on page 708

**Recall**

Load the selected configuration.

If an instrument setting in which a sweep was activated is stored, the sweep is started when the recall command is called.

If an instrument setting which accesses lists is stored, this list is also loaded.

If the list has been deleted in the meantime, an error message appears when the instrument setting is loaded. If the list has been overwritten in the meantime, the new entries will be used.

SCPI command:

`:MMEMory:LOAD:STATe` on page 511

\*`RCL` on page 456

**Recall Immediate x**

Loads the selected configuration from one of the three intermediate memories.

If an instrument setting in which a sweep was activated is stored, the sweep is started when the recall command is called.

If an instrument setting which accesses lists is stored, this list is also loaded.

If the list has been deleted in the meantime, an error message appears when the instrument setting is loaded. If the list has been overwritten in the meantime, the new entries will be used.

A message appears if no instrument configuration is stored in this memory.

SCPI command:

\*`RCL` on page 456

**5.2.8.4 File Manager**

The "File Manager" dialog provides all the functions required for file management. Directories can be created, and files copied, deleted and moved between the directories on the drives (hard disk, memory stick and network drives).

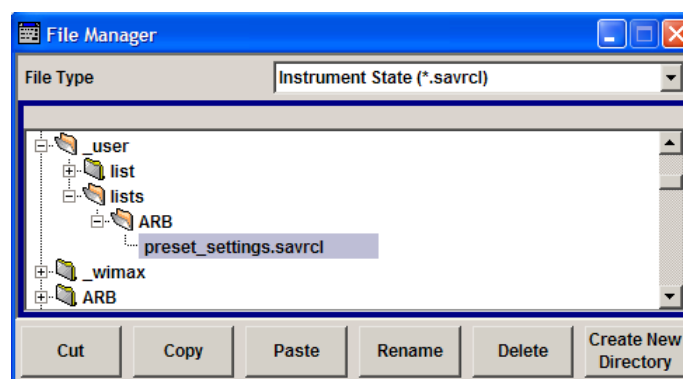

For more information, see [chapter 4.7.2, "File Manager"](#), on page 109.

**File Type**

Selects the file types to be indicated. If a file type with a specific file extension is selected only files with this extension are indicated in the selected directory.

SCPI command:

n.a.

**Directory and File Name**

Selects the directory in which the file to be deleted or copied is located. The window lists all files in this directory. The file to be deleted or copied can be highlighted. The path is indicated above the directory window.

SCPI command:

[:MMEMory:CDIRectory](#) on page 509

**Cut**

Cuts the selected file. It can be pasted into a different directory using the "Paste" button.

SCPI command:

[:MMEMory:DELeTe](#) on page 511

**Copy**

Copies the selected file. It can be pasted into a different or the same directory using the "Paste" button. When pasting the file into the same directory file name `Copy of <file name>` is given automatically. When pasting the file into a different directory, the original file name is kept.

SCPI command:

[:MMEMory:COpy](#) on page 509

**Paste**

Pastes the file that has been copied or cut before.

SCPI command:

n.a.

**Rename**

Renames the selected file or directory. The new name can be entered in the "New File-name" dialog.

SCPI command:

[:MMEMory:MOVE](#) on page 512

**Delete**

Deletes the selected file. Before the file is deleted, a message appears prompting the user to confirm deletion of the file.

SCPI command:

[:MMEMory:DELeTe](#) on page 511



### Create New Directory

Creates a new directory. The name of the new directory can be entered in the "New Directory" dialog.

**Note:** When the subdirectory is entered, it is possible to enter an absolute path name (e.g. D:USER/MEAS) or the path relative to the current directory (e.g. ../MEAS).

The directory is created as a subdirectory in the selected level.

SCPI command:

[:MMEMory:MDIRectory](#) on page 511

## 5.3 Graphical Display - Graphics

The R&S Signal Generator can be used to graphically display the generated baseband signal. A selection of different signal displays assists the user in assessing and checking the increasingly complex modulation signals.



The Graphics function block is available for instruments with the option:

- R&S SMJ-B13 (Baseband Main Module) and one of the options R&S SMJ-B9/B10/B11 (UniCod + ARB)
- R&S SMJ-B62 (Noise Generator)

It is the baseband signal actually generated that is recorded and displayed, and not a signal calculated on the basis of the set parameters.

This graphical display allows the user to quickly view and check the current signal characteristics and also gives an overview of the changes in the signal over time. The signal quality can be permanently monitored. The results of parameter changes on the signal, such as a change in modulation mode, or the effects of certain configurations, e.g. the activation of several base stations in the case of (W)CDMA signals, can be analyzed directly in the display. Freezing the signal and then zooming permit a detailed evaluation of any signal segment. The definition and display of one or more reference curves makes it possible to compare various signals (i.e. by comparing the CCDF (Complementary Cumulative Distribution Function) with different channelization codes, or the spectra if different filter parameters are selected).

The displayed signal segment can be influenced by selecting the trigger that defines the time for recording to start. With automatic triggering, the signal is tapped at the point in the signal path that is best for the respective display. The displayed signal segment is selected internally depending on the signal such that the signal characteristics of interest (e.g. the useful signal) are displayed. This selection is appropriate for a representative display of the complete signal.

In addition, a user-definable trigger is available with which the displayed signal segment can be limited.

The time resolution can be set either automatically or manually, whereby for manual setting the bandwidth for which the trace is to be displayed is selected. The transient recorders used for signal recording have a variable recording depth which is specified under the respective display.

In addition to the large graphics window, the display can also be shown in a small window ("smart graphics"). This window is fitted into the block diagram as a block, and can be used for basic checking purposes (e.g. whether the signal is still being generated).

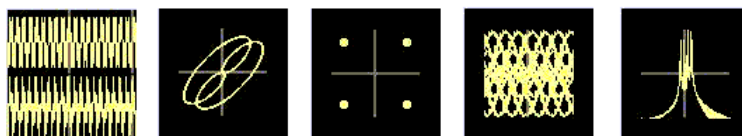

### 5.3.1 Graphics Settings Menu

The "Graphics Settings" menu for selecting the graphical display of the output signal is opened either in the "Graphics" function block or in the menu with the same name which is opened using the MENU key.

The signal display can be selected and activated in the menu.

With two-path instruments, the settings for the two paths can be entered separately. The signals can be displayed simultaneously in two separate windows.

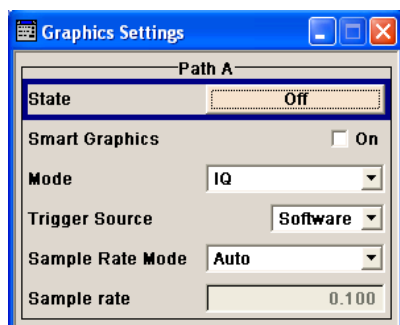

#### State

Activates the selected graphical display.

After activation, the diagram selected with "Mode" is displayed in the block diagram.

At the bottom of each graphics window there are several buttons for freezing and zooming the display and for activating a reference curve.

For more information, see [chapter 5.3.2, "Bar of Graphics Window"](#), on page 155.

SCPI command:

`[ :SOURce<hw> ] :BB:GRAPhics:STATe` on page 616

#### Smart Graphics

Activates the "smart graphics".

The graphic is displayed in a small window which is roughly the size of a block. These windows are displayed permanently in the block diagram until they are deactivated, and allow basic checking of the signal. They do not contain any buttons.

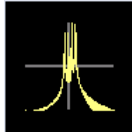

SCPI command:

[\[:SOURCE<hw>\]:BB:GRAPHics:SMART:STATE](#) on page 615

### Mode

Selects the graphical signal display. The display is not shown until it has been activated with "Status On".

The individual signal displays are described in the [chapter 5.3.3, "Signal Displays"](#), on page 157.

SCPI command:

[\[:SOURCE<hw>\]:BB:GRAPHics:MODE](#) on page 615

### Trigger Source

Defines the trigger for the starting time of the graphic recording.

- |            |   |
|------------|---|
| "Software" | Recording of signals is started automatically in specified intervals. This asynchronous method is appropriate when a representative display of the complete signal is desired, as recording starts in a random time reference to the signal.  |
| "Marker 1" | The starting point for recording signals is determined by marker 1 in the menu of the active standard. This synchronous method is appropriate when specific signal segments are to be shown in greater detail. With periodic signals, a static image is obtained by selecting a period length of marker 1 that is equal to the signal period. The displayed signal segment can be shifted as needed by entering a marker delay in the Trigger/Marker menu of the active standard. |

SCPI command:

[\[:SOURCE<hw>\]:BB:GRAPHics:TRIGger:SOURce](#) on page 617

### Scrambling Code

(only if Code Domain (3GPP FDD DL) is selected)

Sets the scrambling code if the "Code Domain" display is selected. Since it is possible to select a different scrambling code in the menu for each of the 4 base stations and it is also possible to display an external signal, the scrambling code for which the display is to be generated must be explicitly specified here.

SCPI command:

n.a.

**Sample Rate Mode**

Sets how the time resolution of the signal is determined. Maximum resolution corresponds to a display covering the entire signal bandwidth. The higher the resolution is, the shorter the length of the displayed signal segment will be for the specified recording depth.

"Auto"	The resolution is set to an optimum value on the basis of the signal and display type.
"Full Bandwidth"	The resolution is set such that the display covers the entire signal bandwidth.
"User"	Under "Graphics Sample Rate", the user can determine the resolution by setting the signal bandwidth for which the display is to be generated.

SCPI command:

[\[:SOURce<hw>\]:BB:GRAPhics:SRATe:MODE](#) on page 615

**Graphics Sample Rate**

With "Auto" and "Full Bandwidth":

Displays the signal bandwidth for which the display is to be generated.

With "User":

Selects the signal bandwidth for which the display is to be generated. The setting range moves between the minimum and maximum bandwidth which is possible for the selected display. The selection is made graphically by moving the pointer.

SCPI command:

[\[:SOURce<hw>\]:BB:GRAPhics:SRATe:USER](#) on page 616

**5.3.2 Bar of Graphics Window**

At the bottom of each graphics window there are buttons for freezing and zooming the display and for defining and activating a reference curve.

**Run**

Freezes the current display.

Clicking the button again reactivates the normal, permanently updated display.

Freezing the display allows it to be analyzed more easily. Zooming the display at the same time permits detailed evaluation of any signal segment.

SCPI command:

n.a.

**Zoom In (only possible with mouse)**

The mouse can be used to freely select any section to be zoomed. This section is selected by pressing the left-hand mouse key and dragging a rectangular marquee. In this way a display can be zoomed in several steps. The zoom is cancelled by clicking the "Zoom Out" button.

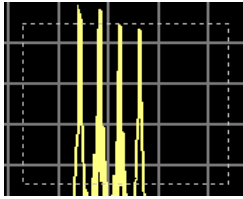

SCPI command:  
n.a.

#### Zoom out

Cancels the zoom.

SCPI command:  
n.a.

#### Time

(I/Q mode only)

Switches to seconds for time representation on the X axis of the I/Q diagram.

SCPI command:  
n.a.

#### Show ref

Displays the reference curve(s). All defined reference curves are displayed simultaneously (see the description of the "Copy to ref" button).

The reference curves are displayed together with the current signal. They allow visual comparison of two or more signals with different settings, e.g. with different filters.

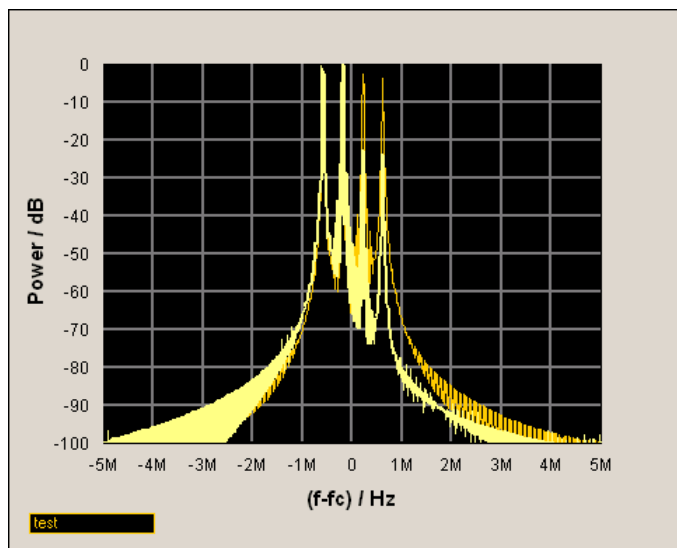

Clicking the button again hides the reference curves.

The reference curves must be defined beforehand using the "Copy to Ref" button.

SCPI command:  
n.a.

**Copy to ref**

Defines the current curve as the reference curve.

A window opens in which the curve can be given a comment and a color.

First of all the desired color is highlighted in the top window. If this color has already been assigned to a reference curve, this curve is overwritten. The command is entered in the bottom "Comment" section. This comment then appears next to the highlighted color.

Up to 5 reference curves can be defined and displayed simultaneously in different colors together with the current signal.

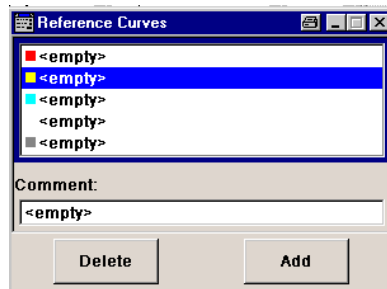

Each reference curve is available until it is deleted.

"Display area" The comments entered for the defined reference curve are shown in the display area next the assigned color. A maximum of five colors (and reference curves) are available. If no reference curve is assigned to a particular color, the comment <empty> is displayed.

"Comment" Enters a comment for the current curve which is to be defined as the reference curve. This comment then appears next to the highlighted color in the display area.

"Delete" Deletes the curve highlighted in the display area. Curves which are no longer required can be deleted to reduce the number of reference curves displayed simultaneously.

"Assign" Defines the current curve as the reference curve. The new reference curve is shown together with the entered comment next to the selected color in the display area.

SCPI command:

n.a.

**5.3.3 Signal Displays**

All signal displays which are used for analyzing a baseband signal can be selected. A number of signal displays are only available if the corresponding signal is generated, e.g. Code Domain only available for (W)CDMA signals.

**5.3.3.1 I/Q Diagram**

The I/Q diagram displays the inphase component ( $i[t]$ ) and quadrature component ( $q[t]$ ) of the I/Q signal over time.

The diagram is displayed in a window with two separate coordinate systems. The coordinate systems have identical X and Y axes. The time (in number of symbols, chips or samples depending on the signal) is plotted on the X axes, and the amplitude scaled to the peak envelope power (PEP) is plotted on the Y axes (minimum scaled amplitude = -1; maximum scaled amplitude = +1). The recording depth is 1 kSamples.

This signal is picked off at the output of the baseband main module ("Impairment" function block), i.e. contained in the displayed signal is:

- impairment of the signal as defined by the user and the addition of noise.

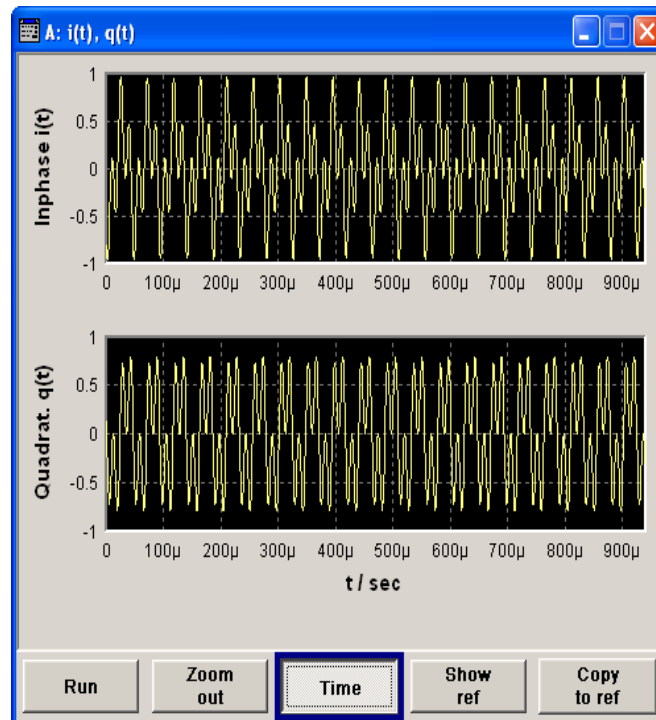

### 5.3.3.2 Vector Diagram

The Q component is displayed over the I component in the vector diagram. Each point is determined by a vector. The amplitudes of the signal components scaled to the peak envelope power (PEP) are plotted on the X and Y axis (minimum scaled amplitude = -1; maximum scaled amplitude = +1).

This display shows the curves between the various states of modulation mapping. The recording depth is 1 kSamples.

This signal is picked off at the output of the baseband main module ("Impairment" function block), i.e. contained in the displayed signal is:

- impairment of the signal as defined by the user and the addition of noise.

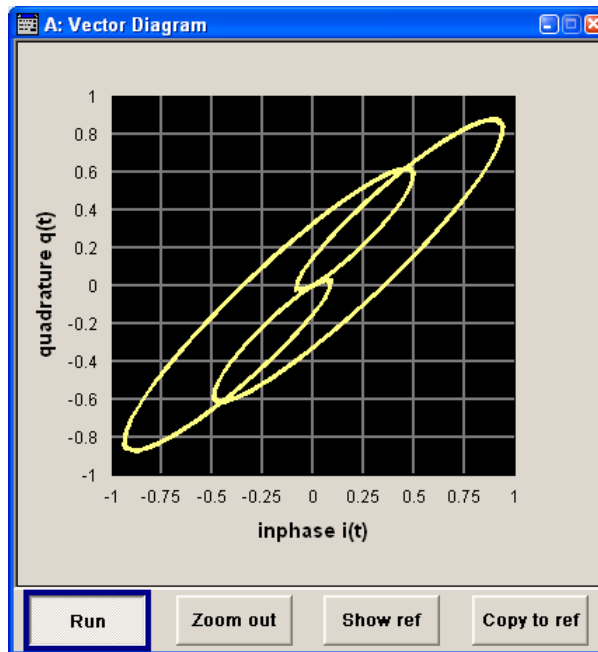

### 5.3.3.3 Constellation Diagram

In the constellation diagram, the Q component is also displayed over the I component. However, only the values at the constellation points (signal value at the ideal scanning instant of the symbol) are displayed, i.e. for each symbol only 1 value in the form of a circle is shown for the I and Q component.

The amplitudes of the signal components scaled to the peak envelope power (PEP) are plotted on the X and Y axis (minimum scaled amplitude = -1; maximum scaled amplitude = +1). The recording depth is 2kSamples.

This signal is picked off at the output of the baseband main module ("Impairment" function block), i.e. contained in the displayed signal is:

- impairment of the signal as defined by the user and the addition of noise.

This display shows the various states of modulation mapping which occur in the signal. The example shows the constellation diagram of a QPSK modulation signal.



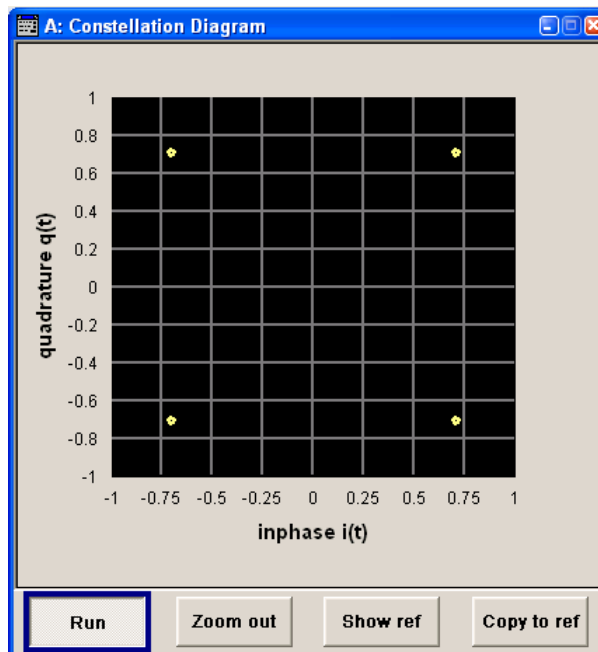

#### 5.3.3.4 Eye Diagram

The eye diagram displays synchronized and superimposed sections of either the inphase or quadrature components of the signal.

The display width (eye length) is set at 2 symbols; several hundred curve segments are superimposed. The time (in the range  $\pm 1$  symbol) is plotted on the X axis, and the amplitude scaled to the peak envelope power (PEP) is plotted on the Y axis (minimum scaled amplitude = -1; maximum scaled amplitude = +1). The beginning of recording is synchronous to the symbol and chip clock pulse. The recording depth is 2kSamples.

This signal is picked off at the output of the baseband main module ("Impairment" function block), i.e. contained in the displayed signal is:

- impairment of the signal as defined by the user and the addition of noise.

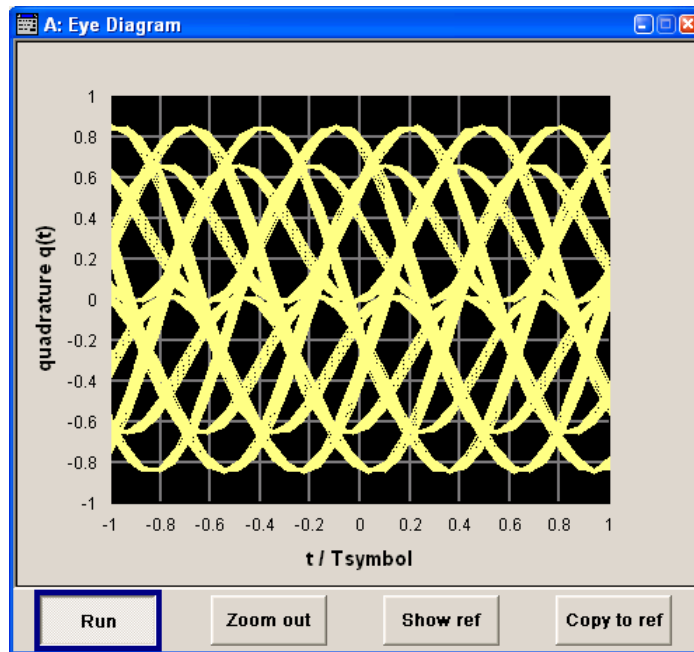

### 5.3.3.5 CCDF Display

The **Complementary Cumulative Distribution Function** shows the probability with which the output signal will exceed the average power.

The level over the average power is plotted from 0 to 20 dB on the X axis; the average power (RMS) corresponds to the origin. The probability of exceeding the average power is plotted between 0.0001% and 100% on the Y axis. The recording depth is 8kSamples.

This signal is picked off at the output of the baseband main module ("Impairment" function block), i.e. contained in the displayed signal is:

- impairment of the signal as defined by the user and the addition of noise.

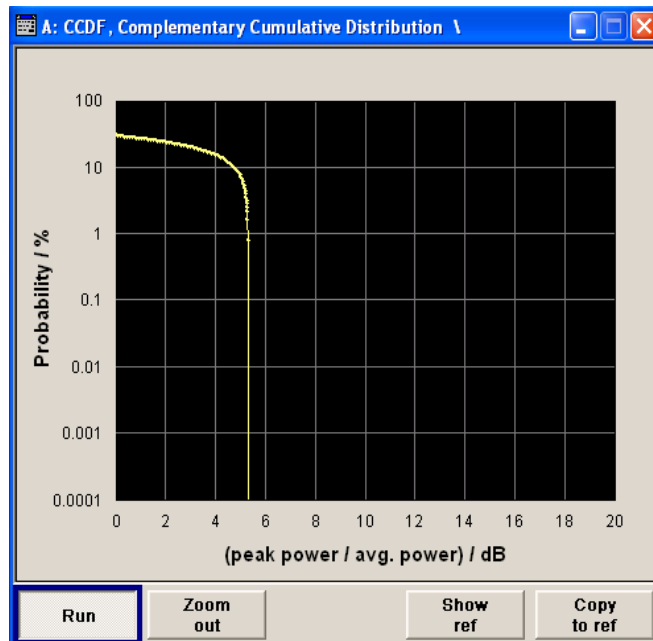

#### 5.3.3.6 Power Spectrum

With the spectrum display, the signal spectrum is calculated from the I/Q signal by means of Fast Fourier Transform (FFT).

The power density over frequency is displayed. The power density is plotted on the Y axis, and the frequency is plotted symmetrically on the X axis (-sampling rate/2 to +sampling rate/2). FFT Points indicates the number of I/Q value pairs which are used for calculating a (part-)FFT. AVG indicates the number of subspectra used for averaging. The recording depth is 8kSamples.

This signal is picked off at the output of the baseband main module ("Impairment" function block), i.e. contained in the displayed signal is:

- impairment of the signal as defined by the user and the addition of noise.

The spectrum display of the output signal is particularly suitable for checking multi carrier signals.

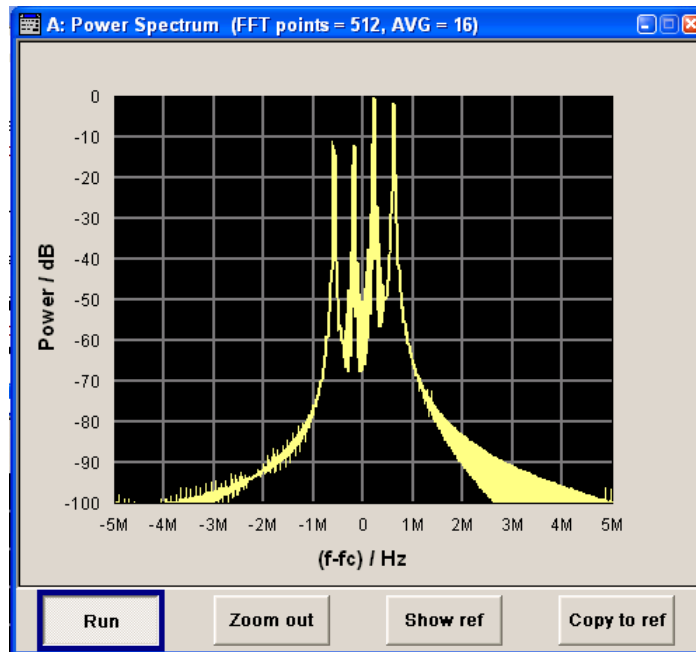

## 5.4 Bit and Block Error Rate Measurements - BERT Block

The R&S Signal Generator contains an integrated bit error rate tester which makes it possible to evaluate a signal demodulated and decoded by a DUT by measuring the bit error rate. A known PRBS-modulated data sequence (PRBS = **p**seudo **r**andom **b**inary **s**equences) is sent to the DUT. The PRBS data sequence is decoded by the DUT and sent to the R&S Signal Generator in the form of clock and data signals. The bit error rate tester of the R&S Signal Generator synchronizes to the known PRBS sequence and counts the bit errors. The quotient obtained by dividing the number of error bits by the total number of bits is the BER.

In addition, a block error rate measurement can be used to verify CRC checksums. The ratio of errored blocks to total blocks yields the block error rate.

The settings are shown in the block diagram in the "BERT" function block and in the menu of the same name that is accessed via the MENU button.

The equipment layout for the basic unit (R&S Signal Generator with B10x frequency option) includes the option R&S SMJ-K80 (Bit Error Rate Tester).

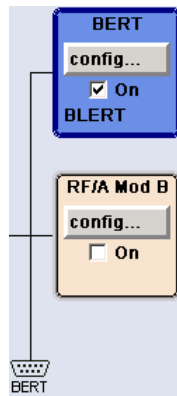

The "BERT" interface is located on the rear panel. Besides the data and clock input, it provides further inputs for masking data containing the PRBS sequence. The interface description can be found in [chapter A.4, "BERT Connector"](#), on page 758.

### 5.4.1 Test setup

The following figure shows the test setup for the bit/block error rate measurement. The data used to drive the DUT can be generated by the R&S Signal Generator or an user-defined external source. The R&S Signal Generator can generate any externally computed modulation signals that were created using e.g. R&S WinIQSIM2 software (see [chapter 5.8.3.1, "ARB User Interface"](#), on page 355).

A known PRBS sequence must be used for the bit error rate measurement.

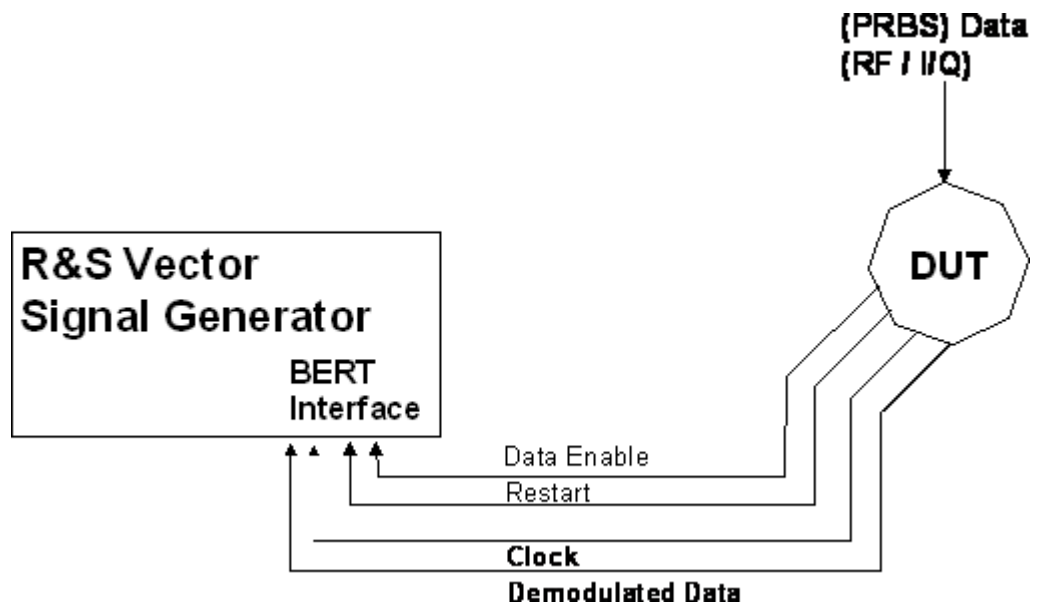

*Fig. 5-1: Test setup for bit or block error rate measurement.*

The DUT is driven using a known data sequence. It demodulates the data and sends it together with a clock signal to the R&S Signal Generator. The Data Enable signal marks

the user data of the signal. The restart signal for restarting the PRBS calculation is only important for the bit error rate measurement.

#### 5.4.2 PRBS data

To be able to detect faulty bits by a BER measurement, the data generation polynomial must be known. PRBS sequences are therefore used as the method for computing the data (see [chapter 5.8.1.1, "Internal PRBS Data and Data Patterns"](#), on page 303). These quasi-random bit sequences are repeated periodically, depending on the polynomial selected. A randomly selected initial status yields exactly one subsequent status. The initial status and therefore the subsequent status occur only once in the whole sequence.

Hence an advantage of the PRBS data is that the bit error detector must know only the polynomial but not the entire sequence. At the start of a measurement, the feedback shift register is filled once with the applied data sequence (which corresponds to the synchronization time) and is subsequently switched from "fill" to "feedback". This creates a defined initial status and generates exactly the same data that the applied data stream should have. Faulty bits can thus be identified and counted by comparing the received data with the results obtained from the shift register.

Creating a defined initial status makes it possible to start the analysis anywhere in the bit stream, i.e. the bit-stream source and the analyzer need not be synchronized. Delays of the DUT and transmission over long air paths, where the transmitter and the receiver are located at separate sites, therefore do not present a problem.

#### 5.4.3 CRC polynomial

In the block error rate measurement, the checksum (CRC) that contains the data signal fed to the DUT is compared with the checksum that the block error rate tester calculates from the feedback data. If the two checksums differ, a block error is counted. The quotient obtained by dividing the number of faulty blocks by the total number of blocks is the block error rate.

At the beginning of the data, the shift register is initialized with 0. All user data bits are then shifted through the shift register. The CRC component is then read into a second register and compared bit by bit with the result of the calculation.

CCITT CRC 16 :  $G(x) = x^{16} + x^{12} + x^5 + x^1$  is the CRC polynomial supported.

The user data is marked by a signal that comes from the DUT and is fed to the "Data Enable" input of the BERT interface.

#### 5.4.4 Clock signal

Usually the clock signal is provided by the DUT. If not, the bit clock can be extracted from the CLOCK output connector (only with "Custom Dig Mod" signals in realtime). If signals complying with other digital standards are generated or if ARB waveforms are used, a marker signal can be used as a clock. As the DUT causes a delay, the ratio of clock-to-data travel times must always be taken into account and checked with an oscilloscope if

necessary. The R&S Signal Generator indicates the status of the clock and data lines and of the synchronization in the menus.

#### 5.4.5 Ending the measurement

The measurement results usually lie in the range of  $10^{-2}$  to  $10^{-9}$  for the bit error rate, and in the range of  $10^{-2}$  to  $10^{-4}$  for the block error rate. This means that a very large number of bits or blocks may have to be tested before a faulty bit or block occurs. Because of the large number of bits/blocks involved, the measurement time is usually very long. Since 32-bit-wide counters are used for the total number of bits/blocks and the number of error bits, the maximum measurement time is  $4.29 \times 10^9$  bits.

To keep the measurement times short for both small and large bit/block error rates, the R&S Signal Generator provides a number of ways to end the measurement. In addition to manually interrupting the count, two termination criteria can be selected:

1. reaching a user-defined number of checked data bits/blocks;
2. a maximum number of detected errors.

The measurement stops as soon as one of the two criteria has been met. The display shows which of the two criteria caused the measurement to stop.



The BER/BLER measurement measures statistical bit/block errors, i.e. errors which do not occur at regular intervals but at random. Although a single measurement determines the exact number of errors in the measured interval, a statistically reliable BER/BLER can only be obtained when a sufficient number of errors occur in the observed interval. This is the only way to ensure that the single BER/BLER measurement result approaches the true error rate with high probability.

Bit error rates of approximately 50 % indicate a faulty measurement.

#### 5.4.6 Interrupt-free measurement

In the case of continuously generated signals that contain whole-number multiples of the PRBS sequence, the measurement occurs without interruption. Only the data and clock lines of the BERT interface are used for the measurement. The length of the random sequence is 2 to the power of the degree of the polynomial minus 1. For example, PRBS9 length of 511 ( $2^9$  equals 512 minus 1).

#### 5.4.7 Restart function

The "Restart" function makes it possible to perform BER measurements with short signals or with signals that are not continuously generated (and therefore do not contain any whole-number multiples of PRBS sequences). An external signal at the BERT input halts the measurement and restarts it when the data sequence begins, and the BER results of the relevant (sub)sequences are integrated.

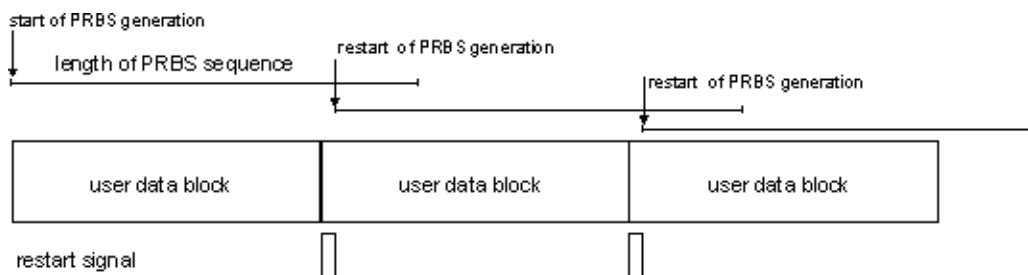

**Fig. 5-2:** The length of the signal is too short for a complete PRBS sequence; PRBS generation is restarted by the Restart signal when the signal begins anew.

Frames generated by the R&S Signal Generator or the R&S WinIQSIM2 software contain continuous PRBS data, i.e. the PRBS sequence is continuously written to the user data fields. Consequently, if the R&S Signal Generator is used as a data source, a restart is only necessary if (e.g. when using a waveform) the total length of the signal does not equal a whole-number multiple of a PRBS sequence.

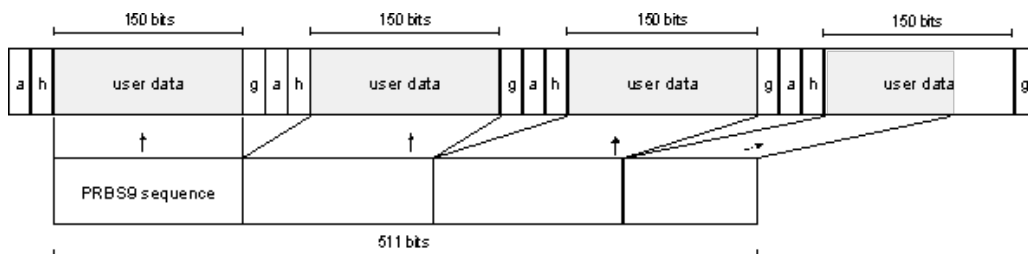

**Fig. 5-3:** TDMA signal generated by the R&S Signal Generator with user data that contains the PRBS data sequence. The PRBS sequence is continuously written to the user data fields.

### 5.4.8 Data Enable

In the case of the bit error rate measurement, the data signals usually contain not only PRBS data but also other data (e.g. sync and preambles, see figure) that would result in bit errors. The BER measurement for this data can then be interrupted using the "Data Enable" signal. The "Data Enable" signal is fed in at the BERT input.

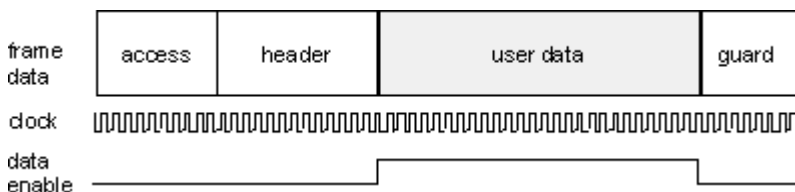

**Fig. 5-4:** TDMA signal with user data that contains the PRBS data sequence and various check fields which should be ignored for the bit error rate measurement. Below that are the associated clock and Data Enable signals.

In the case of the block error rate measurement, the "Data Enable" signal masks the user data (see following figure).



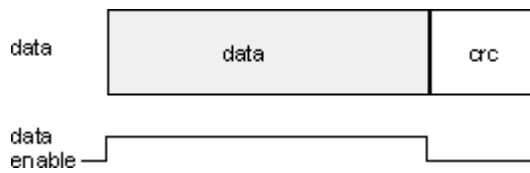

Fig. 5-5: Data Enable signal with block error rate measurement.

### 5.4.9 Pattern Ignore

Bit sequences of 32 bits or more with only "1" or "0", which some mobile radio standards provide instead of frame data when faulty frames are detected, can also be excluded from the measurement using the "Pattern Ignore" function (see figure).

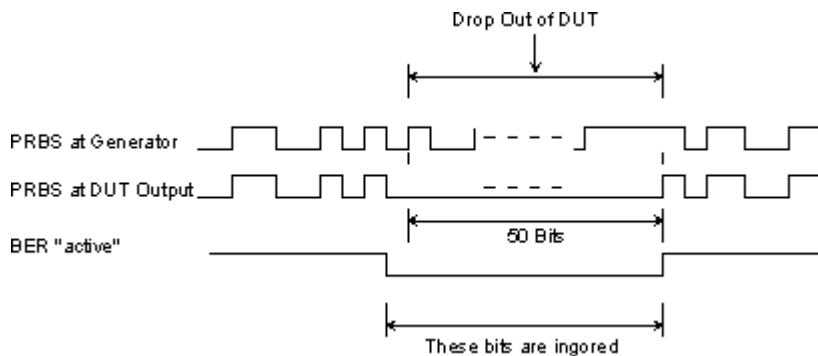
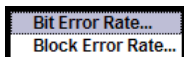

Fig. 5-6: Example of functionality of Pattern Ignore: 50 bits were set to "0" by the DUT. These 50 bits plus the preceding "0" are ignored in the bit error rate measurement.

### 5.4.10 Bit Error Rate Menu



The "Bit Error Rate" menu for configuring the bit error rate measurement is called either in the "BERT" function block or via the MENU button under "BERT"

The top section of the "Bit Error Rate" menu is used to switch on the bit error rate measurement and display the results and current status of the measurement.

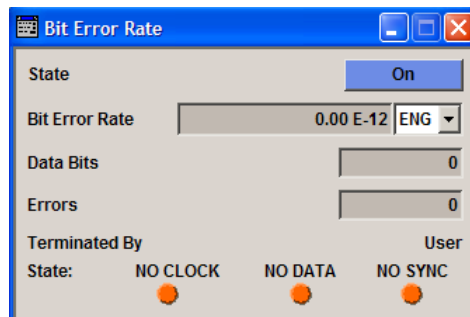

The "Configuration" section is used to select the type of measurement the data source and the termination criteria.

If the data is not cyclically continued, the measurement can be selectively interrupted and restarted. Certain data sections and frames that have been marked as faulty can be excluded from the measurement.

Configuration

Mode: Single

Max. Data Bits: 10 000 000

Max. Errors: 100

PRBS: PRBS 9

Data Polarity: Norm

Clock Slope: Pos

External Restart: On

Data Enable: Not Used

Pattern Ignore: Off

Threshold (BER): 1.00 V

Impedance (BER): 1 kΩ / GND

#### 5.4.10.1 General Settings

##### State

Switches the bit error rate measurement on/off. Depending on the selection in the "Mode" box, either a continuous measurement ("Auto") or a single measurement ("Single") is carried out. A single measurement must be started by clicking the "Execute Single" button.

SCPI command:

[:BERT:STATe](#) on page 484

##### Bit Error Rate

Displays the measured bit error rate.

The bit error rate is the ratio of occurred errors to transmitted data bits.

The display unit can be selected in the box to the right of the value.

"ENG"	The bit error rate is output in exponential notation with the exponent – 3 or –6.
"SCI"	The bit error rate is output in scientific notation, i.e. standardized to one place to the left of the decimal.
"%"	The bit error rate is output in percent.
"ppm"	The bit error rate is output in parts per million.

SCPI command:

[:BLER:RESult](#) on page 477

[:BERT:UNIT](#) on page 485

**Data Bits**

Displays the current number of data bits checked.

SCPI command:

[:BERT:RESult](#) on page 477

**Errors**

Displays the current number of occurred errors.

SCPI command:

[:BERT:RESult](#) on page 477

**Terminated By**

Displays the termination criterion for the measurement.

These criteria can be entered to keep the duration of the measurement short for low as well as high bit error rates.

The last measurement result is displayed after the measurement has been terminated.

"User"                    The measurement was manually terminated by the user switching the state to off.

"Number of Data Bits"    The measurement was terminated because the specified number of data bits was reached

"Number of Errors"        The measurement was terminated because the specified number of errors was reached.

SCPI command:

[:BERT:STATE](#) on page 484

[:BERT:STOP](#) on page 484

**State**

Displays the status of the measurement.

This enables the user to check whether the measurement functions. The status of the data and clock lines and of synchronization is checked and displayed.

If a faulty status is displayed, the signals can be checked at the BERT interface using an oscilloscope.

"Clock"                    The applied clock signal was detected.

"No Clock"                The applied clock signal was not detected. Possible causes are:

- Clock recovery is not available (e.g. with tests of RF components). If the signal is generated using the R&S Signal Generator, the bit clock can be extracted from the CLOCK output connector (only with "Custom Dig Mod" signals in realtime). If signals complying with other digital standards are generated or if ARB waveforms are used, a marker signal can be used as a clock. As the DUT causes a delay, the ratio of clock-to-data travel times must always be taken into account and checked with an oscilloscope if necessary.
- The wrong impedance for the applied clock rate was selected (see "Impedance" parameter).
- The wrong threshold for the applied clock signal was selected (see "Threshold").

"Data"	The applied data signal was detected.
"No Data"	<p>The applied data signal was not detected. Only clocked-in signals are detected; if the clock signal is missing, then data changes will also not be detected.</p> <p>If the data is not detected despite the detected clock signal, this may be caused by the following:</p> <ul style="list-style-type: none"><li>• The signal from the DUT is missing.</li><li>• The wrong impedance for the applied clock rate was selected (see "Impedance" parameter).</li><li>• The wrong threshold for the applied data signal was selected (see Threshold parameter).</li></ul>
"Sync"	The measurement is synchronized.

**"No Sync"**

The measurement is not synchronized.

Generally, a measurement cannot be synchronized until a clock and a data signal have been detected. If synchronization still does not occur, this may be caused by the following:

- The selected PRBS is not correct. For the bit error rate measurement, the PRBS sequence on which the data is based must be set on the bit error rate tester. If the PRBS is not correct, the BER measurement cannot synchronize to the data (due to the incorrect polynomial).
- A wrong clock slope is used, which violates setup or hold times (see "Clock Slope" parameter).
- The travel times of clock and data are unfavorable (e.g. clock slope at data change). Check the relationship of clock to data using an oscilloscope and optimize the travel times (e.g. clock slope when the data signal applied is stable).
- Reflections on the clock line occur, clocking the data signal into the BER measurement twice, e.g. on lines without termination. The R&S Signal Generator input is not terminated.
- Incorrect polarity of data signal (or "Data Enable" signal). In this case the PRBS cannot synchronize. Note that an inversion of the output signal specified for some cases by the PRBS standard is performed automatically upon PRBS selection. Manual inversion of the data signal is therefore not required.

No Sync status and an error rate of approx. 50%:

- A bit error occurs during synchronization (e.g. nine data bits with PRBS9). The BER measurement is set up incorrectly. This fault is internally detected and automatically corrected.
- If data that is not cyclically continued (i.e. when a break in the sequence occurs at the memory wrap-around), the measurement will not be started at the right time. The signal on the "Restart" line enables the measurement to be started optimally at the beginning of the sequence.

SCPI command:

`:BERT:RESult` on page 477

### 5.4.10.2 Configuration

The "Configuration" section is used to select the type of measurement, the data source and the termination criteria. If the data is not cyclically continued, the measurement can be selectively interrupted and restarted. Certain data areas and frames that have been marked as faulty can be excluded from the measurement.

#### Mode

Selects the type of measurement: single or continuous measurement.

- "Auto" Continuous measurement of bit error rate. If either or both of the termination criteria are met, the measurement in progress is terminated and immediately a new one is started automatically. Depending on the settings made, a measurement may take considerable time. During the first measurement, intermediate results are displayed. For the measurements that follow, only the final results are shown. The parameters "Data Bits" and "Errors" are continuously updated and indicate the relative values for the measurement in progress. To start a continuous measurement, use the command `:BERT:START` on page 484. To stop a measurement, use the command `:BERT:STOP` on page 484.
- "Single" Single measurement of bit error rate. The measurement is started by clicking the "Execute Single" button. If a measurement is in progress, the current values for "Bit Error Rate", "Errors" and "Data Bits" are cyclically displayed. The measurement is terminated when either or both of the termination criteria have been reached. To start a new measurement, the "Execute Single" button must be clicked again.

SCPI command:

`:BERT:SEquence` on page 478

#### Max Data Bits

Enter the number of transmitted data bits to be checked before the measurement is terminated.

This criterion terminates the BER measurement after the specified number of data bits, even if very few errors or none at all have been detected. With a low number of bit errors, the measurement result may be statistically unreliable.

If the measurement is terminated because the number of data bits entered here was checked, "Number of Data Bits" appears to the right of "Terminated By".

Data excluded from the measurement by "Data Enable" or "Pattern Ignore" is not counted.

SCPI command:

`:BERT:SETup:MCOUNT` on page 482

#### Max Errors

Enter the number of bit errors to occur before the measurement is terminated.

This criterion terminates the measurement relatively quickly if the error rate is high. The measurement result is statistically reliable, since many errors were already counted.

If the measurement is terminated because the number of bit errors entered here was reached, Number of Errors appears to the right of Terminated By.

SCPI command:

`:BERT:SETup:MERRor` on page 482

#### PRBS

Selects the PRBS sequence. The data generated by the PRBS generator is used as a reference for the measurement.

**Note:** Standard-compliant data inversion for PRBS15 and PRBS23 is performed automatically when the PRBS is selected. "Data Polarity" remains unaffected.

SCPI command:

`:BERT:SETup:TYPE` on page 483

### Data Polarity

Sets the polarity of the feedback data bits.

**Note:** Standard-compliant data inversion for PRBS15 and PRBS23 is performed automatically when the PRBS is selected. "Data Polarity" remains unaffected.

"Norm" High level stands for logic 1, low level for logic 0.

"Inv" Low level stands for logic 1, high level for logic 0.

SCPI command:

`:BERT:SETup:DATA[:POLarity]` on page 480

### Clock Slope

Sets the polarity of the active slope of the feedback clock.

"Pos" The positive slope of the clock signal is active.

"Neg" The negative slope of the clock signal is active.

SCPI command:

`:BERT:SETup:CLOCK[:POLarity]` on page 479

### Impedance

Sets the input impedance of the BERT inputs "Clock", "Data", "Data Enable" and "Restart".

For high clock rates, 50 Ohms should be selected.

SCPI command:

`[:SOURce]:INPut:BERT:IMPedance` on page 485

### Threshold

Sets high/low threshold in volts for the BERT inputs "Clock", "Data", "Data Enable" and "Restart".

The variable threshold makes it possible to align the BERT interface with the level of different input signals. In addition, reflections and other interference can be suppressed by selecting the appropriate threshold.

SCPI command:

`[:SOURce]:INPut:BERT:THReshold` on page 485

### External Restart

Activates/deactivates an external restart of the BER measurement.

## Bit and Block Error Rate Measurements - BERT Block

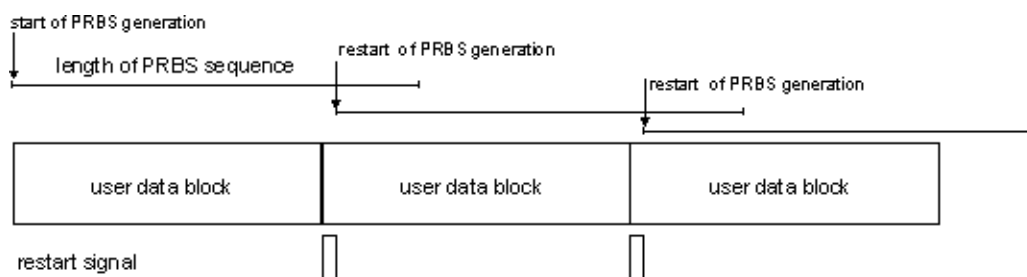

The length of the signal is too short for a complete PRBS sequence; PRBS generation is restarted by the "Restart" signal when the signal begins anew.

**"On"** The reset signal for the BER measurement is fed via the "Restart" input of the BERT interface.

If the PRBS cannot be continued uninterrupted, the BER measurement must be stopped at the end of the data sequence and subsequently restarted at the beginning of the new data sequence. The measurement is stopped and started via a 0-1-0 slope of the restart signal. A transition from logic 0 to 1 causes a partial result to be generated and the measurement to be stopped. A transition from 1 to 0 starts the measurement for the next subinterval. This measurement is synchronized anew.

If the R&S Signal Generator is used as a data source, a signal in which a single 1 was coded at the end of the data sequence can be used as a restart signal at the R&S Signal Generator marker output. This causes the BER measurement to stop briefly at the end of the data sequence and start again.

Partial results (number of data and error bits) are added up until the predefined total number of data or error bits is reached or exceeded. The measurement is reset by "Pattern Ignore" or "Data Enable", regardless of its status.

**"Off"** The reset signal for the BER measurement is generated internally. This setting is suitable for PRBS sequences that run continuously and thus ensure uninterrupted repetition.

SCPI command:

[:BERT:SETup:REStart:STATe](#) on page 482

### Data Enable

Activates/deactivates the use of the "Data Enable" signal and sets the polarity of this signal if it is used.

The "Data Enable" signal marks the data that is actually to be evaluated for the BER measurement. Any data in addition to the PRBS sequence is masked and thus not evaluated (e.g. sync, preambles, other channels, etc that are present in the data bits supplied by the DUT).

The signal is fed in at the "Data Enable" input of the BERT interface. It is generated by the DUT but can also be provided by the R&S Signal Generator in the form of a marker signal.

**Note:** If the data is not enabled, the BER measurement is stopped completely. The identification circuit for "Pattern Ignore" as well as the PRBS generator of the BER measure-



ment wait as long as data is not enabled. If the data is enabled, the measurement is continued.

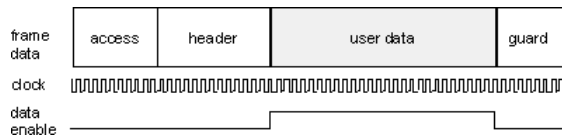

The figure shows a TDMA signal with user data that contains the PRBS data sequence and various check fields which should be ignored for the bit error rate measurement. Below that are the associated clock and "Data Enable" signals.

- "Not Used" Any signal at the "Data Enable" input is ignored; all data at the BERT data input is used for the measurement.
- "High" The "Data Enable" signal is used. The only data measured is the data at the BERT data input during a high level of the "Data Enable" signal. The measurement is interrupted during a low level of the "Data Enable" signal.
- "Low" The "Data Enable" signal is used. The only data measured is the data at the BERT data input during a low level of the "Data Enable" signal. The measurement is interrupted during a high level of the "Data Enable" signal.

SCPI command:

[:BERT:SETup:DENable](#) on page 480

### Pattern Ignore

Activates/deactivates ignoring of pure "0" or "1" bit sequences at least 32 bits long. Activating "Pattern Ignore" excludes faulty frames from the measurement.

In the case of some mobile radio standards, pure "0" or "1" bit sequences are generated when errors (e.g. an incorrect checksum) are detected within a frame. These sequences, instead of the frame data, are provided for the BER measurement and signal that the frame in question should not be used for the measurement.

The R&S Signal Generator ignores sequences of 32 bits or longer.

**Note:** While ignoring the bits, the PRBS generator for the BER measurement keeps running. Following the "0" or "1" sequence, the BER measurement is continued as if the ignored sequence had contained PRBS data.

If "Pattern Ignore" is switched on, synchronization time is 32 bits longer.

If "Pattern Ignore" and "External Restart" are active at the same time, the measurement terminates immediately when the restart signal is applied. None of the 32 bits within the "Pattern Ignore" detector is evaluated.

If "Data Enable" and "Pattern Ignore" are active at the same time, "Data Enable" is given priority, i.e. bits that are not enabled are not examined for "0" or "1" sequences.

**Example:**

50 bits were set to "0" by the DUT. These 50 bits plus the preceding "0" are ignored in the bit error rate measurement.

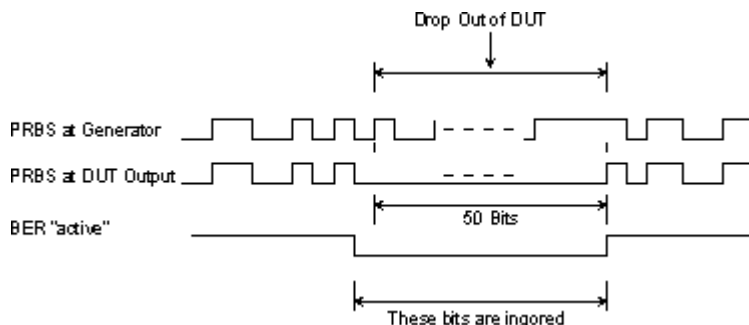

- "Off"                    Pattern Ignore is not active.
- "All 1"                 Bit sequences consisting of 32 or more consecutive "1" data are not used (i.e. ignored) for the BER measurement.
- "All 0"                 Bit sequences consisting of 32 or more consecutive "0" data are not used (i.e. ignored) for the BER measurement.

SCPI command:

[:BERT:SETup:IGNore](#) on page 481 [:BERT:SETup:DEnable](#) on page 480

### 5.4.11 Block Error Rate Menu

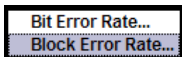

The "Block Error Rate" menu for configuring the block error rate measurement is called either in the "BERT" function block or via the MENU button under "BERT."

The top section of the "Block Error Rate" menu is used to switch on the block error rate measurement and display the results and current status of the measurement.

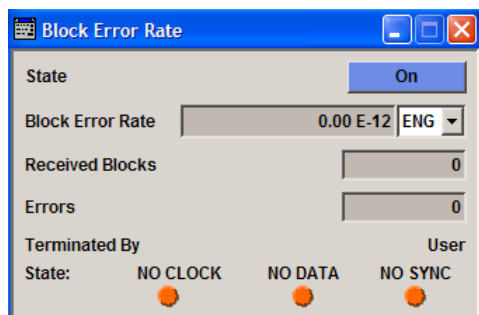

The "Configuration" section is used to select the type of measurement and the termination criteria and to set the polarity of the input signals.

Configuration	
Mode	Single
Max. Received Blocks	100 000
Max. Errors	100
BLER Type	CRC 16
CRC Order	LSB first
Data Polarity	Norm
Clock Slope	Pos
Data Enable	Low
Threshold (BER)	1.00 V
Impedance (BER)	1 kΩ / GND

#### 5.4.11.1 General Settings

##### State

Switches the block error rate measurement on/off.

Depending on the setting in the "Mode" box, either a continuous measurement ("Auto") or a single measurement ("Single") is carried out. A single measurement must be started by clicking the "Execute Single" button.

SCPI command:

:BLER:STATe on page 484

##### Block Error Rate

Displays the measured block error rate.

The block error rate is the ratio of faulty blocks to total blocks.

The display unit can be selected in the box to the right of the value.

"ENG"            The block error rate is output in exponential notation with the exponent  $-3$  or  $-6$ .

"SCI"            The block error rate is output in scientific notation, i.e. standardized to one place to the left of the decimal.

"%"              The block error rate is output in percent.

"ppm"           The block error rate is output in parts per million.

SCPI command:

:BLER:UNIT on page 485

##### Received Blocks

Displays the current number of data blocks checked.

SCPI command:

:BLER:RESult on page 477

**Errors**

Displays the current number of occurred errors.

SCPI command:

[:BLER:RESult](#) on page 477

**Terminated By**

Displays the termination criterion for the measurement.

These criteria can be entered to keep the duration of the measurement short for low as well as high block error rates.

The last measurement result is displayed after the measurement has been terminated.

"User"                    The measurement was manually terminated by the user switching the state to off.

SCPI command:

[:BLER:STATE](#) on page 484

[:BLER:STOP](#) on page 484

"Number of Data Blocks"    The measurement was terminated because the specified number of data blocks was reached.

"Number of Errors"        The measurement was terminated because the specified number of errors was reached.

SCPI command:

[:BLER:RESult](#) on page 477

**State**

Displays the status of the measurement.

A green LED indicates a correct status, a red LED a critical status.

This allows the user to check whether the measurement functions. The status of the data and clock lines and of synchronization is checked and displayed.

If a faulty status is displayed, the signals can be checked at the BERT interface using an oscilloscope.

"Clock"                    The applied clock signal was detected.

"No Clock"                The applied clock signal was not detected.

Possible causes are:

- Clock recovery is not available (e.g. with tests of RF components). If the signal is generated using the instrument family, the bit clock can be extracted from the CLOCK output connector (only with "Custom Dig Mod" signals in realtime). If signals complying with other digital standards are generated or if ARB waveforms are used, a marker signal can be used as a clock. As the DUT causes a delay, the ratio of clock-to-data travel times must always be taken into account and checked with an oscilloscope if necessary.
- The wrong impedance for the applied clock rate was selected (see "Impedance" parameter).
- The wrong threshold for the applied clock signal was selected (see "Threshold" parameter).

"Data"	The applied data signal was detected.
"No Data"	The applied data signal was not detected. Possible causes are: <ul style="list-style-type: none"> <li>• The signal from the DUT is missing.</li> <li>• The wrong impedance for the applied clock rate was selected (see "Impedance" parameter).</li> <li>• The wrong threshold for the applied data signal was selected (see "Threshold" parameter)</li> </ul>
"Sync"	The measurement is synchronized.
"No Sync"	The measurement is not synchronized. Generally, a measurement cannot be synchronized until a clock and a data signal have been detected. If synchronization still does not occur, this may be caused by the following: <ul style="list-style-type: none"> <li>• A wrong clock slope is used, which violates setup or hold times (see "Clock Slope" parameter).</li> <li>• Reflections on the clock line occur and clock the data signal into the BER measurement twice, e.g. on lines without termination. The R&amp;S Signal Generator input is <b>not</b> terminated.</li> <li>• The travel times of clock and data are unfavorable (e.g. clock slope with data change). Check the relationship of clock to data using an oscilloscope and optimize the travel times (e.g. clock slope when the data signal applied is stable).</li> </ul>

SCPI command:

:BLER:RESult on page 477

#### 5.4.11.2 Configuration

The "Configuration" section is used to select the type of measurement and the termination criteria and to set the polarity of the input signals.

##### Mode

Selects the type of measurement: single or continuous measurement.

"Auto"	Continuous measurement of block error rate. If either or both of the termination criteria are met, the current measurement is terminated and immediately a new one is started automatically. Depending on the settings made, a measurement may take considerable time. During the first measurement, intermediate results are displayed. For the measurements that follow, only the final results are shown. The parameters "Received Blocks" and "Errors" are continuously updated and indicate the relative values for the measurement in progress. To start a continuous measurement, use the command :BLER:START on page 484. To stop a measurement, use the command :BLER:STOP on page 484.
--------	--

"Single" Single measurement of bit error rate. The measurement is started by clicking the "Execute Single" button.  
If a measurement is in progress, the current values for "Block Error Rate", "Errors" and "Received Blocks" are cyclically displayed. The measurement is terminated when either or both of the termination criteria have been reached. To start a new measurement, the "Execute Single" button must be clicked again.

SCPI command:

[:BLER:SEQuence](#) on page 478

[:TRIGger:BLER\[:IMMediate\]](#) on page 486

#### Max Received Blocks

Enter the number of transmitted data blocks to be checked before the measurement is terminated.

This criterion will terminate the BLER measurement after the specified number of data blocks, even if very few errors or none at all have been detected. With a low number of block errors, the measurement result may be statistically unreliable.

If the measurement is terminated because the number of data blocks entered here was checked, "Number of Data Blocks" appears to the right of "Terminated By".

SCPI command:

[:BLER:SETup:MCOUNT](#) on page 482

#### Max Errors

Enter the number of block errors to occur before the measurement is terminated.

This criterion terminates the measurement relatively quickly if the error rate is high. The measurement result is statistically reliable, since many errors were already counted.

If the measurement is terminated because the number of block errors entered here was reached, "Number of Errors" appears to the right of "Terminated By".

SCPI command:

[:BLER:SETup:MERRor](#) on page 482

#### CRC Order

Selects the byte order of the checksum (CRC).

"LSB" The checksum starts with the least significant byte.

"MSB" The checksum starts with the most significant byte.

SCPI command:

[:BLER:SETup:CORDer](#) on page 479

#### BLER Type

Displays the CRC polynomial used. CCITT CRC 16 :  $G(x) = x^{16} + x^{12} + x^5 + x^1$  is the CRC polynomial supported.

SCPI command:

[:BLER:SETup:TYPE](#) on page 483

**Data Polarity**

Sets the polarity of the feedback data blocks.

SCPI command:

[:BLER:SETup:DATA\[:POLarity\]](#) on page 480

**Clock Slope**

Sets the polarity of the active slope of the feedback clock.

SCPI command:

[:BLER:SETup:CLOCK\[:POLarity\]](#) on page 479

**Impedance**

Sets the input impedance of the BERT inputs "Clock", "Data", "Data Enable" and "Restart".

For high clock rates, 50 Ohms should be selected.

SCPI command:

[\[:SOURce\]:INPut:BERT:IMPedance](#) on page 485

**Threshold**

Sets high/low threshold in volts for the BERT inputs "Clock", "Data", "Data Enable" and "Restart".

The variable threshold makes it possible to align the BERT interface with the level of different signals. In addition, reflections and other interference can be suppressed by selecting the appropriate threshold.

SCPI command:

[\[:SOURce\]:INPut:BERT:THReshold](#) on page 485

**Data Enable**

Sets the polarity of the "Data Enable" signal.

The "Data Enable" signal marks the user data of the signal.

The signal is generated by the DUT and fed in at the "Data Enable" input of the BERT interface.

"High"	If the "Data Enable" signal is at a high level, the data bits at the BERT data input are interpreted as user data. During a low level of the "Data Enable" signal, they are interpreted as checksum bits.
"Low"	If the "Data Enable" signal is at a low level, the data bits at the BERT data input are interpreted as user data. During a high level of the "Data Enable" signal, they are interpreted as checksum bits.

SCPI command:

[:BLER:SETup:DENable](#) on page 480

## 5.5 RF Signal and Analog Modulations - RF Block

### 5.5.1 Overview of RF Signal

Settings for the RF output signal and analog modulation are made under "RF Signal" and "Analog Modulations". These settings can be accessed in the block diagram by way of the "RF/A MOD" function block, or by means of the menu with the same name which is opened using the MENU key.

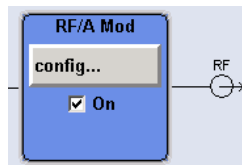

The function block is available for the basic unit (R&S SMJ-B10x) without additional equipment options.

#### 5.5.1.1 RF Output

To activate and deactivate the RF output signal, use one of the following alternatives:

- directly using the TOGGLE ON/OFF key (the function block must be highlighted beforehand)
- by means of the RF ON/OFF key (the current entry focus is irrelevant)
- by changing the state of the "RF/A Mod" functional block (see ["State RF"](#) on page 184)
- by enabling/disabling the RF in the "Configure" menu of the "RF/A Mod" block (see ["RF Output State"](#) on page 184).

The current state of the RF output (activated and deactivated) is indicated in the block diagram by means of the different block color and the status of the "On" checkbox.

The disconnected connection to the output is additionally shown when the output is deactivated.

Active analog modulation is also indicated in the block.



To query the impedance of the RF outputs, use the command `:OUTPut<hw>:IMPedance` on page 515.



**State RF**

Activated/deactivates the RF output by changing the state of the "RF" functional block. Alternatively, the RF ON/OFF key can be used.

SCPI command:

`:OUTPut<hw> [: STATe]` on page 516

**RF Output State**

Activated/deactivates the RF output by enabling/disabling the RF in the "Configure" dialog of the "RF" block.

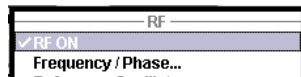

SCPI command:

`:OUTPut<hw> [: STATe]` on page 516

**5.5.1.2 Overview of the RF Signal Settings**

The CW, Sweep and List modes are available for generating the RF signal.

- **CW**  
The RF signal is generated with the set frequency and level. This is the default mode.
- **Sweep**  
The RF signal is generated as a sweep with the set parameters.  
It is not possible to activate frequency, level and LF sweep simultaneously.
- **List Mode**  
The RF signal is generated on the basis of a list of predefined frequency and level values. The duration of the individual steps can be predefined.

Instruments connected downstream can be taken into consideration when setting the frequency and level by entering a frequency and/or level offset.

Automatic level control ("ALC") ensures maximum level accuracy, even with I/Q modulation.

User-specific lists which contain level correction values for any frequency range ("User Correction") can be created to, for example, compensate the cable attenuation in a test assembly setup.

The R&S Signal Generator generates the RF signal in unmodulated or analog form. The signal generator is equipped therefore with the following sources for analog modulations:

- an internal LF generator
- the external modulation input EXT MOD at the rear of the instrument

An external trigger signal for the analog modulations, the sweeps and the LIST mode can be provided at the INST TRIG input.

The input REF IN is used to input an external instrument reference, and the output REF OUT serves as the output of the reference frequency (internal or external).

## 5.5.2 RF Frequency Settings

The value of the RF frequency is displayed in the header of the instrument's display ("Freq"). This field provides the direct input of the RF frequency. Alternatively, you can enter the RF frequency in the "Frequency/Phase" dialog.



Be aware that the displayed RF frequency in the header, and the RF output frequency, entered in the "Frequency/Phase" dialog can be different, as explained in the following section.

### 5.5.2.1 RF Frequency vs. RF Output Frequency

The signal generator offers the possibility, to take additional frequency modifications of a downstream instrument into consideration, such as an offset set by a mixer, or a multiple of the frequency by a frequency multiplier. The R&S SMJ indicates the resulting frequency, including offset and multiplication factor in the header of the screen. I.e. the indicated frequency corresponds to the frequency at the output of the downstream instrument. However, the frequency at the RF output of your signal generator always corresponds to the frequency set in the "Frequency/Phase" dialog.

In this dialog, you can also enter the values of the downstream instrument.

A set frequency offset is indicated by the "FREQ OFFSET" status message.

The correlation between the RF frequency, the RF output frequency and the frequency offset is as follows:

"Freq" (in header) = "RF output frequency" (Frequency in dialog) \* "Multiplier" factor (Multiplier in dialog) + "Freq offset" (Offset in dialog)

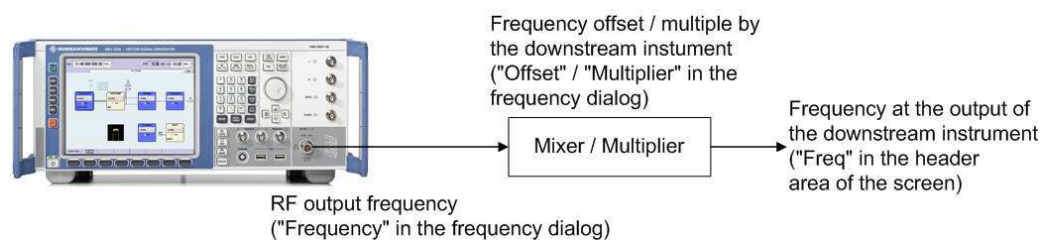

### 5.5.2.2 Configuring RF Frequency

To change the RF frequency, press the FREQ key and enter the desired frequency. Changes to the RF frequency have an immediate effect (without confirmation with the ENTER key) on the output signal.

#### RF Freq

Enters the RF frequency, considering the frequency offset.

**Note:** The SCPI command sets the level of the "Freq" display, i.e. an entered frequency offset and multiplier factor are taken into consideration in the frequency value.

SCPI command:

[ :SOURce<hw> ] :FREQuency [ :CW | :FIXed ] on page 656

### 5.5.2.3 Frequency Menu

In the combined "Frequency/Phase" dialog, you can enter the frequency, the frequency offset and multiplication factor of a downstream instrument, set the step width for the frequency entry using the rotary knob, and set the phase for the RF output signal.

To open the "Frequency/Phase" dialog, select "RF/A Mod > Configure > Frequency" or use the MENU key under "RF/A Mod".

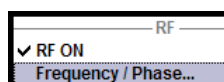

The "Frequency/Phase" dialog is divided into the several sections.

Frequency and offset of the RF output signal are set in the "Frequency Settings" section in the upper part of the dialog. In addition, the multiplier factor of an externally connected multiplier is specified.

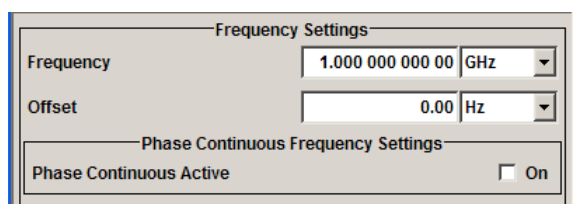

"Phase Continuous Frequency Settings" can be activated in the respective section and are described in [chapter 5.5.3.2, "Phase Continuous Frequency Setting"](#), on page 188.

The step width which is used when setting the frequency using the rotary knob (with "Variation Active On") is set in the "User Variation" section.

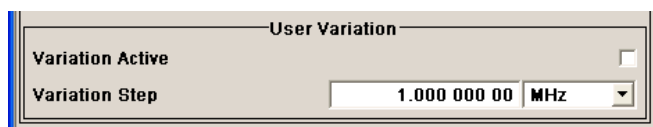

The phase of the output signal can be changed in the "Phase Settings" section. The "Phase Settings" menu is described in [chapter 5.5.3, "Phase Settings"](#), on page 188.

The parts concern the settings of the reference oscillator and are described in [chapter 5.5.4, "Reference Oscillator"](#), on page 191.

The lower parts concern the settings of the local oscillator (LO) and are described in [chapter 5.5.5, "Local Oscillator - LO Coupling"](#), on page 193.

#### Frequency Settings

The frequency, offset and multiplier factor are set in the top section of the menu.

**Frequency - RF Signal**

Sets the RF frequency of the RF output connector. The frequency entered and displayed here corresponds to the frequency at the RF output, i.e. any offset entry is not taken into consideration.

**Note:** The SCPI command `SOUR:FREQ` sets the frequency of the "FREQ" display, i.e. the frequency containing offset.

SCPI command:  
n.a.

**Frequency Offset - RF Signal**

Sets the frequency offset relative to the RF frequency. The frequency offset of a downstream instrument (e.g. a mixer) is entered.

The entry does not change the value of the RF frequency at the RF output. It only changes the RF frequency displayed in the display header. The value of the RF frequency in the header corresponds to the frequency at the output of the downstream instrument.

SCPI command:  
`[ :SOURce<hw> ] :FREQuency:OFFSet` on page 659

**Multiplier - RF Signal**

Sets the multiplication factor for the RF frequency.

In the frequency field of the status bar, the instrument adjusts its frequency display according to the set multiplication factor. This frequency value shows the frequency at the output of the downstream multiplier. The entry does not change the RF frequency at the RF output of the R&S SMJ.

SCPI command:  
`[ :SOURce<hw> ] :FREQuency:MULTiplier` on page 659

**Phase Continuous Frequency Settings**

A phase continuous mode can be enabled in the "Phase Continuous Frequency Settings" section (see [chapter 5.5.3.2, "Phase Continuous Frequency Setting"](#), on page 188).

**User Variation**

If the frequency is set using the rotary knob, the step width is defined in the "User Variation" section.

**Variation Active - RF Signal**

Activates the user-defined step width used when varying the frequency value with the rotary knob.

"ON"	The frequency value set with the rotary knob is varied using the user-defined step width which is entered under "Variation Step".
"OFF"	The frequency value set with the rotary knob is varied in steps of one unit at the cursor position (standard operating mode).

SCPI command:  
`[ :SOURce<hw> ] :FREQuency:STEP:MODE` on page 662

**Variation Step - RF Signal**

Sets the user-defined step width. This step width is used when entering the RF frequency using the rotary knob. Frequency variation with this step width must also be activated with "Variation Active".

SCPI command:

[ :SOURce<hw> ] :FREQuency:STEP [ :INCRe ment ] on page 662

**5.5.3 Phase Settings**

The phase of the RF output signal can be changed in the "Phase Settings" section of the "RF Frequency/Phase" menu.

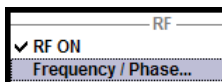
**5.5.3.1 Phase Menu**

To open the "Frequency/Phase" menu, select "RF/A Mod" > "Configure" > "Frequency/Phase" or use the MENU key under RF/A Mod.

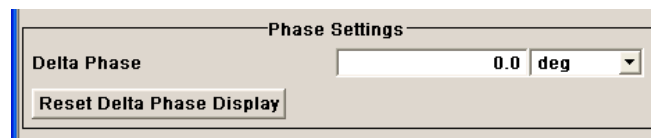
**Delta Phase - RF Signal**

Sets the phase of the RF signal. The current phase of the signal is used as the reference. This function allows, for example, the phase of the output signal to be synchronized with the phase of a signal from a second signal generator.

SCPI command:

[ :SOURce<hw> ] :PHASe on page 700

**Reset Delta Phase Display - RF Signal**

Resets delta phase value. The set phase is adopted as the new current phase, i.e. the delta phase value is reset to 0.

SCPI command:

[ :SOURce<hw> ] :PHASe:REFerence on page 701

**5.5.3.2 Phase Continuous Frequency Setting**

The phase continuous mode can be enabled in the "Phase Continuous Frequency Settings" section of the "Frequency" menu. In this mode, the output sinewave is phase continuous, i.e. there is no phase discontinuity or glitch when changing the frequency.

At the transition from one frequency to another an intermediate frequency (switching transient) occurs, which causes spurs (see figure below). The transient is due to changes of the synthesizer settings (e.g. dividers, filters, phase detectors).

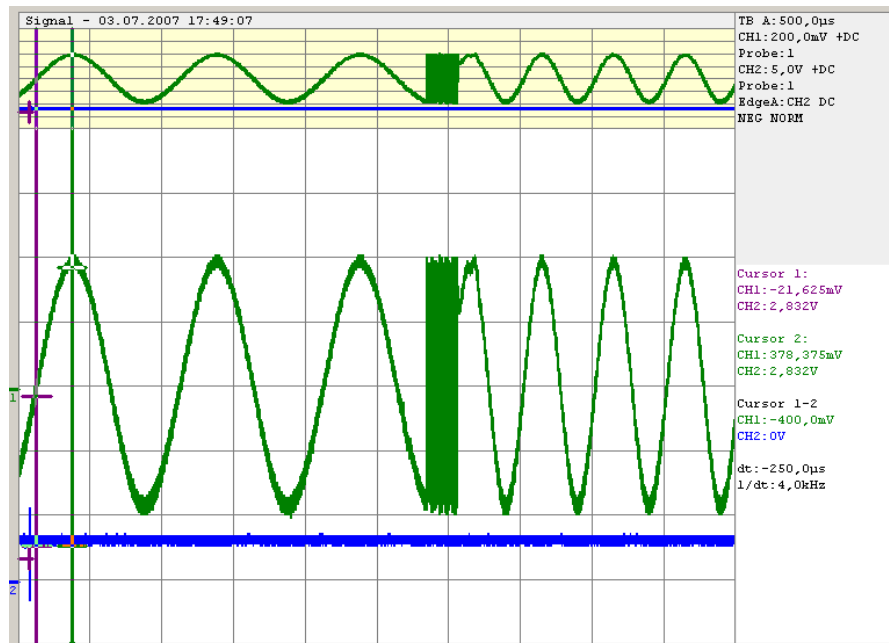

**Fig. 5-7: Transition for a 1 kHz step at 1 GHz without phase continuous mode active. For the graphical display the signal is down converted into the kHz range.**

The phase continuous mode freezes the settings of the synthesizer (e.g. dividers, filters, phase detectors) which could generate phase discontinuities when changed. The frequency change is effectively performed by changing the fine resolution synthesizer. This allows a phase continuous change from one frequency to another without any transients (see figure below).

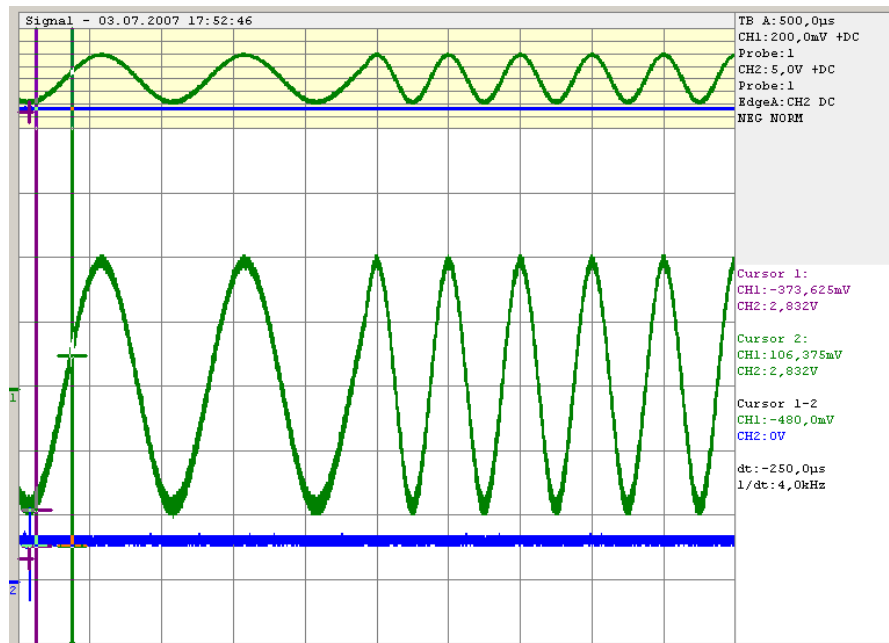

**Fig. 5-8: Transition for a 1 kHz step at 1 GHz with phase continuous mode active. For the graphical display the signal is down converted into the kHz range.**

The available frequency range for phase continuous settings is limited by the fine resolution synthesizer used and varies with the RF frequency setting at the point of activating the phase continuous mode.

Depending on the instrument equipment - with or without option R&S SMJ-B22 - the fine resolution synthesizer used is a DDS (Direct Digital Synthesizer, with option R&S SMJ-B22) or a Fractional N-Synthesizer (without option R&S SMJ-B22). The DDS provides generally a wider frequency range for phase continuous settings. In addition, two modes (narrow and wide) allow a selection either in favor of higher signal quality or in favor of an especially wide frequency range.



When phase continuous frequency setting is active, data sheet values no longer apply. Activating frequency or phase modulation deactivates phase continuous settings and vice versa.

### Setting a Phase Continuous Frequency Sweep

1. In the "RF Frequency Sweep" Menu, if the sweep is active, switch it off.
2. In the "RF Frequency" Menu under the "Phase Continuous Frequency Settings" dialog
  - a) If the "Phase Continuous Frequency Mode" is Active, switch it off
  - b) Set "Frequency Range" to "Narrow"
  - c) Select the RF frequency
  - d) Check displayed Frequency Range
  - e) If the "Frequency Range" corresponds to the selected frequency range, check the "Phase Continuous Active" box
  - f) If "Frequency Range" in Narrow Mode does not, select "Wide" for the Frequency Range and check the Phase Continuous Active box
3. In the "RF Frequency Sweep" dialog
  - a) Modify the "Start Freq" and "Stop Freq" or "Center Frequency" and "Span" as needed.
  - b) Set the RF frequency sweep State to "ON".

### Optimum user settings for the phase continuous frequency sweep

In the "RF Frequency Sweep" dialog there are some settings that will improve the phase continuous sweep results for both "Narrow" and "Wide" mode choices.

1. "Step Lin": low step size  
In order to get the best spur performance during frequency change, it is recommended to reduce the step size and (if necessary) increase the sweep speed by decreasing the Dwell Time. Effectively, the sweep will be performed in the same amount of time, but with smaller step sizes.
2. "Shape": Triangle sweep

The triangle sweep offers a uniform forward sweep and return to the beginning frequency. The saw tooth sweep produces a uniform forward sweep with an abrupt reset to the starting frequency. The abrupt reset can generate spurs.

### Phase Continuous Frequency Settings Menu

The "Phase Continuous Frequency Settings" are available in the middle section of the "Frequency/Phase" dialog.

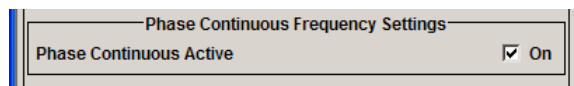

### Phase Continuous Active

Activates/deactivates phase continuous frequency settings. For a given RF frequency setting, phase continuous frequency changes are possible in a limited frequency range. The range is typically +/-0.5 MHz in the main synthesizer octave of 750 MHz to 1.5 GHz. For the tuning range of other frequencies see table below.

RF frequency [MHZ]	Typ . range
$f \leq 6.6$	125 kHz
$6.6 < f \leq 11.71875$	7.813 kHz
$11.71875 < f \leq 23.4375$	15.625 kHz
$23.4375 < f \leq 46.875$	31.25 kHz
$46.875 < f \leq 93.75$	62.5 kHz
$93.75 < f \leq 187.5$	125 kHz
$187.5 < f \leq 375$	250 kHz
$375 < f \leq 750$	500 kHz
$750 < f \leq 1500$	1 MHz
$1500 < f \leq 3000$	2 MHz
$3000 < f \leq 6000$	4 MHz

**Note:** If "Phase Continuous" is "Active" a setting of the "RF Frequency" outside the available "Frequency Range" causes an error. A settings conflict is displayed.

SCPI command:

[\[:SOURce<hw>\]:FREQuency:PHASe:CONTInuous:STATe](#) on page 660

### 5.5.4 Reference Oscillator

In the internal reference mode the internal reference signal is available at the REF OUT connector. The frequency of the internal reference signal is permanently set to 10 MHz.



The frequency of the internal reference oscillator can be impaired by means of the EXT TUNE input (AUX I/Q connector at rear of instrument) (**Frequency Adjustment**; see data sheet for technical information).



The settings of the reference oscillator are not influenced by an instrument preset ("PRESET" key).

#### 5.5.4.1 Reference Oscillator Dialog

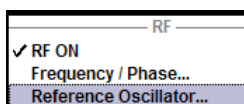

To open the "Reference Oscillator" dialog, select "RF/A Mod > Configure > Reference Oscillator" or use the MENU key under "RF/A Mod".

The reference oscillator is set in the lower area of the group menu "Frequency/Phase". The upper areas are for setting the frequency and phase of the RF output signal. For more information, see [chapter 5.5.2.3, "Frequency Menu"](#), on page 186 and [chapter 5.5.3, "Phase Settings"](#), on page 188 respectively.

The menu is used to select the source, to enter the frequency of an external reference signal and to adjust the reference frequency.

##### Source - Reference Oscillator

Selects the source of the reference frequency.

- "Internal" The internal reference signal of 10 MHz is used, comprising either the calibrated or a user-defined adjustment value.
- "External" An external reference signal is used. The frequency of the external reference signal must be selected under "External Reference Frequency".

SCPI command:

`[[:SOURce]:ROScillator:SOURce` on page 716

##### Deactivate RF Output - Reference Oscillator

Determines if the RF output is switched off in case of a missing external reference signal for selection external source.

If enabled, this setting ensures that no improper RF signal due to the missing external reference signal is output and used for measurements.

In addition to the error message "Ext Ref missing", the information "RF output deactivated" is indicated.

This setting is not influenced by a reset.

SCPI command:

[\[:SOURce\]:ROSCillator:EXTernal:RFOFF:STATe](#) on page 715

#### External Reference Frequency

Selects the frequency of the external reference signal. An external reference signal with a frequency of 5 MHz, 10 MHz or 13 MHz can be used.

SCPI command:

[\[:SOURce\]:ROSCillator:EXTernal:FREQuency](#) on page 715

#### Synchronization Bandwidth - RF Signal

(Source External only)

Selects the synchronization bandwidth for an external reference signal. The wideband setting is provided for using very good reference sources of high spectral purity.

"Narrow" Synchronization bandwidth is 1 Hz.

"Wide" Synchronization bandwidth is 750 Hz.

SCPI command:

[\[:SOURce\]:ROSCillator:EXTernal:SBANdwidth](#) on page 715

#### Adjustment Active - Reference Oscillator

Selects adjustment mode.

"OFF" The calibrated adjustment value of the internal reference frequency is used. This value is determined at one of the R&S service shops during calibration.

"ON" A user-defined adjustment value is used. The value is entered under "Adjustment DAC Value". This allows the frequency to be impaired freely, for example to simulate a frequency error. The instrument is no longer in the calibrated state. However, the calibration value is not changed and the instrument resumes the calibrated state after switching the "Adjustment State" to Off.

SCPI command:

[\[:SOURce\]:ROSCillator\[:INTernal\]:ADJust\[:STATe\]](#) on page 716

#### Adjustment DAC Value

Enters a user-defined adjustment value for the internal reference frequency. This value is not used unless "Adjustment Active On" is selected.

SCPI command:

[\[:SOURce\]:ROSCillator\[:INTernal\]:ADJust:VALue](#) on page 716

### 5.5.5 Local Oscillator - LO Coupling

The LO Coupling function allows a distribution of the local oscillator signal in way that multiple RF signals can be driven by the same LO signal. This is mandatory for minimizing the phase drift between these RF signals.

The LO Coupling function is available only for instruments equipped with the option R&S SMJ-B90 (Phase Coherence).

The local oscillator signal is available at the LO OUT connector (rear of instrument).

In the external local oscillator mode, an external signal must be input at the LO IN connector.

### 5.5.5.1 Phase Coherence

Phase coherence of two RF signals means that there is a defined and stable phase relationship between two (or more) RF carriers, i.e. there is a fixed delta phase  $\Delta\Phi$  between the carriers. Strictly speaking, phase coherence is only defined for CW carriers with the same frequency (or for CW carriers at frequencies that are multiples of each other).

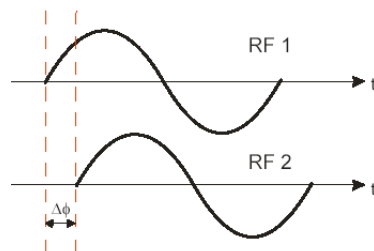

If two signal generators are coupled via their 10 MHz reference, they are generating exactly the same frequency but only from the long term perspective. Having a closer look into the instantaneous differential phase (“delta phase”) of these two RF signals, this is quite instable due to:

- phase noise of the two synthesizers
- “weak” coupling at 10 MHz and a long synthesis chain up to the RF domain
- temperature differences which cause a change of the effective electrical length of some synthesizer components

Most critical for a stable delta phase is the thermal RF phase drift between multiple RF synthesizers. This drift can be minimized down to  $0.1^\circ$  by use of a common synthesizer, i.e. a common local oscillator (LO) signal, for all RF carriers. Only if this LO signal (which is internally used for upconverting the baseband signal to the RF) is the same for all carriers, a stable phase between the RF signals can be achieved.

### 5.5.5.2 Typical Applications

The LO Coupling function can be used to generate a MxN MIMO signal.

- Generation of 2xN MIMO signal with two R&S Signal Generators, working in External mode.

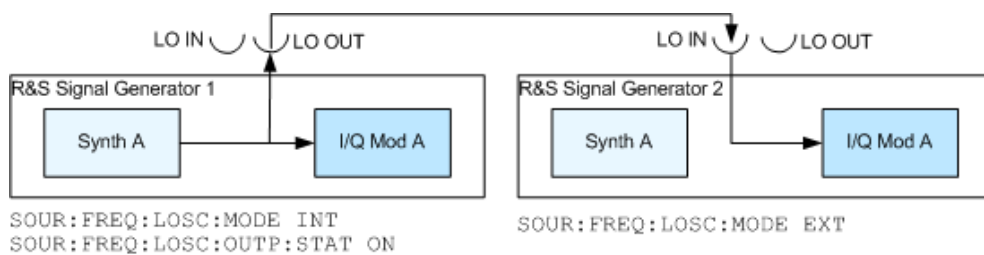

5.5.5.3 LO Coupling Menu

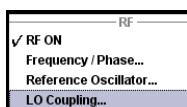

To open the "LO Coupling" menu, select "RF/A Mod > Configure > LO Coupling" or use the MENU key under "RF/A Mod".

The menu is available only for instruments equipped with the option R&S SMJ-B90.

This option enables phase coherent RF outputs of two or more RF paths.

The local oscillator coupling is set in the lower area of the group menu "Frequency/Phase". The menu is used to select the mode of the LO coupling and the state of the local oscillator output.

For more information about the upper areas, see:

- [chapter 5.5.2.3, "Frequency Menu"](#), on page 186
- [chapter 5.5.3.1, "Phase Menu"](#), on page 188
- [chapter 5.5.4.1, "Reference Oscillator Dialog"](#), on page 192

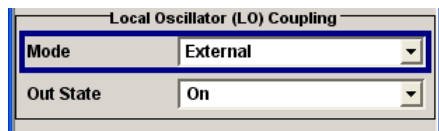

Mode - LO Coupling

Selects the mode of the local oscillator coupling.

"Internal" This mode corresponds to a normal operation. The internal local oscillator is used.

"External" An external signal is used.

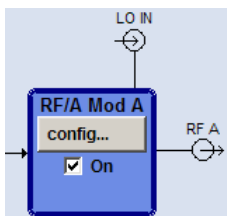

**Note:** Selection of LO Coupling "External" mode, disables all parameters in the "Frequency/Phase/Ref Osc" menu.

SCPI command:

`[ :SOURce<hw> ] :FREQuency:LOSCillator:MODE` on page 656

**Out State - LO Coupling**

Switches on/off the LO output.

"On" The internal local oscillator signal is also available on the LO OUT connector (in order to couple two instruments).

"Off" The LO OUT signal is switched off.

SCPI command:

`[ :SOURce<hw> ] :FREQuency:LOSCillator:OUTPut:STATe` on page 656

### 5.5.6 NRP-Z Power Viewer

The R&S signal generator supports R&S NRP-Z power sensors to measure the power of the output signal in the RF path or any freely selectable source. The generator performs up to four power measurements, with the sensors either directly connected, or via the R&S NRP-Z5 USB Sensor Hub.



The R&S NRP-Z5 USB Sensor Hub (high-speed USB 2.0) can host up to 4 R&S NRP-Z sensors and provides simultaneous internal and external triggering of all connected sensors.

You can directly connect the R&S NRP-Z Sensors to the standard NRP sensor connectors of the hub. The hub is connected to the R&S instrument either with the R&S NRP-Z2 extension cable, or via USB using with the adapter cable R&S NRP-Z4.

See also the R&S website <http://www.rohde-schwarz.com> in section "Power Meters & Voltmeters > R&S NRP-Z Sensors" for information on the sensor hub and the available accessories.

To connect an R&S NRP-Z sensor directly, the R&S SMJ provides the SENSOR connector. A sensor connected there is always assigned as "Sensor 1". Alternatively, you can connect a sensor at a USB interface, using one of the USB adapters R&S NRP-Z3 or R&S NRP-Z4.

The instrument automatically detects a connected R&S NRP-Z power sensor and indicates it in the "NRP-Z Power Viewer" dialog. In addition, you find device specific information on the connected sensor in the [chapter 5.2.3.6, "NRP-Z Info/Update"](#), on page 126. For information on the scope of your power sensor refer to the manual of your R&S NRP-Zxx power sensor.

A sensor continuously measures the average signal power of the selected source. The signal generator shows the result in either the "NRP-Z Power Viewer" dialog, or directly in the block diagram. You can activate the permanent display in the block diagram in the "NRP-Z Power Viewer" dialog. This dialog provides access to all parameters concerning sensor settings, like average or peak display, reference source, filter and level offset, see [NRP-Z Power Viewer Settings](#).

The signal generator also supports the use of R&S NRP-Z power sensors for the acquisition of level correction data. The acquired level correction data is used to create and activate lists in which level correction values predefined by the user are freely assigned to RF frequencies. Correction is performed by the user-defined table values being added

to the output level for the respective RF frequency (see [chapter 5.5.9, "User Correction"](#), on page 209).

### 5.5.6.1 NRP-Z Power Viewer Settings

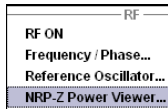

To open the "NRP-Z Power Viewer" menu, select "RF/A Mod > Configure > NRP-Z Power Viewer" or use the MENU key under "RF/A Mod".

The menu is structured like a table showing the values for sensor 1 in the left "column" and the values of the second/third sensor in the middle/right "column". The instrument detects connected sensors automatically and indicates them in the dialog.

"Sensor 1" is firmly assigned to the sensor on the circled SENSOR socket. If no sensor is connected to this socket, channel 1 remains not assigned. Sensors 2...4 are assigned to the sensors at the USB connectors, according to their sequence of connection.

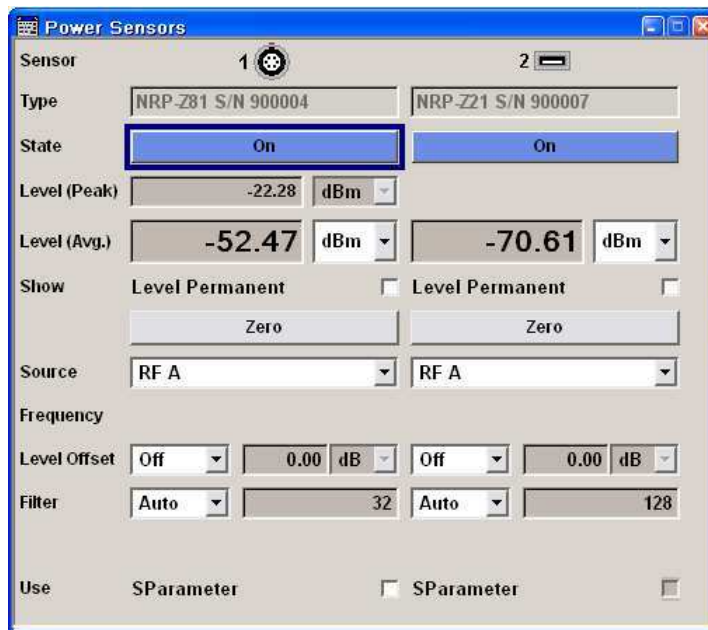

#### Sensor - Power Viewer

Indicates the connector used for the detected sensors. The values listed below belong to the respective sensor.

In remote control, the sensors are set up using the `SENSe` commands. The remote measurement is triggered by the `READ` query which also provides the measurement results.

The sensor is selected by suffix 1, 2, 3 or 4 in key word `SENSe` or `READ` of the command header.

Suffix 1 denotes the sensor connected to SENSOR, suffix 2 the one at the first USB interface, and suffix 3 and 4 are assigned to the sensors at the following USB interfaces. The suffix is identical to the index which is assigned automatically to each sensor upon connection.

**Note:** The software version of the connected power sensor can be retrieved by means of the remote control command `:SENS:POW:TYPE?`.

Use the "Setup >" [chapter 5.2.3.6, "NRP-Z Info/Update"](#), on page 126 dialog to update the sensor software.

SCPI command:

[SENSe<ch>\[:POWer\]:STATus\[:DEVice\]](#) on page 523

#### Type - Power Sensors

Indicates the type and the serial number of the connected R&S NRP-Z power sensor. The sensor type is automatically detected.

SCPI command:

[SENSe<ch>\[:POWer\]:TYPE](#) on page 524

[SENSe<ch>\[:POWer\]:SNUMber](#) on page 523

#### State - Power Sensors

Activates/deactivates level measurement by the power sensor.

The local state is set with the `INIT` command. Switching the local state off enhances the measurement performance.

In remote control, the sensors are set up using the `SENSe` commands. The remote measurement is triggered by the `READ` query which also provides the measurement results. The state is not influenced by these commands, measurements results can be retrieved with local State on or off.

The sensor is selected by suffix 1, 2, 3 or 4 in key word `SENSe` or `READ` of the command header.

Suffix 1 denotes the sensor connected to `SENSOR`, suffix 2 the one at the first USB interface, and suffix 3 and 4 are assigned to the sensors at the following USB interfaces. The suffix is identical to the index which is assigned automatically to each sensor upon connection.

To query the availability of a sensor at a given connector, use the command

[SENSe<ch>\[:POWer\]:STATus\[:DEVice\]](#) on page 523.

SCPI command:

[:INITiate<ch>\[:POWer\]:CONTinuous](#) on page 518

#### Level (Peak) - Power Sensors

With certain power sensors only, e.g. R&S NRP-Z81.

Indicates the measured peak level value with the selected unit.

SCPI command:

[:READ<ch>\[:POWer\]](#) on page 518

#### Level (Avg.) - Power Sensors

Indicates the measured level value with the selected unit.

SCPI command:

[:READ<ch>\[:POWer\]](#) on page 518

#### Unit - Power Sensors

Selects the unit used for result display.

The power sensor provides the measured value in Watt.

In which unit the measured value is indicated is selected here and might be Watt, dBm or dBuV.

SCPI command:

`SENSe<ch>:UNIT[:POWer]` on page 525

### Permanent Display State - Power Sensors

Activates the permanent indication of the power measurement result in the upper right corner of the block diagram. The instrument shows the type of sensor, the corresponding connector, the measurement source and - if set - the offset.

2	NRP-Z110fs	-83.10dBm	RF
3	NRP-Z81	-59.39dBm	User

It is possible to switch the permanent display active for several sensors. The instrument indicates the values of a maximum of two sensors simultaneously, in ascending order of connected channels. If you activate the display of a third sensor, the instrument fades out the values of the last highest channel number automatically.

SCPI command:

`SENSe<ch>[:POWer]:DISPlay:PERManent:STATe` on page 519

### Display Priority - Power Sensors

Selects whether the average or the peak power measurement result is indicated when permanent display is active.

SCPI command:

`SENSe<ch>[:POWer]:DISPlay:PERManent:PRIority` on page 519

### Zero - Power Sensors

Activates the auto zero function.

Zeroing calibrates the external power sensor by adjusting its reading at zero signal power. For this purpose, the RF power source must be switched off or disconnected from the sensor (see tips below). R&S power sensors automatically detect the presence of any significant input power. This aborts zeroing and generates an error message. Zeroing can take a few seconds, depending on the sensor model; refer to the documentation of your external power sensor for more information.

### Tips for zeroing

Zeroing should be performed:

- During warm-up after switching on or connecting the instrument
- After a substantial change of the ambient temperature
- After fastening the power sensor module to an RF connector at high temperature
- After several hours of operation
- When very low-power signals are to be measured, e.g. less than 10 dB above the lower measurement limit.
- Switch off the RF power source for zeroing; do not disconnect it from the power sensor. In this way you will maintain the thermal equilibrium, and zeroing will also compensate for the noise superimposed on the measured signal (e.g. from a broadband amplifier).

SCPI command:

`SENSe<ch>[:POWer]:ZERO` on page 524



**Source - Power Sensors**

Selects the source for measurement.

- |        |  |
|--------|--|
| "RF"   | Measurement source is the RF signal of the generator. The RF frequency is used as the measurement frequency of the sensor and the corresponding correction factor is used.<br>In this mode the RF frequency of the generator is send to the sensor automatically if changed. |
| "User" | Measurements source is any freely selectable source. The frequency is entered manually under frequency (e.g. for measurement of amplifier gain with 2 sensors).  |

SCPI command:

[SENSe<ch>\[:POWer\]:SOURce](#) on page 523

**Frequency - Power Sensors**

Source User only

Enters the frequency for measurement source "User".

SCPI command:

[SENSe<ch>\[:POWer\]:FREQuency](#) on page 522

**Level Offset - Power Sensors**

Activates and defines a level offset which is added to the measured value. This allows e.g. an attenuator in the signal path to be taken into account. The offset is always entered in dB, irrespective of the selected unit for result display.

SCPI command:

[SENSe<ch>\[:POWer\]:OFFSet:STATe](#) on page 523

[SENSe<ch>\[:POWer\]:OFFSet](#) on page 522

**Auto Once**

Searches for the optimum filter length for the current measurement conditions and indicates value in the "Filter Length" field above.

SCPI command:

[SENSe<ch>\[:POWer\]:FILTer:SONCe](#) on page 521

**Filter Length - Power Sensors**

Selects the filter length used for measurement. The filter length is the multiplier for the measurement time and thus directly influences it.

The averaging filter is used to reduce fluctuations in the measured result to the extent desired. Such fluctuations can be caused by inherent noise of the measuring instrument, modulation of the measurement signal or beats from the superposition of adjacent carriers. A more stable display has to be traded off against longer measurements. The measurement result is obtained from a two-stage averaging process.

**Note:** Longer measurements does not mean that it takes longer to display a new result, but rather that it takes longer for the result to settle when the power changes.

Measurements are continuously repeated in a predefined time window. The measurement result is obtained by averaging the measured values for the last  $2N$  time windows. The number  $N$  is the filter length, the factor of 2 arises because the output signals from the microwave detector to suppress low-frequency noise are chopped at the same rate as the time windows, which means that an independent measured value can only be obtained from two consecutive values. As the filter length is the multiplier for the time window it directly influences the measurement time.

The filter length can be selected automatically or can be manually set to a fixed value. As a preliminary, you should always check if the auto mode is giving satisfactory results because you will always have to adjust an optimal, manual filter-length setting if the power is not constant.

Selection "Fixed Noise" is offered for reaching defined measurement accuracy.

"Auto" The filter length is automatically selected and adapted to the currently measured value. With very high signals the filter length and therefore the measurement time can be short. With very low signal levels the filter length and therefore the measurement time is increased in order to reduce noise. The used filter length is indicated in the field to the right.

"User" The filter length is set manually. The filter length is entered in the entry window to the right. As the filter length works as a multiplier for the time window, this results in a constant measurement time. Values 1 and  $2^n$  are settable.

**Note:** The time window varies depending on the used sensor. For most sensors it is fixed to 20 ms. For the R&S NRP-Z81 sensor it is 10 us. Therefore, the user filter length for the R&S NRP-Z81 has to be about 1000 times larger than the filter length for other sensors in order to achieve the same filtering result.

The "Auto Once" button can be used to search for the optimum filter length for the current measurement conditions. The found filter length is indicated in the field to the right.

"Fixed Noise" The averaging factor is selected so that the sensor's intrinsic noise (2 standard deviations) does not exceed the specified noise content. The desired noise content is entered in the entry field to the right. To avoid very long settling times when the power is low, the averaging factor can be limited with the "Timeout" parameter.

SCPI command:

[SENSe<ch>\[:POWER\]:FILTer:TYPE](#) on page 521

[SENSe<ch>\[:POWER\]:FILTer:LENGth:AUTO](#) on page 519

[SENSe<ch>\[:POWER\]:FILTer:LENGth\[:USER\]](#) on page 520

[SENSe<ch>\[:POWER\]:FILTer:NSRatio](#) on page 520

[SENSe<ch>\[:POWER\]:FILTer:NSRatio:MTIME](#) on page 520

#### Use SParameter - Power Sensors ← Filter Length - Power Sensors

Activates the use of the S-Parameter correction data of the connected power sensor. For sensors with attenuator this checkbox is automatically checked.

Refer to the manual of the connected R&S NRP-Zxx power sensor for a description on how to use the SParameter table.

SCPI command:

`SENSe<ch>[:POWer]:CORRection:SPDevice:STATe` on page 519

## 5.5.7 RF Level/EMF

### 5.5.7.1 Overview of RF Level



#### Message "Level overrange/underrange"

If this message appears in the status line, the following parameter is in the overrange (see data sheet):

- the set level ("Level")
- the displayed peak envelope power ("PEP") for Digital Modulation or Digital Standard

The correct level setting and signal quality cannot be guaranteed if the set level is in the overrange/underrange.

The value of the RF level is displayed in the level field in the header of the instrument's display and the easiest way to set the RF level is to set it directly in this field.



The center line ("Level") and, to the left of this, the peak envelope power ("PEP") of the modulated RF output signal is displayed in the case of digital modulation or digital standard.

Be aware, that there is a difference between the RF level displayed in the header and the RF output level set in the "Level/EMF" dialog of the "RF" block.

#### RF level vs. RF output level

The level entered and displayed in the "Level" field takes the offset of any downstream attenuators/amplifiers into consideration by way of calculation. This means that with a level offset the level displayed in the header does not correspond to the level at the RF output, but rather to the level at the output of the downstream instrument.

This allows the desired level at the output of downstream instruments to be entered. The R&S Signal Generator changes the RF output level according to the set offset.

However, the level entered and displayed in the "Level" menu of the "RF" function block always corresponds to the RF output level. Any level offset is not taken into consideration.

The level offset is entered in the "Level" menu. Here it is also possible to set the level without taking the offset into consideration, and to make other settings, such as level offset, attenuator mode, power-on state.

The correlation is as follows:

"Level" (in header) = "RF output level" (Level in menu) + "Level offset" (Offset in menu)

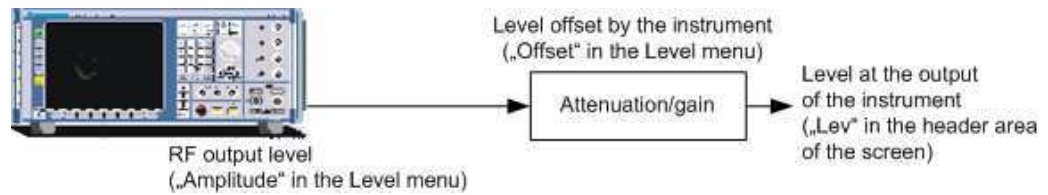

The RF output is protected against overloading by an external signal applied to the RF output (see ["Reverse Power Protection"](#) on page 206).

### Setting the RF level

To change the RF level, press the LEVEL key and enter the desired level. Changes to the RF level have an immediate effect (without confirmation with the Enter key) on the output signal.

#### RF Level

Enters the RF level, considering the level offset (see ["RF level vs. RF output level"](#) on page 202).

**Note:** Some SW options have specific requirements about the calculation of the level of the output signal, e.g. the displayed value corresponds to the level at the start simulation time, there are correction coefficients to be applied, etc. In cases like this, the displayed value in the header of the instrument does not always correspond to the level at the RF output!

When working with a SW option, always refer to the corresponding documentation for related specific information.

dBm, dBuV, mV and uV can be used as the level units. The 4 unit keys are labeled with these units.

**Note:** The SCPI command sets the level of the "Level" display, i.e. an entered level offset is taken into consideration in the level value.

SCPI command:

`[ :SOURce<hw> ] :POWER [ :LEVel ] [ :IMMediate ] [ :AMPLitude ]` on page 706

### 5.5.7.2 RF Level

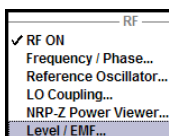

To open the "RF Level/EMF" dialog, select "RF/A Mod > Configure > Level/EMF" or use the MENU key under "RF/A Mod".

The combined menu "RF Level / EMF" is divided into the several sections.

The top sections of this dialog provide access to the level settings.

The offset-free level, level offset and level limit are set in the top section of the menu. The attenuator mode is set in the "Attenuator Settings" section.

The step width which is used when setting the level using the rotary knob (with "Variation Active On") is set in the "User Variation" section.

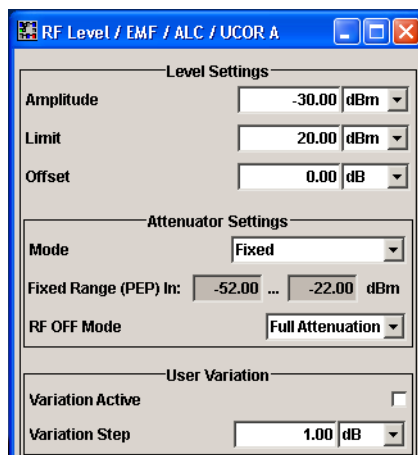

The power-on behavior of the instrument and the level display in the display header are set in the "Power-On / EMF Settings" section (see [chapter 5.5.7.3, "Power-On/EMF Settings"](#), on page 207).

The lower sections provide access to the "Automatic Level Control" settings and to function User Correction settings. For more information about this functions, see [chapter 5.5.8, "Automatic Level Control - ALC"](#), on page 207 and [chapter 5.5.9, "User Correction"](#), on page 209.

### Level Settings

The offset-free level, attenuation mode, level offset and level limit are set in the top section of the menu.

#### Amplitude

Sets the RF level of the RF output connector.

The level entered and displayed here corresponds to the level at the RF output, i.e. any offset entry is not taken into consideration.

**Note:** The SCPI command `[ :SOURce<hw> ] :POWer [ :LEVel ] [ :IMMediate ] [ :AMPLitude ]` sets the level of the "Level" display, i.e. the level containing offset.

SCPI command:

`[ :SOURce<hw> ] :POWer :POWer` on page 710

#### Limit - RF Level

Sets the level limit.

The value specifies the upper limit of the level at the RF output connector. A message appears if an attempt is made to set a level above this limit and the level at the RF output is confined to the upper limit. However, the level indication is not influenced.

The value is not affected by an instrument preset (PRESET key), \*RST and the "Save/Recall" function. This parameter is influenced only by the [Factory Preset](#) and its factory value is equal to the upper limit.

SCPI command:

`[ :SOURce<hw> ] :POWer :LIMit [ :AMPLitude ]` on page 708

**Offset (Level)**

Sets the level offset relative to the RF level.

The level offset of a downstream instrument (e.g. an attenuator or amplifier) is entered.

The entry does not change the value of the RF level at the RF output. It only changes the RF level displayed in the display header. The value of the RF level in the header corresponds to the level at the output of the downstream instrument.

SCPI command:

[\[:SOURce<hw>\]:POWer\[:LEVel\]\[:IMMediate\]:OFFSet](#) on page 707

**Attenuator Settings**

The attenuator mode is set in the Attenuator Settings section.

**Attenuator Mode**

Sets the attenuator mode at the RF output.

"Auto" Standard mode.  
The electronically switching attenuator switches with a 5 dB step width at fixed switching points.

"Fixed" The level settings are made without switching the attenuator. When this operating mode is switched on, the attenuator and the relays are fixed in their current positions to provide level settings without interruption. The resulting variation range is defined and displayed under "Attenuator Fixed Range".

**Note:** The function is effective when automatic level control is activated ("ALC State = On").

If the normal variation range is overranged or underranged, level errors increase considerably and the warning "Level under/overrange" appears in the info line. The spectral purity of the output signal decreases with high attenuation.

SCPI command:

[:OUTPut<hw>:AMODE](#) on page 514

**Fixed Range (PEP) In**

Displays the level range in which the level is set without interruption for the "Attenuator Mode fixed" setting.

SCPI command:

[:OUTPut<hw>:AFIXed:RANGe:UPPer](#) on page 514

[:OUTPut<hw>:AFIXed:RANGe:LOWer](#) on page 513

**RF OFF Mode**

Selects the attenuator mode, when the RF signal is switched off.

The setting of the RF OFF mode is not affected by an instrument preset (PRESET key), \*RST and the "Save/Recall" function. This parameter is influenced only by the [Factory Preset](#).

- "Unchanged" Freezes the setting of the attenuator when RF is switched off. The attenuator is only activated when RF is switched on. This setting is recommended if a constant VSWR (**V**oltage **S**tanding **W**ave **R**atio) is required.
- "Full Attenuation" Sets attenuation to maximum when the RF signal is switched off. This setting is recommended for applications that require a high level of noise suppression.

SCPI command:

`[ :SOURce<hw> ] :POWer:ATTenuation:RFOFF:MODE` on page 706

### User Variation

If the level is set using the rotary knob, the step width is defined in the "User Variation" section.

### Variation Active

Activates the user-defined step width used when varying the level value with the rotary knob.

- "ON" The level value set with the rotary knob is varied using the user-defined step width which is entered under "Variation Step".
- "OFF" The level value set with the rotary knob is varied in steps of one unit at the cursor position (standard operating mode).

SCPI command:

`[ :SOURce<hw> ] :POWer:STEP:MODE` on page 712

### Variation Step

Sets the user-defined step width for entering the RF level using the rotary knob. Level variation with this step width must also be activated with "Variation Active".

SCPI command:

`[ :SOURce<hw> ] :POWer:STEP [ :INCRement ]` on page 711

### Reverse Power Protection

Starting from serial number 101001, the R&S Signal Generator (all frequency options) is equipped against overloading by an external signal applied to the RF output.

The reverse power protection is tripped when the power of the external signal becomes too high. A relay opens and interrupts the internal connection to the RF output. This condition is indicated in the display header by the "OVERLOAD" status message.

### Overload

If an "Overload" status message is indicated in the display header, reset the overload protection by pressing the RF ON/OFF key.

The RF input is activated when the overload protection is reset.

SCPI command:

`:OUTPut<hw>:PROTection:TRIPped` on page 516

`:OUTPut<hw>:PROTection:CLEar` on page 515

`:OUTPut<hw> [ :STATe ]` on page 516

### 5.5.7.3 Power-On/EMF Settings

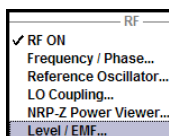

The power-on behavior of the R&S SMJ and the level display in the display header are set in the "Power-On / EMF Settings" section of the "RF Level/EMF/ALC/UCOR" dialog.

To open the "RF Level/EMF" dialog, select "RF/A Mod > Configure > Level/EMF" or use the MENU key under "RF/A Mod".

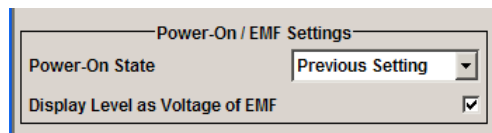

#### Power-On State - RF Signal

Selects the state which the RF output is to assume after the instrument is switched on.

"RF Off" The output is deactivated when the instrument is switched on.

"Previous Setting" When the instrument is switched on, the output assumes the same state as it had when the instrument was switched off.

SCPI command:

:OUTPut<hw>[:STATe]:PON on page 516

#### Display Level as Voltage of EMF - RF Level

Activates display of the signal level as voltage of the EMF (no-load voltage). If this setting is deactivated, the level is displayed as a voltage over a 50 Ohm load (preset state).

SCPI command:

n.a.

## 5.5.8 Automatic Level Control - ALC

Your signal generator is equipped with an automatic level control unit to obtain best RF level accuracy.

**Automatic Level Control (ALC)** is an adaptive control system to stabilize the RF output level. It continuously monitors the current level and adjusts it to keep a steady state over temperature and time.



ALC is active in almost all applications by default. However, the **Pulse Modulation** mode excludes ALC, as the control loop would detect incorrect values and result in level deviations.

Also note that ALC may detect incorrect values in **multi-transmitter** test setups. If multiple generators are coupled, reverse power may affect the ALC readings. Based on incorrect values, ALC would have an impact on the signal to intermodulation ratio.

#### ALC States

The following description basically explains the ALC states and their principle of operation. In particular **ALC OFF (Sample & Hold)** gives an overview on the function in terms of the equipment of the generator.



The R&S SMJ offers the ALC states:

- **AUTO**  
automatically adjusts the output level to the operating conditions.
- **On**
- enables ALC permanently, regardless of the currently selected mode.
- **Off**  
deactivates ALC.  
The instrument switches to **Sample & Hold (S&H)** state, which still allows to maintain a constant output level.

The following section explains the functionality of "Sample & Hold", to provide an overview and to indicate what is to be considered. "On" and "Auto" require no additional explanation. Furthermore, find the ALC state settings described in detail in [State - ALC](#).

### ALC OFF (Sample & Hold)

In "S&H" mode, the signal generator switches for a short period of time into CW mode and activates ALC. ALC adjusts the level to the set value and the generator holds the value (freeze). Then, the generator switches ALC off again and back to the operating mode.

RF output behaviour during Sample & Hold depends on the configuration of your instrument. Instruments equipped with...:

- an **electronic step attenuator**  
The level is decreased by 30 dB.
- a **mechanical step attenuator**

The level control status is permanently displayed as a status message in the info line.



#### 5.5.8.1 Automatic Level Control Settings

To open the "Automatic Level Control" dialog, select "RF/A Mod > Configure > Automatic Level Control" or use the MENU key under "RF/A Mod".

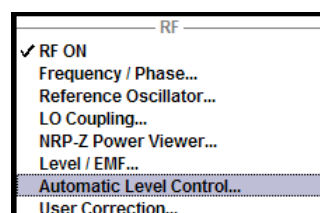

The combined dialog "ALC / UCOR" is divided into the several sections and provides access to the "Automatic Level Control" settings and to function "User Correction", see [chapter 5.5.9, "User Correction"](#), on page 209).

The top sections of the dialog provide access to the level and attenuator settings (see [chapter 5.5.7.3, "Power-On/EMF Settings"](#), on page 207 and [chapter 5.5.7.2, "RF Level"](#), on page 203).



### State - ALC

Activates/deactivates internal level control.

- |                       |   |
|-----------------------|---|
| "Auto"                | The instrument selects the most appropriate ALC mode automatically. ALC is on in most operating conditions. Default state.  |
| "On"                  | Activates ALC, regardless of the operating conditions.<br>If "Attenuator Mode Fixed" is selected in addition, the instrument adjusts the level of every level and frequency setting.                      |
| "Off (Sample & Hold)" | Deactivates internal level control.<br>Sample & hold closes the level control loop at every frequency and level change for a short period of time. The level control voltage is sampled and then clamped. |

SCPI command:

[\[:SOURce<hw>\]:POWER:ALC\[:STATe\]](#) on page 705

### Search Once - ALC

Forces the generator to execute level adjustment once, although the "Sample & Hold" mode is active.

SCPI command:

[\[:SOURce<hw>\]:POWER:ALC:SONCe](#) on page 705

### Protect RF Output - ALC

The signal is attenuated for about 40 dB to protect external devices against internal signals, if the following prerequisites are fulfilled

- ALC state is On or AUTO
- High-Power Mode is Off
- I/Q Modulator is On
- Baseband is armed

SCPI command:

[:OUTPut<hw>:PROTection:STATe](#) on page 515

## 5.5.9 User Correction

The "User Correction" function is used to create and activate lists in which level correction values predefined by the user are freely assigned to RF frequencies. Correction is performed by the user-defined table values being added to the output level for the respective RF frequency.

With frequencies which are not contained in the list, the level correction is determined by interpolation of the closest correction values.

The lists are created in the "List Editor". Each list is stored in its own file with the predefined file extension \*.uco. The name of the User Correction file can be freely selected. The files are loaded from the "Lists..." file manager. Externally created tables with pairs of frequency and level values can be converted into User Correction files using the import function. The external files must have the file extension \*.txt or \*.csv. These file formats are provided e.g. by the Microsoft Excel program. The separators for table columns and for decimal floating-point numerals can be set. In addition, internally created User Correction data can be exported into ASCII files using the export function.

The amplitude can also be linearized automatically by means of an R&S NRP power sensor connected to one of the generator output signals. With the aid of the "Fill with Sensor" function, a table with correction values for external test assemblies can be automatically determined, e.g. for compensating the frequency response of cables. The User Correction list with the correction values acquired by the sensor is generated in the "Edit User Correction List" menu. The correction values can be acquired any time irrespective of the modulation settings of the generator.

Multi level measurements allow to take into account the changing VSWR for the different attenuator settings.

If user correction is activated, the "UCOR" display (User Correction) is shown in the header together with the "Level" display. The RF output level is the sum of both values.

"Level" + "UCOR" = Output level

If activated, user correction is effective in all operating modes.

### 5.5.9.1 User Correction Menu

Automatic Level Control...  
User Correction...

To open the "User Correction" menu, select "RF/A Mod > Configure User Correction" or use the MENU key under "RF/A Mod".

The combined menu "ALC/UCOR" is divided into the several sections.

The top sections provide access to the level and attenuator settings, see [chapter 5.5.7.2, "RF Level"](#), on page 203, and to the automatic level control settings, see [chapter 5.5.8, "Automatic Level Control - ALC"](#), on page 207.

#### User Correction Settings

The "User Correction" settings are set in the most lower section of the combined dialog; this section is used to activate/deactivate user correction, and to create, select and activate the lists.

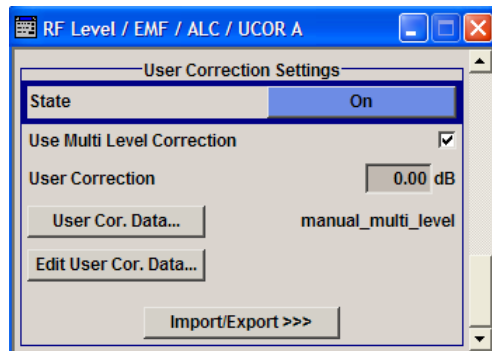

### State - User Correction

Activates/deactivates user correction.

The "UCOR" status message appears in the frequency and level display.

SCPI command:

[\[:SOURce<hw>\]:CORRection\[:STATe\]](#) on page 651

### Use Multi Level Correction - User Correction

Activates the use of the multi level correction data (see [chapter 5.5.9.3, "Filling the Correction List with Power Sensor Measurement Data"](#), on page 216) if checked. Otherwise the Single Level Correction measurement data is used.

SCPI command:

[\[:SOURce<hw>\]:CORRection:MLEvel:STATe](#) on page 651

### User Correction Value - User Correction

Indicates the current value for level correction.

SCPI command:

[\[:SOURce<hw>\]:CORRection:VALue](#) on page 652

### User Cor. Data - User Correction

Calls the "File Select" menu for selecting and creating a list or the "File Manager".

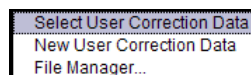

SCPI command:

[\[:SOURce\]:CORRection:CSET:DELeTe](#) on page 647

[\[:SOURce<hw>\]:CORRection:CSET\[:SELeCt\]](#) on page 651

### Edit User Cor. Data - User Correction

Calls the editor for editing the selected user correction list.

A list consists of any number of frequency/level value pairs. The currently selected list is displayed.

Each list is saved as a separate file with extension \*.uco. The file name and the directory to which the file is saved are user-selectable.

Multi level lists which are filled automatically using the Fill with sensor function consist of nine level columns, one for each attenuator stage (see chapter 5.5.9.3, "Filling the Correction List with Power Sensor Measurement Data", on page 216).

**Note:** Save list only after filling both columns (frequency and level), otherwise the entries are lost.

	Frequency / Hz	Power / dB	Power [1] @ HP/ dB	Power [2] @ 0 dB/ dB	Power [3] @ 5 dB/ dB
1	10 000 000.00	3.00	3.56	3.51	3.52
2	20 000 000.00	3.96	3.52	3.90	3.96
3	30 000 000.00	4.07	3.79	4.07	4.06
4	40 000 000.00	3.70	3.84	3.73	3.70
5	50 000 000.00	3.38	3.56	3.35	3.38
6	60 000 000.00	3.59	3.68	3.58	3.59
7	70 000 000.00	4.04	4.02	4.06	4.04
8	80 000 000.00	4.06	3.90	4.12	4.15
9	90 000 000.00	3.88	3.58	3.82	3.88
10	100 000 000.00	3.64	3.84	3.68	3.63
11	110 000 000.00	3.79	4.26	3.85	3.79
12	120 000 000.00	4.17	4.03	4.07	4.16
13	130 000 000.00	4.36	3.58	4.27	4.35
14	140 000 000.00	4.18	3.94	4.27	4.18
15	150 000 000.00	3.85	4.48	3.96	3.84
16	160 000 000.00	3.91	4.25	3.80	3.90
17	170 000 000.00	4.29	3.71	4.15	4.28

"Frequency / Hz"

Enters the frequency to which the level correction value applies.

**Note:** The "Fill..." function allows to automatically enter any number of frequencies with freely selectable range and increment.

Using the "Fill With Sensor" function of the "Edit" sub menu requires only the entry of the frequency values. The level values are automatically acquired by the connected power sensor.

"Power / Power[1..9] @ HP.. 35 dB"

Enters the level correction value to which the specified frequency applies. The values can be entered manually or automatically with the "Fill With Sensor" function (available in the "Edit" sub menu).

"Goto"

Selects row for editing.

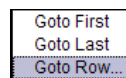

If Goto row is selected, a window opens for entering the requested row.

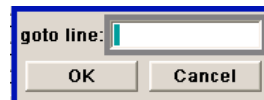

"Edit" Calls a selection of possible actions described below.

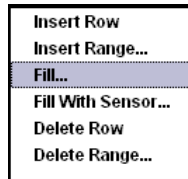

"Insert Row" Insert a new row before the marked row.

"Insert Range" Insert new rows before the marked row. The number of rows to be inserted can be defined in an entry window.

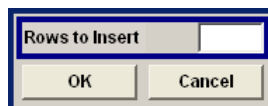

"Fill...." Opens a sub menu for defining a set of list values to be automatically entered in the ucor list (see [chapter 5.5.9.2, "Filling the Correction List automatically"](#), on page 215).

"Fill With Sensor" Calls the menu to activate the filling of the user correction list with level values acquired by the selected power sensor (see [chapter 5.5.9.3, "Filling the Correction List with Power Sensor Measurement Data"](#), on page 216).

"Delete Row" Deletes the marked row.

"Delete Range..." Allows to delete any number of rows starting with the marked row. The number of rows to be deleted can be defined in an entry window.

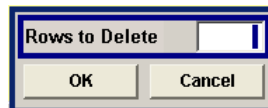

"Save as" Open the file menu to save the list under a new name.

**Note:** Save list only after filling both columns (frequency and level), otherwise the entries are lost.

Each list is saved to the R&S Signal Generator hard disk as a separate file with the file prefix \*.uco. The file name and the directory to which the file is saved are user-selectable.

"Save" The list is saved under its current name.

SCPI command:

[\[:SOURce<hw>\]:CORRection:CSET\[:SElect\]](#) on page 651

[\[:SOURce<hw>\]:CORRection:CSET:DATA:FREQuency](#) on page 644

[\[:SOURce<hw>\]:CORRection:CSET:DATA:POWer](#) on page 645

### Import/Export

User correction list can be imported from externally created files or exported into text or CSV-files. The import/export settings are available after clicking the "Import/Export" button.

**Import/Export >>>**

Expands the menu with the area for import and export of user correction files.

Externally edited Excel tables with any number of frequency/level value pairs can be imported as text or CSV-files and used for user correction.

Multi level lists which are filled automatically using the "Fill with sensor" function consist of nine level columns, one for each attenuator stage (see [chapter 5.5.9.3, "Filling the Correction List with Power Sensor Measurement Data"](#), on page 216).

Conversely, you can also export internally created user correction lists as text or CSV-files.

**Mode - User Correction**

Selects if user correction lists should be imported or exported. The settings offered depend on the selected mode.

SCPI command:

[\[:SOURce<hw>\]:CORRection:DEXChange:MODE](#) on page 650

**Extension - User Correction**

Selects the file extension of the ASCII file to be imported or exported. Selection "TXT" (text file) or "CSV" (Excel file) is available.

SCPI command:

[\[:SOURce<hw>\]:CORRection:DEXChange:AFILe:EXTension](#) on page 647

**Decimal Point - User Correction**

Selects the decimal separator used in the ASCII data between '.' (decimal point) and ',' (comma) with floating-point numerals.

SCPI command:

[\[:SOURce<hw>\]:CORRection:DEXChange:AFILe:SEParator:DECimal](#) on page 649

**Column Separator- User Correction**

Selects the separator between the frequency and level column of the ASCII table the user correction list is exported to or imported from.

SCPI command:

`[ :SOURce<hw> ] :CORRection:DEXChange:AFILe:SEParator:COLumn`  
on page 648

**Select ASCII Source / Destination - User Correction**

Calls the "File Manager" for selecting the ASCII file to be imported into a user correction list (source) or the ASCII file the user correction list is exported (destination) in.

SCPI command:

`[ :SOURce<hw> ] :CORRection:DEXChange:AFILe:SElect` on page 648

**Destination / Source - User Correction**

Calls the "File Manager" for selecting the user correction list to be exported (source) into an ASCII file or the destination for the ASCII file to be imported (destination) in.

SCPI command:

`[ :SOURce<hw> ] :CORRection:DEXChange:SElect` on page 650

**Import / Export - User Correction**

Starts the export or import of the selected file.

When import is selected, the ASCII file is imported as user correction list.

When export is selected, the user correction list is exported into the selected ASCII file.

SCPI command:

`[ :SOURce<hw> ] :CORRection:DEXChange:EXECute` on page 649

**5.5.9.2 Filling the Correction List automatically**

The "Fill Table" menu enables you to automatically set the level correction values.

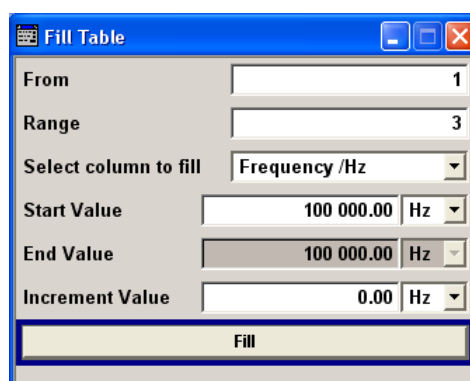

The start line and the number of rows to be filled are defined under "From" and "Range."

The column to be filled is selected under "Select column to fill". Depending on the selection here, the default for start, end, and increment value are set. As the settings are interdependent, a change of one parameter may result in the automatic change of one



or more of the other parameters. The filling of the column with the selected value settings is started with button "Fill".



The correction list entries are only computed when the "Fill" button is pressed.

**From**

Sets the start value of the index range.

SCPI command:

n.a.

**Range**

Sets the range for filling the table.

SCPI command:

n.a.

**Select column to fill**

Selects either the frequency or the level column to be filled with the value defined below.

SCPI command:

n.a.

**Start value**

Sets the start value for the frequency or the level entries.

SCPI command:

n.a.

**End value**

Displays the end value for the frequency or the level entries.

SCPI command:

n.a.

**Increment value**

Sets the increment for the frequency or the level entries.

SCPI command:

n.a.

**Fill**

Fills the selected column in the set range with values, starting with the start value and using the set increment.

SCPI command:

n.a.

### 5.5.9.3 Filling the Correction List with Power Sensor Measurement Data

The level correction values for the user correction list can be acquired by means of R&S NRP power sensors. The R&S NRP sensors are connected to either the SENSOR con-

nector or to one of the USB interfaces. Configuration of the connection is performed in the "Power Sensor" menu (see [chapter 5.5.6, "NRP-Z Power Viewer"](#), on page 196). The filling of the ucor list with measurement data is performed in the ucor list editor (see ["Edit User Cor. Data - User Correction"](#) on page 211).

In the editor, the frequencies for which the correction values are to be acquired are entered in the frequency column (either manually or by means of the "Fill..." menu).



Do not save the list at this point, because the frequency entries are lost as long as there are no entries for the level column also. In the following these entries are automatically acquired by the connected power sensor.

All level correction values for the given frequency values are measured using the Power Sensor and automatically filled in the selected list after the "Execute" button is pressed. The list is automatically stored and recalled again after filling.

### Fill User Correction Data with Sensor Settings

The "Fill with Sensor" button of the "Edit User Correction Data" menu opens the associated menu.

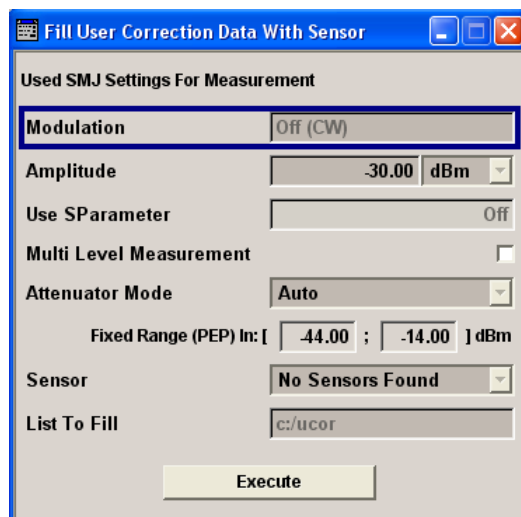

The menu indicates the relevant generator settings.

### Fill User Correction Data with Sensor

All settings are read-only, except the "Sensor" and "Multi Level Measurements".

In case more than one sensor is connected to the instrument, the sensor can be selected in the "Sensor" field of the menu; "Multi Level Correction" can be activated.

The "Execute" button is only enabled if a sensor is detected and the user correction list contains at least one frequency value.

SCPI command:

```
[ :SOURce<hw> ] :CORRection:CSET:DATA [ :SENSor<ch> ] [ :POWer ] :SONCe
```

on page 646

### Multi Level Correction

When "Multi Level Correction" is activated, separate measurements are made for the different attenuator settings up to 35 dB. Thus, the changes in VSWR for the different settings are taken into account, the level accuracy increases. For ranges from 40 dB on the changes in VSWR are negligible. The reference level is set internally and cannot be controlled by the user. The measurement results are entered into additional columns of the "User Correction" list.

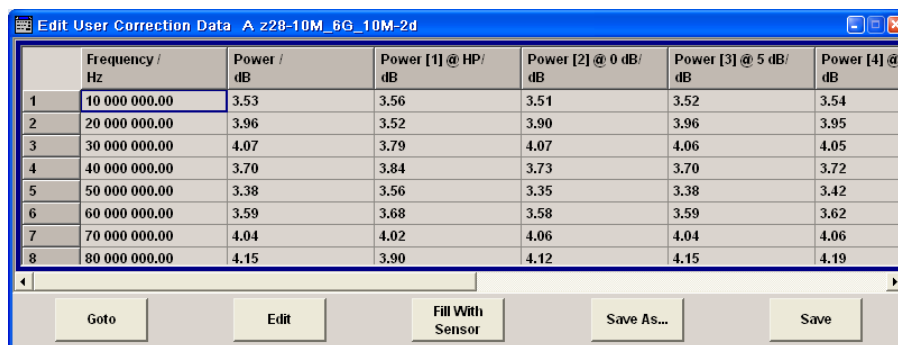

	Frequency / Hz	Power / dB	Power [1] @ HP/ dB	Power [2] @ 0 dB/ dB	Power [3] @ 5 dB/ dB	Power [4] @
1	10 000 000.00	3.53	3.56	3.51	3.52	3.54
2	20 000 000.00	3.96	3.52	3.90	3.96	3.95
3	30 000 000.00	4.07	3.79	4.07	4.06	4.05
4	40 000 000.00	3.70	3.84	3.73	3.70	3.72
5	50 000 000.00	3.38	3.56	3.35	3.38	3.42
6	60 000 000.00	3.59	3.68	3.58	3.59	3.62
7	70 000 000.00	4.04	4.02	4.06	4.04	4.06
8	80 000 000.00	4.15	3.90	4.12	4.15	4.19

The Multi Level Correction measurements are made in addition to a Single Level Correction measurement. When the user correction list is activated, it is possible to select which of the measurements is to be used for level correction.

### Multi Level Values

The measurement values for the different attenuator settings are retrieved separately. The numeric suffix at MLEV correlates to the index of the column, e.g. suffix 3 denotes the column with the values for attenuator setting 5 dB.

SCPI command:

[\[:SOURce<hw>\]:CORRection:CSET:DATA:POWer:MLEV<ch>:STATe](#) on page 646

[\[:SOURce<hw>\]:CORRection:CSET:DATA:POWer:MLEV<ch>](#) on page 645

## 5.5.10 Reverse Power Protection

Starting from serial number 101001, the R&S Signal Generator (all frequency options) is equipped against overloading by an external signal applied to the RF output.

The reverse power protection is tripped when the power of the external signal becomes too high. A relay opens and interrupts the internal connection to the RF output. This condition is indicated in the display header by the "OVERLOAD" status message.

### Overload

If an "Overload" status message is indicated in the display header, reset the overload protection by pressing the RF ON/OFF key.

The RF input is activated when the overload protection is reset.

SCPI command:

[:OUTPut<hw>:PROTection:TRIPped](#) on page 516

[:OUTPut<hw>:PROTection:CLEar](#) on page 515

[:OUTPut<hw>\[:STATe\]](#) on page 516

## 5.5.11 Analog Modulations

### 5.5.11.1 Overview

The R&S Signal Generator provides the analog modulations amplitude modulation (AM), broadband amplitude modulation (BB-AM) and pulse modulation (Pulse) for the basic unit (R&S SMJ+ frequency option R&S SMJ-B10x) without additional equipment options.

However, the analog modulations frequency modulation (FM) and phase modulation (PhiM) require option R&S SMJ-B20 (FM/PhiM Modulator).

Settings for the modulation are made in separate modulation menus. These menus can be accessed in the block diagram by way of the "RF/A Mod" function block, or by means of the menu with the same name which is opened using the MENU key.

#### Enabling/Disabling Analog Modulations using the MOD On/Off Key

The MOD ON/OFF key switches the modulations on and off.

#### MOD ON/OFF

Press the MOD ON/OFF key to enable/disable analog modulations.

Pressing the key again restores the status that was active before the last switch-off. "MOD OFF" is displayed in the info line of the header next to the "Level" field.

SCPI command:

`[ :SOURce<hw> ] :MODulation [ :ALL ] :STATe` on page 700

#### Modulation Sources

The following modulations use internal and external modulation sources:

- Amplitude modulation
- Pulse modulation
- Frequency modulation
- Phase modulation

Only external modulation sources can be used for a BB-AM.

#### Internal Modulation Sources

The LF generator is available as internal modulation source. The generator supplies sinusoidal signals in the frequency range 0.1 Hz to 1 MHz. With pulse modulation, the sinusoidal signal from the LF generator is formed internally into a rectangular signal used to actuate the pulse modulator.

The noise generator supplies white noise with selectable bandwidth and level distribution.

See also [chapter 5.5.12.1, "Overview of LF Generator"](#), on page 232.

### External Modulation Sources

The EXT MOD input at the rear of the instrument is provided as the external modulation source for amplitude, pulse, frequency and phase modulation. The external signal for broadband amplitude modulation is fed in via the I-input.

The external modulation signal at the input must have a voltage of  $U_S = 1 \text{ V}$  ( $U_{\text{EFF}} = 0.707 \text{ V}$ ) in order to achieve the displayed modulation depth and range. The input voltage should not exceed 1.1 Vs, otherwise modulation distortions might occur. With external pulse modulation, the switching point is max. 2.4 V and the voltage at the input should not exceed 5 V. The maximum modulation frequency is 10 MHz for frequency and phase modulation.

### Simultaneous Operation of Several Modulations or Other Operating Modes

The table shows the modulations and operating modes which can be activated simultaneously (+) or which deactivate each other (-).

	AM	FM	PhiM	Pulse	BB-AM	I/Q	DM	ARB
Amplitude modulation (AM)	/	+	+	+	-	-	-	-
Frequency modulation (FM)	+	/	-	+	+	+	+	+
Phase modulation (PhiM)	+	-	/	+	+	+	+	+
Pulse modulation	+	+	+	/	+	+	+	+
Broadband AM (BB-AM)	-	+	+	+	/	-	-	-
Vector modulation (I/Q)	-	+	+	+	-	/	-	-
Digital modulation (DM)	-	+	+	+	-	-	/	-
ARB	-	+	+	+	-	-	-	/

#### 5.5.11.2 Amplitude Modulation (AM)

An internal or external source can be selected for amplitude modulation. The LF GEN modulation generator is available as the internal source. The I/Q modulator is used for amplitude modulation. Two-tone AM is possible by simultaneously switching on the external and internal source.

The EXT MOD input connector for external feed of analog modulation signals is at the rear of the instrument. The coupling mode of the input (AC or DC) can be selected.

It is not possible to use AM simultaneously with:

- broadband AM,
- I/Q modulation,
- arbitrary waveform generation,
- digital modulation and
- digital standards.

The AM modulation depth is limited by the maximum peak envelope power (PEP).

### Amplitude Modulation Settings

To open the "Amplitude Modulation" dialog, select "RF/A Mod > Configure > Amplitude Modulation" or use the MENU key under "RF/A Mod".

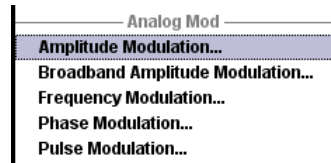

The middle section of the combined dialog "Pulse/Amplitude Modulation/Broadband AM" provides access to the amplitude modulation settings.

The top section provides access to the pulse modulation settings, see [chapter 5.5.11.6, "Pulse Modulation \(PM\)"](#), on page 230.

The lower section provides access to the broadband amplitude modulation settings, see [chapter 5.5.11.3, "Broadband Amplitude Modulation \(BB-AM\)"](#), on page 223.

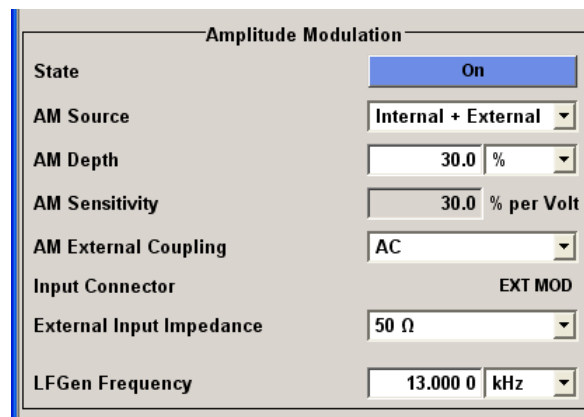

#### State

Activates/deactivates AM modulation.

Activation of AM deactivates:

- BB AM,
- I/Q modulation,
- arbitrary waveform generation,
- digital modulation and
- digital standards.

SCPI command:

[ :SOURce<hw> ] :AM:STATe on page 528

#### AM Source

Selects the source for the AM signal.

"Internal" Selects the internal LF generator as the source for AM modulation.

"External" Selects the external source.  
The external signal is input via the EXT MOD connector.

"Intern + Extern" Selects the internal and external source at the same time. This setting enables two-tone AM modulation.

SCPI command:

[\[:SOURce<hw>\]:AM:SOURce](#) on page 528

### AM Depth

Sets the modulation depth in percent.

SCPI command:

[\[:SOURce<hw>\]:AM\[:DEPTh\]](#) on page 526

### LF Gen Frequency

Sets the frequency of the LF generator.

This setting affects all analog modulations which use the LF generator as the internal modulation source.

SCPI command:

[\[:SOURce\]:LFOutput:FREQuency](#) on page 680

### AM Sensitivity

(Source External only)

Displays the input sensitivity of the EXT MOD input in %/V.

The modulation depth entered under "AM Depth" is reached with 1 volt modulation of the input.

SCPI command:

[\[:SOURce<hw>\]:AM:SENSitivity](#) on page 527

### AM External Coupling

(Source External only)

Selects the coupling mode (AC or DC) for external feed.

**Note:** Coupling for external feed via input EXT MOD can be set independently for all modulations with external source.

SCPI command:

[\[:SOURce<hw>\]:AM:EXTernal:COUPling](#) on page 527

### AM Input Connector

Displays the modulation input. The display only appears in the case of external modulation.

SCPI command:

n.a.

### External Input Impedance

(Source External only)

Selects the impedance for external feed via the EXT MOD input.

Selection 50 Ohm and high (>100 kOhm) is available.

**Note:** This setting affects all analog modulations which use the external modulation source.

SCPI command:

[ :SOURce<hw> ] :INPut:MODext:IMPedance on page 664

### 5.5.11.3 Broadband Amplitude Modulation (BB-AM)

With broadband amplitude modulation the I/Q modulator is used for amplitude modulation.

An external source is always used. The modulation input is the I-input of the I/Q modulator. The sensitivity for broadband amplitude modulation is 0.25V / 100% modulation depth. It is not possible to set a modulation depth for BB-AM.

It is not possible to use BB-AM simultaneously with:

- AM,
- I/Q modulation,
- arbitrary waveform generation (ARB),
- digital modulation and
- digital standards.

The upper level limit for BB-AM is the same as that for I/Q modulation. PEP is up to 6 dB above the display value, depending on the modulation depth.

#### Broadband Amplitude Modulation Menu

To open the "Broadband Amplitude Modulation" menu, select "RF/A Mod > Configure > Broadband Amplitude Modulation" or use the MENU key under "RF/A Mod".

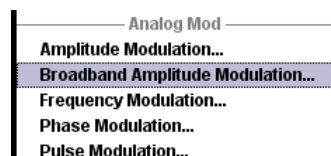

The combined menu "Pulse Modulation/Amplitude Modulation /Broadband AM" provides access to the Broadband AM configuration in the bottom section.

The top section provides access to the pulse modulation settings; see [chapter 5.5.11.6, "Pulse Modulation \(PM\)"](#), on page 230.

The middle section provides access to the amplitude modulation settings; see [chapter 5.5.11.2, "Amplitude Modulation \(AM\)"](#), on page 220.

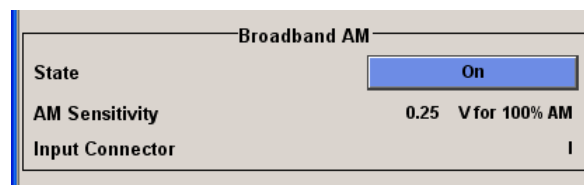



**State**

Activates/deactivates broadband AM modulation. Activation of broadband AM deactivates AM, I/Q modulation, digital modulation and digital standards.

SCPI command:

`[ :SOURce<hw> ] :AM:BBANd [ :STATe ]` on page 526

**AM Sensitivity**

Displays the input sensitivity of the I IN input in V/100% modulation depth. The input sensitivity cannot be influenced in the case of broadband AM since it is not possible to set the range.

SCPI command:

`[ :SOURce<hw> ] :AM:BBANd:SENSitivity` on page 526

**Input Connector**

Displays the modulation input (I-input connector of the I/Q modulator).

SCPI command:

n.a.

**5.5.11.4 Frequency Modulation (FM)**

Frequency modulation (FM) requires option R&S SMJ-B20 (FM/PhiM Modulator).

An internal and/or external source can be selected for frequency modulation. The LF GEN modulation generator is available as the internal source. Two-tone FM is possible by simultaneously switching on the external and internal source.

The EXT MOD input connector for external feed is at the rear of the instrument. The coupling mode of the input (AC or DC) and 50 Ohm or high (> 10 kOhm) impedance can be selected.



It is not possible to use frequency modulation simultaneously with phase modulation.

**Frequency Modulation Settings**

To open the "Frequency Modulation" menu, select "RF/A Mod > Configure > Frequency Modulation" or use the MENU key under "RF/A Mod".

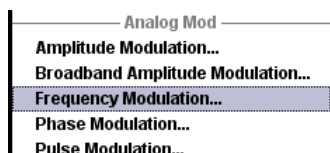

The top section of the combined menu "Frequency/Phase Modulation" provides access to the frequency modulation settings.

The the lower section of the combined menu provides access to phase modulation, see [chapter 5.5.11.5, "Phase Modulation \(PhiM\)"](#), on page 227

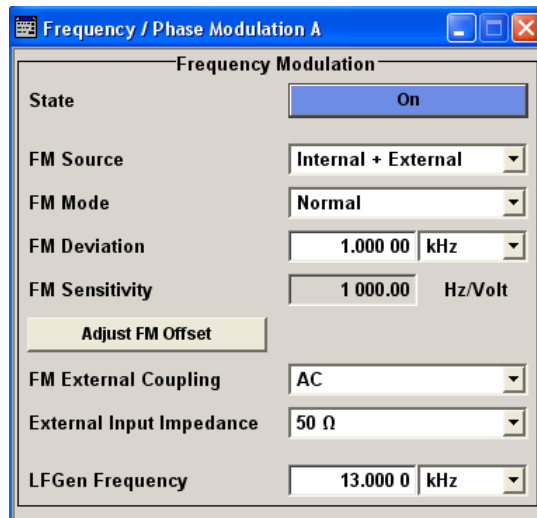
**State**

Activates/deactivates FM modulation.

Activation of FM deactivates phase modulation.

SCPI command:

[\[:SOURce<hw>\]:FM:STATe](#) on page 654

**FM Source**

Selects the source for the FM signal.

"Internal" Selects the internal LF generator as the source for FM modulation.

"External" Selects the external source.  
The external signal is input via the EXT MOD connector.

"Internal + External" Selects the internal and external source at the same time.  
This setting enables two-tone FM modulation.

SCPI command:

[\[:SOURce<hw>\]:FM:SOURce](#) on page 654

**FM Mode**

Selects the mode for the frequency modulation.

"Normal" The maximum range for modulation bandwidth and FM deviation is available.

SCPI command:

[\[:SOURce<hw>\]:FM:MODE](#) on page 653

**FM Deviation**

Sets the modulation deviation in Hz.

The deviation is given as the absolute deviation in relation to the set center frequency, e.g. a deviation 5 MHz at a center frequency of 1 GHz leads to a frequency modulation between 995 MHz and 1005 MHz.

The maximal deviation depends on the RF frequency set and the selected modulation mode (see data sheet). It is possible to enter a deviation that is too high for a certain RF frequency or to vary the RF frequency to a range in which the deviation can no longer be set. In this case the maximally possible deviation is set and an error message is displayed.

The deviation of the internal source must not exceed the deviation of the external source in case of modulation source "Int+Ext".

SCPI command:

[\[:SOURce<hw>\]:FM\[:DEVIation\]](#) on page 652

### LF Gen Frequency

Sets the frequency of the LF generator.

This setting affects all analog modulations which use the LF generator as the internal modulation source.

SCPI command:

[\[:SOURce\]:LFOutput:FREQuency](#) on page 680

### FM Sensitivity

(Source External only)

Displays the input sensitivity of the EXT MOD input in Hz/V.

The modulation depth entered under "FM Depth" is reached with 1 Volt (=  $U_{peak}$ ) of the input signal.

**Note:** The input voltage should not exceed 1.1  $V_p$  otherwise modulation distortions might occur.

SCPI command:

[\[:SOURce<hw>\]:FM:SENSitivity](#) on page 654

### Adjust FM Offset

Starts the adjustment for the FM/PhiM modulator. The option is adjusted with respect to DC-offset.

SCPI command:

[:CALibration<hw>:FMOffset\[:MEASure\]](#) on page 487

### FM External Coupling

(Source External only)

Selects the coupling mode (AC or DC) for external feed.

**Note:** Coupling for external feed via input EXT MOD can be set independently for all modulations with external source.

"AC"                    The d.c. voltage content is separated from the modulation signal.

"DC"                    The modulation signal is not altered.

SCPI command:

[\[:SOURce<hw>\]:FM:EXTernal:COUpling](#) on page 653

### External Input Impedance

(Source External only)

Selects the impedance for external feed via the EXT MOD input.

Selection 50 Ohm and high (>100 kOhm) is available.

**Note:** This setting affects all analog modulations which use the external modulation source.

SCPI command:

[ :SOURce<hw> ] : INPut : MODext : IMPedance on page 664

### 5.5.11.5 Phase Modulation (PhiM)

Phase modulation (PhiM) requires option R&S SMJ-B20 (FM/PhiM Modulator).



It is not possible to use phase modulation simultaneously with frequency modulation.

An internal and/or external source can be selected for phase modulation. The LF GEN modulation generator is available as the internal source.

The EXT MOD input connector for external feed of analog modulation signals is at the rear of the instrument. The coupling mode of the input (AC or DC) and the impedance can be selected.

Selection between the following modulation modes is possible:

- "High Bandwidth" mode with full setting range for modulation bandwidth and limited PhiM deviation.
- "High Deviation" mode with full setting range for PhiM deviation and a reduced setting range for modulation bandwidth. Phase noise is reduced in the lower modulation frequency range compared to the default mode.

#### Phase Modulation Menu

To open the "Phase Modulation" menu, select "RF/A Mod > Configure > Phase Modulation" or use the MENU key under "RF/A Mod".

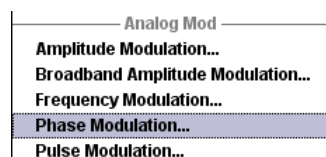

The lower section of the combined menu Frequency/Phase Modulation provides access to the phase modulation settings.

The upper section provides access to the frequency modulation, see [chapter 5.5.11.4, "Frequency Modulation \(FM\)"](#), on page 224

Phase Modulation	
State	On
ΦM Source	Internal + External
ΦM Mode	High Bandwidth
ΦM Deviation	1.000 000 rad
ΦM Sensitivity	1.000 000 rad per Volt
ΦM External Coupling	AC
External Input Impedance	50 Ω
LFGGen Frequency	13.000 0 kHz

**State**

Activates/deactivates PhiM modulation.

Activation of PhiM deactivates frequency modulation.

SCPI command:

[ :SOURce<hw> ] :PM:STATe on page 704

**PhiM Source**

Selects the source for the PhiM signal.

"Internal" Selects the internal LF generator as the source for PhiM modulation.

"External" Selects the external source.  
The external signal is input via the EXT MOD connector.

"Internal + External" Selects the internal and external source at the same time.

SCPI command:

[ :SOURce<hw> ] :PM:SOURce on page 703

**PhiM Mode**

Selects the mode for the phase modulation.

"High Bandwidth" The maximum range for modulation bandwidth is available. However, phase noise is increased for low frequencies. The range for PhiM deviation is limited.

This mode is recommended for high modulation frequencies.

"High Deviation" The maximum range for PhiM deviation is available. Phase noise is improved for low frequencies compared to the default mode. The range for modulation frequency is limited (see data sheet).

This mode is recommended for low modulation frequencies and/or high PhiM deviation.

SCPI command:

[ :SOURce<hw> ] :PM:MODE on page 702

**PhiM Deviation**

Sets the modulation depth in RAD or degrees.

The maximal deviation depends on the RF frequency set and the selected modulation mode (see data sheet). It is possible to enter a deviation that is too high for a certain RF frequency or to vary the RF frequency to a range in which the deviation can no longer be set. In this case the maximally possible deviation is set and an error message is displayed.

SCPI command:

[\[:SOURce<hw>\]:PM\[:DEVIation\]](#) on page 701

### LF Gen Frequency

Sets the frequency of the LF generator.

This setting affects all analog modulations which use the LF generator as the internal modulation source.

SCPI command:

[\[:SOURce\]:LFOutput:FREQuency](#) on page 680

### PhiM Sensitivity

(Source External only)

Displays the input sensitivity of the EXT MOD input in RAD/V.

The modulation depth entered under "PhiM Depth" is reached with 1 volt ( $=U_{\text{peak}}$ ) of the input signal.

**Note:** The input voltage should not exceed  $1.1 V_p$  otherwise modulation distortions might occur.

SCPI command:

[\[:SOURce<hw>\]:PM:SENSitivity](#) on page 703

### Mod External Coupling

Selects the coupling mode (AC OR DC) for external feed.

**Note:** Coupling for external feed via input EXT MOD can be set independently for all modulations with external source.

"AC"                    The DC voltage content is separated from the modulation signal.

"DC"                    The modulation signal is not altered.

SCPI command:

[\[:SOURce<hw>\]:PM:EXTernal:COUpling](#) on page 702

### External Input Impedance

(Source External only)

Selects the impedance for external feed via the EXT MOD input.

Selection 50 Ohm and high (>100 kOhm) is available.

**Note:** This setting affects all analog modulations which use the external modulation source.

SCPI command:

[\[:SOURce<hw>\]:INPut:MODext:IMPedance](#) on page 664

### 5.5.11.6 Pulse Modulation (PM)

Pulse modulation is available for the basic unit (R&S SMJ + frequency option R&S SMJ-B10x) without additional equipment options.

An internal or external source can be selected for pulse modulation. A simple rectangular signal with selectable repetition frequency is available as the internal signal. This signal is formed from the sinusoidal signal supplied by the LF generator.

The external signal is input via the EXT MOD connector at the rear of the instrument. The polarity of the external pulse modulation can be selected. If Polarity is set to Normal, the RF level is ON if the level is HIGH at the modulation input.



#### Automatic Level Control is deactivated with pulse modulation!

When pulse modulation is activated, the ALC state of the R&S SMJ is automatically changed to "ALC OFF" ("Sample & Hold"). In this state, the ALC loop is opened and the output level is not regulated but the level modulator is set directly. In order to set the correct output level, a sample & hold measurement is executed after each frequency or level setting.

The level is decreased by 30 dB during "Sample&Hold" measurement.

#### Pulse Modulation Settings

To open the "Pulse Modulation" menu, select "RF/A Mod > Configure > Pulse Modulation" or use the MENU key under "RF/A Mod".

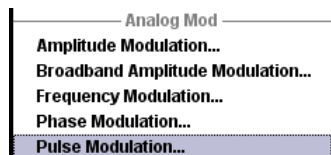

In the upper section of the menu, the modulation source is selected and the modulation switched on. The configuration of the selected external and/or internal modulation source is performed in the lower section of the menu.

The menu varies according to the selected modulation source.

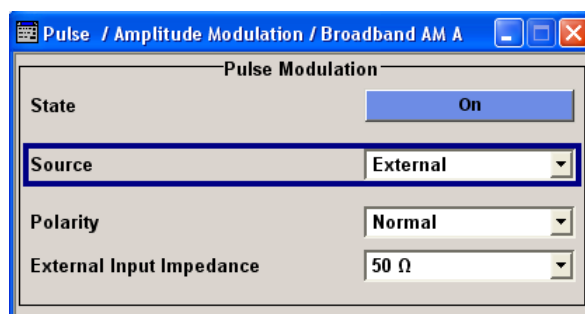

#### State

Activates/deactivates pulse modulation.

Activation of pulse modulation deactivates ALC and power ramping.

SCPI command:

[\[:SOURce<hw>\]:PULM:STATe](#) on page 714

### Source

Selects the source for the pulse modulation signal.

"Internal"           Selects the internal source. The LF generator generates a rectangular pulse with the set frequency.

"External"           Selects the external source.  
The external modulation signal is input via the PULSE EXT connector.

SCPI command:

[\[:SOURce<hw>\]:PULM:SOURce](#) on page 713

### LFGen Frequency - Pulse Modulation

Sets the repetition frequency of the internal signal.

This setting affects all analog modulations which use the LF generator as the internal modulation source.

With two-path instruments, the setting affects both paths.

SCPI command:

[\[:SOURce\]:LFOutput:FREQuency](#) on page 680

### External Input Impedance

(Source External only)

Selects the impedance for external feed via the EXT MOD input.

Selection 50 Ohm and high (>100 kOhm) is available.

**Note:** This setting affects all analog modulations which use the external modulation source.

SCPI command:

[\[:SOURce<hw>\]:INPut:MODext:IMPedance](#) on page 664

### Polarity

(External Source only)

Selects the polarity of the modulation signal.

"Normal"           The RF signal is **On** while the level is high at the modulation input.

"Inverted"          The RF signal is **Off** while the level is high at the modulation input.

SCPI command:

[\[:SOURce<hw>\]:PULM:POLarity](#) on page 713



## 5.5.12 LF Generator and LF Output - Mod Gen

### 5.5.12.1 Overview of LF Generator

The internal LF generator is available as the internal source for the analog modulations AM, FM / PM and Pulse, and also as the signal source for the LF output at the rear of the instrument.

The frequency setting for the LF generator can be made both in the modulation menus and in the "LF Output" menu.

A change to the frequency of the LF generator automatically has an effect on modulation if the LF generator is selected as the modulation source (i.e. "Internal" is selected as "Source").

The LF Sweep mode is activated in the "LF Sweep" dialog (see [chapter 5.5.13.4, "LF Frequency Sweep"](#), on page 246). "RF frequency" and "RF Level" sweeps are activated in the respective menus of the RF block.

### 5.5.12.2 LF Output

To open the "LF Output" dialog, select "RF/A Mod > Configure > LF Output" or use the MENU key under "RF/A Mod".

The combined menu "LF Output / LF Frequency Sweep" provides access to the LF output configuration in the bottom section. The top sections provide access to the LF Sweep mode settings, see [chapter 5.5.13.4, "LF Frequency Sweep"](#), on page 246.

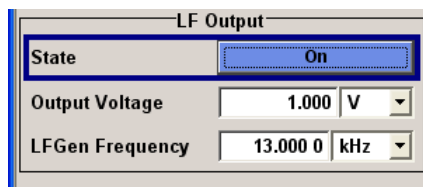

#### LF Output Menu

##### State - LF Output

Activates/deactivates the LF output. This setting has no effect on the modulations.

The modulation signal is output at the LF OUTPUT connector of the instrument.

SCPI command:

`[ :SOURce ] :LFOutput [ :STATe ]` on page 683

##### Output Voltage - LF Output

Sets the output voltage of the LF output. The entered value determines the peak voltage.

SCPI command:

`[ :SOURce ] :LFOutput :VOLTagE` on page 687

**LF Gen Frequency**

Sets the frequency of the LF generator.

This setting affects all analog modulations which use the LF generator as the internal modulation source.

SCPI command:

`[ :SOURce ] :LFOutput :FREQuency` on page 680

**5.5.13 Sweep Mode****5.5.13.1 Overview**

The R&S Signal Generator offers three different sweep types (frequency sweep, level sweep and LF sweep) to be activated alternatively. Each type has 6 modes which differ with respect to the sweep cycle mode (continuous, individual and step-by-step) and triggering mode (automatic, internal and external).



Sweeps and List mode can not be activated simultaneously, they deactivate each other.

A phase continuous frequency sweep can be generated after activating the phase continuous mode, see "[Setting a Phase Continuous Frequency Sweep](#)" on page 190.

**Setting a sweep**

A sweep is set in five basic steps which are shown below taking a frequency sweep as an example.

1. Set the sweep range ("Start Freq" and "Stop Freq" or "Center Freq" and "Span").
2. Select linear or logarithmic sweep spacing ("Spacing").
3. Set the step width ("Step Lin/Log") and dwell time ("Dwell Time").
4. Activate the sweep ("Mode" to Auto, Single, Step or Extern Single, Extern Step).
5. Trigger the sweep, except for Auto mode ("Execute Single Sweep", Current Frequency or External Trigger Signal).



It is recommended to switch off the GUI update for optimum sweep performance especially with short dwell times (see [chapter 5.2.3.5, "Gui Update"](#), on page 125).

**5.5.13.2 RF Frequency Sweep**

The dialog is used to activate and configure a sweep for the RF frequency.

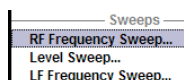

To open the "Frequency Sweep" menu, select "RF/A Mod > Configure > RF Frequency Sweep" or use the menu tree of the MENU key under "RF Signal".

In the top section of the menu, the RF sweep mode is activated and the sweep mode is selected.

The buttons are used to reset the RF sweep (all sweep modes) or to execute the RF sweep ("Single" mode).

The sweep range, sweep spacing and dwell time are set in the bottom section.

The sweep range of the RF sweep can be entered in two ways, either by entering the "Start" and "Stop" value or by entering the "Center" and "Span".

The two sets of parameters influence each other in the following way:

- "Start Freq" = "Center Freq" - "Span"/2
- "Stop Freq" = "Center Freq" + "Span"/2
- "Center Freq" = ("Start Freq" + STOP FREQ)/2
- "Span" = "Stop Freq" - "Start Freq"

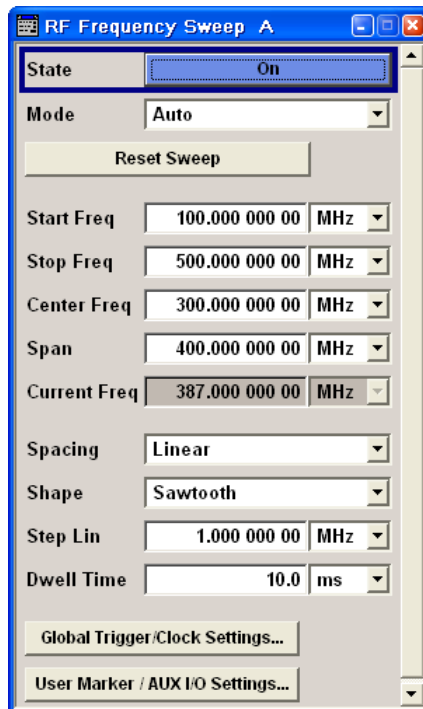

## RF Frequency Sweep Settings

### State - Frequency Sweep

Activates/deactivates RF sweep mode.

**Note:** Activating the RF-Sweep mode automatically disables other sweep modes, and the list mode.

SCPI command:

[ :SOURce<hw> ] :FREQuency:MODE on page 658

### Mode - Frequency Sweep

Selects the sweep instrument operating mode and the sweep mode.

"Auto" Sets an automatic repeated sweep cycle. If a different sweep mode was activated prior to the "Auto" mode, the cycle continues from the current sweep setting.  
The "Reset Sweep" button resets the sweep to the start frequency.

**Example:**

```
SOUR:SWE:FREQ:MODE AUTO
TRIG:FSW:SOUR AUTO
SOUR:FREQ:MODE SWE
```

"Single" Sets a single sweep cycle. The sweep is triggered by the "Execute Single Sweep" button.  
If a different sweep mode was activated prior to the "Single" mode, the current sweep is stopped. The "Single" sweep always starts at the start frequency when triggered.  
The "Reset Sweep" button resets the sweep to the start frequency.

**Example:**

```
SOUR:SWE:FREQ:MODE AUTO
TRIG:FSW:SOUR SING
SOUR:FREQ:MODE SWE
SOUR:SWE:FREQ:EXEC
```

"Step" Sets a step-by-step sweep cycle. When mode "Step" is activated, the frequency is set to the sweep "Start Freq". To step through the sweep frequencies manually, open the "Current Freq" field for input and use the UP / DOWN navigation keys or the rotary knob. You can determine the step width below in the entry field "Step Lin" or "Step Log", see [Step Lin/Log - Frequency Sweep](#). If a sweep range border frequency ("Start Freq" or "Stop Freq") is reached, step commands in direction out of the sweep range are ignored. The "Reset Sweep" button resets the sweep to the start frequency.

**Note:** To step through the sweep frequencies in remote control mode, use the `FREQ:MAN` command with the `UP` or `DOWN` parameter.

**Example:**

```
SOUR:FREQ:CENT 300MHz
```

```
SOUR:FREQ:SPAN 400MHz
```

```
SOUR:SWE:FREQ:SPAC LIN
```

```
SOUR:SWE:FREQ:STEP:LIN 100MHz
```

```
SOUR:FREQ:MODE MAN
```

set sweep mode "Step".

```
SOUR:FREQ:MODE SW
```

activate sweep mode, the frequency is set to "Start Freq".

```
SOUR:FREQ:MAN UP
```

set the frequency to the next higher sweep frequency.

```
SOUR:FREQ:MAN DOWN
```

set the frequency to the next lower sweep frequency.

"Extern Single" Sets a single sweep cycle. The sweep is triggered by an external trigger signal. If a different sweep mode was activated prior to the "Extern Single" mode, the current sweep is stopped. The "Extern Single" sweep always starts at the start frequency when triggered. Refer to the description of the rear panel for information about the connectors for external trigger signal input (see [chapter 2.2, "Rear Panel Tour"](#), on page 26). The "Reset Sweep" button resets the sweep to the start frequency.

**Example:**

```
SOUR:SWE:FREQ:MODE AUTO
```

```
TRIG:FSW:SOUR EXT
```

```
SOUR:FREQ:MODE SWE (External trigger)
```

"Extern Step" Sets a step-by-step sweep cycle. Each sweep step is triggered by an external trigger signal (trigger source as described under "Extern Single"). The step width is set below at entry field "Step Lin" or "Step Log".  
If a different sweep mode was activated prior to the "Extern Step" mode, the current sweep is stopped. The "Extern Step" sweep always starts at the start frequency when triggered.  
The "Reset Sweep" button resets the sweep to the start frequency.

**Example:**

```
SOUR:SWE:FREQ:MODE STEP
SOUR:SWE:FREQ:SPAC LIN
SOUR:SWE:FREQ:STEP:LIN 1MHz
TRIG:FSW:SOUR EXT
SOUR:FREQ:MODE SWE (External trigger)
```

"Extern Start/Stop" Sets an automatically repeated sweep cycle that is started, stopped and restarted by subsequent external trigger events.  
The first external trigger signal starts the sweep (Start).  
The next external trigger signal stops the sweep at the current frequency (Stop).  
The third external trigger signal starts the sweep at the start frequency (Start).  
If a different sweep mode was activated prior to the "Extern Start/Stop" mode, the current sweep is stopped and the "Extern Start/Stop" sweep starts at the start frequency when triggered.  
The "Reset" button resets the sweep to the start frequency.  
Refer to the description of the rear panel for information about the connectors for external trigger signal input.  
The external trigger signal is input at the rear of the instrument (BNC connector INST TRIG).

**Example:**

```
SOUR:SWE:FREQ:MODE AUTO
TRIG:FSW:SOUR EAUT
SOUR:FREQ:MODE SWE (External trigger)
```

SCPI command:

[ :SOURce<hw> ] :SWEep [ :FREQuency ] :MODE on page 719  
:TRIGger<hw>:FSWEEP:SOURce on page 740  
[ :SOURce<hw> ] :FREQuency:MODE on page 658

**Execute Single Sweep - Frequency Sweep**

Triggers the sweep manually. A manual sweep can only be triggered if "Mode Single" is selected.

SCPI command:

[ :SOURce<hw> ] :SWEep [ :FREQuency ] :EXECute on page 718

**Reset Sweep - Frequency Sweep**

Resets the sweep. The start frequency is set and the next sweep starts from there.

SCPI command:

[\[:SOURce<hw>\]:SWEep:RESet\[:ALL\]](#) on page 725

**Start Freq - Frequency Sweep**

Sets the start frequency.

SCPI command:

[\[:SOURce<hw>\]:FREQuency:STARt](#) on page 661

**Stop Freq - Frequency Sweep**

Sets the stop frequency.

SCPI command:

[\[:SOURce<hw>\]:FREQuency:STOP](#) on page 661

**Center Freq - Frequency Sweep**

Sets the center frequency.

SCPI command:

[\[:SOURce<hw>\]:FREQuency:CENTer](#) on page 655

**Span - Frequency Sweep**

Sets the span.

SCPI command:

[\[:SOURce<hw>\]:FREQuency:SPAN](#) on page 660

**Current Freq - Frequency Sweep**

Displays the current frequency.

If "Step" is set, the frequency for the next frequency step of the sweep is entered here.

SCPI command:

[\[:SOURce<hw>\]:FREQuency:MANual](#) on page 657

**Spacing - Frequency Sweep**

Selects linear or logarithmic sweep spacing.

- |               |  |
|---------------|--|
| "Linear"      | With the linear sweep, the step width is a fixed frequency value which is added to the current frequency. The step width is entered below.   |
| "Logarithmic" | With the logarithmic sweep, the step width is a constant fraction of the current frequency. This fraction is added to the current frequency. The logarithmic step width is entered below in %. |

SCPI command:

[\[:SOURce<hw>\]:SWEep\[:FREQuency\]:SPACing](#) on page 720

**Shape - RF Frequency Sweep**

Selects the cycle mode for a sweep sequence (shape).

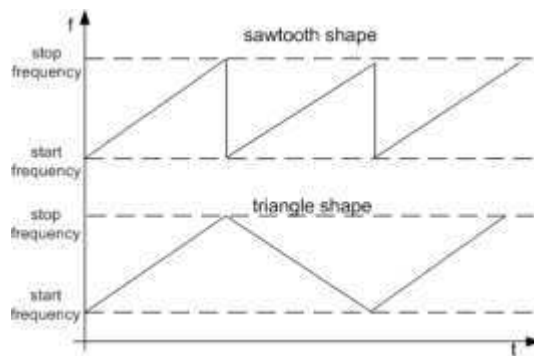

"Sawtooth" One sweep runs from start to stop frequency. Each subsequent sweep starts at the start frequency, i.e. the shape of the sweep sequence resembles a sawtooth.

"Triangle" One sweep runs from start to stop frequency and back, i.e. the shape of the sweep resembles a triangle. Each subsequent sweep starts at the start frequency.

SCPI command:

[\[:SOURce<hw>\]:SWEep\[:FREQuency\]:SHAPE](#) on page 720

### Step Lin/Log - Frequency Sweep

Sets the step width for the individual sweep steps. This entry is effective for all sweep modes.

"Step Lin" or "Step Log" is displayed depending on whether "Spacing Lin" or "Log" is selected.

"Step Lin" With the linear sweep, the step width is a fixed frequency value which is added to the current frequency. The linear step width is entered in Hz.

SCPI command:

[\[:SOURce<hw>\]:SWEep\[:FREQuency\]:STEP\[:LINear\]](#) on page 721

"Step Log" With the logarithmic sweep, the step width is a constant fraction of the current frequency. The logarithmic step width is entered in %. Successive frequencies are calculated as follows:

- **start\_f < stop\_f**  
 $f_2 = f_1 * (1 + \text{step\_log} / 100)$   
 If  $f_2 > \text{stop\_f}$ :  $f_2$  is set to  $\text{stop\_f}$ .
- **start\_f > stop\_f**  
 $f_2 = f_1 / (1 + \text{step\_log} / 100)$   
 If  $f_2 < \text{stop\_f}$ :  $f_2$  is set to  $\text{stop\_f}$ .

When the shape "Triangle" is set, the frequency values on the slope from **stop\_f back to start\_f** are the same as on the slope from **start\_f to stop\_f**.

SCPI command:

[\[:SOURce<hw>\]:SWEep\[:FREQuency\]:STEP:LOGarithmic](#) on page 722



### Dwell Time - Frequency Sweep

Sets the dwell time. The dwell time determines the duration of the individual sweep steps.

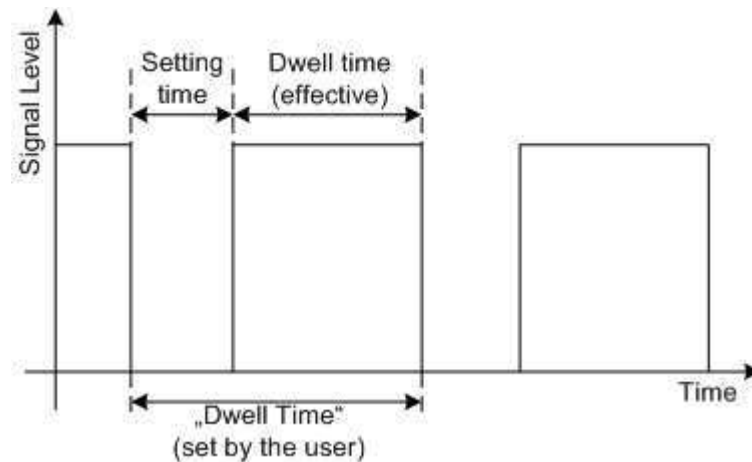

The "Dwell Time" set by the user is used as the step time of the sweep. The effective net dwell time is shorter, reduced by the setting time. This setting time may be greater than the time specified in the data sheet.

#### Note:

It is recommended to switch off the GUI update for optimum sweep performance especially with short dwell times (see [chapter 5.2.3.5, "Gui Update"](#), on page 125).

SCPI command:

`[ :SOURce<hw> ] :SWEep [ :FREQuency ] :DWELl` on page 718

### Global Trigger/Clock Settings

Calls the "Global Trigger/Clock Settings" dialog. This dialog is used among other things for setting the polarity of the active slope of an applied instrument trigger.

See [chapter 5.2.3.10, "Global Trigger/Clock/External Input Settings"](#), on page 129.

### User Marker / AUX I/O

Calls the menu for configuring the AUX I/O and user interfaces (see [chapter 5.2.3.12, "User Marker / AUX I/O Settings"](#), on page 132).

The pin assignment of the AUX I/O interface is shown in the "User Marker / AUX I/O Configuration" menu; the assignment of the USER pins 2...4 and USER 1 BNC connector can be changed.

### 5.5.13.3 RF Level Sweep

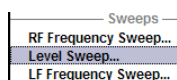

To open the "Level Sweep" menu, select "RF/A Mod > Configure > Level Sweep" or use the MENU key under "RF/A Mod".

### RF Level Sweep Settings

The "RF Level Sweep" dialog is used to activate and configure a sweep for the RF level.

In the top section, the Level Sweep is activated and the sweep mode is selected. The buttons are used to reset the level sweep (all sweep modes) or to execute the level sweep ("Single" mode).

The sweep range, sweep spacing and dwell time are set in the bottom section.

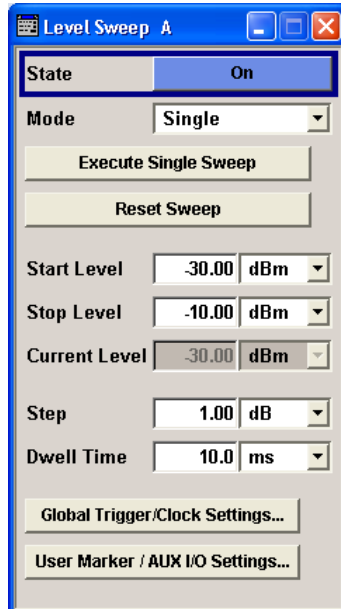

#### State - Level Sweep

Activates Level Sweep mode.

**Note:** Activating the RF level sweep mode automatically disables other sweep modes, and the list mode.

SCPI command:

[ :SOURce<hw> ] : POWer : MODE on page 709

#### Mode - Level Sweep

Selects the level sweep instrument operating mode and the sweep mode.

"Auto" Sets an automatically repeated sweep cycle. If a different sweep mode was activated prior to the "Auto" mode, the cycle continues from the current sweep setting.

The "Reset Sweep" button resets the sweep to the start level.

#### Example:

```
SOUR:SWE:POW:MODE AUTO
TRIG:PSW:SOUR AUTO
SOUR:POW:MODE SWE
```

"Single" Sets a single sweep cycle. The sweep is triggered by the "Execute Single Sweep" button.  
 If a different sweep mode was activated prior to the "Single" mode, the current sweep is stopped. The single sweep always starts at the start level.  
 The "Reset Sweep" button resets the sweep to the start level.

**Example:**

```
SOUR:SWE:POW:MODE AUTO
TRIG:PSW:SOUR SING
SOUR:POW:MODE SWE
SOUR:SWE:POW:EXEC
```

"Step" Sets a step-by-step sweep cycle.  
 If this mode is activated, the cursor moves to the value displayed for "Current Level". Each sweep step is triggered by a variation of the value in the "Current Level" entry window. The step width is set below at entry field "Step".  
 If this mode is activated, the cursor moves to the value displayed for "Current Level". If a different sweep mode was activated prior to the "Step" mode, the current sweep is stopped. The step sweep starts at the current level value.  
 The "Reset Sweep" button resets the sweep to the start level.

**Example:**

```
SOUR:SWE:POW:MODE MAN
SOUR:SWE:POW:STEP 0.5
SOUR:POW:MODE SWE
SOUR:POW:MAN -16
```

The value entered with command `SOUR:SWE:POW:STEP` sets the step width.

The value entered with command `SOUR:POW:MAN` has no effect, the command only triggers the next sweep step. However, the value has to be in the currently set sweep range (start to stop). In remote control only a step-by-step sweep from start to stop frequency is possible.

- "Extern Single" Sets a single sweep cycle. The sweep is triggered by an external trigger signal.  
If a different sweep mode was activated prior to the "Extern Single" mode, the current sweep is stopped. The "Extern Single" sweep always starts at the start level.  
Refer to the description of the rear panel for information about the connectors for external trigger signal input (see [chapter 2.2, "Rear Panel Tour"](#), on page 26).  
The "Reset Sweep" button resets the sweep to the start level.

**Example:**

```
SOUR:SWE:POW:MODE AUTO
TRIG:PSW:SOUR EXT
SOUR:POW:MODE SWE (External trigger)
```

- "Extern Step" Sets a step-by-step sweep cycle. Each sweep step is triggered by an external trigger signal (trigger source as described under "Extern Single"). The step width corresponds to the step width of the rotary knob. If a different sweep mode was activated prior to the "Extern Step" mode, the current sweep is stopped. The "Extern Step" sweep always starts at the start level.  
The "Reset Sweep" button resets the sweep to the start level.

**Example:**

```
SOUR:SWE:POW:MODE STEP
SOUR:SWE:POW:STEP 0.5
TRIG:PSW:SOUR EXT
SOUR:POW:MODE SWE (External trigger)
```

"Extern Start/ Stop" Sets an automatically repeated sweep cycle that is started, stopped and restarted by subsequent external trigger events. The first external trigger signal starts the sweep (Start). The next external trigger signal stops the sweep at the current frequency (Stop). The third external trigger signal starts the sweep at the start frequency (Start). If a different sweep mode was activated prior to the "Extern Start/ Stop" mode, the current sweep is stopped and the "Extern Start/Stop" sweep starts at the start frequency when triggered. The "Reset" button resets the sweep to the start level. Refer to the description of the rear panel for information about the connectors for external trigger signal input (see [chapter 2.2, "Rear Panel Tour"](#), on page 26).

**Example:**

```
SOUR:SWE:POW:MODE AUTO
TRIG:PSW:SOUR EAUT
SOUR:POW:MODE SWE (External trigger)
```

SCPI command:

[\[:SOURce<hw>\]:SWEep:POWer:MODE](#) on page 723  
[:TRIGger<hw>:PSWEEP:SOURce](#) on page 741.  
[\[:SOURce<hw>\]:POWer:MODE](#) on page 709

**Reset Sweep - Level Sweep**

Resets the sweep. The start level is set and the next sweep starts from there.

SCPI command:

[\[:SOURce<hw>\]:SWEep:RESet \[:ALL\]](#) on page 725

**Execute Single Sweep - Level Sweep**

Triggers the sweep manually. A manual sweep can only be triggered if "Mode Single" is selected.

**Example:**

```
SOUR:SWE:POW:MODE AUTO
TRIG:PSW:SOUR SING
SOUR:POW:MODE SWE
SOUR:SWE:EXEC
```

SCPI command:

[\[:SOURce<hw>\]:SWEep:POWer:EXECute](#) on page 723

**Start Level - Level Sweep**

Sets the start level.

SCPI command:

[\[:SOURce<hw>\]:POWer:STARt](#) on page 711

**Stop Level - Level Sweep**

Sets the stop level.

SCPI command:

[\[:SOURce<hw>\]:POWer:STOP](#) on page 712

**Current Level - Level Sweep**

Displays the current level.

If "Step" is set, the level for the next level step of the sweep is entered here.

SCPI command:

[\[:SOURce<hw>\]:POWer:MANual](#) on page 709

**Shape - RF Level Sweep**

Selects the cycle mode for a sweep sequence (shape).

"Sawtooth" One sweep runs from the start level to the stop level. The subsequent sweep starts at the start level again, i.e. the shape of sweep sequence resembles a sawtooth.

"Triangle" One sweep runs from start to stop level and back, i.e. the shape of the sweep resembles a triangle. Each subsequent sweep starts at the start level again.

SCPI command:

[\[:SOURce<hw>\]:SWEep:POWer:SHApe](#) on page 724

**Step - Level Sweep**

Sets the step width for the individual sweep steps. This entry is effective for all sweep modes.

With the level sweep, the logarithmic step width is a constant fraction of the current level. This fraction is added to the current level. The logarithmic step width is entered in dB.

SCPI command:

[\[:SOURce<hw>\]:SWEep:POWer:STEP\[:LOGarithmic\]](#) on page 724

**Dwell Time - Level Sweep**

Enters the dwell time and determines the duration of the individual sweep steps.

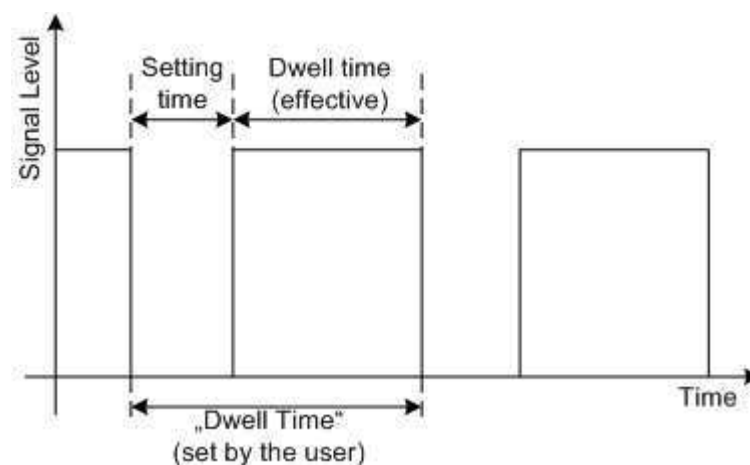

The "Dwell Time" set by the user is used as the step time of the sweep. The effective net dwell time is shorter, reduced by the setting time. This setting time may be greater than the time specified in the data sheet.

**Note:**

It is recommended to switch off the GUI update for optimum sweep performance especially with short dwell times (see [chapter 5.2.3.5, "Gui Update"](#), on page 125).

SCPI command:

[ :SOURce<hw> ] :SWEep:POWer:DWELl on page 722

**Global Trigger/Clock Settings**

Calls the "Global Trigger/Clock Settings" dialog. This dialog is used among other things for setting the polarity of the active slope of an applied instrument trigger.

See [chapter 5.2.3.10, "Global Trigger/Clock/External Input Settings"](#), on page 129.

**User Marker / AUX I/O**

Calls the menu for configuring the AUX I/O and user interfaces (see [chapter 5.2.3.12, "User Marker / AUX I/O Settings"](#), on page 132).

The pin assignment of the AUX I/O interface is shown in the "User Marker / AUX I/O Configuration" menu; the assignment of the USER pins 2...4 and USER 1 BNC connector can be changed.

#### 5.5.13.4 LF Frequency Sweep

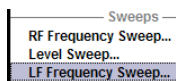

The "LF Frequency Sweep" dialog is used to activate and configure a sweep for the LF frequency.

To open the "LF Frequency Sweep" menu, select "RF/A Mod > Configure > LF Frequency Sweep" or use the MENU key under "RF/A Mod".

The top sections of the combined menu "LF Output / LF Frequency Sweep" provide access to the "LF Frequency Sweep" mode settings.

In the top section, the LF Sweep mode is activated and the sweep mode is selected. The buttons are used to reset the LF sweep (all sweep modes) or to execute the LF sweep ("Single" mode).

The sweep range, sweep spacing and dwell time are set in the bottom of the section.

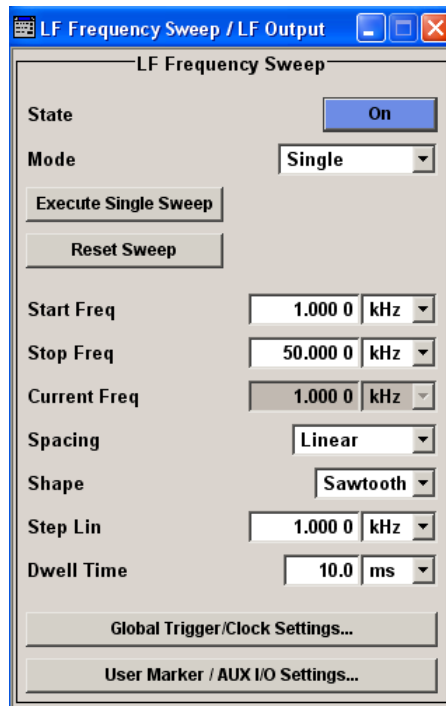

The lower section provides access to the "LF Output" settings, see [chapter 5.5.12.2, "LF Output"](#), on page 232.

#### State - LF Sweep

Activates LF Sweep mode.

**Note:** Activating the LF frequency sweep automatically deactivates the list mode, RF level sweep and RF frequency sweep.

SCPI command:

[\[:SOURce\]:LFOutput:FREQUENCY:MODE](#) on page 681

#### Mode - LF Sweep

Selects the Sweep instrument operating mode and Sweep mode.

"Auto" Sets are automatic repeated sweep cycle. If a different sweep mode was activated prior to the "Auto" mode, the cycle continues from the current sweep setting.

The "Reset Sweep" button resets the sweep to the start frequency.

#### Example:

```
SOUR:LFO:SWE:FREQ:MODE AUTO
```

```
TRIG0:SWE:SOUR AUTO
```

```
SOUR:LFO:FREQ:MODE SWE
```



"Single" Sets a single sweep cycle. The sweep is triggered by the "Execute Single Sweep" button.  
If a different sweep mode was activated prior to the "Single" mode, the current sweep is stopped. The "Single" sweep always starts at the start frequency.  
The "Reset Sweep" button resets the sweep to the start frequency.

**Example:**

```
SOUR:LFO:SWE:FREQ:MODE AUTO
TRIG0:SWE:SOUR SING
SOUR:LFO:FREQ:MODE SWE
SOUR:LFO:SWE:FREQ:EXEC
```

"Step" Sets a step-by-step sweep cycle. Each sweep step is triggered by a variation of the value in the "Current Freq" entry window.  
If this mode is activated, the cursor moves to the value displayed for "Current Freq". If a different sweep mode was activated prior to the "Step" mode, the current sweep is stopped. The "Step" sweep starts at the current LF frequency.  
The "Reset Sweep" button resets the sweep to the start frequency.

**Example:**

```
SOUR:LFO:SWE:FREQ:MODE MAN
SOUR:LFO:FREQ:MODE SWE
SOUR:LFO:SWE:FREQ:SPAC LIN
SOUR:LFO:SWE:FREQ:STEP:LIN 1E34
SOUR:LFO:FREQ:MAN 12 kHz
```

The value entered with command

```
SOUR:LFO:SWE:FREQ:STEP:LIN|LOG
```

 sets the step width.

The value entered with command `SOUR:LFO:FREQ:MAN` has no effect, the command only sets the next sweep step. In remote control only a step-by-step sweep from start to stop frequency is possible

"Extern Single" Sets a single sweep cycle. The sweep is triggered by an external trigger signal.  
If a different sweep mode was activated prior to the "Extern Single" mode, the current sweep is stopped. The "Extern Single" sweep always starts at the start frequency.  
The external trigger signal is input at the BNC connector INST TRIG.  
The "Reset Sweep" button resets the sweep to the start frequency.

**Example:**

```
SOUR:LFO:SWE:FREQ:MODE AUTO
TRIG0:SWE:SOUR EXT
SOUR:LFO:FREQ:MODE SWE (External trigger)
```

"Extern Step" Sets a step-by-step sweep cycle. Each sweep step is triggered by an external trigger signal (trigger source as described under "Extern Single"). The step width corresponds to the step width set for the rotary knob.  
If a different sweep mode was activated prior to the "Extern Step" mode, the current sweep is stopped. The "Extern Step" sweep always starts at the LF start frequency.  
The "Reset Sweep" button resets the sweep to the start frequency.

**Example:**

```
SOUR:LFO:SWE:FREQ:MODE AUTO
```

```
TRIG0:SWE:SOUR EXT
```

```
SOUR:LFO:FREQ:MODE SWE (External trigger)
```

"Extern Start/Stop" Sets an automatically repeated sweep cycle that is started, stopped and restarted by subsequent external trigger events.  
The first external trigger signal starts the sweep (Start).  
The next external trigger signal stops the sweep at the current frequency (Stop).  
The third external trigger signal starts the sweep at the start frequency (Start).  
If a different sweep mode was activated prior to the "Extern Start/Stop" mode, the current sweep is stopped and the "Extern Start/Stop" sweep starts at the start frequency when triggered.  
The "Reset" button resets the sweep to the start frequency.  
The external trigger signal is input at the BNC connector INST TRIG.

**Example:**

```
SOUR:LFO:SWE:FREQ:MODE AUTO
```

```
TRIG0:SWE:SOUR EAUT
```

```
SOUR:LFO:FREQ:MODE SWE (External trigger)
```

SCPI command:

[\[:SOURce\]:LFOutput:SWEep\[:FREQuency\]:MODE](#) on page 684

[:TRIGger<hw>\[:SWEep\]:SOURce](#) on page 742

[\[:SOURce\]:LFOutput:FREQuency:MODE](#) on page 681

**Execute Single Sweep - LF Sweep**

Triggers the sweep manually. A manual sweep can only be triggered if "Mode Single" is selected.

SCPI command:

[\[:SOURce\]:LFOutput:SWEep\[:FREQuency\]:EXECute](#) on page 683

**Reset Sweep - LF Sweep**

Resets the sweep. The start frequency is set and the next sweep starts from there.

SCPI command:

[\[:SOURce<hw>\]:SWEep:RESet\[:ALL\]](#) on page 725

**Start Freq - LF Sweep**

Sets the start frequency.

SCPI command:

[\[:SOURce\]:LFOutput:FREQuency:START](#) on page 682

**Stop Freq - LF Sweep**

Sets the stop frequency.

SCPI command:

[\[:SOURce\]:LFOutput:FREQuency:STOP](#) on page 683

**Current Freq - LF Sweep**

Displays the current frequency.

If "Step" is set, the frequency for the next frequency step of the sweep is entered here.

SCPI command:

[\[:SOURce\]:LFOutput:FREQuency:MANual](#) on page 681

**Spacing - LF Sweep**

Selects linear or logarithmic sweep spacing.

SCPI command:

[\[:SOURce\]:LFOutput:SWEep\[:FREQuency\]:SPACing](#) on page 685

**Shape - LF Frequency Sweep**

Selects the cycle mode for a sweep sequence (shape)

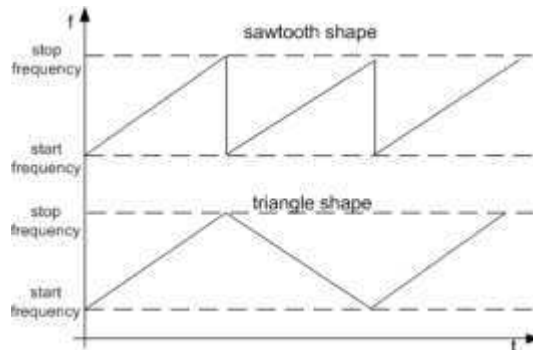

"Sawtooth" One sweep runs from start to stop frequency. Each subsequent sweep starts at the start frequency, i.e. the shape of the sweep sequence resembles a sawtooth.

"Triangle" One sweep runs from start to stop frequency and back, i.e. the shape of the sweep resembles a triangle. Each subsequent sweep starts at the start frequency.

SCPI command:

[\[:SOURce\]:LFOutput:SWEep\[:FREQuency\]:SHAPE](#) on page 685

**Step Lin/Log - LF Sweep**

Sets the step width for the individual sweep steps. This entry is effective for all sweep modes.

"Step Lin" or "Step Log" is displayed depending on whether "Spacing Lin" or "Log" is selected.

"Step Lin" With the linear sweep, the step width is a fixed frequency value which is added to the current frequency. The linear step width is entered in Hz.

SCPI command:

`[ :SOURce ] :LFOutput :SWEep [ :FREQuency ] :STEP [ :LINear ]` on page 686

"Step Log" With the logarithmic sweep, the step width is a constant fraction of the current frequency. This fraction is added to the current frequency. The logarithmic step width is entered in %.

SCPI command:

`[ :SOURce ] :LFOutput :SWEep [ :FREQuency ] :STEP :LOGarithmic` on page 686

### Dwell Time - LF Sweep

Sets the dwell time. The dwell time determines the duration of the individual sweep steps.

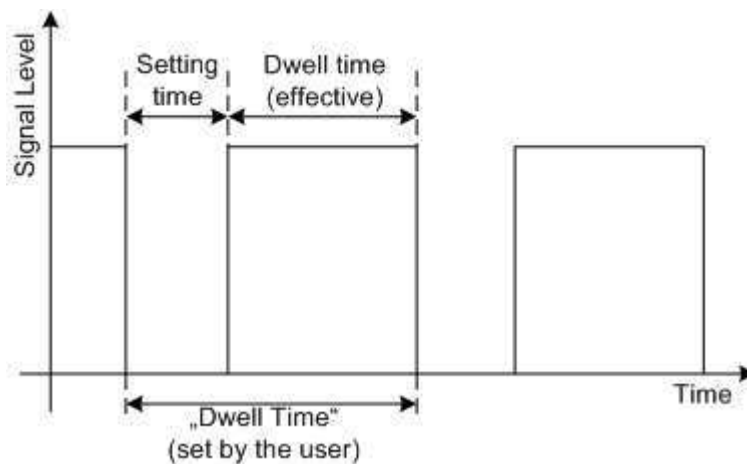

The "Dwell Time" set by the user is used as the step time of the sweep. The effective net dwell time is shorter, reduced by the setting time. This setting time may be greater than the time specified in the data sheet.

#### Note:

It is recommended to switch off the GUI update for optimum sweep performance especially with short dwell times (see [chapter 5.2.3.5, "Gui Update"](#), on page 125).

SCPI command:

`[ :SOURce ] :LFOutput :SWEep [ :FREQuency ] :DWELL` on page 683

### Global Trigger/Clock Settings

Calls the "Global Trigger/Clock Settings" dialog. This dialog is used among other things for setting the polarity of the active slope of an applied instrument trigger.

See [chapter 5.2.3.10, "Global Trigger/Clock/External Input Settings"](#), on page 129.

### User Marker / AUX I/O

Calls the menu for configuring the AUX I/O and user interfaces (see [chapter 5.2.3.12, "User Marker / AUX I/O Settings"](#), on page 132).

The pin assignment of the AUX I/O interface is shown in the "User Marker / AUX I/O Configuration" menu; the assignment of the USER pins 2...4 and USER 1 BNC connector can be changed.

### 5.5.14 List Mode

Similar to a sweep, a series of previously defined frequency and level points is processed in List mode. In contrast to a sweep, however, a list with freely selectable value pairs (frequency and level) can be created. The value range for frequency and level covers the entire configurable value range of the instrument.



List mode and sweeps can not be activated simultaneously, they deactivate each other.

The lists can be created in the "List Editor". Each list is stored in its own file with the predefined file extension \*.lsw. The name of the list file can be freely selected. The files are loaded from the "Lists..." file manager. Externally created tables with pairs of frequency and level values can be converted into List files using the import function. The external files must have the file extension \*.txt or \*.csv. These file formats are provided e.g. by the Microsoft®Excel program. The separators for table columns and for decimal floating-point numerals can be set. In addition, internally created List data can be exported into ASCII files using the export function.

The necessary hardware settings are calculated the first time a list is processed. With long dwell times, this calculation can be performed while the list is being processed; the entered dwell times are observed. With very short dwell times, calculation of the hardware settings increases the dwell time for the initial processing cycle; the entered value is only observed from the second processing cycle onwards. In this case a message appears to inform the user that there is a deviation between the current and set dwell times. No further calculations are required after the first run through a list. The current dwell times will definitely no longer deviate from the set dwell times.

The list is processed from the beginning to the end of the list (modes "Auto", ("External") "Single", ("External") "Step").

#### 5.5.14.1 List Mode Dialog

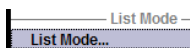

To open the "List Mode" menu, select "RF/A Mod > Configure > List Mode" or use the MENU key under "RF/A Mod".

The menu is used to activate/deactivate the operating mode List, to create, select and activate the lists, and to select the trigger mode and the dwell time.

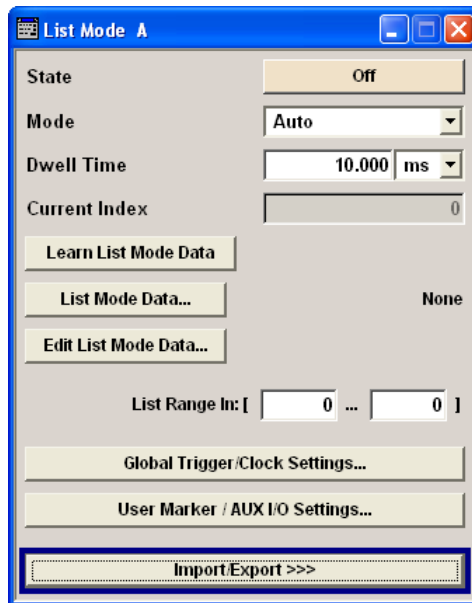

## General Settings

### State - List Mode

Activates/deactivates the List mode. The currently selected list is processed.

In case of a new or modified list, the necessary hardware settings are automatically determined on activation of the list mode. The data determined in this way is stored along with the list and is available whenever the list is used again.

This means that when activating the list mode, the system checks whether any hardware settings are present. If so, the list is started immediately, but if not they are automatically determined (the list is learnt).

A "Learn List Mode Data" button is available for deliberately activating list learning.

**Note:** Activating the list mode automatically deactivates all sweeps. During list mode the frequency and level indications do not display the currently set values.

SCPI command:

[ :SOURce<hw> ] :FREQuency:MODE on page 658

### Mode - List Mode

Selects the cycle mode of the List mode.

"Auto" Cycle from the beginning to the end of the list with automatic restart at the beginning. If a different mode was activated prior to the Auto mode, the cycle continues from the beginning of the list. The duration of a list step is determined by the set dwell time.  
Button "Reset" restarts the list at the starting point.

"Single" Single cycle from the beginning to the end of the list. If "Single" is selected, the cycle is not started immediately. The "Execute Single" button appears under the "Mode" line. The cycle is started with this button. The duration of a list step is determined by the set dwell time. Button "Reset" restarts the list at the starting point.



"Step" Manual, step-by-step processing of the list. Activating "Step" stops the current list and the cursor moves to the value displayed for "Current Index". It is now possible to scroll up and down in the list in discrete steps by varying the index. The duration of a list step is determined by the time between two index entries. Button "Reset" restarts the list at the starting point.



"Extern Single" Single cycle from the beginning to the end of the list as with "Single", but started by an external trigger. The external trigger signal is input at the BNC connector INST TRIG. Button "Reset" restarts the list at the starting point.

"Extern Step" Step-by-step cycle using the external trigger signal. Each trigger event starts a single step. The duration of a list step is determined by the time between two trigger events. The external trigger signal is input at the BNC connector INST TRIG. Button "Reset" restarts the list at the starting point.

SCPI command:

[\[:SOURce<hw>\]:LIST:MODE](#) on page 697

[\[:SOURce<hw>\]:LIST:TRIGger:SOURce](#) on page 699

#### Execute Single - List Mode

Triggers the list manually. This button is available only if mode "Single" is selected.

SCPI command:

[\[:SOURce<hw>\]:LIST:TRIGger:EXECute](#) on page 699

#### Reset - List Mode

Resets the list to the starting point.

SCPI command:

[\[:SOURce<hw>\]:LIST:RESet](#) on page 698

#### Dwell Time - List Mode

Enters the dwell time. The dwell time determines the duration of a list step in list operating modes "Auto", "Single" and "Extern Single". In these modes a complete list is processed either once or continuously.

In list operating modes "Step" and "Extern Step", the set dwell time does not affect signal generation. In this case, the duration of a list step is determined by the time between two (internal or external) trigger events.

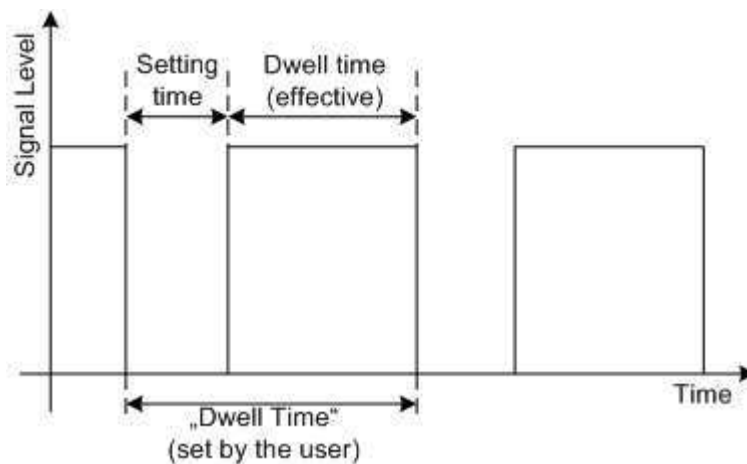

The "Dwell Time" set by the user is used as the step time of the list mode. The effective net dwell time is shorter, reduced by the setting time. This setting time may be greater than the time specified in the data sheet.

SCPI command:

[\[:SOURCE<hw>\]:LIST:DWELL](#) on page 694

#### Current Index - List Mode

Sets the list index in "Step" mode.

SCPI command:

[\[:SOURCE<hw>\]:LIST:INDEX](#) on page 695

#### Blank RF Output (Default ON) - List Mode

Activates/deactivates RF output blanking. If activated, blanking occurs on all frequency changes. If deactivates, blanking is always disabled.

SCPI command:

[:OUTPUT<hw>:BLANK:LIST:STATE](#) on page 514

#### Learn List Mode Data... - List Mode

Starts the determination of the hardware setting for the selected list. The data determined in this way is stored along with the list.

It may be necessary to deliberately activate list learning in the event of greatly altered environmental conditions that require new hardware settings.

If this is not done, a previously learned hardware setting will continue to be used when list mode is switched on ("State = On"). If no setting is available, e.g. when the list is used for the first time, learning is automatically activated.

SCPI command:

[\[:SOURCE<hw>\]:LIST:LEARN](#) on page 697

#### List Mode Data... - List Mode

Calls the "File Select" menu for selecting and creating a list or the "File Manager".





SCPI command:

- [ :SOURce<hw> ] :LIST:SElect on page 699
- [ :SOURce<hw> ] :LIST:DElete on page 689
- [ :SOURce<hw> ] :LIST:DElete:ALL on page 690

**Edit List Mode Data... - List Mode**

Calls the editor for editing the selected list. A list consists of any number of frequency/level value pairs. The currently selected list is displayed.

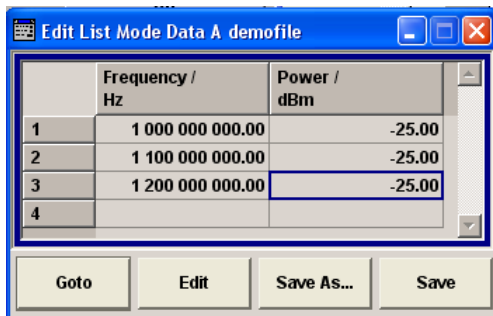

"Frequency / Hz" Enter the frequency of the frequency/power value pair.

SCPI command:

- [ :SOURce<hw> ] :LIST:FREquency on page 694

"Power /dBm" Enter the level of the frequency/power value pair.

SCPI command:

- [ :SOURce<hw> ] :LIST:POWer on page 698

"Goto" Selects row for editing.



If "Goto row" is selected, a window opens for entering the requested row.

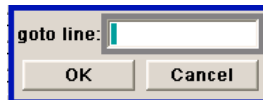

"Edit" Calls a selection of possible actions described below.



"Insert Row" Inserts a new row before the marked row.

"Insert Range" Inserts new rows before the marked row. The number of rows to be inserted can be defined in an entry window.

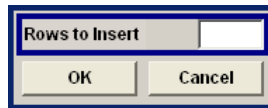

"Fill...." Opens a sub menu for defining a set of list values to be automatically entered in the List Mode table (see [chapter 5.5.14.2, "Filling the List Mode Data automatically"](#), on page 259).

"Delete Row" Deletes the marked row.

"Delete Range..." Allows to delete any number of rows starting with the marked row. The number of rows to be deleted can be defined in an entry window.

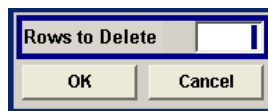

"Save as" Open the file menu to save the list under a new name. Each list is saved to the instrument's hard disk as a separate file with the file prefix \*.lsw. The file name and the directory to which the file is saved are user-selectable.

"Save" The list is saved under its current name.

### List Range In - List Mode

Defines an index range in the current list by setting the start and stop index. Only the values in the selected index range are processed in List mode, all other list entries are ignored.

SCPI command:

[\[:SOURce<hw>\]:LIST:INDEX:START](#) on page 696

[\[:SOURce<hw>\]:LIST:INDEX:STOP](#) on page 696

### Global Trigger/Clock Settings

Calls the "Global Trigger/Clock Settings" dialog. This dialog is used among other things for setting the polarity of the active slope of an applied instrument trigger.

See [chapter 5.2.3.10, "Global Trigger/Clock/External Input Settings"](#), on page 129.

### User Marker / AUX I/O

Calls the menu for configuring the AUX I/O and user interfaces (see [chapter 5.2.3.12, "User Marker / AUX I/O Settings"](#), on page 132).

The pin assignment of the AUX I/O interface is shown in the "User Marker / AUX I/O Configuration" menu; the assignment of the USER pins 2...4 and USER 1 BNC connector can be changed.

### Import/Export

Lists can be imported from externally created files or exported into text or CSV-files. The import/export settings are available after clicking the "Import/Export" button.

**Import/Export - List Mode**

Expands the menu with the area for import and export of list mode files.

Externally edited Excel tables with frequency/level pairs can be imported as text or CSV-files and used for list mode.

On the other hand, internally created list mode lists can be exported as text or CSV-files.

**Mode - List Mode**

Selects if list mode lists should be imported or exported. The settings offered below depend on the selected mode.

SCPI command:

[\[:SOURce<hw>\]:LIST:DEXChange:MODE](#) on page 693

**Extension - List Mode**

Selects the file extension of the ASCII file to be imported or exported. Selection TXT (text file) or CSV (Excel file) is available.

SCPI command:

[\[:SOURce<hw>\]:LIST:DEXChange:AFILe:EXTension](#) on page 691

**Decimal Point - List Mode**

Selects the decimal separator used in the ASCII data between '.' (decimal point) and ',' (comma) with floating-point numerals.

SCPI command:

[\[:SOURce<hw>\]:LIST:DEXChange:AFILe:SEParator:DECimal](#) on page 692

**Column Separator- List Mode**

Selects the separator between the frequency and level column of the ASCII table.

SCPI command:

[\[:SOURce<hw>\]:LIST:DEXChange:AFILe:SEParator:COLumn](#) on page 691

**Select ASCII Source / Destination - List Mode**

Calls the "File Manager" for selecting the ASCII file to be imported into a list mode list (source) or the ASCII file the list mode list is exported (destination) in.

SCPI command:

[\[:SOURce<hw>\]:LIST:DEXChange:AFILe:SElect](#) on page 691

**Select Destination / Source - List Mode**

Calls the "File Manager" for selecting the list mode list to be exported (source) into an ASCII file or the destination for the ASCII file to be imported (destination) in.

SCPI command:

`[ :SOURce<hw> ] :LIST:DEXChange:SElect` on page 693

**Import / Export - List Mode**

Starts the export or import of the selected file.

When import is selected, the ASCII file is imported as list mode list.

When export is selected, the list mode list is exported into the selected ASCII file.

SCPI command:

`[ :SOURce<hw> ] :LIST:DEXChange:EXECute` on page 692

**5.5.14.2 Filling the List Mode Data automatically**

The "Fill List Mode Data" menu enables you to automatically set the values in the List Mode table.

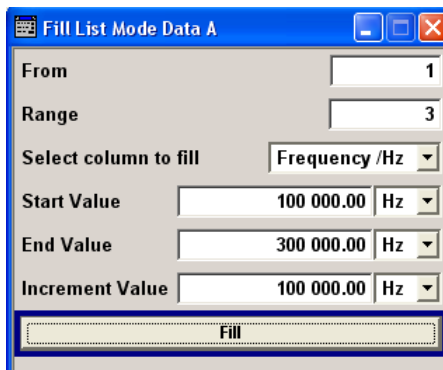

The start line and the number of rows to be filled are defined under "From" and "Range".

The column to be filled is selected under "Select column to fill". Depending on the selection here, the default for start, end, and increment value are set. As the settings are interdependent, a change of one parameter may result in the automatic change of one or more of the other parameters.

The filling of the column with the selected value settings is started with button "Fill".



The list entries are only computed when the "Fill" button is pressed.

**From**

Sets the start value of the index range.

SCPI command:

n.a.

**Range**

Sets the range for filling the table.

SCPI command:

n.a.

**Select column to fill**

Selects either the frequency or the level column to be filled with the value defined below.

SCPI command:

n.a.

**Start value**

Sets the start value for the frequency or the level entries.

SCPI command:

n.a.

**End value**

Sets the end value for the frequency or the level entries.

SCPI command:

n.a.

**Increment value**

Sets the increment for the frequency or the level entries.

SCPI command:

n.a.

**Fill**

Fills the selected column in the set range with values, starting with the start value and using the set increment.

SCPI command:

n.a.

## 5.6 I/Q Modulation - I/Q Mod Block

The R&S Signal Generator offers I/Q modulation with:

- external analog I/Q signals,
- internal digital signals.

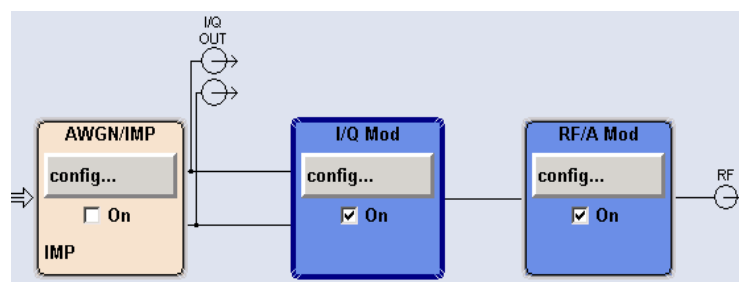

I/Q modulation with an external analog I/Q signal is possible for the basic unit (R&S SMJ with frequency option R&S SMJ-B10x) without additional equipment options.

The basic equipment configuration for generating an internal baseband signal includes the options R&S SMJ-B13 (Baseband Main Module) and R&S SMJ-B9/B10/B11 (Unicod and ARB).

The internally generated baseband signal is configured in the Baseband function block (see [chapter 5.8, "Baseband Signal - Baseband Block"](#), on page 301). Before the signal is fed into the I/Q modulator, noise can be added and/or the signal can be impaired. Impairment at this point along the signal flow is offered to allow a signal to be output at the I/Q-OUT outputs (a signal which, for example, compensates signal distortion in a connected test object (DUT)).

Impairment is integrated in the basic unit. The generation of noise requires the option R&S SMJ-K62 (AWGN).

Impairments can also be set in the I/Q Mod menu to allow an externally applied analog I/Q signal to be impaired. An internal baseband signal can thus be impaired both digital (in the Impairment block in the Impairment menu) and analog in the I/Q modulator. If impairments are set in both menus, they superimpose each other in the signal.

### 5.6.1 I/Q Modulator

To select the input signal of the I/Q modulator and to open the "I/Q Settings" menu, select "I/Q Mod > Configure".

The "I/Q Settings" menu containing the modulation settings is opened in the top section (see [chapter 5.6, "I/Q Modulation - I/Q Mod Block"](#), on page 260).

Use the "I/Q Mod In" section to select the input signal:

- select "Analog Wideband I/Q In", if the external analog signal is fed into the I/Q modulator.  
The maximum available RF bandwidth is described in the instruments specifications (see data sheet).
- select "Internal Baseband I/Q In", if the internally generated baseband signal is used.  
The RF bandwidth is reduced (see data sheet).

Alternatively, the input signal can be selected in the "I/Q Settings" menu (see [chapter 5.6, "I/Q Modulation - I/Q Mod Block"](#), on page 260).

### 5.6.2 I/Q Settings

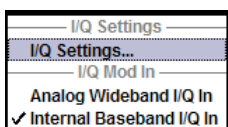

To open the menu for setting the I/Q modulation parameters, select "I/Q Mod > Configure > I/Q Settings" or use the MENU key.



System error correction of the I/Q modulator permits precise and repeatable measurements. The correction routine should be called in the case of temperature fluctuations of several degrees. To call the routine, press the SETUP key and select "System > Internal Adjustment " and execute the desired adjustment procedure.

It is not possible to activate an I/Q modulation with an external analog signal ("Analog Wideband I/Q In") simultaneously with:

- AM,
- digital modulation,
- digital standards,
- noise,
- arbitrary waveform generation and
- multi carrier CW

I/Q modulation is activated and the source entered in the top section of the menu.

Source: Analog Wideband I/Q Input

State: On

I/Q impairment for specific impairment of the I/Q modulation is set in the "Impairments" section.

Impairments

State:  On

I Offset: 0.00 %

Q Offset: 0.00 %

Gain Imbalance: 0.000 dB

Quadrature Offset: 0.00 deg

I/Q control can be swapped in the lower section of the menu and the optimized settings for wideband modulation signals can be activated.

I/Q Swap:  On

I/Q Wideband:  On

The bottom section of the menu differs depending on the selected input signal ("Analog Wideband I/Q Input" or "Internal Baseband").

The crest factor is input for the external signal.

The gain is selected for the internal and external signal.

Analog Wideband I/Q Input

Crest Factor: 0.00 dB

Gain: 3 dB (Best For High 3GPP ACLR)

### 5.6.2.1 General I/Q Mod Settings

#### **IQ Source - I/Q Mod**

Selects the input signal for the I/Q modulator.

"Analog Wideband I/Q In" Selects an external analog signal as the input signal. The signal must be applied at the inputs I and Q.

"Internal Baseband I/Q In" Selects the internal baseband signal as the input signal. This setting requires the additional equipment options for generating the various baseband signals.

SCPI command:

`[ :SOURce<hw> ] :IQ:SOURce` on page 668

#### **State - I/Q Mod**

Activates/deactivates I/Q modulation.

If "Analog Wideband I/Q In" is selected, the I/Q modulator is also deactivated and activated.

If "Internal Baseband I/Q In" is selected, the I/Q modulator is always activated automatically as soon as signal generation is activated in the "Baseband" block. It can, however, be deactivated later, e.g. if only the baseband signal which is output at the I/Q outputs is relevant.

SCPI command:

`[ :SOURce<hw> ] :IQ:STATe` on page 669

### 5.6.2.2 Impairments

I/Q impairment for specific impairment of the I/Q modulation is set in the "Impairments" section.

#### **State - Impairments I/Q Mod**

Activates/deactivates I/Q impairment.

If activated, the settings for leakage, I/Q imbalance and quadrature offset become effective.

Whether or not I/Q impairment is activated is indicated in the function block.

**Note:** It is advisable to switch automatic level control to the Sample&Hold mode, as otherwise level errors may occur (see [chapter 5.5.8, "Automatic Level Control - ALC"](#), on page 207).

SCPI command:

`[ :SOURce<hw> ] :IQ:IMPairment [ :STATe ]` on page 668

#### **Offset - I/Q Mod**

Sets the carrier offset (in percent) of the amplitudes (scaled to the peak envelope power (PEP) for the I and/or Q signal component.



An ideal I/Q modulator suppresses the carrier offset completely (offset = 0 percent). If an offset value is entered for a component, a carrier offset with fixed amplitude is added to the signal. In the diagram, all I values or Q values are offset by a fixed amplitude value depending on the entered percentage.

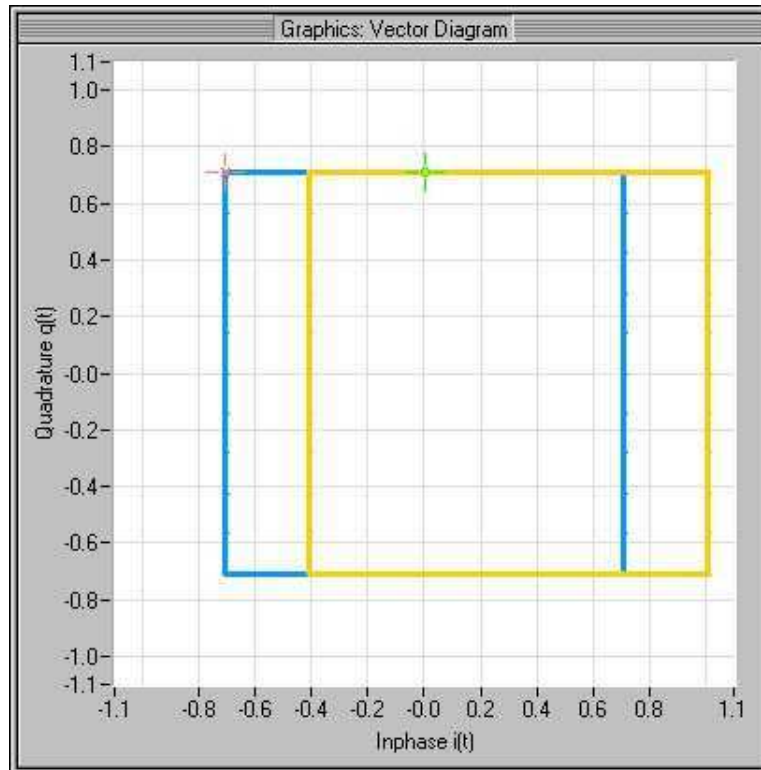

**Fig. 5-9: Effect of offset for the I component**

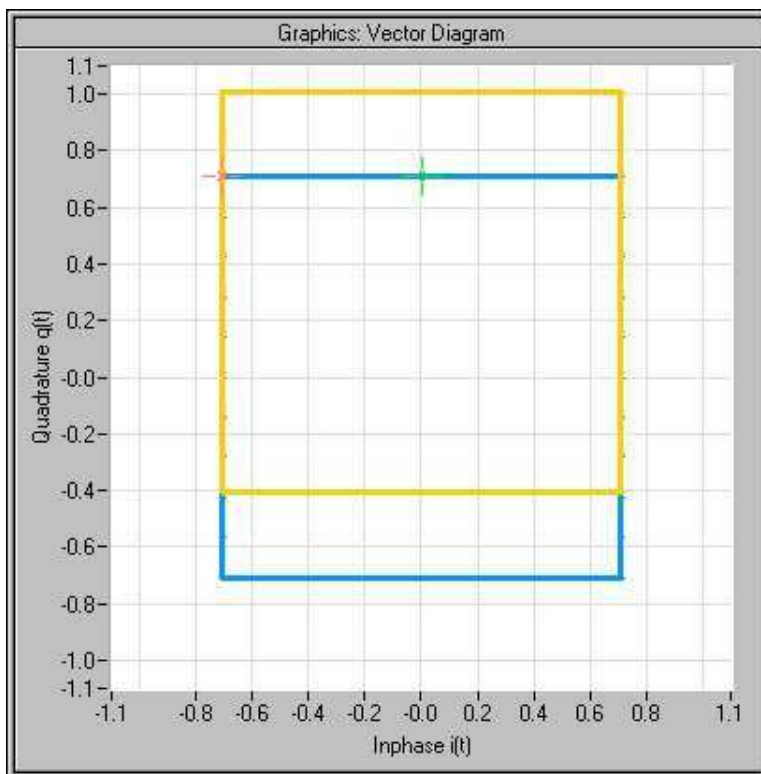
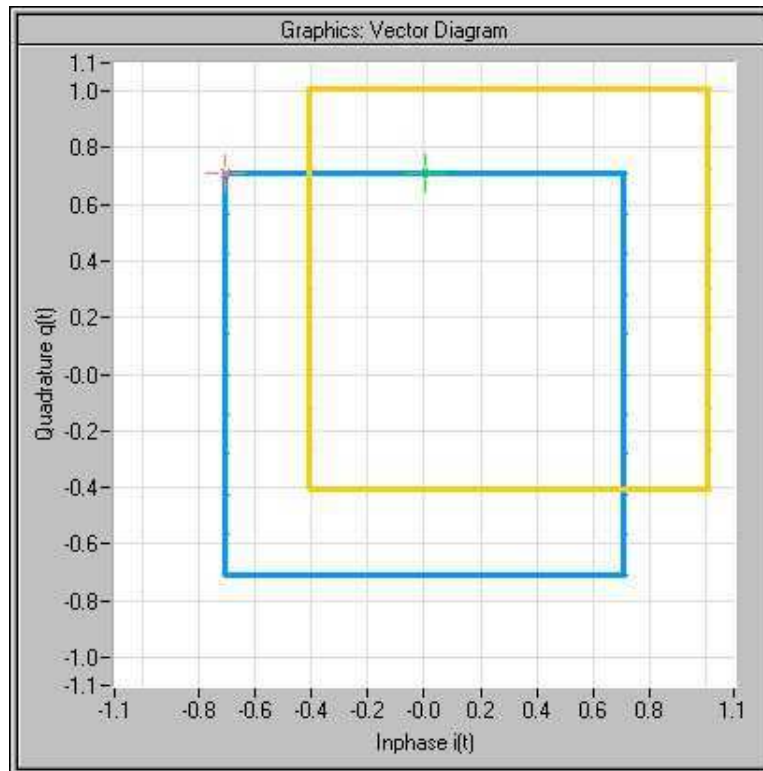

Fig. 5-10: Effect of offset for the Q component



**Fig. 5-11: Effect of an identical offset for both signal components**

SCPI command:

`[ :SOURCE<hw> ] :IQ:IMPairment:LEAKage:I` on page 667

`[ :SOURCE<hw> ] :IQ:IMPairment:LEAKage:Q` on page 668

#### Gain Imbalance - I/Q Mod

Sets the imbalance of the I and Q vector.

The entry is made in dB (default) or %, where 1 dB offset is roughly 12 % according to the following:

$$\text{Imbalance [dB]} = 20 \log ( | \text{GainQ} | / | \text{GainI} | )$$

An ideal I/Q modulator amplifies the I and Q signal path by exactly the same degree. The imbalance corresponds to the difference in amplification of the I and Q channel and therefore to the difference in amplitude of the signal components. In the vector diagram, the length of the I vector changes relative to the length of the Q vector.

Positive values mean that the Q vector is amplified more than the I vector by the corresponding percentage.

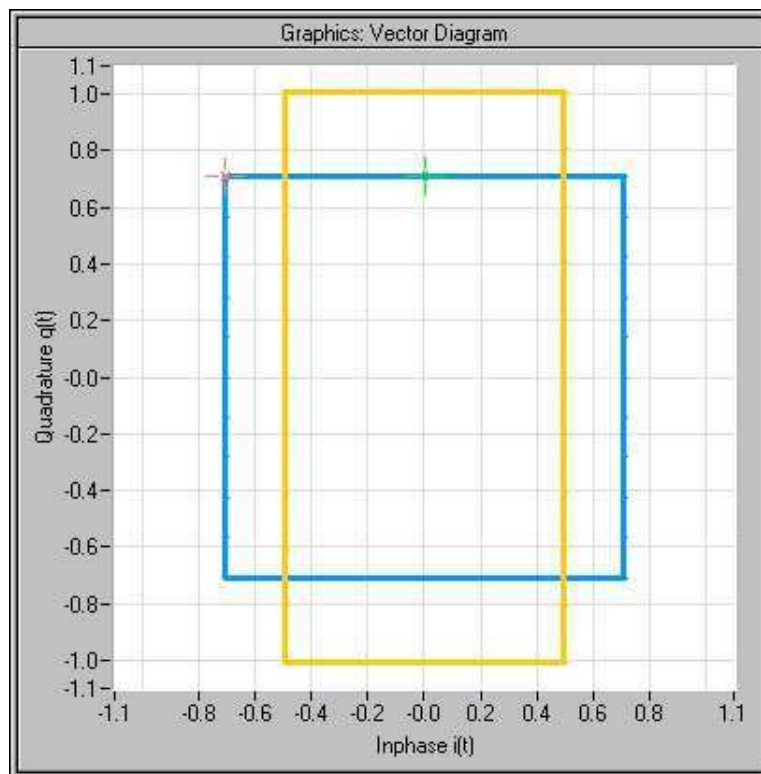

**Fig. 5-12: Effect of a positive gain imbalance**

Negative values mean that the I vector is amplified more than the Q vector by the corresponding percentage:

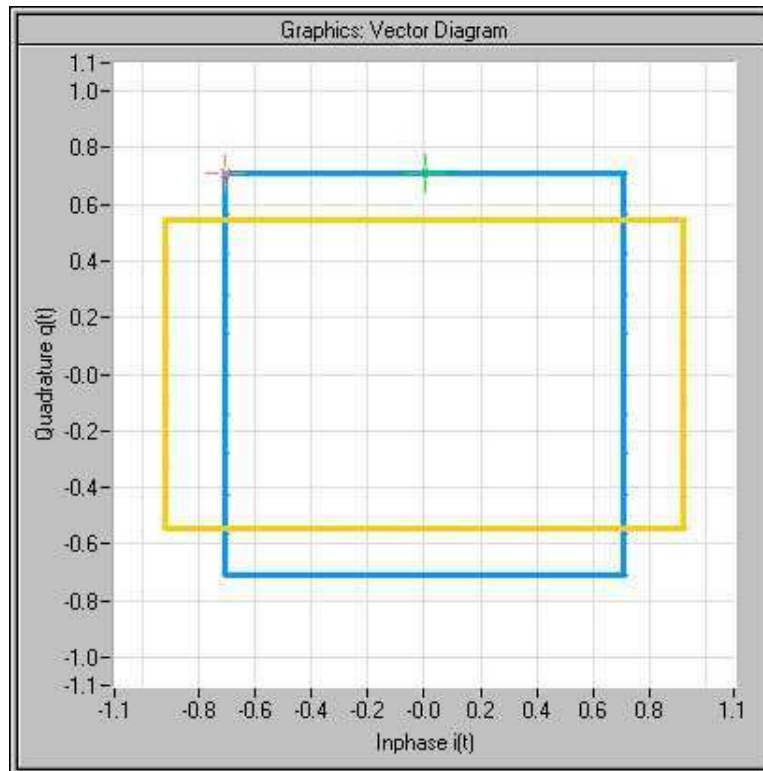

**Fig. 5-13: Effect of a negative gain imbalance**

SCPI command:

`[ :SOURce<hw> ] :IQ:IMPairment:IQRatio[:MAGNitude]` on page 667

#### Quadrature Offset - I/Q Mod

Sets the quadrature offset.

An ideal I/Q modulator sets the phase angle to exactly 90 degrees. With a quadrature offset, the phase angle between the I and Q vector deviates from the ideal 90 degrees, the amplitudes of both components are of the same size. In the vector diagram, the quadrature offset causes the coordinate system to shift.

A positive quadrature offset means a phase angle greater than 90 degrees:

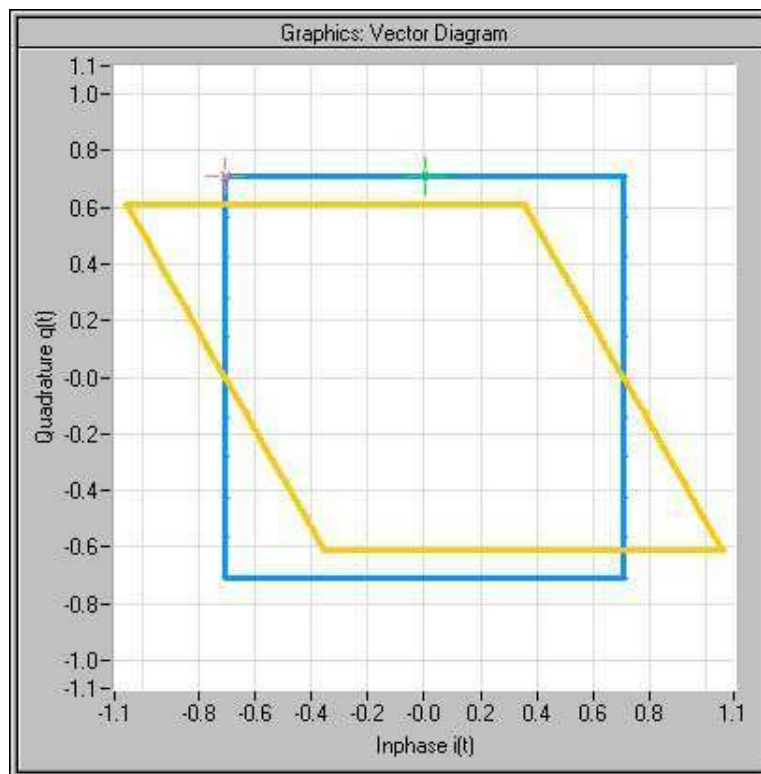

**Fig. 5-14: Effect of a positive quadrature offset**

A negative quadrature offset means a phase angle less than 90 degrees:

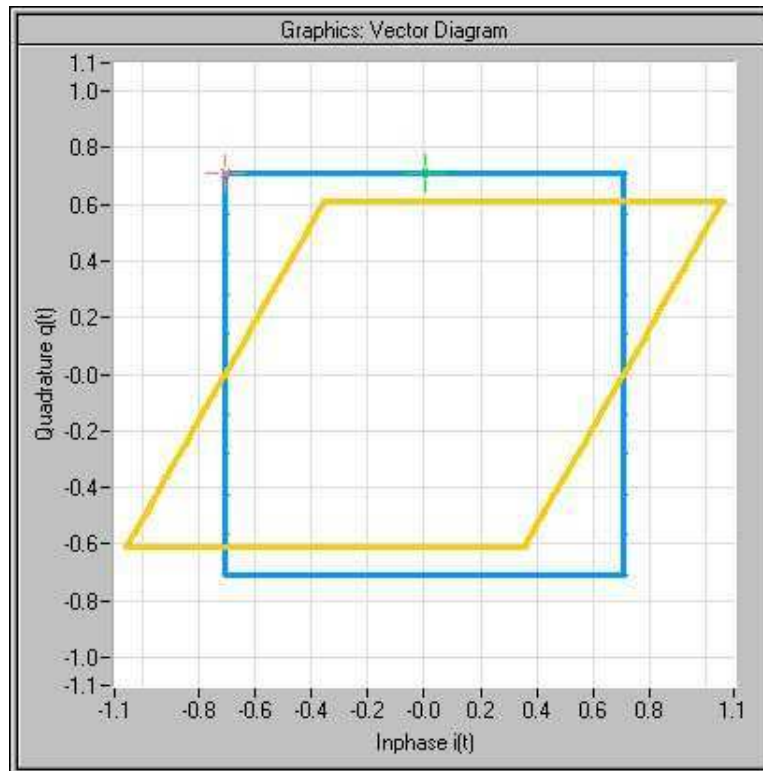

**Fig. 5-15: Effect of a negative quadrature offset**

SCPI command:

`[ :SOURce<hw> ] :IQ:IMPairment:QUADrature: [ANGLE]` on page 668

### 5.6.2.3 I/Q Swap and I/Q Wideband

The I/Q control can be swapped and the optimized setting for wideband signals can be selected in the middle section of the menu.

#### I/Q-Swap - I/Q Mod

Selects normal or swapped I/Q control for an external analog signal. The modulation sidebands are inverted by swapping the I and Q signals.

This parameter enables I/Q modulation to be performed on signals according to IS2000 (cdma2000 standard) and the majority of all other standards. As a result, an I/Q demodulator defined according to IS2000 can also be used for demodulating the generated signals.

The I/Q modulator defined in the IS2000 standard differs from the definition in the R&S Signal Generator. The definition on which the R&S Signal Generator is based is used by virtually all digital communication standards (except IS95 and IS2000).

In the final step, the filtered I/Q signal is modulated to the desired RF in a different way in the I/Q modulator:

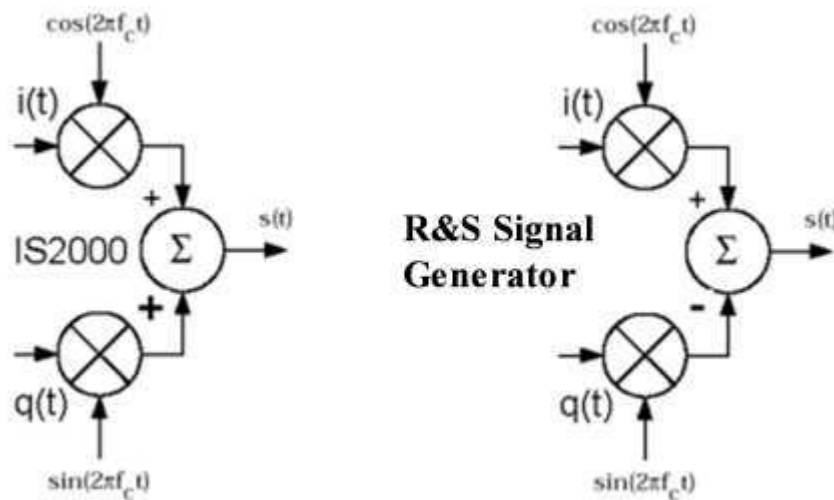

Fig. 5-16: Definition of I/Q modulator in IS2000 and R&S Signal Generator *f*

According to IS2000, the RF signal  $s(t)$  is derived from the baseband I/Q signal as follows:  
 $s(t) = i(t)\cos(2\pi f_c t) + q(t)\sin(2\pi f_c t)$

The instrument family is based on the following definition:

$$s(t) = i(t)\cos(2\pi f_c t) - q(t)\sin(2\pi f_c t)$$

"I/Q Swap" must now be set to "On" so that an I/Q modulator defined according to IS2000 can cope with the RF signal generated by the R&S Signal Generator.

"Off" I/Q control is normal.

"On" The I and Q signals are swapped.

SCPI command:

[\[:SOURce<hw>\]:IQ:SWAP\[:STATe\]](#) on page 669

#### I/Q-Wideband - I/Q Mod

Optimized setting for wideband modulation signals (>5 MHz). Optimized setting for wideband modulation signals (>5 MHz).

The modulation frequency response is decreased at the expense of poorer harmonic suppression. This is achieved by shifting the switching frequencies of the lowpass filters in the output section.

SCPI command:

[\[:SOURce<hw>\]:IQ:WBState](#) on page 669

#### 5.6.2.4 Analog Wideband I/Q Input

In the bottom section of the menu the crest factor is input for the external signal and the gain is selected for the internal and external signal ("Analog Wideband I/Q Input" or "Internal Baseband").

#### Crest Factor - I/Q Mod

(Analog Wideband I/Q Input only)



Sets the crest factor of the external analog signal.

The crest factor gives the difference in level between the peak envelope power (PEP) and average power value (RMS) in dB.

This value is necessary to allow the correct output power to be generated at the RF output. When the set output power is generated, the R&S Signal Generator uses this value to compensate the average power which is lower compared to the peak power.

The maximum input voltage at the I/Q input is equated to the peak power and is used as the "reference" for setting the level of the output signal. Since the signal does not usually supply the peak power at a constant level and instead supplies a lower average power, the crest factor specifies how many dB have to be added internally so that the correct output power is achieved.

SCPI command:

`[ :SOURce<hw> ] :IQ:CREStfactor` on page 666

### Baseband Gain-Gain - I/Q Mod

Optimizes the modulation of the I/Q modulator for any measurement requirement.

The modulation is determined by selecting the gain.

#### Note:

The remote-control commands to be used depend on the selected I/Q input signal (`SOURce:IQ:SOURce ANALog | BASEband`).

- For the Analog Wideband I/Q input signal, the commands of system `SOURce:IQ:GAIN` are valid.
- For the internal or external Baseband I/Q input signal (`SOURce:IQ:SOURce BASEband`), the commands of system `SOURce:BB:IQGain` are valid.

"Auto"	(digital baseband signal only) With this setting, the modulation is automatically optimized for the internally set baseband signal.
"- 3dB (Low Distortion)"	Activates -3 dB gain. With this setting, signal distortions are minimized.
"0 dB (Standard)"	Activates 0 dB gain
"3 dB (High 3GPP ACLR)"	Activates 3 dB gain. This setting is recommended for 3GPP signals with very high adjacent channel power ratio (ACPR).
"6dB (Low Noise)"	Activates 6 dB gain. With this setting, signal noise is minimized.

SCPI command:

`[ :SOURce<hw> ] :IQ:GAIN` on page 666 (for analog I/Q signal)

`[ :SOURce<hw> ] :BB:IQGain` on page 669 (for digital I/Q signal)

## 5.7 Impairment of Digital I/Q Signal and Noise Generator - AWGN/IMP Block

The R&S SMJ allows the digital I/Q signal to be impaired before it is passed on to the I/Q modulator, and also noise to be added to the signal. The noise generator can also be used to generate a pure noise signal.

These settings are available in the block diagram in the "AWGN/IMP" function block as well as in the menu with the same name which is opened using the MENU key.

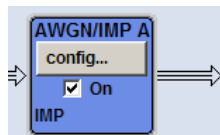

The equipment options for the basic unit (R&S SMJ with frequency option R&S SMJ-B10x) include the option R&S SMJ-B13 (Baseband Main Module) for Impairments and the option R&S SMJ-K62 (Noise Generator) for "AWGN".

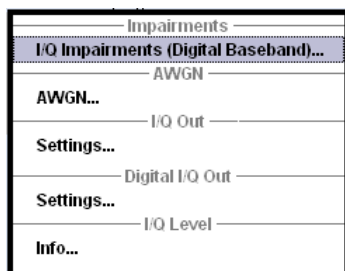

Selecting the menu item "I/Q Impairments (Digital Baseband)..." opens the I/Q impairment settings dialog. This dialog covers the settings for I/Q impairment, like carrier leakage, imbalance and quadrature offset.

To access the AWGN settings, select "AWGN...". This dialog contains the settings of the RFI signal generator, noise level configuration and CW interfering parameters.

Selecting the menu item "I/Q Out Settings" opens a dialog with the parameters for the I/Q output signal.

The "I/Q Out Settings" dialog is available for analog and digital I/Q output signals. These dialogs are accessible under the menu sections with the corresponding names.

"Info..." opens a dialog, displaying information on the baseband signal level.

The single ended or differential output is configured in the "I/Q Out Settings" dialog.

The single ended or differential output requires option R&S SMJ-B16, Differential Output.

### 5.7.1 Impairments

Impairment of the digital I/Q signal can be used, for example, to compensate the distortion of a test object or to check the effect of a disturbed signal on a test object. For this purpose, the I/Q signal can be output at the I/Q OUT outputs. On the other hand, the I/Q impair-

ments used internally for compensating signal distortion can be deactivated by the I/Q modulator in order to, for example, test its own baseband components.



In addition to impairment of the digital I/Q signal, the R&S SMJ also allows impairment of the analog signal to be set in the I/Q modulator. The relevant settings are made in the I/Q Mod function block (see [chapter 5.6, "I/Q Modulation - I/Q Mod Block"](#), on page 260).

### 5.7.1.1 Impairment Settings Menu

To access the "Impairment Settings" menu for setting the digital I/Q impairments, select "AWGN/IMP > Configure > I/Q Impairments" or use the MENU key under "AWGN/IMP".

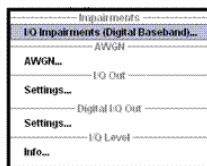

I/Q impairment is activated and set in the "I/Q Impairments" section.

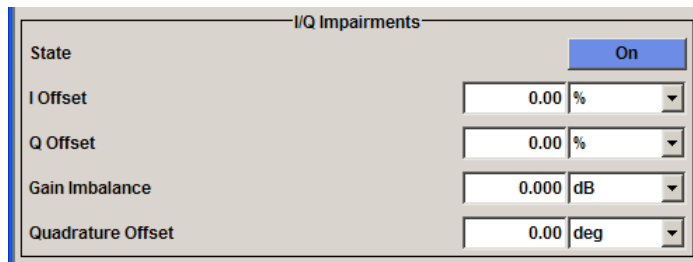

"Internal compensation" of signal distortions of the RF output can be activated / deactivated.

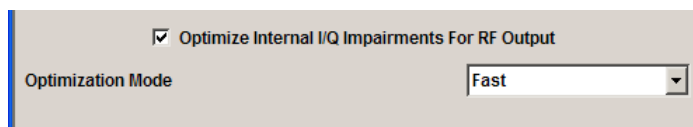

### I/Q Impairments

In the "I/Q Impairments" section the parameters for carrier leakage, imbalance and quadrature offset can be set and I/Q impairment is activated.

#### State - Digital Impairments

Activates/deactivates digital I/Q impairment.

When activated, the settings for carrier leakage, I/Q imbalance and quadrature offset become effective.

Internal predistortion for compensating the I/Q modulator is not influenced by this setting.

SCPI command:

`[ :SOURce<hw> ] :BB:IMPairment:STATe` on page 619

**I/Q Offset - Digital Impairments**

Sets the carrier leakage (in percent) of the amplitudes (scaled to the peak envelope power (PEP)) for the I and/or Q signal component.

An ideal I/Q modulator suppresses the carrier leakage completely (offset = 0 percent). If an offset is entered for a component, a carrier leakage with fixed amplitude is added to the signal. In the diagram, all I values or Q values are offset by a fixed amplitude value depending on the entered percentage.

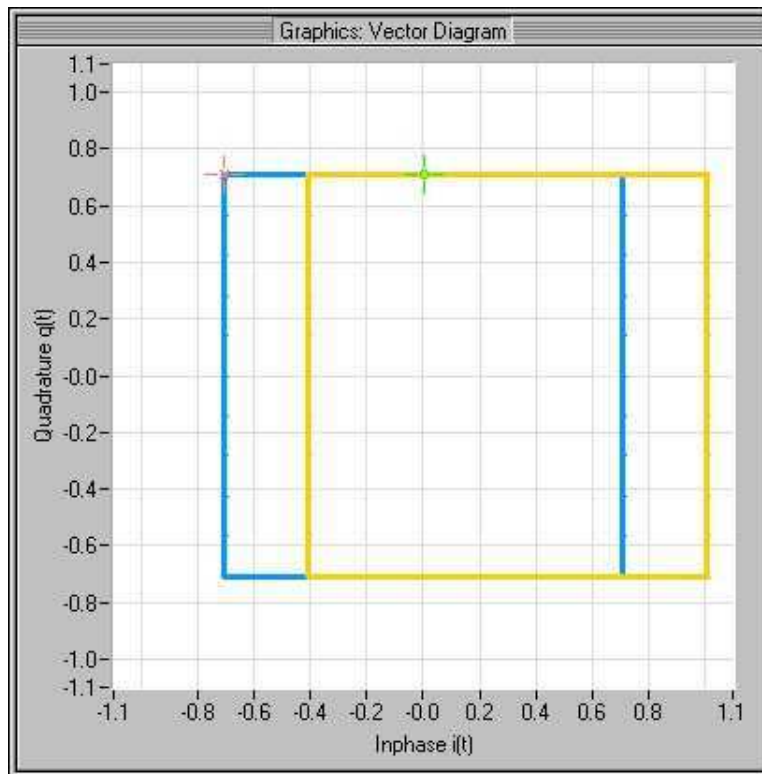

**Fig. 5-17: Effect of offset for the I component**

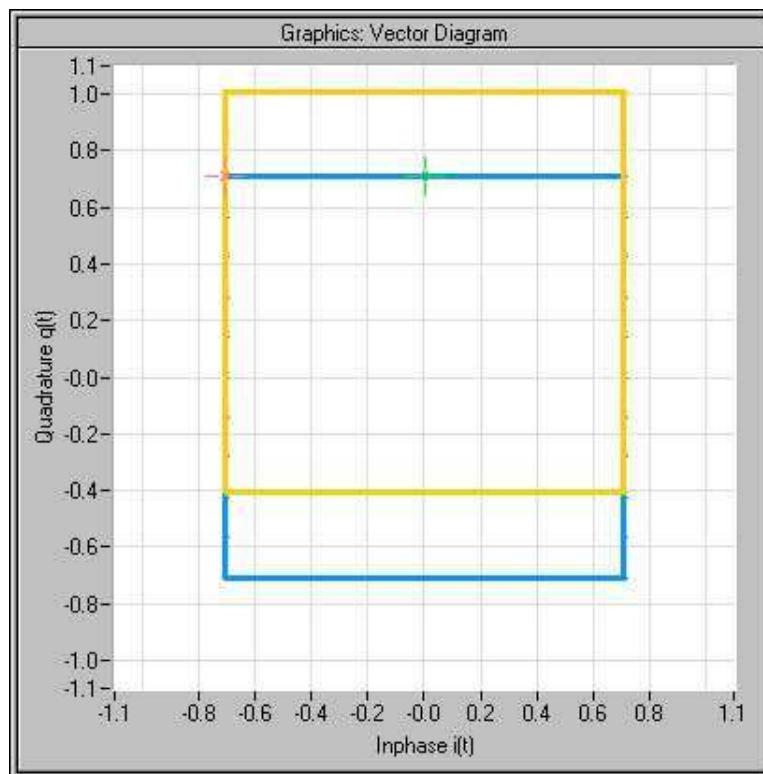

**Fig. 5-18: Effect of offset for the Q component**

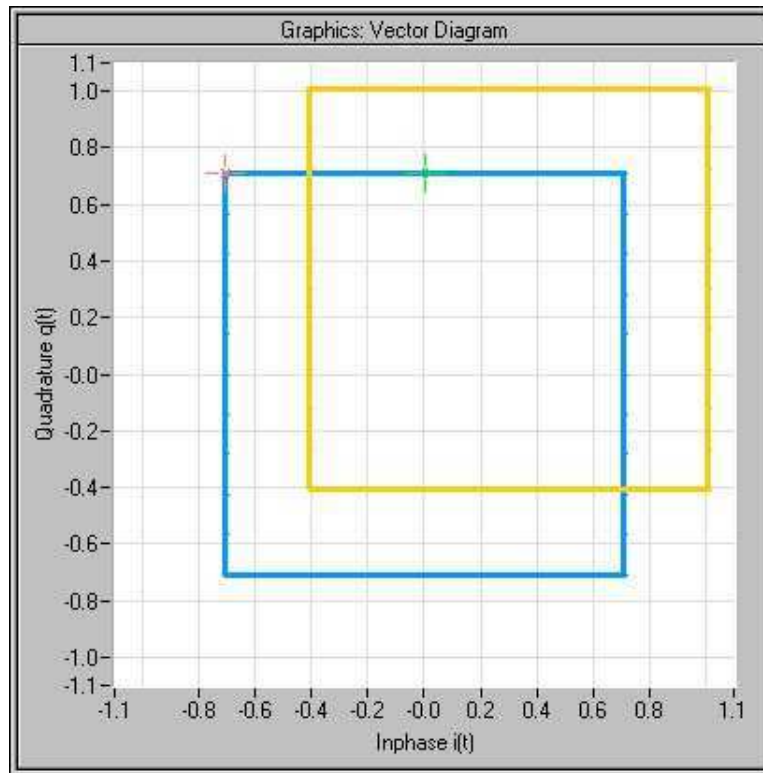

**Fig. 5-19: Effect of an identical offset for both signal components**

SCPI command:

`[ :SOURCE<hw> ] :BB:IMPairment:LEAKage:I` on page 618

`[ :SOURCE<hw> ] :BB:IMPairment:LEAKage:Q` on page 618

### Gain Imbalance - Digital Impairments

Sets the imbalance of the I and Q vector.

The entry is made in dB (default) or %, where 1 dB offset is roughly 12 % according to the following:

$$\text{Imbalance [dB]} = 20 \log ( | \text{GainQ} | / | \text{GainI} | )$$

An ideal I/Q modulator amplifies the I and Q signal path by exactly the same degree. The imbalance corresponds to the difference in amplification of the I and Q channel and therefore to the difference in amplitude of the signal components. In the vector diagram, the length of the I vector changes relative to the length of the Q vector.

Positive values mean that the Q vector is amplified more than the I vector by the corresponding percentage.

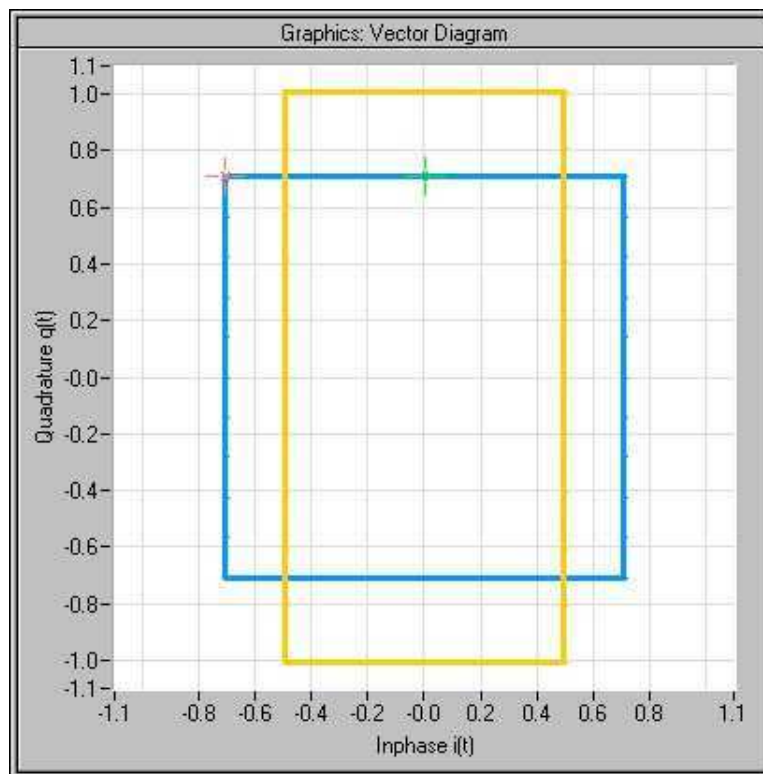

**Fig. 5-20: Effect of a positive gain imbalance**

Negative values mean that the I vector is amplified more than the Q vector by the corresponding percentage:

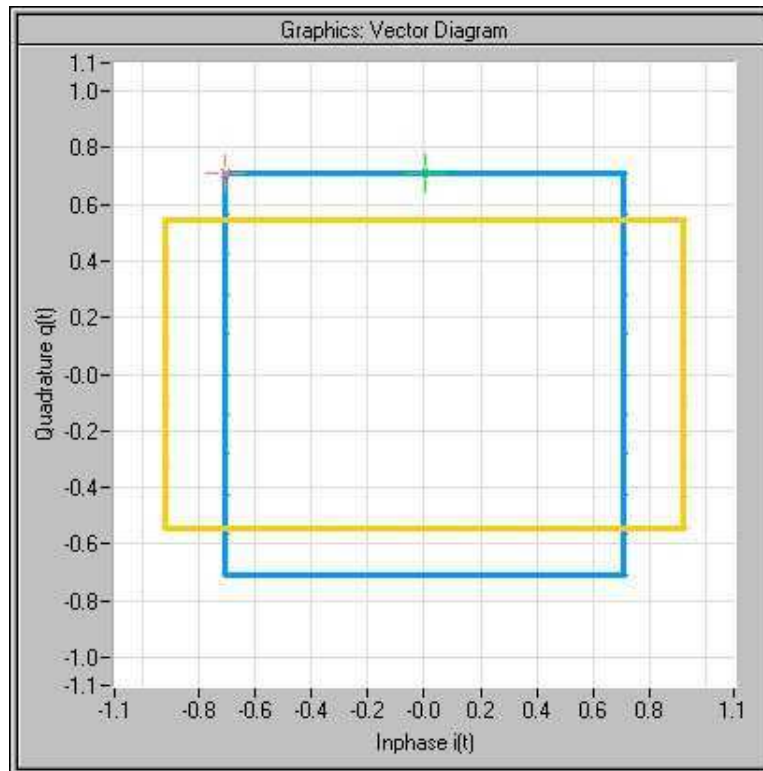

**Fig. 5-21: Effect of a negative gain imbalance**

SCPI command:

[\[:SOURCE<hw>\]:BB:IMPairment:IQRatio](#) on page 617

### Quadrature Offset - Digital Impairments

Sets the quadrature offset.

An ideal I/Q modulator sets the phase angle to exactly 90 degrees. With a quadrature offset, the phase angle between the I and Q vector deviates from the ideal 90 degrees, the amplitudes of both components are of the same size. In the vector diagram, the quadrature offset causes the coordinate system to shift.

A positive quadrature offset means a phase angle greater than 90 degrees:



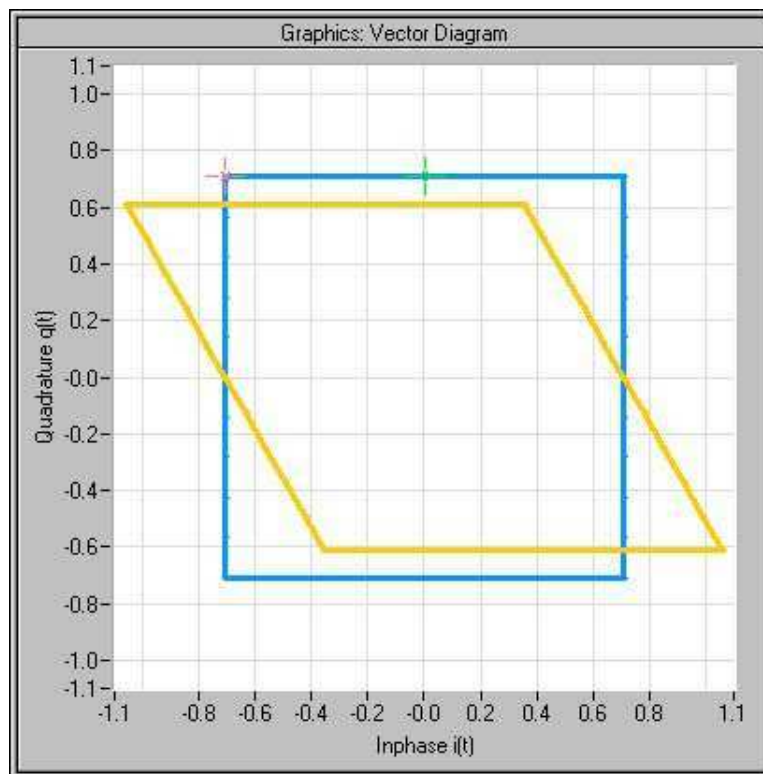

**Fig. 5-22: Effect of a positive quadrature offset**

A negative quadrature offset means a phase angle less than 90 degrees:

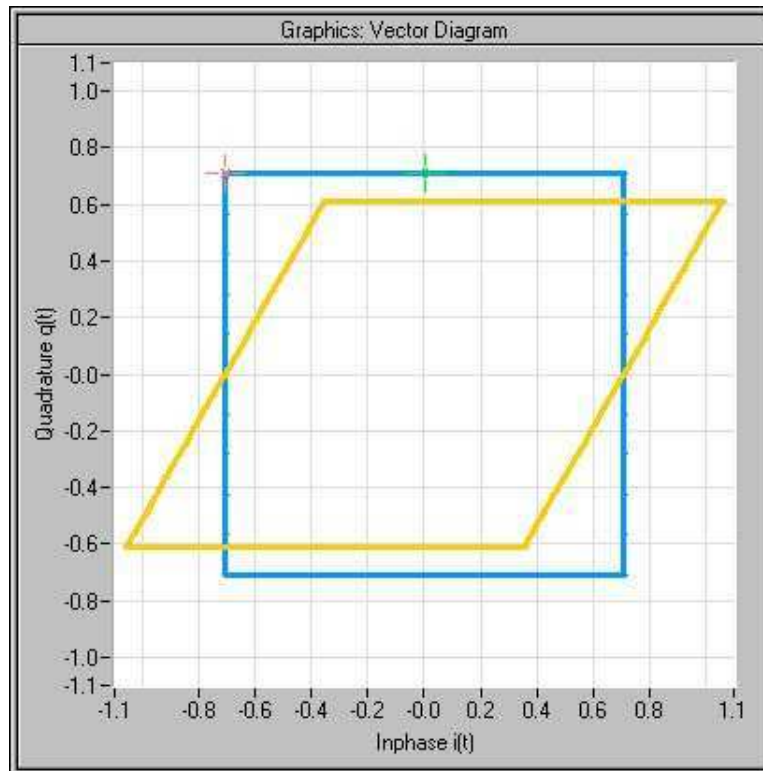

**Fig. 5-23: Effect of a negative quadrature offset**

SCPI command:

`[ :SOURce<hw> ] :BB:IMPairment:QUADrature [ :ANGLE ]` on page 619

### Internal Compensation

"Internal compensation" of signal distortions "of the RF output "can be activated / deactivated.

#### Optimize internal IQ-Impairments for RF Output - Digital Impairments

Activates or deactivates internal compensation of signal distortions of the RF output. Signal distortions can be either optimized for the RF output (active) or for the differential I/Q output (not active).

SCPI command:

`[ :SOURce<hw> ] :BB:IMPairment:OPTimization:STATe` on page 619

#### Optimization Mode - Digital Impairments

Selects the optimization mode.

"Fast" Optimization is reached by compensation for I/Q skew.

"High Quality" Optimization is reached by compensation for I/Q skew and frequency response correction.

SCPI command:

`[ :SOURce<hw> ] :BB:IMPairment:OPTimization:MODE` on page 618

## 5.7.2 AWGN - Noise Generator

The noise generator generates an AWGN signal (Additive White Gaussian Noise) in the digital baseband, i.e. the noise power density has a Gaussian distribution and is distributed evenly across the frequency. This noise signal superimposes the (interference-free) useful signal ("Additive Noise" mode). Typical applications for the noise generator are bit-error or block-error measurements, depending on the set S/N or C/N ratio.

The Gaussian noise is generated by means of feedback shift registers with subsequent probability transformation. The switching configuration is such that virtually ideal statistical characteristics are achieved:

- I and Q paths are decorrelated from each other.
- The crest factor of 18 dB allows very small probabilities to be realized.
- The period of the noise signal depends on the selected system bandwidth. The relationship of period P to system bandwidth  $B_{\text{sys}}$  is approximated:

$$P \approx 1 \cdot 10^{13} / B_{\text{sys}}$$

This results in periods between 317 years with minimum bandwidth and approximately 2 days with maximum bandwidth.

This results in a period of approximately one month for 3GPP FDD with a bandwidth of 3.84 Mcps, and a period of 427 days for GSM with 270.833 kpsps.

Scalable low-pass filters are used to produce a noise level with both a broad dynamic range and a broad bandwidth range (from 1 kHz to 60 MHz).

Apart from the "Additive Noise" mode, there are also the "Noise Only" and the "CW Interferer" mode. In the "Noise Only" mode a pure noise signal is generated and modulated to the carrier. In the "CW Interferer mode", a sinusoidal signal with an adjustable frequency offset to the baseband signal is generated and added to the baseband signal by means of a counter instead of a shift register.

### 5.7.2.1 AWGN Settings Dialog

To open the "AWGN Settings" menu for setting the noise generator, select "AWGN/IMP > Configure > AWGN" or use the MENU key under "AWGN/IMP".

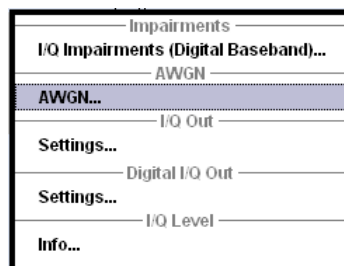

The "AWGN Settings" menu is divided into the following sections.

The RFI signal generator is activated, the mode selected and the interfering signal is configured in the top section of the menu.

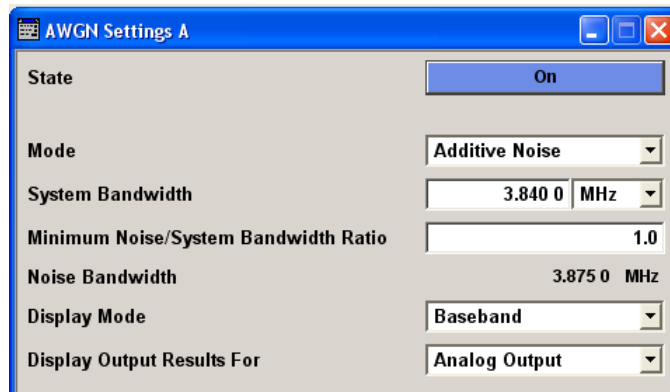

The level of the interfering signal is configured in the "Noise Level Configuration And Output Results" section.

In "Additive Noise" and "CW interferer" mode, the interfering level can be defined and the resulting total level displayed here.

In "Noise Only" mode, only the noise level can be set here.

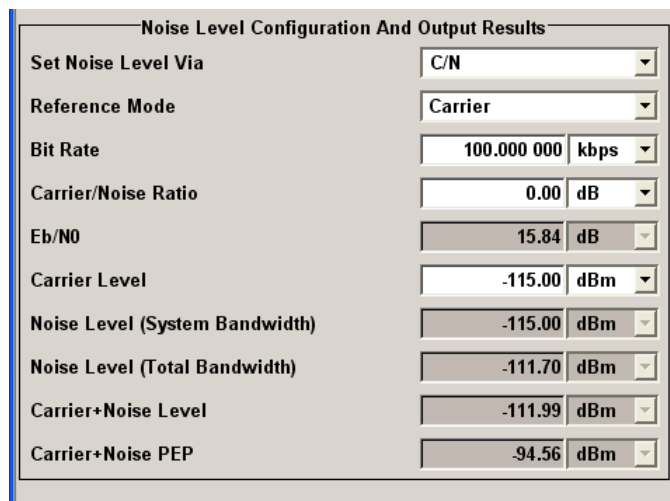

### AWGN Settings

The RFI signal generator is activated, the mode selected and the interfering signal is configured in the top section of the menu.

#### State - AWGN

Activates/deactivates the RFI signal generator. The interferer (AWGN or CW interferer, depending on the selected mode) is generated as after the generator is activated.

SCPI command:

[ :SOURce<hw> ] :AWGN:STATe on page 536

#### Mode - AWGN

Selects the mode for generating the interfering signal.

"Additive Noise"      The AWGN noise signal with selectable system bandwidth is added to the baseband signal.

## Impairment of Digital I/Q Signal and Noise Generator - AWGN/IMP Block

- "Noise Only" The pure AWGN noise signal with selectable system bandwidth is modulated to the carrier. The connection to the baseband is interrupted.
- "CW Interferer" A sine with a defined frequency offset is added to the baseband signal. The calculation of  $E_b/N_0$  ratio is omitted.

SCPI command:

[ :SOURce<hw> ] :AWGN:MODE on page 533

#### System Bandwidth - AWGN

(Additive Noise and Noise Only)

Sets the RF bandwidth to which the set carrier/noise ratio relates.

Within this frequency range, the signal is superimposed with a noise signal whose level corresponds exactly to the set C/N or S/N ratio.

**Note:** The noise signal is not generated arbitrarily for a particular bandwidth, but instead it is generated in steps. Noise therefore also occurs outside the set system bandwidth.

SCPI command:

[ :SOURce<hw> ] :AWGN:BWIDth on page 529

#### Minimum Noise/System Bandwidth Ratio - AWGN

(Additive Noise and Noise Only)

Sets the ratio of minimum noise bandwidth to system bandwidth.

**Note:** The noise signal is not generated arbitrarily for a particular bandwidth, but instead it is generated in steps. Noise therefore also occurs outside the set system bandwidth.

With this parameter the minimum real noise bandwidth can be set as required by some standards. It does not influence the calculation of level from the set C/N or S/N ratio in relation to system bandwidth.

The overall bandwidth is calculated as follow and may not exceed 80 MHz.

Overall Bandwidth = System BW x Minimum Noise/System BW Ratio

SCPI command:

[ :SOURce<hw> ] :AWGN:BWIDth:RATio on page 530

#### Noise Bandwidth - AWGN

(Additive Noise and Noise Only)

Indicates the real noise bandwidth. The value is only indicated for "State On".

**Note:** The noise signal is not generated arbitrarily for a particular bandwidth, but instead it is generated in steps. Noise therefore also occurs outside the set system bandwidth.

SCPI command:

[ :SOURce<hw> ] :AWGN:BWIDth:NOISe on page 529

#### Display Mode - AWGN

Sets the display mode to Baseband or RF.

SCPI command:

[ :SOURce<hw> ] :AWGN:DISP:MODE on page 531

**Display Output Results For - AWGN**

(Additive Noise and Noise Only)

Selects the display of output results for the analog (DACIF) or the digital (BBOUT) signal path.

**Note:** This selection field is only available with the option R&S SMJ-B18, Baseband Digital I/Q Out. If the instrument is not equipped with this option the parameters of the analog signal path are displayed.

"Analog Output" The parameters of the analog signal path are displayed.

"Digital Output" The parameters of the digital signal path are displayed.

SCPI command:

[\[:SOURce<hw>\]:AWGN:DISP:OREsults](#) on page 531

**Target CW Frequency - AWGN**

(CW Interferer mode only)

Sets the desired frequency of the sine in "CW Interferer" mode.

SCPI command:

[\[:SOURce<hw>\]:AWGN:FREQuency:TARGet](#) on page 532

**Resulting CW Frequency - AWGN**

(CW Interferer mode only)

Indication of the actual CW frequency of the sinusoidal signal in "CW Interferer" mode.

The actual frequency may differ from the desired frequency, since the resolution is limited to 0.7 Hz.

**Tip:** The desired frequency constellation can be precisely set with an accuracy of up to 0.01 Hz by selecting a suitable frequency offset of the baseband source (e.g. Custom Dig Mod) and by correcting the RF frequency by the difference between Resulting and Target CW Frequency.

SCPI command:

[\[:SOURce<hw>\]:AWGN:FREQuency:RESult](#) on page 532

**Noise/Interferer Level Configuration And Output Results**

The interfering signal is configured in the "Noise/Interferer Level Configuration and Output Results" section.

**Set Noise Level via - AWGN**

(Additive Noise only)

Selects the mode for setting the noise level

"C/N ""S/N" The noise level is set on the basis of the value entered for the carrier/noise or signal/noise ratio. Whether a selection of C/N or S/N is enabled, depends on the selected "Display Mode". With digital modulation, the associated  $E_b/N_0$  value is determined and displayed.

## Impairment of Digital I/Q Signal and Noise Generator - AWGN/IMP Block

" $E_b/N_0$ " The noise level is set on the basis of the value entered for the ratio of bit energy to noise power density. The associated C/N or S/N value is displayed. The correlation between the two values is as follows:  
 $C/N$  or  $S/N = (E_b/N_0) \cdot (f_{bit}/B_{sys})$ , where  
 $f_{bit}$  is the Bit rate (Symbol rate x Modulation value)  
 $B_{sys}$  is the System bandwidth  
 With "Custom Dig Mod" signals, the bit rate used for calculation is defined by the selected standard in the "Custom Digital Mod" dialog. With "Digital Standard" signals, the bit rate to be used for calculating the  $E_b/N_0$  can be entered at "Bit Rate".  
 Some test cases with the 3GPP base station tests (TS 25.141) specify, for example, E/N settings that apply to channel-coded data or block segments.

SCPI command:

[ :SOURce<hw> ] :AWGN:POWer:MODE on page 534

### Reference Mode - AWGN

(Additive Noise and CW Interferer, Display Mode set to RF)

Select reference mode if the C/N or  $E_b/N_0$  ratio is changed.

"Carrier" If the C/N value or  $E_b/N_0$  value changes, the carrier level is kept constant and the noise level is adjusted. This is the standard procedure for measuring the bit error rate versus the noise power.

"Noise" If the C/N value or  $E_b/N_0$  value changes, the noise level is kept constant and the carrier level is adjusted.  
 Some test cases of 3GPP Base Station Tests (TS 25.141) specify, for example, that the noise power be permanently set as a function of the base station power class, whereas the carrier power is variable.

SCPI command:

[ :SOURce<hw> ] :AWGN:POWer:RMODE on page 535

### Bit Rate - AWGN

(Additive Noise only)

Sets or indicates the bit rate used for converting C/N or S/N to  $E_b/N_0$ .

With "Custom Digital Mod" signals, the bit rate used is indicated here. It is defined by the choice of the standard in the "Custom Digital Mod" menu.

With "Digital Standard" signals, the bit rate used for converting C/N or S/N to  $E_b/N_0$  is set here.

When generating a "Digital Standard", it is thus possible to select which bit rate is to be used for calculating the ratio of bit energy to noise power density, e.g. the bit rate before or after channel coding.

SCPI command:

[ :SOURce<hw> ] :AWGN:BRATe on page 529

### Carrier/Noise Ratio / Signal/Noise Ratio

(Additive Noise and CW Interferer only)

Sets the carrier/noise, signal/noise or signal/interferer ratio.

Whether a configuration of C/N or S/N is enabled, depends on the selected "Display Mode".

- In "Carrier Reference Mode", this entry determines the RFI power and thus the power of the output signal. It does not affect the power of the useful signal, i.e. the carrier power remains constant.
- In "Noise Reference Mode", this entry determines the power of the useful signal, i.e. the carrier power. The RFI power remains constant.
- The level of the noise signal which is derived from the entered C/N or S/N value is displayed in the menu under "Noise Level". The value is displayed automatically in the units of the useful signal.
- The level of the useful signal is displayed in the menu under "Carrier Level" and can also be changed there. The displayed value corresponds to the value in the "Level" display field.
- The level of the output signal is displayed under "Carrier Level + Noise".

If "Set Noise Level via  $E_b/N_0$ " is selected, the associated C/N or S/N value is displayed here.

SCPI command:

[\[:SOURce<hw>\]:AWGN:CNRatio](#) on page 530

### $E_b/N_0$ - AWGN

(Additive Noise only)

Sets the ratio of bit energy to noise power density in "Additive Noise" mode.

- In "Carrier Reference Mode", this entry determines the noise level and therefore also the level of the output signal. It does not affect the level of the useful signal, i.e. the carrier level is kept constant.
- In "Noise Reference Mode", this entry determines the level of the useful signal, i.e. the carrier level. the noise level is kept constant.
- The level of the noise signal which is derived from the entered  $E_b/N_0$  value is displayed under "Noise Level". The value is displayed automatically in the units of the useful signal.
- The level of the useful signal is displayed in the menu under "Carrier Level". The displayed value corresponds to the value in the "Level" display field.
- The level of the output signal is displayed under "Carrier Level + Noise".

If "Set Noise Level via C/N or S/N" is selected, the associated  $E_b/N_0$  value is displayed here.

SCPI command:

[\[:SOURce<hw>\]:AWGN:ENRatio](#) on page 531

### Carrier Level / Signal Level

(Additive Noise and CW Interferer)

The name of this parameter depends on the selected "Display Mode".

- In "Carrier Reference Mode", this parameter sets the carrier level. This entry corresponds to the level entered in the Level header.  
The level of the noise signal which is derived from the entered C/N or S/N value is displayed under "Noise Level". The value is displayed automatically in the units of the useful signal.



- In "Noise Reference Mode", this parameter indicates the carrier level which is derived from the entered C/N or S/N value. This indication corresponds to the level indicated in the "Level" header.

The noise level can be set under "Noise Level".

**Note:** The peak envelope power (PEP) specified in the header corresponds to the PEP value of the carrier. The PEP value of the overall signal is displayed in the menu under "Carrier+Noise PEP".

SCPI command:

[\[:SOURce<hw>\]:AWGN:POWer:CARRier](#) on page 533

### Noise Level (System Bandwidth) / Interferer Level

(Additive Noise, Noise Only, CW Interferer)

- "Noise Only" mode
  - Sets the level of the noise signal. This entry corresponds to the level entered in the "Level" header.
- "Additive Noise" mode
  - "Noise Reference Mode"
    - Sets the level of the noise signal. The level of the carrier is derived from the entered C/N or S/N or Eb/N0 value.
  - "Carrier Reference Mode"
    - Displays the level of the noise signal in the system bandwidth. The level of the noise signal is derived from the entered C/N or S/N or Eb/N0 value. The carrier level is entered under "Carrier Level"; respectively the signal level is displayed under "Signal Level".
- "CW Interferer" mode
  - "Noise Reference Mode"
    - Sets the level of the interfering signal. The level of the carrier is derived from the entered C/N or S/N value.
  - "Carrier Reference Mode"
    - Displays the level of the interfering signal. The level of the interfering signal is derived from the entered C/N or S/N value. The carrier level is entered under "Carrier Level".

**Note:** The noise signal is not generated arbitrarily for a particular bandwidth, but instead it is generated in steps. Noise therefore also occurs outside the set system bandwidth. This means that the total measurable noise level (see below) usually exceeds the value displayed here. Correct measurement of the noise level within the system bandwidth is possible by means of channel power measurement using a signal analyzer.

## Impairment of Digital I/Q Signal and Noise Generator - AWGN/IMP Block

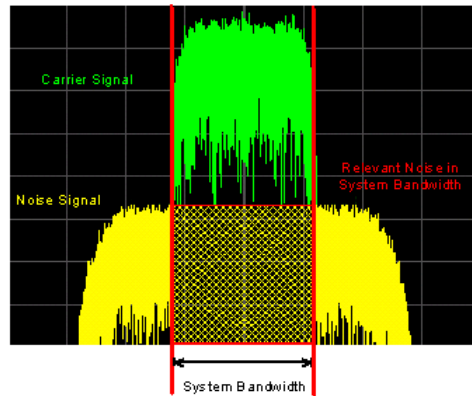

SCPI command:

`[ :SOURce<hw> ] :AWGN:POWer:NOISe` on page 534

#### Noise Level (Total Bandwidth) - AWGN

Displays the level of the noise signal in the total bandwidth in "Noise Only" and "Additive Noise" mode.

SCPI command:

`[ :SOURce<hw> ] :AWGN:POWer:NOISe:TOTal` on page 535

#### Carrier + Noise Level / Signal + Noise Level (System Bandwidth) / Carrier + Interferer Level / Signal + Interferer Level

(Additive Noise and CW Interferer)

Displays the overall level of the noise/interferer signal plus useful signal.

**Tip:** In the mode "Additive Noise" the "Display Output Results For" (analog or digital) has to be set before.

The name of this parameter depends on the selected "Display Mode".

SCPI command:

`[ :SOURce<hw> ] :AWGN:POWer:SUM` on page 535

#### Carrier + Noise PEP / Signal + Noise PEP (Total Bandwidth) / Carrier + Interferer PEP / Signal + Interferer PEP

(Additive Noise and CW Interferer)

Displays the peak envelope power of the overall signal comprised of noise signal plus useful signal.

The name of this parameter depends on the selected "Display Mode".

**Note:** The peak envelope power (PEP) specified in the header corresponds to the PEP value of the carrier.

In the mode "Additive Noise" the "Display Output Results For" (analog or digital) has to be set before.

SCPI command:

`[ :SOURce<hw> ] :AWGN:POWer:SUM:PEP` on page 536

### 5.7.3 Output of the Baseband Signal - I/Q Out

The R&S Signal Generator provides various outputs of the baseband signal.

The digitally modulated signal can either be output directly or converted to an analog I/Q baseband output signal. The **analog baseband signal** can be output single-ended or differential (non-inverted).

The single ended or differential output requires option R&S SMJ-B16, Differential Output.

The analog signal is output at the I/Q output connectors I OUT/I OUT BAR and Q OUT/Q OUT BAR on the rear panel of the instrument.

The output of the **digital baseband signal** requires the option R&S SMJ-B18, Digital I/Q Out. The signal is output at the standardized (LVDS) digital I/Q interface on the rear panel.

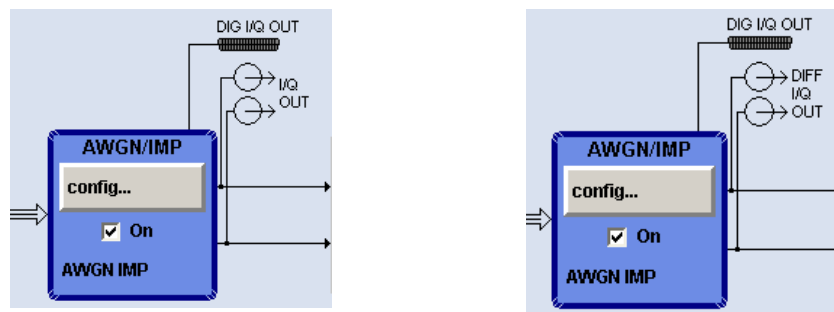

#### 5.7.3.1 I/Q Out Settings Menu

The settings dialogs for the analog and digital signal output are available in the block diagram in the "AWGN/IMP" function block as well as in the menu with the same name which is opened using the MENU key.

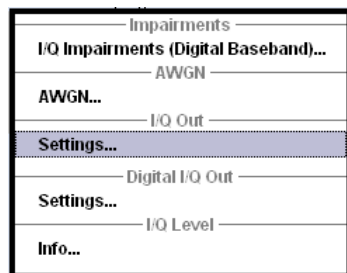

Selecting the menu item "I/Q Out Settings" opens a dialog with the parameters for the I/Q output signal.

The "I/Q Out" Settings dialog is available for analog and digital I/Q output signals. These dialogs are accessible under the menu sections with the corresponding names.

### 5.7.3.2 Analog I/Q Output

The differential output of the R&S Signal Generator provides symmetrical signals for differential inputs of DUTs without the need of additional external electric network.

The operating point of the inputs can be set by a definable DC-voltage (bias). In addition an offset between inverting and non-inverting output can be set to balance a difference of the best operating points.

The equipment options for the basic unit (R&S SMJ with frequency option R&S SMJ-B10x) include the option R&S SMJ-B13 (Baseband Main Module) and the option R&S SMJ-B16 (Differential Output) for "I/Q Out...".



Option R&S SMJ-B16 (Differential Outputs) cannot be fitted together with options R&S SMJ-B81 (Rear Panel Connectors), because they use the same connectors.

#### Optimize IQ-Signals for RF Output

Activates/deactivates optimization of level accuracy and imbalance for RF Output.

Level accuracy and imbalance can be either optimized for RF output (active) or for differential outputs (not active).

SCPI command:

`[ :SOURce<hw> ] :IQ:OUTPut:BIAS:OPTimization[:RF]:STATe` on page 672

#### I/Q Output Type

Selects the type of output. The analog outputs can be operated in "Single Ended" mode or "Differential" (non-inverted) mode. The menu changes depending on the selected output mode

- "Differential" Differential output at I OUT and I OUT BAR or Q OUT and Q OUT BAR.  
The analog I/Q signal components are output at I/Q OUT and I/Q OUT BAR. A bias to set the operating point of DUT can be defined. In addition an offset between inverting and non-inverting output can be set to balance a difference of the best operating points.

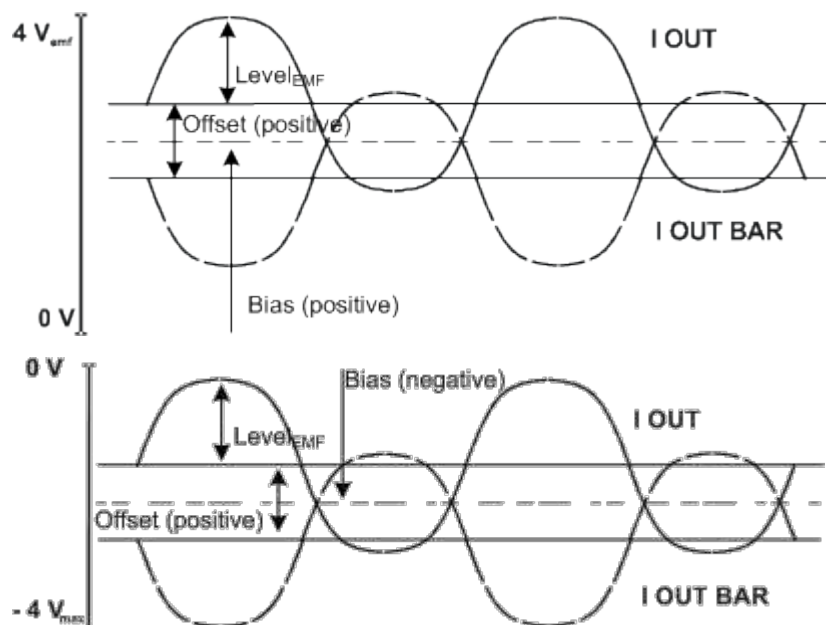

- "Single Ended" Single-ended output at I OUT and Q OUT.  
A bias between I/Q OUT and ground can be defined (requires the option R&S SMJ-B16, Differential I/Q Output).

SCPI command:

[\[:SOURce<hw>\]:IQ:OUTPut:TYPE](#) on page 674

### Output Mode

Selects the mode for setting the outputs - independent or together. The menu changes depending on the selection here.

- "Fixed" The settings for the I/Q signal components are fixed and cannot be changed.
- "Level Vp (EMF)" (Single ended) = 1.0 V
  - "Level Vp (EMF)" (Differential) = 2.0 V
  - "Bias" = 0 V
  - "Offset" = 0 V
- "Variable" The settings for the I/Q signal components are not fixed and can be modified.

SCPI command:

[\[:SOURce<hw>\]:IQ:OUTPut:MODE](#) on page 673

**I/Q Level Vp EMF**

Sets the output voltage for both signal components. Small differences at the inputs can be taken into account via impairment settings (see [chapter 5.7.1.1, "Impairment Settings Menu"](#), on page 274).

Single ended Output:

- Value range: 20 mV ... 2 V EMF.
- The maximum overall output voltage (" $\text{Level}_{\text{EMF}}$ " + " $|\text{Bias}_{\text{EMF}}|$ ") is 3.7 V.

Differential Output:

- Value range: 40 mV ... 4 V EMF.
- The maximum overall output voltage (" $0.5 * \text{Level}_{\text{EMF}}$ " + " $|\text{Bias}_{\text{EMF}}|$ " + " $0.5 * \text{Offset}$ ") is 3.7 V.

SCPI command:

[\[:SOURce<hw>\]:IQ:OUTPut\[:ANALog\]:POWer:PEP](#) on page 672

**Resulting I/Q Level Vp EMF**

Displays the resulting output off-load voltage of both signal components at the rear panel.

SCPI command:

[\[:SOURce<hw>\]:IQ:OUTPut\[:ANALog\]:POWer:PEP:RESult](#) on page 672

**Couple IQ Bias**

(Variable output mode only)

Activates/deactivates coupling of bias setting of the I-signal and Q-signal component. For activated coupling, the setting can be made for the I-signal component, it automatically applies to the Q-signal component as well. The fields for setting the Q-signal component are shaded.

SCPI command:

[\[:SOURce<hw>\]:IQ:OUTPut:BIAS:COUPling\[:STATe\]](#) on page 671

**Bias (EMF)**

Sets the bias. A DC voltage is superimposed upon the I or Q signal. The maximum overall voltage (" $\text{Level}_{\text{EMF}}$ " + " $\text{Bias}_{\text{EMF}}$ " + " $\text{Offset}_{\text{EMF}}$ ") is 3.7 volts.

This way, the operating point of a DUT can be set.

SCPI command:

[\[:SOURce<hw>\]:IQ:OUTPut:BIAS:I](#) on page 671

[\[:SOURce<hw>\]:IQ:OUTPut:BIAS:Q](#) on page 671

**Offset (EMF)**

(available only for output type "Differential" only)

Sets an offset between the inverting and the non-inverting output.

The value range is dynamically adjusted in order to respect the following constrains:

The maximum overall voltage (" $\text{Level}_{\text{EMF}}$ " + " $\text{Bias}_{\text{EMF}}$ " + " $\text{Offset}$ ") is 3.7 V.

The set value is set half in the positive and half in the negative direction:

- A **positive offset** is set with half of the value in positive direction at the non-inverting outputs, in negative direction at the inverting outputs, respectively.

For example, if a 100.0 mV offset value is set for the I signal component, the output signal at "I OUT" will have a 50.0 mV offset and the output signal at "I OUT Bar" will have a -50.0mV offset.

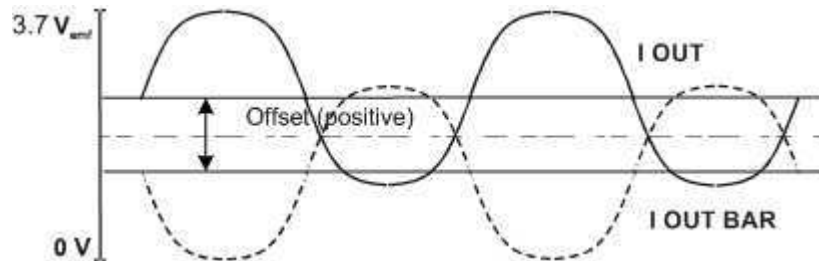

- A **negative offset** is set with half of the value in negative direction at the non-inverting outputs, in positive direction at the inverting outputs, respectively.

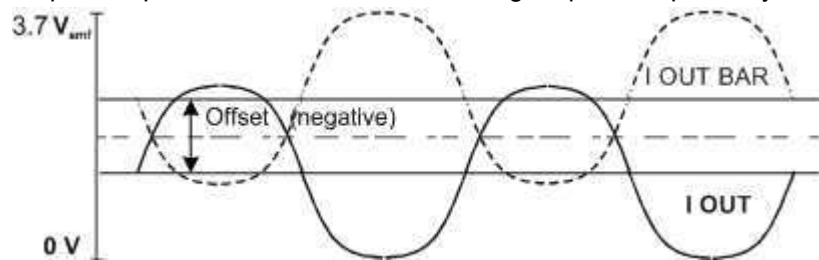

SCPI command:

[\[:SOURce<hw>\]:IQ:OUTPut:OFFSet:I](#) on page 673

[\[:SOURce<hw>\]:IQ:OUTPut:OFFSet:Q](#) on page 673

### 5.7.3.3 Digital I/Q Output Settings

The digital baseband signal is output at a standardized (LVDS) digital I/Q interface.

To access the settings for the digital I/Q output:

1. select "Block Diagram > AWGN/IMP > Config... > Digital I/Q Out > Settings" or
2. press the MENU key and select "AWGN/IMP > Digital I/Q Output > Settings".

The output of the digital baseband signal is available with the option R&S SMJ-B18, Digital I/Q Out. Two-path instruments require a second option R&S SMJ-B18, Digital I/Q Out for digital output.

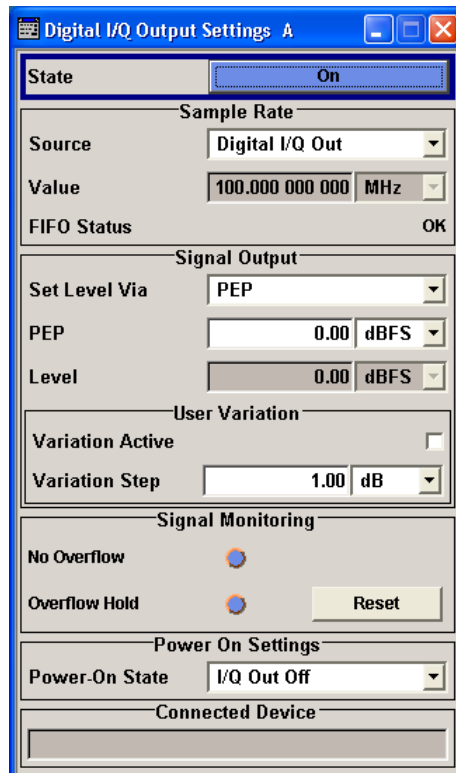

If an "R&S EX-IQ-BOX" is connected the R&S SMJ recognizes this module automatically. Then, the button "EX-I/Q-Box Settings..." is displayed in the "Digital I/Q Output Settings" dialog for configuring the parameters of the R&S EX-IQ-BOX (see "R&S EX-IQ-BOX" Manual). Additionally the components of the recognized R&S EX-IQ-BOX are listed in the Hardware Config, section Baseband Assembly.

## Digital I/Q Output General Settings

### State - Digital I/Q Output

Switches On/Off the digital I/Q output signal.

SCPI command:

`[ :SOURce<hw> ] :IQ:OUTPut:DIGital:STATe` on page 679

### EX-I/Q-Box Settings... - Digital I/Q Output

(With a connected R&S EX-IQ-BOX only)

Opens the main settings dialog of the R&S EX-IQ-BOX.

SCPI command:

n.a.

### Sample Rate

In the "Sample Rate" section the sample rate for the digital I/Q output signal can be set and the state of signal transmission is indicated by the FIFO Status.



**Sample Rate Source - Digital I/Q Output**

Selects the source for the sample rate of the digital I/Q output signal.

**Note:** With a connected **R&S EX-IQ-BOX** either the internal clock source (User defined) or an external clock (Digital I/Q In) can be selected in the settings dialog of the R&S EX-IQ-BOX. Therefore, the sample rate source is only indicated in this field.

"User Defined" The internally generated clock reference signal is used. The sample rate is calculated and displayed in the field "Value".

"Digital I/Q Out" An external clock reference signal is used. The clock signal is directly fed in via pin CLK2 of the digital output interface (option R&S SMJ-B18, Digital I/Q Out). The sample rate is estimated and displayed in the field "Value".

SCPI command:

[\[:SOURce<hw>\]:IQ:OUTPut:DIGital:SRATe:SOURce](#) on page 679

**Sample Rate Value - Digital I/Q Output**

Sets or displays the sample rate of the digital I/Q output signal, depending on the selected sample rate "Source".

SCPI command:

[\[:SOURce<hw>\]:IQ:OUTPut:DIGital:SRATe](#) on page 678

**FIFO Status - Digital I/Q Output**

Indicates the state of the signal transmission.

"OK" Resampling is working properly.

"OFL = Over-flow" The external sample rate frequency is too high which causes an overflow in signal transmission.

"URUN = Underrun" The external sample rate is too low which causes an underrun in signal transmission.

SCPI command:

[\[:SOURce<hw>\]:IQ:OUTPut:DIGital:SRATe:FIFO\[:STATus\]](#) on page 678

**Signal Output**

The level of the output signal is set in the "Signal Output" section. For entering the value, level type "PEP" or "Level" can be selected.

**Set Level Via - Digital I/Q Out**

Selects the level type (PEP/Level) that is used to set the signal level. Either the PEP or the Level entry field can be edited.

"PEP" The signal level is expressed in terms of a peak envelope power value (PEP).

The level entry fields and the corresponding units are displayed in the status bar.

## Impairment of Digital I/Q Signal and Noise Generator - AWGN/IMP Block

"Level" The signal level is expressed in terms of an rms value. The level entry fields and the corresponding units are displayed in the status bar.

SCPI command:

`[ :SOURce<hw> ] :IQ:OUTPut:POWer:VIA` on page 677

#### PEP - Digital I/Q Out

The signal level is expressed in terms of a peak envelope power value (PEP).

The level entry fields and the corresponding units are displayed in the status bar. The level display always refers to both signal components ( $\text{SQR}(I^2+Q^2)$ ).

SCPI command:

`[ :SOURce<hw> ] :IQ:OUTPut:DIGital:POWer:PEP` on page 676

#### Level - Digital I/Q Out

The signal level is expressed in terms of an rms level value.

The level entry fields and the corresponding unit are displayed in the status bar. The level display always refers to both signal components ( $\text{SQR}(I^2+Q^2)$ ).

SCPI command:

`[ :SOURce<hw> ] :IQ:OUTPut:DIGital:POWer:LEVel` on page 676

#### User Variation

If the level is set using the rotary knob, the step width is defined in the User Variation section.

#### Variation Active - Digital I/Q Out

Activates the user-defined step width that is used by varying the level value with the rotary knob.

"On" The level value set with the rotary knob is varied using the user-defined step width which is entered under "Variation Step".

"Off" The level value set with the rotary knob is varied in steps of one unit at the cursor position (standard operating mode).

SCPI command:

`[ :SOURce<hw> ] :IQ:OUTPut:DIGital:POWer:STEP:MODE` on page 677

#### Variation Step - Digital I/Q Out

Sets the user defined step width for entering the level value using the rotary knob. Level variation with this step width must be activated with "Variation Active ON".

SCPI command:

`[ :SOURce<hw> ] :IQ:OUTPut:DIGital:POWer:STEP[:INCRement]` on page 677

#### Signal Monitoring

The section "Signal Monitoring" indicates digital signal clipping.

**Overflow - Digital I/Q Out**

Indicates that the I/Q output signal is currently clipped. This indication also appears in the block diagram close to the digital I/Q Out connector.

Overload may occur, e.g. if the level of the output signal, or the noise level (AWGN) are too high.

SCPI command:

[\[:SOURce\]:IQ:OUTPut:DIGital:OFLow:STATe](#) on page 675

**Overflow Hold - Digital I/Q Out**

Indicates an overflow since last reset.

The overflow hold state can be reset via the "Reset" button next to the LED, or is reset automatically by starting a new signal generation or by setting new values to the output level.

SCPI command:

[\[:SOURce\]:IQ:OUTPut:DIGital:OFLow:HOLD:STATe](#) on page 675

**Reset - Digital I/Q Out**

Executes a reset of the overflow hold state and LED.

SCPI command:

[\[:SOURce\]:IQ:OUTPut:DIGital:OFLow:HOLD:RESet](#) on page 675

**Power On Settings**

The power on behaviour of the R&S SMJ is set in the "Power On Settings" section.

**Power-On State - Digital I/Q Out**

Selects the state which the digital I/Q Output is to resume after the instrument is switched on.

"I/Q Out Off"      The output is deactivated when the instrument is switched on.

"Previous Setting"      When the instrument is switched on the digital I/Q output resumes to the status that was active before the last switch off.

SCPI command:

[\[:SOURce<hw>\]:IQ:OUTPut:DIGital:PON](#) on page 676

**Connected Device - Digital I/Q Out**

Indicates the ID of an externally connected R&S Instrument.

SCPI command:

[\[:SOURce<hw>\]:IQ:OUTPut:DIGital:CDEvice](#) on page 675

**5.7.4 I/Q Level - Info...**

The signal levels and the crest factor of the baseband signal at the I/Q output connectors are indicated in the dialog box "Baseband Signal Level".

This information is needed by the user, for example, in order to use the I/Q signal externally and to adjust the level correctly there, or to see how the signal is modulated.



Up to baseboard version DacBoard 1141.8090.xx the calculated signal levels are displayed. From "DacBoard 1141.8190.02" or higher monitoring the measurement with or without interfering is provided.

Information on the baseband I/Q signal during measurement is indicated in the section "Baseband Signal Level Measurement". Level, crest factor and duration of the measurement can be displayed for the signal either with or without interfering.



Monitoring the measurement of the digital I/Q baseband signal requires the baseboard version "DacBoard 1141.8190.02" or higher. Up to baseboard version DacBoard 1141.8090.xx only the calculated signal levels are provided.

The currently equipped DacBoard is listed in the dialog "Setup > System > Hardware Config, section Baseband Assembly" (see [chapter 5.2.3.2, "Hardware Config"](#), on page 121).

To open the "Info..." dialog for information on the baseband I/Q signal during measurement, select "AWGN/IMP > Configure > Info" or use the MENU key under "AWGN/IMP".

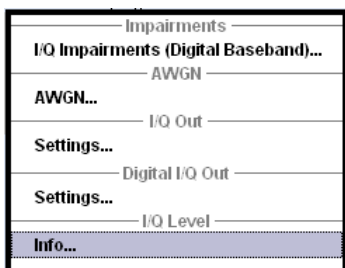

#### 5.7.4.1 Baseband Signal Level

The signal levels and the crest factor of the baseband signal at the I/Q output connectors are indicated in the dialog box "Baseband Signal Level".

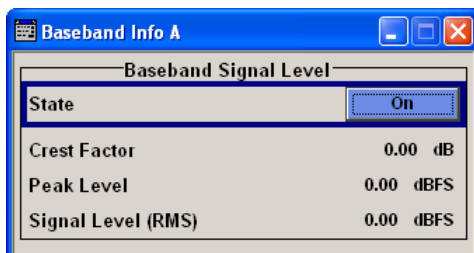

#### Crest Factor - Digital Impairments

Indicates the crest factor of the baseband signal.

The crest factor is calculated from the two level parameters as follows:

$$\text{Crest[dB]} = \text{Peak\_Level[dBFs]} / \text{Signal\_Level[dBFs]}$$

SCPI command:

`[ :SOURce<hw> ] :BB:CFACTOR` on page 641

**Peak Level - Digital Impairments**

Indicates the peak level of the baseband signal relative to full scale of 0.5 V (in terms of dB full scale).

SCPI command:

`[ :SOURce<hw> ] :BB:POWer:PEAK` on page 642

**Signal Level (RMS) - Digital Impairments**

Indicates the rms level of the baseband signal relative to full scale of 0.5 V (in terms of dB full scale).

SCPI command:

`[ :SOURce<hw> ] :BB:POWer:RMS` on page 642

**5.7.4.2 Baseband Signal Level Measurement**

Information on the baseband I/Q signal during measurement is indicated in the section "Baseband Signal Level Measurement". Level, crest factor and duration of the measurement can be displayed for the signal either with or without interfering.

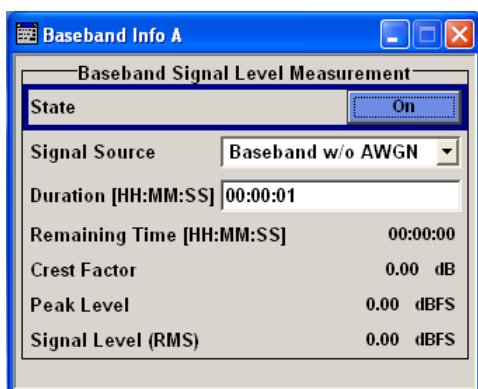
**State - Digital Impairments - Measurement**

Activates/deactivates the measurement of the digital I/Q baseband signal.

When activated, information on the peak level, rms level and crest factor are indicated. Additionally the duration of the measurement can be set.

SCPI command:

`[ :SOURce<hw> ] :BB:MEASurement [ :STATe ]` on page 641

**Signal Source - Digital Impairments - Measurement**

Selects the signal for the measurement. The signal level and crest factor can be retrieved either from the interference-free digital I/Q baseband signal or the signal superimposed by the noise generator AWGN.

"Baseband w/o AWGN" Activates the measurement of the interference-free baseband signal.

"Baseband with AWGN" Activates the measurement of the baseband signal after an AWGN noise signal is added.

SCPI command:

`[ :SOURce<hw> ] :BB:MEASurement :SOURce` on page 641

**Duration - Digital Impairments - Measurement**

Enters the time for the measurement of the digital I/Q baseband signal in the range of 1 s ... 3 h. The time is to be entered in format "hh:mm:ss".

SCPI command:

`[ :SOURce<hw> ] :BB:MEASurement:DURation` on page 639

**Remaining Time - Digital Impairments - Measurement**

Indicates the remaining time until the measurement of the digital I/Q baseband signal is completed. The time is displayed in format "hh:mm:ss".

SCPI command:

`[ :SOURce<hw> ] :BB:MEASurement:RTIME` on page 640

**Crest Factor - Digital Impairments - Measurement**

Indicates the crest factor of the baseband signal during measurement.

SCPI command:

`[ :SOURce<hw> ] :BB:MEASurement:CFACTOR` on page 639

**Peak Level - Digital Impairments - Measurement**

Indicates the peak level of the baseband signal relative to full scale of 0.5 V (in terms of dB full scale) during measurement.

SCPI command:

`[ :SOURce<hw> ] :BB:MEASurement:POWer:PEAK` on page 640

**Signal Level (RMS) - Digital Impairments - Measurement**

Indicates the rms level of the baseband signal relative to full scale of 0.5 V (in terms of dB full scale) during measurement.

SCPI command:

`[ :SOURce<hw> ] :BB:MEASurement:POWer:RMS` on page 640

## 5.8 Baseband Signal - Baseband Block

The R&S Signal Generator provides you with the ability to generate digital modulation signals in accordance with the definitions in the digital standards or with user-definable characteristics. Signals are generated in realtime or from a data store with the aid of external and internal data. You can also load externally computed modulation signals into the R&S Signal Generator in the form of waveform files.

Several digital standards are provided, plus digital modulation with user-definable signal characteristics, generation of waveforms with the aid of the Arbitrary Waveform Generator and generation of multi carrier CW signals with the aid of Multi Carrier CW.

The settings for digital modulation can be accessed in the block diagram via the "Baseband" function block or with the aid of the MENU key.

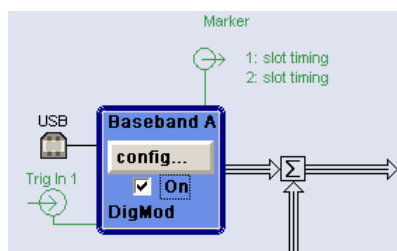

The equipment layout for generating the internal, digital modulation signals includes the options Baseband Main Module (B13) and one of the options Baseband Generator (B9/B10/B11). The three Baseband Generator options feature different ARB memory sizes (see data sheet). Apart from the memory size, however, the options offer the same functionality, either one can be installed.

In addition, the appropriate option is required for the digital standards. These options are specified in the description of the respective standard.

In the subsequent signal route the baseband signals can be frequency-shifted, detuned or loaded with noise (see [chapter 5.7, "Impairment of Digital I/Q Signal and Noise Generator - AWGN/IMP Block"](#), on page 273).

### 5.8.1 Data and Signal Sources in Baseband

This section describes the common characteristics of the signals used for generating the baseband signal for all standards, including for example all listed data sources. The selection in the digital menus at any given time depends on the parameter and standard concerned and is clear from the selection list offered in the menu. The external data sources may therefore not be available in certain cases.

Characteristics which are uniquely specific to particular standards are described in the corresponding manual.

The following input signals are used when digital modulation signals are being generated:

- Modulation data
- Clock signals
- Control signals

The input signals can be both internally generated and supplied from an external source. The internally generated data and clock signals are output not only on the DATA and CLOCK connectors but also on the corresponding pins of the AUX I/O interface.

Likewise control signals and also trigger signals for triggering signal generation in the R&S Signal Generator can be internally generated or supplied from an external source.

Up to four marker output signals for synchronizing external instruments can be user-defined.

Externally computed waveform files can be loaded in the instrument using computer interfaces or IEC bus.

Waveform files are processed with the aid of the Arbitrary Waveform Generator (ARB), see [chapter 5.8.3, "Arbitrary Waveform Generator ARB"](#), on page 352.

Internally the "Multi Carrier CW" menu for defining multi carrier waveforms is available (see [chapter 5.8.4, "Multi Carrier Continuous Wave"](#), on page 399).

### 5.8.1.1 Internal PRBS Data and Data Patterns

PRBS generators deliver pseudo-random binary sequences of differing length and duration. They are known as maximum length sequences, and are generated with the aid of ring shift registers with feedback points determined by the polynomial.

By way of example, the diagram below shows a 9-bit generator with feedback to registers 4 and 0 (output).

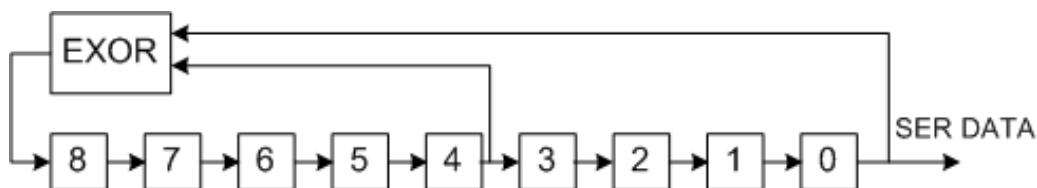
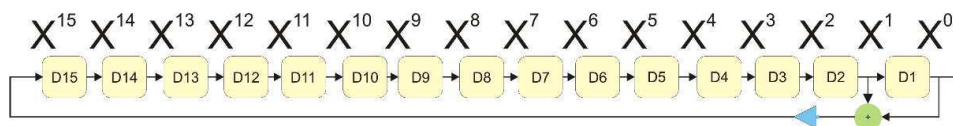

Fig. 5-24: 9-bit PRBS generator



For PRBS15 and PRBS23, a CCITT V.52-compliant data inversion is performed in the feedback path automatically as shown below:



The pseudo-random sequence from a PRBS generator is uniquely defined by the register number and the feedback. The following table describes all the available PRBS generators:

Table 5-2: PRBS generators

PRBS generator	Length in bits	Feedback to	Menu selection
9-bit	$2^9 - 1 = 511$	Registers 4, 0	PRBS 9
11-bit	$2^{11} - 1 = 2047$	Registers 2, 0	PRBS 11
16-bit	$2^{16} - 1 = 65535$	Registers 5, 3, 2, 0	PRBS 16
20-bit	$2^{20} - 1 = 1048575$	Registers 3, 0	PRBS 20
21-bit	$2^{21} - 1 = 2097151$	Registers 2, 0	PRBS 21

The "Data Source" selection for PRBS data from the menus is "PN11, ...".

Simple data patterns such as binary 0 strings or 1 strings can also be used as internal modulation data. The "Data Source" selection from the menus is "ALL 0", "ALL 1". A variable bit string with a maximum length of 64 bits can be entered in an input field by selecting "Pattern."



### 5.8.1.2 Internal Modulation Data from Lists

Internal modulation data can be generated and stored in the form of binary lists. A separate file is created for each list and held on the instrument's hard disk.

The file name can be defined by the user.

The "Data Source" selection from the menus is "Data List". When this menu item is chosen the "Select Data List" button appears; this opens the file-selection window for data lists. A list can be created and edited in the "Data List Editor", which is accessed from the menu via the "List Management" or "Data List Management" button.

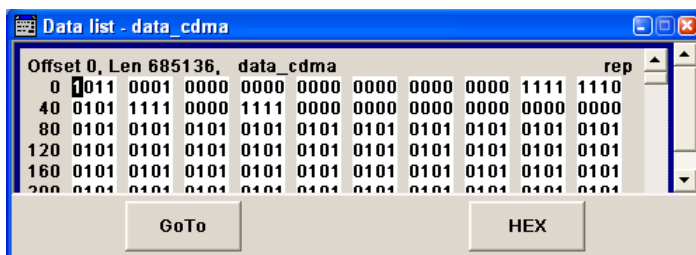

The maximum length of a data list is determined by the size of the data list memory (see data sheet). There is no restriction on the number of lists that can be stored.

### 5.8.1.3 External Synchronous Modulation Data

#### External Serial Modulation Data via the DATA Connector

For "Custom Digital Modulation", serial modulation data can be supplied bit-by-bit via the DATA connector. The "Data Source" selection from the menu is "Extern Serial".



In the case of modulation modes with more than 1bit/symbol, the most significant bit (MSB) must be fed in first (MSB first).

The clock reference (symbol clock) used to read in the data can be either internal or external.

External serial data is output on the PARDATA pins of the AUX I/O interface as parallel data LSB-justified.

The maximum data rate for serial data processing can be found in the data sheet.

#### External Parallel Modulation Data via the AUX I/O Interface

For "Custom Digital Modulation", parallel data can be supplied symbol-by-symbol via the AUX I/O interface (D0 – D9). The "Data Source" selection from the menu is "Extern Parallel".



In the case of modulation modes with fewer than 10bits/symbol, the data must be applied LSB-justified. In the case of 8-PSK modulation for example (3bits/symbol) only data lines D0, D1 and D2 are used.

The clock reference (symbol clock) used to read in the data can be either internal or external.

External parallel data is output on the DATA connector serially. However, there is a maximum data rate above which serial data processing becomes impossible and the DATA connector becomes high-impedance. The maximum data rate for parallel data processing is shown in the data sheet.

#### 5.8.1.4 Clock Signals

The clock reference used for generating the timing pulse can be either internal or external ("Clock Source" selection from the menu: "Internal / External").

##### Internal clock reference



The table below gives an overview of the generated clock signals and the connectors they are output at for the case a internal clock reference is selected.

Connector	Location	Clock Mode
CLOCK	front panel	Symbol clock
CLOCK OUT	rear panel	Choice of bit clock or symbol clock
BITCLK	AUX I/O interface, rear panel	Bit clock
SYMBCLK	AUX I/O interface, rear panel	Symbol clock

The clock output signals are assigned in the menu sequence "Setup > Environment > Global Trigger/Clock/External Inputs > USER Marker /AUX I/O Settings".

##### External clock reference



An external clock is always supplied via the CLOCK connector. When the external clock reference is selected, the internal clock is synchronized to it. The table bellow gives an overview of the connectors the internal clocks are output at.

Connector	Location	Clock Mode
CLOCK OUT	rear panel	Choice of bit clock or symbol clock
BITCLK	AUX I/O interface, rear panel	Bit clock
SYMBCLK	AUX I/O interface, rear panel	Symbol clock

The active edge of the external clock signal on the CLOCK input is selectable (menu "Setup > System > Global Trigger/Clock/External Inputs"). Internally the rising edge is always taken as the active edge. The active rising edge of the internal clocks is therefore synchronized with either the rising or the falling edge of the external clock reference. A symbol clock can be supplied externally or, if internally generated or externally asynchronous data is being fed in, a multiple of a symbol clock can be supplied.

In order for the clock synthesizer on the R&S SMJ to be synchronized correctly, the external clock reference must first be applied and the correct symbol rate must then be set. Until this has been done the external clock source must not be selected ("Clock Source External").



The symbol rate set must not deviate from the symbol rate of the external signal by more than 2% (see also data sheet).

### 5.8.1.5 Synchronizing Data Signals and Clock Signals

When selecting data signals and clock signals, the following operating modes are possible:

- Internal clock and internal data
- Internal clock and external synchronous data
- External clock and external synchronous data
- External clock and either internal data or external asynchronous data

#### Internal Clock and Internal Data

When internal data is selected, this data is output in serial mode on the DATA connector or in parallel mode on the PARADATA pins of the AUX I/O interface ("Custom Digital Modulation").

In modulation modes with fewer than 10bits/symbol, the parallel data is output LSB-justified. In the case of 8-PSK modulation for example (3bits/symbol) only data lines D0, D1 and D2 are used.

In the following example, the diagram shows the output signals of an 8-PSK modulation (3 bits per symbol) on the serial DATA interface. The positive edge of the clock is always used when outputting data. The data source is a data list with 15 bits = 001 010 100 101 110 (5 symbols).

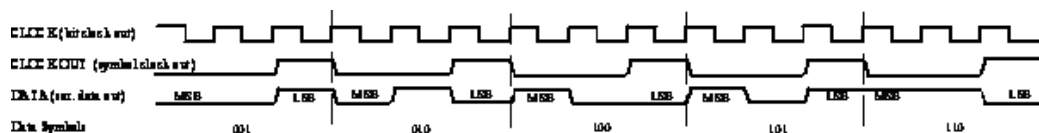

Fig. 5-25: Output signal on the serial data interface and clock output signals on the AUX I/O interface

There is a maximum data rate above which serial data processing becomes impossible. This data rate can be found in the data sheet. If the rate is exceeded the DATA connector becomes high-impedance, and the output on the CLOCK connector is the symbol clock instead of the bit clock.

In the following example, the diagram shows the output signals of an 8-PSK modulation (3 bits per symbol) on the parallel interface. The data source is a data list with 15 bits = 001 010 100 101 110 (5 symbols).

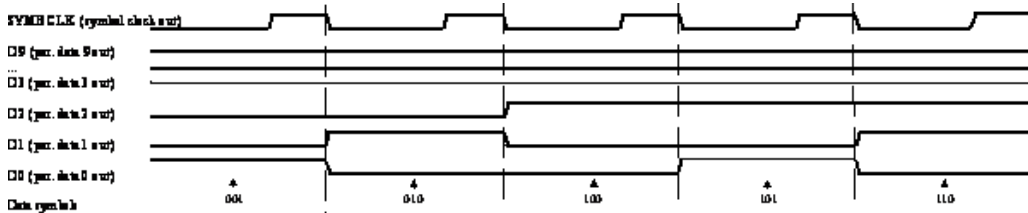

Fig. 5-26: Data and clock output signals on the parallel AUX I/O interface

In order for parallel external data to be retrieved correctly the rising edge of the symbol clock must be used, since the timing between the falling edge of the symbol clock and the data switch on the parallel interface is undefined.

**Internal Clock and External Synchronous Data**

**External serial data**

When serial data for "Custom Digital Modulation" is being fed in via the DATA connector on the front panel, the symbol clock acts as a scanning pulse (strobe) so as to mark the least significant bit in a symbol.

The clock signals are output on the CLOCK and CLOCK OUT connectors (front panel and rear panel respectively, choice of bit clock or symbol clock on the latter) and on the BITCLK or SYMBCLK pins on the AUX I/O interface. Optimum timing is achieved from using the output signal on the CLOCK connector on the front panel. The setup and hold times (see following diagram,  $t_{setup}$  and  $t_{hold}$ ) that must be maintained in the R&S Signal Generator to ensure that the serial data is accepted correctly can be found in the data sheet.

The following diagram illustrates the timing ratios between data and clock when serial data is being supplied from an external source and the internal clock source is being used.

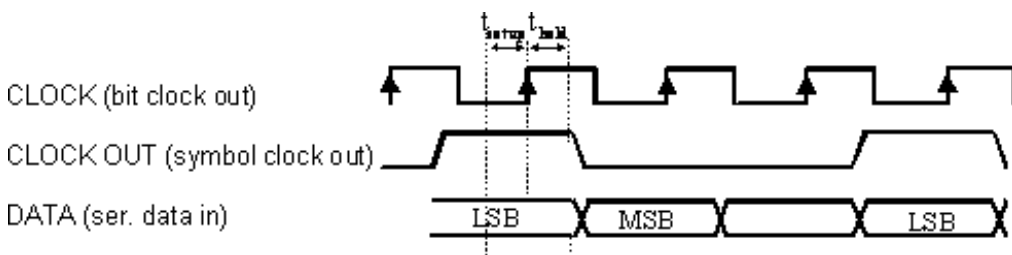

Fig. 5-27: External serial data and the clock signals which are output (bit clock and symbol clock). The setup time ( $t_{setup}$ ) and hold time ( $t_{hold}$ ) can be found in the data sheet.

**External parallel data**

When parallel data for "Custom Digital Modulation" is being fed in via the AUX I/O interface (D0 – D9), the internal symbol clock is used.

The symbol clock is output on the CLOCK OUT connector (rear panel, choice of bit clock or symbol clock) and on the SYMBCLK pin on the AUX I/O interface. Optimum timing is achieved by using the symbol clock on the SYMBCLK pin on the AUX I/O interface. The setup and hold times (see following diagram,  $t_{setup}$  and  $t_{hold}$ ) that must be maintained in the R&S Signal Generator to ensure that the serial data is accepted correctly can be found in the data sheet.

The following diagram illustrates the timing ratios between data and clock when parallel data is being supplied from an external source and the internal clock source is being used.

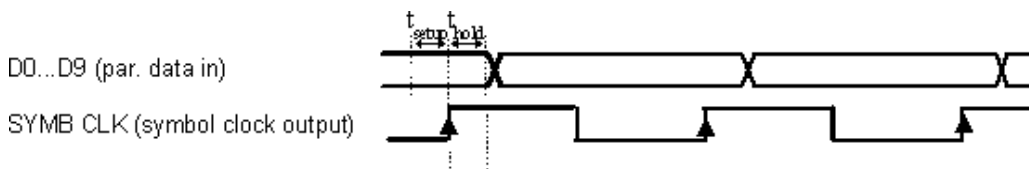

**Fig. 5-28: External parallel data, internal clock signal and the clock signal that is output on the AUX I/O interface** The setup time ( $t_{setup}$ ) and hold time ( $t_{hold}$ ) can be found in the data sheet.

### External Clock and External Synchronous Data

When synchronous modulation data is being fed in from an external source for "Custom Digital Modulation", clock generation in the R&S Signal Generator can be synchronized on the rising or falling edge of an external symbol clock. The clock reference is supplied on the CLOCK connector (front panel).

The clock signals generated as a result are output on the CLOCK OUT connector (rear panel, choice of bit clock or symbol clock) and on the BITCLK or SYMBCLK pins on the AUX I/O interface.

### External serial data

The following diagram illustrates the timing ratios between data and clock when serial data is being supplied from an external source and an external reference clock is being used.

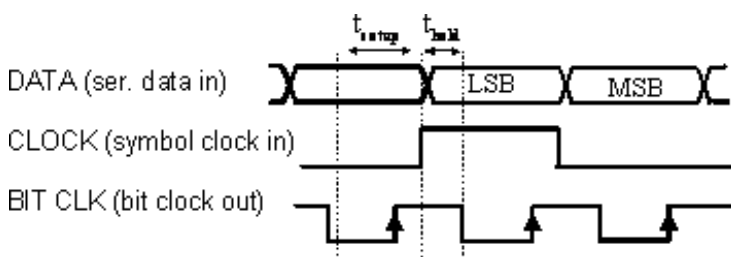
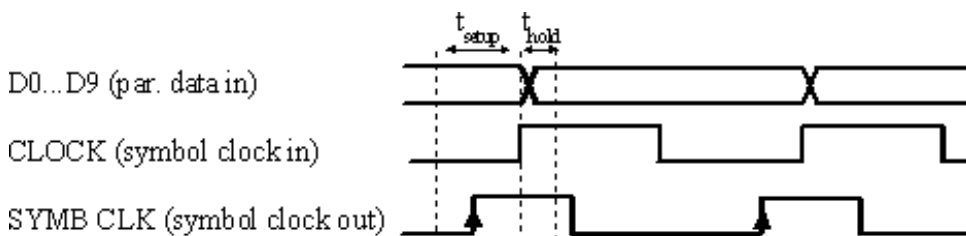

**Fig. 5-29: External serial data and external symbol clock - 3 bits/symbol with high and low active symbol clock for marking the LSB.** The data and the symbol clock must change state simultaneously. The setup time ( $t_{setup}$ ) and hold time ( $t_{hold}$ ) can be found in the data sheet.

A bit clock is generated from the externally supplied symbol clock and is used for reading the serial data into the R&S Signal Generator. The active edge of this bit clock is located ahead of the symbol clock.

### External parallel data

The following diagram illustrates the timing ratios between data and clock when parallel data is being supplied from an external source and an external reference clock is being used.



**Fig. 5-30: External parallel data with high and low active external symbol clock. The setup time ( $t_{setup}$ ) and hold time ( $t_{hold}$ ) can be found in the data sheet.**

The R&S Signal Generator uses the externally supplied symbol clock to generate an internal symbol clock that defines the sampling points at which the parallel data is read into the R&S Signal Generator. These sampling points are also located a little ahead of the external symbol clock.

### External Clock and Internal or External Asynchronous Data

If the modulation data is generated internally or supplied asynchronously from an external source, clock generation in the R&S SMJ can be synchronized on an external symbol clock, or a multiple thereof, which is fed in on the CLOCK connector (front panel). Synchronization can be based on the rising edge or falling edge according to choice. The maximum permissible multiple symbol clock can be found in the data sheet.

#### 5.8.1.6 Control Signals

The following control signals are processed in the R&S SMJ:

- "Burst Gate" for power ramping
- "Level Attenuation" for power ramping
- "CW" for controlling the CW (continuous wave) mode  
The "CW" signal turns off digital modulation. The signal is output in unmodulated form. In case of standards in which it is possible to switch between different modulation modes, the signal is output only and cannot be supplied from an external source. In such cases it indicates the modulation mode internally (standard GSM: signal high (1) = modulation mode GMSK and signal low (0) = modulation mode 8PSK EDGE).

The CW control signal is generated internally and fed to the AUX I/O interface. The control signals for power ramping can be provided externally for Custom Digital Modulation only. When generated internally the signals are output on the AUX I/O interface.

A dedicated internal "Control Data Editor" is provided for defining the control signals. This editor with its intuitive graphical interface can be used to define and save control signals. Definition by generating or editing a binary list is no longer necessary (though it is still possible via the IEC bus).

A separate file with the file extension \*.dm\_iqc is created for each defined control signal and held on the R&S Signal Generator hard disk.

If the "Component Data Editor" is used, the "Control Data Editor" is integrated with it. The defined control data is not held separately, but stored with the data structure. This applies both to signals of the Data Editor Realtime and the Data Editor Offline.

### Power Ramping and Level Attenuation

In TDMA radio networks it is necessary to control the RF output signal envelope synchronously for the purpose of digital modulation. The signals "Burst" Gate and "Lev Att" are used for this. These signals are internally generated.

In case of "Custom Digital Modulation", they can also be supplied from an external source via the AUX I/O interface.

When power ramping is enabled, a ramp is generated whenever there is a data switch on the "Burst" signal (from high to low or low to high). The steepness of this ramp can be adjusted. Power ramping is enabled and configured in the "Power Ramp Control" sub-menu.

The "Lev\_Att" signal is used to control a defined level attenuation. If level attenuation is enabled, the modulation signal level is attenuated by a defined value if the "Lev\_Att" signal is high. The level attenuation value is defined in the "Power Ramp Control" menu. For the "GSM/EDGE" standard a maximum of 7 different level attenuation values can be defined and allocated separately to the 8 slots quite independently of one another. Level attenuation is enabled either in the "Power Ramp Control" menu (Custom Digital Modulation) or in the "Burst Editor" (GSM/EDGE).

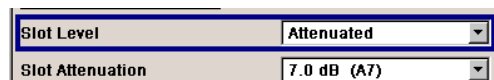

Level attenuation enables to simulate radio stations located at various distances.

The diagram below shows an example of how the power ramping signals work.

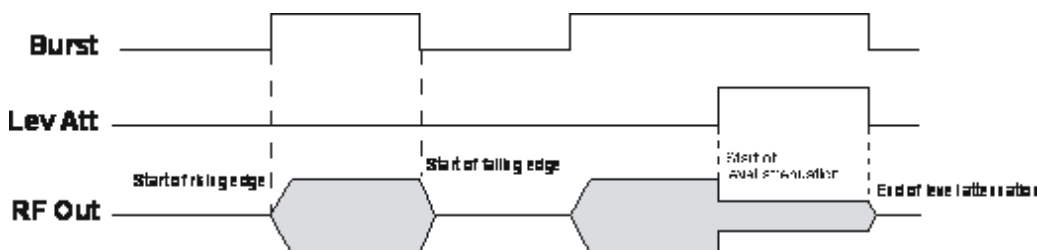

**Fig. 5-31: Signal behavior when power ramping is enabled. The Burst Gate signal defines the start of the rising and falling edges of the envelope, and the Lev Att signal defines the start and end of level attenuation. The level attenuation value is defined in the Power Ramp Control menu.**

#### 5.8.1.7 Trigger Signals

In the R&S Signal Generator, trigger signals are internally generated or externally supplied signals which start signal generation at a particular point in time.

Signal generation can also take place without triggering, in which case the signal is then generated in full after modulation is powered up. A trigger event either has no effect on signal generation (menu setting "Trigger Mode Auto") or triggers a signal restart (menu setting "Trigger Mode Retrigger").

If signal generation is triggered, the signal is continuously generated after the first trigger. In the "Armed\_Auto" mode, a further trigger event has no effect. In the "Armed\_Retrig" mode, every additional trigger event triggers a restart of the signal. In both cases, triggering can be reset to the initial state ("armed"), i.e. signal generation is stopped and the instrument waits for the next trigger to start signal generation anew.

The status of signal generation ("Running" or "Stopped") is displayed for all trigger modes in the corresponding trigger menu of the digital standard currently switched on. The signal generation status particularly with an external trigger can thus be checked.

Internal and external trigger sources are available for triggering.

- Internally, triggering is carried out manually by pressing the "Execute Trigger" button (menu selection "Internal").
- External trigger signals can be fed in via the TRIGGER connector (menu selection "External").

In the case of external triggering and internal triggering by the trigger signal on the second path, the start can be delayed by a definable number of symbols (menu setting "Trigger Delay External"). This makes it possible to purposely simulate the time delay between a base station signal and a user equipment signal, for example in the course of base station tests.

The effect of a restarted trigger signal in the "Retrigger" trigger mode can be suppressed for a definable number of symbols (menu setting "External Trigger Inhibit"). By this means the trigger can be suppressed for a definable number of frames, for example in the course of base station tests, and yet the signal can still be generated synchronously. In each frame the base station generates a trigger which would cause a signal generation restart every time but for the suppression.

**Example:**

Entering 1000 samples means that after a trigger event, any subsequent trigger signal is ignored for the space of 1000 samples.

#### 5.8.1.8 Marker Output Signals

The R&S Signal Generator generates user-definable marker output signals which can be used to synchronize external instruments. By this means a slot clock or frame clock can be set, for instance, or the start of a particular modulation symbol can be marked.

Four marker outputs are available. The outputs for markers 1 to 3 are defined, but marker 4 can be placed on one of the USER outputs according to choice.



Marker	Connector	Location
Markers 1/2	MARKER 1 / 2 BNC connectors	front panel
Marker 3	MARKER 3 pin of the AUX I/O connector	rear panel
Marker 4	USER1 BNC connector or USER2/3/4 pins of the AUX I/O connector	rear panel

## 5.8.2 Digital Modulation - Custom Digital Modulation

The R&S Signal Generator can generate digital modulation signals with user-definable characteristics. Baseband filtering and the symbol rate can be set within wide limits.

### 5.8.2.1 Overview and Required Options

The equipment layout for generating the digital modulation signals includes the options Baseband Main Module (R&S SMJ-B13) and Baseband Generator (R&S SMJ-B9/B10/B11).

When modulation is ON, a two-part level indication is shown in the header section of the display. This displays both the average power (LEVEL) and the peak envelope power (PEP) of the modulated output signal.



The difference between PEP and LEVEL depends on the modulation type and the filtering: Both values are pre-measured internally so that the displayed values match the true values in the signal. When external signals are used, they are replaced by PRBS data during pre-measurement.

### 5.8.2.2 Modulation Types - Custom Digital Mod

The available predefined modulation types are ASK (amplitude shift keying), FSK (frequency shift keying), PSK (phase shift keying) and QAM (quadrature amplitude modulation). Additionally, a user defined modulation mapping can be applied (see ["User Mapping"](#) on page 316).

The actual modulation procedure is described by mapping, which assigns I and Q values (PSK and QAM) or frequency shifts (FSK) to every modulation symbol that occurs. This is represented graphically in the constellation diagrams.

The mapping for the selected modulation type is displayed in the "More..." submenu in the "Modulation" menu section (see ["More - Modulation Type - Digital Modulation"](#) on page 331).

The QAM procedures 16QAM, 32QAM, 64QAM have been produced in accordance with ETSI standard ETS 300429 for digital video broadcasting (DVB). The QAM procedures 256QAM and 1024QAM are not specified in this standard, but have been produced according to the same basic principles.

In the case of all FSK procedures, the user can set the symbol rate fSYMB up to a maximum value (see data sheet). If MSK is selected, the frequency deviation (FSK deviation) cannot be set since it is permanently set to 1/4 of the symbol rate.

Table 5-3: Modulation type and associated mapping

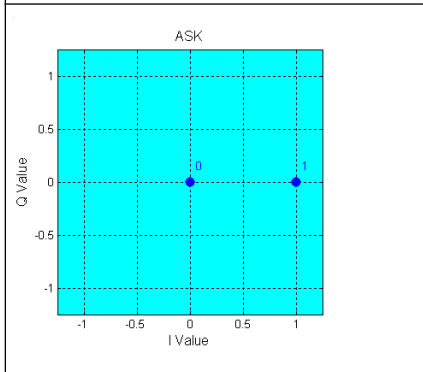
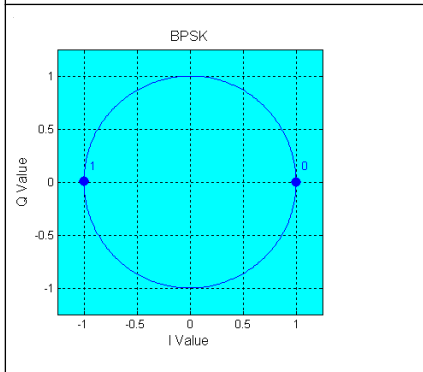
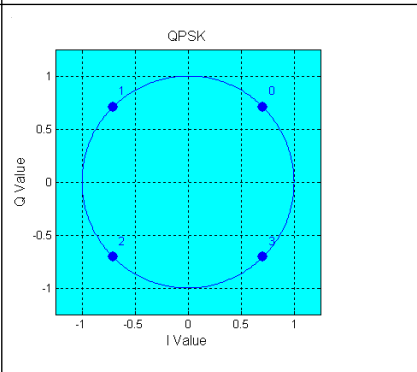
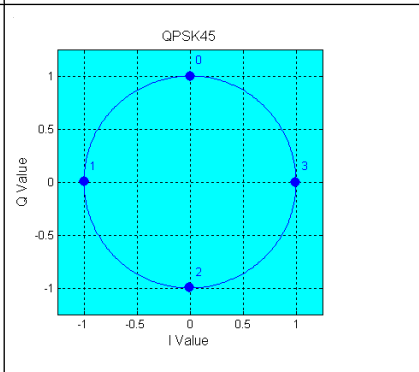
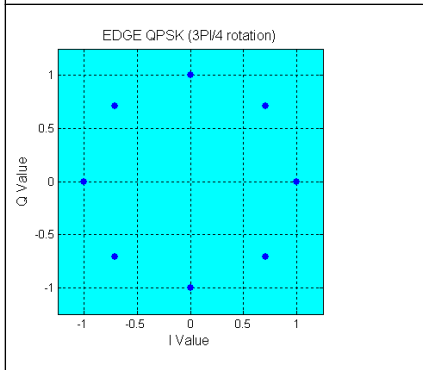
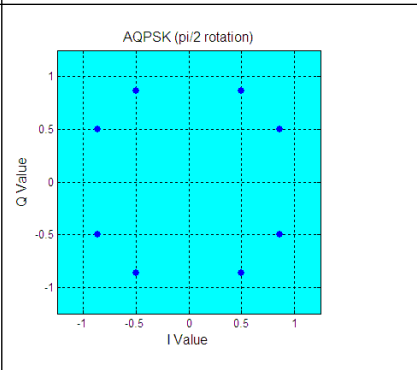
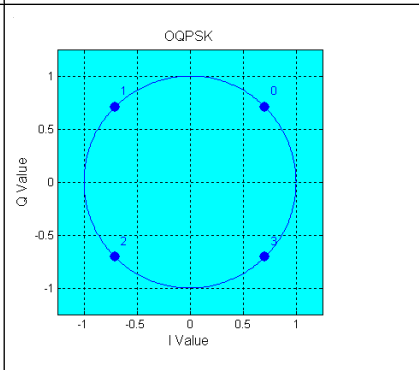
<p><b>ASK</b> 1 bit per symbol SOUR:BB:DM:FORM ASK</p> 		
<p><b>PSK</b></p>		
<p><b>BPSK</b> 1 bit per symbol SOUR:BB:DM:FORM BPSK</p> 	<p><b>QPSK</b> 2 bits per symbol SOUR:BB:DM:FORM QPSK</p> 	<p><b>QPSK 45° Offset</b> 2 bits per symbol, 45° rotation SOUR:BB:DM:FORM QPSK45</p> 
<p><b>QPSK EDGE</b> 2 bits per symbol, 3pi/4 rotation SOUR:BB:DM:FORM QEDGE</p> 	<p><b>AQPSK</b> 2 bits per symbol, pi/2 rotation SOUR:BB:DM:FORM AQPSK</p> 	<p><b>OQPSK</b> 2 bits per symbol, Q offset SOUR:BB:DM:FORM OQPSK</p> 

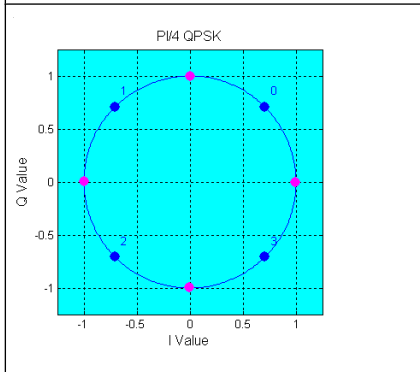
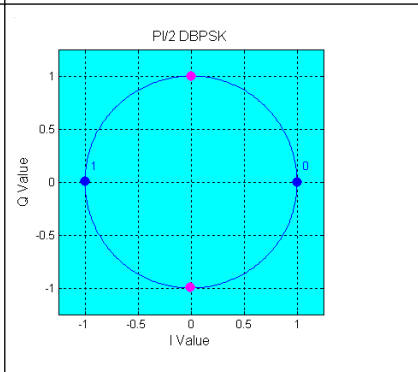
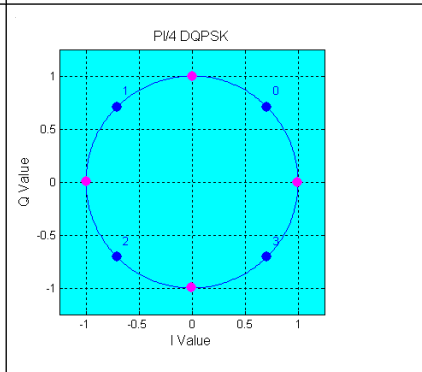
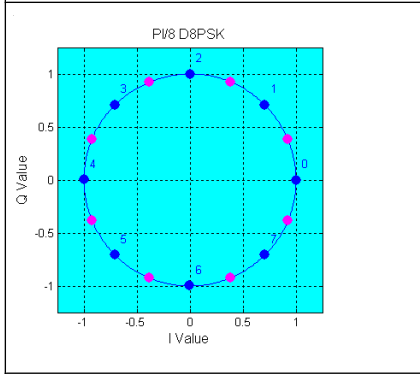
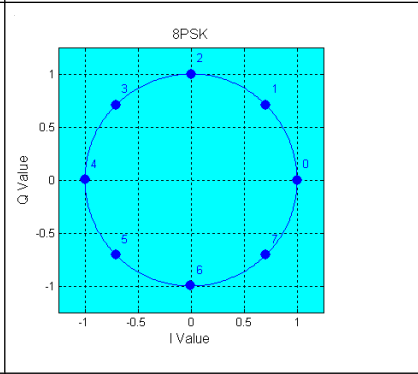
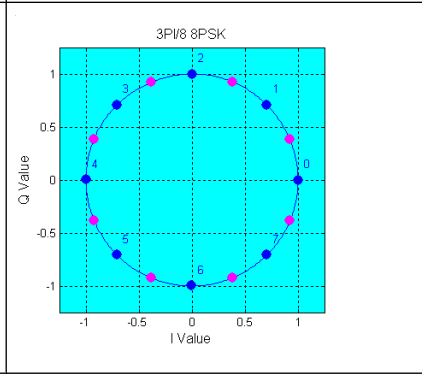
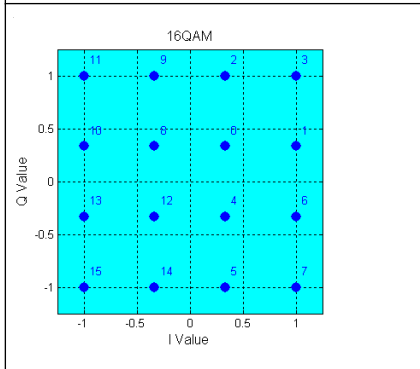
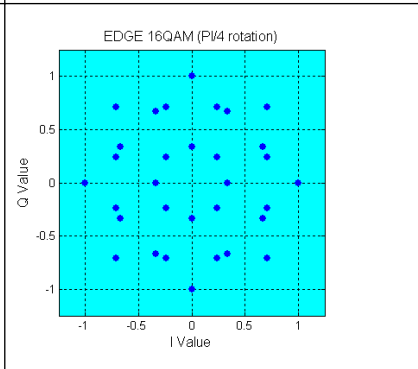
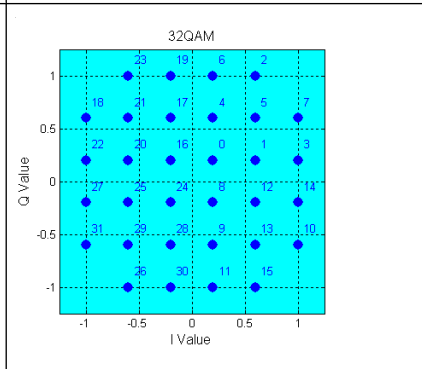
<p><b>pi/4-QPSK</b> 2 bits per symbol pi/4rotation SOUR:BB:DM:FORM P4QP</p>	<p><b>pi/2-DBPSK</b> 1 bit per symbol Differential coding, pi/2 rotation SOUR:BB:DM:FORM P2DB</p>	<p><b>pi/4-DQPSK</b> 2 bits per symbol Differential coding, pi/4 rotation SOUR:BB:DM:FORM P4DQ</p>
		
<p><b>pi/8-D8PSK</b> 3 bits per symbol Differential coding, pi/8 rotation SOUR:BB:DM:FORM P8D8</p>	<p><b>8PSK</b> 3 bits per symbol SOUR:BB:DM:FORM PSK8</p>	<p><b>8PSK EDGE (3pi/8 8PSK)</b> 3 bits per symbol Edge coding, 3pi/8 rotation SOUR:BB:DM:FORM P8ED</p>
		
<p><b>QAM</b></p>		
<p><b>16QAM</b> 4 bits per symbol SOUR:BB:DM:FORM QAM16</p>	<p><b>16QAM EDGE</b> 4 bits per symbol, pi/4 rotation SOUR:BB:DM:FORM QAM16EDGE</p>	<p><b>32QAM</b> 5 bits per symbol SOUR:BB:DM:FORM QAM32</p>
		

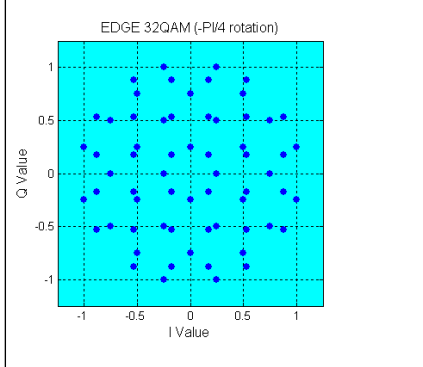
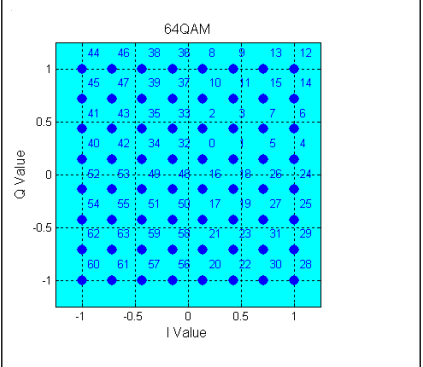
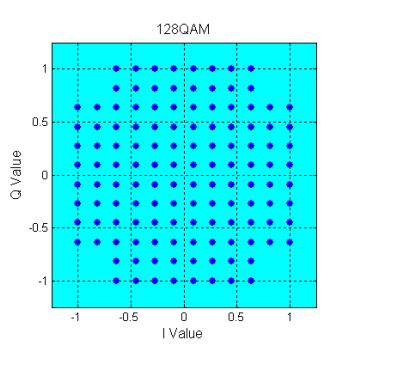
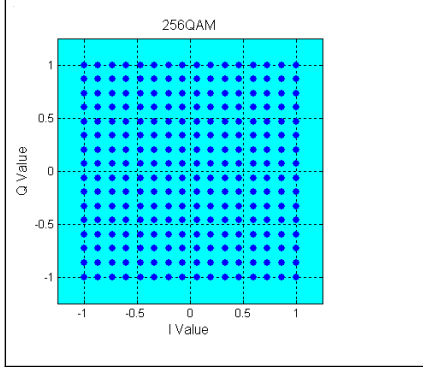
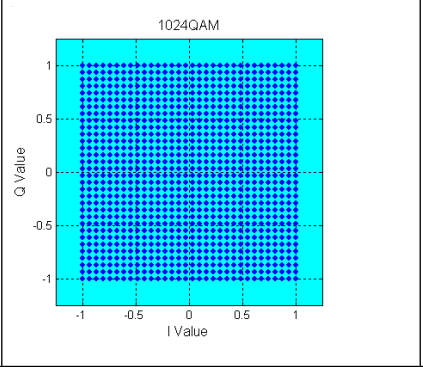
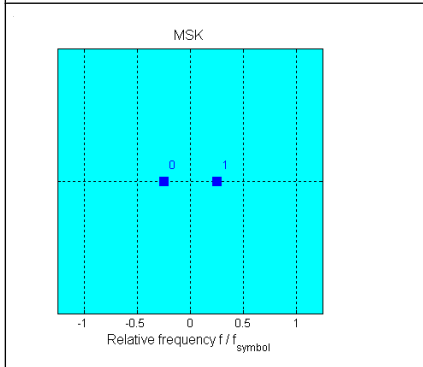
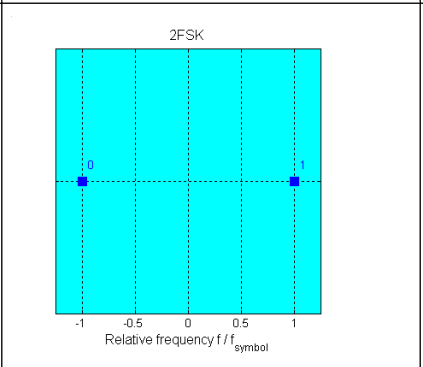
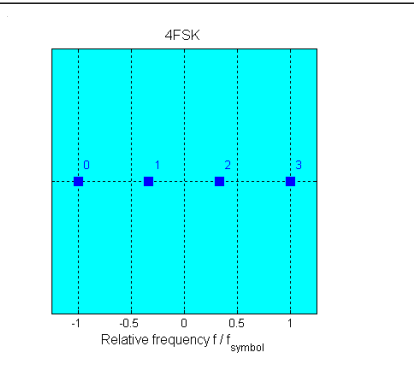
<p><b>32QAM EDGE</b> 5 bits per symbol, <math>-\pi/4</math> rotation SOUR:BB:DM:FORM QAM32Edge</p> 	<p><b>64QAM</b> 6 bits per symbol SOUR:BB:DM:FORM QAM64</p> 	<p><b>128QAM</b> 7 bits per symbol SOUR:BB:DM:FORM QAM128</p> 
<p><b>256QAM</b> 8 bits per symbol SOUR:BB:DM:FORM QAM256</p> 	<p><b>1024QAM</b> 10 bits per symbol SOUR:BB:DM:FORM QAM1024</p> 	
<p><b>FSK</b></p>		
<p><b>MSK</b> 1 bit per symbol, FSK deviation SOUR:BB:DM:FORM MSK SOUR:BB:DM:FSK:DEV 0.1 MHz</p> 	<p><b>2FSK</b> 1 bit per symbol SOUR:BB:DM:FORM FSK2</p> 	<p><b>4FSK</b> 2 bit per symbol SOUR:BB:DM:FORM FSK4</p> 

In addition to the FSK modulations, a variable FSK modulation with definable deviation per symbol is available.

[ :SOURce<hw> ] :BB:DM:FORMat on page 598

### User Mapping

A user defined modulation mapping file can also be selected as modulation mapping source. The user modulation mapping file must have extension \*.vam and can be created with the R&S mapping wizard. The mapping wizard (mapwiz) is a tool from Rohde & Schwarz designed for editing modulation schemes (e.g. QPSK, 32QAM). Its main purpose is the assignment of logical symbol numbers to constellation points and the selection of modulation specific parameters. Beyond this it supports the creation of nearly any arbitrarily chosen constellation diagram. The output of mapwiz is a mapping file (\*.vam) that can be imported on a R&S SMJ. The program was developed on a 32-bit Microsoft Windows platform under MATLAB. For more information, refer to the description "Introduction to "mapwiz" Mapping Editor" on the Rohde&Schwarz Internet page.

#### 5.8.2.3 Coding - Custom Digital Mod

Modulation symbols are coded directly before I and Q values or frequency shifts are assigned. Coding is thus directly related to modulation methods, which is the reason why codings are not freely combinable with modulation methods. The following table shows which of the coding combinations are available and defines the modulation types for which the various coding procedures can be used.

In the notation used below  $a_n$  denotes the n-th input symbol and  $b_n$  denotes the correspondingly coded output symbol. Individual bits in the symbols from the LSB (least significant bit) to the MSB (most significant bit) are denoted by  $a_{0n}$ ,  $a_{1n}$  and so on. The same applies to the output symbols.

Table 5-4: Permissible coding combinations for modulation symbols and modulation type

	OFF	Differential	Phase Diff.	Diff. +Gray	Gray	GSM	NADC, PDC, PHS, TETRA, APCO25 (PSK), PWT	TFTS/ TETRA	INMARSAT, ICO, WCDMA, cdma2000	VDL	APCO25 (FSK)	APCO25 (8PSK)
ASK	X	X		X	X							
BPSK	X	X		X	X							
$\pi/2$ DBPSK	X				X							
QPSK	X	X		X	X				X			
QPSK EDGE	X											
QPSK45° Offset	X	X		X	X							
$\pi/4$ QPSK	X	X			X							
$\pi/4$ DQPSK	X				X		X	X				
8PSK	X	X		X	X					X		
AQPSK	X	X		X	X							

	OFF	Differ- ential	Phase Diff.	Diff. +Gray	Gray	GSM	NADC, PDC, PHS, TETRA, APCO25 (PSK), PWT	TFTS/ TETRA	INMARSAT, ICO, WCDMA, cdma2000	VDL	APCO25 (FSK)	APCO25 (8PSK)
OQPSK	X	X		X	X							
8PSK_EDGE	X											
PI/8 D8PSK	X				X							X
MSK	X	X		X	X	X						
2FSK	X	X		X	X	X						
4FSK	X	X		X	X						X	
8FSK	X	X		X	X							
16FSK	X	X		X	X							
16QAM	X	X	X	X	X							
16QAM EDGE	X											
32QAM	X	X	X	X	X							
32QAM EDGE	X											
64QAM	X	X	X	X	X							
128QAM	X	X	X	X	X							
256QAM	X	X	X	X	X							
1024QAM	X	X	X	X	X							

### Modulation type pi/4DQPSK

With differential coding switched on at the same time, a constellation diagram is obtained for pi/4DQPSK which is similar to that obtained for 8PSK. Phase shifts are however assigned to the individual modulation symbols. The following tables show the assignment of modulation symbols to phase shifts of the I/Q vector in relation to the selected coding.

**Table 5-5: Phase shifts for pi/4DQPSK**

Modulation symbol $a_n$ (binary indication: MSB, LSB)	00	01	10	11
Phase shifts without coding	+ 45°	+ 135°	- 135°	- 45°
Phase shifts with coding NADC, PDC, PHS, TETRA or APCO25 (PSK)	+ 45°	+ 135°	- 45°	- 135°
Phase shifts with coding TFTS	- 135°	+ 135°	- 45°	+ 45°

### Coding algorithms

Common coding types are listed in the following table.

Table 5-6: Coding algorithms

Coding	Coding algorithm	Applicable for K bit/symbol
NONE	$b_n = a_n$	$k = 1 \dots 8$
Differential	$b_n = (a_n + b_{n-1}) \text{ modulo } 2^k$	$k = 1 \dots 7$
Differential + Gray	Gray coding with additional differential coding	$k = 1 \dots 7$
GSM	$dc_n = \text{not}(d_n \text{ exor } d_{n-1})$	$k = 1$

**Example: Differential coding for QPSK modulation with K = 2 bit/symbol**

Decimal display; value range for modulation symbols

$$a_n \in \{0; 1; 2; 3\}$$

Recursive coding is defined as follows:  $b_n = (a_n + b_{n-1}) \text{ modulo } 4$

Depending on the state of a preceding modulation symbol  $b_{n-1}$  the coded modulation symbol  $b_n$  is obtained for example from modulation symbol  $a_n = 2$  as follows:

$a_n = 2$	$b_{n-1}$	$b_n$
	0	2
	1	3
	2	0
	3	1

By means of differential coding, the assignment between modulation symbols and phase differences shown in the following table is generated:

Modulation symbol $a_n$ (binary, MSB, LSB)	00	01	10	11
Phase difference	$0^\circ$	$90^\circ$	$180^\circ$	$270^\circ$

**Example: Gray and differential coding for 8PSK modulation**

First, a gray coding is performed according to the gray code. Afterwards, a differential coding is performed according to the recursive coding algorithm quoted above. The assignment between modulation symbols and phase differences shown in the following table is generated:

"Differential coding according to VDL" can be used for modulation types with 3 bits/symbol, e.g. 8PSK.

**Table 5-7: Differential coding according to VDL**

Modulation symbol $d_n$ (binary, MSB, LSB)	000	001	010	011	100	101	110	111
Phase difference	0°	45°	135°	90°	315°	270°	180°	225°

"Phase differential coding" INMARSAT and PHASE DIFF correspond to system standards Inmarsat-M and DVB according to ETS 300 429. The INMARSAT coding can generally be used for modulation types with 2 bits/symbol, such as QPSK. It uses the following algorithm.

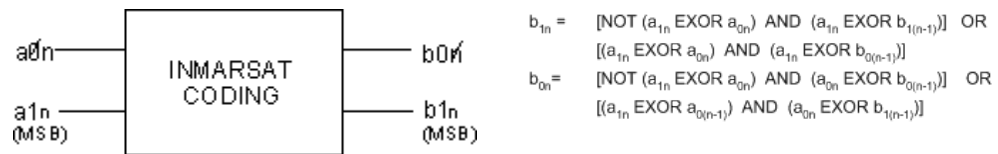
**5.8.2.4 Baseband Filter - Custom Digital Mod**

The R&S SMJ offers a wide selection of predefined baseband filters. The filter characteristic for the selected filter is displayed in the "More..." submenu in the "Filter" menu section (see "Filter" on page 333). Additionally, a user defined filter can be selected (see "User filter" on page 322).

The following table shows the filters that are available, together with the associated parameters and IEC bus commands. The filter characteristic is displayed in graphical form.

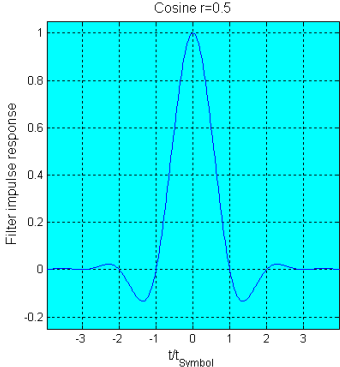
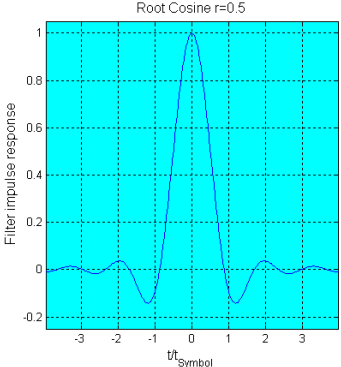
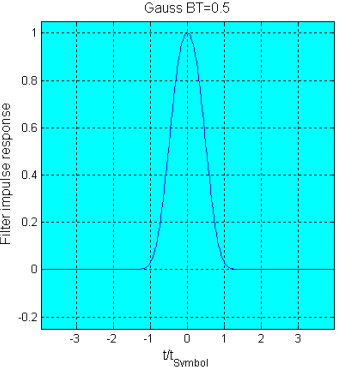
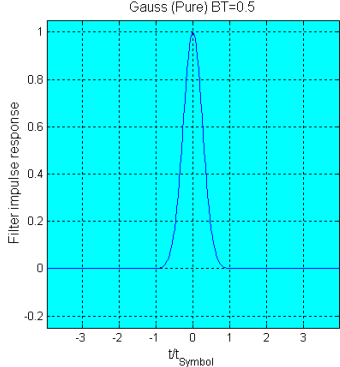
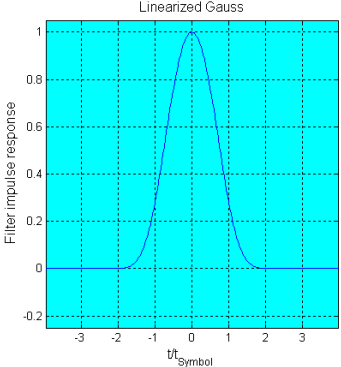
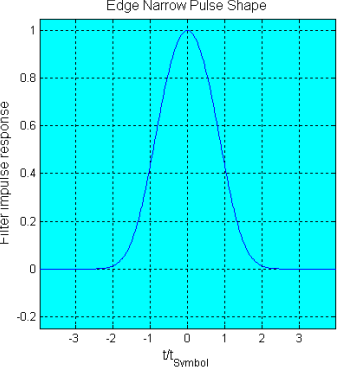

Table 5-8: Baseband filter

<p>Cosine Roll Off Factor SOUR:BB:DM:FILT:TYPE COS SOUR:BB:DM:FILT:PAR:COS 0.99 Bandwidth SOUR:BB:DM:FILT:PAR:COS:BAND 7200</p>	<p>Root Cosine Roll Off Factor SOUR:BB:DM:FILT:TYPE RCOS SOUR:BB:DM:FILT:PAR:RCOS 0.99</p>	<p>Gauss (FSK) B x T SOUR:BB:DM:FILT:TYPE GAUS SOUR:BB:DM:FILT:PAR:GAUS 2.5</p>
		
<p>Pure Gauss B x T SOUR:BB:DM:FILT:TYPE PGA SOUR:BB:DM:FILT:PAR:PGA 2.5</p>	<p>Gauss Linearized SOUR:BB:DM:FILT:TYPE LGA</p>	<p>Edge Narrow Pulse Shape SOUR:BB:DM:FILT:TYPE ENPShape</p>
		
<p>Edge Wide Pulse Shape SOUR:BB:DM:FILT:TYPE EWPShape</p>	<p>cdmaOne SOUR:BB:DM:FILT:TYPE CONE</p>	<p>cdmaOne 705 kHz SOUR:BB:DM:FILT:TYPE COF705</p>

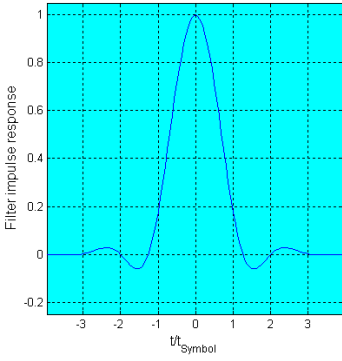
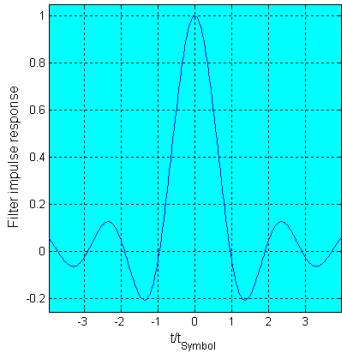
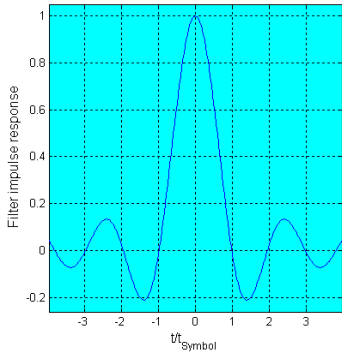
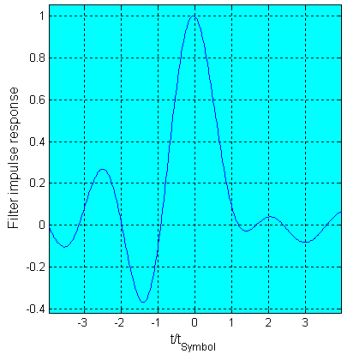
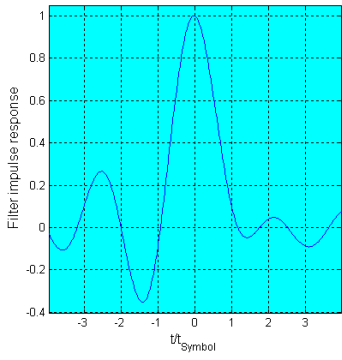
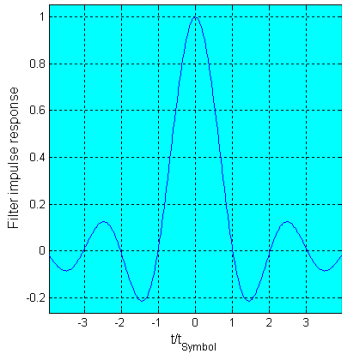
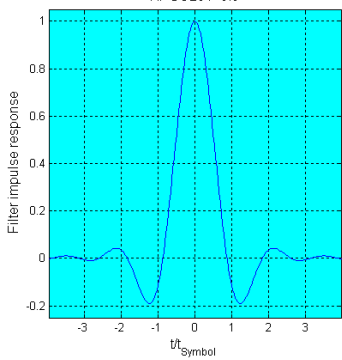
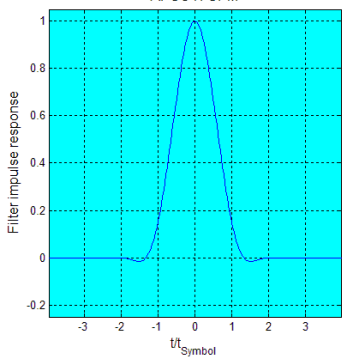
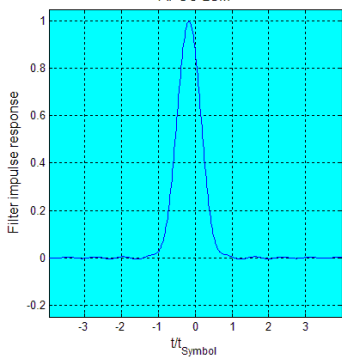
<p>Edge Wide Pulse Shape</p> 	<p>CdmaOne</p> 	<p>CdmaOne 705kHz</p> 
<p>cdmaOne + Equalizer SOUR:BB:DM:FILT:TYPE COE</p>	<p>cdmaOne 705 kHz + Equalizer SOUR:BB:DM:FILT:TYPE COFE228</p>	<p>cdma2000 3X SOUR:BB:DM:FILT:TYPE DM3x</p>
<p>CdmaOne with equalizer</p> 	<p>CdmaOne 705 kHz with equalizer</p> 	<p>Cdma2000 3X</p> 
<p>APCO25 Roll Off Factor SOUR:BB:DM:FILT:TYPE APCO25 SOUR:BB:DM:FILT:PAR:APC 0.5</p>	<p>APCO25 (H-CPM) SOUR:BB:DM:FILT:TYPE APCO25Hcpm</p>	<p>APCO25 (LSM) SOUR:BB:DM:FILT:TYPE APCO25Lsm Gauss Cut Off Frequency SOUR:BB:DM:FILT:PAR:APCO25L:GAUSS 25000 Gauss Cut Off Frequency SOUR:BB:DM:FILT:PAR:APCO25:LOWP 75000</p>
<p>APCO25 r=0.5</p> 	<p>APCO H-CPM</p> 	<p>APCO LSM</p> 

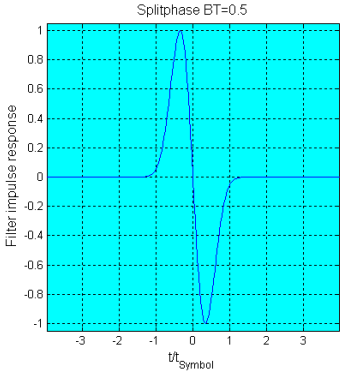
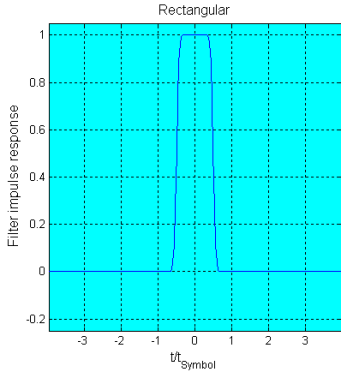
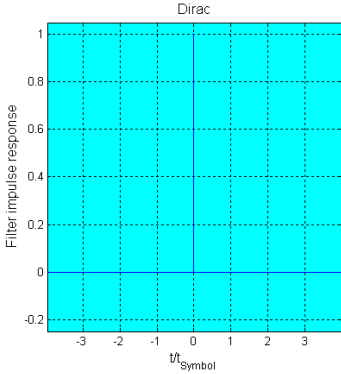
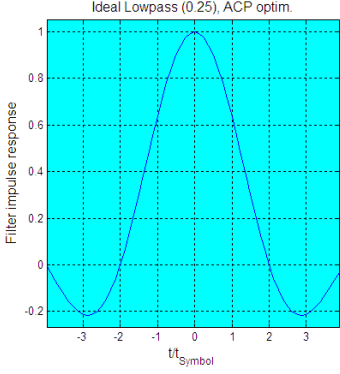
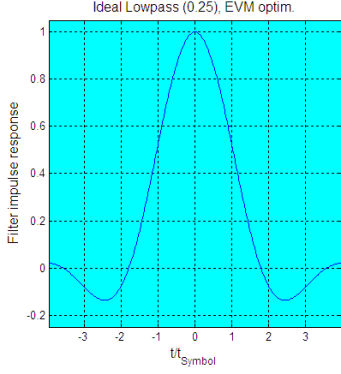
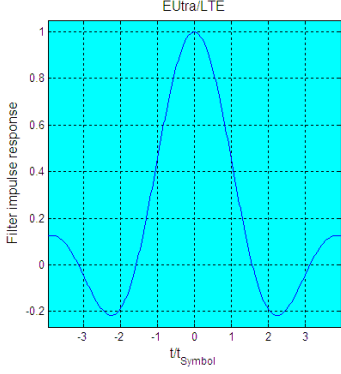
<p><b>Split Phase</b>  <b>BxT</b>  SOUR:BB:DM:FILT:TYPE SPH  SOUR:BB:DM:FILT:PAR:SPH 0.15</p>	<p><b>Rectangular</b>  SOUR:BB:DM:FILT:TYPE RECT</p>	<p><b>Dirac</b>  SOUR:BB:DM:FILT:TYPE DIRac</p>
		
<p><b>Lowpass ACP opt.</b>  SOUR:BB:DM:FILT:TYPE LPASs  SOUR:BB:DM:FILT:PAR:LAPS 0.5</p>	<p><b>Lowpass EVM opt.</b>  BB:DM:FILT:TYPE LPASSEVM  BB:DM:FILT:PAR:LAPSEVM 0.5</p>	<p><b>EUTRA/LTE</b>  SOUR:BB:DM:FILT:TYPE LTEFilter</p>
		

### User filter

The user filter file must have extension `*.vaf` and can be created with the R&S filter wizard.

The filter wizard (filtwiz) is a tool from Rohde & Schwarz designed for creating filter files that can be imported on a R&S SMJ. Its main purpose is the conversion of user-defined finite impulse response (FIR) filters into the filter format (`*.vaf`). Beyond this filt wiz provides designs for standard filters, e.g. Root Raised Cosine, Gaussian.

The program was developed on a 32-bit Microsoft Windows platform under MATLAB.

For more information, refer to the description "Introduction to "filtwiz" Filter Editor" on the Rohde&Schwarz Internet page.

### 5.8.2.5 Conflicting Settings - Custom Digital Mod

Having selected a modulation procedure, not every combination is possible when selecting the settings for the modulation parameters "Symbol Rate" and "Coding". These restrictions inevitably give rise to conflicting settings if a parameter is changed and leads to a prohibited combination.

A conflicting setting is indicated by a message on the Info line in the display. The R&S SMJ displays the setting entered by the user, but the modulation signal actually generated does not correspond to this display. A conflict of settings can be triggered if the user changes a parameter inappropriately. The message disappears as soon as a conflict-free setting is entered.

A list of the possible settings conflicts and messages in digital modulation can be found in [chapter 9, "Error Messages"](#), on page 747.

### 5.8.2.6 Custom Digital Mod User Interface

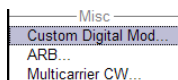

The menu for setting digital modulation can be opened either in the "Baseband" block or in the menu tree under "Baseband".

The "Custom Digital Modulation" menu enables direct selection of the data source, standard, symbol rate, coding, modulation type and filter. All other settings are entered in submenus which are called via "More" buttons.

The upper part of the menu is used for powering up digital modulation as well as for calling the default settings and user-defined standards.



The data source is selected and set in the "Data Source" section.

The "List Management" button opens a submenu for calling the data editor and the file manager.

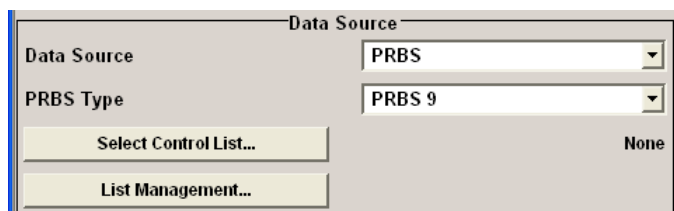

The middle part of the menu is used for selecting the standard, the symbol rate and the coding.

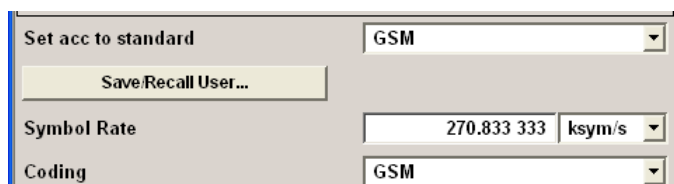

The modulation type is set in the "Modulation" section.

The "More" button opens a submenu that displays the mapping for the selected modulation.

This submenu can also be used to enable switching the signal between modulated and unmodulated.

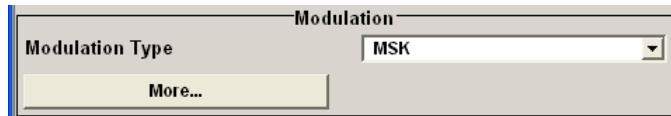

The filter is set in the "Filter" section. The "More" button opens a submenu where the filter characteristic of the selected filter is displayed.

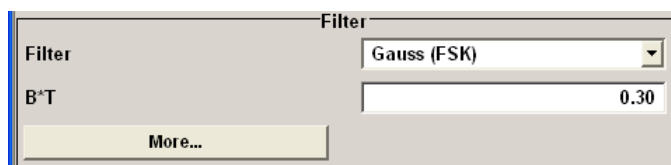

The buttons in the lower part of the menu open submenus for power ramping and for configuring triggers, markers and clocks.

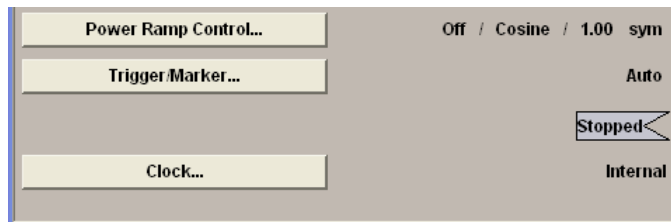

In each case the current setting is displayed next to the button.

### General Settings

The upper part of the menu is used for powering up digital modulation as well as for calling the default settings and user-defined standards.

#### State - Digital Modulation

Enables/disables digital modulation.

Switching on digital modulation turns off all the other digital standards.

The digital modulation is generated in realtime (no precalculated signal), and therefore all parameter changes (in the ON state) directly affect the output signal.

SCPI command:

[\[:SOURce<hw>\]:BB:DM:STATe](#) on page 583

#### Set To Default - Digital Modulation

Calls default settings. The values are shown in the following table.

Parameter	Value
State	Not affected by Set to Default
Data Source	PRBS 9
Standard	GSM
Symbol Rate	270.833 ksymb/s
Coding	GSM
Modulation Type	MSK
Filter	Gauss (FSK)
Filter Parameter BxT	0.3
<b>Power Ramp Control</b>	
Attenuation	15 dB
Ramp Time	1 sym
Ramp Function	Cosine
Fall Delay	0
Rise Delay	0
Source	Internal
State	Off
<b>Trigger</b>	Mode Auto, Source Internal
<b>Clock</b>	
Source	Internal
Mode	Symbol

SCPI command:

[ :SOURce<hw> ] :BB:DM:PRESet on page 582

### Save/Recall - Digital Modulation

Calls the "Save/Recall" dialog.

From the "Save/Recall" dialog the "File Select" windows for saving and recalling the complete settings in the "Custom Digital Modulation" menu can be called.

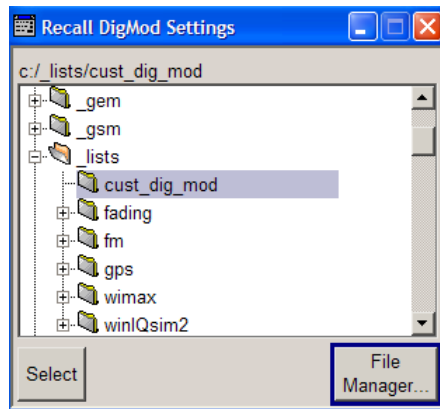

The Digital Modulation Settings are stored as files with the predefined file extension \* .dm. The file name and the directory they are stored in are user-definable.

The complete settings in the "Custom Digital Modulation" dialog are saved and recalled.

SCPI command:

[\[:SOURce<hw>\]:BB:DM:SETTing:CATalog](#) on page 612

[\[:SOURce<hw>\]:BB:DM:SETTing:DELeTe](#) on page 612

[\[:SOURce<hw>\]:BB:DM:SETTing:LOAD](#) on page 613

[\[:SOURce<hw>\]:BB:DM:SETTing:STORe](#) on page 613

### Fast Save

Determines whether the instrument performs an absolute or a differential storing of the settings.

Enable this function to accelerate the saving process by saving only the settings with values different to the default ones.

**Note:** This function is not affected by the "Preset" function.

SCPI command:

[\[:SOURce<hw>\]:BB:DM:SETTing:STORe:FAST](#) on page 613

[\[:SOURce<hw>\]:BB:ARB:MCARrier:SETTing:STORe:FAST](#) on page 564

refer to the description of firmware options for the syntax of the corresponding SCPI commands

### Data Source

The data source is selected and set in the "Data Source" section. The parameters offered depend on the data source selected. The More button opens a submenu for calling the data editor and the file manager.

#### Data Source - Digital Modulation

Selects the data source (see [chapter 5.8.1, "Data and Signal Sources in Baseband"](#), on page 302).

You may choose from the following data sources:

"All 0, All 1"      0 data or 1 data is internally generated.

"PRBS, PRBS Type" PRBS data in accordance with the IUT-T with period lengths between 29-1 and 223-1 are internally generated. The length is selected in the "PRBS Type" input box.



SCPI command:

[ :SOURce<hw> ] :BB:DM:PRBS [ :LENGth ] on page 581

"Pattern" A user-definable bit pattern with a maximum length of 64 bits is internally generated. The bit pattern is defined in the "Pattern" input box.

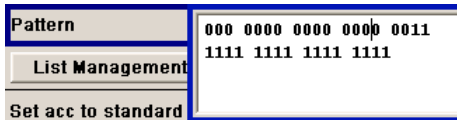

"Data List ..., Select Data" Data lists will be used. Data lists can be generated internally in the data editor or externally. Data lists are selected in the "File Select" window, which is called by means of the "Select Data" button.



The "File" "Manager" is used to transmit external data lists to the R&S Signal Generator, and can be called within every "File" Select window by means of the "File" "Manager" button.

SCPI command:

[ :SOURce<hw> ] :BB:DM:DLISt:SElect on page 609

"External Serial" External serial data is supplied via the DATA connector.

"External Parallel (AUX I/O)" External parallel data is supplied externally via the PARADATA pins on the AUX I/O interface.

SCPI command:

[ :SOURce<hw> ] :BB:DM:SOURce on page 582

**List Management - Digital Modulation**

Calls the menu for managing data and control lists (see "List Management" on page 335).

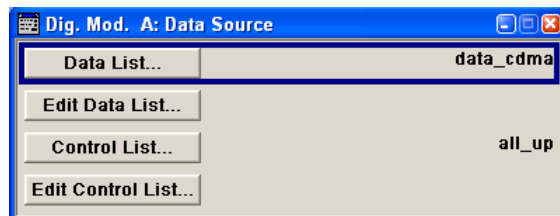

SCPI command:

n.a.



### Standard, Symbol Rate, Coding

The middle part of the menu is used for selecting the standard, the symbol rate and the coding.

### Set acc. to Standard - Digital Modulation

Selects a standard.

After selection, modulation parameters "Modulation Type", "Symbol Rate", "Filter" and "Coding" are automatically set in accordance with the standard.

If one of these parameters is subsequently altered, the display changes to User. The User setting can be saved to a file so that it can be recalled at some later time ("Save/Recall User.." button).

The following table shows the standards that are available, together with the associated settings of the modulation parameters.

**Table 5-9: Standards - Custom Digital Modulation**

Standard	Modulation	Symbol Rate	Filter	Coding	Parameter for SCPI command
APCO Phase1 C4FM	4FSK, Deviation 1.8 KHz	4.8 ksym/s	APCO25, roll off = 0.2	APCO25(FSK)	APCOPH1C4fm
APCO Phase1 CQPSK	pi/4-DQPSK	4.8 ksym/s	Cosine, roll off = 0.2, BW = 4.8 KHz	APCO25(PSK)	APCOPH1CQpsk
APCO Phase2 H-CPM	4FSK, Deviation 3 KHz	6 ksym/s	APCO25 (H-CPM)	APCO25(FSK)	APCOPH2HCpm
APCO Phase2 H-DQPSK	pi/4-DQPSK	6 ksym/s	Cosine, roll off = 1, BW = 7.2 KHz	APCO25(PSK)	APCOPH2HDQpsk
APCO Phase2 H-D8PSK Wide	pi/8-D8PSK	4 ksym/s	Cosine, roll off = 1, BW = 7.2 KHz	APCO25(8PSK)	APCOPH2HD8PSKW
APCO Phase2 H-D8PSK Narrow	pi/8-D8PSK	4 ksym/s	Cosine, roll off = 1, BW = 5 KHz	APCO25(8PSK)	APCOPH2HD8PSKN
APCO Phase1 LSM	pi/4-DQPSK	4.8 ksym/s	APCO25 (LSM), Gauss Cut Off = 2.04 KHz, Low-pass Cut Off = 6.2 KHz	APCO25(8FSK)	APCOPH1Lsm
APCO Phase1 WCQPSK	pi/4-DQPSK	4.8 ksym/s	Cosine, roll off = 1, BW = 7.2 KHz	APCO25(8FSK)	APCOPH1Wcqpsk
Bluetooth	2FSK, Deviation 160.0 kHz	1.0 Msym/s	Gauss, B*T = 0.5	OFF	BLUetooth
DECT	2FSK, Deviation 288.0 kHz	1.152 Msym/s	Gauss, B*T = 0.5	OFF	DECT
ETC (ARIB STD T55)	ASK, ASK Depth 100%	1.024 Msym/s	Split Phase, B*T = 2.0	OFF	ETC
GSM	MSK	270.833333 ksym/s	Gauss, B*T = 0.3	GSM	GSM
GSM EDGE	8PSK EDGE (3pi/8 8PSK)	270.833333 ksym/s	Gauss linear	OFF	GSMEdge
NADC	pi/4 DQPSK	24.3 ksym/s	Root Cosine, alpha = 0.35	NADC	NADC

Standard	Modulation	Symbol Rate	Filter	Coding	Parameter for SCPI command
PDC	pi/4 DQPSK	21.0 ksym/s	Root Cosine, alpha = 0.50	PDC	PDC
PHS	pi/4 DQPSK	192.0 ksym/s	Root Cosine, alpha = 0.50	PHS	PHS
TETRA	pi/4 DQPSK	18.0 ksym/s	Root Cosine, alpha = 0.35	TETRA	TETRA
WCDMA 3GPP	QPSK 45° Offset	3.84 Msym/s	Root Cosine, alpha = 0.22	WCDMA 3GPP	W3GPP
TD-SCDMA	QPSK 45° Offset	1.28 Msym/s	Root Cosine, alpha = 0.22	OFF	TCSCdma
cdma2000 Forward	QPSK	1.2288 Msym/s	cdmaOne + Equalizer	cdma2000	CFORward
cdma2000 Reverse	Offset QPSK	1.2288 Msym/s	cdmaOne	cdma2000	CREVerse
Worldspace	QPSK	1.84 Msym/s	Root Cosine, alpha = 0.40	OFF	WORLdspace
TFTS	pi/4 DQPSK	22.1 ksym/s	Root Cosine, alpha = 0.40	TFTS/ TETRA	TFTS

SCPI command:

[\[:SOURCE<hw>\]:BB:DM:STANDARD](#) on page 583

### Save/Recall User - Digital Modulation

Calls the "Save/Recall User" menu.

From the "Save/Recall User Standard" menu the "File Select" windows for saving and recalling user-defined standards and the "File Manager" can be called.



User standards are stored as files with the predefined file extension \*.dm\_stu. The file name and the directory they are stored in are user-definable.

SCPI command:

[\[:SOURCE<hw>\]:BB:DM:STANDARD:ULIST:CATALOG](#) on page 613

[\[:SOURCE<hw>\]:BB:DM:STANDARD:ULIST:DELETE](#) on page 614

[\[:SOURCE<hw>\]:BB:DM:STANDARD:ULIST:LOAD](#) on page 614

[\[:SOURCE<hw>\]:BB:DM:STANDARD:ULIST:STORE](#) on page 614

### Symbol Rate - Digital Modulation

Selects the symbol rate.

The value range is dependent on the selected modulation type.

When the modulation type changes, the range is automatically redefined. If the set symbol rate is outside this range, an error message is generated and the maximum value for the newly chosen modulation type is automatically set.

SCPI command:

[\[:SOURCE<hw>\]:BB:DM:SRATE](#) on page 583

### Coding - Digital Modulation

Selects the coding (see [chapter 5.8.2.3, "Coding - Custom Digital Mod"](#), on page 316).

The menu offers only the coding settings that are permissible for the chosen modulation type. The other coding methods are grayed out.

If the system is subsequently switched to a modulation type for which the selected coding is not available, coding is automatically set to OFF.

SCPI command:

[ :SOURce<hw> ] :BB:DM:CODing on page 598

### Modulation

The modulation type is set in the "Modulation section". The parameters offered depend on what is currently selected. The "More..." button opens a submenu for displaying the user-defined mapping.

#### Modulation Type - Digital Modulation

Selects a modulation type.

The associated symbol mapping is displayed in the "More..." submenu (see [chapter 5.8.2.2, "Modulation Types - Custom Digital Mod"](#), on page 312).

If the "coding" that is set is not possible with the chosen modulation type, "coding" is set to "Off".

For selection "Variable FSK", the deviation of each symbol can be set in the "More..." submenu.

SCPI command:

[ :SOURce<hw> ] :BB:DM:FORMat on page 598

#### Load User Mapping - Digital Modulation

Selects user defined mapping table. This opens the "Select List File User Mapping" window in which the mapping table can be selected (see ["User Mapping"](#) on page 316). The button is only available if modulation type "USER" is selected.

The button "File Manager" calls the "File Manager" menu. The "File" "Manager" menu is used to display and delete files.

SCPI command:

[ :SOURce<hw> ] :BB:DM:MLISt:SElect on page 612

[ :SOURce<hw> ] :BB:DM:MLISt:CATalog on page 604

[ :SOURce<hw> ] :BB:DM:MLISt:DElete on page 611

#### ASK Depth - Digital Modulation

Sets the modulation depth  $m$  for ASK modulation.

$$m = (\text{Amplitude}_{\max} - \text{Amplitude}_{\min}) / (\text{Amplitude}_{\max} + \text{Amplitude}_{\min})$$

SCPI command:

[ :SOURce<hw> ] :BB:DM:ASK:DEPTh on page 597

#### FSK Deviation - Digital Modulation

Sets the frequency deviation for FSK modulation. The range of values depends on the chosen symbol rate (see data sheet).

Whenever "MSK" is selected, the deviation corresponds to 1/4 of the symbol rate and cannot be set.

SCPI command:

[\[:SOURce<hw>\]:BB:DM:FSK:DEVIation](#) on page 599

### Angle Alpha

For AQPSK modulation, sets the angle alpha between the point (0,0) and the I axis.

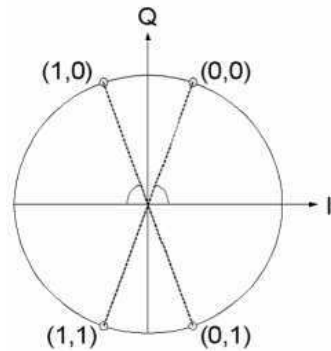

SCPI command:

[\[:SOURce<hw>\]:BB:DM:AQPSk:ANGLE](#) on page 597

### More - Modulation Type - Digital Modulation

Calls the submenu which displays the mapping of the currently selected modulation type and the digital modulation delay in the case of an external data source.

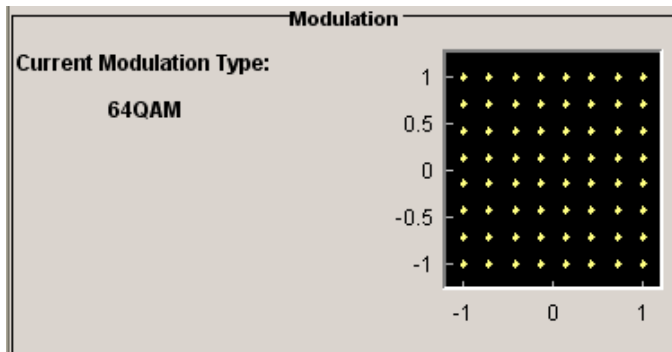

The "Modulation - CW Switching" section can be used to enable switching of the signal between modulated and unmodulated.

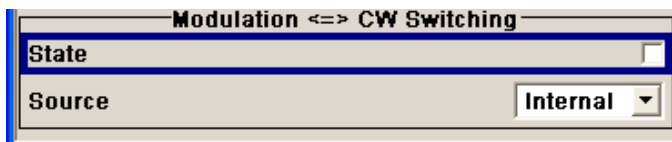

In case of selection "Variable FSK", the FSK type and the deviation for each symbols is set in the "Variable FSK" section.

Variable FSK	
FSK Type	4FSK
Deviation 0000	-135.416 5 kHz
Deviation 0001	45.138 8 kHz
Deviation 0010	45.138 8 kHz
Deviation 0011	135.416 5 kHz

### FSK Type - Digital Modulation

(Variable FSK only)

Selects the FSK modulation type for selection "Variable FSK".

You may choose from 4FSK, 8FSK and 16FSK.

SCPI command:

[\[:SOURce<hw>\]:BB:DM:FSK:VARiable:TYPE](#) on page 599

### Deviation xxxx - Digital Modulation

(Variable FSK only)

Set the deviation of the associated symbol. The number of symbols depends on the selected modulation type. The value of each symbol is indicated in binary format.

SCPI command:

[\[:SOURce<hw>\]:BB:DM:FSK:VARiable:SYMBOL<ch>:DEVIation](#) on page 599

### Modulation Delay - Digital Modulation

(Data Source ext serial and ext parallel only)

Displays the digital modulation delay from the data input to the I/Q output.

The value is displayed only if an external synchronous data source is selected. In this case the value represents the delay between the active clock edge for data and the corresponding peak I/Q value (associated with this data item) on the I/Q connectors.

SCPI command:

[\[:SOURce<hw>\]:BB:DM:MDELay](#) on page 600

### Current Modulation Type - Digital Modulation

Displays the currently selected modulation type together with its associated mapping.

SCPI command:

n.a.

### Modulation - CW Switching

The "Modulation <=> CW Switching" section is used to enable switching the signal between modulated and unmodulated.

### State Mod - CW - Digital Modulation

Enables switching between a modulated and an unmodulated signal.

Switching is carried out by a control signal (CW) that is defined internally in the control list or supplied from an external source via a user-defined input.

SCPI command:

`[ :SOURce<hw> ] :BB:DM:SWITching:STATe` on page 584

#### Source Mod - CW - Digital Modulation

Selects the CW control signal for switching between a modulated and an unmodulated signal.

"Internal" The CW signal in the control list is used for the control.  
The internal signal can be output on one of the user interfaces.

"External" The control signal on the CW pin of the AUX I/O connector is used.

SCPI command:

`[ :SOURce<hw> ] :BB:DM:SWITching:SOURce` on page 584

#### Filter

The filter is set in the Filter section.

#### Filter - Digital Modulation

Selects the baseband filter (see [chapter 5.8.2.4, "Baseband Filter - Custom Digital Mod"](#), on page 319).

SCPI command:

`[ :SOURce<hw> ] :BB:DM:FILTer:TYPE` on page 596

#### Filter Parameter - Digital Modulation

Sets the filter parameter.

The filter parameter offered ("Roll Off Factor" or "B x T") depends on the currently selected filter type.

SCPI command:

`[ :SOURce<hw> ] :BB:DM:FILTer:PARAmeter:APCO25` on page 595

`[ :SOURce<hw> ] :BB:DM:FILTer:PARAmeter:COSSine [ :ROLLoff ]` on page 595

`[ :SOURce<hw> ] :BB:DM:FILTer:PARAmeter:GAUSSs` on page 595

`[ :SOURce<hw> ] :BB:DM:FILTer:PARAmeter:PGAuss` on page 595

`[ :SOURce<hw> ] :BB:DM:FILTer:PARAmeter:RCOSSine` on page 595

`[ :SOURce<hw> ] :BB:DM:FILTer:PARAmeter:SPHase` on page 595

#### Cut Off Frequency Factor - Digital Modulation

(available for filter parameter Lowpass and APCO25 (LSM) only)

Sets the value for the cut off frequency factor. The cut off frequency of the filter can be adjusted to reach spectrum mask requirements.

SCPI command:

`[ :SOURce<hw> ] :BB:DM:FILTer:PARAmeter:LPASSs` on page 595

`[ :SOURce<hw> ] :BB:DM:FILTer:PARAmeter:LPASSEVM` on page 595

`[ :SOURce<hw> ] :BB:DM:FILTer:PARAmeter:APCO25Lsm:GAUSSs` on page 596

`[ :SOURce<hw> ] :BB:DM:FILTer:PARAmeter:APCO25Lsm:LOWPass` on page 596

**Bandwidth - Digital Modulation**

Determines the bandwidth of the cosine filter, so that the function  $H(f) = 0$  is fulfilled for  $f \geq (1 + \text{RollOff}) * \text{Bandwidth} / 2$ .

SCPI command:

`[ :SOURce<hw> ] :BB:DM:FILTer:PARAmeter:COSSine:BANDwidth` on page 596

**Oversampling - Digital Modulation**

Determines the upsampling factor. If the check box is activated, the most sensible parameter values are selected. The value depends on the coherence check. If the check box is deactivated, the values can be changed manually.

SCPI command:

`[ :SOURce<hw> ] :BB:DM:FILTer:OSAMpling:AUTO` on page 594

`[ :SOURce<hw> ] :BB:DM:FILTer:OSAMpling` on page 594

**More - Filter - Digital Modulation**

Calls the menu for displaying the filter characteristic of the currently selected filter.

**Load User Filter- Filter - Digital Modulation**

Calls the menu "Select List User Filter" for selecting a user-defined filter file with extension `*.vaf` (see "User filter" on page 322). The button is only available if filter type "USER" is selected.

The button "File" "Manager" calls the "File" "Manager" menu. The "File" "Manager" menu is used to display and delete files.

SCPI command:

`[ :SOURce<hw> ] :BB:DM:FLISt:SElect` on page 610

`[ :SOURce<hw> ] :BB:DM:FLISt:CATalog` on page 604

`[ :SOURce<hw> ] :BB:DM:FLISt:DElete` on page 610

**Current Filter Response**

Displays the filter characteristic of the currently selected filter.

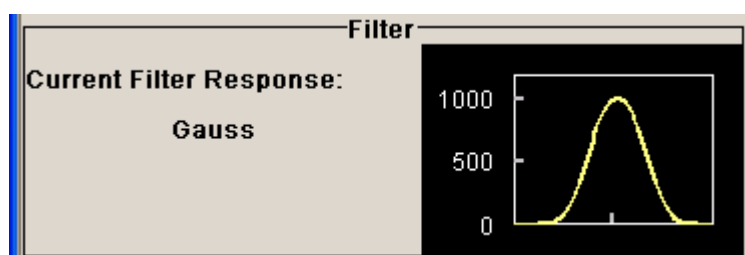

SCPI command:

n.a.

**Power Ramp**

The lower part of the Custom Digital Modulation menu is used for setting triggers, marker and clocks, as well as for power ramp settings.

**Power Ramp Control - Digital Modulation**

Calls the power ramp control menu (see ["Power Ramp Control"](#) on page 342).

SCPI command:  
n.a.

**Trigger/Marker - Digital Modulation**

Calls the "Trigger/Marker/Clock" dialog, used to select the trigger source, set the time delay on an external trigger signal and configure the marker output signals.

See ["Trigger/Marker/Clock"](#) on page 345.

SCPI command:  
n.a.

**Execute Trigger - Digital Modulation**

Executes trigger manually. A manual trigger can be executed only when an internal trigger source and a trigger mode other than Auto have been selected.

SCPI command:  
`[ :SOURce<hw> ] :BB:DM:TRIGger:EXECute` on page 587

**Clock - Digital Modulation**

Calls the "Trigger/Marker/Clock" menu. The "Trigger/Marker/Clock" menu is used to select the clock source (see ["Clock Settings"](#) on page 351).

SCPI command:  
n.a.

**List Management**

The "List Management" menu is called from the "Custom Digital Modulation" main menu.

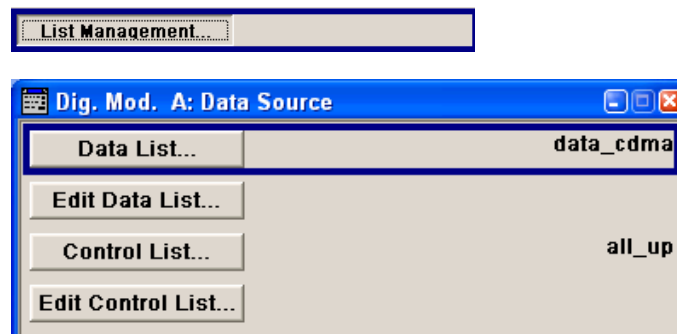

The data and control lists are selected and created in the "File Select" menu which is called up by means of the "Data List..." and "Control List..." buttons.



The "File Manager" is used to copy, rename and delete files and to create directories.

For more information, see [chapter 4.7, "File Management"](#), on page 106.



To ensure that the selected data or control list is used for generating the digital signal, the list must be selected as the data source:

Data	Parameter	Selection
Digital data	"Source"	DList
Marker	"Marker Mode"	CList
Control signals CW, Level Attenuation and Burst Gate	"Source"	Internal

The data editor is called using the "Edit Data List..." and "Edit Control List ..." buttons. The contents of the selected list are displayed.

Operating the list editors is described in [chapter 4.5.1, "Working with List Editor"](#), on page 97.

#### Select Data/Control List - Digital Modulation

Selects data/control list. This opens the "File Select" window in which the data/control list can be selected.

SCPI command:

[\[:SOURce<hw>\]:BB:DM:DLIST:SElect](#) on page 609

[\[:SOURce<hw>\]:BB:DM:CLIST:SElect](#) on page 607

#### Create Data/Control List - Digital Modulation

Creates new data/control list. This opens the "File Select" window in which the data/control list can be created.

The file name has to be entered in field "File Name:". The new list contains no data, it can be edited in the list editor.

SCPI command:

[\[:SOURce<hw>\]:BB:DM:DLIST:SElect](#) on page 609

[\[:SOURce<hw>\]:BB:DM:CLIST:SElect](#) on page 607

#### File Manager - Digital Modulation

Calls the "File Manager".

The "File Manager" is used to copy, delete and rename files and to create new directories.

For detailed description, see [chapter 4.7.2, "File Manager"](#), on page 109.

SCPI command:

[\[:SOURce<hw>\]:BB:DM:DLIST:SElect](#) on page 609

[\[:SOURce<hw>\]:BB:DM:DLIST:COpy](#) on page 605

[\[:SOURce<hw>\]:BB:DM:DLIST:DElete](#) on page 609

[\[:SOURce<hw>\]:BB:DM:CLIST:SElect](#) on page 607

[\[:SOURce<hw>\]:BB:DM:CLIST:COpy](#) on page 605

[\[:SOURce<hw>\]:BB:DM:CLIST:DElete](#) on page 607

### Data List Editor

The "Data List Editor" for editing the selected data list is called up in the "List Management" submenu of the "Custom Digital Modulation" main menu by means of the "Edit Data List..." button.

See [chapter 4.5, "Editors"](#), on page 97 for description on how to use the editor.

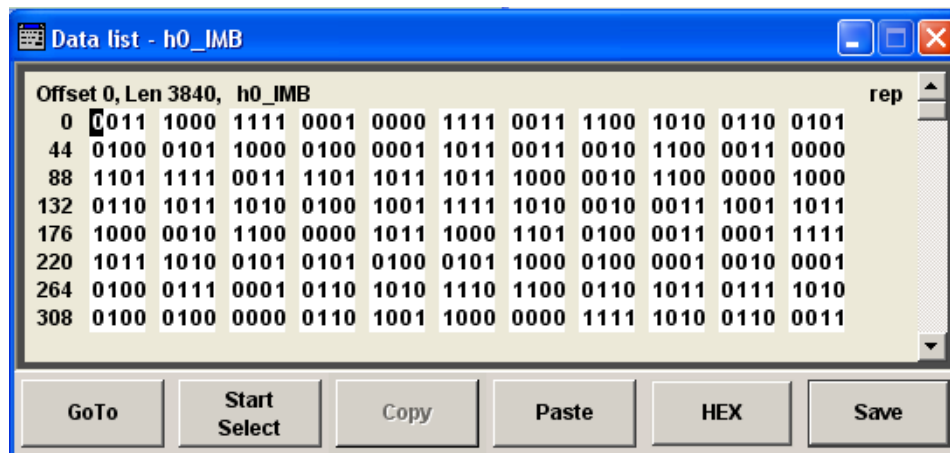

### Data List Editor

A list of binary values with a maximum length of  $2^{31}$  bits can be entered in the "Data List Editor". This value corresponds to a file size of approx. 268 Mbyte.

To increase readability, the bits are displayed in groups of four. The current cursor position, the length of the list and the list file name are displayed above the list. The offset starts with the value 0 which corresponds to the bit position on the left side of the first row, i.e. the beginning of the list. On the left edge of the editor, the last three offset positions are specified at the beginning of the row.

An existing list can be edited in the insert or overwrite mode.

SCPI command:

[\[:SOURce<hw>\]:BB:DM:DLIST:SElect](#) on page 609

[\[:SOURce<hw>\]:BB:DM:DLIST:DATA](#) on page 608

[\[:SOURce<hw>\]:BB:DM:DLIST:DATA:APPend](#) on page 608

### GoTo ← Data List Editor

Opens the entry window for the bit position. The cursor marks the bit at the selected position.



SCPI command:

n.a.

**Start Select ← Data List Editor**

Defines the current cursor position as the start position for the range to be marked. The stop position is defined by entering an offset under "GoTo".

When a start position has been activated, the button will be re-labelled to "Undo Select". When the button is clicked now, the selected range will be deactivated.

SCPI command:

n.a.

**Copy ← Data List Editor**

Copies the selected values.

SCPI command:

n.a.

**Cut ← Data List Editor**

Cuts the selected values.

SCPI command:

n.a.

**Paste ← Data List Editor**

Pastes the values that have been copied or cut before.

SCPI command:

n.a.

**Hex ← Data List Editor**

Switchover to hexadecimal display.

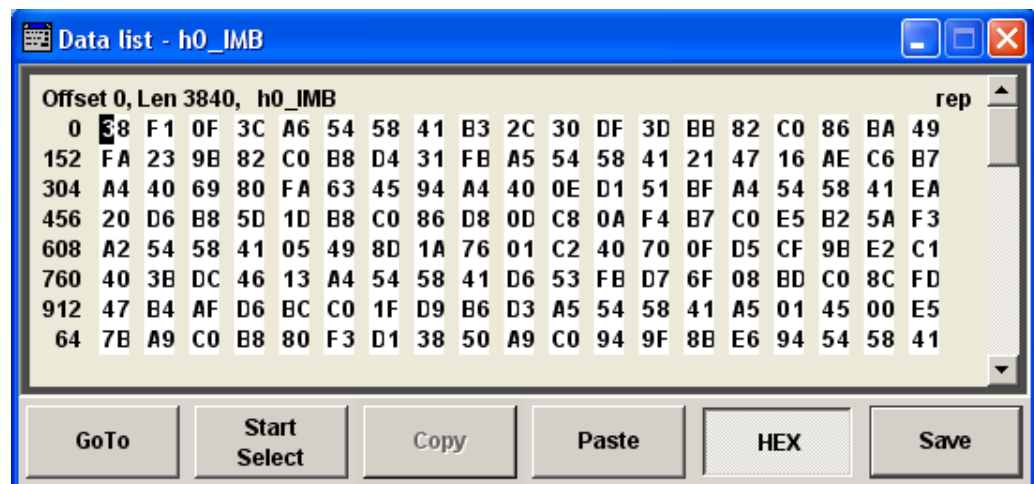

Each four bits are displayed as a hexadecimal value: To increase readability, the hexadecimal values in turn are displayed in pairs of two. The hex functions are automatically assigned to the numeric keys at the front panel.

SCPI command:

n.a.

**Save (Data List) ← Data List Editor**

Saves the changes made to the Data List file selected for editing.

SCPI command:  
n.a.

### Control and Marker List Editor

The "Control and Marker List Editor" for editing the selected control list is called up in the "List Management" submenu of the "Custom Digital Modulation" main menu by means of the "Edit Control List"... button.

**Edit Control List...**

The available marker signals and the CW, Hop, Burst Gate and Level Attenuation control signals can be defined in the "Control and Marker List Editor".



The marker signals defined in the Control and Marker List Editor are activated by selecting the Marker mode "CList" in the "Trigger/Marker/Clock" menu. The control signals have to be activated by selecting an "Internal Source" in the respective setting menu, e.g. the "Power Ramp Control" menu for the Burst Gate and Level Attenuation control signals.

The available marker/control signals are color-coded. In the left "Configure Control Signal" section, each individual signal is assigned a colour; a check in the check box shows the marker for which the "CList" marker type has been selected and the control signal for which the "Internal" source has been selected.



In the "Select Ramp to Edit" section the signal characteristics are graphically displayed. The scaling of the x-axis is always adapted to the overall length of the control list to provide constant overview of all defined ramps.

The ramps can be assigned the exact bit position in the signal by means of

- The bit scale below the marker/control signal characteristic.

- The display of the current cursor position in the "Cursor" menu section if the cursor marks the ramp.

The ramps can be set either graphically in the "Select Ramp to Edit" section or in the table of the "Positions <Signal>" section in the lower right corner. To make the setting easy, a selection of preset ramp characteristics is offered in the "Preset Ramp <Signal>" section.

#### Edit Control List

The configuration of the currently selected control list is displayed. This list is either selected in the "File Select" menu ("List Management" submenu by means of the "Control List..." button) or via the remote-control command.

SCPI command:

`[ :SOURce<hw> ] :BB:DM:CLIST:SElect` on page 607

`[ :SOURce<hw> ] :BB:DM:CLIST:DATA` on page 606

#### Configure Control Signal - Digital Modulation

Displays the colour the marker/control signal has been assigned.

Displays whether the "CList" marker type has been selected in the Trigger/Marker/Clock menu for this marker.

Displays whether the "Internal" source has been selected for this control signal in the individual setting menu.

Burst Gate and Level Attenuation are set in the "Power Ramping" submenu, CW in the "Modulation" submenu.

The source "CList/Internal" for the individual marker/control signal can be selected here as well and will then be used in the associated menus.

SCPI command:

n.a.

#### Select Ramp to Edit - Digital Modulation

Graphically edit marker/control signals.

For this purpose, the cursor is set to the position where a ramp is required. The ramp is generated by pressing Enter (e.g. clicking on the rotary knob). Any number of ramps can be defined per marker. Each of the generated ramp positions will be saved even if the definition of another ramp produces a low/low or high/high transition. These ramps are displayed as dashed lines.

Existing ramps can be shifted after the cursor has been placed on the ramp and Enter has been pressed - it then changes colour twice. The ramp is shifted by using the cursor keys or the rotary knob. The new position is determined by pressing Enter again.

Ramps can be deleted by means of the BACKSPACE key after the cursor has been placed on the ramp.

For detailed information on how to operate the control and marker list editor, see [chapter 4.5.3, "Working with Control and Marker List Editor"](#), on page 100.

SCPI command:

n.a.

**Total List Length - Digital Modulation**

Enters the length of the definition range of the control list in bits. The starting value is always bit 0. The entire definition range is displayed, i.e. the bit scale is adapted to the entry.

With very long control lists, the displayed area can be zoomed around the current cursor position ("Zoom in" button).

The preset functions set the ramp in the center of the currently selected area.

If the definition range is decreased, the ramps outside the range are lost.

When used, the control list is always repeated over the length of the definition range if the length of the data list exceeds the length of the control list.

SCPI command:

n.a.

**Preset Type - Digital Modulation**

Activates presetting for the ramp characteristic of the selected control signal. The pre-setting is selected with "Preset Type" and activated by means of the "Preset" button.

You can select from:

"All Up "	The marker/control signal is continuously high.
"All Down"	The marker/control signal is continuously low.
"Ramp Up"	The marker/control signal contains a ramp from low to high. The ramp is shifted to the center of the displayed signal area and can subsequently be shifted as required.
"Ramp Down"	The marker/control signal contains a ramp from high to low. The ramp is shifted to the center of the displayed signal area and can subsequently be shifted as required.
"Ramp Up/ Down"	The marker/control signal contains a ramp from low to high and from high to low. The ramps are symmetrically shifted around the center of the displayed signal area and can subsequently be shifted as required.
"Ramp Down/ Up"	The marker/control signal contains a ramp from high to low and from low to high. The ramps are symmetrically shifted around the center of the displayed signal area and can subsequently be shifted as required.

SCPI command:

n.a.

**Cursor Position - Digital Modulation**

Enters the cursor position.

In the graphic display, the cursor is positioned according to the entry.

Vice versa, graphically shifting the cursor will change the displayed value.

If the entered value exceeds the selected length of the definition range, the length is adjusted automatically.

SCPI command:

n.a.

**Positions Control Signal - Digital Modulation**

Opens table by using the "Edit Table .." button.

The ramps of the selected signal can be edited in the table. When the table is opened, the current configuration of the selected marker/control signal is displayed.

	Ramp Positions	Ramp State
1	20	High
2	50	Low
3	66	High
4	71	Low
5	81	High
6	223	Low
7		Low High

The bit position is specified in the "Ramp Position" column, the high or low signal status in the "Ramp State" column. At the end of the list, there is always a blank row for entering new values.

The changes are accepted in the graphic display after pressing the "Accept" button.

SCPI command:

n.a.

#### Zoom/Visible - Digital Modulation

Zooms the displayed area of the control list. The designation of the button changes from "Zoom in" to "Zoom out".

With long control lists, the displayed area can be zoomed around the current "Cursor Position".

Parameter "Visible/Bits Visible" determines the number of symbols/bits to be displayed.

Ramps outside the displayed area are not lost by zooming.

SCPI command:

n.a.

#### Save/Save As - Digital Modulation

Pressing the "Save" button saves the changes made to the CList file selected for editing.

Selecting the "Save As" button creates a new control list. This opens the "Create Lists Files Which Name?" window in which the control list can be created.

The file name has to be entered in field "File Name."

SCPI command:

n.a.

#### Power Ramp Control

The Power Ramp Control menu is accessed via the "Custom Digital Modulation" main menu.

The menu is used to set the power ramping. Control signals "Burst" and "Lev\_Att" are used to control power ramping (see "[Power Ramping and Level Attenuation](#)" on page 310).



Power ramping is possible up to a symbol rate of 5 MHz. If a higher symbol rate is set, power ramping is automatically switched off and an error message is output.

<b>State</b>	Off
<b>Source</b>	Internal
<b>Ramp Function</b>	Cosine
<b>Ramp Time</b>	1.00 sym
<b>Rise Delay</b>	0.00 sym
<b>Fall Delay</b>	0.00 sym
<b>Attenuation</b>	15.0 dB
<b>Power Ramping / Level Attenuation</b>	
<b>In Baseband Only</b>	<input type="checkbox"/> On

#### State - Power Ramp Control - Digital Modulation

Enables/disables power ramping.

SCPI command:

[\[:SOURce<hw>\]:BB:DM:PRAMP\[:STATe\]](#) on page 602

#### Source - Power Ramp Control - Digital Modulation

Enters the source for the power ramp control signals.

"Internal"      The control signals in the internal control list are used for control purposes.  
The signals are output on the LEV\_ATT and BURST pin on the AUX I/O interface of path A.

"External Digital"      The control signal is fed in via the AUX I/O interface.

SCPI command:

[\[:SOURce<hw>\]:BB:DM:PRAMP:SOURce](#) on page 602

#### Ramp Function - Digital Modulation

Enters the form of the transmitted power, i.e. the shape of the rising and falling edges during power ramp control.

"Linear"      The transmitted power rises and falls linear fashion.



"Cosine" The transmitted power rises and falls with a cosine-shaped edge. This gives rise to a more favorable spectrum than the "Linear" setting.

SCPI command:

[ :SOURce<hw> ] :BB:DM:PRAMP:SHAPE on page 601

#### Ramp Time - Digital Modulation

Enters the power ramping rise time and fall time for a burst. The setting is expressed in symbols.

SCPI command:

[ :SOURce<hw> ] :BB:DM:PRAMP:TIME on page 602

#### Rise Delay - Power Ramp Control - Digital Modulation

Sets the offset in the rising edge of the envelope at the start of a burst.

A positive value gives rise to a delay (the envelope length decreases) and a negative value causes an advance (the envelope length increases). The setting is expressed in symbols.

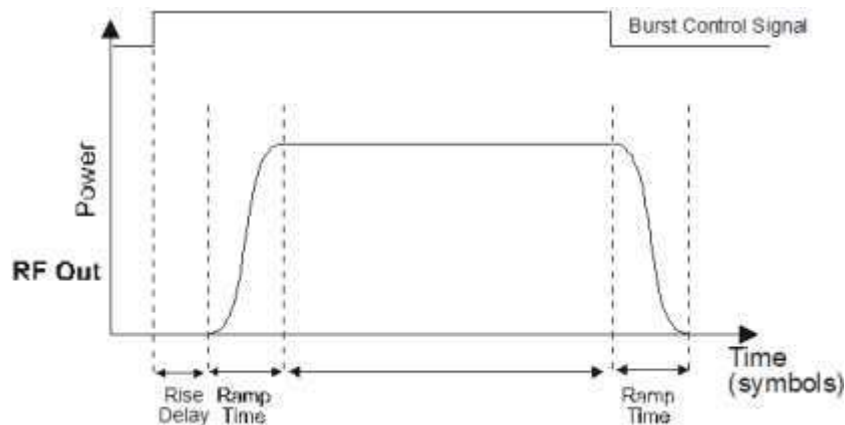

SCPI command:

[ :SOURce<hw> ] :BB:DM:PRAMP:RDELay on page 601

#### Fall Delay - Power Ramp Control - Digital Modulation

Sets the offset in the falling edge of the envelope at the end of a burst.

A positive value gives rise to a delay, the envelope length increases and a negative value causes an advance (the envelope length decreases). The setting is expressed in symbols.

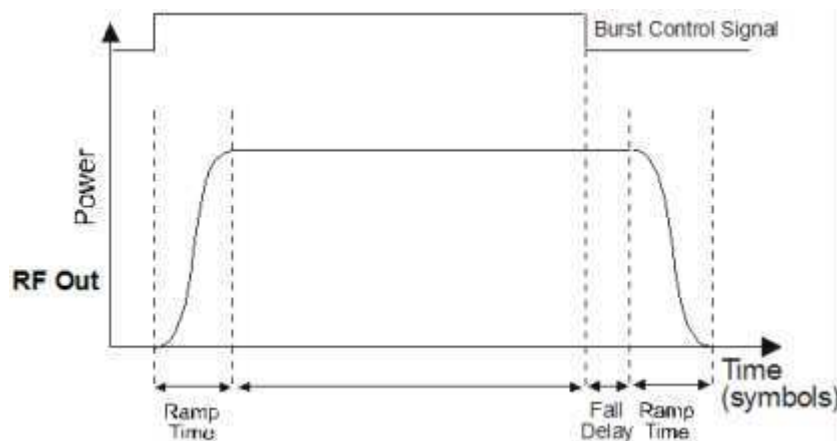

SCPI command:

[\[:SOURce<hw>\]:BB:DM:PRAMP:FDElay](#) on page 601

#### Attenuation - Power Ramp Control - Digital Modulation

Sets the level attenuation relative to the average level for the signal ranges in which the level is set to "attenuated" (LEV\_ATT control signal).

The LEV\_ATT control signal is defined in "the Control Data Editor" or supplied via the LEV\_ATT pin on the AUX I/O interface.

SCPI command:

[\[:SOURce<hw>\]:BB:DM:PRAMP:ATTenuation](#) on page 600

#### Baseband Only - Power Ramp Control - Digital Modulation

Restricts power ramping to the baseband signal.

- |       |   |
|-------|---|
| "Off" | Level attenuation is effected via the attenuator stages in the RF section; only the remaining part is attenuated in the baseband. The signal is issued at the RF output with the defined level values.  |
| "On"  | Level attenuation is effected in the baseband only.<br>This setting is mandatory in the following cases: When only the baseband signal is issued at the I/Q outputs. It is thus ensured that, with power ramping active, this signal is output with the defined level values. |

SCPI command:

[\[:SOURce<hw>\]:BB:DM:PRAMP:BBONLY\[:STATe\]](#) on page 601

#### Trigger/Marker/Clock

The "Trigger/Marker/Clock" dialog is accessed via the "Custom Digital Modulation" main menu.

The "Trigger In" section is where the trigger for the modulation signal is set. Various parameters will be provided for the settings, depending on which trigger source - internal or external - is selected. The current status of signal generation ("Running" or "Stopped") is indicated for all trigger modes.

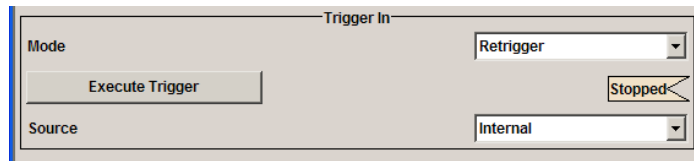

The "Marker Mode" section is where the marker signals at the MARKER output connectors are configured.

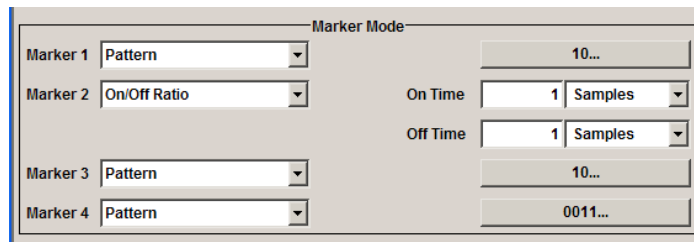

The "Marker Delay" section is where a marker signal delay can be defined, either without restriction or restricted to the dynamic section, i.e., the section in which it is possible to make settings without restarting signal and marker generation.

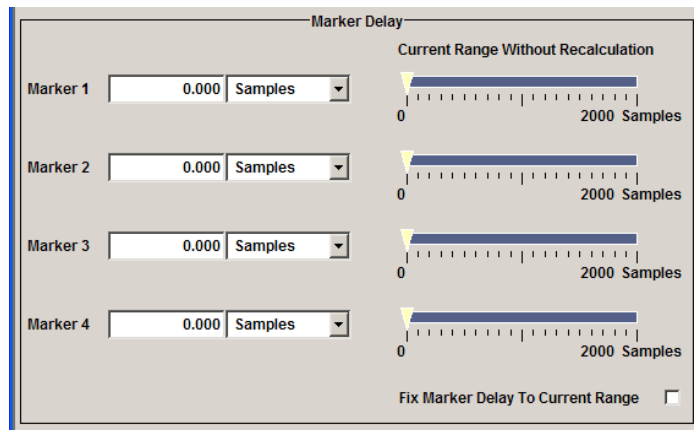

The "Clock Settings" section is where the clock source is selected and - in the case of an external source - the clock type.

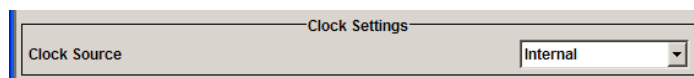

The "Global Trigger/Clock Settings" button leads to a submenu for general trigger, clock and external input settings.



### Trigger In

The "Trigger In" section is used to configure the trigger signal for the digital modulation. The current status of signal generation is indicated for all trigger modes.

**Trigger Mode - Digital Modulation**

Selects trigger mode.

"Auto"	The digital modulation signal is generated continuously.
"Retrigger"	The digital modulation signal is generated continuously. A trigger event (internal with "Execute Trigger" or external) causes a restart.
"Armed_Auto"	The digital modulation signal is generated only when a trigger event occurs. Then the digital modulation signal is generated continuously. Button "Arm" stops signal generation. A subsequent trigger event (internal with "Execute Trigger" or external) causes a restart.
"Armed_Retrigger"	The digital modulation signal is generated only when a trigger event occurs. Then the signal is generated continuously. Every subsequent trigger event (internal with "Execute Trigger" or external) causes a restart. The button "Arm" stops signal generation. A subsequent trigger event (internal with "Execute Trigger" or external) causes a restart.
"Single"	The digital modulation signal is generated only when a trigger event occurs. Then the signal is generated once to the length specified at "Signal Duration". Every subsequent trigger event (internal with "Execute Trigger" or external) causes a restart.

SCPI command:

[\[:SOURce<hw>\]:BB:DM\[:TRIGger\]:SEQuence](#) on page 591

**Trigger Signal Duration - Digital Modulation**

Enters the length of the signal sequence to be output in the "Single" trigger mode. The input is to be expressed in symbols.

SCPI command:

[\[:SOURce<hw>\]:BB:DM:TRIGger:SLENgth](#) on page 589

**Running - Stopped - Digital Modulation**

Displays the status of signal generation for all trigger modes. This display appears only when Custom Dig Mod is enabled (State On).

"Running"	The digital modulation signal is generated; a trigger was (internally or externally) initiated in triggered mode. If Armed_Auto and Armed_Retrigger have been selected, generation of signals can be stopped with the "Arm" button. A new trigger (internally with "Execute Trigger" or externally) causes a restart.
"Stopped"	The signal is not generated, and the instrument waits for a trigger event (internal or external).

SCPI command:

[\[:SOURce<hw>\]:BB:DM:TRIGger:RMODe](#) on page 589

**Arm - Digital Modulation**

Stops signal generation. This button appears only with "Running" signal generation in the "Armed\_Auto" and "Armed\_Retrigger" trigger modes.

Signal generation can be restarted by a new trigger (internally with "Execute Trigger" or externally).

SCPI command:

[\[:SOURce<hw>\]:BB:DM:TRIGger:ARM:EXECute](#) on page 586

### Execute Trigger - Digital Modulation

Executes trigger manually. A manual trigger can be executed only when an internal trigger source and a trigger mode other than "Auto" have been selected.

SCPI command:

[\[:SOURce<hw>\]:BB:DM:TRIGger:EXECute](#) on page 587

### Trigger Source - Digital Modulation

Selects trigger source.

"Internal" The trigger event is executed by "Execute Trigger". As a precondition a trigger mode other than "Auto" must be selected.

"External (TRIGGER)" The trigger event is executed with the aid of the active edge of an external trigger signal. The trigger signal is supplied via the TRIGGER connector.

The polarity, the trigger threshold and the input impedance of the TRIGGER input can be set in the GLOBAL TRIGGER SETTINGS menu.

SCPI command:

[\[:SOURce<hw>\]:BB:DM:TRIGger:SOURce](#) on page 589

### Sync. Output to External Trigger

(enabled for "Trigger Source" External)

Enables/disables output of the signal synchronous to the external trigger event.

"On" Corresponds to the default state of this parameter. The signal calculation starts simultaneously with the external trigger event but because of the instrument's processing time the first samples are cut off and no signal is outputted. After elapsing of the internal processing time, the output signal is synchronous to the trigger event.

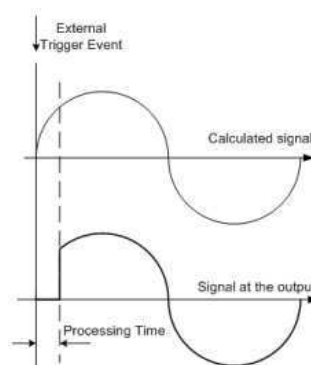

"Off" The signal output begins after elapsing of the processing time and starts with sample 0, i.e. the complete signal is outputted. This mode is recommended for triggering of short signal sequences with signal duration comparable with the processing time of the instrument.

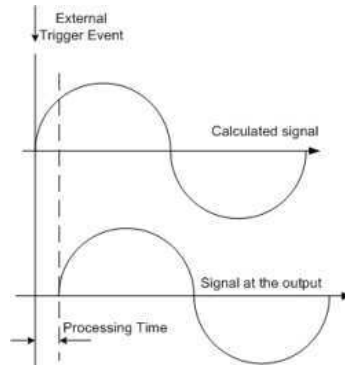

SCPI command:

`[ :SOURce<hw> ] :BB:DM:TRIGger:EXTernal:SYNChronize:OUTPut`  
on page 587

#### External Delay - Digital Modulation

Sets trigger signal delay in symbols on external triggering.

This enables the R&S SMJ to be synchronized with the device under test or other external devices.

SCPI command:

`[ :SOURce<hw> ] :BB:DM:TRIGger [ :EXTernal<ch> ] :DELay` on page 590

#### External Inhibit - Digital Modulation

(available on external triggering)

Sets the duration for inhibiting a new trigger event subsequent to triggering. The input is to be expressed in symbols.

In the "Retrigger" mode every trigger signal causes signal generation to restart. This restart is inhibited for the specified number of samples.

SCPI command:

`[ :SOURce<hw> ] :BB:DM:TRIGger [ :EXTernal<ch> ] :INHibit` on page 590

#### Marker Mode

The marker output signal for synchronizing external instruments is configured in the Marker Settings section "Marker Mode".

#### Marker x - Digital Modulation

Selects a marker signal for the associated MARKER output.

"CList" A marker signal that is defined in the selected control list is generated.

"Pulse" A regular marker signal is generated. The clock frequency is defined by entering a divider. The frequency is derived by dividing the sample rate by the divider. The input box for the divider opens when "Pulse" is selected, and the resulting pulse frequency is displayed below it.

Divider	8.00
Frequency	33.854 17 kHz

SCPI command:

[\[:SOURce<hw>\]:BB:DM:TRIGger:OUTPut<ch>:PULSe:DIVider](#) on page 593

"Pattern" A marker signal that is defined by a bit "pattern" is generated. The "pattern" has a maximum length of 64 bits and is defined in an input field which opens when "pattern" is selected.

0000 0000
-----------

SCPI command:

[\[:SOURce<hw>\]:BB:DM:TRIGger:OUTPut<ch>:PATtern](#) on page 593

"ON/OFF ratio" A regular marker signal that is defined by an ON/OFF ratio is generated. A period lasts one ON and OFF cycle.

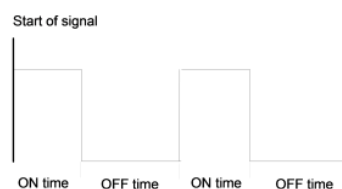

The ON time and OFF time are each expressed as a number of symbols and are set in an input field which opens when "ON/OFF ratio" is selected.

On Time	2	Sym
Off Time	3	Sym

SCPI command:

[\[:SOURce<hw>\]:BB:DM:TRIGger:OUTPut<ch>:OFFTime](#) on page 592

[\[:SOURce<hw>\]:BB:DM:TRIGger:OUTPut<ch>:ONTime](#) on page 592

SCPI command:

[\[:SOURce<hw>\]:BB:DM:TRIGger:OUTPut<ch>:MODE](#) on page 591

### Marker Delay

The "Marker Delay" section can be used to set a delay for the markers.

#### Marker x Delay - Digital Modulation

Enters the delay between the marker signal at the marker outputs and the start of the signal.

The input is expressed as a number of symbols.

If the setting "Fix marker delay to dynamic range" is enabled, the setting range is restricted to the dynamic range. In this range the delay of the marker signals can be set without restarting the marker and signal.

The allocation of marker signals to the outputs is described in the section [chapter 5.8.1.8, "Marker Output Signals"](#), on page 311.

SCPI command:

`[ :SOURce<hw> ] :BB:DM:TRIGger:OUTPut<ch>:DELay` on page 588

#### Current Range without Recalculation - Digital Modulation

Displays the dynamic range within which the delay of the marker signals can be set without restarting the marker and signal.

The delay can be defined by moving the setting mark.

SCPI command:

`[ :SOURce<hw> ] :BB:DM:TRIGger:OUTPut<ch>:DELay:MAXimum` on page 588

`[ :SOURce<hw> ] :BB:DM:TRIGger:OUTPut<ch>:DELay:MINimum` on page 588

#### Fix marker delay to current range - Digital Modulation

Restricts the marker delay setting range to the dynamic range. In this range the delay can be set without restarting the marker and signal.

SCPI command:

`[ :SOURce<hw> ] :BB:DM:TRIGger:OUTPut:DELay:FIXed` on page 588

#### Clock Settings

The clock source is selected in the Clock Settings section.

#### Clock Source - Digital Modulation

Selects the clock source (also see section "Clock Signals", page 2).

- |            |  |
|------------|--|
| "Internal" | The internal clock reference is used.  |
| "External" | The external clock reference is fed in as the symbol clock or a multiple thereof via the CLOCK connector.<br>The chip rate must be correctly set to an accuracy of ( $\pm 2\%$ (see data sheet)).<br>The polarity of the clock input can be changed with the aid of "Global Trigger/Clock/External Input "Settings". |

SCPI command:

`[ :SOURce<hw> ] :BB:DM:CLOCK:SOURCE` on page 585

#### Clock Mode - Digital Modulation

Enters the type of externally supplied clock.

- |                   |  |
|-------------------|--|
| "Symbol"          | A symbol clock is supplied via the CLOCK connector.  |
| "Multiple Symbol" | A multiple of the symbol clock is supplied via the CLOCK connector, the symbol clock is derived internally from this.<br>The "Multiplier" window provided allows the multiplication factor to be entered.<br><b>Note:</b> This setting is not possible if the serial or parallel external data source is selected. |



"Bit" A bit clock is supplied via the CLOCK connector; the symbol clock is derived internally from this.

**Note:** This setting is not possible if the serial or parallel external data source is selected.

SCPI command:

[\[:SOURce<hw>\]:BB:DM:CLOCK:MODE](#) on page 584

#### Symbol Clock Multiplier - Digital Modulation

Enters the multiplication factor for clock type "Multiple".

SCPI command:

[\[:SOURce<hw>\]:BB:DM:CLOCK:MULTIPLIER](#) on page 585

#### Measured External Clock

Displays the measured frequency of the external clock signal. This enables the user to permanently monitor the frequency of the externally introduced clock.

This information is displayed only if the external clock source has been selected.

SCPI command:

[:CLOCK:INPut:FREQuency](#) on page 489

#### Global Trigger/Clock/Input Settings - Digital Modulation

Calls the "Global Trigger/Clock/Input Settings" menu. This menu is used among other things for setting the trigger threshold, the input impedance and the polarity of the clock and trigger inputs.

The parameters in this menu affect all digital modulations and standards, and are described in the [chapter 5.2.3.10, "Global Trigger/Clock/External Input Settings"](#), on page 129.

SCPI command:

n.a.

### 5.8.3 Arbitrary Waveform Generator ARB

The Arbitrary Waveform Generator (ARB) is an I/Q modulation source forming an integral part of the R&S Signal Generator. It can be used to output any externally calculated modulation signals or internally generated multi carrier signals or waveform files.

The Arbitrary Waveform Generator is incorporated in the Baseband Generator (R&S SMJ-B9/B10/B11) option. The Baseband Main Module (R&S SMJ-B13) option is also required.

The three Baseband Generator options feature different ARB memory sizes (see data sheet). Apart from the memory size, however, the three options offer the same functionality, either one can be installed.

#### Sources for waveform files

The R&S Signal Generator can generate ARB waveforms internally. The ARB generator enables the calculation and the generation of multi segment and multi carrier waveform files. Several digital standards provide the special function "Generate Waveform File" and

enable the calculation and storage of the signal as a waveform file that can be afterwards processed by the ARB generator.

The ARB can also process externally generated waveform files, e.g. the waveform files generated on a PC by the Windows software package R&S WinIQSIM2 or signals calculated using a mathematical program such as Matlab. For more information, see Application Note 1MA28, "IQWizard - I/Q Signal Measurement and Conversion", which can be obtained from the Rohde&Schwarz web site at <http://www.rohde-schwarz.com>.

The externally generated waveform files can be loaded into the instrument via one of the available interfaces (USB, LAN or GPIB).

### Multi segment and multi carrier waveforms

To fulfill the requirements of some test systems and to enable rapid alternation between different waveforms with differing test signals, the R&S Signal Generator provides the functionality to generate multi segment waveform files. A multi segment waveform is a combination of multiple waveforms called segments. Each segment represents a completely independent waveform that can be output with its own marker and clock settings. The entire multi segment waveform is loaded into memory. The segment intended to be output at any given moment can be selected by the user. It is therefore possible to alternate between the individual waveform segments without experiencing any delay due to the loading operation.

There are however additionally requirements concerning the clock settings if some special triggering is necessary.

If very high switchover speeds are required, the test signals can be continuously scrolled through with the aid of an external trigger or by applying a predefined "play list". For this purpose the segments must have a common sample rate. If the combined waveforms have different sample rates, they can be adapted to a common sample rate by resampling. By the same procedure the instantaneous amplitude of the various waveforms can be scaled to a common RMS level.

Typical applications for the multi segment mode are described in the section "[Typical Applications for Multi Segment Waveforms](#)" on page 386.

Multi carrier waveforms consisting of up to 512 carriers modulated by user-selectable baseband signals can be created in order to simulate complex multi carrier scenarios with different baseband signals (e.g. CDMA2000 or 3GPP FDD).

### Waveform sample rate

The Arbitrary Waveform Generator includes a resampling unit that interpolates the input samples to reach a target digital output I/Q sample rate before digital-to-analog conversion (DAC). The input sample rate  $f_{input}$  is given by the default sample rate tag of the waveform file or is set by the user in the ARB panel.

The R&S SMJ uses a 100 MHz system clock and a sample rate of 100 MSamples/s.

The resampling lowpass limits the signal bandwidth to a maximum of  $1.36 \times f_{input}$ . Within a bandwidth of  $0.68 \times f_{input}$  the resampler lowpass is distortion-free. Thus, an externally created waveform file have to provide a sample rate  $f_{input}$  that is high enough for perfect signal reconstruction.

For distortion-free resampling the lower bound of the required sample rate  $f_{\text{input}}$  is calculated by:

$$f_{\text{input}} \geq \text{Signal bandwidth} / 0.68$$

In case of digital modulation this means that the oversampling factor ( $f_{\text{input}} = \text{symbol rate} \times \text{oversampling factor}$ ) that is applied for impulse forming is high enough.

The lower bound of the oversampling factor is given by:

$$\text{oversampling factor} \geq \text{signal bandwidth} / (\text{symbol rate} \times 0.68)$$

### Example:

For the WCDMA standard 3GPP FDD with root raised cosine filter ( $\alpha = 0.22$ ) and a symbol rate (chip rate) of 3.84 MHz the minimum oversampling factor is calculated as follow:

$$3.84 \text{ MHz} \times (1+0.22) / (3.84 \text{ MHz} \times 0.68) = 1.794$$

A modulation signal with a sample rate of 100 MHz is passed directly to the digital-to-analog converter (DAC), i.e. the resampling unit is bypassed (see figure below). After the DAC the signal is finally limited to a maximum bandwidth of 80 MHz.

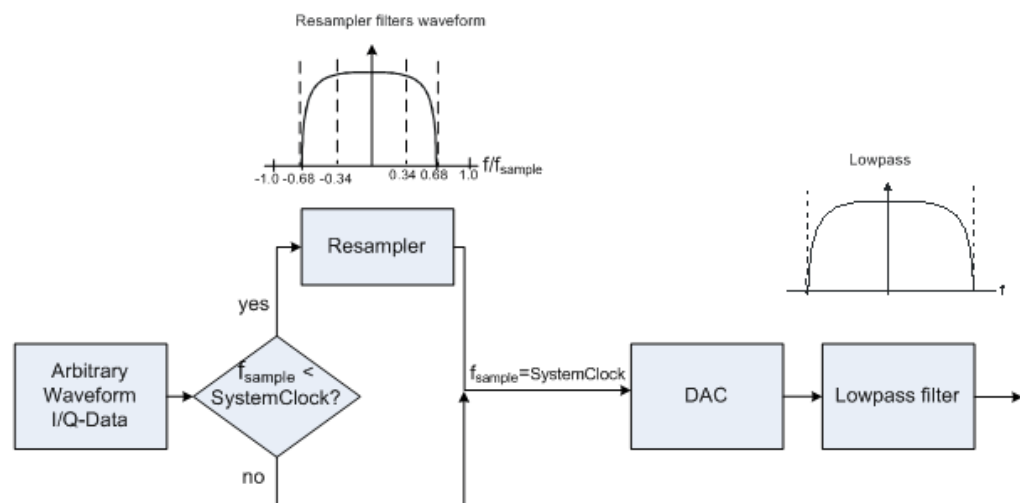

Waveforms generated by the R&S WinIQSIM2 software can be optimized by choosing a suitable integer oversampling factor.

In comparison with conventional ARB generators that often assume oversampling factors of 4, the ARB generator of the R&S Signal Generator requires low oversampling factors (see the example above), but still providing excellent signal quality in terms of EVM and ACP.

A reduced sample rate saves significantly the amount of memory or allows an increased signal cycle time, vice versa.

### Dependency between the number of marker signals and the waveform length

The R&S Signal Generator provides the possibility to define marker signals, that are sent to the marker outputs in synchronicity with the I/Q output signals. Marker signals can be

either predefined or subsequently defined; marker setting such as delay can be adjusted in the corresponding [Trigger/Marker/Clock Settings](#) dialog.

The I/Q data and marker data are located in separate memory areas of the SDRAM and can be independently configured whereas each marker signal requires one bit of the available memory size. In some cases, it might be useful to generate a modulation signal without additional marker signal in order to increase the maximum waveform length.

The example below explains the dependency between the number of enabled marker signals, the available memory size and the resulting waveform length.

The calculation for an instrument equipped with option R&S SMJ-B10 is as follows:

Memory	Size	256 MB
Required	for I/Q data	$2 \times 16 \text{ bits} = 32 \text{ bits}$ (16 bits per I/Q channel)
Memory	for 4 enabled markers	$4 \times 1 \text{ bit} = 4 \text{ bits}$
Size	total	$32 + 4 = 36 \text{ bits} = 4.5 \text{ bytes}$
Waveform	Length (with 4 markers)	$256 \text{ MB} / 4.5 \text{ bytes} = 56 \text{ MSamples}$
Maximum	Waveform Length	$256 \text{ MB} / 4 \text{ bytes} = 64 \text{ MSamples}$

Hence a memory size of 256 MB yields a maximum waveform length of 56 MSamples if four markers are enabled. The maximum waveform length increases to 64 MSamples if the internal hardware markers are used, and the complete memory is available for I/Q data.

A maximum waveform length of 16 MSamples is available therefore for instruments equipped with option R&S SMJ-B11.

The minimum length of a waveform is 512 samples. If a waveform is shorter than this, it is automatically repeated until it reaches the minimum length.

### 5.8.3.1 ARB User Interface

To access the ARB dialog, select "Baseband > ARB" or use the MENU key under "Baseband".

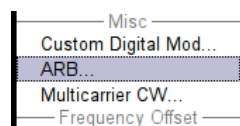

The "ARB" dialog is divided into an upper and a lower general part together with a "Marker" section.

The upper part of the menu is used for powering up, selecting and configuring ARB modulation.

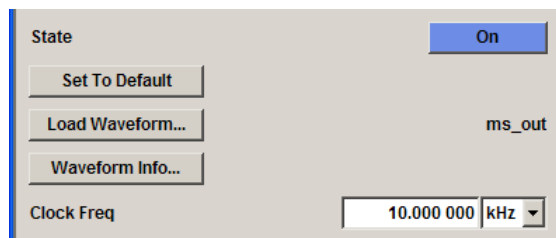

The section "Multi Segment Waveform Options" is only indicated if a multi segment waveform is loaded. In this part, the segment to be output is selected.

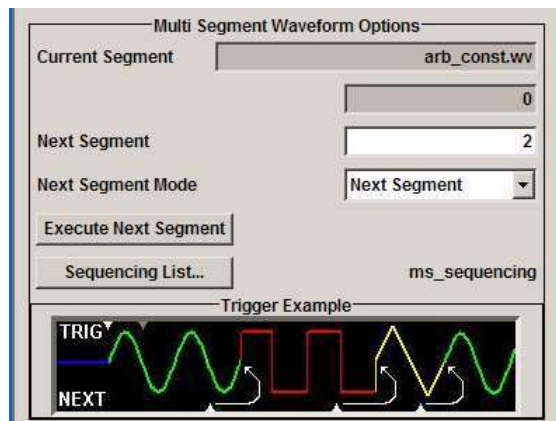

The buttons in the lower part of the menu open submenus for setting triggers and clocks, for configuring the test signal and for calculating a multi segment waveform or a multi carrier waveform.

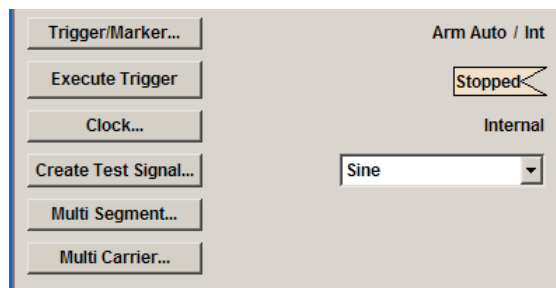

### ARB MOD Main Menu

The upper part of the menu is used for powering up, selecting and configuring ARB modulation.

The lower part of the menu is used for setting triggers and clocks, as well as for file management. Test signals can be output for test purposes.

### Multi Segment Waveform Options

The section "Multi Segment Waveform Options" of the menu is only displayed if a multi segment waveform is loaded.

The section comprises the settings necessary to adjust the trigger for the switch between the segments of a multi segment waveform. The parameters displayed depend on the selected trigger source.

The parameters in this sections are identical with the parameters in the section "Next Segment Trigger In" in the "Trigger/Marker" dialog; for detailed information see "[Next Segment Trigger In](#)" on page 365.

### State (ARB)

Enables/disables ARB modulation.

Switching on this standard turns off all the other digital standards and digital modulation types.

The output is based on the waveform file that is loaded. The name of the waveform file is displayed next to "Load Waveform".

If a multi segment waveform is loaded the section "Multi Segment Waveform Options" is indicated. In this section, the segment to be output is selected.

If no waveform file is loaded, ARB modulation cannot be powered up. "None" will be displayed next to "Load Waveform". An error message asks the user to load a waveform file:

"No waveform file loaded. ARB MOD state remains off. Please select a waveform file to load, before switching ARB MOD state on."

SCPI command:

[ :SOURce<hw> ] :BB:ARB:STATe on page 538

### Set To Default

Calls default settings. The values are shown in the [table 5-10](#).

**Table 5-10: Default Settings**

Parameter	Value
State	Off
Clock Freq.	1 MHz
Trigger Mode	Auto
Trigger Source	Internal
Marker State	Off
Marker Mode	Unchanged
Clock Source	Internal

SCPI command:

[ :SOURce<hw> ] :BB:ARB:PRESet on page 538

### Load Waveform

Calls the "File Select "menu for loading the waveform file.

The files last used are listed in the "Recent Data Sets" section. The directory can be selected from the center left section. All waveform files (file extension \*.wv) available from the selected directory are listed on the right side. The file info (tag contents and multi segment state) for the selected file is displayed below the file section.

The "Select..." button selects the marked file. This file is loaded when the ARB modulation is enabled ("State On").

The "File Manager..." button leads to the file manager.

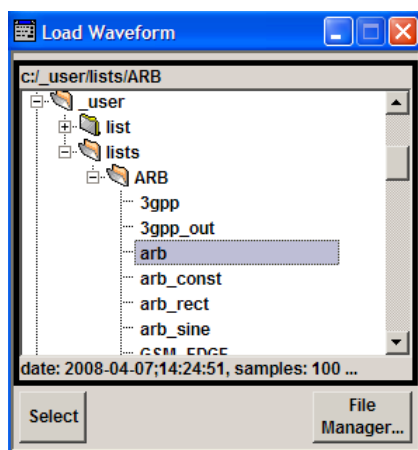

SCPI command:

[ :SOURce<hw> ] :BB:ARB:WAVEform:SElect on page 570

### Waveform Info

Opens a dialog with detailed information about the currently selected waveform.

The waveform information displayed in this dialog depends on whether the selected waveform file is a multi segment one or not. All parameters are read-only.

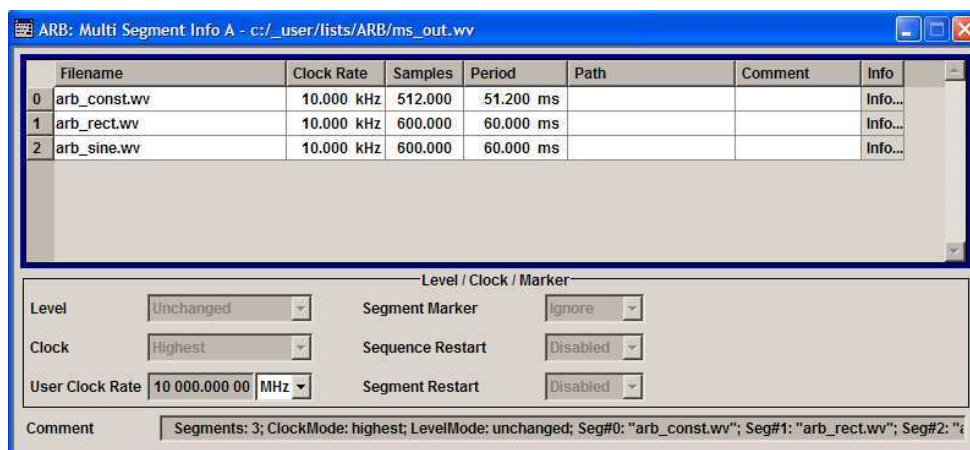

For non-multi segment waveform files, the values of the settings can be queried by means of the Tag commands (see [chapter 7.3, "R&S Signal Generator Waveform and List Format"](#), on page 459).

SCPI command:

n.a.

**HDD Streaming**

Enables/disables the streaming of modulation data direct form the hard drive (HDD).

HDD streaming is recommended for processing of large files that require more ARB memory than the currently installed one.

HDD Streaming is enabled for waveform with "Clock Freq."  $\leq$  1 MHz and "Number of Samples"  $>$  16 MS.

SCPI command:

[\[:SOURce<hw>\]:BB:ARB:WAVEform:HDDStreaming:STATe](#) on page 569

**Streaming Buffer**

(enabled for waveform with "Clock Freq."  $\leq$  1MHz and "Number of Samples"  $>$  16MS)

Displays the filling level of the streaming buffer.

During normal operation, the streaming buffer level should have a value of 90% .. 100%. Buffer level around 0% indicates a buffer underrun and the signal processing will be interrupted.

Adjustment in the parameter value or state usually results in short decreasing of the streaming buffer level but this buffer state should not be misunderstood as buffer under-run.

SCPI command:

[\[:SOURce<hw>\]:BB:ARB:WAVEform:HDDStreaming:BLEVel](#) on page 568

**Clock Frequency**

Displays or enters the ARB output clock rate.

When the waveform file is loaded, this value is automatically set to the clock rate defined in the file (Clock tag). The user can subsequently alter the value if necessary.

When intending to work with an external clock source, the frequency to be applied must be entered here.

SCPI command:

[\[:SOURce<hw>\]:BB:ARB:CLOCK](#) on page 538

**Trigger/Marker**

Calls the Trigger and Marker menu.

This menu is used to select the trigger source, set the time delay on an external trigger signal and configure the marker output signals (see "[Trigger/Marker/Clock Settings](#)" on page 360).

SCPI command:

n.a.

**Execute Trigger**

Executes trigger manually. A manual trigger can be executed only when an internal trigger source and a trigger mode other than Auto are selected.

SCPI command:

[\[:SOURce<hw>\]:BB:ARB:TRIGger:EXECute](#) on page 541



**Clock**

Calls the "Clock" menu. The "Clock" menu is used to select the clock source (see ["Clock Settings"](#) on page 372).

SCPI command:

n.a.

**Create Test Signal...**

Selects the form of the test signal and calls the menu for generating it. A sinusoidal, rectangular or test signal with constant I/Q can be selected.

See the corresponding section for detailed description of the parameters for the selected test signal:

- ["Sine Test Signals"](#) on page 373
- ["Rect Test Signal"](#) on page 374
- ["Const IQ Test Signal"](#) on page 376

SCPI command:

n.a.

**Multi Segment**

Calls the menu for calculating multi segment waveforms (see [chapter 5.8.3.2, "Multi Segment Waveforms"](#), on page 376).

SCPI command:

n.a.

**Multi Carrier**

Calls the menu for calculating multi carrier waveforms (see [chapter 5.8.3.3, "Multi Carrier Waveforms"](#), on page 387).

SCPI command:

n.a.

**Trigger/Marker/Clock Settings**

To access this dialog, select "Main Menu > Trigger/Marker".

The "Trigger In" section is where the trigger for the signal is set. Various parameters will be provided for the settings, depending on which trigger source - internal or external - is selected. The current status of signal generation ("Running" or "Stopped") is indicated for all trigger modes.

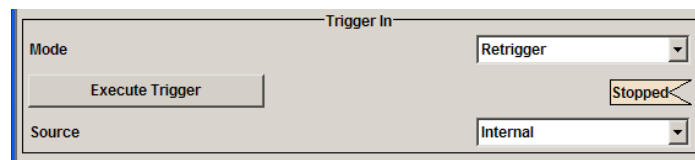

The "Next Segment Trigger In" is where the segment triggering is configured. This section is enabled only for multi segment waveforms.

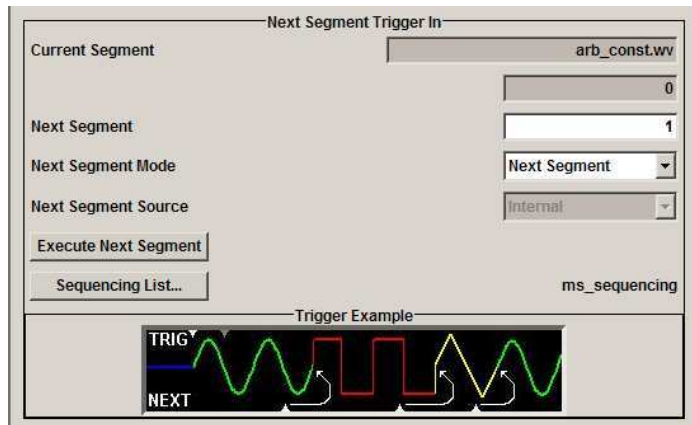

The "Marker Mode" section is where the marker signals at the MARKER output connectors are configured.

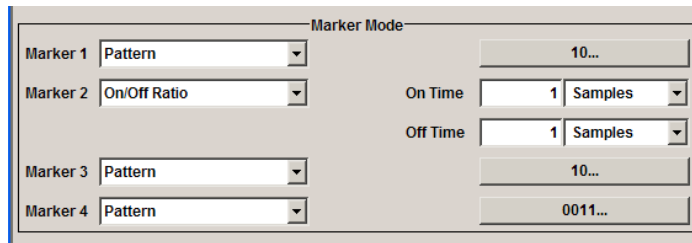

The "Marker Delay" section is where a marker signal delay can be defined, either without restriction or restricted to the dynamic section, i.e., the section in which it is possible to make settings without restarting signal and marker generation.

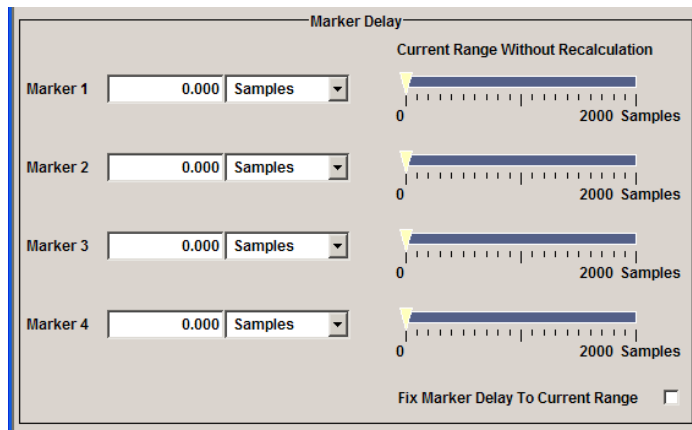

The "Clock Settings" section is where the clock source is selected and - in the case of an external source - the clock type.

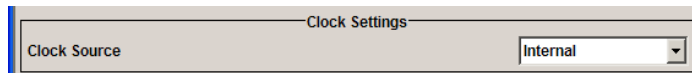

The buttons in the last section lead to submenu for general trigger, clock and mapping settings.

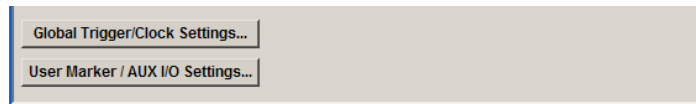

### Trigger In

The "Trigger In" section is where the trigger for the signal is set. Various parameters will be provided for the settings, depending on which trigger source - internal or external - is selected. The current status of signal generation ("Running" or "Stopped") is indicated for all trigger modes.

### Trigger Mode

Selects trigger mode.

The trigger mode determines the effect of a trigger on the signal generation.

"Auto"	The signal is generated continuously.
"Retrigger"	The signal is generated continuously. A trigger event (internal or external) causes a restart.
"Armed_Auto"	The signal is generated only when a trigger event occurs. Then the signal is generated continuously. Button "Arm" stops signal generation. A subsequent trigger event (internal with "Execute Trigger" or external) causes a restart.
"Armed_Retrigger"	The signal is generated only when a trigger event occurs. Then the signal is generated continuously. Every subsequent trigger event causes a restart. Button "Arm" stops signal generation. A subsequent trigger event (internal with "Execute Trigger" or external) causes a restart.
"Single"	The signal is generated only when a trigger event occurs. Then the signal is generated once to the length specified at "Signal Duration". Every subsequent trigger event (internal with "Execute Trigger" or external) causes a restart.

SCPI command:

[\[:SOURce<hw>\]:BB:ARB\[:TRIGger\]:SEQUence](#) on page 546

### Signal Duration Unit

Defines the unit for the entry of the length of the signal sequence to be output in the "Single" trigger mode.

SCPI command:

[\[:SOURce<hw>\]:BB:ARB:TRIGger:SLUNit](#) on page 544

### Signal Duration

Defines the length of the signal sequence to be output in the "Single" trigger mode. The unit of the entry is defined under "Signal Duration Unit". It is then possible to output deliberately just part of the signal, an exact sequence of the signal, or a defined number of repetitions of the signal.

SCPI command:

[\[:SOURce<hw>\]:BB:ARB:TRIGger:SLENgth](#) on page 543

**Running/Stopped**

Displays the status of signal generation for all trigger modes. This display appears only when signal generation is enabled ("State" On).

"Running"	The waveform is output; a trigger was (internally or externally) initiated in triggered mode. If "Armed_Auto" and "Armed_Retrigger" have been selected, generation of signals can be stopped with the "Arm" button. A new trigger (internally with "Execute Trigger" or externally) causes a restart.
"Stopped"	The Waveform output is stopped. The instrument waits for an internal or external trigger event to restart. ARB modulation is disabled (State Off).

SCPI command:

[\[:SOURce<hw>\]:BB:ARB:TRIGger:RMODE](#) on page 543

**Arm**

Stops waveform output. This button appears only with "Running" signal generation in the "Armed\_Auto" and "Armed\_Retrigger" trigger modes.

Signal output can be restarted by a new trigger (internally with "Execute Trigger" or externally).

SCPI command:

[\[:SOURce<hw>\]:BB:ARB:TRIGger:ARM:EXECute](#) on page 540

**Execute Trigger**

Executes trigger manually. A manual trigger can be executed only when an internal trigger source and a trigger mode other than "Auto" have been selected.

SCPI command:

[\[:SOURce<hw>\]:BB:ARB:TRIGger:EXECute](#) on page 541

**Trigger Source**

Selects trigger source. This setting is effective only when a trigger mode other than "Auto" has been selected.

"Internal"	The trigger event is executed by "Execute Trigger".
"External (TRIGGER 1 / 2)"	The trigger event is executed with the aid of the active edge of an external trigger signal. The trigger signal is supplied via the TRIGGER connector. The polarity, the trigger threshold and the input impedance of the TRIGGER input can be set in the "Global Trigger/Clock Settings" dialog. <b>Note:</b> For multi segment waveforms, an external trigger source can be used for cyclical output of the segments. Each trigger event starts the output of the next segment. After the last segment, the first segment is output again.

SCPI command:

[\[:SOURce<hw>\]:BB:ARB:TRIGger:SOURce](#) on page 545

**Sync. Output to External Trigger**

(enabled for "Trigger Source" External)

Enables/disables output of the signal synchronous to the external trigger event.

"On"

Corresponds to the default state of this parameter.

The signal calculation starts simultaneously with the external trigger event but because of the instrument's processing time the first samples are cut off and no signal is outputted. After elapsing of the internal processing time, the output signal is synchronous to the trigger event.

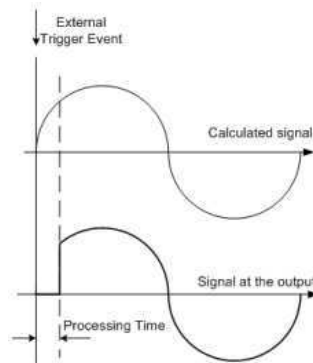

"Off"

The signal output begins after elapsing of the processing time and starts with sample 0, i.e. the complete signal is outputted.

This mode is recommended for triggering of short signal sequences with signal duration comparable with the processing time of the instrument.

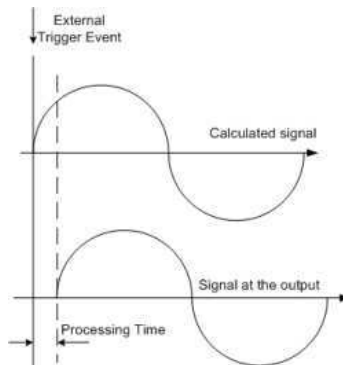

SCPI command:

`[ :SOURce<hw> ] :BB:ARB:TRIGger:EXTeRnal:SYNChronize:OUTPut`  
on page 541

### Trigger Delay

Sets the trigger signal delay in samples on external triggering or on internal triggering via the second path.

Sets the trigger signal delay in samples on external triggering.

This enables the R&S Signal Generator to be synchronized with the device under test or other external devices.

SCPI command:

`[ :SOURce<hw> ] :BB:ARB:TRIGger [ :EXTeRnal<1|2> ] :DELay` on page 545

### Trigger Inhibit

Sets the duration for inhibiting a new trigger event subsequent to triggering. The input is to be expressed in samples.

In the "Retrigger" mode, every trigger signal causes signal generation to restart. This restart is inhibited for the specified number of samples.

This parameter is only available on external triggering.

SCPI command:

[\[:SOURce<hw>\]:BB:ARB:TRIGger\[:EXTernal<1|2>\]:INHibit](#) on page 545

### Next Segment Trigger In

The section "Next Segment Trigger" In of the menu is only displayed if a multi segment waveform is loaded.

The section comprises the settings necessary to adjust the trigger for the switch between the segments of a multi segment waveform. The parameters displayed depend on the selected trigger source.

### Current Segment

Indication of the waveform segment (segment file name and index) that is currently output.

SCPI command:

[\[:SOURce<hw>\]:BB:ARB:WSEGment](#) on page 571

[\[:SOURce<hw>\]:BB:ARB:WSEGment:NAME](#) on page 578

### Next Segment

Selects the waveform segment to be output next. It determines the start segment when switching on the ARB and enables switchover to any other segment.

The switchover is performed either after receiving an external next segment trigger event or, for the internal trigger case, by changing the segment index in the "Next Segment" field. The definition whether the new segment is generated immediately or only after the previous segment has been fully generated (wrap around) is determined by the parameter [Next Segment Mode](#).

The segment currently being output (segment index and file name) is displayed at "Current Segment". The subsequent trigger event after the last segment causes the first segment to be output again.

SCPI command:

[\[:SOURce<hw>\]:BB:ARB:WSEGment:NEXT](#) on page 578

### Next Segment Mode

Sets the segmented trigger mode of a multi segment waveform, i.e. defines the way the **switch over between the segments** in a multi segment waveform will be executed:

- In "Same Segment" mode, the processing of the multi segment waveform file is similar to the processing of a non-multi segment waveform, i.e. there is no switching to consecutive segment the upon receiving of a trigger event. Switching between the segments is triggered by changing the segment index in the "Next Segment" field.

- When "Next Segment" is selected, the current segment ceases to be output as soon as a trigger event for a new segment occurs, and the new segment starts to be output after a system-imposed signal gap.

The following figure shows an example of the transition from a sinewave signal segment to a sawtooth segment (I channel, above) in the case of next segment external triggering (below).

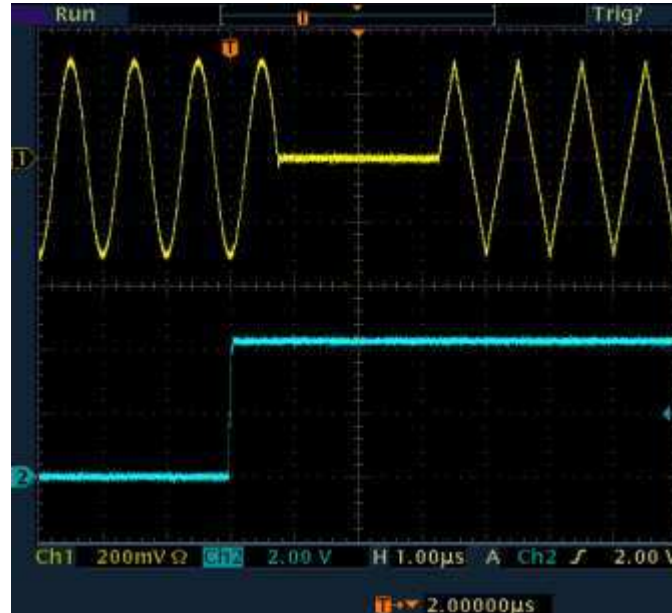

- When "Next Segment" Seamless is selected and a new segment trigger event occurs, the new segment is not output until the whole of the current segment has been output (wrap around). In this case the signal transition is seamless. As a prerequisite for a seamless switchover, all segments must have the same sample rate.

The following figure shows an example of the seamless transition from a sinewave signal segment to a sawtooth segment (I channel, above) in the case of next segment external triggering (below).

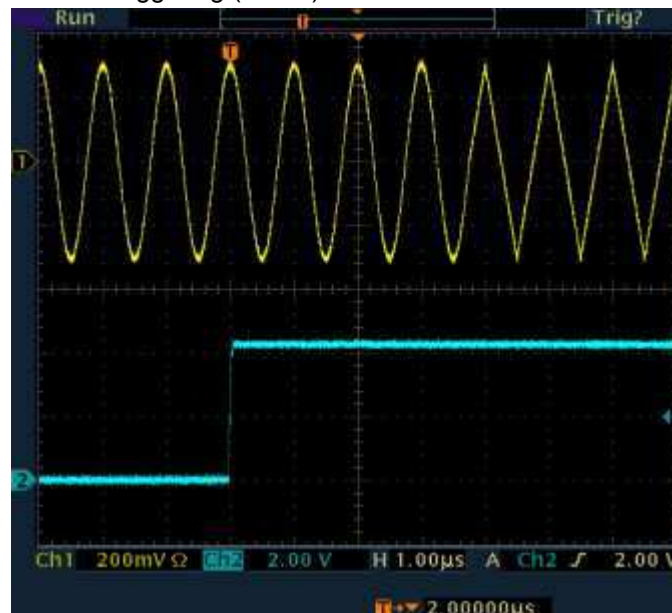

The regular trigger mode for starting the waveform generation and **triggering the whole multi segment sequence** is set with the parameters in the "Trigger In" section of the "Trigger/Marker/Clock" dialog.

The segment currently being output is displayed at "Current Segment".

The "Trigger Example" graph displays schematically the waveform output, depending on the activated trigger and the next segment settings.

"Same Segment"

Depending on the trigger setting, the currently selected segment is continuously output either immediately or after a trigger event.

Signal generation takes place differently according to the trigger selected in the "Trigger In" section:

- In the case of "Trigger = Auto", output starts at once and the segment is generated continuously. Trigger events are ignored. If the segment is changed in "Next Segment", output of the current segment is stopped and the new segment is output immediately, following a system-imposed signal gap (see above).
- In the case of "Trigger = Armed\_Auto", output starts after the first trigger event. The segment is then generated continuously. Further trigger events are ignored. If the segment is changed in "Next Segment", signal output is stopped and the new segment is not output until a trigger occurs.
- In the case of "Trigger = Retrigger", output starts at once and the segment is generated continuously, a trigger event causes a restart. If the segment is changed in "Next Segment", output of the current segment is stopped and the new segment is output immediately, following a system-imposed signal gap (see above).
- In the case of "Trigger = Armed\_Retrigger", output starts after the first trigger event. The segment is then generated continuously. Further trigger events cause a restart. If the segment is changed in "Next Segment", signal output is stopped and the new segment is not output until a trigger occurs.
- In the case of "Trigger = Single", output starts after the first trigger event. The segment is then generated once. Further trigger events cause a restart. If the segment is changed in "Next Segment", signal output is not stopped. The new segment is not output until a trigger occurs.



## "Next Segment"

Depending on the trigger setting, the segment selected under "Next Segment" is output either immediately or after a trigger event.

- In the case of "internal Trigger = Auto", output starts at once and the segment is generated continuously.  
If the segment index is changed in "Next Segment", output of the current segment is stopped and the new segment is output immediately, following a system-imposed signal gap.
- In the case of "internal Trigger = Armed\_Auto", output starts after the first trigger event. The segment is then generated continuously.  
If the segment index is changed in "Next Segment", output of the current segment is stopped and the new segment is output immediately, following a system-imposed signal gap.
- In the case of "internal Trigger = Armed\_Auto", output starts after the first trigger event. The segment is then generated continuously.  
If the segment index is changed in "Next Segment", signal output is stopped and the new segment is not output until a trigger occurs.
- In the case of "internal Trigger = Single", output starts after the first trigger event. The segment is then generated once. Further trigger events cause a restart.  
If the segment index is changed in "Next Segment", the new segment is not output until a trigger occurs.
- In the case of "External Trigger = Auto", output starts at once and the segment is generated continuously.  
Each trigger event switches over to outputting the subsequent segment, following a system-imposed signal gap.  
If the segment index is changed in "Next Segment", output of the current segment is stopped and the new segment is output immediately, following a system-imposed signal gap.  
The subsequent trigger event after the last segment causes the first segment to be output again.
- In the case of "External Trigger = Armed\_Auto", output starts after the first trigger event. The segment is then generated continuously.  
Each trigger event switches over to outputting the subsequent segment, following a system-imposed signal gap.  
If the segment is changed in Next Segment, signal output is stopped and the new segment is not output until a trigger occurs.  
The subsequent trigger event after the last segment causes the first segment to be output again.
- In the case of "External Trigger = Single", output starts after the first trigger event. The segment is then generated once.  
Each trigger event switches over to outputting the subsequent segment once.  
If the segment is changed in "Next Segment", signal output is not stopped. The new segment is not output until a trigger occurs.  
The subsequent trigger event after the last segment causes the first segment to be output again.  
The remaining trigger modes ("Retrigger" and "Armed\_Retrigger") are not available.

"Next Segment Seamless"	<p>The segment selected under "Next Segment" is output. This mode is only available if all segments have the same sample rate.</p> <ul style="list-style-type: none"> <li>• In the case of "Internal Trigger = Auto", output starts at once and the segment is generated continuously. If the segment is changed in "Next Segment", the new segment is output seamlessly after the output of the current segment is complete.</li> <li>• In the case of "internal Trigger = Armed_Auto", output starts after the first trigger event. The segment is then generated continuously. If the segment is changed in "Next Segment", signal output is stopped and the new segment is not output until a trigger occurs.</li> <li>• In the case of "External Trigger = Auto", output starts at once and the segment is generated continuously. Each trigger event switches over to outputting the subsequent segment once the output of the current segment has been completed. If the segment is changed in "Next Segment", the new segment is output seamlessly after the output of the current segment is complete.</li> <li>• In the case of "External Trigger = Armed_Auto", output starts after the first trigger event. The segment is then generated continuously. Each trigger event switches over to outputting the subsequent segment once the output of the current segment has been completed. If the segment is changed in "Next Segment", signal output is stopped and the new segment is not output until a trigger occurs.</li> </ul> <p>The remaining trigger modes ("Retrigger" and "Armed_Retrigger") are not available.</p>
"Sequencer"	<p>The waveform files are processed according to the order and repetition cycles defined in the special sequencing list file (*.wvs) assigned to the multi segment waveform file.</p> <p>This "play list" is defined in the <a href="#">Multi Segment Waveform Sequencing</a> dialog.</p> <p><b>Note:</b> This feature is disabled in case the segments in the multi segment waveform file have different clock rates.</p>

SCPI command:

`[ :SOURce<hw> ] :BB:ARB:TRIGger:SMODE` on page 544

#### Next Segment Source

Displays the next segment source, internal or external, as selected with the parameter "Trigger Source".

SCPI command:

`[ :SOURce<hw> ] :BB:ARB:WSEGment:NEXT:SOURce` on page 579

#### Execute Next Segment

Triggers manually switchover to the subsequent segment in the mutli segment file. A manual trigger can be executed only when an internal "Next Segment Source" has been selected.

To perform a switchover to any segment within the multi segment file, adjust the parameter "Next Segment".

This parameter is disabled, if a sequencing play list is enabled.

SCPI command:

`[ :SOURce<hw> ] :BB:ARB:WSEgment:NEXT:EXECute` on page 579

### Sequencing List

Open a dialog box for defining the "play lists" (see "[Multi Segment Waveform Sequencing](#)" on page 383).

SCPI command:

`[ :SOURce<hw> ] :BB:ARB:WSEgment:SEquence:SElect` on page 580

### Trigger Example

Displays an example of a multi segment waveform. The currently enabled trigger and next segment mode are considered. After the instrument switch on, the graph of the last loaded waveform is displayed.

**Note:** The curves plotted in this dialog box are textbook examples, "not measured" waveforms. They are intended to visualize the trigger and next segment settings more clearly.

SCPI command:

n.a.

### Marker Mode

The marker output signal for synchronizing external instruments is configured in the "Marker Settings" section "Marker Mode".

#### Marker Mode

Selects a marker signal for the associated "MARKER" output.

**Note:** The marker trace in the waveform file remains unchanged in any case. It is not overwritten, even if something else than Unchanged has been selected.

- |             |   |
|-------------|---|
| "Unchanged" | The marker signal remains unchanged as defined in the waveform file.  |
| "Restart"   | A marker signal is generated at the start of each ARB sequence. This marker mode is not enabled for muti segment waveforms.   |
| "Pulse"     | A regular marker signal is generated. The pulse frequency is defined by entering a divider. The frequency is derived by dividing the sample rate by the divider. The input box for the divider opens when "Pulse" is selected, and the resulting pulse frequency is displayed below it. The precision of the frequency setting depends on the sampling rate. The maximum pulse frequency is equal to half of the sampling rate. |

SCPI command:

`[ :SOURce<hw> ] :BB:ARB:TRIGger:OUTPut<ch>:PULSe:DIVider` on page 548

`[ :SOURce<hw> ] :BB:ARB:TRIGger:OUTPut<ch>:PULSe:FREQuency`  
on page 548

"Pattern " A marker signal that is defined by a bit pattern is generated. The pattern has a maximum length of 64 bits and is defined in an input field which opens when "pattern" is selected.  
The pattern bits switch the marker signal to high and low state.

SCPI command:

[\[:SOURce<hw>\]:BB:ARB:TRIGger:OUTPut<ch>:PATTern](#) on page 548

"ON/OFF Period" A regular marker signal that is defined by an ON/OFF ratio is generated. A period lasts one ON and OFF cycle.

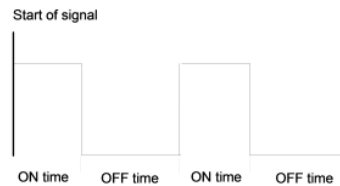

The "ON Time" and "OFF Time" are each expressed as a number of samples and are set in an input field which opens when ON/OFF ratio is selected.

SCPI command:

[\[:SOURce<hw>\]:BB:ARB:TRIGger:OUTPut<ch>:OFFTime](#) on page 547

[\[:SOURce<hw>\]:BB:ARB:TRIGger:OUTPut<ch>:ONTime](#) on page 547

SCPI command:

[\[:SOURce<hw>\]:BB:ARB:TRIGger:OUTPut<ch>:MODE](#) on page 547

### Marker Delay

The delay of the signals on the MARKER outputs is set in the "Marker Delay" section.

### Marker x Delay

Enters the delay between the marker signal at the marker outputs and the start of the frame or slot.

The input is expressed as a number of symbols. If the setting "Fix marker delay to dynamic range" is enabled, the setting range is restricted to the dynamic range. In this range the delay of the marker signals can be set without restarting the marker and signal.

SCPI command:

[\[:SOURce<hw>\]:BB:ARB:TRIGger:OUTPut<ch>:DELay](#) on page 542

### Current Range without Recalculation

Displays the dynamic range within which the delay of the marker signals can be set without restarting the marker and signal.

The delay can be defined by moving the setting mark.

SCPI command:

[\[:SOURce<hw>\]:BB:ARB:TRIGger:OUTPut<ch>:DELay:MINimum](#) on page 542

[\[:SOURce<hw>\]:BB:ARB:TRIGger:OUTPut<ch>:DELay:MAXimum](#) on page 542

**Fix marker delay to current range**

Restricts the marker delay setting range to the dynamic range. In this range the delay can be set without restarting the marker and signal.

SCPI command:

[\[:SOURce<hw>\]:BB:ARB:TRIGger:OUTPut:DElay:FIXed](#) on page 541

**Clock Settings**

The "Clock Settings" is used to set the clock source and a delay if required.

**Clock Source**

Selects the clock source.

- |            |  |
|------------|--|
| "Internal" | The internal clock reference is used to generate the symbol clock.   |
| "External" | The external clock reference is fed in as the symbol clock or multiple thereof via the CLOCK connector.<br>The symbol rate must be correctly set to an accuracy of +/-2 % (see data sheet).<br>The polarity of the clock input can be changed with the aid of "Global Trigger/Clock Settings". |

SCPI command:

[\[:SOURce<hw>\]:BB:ARB:CLOCK:SOURCE](#) on page 539

**Clock Mode**

Enters the type of externally supplied clock.

- |                   |   |
|-------------------|---|
| "Sample"          | A sample clock is supplied via the CLOCK connector.   |
| "Multiple Sample" | A multiple of the sample clock is supplied via the CLOCK connector; the sample clock is derived internally from this.<br>The "Multiplier" window provided allows the multiplication factor to be entered. |

SCPI command:

[\[:SOURce<hw>\]:BB:ARB:CLOCK:MODE](#) on page 539

**Sample Clock Multiplier**

Enters the multiplication factor for clock type "Multiple".

SCPI command:

[\[:SOURce<hw>\]:BB:ARB:CLOCK:MULTIplier](#) on page 539

**Measured External Clock**

Indicates the measured frequency of the external clock signal. This enables the user to permanently monitor the frequency of the externally introduced clock.

This information is displayed only if the external clock source has been selected.

SCPI command:

CLOC:INP:FREQ?

### Global Settings

The buttons in this section lead to submenu for general trigger, clock and mapping settings.

### Global Trigger/Clock Settings

Calls the "Global Trigger/Clock/Input Settings" dialog.

This dialog is used among other things for setting the trigger threshold, the input impedance and the polarity of the clock and trigger inputs.

The parameters in this menu affect all digital modulations and standards, and are described in [chapter 5.2.3.10, "Global Trigger/Clock/External Input Settings"](#), on page 129.

### User Marker / AUX I/O Settings

Calls the "User Marker AUX I/O Settings" menu, used used to map the connector on the rear of the instruments.

See also [chapter 5.2.3.12, "User Marker / AUX I/O Settings"](#), on page 132.

### Sine Test Signals

To access the "Sine Test Signals" dialog, in the "ARB MOD" dialog set the parameter "Create Test Signal" to Sine and press "Create Test Signal".

The menu can be used to configure a sinusoidal test signal. A sine wave is generated on the I path, and a sine wave of the same frequency but phase-shifted is generated on the Q path.

The signal actually set is displayed in graphical form in the center of the menu.

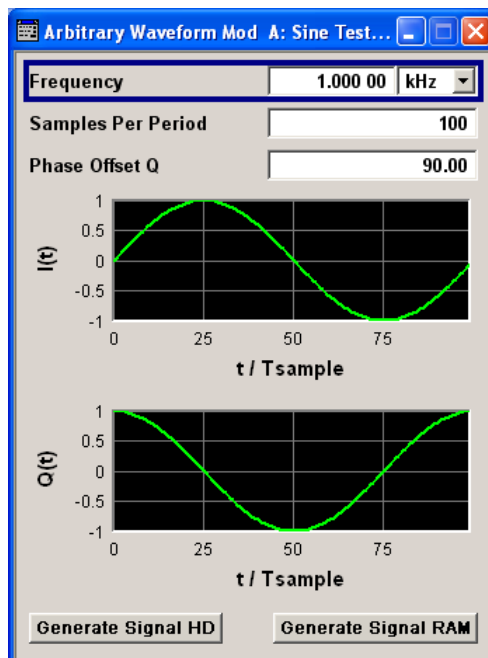

**Frequency (Sine Test Signal)**

Enters the frequency of the test signal.

SCPI command:

[\[:SOURce<hw>\]:BB:ARB:TSIGnal:SINE:FREQuency](#) on page 551

**Samples per Period (Sine Test Signal)**

Enters the number of sample values required from the sine wave per period.

The resulting clock rate must not exceed the maximum ARB clock rate (see data sheet). The number of sample values is automatically restricted by reference to the set frequency.

SCPI command:

[\[:SOURce<hw>\]:BB:ARB:TSIGnal:SINE:SAMPles](#) on page 552

**Phase Offset Q (Sine Test Signal)**

Enters the phase offset of the sinewave signal on the Q channel relative to the sinewave signal on the I channel.

SCPI command:

[\[:SOURce<hw>\]:BB:ARB:TSIGnal:SINE:PHASe](#) on page 551

**Generate Signal HD (Sine Test Signal)**

Generates a signal and saves it to a file.

The File Select window opens automatically and the signal can be stored as a waveform file.

SCPI command:

[\[:SOURce<hw>\]:BB:ARB:TSIGnal:SINE:CREate:NAMed](#) on page 549

**Generate Signal RAM (Sine Test Signal)**

Generates a signal and uses it as output straight away.

SCPI command:

[\[:SOURce<hw>\]:BB:ARB:TSIGnal:SINE:CREate](#) on page 549

**Rect Test Signal**

To access the "Sine Test Signals" dialog, in the "ARB MOD" dialog set the parameter "Create Test Signal" to Rect and press "Create Test Signal".

The dialog can be used to configure a rectangular test signal. A rectangular test signal with a duty factor of 0.5 is created. Amplitude and offset are adjustable. Both paths, I and Q, get the same signal.

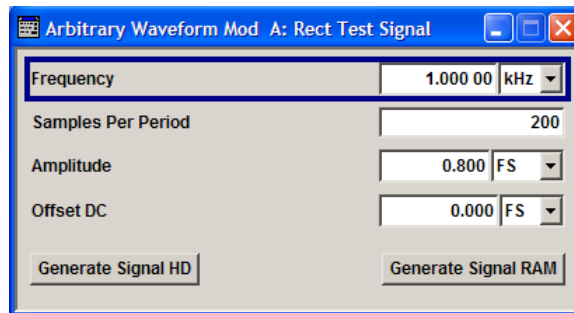
**Frequency (Rect Test Signal)**

Enters the frequency of the test signal.

SCPI command:

[\[:SOURce<hw>\]:BB:ARB:TSIGnal:RECTangle:FREQuency](#) on page 550

**Samples per Period (Rect Test Signal)**

Enters the number of sample values required for the rectangular signal per period.

The resulting clock rate must not exceed the maximum ARB clock rate (see data sheet).

The number of sample values is automatically restricted by reference to the set frequency.

SCPI command:

[\[:SOURce<hw>\]:BB:ARB:TSIGnal:RECTangle:SAMPles](#) on page 551

**Amplitude (Rect Test Signal)**

Enters the digital amplitude of the rectangular wave.

The abbreviation FS means full scale.

SCPI command:

[\[:SOURce<hw>\]:BB:ARB:TSIGnal:RECTangle:AMPLitude](#) on page 550

**Offset DC (Rect Test Signal)**

Enters a DC component.

SCPI command:

[\[:SOURce<hw>\]:BB:ARB:TSIGnal:RECTangle:OFFSet](#) on page 550

**Generate Signal HD (Rect Test Signal)**

Generates a signal and saves it to a file.

The File Select window opens automatically and the signal can be stored as a waveform file.

SCPI command:

[\[:SOURce<hw>\]:BB:ARB:TSIGnal:RECTangle:CREate:NAMed](#) on page 549

**Generate Signal RAM (Rect Test Signal)**

Generates a signal and uses it as output straight away.

SCPI command:

[\[:SOURce<hw>\]:BB:ARB:TSIGnal:SINE:CREate](#) on page 549



### Const IQ Test Signal

To access the "Sine Test Signals" dialog, in the "ARB MOD" dialog set the parameter "Create Test Signal" to Const I/Q and press "Create Test Signal".

The dialog can be used to configure a continuous test signal with constant I/Q. The I and Q values for each path are adjustable but constant. The I and Q values are entered as a decimal number, which is decimal-to-binary converted internally. The signal is provided as a 16-bit wide digital signal for both I and Q channels.

Converted to analog the signal is output directly at the BNC connectors I and Q outputs of the instrument.

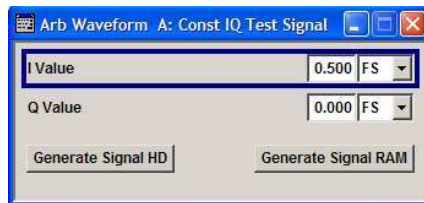

#### I Value (Const IQ Test Signal)

Enters the value for the I component of the test signal.

SCPI command:

[\[:SOURce<hw>\]:BB:ARB:TSIGnal:CIQ:I](#) on page 550

#### Q Value (Const IQ Test Signal)

Enters the value for the Q component of the test signal.

SCPI command:

[\[:SOURce<hw>\]:BB:ARB:TSIGnal:CIQ:Q](#) on page 550

#### Generate Signal HD

Generates a signal and saves it to a file.

The File Select window opens automatically and the signal can be stored as a waveform file.

SCPI command:

[\[:SOURce<hw>\]:BB:ARB:TSIGnal:CIQ:CREate:NAMed](#) on page 549

#### Generate Signal RAM

Generates a signal and uses it as output straight away.

SCPI command:

[\[:SOURce<hw>\]:BB:ARB:TSIGnal:CIQ:CREate](#) on page 549

### 5.8.3.2 Multi Segment Waveforms

To fulfill the requirements of some test systems and to enable rapid alternation between different waveforms with differing test signals, the R&S Signal Generator provides the functionality to generate multi segment waveform files. A multi segment waveform is a combination of multiple waveforms called segments. Each segment represents a completely independent waveform that can be output with its own marker and clock settings.

The entire multi segment waveform is loaded into memory. The segment intended to be output at any given moment can be selected by the user. It is therefore possible to alternate between the individual waveform segments without experiencing any delay due to the loading operation.

If very high switchover speeds are required, the test signals can be continuously scrolled through with the aid of an external trigger or by applying a predefined "play list". For this purpose the segments must have a common sample rate. If the combined waveforms have different sample rates, they can be adapted to a common sample rate by resampling. By the same procedure the instantaneous amplitude of the various waveforms can be scaled to a common RMS level.

To access the "Multi Segment" dialog, select "Baseband > ARB > Multi Segment...".

The menu can be used to create a multi segment waveform from existing waveforms and save it under its own name. As with normal waveforms, the file extension is \*.wv. Information on whether a file is a multi segment waveform is displayed in the File menu with the tag information when a waveform is loaded. Additionally, an information about the waveform can be acquired in the "Waveform Info" dialog.

If the combined waveforms have different sample rates, they can be adapted to a common sample rate by resampling. By the same procedure the instantaneous amplitude of the various waveforms can be scaled to a common rms level.

The configuration of a multi segment waveform, that is to say details of how it is made up from different waveforms, the level and clock rate settings, and the file name, can be saved separately in a list. The file extension is \*.inf\_mswv. This method can be used to create any number of configurations as a basis for defining further multi segment waveforms.

#### **Example for the creation of a multi segment waveform file.**

1. Select "New List" to create empty list.
2. Use the "Append" function to add two or more waveform files.
3. Adjust the "Level", "Clock" and "Segment Marker" settings.
4. Select the "Output File" and enter file name.
5. Select "Save List" to save the configuration.
6. Select "Create" or "Create and Load" to create and save the multi segment waveform.

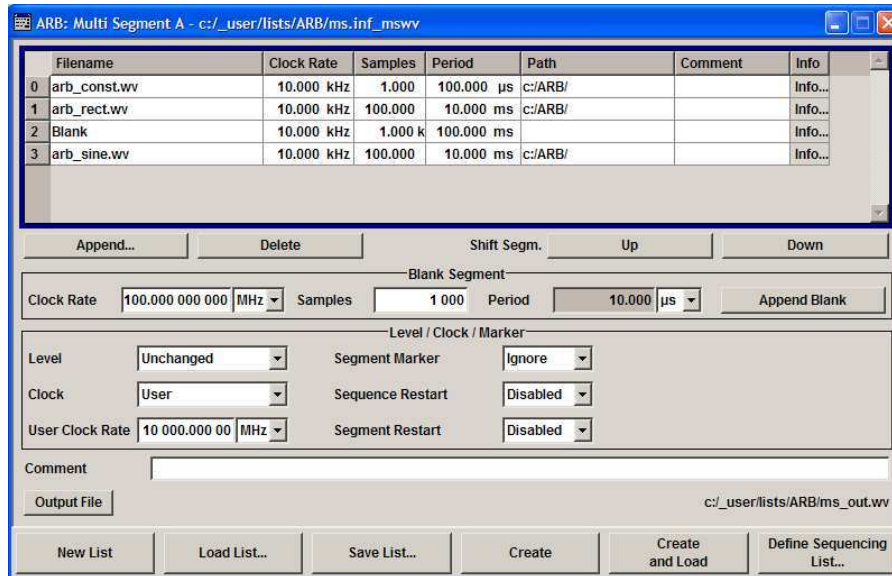

### Multi Segment File Contents

The upper part of the dialog provides the functions, necessary to create and adjust the contents of the multi segment file.

### Multi Segment Table

The table lists the individual waveforms (segments) of the selected multi segment waveform. The information about the segments is taken from the tags of the corresponding waveform files.

"Segment#"	Indication of segment index. The segment index is used to select the segment to be output. The segment index also defines the sequence of the output during triggering in the "Next Segment" or "Next Segment Seamless".
"Waveform"	Indication of the waveform file name of the segment.
"Clock Rate"	Indication of the clock rate of the segment.
"Samples"	Indication of the number of samples in the segment.
"Period"	Indication of the segment duration.
"Path"	Indication of the location of the waveform file used for the corresponding segment.
"Comment"	Indication of the comment on the segment.

"Info" Opens a dialog with detailed information about the currently selected waveform.

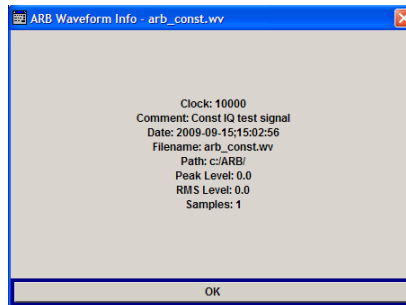

SCPI command:  
n.a.

### Append

Opens the file menu to enter the file name of the waveform file to be appended.

SCPI command:

[\[:SOURce<hw>\]:BB:ARB:WSEGment:CONFigure:SEGment:CATalog](#)  
on page 577

[\[:SOURce<hw>\]:BB:ARB:WSEGment:CONFigure:SEGment:APPend](#) on page 577

### Delete

Deletes the selected segment.

SCPI command:

[\[:SOURce<hw>\]:BB:ARB:WSEGment:CONFigure:DELete](#) on page 574

### Shift Seg.# Up/Down

Shifts the selected segment up and down.

### Blank Segment

The Blank Segment section is where a blank segment can be configured.

#### Clock Rate

Selects the clock rate of the blank segment.

SCPI command:

[\[:SOURce<hw>\]:BB:ARB:WSEGment:CONFigure:BLANk:APPend](#) on page 572

#### Samples

Selects the number of samples for the blank segment.

SCPI command:

[\[:SOURce<hw>\]:BB:ARB:WSEGment:CONFigure:BLANk:APPend](#) on page 572

#### Period

Displays the resulting period for the blank segment.

SCPI command:

n.a.

**Append Blank**

Adds the blank segment to the multi segment file.

SCPI command:

`[ :SOURce<hw> ] :BB:ARB:WSEgment:CONFigure:BLANk:APPend` on page 572

**Level / Clock /Marker**

The Level/Marker/Clock section provides the parameters necessary to adjust the level, marker and clock settings for the selected multi segment waveform file.

**Level**

Defines the level mode for the multi segment waveform.

"Unchanged"     Concerning the level settings, the segments are output exactly as defined in the files. The "Level" display applies only to the segment with the highest rms value. In some circumstances the remaining segments are output at a lower level than that displayed.

"Equal RMS"     Segments are output so that all segments have the same rms value. The "Level" display applies to all segments.

SCPI command:

`[ :SOURce<hw> ] :BB:ARB:WSEgment:CONFigure:LEVel [ :MODE ]` on page 574

**Clock**

Selects the clock rate mode for the multi segment waveform.

"Unchanged"     A segment is output with the clock rate defined in the file. If segments have different clock rates, extended trigger mode "Next Segment" allows internal segment switchovers only ("Internal" trigger source). Extended trigger mode "Next Segment Seamless" can only be selected if all segments have the same clock rate.

"Highest"        All segments are output at the highest available clock rate. This mode provides very short switchover times between segments. The time for calculating the multi segment waveform is increased since the individual segments have to be resampled.

"User"            All segments are output at the clock rate defined in "User Clock". This mode provides very short switchover times between segments. The time for calculating the multi segment waveform is increased since the individual segments have to be resampled.

SCPI command:

`[ :SOURce<hw> ] :BB:ARB:WSEgment:CONFigure:CLOCK:MODE` on page 573

**User Clock Rate**

Defines the sample rate used for multi segment waveform output in case of Clock Mode "User".

SCPI command:

`[ :SOURce<hw> ] :BB:ARB:WSEgment:CONFigure:CLOCK` on page 573

**Segment Marker**

Defines the way the marker information within the separate segments is processed.

- |             |  |
|-------------|--|
| "Ignore"    | The marker information carried in the individual segment waveform files is not considered.               |
| "Take Over" | The output waveform file contains the marker information as configured in the individual waveform files. |

SCPI command:

`[ :SOURce<hw> ] :BB:ARB:WSEgment:CONFigure:MARKer:MODE` on page 576

**Sequence Restart**

Enables/disables the generation of an additional marker restart signal in the output waveform file.

If additional marker generation is enabled, the existing marker signals in the individual segment waveform files are not considered.

- |                     |   |
|---------------------|---|
| "Disable"           | No additional marker is generated.  |
| "Marker<br>1/2/3/4" | Generates a restart marker signal at the beginning of the first segment for the corresponding marker.<br>Use this setting to generate a restart marker for the complete sequence. |

SCPI command:

`[ :SOURce<hw> ] :BB:ARB:WSEgment:CONFigure:MARKer:FSEgment`  
on page 575

**Segment Restart**

Enables/disables the generation of an additional marker restart signal in the output waveform file.

If additional marker generation is enabled, the existing marker signals in the individual segment waveform files are not considered.

- |                     |   |
|---------------------|---|
| "Disable"           | No additional marker is generated.  |
| "Marker<br>1/2/3/4" | Generates a restart marker signal at the beginning of each segment for the corresponding marker.<br>The segment begin is defined by the low-high slope of the marker. This applies for switching between two segments as well as in case of segment replay. |

SCPI command:

`[ :SOURce<hw> ] :BB:ARB:WSEgment:CONFigure:MARKer:ESEgment`  
on page 575

**Output File**

In the Output File section, the output file name is specified and a comment can be added to the file.

**Comment**

Adds a comment to the multi segment file.

SCPI command:

`[ :SOURce<hw> ] :BB:ARB:WSEgment:CONFigure:COMMent` on page 574

**Output file**

Opens the File menu, where the file name of the multi segment waveform which has to be calculated can be entered. The multi segment waveform is saved under this name by clicking the "Create" or "Create and Load" button.

A name must also be entered here before the list can be saved as a configuration file ("Save List"). In this case the name is needed for internal storage procedures. It is entered as the default name for the multi segment waveform file when loading the list.

SCPI command:

[\[:SOURce<hw>\]:BB:ARB:WSEGment:CONFigure:OFILe](#) on page 576

**Handling of Multi Segment Files**

The buttons in this sections are provided for handling of the multi segment files.

**Save List**

Saves the current entries of the table in a configuration file, including the level mode, clock mode, segment marker mode and output file name settings.

The file name is entered in the "File" menu. Configuration files have the file extension \*.inf\_mswv. They can be used later as the basis for further multi segment waveforms.

Before a multi segment configuration file can be saved, a file name must be entered in "Output File", since this is saved with the configuration file for internal purposes.

SCPI command:

The configuration file to be used for the creation of the multi segment waveform is defined with the command:

[\[:SOURce<hw>\]:BB:ARB:WSEGment:CREate](#)

or [\[:SOURce<hw>\]:BB:ARB:WSEGment:CLOad](#)

The file name of the waveform file is always determined with the command [\[:SOURce<hw>\]:BB:ARB:WSEGment:CONFigure:OFILe](#)

**Load List**

Opens the file menu to select the configuration file to be edited.

SCPI command:

[\[:SOURce<hw>\]:BB:ARB:WSEGment:CONFigure:CATalog](#) on page 573

[\[:SOURce<hw>\]:BB:ARB:WSEGment:CONFigure:SElect](#) on page 577

**New List**

Calls the "Create Multi Segment Waveform List" dialog to enter the name of the new file.

A new new configuration table is created.

SCPI command:

[\[:SOURce<hw>\]:BB:ARB:WSEGment:CONFigure:SElect](#) on page 577

**Define Sequencing List**

Open a dialog box for configuring of the play lists (see "[Multi Segment Waveform Sequencing](#)" on page 383).

SCPI command:

n.a.

**Create**

Creates a new multi segment waveform using the current table entries.

This multi segment waveform is saved with the file name specified in "Output File". As with normal waveforms, the file extension is "\*.wv".

Depending on the configuration of the multi segment waveform, calculation may take some time. A panel with a progress bar and an "Abort" button appears during creating of the multi segment waveform.

In remote control the configuration file to be used for the creation of the multi segment waveform is defined with the command: `[ :SOURce<hw> ] :BB:ARB:WSEGment : CREate` or `[ :SOURce<hw> ] :BB:ARB:WSEGment : CLOad`.

The file name of the waveform file is always determined with the command `[ : SOURce<hw> ] :BB:ARB:WSEGment : CONFigure : OFILe`

SCPI command:

`[ : SOURce<hw> ] :BB:ARB:WSEGment : CREate` on page 578

**Create and Load**

Creates a new multi segment waveform using the current table entries.

This multi segment waveform is saved with the file name specified in "Output File". As with normal waveforms, the file extension is \*.wv.

Depending on the configuration of the multi segment waveform, calculation may take some time.

Following this the "Create Multi Segment Waveform File" submenu is closed and the new multi segment waveform is loaded.

In remote control the configuration file to be used for the creation of the multi segment waveform is defined with the command: `[ :SOURce<hw> ] :BB:ARB:WSEGment : CREate` or `[ :SOURce<hw> ] :BB:ARB:WSEGment : CLOad`.

The file name of the waveform file is always determined with the command `[ : SOURce<hw> ] :BB:ARB:WSEGment : CONFigure : OFILe`

SCPI command:

`[ : SOURce<hw> ] :BB:ARB:WSEGment : CLOad` on page 571

**Multi Segment Waveform Sequencing**

The settings provided in the "Multi Segment Waveform Sequencing" dialog can be adjusted to create a "play list", i.e. to define the sequence in which the waveform file segments are processed and how many times each of them is repeated. The configured play list is displayed in form of a "Sequencing Graphic".



All segments in a "play list" must have the same clock rate.

In the "ARB" main dialog or in the "ARB Trigger/Marker/Clock" dialog, set the "Next Segment Mode" to "Sequencer" to activate the configured "play list".





### Sequencing List

Displays the name of the selected sequencing list file, i.e. the file with the “play list” settings.

The sequencing list file has an extension \*.wvs and is automatically assigned to but independent from the multi segment file. By default, both files have the same name and are located in the same file directory. More than one sequencing list files can be created per multi segment waveform file.

The sequencing list file carries information only about the segment number, the corresponding wavefile names are retrieved from the assigned multi segment waveform file, i.e. the same sequencing list file can be reused for different multi segment waveform files with the same number of segments.

Changes and re-calculations of a multi segment waveform file cause a re-check whether the assigned sequencing list files are still valid. A message is displayed to inform about necessary corrections in the “play list”.

SCPI command:

n.a.

### Assigned to Multi Seg. Waveform

Displays the name of the multi segment waveform file the current sequencing list file is assigned to.

SCPI command:

n.a.

### Sequencing Play List

The "Sequencing Play List" table is used to define the sequence in which the waveform file segments are processed and how many times each of them is repeated.

#### Id# ← Sequencing Play List

Indication of the row number.

n.a.

#### State ← Sequencing Play List

Enables/disables the selected row. Only active segments are processed.

n.a.

#### **Segment# ← Sequencing Play List**

Indication of segment index.

The sequencing list file carries information only about the segment index, the corresponding wavefile names are retrieved from the assigned multi segment waveform file.

n.a.

#### **Waveform ← Sequencing Play List**

Indication of the waveform file name of the segment. The file name is retrieved from the assigned multi segment waveform file.

Available for selection are only waveform files from the pool of segments of the selected multi segment waveform file.

n.a.

#### **Repetition Cycles ← Sequencing Play List**

Sets the number of times the selected segment is cyclically repeated before the next segment in the sequence is processed.

n.a.

#### **Next ← Sequencing Play List**

Determines the action after completing the current one, like for instance which segment is processed after the processing of the current one is finished.

"Next Id#"	The next active segment in the play list is processed.
"Blank"	After the processing of the current segment is completed, the signal output is stopped until a signal restart like a retrigger signal is received. A restart signal causes a complete restart of the sequencing play list.
"Endless"	The current segment is re-played until a signal restart like a retrigger signal is received and the complete sequencing play list is restarted. Only active segments are considered.
"Goto Id#"	Determines the row number of the segment to be processed next. This feature is currently limited for the first 32 rows.

SCPI command:

n.a.

#### **Info ← Sequencing Play List**

Opens a dialog with detailed information about the currently selected waveform.

See also "[Waveform Info](#)" on page 358.

SCPI command:

n.a.

#### **Append**

Inserts a new row at the end of the sequencing play list table.

SCPI command:

[ :SOURce<hw> ] :BB:ARB:WSEGment:SEquence:SElect on page 580

[ :SOURce<hw> ] :BB:ARB:WSEGment:SEquence:APPend on page 579

**Delete**

Deletes the selected row.

SCPI command:

n.a.

**Shift Id# Up/Down**

Shifts the selected row up and down.

SCPI command:

n.a.

**Sequencing Graphic**

Displays the play list graph according to the current configuration.

The graph shows the segment sequence, the segment number and the number of times, the segment is repeated; considered are only the active segments.

SCPI command:

n.a.

**New Sequencing List**

Opens the "Select Sequencing List" dialog to enter the name of the new file.

SCPI command:

n.a.

**Load Sequencing List**

Opens the "Select Sequencing List" dialog to select an existing play list file.

SCPI command:

n.a.

**Save Sequencing List**

Saves the current entries of the table in a play list file.

The default file name of the play list file is the same as the multi segment waveform file name, but it can be changed.

Play list files have the file extension \*.wvs.

SCPI command:

n.a.

**Typical Applications for Multi Segment Waveforms**

This section gives examples of the typical applications for multi segment waveforms.

**High Speed Switchovers**

To test DUTs/chips using different test signals at high throughput requires extremely fast switchovers (for instance when testing ATE devices during manufacture). The following settings enable switching times of approx. 5 us and the test signals are scrolled through with the aid of an external trigger signal:

1. "Trigger Mode" = "Auto"

2. "Trigger Source" = "External Trigger"
3. If the waveforms have different sample rates:  
"Clock Mode" = "Highest" or "User" (when creating the waveform in the Multi Segment Editor)

### Flexible Dynamic Switchovers

When testing DUTs using different test signals, it may be necessary to switch dynamically and flexibly between any of the test signals, for instance depending on the outcome of the previous test. When using remote control via an external computer, the following settings enable switching times of approx. 20 ms for segments with the same sample rate and approx. 200 ms for segments with different sample rates:

1. "Extended Trigger Mode" = "Next Segment"
2. "Trigger Mode" = "Auto"
3. "Trigger Source" = "Internal"

### Flexible Dynamic Switchovers without Signal Interruptions

Testing receivers requires a continuous output of different test signals without interrupting the signal. The test signals then produce a complex total signal with no signal gaps on switchover. Control procedures can use a simulated back channel of the receiver (trigger line or remote control).

Switching times depend on the length of the segment currently being output, since switchover to the next segment does not take place until the current segment comes to an end.

1. "Extended Trigger Mode" = "Next Segment Seamless"
2. "Trigger Mode" = "Auto"
3. "Trigger Source" = "Internal or External"  
If the waveforms have different sample rates:
4. "Clock Mode" = "Highest" or "User" (when creating the waveform in the Multi Segment Editor)

#### 5.8.3.3 Multi Carrier Waveforms

Multi carrier waveforms consisting of up to 32 carriers modulated by user-selectable baseband signals can be created in order to simulate complex multi carrier scenarios with different baseband signals (e.g. CDMA2000 or 3GPP FDD).

The carriers are equally spaced and centered toward the RF frequency or baseband DC line, respectively. The carrier spacing is adjustable within the total available baseband bandwidth of 80 MHz. Each carrier can be separately defined in terms of power, phase and modulated input signal. Optionally, crest factor optimization can be applied.

Thus, multi carrier waveforms can be very easily configured as broadband test signals and used for such purposes as transmitter or receiver tests. Even complex multi carrier

scenarios composed of signals from different digital standards can be created and used for these tests.

### Example for the creation of a multi carrier waveform file

1. Configure general settings
2. Configure carrier table
3. Enter file name of multi carrier waveform ("Output File")
4. Save and load multi carrier waveform ("Create" or "Create and Load")

### User Interface

To access the "Multi Carrier" dialog, select "Baseband > ARB > Multi Carrier...".

The menu can be used to create a multi carrier waveform and save it under its own name. As with normal waveforms, the file extension is \*.wv. Information on clock rate, number of samples and creation day is displayed in the File menu when a waveform is loaded.

The "Multi Carrier" dialog is divided into the following sections.

The upper part of the menu is used for calling the default settings and saving and recalling the submenu settings.

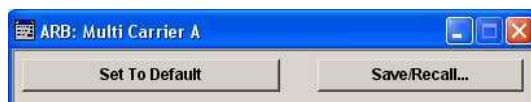

The General Settings section is used to configure the main multi carrier waveform.

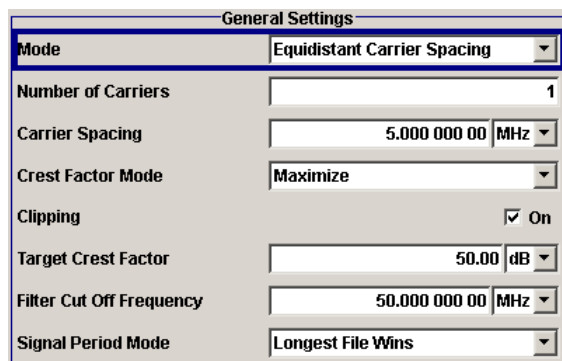

The buttons in the middle part of the menu open submenus for defining the carrier table. The carrier settings can be checked in the graphical "Carrier Graph" submenu.



The "Output Settings" section indicates the name, the size and the clock rate of the multi carrier waveform (after calculation).

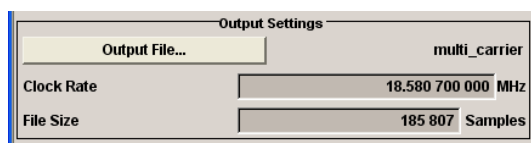

The buttons in the lower part of the menu activate creation and optionally loading of multi carrier waveform files into the main ARB menu.



### Default Settings and State

The upper part of the dialog is used for calling the default settings and saving and recalling existing ARB multi carrier submenu settings.

### Set to Default

Calls default settings. The values are shown in the following table.

Parameter	Value
Number of Carriers	1
Carrier Spacing	0 MHz
Crest Factor Mode	Off
Signal Period Mode	Longest file wins

SCPI command:

[\[:SOURce<hw>\]:BB:ARB:MCARrier:PRESet](#) on page 563

### Save/Recall Frame

Calls the "Save/Recall" menu.

From the "Save/Recall" menu the "File Select" windows for saving and recalling the configurations of the ARB "Multi Carrier" submenu and the "File Manager" can be called.



Multi Carrier configurations are stored as files with the predefined file extension `*.arb_multcarr`. The file name and the directory they are stored in are user-definable.

The complete settings in the Multi Carrier menu are saved and recalled.

"Recall Multi Carrier Settings" Opens the "File Select" window for loading a saved Multi Carrier configuration. The configuration of the selected (highlighted) file is loaded by pressing the "Select" button.

- "Save Multi Carrier Settings" Opens the "File Select" window for saving the current Multi Carrier signal configuration.  
The name of the file is specified in the "File name" entry field, the directory selected in the "Save Into" field. The file is saved by pressing the "Save" button.  
The "Fast Save" checkbox determines whether the instrument performs an absolute or a differential storing of the settings. Enable this function to accelerate the saving process by saving only the settings with values different to the default ones. "Fast Save" is not affected by the "Preset" function.
- "File Manager" Calls the "File Manager".  
The "File Manager" is used to copy, delete, and rename files and to create new directories.

SCPI command:

[\[:SOURCE<hw>\]:BB:ARB:MCARrier:SETTing:CATalog](#) on page 564

[\[:SOURCE<hw>\]:BB:ARB:MCARrier:SETTing:LOAD](#) on page 564

[\[:SOURCE<hw>\]:BB:ARB:MCARrier:SETTing:STORe:FAST](#) on page 564

[\[:SOURCE<hw>\]:BB:ARB:MCARrier:SETTing:STORe](#) on page 564

### General Settings

The "General Settings" section is used to configure the Multi Carrier signal.

#### Mode

Selects the carrier frequency mode.

"Equidistant Carrier Spacing" Sets an equidistant carrier spacing. The carrier frequency in the carrier table is not configurable.

"Arbitrary Carrier Frequency" Enables you to specify the carrier frequency in the carrier table. Carrier spacing is irrelevant.

SCPI command:

[\[:SOURCE<hw>\]:BB:ARB:MCARrier:CARRier:MODE](#) on page 553

#### Number of Carriers

Sets the number of carriers for the multi carrier waveform.

By default the multi carrier table lists 1 carrier. A maximum of 32 carriers can be configured and activated.

When the number of carriers is increased, the multi carrier table is extended by adding further lines at the end of the table. If these carrier already have been defined before, the settings are preset according to the former settings. Otherwise the parameters are preset with the default values.

SCPI command:

[\[:SOURCE<hw>\]:BB:ARB:MCARrier:CARRier:COUNt](#) on page 553

#### Carrier Spacing

Sets the frequency spacing between adjacent carriers of the multi carrier waveform.

The carriers are arranged symmetrically around the RF carrier.

The maximum carrier spacing is limited to

**Carrier spacing = Total baseband bandwidth / (Number of carriers - 1);**

The total baseband bandwidth is 80 MHz.

**Note:** In order to avoid wrap-around problems, the effective "Carrier Spacing" might be slightly modified.

The Carrier Spacing is rounded in that way that the carrier closest to the center RF frequency shows no phase jump assuming that the carrier is unmodulated.

- For odd number of carriers:  
RoundedCarrierSpacing=1/OutputSignalDuration\* round(CarrierSpacing \* OutputSignalDuration);
- For even number of carriers:  
RoundedCarrierSpacing=2/OutputSignalDuration\*round(0.5 \*CarrierSpacing \*OutputSignalDuration).

SCPI command:

`[ :SOURce<hw> ] :BB:ARB:MCARrier:CARRier:SPACing` on page 554

### Crest Factor Mode

Selects the mode for optimizing the crest factor by calculating the carrier phases.

The crest factor represents the ratio of the peak voltage value to the rms voltage value. The higher the crest factor and resulting dynamics of a signal, the greater the requirement for a power amplifier fed by the signal to be linear.

The following modes are available:

"Off"	There is no automatic setting for minimizing or maximizing the crest factor. The "Phase" setting as defined in the carrier table is in use.
"Minimize"	The crest factor is minimized by internally calculating optimized carrier phases. The Phase setting displayed in the carrier table is invalid.
"Maximize"	The crest factor is maximized by internally calculating optimized carrier phases. The Phase setting displayed in the carrier table is invalid.

SCPI command:

`[ :SOURce<hw> ] :BB:ARB:MCARrier:CFACTOR:MODE` on page 556

### Clipping

Switches baseband clipping on and off.

Clipping reduces the peak power of the resulting multi carrier signal according to the input parameter "Target Crest Factor".

The resulting clipped peak power is defined by sum of the the RMS level of the unclipped multi carrier signal and the input parameter "Target Crest Factor". Note that clipping reduces also the RMS level. Hence the resulting crest factor of the clipped signal is slightly above the "Target Crest Factor". In order to get the unclipped parts of the clipped multi-carrier signal matched with the unclipped multicarrier signal, the RF output power should be reduced by the difference between resulting crest factor and "Target Crest Factor".

SCPI command:

`[ :SOURce<hw> ] :BB:ARB:MCARrier:CLIPping[:STATe]` on page 558

### Target Crest Factor

Sets the value of the desired crest factor, if baseband clipping is enabled.



A "Target Crest Factor" above the crest factor of the unclipped multicarrier signal has no effect.

SCPI command:

`[ :SOURce<hw> ] :BB:ARB:MCARrier:CLIPping:CFACTOR` on page 557

#### Filter Cut Off Frequency

Sets the cut off frequency of the final lowpass filter, if baseband clipping is enabled.

When the cut off frequency is set as half of the output sample rate, a final lowpass filter improves the spectrum of the clipped multicarrier signal, but may also increase the resulting crest factor.

SCPI command:

`[ :SOURce<hw> ] :BB:ARB:MCARrier:CLIPping:CUToff` on page 557

#### Signal Period Mode

Selects the mode for calculating the resulting signal period of the multi carrier waveform. The carrier table provides an information button to obtain sample rate and file length data of each carrier.

The resulting period is always calculated for all carriers in the carrier table irrespective of their state (ON/OFF).

**Note:** Wrap-around and timing problems may occur when I/Q signals of different length are used. Thus, demodulation of a carrier may be difficult or even impossible. It is therefore recommended to consider the timing already when creating the input I/Q files or to adjust the signal duration to the carrier which is subsequently demodulated (in this case, the other carriers are for interfering the signal only). These problems do not arise with signals of the same standard (e.g. 3GPP).

The following modes are available:

"Longest File Wins"	The resulting signal period is defined by the longest I/Q file in the carrier table. Shorter I/Q files are periodically repeated.
"Shortest File Wins"	The resulting signal period is defined by the shortest I/Q file in the carrier table. Only the first part of longer I/Q files is used.
"User"	The signal period can be set by the user in the "Signal Period" field. Shorter I/Q files are repeated periodically, and only the first part of longer I/Q files is used.

SCPI command:

`[ :SOURce<hw> ] :BB:ARB:MCARrier:TIME:MODE` on page 565

#### Signal Period

Sets the signal period in Signal Duration Mode "User". Shorter I/Q files are repeated periodically, and only the first part of longer I/Q files is used.

SCPI command:

`[ :SOURce<hw> ] :BB:ARB:MCARrier:TIME` on page 565

#### Carrier Table Submenu

Calls the table for configuring individual carriers. A selectable carrier range can be set with the aid of the optional "Carrier Table Assistant" (see "Multi Carrier Table" on page 394).

The multi carrier configuration can be checked with the aid of the "Carrier Graph".

### Carrier Graph

Calls a graphical representation of the current multi carrier configuration in the frequency domain.

The height of the bars corresponds to the chosen gain of each individual carrier. The bandwidth of the carriers signals is indicated by the width of the bars.

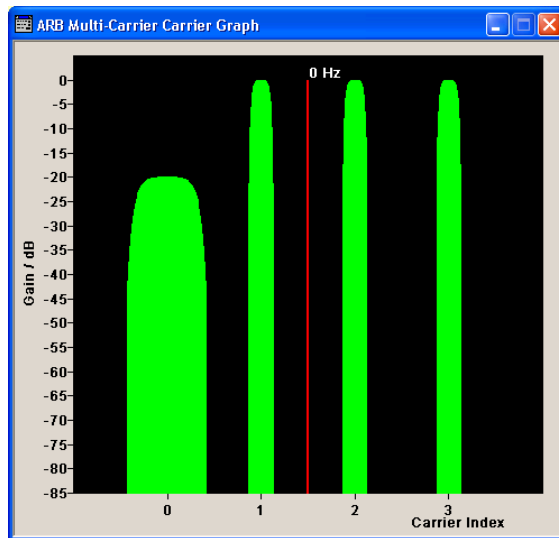

### Output Settings

The "Output Settings" section in the multi carrier main menu indicates the name, the size and the clock rate of the currently calculated multi carrier output file.

#### File

Opens the "File" menu, where the output file name of the multi carrier waveform which has to be calculated can be entered.

The multi carrier waveform is calculated and saved under this name by clicking the "Create" or "Create and Load" button.

SCPI command:

[\[:SOURce<hw>\]:BB:ARB:MCARrier:OFILe](#) on page 563

#### Clock Rate

Displays the resulting sample rate at which the multi carrier waveform is output by the arbitrary waveform generator. The output clock rate depends on the number of carriers, carrier spacing and input sample rate of the leftmost or rightmost carriers.

SCPI command:

[\[:SOURce<hw>\]:BB:ARB:MCARrier:CLOCK](#) on page 559

#### File Size

Displays the resulting number of samples of the multi carrier waveform.

SCPI command:

[\[:SOURce<hw>\]:BB:ARB:MCARrier:SAMPles](#) on page 563

**Create**

Creates a new multi carrier waveform defined by the multi carrier table and General Setting entries.

This multi carrier waveform is saved with the file name specified in "Output File". If no file name is specified, the File Manager opens so that the file name can be entered. As with normal waveforms, the file extension is \*.wv.

Depending on the configuration of the multi carrier waveform, calculation may take some time. A panel with a progress bar and an "Abort" button appears during the calculation process.

SCPI command:

`[ :SOURce<hw> ] :BB:ARB:MCARrier:CREate` on page 559

**Create and Load**

Creates a new multi carrier waveform defined by the multi carrier table and General Setting entries and loads it subsequently in the "ARB" main menu.

This multi carrier waveform is saved with the file name specified in "Output File". If no file name is specified, the File Manager opens so that the file name can be entered. As with normal waveforms, the file extension is \*.wv.

Depending on the configuration of the multi carrier waveform, calculation may take some time. A panel with a progress bar and an "Abort" button appears during the calculation process.

SCPI command:

`[ :SOURce<hw> ] :BB:ARB:MCARrier:CLoad` on page 558

**Muti Carrier Table**

The "Multi Carrier Table" manu is oped by means of the "Carrier Table" button in the middle part of the Multi Carrier Waveforms menu. The carrier settings can be checked in the graphical "Carrier Graph" submenu.

The "Carrier Table Assistant" section can be used to set a selectable carrier range. This section serves as a optional mean to quickly set up a multi carrier scenario within a specified carrier range.

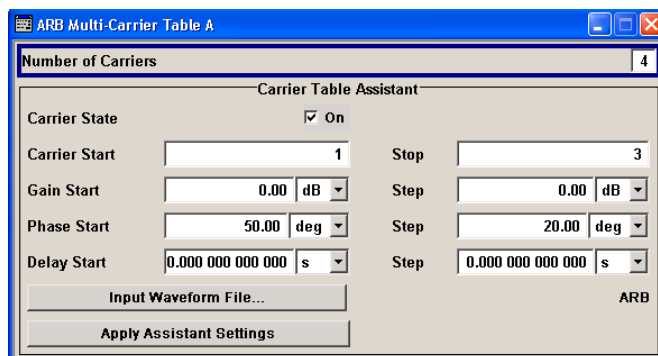

	State	Carrier Freq [MHz]	Gain [dB]	Phase [deg]	Delay [ns]	File	Info	!!!
0	On	-7.500 000	0.00	0.00		0 \Lists\Arb\ArbMccwDummy	Info...	
1	On	-2.500 000	0.00	0.00		0 \Lists\Arb\ArbMccwDummy	Info...	
2	On	2.500 000	0.00	0.00		0 \Lists\Arb\ArbMccwDummy	Info...	
3	Off	7.500 000	0.00	0.00		0 \Lists\Arb\ArbMccwDummy	Info...	

### Carrier Table Assistant

#### Number of Carriers

Defines the number of carriers of the multi carrier waveform.

This parameter is identical to that in the "General Setting" section.

SCPI command:

`[ :SOURce<hw> ] :BB:ARB:MCARrier:CARRier:COUNT` on page 553

#### Carrier State

Switches the carriers in the range "Carrier Start" to "Carrier Stop" on/off.

SCPI command:

`[ :SOURce<hw> ] :BB:ARB:MCARrier:EDIT:CARRier:STATe` on page 563

#### Carrier Start

Defines the start index of the carrier range to which the assistant settings are intended to apply.

SCPI command:

`[ :SOURce<hw> ] :BB:ARB:MCARrier:EDIT:CARRier:START` on page 562

#### Carrier Stop

Defines the stop index of the carrier range to which the assistant settings are intended to apply.

SCPI command:

`[ :SOURce<hw> ] :BB:ARB:MCARrier:EDIT:CARRier:STOP` on page 562

#### Gain Start

Sets the gain of the carrier marked by "Carrier Start".

SCPI command:

`[ :SOURce<hw> ] :BB:ARB:MCARrier:EDIT:CARRier:POWER[:START]`  
on page 562

#### Gain Step

Sets the step width that is used to increment the gain

The resulting carrier gain in the carrier table equals:

#### GainStart + n\* Gain Step

where n ranges from 0 to (Carrier Stop - Carrier Start).

SCPI command:

`[ :SOURce<hw> ] :BB:ARB:MCARrier:EDIT:CARRier:POWER:STEP` on page 562

**Phase Start**

Sets the phase of the carrier marked by "Carrier Start".

SCPI command:

```
[ :SOURce<hw> ] :BB:ARB:MCARrier:EDIT:CARRier:PHASe [ :STARt ]
```

on page 561

**Phase Step**

Sets the step width that is used to increment the phase.

The resulting phase in the carrier table equals:

**PhaseStart + n\* PhaseStep**

where n ranges from 0 to (Carrier Stop – Carrier Start)

SCPI command:

```
[ :SOURce<hw> ] :BB:ARB:MCARrier:EDIT:CARRier:POWer:STEP on page 562
```

**Delay Start**

Sets the delay of the carrier marked by "Carrier Start".

SCPI command:

```
[ :SOURce<hw> ] :BB:ARB:MCARrier:EDIT:CARRier:DELay [ :STARt ]
```

on page 560

**Delay Step**

Sets the step width that is used to increment the delay

The resulting delay in the carrier table equals:

**DelayStart + n\* DelayStep**

where n ranges from 0 to (Carrier Stop – Carrier Start).

SCPI command:

```
[ :SOURce<hw> ] :BB:ARB:MCARrier:EDIT:CARRier:DELay:STEP on page 559
```

**Input Waveform File**

Calls the "File" menu for selecting the inputfile with the I/Q signal to be modulated onto all carriers of the selected carrier range.

SCPI command:

```
[ :SOURce<hw> ] :BB:ARB:MCARrier:EDIT:CARRier:FILE on page 561
```

**Apply Assistant Settings**

Transfer the assistant settings to the carrier table.

SCPI command:

```
[ :SOURce<hw> ] :BB:ARB:MCARrier:EDIT:CARRier:EXECute on page 560
```

**Carrier Table**

The table displays the settings of all available carriers. Previously applied assistant settings can be further refined. The number of lines corresponds to the number of carriers.

**Note:** The phase/deg settings are only valid if optimization of the crest factor is disabled ("Crest Factor Mode" = Off).

	State	Carrier Freq [MHz]	Gain [dB]	Phase [deg]	Delay [ns]	File	Info	!!!
0	On	-7.500 000	0.00	0.00		0 \Lists\Arb\ArbMccwDummy	Info...	
1	On	-2.500 000	0.00	0.00		0 \Lists\Arb\ArbMccwDummy	Info...	
2	On	2.500 000	0.00	0.00		0 \Lists\Arb\ArbMccwDummy	Info...	
3	Off	7.500 000	0.00	0.00		0 \Lists\Arb\ArbMccwDummy	Info...	

**No ← Carrier Table**

Indicates the carrier index ranging from 0 to (number of carriers -1).

Individual carriers can be set using the remote control commands by specifying the index in the parameter CARR.

**State ← Carrier Table**

Switches On/Off a carrier.

SCPI command:

[\[:SOURce<hw>\]:BB:ARB:MCARrier:CARRier<ch>:STATe](#) on page 556

**Carrier Freq [MHz] ← Carrier Table**

Sets the carrier frequency.

**Note:** The carrier frequency can only be set in "Arbitrary Carrier frequency" mode. For "Equidistant Carrier Spacing", the carrier spacing is determined automatically.

SCPI command:

[\[:SOURce<hw>\]:BB:ARB:MCARrier:CARRier<ch>:FREQuency](#) on page 555

**Gain ← Carrier Table**

Sets the gain of a carrier.

SCPI command:

[\[:SOURce<hw>\]:BB:ARB:MCARrier:CARRier<ch>:POWER](#) on page 556

**Phase ← Carrier Table**

Sets the starting phase of a carrier.

SCPI command:

[\[:SOURce<hw>\]:BB:ARB:MCARrier:CARRier<ch>:PHASe](#) on page 556

**Delay ← Carrier Table**

Sets the starting delay of a carrier.

SCPI command:

[\[:SOURce<hw>\]:BB:ARB:MCARrier:CARRier<ch>:DELay](#) on page 555

**File ← Carrier Table**

Calls the "File" menu for selecting the input file with the I/Q signal to be modulated onto the carrier.

SCPI command:

[\[:SOURce<hw>\]:BB:ARB:MCARrier:CARRier<ch>:FILE](#) on page 555

**Info ← Carrier Table**

Indicates the sample rate, number of I/Q value pairs (number of samples), and the resulting signal period of the selected I/Q input file.

SCPI command:

n.a.

**!!! ← Carrier Table**

Indicates an occurred conflict by a means of a red LED. A conflict arises when the carriers overlap.

**Example:**

A conflict is indicated both in the table, as well as in the graph, as shown in the following figures:

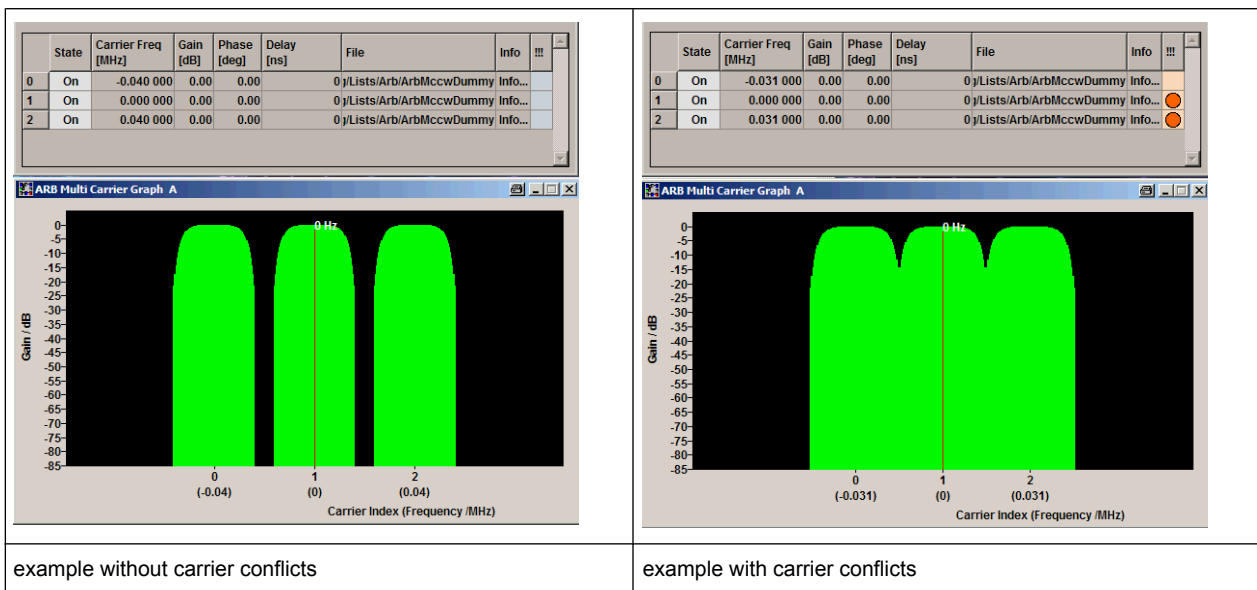

SCPI command:

[\[:SOURce<hw>\]:BB:ARB:MCARrier:CARRier<ch>:CONFLICT](#) on page 554

**Typical Applications for Multi Carrier Waveforms**

High Power Amplifiers of multi carrier base stations face increased requirements in terms of linearity and acceptable intermodulation performance.

A standard transmitter test might be quickly setup by the following instructions:

1. Load a standardized 3GPP downlink test model, e.g. "Test Model 1\_16" and set State to "ON".
2. Create a 3GPP Testmodel ARB file by activating "Generate Waveform File".
3. Setup a multi carrier scenario with 4 carriers and a carrier spacing of 5 MHz.
4. Apply the input file containing the previously generated 3GPP testmodel to all 4 carriers.

## 5.8.4 Multi Carrier Continuous Wave

The R&S SMJ can generate a Multi Carrier CW signal with user-definable offset from carrier, based on a selection of up to 8192 unmodulated carriers. Each carrier can be separately set and switched on, or multiple carriers can be jointly configured. Automatic start phase setting is provided in order to minimize the crest factor.

Multi Carrier CW signals can be very easily configured as broadband test signals and used for such purposes as receiver tests.

To access the dialog for setting a Multi Carrier CW signal, select "Baseband > Multi Carrier CW" or use MENU key under "Baseband".



### 5.8.4.1 Multi Carrier CW User Interface

The "Multi Carrier CW" dialog is divided into the following sections.

The upper part of the menu is used for powering up the Multi Carrier CW and calling the default settings.

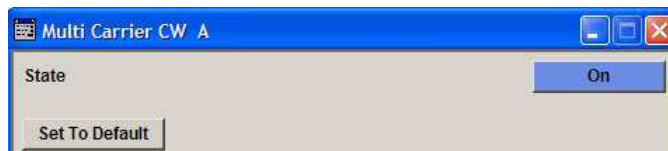

The "Carrier Setup" section is used to configure the Multi Carrier CW signal.

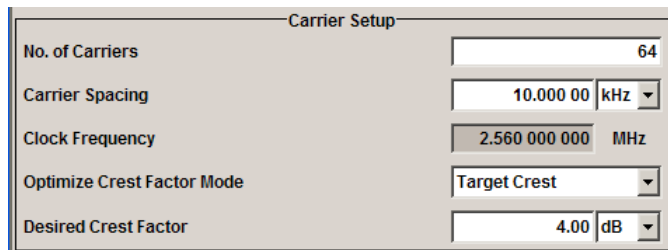

The "Table Setup Assistant" section can be used to set a selectable carrier range.

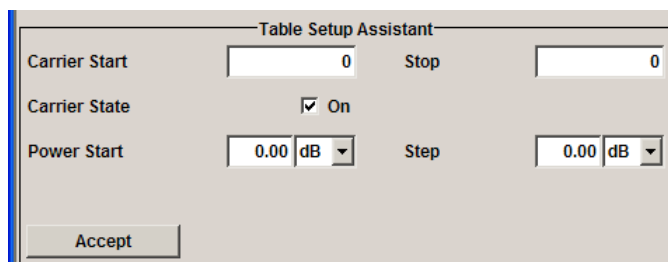

The buttons in the lower part of the menu open dialogs for defining carrier tables and for configuring markers, triggers and clocks.

The carrier settings can be visualized in the graphical "Carrier Graph" dialog.



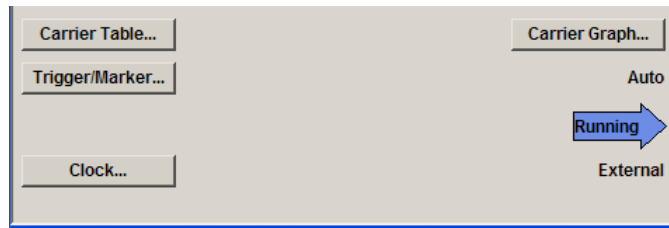

### General Settings for Multi Carrier CW

The upper part of the menu is used for powering up the Multi Carrier CW signal and calling the default settings.

#### State

Enables/disables the Multi Carrier CW.

Switching on this standard turns off all the other digital standards and digital modulation modes.

Since Multi Carrier CW signals are computed in arbitrary waveform mode, changes to the settings of individual carriers are not adopted until the Accept button is pressed. This applies to the settings in the "Table Setup Assistant" section and the "Carrier Table" dialog.

SCPI command:

[ :SOURce<hw> ] :BB:MCCW:STATe on page 620

#### Set to Default

Calls default settings. The values are shown in the following table.

Parameter	Value
State	Not affected by "Set to Default"
<b>Carrier Setup</b>	
Number of Carriers	64
Carrier Spacing	10 kHz
Optimize Crest Factor	Chirp
Desired Crest Factor	3 dB
<b>Trigger</b>	
Mode	Auto
Source	Internal
Ext. Delay	0
Ext. Inhibit	0
<b>Marker</b>	
Channel 1...4	Restart
<b>Clock</b>	
Source	Internal

Parameter	Value
<b>Multi Channel Setup</b>	
Start Carrier	0
Stop Carrier	0
State	ON
Power	0 dB
Power Step	0 dB
Initial Phase	0°
Phase Step	0°
<b>Channel Setup</b>	
State	ON
Phase	0°
Power	0 dB

SCPI command:

[\[:SOURce<hw>\]:BB:MCCW:PRESet](#) on page 621

### Carrier Setup

The "Carrier Setup" section is used to configure the Multi Carrier CW.

#### Number of Carriers

Sets the number of carriers for the Multi Carrier CW signal.

By default the multi carrier table already lists 64 carriers that are preset to the settings State = ON, Power = 0 dB, Phase = 0°.

When entering fewer carriers than the table contains, the approach is generally to delete the superfluous entries from the table, and when entering more carriers than the table contains the missing entries are usually added at the end of the table.

SCPI command:

[\[:SOURce<hw>\]:BB:MCCW:CARRier:COUNT](#) on page 621

#### Carrier Spacing

Sets the spacing between carriers for the Multi Carrier CW signal.

The carriers are arranged symmetrically around the HF carrier.

The total bandwidth is calculated as follow:

Total Bandwidth = ("Number of Carriers" - 1) \* "Carrier Spacing"

The result must not exceed the system bandwidth of the instrument (see data sheet).

SCPI command:

[\[:SOURce<hw>\]:BB:MCCW:CARRier:SPACing](#) on page 623

**Clock Frequency**

Displays the clock rate at which the multi carrier signal is output by the arbitrary waveform generator. The output clock rate depends on the number of carriers and the selected carrier offset.

The value indicates the resolution during the marker generation.

SCPI command:

[ :SOURce<hw> ] :BB:MCCW:CLOCK on page 625

**Optimize Crest Factor Mode**

Selects the mode for automatically minimizing the crest factor.

The carrier start phases are automatically set to this.

The crest factor represents the ratio of the peak voltage value to the rms voltage value. The higher the crest factor and resulting dynamics of a signal, the greater the requirement for a power amplifier fed by the signal to be linear.

A very high crest factor arises when the carriers have an identical start phase, since the carriers are periodically superposed and very high peak voltages occur in relation to the rms voltage values.

Methods of reducing the crest factor differ with regard to both the optimization achievable and the time required for computation.

"Off"	There are no automatic settings for minimizing the crest factor. The "Phase" setting has an effect.
"Chirp"	Very rapid crest factor optimization regardless of the number of carriers. A minimal crest factor of < 3 dB is only obtained for multi carrier signals in which all carriers are switched on and the power of the carriers is identical. In a configuration which differs from this, the achievable crest factor is worse.
"Target Crest"	Optimization of the crest factor to a desired value for all carrier configurations. The optimization time depends on the number of carriers and the desired crest factor. Computation time increases only when the number of carriers exceeds 256 and the crest factor is below 4 dB. The desired value can be entered in "Desired Crest Factor".  <b>Note:</b> Optimization can be cancelled at any time, and the current value being displayed at that moment is then used.

SCPI command:

[ :SOURce<hw> ] :BB:MCCW:CFACTOR:MODE on page 624

**Desired Crest Factor**

Enters the desired crest factor.

This is only possible when the optimization "Target Crest" has been selected.

SCPI command:

[ :SOURce<hw> ] :BB:MCCW:CFACTOR on page 624

**Table Setup Assistant**

The "Table Setup Assistant" section can be used to set a selectable carrier range. The carrier table can be edited in the "Carrier Table" dialog.

**Carrier Start**

Defines the start index of the carrier range to which the following settings are intended to apply.

SCPI command:

`[ :SOURce<hw> ] :BB:MCCW:EDIT:CARRier:START` on page 627

**Carrier Stop**

Defines the stop index of the carrier range to which the following settings are intended to apply.

SCPI command:

`[ :SOURce<hw> ] :BB:MCCW:EDIT:CARRier:STOP` on page 628

**Carrier State**

Switches the carriers in the carrier range on/off.

SCPI command:

`[ :SOURce<hw> ] :BB:MCCW:EDIT:CARRier:STATe` on page 628

**Power Start**

Sets the power of the starting carrier.

SCPI command:

`[ :SOURce<hw> ] :BB:MCCW:EDIT:CARRier:POWer [ :START ]` on page 627

**Power Step**

Sets the width of the step with which the power will be changed from carrier to carrier.

The carrier power that is set with **Power + n\* Power Step** must be within the valid value range -80 dB to 0 dB.

SCPI command:

`[ :SOURce<hw> ] :BB:MCCW:EDIT:CARRier:POWer:STEP` on page 627

**Phase Start**

Sets the phase of the starting carrier. This setting is only available for "Optimize Crest Factor Mode" = Off.

SCPI command:

`[ :SOURce<hw> ] :BB:MCCW:EDIT:CARRier:PHASe [ :START ]` on page 626

**Phase Step**

Sets the width of the step with which the phase will be changed from carrier to carrier.

The phase that is set with **Phase + n\* Phase Step** must be within the valid value range 0° to 360°.

This setting is only available for "Optimize Crest Factor Mode" = Off.

SCPI command:

`[ :SOURce<hw> ] :BB:MCCW:EDIT:CARRier:PHASe:STEP` on page 626

**Accept**

Adopts the carrier range setting into the table ("Carrier Table").

SCPI command:

[\[:SOURce<hw>\]:BB:MCCW:EDIT:CARRIER:EXECute](#) on page 625

**Carrier Table and Carrier Graph**

The lower part of the menu is used to open submenus for configuring carrier tables and for setting triggers, markers and clocks.

**Carrier Table**

Calls the table for configuring individual carriers. This configuration can be checked with the aid of the "Carrier Graph".

	State	Power / dB	Phase / deg
0	On	0.00	0.00
1	On	0.00	0.00
2	On	0.00	0.00
3	Off	0.00	0.00
4	Off	0.00	0.00
5	Off	0.00	0.00
6	On	0.00	0.00
7	On	0.00	0.00
8	On	0.00	0.00

The table displays the settings of all available carriers. Carriers in the On state are highlighted. All carrier parameters can be edited in the table.

The Multi Carrier CW signal is only computed when the "Accept" button is pressed. Whenever the table contains settings that have not yet been adopted with the "Accept" button, the background is yellow.

**Note:** The phase/deg settings are only valid if optimization of the crest factor is disabled ("Optimize Crest Factor" = Off).

- "No." This is the carrier index.
- "State" Switch a carrier on/off
- "Power" Sets the power of a carrier.
- "Phase" Sets the starting phase of a carrier.
- "Accept" Transfer the settings in the carrier table into the instrument.

SCPI command:

[\[:SOURce<hw>\]:BB:MCCW:CARRIER:LIST:STATE](#) on page 622

[\[:SOURce<hw>\]:BB:MCCW:CARRIER:STATE](#) on page 624

[\[:SOURce<hw>\]:BB:MCCW:CARRIER:LIST:POWER](#) on page 622

[\[:SOURce<hw>\]:BB:MCCW:CARRIER:POWER](#) on page 623

[\[:SOURce<hw>\]:BB:MCCW:CARRIER:LIST:PHASE](#) on page 621

[\[:SOURce<hw>\]:BB:MCCW:CARRIER:PHASE](#) on page 622

### Carrier Graph

Calls a graphical representation of the chosen carrier configuration.

The carriers are on the X-axis and the colored bars represent those carriers which are in the On state. Power is on the Y-axis, and the height of the bars corresponds to the chosen power of each individual carrier.

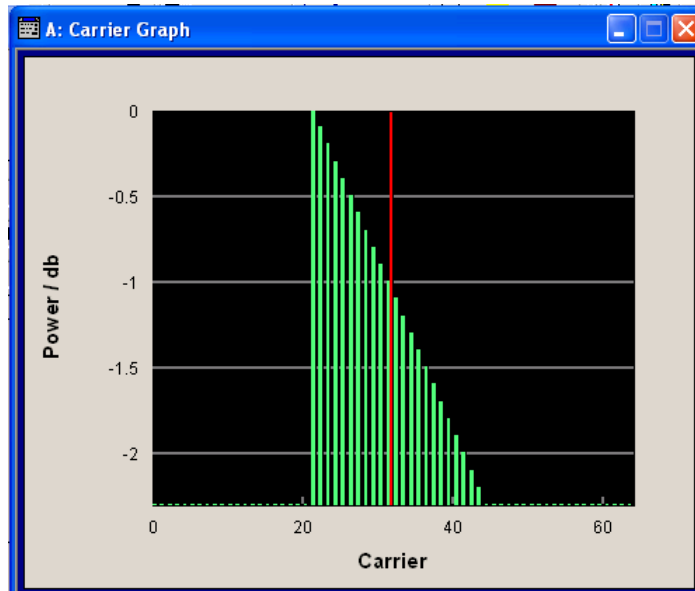

SCPI command:

n.a.

### Trigger/Marker

Calls the "Trigger/Marker" dialog (see ["Trigger/Marker/Clock Settings"](#) on page 405).

This dialog is used to select the trigger source, set the time delay on an external trigger signal and configure the marker output signals.

SCPI command:

n.a.

### Clock

Calls the "Clock" dialog for selecting the clock source (see ["Clock Settings"](#) on page 411).

SCPI command:

n.a.

### Trigger/Marker/Clock Settings

To access this dialog, select "Main Menu > Trigger/Marker".

The "Trigger In" section is where the trigger for the signal is set. Various parameters will be provided for the settings, depending on which trigger source - internal or external - is selected. The current status of signal generation ("Running" or "Stopped") is indicated for all trigger modes.

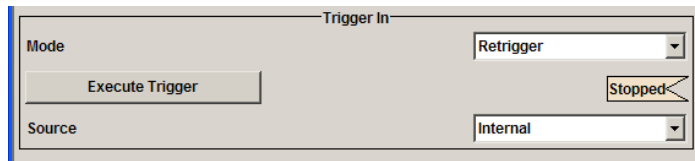

The "Marker Mode" section is where the marker signals at the MARKER output connectors are configured.

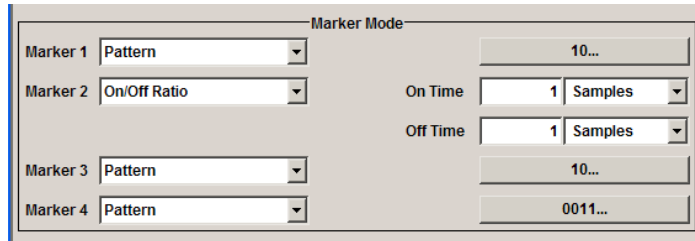

The "Marker Delay" section is where a marker signal delay can be defined, either without restriction or restricted to the dynamic section, i.e., the section in which it is possible to make settings without restarting signal and marker generation.

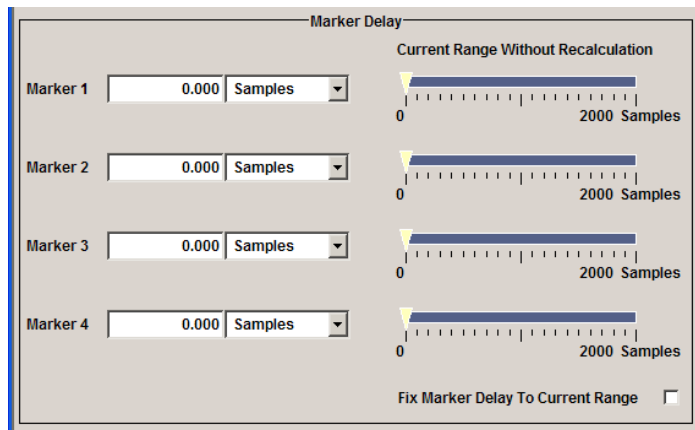

The "Clock Settings" section is where the clock source is selected and - in the case of an external source - the clock type.

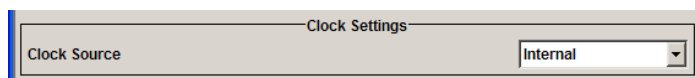

The buttons in the last section lead to submenu for general trigger, clock and mapping settings.



### Trigger In

The "Trigger In" section is where the trigger for the signal is set. Various parameters will be provided for the settings, depending on which trigger source - internal or external - is

selected. The current status of signal generation ("Running" or "Stopped") is indicated for all trigger modes.

### Trigger Mode

Selects trigger mode.

The trigger mode determines the effect of a trigger on the signal generation.

"Auto"	The signal is generated continuously.
"Retrigger"	The signal is generated continuously. A trigger event (internal or external) causes a restart.
"Armed_Auto"	The signal is generated only when a trigger event occurs. Then the signal is generated continuously. Button "Arm" stops signal generation. A subsequent trigger event (internal with "Execute Trigger" or external) causes a restart.
"Armed_Retrigger"	The signal is generated only when a trigger event occurs. Then the signal is generated continuously. Every subsequent trigger event causes a restart. Button "Arm" stops signal generation. A subsequent trigger event (internal with "Execute Trigger" or external) causes a restart.
"Single"	The signal is generated only when a trigger event occurs. Then the signal is generated once to the length specified at "Signal Duration". Every subsequent trigger event (internal with "Execute Trigger" or external) causes a restart.

SCPI command:

[\[:SOURce<hw>\]:BB:MCCW\[:TRIGger\]:SEQuence](#) on page 633

### Signal Duration

Defines the length of the signal sequence to be output in the "Single" trigger mode. The unit of the entry is defined under "Signal Duration Unit". It is then possible to output deliberately just part of the signal, an exact sequence of the signal, or a defined number of repetitions of the signal.

SCPI command:

[\[:SOURce<hw>\]:BB:MCCW:TRIGger:SLENgth](#) on page 631

### Running/Stopped

Displays the status of signal generation for all trigger modes. This display appears only when signal generation is enabled ("State" On).

"Running"	The modulation signal is generated; a trigger was (internally or externally) initiated in triggered mode. If "Armed_Auto" and "Armed_Retrigger" have been selected, generation of signals can be stopped with the "Arm" button. A new trigger (internally with "Execute Trigger" or externally) causes a restart.
"Stopped"	The signal is not generated, and the instrument waits for a trigger event (internal or external).

SCPI command:

[\[:SOURce<hw>\]:BB:MCCW:TRIGger:RMODE](#) on page 631



**Arm**

Stops signal generation. This button appears only with "Running" signal generation in the "Armed\_Auto" and "Armed\_Retrigger" trigger modes.

Signal generation can be restarted by a new trigger (internally with "Execute Trigger" or externally).

SCPI command:

[\[:SOURce<hw>\]:BB:MCCW:TRIGger:ARM:EXECute](#) on page 629

**Execute Trigger**

Executes trigger manually. A manual trigger can be executed only when an internal trigger source and a trigger mode other than "Auto" have been selected.

SCPI command:

[\[:SOURce<hw>\]:BB:MCCW:TRIGger:EXECute](#) on page 629

**Trigger Source**

Selects trigger source. This setting is effective only when a trigger mode other than "Auto" has been selected.

- |                            |   |
|----------------------------|---|
| "Internal"                 | The trigger event is executed by "Execute Trigger".   |
| "External (TRIGGER 1 / 2)" | The trigger event is executed with the aid of the active edge of an external trigger signal.<br>The trigger signal is supplied via the TRIGGER connector.<br>The polarity, the trigger threshold and the input impedance of the TRIGGER input can be set in the "Global Trigger/Clock Settings" dialog. |

SCPI command:

[\[:SOURce<hw>\]:BB:MCCW:TRIGger:SOURce](#) on page 632

**Sync. Output to External Trigger**

(enabled for Trigger Source External)

Enables/disables output of the signal synchronous to the external trigger event.

- |      |  |
|------|--|
| "On" | Corresponds to the default state of this parameter.<br>The signal calculation starts simultaneously with the external trigger event but because of the instrument's processing time the first samples are cut off and no signal is outputted. After elapsing of the internal processing time, the output signal is synchronous to the trigger event. |
|------|--|

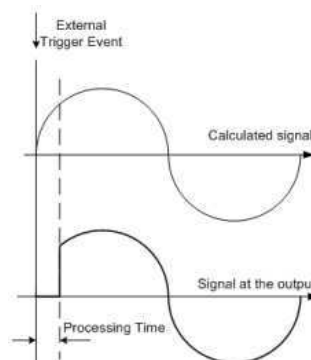

"Off"

The signal output begins after elapsing of the processing time and starts with sample 0, i.e. the complete signal is outputted.

This mode is recommended for triggering of short signal sequences with signal duration comparable with the processing time of the instrument.

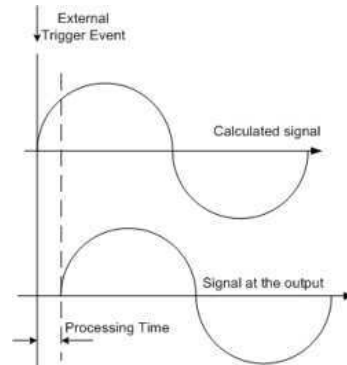

SCPI command:

`[ :SOURce<hw> ] :BB:MCCW:TRIGger:EXTernal:SYNChronize:OUTPut`  
on page 629

### Trigger Delay

Sets the trigger signal delay in samples on external triggering or on internal triggering via the second path.

Sets the trigger signal delay in samples on external triggering.

This enables the R&S Signal Generator to be synchronized with the device under test or other external devices.

SCPI command:

`[ :SOURce<hw> ] :BB:MCCW:TRIGger [ :EXTernal<ch> ] :DELay` on page 632

### Trigger Inhibit

Sets the duration for inhibiting a new trigger event subsequent to triggering. The input is to be expressed in samples.

In the "Retrigger" mode, every trigger signal causes signal generation to restart. This restart is inhibited for the specified number of samples.

This parameter is only available on external triggering.

SCPI command:

`[ :SOURce<hw> ] :BB:MCCW:TRIGger [ :EXTernal<ch> ] :INHibit` on page 632

### Marker Mode

The marker output signal for synchronizing external instruments is configured in the marker settings section "Marker Mode".

#### Marker Mode

Selects a marker signal for the associated "MARKER" output.

"Restart" A marker signal is generated at the start of the waveform.

"Pulse" A regular marker signal is generated. The pulse frequency is defined by entering a divider. The frequency is derived by dividing the sample rate by the divider. The input box for the divider opens when "Pulse" is selected, and the resulting pulse frequency is displayed below it.

SCPI command:

[\[:SOURce<hw>\]:BB:MCCW:TRIGger:OUTPut<ch>:PULSe:DIVider](#) on page 637

[\[:SOURce<hw>\]:BB:MCCW:TRIGger:OUTPut<ch>:PULSe:FREQuency](#)

on page 637

"Pattern " A marker signal that is defined by a bit pattern is generated. The pattern has a maximum length of 64 bits and is defined in an input field which opens when pattern is selected.

SCPI command:

[\[:SOURce<hw>\]:BB:MCCW:TRIGger:OUTPut<ch>:PATtern](#) on page 636

"ON/OFF Period" A regular marker signal that is defined by an ON/OFF ratio is generated. A period lasts one ON and OFF cycle. The "ON Time" and "OFF Time" are each expressed as a number of samples and are set in an input field which opens when ON/OFF ratio is selected.

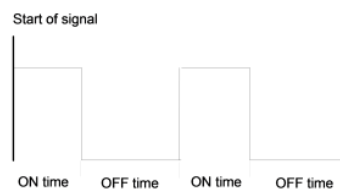

SCPI command:

[\[:SOURce<hw>\]:BB:MCCW:TRIGger:OUTPut<ch>:ONTime](#) on page 636

[\[:SOURce<hw>\]:BB:MCCW:TRIGger:OUTPut<ch>:OFFTime](#) on page 636

SCPI command:

[\[:SOURce<hw>\]:BB:MCCW:TRIGger:OUTPut<ch>:MODE](#) on page 635

### Marker Delay

The delay of the signals on the MARKER outputs is set in the "Marker Delay" section.

#### Marker x Delay

Enters the delay between the marker signal at the marker outputs and the start of the frame or slot.

The input is expressed as a number of symbols. If the setting "Fix marker delay to dynamic range" is enabled, the setting range is restricted to the dynamic range. In this range the delay of the marker signals can be set without restarting the marker and signal.

SCPI command:

[\[:SOURce<hw>\]:BB:MCCW:TRIGger:OUTPut<ch>:DELay](#) on page 634

#### Current Range without Recalculation

Displays the dynamic range within which the delay of the marker signals can be set without restarting the marker and signal.

The delay can be defined by moving the setting mark.

SCPI command:

[ :SOURce<hw> ] :BB:MCCW:TRIGger:OUTPut<ch>:DELay:MINimum on page 635

[ :SOURce<hw> ] :BB:MCCW:TRIGger:OUTPut<ch>:DELay:MAXimum on page 634

#### Fix marker delay to current range

Restricts the marker delay setting range to the dynamic range. In this range the delay can be set without restarting the marker and signal.

SCPI command:

[ :SOURce<hw> ] :BB:MCCW:TRIGger:OUTPut:DELay:FIXed on page 634

### Clock Settings

The Clock Settings is used to set the clock source and a delay if required.

#### Clock Source

Selects the clock source.

"Internal"            The internal clock reference is used to generate the symbol clock.

"External"            The external clock reference is fed in as the symbol clock or multiple thereof via the CLOCK connector.  
The polarity of the clock input can be changed with the aid of "Global Trigger/Clock Settings".

SCPI command:

[ :SOURce<hw> ] :BB:MCCW:CLOCK:SOURCE on page 638

#### Clock Mode

Enters the type of externally supplied clock.

"Sample"            A sample clock is supplied via the CLOCK connector.

"Multiple Sam-    A multiple of the sample clock is supplied via the CLOCK connector;  
ple"                    the sample clock is derived internally from this.

SCPI command:

[ :SOURce<hw> ] :BB:MCCW:CLOCK:MODE on page 638

#### Clock Multiplier

Enters the multiplication factor for clock type "Multiple".

SCPI command:

[ :SOURce<hw> ] :BB:MCCW:CLOCK:MULTIplier on page 638

#### Measured External Clock

Indicates the measured frequency of the external clock signal. This enables the user to permanently monitor the frequency of the externally introduced clock.

This information is displayed only if the external clock source has been selected.

SCPI command:

CLOC:INP:FREQ?

**Global Settings**

The buttons in this section lead to submenu for general trigger, clock and mapping settings.

This settings are available for R&S SMx and R&S AMU instruments only.

**Global Trigger/Clock Settings**

Calls the "Global Trigger/Clock/Input Settings" dialog.

This dialog is used among other things for setting the trigger threshold, the input impedance and the polarity of the clock and trigger inputs.

The parameters in this menu affect all digital modulations and standards, and are described in chapter "Global Trigger/Clock/Input Settings" in the Operating Manual.

**User Marker / AUX I/O Settings**

Calls the "User Marker AUX I/O Settings" menu, used to map the connector on the rear of the instruments.

See also "User Marker / AUX I/O Settings" in the Operating Manual.

## 6 Remote Control Basics

This chapter provides basic information on operating an instrument via remote control.

### 6.1 Remote Control Interfaces and Protocols

The instrument supports different interfaces for remote control. The following table gives an overview.

**Table 6-1: Remote control interfaces and protocols**

Interface	Protocols, VISA <sup>*)</sup> address string	Remarks
Local Area Network (LAN)	Protocols: <ul style="list-style-type: none"> <li>VXI-11 VISA<sup>*)</sup> address string: TCPIP:: host address[: LAN device name]: INSTR]</li> <li>socket communication (Raw Ethernet, simple telnet) VISA<sup>*)</sup> address string: TCPIP:: host address[: LAN device name]: :&lt;port&gt;::SOCKET</li> </ul>	A LAN connector is located on the front or rear panel of the instrument, or both.  The interface is based on TCP/IP and supports various protocols.  For a description of the protocols refer to: <ul style="list-style-type: none"> <li>chapter 6.1.3.2, "VXI-11 Protocol", on page 416</li> <li>chapter 6.1.3.3, "Socket Communication", on page 417</li> </ul>
GPIB (IEC/IEEE Bus Interface)	VISA <sup>*)</sup> address string:  GPIB:: primary address[: INSTR]  (no secondary address)	Optional GPIB bus interfaces according to standard IEC 625.1/IEEE 488.1 are located on the rear panel of the instrument.  For a description of the interface refer to <a href="#">chapter 6.1.4, "GPIB Interface (IEC/IEEE Bus Interface)"</a> , on page 417.

<sup>\*)</sup> VISA is a standardized software interface library providing input and output functions to communicate with instruments. A VISA installation on the controller is a prerequisite for remote control over LAN (when using VXI-11 protocol). However, no VISA installation is necessary to remote control while using socket communication. For more information, see [chapter 6.1.1, "VISA Libraries"](#), on page 414.



Within this interface description, the term GPIB is used as a synonym for the IEC/IEEE bus interface.

#### SCPI (Standard Commands for Programmable Instruments)

SCPI commands - messages - are used for remote control. Commands that are not taken from the SCPI standard follow the SCPI syntax rules. The instrument supports the SCPI version 1999. The SCPI standard is based on standard IEEE 488.2 and aims at the standardization of device-specific commands, error handling and the status registers. The tutorial "Automatic Measurement Control - A tutorial on SCPI and IEEE 488.2" from

John M. Pieper (R&S order number 0002.3536.00) offers detailed information on concepts and definitions of SCPI.

Tables provide a fast overview of the bit assignment in the status registers. The tables are supplemented by a comprehensive description of the status registers.

### 6.1.1 VISA Libraries

VISA is a standardized software interface library providing input and output functions to communicate with instruments. The I/O channel (LAN or TCP/IP, USB, GPIB,...) is selected at initialization time by means of the channel-specific address string ("VISA resource string"), or by an appropriately defined VISA alias (short name). A VISA installation is a prerequisite for remote control using the following interfaces:

- [chapter 6.1.3.2, "VXI-11 Protocol"](#), on page 416
- [chapter 6.1.4, "GPIB Interface \(IEC/IEEE Bus Interface\)"](#), on page 417

For more information about VISA refer to the user documentation.

### 6.1.2 Messages

The messages transferred on the data lines are divided into the following categories:

- **Interface messages**  
Interface messages are transmitted to the instrument on the data lines, with the attention line being active (LOW). They are used to communicate between the controller and the instrument. Interface messages can only be sent by instruments that have GPIB bus functionality. For details see the sections for the required interface.
- **Instrument messages**  
Instrument messages are employed in the same way for all interfaces, if not indicated otherwise in the description. Structure and syntax of the instrument messages are described in [chapter 6.3, "SCPI Command Structure"](#), on page 432. A detailed description of all messages available for the instrument is provided in the chapter "Remote Control Commands".  
There are different types of instrument messages, depending on the direction they are sent:
  - Commands
  - Instrument responses

#### Commands

Commands (program messages) are messages the controller sends to the instrument. They operate the instrument functions and request information. The commands are subdivided according to two criteria:

- According to the effect they have on the instrument:
  - **Setting commands** cause instrument settings such as a reset of the instrument or setting the frequency.

- **Queries** cause data to be provided for remote control, e.g. for identification of the instrument or polling a parameter value. Queries are formed by directly appending a question mark to the command header.
- According to their definition in standards:
  - **Common commands**: their function and syntax are precisely defined in standard IEEE 488.2. They are employed identically on all instruments (if implemented). They refer to functions such as management of the standardized status registers, reset and self test.
  - **Instrument control commands** refer to functions depending on the features of the instrument such as frequency settings. Many of these commands have also been standardized by the SCPI committee. These commands are marked as "SCPI compliant" in the command reference chapters. Commands without this SCPI label are device-specific, however, their syntax follows SCPI rules as permitted by the standard.

### Instrument responses

Instrument responses (response messages and service requests) are messages the instrument sends to the controller after a query. They can contain measurement results, instrument settings and information on the instrument status.

## 6.1.3 LAN Interface

To be integrated in a LAN, the instrument is equipped with a LAN interface, consisting of a connector, a network interface card and protocols. For remote control via a network, the PC and the instrument must be connected via the LAN interface to a common network with TCP/IP network protocol. They are connected using a commercial RJ45 cable. The TCP/IP network protocol and the associated network services are preconfigured on the instrument. Software for instrument control and (for specified protocols only) the VISA program library must be installed on the controller.

### VISA library

Instrument access via VXI-11 protocols is usually achieved from high level programming platforms using VISA as an intermediate abstraction layer. VISA encapsulates the low level VXI or GPIB function calls and thus makes the transport interface transparent for the user. See [chapter 6.1.1, "VISA Libraries"](#), on page 414 for details.

### IP address

Only the IP address or the computer name (LAN device name) is required to set up the connection. The IP address/computer name is part of the "visa resource string" used by the programs to identify and control the instrument.

Forms of the VISA resource string:

VXI-11 protocol: `TCPIP::host address[::LAN device name][::INSTR]`,  
where:

- **TCPIP** designates the network protocol used
- **host address** is the IP address



- **LAN device name** is the computer name of the control device (alternative to IP address)
- **INSTR** indicates that the VXI-11 protocol is used

Socket protocol:

TCPIP::*host address*[:*LAN device name*]::*port*::SOCKET, where:

- **TCPIP** designates the network protocol used
- **host address** is the IP address
- **LAN device name** is the computer name of the control device (alternative to IP address)
- **port** determines the used port number
- **SOCKET** indicates that the Socket protocol is used

**Example:**

Instrument has the IP address *192.1.2.3*; the valid VXI-11 resource string is:

```
TCPIP::192.1.2.3::INSTR
```

Computer name is *RSSM1*; the valid resource string is:

```
TCPIP::RSSM1::INSTR
```



### Identifying instruments in a network

If several instruments are connected to the network, each instrument has its own IP address and associated resource string. The controller identifies these instruments by means of the resource string.

#### 6.1.3.1 HiSLIP Protocol

The HiSLIP (**H**igh **S**peed **L**AN **I**nstrument **P**rotocol) is a protocol for TCP-based instruments specified by the IVI foundation. Compared to its predecessor VXI-11, it provides speed and other improvements. HiSLIP is encapsulated in VISA; the resource string reads `TCPIP::R&S SMJ IP address::HISLIP`.

The internal VISA library of the R&S SMJ supports HiSLIP. If the connection fails, access the Windows control panel of the controlled instrument and open port 5025 for incoming connections.

#### 6.1.3.2 VXI-11 Protocol

The VXI-11 standard is based on the ONC RPC (Open Network Computing Remote Procedure Call) protocol which in turn relies on TCP/IP as the network/transport layer. The TCP/IP network protocol and the associated network services are preconfigured. TCP/IP ensures connection-oriented communication, where the order of the exchanged messages is adhered to and interrupted links are identified. With this protocol, messages cannot be lost.

### 6.1.3.3 Socket Communication

An alternative way for remote control of the software is to establish a simple network communication using sockets. The socket communication, also referred as "Raw Ethernet communication", does not necessary require a VISA installation on the remote controller side.

The simplest way to establish socket communication is to use the built-in telnet program. The telnet program is part of every operating system and supports a communication with the software on a command-by-command basis. For better utilization and to enable automation by means of programs, user defined sockets can be programmed.

Socket connections are established on a specially defined port. The socket address is a combination of the IP address or the host name of the instrument and the number of the port configured for remote-control. All R&S Signal Generator use port number 5025 for this purpose. The port is configured for communication on a command-to-command basis and for remote control from a program.

### 6.1.3.4 LAN Interface Messages

In the LAN connection, the interface messages are called low-level control messages. These messages can be used to emulate interface messages of the GPIB bus.

Command	Long term	Effect on the instrument
&ABO	Abort	Aborts processing of the commands just received.
&DCL	Device Clear	Aborts processing of the commands just received and sets the command processing software to a defined initial state. Does not change the instrument setting.
&GTL	Go to Local	Transition to the "local" state (manual control).
&GTR	Go to Remote	Transition to the "remote" state (remote control).
&GET	Group Execute Trigger	Triggers a previously active instrument function (e.g. a sweep). The effect of the command is the same as with that of a pulse at the external trigger signal input.
&LLO	Local Lockout	Disables switchover from remote control to manual control by means of the front panel keys.
&NREN	Not Remote Enable	Enables switchover from remote control to manual operation by means of the front panel keys
&POL	Serial Poll	Starts a serial poll.

## 6.1.4 GPIB Interface (IEC/IEEE Bus Interface)

To be able to control the instrument via the GPIB bus, the instrument and the controller must be linked by a GPIB bus cable. A GPIB bus card, the card drivers and the program libraries for the programming language used must be provided in the controller. The controller must address the instrument with the GPIB bus address (see [chapter 6.1.4.2, "GPIB Instrument Address"](#), on page 419).

### Characteristics

The GPIB interface is described by the following characteristics:

- Up to 15 instruments can be connected
- The total cable length is restricted to a maximum of 15 m; the cable length between two instruments should not exceed 2m.
- A wired "OR"-connection is used if several instruments are connected in parallel, since the slowest instrument determines the speed.



Any connected IEC bus cable must be terminated by an instrument or controller.

#### 6.1.4.1 GPIB Interface Messages

Interface messages are transmitted to the instrument on the data lines, with the attention line (ATN) being active (LOW). They are used for communication between the controller and the instrument and can only be sent by a computer which has the function of a GPIB bus controller. GPIB interface messages can be further subdivided into:

- **Universal commands:** act on all instruments connected to the GPIB bus without previous addressing
- **Addressed commands:** only act on instruments previously addressed as listeners

#### Universal Commands

Universal commands are encoded in the range 10 through 1F hex. They affect all instruments connected to the bus and do not require addressing.

Command	Effect on the instrument
DCL (Device Clear)	Aborts the processing of the commands just received and sets the command processing software to a defined initial state. Does not change the instrument settings.
IFC (Interface Clear) *)	Resets the interfaces to the default setting.
LLO (Local Lockout)	The LOC/IEC ADDR key is disabled.
SPE (Serial Poll Enable)	Ready for serial poll.
SPD (Serial Poll Disable)	End of serial poll.
PPU (Parallel Poll Unconfigure)	End of the parallel-poll state.
*) IFC is not a real universal command, it is sent via a separate line; however, it also affects all instruments connected to the bus and does not require addressing	

#### Addressed Commands

Addressed commands are encoded in the range 00 through 0F hex. They only affect instruments addressed as listeners.

Command	Effect on the instrument
GET (Group Execute Trigger)	Triggers a previously active instrument function (e.g. a sweep). The effect of the command is the same as with that of a pulse at the external trigger signal input.
GTL (Go to Local)	Transition to the "local" state (manual control).
GTR (Go to Remote)	Transition to the "remote" state (remote control).
PPC (Parallel Poll Configure)	Configures the instrument for parallel poll.
SDC (Selected Device Clear)	Aborts the processing of the commands just received and sets the command processing software to a defined initial state. Does not change the instrument setting.

### 6.1.4.2 GPIB Instrument Address

In order to operate the instrument via remote control, it must be addressed using the GPIB address. The remote control address is factory preset, but it can be changed if it does not fit in the network environment. For remote control, addresses 0 through 30 are allowed. The GPIB address is maintained after a reset of the instrument settings.

#### Changing the GPIB address of the instrument

The GPIB address can be changed manually or using a remote control command.

1. Manually: press the SETUP key and select "Remote > GPIB".



Select parameter "GPIB channel address" and set the GPIB address.

2. Using remote control command:

```
SYST:COMM:GPIB:ADDR 18
```

## 6.2 Starting a Remote Control Session

The instrument and the controller have to be connected with the suitable cable and switched on.

A remote control program must open a connection to the instrument (using VISA functionality), before it can send commands to and receive device responses from the instrument.



#### Instrument Address

In order to operate the instrument via remote control it must be addressed using the defined interface address. See [chapter 6.1.3, "LAN Interface"](#), on page 415 or [chapter 6.1.4, "GPIB Interface \(IEC/IEEE Bus Interface\)"](#), on page 417 for details.



The VISA resource strings are indicated in the "Setup > Remote Channel Settings" menu.

Refer to [chapter 6.2.3, "Examples"](#), on page 421 for practical examples on setting up of a remote control link and starting of a remote control session.

## 6.2.1 Switching to Remote Control

When it is switched on, the instrument is always in the manual operating state and can be operated via the front panel controls (for instruments equipped with a display) or via mouse and external keyboard.

### Starting remote control

1. Send a command from a controller to the instrument.

The instrument is switched to remote control as soon as it receives a command from the controller.

While remote control is active, operation via the front panel or via mouse and keyboard is disabled and "REMOTE" is displayed in the status line.

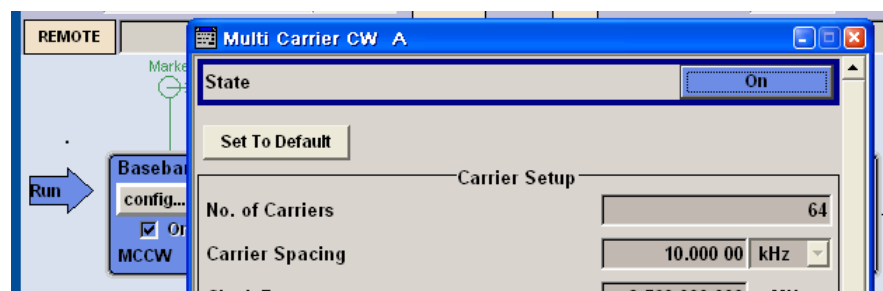

The instrument remains in the remote state until it is reset to the manual state via the instrument or via the remote control interface (see [chapter 6.2.2, "Returning to Manual Operation"](#), on page 421).

**Tip:** Switching from manual operation to remote control and vice versa does not affect the other instrument settings.

2. Although operation via front panel, mouse and keyboard is disabled, the dialog boxes can still be opened, e.g. to verify settings, but buttons and setting fields are displayed in gray and cannot be activated.

Use the command `SYST:KLOC ON` to disable the access to the dialogs.

3. To prevent unintentional return to manual operation, disable the LOCAL key of the instrument using the `&LLO` command (see [chapter 6.1.3.4, "LAN Interface Messages"](#), on page 417).

The instrument switches to "REM-LLO" state and transition to manual mode is not anymore possible via the remote control command `*GTL`.

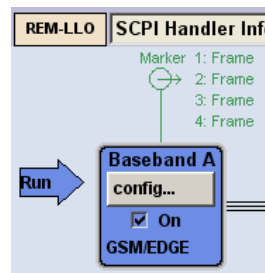

Switching to manual mode is only possible via remote control then.

4. Enable the LOCAL key with the interface message `&NREN`.

## 6.2.2 Returning to Manual Operation



Before returning to manual control, command processing must be completed. Otherwise, the instrument switches back to remote control immediately.

- ▶ To return to manual operation, use one of the following ways:
  - a) Press the LOCAL key on the front panel.
  - b) Select "Setup > Remote Control Channels" and press "Local".
  - c) While using the socket communication, terminate the remote control session.
  - d) Send the interface command `&GTL` via the remote control interface.

**Tip:** Use the `&NREN` to enable the LOCAL key if the key is disabled.

## 6.2.3 Examples

This sections provides examples for setting up of remote control connection and starting a remote control session over LAN and GPIB interfaces.

This section assumes basic knowledge of programming and operation of the controller. A description of the interface commands can be obtained from the relevant manuals.

### 6.2.3.1 Remote Control over GPIB

The program example in this section is written in VISUAL BASIC. A condition for programming in VISUAL BASIC is that the modules NIGLOBAL (`Niglobal.bas`) and VBIB32 (`Vbib_32.bas`) are added to the projects.



Drivers for instrument, e.g. IVI-COM and LabVIEW drivers, are available in the download area of the product website ([http://www2.rohde-schwarz.com/en/products/test\\_and\\_measurement/product\\_categories/signal\\_generation/](http://www2.rohde-schwarz.com/en/products/test_and_measurement/product_categories/signal_generation/)).

### Starting a remote control session over GPIB

As a prerequisite, the GPIB address of the instrument, which is factory-set to 28, must not have been changed.

1. Connect instrument and controller using GPIB cable and switch them on.
2. Execute following commands on the controller:
  - a) Open port to the instrument  
`CALL IBFIND("DEV1", generator%)`
  - b) Inform controller about instrument address  
`CALL IBPAD(generator%, 28)`
  - c) Reset instrument  
`CALL IBWRT(generator%, "*RST;*CLS")`
  - d) Set instrument to new address  
`CALL IBWRT(generator%, "SYST:COMM:GPIB:ADDR 18")`
  - e) Inform controller about new address  
`CALL IBPAD(generator%, 18)`

The GPIB address of the instrument is changed.

3. To return to manual operation, press the LOCAL key at the front panel.

#### 6.2.3.2 Remote Control over LAN using VXI-11 Protocol

Through the examples in this section, the program 'Measurement & Automation Explorer' from National Instruments under Windows operating system is used for setting up a LAN remote control link and starting a remote control session.

#### Configuring the controller



The instrument is preconfigured for networks using DHCP (dynamic host configuration protocol). If this configuration is used, enter the computer name in the position of the IP address.

To enable the external controller to communicate with the software via TCP/IP protocol, set up a remote control link as follow:

1. Connect the controller and the instrument to the network (network cable) and switch them on.
2. Start the 'Measurement & Automation Control' program on the controller.
3. Select "Devices and Interfaces > Create New".



4. Select "VISA TCP/IP Resource" and confirm with "Next".



5. Choose the type of TCP/IP resource you wish to add and select Next.

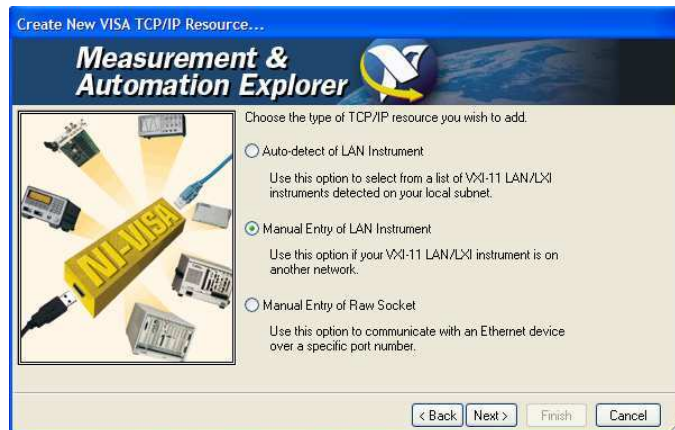

6. Enter the IP address or the host name of the R&S SMJ and select "Next".





7. Enter the alias name if required.  
The alias name must not be mistaken for the computer name. It is only used for instrument identification within the program and displayed in the menu as an option in case of an Ethernet link.
8. Confirm the settings with "Finish".  
The instrument is configured and the settings are displayed in the "TCP/IP Settings" tab.

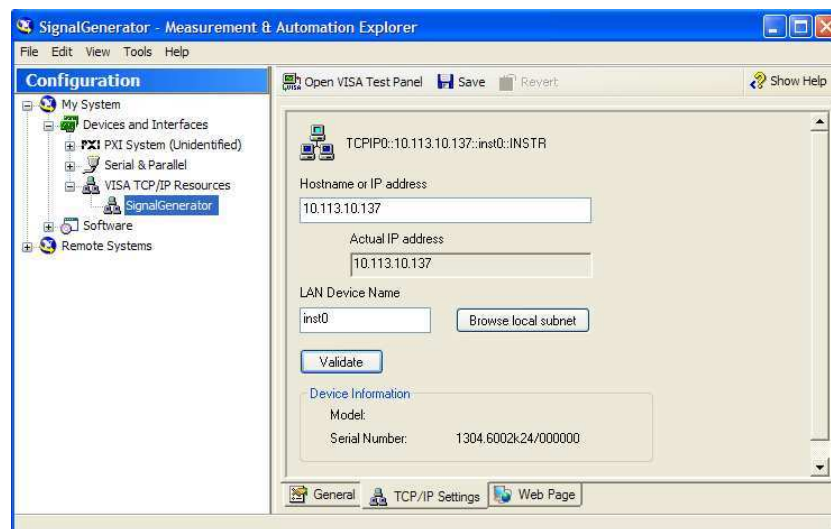

9. To test the connection, select "Validate".  
A message indicates whether the link to the instrument can be set up or not.



If a connection cannot be set up, check whether the controller and the instrument are connected to the network (network cable) and switched on. Correct spelling of the IP address or the computer name can also be checked. For further error location, inform the network administrator. In large networks, specification of additional addresses may be required for link setup, e.g. gateway and subnet mask, which are known to the network administrator.

The instrument is now registered in the program and can be addressed via the resource string or alias name.

### Starting a remote control over LAN (using VXI-11)

1. Start the 'Measurement & Automation Explorer' on the controller.
2. In the "Configuration" window, select "Device and Interfaces > VISA TCP/IP Resources", select the required instrument and select "Open VISA Test Panel".

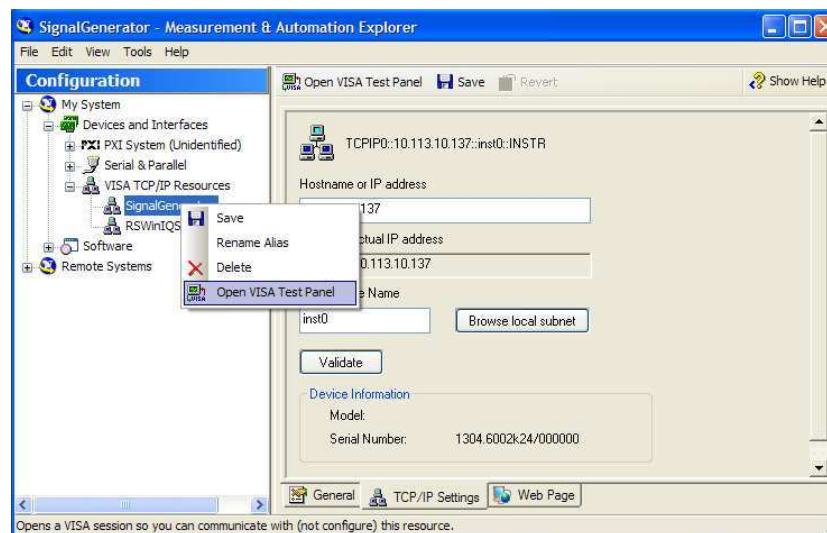

3. In the "viWrite" tab, write the command to be send to the instrument and select "Execute".

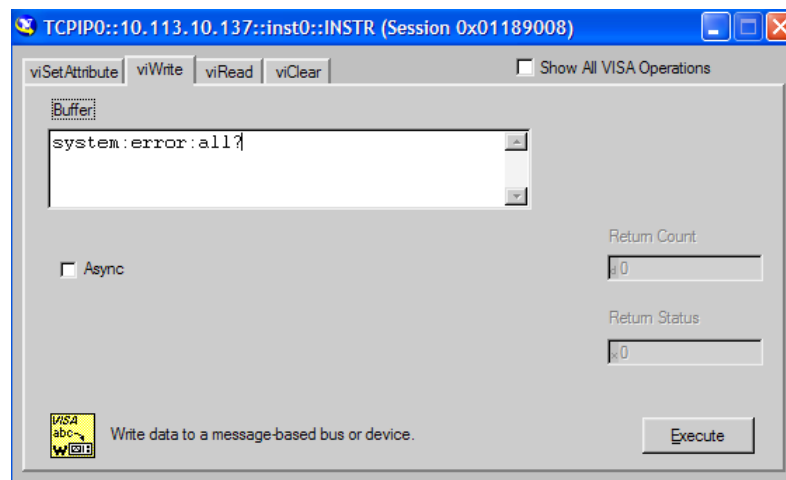

Instrument responses are displayed on the "viRead" tab.

**Tip:** For further program operation refer to the online help of the program.

### 6.2.3.3 Remote Control over LAN using Socket Communication

This chapter provides an example on how to establish a remote control connection over telnet protocol and a simple sockets-based program example that can be further developed.

#### Setting up a Telnet Connection

To control the software, only a telnet program is required. The telnet program is part of every operating system.

1. To establish a Telnet connection with the R&S SMJ, start the telnet program and enter the socket address.

The socket address is a combination of the IP address or the host name of the R&S SMJ and the number of the port configured for remote-control via telnet.

**Tip:** The R&S SMJ uses the port number 5025 for remote connection via Telnet.

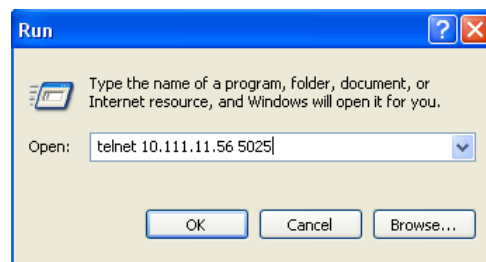

The connection to the instrument is set up and remote-control commands can be sent.

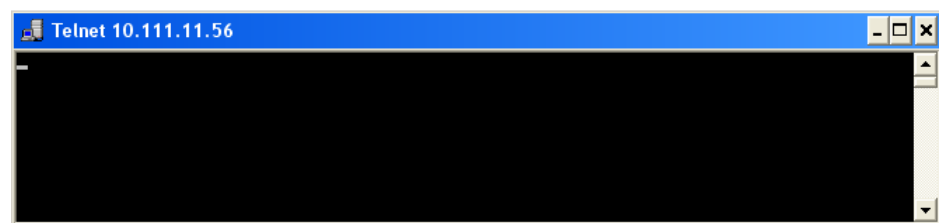

2. Even if the cursor is not visible on the screen, enter blind a remote-control command and confirm with Enter.

```

Telnet 10.111.11.56
Freq?
1500000000
freq 1.5 GHZ
Freq?
1500000000
pow?
0
pow -30
pow?
-30
-

```

After the first remote-control command had been send, the instrument is in the "REMOTE" state, i.e. instrument control from the front panel or via mouse and keyboard is disabled and "REMOTE" is displayed in the status line.

### TcpClient program examples

The following program example shows a simple TcpClient class that is intended to explain on how to get started with programming of sockets.

The example sets up a socket communication to R&S SMJ and opens a simple user interface, very similar to the telnet, which allows input of commands. To enable real automation, further development of the program is required.

#### TcpClient.h

```

#include <string>
using namespace std;

//defines structs for socket handling
#ifdef LINUX
#include "Winsock2.h"
#else
#include <netinet/in.h>
#endif

typedef struct sockaddr_in SockAddrStruct;
typedef struct hostent HostInfoStruct;
class TcpClient
{
public:
    TcpClient();
    ~TcpClient();
    void connectToServer( string &hostname, int port );
    void disconnect( );
    void transmit( string &txString );
    void receive( string &rxString );
    string getCurrentHostName( ) const;
    int getCurrentPort( ) const;
private:
    string currentHostName;

```

```

int currentPort;
int currentSocketDescr;
SockAddrStruct serverAddress;
HostInfoStruct * currentHostInfo;
bool clientIsConnected;
int receiveBufferSize;
};

```

### TcpClient.cpp

```

#ifdef LINUX
#include <netdb.h>
#include <unistd.h>
#endif

#include "TcpClient.h"
TcpClient::TcpClient()
: currentHostName( "" )
, currentPort( 0 )
, currentSocketDescr( 0 )
, serverAddress ( )
, currentHostInfo( NULL )
, clientIsConnected( false )
, receiveBufferSize( 1024 )
{}
TcpClient::~TcpClient()
{
currentHostInfo = NULL;
}
void TcpClient::connectToServer( string &hostname, int port )
{
currentHostInfo = gethostbyname( hostname.c_str( ) );
if( currentHostInfo == NULL )
{
#ifdef LINUX
int error = WSAGetLastError();
switch (error)
{
case WSANOTINITIALISED: throw string(" A successful case WSAStartup
call must occur before using this function."); break;
case WSAENETDOWN: throw string
(" The network subsystem has failed."); break;
case WSAHOST_NOT_FOUND: throw string
(" Authoritative answer host not found."); break;
case WSATRY_AGAIN: throw string
(" Nonauthoritative host not found, or server failure."); break;
case WSANO_RECOVERY: throw string
(" A nonrecoverable error occurred."); break;
case WSANO_DATA: throw string
(" Valid name, no data record of requested type."); break;

```

```

        case WSAEINPROGRESS: throw string(" A blocking Windows Sockets 1.1 call
is in progress, or the service provider is still processing a callback function.")
; break;
        case WSAEFAULT: throw string
(" The name parameter is not a valid part of the user address space."); break;
        case WSAEINTR: throw string
(" A blocking Windows Socket 1.1 call was canceled through case
WSACancelBlockingCall."); break;
    }
#endif

    currentHostName = "";
    currentPort = 0;
    currentHostInfo = NULL;
    clientIsConnected = false;
    throw string("error connecting host\n" );
}
else
{
    currentHostName = hostname;
    currentPort = port;
    currentSocketDescr = socket(AF_INET, SOCK_STREAM, 0);
    if( currentSocketDescr == 0 )
    {
        currentHostName = "";
        currentPort = 0;
        currentHostInfo = NULL;
        clientIsConnected = false;
        throw string("can't create socket\n" );
    }
    serverAddress.sin_family = currentHostInfo->h_addrtype;
    serverAddress.sin_port = htons( currentPort );
    memcpy( (char *) &serverAddress.sin_addr.s_addr, currentHostInfo->
h_addr_list[0], currentHostInfo->h_length );
    if( connect( currentSocketDescr, ( struct sockaddr *) &serverAddress,
sizeof(serverAddress) ) < 0 )
    {
        throw string("can't connect server\n" );
    }
    clientIsConnected = true;
}
}
void TcpClient::disconnect( )
{
    if( clientIsConnected )
    {
#ifdef LINUX
        closesocket( currentSocketDescr );
#else
        close( currentSocketDescr );
#endif
    }
}

```

```

        #endif
    }
    currentSocketDescr = 0;
    currentHostName = "";
    currentPort = 0;
    currentHostInfo = NULL;
    clientIsConnected = false;
}

void TcpClient::transmit( string &txString )
{
    if( !clientIsConnected )
    {
        throw string("connection must be established before any data can be sent\n");
    }
    char * transmitBuffer = new char[txString.length() +1];
    memcpy( transmitBuffer, txString.c_str(), txString.length() );
    transmitBuffer[txString.length()] = '\n'; //newline is needed!
    if( send( currentSocketDescr, transmitBuffer, txString.length() + 1, 0 ) < 0 )
    {
        throw string("can't transmit data\n");
    }
    delete [] transmitBuffer;
}

void TcpClient::receive( string &rxString )
{
    if( !clientIsConnected )
    {
        throw string("connection must be established before any data can be received\n");
    }
    char * receiveBuffer = new char[receiveBufferSize];
    memset( receiveBuffer, 0, receiveBufferSize );
    bool receiving = true;
    while( receiving )
    {
        int receivedByteCount = recv( currentSocketDescr, receiveBuffer,
            receiveBufferSize, 0 );
        if( receivedByteCount < 0 )
        {
            throw string("error while receiving data\n");
        }
        rxString += string( receiveBuffer );
        receiving = ( receivedByteCount == receiveBufferSize );
    }
    delete [] receiveBuffer;
}

string TcpClient::getCurrentHostName( ) const
{
    return currentHostName;
}

int TcpClient::getCurrentPort( ) const

```

```

{
    return currentPort;
}

```

### TelnetClient.cpp

```

//TelnetClient.cpp: Defines the entry point for the console application.//

#include <iostream>
#include "TcpClient.h"
void printUsage()
{
    cout<<"usage: EthernetRawCommand <server-ip> [scpi-command]"<<endl;
}
int main( int argc, char *argv[] )
{
    int errorCode = 0; //no error
    bool useSingleCommand = false;
    string singleCommand = "";
    string hostname = "";
    int port = 5025;
    string input = "";
    TcpClient client;
    switch( argc )
    {
    case 3:
        useSingleCommand = true;
        singleCommand = argv[2];
    case 2:
        hostname = argv[1];
        break;
    default:
        printUsage();
        getchar();
        return(-1);
    }
    try
    {
#ifdef LINUX
        WORD wVersionRequested = MAKEWORD( 2, 2 );
        WSADATA wsaData;
        int err = WSASStartup( wVersionRequested, &wsaData );
        if ( err != 0 )
        {
            throw string ("Could not find a usable WinSock DLL.");
        }
#endif
        client.connectToServer( hostname, port );
        bool terminate = false;
        while( !terminate )

```



```

{
    char buffer[1024];
    if( useSingleCommand )
    {
        input = singleCommand; //send string
    }
    else
    {
        cout <<">";
        cin.getline( buffer, 1024 );
        input = buffer;
        if( input == "end" )
        {
            terminate = true;
        }
    }
    if( !terminate)
    {
        client.transmit( input ); //send string
        int qPos = input.find( "?", 0 );
        //receive string only when needed
        if( qPos > 0 )
        {
            string rcStr = "";
            client.receive( rcStr );
            cout << rcStr;
        }
    }
    if( useSingleCommand )
    {
        terminate = true;
    }
}
}catch( const string errorString )
{
    cout<<errorString<<endl<<endl;
    cout<<"Press Enter to exit"<<endl;
    getchar();
}
client.disconnect( );
return errorCode;
}

```

### 6.3 SCPI Command Structure

SCPI commands consist of a so-called header and, in most cases, one or more parameters. The header and the parameters are separated by a "white space" (ASCII code 0

to 9, 11 to 32 decimal, e.g. blank). The headers may consist of several mnemonics (keywords). Queries are formed by appending a question mark directly to the header.

The commands can be either device-specific or device-independent (common commands). Common and device-specific commands differ in their syntax.

### 6.3.1 Syntax for Common Commands

Common (=device-independent) commands consist of a header preceded by an asterisk (\*) and possibly one or more parameters.

#### Examples:

*RST	RESET	Resets the instrument.
*ESE	EVENT STATUS ENABLE	Sets the bits of the event status enable registers.
*ESR?	EVENT STATUS QUERY	Queries the contents of the event status register.
*IDN?	IDENTIFICATION QUERY	Queries the instrument identification string.

### 6.3.2 Syntax for Device-Specific Commands



Not all commands used in the following examples are necessarily implemented in the instrument.

For demonstration purposes only, assume the existence of the following commands for this section:

- DISPLAY[:WINDOW<1...4>]:MAXimize <Boolean>
- FORMAT:READings:DATA <type>[,<length>]
- HCOpy:DEvice:COLor <Boolean>
- HCOpy:DEvice:CMAP:COLor:RGB <red>,<green>,<blue>
- HCOpy[:IMMediate]
- HCOpy:ITEM:ALL
- HCOpy:ITEM:LABel <string>
- HCOpy:PAGE:DIMensions:QUADrant [<N>]
- HCOpy:PAGE:ORientation LANDscape | PORTrait
- HCOpy:PAGE:SCALE <numeric value>
- MMEMory:COpy <file\_source>,<file\_destination>
- SENSE:BANDwidth|BWIDth[:RESolution] <numeric\_value>
- SENSE:FREQuency:STOP <numeric value>
- SENSE:LIST:FREQuency <numeric\_value>{,<numeric\_value>}

### Long and short form

The mnemonics feature a long form and a short form. The short form is marked by upper case letters, the long form corresponds to the complete word. Either the short form or the long form can be entered; other abbreviations are not permitted.

#### Example:

`HCOPY:DEVIce:COLor ON` is equivalent to `HCOP:DEV:COL ON`.



### Case-insensitivity

Upper case and lower case notation only serves to distinguish the two forms in the manual, the instrument itself is case-insensitive.

---

### Numeric suffixes

If a command can be applied to multiple instances of an object, e.g. specific channels or sources, the required instances can be specified by a suffix added to the command. Numeric suffixes are indicated by angular brackets (<1...4>, <n>, <i>) and are replaced by a single value in the command. Entries without a suffix are interpreted as having the suffix 1.

#### Example:

Definition: `HCOPY:PAGE:DIMensions:QUADrant [<N>]`

Command: `HCOP:PAGE:DIM:QUAD2`

This command refers to the quadrant 2.



### Different numbering in remote control

For remote control, the suffix may differ from the number of the corresponding selection used in manual operation. SCPI prescribes that suffix counting starts with 1. Suffix 1 is the default state and used when no specific suffix is specified.

Some standards define a fixed numbering, starting with 0. If the numbering differs in manual operation and remote control, it is indicated for the corresponding command.

---

### Optional mnemonics

Some command systems permit certain mnemonics to be inserted into the header or omitted. These mnemonics are marked by square brackets in the description. The instrument must recognize the long command to comply with the SCPI standard. Some commands are considerably shortened by these optional mnemonics.

#### Example:

Definition: `HCOPY[:IMMEDIATE]`

Command: `HCOP:IMM` is equivalent to `HCOP`



### Optional mnemonics with numeric suffixes

Do not omit an optional mnemonic if it includes a numeric suffix that is relevant for the effect of the command.

#### Example:

Definition: `DISPlay[:WINDow<1...4>]:MAXimize <Boolean>`

Command: `DISP:MAX ON` refers to window 1.

In order to refer to a window other than 1, you must include the optional `WINDow` parameter with the suffix for the required window.

`DISP:WIND2:MAX ON` refers to window 2.

### Parameters

Parameters must be separated from the header by a "white space". If several parameters are specified in a command, they are separated by a comma (.). For a description of the parameter types, refer to [chapter 6.3.3, "SCPI Parameters"](#), on page 436.

#### Example:

Definition: `HCOPy:DEVice:CMAP:COLor:RGB <red>, <green>, <blue>`

Command: `HCOP:DEV:CMAP:COL:RGB 3,32,44`

## Special characters

	<p><b>Parameters</b></p> <p>A vertical stroke in parameter definitions indicates alternative possibilities in the sense of "or". The effect of the command differs, depending on which parameter is used.</p> <p><b>Example:</b></p> <p>Definition: <code>HCOPY:PAGE:ORIENTATION LANDscape   PORTRait</code></p> <p>Command <code>HCOPY:PAGE:ORI LAND</code> specifies landscape orientation</p> <p>Command <code>HCOPY:PAGE:ORI PORT</code> specifies portrait orientation</p> <p><b>Mnemonics</b></p> <p>A selection of mnemonics with an identical effect exists for several commands. These mnemonics are indicated in the same line; they are separated by a vertical stroke. Only one of these mnemonics needs to be included in the header of the command. The effect of the command is independent of which of the mnemonics is used.</p> <p><b>Example:</b></p> <p>Definition: <code>SENSE:BANDwidth BWIDTH[:RESolution] &lt;numeric_value&gt;</code></p> <p>The two following commands with identical meaning can be created:</p> <p><code>SENS:BAND:RES 1</code></p> <p><code>SENS:BWID:RES 1</code></p>
[]	<p>Mnemonics in square brackets are optional and may be inserted into the header or omitted.</p> <p><b>Example:</b> <code>HCOPY[:IMMEDIATE]</code></p> <p><code>HCOPY:IMM</code> is equivalent to <code>HCOPY</code></p>
{ }	<p>Parameters in curly brackets are optional and can be inserted once or several times, or omitted.</p> <p><b>Example:</b> <code>SENSE:LIST:FREQUENCY &lt;numeric_value&gt;{,&lt;numeric_value&gt;}</code></p> <p>The following are valid commands:</p> <p><code>SENS:LIST:FREQ 10</code></p> <p><code>SENS:LIST:FREQ 10,20</code></p> <p><code>SENS:LIST:FREQ 10,20,30,40</code></p>

### 6.3.3 SCPI Parameters

Many commands are supplemented by a parameter or a list of parameters. The parameters must be separated from the header by a "white space" (ASCII code 0 to 9, 11 to 32 decimal, e.g. blank). Allowed parameters are:

- Numeric values
- Special numeric values
- Boolean parameters
- Text
- Character strings
- Block data

The parameters required for each command and the allowed range of values are specified in the command description.

### Numeric values

Numeric values can be entered in any form, i.e. with sign, decimal point and exponent. Values exceeding the resolution of the instrument are rounded up or down. The mantissa may comprise up to 255 characters, the exponent must lie inside the value range -32000 to 32000. The exponent is introduced by an "E" or "e". Entry of the exponent alone is not allowed. In the case of physical quantities, the unit can be entered. Allowed unit prefixes are G (giga), MA (mega), MOHM and MHZ (also allowed), K (kilo), M (milli), U (micro) and N (nano). If the unit is missing, the basic unit is used.

**Example:** `SENS:FREQ:STOP 1.5GHz = SENS:FREQ:STOP 1.5E9`

### Units

For physical quantities, the unit can be entered. Allowed unit prefixes are:

- G (giga)
- MA (mega), MOHM, MHZ
- K (kilo)
- M (milli)
- U (micro)
- N (nano)

If the unit is missing, the basic unit is used.

### Example:

`SENSe:FREQ:STOP 1.5GHz = SENSe:FREQ:STOP 1.5E9`

Some settings allow relative values to be stated in percent. According to SCPI, this unit is represented by the `PCT` string.

### Example:

`HCOP:PAGE:SCAL 90PCT`

### Special numeric values

The texts listed below are interpreted as special numeric values. In the case of a query, the numeric value is provided.

- **MIN/MAX**  
MINimum and MAXimum denote the minimum and maximum value.
- **DEF**  
DEFault denotes a preset value which has been stored in the EPROM. This value conforms to the default setting, as it is called by the `*RST` command.
- **UP/DOWN**  
UP, DOWN increases or reduces the numeric value by one step. The step width can be specified via an allocated step command for each parameter which can be set via UP, DOWN.
- **INF/NINF**

INFINITY, Negative INFINITY (NINF) represent the numeric values 9.9E37 or -9.9E37, respectively. INF and NINF are only sent as instrument responses.

- **NAN**

Not A Number (NAN) represents the value 9.91E37. NAN is only sent as a instrument response. This value is not defined. Possible causes are the division of zero by zero, the subtraction of infinite from infinite and the representation of missing values.

**Example:**

Setting command: `SENSe:LIST:FREQ MAXimum`

Query: `SENS:LIST:FREQ?`, Response: `3.5E9`



**Queries for special numeric values**

The numeric values associated to `MAXimum`/`MINimum`/`DEFault` can be queried by adding the corresponding mnemonics to the command. They must be entered following the quotation mark.

Example: `SENSe:LIST:FREQ? MAXimum`

Returns the maximum numeric value as a result.

**Boolean Parameters**

Boolean parameters represent two states. The "ON" state (logically true) is represented by "ON" or a numeric value 1. The "OFF" state (logically untrue) is represented by "OFF" or the numeric value 0. The numeric values are provided as the response for a query.

**Example:**

Setting command: `HCOpy:DEV:COL ON`

Query: `HCOpy:DEV:COL?`

Response: `1`

**Text parameters**

Text parameters observe the syntactic rules for mnemonics, i.e. they can be entered using a short or long form. Like any parameter, they have to be separated from the header by a white space. In the case of a query, the short form of the text is provided.

**Example:**

Setting command: `HCOpy:PAGE:ORIENTATION LANDscape`

Query: `HCOp:PAGE:ORI?`

Response: `LAND`

**Character strings**

Strings must always be entered in quotation marks (' or ").

**Example:**

```
HCOP:ITEM:LABel "Test1" or HCOP:ITEM:LABel 'Test1'
```

**Block data**

Block data is a format which is suitable for the transmission of large amounts of data. A command using a block data parameter has the following structure:

**Example:**

```
FORMat:READings:DATA #45168xxxxxxxx
```

The ASCII character # introduces the data block. The next number indicates how many of the following digits describe the length of the data block. In the example the 4 following digits indicate the length to be 5168 bytes. The data bytes follow. During the transmission of these data bytes all end or other control signs are ignored until all bytes are transmitted.

#0 specifies a data block of indefinite length. The use of the indefinite format requires a `NL^END` message to terminate the data block. This format is useful when the length of the transmission is not known or if speed or other considerations prevent segmentation of the data into blocks of definite length.

### 6.3.4 Overview of Syntax Elements

The following table provides an overview of the syntax elements:

:	The colon separates the mnemonics of a command. In a command line the separating semicolon marks the uppermost command level.
;	The semicolon separates two commands of a command line. It does not alter the path.
,	The comma separates several parameters of a command.
?	The question mark forms a query.
*	The asterisk marks a common command.
'' ..	Quotation marks introduce a string and terminate it (both single and double quotation marks are possible).
#	The hash symbol introduces binary, octal, hexadecimal and block data. <ul style="list-style-type: none"> <li>• Binary: #B10110</li> <li>• Octal: #O7612</li> <li>• Hexa: #HF3A7</li> <li>• Block: #21312</li> </ul>
	A "white space" (ASCII-Code 0 to 9, 11 to 32 decimal, e.g. blank) separates the header from the parameters.

### 6.3.5 Structure of a command line

A command line may consist of one or several commands. It is terminated by one of the following:



- a <New Line>
- a <New Line> with EOI
- an EOI together with the last data byte

Several commands in a command line must be separated by a semicolon ";". If the next command belongs to a different command system, the semicolon is followed by a colon.

**Example:**

```
MMEM:COPY "Test1", "MeasurementXY";:HCOP:ITEM ALL
```

This command line contains two commands. The first command belongs to the MMEM system, the second command belongs to the HCOP system.

If the successive commands belong to the same system, having one or several levels in common, the command line can be abbreviated. To this end, the second command after the semicolon starts with the level that lies below the common levels. The colon following the semicolon must be omitted in this case.

**Example:**

```
HCOP:ITEM ALL;:HCOP:IMM
```

This command line contains two commands. Both commands are part of the HCOP command system, i.e. they have one level in common.

When abbreviating the command line, the second command begins with the level below HCOP. The colon after the semicolon is omitted. The abbreviated form of the command line reads as follows:

```
HCOP:ITEM ALL;IMM
```

A new command line always begins with the complete path.

**Example:**

```
HCOP:ITEM ALL
```

```
HCOP:IMM
```

### 6.3.6 Responses to Queries

A query is defined for each setting command unless explicitly specified otherwise. It is formed by adding a question mark to the associated setting command. According to SCPI, the responses to queries are partly subject to stricter rules than in standard IEEE 488.2.

- The requested parameter is transmitted without a header.  
**Example:** HCOP:PAGE:ORI?, Response: LAND
- Maximum values, minimum values and all other quantities that are requested via a special text parameter are returned as numeric values.  
**Example:** SENSE:FREQUENCY:STOP? MAX, Response: 3.5E9
- Numeric values are output without a unit. Physical quantities are referred to the basic units or to the units set using the Unit command. The response 3.5E9 in the previous example stands for 3.5 GHz.

- Truth values (Boolean values) are returned as 0 (for OFF) and 1 (for ON).

**Example:**

Setting command: `HCOPy:DEV:COL ON`

Query: `HCOPy:DEV:COL?`

Response: 1

- Text (character data) is returned in a short form.

**Example:**

Setting command: `HCOPy:PAGE:ORIENTATION LANDscape`

Query: `HCOp:PAGE:ORI?`

Response: LAND

## 6.4 Command Sequence and Synchronization

IEEE 488.2 defines a distinction between overlapped and sequential commands:

- A sequential command is one which finishes executing before the next command starts executing. Commands that are processed quickly are usually implemented as sequential commands. Sequential commands are not implemented in the instrument, however the execution time of most commands is so short that they act as sequential commands when sent in different command lines.
- An overlapping command is one which does not automatically finish executing before the next command starts executing. Usually, overlapping commands take longer to process and allow the program to do other tasks while being executed. If overlapping commands do have to be executed in a defined order, e.g. in order to avoid wrong measurement results, they must be serviced sequentially. This is called synchronization between the controller and the instrument.

Setting commands within one command line, even though they may be implemented as sequential commands, are not necessarily serviced in the order in which they have been received. In order to make sure that commands are actually carried out in a certain order, each command must be sent in a separate command line.

**Example: Commands and queries in one message**

The response to a query combined in a program message with commands that affect the queried value is not predictable.

The following commands always return the specified result:

```
:FREQ:STAR 1GHZ;SPAN 100 :FREQ:STAR?
```

Result:

```
1000000000 (1 GHz)
```

Whereas the result for the following commands is not specified by SCPI:

```
:FREQ:STAR 1GHz;STAR?;SPAN 1000000
```

The result could be the value of `START` before the command was sent since the instrument might defer executing the individual commands until a program message terminator is received. The result could also be 1 GHz if the instrument executes commands as they are received.



As a general rule, send commands and queries in different program messages.

#### Example: Overlapping command with \*OPC

The instrument implements `INITiate[:IMMEDIATE]` as an overlapped command. Assuming that `INITiate[:IMMEDIATE]` takes longer to execute than `*OPC`, sending the following command sequence results in initiating a sweep and, after some time, setting the `OPC` bit in the `ESR`:

```
INIT; *OPC.
```

Sending the following commands still initiates a sweep:

```
INIT; *OPC; *CLS
```

However, since the operation is still pending when the instrument executes `*CLS`, forcing it into the "Operation Complete Command Idle" State (OCIS), `*OPC` is effectively skipped. The `OPC` bit is not set until the instrument executes another `*OPC` command.

#### Example: Overlapped command followed by non-conflicting commands

Suppose that the instrument is switched on to provide a real time test signal that requires some calculation time. At the same time some settings for the configuration of a different signal are made which do not interact with the generated signal (e.g. the signal may be used later on). The signal generation and the signal configuration are independent from each other, so none of the following overlapped commands needs to be synchronized:

```
SOUR:BB:3GPP:STAT ON
```

```
SOUR:BB:GSM:FORM FSK2
```

## 6.4.1 Preventing Overlapping Execution

To prevent an overlapping execution of commands, one of the commands `*OPC`, `*OPC?` or `*WAI` can be used. All three commands cause a certain action only to be carried out after the hardware has been set. By suitable programming, the controller can be forced to wait for the corresponding action to occur.

**Table 6-2: Synchronization using \*OPC, \*OPC? and \*WAI**

Com-mand	Action	Programming the controller
*OPC	Sets the Operation Complete bit in the ESR after all previous commands have been executed.	<ul style="list-style-type: none"> <li>Setting bit 0 in the ESE</li> <li>Setting bit 5 in the SRE</li> <li>Waiting for service request (SRQ)</li> </ul>
*OPC?	Stops command processing until 1 is returned. This is only the case after the Operation Complete bit has been set in the ESR. This bit indicates that the previous setting has been completed.	Sending *OPC? directly after the command whose processing should be terminated before other commands can be executed.
*WAI	Stops further command processing until all commands sent before *WAI have been executed.	Sending *WAI directly after the command whose processing should be terminated before other commands are executed.

Command synchronization using \*WAI or \*OPC? appended to an overlapped command is a good choice if the overlapped command takes only little time to process. The two synchronization techniques simply block overlapped execution of the command.

For time consuming overlapped commands it is usually desirable to allow the controller or the instrument to do other useful work while waiting for command execution. Use one of the following methods:

#### **\*OPC with a service request**

1. Set the OPC mask bit (bit no. 0) in the ESE: \*ESE 1
2. Set bit no. 5 in the SRE: \*SRE 32 to enable ESB service request.
3. Send the overlapped command with \*OPC
4. Wait for a service request

The service request indicates that the overlapped command has finished.

#### **\*OPC? with a service request**

1. Set bit no. 4 in the SRE: \*SRE 16 to enable MAV service request.
2. Send the overlapped command with \*OPC?
3. Wait for a service request

The service request indicates that the overlapped command has finished.

#### **Event Status Register (ESE)**

1. Set the OPC mask bit (bit no. 0) in the ESE: \*ESE 1
2. Send the overlapped command without \*OPC, \*OPC? or \*WAI
3. Poll the operation complete state periodically (by means of a timer) using the sequence: \*OPC; \*ESR?

A return value (LSB) of 1 indicates that the overlapped command has finished.

#### **\*OPC? with short timeout**

1. Send the overlapped command without \*OPC, \*OPC? or \*WAI
2. Poll the operation complete state periodically (by means of a timer) using the sequence: <short timeout>; \*OPC?
3. A return value (LSB) of 1 indicates that the overlapped command has finished. In case of a timeout, the operation is ongoing.
4. Reset timeout to former value
5. Clear the error queue with SYStem:ERRor? to remove the "-410, Query interrupted" entries.

### Using several threads in the controller application

As an alternative, provided the programming environment of the controller application supports threads, separate threads can be used for the application GUI and for controlling the instrument(s) via SCPI.

A thread waiting for a \*OPC? thus will not block the GUI or the communication with other instruments.

## 6.5 Status Reporting System

The status reporting system stores all information on the current operating state of the instrument, and on errors which have occurred. This information is stored in the status registers and in the error queue. Both can be queried with the commands `STATUS...`

### 6.5.1 Hierarchy of status registers

As shown in the following figure, the status information is of hierarchical structure.

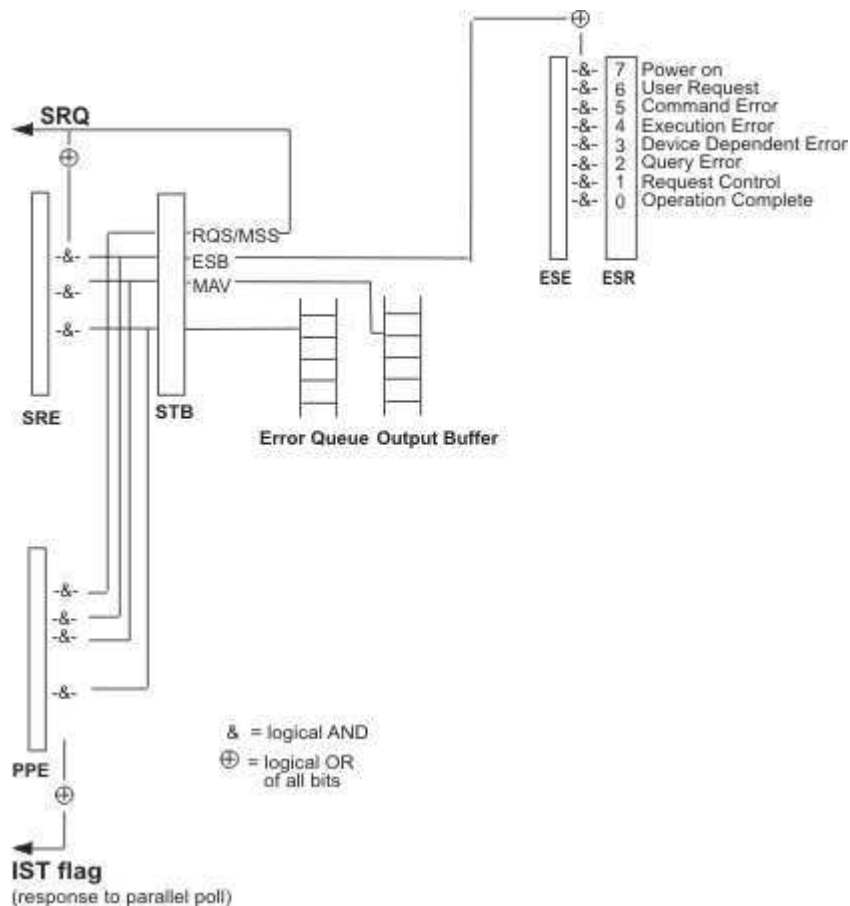

Fig. 6-1: Graphical overview of the status registers hierarchy

- **STB, SRE**  
The STatus Byte (*STB*) register and its associated mask register Service Request Enable (*SRE*) form the highest level of the status reporting system. The *STB* provides a rough overview of the instrument status, collecting the information of the lower-level registers.
- **ESR, SCPI registers**  
The *STB* receives its information from the following registers:
  - The Event Status Register (*ESR*) with the associated mask register standard Event Status Enable (*ESE*).
  - The *STATUS:OPERation* and *STATUS:QUEStionable* registers which are defined by SCPI and contain detailed information on the instrument.
- **IST, PPE**  
The *IST* flag ("Individual STatus"), like the *SRQ*, combines the entire instrument status in a single bit. The *PPE* fulfills the same function for the *IST* flag as the *SRE* for the service request.
- **Output buffer**  
The output buffer contains the messages the instrument returns to the controller. It is not part of the status reporting system but determines the value of the *MAV* bit in the *STB* and thus is represented in the overview.

All status registers have the same internal structure.



#### **SRE, ESE**

The service request enable register *SRE* can be used as *ENABLE* part of the *STB* if the *STB* is structured according to SCPI. By analogy, the *ESE* can be used as the *ENABLE* part of the *ESR*.

---

### **6.5.2 Structure of a SCPI Status Register**

Each standard SCPI register consists of 5 parts. Each part has a width of 16 bits and has different functions. The individual bits are independent of each other, i.e. each hardware status is assigned a bit number which is valid for all five parts. Bit 15 (the most significant bit) is set to zero for all parts. Thus the contents of the register parts can be processed by the controller as positive integers.

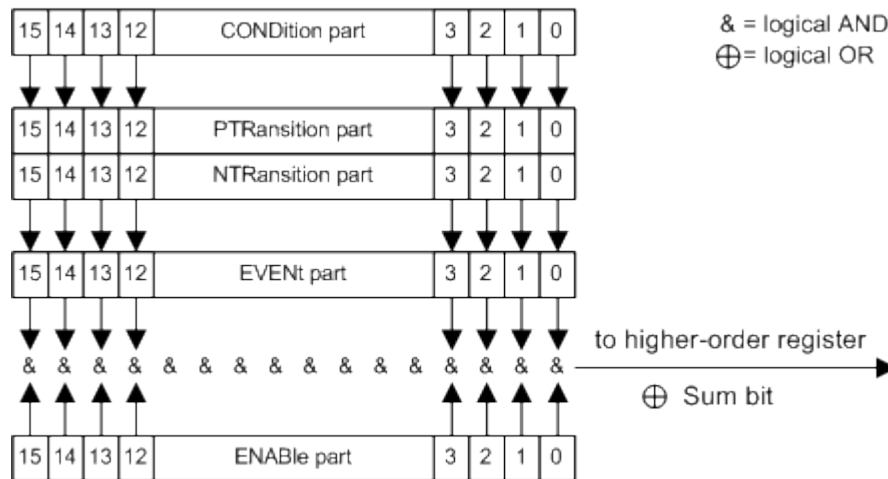

Fig. 6-2: The status-register model

### Description of the five status register parts

The five parts of a SCPI register have different properties and functions:

- **CONDition**

The **CONDition** part is written into directly by the hardware or the sum bit of the next lower register. Its contents reflect the current instrument status. This register part can only be read, but not written into or cleared. Its contents are not affected by reading.

- **PTRansition**

The two transition register parts define which state transition of the **CONDition** part (none, 0 to 1, 1 to 0 or both) is stored in the **EVENT** part.

The **Positive-TRansition** part acts as a transition filter. When a bit of the **CONDition** part is changed from 0 to 1, the associated **PTR** bit decides whether the **EVENT** bit is set to 1.

- **PTR** bit =1: the **EVENT** bit is set.
- **PTR** bit =0: the **EVENT** bit is not set.

This part can be written into and read as required. Its contents are not affected by reading.

- **NTRansition**

The **Negative-TRansition** part also acts as a transition filter. When a bit of the **CONDition** part is changed from 1 to 0, the associated **NTR** bit decides whether the **EVENT** bit is set to 1.

- **NTR** bit =1: the **EVENT** bit is set.
- **NTR** bit =0: the **EVENT** bit is not set.

This part can be written into and read as required. Its contents are not affected by reading.

- **EVENT**

The **EVENT** part indicates whether an event has occurred since the last reading, it is the "memory" of the condition part. It only indicates events passed on by the transition filters. It is permanently updated by the instrument. This part can only be read by the user. Reading the register clears it. This part is often equated with the entire register.

- **ENABLE**

The `ENABLE` part determines whether the associated `EVENT` bit contributes to the sum bit (see below). Each bit of the `EVENT` part is "ANDed" with the associated `ENABLE` bit (symbol '&'). The results of all logical operations of this part are passed on to the sum bit via an "OR" function (symbol '+').

`ENABLE` bit = 0: the associated `EVENT` bit does not contribute to the sum bit

`ENABLE` bit = 1: if the associated `EVENT` bit is "1", the sum bit is set to "1" as well.

This part can be written into and read by the user as required. Its contents are not affected by reading.

### Sum bit

The sum bit is obtained from the `EVENT` and `ENABLE` part for each register. The result is then entered into a bit of the `CONDition` part of the higher-order register.

The instrument automatically generates the sum bit for each register. Thus an event can lead to a service request throughout all levels of the hierarchy.

## 6.5.3 Contents of the Status Registers

In the following sections, the contents of the status registers are described in more detail.

### 6.5.3.1 Status Byte (STB) and Service Request Enable Register (SRE)

The `Status Byte` (STB) is already defined in IEEE 488.2. It provides a rough overview of the instrument status by collecting the pieces of information of the lower registers. A special feature is that bit 6 acts as the sum bit of the remaining bits of the status byte.

The STB is read using the command `*STB` or a serial poll.

The `Status Byte` (STB) is linked to the `Service Request Enable` (SRE) register. Each bit of the STB is assigned a bit in the SRE. Bit 6 of the SRE is ignored. If a bit is set in the SRE and the associated bit in the STB changes from 0 to 1, a service request (SRQ) is generated. The SRE can be set using the command `*SRE` and read using the command `*SRE?`.

**Table 6-3: Meaning of the bits used in the status byte**

Bit No.	Meaning
0...1	Not used
2	Error Queue not empty The bit is set when an entry is made in the error queue. If this bit is enabled by the SRE, each entry of the error queue generates a service request. Thus an error can be recognized and specified in greater detail by polling the error queue. The poll provides an informative error message. This procedure is to be recommended since it considerably reduces the problems involved with remote control.
3	Not used.
4	MAV bit (message available) The bit is set if a message is available in the output buffer which can be read. This bit can be used to enable data to be automatically read from the instrument to the controller.



Bit No.	Meaning
5	ESB bit Sum bit of the event status register. It is set if one of the bits in the event status register is set and enabled in the event status enable register. Setting of this bit indicates a serious error which can be specified in greater detail by polling the event status register.
6	MSS bit (master status summary bit) The bit is set if the instrument triggers a service request. This is the case if one of the other bits of this registers is set together with its mask bit in the service request enable register SRE.
7	Not used.

### 6.5.3.2 IST Flag and Parallel Poll Enable Register (PPE)

As with the SRQ, the IST flag combines the entire status information in a single bit. It can be read by means of a parallel poll (see [chapter 6.5.5.3, "Parallel Poll"](#), on page 450) or using the command `*IST`.

The parallel poll enable register (PPE) determines which bits of the STB contribute to the IST flag. The bits of the STB are "ANDed" with the corresponding bits of the PPE, with bit 6 being used as well in contrast to the SRE. The IST flag results from the "ORing" of all results. The PPE can be set using commands `*PRE` and read using command `*PRE?`.

### 6.5.4 Event Status Register (ESR) and Event Status Enable Register (ESE)

The ESR is defined in IEEE 488.2. The event status register can be read out using command `*ESR` on page 454. The ESE is the associated enable part. It can be set using the command `*ESE` on page 454 and read using the command `*ESE?`.

**Table 6-4: Meaning of the bits used in the event status register**

Bit No.	Meaning
0	Operation Complete This bit is set on receipt of the command <code>*OPC</code> exactly when all previous commands have been executed.
1	not used
2	Query Error This bit is set if either the controller wants to read data from the instrument without having sent a query, or if it does not fetch requested data and sends new instructions to the instrument instead. The cause is often a query which is faulty and hence cannot be executed.
3	Device-dependent Error This bit is set if a device dependent error occurs. An error message with a number between 300 and 399 or a positive error number, which denotes the error in greater detail, is entered into the error queue.
4	Execution Error This bit is set if a received command is syntactically correct but cannot be performed for other reasons. An error message with a number between 200 and 300, which denotes the error in greater detail, is entered into the error queue.

Bit No.	Meaning
5	Command Error This bit is set if a command which is undefined or syntactically incorrect is received. An error message with a number between 100 and 200, which denotes the error in greater detail, is entered into the error queue.
6	User Request This bit is set on pressing the LOCAL key, i.e. when the instrument is switched over to manual operation.
7	Power On (supply voltage on) This bit is set on switching on the instrument.

### 6.5.5 Application of the Status Reporting System

The purpose of the status reporting system is to monitor the status of one or several devices in a measuring system. To do this and react appropriately, the controller must receive and evaluate the information of all devices. The following standard methods are used:

- **Service request** (SRQ) initiated by the instrument
- **Serial poll** of all devices in the bus system, initiated by the controller in order to find out who sent a SRQ and why
- **Parallel poll** of all devices
- Query of a **specific instrument status** by means of commands
- Query of the **error queue**

#### 6.5.5.1 Service Request

Under certain circumstances, the instrument can send a service request (SRQ) to the controller. Usually this service request initiates an interrupt at the controller, to which the control program can react appropriately. An SRQ is always initiated if one or several of bits 2, 4 or 5 of the status byte are set and enabled in the SRE. Each of these bits combines the information of the error queue or the output buffer. In order to use the possibilities of the service request effectively, all bits should be set to "1" in the enable registers SRE and ESE.

#### Example:

Use command \*OPC to generate an SRQ .

\*ESE 1 - set bit 0 of ESE (Operation Complete)

\*SRE 32 - set bit 5 of SRE (ESB).

After its settings have been completed, the instrument generates an SRQ.

The SRQ is the only possibility for the instrument to become active on its own. Each controller program should set the instrument such that a service request is initiated in the case of malfunction. The program should react appropriately to the service request.

### 6.5.5.2 Serial Poll

In a serial poll, just as with command `*STB`, the status byte of an instrument is queried. However, the query is realized via interface messages and is thus clearly faster.

The serial poll method is defined in IEEE 488.1 and used to be the only standard possibility for different instruments to poll the status byte. The method also works for instruments which do not adhere to SCPI or IEEE 488.2.

The serial poll is mainly used to obtain a fast overview of the state of several instruments connected to the controller.

### 6.5.5.3 Parallel Poll

In a parallel poll, up to eight instruments are simultaneously requested by the controller using a single command to transmit 1 bit of information each on the data lines, i.e., to set the data line allocated to each instrument to a logical "0" or "1".

In addition to the SRE register, which determines the conditions under which an SRQ is generated, there is a Parallel Poll Enable register (PPE) which is ANDed with the STB bit by bit, considering bit 6 as well. This register is ANDed with the STB bit by bit, considering bit 6 as well. The results are ORed, the result is possibly inverted and then sent as a response to the parallel poll of the controller. The result can also be queried without parallel poll using the command `*IST`.

The instrument first has to be set for the parallel poll using the command `PPC`. This command allocates a data line to the instrument and determines whether the response is to be inverted. The parallel poll itself is executed using `PPE`.

The parallel poll method is mainly used to find out quickly which one of the instruments connected to the controller has sent a service request. To this effect, SRE and PPE must be set to the same value.

### 6.5.5.4 Query of an instrument status

Each part of any status register can be read using queries. There are two types of commands:

- The common commands `*ESR?`, `*IDN?`, `*IST?`, `*STB?` query the higher-level registers.
- The commands of the `STATus` system query the SCPI registers (`STATus:QUEStionable...`)

The returned value is always a decimal number that represents the bit pattern of the queried register. This number is evaluated by the controller program.

Queries are usually used after an SRQ in order to obtain more detailed information on the cause of the SRQ.

### 6.5.5.5 Error Queue

Each error state in the instrument leads to an entry in the error queue. The entries of the error queue are detailed plain text error messages that can be looked up in the Error Log or queried via remote control using `SYSTem:ERRor[:NEXT]?` or `SYSTem:ERRor:ALL?`. Each call of `SYSTem:ERRor[:NEXT]?` provides one entry from the error queue. If no error messages are stored there any more, the instrument responds with 0, "No error".

The error queue should be queried after every SRQ in the controller program as the entries describe the cause of an error more precisely than the status registers. Especially in the test phase of a controller program the error queue should be queried regularly since faulty commands from the controller to the instrument are recorded there as well.

### 6.5.6 Reset Values of the Status Reporting System

The following table contains the different commands and events causing the status reporting system to be reset. None of the commands, except `*RST` and `SYSTem:PRESet`, influence the functional instrument settings. In particular, `DCL` does not change the instrument settings.

*Table 6-5: Resetting the status reporting system*

Event	Switching on supply voltage Power-On-Status-Clear		DCL, SDC (Device Clear, Selected Device Clear)	*RST or SYS- Tem:PRE- Set	STA- Tus:PRE- Set	*CLS
	0	1				
Clear STB, ESR	-	yes	-	-	-	yes
Clear SRE, ESE	-	yes	-	-	-	-
Clear PPE	-	yes	-	-	-	-
Clear error queue	yes	yes	-	-	-	yes
Clear output buffer	yes	yes	yes	1)	1)	1)
Clear command processing and input buffer	yes	yes	yes	-	-	-

1) The first command in a command line that immediately follows a <PROGRAM MESSAGE TERMINATOR> clears the output buffer.

## 6.6 General Programming Recommendations

### Initial instrument status before changing settings

Manual operation is designed for maximum possible operating convenience. In contrast, the priority of remote control is the "predictability" of the instrument status. Thus, when a command attempts to define incompatible settings, the command is ignored and the

instrument status remains unchanged, i.e. other settings are not automatically adapted. Therefore, control programs should always define an initial instrument status (e.g. using the \*RST command) and then implement the required settings.

#### **Command sequence**

As a general rule, send commands and queries in different program messages. Otherwise, the result of the query may vary depending on which operation is performed first (see also Preventing Overlapping Execution).

#### **Reacting to malfunctions**

The service request is the only possibility for the instrument to become active on its own. Each controller program should instruct the instrument to initiate a service request in case of malfunction. The program should react appropriately to the service request.

#### **Error queues**

The error queue should be queried after every service request in the controller program as the entries describe the cause of an error more precisely than the status registers. Especially in the test phase of a controller program the error queue should be queried regularly since faulty commands from the controller to the instrument are recorded there as well.

## 7 Remote Control Commands

In the following, all remote-control commands will be presented in detail with their parameters and the ranges of numerical values.

For an introduction to remote control and the status registers, refer to [chapter 6, "Remote Control Basics"](#), on page 413.

### 7.1 Common Commands

Common commands are described in the IEEE 488.2 (IEC 625-2) standard. These commands have the same effect and are employed in the same way on different devices. The headers of these commands consist of "\*" followed by three letters. Many common commands are related to the Status Reporting System.

Available common commands:

*CAL.....	453
*CLS.....	453
*ESE.....	454
*ESR.....	454
*IDN.....	454
*IST.....	454
*OPC.....	455
*OPT.....	455
*PCB.....	455
*PRE.....	455
*PSC.....	455
*RCL.....	456
*RST.....	456
*SAV.....	456
*SRE.....	456
*STB.....	457
*TRG.....	457
*TST.....	457
*WAI.....	457

---

#### \*CAL

Calibration Query

Initiates a calibration of the instrument and subsequently queries the calibration status. Responses > 0 indicate errors.

---

#### \*CLS

CLear Status

Sets the status byte (STB), the standard event register (ESR) and the `EVENT` part of the `QUESTIONABLE` and the `OPERATION` registers to zero. The command does not alter the mask and transition parts of the registers. It clears the output buffer.

**Usage:** Setting only

**\*ESE <Value>**

Event Status Enable

Sets the event status enable register to the specified value. The query returns the contents of the event status enable register in decimal form.

**Parameters:**

<Value> Range: 0 to 255

**\*ESR?**

Event Status Read

Returns the contents of the event status register in decimal form and subsequently sets the register to zero.

**Return values:**

<Contents> Range: 0 to 255

**Usage:** Query only

**\*IDN?**

IDeNtification: returns the instrument identification.

**Return values:**

<ID> "Rohde&Schwarz,<device type>,<serial number>,<firmware version>"

**Example:** Rohde&Schwarz,ZVA8-4Port,12345,0.10.1.23

**Usage:** Query only

**\*IST?**

Individual SStatus query

Returns the contents of the IST flag in decimal form. The IST flag is the status bit which is sent during a parallel poll.

**Return values:**

<ISTflag> 0 | 1

**Usage:** Query only

---

**\*OPC**

Operation Complete

Sets bit 0 in the event status register when all preceding commands have been executed. This bit can be used to initiate a service request. The query form writes a "1" into the output buffer as soon as all preceding commands have been executed. This is used for command synchronization.

---

**\*OPT?**

OPTion identification query

Queries the options included in the instrument. For a list of all available options and their description refer to the CD-ROM.

**Return values:**

<Options>                      The query returns a list of options. The options are returned at fixed positions in a comma-separated string. A zero is returned for options that are not installed.

**Usage:**                              Query only

---

**\*PCB <Address>**

Pass Control Back

Indicates the controller address to which remote control is returned after termination of the triggered action.

**Setting parameters:**

<Address>                      Range:      0 to 30

**Usage:**                              Setting only

---

**\*PRE <Value>**

Parallel poll Register Enable

Sets parallel poll enable register to the indicated value. The query returns the contents of the parallel poll enable register in decimal form.

**Parameters:**

<Value>                              Range:      0 to 255

---

**\*PSC <Action>**

Power on Status Clear

Determines whether the contents of the `ENABLE` registers are preserved or reset when the instrument is switched on. Thus a service request can be triggered when the instrument is switched on, if the status registers ESE and SRE are suitably configured. The query reads out the contents of the "power-on-status-clear" flag.



**Parameters:**

<Action>	0   1
<b>0</b>	The contents of the status registers are preserved.
<b>1</b>	Resets the status registers.

**\*RCL** <Number>

ReCaLI calls up the instrument settings from an intermediate memory identified by the specified number. The instrument settings can be stored to this memory using the command **\*SAV** with the associated number.

It also activates the instrument settings which are stored in a file and loaded using the `MMEMory:LOAD <number>, <file_name.extension>` command.

**\*RST**

ReSeT

Sets the instrument to a defined default status. The default settings are indicated in the description of commands.

The command is equivalent to `SYSTem:PRESet`.

**Usage:** Setting only

**\*SAV** <Number>

SAVe stores the current instrument settings under the specified number in an intermediate memory. The settings can be recalled using the command **\*RCL** with the associated number.

To transfer the stored instrument settings in a file, use the command `:MMEMory:STORe:STATe`.

**\*SRE** <Contents>

Service Request Enable

Sets the service request enable register to the indicated value. This command determines under which conditions a service request is triggered.

**Parameters:**

<Contents>	Contents of the service request enable register in decimal form. Bit 6 (MSS mask bit) is always 0. Range: 0 to 255
------------	--

---

**\*STB?**

STatus Byte query

Reads the contents of the status byte in decimal form.

**Usage:** Query only

---

**\*TRG**

TRiGger

Triggers all actions waiting for a trigger event. In particular, \*TRG generates a manual trigger signal (Manual Trigger). This common command complements the commands of the TRIGger subsystem.

**Usage:** Event

---

**\*TST?**

self TeST query

Triggers selftests of the instrument and returns an error code in decimal form (see Service Manual supplied with the instrument). "0" indicates no errors occurred.

**Usage:** Query only

---

**\*WAI**

WAIt to continue

Prevents servicing of the subsequent commands until all preceding commands have been executed and all signals have settled (see also command synchronization and \*OPC).

**Usage:** Event

## 7.2 Preset Commands

The preset commands are not bundled in one subsystem. Therefore, they are listed separately in this section. In addition, a specific preset command is provided for each digital standard and for the fader. These specific commands are described in the associated subsystems.

Four presetting actions are available:

- Activating the default state of all internal instrument functions (\*RST on page 456). Functions that concern the integration of the instrument into a measurement setup are not changed, e.g. GPIB address or reference oscillator source settings.
- Activating the preset state of the parameters related to the selected signal path (: SOURce<hw> : PRESet on page 458)

- Activating the preset state of all parameters that are not related to the signal path ([:DEVIce:PRESet](#) on page 458)
- Activating the original state of delivery (factory reset, [:SYSTem:FPreSet](#) on page 458). Only functions that are protected by a password remain unchanged as well as the passwords themselves.

---

#### **:DEVIce:PRESet**

The command presets all parameters which are not related to the signal path. This includes presetting the LF generator and bit/block error measurement.

**Example:**                    `DEV:PRESet`  
presets all instruments settings that are not related to the signal path

**Usage:**                    Event

---

#### **:SOURce<hw>:PRESet**

The command presets all parameters which are related to the selected signal path.

Fading (if available) and transient recorder are only preset by command `*RST`.

**Example:**                    `SOUR:PRESet`  
presets all settings that are related to signal path

---

#### **SYSTem:PRESet**

The command triggers an instrument reset. It has the same effect as:

- the PRESET key on the front panel
- the `*RST` command

For an overview of the settings affected by the preset function, see [chapter 5.2.2, "Default Instrument Settings - Preset Key"](#), on page 118.

**Example:**                    `SYST:PRESet`  
All instrument settings (also those that are not currently active) are reset to their default values.

**Usage:**                    Setting only

---

#### **:SYSTem:FPreSet**

The command triggers an instrument reset to the original state of delivery.

**Note:** Since Factory Preset resets the Remote Channel and network settings to the default values, executing Factory Preset via remote control terminates the connection to the instrument, if these settings had been configured to values different to the default ones!

The factory preset function resets nearly all instrument settings. In addition to the regular preset by means of the PRESET key, a "Factory Preset" resets also the following values:

- Reference frequency settings ("Ref Oscillator" menu)
- Power on settings ("Level/EMF" menu)
- Network settings including hostname ("Setup" menu)
- Remote Channel settings including GPIB address ("Setup" menu)
- Start/Stop Gui Update ("Setup" menu)
- Display and keyboard settings ("Setup" menu).

To maintain security, password settings and all settings protected by these passwords like disabled USB and LAN connections are not changed.

Not affected by the "Factory Preset" are also user data, lists or instrument settings files, created for example by means of the Save/Recall function.

**Example:**                    `SYST:FPR`  
all instrument settings (also those that are not currently active) are reset to the factory values.

**Usage:**                    Event

## 7.3 R&S Signal Generator Waveform and List Format

The R&S SMJ uses a tag-oriented format for externally or internally generated waveforms as well as for data and control lists. The data can be transmitted via the GPIB interface from an external computer to the instrument and vice versa.

For these purposes the file is transmitted as a binary data block, using SCPI command `[ :SOURce<hw> ] :BB:ARB:WAVEform:DATA.`



A waveform version number is not necessary due to the flexible, tag-based form.

Tags are self-contained information units. Their general format is `{Name: Data}` or `{Name-Length: Data}`. The colon separates the name part and the data part. The colon can be followed by a space for the sake of legibility.

The **Name** identifies the tag. It is always expressed in capital letters.

The **Data** is tag-specific, and in most cases it is in ASCII plain text.

The **Length** specifies the number of bytes in a `WAVEFORM` tag or `DATA LIST` tag (from `: to` }, ASCII integer).

Each waveform file must begin with the `TYPE` tag. The sequence of the remaining tags is arbitrary. For each tag an indication shows whether it must be included in the file concerned (mandatory) or may be included (optional).

Unknown tags are not analyzed by the R&S SMJ. On the other hand they are left unchanged, are saved without an error message and can be read back again.

R&S AMIQ waveforms can also be loaded on the instrument, where they are converted internally into an R&S SMJ waveform.

### 7.3.1 Tag Description

This section first describe the mandatory `TYPE` tag which identifies the file and is always located at the start of the file. The rest of the tags used in the R&S SMJ are then described in alphabetical order. Most tags are valid for all three file types. If a tag is valid only for a single file type, e.g. only for a waveform, this fact is indicated in the description.

{TYPE: magic, xxxxxxxx}.....	460
{CLOCK: frequency}.....	461
{COMMENT: string} .....	462
{COPYRIGHT: string}.....	462
{DATA BITLENGTH: BitLength}.....	462
{DATA LIST-Length: #d0d1...dx...dN-1...}.....	463
{DATE: yyyy-mm-dd;hh:mm:ss}.....	463
{CONTROL LENGTH: ControlLength}.....	463
{LEVEL OFFS: RMSOffset_dB,PeakOffset_dB} .....	463
{SAMPLES: Samples}.....	464
{[TRACE] LIST [#]: Pos0:Val0;Pos1:Val1;...Posx:Valx;...PosN-1:ValN-1}.....	465
{WAVEFORM-Length: #I0Q0I1Q1...IxQx...IN-1QN-1...}.....	465
{MWV_SEGMENT_COUNT: NumOfSeg}.....	467
{MWV_SEGMENT_LENGTH: SamplesSeg0, SamplesSeg1, ..., SamplesSegN-1}.....	467
{MWV_SEGMENT_START: SampleStartOffsetSeg0, SampleStartOffsetSeg1, ..., SampleStartOffsetSegN-1}.....	468
{MWV_SEGMENT_CLOCK_MODE: Mode}.....	468
{MWV_SEGMENT_CLOCK: ClockSeg0, ClockSeg1, ..., ClockSegN-1}.....	469
{MWV_SEGMENT_LEVEL_OFFS: RMSOffset_dBSeg0, PeakOffset_dBSeg0, ...,RMSOffset_dBSegN-1, PeakOffset_dBSegN-1} .....	470
{MWV_SEGMENT_FILES: "FileNameSeg0.wv", "FileNameSeg1.wv", ..., "FileNameSegN-1.wv"}.....	470
{MWV_SEGMENTx_COMMENT: text}.....	470
{CONTROL LIST WIDTH4-Length: #m0m1...mx...mM-1}.....	470

---

#### **{TYPE: magic, xxxxxxxx}**

##### **(mandatory, must be the first tag in the file)**

The `TYPE` tag identifies the file as a valid R&S SMJ file. It must be present and must be the first in the waveform. If a file of the same name already exists on the target medium, it is overwritten.

**Tip:** R&S AMIQ waveforms can also be loaded on the instrument, where they are converted internally into an R&S SMJ waveform.

**Setting parameters:**

magic	Designates the file type and has the following values: <b>SMU-WV</b> The file contains a valid R&S SMJ waveform. <b>SMU-MWV</b> The file contains a valid R&S SMJ multi segment waveform. <b>SMU-DL</b> The file contains a valid R&S SMJ data list. <b>SMU-CL</b> The file contains a valid R&S SMJ control list.
xxxxxxx	Is an ASCII-coded checksum of the data part of the <code>WAVEFORM</code> tag in the file. This value is always 0 for data lists and control lists. The checksum for waveforms is used for detecting transmission errors. If the <code>TYPE</code> tag contains 0 or a non-numeric value for the checksum, it is ignored. It is calculated in accordance with the algorithm given bellow, where 'start' is a pointer to the first byte after the '#' character in the <code>WAVEFORM</code> tag and 'length' is the number of bytes between 'start' and the closing curly bracket (excluding the latter; 'length' must be divisible by 4 without a remainder): <pre>UINT32 checksum(void *start, UINT32 length) {     UINT32 i, result = 0xA50F74FF;     for(i=0; i &lt; length/4; i++)         result = result ^ ((UINT32 *)start)[i];     return(result); }</pre>
<b>Example:</b>	<pre>{TYPE: SMU-WV,106656} BB:ARB:WAV:TAG? 'TYPE'</pre> queries the content of the <code>TYPE</code> tag. Response: 'SMU-WV,106656' this is a valid waveform.

**{CLOCK: frequency}****(mandatory for waveforms)**

The tag specifies the clock frequency at which the waveform has to be output, in Hz (on multi segment waveforms this tag contains the maximal clock of all segments).

A query of `ARB:CLOCK?` after loading the waveform returns the value set using the `CLOCK` tag. This value can subsequently be altered with the aid of the `ARB:CLOCK?` command.

<b>Example:</b>	<pre>{CLOCK: 54000000} BB:ARB:WAV:TAG? 'CLOCK'</pre> queries the content of the <code>CLOCK</code> tag. Response: 54000000 the clock frequency is set to 54 MHz.
-----------------	--

**Usage:** Setting only

---

**{COMMENT: string}**

The tag contains a plain text ASCII string of arbitrary length. The string is not analyzed in the R&S SMJ. It is used to describe the file. The string is allowed to contain all printable ASCII characters except the closing curly bracket.

**Example:**           {COMMENT: File with data for 3GPP enhanced channels}  
 BB:ARB:WAV:TAG? 'COMMENT'  
 queries the content of the COMMENT tag of the selected waveform file.  
 Response: 'File with data for 3GPP enhanced channels'  
 the comment on the waveform reads "File with data for 3GPP enhanced channels".

**Usage:** Setting only

---

**{COPYRIGHT: string}**

The tag contains an ASCII string of arbitrary length. The string is not analyzed in the R&S SMJ. It is used to store copyright information about the file content.

**Example:**           {COPYRIGHT: Rohde&Schwarz}  
 BB:ARB:WAV:TAG? 'COPYRIGHT'  
 queries the content of the COPYRIGHT tag of the selected waveform file.  
 Response: 'Rohde&Schwarz'  
 copyright resides with Rohde&Schwarz.

**Usage:** Setting only

---

**{DATA BITLENGTH: BitLength}**

**(mandatory for data lists)**

The tag contains the length of the data held in the DATA LIST tag in bits in ASCII format.

**Example:**           {DATA BITLENGTH: 444}  
 BB:DM:DLIS:TAG? 'DATA BITLENGTH'  
 queries the content of the DATA BITLENGTH tag of the selected data list file.  
 Response: '444'  
 the data list is 444 bits long.

**Usage:** Setting only

**{DATA LIST-Length: #d0d1...dx...dN-1...}****(mandatory for data lists)**

The tag contains the actual bit sequence of the data list in binary format.

**Setting parameters:**

**Length** Defines the number of bytes in the `DATA LIST` tag in ASCII Format (for format see `WAVEFORM` length).

**dx** Data bits in binary format (8-bit unsigned characters, MSB first).

**Example:** `DATA LIST-17: #d0d1...dx...d127}`  
16 bytes containing 128 data bits, first bit is the MS bit of the first byte.

**Usage:** Setting only

**{DATE: yyyy-mm-dd;hh:mm:ss}****(optional)**

The tag contains the date and time at which the file was created. The year must be expressed as four digits. The instrument does not analyze this tag.

**Example:** `{DATE: 2009-04-02;14:32:12}`  
`BB:ARB:WAV:TAG? 'DATE'`  
queries the content of the `DATE` tag of the selected waveform file.  
`Response: '2009-04-02;14:32:12'`  
the waveform was created on April 2, 2009 at 14 hrs 32 min

**Usage:** Setting only

**{CONTROL LENGTH: ControlLength}****(optional / recommended for marker and control lists)**

The tag contains the length of the control list in ASCII format. If this tag is not used, the marker and control list length is determined by the highest position used in one of the `LIST` tags. It is recommended to set this value to be equal to the number of samples in order to keep marker signals and wave data synchronized.

**Example:** `{CONTROL LENGTH: 444}`  
`BB:ARB:WAV:TAG? 'CONTROL LENGTH'`  
queries the length of the control list.  
`Response: '444'`

**Usage:** Setting only

**{LEVEL OFFS: RMSOffset\_dB,PeakOffset\_dB}****(recommended for waveforms)**



The tag determines the level of the ARB signal in the waveform file. The offset levels define the offset of rms and peak value relative to the 16-bit full scale modulation  $(-32767$  to  $+ 32767) = 0$  dB.

**Setting parameters:**

**RMSOffset\_dB** Defines the RMS level offset of the signal relative to full scale ARB signal in the `WAVEFORM` tag. The offset is defined in ASCII float format. The value is always positive.  
A 3dB value indicates that the RMS level of the signal is 3 dBs below the full scale.  
full scale = max. amplitude of vector of I/Q samples =  $|S_{IQ}|_{max} = \sqrt{I^2+Q^2}_{max} = 0$  dB

**PeakOffset\_dB** Defines the peak level offset of the signal relative to full scale for the ARB signal in the `WAVEFORM` tag. The offset is defined in ASCII float format.  
The value usually equals 0 dB as in the majority of cases the I/Q samples (signed 16-bit integer values) are modulated to full scale:  
Full scale = 0 dB = max. amplitude of vector of I/Q samples =  $|S_{IQ}|_{max} = \sqrt{I^2+Q^2}_{max} = (2^{15})-1 = 32767$ .

A positive `PeakOffset_dB` value indicates that a headroom to full scale is provided when generating the waveform. A negative `PeakOffset_dB` value indicates that overrange is likely for some samples, i.e. clipping might occur.

The crest factor can be calculated from the two values as follows:  
Crest Factor =  $|PeakOffset\_dB - RMSOffset\_dB|$

**Example:**

```
{LEVEL OFFS: 3.45,2}
```

```
BB:ARB:WAV:TAG? 'LEVEL OFFS'
```

queries the content of the 'LEVEL OFFS' tag of the selected waveform file.

```
Response: '3.45,2'
```

the level of the waveform is below full scale, clipping will not occur.

**Usage:**

Setting only

**{SAMPLES: Samples}**

**(recommended for waveforms)**

The tag contains the number of I/Q samples in the waveform in ASCII format.

On multi segment waveforms, this tag contains the total I/Q samples of all segments.

**Example:**

```
{SAMPLES: 4333}
```

```
BB:ARB:WAV:TAG? 'SAMPLES'
```

queries the content of the `SAMPLES` tag of the selected waveform file.

```
Response: '4333'
```

the waveform contains 4333 I/Q samples.

**Usage:**

Setting only

---

**{[TRACE] LIST [#]: Pos0:Val0;Pos1:Val1;...Posx:Valx;...PosN-1:ValN-1}**

**(mandatory for control lists / optional for waveforms)**

The tag contains the data for the marker and control signals in the control list or the marker signals of ARB waveforms. To select which of these signals is defined, [TRACE] and the associated number are used. For ARB waveforms it is only meaningful to define marker signals (on ARB multi segment waveforms these tags will be ignored).

**Setting parameters:**

[TRACE]	Specifies the name of the marker or control signal. You may choose from the following names: MARKER; BURST; LEVATT; CW MODE; HOP, MAP
[#]	Specifies the number in the case of control signals and marker signals with the same name. There is a choice between 4 markers and 3 LEVATT signals. Lines LEVATT 1 and 2 are needed for internal purposes and should not be used.
Pos	Specifies in ASCII format the number of the position in the sequence, with effect from which the binary state of the marker or of the control signal changes from 0 to 1 or from 1 to 0.
Val	Specifies the binary state of the marker or of the control signal {0; 1} from Pos <sub>x</sub> to Pos <sub>x+1</sub> exclusive in ASCII format.

**Example:**

```
{MARKER LIST 1: 0:0;10:1;20:0;30:1}
BB:DM:CLIS:TAG? 'MARKER LIST 1'
```

queries the content of the MARKER LIST 1 tag of the selected control list file.

Response: '0:0;10:1;20:0;30:1'

the marker setting for samples 0 to 9 = 0 (low), for 10 to 19 = 1 (high) and for 20 to 29 = 0. From sample 30 onward the marker setting = 1.

**Example:**

```
{LEVATT LIST 1: 0:0;10:1;20:0;30:1}
BB:DM:CLIS:TAG? 'LEVATT LIST 1'
```

queries the content of the LEVATT LIST 1 tag of the selected control list file.

Response: '0:0;10:1;20:0;30:1'

level attenuation applies to data values 10 to 19 (high) and from data value 30 onward.

**Usage:** Setting only

---

**{WAVEFORM-Length: #I0Q0I1Q1...IxQx...IN-1QN-1...}**

**(mandatory for waveforms)**

The tag contains the actual waveform data or multi segment waveform data (I/Q stream).

The TYPE tag decides, whether the waveform file contains a normal waveform or a multi segment waveform.

The following figure shows the principle of multi segment work mode.

## ARB Multi Segment

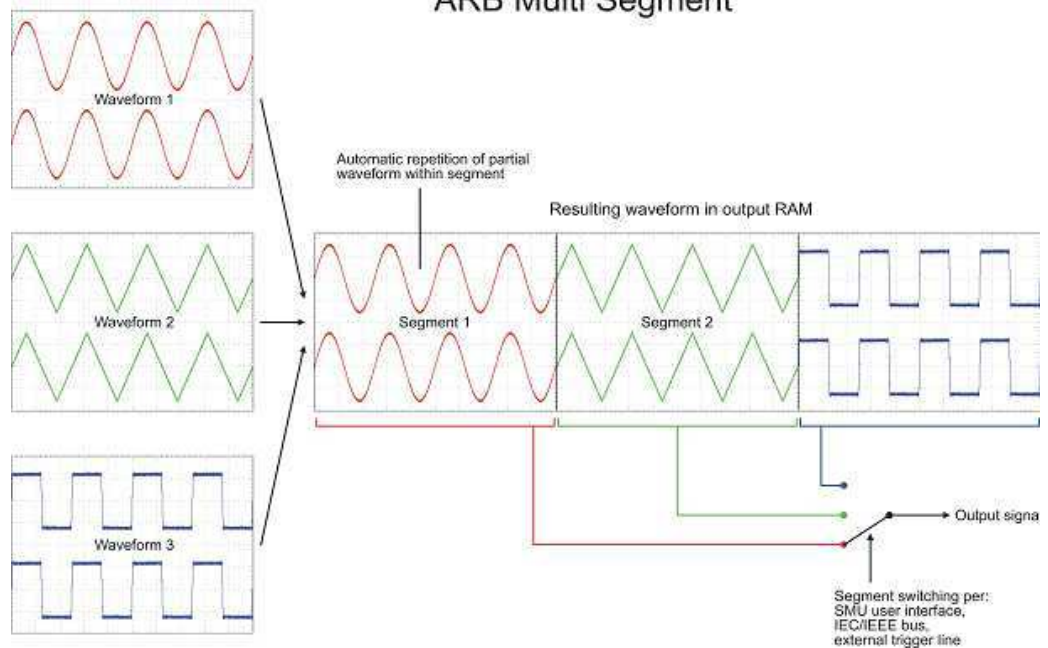

At 50 Ohm between the inner and outer conductors of the I and Q outputs, an amplitude  $V_p$  of  $\pm 0.5$  Volt arises on the I/Q output connectors of the R&S SMJ. The illustration also applies to the Q output.

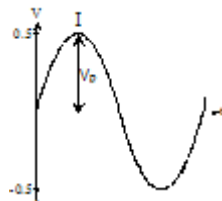
**Setting parameters:**

Length

Specifies the number of bytes in a WAVEFORM tag and is calculated as follow:

Length = Number of I/Q pairs \* 4 (i.e. 2 bytes per I and 2 bytes per Q value) + 1 byte (i.e. the length of the #).

- I Q** `IxQx...` represents binary data (16-bit signed integer in 2's complement notation) containing the I and Q component alternately and starting with the I component. Each component consists of two bytes, least significant byte (LSB) first.  
The values of the two bytes in an I component and a Q component are in the range 0x0 to 0xFFFF (-32767 to +32767). This value is transferred to the D/A converter.  
This tag is also used to store multi segment waveforms. The I/Q streams of the individual waveforms are directly concatenated to one collectively waveform I/Q stream.  
The number of segments and the start offset and length of the individual segments inside the total waveform I/Q stream is determined by the additional tags [MWV\\_SEGMENT\\_COUNT](#), [MWV\\_SEGMENT\\_START](#) and [MWV\\_SEGMENT\\_LENGTH](#).  
Further `MWV_SEGMENT_...` tags are also available, i.e. for level and clock information etc.
- Example:** `{WAVEFORM-401:#I0,Q0,I1,Q1,I2,Q2,...I99,Q99}`  
100 I/Q pairs with 4 bytes each are transmitted - none multi segment
- Example:** **Multi Segment**  
`{WAVEFORM-1201:`  
`#I0,Seg0,Q0,Seg0,I1,Seg0,Q1,Seg0,...I99,Seg0,Q99,Seg0,I0,Seg1,Q0,Seg1,I1,Seg1,`  
`Q1,Seg1,... I199,Seg1,Q199,Seg1}`  
(2 segments: segment 0 with 100 I/Q pairs, segment 1 with 200 I/Q pairs. Each I/Q pair consist of 2\*16 bit = 4 bytes)  
The data is transmitted using SCPI command  
`BB:ARB:WAVE:DATA.`
- Usage:** Setting only

**{MWV\_SEGMENT\_COUNT: NumOfSeg}****(mandatory for multi segment waveforms)**

The tag contains the number of segments in the multi segment waveform in ASCII integer format.

**Example:** `{MWV_SEGMENT_COUNT: 2}`  
Multi segment waveform with 2 segments

**Usage:** Setting only

**{MWV\_SEGMENT\_LENGTH: SamplesSeg0, SamplesSeg1, ..., SamplesSegN-1}****(mandatory for multi segment waveforms)**

The tag contains a list of I/Q sample lengths for every segment in the multi segment waveform in ASCII integer format.

**Example:** `{MWV_SEGMENT_LENGTH: 100,200}`  
 2 segments: 100 samples in segment 0 and 200 samples in segment 1.

**Usage:** Setting only

**{MWV\_SEGMENT\_START:  
 SampleStartOffsetSeg0, SampleStartOffsetSeg1, ..., SampleStartOffsetSegN-1}**

**(mandatory for multi segment waveforms)**

The tag contains a list of I/Q sample start offsets for every segment in the multi segment waveform in ASCII integer format.

**Example:** `{MWV_SEGMENT_START: 0,100}`  
 2 segments with 100 samples in segment 0 and 200 samples in segment 1.  
 Sample start offset of first segment 0 is 0 samples, start offset of next segment 1 is the sample length of segment 0 = 100 samples.

**Usage:** Setting only

**{MWV\_SEGMENT\_CLOCK\_MODE: Mode}**

**(mandatory for multi segment waveforms)**

The tag contains a string in ASCII format which supplies the clock rate mode, that was used for calculation of the multi segment output waveform.

The tag `CLOCK` contains always the highest clock rate of all segments.

The tag `MWV_SEGMENT_CLOCK` contains the clock rates of the individual segments.

**Setting parameters:**

Mode

**UNCHANGED**

The segments may have different clock rates.

During the multi segment calculation, the clock rates of all individual original waveforms were taken over unchanged in the segments of the multi segment output waveform (no software resampling is done).

If the segments have different clock rates, there are some restrictions on signal output, i.e. switching per external trigger and seamless switching between segments is not possible.

If all segments have already an identical clock rate, this mode is usually set to `HIGHEST`.

**HIGHEST**

All segments have an identical clock rate, which is the highest clock rate of all original waveforms.

If an individual original waveform has a lower clock rate, an upsampling to the highest clock rate will be performed on calculation of the multi segment output waveform.

**USER**

All segments have an identical clock rate, which is given by the user.

Note: Only upsampling is allowed, no downsampling!

If an individual original waveform has a lower clock rate, an upsampling to the user clock rate will be performed on calculation of the multi segment output waveform.

**Example:**

```
{MWV_SEGMENT_CLOCK_MODE: UNCHANGED}
{MWV_SEGMENT_CLOCK_MODE: HIGHEST}
{MWV_SEGMENT_CLOCK_MODE: USER}
```

**Usage:**

Setting only

**{MWV\_SEGMENT\_CLOCK: ClockSeg0, ClockSeg1, ..., ClockSegN-1}****(mandatory for multi segment waveforms)**

The tag contains a list of clock frequencies for every segment in the multi segment waveform in ASCII floating point format.

**Example:**

```
{MWV_SEGMENT_CLOCK: 100e6,80e6}
```

2 segments: clock of segment 0 is 100 MHz, clock of segment 1 is 80 MHz.

Note: If the segments have different clock frequencies, there are some restrictions on signal output, i.e. seamless switching between segments is only possible, if all segments have the same clock frequency. Software resampling (upsampling) can be used to bring all segments to the same clock.

**Usage:**

Setting only

**{MWV\_SEGMENT\_LEVEL\_OFFS:****RMSOffset\_dBSeg0, PeakOffset\_dBSeg0, ..., RMSOffset\_dBSegN-1, PeakOffset\_dBSegN-****(mandatory for multi segment waveforms)**

The tag contains a list of level pairs in ASCII floating point format, one pair for every segment in the multi segment waveform. The first value of a level pair defines the rms offset and the second value the peak offset relative to the 16-bit full scale modulation (-32767; + 32767) = 0 dB. The meaning of one level value pair is the same as in the [LEVEL OFFS](#) tag for normal waveforms.

**Example:** `{MWV_SEGMENT_LEVEL_OFFS: 3.0,0.0,6.0,0.0}`  
 2 segments: RMS level of segment 0 is 3dB below full scale; RMS level of segment 1 ist 6dB below full scale. Peak level of both segments is 0 dB full scale.

**Usage:** Setting only**{MWV\_SEGMENT\_FILES:****"FileNameSeg0.wv", "FileNameSeg1.wv", ..., "FileNameSegN-1.wv"}****(optional for multi segment waveforms)**

The tag contains a list of file names for every segment in the multi segment waveform in ASCII format.

**Example:** `{MWV_SEGMENT_FILES: "d:\waveforms\sine.wv", "d:\waveforms\rect.wv"}`

**Usage:** Setting only**{MWV\_SEGMENTx\_COMMENT: text}****(optional for multi segment waveforms)**

The tag contains a user comment for a specific segment  $x = [0 \dots \text{NumOfSeg}-1]$  in the multi segment waveform in ASCII format.

**Example:** `{MWV_SEGMENT1_FILES: segment 1 contains a QPSK signal.}`

**Usage:** Setting only**{CONTROL LIST WIDTH4–Length: #m0m1...mx...mM-1}****(optional for waveforms and multi segment waveforms)**

The tag contains a binary marker element stream, which will be given out synchronously to the I/Q sample sequence. One marker element  $m_x$  consists of 4 bit, which are assigned to the 4 possible marker lines of the instrument (one bit per marker line). One 4 bit marker elements is needed for every I/Q sample in the `WAVEFORM` tag - so the number of marker elements  $M$  should be equal to the number of I/Q samples. The `CONTROL LENGTH` tag has to contain the number of all marker elements  $M$ .

MSB 7	Byte						LSB 1
Marker element $m_x$ (synchronous to I/Q Sample $x$ )				Marker element $m_{x+1}$ (synchronous to I/Q Sample $x+1$ )			
Marker 4	Marker 3	Marker 2	Marker 1	Marker 4	Marker 3	Marker 2	Marker 1

Fig. 7-1: Marker element in 4-bit binary format bit order

For standard waveforms the `MARKER LIST x` tags are a more compact way to define markers, but in principle this `CONTROL LIST WIDTH4` format can also be used instead of the `MARKER LIST x` tags.

For multi segment waveforms this `CONTROL LIST WIDTH4` format is required for marker definition. The binary marker streams of the individual segments are directly concatenated (without any gap) to one collectively marker stream.

#### Setting parameters:

**Length** Defines the number of bytes in the `CONTROL LIST WIDTH4` tag in ASCII Format and is calculated as follow:  

$$\text{Length} = \text{Size of "\#"} (1 \text{ byte}) + \text{Number of marker elements } m_x * (4 \text{ bit}) / (8 \text{ bits/byte})$$
The value is rounded up for byte alignment.

**$m_x$**  Marker element in 4-bit binary format.

**Example:** {`CONTROL LIST WIDTH4-51: #m0m1...mx...m99`}  
100 marker elements, each marker element with 4 bits

**Usage:** Setting only

### 7.3.2 Creating a Waveform Manually

We will use the example of a sine function in the I channel and a cosine function in the Q channel, each with 20 points, to explain how a waveform file `SICO.WV` is generated.

The sine and cosine values are calculated by a short program written in the programming language C (see the following example for creating a C-program). They are stored in the file `SICO.TXT` as follows:

Contents of `SICO.TXT`:  
Sine (I) Cosine (Q)

```
0.000000 1.000000
0.309017 0.951057
0.587785 0.809017
0.809017 0.587785
0.951057 0.309017
1.000000 -0.000000
0.951056 -0.309017
0.809017 -0.587785
0.587785 -0.809017
```



```

0.309017 -0.951056
-0.000000 -1.000000
-0.309017 -0.951057
-0.587785 -0.809017
-0.809017 -0.587785
-0.951056 -0.309017
-1.000000 0.000000
-0.951056 0.309017
-0.809017 0.587785
-0.587785 0.809017
-0.309017 0.951057

```

The decimal values in `SICO.TXT` should be normalized such that they are between  $-1.0$  and  $+1.0$ . The waveform file `SICO.WV` will be based on the contents of this file.

To be read by the R&S SMJ these waveform data must be coded binary and packed into an appropriate `WAVEFORM` tag. A tag consists of a name and a data set and is enclosed in curved brackets. The tag is a kind of label carrying information about what the R&S SMJ should do with the data set (see above and step 3 of the following instructions).

The following steps outline how to create the waveform file `SICO.WV`:

1. The values from the file `SICO.TXT` must be converted into binary format consisting of integer numbers without a sign and with 16-bit width. The numeric range between  $-1.0$  and  $+1.0$  corresponds to the modulation range of the waveform D/A converter of 65535 ( $2^{16}-1$ ).

+1.0 ->	32767	= 0x7FFF
0.0 ->	0	= 0x0000
-1.0 ->	-32767	= 0x8001

A further C-program is suitable for creating the binary data set from the ASCII values stored in `SICO.TXT` file (see following example for creating a C-program). This program stores the binary data set to a file called `SICO.WV`.

The contents of the file `SICO.WV` reads as follows:

```
IQIQIQIQIQIQIQI ... IQ
```

**Note:** There is no readable representation for binary values in this document. This is why we use the sequence `IQIQIQ` to characterize the binary code in the present example.

2. The file `SICO.WV` now contains the binary data set corresponding to the 20 I/Q pairs. Before this binary data set can be further processed in step 3, the `TYPE` and the `CLOCK` tag must be placed in front.

To enter the `TYPE` tag in the `SICO.WV` file an ASCII editor which is able to handle binary data as well, e.g. the Microsoft Windows editor `NOTEPAD.EXE`, must be used.

Now the contents of the `SICO.WV` file read:

```
{TYPE: SMU-WV, 0}{CLOCK: 10e6} IQIQIQIQIQIQIQIQIQIQIQI ... IQ
```

To simplify our example the checksum is set to 0, i.e. the instrument does not evaluate a checksum.

- The binary data must now be packed into a **WAVEFORM** tag with the following structure:

```
{WAVEFORM-Length: #IQIQIQIQIQIQIQIQIQI ... IQ}
```

The editor mentioned above which can handle binary data is now used to place the string {WAVEFORM-81: # in front and the symbol } at the end of the data set.

The **Length** of the data set is the number of bytes of the data set and is calculated as the sum of the number of I/Q pairs \* 4 (2 bytes per I and per Q value) and one 1 byte for the symbol #.

In our example containing a sine and a cosine with 20 pairs for each wave, the resulting length is 81.

**Note:** There is no readable representation for binary values in this document. This is why we use the sequence IQIQIQ to characterize the binary code in the present example!

The contents of the waveform file `SICO.WV` for 20 I/Q pairs is now ready for operation and reads.

```
{TYPE: SMU-WV,0}
{CLOCK: 10e6}
{WAVEFORM-81: #IQIQIQIQIQIQ ... IQ}
```

The tags **TYPE**, **CLOCK** and **WAVEFORM** are mandatory for each waveform. All other tags are optional and can be inserted after the **TYPE** tag in arbitrary order, e.g.

```
{TYPE: SMU-WV,0}
{COMMENT: I/Q=sine/cosine, 20 points, clock 10 MHz}
{CLOCK: 10e6}
{Samples:20}
{WAVEFORM-81:#IQIQIQIQIQIQ ... IQ}
```

### C-programs for creating the `SICO.TXT` file and for generating the waveform file

C-program for creating the file `SICO.TXT` containing 20 sine and cosine pairs:

```
#include <stdlib.h>
#include <stdio.h>
#include <math.h>
void main(void)
{
    const unsigned int samples = 20;
    const float pi = 3.141592654;
    float grad, rad;
    FILE *fp;
    int i;
    fp = fopen("SICO.TXT", "w");
    if (fp == 0)
        return;
    for (i=0; i<samples; i++)
    {
        grad = (360.0 / (float)samples) * (float)i;
```

```

        rad = grad * (pi / 180.0);
        fprintf(fp, "%f %f\n", sin(rad), cos(rad));
    }
    fclose(fp);
}

```

Extract from a C-program generating a binary data set from the I/Q pairs in the file SICO.TXT and storing the result to file SICO.WV:

```

#include <stdlib.h>
#include <stdio.h>
#include <math.h>
void main(void)
{
    const unsigned int samples = 20; // Number of samples to convert
    FILE *fp_sour, *fp_dest;
    float i_float, q_float;
    unsigned short i_usint, q_usint;
    int i;
    fp_sour = fopen("SICO.TXT", "rt");
    if (fp_sour == 0)
        return;
    fp_dest = fopen("SICO.WV", "wb");
    if (fp_dest == 0)
    {
        fclose(fp_sour);
        return;
    }
    // Write required tags to waveform file
    fprintf(fp_dest, "{TYPE: SMU-WV,0}");
    fprintf(fp_dest, "{CLOCK: 10e6}");
    fprintf(fp_dest, "{SAMPLES: %d}", samples);
    fprintf(fp_dest, "{WAVEFORM-%d:#", (samples * 4) + 1);
    for (i=0; i<samples; i++)
    {
        // Read I/Q pair from ASCII file
        if (fscanf(fp_sour, "%f %f", &i_float, &q_float) == EOF)
            break;
        // Convert I/Q pair to unsigned short
        i_usint = (unsigned short)floor((i_float * 32767.0) + 0.5);
        q_usint = (unsigned short)floor((q_float * 32767.0) + 0.5);
        // Write converted I/Q pair to waveform file
        fwrite(&i_usint, 2, 1, fp_dest);
        fwrite(&q_usint, 2, 1, fp_dest);
    }
    fprintf(fp_dest, "}");
    fclose(fp_dest);
    fclose(fp_sour);
}

```

### 7.3.3 Creating an ASCII C-List Manually

When you create the C-list in the editor, as shown in the figure, you get an ASCII file with the extension \*.dm\_iqc (see the example [C-List ASCII File](#)).

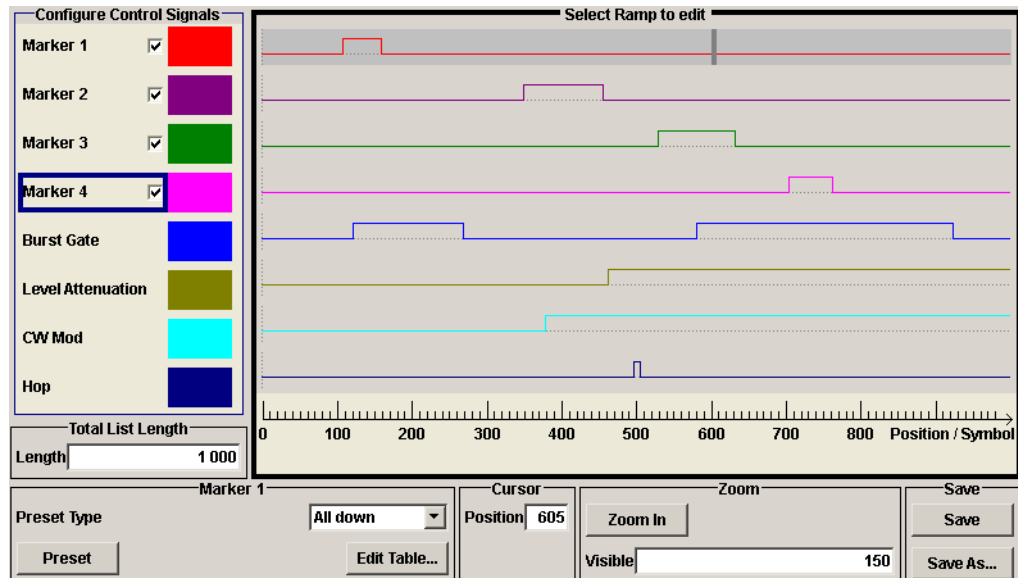

Fig. 7-2: Representation in the C-List Editor

#### Example: C-List ASCII File

C-List in ASCII format, corresponding to C-List editor [figure 7-2](#):

```
{TYPE:SMU-CL}{COPYRIGHT:2003 Rohde&Schwarz SMU}{DATE:2011-07-19;14:58:44}
{HOP LIST:0:0;498:1;506:0}{CW MODE LIST:0:0;380:1}{LEVATT LIST 1:0:0;464:1}
{BURST LIST:0:0;122:1;270:0;582:1;924:0}
{MARKER LIST 4:0:0;706:1;764:0}{MARKER LIST 3:0:0;530:1;633:0}
{MARKER LIST 2:0:0;350:1;457:0}{MARKER LIST 1:0:0;108:1;160:0}
{CONTROL LENGTH:1000}
```

The tags to the traces in the C-List editor are:

- HOP LIST
- CW MODE LIST
- LEVATT LIST 1
- BURST LIST
- MARKER LIST 4
- MARKER LIST 3
- MARKER LIST 2
- MARKER LIST 1
- CONTROL LENGTH

CONTROL LENGTH defines the periodicity of the total C-List. The remaining tags define the individual markers or control traces in a combined state/starting time way within the C-List period.

If you want to write an ASCII C-List directly without using the C-List editor, a special syntax has to be taken into account:

- The tag and the following [state: start time]-pairs are separated by a colon ":".
- The [state: start time] pairs in turn are separated by semicolons ";".
- The list state can be either 0 or 1.
- The time unit is the simple period.

**Example:**

"CW MODE LIST 0:0;380:1" for a CW trace:

The list status starts at time 0 with 0, and at time point 380 symbol periods after start, it changes to 1.



With the commands `BB:DM:CLIST:...` you can also generate control lists in binary format, if required. See "[DM Lists](#)" on page 603.

## 7.4 BERT and BLER Subsystems

These subsystems contain the commands for the bit and block error rate measurement. Since the commands for these two subsystems are essentially identical, they are summarized in the following section.

<code>:BLER:RESult</code> .....	477
<code>:BERT:RESult</code> .....	477
<code>:BLER:SEQuence</code> .....	478
<code>:BERT:SEQuence</code> .....	478
<code>:BLER:SETup:CLOCK[:POLarity]</code> .....	479
<code>:BERT:SETup:CLOCK[:POLarity]</code> .....	479
<code>:BLER:SETup:CORDer</code> .....	479
<code>:BLER:SETup:DATA[:POLarity]</code> .....	480
<code>:BERT:SETup:DATA[:POLarity]</code> .....	480
<code>:BLER:SETup:DENable</code> .....	480
<code>:BERT:SETup:DENable</code> .....	480
<code>:BERT:SETup:IGNore</code> .....	481
<code>:BLER:SETup:MCOunt</code> .....	482
<code>:BERT:SETup:MCOunt</code> .....	482
<code>:BLER:SETup:MERRor</code> .....	482
<code>:BERT:SETup:MERRor</code> .....	482
<code>:BERT:SETup:REStart:STATe</code> .....	482
<code>:BERT:SETup:TYPE</code> .....	483
<code>:BLER:SETup:TYPE</code> .....	483
<code>:BLER:START</code> .....	484
<code>:BERT:START</code> .....	484
<code>:BLER:STATe</code> .....	484
<code>:BERT:STATe</code> .....	484
<code>:BLER:STOP</code> .....	484
<code>:BERT:STOP</code> .....	484

:BLER:UNIT.....	485
:BERT:UNIT.....	485
[:SOURce]:INPut:BERT:IMPedance.....	485
[:SOURce]:INPut:BERT:THReshold.....	485
:TRIGger:BLER[:IMMediate].....	486
:TRIGger:BERT[:IMMediate].....	486

**:BLER:RESult?****:BERT:RESult?**

Queries the result of the last BER measurement/BLER measurement. The response consists of seven results separated by commas. In the first measurement following the start, intermediate results for the number of data bits/data blocks, error bits/errors and error rate are also queried. In the following measurements (only for `BERT:SEQ AUTO/` for `BLER:SEQ AUTO`) only the final results of each single measurement are queried

**Note:** At the end of a measurement, the restart of a new one is delayed until the first measurement result has been queried with `BERT:RES`. The resulting brief measurement interruption is irrelevant because the subsequent measurement will be synchronized within 24 data bits.

**Return values:**

&lt;Result&gt;

string

**<data bits/data blocks>**

Number of checked data bits/data blocks

**<errors>**

Number of error bits/errors

**<error rate>**

If no termination criterion has been reached since the beginning of the measurement, the current quotient of "Number of error bits/errors" and "Number of data bits/data blocks" is entered. As soon as at least one final result has been reached in continuous measurement, the most recent final result is entered.

**<measurement status>**

Status of measurement.

1 = Measurement has been terminated, i.e. the number of data bits/data blocks or error bits/errors preset by the commands

`BERT|BLER:SETup:MCOunt` and

`BERT|BLER:SETup:MERRor` has been reached, or the measurement has been stopped by the command `BERT|BLER:STOP`.

0 = Measurement has not been terminated.

**<clock detected>**

Status of clock line

1 = Clock line active

0 = Clock line not active

**<data detected>**

Status of data line

1 = Data line active (only clocked data is detected; if the clock signal is missing, a data change is also not detected).

0 = Data line is not active.

**<synchronization status>**

1 = The measurement is synchronized, i.e. the clock and data lines are active and the "Number of error bits/errors" to "Number of data bits/data blocks" ratio is better than 0.1, so that the measurement ratio can be assumed to be realistic.

0 = The measurement is not synchronized.

**Example:**`BERT:RES`

queries the results of the bit error rate measurement.

Response: "1000,5,5E-4,1,1,1,1"

The measurement has been terminated, and synchronization has been performed. Out of 1000 data bits, 5 error bits were measured, yielding an error rate of 0.005.

**Usage:**

Query only

---

**:BLER:SEQuence** <Sequence>

**:BERT:SEQuence** <Sequence>

Selects the type of measurement: single or continuous measurement.

These commands are automatically set to AUTO by `BERT:START` or `BLER:START`.

**Parameters:**

&lt;Sequence&gt;

AUTO | SINGle

**AUTO**

Continuous measurement. If one or both termination criteria are met, the measurement in progress is terminated. At the end of a measurement, the restart of a new one is delayed until the first measurement result has been queried with `BERT:RES`. The resulting brief measurement interruption is irrelevant because the subsequent measurement will be synchronized within 24 data bits.

**SINGle**

Single measurement. A single measurement must be started with `:TRIG:BERT`. A single measurement is terminated once the set number of data bits/blocks or number of errors is reached

\*RST: AUTO

**Example:**`BERT:SEQ SING`

selects single measurement.

**Example:**`TRIG: BERT`

starts the single measurement.

**Options:**

Dependencies: These commands are automatically set to AUTO by `BERT:START` or `BLER:START`

**:BLER:SETup:CLOCK[:POLarity]** <Polarity>**:BERT:SETup:CLOCK[:POLarity]** <Polarity>

Sets the polarity of the active slope of the feedback clock.

**Parameters:**

&lt;Polarity&gt;

RISing | FALLing

**RISing**

The positive slope of the clock signal is active.

**FALLing**

The negative slope of the clock signal is active.

\*RST: RISing

**Example:**`BERT:SET:CLOC FALL`

selects the falling slope of the clock signal as the active slope.

**:BLER:SETup:CORDer** <COrder>

Sets the byte order of the checksum (CRC).



**Parameters:**`<COrder>`            LSB | MSB**LSB**

The checksum starts with the least significant byte.

**MSB**

The checksum starts with the most significant byte.

\*RST:            LSB

**Example:**`BLER:SET:CORD MSB`

the checksum starts with the most significant byte.

`:BLER:SETup:DATA[:POLarity] <Polarity>``:BERT:SETup:DATA[:POLarity] <Polarity>`

Sets the polarity of the feedback data bits.

**Parameters:**`<Polarity>`            NORMal | INVerted**NORMal**

High level stands for a logic 1, low level for a logic 0.

**INVerted**

Low level stands for a logic 1, high level for a logic 0.

\*RST:            NORMal

**Example:**`BERT:SET:DATA INV`

sets inversion of data signal.

`:BLER:SETup:DENable <DENable>``:BERT:SETup:DENable <DENable>`

Activates/deactivates the use of the **Data Enable** signal and the polarity of the signal if it is used. The **Data Enable** signal marks the data that is actually to be evaluated for the BER measurement. Any data in addition to the PRBS sequence is masked and thus not evaluated (e.g. sync, preambles, other channels, etc that are present in the data bits supplied by the DUT).

**Parameters:**

&lt;DEnable&gt;

OFF | LOW | HIGH

**OFF**

Any signal at the **Data Enable** input is ignored; all data at the BERT data input is used for the measurement.

**HIGH**

The **Data Enable** signal is used. The only data measured is the data at the BERT data input during a high level of the **Data Enable** signal. The measurement is interrupted during a low level of the **Data Enable** signal.

**LOW**

The **Data Enable** signal is used. The only data measured is the data at the BERT data input during a low level of the **Data Enable** signal. The measurement is interrupted during a high level of the **Data Enable** signal.

\*RST: OFF

**Example:**

BERT:SET:DEN HIGH

The measurement is interrupted during the low level of the **Data Enable** input.

**:BERT:SETup:IGNore <Ignore>**

Activates/deactivates ignoring of pure "0" or "1" bit sequences at least 32 bits long. Activating excludes faulty frames from the measurement. In the case of some mobile radio standards, pure "0" or "1" bit sequences are generated when errors (e.g. an incorrect checksum) are detected within a frame. These sequences, instead of the frame data, are provided for the BER measurement and signal that the frame in question should not be used for the measurement.

**Parameters:**

&lt;Ignore&gt;

OFF | ZERO | ONE

**OFF**

Pattern Ignore is not active.

**ONE**

Bit sequences consisting of 32 or more consecutive "1" data are not used (i.e. ignored) for the BER measurement.

**ZERO**

Bit sequence consisting of 32 or more consecutive "0" data are not used (i.e. ignored) for the BER measurement.

\*RST: 0

**Example:**

BERT:SET:IGN ONE

specifies that bit sequences of "1" data at least 32 bits long are not used for the measurement.

---

```
:BLER:SETup:MCOunt <Mcount>
```

```
:BERT:SETup:MCOunt <Mcount>
```

Enters the number of transmitted data bits/data blocks to be checked before the measurement is terminated. With a BER measurement, data that was suppressed by `BERT:SETup:DEnable` is not counted. This termination criterion always terminates the measurement after the specified number of data bits/data blocks. Starting from this point, the fourth value is output with 1 (= terminate measurement) if the result is queried with `:BERT|BLER:RES`. If the continuous measurement mode (`BERT|BLER:SEQ AUTO`) has been selected, the measurement is restarted once the results have been queried.

**Parameters:**

```
<Mcount>          integer
                   Range:    0 to 4294967295
                   Increment: 1
                   *RST:    1E7
```

**Example:** `BERT:SET:MCO 1E6`  
sets a measurement over 1000000 data bits.

**Example:** `BLER:SET:MCO 1E3`  
sets a measurement over 1000 data blocks.

---

```
:BLER:SETup:MERRor <Merror>
```

```
:BERT:SETup:MERRor <Merror>
```

Enters the number of errors to occur before the measurement is terminated. This termination criterion always terminates the measurement after the specified number of errors. Starting from this point, the fourth value is output with 1 (= terminate measurement) if the measurement result is queried with `:BERT|BLER:RES`.

**Parameters:**

```
<Merror>          integer
                   Range:    0 to 4294967295
                   Increment: 1
                   *RST:    100
```

**Example:** `BERT:SET:MERR 1E4`  
sets a measurement over 1000 errors.

---

```
:BERT:SETup:REStart:STATe <State>
```

Activates/deactivates an external restart of the BER measurement.

**Parameters:**

&lt;State&gt;

0 | 1 | OFF | ON

**OFF**

The reset signal for the BER measurement is generated internally. This setting is suitable for PRBS sequences that run continuously and thus ensure uninterrupted repetition.

**ON**

The reset signal for the BER measurement is fed via the **Restart** input of the BERT interface.

If the PRBS sequence cannot be continued uninterruptedly, the BER measurement must be stopped at the end of the data sequence and subsequently restarted at the beginning of the new data sequence. The measurement is stopped and started via a 0-1-0 slope of the **Restart** signal. A transition from logic 0 to 1 causes a partial result to be generated and the measurement to be stopped. A transition from 1 to 0 starts the measurement for the next subinterval. This measurement is synchronized anew. If the R&S Vector Signal Generator is used as a data source, a signal in which a single 1 was coded at the end of the data sequence can be used as a restart signal at the R&S Vector Signal Generator marker output. This causes the BER measurement to stop briefly at the end of the data sequence and start again.

Partial results (number of data and error bits) are added up until the predefined total number of data or error bits is reached or exceeded.

The measurement is reset by **Pattern Ignore** or **Data Enable**, regardless of its status.

```
*RST:      0
```

**Example:**

```
BERT:SET:REST:STAT ON
```

The external signal restarts the measurement.

**:BERT:SETup:TYPE <Type>**

Selects the PRBS sequence. The data generated by the PRBS generator is used as a reference for the measurement.

**Parameters:**

&lt;Type&gt;

```
PRBS9 | PRBS11 | PRBS15 | PRBS16 | PRBS20 | PRBS21 |
PRBS23 | PN9 | PN11 | PN15 | PN16 | PN20 | PN21 | PN23
```

```
*RST:      PRBS9
```

**Example:**

```
BERT:SET:TYPE PN15
```

sets a pseudo random binary sequence consisting of 32767 bits.

**:BLER:SETup:TYPE?**

Queries the CRC polynomial used. CCITT CRC 16 :  $G(x) = x^{16} + x^{12} + x^5 + x^1$  is the CRC polynomial supported.

**Return values:**

<Type> CRC16  
 \*RST: CRC16

**Example:**

BLER:SET:TYPE  
 queries the type of measurement.

**Example:**

Response: CRC16

**Usage:**

Query only

**:BLER:START****:BERT:START**

Starts a continuous measurement.

These commands automatically set BERT:SEQ:MODE or BLER:SEQ:MODE to AUTO and BERT:STATE or BLER:STATE to ON.

**Example:**

BERT:STAR  
 starts a continuous measurement.

**Usage:**

Event

**:BLER:STATE <State>****:BERT:STATE <State>**

Switches the measurement on/off. Depending on the selected mode, either a continuous measurement (BERT|BLER:SEQ:AUTO) or a single measurement (BERT|BLER:SEQ:SING) is carried out. A single measurement must be triggered (:TRIG:BERT|BLER).

These commands are automatically set to ON by BERT:START or BLER:START and to OFF by BERT:STOP or BLER:STOP.

**Parameters:**

<State> 0 | 1 | OFF | ON  
 \*RST: 0

**Example:**

BERT:SEQ:SING  
 selects a single measurement.  
 BERT:STAT:ON  
 switches the BER measurement on.

**Example:**

TRIG:BERT  
 starts a single measurement.

**:BLER:STOP****:BERT:STOP**

Stops an ongoing measurement.

These commands automatically set BERT:STATE or BLER:STATE to OFF

**Example:** `BERT:STOP`  
stops the measurement. To start a new measurement, the BER measurement must be switched on again by `BERT:STATe ON`.

**Usage:** Event

**:BLER:UNIT <Unit>**

**:BERT:UNIT <Unit>**

Sets the unit for the error rate display on the screen. `BERT|BLER:RES` always specifies the error rate as the quotient of "Number of errors" and "Number of data items", unaffected by this command.

**Parameters:**

<Unit>                   ENGINEering | SCientific | PCT | PPM

**ENGINEering**

The error rate is output in exponential notation with the exponent  $-3$  or  $-6$ .

**SCientific**

The error rate is output in scientific notation, i.e. standardized to one place to the left of the decimal.

**PCT**

The error rate is output in percent.

**PPM**

The error rate is output in parts per million.

\*RST:           ENGINEering

**Example:** `BERT:UNIT PPM`  
selects the unit "ppm" for the display of the error rate.

**[:SOURce]:INPut:BERT:IMPedance <Impedance>**

The command sets the impedance of the BERT inputs **CLOCK**, **DATA**, **DATA ENABLE** and **RESTART**.

**Parameters:**

<Impedance>           G1K | G50 | G10K

\*RST:           G1K

**Example:** `INP:BERT:IMP G50`  
The impedance of the BERT inputs is set to 50 ohm to ground.

**[:SOURce]:INPut:BERT:THReshold <Threshold>**

The command sets the high/low threshold of the BERT inputs **Clock**, **Data**, **Data Enable** and **Restart**. In the case of positive polarity, this threshold determines the point as of which a signal is high (active) or low (inactive).

**Parameters:**

<Threshold> float  
 Range: 0.01 to 2  
 Increment: 0.01  
 \*RST: 1.00V  
 Default unit: Volt

**Example:**

```
INP:BERT:THR 1 V
```

A high/low threshold of 1 volt is set at the BERT inputs. The signal is high (active) for a signal voltage of 1 volt and higher.

**:TRIGger:BLER[:IMMediate]****:TRIGger:BERT[:IMMediate]**

Triggers a single bit error rate or block error rate measurement if the single trigger mode (BERT|BLER:SEQ SING) is selected.

**Example:**

```
BERT:SEQ SING
```

selects the single trigger mode.

**Example:**

```
TRIG:BERT
```

starts a single bit error rate measurement.

**Usage:**

Event

## 7.5 CALibration Subsystem

The CALibration system contains the commands for adjustment. Adjustment is triggered by the query commands. The response "0" indicates error-free adjustment, and the response "1" means that an error occurred during adjustment.

:CALibration:ALL[:MEASure].....	486
:CALibration<hw>:FMOfset[:MEASure].....	487
:CALibration<hw>:FREQuency[:MEASure].....	487
:CALibration<hw>:IQModulator:FULL.....	487
:CALibration<hw>:IQModulator:LOCal.....	488
:CALibration<hw>:LEVel[:MEASure].....	488
:CALibration<hw>:LEVel:STATe.....	488
:CALibration<hw>:LEVel:HACCuracy[:STATe].....	488

**:CALibration:ALL[:MEASure]?**

The command starts all internal adjustments for which no external measuring equipment is needed.

**Return values:**

<Measure> 0 | 1

**Example:** `CAL:ALL:MEAS?`  
starts the adjustment of all functions for the entire instrument.  
Response: "0"  
adjustment has been performed successfully.

**Usage:** Query only  
SCPI confirmed

---

#### **:CALibration<hw>:FMOffset[:MEASure]?**

The command starts all adjustment for the FM/PhiM modulator.

**Return values:**

<Measure> 0 | 1

**Example:** `CAL:FMOF?`  
starts the adjustments for the FM/Phim modulator.  
Response: "0"  
the adjustments have been performed successfully

**Usage:** Query only

---

#### **:CALibration<hw>:FREQuency[:MEASure]?**

The command starts all adjustments which affect the frequency.

**Return values:**

<Measure> 0 | 1

**Example:** `CAL:FREQ:MEAS?`  
starts the adjustments for maximum frequency accuracy.  
Response: "0"  
the adjustments have been performed successfully.

**Usage:** Query only

---

#### **:CALibration<hw>:IQModulator:FULL?**

The command starts adjustment of the I/Q modulator for the entire frequency range. The I/Q modulator is adjusted with respect to carrier leakage, I/Q imbalance and quadrature.

**Return values:**

<Full> 0 | 1

**Example:** `CAL:IQM:FULL?`  
starts adjustments for the I/Q modulator across the entire frequency range.  
Response: "0"  
adjustment has been performed successfully

**Usage:** Query only



**:CALibration<hw>:IQModulator:LOCAl?**

The command starts adjustment of the I/Q modulator for the currently set frequency, I/Q swap and baseband gain. The I/Q modulator is adjusted with respect to carrier leakage, I/Q imbalance and quadrature.

**Return values:**

<Local>                    0 | 1

**Example:**

CAL: IQM: LOC?

starts adjustment for the I/Q modulator for the currently set frequency.

Response: 0

adjustment has been performed successfully

**Usage:**

Query only

**:CALibration<hw>:LEVel[:MEASure]?**

The command starts all adjustments which affect the level.

**Return values:**

<Measure>                0 | 1

**Example:**

CAL: LEV: MEAS?

starts adjustments for maximum level accuracy.

Response: "0"

adjustment has been performed successfully.

**Usage:**

Query only

**:CALibration<hw>:LEVel:STATe <State>**

The command switches on or off internal level correction.

**Parameters:**

<State>                    ON | OFF

\*RST:                    ON

**Example:**

CAL: LEV: STAT

switches on level correction.

**:CALibration<hw>:LEVel:HACCuracy[:STATe] <State>**

Enables/disables level adjustment with high accuracy.

**Parameters:**

<State>                    0 | 1 | OFF | ON

\*RST:                    OFF

**Example:**

CAL: LEV: HACC: STAT ON

switches on Hight Accuracy Level Adjustment

## 7.6 CLOCK Subsystem

The CLOCK system contains the commands for configuration of the signals at the clock output and input connectors.

:CLOCK:INPut:FREQuency.....	489
:CLOCK:INPut:SLOPe.....	489
:CLOCK:OUTPut:MODE.....	489
:CLOCK:OUTPut:SOURce.....	490

---

### :CLOCK:INPut:FREQuency?

The command sets the measured frequency of the external clock signal. An external clock reference must be supplied at the CLOCK input.

#### Return values:

<Frequency> float

#### Example:

CLOC:INP:FREQ

queries the measured frequency of the external clock reference.

#### Usage:

Query only

---

### :CLOCK:INPut:SLOPe <Slope>

The command sets the active slope of an externally applied clock signal at the CLOCK connector.

#### Parameters:

<Slope> NEGative | POSitive  
\*RST: POSitive

#### Example:

CLOC:INP:SLOP NEG

The active slope of the external clock signal at the CLOCK connector is the falling slope.

---

### :CLOCK:OUTPut:MODE <Mode>

The command sets the output of bit or symbol clock pulses at the CLOCK OUT connector at the rear panel.

#### Parameters:

<Mode> SYMBol | BIT  
\*RST: SYMBol

#### Example:

CLOC:OUTP:MODE SYMB

The internal symbol clock is output at the CLOCK OUT connector.

**:CLOCK:OUTPUT:SOURce? <Source>**

The command queries the path for which the clock signal at the CLOCK OUT connector is to be output.

**Return values:**

<Source>                   A  
 \*RST:                    A

**Example:**

CLOC:OUTP:SOUR

queries the path for which the clock signal at the CLOCK OUT connector is to be output.

Response: A

The clock signal of path is output at the CLOCK OUT connector.

**Usage:**                    Query only

## 7.7 DIAGnostic Subsystem

The `DIAGnostic` system contains the commands used for instrument diagnosis and servicing. SCPI does not define any `DIAGnostic` commands; the commands listed here are all Device-specific. All `DIAGnostic` commands are query commands which are not influenced by `*RST`.

<code>:DIAGnostic&lt;hw&gt;:BGInfo</code> .....	490
<code>:DIAGnostic&lt;hw&gt;:BGInfo:CATalog</code> .....	491
<code>:DIAGnostic:INFO:OTIME</code> .....	491
<code>:DIAGnostic:INFO:POCount</code> .....	491

**:DIAGnostic<hw>:BGInfo?**

The command checks the modules available in the instrument using the variant and revision state.

If the command is sent without parameters being specified, a complete list of all modules is returned (the various entries are separated by commas). The length of the list is variable and depends on the instrument equipment configuration.

If the command is sent with parameters, a list of the specified modules is returned (the various entries are separated by commas). A list of modules names can be called up using the command `:DIAGnostic<hw>:BGInfo:CATalog` on page 491.

**Return values:**

<Bginfo>                    < Module name> <Module stock number incl. variant> <Module revision> <Module serial number>

Each entry for one module consists of four parts which are separated by space characters.

**Example:**           DIAG:BGIN  
 Queries the instrument configuration.  
**Response:** MBRD, SSYN, IQOP3, IQOP3\_LCM, . . . .  
 returns the data of all available modules.  
 DIAG:BGIN? 'MBRD'  
 Queries the configuration of the motherboard.  
**Response:**           MBRD 1141.3501.02 1.5.3 100023  
 Module motherboard with stock number 1141.3501.01 has revision 1.5.3 and serial number 100023.

**Usage:**            Query only

#### :DIAGnostic<hw>:BGInfo:CATalog?

The command queries the names of the assemblies available in the instrument.

A complete list of all assemblies is returned (the various entries are separated by commas). The length of the list is variable and depends on the instrument equipment configuration.

**Return values:**

<Catalog>           string

**Example:**

DIAG:BGIN:CAT

queries the names of the assemblies.

**Response:** MBRD, SSYN, IQOP3, IQOP3\_LCM, . . . .

**Usage:**

Query only

#### :DIAGnostic:INFO:OTIMe?

The command queries the number of operation hours.

**Return values:**

<OTIMe>            float

**Example:**

DIAG:INFO:OTIM

queries the operation hours.

**Response:**        100023

The instrument was operated for 100023 hours up to now.

**Usage:**

Query only

#### :DIAGnostic:INFO:POCount?

The command queries the number of power-on events.

**Return values:**

<Pocount>         float

**Example:**           DIAG:INFO:POC  
 queries the number of power on events.  
 Response:       123  
 The instrument was switched on for 123 times up to now.

**Usage:**           Query only

## 7.8 DISPlay Subsystem

The DISPlay system contains the commands to set the power-save mode of the instrument.

---

**:DISPlay:PSAVe:HOLDoff** <Holdoff>

This command sets the wait time for the screen-save mode of the display. The available value range is 1 to 60 minutes, the resolution 1 minute. The entry is dimensionless.

**Parameters:**

<Holdoff>           float  
 Range:       1 to 60  
 \*RST:       1  
 Default unit: minute

**Example:**           DISP:PSAV:HOLD 10  
 sets the wait for the screen saver mode to 10 minutes.

---

**:DISPlay:PSAVe[:STATe]** <State>

This command activates/deactivates the screen-save mode of the display. With the screen-save mode activated the display including backlight is completely switched off after the elapse of the wait time (see command `DISPlay:PSAVe:HOLDoff`) when no entries via front panel, external mouse or external keyboard are made.

This mode is recommended for preserving the display especially if the instrument is exclusively operated via remote control.

**Parameters:**

<State>           0 | 1 | OFF | ON  
 \*RST:       OFF

**Example:**           DISP:PSAV ON  
 activates screen saver mode.

## 7.9 FORMat Subsystem

The FORMat subsystem contains the commands which determine the format of the data that the R&S SMJ returns to the controller. This affects all query commands which return

a list of numerical data or block data. Reference is made to this in the descriptions of the commands.

:FORMat:BORDER.....	493
:FORMat[:DATA].....	493
:FORMat:SREGister.....	494

---

#### :FORMat:BORDER <Border>

The command determines the sequence of bytes within a binary block. This only affects blocks which use the IEEE754 format internally.

##### Parameters:

<Border>                    NORMal | SWAPped

##### **NORMal**

The instrument expects (with setting commands) and sends (with queries) the least significant byte of each IEEE754 floating-point number first and the most significant byte last.

##### **SWAPped**

The instrument expects (with setting commands) and sends (with queries) the most significant byte of each IEEE754 floating-point number first and the least significant byte last.

\*RST:            NORMal

##### Example:

FORM:BORD SWAP

the data is transferred with the most significant bit first.

---

#### :FORMat[:DATA] <Data>

The command determines the data format which the R&S Signal Generator uses to return data. When data is transferred from the control computer to the instrument, the instrument detects the data format automatically. In this case, the value set here is irrelevant.

##### Parameters:

<Data>                    ASCii | PACKed

##### **ASCii**

Numerical data is transferred as plain text separated by commas.

##### **PACKed**

Numerical data is transferred as binary block data. The format within the binary data depends on the command. The various binary data formats are explained in the description of the parameter types.

\*RST:            ASCii

##### Example:

FORM ASC

The data is transferred as ASCII data.

**:FORMat:SREGister** <Sregister>

The command determines the numerical format which is returned when the status registers are queried.

**Parameters:**

&lt;Sregister&gt;

ASCIi | BINary | HEXadecimal | OCTal

**ASCIi**

The register content is returned as a decimal number.

**BINary**

The register content is returned as a binary number. #B is placed in front of the number.

**HEXadecimal**

The register content is returned as a hexadecimal number. #H is placed in front of the number.

**OCTal**

The register content is returned as an octal number. #Q is placed in front of the number.

\*RST: ASCii

**Example:**

FORM:SREG HEX

The register content is returned as a hexadecimal number.

## 7.10 HCOpy Subsystem

The HCOpy subsystem contains the commands to generate a hardcopy of the display.

:HCOpy:DATA.....	495
:HCOpy:DEvice.....	495
:HCOpy:DEvice:LANGUage.....	495
:HCOpy[:EXECute].....	496
:HCOpy:FILE[:NAME].....	496
:HCOpy:FILE[:NAME]:AUTO.....	496
:HCOpy:FILE[:NAME]:AUTO:DIRectory.....	497
:HCOpy:FILE[:NAME]:AUTO:DIRectory:CLEar.....	497
:HCOpy:FILE[:NAME]:AUTO:FILE.....	497
:HCOpy:FILE[:NAME]:AUTO[:FILE]:DAY.....	498
:HCOpy:FILE[:NAME]:AUTO[:FILE]:DAY:STATe.....	498
:HCOpy:FILE[:NAME]:AUTO[:FILE]:MONTH.....	498
:HCOpy:FILE[:NAME]:AUTO[:FILE]:MONTH:STATe.....	498
:HCOpy:FILE[:NAME]:AUTO[:FILE]:NUMBer.....	498
:HCOpy:FILE[:NAME]:AUTO[:FILE]:PREFix.....	499
:HCOpy:FILE[:NAME]:AUTO[:FILE]:PREFix:STATe.....	499
:HCOpy:FILE[:NAME]:AUTO[:FILE]:YEAR.....	499
:HCOpy:FILE[:NAME]:AUTO[:FILE]:YEAR:STATe.....	500
:HCOpy:FILE[:NAME]:AUTO:STATe.....	500
:HCOpy:IMAGe:FORMat.....	500
:HCOpy:IMAGe:SIZE.....	500

:HCOPY:PRINter:LIST.....	501
:HCOPY:PRINter[:NAME].....	501
:HCOPY:PRINter:PAGE:MARGins.....	501
:HCOPY:PRINter:PAGE:ORientation.....	501
:HCOPY:PRINter:PAGE:SIZE.....	502
:HCOPY:PRINter:PAGE:UNIT.....	502

---

### :HCOPY:DATA?

The command transfers the hardcopy data directly as a NByte stream to the remote client.

#### Return values:

<Data>                    string

**Example:**                HCOP:DEV:LANG JPG  
                               HCOP:DATA?  
                               transfers the hardcopy to the remote client.

**Usage:**                    Query only

---

### :HCOPY:DEvice <Device>

The command selects the destination to which the hardcopy (snapshot) should be transferred to. The hardcopy either can be printed out by selecting PRINter or can be saved in a file by selecting FILE.

#### Parameters:

<Device>                    FILE | PRINter  
                               \*RST:            FILE

**Example:**                HCOP:DEV FILE  
                               the hardcopy will be stored in a file.

---

### :HCOPY:DEvice:LANGuage <Language>

The command selects the bitmap graphic format for the screenshot. It is also possible to directly retrieve the data using command HCOP:DATA?. This command is an alias to command HCOPY:IMAGe:FORMat.

#### Parameters:

<Language>                    BMP | JPG | XPM | PNG  
                               \*RST:            BMP

**Example:**                HCOP:DEV:LANG BMP  
                               selects bitmap as image format.  
                               HCOP:FILE 'E:/HCOPY'  
                               defines the directory, path and file name for storing the hardcopy.  
                               HCOP  
                               triggers the hardcopy generation.



**:HCOPY[:EXECute]**

The command triggers the generation of a hardcopy.

The data is either written into a file or sent to the selected printer.

**Example:** HCOP  
triggers the generation of a hardcopy of the current display.

**Usage:** Event

**:HCOPY:FILE[:NAME] <Name>**

This command creates/selects a file into which the hardcopy will be stored. The path is specified together with the file name. Access to the file via remote control is possible using the commands of the MMEM-Subsystem. In contrast, command `HCOPY:DATA?` transfers the hardcopy contents directly to the remote client where they can be further processed.

If automatic file naming is activated, the hardcopy is stored into a file with an automatically generated name (commands `HCOPY:FILE[:NAME]:AUTO:...`).

**Parameters:**

<Name> string

**Example:** HCOP:FILE:NAME 'E:/HCOPY'  
defines the hardcopy file name.

**:HCOPY:FILE[:NAME]:AUTO?**

This command queries the path including the file name of the file with automatically generated name.

**Return values:**

<Auto> string

**Example:** HCOP:DEV:LANG BMP  
selects output format \*.bmp.  
HCOP:FILE:AUTO:DIR 'E:/HCOPY'  
defines the destination directory 'E:/HCOPY'.  
HCOP:FILE:AUTO:PREFIX 'gen'  
the file name starts with the prefix 'gen'. The usage of automatic naming with prefix and date in the file name is preset (...:STAT ON).  
HCOP  
triggers the generation of a hardcopy of the current trace.  
HCOP:FILE:AUTO?  
queries the path including the file name  
Response:  
E:/HCOPY/gen101012008001.bmp'

**Usage:** Query only

**:HCOPY:FILE[:NAME]:AUTO:DIRectory <Directory>**

This command defines the directory into which the hardcopy files will be stored if auto naming is activated (HCOPY:FILE:AUTO:STAT ON). The directory will be created if it does not exist yet.

**Parameters:**

<Directory>                    string  
 \*RST:                         .\HCopy

**Example:**                    HCOPI:FILE:AUTO:DIR 'E:/HCopy'  
 defines the destination directory 'E:/HCopy'

**:HCOPY:FILE[:NAME]:AUTO:DIRectory:CLEar**

This command deletes all files with extensions "bmp", "img", "png" and "xpm" in the directory set for automatic naming.

**Example:**                    HCOPI:FILE:AUTO:DIR:CLE  
 deletes all image files with extensions "bmp", "img", "png" and "xpm".

**Usage:**                        Event

**:HCOPY:FILE[:NAME]:AUTO:FILE?**

This command queries the file name that was generated using the automatic naming settings. By default the automatically generated file name is composed of:

<Prefix><YYYY><MM><DD><Number>.<Format>.

Each component can be deactivated/activated separately to individually design the file name.

**Return values:**

<File>                         string

**Example:**                    HCOPI:DEV:LANG BMP  
 selects output format \*.bmp.  
 HCOPI:FILE:AUTO:DIR 'E:/HCopy'  
 defines the destination directory 'E:/HCopy'  
 HCOPI:FILE:AUTO:PREFIX 'gen'  
 the file name starts with the prefix 'gen'. The usage of automatic naming with prefix and date in the file name is preset (...:STAT ON).  
 HCOPI  
 triggers the generation of a hardcopy of the current trace.  
 HCOPI:FILE:AUTO:FILE?  
 queries the file name  
 Response: 'gen101012008001.bmp'

**Usage:**                        Query only

---

**:HCOPY:FILE[:NAME]:AUTO[:FILE]:DAY?**

The command returns the day of the current system date which will be used in the file name if automatic naming is activated.

**Return values:**

<Day> float

**Example:**

HCOPY:FILE:AUTO:DAY?

returns the day in the date part of the automatic file name.

**Usage:**

Query only

---

**:HCOPY:FILE[:NAME]:AUTO[:FILE]:DAY:STATe <State>**

This command activates the usage of the day in the automatic file name.

**Parameters:**

<State> 0 | 1 | OFF | ON

\*RST: ON

**Example:**

HCOPY:FILE:AUTO:DAY:STAT OFF

deactivates the use of the day in the automatically generated file name.

---

**:HCOPY:FILE[:NAME]:AUTO[:FILE]:MONTH?**

This command queries the month in the date part in the automatic file name.

**Return values:**

<Month> float

**Example:**

HCOPY:FILE:AUTO:MONTH?

queries the month in the date part in the automatic file name.

**Usage:**

Query only

---

**:HCOPY:FILE[:NAME]:AUTO[:FILE]:MONTH:STATe <State>**

This command activates the usage of the month in the automatic file name.

**Parameters:**

<State> 0 | 1 | OFF | ON

\*RST: ON

**Example:**

HCOPY:FILE:AUTO:MONTH:STAT OFF

deactivates the usage of the month in the automatic file name.

---

**:HCOPY:FILE[:NAME]:AUTO[:FILE]:NUMBER?**

This command queries the number in the automatic file name. The number is assigned in such a way that always the lowest possible value for an unique file name within the selected path is used.

On initially switching on the device the number will be reset to the lowest possible value. Starting with number 0 the output directory will be scanned for already existing files. As long as files with the same name are existing the number will be incremented by 1. The number will be automatically set to a number so that the resulting file name will be unique within the selected path. The current number will not be saved in the save recall file but will be temporarily stored within the database. On subsequent saves the number will be incremented.

**Return values:**

<Number> float

**Example:**

HCOPY:FILE:AUTO:NUMB?  
queries the number in the automatic file name.

**Usage:**

Query only

**:HCOPY:FILE[:NAME]:AUTO[:FILE]:PREFIX <Prefix>**

This command defines the prefix part in the automatic file name. The usage of the prefix is activated with command `HCOPY:FILE:AUTO:PREFIX:STAT ON`.

**Parameters:**

<Prefix> string  
\*RST: HCopy

**Example:**

HCOPY:FILE:AUTO:PREFIX 'Snapshot'  
appends "Snapshot" as prefix to the generated file name.

**:HCOPY:FILE[:NAME]:AUTO[:FILE]:PREFIX:STATE <State>**

This command activates the usage of the prefix in the automatic file name. The prefix is entered with command `HCOPY:FILE:AUTO:PREFIX`.

**Parameters:**

<State> 0 | 1 | OFF | ON  
\*RST: ON

**Example:**

HCOPY:FILE:AUTO:PREFIX:STAT OFF  
deactivates the usage of the prefix in the automatic file name.

**:HCOPY:FILE[:NAME]:AUTO[:FILE]:YEAR?**

This command queries the year in the date part in the automatic file name.

**Return values:**

<Year> float

**Example:**

HCOPY:FILE:AUTO:YEAR?  
queries the year in the date part in the automatic file name.

**Usage:**

Query only

---

**:HCOPY:FILE[:NAME]:AUTO[:FILE]:YEAR:STATe <State>**

This command activates the usage of the year in the automatic file name.

**Parameters:**

<State>            0 | 1 | OFF | ON  
\*RST:            ON

**Example:**

HCOP:FILE:AUTO:YEAR:STAT OFF  
deactivates the usage of the year in the automatic file name.

---

**:HCOPY:FILE[:NAME]:AUTO:STATe <State>**

This command activates/deactivates automatic naming of the hardcopy files.

**Parameters:**

<State>            0 | 1 | OFF | ON  
\*RST:            ON

**Example:**

HCOP:FILE:AUTO:STAT OFF  
deactivates automatic naming.

---

**:HCOPY:IMAGe:FORMat <Format>**

This command selects the bitmap graphic format for the screenshot. It is also possible to directly retrieve the data using command `HCOP:DATA?`.

This command is an alias to command `HCOPY:DEVIce:LANGUage`.

**Parameters:**

<Format>           BMP | JPG | XPM | PNG  
\*RST:            BMP

**Example:**

HCOP:IMAG:FORM XPM  
selects the image format XPM.

---

**:HCOPY:IMAGe:SIZE <Size>**

The command selects the image size of the hardcopy. The first value of the size setting defines the width, the second value the height of the image.

**Parameters:**

<Size>            320,640 | 640,480 | 800,600 | 1024,768  
\*RST:            depends on device

**Example:**

HCOP:IMAG:SIZE 640,480  
sets width and height of the image.

---

**:HCOPY:PRINter:LIST?**

The command queries the available printers. If the list is empty, no printer driver is installed.

**Return values:**

<List>                    string

**Example:**

HCOPY:PRIN:LIST?  
returns a list of the available printers.

**Usage:**

Query only

---

**:HCOPY:PRINter[:NAME] <Name>**

The command selects the printer.

**Parameters:**

<Name>                    string

**Example:**

HCOPY:PRIN:NAME "printer1"  
selects printer printer1.

---

**:HCOPY:PRINter:PAGE:MARGins <Margins>**

The command defines the margins of the paper for printing the hardcopy. The values are entered in the sequence <top,bottom,left,right>, the values are separated by commas. A dot is used as decimal separator. Depending on the set physical unit by the parameter Unit, width and height are expressed in cm or inches.

**Parameters:**

<Margins>                \*RST:        2.5,2.5,2.5,2.5

**Example:**

HCOPY:PRIN:PAGE:UNIT IN  
sets the physical unit for the page layout values to inches.  
HCOPY:PRIN:PAGE:MARG 2.5,2.0,1.5,1.5  
sets the margin values of the page layout to top=2.5 inches, bottom=2.0 inches, left=1.5 inches and right=1.5 inches.

---

**:HCOPY:PRINter:PAGE:ORientation <Orientation>**

The command defines the orientation of the printer page..

**Parameters:**

<Orientation>            PORTRait | LANDscape  
\*RST:            PORTRait

**Example:**

HCOPY:PRIN:PAGE:ORI LAND  
selects landscape orientation for the printer page.

---

**:HCOPy:PRINter:PAGE:SIZE <Size>**

The command selects the size of the printer paper.

**Parameters:**

<Size>                   LETTER | LEGAL | EXECutive | A4 | A5  
\*RST:            LETTER

**Example:**

```
HCOP:PRIN:PAGE:SIZE LETT
sets the page size to letter format.
HCOP:PRIN:PAGE:SIZE?
returns the selected page size, e.g. LETT
```

**:HCOPy:PRINter:PAGE:UNIT <Unit>**

This command defines the physical unit used for defining the page size and margins.

**Parameters:**

<Unit>                   CM | IN  
\*RST:            CM

**Example:**

```
HCOP:PRIN:PAGE:UNIT IN
selects unit inch.
```

## 7.11 KBOard Subsystem

The KBOard system contains the commands to set the external keyboard.

<a href="#">:KBOard:LANGuage</a> .....	502
<a href="#">:KBOard:LAYout</a> .....	502

**:KBOard:LANGuage <Language>**

This command selects the keyboard language. The assignment of some keys depends on the selected language.

**Parameters:**

<Language>            US | DE  
\*RST:            US

**Example:**

```
KBO:LANG US
selects keyboard language American English.
```

**Usage:**

SCPI confirmed

**:KBOard:LAYout?**

This command selects the keyboard language. The assignment of some keys depends on the selected language.

**Return values:**

<Layout> CHINese | DANish | DUTCh | ENGUK | ENGUS | FINNish |  
 FRENch | FREBe | FRECa | GERMan | ITALian | JAPANese |  
 KORean | NORWegian | PORTuguese | RUSSian | SPANish |  
 SWEDish  
 \*RST: US

**Example:**

KBO:LAY US  
 activates American keyboard layout.

**Usage:**

Query only  
 SCPI confirmed

## 7.12 MMEMory Subsystem

The MMEMory subsystem (**Mass Memory**) contains the commands for managing files and directories as well as for loading and storing complete instrument settings in files.

The various drives can be selected using the "mass storage unit specifier" <msus>. The internal hard disk is selected with `D:\`, and a memory stick which is inserted at the USB interface is selected with `E:\`. The resources of a network can also be selected with <msus> in the syntax of the respective network, e.g. using the UNC format (Universal Naming Convention): `\\server\share`.

The default drive is determined using the command `MMEMory:MSIS <msus>`.



The `C:` drive is a protected system drive. This drive should not be accessed. Reconstruction of the system partition will not be possible without loss of data.

### 7.12.1 File Naming Conventions

To enable files in different file systems to be used, the following file naming conventions should be observed.

The file name can be of any length and no distinction is made between uppercase and lowercase letters. The file and the optional file extension are separated by a dot. All letters and numbers are permitted (numbers are, however, not permitted at the beginning of the file name). Where possible, special characters should not be used. Use of the slashes "/" and "\" should be avoided since they are used in file paths. A number of names are reserved by the operating system, e.g. `CLOCK$`, `CON`, `AUX`, `COM1` . . . `COM4`, `LPT1` . . . `LPT3`, `NUL` and `PRN`.

In the R&S Signal Generator all files in which lists and settings are stored are given a characteristic extension. The extension is separated from the actual file name by a dot (see [chapter 4.7.2.1, "Extensions for User Files"](#), on page 110 for an overview the file types).

The two characters "\*" and "?" function as "wildcards", i.e. they are used for selecting several files. The "?" character represents exactly one character, while the "\*" character



represents all characters up to the end of the file name. "\*" therefore stands for all the files in a directory.

When used in conjunction with the commands, the parameter <file\_name> is specified as a string parameter with quotation marks. It can contain either the complete path including the drive, only the path and file name, or only the file name. The file name must include the file extension. The same applies for the parameters <directory\_name> and <path>.

Depending on how much information is provided, either the values specified in the parameter or the values specified with the commands `MMEM:MSIS` (default drive) and `MMEM:CDIR` (default directory) are used for the path and drive setting in the commands.

Before the instrument settings can be stored in a file, they have to be stored in an intermediate memory using common command `*SAV <number>`. The specified number is subsequently used in the `:MMEMory:STORe:STATe` command. Also, subsequently to loading a file with instrument settings with command `:MMEMory:LOAD:STATe`, these settings have to be activated with the common command `*RCL <number>`.

## 7.12.2 Extensions for User Files

The following table list all available file extensions for user files. The currently available files on the instrument depends on the installed options.

**Table 7-1: List of the automatically assigned file extensions in the instrument**

Function/Digital Standard	List type	Contents	File suffix
Instrument State	Settings	Instrument settings	*.savrcl
"User Correction"	List	User-defined level correction values	*.uco
"List Mode"	List	User-defined frequency/level value pairs	*.lsw
"Frequency Response Correction"	Settings	User-defined frequency response correction file	*.frc
"Arbitrary Waveform Generator"	Waveform	ARB waveforms ARB multi segment waveforms	*.wv
	Waveform	ARB multi carrier settings	*.arb_mult carr
	Configuration data	Configuration file for creation of multisegment ARB waveforms	*.inf_mswv
	Play List	ARB Sequencing List	*.wvs
"DM"	Data List	Digital modulation data	*.dm_iqd *.tdm
	Control List	Data to control digital modulation	*.dm_iqc
	Settings	Digital modulation settings	*.dm
	User Standard	Digital modulation user standard	*.dm_stu

Function/Digital Standard	List type	Contents	File suffix
	User Mapping	Digital modulation user mapping	*.vam
	User Filter	Digital modulation user filter	*.vaf
"NRP Settings"	Settings	NRP Settings	*.nrp
EX-IQ-Box	User Settings	EX-IQ-Box User Defined Settings	*.iqbox
"Fading"	Fading	Fading data	*.fad
"GSM/EDGE"	Settings	GSM/EDGE settings	*.gsm
	Slot	User-defined slot data	*.gsm_slu
	Frame	User-defined frame data	*.gsm_fu
	Slot	Higher symbol rate slot	*.gsm_hslu
	Frame	Higher symbol rate frame	*.gsm_hfu
"Bluetooth"	Bluetooth Settings	Complete setting of the Bluetooth menu	*.bto
"TETRA"	TETRA Settings	Complete setting of the TETRA menu	*.tetra
"3GPP FDD"	Settings	Complete setting of the 3GPP (FDD) menu	*.3g
	Settings	Channel coding enhanced DPCH channels (downlink)	*.3g_ccod_dl_s
	Settings	Channel coding enhanced DPDCH channels (uplink)	*.3g_ccod_ul
"CDMA2000"	Settings	Complete setting of the CDMA2000 menu	*.cdma2k
"TD-SCDMA2000"	Settings	Complete setting of the TD-SCDMA2000 menu	*.tdscdma
	Settings	Test Model for TD-SCDMA2000	*.tdtmd
1xEV-DO	Settings	Complete setting of the 1xEV-DO menu	*.evdo
"IEEE 802.11 WLAN"	Settings	Complete setting of the IEEE 802.11 WLAN menu	*.wlan
"IEEE 802.11 n WLAN"	Settings	Complete setting of the IEEE 802.11n WLAN menu	*.wlann
	Settings	Beamforming data	*.bmf
"IEEE 802.16 WiMAX"	Settings	Complete setting of the IEEE 802.16 WiMAX menu	*.wimax
"EUTRA/LTE"	Settings	Complete setting of the EUTRA/LTE menu	*.eutra
	Settings	TDD Settings	*.lte_tdd
	Settings	User-defined IQ-File	*.iqw
"GPS"	Settings	Complete setting of the GPS/A-GPS menu	*.gps

Function/Digital Standard	List type	Contents	File suffix
	Settings	GPS Almanac Settings	*.txt *.alm *.al3
	Settings	GPS Waypoints File	*.txt
	Settings	GPS Generated Almanac File	*rs_al *.rs_yuma
	Settings	GPS Ionospheric File	*.rs_ion
	Settings	GPS Navigation Data	*.rs_nav
	Settings	GPS UTC File	*.rs_utc *.rs_acq
"FM-Stereo"	Settings	Complete setting of the FM-Stereo menu	*.fmstereo
	Settings	FM-Stereo Group Type Settings	*.fm_gt
	Settings	FM-Stereo Group Hex Type Settings	*.fm_ghex
	Waveform File	Waveform File	*.wav
"Sirius"	Settings	Complete setting of the Sirius menu	*.sirius
"XM-Radio"	Settings	Complete setting of the XM-Radio menu	*.xmradio
	Settings	XM-Radio TWTA Data	*.twta
"DVB"	Settings	Complete setting of the DVB menu	*.dvb
	Settings	DVB Transport Stream	*.gts *.ts *.trp
"DAB/T-DMB"	Settings	Complete setting of the DAB/T-DMB menu	*.dab
	Settings	DAB ETI Files	*.eti *.xeti

### 7.12.3 Examples

In these examples, the current instrument setting is stored in the file `test1.savrcl` in the directory `user`.

#### Storing and Loading Current Settings

1. Store the current setting in an intermediate memory with number 4. This setting can be called using command `*RCL` and the associated number of the memory, e.g. `*RCL 4`.  
`*SAV 4`
2. To store the settings in a file in a specific directory, specify the complete path.  
`MMEM:STOR:STAT 4,"d:\user\test.savrcl"`

3. To store the settings in a file in the default drive, set the default drive and specify only the file name.  

```
MMEM:MSIS 'D:\user'*SAV 4
MMEM:STOR:STAT 4,"test.savrcl"
```
4. Load the file `test.savrcl` in the user directory.  

```
MMEM:LOAD:STAT 4,'D:/user/test.savrcl'
```
5. Activate the instrument setting of the file `test.savrcl`.  

```
*RCL 4
```

### Working with Files and Directories

1. Read out all files in the specified directory.  

```
MMEM:CAT? 'E:/user'
```

**Response:** 127145265,175325184,"test,DIR,0","temp,DIR,0","readme.txt,ASC,1324","state.savrcl,STAT,5327","waveform.wv,BIN,2342"

the directory `E:/user` contains the subdirectories `test` and `temp` as well as the files `readme.txt`, `state.savrcl` and `waveform.wv` which have different file types.

**Tip:** To query only the subdirectories of the current or specified directory, perform:  

```
MMEM:DCAT? 'E:/user'
```

**Response:** 'test', 'temp'

To query only the number of subdirectories in the current or specified directory, perform:  

```
MMEM:DCAT:LENG? 'E:/user'
```

**Response:** 2
2. To query the number of files in the current or specified directory, perform:  

```
MMEM:CAT:LENG? 'E:/user'
```

**Response:** 3
3. Create a new subdirectory for mass memory storage in the specified directory.  

```
MMEM:MDIR 'E:/user/new'
```
4. Copy the file `state` to a new file.  

```
MMEM:COPY 'D:/user/state.savrcl','E:/user/new'
```
5. Rename the file `state`.  

```
MMEM:MOVE 'state.savrcl','state_new.savrcl'
```
6. Remove the `test` directory.  

```
MMEM:RDIR 'E:/user/test'
```

## 7.12.4 Remote Control Commands

<a href="#">:MMEMory:CATalog</a> .....	508
<a href="#">:MMEMory:CATalog:LENGth</a> .....	508

:MMEMory:CDIRectory.....	509
:MMEMory:COPY.....	509
:MMEMory:DATA.....	510
:MMEMory:DCATalog.....	510
:MMEMory:DCATalog:LENGth.....	510
:MMEMory:DELeTe.....	511
:MMEMory:LOAD:STATe.....	511
:MMEMory:MDIRectory.....	511
:MMEMory:MOVE.....	512
:MMEMory:MSIS.....	512
:MMEMory:RDIRectory.....	512
:MMEMory:STORe:STATe.....	512

---

### :MMEMory:CATalog? <path>

Returns the content of the current or a specified directory.

#### Query parameters:

<path> string  
String parameter to specify the directory. If the directory is omitted, the command queries the content of the current directory, queried with `MMEM:CDIR` command.

#### Return values:

<path> <used\_memory>,<free\_memory>,<file\_name>,<file\_entry>,...  
**<used\_memory>**  
Total amount of storage currently used in the directory, in bytes.  
**<free\_memory>**  
Total amount of storage available in the directory, in bytes.  
**<file\_entry>**  
All files of the directory are listed with their file name, format and size in bytes.

**Example:** See "[Working with Files and Directories](#)" on page 507.

**Usage:** Query only

---

### :MMEMory:CATalog:LENGth?

Returns the number of files in the current or in the specified directory.

#### Return values:

<Length> <path>  
String parameter to specify the directory. If the directory is omitted, the command queries the content of the current directory, queried with `MMEM:CDIR` command.

<count> Number of files

**Example:** See "[Working with Files and Directories](#)" on page 507.

**Usage:** Query only

**:MMEMory:CDIRectory** <Cdirectory>

Changes the default directory for mass memory storage. The directory is used for all subsequent `MMEM` commands if no path is specified with them. It is also possible to change to a higher directory using two dots `'..'`.

**Setting parameters:**

<Cdirectory>            <directory\_name>

**Example:**            See "[Working with Files and Directories](#)" on page 507.

**Usage:**              Setting only  
SCPI confirmed

**:MMEMory:COPY** <file\_source>[,<file\_destination>]

Copies an existing to a new file. Instead of just a file, this command can also be used to copy a complete directory together with all its files.

It is also possible to specify the path using another parameter. The command is:

```
MMEMory:COPY
<file_source><msus_source>[,<file_destination>,
<msus_destination>]
```

**Setting parameters:**

<file\_source>            string

String parameter to specify the name of the file to be copied. If <destination> is not specified, <source> is copied to the `MMEM:MSIS` drive and the `MMEM:CDIR` directory. Files which already exist with the same name in the destination directory are overwritten without an error message.

It is also possible to specify the path using another parameter. The command is: `MMEMory:COPY`

```
<file_source><msus_source>[,<file_destination>,
<msus_destination>]
```

file\_destination        string

String parameter to specify the name of the new file. If no file destination is specified, the source file is copied to the current directory, queried with the `MMEM:CDIR` command. Files which already exist with the same name in the destination directory are overwritten without an error message.

**Example:**            See "[Working with Files and Directories](#)" on page 507.

**Usage:**              Event  
SCPI confirmed

---

```
:MMEMory:DATA <file_name>[,<binary block data>]
:MMEMory:DATA? <file_name>
```

Writes the block data <binary block data> to the file identified by <file\_name>. The IEC/IEEE-bus terminator should be set to EOI in order to ensure correct data transfer.

The associated query command transfers the specified file from the instrument to the IEC/IEEE bus and then on to the control computer. It is important to ensure that the intermediate memory on the control computer is large enough to take the file. In this case, the setting for the IEC/IEEE-bus terminator is irrelevant. This command can be used to read/transfer stored instrument settings or waveforms directly from/to the instrument.

**Parameters:**

<file\_name> String parameter to specify the name of the file.

**Setting parameters:**

<binary block data> #<number><length entry><block data>  
 # always comes first in the binary block  
 <number> the first digit indicates how many digits the subsequent length entry has  
 <length entry> indicates the number of subsequent bytes  
 <binary block data> binary block data for the specified length.

**Example:**

```
MMEM:DATA 'TEST1.WV',#3767<binary data>
writes the block data to the file test1.wv.
The digit "3" indicates a length entry of 3 digits; the digits "767"
indicate a length of the binary data in bytes.
MMEM:DATA? 'TEST1.WV'
sends the data of the file Test1.wv from the instrument to the
controller in the form of a binary block.
```

---

**:MMEMory:DCATalog?**

Returns the subdirectories of the current or specified directory.

**Query parameters:**

<path\_name> String parameter to specify the directory. If the directory is omitted, the command queries the content of the current directory, queried with `MMEM:CDIR` command.

**Return values:**

<Dcatalog> <file\_entry>  
 Names of the subdirectories separated by colons. The first two strings are related to the parent directory.

**Example:** See "[Working with Files and Directories](#)" on page 507.

**Usage:** Query only

---

**:MMEMory:DCATalog:LENGth?** [<path\_name>]

Returns the number of subdirectories in the current or specified directory.

**Query parameters:**

<path\_name> String parameter to specify the directory. If the directory is omitted, the command queries the contents of the current directory, to be queried with `MMEM:CDIR` command.

**Return values:**

<file\_entry\_count> Number of parent and subdirectories.

**Example:** See ["Working with Files and Directories"](#) on page 507.

**:MMEMory:DELeTe** <Delete>

Removes a file from the specified directory.

**Setting parameters:**

<Delete> <file\_name>  
String parameter to specify the name and directry of the file to be removed.

**Example:** See ["Working with Files and Directories"](#) on page 507.

**Usage:** Event  
SCPI confirmed

**:MMEMory:LOAD:STATe** <sav\_rcl\_state\_number>, <file\_name>

This command loads the specified file stored under the specified name in an internal memory.

After the file has been loaded, the instrument setting must be activated using an `*RCL` command.

**Setting parameters:**

<sav\_rcl\_state\_number> Determines to the specific <number> to be used with the `*RCL` command, e.g. `*RCL 4`.  
<file\_name> String parameter to specify the file name with extension `*.savrcl`.

**Example:** See ["Storing and Loading Current Settings"](#) on page 506.

**Usage:** Setting only

**:MMEMory:MDIRectory** <directory\_name>

Creates a new subdirectory for mass memory storage in the specified directory. If no directory is specified, a subdirectory is created in the default directory. This command can also be used to create a directory tree.

**Setting parameters:**

<directory\_name> string  
String parameter to specify the new directory.

**Example:** See ["Working with Files and Directories"](#) on page 507.



**Usage:** Setting only

---

**:MMEMory:MOVE** <file\_source>, <file\_destination>

Moves an existing file to a new location or, if no path is specified, renames an existing file.

It is also possible to specify the path using another parameter. The command is:

MMEMory:MOVE

file\_source,msus\_source[, file\_destination, msus\_destination]

**Setting parameters:**

<file\_source> String parameter to specify the name of the file to be moved.

<file\_destination> String parameters to specify the name of the new file.

**Example:** See "[Working with Files and Directories](#)" on page 507.

**Usage:** Setting only  
SCPI confirmed

---

**:MMEMory:MSIS** <Msis>

The command sets the drive (or network resource in the case of networks) using `msus` (MSIS = Mass Storage Identification String). This setting is effective for all `MMEMory` commands where the drive is not explicitly specified in the parameter.

**Parameters:**

<Msis> string  
\*RST: D:\

**Example:** See "[Storing and Loading Current Settings](#)" on page 506.

**Usage:** SCPI confirmed

---

**:MMEMory:RDIRECTory** <Rdirectory>

Removes an existing directory from the mass memory storage system. If no directory is specified, the subdirectory with the specified name is deleted in the default directory.

**Setting parameters:**

<Rdirectory> string  
String parameter to specify the directory to be deleted.

**Example:** See "[Working with Files and Directories](#)" on page 507.

**Usage:** Setting only

---

**:MMEMory:STORE:STATE** <sav\_rcl\_state\_number>, <file\_name>

Stores the current instrument setting in the specified file.

The instrument setting must first be stored in an internal memory with the same number using the common command \*SAV.

**Setting parameters:**

<save\_rcl\_state\_number> Corresponds to the specific <number> defined with the \*SAV command, e.g. \*SAV 4.

<file\_name> String parameter to specify the file name with extension \*.savrcl.

**Example:** See "Storing and Loading Current Settings" on page 506.

**Usage:** Event

## 7.13 OUTPut Subsystem

The OUTPut system contains the commands which set the properties of the RF OUTPUT connectors and USER connectors.

The properties of the LF output connector are set in the [chapter 7.15.10, "SOURCE:LFOutput Subsystem"](#), on page 679 system.

:OUTPut<hw>:AFIXed:RANGe:LOWer.....	513
:OUTPut<hw>:AFIXed:RANGe:UPPer.....	514
:OUTPut<hw>:AMODE.....	514
:OUTPut<hw>:BLANK:LIST:STATe.....	514
:OUTPut:BLANK:POLarity.....	514
:OUTPut<hw>:IMPedance.....	515
:OUTPut<hw>:PROTection:CLEar.....	515
:OUTPut<hw>:PROTection:STATe.....	515
:OUTPut<hw>:PROTection:TRIPped.....	516
:OUTPut<hw>[:STATe].....	516
:OUTPut<hw>[:STATe]:PON.....	516
:OUTPut:USER<ch>:SOURce.....	516

---

### :OUTPut<hw>:AFIXed:RANGe:LOWer?

The command queries the minimum level which can be set without the attenuator being adjusted (Attenuator FIXed).

**Return values:**

<Lower> float  
Default unit: dBm

**Example:** OUTP:AFIX:RANG:LOW  
queries the minimum level for the FIXed setting.

**Example:** Response: -50  
The minimum level is -50 dBm.

**Usage:** Query only

**:OUTPut<hw>:AFIXed:RANGe:UPPer?**

The command queries the maximum level which can be set without the attenuator being adjusted (Attenuator FIXed).

**Return values:**

<Upper> float  
Default unit: dBm

**Example:** `OUTP:AFIX:RANG:UPP`  
queries the maximum level for the FIXed setting for the RF output.

**Example:** Response: `-27`  
The maximum level is -27 dBm.

**Usage:** Query only

**:OUTPut<hw>:AMODe <Amode>**

The command switches the mode of the attenuator at the RF output (Attenuator MODe).

**Parameters:**

<Amode> AUTO | FIXed

**AUTO**

The electronically switching attenuator switches with a 5 dB step width at fixed switching points.

**FIXed**

The attenuator is fixed at the current position. The uninterrupted level settings are made if automatic level control is activated (`SOURce:POWer:ALC ON`).

\*RST: AUTO

**Example:** `POW:ALC ON`  
activates automatic level control for RF output.  
`OUTP:AMOD FIX`  
sets the fixed mode with uninterrupted level for RF output.

**:OUTPut<hw>:BLANK:LIST:STATe <State>**

The command activates/deactivates RF output blanking.

**Parameters:**

<State> 0 | 1 | OFF | ON

\*RST: ON

**Example:** `OUTP:BLAN:LIST:STAT ON`  
activates the RF Output blanking.

**:OUTPut:BLANK:POLarity <Polarity>**

The command sets the polarity of the No Signal (Blank) Marker.

**Parameters:**

<Polarity>            NORMal | INVerted  
 \*RST:                NORMal

**Example:**                OUTP:BLAN:POL NORM

**:OUTPut<hw>:IMPedance?**

The command queries the impedance of the RF outputs. This permits converting the output level between units V and W. The impedances cannot be changed.

**Return values:**

<Impedance>            G50 | G1K | G10K  
 Default unit: Ohm

**Example:**                OUTP:IMP  
 queries the impedance of RF output.  
 Response:            50  
 the impedance is 50 ohms

**Usage:**                    Query only  
 SCPI confirmed

**:OUTPut<hw>:PROTection:CLEar**

The command resets the protective circuit after it has been tripped. The state of the output is again determined by `OUTPut:STATe`.

The RF outputs of the R&S Signal Generator (starting from serial number 101001) are protected by a protective circuit which deactivates the output in the case of an externally applied overvoltage. This does not change the value of `OUTPut:STATe`.

**Example:**                OUTP:PROT:CLE  
 resets the protective circuit for RF output.

**Usage:**                    Event  
 SCPI confirmed

**:OUTPut<hw>:PROTection:STATe <State>**

The command attenuates the RF output signal for about 40 dB to protect external devices against internal signals.

**Parameters:**

<State>                 0 | 1 | OFF | ON  
 \*RST:                 OFF

**Example:**                OUTP:PROT:STAT ON  
 attenuates the RF Output signal for about 40 dB.

**Usage:**                    SCPI confirmed

**:OUTPut<hw>:PROTection:TRIPped?**

The command queries the state of the protective circuit.

**Return values:**

<Tripped> 0 | 1 | OFF | ON

**Example:**

OUTP:PROT:TRIP

Queries the state of the protective circuit for RF output A.

Response: 0

The protective circuit has not tripped.

Response: 1

The protective circuit has tripped.

**Usage:**

Query only

**:OUTPut<hw>[:STATe] <State>**

This command activates and deactivates the RF output.

**Parameters:**

<State> 0 | 1 | OFF | ON

**Example:**

OUTP OFF

deactivates the RF output.

**Usage:**

SCPI confirmed

**:OUTPut<hw>[:STATe]:PON <Pon>**

This command selects the state which the RF output assumes when the instrument is switched on.

**Parameters:**

<Pon> OFF | UNCHanged

**OFF**

The output is deactivated when the instrument is switched on.

**UNCHanged**

When the instrument is switched on, the output remains in the same state as it was when the instrument was switched off.

**Example:**

OUTP:PON OFF

RF output A is deactivated when the instrument is switched on.

**:OUTPut:USER<ch>:SOURce <Source>**

The command selects the signal for the specified USER interface.

Some signals which can be applied at the USER interface are permanently assigned and some are assigned using a dedicated command (e.g. `OUTP:CW:SOURce` for the CW control signal).

The general purpose input (`GPINput`) is available for USER interfaces 1 and 2 only.

**Parameters:**

<Source> AMARk4 | BMARK4 | ACW | BCW | ABLank | BBLank | AHOP |  
 BHOP | BBITclock | BSYMBOLclock | BATTenuator | BBURst |  
 ATRig | BTRig | GPINput  
 \*RST: USER1 = AMARker4; USER 2 = ACW; USER 3 =  
 ABLank; USER 4 = ATRig

**Example:**

OUTP:USER2 AMAR  
 causes the marker signal to be output at the USER2 pin of theAUX  
 I/O interface.  
 OUTP:CLOC:MODE SYMB  
 specifies that the internally generated clock pulse is a symbol clock  
 pulse.  
 OUTP:CLOC:STAT ON  
 activates output of the symbol clock pulse at the USER2 pin

## 7.14 SENSe, READ and INITiate Subsystems

The SENSe subsystem contains the commands for configuring the power measurements with R&S NRP-Zxx power sensor(s) connected to the generator. The measurement is started and the measurement result retrieved with the READ command. The description of this commands is included in the following.

Up to four sensors can be connected to the signal generator. They are distinguished by means of the suffix under SENSe:

- Power sensor connected to the SENSOR port = SENSe [ 1 ]
- power sensor connected first to one of the USB interfaces = SENSe 2
- further power sensors connected second and third via USB = SENSe 3 and SENSe 4

:INITiate<ch>[:POWer]:CONTInuous.....	518
:READ<ch>[:POWer].....	518
SENSe<ch>[:POWer]:CORRection:SPDeVice:STATe.....	519
SENSe<ch>[:POWer]:DISPlay:PERManent:STATe.....	519
SENSe<ch>[:POWer]:DISPlay:PERManent:PRlOrity.....	519
SENSe<ch>[:POWer]:FILTer:LENGTh:AUTO.....	519
SENSe<ch>[:POWer]:FILTer:LENGTh[:USER].....	520
SENSe<ch>[:POWer]:FILTer:NSRatio.....	520
SENSe<ch>[:POWer]:FILTer:NSRatio:MTIME.....	520
SENSe<ch>[:POWer]:FILTer:SONCe.....	521
SENSe<ch>[:POWer]:FILTer:TYPE.....	521
SENSe<ch>[:POWer]:FREQUency.....	522
SENSe<ch>[:POWer]:OFFSet.....	522
SENSe<ch>[:POWer]:OFFSet:STATe.....	523
SENSe<ch>[:POWer]:SNUMber.....	523
SENSe<ch>[:POWer]:SOURce.....	523
SENSe<ch>[:POWer]:STATus[:DEVice].....	523
SENSe<ch>[:POWer]:SVERsion.....	524

SENSe<ch>[:POWER]:TYPE.....	524
SENSe<ch>[:POWER]:ZERO.....	524
SENSe<ch>:UNIT[:POWER].....	525

---

#### **:INITiate<ch>[:POWER]:CONTinuous <Continuous>**

The command switches the local state of the continuous power measurement by the R&S NRP-Zxx power sensors on and off. Switching the local state off enhances the measurement performance during remote control

The remote measurement is triggered by the READ query (command `:READ<ch>[:POWER]` on page 518) which also provides the measurement results. The local state is not influenced by this command, measurements results can be retrieved with local state on or off.

#### **Parameters:**

<Continuous>            0 | 1 | OFF | ON  
 \*RST:                    OFF

#### **Example:**

```
INIT:CONT ON
switches local state of continuous power measurement on.
```

---

#### **:READ<ch>[:POWER]?**

The command triggers the measurement with power sensors and provides the power measurement result of the selected power sensor. The value is provided with the unit set with command `SENSe:UNIT[:POWER]`.

For certain power sensors, e.g. R&S NRP-Z81, two values are returned, first the value for the average level and - separated by a comma - the peak level

**Note:** The local state is not influenced by this command, measurements results can be retrieved with local state on or off. For long measurement times it is recommended to use a SRQ (MAV bit) for command synchronization.

#### **Suffix:**

<ch>                      1..3

#### **Return values:**

<Power>                    string

#### **Example:**

```
SENS:UNIT DBM
selects unit dBm for presentation of measurement result.
READ1?
queries the measurement result of the sensor connected to the
SENSOR interface.
Response: -45.6246576745440230
-45.6 dBm were measured at the given frequency.
or e.g. for R&S NRP-Z81
Response:
-55.62403263352178,-22.419472478812476
-55,6 dbm is the measured average level, -22.4 dBm is the mea-
sured peak level at the given frequency
```

**Usage:** Query only

---

### SENSe<ch>[:POWER]:CORRection:SPDevice:STATe <State>

The command activates the use of the s-parameters correction data of the selected power sensor.

**Note:** For power sensor with attenuator this command is automatically set to ON.

**Parameters:**

<State> 0 | 1 | OFF | ON  
\*RST: OFF

**Example:**

SENS:POW:CORR:SPD:STAT ON  
activates the use of the s-parameters correction data of power sensor 1.

---

### SENSe<ch>[:POWER]:DISPlay:PERManent:STATe <State>

The command switches on and off the permanent indication of the power measurement result in the upper right corner of the block diagram. For each sensor, the type of sensor, the connector, the measurement source and - if set - the offset is indicated.

**Parameters:**

<State> 0 | 1 | OFF | ON  
\*RST: OFF

**Example:**

SENS1:POW:DISP:PERM:STAT ON  
the permanent viewer is switched on.

---

### SENSe<ch>[:POWER]:DISPlay:PERManent:PRIOrity <Priority>

The command selects which power measurement result (average or peak power) is indicated when permanent display is active.

**Parameters:**

<Priority> AVERAge | PEAK  
\*RST: AVERAge

**Example:**

SENS1:DISP:PERM:STAT ON  
the permanent viewer is switched on.  
SENS1:DISP:PERM:PRI AVER  
the measured average power is indicated.

---

### SENSe<ch>[:POWER]:FILTer:LENGth:AUTO?

The command queries the current filter length for auto filter mode  
(:SENSe<[1]...3>:POWER:FILTer:TYPE AUTO)

**Return values:**

<Auto> float



**Example:**            `SENS1:FILT:TYPE AUTO`  
 selects auto filter mode for the power sensor connected to the SENSOR connector.  
`SENS1:FILT:LENG:AUTO?`  
 queries the automatically set filter length.  
 Response: 1024

**Usage:**            Query only

#### **SENSe<ch>[:POWer]:FILTer:LENGth[:USER] <User>**

The command selects the filter length for user filter mode (`SENSe:POWer:FILTer:TYPE USER`). As the filter length works as a multiplier for the time window, a constant filter length results in a constant measurement time. Values 1 and  $2^n$  are settable.

The time window is fixed to 20 ms.

#### **Parameters:**

<User>            float  
 Range:            1 to 65536  
 \*RST:            1

**Example:**            `SENS:FILT:TYPE USER`  
 selects user filter mode.  
`SENS:FILT:LENG 16`  
 sets a filter length of 16. The resulting measurement time is 640 ms ( $2 \times 16 \times 20$  ms).

#### **SENSe<ch>[:POWer]:FILTer:NSRatio <Nsratio>**

The command defines the noise content for fixed noise filter mode (`:SENSe<[1]...3>:POWer:FILTer:TYPE NSRatio`). This value determines the proportion of intrinsic noise in the measured result.

#### **Parameters:**

<Nsratio>            float  
 Range:            0.0001 to 1.0  
 \*RST:            0.01

**Example:**            `SENS1:FILT:TYPE NSR`  
 selects fixed noise filter mode for the power sensor connected to the SENSOR connector.  
`SENS1:FILT:NSR 0.2`  
 sets a noise content of 0.2.

#### **SENSe<ch>[:POWer]:FILTer:NSRatio:MTIME <Mtime>**

The command defines the timeout for fixed noise filter mode (`:SENSe<[1]...3>:POWer:FILTer:TYPE NSRatio`). This value ensures limited settling times.

**Parameters:**

<Mtime> float  
 Range: 1.0 to 999.99  
 \*RST: 4  
 Default unit: s

**Example:**

```
SENS1:FILT:TYPE NSR
selects fixed noise filter mode for the power sensor connected to
the SENSOR connector.
SENS1:FILT:NSR .2
sets a noise content of 0.2.
SENS1:FILT:NSR:MTIM 5
limits the settling time to 5 seconds
```

**SENSe<ch>[:POWER]:FILTer:SONCe**

The command activates the search for the optimum filter length for the current measurement conditions. The found filter length can be retrieved with command :SENSe:POWer:FILTer:LENGth:USER?. This command is only available for user filter mode (:SENSe:POWer:FILTer:TYPE USER).

**Example:**

```
SENS:FILT:TYPE USER
selects user filter mode.
SENS:FILT:SONC
activates the search for the optimum filter length.
SENS:FILT:LENG?
returns the found optimum filter length.
Response: 128
```

**Usage:**

Event

**SENSe<ch>[:POWER]:FILTer:TYPE <Type>**

The command selects the filter mode. The filter length is the multiplier for the time window and thus directly influences the measurement time.

**Parameters:**

&lt;Type&gt;

AUTO | USER | NSRatio

**AUTO**

The filter length is automatically selected depending on the measured value. For high values, a short filter length is selected and for low values a long filter length is selected.

**USER**

The filter length is set manually. As the filter length works as a multiplier for the measurement time, this results in a constant measurement time.

**NSRatio**

The filter length (averaging factor) is selected so that the sensor's intrinsic noise (2 standard deviations) does not exceed the specified noise content. The desired noise content is entered with command `SENSe:FILTer:NSRatio`.

To avoid very long settling times when the power is low, the averaging factor can be limited with the Timeout parameter (command `SENSe:FILTer:NSRatio:MTIME`).

```
*RST:      AUTO
```

**Example:**

```
SENS:FILT:TYPE AUTO
selects automatic filter selection.
```

**SENSe<ch>[:POWER]:FREQuency <Frequency>**

The command sets the RF frequency of the source if the user source is selected (`SENSe[:POWER]:SOURce USER`).

**Parameters:**

&lt;Frequency&gt;

float

```
*RST:      1 GHz
```

**Example:**

```
SENS:SOUR USER
selects user-defined source.
SENS:FREQ 2.44 GHz
enters the RF frequency of the source which is 2.44 GHz.
```

**SENSe<ch>[:POWER]:OFFSet <Offset>**

The command enters a level offset which is added to the measured level value after activation with command `SENSe[:POWER]:OFFSet:STATe ON`. This allows e.g. an attenuator in the signal path to be taken into account.

**Parameters:**

&lt;Offset&gt;

float

```
Range:     -100.0 to 100.0
```

```
*RST:      0
```

```
Default unit: dB
```

**Example:**                `SENS:POW:OFFS 10.0`  
sets a level offset of 10 dB

---

#### **SENSe<ch>[:POWer]:OFFSet:STATe <State>**

The command activates the addition of the level offset to the measured value. The level offset value is set with command `SENSe[:POWer]:OFFSet`.

#### **Parameters:**

<State>                `0 | 1 | OFF | ON`  
\*RST:                `OFF`

**Example:**                `SENS1:POW:OFFS 0.4dB`  
sets a level offset of 0.4 dB  
`SENS1:POW:OFFS:STAT ON`  
a level offset of 0.4 dB is added to the measured value.

---

#### **SENSe<ch>[:POWer]:SNUMber?**

The command queries the serial number of the sensor.

#### **Return values:**

<Snumber>            `string`

**Example:**                `SENS:SNUM?`  
queries the serial number.

**Usage:**                `Query only`

---

#### **SENSe<ch>[:POWer]:SOURce <Source>**

The command selects the signal source for the measurement.

#### **Parameters:**

<Source>                `A | B | USER`  
\*RST:                `A`

**Example:**                `SENS:SOUR A`  
selects the RF signal as measurement source. The RF frequency is used as the measurement frequency of the sensor and the corresponding correction factor is used. The level setting of the instrument serves as reference level of the measurement.

---

#### **SENSe<ch>[:POWer]:STATus[:DEVice]?**

The command queries if a sensor is connected to the signal generator.

The sensor is selected by suffix in the keyword `SENSe` or `READ` of the command header. Suffix 1 denotes the sensor connected to the `SENSOR` connector, suffix 2 the sensor connected first to one of the USB interfaces and suffix 3 the sensor connected second to one of the USB interfaces.

**Return values:**

<DEVIce> 0 | 1 | OFF | ON

**Example:**

SENS:STAT?

queries if a sensor is connected to the instrument.

Response: 1

a sensor is connected to the POWER SENSOR interface.

**Usage:**

Query only

**SENSe<ch>[:POWER]:SVERsion?**

The command queries the software version of the connected R&S NRP power sensor.

**Return values:**

<Sversion> string

**Example:**

SENS:POW:SVER?

queries the software version of the R&S NRP power sensor.

**Usage:**

Query only

**SENSe<ch>[:POWER]:TYPE?**

The command queries the type of sensor. The type is automatically detected.

**Return values:**

<Type> string

**Example:**

SENS:TYPE?

queries the type of sensor connected to the POWER SENSOR connector.

Response: NRP-Z21

the R&S NRP-Z21 sensor is used.

**Usage:**

Query only

**SENSe<ch>[:POWER]:ZERO**

The command activates the autozero function. Zeroing is required in regular interval (at least once a day) and if the temperature has varied more than about 5 °C, if the sensor has been replaced or if measurements of signals with very low power are to be performed. The RF power source must be switched off or disconnected from the sensor before starting the autozero function.

**Example:**

SENS:ZERO

activates autozero function.

**Usage:**

Event

**SENSe<ch>:UNIT[:POWer] <Power>**

The command selects the unit used for result query with command READ. The power sensor provides the measured value in Watt. In which unit the measured value is returned is selected here and might be either Watt, dBm or dBuV.

**Parameters:**

<Power> DBM | DBUV | WATT  
\*RST: DBM

**Example:**

```
SENS2:UNIT DBM
selects unit dBm for the measured value returned by command
READ.
READ2?
Response: 7.34
7.34 dBm are measured by sensor 2.
```

## 7.15 SOURce Subsystem

The SOURce subsystem contains the commands for configuring the digital and analog signals.

**SOURce<hw>**

For one-path instruments, the keyword SOURce is optional and can be omitted.

• SOURce:AM Subsystem.....	526
• SOURce:AWGN Subsystem.....	528
• SOURce:BB Subsystem.....	537
• SOURce:CORRection Subsystem.....	642
• SOURce:FM Subsystem.....	652
• SOURce:FREQuency Subsystem.....	655
• SOURce:INPut Subsystem.....	663
• SOURce:IQ Subsystem.....	666
• SOURce:IQ:OUTput Subsystem.....	670
• SOURce:LFOutput Subsystem.....	679
• SOURce:LIST Subsystem.....	687
• SOURce:MODulation Subsystem.....	700
• SOURce:PHASe Subsystem.....	700
• SOURce:PM Subsystem.....	701
• SOURce:POWer Subsystem.....	704
• SOURce:PULM Subsystem.....	713
• SOURce:ROSCillator Subsystem.....	714
• SOURce:SWEep Subsystem.....	717

### 7.15.1 SOURce:AM Subsystem

The AM subsystem contains the commands for checking the amplitude modulation and also the broadband amplitude modulation.

The settings for the internal modulation source (LF generator) are made in the `SOURce:LFOutput` subsystem.

<code>[SOURce&lt;hw&gt;]:AM:BBANd:SENSitivity</code> .....	526
<code>[SOURce&lt;hw&gt;]:AM:BBANd[:STATe]</code> .....	526
<code>[SOURce&lt;hw&gt;]:AM[:DEPTh]</code> .....	526
<code>[SOURce&lt;hw&gt;]:AM:EXTeRnal:COUPling</code> .....	527
<code>[SOURce&lt;hw&gt;]:AM:SENSitivity</code> .....	527
<code>[SOURce&lt;hw&gt;]:AM:SOURce</code> .....	528
<code>[SOURce&lt;hw&gt;]:AM:STATe</code> .....	528

---

#### `[SOURce<hw>]:AM:BBANd:SENSitivity?`

The command queries the input sensitivity in V/100% modulation depth.

##### Return values:

<Sensitivity> float

##### Example:

`AM:BBAN:SENS?`

queries the input sensitivity for the BB-AM modulation signal at the I input.

Response: 0.25

the input sensitivity is 0.25 V / 100 % depth

##### Usage:

Query only  
SCPI confirmed

---

#### `[SOURce<hw>]:AM:BBANd[:STATe] <State>`

The command activates/deactivates the broadband amplitude modulation. It is not possible to set a modulation depth for BB-AM. The modulation input is the I IN connector.

Activation of broadband amplitude modulation deactivates AM, ARB, I/Q modulation, digital modulation and all digital standards.

##### Parameters:

<State> 0 | 1 | OFF | ON  
\*RST: OFF

##### Example:

`AM:BBAN ON`

activates BB-AM modulation.

##### Usage:

SCPI confirmed

---

#### `[SOURce<hw>]:AM[:DEPTh] <Depth>`

The command sets the modulation depth of the amplitude modulation in percent. The modulation depth is limited by the maximum peak envelope power (PEP).

**Parameters:**

<Depth> float  
 Range: 0 to 100  
 Increment: See data sheet  
 \*RST: 30  
 Default unit: PCT

**Example:**

AM 15PCT  
 sets the AM modulation depth to 15 percent

**[:SOURce<hw>]:AM:EXTernal:COUPling <Coupling>**

The command selects the coupling mode for the external modulation input in the case of amplitude modulation.

**Parameters:**

<Coupling> AC | DC  
**AC**  
 The DC voltage component is disconnected from the modulation signal.  
**DC**  
 The modulation signal is not changed.  
 \*RST: AC

**Example:**

AM:EXT:COUP AC  
 Selects the coupling mode AC for external amplitude modulation.

**Usage:**

SCPI confirmed

**[:SOURce<hw>]:AM:SENSitivity?**

The command queries the input sensitivity of the external modulation input in %/V. The command is only effective if the external modulation source is selected (SOUR:AM:SOUR EXT). The returned value depends on the modulation depth setting (SOUR:AM:DEPTH). This value is assigned to the voltage value for full modulation of the input.

**Return values:**

<Sensitivity> float

**Example:**

AM:DEPT 50  
 sets a modulation depth of 50 %.  
 AM:SENS?  
 queries the input sensitivity at the external modulation input.  
 Response: 50  
 since the voltage value for full modulation is 1V, the resulting sensitivity is precisely 50%/V.

**Usage:**

Query only  
 SCPI confirmed



**[:SOURce<hw>]:AM:SOURce <Source>**

The command selects the modulation source for amplitude modulation.

Internal and external modulation source can be selected at the same time.

**Parameters:**

<Source> INT | EXT

**INT**

INT is the LF generator. The frequency of the internal modulation signal can be set in the `SOURce:LFOutput` subsystem.

**EXT**

The external signal is input at the EXT MOD connector.

\*RST: INTernal

**Example:**

AM:SOUR INT

selects the internal modulation source.

**Usage:**

SCPI confirmed

**[:SOURce<hw>]:AM:STATe <State>**

The command activates/deactivates amplitude modulation.

Activation of amplitude modulation deactivates ARB, I/Q modulation, digital modulation and all digital standards.

**Parameters:**

<State> 0 | 1 | OFF | ON

**Example:**

AM:STAT ON

activates AM modulation.

**Usage:**

SCPI confirmed

## 7.15.2 SOURce:AWGN Subsystem

The `SOURce:AWGN` subsystem contains the commands for setting the noise generator.

<code>[:SOURce&lt;hw&gt;]:AWGN:BRATe</code> .....	529
<code>[:SOURce&lt;hw&gt;]:AWGN:BWIDth</code> .....	529
<code>[:SOURce&lt;hw&gt;]:AWGN:BWIDth:NOISe</code> .....	529
<code>[:SOURce&lt;hw&gt;]:AWGN:BWIDth:RATio</code> .....	530
<code>[:SOURce&lt;hw&gt;]:AWGN:CNRatio</code> .....	530
<code>[:SOURce&lt;hw&gt;]:AWGN:DISP:MODE</code> .....	531
<code>[:SOURce&lt;hw&gt;]:AWGN:DISP:ORESults</code> .....	531
<code>[:SOURce&lt;hw&gt;]:AWGN:ENRatio</code> .....	531
<code>[:SOURce&lt;hw&gt;]:AWGN:FREQuency:RESult</code> .....	532
<code>[:SOURce&lt;hw&gt;]:AWGN:FREQuency:TARGet</code> .....	532
<code>[:SOURce&lt;hw&gt;]:AWGN:MODE</code> .....	533
<code>[:SOURce&lt;hw&gt;]:AWGN:POWEr:CARRier</code> .....	533
<code>[:SOURce&lt;hw&gt;]:AWGN:POWEr:MODE</code> .....	534

<code>[:SOURce&lt;hw&gt;]:AWGN:POWer:NOISe</code> .....	534
<code>[:SOURce&lt;hw&gt;]:AWGN:POWer:NOISe:TOTal</code> .....	535
<code>[:SOURce&lt;hw&gt;]:AWGN:POWer:RMODe</code> .....	535
<code>[:SOURce&lt;hw&gt;]:AWGN:POWer:SUM</code> .....	535
<code>[:SOURce&lt;hw&gt;]:AWGN:POWer:SUM:PEP</code> .....	536
<code>[:SOURce&lt;hw&gt;]:AWGN:STATe</code> .....	536

---

### `[:SOURce<hw>]:AWGN:BRATe <BRate>`

This command sets the bit rate which is used for calculation of bit energy to noise power ratio from carrier/noise ratio for Digital Standard signals

For "Custom Digital Mod" signals, the bit rate which is used for calculation can be queried with this command.

Valid units are bps, kbps and mabps as well as b/s, kb/s and mab/s.

#### Parameters:

<code>&lt;BRate&gt;</code>	float
	Range: 400 bps to 250E6 bps
	Increment: 0.001
	*RST: 100000

#### Example:

`AWGN:BRAT?`

queries the bit rate which is used for calculation of the Eb/N0 value from the C/N value.

---

### `[:SOURce<hw>]:AWGN:BWIDth <BWidth>`

This command sets the system bandwidth. The noise signal at the level which corresponds to the specified carrier/noise ratio is generated in the bandwidth specified here.

This command is available for modes Additive Noise and Noise Only (`SOUR:AWGN:MODE ADD|ONLY`).

#### Parameters:

<code>&lt;BWidth&gt;</code>	float
	Range: 1.0E3 to 100.0E6
	Increment: 0.1 kHz
	*RST: 3.84 MHz

#### Example:

`AWGN:BWID 10 MHz`

sets a system bandwidth of 10 MHz.

#### Options:

B13 and K62

---

### `[:SOURce<hw>]:AWGN:BWIDth:NOISe?`

Queries the real noise bandwidth.

This command is available for modes Additive Noise and Noise Only (`SOUR:AWGN:MODE ADD|ONLY`).

**Return values:**

<Noise> float  
 Range: 0 to 200E6  
 Increment: 100  
 \*RST: 0

**Example:**

AWGN:BWID:NOIS?  
 queries the noise bandwidth.

**Usage:**

Query only

**[:SOURce<hw>]:AWGN:BWIDth:RATio <Ratio>**

This command is available for modes **Additive Noise** and **Noise Only** (SOUR:AWGN:MODE ADD|ONLY).

This command sets the ratio of minimum real noise bandwidth to system bandwidth.

The overall bandwidth is calculated as follow and may not exceed 80 MHz:

Overall Bandwidth = System BW x Minimum Noise/System BW Ratio

Therefore, the available value range depends on the selected system bandwidth.

**Parameters:**

<Ratio> float  
 Range: 1 to Max  
 Increment: 0.1  
 \*RST: 1

**Example:**

AWGN:BWID:RAT 2  
 sets a minimum noise/system bandwidth ratio of 2.

**[:SOURce<hw>]:AWGN:CNRatio <CnRatio>**

This command sets the carrier/interferer ratio. The value range depends on the selected AWGN mode (AWGN:MODE ADD|ONLY|CW).

- "Reference Mode Carrier" (AWGN:POW:RMODE CARRIER)  
 The noise level is adjusted to the set C/N ratio and the carrier level is kept constant.
- "Reference Mode Noise" (AWGN:POW:RMODE NOISE)  
 The carrier level is adjusted to the set C/N ratio and the noise level is kept constant.

This command is available for modes "Additive Noise" and "CW Interferer" (SOUR:AWGN:MODE ADD|CW).

**Parameters:**

<CnRatio> float  
 Range: -50.00 to 40.00  
 Increment: 0.01  
 \*RST: 0  
 Default unit: dB

**Example:**            AWGN:CNR 10  
                          sets a carrier/noise ratio of 10 dB.

**[:SOURce<hw>]:AWGN:DISP:MODE <Mode>**

Selects the display mode to Bseband or RF.

**Parameters:**

<Mode>                RF | BB  
                          \*RST:        RF

**Example:**            AWGN:DISP:MODE RF  
                          sets the display mode to RF

**[:SOURce<hw>]:AWGN:DISP:ORESults <OResults>**

This command selects the display of output results for the analog (DACIF) or the digital (BBOUT) signal path.

**Note:** This command is only available with the option R&S SMJ-B18, Baseband Digital I/Q Out. If the instrument is not equipped with this option the parameters of the analog signal path are displayed.

This command is available for modes Additive Noise and Noise Only (SOUR:AWGN:MODE ADD|ONLY) and for Display Mode set to Baseband (AWGN:DISP:MODE BB).

**Parameters:**

<OResults>            ANALog | DIGital  
                          **ANALog**  
                          The parameters of the analog signal path are displayed.  
                          **DIGital**  
                          The parameters of the digital signal path are displayed.  
                          \*RST:        ANALog

**Example:**            AWGN:MODE ONLY  
                          activates the generation of a pure noise for path A.  
                          AWGN:DISP:MODE BB  
                          sets the display mode to Baseband.  
                          AWGN:DISP:MODE DIG  
                          displays the output results of the digital signal of path A.

**[:SOURce<hw>]:AWGN:ENRatio <EnRatio>**

This command sets the ratio of bit energy to noise power density in "Additive Noise" mode.

Depending on the selected reference mode either the noise level (AWGN:POW:RMODE NOISE) or the carrier level (AWGN:POW:RMODE CARRIER) is adjusted to the set  $E_b/N_0$  ratio.

- "Reference Mode Carrier" (AWGN:POW:RMODE CARRIER)  
the noise level is adjusted to the set  $E_b/N_0$  ratio and the carrier level is kept constant.

- "Reference Mode Noise" (AWGN:POW:RMOd NOISe)  
the carrier level is adjusted to the set  $E_b/N_0$  ratio and the noise level is kept constant.

For **Digital Standard** signals, the bit rate used for calculation of  $E_b/N_0$  value from C/N value can be entered with command `SOUR:AWGN:BRAT`.

For **Custom Digital Mod** signals the bit rate used for calculation of  $E_b/N_0$  value from C/N value is determined by the selected standard (`SOURce:BB:DM:STANdard`) and cannot be changed.

**Parameters:**

<EnRatio> float  
Range: -30 to 30  
Increment: 0.001  
\*RST: 0  
Default unit: dB

**Example:** `AWGN:ENR 10`  
sets a ratio of bit energy to noise power density of 10 dB

**[[:SOURce<hw>]:AWGN:FREQuency:RESult?**

This command queries the actual frequency of the sine in the **CW Interferer** mode.

The actual frequency may differ from the desired frequency, since the resolution is limited to 0.7 Hz.

**Return values:**

<Result> float  
Range: -40E6 to 40E6  
Increment: 0.01  
\*RST: 0

**Example:** `AWGN:FREQ:RES?`  
queries the actual frequency of the interfering sine

**Usage:** Query only

**[[:SOURce<hw>]:AWGN:FREQuency:TARGet <Target>**

This command sets the desired frequency of the sine in "CW Interferer" mode (`AWGN:MODE CW`).

The resulting frequency may differ from the desired frequency because of the limited frequency resolution of 0.7 Hz.

**Parameters:**

<Target> float  
Range: -40E6 to 40E6  
Increment: 0.01  
\*RST: 0

**Example:** `AWGN:FREQ:TARG 2kHz`  
sets a frequency of 2 kHz for the interfering sine.

---

**[:SOURce<hw>]:AWGN:MODE <Mode>**

This command selects the mode for generating the interfering signal.

**Parameters:**

<Mode> ONLY | ADD | CW

**ADD**

The AWGN noise signal is added to the baseband signal.

**ONLY**

The pure AWGN noise signal is modulated to the carrier. The connection to the baseband is interrupted

**CW**

The sine interfering signal is added to the baseband signal.

\*RST: ADD

**Example:** `AWGN:MODE ONLY`  
activates the generation of a pure noise.  
`AWGN:STAT ON`  
switches on the generation of a pure noise.

---

**[:SOURce<hw>]:AWGN:POWer:CARRier <Carrier>**

available for modes "Additive Noise" and "CW Interferer" (`SOUR:AWGN:MODE ADD|CW`)

This command either sets or queries the carrier or signal level depending on the selected reference mode.

- "Reference Mode Carrier" (`SOUR:AWGN:POW:RMOD CARR`)  
Sets the carrier level. The level of the noise signal is derived from the entered C/N value.
- "Reference Mode Noise" (`SOUR:AWGN:POW:RMOD NOIS`)  
queries the carrier level which is derived from the entered C/N value. The noise level is set with command `SOUR:AWGN:POW:NOISe`.

**Parameters:**

<Carrier> float  
Range: min to 20  
Increment: 0.01  
\*RST: 0  
Default unit: dBm

**Example:** `AWGN:DISP:MODE RF`  
sets the display mode to RF  
`AWGN:POW:CARR?`  
queries the carrier level

---

**[:SOURce<hw>]:AWGN:POWer:MODE <Mode>**

This command selects the mode for setting the noise level.

This command is available for mode "Additive Noise" (SOUR:AWGN:MODE ADD).

**Parameters:**

<Mode>

CN | SN | EN

**CN|SN**

available for mode Additive Noise (SOUR:AWGN:MODE ADD).

The noise level is set on the basis of the value entered for the carrier/noise or signal/noise ratio (AWGN:CNR|SNR).

Whether a selection of C/N or S/N is enabled, depends on the selected "Display Mode" (AWGN:DISP:MODE BB|RF)

**EN**

The noise level is set on the basis of the value entered for the ratio of bit energy to noise power density (AWGN:ENR).

\*RST: CN|SN

**Example:**

AWGN:DISP:MODE RF

sets the display mode to RF

SOUR:AWGN:POW:MODE CN

the noise level is set on the basis of the value entered for the carrier/noise ratio (AWGN:CNR).

---

**[:SOURce<hw>]:AWGN:POWer:NOISe <Noise>**

Available for modes Additive Noise, Noise Only and CW Interferer (SOUR:AWGN:MODE ADD|ONLY|CW).

This command sets or queries the noise level in the system bandwidth depending on the selected modes:

- "Additive Noise" and "CW Interferer" mode (SOUR:AWGN:MODE ADD|CW)
  - "Reference Mode Carrier" (SOUR:AWGN:POW:RMODE CARR)
 

The command queries the noise/interferer level which is derived from the entered C/N value. The carrier level is set with command SOUR:AWGN:POW:CARRier.
  - "Reference Mode Noise" (SOUR:AWGN:POW:RMODE NOIS)
 

The command sets the noise/interferer level. The level of the carrier signal is derived from the entered C/N value.
- "Noise Only" mode
 

The command sets the noise level.

**Parameters:**

<Noise>

float

Default unit: dBm

**Example:**

SOUR:AWGN:POW:NOIS?

queries the noise level in the system bandwidth.

Response: 10

the noise level in the system bandwidth is 10 dBm.

**[ :SOURce<hw>]:AWGN:POWer:NOISe:TOTal?**

Available for modes Additive Noise and Noise Only (SOUR:AWGN:MODE ADD|ONLY)

This command queries the noise level in the total bandwidth.

**Tip:** "Display Output Results For" ([ :SOURce<hw>]:AWGN:DISP:ORESuLts) the analog or digital signal path has to be set before.

**Return values:**

<Total> float  
 Range: -145 to 20  
 Increment: 0.01  
 \*RST: -30

**Example:**

SOUR:AWGN:POW:NOIS:TOT?  
 queries the noise level in the total bandwidth.  
 Response: 15  
 the noise level in the total bandwidth is 15 dBm.

**Usage:**

Query only

**[ :SOURce<hw>]:AWGN:POWer:RMODe <RMode>**

This command selects the mode for setting the interfering signal.

This command is available for modes "Additive Noise" and "CW Interferer" (SOUR:AWGN:MODE ADD|CW) and Display Mode set to RF (AWGN:DISP:MODE RF).

**Parameters:**

<RMode> CARRier | NOISe

**CARRier**

The carrier level is kept constant when the C/N value or Eb/N0 value is changed. The noise level is adjusted.

**NOISe**

The noise level is kept constant when the C/N value or Eb/N0 value is changed. The carrier level is adjusted.

\*RST: CARRier

**Example:**

AWGN:MODE ADD  
 selects Additive Noise mode.  
 AWGN:DISP:MODE RF  
 sets the display mode to RF  
 AWGN:POW:RMODe NOIS  
 selects Reference Mode Noise. The noise level is kept constant when the C/N value or Eb/N0 value is changed. The carrier level is adjusted.

**[ :SOURce<hw>]:AWGN:POWer:SUM?**

Available for modes "Additive Noise" and "CW Interferer" (SOUR:AWGN:MODE ADD|CW)



This command queries the overall level of the noise signal plus useful signal.

**Tip:** "Display Output Results For" (`[ :SOURce<hw> ] :AWGN:DISP:ORESults`) the analog or digital signal path has to be set before.

**Return values:**

<Sum> float  
 Range: -145 to 20  
 Increment: 0.01  
 \*RST: 0

**Example:** `SOUR:AWGN:POW:SUM?`  
 queries the overall level of the noise signal plus useful signal.

**Usage:** Query only

**[ :SOURce<hw> ] :AWGN:POWer:SUM:PEP?**

Available for modes Additive Noise and CW Interferer (`SOUR:AWGN:MODE ADD|CW`)

This command queries the peak envelope power of the overall signal comprised of noise signal plus useful signal.

**Tip:** "Display Output Results For" (`[ :SOURce<hw> ] :AWGN:DISP:ORESults`) the analog or digital signal path has to be set before.

**Return values:**

<Pep> float  
 Range: -145 to 20  
 Increment: 0.01  
 \*RST: 0

**Example:** `SOUR:AWGN:POW:SUM:PEP?`  
 queries the peak envelope power of the overall signal.

**Usage:** Query only

**[ :SOURce<hw> ] :AWGN:STATe <State>**

This command activates or deactivates the white noise (AWGN = Averaged White Gaussian Noise). The noise signal is either superimposed on the baseband signal ("Additive Noise" mode (`SOUR:AWGN:MODE ADD`)) or is output as a pure noise signal ("Noise Only" mode (`SOUR:AWGN:MODE ONLY`)). In addition, a sine with adjustable frequency offset to the baseband signal can be generated as an RFI signal ("CW Interferer" mode; `SOUR:AWGN:MODE CW`).

**Parameters:**

<State> 0 | 1 | OFF | ON  
 \*RST: 0

**Example:** `AWGN:STAT ON`  
 activates the RFI signal generator.

### 7.15.3 SOURce:BB Subsystem

This subsystem contains all commands for digital signal generation. It is divided into several subsystems which are described separately.

#### OUTPut<ch>

The numeric suffix to OUTPut distinguishes between the available markers.

#### EXternal<ch>

The numeric suffix to EXternal distinguishes between the available external trigger inputs.

• SOURce:BB Subsystem General Commands.....	537
• SOURce:BB:ARB Subsystem.....	537
• SOURce:BB:DM Subsystem.....	580
• SOURce:BB:GRAPhics Subsystem.....	615
• SOURce:BB:IMPairment Subsystem.....	617
• SOURce:BB:MCCW Subsystem.....	620
• SOURce:BB:MEASurement Subsystem.....	639
• SOURce:BB:POWer Subsystem.....	641

#### 7.15.3.1 SOURce:BB Subsystem General Commands

The following section describes the commands for setting the frequency shift and the phase offset for the signal at the "Baseband" block output.

#### 7.15.3.2 SOURce:BB:ARB Subsystem

The ARB subsystem contains the commands for setting the ARB Generator. Settings for clock and trigger interfaces and for external outputs are entered in the SOURce:INPut and SOURce:OUTput subsystems.

Section [chapter 7.3, "R&S Signal Generator Waveform and List Format"](#), on page 459 describes the ARB waveform format and how it is used to transmit waveforms via the IEC bus.

• Common Settings.....	537
• Clock Settings.....	538
• Trigger Settings.....	540
• Marker Settings.....	546
• Test Signals Settings.....	549
• SOURce:BB:ARB:MCAR Subsystem.....	552
• SOURce:BB:ARB:WAV Subsystem.....	566
• SOURce:BB:ARB:WSEG Subsystem.....	570

#### Common Settings

[SOURce<hw>]:BB:ARB:PRESet.....	538
[SOURce<hw>]:BB:ARB:STATe.....	538

**[[:SOURce<hw>]:BB:ARB:PRESet**

The command sets all ARB generator parameters to their default values.

**Example:** `BB:ARB:PRES`  
resets the ARB generator to default values.

**Usage:** Event

**[[:SOURce<hw>]:BB:ARB:STATe <State>**

The command enables the ARB generator. Any other standards or digital modulation that may be in the ON state are automatically turned OFF.

`ARB:STAT ON` is only possible after the selection of a waveform. The selected waveform is output straight away (`ARB:SEQ AUTO|RETRigger`) or after the first trigger event (`ARB:SEQ AAUT|ARET`), depending on the trigger setting.

**Parameters:**

<State> 0 | 1 | OFF | ON  
\*RST: 0

**Example:** `BB:ARB:WAV:SEL 'wave1'`  
loads waveform file `wave1.wv` from the default directory.  
`BB:ARB:TRIG:SEQ RETR`  
sets trigger mode Retrigger.  
`BB:ARB:STAT ON`  
switches on the ARB generator. The selected waveform is output straight away. A trigger event causes signal output to restart.

**Clock Settings**

<a href="#">[:SOURce&lt;hw&gt;]:BB:ARB:CLOCK</a> .....	538
<a href="#">[:SOURce&lt;hw&gt;]:BB:ARB:CLOCK:MODE</a> .....	539
<a href="#">[:SOURce&lt;hw&gt;]:BB:ARB:CLOCK:MULTIPLIER</a> .....	539
<a href="#">[:SOURce&lt;hw&gt;]:BB:ARB:CLOCK:SOURce</a> .....	539

**[[:SOURce<hw>]:BB:ARB:CLOCK <Clock>**

The command sets the clock rate in samples. Loading a waveform waveform (`ARB:WAV:SEL <name>`) sets the clock rate that is defined in the waveform tag 'clock'. The command subsequently changes the clock rate; see data sheet for value range.

In the case of an external clock source (selection `ARB:CLOCK:SOURce EXTERNAL`) the clock for the external source must be entered with this command.

**Parameters:**

<Clock> float  
Range: 400 Hz to 100 MHz  
Increment: 0.001 Hz  
\*RST: 1 MHz

**Example:** `BB:ARB:CLOC:SOUR INT`  
 selects the internal clock source for generating waveforms.  
`BB:ARB:CLOC 0.5 MHz`  
 sets the clock rate to 0.5 MHz.

---

**[:SOURce<hw>]:BB:ARB:CLOCK:MODE <Mode>**

The command enters the type of externally supplied clock (`:BB:ARB:CLOCK:SOURce EXTernal`). When `MSAMple` is used, a multiple of the sample clock is supplied via the `CLOCK` connector and the sample clock is derived internally from this. The multiplier is entered with the command `:BB:ARB:CLOCK:MULTiplier`.

**Parameters:**

<Mode>                    `SAMPlE | MSAMPlE`  
 \*RST:                    `SAMPlE`

**Example:** `BB:ARB:CLOC:MODE SAMP`  
 selects clock type "Sample", i.e. the supplied clock is a sample clock.

---

**[:SOURce<hw>]:BB:ARB:CLOCK:MULTiplier <Multiplier>**

The command specifies the multiplier for clock type "Multiple Samples" (`:BB:ARB:CLOCK:MODE MSAM`) in the case of an external clock source.

**Parameters:**

<Multiplier>            `integer`  
 Range:                  `1 to 64`  
 \*RST:                    `4`

**Example:** `BB:ARB:CLOC:SOUR EXT`  
 selects the external clock source. The clock is supplied via the `CLOCK` connector.  
`BB:ARB:CLOC:MODE MSAM`  
 selects clock type Multiple Samples, i.e. the supplied clock has a rate which is a multiple of the sample rate.  
`BB:ARB:CLOC:MULT 12`  
 The multiplier for the external clock rate is 12.

---

**[:SOURce<hw>]:BB:ARB:CLOCK:SOURce <Source>**

The command selects the source for the digital modulation clock.

**Parameters:**

<Source> INTERNAL | EXTERNAL | AINTERNAL

**INTERNAL**

The internal clock reference is used.

**EXTERNAL**

The external clock reference is supplied to the CLOCK connector.

\*RST: INTERNAL

**Example:**

BB:ARB:CLOC:SOUR EXT

selects an external clock reference. The clock is supplied via the CLOCK connector.

BB:ARB:CLOC:MODE SAMP

enters clock type sample.

**Trigger Settings**

[SOURce<hw>]:BB:ARB:TRIGger:ARM:EXECute.....	540
[SOURce<hw>]:BB:ARB:TRIGger:EXECute.....	541
[SOURce<hw>]:BB:ARB:TRIGger:EXTErnal:SYNChronize:OUTPut.....	541
[SOURce<hw>]:BB:ARB:TRIGger:OUTPut:DELay:FIXed.....	541
[SOURce<hw>]:BB:ARB:TRIGger:OUTPut<ch>:DELay.....	542
[SOURce<hw>]:BB:ARB:TRIGger:OUTPut<ch>:DELay:MAXimum.....	542
[SOURce<hw>]:BB:ARB:TRIGger:OUTPut<ch>:DELay:MINimum.....	542
[SOURce<hw>]:BB:ARB:TRIGger:RMODE.....	543
[SOURce<hw>]:BB:ARB:TRIGger:SLENGth.....	543
[SOURce<hw>]:BB:ARB:TRIGger:SLUNit.....	544
[SOURce<hw>]:BB:ARB:TRIGger:SMODE.....	544
[SOURce<hw>]:BB:ARB:TRIGger:SOURce.....	545
[SOURce<hw>]:BB:ARB:TRIGger[EXTErnal<1 2>]:DELay.....	545
[SOURce<hw>]:BB:ARB:TRIGger[EXTErnal<1 2>]:INHibit.....	545
[SOURce<hw>]:BB:ARB[TRIGger]:SEQUence.....	546

**[SOURce<hw>]:BB:ARB:TRIGger:ARM:EXECute**

The command stops waveform output for trigger modes Armed\_Auto and Armed\_Retrigger. A subsequent internal or external trigger event restart waveform output.

**Example:**

BB:ARB:TRIG:SOUR INT

sets internal triggering.

BB:ARB:TRIG:SEQ ARET

sets Armed\_Retrigger mode, i.e. every trigger event causes waveform output to restart.

BB:ARB:TRIG:EXEC

executes a trigger, waveform output is started.

BB:ARB:TRIG:ARM:EXEC

waveform output is stopped.

BB:ARB:TRIG:EXEC

executes a trigger, waveform output is started again.

**Usage:**

Event

**[:SOURce<hw>]:BB:ARB:TRIGger:EXECute**

The command executes a trigger. The internal trigger source must be selected using the command `ARB:TRIGger:SOURce INTernal` and a trigger mode other than `AUTO` must be selected using the command `:ARB:SEQuence`.

**Example:**

```
BB:ARB:TRIG:SOUR INT
sets internal triggering.
BB:ARB:SEQ RETR
sets Retrigger mode, i.e. every trigger event causes signal output
to restart.
BB:ARB:TRIG:EXEC
executes a trigger.
```

**Usage:** Event

**[:SOURce<hw>]:BB:ARB:TRIGger:EXTernal:SYNChronize:OUTPut <Output>**

(enabled for "Trigger Source" External)

Enables/disables output of the signal synchronous to the external trigger event.

**Parameters:**

<Output> 0 | 1 | OFF | ON

**ON**

The signal calculation starts simultaneously with the external trigger event but because of the instrument's processing time the first samples are cut off and no signal is outputted. After elapsing of the internal processing time, the output signal is synchronous to the trigger event.

**OFF**

The signal output begins after elapsing of the processing time and starts with sample 0, i.e. the complete signal is outputted. This mode is recommended for triggering of short signal sequences with signal duration comparable with the processing time of the instrument.

\*RST: ON

**Example:**

```
BB:ARB:TRIG:SOUR EXT
sets external triggering.
BB:ARB:TRIG:EXT:SYNC:OUTP ON
enables synchronous output to external trigger
```

**[:SOURce<hw>]:BB:ARB:TRIGger:OUTPut:DELay:FIXed <Fixed>**

The command restricts the marker delay setting range to the dynamic range. In this range the delay can be set without restarting the marker and signal. If a delay is entered in setting `ON` but is outside this range, the maximum possible delay is set and an error message is output.

The setting always affects every marker.

**Parameters:**

<Fixed> 0 | 1 | OFF | ON  
 \*RST: 0

**Example:**

BB:ARB:TRIG:OUTP:DEL:FIX ON  
 restricts the marker signal delay setting range to the dynamic range.

**[[:SOURce<hw>]:BB:ARB:TRIGger:OUTPut<ch>:DELay <Delay>**

The command defines the delay between the signal on the marker outputs and the start of the signals, expressed in terms of samples.

Command :BB:ARB:TRIGger:OUTPut:DELay:FIXed ON can be used to restrict the range of values to the dynamic range, i.e. the range within which a delay of the marker signals can be set without restarting the marker and signal.

**Parameters:**

<Delay> float  
 Range: 0 to 2<sup>20</sup>-1  
 Increment: 1  
 \*RST: 0  
 Default unit: Symbol

**Example:**

BB:ARB:TRIG:OUTP2:DEL 16  
 sets a delay of 16 samples for the signal on connector MARKER 2.

**[[:SOURce<hw>]:BB:ARB:TRIGger:OUTPut<ch>:DELay:MAXimum?  
[:SOURce<hw>]:BB:ARB:TRIGger:OUTPut<ch>:DELay:MINimum?**

The command queries the minimum marker delay for setting :BB:ARB:TRIGger:OUTPut:DELay:FIXed ON.

**Return values:**

<Minimum> float  
 Range: 0 to 16777215  
 Increment: 1E-3  
 \*RST: 0

**Example:**

BB:ARB:TRIG:OUTP:DEL:FIX ON  
 restricts the marker signal delay setting range to the dynamic range.

BB:ARB:TRIG:OUTP:DEL:MIN  
 queries the minimum of the dynamic range.

Response: 0  
 the minimum for the marker delay setting is 0 samples.

**Usage:**

Query only

**[[:SOURce<hw>]:BB:ARB:TRIGger:RMODE?**

The command queries the status of waveform output or all trigger modes with ARB on.

**Return values:**

&lt;RMode&gt;

STOP | RUN

**RUN**

The waveform is output. A trigger event occurred in the triggered mode.

**STOP**

The waveform is not output. A trigger event did not occur in the triggered modes, or waveform output was stopped by the command: `BB:ARB:TRIG:ARM:EXECute` (armed trigger modes only).

**Example:**

```
BB:ARB:TRIG:SOUR EXT
```

sets external triggering via the TRIGGER 1 connector.

```
BB:ARB:TRIG:MODE ARET
```

selects the Armed\_Retrigger mode.

```
BB:ARB:TRIG:RMODE?
```

queries the current status of waveform output.

```
Response: RUN
```

the waveform is output, an external trigger was executed.

**Usage:**

Query only

**[[:SOURce<hw>]:BB:ARB:TRIGger:SLENGTH <SLength>**

The command defines the length of the signal sequence to be output in the Single trigger mode. The unit is defined with command `SOUR:BB:ARB:TRIG:SLUNIT`. It is possible to output deliberately just part of the waveform, an exact sequence of the waveform, or a defined number of repetitions of the waveform.

**Parameters:**

&lt;SLength&gt;

float

Range: 1 to  $2^{32}-1$

\*RST: 1 Waveform length

Default unit: sample

**Example:**

```
BB:ARB:SEQ SING
```

sets trigger mode Single.

```
BB:ARB:TRIG:SLUN SAMP
```

sets unit Samples for the entry of sequence length.

```
BB:ARB:TRIG:SLEN 200
```

sets a sequence length of 200 samples. The first 200 samples of the current waveform will be output after the next trigger event.



**[:SOURce<hw>]:BB:ARB:TRIGger:SLUNit <SLunit>**

The command defines the unit for the entry of the length of the signal sequence (SOUR:BB:ARB:TRIG:SLEN) to be output in the "Single" trigger mode (SOUR:BB:ARB:SEQ SING).

**Parameters:**

<SLunit> SEQUENCE | SAMPLE  
\*RST: SEQUENCE

**Example:**

```
BB:ARB:SEQ SING
sets trigger mode Single.
BB:ARB:TRIG:SLUN SEQ
sets unit Sequence length for the entry of sequence length.
BB:ARB:TRIG:SLEN 2
sets a sequence length of 2 waveforms. The current waveforms
will be output twice after the next trigger event.
```

**[:SOURce<hw>]:BB:ARB:TRIGger:SMODE <SMode>**

The command selects the extended trigger mode for multi segment waveforms.

**Parameters:**

<SMode> SAME | NEXT | SEQUencer | NSEam

**SAME**

The currently selected segment is output repeatedly.

**NEXT**

The current segment ceases to be output as soon as a new segment is entered with command :BB:ARB:WSEG:NEXT and the new segment starts to be output after a system-imposed signal gap.

**NSEam**

The segment selected with command :BB:ARB:WSEG:NEXT is not output until the whole of the current segment has been output (wrap around). In this case the signal transition is seamless.

**SEQUencer**

The waveform files are processed according to the order and repetition cycles defined in the special sequencing list file (\*.WVS) assigned to the multi segment waveform file.

This "play list" is selected with the command

```
BB:ARB:WSEG:SEQ:SEL.
```

\*RST: NEXT

**Example:**

```
SOUR2:BB:ARB:SEQ AUTO
selects trigger mode AUTO.
SOUR2:BB:ARB:TRIG:SMOD SAME
the same segment of the waveform is output repeatedly.
```

---

**[:SOURce<hw>]:BB:ARB:TRIGger:SOURce <Source>**

The command selects the trigger source.

**Parameters:**

<Source>                    INTernal | EXTernal | BEXTernal

**INTernal**

Triggering is executed by means of the Trigger command in the case of remote control, and by means of "Execute Trigger" in the case of manual operation.

**EXTernal**

Triggering is executed by means of the signal on the TRIGGER 1 connector.

**BEXTernal**

Triggering is executed by means of the signal on the TRIGGER 2 connector.

\*RST:            INTernal

**Example:**

BB:ARB:TRIG:SOUR INT  
sets internal triggering.

---

**[:SOURce<hw>]:BB:ARB:TRIGger[:EXTernal<1|2>]:DELay <Delay>**

The command specifies the trigger delay (expressed as a number of samples) for external triggering.

The numeric suffix to EXTernal distinguishes between the external trigger via the TRIGGER 1 (suffix 1) and TRIGGER 2 (suffix 2) connector.

**Parameters:**

<Delay>                    float  
Range:            0 to 2<sup>32</sup>-1  
Increment:       1  
\*RST:            0  
Default unit: sample

**Example:**

BB:ARB:TRIG:SOUR EXT  
selects an external trigger via the TRIGGER 1 connector  
BB:ARB:TRIG:DEL 200  
sets a delay of 200 samples for the trigger.

---

**[:SOURce<hw>]:BB:ARB:TRIGger[:EXTernal<1|2>]:INHibit <Inhibit>**

The command specifies the number of samples by which a restart is to be inhibited following a trigger event. This command applies only in the case of external triggering.

The numeric suffix to EXTernal distinguishes between the external trigger via the TRIGGER 1 (suffix 1) and TRIGGER 2 (suffix 2) connector.

**Parameters:**

<Inhibit> float  
 Range: 0 to 67108863  
 \*RST: 0  
 Default unit: sample

**Example:**

```
BB:ARB:TRIG:SOUR EXT
selects an external trigger via the TRIGGER 1 connector
BB:ARB:TRIG:INH 200
sets a restart inhibit for 200 samples following a trigger event.
```

**[:SOURce<hw>]:BB:ARB[:TRIGger]:SEQuence <Sequence>**

The command selects the trigger mode.

**Parameters:**

<Sequence> AUTO | RETRigger | AAUTo | ARETrigger | SINGLE

**AUTO**

The waveform is output continuously.

**RETRigger**

The waveform is output continuously. A trigger event (internal or external) causes a restart.

**AAUTo**

The waveform is output only when a trigger event occurs. After the trigger event the waveform is output continuously. Waveform output is stopped with command `SOUR:BB:ARB:TRIG:ARM:EXEC` and started again when a trigger event occurs.

**ARETrigger**

The waveform is output only when a trigger event occurs. The device automatically toggles to RETRIG mode. Every subsequent trigger event causes a restart. Waveform output is stopped with command `SOUR:BB:ARB:TRIG:ARM:EXEC` and started again when a trigger event occurs.

**SINGLE**

The waveform is output only when a trigger event occurs. After the trigger event the waveform is output once to the set sequence length (`SOUR:BB:ARB:TRIG:SLEN`). Every subsequent trigger event causes a restart.

\*RST: RETRigger

**Example:**

```
BB:ARB:SEQ AAUT
sets the "Armed_auto" trigger mode; the device waits for the first
trigger (e.g. with *TRG) and then generates the signal continu-
ously.
```

**Marker Settings**

[\[:SOURce<hw>\]:BB:ARB:TRIGger:OUTPut<ch>:MODE.....547](#)  
[\[:SOURce<hw>\]:BB:ARB:TRIGger:OUTPut<ch>:OFFTime.....547](#)

<code>[:SOURce&lt;hw&gt;]:BB:ARB:TRIGger:OUTPut&lt;ch&gt;:ONTime</code> .....	547
<code>[:SOURce&lt;hw&gt;]:BB:ARB:TRIGger:OUTPut&lt;ch&gt;:PATTern</code> .....	548
<code>[:SOURce&lt;hw&gt;]:BB:ARB:TRIGger:OUTPut&lt;ch&gt;:PULSe:DIVider</code> .....	548
<code>[:SOURce&lt;hw&gt;]:BB:ARB:TRIGger:OUTPut&lt;ch&gt;:PULSe:FREQuency</code> .....	548

---

### `[:SOURce<hw>]:BB:ARB:TRIGger:OUTPut<ch>:MODE <Mode>`

The command defines the signal for the selected marker output.

#### Parameters:

<Mode>

UNCHanged | REStart | PULSe | PATTern | RATio

#### **UNCHanged**

A marker signal as defined in the waveform file (tag 'marker mode x') is generated.

#### **REStart**

A marker signal is generated at every waveform start.

#### **PULSe**

A pulsed marker signal is generated. The pulse frequency (= symbol rate/divider) is defined with the

`SOUR:BB:ARB:TRIG:OUTP:PULS:DIV` command and can be queried with the `SOUR:BB:ARB:TRIG:OUTP:PULS:FREQ?` command.

#### **PATTern**

A marker signal is generated with the aid of a user-definable bit pattern. The bit pattern is entered with the aid of command `:BB:ARB:TRIGger:OUTPut:PATTern`. The bit pattern is a maximum of 32 bits long.

#### **RATio**

A regular marker signal corresponding to the Time Off / Time On specifications in the com-

mands `:ARB:TRIGger:OUTPut:OFFTime`

and `:ARB:TRIGger:OUTPut:ONTime` is generated.

\*RST: UNCHanged

#### Example:

`BB:ARB:TRIG:OUTP2:MODE PULS`

selects the pulsed marker signal on output MARKER 2.

`BB:ARB:TRIG:OUTP2:STAT ON`

activates the pulsed marker signal on output MARKER 2.

---

### `[:SOURce<hw>]:BB:ARB:TRIGger:OUTPut<ch>:OFFTime <OffTime>`

### `[:SOURce<hw>]:BB:ARB:TRIGger:OUTPut<ch>:ONTime <OnTime>`

The command sets the number of samples in a period (ON time + OFF time) during which the marker signal in setting `:ARB:TRIGger:OUTPut:MODE RATio` on the marker outputs is ON.

**Parameters:**

<OnTime> float  
 Range: 1 to 14913079  
 \*RST: 1

**Example:**

BB:ARB:TRIG:OUTP2:ONT 20  
 sets an ON time of 20 samples for marker 2

**[[:SOURce<hw>]:BB:ARB:TRIGger:OUTPut<ch>:PATTern <Pattern>**

The command defines the bit pattern used to generate the marker signal in the setting `SOURce:BB:ARB:TRIGger:OUTPut:MODE PATTern` 0 is marker off, 1 is marker on.

**Parameters:**

<Pattern> <32 bits pattern>  
 \*RST: 0

**Example:**

BB:ARB:TRIG:OUTP2:PATT #H39FE0000, 32  
 sets a bit pattern.  
 BB:ARB:TRIG:OUTP2:MODE PATT  
 activates the marker signal according to a bit pattern on output MARKER 2.

**[[:SOURce<hw>]:BB:ARB:TRIGger:OUTPut<ch>:PULSe:DIVider <Divider>**

The command sets the divider for the pulsed marker signal in the setting `SOURce:BB:ARB:TRIGger:OUTPut:MODE PULSe`. The pulse frequency is derived by dividing the symbol rate by the divider.

**Parameters:**

<Divider> integer  
 Range: 2 to 1024  
 Increment: 1  
 \*RST: 2

**Example:**

BB:ARB:TRIG:OUTP2:PULS:DIV 2  
 sets the divider for the marker signal on output MARKER 2 to the value 2.  
 BB:ARB:TRIG:OUTP2:FREQ?  
 queries the resulting pulse frequency of the marker signal  
 Response: 66 000  
 the resulting pulse frequency is 66 kHz.

**[[:SOURce<hw>]:BB:ARB:TRIGger:OUTPut<ch>:PULSe:FREQuency?**

The command queries the pulse frequency of the pulsed marker signal in the setting `SOURce:BB:ARB:TRIGger:OUTPut:MODE PULSe`. The pulse frequency is derived by dividing the symbol rate by the divider. The divider is defined with command `:BB:ARB:TRIG:OUTP:PULS:DIV`.

**Return values:**

&lt;Frequency&gt; float

**Example:**

```
BB:ARB:TRIG:OUTP2:PULS:DIV 4
sets the divider for the marker signal on output MARKER 2 to the
value 4.
BB:ARB:TRIG:OUTP2:MODE PULS
enables the pulsed marker signal.
BB:ARB:TRIG:OUTP2:PULS:FREQ?
queries the pulse frequency of the marker signal.
Response: 33 000
the resulting pulse frequency is 33 kHz.
```

**Usage:** Query only**Test Signals Settings**

<code>[SOURce&lt;hw&gt;]:BB:ARB:TSIGnal:CIQ:CREate</code>	549
<code>[SOURce&lt;hw&gt;]:BB:ARB:TSIGnal:RECTangle:CREate</code>	549
<code>[SOURce&lt;hw&gt;]:BB:ARB:TSIGnal:SINE:CREate</code>	549
<code>[SOURce&lt;hw&gt;]:BB:ARB:TSIGnal:CIQ:CREate:NAMed</code>	549
<code>[SOURce&lt;hw&gt;]:BB:ARB:TSIGnal:RECTangle:CREate:NAMed</code>	549
<code>[SOURce&lt;hw&gt;]:BB:ARB:TSIGnal:SINE:CREate:NAMed</code>	549
<code>[SOURce&lt;hw&gt;]:BB:ARB:TSIGnal:CIQ:I</code>	550
<code>[SOURce&lt;hw&gt;]:BB:ARB:TSIGnal:CIQ:Q</code>	550
<code>[SOURce&lt;hw&gt;]:BB:ARB:TSIGnal:RECTangle:AMPLitude</code>	550
<code>[SOURce&lt;hw&gt;]:BB:ARB:TSIGnal:RECTangle:FREQuency</code>	550
<code>[SOURce&lt;hw&gt;]:BB:ARB:TSIGnal:RECTangle:OFFSet</code>	550
<code>[SOURce&lt;hw&gt;]:BB:ARB:TSIGnal:RECTangle:SAMPles</code>	551
<code>[SOURce&lt;hw&gt;]:BB:ARB:TSIGnal:SINE:FREQuency</code>	551
<code>[SOURce&lt;hw&gt;]:BB:ARB:TSIGnal:SINE:PHASe</code>	551
<code>[SOURce&lt;hw&gt;]:BB:ARB:TSIGnal:SINE:SAMPles</code>	552

---

```
[SOURce<hw>]:BB:ARB:TSIGnal:CIQ:CREate
[SOURce<hw>]:BB:ARB:TSIGnal:RECTangle:CREate
[SOURce<hw>]:BB:ARB:TSIGnal:SINE:CREate
```

Generates a signal and uses it as output straight away.

**Example:** `BB:ARB:TSIG:SINE:CRE`  
generates a test sine signal and uses it as output straight away.

**Usage:** Event

---

```
[SOURce<hw>]:BB:ARB:TSIGnal:CIQ:CREate:NAMed <Filename>
[SOURce<hw>]:BB:ARB:TSIGnal:RECTangle:CREate:NAMed <Filename>
[SOURce<hw>]:BB:ARB:TSIGnal:SINE:CREate:NAMed <Filename>
```

Generates a signal and saves it to a waveform file.

**Setting parameters:**

&lt;Filename&gt; string

**Example:** `BB:ARB:TSIG:SINE:CRE:NAM 'sine_test'`  
generates a test sine signal and saves it into the wavefile `sine_test`.

**Usage:** Setting only

**[[:SOURce<hw>]:BB:ARB:TSIGnal:CIQ:I <I>  
[:SOURce<hw>]:BB:ARB:TSIGnal:CIQ:Q <TSig>**  
Sets the value for the Q component of the test signal

**Parameters:**

<TSig> float  
Range: -0.5 to 0.5  
Increment: 0.001  
\*RST: 0  
Default unit: FS

**Example:** `BB:ARB:TSIG:CIQ:Q 0.5`  
sets the value for the Q component of the test signal.

**[[:SOURce<hw>]:BB:ARB:TSIGnal:RECTangle:AMPLitude <Amplitude>**

Sets the digital amplitude of the rectangular wave.

**Parameters:**

<Amplitude> float  
Range: 0 to 1  
Increment: 0.001  
\*RST: 0.800  
Default unit: FS

**Example:** `BB:ARB:TSIG:RECT:AMPL 0.5`  
sets the amplitude of the test signal

**[[:SOURce<hw>]:BB:ARB:TSIGnal:RECTangle:FREQuency <Frequency>**

The command sets the frequency of the test signal.

**Parameters:**

<Frequency> float  
Range: 100 Hz to 25.0E6 Hz  
Increment: 0.01  
\*RST: 1 kHz

**Example:** `BB:ARB:TSIG:RECT:FREQ 100 kHz`  
sets the frequency of the test signal of 100 kHz.

**[[:SOURce<hw>]:BB:ARB:TSIGnal:RECTangle:OFFSet <Offset>**

Sets the DC component.

**Parameters:**

<Offset> float  
 Range: -1 to 1  
 Increment: 0.001  
 \*RST: 0  
 Default unit: FS

**Example:**

BB:ARB:TSIG:RECT:OFFS 0.5  
 sets the DC component

**[:SOURce<hw>]:BB:ARB:TSIGnal:RECTangle:SAMPles <Samples>**

Sets the number of sample values required for the rectangular signal per period.

**Parameters:**

<Samples> integer  
 Range: 4 to 1000  
 Increment: 1  
 \*RST: 100

**Example:**

BB:ARB:TSIG:RECT:SAMP 400  
 sets 400 samples per period

**[:SOURce<hw>]:BB:ARB:TSIGnal:SINE:FREQuency <Frequency>**

The command sets the frequency of the simple sinusoidal test signal. This signal is used as output via the I channel. A sine wave of the same frequency but optionally phase-shifted is generated on the Q path (ARB:TSIGnal:SINE:POFFset).

**Parameters:**

<Frequency> float  
 Range: 100 to Max  
 Increment: 0.01  
 \*RST: 1000  
 Default unit: Hz

**Example:**

BB:ARB:TSIG:SINE:FREQ 100 kHz  
 sets a sine signal of 100 kHz.

**[:SOURce<hw>]:BB:ARB:TSIGnal:SINE:PHASe <Phase>**

The command sets the phase offset of the sine wave on the Q channel relative to the sine wave on the I channel.

**Parameters:**

<Phase> float  
 Range: -180 to 180  
 Increment: 0.01  
 \*RST: 90  
 Default unit: DEG



**Example:** `BB:ARB:TSIG:SINE:PHAS 90`  
sets a phase offset of 90 degrees.

---

**[:SOURce<hw>]:BB:ARB:TSIGnal:SINE:SAMPles <Samples>**

The command sets the sample rate for the sine signal in samples per period.

The resulting clock rate must not exceed the maximum ARB clock rate of 100 MHz.

The maximum value is automatically restricted by reference to the set frequency and has to fulfill the rule  $\text{Frequency} * \text{Samples} \leq \text{ARB clock rate}$ .

**Parameters:**

<Samples> integer  
 Range: 4 to 1000  
 Increment: 1  
 \*RST: 100  
 Default unit: 100 samples per period

**Example:** `BB:ARB:TSIG:SINE:SAMP 100`  
sets a sample rate of 100 samples per period.

### SOURce:BB:ARB:MCAR Subsystem

The `MCARrier` subsystem contains the commands for setting the Multi Carrier Waveform Generator.

Section [chapter 7.3, "R&S Signal Generator Waveform and List Format"](#), on page 459 describes the ARB waveform format and how it is used to transmit waveforms via the IEC bus.

#### CARRier<ch>

The numerical suffix under `CARRier` distinguish between the carriers. The value range is 0 .. 31.

<code>[:SOURce&lt;hw&gt;]:BB:ARB:MCARrier:CARRier:COUNT</code> .....	553
<code>[:SOURce&lt;hw&gt;]:BB:ARB:MCARrier:CARRier:MODE</code> .....	553
<code>[:SOURce&lt;hw&gt;]:BB:ARB:MCARrier:CARRier:SPACing</code> .....	554
<code>[:SOURce&lt;hw&gt;]:BB:ARB:MCARrier:CARRier&lt;ch&gt;:CONFLict</code> .....	554
<code>[:SOURce&lt;hw&gt;]:BB:ARB:MCARrier:CARRier&lt;ch&gt;:DELay</code> .....	555
<code>[:SOURce&lt;hw&gt;]:BB:ARB:MCARrier:CARRier&lt;ch&gt;:FILE</code> .....	555
<code>[:SOURce&lt;hw&gt;]:BB:ARB:MCARrier:CARRier&lt;ch&gt;:FREQuency</code> .....	555
<code>[:SOURce&lt;hw&gt;]:BB:ARB:MCARrier:CARRier&lt;ch&gt;:PHASe</code> .....	556
<code>[:SOURce&lt;hw&gt;]:BB:ARB:MCARrier:CARRier&lt;ch&gt;:POWer</code> .....	556
<code>[:SOURce&lt;hw&gt;]:BB:ARB:MCARrier:CARRier&lt;ch&gt;:STATe</code> .....	556
<code>[:SOURce&lt;hw&gt;]:BB:ARB:MCARrier:CFACtor:MODE</code> .....	556
<code>[:SOURce&lt;hw&gt;]:BB:ARB:MCARrier:CLIPping:CFACtor</code> .....	557
<code>[:SOURce&lt;hw&gt;]:BB:ARB:MCARrier:CLIPping:CUTOff</code> .....	557
<code>[:SOURce&lt;hw&gt;]:BB:ARB:MCARrier:CLIPping[STATe]</code> .....	558
<code>[:SOURce&lt;hw&gt;]:BB:ARB:MCARrier:CLOad</code> .....	558
<code>[:SOURce&lt;hw&gt;]:BB:ARB:MCARrier:CLOCK</code> .....	559

[:SOURce<hw>]:BB:ARB:MCARrier:CREate.....	559
[:SOURce<hw>]:BB:ARB:MCARrier:EDIT:CARRier:DELay:STEP.....	559
[:SOURce<hw>]:BB:ARB:MCARrier:EDIT:CARRier:DELay[:STARt].....	560
[:SOURce<hw>]:BB:ARB:MCARrier:EDIT:CARRier:EXECute.....	560
[:SOURce<hw>]:BB:ARB:MCARrier:EDIT:CARRier:FILE.....	561
[:SOURce<hw>]:BB:ARB:MCARrier:EDIT:CARRier:PHASe:STEP.....	561
[:SOURce<hw>]:BB:ARB:MCARrier:EDIT:CARRier:PHASe[:STARt].....	561
[:SOURce<hw>]:BB:ARB:MCARrier:EDIT:CARRier:POWER:STEP.....	562
[:SOURce<hw>]:BB:ARB:MCARrier:EDIT:CARRier:POWER[:STARt].....	562
[:SOURce<hw>]:BB:ARB:MCARrier:EDIT:CARRier:STARt.....	562
[:SOURce<hw>]:BB:ARB:MCARrier:EDIT:CARRier:STOP.....	562
[:SOURce<hw>]:BB:ARB:MCARrier:EDIT:CARRier:STATe.....	563
[:SOURce<hw>]:BB:ARB:MCARrier:OFILe.....	563
[:SOURce<hw>]:BB:ARB:MCARrier:PRESet.....	563
[:SOURce<hw>]:BB:ARB:MCARrier:SAMPles.....	563
[:SOURce<hw>]:BB:ARB:MCARrier:SETTing:CATalog.....	564
[:SOURce<hw>]:BB:ARB:MCARrier:SETTing:LOAD.....	564
[:SOURce<hw>]:BB:ARB:MCARrier:SETTing:STORe.....	564
[:SOURce<hw>]:BB:ARB:MCARrier:SETTing:STORe:FAST.....	564
[:SOURce<hw>]:BB:ARB:MCARrier:TIME.....	565
[:SOURce<hw>]:BB:ARB:MCARrier:TIME:MODE.....	565

---

#### **[:SOURce<hw>]:BB:ARB:MCARrier:CARRier:COUNT <Count>**

The command sets the number of carriers in the ARB multi carrier waveform.

The total bandwidth (**Number of carriers - 1**) \***Carrier spacing** is 80 MHz.

The number of carriers entered therefore defines the maximum carrier spacing (`:BB:ARB:MCARrier:CARRier:SPACing`) and the carrier spacing is reduced if the total bandwidth is not respected when entering the number of carriers.

#### **Parameters:**

<Count>	integer
Range:	1 to 512
Increment:	1
*RST:	1

#### **Example:**

```
BB:ARB:MCAR:CARR:COUN 10
sets 10 carriers for the multi carrier waveform.
```

---

#### **[:SOURce<hw>]:BB:ARB:MCARrier:CARRier:MODE <mode>**

The command sets the carrier frequency mode.

**Parameters:**

<mode> EQUidistant | ARBitrary

**EQUidistant**

Sets an equidistant carrier spacing. The carrier frequency in the carrier table is not configurable.

**ARBitrary**

Enables you to specify the carrier frequency in the carrier table. Carrier spacing is irrelevant.

\*RST: EQUidistant

**Example:**

BB:ARB:MCAR:CARR:MODE EQU

sets an equidistant carrier spacing. The carrier frequency can not be set.

**[:SOURce<hw>]:BB:ARB:MCARrier:CARRier:SPACing <Spacing>**

The command sets the frequency spacing between adjacent carriers of the multi carrier waveform. The carriers are generated symmetrically around the RF carrier. The maximum carrier spacing is limited to **Carrier spacing = Total baseband bandwidth / (Number of carriers - 1)**.

The total baseband bandwidth is 80 MHz.

**Note:** In order to avoid wrap-around problems, the effective "Carrier Spacing" might be slightly modified. The "Carrier Spacing" is rounded in that way that the carrier closest to the center RF frequency shows no phase jump assuming that the carrier is unmodulated.

- For odd number of carriers:  
RoundedCarrierSpacing=1/OutputSignalDuration\* round(CarrierSpacing \* OutputSignalDuration);
- For even number of carriers:  
RoundedCarrierSpacing=2/OutputSignalDuration\*round(0.5 \*CarrierSpacing \* OutputSignalDuration);

**Parameters:**

<Spacing> float  
Range: 0.0 to 120E6  
Increment: 0.01  
\*RST: 0  
Default unit: Hz

**Example:**

BB:ARB:MCAR:CARR:SPAC 10 MHz  
sets a carrier spacing of 10 MHz.

**[:SOURce<hw>]:BB:ARB:MCARrier:CARRier<ch>:CONFLICT?**

Queries carrier conflicts. A conflict arises when the carriers overlap.

**Return values:**

<conflict> 0 | 1 | OFF | ON  
\*RST: 0

**Example:** `BB:ARB:MCAR:CARR:CONF?`  
 queries the multi carrier conflict state.  
 Response: 0 no conflict has occurred.

**Usage:** Query only

**[:SOURce<hw>]:BB:ARB:MCARrier:CARRier<ch>:DELay <Delay>**

The command sets the start delay of the selected carrier.

**Parameters:**

<Delay> float  
 Range: 0 to 1  
 Increment: 1E-9  
 \*RST: 0  
 Default unit: s

**Example:** `BB:ARB:MCAR:CARR15:DEL 5us`  
 sets a start delay of 50 us for carrier 15.

**[:SOURce<hw>]:BB:ARB:MCARrier:CARRier<ch>:FILE <File>**

The command selects the file with I/Q data to be modulated onto the selected carrier.

**Parameters:**

<File> <file name>

**Example:** `BB:ARB:MCAR:CARR15:FILE 'D:/IQ_wcdma'`  
 selects file IQ\_wcdma. The data of the file is modulated onto carrier 15.

**[:SOURce<hw>]:BB:ARB:MCARrier:CARRier<ch>:FREQuency <Frequency>**

Sets or indicates the carrier frequency, depending on the selected carrier frequency mode.

The carrier frequency can be set in "Arbitrary Carrier frequency" mode. For "Equidistant Carrier Spacing", the carrier spacing is determined automatically.

**Parameters:**

<Frequency> integer  
 Range: -40.0E6 to 40.0E6  
 Increment: 1  
 \*RST: 0

**Example:** `BB:ARB:MCAR:CARR:MODE ARB`  
 activates ARB multi carrier mode.  
`BB:ARB:MCAR:CARR:FREQ 5.0`  
 sets 5.0 MHz carrier frequency.

---

**[ :SOURce<hw>]:BB:ARB:MCARrier:CARRier<ch>:PHASe <Phase>**

The command sets the start phase of the selected carrier.

The phase settings are only valid if optimization of the crest factor is disabled  
( :SOURce:BB:ARB:MCARrier:CFACTOR:MODE OFF).

**Parameters:**

<Phase> float  
 Range: 0 to 359.99  
 Increment: 0.01  
 \*RST: 0  
 Default unit: DEG

**Example:** BB:ARB:MCAR:CARR15:PHAS 90 DEG  
 sets a start phase of 90° for carrier 15.

---

**[ :SOURce<hw>]:BB:ARB:MCARrier:CARRier<ch>:POWER <Power>**

The command sets the gain of the selected carrier.

**Parameters:**

<Power> float  
 Range: -80 to 0  
 Increment: 0.01  
 \*RST: 0  
 Default unit: dB

**Example:** BB:ARB:MCAR:CARR15:POW -50 dB  
 sets the power of carrier 15 to -50 dB.

---

**[ :SOURce<hw>]:BB:ARB:MCARrier:CARRier<ch>:STATE <State>**

The command switches the selected carrier on or off.

**Parameters:**

<State> 0 | 1 | OFF | ON  
 \*RST: ON

**Example:** BB:ARB:MCAR:CARR15:STAT ON  
 switches carrier 15 on.

---

**[ :SOURce<hw>]:BB:ARB:MCARrier:CFACTOR:MODE <Mode>**

The command sets the mode for optimizing the crest factor by calculating the carrier phases.

**Parameters:**

&lt;Mode&gt;

OFF | MIN | MAX

**OFF**

There is no automatic setting for minimizing or maximizing the crest factor. The Phase setting (command `BB:ARB:MCAR:CARR:PHAS`) is in use.

**MIN**

The crest factor is minimized by internally calculating optimized carrier phases. The Phase setting (command `BB:ARB:MCAR:CARR:PHAS`) is invalid.

**MAX**

The crest factor is maximized by internally calculating optimized carrier phases. The Phase setting (command `BB:ARB:MCAR:CARR:PHAS`) is invalid.

\*RST: OFF

**Example:**`BB:ARB:MCAR:CFAC:MODE OFF`

switches off automatic crest factor optimization. The setting `SOUR:BB:ARB:MCAR:CARR:PHAS` has an effect.

**[:SOURce<hw>]:BB:ARB:MCARrier:CLIPping:CFACtor <CFactor>**

Sets the value of the desired crest factor, if baseband clipping is enabled (`BB:ARB:MCAR:CLIP:STAT ON`).

A Target Crest Factor above the crest factor of the unclipped multicarrier signal has no effect.

**Parameters:**

&lt;CFactor&gt;

float

Range: -50 to 50

Increment: 0.01

\*RST: 50

Default unit: dB

**Example:**`BB:ARB:MCAR:CLIP:STAT ON`

enables clipping.

`BB:ARB:MCAR:CLIP:CFAC 37 dB`

sets the target crest factor.

**[:SOURce<hw>]:BB:ARB:MCARrier:CLIPping:CUToff <Cutoff>**

Sets the cut off frequency of the final lowpass filter, if baseband clipping is enabled (`BB:ARB:MCAR:CLIP:STAT ON`).

When the cut off frequency is set as half of the output sample rate, a final lowpass filter improves the spectrum of the clipped multicarrier signal, but may also increase the resulting crest factor.

**Parameters:**

<Cutoff> float  
 Range: 0 to 50E6  
 Increment: 0.01  
 \*RST: 50E6  
 Default unit: MHz

**Example:**

```
BB:ARB:MCAR:CLIP:STAT ON
enables clipping
BB:ARB:MCAR:CLIP:CUT 50 MHz
sets the cut off frequency of the filter.
```

**[[:SOURce<hw>]:BB:ARB:MCARrier:CLIPping[:STATe] <State>**

Switches baseband clipping on and off.

Clipping reduces the peak power of the resulting multi carrier signal according to the value set with the command `BB:ARB:MCAR:CLIP:CFAC`.

The resulting clipped peak power is defined by sum of the the RMS level of the unclipped multi carrier signal and the input parameter Target Crest Factor. Note that clipping reduces also the RMS level. Hence the resulting crest factor of the clipped signal is slightly above the Target Crest Factor. In order to get the unclipped parts of the clipped multi-carrier signal matched with the unclipped multicarrier signal, the RF output power should be reduced by the difference between resulting crest factor and Target Crest Factor.

**Parameters:**

<State> 0 | 1 | OFF | ON  
 \*RST: 0

**Example:**

```
BB:ARB:MCAR:CLIP:STAT ON
enables clipping
BB:ARB:MCAR:CLIP:CFAC 37 dB
sets the target crest factor.
```

**[[:SOURce<hw>]:BB:ARB:MCARrier:CLOad <Cload>**

This command creates a multi carrier waveform using the current entries of the carrier table.

This multi carrier waveform is saved with the file name specified with command `SOUR:BB:ARB:MCAR:OFIL`. The file extension is `*.wv`. Digital standard "ARB" is activated, the new multi carrier waveform is loaded and is output in accordance to the trigger settings.

**Parameters:**

<Cload> <file name>

**Example:** `MMEM:CDIR 'D:/user/waveform'`  
 sets the default directory to `D:/user/waveform`.  
`BB:ARB:MCAR:OFIL 'mcar1_2'`  
 defines the file name `mcar1_2.wv` for the multi carrier waveform.  
`BB:ARB:MCAR:CLO`  
 creates multi carrier waveform `mcar1_2.wv`.  
 The new multi carrier waveform is loaded and digital standard "ARB" is activated.

**Usage:** Event

#### **[:SOURce<hw>]:BB:ARB:MCARrier:CLOCK?**

The command queries the resulting sample rate at which the multi carrier waveform is output by the arbitrary waveform generator. The output clock rate depends on the number of carriers, carrier spacing and input sample rate of the leftmost or rightmost carriers.

**Return values:**

<Clock> float  
 Range: 400 to Max  
 Increment: 1E-3

**Example:** `BB:ARB:MCAR:CLOC?`  
 queries the ARB multi carrier output clock rate.

**Usage:** Query only

#### **[:SOURce<hw>]:BB:ARB:MCARrier:CREate**

This command creates a multi carrier waveform using the current settings of the carrier table. The multi carrier waveform is saved into the file defined with command `SOUR:BB:ARB:MCAR:OFIL`. The file extension is `*.wv`.

**Example:** `MMEM:CDIR 'D:/user/waveform'`  
 sets the default directory to `D:/user/waveform`.  
`BB:ARB:MCAR:OFIL 'multi_wv1'`  
 defines the file name `multi_wv1.wv` for the multi carrier waveform.  
`BB:ARB:MCAR:CRE`  
 creates multi carrier waveform `multi_wv1.wv`.

**Usage:** Event

#### **[:SOURce<hw>]:BB:ARB:MCARrier:EDIT:CARRier:DELay:STEP <Step>**

The command sets the step width by which the start delays of the carriers in the defined carrier range will be incremented.



**Parameters:**

<Step> float  
 Range: -1 to 1  
 Increment: 1E-9  
 \*RST: 0  
 Default unit: s

**Example:**

BB:ARB:MCAR:EDIT:CARR:DEL 5 us  
 sets a start delay of 5 us for the carriers in the carrier range.  
 BB:ARB:MCAR:EDIT:CARR:DEL:STEP 1 us  
 the start delay is incremented by 1us for each carrier, i.e. the first carrier has a start delay of 5us, the second a start delay of 6 us, etc.

**[[:SOURce<hw>]:BB:ARB:MCARrier:EDIT:CARRier:DELay[:STARt] <Start>**

The command sets the start delay for the individual carriers in the defined carrier range. If the command :BB:ARB:MCAR:EDIT:CARR:DEL:STEP is used to define a step width, the delay entered here applies only to the starting carrier. The delays of the remaining carriers are stepped up or down by the delay value specified in the :BB:ARB:MCAR:EDIT:CARR:DEL:STEP command.

**Parameters:**

<Start> float  
 Range: 0 to 1  
 Increment: 1E-9  
 \*RST: 0  
 Default unit: s

**Example:**

BB:ARB:MCAR:EDIT:CARR:DEL 5us  
 sets a start delay of 5 us for the carriers in the carrier range.

**[[:SOURce<hw>]:BB:ARB:MCARrier:EDIT:CARRier:EXECute**

The command adopts the settings for the carrier range which has been defined using the :BB:ARB:MCAR:EDIT:CARR:... commands.

**Example:**

BB:ARB:MCAR:EDIT:CARR:STAR 4  
 the carrier range starts at carrier 2.  
 BB:ARB:MCAR:EDIT:CARR:STOP 20  
 the carrier range stops at carrier 20.  
 BB:ARB:MCAR:EDIT:CARR:STAT ON  
 sets all the carriers in the carrier range (2 to 20) to ON.  
 BB:ARB:MCAR:EDIT:CARR:EXEC  
 transfers the assistant settings for carrier 2 to 20 into the carrier table.

**Usage:** Event

---

```
[:SOURce<hw>]:BB:ARB:MCARrier:EDIT:CARRier:FILE <File>
```

**Parameters:**

```
<File>          string
```

**Example:** `BB:ARB:MCAR:EDIT:CARR:FILE 'D:/IQ_wcdma'`  
selects input file `IQ_wcdma`. The data of the file are modulated onto the carriers in the defined carrier range.

---

```
[:SOURce<hw>]:BB:ARB:MCARrier:EDIT:CARRier:PHASe:STEP <Step>
```

The command sets the step width by which the start phases of the carriers in the defined carrier range will be incremented.

The phase settings are only valid if optimization of the crest factor is disabled (`:SOURce:BB:ARB:MCARrier:CFACTOR:MODE OFF`).

**Parameters:**

```
<Step>          float
                Range:    -359.99 to 359.99
                Increment: 0.01
                *RST:      0
                Default unit: DEG
```

**Example:** `BB:ARB:MCAR:EDIT:CARR:PHAS 90 DEG`  
sets a start phase of 90° for the carriers in the carrier range.  
`BB:ARB:MCAR:EDIT:CARR:PHAS:STEP 1 DEG`  
the start phase is incremented by 1° for each carrier, i.e. the first carrier has a start phase of 90°, the second a start phase of 91°, etc.

---

```
[:SOURce<hw>]:BB:ARB:MCARrier:EDIT:CARRier:PHASe[:START] <Start>
```

The command sets the start phase for the individual carriers in the defined carrier range. If the command `:BB:ARB:MCAR:EDIT:CARR:PHAS:STEP` is used to define a step width, the phase entered here applies only to the starting carrier. The phases of the remaining carriers are stepped up or down by the phase value specified in the `:BB:ARB:MCAR:EDIT:CARR:PHAS:STEP` command.

The phase settings are only valid if optimization of the crest factor is disabled (`:SOURce:BB:ARB:MCARrier:CFACTOR:MODE OFF`).

**Parameters:**

```
<Start>         float
                Range:    0 to 359.99
                Increment: 0.01
                *RST:      0
                Default unit: DEG
```

**Example:** `BB:ARB:MCAR:EDIT:CARR:PHAS 90 DEG`  
sets a start phase of 90° for the carriers in the carrier range.

---

**[[:SOURce<hw>]:BB:ARB:MCARrier:EDIT:CARRier:POWER:STEP <Step>**

The command sets the step width by which the starting power of the carriers in the defined carrier range will be incremented.

**Parameters:**

<Step> float  
 Range: -80 to 80  
 Increment: 0.01  
 \*RST: 0  
 Default unit: dB

**Example:**

BB:ARB:MCAR:EDIT:CARR:POW -80dB  
 sets a power of -80 dB for the carriers in the carrier range.  
 BB:ARB:MCAR:EDIT:CARR:POW:STEP 1 dB  
 the power is incremented by 1dB for each carrier, i.e. the first carrier has -80dB, the second -79dB, etc.

---

**[[:SOURce<hw>]:BB:ARB:MCARrier:EDIT:CARRier:POWER[:START] <Start>**

The command sets the power for the individual carriers in the defined carrier range. If the command :BB:ARB:MCAR:EDIT:CARR:POW:STEP is used to define a step width, the power entered here applies only to the starting carrier. The power of the remaining carriers is stepped up or down by the power specified in the :BB:ARB:MCAR:EDIT:CARR:POW:STEP command.

**Parameters:**

<Start> float  
 Range: -80 to 0  
 Increment: 0.01  
 \*RST: 0  
 Default unit: dB

**Example:**

BB:ARB:MCAR:EDIT:CARR:POW -50 dB  
 sets the power of the carriers in the carrier range to -50 dB.

---

**[[:SOURce<hw>]:BB:ARB:MCARrier:EDIT:CARRier:START <Start>**

**[[:SOURce<hw>]:BB:ARB:MCARrier:EDIT:CARRier:STOP <Stop>**

The command selects the last carrier in the carrier range to which the settings with the :BB:ARB:MCAR:EDIT:CARR:. . . commands shall apply.

**Parameters:**

<Stop> integer  
 Range: 0 to 511  
 Increment: 1  
 \*RST: 0

**Example:**

BB:ARB:MCAR:EDIT:CARR:STOP 4  
 the carrier range stops at carrier 4.

---

**[ :SOURce<hw> ]:BB:ARB:MCARrier:EDIT:CARRier:STATe <State>**

The command switches all the carriers in the selected carrier range on or off.

**Parameters:**

<State>                    0 | 1 | OFF | ON  
\*RST:                    1

**Example:**

BB:ARB:MCAR:EDIT:CARR:STAT ON  
sets all the carriers in the carrier range to ON.

---

**[ :SOURce<hw> ]:BB:ARB:MCARrier:OFILe <OFile>**

This command defines the output file name for the multi carrier waveform. This file name is used when a waveform is calculated (command SOUR:BB:ARB:MCAR:CLoad or SOUR:BB:ARB:MCAR:CREate). The file extension is \*.wv.

**Parameters:**

<OFile>                    string

**Example:**

MMEM:CDIR 'D:/user/waveform'  
sets the default directory to D:/user/waveform.  
BB:ARB:MCAR:OFIL 'mcar1\_2'  
defines the file name mcar1\_2.wv for the multi carrier waveform file

---

**[ :SOURce<hw> ]:BB:ARB:MCARrier:PRESet**

The command sets all ARB multi carrier parameters to their default values.

**Example:**

BB:ARB:MCAR:PRES  
resets the ARB multi carrier parameters to default values.

**Usage:**

Event

---

**[ :SOURce<hw> ]:BB:ARB:MCARrier:SAMPles?**

The command queries the resulting file size. The file size is returned in samples.

**Return values:**

<Samples>                    integer  
Range:                    0 to INT\_MAX  
Increment:                1  
\*RST:                    0

**Example:**

BB:ARB:MCAR:SAMP?  
queries the file size of the currently calculated multi carrier waveform.

**Usage:**

Query only

---

**[[:SOURce<hw>]:BB:ARB:MCARrier:SETting:CATalog?**

This command queries the available settings files in the specified default directory. The settings files are used to set the ARB multi carrier submenu. Only files with the file extension `*.arb_multcarr` will be listed.

**Return values:**

<Catalog> string

**Example:**

```
MMEM:CDIR 'D:/user/waveform'
sets the default directory to D:/user/waveform.
BB:ARB:MCAR:SETT:CAT?
reads out all the settings files in the default directory.
Response: mcar1, mcar2
the directory contains the configuration files mcar1.arb_multcarr and mcar2.arb_multcarr.
```

**Usage:** Query only

**[[:SOURce<hw>]:BB:ARB:MCARrier:SETting:LOAD <Filename>**

The command loads the settings file. If a settings file with the specified name does not yet exist, it is created. The file extension may be omitted. Only files with the file extension `*.arb_multcarr` will be loaded or created.

**Setting parameters:**

<Filename> string

**Example:**

```
BB:ARB:MCAR:SETT:LOAD 'D:/user/waveform/new'
creates settings file new.arb_multcarr.
```

**Usage:** Setting only

**[[:SOURce<hw>]:BB:ARB:MCARrier:SETting:STORE <Filename>**

The command stores the current settings of submenu "Multi Carrier" in a file in the specified directory. The file extension may be omitted, the files are stored with the file extension `*.arb_multcarr`.

**Setting parameters:**

<Filename> string

**Example:**

```
BB:ARB:MCAR:SETT:STOR 'D:/user/waveform/mcarr2'
stores settings file mcarr2.arb_multcarr in the default directory.
```

**Usage:** Setting only

**[[:SOURce<hw>]:BB:ARB:MCARrier:SETting:STORE:FAST <Fast>**

Determines whether the instrument performs an absolute or a differential storing of the settings.

Enable this function to accelerate the saving process by saving only the settings with values different to the default ones.

**Note:** This function is not affected by the "Preset" function.

**Parameters:**

<Fast>                    0 | 1 | OFF | ON  
 \*RST:                    1

**[[:SOURce<hw>]:BB:ARB:MCARrier:TIME <Time>**

The command sets the user-defined signal period. This setting is only possible for Signal Period Mode User (BB:ARB:MCAR:TIME:MODE USER).

**Parameters:**

<Time>                    float  
 Range:                    0 to 1E9  
 Increment:                1E-9  
 \*RST:                    0  
 Default unit: s

**Example:**

BB:ARB:MCAR:TIME:MODE USER  
 selects Signal Period Mode User.  
 BB:ARB:MCAR:TIME 10 s  
 sets a signal period of 10 seconds

**[[:SOURce<hw>]:BB:ARB:MCARrier:TIME:MODE <Mode>**

The command selects the mode for calculating the resulting signal period of the multi carrier waveform. The resulting period is always calculated for all carriers in the carrier table irrespective of their state (ON/OFF).

**Parameters:**

<Mode>                    USER | LONG | SHORt

**LONG**

The resulting signal period is defined by the longest I/Q file in the carrier table. Shorter I/Q files are periodically repeated.

**SHORt**

The resulting signal period is defined by the shortest I/Q file in the carrier table. Only the first part of longer I/Q files is used.

**USER**

The signal period can be set with command SOUR:BB:ARB:MCARr:TIME. Shorter I/Q files are repeated periodically, and only the first part of longer I/Q files is used.

\*RST:                    LONG

**Example:**

BB:ARB:MCAR:TIME:MODE LONG  
 selects signal period mode long

**SOURce:BB:ARB:WAV Subsystem**

The WAVeform subsystem contains the commands for working with waveform files.

<code>[SOURce&lt;hw&gt;]:BB:ARB:WAVeform:CATalog</code> .....	566
<code>[SOURce&lt;hw&gt;]:BB:ARB:WAVeform:CATalog:LENGth</code> .....	566
<code>[SOURce&lt;hw&gt;]:BB:ARB:WAVeform:DATA</code> .....	567
<code>[SOURce&lt;hw&gt;]:BB:ARB:WAVeform:DELeTe</code> .....	568
<code>[SOURce&lt;hw&gt;]:BB:ARB:WAVeform:FREE</code> .....	568
<code>[SOURce&lt;hw&gt;]:BB:ARB:WAVeform:HDDStreaming:BLEVel</code> .....	568
<code>[SOURce&lt;hw&gt;]:BB:ARB:WAVeform:HDDStreaming:STATe</code> .....	569
<code>[SOURce&lt;hw&gt;]:BB:ARB:WAVeform:POINts</code> .....	569
<code>[SOURce&lt;hw&gt;]:BB:ARB:WAVeform:SELeCt</code> .....	570
<code>[SOURce&lt;hw&gt;]:BB:ARB:WAVeform:TAG</code> .....	570

**`[SOURce<hw>]:BB:ARB:WAVeform:CATalog?`**

This command reads out the files in the default directory. The default directory is set using command `MMEM:CDIRectory`. When the names of the waveform files are returned they are separated by commas. Only files with the file extension `*.wav` will be listed.

**Return values:**

<Catalog>                    string

**Example:**

```
MMEM:CDIR 'D:/user/waveform'
sets the default directory to D:/user/waveform.
BB:ARB:WAV:CAT?
reads out all the files in the default directory.
Response: sin1, wave
the directory contains the waveform files sin1.wav and
wave.wav.
```

**Usage:**                    Query only

**`[SOURce<hw>]:BB:ARB:WAVeform:CATalog:LENGth?`**

This command reads out the files in the default directory and returns the number of waveform files in this directory. The default directory is set using command `MMEM:CDIRectory`. Only files with the file extension `*.wav` will be listed.

**Return values:**

<Length>                    integer  
 Number of waveform files in default directory  
 Range:            0 to INT\_MAX  
 Increment:       1  
 \*RST:            0

**Example:**           MMEM:CDIR 'D:/user/waveform'  
                   sets the default directory to D:/user/waveform.  
                   BB:ARB:WAV:CAT?  
                   reads out all the files in the default directory.  
                   Response: sin1, wave  
                   the directory contains the waveform files 'sin1.wv' and  
                   'wave.wv'.  
                   BB:ARB:WAV:CAT:LEN?  
                   Response: 2

**Usage:**            Query only

---

**[ :SOURce<hw>]:BB:ARB:WAVEform:DATA <Filename>, <Data>**  
**[ :SOURce<hw>]:BB:ARB:WAVEform:DATA? <Tag>**

The **setting** command writes the block data <binary data block> to the file identified by <waveform filename>. The complete content of the waveform file is transmitted as binary data block.

The IEC bus delimiter should be set to EOI when this is done, in order to ensure trouble-free data transmission.

The **query** command queries the content of the specified tag of the selected waveform file (see [chapter 7.3, "R&S Signal Generator Waveform and List Format"](#), on page 459).

By default, the waveform files are saved in the default directory of the instrument (C:\Program Files\Rohde&Schwarz\SMJFirmware\Lists).

To access the waveform files in this default directory, only the file name is required, without the path and the file extension.

However, to access waveform files located in a directory different to the default one, the complete file path and file name are required.

**Parameters:**

<Filename>           string

**Setting parameters:**

<Data>               string

Specifies the name of the wavefile in that the binary data will be copied. Waveform data is stored only in files with the specific file extensions \*.wv.

**Query parameters:**

<Tag>                'comment' | 'copyright' | 'date' | 'lacfilter' | 'marker name' |  
                       'poweroffset'

**Example:**

**Setting**

BB:ARB:WAV:DATA 'D:/user/TEST1.WV', #3767<bin  
 data block>

writes the block data to file 'test1.wv' in the D:/user directory.



**Example:****Query**

BB:ARB:WAV:DATA? 'D:/user/TEST1.WV', 'comment'  
 queries the content of the 'comment' tag of file wave1.wv in the user directory

Response: "Sine wave for test purposes"

**[:SOURce<hw>]:BB:ARB:WAVeform:DELeTe <Filename>**

The command deletes the specified waveform file. If the file is not on the default path, the path must be specified at the same time. The file extension may be omitted. Only files with the file extension \*.wv will be deleted.

**Setting parameters:**

<Filename> string

**Example:**

BB:ARB:WAV:DEL 'D:/user/wave1.wv'  
 deletes waveform file wave1.wv.

**Usage:**

Setting only

**[:SOURce<hw>]:BB:ARB:WAVeform:FREE?**

The command queries the free disk space on the default path of the instrument's harddisk.

**Return values:**

<Free> integer  
 Range: 0 to INT\_MAX  
 Increment: 1  
 \*RST: 1

**Example:**

MMEM:CDIR 'D:/user/waveform'  
 sets the default directory to D:/user/waveform.  
 BB:ARB:WAV:FREE?  
 queries the free disk space in directory D:/user/waveform.

**Usage:**

Query only

**[:SOURce<hw>]:BB:ARB:WAVeform:HDDStreaming:BLEVeI?**

Queries the filling level of the streaming buffer.

During normal operation, the streaming buffer level should have a value of 90% .. 100%. Buffer level around 0% indicates a buffer underrun and the signal processing will be interrupted.

Adjustment in the parameter value or state usually results in short decreasing of the streaming buffer level but this buffer state should not be mislead with buffer underrun.

**Return values:**

<BLevel> integer  
 Range: 0 to 100  
 Increment: 1  
 \*RST: 0

**Example:**

BB:ARB:WAV:HDDS:STAT ON  
 enables HDD streaming.  
 BB:ARB:WAV:HDDS:BLEV?  
 queries the streaming buffer level.  
 Response: 94%

**Usage:**

Query only

**[[:SOURce<hw>]:BB:ARB:WAVeform:HDDStreaming:STATe <State>**

Enables/disables the streaming of modulation data direct form the hard drive (HDD).

HDD streaming is recommended for processing of large files that require more ARB memory than the currently installed one.

**Parameters:**

<State> 0 | 1 | OFF | ON  
 \*RST: 1

**Example:**

BB:ARB:WAV:HDDS:STAT ON  
 enables HDD streaming.

**[[:SOURce<hw>]:BB:ARB:WAVeform:POINTs?**

The command queries the number of samples in the waveform file selected using command :ARB:WAV:SEL. Only the file name has to be entered. Only files with the file extension \*.wv will be read out.

**Return values:**

<Points> <waveform filename>  
 Range: 0 to 1000  
 Increment: 1  
 \*RST: 1

**Example:**

BB:ARB:WAV:POINT?  
 queries the number of I/Q values pairs in the waveform file.  
 Response: 401  
 the waveform file contains 401 I/Q values pairs.

**Usage:**

Query only

**[:SOURce<hw>]:BB:ARB:WAVeform:SElect <Filename>**

The command selects the waveform file. If the file is not on the default path, the path must be specified at the same time. If no file of the specified name exists, it is created. The file extension may be omitted. Only files with the file extension \*.wv will be created or loaded.

**Parameters:**

<Filename>                    string

**Example:**

```
BB:ARB:WAV:SEL 'D:/user/wave1.wv'
selects waveform file 'wave1.wv' from the D:/user directory and
loads it..
BB:ARB:TRIG:SEQ AAUT
sets trigger mode Armed_Auto.
BB:ARB:TRIG:SOUR INT
selects internal triggering.
BB:ARB:STAT ON
switches on the ARB generator.
BB:ARB:TRIG:EXEC
starts generating the selected waveform.
```

**[:SOURce<hw>]:BB:ARB:WAVeform:TAG?**

The command queries the content of the specified tag of the selected Waveform file file (see [chapter 7.3, "R&S Signal Generator Waveform and List Format"](#), on page 459).

**Return values:**

<Tag>                        string

**Example:**

```
BB:ARB:WAV:TAG? 'comment'
queries the content of the 'comment' tag.
Response: "Sine wave for test purposes"
```

**Usage:**                    Query only

**SOURce:BB:ARB:WSEG Subsystem**

The WSEGment subsystem contains the commands for setting the Multi Segment Waveform Generator.

Section [chapter 7.3, "R&S Signal Generator Waveform and List Format"](#), on page 459 describes the ARB waveform format and how it is used to transmit waveforms via the IEC bus.

<a href="#">[:SOURce&lt;hw&gt;]:BB:ARB:WSEGment.....</a>	571
<a href="#">[:SOURce&lt;hw&gt;]:BB:ARB:WSEGment:CLOad.....</a>	571
<a href="#">[:SOURce&lt;hw&gt;]:BB:ARB:WSEGment:CONFigure:BLANK:APPend.....</a>	572
<a href="#">[:SOURce&lt;hw&gt;]:BB:ARB:WSEGment:CONFigure:CATalog.....</a>	573
<a href="#">[:SOURce&lt;hw&gt;]:BB:ARB:WSEGment:CONFigure:CLOCK.....</a>	573
<a href="#">[:SOURce&lt;hw&gt;]:BB:ARB:WSEGment:CONFigure:CLOCK:MODE.....</a>	573
<a href="#">[:SOURce&lt;hw&gt;]:BB:ARB:WSEGment:CONFigure:COMMENT.....</a>	574
<a href="#">[:SOURce&lt;hw&gt;]:BB:ARB:WSEGment:CONFigure:DELeTe.....</a>	574

[:SOURce<hw>]:BB:ARB:WSEGment:CONFigure:LEVel[:MODE].....	574
[:SOURce<hw>]:BB:ARB:WSEGment:CONFigure:MARKer:ESEGment.....	575
[:SOURce<hw>]:BB:ARB:WSEGment:CONFigure:MARKer:FSEGment.....	575
[:SOURce<hw>]:BB:ARB:WSEGment:CONFigure:MARKer:MODE.....	576
[:SOURce<hw>]:BB:ARB:WSEGment:CONFigure:OFILe.....	576
[:SOURce<hw>]:BB:ARB:WSEGment:CONFigure:SEGMENT:APPend.....	577
[:SOURce<hw>]:BB:ARB:WSEGment:CONFigure:SEGMENT:CATalog.....	577
[:SOURce<hw>]:BB:ARB:WSEGment:CONFigure:SELEct.....	577
[:SOURce<hw>]:BB:ARB:WSEGment:CREate.....	578
[:SOURce<hw>]:BB:ARB:WSEGment:NAME.....	578
[:SOURce<hw>]:BB:ARB:WSEGment:NEXT.....	578
[:SOURce<hw>]:BB:ARB:WSEGment:NEXT:EXECute.....	579
[:SOURce<hw>]:BB:ARB:WSEGment:NEXT:SOURce.....	579
[:SOURce<hw>]:BB:ARB:WSEGment:SEQuence:APPend.....	579
[:SOURce<hw>]:BB:ARB:WSEGment:SEQuence:SELEct.....	580

---

### **[:SOURce<hw>]:BB:ARB:WSEGment?**

This command queries the currently output segment of the multi segment waveform.

#### **Return values:**

<Wsegment>            integer  
                           Range:     0 to 1023  
                           Increment: 1  
                           \*RST:     0

**Example:**            BB:ARB:WSEG?  
                           queries the currently output segment.  
                           Response 2  
                           segment 2 is currently output.

**Usage:**                Query only

---

### **[:SOURce<hw>]:BB:ARB:WSEGment:CLOad <Filename>**

This command creates a multi segment waveform using the current entries of the specified configuration file.

This multi segment waveform is saved with the file name specified in the configuration file. The file extension is \*.wv. Digital standard "ARB" is activated, the new multi segment waveform is loaded and the first segment is output in accordance to the trigger settings.

#### **Setting parameters:**

<Filename>            string

**Example:** `MMEM:CDIR 'D:/user/waveform'`  
 sets the default directory to D:/user/waveform.  
`BB:ARB:WSEG:CONF:SEL 'multi_sin'`  
 creates the configuration file `multi_sin.inf_mswv` in the default directory.  
`BB:ARB:WSEG:CONF:SEGM:APP 'sinus1'`  
 includes waveform `sinus1.wv` as segment 1 in the configuration file. The waveform must be available in the default directory.  
`BB:ARB:WSEG:CONF:SEGM:APP 'sinus2'`  
 includes waveform `sinus2.wv` as segment 2 in the configuration file. The waveform must be available in the default directory.  
`BB:ARB:WSEG:CONF:OFIL 'mseg1_2'`  
 defines the file name `mseg1_2.wv` for the multi segment waveform.  
`BB:ARB:WSEG:CLO 'multi_sin'`  
 creates multi segment waveform `mseg1_2.wv` using the settings of the configuration file `multi_sin.inf_mswv`.  
 The new multi segment waveform is loaded and digital standard "ARB" is activated.

**Usage:** Setting only

---

**[[:SOURce<hw>]:BB:ARB:WSEGment:CONFigure:BLANK:APPend <SampCount>, <Frequency>**

Adds a blank segment to the multi segment file.

**Setting parameters:**

**<SampCount>** float  
 Specifies the number of samples.  
 Range: 512 to 1E7  
 Increment: 1  
 \*RST: 1000

**<Frequency>** float  
 Determines the clock rate.  
 Range: 400 Hz to Max (depends on instrument type)  
 Increment: 0.001  
 \*RST: 1E8

**Example:** `SOUR:BB:ARB:WSEG:CONF:SEL "MSegFile"`  
 selects a multi segment file.  
`SOUR:BB:ARB:WSEG:CONF:BLAN:APP 1000,100000000`  
 adds a blank segment with 1000 samples and 100 MHz clock rate to the selected multi segment file

**Usage:** Setting only

**[ :SOURce<hw> ]:BB:ARB:WSEgment:CONFigure:CATalog?**

This command queries the available configuration files in the specified default directory. The configuration files are used to create multi segment waveform files.

**Return values:**

<Catalog>                    string

**Example:**

```
MMEM:CDIR 'D:/user/waveform'
sets the default directory to D:/use/waveform.
BB:ARB:WSEG:CONF:CAT?
reads out all the configuration files in the default directory.
Response: mult1, multi2
the directory contains the configuration files multi1.inf_mswv
and multi2.inf_mswv.
```

**Usage:**                    Query only

**[ :SOURce<hw> ]:BB:ARB:WSEgment:CONFigure:CLOCK <Clock>**

This command defines the clock rate used for multi segment waveform output in case of Clock Mode "User" (:BB:ARB:WSEG:CONF:CLOCK:MODE USER).

**Parameters:**

<Clock>                    float  
Increment: 1E-3  
\*RST:                    max SampleRate

**Example:**

```
BB:ARB:WSEG:CONF:CLOC:MODE USER
selects Clock Mode User.
BB:ARB:WSEG:CONF:CLOC 50MHz
defines a clock rate of 50 MHz.
```

**[ :SOURce<hw> ]:BB:ARB:WSEgment:CONFigure:CLOCK:MODE <Mode>**

This command selects the clock rate mode for the multi segment waveform.

**Parameters:**

<Mode> UNCHanged | HIGHest | USER

**UNCHanged**

The segments are output with the clock rate defined in the waveform file. Extended Trigger Mode "Next Segment Seamless" (:BB:ARB:TRIG:SMOD NSEam) can only be selected if all segments have the same clock rate. Extended Trigger Mode "Next Segment" (:BB:ARB:TRIG:SMOD NEXT) can only be selected if trigger mode "Internal" is selected (:BB:ARB:TRIG:SOUR INT).

**HIGHest**

The segments are output at the highest available clock rate.

**USER**

The segments are output with the clock rate defined with command :BB:ARB:WSEG:CONF:CLOC

\*RST: UNCHanged

**Example:**

BB:ARB:WSEG:CONF:CLOC:MODE UNCH  
selects clock mode unchanged. The segments are output with the clock rate defined in the waveform file.

**[:SOURce<hw>]:BB:ARB:WSEGment:CONFigure:COMment <Comment>**

This command enters a comment for the configuration file. The configuration file must be specified with command :BB:ARB:WSEG:CONF:SEL.

**Parameters:**

<Comment> string

**Example:**

BB:ARB:WSEG:CONF:COMM <3gpp\_up>  
enters comment "3gpp\_up".

**[:SOURce<hw>]:BB:ARB:WSEGment:CONFigure:DELeTe <Filename>**

This command deletes the configuration file. The configuration files are used to create multi segment waveform files.

**Setting parameters:**

<Filename> string

**Example:**

MMEM:CDIR 'D:/user/waveform'  
sets the default directory to D:/user/waveform.  
BB:ARB:WSEG:CONF:DEL 'multil'  
deletes configuration file multil.inf\_mswv.

**Usage:**

Setting only

**[:SOURce<hw>]:BB:ARB:WSEGment:CONFigure:LEVel[:MODE] <Mode>**

This command selects the level mode for the multi segment waveform.

**Parameters:**

&lt;Mode&gt; UNCHanged | ERMS

**UNCHanged**

The segments are output exactly as defined in the files.

**ERMS**

The segments are output so that all segments have the same rms value.

\*RST: UNCHanged

**Example:**

BB:ARB:WSEG:CONF:LEV:MODE UNCH

selects level mode unchanged. The segments are output as defined in the waveform file.

**[[:SOURce<hw>]:BB:ARB:WSEGment:CONFigure:MARKer:ESEGment <Mode>**

Enables/disables the generation of an additional marker restart signal in the output waveform file.

If additional marker generation is enabled, the existing marker signals in the individual segment waveform files are not considered.

**Parameters:**

&lt;Mode&gt; OFF | MRK1 | MRK2 | MRK3 | MRK4

**OFF**

No additional marker is generated.

**MRK1|MRK2|MRK3|MRK4**

Generates a restart marker signal at the beginning of each segment for the corresponding marker.

The segment begin is defined by the low-high slope of the marker. This applies for switching between two segments as well as in case of segment replay.

\*RST: OFF

**Example:**

BB:ARB:WSEG:CONF:SEL 'ConfComm'

BB:ARB:WSEG:CONF:MARK:ESEG MRK3

**[[:SOURce<hw>]:BB:ARB:WSEGment:CONFigure:MARKer:FSEGment <Mode>**

Enables/disables the generation of an additional marker restart signal in the output waveform file.

If additional marker generation is enabled, the existing marker signals in the individual segment waveform files are not considered.



**Parameters:**

&lt;Mode&gt;

OFF | MRK1 | MRK2 | MRK3 | MRK4

**OFF**

No additional marker is generated.

**MRK1|MRK2|MRK3|MRK4**

Generates a restart marker signal at the beginning of the first segment for the corresponding marker.

Use this setting to generate a restart marker for the complete sequence.

\*RST: OFF

**Example:**

```
BB:ARB:WSEG:CONF:SEL 'ConfComm'
BB:ARB:WSEG:CONF:MARK:FSEG MRK3
```

**[:SOURce<hw>]:BB:ARB:WSEGment:CONFigure:MARKer:MODE <Mode>**

Defines the way the marker information within the separate segments is processed.

**Parameters:**

&lt;Mode&gt;

IGNore | TAKE

**IGNore**

The marker information carried in the individual segment waveform files is not considered.

**TAKE**

The output waveform file contains the marker information as configured in the individual waveform files.

\*RST: TAKE

**Example:**

```
BB:ARB:WSEG:CONF:SEL 'ConfComm'
BB:ARB:WSEG:CONF:MARK:MODE TAKE
```

**[:SOURce<hw>]:BB:ARB:WSEGment:CONFigure:OFILe <OFile>**

This command defines the file name for the multi segment waveform. This file name is stored in the configuration file and is used when a waveform is created (command :BB:ARB:WSEG:CLOad or :BB:ARB:WSEG:CREate). The file extension is \*.wv.

**Parameters:**

&lt;OFile&gt;

string

**Example:**

```
M MEM:CDIR 'D:/user/waveform'
sets the default directory to D:/user/waveform.
BB:ARB:WSEG:CONF:SEL 'multil'
creates the configuration file multil.inf_mswv in default directory.
BB:ARB:WSEG:CONF:OFIL 'mseg1_2'
defines the file name mseg1_2.wv for the multi segment waveform file created using configuration file multil.inf_mswv.
```

**[[:SOURce<hw>]:BB:ARB:WSEGment:CONFigure:SEGMent:APPend <Waveform>**

This command appends the specified waveform to the configuration file.

**Setting parameters:**

<Waveform>            string

**Example:**

```
MMEM:CDIR 'D:/user/waveform'
sets the default directory to D:/user/waveform.
BB:ARB:WSEG:CONF:SEL 'new'
creates the configuration file new.inf_mswv in the default direc-
tory.
BB:ARB:WSEG:CONF:SEGM:APP 'arb1'
appends waveform arb1.wv to configuration file new. Waveform
arb1 will be the first segment of a multi segment waveform cre-
ated with configuration file new.
```

**Usage:**                    Setting only

**[[:SOURce<hw>]:BB:ARB:WSEGment:CONFigure:SEGMent:CATalog?**

This command queries the segments of the currently selected configuration file.

**Return values:**

<Catalog>                string

**Example:**

```
MMEM:CDIR 'D:/user/waveform'
sets the default directory to D:/user/waveform.
BB:ARB:WSEG:CONF:SEL 'multi_sin'
selects the configuration file multi_sin.inf_mswv .
BB:ARB:WSEG:CONF:SEGM:CAT?
queries the segments of the selected configuration file.
Response: arb4, arb2
The configuration file includes the segments arb4.wv and
arb2.wv.
```

**Usage:**                    Query only

**[[:SOURce<hw>]:BB:ARB:WSEGment:CONFigure:SELEct <Filename>**

The command selects the configuration file in the default directory A path can also be specified, in which case the files in the specified directory are selected. If a configuration file with the specified name does not yet exist, it is created. The file extension may be omitted. Only files with the file extension \*.inf\_mswv will be selected or created.

**Parameters:**

<Filename>                string

**Example:**

```
MMEM:CDIR 'D:/user/waveform'
sets the default directory to D:/user/waveform.
BB:ARB:WSEG:CONF:SEL 'new'
create configuration file new.inf_mswv in the default directory.
```

**[[:SOURce<hw>]:BB:ARB:WSEGment:CREate <Filename>**

This command creates a multi segment waveform using the current settings of the specified configuration file. The multi segment waveform is saved into the file defined in the configuration file. The file extension is \*.wv.

**Setting parameters:**

<Filename>            string

**Example:**

```
MMEM:CDIR 'D:/user/waveform'
sets the default directory to D:/user/waveform.
BB:ARB:WSEG:CONF:SEL 'new'
creates the configuration file new.inf_mswv in the default directory.
BB:ARB:WSEG:CONF:SEGM:APP 'arb1.wv'
'includes waveform arb1.wv as segment 1 in the configuration file. The waveform must be available in the default directory.
BB:ARB:WSEG:CONF:OFIL 'multi_wv1'
defines the file name multi_wv1.wv for the multi segment waveform.
BB:ARB:WSEG:CRE 'new'
creates multi segment waveform multi_wv1.wv using the settings of the configuration file new.inf_mswv.
```

**Usage:**                    Setting only

**[[:SOURce<hw>]:BB:ARB:WSEGment:NAME?**

This command queries the name of the waveform of the currently output segment of the multi segment waveform.

**Return values:**

<Name>                    string

**Example:**

```
BB:ARB:WSEG:NAME?
queries the currently output segment.
```

**Usage:**                    Query only

**[[:SOURce<hw>]:BB:ARB:WSEGment:NEXT <Next>**

This command selects the segment to be output.

**Parameters:**

<Next>                    integer

Range:            0 to 1023

Increment:        1

\*RST:             0

**Example:**

```
MMEM:CDIR 'D:/user/waveform'
```

sets the default directory to root/user/waveform.

```
BB:ARB:WSEG:NEXT 2
```

selects segment 2 to be output.

```
BB:ARB:TRIG:SMOD NEXT
```

selects extended trigger mode next, i.e. the segment specified with command :BB:ARB:WSEG:NEXT will be output.

```
BB:ARB:SEQ AUTO
```

selects trigger mode Auto.

```
BB:ARB:WAV:SEL 'multi_wv1'
```

loads multi segment waveform multi\_wv1.wv. Generation of segment 2 starts.

```
BB:ARB:WSEG:NEXT 3
```

switched at once to output of segment 3.

---

#### **[:SOURce<hw>]:BB:ARB:WSEGment:NEXT:EXECute**

Triggers manually switchover to the subsequent segment in the mutli segment file. A manual trigger can be executed only when an internal next segment source (BB:ARB:WSEG:NEXT:SOUR INT) has been selected.

To perform a switchover to any segment within the multi segment file, select the next segment with the command BB:ARB:WSEG:NEXT.

This command is disabled, if a sequencing play list is enabled.

**Example:**

```
BB:ARB:WSEG:NEXT:SOUR INT
```

selects internal next segment source.

```
BB:ARB:WSEG:NEXT 2
```

selects segment 2 to be output.

```
BB:ARB:WSEG:NEXT:EXEC
```

executes a switchover to the next segment.

**Usage:** Event

---

#### **[:SOURce<hw>]:BB:ARB:WSEGment:NEXT:SOURce <Source>**

Queries the next segment source.

#### **Parameters:**

<Source> INTernal | USR1  
\*RST: INTernal

**Example:**

```
BB:ARB:WSEG:NEXT:SOUR?
```

queries the next segment source.

---

#### **[:SOURce<hw>]:BB:ARB:WSEGment:SEQuence:APPend <State>, <Segment>, <Count>, <Next>**

Appends a new segment to the selected sequencing play list.

**Setting parameters:**

<State>	ON   OFF activates/deactivates the appended segment *RST: ON
<Segment>	integer indicates the number of the segment as in the multi segment waveform file Range: 0 to SegmentCount - 1 Increment: 1
<Count>	integer defines how many times this segment is repeated Range: 1 to 65535 Increment: 1
<Next>	NEXT   BLANK   ENDLess   SEG0   SEG1   ...   SEG31   0...maxSegment determines the action after completing the current segment, like for instance which segment is processed after the processing of the current one is finished.

**Example:**

```
BB:ARB:WSEG:SEQ:SEL 'D:
/user/waveform/play_list_1'
selects the sequencing list play_list_1.wvs.
BB:ARB:WSEG:SEQ:APP ON,3,15,BLANK
appends the segment number 3 as a new segment to the sequencing list; this segment is activated and will be repeated 15 times and followed by a blank segment.
```

**Usage:** Setting only

---

**[:SOURce<hw>]:BB:ARB:WSEGment:SEQuence:SELEct <Filename>**

Selects the sequencing list (files with extension \*.wvs)

**Parameters:**

<Filename> string

**Example:**

```
BB:ARB:WSEG:SEQ:SEL 'D:
/user/waveform/play_list_1'
selects the sequencing list play_list_1.wvs.
```

**7.15.3.3 SOURce:BB:DM Subsystem**

The commands in the SOURce:BB:DM subsystem are described in two sections, separated into configuring digital modulation and lists for digital modulation.

## DM General Remote-Control Commands

The following section contains the commands for generating the digital modulation signal.

• <a href="#">Common Settings</a> .....	581
• <a href="#">Clock Settings</a> .....	584
• <a href="#">Trigger Settings</a> .....	586
• <a href="#">Marker Settings</a> .....	591
• <a href="#">Filter Settings</a> .....	594
• <a href="#">Modulation Settings</a> .....	597
• <a href="#">Power Ramp</a> .....	600

### Common Settings

<a href="#">[:SOURce&lt;hw&gt;]:BB:DM:PATtern</a> .....	581
<a href="#">[:SOURce&lt;hw&gt;]:BB:DM:PRBS[:LENGth]</a> .....	581
<a href="#">[:SOURce&lt;hw&gt;]:BB:DM:PRESet</a> .....	582
<a href="#">[:SOURce&lt;hw&gt;]:BB:DM:SOURce</a> .....	582
<a href="#">[:SOURce&lt;hw&gt;]:BB:DM:SRATe</a> .....	583
<a href="#">[:SOURce&lt;hw&gt;]:BB:DM:STANdard</a> .....	583
<a href="#">[:SOURce&lt;hw&gt;]:BB:DM:STATe</a> .....	583
<a href="#">[:SOURce&lt;hw&gt;]:BB:DM:SWITching:SOURce</a> .....	584
<a href="#">[:SOURce&lt;hw&gt;]:BB:DM:SWITching:STATe</a> .....	584

---

### **[:SOURce<hw>]:BB:DM:PATtern <Pattern>**

The command selects the data pattern for the internal data when PATtern is selected as the data source. The maximum length is 64 bits.

#### Parameters:

<Pattern>                    integer  
                                   Range:        #B0,1 to #B111...1,64  
                                   \*RST:        #B0,1

#### Example:

```
BB:DM:SOUR PATT
selects Pattern as the data source for digital modulation.
BB:DM:PATT #B01110111010101010,17
generates the user-defined sequence of 0/1 data.
```

---

### **[:SOURce<hw>]:BB:DM:PRBS[:LENGth] <Length>**

The command defines the length of the pseudo-random sequence in accordance with the following equation:

$$\text{Length} = (2^{\text{Length}}) - 1$$

#### Parameters:

<Length>                    9 | 11 | 15 | 16 | 20 | 21 | 23  
                                   \*RST:        9

**Example:** `BB:DM:SOUR PRBS`  
 The internal pseudo-random generator is used as the data source.  
`BB:DM:PRBS 9`  
 An internal pseudo-random sequence of 511 bits will be generated.

---

#### **[:SOURce<hw>]:BB:DM:PRESet**

The command calls the default settings for digital modulation.

**Example:** `BB:DM:PRESet`  
 calls the default settings for DM.

**Usage:** Event

---

#### **[:SOURce<hw>]:BB:DM:SOURce <Source>**

The command selects the data source.

#### **Parameters:**

<Source>

ZERO | ONE | PRBS | PATTern | DLISt | SERial | PARallel

#### **ZERO**

An internally generated 0 data sequence is used.

#### **ONE**

An internally generated 1 data sequence is used.

#### **PRBS**

The pseudo-random sequence generator is used as the data source. The length of the random sequence is defined with the aid of command `SOURce:BB:DM:PRBS`.

#### **PATTern**

Internally generated data with a fixed pattern is used. The data pattern is defined using command `SOURce:BB:DM:PATTern`.

#### **DLISt**

Data from the selected data list is used.

#### **SERial**

External data from the serial interface is used.

#### **PARallel**

External data from the serial interface is used.

\*RST: PRBS

**Example:** `BB:DM:SOUR DLIS`  
 the internal data generator is used.  
`BB:DM:DLIS:SEL 'test'`  
 the data list `test.dm_iqd` is used.

**[:SOURce<hw>]:BB:DM:SRATe <SRate>**

The command sets the symbol rate. The value range is dependent on the selected modulation type. On changing to an FSK modulation type, excessively high values are automatically limited to the maximum value that can be set for FSK (see data sheet). The symbol rate can be entered in Hz/kHz/MHz or Symb/s / kSymb/s and MSymb/s.

When a standard is selected (DM:STANdard), the symbol rate is automatically set to the appropriate default value.

The value range is dependent on the selected modulation type (:BB:DM:FORM). When a standard is selected (:BB:DM:STAN), the symbol rate is set to the default value.

**Parameters:**

<SRate> float  
 Range: 400Hz to 15MHz (FSK) / 25 MHz  
 Increment: 0.001Hz  
 \*RST: 270833kHz  
 Default unit: Hz

**Example:**

BB:DM:SRAT 10 MHz  
 sets a symbol rate of 10 MHz.

**[:SOURce<hw>]:BB:DM:STANdard <Standard>**

The command selects the standard. After selection, modulation parameters "Modulation Type" (:BB:DM:FORMat), "Symbol Rate" (:BB:DM:SRATe), "Filter" (:BB:DM:FILTer:TYPE and :BB:DM:FILTer:PARAmeter:...) and "Coding" (:BB:DM:CODing) are automatically set in accordance with the standard. The USER parameter cannot be set. A query returns this value if a user-defined Custom Dig Mod setting was loaded or if one of the associated settings was changed subsequent to the selection of a standard. The user defined settings are stored and loaded with commands :BB:DM:STAN:ULIS:... (see "DM Lists" on page 603).

**Parameters:**

<Standard> USER | BLUetooth | DECT | ETC | GSM | GSMEdge | NADC | PDC | PHS | TETRa | W3GPp | TDSCdma | CFORward | CREVerse | WORLdspace | TFTS | APCOPH1C4fm | APCOPH1CQpsk | APCOPH2HCpm | APCOPH2HDQpsk | APCOPH2HD8PSKW | APCOPH2HD8PSKN | APCOPH1Lsm | APCOPH1Wcqpsk  
 \*RST: GSM

**Example:**

BB:DM:STAN DECT  
 selects digital modulation according to the DECT standard.

**[:SOURce<hw>]:BB:DM:STATe <State>**

The command enables or disables digital modulation. Switching on digital modulation turns off all the other digital standards.



Enabling digital modulation (BB:DM:STAT ON) turns off all the other standards.

**Parameters:**

<State> 0 | 1 | OFF | ON  
\*RST: OFF

**Example:**

BB:DM:STAT ON  
switches digital modulation on.

**[:SOURce<hw>]:BB:DM:SWITching:SOURce <Source>**

The command selects the source of the CW control signal for switching between a modulated and an unmodulated signal.

**Parameters:**

<Source> INTernal | EXTernal

**INTernal**

The CW signal in the control list is used for the control.  
The internal signal can be output on one of the user interfaces.

**EXTernal**

The control signal on the CW pin of the AUX I/Q connector is used.

\*RST: INTernal

**Example:**

BB:DM:SWIT INT  
the CW signal in the control list is used for the control.

**[:SOURce<hw>]:BB:DM:SWITching:STATe <State>**

The command enables switching between a modulated and an unmodulated signal.

**Parameters:**

<State> 0 | 1 | OFF | ON  
\*RST: 0

**Example:**

BB:DM:SWIT:STAT INT  
CW switching is active.

**Clock Settings**

<a href="#">[:SOURce&lt;hw&gt;]:BB:DM:CLOCK:MODE.....</a>	584
<a href="#">[:SOURce&lt;hw&gt;]:BB:DM:CLOCK:MULTiplier.....</a>	585
<a href="#">[:SOURce&lt;hw&gt;]:BB:DM:CLOCK:SOURce.....</a>	585

**[:SOURce<hw>]:BB:DM:CLOCK:MODE <Mode>**

The command enters the type of externally supplied clock (:BB:DM:CLOCK:SOURce EXTernal).

The bit clock and the symbol clock differ only in the case of modulations that have more than two states, i.e. that require more than one bit for encoding each state. When `MSYMBOL` is used, a multiple of the symbol clock is supplied via the `CLOCK` connector and the symbol clock is derived internally from this. The multiplier is entered with the command `:BB:DM:CLOCK:MULTIPLIER`.

It is not possible to select `BIT` and `MSYMBOL` in the case of an external serial or external parallel data source (`SOUR:BB:DM:SOUR SER` and `PAR`).

**Parameters:**

<Mode> SYMBOL | MSYMBOL | BIT  
\*RST: SYMBOL

**Example:**

`BB:DM:CLOCK:MODE SYMB`  
selects clock type Symbols, i.e. the supplied clock is a symbol clock.

**[[:SOURce<hw>]:BB:DM:CLOCK:MULTIPLIER <Multiplier>**

The command specifies the multiplier for clock type **Multiple Symbols** (`BB:DM:CLOCK:MODE MSYM`) in the case of an external clock source.

**Parameters:**

<Multiplier> float  
Range: 1 to 64  
Increment: 1  
\*RST: 4

**Example:**

`BB:DM:CLOCK:SOUR EXT`  
selects the external clock source. The clock is supplied via the `CLOCK` connector.  
`BB:DM:CLOCK:MODE MSYM`  
selects clock type Multiple Symbols, i.e. the supplied clock has a rate which is a multiple of the symbol rate.  
`BB:DM:CLOCK:MULT 12`  
the multiplier for the external clock rate is 12.

**[[:SOURce<hw>]:BB:DM:CLOCK:SOURCE <Source>**

The command selects the source for the digital modulation clock.

**Parameters:**

<Source>                   INTernal | EXTernal | COUPled

**INTernal**

The internal clock reference is used.

**EXTernal**

The external clock reference is supplied to the CLOCK connector.

**COUPled**

The clock reference (internal or external) is selected automatically according to the selected data source, i.d. if the data source changes (BB:DM:DATA:SOUR) the clock source is automatically changed correspondingly as well.

\*RST:           INTernal

**Example:**

BB:DM:CLOC:SOUR INT  
selects the internal clock reference.

**Trigger Settings**

The numeric suffix to OUTPut distinguishes between the available markers.

[SOURce<hw>]:BB:DM:TRIGger:ARM:EXECute.....	586
[SOURce<hw>]:BB:DM:TRIGger:EXECute.....	587
[SOURce<hw>]:BB:DM:TRIGger:EXTernal:SYNChronize:OUTPut.....	587
[SOURce<hw>]:BB:DM:TRIGger:OUTPut:DELay:FIXed.....	588
[SOURce<hw>]:BB:DM:TRIGger:OUTPut<ch>:DELay.....	588
[SOURce<hw>]:BB:DM:TRIGger:OUTPut<ch>:DELay:MINimum.....	588
[SOURce<hw>]:BB:DM:TRIGger:OUTPut<ch>:DELay:MAXimum.....	588
[SOURce<hw>]:BB:DM:TRIGger:RMODE.....	589
[SOURce<hw>]:BB:DM:TRIGger:SLENgth.....	589
[SOURce<hw>]:BB:DM:TRIGger:SOURce.....	589
[SOURce<hw>]:BB:DM:TRIGger[EXTernal<ch>]:DELay.....	590
[SOURce<hw>]:BB:DM:TRIGger[EXTernal<ch>]:INHibit.....	590
[SOURce<hw>]:BB:DM[:TRIGger]:SEQuence.....	591

**[SOURce<hw>]:BB:DM:TRIGger:ARM:EXECute**

The command stops signal generation for trigger modes Armed\_Auto and Armed\_Ret-rigger. A subsequent internal or external trigger event restart signal generation.

**Example:**

BB:DM:TRIG:SOUR INT  
sets internal triggering.  
BB:DM:TRIG:SEQ ARET  
sets Armed\_Retrigger mode, i.e. every trigger event causes signal generation to restart.  
BB:DM:TRIG:EXEC  
executes a trigger, signal generation is started.  
BB:DM:TRIG:ARM:EXEC  
signal generation is stopped.  
BB:DM:TRIG:EXEC  
executes a trigger, signal generation is started again.

**Usage:** Event

---

**[[:SOURce<hw>]:BB:DM:TRIGger:EXECute**

The command executes a trigger. The internal trigger source must be selected using the command `:BB:DM:TRIG:SOUR INT` and a trigger mode other than AUTO must be selected using the command `:BB:DM:TRIG:SEQ`.

**Example:**

```
BB:DM:TRIG:SOUR INT
sets internal triggering.
BB:DM:TRIG:SEQ RETR
sets Retrigger mode, i.e. every trigger event causes signal generation to restart.
BB:DM:TRIG:EXEC
executes a trigger.
```

**Usage:** Event

---

**[[:SOURce<hw>]:BB:DM:TRIGger:EXTernal:SYNChronize:OUTPut <Output>**

(enabled for "Trigger Source" External)

Enables/disables output of the signal synchronous to the external trigger event.

**Parameters:**

<Output>

0 | 1 | OFF | ON

**ON**

The signal calculation starts simultaneously with the external trigger event but because of the instrument's processing time the first samples are cut off and no signal is outputted. After elapsing of the internal processing time, the output signal is synchronous to the trigger event.

**OFF**

The signal output begins after elapsing of the processing time and starts with sample 0, i.e. the complete signal is outputted. This mode is recommended for triggering of short signal sequences with signal duration comparable with the processing time of the instrument.

\*RST: ON

**Example:**

```
BB:DM:TRIG:SOUR EXT
sets external triggering.
BB:DM:TRIG:EXT:SYNC:OUTP ON
enables synchronous output to external trigger
```

**[ :SOURce<hw>]:BB:DM:TRIGger:OUTPut:DELay:FIXed <Fixed>**

The command restricts the marker delay setting range to the dynamic range. In this range the delay can be set without restarting the marker and signal. If a delay is entered in setting ON but is outside this range, the maximum possible delay is set and an error message is generated.

The numeric suffix in `OUTPut` has no significance for this command, since the setting always affects every marker.

**Parameters:**

<Fixed>                    0 | 1 | OFF | ON  
\*RST:                    0

**Example:**

`BB:DM:TRIG:OUTP:DEL:FIX ON`  
restricts the marker signal delay setting range to the dynamic range.

**[ :SOURce<hw>]:BB:DM:TRIGger:OUTPut<ch>:DELay <Delay>**

The command defines the delay between the signal on the marker outputs and the start of the signal, expressed in terms of symbols. Command `[ :SOURce<hw>]:BB:DM:TRIGger:OUTPut:DELay:FIXed` can be used to restrict the range of values to the dynamic range, i.e. the range within which a delay of the marker signals can be set without restarting the marker and signal.

**Parameters:**

<Delay>                    float  
Range:                    0 to 100 000 Symbols  
Increment:                1 symbol  
\*RST:                    0 symbol

**Example:**

`BB:DM:TRIG:OUTP2:DEL 16`  
sets a delay of 16 symbols for the signal on connector MARKER 2.

**[ :SOURce<hw>]:BB:DM:TRIGger:OUTPut<ch>:DELay:MINimum?  
[ :SOURce<hw>]:BB:DM:TRIGger:OUTPut<ch>:DELay:MAXimum?**

The command queries the maximum marker delay for setting `:BB:DM:TRIG:OUTP:DEL:FIX ON`.

**Return values:**

<Maximum>                float

**Example:**

`BB:DM:TRIG:OUTP:DEL:FIX ON`  
restricts the marker signal delay setting range to the dynamic range.  
`BB:DM:TRIG:OUTP:DEL:MAX`  
queries the maximum of the dynamic range.  
Response: 2000  
the maximum for the marker delay setting is 2000 symbols.

**Usage:** Query only

---

**[:SOURce<hw>]:BB:DM:TRIGger:RMODE?**

The command displays the status of signal generation for all trigger modes with digital modulation on.

**Return values:**

<RMode>

STOP | RUN

**RUN**

The signal is generated. A trigger event occurred in the triggered mode.

**STOP**

The signal is not generated. A trigger event did not occur in the triggered modes, or signal generation was stopped by the command `:BB:DM:TRIG:ARM:EXECute` (armed trigger modes only).

**Example:**

`BB:DM:TRIG:SOUR EXT`

sets external triggering via the TRIGGER 1 connector.

`BB:DM:TRIG:MODE ARET`

selects the Armed\_Retrigger mode

`BB:DM:TRIG:RMODE?`

queries the current status of signal generation.

Response: RUN

the signal is generated, an external trigger was executed.

**Usage:** Query only

---

**[:SOURce<hw>]:BB:DM:TRIGger:SLENgth <SLength>**

The command defines the length of the signal sequence to be output in the "Single" trigger mode.

**Parameters:**

<SLength>

float

Range: 1 to 4294967295

\*RST: 1000

Default unit: symbol

**Example:**

`BB:DM:SEQ SING`

sets trigger mode Single.

`BB:DM:TRIG:SLEN 200`

sets a sequence length of 200 symbols. 200 symbols will be output after the next trigger event.

---

**[:SOURce<hw>]:BB:DM:TRIGger:SOURce <Source>**

The command selects the trigger source.

**Parameters:**

&lt;Source&gt;

INTernal | EXTernal | BEXTernal

**INTernal**

Triggering is executed by means of the Trigger command `SOURce:BB:DM:TRIGger:EXECute`, `TRIGger:BB:DM:IMMediate` or `*TRG` in the case of remote control and by means of "Execute Trigger" in the case of manual operation.

**EXTernal**

Triggering is executed by means of the signal on the TRIGGER 1 connector.

**BEXTernal**

Triggering is executed by means of the signal on the TRIGGER 2 connector.

**Example:**

```
BB:DM:TRIG:SOUR EXT
```

sets external triggering via the TRIGGER 1 connector.

**[:SOURce<hw>]:BB:DM:TRIGger[:EXTernal<ch>]:DELay <Delay>**

The command specifies the trigger delay (expressed as a number of symbols) for external triggering.

**Parameters:**

&lt;Delay&gt;

float

Range: 0 to 65535

\*RST: 0

Default unit: symbol

**Example:**

```
BB:DM:TRIG:SOUR EXT
```

selects an external trigger via the TRIGGER 1 connector.

```
BB:DM:TRIG:DEL 50
```

sets a delay of 50 symbols for the trigger.

**[:SOURce<hw>]:BB:DM:TRIGger[:EXTernal<ch>]:INHibit <Inhibit>**

The command specifies the number of symbols by which a restart is to be inhibited following a trigger event. This command applies only in the case of external triggering.

**Parameters:**

&lt;Inhibit&gt;

float

Range: 0 to 67108863

\*RST: 0

Default unit: symbol

**Example:**

```
BB:DM:TRIG:SOUR EXT
```

selects an external trigger via the TRIGGER 1 connector.

```
BB:DM:TRIG:INH 200
```

sets a restart inhibit for 200 symbols following a trigger event.

---

**[[:SOURce<hw>]:BB:DM[:TRIGger]:SEQuence <Sequence>**

The command selects the trigger mode.

**Parameters:**

<Sequence>

AUTO | RETRigger | AAUTO | ARETrigger | SINGLE

**AUTO**

The modulation signal is generated continuously.

**RETRigger**

The modulation signal is generated continuously. A trigger event (internal or external) causes a restart.

**AAUTO**

The modulation signal is generated only when a trigger event occurs. After the trigger event the signal is generated continuously. Signal generation is stopped with command

`SOUR:BB:DM:TRIG:ARM:EXEC` and started again when a trigger event occurs.

**ARETrigger**

The modulation signal is generated only when a trigger event occurs. The device automatically toggles to RETRIG mode. Every subsequent trigger event causes a restart. Signal generation is stopped with command `SOUR:BB:DM:TRIG:ARM:EXEC` and started again when a trigger event occurs.

**SINGLE**

The modulation signal is generated only when a trigger event occurs. After the trigger event the signal is generated once to the set sequence length (`SOUR:BB:DM:TRIG:SLen`). Every subsequent trigger event caused a restart.

\*RST: AUTO

**Example:**

`BB:DM:SEQ AAUT`

sets the "Armed\_auto" trigger mode; the device waits for the first trigger (e.g. with \*TRG) and then generates the signal continuously.

**Marker Settings**

<code>[[:SOURce&lt;hw&gt;]:BB:DM:TRIGger:OUTPut&lt;ch&gt;:MODE</code> .....	591
<code>[[:SOURce&lt;hw&gt;]:BB:DM:TRIGger:OUTPut&lt;ch&gt;:OFFTime</code> .....	592
<code>[[:SOURce&lt;hw&gt;]:BB:DM:TRIGger:OUTPut&lt;ch&gt;:ONTime</code> .....	592
<code>[[:SOURce&lt;hw&gt;]:BB:DM:TRIGger:OUTPut&lt;ch&gt;:PATTern</code> .....	593
<code>[[:SOURce&lt;hw&gt;]:BB:DM:TRIGger:OUTPut&lt;ch&gt;:PULSe:DIVider</code> .....	593
<code>[[:SOURce&lt;hw&gt;]:BB:DM:TRIGger:OUTPut&lt;ch&gt;:PULSe:FREQUency</code> .....	593

---

**[[:SOURce<hw>]:BB:DM:TRIGger:OUTPut<ch>:MODE <Mode>**

The command defines the signal for the selected marker output.



**Parameters:**

&lt;Mode&gt;

CLISt | PULSe | PATTeRn | RATio | TRIGger

**CLISt**

A marker signal that is defined in the selected control list is generated.

**PULSe**

A pulsed marker signal is generated. The pulse frequency (= symbol rate/divider) is defined with the

`SOUR:BB:DM:TRIG:OUTP:PULSe:DIVIder` command and can be queried with the

`SOUR:BB:DM:TRIG:OUTP:PULSe:FREQuency?` command.

**PATTeRn**

A marker signal is generated with the aid of a user-definable bit pattern. The bit pattern is entered with the aid of command

`SOURce:BB:DM:TRIGger:OUTPut:PATTeRn`. The bit pattern is a maximum of 32 bits long.

**RATio**

A regular marker signal corresponding to the Time Off / Time On specifications in the commands

`SOURce:BB:DM:TRIGger:OUTPut:OFFT` and

`SOURce:BB:DM:TRIGger:OUTPut:ONT` is generated.

\*RST:        RATio

**Example:**

`BB:DM:TRIG:OUTP2:MODE PULS`

selects the pulsed marker signal on output MARKER 2.

**[:SOURce<hw>]:BB:DM:TRIGger:OUTPut<ch>:OFFTime <OffTime>**

The command sets the number of symbols in a period (ON time + OFF time) during which the marker signal in setting `SOURce:BB:DM:TRIGger:OUTPut:MODE RATio` on the marker outputs is OFF.

**Parameters:**

&lt;OffTime&gt;

integer

Range:        1 to 16777215

Increment:    1

\*RST:        1

Default unit: symbol

**Example:**

`BB:DM:TRIG:OUTP2:OFFT 20`

sets an OFF time of 20 symbols for marker signal 2.

**[:SOURce<hw>]:BB:DM:TRIGger:OUTPut<ch>:ONTTime <OnTime>**

The command sets the number of symbols in a period (ON time + OFF time) during which the marker signal in setting `SOURce:BB:DM:TRIGger:OUTPut:MODE RATio` on the marker outputs is ON.

**Parameters:**

<OnTime> float  
 Range: 1 to 16777215  
 \*RST: 1  
 Default unit: symbol

**Example:**

BB:DM:TRIG:OUTP2:ONT 20  
 sets an ON time of 20 symbols for marker 2

**[:SOURce<hw>]:BB:DM:TRIGger:OUTPut<ch>:PATTern <Pattern>**

The command defines the bit pattern used to generate the marker signal in the setting `SOURce:BB:DM:TRIGger:OUTPut:MODE PATTern`. 0 is marker off, 1 is marker on.

**Parameters:**

<Pattern> integer  
 Range: #B0,1 to #B111...1,32  
 \*RST: #B,1

**Example:**

BB:DM:TRIG:OUTP2:PATT #B000000011111111,15  
 sets a bit pattern.  
 BB:DM:TRIG:OUTP2:MODE PATT  
 activates the marker signal according to a bit pattern on output MARKER 2.

**[:SOURce<hw>]:BB:DM:TRIGger:OUTPut<ch>:PULSe:DIVider <Divider>**

The command sets the divider for Pulse marker mode (`SOUR:BB:DM:TRIGr:OUTP:MODE PULSe`). The resulting pulse frequency is derived by dividing the symbol rate by the divider.

**Parameters:**

<Divider> integer  
 Range: 2 to 1024  
 Increment: 1  
 \*RST: 2

**Example:**

BB:DM:TRIG:OUTP2:PULS:DIV 2  
 sets the divider to 2 for the marker signal on output MARKER 2.  
 BB:DM:TRIG:OUTP2:FREQ?  
 queries the resulting pulse frequency of the marker signal.  
 Response: 66 000  
 the resulting pulse frequency is 66 kHz.

**[:SOURce<hw>]:BB:DM:TRIGger:OUTPut<ch>:PULSe:FREQuency?**

The command queries the pulse frequency of the pulsed marker signal in the setting `SOURce:BB:DM:TRIGger:OUTPut:MODE PULSe`. The pulse frequency is derived by dividing the symbol rate by the divider.

**Return values:**

&lt;Frequency&gt; float

**Example:**

BB:DM:TRIG:OUTP2:PULS:DIV 2

sets the divider marker signal on output MARKER 2 to the value 2.

BB:DM:TRIG:OUTP2:MODE PULS

enables the pulsed marker signal.

BB:DM:TRIG:OUTP2:PULS:FREQ?

queries the pulse frequency of the marker signal.

Response: 33 000

the resulting pulse frequency is

**Usage:** Query only**Filter Settings**

[SOURce<hw>]:BB:DM:FILTer:OSAMpling.....	594
[SOURce<hw>]:BB:DM:FILTer:OSAMpling:AUTO.....	594
[SOURce<hw>]:BB:DM:FILTer:PARAmeter:COsine[ROLLoff].....	595
[SOURce<hw>]:BB:DM:FILTer:PARAmeter:GAUSS.....	595
[SOURce<hw>]:BB:DM:FILTer:PARAmeter:LPASS.....	595
[SOURce<hw>]:BB:DM:FILTer:PARAmeter:LPASSEVM.....	595
[SOURce<hw>]:BB:DM:FILTer:PARAmeter:PGAuss.....	595
[SOURce<hw>]:BB:DM:FILTer:PARAmeter:RCOSine.....	595
[SOURce<hw>]:BB:DM:FILTer:PARAmeter:SPHase.....	595
[SOURce<hw>]:BB:DM:FILTer:PARAmeter:APCO25.....	595
[SOURce<hw>]:BB:DM:FILTer:PARAmeter:COsine:BANDwidth.....	596
[SOURce<hw>]:BB:DM:FILTer:PARAmeter:APCO25Lsm:GAUSS.....	596
[SOURce<hw>]:BB:DM:FILTer:PARAmeter:APCO25Lsm:LOWPass.....	596
[SOURce<hw>]:BB:DM:FILTer:TYPE.....	596

**[SOURce<hw>]:BB:DM:FILTer:OSAMpling <OSampling>**

The command sets the upsampling factor.

**Parameters:**

<OSampling> integer  
 Range: 1 to 32  
 Increment: 1  
 \*RST: 32

**Example:**

BB:DM:FILT:OSAM 32

sets the upsampling factor to 32.

**[SOURce<hw>]:BB:DM:FILTer:OSAMpling:AUTO <Auto>**

The command activates/deactivates the upsampling factor state. If activated, the most sensible parameter values are selected. The value depends on the coherence check. If deactivated, the values can be changed manually.

**Parameters:**

<Auto> 0 | 1 | OFF | ON  
 \*RST: 1

**Example:**

BB:DM:FILT:OSAM:AUTO ON

The most sensible parameters are selected automatically.

---

**[[:SOURce<hw>]:BB:DM:FILT:PARAmeter:COsine[:ROLLoff] <Cosine>**

**[[:SOURce<hw>]:BB:DM:FILT:PARAmeter:GAUSS <Gauss>**

**[[:SOURce<hw>]:BB:DM:FILT:PARAmeter:LPASs <LPass>**

**[[:SOURce<hw>]:BB:DM:FILT:PARAmeter:LPASSEVM <LPassEvm>**

**[[:SOURce<hw>]:BB:DM:FILT:PARAmeter:PGAuss <PGauss>**

**[[:SOURce<hw>]:BB:DM:FILT:PARAmeter:RCOSine <RCosine>**

**[[:SOURce<hw>]:BB:DM:FILT:PARAmeter:SPHase <SPHase>**

**[[:SOURce<hw>]:BB:DM:FILT:PARAmeter:APCO25 <Apco25>**

The command sets the roll-off factor for filter type APCO25.

On selecting filter APCO25, the filter parameter is set to the default value.

**Parameters:**

<Apco25> float  
 Range: 0.05 to 0.99  
 Increment: 0.01  
 \*RST: 0.2

<Cosine> float  
 Range: 0.05 to 1.0  
 Increment: 0.01  
 \*RST: 0.35

<Gauss> float  
 Range: 0.15 to 100000  
 Increment: 0.01  
 \*RST: 0.3

<LPass> float  
 Range: 0.05 to 2  
 Increment: 0.01  
 \*RST: 0.5

<LPassEvm> float  
 Range: 0.05 to 2  
 Increment: 0.01  
 \*RST: 0.5

<PGauss> float  
 Range: 0.15 to 2.5  
 Increment: 0.01  
 \*RST: 0.3

<RCosine> float  
 Range: 0.05 to 1.0  
 Increment: 0.01  
 \*RST: 0.35

<SPhase> float  
 Range: 0.15 to 2.5  
 Increment: 0.01  
 \*RST: 2

**Example:** BB:DM:FILT:PAR:APCO25 0.2  
 sets the roll-off factor to 0.2 for filter type APCO25.

**[ :SOURce<hw> ]:BB:DM:FILT:PAR:PARAMeter:COsine:BA NDwidth <FiltParm>**

Sets the bandwidth of the cosine filter.

**Parameters:**

<FiltParm> float  
 Range: 400 to 25E6  
 Increment: 1E-3  
 \*RST: 270833.333

**Example:** :BB:DM:FILT:TYPE COS  
 :BB:DM:FILT:PAR:COS:BA ND 7200

**[ :SOURce<hw> ]:BB:DM:FILT:PAR:PARAMeter:APCO25Lsm:GAUSs <FiltParm>**  
**[ :SOURce<hw> ]:BB:DM:FILT:PAR:PARAMeter:APCO25Lsm:LOWPass <FiltParm>**

Sets the cut off frequency for the lowpass/ gauss filter.

**Parameters:**

<FiltParm> float  
 Range: 400 to 25E6  
 Increment: 1E-3  
 \*RST: 270833.333

**Example:** :BB:DM:FILT:TYPE APCO25Lsm  
 :BB:DM:FILT:PAR:APCO25L:LOWP 5166.667  
 :BB:DM:FILT:PAR:APCO25L:GAUS 1700

**[ :SOURce<hw> ]:BB:DM:FILT:TYPE <Type>**

The command selects the filter type.

When a standard is selected (:BB:DM:STAN), the filter type and filter parameter are set to the default value.

**Parameters:**

<Type> RCOSine | COSine | GAUSs | LGAuss | CONE | COF705 |  
 COEQUALizer | COFEQUALizer | C2K3x | APCO25 | SPHase |  
 RECTangle | USER | PGAuss | LPASs | DIRac | ENPShape |  
 EWPSHape | LTEFilter | LPASSEVM | APCO25Hcpm |  
 APCO25Lsm  
 \*RST: GAUSs

**Example:**

BB:DM:FILT:TYPE COS  
 selects the Cosine filter type.

**Modulation Settings**

[[:SOURce<hw>]:BB:DM:AQPSk:ANGLE.....	597
[[:SOURce<hw>]:BB:DM:ASK:DEPTH.....	597
[[:SOURce<hw>]:BB:DM:CODing.....	598
[[:SOURce<hw>]:BB:DM:FORMat.....	598
[[:SOURce<hw>]:BB:DM:FSK:DEViation.....	599
[[:SOURce<hw>]:BB:DM:FSK:VARiable:SYMBOL<ch>:DEViation.....	599
[[:SOURce<hw>]:BB:DM:FSK:VARiable:TYPE.....	599
[[:SOURce<hw>]:BB:DM:MDELay.....	600

**[[:SOURce<hw>]:BB:DM:AQPSk:ANGLE <Angle>**

For AQPSK modulation, sets the angle alpha between the point (0,0) and the I axis.

**Parameters:**

<Angle> float  
 Range: 0 to 180  
 Increment: 0.01  
 \*RST: 0  
 Default unit: Deg

**Example:**

BB:DM:FORM AQPS  
 selects modulation type AQPSK.  
 BB:DM:AQPS:ANGL 45

**[[:SOURce<hw>]:BB:DM:ASK:DEPTH <Depth>**

The command sets the ASK modulation depth when modulation type ASK is selected.

**Parameters:**

<Depth> float  
 Range: 0 to 100  
 Increment: 0.1PCT  
 \*RST: 100  
 Default unit: PCT

**Example:** `BB:DM:FORM ASK`  
selects the ASK modulation type.  
`BB:DM:ASK:DEPT 50 PCT`  
sets a modulation depth of 50 percent.

---

**[:SOURce<hw>]:BB:DM:CODing <Coding>**

The command selects the modulation coding.

If the modulation type selected (`:BB:DM:FORM`) is not possible with the coding that has been set, it is automatically set to OFF (`:BB:DM:COD OFF`).

When a standard is selected (`:BB:DM:STAN`), the coding is set to the default value.

**Parameters:**

<Coding> OFF | DIFF | DPHS | DGRay | GRAY | GSM | NADC | PDC | PHS |  
TETRa | APCO25 | PWT | TFTS | INMarsat | VDL | EDGE |  
APCO25FSK | ICO | CDMA2000 | WCDMA | APCO258PSK

**DPHS**

Phase Difference

**DGRay**

Difference + Gray

\*RST: INTernal

**Example:** `BB:DM:COD GRAY`  
selects GRAY coding. This coding is valid for all modulation types.

---

**[:SOURce<hw>]:BB:DM:FORMat <Format>**

The command selects the modulation type.

If the coding that is set (`:BB:DM:COD`) is not possible with the modulation type selected, it is automatically set to OFF (`:BB:DM:COD OFF`).

When a standard is selected (`:DM:STAN`), the modulation type is set to the default value.

**Parameters:**

<Format> ASK | BPSK | P2DBpsk | QPSK | QPSK45 | OQPSk | P4QPSk |  
P4DQpsk | PSK8 | P8D8psk | P8EDge | QAM16 | QAM32 |  
QAM64 | QAM256 | QAM1024 | MSK | FSK2 | FSK4 | USER |  
FSKVar | QAM128 | QEDGe | QAM16EDge | QAM32EDge |  
AQPSk

\*RST: MSK

**Example:** `BB:DM:FORM QPSK`  
selects modulation type QPSK.

**[ :SOURce<hw> ]:BB:DM:FSK:DEVIation <Deviation>**

The command sets the frequency deviation when FSK modulation is selected. The range of values depends on the symbol rate that is set (see data sheet) and the maximum deviation is 10 MHz.

If the symbol rate that is set exceeds the maximum possible value for the chosen frequency deviation, it is suitably adapted ( :BB:DM:SRAT ).

**Parameters:**

<Deviation> float  
 Range: 1 to 40E6  
 Increment: 0.5  
 \*RST: 135416.5

**Example:**

```
BB:DM:FORM FSK
selects FSK modulation.
BB:DM:FSK:DEV 10 MHz
sets the frequency deviation to 10 MHz.
```

**[ :SOURce<hw> ]:BB:DM:FSK:VARiable:SYMBol<ch>:DEVIation <Deviation>**

The command sets the deviation of the selected symbol for variable FSK modulation mode.

**Suffix:**

<ch> 0 .. 16  
 The number of symbols (and therefore the suffix range) depends on the selected FSK modulation type.

**Parameters:**

<Deviation> float  
 The range of values depends on the symbol rate that is set (see data sheet) and the maximum deviation is 10 MHz.  
 Range: -40E6 to 40E6  
 Increment: 0.5  
 Default unit: Hz

**Example:**

```
BB:DM:FORM FSKV
selects Variable FSK modulation.
BB:DM:FSK:VAR:TYPE FSK16
selects 16FSK modulation.
BB:DM:FSK:VAR:SYMB0:DEV 135000
sets the frequency deviation of the least significant symbol to 135 kHz.
```

**[ :SOURce<hw> ]:BB:DM:FSK:VARiable:TYPE <Type>**

The command selects the modulation type for Variable FSK.



**Parameters:**

<Type> FSK4 | FSK8 | FSK16  
 \*RST: FSK4

**Example:**

BB:DM:FORM FSKV  
 selects Variable FSK modulation.  
 BB:DM:FSK:VAR:TYPE FSK16  
 selects 16FSK modulation.

**[[:SOURce<hw>]:BB:DM:MDElay?**

The command queries the digital modulation delay from the data input to the I/Q output in the case of external modulation.

**Return values:**

<MDelay> float

**Example:**

BB:DM:MDEL?  
 queries the delay in the case of external modulation.  
 Response: 0.4 ms  
 the delay is 0.4 ms.

**Usage:**

Query only

**Power Ramp**

[[:SOURce<hw>]:BB:DM:PRAMP:ATTenuation.....	600
[[:SOURce<hw>]:BB:DM:PRAMP:BBONLY[:STATe].....	601
[[:SOURce<hw>]:BB:DM:PRAMP:FDElay.....	601
[[:SOURce<hw>]:BB:DM:PRAMP:RDElay.....	601
[[:SOURce<hw>]:BB:DM:PRAMP:SHAPE.....	601
[[:SOURce<hw>]:BB:DM:PRAMP:SOURce.....	602
[[:SOURce<hw>]:BB:DM:PRAMP:TIME.....	602
[[:SOURce<hw>]:BB:DM:PRAMP[:STATe].....	602

**[[:SOURce<hw>]:BB:DM:PRAMP:ATTenuation <Attenuation>**

The command sets the level attenuation for signal ranges that are flagged with level attribute **attenuated** by the LEV\_ATT control signal.

**Parameters:**

<Attenuation> float  
 Range: 0 to 50  
 Increment: 0.1  
 \*RST: 15  
 Default unit: dB

**Example:**

BB:DM:PRAMP:ATT 15 dB  
 sets a level attenuation of 15 dB.

**[[:SOURce<hw>]:BB:DM:PRAMP:BBONLY[:STATE] <State>**

This command selects power ramping in the baseband only or mixed power ramping in the baseband and the RF section.

The **ON** setting is mandatory if, with power ramping active, only the baseband signal is output (I/Q outputs)

Only then can a signal with a defined, predictable level be output.

**Parameters:**

<State>                    0 | 1 | OFF | ON  
 \*RST:                    OFF

**Example:**

BB:DM:PRAMP:BBON ON  
 selects power ramping in the baseband only.

**[[:SOURce<hw>]:BB:DM:PRAMP:FDELAY <FDelay>**

The command sets the delay in the falling edge. A positive value gives rise to a delay and a negative value causes an advance. The setting is expressed in symbols.

**Parameters:**

<FDelay>                    float  
 Range:                    -4 to 4  
 Increment:                0.01  
 \*RST:                    0  
 Default unit: symbol

**Example:**

BB:DM:PRAMP:FDEL 1  
 The falling edge starts 1 symbol later.

**[[:SOURce<hw>]:BB:DM:PRAMP:RDELAY <RDelay>**

The command sets the delay in the rising edge. A positive value gives rise to a delay and a negative value causes an advance. The setting is expressed in symbols.

**Parameters:**

<RDelay>                    float  
 Range:                    -4 to 4  
 Increment:                0.01  
 \*RST:                    0  
 Default unit: symbol

**Example:**

BB:DM:PRAMP:RDEL 1  
 The rising edge starts 1 symbol later.

**[[:SOURce<hw>]:BB:DM:PRAMP:SHAPE <Shape>**

The command sets the edge shape of the ramp envelope.

**Parameters:**

<Shape> LINear | COSine  
 \*RST: COSine

**Example:**

BB:DM:PRAM:SHAP COS  
 selects a cosine-shaped rise and fall for the transmitted power edge.

**[:SOURce<hw>]:BB:DM:PRAMP:SOURce <Source>**

The command sets the source for the power ramp control signals.

**Parameters:**

<Source> INTernal | EXTernal

**INTernal**

The internal control signals LEV\_ATT and BURST are used. Control signals are stored in dedicated lists. When remote control is in use, the list to be used is defined, selected and enabled with the aid of SOURce:BB:DM:CLISt:... commands.

**EXTernal**

The digital control signals LEV\_ATT and BURST are supplied via the control signal inputs on the AUX I/O connector.

\*RST: INTernal

**Example:**

BB:DM:PRAM:SOUR INT  
 enables the use of internal control signals for power ramp control.

**[:SOURce<hw>]:BB:DM:PRAMP:TIME <Time>**

The command sets the power ramping rise time and fall time for a burst.

**Parameters:**

<Time> float  
 Range: 0.25 to 16  
 Increment: 0.01  
 \*RST: 1  
 Default unit: symbol

**Example:**

BB:DM:PRAM:TIME 2  
 sets a time of 2 symbols for the edges to rise and fall.

**[:SOURce<hw>]:BB:DM:PRAMP[:STATE] <State>**

The command enables or disables power ramping.

**Parameters:**

<State> 0 | 1 | OFF | ON  
 \*RST: 0

**Example:** BB:DM:PRAM:STAT ON  
switches power ramping on.

### DM Lists

The following section brings together the commands for defining and managing the data lists and control lists for digital modulation.

Lists are stored as files with specific file extensions in a user-definable directory (see [table 7-2](#)). The directory which applies to the commands that follow is defined using the command `MMEMoRY:CDIR`. Files in this directory can be accessed by quoting the file name. The path and extension are not needed.

**Table 7-2: Overview of the used list types**

List type	Content	File extension
Data List	Digital modulation data	*.dm_iqd
Control List	Digital modulation control data	*.dm_iqc
User Standards	User settings of digital modulation	*.dm_stu
Usr Filter	Usr filter settings	*.vaf
User Mapping	User mapping settings	*.vam

It is not possible to use other file extensions with the commands. Attempting to do so will cause an error message. If the file extension is changed in any other way (e.g. by directly accessing the file system) the lists are no longer recognized and therefore invalid.



Since the format of control lists refer to the input, the `CLIST` commands always create a binary control list, even if ASCII format is specified. Note therefore, if you want to create a \*.wv file with R&S WinIQSIM2 using a control list, you have to use the input control list in ASCII format. See the example in [chapter 7.3.3, "Creating an ASCII C-List Manually"](#), on page 475 for information on how to create a C-list in ASCII format.

### List of Commands

<code>[:SOURce&lt;hw&gt;]:BB:DM:CLIST:CATalog</code> .....	604
<code>[:SOURce&lt;hw&gt;]:BB:DM:DLIST:CATalog</code> .....	604
<code>[:SOURce&lt;hw&gt;]:BB:DM:FLIST:CATalog</code> .....	604
<code>[:SOURce&lt;hw&gt;]:BB:DM:MLIST:CATalog</code> .....	604
<code>[:SOURce&lt;hw&gt;]:BB:DM:CLIST:FREE</code> .....	604
<code>[:SOURce&lt;hw&gt;]:BB:DM:DLIST:FREE</code> .....	604
<code>[:SOURce&lt;hw&gt;]:BB:DM:FLIST:FREE</code> .....	604
<code>[:SOURce&lt;hw&gt;]:BB:DM:MLIST:FREE</code> .....	604
<code>[:SOURce&lt;hw&gt;]:BB:DM:CLIST:COPY</code> .....	605
<code>[:SOURce&lt;hw&gt;]:BB:DM:DLIST:COPY</code> .....	605
<code>[:SOURce&lt;hw&gt;]:BB:DM:CLIST:TAG</code> .....	605
<code>[:SOURce&lt;hw&gt;]:BB:DM:DLIST:TAG</code> .....	605
<code>[:SOURce&lt;hw&gt;]:BB:DM:CLIST:DATA</code> .....	606
<code>[:SOURce&lt;hw&gt;]:BB:DM:CLIST:DELeTe</code> .....	607
<code>[:SOURce&lt;hw&gt;]:BB:DM:CLIST:POINts</code> .....	607

<code>[:SOURce&lt;hw&gt;]:BB:DM:CLISt:SElect</code> .....	607
<code>[:SOURce&lt;hw&gt;]:BB:DM:DLISt:DATA</code> .....	608
<code>[:SOURce&lt;hw&gt;]:BB:DM:DLISt:DATA:APPend</code> .....	608
<code>[:SOURce&lt;hw&gt;]:BB:DM:DLISt:DELeTe</code> .....	609
<code>[:SOURce&lt;hw&gt;]:BB:DM:DLISt:POINts</code> .....	609
<code>[:SOURce&lt;hw&gt;]:BB:DM:DLISt:SElect</code> .....	609
<code>[:SOURce&lt;hw&gt;]:BB:DM:FLISt:DELeTe</code> .....	610
<code>[:SOURce&lt;hw&gt;]:BB:DM:FLISt:POINts</code> .....	610
<code>[:SOURce&lt;hw&gt;]:BB:DM:FLISt:SElect</code> .....	610
<code>[:SOURce&lt;hw&gt;]:BB:DM:MLISt:DELeTe</code> .....	611
<code>[:SOURce&lt;hw&gt;]:BB:DM:MLISt:POINts</code> .....	611
<code>[:SOURce&lt;hw&gt;]:BB:DM:MLISt:SElect</code> .....	612
<code>[:SOURce&lt;hw&gt;]:BB:DM:SETTing:CATalog</code> .....	612
<code>[:SOURce&lt;hw&gt;]:BB:DM:SETTing:DELeTe</code> .....	612
<code>[:SOURce&lt;hw&gt;]:BB:DM:SETTing:LOAD</code> .....	613
<code>[:SOURce&lt;hw&gt;]:BB:DM:SETTing:STORe</code> .....	613
<code>[:SOURce&lt;hw&gt;]:BB:DM:SETTing:STORe:FAST</code> .....	613
<code>[:SOURce&lt;hw&gt;]:BB:DM:STANdard:ULISt:CATalog</code> .....	613
<code>[:SOURce&lt;hw&gt;]:BB:DM:STANdard:ULISt:DELeTe</code> .....	614
<code>[:SOURce&lt;hw&gt;]:BB:DM:STANdard:ULISt:LOAD</code> .....	614
<code>[:SOURce&lt;hw&gt;]:BB:DM:STANdard:ULISt:STORe</code> .....	614

---

**`[:SOURce<hw>]:BB:DM:CLISt:CATalog?`**

**`[:SOURce<hw>]:BB:DM:DLISt:CATalog?`**

**`[:SOURce<hw>]:BB:DM:FLISt:CATalog?`**

**`[:SOURce<hw>]:BB:DM:MLISt:CATalog?`**

Queries the user mapping lists present in the default directory. The default directory is set using command `MMEM:CDIRectory`. When the names of the files are returned they are separated by commas.

The command only reads out files with the `*.vam` extension (see also [table 7-2](#)).

**Return values:**

<Catalog>                    string

**Example:**

`BB:DM:FORM USER`

selects the User modulation type.

`MMEM:CDIR 'D:/user/mapping_List'`

sets the default directory for the user mapping lists.

`BB:DM:MLIS:CAT?`

queries the user mapping lists in the directory.

**Usage:**

Query only

---

**`[:SOURce<hw>]:BB:DM:CLISt:FREE?`**

**`[:SOURce<hw>]:BB:DM:DLISt:FREE?`**

**`[:SOURce<hw>]:BB:DM:FLISt:FREE?`**

**`[:SOURce<hw>]:BB:DM:MLISt:FREE?`**

Queries the user modulation mapping list free memory.

**Return values:**

<Free> integer  
 Range: 0 to INT\_MAX  
 Increment: 1  
 \*RST: 0

**Example:**

BB:DM:FORM USER  
 selects the User modulation type.  
 BB:DM:FLIS:FREE?  
 queries the free memory.

**Usage:**

Query only

**[[:SOURce<hw>]:BB:DM:CLIS:COPY <Filename>**

**[[:SOURce<hw>]:BB:DM:DLIS:COPY <Filename>**

The command copies the selected data list into the data list specified by <list name>. If a data list with the specified name already exists, it is overwritten. If it does not yet exist, it is created.

The source file has to be available in the default directory. The default directory is set using command `MMEM:CDIRectory`. A path can be specified, in which case the source file is copied into the file <list name> in the specified directory. The file extension may be omitted.

Only files with the file extension `*.dm_iqc` will be copied (see also [table 7-2](#)).

**Setting parameters:**

<Filename> string

**Example:**

BB:DM:DLIS 'd\_list1'  
 selects data list d\_list1.  
 BB:DM:DLIS:COPY 'd\_list2'  
 copies the content of data list d\_list1 into data list d\_list2.  
 Any existing content in data list d\_list2 is overwritten.

**Usage:**

Setting only

**[[:SOURce<hw>]:BB:DM:CLIS:TAG?**

**[[:SOURce<hw>]:BB:DM:DLIS:TAG?**

The command queries the content of the specified tag in the selected file.

**Return values:**

<Tag> <control list>,<tag name>

**Example:**

BB:DM:DLIS:TAG 'D\_list1','date'  
 queries the Date tag in control list D\_list1.  
 Response:10.10.2008  
 the data list was created on 10.10.2008.

**Usage:**

Query only

**[:SOURce<hw>]:BB:DM:CLIS:DATA <Data>**

The command sends the data to the currently selected control list. If the list already contains data, it is overwritten. This command only writes data into the data section of the file.

The values for the control signals are sent, arranged in a 8-bit value as follows:

Signal	Order	Decimal value of bits
Marker 1	LSBit	1
Marker 2		2
Marker 3		4
Marker 4		8
Burst =	LSBit	16
LevAtt1	LSBit	32
CWMod	LSBit	64
Hop	MSBit	128

The data can also be sent as a binary block, each binary block being a 2-byte value in which the 16 bits represent the binary values (16-bit unsigned integer, 2 bytes, LSByte first). When binary data transmission is in use, command `:SYSTEM:COMMunicate:GPIB:LTERminator EOI` should be used to set the termination character mode to 'EOI control data message only' so that a random LF in the data sequence is not interpreted as End, thereby prematurely terminating the data transmission. The command `...LTER STANDard` resets the mode.

For query purposes, the command `:FORMat ASCii | PACKed` can be used to switch between the formats. The byte sequence is defined in the IEC bus standard as 'most significant byte first'

**Note:** C-Lists are created in binary format. However, if you need the C-List in ASCII format, e.g. for creating a waveform file with R&S WinIQSIM2, see the example in [chapter 7.3.3, "Creating an ASCII C-List Manually"](#), on page 475.

\*RST has no effect on data lists. This command is without query.

**Setting parameters:**

<Data> string

**Example:**

```
BB:DM:CLIS:SEL 'c_list1'
```

selects the control list.

```
BB:DM:CLIS:DATA 0,0,0,0,8,8,8,0,0,0,0...
```

enters the control values in list c\_list1. In the example, only ramps for marker 4 are set.

**Usage:**

Setting only

**[:SOURce<hw>]:BB:DM:CLIS:DELeT** <Filename>

The command deletes the specified control list from the default directory. The default directory is set using command `MMEM:CDIRectory`. A path can also be specified, in which case the files in the specified directory are deleted. The file extension may be omitted. Only files with the file extension `*.dm_iqc` will be deleted.

**Setting parameters:**

<Filename>                    <list name>

**Example:**                    `BB:DM:CLIS:DEL 'c_list3'`  
deletes control list `c_list3`.

**Usage:**                      Setting only

**[:SOURce<hw>]:BB:DM:CLIS:POINtS?**

The command queries the number of lines (2 bytes) in the currently selected list.

**Return values:**

<Points>                      integer  
Range:                    0 to INT\_MAX  
Increment:                1  
\*RST:                     0

**Example:**                    `BB:DM:CLIS:SEL "c_list1"`  
selects control list `c_list1`.  
`BB:DM:CLIS:POIN?`  
queries the number of lines in the control list.  
Response: 20  
the control list consists of 20 lines.

**Usage:**                      Query only

**[:SOURce<hw>]:BB:DM:CLIS:SELeCt** <Filename>

The command selects the control list in the default directory. The default directory is set using command `MMEM:CDIRectory`. A path can also be specified, in which case the files in the specified directory are selected. If a control list with the specified name does not yet exist, it is created. The file extension may be omitted. Only files with the file extension `*.dm_iqc` will be selected or created.

**Parameters:**

<Filename>                    <list name>

**Example:**                    `BB:DM:CLIS:SEL 'c_list1'`  
selects control list `c_list1`.



**[[:SOURce<hw>]:BB:DM:DLIS:DATA <Data>**

The **Setting** command sends the bit data to the data list selected with the aid of `:BB:DM:DLIS:SElect`. Any existing content in the data list is overwritten. This command only writes data into the data section of the file.

This command sends the bit data to the selected data list, which is overwritten. The data can also be sent as block data in binary or PACKed format, each byte being interpreted as 8 data bits. In this case, command `:SYSTEM:COMMunicate:GPIB:LTERminator EOI` should be used to set the termination character mode to 'EOI control data message only' so that a random LF in the data sequence is not interpreted as End, thereby prematurely terminating the data transmission. The command `...LTER STAN` resets the mode.

The **query** reads out the data part of the data list. If the query is expanded by using the two parameters <start> and <length>, the list is read out in smaller sections. Start and Length are expressed in bits. Without the parameters the total length is always read out starting from address 1. The command `:FORMat ASCii | PACKed` can be used to select the data format. The byte sequence is defined in the IEC bus standard (read/write most significant byte first). \*RST has no effect on data lists.

**Parameters:**

<Data> integer

**Example:**

```
BB:DM:DLIS:SEL 'dlist1'
```

selects data list dlist1. If the file does not yet exist, it is created.

```
BB:DM:DLIS:DATA 1,1,1,0,0,0,1,1,0,1...
```

sends the specified data to file dlist1. Any data already present is overwritten.

**Example:**

```
BB:DM:DLIS:SEL 'dlist1'
```

selects data list dlist1.

```
FORM ASCI
```

selects ASCII data transmission format.

```
BB:DM:DLIS:DATA? 2048,1024
```

queries the data starting at bit 2048 for 1024 bits.

**[[:SOURce<hw>]:BB:DM:DLIS:DATA:APPend <Bits>**

The command appends the bit data onto the end of the existing data in the selected data list. This means that existing content in the data list is not overwritten. By this means very long data lists can be built up piecemeal. The data format is as specified in command `SOURce:BB:DM:DLIS:DATA`.

The command cannot be used with an empty data list, such as one that has just been created, for example. In this case the command `SOURce:BB:DM:DLIS:DATA` must first be used to enter modulation data in the list.

\*RST has no effect on data lists.

**Setting parameters:**

<Bits> 0 | 1 {0 | 1} | block data

**Example:** BB:DM:DLIS:SEL ' d\_list2'  
 selects data list d\_list2.  
 FORM ASC  
 selects ASCII data transmission format.  
 BB:DM:DLIS:DATA:APP 1,1,1,0,0,0,1,1,0,1...  
 adds the specified numeric data to the existing data in data list d\_list2.

**Usage:** Setting only

**[:SOURce<hw>]:BB:DM:DLIS:DELeTe <Filename>**

The command deletes the specified data list. from the default directory. The default directory is set using command `MMEM:CDIRectory`. A path can also be specified, in which case the files in the specified directory are deleted. The file extension may be omitted. Only files with the file extension `*.dm_iqd` will be deleted.

**Setting parameters:**

<Filename> string

**Example:** BB:DM:DLIS:DEL ' d\_list2'  
 deletes data list d\_list2.

**Usage:** Setting only

**[:SOURce<hw>]:BB:DM:DLIS:POINts <Points>**

The command defines the number of bits in the selected data list to be utilized. When a list is being filled with block data, this data is only ever sent in multiples of 8 bits. However the exact number of bits to be exploited can be set to a different figure. The superfluous bits in the list are then ignored.

**Parameters:**

<Points> integer  
 Range: 0 to INT\_MAX  
 Increment: 1  
 \*RST: 0

**Example:** BB:DM:DLIS:POIN 234  
 defines the number of bits in the data list to be utilized as 234 bits. If the list was filled with block data, at least the last 6 bits will be ignored.

**[:SOURce<hw>]:BB:DM:DLIS:SELeCt <Select>**

The command selects the data list in the default directory. The default directory is set using command `MMEM:CDIRectory`. A path can also be specified, in which case the files in the specified directory are selected. If a data list with the specified name does not yet exist, it is created. The file extension may be omitted. Only files with the file extension `*.dm_iqd` will be selected or created.

The modulation data in this data list is used when the data source is selected using the command `SOURce:BB:DM:SOURce DLIS`.

**Setting parameters:**

<Select>                    <list name>

**Example:**                    `BB:DM:DLIS:SEL 'd_list2'`  
selects data list `d_list2`.

**Usage:**                        Setting only

**[SOURce<hw>]:BB:DM:FLIS:DELeT** <Filename>

Deletes the specified user filter file. The default directory is set using command `MMEM:CDIRectory`. A path can also be specified, in which case the files in the specified directory are read. The file extension may be omitted. Only files with the file extension `*.vaf*.vaf` will be deleted.

**Setting parameters:**

<Filename>                    string

**Example:**                    `BB:DM:FILT:TYPE USER`  
selects the User filter type.  
`MMEM:CDIR 'D:/user/Filter_List'`  
sets the default directory for the user-defined filters.  
`BB:DM:FLIS:DEL user_filter3`  
deletes the user-defined filter.

**Usage:**                        Setting only

**[SOURce<hw>]:BB:DM:FLIS:POINts?**

Queries the user filter list length.

**Return values:**

<Points>                        integer  
Range:                    0 to INT\_MAX  
Increment:                1  
\*RST:                      0

**Example:**                    `BB:DM:FILT:TYPE USER`  
selects the User filter type.  
`BB:DM:FLIS:POIN?`  
queries the list length.

**Usage:**                        Query only

**[SOURce<hw>]:BB:DM:FLIS:SELeCt** <Filename>

The command selects the user-defined filter (`*.vaf`).

The directory applicable to the following command is defined with the command `MMEM:CDIRectory`. To access the files in this directory, only the file name is required, without the path and the file extension.

**Parameters:**

<Filename>                    string

**Example:**

```
BB:DM:FILT:TYPE USER
selects the User filter type.
MMEM:CDIR 'D:/user/Filter_List'
sets the default directory for the user-defined filters.
BB:DM:FLIS:SEL user_filter3
selects the user-defined filter.
```

**[:SOURce<hw>]:BB:DM:MLIS:DELeTe <Filename>**

Deletes the specified user mapping file. The default directory is set using command `MMEM:CDIRectory`. A path can also be specified, in which case the files in the specified directory are read. The file extension may be omitted. Only files with the file extension `*.vam` will be deleted.

**Setting parameters:**

<Filename>                    string

**Example:**

```
BB:DM:FORM USER
selects the User modulation type.
MMEM:CDIR 'D:/user/mapping_List'
sets the default directory for the user mapping lists.
BB:DM:MLIS:DEL user_mapping3
deletes the user mapping list.
```

**Usage:**                    Setting only

**[:SOURce<hw>]:BB:DM:MLIS:POINts?**

Queries the user modulation mapping list length.

**Return values:**

<Points>                    integer  
                               Range:     0 to INT\_MAX  
                               Increment: 1  
                               \*RST:     0

**Example:**

```
BB:DM:FORM USER
selects the User modulation type.
BB:DM:MLIS:POIN?
queries the list length.
```

**Usage:**                    Query only

**[[:SOURce<hw>]:BB:DM:MLIS:SElect <Filename>**

The command selects the user mapping list in the default directory. The default directory is set using command `MMEM:CDIRectory`. A path can also be specified, in which case the files in the specified directory are selected. If a user mapping list with the specified name does not yet exist, it is created. The file extension may be omitted. Only files with the file extension `*.vam` will be selected or created.

**Parameters:**

<Filename>                    string

**Example:**                    `BB:DM:MLIS:SEL 'c_list1'`  
selects the user mapping list `c_list1`.

**[[:SOURce<hw>]:BB:DM:SETTing:CATalog?**

This command reads out the files with Custom Digital Modulation settings in the default directory. The default directory is set using command `MMEM:CDIRectory`. Only files with the file extension `*.dm` will be listed.

**Return values:**

<Catalog>                    string

**Example:**                    `MMEM:CDIR 'D:/user/dig_mod'`  
sets the default directory.  
`BB:DM:SETT:CAT?`  
reads out all the files with Custom Digital Modulation settings in the default directory.  
Response: `'DM_1'`  
the file `DM_1` with Custom Digital Modulation settings is available.

**Usage:**                      Query only

**[[:SOURce<hw>]:BB:DM:SETTing:DELeTe <Filename>**

This command deletes the selected file with Custom Digital Modulation settings. The directory is set using command `MMEM:CDIRectory`. A path can also be specified, in which case the files in the specified directory are read. The file extension may be omitted. Only files with the file extension `*.dm` will be deleted.

**Setting parameters:**

<Filename>                    string

**Example:**                    `BB:DM:STAN:ULIS:DEL 'DM_1'`  
deletes file `DM_1`.

**Usage:**                      Setting only

**[[:SOURce<hw>]:BB:DM:SETTING:LOAD <Filename>**

This command loads the selected file with Custom Digital Modulation settings. The directory is set using command `MMEM:CDIRECTORY`. A path can also be specified, in which case the files in the specified directory are read. The file extension may be omitted. Only files with the file extension `*.dm` will be loaded.

**Setting parameters:**

<Filename> string

**Example:** `BB:DM:STAN:ULIS:LOAD 'DM_1'`  
loads file `DM_1`.

**Usage:** Setting only

**[[:SOURce<hw>]:BB:DM:SETTING:STORE <Filename>**

This command stores the current Custom Digital Modulation settings into the selected file. The directory is set using command `MMEM:CDIRECTORY`. A path can also be specified, in which case the files in the specified directory are read. Only the file name has to be entered. User Standards are stored as files with the specific file extensions `*.dm`.

**Setting parameters:**

<Filename> string

**Example:** `BB:DM:STAN:ULIS:STOR 'DM_QAM'`  
stores the current Custom Digital Modulation settings into file `DM_QAM`.

**Usage:** Setting only

**[[:SOURce<hw>]:BB:DM:SETTING:STORE:FAST <Fast>**

Determines whether the instrument performs an absolute or a differential storing of the settings.

Enable this function to accelerate the saving process by saving only the settings with values different to the default ones.

**Note:** This function is not affected by the "Preset" function.

**Parameters:**

<Fast> 0 | 1 | OFF | ON  
\*RST: 1

**[[:SOURce<hw>]:BB:DM:STANDARD:ULIST:CATALOG?**

This command reads out the files with Digital Standard settings in the default directory. The default directory is set using command `MMEM:CDIRECTORY`. Only files with the file extension `*.dm_stu` will be listed.

**Return values:**

<Catalog> string

**Example:** `MMEM:CDIR 'D:/user/dig_mod'`  
sets the default directory.  
`BB:DM:STAN:ULIS:CAT?`  
reads out all the files with Digital Standard settings in the default directory.  
Response: `'DM_QAM'`  
the file `DM_QAM` with Digital Standard settings is available.

**Usage:** Query only

**[:SOURce<hw>]:BB:DM:STANdard:ULIS:DELete <Filename>**

This command deletes the selected file with Digital Standard settings. The directory is set using command `MMEM:CDIRectory`. A path can also be specified, in which case the files in the specified directory are read. The file extension may be omitted. Only files with the file extension `*.dm_stu` will be deleted.

**Setting parameters:**

<Filename> string

**Example:** `BB:DM:STAN:ULIS:DEL 'DM_QAM'`  
deletes file 'DM\_QAM'.

**Usage:** Setting only

**[:SOURce<hw>]:BB:DM:STANdard:ULIS:LOAD <Filename>**

This command loads the selected file with Digital Standard settings. The directory is set using command `MMEM:CDIRectory`. A path can also be specified, in which case the files in the specified directory are read. The file extension may be omitted. Only files with the file extension `*.dm_stu` will be loaded.

**Setting parameters:**

<Filename> string

**Example:** `BB:DM:STAN:ULIS:LOAD 'DM_QAM'`  
loads file 'DM\_QAM'.

**Usage:** Setting only

**[:SOURce<hw>]:BB:DM:STANdard:ULIS:STORE <Filename>**

This command stores the current Digital Standard settings into the selected file. The directory is set using command `MMEM:CDIRectory`. A path can also be specified, in which case the files in the specified directory are read. Only the file name has to be entered. User Standards are stored as files with the specific file extensions `*.dm_stu`.

**Setting parameters:**

<Filename> string

**Example:** `BB:DM:STAN:ULIS:STOR 'DM_QAM'`  
stores the current Digital Standard settings into file 'DM\_QAM'.

**Usage:** Setting only

#### 7.15.3.4 SOURce:BB:GRAPhics Subsystem

This subsystem contains the commands used to setup the graphical display.

<code>[:SOURce&lt;hw&gt;]:BB:GRAPhics:MODE</code> .....	615
<code>[:SOURce&lt;hw&gt;]:BB:GRAPhics:SMART:STATe</code> .....	615
<code>[:SOURce&lt;hw&gt;]:BB:GRAPhics:SRATe:MODE</code> .....	615
<code>[:SOURce&lt;hw&gt;]:BB:GRAPhics:SRATe:USER</code> .....	616
<code>[:SOURce&lt;hw&gt;]:BB:GRAPhics:STATe</code> .....	616
<code>[:SOURce&lt;hw&gt;]:BB:GRAPhics:TRIGger:SOURce</code> .....	617

---

#### `[:SOURce<hw>]:BB:GRAPhics:MODE <Mode>`

Selects the graphical signal display.

**Parameters:**

<Mode> IQ | VECTor | CCDF | PSPectrum | CONSTellation | EYEI |  
EYEQ  
\*RST: IQ

**Example:** `BB:GRAP:MODE VECT`  
selects vector diagram.

---

#### `[:SOURce<hw>]:BB:GRAPhics:SMART:STATe <State>`

Activates/deactivates the "smart graphics".

**Parameters:**

<State> 0 | 1 | OFF | ON  
\*RST: 0

**Example:** `BB:GRAP:SMAR:STAT ON`  
Activates smart graphics.

---

#### `[:SOURce<hw>]:BB:GRAPhics:SRATe:MODE <Mode>`

Sets how the time resolution of the signal is determined. Maximum resolution corresponds to a display covering the entire signal bandwidth. The higher the resolution is, the shorter the length of the displayed signal segment will be for the specified recording depth.



**Parameters:**

<Mode> AUTO | FULL | USER

**AUTO**

The resolution is set to an optimum value on the basis of the signal and display type.

**FULL**

The resolution is set such that the display covers the entire signal bandwidth.

**USER**

with the command `SOUR:BB:GRAP:SRAT:USER`, the user can determine the resolution by setting the signal bandwidth for which the display is to be generated

\*RST: AUTO

**Example:**

`BB:GRAP:SRAT:MODE FULL`  
sets the sample rate mode.

**[:SOURce<hw>]:BB:GRAPhics:SRATe:USER <User>**

(Enabled for `BB:GRAPH:SRAT:MODE USER`)

Selects the signal bandwidth for which the display is to be generated. The setting range moves between the minimum and maximum bandwidth which is possible for the selected display. The selection is made graphically by moving the pointer.

**Parameters:**

<User> float  
Range: 0.1 to 100  
Increment: 0.1  
\*RST: 10  
Default unit: PCT

**Example:**

`BB:GRAP:SRAT:MODE USER`  
sets the sample rate mode.

**Example:**

`BB:GRAP:SRAT:USER 20`  
sets the sample rate factor.

**[:SOURce<hw>]:BB:GRAPhics:STATe <State>**

Activates/deactivates the selected graphical display.

**Parameters:**

<State> 0 | 1 | OFF | ON  
\*RST: 0

**Example:**

`BB:GRAP:STAT ON`  
activates the graphical graphics.

**[:SOURce<hw>]:BB:GRAPhics:TRIGger:SOURce <Source>**

Defines the trigger for the starting time of the graphic recording.

**Parameters:**

<Source>                      SOFTware | MARKer

**SOFTware**

Recording of signals is started automatically in specified intervals. This asynchronous method is appropriate when a representative display of the complete signal is desired, as recording starts in a random time reference to the signal.

**MARKer**

The starting point for recording signals is determined by "Marker 1" in the menu of the active standard.

This synchronous method is appropriate when specific signal segments are to be shown in greater detail. With periodic signals, a static image is obtained by selecting a period length of "Marker 1" that is equal to the signal period.

The displayed signal segment can be shifted as needed by entering a "Marker Delay" in the "Trigger/Marker" menu of the active standard.

\*RST:                      SOFTware

**Example:**

BB:GRAP:TRIG:SOUR MARK  
sets the trigger source.

### 7.15.3.5 SOURce:BB:IMPairment Subsystem

This subsystem contains the commands for the digital I/Q impairments.

Included in this section is also the description of command

SOURce:BB:IQOutput:SOURce that determined the source for the I/Q output connectors.

<a href="#">[:SOURce&lt;hw&gt;]:BB:IMPairment:IQRatio</a> .....	617
<a href="#">[:SOURce&lt;hw&gt;]:BB:IMPairment:LEAKage:I</a> .....	618
<a href="#">[:SOURce&lt;hw&gt;]:BB:IMPairment:LEAKage:Q</a> .....	618
<a href="#">[:SOURce&lt;hw&gt;]:BB:IMPairment:OPTimization:MODE</a> .....	618
<a href="#">[:SOURce&lt;hw&gt;]:BB:IMPairment:OPTimization:STATE</a> .....	619
<a href="#">[:SOURce&lt;hw&gt;]:BB:IMPairment:QUADrature[:ANGLE]</a> .....	619
<a href="#">[:SOURce&lt;hw&gt;]:BB:IMPairment:STATE</a> .....	619

**[:SOURce<hw>]:BB:IMPairment:IQRatio <IqRatio>**

This command sets the ratio of I modulation to Q modulation (amplification "imbalance"). The input may be either in dB or %. The resolution is 0.001 dB, an input in percent is rounded to the closest valid value in dB. A query returns the value in dB.

**Parameters:**

<IqRatio> float  
 Range: -1 to 1  
 Increment: 1E-4  
 \*RST: 0

**Example:**

BB:IMP:IQR 3 PCT  
 sets the imbalance to 3 percent.  
 BB:IMP:IQR?  
 queries the imbalance.  
 Response: 0.259000  
 the value is returned in dB  
 BB:IMP:IQR 1  
 sets the imbalance to 1 dB.

**[:SOURce<hw>]:BB:IMPairment:LEAKage:I <I>**

This command sets the carrier leakage amplitude for the I-signal component.

**Parameters:**

<I> float  
 Range: -10 to 10  
 Increment: 0.01  
 \*RST: 0  
 Default unit: PCT

**Example:**

BB:IMP:LEAK:I 3 PCT  
 sets the leakage for the I-component to 3 percent.

**[:SOURce<hw>]:BB:IMPairment:LEAKage:Q <Q>**

This command sets the carrier leakage amplitude for the Q-signal component.

**Parameters:**

<Q> float  
 Range: -10 to 10  
 Increment: 0.01  
 \*RST: 0  
 Default unit: PCT

**Example:**

BB:IMP:LEAK:Q 3 PCT  
 sets the leakage for the Q-component to 3 percent.

**[:SOURce<hw>]:BB:IMPairment:OPTimization:MODE <Mode>**

This command sets the optimization mode.

**Parameters:**

&lt;Mode&gt; FAST | QHIGH

**FAST**

Optimization is reached by compensation for I/Q skew.

**QHIGH**

Optimization is reached by compensation for I/Q skew and frequency response correction.

\*RST: FAST

**Example:**

```
BB:IMP:OPT:MODE FAST
sets the optimization mode Fast.
```

[:SOURce&lt;hw&gt;]:BB:IMPAirment:OPTimization:STATe &lt;State&gt;

This command activates and deactivates internal compensation of signal distortions by the I/Q modulator.

**Parameters:**

&lt;State&gt; 0 | 1 | OFF | ON

\*RST: OFF

**Example:**

```
BB:IMP:OPT:STAT ON
activates internal compensation of signal distortions.
```

[:SOURce&lt;hw&gt;]:BB:IMPAirment:QUADrature[:ANGLe] &lt;Angle&gt;

This command sets the quadrature offset for the digital I/Q signal.

**Parameters:**

&lt;Angle&gt; float

Range: -10 to 10

Increment: 0.01

\*RST: 0

Default unit: DEG

**Example:**

```
BB:IMP:QUAD:ANGL -5DEG
sets the quadrature offset to -5 degrees.
```

[:SOURce&lt;hw&gt;]:BB:IMPAirment:STATe &lt;State&gt;

The command activates (ON) and deactivates (OFF) the three impairment or correction values LEAKage, QUADrature and IQRatio for the digital baseband signal prior to input into the I/Q modulator.

**Parameters:**

&lt;State&gt; 0 | 1 | OFF | ON

\*RST: 0

**Example:**

```
BB:IMP:STAT OFF
deactivates digital impairment.
```

### 7.15.3.6 SOURce:BB:MCCW Subsystem

This subsystem contains the commands for setting the Multi Carrier CW signals.

#### Suffixes

##### SOURce<hw>

For one-path instruments, the keyword SOURce is optional and can be omitted.

The numeric suffix to SOURce distinguishes between signal generation for path A and path B in the case of two-path instruments:

- SOURce [ 1 ] = path A  
The keyword SOURce is optional and can be omitted
- SOURce2 = path B  
The keyword SOURce is mandatory, i.e. the command must contain the keyword with suffix 2.

##### OUTPut<ch>

The numeric suffix to OUTPut distinguishes between the available markers.

#### General Settings and Carrier Setup Settings

[SOURce<hw>]:BB:MCCW:STATe.....	620
[SOURce<hw>]:BB:MCCW:PRESet.....	621
[SOURce<hw>]:BB:MCCW:CARRier:COUNT.....	621
[SOURce<hw>]:BB:MCCW:CARRier:LIST:PHASe.....	621
[SOURce<hw>]:BB:MCCW:CARRier:LIST:POWer.....	622
[SOURce<hw>]:BB:MCCW:CARRier:LIST:STATe.....	622
[SOURce<hw>]:BB:MCCW:CARRier:PHASe.....	622
[SOURce<hw>]:BB:MCCW:CARRier:POWer.....	623
[SOURce<hw>]:BB:MCCW:CARRier:SPACing.....	623
[SOURce<hw>]:BB:MCCW:CARRier:STATe.....	624
[SOURce<hw>]:BB:MCCW:CFACTOR.....	624
[SOURce<hw>]:BB:MCCW:CFACTOR:MODE.....	624
[SOURce<hw>]:BB:MCCW:CLOCK.....	625
[SOURce<hw>]:BB:MCCW:EDIT:CARRier:EXECute.....	625
[SOURce<hw>]:BB:MCCW:EDIT:CARRier:PHASe:STEP.....	626
[SOURce<hw>]:BB:MCCW:EDIT:CARRier:PHASe[:START].....	626
[SOURce<hw>]:BB:MCCW:EDIT:CARRier:POWer:STEP.....	627
[SOURce<hw>]:BB:MCCW:EDIT:CARRier:POWer[:START].....	627
[SOURce<hw>]:BB:MCCW:EDIT:CARRier:START.....	627
[SOURce<hw>]:BB:MCCW:EDIT:CARRier:STATe.....	628
[SOURce<hw>]:BB:MCCW:EDIT:CARRier:STOP.....	628

##### [SOURce<hw>]:BB:MCCW:STATe <State>

The command turns on the Multi Carrier CW signal. Any other digital standards or digital modulation that may be in the ON state will be automatically turned OFF.

**Parameters:**

<State> 0 | 1 | OFF | ON  
 \*RST: OFF

**Example:**

BB:MCCW:STAT ON  
 switches on generation of the Multi Carrier CW signal.

**[:SOURce<hw>]:BB:MCCW:PRESet**

The command sets all multi carrier signal parameters to their default values.

**Example:**

BB:MCCW:PRESet  
 resets the Multi Carrier settings to default values.

**Usage:**

Event

**[:SOURce<hw>]:BB:MCCW:CARRier:COUNT <Count>**

The command sets the number of carriers in the Multi Carrier CW signal. The total bandwidth is calculated as (Number of carriers - 1) \* Carrier spacing and must not exceed the system bandwidth of the instrument (see data sheet).

The carrier spacing (:BB:MCCW:CARRier:SPACing) is reduced if the total bandwidth is not respected when entering the number of carriers.

The number of carriers entered therefore defines the maximum carrier spacing (:BB:MCCW:CARRier:SPACing).

**Parameters:**

<Count> integer  
 Range: 1 to 8192  
 \*RST: 64

**Example:**

BB:MCCW:CARR:COUNT 10  
 sets 10 CW carriers for the multi carrier signal.

**[:SOURce<hw>]:BB:MCCW:CARRier:LIST:PHASe <Phase>**

The command sets the start phase of the carrier with the aid of a value list. The first value in the list is assigned to the carrier with index 0, the second value to the carrier with index 1, etc. The maximum length corresponds to the maximum number of multi carriers. There is no need to enter all the values every time. Values not set by the value list are set with the default values provided they have already been explicitly set by a previous command. If this is the case, the values continue to apply until overwritten.

**Parameters:**

<Phase> string  
 Range: 0 to 360  
 Increment: 0.01  
 \*RST: 0  
 Default unit: DEG

**Example:** BB:MCCW:CARR:LIST:PHAS 90 DEG, 90 DEG, 90 DEG,  
80 DEG  
sets a start phase for carriers 0, 1, 2 and 3.  
BB:MCCW:CARR:LIST:PHAS 2, 3  
queries the phase of carrier 1, 2 and 3.  
Response: 90, 90, 80

---

**[:SOURce<hw>]:BB:MCCW:CARRier:LIST:POWER <Power>**

The command sets the power of the carrier with the aid of a value list. The first value in the list is assigned to the carrier with index 0, the second value to the carrier with index 1, etc. The maximum length corresponds to the maximum number of multi carriers. There is no need to enter all the values every time. Values not set by the value list are set with the default values provided they have already been explicitly set by a previous command. If this is the case, the values continue to apply until overwritten.

**Parameters:**

<Power> string  
Increment: 0.01 dB  
\*RST: 0 dB

**Example:** BB:MCCW:CARR:LIST:POW -65 dB, -30 dB, -50  
dB, . . .  
sets the power of carrier 0 to -65 dB, carrier 1 to -30 dB and so on.  
BB:MCCW:CARR:LIST:POW 2, 2  
queries the power of carrier 1 and 2.  
Response: -30, -50

---

**[:SOURce<hw>]:BB:MCCW:CARRier:LIST:STATe <State>**

The command switches the carrier on or off with the aid of a value list. The first value in the list is assigned to the carrier with index 0, the second value to the carrier with index 1, etc. The maximum length corresponds to the maximum number of multi carriers. There is no need to enter all the values every time. Values not set by the value list are set with the default values provided they have already been explicitly set by a previous command. If this is the case, the values continue to apply until overwritten.

**Parameters:**

<State> ON | OFF[,ON | OFF,...]  
\*RST: ON

**Example:** BB:MCCW:CARR:LIST:STAT ON, OFF, ON, . . . .  
switches carrier 0 on, carrier 1 off, etc.  
BB:MCCW:CARR:LIST:POW 2, 2  
queries the states of carrier 1 and 2.  
Response: 0, 1

---

**[:SOURce<hw>]:BB:MCCW:CARRier:PHASe <Phase>**

The command sets the start phase of the selected carrier.

The phase settings are only valid if optimization of the crest factor is disabled  
(:SOURce:BB:MCCW:CFACTOR:MODE OFF).

**Parameters:**

<Phase> float  
Sets the start phase of the selected carrier.  
Range: 0 to 359.99  
Increment: 0.01  
\*RST: 0  
Default unit: DEG

**Example:** BB:MCCW:CARR:PHAS 15,90  
sets a start phase of 90 DEG for carrier 15.

**[:SOURce<hw>]:BB:MCCW:CARRIER:POWER <Power>**

The command sets the power of the selected carrier.

**Parameters:**

<Power> float  
Sets the power of the selected carrier.  
Range: -80 to 0  
Increment: 0.01  
\*RST: 0

**Example:** BB:MCCW:CARR:POW 15, -50 dB  
sets the power of carrier 15 to -50 dB.

**[:SOURce<hw>]:BB:MCCW:CARRIER:SPACING <Spacing>**

The command sets the carrier spacing.

The carriers are generated symmetrically around the center carrier. The total bandwidth is calculated as ("Number of carriers" - 1) \* "Carrier spacing" and must not exceed the system bandwidth of the instrument (see data sheet).

The maximum carrier spacing that can be set is dependent on the chosen number of carriers

The maximum carrier spacing is automatically reduced so that the maximum total bandwidth is not exceeded on entering the number of carriers

(:BB:MCCW:CARRIER:COUNT).

**Parameters:**

<Spacing> float  
Range: 0 to 120E6  
Increment: 0.01  
\*RST: 10E3

**Example:** BB:MCCW:CARR:SPAC 10 MHz  
sets a carrier spacing of 10 MHz.



**[[:SOURce<hw>]:BB:MCCW:CARRier:STATe <State>**

The command switches the selected carrier on or off.

The counting in remote control differs from the numbers in the carrier table. Index 0 corresponds to number 1 (first line) in the table. Therefore, switching the state of the channel via remote control always switches the state of <channel index> + 1 in the table.

**Parameters:**

<State>                   0 | 1 | OFF | ON  
\*RST:                    0

**Example:**

BB:MCCW:CARR:STAT 15, ON  
switches carrier 16 on.

**[[:SOURce<hw>]:BB:MCCW:CFACTOR <CFactor>**

The command sets the desired crest factor for the multi carrier signal on selection of the command `SOUR:BB:MCCW:CFAC:MODE SLOW`.

**Parameters:**

<CFactor>               float  
Range:                 0 to 30  
Increment:            0.01  
\*RST:                 3

**Example:**

BB:MCCW:CFAC:MODE SLOW  
sets the Target Crest optimization mode.  
BB:MCCW:CFAC 10 dB  
sets the desired crest factor to 10 dB.

**[[:SOURce<hw>]:BB:MCCW:CFACTOR:MODE <Mode>**

The command sets the mode by which automatic settings will minimize the crest factor or hold it at a chosen value.

**Parameters:**

&lt;Mode&gt;

OFF | CHIRp | SLOW

**OFF**

Crest factor optimization is switched off. The carrier PHASE setting has an effect.

**CHIRp**

The crest factor is very rapidly optimized to < 3 dB for multi carrier signals so that all carriers are switched on and have the same amplitude. The computation time is independent of the number of carriers. In other carrier configurations the achievable crest factor is worse.

**SLOW**

The crest factor entered using `SOURCEBB:MCCW:CFACtor` is maintained for all carrier configurations by means of automatic settings. The computation time depends on the number of carriers and on the crest factor that has been set. Computation time increases only when the number of carriers exceeds 256 and the crest factor is above 4 dB.

\*RST: CHIRp

**Example:**

BB:MCCW:CFAC:MODE OFF

switches off automatic crest factor optimization.

The setting `SOURCEBB:MCCW:CARR:PHAS` has an effect.**[[:SOURce<hw>]:BB:MCCW:CLOCK?**

The command queries the output clock rate. The output clock rate depends on the number of carriers and the selected carrier spacing.

**Return values:**

&lt;Clock&gt;

float

Range: 0 to Max

Increment: 1E-3

\*RST: 0

**Example:**

BB:MCCW:CLOC?

queries the output clock rate.

Response: 256 000 000

the output clock rate is 256 MHz.

**Usage:**

Query only

**[[:SOURce<hw>]:BB:MCCW:EDIT:CARRIER:EXECute**

The command adopts the settings for the carrier range which has been defined using the `:BB:MCCW:EDIT:CARR:...` commands.

**Example:**

```
BB:MCCW:EDIT:CARR:STAR 4
the carrier range starts at carrier 4.
BB:MCCW:EDIT:CARR:STOP 400
the carrier range stops at carrier 400.
BB:MCCW:EDIT:CARR:STAT ON
sets all the carriers in the carrier range to ON.
BB:MCCW:EDIT:CARR:EXEC
adopts the settings for all the carriers in the carrier range.
BB:MCCW:STAT
starts generation of the multi carrier signal. Carriers 4 to 400 are
in the ON state.
```

**Usage:** Event

---

**[:SOURce<hw>]:BB:MCCW:EDIT:CARRier:PHASe:STEP <Step>**

The command sets the step width by which the start phases of the carriers in the defined carrier range will be incremented.

The phase settings are only valid if optimization of the crest factor is disabled  
(:SOURce:BB:MCCW:CFACTOR:MODE OFF).

**Parameters:**

<Step> float  
 Range: -359.99 to 359.99  
 Increment: 0.01  
 \*RST: 0

**Example:**

```
BB:MCCW:EDIT:CARR:PHAS 90 DEG
sets a start phase of 90° for the carriers in the carrier range.
BB:MCCW:EDIT:CARR:PHAS:STEP 1 DEG
the start phase is incremented by 1° for each carrier, i.e. the first
carrier has a start phase of 90°, the second a start phase of 91°,
etc.
```

---

**[:SOURce<hw>]:BB:MCCW:EDIT:CARRier:PHASe[:START] <Start>**

The command sets the start phase for the individual carriers in the defined carrier range. If the command :BB:MCCW:EDIT:CARR:PHAS:STEP is used to define a step width, the phase entered here applies only to the starting carrier. The phases of the remaining carriers are stepped up or down by the phase value specified in the :BB:MCCW:EDIT:CARR:PHAS:STEP command.

The phase settings are only valid if optimization of the crest factor is disabled  
(SOURce:BB:MCCW:CFACTOR:MODE OFF).

**Parameters:**

<Start> float  
 Range: 0 to 359.99  
 Increment: 0.01  
 \*RST: 0

**Example:** `BB:MCCW:EDIT:CARR:PHAS 90 DEG`  
sets a start phase of 90° for the carriers in the carrier range.

---

**[:SOURce<hw>]:BB:MCCW:EDIT:CARRIER:POWER:STEP <Step>**

The command sets the step width by which the starting power of the carriers in the defined carrier range will be incremented.

**Parameters:**

<Step> float  
Range: -80 to 80  
Increment: 0.01  
\*RST: 0

**Example:** `BB:MCCW:EDIT:CARR:POW -80dB`  
sets a power of -80 dB for the carriers in the carrier range.  
`BB:MCCW:EDIT:CARR:POW:STEP 1 dB`  
the power phase is incremented by dB for each carrier, i.e. the first carrier has -80 dB, the second -79 dB, etc.

---

**[:SOURce<hw>]:BB:MCCW:EDIT:CARRIER:POWER[:START] <Start>**

The command sets the power for the individual carriers in the defined carrier range. If the command `:BB:MCCW:EDIT:CARR:POW:STEP` is used to define a step width, the power entered here applies only to the starting carrier. The power of the remaining carriers is stepped up or down by the power specified in the `:BB:MCCW:EDIT:CARR:POW:STEP` command.

**Parameters:**

<Start> float  
Range: -80 to 0  
Increment: 0.01  
\*RST: 0

**Example:** `BB:MCCW:EDIT:CARR:POW -50 dB`  
sets the power of the carrier to -50 dB.

---

**[:SOURce<hw>]:BB:MCCW:EDIT:CARRIER:START <Start>**

The command selects the first carrier in the carrier range to which the settings with the `:BB:MCCW:EDIT:CARR:...` commands shall apply.

**Parameters:**

<Start> integer  
Range: 0 to 8191  
Increment: 1  
\*RST: 0

**Example:** `BB:MCCW:EDIT:CARR:STAR 4`  
the carrier range starts at carrier 4.

**[:SOURce<hw>]:BB:MCCW:EDIT:CARRIER:STATE <State>**

The command switches all the carriers in the selected carrier range on or off.

**Parameters:**

<State>                    0 | 1 | OFF | ON  
 \*RST:                    1

**Example:**

BB:MCCW:EDIT:CARR:STAT ON  
 sets all the carriers in the carrier range to ON.

**[:SOURce<hw>]:BB:MCCW:EDIT:CARRIER:STOP <Stop>**

The command selects the last carrier in the carrier range to which the settings with the :BB:MCCW:EDIT:CARR:... commands shall apply.

**Parameters:**

<Stop>                    integer  
 Range:                    0 to 8191  
 Increment:                1  
 \*RST:                    0

**Example:**

BB:MCCW:EDIT:CARR:STOP 40  
 the carrier range stops at carrier 40.

**Trigger Settings**

The trigger settings are available for R&S SMx and R&S AMU instruments only.

**EXTernal<ch>**

The numeric suffix to EXTernal<ch> distinguishes between the external trigger via the TRIGGER 1 (suffix 1) and TRIGGER 2 (suffix 2) connector.

<a href="#">[:SOURce&lt;hw&gt;]:BB:MCCW:TRIGger:ARM:EXECute</a> .....	629
<a href="#">[:SOURce&lt;hw&gt;]:BB:MCCW:TRIGger:EXECute</a> .....	629
<a href="#">[:SOURce&lt;hw&gt;]:BB:MCCW:TRIGger:EXTernal:SYNChronize:OUTPut</a> .....	629
<a href="#">[:SOURce&lt;hw&gt;]:BB:MCCW:TRIGger:OBASeband:DELay</a> .....	630
<a href="#">[:SOURce&lt;hw&gt;]:BB:MCCW:TRIGger:OBASeband:INHibit</a> .....	630
<a href="#">[:SOURce&lt;hw&gt;]:BB:MCCW:TRIGger:RMODE</a> .....	631
<a href="#">[:SOURce&lt;hw&gt;]:BB:MCCW:TRIGger:SLENgth</a> .....	631
<a href="#">[:SOURce&lt;hw&gt;]:BB:MCCW:TRIGger:SOURce</a> .....	632
<a href="#">[:SOURce&lt;hw&gt;]:BB:MCCW:TRIGger[:EXTernal&lt;ch&gt;]:DELay</a> .....	632
<a href="#">[:SOURce&lt;hw&gt;]:BB:MCCW:TRIGger[:EXTernal&lt;ch&gt;]:INHibit</a> .....	632
<a href="#">[:SOURce&lt;hw&gt;]:BB:MCCW[:TRIGger]:SEQuence</a> .....	633

**[:SOURce<hw>]:BB:MCCW:TRIGger:ARM:EXECute**

The command stops signal generation for trigger modes Armed\_Auto and Armed\_Retrigger. A subsequent internal or external trigger event restart signal generation.

**Example:**

```
BB:MCCW:TRIG:SOUR INT
sets internal triggering.
BB:MCCW:TRIG:SEQ ARET
sets Armed_Retrigger mode, i.e. every trigger event causes signal
generation to restart.
BB:MCCW:TRIG:EXEC
executes a trigger, signal generation is started.
BB:MCCW:TRIG:ARM:EXEC
signal generation is stopped.
BB:MCCW:TRIG:EXEC
executes a trigger, signal generation is started again.
```

**Usage:** Event

**[:SOURce<hw>]:BB:MCCW:TRIGger:EXECute**

The command executes a trigger. The internal trigger source must be selected using the command `MCCW:TRIGger:SOURce INTernal` and a trigger mode other than `AUTO` must be selected using the command `:BB:MCCW:TRIGger:MODE`.

**Example:**

```
BB:MCCW:TRIG:SOUR INT
sets internal triggering.
BB:MCCW:TRIG:SEQ RETR
sets Retrigger mode, i.e. every trigger event causes signal gen-
eration to restart.
BB:MCCW:TRIG:EXEC
executes a trigger.
```

**Usage:** Event

**[:SOURce<hw>]:BB:MCCW:TRIGger:EXTernal:SYNChronize:OUTPut <Output>**

(enabled for Trigger Source External)

Enables/disables output of the signal synchronous to the external trigger event.

**Parameters:**

&lt;Output&gt;

0 | 1 | OFF | ON

**ON**

The signal calculation starts simultaneously with the external trigger event but because of the instrument's processing time the first samples are cut off and no signal is outputted. After elapsing of the internal processing time, the output signal is synchronous to the trigger event.

**OFF**

The signal output begins after elapsing of the processing time and starts with sample 0, i.e. the complete signal is outputted. This mode is recommended for triggering of short signal sequences with signal duration comparable with the processing time of the instrument.

\*RST: 1

**Example:**

BB:MCCW:TRIG:SOUR EXT

sets external triggering.

BB:MCCW:TRIG:EXT:SYNC:OUTP ON

enables synchronous output to external trigger.

**[[:SOURce<hw>]:BB:MCCW:TRIGger:OBASeband:DELay <Delay>**

The command specifies the trigger delay (expressed as a number of samples) for external triggering.

**Parameters:**

&lt;Delay&gt;

float

Range: 0 to 65535

Increment: 0.01

\*RST: 0

**Example:**

BB:MCCW:TRIG:SOUR EXT

selects an external trigger via the TRIGGER 1 connector.

BB:MCCW:TRIG:DEL 200

sets a delay of 200 samples for the trigger.

**[[:SOURce<hw>]:BB:MCCW:TRIGger:OBASeband:INHibit <Inhibit>**

The command specifies the number of samples by which a restart is to be inhibited following a trigger event. This command applies only in the case of external triggering.

**Parameters:**

&lt;Inhibit&gt;

integer

Range: 0 to 67108863

Increment: 1

\*RST: 0

**Example:** `BB:MCCW:TRIG:SOUR EXT`  
 selects an external trigger via the TRIGGER 1 connector.  
`BB:MCCW:TRIG:INH 200`  
 sets a restart inhibit for 200 samples following a trigger event.

---

#### **[:SOURce<hw>]:BB:MCCW:TRIGger:RMODE?**

The command queries the current status of signal generation for all trigger modes with Multi Carrier CW on.

#### **Return values:**

<RMode>                    STOP | RUN

**RUN**  
 The signal is generated. A trigger event occurred in the triggered mode.

**STOP**  
 The signal is not generated. A trigger event did not occur in the triggered modes, or signal generation was stopped by the command `BB:MCCW:TRIG:ARM:EXECute` (armed trigger modes only).

**Example:** `SOURBB:MCCW:TRIG:SOUR EXT`  
 sets external triggering via the TRIGGER 1 connector.  
`SOURBB:MCCW:TRIG:MODE ARET`  
 selects the Armed\_Retrigger mode  
`SOURBB:MCCW:TRIG:RMODE?`  
 queries the current status of signal generation.  
 Response: RUN  
 the signal is generated, an external trigger was executed.

**Usage:**                    Query only

---

#### **[:SOURce<hw>]:BB:MCCW:TRIGger:SLENgth <SLength>**

The command defines the length of the signal sequence to be output in the "Single" trigger mode. The input is to be expressed in samples. It is then possible to output deliberately just part of the waveform, an exact sequence of the waveform, or a defined number of repetitions of the waveform.

#### **Parameters:**

<SLength>                    integer

Range:                    1 to 1000

Increment:                1

\*RST:                      1

**Example:** `SOURBB:MCCW:SEQ SING`  
 sets trigger mode Single.  
`SOURBB:MCCW:TRIG:SLEN 200`  
 sets a sequence length of 200 samples. The first 200 samples of the current waveform will be output after the next trigger event.



---

```
[ :SOURce<hw>]:BB:MCCW:TRIGger:SOURce <Source>
```

The command selects the trigger source.

**Parameters:**

<Source>                    INTernal | EXTernal | BEXTernal | OBASeband

**INTernal**

Triggering is executed by means of the Trigger command `BB:MCCW:TRIG:EXECute` in the case of remote control, and by means of "Execute Trigger" in the case of manual operation.

**EXTernal**

Triggering is executed by means of the signal on the TRIGGER 1 connector.

\*RST:            INT

**Example:**

```
BB:MCCW:TRIG:SOUR INT
sets internal triggering.
```

---

```
[ :SOURce<hw>]:BB:MCCW:TRIGger[:EXTernal<ch>]:DELay <Delay>
```

The command specifies the trigger delay (expressed as a number of samples) for external triggering.

**Parameters:**

<Delay>                    float  
 Range:            0 to 65535  
 Increment:       0.01  
 \*RST:            0

**Example:**

```
BB:MCCW:TRIG:SOUR EXT
selects an external trigger via the TRIGGER 1 connector
BB:MCCW:TRIG:DEL 200
sets a delay of 200 samples for the trigger.
```

---

```
[ :SOURce<hw>]:BB:MCCW:TRIGger[:EXTernal<ch>]:INHibit <Inhibit>
```

The command specifies the number of samples by which a restart is to be inhibited following a trigger event. This command applies only in the case of external triggering.

**Parameters:**

<Inhibit>                   integer  
 Range:            0 to 67108863  
 Increment:       1  
 \*RST:            0

**Example:**

```
BB:MCCW:TRIG:SOUR EXT
selects an external trigger via the TRIGGER 1 connector.
BB:MCCW:TRIG:INH 200
sets a restart inhibit for 200 samples following a trigger event.
```

**[[:SOURce<hw>]:BB:MCCW[:TRIGger]:SEQuence <Sequence>**

The command selects the trigger mode.

**Parameters:**

<Sequence>

AUTO | RETRigger | AAUTo | ARETrigger | SINGle

**AUTO**

The multi carrier signal is generated continuously.

**RETRigger**

The multi carrier signal is generated continuously. A trigger event (internal or external) causes a restart.

**AAUTo**

The multi carrier signal is generated only when a trigger event occurs. After the trigger event the signal is generated continuously. Signal generation is stopped with command `SOURBB:MCCW:TRIG:ARM:EXEC` and started again when a trigger event occurs.

**ARETrigger**

The multi carrier signal is generated only when a trigger event occurs. The device automatically toggles to RETRIG mode. Every subsequent trigger event causes a restart. Signal generation is stopped with command `SOURBB:MCCW:TRIG:ARM:EXEC` and started again when a trigger event occurs.

**SINGle**

The multi carrier signal is output only when a trigger event occurs. After the trigger event the signal is output once to the set sequence length (`SOURBB:MCCW:TRIG:SLen`). Every subsequent trigger event causes a restart.

\*RST: RETRigger

**Example:**

`BB:MCCW:SEQ AAUT`

sets the "Armed\_auto" trigger mode; the device waits for the first trigger (e.g. with \*TRG) and then generates the signal continuously.

**Marker Settings**

This section lists the remote control commands, necessary to configure the markers.



The marker delay settings are available for R&S SMx and R&S AMU instruments only.

<code>[[:SOURce&lt;hw&gt;]:BB:MCCW:TRIGger:OUTPut:DELay:FIXed</code> .....	634
<code>[[:SOURce&lt;hw&gt;]:BB:MCCW:TRIGger:OUTPut&lt;ch&gt;:DELay</code> .....	634
<code>[[:SOURce&lt;hw&gt;]:BB:MCCW:TRIGger:OUTPut&lt;ch&gt;:DELay:MAXimum</code> .....	634
<code>[[:SOURce&lt;hw&gt;]:BB:MCCW:TRIGger:OUTPut&lt;ch&gt;:DELay:MINimum</code> .....	635
<code>[[:SOURce&lt;hw&gt;]:BB:MCCW:TRIGger:OUTPut&lt;ch&gt;:MODE</code> .....	635
<code>[[:SOURce&lt;hw&gt;]:BB:MCCW:TRIGger:OUTPut&lt;ch&gt;:OFFTime</code> .....	636

<code>[:SOURce&lt;hw&gt;]:BB:MCCW:TRIGger:OUTPut&lt;ch&gt;:ONTime</code> .....	636
<code>[:SOURce&lt;hw&gt;]:BB:MCCW:TRIGger:OUTPut&lt;ch&gt;:PATTern</code> .....	636
<code>[:SOURce&lt;hw&gt;]:BB:MCCW:TRIGger:OUTPut&lt;ch&gt;:PULSe:DIVider</code> .....	637
<code>[:SOURce&lt;hw&gt;]:BB:MCCW:TRIGger:OUTPut&lt;ch&gt;:PULSe:FREQUency</code> .....	637

---

#### **`[:SOURce<hw>]:BB:MCCW:TRIGger:OUTPut:DELay:FIXed <Fixed>`**

The command restricts the marker delay setting range to the dynamic range. In this range the delay can be set without restarting the marker and signal. If a delay is entered in setting ON but is outside this range, the maximum possible delay is set and an error message is generated.

The numeric suffix in OUTPut has no significance for this command, since the setting always affects every marker.

##### **Parameters:**

<Fixed>                    0 | 1 | OFF | ON  
 \*RST:                    0

##### **Example:**

`BB:MCCW:TRIG:OUTP:DEL:FIX ON`  
 restricts the marker signal delay setting range to the dynamic range.

---

#### **`[:SOURce<hw>]:BB:MCCW:TRIGger:OUTPut<ch>:DELay <Delay>`**

The command defines the delay between the signal on the marker outputs and the start of the signals, expressed in terms of samples. Command `:BB:MCCW:TRIGger:OUTPut:DELay:FIXed ON` can be used to restrict the range of values to the dynamic range, i.e. the range within which a delay of the marker signals can be set without restarting the marker and signal.

##### **Parameters:**

<Delay>                    float  
 Range:                    0 to  $2^{20}-1$  symbols  
 Increment:                1E-3  
 \*RST:                    0 symbols

##### **Example:**

`BB:MCCW:TRIG:OUTP2:DEL 16`  
 sets a delay of 16 samples for the signal on connector MARKER 2.

---

#### **`[:SOURce<hw>]:BB:MCCW:TRIGger:OUTPut<ch>:DELay:MAXimum?`**

The command queries the maximum marker delay for setting `:BB:MCCW:TRIGger:OUTPut:DELay:FIXed ON`.

##### **Return values:**

<Maximum>                float  
 Range:                    0 to 16777215  
 Increment:                1E-3

**Example:** `BB:MCCW:TRIG:OUTP:DEL:FIX ON`  
 restricts the marker signal delay setting range to the dynamic range.  
`BB:MCCW:TRIG:OUTP:DEL:MAX`  
 queries the maximum of the dynamic range.  
 Response: 2000  
 the maximum for the marker delay setting is 2000 samples.

**Usage:** Query only

**[:SOURce<hw>]:BB:MCCW:TRIGger:OUTPut<ch>:DELay:MINimum?**

The command queries the minimum marker delay for setting `:BB:MCCW:TRIGger:OUTPut: DELay:FIXed ON`.

**Return values:**

<Minimum> float  
 Range: 0 to 16777215  
 Increment: 1E-3  
 \*RST: 0

**Example:** `BB:MCCW:TRIG:OUTP:DEL:FIX ON`  
 restricts the marker signal delay setting range to the dynamic range.  
`BB:MCCW:TRIG:OUTP:DEL:MIN`  
 queries the minimum of the dynamic range.  
 Response: 0  
 the minimum for the marker delay setting is 0 samples.

**Usage:** Query only

**[:SOURce<hw>]:BB:MCCW:TRIGger:OUTPut<ch>:MODE <Mode>**

The command defines the signal for the selected marker output.

**Parameters:**

&lt;Mode&gt;

REStart | PULSe | PATTern | RATio

**REStart**

A brief marker signal is generated at the start of the waveform.

**PULSe**

A pulsed marker signal is generated. The pulse frequency (= sample rate/divider) is defined with the

SOUR:BB:MCCW:TRIG:OUTP:PULSe:DIVider command and can be queried with the

SOUR:BB:MCCW:TRIG:OUTP:PULSe:FREQuency? command.

**PATTern**

A marker signal is generated with the aid of a user-definable bit pattern. The bit pattern is entered with the aid of command

SOURce:BB:MCCW:TRIGger:OUTPut:PATTern. The bit pattern is a maximum of 32 bits long.

**RATio**

A regular marker signal corresponding to the Time Off / Time On specifications in the commands

SOURce:BB:MCCW:TRIGger:OUTPut:OFFT and

SOURce:BB:MCCW:TRIGger:OUTPut:ONT is generated.

\*RST: REStart

**Example:**

BB:MCCW:TRIG:OUTP2:MODE PULS

selects the pulsed marker signal on output MARKER 2.

[:SOURce&lt;hw&gt;]:BB:MCCW:TRIGger:OUTPut&lt;ch&gt;:OFFTime &lt;OffTime&gt;

[:SOURce&lt;hw&gt;]:BB:MCCW:TRIGger:OUTPut&lt;ch&gt;:ONTime &lt;OnTime&gt;

The command sets the number of samples in a period (ON time + OFF time) during which the marker signal in setting SOURce:BB:MCCW:TRIGger:OUTPut:MODE RATio on the marker outputs is ON.

**Parameters:**

&lt;OnTime&gt;

integer

Range: 1 to 16777215

Increment: 1

\*RST: 1

**Example:**

BB:MCCW:TRIG:OUTP2:ONT 20

sets an ON time of 20 samples for marker 2.

[:SOURce&lt;hw&gt;]:BB:MCCW:TRIGger:OUTPut&lt;ch&gt;:PATTern &lt;Pattern&gt;

The command defines the bit pattern used to generate the marker signal in the setting SOURce:BB:MCCW:TRIGger:OUTPut:MODE PATTern 0 is marker off, 1 is marker on.

**Parameters:**

&lt;Pattern&gt;

&lt;32 bit pattern&gt;

\*RST: 0

**Example:** `BB:MCCW:TRIG:OUTP2:PATT #HE0F52,20`  
sets a bit pattern.  
`BB:MCCW:TRIG:OUTP2:MODE PATT`  
activates the marker signal according to a bit pattern on output  
MARKER 2.

---

**[:SOURce<hw>]:BB:MCCW:TRIGger:OUTPut<ch>:PULSe:DIVider <Divider>**

The command sets the divider for Pulse marker mode  
(`SOUR:BB:MCCW:TRIG:OUTP:MODE PULSe`). The resulting pulse frequency is derived  
by dividing the symbol rate by the divider.

**Parameters:**

<Divider> integer  
Range: 2 to 1024  
Increment: 1  
\*RST: 2

**Example:** `BB:MCCW:TRIG:OUTP2:PULS:DIV 2`  
sets the divider for the marker signal on output MARKER 2 to the  
value 2.  
`BB:MCCW:TRIG:OUTP2:FREQ?`  
queries the resulting pulse frequency of the marker signal  
Response: 66 000  
the resulting pulse frequency is 66 kHz.

---

**[:SOURce<hw>]:BB:MCCW:TRIGger:OUTPut<ch>:PULSe:FREQuency?**

The command queries the pulse frequency of the pulsed marker signal in the setting  
`SOUR:BB:MCCW:TRIG:OUTP:MODE PULS`. The pulse frequency is derived by dividing  
the symbol rate by the divider. The divider is defined with command  
`SOUR:BB:MCCW:TRIG:OUTP:PULS:DIV`.

**Return values:**

<Frequency> float  
Increment: 1E-3

**Example:** `BB:MCCW:TRIG:OUTP2:PULS:DIV 4`  
sets the divider for the marker signal on output MARKER 2 to the  
value 4.  
`BB:MCCW:TRIG:OUTP2:MODE PULS`  
enables the pulsed marker signal  
`BB:MCCW:TRIG:OUTP2:PULS:FREQ?`  
queries the pulse frequency for the marker signal.  
Response: "33 000"  
the resulting pulse frequency is 33 kHz.

**Usage:** Query only

## Clock Settings

This section lists the remote control commands, necessary to configure the clock.



The clock settings are available for R&S SMx and R&S AMU instruments only.

<code>[[:SOURce&lt;hw&gt;]:BB:MCCW:CLOCK:MODE</code> .....	638
<code>[[:SOURce&lt;hw&gt;]:BB:MCCW:CLOCK:MULTIPLIER</code> .....	638
<code>[[:SOURce&lt;hw&gt;]:BB:MCCW:CLOCK:SOURce</code> .....	638

### `[[:SOURce<hw>]:BB:MCCW:CLOCK:MODE <Mode>`

The command enters the type of externally supplied clock (`:BB:MCCW:CLOCK:SOURce EXTERNAL`). When `MSAMPLE` is used, a multiple of the sample clock is supplied via the `CLOCK` connector and the sample clock is derived internally from this. The multiplier is entered with the command `BB:MCCW:CLOCK:MULTIPLIER`.

#### Parameters:

<Mode>                   SAMPLE | MSAMPLE  
\*RST:                   SAMPLE

#### Example:

```
BB:MCCW:CLOCK:MODE SAMP
selects clock type "Sample", i.e. the supplied clock is a sample
clock.
```

### `[[:SOURce<hw>]:BB:MCCW:CLOCK:MULTIPLIER <Multiplier>`

The command specifies the multiplier for clock type "Multiple Samples" (`:BB:MCCW:CLOCK:MODE MSAM`) in the case of an external clock source.

#### Parameters:

<Multiplier>           integer  
Range:                1 to 64  
Increment:            1  
\*RST:                 4

#### Example:

```
BB:MCCW:CLOCK:SOUR EXT
selects the external clock source. The clock is supplied via the
CLOCK connector.
BB:MCCW:CLOCK:MODE MSAM
selects clock type "Multiple Samples", i.e. the supplied clock has
a rate which is a multiple of the sample rate.
BB:MCCW:CLOCK:MULT 12
the multiplier for the external clock rate is 12.
```

### `[[:SOURce<hw>]:BB:MCCW:CLOCK:SOURce <Source>`

The command selects the source for the digital modulation clock.

**Parameters:**

<Source> INTernal | EXTernal | AINTernal

**INTernal**

The internal clock reference is used.

**EXTernal**

The external clock reference is supplied to the CLOCK connector.

\*RST: INTernal

**Example:**

BB:MCCW:CLOC:SOUR EXT

selects an external clock reference. The clock is supplied via the CLOCK connector.

### 7.15.3.7 SOURce:BB:MEASurement Subsystem

This subsystem contains the commands for measuring the level values of the digital baseband signal.



Monitoring the measurement of the digital I/Q baseband signal requires the baseboard version "DacBoard 1141.8190.02" or higher. Up to baseboard version DacBoard 1141.8090.xx only the calculated signal levels are provided.

The currently equipped DacBoard is listed in the dialog "Setup > System > Hardware Config, section Baseband Assembly" (see [chapter 5.2.3.2, "Hardware Config"](#), on page 121).

#### [SOURce<hw>]:BB:MEASurement:CFACtor?

This command indicates the crest factor of the baseband signal during measurement.

**Return values:**

<CFactor> float  
 Range: 0 to 100  
 Increment: 0.01  
 \*RST: 0  
 Default unit: dB

**Example:**

BB:MEAS:CFAC

Queries the measured crest factor of the baseband signal.

**Usage:**

Query only

#### [SOURce<hw>]:BB:MEASurement:DURation <Duration>

This command sets the time for the measurement of the digital I/Q baseband signal in the range of 1 s ... 3 h. The time is to be entered in format "hh:mm:ss".



**Parameters:**

<Duration> string  
 Range: 1s to 3h  
 \*RST: 1s  
 Default unit: hh:mm:ss

**Example:**

BB:MEAS:DUR "00:15:30"  
 sets the measurement duration to 15 minutes and 30 seconds.

**[[:SOURce<hw>]:BB:MEASurement:POWER:PEAK?**

This command indicates the peak level of the baseband signal relative to full scale of 0.5 V (in terms of dB full scale) during measurement.

**Return values:**

<Peak> float  
 Range: -10 to 10  
 Increment: 0.01  
 \*RST: 0  
 Default unit: dBfs

**Example:**

BB:MEAS:POW:PEAK  
 Queries the peak level of the baseband signal.

**Usage:**

Query only

**[[:SOURce<hw>]:BB:MEASurement:POWER:RMS?**

This command indicates the rms level of the baseband signal relative to full scale of 0.5 V (in terms of dB full scale) during measurement.

**Return values:**

<Rms> float  
 Range: -100 to 10  
 Increment: 0.01  
 \*RST: 0  
 Default unit: dBfs

**Example:**

BB:MEAS:POW:RMS  
 Queries the rms level of the baseband signal.

**Usage:**

Query only

**[[:SOURce<hw>]:BB:MEASurement:RTIME?**

This command indicates the remaining time until the measurement of the digital I/Q baseband signal is completed. The time is displayed in format "hh:mm:ss".

**Return values:**

<RTIME> string

**Example:** `BB:MEAS:RTIM`  
Queries the remaining measurement duration.

**Usage:** Query only

#### **[:SOURce<hw>]:BB:MEASurement:SOURce <Source>**

This command selects the signal source for the measurement. The signal level and crest factor can be retrieved either from the interference-free digital I/Q baseband signal or the signal superimposed by the noise generator AWGN.

#### **Parameters:**

<Source> BB | BAWGn

**BB**  
(Baseband Signal without AWGN)  
Selects the measurement of the interference-free baseband signal.

**BAWGn**  
(Baseband with AWGN)  
Selects the measurement of the baseband signal after an AWGN noise signal is added.

\*RST: BB

**Example:** `BB:MEAS:SOURC BAWG`  
selects the measurement of the digital baseband signal interfered with a noise signal.

#### **[:SOURce<hw>]:BB:MEASurement[:STATe] <State>**

Activates/deactivates the measurement of the digital I/Q baseband signal. When activated, information on the peak level, rms level and crest factor are indicated. Additionally the duration of the measurement can be set.

#### **Parameters:**

<State> 0 | 1 | OFF | ON

\*RST: OFF

**Example:** `BB:MEAS:STAT ON`  
starts measuring the real level values of the digital I/Q baseband signal.

### 7.15.3.8 SOURce:BB:POWer Subsystem

This subsystem contains the commands for retrieving the level values of the digital baseband signal.

#### **[:SOURce<hw>]:BB:CFACTOR?**

This command queries the crest factor of the baseband signal.

**Return values:**

<CFactor> float  
 Range: 0 to 100  
 Increment: 0.01  
 \*RST: 0  
 Default unit: dB

**Example:**

BB:CFAC  
 queries the crest factor of the baseband signal.

**Usage:**

Query only

**[[:SOURce<hw>]:BB:POWER:PEAK?**

This command queries the peak level of the baseband signal relative to full scale of 0.5 V (in terms of dB full scale).

**Return values:**

<Peak> float  
 Range: -145 to 30  
 Increment: 0.01  
 \*RST: 0  
 Default unit: dBfs

**Example:**

BB:POW:PEAK  
 queries the peak level of the baseband signal.

**Usage:**

Query only

**[[:SOURce<hw>]:BB:POWER:RMS?**

This command queries the rms level of the baseband signal relative to full scale of 0.5V (in terms of dB full scale).

**Return values:**

<Rms> float  
 Range: -145 to 30  
 Increment: 0.01  
 \*RST: 0  
 Default unit: dBfs

**Example:**

BB:POW:RMS  
 queries the rms level of the baseband signal.

**Usage:**

Query only

### 7.15.4 SOURce:CORRection Subsystem

The output level is corrected in the CORRection subsystem. Correction is performed by user-defined table values being added to the output level for the respective RF frequency.

In the R&S SMJ, this subsystem is used to select, transfer and activate user correction tables.

Each list is stored as a file. The name of the user correction file can be freely selected. The file extension \*.uco is assigned automatically and cannot be changed.

The files can be stored in a freely selectable directory and opened from there. The default directory is set using command :MMEMory:CDIRectory on page 509. In the case of files which are stored in the default directory, only the file name has to be specified in commands. Otherwise, the complete absolute path has to be specified with every command. The extension can be omitted in any case.



In the following command examples, the files are stored in the default directory.

The amplitude can also be linearized automatically by means of a R&S NRP power sensor connected to the generator output signal. With the aid of the command [:SOURce<hw>]:CORRection:CSET:DATA[:SENSor<ch>][:POWer]:SONCe, a list with correction values for external test assemblies can be automatically determined, e.g. for compensating the frequency response of cables. The correction values can be acquired any time irrespective of the modulation settings of the generator.

Multi level measurements allow to take into account the changing VSWR for the different attenuator settings (see [:SOURce<hw>]:CORRection:CSET:DATA:POWer:MLEVel<ch> on page 645).

[:SOURce]:CORRection:CSET:CATalog.....	644
[:SOURce<hw>]:CORRection:CSET:DATA:FREQUency.....	644
[:SOURce<hw>]:CORRection:CSET:DATA:FREQUency:POINts.....	644
[:SOURce<hw>]:CORRection:CSET:DATA:POWer.....	645
[:SOURce<hw>]:CORRection:CSET:DATA:POWer:POINts.....	645
[:SOURce<hw>]:CORRection:CSET:DATA:POWer:MLEVel<ch>.....	645
[:SOURce<hw>]:CORRection:CSET:DATA:POWer:MLEVel:STATe.....	646
[:SOURce<hw>]:CORRection:CSET:DATA[:SENSor<ch>][:POWer]:SONCe.....	646
[:SOURce]:CORRection:CSET:DELete.....	647
[:SOURce<hw>]:CORRection:DEXChange:AFILe:CATalog.....	647
[:SOURce<hw>]:CORRection:DEXChange:AFILe:EXTension.....	647
[:SOURce<hw>]:CORRection:DEXChange:AFILe:SElect.....	648
[:SOURce<hw>]:CORRection:DEXChange:AFILe:SEParator:COLumn.....	648
[:SOURce<hw>]:CORRection:DEXChange:AFILe:SEParator:DECimal.....	649
[:SOURce<hw>]:CORRection:DEXChange:EXECute.....	649
[:SOURce<hw>]:CORRection:DEXChange:MODE.....	650
[:SOURce<hw>]:CORRection:DEXChange:SElect.....	650
[:SOURce<hw>]:CORRection:CSET[:SElect].....	651
[:SOURce<hw>]:CORRection:MLEVel:STATe.....	651
[:SOURce<hw>]:CORRection[:STATe].....	651
[:SOURce<hw>]:CORRection:VALue.....	652

**[[:SOURce]:CORRection:CSET:CATalog?**

The command requests a list of user correction tables. The individual lists are separated by commas.

The lists are stored with the fixed file extensions \*.ucor in a directory of the user's choice. The directory applicable to the commands is defined with the command  
MMEMoRY:CDIR.

**Return values:**

<Catalog>                    string

**Example:**

```
MMEM:CDIR 'D:/Lists/ucor'
selects the directory for the user correction files.
CORR:CSET:CAT?
queries which correction tables are available.
Response:UCOR1,UCOR2,UCOR3
the correction tables UCOR1, UCOR2 and UCOR3 are available.
```

**Usage:**                    Query only

**[[:SOURce<hw>]:CORRection:CSET:DATA:FREQuency <Frequency>**

The command transfers the frequency data to the table selected with :CORRection:CSET:SElect.

The numerical suffix at SOURce must not be used for this command.

**Parameters:**

<Frequency>                Frequency#1[, Frequency#2, ...]  
Range:            300 kHz to RFmax (depending on model)  
Default unit: Hz

**Example:**

```
CORR:CSET 'D:/Lists/ucor/ucor1'
selects the table ucor1.
CORR:CSET:DATA:FREQ 100MHz,102MHz,103MHz,...
enters the frequency value in the table ucor1.
```

**[[:SOURce<hw>]:CORRection:CSET:DATA:FREQuency:POINts?**

The command queries the number of frequency values in the selected table.

The numerical suffix at SOURce must not be used for this command.

**Return values:**

<Points>                    float

**Example:**

```
CORR:CSET 'D:/Lists/ucor/ucor1'
selects the table ucor1.
CORR:CSET:DATA:FREQ:POIN?
queries the number of frequency values in the table ucor1.
Response: 440
the table ucor1 contains 440 frequency values.
```

**Usage:** Query only

---

**[:SOURce<hw>]:CORRection:CSET:DATA:POWER <Power>**

The command transfers the level data to the table selected with :CORRection:CSET:SELEct.

\*RST does not affect data lists. The numerical suffix at SOURce must not be used for this command.

**Parameters:**

<Power> Power#1[, Power#2, ...]  
 Range: -40 dB to 6 dB  
 Default unit: dB

**Example:**

CORR:CSET 'D:/Lists/ucor/ucor1'  
 selects the table ucor1.  
 CORR:CSET:DATA:POW 1dB, 0.8dB, 0.75dB, ...  
 enters the level values in the table ucor1.

---

**[:SOURce<hw>]:CORRection:CSET:DATA:POWER:POINTs?**

The command queries the number of level values in the selected table.

The numerical suffix at SOURce must not be used for this command.

**Return values:**

<Points> float

**Example:**

CORR:CSET 'D:/Lists/ucor/ucor1'  
 selects the table ucor1.  
 CORR:CSET:DATA:POW:POIN?  
 queries the number of level values in the table ucor1.  
 Response: 440  
 the table ucor1 contains 440 level values.

**Usage:** Query only

---

**[:SOURce<hw>]:CORRection:CSET:DATA:POWER:MLEV<ch>?**

The command queries the measurement results of a multi channel measurement. The values of each column of the user correction list are queried separately, i.e. the correction values for a specific attenuator setting.

**Suffix:**

<ch> 1..9  
 Numeric suffix 1 denotes the high power measurement, suffixes 2 to 9 the different attenuator settings starting at 0 dB up to 35 dB in 5 dB steps.

**Return values:**

<MLEV> string  
 \*RST: OFF

**Example:**

SOUR:CORR:CSET:DATA:POW:MLEV4?  
 queries the level correction values for attenuator setting 10 dB.

**Usage:**

Query only

**[[:SOURce<hw>]:CORRection:CSET:DATA:POWer:MLeV:STATe <State>**

The command activates the acquisition of multi level data with a connected power sensor. Separate measurements are made for the different attenuator ranges up to 40 dB. Thus, the changes in VSWR for the different ranges are taken into account, the level accuracy increases. For ranges from 40 dB on the changes in VSWR are negligible. The reference level is set internally and cannot be controlled by the user. The measurement results are entered into additional columns of the User Correction list. The Multi Level Correction measurements are made in addition to a Single Level Correction measurement. When the user correction list is activated, it is possible to select which of the measurements is to be used for level correction (command SOUR:CORR:MLeV:STAT ON).

**Parameters:**

<State> 0 | 1 | OFF | ON  
 \*RST: OFF

**Example:**

SOUR:CORR:CSET:DATA:POW:MLeV:STAT ON  
 activates the acquisition of multi level data with a connected power sensor.

**[[:SOURce<hw>]:CORRection:CSET:DATA[:SENSor<ch>]:POWer]:SONCe**

The command fills the selected user correction list with the level values measured by the power sensor for the given frequencies.

The power sensor used is selected by the suffix in key word SENSE of the command header.

**Suffix:**

<ch> 1 .. 3  
 Suffix 1 denotes the sensor connected to the SENSOR connector, suffix 2 the sensor connected first to one of the USB interfaces and suffix 3 the sensor connected second to one of the USB interfaces.

**Example:**

CORR:CSET:DATA:SENS:POW:SONC  
 fills the user correction list with level values acquired by the power sensor connector to the SENSOR connector.

**Usage:**

Event

**[[:SOURce]:CORRection:CSET:DELeTe <Delete>**

The command deletes the specified table.

The lists are stored with the fixed file extensions `*.ucor` in a directory of the user's choice. The directory applicable to the commands is defined with the command `MMEMoRY:CDIR`. A path can also be specified in command `:SOUR:CORR:CSET:CAT?`, in which case the file in the specified directory is deleted.

The numerical suffix under SOURce is irrelevant.

**Setting parameters:**

<Delete>                    <table name>

**Example:**                    `MMEM:CDIR 'D:/Lists/ucor'`  
selects the directory for the user correction files.  
`CORR:CSET:DEL 'UCOR1'`  
deletes the table `ucor1`.

**Usage:**                    Event

**[[:SOURce<hw>]:CORRection:DEXChange:AFILe:CATalog?**

The command requests a list of available ASCII files for export/import of user correction data. The individual files are separated by commas.

The ASCII files are stored with the fixed file extensions `*.txt` or `*.csv` in a directory of the user's choice. The directory applicable to the commands is defined with the command `MMEMoRY:CDIR`.

**Return values:**

<Catalog>                    string

**Example:**                    `MMEM:CDIR 'D:/lists/ucor/import'`  
selects the directory for the ASCII files with frequency and level value pairs.  
`CORR:DEXC:AFIL:EXT TXT`  
selects that ASCII files with extension `*.txt` are listed.  
`CORR:DEXC:AFIL:CAT?`  
queries the available files with extension `*.txt`.  
Response: `'ucor1,ucor2'`  
the ASCII files `ucor1.txt` and `ucor2.txt` are available.

**Usage:**                    Query only

**[[:SOURce<hw>]:CORRection:DEXChange:AFILe:EXTension <Extension>**

The command selects the file extension of the ASCII file to be imported or exported. Selection TXT (text file) or CSV (Excel file) is available.

**Parameters:**

<Extension>                    TXT | CSV  
\*RST:                    TXT



**Example:** `MMEM:CDIR 'D:/lists/ucor/import'`  
 selects the directory for the ASCII files with frequency and level value pairs.  
`CORR:DEXC:AFIL:EXT TXT`  
 selects that ASCII files with extension \*.txt are listed.  
`CORR:DEXC:AFIL:CAT?`  
 queries the available files with extension \*.txt.  
 Response: 'list1,list2'  
 the ASCII files `ucor1.txt` and `ucor2.txt` are available.

---

#### **[:SOURce<hw>]:CORRection:DEXChange:AFILe:SElect <Select>**

The command selects the ASCII file to be imported or exported.

The ASCII files are stored with the fixed file extensions \*.txt or \*.csv in a directory of the user's choice. The directory applicable to the commands is defined with the command `MMEMemory:CDIR`. A path can also be specified in command

`SOUR:CORR:DEXC:AFIL:SEL`, in which case the files are stored or loaded in the specified directory.

#### **Parameters:**

<Select>                    <ascii file name>

#### **Example:**

`CORR:DEXC:MODE IMP`  
 selects that ASCII files with frequency and level value pairs are imported and transferred into user correction lists.  
`CORR:DEXC:AFIL:SEL 'D:/user/ucor/import/ucor.csv'`  
 selects that ASCII file `ucor.csv` is imported.  
`CORR:DEXC:SEL 'D:/user/ucor/import/ucor_imp'`  
 selects that the ASCII file `ucor.csv` is imported into user correction list `ucor_imp`.

---

#### **[:SOURce<hw>]:CORRection:DEXChange:AFILe:SEParator:COLumn <Column>**

The command selects the separator between the frequency and level column of the ASCII table.

#### **Parameters:**

<Column>                    TABulator | SEMicolon | COMMa | SPACe  
 \*RST:                    SEMicolon|

**Example:**

```

CORR:DEXC:MODE EXP
selects that the user correction list is exported into an ASCII file.
CORR:DEXC:AFIL:SEL 'D:
/user/ucor/import/ucor.csv'
selects ASCII file ucor.csv as destination for the user correction
list data.
CORR:DEXC:AFIL:SEP:COL TAB
the pairs of frequency and level values are separated by a tabu-
lator.
CORR:DEXC:AFIL:SEP:DEC DOT
selects the decimal separator dot.
CORR:DEXC:SEL 'D:/user/ucor/import/ucor_imp'
selects that the user correction list ucor_imp is imported into ASCII
file ucor.csv.

```

**[:SOURce<hw>]:CORRection:DEXChange:AFILe:SEParator:DECimal <Decimal>**

The command the decimal separator used in the ASCII data between '.' (decimal point) and ',' (comma) with floating-point numerals.

**Parameters:**

```

<Decimal>          DOT | COMMa
*RST:              DOT

```

**Example:**

```

CORR:DEXC:MODE EXP
selects that the user correction list is exported into an ASCII file.
CORR:DEXC:AFIL:SEL 'D:
/user/ucor/import/ucor.csv'
selects ASCII file ucor.csv as destination for the user correction
list data.
CORR:DEXC:AFIL:SEP:COL TAB
the pairs of frequency and level values are separated by a tabu-
lator.
CORR:DEXC:AFIL:SEP:DEC DOT
selects the decimal separator dot.
CORR:DEXC:SEL 'D:/user/ucor/import/ucor_imp'
selects that the user correction list ucor_imp is imported into ASCII
file ucor.csv.

```

**[:SOURce<hw>]:CORRection:DEXChange:EXECute**

The command starts the export or import of the selected file. When import is selected, the ASCII file is imported as user correction list. When export is selected, the user correction list is exported into the selected ASCII file.

**Example:**

```
CORR:DEXC:MODE IMP
```

selects that ASCII files with frequency and level value pairs are imported and transferred into user correction lists.

```
CORR:DEXC:AFIL:SEL 'D:
/user/ucor/import/ucor.csv'
```

selects that ASCII file ucor.csv is imported.

```
CORR:DEXC:SEL 'D:/user/ucor/import/ucor_imp'
```

selects that the ASCII file ucor.csv is imported into user correction list ucor\_imp.

```
CORR:DEXC:EXEC
```

starts the import of the ASCII file data into the user correction file.

**Usage:** Event

---

#### **[:SOURce<hw>]:CORRection:DEXChange:MODE <Mode>**

The command selects if user correction lists should be imported or exported. Depending on the selection here, the file select command defines either the source or the destination for user correction lists and ASCII files.

#### **Parameters:**

<Mode>                   IMPort | EXPort  
\*RST:                   IMPort

**Example:**

```
CORR:DEXC:MODE IMP
```

selects that ASCII files with frequency and level value pairs are imported and transferred into user correction lists.

```
CORR:DEXC:AFIL:SEL 'D:
/user/ucor/import/ucor.csv'
```

selects that ASCII file ucor.csv is imported.

```
CORR:DEXC:SEL 'D:/user/ucor/import/ucor_imp'
```

selects that the ASCII file ucor.csv is imported into user correction list ucor\_imp.

---

#### **[:SOURce<hw>]:CORRection:DEXChange:SELEct <Select>**

The command selects the user correction list to be imported or exported.

The user correction files are stored with the fixed file extensions \*.uco in a directory of the user's choice. The directory applicable to the commands is defined with the command `MMEMory:CDIR`. A path can also be specified in command `SOUR:CORR:DEXC:SEL`, in which case the files are stored or loaded in the specified directory.

#### **Parameters:**

<Select>                   <list name>

**Example:**           CORR:DEXC:MODE IMP  
 selects that ASCII files with frequency and level value pairs are imported and transferred into user correction lists.  
 CORR:DEXC:AFIL:SEL 'D:  
 /user/ucor/import/ucor.csv'  
 selects that ASCII file ucor.csv is imported.  
 CORR:DEXC:SEL 'D:/user/ucor/import/ucor\_imp'  
 selects that the ASCII file ucor.csv is imported into user correction list ucor\_imp.

---

#### **[:SOURce<hw>]:CORRection:CSET[:SElect] <Select>**

The command selects the table for user correction. Level correction must also be activated with the command SOURce<hw>:CORRection:CSET:STATe ON.

The lists are stored with the fixed file extensions \*.uco in a directory of the user's choice. The directory applicable to the commands is defined with the command MMEMoRY:CDIR. A path can also be specified in command :SOUR:CORR:CSET:SEL, in which case the files in the specified directory are selected.

#### **Parameters:**

<Select>           <table name>

**Example:**           CORR:CSET 'D:/Lists/ucor/ucor1'  
 selects the table ucor1.  
 CORR ON  
 activates level correction. Correction is performed using the table ucor1.

**Usage:**           Event

---

#### **[:SOURce<hw>]:CORRection:MLEVel:STATe <State>**

The command activates the use of multi level data for user correction. The setting is only available for user correction list with multi level correction data (see command SOUR:CORR:CSET:DATA:POW:MLEV:STAT ON).

#### **Parameters:**

<State>           0 | 1 | OFF | ON  
 \*RST:           OFF

**Example:**           SOUR:CORR:MLEV:STAT ON  
 activates the use of multi level correction data for user correction.

---

#### **[:SOURce<hw>]:CORRection[:STATe] <State>**

The command activates/deactivates level correction. Level correction is performed using the table which has been selected with the command CORRection:CSET:SElect.

**Parameters:**

<State> 0 | 1 | OFF | ON  
 \*RST: OFF

**Example:**

SOUR:CORR:CSET 'D:/lists/ucor/ucor1'  
 selects the table ucor1.  
 SOUR:CORR ON  
 activates user correction.

**[:SOURce<hw>]:CORRection:VALue?**

The command requests the current value for user correction.

**Return values:**

<Value> float

**Example:**

CORR:VAL?  
 queries the value currently used for level correction.  
 Response: -3  
 the correction value is - 3 dB.

**Usage:**

Query only

## 7.15.5 SOURce:FM Subsystem

The FM subsystem contains the commands for checking the frequency modulation.

The settings for the internal modulation source (LF generator) are made in the SOURce:LFOuTput subsystem /see [chapter 7.15.10, "SOURce:LFOuTput Subsystem"](#), on page 679).

For information about the required options, see [chapter 5.5.11.4, "Frequency Modulation \(FM\)"](#), on page 224.

<a href="#">[:SOURce&lt;hw&gt;]:FM[:DEVIation]</a> .....	652
<a href="#">[:SOURce&lt;hw&gt;]:FM:EXTeRnal:COUPling</a> .....	653
<a href="#">[:SOURce&lt;hw&gt;]:FM:MODE</a> .....	653
<a href="#">[:SOURce&lt;hw&gt;]:FM:SENSitivity</a> .....	654
<a href="#">[:SOURce&lt;hw&gt;]:FM:SOURce</a> .....	654
<a href="#">[:SOURce&lt;hw&gt;]:FM:STATe</a> .....	654

**[:SOURce<hw>]:FM[:DEVIation] <Deviation>**

The command sets the modulation deviation of the frequency modulation in Hz. The maximal deviation depends on the RF frequency set and the selected modulation mode (see data sheet).

**Parameters:**

<Deviation> float  
 Range: 0 Hz to 10 MHz  
 Increment: See data sheet  
 \*RST: 10 kHz  
 Default unit: Hz

**Example:**

FM 5E3  
 sets the FM modulation deviation to 5 kHz.

**Usage:**

SCPI confirmed

**[:SOURce<hw>]:FM:EXTernal:COUPling <Coupling>**

The command selects the coupling mode for the external modulation input in the case of frequency modulation.

**Note:** Coupling for external feed via input EXT MOD can be set independently for modulations AM, FM and PhiM.

**Parameters:**

<Coupling> AC | DC  
**AC**  
 The DC voltage component is disconnected from the modulation signal.  
**DC**  
 The modulation signal is not changed.  
 \*RST: AC

**Example:**

FM:EXT:COUP AC  
 selects the coupling mode AC for external frequency modulation.

**Usage:**

SCPI confirmed

**[:SOURce<hw>]:FM:MODE <Mode>**

The command selects the mode for the frequency modulation.

**Parameters:**

<Mode> NORMal  
**NORMal**  
 The maximum range for modulation bandwidth and FM deviation is available.  
 \*RST: NORMal

**Example:**

FM:MODE NORM  
 selects normal mode for external frequency modulation.

**Usage:**

SCPI confirmed

**[:SOURce<hw>]:FM:SENSitivity?**

The command queries the input sensitivity of the EXT MOD input in Hz/V.

The command is only effective if the external modulation source is selected (SOUR:FM:SOUR EXT). The returned value depends on the modulation deviation setting (SOUR:FM:DEVIation). This value is assigned to the voltage value for full modulation of the input signal.

**Return values:**

<Sensitivity> float

**Example:**

```
FM:DEV 5E3
```

sets a modulation deviation of 5 kHz.

```
FM:SENS
```

queries the input sensitivity at the external modulation input.

```
Response: 5E3
```

since the voltage value for full modulation is 1V, the resulting sensitivity is precisely 5000Hz/V.

**Usage:**

Query only  
SCPI confirmed

**[:SOURce<hw>]:FM:SOURce <Source>**

The command selects the modulation source for frequency modulation. Internal and external modulation source can be selected at the same time.

**Parameters:**

<Source> INT | EXT | INT,EXT

**INT**

INT is the LF generator. The frequency of the internal modulation signal can be set in the SOURce:LFOutput subsystem.

**EXT**

The external signal is input at the EXT MOD connector.

```
*RST: INTERNAL
```

**Example:**

```
FM:SOUR INT
```

selects the internal modulation source.

**Usage:**

SCPI confirmed

**[:SOURce<hw>]:FM:STATe <State>**

The command activates/deactivates frequency modulation.

Activation of FM (FM:STAT ON) deactivates phase modulation.

**Parameters:**

<State> 0 | 1 | OFF | ON

```
*RST: OFF
```

**Example:** FM:STAT ON  
Activates FM modulation.

**Usage:** SCPI confirmed

### 7.15.6 SOURce:FREQUENCY Subsystem

This subsystem contains the commands used to define the frequency settings for the RF sources and sweeps.

[SOURce<hw>]:FREQUENCY:CENTer.....	655
[SOURce<hw>]:FREQUENCY:LOSCillator:MODE.....	656
[SOURce<hw>]:FREQUENCY:LOSCillator:OUTPut:STATe.....	656
[SOURce<hw>]:FREQUENCY[:CW]:FIXed].....	656
[SOURce<hw>]:FREQUENCY[:CW]:FIXed]:RCL.....	657
[SOURce<hw>]:FREQUENCY:MANual.....	657
[SOURce<hw>]:FREQUENCY:MODE.....	658
[SOURce<hw>]:FREQUENCY:MULTiplier.....	659
[SOURce<hw>]:FREQUENCY:OFFSet.....	659
[SOURce<hw>]:FREQUENCY:PHASe:CONTinuous:STATe.....	660
[SOURce<hw>]:FREQUENCY:SPAN.....	660
[SOURce<hw>]:FREQUENCY:START.....	661
[SOURce<hw>]:FREQUENCY:STOP.....	661
[SOURce<hw>]:FREQUENCY:STEP[:INCRement].....	662
[SOURce<hw>]:FREQUENCY:STEP:MODE.....	662

---

#### [SOURce<hw>]:FREQUENCY:CENTer <Center>

The command sets the center frequency of the sweep. This setting in combination with the span setting ([SOURce:]FREQUENCY:SPAN) defines the sweep range.

This command is linked to the commands [SOURce:]FREQUENCY:START and [SOURce:]FREQUENCY:STOP, i.e. changing these values causes the CENTER value to change, and vice versa:

$$\text{CENTer} = (\text{START} + \text{STOP}) / 2$$

As with the "Frequency" value entered in the header, the OFFSet value is also taken into consideration with this command. The specified value range is therefore only effective if OFFSet is set to 0. The value range for other OFFSet values can be calculated using the following formula:

$$300 \text{ kHz} + \text{OFFSet} \dots \text{RF}_{\text{max}} + \text{OFFSet}$$

#### Parameters:

<Center> float  
 Range: 300kHz to RFmax (RFmax depending on model)  
 Increment: 0.01Hz  
 \*RST: 300MHz  
 Default unit: Hz



**Example:**            `FREQ:CENT 400 MHz`  
 sets the center frequency for the frequency sweep to 400 MHz.  
`FREQ:SPAN 200 MHz`  
 sets a span of 200 MHz. This sets the sweep range to 300 MHz to 500 MHz.

**Usage:**            SCPI confirmed

**[:SOURce<hw>]:FREQuency:LOSCillator:MODE <Mode>**

Selects the mode of the local oscillator coupling.

**Parameters:**

<Mode>            INTernal | EXTernal

**INTernal**

The signal of the internal local oscillator is used. This mode corresponds to a normal operation.

**EXTernal**

An external signal is used for path A.

**Note:** Selection of LO Coupling "External" mode, disables all parameters in the "Frequency/Phase/Ref Osc" dialog of the selected path.

\*RST:            INT

**Example:**            `FREQ:LOSC:MODE EXT`  
 sets the LO coupling mode to External.

**Usage:**            SCPI confirmed

**[:SOURce<hw>]:FREQuency:LOSCillator:OUTPut:STATe <State>**

Switches on/off the LO output.

**Parameters:**

<State>            0 | 1 | OFF | ON

\*RST:            OFF

**Example:**            `FREQ:LOSC:OUTP:STAT ON`  
 switches on the LO output state.

**Usage:**            SCPI confirmed

**[:SOURce<hw>]:FREQuency[:CW]:FIXed] <Fixed>**

The command sets the frequency of the RF output signal for CW mode (`SOURce:FREQuency:MODE CW`). In Sweep mode (`SOURce:FREQuency:MODE SWEep`), this value is linked to the current sweep frequency.

In addition to a numerical value, it is also possible to specify UP and DOWN. The frequency is then increased or decreased by the value which is set under

`[SOURce< [1] | 2>:]FREQuency:STEP.`

As with the "FREQ" value entered in the display, the OFFSet value is also taken into consideration with this command. The specified value range is therefore only effective if OFFSet is set to 0. The value range for other OFFset values can be calculated using the following formula:

$$300 \text{ kHz} + \text{OFFSet} \dots \text{RF}_{\text{max}} + \text{OFFSet}$$

**Correlation:** FREQ for FREQ:MODE SWE is linked to sweep frequency.

**Parameters:**

<Fixed> float  
 Range: 300kHz to RFmax  
 Increment: 0.01Hz  
 \*RST: 1GHz  
 Default unit: Hz

**Example:** FREQ 500kHz  
 sets the frequency of RF output signal A to 500 kHz.

**Usage:** SCPI confirmed

**[:SOURce<hw>]:FREQuency[:CW|:FIXed]:RCL <Rcl>**

The command determines whether the current frequency setting is retained or whether the stored frequency setting is adopted when an instrument configuration is loaded.

\*RST does not affect this setting.

**Parameters:**

<Rcl> INCLude | EXCLude

**INCLude**

The stored frequency is also loaded when a stored instrument configuration is loaded.

**EXCLude**

The RF frequency is not loaded when a stored instrument configuration is loaded. The current frequency is retained.

\*RST: no default

**Example:** FREQ:RCL INCL  
 The stored frequency is set if the Recall command is called.

**Usage:** SCPI confirmed

**[:SOURce<hw>]:FREQuency:MANual <Manual>**

In Sweep mode (:SOUR:FREQ:MODE SWE) the command sets the frequency for the next sweep step in the "Step" sweep mode (SOUR:SWE:MODE MAN).

The parameter <Manual> must be a frequency value between the settings [SOUR]:FREQ:STAR and . . . :STOP. Each sweep step is triggered by a separate SOUR:FREQ:MAN command. UP or DOWN trigger the next sweep step in direction of higher or lower frequencies.

As with the "Frequency" value entered in the header, the `OFFSet` value is also taken into consideration with this command. The specified value range is therefore only effective if `OFFSet` is set to 0. The value range for other `OFFSet` values can be calculated using the following formula:

$$\text{START} + \text{OFFSet} \dots \text{STOP} + \text{OFFSet}$$

**Parameters:**

<Manual> float  
 Range: START to STOP  
 Increment: 0.01Hz  
 \*RST: 100MHz  
 Default unit: Hz

**Example:** `SWE:MODE MAN`  
 sets the Step sweep mode.

**Example:** `FREQ:MODE SWE`  
 sets the Frequency Sweep mode. The sweep start frequency is output.  
`FREQ:MAN UP`  
 triggers the next higher sweep step.  
`FREQ:MAN 500MHz`  
 outputs 500 MHz RF frequency (must be within the sweep frequency range).  
`FREQ:MAN DOWN`  
 triggers the next lower sweep step relative to 500 MHz.

**Usage:** SCPI confirmed

---

**[:SOURce<hw>]:FREQuency:MODE <Mode>**

The command sets the instrument operating mode and therefore also the commands used to set the output frequency.

**Parameters:**

&lt;Mode&gt;

CW | FIXed | SWEep | LIST

**CW|FIXed**

The instrument operates in fixed-frequency mode; CW and FIXed are synonyms. The output frequency is set with :SOURce:FREQuency:CW|FIXed.

**SWEep**

The instrument operates in SWEep mode. The frequency is set using the commands SOURce:FREQuency:STARt; STOP; CENTer; SPAN; MANual.

**LIST**

The instrument processes a list of frequency and level settings for the selected path.

The List mode settings are made in the [SOURce:LIST Subsystem](#). The setting SOURce:FREQuency:MODE LIST also sets the command SOURce:POWer:MODE automatically to LIST.

**Correlation:** FREQ:MODE LIST sets POW:MODE LIST

\*RST: CW

**Example:**

```
FREQ:MODE SWE
```

sets the SWEep mode. The settings under

SOURce:FREQuency:STARt; STOP; CENTer; SPAN; MANual become effective.

**Usage:**

SCPI confirmed

**[ :SOURce<hw> ]:FREQuency:MULTiplier <Multiplier>**

The command sets the value for the multiplication factor of a subsequent downstream instrument.

**Parameters:**

&lt;Multiplier&gt;

float

Range: 1 to 10000

\*RST: 1

**Example:**

```
FREQ:MULT 1
```

sets the multiplication factor to 1.

**[ :SOURce<hw> ]:FREQuency:OFFSet <Offset>**

The command sets the frequency offset of a downstream instrument, e.g. a mixer. If a frequency offset is entered, the frequency entered with SOURce:FREQuency: . . . no longer corresponds to the RF output frequency. The following correlation applies:

SOURce:FREQuency: . . . = RF output frequency + SOURce:FREQuency:OFFSet.

Entering an offset does not change the RF output frequency, but rather the query value of SOURce:FREQuency: . . . .

**Parameters:**

<Offset> float  
 Range: -67GHz to 67GHz  
 Increment: 0.01Hz  
 \*RST: 0Hz  
 Default unit: Hz

**Example:**

FREQ:OFFS 500kHz  
 sets the frequency offset to 500 kHz.

**Usage:**

SCPI confirmed

**[ :SOURce<hw> ]:FREQuency:PHASe:CONTInuous:STATe <State>**

Activates/deactivates phase continuous frequency settings. For a given RF frequency setting, phase continuous frequency changes are possible in a limited frequency range (see [chapter 5.5.3.2, "Phase Continuous Frequency Setting"](#), on page 188).

The output sinewave is phase continuous, i.e. there will be no phase discontinuity or glitch when changing the frequency.

**Note:** Restricted structure of command line. As long as phase continuous mode is active, only one command in a command line is processed. A second command in the command line will be ignored.

**Parameters:**

<State> 0 | 1 | OFF | ON  
 \*RST: OFF

**Example:**

FREQ:PHAS:CONT:STAT ON  
 activates phase continuous mode.

**[ :SOURce<hw> ]:FREQuency:SPAN <Span>**

This command specifies the span for the sweep. This setting in combination with the center frequency setting ([SOUR]:FREQ:CENT) defines the sweep range.

This command is linked to the commands [SOUR]:FREQ:STAR and [:SOUR]:FREQ:STOP, i.e. changing these values causes the SPAN value to change, and vice versa:

$$\text{SPAN} = (\text{STOP} - \text{START})$$

Negative values for SPAN are permitted; START > STOP then applies.

**Parameters:**

<Span> float  
 Range: 0 to RFmax  
 Increment: 0.01Hz  
 \*RST: 400MHz

**Example:**            `FREQ:CENT 400 MHz`  
                           sets the center frequency of the frequency sweep to 400 MHz.  
                           `FREQ:SPAN 200 MHz`  
                           sets a span of 200 MHz. This sets the sweep range to 300 MHz  
                           to 500 MHz.

**Usage:**             SCPI confirmed

#### **[ :SOURce<hw>]:FREQuency:START <Start>**

This command sets the start frequency for the sweep mode. `START` can be greater than `STOP`.

This command is linked to the commands `[SOUR]:FREQ:CENT` and `[SOUR]:FREQ:SPAN`, i.e. changing these values causes the `START` value to change, and vice versa:

$$START = (CENTer - SPAN/2).$$

As with the "Frequency" value entered in the header, the `OFFSet` value is also taken into consideration with this command. The specified value range is therefore only effective if `OFFSet` is set to 0. The value range for other `OFFSet` values can be calculated using the following formula:

$$300 \text{ kHz} + OFFSet \dots RF_{max} + OFFSet$$

#### **Parameters:**

`<Start>`             float  
                           Range:     300kHz to RFmax  
                           Increment: 0.01Hz  
                           \*RST:     100MHz

**Example:**            `FREQ:START 1 MHz`  
                           sets the start frequency for the frequency sweep to 1 MHz.  
                           `FREQ:STOP 2 GHz`  
                           sets the stop frequency for the frequency sweep to 2 GHz.

**Usage:**             SCPI confirmed

#### **[ :SOURce<hw>]:FREQuency:STOP <Stop>**

This command sets the stop frequency for the sweep mode. `STOP` can be less than `START`.

This command is linked to the commands `[ :SOUR]:FREQ:CENT` and `[ :SOUR]:FREQ:SPAN`, i.e. changing these values causes the `START` value to change, and vice versa:

$$STOP = (CENTer + SPAN/2)$$

As with the "Frequency" value entered in the header, the `OFFSet` value is also taken into consideration with this command. The specified value range is therefore only effective if `OFFSet` is set to 0. The value range for other `OFFSet` values can be calculated using the following formula:

$$300 \text{ kHz} + \text{OFFSet} \dots \text{RF}_{\text{max}} + \text{OFFSet}$$

**Parameters:**

<Stop> float  
 Range: 300kHz to RFmax  
 Increment: 0.01Hz  
 \*RST: 500 MHz  
 Default unit: Hz

**Example:**

`FREQ:STOP 2 GHz`  
 sets the stop frequency for the frequency sweep to 2 GHz.  
`FREQ:STAR 1 MHz`  
 sets the start frequency for the frequency sweep to 1 MHz.

**Usage:**

SCPI confirmed

**[[:SOURce<hw>]:FREQUENCY:STEP[:INCRement] <Increment>**

The command sets the step width for the frequency setting if the frequency values `UP/DOWN` are used and variation mode `SOUR:FREQ:STEP:MODE USER` is selected. The command is linked to "Variation Step" for manual control, i.e. the command also sets the step width of the rotary knob for "Variation Active" on.

**Parameters:**

<Increment> float  
 Range: 0Hz to RFmax - 100kHz  
 Increment: 0.01Hz  
 \*RST: 1MHz

**Example:**

`FREQ:STEP 50 kHz`  
 sets the step width for the frequency setting to 50 kHz.

**[[:SOURce<hw>]:FREQUENCY:STEP:MODE <Mode>**

This command activates (`USER`) or deactivates (`DECimal`) the user-defined step width used when varying the frequency value with the frequency values `UP/DOWN`. The command is linked to the command "Variation Active" for manual control, i.e. the command also activates/deactivates the user-defined step width used when varying the frequency value with the rotary knob.

**Parameters:**

<Mode> DECimal | USER  
 \*RST: DECimal

**Example:**            `FREQ:STEP 50 kHz`  
 sets the step width for the frequency setting to 50 kHz.  
`FREQ:STEP:MODE USER`  
 activates this step width for frequency variation with the rotary knob (manual control) and with frequency values `UP/DOWN` (remote control).

### 7.15.7 SOURce:INPut Subsystem

The `SOURce:INPut` subsystem contains the commands for configuring the inputs for trigger, data and control signals. A common trigger threshold and input impedance is effective for all trigger and control signal inputs.

The settings influence the digital modulations, the generation of waveforms or multicarrier signals, and all digital standards. Irrespective of this, a common threshold and input impedance is effective for the serial and parallel data input (Path A only). These data sources are available for digital modulation ("Custom Digital Modulation").

<code>[:SOURce]:INPut:DATA:IMPedance</code> .....	663
<code>[:SOURce]:INPut:DATA:THReshold</code> .....	663
<code>[:SOURce&lt;hw&gt;]:INPut:MODext:IMPedance</code> .....	664
<code>[:SOURce]:INPut:TRIGger:BBANd:SLOPe</code> .....	664
<code>[:SOURce]:INPut:TRIGger:IMPedance</code> .....	664
<code>[:SOURce]:INPut:TRIGger:LEVel</code> .....	665
<code>[:SOURce]:INPut:TRIGger:SLOPe</code> .....	665

---

#### **`[:SOURce]:INPut:DATA:IMPedance` <Impedance>**

The command sets the impedance of all data inputs.

The setting affects the serial data input `DATA` at the front of the instrument and the serial data inputs `DATA` at the AUX I/O interface at the rear of the instrument.

#### **Parameters:**

<Impedance>            `G1K | G50`  
                               `*RST:        G1K`

**Example:**            `INP:DATA:IMP G50`  
 all data inputs are set to 50 ohm to ground.

---

#### **`[:SOURce]:INPut:DATA:THReshold` <Threshold>**

The command sets the high/low threshold of the data inputs in the baseband section. In the case of positive polarity, this threshold determines the point as of which a signal is high (active) or low (inactive).

The setting affects the serial data input `DATA` at the front of the instrument and the serial data inputs `DATA` at the AUX I/O interface at the rear of the instrument.



**Parameters:**

<Threshold> float  
 Range: 0 to 2  
 \*RST: 1V  
 Default unit: V

**Example:**

INP:DATA:THR 1 V  
 a high/low threshold of 1 volt is set at all data inputs of the base-band section. The signal is high (active) for a signal voltage of 1 volt and higher.

**[[:SOURce<hw>]:INPut:MODext:IMPedance <Impedance>**

Selects the impedance for external feed via the EXT MOD input.

**Parameters:**

<Impedance> HIGH | G50  
**HIGH**  
 > 100 kOhm to ground  
**G50**  
 50 Ohm to ground  
 \*RST: HIGH

**Example:**

INP:MOD:IMP HIGH  
 the EXT MOD input is set to > 100 kOhm to ground.

**[[:SOURce]:INPut:TRIGger:BBANd:SLOPe <Slope>**

The command sets the active slope of an externally applied trigger signal at the TRIGGER connectors. The setting is effective for both connectors at the same time.

**Parameters:**

<Slope> NEGative | POSitive  
 \*RST: POSitive

**Example:**

INP:TRIG:BBAN:SLOP NEG  
 the active slope of the external trigger signal at the TRIGGER connectors is the falling slope.

**[[:SOURce]:INPut:TRIGger:IMPedance <Impedance>**

The command sets the impedance of the trigger and control signal inputs and affects:

- TRIGGER inputs
- CLOCK inputs
- CW, BURST, and LEV\_ATT inputs (AUX I/O connector)

**Parameters:**

<Impedance>            G1K | G50

**G1K**  
1 kOhm to ground

**G50**  
50 Ohm to ground

\*RST:            G1K

**Example:**

INP:TRIG:IMP G50  
all trigger and control signal inputs are set to 50 ohm to ground.  
This setting is recommended in the case of high clock rates.

**[:SOURce]:INPut:TRIGger:LEVel <Level>**

The command sets the high/low threshold of the trigger and control signal inputs in the baseband section. In the case of positive polarity, this threshold determines the point at which a signal is high (active) or low (inactive).

The command affects:

- TRIGGER inputs
- CLOCK inputs
- CW, BURST, and LEV\_ATT inputs (AUX I/O connector)

**Parameters:**

<Level>                    float

Range:            0.01 to 2

Increment:    0.01

\*RST:            1

Default unit: V

**Example:**

INP:TRIG:LEV 1 V  
a high/low threshold of 1 volt is set at all trigger and control signal inputs of the baseband section. In the case of positive polarity, the signal is high (active) for a signal voltage of 1 volt and higher.

**[:SOURce]:INPut:TRIGger:SLOPe <Slope>**

Sets the polarity of the active slope of an externally applied trigger signal at the trigger input (BNC connector at the rear of the instrument).

**Parameters:**

<Slope>                    NEGative | POSitive

\*RST:            POSitive

**Example:**

INP:TRIG:SLOP NEG  
the active slope of the external trigger signal at the trigger input is the falling slope.

## 7.15.8 SOURce:IQ Subsystem

This subsystem contains the commands for checking the I/Q modulation.

<code>[SOURce&lt;hw&gt;]:IQ:CREStfactor</code> .....	666
<code>[SOURce&lt;hw&gt;]:IQ:GAIN</code> .....	666
<code>[SOURce&lt;hw&gt;]:IQ:IMPAirment:IQRatio[MAGNitude]</code> .....	667
<code>[SOURce&lt;hw&gt;]:IQ:IMPAirment:LEAKage:I</code> .....	667
<code>[SOURce&lt;hw&gt;]:IQ:IMPAirment:LEAKage:Q</code> .....	668
<code>[SOURce&lt;hw&gt;]:IQ:IMPAirment:QUADrature[ANGLE]</code> .....	668
<code>[SOURce&lt;hw&gt;]:IQ:IMPAirment[STATE]</code> .....	668
<code>[SOURce&lt;hw&gt;]:IQ:SOURce</code> .....	668
<code>[SOURce&lt;hw&gt;]:IQ:STATe</code> .....	669
<code>[SOURce&lt;hw&gt;]:IQ:SWAP[STATE]</code> .....	669
<code>[SOURce&lt;hw&gt;]:IQ:WBState</code> .....	669
<code>[SOURce&lt;hw&gt;]:BB:IQGain</code> .....	669

---

### `[SOURce<hw>]:IQ:CREStfactor <CrestFactor>`

This command specifies the crest factor of the external analog signal.

#### Parameters:

<code>&lt;CrestFactor&gt;</code>	float
	Range: 0 dB to 35 dB
	Increment: 0.01dB
	*RST: 0 dB
	Default unit: dB

#### Example:

`IQ:CRES 10`  
specifies a crest factor of 10 dB for the external analog signal.

---

### `[SOURce<hw>]:IQ:GAIN <Gain>`

This command specifies the baseband gain for the external analog wideband I/Q signal. Thus, the modulation of the I/Q modulator can be optimized for any measurement requirement. The gain settings for an internal or external baseband signal are performed with command `SOUR:BB:IQGain`.

**Parameters:**

&lt;Gain&gt;

DBM3 | DB0 | DB3 | DB6

**DBM3**

Activates 0 dB gain.

With this setting, signal distortions are minimized.

**DB0**

Activates 0 dB gain (standard settings).

**DB3**

Activates 0 dB gain.

This setting is recommended for 3GPP signals with very high adjacent channel power ratio (ACPR).

**DB6**

Activates 0 dB gain.

With this setting, signal noise is minimized.

Increment: 0.01dB

\*RST: External Wideband: 3 dB

**Example:**

IQ:SOUR ANAL

selects an external analog signal as the input signal for the I/Q modulator. The signal must be applied at the inputs I and Q.

**Example:**

IQ:GAIN DB0

sets gain 0 dB (standard).

**[:SOURce<hw>]:IQ:IMPairment:IQRatio[:MAGNitude] <Magnitude>**

This command sets the ratio of I modulation to Q modulation (amplification “imbalance”).

**Parameters:**

&lt;Magnitude&gt;

float

Range: -1.0dB to +1.0dB

Increment: 0.005dB

\*RST: 0

Default unit: 0dB

**Example:**

IQ:IMP:IQR 0.5 dB

sets the imbalance.

**[:SOURce<hw>]:IQ:IMPairment:LEAKage:I <I>**

This command sets the carrier offset for the I-channel of the I/Q modulation.

**Parameters:**

&lt;I&gt;

float

Range: -10 to 10

Increment: 0.02PCT

\*RST: 0

Default unit: PCT

**Example:** `IQ:IMP:LEAK:I 3 PCT`  
sets the leakage for the I-channel to 3 percent.

---

**[:SOURce<hw>]:IQ:IMPAirment:LEAKage:Q <Q>**

This command sets the carrier leakage amplitude for the Q-channel of the I/Q modulation.

**Parameters:**

<Q> float  
Range: -10 to 10  
Increment: 0.02PCT  
\*RST: 0PCT  
Default unit: PCT

**Example:** `IQ:IMP:LEAK:Q 3 PCT`  
sets the leakage for the Q-channel to 3 percent.

---

**[:SOURce<hw>]:IQ:IMPAirment:QUADrature:[ANGLe] <Angle>**

This command sets the quadrature offset for the I/Q modulation.

**Parameters:**

<Angle> float  
Range: -10.0DEG to 10.0DEG  
Increment: 0.02DEG  
\*RST: 0DEG  
Default unit: DEG

**Example:** `IQ:IMP:QUAD:ANGL -5DEG`  
sets the quadrature offset to -5 degrees.

---

**[:SOURce<hw>]:IQ:IMPAirment[:STATe] <State>**

The command activates (ON) and deactivates (OFF) the three impairment or correction values LEAKage, QUADrature and IQRatio for the analog signal in the I/Q modulator.

**Parameters:**

<State> 0 | 1 | OFF | ON  
\*RST: OFF

**Example:** `IQ:IMP OFF`  
deactivates I/Q impairment.

---

**[:SOURce<hw>]:IQ:SOURce <Source>**

This command selects the input signal for the I/Q modulator.

Selecting ANALog (Wideband I/Q In) switches off:

- `SOURce:AM:STATe OFF`
- `SOURce:BBAM:STATe OFF`

- SOURce:BB:DM:STATe OFF
- SOURce:BB:<Dig. Standard>:STATe OFF

**Parameters:**

<Source>            BAsEband | ANALog  
 \*RST:            BAsEband

**Example:**

IQ:SOUR ANAL  
 selects an external analog signal as the input signal. The signal must be applied at the inputs I and Q.

**[:SOURce<hw>]:IQ:STATe <State>**

This command activates and deactivates I/Q modulation.

**Parameters:**

<State>            0 | 1 | OFF | ON  
 \*RST:            OFF

**Example:**

IQ:STAT ON  
 activates I/Q modulation.

**[:SOURce<hw>]:IQ:SWAP[:STATe] <State>**

When set to ON, this command swaps the I and Q channel.

**Parameters:**

<State>            0 | 1 | OFF | ON  
 \*RST:            OFF

**Example:**

IQ:SWAP ON  
 swaps the I and Q channel.

**[:SOURce<hw>]:IQ:WBSTate <Wbstate>**

This command selects optimized setting for wideband modulation signals (>5 MHz) (State ON).

**Parameters:**

<Wbstate>            0 | 1 | OFF | ON  
 \*RST:            OFF

**Example:**

IQ:WBST ON  
 activates optimized setting for wideband signals.

**[:SOURce<hw>]:BB:IQGain <lqgain>**

This command specifies the baseband gain for the internal baseband signal.

Thus, the modulation of the I/Q modulator can be optimized for any measurement requirement. The gain settings for an external analog wideband signal (**Analog Wideband I/Q In**) are performed with command :SOURce:IQ:GAIN

**Parameters:**

<lqgain> AUTO | DBM3 | DB0 | DB3 | DB6

**AUTO**

Activates automatic setting. The modulation is automatically optimized for the internally set baseband signal

**DBM3**

Activates 0 dB gain.

With this setting, signal distortions are minimized.

**DB0**

Activates 0 dB gain (standard settings).

**DB3**

Activates 0 dB gain.

**DB6**

Activates 0 dB gain.

With this setting, signal noise is minimized.

Increment: 0.01 dB

\*RST: AUTO

**Example:**

`IQ:SOUR BAS`

selects the internal baseband signal as the input signal of the I/Q modulator.

`BB:IQG DB6`

sets gain 6dB (best for low noise).

## 7.15.9 SOURce:IQ:OUTput Subsystem

### 7.15.9.1 Analog I/Q Outputs

This subsystem contains the commands for configuring the differential output.

For information about the required options, see [chapter 5.7.3.2, "Analog I/Q Output"](#), on page 291.

<code>[:SOURce&lt;hw&gt;]:IQ:OUTPut:BIAS:COUPling[:STATe]</code> .....	671
<code>[:SOURce&lt;hw&gt;]:IQ:OUTPut:BIAS:I</code> .....	671
<code>[:SOURce&lt;hw&gt;]:IQ:OUTPut:BIAS:Q</code> .....	671
<code>[:SOURce&lt;hw&gt;]:IQ:OUTPut:BIAS:OPTimization[:RF]:STATe</code> .....	672
<code>[:SOURce&lt;hw&gt;]:IQ:OUTPut:LEVel</code> .....	672
<code>[:SOURce&lt;hw&gt;]:IQ:OUTPut[:ANALog]:POWER:PEP</code> .....	672
<code>[:SOURce&lt;hw&gt;]:IQ:OUTPut[:ANALog]:POWER:PEP:RESult</code> .....	672
<code>[:SOURce&lt;hw&gt;]:IQ:OUTPut:MODE</code> .....	673
<code>[:SOURce&lt;hw&gt;]:IQ:OUTPut:OFFSet:I</code> .....	673
<code>[:SOURce&lt;hw&gt;]:IQ:OUTPut:OFFSet:Q</code> .....	673
<code>[:SOURce&lt;hw&gt;]:IQ:OUTPut:TYPE</code> .....	674

**[[:SOURce<hw>]:IQ:OUTPut:BIAS:COUPling[:STATe] <State>**

This command activates/deactivates coupling of bias setting of the I-signal and Q-signal component.

If coupling is activated, settings made for the I-signal component (SOUR:IQ:OUT:BIAS:I) automatically applies to the Q-signal (SOUR:IQ:OUT:BIAS:Q)

**Parameters:**

<State>                    0 | 1 | OFF | ON  
\*RST:                    0

**Example:**

IQ:OUTP:BIAS:COUP ON  
activates coupling of bias settings of the two components.

**[[:SOURce<hw>]:IQ:OUTPut:BIAS:I <I>**

This command sets the amplifier bias.

The maximum overall voltage depends on the I/Q output type.

- Single ended:  $IQ:OUTP:POW:PEP + SOUR:IQ:OUTP:BIAS:I|Q \leq 3.7$  volts.
- Differential:  
 $0.5 * IQ:OUTP:POW:PEP + SOUR:IQ:OUTP:BIAS:I|Q + 0.5 * SOUR:IQ:OUTP:OFFS:I|Q \leq 3.7$  volts.

**Parameters:**

<I>                            float  
Range:                    -3.6 to 3.6  
Increment:                0.002  
\*RST:                    0

**[[:SOURce<hw>]:IQ:OUTPut:BIAS:Q <Q>**

This command sets the amplifier bias.

The maximum overall voltage depends on the I/Q output type.

- Single ended:  $IQ:OUTP:POW:PEP + SOUR:IQ:OUTP:BIAS:I|Q \leq 3.7$  volts.
- Differential:  
 $0.5 * IQ:OUTP:POW:PEP + SOUR:IQ:OUTP:BIAS:I|Q + 0.5 * SOUR:IQ:OUTP:OFFS:I|Q \leq 3.7$  volts.

**Parameters:**

<Q>                            float  
Range:                    -3.6 to 3.6  
Increment:                0.002  
\*RST:                    0

**Example:**

IQ:OUTP:BIAS:Q 0.1 V  
sets a bias of 100 mV for the Q-signal.



---

**[[:SOURce<hw>]:IQ:OUTPut:BIAS:OPTimization[:RF]:STATe <State>**

This command activates/deactivates optimization of level accuracy and imbalance for RF Output. Level accuracy and imbalance can be either optimized for RF output (active) or for differential outputs (not active).

**Parameters:**

<State>                    0 | 1 | OFF | ON  
 \*RST:                    0

**Example:**                IQ:OUTP:BIAS:OPT:STAT ON  
 activates optimization for RF output.

---

**[[:SOURce<hw>]:IQ:OUTPut:LEVel <Level>**

**[[:SOURce<hw>]:IQ:OUTPut[:ANALog]:POWer:PEP <Pep>**

This command sets the off-load voltage.

Single ended Output:

- Value range: 20 mV ... 2 V EMF.
- The maximum overall output voltage  
 ( $\text{SOUR:IQ:OUTP:POW:PEP} + \text{SOUR:IQ:OUTP:BIAS:I|Q}$ ) is 3.7 V

Differential Output:

- Value range: 40 mV ... 4 V EMF.
- The maximum overall output voltage  
 ( $0.5 * \text{SOUR:IQ:OUTP:POW:PEP} + \text{SOUR:IQ:OUTP:BIAS:I|Q} + 0.5 * \text{SOUR:IQ:OUTP:OFFS:I|Q}$ ) is 3.7 V

**Parameters:**

<Pep>                    float  
 Range:                    0.02 to 2  
 Increment:                0.001  
 \*RST:                    1  
 Default unit: V

**Example:**                IQ:OUTP:POW:PEP 2 V  
 sets a off-load level of 2 V

---

**[[:SOURce<hw>]:IQ:OUTPut[:ANALog]:POWer:PEP:RESult?**

Displays the resulting output off-load voltage of both signal components at the rear panel.

**Return values:**

<Result>                    float  
 Range:                    0.02 to 4  
 Increment:                0.001  
 \*RST:                    1

**Usage:**                    Query only

**[ :SOURce<hw>]:IQ:OUTPut:MODE <Mode>**

This command selects the mode for setting the outputs.

Selection **FIXed** locks all **IQ:OUTPut**-commands except for **IQ:OUTPut:TYPE** and sets them to predefined values ( **\*RST**).

**Parameters:**

<Mode>                      **FIXed** | **VARiable**

**FIXed**

The settings are fixed and cannot be changed.

Single ended: **IQ:OUTP:POW:PEP = 1V**.

Differential: **IQ:OUTP:POW:PEP = 2V**.

**IQ:OUTPut:BIAS:I|Q = 0V**

**IQ:OUTPut:OFFSet:I|Q = 0V**

**VARiable**

The settings can be changed (command **[ :SOURce<hw>]:IQ:OUTPut[:ANALog]:POWer:PEP** on page 672).

**\*RST:**                      **FIXed**

**Example:**

**SOUR:IQ:OUTP:MODE VAR**

**SOUR:IQ:OUTP:ANAL:POW:PEP 2V**

**[ :SOURce<hw>]:IQ:OUTPut:OFFSet:I <I>**

The command is only valid for output type Differential (**IQ:OUTP:TYPE DIFF**).

This command sets an offset between the inverting and non-inverting output.

The maximum overall voltage

$(0.5 * IQ:OUTP:POW:PEP + SOUR:IQ:OUTP:BIAS:I|Q + 0.5 * SOUR:IQ:OUTP:OFFS:I|Q)$  is 3.7 volts.

**Parameters:**

<I>                              float  
 Range:                      -0.3 to 0.3  
 Increment:                2E-4  
 \*RST:                        0  
 Default unit: V

**Example:**

**IQ:OUTP:TYPE DIFF**

the I/Q-signal components are output differential

**:IQ:OUTP:OFFS:I 0.05 V**

sets an offset of 50 mV for the I-signal.

**[ :SOURce<hw>]:IQ:OUTPut:OFFSet:Q <Q>**

The command is only valid for output type Differential (**IQ:OUTP:TYPE DIFF**).

This command sets an offset between the inverting and non-inverting output.

The maximum overall voltage

$(0.5 * IQ:OUTP:POW:PEP + SOUR:IQ:OUTP:BIAS:I|Q + 0.5 * SOUR:IQ:OUTP:OFFS:I|Q)$  is 3.7 volts.

**Parameters:**

<Q> float  
 Range: -0.3 to 0.3  
 Increment: 2E-4  
 \*RST: 0

**Example:**

`IQ:OUTP:TYPE DIFF`  
 The I/Q-signal components are output differential.  
`IQ:OUTP:OFFS:I 0.05 V`  
 sets an offset of 50 mV for the I-signal.

---

**[:SOURce<hw>]:IQ:OUTPut:TYPE <Type>**

This command selects the output type.

**Parameters:**

<Type> SINGle | DIFFerential  
**SINGle**  
 The I/Q-signal components are output single-ended.  
**DIFFerential**  
 The I/Q-signal components are output differential.  
 A bias can be defined.  
 \*RST: SINGle

**Example:**

`IQ:OUTP:TYPE DIFF`  
 the I/Q-signal components are output differential.

### 7.15.9.2 Digital I/Q Outputs

This subsystem contains the commands for configuring the digital I/Q output. The digital signal can be output with the aid of a standardized (LVDS) digital user interface.

For information about the required options, see [chapter 5.7.3.3, "Digital I/Q Output Settings"](#), on page 294.

<code>[:SOURce&lt;hw&gt;]:IQ:OUTPut:DIGital:CDEvice</code> .....	675
<code>[:SOURce]:IQ:OUTPut:DIGital:OFLow:HOLD:RESet</code> .....	675
<code>[:SOURce]:IQ:OUTPut:DIGital:OFLow:HOLD:STAtE</code> .....	675
<code>[:SOURce]:IQ:OUTPut:DIGital:OFLow:STAtE</code> .....	675
<code>[:SOURce&lt;hw&gt;]:IQ:OUTPut:DIGital:PON</code> .....	676
<code>[:SOURce&lt;hw&gt;]:IQ:OUTPut:DIGital:POWer:LEVel</code> .....	676
<code>[:SOURce&lt;hw&gt;]:IQ:OUTPut:DIGital:POWer:PEP</code> .....	676
<code>[:SOURce&lt;hw&gt;]:IQ:OUTPut:DIGital:POWer:STEP[:INCRement]</code> .....	677
<code>[:SOURce&lt;hw&gt;]:IQ:OUTPut:DIGital:POWer:STEP:MODE</code> .....	677
<code>[:SOURce&lt;hw&gt;]:IQ:OUTPut:POWer:VIA</code> .....	677
<code>[:SOURce&lt;hw&gt;]:IQ:OUTPut:DIGital:SRATe</code> .....	678
<code>[:SOURce&lt;hw&gt;]:IQ:OUTPut:DIGital:SRATe:FIFO[:STATus]</code> .....	678

<a href="#">[:SOURce&lt;hw&gt;]:IQ:OUTPut:DIGital:SRATe:SOURce.....</a>	679
<a href="#">[:SOURce&lt;hw&gt;]:IQ:OUTPut:DIGital:STATe.....</a>	679

---

### **[:SOURce<hw>]:IQ:OUTPut:DIGital:CDEvice?**

#### **Digital Output only.**

This command indicates the ID of a connected R&S Instrument or R&S Device.

#### **Return values:**

<CDevice>                      string

**Example:**                      IQ:OUTP:DIG:CDEV?  
queries the connected device ID.

**Usage:**                        Query only

---

### **[:SOURce]:IQ:OUTPut:DIGital:OFLow:HOLD:RESet**

This command executes a reset of the overflow hold state and LED.

**Example:**                      SOUR:IQ:OUTP:DIG:OFL:HOLD:RESet  
resets the overflow hold state.

**Usage:**                        Event

---

### **[:SOURce]:IQ:OUTPut:DIGital:OFLow:HOLD:STATe?**

This command queries an overflow since the last reset. The overflow hold state can be reset via the Reset button next to the LED, or is reset automatically by starting a new signal generation or by setting new values to the output level.

#### **Return values:**

<State>                        0 | 1 | OFF | ON  
\*RST:                        0

**Example:**                      SOUR:IQ:OUTP:DIG:OFL:HOLD:STAT?  
queries the overflow state.  
Response: "0" (no overflow)

**Usage:**                        Query only

---

### **[:SOURce]:IQ:OUTPut:DIGital:OFLow:STATe?**

This command queries the current overflow state of the output signal and indicates that the I/Q output signal is currently clipped.

#### **Return values:**

<State>                        0 | 1 | OFF | ON  
\*RST:                        0

**Example:**                      IQ:OUTP:DIG:OFL:STAT?  
queries the overflow state.  
Response: "0" (no overflow).

**Usage:** Query only

---

**[[:SOURce<hw>]:IQ:OUTPut:DIGital:PON <Pon>**

This command selects the state which the digital I/Q Output is to assume after the instrument is switched on.

**Parameters:**

<Pon> OFF | UNCHanged  
\*RST: OFF

**Example:**

`IQ:OUTP:DIG:PON OFF`  
deactivates the output when the instrument is switched on.  
`IQ:OUTP:DIG:PON UNCH`  
sets the output to the status that was active before the last switch off.

**Options:** B13 and B18

---

**[[:SOURce<hw>]:IQ:OUTPut:DIGital:POWER:LEVel <Level>**

This command sets the rms level of the digital output signal. The level entry fields and the appropriate units (dBFS) are displayed in the status bar. The level display refers to both signal components ( $\sqrt{I^2+Q^2}$ ).

**Parameters:**

<Level> float  
Range: -90 to 0  
Increment: 0.01  
\*RST: 0  
Default unit: dBFS

**Example:**

`IQ:OUTP:DIG:POW:LEV -10`  
sets the output signal level to -10 dBFS.

**Options:** B13 and B18

---

**[[:SOURce<hw>]:IQ:OUTPut:DIGital:POWER:PEP <Pep>**

This command sets the peak envelope power of the digital output signal (PEP). The level entry fields and the appropriate units (dBFS) are displayed in the status bar. The level display refers to both signal components ( $\sqrt{I^2+Q^2}$ ).

**Parameters:**

<Pep> float  
Range: -90 to 0  
Increment: 0.01  
\*RST: 0  
Default unit: dBFS

**Example:**

`IQ:OUTP:DIG:POW:PEP -10`  
sets the signal output level to -10 dBFS.

**Options:** B13 and B18

---

**[:SOURce<hw>]:IQ:OUTPut:DIGital:POWer:STEP[:INCRement] <Increment>**

The command sets the step width for the frequency setting if the frequency values UP/DOWN are used and variation mode `SOUR:IQ:OUTP:DIG:POW:STEP:MODE USER` is selected. The command is linked to "Variation Step" for manual operation, i.e. the command also sets the step width of the rotary knob for "Variation Active ON".

**Parameters:**

<Increment> float  
 Range: 0 to 100  
 Increment: 0.01  
 \*RST: 1  
 Default unit: dB

**Example:** `SOUR:IQ:OUTP:ANAL:POW:STEP:INCR 50 mV`  
 sets the step width for the level setting to 50 mV.

**Options:** B13 and B18

---

**[:SOURce<hw>]:IQ:OUTPut:DIGital:POWer:STEP:MODE <Mode>**

This command activates (USER) or deactivates (DECimal) the user-defined step width used when varying the level value with the level values UP/DOWN. The command is linked to setting **Variation Active** for manual operation, i.e. the command also activates/deactivates the user-defined step width used when varying the level value with the rotary knob.

**Parameters:**

<Mode> DECimal | USER  
 \*RST: DECimal

**Example:** `IQ:OUTP:DIG:POW:STEP:MODE USER`  
 activates the step width for level variation with the rotary knob (manual operation) and with level values UP/DOWN (remote control).

**Options:** B13 and B18

---

**[:SOURce<hw>]:IQ:OUTPut:POWer:VIA <Via>**

This command activates the selected I/Q output level entry fields of the currently selected signal path in the status bar.

**Parameters:**

&lt;Via&gt;

PEP | LEVel

**PEP**

The signal level is expressed in terms of a peak envelope power value (PEP). The level entry fields and the corresponding units are displayed in the status bar.

**LEVel**

The signal level is expressed in terms of a rms value. The level entry field and the corresponding units are displayed in the status bar.

\*RST: PEP

**Example:**

IQ:OUTP:POW:VIA PEP

the I/Q-signal level is set via PEP for the signal of path A.

[:SOURce&lt;hw&gt;]:IQ:OUTPut:DIGital:SRATe &lt;SRate&gt;

Using the sample rate source User the command sets the sample rate value of the output signal. This command is not active for external clock sources

**Parameters:**

&lt;SRate&gt;

float

Range: 400 to 100 MHz

Increment: 0.01 Hz

\*RST: 1E8

**Example:**

IQ:OUTP:DIG:SRAT:MODE USER

with sample rate source User the internally generated clock reference signal is selected.

IQ:OUTP:DIG:SRAT 100 MHz

the sample rate for the output signal is set to 100 MHz.

**Options:**

B13 and B18

[:SOURce&lt;hw&gt;]:IQ:OUTPut:DIGital:SRATe:FIFO[:STATus]?

This command queries the state of the signal transmission.

**Return values:**

&lt;Status&gt;

OK | OFLow | URUN

**OK**

Resampling is working properly.

**OFLow (Overflow)**

The external sample rate frequency is too high which causes an overflow in signal transmission.

**URUN (Underrun)**

The external sample rate is too low which causes an underrun in signal transmission.

\*RST: OK

**Example:** `SOUR:BBIN:SRAT:FIFO:STATus?`  
queries the FIFO Status of the sample rate.

**Usage:** Query only

**[[:SOURce<hw>]:IQ:OUTPut:DIGital:SRate:SOURce <Source>**

This command selects the source for setting the sample rate of the digital I/Q output signal.

**Note:** With a connected R&S EX-IQ-Box either the internal clock source (User defined) or an external clock (Digital I/Q In) can be selected in the settings dialog of the R&S EX-IQ-Box. Therefore, the sample rate source is only indicated in this field.

**Parameters:**

<Source> USER | DIN | DOUT | USER | DOUT

**USER**

The internally generated clock reference signal is used (option R&S SMJ-B13). The sample rate is calculated and displayed in the field "Value".

**DOUT**

An external clock reference signal is used. The clock signal is directly fed in via pin CLK2 of the digital output interface (option R&S SMJ-B18, Digital I/Q Out). The sample rate is displayed in the field "Value".

\*RST: USER

**Example:** `IQ:OUTP:DIG:SRAT:SOUR USER`  
the internally generated clock reference signal is selected.

**[[:SOURce<hw>]:IQ:OUTPut:DIGital:STATe <State>**

This command switches on and off the digital I/Q output signals.

**Parameters:**

<State> 0 | 1 | OFF | ON

\*RST: 0

**Example:** `IQ:OUTP:DIG:STAT ON`  
the digital I/Q output signals of path A are activated.

**Options:** B13 and B18

### 7.15.10 SOURce:LFOutput Subsystem

This subsystem contains the commands for setting the LF signal source in CW and Sweep mode as well as for analog modulation.



**Example**

The following example shows how to set an LF sweep.

1. Set the sweep range.  

```
LFOutput:FREQUENCY:START 4 kHz
LFOutput:FREQUENCY:STOP 10 kHz
```
2. Select linear or logarithmic sweep spacing.  

```
LFOutput:SWEep[:FREQUENCY]:SPACing LIN
```
3. Set the step width and dwell time.  

```
LFOutput:SWEep[:FREQUENCY]:STEP[:LINear] 100 Hz
LFOutput:SWEep[:FREQUENCY]:DWELL 20 ms
```
4. Determine the sweep mode.  

```
LFOutput:SWEep:MODE AUTO
```
5. Determine the trigger.  

```
TRIGger0:SOURce SINGLE
```
6. Activate the sweep.  

```
LFOutput:FREQUENCY:MODE SWEep
```
7. Trigger the sweep (depending on the mode).  

```
LFOutput:SWEep:EXECute
```

<a href="#">[:SOURce]:LFOutput:FREQUENCY</a> .....	680
<a href="#">[:SOURce]:LFOutput:FREQUENCY:MANual</a> .....	681
<a href="#">[:SOURce]:LFOutput:FREQUENCY:MODE</a> .....	681
<a href="#">[:SOURce]:LFOutput:FREQUENCY:START</a> .....	682
<a href="#">[:SOURce]:LFOutput:FREQUENCY:STOP</a> .....	683
<a href="#">[:SOURce]:LFOutput[:STATe]</a> .....	683
<a href="#">[:SOURce]:LFOutput:SWEep[:FREQUENCY]:DWELL</a> .....	683
<a href="#">[:SOURce]:LFOutput:SWEep[:FREQUENCY]:EXECute</a> .....	683
<a href="#">[:SOURce]:LFOutput:SWEep[:FREQUENCY]:MODE</a> .....	684
<a href="#">[:SOURce]:LFOutput:SWEep[:FREQUENCY]:POINTS</a> .....	684
<a href="#">[:SOURce]:LFOutput:SWEep[:FREQUENCY]:SHAPE</a> .....	685
<a href="#">[:SOURce]:LFOutput:SWEep[:FREQUENCY]:SPACing</a> .....	685
<a href="#">[:SOURce]:LFOutput:SWEep[:FREQUENCY]:STEP[:LINear]</a> .....	686
<a href="#">[:SOURce]:LFOutput:SWEep[:FREQUENCY]:STEP:LOGarithmic</a> .....	686
<a href="#">[:SOURce]:LFOutput:VOLTage</a> .....	687

**[:SOURce]:LFOutput:FREQUENCY <Frequency>**

The command sets the frequency of the LF signal for CW mode (:SOUR:MODE CW mode). The setting is valid for all analog modulations (AM/FM/PhiM/Pulse) with internal modulation source.

In Sweep mode (SOUR:LFO:FREQ:MODE SWE), the frequency is linked to the sweep frequency.

**Parameters:**

<Frequency> float  
 Range: 0.1 Hz to 1 MHz  
 Increment: 0.1 Hz  
 \*RST: 1 kHz  
 Default unit: Hz

**Example:**

LFO:FREQ 5kHz  
 sets the frequency of the LF signal to 5 kHz

**[[:SOURce]:LFO]Output:FREQUENCY:MANual <Manual>**

In Sweep mode (SOUR:LFO:FREQ:MODE SWE) the command sets the frequency for the next sweep step in the "Step" sweep mode (SOUR:LFO:SWE:MODE MAN). Here only frequency values between the settings SOUR:LFO:FREQ:STAR and . . . :STOP are permitted. Each sweep step is triggered by a separate SOUR:LFO:FREQ:MAN command.

**Parameters:**

<Manual> float  
 Range: START to STOP  
 Increment: 0.1 Hz  
 \*RST: 1 kHz

**Example:**

LFO:SWE:MODE MAN  
 sets the "Step" sweep mode.  
 LFO:FREQ:MAN 5 kHz  
 sets an LF frequency of 5 kHz for the next step in the "Step" sweep mode.  
 LFO:FREQ:MODE SWE  
 sets the LF Sweep mode. An LF frequency of 5 kHz is output.  
 LFO:FREQ:MAN 5.1 kHz  
 triggers the next sweep step with a frequency of 5.1 kHz.

**[[:SOURce]:LFO]Output:FREQUENCY:MODE <Mode>**

The command sets the instrument operating mode and therefore also the commands used to set the output frequency.

**Parameters:**

&lt;Mode&gt;

CW | FIXed | SWEep

**CW|FIXed**

The instrument operates in fixed-frequency mode. CW and FIXed are synonyms.

The output frequency is set with [:SOURce]:LFOuTput:FREQuency.

**SWEep**

The instrument operates in SWEep mode. The frequency is set using the commands [:SOURce]:LFOuTput:FREQuency:STARt, [:SOURce]:LFOuTput:FREQuency:STOP or [:SOURce]:LFOuTput:FREQuency:MANual.

\*RST: CW

**Example:**

LFO:FREQ:MODE SWE

sets the SWEep mode. The settings under

SOURce:LFOuTput:FREQuency:STARt; STOP; MANual become effective.

**[:SOURce]:LFOuTput:FREQuency:STARt <Start>**

This command sets the start frequency for the LF Sweep mode.

**Parameters:**

&lt;Start&gt;

float

Range: 0.1 Hz to 1 MHz

Increment: 0.1 Hz

\*RST: 1 kHz

**Example:**

RST\*

activates all presettings.

LFO:SWE:MODE AUTO

sets the AUTO sweep mode, i.e. each trigger triggers a complete sweep.

TRIG0:SOUR SING

sets the SINGLE trigger mode, i.e. the sweep is triggered by the command :LFOuTput:SWEep:EXECute or \*TRG.

LFO:FREQ:STAR 100 kHz

sets the start frequency for the LF sweep to 100 kHz.

LFO:FREQ:STOP 200 kHz

sets the stop frequency of the LF sweep to 200 kHz.

LFO:FREQ:MODE SWE

sets the LF sweep mode.

LFO:SWE:EXEC

a one-off LF sweep from 100 kHz to 200 kHz is performed. The linear step width is 1 kHz with a dwell time of 15 ms (preset values).

**[[:SOURce]:LFOutput:FREQuency:STOP <Stop>**

This command sets the stop frequency for the LF sweep.

**Parameters:**

<Stop> float  
 Range: 0.1 Hz to 1 MHz  
 Increment: 0.1 Hz  
 \*RST: 50 kHz

**Example:**

LFO:FREQ:STOP 200 kHz  
 sets the stop frequency for the LF sweep to 200 kHz.  
 LFO:FREQ:STAR 100 kHz  
 sets the start frequency for the LF sweep to 100 kHz.

**[[:SOURce]:LFOutput[:STATe] <State>**

The command activates/deactivates the LF output.

**Parameters:**

<State> 0 | 1 | OFF | ON  
 \*RST: OFF

**Example:**

LFO ON  
 activates the LF output. The settings under LFO:FREQ and  
 LFO:SWE become effective.

**[[:SOURce]:LFOutput:SWEep[:FREQuency]:DWELI <Dwell>**

The command sets the dwell time for each frequency step of the sweep.

**Tip:** It is recommended to switch off the "GUI Update" for optimum sweep performance especially with short dwell times ([SYSTem:DISPlay:UPDate OFF](#)).

**Parameters:**

<Dwell> float  
 Range: 10.0E-3 to 100  
 Increment: 100.0E-6  
 \*RST: 10.0E-3  
 Default unit: s

**Example:**

LFO:SWE:DWEL 20 ms  
 sets a dwell time of 20 ms.

**[[:SOURce]:LFOutput:SWEep[:FREQuency]:EXECute**

The command immediately starts an LF sweep.

The MODE setting ([\[:SOURce\]:LFOutput:SWEep\[:FREQuency\]:MODE](#)) determines which sweep is executed, e.g. [SOURce:LFOutput:SWEep:FREQuency:MODE STEP](#).

The command corresponds to the manual-control [Execute Single Sweep - LF Sweep](#).

**Example:**           LFO:SWE:MODE SING  
sets the single cycle mode of the LF sweep.  
LFO:SWE:EXEC  
starts one cycle of the LF sweep.

**Usage:**            Event

**[[:SOURce]:LFOOutput:SWEep[:FREQUENCY]:MODE <Mode>**

The command sets the cycle mode of the LF sweep.

The assignment of the GPIB commands to the sweep modes is given in the description of the sweep menus.

**Parameters:**

<Mode>

AUTO | MANual | STEP

**AUTO**

Each trigger triggers exactly one complete sweep.

**MANual**

The trigger system is not active. Each frequency step of the sweep is triggered individually, either by varying the "Current Frequency" value using the rotary knob under manual control or by means of a :LFOOutput:FREQ:MAN command under remote control.

With manual control, the frequency increases or decreases (depending on the direction of the rotary encoder) by the value specified under SOUR:LFO:SWE:FREQ:STEP:LIN (linear spacing) or . . . :STEP:LOG (logarithmic spacing).

With remote control, the frequency increases by the value specified under LFO:SWE:FREQ:STEP:LIN|LOG which each sent [:SOURce]:LFOOutput:FREQUENCY:MANual command, irrespective the value entered there.

**STEP**

Each trigger triggers one sweep step only. The frequency increases by the value entered under

[SOURce:]LFOOutput:SWEep:STEP.

\*RST:            AUTO

**Example:**           LFO:SWE:MODE AUTO  
selects Mode Auto.

**[[:SOURce]:LFOOutput:SWEep[:FREQUENCY]:POINTS <Points>**

The command sets the number of steps in an LF sweep.

The command is linked to the command :LFOOutput:SWEep[:FREQUENCY]:STEP as follows:

- for linear sweeps and START < STOP

$$\text{POINTS} = ((\text{STOP} - \text{START}) / \text{STEP} : \text{LIN}) + 1$$

- for logarithmic sweeps and  $\text{START} < \text{STOP}$   

$$\text{POINTS} = ((\log \text{STOP} - \log \text{START}) / \log \text{STEP} : \text{LOG}) + 1$$

If POINTS changes, the value of STEP is adjusted. The START and STOP value is retained.

Two separate POINTS values are used for linear or logarithmic sweep spacing (LFO:SWEEP[:FREQUENCY]:SPACING LIN | LOG). The command is always effective for the currently set sweep spacing.

**Parameters:**

<Points> float  
 Increment: 1  
 \*RST: 100

**Example:**

```
LFO:FREQ:STAR
sets the start frequency to 2 kHz.
LFO:FREQ:STOP
sets the stop frequency to 20 kHz
LFO:SWE:SPAC LIN
sets linear sweep spacing.
LFO:SWE:POIN 11
sets 11 sweep steps for linear sweep spacing. The sweep step
width (STEP) is automatically set to 2 kHz.
```

**[[:SOURce]:LFO:SWEEP[:FREQUENCY]:SHAPE <Shape>**

The command sets the cycle mode for a sweep sequence (shape).

**Parameters:**

<Shape> SAWTooth | TRIangle

**SAWTooth**

One sweep runs from start to stop frequency. Each subsequent sweep starts at the start frequency, i.e. the shape of the sweep sequence resembles a sawtooth.

**TRIangle**

One sweep runs from start to stop frequency and back, i.e. the shape of the sweep resembles a triangle. Each subsequent sweep starts at the start frequency.

\*RST: SAWTooth

**Example:**

```
SOUR:LFO:SWE:SHAP TRI
selects the sweep cycle with alternating ascending and descend-
ing sweep directions.
```

**[[:SOURce]:LFO:SWEEP[:FREQUENCY]:SPACING <Spacing>**

The command selects linear or logarithmic sweep spacing.

**Parameters:**

<Spacing> LINear | LOGarithmic  
 \*RST: LINear

**Example:**

LFO:SWE:SPAC LIN  
 selects linear sweep spacing.

**[:SOURce]:LFOOutput:SWEep[:FREQuency]:STEP[:LINear] <Linear>**

The command sets the step width for the linear sweep.

This command is linked to the command :LFOOutput:SWEep[:FREQuency]:POINTs as follow.

- for  $START < STOP$ :  
 $POINTS = ((STOP - START) / STEP:LIN) + 1$

If  $STEP:LIN$  changes, the value of  $POINTS$  is adjusted. The  $START$  and  $STOP$  value is retained.

**Parameters:**

<Linear> float  
 Range: 0 to  $STOP - START$   
 Increment: 0.1 Hz

**Example:**

LFO:FREQ:STAR  
 sets the start frequency to 2 kHz.  
 LFO:FREQ:STOP  
 sets the stop frequency to 20 kHz.  
 LFO:SWE:SPAC LIN  
 sets linear sweep spacing.  
 LFO:SWE:STEP 2 kHz  
 sets the sweep step width to 2 kHz. The number of sweep steps for linear sweep spacing ( $POINTS$ ) is automatically set to 11.

**[:SOURce]:LFOOutput:SWEep[:FREQuency]:STEP:LOGarithmic <Logarithmic>**

The command specifies the step width factor for logarithmic sweeps. The next frequency value of a sweep is calculated (for  $START < STOP$ ) using the following formula:

$New\ frequency = Old\ frequency + STEP:LOG \times Old\ frequency$

$STEP:LOG$  therefore gives the fraction of the old frequency. The frequency is increased by this fraction for the next sweep step. Usually  $STEP:LOG$  is given in percent, whereby the suffix PCT must always be used.

The command is linked to the command :LFOOutput:SWEep[:FREQuency]:POINTs as follows:

- for logarithmic sweeps and  $START < STOP$ :  
 $POINTS = ((\log STOP - \log START) / \log STEP:LOG) + 1$

If  $STEP:LOG$  changes, the value of  $POINTS$  is adjusted. The  $START$  and  $STOP$  value is retained.

**Parameters:**

<Logarithmic> float  
 Range: 0.01PCT to 100PCT  
 Increment: 0.01PCT  
 \*RST: 1

**Example:**

LFO:FREQ:STAR  
 sets the start frequency to 1 kHz.  
 LFO:FREQ:STOP  
 sets the stop frequency to 100 kHz.  
 LFO:SWE:SPAC LOG  
 sets logarithmic sweep spacing.  
 LFO:SWE:STEP:LOG 10PCT  
 sets the step width for logarithmic sweep spacing to 10% of the previous frequency in each instance.

**[:SOURce]:LFOutput:VOLTage <Voltage>**

The command sets the output voltage of the LF output.

**Parameters:**

<Voltage> float  
 Range: 0 to 4  
 Increment: 0.001  
 \*RST: 1  
 Default unit: V

**Example:**

LFO:VOLT 3 V  
 sets the voltage of the LF output to 3 V.

### 7.15.11 SOURce:LIST Subsystem

This subsystem contains the commands for the List mode of the instrument.

The following settings are required to operate the instrument in List mode:

## 1. Create a list.

If a list which does not exist is selected with the `:LIST:SEL` command, an empty list with the name of the selected list is created.

```
SOURce1:LIST:SEL "New_list"
```

## 2. Fill the list with values.

All list components must be of the same length. This does not apply to components of length 1. This is interpreted as if the component has the same length as the other components and as if all values are the same as the first value.

```
SOURce1:LIST:FREQ 100 MHz, 110 MHz, 120 MHz...
```

```
SOURce1:LIST:POW 2dBm, -1dBm, 0dBm...
```

## 3. Select a list.



If a new empty file has been created with the `:LIST:SEL` command, this file is selected, otherwise an existing list must be selected before the List mode is activated.

```
SOURce1:LIST:SEL "Old_list"
```

4. Set the dwell time.

The dwell time determines the duration of the individual list steps.

```
SOURce1:LIST:DWELL 3ms
```

5. Set the List mode.

The List mode determines the way in which the list is processed. In the example the list is processed once only or repeatedly depending on the trigger setting.

```
SOURce1:LIST:MODE AUTO
```

6. Determine the trigger.

In the example each trigger causes the list to be processed once from beginning to end.

```
SOURce:LIST:TRIGger:SOURce SINGLE
```

7. Activate the List mode.

```
SOURce1:FREQuency:MODE LIST
```

8. Trigger the list (depending on the mode).

```
SOURce1:LIST:TRIGger:EXECute
```

9. Deactivate the List mode.

```
SOURce1:FREQuency:MODE CW
```



SCPI refers to the individual lists as segments.

<code>[:SOURce&lt;hw&gt;]:LIST:CATalog</code> .....	689
<code>[:SOURce&lt;hw&gt;]:LIST:DELeTe</code> .....	689
<code>[:SOURce&lt;hw&gt;]:LIST:DELeTe:ALL</code> .....	690
<code>[:SOURce&lt;hw&gt;]:LIST:DEXChange:AFILe:CATalog</code> .....	690
<code>[:SOURce&lt;hw&gt;]:LIST:DEXChange:AFILe:EXTension</code> .....	691
<code>[:SOURce&lt;hw&gt;]:LIST:DEXChange:AFILe:SELeCt</code> .....	691
<code>[:SOURce&lt;hw&gt;]:LIST:DEXChange:AFILe:SEParator:COLumn</code> .....	691
<code>[:SOURce&lt;hw&gt;]:LIST:DEXChange:AFILe:SEParator:DECimal</code> .....	692
<code>[:SOURce&lt;hw&gt;]:LIST:DEXChange:EXECute</code> .....	692
<code>[:SOURce&lt;hw&gt;]:LIST:DEXChange:MODE</code> .....	693
<code>[:SOURce&lt;hw&gt;]:LIST:DEXChange:SELeCt</code> .....	693
<code>[:SOURce&lt;hw&gt;]:LIST:DWELL</code> .....	694
<code>[:SOURce&lt;hw&gt;]:LIST:FREE</code> .....	694
<code>[:SOURce&lt;hw&gt;]:LIST:FREQuency</code> .....	694
<code>[:SOURce&lt;hw&gt;]:LIST:FREQuency:POINts</code> .....	695
<code>[:SOURce&lt;hw&gt;]:LIST:INDex</code> .....	695
<code>[:SOURce&lt;hw&gt;]:LIST:INDex:START</code> .....	696
<code>[:SOURce&lt;hw&gt;]:LIST:INDex:STOP</code> .....	696
<code>[:SOURce&lt;hw&gt;]:LIST:LEARn</code> .....	697
<code>[:SOURce&lt;hw&gt;]:LIST:MODE</code> .....	697

<code>[:SOURce&lt;hw&gt;]:LIST:POWer</code> .....	698
<code>[:SOURce&lt;hw&gt;]:LIST:POWer:POINts</code> .....	698
<code>[:SOURce&lt;hw&gt;]:LIST:RESet</code> .....	698
<code>[:SOURce&lt;hw&gt;]:LIST:SElect</code> .....	699
<code>[:SOURce&lt;hw&gt;]:LIST:TRIGger:EXECute</code> .....	699
<code>[:SOURce&lt;hw&gt;]:LIST:TRIGger:SOURce</code> .....	699

---

### `[:SOURce<hw>]:LIST:CATalog?`

The command requests a list of available lists. The individual lists are separated by commas.

The lists are stored with the fixed file extensions `*.lsw` in a directory of the user's choice. The directory applicable to the commands is defined with the command `MMEMoRY:CDIR`.

#### Return values:

<Catalog>                    string

#### Example:

```
MMEM:CDIR 'D:/Lists/Listmode'
selects the directory for the list mode files.
LIST:CAT?
queries the available lists.
Response: 'list1,list2'
the lists list1 and list2 are available.
```

**Usage:**                    Query only

---

### `[:SOURce<hw>]:LIST:DELeTe <Delete>`

The command deletes the specified list.

The files are stored with the fixed file extensions `*.lsw` in a directory of the user's choice. The directory applicable to the command is defined with the command `MMEMoRY:CDIR`. To access the files in this directory, only the file name has to be given, without the path and the file extension. A path can also be specified in command `:SOUR:LIST:CAT?`, in which case the file in the specified directory is deleted.

\*RST does not affect data lists.

#### Setting parameters:

<Delete>                    <list file name>

#### Example:

```
MMEM:CDIR 'D:/Lists/Listmode'
selects the directory for the list mode files.
LIST:DEL 'LIST1'
deletes the list list1.
```

**Usage:**                    Setting only

**[[:SOURce<hw>]:LIST:DELeTe:ALL**

The command deletes all lists in the set directory. The List mode must be deactivated beforehand to ensure that no lists are selected when this command is called (SOUR:FREQ:MODE CW or SWE).

The files are stored with the fixed file extensions \*.lsw in a directory of the user's choice. The directory applicable to the command is defined with the command MMEMoRY:CDIR. A path can also be specified in command SOUR:LIST:CAT?, in which case all list mode files in the specified directory are deleted.

\*RST does not affect data lists.

**Example:**

```
MMEM:CDIR 'D:/Lists/Listmode'
```

selects the directory for the list mode files.

```
FREQ:MODE SWE
```

deactivates the List mode for RF output and activates the Sweep mode.

```
SOUR2:FREQ:MODE SWE
```

deactivates the List mode for RF output and activates Sweep mode.

```
LIST:DEL:ALL
```

deletes all list mode files available in the set directory.

**Usage:** Event

**[[:SOURce<hw>]:LIST:DEXChange:AFILe:CATalog?**

The command requests a list of available ASCII files for export/import of list mode data. The individual files are separated by commas.

The ASCII files are stored with the fixed file extensions \*.txt or \*.csv in a directory of the user's choice. The directory applicable to the commands is defined with the command MMEMoRY:CDIR.

**Return values:**

<Catalog> string

**Example:**

```
MMEM:CDIR 'D:/lists/listmode/import'
```

selects the directory for the ASCII files with frequency and level value pairs.

```
LIST:DEXC:AFIL:EXT TXT
```

selects that ASCII files with extension \*.txt are listed.

```
LIST:DEXC:AFIL:CAT?
```

queries the available files with extension \*.txt.

Response: 'list1,list2'

the ASCII files list1.txt and list2.txt are available.

**Usage:** Query only

**[[:SOURce<hw>]:LIST:DEXChange:AFILe:EXTension <Extension>**

The command selects the file extension of the ASCII file to be imported or exported. Selection `TXT` (text file) or `CSV` (Excel file) is available.

**Parameters:**

<Extension>            `TXT | CSV`  
 \*RST:                `TXT`

**Example:**

```
MMEM:CDIR 'D:/lists/listmode/import'
selects the directory for the ASCII files with frequency and level
value pairs.
LIST:DEXC:AFIL:EXT TXT
selects that ASCII files with extension *.txt are listed.
LIST:DEXC:AFIL:CAT?
queries the available files with extension *.txt.
Response: 'list1,list2'
the ASCII files list1.txt and list2.txt are available.
```

**[[:SOURce<hw>]:LIST:DEXChange:AFILe:SElect <Select>**

The command selects the ASCII file to be imported or exported.

The ASCII files are stored with the fixed file extensions `*.txt` or `*.csv` in a directory of the user's choice. The directory applicable to the commands is defined with the command `MMEMory:CDIR`. A path can also be specified in command `SOUR:LIST:DEXC:AFIL:SEL`, in which case the files are stored or loaded in the specified directory.

**Parameters:**

<Select>                <ascii\_file\_name>

**Example:**

```
LIST:DEXC:MODE IMP
selects that ASCII files with frequency and level value pairs are
imported and transferred into list mode lists.
LIST:DEXC:AFIL:SEL 'D:
/user/listmode/import/list.csv'
selects that ASCII file list.csv is imported.
LIST:DEXC:SEL 'D:
/user/listmode/import/list_imp'
selects that the ASCII file list.csv is imported into list mode list
list_imp.
```

**[[:SOURce<hw>]:LIST:DEXChange:AFILe:SEParator:COLumn <Column>**

The command selects the separator between the frequency and level column of the ASCII table.

**Parameters:**

<Column>                `TABulator | SEMicolon | COMMa | SPACe`  
 \*RST:                `COMMa`

**Example:**

```
LIST:DEXC:MODE EXP
selects that the list mode list is exported into an ASCII file.
LIST:DEXC:AFIL:SEL 'D:
/user/listmode/import/list.csv'
selects ASCII file list.csv as destination for the list mode list
data.
LIST:DEXC:AFIL:SEP:COL TAB
the pairs of frequency and level values are separated by a tabu-
lator.
LIST:DEXC:AFIL:SEP:DEC DOT
selects the decimal separator dot.
LIST:DEXC:SEL 'D:
/user/listmode/import/list_imp'
selects that the list mode list list_imp is imported into ASCII file
list.csv.
```

---

**[:SOURce<hw>]:LIST:DEXChange:AFILe:SEParator:DECimal <Decimal>**

The command the decimal separator used in the ASCII data between '.' (decimal point) and ',' (comma) with floating-point numerals.

**Parameters:**

<Decimal>            DOT | COMMa  
 \*RST:            DOT

**Example:**

```
LIST:DEXC:MODE EXP
selects that the list mode list is exported into an ASCII file.
LIST:DEXC:AFIL:SEL 'D:
/user/listmode/import/list.csv'
selects ASCII file list.csv as destination for the list mode list
data.
LIST:DEXC:AFIL:SEP:COL TAB
the pairs of frequency and level values are separated by a tabu-
lator.
LIST:DEXC:AFIL:SEP:DEC DOT
selects the decimal separator dot.
LIST:DEXC:SEL 'rootD:
/user/listmode/import/list_imp'
selects that the list mode list list_imp is imported into ASCII file
list.csv.
```

---

**[:SOURce<hw>]:LIST:DEXChange:EXECute**

The command starts the export or import of the selected file. When import is selected, the ASCII file is imported as list mode list. When export is selected, the list mode list is exported into the selected ASCII file.

**Example:**

```
LIST:DEXC:MODE IMP
selects that ASCII files with frequency and level value pairs are
imported and transferred into list mode lists.
LIST:DEXC:AFIL:SEL 'D:
/user/listmode/import/list.csv'
selects that ASCII file list.csv is imported.
LIST:DEXC:SEL 'D:
/user/listmode/import/list_imp'
selects that the ASCII file list.csv is imported into list mode list
list_imp.
LIST:DEXC:EXEC
starts the import of the ASCII file data into the list mode file.
```

**Usage:** Event

---

#### **[[:SOURce<hw>]:LIST:DEXChange:MODE <Mode>**

The command selects if list mode lists should be imported or exported. Depending on the selection here, the file select command defines either the source or the destination for list mode lists and ASCII files.

#### **Parameters:**

<Mode> IMPort | EXPort  
\*RST: IMPort

**Example:**

```
LIST:DEXC:MODE IMP
selects that ASCII files with frequency and level value pairs are
imported and transferred into list mode lists.
LIST:DEXC:AFIL:SEL 'D:
/user/listmode/import/list.csv'
selects that ASCII file list.csv is imported.
LIST:DEXC:SEL 'rootD:
/user/listmode/import/list_imp'
selects that the ASCII file list.csv is imported into list mode list
list_imp.
```

---

#### **[[:SOURce<hw>]:LIST:DEXChange:SElect <Select>**

The command selects the list mode list to be imported or exported.

The list mode files are stored with the fixed file extensions \*.lsw in a directory of the user's choice. The directory applicable to the commands is defined with the command `MMEMory:CDIR`. A path can also be specified in command `SOUR:LIST:DEXC:SEL`, in which case the files are stored or loaded in the specified directory.

#### **Parameters:**

<Select> <list\_name>

**Example:** LIST:DEXC:MODE IMP  
 selects that ASCII files with frequency and level value pairs are imported and transferred into list mode lists.  
 LIST:DEXC:AFIL:SEL `D:  
 /user/listmode/import/list.csv'  
 selects that ASCII file list.csv is imported.  
 LIST:DEXC:SEL `D:  
 /user/listmode/import/list\_imp'  
 selects that the ASCII file list.csv is imported into list mode list list\_imp.

---

**[:SOURce<hw>]:LIST:DWELI <Dwell>**

The command sets the time for which the instrument retains a setting.

**Parameters:**

<Dwell> float  
 Range: 0.5 ms to 100 s  
 Increment: 1E-4  
 \*RST: 10.0 ms  
 Default unit: s

**Example:** LIST:DWEL 15  
 each setting in the list is retained for 15 ms.

---

**[:SOURce<hw>]:LIST:FREE?**

This command queries on the free storage space for list mode lists.

**Return values:**

<Free> integer  
 Range: 0 to INT\_MAX  
 Increment: 1  
 \*RST: 0

**Example:** LIST:FREE?

**Usage:** Query only

Response: 2147483647;1

---

**[:SOURce<hw>]:LIST:FREQuency <Frequency>**

The command fills the FREQuency part of the selected list with data.

\*RST does not affect data lists.

**Parameters:**

&lt;Frequency&gt;

&lt;Frequency#1&gt;{, &lt;Frequency#2&gt;, ...} | block data

The data can be given either as a list of numbers (list can be of any length and list entries must be separated by commas) or as binary block data. When block data is transferred, 8 (4) bytes are always interpreted as a floating-point number with double accuracy (see :FORMat [:DATA] on page 493).

Range: 300 kHz to RFmax (RFmax depending on model)

**Example:**

```
LIST:SEL 'D:/Lists/Listmode/list3'
```

selects list3 for editing. List3 is created if it does not yet exist.

```
SOUR:LIST:FREQ 1.4GHz, 1.3GHz, 1.2GHz,...
```

specifies the frequency values in list3. If the list already contains data, it is overwritten.

**Usage:**

SCPI confirmed

**[[:SOURce<hw>]:LIST:FREQUENCY:POINTS?**

The command queries the length (in points) of the FREQUENCY component of the selected list.

**Return values:**

&lt;Points&gt;

float

**Example:**

```
LIST:SEL 'D:/Lists/Listmode/list3'
```

selects list3 for editing. List3 is created if it does not yet exist.

```
LIST:FREQ:POIN?
```

queries the number of frequency values in list3.

Response: 327

list3 has 327 frequency entries.

**Usage:**

Query only

**[[:SOURce<hw>]:LIST:INDEX <Index>**

The command sets the list index in step mode (LIST:MODE STEP).

After the trigger signal the frequency and level settings of the selected index are processed in List mode.

**Parameters:**

&lt;Index&gt;

float

\*RST: 0



**Example:**

```
LIST:SEL 'D:/Lists/Listmode/list3'
```

selects list3 for use in List mode.

```
FREQ:MODE LIST
```

activates List mode. List3 is processed.

```
LIST:MODE STEP
```

selects manual, step-by-step processing of the list.

```
LIST:IND 5
```

the frequency/level value pair with index 5 is executed.

```
TRIG:LIST:SOUR SING
```

selects triggering by means of the single trigger. The list is executed once.

```
SOUR:LIST:TRIG:EXEC
```

triggers the processing of the selected list.

---

#### **[[:SOURce<hw>]:LIST:INDEX:START <Start>**

The command sets the start index of the index range which defines a subgroup of frequency/level value pairs in the current list. Only the values in the set index range (:LIST:INDEX:START ... :LIST:INDEX:STOP) are processed in List mode.

#### **Parameters:**

<Start> float  
 Range: 0 to list length  
 \*RST: 0

**Example:**

```
LIST:SEL 'D:/Lists/Listmode/list3'
```

selects list3 for use in List mode.

```
LIST:IND:STAR 25
```

sets 25 as start index of the index range.

```
LIST:IND:STOP 49
```

sets 49 as stop index of the index range.

```
FREQ:MODE LIST
```

activates List mode. The frequency/level value pairs from index 25 to index 49 in list3 are processed. All other entries of the list are ignored.

---

#### **[[:SOURce<hw>]:LIST:INDEX:STOP <Stop>**

The command sets the stop index of the index range which defines a subgroup of frequency/level value pairs in the current list. Only the values in the set index range (:LIST:INDEX:START ... :LIST:INDEX:STOP) are processed in List mode.

#### **Parameters:**

<Stop> float  
 Range: 0 to list length  
 \*RST: 0

**Example:**           LIST:SEL 'D:/Lists/Listmode/list3'  
 selects list3 for use in List mode.  
 LIST:IND:STAR 25  
 sets 25 as start index of the index range.  
 LIST:IND:STOP 49  
 sets 49 as stop index of the index range.  
 FREQ:MODE LIST  
 activates List mode. The frequency/level value pairs from index 25 to index 49 in list3 are processed. All other entries of the list are ignored.

---

#### **[:SOURce<hw>]:LIST:LEARn**

The command learns the selected list, i.e. it determines the hardware setting for the entire list. The data determined in this way is stored together with the list. When the list is activated for the first time, these settings are calculated automatically.

**Example:**           LIST:SEL 'D:/Lists/Listmode/list3'  
 selects list3. List3 is created if it does not yet exist.  
 LIST:LEAR  
 starts learning of the hardware setting for list3 and stores the setting.

**Usage:**             Event

---

#### **[:SOURce<hw>]:LIST:MODE <Mode>**

The command specifies how the list is to be processed (similar to SOURce:SWEp:MODE).

#### **Parameters:**

<Mode>

AUTO | STEP

#### **AUTO**

Each trigger event triggers a complete list cycle. Possible trigger settings for :LIST:TRIGger:SOURce are AUTO, SINGLE and EXT.

#### **STEP**

Each trigger event triggers only one step in the list processing cycle. The list is processed in ascending order.

Possible trigger settings for :LIST:TRIGger:SOURce are SINGLE and EXT

\*RST:        AUTO

**Example:**           LIST:MODE STEP  
 selects step-by-step processing of the list.

**Usage:**             SCPI confirmed

**[[:SOURce<hw>]:LIST:POWer <Power>**

The command fills the Level part of the selected list with data.

\*RST does not affect data lists.

**Parameters:**

<Power> <Power#1>{, <Power#2>, ...} | block data

The data can be given either as a list of numbers (list can be of any length and list entries must be separated by commas) or as binary block data. When block data is transferred, 8 (4) bytes are always interpreted as a floating-point number with double accuracy (see :FORMat [:DATA] on page 493).

Range: Minimum level to Maximum level

Default unit: dBm

**Example:**

```
LIST:SEL 'D:/Lists/Listmode/list3'
```

selects list3 for editing. List3 is created if it does not yet exist.

```
LIST:POW 0dBm, 2dBm, 2dBm, 3dBm, ..
```

specifies the level values in list3. The number of level values must correspond to the number of frequency values. The previous data is overwritten.

**Usage:**

SCPI confirmed

**[[:SOURce<hw>]:LIST:POWer:POINts?**

The command queries the length (in points) of the LEVel part of the selected list.

**Return values:**

<points> float

**Example:**

```
LIST:SEL 'D:/Lists/Listmode/list3'
```

selects list3 for editing. List3 is created if it does not yet exist.

```
LIST:POW:POIN?
```

queries the number of levels in list3.

Response: 327

LIST2 has 327 level entries.

**Usage:**

Query only

SCPI confirmed

**[[:SOURce<hw>]:LIST:RESet**

The command resets the list to the starting point.

**Example:**

```
LIST:RES
```

resets the list to the starting point.

**Usage:**

Event

**[[:SOURce<hw>]:LIST:SElect <Select>**

The command selects the specified list. If a new list is to be created, the name can be entered here. The list is created if it does not yet exist. The list selected here is available for the further processing steps (editing) and is used in the instrument when the List mode is activated.

The files are stored with the fixed file extensions \*.lsw in a directory of the user's choice. The directory applicable to the command is defined with the command `MMEMory:CDIR`. A path can also be specified in command `:SOUR:LIST:SEL` in which case the list mode file in the specified directory is selected.

\*RST does not affect data lists.

**Parameters:**

<Select>                    '<list name>'

**Example:**

```
LIST:SEL 'D:/Lists/Listmode/list3'
```

selects list3 for editing. List3 is created if it does not yet exist.

**[[:SOURce<hw>]:LIST:TRIGger:EXECute**

The command immediately starts the processing of a list in list mode. It corresponds to the manual-control command "Execute Single."

**Example:**

```
SOUR:LIST:TRIG:EXEC
```

triggers the processing of the selected list.

**Usage:**

Event

**[[:SOURce<hw>]:LIST:TRIGger:SOURce <Source>**

The command sets the trigger source for the LIST mode.

The names of the parameters correspond to those under sweep mode. SCPI uses other names for the parameters; these names are also accepted by the instrument. The SCPI names should be used if compatibility is an important consideration. An overview of the various names is given in the following table:

R&S name	SCPI name	Command under manual control
AUTO	IMMediate	MODE AUTO
SINGle	BUS	MODE SINGLE or STEP
EXTernal	EXTernal	MODE EXT TRIG SINGLE or EXT TRIG STEP

**Parameters:**

&lt;Source&gt;

AUTO | IMMEDIATE | SINGLE | BUS | EXTERNAL

**AUTO|IMMEDIATE**

The trigger is free-running, i.e. the trigger condition is fulfilled continuously. The selected list in List mode is restarted as soon as it is finished.

**SINGLE|BUS**

The list is triggered by the GPIB commands `[ :SOURce<hw> ] : LIST:TRIGger:EXECute`. The list is executed once.

**EXTERNAL**

The list is triggered externally via the INST TRIG connector. The list is executed once.

\*RST: SINGLE

**Example:**

LIST:TRIG:SOUR EXT

selects triggering by means of the external trigger.

### 7.15.12 SOURce:MODulation Subsystem

This subsystem contains the command for switching on/off all modulations.

---

**[ :SOURce<hw> ] : MODulation [ : ALL ] : STATe <State>**

The command switches the modulations on and off.

The command `SOUR:MOD:ALL:STAT OFF` switches all modulations off. A subsequent command `SOUR:MOD:ALL:STAT ON` restores the status that was active before the last switch-off. "MOD OFF" is displayed in the info line of the header next to the "Level" field.

**Parameters:**

&lt;State&gt;

0 | 1 | OFF | ON

**Example:**

MOD:STAT OFF

switches off all modulations.

### 7.15.13 SOURce:PHASe Subsystem

This subsystem contains the commands for adjusting the phase of the RF output signal relative to a reference signal of the same frequency.

<code>[ :SOURce&lt;hw&gt; ] : PHASe</code> .....	700
<code>[ :SOURce&lt;hw&gt; ] : PHASe:REFerence</code> .....	701

---

**[ :SOURce<hw> ] : PHASe <Phase>**

The command specifies the phase variation relative to the current phase. The variation can be specified in RADians.

**Parameters:**

<Phase> float  
 Range: -359.9 to 359.9  
 Increment: 0.1 deg  
 \*RST: 0.0 deg

**Example:**

PHAS 2DEG  
 changes the phase by 2 degrees relative to the current phase.  
 PHAS:REF  
 adopts the set phase as the current phase.

**Usage:** SCPI confirmed

**[:SOURce<hw>]:PHASe:REFerence**

The command adopts the phase set with `SOURce:PHASe:ADJUse` as the current phase.

**Example:**

PHAS 0.1RAD  
 changes the phase by 0.1 RAD relative to the current phase.  
 PHAS:REF  
 adopts the set phase as the current phase.

**Usage:** Event  
 SCPI confirmed

### 7.15.14 SOURce:PM Subsystem

The PM subsystem contains the commands for checking the phase modulation. The settings for the internal modulation source (LF generator) are made in the [SOURce:LFOutput](#) subsystem.

For information about the required options, see [chapter 5.5.11.5, "Phase Modulation \(PhiM\)"](#), on page 227.

<a href="#">[:SOURce&lt;hw&gt;]:PM[:DEViation]</a> .....	701
<a href="#">[:SOURce&lt;hw&gt;]:PM:EXTernal:COUPling</a> .....	702
<a href="#">[:SOURce&lt;hw&gt;]:PM:MODE</a> .....	702
<a href="#">[:SOURce&lt;hw&gt;]:PM:SENSitivity</a> .....	703
<a href="#">[:SOURce&lt;hw&gt;]:PM:SOURce</a> .....	703
<a href="#">[:SOURce&lt;hw&gt;]:PM:STATe</a> .....	704

**[:SOURce<hw>]:PM[:DEViation] <Deviation>**

The command sets the modulation deviation of the phase modulation in RAD. The maximal deviation depends on the RF frequency set and the selected modulation mode (see data sheet).

The deviation of the internal source must not exceed the deviation of the external source in case of modulation source "Int+Ext" (`PM:SOURce INT,EXT`).

**Parameters:**

<Deviation> float  
 Range: 0 to 20  
 Increment: See data sheet  
 \*RST: 1  
 Default unit: RAD

**Example:**

PM 5  
 sets the PM modulation deviation to 5 RAD

**Usage:**

SCPI confirmed

**[[:SOURce<hw>]:PM:EXTernal:COUPling <Coupling>**

The command selects the coupling mode for the external modulation input in the case of phase modulation.

**Note:** Coupling for external feed via input EXT MOD can be set independently for modulations AM, PM and PhiM.

**Note:** Coupling for external feed via input FM/PM EXT can be set independently for modulations PM and PhiM.

**Parameters:**

<Coupling> AC | DC  
**AC**  
 The DC voltage component is disconnected from the modulation signal.  
**DC**  
 The modulation signal is not changed.  
 \*RST: AC

**Example:**

PM:EXT:COUP AC  
 selects the coupling mode AC for external phase modulation.

**Usage:**

SCPI confirmed

**[[:SOURce<hw>]:PM:MODE <Mode>**

The command selects the mode for the phase modulation.

**Parameters:**

<Mode> HBANdwidth | HDEViation | LNOise

**HBANdwidth**

The maximum range for modulation bandwidth is available. However, phase noise is increased for low frequencies. The range for PhiM deviation is limited. This mode is recommended for high modulation frequencies.

**HDEViation**

The maximum range for PhiM deviation is available. Phase noise is improved for low frequencies. The range for modulation frequency is limited (see data sheet). This mode is recommended for low modulation frequencies and/or high PhiM deviation.

**LNOise**

Phase modulation with phase noise and spurious characteristics close to CW mode. The range for modulation bandwidth and PM deviation is limited (see data sheet)

\*RST: HBANdwidth

**Example:**

```
PM:MODE LNO
selects Low Noise mode for external phase modulation.
```

**Usage:**

SCPI confirmed

**[[:SOURce<hw>]:PM:SENSitivity?**

The command queries the input sensitivity of the EXT MOD input in RAD/V. The command is only effective if the external modulation source is selected (SOUR:PM:SOUR EXT). The returned value depends on the modulation deviation setting (SOUR:PM:DEViation). This value is assigned to the voltage value for full modulation of the input.

**Return values:**

<Sensitivity> float

**Example:**

```
PM:DEV 1
sets a modulation deviation of 1RAD.
PM:SENS?
queries the input sensitivity at the EXT MOD input.
Response: 1
since the voltage value for full modulation is 1V, the resulting sensitivity is precisely 1RAD/V.
```

**Usage:**

Query only  
SCPI confirmed

**[[:SOURce<hw>]:PM:SOURce <Source>**

The command selects the modulation source for phase modulation.



**Parameters:**

<Source> INTernal | EXTernal | INT,EXT

**INTernal**

INT is the LF generator. The frequency of the internal modulation signal can be set in the `SOURce:LFOutput` subsystem.

**EXTernal**

The external signal is input at the EXT MOD connector.

**INT,EXT**

Internal and external modulation source can be selected at the same time.

\*RST: INTernal

**Example:**

PM:SOUR INT  
selects the internal modulation source.

**Usage:**

SCPI confirmed

**[:SOURce<hw>]:PM:STATe <State>**

The command activates/deactivates phase modulation. Activation of phase modulation deactivates frequency modulation.

**Parameters:**

<State> 0 | 1 | OFF | ON

\*RST: OFF

**Example:**

PM:STAT ON  
activates PM modulation.

**Usage:**

SCPI confirmed

### 7.15.15 SOURce:POWer Subsystem

This subsystem contains the commands for setting the output level, level control and level correction of the RF signal.

Other units can also be used instead of dBm:

- by entering the unit directly after the numerical value (example :`POW 0.5V`)
- by changing the DEFault unit in the `UNIT` system (see the command `:UNIT:POWer`).

<code>[:SOURce&lt;hw&gt;]:POWer:ALC:OMODE</code> .....	705
<code>[:SOURce&lt;hw&gt;]:POWer:ALC:SONCe</code> .....	705
<code>[:SOURce&lt;hw&gt;]:POWer:ALC[:STATe]</code> .....	705
<code>[:SOURce&lt;hw&gt;]:POWer:ATTenuation:RFOFf:MODE</code> .....	706
<code>[:SOURce&lt;hw&gt;]:POWer[:LEVel][:IMMediate][:AMPLitude]</code> .....	706
<code>[:SOURce&lt;hw&gt;]:POWer[:LEVel][:IMMediate]:OFFSet</code> .....	707
<code>[:SOURce&lt;hw&gt;]:POWer[:LEVel][:IMMediate]:RCL</code> .....	708
<code>[:SOURce&lt;hw&gt;]:POWer:LIMit[:AMPLitude]</code> .....	708
<code>[:SOURce&lt;hw&gt;]:POWer:MANual</code> .....	709

<code>[SOURce&lt;hw&gt;]:POWer:MODE</code> .....	709
<code>[SOURce&lt;hw&gt;]:POWer:PEP</code> .....	710
<code>[SOURce&lt;hw&gt;]:POWer:POWer</code> .....	710
<code>[SOURce&lt;hw&gt;]:POWer:START</code> .....	711
<code>[SOURce&lt;hw&gt;]:POWer:STEP[:INCRement]</code> .....	711
<code>[SOURce&lt;hw&gt;]:POWer:STEP:MODE</code> .....	712
<code>[SOURce&lt;hw&gt;]:POWer:STOP</code> .....	712

---

#### `[SOURce<hw>]:POWer:ALC:OMODe <OffMode>`

The command sets the level control mode which becomes active when automatic level control is deactivated (ALC Off).

##### Parameters:

<OffMode>                    SHOLd

##### **SHOLd**

Level control is activated briefly if the level or frequency changes ("ALC Off Sample & Hold").

\*RST:            SHOLd

##### Example:

`POW:ALC OFF`

deactivates automatic level control for RF output A.

`POW:ALC:OMOD SHOL`

level control is briefly activated if the frequency or level changes.

---

#### `[SOURce<hw>]:POWer:ALC:SONCe`

The command briefly activates level control for correction purposes.

##### Example:

`POW:ALC OFF`

deactivates automatic level control for RF output A.

`POW:ALC:SONC`

level control is performed once only.

##### Usage:

Event

---

#### `[SOURce<hw>]:POWer:ALC[:STATe] <State>`

The command activates/deactivates automatic level control.

**Parameters:**

&lt;State&gt;

ON | OFF | AUTO

**ON**

Internal level control is permanently activated.

**OFF**

Internal level control is deactivated; Sample &amp; Hold mode is activated.

**AUTO**

Internal level control is activated/deactivated automatically depending on the operating state.

\*RST: AUTO

**Example:**

POW:ALC ON

activates automatic level control for RF output A.

**[[:SOURce<hw>]:POWER:ATTenuation:RFOff:MODE <Mode>**

The command selects the attenuator mode, when the RF signal is switched off.

The setting of the RF OFF mode is not affected by an instrument preset (PRESET key), \*RST and the "Save/Recall" function. This parameter is influenced only by the [Factory Preset](#).

**Parameters:**

&lt;Mode&gt;

UNCHanged | FATTenuated

**UNCHanged**

Freezes the setting of the attenuator when RF is switched off. The attenuator is only activated when RF is switched on.

This setting recommended if a constant VSWR (Voltage Standing Wave Ratio) is required.

**FATTenuated**

Sets attenuation to maximum when the RF signal is switched off. This setting is recommended for applications that require a high level of noise suppression.

\*RST: FATTenuated

**Example:**

SOUR:POW:ATT:RFOF:MODE FATT

sets the RF OFF attenuator to maximum.

**[[:SOURce<hw>]:POWER[:LEVel][:IMMediate][:AMPLitude] <Amplitude>**

The command sets the RF output level in CW mode. In addition to numerical values, it is also possible to specify UP and DOWN. The level is then increased or decreased by the value specified under [[:SOURce<hw>]:]POWER:STEP.

As with the **Level** value entered in the header, the **OFFSet** value is also taken into consideration with this command.

The specified value range is therefore only effective if `:SOURce:POWer:OFFSet` is set to 0. The value range for other `OFFSet` values can be calculated using the following formula:

Minimum level + `OFFSet` ... Maximum level + `OFFSet`

The keywords of this command are largely optional. Therefore, both the long and short form of the command are shown in the example.

**Parameters:**

<Amplitude> Minimum level ... Maximum level  
 The value range for the level setting varies according to the instrument model.  
 The values are given in the data sheet.  
 Increment: 0.01 dB  
 \*RST: -30 dBm  
 Default unit: dBm

**Example:**

`SOUR:POW:LEV:IMM:AMPL 15`  
 or  
`:POW 15`  
 sets the RF level at output A to 15 dBm.

**Usage:**

SCPI confirmed

**[[:SOURce<hw>]:POWer[:LEVel][:IMMediate]:OFFSet <Offset>**

**Note:** The level offset is also effective for level sweeps!

The command specifies the constant level offset of a downstream attenuator/amplifier. If a level offset is entered, the level entered with `:POWer` no longer corresponds to the RF output level.

The following correlation applies:

`:POWer` = RF output level + `POWer:OFFSet`.

Entering a level offset does not change the RF output level, but rather the query value of `:POWer`.

For more information, see "[RF level vs. RF output level](#)" on page 202.

Only dB is permitted as the unit here. The linear units (V, W, etc.) are not permitted.

The keywords of this command are largely optional. Therefore, both the long and short form of the command are shown in the example.

**Parameters:**

<Offset> float  
 Range: -100 dB to 100 dB  
 Increment: 0.01 dB  
 \*RST: 0 dB  
 Default unit: dB

**Example:**           SOURce:POWer:LEVel:IMMediate:OFFSet -10  
                           or  
                           POW:OFFS 10  
                           sets the RF level offset to 10 dB

**Usage:**             SCPI confirmed

#### **[:SOURce<hw>]:POWer[:LEVel][:IMMediate]:RCL <Rcl>**

The command determines whether the current level is retained or whether the stored level setting is adopted when an instrument configuration is loaded.

\*RST does not affect this setting.

**Parameters:**

<Rcl>                   INCLude | EXCLude

**INCLude**

The stored level is also loaded when a stored instrument configuration is loaded.

**EXCLude**

The RF level is not loaded when a stored instrument configuration is loaded. The current level is retained.

\*RST:               no default

**Example:**           POW:RCL INCL  
                           the stored level is set if the Recall command is called.

**Usage:**             SCPI confirmed

#### **[:SOURce<hw>]:POWer:LIMit[:AMPLitude] <Amplitude>**

The command limits the maximum RF output level in CW and SWEEP mode. It does not influence the "Level" display or the response to the POW? query command.

The value is not affected by an instrument preset (PRESET key), \*RST and the Save/ Recall function. This parameter is influenced only by the factory preset (SYST:FPR) and its factory value is equal to the upper limit.

**Parameters:**

<Amplitude>           float

**Minimum level ... Maximum level**

The value range for the level setting varies according to the instrument model.

The values are given in the data sheet.

Increment: 0.01 dB

\*RST:               30 dBm

Default unit: dBm

**Example:**           SOURce:POWer:LIMit:AMPLitude 10  
                           or  
                           :POW:LIM 10  
                           limits the RF level to maximum +10 dBm.

**Usage:**            SCPI confirmed

#### **[:SOURce<hw>]:POWer:MANual <Manual>**

In Sweep mode (:SOUR:POW:MODE SWE) the command sets the level for the next sweep step in the Step sweep mode (:SOUR:SWE:POW:MODE MAN). Here only level values between the settings [:SOUR]:POW:STAR and [:SOUR]:POW:STOP are permitted. Each sweep step is triggered by a separate :SOUR:POW:MAN command.

As with the "Level" value entered in the "RF Level" menu, the OFFSet value is also taken into consideration with this command.

The specified value range is therefore only effective if :SOURce:POWer:OFFSet is set to 0. The value range for other OFFset values can be calculated using the following formula:

Minimum level + OFFSet ... Maximum level + OFFSet

#### **Parameters:**

<Manual>

float

#### **Minimum level ... Maximum level**

The value range for the level setting varies according to the instrument model

The values are given in the data sheet.

Increment: 0.01 dBm

\*RST: -30 dBm

Default unit: dBm

**Example:**           POW:SWE:MODE MAN  
                           sets the Step sweep mode for RF output A.  
                           POW:MAN -5 dBm  
                           sets an RF level of -5 dBm for the next setting in the Step sweep mode for RF output A.  
                           POW:MODE SWE  
                           sets the Level Sweep mode for RF output A.  
                           POW:MAN -5.5 dBm  
                           triggers the next sweep step with a level of -5.5 dBm.

**Usage:**            SCPI confirmed

#### **[:SOURce<hw>]:POWer:MODE <Mode>**

The command sets the instrument operating mode and therefore also the commands used to set the output level.

**Parameters:**

&lt;Mode&gt;

CW | FIXed | SWEep

**CW|FIXed**

The instrument operates at a constant level. CW and FIXed are synonyms. The output level is set with :SOURce:POWer.

**SWEep**

The instrument operates in SWEep mode.

The level is set using the commands SOURce:POWer:START; STOP; MANual.

**LIST**

The instrument processes a list of frequency and level settings.

The List mode settings are made in the [SOURce:LIST Subsystem](#) subsystem.

The setting SOURce:POWer:MODE LIST also sets the command SOURce:FREQuency:MODE automatically to LIST.

\*RST: CW

**Example:**

POW:MODE SWEep

sets the SWEep mode. The settings under SOURce:POW:START; STOP; MANual become effective.

**Usage:**

SCPI confirmed

**[ :SOURce<hw>]:POWer:PEP?**

With digital modulation and all digital standards, the command returns the peak envelope power (PEP) in dBm (the value which is shown under the **Level** specification in the PEP lines in the display header).

**Return values:**

&lt;Pep&gt;

float

**Example:**

POW:PEP?

queries the PEP value for RF output A in the case of digital modulation.

Response: 4

the PEP value for RF output A is 4 dBm.

**Usage:**

Query only

SCPI confirmed

**[ :SOURce<hw>]:POWer:POWer <Power>**

Sets the RF level of the RF output connector.

The level entered with this command corresponds to the level at the RF output, i.e. any offset entry is not taken into consideration.

**Note:** The SCPI command [ :SOURce<hw>]:POWer[:LEVel] [:IMMediate] [:AMPLitude] sets the level of the "Level" display, i.e. the level containing offset.

**Parameters:**

&lt;Power&gt;

Minimum level ... Maximum level

The value range for the level setting varies according to the instrument model.

The values are given in the data sheet.

Increment: 0.01 dB

\*RST: -30 dBm

Default unit: dBm

**Example:**

SOUR:POW:POW 15

sets the RF level at output to 15 dBm.

**[[:SOURce<hw>]:POWER:START <Start>**

The command sets the RF start level in Sweep mode.

As with the "Level" value entered in the "RF Level" menu, the `OFFSet` value is also taken into consideration with this command.

The specified value range is therefore only effective if `:SOURce:POWer:OFFSet` is set to 0. The value range for other `OFFSet` values can be calculated using the following formula:

$$\text{Minimum level} + \text{OFFSet} \dots \text{Maximum level} + \text{OFFSet}$$
**Parameters:**

&lt;Start&gt;

float

**Minimum level ... Maximum level**

The value range for the level setting varies according to the instrument model. The values are given in the data sheet.

Increment: 0.01 dB

\*RST: -30 dBm

Default unit: dBm

**Example:**

POW:STAR -20 dBm

sets the start level for the level sweep to -15 dBm for RF output A.

**Usage:**

SCPI confirmed

**[[:SOURce<hw>]:POWER:STEP[:INCRement] <Increment>**

The command sets the step width for the level setting if `UP` and `DOWN` are used as the level values and variation mode `:SOUR:POW:STEP:MODE USER` is selected. The command is linked to setting "Variation Step" for manual control, i.e. the command also sets the step width of the rotary knob for "Variation Active On".



**Parameters:**

<Increment> float  
 Range: 0 dB to 100 dB  
 Increment: 0.01 dB  
 \*RST: 1 dB  
 Default unit: dB

**Example:**

```
SOURce:POWer:STEP:INCRement 2
or
POW:STEP 2
```

sets the step width for entering the RF level to 2 dB.

**[[:SOURce<hw>]:POWer:STEP:MODE <Mode>**

This command activates (USER) or deactivates (DECimal) the user-defined step width used when varying the level value with the level values UP/DOWN. The command is linked to setting "Variation Active" for manual control, i.e. the command also activates/deactivates the user-defined step width used when varying the level value with the rotary knob.

**Parameters:**

<Mode> DECimal | USER  
 \*RST: DECimal

**Example:**

```
POW:STEP 2
```

sets the step width for the level setting to 2 dB.

```
POW:STEP:MODE USER
```

activates this step width for level variation with the rotary knob (manual control) and with level values UP/DOWN (remote control).

**[[:SOURce<hw>]:POWer:STOP <Stop>**

The command sets the stop level in Sweep mode.

As with the **Level** value entered in the **RF Level** menu, the OFFSet value is also taken into consideration with this command.

The specified value range is therefore only effective if :SOURce:POWer:OFFSet is set to 0. The value range for other OFFset values can be calculated using the following formula:

Minimum level + OFFSet ... Maximum level + OFFSet

**Parameters:**

<Stop> float  
**Minimum level ... Maximum level**  
 The value range for the level setting varies according to the instrument model.  
 The values are given in the data sheet.  
 Increment: 0.01 dB  
 \*RST: -10 dBm  
 Default unit: dBm

**Example:** POW:STOP 3  
sets the stop level for the level sweep to 3 dBm for RF output A.

**Usage:** SCPI confirmed

### 7.15.16 SOURce:PULM Subsystem

This subsystem contains the commands for setting the pulse modulation.

The LF generator is used as the internal modulation source. The pulse frequency of the internal rectangular signal is therefore set in the SOURce:LFOuTput subsystem.

<a href="#">[:SOURce&lt;hw&gt;]:PULM:OUTPut:SYNC[:STATe]</a> .....	713
<a href="#">[:SOURce&lt;hw&gt;]:PULM:POLarity</a> .....	713
<a href="#">[:SOURce&lt;hw&gt;]:PULM:SOURce</a> .....	713
<a href="#">[:SOURce&lt;hw&gt;]:PULM:STATe</a> .....	714

---

#### **[:SOURce<hw>]:PULM:OUTPut:SYNC[:STATe] <Sync>**

Activates the use of the *Valid Signal* for synchronization of pulse modulation.

**Parameters:**

<Sync> OFF | ON | 1 | 0  
\*RST: OFF

**Example:** :PULM:OUTP:SYNC ON  
activates the use of the valid signal.

---

#### **[:SOURce<hw>]:PULM:POLarity <Polarity>**

The command sets the polarity between modulating and modulated signal. This command is only effective for an external modulation signal.

**Parameters:**

<Polarity> NORMal | INVerted

**NORMal**

The RF signal is suppressed during the pulse pause.

**INVerted**

The RF signal is suppressed during the pulse.

\*RST: NORMal

**Example:** PULM:SOUR EXT  
selects the external modulation source.

**Example:** PULM:POL INV  
selects inverted polarity.

---

#### **[:SOURce<hw>]:PULM:SOURce <Source>**

The command selects the source for pulse modulation.

**Parameters:**

&lt;Source&gt;            INTernal | EXTernal

**INTernal**

The internally generated rectangular signal is used for the pulse modulation. The frequency of the internal signal can be set in the SOURce:LFOuTput subsystem.

**EXTernal**

The signal applied externally via the EXT MOD connector is used for the pulse modulation.

\*RST:            INTernal

**Example:**

```
PULM:SOUR INT
selects the internal modulation source.
```

**Example:**

```
PULM:STAT ON
activates the pulse modulation.
```

**Usage:**

SCPI confirmed

**[:SOURce<hw>]:PULM:STATe <State>**

The command activates/deactivates the pulse modulation.

**Parameters:**

&lt;State&gt;            0 | 1 | OFF | ON

\*RST:            OFF

**Example:**

```
PULM:STAT ON
activates pulse modulation with the modulation source selected
under SOURce:PULM:SOURce.
```

**Usage:**

SCPI confirmed

### 7.15.17 SOURce:ROSCillator Subsystem

This subsystem contains the commands for setting the external and internal reference frequency.



The commands of this subsystem are not affected by an instrument reset (\*RST on page 456).

<a href="#">[:SOURce]:ROSCillator:EXTernal:FREQUency</a> .....	715
<a href="#">[:SOURce]:ROSCillator:EXTernal:RFOFf:STATe</a> .....	715
<a href="#">[:SOURce]:ROSCillator:EXTernal:SBANdwidth</a> .....	715
<a href="#">[:SOURce]:ROSCillator[:INTernal]:ADJust:VALue</a> .....	716
<a href="#">[:SOURce]:ROSCillator[:INTernal]:ADJust[:STATe]</a> .....	716
<a href="#">[:SOURce]:ROSCillator:SOURce</a> .....	716

**[[:SOURce]:ROSCillator:EXTernal:FREQuency <Frequency>**

The command informs the instrument of the frequency of the external reference.

**Parameters:**

<Frequency>            5MHz | 10MHz | 13MHz  
 Default unit: Hz

**Example:**

ROSC:SOUR EXT  
 selects the external source. The reference must be input at the REF IN input.  
 ROSC:EXT:FREQ 5MHz  
 informs the instrument that the external reference frequency is 5MHz.

**Usage:**

SCPI confirmed

**[[:SOURce]:ROSCillator:EXTernal:RFOFF:STATe <State>**

The command determines if the RF output is switched off in case of a missing external reference signal for selection external source.

If enabled, this setting ensures that no improper RF signal due to the missing external reference signal is output and used for measurements.

In addition to the error message "Ext Ref missing", message "RF output deactivated" is generated.

**Parameters:**

<State>                0 | 1 | OFF | ON

**Example:**

ROSC:SOUR EXT  
 selects the external source. The reference must be input at the REF IN input.

**Example:**

ROSC:EXT:RFOFF:STAT ON  
 In case of a missing external signal, no RF signal is output.

**[[:SOURce]:ROSCillator:EXTernal:SBANDwidth <Sbandwidth>**

The command selects the synchronization bandwidth for an external reference signal.

**Parameters:**

<Sbandwidth>        WIDE | NARRow

**NARRow**

Synchronization bandwidth is approx. 1 Hz.

**WIDE**

Synchronization bandwidth is approx. 750 Hz.

**Example:**

```
ROSC:SOUR EXT
selects the external source.
ROSC:EXT:FREQ 5 MHz
informs the instrument that the external reference has a frequency
of 5 MHz.
ROSC:EXT:SBAN WID
selects wideband setting for synchronization bandwidth.
```

**[[:SOURce]:ROSCillator[:INTernal]:ADJust:VALue <Value>**

The command specifies the frequency correction value (adjustment value).

**Parameters:**

<Value> float  
 Range: 0 to 4095  
 Increment: 1

**Example:**

```
ROSC:ADJ:VAL 1400
sets the adjustment value to 1400.
```

**[[:SOURce]:ROSCillator[:INTernal]:ADJust[:STATe] <State>**

The command determines whether the calibrated (OFF) or a user-defined (ON) adjustment value is used for fine adjustment of the frequency. With STATE ON, the instrument is no longer in the calibrated state. However, the calibration value is not changed and the instrument resumes the calibrated state after switching the Adjustment State to Off.

**Parameters:**

<State> 0 | 1 | OFF | ON  
 \*RST: 0

**Example:**

```
ROSC:SOUR INT
selects the internal source.
ROSC:ADJ ON
activates use of a user-defined adjustment value.
ROSC:ADJ:VAL 1400
sets the adjustment value to 1400.
```

**[[:SOURce]:ROSCillator:SOURce <Source>**

The command selects between internal and external reference frequency.

**Parameters:**

&lt;Source&gt;

INTernal | EXTernal

**INTernal**

The internal reference oscillator is used.

**EXTernal**

An external reference signal is used. It must be input at the REF IN connector at the rear of the instrument.

The instrument is informed of the frequency of the external reference signal by means of the command [:SOURce]:

ROSCillator:EXTernal:FREQuency.

**Example:**

ROSC:SOUR EXT

selects the external source.

ROSC:EXT:FREQ 5 MHz

informs the instrument that the external reference has a frequency of 5 MHz.

### 7.15.18 SOURce:SWEep Subsystem

This subsystem contains the commands for checking the RF sweeps, i.e. the sweeps of the RF generators. Sweeps are always triggered, except for the MANual sweep mode. The frequency sweep is activated by the command SOURce:FREQuency:MODE SWEep, and the level sweep by the command SOURce:POWer:MODE SWEep. All sweeps, including the LF sweep, can be set independently of each other.

This example shows how to set up a frequency sweep.

1. Set the sweep range.  
[SOURce:]FREQuency:CENTer 200 MHz  
[SOURce:]FREQuency:SPAN 300 MHz
2. Select linear or logarithmic spacing.  
[SOURce:]SWEep[:FREQuency]:SPACing LIN
3. Set the step width and dwell time.  
[SOURce:]SWEep[:FREQuency]:STEP:LINear 20 MHz  
[SOURce:]SWEep[:FREQuency]:DWELl 12 ms
4. Select the trigger mode.  
TRIGger:]FSweep:SOURce SINGLE
5. Select the sweep mode and activate the sweep.  
[SOURce:]SWEep[:FREQuency]:MODE AUTO  
[SOURce:]FREQuency:MODE SWEep
6. Trigger the sweep.  
[SOURce:]SWEep[:FREQuency]:EXECute



It is recommended to switch off the "GUI Update" for optimum sweep performance especially with short dwell times (`SYSTem:DISPlay:UPDate OFF`).

<code>[:SOURce&lt;hw&gt;]:SWEep[:FREQuency]:DWELI</code> .....	718
<code>[:SOURce&lt;hw&gt;]:SWEep[:FREQuency]:EXECute</code> .....	718
<code>[:SOURce&lt;hw&gt;]:SWEep[:FREQuency]:MODE</code> .....	719
<code>[:SOURce&lt;hw&gt;]:SWEep[:FREQuency]:POINts</code> .....	719
<code>[:SOURce&lt;hw&gt;]:SWEep[:FREQuency]:SHAPE</code> .....	720
<code>[:SOURce&lt;hw&gt;]:SWEep[:FREQuency]:SPACing</code> .....	720
<code>[:SOURce&lt;hw&gt;]:SWEep[:FREQuency]:STEP[:LINear]</code> .....	721
<code>[:SOURce&lt;hw&gt;]:SWEep[:FREQuency]:STEP:LOGarithmic</code> .....	722
<code>[:SOURce&lt;hw&gt;]:SWEep:POWer:DWELI</code> .....	722
<code>[:SOURce&lt;hw&gt;]:SWEep:POWer:EXECute</code> .....	723
<code>[:SOURce&lt;hw&gt;]:SWEep:POWer:MODE</code> .....	723
<code>[:SOURce&lt;hw&gt;]:SWEep:POWer:POINts</code> .....	723
<code>[:SOURce&lt;hw&gt;]:SWEep:POWer:SHAPE</code> .....	724
<code>[:SOURce&lt;hw&gt;]:SWEep:POWer:SPACing:MODE</code> .....	724
<code>[:SOURce&lt;hw&gt;]:SWEep:POWer:STEP[:LOGarithmic]</code> .....	724
<code>[:SOURce&lt;hw&gt;]:SWEep:RESet[:ALL]</code> .....	725

### `[:SOURce<hw>]:SWEep[:FREQuency]:DWELI <Dwell>`

The command sets the time taken for each frequency step of the sweep.

The keyword `[:FREQuency]` can be omitted (see example). The command is then SCPI-compliant.

**Tip:** It is recommended to switch off the "GUI Update" for optimum sweep performance especially with short dwell times (`SYSTem:DISPlay:UPDate OFF`).

#### Parameters:

`<Dwell>` float  
 Range: 10.0E-3 to 100  
 Increment: 100.0E-6  
 \*RST: 10.0E-3  
 Default unit: s

**Example:** `SWE:DWEL 12 ms`  
 sets a dwell time of 12 ms for a frequency sweep at the RF output.

### `[:SOURce<hw>]:SWEep[:FREQuency]:EXECute`

The command triggers a sweep.

The command is only valid for sweep mode Single (`SOURce:SWEep:FREQuency:MODE SINGle`). The command corresponds to the manual-control command "Execute Single Sweep".

**Example:** `SWE:FREQ:EXEC`  
 triggers a frequency sweep at the RF output.

**Usage:** Event

---

**[ :SOURce<hw>]:SWEep[:FREQuency]:MODE <Mode>**

Sets the sweep mode.

The keyword [ :FREQuency] can be omitted (see example). The command is then SCPI-compliant.

**Parameters:**

<Mode> AUTO | MANual | STEP

**AUTO**

Each trigger triggers exactly one complete sweep.

**MANual**

The trigger system is not active. Each frequency step of the sweep is triggered individually, either by varying the "Current Frequency" value using the rotary knob under manual control or by means of a `FREQ:MAN` command under remote control. With manual control, the frequency increases or decreases (depending on the direction of the rotary encoder) by the value specified under `FREQ:STEP:INCRement`. With remote control, the frequency is set directly with the command `:FREQ:MAN`.

**STEP**

Each trigger triggers one sweep step only (Mode Single Step). The frequency increases by the value entered under `SOUR:SWE:FREQ:STEP:LIN` (linear spacing) or `...:STEP:LOG` (logarithmic spacing).

\*RST: AUTO

**Example:**

`SWE:MODE AUTO`

selects **Mode Auto** for a frequency sweep at the RF output.

---

**[ :SOURce<hw>]:SWEep[:FREQuency]:POINTs <Points>**

The command sets the number of steps in an RF sweep.

The command is linked to the command `:SWEep[:FREQuency]:STEP` as follows:

- for linear sweeps  
 $POINTs = (SPAN / STEP:LIN) + 1$
- logarithmic sweeps and `START < STOP:`  
 $POINTs = ((\log STOP - \log START) / \log STEP:LOG) + 1$

If `POINTs` changes, the value of `STEP` is adjusted. The `START` and `STOP` value is retained.

Two separate `POINTs` values are used for linear or logarithmic sweep spacing (`:SWEep[:FREQuency]:SPACing LIN | LOG`). The command is always effective for the currently set sweep spacing.

**Parameters:**

<Points> float



**Example:**

```
FREQ:STAR
sets the start frequency to 100 MHz.
FREQ:STOP
sets the stop frequency to 500 MHz.
SWE:SPAC LIN
sets linear sweep spacing.
SWE:POIN 401
sets 401 sweep steps for linear sweep spacing. The sweep step
width (STEP) is automatically set to 1 MHz.
```

---

**[ :SOURce<hw>]:SWEep[:FREQuency]:SHAPE <Shape>**

The command sets the cycle mode for a sweep sequence (shape).

**Parameters:**

<Shape>

SAWTooth | TRiangle

**SAWTooth**

One sweep runs from start to stop frequency. Each subsequent sweep starts at the start frequency, i.e. the shape of the sweep sequence resembles a sawtooth.

**TRiangle**

One sweep runs from start to stop frequency and back, i.e. the shape of the sweep resembles a triangle. Each subsequent sweep starts at the start frequency.

\*RST: SAWTooth

**Example:**

```
SOUR:SWE:SHAP TRI
selects the sweep cycle with alternating ascending and descend-
ing sweep directions.
```

---

**[ :SOURce<hw>]:SWEep[:FREQuency]:SPACing <Spacing>**

The command selects the sweep spacing.

The keyword [ :FREQuency] can be omitted (see example). The command is then SCPI-compliant.

**Parameters:**

&lt;Spacing&gt; LINear | LOGarithmic

**LINear**

With the linear sweep, the step width is a fixed frequency value which is added to the current frequency. The step width for linear sweep is entered in Hz (see [:SOURce<hw>]:SWEep[:FREQuency]:STEP[:LINear] on page 721).

**LOGarithmic**

With the logarithmic sweep, the step width is a constant fraction of the current frequency. This fraction is added to the current frequency. The logarithmic step width is entered in % (see [:SOURce<hw>]:SWEep[:FREQuency]:STEP:LOGarithmic on page 722).

\*RST: LIN

**Example:**

```
SWE:SPAC LIN
selects linear sweep spacing for a frequency sweep at the RF output.
```

---

**[:SOURce<hw>]:SWEep[:FREQuency]:STEP[:LINear] <Linear>**

The command sets the step width for linear sweeps.

This command is linked to the command :SWEep[:FREQuency]:POINTs as follows:

$$\text{POINTs} = (\text{SPAN} / \text{STEP:LIN}) + 1$$

If STEP:LIN changes, the value of POINTs is adjusted. The START and STOP value is retained.

The keywords [:FREQuency] and [:LINear] can be omitted (see example). The command is then SCPI-compliant.

**Parameters:**

<Linear> float  
 Range: 0.001 Hz to (STOP - START)  
 Increment: 0.001 Hz  
 \*RST: 1 MHz  
 Default unit: MHz

**Example:**

```
FREQ:STAR 1GHz
sets the start frequency to 1 GHz.
FREQ:STOP 5GHz
sets the stop frequency to 5 GHz.
SWE:SPAC LIN
sets linear sweep spacing.
SWE:STEP 2 MHz
sets the step width for linear sweep spacing to 2 MHz (RF sweep)
at the RF output. The number of sweep steps for linear sweep
spacing (POINTs) is automatically set to 2001.
```

**[[:SOURce<hw>]:SWEep[:FREQuency]:STEP:LOGarithmic <Logarithmic>**

The command specifies the step width factor for logarithmic sweeps. The next frequency value of a sweep is calculated (for `START < STOP`) using the following formula:

New frequency = Old frequency + `STEP:LOG` x Old frequency

`STEP:LOG` therefore gives the fraction of the old frequency. The frequency is increased by this fraction for the next sweep step. Usually `STEP:LOG` is given in percent, whereby the suffix `PCT` must always be used.

The command is linked to the command `:SWEep[:FREQuency]:POINTs` for `START < STOP` as follows:

$$\text{POINTs} = ((\log \text{STOP} - \log \text{START}) / \log \text{STEP:LOG}) + 1$$

If `STEP:LOG` changes, the value of `POINTs` is adjusted. The `START` and `STOP` value is retained.

**Parameters:**

<Logarithmic> float  
 Range: 0.01 to 9999  
 Increment: 0.01 PCT  
 \*RST: 1 PCT

**Example:**

`FREQ:STAR 1GHz`  
 sets the start frequency to 1 GHz.  
`FREQ:STOP 5GHz`  
 sets the stop frequency to 5 GHz.  
`SWE:SPAC LOG`  
 sets logarithmic sweep spacing.  
`SWE:STEP:LOG 10PCT`  
 sets the step width for logarithmic sweep spacing to 10% of the previous frequency in each instance (for a frequency sweep).

**[[:SOURce<hw>]:SWEep:POWer:DWELI <Dwell>**

The command sets the time taken for each level step of the sweep.

**Tip:** It is recommended to switch off the "GUI Update" for optimum sweep performance especially with short dwell times (`SYSTem:DISPlay:UPDate OFF`).

**Parameters:**

<Dwell> float  
 Range: 1.0E-3 to 100  
 Increment: 100.0E-6  
 \*RST: 15.0E-3  
 Default unit: s

**Example:**

`SWE:POW:DWEL 12 ms`  
 sets a dwell time of 12 ms for a level sweep at the RF output.

---

**[[:SOURce<hw>]:SWEep:POWer:EXECute**

The command triggers a sweep.

**Example:**                `SWE:POW:EXEC`  
                              triggers a level sweep at the RF output.

**Usage:**                 Event

---

**[[:SOURce<hw>]:SWEep:POWer:MODE <Mode>**

The command sets the cycle mode of the level sweep.

**Parameters:**

<Mode>                    `AUTO | MANual | STEP`

**AUTO**

Each trigger triggers exactly one complete sweep.

**MANual**

The trigger system is not active. Each level step of the sweep is triggered individually, either by varying the "Current Level" value using the rotary knob under manual control or by means of a `POW:MAN` command under remote control.

With manual control, the level increases or decreases (depending on the direction of the rotary encoder) by the value specified under `SOUR:SWE:POW:STEP`. With remote control, the level increases by the value specified under `SWEep:POW:STEP` which each sent `:POW:MAN` command, irrespective the value entered there.

**STEP**

Each trigger triggers one sweep step only. The level increases by the value entered under `:SWEep:POWer:STEP`.

\*RST:                    `AUTO`

**Example:**                `SWE:POW:MODE AUTO`  
                              selects Mode Auto for a level sweep at RF output.

---

**[[:SOURce<hw>]:SWEep:POWer:POINTs <Points>**

The command sets the number of steps in a level sweep. The command is linked to the command `:SWEep:POWer:STEP` as follows:

$$\text{POINTs} = ((\text{STOP} - \text{START}) / \text{STEP:LOG}) + 1$$

If `POINTs` changes, the value of `STEP` is adjusted. The `START` and `STOP` value is retained.

**Parameters:**

<Points>                 float  
                              \*RST:                 `20dB`

---

**Example:**            `POW:STAR - 30 dBm`  
                           sets the start frequency to -30 dBm.  
                           `POW:STOP - 10 dBm`  
                           sets the stop frequency to -10 dBm.  
                           `SWE:POW:POIN 20`  
                           sets 20 sweep steps. The sweep step width (`STEP`) is automatically set to 1 dB.

---

#### **[[:SOURce<hw>]:SWEep:POWer:SHAPe <Shape>**

The command sets the cycle mode for a sweep sequence (shape).

#### **Parameters:**

<Shape>            SAWTooth | TRiangle

#### **SAWTooth**

One sweep runs from the start level to the stop level. The subsequent sweep starts at the start level again, i.e. the shape of sweep sequence resembles a sawtooth.

#### **TRiangle**

One sweep runs from start to stop level and back, i.e. the shape of the sweep resembles a triangle. Each subsequent sweep starts at the start level again.

\*RST:            SAWTooth

**Example:**            `SOUR:SWE:POW:SHAP TRI`  
                           selects the sweep cycle with alternating ascending and descending sweep directions.

---

#### **[[:SOURce<hw>]:SWEep:POWer:SPACing:MODE?**

The command queries the sweep spacing. The sweep spacing for level sweeps is always linear.

**Example:**            `SWE:POW:SPAC:MODE?`  
                           queries the sweep spacing for a level sweep at RF output.  
                           Result: LIN  
                           linear spacing

**Usage:**            Query only

---

#### **[[:SOURce<hw>]:SWEep:POWer:STEP[:LOGarithmic] <Logarithmic>**

The command sets the step width factor for logarithmic sweeps. The next level value of a sweep is calculated (for `START < STOP`) using the following formula:

New level = Old level + `STEP:LOG` x Old level

`STEP:LOG` therefore gives the fraction of the old level. The level is increased by this fraction for the next sweep step. Usually `STEP:LOG` is given in decibels, whereby the suffix dB must always be used.

The command is linked to the command `:SWEep:POWer:POINts` for `START < STOP` as follows:

$$\text{POINTs} = ((\text{STOP} - \text{START}) / \text{STEP:LOG}) + 1$$

If `STEP:LOG` changes, the value of `POINTs` is adjusted. The `START` and `STOP` value is retained.

**Parameters:**

<Logarithmic> float  
 Range: 0.01 to 139 dB  
 Increment: 0.01 dB  
 \*RST: 1

**Example:**

`SWE:POW:STEP 10dB`

sets the step width for logarithmic sweep spacing to 10 dB of the previous level in each instance (for a level sweep).

**[:SOURce<hw>]:SWEep:RESet[:ALL]**

The command resets all active sweeps to the starting point.

**Example:**

`SWE:RES`

resets all active sweeps to the starting point.

## 7.16 STATus Subsystem

This system contains the commands for the status reporting system. \*RST on page 456 has no effect on the status registers.

Queries return the current value of the respective register, which permits a check of the device status. A decimal value between 0 and 32767 ( $=2^{15}-1$ ) is returned.

The configuration commands set the respective register thus determining which status changes of the R&S SMJ causes the status registers to be changed. A decimal value between 0 and 32767 ( $=2^{15}-1$ ) is set.

<code>STATus:OPERation:CONDition</code> .....	726
<code>STATus:OPERation:ENABle</code> .....	726
<code>STATus:OPERation[:EVENT]</code> .....	726
<code>STATus:OPERation:NTRansition</code> .....	726
<code>STATus:OPERation:PTRansition</code> .....	727
<code>STATus:PRESet</code> .....	727
<code>STATus:QUESTionable:CONDition</code> .....	727
<code>STATus:QUESTionable:ENABle</code> .....	728
<code>STATus:QUESTionable[:EVENT]</code> .....	728
<code>STATus:QUESTionable:NTRansition</code> .....	728
<code>STATus:QUESTionable:PTRansition</code> .....	729
<code>STATus:QUEue[:NEXT]</code> .....	729

**STATus:OPERation:CONDition?** <Condition >

The command queries the content of the CONDition part of the STATus:OPERation register. This part contains information on the action currently being performed in the instrument. The content is not deleted after being read out since it indicates the current hardware status.

**Parameters:**

<Condition >                    string

**Example:**

STAT:OPER:COND  
queries the Status:Operation:Condition register.

**Usage:**

Query only  
SCPI confirmed

**STATus:OPERation:ENABle** <Enable>

The command sets the bits of the ENABle part of the STATus:OPERation register. This setting determines which events of the Status-Event part are forwarded to the sum bit in the status byte. These events can be used for a service request.

**Parameters:**

<Enable>                        string

**Example:**

STAT:OPER:ENAB 32767  
all events are forwarded to the sum bit of the status byte.

**Usage:**

SCPI confirmed

**STATus:OPERation[:EVENT]?** <EVENT>

The command queries the content of the EVENT part of the STATus:OPERation register. This part contains information on the actions performed in the instrument since the last readout. The content of the EVENT part is deleted after being read out.

**Parameters:**

<EVENT>                        string

**Example:**

STAT:OPER:EVEN  
queries the STATus:OPERation:EVENT register.

**Usage:**

Query only  
SCPI confirmed

**STATus:OPERation:NTRansition** <Ntransition>

The command sets the bits of the NTRansition part of the STATus:OPERation register. If a bit is set, a transition from 1 to 0 in the condition part causes an entry to be made in the EVENT part of the register. The disappearance of an event in the hardware is thus registered, e.g. the end of an adjustment.

**Parameters:**

<Ntransition>                    string

**Example:** `STAT:OPER:NTR 0`  
 a transition from 1 to 0 in the condition part of the Status:Operation register does not cause an entry to be made in the EVENT part.

**Usage:** SCPI confirmed

#### **STATus:OPERation:PTRansition** <Ptransition>

The command sets the bits of the PTRansition part of the STATus:OPERation register. If a bit is set, a transition from 0 to 1 in the condition part causes an entry to be made in the EVENT part of the register. A new event in the hardware is thus registered, e.g. the start of an adjustment.

**Parameters:**  
 <Ptransition> string

**Example:** `STAT:OPER:PTR 32767`  
 all transitions from 0 to 1 in the condition part of the Status:Operation register cause an entry to be made in the EVENT part.

**Usage:** SCPI confirmed

#### **STATus:PRESet** <Preset>

The command resets the status registers. All PTRansition parts are set to FFFFh (32767), i.e. all transitions from 0 to 1 are detected. All NTRansition parts are set to 0, i.e. a transition from 1 to 0 in a CONDition bit is not detected. The ENABLE parts of STATus:OPERation and STATus:QUESTionable are set to 0, i.e. all events in these registers are not passed on.

**Parameters:**  
 <Preset> string

**Example:** `STAT:PRES`  
 resets the status registers.

**Usage:** Event  
 SCPI confirmed

#### **STATus:QUESTionable:CONDition?** <Condition >

The command queries the content of the CONDition part of the STATus:QUESTionable register. This part contains information on the action currently being performed in the instrument. The content is not deleted after being read out since it indicates the current hardware status.

**Parameters:**  
 <Condition > string

**Example:** `STAT:OPER:COND`  
 queries the Status:Questionable:Condition register.



**Usage:** Query only  
SCPI confirmed

---

#### **STATus:QUEStionable:ENABle** <Enable>

The command sets the bits of the ENABle part of the STATus:QUEStionable register. This setting determines which events of the Status-Event part are enabled for the sum bit in the status byte. These events can be used for a service request.

**Parameters:**  
<Enable> string

**Example:** STAT:OPER:ENAB 1  
problems when performing an adjustment cause an entry to be made in the sum bit.

**Usage:** SCPI confirmed

---

#### **STATus:QUEStionable[:EVENT]?** <EVENT>

The command queries the content of the EVENT part of the STATus:QUEStionable register. This part contains information on the actions performed in the instrument since the last readout. The content of the EVENT part is deleted after being read out.

**Parameters:**  
<EVENT> string

**Example:** STAT:QUES:EVENT?  
queries the Status:Questionable:Event register.

**Usage:** Query only  
SCPI confirmed

---

#### **STATus:QUEStionable:NTRansition** <Ntransition>

The command sets the bits of the NTRansition part of the STATus:QUEStionable register. If a bit is set, a transition from 1 to 0 in the condition part causes an entry to be made in the EVENT part of the register.

**Parameters:**  
<Ntransition> string

**Example:** STAT:OPER:NTR 0  
A transition from 1 to 0 in the condition part of the Status:Questionable register does not cause an entry to be made in the EVENT part.

**Usage:** SCPI confirmed

**STATus:QUEStionable:PTRansition** <Ptransition>

The command sets the bits of the NTRansition part of the STATus:QUEStionable register. If a bit is set, a transition from 1 to 0 in the condition part causes an entry to be made in the EVENT part of the register.

**Parameters:**

<Ptransition>                    string

**Example:**

STAT:OPER:PTR 32767

All transitions from 0 to 1 in the condition part of the Status:Questionable register cause an entry to be made in the EVENT part.

**Usage:**

SCPI confirmed

**STATus:QUEue[:NEXT]?**

The command queries the oldest entry in the error queue and then deletes it. Positive error numbers denote device-specific errors, and negative error numbers denote error messages defined by SCPI. If the error queue is empty, 0 ("No error") is returned. The command is identical to SYSTem:ERRor?

**Return values:**

<NEXT>                            string

**Example:**

STAT:QUE

queries the oldest entry in the error queue.

Response: 0, 'no error'

No errors have occurred since the error queue was last read out.

**Usage:**

Query only  
SCPI confirmed

## 7.17 SYSTEM Subsystem

The SYSTem subsystem contains a series of commands for general functions which do not directly affect signal generation.

:SYSTem:BEEPer:STATe.....	730
:SYSTem:COMMunicate:GPIB:LTERminator.....	730
:SYSTem:COMMunicate:GPIB[:SELF]:ADDRESS.....	730
:SYSTem:COMMunicate:NETWork[:COMMON]:WORKgroup.....	731
:SYSTem:COMMunicate:NETWork:RESource.....	731
:SYSTem:COMMunicate:GPIB:RESource.....	731
:SYSTem:COMMunicate:SOCKET:RESource.....	731
:SYSTem:DATE.....	732
:SYSTem:DISPlay:UPDate.....	732
SYSTem:ERRor:ALL.....	732
SYSTem:ERRor:CODE:ALL.....	732
SYSTem:ERRor:CODE[:NEXT].....	733
SYSTem:ERRor:COUNT.....	733

SYSTem:ERRor[:NEXT].....	734
:SYSTem:KLOCK.....	734
:SYSTem:PROTect<ch>[:STATe].....	734
SYSTem:SERRor.....	735
:SYSTem:STARtup:COMPlete.....	735
:SYSTem:TIME.....	735
SYSTem:VERSiOn.....	736

---

#### :SYSTem:BEEPer:STATe <State>

This command switches the key beep on or off.

##### Parameters:

<State>            0 | 1 | OFF | ON  
 \*RST:            OFF

##### Example:

```
SYST:BEEP:STAT OFF
```

No acoustic signal is output when a key on the front panel is pressed.

##### Usage:

SCPI confirmed

---

#### :SYSTem:COMMunicate:GPIB:LTERminator <Lterminator>

The command sets the terminator recognition for remote control via GPIB bus.

##### Parameters:

<Lterminator>    STANdard | EOI

##### EOI

The terminator must be sent together with the line message EOI (End of Line). This setting is recommended for binary block transmissions where a character could coincidentally have the value LF (Line Feed) but is not intended as the terminator. This setting must be selected for block data with undefined length.

##### STANdard

An LF (Line Feed) is recognized as the terminator regardless of whether it is sent with or without EOI.

\*RST:            STANdard

##### Example:

```
SYST:COMM:GPIB:LTER EOI
```

only a character which is sent simultaneously with the line message EOI is accepted as the terminator.

---

#### :SYSTem:COMMunicate:GPIB[:SELf]:ADDRes <Address>

Sets the GPIB address.

##### Parameters:

<Address>            integer  
 Range:            1 to 30  
 \*RST:            28

**Example:**                `SYST:COMM:GPIB:ADDR 14`  
sets GPIB address.

---

### **:SYSTEM:COMMunicate:NETWork[:COMMON]:WORKgroup <Workgroup>**

The command enters the individual workgroup name of the instrument.

**Parameters:**  
<Workgroup>                string

**Example:**                `SYST:COMM:NETW:COMM:WORK 'TEST_09'`  
enters the workgroup name 'TEST\_09'.

---

### **:SYSTEM:COMMunicate:NETWork:RESource <Resource>**

The command queries the VISA resource string. This string is used for remote control of the instrument with VXI-11 protocol.

**Parameters:**  
<Resource>                string

**Example:**                `SYST:COMM:NETW:RES`  
queries the VISA resource string.  
Response: `TCPIP::192.1.2.3::INSTR`

---

### **:SYSTEM:COMMunicate:GPIB:RESource?**

The command queries the visa resource string for remote control via the GPIB interface. This string is used for remote control of the instrument.

To change the GPIB address, use the command `SYST:COMM:GPIB:ADDR`.

**Return values:**  
<Resource>                string

**Example:**                `SYST:COMM:GPIB:RES`  
queries the VISA resource string.  
Response: `GPIB::28::INSTR`

**Usage:**                    Query only

---

### **:SYSTEM:COMMunicate:SOCKet:RESource?**

The command queries the visa resource string for remote control via the Socket interface.

**Return values:**  
<Resource>                string

**Example:**                `SYST:COMM:SOCK:RES?`

**Usage:**                    Query only

---

**:SYSTem:DATE** <Date>

The command queries / sets the date for the instrument-internal calendar.

This parameter is protected, in order to prevent accidental changes. It can be accessed with protection level 1, see `:SYSTem:PROTeCt<ch>[:STATe]` on page 734.

**Parameters:**

<Date>                    <year>,<month>,<day>

**Example:**

SYST:DATE?

Response: 2011, 05, 01 - it is the 1st of May in 2011.

---

**:SYSTem:DISPlay:UPDate** <Update>

The command switches the update of the display on/off. A switchover from remote control to manual control always sets the status of the update of the display to ON.

**Parameters:**

<Update>                0 | 1 | OFF | ON  
\*RST:                ON

**Example:**

SYST:DISP:UPD OFF

switches update of displayed parameter values off.

---

**SYSTem:ERRor:ALL?**

The command queries all entries in the error queue and then deletes them.

**Parameters:**

<All>                    string

**0**

"No error", i.e the error queue is empty.

**positive value**

Positive error numbers denote device-specific errors.

**negative value**

Negative error numbers denote error messages defined by SCPI

**Example:**

SYST:ERR:ALL?

queries all entries in the error queue.

Response: 0, 'no error'

No errors have occurred since the error queue was last read out.

**Usage:**

Query only

---

**SYSTem:ERRor:CODE:ALL?**

The command queries all entries in the error queue and then deletes them. Only the error numbers are returned and not the entire error text.

**Return values:**

<All> string  
**0**  
 "No error", i.e. the error queue is empty  
**positive value**  
 Positive error numbers denote device-specific errors  
**negative value**  
 Negative error numbers denote error messages defined by SCPI.

**Example:**

SYST:ERR:CODE:ALL  
 queries all entries in the error queue.  
 Response: 0  
 no errors have occurred since the error queue was last read out.

**Usage:**

Query only

**SYSTem:ERRor:CODE[:NEXT]?**

The command queries the oldest entry in the error queue and then deletes it. Only the error number is returned and not the entire error text.

**Return values:**

<Next> string  
**0**  
 "No error", i.e. the error queue is empty  
**positive value**  
 Positive error numbers denote device-specific errors  
**negative value**  
 Negative error numbers denote error messages defined by SCPI.

**Example:**

SYST:ERR:CODE  
 queries the oldest entry in the error queue.  
 Response: 0  
 No errors have occurred since the error queue was last read out.

**Usage:**

Query only

**SYSTem:ERRor:COUNT?**

The command queries the number of entries in the error queue. If the error queue is empty, '0' is returned.

**Return values:**

<Count> string

**Example:**

SYST:ERR:COUN  
 queries the number of entries in the error queue.  
 Response: 1  
 One error has occurred since the error queue was last read out.

**Usage:**

Query only

**SYSTem:ERRor[:NEXT]?**

The command queries the oldest entry in the error queue and then deletes it.

The command is identical to the command `STATus:QUEue:NEXT`.

**Return values:**

`<Next>` string

**0**  
"No error", i.e. the error queue is empty

**positive value**  
Positive error numbers denote device-specific errors

**negative value**  
Negative error numbers denote error messages defined by SCPI.

**Example:**

`SYST:ERR?`  
queries the oldest entry in the error queue.  
Response: 0, 'no error'  
No errors have occurred since the error queue was last read out.

**Usage:** Query only

**:SYSTem:KLOCK <Klock>**

This command (**Keyboard LOCK**) disables the front panel keyboard of the instrument including the LOCAL key, or enables it again (OFF).

**Parameters:**

`<Klock>` 0 | 1 | OFF | ON  
\*RST: OFF

**Example:**

`SYST:KLOC ON`  
activates the keyboard lock. The keyboard cannot be operated again until it has been enabled with `SYST:KLOC OFF`.

**:SYSTem:PROTect<ch>[:STATe] <State>,<password>**

The command activates and deactivates the specified protection level.

**Suffix:**

`<ch>` Indicates the protection level.  
There are several protection levels which disable specific service functions (authorized personnel of R&S Service Departments only).

**Parameters:**

`<State>` 0 | 1 | OFF | ON

<password> The respective functions are disabled when the protection level is activated. No password is required for activation. A password must be entered to deactivate the protection level. The password for the first level is 123456. This protection level can be used to lock-out internal adjustments.

**Example:** `SYST:PROT1 ON`  
 activates protection level 1. Internal adjustments are only possible after deactivating the lock-out.  
`SYST:PROT1 OFF, 123456`  
 deactivates protection level 1. Internal adjustments are enabled again.

**Usage:** SCPI confirmed

### SYSTem:SERRor?

This command returns a list of all errors existing at the time when the query is started. This list corresponds to the display on the info page under manual control.

**Return values:**

<Serror> string

**Example:** `SYST:SERR`  
 queries all errors existing in the error queue.

**Example:** Response: -221, 'Settings conflict', 153, 'Input voltage out of range'  
 The two returned errors have occurred since the error queue was last queried.

**Usage:** Query only

### :SYSTem:STARtup:COMPlete?

The command queries if the startup of the instrument is completed.

**Return values:**

<Complete> 0 | 1 | OFF | ON  
 \*RST: 0

**Example:** `SYST:STAR:COMP`  
 Response: 1  
 The startup of the instrument is completed.

**Usage:** Query only

### :SYSTem:TIME <Time>

The command queries / sets the time for the instrument-internal clock.

The parameter is protected, in order to prevent accidental changes. It can be accessed with protection level 1, see `:SYSTem:PROTect<ch>[:STATe]` on page 734.



**Parameters:**

<Time> 0...23,0...59,0...59

**Example:**

SYST:TIME?

Response: 12, 0, 0 it is precisely 12 pm.

---

**SYSTem:VERSion?**

The command queries the SCPI version with which the instrument complies.

**Return values:**

<Version> string

**Example:**

SYST:VERS

queries the SCPI version.

Response: 1996

The instrument complies with the version from 1996.

**Usage:**

Query only

## 7.18 TEST Subsystem

The TEST system contains the commands for performing the routines as well as for direct manipulation of the hardware assemblies (:TEST:DIReCt).

The self tests return a "0" if the test is performed successfully, otherwise a value other than "0" is returned. None of the commands of this system have an \*RST value.

**NOTICE****Improper use may destroy the assembly!**

The respective hardware assembly responds directly to the :TEST:DIReCt command; any safety mechanisms are bypassed. The command is used for servicing purposes and should not be applied by the user.

---

:TEST:BB:CONNection.....	736
:TEST<hw>:BBOut:LRATe.....	737
:TEST<hw>:BBOut:TTEST[:STATe].....	737
:TEST:CONNeCtor:AUXio.....	737
:TEST<hw>:DIReCt.....	738

---

**:TEST:BB:CONNection?**

The command performs a connection test on each of the internal digital baseband links. This implies all installed options as baseband inputs, motherboard, universal coding generators, fading simulators, and baseband outputs.

**Return values:**

<Connection> 0 | 1 | OFF | ON

**Example:**            `TEST:BB:CONNECTION?`  
                           Response: "0" on success, "1" on fail

**Usage:**             Query only

**:TEST<hw>:BBOut:LRATe <LRate>**

The command sets the interface speed.

The "External LVDS Test" is used to check the correct data transmission of the digital baseband outputs (BBOU).

An external cable connection is needed to perform this test successfully. An output must be connected to an input with the digital I/Q cable. Always an input/output pair is tested together. The input and the output can be on the same instrument, or alternatively on two different instruments. Given an arbitrary cable connection, the appropriate Tx test can be activated with different interface speeds (LVDS rate).

On the connected input, this test sequence is received and can be compared with the expected test signal.

**Parameters:**

<LRate>                float  
                           Range:        66 MHz to 100 MHz

**Example:**            `TEST:BBOut:LRATe 90MHZ`  
                           sets the LVDS interface rate to 90 MHz

**:TEST<hw>:BBOut:TTEST[:STATe] <State>**

This command activates the transmission of a known pseudo-random sequence (On).

**Parameters:**

<State>                0 | 1 | OFF | ON  
                           \*RST:        0

**Example:**            `TEST:BBO:TTEST:STAT ON`  
                           starts the transmission of a signal test sequence .

**:TEST:CONNector:AUXio?**

The command triggers a test of the AUX IQ interface (see Service Manual Instrument, section "Performance Test"). This function is only available via remote control.

**Example:**            `TEST:CONN:AUX?`

**Usage:**             Query only

```
:TEST<hw>:DIRect <HW_assembly>,<subaddress>,<hex data string>
:TEST<hw>:DIRect? <HW_assembly>,<subaddress>
```

The respective hardware assembly responds directly to the command; any safety mechanisms are bypassed. This function is only available via remote control.

**Example:**

```
TEST:DIR 'SSYN',0,#H12345678
TEST:DIR? 'SSYN',0
Response: #H12345678
```

## 7.19 TRIGger Subsystem

The TRIGger system contains the commands for selecting the trigger source for the RF and LF sweep. The trigger input connectors are configured in the SOURCE:INPut subsystem.

The trigger system of the R&S SMJ is a simplified implementation of the SCPI trigger system. The TRIGger system differs from the SCPI system as follows:

- No INITiate command; the instrument behaves as if INITiate:CONTinuous ON were set.
- Under TRIGger several sweep subsystems exist.

Other commands associated with the trigger system of the R&S SMJ can be found in the modulation and RF signal subsystems.

**TRIGger<hw>**

- Suffix TRIGger<1|2> is not permitted
- TRIGger0 activates the LF output.

**Table 7-3: Cross-reference between the manual and remote control**

R&S name	SCPI name	Command under manual control
AUTO	IMMediate	"Auto" mode
SINGLE	BUS	"Single" mode.
EXTernal	EXTernal	"Ext Single" and "Ext Step" mode. Use command LFO:SWEEP:MODE to select between the two sweep modes.
EAUTO	-	"Ext Start/Stop" mode.

TRIGger0[:SWEep]:SOURce.....	739
:TRIGger<hw>:LFFSweep:SOURce.....	739
:TRIGger<hw>:FSWEEP[:IMMediate].....	739
:TRIGger<hw>:FSWEEP:SOURce.....	740
:TRIGger<hw>:PSWEEP[:IMMediate].....	740
:TRIGger<hw>:PSWEEP:SOURce.....	741
:TRIGger<hw>[:SWEep][:IMMediate].....	742
:TRIGger<hw>[:SWEep]:SOURce.....	742

**TRIGger0[:SWEep]:SOURce <Source>**  
**:TRIGger<hw>:LFFSweep:SOURce <Source>**

The command sets the trigger source for the LF sweep. The trigger is triggered by the command `:SOURce:LFOutput:SWEep[:FREQuency]EXECute`.

The names of the parameters correspond directly to the various settings under manual control. SCPI uses other names for the parameters; these names are also accepted by the instrument. The SCPI names should be used if compatibility is an important consideration.

An overview of the various names is given in the [table 7-3](#).

**Parameters:**

<Source>	AUTO   IMMEDIATE   SINGLE   BUS   EXTERNAL   EAUTO
	<b>AUTO IMMEDIATE</b>
	The trigger is free-running, i.e. the trigger condition is fulfilled continuously. As soon as one sweep is finished, the next sweep is started.
	<b>SINGLE BUS</b>
	One complete sweep cycle is triggered by the GPIB commands <code>[:SOURce]:LFOutput:SWEep[:FREQuency]:EXECute</code> or <code>*TRG</code> .
	The mode has to be set to AUTO ( <code>[:SOURce]:LFOutput:SWEep[:FREQuency]:MODE</code> ).
	<b>EXTERNAL</b>
	The sweep is triggered externally via the INST TRIG connector.
	<b>EAUTO</b>
	The sweep is triggered externally via the INST TRIG connector. As soon as one sweep is finished, the next sweep is started. A second trigger event stops the sweep at the current frequency, a third trigger event starts the trigger at the start frequency, and so on.
	*RST:        SINGLE

**Example:**            `TRIG:LFFS:SOUR EXT`  
 selects triggering with an external trigger.

**:TRIGger<hw>:FSWEEP[:IMMEDIATE]**

The command immediately starts an RF frequency sweep cycle.

The command is only effective for sweep mode "Single" (`SOUR:SWE:FREQ:MODE AUTO` in combination with `TRIG:FSW:SOUR SING`).

The command corresponds to the manual control "Execute Single Sweep".

**Example:** `SWE:FREQ:MODE AUTO`  
 sets the triggered sweep mode, i.e. a trigger is required to start the sweep.  
`TRIG:FSW:SOUR SING`  
 sets the "Single" trigger mode, i.e. a trigger starts a single sweep.  
`TRIG:FSW`  
 starts a single RF frequency sweep.

**Usage:** Event

**:TRIGger<hw>:FSweep:SOURce <Source>**

The command sets the trigger source for the RF frequency sweep.

The names of the parameters correspond directly to the various settings under manual control. SCPI uses other names for the parameters; these names are also accepted by the instrument. The SCPI names should be used if compatibility is an important consideration.

An overview of the various names is given in [table 7-3](#).

**Parameters:**

<Source> AUTO | IMMEDIATE | SINGLE | BUS | EXTERNAL | EAUTO

**AUTO|IMMEDIATE**  
 The trigger is free-running, i.e. the trigger condition is fulfilled continuously. As soon as one sweep is finished, the next sweep is started.

**SINGLE|BUS**  
 One complete sweep cycle is triggered by the GPIB commands `[ :SOURce<hw> ] :SWEep [ :FREQuency ] :EXECute, :TRIGger<hw>:FSweep [ :IMMEDIATE ]` or \*TRG. The mode has to be set to AUTO (`:SOURce:SWEep:FREQuency:MODE AUTO`).

**EXTERNAL**  
 The sweep is triggered externally via the INST TRIG connector.

**EAUTO**  
 The sweep is triggered externally via the INST TRIG connector. As soon as one sweep is finished, the next sweep is started. A second trigger event stops the sweep at the current frequency, a third trigger event starts the trigger at the start frequency, and so on.

\*RST: SINGLE

**Example:** `TRIG:FSW:SOUR EXT`  
 selects triggering with an external trigger.

**:TRIGger<hw>:PSweep[:IMMEDIATE]**

The command immediately starts an RF level sweep.

The command is only effective for sweep mode "Single" (SOURCE:SWEEP:POWER:MODE AUTO in combination with TRIG:PSW:SOUR SING).

The command corresponds to the manual control "Execute Single Sweep".

**Example:**

```
SWE:POW:MODE AUTO
selects the triggered sweep mode, i.e. a trigger is required to start
the sweep.
TRIG:PSW:SOUR AUTO
sets the Single trigger mode, i.e. a trigger starts a single sweep.
TRIG:PSW
starts a single RF level sweep.
```

**Usage:** Event

---

**:TRIGger<hw>:PSWEEP:SOURce <Source>**

The command sets the trigger source for the RF level sweep.

The names of the parameters correspond directly to the various settings under manual control. SCPI uses other names for the parameters; these names are also accepted by the instrument. The SCPI names should be used if compatibility is an important consideration.

An overview of the various names is given in [table 7-3](#).

**Parameters:**

<Source>

AUTO | IMMEDIATE | SINGLE | BUS | EXTERNAL | EAUTO

**AUTO|IMMEDIATE**

The trigger is free-running, i.e. the trigger condition is fulfilled continuously. As soon as one sweep is finished, the next sweep is started.

**SINGLE|BUS**

One complete sweep cycle is triggered by the GPIB commands [:SOURCE<hw>]:SWEEP:POWER:EXECUTE, :TRIGger<hw>:PSWEEP[:IMMEDIATE] or \*TRG. The mode has to be set to AUTO (:SOURCE:SWEEP:LEVEL:MODE AUTO).

**EXTERNAL**

The sweep is triggered externally via the INST TRIG connector.

**EAUTO**

The sweep is triggered externally via the INST TRIG connector. As soon as one sweep is finished, the next sweep is started. A second trigger event stops the sweep at the current frequency, a third trigger event starts the trigger at the start frequency, and so on.

\*RST: SINGLE

**Example:**

```
TRIG:PSW:SOUR EXT
selects triggering with an external trigger.
```

**:TRIGger<hw>[:SWEep][:IMMediate]**

The command starts all sweeps which are activated for the respective path. The command starts all sweeps which are activated.

The sweep to be executed depends on the respective MODE setting (`:SOUR:SWEep:POW|FREQ:MODE` and `:SOUR:LFO:SWEep[:FREQ]:MODE`).

The command corresponds to the manual-control command "Execute Trigger".

**Example:** TRIG  
starts all active sweeps.

**Usage:** Event

**:TRIGger<hw>[:SWEep]:SOURce <Source>**

The command sets the trigger source for all sweeps.

The names of the parameters correspond directly to the various settings under manual control. SCPI uses other names for the parameters; these names are also accepted by the instrument. The SCPI names should be used if compatibility is an important consideration.

An overview of the various names is given in the [table 7-3](#).

**Parameters:**

<Source>

AUTO | IMMediate | SINGle | BUS | EXTernal | EAUTO

**AUTO|IMMediate**

The trigger is free-running, i.e. the trigger condition is fulfilled continuously. As soon as one sweep is finished, the next sweep is started.

**SINGle|BUS**

One complete sweep cycle is triggered by the GPIB commands `:SOURce:SWEep:POWer|FREQuency:EXEC`, `TRIGger:PSWep|FSWep:IMMediate` or `*TRG`.

If `:SOURce:SWEep:POWer:MODE` is set to STEP, one step is executed.

The mode has to be set to AUTO.

**EXTernal**

The sweep is triggered externally via the INST TRIG connector.

**EAUTO**

The sweep is triggered externally via the INST TRIG connector. As soon as one sweep is finished, the next sweep is started. A second trigger event stops the sweep at the current frequency, a third trigger event starts the trigger at the start frequency, and so on.

\*RST: SINGle

**Example:** TRIG0:SOUR EXT  
selects triggering with an external trigger. The trigger is input via the INST TRIG connector.

**Usage:** Setting only

## 7.20 UNIT Subsystem

The UNIT subsystem contains the commands specifying which units are valid if no unit is indicated in a command. These settings are valid for the entire instrument.

---

**:UNIT:ANGLE** <Angle>

The command defines the default unit for the phase modulation angle. It is not valid for other commands which determine angle values, e.g. RF phase. It does not influence the manual control parameter unit and the display.

**Parameters:**

<Angle>                   DEGree | DEGRee | RADian  
\*RST:                   RADian

**Example:**

UNIT:ANGL DEG  
sets default unit DEG for all commands which determine angle values.

---

**:UNIT:POWer** <Power>

The command defines the default unit for power. It is valid for all commands which determine power values. It does not influence the manual control parameter unit and the display.

**Parameters:**

<Power>                   V | DBUV | DBM  
\*RST:                   DBM

**Example:**

UNIT:POW V  
sets default unit V for all commands which determine power values.





## 8 Maintenance

The instrument does not need periodic maintenance. Only the cleaning of the instrument is essential. The outside of the instrument is suitably cleaned using a soft, line-free dust cloth. Make sure that the air vents are not obstructed.

---

**⚠ WARNING****Shock hazard**

Before cleaning the instrument, make sure that the instrument is switched off and disconnected from all power supplies.

---

**NOTICE****Instrument damage caused by cleaning agents**

Cleaning agents contain substances that may damage the instrument, e.g. cleaning agents that contain a solvent may damage the front panel labeling or plastic parts.

Never use cleaning agents such as solvents (thinners, acetone, etc), acids, bases, or other substances.

The outside of the instrument can be cleaned sufficiently using a soft, lint-free dust cloth.

---

Follow the instructions in the service manual and the safety instructions when exchanging modules or ordering spares. The order no. for spare parts is included in the service manual. The service manual includes further information particularly on troubleshooting, repair, exchange of modules and alignment.

The address of our support center and a list of all Rohde & Schwarz service centers can be found at the beginning of this manual.

### 8.1 Storing and Packing

The storage temperature range of the instrument is given in the data sheet. If the instrument is to be stored for a longer period of time, it must be protected against dust.

Repack the instrument as it was originally packed when transporting or shipping. The two protective foam plastic parts prevent the control elements and connectors from being damaged. The antistatic packing foil avoids any undesired electrostatic charging to occur.

If you do not use the original packaging, use a sturdy cardboard box of suitable size and provide for sufficient padding to prevent the instrument from slipping inside the package. Wrap antistatic packing foil around the instrument to protect it from electrostatic charging.



## 9 Error Messages

This chapter describes the error messages of the R&S SMJ. The error messages are output in the "Info" line on the screen and entered in the error/event queue of the status reporting system.

A great variety of different messages such as status messages, error messages, warnings or information are displayed in the header field of the screen. Some error messages require that the error must be eliminated before correct instrument operation can be ensured. The info window with a list of current messages and a detailed description of each message can be opened with the INFO key.

In the remote control mode, error messages are entered in the error/event queue of the status reporting system and can be queried with the command `SYSTEM:ERROR?`. If the error queue is empty, 0 ("No error") is returned.

### 9.1 Status Information

The status messages are displayed in the header section of the screen. The status information gives the user an overview of the main operating states and settings of the instrument. The states are indicated for information only and do not necessitate any action by the user. Status information is displayed between the frequency and level fields, at the left of the info line or in the info line itself.

#### 9.1.1 Status information displayed between the frequency and level fields

This chapter gives an overview of the status messages displayed between the frequency and level fields.

##### **RF OFF**

The RF output is switched off

##### **MOD OFF**

All modulations are switched off

##### **FREQ OFFSET**

A frequency offset is set.

The frequency entered and displayed in the "Frequency" field takes any set frequency offset into consideration, e.g. an offset set for a downstream instrument. This means that with a frequency offset the frequency displayed in the header does not correspond to the frequency at the RF output, but rather to the frequency at the output of the downstream instrument.

This allows the target frequency at the output of a downstream instrument to be entered in the frequency field. The signal generator changes the RF output frequency according to the entered offset.

However, the frequency entered and displayed in the "Frequency/Phase" dialog of the "RF" function block always corresponds to the RF output frequency. Any frequency offset is not taken into consideration.

The correlation is as follows:

Freq in header = RF output frequency (= Freq in dialog) + Freq offset (= Offset in dialog)

#### **OVERLOAD**

The power of the external signal applied to the RF output is too high. The overload protection is tripped and the connection between the RF output and attenuator is interrupted. The overload protection is reset by pressing the RF ON/OFF key. The RF input is activated when the overload protection is reset.

#### **LEVEL OFFSET**

A level offset is set.

The level entered and displayed in the "Level" field takes the offset of any downstream attenuators/amplifiers into consideration by way of calculation. This means that with a level offset the level displayed in the header does not correspond to the level at the RF output, but rather to the level at the output of the downstream instrument.

This allows the target level at the output of downstream instruments to be entered. The signal generator changes the RF output level according to the set offset.

However, the level entered and displayed in the "Level" dialog of the "RF" function block always corresponds to the RF output level. Any level offset is not taken into consideration.

The correlation is as follows:

Level in header = RF output level (= Level in dialog) + Level offset

#### **EXT REF**

An external reference is used.

The external signal with selectable frequency and defined level must be input at the REF IN connector. It is output at the REF OUT connector.

#### **BUSY**

A setting or calculation is executed.

### **9.1.2 Status information displayed to the left of the Info line**

This chapter gives an overview of the status messages displayed to the left of the Info line.

#### **REMOTE**

The instrument is remote controlled.

The keys on the front panel are usable, but all parameters are in read only mode.

The LOCAL key switches the instrument from remote control to manual operation. The current command must be fully processed before the mode is switched, otherwise the instrument switches immediately back to remote control.

**REM-LLO**

The instrument is remote (**REM**ote) controlled. The LOCAL key is disabled by remote control with the command **LLO** (**LocalLockOut**).

The keys on the front panel are usable, but all parameters are in read only mode.

The instrument can be switched from remote control to manual operation by means of remote control only (e.g. with the Visual Basic command `CALL IBLOC (generator%)` or by `&NREN`).

**LOC-LLO**

For operating directly the instrument is placed from remote control to manual operation (Local State). The LOCAL key was disabled by remote control with the command **LLO** (**LocalLockOut**).

With the next activating of the remote control mode, the instrument cannot be switched to manual operation by the operator. The status information changes to "REM-LLO".

The instrument can be switched to manual operation by means of remote control only (e.g. with the Visual Basic command `CALL IBLOC (generator%)`).

**SYS CTRL**

Indicates that the instrument is controlling another instrument.

### 9.1.3 Status information displayed in the Info line

This chapter gives an overview of the status messages displayed in the Info line.

**RFSweep / LevelSweep / LFSweep**

The indicated sweep is enabled.

**ALC On / Auto / S&H**

The status of the automatic level control is indicated:

- ON  
automatic level control permanently on
- Auto  
automatic level control is automatically adapted to the operating states
- S&H  
automatic level control off, recalibration of the level whenever the level or frequency is set (sample and hold mode)

**ListMode**

List mode is active.

The values of the frequency/level pairs in the selected list are set for the chosen dwell time.

**AttFixed**

Attenuator fixed mode is active.

The uninterrupted level settings are made in a fixed range without attenuator switching. The variation range is set automatically when this mode is activated. The range is displayed under "Attenuator Fixed Range" in the "Level" dialog.

**UCorr**

User Correction is active.

The level is corrected by the given values in the selected user correction list. Correction is performed by the user-defined list values being added to the output level for the respective RF frequency. With frequencies which are not contained in the list, the level correction is determined by interpolation of the closest correction values.

**OvenCold**

The reference oscillator has not yet reached its nominal frequency.

When switching on from the STANDBY mode, the specified frequency accuracy is reached immediately. If the power switch was switched off, the reference oscillator needs some warm-up time to reach its nominal frequency. During this period of time, the output frequency does not yet reach its final value either.

## 9.2 Error Messages

Messages indicate errors in the instrument. They are displayed in the info line in different colors depending on their importance and display duration. Errors (e.g. no calibration data) are displayed in red, information (e.g. file not found) and warnings in black. Warnings indicate less significant errors (e.g. the instrument operates outside specified data).

### 9.2.1 Volatile messages

Volatile messages report automatic settings in the instrument (e.g. switching off of incompatible types of modulation) or on illegal entries that are not accepted by the instrument (e.g. range violations). They are displayed in the info line on a yellow background. They are displayed on top of status information or permanent messages.

Volatile messages do not normally demand user actions and disappear automatically after a brief period of time. They are stored in the history, however.

SCPI command: `SYSTem:ERRor:ALL` or `SYSTem:ERRor[:NEXT]`

### 9.2.2 Permanent messages

Permanent messages are displayed if an error occurs that impairs further instrument operation, e.g. a hardware fault. The error signaled by a permanent message must be eliminated before correct instrument operation can be ensured.

The message is displayed until the error is eliminated. It covers the status display in the info line. After error elimination, the message automatically disappears and is also recorded in the history.

SCPI command: `SYSTem:SERRor`

## 9.3 SCPI-Error Messages

The SCPI error messages are the same in all SCPI instruments. Detailed information and an overview of all error messages as defined in SCPI standard can be found in the corresponding documentation.

The errors are assigned negative numbers. The error text being entered into the error/event queue or being displayed is printed in bold face on the left together with the error code. Below the error text, there is an explanation as to the respective error.

## 9.4 Device-Specific Error Messages

The following table contains all error messages specific for the instrument in alphabetical order, as well as an explanation of the error situation. The positive error codes mark the errors specific of the instrument.

The device-specific error messages set bit 3 in the ESR register.



The index provides a list of the error messages sorted according to their error codes.

Error Code	Error	Description	Remedy
50	Extern reference out of range or disconnected	External reference is selected but no external signal is applied or the signal is out of range.	<ul style="list-style-type: none"> <li>Check the selected reference signal source (internal or external) in the "Setup &gt; Reference Oscillator" dialog.</li> <li>Change setting to 'internal' if no appropriate external source is available.</li> </ul>
140	This modulation forces other modulations off	<p>A modulation has been switched on which cannot be used at the same time as an already active modulation. The previous modulation has been switched off.</p> <p>Example: Enabling modulation GSM/EDGE switches any active digital modulation off.</p>	
180	Adjustment failed	Adjustment could not be executed	The adjustment data have to be generated first by an internal or external adjustment or to be loaded into the device (see <a href="#">chapter 5.2.3.1, "Internal Adjustments"</a> , on page 119).
182	Adjustment data missing	Adjustment data are missing.	The adjustment data have to be generated first by an internal or external adjustment or to be loaded into the instrument.



Error Code	Error	Description	Remedy
183	Adjustment data invalid	Adjustment data are invalid and must be restored.	The adjustment data have to be generated again by an internal or external adjustment or to be loaded into the instrument.
200	Cannot access hardware	The data transmission to a module was unsuccessful.	The module is not installed, not properly installed or missing.
201	Hardware revision out of date	A later version of certain parts of the instrument is necessary to execute the function selected.	The driver does not support the installed version of a module.
202	Cannot access the EEPROM	A error occurs when writing or reading a EEPROM.	The EEPROM might be defect and has to be replaced.
203	Invalid EEPROM data	Reading a EEPROM is possible, however the data are inconsistent.	
204	Driver initialization failed	Initialization of a driver fails when booting the instrument firmware.	The driver is not compatible with the hardware or software configuration of the instrument.
241	No current list	There is no list selected. To execute the required operation, a list has to be selected in the related menu. If no list is available, a new list must be created.	
242	Unknown list type specified	The list type selected is not valid for the required operation.  For instance, the file extension for waveform list files is *.wv. It is not possible to enter another file extension when selecting a list.	Check the selected list type.
261	Waveform Protected	The selected waveform file cannot be transferred to a controller. The waveform is produced with simulation software R&S WinIQSIM2 and is protected.	
460	Cannot open file	The selected file can not be opened.	Check the path and file name.
461	Cannot write file	The file can not be written.	Check if the file is read-only.
462	Cannot read file	The file can not be read.	Check if the file contents are compatible with the file type.
463	Filename missing	The required operation cannot be executed because the file name is not specified.	A file name has to be entered when creating a new list.

Error Code	Error	Description	Remedy
464	Invalid filename extension	The file extension is not valid for the required operation.	Check the file extension. For instance, the file extension for waveform list files is *.wv. It is not possible to enter another file extension when storing a list.
465	File contains invalid data	The selected file contains data that is not valid for the file type. The file extension determines the data that is valid for this file type. If the file extension is changed the lists are no longer recognized and the data are therefore invalid. Example: the extension of a waveform file (= *.wv) was changed to *.txt	Check the file extension.



## A Hardware Interfaces

This section covers hardware related topics, like pin assignment of the GPIB bus interface, monitor and AUX I/O connectors.

The remote control interfaces are described in details in [chapter 6, "Remote Control Basics"](#), on page 413.

All other interfaces are described in [chapter 2.1, "Front Panel Tour"](#), on page 19 and [chapter 2.2, "Rear Panel Tour"](#), on page 26.

For specifications refer to the data sheet.

### A.1 GPIB Bus Interface

#### Pin assignment

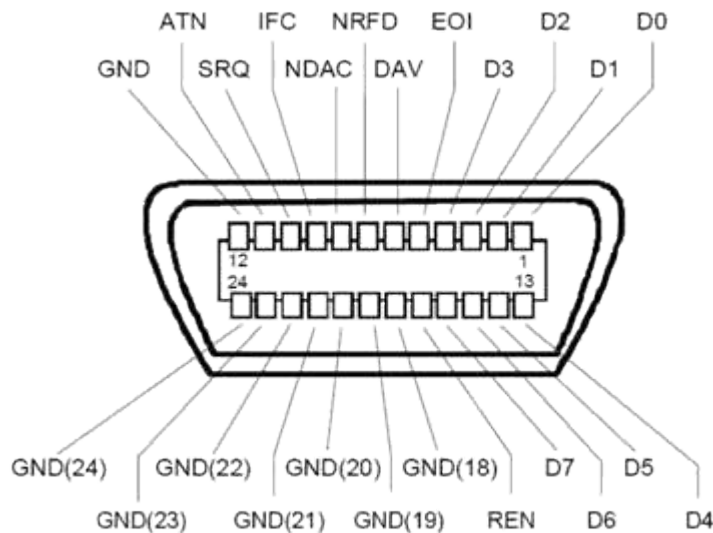

*Fig. 1-1: Pin assignment of GPIB bus interface*

#### Bus lines

- Data bus with 8 lines D0 to D7:  
The transmission is bit-parallel and byte-serial in the ASCII/ISO code. D0 is the least significant bit, D7 the most significant bit.
- Control bus with five lines:  
**IFC** (Interface Clear): active LOW resets the interfaces of the instruments connected to the default setting.  
**ATN** (Attention): active LOW signals the transmission of interface messages, inactive HIGH signals the transmission of device messages.

**SRQ** (Service Request): active LOW enables the connected device to send a service request to the controller.

**REN** (Remote Enable): active LOW permits switchover to remote control.

**EOI** (End or Identify): has two functions in connection with ATN:

- ATN=HIGH active LOW marks the end of data transmission.
- ATN=LOW active LOW triggers a parallel poll.

- Handshake bus with three lines:

**DAV** (Data Valid): active LOW signals a valid data byte on the data bus.

**NRFD** (Not Ready For Data): active LOW signals that one of the connected devices is not ready for data transfer.

**NDAC** (Not Data Accepted): active LOW signals that the instrument connected is accepting the data on the data bus.

### Interface Functions

Instruments which can be controlled via GPIB bus can be equipped with different interface functions. The interface function for the R&S SMJ are listed in the following table.

**Table 1-1: GPIB bus interface functions**

Control character	Interface function
SH1	Handshake source function (source handshake), full capability
AH1	Handshake sink function (acceptor handshake), full capability
L4	Listener function, full capability, de-addressed by MTA.
T6	Talker function, full capability, ability to respond to serial poll, deaddressed by MLA
SR1	Service request function (Service Request), full capability
PP1	Parallel poll function, full capability
RL1	Remote/Local switch over function, full capability
DC1	Reset function (Device Clear), full capability
DT1	Trigger function (Device Trigger), full capability

## A.2 AUX I/O Connector



For an overview of the signals that can be applied at the USER connector, see [table 5-1](#).

Table 1-2: Pin assignment of the AUX I/O Connector connector

Pin	Signal	Description
1 .. 25	Ground $\perp$	Ground
26	LEV ATT	Signal input/output for controlling the level attenuation. With <b>external</b> envelope curve control ("Custom Digital Modulation" only), the pin is the input for the control signal LEV_ATT. With <b>internal</b> envelope curve control, the control signal LEV_ATT is output for Path A.
27	CW MODE	Signal input for controlling the switchover between the modulated and unmodulated RF signal with activated external modulation/CW switching in the "Custom Digital Modulation" menu. Signal output for the CW control signal with internal source selected. This signal marks the CW mode in which digital modulation is deactivated and the RF signal is output in unmodulated form. In the case of digital standards with selectable modulation mode, the signal indicates the active modulation mode (GSM: (G)MSK = high, 8PSK EDGE = low).
28	not used	not used
29 .. 38	PARDATA0 .. PARDATA9	Parallel data input/output 0...D with 10-bit word width for digital modulation. If the data source "External Parallel" is selected, these pins are the data inputs. If a different data source is selected, the data is output here ("Custom Digital Modulation", Path A).
39	USER 3	USER input/output which can be configured for various purposes.
40	USER 4	USER input/output which can be configured for various purposes.
41	MARKER 3	Output for the freely programmable marker signal 3 of Path A. The output is permanently assigned.
42	not used	not used
43	not used	not used
44	not used	not used
45	BURST	Signal input/output for controlling the burst ramp. With <b>external</b> envelope curve control ("Custom Digital Modulation" only), the pin is the input for the control signal "BURST_RAMP". With <b>internal</b> envelope curve control, the control signal "BURST_RAMP" is output for Path A.
46	EXT TUNE	Tuning input for the internal reference frequency.
47	BITCLK	Output Bit clock for internal mode.
48	USER 2	USER input/output which can be configured for various purposes.
49	SYMBCLK	Symbol clock output for internal mode.
50	not used	not used

### A.3 Monitor Connector (MONITOR)

The 15-pin Sub-D female connector MONITOR at the rear panel is intended for connecting an external VGA monitor.

*Table 1-3: Pin assignment of the MONITOR connector*

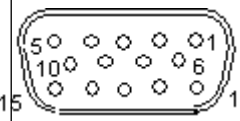
Monitor Connector	Pin	Signal	Pin	Signal	Pin	Signal
	1	Red (output)	6	GND	11	(NC)
	2	Green (output)	7	GND	12	(NC)
	3	Blue (output)	8	GND	13	HSYNC (output)
	4	(NC)	9	GND	14	VSYNC (output)
	5	GND	10	GND	15	(NC)

### A.4 BERT Connector

The 9-pin Sub-D connector BERT at the rear panel is available for the input signals of the integrated bit error rate tester (option BER/BLE Measurement (R&S SMJ-K80)).

*Table 1-4: Pin assignment of the BERT connector*

Monitor Connector	Pin	Signal	Pin	Signal
	1	GND	6	CLOCK
	2	GND	7	DATA
	3	GND	8	DATA ENABLE
	4	GND	9	RESTART
	5	GND		

The input signals are not terminated in the instrument. The impedance (50 ohm) and the threshold (0.0128..1.998 V) of the inputs can be set in the "BERT" menu.

The following figure shows the circuit diagram of the BERT function.

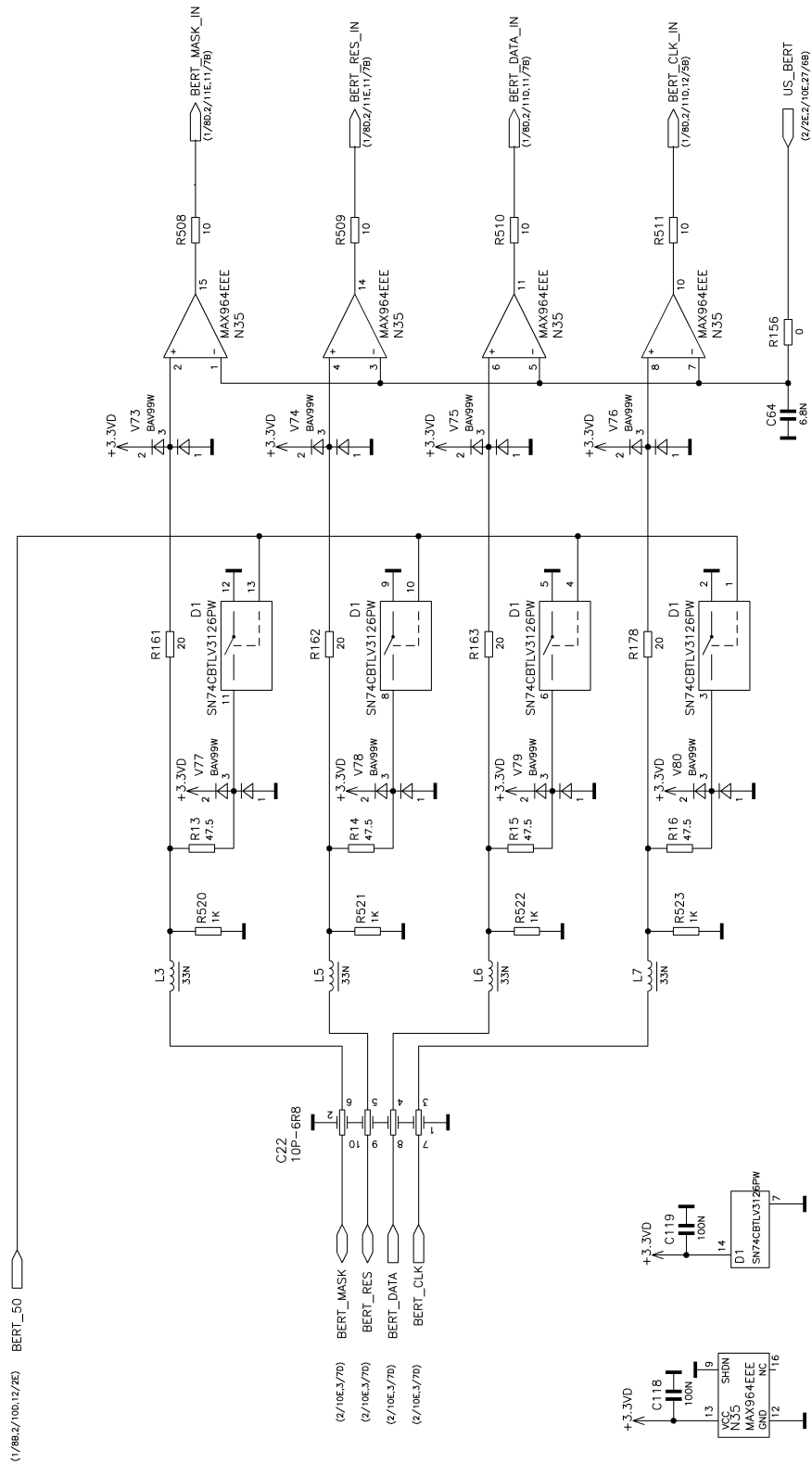

Fig. 1-2: BERT circuit diagram





## List of Commands

*CAL.....	453
*CLS.....	453
*ESE.....	454
*ESR.....	454
*IDN.....	454
*IST.....	454
*OPC.....	455
*OPT.....	455
*PCB.....	455
*PRE.....	455
*PSC.....	455
*RCL.....	456
*RST.....	456
*SAV.....	456
*SRE.....	456
*STB.....	457
*TRG.....	457
*TST.....	457
*WAI.....	457
:BERT:RESult.....	477
:BERT:SEQuence.....	478
:BERT:SETup:CLOCK[:POLarity].....	479
:BERT:SETup:DATA[:POLarity].....	480
:BERT:SETup:DENable.....	480
:BERT:SETup:IGNore.....	481
:BERT:SETup:MCOunt.....	482
:BERT:SETup:MERRor.....	482
:BERT:SETup:REStart:STATe.....	482
:BERT:SETup:TYPE.....	483
:BERT:START.....	484
:BERT:STATe.....	484
:BERT:STOP.....	484
:BERT:UNIT.....	485
:BLER:RESult.....	477
:BLER:SEQuence.....	478
:BLER:SETup:CLOCK[:POLarity].....	479
:BLER:SETup:CORDer.....	479
:BLER:SETup:DATA[:POLarity].....	480
:BLER:SETup:DENable.....	480
:BLER:SETup:MCOunt.....	482
:BLER:SETup:MERRor.....	482
:BLER:SETup:TYPE.....	483
:BLER:START.....	484
:BLER:STATe.....	484
:BLER:STOP.....	484

:BLER:UNIT.....	485
:CALibration:ALL[:MEASure].....	486
:CALibration<hw>:FMOffset[:MEASure].....	487
:CALibration<hw>:FREQuency[:MEASure].....	487
:CALibration<hw>:IQModulator:FULL.....	487
:CALibration<hw>:IQModulator:LOCAl.....	488
:CALibration<hw>:LEVel:HACCuracy[:STATe].....	488
:CALibration<hw>:LEVel:STATe.....	488
:CALibration<hw>:LEVel[:MEASure].....	488
:CLOCK:INPut:FREQuency.....	489
:CLOCK:INPut:SLOPe.....	489
:CLOCK:OUTPut:MODE.....	489
:CLOCK:OUTPut:SOURce.....	490
:DEvice:PRESet.....	458
:DIAGnostic:INFO:OTIME.....	491
:DIAGnostic:INFO:POCounT.....	491
:DIAGnostic<hw>:BGInfo.....	490
:DIAGnostic<hw>:BGInfo:CATalog.....	491
:DISPlay:PSAVe:HOLDoff.....	492
:DISPlay:PSAVe[:STATe].....	492
:FORMat:BOrDer.....	493
:FORMat:SREGister.....	494
:FORMat[:DATA].....	493
:HCOPy:DATA.....	495
:HCOPy:DEvice.....	495
:HCOPy:DEvice:LANGuage.....	495
:HCOPy:FILE[:NAME].....	496
:HCOPy:FILE[:NAME]:AUTO.....	496
:HCOPy:FILE[:NAME]:AUTO:DIRectory.....	497
:HCOPy:FILE[:NAME]:AUTO:DIRectory:CLEar.....	497
:HCOPy:FILE[:NAME]:AUTO:FILE.....	497
:HCOPy:FILE[:NAME]:AUTO:STATe.....	500
:HCOPy:FILE[:NAME]:AUTO[:FILE]:DAY.....	498
:HCOPy:FILE[:NAME]:AUTO[:FILE]:DAY:STATe.....	498
:HCOPy:FILE[:NAME]:AUTO[:FILE]:MONTH.....	498
:HCOPy:FILE[:NAME]:AUTO[:FILE]:MONTH:STATe.....	498
:HCOPy:FILE[:NAME]:AUTO[:FILE]:NUMBER.....	498
:HCOPy:FILE[:NAME]:AUTO[:FILE]:PREFIX.....	499
:HCOPy:FILE[:NAME]:AUTO[:FILE]:PREFIX:STATe.....	499
:HCOPy:FILE[:NAME]:AUTO[:FILE]:YEAR.....	499
:HCOPy:FILE[:NAME]:AUTO[:FILE]:YEAR:STATe.....	500
:HCOPy:IMAGe:FORMat.....	500
:HCOPy:IMAGe:SIZE.....	500
:HCOPy:PRINter:LIST.....	501
:HCOPy:PRINter:PAGE:MARGins.....	501
:HCOPy:PRINter:PAGE:ORientation.....	501
:HCOPy:PRINter:PAGE:SIZE.....	502
:HCOPy:PRINter:PAGE:UNIT.....	502

:HCOPy:PRINter[:NAME].....	501
:HCOPy:EXECute].....	496
:INITiate<ch>[:POWer]:CONTInuous.....	518
:KBOard:LANGUage.....	502
:KBOard:LAYout.....	502
:MMEMory:CATalog.....	508
:MMEMory:CATalog:LENGth.....	508
:MMEMory:CDIRectory.....	509
:MMEMory:COPI.....	509
:MMEMory:DATA.....	510
:MMEMory:DCATalog.....	510
:MMEMory:DCATalog:LENGth.....	510
:MMEMory:DELeTe.....	511
:MMEMory:LOAD:STATe.....	511
:MMEMory:MDIRectory.....	511
:MMEMory:MOVE.....	512
:MMEMory:MSIS.....	512
:MMEMory:RDIRectory.....	512
:MMEMory:STORe:STATe.....	512
:OUTPut:BLANK:POLarity.....	514
:OUTPut:USER<ch>:SOURce.....	516
:OUTPut<hw>:AFIXed:RANGe:LOWer.....	513
:OUTPut<hw>:AFIXed:RANGe:UPPer.....	514
:OUTPut<hw>:AMODE.....	514
:OUTPut<hw>:BLANK:LIST:STATe.....	514
:OUTPut<hw>:IMPedance.....	515
:OUTPut<hw>:PROTEction:CLEar.....	515
:OUTPut<hw>:PROTEction:STATe.....	515
:OUTPut<hw>:PROTEction:TRIPped.....	516
:OUTPut<hw>[:STATe].....	516
:OUTPut<hw>[:STATe]:PON.....	516
:READ<ch>[:POWer].....	518
:SOURce<hw>:PRESet.....	458
:SYSTem:BEEPer:STATe.....	730
:SYSTem:COMMunicate:GPIB:LTERminator.....	730
:SYSTem:COMMunicate:GPIB:RESource.....	731
:SYSTem:COMMunicate:GPIB[:SELF]:ADDRess.....	730
:SYSTem:COMMunicate:NETWork:RESource.....	731
:SYSTem:COMMunicate:NETWork[:COMMOn]:WORKgroup.....	731
:SYSTem:COMMunicate:SOCKet:RESource.....	731
:SYSTem:DATE.....	732
:SYSTem:DISPlay:UPDate.....	732
:SYSTem:FPReset.....	458
:SYSTem:KLOCK.....	734
:SYSTem:PROTEct<ch>[:STATe].....	734
:SYSTem:STARtup:COMPLete.....	735
:SYSTem:TIME.....	735
:TEST:BB:CONNection.....	736

:TEST:CONNector:AUXio.....	737
:TEST<hw>:BBOut:LRATe.....	737
:TEST<hw>:BBOut:TTEST[:STATe].....	737
:TEST<hw>:DIRect.....	738
:TRIGger:BERT[:IMMEDIATE].....	486
:TRIGger:BLER[:IMMEDIATE].....	486
:TRIGger<hw>:FSWeep:SOURce.....	740
:TRIGger<hw>:FSWeep[:IMMEDIATE].....	739
:TRIGger<hw>:LFFSweep:SOURce.....	739
:TRIGger<hw>:PSWeep:SOURce.....	741
:TRIGger<hw>:PSWeep[:IMMEDIATE].....	740
:TRIGger<hw>[:SWEep]:SOURce.....	742
:TRIGger<hw>[:SWEep][:IMMEDIATE].....	742
:UNIT:ANGLE.....	743
:UNIT:POWer.....	743
SENSe<ch>:UNIT[:POWer].....	525
SENSe<ch>[:POWer]:CORRection:SPDevice:STATe.....	519
SENSe<ch>[:POWer]:DISPlay:PERManent:PRiority.....	519
SENSe<ch>[:POWer]:DISPlay:PERManent:STATe.....	519
SENSe<ch>[:POWer]:FILTer:LENGth:AUTO.....	519
SENSe<ch>[:POWer]:FILTer:LENGth[:USER].....	520
SENSe<ch>[:POWer]:FILTer:NSRatio.....	520
SENSe<ch>[:POWer]:FILTer:NSRatio:MTIME.....	520
SENSe<ch>[:POWer]:FILTer:SONCe.....	521
SENSe<ch>[:POWer]:FILTer:TYPE.....	521
SENSe<ch>[:POWer]:FREQUency.....	522
SENSe<ch>[:POWer]:OFFSet.....	522
SENSe<ch>[:POWer]:OFFSet:STATe.....	523
SENSe<ch>[:POWer]:SNUMber.....	523
SENSe<ch>[:POWer]:SOURce.....	523
SENSe<ch>[:POWer]:STATus[:DEVice].....	523
SENSe<ch>[:POWer]:SVERsion.....	524
SENSe<ch>[:POWer]:TYPE.....	524
SENSe<ch>[:POWer]:ZERO.....	524
STATus:OPERation:CONDition.....	726
STATus:OPERation:ENABle.....	726
STATus:OPERation:NTRansition.....	726
STATus:OPERation:PTRansition.....	727
STATus:OPERation[:EVENT].....	726
STATus:PRESet.....	727
STATus:QUEStionable:CONDition.....	727
STATus:QUEStionable:ENABle.....	728
STATus:QUEStionable:NTRansition.....	728
STATus:QUEStionable:PTRansition.....	729
STATus:QUEStionable[:EVENT].....	728
STATus:QUEue[:NEXT].....	729
SYSTem:ERRor:ALL.....	732
SYSTem:ERRor:CODE:ALL.....	732

SYSTem:ERRor:CODE[:NEXT].....	733
SYSTem:ERRor:COUNT.....	733
SYSTem:ERRor[:NEXT].....	734
SYSTem:PRESet.....	458
SYSTem:SERRor.....	735
SYSTem:VERSion.....	736
TRIGger0[:SWEep]:SOURce.....	739
[:SOURce<hw>]:AM:BBANd:SENSitivity.....	526
[:SOURce<hw>]:AM:BBANd[:STATe].....	526
[:SOURce<hw>]:AM:EXTernal:COUPling.....	527
[:SOURce<hw>]:AM:SENSitivity.....	527
[:SOURce<hw>]:AM:SOURce.....	528
[:SOURce<hw>]:AM:STATe.....	528
[:SOURce<hw>]:AM[:DEPTh].....	526
[:SOURce<hw>]:AWGN:BRATe.....	529
[:SOURce<hw>]:AWGN:BWIDth.....	529
[:SOURce<hw>]:AWGN:BWIDth:NOISe.....	529
[:SOURce<hw>]:AWGN:BWIDth:RATio.....	530
[:SOURce<hw>]:AWGN:CNRatio.....	530
[:SOURce<hw>]:AWGN:DISP:MODE.....	531
[:SOURce<hw>]:AWGN:DISP:ORESults.....	531
[:SOURce<hw>]:AWGN:ENRatio.....	531
[:SOURce<hw>]:AWGN:FREQuency:RESult.....	532
[:SOURce<hw>]:AWGN:FREQuency:TARGeT.....	532
[:SOURce<hw>]:AWGN:MODE.....	533
[:SOURce<hw>]:AWGN:POWer:CARRier.....	533
[:SOURce<hw>]:AWGN:POWer:MODE.....	534
[:SOURce<hw>]:AWGN:POWer:NOISe.....	534
[:SOURce<hw>]:AWGN:POWer:NOISe:TOTal.....	535
[:SOURce<hw>]:AWGN:POWer:RMODE.....	535
[:SOURce<hw>]:AWGN:POWer:SUM.....	535
[:SOURce<hw>]:AWGN:POWer:SUM:PEP.....	536
[:SOURce<hw>]:AWGN:STATe.....	536
[:SOURce<hw>]:BB:ARB:CLOCK.....	538
[:SOURce<hw>]:BB:ARB:CLOCK:MODE.....	539
[:SOURce<hw>]:BB:ARB:CLOCK:MULTiplier.....	539
[:SOURce<hw>]:BB:ARB:CLOCK:SOURce.....	539
[:SOURce<hw>]:BB:ARB:MCARrier:CARRier:COUNT.....	553
[:SOURce<hw>]:BB:ARB:MCARrier:CARRier:MODE.....	553
[:SOURce<hw>]:BB:ARB:MCARrier:CARRier:SPACing.....	554
[:SOURce<hw>]:BB:ARB:MCARrier:CARRier<ch>:CONFLict.....	554
[:SOURce<hw>]:BB:ARB:MCARrier:CARRier<ch>:DELay.....	555
[:SOURce<hw>]:BB:ARB:MCARrier:CARRier<ch>:FILE.....	555
[:SOURce<hw>]:BB:ARB:MCARrier:CARRier<ch>:FREQuency.....	555
[:SOURce<hw>]:BB:ARB:MCARrier:CARRier<ch>:PHASe.....	556
[:SOURce<hw>]:BB:ARB:MCARrier:CARRier<ch>:POWer.....	556
[:SOURce<hw>]:BB:ARB:MCARrier:CARRier<ch>:STATe.....	556
[:SOURce<hw>]:BB:ARB:MCARrier:CFACTor:MODE.....	556

[:SOURce<hw>]:BB:ARB:MCARrier:CLIPping:CFActor.....	557
[:SOURce<hw>]:BB:ARB:MCARrier:CLIPping:CUToff.....	557
[:SOURce<hw>]:BB:ARB:MCARrier:CLIPping[:STATe].....	558
[:SOURce<hw>]:BB:ARB:MCARrier:CLOCK.....	559
[:SOURce<hw>]:BB:ARB:MCARrier:CLOad.....	558
[:SOURce<hw>]:BB:ARB:MCARrier:CREate.....	559
[:SOURce<hw>]:BB:ARB:MCARrier:EDIT:CARRier:DELAy:STEP.....	559
[:SOURce<hw>]:BB:ARB:MCARrier:EDIT:CARRier:DELAy[:STARt].....	560
[:SOURce<hw>]:BB:ARB:MCARrier:EDIT:CARRier:EXECute.....	560
[:SOURce<hw>]:BB:ARB:MCARrier:EDIT:CARRier:FILE.....	561
[:SOURce<hw>]:BB:ARB:MCARrier:EDIT:CARRier:PHASe:STEP.....	561
[:SOURce<hw>]:BB:ARB:MCARrier:EDIT:CARRier:PHASe[:STARt].....	561
[:SOURce<hw>]:BB:ARB:MCARrier:EDIT:CARRier:POWER:STEP.....	562
[:SOURce<hw>]:BB:ARB:MCARrier:EDIT:CARRier:POWER[:STARt].....	562
[:SOURce<hw>]:BB:ARB:MCARrier:EDIT:CARRier:STARt.....	562
[:SOURce<hw>]:BB:ARB:MCARrier:EDIT:CARRier:STATe.....	563
[:SOURce<hw>]:BB:ARB:MCARrier:EDIT:CARRier:STOP.....	562
[:SOURce<hw>]:BB:ARB:MCARrier:OFILe.....	563
[:SOURce<hw>]:BB:ARB:MCARrier:PRESet.....	563
[:SOURce<hw>]:BB:ARB:MCARrier:SAMPles.....	563
[:SOURce<hw>]:BB:ARB:MCARrier:SETTing:CATalog.....	564
[:SOURce<hw>]:BB:ARB:MCARrier:SETTing:LOAD.....	564
[:SOURce<hw>]:BB:ARB:MCARrier:SETTing:STORe.....	564
[:SOURce<hw>]:BB:ARB:MCARrier:SETTing:STORe:FAST.....	564
[:SOURce<hw>]:BB:ARB:MCARrier:TIME.....	565
[:SOURce<hw>]:BB:ARB:MCARrier:TIME:MODE.....	565
[:SOURce<hw>]:BB:ARB:PRESet.....	538
[:SOURce<hw>]:BB:ARB:STATe.....	538
[:SOURce<hw>]:BB:ARB:TRIGger:ARM:EXECute.....	540
[:SOURce<hw>]:BB:ARB:TRIGger:EXECute.....	541
[:SOURce<hw>]:BB:ARB:TRIGger:EXTernal:SYNChronize:OUTPut.....	541
[:SOURce<hw>]:BB:ARB:TRIGger:OUTPut:DELAy:FIXed.....	541
[:SOURce<hw>]:BB:ARB:TRIGger:OUTPut<ch>:DELAy.....	542
[:SOURce<hw>]:BB:ARB:TRIGger:OUTPut<ch>:DELAy:MAXimum.....	542
[:SOURce<hw>]:BB:ARB:TRIGger:OUTPut<ch>:DELAy:MINimum.....	542
[:SOURce<hw>]:BB:ARB:TRIGger:OUTPut<ch>:MODE.....	547
[:SOURce<hw>]:BB:ARB:TRIGger:OUTPut<ch>:OFFTime.....	547
[:SOURce<hw>]:BB:ARB:TRIGger:OUTPut<ch>:ONTTime.....	547
[:SOURce<hw>]:BB:ARB:TRIGger:OUTPut<ch>:PATTern.....	548
[:SOURce<hw>]:BB:ARB:TRIGger:OUTPut<ch>:PULSe:DIVider.....	548
[:SOURce<hw>]:BB:ARB:TRIGger:OUTPut<ch>:PULSe:FREQuency.....	548
[:SOURce<hw>]:BB:ARB:TRIGger:RMODE.....	543
[:SOURce<hw>]:BB:ARB:TRIGger:SLENgth.....	543
[:SOURce<hw>]:BB:ARB:TRIGger:SLUNit.....	544
[:SOURce<hw>]:BB:ARB:TRIGger:SMODE.....	544
[:SOURce<hw>]:BB:ARB:TRIGger:SOURce.....	545
[:SOURce<hw>]:BB:ARB:TRIGger[:EXTernal<1 2>]:DELAy.....	545
[:SOURce<hw>]:BB:ARB:TRIGger[:EXTernal<1 2>]:INHibit.....	545

[:SOURce<hw>]:BB:ARB:TSIGnal:CIQ:CREate.....	549
[:SOURce<hw>]:BB:ARB:TSIGnal:CIQ:CREate:NAMed.....	549
[:SOURce<hw>]:BB:ARB:TSIGnal:CIQ:I.....	550
[:SOURce<hw>]:BB:ARB:TSIGnal:CIQ:Q.....	550
[:SOURce<hw>]:BB:ARB:TSIGnal:RECTangle:AMPLitude.....	550
[:SOURce<hw>]:BB:ARB:TSIGnal:RECTangle:CREate.....	549
[:SOURce<hw>]:BB:ARB:TSIGnal:RECTangle:CREate:NAMed.....	549
[:SOURce<hw>]:BB:ARB:TSIGnal:RECTangle:FREQuency.....	550
[:SOURce<hw>]:BB:ARB:TSIGnal:RECTangle:OFFSet.....	550
[:SOURce<hw>]:BB:ARB:TSIGnal:RECTangle:SAMPles.....	551
[:SOURce<hw>]:BB:ARB:TSIGnal:SINE:CREate.....	549
[:SOURce<hw>]:BB:ARB:TSIGnal:SINE:CREate:NAMed.....	549
[:SOURce<hw>]:BB:ARB:TSIGnal:SINE:FREQuency.....	551
[:SOURce<hw>]:BB:ARB:TSIGnal:SINE:PHASe.....	551
[:SOURce<hw>]:BB:ARB:TSIGnal:SINE:SAMPles.....	552
[:SOURce<hw>]:BB:ARB:WAVeform:CATalog.....	566
[:SOURce<hw>]:BB:ARB:WAVeform:CATalog:LENGth.....	566
[:SOURce<hw>]:BB:ARB:WAVeform:DATA.....	567
[:SOURce<hw>]:BB:ARB:WAVeform:DELete.....	568
[:SOURce<hw>]:BB:ARB:WAVeform:FREE.....	568
[:SOURce<hw>]:BB:ARB:WAVeform:HDDStreaming:BLEVel.....	568
[:SOURce<hw>]:BB:ARB:WAVeform:HDDStreaming:STATe.....	569
[:SOURce<hw>]:BB:ARB:WAVeform:POINts.....	569
[:SOURce<hw>]:BB:ARB:WAVeform:SELect.....	570
[:SOURce<hw>]:BB:ARB:WAVeform:TAG.....	570
[:SOURce<hw>]:BB:ARB:WSEGment.....	571
[:SOURce<hw>]:BB:ARB:WSEGment:CLOad.....	571
[:SOURce<hw>]:BB:ARB:WSEGment:CONFigure:BLANK:APPend.....	572
[:SOURce<hw>]:BB:ARB:WSEGment:CONFigure:CATalog.....	573
[:SOURce<hw>]:BB:ARB:WSEGment:CONFigure:CLOCK.....	573
[:SOURce<hw>]:BB:ARB:WSEGment:CONFigure:CLOCK:MODE.....	573
[:SOURce<hw>]:BB:ARB:WSEGment:CONFigure:COMMeNt.....	574
[:SOURce<hw>]:BB:ARB:WSEGment:CONFigure:DELete.....	574
[:SOURce<hw>]:BB:ARB:WSEGment:CONFigure:LEVel[.MODE].....	574
[:SOURce<hw>]:BB:ARB:WSEGment:CONFigure:MARKer:ESegment.....	575
[:SOURce<hw>]:BB:ARB:WSEGment:CONFigure:MARKer:FSEgment.....	575
[:SOURce<hw>]:BB:ARB:WSEGment:CONFigure:MARKer:MODE.....	576
[:SOURce<hw>]:BB:ARB:WSEGment:CONFigure:OFILe.....	576
[:SOURce<hw>]:BB:ARB:WSEGment:CONFigure:SEGMeNt:APPend.....	577
[:SOURce<hw>]:BB:ARB:WSEGment:CONFigure:SEGMeNt:CATalog.....	577
[:SOURce<hw>]:BB:ARB:WSEGment:CONFigure:SELect.....	577
[:SOURce<hw>]:BB:ARB:WSEGment:CREate.....	578
[:SOURce<hw>]:BB:ARB:WSEGment:NAME.....	578
[:SOURce<hw>]:BB:ARB:WSEGment:NEXT.....	578
[:SOURce<hw>]:BB:ARB:WSEGment:NEXT:EXECute.....	579
[:SOURce<hw>]:BB:ARB:WSEGment:NEXT:SOURce.....	579
[:SOURce<hw>]:BB:ARB:WSEGment:SEQuence:APPend.....	579
[:SOURce<hw>]:BB:ARB:WSEGment:SEQuence:SELect.....	580



[:SOURce<hw>]:BB:ARB[:TRIGger]:SEQuence.....	546
[:SOURce<hw>]:BB:CFACTOR.....	641
[:SOURce<hw>]:BB:DM:AQPSk:ANGLE.....	597
[:SOURce<hw>]:BB:DM:ASK:DEPTH.....	597
[:SOURce<hw>]:BB:DM:CLISt:CATalog.....	604
[:SOURce<hw>]:BB:DM:CLISt:COPI.....	605
[:SOURce<hw>]:BB:DM:CLISt:DATA.....	606
[:SOURce<hw>]:BB:DM:CLISt:DELe.....	607
[:SOURce<hw>]:BB:DM:CLISt:FREE.....	604
[:SOURce<hw>]:BB:DM:CLISt:POINts.....	607
[:SOURce<hw>]:BB:DM:CLISt:SELe.....	607
[:SOURce<hw>]:BB:DM:CLISt:TAg.....	605
[:SOURce<hw>]:BB:DM:CLOCK:MODE.....	584
[:SOURce<hw>]:BB:DM:CLOCK:MULTiplier.....	585
[:SOURce<hw>]:BB:DM:CLOCK:SOURce.....	585
[:SOURce<hw>]:BB:DM:CODing.....	598
[:SOURce<hw>]:BB:DM:DLISt:CATalog.....	604
[:SOURce<hw>]:BB:DM:DLISt:COPI.....	605
[:SOURce<hw>]:BB:DM:DLISt:DATA.....	608
[:SOURce<hw>]:BB:DM:DLISt:DATA:APPend.....	608
[:SOURce<hw>]:BB:DM:DLISt:DELe.....	609
[:SOURce<hw>]:BB:DM:DLISt:FREE.....	604
[:SOURce<hw>]:BB:DM:DLISt:POINts.....	609
[:SOURce<hw>]:BB:DM:DLISt:SELe.....	609
[:SOURce<hw>]:BB:DM:DLISt:TAg.....	605
[:SOURce<hw>]:BB:DM:FiLTer:OSAMpling.....	594
[:SOURce<hw>]:BB:DM:FiLTer:OSAMpling:AUTO.....	594
[:SOURce<hw>]:BB:DM:FiLTer:PARAmeter:APCO25.....	595
[:SOURce<hw>]:BB:DM:FiLTer:PARAmeter:APCO25Lsm:GAUSSs.....	596
[:SOURce<hw>]:BB:DM:FiLTer:PARAmeter:APCO25Lsm:LOWPass.....	596
[:SOURce<hw>]:BB:DM:FiLTer:PARAmeter:COSSine:BANDwidth.....	596
[:SOURce<hw>]:BB:DM:FiLTer:PARAmeter:COSSine[:ROLLoff].....	595
[:SOURce<hw>]:BB:DM:FiLTer:PARAmeter:GAUSSs.....	595
[:SOURce<hw>]:BB:DM:FiLTer:PARAmeter:LPASSEVM.....	595
[:SOURce<hw>]:BB:DM:FiLTer:PARAmeter:LPASSs.....	595
[:SOURce<hw>]:BB:DM:FiLTer:PARAmeter:PGAuss.....	595
[:SOURce<hw>]:BB:DM:FiLTer:PARAmeter:RCOSSine.....	595
[:SOURce<hw>]:BB:DM:FiLTer:PARAmeter:SPHase.....	595
[:SOURce<hw>]:BB:DM:FiLTer:TYPE.....	596
[:SOURce<hw>]:BB:DM:FLISt:CATalog.....	604
[:SOURce<hw>]:BB:DM:FLISt:DELe.....	610
[:SOURce<hw>]:BB:DM:FLISt:FREE.....	604
[:SOURce<hw>]:BB:DM:FLISt:POINts.....	610
[:SOURce<hw>]:BB:DM:FLISt:SELe.....	610
[:SOURce<hw>]:BB:DM:FORMat.....	598
[:SOURce<hw>]:BB:DM:FSK:DEVIation.....	599
[:SOURce<hw>]:BB:DM:FSK:VARiable:SYMBOL<ch>:DEVIation.....	599
[:SOURce<hw>]:BB:DM:FSK:VARiable:TYPE.....	599

[:SOURce<hw>]:BB:DM:MDElay.....	600
[:SOURce<hw>]:BB:DM:MLISt:CATalog.....	604
[:SOURce<hw>]:BB:DM:MLISt:DElete.....	611
[:SOURce<hw>]:BB:DM:MLISt:FREE.....	604
[:SOURce<hw>]:BB:DM:MLISt:POINts.....	611
[:SOURce<hw>]:BB:DM:MLISt:SElect.....	612
[:SOURce<hw>]:BB:DM:PATtern.....	581
[:SOURce<hw>]:BB:DM:PRAMp:ATTenuation.....	600
[:SOURce<hw>]:BB:DM:PRAMp:BBONly[:STATe].....	601
[:SOURce<hw>]:BB:DM:PRAMp:FDElay.....	601
[:SOURce<hw>]:BB:DM:PRAMp:RDElay.....	601
[:SOURce<hw>]:BB:DM:PRAMp:SHApe.....	601
[:SOURce<hw>]:BB:DM:PRAMp:SOURce.....	602
[:SOURce<hw>]:BB:DM:PRAMp:TIME.....	602
[:SOURce<hw>]:BB:DM:PRAMp[:STATe].....	602
[:SOURce<hw>]:BB:DM:PRBS[:LENGth].....	581
[:SOURce<hw>]:BB:DM:PRESet.....	582
[:SOURce<hw>]:BB:DM:SETTing:CATalog.....	612
[:SOURce<hw>]:BB:DM:SETTing:DElete.....	612
[:SOURce<hw>]:BB:DM:SETTing:LOAD.....	613
[:SOURce<hw>]:BB:DM:SETTing:STORE.....	613
[:SOURce<hw>]:BB:DM:SETTing:STORE:FAST.....	613
[:SOURce<hw>]:BB:DM:SOURce.....	582
[:SOURce<hw>]:BB:DM:SRATe.....	583
[:SOURce<hw>]:BB:DM:STANdard.....	583
[:SOURce<hw>]:BB:DM:STANdard:ULISt:CATalog.....	613
[:SOURce<hw>]:BB:DM:STANdard:ULISt:DElete.....	614
[:SOURce<hw>]:BB:DM:STANdard:ULISt:LOAD.....	614
[:SOURce<hw>]:BB:DM:STANdard:ULISt:STORE.....	614
[:SOURce<hw>]:BB:DM:STATe.....	583
[:SOURce<hw>]:BB:DM:SWITching:SOURce.....	584
[:SOURce<hw>]:BB:DM:SWITching:STATe.....	584
[:SOURce<hw>]:BB:DM:TRIGger:ARM:EXECute.....	586
[:SOURce<hw>]:BB:DM:TRIGger:EXECute.....	587
[:SOURce<hw>]:BB:DM:TRIGger:EXTernal:SYNChronize:OUTPut.....	587
[:SOURce<hw>]:BB:DM:TRIGger:OUTPut:DElay:FIXed.....	588
[:SOURce<hw>]:BB:DM:TRIGger:OUTPut<ch>:DElay.....	588
[:SOURce<hw>]:BB:DM:TRIGger:OUTPut<ch>:DElay:MAXimum.....	588
[:SOURce<hw>]:BB:DM:TRIGger:OUTPut<ch>:DElay:MINimum.....	588
[:SOURce<hw>]:BB:DM:TRIGger:OUTPut<ch>:MODE.....	591
[:SOURce<hw>]:BB:DM:TRIGger:OUTPut<ch>:OFFTime.....	592
[:SOURce<hw>]:BB:DM:TRIGger:OUTPut<ch>:ONTime.....	592
[:SOURce<hw>]:BB:DM:TRIGger:OUTPut<ch>:PATtern.....	593
[:SOURce<hw>]:BB:DM:TRIGger:OUTPut<ch>:PULSe:DIVider.....	593
[:SOURce<hw>]:BB:DM:TRIGger:OUTPut<ch>:PULSe:FREQUency.....	593
[:SOURce<hw>]:BB:DM:TRIGger:RMODE.....	589
[:SOURce<hw>]:BB:DM:TRIGger:SENGth.....	589
[:SOURce<hw>]:BB:DM:TRIGger:SOURce.....	589

[:SOURce<hw>]:BB:DM:TRIGger[:EXtErnal<ch>]:DELay.....	590
[:SOURce<hw>]:BB:DM:TRIGger[:EXtErnal<ch>]:INHibit.....	590
[:SOURce<hw>]:BB:DM[:TRIGger]:SEQuence.....	591
[:SOURce<hw>]:BB:GRAPhics:MODE.....	615
[:SOURce<hw>]:BB:GRAPhics:SMARt:STATe.....	615
[:SOURce<hw>]:BB:GRAPhics:SRATe:MODE.....	615
[:SOURce<hw>]:BB:GRAPhics:SRATe:USER.....	616
[:SOURce<hw>]:BB:GRAPhics:STATe.....	616
[:SOURce<hw>]:BB:GRAPhics:TRIGger:SOURce.....	617
[:SOURce<hw>]:BB:IMPairment:IQRatio.....	617
[:SOURce<hw>]:BB:IMPairment:LEAKage:I.....	618
[:SOURce<hw>]:BB:IMPairment:LEAKage:Q.....	618
[:SOURce<hw>]:BB:IMPairment:OPTimization:MODE.....	618
[:SOURce<hw>]:BB:IMPairment:OPTimization:STATe.....	619
[:SOURce<hw>]:BB:IMPairment:QUADrature[:ANGLe].....	619
[:SOURce<hw>]:BB:IMPairment:STATe.....	619
[:SOURce<hw>]:BB:IQGain.....	669
[:SOURce<hw>]:BB:MCCW:CARRier:COUNT.....	621
[:SOURce<hw>]:BB:MCCW:CARRier:LIST:PHASe.....	621
[:SOURce<hw>]:BB:MCCW:CARRier:LIST:POWer.....	622
[:SOURce<hw>]:BB:MCCW:CARRier:LIST:STATe.....	622
[:SOURce<hw>]:BB:MCCW:CARRier:PHASe.....	622
[:SOURce<hw>]:BB:MCCW:CARRier:POWer.....	623
[:SOURce<hw>]:BB:MCCW:CARRier:SPACing.....	623
[:SOURce<hw>]:BB:MCCW:CARRier:STATe.....	624
[:SOURce<hw>]:BB:MCCW:CFACTor.....	624
[:SOURce<hw>]:BB:MCCW:CFACTor:MODE.....	624
[:SOURce<hw>]:BB:MCCW:CLOCK.....	625
[:SOURce<hw>]:BB:MCCW:CLOCK:MODE.....	638
[:SOURce<hw>]:BB:MCCW:CLOCK:MULTIplier.....	638
[:SOURce<hw>]:BB:MCCW:CLOCK:SOURce.....	638
[:SOURce<hw>]:BB:MCCW:EDIT:CARRier:EXECute.....	625
[:SOURce<hw>]:BB:MCCW:EDIT:CARRier:PHASe:STEP.....	626
[:SOURce<hw>]:BB:MCCW:EDIT:CARRier:PHASe[:STARt].....	626
[:SOURce<hw>]:BB:MCCW:EDIT:CARRier:POWer:STEP.....	627
[:SOURce<hw>]:BB:MCCW:EDIT:CARRier:POWer[:STARt].....	627
[:SOURce<hw>]:BB:MCCW:EDIT:CARRier:STARt.....	627
[:SOURce<hw>]:BB:MCCW:EDIT:CARRier:STATe.....	628
[:SOURce<hw>]:BB:MCCW:EDIT:CARRier:STOP.....	628
[:SOURce<hw>]:BB:MCCW:PRESet.....	621
[:SOURce<hw>]:BB:MCCW:STATe.....	620
[:SOURce<hw>]:BB:MCCW:TRIGger:ARM:EXECute.....	629
[:SOURce<hw>]:BB:MCCW:TRIGger:EXECute.....	629
[:SOURce<hw>]:BB:MCCW:TRIGger:EXtErnal:SYNChronize:OUTPut.....	629
[:SOURce<hw>]:BB:MCCW:TRIGger:OBASeband:DELay.....	630
[:SOURce<hw>]:BB:MCCW:TRIGger:OBASeband:INHibit.....	630
[:SOURce<hw>]:BB:MCCW:TRIGger:OUTPut:DELay:FIXed.....	634
[:SOURce<hw>]:BB:MCCW:TRIGger:OUTPut<ch>:DELay.....	634

[:SOURce<hw>]:BB:MCCW:TRIGger:OUTPut<ch>:DELay:MAXimum.....	634
[:SOURce<hw>]:BB:MCCW:TRIGger:OUTPut<ch>:DELay:MINimum.....	635
[:SOURce<hw>]:BB:MCCW:TRIGger:OUTPut<ch>:MODE.....	635
[:SOURce<hw>]:BB:MCCW:TRIGger:OUTPut<ch>:OFFTime.....	636
[:SOURce<hw>]:BB:MCCW:TRIGger:OUTPut<ch>:ONTime.....	636
[:SOURce<hw>]:BB:MCCW:TRIGger:OUTPut<ch>:PATtern.....	636
[:SOURce<hw>]:BB:MCCW:TRIGger:OUTPut<ch>:PULSe:DIVider.....	637
[:SOURce<hw>]:BB:MCCW:TRIGger:OUTPut<ch>:PULSe:FREQuency.....	637
[:SOURce<hw>]:BB:MCCW:TRIGger:RMODE.....	631
[:SOURce<hw>]:BB:MCCW:TRIGger:SLENgth.....	631
[:SOURce<hw>]:BB:MCCW:TRIGger:SOURce.....	632
[:SOURce<hw>]:BB:MCCW:TRIGger[:EXTErnal<ch>]:DELay.....	632
[:SOURce<hw>]:BB:MCCW:TRIGger[:EXTErnal<ch>]:INHibit.....	632
[:SOURce<hw>]:BB:MCCW[:TRIGger]:SEQuence.....	633
[:SOURce<hw>]:BB:MEASurement:CFACTOR.....	639
[:SOURce<hw>]:BB:MEASurement:DURation.....	639
[:SOURce<hw>]:BB:MEASurement:POWer:PEAK.....	640
[:SOURce<hw>]:BB:MEASurement:POWer:RMS.....	640
[:SOURce<hw>]:BB:MEASurement:RTIME.....	640
[:SOURce<hw>]:BB:MEASurement:SOURce.....	641
[:SOURce<hw>]:BB:MEASurement[:STATe].....	641
[:SOURce<hw>]:BB:POWer:PEAK.....	642
[:SOURce<hw>]:BB:POWer:RMS.....	642
[:SOURce<hw>]:CORRection:CSET:DATA:FREQuency.....	644
[:SOURce<hw>]:CORRection:CSET:DATA:FREQuency:POINts.....	644
[:SOURce<hw>]:CORRection:CSET:DATA:POWer.....	645
[:SOURce<hw>]:CORRection:CSET:DATA:POWer:MLEVel:STATe.....	646
[:SOURce<hw>]:CORRection:CSET:DATA:POWer:MLEVel<ch>.....	645
[:SOURce<hw>]:CORRection:CSET:DATA:POWer:POINts.....	645
[:SOURce<hw>]:CORRection:CSET:DATA[:SENSor<ch>][:POWer]:SONCe.....	646
[:SOURce<hw>]:CORRection:CSET[:SELEct].....	651
[:SOURce<hw>]:CORRection:DEXChange:AFILe:CATalog.....	647
[:SOURce<hw>]:CORRection:DEXChange:AFILe:EXTension.....	647
[:SOURce<hw>]:CORRection:DEXChange:AFILe:SELEct.....	648
[:SOURce<hw>]:CORRection:DEXChange:AFILe:SEParator:COLumn.....	648
[:SOURce<hw>]:CORRection:DEXChange:AFILe:SEParator:DECimal.....	649
[:SOURce<hw>]:CORRection:DEXChange:EXECute.....	649
[:SOURce<hw>]:CORRection:DEXChange:MODE.....	650
[:SOURce<hw>]:CORRection:DEXChange:SELEct.....	650
[:SOURce<hw>]:CORRection:MLEVel:STATe.....	651
[:SOURce<hw>]:CORRection:VALue.....	652
[:SOURce<hw>]:CORRection[:STATe].....	651
[:SOURce<hw>]:FM:EXTErnal:COUPLing.....	653
[:SOURce<hw>]:FM:MODE.....	653
[:SOURce<hw>]:FM:SENSitivity.....	654
[:SOURce<hw>]:FM:SOURce.....	654
[:SOURce<hw>]:FM:STATe.....	654
[:SOURce<hw>]:FM[:DEViation].....	652

[:SOURce<hw>]:FREQuency:CENTer.....	655
[:SOURce<hw>]:FREQuency:LOSCillator:MODE.....	656
[:SOURce<hw>]:FREQuency:LOSCillator:OUTPut:STATe.....	656
[:SOURce<hw>]:FREQuency:MANual.....	657
[:SOURce<hw>]:FREQuency:MODE.....	658
[:SOURce<hw>]:FREQuency:MULTiplier.....	659
[:SOURce<hw>]:FREQuency:OFFSet.....	659
[:SOURce<hw>]:FREQuency:PHASe:CONTInuous:STATe.....	660
[:SOURce<hw>]:FREQuency:SPAN.....	660
[:SOURce<hw>]:FREQuency:START.....	661
[:SOURce<hw>]:FREQuency:STEP:MODE.....	662
[:SOURce<hw>]:FREQuency:STEP[:INCRement].....	662
[:SOURce<hw>]:FREQuency:STOP.....	661
[:SOURce<hw>]:FREQuency[:CW]:FIXed].....	656
[:SOURce<hw>]:FREQuency[:CW]:FIXed]:RCL.....	657
[:SOURce<hw>]:INPut:MODext:IMPedance.....	664
[:SOURce<hw>]:IQ:CREStfactor.....	666
[:SOURce<hw>]:IQ:GAIN.....	666
[:SOURce<hw>]:IQ:IMPairment:IQRatio[:MAGNitude].....	667
[:SOURce<hw>]:IQ:IMPairment:LEAKage:I.....	667
[:SOURce<hw>]:IQ:IMPairment:LEAKage:Q.....	668
[:SOURce<hw>]:IQ:IMPairment:QUADrature[:ANGLe].....	668
[:SOURce<hw>]:IQ:IMPairment[:STATe].....	668
[:SOURce<hw>]:IQ:OUTPut:BIAS:COUPling[:STATe].....	671
[:SOURce<hw>]:IQ:OUTPut:BIAS:I.....	671
[:SOURce<hw>]:IQ:OUTPut:BIAS:OPTimization[:RF]:STATe.....	672
[:SOURce<hw>]:IQ:OUTPut:BIAS:Q.....	671
[:SOURce<hw>]:IQ:OUTPut:DIGital:CDEvice.....	675
[:SOURce<hw>]:IQ:OUTPut:DIGital:PON.....	676
[:SOURce<hw>]:IQ:OUTPut:DIGital:POWer:LEVel.....	676
[:SOURce<hw>]:IQ:OUTPut:DIGital:POWer:PEP.....	676
[:SOURce<hw>]:IQ:OUTPut:DIGital:POWer:STEP:MODE.....	677
[:SOURce<hw>]:IQ:OUTPut:DIGital:POWer:STEP[:INCRement].....	677
[:SOURce<hw>]:IQ:OUTPut:DIGital:SRATe.....	678
[:SOURce<hw>]:IQ:OUTPut:DIGital:SRATe:FIFO[:STATus].....	678
[:SOURce<hw>]:IQ:OUTPut:DIGital:SRATe:SOURce.....	679
[:SOURce<hw>]:IQ:OUTPut:DIGital:STATe.....	679
[:SOURce<hw>]:IQ:OUTPut:LEVel.....	672
[:SOURce<hw>]:IQ:OUTPut:MODE.....	673
[:SOURce<hw>]:IQ:OUTPut:OFFSet:I.....	673
[:SOURce<hw>]:IQ:OUTPut:OFFSet:Q.....	673
[:SOURce<hw>]:IQ:OUTPut:POWer:VIA.....	677
[:SOURce<hw>]:IQ:OUTPut:TYPE.....	674
[:SOURce<hw>]:IQ:OUTPut[:ANALog]:POWer:PEP.....	672
[:SOURce<hw>]:IQ:OUTPut[:ANALog]:POWer:PEP:RESult.....	672
[:SOURce<hw>]:IQ:SOURce.....	668
[:SOURce<hw>]:IQ:STATe.....	669
[:SOURce<hw>]:IQ:SWAP[:STATe].....	669

[[:SOURce<hw>]:]IQ:WBSTate.....	669
[[:SOURce<hw>]:]LIST:CATalog.....	689
[[:SOURce<hw>]:]LIST:DELeTe.....	689
[[:SOURce<hw>]:]LIST:DELeTe:ALL.....	690
[[:SOURce<hw>]:]LIST:DEXChange:AFILe:CATalog.....	690
[[:SOURce<hw>]:]LIST:DEXChange:AFILe:EXTension.....	691
[[:SOURce<hw>]:]LIST:DEXChange:AFILe:SELeCt.....	691
[[:SOURce<hw>]:]LIST:DEXChange:AFILe:SEParator:COLumn.....	691
[[:SOURce<hw>]:]LIST:DEXChange:AFILe:SEParator:DECimal.....	692
[[:SOURce<hw>]:]LIST:DEXChange:EXECute.....	692
[[:SOURce<hw>]:]LIST:DEXChange:MODE.....	693
[[:SOURce<hw>]:]LIST:DEXChange:SELeCt.....	693
[[:SOURce<hw>]:]LIST:DWELl.....	694
[[:SOURce<hw>]:]LIST:FREE.....	694
[[:SOURce<hw>]:]LIST:FREQUency.....	694
[[:SOURce<hw>]:]LIST:FREQUency:POINts.....	695
[[:SOURce<hw>]:]LIST:INDEx.....	695
[[:SOURce<hw>]:]LIST:INDEx:STARt.....	696
[[:SOURce<hw>]:]LIST:INDEx:STOP.....	696
[[:SOURce<hw>]:]LIST:LEARn.....	697
[[:SOURce<hw>]:]LIST:MODE.....	697
[[:SOURce<hw>]:]LIST:POWer.....	698
[[:SOURce<hw>]:]LIST:POWer:POINts.....	698
[[:SOURce<hw>]:]LIST:RESEt.....	698
[[:SOURce<hw>]:]LIST:SELeCt.....	699
[[:SOURce<hw>]:]LIST:TRIGger:EXECute.....	699
[[:SOURce<hw>]:]LIST:TRIGger:SOURce.....	699
[[:SOURce<hw>]:]MODulation[:ALL]:STATe.....	700
[[:SOURce<hw>]:]PHASe.....	700
[[:SOURce<hw>]:]PHASe:REFerence.....	701
[[:SOURce<hw>]:]PM:EXTernal:COUPling.....	702
[[:SOURce<hw>]:]PM:MODE.....	702
[[:SOURce<hw>]:]PM:SENSitivity.....	703
[[:SOURce<hw>]:]PM:SOURce.....	703
[[:SOURce<hw>]:]PM:STATe.....	704
[[:SOURce<hw>]:]PM[:DEVIation].....	701
[[:SOURce<hw>]:]POWer:ALC:OMODE.....	705
[[:SOURce<hw>]:]POWer:ALC:SONCe.....	705
[[:SOURce<hw>]:]POWer:ALC[:STATe].....	705
[[:SOURce<hw>]:]POWer:ATTenuation:RFOFF:MODE.....	706
[[:SOURce<hw>]:]POWer:LIMit[:AMPLitude].....	708
[[:SOURce<hw>]:]POWer:MANual.....	709
[[:SOURce<hw>]:]POWer:MODE.....	709
[[:SOURce<hw>]:]POWer:PEP.....	710
[[:SOURce<hw>]:]POWer:POWer.....	710
[[:SOURce<hw>]:]POWer:STARt.....	711
[[:SOURce<hw>]:]POWer:STEP:MODE.....	712
[[:SOURce<hw>]:]POWer:STEP[:INCRement].....	711

[:SOURce<hw>]:POWER:STOP.....	712
[:SOURce<hw>]:POWER[:LEVel][:IMMediate]:OFFSet.....	707
[:SOURce<hw>]:POWER[:LEVel][:IMMediate]:RCL.....	708
[:SOURce<hw>]:POWER[:LEVel][:IMMediate][:AMPLitude].....	706
[:SOURce<hw>]:PULM:OUTPut:SYNC[:STATe].....	713
[:SOURce<hw>]:PULM:POLarity.....	713
[:SOURce<hw>]:PULM:SOURce.....	713
[:SOURce<hw>]:PULM:STATe.....	714
[:SOURce<hw>]:SWEep:POWER:DWELI.....	722
[:SOURce<hw>]:SWEep:POWER:EXECute.....	723
[:SOURce<hw>]:SWEep:POWER:MODE.....	723
[:SOURce<hw>]:SWEep:POWER:POINts.....	723
[:SOURce<hw>]:SWEep:POWER:SHAPE.....	724
[:SOURce<hw>]:SWEep:POWER:SPACing:MODE.....	724
[:SOURce<hw>]:SWEep:POWER:STEP[:LOGarithmic].....	724
[:SOURce<hw>]:SWEep:RESet[:ALL].....	725
[:SOURce<hw>]:SWEep[:FREQuency]:DWELI.....	718
[:SOURce<hw>]:SWEep[:FREQuency]:EXECute.....	718
[:SOURce<hw>]:SWEep[:FREQuency]:MODE.....	719
[:SOURce<hw>]:SWEep[:FREQuency]:POINts.....	719
[:SOURce<hw>]:SWEep[:FREQuency]:SHAPE.....	720
[:SOURce<hw>]:SWEep[:FREQuency]:SPACing.....	720
[:SOURce<hw>]:SWEep[:FREQuency]:STEP:LOGarithmic.....	722
[:SOURce<hw>]:SWEep[:FREQuency]:STEP[:LINear].....	721
[:SOURce]:CORRection:CSET:CATalog.....	644
[:SOURce]:CORRection:CSET:DELeTe.....	647
[:SOURce]:INPut:BERT:IMPedance.....	485
[:SOURce]:INPut:BERT:THReShold.....	485
[:SOURce]:INPut:DATA:IMPedance.....	663
[:SOURce]:INPut:DATA:THReShold.....	663
[:SOURce]:INPut:TRIGger:BBANd:SLOPe.....	664
[:SOURce]:INPut:TRIGger:IMPedance.....	664
[:SOURce]:INPut:TRIGger:LEVel.....	665
[:SOURce]:INPut:TRIGger:SLOPe.....	665
[:SOURce]:IQ:OUTPut:DIGital:OFLow:HOLD:RESet.....	675
[:SOURce]:IQ:OUTPut:DIGital:OFLow:HOLD:STATe.....	675
[:SOURce]:IQ:OUTPut:DIGital:OFLow:STATe.....	675
[:SOURce]:LFOutput:FREQuency.....	680
[:SOURce]:LFOutput:FREQuency:MANual.....	681
[:SOURce]:LFOutput:FREQuency:MODE.....	681
[:SOURce]:LFOutput:FREQuency:STARt.....	682
[:SOURce]:LFOutput:FREQuency:STOP.....	683
[:SOURce]:LFOutput:SWEep[:FREQuency]:DWELI.....	683
[:SOURce]:LFOutput:SWEep[:FREQuency]:EXECute.....	683
[:SOURce]:LFOutput:SWEep[:FREQuency]:MODE.....	684
[:SOURce]:LFOutput:SWEep[:FREQuency]:POINts.....	684
[:SOURce]:LFOutput:SWEep[:FREQuency]:SHAPE.....	685
[:SOURce]:LFOutput:SWEep[:FREQuency]:SPACing.....	685

[[:SOURce]:LFOutput:SWEEp[:FREQuency]:STEP:LOGarithmic].....	686
[[:SOURce]:LFOutput:SWEEp[:FREQuency]:STEP[:LINear]].....	686
[[:SOURce]:LFOutput:VOLTage].....	687
[[:SOURce]:LFOutput[:STATe]].....	683
[[:SOURce]:ROSCillator:EXTernal:FREQuency].....	715
[[:SOURce]:ROSCillator:EXTernal:RFOFf:STATe].....	715
[[:SOURce]:ROSCillator:EXTernal:SBANdwidth].....	715
[[:SOURce]:ROSCillator:SOURce].....	716
[[:SOURce]:ROSCillator[:INTernal]:ADJust:VALue].....	716
[[:SOURce]:ROSCillator[:INTernal]:ADJust[:STATe]].....	716
{CLOCK: frequency}.....	461
{COMMENT: string}.....	462
{CONTROL LENGTH: ControlLength}.....	463
{CONTROL LIST WIDTH4-Length: #m0m1...mx...mM-1}.....	470
{COPYRIGHT: string}.....	462
{DATA BITLENGTH: BitLength}.....	462
{DATA LIST-Length: #d0d1...dx...dN-1...}.....	463
{DATE: yyyy-mm-dd;hh:mm:ss}.....	463
{LEVEL OFFS: RMSOffset_dB,PeakOffset_dB}.....	463
{MWV_SEGMENT_CLOCK: ClockSeg0, ClockSeg1, ..., ClockSegN-1}.....	469
{MWV_SEGMENT_CLOCK_MODE: Mode}.....	468
{MWV_SEGMENT_COUNT: NumOfSeg}.....	467
{MWV_SEGMENT_FILES: "FileNameSeg0.wv", "FileNameSeg1.wv", ..., "FileNameSegN-1.wv"}.....	470
{MWV_SEGMENT_LENGTH: SamplesSeg0, SamplesSeg1, ..., SamplesSegN-1}.....	467
{MWV_SEGMENT_LEVEL_OFFS: RMSOffset_dBSeg0, PeakOffset_dBSeg0, ...,RMSOffset_dBSegN-1, PeakOffset_dBSegN-1}.....	470
{MWV_SEGMENT_START: SampleStartOffsetSeg0, SampleStartOffsetSeg1, ..., SampleStartOffsetSegN-1}.....	468
{MWV_SEGMENTx_COMMENT: text}.....	470
{SAMPLES: Samples}.....	464
{TYPE: magic, xxxxxxxx}.....	460
{WAVEFORM-Length: #I0Q0I1Q1...IxQx...IN-1QN-1...}.....	465
{[TRACE] LIST [#]: Pos0:Val0;Pos1:Val1;...Posx:Valx;...PosN-1:ValN-1}.....	465



# Index

50 - Extern reference out of range or disconnected .....	751
140 - This modulation forces other modulations off .....	751
180 - Adjustment failed .....	751
182 - Adjustment data missing .....	751
183 - Adjustment data invalid .....	752
200 - Cannot access hardware .....	752
201 - Hardware revision out of date .....	752
202 - Cannot access the EEPROM .....	752
203 - Invalid EEPROM data .....	752
204 - river initialization failed .....	752
241 - No current list .....	752
242 - Unknown list type specified .....	752
261 - Waveform Protected .....	752
460 - Cannot open file .....	752
461 - Cannot write file .....	752
462 - Cannot read file .....	752
463 - Filename missing .....	752
464 - Invalid filename extension .....	753
465 - File contains invalid data .....	753
&GTL .....	421
&LLO .....	421
&NREN .....	421
*OPC .....	442
*OPC? .....	442
*RST .....	452
*WAI .....	442

## A

Abort button .....	97
Abort calculation .....	97
Accept	
Security Settings .....	138
Accept Carrier Table - MCCW .....	404
Accept - MCCW .....	404, 625
Access denied .....	88
AC supply .....	27
Activating noise generator .....	536
Additional White Gaussian Noise (option R&S SMJ-K62) .....	67
Additive Noise .....	283, 285, 531, 533
Adjust All .....	120, 486
Adjust FM Offset .....	487
Adjust I/Q modulator .....	121, 487
Adjust Level .....	121, 488
Adjustment Active .....	193, 716
Adjustment Frequency .....	193, 716
Adjustment Path A .....	121
Adjustment value - Reference frequency .....	193, 716
Adjust Synthesis .....	121, 487
Adjust Synthesis Extension .....	121
ALC (automatic level control) .....	207, 705
ALC Auto .....	749
ALC On .....	207, 749
ALC S&H .....	749
ALC Table .....	749
AM Depth .....	222, 526
AM External Coupling .....	222, 527
AM Frequency .....	680
Amplitude of test signal .....	375
AM Sensitivity .....	222, 224, 526, 527

AM Source .....	221, 528
AM State .....	221, 528
Analog Wideband I/Q In .....	263, 668
Angle Alpha .....	331
Annotation Amplitude .....	138
Annotation Frequency .....	138
Append .....	379, 385
Append Blank .....	380
Apply Assistant Settings .....	396, 560
ARB Default settings .....	538
ARBitrary Waveform Generator .....	352
ARB Multi Carrier	
carrier frequency .....	397, 555
conflict .....	398, 554
mode .....	390, 553
ARB State .....	538
Architecture of the instrument .....	63
Arm .....	363, 408
Armed_Auto .....	362, 546, 591, 633
DM .....	347
Armed_Retrigger .....	362, 546, 591, 633
DM .....	347
Arm Trigger .....	540, 586, 629
Arm Trigger - DM .....	347
Arrow keys .....	24
ASCII file import/export	
List Mode .....	252
ASK Depth - DM .....	330, 597
Assemblies display .....	121, 490, 491
ATN .....	755
Attention .....	755
Attenuation - DM .....	345, 600
Attenuator .....	514
Attenuator Mode .....	205, 514
Attenuator settings	
RF OFF mode .....	706
Attenuator Settings	
Fixed Range (PEP) in .....	205
mode .....	205
RF OFF Mode .....	205
AttFixed .....	749
Auto .....	362, 546, 591, 633
DM .....	347
Automatic Naming Hardcopy .....	500
Auto Once	
Power Sensors .....	200
Auto Once - Power Sensors .....	521
AUX I/O interface .....	133

## B

Bandwidth - DM .....	334
Baseband Connection Selftest .....	128
Baseband Gain (I/Q) .....	272, 669
Baseband generator (option R&S SMJ-B9/B10/B11) .....	67
Baseband input module (option R&S SMJ-B17) .....	67
Baseband main module (option R&S SMJ-B13) .....	67
Baseband Only - DM .....	345, 601
Baseband section .....	67
Baseband Trigger Input Slope .....	130, 664
BB-AM State .....	224, 526
Bias - I/Q out .....	293, 671

- BITCLK ..... 757
  - Bit energy to noise power density ..... 287, 531
  - Bit Error Rate Measurement ..... 163, 476
  - Bit Rate - AWGN ..... 286, 529
  - BLER Type ..... 181, 483
  - Block Error Rate Measurement ..... 163, 476
  - Bluetooth Pin ..... 138
  - Boolean parameters ..... 438
  - BURST ..... 757
  - Burst gate ..... 310
  - BUSY ..... 748
  - B x T ..... 595
  - B x T - DM ..... 333
- C**
- Calibration
    - remote ..... 453
  - Carrier/Noise Ratio ..... 286
  - Carrier / Noise Ratio ..... 530
  - Carrier + Interferer Level ..... 289, 535
  - Carrier + Interferer PEP ..... 289, 536
  - Carrier + Noise Level ..... 289, 535
  - Carrier + Noise PEP ..... 289, 536
  - Carrier Delay ..... 397
  - Carrier frequency ..... 397, 555
  - Carrier Gain ..... 397
  - Carrier Graph ..... 393
  - Carrier Graph - MCCW ..... 405
  - Carrier Index ..... 397
  - Carrier level - AWGN ..... 287, 533
  - Carrier Spacing ..... 390, 554
  - Carrier Spacing - MCCW ..... 401, 623
  - Carrier Start ..... 395, 562
  - Carrier Start - MCCW ..... 403, 627
  - Carrier State ..... 395, 397, 556, 563
  - Carrier State - MCCW ..... 403, 622, 624
  - Carrier Stop ..... 395, 562
  - Carrier Stop - MCCW ..... 403, 628
  - Carrier Table Assistant ..... 395, 562
  - Carrier Table Assistant - MCCW ..... 403, 627
  - Carrier Table button- ARB ..... 392
  - Carrier Table - MCCW ..... 404
  - Case-sensitivity
    - SCPI ..... 434
  - CCDF display ..... 161
  - Center Freq ..... 238, 655
  - Change Password - Setup ..... 137
  - Channel x ..... 370
  - Check Front Panel ..... 128
  - Clear status
    - remote ..... 453
  - Clipping ..... 391
  - Clock Frequency ..... 359, 538
  - Clock input slope ..... 489
  - Clock Input Slope ..... 131
  - Clock Mode ..... 372, 411, 539, 638
  - Clock Mode - DM ..... 351, 584
  - Clock Multiplier ..... 372, 411, 539, 585, 638
  - Clock Multiplier - DM ..... 352
  - Clock out mode ..... 489
  - Clock Output Mode ..... 131
  - Clock out source ..... 490
  - Clock Parameter ..... 372
  - Clock rate ..... 359, 379, 559
  - Clock rate mode ..... 380, 573
  - Clock Reference ..... 305
  - Clock Slope ..... 174, 182
    - BERT ..... 479
    - BLER ..... 479
  - Clock Source ..... 372, 411, 539, 638
    - DM ..... 351
  - Clock Source - DM ..... 585
  - Coding ..... 598
  - Coding - DM ..... 329
  - Colon ..... 439
  - Column Separator Import/Export
    - List Mode data ..... 691
  - Column Separator Import/Export - User Correction data ..... 215, 648
  - Comma ..... 439
  - Commands ..... 414
    - Colon ..... 439
    - Comma ..... 439
    - Command line structure ..... 439
    - common ..... 414
    - Double dagger ..... 439
    - GBIP, addressed ..... 419
    - GBIP, universal ..... 418
    - instrument control ..... 414
    - Overlapping ..... 441
    - Question mark ..... 439
    - Quotation mark ..... 439
    - SCPI compliant ..... 414
    - Sequential ..... 441
    - Syntax elements ..... 439
    - White space ..... 439
  - Command sequence
    - recommendation ..... 452
    - remote ..... 457
  - Comment ..... 381
  - Common commands
    - Syntax ..... 433
  - Computer name
    - Changing ..... 44
  - CONDition ..... 446
  - Configure Control Signal - DM ..... 340
  - Confirm Password - Setup ..... 137
  - Conflict ..... 398, 554
  - Connected device - Digital I/Q Output Settings ..... 298, 675
  - Connection to an external controller ..... 45
  - Connector
    - AUX I/O ..... 29
    - BERT ..... 29
    - CLOCK ..... 25, 28
    - CLOCK OUT ..... 30
    - DATA ..... 25, 28
    - EXT MOD ..... 28
    - GPIB ..... 28
    - I ..... 25, 28
    - IEC/IEEE ..... 28
    - INSTR TRIG ..... 30
    - I OUT ..... 28
    - I OUT BAR ..... 28
    - LAN ..... 29
    - LF ..... 27
    - LO IN ..... 30
    - LO OUT ..... 30
    - MARKER 1, 2 ..... 25, 27
    - MARKER 3 ..... 27
    - Monitor ..... 29
    - Q ..... 25, 28
    - Q OUT ..... 28

- Q OUT BAR ..... 28  
 REF IN ..... 28  
 REF OUT ..... 28  
 RF ..... 25, 30  
 SENSOR ..... 26  
 TRIGGER 1 ..... 25  
 TRIGGER 1, 2 ..... 30  
 USB ..... 26  
 USB type A ..... 29  
 USB type B ..... 29  
 USER ..... 30  
 Constellation diagram ..... 159  
 Const IQ Test Signal ..... 376  
 Control bus ..... 755  
 Controller, external ..... 45  
 Control Lists - DM ..... 335, 604  
 Control signals ..... 309  
 Copy – Data Editor ..... 338  
 Copy instrument settings ..... 151, 509  
 Counter ..... 121, 491  
 Count – LF Frequency Sweep ..... 684  
 Couple I/Q Bias ..... 293  
 Coupling mode ..... 226  
   external modulation input ..... 527  
   EXT MOD ..... 702  
   FM ..... 653  
 Coupling mode - EXT MOD (AM) ..... 222  
 CRC Order ..... 181  
 CRC Order - BLER ..... 479  
 Create ..... 383, 394  
 Create and Load ..... 383, 394  
 Create Multi Carrier Waveforms ..... 387  
 Create Multi Segment Waveforms ..... 376  
 Create New Directory ..... 152  
 Crest factor (I/Q) ..... 271, 666  
 Crest factor - baseband ..... 299, 641  
 Crest factor - Baseband Signal Level Measurement ..... 301, 639  
 Crest Factor - MCCW ..... 402  
 Crest Factor Mode ..... 391, 556  
 Current Freq ..... 681  
   LF Sweep ..... 250  
 Current Freq (LF Sweep) ..... 238, 657  
 Current Freq (RF Sweep) ..... 121, 488  
 Current Frequency ..... 695  
   List Mode ..... 255  
 Current Level ..... 245, 709  
 Current Range without Recalculation ..... 371, 410, 542, 588, 634, 635  
 Current Range without Recalculation - DM ..... 351  
 Current Segment ..... 365  
 Current Sensors ..... 126  
 Cursor keys ..... 24  
 Cursor Length - DM ..... 341  
 Cursor Position - DM ..... 341  
 Cust Dig Mod ..... 580  
 Cut ..... 151  
 Cut – Data Editor ..... 338  
 Cut Off Frequency Factor - DM ..... 333  
 CW (continuous wave) ..... 309  
 CW Interferer ..... 283  
 CW Mode ..... 757  
 CW Switching - DM ..... 332, 584
- D**  
 DATA ..... 757  
 Data Bits ..... 170, 477  
 Data Enable ..... 175, 182  
 Data Enable - BERT ..... 480  
 Data List ..... 304  
 Data Lists - DM ..... 335, 604  
 Data pattern ..... 581  
 Data pattern - DM ..... 326  
 Data Polarity ..... 174, 182  
   BERT ..... 480  
   BLER ..... 480  
 Data Source ..... 582  
 Data Source - DM ..... 326  
 Data Valid ..... 755  
 DAV ..... 755  
 Day Hardcopy File Name ..... 498  
 DCL ..... 418  
 Deactivate RF output ..... 192, 715  
 Decimal Point Import/Export  
   List Mode data ..... 692  
 Decimal Point Import/Export - List Mode data ..... 258  
 Decimal Point Import/Export - User Correction data ..... 214, 649  
 DEF ..... 437  
 Default instrument settings ..... 35, 118, 458  
 Default settings ..... 357, 389, 563, 582  
 Default settings - DM ..... 324  
 Default settings - MCCW ..... 400, 621  
 Default values  
   remote ..... 456  
 Delay - Falling Edge of Ramp Envelope - DM ..... 344, 601  
 Delay - Marker ..... 542, 588, 634  
 Delay - Marker - DM ..... 350  
 Delay - Rising Edge of Ramp Envelope - DM ..... 344, 601  
 Delay Start ..... 396, 555, 560  
 Delay Step ..... 396, 559  
 Delay - Trigger ..... 545, 590, 630, 632  
 Delay - Trigger - DM ..... 349  
 Delete ..... 379, 386  
 Delete Hardcopy Files ..... 497  
 Delete instrument settings ..... 151, 511  
 Delta Phase ..... 188, 700  
 Desired Crest Factor ..... 624  
 Desired Crest Factor - MCCW ..... 402  
 Destination - Hardcopy ..... 141  
 Destination Import/Export  
   List Mode data ..... 693  
   User Correction data ..... 215  
 Destination Import/Export - List Mode data ..... 259  
 Destination Import/Export - User Correction data ..... 650  
 Deviation - FSK Modulation ..... 599  
 Deviation - FSK Modulation - DM ..... 330  
 Deviation - Variable FSK Modulation ..... 599  
 Deviation - Variable FSK Modulation - DM ..... 332  
 Device ID ..... 125  
 Device reset ..... 458  
 Device-specific commands ..... 414  
 Device-specific error messages ..... 751  
 DHCP ..... 43  
 Differential coding ..... 598  
 Differential coding - DM ..... 329  
 Differential output ..... 291

Differential settings storing .....	326
Digital I/Q Output - EX-IQ-BOX Settings .....	295
Digital I/Q Output Level - I/Q OUT .....	676
Digital I/Q Output PEP - I/Q OUT .....	297, 676
Digital I/Q Output Power-On State - I/Q OUT .....	298, 676
Digital I/Q Output Sample Rate - I/Q OUT .....	678
Digital I/Q Output State - I/Q OUT .....	295, 679
Digital I/Q Output Step width - I/Q OUT .....	297, 677
Digital I/Q Output Variation Active - I/Q OUT .....	297, 677
Digital I/Q Output Variation Step - I/Q OUT .....	297, 677
Digital Modulation .....	580
Digital output module (option R&S SMJ-B18) .....	67
Directory .....	149, 509
Directory Hardcopy .....	497
Display .....	81
Display I/Q Output Level Via - I/Q OUT .....	296, 677
Display Mode - AWGN .....	284, 531
Display Output Results - AWGN .....	285, 531
Display permanent priority - Power Sensors .....	199
Documentation Overview .....	15
Double dagger .....	439
DOWN .....	437
Duration Baseband Signal Level Measurement .....	639
Duration - Baseband Signal Level Measurement .....	301
Dwell time	
List Mode .....	694
Dwell Time .....	240, 245, 251, 254
Level Sweep .....	722
LF Sweep .....	683
List Mode .....	254
RF Sweep .....	718

**E**

Edge form of ramp envelope - DM .....	343, 601
Edge slope of ramp envelope - DM .....	344, 602
Edit User Correction Data .....	211
EFC (Electronic Frequency Control) .....	191
EMF - Level display .....	207
ENABLE .....	446
Enable/disable beep .....	730
Enable registers	
remote .....	455
Enter License Key .....	125
EOI .....	755
Error messages .....	83
Adjustment data invalid (183) .....	752
Adjustment data missing (182) .....	751
Adjustment failed (180) .....	751
Cannot access hardware (200) .....	752
Cannot access the EEPROM (202) .....	752
Cannot open file (460) .....	752
Cannot read file (462) .....	752
Cannot write file (461) .....	752
Driver initialization failed (204) .....	752
Extern reference out of range or disconnected (50) .....	751
File contains invalid data (465) .....	753
Filename missing (463) .....	752
Hardware revision out of date (201) .....	752
Invalid EEPROM data (203) .....	752
Invalid filename extension (464) .....	753
No current list (241) .....	752
This modulation forces other modulations off (140) .....	751

Unknown list type specified (242) .....	752
Waveform Protected (261) .....	752
Error Messages .....	750
device-specific .....	751
SCPI .....	751
Error messages - display list .....	735
Error queue query .....	729, 732, 733, 734
Error queues	
recommendations .....	452
Errors .....	170, 179, 477
ESR .....	445
EVENT .....	446
Event status enable register	
remote .....	454
Event status register	
remote .....	454
Exclude Frequency .....	149, 657
Exclude Level .....	150, 708
Execute:Baseband Connection Selftest .....	736
Execute Next Segment .....	369, 579
Execute Single	
List Mode .....	254
Execute Single - List Mode .....	699
Execute Single Sweep	
Frequency Sweep .....	237, 718
Level Sweep .....	244, 723
LF Sweep .....	683
Execute Single Sweep - LF Sweep .....	249
Execute Trigger .....	359, 363, 408, 541, 587, 629
Execute Trigger - DM .....	335
EX-IQ-BOX Settings - Digital I/Q Output .....	295
Expiration date of option .....	123
Export Deactivation Response .....	125
Extension Import/Export	
List Mode data .....	691
Extension Import/Export - List Mode data .....	258
Extension Import/Export - User Correction data .....	214, 647, 648
External impedance .....	664
External mode - Local Oscillator .....	193
External modulation data .....	304
External modulation signal .....	220
FM .....	224
External modulation signal - PhiM .....	227
External Reference Frequency .....	193, 715
External Restart .....	174
External Restart - BERT .....	482
External Trigger Delay .....	545, 590, 630, 632
External Trigger Delay - DM .....	349
External Trigger Inhibit .....	545, 590, 630, 632
EXT REF .....	748
EXT TUNE .....	757
Eye diagram .....	160

**F**

Factory Preset .....	139, 458
Fall Delay - DM .....	344, 601
Fast Save .....	326
FIFO Status - Digital I/Q Output Settings .....	296, 678
FIFO Status - OK .....	296, 678
FIFO Status - Overflow .....	296, 678
FIFO Status - Underrun .....	296
File .....	397
File - Hardcopy dialog .....	141
File list .....	149, 508
File Management .....	357

- File menu ..... 147  
File Name - Hardcopy ..... 141, 142  
File setup - Hardcopy ..... 143  
File size ..... 563  
File type selection ..... 151  
Fill Table  
    List Mode ..... 256  
Fill Table From ..... 259  
Fill Table - List mode ..... 259  
Fill Table Range ..... 216, 260  
Filter  
    Power Sensors ..... 200  
Filter Cut Off Frequency ..... 392  
Filter - DM ..... 333  
Filter Length  
    Power Sensors ..... 200  
Filter Length - Power Sensors ..... 519, 520, 521  
Filter Parameter ..... 595  
Filter Parameter - DM ..... 333  
Filter Type ..... 596  
Fine adjustment - Reference frequency ..... 193, 716  
Firmware version ..... 123  
Fix marker delay to current range ..... 372, 411, 541, 634  
Fix marker delay to current range - DM ..... 351, 588  
Floating licences ..... 123  
FM-DC mode ..... 191  
FM Deviation ..... 225, 652  
FM External Coupling ..... 226, 653  
FM Mode ..... 225, 653  
FM Sensibility ..... 654  
FM Sensitivity ..... 226  
FM Source ..... 225, 654  
FM State ..... 225, 654  
FREQ OFFSET ..... 747  
Frequency ..... 203  
    AM ..... 680  
    List mode ..... 694  
    List Mode ..... 256  
    PM ..... 231, 680  
    Power Sensors ..... 200  
    RF output signal ..... 656  
    RF Sweep ..... 661  
Frequency display ..... 82  
Frequency - Multiplier ..... 187  
Frequency Offset ..... 187, 659  
    Multiplier ..... 659  
Frequency of test signal ..... 375  
Frequency - RF output signal ..... 185  
Frequency - RF Signal ..... 187  
Frequency - RF Sweep ..... 238  
Frequency - Test Signal ..... 551  
Frequency - Test Signal ARB ..... 374  
Front panel key emulation ..... 114  
FSK Deviation ..... 599  
FSK Deviation - DM ..... 330  
FSK Type (Variable FSK) ..... 599  
FSK Type (Variable FSK) - DM ..... 332  
Full Range ..... 121, 487  
Fuses ..... 33
- G**
- Gain ..... 556  
Gain (I/Q) ..... 272, 666  
Gain Start ..... 395  
Gain Step ..... 395
- Generate Signal HD ..... 374, 375, 376, 549  
Generate Signal HD - Test Signal ..... 549  
Generate Signal HD - Test Signal ARB ..... 549  
Generate Signal RAM ..... 374, 375, 376, 549  
Generate Signal RAM - Test Signal ARB ..... 549  
GET ..... 419  
Getting started ..... 63  
Global Trigger/Clock/External Input Settings ..... 129  
Global Trigger/Clock Settings ..... 373, 412  
GPIB ..... 133  
    Characteristics ..... 417  
    interface messages ..... 418  
    Remote control interface ..... 413  
GPIB address ..... 419, 730  
GPIB bus address ..... 133  
GPIB bus control  
    remote ..... 455  
GPIB - Visa Resource String ..... 134  
Graphical display of output signal ..... 152  
Graphics block ..... 152  
GTL ..... 419
- H**
- Hardcopy - Destination ..... 141, 495  
Hardcopy Device Size ..... 500  
Hardcopy dialog - File ..... 141  
Hardcopy dialog - Printer ..... 141  
Hardcopy File Name ..... 496, 497  
Hardcopy - File setup ..... 143  
Hardcopy Format ..... 495, 500  
Hardcopy Path ..... 496  
Hardcopy - Printer setup ..... 142  
Hardware Config ..... 121, 490  
Hardware options ..... 122  
HDD Streaming ..... 359, 569  
High Accuracy Level Adjustment ..... 120, 488  
HiSLIP - Visa Resource String ..... 134  
HOP (hopping) ..... 132
- I**
- I/Q diagram ..... 157  
I/Q File ..... 555, 561  
I/Q modulation ..... 260, 263, 669  
I/Q modulation - baseband gain ..... 272, 669  
I/Q modulation - Crest factor ..... 271, 666  
I/Q modulation - gain ..... 272, 666  
I/Q modulation - Impairments ..... 263, 668  
I/QOutput Type - I/Q out ..... 291  
I/Q Swap - I/Q ..... 270, 669  
I/Q Wideband - I/Q ..... 271, 669  
Identification  
    remote ..... 454  
IdPDbsweepResAll ..... 725  
IFC ..... 418, 755  
Imbalance - I/Q analog ..... 266, 667  
Imbalance - I/Q digital ..... 277, 617  
Impairments digital ..... 641  
Impairments analog ..... 263, 668  
Impairments digital ..... 274, 300, 301, 619, 639, 640, 641  
Impedance ..... 174, 182  
    BERT ..... 485  
    BLER ..... 485  
    external input ..... 222, 226, 229, 231  
Impedance data input (ser/par) ..... 663

- Impedance Data Input (ser/par) ..... 130
  - Impedance - RF outputs ..... 515
  - Impedance trigger/control signal input (ser/par) ..... 130, 664
  - Import/Export
    - List Mode data ..... 259, 692
    - User Correction data ..... 214, 215
  - Import/Export - List Mode data ..... 258
  - Import/Export - User Correction data ..... 649
  - Import License Key ..... 125
  - INF ..... 437
  - INFO key ..... 84
  - Input
    - BURST ..... 757
    - CW Mode ..... 757
    - DATA ..... 757
    - EXT TUNE ..... 757
    - LEV-ATT ..... 757
    - USER 2 ..... 757
    - USER 3 ..... 757
    - USER 4 ..... 757
  - Input connector ..... 25, 28, 30
  - Input Waveform File ..... 396
  - Installed Assembly ..... 122
  - Instrument Config ..... 121, 490
  - Instrument messages ..... 414
  - Instrument settings
    - recall ..... 456, 511
    - save ..... 456, 512
  - Instrument settings - recall ..... 149
  - Instrument settings - save ..... 147
  - Instrument Trigger ..... 130
  - Instrument trigger input slope ..... 665
  - Interface
    - functions (GPIB bus) ..... 756
  - Interface - AUX I/O ..... 133
  - Interface Clear ..... 755
  - Interface messages ..... 414, 417
  - Interfaces
    - GPIB ..... 417
  - Internal Baseband I/Q In ..... 263, 668
  - Interrupt ..... 449
  - IP address ..... 415
    - Changing ..... 43
    - Remote Desktop ..... 49
  - IST ..... 445
  - IST flag ..... 448
    - remote ..... 454
  - I Value - Test Signal ARB ..... 376
- K**
- Key
    - Arrow key ..... 25
    - BACKSPACE ..... 24
    - CLOSE ..... 23
    - Cursor key ..... 25
    - DIAGRAM ..... 22
    - ENTER ..... 24
    - ESC ..... 22
    - FILE ..... 22, 146
    - FREQ ..... 21
    - HCOPY ..... 20
    - HELP ..... 20
    - HIDE ..... 23
    - INFO ..... 20
    - INSERT ..... 24
    - LEVEL ..... 22
    - LOCAL ..... 20
    - MENU ..... 23
    - MOD ON/OFF ..... 22, 219
    - ON/OFF ..... 22
    - PRESET ..... 20, 35, 118
    - REARR ..... 23
    - RECALCULATE ..... 22
    - RF ON/OFF ..... 22
    - SETUP ..... 20, 119
    - TOGGLE ..... 22
    - WINBAR ..... 23
  - Keyboard emulation ..... 114
  - Keyboard Language ..... 502
  - Keyboard Layout ..... 131, 502
  - Key combinations ..... 112
  - Key - HELP ..... 145
  - Key - LOCAL ..... 140
  - Keypad ..... 23
  - Keywords
    - see Mnemonics ..... 432
- L**
- LAN
    - Configuration ..... 41
    - Interface ..... 415
    - IP address ..... 415
    - Remote control interface ..... 413
    - VISA ..... 415
    - VXI protocol ..... 416
  - LAN Connection - Setup ..... 138
  - Language Keyboard ..... 502
  - LAN Status - LXI ..... 134
  - Layout Keyboard ..... 131, 502
  - Leakage - I/Q digital ..... 275, 618
  - Learn List Mode Data ..... 255, 697
  - LEV ATT ..... 757
  - Level ..... 203
    - Power Sensors ..... 198
    - RF output ..... 204, 706
    - Step width ..... 711
    - uninterrupted setting ..... 205
  - Level attenuation ..... 310
  - Level Attenuation - DM ..... 345, 600
  - Level control ..... 207, 705
  - Level display ..... 82
  - Level display EMF ..... 207
  - Level EMF - I/Q out ..... 293
  - Level limit ..... 708
    - RF level ..... 204
  - Level mode ..... 380
  - Level mode - ARB ..... 574
  - Level offset ..... 205, 707
  - Level Offset
    - Power Sensors ..... 200
  - LEVEL OFFSET ..... 748
  - Level - Step width ..... 206
  - Level Sweep ..... 240, 709
  - LevelSweep ..... 749
  - Level - Uninterrupted setting ..... 514
  - Level user correction ..... 209
  - LF generator ..... 232
  - LF Gen Frequency ..... 222, 226, 229, 233, 680
  - LF Gen Voltage ..... 232, 687
  - LF output ..... 232
  - LF Output State ..... 232, 683

- LF Sweep ..... 250, 682  
 LFSweep ..... 749  
 Licence for software option ..... 123  
 License Key ..... 124  
 Limit  
   Level ..... 708  
 Limit - Level ..... 204  
 Linux controller ..... 50  
 List Management - DM ..... 327  
 List mode ..... 252, 709  
   manual processing of lists ..... 253  
 ListMode ..... 749  
 List Mode Data ..... 255  
 List Range In ..... 257, 696  
 LLO ..... 418  
 Load instrument settings ..... 149, 456, 511  
 Load list ..... 382  
 Load Sequencing List ..... 386  
 Load User Filter - DM ..... 334  
 Load User Mapping ..... 612  
 Load User Mapping - DM ..... 330  
 Load Waveform ..... 357, 568, 570  
 Local oscillator ..... 193  
 Local - Remote Channel Control ..... 134  
 Local to remote switchover ..... 420, 421  
 Lock keyboard ..... 734  
 LOC-LLO ..... 749  
 Login  
   Operating system ..... 41  
 LO IN connector ..... 193  
 LO OUT output ..... 193  
 LVDS Rate Selftest ..... 128, 737  
 LXI ..... 134  
   Browser interface ..... 59  
   Configuration ..... 57  
   LAN configuration ..... 60  
   Ping ..... 62
- M**
- Malfunctions  
   reacting ..... 452  
 Manual Remote Control ..... 45  
 Manual trigger ..... 587  
 Manual Trigger ..... 359, 541, 629  
 Manual trigger - DM ..... 335  
 Map output connector user x to ..... 133  
 MARKER 3 ..... 757  
 Marker Channel x ..... 591  
 Marker Channel x - DM ..... 349  
 Marker CH x ..... 547  
 Marker Delay ..... 542, 588, 634  
 Marker Delay - DM ..... 350  
 Marker Mode ..... 370, 409  
 Marker output signals ..... 311  
 Marker Pattern ..... 548  
 Marker Positions - DM ..... 341  
 Marker x Delay ..... 371, 410  
 MAX ..... 437  
 Max Data Bits ..... 173  
 Max Data Bits - BERT ..... 482  
 Max Errors ..... 173, 181  
   BERT ..... 482  
   BLER ..... 482  
 Maximal deviation ..... 228  
   FM ..... 225, 652  
   PhiM ..... 701
- Max Received Blocks ..... 181  
 Max Received Blocks - BLER ..... 482  
 Measured External Clock ..... 352, 372, 411  
 Menu structure  
   access denied ..... 88  
   header ..... 88  
   menu area ..... 88  
 Messages  
   commands ..... 414  
   instrument ..... 414  
   instrument responses ..... 415  
   interface ..... 414  
 MIN ..... 437  
 Minimum Noise/System Bandwidth Ratio - AWGN ..... 284, 530  
 Mnemonics ..... 432  
   Optional ..... 434  
 Mode ..... 172, 180, 228, 390, 553  
   FM ..... 225, 653  
   Level Sweep ..... 241, 709, 723  
   LF Gen ..... 247, 681  
   LF Sweep ..... 247, 681, 684  
   List Mode ..... 253, 697  
   PhiM ..... 702  
   RF Frequency ..... 658  
   RF frequency Sweep ..... 234  
   RF Sweep ..... 658, 719  
 Mode - BERT ..... 478  
 Mode - BLER ..... 478  
 Mode - I/Q out ..... 673  
 Mode Import/Export  
   List Mode data ..... 693  
 Mode Import/Export - List Mode data ..... 258  
 Mode Import/Export - User Correction data ..... 214, 650  
 Mode - LO Coupling ..... 195, 656  
 MOD OFF ..... 747  
 MOD ON/OFF Key ..... 219  
 Modular design ..... 63  
 Modulation  
   AM ..... 220  
   BB-AM ..... 223  
   FM ..... 224  
   PhiM ..... 227  
   PM ..... 230  
   Pulse modulation ..... 230  
 Modulation - BB-AM ..... 224, 526  
 Modulation data external ..... 304  
 Modulation Delay for ext. Data ..... 600  
 Modulation Delay for ext. Data - DM ..... 332  
 Modulation depth  
   PhiM ..... 228  
 Modulation depth - AM ..... 222, 526  
 Modulation deviation  
   FM ..... 225, 652  
   PhiM ..... 701  
 Modulation - DM ..... 331  
 Modulation - I/Q ..... 263, 669  
 Modulation input ..... 28  
 Modulation Type ..... 598  
 Modulation Type - DM ..... 330  
 Month Hardcopy File Name ..... 498  
 Multi Carrier CW ..... 399, 620  
 Multi Carrier Waveforms ..... 387  
 Multiplier ..... 539, 585, 638  
   Frequency Offset ..... 659  
 Multiplier - DM ..... 352  
 Multiplier - Frequency ..... 187

- Multi Segment table ..... 378
- Multi Segment Waveforms ..... 376
- Multi transmitter measurements ..... 207
- N**
- NAN ..... 437
- Navigation keys ..... 24
- NDAC ..... 755
- New list ..... 382
- New Password - Setup ..... 137
- New Sequencing List ..... 386
- Next Segment ..... 365
- Next Segment Mode ..... 365
- NINF ..... 437
- No Clock ..... 477
- No Clock BERT ..... 170
- No Clock BLER ..... 179
- Noise Bandwidth - AWGN ..... 284, 529
- Noise generator, switching on ..... 283
- Noise level - AWGN ..... 288, 534
- Noise level Total Bandwidth - AWGN ..... 289, 535
- Noise Only ..... 283, 285, 531, 533
- No-load voltage (EMF) ..... 207
- No Sync ..... 477
- No Sync BERT ..... 170
- No Sync BLER ..... 179
- NRFD ..... 755
- NRP-Z Info ..... 126
- NRP-Z power viewer
  - use SParameter ..... 201
- NTRansition ..... 446
- Number Hardcopy File Name ..... 498
- Number of Carriers ..... 390, 553, 621
- Number of Carriers - MCCW ..... 401
- Number of licences ..... 123
- Numeric values
  - Special ..... 437
- O**
- Offset
  - Frequency ..... 659
  - Level ..... 707
- Offset DC ..... 375
- Offset - Frequency ..... 187
- Offset - I/Q analog ..... 263, 667
- Offset - I/Q out ..... 293
- Offset - Level ..... 205
- Old password - Setup ..... 137
- ON/OFF Ratio Marker ..... 370, 547, 636
- ON/OFF Ratio Marker - DM ..... 349, 592
- Online help
  - Working with ..... 104
- Operating concept ..... 63
- Operating system ..... 39
  - Login ..... 41
  - service packs ..... 40
- Operation complete
  - remote ..... 455
- Operation hours ..... 122, 491
- Optimization mode ..... 281
- Optimize Crest Factor ..... 391, 556
- Optimize Crest Factor - MCCW ..... 402, 624
- Optimize I/Q-Signals for RF Output ..... 291, 672
- Optimize internal I/Q-Impairments for RF Output ..... 281, 619
- Option
  - ARB-Baseband Generator ..... 352
  - Baseband Generator (B9/B10/B11) ..... 301
  - Baseband Main Module (B13) ..... 301
  - Hardware ..... 122
  - R&S SMBV-K18 (Digital Baseband Connectivity) ..... 294
  - Software ..... 122
- Option: expiration date ..... 123
- Option identification
  - remote ..... 455
- Option - R&S SMx-B16 (Differential Output) ..... 291
- Options - Hardcopy ..... 141
- Orientation- Hardcopy ..... 501
- Output
  - BITCLK ..... 757
  - BURST ..... 757
  - DATA ..... 757
  - LEV-ATT ..... 757
  - MARKER 3 ..... 757
  - SYMBCLK ..... 757
  - USER 2 ..... 757
  - USER 3 ..... 757
  - USER 4 ..... 757
- Output buffer ..... 445
- Output connector ..... 25, 27, 28, 29, 30
- Output File ..... 382, 393
- Output - LF ..... 232
- Output Mode - IQ Out ..... 292
- Output Type - IQ out ..... 674
- Output Voltage - LF output ..... 232
- Out State - LO Coupling ..... 196, 656
- OvenCold ..... 750
- Overflow - Digital I/Q Output Settings ..... 298, 675
- Overflow Hold - Digital I/Q Output Settings ..... 298, 675
- Overlapping
  - preventing ..... 442
- Overlapping commands ..... 441
- Overload ..... 206, 218
- OVERLOAD ..... 748
- Oversampling ..... 594
- Oversampling Auto State ..... 594
- Oversampling - DM ..... 334
- P**
- Packing ..... 745
- Paper size - Hardcopy ..... 502
- Parallel poll register enable
  - remote ..... 455
- Parameters
  - Block data ..... 439
  - Boolean ..... 438
  - SCPI ..... 436
  - Special numeric values ..... 437
  - String ..... 439
  - Text ..... 438
  - Units ..... 437
- Part numbers ..... 121
- Password
  - Remote Desktop ..... 49
- Paste ..... 151
- Paste - Data Editor ..... 338
- Path reset ..... 458
- Pattern ..... 581
- Pattern - DM ..... 326
- Pattern Ignore ..... 176



- Pattern Ignore - BERT ..... 481  
 PCI bus ..... 122  
 Peak Level - Baseband Signal Level Measurement .....  
     301, 640  
 Peak level of baseband ..... 300, 642  
 Period ..... 379  
 Phase  
     RF output signal ..... 700  
 Phase continuous Active ..... 191  
 Phase continuous Active - RF Signal ..... 660  
 Phase Offset Q - Test Signal ..... 551  
 Phase Offset Q - Test Signal ARB ..... 374  
 Phase - RF output signal ..... 188  
 Phase Start ..... 396, 556, 621  
 Phase Start - MCCW ..... 403, 622  
 Phase Step ..... 396, 561  
 Phase Step - MCCW ..... 403, 626  
 PhiM Depth ..... 228  
 PhiM External Coupling ..... 229, 702  
 PhiM Mode ..... 228  
 PhiM Sensitivity ..... 229  
 PhiM Source ..... 228, 703  
 PhiM State ..... 228, 704  
 Ping ..... 62  
 Play list ..... 370, 382, 384  
 PM Deviation ..... 701  
 PM Frequency ..... 231, 680  
 PM Sensitivity ..... 703  
 PniM Mode ..... 702  
 Point-to-point connection ..... 42  
 Polarity  
     Pulse Modulation ..... 231, 713  
 Polarity - No signal (blank) marker ..... 133, 514  
 Power  
     List Mode ..... 256  
 Power of starting carrier ..... 395, 556, 622  
 Power of starting carrier - MCCW ..... 403, 623  
 Power-On Count ..... 121, 122  
 Power-On Counter ..... 491  
 Power-On State ..... 207, 516  
 Power ramping ..... 310  
 Power ramping - DM ..... 343, 602  
 Power sensors  
     zero ..... 199  
 Power spectrum ..... 162  
 Power Start ..... 556, 622  
 Power Start - MCCW ..... 403, 623  
 Power Step ..... 562  
 Power Step - MCCW ..... 403, 627  
 PPC ..... 419  
 PPE ..... 445  
 PPE register ..... 448  
 PPU ..... 418  
 PRBS ..... 173  
 PRBS \_BERT ..... 483  
 PRBS generator ..... 303  
 PRBS Type - DM ..... 326, 581  
 Prefix Hardcopy File Name ..... 499  
 Preset ..... 35  
 Preset instrument settings ..... 35  
 Preset - instrument settings ..... 118, 458  
 Printer - Hardcopy dialog ..... 141  
 Printer setup - Hardcopy ..... 142  
 Protection ..... 135  
 Protect RF Output - ALC ..... 209, 515  
 Protocol  
     VXI ..... 416  
 PTRansition ..... 446  
 Pulse Divider Marker ..... 370, 548, 637  
 Pulse Divider Marker - DM ..... 349, 593  
 Pulse Frequency Marker ..... 370, 548, 593, 637  
 Pulse Frequency Marker - DM ..... 349  
 Pulse generator  
     Signal valid as pulse sync ..... 713  
 Pulse modulation ..... 230  
     repetition frequency ..... 231, 680  
     Signal valid as pulse sync ..... 713  
**Q**  
 Quadrature Offset - I/Q analog ..... 268, 668  
 Quadrature Offset - I/Q digital ..... 279, 619  
 Queries ..... 414, 440  
     Status ..... 450  
 Question mark ..... 439, 440  
 Quotation mark ..... 439  
 Q Value - Test Signal ARB ..... 376  
**R**  
 Rackmounting ..... 33  
 Ramp Function - DM ..... 343, 601  
 Ramp Time - DM ..... 344, 602  
 Ratio Noise/System Bandwidth - AWGN ..... 284, 530  
 Recall instrument settings ..... 149, 150, 456, 511  
 Recall intermediate ..... 456  
 Recall Intermediate ..... 150  
 Received Blocks ..... 178  
 Recent data sets ..... 149  
 Recommendations  
     remote control programming ..... 451  
 Rect Test Signal ..... 374  
 Reference frequency  
     external ..... 193  
 Reference frequency adjustment mode ..... 193, 716  
 Reference frequency - external ..... 715  
 Reference Level - AWGN ..... 286  
 Reference Mode - AWGN ..... 535  
 Reference oscillator ..... 191  
 REF OUT output ..... 191  
 Registers ..... 445  
 Remaining Time - Baseband Signal Level Measurement .....  
     ..... 301, 640  
 REM-LLO ..... 749  
 REMOTE ..... 748  
 Remote access ..... 45  
 Remote control  
     Basics ..... 413  
     GPIB address ..... 419  
     Interfaces ..... 413  
     Protocols ..... 413  
 Remote Control  
     GPIB ..... 421  
 Remote control switchover ..... 420  
 Remote Desktop ..... 48  
 Remote operation ..... 48  
 REN ..... 755  
 Rename ..... 151, 512  
 Resart Marker ..... 381  
 Reset  
     List Mode ..... 254  
 Reset Delta Phase Display ..... 188, 700  
 Reset device parameters ..... 458  
 Reset - Digital I/Q Output Settings ..... 298, 675

Reset instrument settings .....	35, 118, 458
Reset path .....	458
Reset values	
remote .....	456
Result .....	170, 178, 477
Resulting CW Frequency - AWGN .....	285, 532
Resulting I/Q Level EMF .....	293, 672
Retrigger .....	362, 546, 591, 633
DM .....	347
Reveived Blocks .....	477
Reverse power protection .....	206, 218
Revisions .....	121
RF frequency .....	186, 656
RFI signal generator, switching on .....	283
RF Level	
limit .....	204
RF OFF .....	747
RF OFF mode	
attenuator settings .....	706
RF ON/OFF key .....	183, 516
RF output	
Power-on state .....	207
RF output level .....	204, 706
RF output - Power-on state .....	516
RF output signal	
Phase adjustment .....	700
RF output signal - Phase adjustment .....	188
RF section .....	69
RF Signal - Frequency .....	187
RFSweep .....	749
Rise Delay - DM .....	344, 601
Roll off factor .....	595
Roll off factor - DM .....	333
Rotary knob .....	24
RST:MCCW - Carrier State:ON .....	622
RST:MCCW - Trigger Source:INTernal .....	632
Running .....	363, 407
Running Mode .....	589
Running - Trigger .....	631
Running - Trigger - DM .....	347
Run Update .....	126
<b>S</b>	
Sample&Hold mode .....	207
Sample-and-Hold mode .....	705
Sample Rate Source - Digital I/Q Output Settings .....	
.....	296, 679
Sample Rate Value- Digital I/Q Output Settings .....	296
Samples .....	379
Samples per Period .....	375
Samples per Period - Test Signal .....	552
Samples per Period - Test Signal ARB .....	374
Save/Recall .....	389
Save As - DM .....	342
Save - DM .....	338, 342
Save immediate .....	147
Save instrument settings .....	147, 456, 512
Save intermediate .....	456
Save List .....	382
Save Sequencing List .....	386
SCPI	
Parameters .....	436
Syntax .....	433
Version .....	413
SCPI compliant commands .....	414
SCPI - error messages .....	751
Screen Saver .....	131
Screen Saver - Setup .....	492
SDC .....	419
Search Once - ALC .....	209, 705
Security Password - Setup .....	138
Security Settings	
Accept .....	138
Annotation Amplitude .....	138
Annotation Frequency .....	138
Change Password .....	137
Confirm Password .....	137
LAN Connection .....	138
New Password .....	137
Old Password .....	137
Security Password .....	138
USB Device .....	137
Segment # .....	378
Segment Down .....	379, 386
Segment Marker .....	381, 576
Segment Up .....	379, 386
Select ASCII Destination	
User Correction data .....	215
Select ASCII Destination - List Mode data .....	258
Select ASCII Source	
User Correction data .....	215
Select List .....	255, 699
Select NRP File .....	126
Select Operation - File menu .....	147
Select Preset Type - DM .....	341
Select Ramp to Edit - DM .....	340
Selftest	
Baseband Connection Selftest .....	128
LVDS Rate .....	128, 737
remote .....	457
Tx Test .....	128, 737
Selftest:Execute:Baseband Connection Selftest .....	736
Sensor - Power Sensors .....	197
Sequencing Graphic .....	386
Sequencing List .....	370, 382, 384
Sequential commands .....	441
Serial bus .....	122
Serial numbers .....	121
Serial - Visa Resource String .....	134
Service packs .....	40
Service request (SRQ) .....	447, 449
Service request enable	
remote .....	456
Service request enable register (SRE) .....	447
Set acc. to Standard .....	583
Set acc. to Standard - DM .....	328
Set Noise Level via .....	285, 534
Setting commands .....	414
Setting not possible .....	88
Setting parameters .....	90
Set to default .....	357, 389, 538, 563, 582
Set to default - DM .....	324
Set to default - MCCW .....	400, 621
Setup key .....	119
Shape	
LF Sweep .....	685
RF Level Sweep .....	245, 724
RF Sweep .....	720
Shape - LF Frequency Sweep .....	250
Shape - RF Sweep .....	238
Show level permanent - Power Sensors .....	199, 519
Signal/Noise Ratio .....	286
Signal + Interferer Level .....	289, 535

- Signal + Interferer PEP ..... 289, 536
- Signal + Noise Level ..... 289, 535
- Signal + Noise PEP ..... 289, 536
- Signal Duration ..... 362, 392, 407
- Signal Duration - Trigger ..... 543, 589
- Signal Duration -Trigger ..... 631
- Signal Duration Unit ..... 362
- Signal Duration Unit - Trigger ..... 544
- Signal Level (RMS) ..... 300, 642
- Signal Level (RMS) - Baseband Signal Level Measurement ..... 301, 640
- Signal level - AWGN ..... 287
- Signal Period Mode ..... 392, 565
- Signal valid as pulse sync
  - pulse generator ..... 713
  - pulse modulation ..... 713
- Sine Test Signals ..... 373
- Slope
  - Instrument trigger input ..... 665
- Slope - External baseband trigger ..... 130, 664
- Softkey ..... 87
- Software options ..... 122
- Source
  - AM ..... 528
  - FM ..... 225, 654
  - Level Sweep Trigger ..... 241, 741
  - LF Sweep Trigger ..... 247, 739
  - List Mode ..... 253
  - List Mode Trigger ..... 699
  - PhiM ..... 228, 703
  - Power Sensors ..... 200
  - Pulse Modulation ..... 231, 713
  - Reference Oscillator ..... 716
  - RF frequency Sweep Trigger ..... 234
  - RF Sweep Trigger ..... 740
- Source - AM ..... 221
- Source - Baseband Signal Level Measurement ..... 300, 641
- Source Import/Export
  - List Mode data ..... 693
  - User Correction data ..... 215
- Source Import/Export- User Correction data ..... 650
- Source Power Ramp Control ..... 602
- Source Power Ramp Control - DM ..... 343
- Source - Power Sensors ..... 523
- Source - Reference Oscillator ..... 192
- Spacing
  - Level Sweep ..... 245, 724
  - LF Sweep ..... 685
  - RF Sweep ..... 720
- Spacing - LF Sweep ..... 250
- Spacing - RF Sweep ..... 238
- Span (RF sweep) ..... 238, 660
- SPD ..... 418
- SPE ..... 418
- Special characters
  - SCPI ..... 436
- Spectrum display ..... 162
- SRE ..... 445
- SRE (service request enable register) ..... 447
- SRQ ..... 755
- SRQ (service request) ..... 447, 449
- Standard ..... 583
- Standard - DM ..... 328
- Standard settings ..... 357, 389, 582
- Standard settings - DM ..... 324
- Standard settings - MCCW ..... 400, 621
- Standby mode ..... 20
- Start
  - BERT ..... 484
  - BLER ..... 484
  - Power Sensors ..... 518
- Start/Stop Gui Update ..... 125, 732
- Start delay ..... 396, 555
- Start Freq ..... 238, 661
- LF Sweep ..... 682
- Start Freq - LF Sweep ..... 250
- Starting gain ..... 395
- Starting power ..... 556, 622
- Starting power - MCCW ..... 403, 623
- Start Level ..... 244, 711
- Start phase ..... 396, 621
- Start phase - MCCW ..... 403, 622
- Start Select - Data Editor ..... 338
- Startup complete ..... 735
- State ..... 169, 178, 357
  - ALC ..... 209, 705
  - BERT ..... 484
  - BLER ..... 484
  - List Mode ..... 253, 658
  - PhiM ..... 228
  - Power Sensors ..... 198
  - Pulse Modulation ..... 230, 714
- State - analog Impairments ..... 263, 668
- State - AWGN ..... 283, 536
- State - Baseband Signal Level Measurement ..... 300, 641
- State - digital Impairments ..... 274, 619
- State - DM ..... 324, 583
- State - MCCW ..... 400, 620
- State Power Ramp Control - DM ..... 343, 602
- State - User Correction ..... 211
- Status
  - Queries ..... 450
- Status byte
  - remote ..... 453, 457
- Status Information ..... 125
- status messages
  - ALC On ..... 749
  - AttFixed ..... 749
  - Auto ..... 749
  - BUSY ..... 748
  - EXT REF ..... 748
  - FREQ OFFSET ..... 747
  - LEVEL OFFSET ..... 748
  - LevelSweep ..... 749
  - LFSweep ..... 749
  - ListMode ..... 749
  - LOC-LLO ..... 749
  - MOD OFF ..... 747
  - OvenCold ..... 750
  - OVERLOAD ..... 748
  - REM-LLO ..... 749
  - REMOTE ..... 748
  - RF OFF ..... 747
  - RFSweep ..... 749
  - S&H ..... 749
  - SYS CTRL ..... 749
  - Table ..... 749
  - UCorr ..... 750
- Status registers ..... 445
  - CONDITION ..... 446
  - ENABLE ..... 446
  - EVENT ..... 446

- model ..... 446
  - NTRansition ..... 446
  - parts ..... 446
  - PTRansition ..... 446
  - Status reporting system ..... 444
    - Application ..... 449
    - common commands ..... 453
  - STB ..... 445
  - Step
    - Level Sweep ..... 245, 724
  - Step Lin
    - LF Sweep ..... 686
    - RF Sweep ..... 721
  - Step Lin - LF Sweep ..... 250
  - Step Lin - RF Sweep ..... 239
  - Step Log
    - LF Sweep ..... 686
    - RF Sweep ..... 722
  - Step Log - LF Sweep ..... 250
  - Step Log - RF Sweep ..... 239
  - Step width
    - Frequency ..... 662
    - Level Sweep ..... 245, 724
    - RF Sweep ..... 721
  - Step width - Frequency ..... 187
  - Step width - RF Sweep ..... 239
  - Stop
    - BERT ..... 484
    - BLER ..... 484
  - Stop Freq
    - LF Sweep ..... 683
    - RF Sweep ..... 661
  - Stop Freq - LF Sweep ..... 250
  - Stop Freq - RF Sweep ..... 238
  - Stop Level ..... 245, 712
  - Stopped ..... 363, 407
  - Stopped - DM ..... 347
  - Storing ..... 745
  - Streaming Buffer ..... 359, 568
  - Suffixes ..... 434
  - Sweep
    - Center frequency ..... 655
    - LF start frequency ..... 682
    - LF stop frequency ..... 683
    - RF frequency Sweep ..... 234
    - RF Sweep ..... 658, 709, 719
    - Start Level ..... 244, 711
    - Stop Level ..... 245, 712
    - Trigger ..... 237, 244, 742
  - Sweep - Center frequency ..... 238
  - Sweep - LF start frequency ..... 250
  - Sweep - LF stop frequency ..... 250
  - Sweep shape
    - LF Sweep ..... 685
    - RF Level Sweep ..... 245, 724
    - RF Sweep ..... 720
  - Sweep shape - LF Frequency Sweep ..... 250
  - Sweep shape - RF Sweep ..... 238
  - Sweep spacing
    - Level Sweep ..... 245, 724
    - RF Sweep ..... 720
  - Sweep spacing - RF Sweep ..... 238
  - Sweep - Trigger ..... 249
  - Symantec Antivirus ..... 56
  - SYMBCLK ..... 757
  - Symbol Clock Multiplier ..... 585
  - Symbol Clock Multiplier - DM ..... 352
  - Symbol Rate ..... 583
  - Symbol Rate - DM ..... 329
  - Sync. Output to External Trigger ..... 348, 363, 408
  - Synchronization bandwidth – Reference oscillator ..... 193
  - Synchronization bandwidth
    - Reference oscillator ..... 715
  - Syntax elements
    - SCPI ..... 439
  - SYS CTRL ..... 749
  - System Bandwidth - AWGN ..... 284, 529
  - System directory ..... 503
- ## T
- Tag Type ..... 468, 469
    - Clock ..... 461
    - Comment ..... 462
    - Control Length ..... 463
    - Control List Width4 ..... 470
    - Copyright ..... 462
    - Data Bitlength ..... 462
    - Data List ..... 463
    - Date ..... 463
    - Level Offset ..... 463
    - Magic ..... 460
    - Samples ..... 464
    - Segment Clock Mode ..... 468
    - Segment Comment ..... 470
    - Segment Count ..... 467
    - Segment Files ..... 470
    - Segment Length ..... 467
    - Segment Level Offset ..... 470
    - Trace List ..... 465
    - Waveform-Length ..... 465
  - Target Crest Factor ..... 391
  - Target CW Frequency - AWGN ..... 285
  - Terminator recognition ..... 730
  - Test Signal ..... 374, 375
  - Threshold ..... 174, 182
  - Threshold - BERT ..... 485
  - Threshold - BLER ..... 485
  - Threshold data input (ser/par) ..... 130, 663
  - Threshold trigger/control signal input ..... 130, 665
  - Trigger ..... 172, 180
    - BERT ..... 486
    - BLER ..... 486
  - Trigger Delay ..... 364, 409
  - Trigger Delay External ..... 545, 590, 630, 632
  - Trigger Delay External - DM ..... 349
  - Trigger Delay Other Baseband - DM ..... 349
  - Trigger event
    - remote ..... 457
  - Trigger Example ..... 370
  - Triggering sweep manually ..... 244, 718, 723
  - Trigger Inhibit ..... 365, 409
  - Trigger Inhibit External ..... 545, 590, 630, 632
  - Trigger Input Slope ..... 130
  - Trigger Mode ..... 362, 544, 546, 591, 633
    - Armed ..... 407
    - Auto ..... 407
    - DM ..... 347
    - Retrigger ..... 407
    - Single ..... 407
  - Trigger parameters - DM ..... 345
  - Trigger Signal Duration - DM ..... 347
  - Trigger signals ..... 310

Trigger Source .....	363, 408, 545, 632
Level Sweep .....	241, 741
LF Sweep .....	247, 739
List Mode .....	253, 699
RF frequency Sweep .....	234
RF Sweep .....	740
Trigger Source - DM .....	348, 589
Trigger Source - Graphics .....	154
Trigger Status .....	543
Tx Test Selftest .....	128, 737
Type	
Power Sensors .....	198
Type - Power Sensors .....	524, 525

**U**

UCorr .....	750
Ultr@VNC .....	50
Uninterrupted level setting .....	205, 514
Unit .....	169, 178
BERT .....	485
BLER .....	485
Power Sensors .....	198
Units .....	437
Input .....	23
UNIX controller .....	50
UP .....	437
Update sensor .....	126
Update - Setup System .....	127
USB Device - Setup .....	137
Use Level Adjustment Data .....	121, 488
USER 2 .....	757
USER 3 .....	757
USER 4 .....	757
User Clock .....	380, 573
User Correction .....	209
User Correction Data .....	211, 644
User Filter .....	610
User Filter Catalog - DM .....	334, 604
User Filter Delete - DM .....	334, 610
User Filter Free Memory .....	604
User Filter List Length - DM .....	610
User ID	
Remote Desktop .....	49
User Mapping Catalog - DM .....	330
User Mapping Delete - DM .....	330
User mapping Free Memory .....	604
User mapping Lists Catalog .....	604
User Mapping Lists Delete .....	611
User Marker / AUX I/O Settings .....	373, 412
User Marker - AUX I/O Configuration .....	240, 246, 251, 257
User Modulation Mapping List Length .....	611
Use SParameter	
NRP-Z power viewer .....	201
Use SParameters - Power Sensors .....	519

**V**

Value - User Correction .....	211
Variable FSK Deviation .....	599
Variable FSK Deviation - DM .....	332
Variation Active .....	187
Variation Step .....	187, 188, 206, 662, 711, 712
Vector diagram .....	158
Vector modulation .....	260
Virus protection .....	40

Virus-Protection Software .....	56
VISA .....	413, 415
Libraries .....	414
Resource string .....	414, 415
Visa Resource String .....	134
Ethernet .....	731
GPIB .....	731
Socket .....	731
Visual check of signal characteristics .....	152
VNC connection .....	50
Voltage - LF output .....	687
Voltage threshold .....	130, 665
VXI11 - Visa Resource String .....	134
VXI protocol .....	416

**W**

Wait	
remote .....	457
Wait Time .....	131
Wait Time - Setup .....	492
Warnings .....	83, 750
Waveform File .....	357, 568, 570
Waveform Info .....	358, 378, 385
White space .....	439
Wideband setting - I/Q .....	263, 669
Winbar .....	87
Windows XP .....	39
access .....	41
Workgroup - Setup .....	731

**Y**

Year Hardcopy File Name .....	499, 500
-------------------------------	----------

**Z**

Zero	
power sensors .....	199
Zero - Power Sensors .....	524
Zoom - DM .....	342